



UNITED STATES  
NUCLEAR REGULATORY COMMISSION  
TECHNICAL TRAINING CENTER

# **POWER PLANT ENGINEERING COURSE MANUAL**

*A-4-1*

---



---

**TABLE OF CONTENTS**

	<u>Page</u>
LIST OF TABLES .....	xv
LIST OF ILLUSTRATIONS .....	xvi
1.0 BASIC PLANT CYCLES .....	1-1
1.1 Boiling Water Reactor Overview .....	1-1
1.1.1 BWR Product Lines .....	1-2
1.1.2 Primary and Auxiliary Systems .....	1-2
1.1.3 Control Systems .....	1-4
1.1.4 Emergency Core Cooling Systems .....	1-5
1.1.5 Plant Startup .....	1-6
1.1.6 Plant Shutdown .....	1-7
1.2 Pressurized Water Reactor Overview .....	1-8
1.2.1 Primary Systems - PWR .....	1-9
1.2.2 Secondary Systems .....	1-12
1.2.3 Control Systems .....	1-13
1.2.4 Emergency Systems .....	1-14
1.2.5 Plant Startup - PWR .....	1-15
1.2.6 Plant Shutdown - PWR .....	1-16
1.3 Barriers to Release of Fission Products .....	1-17
1.3.1 BWR Plant Fission Product Barriers .....	1-17
1.3.2 PWR Plant Fission Product Barriers .....	1-17
1.4 Summary .....	1-17
2.0 REACTOR PHYSICS .....	2-1
2.1 Introduction .....	2-1
2.2 Fission Process .....	2-1
2.3 Nuclear Cross Section .....	2-2
2.4 Slowing Down of Neutrons .....	2-3
2.5 Multiplication Factor .....	2-4
2.5.1 Fast Fission Factor ( $\epsilon$ ) .....	2-5
2.5.2 Fast Nonleakage Factor ( $L_f$ ) .....	2-5
2.5.3 Resonance Escape Probability ( $p$ ) .....	2-5
2.5.4 Thermal Nonleakage Factor ( $L_{th}$ ) .....	2-5

	<u>Page</u>
2.5.5 Thermal Utilization Factor ( $f$ ) .....	2-5
2.5.6 Reproduction Factor ( $\eta$ ) .....	2-6
2.6 Reactivity ( $\rho$ ).....	2-6
2.7 Reactor Period and Startup Rate .....	2-6
2.8 Reactivity Coefficients .....	2-7
2.8.1 Moderator Temperature Coefficient (MTC) .....	2-7
2.8.2 Moderator Void Coefficient ( $\alpha_v$ ) .....	2-8
2.8.3 Pressure Coefficient .....	2-8
2.8.4 Fuel Temperature (Doppler) Coefficient (FTC).....	2-9
2.8.5 Power Coefficient.....	2-10
2.8.6 Reactivity Coefficient Values .....	2-10
2.9 Behavior of Reactivity Coefficients in a BWR.....	2-10
2.9.1 Moderator Temperature Coefficient - BWR .....	2-10
2.9.2 Moderator Void Coefficient - BWR.....	2-11
2.9.3 Fuel Temperature (Doppler) Coefficient - BWR .....	2-11
2.9.4 Power Coefficient - BWR .....	2-11
2.10 Behavior of Reactivity Coefficients in a PWR .....	2-11
2.10.1 Moderator Temperature Coefficient - PWR.....	2-11
2.10.2 Moderator Void Coefficient - PWR .....	2-12
2.10.3 Fuel Temperature (Doppler) Coefficient - PWR.....	2-12
2.10.4 Power Coefficient - PWR.....	2-12
2.11 Control Rod Worth.....	2-12
2.12 Boron Worth.....	2-13
2.13 Fission Product Poisons .....	2-14
2.14 Burnable Poisons.....	2-16
2.15 Subcritical Multiplication.....	2-16
2.16 Neutron Production .....	2-17
2.16.1 Effect of Delayed Neutrons on Reactor Control .....	2-18
2.17 Reactor Startup - BWR .....	2-19
2.17.1 The Source Range .....	2-19
2.17.2 The Intermediate Range and Reactor Heatup .....	2-19
2.17.3 The Power Range .....	2-19

	<u>Page</u>
2.18 Reactor Startup - PWR .....	2-20
2.18.1 Source and Intermediate Ranges .....	2-20
2.18.2 Power Range .....	2-21
2.19 Decay Heat Production After Shutdown .....	2-21
<b>3.0 HEAT TRANSFER AND THERMAL HYDRAULICS .....</b>	<b>3-1</b>
3.1 Introduction .....	3-1
3.2 Steam Power Cycle .....	3-1
3.2.1 Overview of the Steam Power Cycle .....	3-1
3.2.2 The First Law of Thermodynamics .....	3-2
3.2.3 The Second Law of Thermodynamics .....	3-3
3.2.4 Thermodynamic Cycle Efficiency .....	3-3
3.2.5 T-S and H-S Cycle Diagrams .....	3-4
3.2.6 Steam Power Cycle Analysis .....	3-6
3.2.7 Example Cycle Analysis .....	3-7
3.2.8 Improving Cycle Efficiency .....	3-9
3.3 Basic Heat Transfer Mechanisms and Principles .....	3-10
3.3.1 Conduction .....	3-10
3.3.2 Radiation .....	3-12
3.3.3 Convection .....	3-12
3.4 Practical Applications of Heat Transfer in the Plant .....	3-13
3.4.1 Physical Parameters of Basic Heat Transfer .....	3-13
3.4.2 Heat Transfer in Heat Exchangers .....	3-15
3.5 Boiling Heat Transfer .....	3-16
3.5.1 Physical Parameters of Boiling Heat Transfer .....	3-17
3.5.2 Steam Generation Characteristics .....	3-19
3.6 Reactor Thermal and Hydraulic Performance .....	3-20
3.6.1 Performance Objectives .....	3-20
3.6.2 Departure from Nucleate Boiling .....	3-22
3.7 Reactor Plant Heat Balances .....	3-24
3.7.1 PWR Heat Balance .....	3-24
3.7.2 BWR Heat Balance .....	3-26
3.8 Natural Circulation in Reactors .....	3-27



	<u>Page</u>
4.0	PROCESS CHEMISTRY ..... 4-1
4.1	Acids and Bases ..... 4-1
4.2	Conductivity ..... 4-3
4.3	Radiolysis of Water ..... 4-5
4.4	Voltaic Cells ..... 4-6
4.5	Corrosion ..... 4-7
4.5.1	Corrosion of Iron ..... 4-7
4.5.2	Corrosion Rate ..... 4-9
4.6	Types of Corrosion ..... 4-9
4.7	Crud ..... 4-11
4.8	Sources of Radioactivity in Reactor Coolant ..... 4-14
4.8.1	Activation of Corrosion Products ..... 4-14
4.8.2	Activation of Water ..... 4-14
4.8.3	Activation of Water Impurities ..... 4-15
4.8.4	Fission Products ..... 4-16
4.9	Detection of Fuel Cladding Failures ..... 4-16
4.10	Ion Exchangers and Demineralizers ..... 4-18
4.10.1	Deep Bed Demineralizers ..... 4-20
4.10.2	Powdered Resin Filter Demineralizers ..... 4-20
4.11	Basic Water Chemistry Requirements ..... 4-21
5.0	PRINT READING ..... 5-1
5.1	Introduction ..... 5-1
5.2	Categories of Drawings ..... 5-1
5.2.1	Drafting Organization ..... 5-2
5.2.2	Status of Modifications ..... 5-2
5.2.3	Controlled vs. Information Only ..... 5-2
5.3	Print Reading Fundamentals ..... 5-3
5.3.1	Indexes ..... 5-3
5.3.2	Title Block ..... 5-3

	<u>Page</u>
5.3.3 Numbering Systems .....	5-3
5.3.4 Grids .....	5-4
5.3.5 Revisions .....	5-4
5.4 Piping and Instrumentation Diagrams .....	5-4
5.4.1 P&ID Symbols .....	5-4
5.4.2 P&ID Examples .....	5-4
5.5 One-Line Electrical Diagrams and Control Wiring Diagrams .....	5-6
5.5.1 Purposes .....	5-6
5.5.2 Symbols and Notation .....	5-7
5.5.3 Examples .....	5-8
5.6 Logic Diagrams .....	5-9
5.6.1 Logic Diagram Symbols .....	5-9
5.6.2 Logic Diagram Examples .....	5-10
5.7 Summary .....	5-11

**APPENDIX 5A STANDARD ELECTRICAL DEVICE NUMBERS  
AND FUNCTIONS .....**

5A-1 Purpose of Device Function Number .....	5A-1
5A.2 Standard Device Function Numbers .....	5A-1
5A.3 Supervisory Control and Indication .....	5A-7
5A.4 Suffix Letters .....	5A-7
5A.4.1 Letters for Separate Auxiliary Devices .....	5A-8
5A.4.2 Letters for Condition/Electrical Quantity .....	5A-8
5A.4.3 Letters for Location of Main Device in the Circuit .....	5A-9
5A.4.4 Letters for Parts of the Main Device .....	5A-9
5A.4.5 Other Letter Designations .....	5A-12
5A.4.6 Lower Case Letters .....	5A-12
5A.5 Suffix Numbers .....	5A-12
5A.6 Devices Performing More Than One Function .....	5A-12
5A.7 Representation of Device Contacts on Electrical Diagrams .....	5A-13

6.0	BASIC ELECTRICAL .....	6-1
6.1	Electrical Fundamentals .....	6-1
6.1.1	Voltage .....	6-1
6.1.2	Current .....	6-2
6.1.3	Resistance .....	6-2
6.2	Electricity and Magnetism .....	6-3
6.2.1	Electric Current Produces a Magnetic Field .....	6-3
6.2.2	Simple Relay .....	6-3
6.2.3	Electromagnetic Induction .....	6-4
6.2.4	Two Pole AC Generator .....	6-4
6.3	Real, Apparent and Reactive Power .....	6-4
6.3.1	Root Mean Square or Effective Values of Voltage and Current .....	6-5
6.3.2	Real Power and Reactive Power in AC Circuits .....	6-6
6.3.3	Real Power in Complex Circuits .....	6-9
6.3.4	Reactive Power in Complex Circuits .....	6-10
6.3.5	Impedance .....	6-10
6.3.6	Power Triangles .....	6-10
6.3.7	Leading and Lagging Power Factors .....	6-11
6.4	Three Phase Systems .....	6-11
6.4.1	Phase and Line Relationships in Three-Phase Systems .....	6-12
6.4.2	Power in Three-Phase Systems .....	6-13
6.4.3	Grounded Three-Phase Systems .....	6-13
6.5	Transformers .....	6-14
6.5.1	Theory of Operation .....	6-14
6.5.2	Ideal Transformers .....	6-15
6.5.3	The Autotransformer .....	6-16
7.0	GENERATORS .....	7-1
7.1	Introduction .....	7-1
7.2	Polyphase and Multiple Pole Generators .....	7-1
7.3	Generator Construction .....	7-2
7.3.1	The Stator (or Armature) .....	7-2
7.3.2	The Rotor .....	7-3
7.3.3	Exciter .....	7-3
7.3.4	Brushless Exciter .....	7-4

	<u>Page</u>
7.4 Generator Auxiliary Systems .....	7-4
7.4.1 Stator Water Cooling System .....	7-4
7.4.2 Hydrogen Cooling System .....	7-4
7.4.3 Generator Core Monitor .....	7-4
7.4.4 Gas Control System .....	7-5
7.4.5 Hydrogen Seal Oil System .....	7-5
7.5 Generator Operation .....	7-5
7.5.1 Speed and Voltage Regulation .....	7-5
7.5.2 Single Generator Supplying an Isolated Load .....	7-6
7.5.3 The Infinite Bus .....	7-7
7.5.4 Paralleling Generators .....	7-8
7.6 Generator Limitations .....	7-8
8.0 AC MOTORS .....	8-1
8.1 Introduction .....	8-1
8.2 AC Motor Theory .....	8-1
8.2.1 Development of a Rotating Field .....	8-1
8.2.2 Motor Synchronous Speed .....	8-2
8.2.3 AC Motor Losses and Efficiency .....	8-2
8.3 Three-Phase Induction Motors .....	8-3
8.3.1 Induction Motor Construction .....	8-3
8.3.2 Induction Motor Operation .....	8-3
8.3.3 Induction Motor Response to an Increase in Load .....	8-4
8.4 Single-Phase AC Motors .....	8-4
8.4.1 Shaded Pole Single-Phase Motors .....	8-4
8.4.2 Induction-Start Single-Phase Motors .....	8-4
8.4.3 Capacitor-Start Single-Phase Motors .....	8-5
8.5 Synchronous Motors .....	8-5
8.5.1 Synchronous Motor Operation .....	8-5
8.5.2 Synchronous Motor Speed .....	8-5
8.5.3 Overexcited Synchronous Motors .....	8-6
8.5.4 Synchronous Motor Applications .....	8-6
8.6 Motor Starting Current .....	8-6
8.6.1 No-Load Starting .....	8-7
8.7 Starting Circuits .....	8-7

	<u>Page</u>
8.7.1 General .....	8-7
8.7.2 Full-Voltage Starters .....	8-8
8.7.3 Primary-Resistor Starters .....	8-8
8.7.4 Autotransformer Starters .....	8-8
9.0 ELECTRICAL DISTRIBUTION EQUIPMENT .....	9-1
9.1 General Discussion .....	9-1
9.2 Generic Distribution System .....	9-1
9.2.1 Power Distribution Grid .....	9-2
9.2.2 Switchyard Bus Arrangements .....	9-3
9.2.3 Electrical System Design Requirements .....	9-3
9.2.4 Offsite (Preferred) Power Connections .....	9-4
9.2.5 Onsite Power System Terms .....	9-4
9.2.6 Vital and Nonvital Subsystems .....	9-6
9.3 Switchyard Connection Components .....	9-7
9.3.1 Switchyard Transformers .....	9-7
9.3.2 High Voltage Buses and Bus Ducts .....	9-7
9.3.3 Disconnects .....	9-7
9.4 Circuit Breakers and Breaker Control .....	9-8
9.4.1 Air Circuit Breakers .....	9-9
9.4.2 Air-Blast Circuit Breakers .....	9-9
9.4.3 Oil Circuit Breakers .....	9-10
9.4.4 Vacuum Circuit Breakers .....	9-10
9.4.5 Breaker Control .....	9-11
9.5 Protective Relays .....	9-11
9.5.1 Instantaneous or High-speed .....	9-12
9.5.2 Definite Time Delay .....	9-12
9.5.3 Inverse Time Delay .....	9-12
9.6 Fuses .....	9-12
9.6.1 Low-Voltage Cartridge Fuse .....	9-13
9.6.2 High-Voltage Fuses .....	9-13
9.7 Special Onsite Distribution Equipment .....	9-13
9.7.1 Automatic Bus Transfer Devices .....	9-13
9.7.2 Inverters and Battery Chargers .....	9-13
9.7.3 Motor-Generator Sets .....	9-13
9.7.4 Uninterruptible Power Supplies .....	9-14

	<u>Page</u>
9.8 Batteries.....	9-14
9.8.1 Cells and Batteries.....	9-14
9.8.2 Construction of a Lead-Acid Storage Battery.....	9-14
9.8.3 Storage Battery Operation.....	9-15
9.8.4 Hydrometer.....	9-17
9.8.5 Potential Difference and Current.....	9-17
9.8.6 Cell Capacity.....	9-17
9.8.7 Battery Charges.....	9-18
9.9 Emergency Responses.....	9-18
9.9.1 Plant Trip.....	9-18
9.9.2 Loss of Offsite Power.....	9-19
9.9.3 Safety Injection Actuation.....	9-19
10.0 PIPING.....	10-1
10.1 General Description.....	10-1
10.2 Pipe.....	10-1
10.2.1 Piping Standards.....	10-1
10.2.2 Pipe Size and Schedule.....	10-2
10.2.3 Pipe Materials and Applications.....	10-3
10.3 Pipe Hangers, Supports, and Snubbers.....	10-3
10.3.1 Adjustable Hangers.....	10-4
10.3.2 Variable Spring Hangers.....	10-4
10.3.3 Constant Supports.....	10-4
10.3.4 Roller Stand Supports.....	10-4
10.3.5 Snubbers.....	10-4
10.4 Valves.....	10-5
10.4.1 Common Valve Parts.....	10-5
10.4.2 Gate Valves.....	10-7
10.4.3 Globe Valves.....	10-7
10.4.4 Check Valves.....	10-9
10.4.5 Butterfly Valves.....	10-10
10.4.6 Safety and Relief Valves.....	10-10
10.4.7 Specialty Valves.....	10-12
10.4.8 Valve Packing.....	10-16
10.4.9 Gaskets.....	10-16
10.5 Valve Operators.....	10-17
10.5.1 Manual Operators.....	10-17

	<u>Page</u>
10.5.2 Electric Operators.....	10-17
10.5.3 Pneumatic Operators .....	10-24
10.5.4 Hydraulic Operators .....	10-25
11.0 TURBINES .....	11-1
11.1 Introduction .....	11-1
11.2 Turbine Design Types .....	11-1
11.2.1 Impulse Turbines.....	11-1
11.2.2 Reaction Turbines .....	11-2
11.3 Turbine Staging .....	11-2
11.3.1 Impulse Turbine Compounding .....	11-2
11.3.2 Reaction Turbine Compounding .....	11-3
11.3.3 Stage Efficiencies in Practical Turbines.....	11-3
11.4 Construction Details .....	11-4
11.4.1 Stage Sealing .....	11-4
11.5 Axial Thrust Loading .....	11-4
11.5.1 Rotor Designs .....	11-5
11.5.2 Shaft Sealing System.....	11-5
11.5.3 Rotor Glands .....	11-5
11.5.4 Gland Steam Condenser .....	11-6
11.6 Practical Turbine Types .....	11-6
11.6.1 Condensing vs. Noncondensing .....	11-6
11.6.2 Extraction vs. Nonextraction.....	11-6
11.7 Reheat vs. Nonreheat.....	11-6
11.7.1 Single Casing vs. Compound Turbines.....	11-7
11.7.2 Single vs. Multiple Flow .....	11-7
11.8 Modern Power Plant Turbines.....	11-7
11.8.1 Turbine Valves .....	11-8
11.8.2 Electro-hydraulic Control System .....	11-8
11.8.3 Lube Oil System .....	11-8
11.8.4 Turbine Bearings .....	11-9
11.8.5 Extraction Steam .....	11-10
11.8.6 Exhaust Hood Spray .....	11-11
11.8.7 Turning Gear .....	11-11
11.8.8 Front Standard .....	11-11
11.8.9 Turbine Governor .....	11-11

	<u>Page</u>
11.9 Turbine Operational Problems .....	11-12
11.9.1 Vibration .....	11-12
11.9.2 Critical Speeds .....	11-13
11.9.3 Water Induction .....	11-14
11.9.4 Overspeed .....	11-14
11.9.5 Low Lube Oil Pressure/High Thrust Bearing Wear .....	11-15
11.9.6 Reactor Trip .....	11-15
11.10 Standby Auxiliary Turbines .....	11-15
12.0 PUMPS .....	12-1
12.1 Introduction .....	12-1
12.1.1 Head .....	12-1
12.2 Principles of Liquid Pumping .....	12-2
12.2.1 Centrifugal Force .....	12-2
12.2.2 Volumetric Displacement .....	12-3
12.2.3 Transference of Momentum .....	12-3
12.3 Centrifugal Pumps .....	12-3
12.3.1 Casings .....	12-4
12.3.2 Impellers .....	12-4
12.3.3 Pump Shafts .....	12-5
12.3.4 Stuffing Boxes .....	12-6
12.3.5 Mechanical Seals .....	12-7
12.3.6 Bearings .....	12-8
12.3.7 Cavitation .....	12-8
12.3.8 Suction Head .....	12-9
12.4 Positive Displacement Pumps .....	12-10
12.4.1 Liquid End Construction .....	12-11
12.4.2 Pulsations .....	12-12
12.4.3 Flow Characteristics .....	12-12
12.4.4 Net Positive Suction Head Requirements .....	12-12
12.5 Jet Pumps .....	12-12
12.6 Operating Characteristics of a Centrifugal Pump .....	12-13
12.6.1 Single Pump Operations .....	12-13
12.6.2 Centrifugal Pump Laws .....	12-13
12.6.3 Operating Point .....	12-13
12.6.4 Shutoff Head and Runout Conditions .....	12-14
12.6.5 Multiple Pump Operations .....	12-15



	<u>Page</u>
12.7 Operating Characteristics of a Positive Displacement Pump .....	12-15
13.0 DIESEL GENERATORS .....	13-1
13.1 Introduction .....	13-1
13.2 General .....	13-1
13.2.1 Four-Stroke Diesel Engine .....	13-1
13.2.2 Two-Stroke Diesel Engine .....	13-2
13.3 Diesel Systems .....	13-2
13.3.1 Starting System .....	13-3
13.3.2 Fuel Systems .....	13-3
13.3.3 Diesel Engine Lube Oil System .....	13-5
13.3.4 Cooling Systems .....	13-6
13.3.5 Scavenging Air, Supercharging, and Turbocharging Systems .....	13-6
13.3.6 Governor Systems .....	13-8
13.4 Emergency Starts .....	13-11
13.5 Emergency Responses .....	13-11
14.0 PROCESS INSTRUMENTATION .....	14-1
14.1 Introduction .....	14-1
14.2 Basic Instrument Channels .....	14-1
14.3 Temperature .....	14-2
14.3.1 Thermocouples .....	14-2
14.3.2 Resistance Temperature Detector .....	14-4
14.4 Pressure .....	14-6
14.4.1 Bourdon Tube .....	14-7
14.4.2 Bellows .....	14-7
14.4.3 Diaphragm .....	14-7
14.5 Mechanical - Electrical Conversion .....	14-7
14.5.1 Force Balance Transmitter .....	14-7
14.5.2 Movable Core Transmitter .....	14-8
14.5.3 Variable Capacitance Transmitter .....	14-8
14.5.4 Strain Gauge .....	14-8

	<u>Page</u>
14.6 Flow Rate Measurement.....	14-9
14.6.1 Orifice Plate.....	14-9
14.6.2 Flow Nozzle .....	14-9
14.6.3 Flow Venturi .....	14-10
14.6.4 Elbow Flow Measuring Device .....	14-10
14.6.5 Pitometer.....	14-10
14.7 Flow Sensors .....	14-11
14.7.1 Bellows Flow Sensor.....	14-11
14.7.2 Diaphragm Flow Sensor .....	14-11
14.7.3 Magnetic Flow Sensor.....	14-11
14.8 Level .....	14-11
14.8.1 Level Error .....	14-12
14.9 Signal Processing .....	14-13
14.10 Calibration .....	14-13
14.11 Environmental Qualification .....	14-14
14.12 Compensating Measures for Adverse Environment.....	14-14
14.13 Summary .....	14-15
<b>15.0 CONTROLLERS .....</b>	<b>15-1</b>
15.1 Introduction .....	15-1
15.2 Controller Terminology.....	15-1
15.3 Examples of Feedback Control .....	15-2
15.4 Controller Operation .....	15-3
15.4.1 Bistable Control.....	15-4
15.4.2 Proportional Control.....	15-5
15.4.3 Proportional Integral Control .....	15-6
15.4.4 Proportional Derivative Control .....	15-7
15.4.5 Proportional Integral Derivative Control .....	15-8
15.5 Comparison of Control Modes .....	15-9
15.6 Summary .....	15-9

	<u>Page</u>
16.0 NUCLEAR INSTRUMENTATION .....	16-1
16.1 Introduction .....	16-1
16.2 Nuclear Ionization .....	16-2
16.3 Nuclear Ionization Detectors .....	16-3
16.3.1 Recombination Region .....	16-3
16.3.2 Ionization Region .....	16-4
16.3.3 Proportional Region .....	16-4
16.3.4 Limited Proportional Region .....	16-4
16.3.5 Geiger-Mueller Region .....	16-5
16.3.6 Continuous Discharge Region .....	16-5
16.4 Neutron Detection .....	16-5
16.5 Proportional Type Detectors .....	16-6
16.5.1 BF <sub>3</sub> Proportional Counter .....	16-6
16.5.2 Source Range/Startup Channel Gamma Compensation .....	16-7
16.6 Ionization Type Detectors .....	16-8
16.6.1 Fission Chamber .....	16-8
16.6.2 Compensated Ion Chamber (CIC) .....	16-9
16.6.3 Uncompensated Ion Chamber .....	16-10
16.7 Self-Powered Detectors (SPND) .....	16-10

**LIST OF TABLES**

<u>Table</u>	<u>Page</u>
1-1 GE BWR Product Lines .....	1-19
2-1 Neutrons From Fission .....	2-23
2-2 Microscopic Cross Section ( $\sigma$ ) Values .....	2-25
2-3 Ineffective Subcritical Multiplication .....	2-27
2-4 Subcritical Multiplication .....	2-29
2-5 Delayed Neutron Fraction for Various Fuels .....	2-31
2-6 Delayed Heat Production Following Reactor Shutdown From Full Power .....	2-33
4-1 pH and Ion Concentrations .....	4-23
4-2 Activated Corrosion Products .....	4-25
4-3 Radioiodines .....	4-27
4-4 Fission Gases .....	4-29
4-5 Soluble Metal Ions .....	4-31
4-6 Resin Affinity .....	4-33
8-1 Synchronous Motor Characteristics and Applications .....	8-9
9-1 Definitions .....	9-21
10-1 Pipe Data .....	10-27
10-2 Allowable Stress Values for Temperatures 650 to 1150°F .....	10-29

LIST OF ILLUSTRATIONS

<u>Figure</u>		<u>Page</u>
1-1	Boiling Water Reactors in Various Systems .....	1-21
1-2	Basic BWR Power Plant .....	1-23
1-3	Simplified BWR Primary and Auxiliary Systems .....	1-25
1-4	BWR Reactor Vessel .....	1-27
1-5	BWR Control Systems .....	1-29
1-6	Emergency Core Cooling System .....	1-31
1-7	Basic PWR Power Plant .....	1-33
1-8	Simplified PWR System Composite .....	1-35
1-9	PWR Reactor Vessel .....	1-37
1-10	Simplified Reactor Vessel .....	1-39
1-11	Typical PWR Fuel Assembly .....	1-41
1-12	Westinghouse Steam Generator .....	1-43
1-13	Steam Generator Secondary-side Flowpaths .....	1-45
1-14	PWR Control Systems .....	1-47
1-15	Emergency Core Cooling System Simplified Composite .....	1-49
2-1	Fission Neutron Energy .....	2-35
2-2	U-235 Absorption Cross-Section Vs. Energy .....	2-37
2-3	Neutron Cycle in a Thermal Reactor .....	2-39
2-4	Moderator Temperature Coefficient .....	2-41
2-5	Void Coefficient .....	2-43
2-6	Resonance Absorption (Stationary Nucleus) .....	2-45

<u>Figure</u>		<u>Page</u>
2-7	Resonance Capture .....	2-47
2-8	U-238 Cross Section Curve .....	2-49
2-9	FTC Vs. Fuel Temperature .....	2-51
2-10	Total Power Defect .....	2-53
2-11	Moderator Temperature Coefficient .....	2-55
2-12	Differential Rod Worth Curve .....	2-57
2-13	Integral Rod Worth Curve .....	2-59
2-14	Boron Worth Vs. Moderator Temperature .....	2-61
2-15	Fission Yield Curve .....	2-63
2-16	Xenon Reactivity Vs. Reactor Power as Function of Time .....	2-65
2-17	Xenon Peaking .....	2-67
2-18	Samarium Buildup .....	2-69
2-19	Samarium Peaking .....	2-71
2-20	Subcritical Multiplication .....	2-73
2-21	Delayed Neutron Production .....	2-75
2-22	Delayed Neutron Effects .....	2-77
3-1	Basic Steam-Water Power Cycle .....	3-29
3-2	Simple Power Cycle .....	3-31
3-3	Temperature-Entropy Diagram for Analysis of Simple Steam Cycle .....	3-33
3-4	Mollier Diagram .....	3-35
3-5	Basic Steam Cycle .....	3-37
3-6	T-S Diagram for Basic Steam Cycle .....	3-39
3-7	H-S Diagram for Basic Steam Cycle .....	3-41

<u>Figure</u>	<u>Page</u>
3-8 Steam Cycle with Feedwater Heating and Steam Reheating .....	3-43
3-9 T-S Diagram for Steam Cycle (Ideal) with Feedwater Heating and Steam Reheating.....	3-45
3-10 Heat Conduction Through a Plane Wall .....	3-47
3-11 Convection Heat Transfer From a Surface.....	3-49
3-12 Heat Transfer Curve .....	3-51
3-13 Effects of Flow on Convection Heat Transfer .....	3-53
3-14 Heat Transfer for a Typical Heat Exchanger.....	3-55
3-15 Boiling Heat Transfer .....	3-57
3-16 Transition Boiling .....	3-59
3-17 Effect of a Pressure Increase on Boiling Heat Transfer .....	3-61
3-18 Effect of a Pressure Decrease on Boiling Heat Transfer.....	3-63
3-19 Effect of a Flow Increase on Boiling Heat Transfer .....	3-65
3-20 Cyclone-Type Moisture Separator .....	3-67
3-21 Chevron-Type Moisture Separator .....	3-69
3-22 Fuel Arrangement Showing Centerline.....	3-71
3-23 Fuel Channel Boiling Conditions .....	3-73
3-24 PWR Reactor Core Heat Balance Diagram.....	3-75
3-25 BWR Reactor Core Heat Balance Diagram .....	3-77
3-26 Natural Circulation .....	3-79
4-1 Voltaic Cell Operation .....	4-35
4-2 Corrosion of Iron .....	4-37
4-3 Crevice Corrosion .....	4-39

<u>Figure</u>		<u>Page</u>
4-4	Factors Affecting Crevice Corrosion .....	4-41
4-5	Pitting Corrosion .....	4-43
4-6	Cu-Zn Galvanic Cell .....	4-45
4-7	Intergranular Corrosion .....	4-47
4-8	Recoil Range .....	4-49
4-9	Basic Resin Structure .....	4-51
4-10	Common Resin Representations .....	4-53
4-11	Deep Bed Demineralizer .....	4-55
4-12	Typical Filter/Demineralizer Unit .....	4-57
5-1	Partial Print Index .....	5-13
5-2	Typical P&ID Symbol List .....	5-15
5-3	P&ID Symbol List - Part 1 .....	5-17
5-4	P&ID Symbol List - Part 2 .....	5-19
5-5	Diesel Air Start System Sketch .....	5-21
5-6	Diesel Air Start System P&ID .....	5-23
5-7	Auxiliary Feedwater and Steam Generator (Partial) .....	5-25
5-8	Auxiliary Feedwater and Steam Generator Blowdown Systems (Partial) .....	5-27
5-9	Elementary Electrical (Three-Line) Diagram .....	5-29
5-10	Typical One-Line Diagram Legend .....	5-31
5-11	Diesel Generator Tie Breaker Control Wiring Diagram .....	5-33
5-12	Electrical Distribution System Sketch .....	5-35
5-13	Electrical Distribution System One-Line Diagram .....	5-37
5-14	Logic Functions .....	5-39



<u>Figure</u>	<u>Page</u>
5-15	Miscellaneous Logic Diagram Symbols .....5-41
5-16	Typical Logic Diagram Symbols .....5-43
5-17	Training Sketch of Reactor Trip Logic .....5-45
5-18	Pressurizer Pressure Logic Diagram .....5-47
6-1	Graph of Alternating Current in an AC Circuit.....6-17
6-2A	Resistors in Series .....6-19
6-2B	Resistors in Parallel .....6-19
6-3	Direction of Magnetic Field is from North to South Pole .....6-21
6-4	Schematic Presentation of Relay and Associated Circuits .....6-23
6-5	Two-Pole AC Generator .....6-25
6-6	Generation of a Sine Wave.....6-27
6-7	Determining the Effective Value of an Alternating Current .....6-29
6-8	Real Power in a Purely Resistive Circuit .....6-31
6-9	Reactive Power in a Purely Inductive Circuit .....6-33
6-10	Principle of Parallel Plate Capacitor .....6-35
6-11	Reactive Power in a Purely Capacitive Circuit .....6-37
6-12	Complex AC Circuit:.....6-39
6-13	Impedance in AC Circuits .....6-41
6-14A	General Plot of Power Components .....6-43
6-14B	Power Triangle .....6-43
6-15	Application of Power Triangle .....6-45
6-16A	Three-phase Source .....6-47
6-16B	Wye Connection .....6-47

<u>Figure</u>		<u>Page</u>
6-16C	Delta Connection .....	6-47
6-17	Instantaneous Power in a Three-Phase System .....	6-49
6-18	Elements of Simple Transformer .....	6-51
6-19	Schematic Diagram of Step-Down Autotransformer .....	6-53
7-1	Revolving Field Generator and Resultant Output .....	7-11
7-2	Three-Phase Generator and Resultant Output .....	7-13
7-3	Four-Pole, Three-Phase AC Generator and Schematic Diagram for Y-Connected Armature Windings .....	7-15
7-4	Generator Stator or Armature .....	7-17
7-5	Stator Bar Assemblies in Stator Core Slots .....	7-19
7-6	Simplified Rotor Assembly .....	7-21
7-7	Exciter System .....	7-23
7-8	Brushless Exciter System .....	7-25
7-9A	Speed Regulator Characteristic .....	7-27
7-9B	Voltage Regulator Characteristic .....	7-27
7-10A	Generator Supplying Isolated Loads .....	7-29
7-10B	Power Triangles .....	7-29
7-10C	Regulator Characteristic for Generator Supplying Isolated Loads .....	7-29
7-11	Effect of Increasing No-Load Frequency and Voltage Setpoints to Generator Supplying Isolated Loads .....	7-31
7-12	Frequency and Voltage Characteristics of an Infinite Bus .....	7-33
7-13	Generator in Parallel with an Infinite Bus .....	7-35
7-14	Load Sharing Between a Generator and an Infinite Bus .....	7-37
7-15	Frequency Requirements for Paralleling Generators .....	7-39

<u>Figure</u>	<u>Page</u>
7-16      Synchroscope .....	7-41
7-17      Operating Quadrants .....	7-43
7-18      Generator Capability Curves .....	7-45
8-1        Development of a Rotating Field .....	8-11
8-2        Squirrel Cage Induction Motor .....	8-13
8-3        Wound Rotor Induction Motor .....	8-15
8-4        Shaded-Pole Single-Phase Motor .....	8-17
8-5        Induction-Start Single-Phase Motor .....	8-19
8-6        Capacitor-Start Single-Phase Motor .....	8-21
8-7        Indicating the General Areas of Application of Synchronous and Induction Motors .....	8-23
8-8        AC Motor Starting Current Curve .....	8-25
8-9        Magnetic Across-The-Line Starter .....	8-27
8-10      Primary Resistor Starter Diagram .....	8-29
8-11      Autotransformer Starting Diagram .....	8-31
9-1        Simplified Grid System .....	9-23
9-2        Typical Distribution System .....	9-25
9-3        In-Plant Load Tripping .....	9-27
9-4        Switchyard Bus Arrangement .....	9-29
9-5        Parallel Bus Arrangement .....	9-31
9-6        Ring Bus Arrangement .....	9-33
9-7        Typical Onsite Electrical Distribution System .....	9-35
9-8        Vital and Nonvital Subsystems .....	9-37

<u>Figure</u>		<u>Page</u>
9-9	In-Plant Protective Bus Ducts .....	9-39
9-10	Solenoid-Operated Circuit Breaker Operating Mechanism .....	9-41
9-11	Air Circuit Breaker Operation .....	9-43
9-12	Load Center With Air Circuit Breakers .....	9-45
9-13	Cam-Operated Breaker Sequence .....	9-47
9-14	Air-Blast Circuit Breaker .....	9-49
9-15	Oil Circuit Breaker .....	9-51
9-16	Vacuum Circuit Breaker .....	9-53
9-17	Breaker Control Circuit .....	9-55
9-18	Protective Relays .....	9-57
9-19	Typical Fuses .....	9-59
9-20	Uninterruptible Power Supply .....	9-61
9-21	Lead-Acid Battery Construction .....	9-63
9-22	Basic Chemical Action of a Lead-Acid Storage Battery .....	9-65
10-1	Common Adjustable Hangers .....	10-31
10-2	Variable Spring Hanger .....	10-33
10-3	Constant Support .....	10-35
10-4	Roller Stands .....	10-37
10-5	Hydraulic Snubber Basic Arrangement .....	10-39
10-6	Basic Components of Gate Valves .....	10-41
10-7	Typical Globe Valve .....	10-43
10-8	Globe Valve with Conventional Disk and Conical Seat .....	10-45
10-9	Angle Globe Valve .....	10-47

<u>Figure</u>		<u>Page</u>
10-10	Needle Valve .....	10-49
10-11	Swing - Check Valve.....	10-51
10-12	Lift - Check Valve .....	10-53
10-13	Stop - Lift - Check Valve .....	10-55
10-14	Butterfly Valve .....	10-57
10-15	Nozzle Reaction Safety Valve.....	10-59
10-16	Huddling Chamber Safety Valve .....	10-61
10-17	Relief Valve.....	10-63
10-18	Direct-Acting and Pilot-Operated Solenoid Valves .....	10-65
10-19	Two Types of Plug Valves .....	10-67
10-20	Ball Valve.....	10-69
10-21	Diaphragm Valves.....	10-71
10-22	Air-Operated Single-Seated Control Valve.....	10-73
10-23	Double-Seated Control Valve .....	10-75
10-24	Self-Contained Pressure-Reducing Valve .....	10-77
10-25	Three-Way Valve for Diverting Service .....	10-79
10-26	Three-Way Valve for Combining Service .....	10-81
10-27	Deluge Valve .....	10-83
10-28	Electric Valve Operator .....	10-85
10-29	Cutaway View of a SMB-0 Limitorque Operator .....	10-87
10-30	SMB-0 Limitorque Operator .....	10-89
10-31	Simplified Worm Operation Diagram .....	10-91
10-32	SMB-0 Limitorque Operator (Exploded View) .....	10-93

<u>Figure</u>		<u>Page</u>
10-33	SMB-000/00 Limitorque Operator .....	10-95
10-34	SMB-000 Limitorque Operator (Exploded View) .....	10-97
10-35	Basic MOV Valve Control Circuit with Seal-in .....	10-99
10-36	Basic MOV Throttle Valve Control Circuit .....	10-101
10-37	Diaphragm Operators .....	10-103
10-38	Simple E/P Converter .....	10-105
10-39	Hydraulic Operators .....	10-107
11-1	Impulse Turbine Principle .....	11-17
11-2	Ideal Turbines .....	11-19
11-3	Reaction Turbine Principle .....	11-21
11-4	Velocity Compound Staging (Curtis Stage) Pressure-Velocity Diagram .....	11-23
11-5	Pressure Compound Staging Pressure-Velocity Diagram .....	11-25
11-6	Reaction and Impulse Efficiencies .....	11-27
11-7	Interstage Sealing .....	11-29
11-8	Double-Flow Rotor .....	11-31
11-9	Rotor Types .....	11-33
11-10	Shaft Gland Sealing System .....	11-35
11-11	Labyrinth Seals .....	11-37
11-12	Gland Seal Steam Distribution .....	11-39
11-13	Turbine Types .....	11-41
11-14	Four Cylinder Nuclear Unit .....	11-45
11-15	Four Cylinder Turbine, Cross Section .....	11-47
11-16	Main Steam System .....	11-49

<u>Figure</u>	<u>Page</u>
11-17 EHC System Hydraulic Power Unit.....	11-51
11-18 Turbine Lube Oil System .....	11-53
11-19 Typical Journal Bearing .....	11-55
11-20 Thrust Bearing .....	11-57
11-21 Side-Mounted Turning Gear .....	11-59
11-22 Flyweight Governor System .....	11-61
11-23 Rotor Critical Speeds .....	11-63
12-1 Volute Casing Pump.....	12-17
12-2 Multistage (Three) Pump Impeller and Shaft Assembly.....	12-19
12-3 Radial Reaction Forces in Pumps.....	12-21
12-4 Radial Reaction Forces in Single-Volute Versus Double-Volute Pumps .....	12-23
12-5 Double-Volute Casing Pump .....	12-25
12-6 Double-Suction Impeller .....	12-27
12-7 Conventional Stuffing Box with Bottoming Ring .....	12-29
12-8 Seal Cage Arrangement.....	12-31
12-9 Typical Mechanical Pump Seal Construction .....	12-33
12-10 Internal Versus External Pump Mechanical Seal Assemblies .....	12-35
12-11 Double Mechanical Seal.....	12-37
12-12 Displacement of a Solid in a Liquid .....	12-39
12-13 Suction and Discharge Strokes of a Reciprocating Pump .....	12-41
12-14 Schematic of a Double-Acting Liquid End Reciprocating Pump .....	12-43
12-15 Liquid End, Vertical Pump.....	12-45
12-16 Stuffing Box .....	12-47

<u>Figure</u>		<u>Page</u>
12-17	Discharge Rates for Single Double-Acting and Triplex Single-Acting Pumps .....	12-49
12-18	Flow Characteristics of Simple and Duplex Pumps .....	12-51
12-19	Required NPSH for a Triplex Pump.....	12-53
12-20	Jet Pump .....	12-55
12-21	Centrifugal Pump Characteristic Curve .....	12-57
12-22	Changing Speeds for Centrifugal Pump.....	12-59
12-23	Characteristic Curves for a Three-Stage Centrifugal Pump .....	12-61
12-24	Operating Point for a Centrifugal Pump.....	12-63
12-25	Change in Operating Point Due to Pump Wear .....	12-65
12-26	Pump Characteristic Curve for Two Identical Centrifugal Pumps Used in Parallel.....	12-67
12-27	Operating Point for Two Centrifugal Pumps in Parallel .....	12-69
12-28	Pump Characteristic Curve for Two Identical Centrifugal Pumps Used in Series .....	12-71
12-29	Operating Point for Two Centrifugal Pumps in Series.....	12-73
12-30	Positive Displacement Pump Characteristic Curve.....	12-75
13-1	Four-Stroke Diesel Engine Cycle .....	13-13
13-2	Two-Stroke Diesel Engine Cycle .....	13-15
13-3	Typical Diesel Air Starting System .....	13-17
13-4	Air Start Valves .....	13-19
13-5	Diesel Fuel Oil System .....	13-21
13-6	Diesel Generator Lube Oil System.....	13-23
13-7	Diesel Cooling System .....	13-25



<u>Figure</u>	<u>Page</u>
13-8 Diesel Cycle Timing .....	13-27
13-9 Roots Blower Scavenging System .....	13-29
13-10 Turbocharger System .....	13-31
13-11 Simple Mechanical Governor .....	13-33
13-12 Hydraulic Governor .....	13-35
13-13 Hydraulic Governor with Feedback .....	13-37
13-14 Hydraulic Governor with Compensating Device .....	13-39
13-15 Electric Governor .....	13-41
14-1 Basic Instrument Channel .....	14-17
14-2 Basic Thermocouple Diagrams .....	14-19
14-3 Detailed Thermocouple Circuit .....	14-21
14-4 Resistance - Temperature Characteristics of Metals at Elevated Temperatures .....	14-23
14-5 Resistance Temperature Detector .....	14-25
14-6 Wheatstone-Bridge Circuit .....	14-27
14-7 Remote RTD Connections .....	14-29
14-8 Pressure Units .....	14-31
14-9 Bourdon Tube Pressure Gauge .....	14-33
14-10 Diaphragm/Bellows Pressure Sensors .....	14-35
14-11 Force Balance Transmitter .....	14-37
14-12 Movable Core Transmitter .....	14-39
14-13 Variable Capacitance Differential Pressure Sensor .....	14-41
14-14 Strain Gauge .....	14-43

<u>Figure</u>		<u>Page</u>
14-15	Primary Elements .....	14-45
14-16	Elbow Flow Measuring Device .....	14-47
14-17	Pitometer Flow Tube .....	14-49
14-18	Bellows Flow Sensor .....	14-51
14-19	Diaphragm Flow Sensor .....	14-53
14-20	Magnetic Flow Sensor .....	14-55
14-21	Level Measuring Device for Tank Open to Atmospheric Pressure .....	14-57
14-22	Differential Pressure Level Detector .....	14-59
14-23	Reference Leg Differential Pressure System .....	14-61
14-24	Pressurizer Differential Pressure Level Detector .....	14-63
14-25	Current Loop .....	14-65
15-1	Block Diagram of Feedback Control System .....	15-11
15-2	Control System Response .....	15-13
15-3	Manual and Automatic Feedback Controls for Thermal Systems .....	15-15
15-4	Steam Generator Water Level Control System .....	15-17
15-5	Simple Bistable Control .....	15-19
15-6	Bistable Control with Deadband Reaction to Decrease in Steam Demand .....	15-21
15-7	Bistable Response to Step Change in Input .....	15-23
15-8	Proportional Band .....	15-25
15-9	Response of Proportional Controller to Decrease in Steam Demand .....	15-27
15-10	Proportional Controller Response to Step Change in Input (Gain = 1) .....	15-29
15-11	Proportional Integral Control .....	15-31

<u>Figure</u>	<u>Page</u>
15-12	Response of Proportional Integral Controller to Decrease in Steam Demand .... 15-33
15-13	Proportional Integral Controller Response to Step Change in Level Setpoint.... 15-35
15-14	Proportional Derivative Control ..... 15-37
15-15	Response of Proportional Derivative Controller to Decrease in Steam Demand ..... 15-39
15-16	Response of Proportional Derivative Controller to Step Change in Setpoint ..... 15-41
15-17	Proportional Integral Derivative Control ..... 15-43
15-18	PID Controller Characteristics ..... 15-45
15-19	Effects of Change in Demand ..... 15-47
16-1	Neutron Detector Operational Ranges ..... 16-11
16-2	Gas-Filled Detector ..... 16-13
16-3	Gas Ionization Curves for Constant Incident Radiation Fields ..... 16-15
16-4	BF <sub>3</sub> Proportional Counter ..... 16-17
16-5	Startup Channel ..... 16-19
16-6	Fission Chamber ..... 16-21
16-7	Compensated Ion Chamber ..... 16-23
16-8	Uncompensated Ion Chamber ..... 16-25
16-9	Self-Powered Neutron Detector ..... 16-27

## 1.0 BASIC PLANT CYCLES

### Learning Objectives

After studying this chapter, you should be able to perform the following for PWR and BWR plants:

1. Describe the basic flowpaths for the major heat transfer cycle(s).
  - a. Primary
  - b. Secondary (PWR only)
2. Describe the functions and basic operation of major plant systems and components.
  - a. Primary
  - b. Secondary (PWR only)
  - c. Emergency
  - d. Control
3. Describe the sequence of basic operations necessary to perform a plant startup and plant shutdown.
4. List the principal barriers to the release of radioactive fission products.

### 1.1 Boiling Water Reactor Overview

Commercial nuclear power plants in the United States fall into two broad design categories. Specifically, these design categories are dual-cycle plants and direct-cycle plants. Dual-cycle plants are characterized by two physically independent fluid systems which separate the high pressure radioactive reactor coolant (primary system) from the low pressure non-radioactive steam/condensate systems (secondary system). Pressurized water reactors are examples of dual-cycle systems.

Direct cycle plants are fundamentally different from dual-cycle plants. Direct-cycle plants generate steam in the reactor and pass the steam directly to the turbine. Boiling water reactors are examples of direct-cycle plants. As shown in Figure 1-1, there is no distinction between primary

or secondary systems as there is in a PWR. The direct-cycle design used in commercial boiling water reactors offers numerous operational and maintenance advantages for the owner-utilities.

The basic operation of a forced-circulation direct-cycle BWR is shown in Figure 1-2. Inside the BWR vessel (A), a steam-water mixture is produced as coolant water removes heat from the reactor core (B). The steam-water mixture moves upward and into the moisture separator (C), where water droplets are removed before the steam is allowed to enter the steam line (D). The steam turns the turbine (E), which turns the electrical generator (F). The steam then enters the condenser (G), where it is condensed into water. The water is pumped by the feedwater pump (H) from the condenser back into the reactor vessel. The recirculation pump (I) and jet pump (J) allow the operator to vary the coolant flow rate (and thus change reactor power).

The fluid flow rates and reactivity levels<sup>1</sup> in a forced-circulation direct-cycle BWR require close control of steam flow from the reactor, feedwater flow into the reactor, recirculation flow through the reactor, and control rod positions. The design of the control systems considers conventional power generation objectives, such as reliability, ease of operation, response times of the controlling parameters, etc. Beyond the traditional power generation objectives, the control systems must incorporate features specific to reactivity control and nuclear plant safety. These considerations involve effects on moderator<sup>2</sup> temperature, fuel temperature, and moderator void content (amount of steam in the water) as a function of steam pressure; steam generation and feedwater input; fuel exposure; and automatic shutdown of the nuclear chain reaction during unsafe or potentially unsafe conditions.

The BWR material presented here is based on a single facility and is not intended to represent a complete discussion of all BWR facilities and systems. For a more complete and detailed treatment of the material presented here, the reader

should refer to a BWR technology manual or a BWR systems manual. Information about a specific plant can be found in its Final Safety Analysis Report (FSAR).

### 1.1.1 BWR Product Lines

Different product lines or classes of BWRs are designated numerically. There are currently six product lines: BWR/1, 2, 3, 4, 5, and 6. Table 1-1 gives some basic information on the different product lines. The descriptions in this chapter are based on the BWR/4 product line. Plants of this product line became fully operational during the 1980's. Note that the BWR/4 product line does not reflect the state of the art in industry today, but fairly represents the typical designs, systems, and circuits that would be found in most commercial boiling water reactors.

### 1.1.2 Primary and Auxiliary Systems

The BWR primary and auxiliary systems are those that are immediately involved in the direct-cycle BWR concept as part of the steam cycle, or that provide an auxiliary function for the direct-cycle system. These systems are shown in Figure 1-3. The BWR direct steam cycle starts with the reactor vessel, which is part of the reactor coolant pressure boundary and contains the reactor core. The reactor core provides the heat source for steam generation, consisting primarily of the nuclear fuel and control rods for regulating the fission process. The steam generated in the reactor vessel is routed to the steam loads and then condensed into water. The water is then purified, heated, and pumped back to the reactor vessel to be reheated. Water from the reactor vessel is circulated through external pumping loops and is then returned to the reactor vessel to provide forced circulation of flow through the reactor core. Reactor water is continuously purified to minimize impurities. Should the reactor become isolated from its main heat sink, an auxiliary system automatically keeps the reactor core covered with water. The BWR primary and auxiliary systems are discussed in the paragraphs which follow.

### 1.1.2.1 Reactor Vessel

#### The Reactor Vessel

- houses the reactor core,
- serves as part of the reactor coolant pressure boundary,
- supports and aligns the fuel and control rods,
- provides a flow path for the circulation of coolant past the fuel,
- removes moisture from the steam exiting the reactor vessel,
- provides an internal floodable volume to allow for reflooding the reactor core following a loss-of-coolant accident, and
- limits downward control rod motion following a postulated failure of the control rod drive housing.

A typical BWR reactor vessel is shown in Figure 1-4. The reactor vessel is mounted vertically within the primary containment (drywell); it comprises a cylindrical shell with rounded bottom head. The top head is also rounded but it can be removed to facilitate refueling operations. The vessel assembly is supported by a support skirt that is mounted to the reactor vessel support pedestal.

The base material of the reactor vessel and the top and bottom heads is a low carbon steel alloy. The inside wall of the cylindrical shell and bottom head is clad with stainless steel to provide corrosion resistance. The inside of the top head is not clad with stainless steel because it is exposed to the less corrosive steam environment.

The internal components of the reactor vessel are supported from the bottom head and/or the reactor vessel walls. The reactor core is made up of the fuel assemblies, control rods, and nuclear

instrumentation arranged roughly as a vertical cylinder within the reactor vessel. The structure surrounding the reactor core consists of a core shroud, core plate, and top guide.

The components making up the remainder of the reactor vessel internals are the jet pumps, control rod guide tubes and housing, steam separators, steam dryers, feedwater spargers, core spray spargers, standby liquid control injection line, and incore monitors. Except for the zirconium alloy used in the fuel cladding and channels, the reactor internals are made of stainless steel or other corrosion-resistant alloys.

### 1.1.2.2 Fuel and Control Rods

The fuel generates energy from the nuclear fission reaction to provide heat for steam generation. The control rods control reactor power level, both axially and radially, to optimize core performance. They also provide adequate excess negative reactivity<sup>3</sup> to shut down the reactor from any normal operating or accident condition at the most reactive time in core life.

Note that the control rods penetrate the reactor vessel from the bottom, a design that is unique to BWRs. Bottom penetrating control rods offer several advantages during maintenance. Less time is required during refueling outages to remove and reinstall the reactor vessel head since control rod drives are not a factor as they are in PWR refueling operations. Control rods remain operable when the reactor vessel head is removed. Internal moisture removal and steam separation can be more easily accomplished without interference from any top-mounted control rods. In a BWR, a large percentage of voids in the upper part of the core significantly reduces the power in this area. If control rods entered from the top of the core, those rods, which are partially inserted, would severely depress the flux in the upper part of the core. The control rods are also used for axial power shaping by leaving some of them partially inserted in the power portion of the core which helps to control flux peaking<sup>4</sup> in local areas of the

core and yields an optimum fuel burnup. Bottom entry control rods allow maximum use of water as a neutron shield for control rod drive mechanism components.

The reactor core is arranged into fuel cells. Each fuel cell consists of a control rod and the four fuel assemblies that immediately surround it. The four fuel assemblies are supported by a fuel-support piece. Around the outer edge of the core, certain fuel assemblies not immediately adjacent to a control rod are supported by individual peripheral fuel-support pieces.

A fuel assembly consists of a fuel bundle and the fuel channel that surrounds it. A fuel bundle contains 62 fuel rods and 2 water rods arranged in a square 8 by 8 array.

A fuel rod consists of uranium dioxide ( $UO_2$ ) pellets and a zirconium alloy cladding tube. A fuel rod is made by stacking pellets in a cladding tube that is evacuated, back-filled with helium, and sealed by welding plugs in each end of the tube. The pellets are stacked to an active length of 150 inches leaving about 10 inches to act as a fission gas<sup>5</sup> plenum. The water rods are tubes of zirconium alloy cladding without fuel. They have small holes at both the upper and lower ends to allow water to be driven through the rods.

A control rod consists of a sheathed, cruciform array of vertical neutron absorber rods. The absorber rods are small stainless-steel tubes filled with boron carbide ( $B_4C$ ) powder. The control rods can be positioned at 6-inch steps and have a normal withdrawal and insertion speed of 3 inches per second.

### 1.1.2.3 Control Rod Drive System

The Control Rod Drive (CRD) system makes gross changes in core reactivity by positioning the neutron absorbing control rods in response to Reactor Manual Control system (RMCS) signals and by rapidly inserting all control rods to shut down the reactor in response to Reactor Protection

system (RPS) signals.

#### 1.1.2.4 Recirculation System

The Recirculation system provides forced circulation of water through the reactor core, thereby allowing a higher power level to be achieved than with natural circulation alone.

#### 1.1.2.5 Main Steam System and Main Turbine

The Main Steam (MS) system directs steam from the reactor vessel to certain safety-related systems and selected balance-of-plant (BOP) loads. The safety-related systems include the Reactor Core Isolation Cooling (RCIC) system, the High Pressure Coolant Injection (HPCI) system, and the safety/relief valves. The selected BOP loads include the main turbine and turbine bypass valves, reactor feed pump turbines, and steam jet air ejectors. The main turbine accomplishes the primary plant task of converting the steam (heat) energy into the rotational kinetic energy of the turbine shaft, which is physically connected to the rotor of the main generator, where the kinetic energy is converted to electrical output.

#### 1.1.2.6 Condensate and Feedwater System

The Condensate and Feedwater system condenses turbine exhaust and bypass steam, removes impurities, heats the feedwater, and delivers the water back to the reactor vessel at the required rate to maintain correct inventory. The feedwater piping also provides a means for the Reactor Water Cleanup (RWCU) system, the Reactor Core Isolation Cooling (RCIC) system, and the High Pressure Coolant Injection (HPCI) system to discharge water to the reactor vessel.

#### 1.1.2.7 Reactor Core Isolation Cooling System

The RCIC system supplies high pressure makeup water to the reactor vessel when the reactor is isolated from the main condenser and/or the reactor feed pumps have been lost.

#### 1.1.2.8 Reactor Water Cleanup System

The RWCU system maintains reactor water quality by removing corrosion products, fission products, and other impurities that end up in the reactor coolant. The RWCU system also provides a path for the removal of reactor coolant from the reactor vessel during reactor startup and shutdown.

#### 1.1.2.9 Residual Heat Removal System

The Residual Heat Removal system comprises several subsystems. Two of the subsystems of particular interest at this time are the Low Pressure Coolant Injection (LPCI) mode and the Shutdown Cooling (SDC) mode. The LPCI mode will be discussed in the Emergency Core Cooling section that follows. The SDC mode of operation provides a means of removing decay heat from the core following a reactor shutdown. SDC takes a suction from one of the recirculation loops, passes the water through a heat exchanger, and returns the water to the reactor via the recirculation loops.

### 1.1.3 Control Systems

The systems described in the subsections below are used for control of core reactivity under normal, abnormal, and emergency conditions and for process control. The control systems are shown in simplified form in Figure 1-5.

#### 1.1.3.1 Reactor Manual Control System

The RMCS provides rod movement control signals to the control rod drive system to vary core power level and power distribution.

#### 1.1.3.2 Reactor Protection System

The RPS automatically initiates a rapid reactor shutdown (scram) by inserting control rods to preserve the integrity of the fuel cladding and reactor coolant pressure boundary.

### 1.1.3.3 Standby Liquid Control System

The Standby Liquid Control System (SLCS) injects a neutron-absorbing poison solution into the reactor vessel during an emergency when the control rods are unable to shut down the reactor. The SLCS functions independently of any control rod movement and can maintain the reactor sub-critical under all plant conditions.

### 1.1.3.4 Recirculation Flow Control System

The Recirculation Flow Control system (RFCS) provides a means for control of core power level, over a limited range, by controlling recirculation system flow, which, in turn, determines the flow rate of water through the reactor core.

### 1.1.3.5 Electro-Hydraulic Control System

The Electro-Hydraulic Control (EHC) system provides reactor vessel pressure control by positioning the turbine control valves and/or turbine bypass valves to pass an amount of steam flow consistent with the amount being generated in the reactor. The EHC system also controls the speed and/or electrical load on the turbine generator during power operations, and controls reactor pressure during startup, heatup, and cooldown evolutions.

### 1.1.3.6 Feedwater Control System

The Feedwater Control system (FWCS) regulates the flow of feedwater to the reactor vessel to maintain reactor water level. The FWCS measures and uses total steam flow, total feedwater flow, and reactor vessel water level signals to carry out its function.

## 1.1.4 Emergency Core Cooling Systems

The purpose of the Emergency Core Cooling systems (ECCS) is to provide core cooling under loss-of-coolant accident (LOCA) conditions to limit fuel cladding damage. The Code of Federal

Regulations requires the ECCS to be designed so that after any LOCA the reactor core remains in a geometrical configuration amenable to cooling. The basic criteria are to limit fuel cladding temperature and oxidation to minimize clad fragmentation, and to minimize the hydrogen generation from clad oxidation to protect the containment.

The ECCS, shown in Figure 1-6, consists of two high-pressure systems and two low-pressure systems. The high-pressure systems are the HPCI system and the Automatic Depressurization system (ADS). The low pressure systems are the Low Pressure Coolant Injection (LPCI) mode of the Residual Heat Removal (RHR) system and the Core Spray (CS) system.

### 1.1.4.1 High Pressure Coolant Injection System

The HPCI system maintains adequate reactor vessel water inventory for core cooling on small-break LOCAs, depressurizes the reactor vessel to allow the low pressure ECCS to inject on intermediate-break LOCAs, and backs up the function of the Reactor Core Isolation Cooling (RCIC) system under reactor vessel isolation conditions.

### 1.1.4.2 Automatic Depressurization System

The ADS serves as a backup to the HPCI system to depressurize the reactor vessel so that the low pressure ECCS can inject water into the reactor vessel following small- or intermediate-break LOCAs. The ADS provides an automatic actuation signal to approximately half of the safety/relief valves causing these valves to discharge steam from the reactor vessel/main steam lines to the suppression pool.

### 1.1.4.3 Core Spray System

The CS system provides spray cooling to the reactor core to help mitigate the consequences of the large-break LOCAs when reactor pressure is low enough for the system to inject water into the reactor vessel.



### 1.1.4.4 Low Pressure Coolant Injection

The LPCI mode of the RHR system restores and maintains water level in the reactor vessel following large-break LOCAs when reactor pressure is low enough for the system to inject water.

### 1.1.5 Plant Startup

Startup of a commercial nuclear power plant is a complex evolution which requires coordination between control room and plant personnel, attention to detail, adherence to plant procedures, and a thorough understanding of integrated plant operations. The plant startup can be more readily analyzed by subdividing the procedure into four distinct phases, namely prestartup checks, approach to critical, heatup and pressurization, and increase to rated power.

#### 1.1.5.1 Prestartup Checklists

Prestartup checklists are conducted to ensure that all plant systems are operational and are properly aligned for plant startup. The startup checks are typically commenced one week in advance of startup and are conducted by the plant operations and maintenance department personnel. Valve lineups are verified in accordance with the startup procedures, and operational tests, called surveillances, are performed on plant systems to ensure that they will function as designed when required.

The typical plant status prior to a cold startup is as follows:

#### Reactor Auxiliary Systems

Reactor water temperature	approximately 125°F
Reactor water level	normal
Control rods	fully inserted
Recirculation pumps	ready for operation
RWCU system	in operation
RHR-Shutdown Cooling	in operation
Main Steam Isolation	closed
Valves	
Reactor Head Vent	open

#### Turbine Generator and Auxiliary Systems

Turbine	on turning gear
Stop, control, and intercept valve	closed
Hotwell level	normal
Condensate and Feedwater	shutdown

#### Emergency Core Cooling Systems

HPCI	in standby
LPC	in standby
Core Spray	in standby
ADS	in standby

#### Electrical Systems:

Electrical system	supplied from offsite
-------------------	-----------------------

Each system is started and brought online as required to support the plant startup. The first systems to be started are typically the condensate and feedwater systems, and the reactor recirculation system. The condensate and feedwater systems are required to provide a source of water to the reactor. The recirculation system is started as a source of forced cooling to the core in preparation for reactor startup.

#### 1.1.5.2 Approach to Critical<sup>6</sup>

The approach to critical portion of the plant startup procedure involves the withdrawal of control rods to achieve reactor criticality. First, the mode selector switch is moved from the SHUT-DOWN position to the STARTUP/HOT STANDBY position. This position enables the control rods to be withdrawn and enforces reactor protective system scram limits that are reserved for reactor startup conditions. The control rods are withdrawn in the order and sequence specified by the nuclear engineering department. This ensures that reactor thermal limits are not exceeded and that the core is not placed in a condition that has not been thoroughly analyzed by the engineering staff.

The approach to critical is conducted in a slow, deliberate manner. The operators closely monitor control rod movements, reactor power, and reactor period<sup>7</sup> to verify that the reactor is under

control and is responding as expected. The reactor operator will declare the reactor critical when a stable, positive reactor period is attained with no additional control rod movement. Once the reactor has been brought to critical, the reactor operator will continue to increase reactor power in a slow, controlled manner. Typically, the operators will maintain reactor period between 60 to 100 seconds. At this point in the startup, control room personnel will start to draw a vacuum in the main condenser to establish a heat sink for the steam that will be produced during the heatup and pressurization phase of the startup.

### 1.1.5.3 Heatup and Pressurization

The heatup and pressurization phase of the startup commences when reactor power is sufficiently high to increase the temperature of the water in the reactor. This point is referred to as the point of adding heat (POAH). Once at the POAH, control rods are withdrawn from the core as required to maintain a constant heatup rate.

The water in the reactor will eventually reach saturation temperature and will start to boil. The steam will be directed down the main steam lines to warmup the piping and the main turbine. Condensed steam is drained from the steam lines and is directed to the main condenser. As more energy is added to the reactor coolant, the boiling rate will increase. If steam is being produced at a rate greater than it is being removed from the reactor, reactor pressure will increase. The operators will, therefore, restrict the flow of steam through the main steam lines to increase reactor pressure and will continue to raise reactor pressure until it is approximately 1000 psig.

At this point in the plant startup, reactor power is approximately 5%, reactor pressure is 1000 psig, a vacuum exists in the main condenser, one feedwater pump is providing water to the reactor, the mode switch is in the STARTUP/HOT STANDBY position, and the main turbine is in the process of warming up. The operators are now ready to commence the increase to rated power

phase of the plant startup.

### 1.1.5.4 Increase to Rated Power

The operators next place the Mode Selector Switch to RUN. This establishes the reactor protective system scram setpoints at their normal values for full power operation. Control rods are then withdrawn to increase reactor power to approximately 30%. The turbine generator, which by this time has been completely warmed, is placed on line. Additional feedwater pumps are started as required to support the increased steam demand of the turbine. The electrical generator attached to the turbine can now be synchronized to the electric grid and power can be increased to 100% or as specified by the load dispatcher.

### 1.1.6 Plant Shutdown

Over the course of a plant's lifetime, it will become necessary to conduct normal, controlled shutdowns from rated power for refueling or maintenance. Note that shutdown procedures cannot possibly provide for every contingency that might exist and that some degree of flexibility must be permitted. Therefore, some steps of a shutdown procedure may be performed simultaneously or, depending on the existing conditions, some steps may be conducted prior to the shutdown itself. Therefore, the student should focus on the underlying logic and reason for the steps that are taken as opposed to the exact order of the steps as outlined in the following text. For the purposes of this discussion of plant shutdown, assume that the plant is operating at 100% power.

The plant shutdown procedure involves reducing reactor power, divorcing the generator from the electric grid, shutting the reactor down (subcritical), and cooling down and depressurizing the reactor. Each of these phases will be discussed in more detail.

#### 1.1.6.1 Pre-shutdown Checklists

The first step in a plant shutdown requires

plant personnel to complete pre-shutdown checklists. Among other actions, the operators will verify that the lube oil systems associated with the turbine turning gear are operational, the Source Range Monitors (SRMs) and Intermediate Range Monitors (IRMs) are calibrated, and that the Shutdown Cooling mode of the Residual Heat Removal system is operational. Control room personnel will also call the Load Dispatcher to inform him of the planned power reduction.

### 1.1.6.2 Normal Shutdown

When all preparations have been completed, the control room personnel will commence the power reduction by reducing recirculation flow. The flow reduction increases the void fraction in the core, thereby adding negative reactivity and reducing reactor power. When reactor power has been reduced to approximately 55%, the operators will remove one of the two feedwater pumps from service.

Power reduction using recirculation flow will continue until power is approximately 45%. At this point, the reactor operator will drive control rods into the core in accordance with approved procedures to reduce reactor power further. As power decreases, the operators will fully insert the IRMs and SRMs into the core so that power can be adequately monitored through the intermediate range and the source range. The IRMs will typically be fully inserted by the time reactor power has decreased to 10%.

When reactor power is approximately 5%, the operators will remove the generator from the electric grid. They will then start the auxiliary turbine oil systems and the bearing lift pump and remove the turbine from service. The turbine bypass valves are used to dump steam to the main condenser to remove heat from the reactor and control reactor power. At this time, the control room operators will place the Mode Selector Switch to the STARTUP/HOT STANDBY position. This enforces a more conservative set of scram setpoints during the plant startup section.

The reactor operator will continue to insert control rods to further reduce reactor power. The other control room personnel will commence to cooldown and depressurize the reactor by bleeding steam to the main condenser via the turbine bypass valves. Because the water in the core is at saturation conditions, as system pressure decreases, water temperature also decreases. When system pressure has decreased to 250 psig, the demand for feedwater to the reactor will be sufficiently small that the remaining feedwater pump can be secured. The condensate pumps will now provide the motive force for feeding water into the reactor vessel.

Eventually, steam pressure will be so low that continued cooldown with the main condenser is inefficient. The cooldown will be completed using the shutdown cooling mode of the Residual Heat Removal system. Once SDC is in operation, the operators can shut the turbine bypass valves, break vacuum on the main condenser, and shut the system down. The plant is now in a shutdown, cooled down, and depressurized condition.

## 1.2 Pressurized Water Reactor Overview

Most of the operating commercial nuclear power plants use pressurized water reactors (PWRs). Westinghouse supplies about two-thirds of the PWRs in the United States, with the remainder supplied by Combustion Engineering and Babcock & Wilcox. Many of the details of PWRs vary from one vendor to another and even from one reactor to the next of the same vendor design. The PWR descriptions that follow are based on a Westinghouse design. However, the fundamental characteristic of all PWRs remains the same: the primary coolant raises the temperature of feedwater to produce steam in a heat exchanger called a steam generator and this steam drives the turbine.

A simplified schematic of a PWR plant is shown in Figure 1-7. The PWR differs fundamentally from the BWR in that the PWR is a dual-cycle system.

The primary loop contains the heat source consisting of a nuclear fueled core within a reactor vessel where the heat resulting from the controlled fission reaction is transferred to the reactor coolant. The coolant is pumped to the steam generator where the heat is transferred to a secondary loop through a number of U-shaped tubes. The reactor coolant returns back to the reactor vessel to continue the process. An electrically heated pressurizer is connected to the primary loop to maintain pressure above the saturation pressure to prevent bulk boiling of the reactor coolant.

The secondary loop is the heat utilization circuit where dry steam produced in the steam generator flows to a turbine generator where the thermal energy of the steam is converted to mechanical energy in the turbine to produce electrical energy from the generator. The exiting steam is exhausted to a condenser where it is condensed. The condensate is pumped back to the steam generator to continue the cycle.

The purpose of the dual cycle is to reduce the level of radioactive materials (contamination) in the plant's turbines, condensers, and other secondary system components. The primary system serves as a barrier to the release of radioactive materials.

The PWR material presented here is generally based on a single facility and is not intended to represent a complete discussion of all PWR facilities and systems. For a more complete and detailed treatment of the material presented here, the reader should refer to a PWR technology manual or PWR systems manual. Information about a specific plant design can be found in its final safety analysis report (FSAR).

### 1.2.1 Primary Systems - PWR

The major PWR primary systems are shown in Figure 1-8. The Reactor Coolant system (RCS), or primary system, consists of the reactor, where the heat from fission is transferred to the light water coolant; the steam generator(s), where the hot

reactor coolant is circulated through tubes to produce steam; and the reactor coolant pump that circulates the coolant through the heat transfer loop(s). The rated thermal output of a PWR is determined by the size of the reactor and the number of heat transfer loops in the primary system.

#### 1.2.1.1 Reactor Coolant System

The RCS (primary system) consists of a reactor and two, three, or four reactor coolant loops. Each loop contains one steam generator, one or two reactor coolant pumps, stainless steel piping, and instrumentation. The major function of the RCS is to transport heated coolant from the reactor through the steam generators and back to the reactor for reheating. The primary system also contains an electrically heated pressurizer connected to one of the reactor coolant loops. The pressurizer is a cylindrical vessel that is kept about half full of coolant (water) that is maintained in a saturated (or boiling) state. The high-temperature steam volume in the top half of the pressurizer is kept at a high pressure to keep the circulating coolant in the RCS in a liquid state.

#### 1.2.1.2 Reactor Vessel

The reactor vessel encloses and supports the reactor core components and directs the flow of coolant from the RCS loops through the core and back to the RCS loops.

The reactor vessel is a heavy-walled cylindrical tank with a rounded bottom and a removable rounded top. The top (head) is bolted to the reactor vessel during all plant operations except refueling and special maintenance. The side of the reactor vessel has connection points (called nozzles) for reactor coolant piping. Figure 1-9 shows a typical PWR reactor vessel. The reactor vessel has two removable internal assemblies: the lower core support structure and the upper core support structure.

The lower core support structure is also known

as the "core basket" or "core barrel." Its purpose is to support the reactor fuel assemblies and direct reactor coolant flow past the fuel for heat removal. All major portions of this structure are made of stainless steel.

The upper core support structure is also known as the upper internals package or upper plenum assembly. Its purpose is to properly align the top portions of reactor fuel assemblies within the reactor vessel, and to guide and protect control rod cluster assemblies that have been withdrawn from the reactor core. The upper core support structure is primarily made of stainless steel.

The reactor core consists of fuel assemblies, control rods, and a number of neutron source rods and special poison rods. The core is located inside the lower core support structure, which is inside the reactor vessel. The upper core support structure holds the fuel assemblies in their proper location within the vessel as thousands of gallons per minute of coolant water are forced through the core for heat removal.

Figure 1-10 shows a simplified view of a reactor vessel. Reactor coolant enters the reactor vessel via the inlet nozzles. The water flows downward between the core barrel and the vessel wall into the bottom of the vessel. The coolant is then forced upward through flow distribution holes into the core where fuel heat is removed. Upon exiting the core, the coolant mixes in the outlet plenum and exits the reactor vessel through the outlet nozzles.

### 1.2.1.3 Reactor Fuel

The function of the reactor fuel is to provide fissile atoms to support the nuclear fission process, which produces the thermal energy required to heat the coolant for subsequent use in the steam generators.

Figure 1-11 illustrates a typical PWR fuel assembly. PWRs use slightly enriched uranium dioxide pellets for nuclear fuel. "Enrichment"

refers to the percentage of fissionable uranium-235 that is combined with the more abundant and less reactive uranium-238. Common PWR fuel enrichments range from about 2.0% to 3.5% uranium-235. The uranium dioxide fuel pellets are sealed inside a cylindrical metal tube called a fuel rod (or fuel pin). Fuel rods are made of a zirconium alloy.

A number of fuel rods are grouped together to form a fuel assembly (also known as a fuel element or fuel bundle), which is shown in figure 1-11. The number of fuel rods per assembly varies slightly from vendor to vendor. The typical PWR fuel assembly is a square grouping of fuel rods with 15, 16, or 17 rods per side and is 12 feet in length.

All PWR fuel assemblies have a number of tubes that do not contain uranium fuel pellets. These tubes (called control rod guide tubes or thimble tubes) are open at the top, and allow insertion of control rods or instrumentation.

### 1.2.1.4 Control Rods

The function of the control rod system is to control the nuclear fission process by inserting strong neutron absorbers (control rods) into the reactor core. These neutron absorbers can be slowly removed from the core to "start up" the nuclear fission process, or they can be fully inserted into the core to "shut down" the reactor.

The control rods consist of a silver-indium-cadmium or boron carbide mixture sealed inside stainless-steel tubes. The tubes are connected to a cluster assembly. Control rod cluster assemblies are moved up and down within the control rod guide tubes to control reactor power level.

The control rod drive mechanisms (CRDMs) are located above the removable reactor vessel head. The CRDMs are used to withdraw and insert control rods and latch them in the desired position during plant operations. The CRDMs are electromagnetic jacking devices.

When an electric current is directed through the CRDMs, the control rod drive shafts will be either raised, lowered, or held in their present location. The interruption of current flow to the CRDMs releases all control rod drive shafts and allows the control rods to drop into the core (reactor trip or scram).

### 1.2.1.5 Reactor Coolant Pump (RCP)

The reactor coolant pump (RCP) is an electrically driven mechanical device that draws reactor coolant from the steam generator and discharges the coolant into the reactor vessel for removal of heat generated in the reactor fuel. Each Westinghouse reactor coolant loop will have one RCP. Other PWR designs use two RCPs per loop. Typical RCPs are capable of producing 100,000 gpm reactor coolant flow rate.

### 1.2.1.6 Pressurizer

The pressurizer is a cylindrical tank with a rounded top and bottom. It is made of carbon steel and lined with stainless steel. The pressurizer has two purposes:

1. It establishes and maintains the high pressure (2235 psig) that keeps the circulating coolant from boiling at normal operating temperatures between 530° and 595°F.
2. It serves as a surge volume for the Reactor Coolant system. The pressurizer receives water from the RCS piping as increasing temperatures cause water molecules to expand (insurge). Similarly, the pressurizer serves as a source (insurge) of water for the RCS as decreasing temperatures cause water molecules to contract (outsurge).

The bottom portion of the pressurizer contains a bank of electric heaters that will increase pressure when energized. The top section contains a spray nozzle and pressure relief valve connections that can lower pressure.

### 1.2.1.7 Steam Generator-Primary Side

Each reactor coolant loop of the primary system has one steam generator to transfer heat from the reactor coolant to the secondary system. Figure 1-12 shows a typical Westinghouse U-tube steam generator.

Reactor coolant enters the steam generator inlet channel and is directed upward into thousands of metal U-shaped tubes. The coolant transfers some of its heat through the tubes to the secondary system. Coolant water exits the tubes, passes through the outlet channel, and enters the intermediate leg (or crossover leg) piping to provide suction for the reactor coolant pump. (Note: The Babcock and Wilcox design PWRs use steam generators with straight tubes vice U-tubes.)

### 1.2.1.8 Chemical and Volume Control System

The Chemical and Volume Control system (CVCS) provides the following functions:

- Provides a method for primary system cleanup (removal of corrosion products and chemical impurities) and to add chemicals for corrosion control.
- Automatically maintains the volume of the Reactor Coolant system at a desired level by adding water (charging) to or draining water (letdown) from the RCS.
- Provides a method to increase or decrease the concentration of boric acid (neutron absorber) in the reactor coolant for reactor power changes.
- Provides seal water to the reactor coolant pumps.
- Provides an alternate source of spray water for the RCS pressurizer if normal pressurizer spray is unavailable.
- Provides part of the plant's emergency

core cooling system (high pressure safety injection).

### 1.2.1.9 Residual Heat Removal System

The RHR system (also known as the decay heat removal system) provides a means for the transfer of heat energy out of the reactor coolant system during plant shutdowns and emergency conditions.

During a normal reactor shutdown and cooldown, the RHR system transfers reactor decay heat into a separate fluid system (the component cooling water system) and ultimately to the environment. This is accomplished by pumping the hot RCS water from the hot leg through a heat exchanger and back into the RCS via the cold leg.

During plant emergencies, portions of the RHR system are used to inject emergency cooling water into the RCS. The refueling water storage tank (RWST) supplies the source of borated injection water.

## 1.2.2 Secondary Systems

### 1.2.2.1 Steam Generator - Secondary Side

Density differences cause the circulation of water inside a PWR steam generator. Figure 1-13 shows a cutaway section of the secondary side of a steam generator. Feedwater enters the steam generator through a feed nozzle and is distributed by a feed ring. Water leaving the feed ring mixes with water extracted from the exiting steam. The resultant mixture flows downward into the downcomer region between the steam generator shell and the tube bundle wrapper (shroud). The feedwater flows under the shroud and upward around the tube bundle absorbing heat from the primary coolant flowing through the tubes. As the water inside the shroud is heated, steam bubbles form and the water becomes less dense. Prior to exiting the tube bundle region, most of the feedwater boils to steam. The emerging steam is channeled through moisture separators that re-

move entrained moisture to produce dry steam at the steam generator outlet. The extracted water is recirculated (directed outside the shroud where it mixes with incoming feedwater) to produce a good circulation flow within the steam generator.

### 1.2.2.2 Main Steam System

The Main Steam (MS) system receives heat from the RCS via the steam generators. In the steam generators, feedwater is heated to produce high pressure saturated steam. The MS system transfers the steam to the main turbine where the energy of the steam is extracted to turn the turbine rotor and its attached electrical generator. Auxiliary uses for main steam include steam dump, reheat steam, feedwater pump turbine supply, air ejector operating steam, etc.

### 1.2.2.3 Main Turbine - Generator

The main turbine-generator receives the steam from the main steam system. Nozzles increase the kinetic energy (velocity) of the steam and direct it toward the turbine rotor blades, thereby turning the rotor. Being connected to the same shaft, the generator rotor also turns and produces an electrical output. Both high-pressure and low-pressure turbines are used to maximize turbine efficiency and work output.

### 1.2.2.4 Condensate and Feedwater System

The Condensate and Feedwater system condenses turbine exhaust or bypass steam, removes impurities, heats the feedwater, and delivers the water back to the steam generators at the required rate to remove heat from the RCS.

Steam exiting the low pressure turbines enters the main condenser where it passes over tubes containing circulating cooling water. As the steam condenses, it is collected in the bottom of the condenser in the hotwell.

The condensate pumps draw the condensate out of the main condenser hotwell and supply the

booster pumps that increase the pressure of the condensate supplies to the main feedwater pumps. Prior to reaching the main feedwater pumps, the condensate passes through feedwater heaters that add heat to the condensate to increase the overall efficiency of the secondary plant. A portion of the condensate is also directed through a filtration and ion exchange system consisting of condensate demineralizers.

The feedwater pumps draw in the condensate and develop a system pressure sufficient to force the water (now called feedwater) through additional feedwater heaters and into the steam generators.

### 1.2.3 Control Systems

The basic function of a power plant is to supply electrical energy to the power distribution network on demand. To meet this demand (load), the nuclear core must provide heat generation proportional to the demand (electrical power output), and the steam generators must respond with the correct flow of low-moisture steam to the turbine-generator. This is normally accomplished automatically by the coordinated action of several control systems. These systems also provide for the control of rapid disturbances arising from abnormal conditions and for control of processes that maintain the plant in an economical operating condition. The basic control systems are shown in block diagram form in Figure 1-14.

#### 1.2.3.1 Pressurizer Control System

The Pressurizer Control system maintains RCS pressure within design limits by automatically actuating pressurizer heaters and spray valves, and maintains reactor coolant inventory (pressurizer level) by automatically adjusting CVCS letdown and charging flow rates.

#### 1.2.3.2 Rod Control System

The Rod Control system automatically adjusts the power level of the reactor to match the power

demand by the turbine. The direction and speed of control rod movement is based on the reactor coolant temperature needed to meet the turbine power demand, the nuclear power (neutron flux level) rate of change, and the measured reactor coolant temperature.

The Rod Control system has provisions for manual and automatic control rod operation. In an emergency, the Reactor Protection system (RPS) will remove power from the control rod drive mechanisms, causing the control rods to fall into the core and shut down the reactor.

#### 1.2.3.3 Steam Dump (Turbine Bypass) Control System

The steam dumps (turbine bypass valves) are automatically actuated to remove steam from the steam generator (and heat from the RCS) when a large turbine load reduction or turbine trip occurs. Steam is dumped directly to the main condenser to maintain a preset temperature in the RCS.

#### 1.2.3.4 Turbine Control System

The Turbine Control system positions the steam admission valves of the main turbine to control turbine speed and load and to automatically shut-down the turbine when operating setpoints are exceeded. High-pressure hydraulic fluid is supplied to or dumped from valve operators to position the valves. If a turbine trip is required, the entire control system will depressurize causing all turbine steam valves to close quickly.

#### 1.2.3.5 Feedwater Control System

The Feedwater Control system (FWCS), also called the Steam Generator Water Level Control system (SGWLCS), regulates the flow of feedwater to the steam generators to maintain the desired water level. The FWCS monitors steam flow, feedwater flow, and steam generator water level and positions feedwater control valves to ensure an adequate steam generator level is maintained.



### 1.2.3.6 Reactor Protection System

The Reactor Protection system (RPS) provides the following functions:

1. Monitors the plant for abnormal conditions and alerts the operator to take appropriate action.
2. Automatically provides
  - reactor trip (shutdown) signals and
  - engineered safeguards actuation signals when plant conditions reach established safety limits.

Variables that are monitored by the RPS as part of its trip function include:

1. The process variables that are directly related to equipment mechanical limitations, such as pressurizer pressure and water level (to prevent water discharge through safety valves and uncovering of heaters).
2. The process parameters that directly affect the heat transfer capabilities of the reactor, such as steam generator water level, RCS flow rate, and RCS temperature.

Whenever a safety setpoint is exceeded, the reactor will be shut down (1) to prevent fuel rod damage for an anticipated transient (2) to limit core damage for infrequent faults and (3) to protect the reactor coolant pressure boundary. The RPS also provides for manual initiation of a reactor trip in the control room.

### 1.2.4 Emergency Systems

The PWR emergency systems are also known as the Engineered Safety Feature (ESF) systems. The purpose of the ESF systems is to protect public health and safety by mitigating the consequences of accidents that could otherwise lead to failure of the PWRs fission product barriers. Several PWR emergency systems are discussed in the following sections.

### 1.2.4.1 Emergency Core Cooling Systems

The Emergency Core Cooling systems (ECCS) supply borated water to the reactor core in the event of a loss-of-coolant accident to maintain heat removal from the reactor fuel. These systems also ensure that the reactor remains in a shutdown condition during the cooldown accompanying a steamline-break accident.

A simplified composite of the ECCS is shown in Figure 1-15. The ECCS is divided into four subsystems, which are described below. Some of these subsystems or their components are also used during normal plant operations.

#### 1.2.4.1.1 Low Pressure Safety Injection (LPSI) System

The LPSI system is used as the low pressure, high volume portion of the ECCS. During normal plant operation, the LPSI pumps are aligned to take suction from the RWST and discharge into the RCS cold legs. All that is necessary for LPSI injection is that the pumps start and RCS pressure drops below the maximum discharge pressure (200 psig) of the LPSI pumps.

#### 1.2.4.1.2 Accumulator System

The accumulators (often referred to as cold leg accumulators, safety injection tanks, or core flood tanks) are tanks that are filled with borated water and are pressurized to approximately 600 psig with nitrogen gas. During normal plant operations, each accumulator is isolated from its respective RCS loop cold leg by two check valves.

If the RCS pressure decreases below accumulator pressure (e.g., during a LOCA), the check valves will open and the nitrogen gas pressure will force the borated water into the RCS. The accumulators are considered to be passive engineered safety features because no external power source or initiation signal is needed to obtain a fast acting, high injection flow rate.

### 1.2.4.1.3 Safety Injection System

The Safety Injection (SI) system is used as the intermediate pressure, intermediate volume portion of the ECCS. During normal plant operation, the SI pumps are aligned to take suction from the RWST and discharge into the RCS cold legs through the same penetrations used by the LPSI system and the accumulators. All that is necessary for SI pump injection during a LOCA is for the pumps to start and RCS pressure to decrease below the maximum discharge pressure (approximately 1500 psig) of the pumps.

### 1.2.4.1.4 High Pressure Safety Injection (HPSI) System

The HPSI system provides the highest pressure and lowest flow rate of all the ECCS. The HPSI pumps perform dual purpose as the centrifugal charging pumps in the CVCS.

The HPSI pumps will automatically start and align to inject borated water from the RWST into the RCS. The HPSI system provides makeup water to the RCS during a small LOCA when the RCS remains at a relatively high pressure (> 1500 psig).

### 1.2.4.1.5 Refueling Water Storage Tank (RWST)

The RWST provides the source of injection water that is used during the initial stages of a LOCA. This water is supplied to the suctions of the HPSI, LPSI, SI, and containment spray pumps. This water is highly borated to ensure the reactor remains shutdown while the core is cooled.

### 1.2.4.2 Auxiliary Feedwater System

The primary function of the Auxiliary Feedwater (AFW) system is to supply an emergency source of feedwater to the steam generators following accident or transient conditions when the main feedwater system is not available. The AFW system thereby maintains the capability of

the steam generators to remove the stored RCS heat and core decay heat by converting the auxiliary feedwater to steam, which is then discharged to the condenser or to the atmosphere. A secondary function of the AFW system is to provide the normal source of feedwater to the steam generators during shutdown, startup, and low power levels.

### 1.2.4.3 Containment Spray/Cooling System

The Containment Spray system is designed to spray the containment volume with relatively cool water following a LOCA or steam line break to prevent overpressurization. The RWST supplies the suction of the containment spray pumps. In addition to reducing containment pressure and temperature, the spray water will absorb free iodine, thereby reducing the magnitude of the radioactivity release if the containment is breached.

The Containment Cooling system consists of large forced flow air-to-liquid heat exchangers located inside the containment. The coolers are supplied cooling water from an ESF cooling water system (such as the Component Cooling Water system) and are also designed to reduce containment pressure and temperature. Both the Containment Spray and Containment Cooling systems will actuate on high containment pressure.

### 1.2.4.4 Component Cooling Water (CCW) System

The CCW system supplies the cooling water to the ECCS and ESF systems to provide a heat sink and to prevent overheating of system equipment during long-term operation. The system is normally in operation to ensure immediate cooling of systems required for plant and public safety.

## 1.2.5 Plant Startup - PWR

### 1.2.5.1 Plant Heatup

A plant startup commences with filling and venting the RCS and pressurizer. RCPs are oper-

ated intermittently to sweep away air pockets and vent their own seals. Condensate and feedwater systems are recirculated through the condensate demineralizers to adjust chemistry and to remove contaminants. The operability of all ESF equipment is verified prior to heatup of the RCS.

Heatup of the RCS occurs by operating one or more RCPs. Pressurizer heaters are energized to begin steam bubble formation in the pressurizer. When a pressurizer steam bubble exists, pressurizer level is lowered to the normal operating range.

When RCS temperature increases to approximately 300°F, RHR is removed from service and aligned for low pressure safety injection. Pressurizer pressure is increased during the heatup to ensure the RCS remains subcooled.

Steam generators are drained to their normal operating levels and the auxiliary feedwater pumps are operated to maintain SG level. The RCS continues to heat up until normal temperature is achieved (approximately 550°F). At this time, the Steam Dump Control system will begin dumping steam from the steam generators to the main condenser to stabilize RCS temperature.

### 1.2.5.2 Approach to Critical

Upon completion of the RCS heatup, the reactor is taken critical by withdrawal of the control rods. The control rods are withdrawn in a specified order and sequence to ensure the safest and most efficient use of the reactor fuel. Control rod withdrawal is performed in a slow, deliberate manner while the operator continuously monitors the reactor power level. The reactor will be critical when reactor power continues to increase with no control rod movement.

### 1.2.5.3 Increase to Rated Power

Reactor power is increased until it begins to add heat to the RCS. Reactor power is stabilized at approximately 3% with the Steam Dump Control system still maintaining a stable RCS tem-

perature. A main feedwater pump is started for SG water level control, and the auxiliary feedwater pump is stopped. The main turbine is warmed and rolled with steam until it reaches its normal operating speed of 1800 rpm. The main generator is then started electrically and connected to the electrical grid to begin supplying electrical loads.

Main generator load is controlled by using the Turbine Control system. As more steam flow is directed to the main turbine, main generator load increases and the steam dump valves will throttle closed. When the steam dump valves have fully closed, reactor power will increase as generator load increases. Hereafter, the reactor is a slave to the turbine. As turbine-generator load increases, reactor power will automatically increase to keep pace. Full power is reached when the generator reaches its design load or the reactor is operating at 100%.

### 1.2.6 Plant Shutdown - PWR

Prior to commencing a plant shutdown, the electrical system load dispatcher is notified that main generator electrical load will be reduced. If the RCS will be opened for maintenance after shutdown, then RCS hydrogen concentration will be reduced. Instrumentation required for monitoring shutdown conditions (e.g., source range nuclear instrumentation) will have surveillances performed to ensure operability.

Electrical load is reduced by gradually lowering the Turbine Control system load setpoint which slowly closes the main turbine control valves. RCS temperature, pressurizer pressure and level, and steam generator level will be maintained at their programmed setpoints. Control rods will be slowly inserted and/or RCS boron concentration will be slowly increased as main generator load and reactor power decrease.

At approximately 15% load the FWCS is placed in manual control. At approximately 10% load, onsite electrical loads are switched to offsite power. At approximately 1% load, the main generator

output breaker is opened to disconnect the generator from the electrical grid and the main turbine is manually tripped. The reactor is then shut down by manually inserting all control rods.

If an RCS cooldown is desired, then the operators will dump steam to the main condenser. RCS pressure is reduced by manually opening the pressurizer spray valves. When RCS temperature decreases below 300°F and RCS pressure decreases below 350 psig, the RHR system will be placed in service to remove decay heat. The RCS can now be cooled below 200°F. If RCS maintenance is to be performed, the RCS will be completely depressurized and partially drained.

### 1.3 Barriers to Release of Fission Products

When nuclear fuel undergoes fission, highly radioactive fission products are produced. Some fission products decay quickly, thereby losing their radioactivity and posing little hazard to the public. Others remain radioactive for many years and must be contained within the reactor fuel until they can be disposed of properly.

#### 1.3.1 BWR Plant Fission Product Barriers

The first and most important barrier to fission product release in a BWR power plant is the fuel cladding. Restrictions are imposed on reactor operation to ensure the integrity of the clad. However, even with proper operation, fuel clad perforation sometimes occurs. During accident conditions (e.g., loss of reactor coolant), the margin to fuel clad failure is significantly decreased.

Once fission products have escaped through the fuel clad, the BWR primary and auxiliary system boundaries provide the next barrier. These systems comprise the reactor vessel, main steam piping, turbine, condensate, and feedwater systems. The primary and auxiliary systems form a closed loop and should contain the released fission products. Under accident conditions, however, a rupture of one of the system boundaries may occur which would compromise the integrity of the

fission product barrier.

The third and final barrier to fission product release are the primary and secondary containment buildings. The primary containment will condense steam and contain fission products released from a LOCA. The secondary containment is the physical boundary which encloses the primary containment boundary, those systems external to the primary containment which would contain reactor coolant after a LOCA and, the areas in which spent fuel is stored and handled.

#### 1.3.2 PWR Plant Fission Product Barriers

The first and most important barrier to fission product release in a PWR power plant is the fuel cladding. Restrictions are imposed on reactor operation to ensure the integrity of the clad. However, even with proper operation, fuel clad perforation sometimes occurs. During accident conditions (e.g., loss of reactor coolant), the margin to fuel clad failure is significantly decreased.

Once fission products have escaped through the fuel clad, the RCS piping walls provide the next barrier. The RCS is a closed system and should contain the released fission products. However, under accident conditions the RCS piping may become breached.

The third and final barrier to fission product release is the reactor containment building. The containment is a large building surrounding the RCS that is designed to contain the heat energy from an RCS blowdown. Containment building walls are normally made of thick, reinforced concrete that is sheathed and sealed on the inside with quarter-inch thick steel plate.

### 1.4 Summary

The preceding text has presented a basic description of the systems, components, and flowpaths in BWR and PWR commercial nuclear plants. Although there are several vendors of nuclear plants, the systems discussed in this chap-

---

ter are generic and applicable to most commercial nuclear plants in the country.

### FOOTNOTES

<sup>1</sup> Reactivity is a measure of the change in neutron population from one neutron generation to the next.

<sup>2</sup> Moderator is the light water coolant that is circulated through the core to remove the heat generated by fission.

<sup>3</sup> Negative reactivity implies that the neutron population is decreasing from one generation to the next (i.e., power is decreasing).

<sup>4</sup> Flux peaking refers to the phenomena in which the neutron flux (power) in one location of the core is significantly higher than the neutron flux in the immediate surrounding area.

<sup>5</sup> Fission gases, primarily krypton and xenon, are released as byproducts of the fission process.

<sup>6</sup> The reactor is said to be "critical" when the neutron chain reaction is self-sustaining (i.e., enough neutrons are being produced by fission to maintain a steady neutron population).

<sup>7</sup> Reactor period is a measure of the rate of change in reactor power. Specifically, it is the time required for reactor power to change by a factor of "e" ( $\sim 2.72$ ).

Table 1-1. GE BWR Product Lines

Product Line	Year of Introduction	Characteristic Plants
BWR/1	1955	Dresden 1, Big Rock Point, Humboldt Bay <ul style="list-style-type: none"> <li>• First commercial BWRs</li> <li>• First internal steam separation</li> </ul>
BWR/2	1963	Oyster Creek <ul style="list-style-type: none"> <li>• First turnkey plant</li> <li>• Eliminated dual cycle</li> </ul>
BWR/3	1965	Dresden 2 <ul style="list-style-type: none"> <li>• First jet pump application</li> <li>• Improved Emergency Core Cooling system</li> </ul>
BWR/4	1966	Browns Ferry <ul style="list-style-type: none"> <li>• Increased power density 10%</li> </ul>
BWR/5	1969	Lasalle <ul style="list-style-type: none"> <li>• Improved Recirculation system performance</li> <li>• Improved Emergency Core Cooling system performance</li> <li>• Mark II containment</li> </ul>
BWR/6	1972	Grand Gulf <ul style="list-style-type: none"> <li>• Improved core performance</li> <li>• Improved Rod Control systems</li> <li>• Mark III containment</li> </ul>

HUMBOLDT BAY (BWR/1)

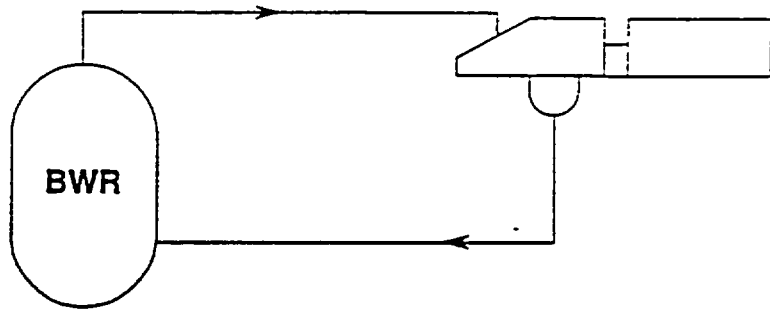

NATURAL CIRCULATION, DIRECT CYCLE

BIG ROCK POINT (BWR/1)  
OYSTER CREEK (BWR/2)  
DRESDEN 2&3 (BWR/3)  
BROWNS FERRY (BWR/4)  
LASALLE 1&2 (BWR/5)  
GRAND GULF 1&2 (BWR/6)

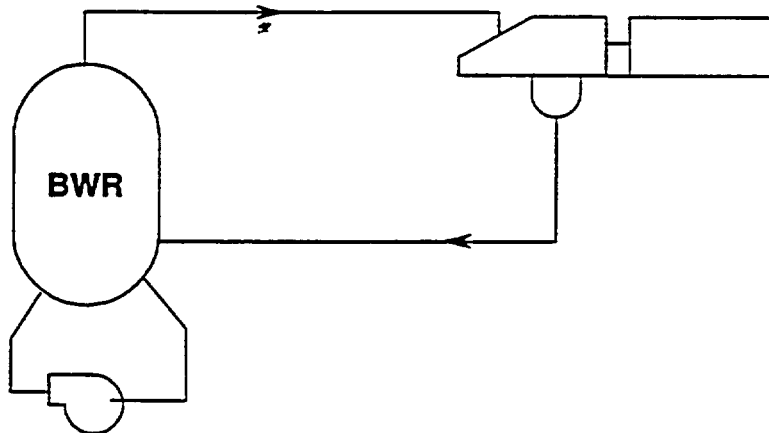

FORCED CIRCULATION, DIRECT CYCLE

Figure 1 - 1. Boiling Water Reactors in Various Systems

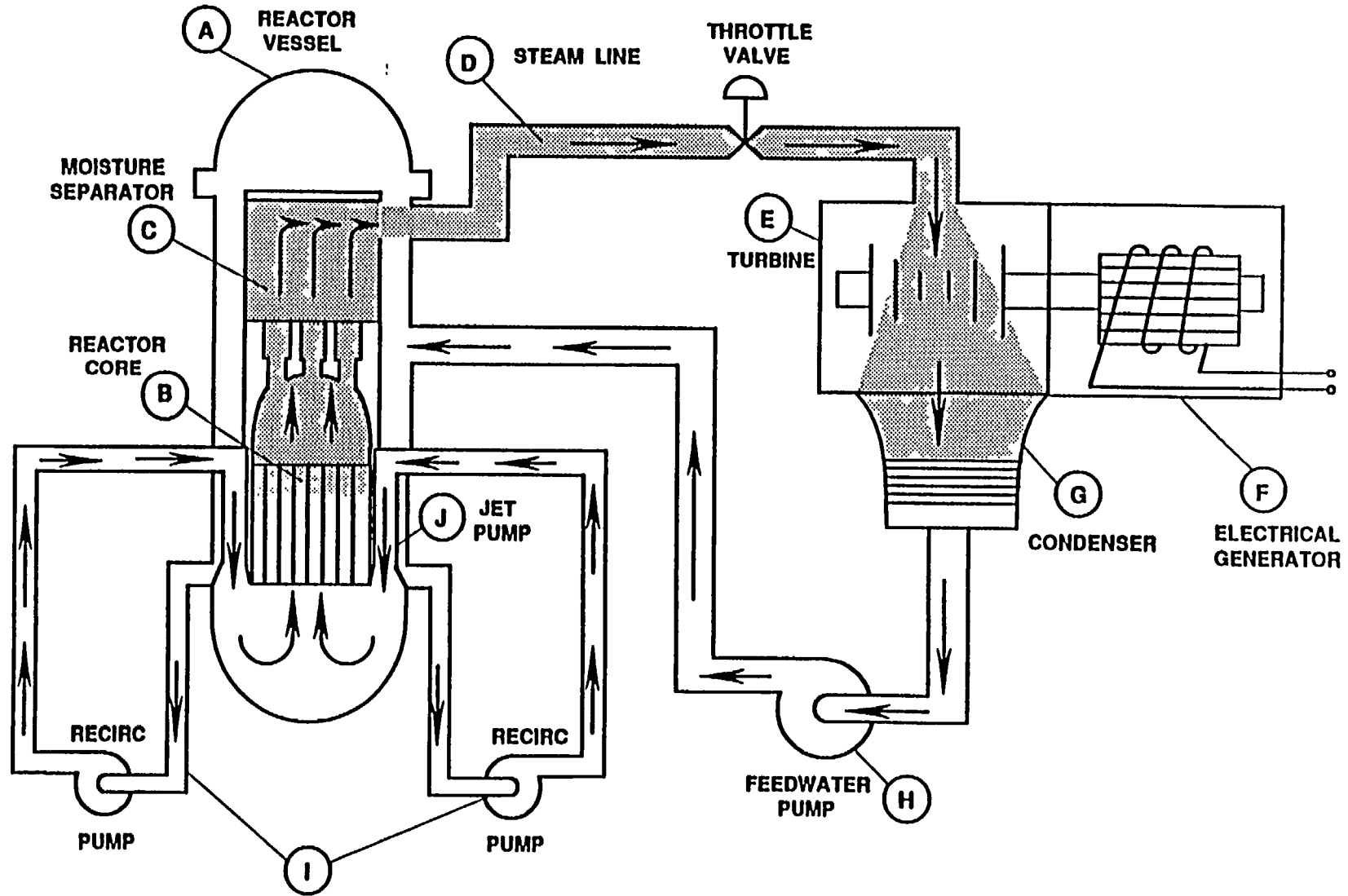

Figure 1 -2. Basic BWR Power Plant





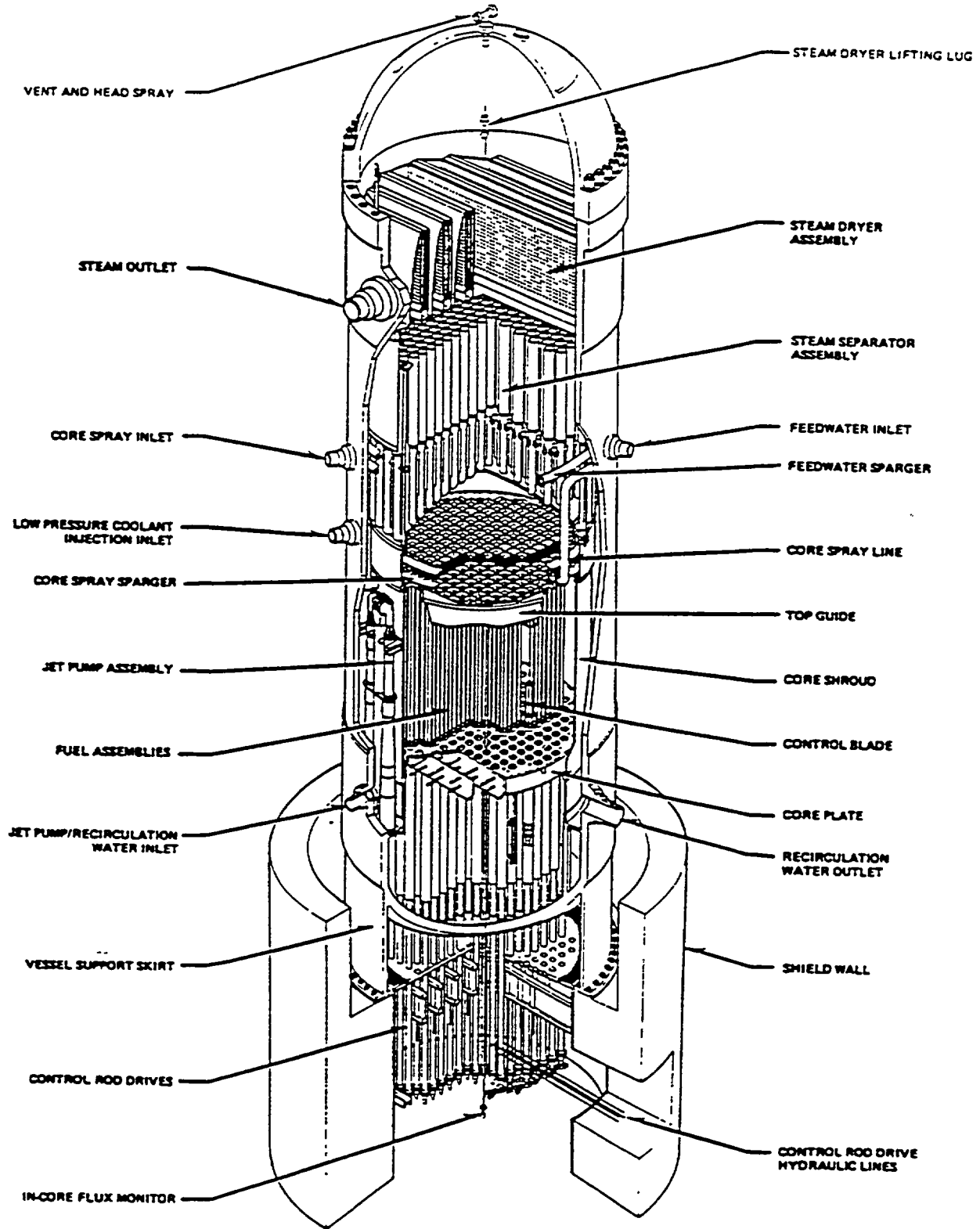

Figure 1-4. BWR Reactor Vessel

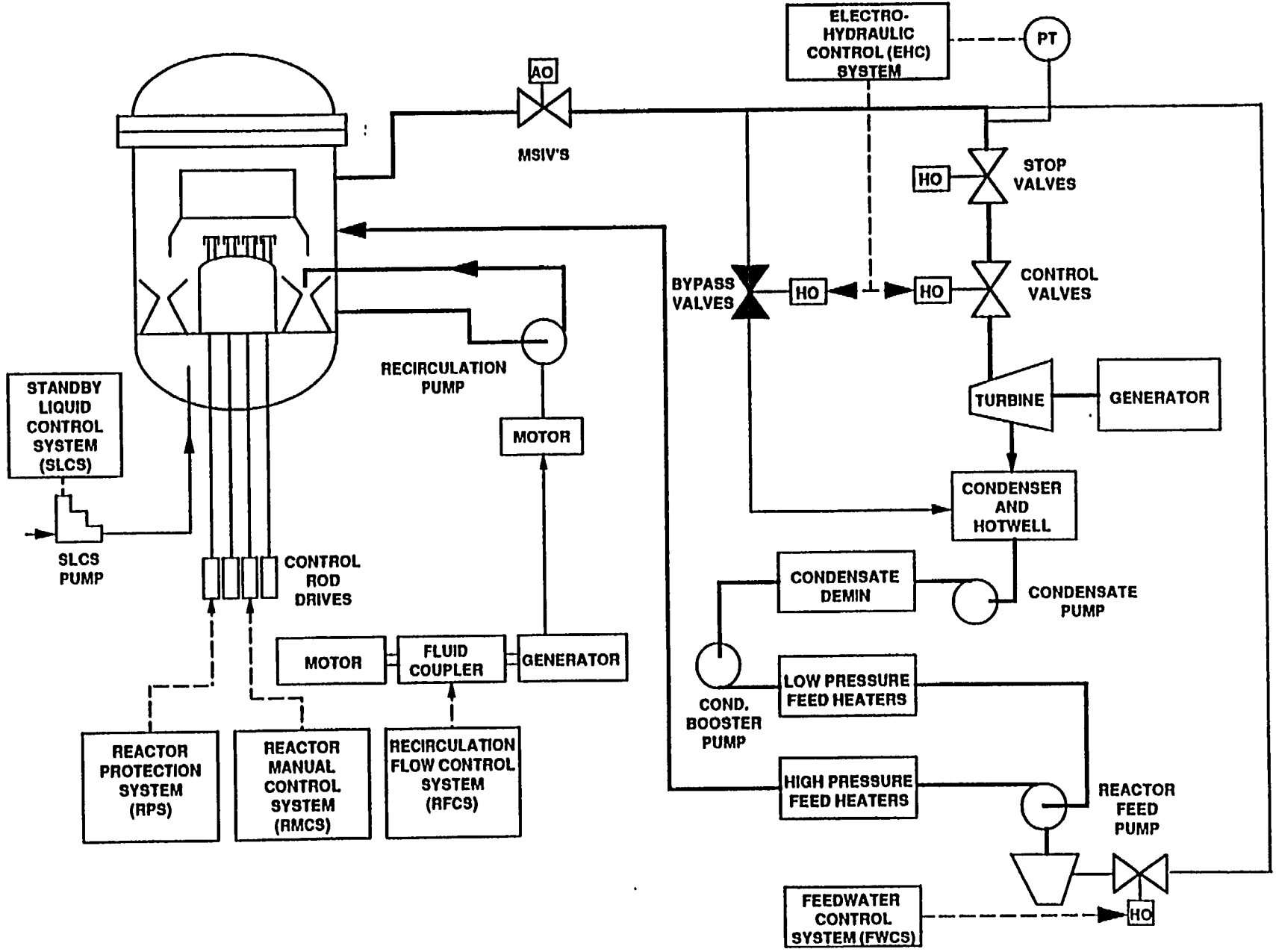

Figure 1-5. BWR Control Systems

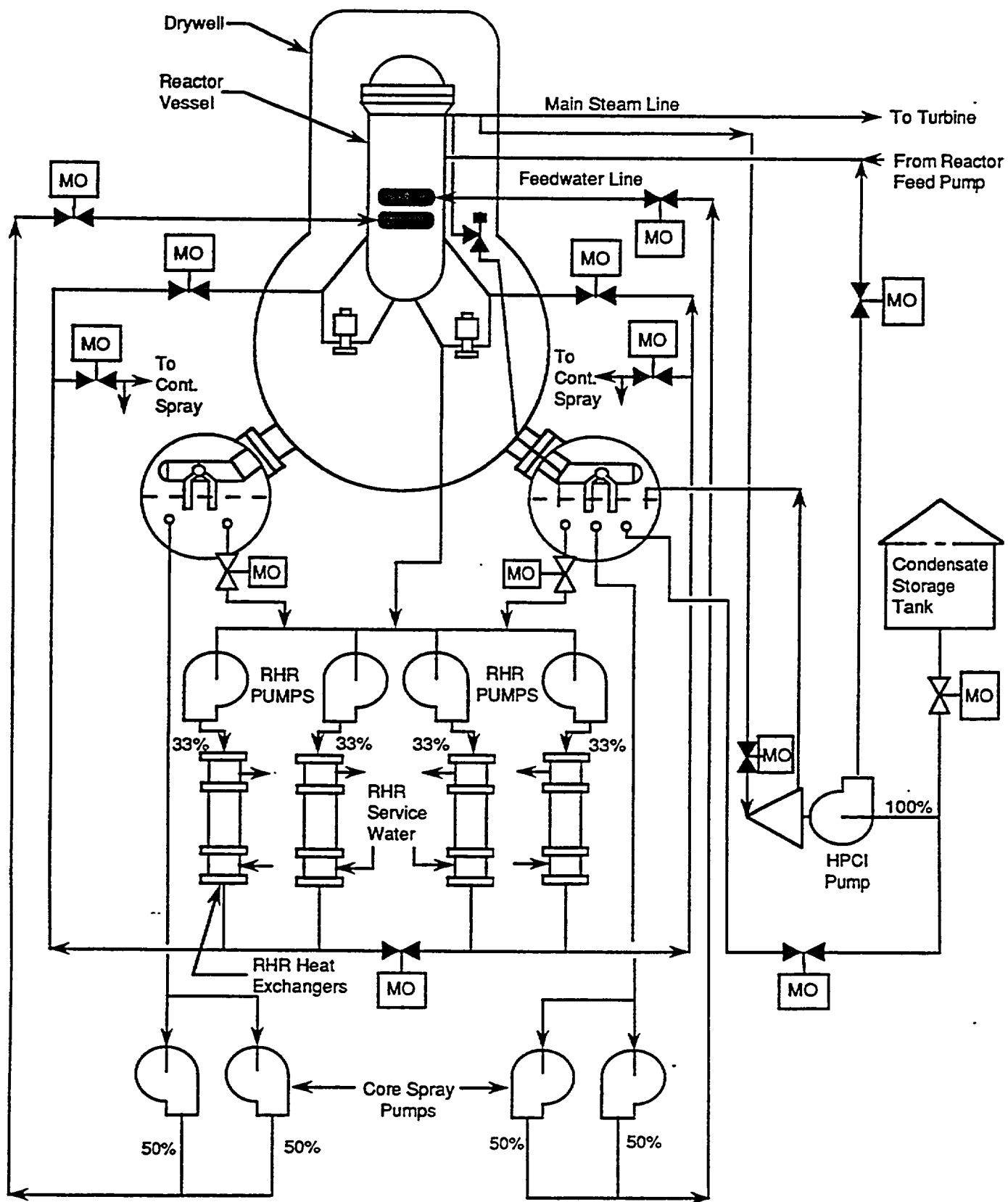

Figure 1-6. Emergency Core Cooling System

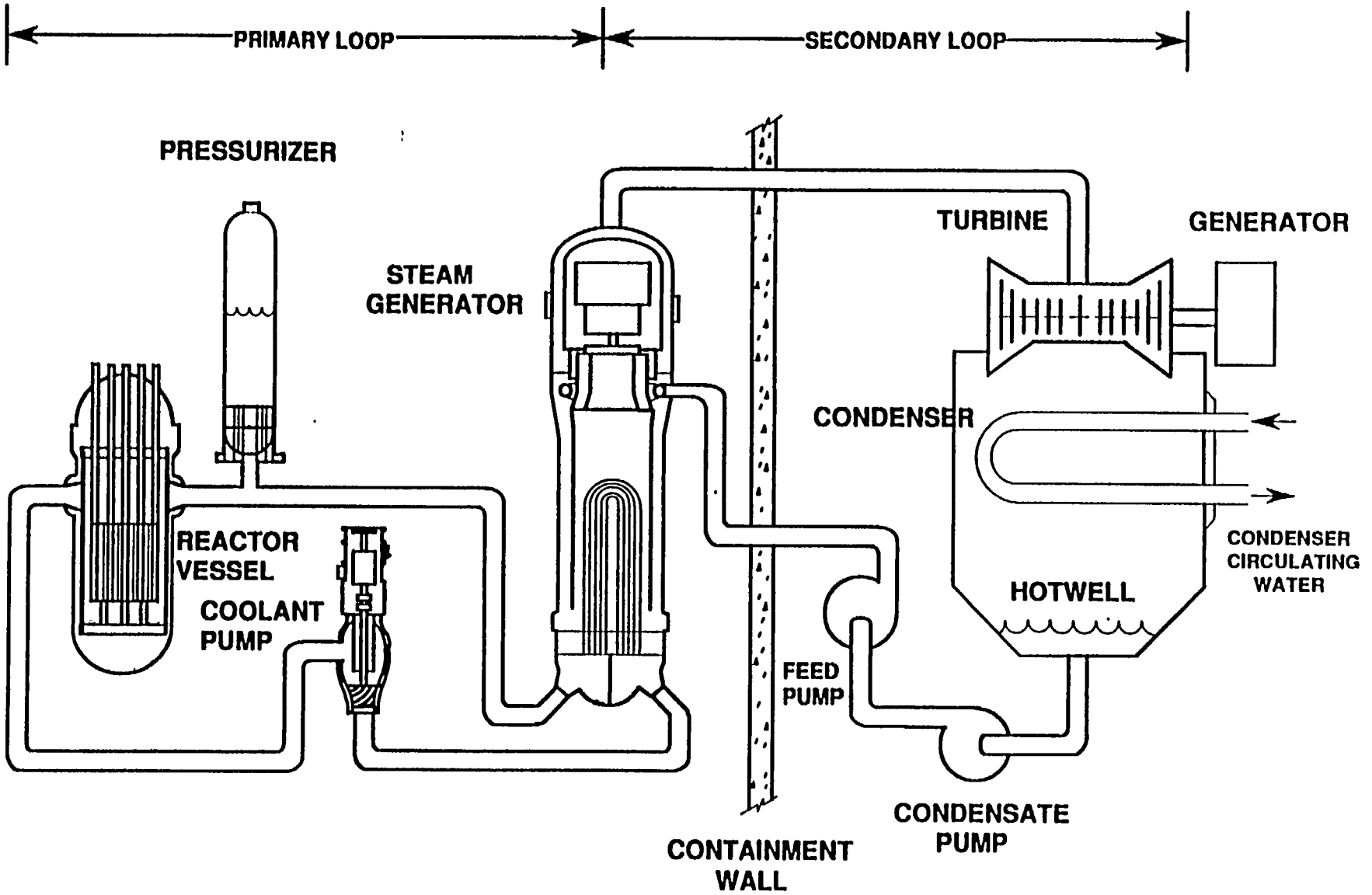

Figure 1 - 7. Basic PWR Power Plant

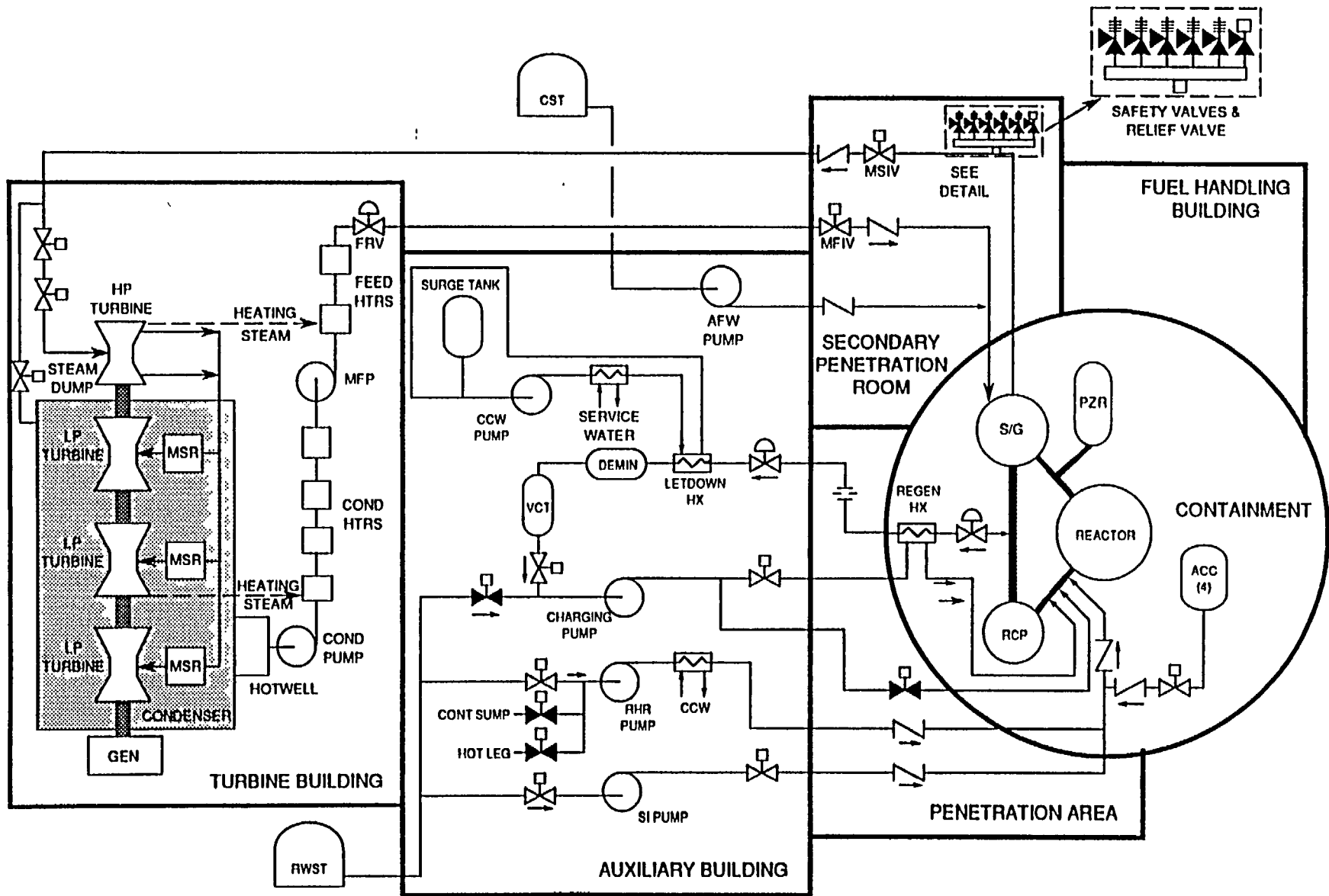

Figure 1-8. Simplified PWR System Composite

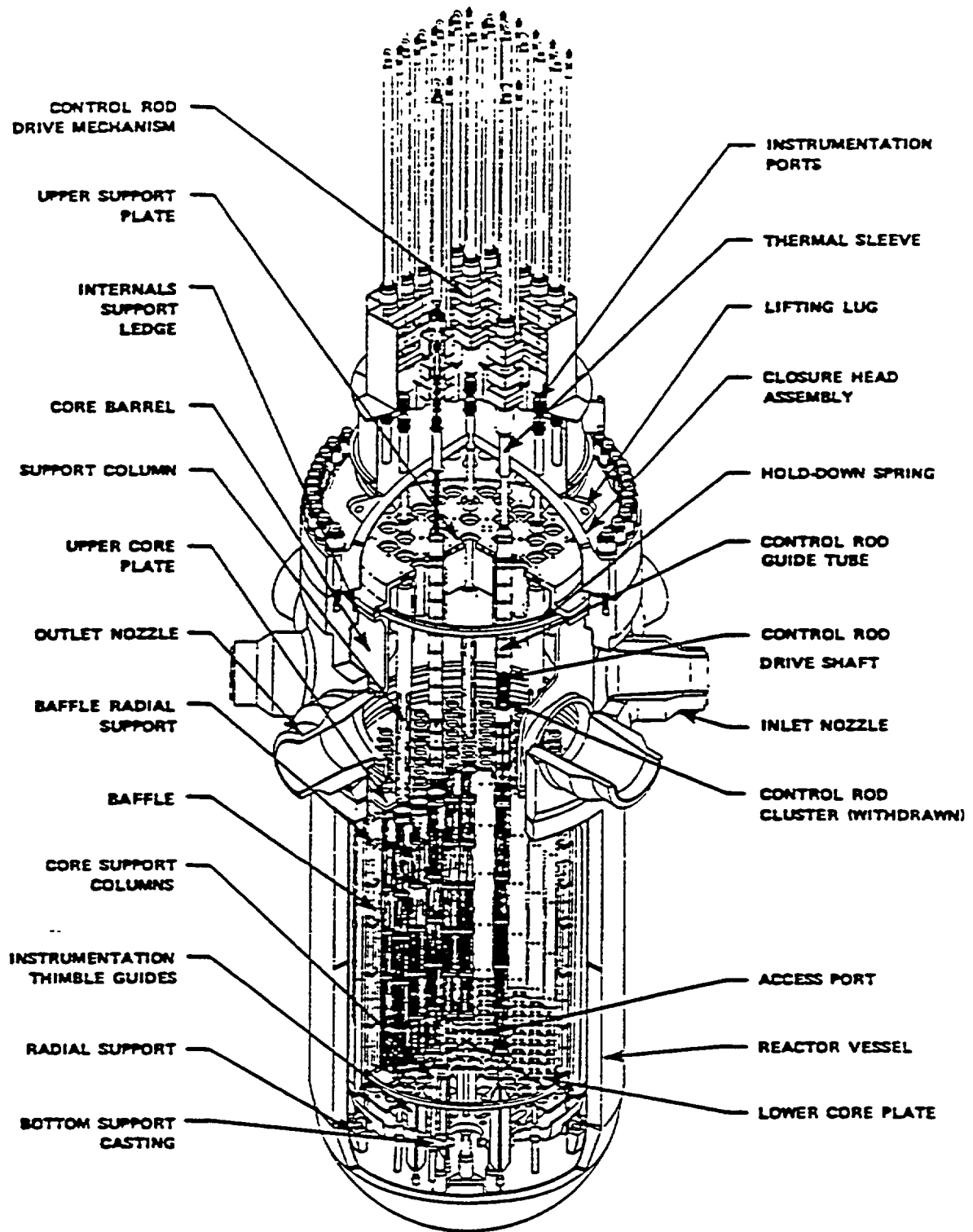

Figure 1-9. PWR Reactor Vessel

# REACTOR INTERNAL ARRANGEMENT

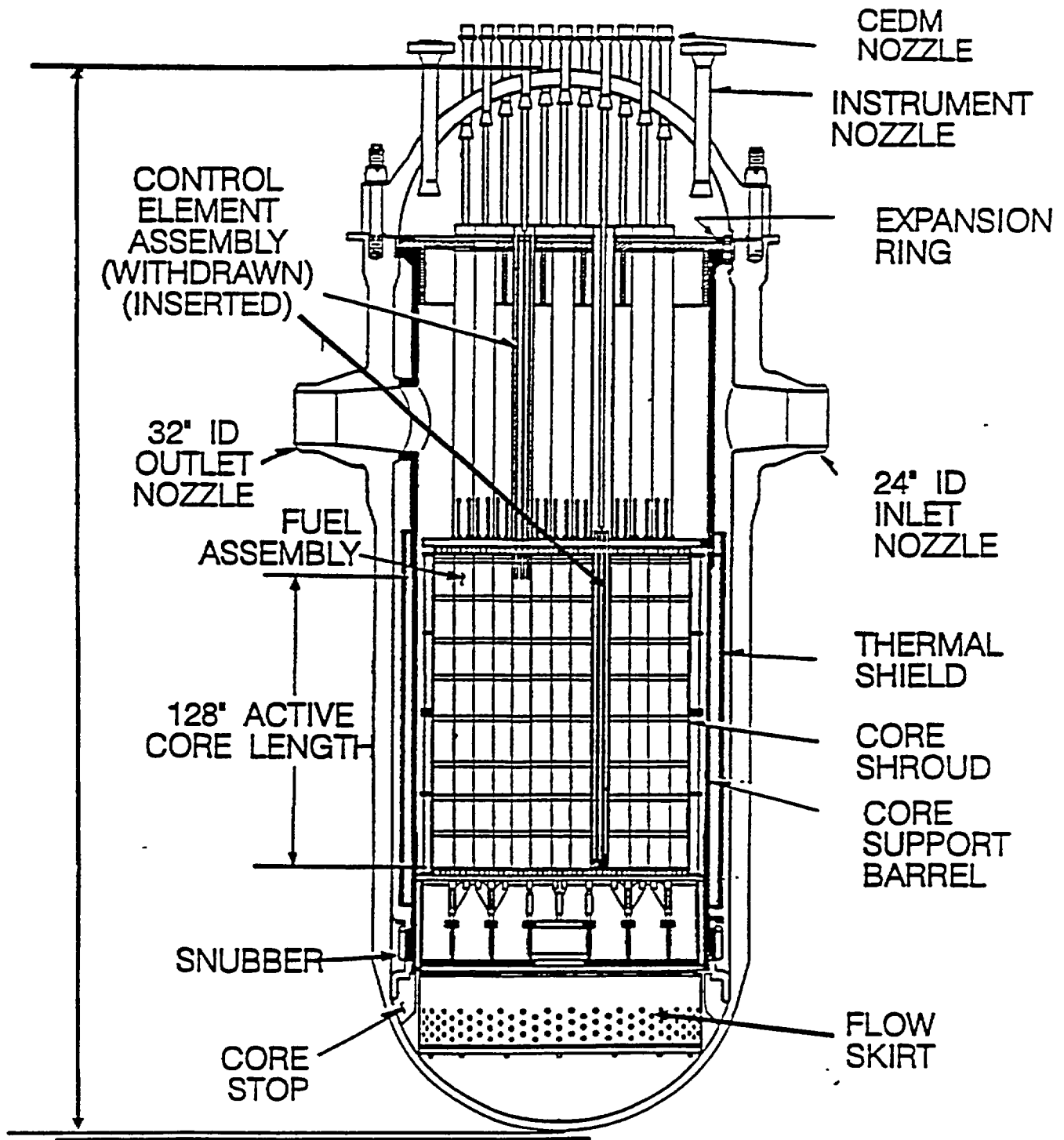

Figure 1-10. Simplified Reactor Vessel



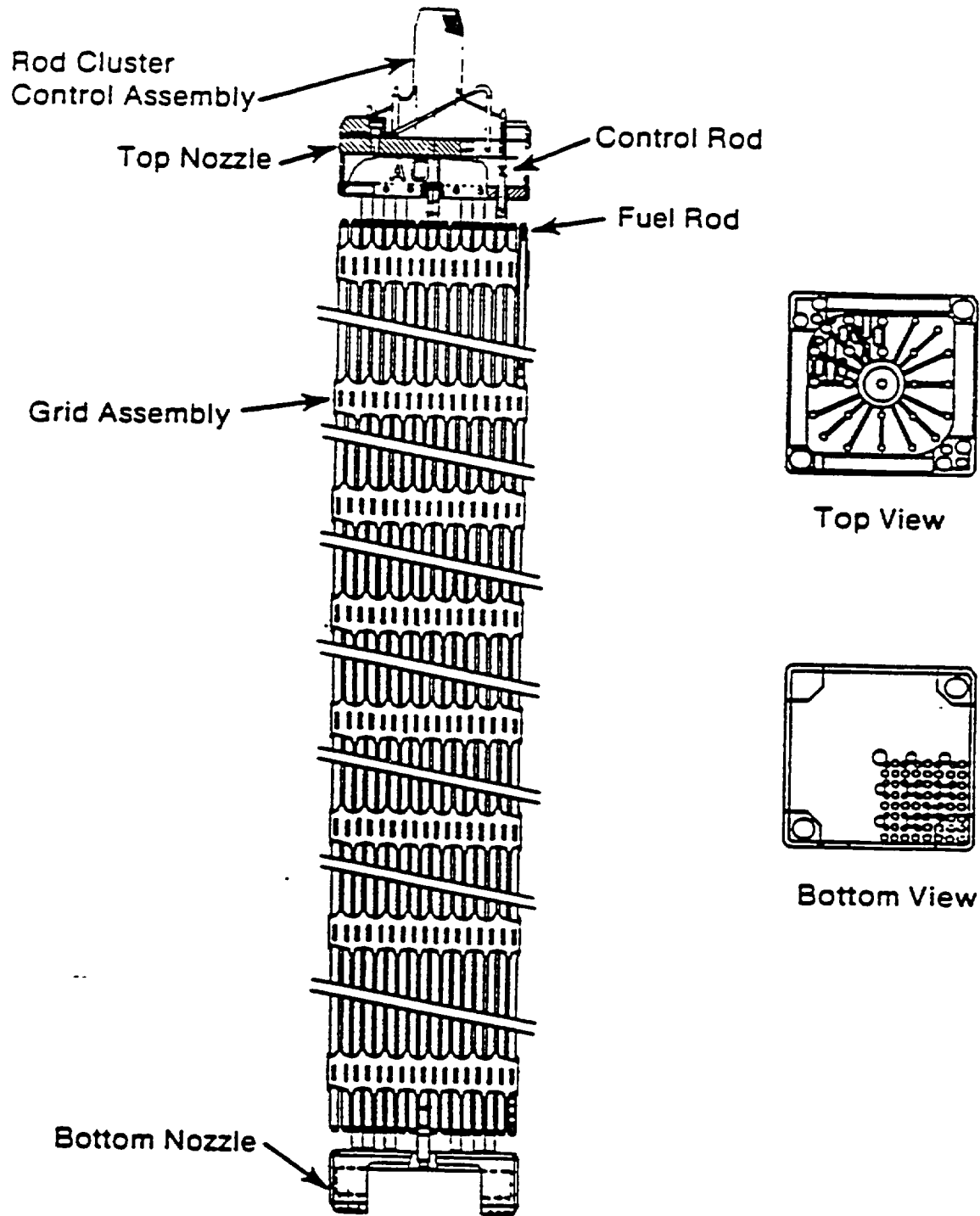

Figure 1-11. Typical PWR Fuel Assembly

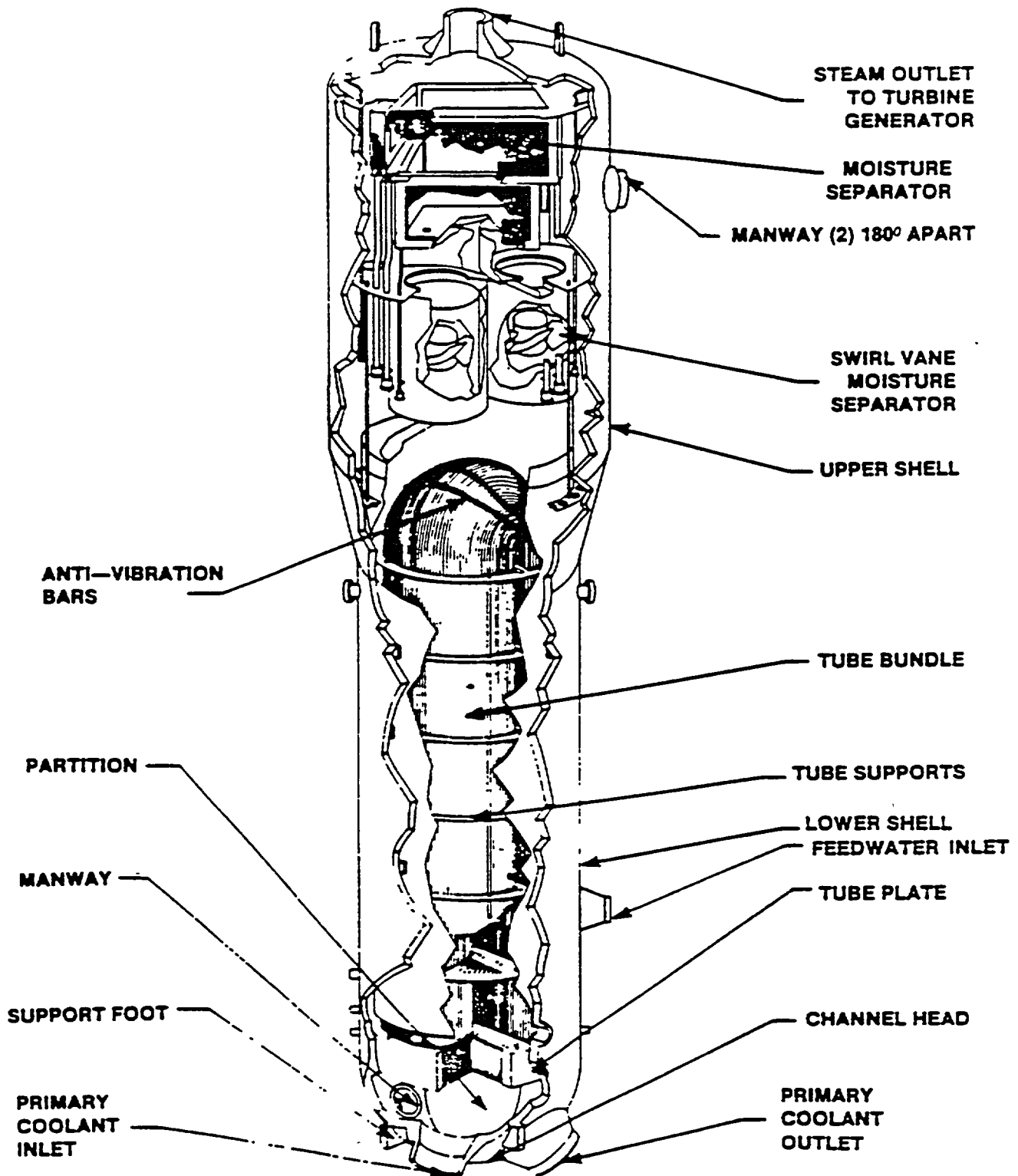

Figure 1-12. Westinghouse Steam Generator

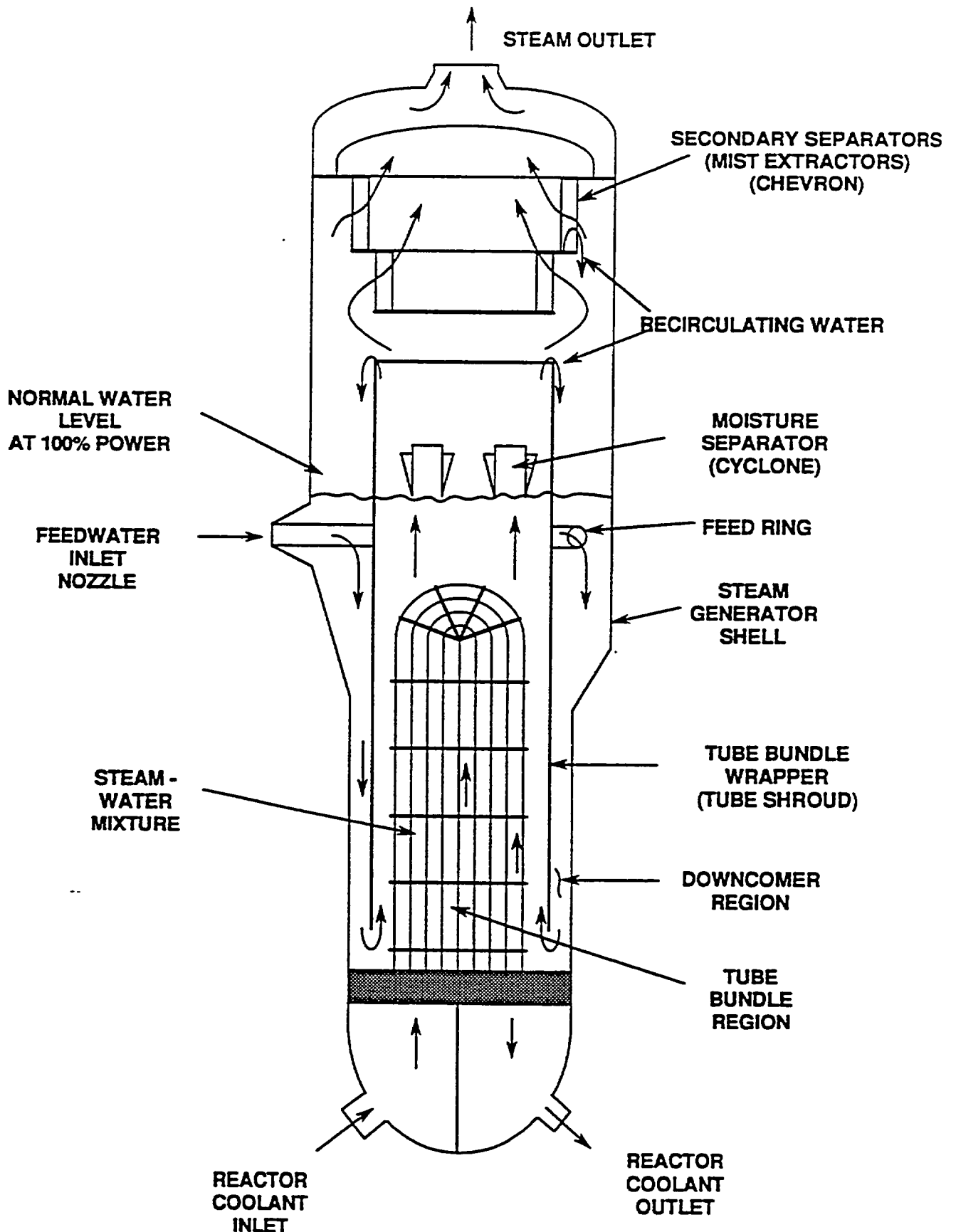

Figure 1-13. Steam Generator Secondary-side Flowpaths

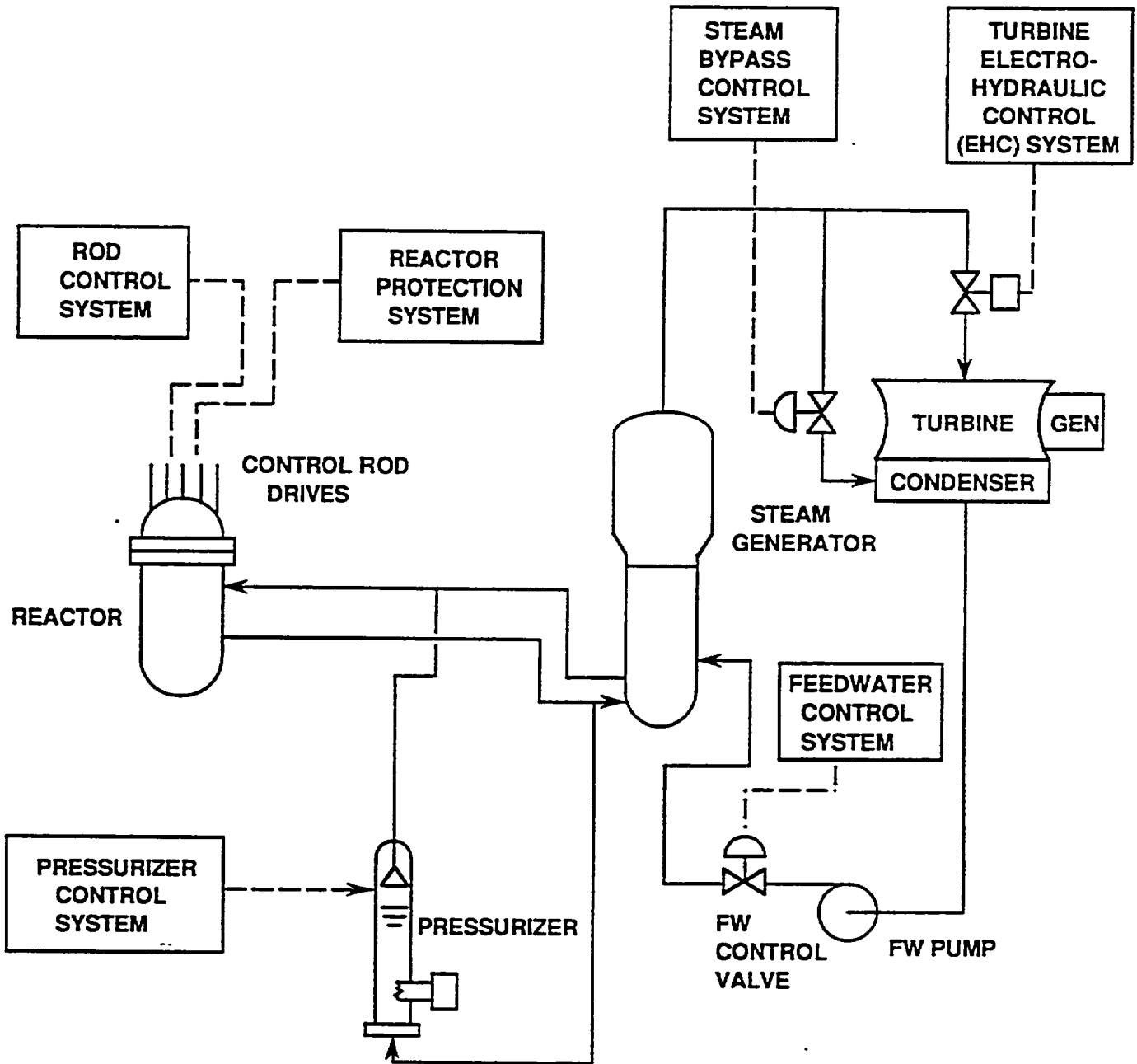

Figure 1-14. PWR Control Systems

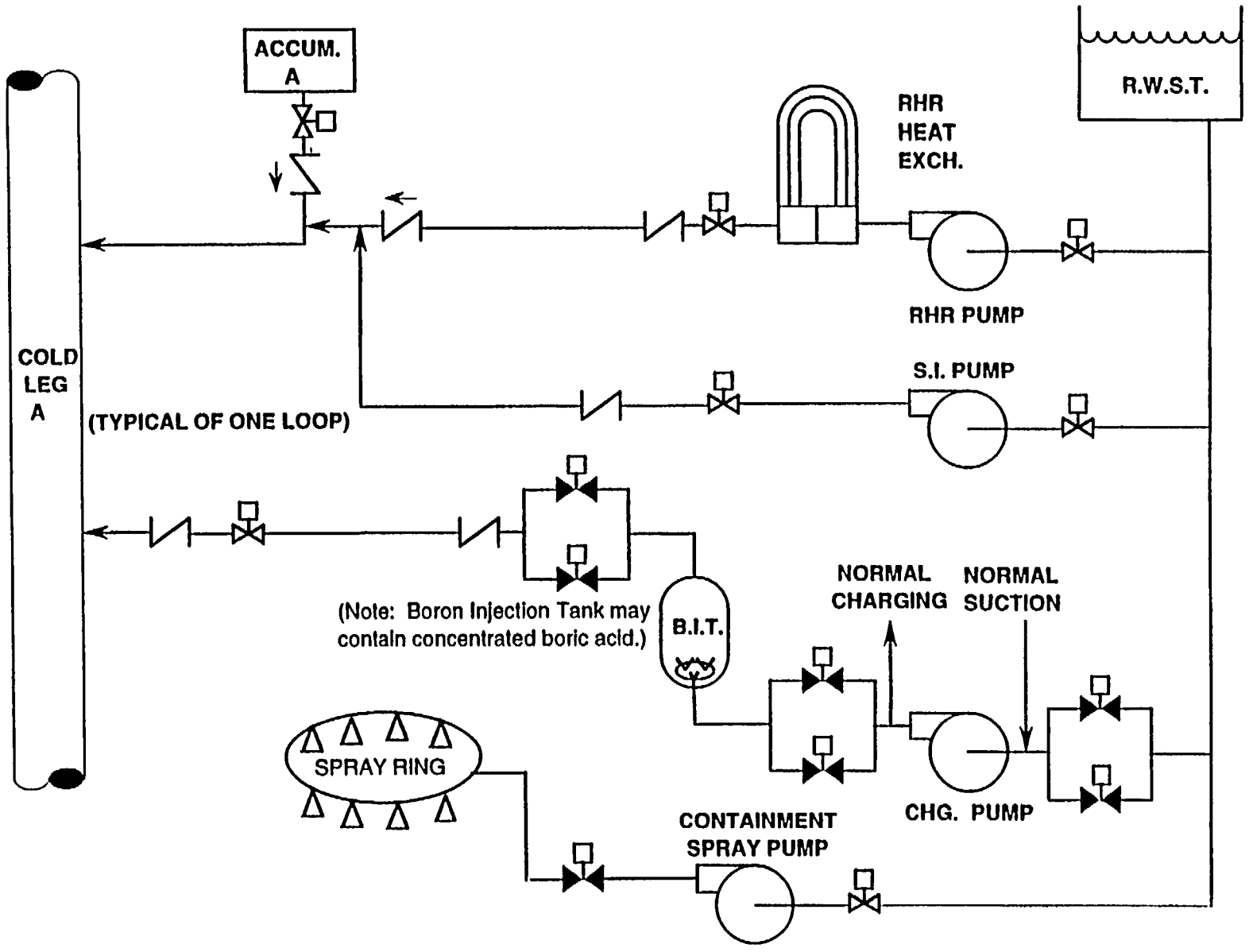

Figure 1 - 15. Emergency Core Cooling System Simplified Composite

## 2.0 REACTOR PHYSICS

### Learning Objectives

After studying this chapter, you should be able to:

1. Describe the basic fission process including:
  - a. Reactor fuels capable of thermal/fast fission
  - b. Probability of neutron absorption in a reactor fuel
  - c. Conversion of fission energy into heat.
2. Define the following terms:
  - a.  $K_{eff}$
  - b. Reactivity
  - c. Startup rate
  - d. Reactor period
  - e. Control rod worth
  - f. Boron worth
3. Compare and contrast the following terms:
  - a. Critical
  - b. Subcritical
  - c. Supercritical
4. Using the factors from the six-factor formula, describe a neutron life cycle from birth to absorption in a reactor fuel.
5. Describe how each of the following coefficients provides reactivity feedback to the reactor.
  - a. Moderator temperature coefficient
  - b. Moderator void coefficient
  - c. Fuel temperature (Doppler) coefficient
  - d. Power coefficient
6. Compare and contrast differential and integral rod worth.
7. Describe how Xe-135 and Sm-149 affect reactivity following a power change.
8. Describe the effects of subcritical multi-

plication on reactor operation.

9. State the reasons for adding burnable poisons to a reactor core.
10. State the purpose of  $1/m$  plots during a reactor startup.
11. Explain the effects of delayed neutrons on reactor control and stability.
12. Describe the source and effects of decay heat following a reactor shutdown.
13. Describe how the following methods of reactivity control are used by the operators:
  - a. Control rods
  - b. Soluble boron (PWR only)
  - c. Core flow (BWR only)

### 2.1 Introduction

This chapter contains a summary of basic nuclear physics and nuclear reactor design principles and terminology. The material presented is broader in scope than can be conveniently covered in the classroom time allotted; therefore, all the written material will not be covered in detail. Basic explanations and definitions of concepts will be given in the classroom. The purpose here is to provide a sound understanding of the basic nuclear processes involved in nuclear power generation.

### 2.2 Fission Process

Nuclear fission is the splitting of the nucleus of an atom into two or more separate nuclei, accompanied by the release of a large amount of energy. Nearly all of the fissions in the reactor are generated in the fuel by neutron absorption, which results in the splitting of the fissionable atoms that make up the fuel. Only a few of the heavy isotopes are available in quantities large enough and have a high enough probability of fissioning to be used as reactor fuel. Commonly used fuels are ura-

ni-233 (U-233), uranium-235 (U-235), uranium-238 (U-238), plutonium-239 (Pu-239), and plutonium-241 (Pu-241). Several other isotopes also undergo fission, but their contribution is always extremely small.

U-235 and U-238 are naturally occurring isotopes with very long half-lives; they account for the majority of the fuel used in commercial reactors. Artificially produced fuels include U-233 (produced by the irradiation of thorium-232 (Th-232) in a reactor) and Pu-239 (produced by irradiation of U-238 in a reactor). Th-232 and U-238 are called fertile materials and are generally placed in the core or in a blanket surrounding the core (in breeder reactors) in order to produce fuel (fissionable material) as the original fuel is used up in fissioning. The ratio of the amount of fuel produced in a reactor to the amount that is used during any period of time is called the conversion ratio of the reactor.

When a fuel nucleus absorbs a neutron, a fission occurs almost immediately. In the case of U-235, the reaction is represented by the following:

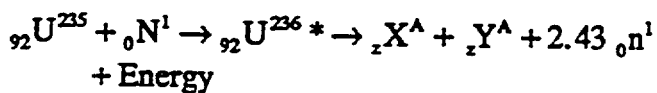

\*Indicates that the isotope is unstable

The total energy released per fission is about 200 Mev for U-235 and is distributed as shown below:

<u>Instantaneous</u>	<u>Mev/Fission</u>
K.E. of fission fragments	165.0
Instantaneous gamma ray energy	7.0
K.E. of fission neutrons (prompt)	<u>5.0</u>
	177.0
<u>Delayed</u>	
β particles from fission products	7.0
Gamma rays from fission products	6.0
Neutrinos	<u>10.0</u>
	23.0

The energy of the neutrinos, which accompany the radioactivity, is not available for producing power because these particles do not interact appreciably with matter; thus, the net energy available is still roughly 200 Mev per fission.

Neutron production (neutrons per fission) varies with the different fissionable isotopes and with the energy at which the fission reaction is caused to take place. Table 2-1 shows some relative values for neutrons per fission for some of the common fuels that are now being used in reactors.

Note that each fission does not produce the same number of neutrons. The neutrons per fission given in Table 2-1 represent an average number produced per fission when a large number of fissions are used to determine the statistics. From individual fissions of a nucleus some reactions produce only one neutron, possibly none, and some reactions produce as many as five neutrons per fission.

The neutrons released from fission vary in energy from essentially thermal energy up to about 15 Mev. More than 98% of all the neutrons produced by fission are below 8 Mev. The energy distribution of these neutrons is shown in Figure 2-1. In section 2.3, the slowing down of these neutrons to thermal equilibrium will be discussed.

## 2.3 Nuclear Cross Section

When a neutron strikes a nucleus, several reactions can occur. One possibility is that the neutron will bounce off a nucleus; this is termed elastic scattering. A second possibility is that the neutron will penetrate the nucleus and form an unstable compound nucleus. If the neutron is then ejected, this is called inelastic scattering. In both cases, the neutron usually will transfer some of its energy to the nucleus. If the nucleus keeps the neutron after the collision, this is called neutron capture. Finally, the captured neutron can cause the nucleus to fission. The probability that a neutron will undergo one of the aforementioned reactions with a nucleus is measured in units of

microscopic cross section. The unit of microscopic cross section,  $\sigma$ , is the barn. (Note that 1 barn =  $10^{-24}$  cm<sup>2</sup>.)

The cross sections are probabilities of interaction, and individual probabilities may be summed to give the total probability. The total cross section  $\sigma_t$  is the sum of the absorption and scattering cross sections:

$$\sigma_t = \sigma_a + \sigma_s.$$

For fissionable material, the absorption cross section is the sum of the fission and capture cross sections:

$$\sigma_a = \sigma_c + \sigma_f.$$

Microscopic cross sections are a function of the target nucleus (U-235, U-238, etc.) and the incident neutron's energy (thermal, epithermal/resonance, or fast). In general, the probability of a given reaction will be increased for neutrons of lower energy and velocity. Typical values of microscopic cross sections for U-235 and B-10 are given in Table 2-2.

The absorption of neutrons tends to follow an inverse velocity trend. Figure 2-2 shows this general trend in U-235. Certain isotopes (such as U-238 and Pu-240) exhibit a strong resonance capture phenomenon at certain incident neutron energy levels. A qualitative explanation of the resonance phenomenon is that certain nuclei have allowable excited states that are discrete. If the energy of the incident neutron is such that the energy of the resultant compound nucleus is equal to one of these states, then the neutron has a high probability of being captured. These excited states occur at certain energies which determine where these isotopes will have an abrupt increase in their capture cross section. These spikes in the cross section curve are referred to as resonance peaks and are most prevalent in the heavier elements.

The total effective cross section presented by all of the nuclei of a given isotope in a cubic

centimeter is referred to as the macroscopic cross section ( $\Sigma$ ):

$$\Sigma = N\sigma,$$

where

$N$  = number of individual atoms (or nuclei) per cubic centimeter, and

$\sigma$  = microscopic cross section in barns.

The macroscopic cross section has dimensions of reciprocal length (cm<sup>-1</sup>). It is sometimes convenient to consider the macroscopic cross section as the probability of neutron interaction per unit track length. The reciprocal of  $\Sigma$  is called the neutron mean free path (denoted by  $\lambda$ ) and is a measure of the average distance a neutron will travel in a substance before it experiences the nuclear reaction under consideration. If a material contains several isotopes the effective macroscopic cross section is:

$$\Sigma_t = \Sigma_1 + \Sigma_2 + \dots + \Sigma_i = N_1\sigma_1 + N_2\sigma_2 + \dots + N_i\sigma_i$$

The number of nuclei per cubic centimeter may be calculated as follows:

$$N = \frac{\rho N_a}{A} = \left( \frac{\text{gm}}{\text{cm}^3} \right) \left( \frac{6.023(10^{23}) \text{ atoms}}{\text{gram atom}} \right) = \frac{\text{atoms}}{\text{cm}^3}$$

where

$N$  = number of nuclei per cm<sup>3</sup>,

$\rho$  = density,

$A$  = atomic weight, and

$N_a$  = Avogadro's number.

## 2.4 Slowing Down of Neutrons

In an operating reactor, the probability of fission for most reactor fuels is generally inversely dependent on the energy of the incident neutrons.



Since fission neutrons are born at high energies (fast neutrons), the probability that they will cause a fission while at that energy is very small; therefore, it is necessary to reduce this neutron energy to a value where the probability that it will cause fission is increased. This is accomplished by interposing relatively non-absorbing nuclei as collision media to reduce the kinetic energy of fission neutrons through the process of scattering. This medium is called the "moderator." It acts to moderate (slow down), or "thermalize" the fission neutrons.

Typical moderators are hydrogen, beryllium, and carbon. Fewer collisions are necessary in a hydrogen medium to cause complete moderation than in carbon, since the atomic mass of hydrogen is smaller, and therefore, able to absorb more kinetic energy from the neutron during the scattering process. The following description is analogous to this scattering process:

If moving billiard ball A strikes stationary billiard ball B, ball B moves away and ball A will come to rest. If billiard ball B is replaced by a bowling ball, moving ball A bounces off, barely transferring any energy to the bowling ball. A neutron-proton collision is like a two-billiard ball collision and a neutron-carbon collision is like a billiard ball-bowling ball collision.

The amount of moderator in a reactor greatly influences the slowing down process. If there is too little moderator, the neutrons are not adequately thermalized. Hence, the probability of fission is reduced as more neutrons will either leak out of the core or be absorbed in nonfissioning materials. If there is too much moderator, the probability that a thermal neutron will be captured by the moderator is greatly increased.

## 2.5 Multiplication Factor

The ratio of the number of thermal neutrons obtained at the end of the neutron cycle to the number of those initiating the cycle is called the

effective multiplication factor and is denoted by  $K_{eff}$ . It is a significant parameter of the nuclear chain reaction because its value determines the rate of neutron level multiplication.

If  $K_{eff} > 1$ , the reactor is supercritical; the neutron population, the fission rate, and energy production are increasing exponentially.

If  $K_{eff} = 1$ , the reactor is critical; the neutron population is constant, as is the fission rate and the energy production. The nuclear chain reaction is sustained and controlled.

If  $K_{eff} < 1$ , the reactor is subcritical; the neutron population, the fission rate, and the energy production are decreasing exponentially.

The initial value of  $K_{eff}$  is affected by the material composition and the geometry of the reactor core. Under normal operating conditions, a power reactor is kept critical; i.e., the equilibrium value of  $K_{eff}$  is 1.0 all the time. Subcriticality leads eventually to shutdown of the reactor. Supercritical operation is necessary during startup and power increase, but care must be taken not to let  $K_{eff}$  become too large or else the reactor will be difficult to control.

The multiplication factor is not a parameter that can be directly observed or measured. To understand how  $K_{eff}$  is affected by changes in core parameters, a six factor formula will be used to illustrate the factors that must be considered when deriving  $K_{eff}$ . Figure 2-3 illustrates these factors.

$$K_{eff} = \epsilon L_f p L_{th} f \eta ,$$

where

- $K_{eff}$  = effective multiplication factor,
- $\epsilon$  = fast fission factor,
- $L_f$  = fast nonleakage probability,
- $p$  = resonance escape probability,
- $L_{th}$  = thermal nonleakage probability,
- $f$  = thermal utilization factor, and
- $\eta$  = reproduction factor.

### 2.5.1 Fast Fission Factor ( $\epsilon$ )

The fast fission factor ( $\epsilon$ ) is the contribution to neutron multiplication from the fissions that occur at higher-than-thermal energies. This contribution is mainly from fast fission of U-238. U-238 will fission only if it absorbs a neutron with kinetic energy above approximately 1.0 Mev. Below 1.0 Mev, the neutron will be captured and will be lost from the fission process. The probability of a fission reaction in U-238 is quite low, but there is so much of this isotope in the reactor core that there is a significant contribution to the multiplication factor. Approximately 7% of the total reactor power is a result of fast fissions. The fast fission factor,  $\epsilon$ , is defined as follows:

$$\epsilon = \frac{\text{Neutrons from all fission}}{\text{Neutrons from thermal fission}}$$

As moderator temperature is increased, the value of  $\epsilon$  increases because neutrons remain at higher energies longer (because of the poorer moderating properties of the water) and are more able to fission the U-238. There is only a slight (almost insignificant) change over the core life-time as a result of U-238 depletion. A typical value for  $\epsilon$  is 1.03.

### 2.5.2 Fast Nonleakage Factor ( $L_f$ )

The fast nonleakage factor,  $L_f$ , is the fraction of neutrons that is not lost due to leakage from the core during the slowing down process. It is also the probability that a neutron will remain in the core and become a thermal neutron without being lost by fast leakage.

As the temperature of the moderator increases,  $L_f$  decreases because of the increased slowing down time and increased leakage from the loss of water.

### 2.5.3 Resonance Escape Probability ( $p$ )

The resonance escape probability, symbolized by  $p$ , is the probability that a neutron will escape

resonance capture during the slowing down process. It is always less than 1.0 when there is any amount of U-238 present in the core, which means that resonance capture by U-238 always removes some of the neutrons.

As the moderator temperature increases, the resonance escape probability decreases because, as the slowing down time increases, more neutrons are likely to exist at the energies susceptible to resonance capture. The resonance escape probability changes over core life because of changes in fuel temperature required for full power operation. Also, other isotopes that are resonance absorbers are being produced.

### 2.5.4 Thermal Nonleakage Factor ( $L_{th}$ )

The thermal nonleakage factor,  $L_{th}$ , is the fraction of the thermal neutrons that do not leak out of the core after becoming thermalized but remain to contribute to the chain reaction.  $L_{th}$  is also the probability that a thermal neutron will remain and be utilized in the core.

The value of  $L_{th}$  decreases as the temperature of the moderator increases for the same reasons given for the fast nonleakage factor.

### 2.5.5 Thermal Utilization Factor ( $f$ )

The thermal utilization factor,  $f$ , is the ratio of the probability that a neutron will be absorbed in the fuel to the probability that the neutron will be absorbed in all the material in the core. It is described by the following equation:

$$f = \frac{\sum_a^{\text{fuel}}}{\sum_a^{\text{fuel}} + \sum_a^{\text{other}}}$$

Where  $\sum_a$  = macroscopic absorption cross section.

An examination of  $f$  shows that the  $\sum_a$  (fuel) comprises only the absorption by the U-235 at the beginning of core life. As Pu-239 begins to build up from the irradiation of U-238 in the core, it is

necessary to consider the change in fuel composition in determining the value of  $f$  at different times in the core lifetime. It is estimated that Pu-239 fissions account for 40% of full reactor power at end of core life.

The plant operator has the greatest effect on this factor since he can control the amount of  $\Sigma_a$  in the core by the insertion and withdrawal of control rods and the addition or dilution of soluble boron (in a PWR). A typical value of  $f$  is 0.83.

### 2.5.6 Reproduction Factor ( $\eta$ )

The reproduction factor,  $\eta$ , is the average number of neutrons produced per thermal neutron absorbed in the fuel. It is based on physical measurement of each type of fuel used in a reactor.

The numerical value of  $\eta$  does not change with core temperature over the range considered for most reactors. There is essentially no change in  $\eta$  over the lifetime of the reactor core because of the closeness of the values of  $\eta$  for U-235 and plutonium-239. A typical value for  $\eta$  is 2.05.

As the reactor operates for a period of time, and Pu-239 begins to contribute to the neutron economy of the core, the average effect of  $\eta$  is expressed by:

$$\eta = \frac{\nu_5 \Sigma_f^{235} + \nu_9 \Sigma_f^{239}}{\Sigma_a^{235} + \Sigma_a^{239} + \Sigma_a^{238}}$$

where

- $\nu$  = average number of neutrons produced from fission and
- $\Sigma$  = macroscopic cross section.

### 2.6 Reactivity ( $\rho$ )

Reactivity is the measure of the fractional change in neutron population per generation in a reactor and is a measure of a reactor's departure from criticality. Reactivity is expressed as ( $\rho$ ) and

may be calculated by the formula:

$$\rho = \frac{K_{eff} - 1}{K_{eff}} = \frac{\Delta K}{K}$$

It can then be seen that in a critical reactor  $k_{eff} = 1$ ,  $\rho = 0$ . A supercritical reactor ( $K_{eff} > 1$ ) will have positive reactivity; a subcritical reactor ( $K_{eff} < 1$ ) will have negative reactivity.

Although reactivity is unitless, it is assigned the units of  $\Delta K/K$  for convenience. Because of the very small amount of reactivity usually present in a core, other units are also used. These are %  $\Delta K/K$  and PCM (percent millirho).

The relationship between these units is:

$$1\Delta K/K = 100\% \Delta K/K = 10^5 \text{ PCM}$$

Some of the factors that affect the reactivity of a reactor core throughout core life are fission product poisons, fuel depletion, moderator temperature, fuel temperature, steam void fraction, reactor pressure, control rods, and burnable poisons.

### 2.7 Reactor Period and Startup Rate

Reactor period is a measure of the rate of change of reactor power and is defined as the time required to change reactor power by a factor of  $e$ , the natural logarithm. The following equation describes the effect of reactor period on power level as a function of time:

$$P = P_0 e^{t/\tau}$$

where

- $P$  = Power after elapsed time,  $t$ ,
- $P_0$  = Initial power,
- $t$  = Elapsed time in seconds, and
- $\tau$  = Reactor period.

Startup rate is another means of measuring the

rate of change of power in a reactor. The startup rate (SUR) is the number of decades (powers of 10) reactor power will change in 1 minute.

As with period, an equation can relate SUR to power level as a function of time.

$$P = P_0 10^{\text{SUR}(t)}$$

where

- P = Power after elapsed time, t,
- P<sub>0</sub> = Initial power,
- t = Elapsed time in minutes, and
- SUR = Startup rate in decades per minute.

Startup rate and period are related by the equation:

$$\tau = \frac{26}{\text{SUR}}$$

Other useful relationships for reactor period are:

$$\tau = 1.44 \text{ DT} = 1.44 \text{ HT},$$

where

doubling time, DT = the time required for reactor power to double, and

halving time, HT = the time for power to halve.

## 2.8 Reactivity Coefficients

When the operating conditions of the core (coolant temperature, coolant pressure, reactor power level, coolant void fraction, fuel temperature, etc.) are changed, the critical status of the core is also changed. A change in any of the above operating parameters will add either positive or negative reactivity to the core. The inherent features in a reactor system that automatically change core reactivity upon a change of a core operating parameter are known as reactivity coefficients.

Each reactivity coefficient is defined as a change in reactivity divided by a unit change in some operating parameter of the reactor. The coefficients that are significant in reactor operations are the moderator temperature coefficient (MTC), moderator void coefficient ( $\alpha_v$ ), fuel temperature coefficient (FTC), and power coefficient. The moderator pressure coefficient is normally very small in PWR plants; in BWR plants, pressure changes primarily affect the moderator void fraction so the pressure coefficient is included in the moderator void coefficient for BWR plants.

### 2.8.1 Moderator Temperature Coefficient (MTC)

The moderator temperature coefficient (MTC) is defined as the change in reactivity that results from a change in the temperature of the moderator in the core. It is measured in units of  $\Delta K/K/^\circ F$ , or change in reactivity per degree Fahrenheit change in the average moderator temperature.

When moderator temperature increases, the moderator density decreases, so fewer moderator molecules are available for slowing down and thermalizing the neutrons. This causes the neutrons to remain at higher energies longer and travel farther, which results in increased leakage and more nonproductive capture. The effect of a moderator temperature increase on  $K_{\text{eff}}$  can be determined by examining the effect on the fast and thermal nonleakage probabilities ( $L_f$  and  $L_{\text{th}}$ ) and the resonance escape probability ( $p$ ). As moderator temperature increases, each of these probabilities ( $L_f$ ,  $L_{\text{th}}$ , and  $p$ ) decreases, which results in a decrease in  $K_{\text{eff}}$ . Because negative reactivity is normally added to the core by an increase in moderator temperature, MTC is normally a negative value.

Some reactor parameter changes cause the value of MTC to change. As moderator temperature increases, MTC becomes more negative. This is because a  $1^\circ F$  increase at a high moderator temperature results in a larger density reduction (larger reduction in molecules available to ther-

malize neutrons) than a 1°F increase at a lower moderator temperature. Therefore, a 1°F increase at a high moderator temperature adds more negative reactivity than a 1°F increase at a low moderator temperature. Conversely, a 1°F decrease at a high moderator temperature adds more positive reactivity than a 1°F decrease at a low moderator temperature. Figure 2-4 illustrates the effect of moderator temperature on MTC.

The MTC should always be negative to contribute to "inherent reactor stability." This means negative reactivity must be inserted when the temperature of the moderator increases. Considering only the reactivity effect of MTC, consider what would happen if the MTC were positive.

With a positive MTC, a small increase in moderator temperature would add positive reactivity, causing reactor power to increase. As power increased, more heat would be added to the moderator causing moderator temperature to increase. As the moderator temperature increased, with positive MTC more positive reactivity would be added, further increasing power, which would raise moderator temperature, etc. It can be seen that reactor power would be self-escalating with a positive MTC.

### 2.8.2 Moderator Void Coefficient ( $\alpha_v$ )

The moderator void coefficient of reactivity is defined as the change in reactivity produced by a 1% change in void fraction ( $\Delta K/K/\%V$ ) and is illustrated in Figure 2-5. As the moderator boils and the void fraction increases, the moderator density decreases resulting in a reactivity change involving several interacting mechanisms. A decrease in moderator density results in less absorption in the moderator, which causes the thermal utilization factor to increase. An increased distance between moderator molecules means that the neutrons travel a greater distance while at higher energies and have a greater probability of being captured in resonance regions of uranium or plutonium; thus, the resonance escape probability decreases. In addition, the distance a neutron

travels after thermalizing also increases, producing a decrease in thermal nonleakage probability. The large negative effects of increased resonance capture and, to a lesser degree, increased thermal leakage outweigh the positive effect of less absorption in the moderator and result in a moderator void coefficient of reactivity which is strongly negative.

The slope of the curve in Figure 2-5 is negative because resonance capture increases more rapidly at high void fraction than at low void fraction. As previously explained, the increased resonance capture results from the decrease in moderation in the steam bubbles. A 1% increase in voids at a high void content displaces a greater percentage of remaining moderator than a 1% increase in voids at a low void content.

Consider two examples: 10% void fraction and 70% void fraction. At 10% void fraction (90% water fraction), a 1% increase in void fraction decreases water fraction from 90% to 89% or roughly 1.1%. At 70% void fraction (30% water fraction), however, a 1% increase in void fraction decreases the water fraction from 30% to 29% or a change of 3.45%. Thus, at higher void fractions, there is a greater percent change in moderator fraction for a given percent change in void fraction than occurs at low void fractions. Therefore, the negative reactivity added at higher void fractions is greater than at lower void fractions.

### 2.8.3 Pressure Coefficient

Some reactor kinetics texts also include a moderator pressure coefficient of reactivity with the other reactivity coefficients. The primary effect of increasing moderator pressure is to increase moderator density, both through compression of the liquid and through compression/condensing of the voids. When the moderator density increases, reactivity increases (as inversely described in section 2.8.1 for MTC). When the moderator pressure decreases, moderator density decreases, causing an insertion of negative reactivity similar to the affects of a temperature in-

crease. If there are no voids in the moderator, however, the moderator density increase per 100 psig increase in pressure is very small (water is nearly incompressible). Therefore, the pressure coefficient in a reactor with essentially single-phase moderator (all PWRs under normal conditions) is insignificant in relation to the other coefficients.

If there are voids in the moderator, a change in pressure directly effects the moderator void fraction. Therefore, the reactivity effect of a pressure change on a moderator with a significant void fraction (all BWRs under normal conditions) is included in the moderator void coefficient of reactivity.

Because the pressure coefficient is not a significant factor in PWR reactor operations, and because the effects of pressure in BWR plants are included in the moderator void coefficient, the pressure coefficient is not further discussed in this manual.

#### 2.8.4 Fuel Temperature (Doppler) Coefficient (FTC)

Another reactivity coefficient of major importance is the fuel temperature (or Doppler) coefficient of reactivity (FTC), which is defined as the change in reactivity that results from a unit change in fuel temperature ( $\Delta K/K/^\circ F$ ). Like MTC, FTC is negative, adding negative reactivity for an increase in fuel temperature. Normally, FTC is the coefficient that acts first to terminate a rapid reactor power increase since a power increase will result in a fuel temperature increase before the moderator can be heated or voids can be created.

An understanding of the FTC requires an understanding of the mechanics of resonance absorption. Resonance absorption occurs when the kinetic energy of the neutron will raise the target nucleus (mainly U-238 and Pu-240) to an allowable excited state. The probability for absorption of a neutron at any other energy is relatively low.

Figure 2-6 shows a simplified cross section versus neutron energy curve as discussed above. The resonance peaks are illustrated as straight vertical lines.

Figure 2-6 would be a correct representation of the resonance absorption peaks if the target nucleus were stationary. However, the target nucleus is in motion and its movement increases with increasing temperature. We measure neutron energy or velocity from an external point of view and not as the target nucleus sees the neutron velocity.

The velocity of a neutron is proportional to the square root of its kinetic energy (KE) so for a neutron with energy  $KE_1$  we can say that it has a velocity  $V_1$ . Figure 2-7 shows that for a stationary target only a neutron with velocity  $V_1$  will undergo resonance absorption. Because the temperature of the target nucleus causes it to be in motion, as shown on Figure 2-7, there is a band of neutron velocities or energies where resonance absorption could occur. In this case, velocities  $V_2$  and  $V_3$  look exactly like  $V_1$  as far as the target nucleus is concerned. Elevating the temperature of the target nucleus will broaden this absorption band. Again, velocities  $V_4$  and  $V_5$  look exactly like  $V_1$  as far as the target nucleus is concerned.

When the target nucleus is in motion, its velocity will cause the probability of absorption for neutrons with velocity  $V_1$  to decrease. The decrease in the height of the resonance peak as well as the increase in width is known as Doppler broadening and is shown on Figure 2-8. If the temperature of the target material is increased more, the resonance peaks will again broaden and decrease in height.

Since neutrons are slowed down in steps, there is a probability that they will never enter the energy band where resonance absorption will take place. As the resonance band broadens due to a temperature increase, more neutrons will enter the band as they are slowing down. With more neutrons in the band, more of them will be absorbed. This increased absorption will result in a negative

reactivity addition.

In case of a deliberate or inadvertent addition of a positive reactivity to a reactor core, the FTC would be the first reactivity coefficient to respond. It is effective almost instantaneously because an increase in reactivity causes the fission rate to increase and produce more heat in the fuel, which in turn causes a decrease in reactivity. As quickly as the heating rate is increased, the FTC becomes effective. A graph of FTC versus fuel temperature is provided in Figure 2-9.

### 2.8.5 Power Coefficient

A change in reactor power normally causes or is accompanied by a change in fuel temperature, moderator temperature, and/or moderator void fraction. Therefore, it is frequently convenient to consider a power coefficient that combines the effects of the fuel temperature, moderator temperature, and void coefficients for changes in reactor power. Power coefficient is expressed as the change in reactivity per change in percent power,  $\Delta K/K/\%$  power, and is negative at all times in core life.

As power is increased, negative reactivity will be added to the core because the power coefficient is negative. Therefore, an equal amount of positive reactivity must be added to keep the reactor critical. When power is decreased quickly, as it is after a trip or scram, the power coefficient adds *positive* reactivity, and negative reactivity insertion is required to make and keep the reactor subcritical. The total amount of reactivity added by a power change is called power defect. Figure 2-10 illustrates power defect as a function of reactor power.

### 2.8.6 Reactivity Coefficient Values

Approximate numerical values for the major reactivity coefficients are as follows:

$$\alpha_v = -1 \times 10^{-3} \frac{\Delta K / K}{\% \text{ voids}}$$

$$\text{MTC} = -1 \times 10^{-4} \frac{\Delta K / K}{^\circ\text{F moderator}}$$

$$\text{FTC} = -1 \times 10^{-5} \frac{\Delta K / K}{^\circ\text{F fuel}}$$

$$\text{Power Coefficient} = -1 \times 10^{-4} \frac{\Delta K / K}{\% \text{ power}}$$

Note that all the significant coefficients are negative. Therefore, if a change in some reactor condition makes a coefficient more negative in value, its absolute value increases. Conversely, if a change in some reactor condition makes a coefficient less negative, its absolute value decreases. This relationship is important to remember.

## 2.9 Behavior of Reactivity Coefficients in a BWR

### 2.9.1 Moderator Temperature Coefficient - BWR

The moderator temperature coefficient of reactivity is affected by core age. As core age increases, the buildup of Pu-240 increases the chance of resonance absorption, causing the coefficient to become more negative (absolute value increases). As the fuel depletes, control rods are withdrawn to add positive reactivity. As control rods are withdrawn, the effective size of the core increases, resulting in decreased fast and thermal neutron leakage, thereby causing the coefficient to become less negative (absolute value decreases). In addition, as control rods are withdrawn, more thermal neutrons are utilized by the fuel, causing the coefficient to become less negative. However, the dominant effect is the increase in thermal neutron utilization resulting in a less negative moderator temperature coefficient at the end of core life, as shown in Figure 2-4. It must be noted that MTC plays an important role during reactor startup and heatup when large moderator temperature changes occur. However, during normal power operation, moderator temperature stays es-

essentially constant and MTC has little reactivity effect.

### 2.9.2 Moderator Void Coefficient - BWR

The behavior of the void coefficient as core age increases is similar to the moderator temperature coefficient. Depending on core design and exposure, the void coefficient may increase, decrease, or remain approximately constant. In general, the void coefficient is inversely proportional to the effective core size, which is determined by the control rod density. As control rods are withdrawn to offset fuel burnout, the effective size of the core increases, resulting in fewer neutrons leaking out of the core and fewer thermal neutrons being absorbed by control rods. Thus, the void coefficient becomes slightly less negative toward the end of core life when all of the control rods are fully withdrawn.

### 2.9.3 Fuel Temperature (Doppler) Coefficient - BWR

As shown in Figure 2-9, FTC becomes less negative as fuel temperature increases. This decrease in the magnitude of FTC is caused by three key factors. First, the incremental broadening of a resonant absorption peak decreases as fuel temperature increases. Second, the elevated fuel temperature increases the average neutron flux energies, causing the neutrons to move through smaller resonance absorption peaks. (As can be seen on Figure 2-8, the resonance absorption peaks are significantly smaller at higher neutron energies.) Third, as fuel temperature increases, Doppler broadening shifts toward the higher energy resonance absorption peaks. Because these peaks are smaller and have already broadened at lower temperatures, the effect on the neutrons that are slowing down will decrease.

Any increase in either the moderator temperature or the core void fraction will cause FTC to become more negative. An increase in either of these parameters will result in longer neutron slowing down lengths and times, thus increasing

the probability of resonance absorption. As resonance absorption increases, FTC becomes more negative.

As the core ages, FTC becomes more negative. The dominant factor resulting in this change is the buildup of Pu-240, which is a strong resonant neutron absorber. Pu-240 is produced when U-238 absorbs a neutron and through a chain of decay results in Pu-239. When Pu-239 absorbs a neutron, it will either fission or decay to Pu-240. As Pu-240 builds into the core, the total resonance absorption increases, thereby causing FTC to become more negative.

### 2.9.4 Power Coefficient - BWR

The interaction of the recirculation pumps with reactor power in BWR plants makes the prediction of power coefficient trends much more complex in BWR plants than in PWR plants. Normally, the fuel temperature coefficient and the moderator void coefficient are both large contributors to the power coefficient. Any reactor parameter change that affects either of these coefficients also affects the power coefficient.

## 2.10 Behavior of Reactivity Coefficients in a PWR

### 2.10.1 Moderator Temperature Coefficient - PWR

Over core life, soluble boron concentration can range anywhere from about 1200 ppm to 10 ppm. As soluble boron concentration in the core decreases, MTC becomes more negative. This is because a 1°F increase in moderator temperature at a low soluble boron concentration will expel fewer boron atoms (neutron absorbers) from the core than a 1°F increase in moderator temperature at a high boron concentration. The expulsion of boron atoms from the core is a positive reactivity component to the MTC. As boron concentration decreases, fewer boron atoms will be expelled from the core for a 1°F moderator increase, thereby resulting in MTC becoming more negative at the



end-of-core life (EOL). Figure 2-11 illustrates the effect of boron concentration on MTC.

During a reactor startup to full power, control rods are generally fully withdrawn. When control rods are partially inserted, more neutron absorber material is in the core. Under these conditions, a 1°F increase in moderator temperature will result in more neutrons being absorbed by the control rods than if the control rods were fully withdrawn. Therefore, control rod insertion results in a more negative MTC. Conversely, as control rods are withdrawn from the core, MTC becomes less negative.

### 2.10.2 Moderator Void Coefficient - PWR

Voiding of the moderator in a PWR occurs only at high power levels and usually does not exceed 0.5%. For this reason, the effects of the void coefficient are negligible when compared with the other reactivity coefficients.

### 2.10.3 Fuel Temperature (Doppler) Coefficient - PWR

The fuel temperature coefficient for a PWR is primarily affected by:

- Fuel temperature,
- Moderator temperature, and
- Core age.

A discussion of how each of the above parameters affects FTC is provided in section 2.9.3.

Remember: As fuel temperature increases, FTC becomes less negative. As core age or moderator temperature increases, FTC becomes more negative. The combined effects result in a more negative FTC at end of core life.

### 2.10.4 Power Coefficient - PWR

At the beginning of core life in a PWR, FTC is the largest contributor to the negative power coefficient, so power coefficient largely follows FTC

changes. As a PWR core ages, the absolute value of MTC increases significantly (becomes much more negative) so that at end of core life, the contributions of FTC and MTC are nearly equal. Therefore, the power coefficient becomes significantly more negative as the core ages, and is nearly doubled by the end of core life.

## 2.11 Control Rod Worth

Control rod worth is the amount of negative reactivity that a control rod or group of control rods can insert into the core. The worth of a control rod is approximately equal to the fraction of core neutrons that it can absorb and is directly proportional to the square of the thermal neutron flux in the vicinity of the rod (or group of rods) and inversely proportional to the square of the core average thermal neutron flux.

$$\text{Rod Worth} \propto \frac{n \text{ flux}_{\text{Tip}}^2}{n \text{ flux}_{\text{Average}}^2}$$

Control rod worth is affected by a variety of factors. Any change in the reactor core that affects the thermal neutron flux will change rod worth. A control rod that is located in an area of the core that exposes it to a high thermal flux will have a greater rod worth.

Changes in moderator temperature will affect control rod worth. As moderator temperature increases, the density of the moderator decreases. For the control rods, the major effect of the density change will be longer thermal neutron diffusion lengths. Therefore, neutrons from deeper within the fuel bundle will be able to travel to the vicinity of a control rod. Hence, the thermal flux at the control rod effectively increases as moderator temperature increases, resulting in an increased control rod worth.

For BWRs a change in the core void fraction will also result in a change in moderator density, thereby changing control rod worth. However, the density change during voiding is much more pro-

nounced. As the core void fraction increases, the density of the moderator decreases significantly. With respect to control rod worth, the major effect is much longer neutron slowing down lengths, meaning that more neutrons will be resonantly absorbed as the neutrons slow down, resulting in a lower thermal neutron flux at the control rod. Therefore, as voids increase in BWRs, the control rod worth decreases.

Fuel temperature also affects control rod worth but is small in magnitude compared to other parameter changes in the core. As fuel temperature increases, the resonance absorption increases, causing a decrease in the thermal flux surrounding the control rod and a decrease in control rod worth.

The effect of core age on control rod worth is quite complex. In BWRs, control rod worth may increase or decrease as the core ages depending on the buildup of fission product poisons, burnable poison depletion, control rod position, fuel depletion, and depletion of the control rod boron. Toward the end of core life, the fuel depletion and the control rod boron depletion are the dominant effects and result in a decreased control rod worth.

In PWRs, as the core ages, soluble boron concentration is reduced. A higher neutron flux exists as less neutrons are absorbed by the boron in the moderator. The neutrons travel farther as less fuel atoms are present and are more likely to be absorbed in a control rod. Therefore, in a PWR, control rod worth increases over core life.

Control rods and groups are sequenced and/or overlapped to make the reactivity addition rate smoother. The differential rod worth is the amount of reactivity added by a 1% insertion of a control rod or group and is illustrated in Figure 2-12. The integral rod worth is the total amount of reactivity added by a control rod or group as it moves from fully withdrawn to fully inserted and is shown in Figure 2-13.

## 2.12 Boron Worth

Boron worth is the change in reactivity associated with a ppm change in the soluble boron concentration of the moderator in a PWR core. The moderator in a PWR typically contains between 10 and 1000 ppm of soluble boron in the form of boric acid. Boron-10 (B-10) has a very high absorption cross section for thermal neutrons that qualifies B-10 as a reactor poison.

Figure 2-14 shows the boron worth versus moderator temperature for BOL and EOL. As moderator temperature increases, boron atoms are spread farther apart, resulting in fewer boron atoms present in the core. Increasing boron concentration by 1 ppm at a higher moderator temperature will add fewer boron atoms to the core. Thus, boron worth becomes less negative as moderator temperature increases.

Boron worth becomes more negative over core life. This is because fuel depletion and the reduction of the boron concentration result in less competition within the core for thermal neutrons. The higher thermal neutron flux makes the boron worth more negative. The increase in the boron worth over core life is not as pronounced at higher moderator temperatures. This is due to the buildup of plutonium, which competes with boron for neutrons.

The boron worth is a ratio of neutrons absorbed in the boron to neutrons absorbed in the fuel:

$$\text{B.W.} = \frac{N_{\text{boron}} \sigma_{\text{boron}}}{N_{\text{fuel}} \sigma_{\text{fuel}}}$$

The reciprocal of this expression would be the inverse boron worth.

$$\frac{1}{\text{B.W.}} = \frac{N_{\text{fuel}} \sigma_{\text{fuel}}}{N_{\text{boron}} \sigma_{\text{boron}}}$$

### 2.13 Fission Product Poisons

In the fission process, the nucleus absorbs a neutron and the resulting nucleus breaks into two or more parts called fission fragments. A detailed investigation of the thermal neutron fission of U-235 has shown that the resultant nucleus splits in many different ways, yielding more than 350 primary fission products (or fission fragments). In Figure 2-15, the percent fission yields of U-235 are plotted against the mass numbers. Note that each mass number represents several isotopes (different elements). During power operation, the isotope Xenon-135 (Xe-135) is formed as a fission product. This isotope has an extremely large capture cross section (2.6 million barns). The isotope is formed in two ways: directly as a fission product (0.3% of the total fission products) and indirectly from the radioactive decay of tellurium-135 (5.9% of the total fission products). The radioactive decay chain of tellurium-135 (Te-135) is as follows:

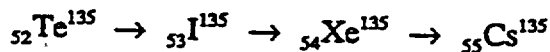

(All decay by  $\beta$  emission)

where

Te-135 half-life = 2 min.,  
 I-135 half-life = 6.7 hr.,  
 Xe-135 half-life = 9.2 hr., and  
 Cs-135 is stable.

Xe-135 captures a thermal neutron, forming Xe-136, which is stable and has a very small capture cross section.

When the reactor is first brought to power, the Xe-135 concentrations (atoms/cm<sup>3</sup>) is slowly built up to an equilibrium. This is due primarily to the relatively long half-lives of I-135 (6.7 hours) and Xe-135 (9.2 hours). Because of the high thermal neutron cross section of Xe-135, as the concentration of the isotope increases, the macroscopic absorption cross section will also increase. Operationally, as xenon builds up, other poisons in the

core (control material such as control rods or boric acid) must be removed to maintain criticality. Provided there is enough control material to remove during this xenon buildup, the xenon concentration reaches equilibrium after approximately 40 hours of power operation.

Equilibrium is a point at which the production of Xe-135 is equal to the removal of Xe-135 by neutron capture plus the loss of Xe-135 through radioactive decay.

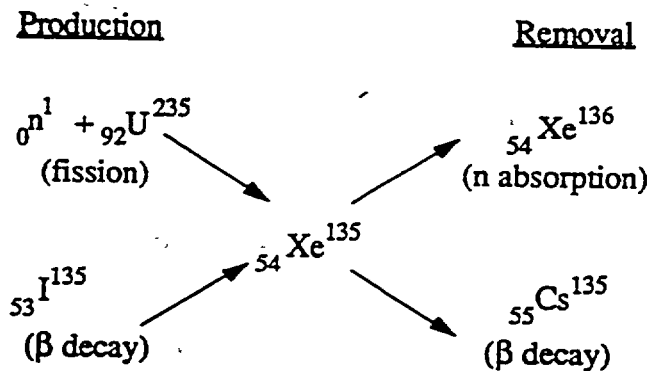

The equilibrium value for the xenon concentration is a function of the reactor neutron flux level (power level). Since Xe-135 absorbs thermal neutrons, its effect on the chain reaction can be described in terms of reactivity. The multiplication factor is lowered primarily by the decrease in the thermal utilization factor. The reactivity effect can be shown to be approximately equal to the ratio of the macroscopic absorption cross section of the xenon to that of the fuel.

A change in power will cause a change in xenon concentration. At the end of the transient (about 2 days) the xenon concentration will reach its new equilibrium, assuming that power is left constant after the change.

Refer to Figure 2-16 at time 50 hours. The reactor has reached an equilibrium xenon concentration for 50% power. Power is then increased to 100%. Initially there is only a small increase in production of xenon because the production as a direct fission product is small (about 0.3%), and

because the iodine concentration does not change very quickly, so the production by decay of iodine remains practically constant. However, removal of xenon is increased significantly because of increased burnout (xenon absorbs neutrons). The decay of xenon to cesium remains almost constant initially. These are only the initial effects, but it can be seen that the removal of xenon has increased more than the production; therefore, xenon concentration decreases. This will continue for a few hours until the iodine concentration has increased enough that xenon production by iodine decay is greater than xenon removal. Eventually, the xenon concentration will reach an equilibrium value corresponding to 100% power. This will happen when production and removal rates are again equal.

Refer to Figure 2-16 at time 150 hours. Power is decreased from 100% to 50%. Xenon production initially is changed very little. Because of the lower neutron population, burnout is reduced and xenon concentration increases. As iodine concentration decreases, production of xenon decreases until removal is greater than production. Then xenon concentration will decrease until equilibrium for 50% power is reached.

A shutdown, shown in Figure 2-17, is similar to a power decrease but causes a greater change in xenon concentration. Production of xenon directly from fission and removal by burnout almost cease. Radioactive decay of iodine (to produce xenon) and radioactive decay of xenon (to remove it) is left. Xenon concentration will increase initially, just as in the power decrease case. However, due to the difference in decay times, the increase will continue longer and reach much higher levels before a decrease occurs. The peak occurs about 8 or 9 hours after shutdown. The reactor will be considered xenon free in about 72 hours.

In some cases, Xe-135 presents moderately sensitive reactor operating conditions. Consider a reactor that has operated at power long enough to establish a high xenon concentration.

Assume that the reactor trips and that a rapid recovery to full power is achieved simultaneously with the point in time at which "peak" xenon occurs (time 9.5 hours in Figure 2-17).

In returning the reactor to power, the negative reactivity associated with the xenon is overcome by withdrawing the control rods to a higher position than normally required. With the high flux of full power operation acting to "burnout" the accumulated Xe-135 and the decay of Xe-135 resulting from the previous shutdown, the concentration quickly falls off, and the result is a relatively fast, positive reactivity insertion. It should be pointed out that properly designed power reactors will overcome this xenon burnout adequately with the proper control rod system operation.

Another important fission product poison encountered in reactor operation is samarium-149 (Sm-149). This stable isotope has a capture cross section of about  $5 \times 10^4$  barns. It enters this system as the end product of the following decay chain:

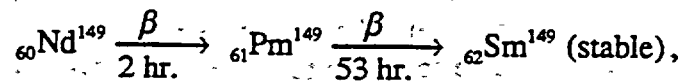

where

Nd = neodymium and  
Pm = promethium.

These products occur in about 1.1% of U-235 fissions. Because Sm-149 is stable, its equilibrium value in any reactor produces about 1%  $\Delta K/K$  reactivity, independent of the neutron flux. The rate at which Sm-149 approaches this equilibrium is determined by the Pm-149 half-life (53 hours). As shown on Figure 2-18, equilibrium is reached in about 60 days. A power increase reduces samarium concentration initially due to increased burnout, but the concentration returns to the same equilibrium value. Upon reactor shutdown, the Sm-149 builds up to an asymptotic value dependent on the power history of the reactor. The promethium concentration is power level dependent. Because the only means of Sm-149

removal (burnout) is essentially removed on a reactor shutdown, the shutdown concentration varies (see Figure 2-19).

### 2.14 Burnable Poisons

A burnable poison is a neutron absorber that is loaded into the reactor at discrete locations during refueling. They are positioned within the core to maintain an optimum neutron flux distribution and to compensate for excess fuel while maintaining a negative MTC (PWR only).

Burnable poisons are loaded into the core so that more fuel can be loaded into the core at the beginning of life. By loading this excess reactivity at the beginning of core life, reactor power operation at 100% power can be extended, thereby reducing the frequency of refueling outages. Boron or gadolinium are often used as the poison material. Upon neutron absorption, the poison loses some of its reactivity. At end of core life, nearly all of the installed poisons will be depleted.

In a BWR, control rods can also be inserted to allow more fuel to be loaded. However, by loading burnable poisons into the core more fuel can be loaded without increasing the number of control rods that must be designed into the reactor core. In addition, the gadolinium is loaded in varying axial concentrations to flatten the core thermal neutron flux to improve the fuel exposure shape in the core. This flux flattening results in a more even burnup of fuel over core life and better margins to fuel limitations.

### 2.15 Subcritical Multiplication

There is some spontaneous fission within the core material. For example, U-235, with a spontaneous fission half-life of  $1.8 \times 10^{17}$  yrs., delivers  $8 \times 10^{-4}$  n/sec/gm; U-238, with a spontaneous fission half-life of  $8 \times 10^{15}$  yrs., delivers  $1.6 \times 10^{-2}$  n/sec/gm.

The spontaneous fission process, however, is insufficient to appreciably register on the neutron

sensors of power reactors. Previous experience with power reactors indicates a background neutron count of 1/6 cps, with the plant cold and a  $K_{eff}$  of 0.97. The specification for startup requires a neutron count rate of at least 1/2 cps with the plant cold at a  $K_{eff}$  of 0.97. To achieve this count rate, a startup neutron source is installed.

When the reactor is operating in the source range, it is necessary to consider the effect of the addition of source neutrons as well as fission neutrons to understand what is happening to the total neutron density. The reason for this is that the factors included in the calculation of  $K_{eff}$  do not account for source neutrons, which are insignificant when compared with the number of fission neutrons at higher power levels.

Subcritical multiplication is the multiplication of source neutrons that occurs as a result of fissions in the fuel of a subcritical reactor. Table 2-3 is discussed below for various reactor shutdown cases.

1. To understand subcritical multiplication first consider a condition in which there is zero subcritical multiplication. If 100 neutrons are inserted into a core with  $K_{eff} = 0$  (no fuel), the neutron level will rapidly decrease to zero as they are absorbed in the water or leak out.
2. As fuel is added to the core,  $K_{eff}$  will increase. In our second case assume  $K_{eff}$  is now 0.5. The neutron population will again decrease to zero, but the fuel will cause the rate of decrease to lengthen.

In this case, as in the first case, we started with 100 neutrons which were followed to absorption. Now consider a source that supplies 100 neutrons to the reactor at the beginning of each generation.

1. Again we will assume  $K_{eff} = 0$ . Because no multiplication is involved, the neutron population will be steady at 100 neutrons as a direct result of the source.

2. The last case (Table 2-4) represents the conditions that actually exist in a reactor. Assume  $K_{\text{eff}} = 0.5$ . Also for convenience assume that a continuous source of 100 neutrons are introduced at the beginning of each generation. This shows the effect of subcritical multiplication.

An equation that yields the equilibrium neutron population is:

$$N_T = S \times \frac{1}{1 - K_{\text{eff}}} = \frac{S}{1 - K_{\text{eff}}} \text{ (only for } K_{\text{eff}} < 1),$$

where

$N_T$  = equilibrium neutron population and  
 $S$  = source.

For this case the results are:

$$N_T = 100 \times \frac{1}{1 - 0.5} = 200 \text{ (after multiplication).}$$

Remember that subcritical multiplication is the equilibrium neutron population divided by the source population. For more practical application consider subcritical multiplication to equal the equilibrium neutron population divided by an initial neutron population following a change in  $K_{\text{eff}}$ . This concept is utilized by operators to compare neutron population between different subcritical conditions.

The term  $M$  may be used to represent subcritical multiplication:

$$M = \frac{CR_2}{CR_1} = \frac{1 - K_{\text{eff}1}}{1 - K_{\text{eff}2}}$$

where

$CR_1$  = the initial count rate and  
 $CR_2$  = the count rate following a change in  $K_{\text{eff}}$ .

The time required for power to level off at some new value following a subcritical reactivity change is a function of the average generation time ( $\bar{\ell}$ ) and the number of generations required to level off.

$$t(\text{sec}) = N(\text{generations}) \times \bar{\ell} \text{ (sec/generation)}$$

Figure 2-20 shows that when  $K_{\text{eff}} = 0.5$ ,  $N = 7$  whereas when  $K_{\text{eff}} = 0.9$ ,  $N = 44$ .

The  $1/M$  plot is a tool used in predicting the point at which a subcritical reactor will reach criticality as reactivity is added in positive increments. The  $1/M$  plot is used because a plot of  $M$  would approach infinity as  $K_{\text{eff}}$  approaches 1.

## 2.16 Neutron Production

The multiplication factor  $K_{\text{eff}}$  was previously discussed in terms of its individual components. This section shows how the term is applied to the actual operating core. Consider a reactor in which  $K_{\text{eff}}$  is exactly 1.0.

With equilibrium established, the neutrons entering into the self-sustaining reaction are a mixture of prompt and delayed neutrons. Prompt neutrons appear at approximately  $10^{-14}$  seconds after a fissioning event, whereas delayed neutrons are not a direct result of a fission but rather a product of the decay of one of the fission products. These neutrons are produced at some time after the original fission and are dependent on the half life of the fission product. The fission products are referred to as delayed neutron precursors. Figure 2-21 shows the decay scheme for the delayed neutron precursor Bromine-87.

The fraction of total fission neutrons that are delayed neutrons is known as the  $\beta$  fraction. As shown in Table 2-5, each fuel has a characteristic  $\beta$  due to its yield of delayed neutron producers. The total  $\beta$  fraction for the fuel is a weighted average of the  $\beta$ 's of the isotopes that combine to make up the fuel.

At BOL 93% of the power generated in the core is generated by the U-235; 7% is generated by the U-238. In a reactor at BOL the total  $\beta$  fraction would be:

$$\begin{aligned}\beta &= (.93)(\beta_{U-235}) + (.07)(\beta_{U-238}) \\ &= (.93)(.0065) + (.07)(.0148) \\ &= .006045 + .001036 \\ &= .0070 \text{ at BOL}\end{aligned}$$

At EOL assume 40% of our power is now generated by Pu-239, 7% by U-238 and 53% by U-235. The total  $\beta$  fraction at EOL would be:

$$\begin{aligned}\beta &= (.53)(\beta_{U-235}) + (.07)(\beta_{U-238}) + (.40)(\beta_{Pu-239}) \\ &= (.53)(.0065) + (.07)(.0148) + (.40)(.0021) \\ &= .003445 + .001036 + .00084 \\ &= .0053 \text{ at EOL.}\end{aligned}$$

Delayed neutrons are born at a lower energy level than the prompt neutrons (.5 Mev vs. 1-2 Mev). This will cause the delayed neutrons to have a different value in the multiplication factor due to this lower energy effect on the fast fission factor and on fast leakage.

Since the delayed neutrons are born at energy levels below the threshold for fast fission (U-238 requires neutron energy  $\geq 1$  Mev to fast fission),  $\beta_{\text{eff}}$  will be less than  $\beta$ .

Being borne at this lower energy level also means that there will be less fast leakage of delayed neutrons. This results in  $\beta_{\text{eff}}$  being greater than  $\beta$ . The combined result of these two effects will be that  $\beta_{\text{eff}}$  is less than  $\beta$  due to the high value of fast fissions in the core.

### 2.16.1 Effect of Delayed Neutrons on Reactor Control

Even though the fraction of delayed neutrons is very low, 0.7% of all the fission neutrons have a large effect on the operation of the reactor. To illustrate this, consider a reactivity change using both prompt and delayed neutrons.

The following equation can be used to calculate a change in neutron population over a given period of time:

$$N = N_0 e^{(K_{\text{eff}}-1)t/\bar{\ell}}$$

where:

$N$  = Number of neutrons after time  $t$ ,  
 $N_0$  = Number of neutrons at  $t = 0$ ,  
 $t$  = time period (seconds), and  
 $\bar{\ell}$  = generation time .

The generation time (mean life time) is the time between the absorption of a neutron in the fuel and the absorption of the resulting fission neutron in some material.

For a prompt neutron, the generation time ( $\bar{\ell}_p$ ) is:

$$\begin{aligned}\bar{\ell}_p &= 10^{-14} \text{ sec (absorption to fission/birth)} \\ &+ 10^{-4} \text{ sec (birth to absorption)} = 10^{-4} \text{ sec} .\end{aligned}$$

The average mean lifetime for delayed neutron precursors is about 10 seconds. This results in a delayed neutron generation time ( $\bar{\ell}_d$ ) of:

$$\begin{aligned}\bar{\ell}_d &= 10^{-14} \text{ sec (absorption to fission)} \\ &+ 10 \text{ sec (fission to birth)} \\ &+ 10^{-4} \text{ sec (birth to absorption)} = 10 \text{ sec} .\end{aligned}$$

The life cycle time or generation time is a weighed average of the lifetimes for prompt and delayed neutrons. Since the delayed neutron fraction is  $\beta$ , then the prompt neutron fraction is  $(1-\beta)$ . These are used as the weighting factors.

To compute a weighted generation time, compute a neutron population change using both prompt and delayed neutrons.

$$\bar{\ell} = (1-\beta)\bar{\ell}_p + (\beta)\bar{\ell}_d$$

Assume BOL conditions  $\beta = .0070$

$$\bar{\ell} = (1-.007)(10^{-4}) + (.007)(10)$$

$$\bar{l} = .0000993 + .07$$

$$\bar{l} = .0700993 \text{ seconds} = .07 \text{ seconds}$$

Figure 2-22 shows that the reactor would be uncontrollable with a life cycle time due to prompt neutrons alone, but with the addition of delayed neutrons the reactor is controllable.

## 2.17 Reactor Startup - BWR

### 2.17.1 The Source Range

The source range covers approximately  $10^{-8}\%$  to  $10^{-4}\%$  reactor power. Positive reactivity is added by control rod withdrawal to establish the reactor critical. Further control rod withdrawal will then establish a rate of power increase into the intermediate range to commence a plant heatup.

The operator verifies, before withdrawing any control rods, that there is a minimum count rate indicated on the source range monitor. As the operator withdraws control rods (nonfissioning neutron absorbers) from the core, he is increasing the thermal utilization factor ( $f$ ), and causing  $K_{\text{eff}}$  to increase. The source range monitor indications will show a slow increase in count rate. The neutrons being counted are coming from incore neutron sources and subcritical multiplication.

Control rods are always withdrawn in a programmed sequence. The sequencing of rod withdrawal minimizes individual rod worths, extends core life, and minimizes the effects of transients.

Control rods are further withdrawn to achieve criticality. The reactor operator announces that the reactor is critical when he observes a continuously increasing power level and a sustained positive period *without* control rod motion. The reactor is actually slightly supercritical at this point. However, it would be difficult and time-consuming to determine when the reactor is first exactly critical in the source range. The operator then adjusts the period to about 100 seconds by control rod withdrawal and allows power to increase into the intermediate range.

### 2.17.2 The Intermediate Range and Reactor Heatup

The intermediate range of reactor operation occurs from reactor power levels of about  $10^{-5}\%$  to about 10%. After criticality is attained, reactor power will continue to steadily increase until some effect turns reactor power. As power increases, the source range monitors will approach the high end of their indicating scale and will be withdrawn from the core when the intermediate range monitors are on scale.

Reactor power will turn when the point of adding heat (POAH) is reached. The POAH occurs when the heat produced by the fission process in the core exceeds the ambient heat losses from the core. At approximately 1% reactor power, the moderator will begin to heat up. As the temperature of the moderator increases, the MTC adds negative reactivity to the core, lengthening the reactor period and slowing the power increase rate. In addition, the fuel temperature is increasing so that the FTC is also adding negative reactivity. To continue the startup, the operator must continue to withdraw control rods to overcome this negative reactivity insertion. As the reactor is heated up, the operator will control the heatup rate (HUR) by rod withdrawal. The operator will maintain a HUR of less than 100°F per hour to prevent inducing excessive thermal stresses in the reactor pressure vessel. When moderator temperature reaches 212°F, reactor pressure will begin increasing. The operator will continue rod withdrawal to heat up and pressurize the reactor to about 540°F and 920 psig, respectively.

### 2.17.3 The Power Range

The power range includes reactor operations from reactor power levels of about 1% to 100%. As reactor power increases to about 3%, the average power range monitoring nuclear instrumentation comes on scale, and at about 10% power, the intermediate range nuclear instruments are withdrawn from the core.



Reactor pressure is maintained at approximately 920 psig by opening the main turbine bypass valves, which dump steam directly to the main condenser. The operator continues to withdraw rods to increase reactor power and steam production until enough steam is being produced to place the main turbine generator in service.

As the operator increases reactor power, the moderator temperature does not change significantly since the reactor is maintained at saturated conditions for 920 psig. Because the moderator temperature is no longer significantly changing, the MTC no longer provides any significant reactivity changes. However, as reactor power increases above 1%, steam bubbles or voids begin production in the core. As the core void fraction increases, the void coefficient ( $\alpha_v$ ) adds negative reactivity to the core, requiring the operator to continue to withdraw rods to increase power.

The fuel temperature is continuing to increase as reactor power is increased. As a result, the FTC is also adding negative reactivity to the core, requiring additional control rod withdrawal.

During reactor power operation, another method of reactor power control is utilized on BWRs. The reactor core flow is increased to attain 100% power. Increasing core flow increases the amount of heat that can be carried away from the fuel by the moderator. As core flow is increased, the void fraction in the core is reduced. When the void fraction in the core is decreased, fewer neutrons are resonantly absorbed while slowing down and fewer neutrons will leak out of the core; therefore, positive reactivity is added to the core. Hence, an increase in core flow results in a reactor power increase.

The operator continues to increase reactor power with a combination of control rod withdrawal and core flow increases to ensure reactor operation within core limitations. The operator will continue to increase reactor power to increase the output of the main turbine generator. In a BWR, the main turbine is "slaved to the reactor."

As reactor power is increased, steam production is increased. After the main turbine generator is placed in service, the main turbine electro-hydraulic control system opens the turbine control valves (and closes the turbine bypass valves) as necessary to maintain a constant 920 psig at the inlet to the turbine control valves. As steam production and steam flow increase with increasing reactor power, the control valves must be opened more and more to maintain the valve inlet pressure at 920 psig. As more steam passes through the main turbine, more work is done and the main generator output increases. Therefore, the turbine load is controlled by the reactor power.

The reactor steam pressure also increases as reactor power increases to offset the increasing friction losses caused by more steam flow in the main steam lines between the reactor and the turbine. At full power the reactor steam pressure in most BWR plants is stable at 985 to 1000 psig with turbine control valve inlet pressure maintained at 920 psig.

## 2.18 Reactor Startup - PWR

Prior to a reactor startup in a PWR, all shutdown rods are withdrawn to ensure adequate shutdown capability. RCS boron concentration is adjusted to a value that has been calculated to produce criticality at a desired rod position during the rod withdrawal. The reactivity added by the boron change is determined using the boron worth.

If the RCS is below normal operating temperature, decay heat or reactor coolant pump operation will be used to raise reactor coolant temperature. This will be a negative reactivity addition as the MTC is negative. Source range count rate is logged on a 1/M plot. The source range count rate is established by the neutron source strength and  $K_{eff}$ .

### 2.18.1 Source and Intermediate Ranges

As control rods are withdrawn, positive reactivity is added causing neutron level to increase.

After each withdrawal, the startup is paused to allow source range count rate to reach an equilibrium value. These values are logged on the 1/M plot and estimated critical rod positions are determined. Once criticality is attained, neutron level continues to increase and the reactor is placed on a positive startup rate. As reactor power increases through the source range and intermediate range, reactivity in the core remains essentially constant. Fuel temperature and moderator temperature remain unchanged until reactor power reaches the POAH.

### 2.18.2 Power Range

When reactor power enters the power range, the rate of fissions has increased sufficiently to produce heat in the fuel that is carried away by the moderator. As fuel and moderator temperatures increase, the FTC and MTC add negative reactivity, thereby reducing the startup rate. Negative reactivity feedback will continue to reduce the startup rate until reactor power stabilizes. At this point, net reactivity is zero.

As reactor power enters the power range, surplus heat is removed from the moderator by the steam generators. The steam generators are maintained in a saturated condition at approximately 1100 psig by automatic steam dumping. If reactor power increases, more steam is dumped to maintain steam generator pressure and moderator temperature nearly constant. As control rods are further withdrawn, reactor power will increase and stabilize as FTC and MTC continue to provide negative reactivity feedback.

When reactor power reaches approximately 10%, the main turbine-generator is placed in service. The extra steam needed for the main turbine-generator causes a reduction in automatic steam dumping. Reactor power is now being controlled by the electrical load carried by the main turbine-generator. The turbine electro-hydraulic control system gradually opens the turbine control valves to increase the electrical output of the generator. As the turbine control valves are opened, more

steam is drawn from the steam generators, which decreases the coolant temperature. A negative MTC results in a positive reactivity addition, which increases reactor power. As fuel temperature increases with the increase in reactor power, negative reactivity is added by the FTC until net reactivity is zero and reactor power stabilizes at a higher value to match the increased electrical load. Unlike a BWR plant, in a PWR plant the reactor is said to be "slaved to the turbine" because reactor power changes follow the main turbine generator electrical load/steam flow changes.

Additional electrical load increases will continue to lower the coolant temperature until the resulting steam generator temperature is too low for efficient electrical power generation. To prevent the coolant temperature decrease when electrical load is increased, positive reactivity must be added by other means. The two methods commonly used to add positive reactivity during an electrical load increase are control rod withdrawal and boron dilution.

### 2.19 Decay Heat Production After Shutdown

When the reactor is shut down, the fuel continues to generate heat even though the fission rate decreases to the level sustained by subcritical multiplication. Highly radioactive fission products continue to decay by emitting alpha, beta, gamma, and other forms of radiation. These emissions interact with the surrounding fuel and reactor materials, thereby transferring significant energy in the form of heat. Reactor cooling must be maintained after shutdown to remove this decay heat and prevent fuel melting.

Decay heat is greatest immediately after a reactor shutdown. As the shorter-lived radioactive fission products complete their decay process, decay heat production tapers off. This accounts for an exponential decrease in decay heat after shutdown. Table 2-6 provides approximate levels of decay heat generation at various time intervals after a reactor shutdown from full rated power.

Chapter 2 Definitions

- $K_{eff}$   
(EFFECTIVE MULTIPLICATION FACTOR)
- The ratio of the number of thermal neutrons available at the end of a neutron cycle to the number of thermal neutrons initiating the cycle.
- REACTIVITY
- The fractional change in neutron population per generation. It is a measure of a reactor's departure from criticality.
- STARTUP RATE
- The number of decades (powers of 10) reactor power changes in one minute.
- REACTOR PERIOD
- The number of seconds required to change reactor power by a factor of e, the base of the natural logarithm (2.718...).
- CONTROL ROD WORTH
- The amount of negative reactivity that a control rod or a group of control rods can insert into the core.
- DIFFERENTIAL CONTROL ROD WORTH
- The amount of reactivity added by a unit (1 inch or 1%) insertion of a control rod or control rod group into the core.
- INTEGRATED CONTROL ROD WORTH
- The total amount of reactivity added by a control rod or control rod group as it moves from fully withdrawn to fully inserted into the core.
- BORON WORTH
- The change in reactivity associated with a one ppm change in the soluble boron concentration in the reactor coolant in a PWR core.
- CRITICAL
- $K_{eff}$  equals 1.0
- SUBCRITICAL
- $K_{eff}$  is less than 1.0
- SUPERCritical
- $K_{eff}$  is greater than 1.0

Table 2-1. Neutrons From Fission

REACTOR FUEL	<u>NEUTRONS</u> <u>FISSION</u>
U-235	2.43
Pu-239	2.90
U-233	2.50
U-238	2.30

Table 2-2. Microscopic Cross Section ( $\sigma$ ) Values

NUCLIDE	REACTIONS	$E_n$	$\sigma$ (barns)
${}_{92}\text{U}^{235}$	Absorption	.025 ev	690
	Scattering	.025 ev	10
	Fission	.025 ev	580
	Capture	.025 ev	110
	Alpha emission	.025 ev	0
${}_{5}\text{B}^{10}$	Absorption	.025 ev	4010
	Capture	.025 ev	0
	Alpha emission	.025 ev	4010
	Scattering	.025 ev	5
	Absorption	1 ev	665
	Absorption	10 ev	200
	Absorption	100 ev	66.5
	Absorption	1000 ev	20.0
	Absorption	10,000 ev	6.65

Table 2-3. Ineffective Subcritical Multiplication

$$K_{\text{eff}} = 0$$

(No Source)

GENERATION	1	2	3	4	5	6	7	8	9	10
NEUTRONS	100	0	0	0	0	0	0	0	0	0

$$K_{\text{eff}} = 0.5$$

(No Source)

GENERATION	1	2	3	4	5	6	7	8	9	10
NEUTRONS	100	50	25	13	6	3				0

$$K_{\text{eff}} = 0$$

(Continuous Source - 100 neutrons/generation)

GENERATION	1	2	3	4	5	6	7	8	9	10
NEUTRONS	100	100	100	100	100	100	100	100	100	100

Table 2-4. Subcritical Multiplication

$$K_{eff} = 0.5$$

(Continuous Source - 100 neutrons/generation)

Generation	1	2	3	4	5	6	7	8	9	10
Neutrons	100	150	175	188	194	197	198	200	200	200

GENERATION	1	2	3	4	5	6	7	8	9	10
	100	50	25	13	6	3	2	1	0	0
		100	50	25	13	6	3	2	1	0
			100	50	25	13	6	3	2	1
				100	50	25	13	6	3	2
					100	50	25	13	6	3
						100	50	25	13	6
							100	50	25	13
								100	50	25
									100	50
										100
TOTAL	100	150	175	188	194	197	199	200	200	200

Table 2-5. Delayed Neutron Fraction for Various Fuels

GROUP	HALF LIFE	DECAY CONSTANT	YIELD	FRACTION	
	$T_{1/2}(\text{SEC})$	$\lambda (\text{SEC}^{-1})$	(NEUTRONS/FISSION)	$\beta$	
U <sup>235</sup>	1	55.72	0.0124	0.00052	0.000215
	2	22.72	0.0305	0.00346	0.001424
	3	6.22	0.111	0.00310	0.001274
	4	2.30	0.301	0.00624	0.002568
	5	0.610	1.14	0.00182	0.000748
	6	0.230	3.01	0.00066	0.000273

TOTAL YIELD: 0.0158

TOTAL DELAYED NEUTRONS FRACTION ( $\beta$ ): 0.0065

GROUP	HALF LIFE	DECAY CONSTANT	YIELD	FRACTION	
	$T_{1/2}(\text{SEC})$	$\lambda (\text{SEC}^{-1})$	(NEUTRONS/FISSION)	$\beta$	
U <sup>238</sup>	1	52.38	0.0132	0.00054	0.000192
	2	21.58	0.0321	0.00564	0.002028
	3	5.00	0.139	0.00667	0.002398
	4	1.93	0.358	0.01599	0.005742
	5	0.490	1.41	0.00927	0.003330
	6	0.172	4.02	0.00309	0.001110

TOTAL YIELD: 0.0412

TOTAL DELAYED NEUTRONS FRACTION ( $\beta$ ): 0.0148

GROUP	HALF LIFE	DECAY CONSTANT	YIELD	FRACTION	
	$T_{1/2}(\text{SEC})$	$\lambda (\text{SEC}^{-1})$	(NEUTRONS/FISSION)	$\beta$	
Pu <sup>239</sup>	1	54.28	0.0128	0.00021	0.000073
	2	23.04	0.0301	0.00182	0.000626
	3	5.60	0.124	0.00129	0.000443
	4	2.13	0.325	0.00199	0.000685
	5	0.618	1.12	0.00052	0.000181
	6	0.257	2.69	0.00027	0.000092

TOTAL YIELD: 0.0061

TOTAL DELAYED NEUTRON FRACTION ( $\beta$ ): 0.0021



**Table 2-6. Delayed Heat Production Following Reactor Shutdown  
From Full Power**

<u>TIME SINCE SHUTDOWN</u>	<u>PERCENT OF FULL POWER</u>
1 second	6.0
1 minute	4.5
1 hour	1.6
1 day	0.7
1 week	0.5
1 month	0.1

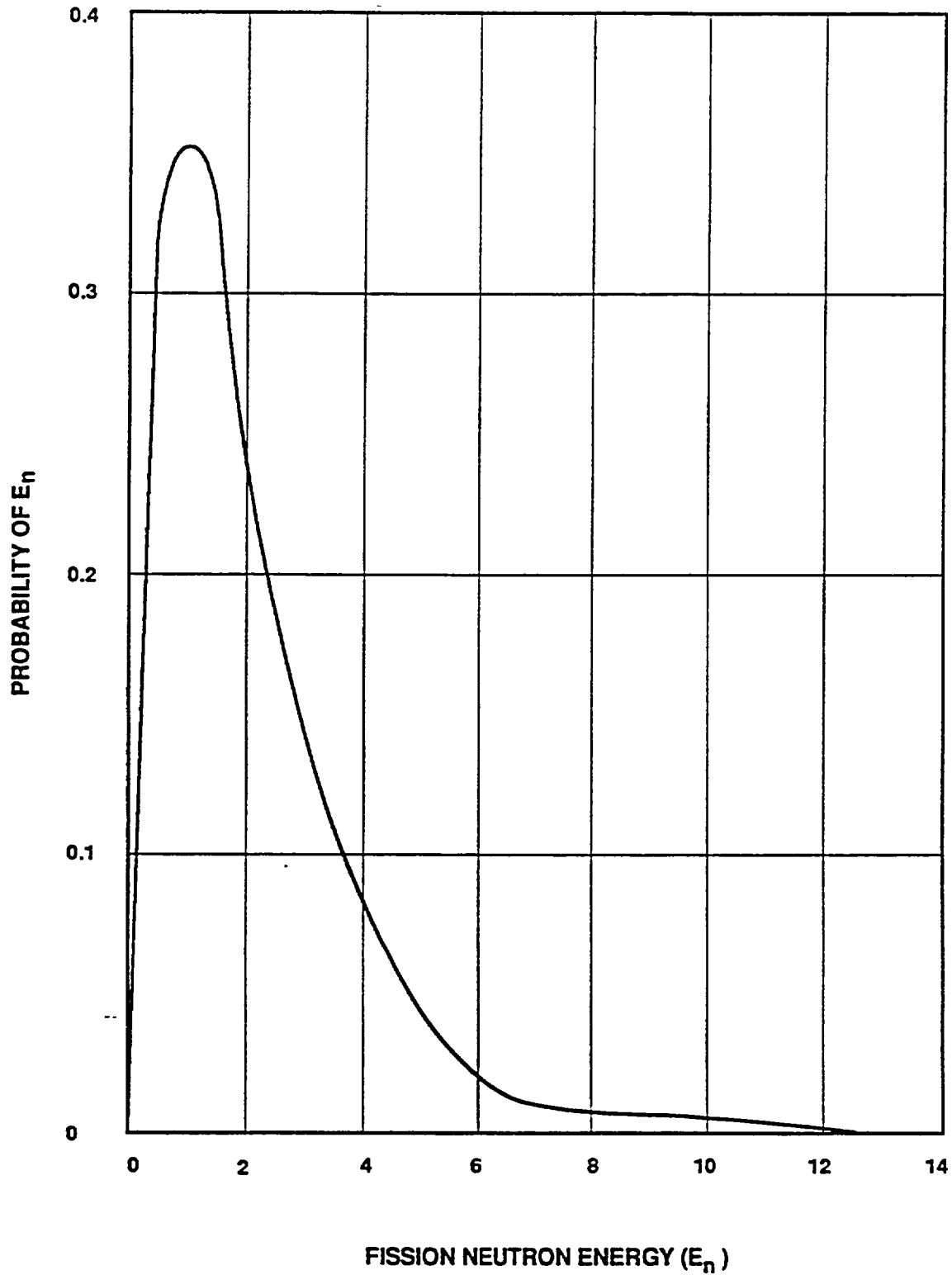

Figure 2 - 1. Fission Neutron Energy

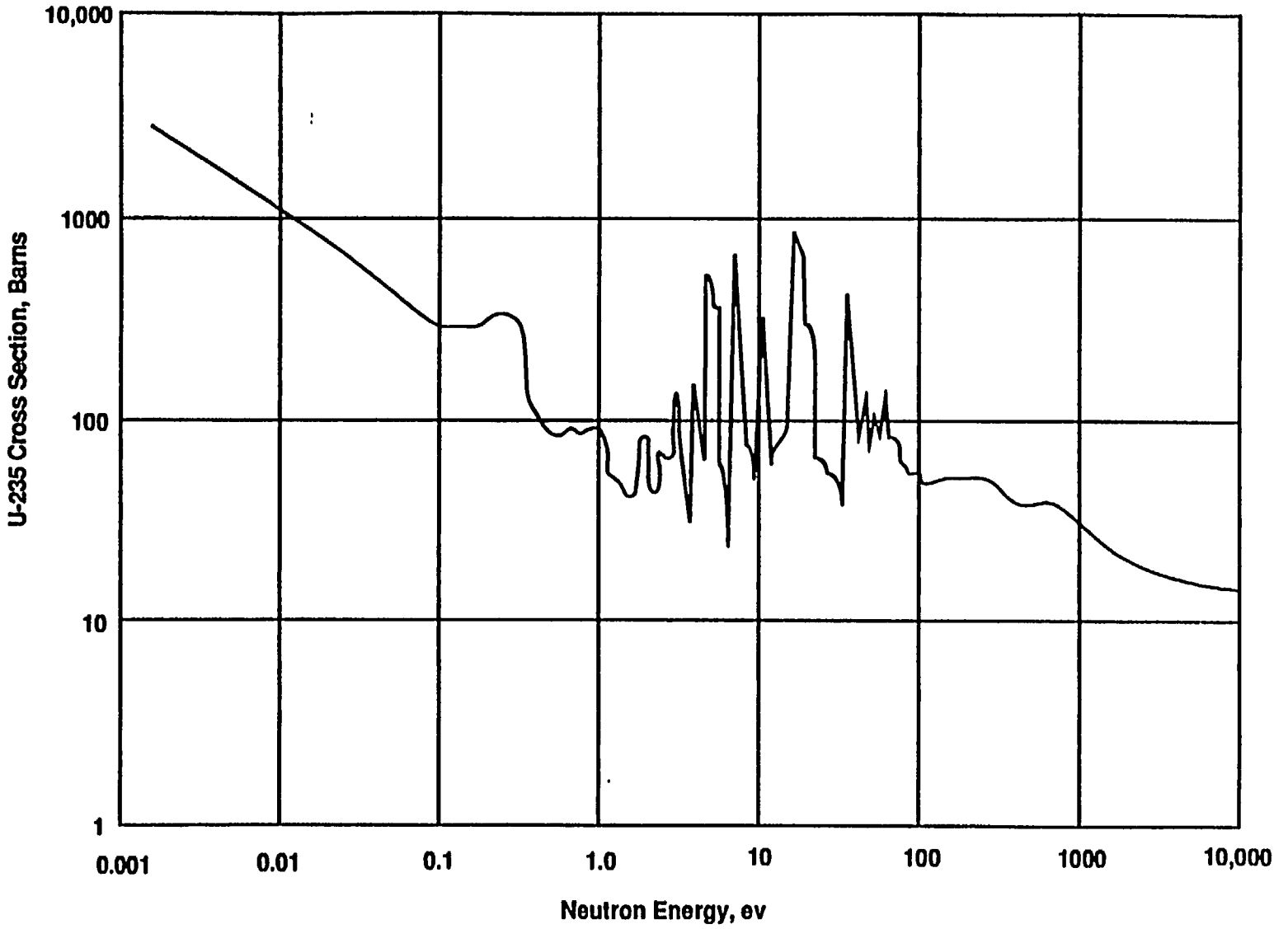
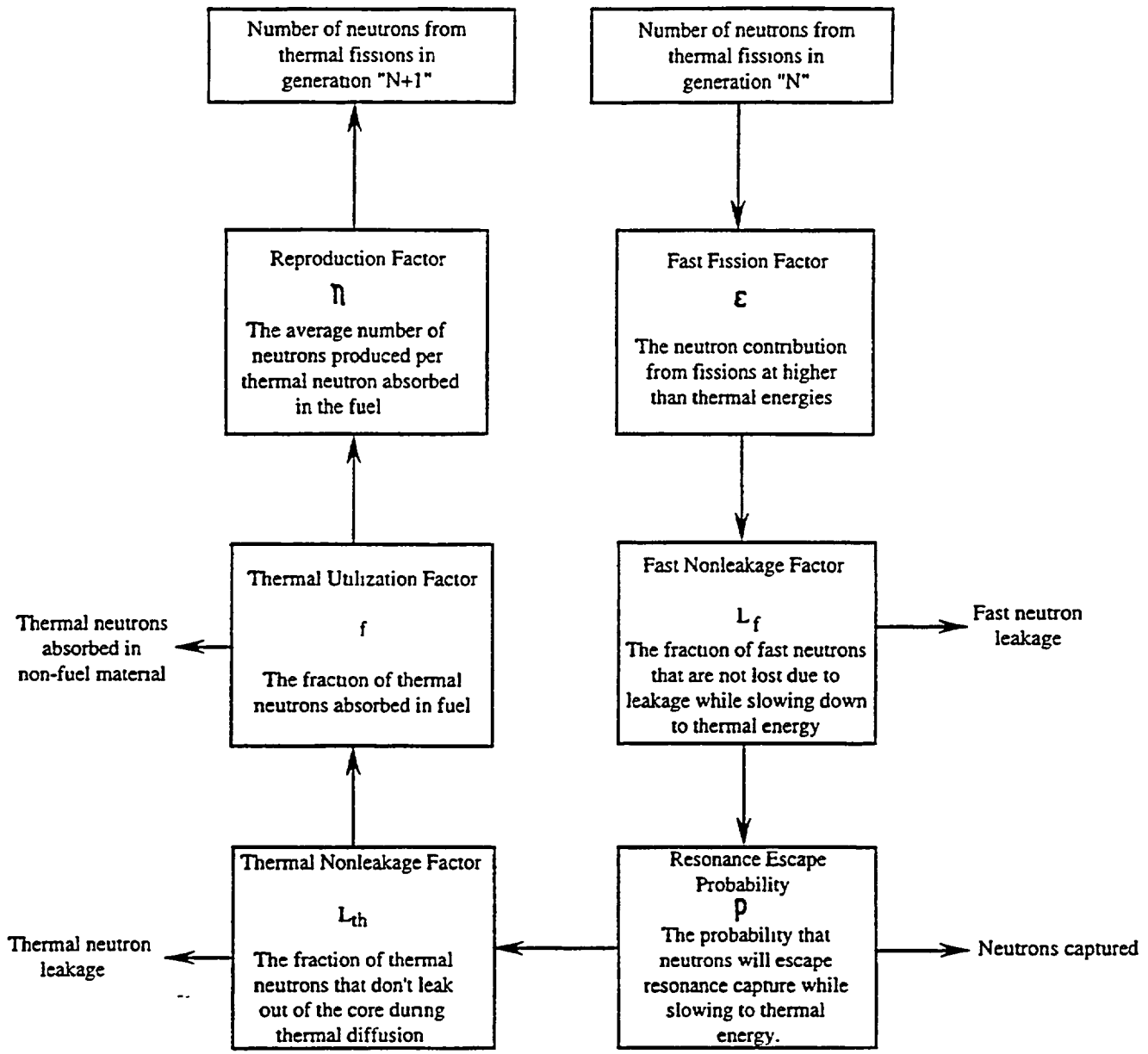

Figure 2 - 2. U-235 Absorption Cross-Section Vs. Energy



$$K_{eff} = \epsilon L_f \rho L_{th} f \eta = \frac{\text{Number of neutrons in "N+1" generation}}{\text{Number of neutrons in "N" generation}}$$

When critical  $K_{eff} = 1$

Figure 2-3. Neutron Cycle in a Thermal Reactor

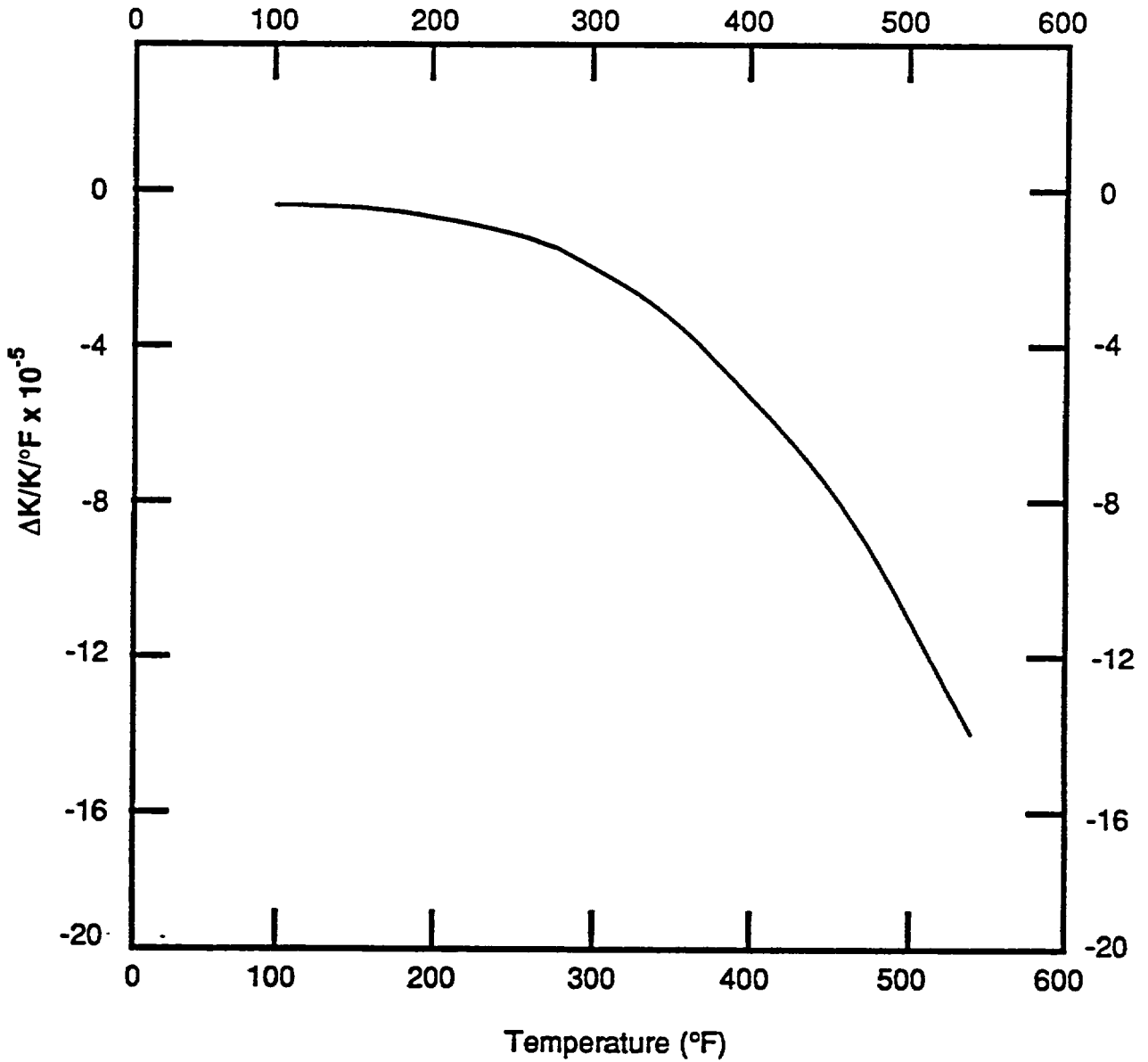

Figure 2-4. Moderator Temperature Coefficient

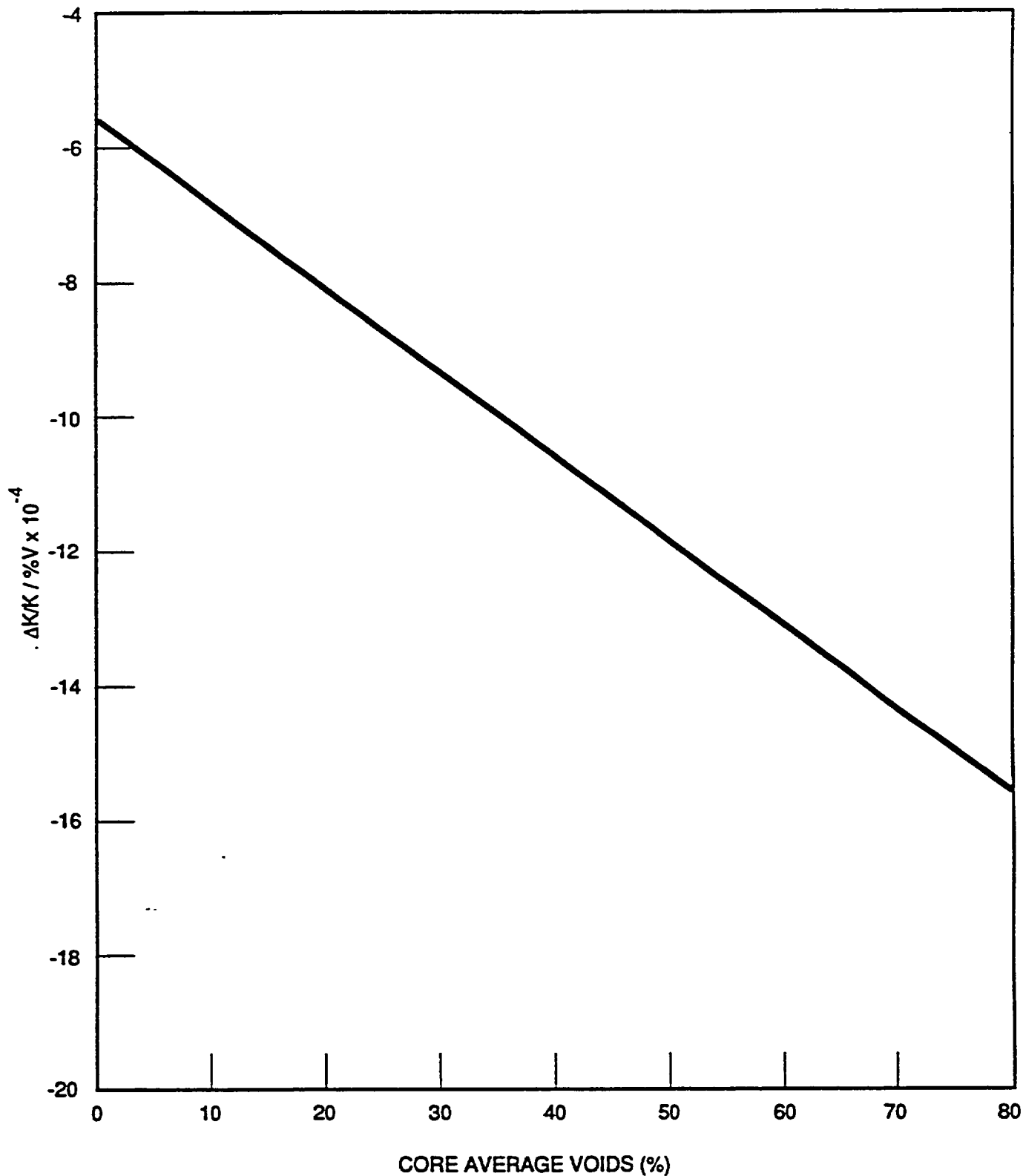

Figure 2-5. Void Coefficient

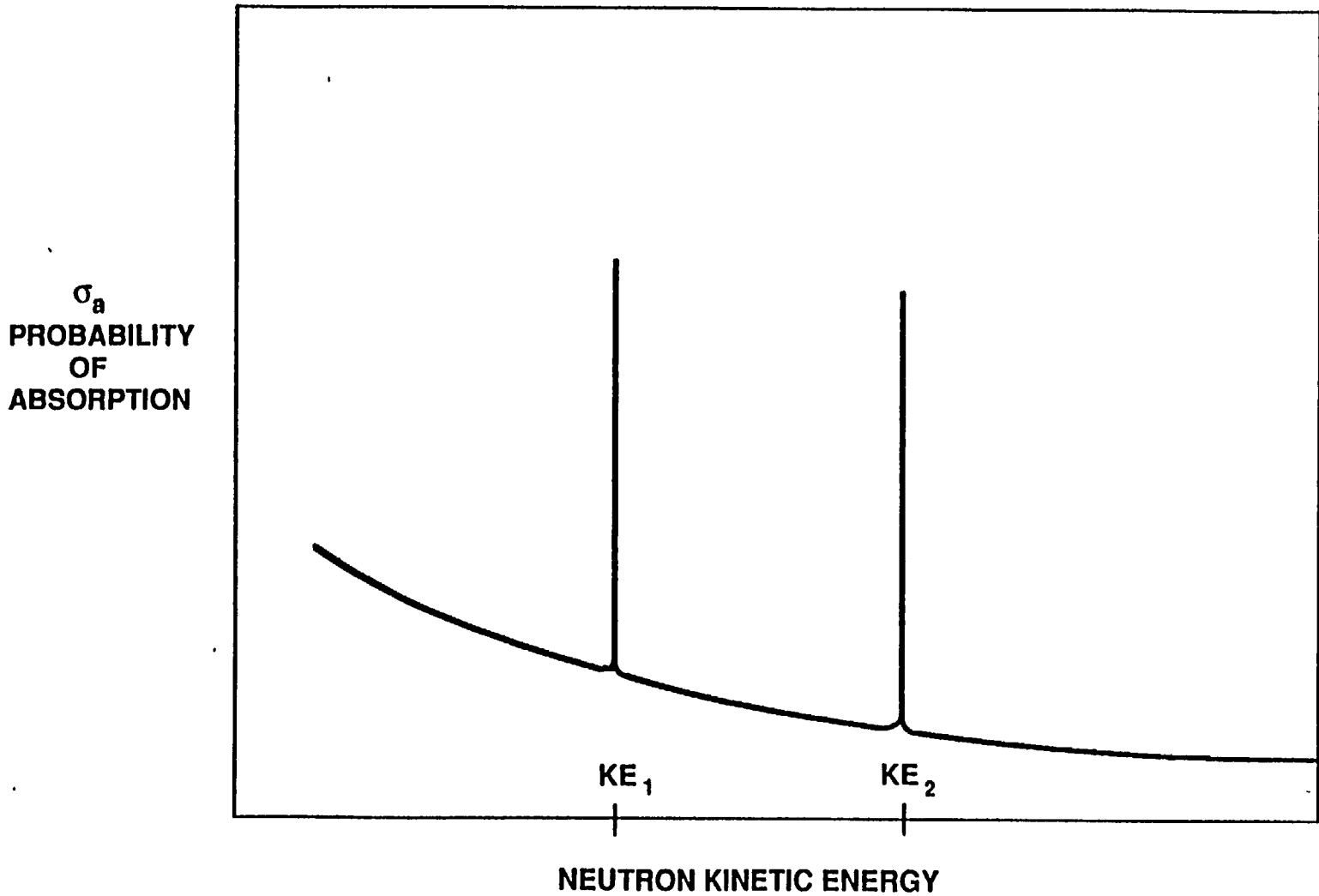

Figure 2 - 6. Resonance Absorption (Stationary Nucleus)

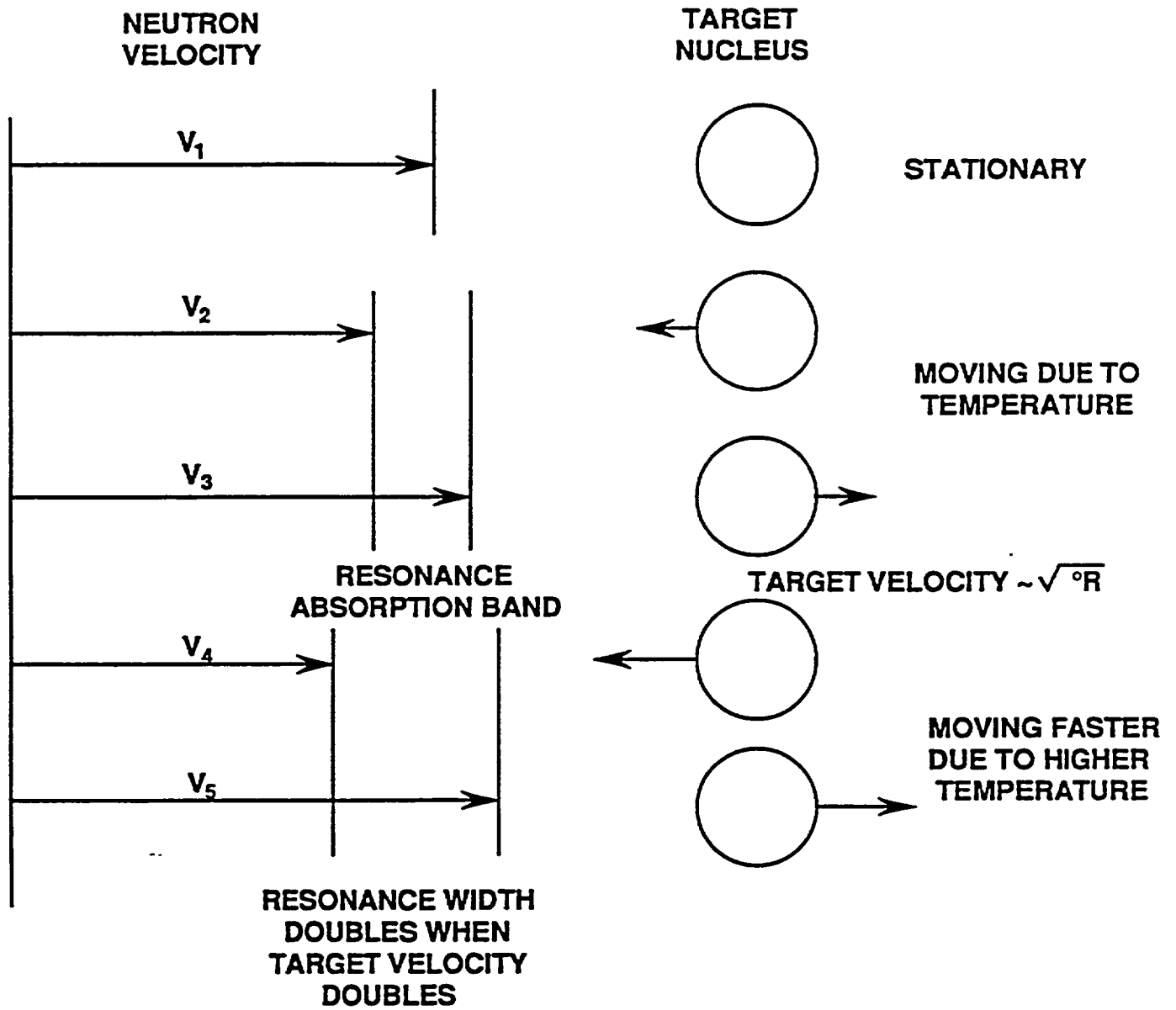

Figure 2-7. Resonance Capture



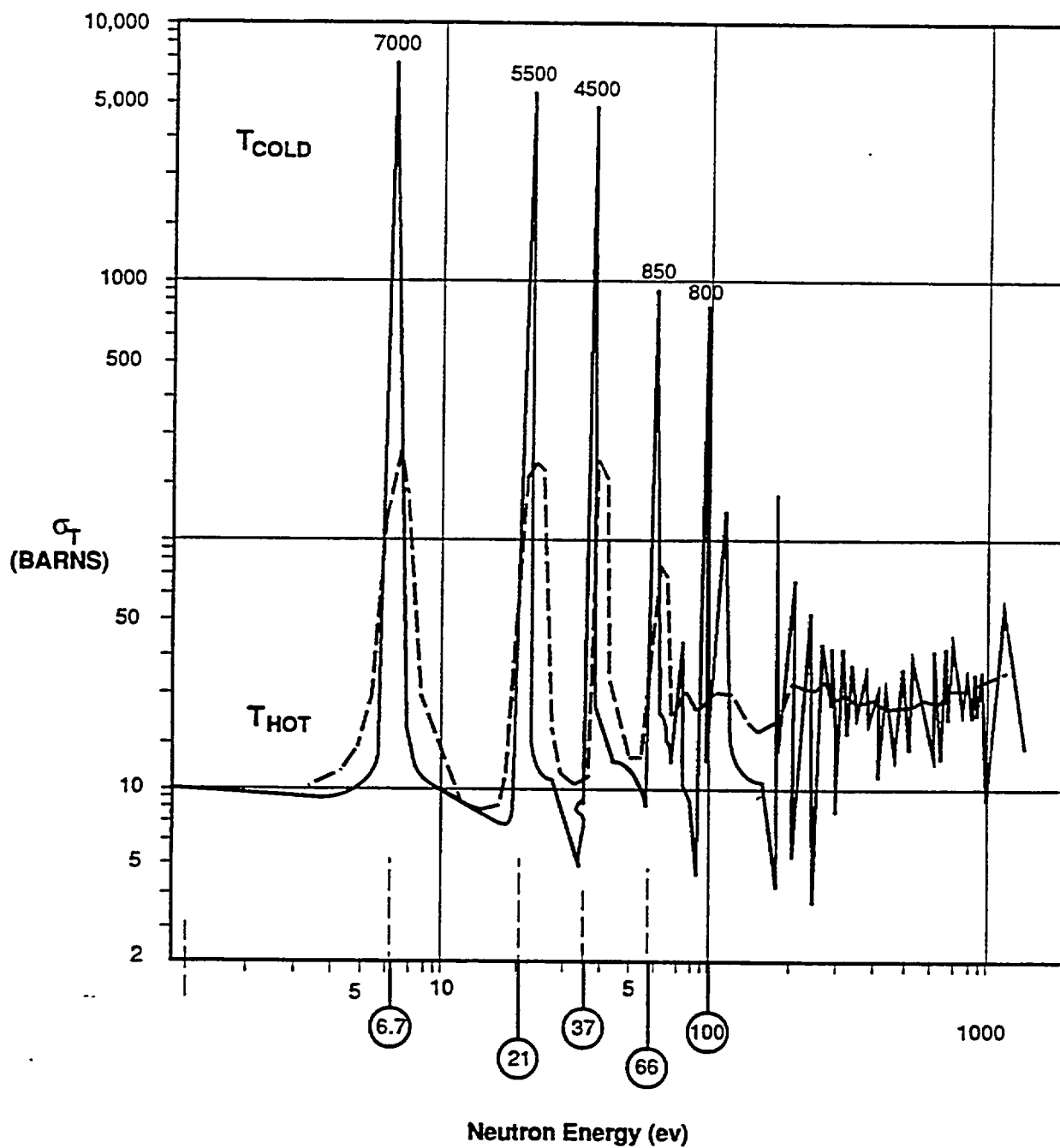

Figure 2 - 8. U - 238 Cross Section Curve

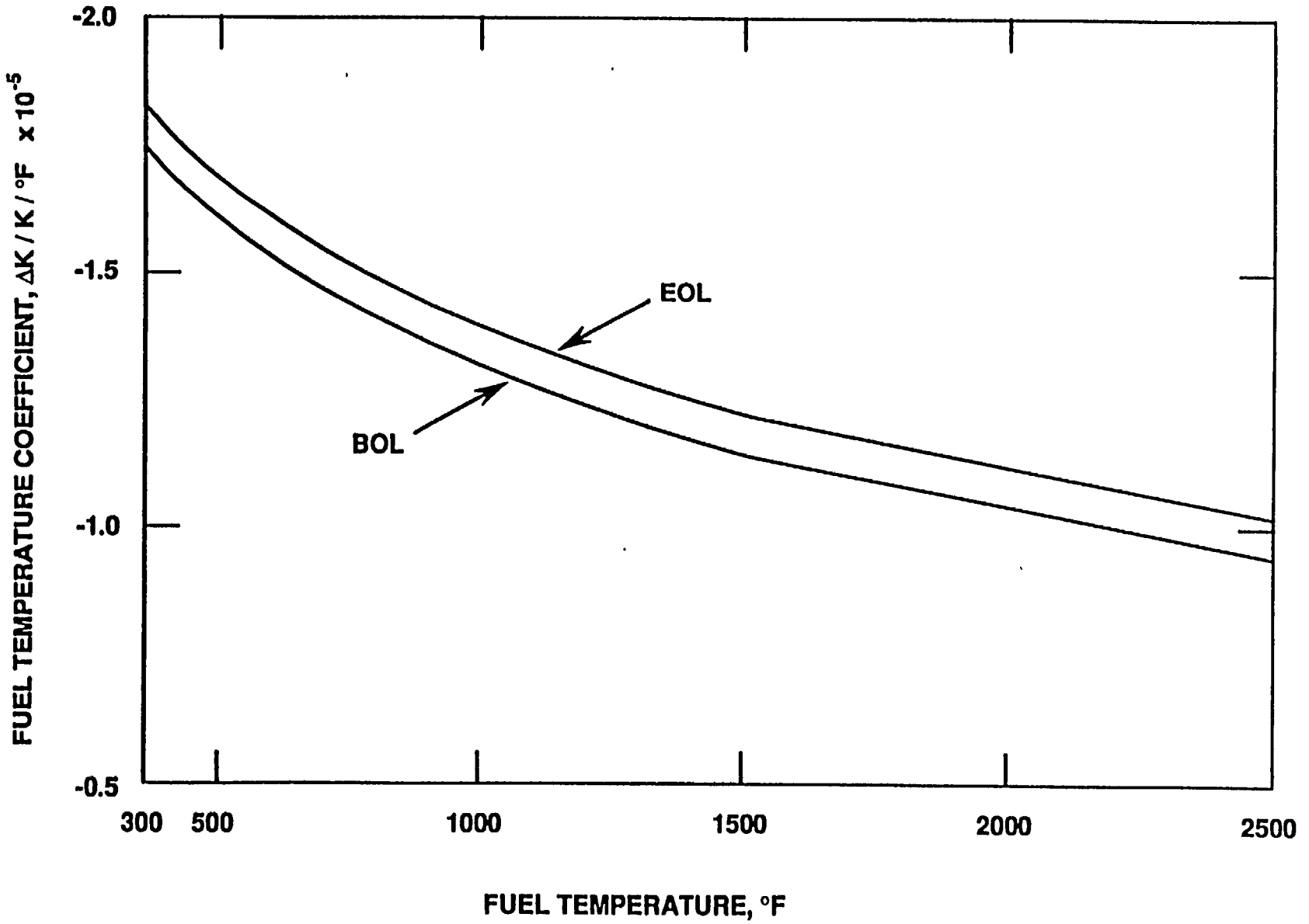

Figure 2-9. FTC Vs. Fuel Temperature

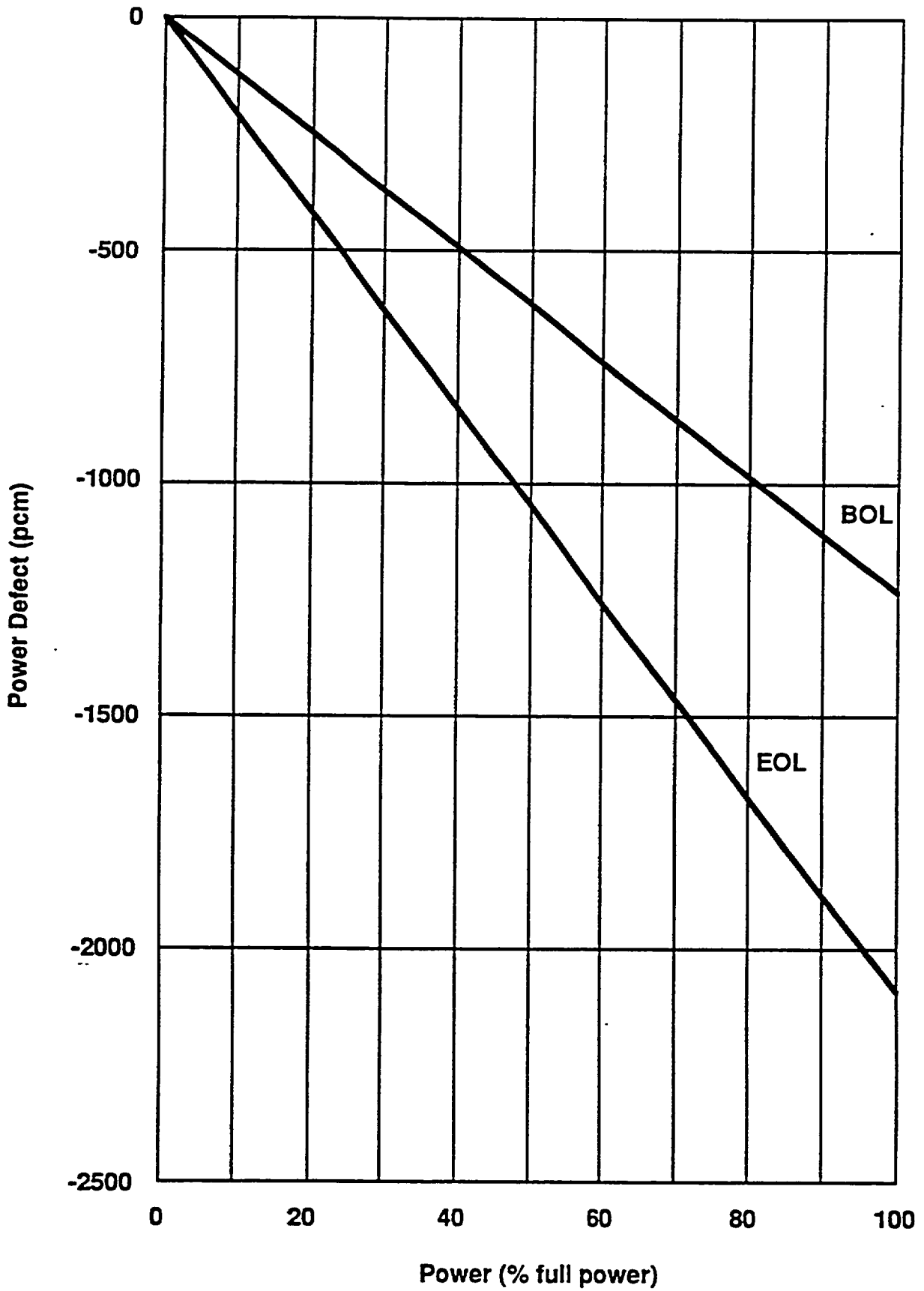

Figure 2-10. Total Power Defect

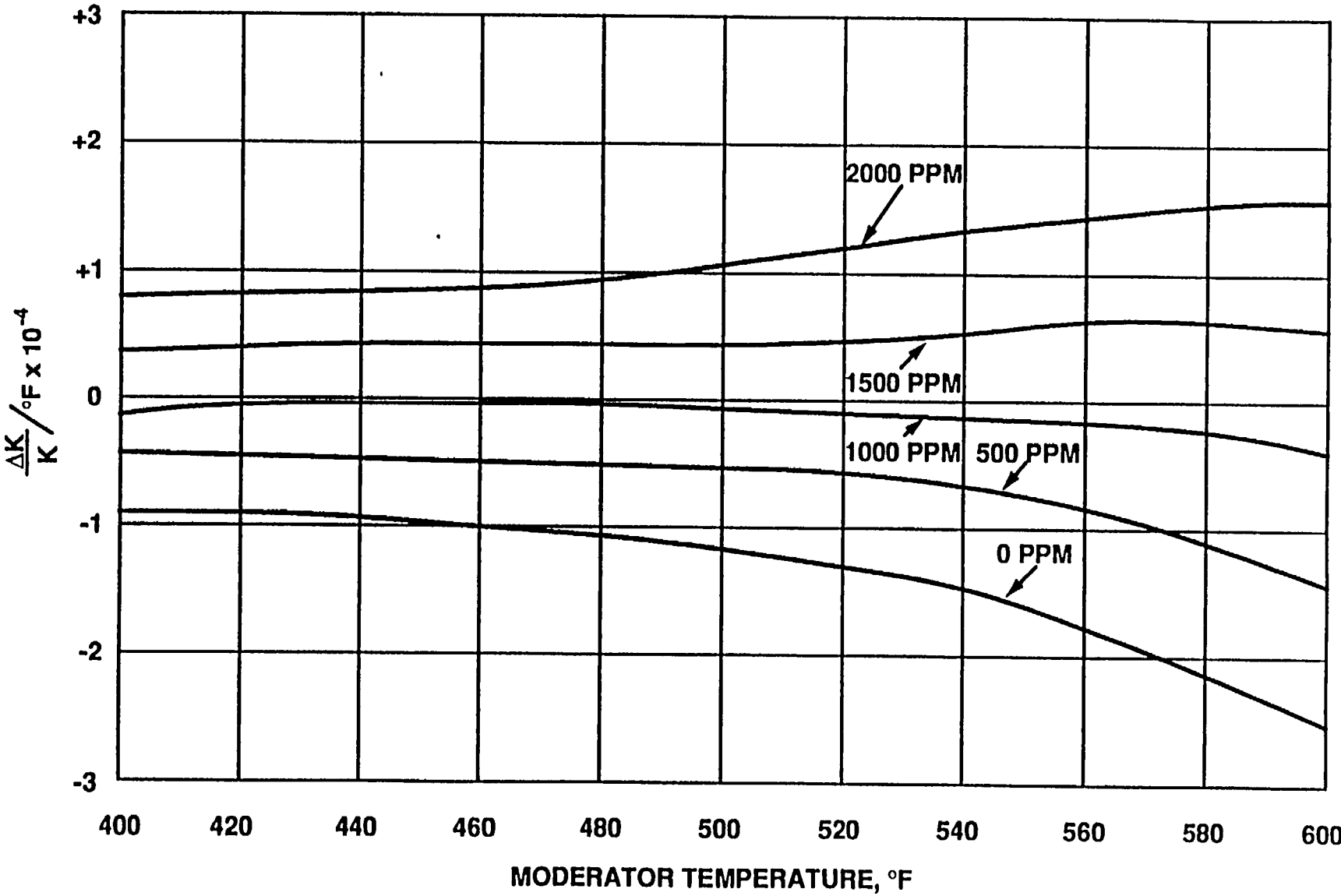

Figure 2- 11. Moderator Temperature Coefficient

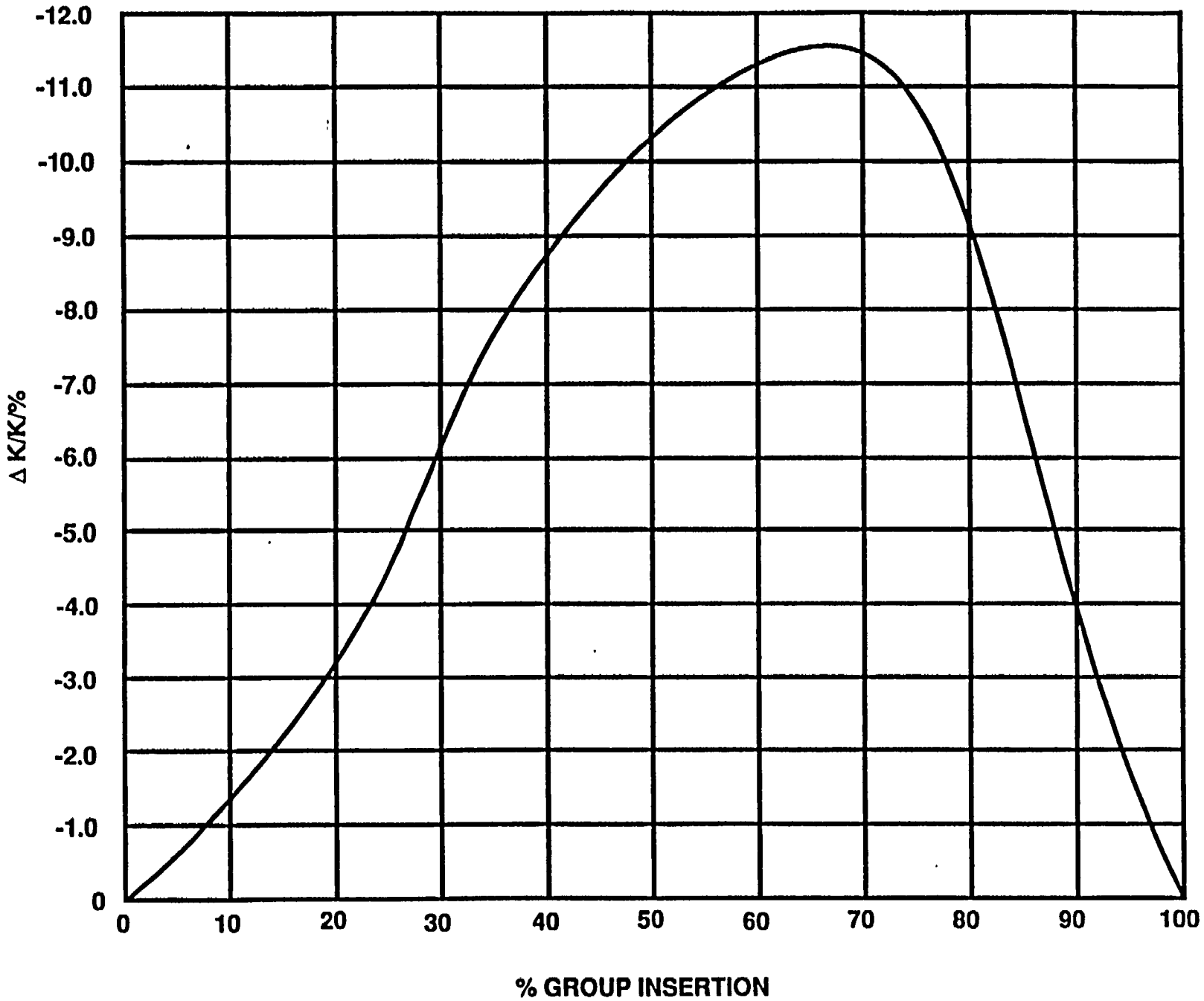

Figure 2-12. Differential Rod Worth Curve

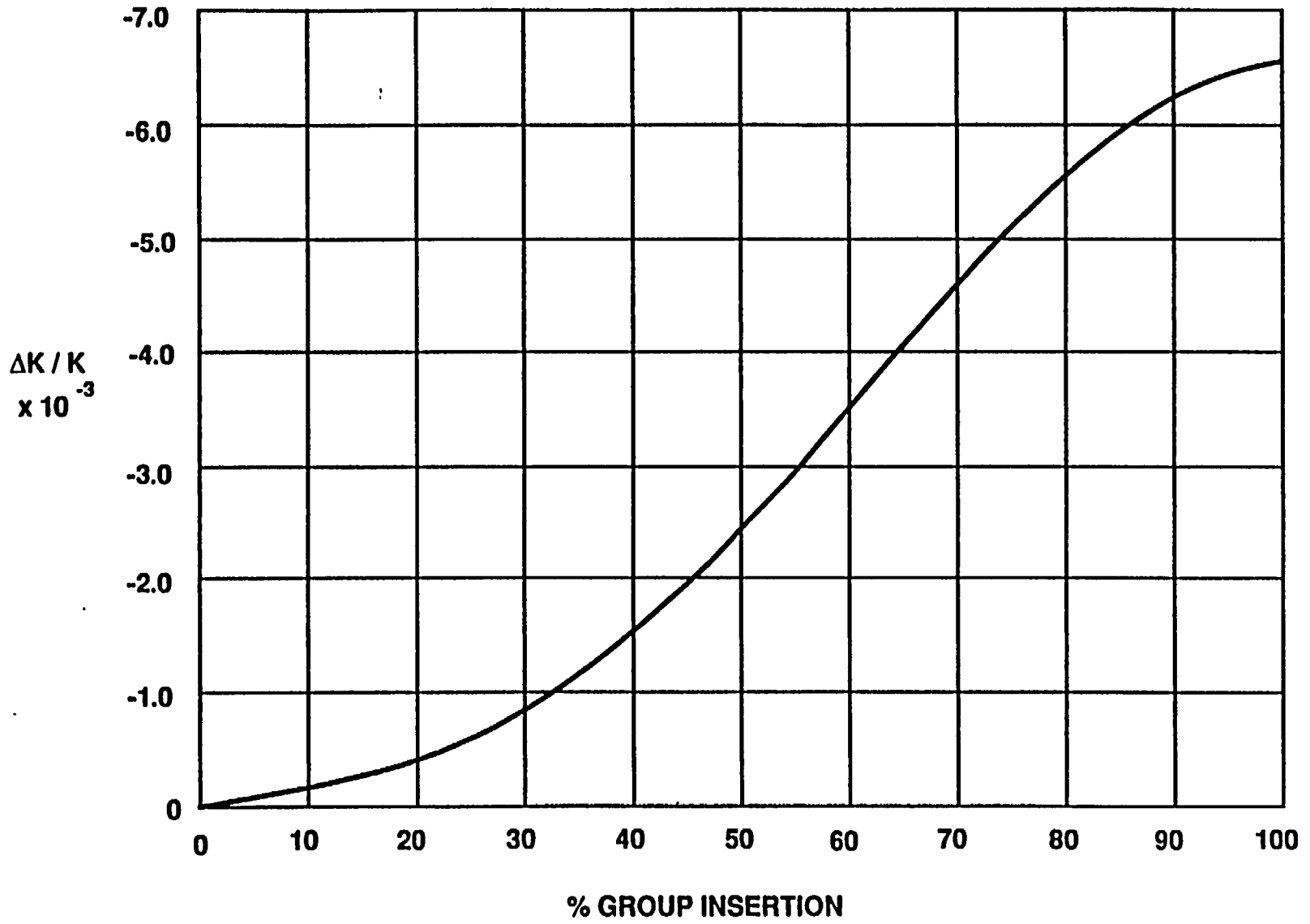

Figure 2-13. Integral Rod Worth Curve

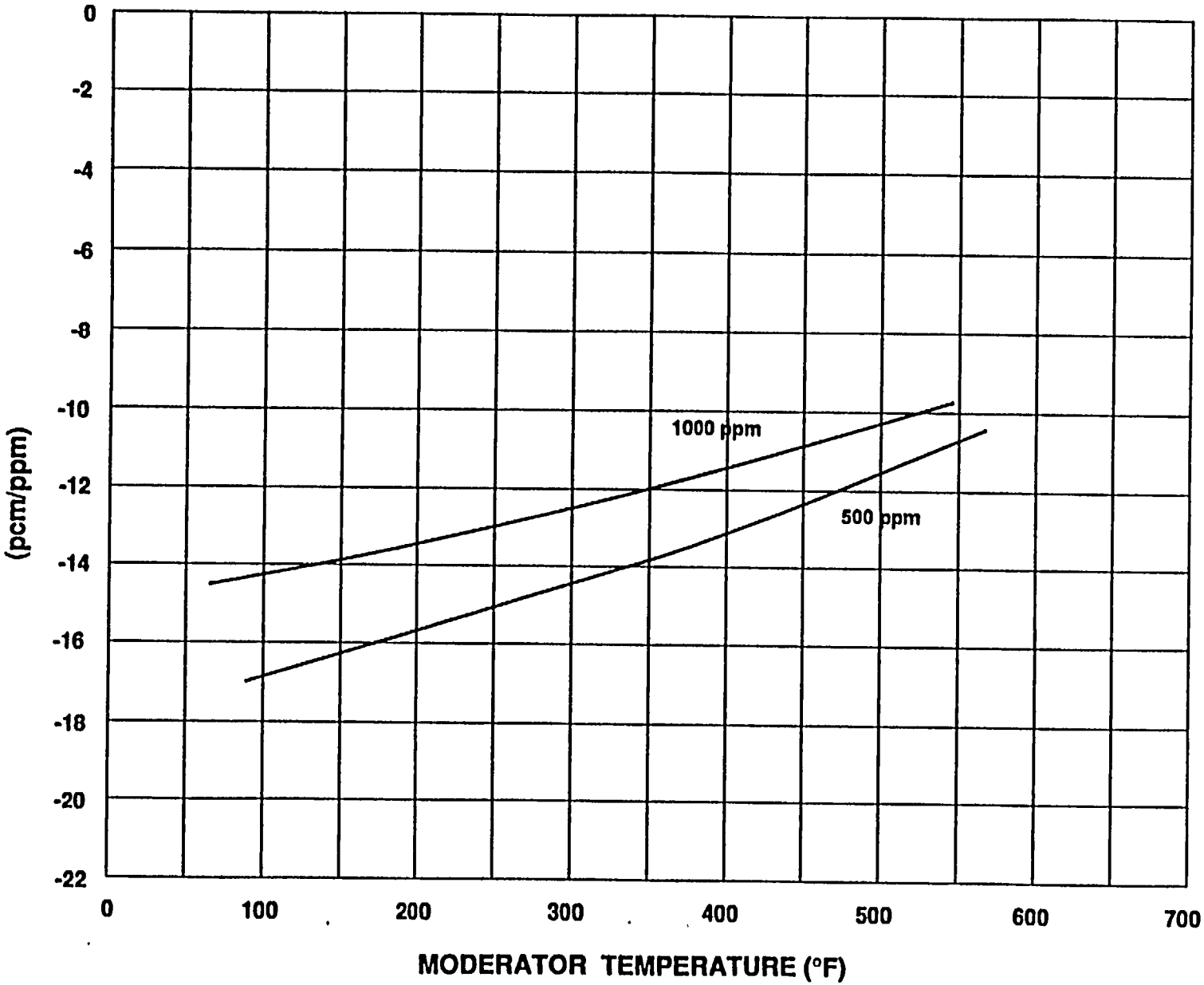

Figure 2-14. Boron Worth Vs. Moderator Temperature

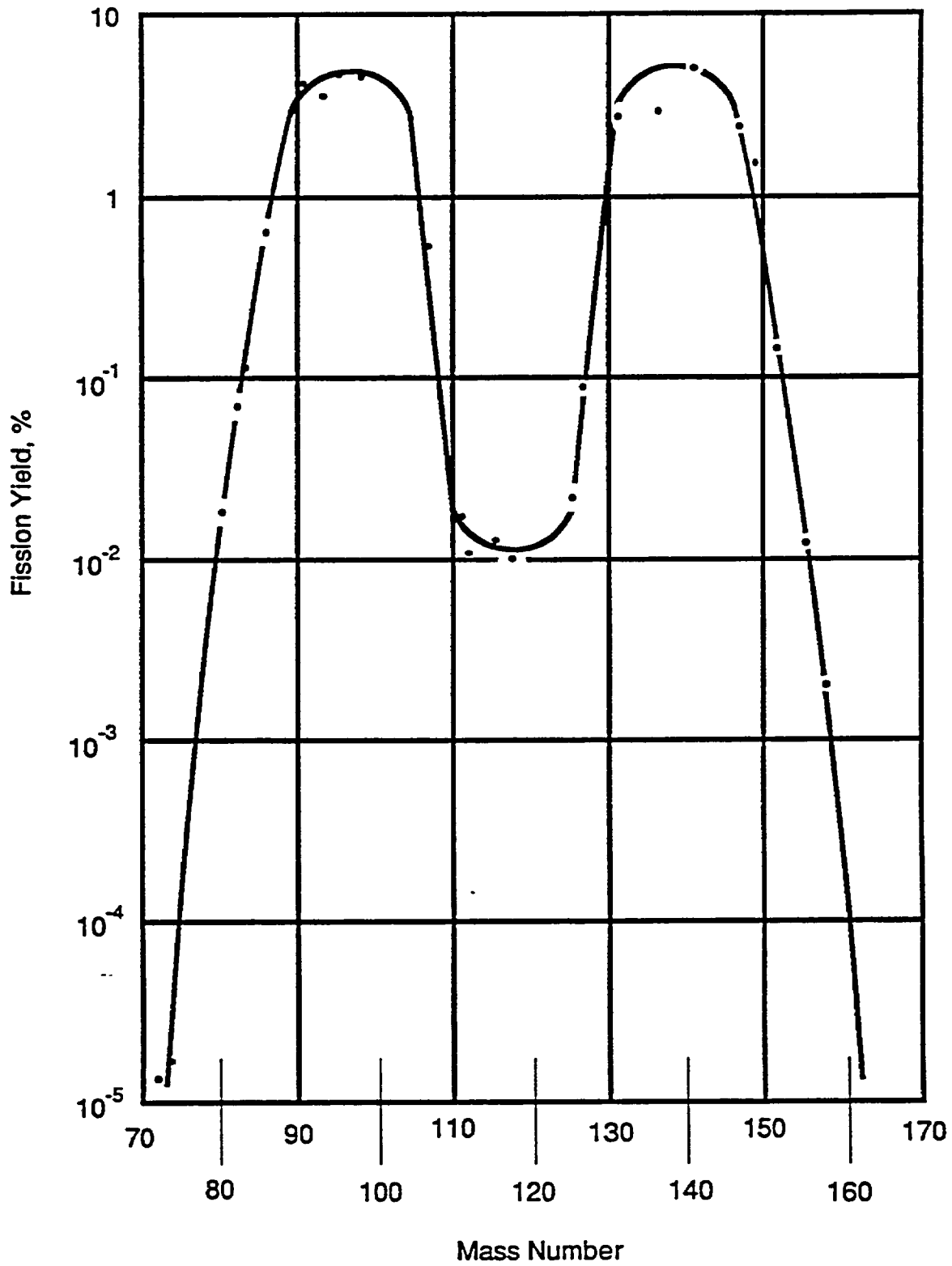

Figure 2-15. Fission Yield Curve



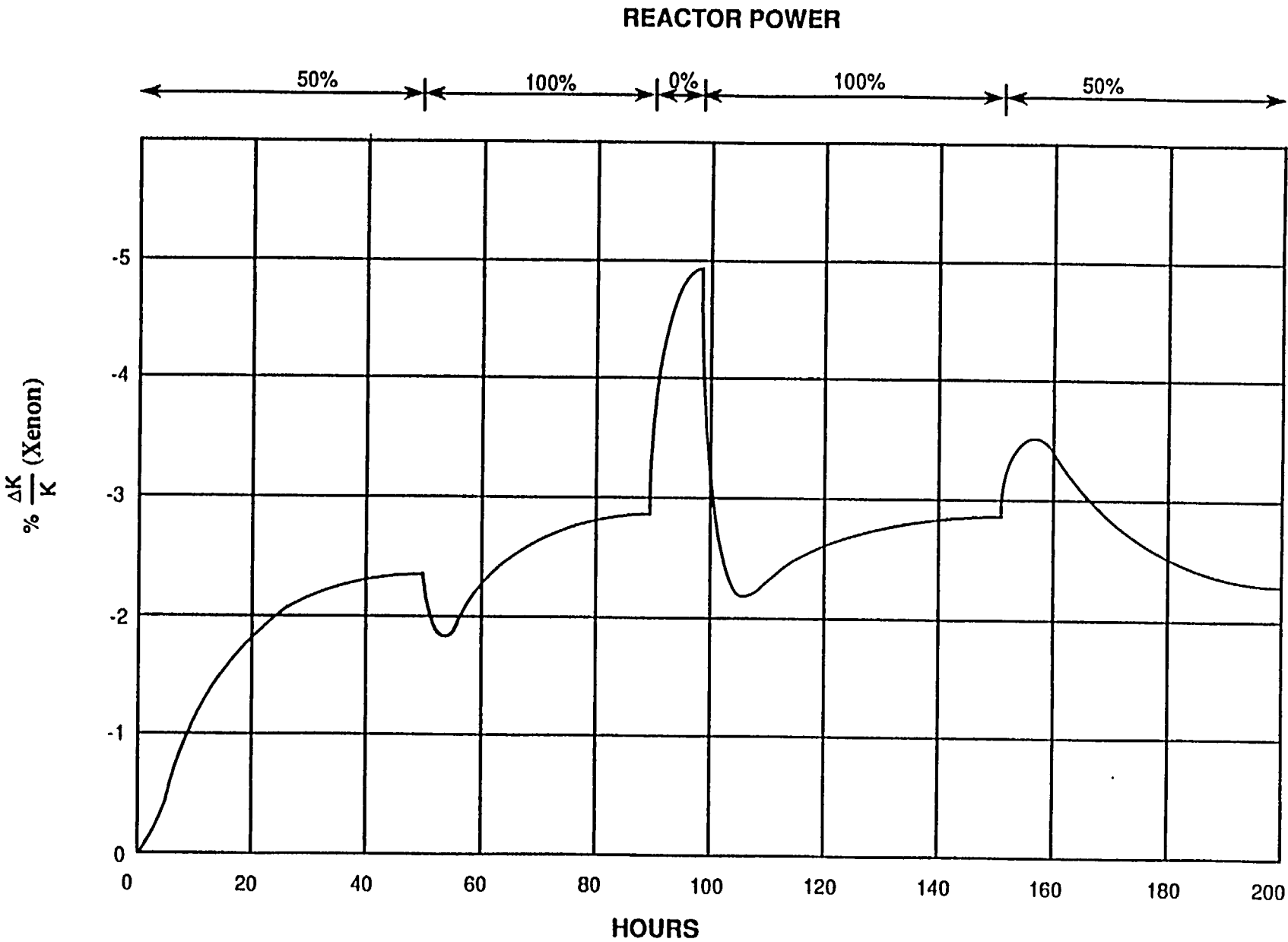

Figure 2-16. Xenon Reactivity Vs. Reactor Power as Function of Time

(%  $\frac{\Delta K}{K}$ ) VERSUS TIME IN HOURS

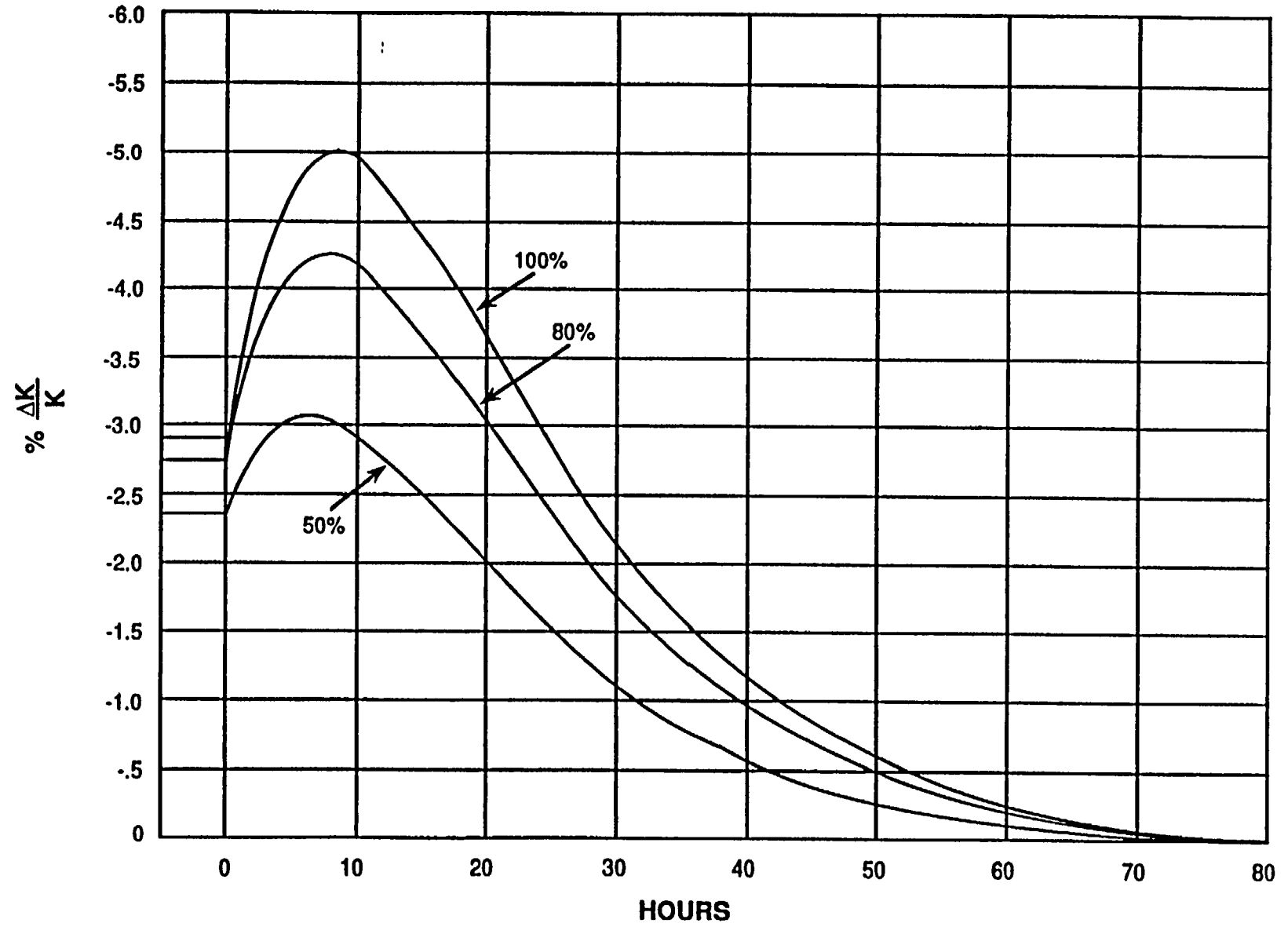

Figure 2-17. Xenon Peaking

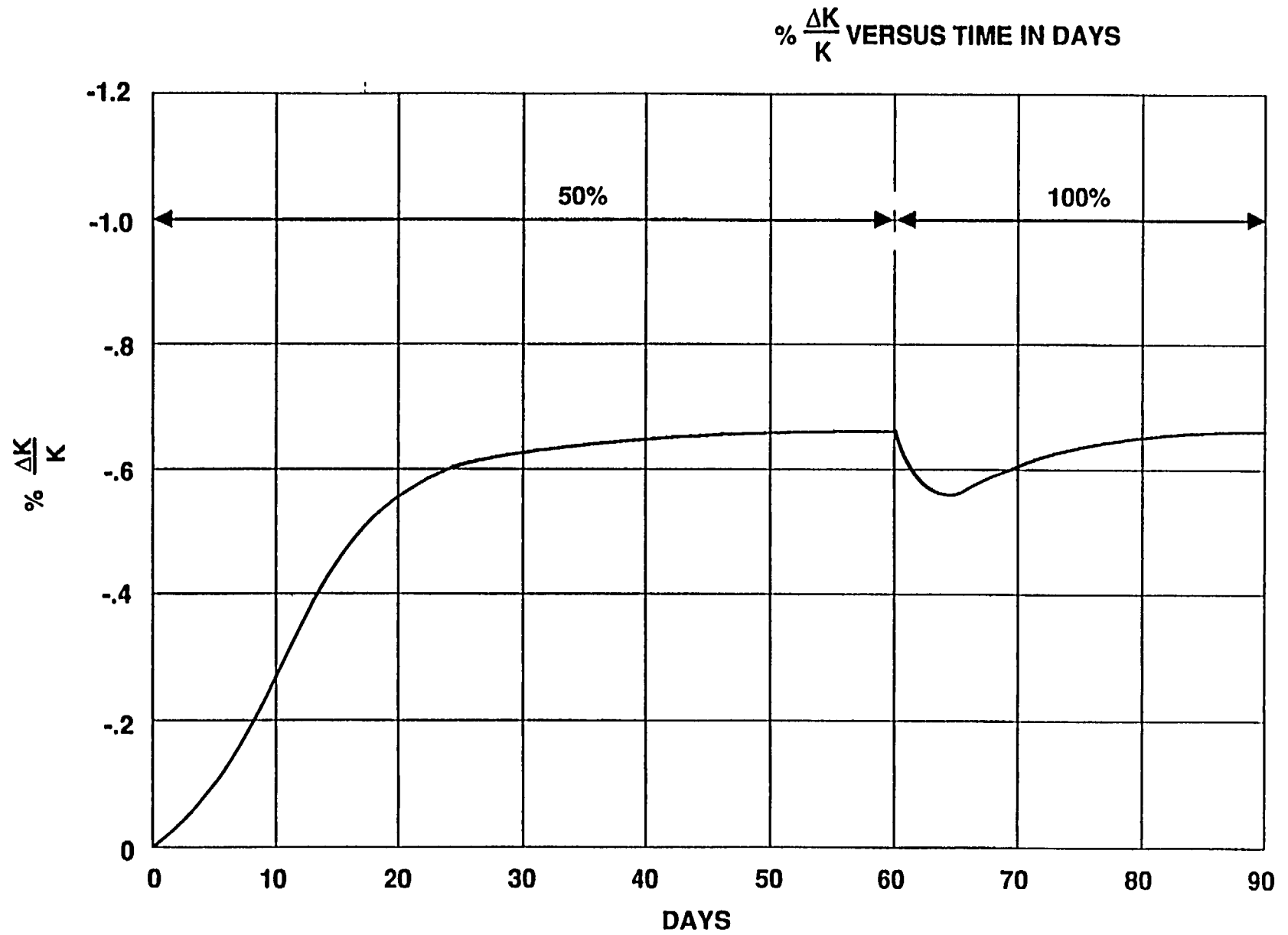

Figure 2 - 18. Samarium Buildup

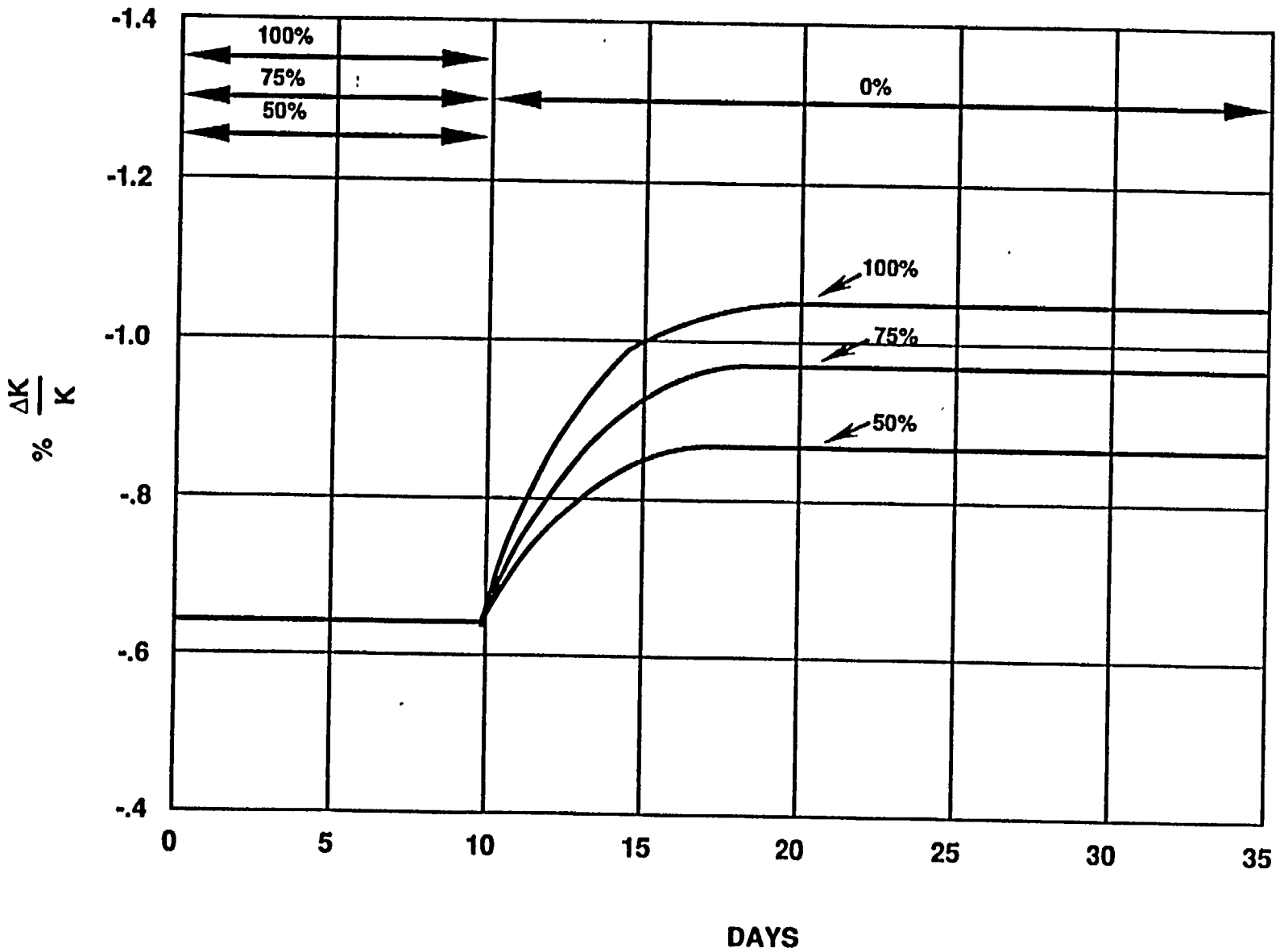
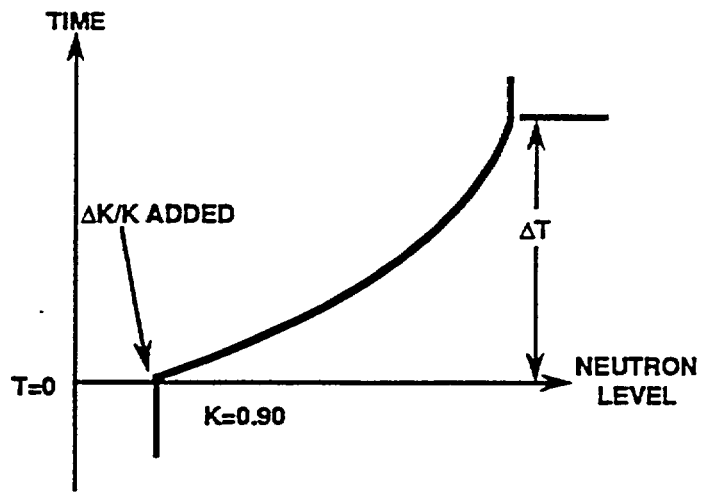
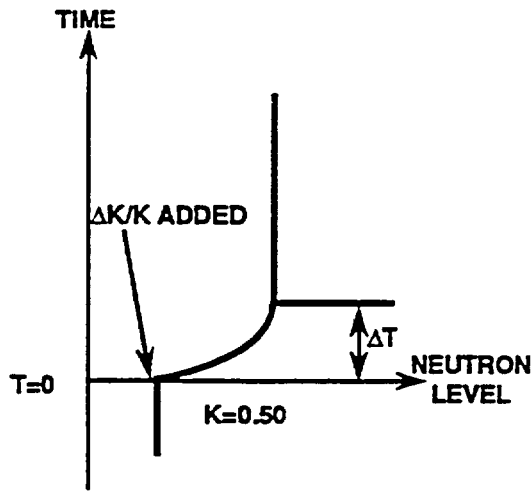

Figure 2-19. Samarium Peaking

CONSIDER TWO CASES:



$$N_t = S_0 (1 + K + K^2 + K^3 + K^4 \dots K^n)$$

GENERATION	COUNT RATE
1	100 + 50
2	100 + 50 + 25
3	100 + 50 + 25 + 12.5
4	100 + 50 + 25 + 12.5 + 6.25

The higher order terms become small quickly. In fact, already by the 7th generation less than one neutron is added per generation.

$$N_t = S_0 (1 + K + K^2 + K^3 + K^4 \dots K^n)$$

GENERATION	COUNT RATE
1	100 + 90
2	100 + 90 + 81
3	100 + 90 + 81 + 73
4	100 + 90 + 81 + 73 + 66

It will take many more generations before the higher order terms become negligibly small. In fact, not until the 44th generation is less than one new neutron added per generation.

Figure 2-20. Subcritical Multiplication

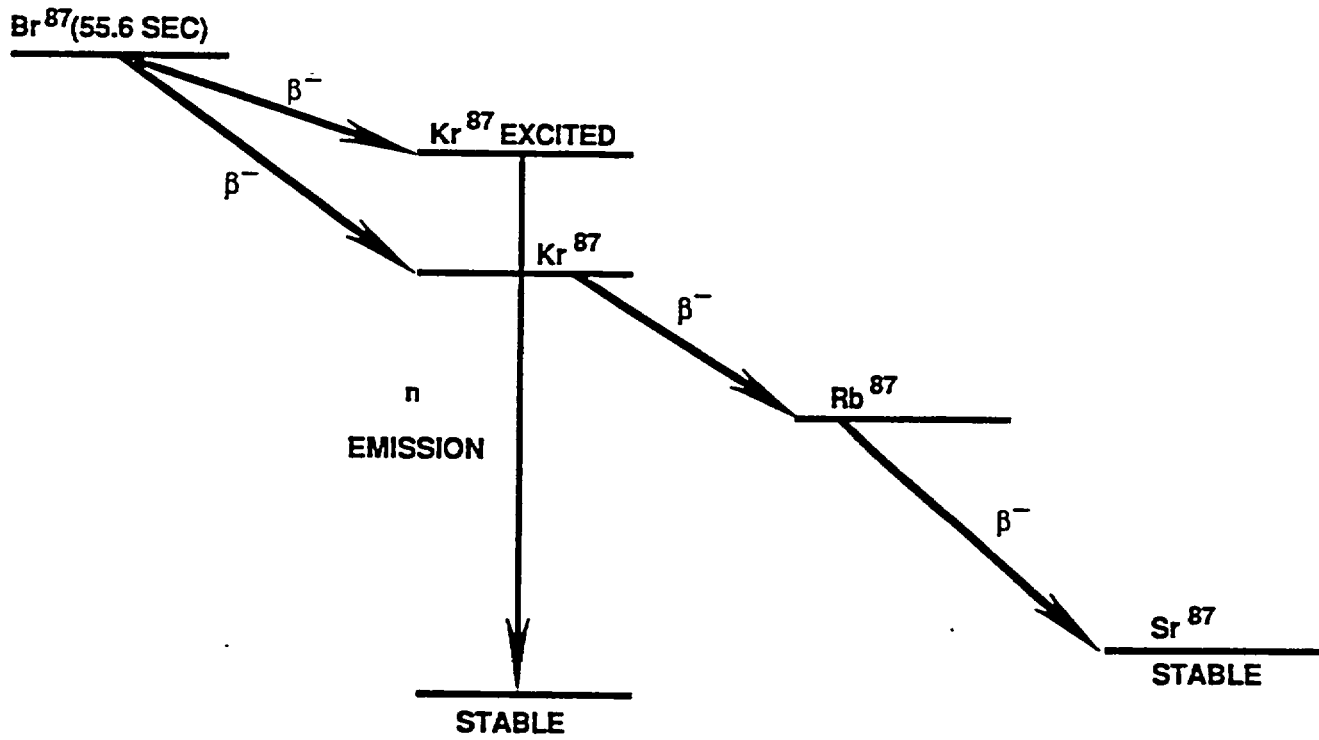

Figure 2 - 21. Delayed Neutron Production

GIVEN:  $N_0 = 10^6$  NEUTRONS

$$t = 5 \text{ SEC}$$

$$\bar{\ell}_p = 10^{-4} \text{ SEC}$$

$$\bar{\ell}_d = 10 \text{ SEC}$$

$$\bar{\ell} = 0.07 \text{ SEC}$$

$$K_{\text{eff}} = 1.001$$

PROMPT  ${}_0N^1$  ONLY

$$N = N_0 e^{(K_{\text{eff}} - 1) t / \bar{\ell}_p}$$

$$N = 10^6 e^{(.001)5/10^{-4}}$$

$$N = 10^6 e^{50}$$

$$N = 10^6 \times 5.184 \times 10^{21}$$

$$N = 5.18 \times 10^{27} \text{ NEUTRONS}$$

PROMPT + DELAYED  ${}_0N^1$

$$N = N_0 e^{(K_{\text{eff}} - 1) t / \bar{\ell}}$$

$$N = 10^6 e^{(.001)5/.07}$$

$$N = 10^6 e^{.0714}$$

$$N = 10^6 \times 1.074$$

$$N = 1.074 \times 10^6 \text{ NEUTRONS}$$

Figure 2 - 22. Delayed Neutron Effects

### 3.0 HEAT TRANSFER AND THERMAL HYDRAULICS

#### Learning Objectives

After studying this chapter, you should be able to:

1. Describe the mechanisms of heat transfer:
  - a. Conduction
  - b. Convection
  - c. Radiation
2. Perform basic calculations associated with a plant cycle including:
  - a. Plant efficiency
  - b. Determining work performed
  - c. Determining heat rejected
3. Describe the heat transfer across a typical reactor fuel rod.
4. Define or explain the meaning of the following terms and concepts:
  - a. Subcooled nucleate boiling
  - b. Bulk nucleate boiling
  - c. Onset of transition boiling
  - d. Critical heat flux
5. Describe how boiling can improve or degrade heat transfer ability.
6. Describe how pressure, temperature, flow, and reactor power can affect the departure from nucleate boiling (DNB).
7. Describe how a heat balance is performed on a PWR and a BWR.

#### 3.1 Introduction

In nuclear power plants water and steam are the media most commonly used to transfer heat energy from the heat production source (reactor) to the mechanical conversion devices (turbines) that drive the electric generators. This chapter discusses the application of fundamental thermo-

dynamic and heat transfer concepts used in reactor and steam plant energy conversion processes. The objective of the material presented in this chapter is to provide a basic understanding of the thermal and hydraulic principles that govern normal operation and the conditions that can limit plant operation.

#### 3.2 Steam Power Cycle

Thomas Savery, an English inventor, built the first steam-powered fire engine in the late seventeenth century. Before the beginning of the nineteenth century a very simple steam engine was being used to pump water out of Scottish coal mines. Since those early times, a whole area of scientific study has been developed around the use of steam to produce power. This area of study is called thermodynamics (thermo, meaning heat; dynamics, meaning work), and it deals with the conversion of heat into work. Thermodynamics is important in the study of power plant performance because, in a nuclear power plant, heat is used to produce steam to do work.

##### 3.2.1 Overview of the Steam Power Cycle

The main components used in the process of converting heat into work are shown schematically in Figure 3-1. The first component shown in Figure 3-1 is the reactor or steam generator, where heat enters the system and water is converted into steam. In a nuclear power plant, the heat used to boil water comes from the nuclear energy produced by the fission process. When the water boils, it turns into steam, a high-temperature, high-pressure gas.

The steam flows through a series of pipes to the next component—the turbine. In the turbine, some of the energy carried by the steam is extracted and turned into useful work. The steam forces the turbine to rotate, and this action turns the generator, which produces electricity. The steam loses some of its energy as it forces the turbine to rotate. When it leaves the turbine, the steam is at a lower pressure and a lower temperature than



when it entered the turbine.

The lower energy steam flows into the next system component—the condenser. The steam in the condenser is cooled by an external water system and changed into water called condensate. During this process the steam loses more of its energy. The heat energy released by the steam is transferred to the cooling water where it is rejected from the system and lost from the cycle.

The condensate from the condenser, now at low pressure and low temperature, flows to the next system component—the pump. The pump increases the pressure of the water and forces it back into the reactor or steam generator so that the process can begin again. The pump increases the water pressure by putting work into the water.

The cycle shown in Figure 3-1 and discussed in this chapter is called the steam-water cycle. It is a continuing cycle. Water is heated until it becomes steam, which powers a turbine. The lower energy steam leaving the turbine passes to the condenser, where it becomes water again. The water is then pumped back into the boiler to restart the cycle.

The steam-water cycle is also a process of heat in/heat out and work in/work out. Heat enters or is added to the system in the reactor or steam generator, and heat is rejected or leaves the system in the condenser. Work enters the system at the pump, and work leaves the system at the turbine.

### 3.2.2 The First Law of Thermodynamics

The first law of thermodynamics states that energy is neither created nor destroyed. The forms that energy takes may change, but the amount of energy remains constant. In a power plant, this law means that the plant cannot produce work unless energy is added.

The concept of the first law is easily applied to the plant. When the energy into the plant equals the energy leaving the plant, the system is said to

be balanced. In this case, energy in equals energy out ( $E_{in} = E_{out}$ ). The energy in the plant remains constant.

If the plant becomes unbalanced, then energy in does not equal energy out. In the unbalanced plant there must be a change in the amount of energy stored in the plant because energy cannot just appear or disappear. This relationship is shown by Equation 3-1:

$$E_{in} = \Delta E_{stored} + E_{out} \quad (3-1)$$

Energy is usually stored in the plant as heat that has increased the temperature of some part of the plant. Energy can be stored in other forms. One example is water stored in a reservoir behind a dam. In this case, energy is stored as potential energy.

During steady-state plant operation, the system is balanced, and energy in equals energy out. This is not the case during startup and shutdown. During startup, the energy coming into the plant is greater than the energy leaving the plant. When this occurs, there is an increase in stored energy, and the plant heats up. During shutdown, the energy coming into the plant is less than the energy leaving the plant. In this situation, the stored energy decreases, and the plant cools down.

The first law of thermodynamics can be used to account for many things that take place during plant operation. First, however, Equation 3-1 must be expanded to include the various forms of energy that can exist in the plant. For a more detailed breakdown, Equation 3-1 can be expanded as follows:

$$\begin{aligned} & (PE + KE + U + PV + W + Q)_{in} \\ & = \Delta(PE + KE + U + PV + W + Q)_{stored} \\ & + (PE + KE + U + PV + W + Q)_{out} \quad (3-2) \end{aligned}$$

The following forms of energy are included in Equation 3-2:

- Potential energy (PE) - energy due to an object's vertical position
- Kinetic energy (KE) - energy due to an object's motion
- Internal energy (U) - energy due to the motion of an object's molecules
- Flow work (PV) - energy due to pressure times volume
- Mechanical work (W) - energy due to a force acting through a distance
- Heat (Q) - the transfer of internal energy into or out of an object

Energy is the potential to do work. In a power plant, a certain amount of energy is added to the plant, and some part of this energy is turned into work. The amount of energy turned into work compared to the energy added is a measure of the power plant efficiency.

### 3.2.3 The Second Law of Thermodynamics

The second law of thermodynamics can be divided into two parts. The first part states that heat naturally flows downhill, that is, from a high temperature region to a low temperature region. A consequence of this phenomenon is that work is required to move heat from a low temperature region to a high temperature region. This part of the second law is easily observed in everyday life. Hot objects naturally lose heat to cooler objects, but work is needed to move heat from the low temperature air in a refrigerator to the higher temperature outside air.

The second part of the law states that not all heat added to a system can be changed into work. This was discovered by the early experimenters with steam engines, who found that all steam

engines had to reject some heat to the environment to produce work. The rejected heat is lost or wasted energy from the viewpoint of the power cycle.

### 3.2.4 Thermodynamic Cycle Efficiency

Experiments have shown that the efficiency of a steam plant cannot exceed a definite limit that depends on the temperature at which heat is added to the cycle and the temperature at which heat is rejected from the cycle. As mentioned above, only some of the heat supplied to a power cycle can be converted to work. Thus, even if the equipment in the plant operated ideally (i.e., perfect performance with no heat loss and no friction), the plant could not achieve 100% thermodynamic efficiency.

This principle can be understood by examining a simple power cycle such as the one shown in Figure 3-2. In the simple cycle, the work done by the cycle is the difference between the heat added in the PWR steam generator (or BWR reactor) and the heat rejected in the condenser.

$$W = Q_{in} - Q_{out}$$

Further, the thermodynamic efficiency of a plant is defined as the ratio of the work to the heat added.

$$E = \frac{W}{Q_{in}}$$

Since the simple cycle is based on reversible (ideal) processes, another characteristic is that the change in entropy during the heat addition process is the same as the change of entropy during the heat rejection process.

$$\Delta S = \frac{Q_{in}}{T_{in}} = \frac{Q_{out}}{T_{out}} \text{ or } \frac{Q_{out}}{Q_{in}} = \frac{T_{out}}{T_{in}}$$

Combining these relationships yields Equation 3-3, which can be used to determine the theoretical maximum efficiency of a heat power cycle.

$$E_{thmax} = \frac{W}{Q_{in}} = \frac{Q_{in} - Q_{out}}{Q_{in}} = 1 - \frac{Q_{out}}{Q_{in}} = 1 - \frac{T_{out}}{T_{in}}$$

$$E_{thmax} = 1 - \frac{T_{out}}{T_{in}} \quad (3-3)$$

In this equation,  $T_{out}$  is the absolute temperature at which heat is rejected from the cycle, and  $T_{in}$  is the absolute temperature at which heat is added to the cycle.

This expression shows why power plants are designed for the highest practical temperature for heat addition and the lowest possible temperature for heat rejection because achieving either or both will increase plant efficiency.

As an example, the temperatures at which a plant operates can be used to calculate the theoretical maximum efficiency for the plant. Assume that all heat is added in the PWR steam generator (or BWR reactor) at 540°F and all heat is rejected in the condenser at 80°F. The maximum theoretical efficiency of the cycle can be calculated using absolute temperatures as follows:

$$E_{thmax} = 1 - \frac{T_{out}}{T_{in}}$$

$$E_{thmax} = 1 - \left( \frac{460 + 80}{460 + 540} \right)$$

$$E_{thmax} = 1 - .54$$

$$E_{thmax} = .46 \text{ or } 46\%$$

On the basis of this calculation, the maximum theoretical efficiency of this plant cycle is 46%. This limit can be used as a point of comparison for the actual efficiency. The actual efficiency of a real plant cycle is always less than the theoretical maximum thermodynamic efficiency. There are a number of reasons for this. First, not all heat is added at the maximum temperature of the plant. This has the effect of reducing the effective tem-

perature for heat addition to the plant. Second, the components and equipment in the plant are not perfectly insulated and some heat is lost from the components and pipes. This heat never has an opportunity to do real work. Third, power cycle components such as pumps and turbines are not frictionless. Friction reduces the amount of work produced by the turbine and increases the amount of work required by the pump. Lastly, not all heat is rejected at the minimum plant temperature. This has the effect of increasing the temperature for heat rejection.

As an example, assume heat addition occurs at 440°F. If 440°F is used for the thermodynamic efficiency calculation, then:

$$E_{thmax} = 1 - \frac{T_{out}}{T_{in}}$$

$$E_{thmax} = 1 - \left( \frac{460 + 80}{460 + 440} \right)$$

$$E_{thmax} = 1 - .6 = .4 \text{ or } 40\%$$

In practice, heat is added over a range of temperatures between 440°F and 540°F. Therefore, the effective temperature for heat addition for the cycle would be between 440°F and 540°F, resulting in a maximum theoretical efficiency somewhere between .40 and .46.

### 3.2.5 T-S and H-S Cycle Diagrams

To operate a power plant at the best efficiency, an understanding of what is happening in each phase of the heat power cycle is needed. A graph called a temperature-entropy (T-S) diagram can be used to investigate plant processes. This diagram is useful for understanding heat, work, and cycle efficiencies.

Figure 3-3 is a T-S diagram for a PWR steam power cycle. The curve shown on the diagram is called the saturation dome. Points on the curve on the left portion of the dome represent water just as

it is ready to boil at various temperatures (i.e., a saturated liquid). Points on the curve on the right portion of the dome represent steam just as it is ready to condense at various temperatures (i.e., a saturated vapor). The area to the left of the saturation dome represents liquid water. The area to the right of the dome represents steam with no water. The area under the dome represents a steam-water mixture. The path or processes in the steam cycle are shown on the diagram. Note the positions of the four basic PWR components — steam generator, turbine, condenser, and pump.

At point 1 on the diagram, water is heated at a constant pressure, and the water temperature increases until the saturated liquid curve is reached. At this point, the water starts to become steam. Boiling occurs at a constant temperature (isothermal process) and constant pressure (isobaric process) under the steam dome until point 2 on the saturated vapor curve is reached where all water has changed to steam.

At point 2 the steam enters the turbine. Because some of the steam's energy is converted into work in the turbine, the steam loses some temperature and pressure. If the turbine is assumed to be an ideal or a perfect machine, the steam will expand in the turbine along the vertical line until point 3 is reached where the steam enters the condenser at condenser pressure. A perfect machine is an idealized concept of a machine that can operate without friction and without heat loss (adiabatic process).

Recall that steam expansion along the vertical line in the turbine means that entropy of the steam remains constant (isentropic) in the turbine. This is only true for an ideal turbine. In a real turbine, entropy actually increases during the steam expansion process and point 3 will lie somewhat to the right of the isentropic expansion point. Because the real steam expansion process is not isentropic, less work is extracted from expansion through a real turbine than an ideal turbine. The mechanical efficiency of a turbine is the ratio of the real turbine work to the ideal turbine work, as

shown in Equation 3-4:

$$E_T = \frac{W_{T_{ideal}}}{W_{T_{actual}}} \quad (3-4)$$

In the condenser, heat is removed from the steam at constant temperature and pressure until point 4 is reached, where all steam condenses to water.

The pump then increases the pressure of the water to point 1 and forces the water back to the steam generator. (Some heat is also added to the water by the feedwater preheaters.) If the pump is assumed to be an ideal or perfect pump (no friction or heat loss), the pump will compress the water along a vertical line, and the entropy will remain constant (isentropic) during the pumping process. In a real pump, entropy actually increases during the pump compression process, and point 1 will lie somewhat to the right of the isentropic compression point. Because the compression process is not isentropic, more work is required to compress water in a real pump than in an ideal pump. The mechanical efficiency of a pump is the ratio of the ideal pump work to the real pump work, as shown in Equation 3-5:

$$E_{pump} = \frac{W_{P_{ideal}}}{W_{P_{actual}}} \quad (3-5)$$

The T-S diagram is a useful tool for explaining how a steam power cycle works. However, actual calculations are more straightforward if the enthalpy is known at each of the four points in the cycle. Enthalpy is not usually found on a T-S diagram, but the required values can be obtained from the steam tables if the state of each point is known. For illustration purposes, lines of constant enthalpy have been drawn on Figure 3-3.

Another way of finding the enthalpy at each of the four points is to use an H-S or Mollier diagram. The Mollier diagram shown in Figure 3-4 is an abbreviated H-S diagram for steam and water. An

advantage of the Mollier diagram is that values of enthalpy can be read directly from the diagram if the state of a point is known.

An inspection of Figure 3-3 shows that some processes in the steam plant cycle are ideally isentropic (steam expansion in the turbine, pressure increase in the feed pump) and some are isothermal (boiling, condensation); however, no steam cycle events are isenthalpic, or constant enthalpy, processes. One process that occurs in a steam plant that is isenthalpic is steam expansion through a throttling device, such as leakage through a safety/relief valve or throttling through a pressure reducing valve. A Mollier diagram is useful for determining the downstream conditions after this isenthalpic steam expansion occurs.

### 3.2.6 Steam Power Cycle Analysis

A basic steam cycle similar to those employed by nuclear power plants is shown in Figure 3-5. Included in the system are a reactor or steam generator, a turbine, a condenser, and a feed pump.

This cycle is also shown on a T-S diagram in Figure 3-6. To summarize the cycle:

- 1-2: Heat addition at constant pressure in the reactor or steam generator.
- 2-3S: Isentropic expansion of the steam through an ideal turbine.
- 3S-4: Heat rejection at constant pressure in the condenser.
- 4-1: Isentropic compression in an ideal pump.

The line 2-3 shows the effect of a non-ideal turbine. Notice the increase in entropy,  $\Delta s$ , which reduces the actual work output of the turbine. In this case, heat rejection in the condenser would occur along line 3-4.

Quantities of energy and work can be calculated directly by plotting the steam cycle on the H-S diagram in Figure 3-7. The important relationships for these calculations are:

1. Heat added:

$$Q_{\text{added}} = q_{1-2} = h_2 - h_1 \quad \text{BTU/lbm}$$

2. Energy converted to work in the ideal turbine is:

$$W_{T \text{ ideal}} = W_{2-3S} = h_2 - h_{3S} \quad \frac{\text{BTU}}{\text{lbm}}$$

Energy converted to work in the real turbine is:

$$W_{T \text{ actual}} = W_{2-3} = h_2 - h_3 = E_T (h_2 - h_{3S}) \quad \frac{\text{BTU}}{\text{lbm}}$$

where  $E_T$  is the real turbine efficiency and is given by:

$$E_T = \frac{h_2 - h_3}{h_2 - h_{3S}}$$

$E_T$  is a characteristic of the specific turbine and the value is provided by the manufacturer. A typical value for  $E_T$  is 85%.

3. Heat rejected in the condenser following an ideal steam expansion is:

$$q_{\text{rejected}} = q_{3S-4} = h_4 - h_{3S} \quad \text{BTU/lbm}$$

Since the turbine is not ideal, the actual energy rejected in the condenser is:

$$q_{\text{rejected}} = q_{3-4} = h_4 - h_3 \quad \text{BTU/lbm}$$

Because  $h_3$  is greater than  $h_{3S}$ , the absolute value of  $q_{3-4}$  is greater than the absolute value of  $q_{3S-4}$ . The negative sign simply indicates heat rejection rather than heat addition.

4. Work used by the feed pump to increase feedwater pressure is:

$$W_{p \text{ ideal}} = W_{4-1} = h_4 - h_1 \quad \text{BTU/lbm}$$

$$W_p \text{ ideal} = E_p \times W_p \text{ actual}$$

$$W_p \text{ ideal} \equiv W_p \text{ actual}$$

A typical value for  $E_p = 90\%$ . In practice,  $W_p \text{ actual}$  and  $W_p \text{ ideal}$  are assumed to be the same since the error introduced by this assumption has little effect on overall plant performance calculations.

### 3.2.7 Example Cycle Analysis

For the purpose of an example, the following quantities will be determined assuming the mass flow rate ( $\dot{m}$ ) in the plant is  $2 \times 10^6$  lbm/hr.

- Heat added in the reactor or steam generator (in a PWR, the heat added in the steam generator is approximately equal to the heat obtained from the reactor),
- Useful work out of the turbine,
- Heat rejected in the condenser,
- Work required to drive the feed pump, and
- The cycle efficiency.

#### 3.2.7.1 Turbine Work

Refer to Figure 3-7, where the analysis starts at point 2 in the cycle. This point is the outlet of the reactor or steam generator and the inlet to the turbine. The assumption is made that the steam supplied to the turbine is a saturated vapor with no superheat. The reactor or steam generator outlet steam pressure is 1015 psia (1000 psig) and the steam mass flow rate is  $2 \times 10^6$  lbm/hr.

From the steam tables or directly from the Mollier diagram, the specific enthalpy of saturated vapor,  $h_g$ , at 1015 psia is about 1191 BTU/lbm. This enthalpy corresponds to point 2 on Figure 3-7.

The steam expands through the turbine and exhausts at the same pressure as the condenser (in

this instance, 2 in Hg absolute). Solving for the point 3S enthalpy can be done on a Mollier diagram. With an isentropic expansion, the steam expands through the turbine along the constant entropy line until point 3S is reached where the constant pressure line for 2 in Hg is intersected. From the Mollier diagram enthalpy axis,  $h_{3S}$  is determined to be approximately 774 BTU/lbm.

To determine  $h_3$ , the actual enthalpy of the exhaust steam, the turbine efficiency relationship and an assumed efficiency of 85% is used.

$$E_T = \frac{h_2 - h_3}{h_2 - h_{3S}}$$

$$E_T \times (h_2 - h_{3S}) = h_2 - h_3$$

$$h_3 = h_2 - E_T \times (h_2 - h_{3S})$$

$$h_3 = 1191 - .85 \times (1191 - 774) \text{ BTU/lbm}$$

$$h_3 = 836 \text{ BTU/lbm}$$

$h_3$  is plotted on the Mollier diagram at the intersection of the 2 in Hg constant pressure line and the 836 BTU/lbm constant enthalpy line.

The actual turbine work output per lbm of steam is:

$$W_{2-3} = h_2 - h_3$$

$$W_{2-3} = 1191 - 836 = 355 \text{ BTU/lbm}$$

The turbine power can be found by multiplying  $W_{2-3}$  by the steam flow rate:

$$\text{Turbine Power} = \dot{m} \times W_{2-3}$$

$$\text{Turbine Power} = 2 \times 10^6 \text{ lbm/hr} \times 355 \text{ BTU/lbm}$$

$$\text{Turbine Power} = 7.1 \times 10^8 \text{ BTU/hr}$$

Turbine power can be converted to ft-lbf/hr,

horsepower, or megawatts (MW) as desired by using the proper conversion factors.

### 3.2.7.2 Condenser Heat Rejection

The heat rejected in the condenser is given by:

$$q_{3-4} = h_4 - h_3$$

The pressure at point 4 is 2 in. Hg absolute or .98 psia. The saturation temperature is 101°F. The saturated steam tables show that point 4 corresponds to a saturated liquid with an enthalpy,  $h_f$ , of about 69 BTU/lbm. Using this value for  $h_4$ , the amount of heat rejected in the condenser per lbm of steam is:

$$q_{3-4} = 69 - 836 = -767 \text{ BTU/lbm}$$

The negative sign means a loss of heat from the system. The rate of heat rejection is this value multiplied by the exhaust flow rate:

$$\dot{Q}_{3-4} = -767 \text{ BTU/lbm} \times 2 \times 10^6 \text{ lbm/hr}$$

$$\dot{Q}_{3-4} = -1.53 \times 10^9 \text{ BTU/hr}$$

Note that more than twice as much heat is rejected in the condenser as is extracted by the turbine.

### 3.2.7.3 Feed Pump Work

Work is required to drive the feed pump which increases the pressure of the feedwater to 1015 psia. This work is given by:

$$W_{4-1} = h_4 - h_1 \text{ BTU/lbm}$$

Since the saturation temperature corresponding to 1015 psia is about 546°F, the pump discharge is subcooled water. From subcooled water tables, the enthalpy for  $h_1$ , compressed water at 101°F and a pressure of about 1000 psia, is about 71.7 BTU/lbm. Therefore, the pump work is:

$$W_{4-1} = 69 - 71.7 = -2.7 \text{ BTU/lbm}$$

The negative sign arises because this is work that must be put into the cycle or done on the system. The pump work load or pumping power is determined by multiplying  $W_{4-1}$  by the mass flow rate:

$$\text{Pumping Power} = \dot{m} \times W_{4-1}$$

$$\text{Pumping Power} = 2 \times 10^6 \text{ lbm/hr} \times (-2.7 \text{ BTU/lbm})$$

$$\text{Pumping Power} = -5.4 \times 10^6 \text{ BTU/hr}$$

The pumping power can be converted to horsepower, ft-lbf/hr, or megawatts as desired by using the proper conversion factor.

Neglecting the minus sign, the magnitude of the ratio of the pumping power to the turbine power is:

$$\frac{\text{Pumping Power}}{\text{Turbine Power}} = \frac{5.4 \times 10^6 \text{ BTU/hr}}{7.1 \times 10^8 \text{ BTU/hr}} = .0076$$

Thus, the ratio of the required pumping power to the turbine power is less than 1%. This small ratio is the primary justification for ignoring pump efficiency in the overall analysis as discussed earlier.

### 3.2.7.4 Heat Addition

The heat added to the cycle is:

$$q_{\text{added}} = q_{1-2} = h_2 - h_1$$

The values of  $h_2$  and  $h_1$  were determined earlier so:

$$q_{1-2} = 1191 - 71.7 = 1119 \text{ BTU/lbm}$$

The heat added to the cycle, which is about equal to the reactor thermal power, is found by multiplying  $q_{1-2}$  by the steam flow rate:

$$\text{Reactor Thermal Power} \equiv \dot{Q}_{\text{in}} = \dot{m} q_{1-2}$$

$$\text{Reactor Thermal Power} = 2 \times 10^6 \text{ lbm/hr} \times 1119 \text{ BTU/lbm}$$

$$\text{Reactor Thermal Power} = 2.24 \times 10^9 \text{ BTU/hr}$$

Since 1 megawatt equals  $3.413 \times 10^6$  BTU/hr, reactor thermal power can be given as:

$$\begin{aligned} \text{Reactor} \\ \text{Thermal} \\ \text{Power} &= 2.24 \times 10^9 \frac{\text{BTU}}{\text{hr}} \times \frac{1 \text{ MW}}{3.413 \times 10^6 \frac{\text{BTU}}{\text{hr}}} \end{aligned}$$

$$\text{Reactor Thermal Power} = 656 \text{ MW}$$

### 3.2.7.5 Cycle Efficiency

The actual cycle efficiency is given by:

$$E_{\text{act}} = \frac{W_{\text{act}}}{Q_{\text{in}}}$$

$W_{\text{act}}$  is the net work of the cycle which is the difference between the turbine and pump work. If pump work is neglected, the net work is the turbine work.

$$E_{\text{act}} = \frac{355 \text{ BTU/lbm}}{1119 \text{ BTU/lbm}}$$

$E_{\text{act}} = 31.7\%$ , which is representative of the actual cycle efficiency of modern nuclear plants.

The actual efficiency can be compared to the maximum theoretical efficiency for this cycle which is given by:

$$E_{\text{thmax}} = 1 - \frac{T_{\text{out}}}{T_{\text{in}}}$$

$$\begin{aligned} T_{\text{out}} &= (\text{Saturation Temperature in Condenser}) \\ &= 101^\circ\text{F} = 561^\circ\text{R} \end{aligned}$$

$$\begin{aligned} T_{\text{in}} &= (\text{Saturation Temperature in reactor/steam} \\ &\text{generator}) = 546^\circ\text{F} = 1006^\circ\text{R} \end{aligned}$$

$$E_{\text{thmax}} = 1 - \frac{561}{1006} = 1 - .558$$

$$E_{\text{thmax}} = .442 = 44.2\%$$

As expected, the actual efficiency is less than the theoretical maximum efficiency.

### 3.2.8 Improving Cycle Efficiency

Any improvements that can be made in cycle efficiency will increase the amount of electric power that can be generated from a given amount of nuclear fuel. As discussed in section 3.2.4, either increasing the effective temperature during heat addition or decreasing the effective temperature during heat rejection will improve cycle efficiency. Various methods are used to improve the efficiency of the steam plant cycle. Two methods commonly used in nuclear power plants are discussed in the following sections.

#### 3.2.8.1 Feedwater Heating

Feedwater heating is used to preheat the feedwater prior to entering the reactor/steam generator. Feedwater heating is accomplished by directing the feedwater through a series of heat exchangers called feedwater heaters. A steam cycle incorporating feedwater heating is shown in Figure 3-8.

The heating medium for the feedwater heaters is typically turbine extraction steam. Extraction steam from the turbines has a high moisture content and is removed from various turbine stages to prevent erosion of the latter-stage blades. After transferring heat to the feedwater, the extraction steam remnants exiting the feedwater heaters are drained to the condensate system or sent to the main condenser.

Preheating the feedwater with extraction steam uses energy that would otherwise be rejected or lost from the steam cycle. Essentially, heating increases the effective temperature for heat addition during steam generation. With warmer



feedwater entering the reactor/steam generator, less reactor heat is required to change each pound of feedwater to steam. The overall effect is an improvement in cycle efficiency. The effect of feedwater heating on the steam plant cycle is shown on a T-S diagram in Figure 3-9.

### 3.2.8.2 Steam Reheating

Steam reheating is used to dry and slightly superheat (reheat) the steam that has been partially expanded in the turbine. In nuclear power plants, reheating is typically accomplished by directing the high pressure turbine exhaust through a heat exchanger called a moisture-separator/reheater (MSR). The dried and reheated steam is then directed to the low pressure turbine for more expansion. A steam plant cycle incorporating reheating is shown in Figure 3-8.

The heating medium for the MSR is typically main steam or high temperature turbine extraction steam. After transferring heat to the cooler high pressure turbine exhaust in the MSR, the heating medium steam remnants are drained to the condensate system or sent to the main condenser. In some plants with feedwater heating, the heating medium steam remnants may also be used in the feedwater heaters.

Removing the moisture from and reheating the high pressure turbine exhaust steam prior to sending it to the low pressure turbine allows the steam expansion to continue to a lower pressure/temperature and thereby reduces the effective temperature for heat rejection during steam condensation. The lower heat rejection temperature is manifested in a lower condenser pressure that permits greater steam expansion in the turbines. A greater steam expansion extracts more work from each pound of steam, which results in an improvement in cycle efficiency. The effect of reheating on the steam plant cycle is shown on a T-S diagram in Figure 3-9.

## 3.3 Basic Heat Transfer Mechanisms and Principles

There are two primary mechanisms of heat transfer: conduction and radiation. Convection, sometimes referred to as separate mechanism, is actually a combination of conduction, radiation, and mass transfer. Conduction heat transfer is a flow of heat through a body or between bodies in direct contact. It results from the transfer of kinetic energy by molecular motion. Radiation heat transfer occurs when energy is exchanged between bodies through an intervening space by electromagnetic waves. Convection is the transfer of heat between a fluid and a surface by circulation or mixing of the fluid. Because convection depends on the fluid's direct contact with the surface, the heat transfer between the fluid molecules and the associated surface involves the mechanism of conduction.

### 3.3.1 Conduction

Conduction is the basic method of heat transfer through any solid material, such as the cladding around fuel elements or the wall of a steam generator tube. Conduction is heat transfer from one molecule to another molecule. Figure 3-10 shows the cladding of a fuel element, with the heat source on one side and water on the other. For simplicity, the cladding is modeled as a wall.

The molecules in the metal wall are constantly vibrating. As the temperature of the metal increases, the energy of the molecules increases and the vibrations become stronger. When a hot molecule strikes a cool molecule, energy transfers to the cool molecule. This cool molecule, in turn, will transfer energy to a still cooler molecule. The process continues until a flow of energy or heat across the metal wall is achieved.

The transfer of energy from hot molecules to cool molecules is the fundamental principle of conduction heat transfer. Therefore, if heat is to be conducted, there must be a temperature difference between the molecules. If there is no temperature

difference, no heat will flow.

The fundamental principles of conduction heat transfer can be summarized as follows:

- There must be a temperature gradient ( $\Delta T$ ) for heat to be transferred through a material.
- The amount of heat transferred per unit time will depend upon the thickness ( $X$ ) of the material. If the material is very thick, little or no heat will be transferred through the wall.
- The amount of heat transferred per unit time will depend on the area ( $A$ ) of the material.
- The amount of heat transferred per unit time will depend upon the thermal conductivity ( $k$ ) of the material. A material that is a poor conductor of heat or a good insulator will have a small  $k$ . A material that is a good conductor of heat or a poor insulator will have a large  $k$ .

With these principles, a word and a mathematical equation can be written to describe conduction heat transfer. The amount of heat transferred is directly proportional to the temperature gradient and total area, and inversely proportional to the material thickness.

Heat transfer rate  $\propto$   $\frac{\text{area} \times \text{temperature gradient}}{\text{material thickness}}$

To make this proportionality an equality, a constant of proportionality can be introduced. This constant is the "coefficient of thermal conductivity" or "thermal conductivity" of the material. The expression then becomes:

Heat transfer rate =  $\frac{\text{thermal conductivity} \times \text{area} \times \text{temp. gradient}}{\text{material thickness}}$

In mathematical terms, this expression becomes Equation 3-6:

$$\dot{Q} = kA \left( \frac{T_1 - T_2}{X} \right), \quad (3-6)$$

where

$\dot{Q}$  = rate of heat transfer (BTU/hr),  
 $k$  = coefficient of thermal conductivity (BTU/hr-ft-°F),  
 $A$  = area of surface (ft<sup>2</sup>),  
 $T_1$  = higher temperature (°F),  
 $T_2$  = lower temperature (°F), and  
 $X$  = material thickness (ft).

Equation 3-6 is called Fourier's Law for time independent, steady-state heat flow.

Thermal conductivity of different materials varies greatly. Metals and alloys have high values of  $k$ , while most insulating materials such as glass wool, cork, and kapok have low values. In actuality, thermal conductivity is somewhat dependent upon temperature, and generally increases with increasing temperature. The variation of  $k$  with temperature in metals is small, however, and for many crystalline substances the thermal conductivity decreases with temperature. For most practical purposes,  $k$  can be assumed to be constant. However, at high temperatures such as those existing in reactor fuel, this assumption can introduce substantial error.

Another frequently used term is "heat flux" ( $\dot{Q}/A$ ). Heat flux is the heat flow rate per unit area and its units are BTU/hr-ft<sup>2</sup>. Heat flux is a convenient way of expressing heat transfer rate on a per unit basis.

Fourier's Law is readily adapted to produce results in terms of heat flux by dividing both sides by the area ( $A$ ), as shown in Equation 3-7:

$$\frac{\dot{Q}}{A} = \frac{k(T_1 - T_2)}{X} \quad (3-7)$$

### 3.3.2 Radiation

Radiation is the transmission of energy by electromagnetic waves across an intervening space. A body emits electromagnetic waves by virtue of its absolute temperature. In general, the body must be extremely hot for a substantial amount of energy to be emitted in this form.

A body having a temperature above absolute zero radiates energy. Electromagnetic waves emitted by such a body are similar to light waves but usually have longer wave lengths. These waves may either be absorbed, transmitted, or reflected by objects which they strike. In turn, the body receives energy from other radiating bodies and either absorbs, transmits, or reflects these waves.

Radiation heat transfer can be a significant method of energy transfer wherever very high temperatures are found. Radiation heat transfer is quite important in high temperature furnaces and internal combustion engines.

Radiation heat transfer from a body depends upon the absolute temperature of the body, the shape of the surface of the body, and a term called the emissivity (ability to emit) of a body. In general, radiation heat transfer from a body can be quite difficult to calculate because the net radiation heat transfer rate is the difference between the energy being radiated by a body and the energy being absorbed by the body. An important point to remember about radiation heat transfer is that the radiation heat transfer between two bodies at temperatures  $T_1$  and  $T_2$  is proportional to  $T_1^4 - T_2^4$ , not  $T_1 - T_2$  as for conduction and convection.

Radiation heat transfer is not an especially important heat transfer mechanism during normal plant operation. One place where radiation heat transfer can be important for nuclear reactors is following a loss-of-coolant accidents (LOCA) when the nuclear fuel is uncovered. Under these conditions, the primary means by which the high temperature fuel element can cool itself prior to

initiation of Emergency Core Cooling Systems (ECCS) is by heat radiation to cooler fuel rods and surroundings. Prevention of this condition is one reason for the thermal safety limits provided for all power reactors.

### 3.3.3 Convection

Convection is the transfer of heat between a fluid and a surface by the circulation or mixing of a fluid. Figure 3-11 shows the convection process. In Figure 3-11, a fluid is flowing over a heated wall surface. Whenever fluid is in contact with a wall, a very thin layer of stagnant fluid exists immediately next to the surface. Such a layer is known as a stagnant (or fluid) film. The film contains several slowly moving layers of fluid only a few molecules thick. Any heat passing from the wall to the bulk fluid must pass through this film. The film's thermal properties are the same as the fluid, but the film's thickness depends on fluid viscosity and the fluid flow conditions. The film is thickest for free convection and laminar flow. It is thinnest during turbulent flow and forced convection. A typical film thickness for free convection is 0.04 inch.

Heat is transferred across the fluid film in a process similar to conduction. The process is slightly different in that there is a mechanical motion of the film (albeit slow). Hence, heat energy is carried away from the surface by two mechanisms as follows:

- The physical collision of fluid molecules and wall material, thereby transferring heat energy in a manner identical to conduction, and
- The mechanical movement of fluid molecules away from the surface and out into the fluid, where stored energy is transferred through random collisions with other fluid molecules.

Convection heat transfer from the heated surface, through the film, and into the bulk fluid, is

described by the same fundamental relationships as conduction heat transfer. The rate at which heat is transferred across the film is proportional to the temperature gradient, the thermal conductivity of the stagnant film, and the total area from which the heat is transferred. The heat transfer rate is inversely proportional to the thickness of the fluid film. Fourier's law can be written for the heat transfer across the film as Equation 3-8:

$$\dot{Q} = \frac{k_f A (T_w - T_f)}{X_f}, \quad (3-8)$$

where

- $\dot{Q}$  = total heat transfer rate (BTU/hr),
- $k_f$  = thermal conductivity of the stagnant film (BTU/hr-ft-°F),
- $A$  = total surface area (ft<sup>2</sup>),
- $T_w$  = wall surface temperature (°F),
- $T_f$  = bulk fluid temperature (°F), and
- $X_f$  = stagnant film thickness (ft).

The heat flux equation is Equation 3-9:

$$\dot{Q}/A = \frac{k_f (T_w - T_f)}{X_f}, \quad (3-9)$$

where  $\dot{Q}/A$  = heat flux (BTU/hr - ft<sup>2</sup>).

The use of this equation would be simple if not for the extreme difficulty of determining actual film thickness ( $X_f$ ) which depends on

- Fluid velocity,
- Fluid viscosity,
- Heat flux,
- Surface roughness, and
- Type of flow (single- or two-phase flow).

Because of these difficulties, it is customary to combine  $k_f/X_f$  and call this new term the film heat transfer coefficient, ( $h_f$ ). Film heat transfer coefficients are normally determined empirically and have units of BTU/hr-ft<sup>2</sup> °F. The basic equation for heat convection from a surface then becomes:

$$\dot{Q}/A = h_f(T_w - T_f) \text{ (BTU/hr-ft}^2\text{)}.$$

If the bulk fluid temperature ( $T_f$ ) is higher than the surface temperature, the heat flux calculated by this equation will be negative. This indicates that the heat flow is from the fluid to the surface (i.e., the fluid is losing heat).

### 3.4 Practical Applications of Heat Transfer in the Plant

#### 3.4.1 Physical Parameters of Basic Heat Transfer

Conduction and convection are the important heat transfer mechanisms in power plants. The key factors affecting conduction and convection are temperature difference across the transferring material, the thickness of the material, the surface area of the transferring material, the type of material, and the flow of fluid along the heated surface.

##### 3.4.1.1 Temperature Difference

Heat flows from a high temperature to low temperature. This high to low temperature difference is represented by  $\Delta T$ . For conduction and convection, heat flow is proportional to  $\Delta T$ . The relationship between heat flow and  $\Delta T$  can be expressed mathematically as follows:

$$\dot{Q} \propto \Delta T$$

$$\dot{Q} = K_T \Delta T,$$

where  $K_T$  is a constant of proportionality.

##### Example:

Heat is being transferred from a source through a wall. Assume that 10 BTUs per hour are transferred when the  $\Delta T$  across the wall is 5°F. How much  $\Delta T$  is required to transfer 12 BTUs per hour?

$$Q \propto \Delta T = K_T \Delta T$$

$$\frac{Q_1}{Q_2} = \frac{\Delta T_1}{\Delta T_2}$$

$$\frac{10 \text{ BTU/hr}}{12 \text{ BTU/hr}} = \frac{5^\circ\text{F}}{\Delta T_2}$$

$$\Delta T_2 = (5^\circ\text{F}) \left( \frac{12}{10} \right)$$

$$\Delta T_2 = 6^\circ\text{F}$$

### 3.4.1.2 Material Thickness

The heat transfer rate is approximately inversely proportional to the material thickness. This relationship can be expressed mathematically as follows:

$$\dot{Q} \propto \frac{1}{X}$$

$$\dot{Q} = \frac{K_X}{X},$$

where  $K_X$  is a constant of proportionality.

#### Example:

Heat is being transferred at a 20 BTU/hr rate through a wall. If the  $\Delta T$  across the wall remains constant, what will be the heat transfer rate if the wall thickness is halved?

$$\dot{Q} = \frac{K_X}{X}$$

$$\dot{Q}_1 X_1 = \dot{Q}_2 X_2; \quad X_2 = \frac{X_1}{2}$$

$$\dot{Q}_2 = \dot{Q}_1 \frac{X_1}{X_2} = \dot{Q}_1 \left( \frac{2X_1}{X_1} \right) = (20)(2) = 40 \text{ BTU/hr}$$

### 3.4.1.3 Area

The heat transfer rate is proportional to the heat transfer area. If every other factor involved in the heat transfer process remains constant when the heat transfer surface area doubles, the total heat transfer would also double. Changing heat transfer area is something that is actually done in the plant. For example, different numbers of feedwater heaters are used for operation at different power levels, as are different numbers of lube oil coolers.

The mathematical relationship is:

$$\dot{Q} \propto A$$

$$\dot{Q} = K_A A,$$

where  $K_A$  is a constant of proportionality.

### 3.4.1.4 Material

The metals in the plant are good conductors. An obvious poor conductor is the insulation used on the piping and turbine. This insulation keeps excess heat from being wasted and keeps the building from becoming unbearably hot.

Other poor conductors are deposits that can build up on the walls of heat transfer surfaces in the reactor, steam generator, or condenser. If deposits build up on heat transfer surfaces, the temperature of the heat source must increase to provide the larger  $\Delta T$  that is necessary to maintain the same heat transfer rate. If the heat source is the reactor fuel, the higher temperature could cause fuel damage unless power levels are decreased. If the heat source is the steam in the condenser, an increase in the steam temperature would result in a smaller temperature drop across the turbine and reduced plant efficiency.

Heat transfer rate is proportional to thermal conductivity. Mathematically, this relationship is:

$$\dot{Q} \propto k$$

$$\dot{Q} = K_k k,$$

where  $K_k$  is a constant of proportionality.

### 3.4.1.5 Flow

Heat is transferred from the walls of the steam generator to the water by convection, which includes conduction through the fluid film before the heat enters the moving water. The thicker the film, the more difficult it is for the heat to be carried away from the heated surface.

Water flowing past a surface strips off the heated water molecules sticking to the surface. An increase in the flow rate causes the removal of more water molecules. Thus, an increase in flow rate decreases the thickness of the film, which decreases the required temperature drop from the wall to the moving water. The result is either a larger amount of heat transfer or a smaller  $\Delta T$ .

The effects of flow on heat transfer from a heat transfer surface into water can be shown on a heat transfer curve as in Figure 3-12. Both of the axes on the graph are logarithmic because the graph has to cover such a wide range. The vertical axis is the heat flux ( $\dot{Q}/A$ ), the amount of heat transferred per unit time. The horizontal axis is the  $\Delta T$  between the surface of the wall and the bulk of the water. The heat transfer curve assumes that pressure, flow, and enthalpy are all constant. If any of these properties change, the curve will change.

The solid line A in Figure 3-13 is a closeup of the convection part of the heat transfer curve in Figure 3-12. Because the slope of line A is 1; the heat transfer rate doubles if the  $\Delta T$  is doubled. If flow is increased, the curve shifts left to line B. If the flow is decreased, the curve shifts right to line C. Thus, for a constant heat transfer rate line D, the higher flow rate will have a smaller  $\Delta T$ .

## 3.4.2 Heat Transfer in Heat Exchangers

The main area of difficulty in calculating heat transfer rates in heat exchangers is determining the heat transfer coefficient ( $h$ ). The heat transfer coefficient is normally determined empirically for different fluids, fluid viscosities, heat flux rates, surface roughnesses, and fluid flow rates. By measuring heat flux and temperature differences, values of  $h_f$  can be found using the heat flux equation discussed earlier. These values are then tabulated in engineering manuals for conditions of common interest. In addition, research has produced formulas that can be used to calculate approximate values of  $h_f$  if conditions such as viscosity and surface roughness are known.

In many heat exchanger applications, a need exists to transfer heat from one fluid, across a solid divider surface (a wall or tube), to another fluid. In this instance, two stagnant films must be considered. In addition, it is quite common that the fluids and their thermal properties differ. Some examples of this application are the turbine lube oil heat exchangers (oil to water) and the generator hydrogen gas coolers (hydrogen to water).

Figure 3-14 is a simple sketch of heat transfer in a typical heat exchanger. Fluid 1 is hotter than fluid 2 and releases its stored energy by heat transfer to fluid 2 (note the thermal gradients).

For simplicity, most heat exchanger calculations are performed for steady-state conditions. Under steady-state conditions the same amount of heat flows through each fluid stagnant film as flows through the heat exchanger tube wall. Because most fluids have smaller thermal conductivities than metals, the thermal gradient is greater across the fluid films than the tube wall. The temperature gradients shown in Figure 3-14 are characteristic of all heat exchangers.

### 3.4.2.1 Heat Transfer Across Tube Walls

To facilitate heat exchanger calculations, an overall heat transfer coefficient ( $U$ ) is defined.

The overall heat transfer coefficient is used for heat transfer between two fluids across a tube wall or several tube walls.  $U$  is an inclusive thermal conductivity factor that can be determined for a specified combination of fluids, flows, and operating conditions. By using previously developed equations for conduction and convection heat transfer, Equation 3-10 that describes the rate of heat transfer from fluid 1 to fluid 2 across several tube walls can be written:

$$\dot{Q} = UA(T_1 - T_2), \quad (3-10)$$

where

- $\dot{Q}$  = total heat transfer rate (BTU/hr),
- $A$  = total tube wall surface area (ft<sup>2</sup>),
- $T_1$  = fluid 1 temperature (°F),
- $T_2$  = fluid 2 temperature (°F), and
- $U$  = overall heat transfer coefficient (BTU/hr-ft<sup>2</sup>-°F).

Equation 3-10 is used to calculate the heat transfer rate across a tube wall, or several tube walls, as from the reactor coolant to the feedwater across the tube walls of a PWR steam generator.

The value of  $U$  incorporates the heat transfer coefficients of the fluid films and the thermal conductivity of the tube wall material. Typical values of  $U$  for various heat exchangers found in a power plant are:

Component	$U$
Condenser and Feedwater Heaters	600 BTU/hr-ft <sup>2</sup> -°F
Lube Oil Cooler	40 BTU/hr-ft <sup>2</sup> -°F
Air Preheater	5 BTU/hr-ft <sup>2</sup> -°F

### 3.4.2.2 Heat Transfer Within One Fluid

The heat transfer within one fluid in a heat exchanger can be determined using a mass and energy approach. The heat transferred by or to a single-phase fluid within a heat exchanger can be calculated using Equation 3-11:

$$\dot{Q} = \dot{m} C_p \Delta T, \quad (3-11)$$

where

- $\dot{Q}$  = total heat transfer rate (BTU/hr),
- $\dot{m}$  = mass flow rate (lbm/hr),
- $C_p$  = heat capacity of the fluid (BTU/lbm-°F)
- $\Delta T$  = temperature change within the fluid (°F)
- $\Delta T = T_{out} - T_{in}$  (within the one fluid).

Equation 3-11 does not depend upon the area of the heat exchanger or the heat transfer coefficient. The heat capacity term,  $C_p$ , refers to the amount of heat contained in each pound-mass of the fluid per °F.

Equation 3-11 is used only for single-phase fluid (when there is no change in state within the fluid). The variation of Equation 3-11, used when the fluid changes state (boils to steam or condenses to condensate), is Equation 3-12:

$$\dot{Q} = \dot{m} (h_{out} - h_{in}), \quad (3-12)$$

where

$h$  = specific enthalpy of the fluid (BTU/lbm),

and enthalpy  $h_{out}$  and  $h_{in}$  represent the energy contained in each pound-mass of the fluid at the exiting state and the entering state.

## 3.5 Boiling Heat Transfer

Boiling heat transfer is heat transferred by the boiling of water. Boiling occurs in the BWR reactor and in the PWR steam generator by design. During an unusual transient, large amounts of additional core boiling could occur and safety limits could be exceeded; therefore, boiling heat transfer is an extremely important topic for accident considerations. Boiling heat transfer is not a fourth method of heat transfer, but it is considered separately because of its importance.

Figure 3-15 is the heat transfer curve that was

introduced earlier. The area of concentration this time is the region above the dotted line that is the boiling heat transfer region. The boiling heat transfer portion of the curve is steeper than the convection portion of the curve. This means that more heat is transferred per  $\Delta T$ , and heat transfer is more effective. In convection heat transfer, heat flow is proportional to  $\Delta T$ . For boiling heat transfer, however, heat flow is proportional to  $\Delta T$  to approximately the 4.5 power.

A microscopic look at a typical heat transfer surface shows small irregularities called nucleation points. Heat is being transferred all along the surface, but the heat at a nucleation point is concentrated into a small amount of water. When the surface temperature gets high enough, a steam bubble forms, grows, and finally breaks away from the surface. This is called nucleate boiling. Unlike single-phase convection, boiling heat transfer is a fast process. During nucleate boiling the water absorbs its latent heat of vaporization and then moves quickly from the heated surface.

There are two requirements for nucleate boiling. First, there must be nucleation points so that steam bubbles can form. Second, the surface temperature must be about 8 to 10 degrees higher than the saturation temperature of the liquid. If the surface is not hot enough, there will be no boiling, and the heat transfer will be only by convection.

As each steam bubble is formed, it moves away from the wall. If the bulk of the water is at a temperature less than saturation, the bubble will cool and condense. This is called subcooled nucleate boiling because the bulk of the water is subcooled below the saturation temperature. If the bulk of the water is at saturation temperature, however, the steam bubble will not cool and condense as it moves away. It will remain as a steam bubble mixed in the bulk water. This process is commonly called bulk boiling or fully developed nucleate boiling.

Convection heat transfer, subcooled nucleate boiling, and bulk boiling are the normal modes of

heat transfer expected during normal plant operation. Another mode of boiling heat transfer is film boiling. Film boiling occurs when so much boiling takes place that all of the steam cannot be removed from the heated surface. When this happens a film of steam forms on the heat transfer surface or wall. The steam acts as an insulator and further impedes heat transfer from the wall, resulting in an immediate jump in wall temperature. Experiments with film boiling have shown that the wall temperature can jump by 25 degrees almost instantaneously. Film boiling is an undesirable mode of heat transfer in nuclear power reactors.

The process of going from nucleate boiling to film boiling is called transition boiling. Transition boiling is shown as a dotted line on the heat transfer curve in Figure 3-16. The line is dotted because the process is so unstable that the heat transfer process actually moves back and forth between nucleate boiling and film boiling. The amount of heat required to cause transition boiling is called the critical heat flux (CHF). This point is also called the departure from nucleate boiling (DNB) point. At DNB, the heat transfer literally departs from nucleate boiling.

Figure 3-16 shows the change in  $\Delta T$  that occurs between nucleate and film boiling at DNB. Most of the time, the heat produced in the reactor core will remain constant. Therefore, if the film boiling stage is reached during some transient, the wall temperature will increase rapidly. This could cause the fuel to overheat or "burn out." For this reason, many safety limits are included during plant design to prevent film boiling.

### 3.5.1 Physical Parameters of Boiling Heat Transfer

The plant operator has control over pressure, temperature, and flow in the plant. A change in any of these physical parameters can have an effect on boiling heat transfer.



### 3.5.1.1 Pressure

If the pressure increases while nucleate boiling heat transfer is taking place, the saturation temperature of the water increases and more heat is required for nucleate boiling to continue. If additional heat is not provided, nucleate boiling heat transfer will stop and convection will become the primary means of heat transfer. Since nucleate boiling promotes more effective heat transfer, a sudden increase in pressure could cause a corresponding increase in the temperature of the heat source.

Figure 3-17 shows the effect of an increase in pressure on the heat transfer curve. Points on curve A indicate the initial boiling curve. An increase in pressure shifts the curve to the right to the new boiling curve line B. If heat flux is constant in the nucleate boiling region  $(\dot{Q}/A)_1$ , a higher  $\Delta T$  is needed because nucleate boiling has been suppressed by the pressure increase. On the other hand, if heat flux is constant in the convection heat transfer region  $(\dot{Q}/A)_2$ , a change in pressure has little effect on  $\Delta T$ .

If nucleate boiling is taking place and the pressure suddenly decreases, the saturation temperature decreases, and more boiling will occur. Depending upon the initial heat transfer rate, such a change could improve the heat transfer or could cause film boiling to occur, resulting in a large increase in the temperature of the heat source. The effect of a pressure decrease on boiling heat transfer is shown in Figure 3-18. Points on curve A represent the initial boiling curve. Decreasing pressure shifts the curve to the left as indicated by curve B. If the initial boiling point is low on the nucleate boiling curve such as point C, and heat flux remains constant during the pressure decrease, a  $\Delta T$  decrease will occur as point C moves to curve B. In this case the heat transfer improves, and the temperature of the heat source is reduced. On the other hand, if the initial boiling point is high on the nucleate boiling curve, such as point D, and heat flux remains constant during the pressure decrease, a large  $\Delta T$  increase will occur as point D

moves to curve B. This shift represents an immediate departure from nucleate boiling, which will cause rapid overheating of the heat source.

Therefore, a loss of pressure may be a major concern for plant safety. A loss of pressure could cause immediate film boiling and consequent damage to the reactor fuel. For normal plant operations, it is best to maintain a constant pressure and make only slow changes in power level.

### 3.5.1.2 Temperature and Reactor Power

The principal direct effect of temperature on heat transfer is through  $\Delta T$ . The greater the  $\Delta T$  between the wall and the bulk fluid, the greater the heat transfer rate and vice-versa. The temperature of the bulk fluid relative to the saturation temperature of the fluid will also influence heat transfer because of the differences that occur between convection and boiling heat transfer. The maximum fluid bulk temperature for saturated conditions is limited by the fluid saturation temperature.

An increase in reactor power level will increase the fuel temperature. The resulting increased wall temperature will increase the  $\Delta T$ , increasing the heat transfer rate.

If nucleate boiling is occurring prior to the reactor power increase, additional nucleate boiling and increased heat transfer will occur. If parameters such as pressure and flow remain unchanged, the bulk fluid temperature and heat transfer rate will increase as the boiling point moves up the heat transfer curve and closer to DNB. If DNB is reached, the heat transfer rate will decrease rapidly causing a corresponding rapid increase in fuel temperature.

### 3.5.1.3 Flow

If the flow of water is suddenly increased during heat transfer, the wall temperature will decrease, which could decrease the amount of nucleate boiling. If the flow is suddenly decreased, the wall temperature will increase, which

could cause film boiling depending upon the initial heat transfer rate. During plant operations, it is best to make only gradual changes to the flow rate through the reactor.

Figure 3-19 shows the effects of a flow increase on boiling heat transfer. The solid line represents the boiling heat transfer curve for the initial flow. The dotted line shows the heat transfer curve for an increased flow. In the convection heat transfer region, an increase in flow at a constant heat flux  $(\dot{Q}/A)_i$  results in a decrease in  $\Delta T$ . This decrease is due to a larger heat transfer coefficient for the higher flow. An increase in flow also increases the critical heat flux for the respective boiling curve. This increase occurs because the increased flow more readily sweeps steam bubbles from the heat transfer surface so that a higher heat transfer rate is needed for a steam film to form.

#### 3.5.1.4 Summary of Parameter Effects on Margin to DNB

As indicated in section 3.5, one of the requirements for reactor safety is the prevention of reaching DNB conditions on the reactor heat transfer curve. An important duty of the plant operator is to control plant parameters such that a safe margin to DNB (or distance from DNB on the heat transfer curve) is maintained. Any sudden, large change in the following plant parameters/directions will DECREASE the margin to DNB:

- Decrease in reactor coolant pressure,
- Decrease in reactor coolant flow rate,
- Increase in reactor power,
- Increase in reactor coolant inlet temperature.

Therefore, the function of the operators and the plant design is to prevent a sudden, large change in these plant parameters/directions.

### 3.5.2 Steam Generation Characteristics

#### 3.5.2.1 Steam Moisture Content and Removal

Boiling is the principal heat transfer mechanism in BWR reactors and PWR steam generators. The steam produced may contain a small quantity of water. This water is referred to as carryover. Carryover has the potential for causing erosion of steam piping and turbine rotor blading.

To prevent carryover, the steam-water mixture flows through separators. There are two basic types of steam-water separators in use:

- Cyclone moisture separator and
- Chevron moisture separators

Figure 3-20 shows a cross-section of a cyclone-type moisture separator. The mixture of water and steam flows through fan-shaped blades. The higher-density water is thrown to the outside, and the steam flows through the middle. The cyclone moisture separator is a very common piece of equipment. Several cyclone separators are located on top of the heat transfer portion of the BWR reactor and PWR steam generator, and virtually all exiting steam flows through them. The water is returned to mix with the entering feedwater.

Figure 3-21 shows a top view of a chevron-type moisture separator, which is used when there are smaller amounts of water in the steam. The chevron separator gets its name from the shape of its plates. Steam and water pass through the separator horizontally. The steam flows through easily, but the water hits the sides and drains down. This action causes the water and steam to separate. The steam exits the separator and the water is returned to mix with the incoming feedwater.

The quality of the exiting steam-water mixture is used to measure the efficiency of the moisture separators. If the quality is 100%, then only steam is present; if the quality is 0%, only water is present. The BWR and PWR steam separation devices provide dry steam with a quality of 99% or

greater.

Sometimes excessive moisture carryover can occur. One cause is improper water chemistry. A high concentration of impurities will cause large bubbles to form when steam is produced. When these bubbles collapse, more moisture droplets are carried along. Another cause of sudden carryover is steam-separator flooding, which can occur if the water level is too high.

### 3.5.2.2 Water Level Changes

Two types of sudden level changes occur in BWR reactors and PWR steam generators. These sudden level changes are called "swell" and "shrink." *Swell* occurs when there is a sudden decrease in steam pressure, and *shrink* occurs when there is a sudden increase in steam pressure.

If the turbine control valves are suddenly opened more, the amount of steam supplied to the turbine is rapidly increased. This increase in the supply of steam to the turbine means that more steam is removed from the BWR reactor or PWR steam generator than is being produced at the moment. This results in a rapid decrease in pressure. When the pressure drops, the steam bubbles in the water increase in size and some of the hot water flashes into steam, creating more steam bubbles. Additionally, the temperature is decreased which produces a greater  $\Delta T$  for heat transfer, so more heat is transferred to the water to produce more steam. All of these factors cause an apparent expansion of the amount of steam-water present. This expansion causes a sudden level increase called swell.

If the steam supply to the turbine is suddenly reduced, an increase in pressure occurs in the BWR reactor or PWR steam generator. Some of the steam bubbles in the water collapse resulting in a contraction of the steam-water mixture. The contraction causes a sudden level decrease called shrink.

Swell and shrink are important because a rapid

power change might result in sudden high or low water levels. The feedwater system can compensate for these conditions by maintaining a programmed level. Program level is usually high for high power and low for low power to account for a certain amount of shrink and swell.

## 3.6 Reactor Thermal and Hydraulic Performance

The principles associated with heat, work, and the movement of water will be applied to the study of thermal and hydraulic performance in the reactor. Thermal and hydraulic performance is the relationship between the heat that is produced in the reactor and the water that flows through the reactor and carries the heat to the steam cycle.

### 3.6.1 Performance Objectives

The reactor core consists of a large number of vertical tubes made of Zircaloy. These tubes enclose (clad) the nuclear fuel, which is in the form of ceramic pellets of uranium dioxide. These pellets produce the heat in the plant.

When the reactor is operating, water is pumped through the core, and it flows around the Zircaloy tubes. Nuclear fission occurs in the fuel pellets, and energy (primarily in the form of heat) is released. The heat is transferred from the ceramic pellet, through the Zircaloy tube, and into water.

To begin to understand thermal and hydraulic performance, it is necessary to look at heat generation and heat removal in the core and the ways that fuel might be damaged during these processes. This information will determine the basis of many of the technical specification operating limits that are designed to protect the plant as well as provide the basis for understanding much of the material on accidents that is included in the Final Safety Analysis Report (FSAR).

The basic consideration of reactor core design is for water to remove the heat generated by the core. One performance goal is to have as much

heat as possible transferred from the fuel to the water in the most efficient way. There are, however, certain objectives that must be met in achieving the best possible performance level and ensuring fuel integrity.

The first objective of thermal and hydraulic design is to ensure that the fuel will not melt. In formal terms, the thermal and hydraulic design of the plant should ensure that the center of the hottest fuel pellet does not melt. Figure 3-22 shows a line drawn through the middle of the fuel pellets called a "centerline." The highest temperature reached in this area is called the "peak centerline temperature." If this temperature exceeds approximately 5000°F, the fuel will melt. (The exact melting temperature will vary slightly over core life.)

The second objective of thermal and hydraulic design of the core is to ensure that the fuel clad is not damaged because the fuel clad is the first barrier against release of fission products to the environment. The reactor design should ensure that the temperature of the clad is not too high because excessive temperature itself can weaken the clad, and because excessive temperature can damage the clad by raising the internal gas pressure in the fuel tube. This pressure, in conjunction with the high temperature, causes the clad to stretch (strain) slightly. If the strain becomes too great, the clad can rupture and release fission products. Normally, the thermal and hydraulic design limits the strain of the fuel clad to less than 1%.

Because fuel and clad damage can occur if reactor core temperatures are too high, reactor designers have to consider the causes of excessive temperature. The two primary causes of excessive temperature are excessive peak power and film boiling.

If too much power is produced, that is, if the nuclear fuel produces too much heat, the temperature of the clad and the fuel rise to the point where they can be damaged. Damage from too much

power is prevented by establishing design limits that are defined in terms of power produced.

Film boiling can cause excessive fuel temperature. As described earlier, water goes through a transition just after the departure from DNB point, and film boiling occurs. Thus, to prevent damage from film boiling, additional limits are set for heat and temperature in the reactor core water in terms of DNB. The overall objective is that the water should not approach the conditions at which the transition to film boiling occurs.

One of the causes of film boiling is the production of too much heat in the fuel. To understand how excessive heat creates excessive temperature and affects core design, it is necessary to examine how heat is generated and distributed in the core. Heat is produced by uranium fissions in the fuel, but this heat is not produced evenly throughout the core. This means that local power levels vary throughout the core. Thus, the local power in the core is determined along the vertical and radial axis of the core. The distribution of power levels at different points in the core is called power distribution, and the variance from average power is called power peaking.

Power peaking involves a factor called the nuclear peaking factor (NPF). The NPF is the power of any local point in the core divided by the average power of the entire core as described in Equation 3-13:

$$\text{NPF} = \frac{\text{local power}}{\text{average power}} \quad (3-13)$$

Another factor is the maximum nuclear peaking factor (MNPF). The MNPF is the highest local power divided by the average power. This is shown in Equation 3-14.

$$\text{MNPF} = \frac{\text{highest local power}}{\text{average power}} \quad (3-14)$$

The MNPF represents the power being generated at the hottest point in the core compared with

an average point. If the MNPF gets too high, the fuel could be damaged. Even though the average power generation might be well within the limits for fuel safety, the local power at one point in the reactor might be high enough to cause damage.

The power in the reactor is measured in units of kilowatts. Using these units, the average power generated per foot in the core can be calculated as shown in the following example.

#### Example:

The first step in calculating the average power per foot is to multiply the total reactor power in megawatts by 1000 to obtain the total reactor power in kilowatts.

$$\begin{aligned} (\text{reactor power in MW}) \times (1000 \text{ kW/MW}) \\ = (\text{reactor power in kW}) \end{aligned}$$

The total reactor power in kilowatts divided by the number of fuel rods in the core yields the average power in kilowatts produced by each rod.

$$\begin{aligned} (\text{total power in kW}) \div (\text{number of rods}) \\ = (\text{average kW per rod}) \end{aligned}$$

The final step is to divide the kilowatts per rod by the length in feet of each rod. This yields the average heat generation rate in kilowatts per foot of fuel rod.

$$\begin{aligned} (\text{average kW per rod}) \div (\text{length of rod in ft}) \\ = (\text{average kW per ft}) \end{aligned}$$

Because power is not produced evenly in the reactor, it is also necessary to determine the maximum heat that will be generated locally. This is done by multiplying the average kilowatts per foot by the MNPF.

$$(\text{average kW per ft}) \times (\text{MNPF}) = (\text{peak kW per ft})$$

The result of this calculation is the maximum local heat generation rate or the peak kilowatts that will be produced in one foot of fuel rod. These

calculations can be used to determine how much heat the hottest part of the reactor will be generating. Reactor designers use the same relationships to determine limits in the reactor to avoid damage to the clad and the fuel.

Fuel damage will occur when the centerline temperature of the fuel exceeds approximately 5000°F. To determine how much heat must be generated to produce this temperature, reactor designers must consider more than just the highest local power generated. Other considerations include heat transfer factors specifically, the thermal conductivity of the fuel, the conductivity of the gas between the fuel and the clad, the conductivity of the clad, and the efficiency of the heat transfer from the fuel to the water.

A major difficulty in considering safety limits for heat generation in the core is that the factors involved in heat transfer do not remain constant over the life of the fuel. The conductivity of the fuel changes during irradiation. Cracks that form on the surface of the fuel pellets tend to decrease their heat transfer capability. Fuel pellets swell as time passes. This swelling decreases the gap between the pellets and the clad and tends to improve heat transfer. Thus, it is not only the factors involved in heat transfer, but also the changes in these factors that must be taken into account in reactor design.

### 3.6.2 Departure from Nucleate Boiling

Reactor designers must set thermal limits that will prevent film boiling. Excessive temperatures in the reactor core can be caused by the generation of too much heat and/or film boiling.

To account for the possibility of film boiling, reactor designers have developed a ratio called the departure from nucleate boiling ratio (DNBR) as shown in Equation 3-15:

$$\text{DNBR} = \frac{\text{critical local heat flux at DNB point}}{\text{actual local heat flux}} \quad (3-15)$$

The DNBR establishes how high local heat generation in the reactor can be before film boiling occurs. In actuality, the reactor is designed to ensure that the departure from nucleate boiling point is never reached.

Example:

Assume that enough heat will be generated to reach the DNB point when the local power reaches 27 kilowatts per foot. Calculate the DNBR when the actual local power is 9 kilowatts per foot.

$$\text{DNBR} = \frac{\text{critical local heat flux}}{\text{actual local heat flux}}$$

$$\text{DNBR} = \frac{27}{9}$$

$$\text{DNBR} = 3$$

Film boiling does not occur when the DNBR is 3. However, if the actual local power increases to 27 kilowatts per foot, the DNBR will drop to 1, and film boiling is just about to occur.

$$\text{DNBR} = \frac{27}{27} = 1$$

In many plants a limit for the DNBR is set at a value greater than 1.0 to provide a margin of safety and to ensure that DNB will never be reached by excessive heat generation. Maintaining the recommended DNBR is one of the most important thermal and hydraulic aspects of safe reactor operation.

Excessive heat generation is not the only cause of film boiling. Other causes depend on whether or not certain factors exceed their design limits. Some of these factors are related to the water properties, the flow, the pressure, the inlet temperature, etc. Additional factors are related to the physical design of the water flow passages. Thus, factors such as manufacturing tolerances in all parts of the reactor must be considered. In many cases, all of the water-related factors are consid-

ered in relation to the amount of heat generated (the nuclear factor). It is important to include every consideration in the reactor design calculations to ensure that film boiling does not occur in the core.

As has been mentioned, film boiling can occur in different ways and can involve different factors. The examination of some of these processes can begin with a look at the flow of water past the fuel rods as shown in Figure 3-23. Water enters the reactor core where heat is produced and flows between the fuel rods. It is subcooled, and heat is transferred by convection. As the water moves past the fuel rods, its temperature rises. Subcooled nucleate boiling and then bulk nucleate boiling occur. The flow at this point is often called bubbly flow because bubbles flow with the water. If the total flow is low, film boiling may occur. During film boiling a layer of bubbles (not actually a film) forms along the fuel rod and prevents water from contacting with the wall of the fuel rod. The temperature of the rod and the fuel increase, and both can be damaged. With normal heat transfer rates, this condition only occurs when the flow of water through the reactor is very low. Normal operating conditions provide sufficient flow to prevent film boiling.

Heat is constantly added as the water-steam bubbles move along the fuel rod, and the bubbles join together to form larger and larger bubbles. If the flow is reduced or if the heat being transferred is too high, the bubbles may become large enough to fill the whole area between the fuel rods. The rods are alternately wet and dry as these bubbles, followed by slugs of water, pass by. This is called slug flow.

If boiling creates so much steam that the steam fills the whole central area and the only water left is a thin layer between the walls of the fuel rods, the flow is called annular flow. A phenomenon called dryout occurs when all the water has been boiled farther up in the core and heat can only be transferred to steam. If this happens, the heat transferred rate is reduced, the temperature of the

clad increases, and the clad and the fuel may be damaged.

Since dryout and film boiling have the same effect on the fuel and the clad, the two are usually grouped together. The two most important variables involved are heat transfer rate and flow. Any time that the heat generated is too great or the flow is too low, the DNB point can be reached and film boiling may follow.

Other factors that are important in limiting the approach to the DNB point include the pressure and the inlet temperature of the water. During routine operations, there is usually not much change in these factors. However, during some accidents, the pressure and inlet temperature may change enough to reach the DNB point.

During steady-state operations, the water in the core is hot and at high pressure. If the pressure drops suddenly, as is possible during an accident, an occurrence similar to the "swell" that was described earlier would occur. As previously discussed, the pressure drop in itself is enough to cause film boiling. In addition, the decreasing pressure would also cause large amounts of steam to form, and this could lead to dryout.

The water that enters the core contains considerable heat. If the temperature of the inlet water is too high, the heat added by the fuel in the reactor will cause too much boiling in the reactor. This excessive boiling could, again, lead to dryout and fuel "burn out."

The conditions at each point in the reactor core are unique and, therefore, the calculation of the CHF is difficult. The CHF must be calculated for every point with the expected operating conditions at that point. The point used for determining plant operating limits will be the one that reaches the DNB point first. Of course, the most critical location in the reactor may vary with changing operating conditions. Normally, however, plant safety analyses and operating procedures will give the values for only the worst case, and the point

itself will not be located.

### 3.7 Reactor Plant Heat Balances

A reactor plant heat balance, which is also called a primary plant calorimetric, is performed to determine the thermal power being produced by the reactor core. A calorimetric is done frequently in a nuclear plant to provide a reliable point of comparison for nuclear instrumentation. Although nuclear power levels can be read directly from nuclear instrumentation, nuclear instrumentation has a tendency to drift. The reactor plant calorimetric is used to keep the nuclear instrumentation accurate.

Heat balances are often done by the unit computer, but operators must know how to do them by hand. This is necessary for several reasons. (1) Hand calculations provide a backup to the computer, if it fails. (2) Hand calculations are often done to ensure that operation is within the technical specifications limit. (3) The reactor heat balance is a basic concept of power plant operation.

#### 3.7.1 PWR Heat Balance

Figure 3-24 shows a typical PWR reactor system and identifies the important parameters used for a PWR heat balance. The heat balance for this PWR is given by the following equation:

$$\dot{Q}_c = \dot{Q}_{sg} + \dot{Q}_{misc} - \dot{Q}_p - \dot{Q}_{bh}$$

where

$$\dot{Q}_c = \text{core thermal power (BTU/hr)}$$

$$\dot{Q}_{sg} = \text{heat delivered to the steam generator (BTU/hr)}$$

$$\dot{Q}_{misc} = \text{miscellaneous heat losses}$$

$$\dot{Q}_p = \text{heat input from main coolant pumps (BTU/hr)}$$

$$\dot{Q}_{bh} = \text{heat input from pressurizer backup heaters (BTU/hr)}$$

The first important point to note is that a calorimetric must be performed while the reactor plant is at steady state power. This is necessary to ensure that a transient condition does not lead to a false calculation.

In a typical PWR heat balance, several factors are either assumed to be constant or are considered to be insignificant. The power input from the reactor coolant pumps ( $\dot{Q}_p$ ) is typically considered to be a known constant that has been determined from prior plant testing. Similarly, the miscellaneous heat loss is considered to be another known constant determined from prior plant testing. Another assumption is that the plant is operated in such a manner that only the pressurizer backup heaters are energized. The backup heater heat input ( $\dot{Q}_{bh}$ ) is then determined from the time the backup heaters are energized during the heat balance. Lastly, the above expression is based on the assumption that steam generator blowdown is secured during the heat balance.

As an example, assume the following average temperatures and pressures were determined during a heat balance.

$$\begin{aligned} P_{sg} &= 1000 \text{ psia} \\ \dot{m}_{fw} &= 15 \times 10^6 \text{ lbm/hr (total for all steam generators)} \\ T_{fw} &= 440^\circ\text{F} \end{aligned}$$

Backup heaters are energized 50% of the time.

The enthalpy of the main steam ( $h_{ms}$ ) from the steam generators can be determined using the saturated steam tables (assuming 100% quality):

$$h_{ms} = h_g \text{ at } 1000 \text{ psia} = 1193 \text{ BTU/lbm}$$

The enthalpy of the feedwater ( $h_{fw}$ ) entering the steam generators can also be determined using the steam tables:

$$h_{fw} = h_f \text{ at } 440^\circ\text{F} = 419 \text{ BTU/lbm}$$

Therefore, the heat delivered to the steam generator ( $\dot{Q}_{sg}$ ) can be calculated using Equation 3-12:

$$\begin{aligned} \dot{Q}_{sg} &= \dot{m}_{fw} (h_{ms} - h_{fw}) \\ \dot{Q}_{sg} &= \left( 15 \times 10^6 \frac{\text{lbm}}{\text{hr}} \right) \left( (1193 - 419) \frac{\text{BTU}}{\text{lbm}} \right) \\ \dot{Q}_{sg} &= 11,610 \times 10^6 \frac{\text{BTU}}{\text{hr}} \end{aligned}$$

Further, assume that  $\dot{Q}_p$  and  $\dot{Q}_{misc}$  are known from prior testing to be  $64.1 \times 10^6 \text{ BTU/hr}$  and  $7.71 \times 10^6 \text{ BTU/hr}$ , respectively. Also, the input power of the pressurizer backup heaters is known to be 1200 KW while energized. Therefore,

$$\begin{aligned} \dot{Q}_p &= 64.1 \times 10^6 \text{ BTU/hr} \\ \dot{Q}_{misc} &= 7.71 \times 10^6 \text{ BTU/hr} \\ \dot{Q}_{bh} &= (1200 \text{ KW}) (.5) 3413 \frac{\text{BTU/hr}}{\text{KW}} \\ &= 2.05 \times 10^6 \text{ BTU/hr} \end{aligned}$$

Therefore, the core thermal power ( $\dot{Q}_c$ ) can be calculated:

$$\dot{Q}_c = (11,610 + 7.71 - 64.1 - 2.05) \times 10^6$$

$$\dot{Q}_c = \frac{11,551.5 \times 10^6 \text{ BTU/hr}}{3.413 \times 10^6 \text{ BTU/hr/MW}}$$

$$\dot{Q}_c = 3385 \text{ MW}$$

$$\text{Percent Reactor Power} = \frac{\text{MW}_{th}}{3752} (100\%)$$

$$\text{Percent Reactor Power} = \frac{3385}{3752} (100\%) = 90.2\%$$



Correct performance of heat balance calculations is vital because a heat balance is the standard by which the nuclear instrumentation is calibrated. For example, suppose (hypothetically) that the levels in the steam generators were allowed to drop from a high level to a low level during performance of a heat balance. This would affect the calculations because the feedwater flow would be less than the steam flow. The calculated power production would be less than the true power production. Enthalpy rise is multiplied by feedwater flow to find power. In this case, feedwater flow would be artificially low, so calculated power would also be low. If the nuclear instruments were indicating true power, they might be incorrectly adjusted to indicate a lower power. This is why heat balance calculations are checked and double-checked.

### 3.7.2 BWR Heat Balance

Figure 3-25 shows a typical BWR reactor system and identifies the important parameters used for a BWR heat balance. The heat balance for this BWR is given by the following equation:

$$\dot{Q}_c = \dot{m}_{fw} (h_{ms} - h_{fw}) + \dot{m}_{rd} (h_{ms} - h_{rd}) + \dot{m}_{cu} (h_{in} - h_{out}) + \dot{Q}_f - \dot{Q}_p$$

where:

$$\dot{Q}_c = \text{core thermal power (BTU/hr)}$$

$$h_{ms} = h_g = \text{the enthalpy of the main steam (BTU/lbm),}$$

$$\dot{m}_{cu} = \text{the cleanup demineralizer flow (lbm/hr),}$$

$$h_{in} = \text{the enthalpy of the flow to the cleanup demineralizer (BTU/lbm),}$$

$$h_{out} = \text{the enthalpy of the flow from the cleanup demineralizer (BTU/lbm),}$$

$$\dot{Q}_f = \text{the fixed heat losses from the reactor (BTU/hr),}$$

$$\dot{m}_{fw} = \text{the feedwater flow (lbm/hr),}$$

$$h_{fw} = \text{the enthalpy of the feedwater (BTU/lbm),}$$

$$\dot{Q}_p = \text{the recirculation pump energy input (BTU/hr),}$$

$$\dot{m}_{rd} = \text{the control rod drive flow to the reactor (BTU/lbm), and}$$

$$h_{rd} = \text{the enthalpy of the control rod drive flow to the reactor (BTU/lbm).}$$

The equation assumes that all of the cleanup flow is returned to the reactor.

As was the case for the PWR, the calorimetric must be performed with the plant at steady state power to ensure a transient condition does not lead to a false calculation.

The feedwater flow value is taken from a calibrated flow meter, which automatically compensates for temperature. This is the most important parameter in the heat balance, and extreme care must be taken to make sure that it is accurate. Recirculation pump power is obtained from calibrated megawatt meters.

In practice, several of the terms of the heat balance are treated as constants because system operation is nearly constant and because the terms themselves do not significantly affect the heat balance calculation. These terms are the control rod drive energy input, the cleanup demineralizer heat extraction, and heat losses from the reactor.

Feedwater flow can be measured more accurately than steam flow. Thus, steam flow is evaluated by measuring the feedwater flow and the control rod drive flow to the reactor with a constant water level. The BWR heat balance equation

includes more terms than the PWR, but the method of solving proceeds in the same manner.

When core power is low, or when an approximate core power value is needed quickly, a simplified determination method can be used. These methods should be used cautiously, and it should be noted that they are only approximations of true core power. There are three methods for approximating core power.

The first method uses the following simplified equation:

$$\dot{Q}_c = \dot{m}_{fw} (h_{ms} - h_{fw}) + \text{constant} .$$

The constant in the equation includes the heat losses and gains caused by the cleanup demineralizer system, the recirculation pumps, and the control rod drive flow. These and other fixed losses can be considered as a single combined fixed quantity because all have a standard mode of operation. When this constant is used, the total operating condition of the plant must be considered. Any nonstandard occurrences such as feedwater heaters being out of service must be considered before the core power value can be given any degree of reliability.

With the second simplified method, core thermal power is related to plant electrical output. Core power and electric generator output are plotted on a graph, and then the graph can be used for a quick determination of core power for given generator outputs. An improvement on this method involves the use of a family of curves with condenser cooling water temperature as the other variable if there is a sizable seasonal variation in temperature. As with the first method, the total operating condition of the plant must be considered.

The third method determines core power from nuclear instrumentation. The accuracy of this method may depend on the number, type, location of neutron sensors, the stability of the power

distribution shape, and the suitability of the calibrating heat balance. The main advantage of this method is the short response time of the nuclear instrumentation.

### 3.8 Natural Circulation in Reactors

Natural circulation flow can occur in PWR and BWR reactors. Natural circulation provides a capability for removing heat and preventing excessive fuel and cladding temperatures when the reactor cooling pumps are not available to provide forced circulation heat removal. The conditions and places where natural circulation occurs differ somewhat depending upon the reactor type. However, the natural circulation mechanism is the same.

Figure 3-26 is a schematic for the natural circulation that can occur between a PWR reactor and steam generator. Establishing natural circulation flow requires that a heat source and a heat sink be present in the system and that the elevation of the heat sink be higher than the elevation of the heat source. The heat sink capacity must also match or exceed the heat source output.

In Figure 3-26 the driving head providing natural circulation in the primary system is produced by the force of gravity and water density differences. As the coolant absorbs heat in the reactor, coolant temperature increases and coolant density decreases. In the steam generator, the coolant transfers its heat to the secondary system and reaches its minimum temperature ( $T_c$ ). The colder, denser water then returns to the reactor. The difference between the density of the cold leg and the hot leg water produces the pressure differential or driving head for the flow.

The heat source for natural circulation flow for PWR and BWR reactors is the reactor core. For PWRs the natural circulation heat sink is the steam generators, which transfer heat to make steam. The steam is dumped to the main condenser through the turbine bypass valves, if possible, or to atmosphere through the atmospheric

dump valves. (The turbine bypass valves are preferred because this method maintains the secondary water inventory, and the possibility of a radioactivity release to the environment is minimized.)

Natural circulation plays a smaller, but still important, role in BWRs. If the reactor recirculation pumps trip during power operations, the reactor is scrammed, and the principle of natural circulation enables the cooler feedwater from the annulus to flow into the core, where it boils and cools the core. The steam then leaves the core and is replaced by more cool water from the annulus. When the reactor is in cold shutdown, a form of natural circulation may be used to prevent thermal stratification (lack of vertical mixing of the coolant in the core) and possible vessel pressurization if the shutdown cooling system is inoperable. To obtain this circulation, the vessel level is raised above the moisture separator skirt to allow natural circulation up through the core, into the annulus via the skirt drains, and then back into the core. With natural circulation established, an alternate heat sink, such as the Reactor Water Cleanup system, may be used to remove the heat from the core coolant.

### Chapter 3 Definitions

#### SUBCOOLED NUCLEATE BOILING

- Boiling characterized by the formation of steam bubbles on a heated surface that move away from the surface and collapse in the bulk stream, where the water is cooler than the saturation temperature.

#### BULK NUCLEATE BOILING

- Boiling characterized by the formation of steam bubbles on a heated surface that move away from the surface and mix with the bulk stream water, which is at saturation temperature.

#### ONSET OF TRANSITION BOILING

- That heat flux at which boiling begins to change from nucleate boiling to film boiling.

#### CRITICAL HEAT FLUX

- The heat flux at which transition boiling begins, which is also the heat flux at which the departure from nucleate boiling occurs.

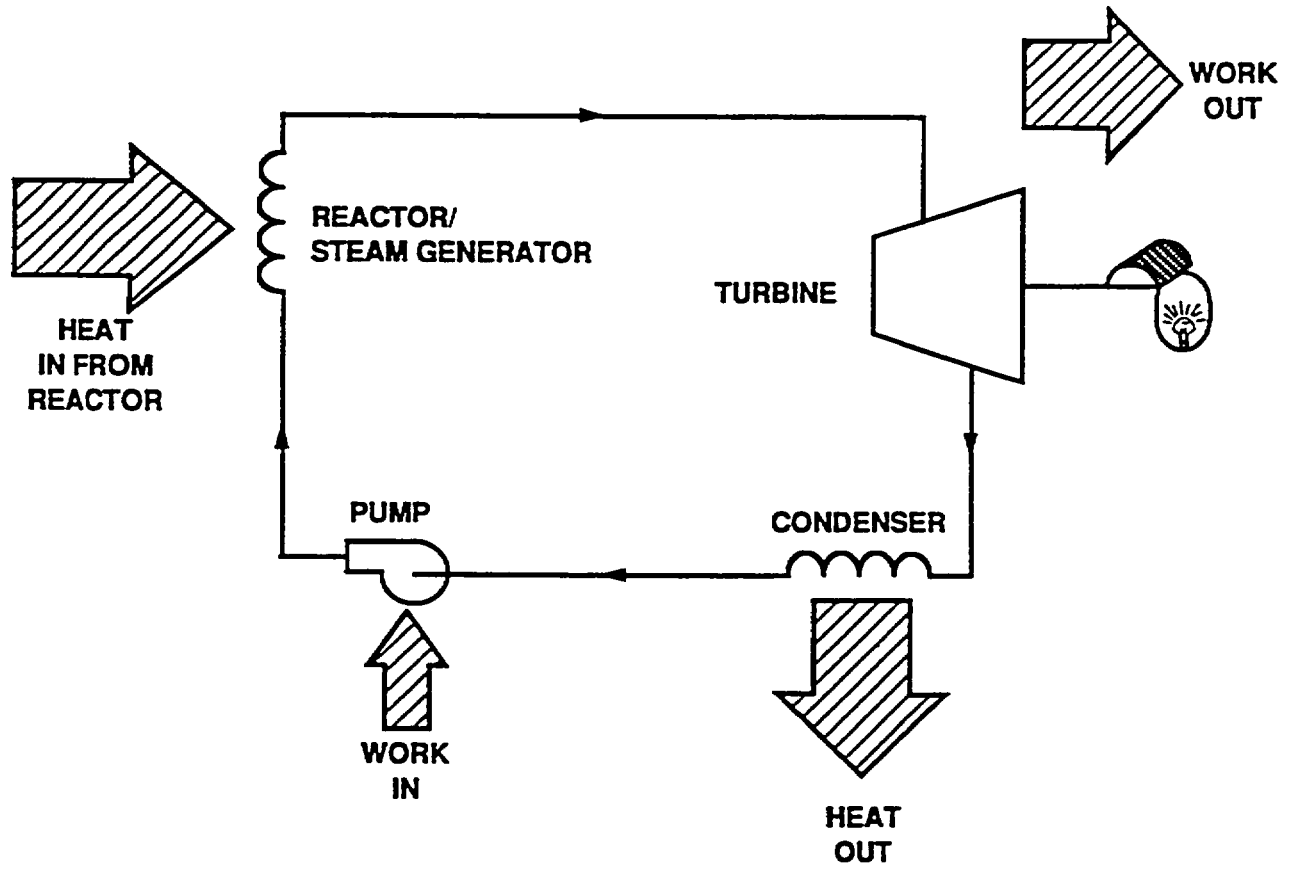
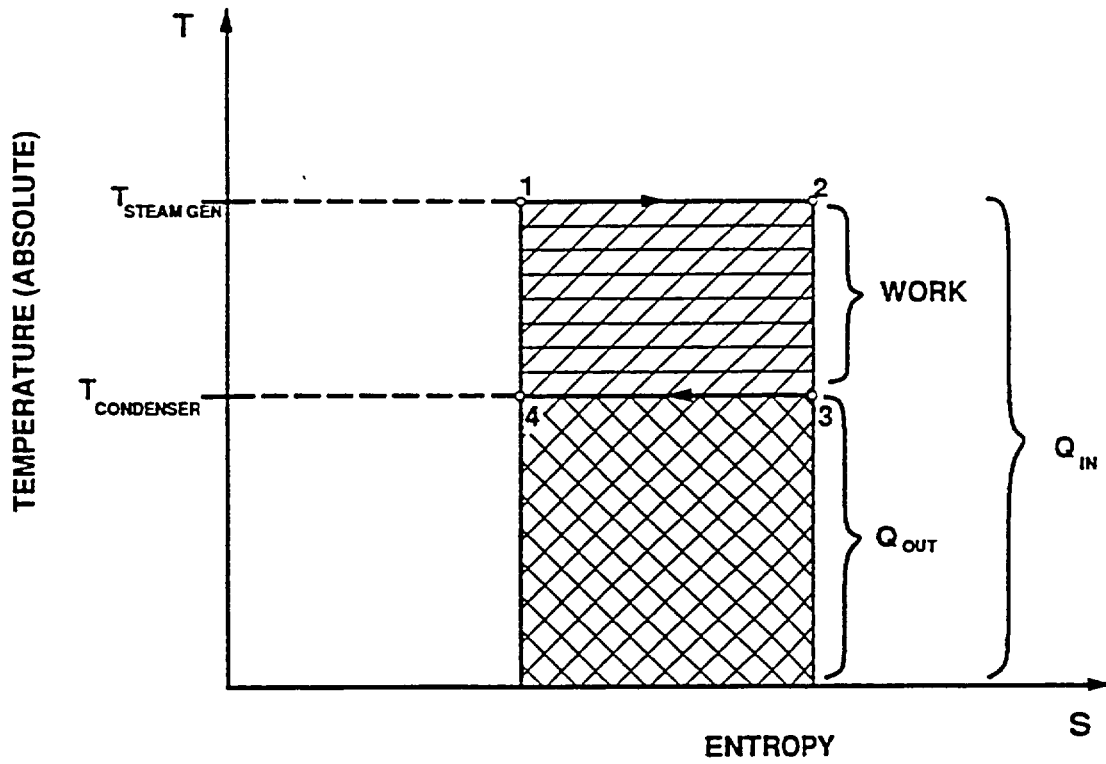

Figure 3-1. Basic Steam-Water Power Cycle



$$Q_{\text{ADDED IN STEAM GENERATOR}} = Q_{1-2} = Q_{\text{IN}}$$

$$Q_{\text{REJECTED IN CONDENSER}} = Q_{3-4} = Q_{\text{OUT}}$$

$$W = Q_{\text{IN}} - Q_{\text{OUT}} = Q_{1-2} - Q_{3-4}$$

Figure 3-2. Simple Power Cycle

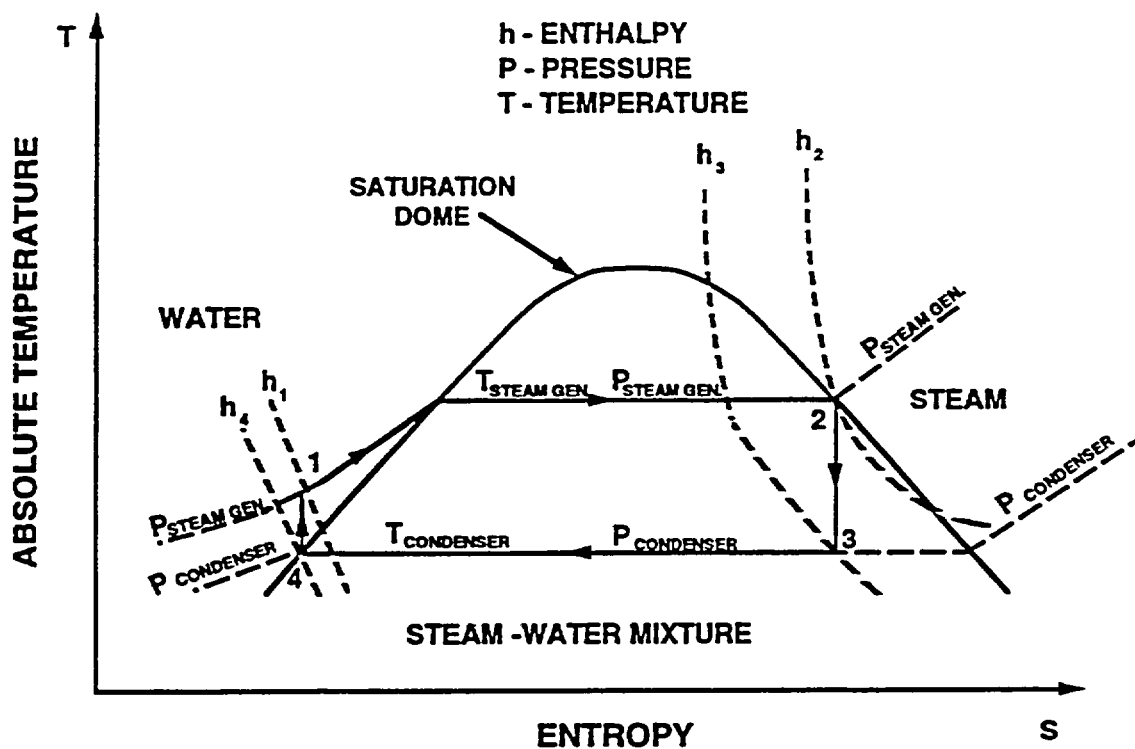

**THERMODYNAMIC PROCESSES**

- 1-2: HEAT ADDITION IN STEAM GENERATOR**
- 2-3: STEAM EXPANSION IN TURBINE**
- 3-4: HEAT REJECTION IN CONDENSER**
- 4-1: PRESSURE INCREASE IN PUMP**

**Figure 3-3. Temperature-Entropy Diagram for Analysis of Simple Steam Cycle**

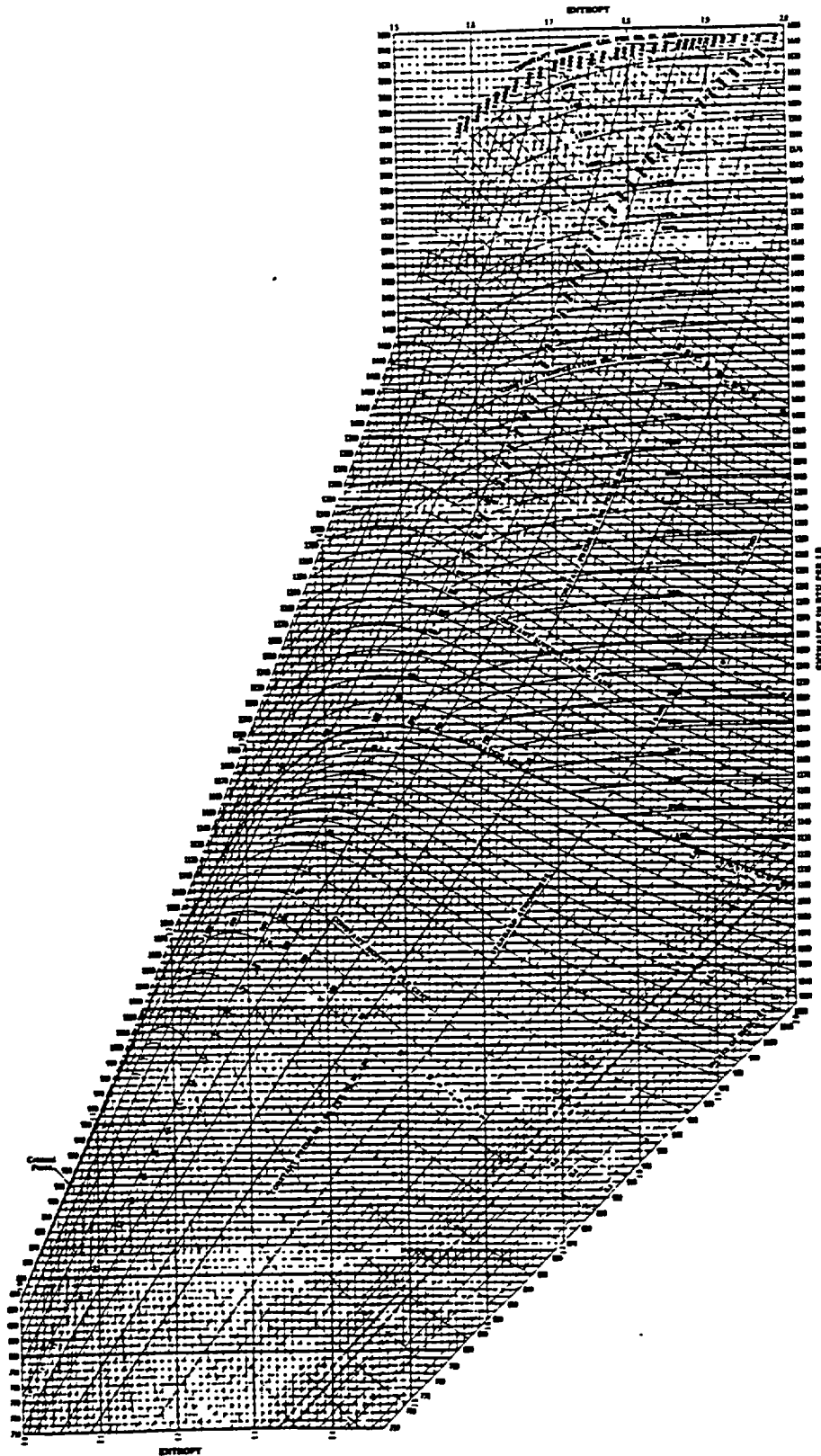

Figure 3-4. Mollier Diagram



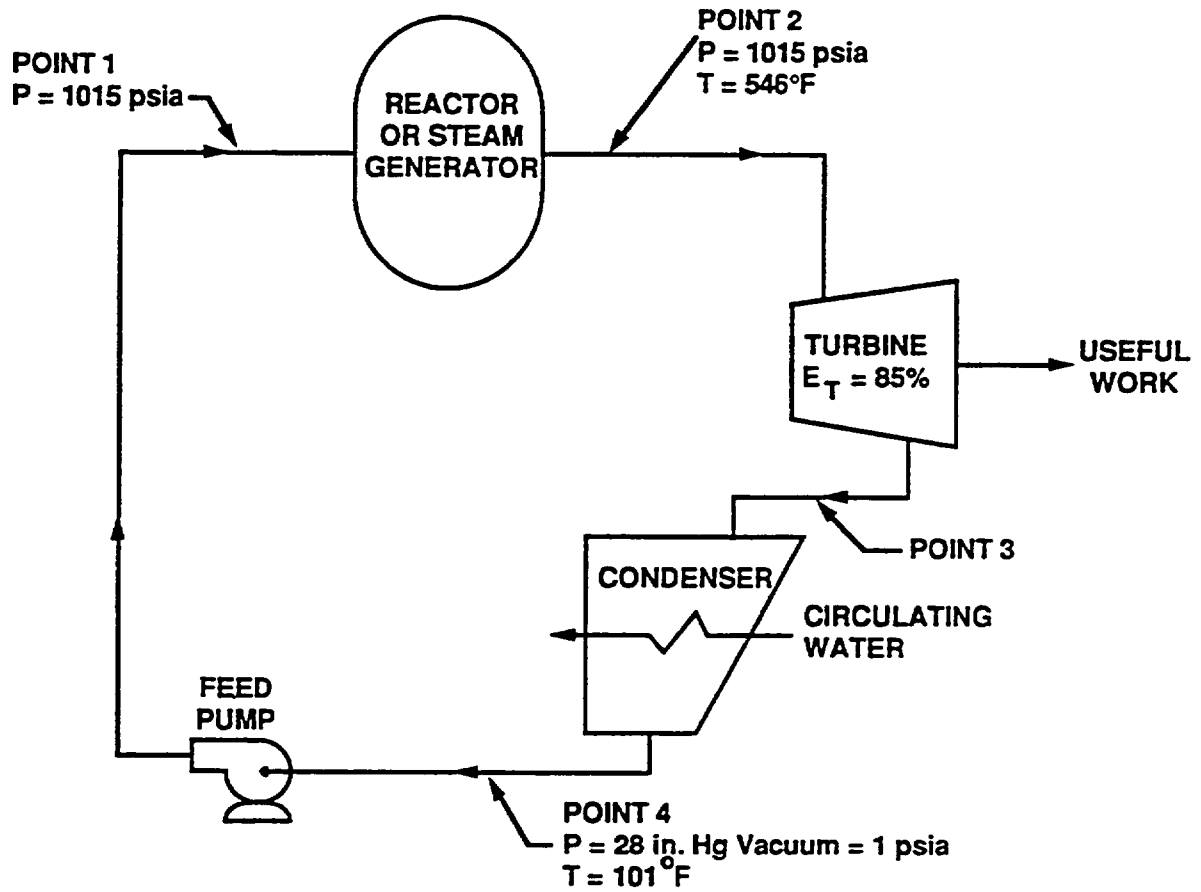

Figure 3-5. Basic Steam Cycle

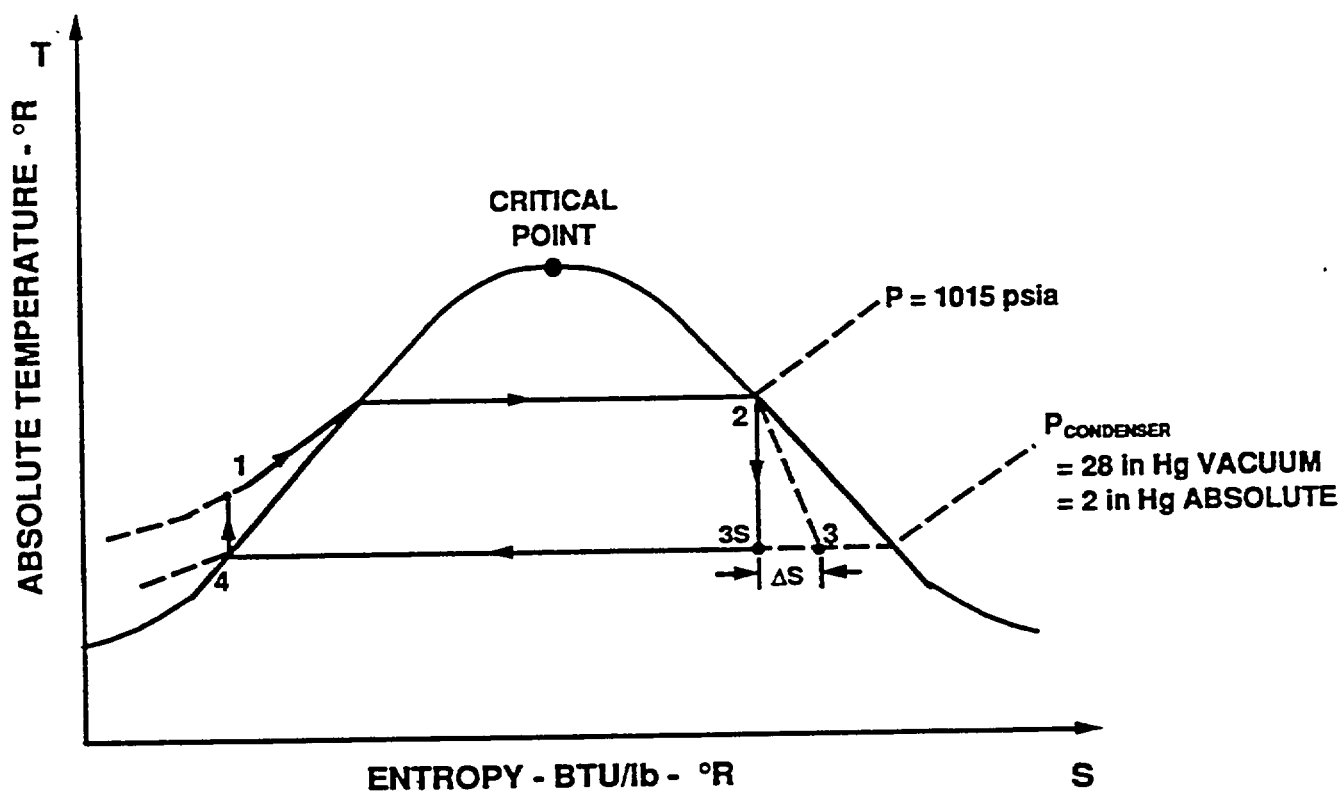

Figure 3-6. T-S Diagram for Basic Steam Cycle

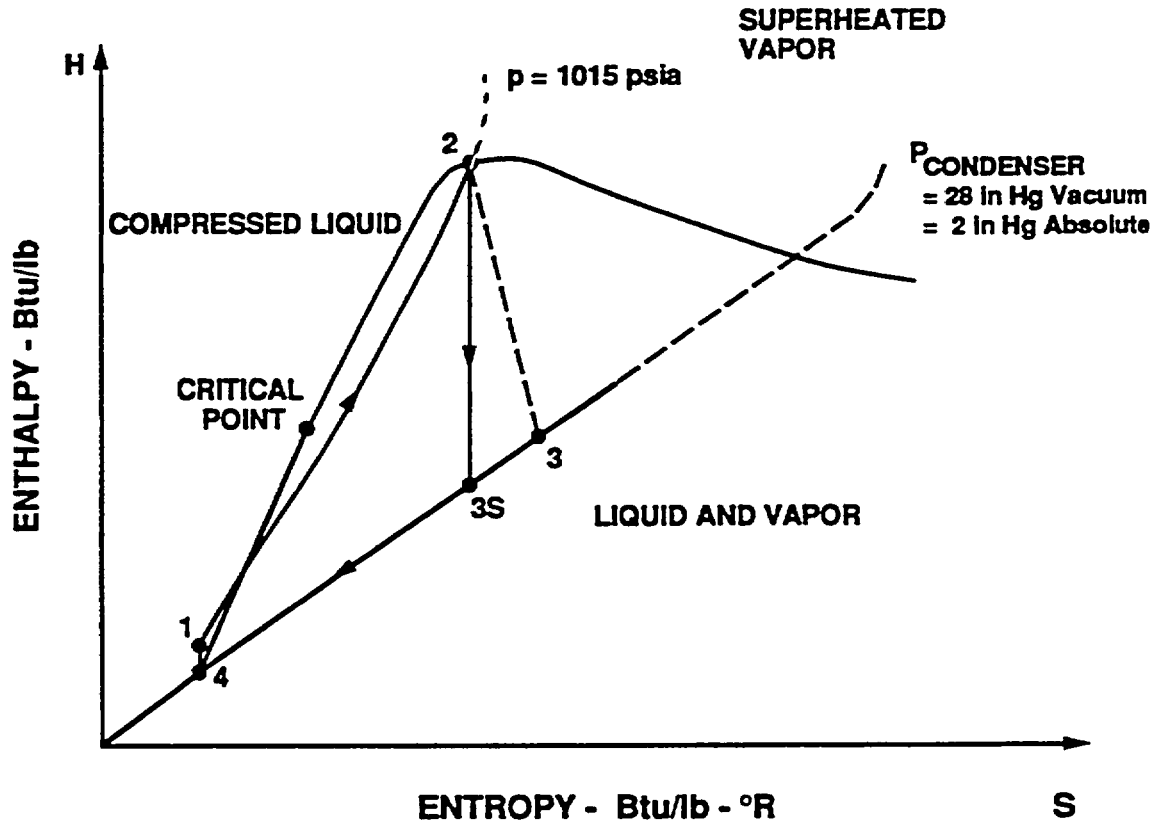

Figure 3-7. H-S Diagram for Basic Steam Cycle

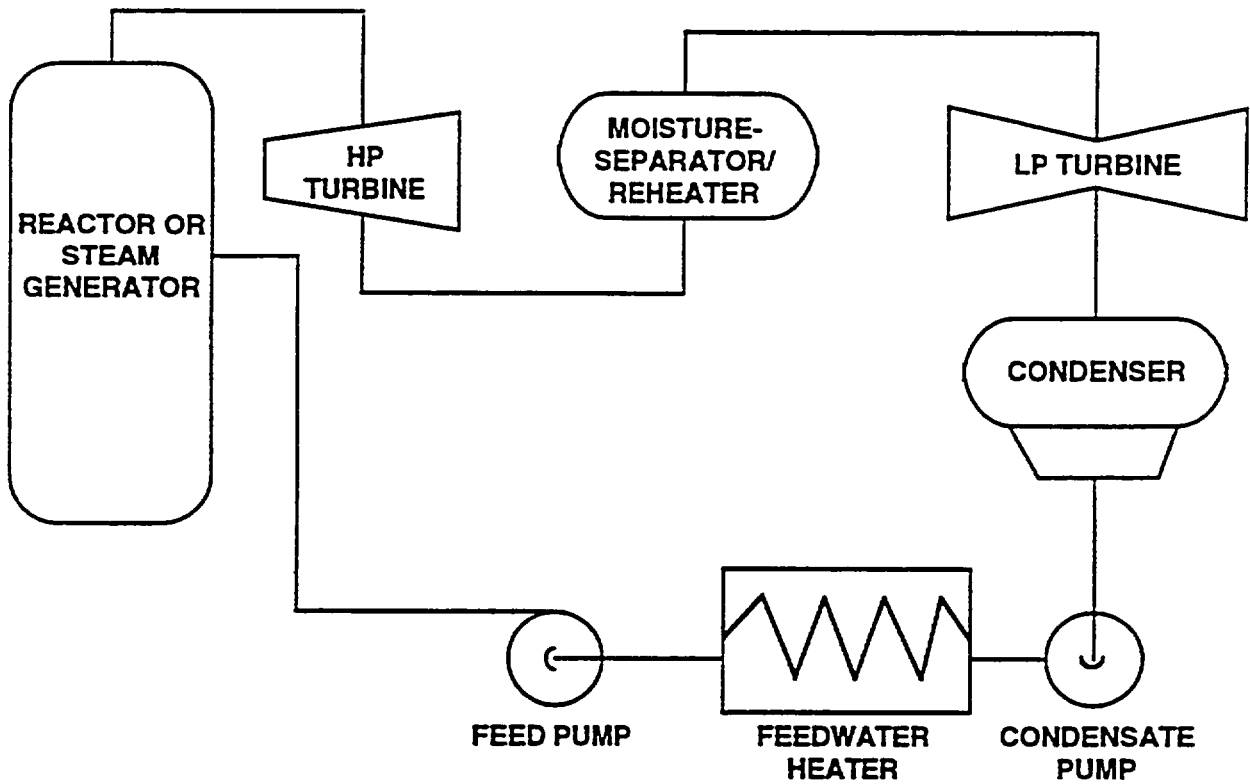
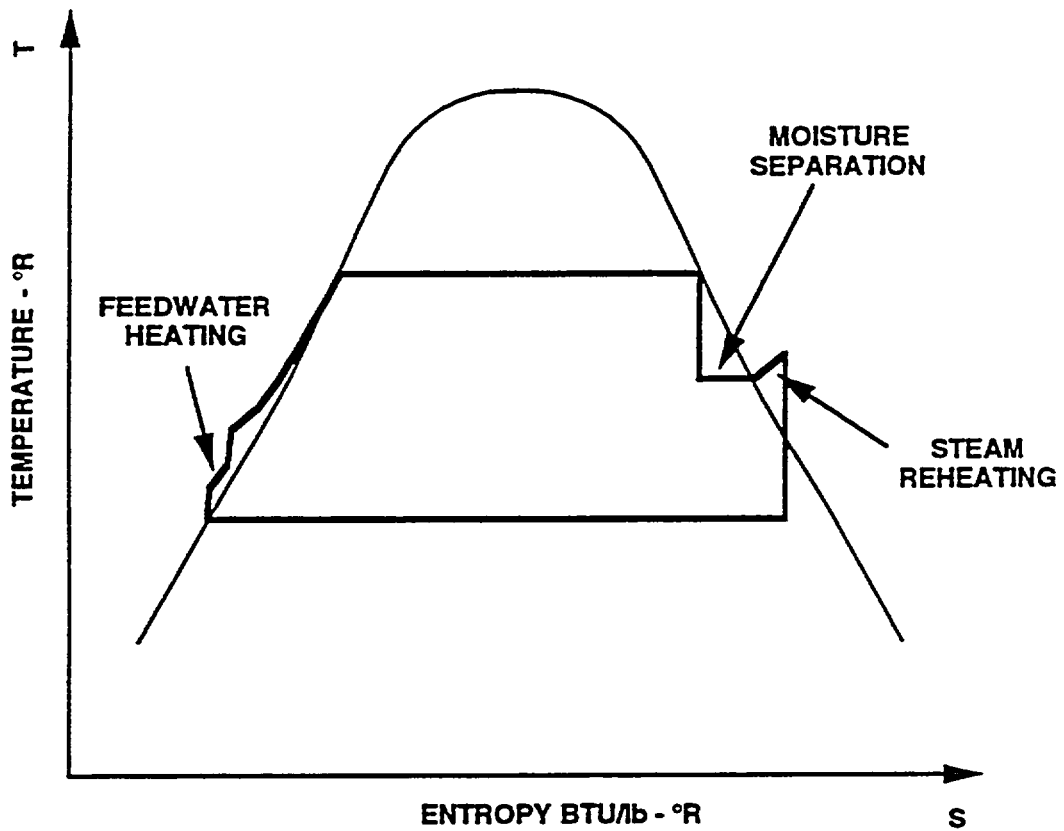

Figure 3-8. Steam Cycle with Feedwater Heating and Reheating



**Figure 3-9. T-S Diagram for Steam Cycle (Ideal) with Feedwater Heating and Steam Reheating**

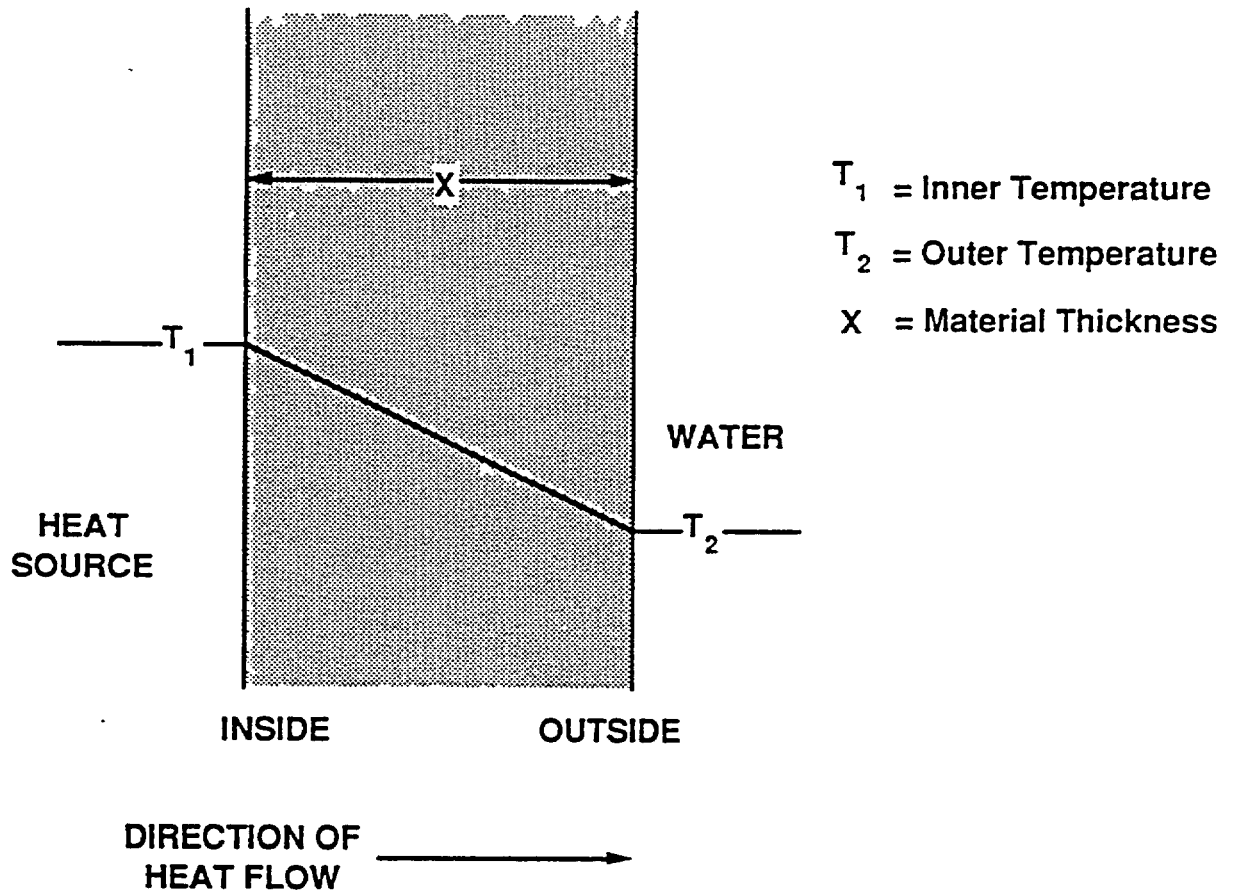

Figure 3-10. Heat Conduction Through a Plane Wall

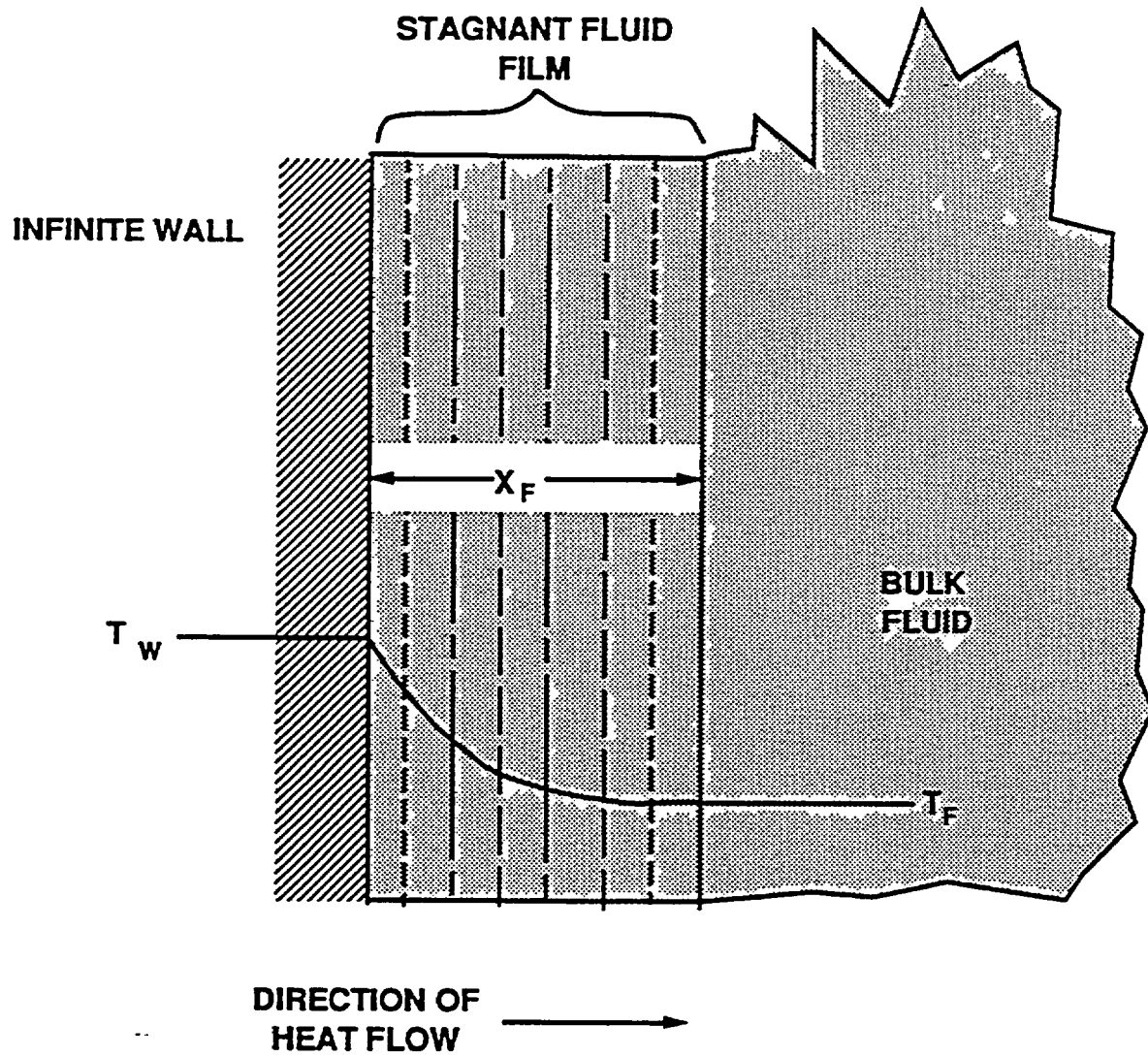

Figure 3-11. Convection Heat Transfer From a Surface

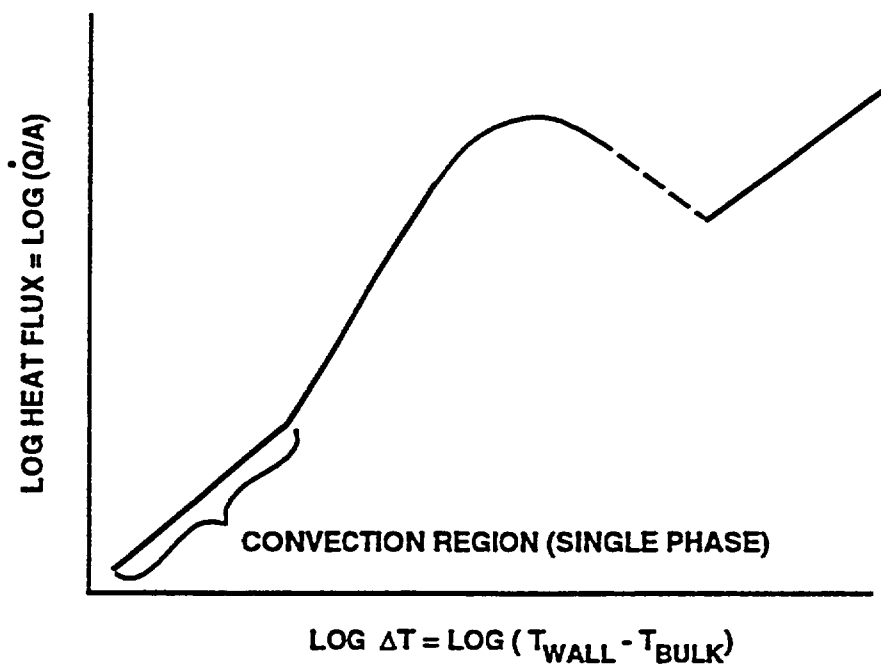

Figure 3-12. Heat Transfer Curve



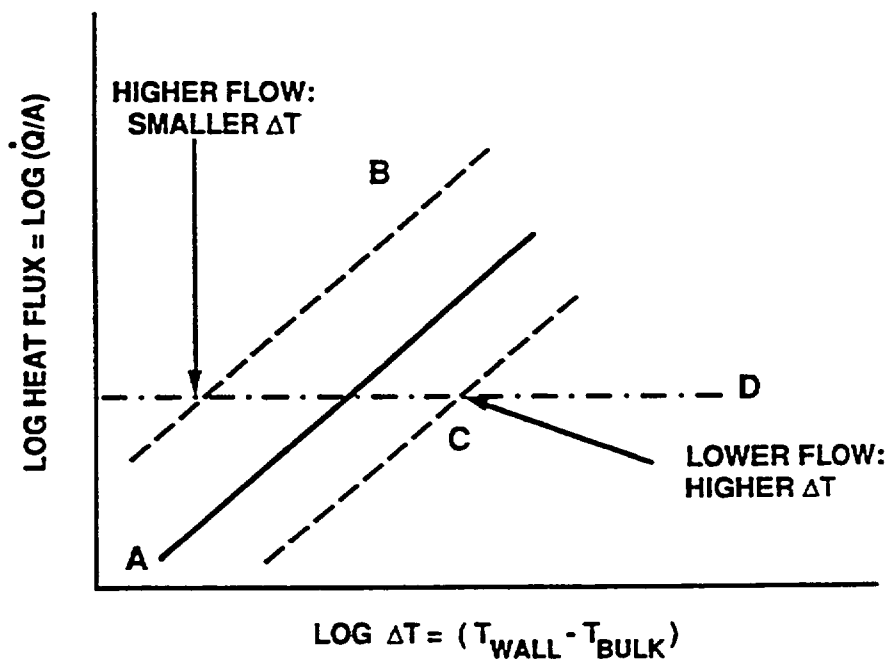

Figure 3-13. Effect of Flow on Convection Heat Transfer

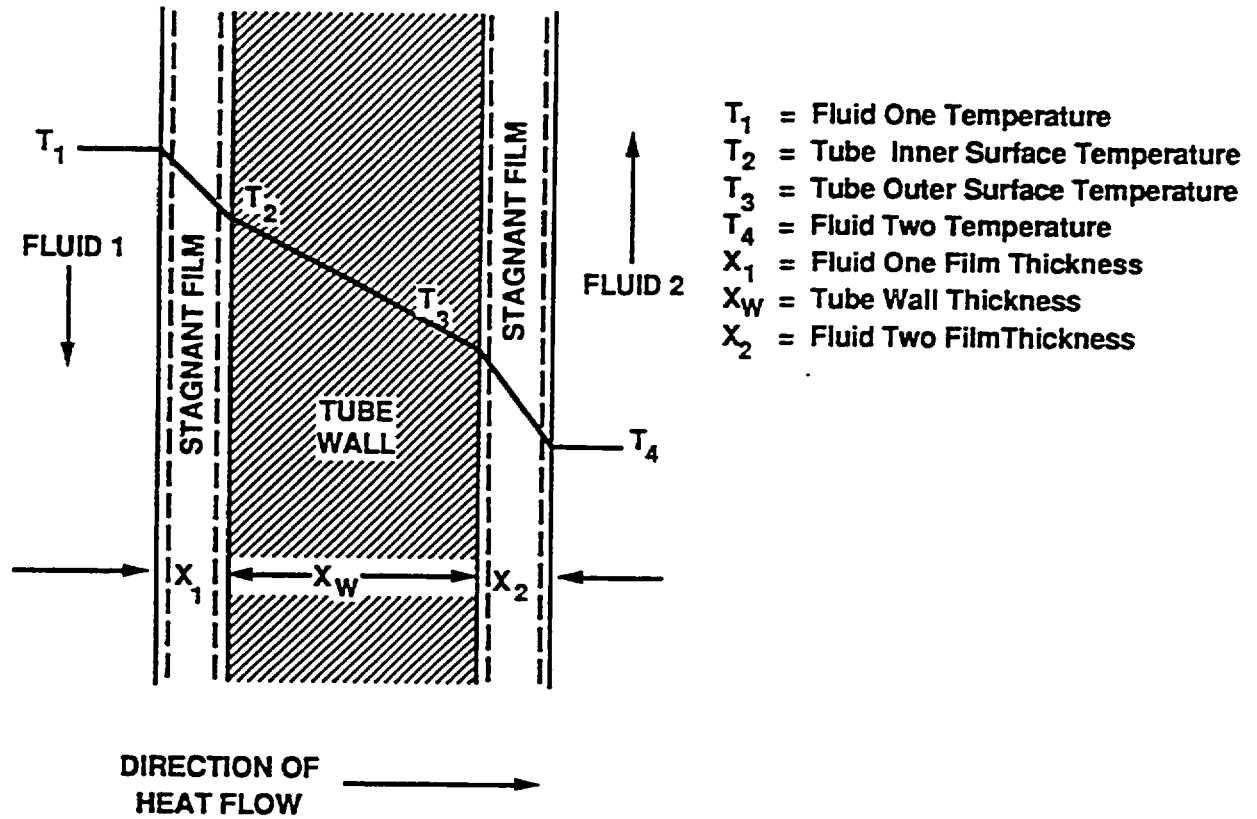

Figure 3-14. Heat Transfer for a Typical Heat Exchanger

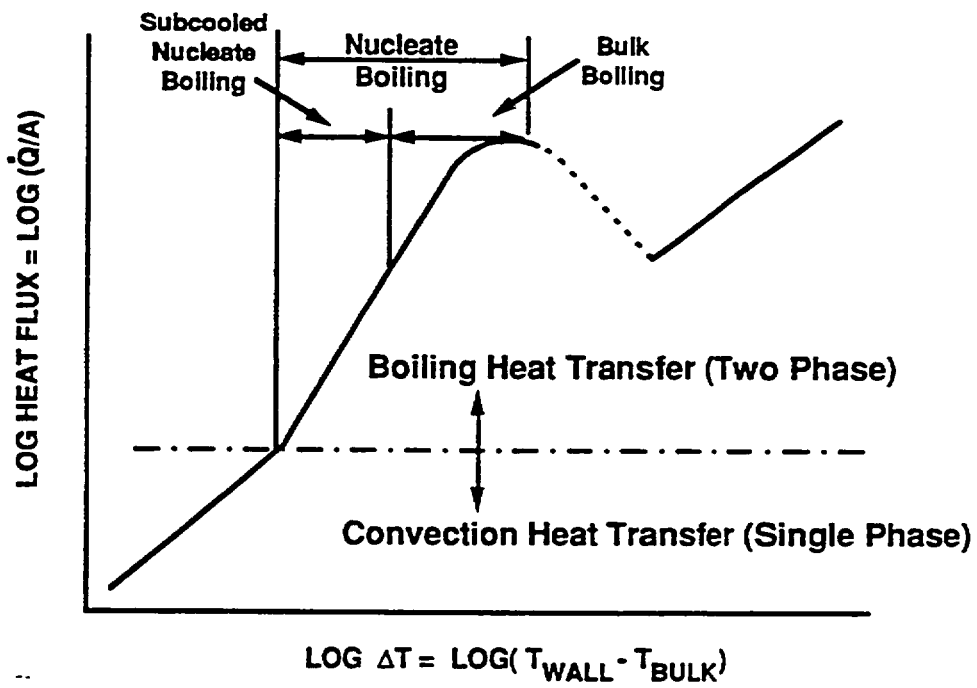

Figure 3-15. Boiling Heat Transfer

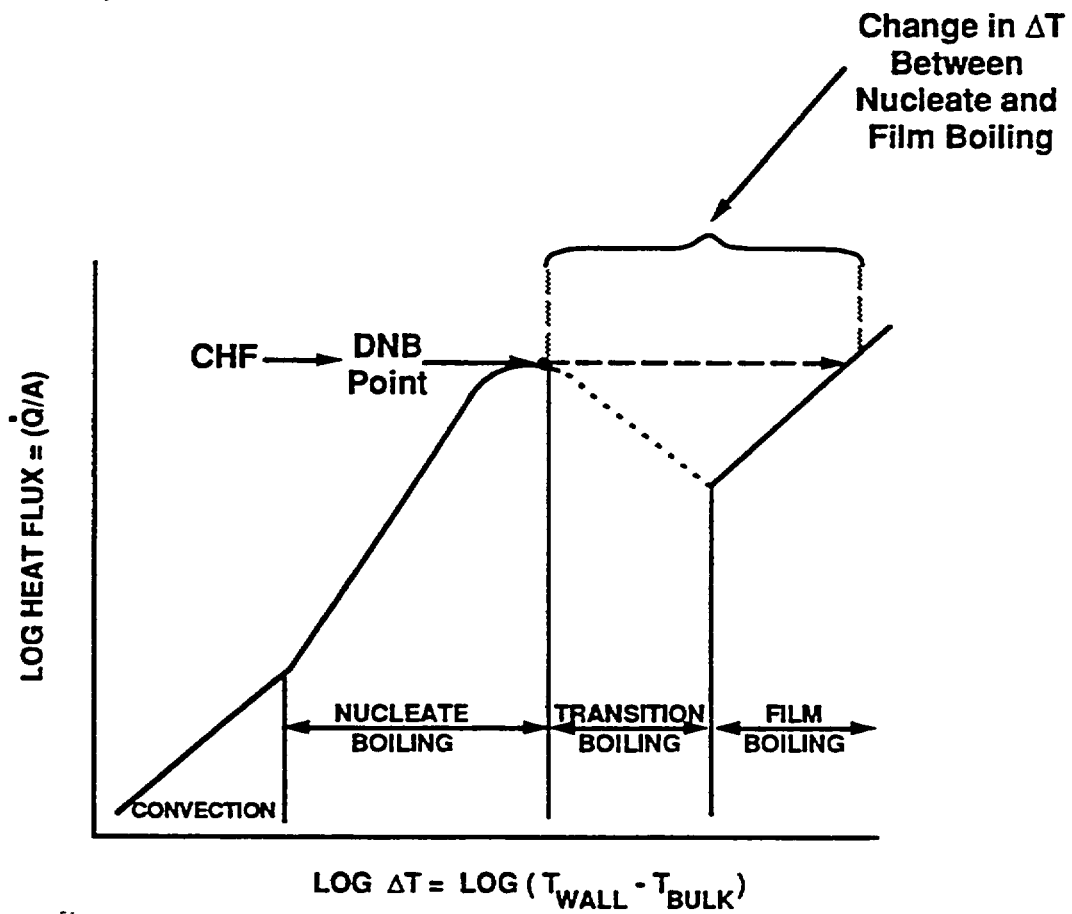

Figure 3-16. Transition Boiling

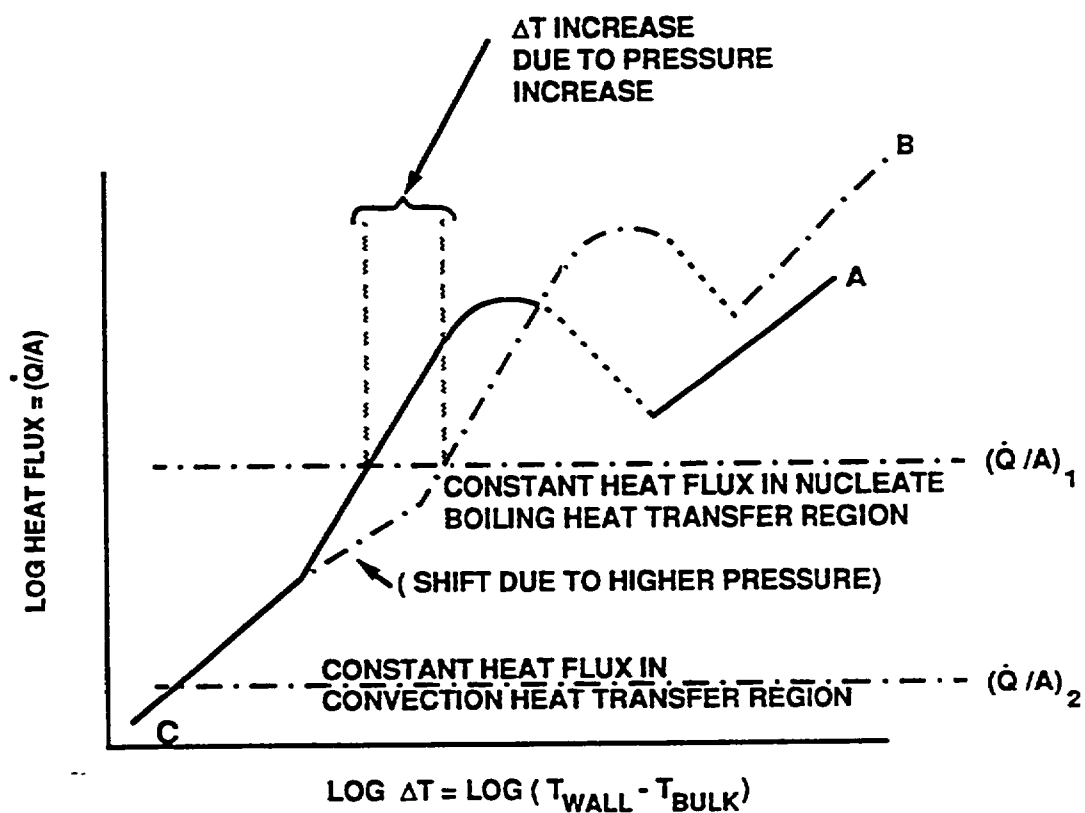

Figure 3-17. Effect of a Pressure Increase on Boiling Heat Transfer

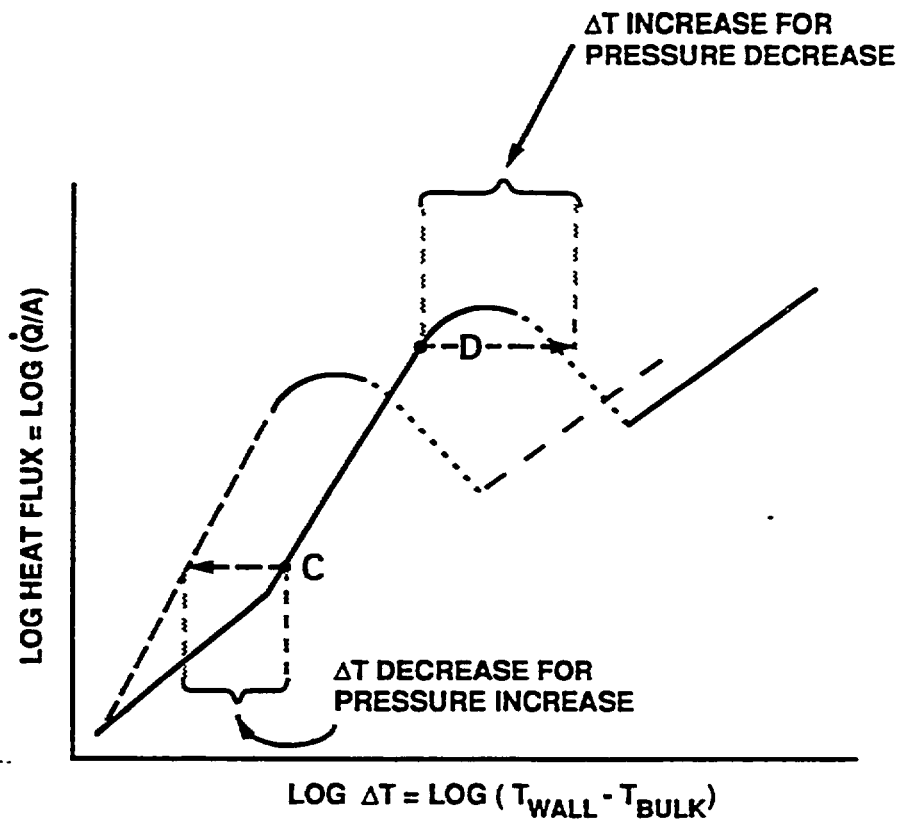

Figure 3-18. Effect of a Pressure Decrease on Boiling Heat Transfer

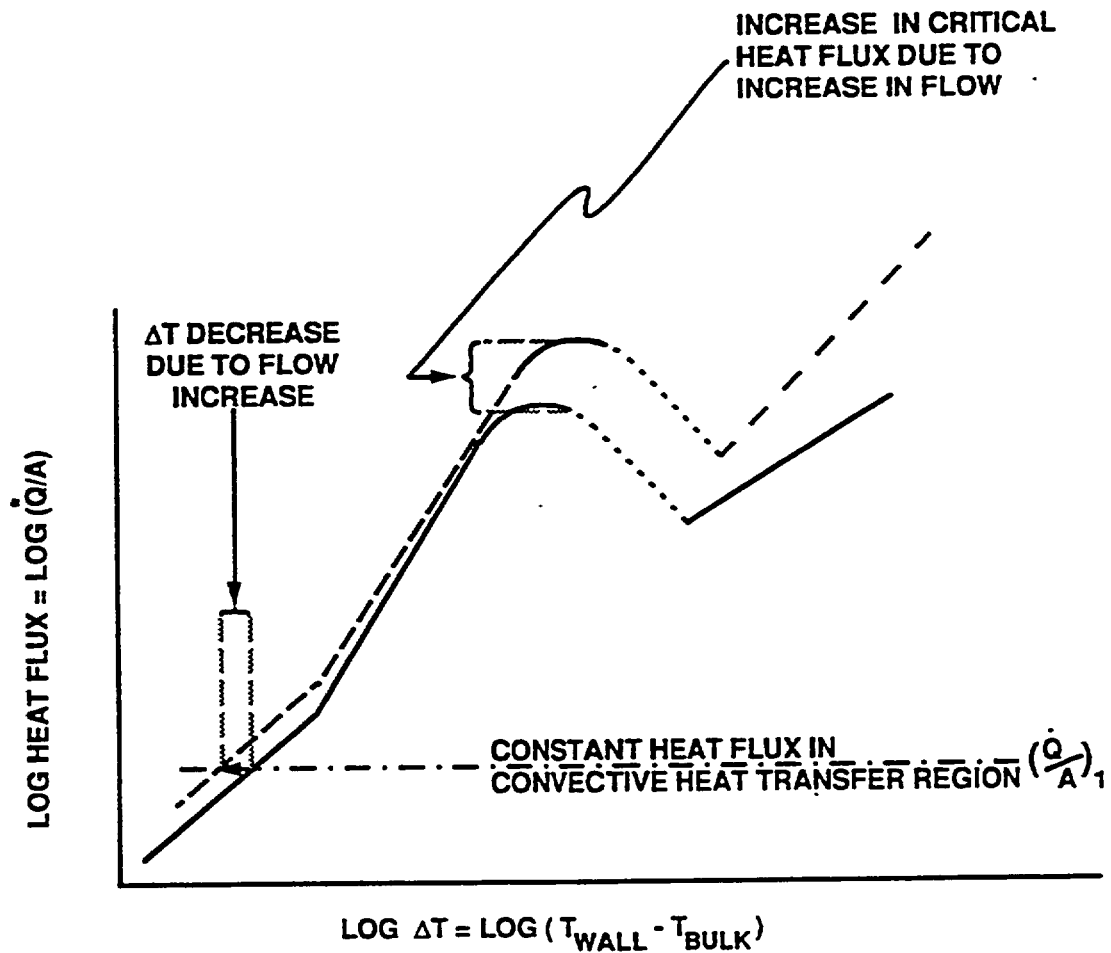

Figure 3-19. Effect of a Flow Increase on Boiling Heat Transfer

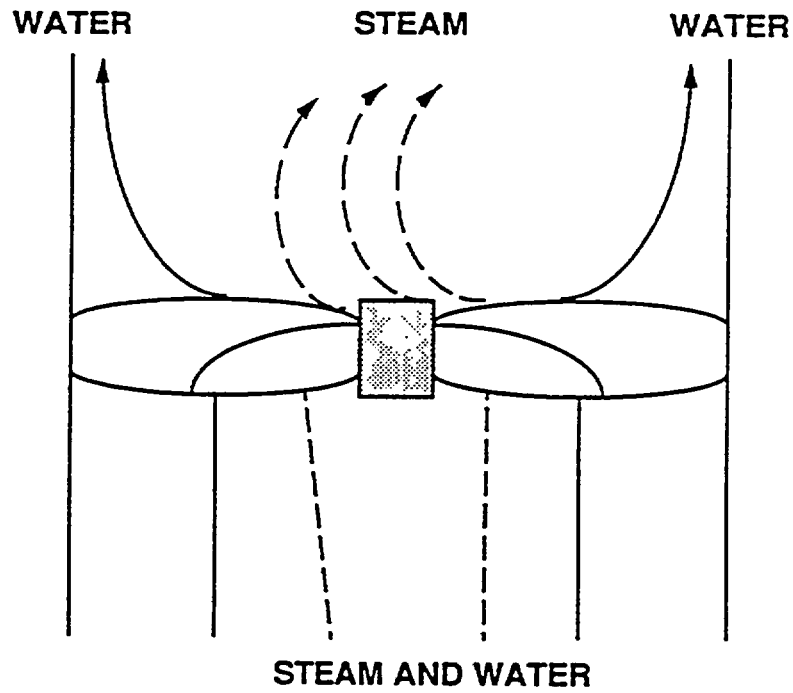

Figure 3-20. Cyclone-Type Moisture Separator



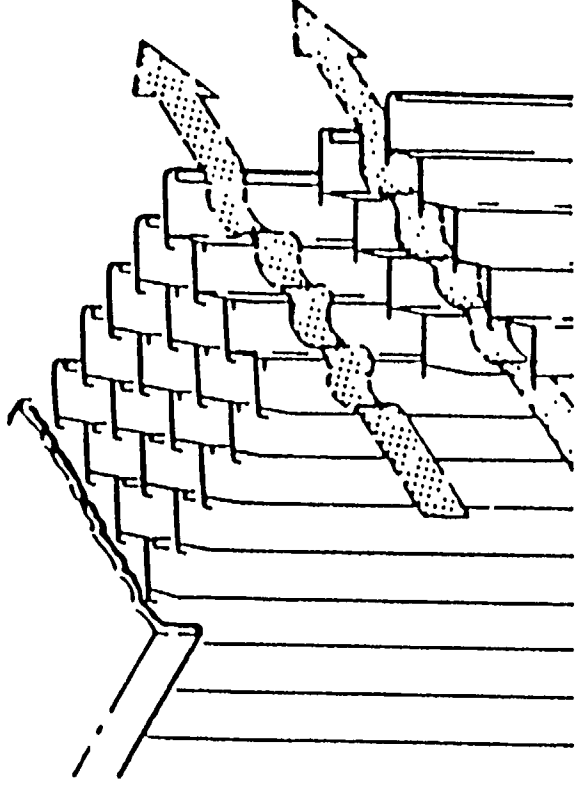

Figure 3-21. Chevron-Type Moisture Separator

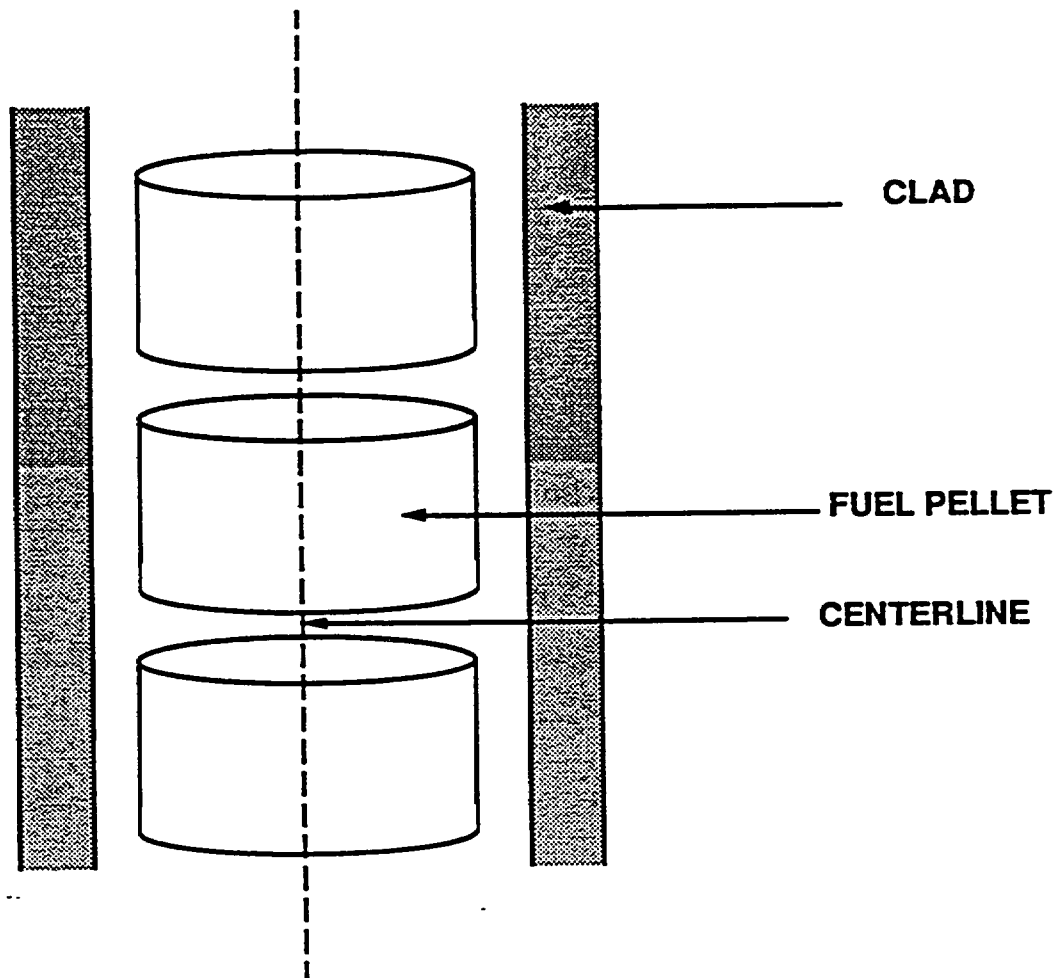

Figure 3-22. Fuel Arrangement Showing Centerline

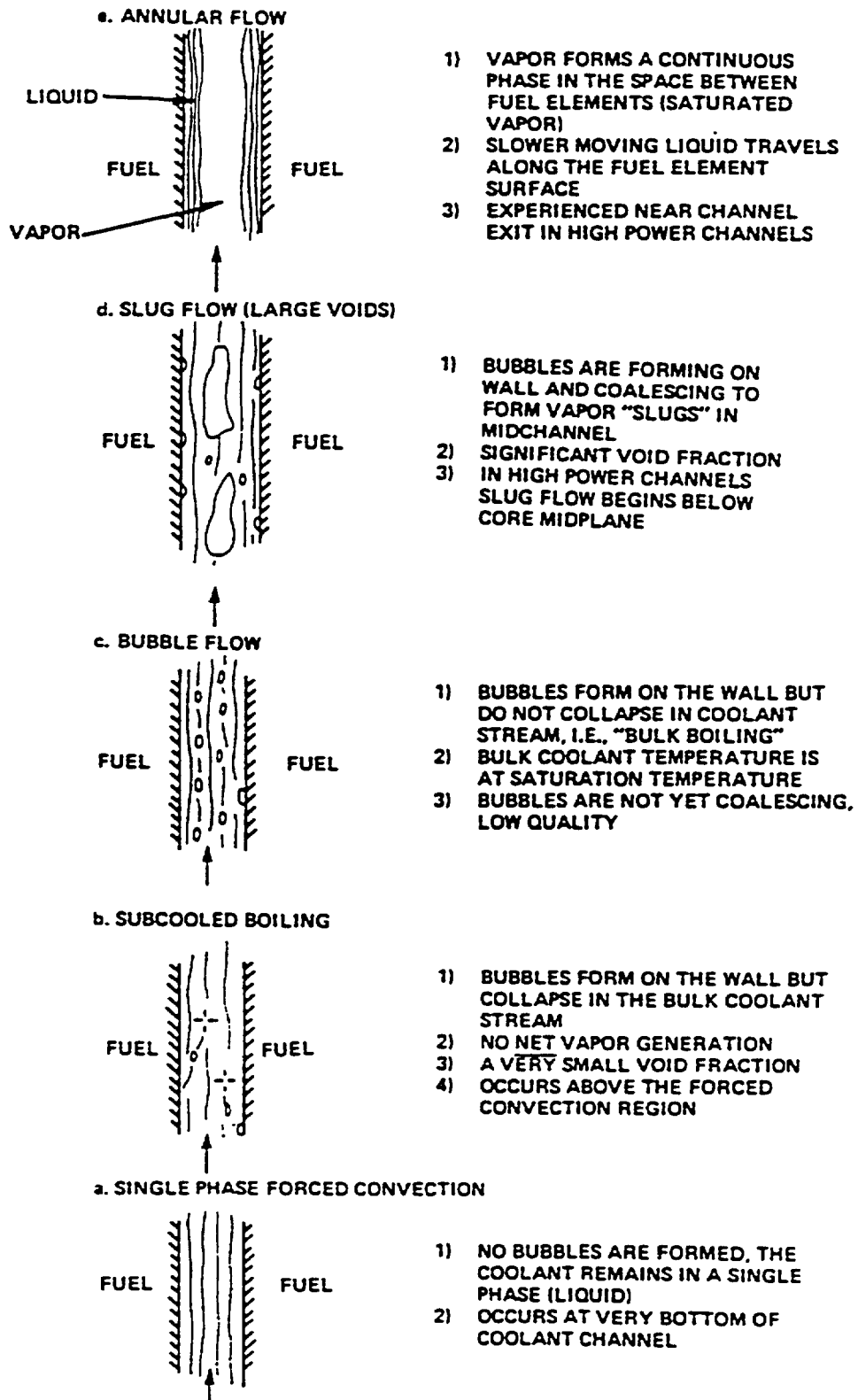

Figure 3-23. Fuel Channel Boiling Conditions

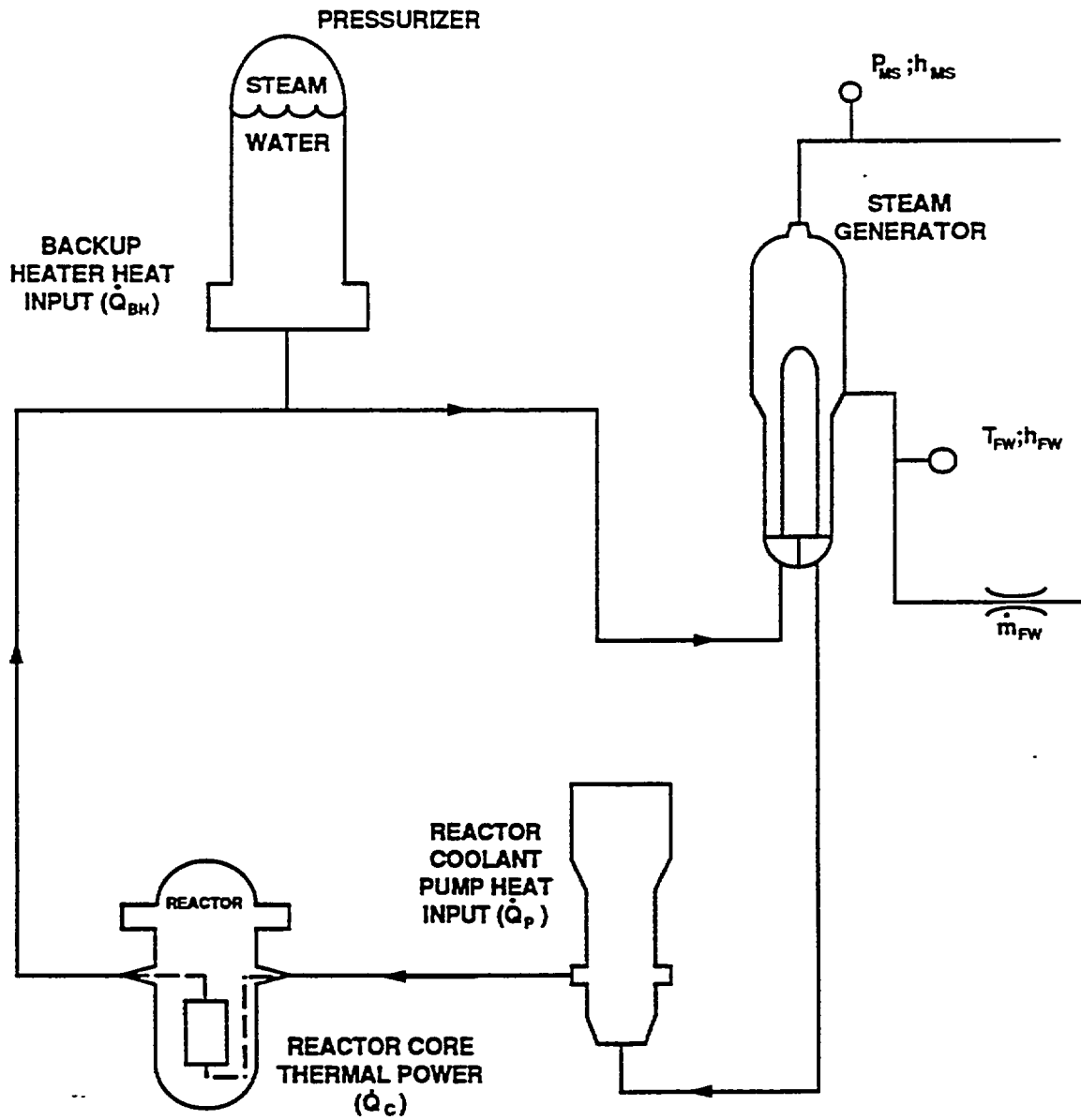

Figure 3-24. PWR Reactor Core Heat Balance Diagram

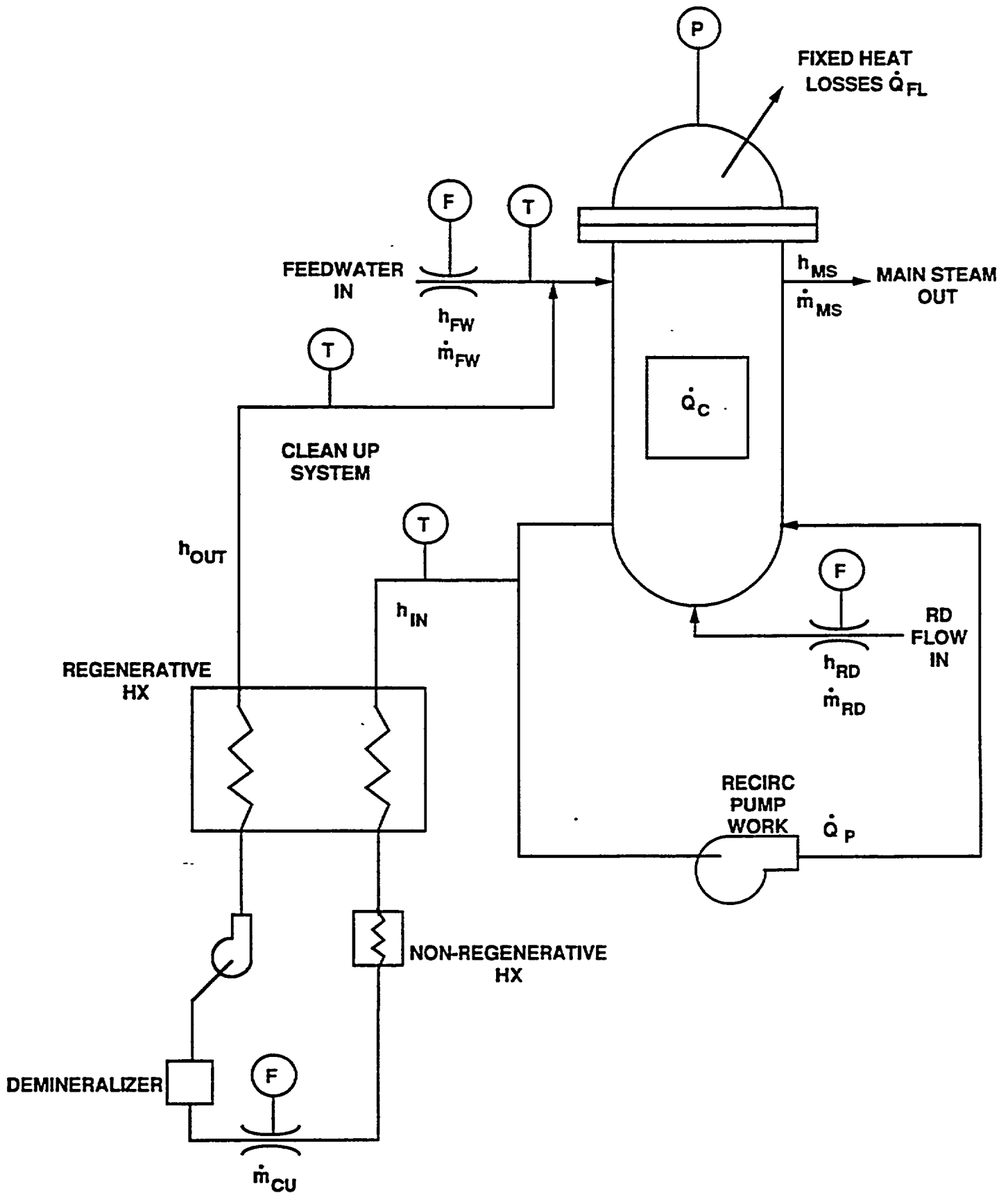
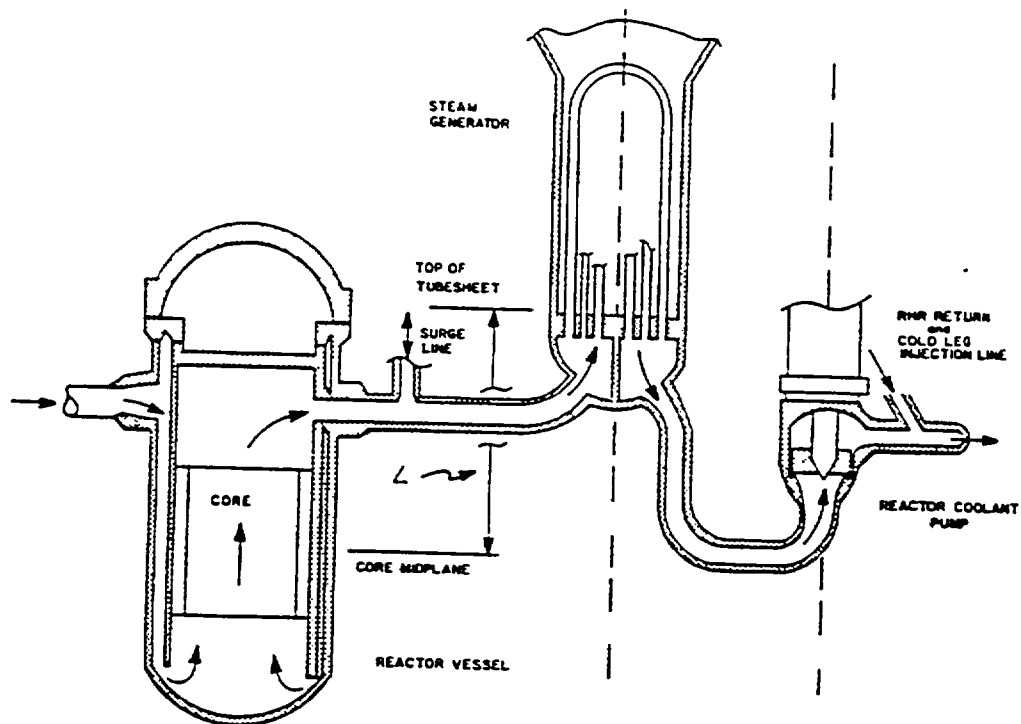

Figure 3-25. BWR Reactor Core Heat Balance Diagram



A. Typical Natural Circulation Geometry

HOT LEG HEAD ( $H_{HL}$ )		COLD LEG HEAD ( $H_{CL}$ )
$T_H ; \rho_H$	2ft. Effective Steam Generator Tube Bundle Height	$T_C ; \rho_C$
$T_H ; \rho_H$	7ft. Effective Reactor Coolant Piping Height	$T_C ; \rho_C$
$T_{AVG} ; \rho_{AVG}$	12ft. Effective Reactor Height	$T_C ; \rho_C$

$$H_{CL} = 2\rho_C g + 7\rho_C g + 12\rho_C g = 21\rho_C g$$

$$\rho_{AVG} = \frac{\rho_H + \rho_C}{2}$$

$$H_{HL} = 12 \left( \frac{\rho_H + \rho_C}{2} \right) g + 7\rho_H g + 2\rho_H g = 15\rho_H g + 6\rho_C g$$

$$H_{NC} = H_{CL} - H_{HL} = 21\rho_C g - 15\rho_H g - 6\rho_C g = 15g(\rho_C - \rho_H)$$

B. Natural Circulation Driving Head

Figure 3-26. Natural Circulation