

DISCLAIMER

UNITED STATES NUCLEAR REGULATORY COMMISSION'S
ADVISORY COMMITTEE ON REACTOR SAFEGUARDS

June 19, 2008

The contents of this transcript of the proceeding of the United States Nuclear Regulatory Commission Advisory Committee on Reactor Safeguards, taken on June 19, 2008, as reported herein, is a record of the discussions recorded at the meeting held on the above date.

This transcript has not been reviewed, corrected and edited and it may contain inaccuracies.

1 UNITED STATES OF AMERICA
2 NUCLEAR REGULATORY COMMISSION

3 + + + + +

4 ADVISORY COMMITTEE ON REACTOR SAFEGUARDS

5 (ACRS)

6 + + + + +

7 SUBCOMMITTEE ON ESBWR

8 + + + + +

9 THURSDAY

10 JUNE 19, 2008

11 + + + + +

12 ROCKVILLE, MARYLAND

13 + + + + +

14 The Subcommittee met at the Nuclear
15 Regulatory Commission, Two White Flint North, Room
16 T2B3, 11545 Rockville Pike, at 8:30 a.m., Dr. Michael
17 Corradini, Chairman, presiding.

18 COMMITTEE MEMBERS:

19 MICHAEL CORRADINI, Chairman

20 JOHN D. SIEBER

21 CHARLES H. BROWN

22 DENNIS C. BLEY

23 J. SAM ARMIJO

24 WILLIAM J. SHACK

25 OTTO L. MAYNARD

NEAL R. GROSS

COURT REPORTERS AND TRANSCRIBERS
1323 RHODE ISLAND AVE., N.W.
WASHINGTON, D.C. 20005-3701

1
2
3
4
5
6
7
8
9
10
11
12
13
14
15
16
17
18
19

JOHN W. STETKAR

CONSULTANTS TO THE ACRS PRESENT:

GRAHAM B. WALLIS

THOMAS S. KRESS

NRC STAFF PRESENT:

AMY CUBBAGE

CHANDU PATEL

MOHAMMED SHAMS

JIM XU

DAVID JENG

SAMIR CHAKRABARTI

HAROLD VANDER MOLEN

ALSO PRESENT:

JEFF WAAL

CLEMENT RAJENDRA

AI-SHEN LIU

RICH MORANTE

JOSEPH BRAVERMAN

NEAL R. GROSS

COURT REPORTERS AND TRANSCRIBERS
1323 RHODE ISLAND AVE., N.W.
WASHINGTON, D.C. 20005-3701

1
2
3
4
5
6
7
8
9
10
11
12
13
14
15
16
17
18
19
20
21
22
23
24
25

T-A-B-L-E O-F C-O-N-T-E-N-T-S

Opening Remarks 4

DCD Sections 3.7 and 3.8 4

 Jeff Wall, GEH

 Ai-Shen Liu

SER Sections 3.7 and 3.8 70

 Chandu Paten, NRO

 David Jeng

 Samir Chakrabarti

Guidance from Committee 108

P-R-O-C-E-E-D-I-N-G-S

8:29 a.m.

CHAIRMAN CORRADINI: Okay. Let's begin the meeting.

I am not going to go through the complete and total welcome. I'll just welcome already back from yesterday. And I'll simply remind everybody the transcript of the meeting will be kept, it will be made available as stated in the *Federal Register* notice.

And it's requested that speakers first identify themselves and speak with sufficient clarity and volume so they can be readily heard.

Mr. Waal, you're up first to talk to us about Sections 3.7 and 3.8 Okay.

MR. WAAL: Thank you. All right.

Good morning.

My name is Jeffrey Waal. I'm with the Regulatory Affairs Staff of GEH in Wilmington, North Carolina, ESBWR Project. And we're here today to discuss Sections 3.7 and 3.8 of the ESBWR DCD.

With me is Mr. Ai-Shen Liu and Mr. Clement Rajendra, who will do the presentation on this section.

MR. LIU: Yes, I will do the presentation.

NEAL R. GROSS

COURT REPORTERS AND TRANSCRIBERS
1323 RHODE ISLAND AVE., N.W.
WASHINGTON, D.C. 20005-3701

1 MR. WAAL: Okay. Okay. Good. I'm glad
2 somebody will.

3 MR. LIU: Clement had his share yesterday.

4 So my name is Ai-Shen Liu. I'm with GE
5 Hitachi, ESBWR Project. And physically and I'm still
6 stationed at San Jose, California.

7 It is my honor to be here today to present
8 to you an overview and a summary of Sections 3.7 and
9 3.8 of ESBWR standard plan design.

10 Chapter 3 overall describes the design of
11 structures, components, equipment and the systems.

12 Sections 3 of which I am going to discuss
13 to you describes the seismic analysis methods for
14 designing structures, systems, components to withstand
15 the effects of Safe Shutdown Earthquake (SSE).

16 So in our design the so called Certified
17 Seismic Design Response Spectra (CSDRS) is an envelope
18 of Reg. Guide 1.60 response factor entered to .3G and
19 North Anna early site permit site-specific spectra.
20 It's a hybrid curve, as you can see the next slide.

21 In addition to the SSE, we also considered
22 the effects of the reactor vibrations caused by the
23 suppression pool hydrodynamic loads. This is, you
24 know, although we still maintained the pressure
25 suppression concept for our design, same as other

NEAL R. GROSS

COURT REPORTERS AND TRANSCRIBERS
1323 RHODE ISLAND AVE., N.W.
WASHINGTON, D.C. 20005-3701

1 EBWRS.

2 MEMBER SIEBER: These are the dynamic
3 loads due to the discharge thing in the suppression
4 pool?

5 MR. LIU: Yes, sir.

6 MEMBER SIEBER: Okay.

7 MR. LIU: In addition to seismic Category
8 1 structures we have another category which is a
9 seismic Category II.

10 MR. WALLIS: I'm sorry. The second bullet
11 refers to something happened and it doesn't refer to
12 a seismic interaction with the suppression pool. It
13 refers to the suppression pool.

14 MR. LIU: Subject to the loading
15 interactive from the discharge.

16 MR. WALLIS: Well, I notice you've got
17 some nice -- as far as I can tell on model of the
18 structures. But you model the water as well when you
19 shake the building?

20 MR. LIU: The water weight are included in
21 the model. Yes, sir.

22 MR. WALLIS: Yes. Okay.

23 MR. LIU: Right.

24 MR. WALLIS: Just the weight

25 MEMBER SIEBER: But not the slosh?

NEAL R. GROSS

COURT REPORTERS AND TRANSCRIBERS
1323 RHODE ISLAND AVE., N.W.
WASHINGTON, D.C. 20005-3701

1 MR. WALLIS: Not the sloshing mechanism
2 or--

3 MR. LIU: That's a separate calculation
4 dynamic response.

5 MR. WALLIS: It's a separate calculation.
6 Okay. So you'll get to that, presumably.

7 MR. LIU: Yes, if you -- no. I can
8 discuss in more detail later on.

9 MEMBER SHACK: Let me just ask Amy a
10 question. We had the discussion on Chapter 19.

11 MS. CUBBAGE: Yes.

12 MEMBER SHACK: So we have this spectra for
13 this analysis and you're still discussing with GEH
14 whether they can use a site specific analysis for the
15 seismic margin calculations? Is that the discussion
16 we were having in Chapter 19?

17 MS. CUBBAGE: Right. That's exactly
18 right.

19 MEMBER SHACK: Has that been settled?

20 MS. CUBBAGE: That has not been settled.
21 No.

22 CHAIRMAN CORRADINI: So what are they
23 using for Chapter 19? You say it again, because I'll
24 say it wrong.

25 MS. CUBBAGE: This way they -- as far as

NEAL R. GROSS

COURT REPORTERS AND TRANSCRIBERS
1323 RHODE ISLAND AVE., N.W.
WASHINGTON, D.C. 20005-3701

1 I know, they've -- and you can correct me if I'm
2 wrong. As far as I know they've designed -- they've
3 done the seismic margins analysis with the certified
4 spectra. And then at the post-construction phase
5 they're going to verify to the site specific and try
6 to reconcile any differences there.

7 CHAIRMAN CORRADINI: Can I say it back to
8 you so I get it right?

9 So right now what we're going to see is an
10 analysis with a double --

11 MS. CUBBAGE: Yes.

12 CHAIRMAN CORRADINI: So then the
13 discussion when we were together on June 3rd implied
14 that they're going to go back to a different spectra,
15 a single -- thank you -- but for what purpose there?
16 That's where I'm a bit confused. I'm sorry.

17 MS. CUBBAGE: I'd like GE to explain what
18 their plan is.

19 MR. LIU: If I may, yes. Let me try to
20 clarify, if I may.

21 In the context of seismic margin in
22 Chapter 19 we were trying to taking into account a
23 more realistic ground motion. In view of the double-
24 hump spectra we have considered in the design, we
25 recognize this double-hump is very conservative. So

NEAL R. GROSS

COURT REPORTERS AND TRANSCRIBERS
1323 RHODE ISLAND AVE., N.W.
WASHINGTON, D.C. 20005-3701

1 as a result the design has, you know, a lot of margin.
2 To do it in a realistic way in the context of PRA we
3 think is rational to take into account more realistic
4 ground motion input.

5 CHAIRMAN CORRADINI: So you get rid of a
6 hump?

7 MR. LIU: In a way, yes sir.

8 CHAIRMAN CORRADINI: Okay.

9 MR. LIU: You know, and that realistic
10 spectrum we'll label it as a so-called a performance
11 based.

12 MEMBER SHACK: Well, no. That's a little
13 different, too. Because as I believe in the early
14 sites permit for North Anna, they used the 1.165 way
15 to come up with the seismic hazard.

16 MR. LIU: I understand.

17 MEMBER SHACK: But now you're going to go
18 to 1.208.

19 MR. LIU: Not exactly. Not exactly.

20 MEMBER SHACK: Oh, see. Okay.

21 MR. LIU: You know, we're trying to
22 utilize the current knowledge of ground motion which
23 has -- you know, other COL applicants, you know, are
24 addressing for their specific sites. But for the
25 purpose of standard plant design we don't have the

NEAL R. GROSS

COURT REPORTERS AND TRANSCRIBERS
1323 RHODE ISLAND AVE., N.W.
WASHINGTON, D.C. 20005-3701

1 luxury of that specific information. Because our
2 intent is to address a wide range of sites.

3 CHAIRMAN CORRADINI: So can I ask a less
4 educated question on this? So just to make sure. So
5 what we're going to see today is this stylized
6 spectrum which adds the North Anna component? But for
7 Chapter 19 you've taken away the North Anna component
8 and have a different stylized curve? Pardon my
9 simplified --

10 MR. LIU: Right. You know, we did not take
11 away the North Anna contribution at all.

12 CHAIRMAN CORRADINI: Or it's not there
13 anymore.

14 MEMBER SHACK: It is. It is. It's all
15 North Anna.

16 CHAIRMAN CORRADINI: No. The second part
17 is going to be changed for Chapter 19.

18 MR. LIU: May I?

19 CHAIRMAN CORRADINI: Yes, I'm sorry.

20 MR. LIU: Would you please clarify what
21 you mean by the second part?

22 CHAIRMAN CORRADINI: Well, can you go to
23 slide 6?

24 MEMBER SIEBER: That's a composite of two
25 different --

NEAL R. GROSS

COURT REPORTERS AND TRANSCRIBERS
1323 RHODE ISLAND AVE., N.W.
WASHINGTON, D.C. 20005-3701

1 CHAIRMAN CORRADINI: That's the composite
2 of two different spectra, right?

3 MR. LIU: Right.

4 CHAIRMAN CORRADINI: Okay. And that's
5 being used today in our discussion?

6 MR. LIU: Yes, sir.

7 CHAIRMAN CORRADINI: Okay. But as you
8 explained it, and I don't mean to go back but I'm just
9 trying to get it all straight, in Chapter 19 this
10 spectra was or was not used? Was not?

11 MR. LIU: Was used together with another
12 curve for the purpose to calculate the fact of
13 safeties associated with each of the important
14 parameters relative to the response.

15 And is there anything I can draw on?
16 Anyway. Let me try to describe it.

17 CHAIRMAN CORRADINI: Okay. Why don't you
18 try words.

19 MR. LIU: Okay. All right.

20 CHAIRMAN CORRADINI: And I apologize.
21 It's my fault for --

22 MR. LIU: That's okay. You know, let me
23 try to describe it in words.

24 So this is a design spectrum we call
25 CSDRS. Okay. For size margin evaluation we have

NEAL R. GROSS

COURT REPORTERS AND TRANSCRIBERS
1323 RHODE ISLAND AVE., N.W.
WASHINGTON, D.C. 20005-3701

1 another curve, which basically you know try to imagine
2 a curve which is, you know, smaller than this curve up
3 to about 9 Hertz.

4 CHAIRMAN CORRADINI: Okay.

5 MR. LIU: Okay?

6 PARTICIPANT: I mean, if I try to explain
7 it, it would be --

8 MEMBER MAYNARD: You've got to be at a
9 microphone.

10 MEMBER SHACK: It's the North Anna curve.

11 MR. LIU: No. That portion, no frequency
12 is not North Anna curve.

13 MEMBER SHACK: Right. The low frequency is
14 the one 1.60 contribution.

15 MR. LIU: For seismology is not in the
16 1.60 either.

17 MEMBER SHACK: Right.

18 MR. LIU: Yes. It's a curve. Basically is
19 the curve is unlocking curve all soil sites among the
20 28 sites. But using this, no. This ground motion
21 calculations methodology. Okay. So that's the
22 envelop of all soil site among 128 except local.

23 CHAIRMAN CORRADINI: Okay.

24 MR. LIU: So that's the curve. You know,
25 we tend to cover the soil sites up to roughly 9 Hertz.

NEAL R. GROSS

COURT REPORTERS AND TRANSCRIBERS
1323 RHODE ISLAND AVE., N.W.
WASHINGTON, D.C. 20005-3701

1 Okay. From that Hertz and up we maintain the North
2 Anna curve. Same magnitude. That's the design that
3 the site include second peak.

4 MEMBER SIEBER: And that came from all the
5 soil sites. That makes sense.

6 CHAIRMAN CORRADINI: And that's what you
7 do for the equipment for the standard plants?

8 MR. LIU: Yes, sir.

9 CHAIRMAN CORRADINI: Okay. But in Chapter
10 19 you remove the black line at the lower frequencies
11 and replace it with something close to the red line
12 that is up there?

13 MR. LIU: Right. But just for the purpose
14 to show the conservatisms in the design which is based
15 on that design curve.

16 CHAIRMAN CORRADINI: Okay. But just to
17 ground it off in my understanding, but that
18 conservatism is not generic anymore because you took
19 away your enveloping --

20 MEMBER SIEBER: Right.

21 MR. LIU: No, it's generic because that
22 lower red curve is enveloping of all soil sites.

23 CHAIRMAN CORRADINI: Then what's the black
24 curve? I thought you said that's what the black curve
25 was. I apologize.

NEAL R. GROSS

COURT REPORTERS AND TRANSCRIBERS
1323 RHODE ISLAND AVE., N.W.
WASHINGTON, D.C. 20005-3701

1 MEMBER MAYNARD: You're saying that the
2 Reg. Guide curve is overly conservative.

3 MR. LIU: Yes, you know relative what we
4 know right now for the soil sites.

5 CHAIRMAN CORRADINI: Okay. Good. That's
6 enough. At least I understand that. So the Reg. Guide
7 curve is conservative relative to your enveloping of
8 soil sites. And then we'll let you guys fight it out
9 with staff. I just wanted to make sure I understood
10 it.

11 MR. LIU: Right.

12 CHAIRMAN CORRADINI: I get it.

13 MS. CUBBAGE: Right. And the issue that
14 staff has is the COL item has the certified design
15 pairing -- let's see. The COL holder shall compare the
16 as-built SSE HCLF to those assumed in the ESBWR
17 seismic margin analysis. Deviation from the HCLF
18 values or other assumptions shall be analyzed to
19 determine if new vulnerabilities have been introduced.

20 So they're comparing to site-specific
21 spectra at that time, the as-built.

22 MEMBER SHACK: But you're agreeing with
23 that then?

24 MS. CUBBAGE: No.

25 MEMBER SHACK: No.

NEAL R. GROSS

COURT REPORTERS AND TRANSCRIBERS
1323 RHODE ISLAND AVE., N.W.
WASHINGTON, D.C. 20005-3701

1 MS. CUBBAGE: This statement can be
2 interpreted as allowing the COL holder to analyze the
3 as-built HCLFs with respect to the site spectra. We
4 want it against the certified spectra.

5 CHAIRMAN CORRADINI: That I get. But
6 aren't you putting -- I mean, I'm mischaracterizing so
7 you can recharacterize. Aren't you putting the COL
8 holders at risk by essentially taking it from the
9 black line to the red line and making them have to
10 reanalyze at the black line? Am I missing something
11 here?

12 MR. LIU: No. I don't think so. Because
13 we're not really changing the design. The design is
14 still based on the black line. The design is still
15 based on the black line. Just when it comes to
16 identification of the margins. The margins in my mind
17 only makes sense, you know, that they are related to
18 a known quantity. Then the known quantity in this
19 sense is site-specific.

20 CHAIRMAN CORRADINI: Okay. All right.

21 MR. LIU: So in our view this stage in
22 standard plants -- you know, this is already --

23 CHAIRMAN CORRADINI: Okay. I see what
24 you're saying. Let's leave it there. I get it.

25 MEMBER SIEBER: But still the PRA will

NEAL R. GROSS

COURT REPORTERS AND TRANSCRIBERS
1323 RHODE ISLAND AVE., N.W.
WASHINGTON, D.C. 20005-3701

1 have a site specific site -- what are these to
2 somebody else will have their terms and chapter --

3 MR. LIU: Yes. The red curve, the site-
4 specific curve already in COLA FSAR in Chapter 2. And
5 COLA applicant obligated to demonstrate that the red
6 curve is below the black curves.

7 MEMBER SIEBER: With your analysis?

8 MR. LIU: Yes.

9 MEMBER SIEBER: Okay.

10 CHAIRMAN CORRADINI: Thank you. Go ahead.
11 I'm sorry. We'll go back to 3?

12 MR. LIU: Okay. Category II. Okay. In
13 addition to Category I structure, you know we have
14 another category or Category II intent is to address
15 those components and structure which are not safety
16 related. They have a potential for interaction with
17 Category I. So we put those things and call them as
18 Category II. So we commit our design of Category II to
19 the same method of analysis and design as Category I.

20 MEMBER SIEBER: That's different is the
21 QA?

22 MR. LIU: Yes, sir.

23 Okay. In Section 3.8 we describe the
24 loads, load combination acceptance criteria for
25 designing seismic Category I structures.

NEAL R. GROSS

COURT REPORTERS AND TRANSCRIBERS
1323 RHODE ISLAND AVE., N.W.
WASHINGTON, D.C. 20005-3701

1 In ESBWR standard plan design the Category
2 I structures include the concrete containment and
3 internal structures, the reactor building and the fuel
4 building, you know. In our design the containment
5 structures is enclosed by the reactor building and
6 integrated with the reactor building. And within the
7 control building we also firewater service complex
8 structure. The roles at the Category I structure in
9 our design.

10 As I briefly mentioned to you --

11 MEMBER BROWN: Can I -- not really
12 understand. The equipment would be designed to the
13 black curve that they have to put in the plant
14 regardless of the PRA and the foundations. But also
15 the hardware and everything else that goes in has to
16 consider the seismic response of the black curve?

17 CHAIRMAN CORRADINI: Right. The complete
18 black curve.

19 MEMBER BROWN: Okay. Okay.

20 CHAIRMAN CORRADINI: Right.

21 MEMBER BROWN: So the only thing that
22 alternate curve could be -- I'm sorry I'm so slow it
23 just took a minute to integrate this, is just PRA type
24 stuff --

25 MS. CUBBAGE: I think the staff is

NEAL R. GROSS

COURT REPORTERS AND TRANSCRIBERS
1323 RHODE ISLAND AVE., N.W.
WASHINGTON, D.C. 20005-3701

1 concerned that there could be some loss of
2 standardization. Because they could justify because of
3 the --

4 MEMBER BROWN: Reducing the design?

5 MS. CUBBAGE: Possibly in some areas just
6 from the perspective of if they could pick up or use
7 the additional margin that's there. I think that's
8 the concern.

9 CHAIRMAN CORRADINI: Would it change the
10 way you classify equipment for later on? I guess what
11 I'm trying to understand is the effect of showing
12 larger margin because I went from black to red. So --
13 or is actually going to change the way maintenance,
14 inspection and equipment usage --

15 MS. CUBBAGE: It's a question of whether
16 they're going to take advantage of that extra margin
17 and change the design in the site-specific area.

18 MEMBER BROWN: Or not require the design
19 to be as robust?

20 MS. CUBBAGE: Now, it won't impact Chapter
21 3, as I understand. Chapter 3 is what it is. But
22 from a margin --

23 MEMBER BROWN: This can only effect
24 equipment that isn't categorized here as I, II or the
25 RTNSS stuff. If you sound something else in the PRA,

NEAL R. GROSS

COURT REPORTERS AND TRANSCRIBERS
1323 RHODE ISLAND AVE., N.W.
WASHINGTON, D.C. 20005-3701

1 you could maybe shave the margin here. But you're
2 stuck here.

3 MS. CUBBAGE: Maybe go to the other
4 microphone.

5 MR. SHAMS: Mohammed Shams. I'm with the
6 staff.

7 I think that Dr. Corradini asked the right
8 question: What are you qualifying the equipment for,
9 the standing equipment? Is it the black, the red or
10 is it the site-specific? Because the site-specific is
11 a whole other spectrum that -- all the way down there.

12 For instance, if we look at Grand Gulf,
13 for instance, that would be like way down, four or
14 five times less than what we're looking at.

15 So my question to GE would be what are you
16 qualifying the equipment for?

17 MR. LIU: But the equipment is qualified
18 to the black curve.

19 MR. SHAMS: Then only the margin
20 calculation will be based on the site-specific.
21 Right. So that means he's just showing the
22 conservatism relative to the site-specific curve.
23 However, the design is going to be the red or be the
24 black, they're both high anyway. We can sort this out
25 which one is the appropriate one.

NEAL R. GROSS

COURT REPORTERS AND TRANSCRIBERS
1323 RHODE ISLAND AVE., N.W.
WASHINGTON, D.C. 20005-3701

1 CHAIRMAN CORRADINI: Okay. That helps.
2 Thank you. Thank you very much. I appreciate it.

3 Does that help?

4 MEMBER BROWN: Yes. I apologize. I just
5 didn't quite get all --

6 CHAIRMAN CORRADINI: Don't apologize.
7 We're still talking over here about it. He's
8 explaining to me quietly.

9 Go ahead.

10 MR. LIU: Okay. Section 3.7.1 is a
11 section describes seismic design parameters. As I
12 mentioned briefly to you, our design spectra so called
13 a CSDRS follows Reg. Guide 1.60 and the North Anna at
14 high frequencies. The reason we choose North Anna is
15 because, you know, it is representative of most severe
16 rock site in the Eastern US.

17 We also recognize that although we take
18 this conservative in the design, is really it's not
19 realistic because to our knowledge none of the
20 recording seismic events, you know simultaneously
21 contains low frequency and excitation and high
22 frequency excitation. We recognize that, you know, by
23 taking double-hump, you know, we are really
24 conservative.

25 MEMBER ARMIJO: So this double-hump is

NEAL R. GROSS

COURT REPORTERS AND TRANSCRIBERS
1323 RHODE ISLAND AVE., N.W.
WASHINGTON, D.C. 20005-3701

1 physically unrealistic?

2 MR. LIU: Yes, sir.

3 MEMBER ARMIJO: Even let's say this Japan
4 earthquake where the Kashiwazaki site's at, was there
5 anything close to this --

6 MR. LIU: No, sir. No.

7 MEMBER ARMIJO: So it's conservative even
8 with respect to what we have from there?

9 MR. LIU: Yes, sir.

10 MEMBER SHACK: Well, you've got to
11 remember this spectrum is anchored at .3g.

12 MEMBER ARMIJO: Oh.

13 MEMBER SHACK: So the Japanese spectra may
14 not have two humps --

15 MR. LIU: But it would have more gs.

16 MEMBER SHACK: More gs.

17 MEMBER ARMIJO: Yes, I understand.

18 MR. LIU: Correct me if I may, you know,
19 our design's really anchored to .5g. Peak
20 acceleration is .5g. Because that high frequency,
21 yes, is .5 although the portion of the low frequency
22 spectra of Reg. Guide 1.60 is --

23 MEMBER ARMIJO: Okay. Yes. This
24 discussion came up before. Okay. Now the 1.60 is
25 anchored to .3. But you're telling me it's really .5?

NEAL R. GROSS

COURT REPORTERS AND TRANSCRIBERS
1323 RHODE ISLAND AVE., N.W.
WASHINGTON, D.C. 20005-3701

1 MR. LIU: For the composite curve.

2 CHAIRMAN CORRADINI: Can we go to the
3 figure if you're going to explain that.

4 MR. LIU: All right.

5 CHAIRMAN CORRADINI: Tell me what you mean
6 by anchored at what frequency, please?

7 MR. LIU: You have to have that actuation
8 value at 100 Hertz. Okay. That's .5g.

9 MEMBER ARMIJO: Okay. There it's .5g.
10 You have to put numbers on these.

11 MR. LIU: That's .5g.

12 MEMBER SHACK: Okay. So you're saying the
13 high frequency is anchored at the .5g?

14 MEMBER BLEY: What's it mean to anchor?

15 CHAIRMAN CORRADINI: It strikes me it
16 means normalizing by some sort of shape function.

17 MR. LIU: That's .5.

18 MEMBER SIEBER: You shape it on top of the
19 acceleration and you make an assumption as to
20 everything looks all right.

21 MR. LIU: Can everybody hear that?

22 MS. CUBBAGE: Yes.

23 MEMBER BROWN: No. I took it as the point
24 at 100 Hertz.

25 MR. LIU: That's the .5. That's what we

NEAL R. GROSS

COURT REPORTERS AND TRANSCRIBERS
1323 RHODE ISLAND AVE., N.W.
WASHINGTON, D.C. 20005-3701

1 call a peak acceleration of the SSE. What I meant by
2 .3g SSE basically is this is .3g Reg. Guide 1.60 what
3 I meant. So this curve up to 9 Hertz follows Reg.
4 Guide 1.60.

5 If I continue this curve at higher
6 frequency, this curve drops down. Then the
7 acceleration at 100 Hertz will be .3.

8 CHAIRMAN CORRADINI: Okay.

9 MR. LIU: That's what I mean by .3g Reg.
10 Guide 1.60. Because in our design we did not use that
11 lower amplitude of .3g 1.60.

12 CHAIRMAN CORRADINI: Got it.

13 MEMBER SHACK: But I mean for a soil site
14 you'd really be a .3g. Because the soil site looks
15 more like the 1.60?

16 MR. LIU: Yes, that's a reality. Yes. You
17 know, for a given site the curve may look like this.

18 MEMBER SIEBER: You mean you'd have even
19 more margin?

20 MR. LIU: No, we designed to this.

21 MEMBER SHACK: Motion frequency.

22 MR. LIU: We designed to the black curve.

23 CHAIRMAN CORRADINI: So just to complete
24 the circuit back to Dr. Armijo's question, if we take
25 a real event such as what occurred in Japan, your

NEAL R. GROSS

COURT REPORTERS AND TRANSCRIBERS
1323 RHODE ISLAND AVE., N.W.
WASHINGTON, D.C. 20005-3701

1 answer to that is that spectrum is below both of
2 these? That was what he was asking.

3 MEMBER SHACK: For that site in Japan,
4 would that spectrum be below this black curve?

5 MR. LIU: As in a spectra shift wise, yes.
6 But I couldn't answer you on the acceleration level.

7 MEMBER SHACK: The actual acceleration,
8 yes.

9 MR. LIU: But our design is .5. As in
10 that Kashiwazaki site, as in the record motion is
11 pretty high.

12 MEMBER ARMIJO: But the design of the ABWR
13 was basically .3g at some frequency. I don't know what
14 it was. But it was --

15 MR. LIU: The ABWR's designed purely to
16 Reg. Guide 1.60 .3g.

17 MEMBER SHACK: Yes. So this is a .3g if
18 you think of it as comparing with the ABWR? .3g at
19 100--

20 CHAIRMAN CORRADINI: So it's a .3g reactor
21 sitting on a site with a higher acceleration?

22 MR. LIU: In the context of the Japan
23 earthquake?

24 CHAIRMAN CORRADINI: That's what he was
25 asking.

NEAL R. GROSS

COURT REPORTERS AND TRANSCRIBERS
1323 RHODE ISLAND AVE., N.W.
WASHINGTON, D.C. 20005-3701

1 MR. LIU: Oh. A little bit -- you know,
2 in Japan they designed to Japan criteria. They did not
3 follow Reg. Guide 1.60 at all.

4 MEMBER ARMIJO: I thought they stuck with
5 the .3g, though. You know more about it than I do.
6 But I'm just trying to see how well your design
7 methods actually protected that plant which went
8 through a severe earthquake. That's really what I was
9 trying to get at. You know, would you have margin
10 against that kind of an earthquake using --

11 MR. LIU: Oh, yes. I think the margin has
12 been clearly demonstrated by this recent Japan
13 earthquake. Also, although the recorded motion was so
14 much higher than what has been designed to, but really
15 no major damage has occurred to the plant.

16 MEMBER ARMIJO: Right.

17 MR. LIU: So that's a very, very good
18 demonstration of adequacy of the design.

19 MEMBER ARMIJO: Some day I'd like to see
20 a curve drawn on that --those curves that say this is
21 what really happened in Japan using these methods and
22 the plant was fine. So, I don't know if you guys can
23 do that. But I understand what you're doing.

24 MR. LIU: Yes. We don't have that
25 information.

NEAL R. GROSS

COURT REPORTERS AND TRANSCRIBERS
1323 RHODE ISLAND AVE., N.W.
WASHINGTON, D.C. 20005-3701

1 CHAIRMAN CORRADINI: Thank you very much.

2 MR. LIU: Now given we have this double-
3 hump, that curve. So for the purpose of analysis we
4 need to generate the artificial time histories. So
5 the time history were generated such that they meet
6 the NUREG, you know, criteria as the latest
7 requirements. Because this curve we'll have to
8 discuss quite extensively. This is the horizontal
9 components of the earthquake and this is a vertical
10 component. Basically follow the same approach as we
11 did for the horizontal.

12 This particular one is, you know, for the
13 frequencies up to 10 Hertz which follow Reg. Guide
14 1.60. Above 10 Hertz.

15 MR. WALLIS: No. No. This is a frequency.
16 You say the time has -- you have to say how long this
17 goes on for.

18 MR. LIU: Oh.

19 MR. WALLIS: That's where your NUREG --

20 MR. LIU: Yes. Our time history duration
21 is 40 seconds.

22 MR. WALLIS: Where is that?

23 MR. LIU: You know, the reason for 40
24 seconds because we found out in order to match lower
25 frequency -- to match the spectra at the lower

NEAL R. GROSS

COURT REPORTERS AND TRANSCRIBERS
1323 RHODE ISLAND AVE., N.W.
WASHINGTON, D.C. 20005-3701

1 frequencies, we need to have a longer duration.

2 MR. WALLIS: But how long is the typical
3 earthquake?

4 MR. LIU: Twenty seconds, I would say.

5 MR. WALLIS: Twenty seconds at point .01
6 Hertz --

7 MEMBER ARMIJO: It feels longer. If you're
8 there, it feels longer.

9 MR. WALLIS: But .01 Hertz is kind of
10 meaningless, isn't it?

11 MEMBER SIEBER: What you're trying to do
12 is get everything to wind up.

13 MR. LIU: .01 is because, you know, the
14 curve methodology for developing the site-specific
15 spectra start at .6 Hertz.

16 MR. WALLIS: Okay. Well, you have to put
17 in time somehow.

18 MR. LIU: Yes, sir.

19 MR. WALLIS: Thank you.

20 MR. LIU: Okay. All right. So this slide
21 describe Section 3.7.2 which is for the system
22 analysis. So it applies to the building structures.
23 As I mentioned earlier, that we have a category -- the
24 Category I structure in our design consists of reactor
25 building, fuel building, control building and the

NEAL R. GROSS

COURT REPORTERS AND TRANSCRIBERS
1323 RHODE ISLAND AVE., N.W.
WASHINGTON, D.C. 20005-3701

1 firewater service complex.

2 The reactor building and the fuel building
3 is integrated structure sitting on a common basement.

4 For the response calculation of the
5 reactor building, we also include the reactor pressure
6 vessel, although the vessel itself is not a structural
7 component. We just want to get the proper interaction
8 of the vessel and the supporting structure.

9 MEMBER SHACK: It's a reasonable mass.

10 MR. LIU: Right. So for the response
11 calculation, the mathematic model we use is a lumped
12 mass stick models. We also -- this model was
13 confirmed to be adequate by comparison with the finite
14 element model.

15 MEMBER BLEY: I'm sorry. With the what?

16 MR. LIU: For the calculation for the
17 design basis response we used a stick model, the
18 conventional stick model for seismic. Okay? But in
19 order to convince ourself to demonstrate, the stick
20 model is adequate. Then we compare it with the finite
21 element model, which is more, you know, refined.

22 CHAIRMAN CORRADINI: So can I ask a
23 question there, if I may? Just to go back to
24 Professor Wallis' question. So with water, large
25 bodies of water what check calculation did you do to

NEAL R. GROSS

COURT REPORTERS AND TRANSCRIBERS
1323 RHODE ISLAND AVE., N.W.
WASHINGTON, D.C. 20005-3701

1 make you feel good about the fact that a point mass
2 with a damper was a good model for a big pool of
3 water?

4 MR. LIU: Okay. Let me address this. For
5 the purpose of prediction of a global response of the
6 structure --

7 CHAIRMAN CORRADINI: Right.

8 MR. LIU: Okay. We lumped the water to
9 the structure. This meaning is to maximize the mass
10 effect. Okay. We did not take advantage of the
11 sloshing and the rigid mass, you know, because --

12 MEMBER ARMIJO: You treat the water is a
13 solid then?

14 MR. LIU: We treat the water as solid.

15 MR. WALLIS: I can understand that when
16 the wall is pushing the water. But when the wall is
17 moving away from the water, does it drag the water
18 with it?

19 MR. LIU: That will be a separate
20 calculation in our design. Like I indicated to you,
21 that to do the global response calculation --

22 MR. WALLIS: You got any cavitation in the
23 water?

24 MR. LIU: Cavitation?

25 MR. WALLIS: Like the pulling the wall

NEAL R. GROSS

COURT REPORTERS AND TRANSCRIBERS

1323 RHODE ISLAND AVE., N.W.

WASHINGTON, D.C. 20005-3701

1 away from the water?

2 MR. LIU: You'll have a negative pressure
3 from the sloshing calculations.

4 MR. WALLIS: Doesn't it make bubbles or
5 displacement? Does it stick to the wall or does it
6 separate from the wall and leave a space?

7 MR. LIU: Well, I don't think there's any
8 separation.

9 MR. WALLIS: Well, I don't know. You have
10 to calculate it, presumably.

11 MR. LIU: Well, no. The only potential
12 separation is the water mass nearest a free surface,
13 which is, you know, they occur in the form of
14 sloshing. Because, you know, the reason I have a flat
15 surface when seismic occurs, you know, the wave -- the
16 certain portion of the pool surface depress, another
17 portion raise up. But for the portion which is below
18 the free surface, they basically move together as a
19 structure.

20 MR. WALLIS: But if you subject the water
21 to a negative pressure, it will tend to separate from
22 the wall. It will tend to evaporate.

23 MR. LIU: Unless it's a dynamic event.
24 But on top of that I have this type of static.

25 MR. WALLIS: And it'll slosh when it comes

NEAL R. GROSS

COURT REPORTERS AND TRANSCRIBERS
1323 RHODE ISLAND AVE., N.W.
WASHINGTON, D.C. 20005-3701

1 back again.

2 I just don't know this, I'm just asking
3 you about it. It seems to me you have to consider it
4 somehow.

5 MR. LIU: Yes. Well, we consider in the
6 design calculations. We follow the standard --

7 MR. WALLIS: So when we get to the design,
8 I can ask you the question again?

9 MR. LIU: Sure.

10 MR. WALLIS: In two years' time, perhaps.

11 MR. LIU: In our design, as I mentioned,
12 we consider this water effect.

13 MR. WALLIS: You do?

14 MR. LIU: Yes.

15 MR. WALLIS: And you know how to do it?

16 MR. LIU: Well, the math is not really
17 that sophisticated. You know, it has been developed
18 for a long, long time.

19 CHAIRMAN CORRADINI: So I thought you were
20 going to answer it differently. I thought you were
21 going to answer in saying that you would look at the
22 local conditions that you got a large and a negative
23 pressure that might cause cavitation, you'd start
24 worrying and checking. But otherwise, you weren't
25 worried.

NEAL R. GROSS

COURT REPORTERS AND TRANSCRIBERS
1323 RHODE ISLAND AVE., N.W.
WASHINGTON, D.C. 20005-3701

1 The finite element model is you treat the
2 water element as if it were something will generate a
3 negative pressure --

4 MR. WALLIS: You calculate an interfacial
5 pressure.

6 CHAIRMAN CORRADINI: Right. But you can
7 check that. Then you start worrying about the
8 behavior where you see them.

9 MR. WALLIS: Especially if it starts doing
10 this. Get one of Dick Leahy's bubbles going into the
11 wall.

12 CHAIRMAN CORRADINI: I'm sorry. Go ahead.
13 Go ahead.

14 MR. LIU: Okay. Let's see. We did a
15 seismic soil-structure interaction. And other details
16 we documented in Appendix 3A.

17 The next slide shows, you know, an
18 overview what SSI analysis cases we considered.

19 In our design we basically, you know,
20 considered two sets of sites, which are uniform sites
21 and the layer sites. Okay.

22 A uniform site, basically you assume the
23 soil is uniform, have space. In that sort of
24 calculation, you know, we did not include
25 environmental effects, which is a conservative

NEAL R. GROSS

COURT REPORTERS AND TRANSCRIBERS
1323 RHODE ISLAND AVE., N.W.
WASHINGTON, D.C. 20005-3701

1 approach.

2 For the layered sites, which you know the
3 condition illustrated in that figure in this slide,
4 basically we vary the stiffness, you know, into
5 different three layers. The top layer stiffness we,
6 you know, assigned pretty much a soft condition. And
7 for the layer immediately below the reactor building,
8 you know, we did some variation on what the stiffness
9 of the soil for that. Then the bottom layer is
10 basically is --

11 MR. WALLIS: Does it make a difference if
12 the water -- if the soil is saturated with water?

13 MR. LIU: Yes. And that will increase the
14 Poisson's ratio. The water effects mainly is a
15 compression wave. So that -- basically that, you
16 know, the compression wave for water -- I forgot
17 exactly. What, is 4800 feet per second?

18 CHAIRMAN CORRADINI: Sounds right.

19 MR. LIU: So to achieve that we adjust the
20 Poisson's ratio to simulate that saturated soil.

21 So for the --

22 MR. WALLIS: Were you ever concerned with
23 fluidization of the soil or where the soil sort of
24 becomes like a fluid when you jiggle it?

25 MR. LIU: No. No, we did not.

NEAL R. GROSS

COURT REPORTERS AND TRANSCRIBERS
1323 RHODE ISLAND AVE., N.W.
WASHINGTON, D.C. 20005-3701

1 MR. WALLIS: That was never a concern?

2 MR. LIU: Well, that's a separate
3 evaluation for potential of a liquefaction. You know,
4 this is a site-specific COLA action for a site to
5 demonstrate.

6 MR. WALLIS: Okay. So your design is not
7 designed to float in a --

8 MR. LIU: No.

9 MEMBER ARMIJO: It's not a barge.

10 MR. LIU: No.

11 MEMBER ARMIJO: It's not a floating
12 nuclear power plant, let's just start there.

13 CHAIRMAN CORRADINI: It's not supposed to
14 be.

15 MEMBER SHACK: They expect to have a
16 foundation.

17 MR. LIU: Yes. Next one, please.

18 MR. WALLIS: So it's up to the COL people
19 to decide if there might be some soil fluidization?

20 MR. LIU: Yes.

21 MR. WALLIS: Okay.

22 MR. LIU: So Section 3.7.3 deal with the
23 seismic design for subsystems.

24 It applies to both Category I and Category
25 II equipment and the piping.

NEAL R. GROSS

COURT REPORTERS AND TRANSCRIBERS
1323 RHODE ISLAND AVE., N.W.
WASHINGTON, D.C. 20005-3701

1 And the dynamic qualification can be
2 performed by analysis, testing or a combination of
3 both.

4 MR. WALLIS: So a fluid soil wouldn't
5 break the building. It would probably transmit lower
6 forces. But it might tilt it?

7 MR. LIU: Right. Right. So what's why
8 we're to confirm there's no potential for
9 liquefaction.

10 MEMBER BLEY: And, Graham, that would
11 break pipes.

12 MR. LIU: The method of analysis for
13 subsystem basically is the same. You know, they are
14 the same as for the systems. You know, you can do a
15 time history analysis, response spectrum analysis or
16 equivalent study analysis.

17 And the damping values we use are
18 consistent with Reg. Guide 1.60 Rev. 1.

19 Then the last subsection in Section 3.7 we
20 deal is 3.7.4 dealing with seismic instrumentation.
21 So we follow Reg. Guide 1.12 for the instrumentation
22 program. And we also follow Reg. Guide 1.16 and the
23 Reg. Guide 1.167 for procedural plant response to
24 earthquake, you know, by referencing the EPRI reports,
25 which are permitted by these two Reg. Guides.

NEAL R. GROSS

COURT REPORTERS AND TRANSCRIBERS
1323 RHODE ISLAND AVE., N.W.
WASHINGTON, D.C. 20005-3701

1 Provided details of soil-structure
2 interaction analyses in Appendix 3A. And we provided
3 details of response structure to containment loads in
4 Appendix 3F.

5 Okay. This is just, you know, a
6 representative response spectra for seismic. This
7 location at the refueling level of the reactor
8 building, which is pretty far up.

9 MR. WALLIS: Well, this damping is a
10 parameter. But --

11 CHAIRMAN CORRADINI: We were waiting for
12 this one. We were waiting for this one.

13 MR. WALLIS: -- which one do you take?

14 MR. LIU: It depends on the equipment.
15 Yes. It depends on the equipment and piping to
16 represent a -- of damping curves for the equipment
17 design, they can choose the proper one.

18 MR. WALLIS: They choose their own
19 damping?

20 MR. LIU: Well, they have to follow
21 requirements. Yes.

22 MEMBER ARMIJO: Could you give me an
23 example of type of equipment that would have the most
24 severe acceleration? Or, I guess it's the highest
25 damping.

NEAL R. GROSS

COURT REPORTERS AND TRANSCRIBERS
1323 RHODE ISLAND AVE., N.W.
WASHINGTON, D.C. 20005-3701

1 CHAIRMAN CORRADINI: Lowest damping.

2 MEMBER ARMIJO: Lowest damping. Lowest
3 damping. So what kind of equipment would be
4 represented by the highest g --

5 MR. LIU: Okay. The lowest damping
6 represents 2 percent. Two percent damping -- let's
7 see--

8 MEMBER BLEY: I believe that's on welded
9 steel structures?

10 MR. LIU: Welded steel structures is 4
11 percent.

12 MEMBER BLEY: Okay.

13 MR. LIU: Oh, four percent for SSE. Two
14 percent --

15 CHAIRMAN CORRADINI: What's this? Just
16 one cast piece of metal right to the foundation?

17 MR. WALLIS: Two percent is a lower limit,
18 is it? Because zero percent might be interesting.

19 CHAIRMAN CORRADINI: Kind of like
20 homogeneous flow for Areva, huh?

21 MR. LIU: No. I think two percent -- I
22 don't -- we used two percent, no? It used to be, you
23 know, in the old Reg. Guide, Reg. Guide 1.61 we, you
24 know -- some small-bore piping use -- I forgot.

25 MR. CHAKRABARTI: Small-bore piping used

NEAL R. GROSS

COURT REPORTERS AND TRANSCRIBERS
1323 RHODE ISLAND AVE., N.W.
WASHINGTON, D.C. 20005-3701

1 to be the lowest.

2 MR. LIU: Like two percent, you know, some
3 small-bore piping two percent? I think the latest
4 Reg. Guide 1.60 increase that damping value for piping
5 to three percent.

6 MR. CHAKRABARTI: Four percent.

7 MR. LIU: Four percent? Okay.

8 So probably in reality this two percent is
9 not too many equipment we use two percent SSE.

10 CHAIRMAN CORRADINI: So can we just back
11 up just for my edification since you guys are talking
12 to each other, it means you all understand it. So
13 there's been some empirical testing with certain
14 shapes and arrangements that say if I have to this and
15 this to that, I can model in a spring-damper system as
16 if it were a mass of somehow and a damping between
17 them with that sort of damping ratio and you get a
18 good match? Is that what I'm getting at? I'm just
19 listening to how you're talking about this. That
20 means there's been some empirical testing and then
21 modeling of those tests to determine what's two, four,
22 eight?

23 MR. LIU: Yes, I think that basically is
24 the basis for the latest Reg. Guide 1.60.

25 CHAIRMAN CORRADINI: Okay. Okay. Then,

NEAL R. GROSS

COURT REPORTERS AND TRANSCRIBERS
1323 RHODE ISLAND AVE., N.W.
WASHINGTON, D.C. 20005-3701

1 I'm sorry, Graham, I didn't mean to interrupt you. Did
2 you have another question. Did you have any other
3 questions, Graham?

4 MR. WALLIS: No, I am just thinking about
5 it.

6 CHAIRMAN CORRADINI: Okay. So I guess my
7 question is just for understanding. Since the spectrum
8 that you showed us at the beginning is the forcing
9 function that puts in the energy, this is just
10 redistributing the energy into some sort of like
11 resonance that these guys are wiggling at a higher g?

12 MR. WALLIS: Right.

13 MR. LIU: At the --

14 CHAIRMAN CORRADINI: Let's just take a
15 case where there's no damping just so we don't get
16 dissipation involved. By conservation of energy if I
17 wiggle it down here and I get a wiggle up there at a
18 bigger g, that means I'm redistributing the energy
19 near a resonance for the structure.

20 MR. LIU: Right. Right.

21 CHAIRMAN CORRADINI: Is that essentially
22 it?

23 MR. LIU: Right.

24 CHAIRMAN CORRADINI: Okay. Fine. Thank
25 you.

NEAL R. GROSS

COURT REPORTERS AND TRANSCRIBERS
1323 RHODE ISLAND AVE., N.W.
WASHINGTON, D.C. 20005-3701

1 MR. LIU: Right. This basically now is
2 just an input to the equipment which is attached to
3 that particular location in the structure.

4 MR. WALLIS: This puzzles me. Because
5 damping doesn't say anything about resonance, does it,
6 or am I somehow confused?

7 CHAIRMAN CORRADINI: No. I was just trying
8 to understand because --

9 MR. WALLIS: But you have to get the
10 resonance to have this amplification. But all this --
11 the parameters on the curves is damping, it's not
12 resonance.

13 CHAIRMAN CORRADINI: They got a forward --

14 MEMBER SHACK: He's got a structure. He's
15 got a structure built in there that gives him that.

16 MR. WALLIS: He's got it built in.

17 MR. WAAL: You know, the response spectra
18 is like the response of a --

19 MR. WALLIS: Of the floor --

20 MR. WAAL: -- family of single degree of
21 freedom system damp oscillators --

22 MR. WALLIS: Okay.

23 MR. WAAL: -- and its objective --

24 MR. WALLIS: Okay.

25 MR. WAAL: -- natural frequency, you

NEAL R. GROSS

COURT REPORTERS AND TRANSCRIBERS
1323 RHODE ISLAND AVE., N.W.
WASHINGTON, D.C. 20005-3701

1 compare the frequency that you have with the response
2 factor there.

3 MR. WALLIS: And the cabinets stay
4 attached to the floor?

5 MR. WAAL: They're bounded to the floor.
6 No bounce?

7 MR. WALLIS: They're all bolted, are they?

8 MR. WAAL: Prewelded.

9 MR. WALLIS: Because the Japanese
10 earthquake, furniture moves around a lot.

11 MR. LIU: That's a non-safety.

12 MEMBER ARMIJO: Not if you're sitting
13 there.

14 CHAIRMAN CORRADINI: Go ahead. Go ahead,
15 move forward.

16 MR. LIU: Okay. They are not a
17 representative spectra, you know, the top of the
18 control building.

19 Then the next one, you know, this is the
20 spectra at the top of the firewater storage tank.

21 And this one, basically, you asked me how
22 conservative, you know, are these. And really is by
23 conserving the high frequency components of the ground
24 motion input. You see we have this high peak, around
25 20/30 Hertz.

NEAL R. GROSS

COURT REPORTERS AND TRANSCRIBERS
1323 RHODE ISLAND AVE., N.W.
WASHINGTON, D.C. 20005-3701

1 MEMBER STETKAR: What kind of -- I'm not
2 a structural guy, so I don't understand most of this
3 stuff so I refer to tables and things like that.

4 You have a table in DCD that applies
5 damping values for various types of equipment.

6 By the way, two percent damping applies to
7 the control rod guide tubes.

8 MR. LIU: Oh. Thank you.

9 MEMBER STETKAR: There is something in the
10 plant that has two percent damping.

11 I've noticed in all of the discussions,
12 you happened to mention the upper elevation of the
13 control building, which is an area that's near and
14 dear to my heart. That's ventilation down below. I
15 don't see any typical damping values for electrical
16 switch gear and cabinets. What do you use for those
17 in your analysis? I mean, there aren't any values
18 here. I was just curious.

19 MR. LIU: Yes.

20 MEMBER STETKAR: You have a equipment, but
21 that's mostly pipes and valves and they don't behave
22 the same as cabinets. So do you use --

23 MR. LIU: Probably is, you know, is
24 basically is made of the welded plates. You know, so
25 it would be the welded structures.

NEAL R. GROSS

COURT REPORTERS AND TRANSCRIBERS
1323 RHODE ISLAND AVE., N.W.
WASHINGTON, D.C. 20005-3701

1 MEMBER STETKAR: They're tall narrow
2 thing, they're not -- I mean, the base is. Like I
3 said, I'm not a structural engineer so maybe I don't
4 quite understand that.

5 CHAIRMAN CORRADINI: So your answer then
6 is that if it's a welded structure, that would be like
7 a four percent damping approximation, is that your
8 point?

9 MR. LIU: Yes.

10 CHAIRMAN CORRADINI: Okay. Okay.

11 MEMBER STETKAR: Thanks.

12 CHAIRMAN CORRADINI: Identify yourself and
13 speak in a mike.

14 MR. MORANTE: My name is Rich Morante. I
15 work for Brookhaven National Laboratory. And I worked
16 with the staff on the revision to Reg. Guide 1.61.

17 Categorization 1.61 there is certain
18 mechanical and electrical equipment that is designed
19 at three percent SSE damping in the Reg. Guide 1.61.
20 These values pretty much are values that have been
21 historically assigned or used.

22 I believe that GE's table here follows
23 very closely with what Reg. Guide 1.61 Rev. 1 says.
24 And it's probably just a single line there that says
25 electrical equipment.

NEAL R. GROSS

COURT REPORTERS AND TRANSCRIBERS
1323 RHODE ISLAND AVE., N.W.
WASHINGTON, D.C. 20005-3701

1 CHAIRMAN CORRADINI: Okay.

2 MR. MORANTE: And it'll say three percent.

3 MEMBER STETKAR: It just says "equipment,"
4 that's why I was curious what types of equipment.

5 MR. MORANTE: It just says equipment in
6 the Reg. Guide --

7 MEMBER STETKAR: I mean it could be, you
8 know, a pump or a diesel generator or a cabinet.
9 Thanks.

10 MR. MORANTE: You did identify that they
11 were consistent with the regulatory guide.

12 MR. WALLIS: What is the damping for the
13 massive water in the pool? I would think there's
14 dampen it. It's just a mass of water that's going to
15 move to-and-fro. And I don't see a mechanism for
16 dampening it.

17 MR. LIU: For the sloshing modes.

18 MR. WALLIS: No, just well for --

19 MR. LIU: That go with the structure
20 together. So there's --

21 MR. WALLIS: But it's not damped, is it?

22 MR. LIU: The follow --

23 MR. WALLIS: I don't see a force to damp
24 the --

25 MR. LIU: No, no, it's not damped. It's

NEAL R. GROSS

COURT REPORTERS AND TRANSCRIBERS
1323 RHODE ISLAND AVE., N.W.
WASHINGTON, D.C. 20005-3701

1 not damped itself.

2 MR. WALLIS: So it's zero dampening of the
3 water? It sloshes.

4 MR. LIU: Basically that, you know, once
5 we treat this -- that part of a water as a region mass
6 attached to the structure, then that body of water
7 will respond together with the structure. As a
8 result, the dampings are associated with the
9 structure, or at least that's what I think.

10 MR. WALLIS: But that's only for the
11 structure part.

12 MR. LIU: No, that takes into account of
13 the water.

14 MR. WALLIS: But if they put a bigger mass
15 on, the effect of damping must be less.

16 MR. LIU: No, no.

17 MR. WALLIS: Yes, surely. I mean, you
18 have a damping on a wiggly wall and you attach it to
19 a huge mass of water, the damping in the wall has no
20 effect on the motion of the water.

21 MEMBER SIEBER: It has an effect on the
22 structure --

23 MR. WALLIS: It has an effect on the
24 structure, but the water damped.

25 MEMBER SIEBER: The effects of damping

NEAL R. GROSS

COURT REPORTERS AND TRANSCRIBERS

1323 RHODE ISLAND AVE., N.W.

WASHINGTON, D.C. 20005-3701

1 causes viscosity.

2 MR. LIU: Yes, the water is not damp out.
3 The water is not damped.

4 MR. WALLIS: But the water itself can have
5 -- can try to get a bigger amplitude.

6 MR. LIU: That's why the water will impose
7 a huge mass to the structure.

8 MR. WALLIS: So if it's going up and down,
9 it can leap off the floor.

10 MR. LIU: But the tank is fully anchored.

11 MR. WALLIS: But the water itself -- you
12 said the furniture is attached to the floor.

13 MR. LIU: Right.

14 MR. WALLIS: So it doesn't jump around.
15 But the water can jump in the tank. Jump off the
16 floor. It's not damped at all.

17 MR. BRAVERMAN: Excuse me. My name is
18 Joseph Braverman. I also work for Brookhaven National
19 Lab and assisting the NRC in reviewing the structural
20 area. Perhaps I can help a bit.

21 As Ai-Shen mentioned, when you analyze
22 pools of water in a structure, there are two
23 components. One is the overall building response. And
24 for that industry practice has always been to lump the
25 mass of the water on the structure. Separately from

NEAL R. GROSS

COURT REPORTERS AND TRANSCRIBERS
1323 RHODE ISLAND AVE., N.W.
WASHINGTON, D.C. 20005-3701

1 that, I think you consider the type of concerns that
2 you're raising. And there are a series of equations
3 that go back since the Army Corps of Engineers that
4 analyze tanks filled with water and what happens under
5 seismic event. The water sloshes, it does this.

6 MR. WALLIS: Right.

7 MR. BRAVERMAN: And the equations consider
8 the water as two components for the water. One is a
9 certain percentage of the water acts as a rigid mass.
10 And another portion of the water acts in a sloshing
11 mode as if it has a spring in a dash pond.

12 And to answer your question about damping
13 for the water, GE has a Section 3.7.3.15 its called
14 Methods for Seismic Analyses of Above-Ground Tanks.
15 And one of the bullets reads as follows: "In
16 determining the spectral acceleration in the
17 horizontal convective mode," that's the sloshing mode,
18 "the acceleration SA sub 2 the fluid damping ratio of
19 one-half percent of critical damping is used unless a
20 higher value can be --"

21 MR. WALLIS: A half of a percent?

22 MR. BRAVERMAN: Half a percent.

23 MR. WALLIS: So it's very small? It's
24 very small?

25 MR. BRAVERMAN: Yes, which means it's

NEAL R. GROSS

COURT REPORTERS AND TRANSCRIBERS
1323 RHODE ISLAND AVE., N.W.
WASHINGTON, D.C. 20005-3701

1 going to have a high acceleration. Lower damping gives
2 you high acceleration.

3 MR. WALLIS: Can it not separate from the
4 floor? If you accelerate vertically enough, the water
5 is going to separate from the floor.

6 MR. BRAVERMAN: Well think of it this way:
7 If you have a glass of water, there's two components,
8 horizontal excitation that when you do that, you can
9 imagine --

10 MR. WALLIS: Vertically, you can, pull the
11 cup away from the water.

12 MR. BRAVERMAN: Yes, but you have to go
13 higher than gravity. And they don't have, I don't
14 think--

15 MR. WALLIS: He's got more than 1g.

16 MR. BRAVERMAN: In the vertical direction,
17 I don't think --

18 MEMBER BLEY: Very seldom. There was an
19 earthquake out in L.A. about ten years ago that threw
20 the roadbed off of the pedestals on one of the ramps.
21 A big surprise that it was higher than the horizontal
22 acceleration.

23 MR. BRAVERMAN: That's very rare.

24 MEMBER BLEY: It's very rare, but it has
25 happened.

NEAL R. GROSS

COURT REPORTERS AND TRANSCRIBERS
1323 RHODE ISLAND AVE., N.W.
WASHINGTON, D.C. 20005-3701

1 MR. BRAVERMAN: Okay.

2 MR. WALLIS: See, he's got 20g or
3 something in some of these curves here.

4 CHAIRMAN CORRADINI: But that's the
5 response.

6 MR. WALLIS: Yes. So that's why the
7 water--

8 CHAIRMAN CORRADINI: That's why I asked
9 about the forcing function being -- if you go back to
10 the slide, whatever it is, it's below a g.

11 MR. WALLIS: But if the water -- if the
12 floor is going to 20g --

13 MR. BRAVERMAN: Excuse me. Let me just
14 clarify that. Again, that is not the acceleration of
15 the floor. That is the acceleration if you attach a
16 lump mass and a spring onto the floor, and it has
17 perfect resonance at that frequency.

18 MR. WALLIS: Yes.

19 MR. BRAVERMAN: Only then could it achieve
20 those kind of g forces.

21 MR. WALLIS: Yes. Yes. So it's not --
22 right. Okay.

23 MR. LIU: Yes, please. Okay. All right.
24 I would like get to into discussion of
25 3.8.

NEAL R. GROSS

COURT REPORTERS AND TRANSCRIBERS
1323 RHODE ISLAND AVE., N.W.
WASHINGTON, D.C. 20005-3701

1 3.8 deals with design of seismic Category
2 of I structures.

3 Section 3.8.1 is for the concrete
4 containment. You know, we have used regular
5 reinforced concrete containment in our design. The
6 containment structure is totally enclosed and it
7 integral with the reactor building.

8 The design details are enclosed in
9 Appendix 3G.

10 The concrete containment design meets all
11 the requirements of Section II, Division 2 of the ASME
12 Code.

13 This figure shows the configuration of the
14 concrete containment. So the containment consists of
15 a drywell and the wetwell.

16 And for the drywell, it further divides
17 into the so called upper drywell and the lower
18 drywell. And the wetwell is a space we have a
19 suppression pool.

20 This is the finite model we have used for
21 the containment vessel. We use a -- computer code.

22 And this just a cut away view of the
23 model.

24 The steel components of the containment
25 are discussed in 3.8.2. They consist of: Personnel

NEAL R. GROSS

COURT REPORTERS AND TRANSCRIBERS
1323 RHODE ISLAND AVE., N.W.
WASHINGTON, D.C. 20005-3701

1 air locks; equipment hatches; penetrations; drywell
2 head, and; the passive containment cooling system
3 condenser.

4 We have six PCCS condensers. They form an
5 integral part of the containment boundary.

6 The steel components of the containment
7 were designed in accordance with ASME Division 1
8 Subsection NE.

9 Section 3.8.3 discussions of concrete and
10 the steel internal structures. They include:
11 Diaphragm floor; the vent wall; the gravity driven
12 cooling system pool walls; reactor shield wall; RPV
13 support brackets, and; the miscellaneous platforms.

14 This shows another view of the containment
15 system and the internal structures.

16 The green portion are the upper pools for
17 PCCS and IC. The blue portion in the middle
18 represents the GDCS pool. Then the blue portion on the
19 bottom represents the suppression pool.

20 MR. WALLIS: What are those things on the
21 very bottom there, those things that are like big test
22 tubes?

23 MR. LIU: Heat exchangers.

24 MR. WALLIS: Those are heat exchangers.

25 All right.

NEAL R. GROSS

COURT REPORTERS AND TRANSCRIBERS
1323 RHODE ISLAND AVE., N.W.
WASHINGTON, D.C. 20005-3701

1 MR. LIU: Yes. And this is the finite
2 element model for the containment internal structures.
3 This is just --

4 MEMBER BLEY: I am just -- a piece of the
5 thread of the analysis. Now when you're doing the
6 finite element analysis is this where you treat the
7 water as a solid mass or do you let the water be water
8 in calculations here?

9 MR. LIU: The effect of water in this
10 analysis we include a hydrostatic effect of the water.
11 We include a dynamic effect of the water.

12 MEMBER BLEY: What about the dynamic?

13 MR. LIU: The dynamic -- okay, dynamic. We
14 include the wall -- we calculate the wall pressures.

15 MEMBER BLEY: And you let the water freely
16 move as it will?

17 MR. LIU: No, we do not monitor the water
18 explicitly. We do the calculation of -- the separate
19 calculation to compute the pressures.

20 MEMBER BLEY: Can you back up to -- right
21 there.

22 MR. LIU: Yes.

23 MEMBER BLEY: We've several different
24 elevations, very large masses of water--

25 MR. LIU: Right.

NEAL R. GROSS

COURT REPORTERS AND TRANSCRIBERS
1323 RHODE ISLAND AVE., N.W.
WASHINGTON, D.C. 20005-3701

1 MEMBER BLEY: That may not be moving in
2 phase in the middle of an earthquake. They start
3 moving together but then as they start sloshing and
4 moving, some will be moving in one direction and some
5 are moving in the other and then they'll come back in
6 phase. Where is that combined effect of these
7 different large masses of water.

8 MR. LIU: The phasing relationship already
9 included in the results of assessment response
10 calculation. In assessment calculation in the model
11 we lump the water originally to the structure.

12 MEMBER BLEY: Yes, I heard that. And then
13 I heard you go back and you look at the water, the
14 sloshing effect separately. But do you look at the
15 three different levels of large water masses at the
16 same time, how they interact with the structure?

17 MR. LIU: Like I say, you know, those are
18 the local effects. The global effect we accounted for
19 by the --

20 MEMBER BLEY: I understand that.

21 MR. LIU: When it comes to local design
22 for the wall and the floor of that particular pool,
23 then we did a separate calculation to compute --

24 MR. WALLIS: Well how is the water
25 attached to the wall? Because, I mean, if it's

NEAL R. GROSS

COURT REPORTERS AND TRANSCRIBERS
1323 RHODE ISLAND AVE., N.W.
WASHINGTON, D.C. 20005-3701

1 pushing on the wall, it's part of the wall. But it's
2 sliding along the wall, it isn't part of the wall. All
3 right. So you've got a coupling between the water and
4 this structure shown in the finite element wall has to
5 be done right.

6 CHAIRMAN CORRADINI: So can I just repeat
7 what you said to Dennis and Graham?

8 So for the overall structural response the
9 water is a dead weight.

10 MR. WALLIS: But attached to what? How
11 attached?

12 CHAIRMAN CORRADINI: Well, I think he said
13 there are three different sets of analyses. But, all
14 right, let's make sure I understand.

15 The first set of analyses is essentially
16 a lump mass and it's just a dead weigh with some sort
17 of damping.

18 Then you said you actually do a finite
19 element where it's still the load, but it's a
20 hydrostatic load.

21 And then you said to Dennis that if you're
22 going to start designing the local wall, then you
23 start worrying about the sloshing. So only in the
24 local event do you actually consider the water motion
25 out of phase with the walls? Do I understand that

NEAL R. GROSS

COURT REPORTERS AND TRANSCRIBERS
1323 RHODE ISLAND AVE., N.W.
WASHINGTON, D.C. 20005-3701

1 correctly?

2 MEMBER SIEBER: That's what I got out of
3 it.

4 MR. LIU: Yes. In the third calculation
5 you just mentioned, the separate calculation for the
6 wall design, yes, we do a calculation to predict the
7 pressure distributions you know of the water sloshing.

8 MEMBER SIEBER: That tells you how thick
9 the wall needs to be.

10 MR. LIU: You know, along the height of
11 the wall --

12 MR. WALLIS: How is it modeled when you
13 have this water in there? Is it attached to the wall
14 or is there some kind of an interface with the wall?

15 MR. LIU: We have these standard equations
16 which has been developed since 1950s.

17 MR. WALLIS: So there's some sort of an
18 interfacial model between --

19 MR. LIU: Yes. Right.

20 MR. WALLIS: -- this mass of water which
21 is in there and wall --

22 MR. LIU: Yes.

23 MR. WALLIS: -- which lets it slide along
24 the wall but not push on it and maybe pull it?

25 MR. LIU: That calculation would predict

NEAL R. GROSS

COURT REPORTERS AND TRANSCRIBERS
1323 RHODE ISLAND AVE., N.W.
WASHINGTON, D.C. 20005-3701

1 what is the highest positive pressure and what is the
2 highest --

3 MR. WALLIS: So I would assume that this
4 is --

5 MR. LIU: No, this methodology has, you
6 know, Joe was pointing out is well established
7 methodology.

8 MR. WALLIS: '50s, yes.

9 MR. LIU: Yes.

10 CHAIRMAN CORRADINI: So now let's roll
11 back. So we have three different calculations. To
12 get back to Dennis' question, what convinces you that
13 the local phenomena does not need to be fed back into
14 the global phenomenon? That's really what he's
15 asking, right? That's what I think you were asking.

16 MEMBER BLEY: That's what I'm asking. And
17 why is it okay to treat each of those pools separately
18 for the wall calculation but not fed back the possible
19 interaction in global? Yes, that's a good way to put
20 it.

21 MR. LIU: The interaction, you know,
22 interaction among the various pools already, you know,
23 is built in modeling parameters in the global
24 analysis.

25 MEMBER ARMIJO: But in the global analysis

NEAL R. GROSS

COURT REPORTERS AND TRANSCRIBERS
1323 RHODE ISLAND AVE., N.W.
WASHINGTON, D.C. 20005-3701

1 the water's not sloshing. It's fixed.

2 MR. LIU: But sloshing is local -- very
3 localized effect. Sloshing is very localized effect.
4 Only, you know, at the surface of the pool.

5 CHAIRMAN CORRADINI: So can I try
6 something on you? The only way I'd buy that argument
7 is if the relative masses of the pool relative to
8 what's holding it is either minimal or at least less
9 than.,

10 MEMBER ARMIJO: It's large.

11 CHAIRMAN CORRADINI: If it's a large mass
12 held by a skinny water tank, then its sloshing out to
13 have a feedback effect that I'd worry about.

14 MR. LIU: In our design -- yes --

15 CHAIRMAN CORRADINI: I think everybody's
16 worried here.

17 MR. LIU: In our design really, although
18 we have many, many, many pools as you can see --

19 CHAIRMAN CORRADINI: Yes.

20 MR. LIU: -- you know, our structure is a
21 heavy structures.

22 CHAIRMAN CORRADINI: Okay.

23 MR. LIU: We have, you know, thick wall,
24 you know --

25 MR. WALLIS: When you present the results

NEAL R. GROSS

COURT REPORTERS AND TRANSCRIBERS
1323 RHODE ISLAND AVE., N.W.
WASHINGTON, D.C. 20005-3701

1 of this analyses, would you present please the
2 pressures and the motion of the water and the
3 amplitude of the sloshing and that sort of thing so
4 that we can get a feel for what you say is happening?

5 MEMBER ARMIJO: I would like to see that.

6 MR. LIU: Yes. I don't have those things,
7 no.

8 MR. WALLIS: Not today. Not today. But
9 some day when you do it --

10 MR. LIU: Okay. Sure.

11 MR. WALLIS: -- I'd like to see a detailed
12 description of what you say is happening to the water.
13 And then we can see if it cavitates or if it sloshes
14 and how big these effects are. And maybe we can be
15 convinced it's all fine. But I don't think we could
16 possibly do it today.

17 CHAIRMAN CORRADINI: But you understand
18 the question that they're asking? I want to make sure
19 we're communicating.

20 The concern really is that we understand
21 that you're doing these layers of analyses. But I
22 think the concern -- the question is is there a
23 feedback so that the local washing machine effect of
24 these pools doesn't cause an adverse feedback to the
25 global response.

NEAL R. GROSS

COURT REPORTERS AND TRANSCRIBERS
1323 RHODE ISLAND AVE., N.W.
WASHINGTON, D.C. 20005-3701

1 MEMBER SIEBER: Structure of the building.

2 CHAIRMAN CORRADINI: Yes.

3 MR. LIU: Yes.

4 CHAIRMAN CORRADINI: Thank you. Go ahead.

5 I'm sorry.

6 MR. LIU: Section 3.8.4 covers other
7 Category I structures. In our design they include:
8 Reactor building structure; the fuel building
9 structure; control building, the firewater service
10 complex.

11 The reactor building and the fuel building
12 are integral to each other and founded on a common
13 basemat. Represent the details of the structure
14 design is Appendix 3G.

15 This is a flow chart indicating how we
16 perform our design calculations. Okay. Basically we
17 started with, you know, we know the structure
18 configuration is, what kind of material we plan to
19 use. And we also definite what are applicable loads.
20 Then we build our finite model. We perform the linear
21 stress analyses. Then for the design of concrete
22 sections, we have to do the section design. We need to
23 the effect of cracking for thermal load, so we took
24 that into account in the design.

25 Then we do a load combination for all

NEAL R. GROSS

COURT REPORTERS AND TRANSCRIBERS
1323 RHODE ISLAND AVE., N.W.
WASHINGTON, D.C. 20005-3701

1 applicable loads.

2 Then for the overall design you'll see in
3 the section design.

4 And then we make sure that the resulting
5 sections code requirements.

6 So that's a standard process, typical
7 process we have used in our design analysis.

8 MEMBER ARMIJO: So you do this analyses
9 for all operating states, refueling as well as full
10 power, hot standby, you do this seismic analyses for
11 all conditions?

12 MR. LIU: The seismic analyses?

13 MEMBER ARMIJO: Yes.

14 MR. LIU: Seismic analyses we do it for
15 operating conditions.

16 MEMBER ARMIJO: How about refueling where
17 you got a lot more water in the vessel and over the
18 vessel, does that make any difference?

19 MR. LIU: Not to the structures. I don't
20 even think that's in the effect of the vessel itself.

21 MEMBER ARMIJO: Okay.

22 CHAIRMAN CORRADINI: Can I just say it
23 back? Because I guess I want to sure.

24 So is it true since I don't know very much
25 about the details that we're hearing, is it true that

NEAL R. GROSS

COURT REPORTERS AND TRANSCRIBERS
1323 RHODE ISLAND AVE., N.W.
WASHINGTON, D.C. 20005-3701

1 you've added substantially to the water masses
2 involved when you go --

3 MR. LIU: Only to the RPV itself.

4 CHAIRMAN CORRADINI: Only to the RPV?

5 MR. LIU: Yes. The RPV needs to be
6 flooded.

7 CHAIRMAN CORRADINI: Okay. Right. And
8 your answer back then is that there's not much
9 difference you say?

10 MR. LIU: Okay. Right.

11 This is a finite model, you know, for the
12 reactor building and the fuel building. This is a cut
13 away view of the same model.

14 This is the model for the control
15 building. The control building is a relatively simple
16 structure. The cut away view for the control
17 building.

18 This is the model for the firewater
19 service complex. It's made of two identical water
20 storage tanks and in between we have the so-called
21 valve pump enclosures for the structure.

22 CHAIRMAN CORRADINI: So what is this? I'm
23 sorry. Excuse me.

24 MR. LIU: The one in the middle?

25 CHAIRMAN CORRADINI: No, the tank.

NEAL R. GROSS

COURT REPORTERS AND TRANSCRIBERS
1323 RHODE ISLAND AVE., N.W.
WASHINGTON, D.C. 20005-3701

1 MR. LIU: The firewater tank.

2 MR. WALLIS: So in there probably the
3 weight of the water is more than the weight of the
4 structure.

5 MR. LIU: But the tank is a concrete tank.
6 Yes, is a heavy concrete tank. It's not a steel tank.

7 MR. WALLIS: Even so, the water's probably
8 heavier than the structure?

9 MR. LIU: Yes, it's lots of water. Yes.

10 And Section 3.8.5 discusses the
11 foundations.

12 The reactor building, including the
13 containment and the fuel building, share same common
14 foundation mat.

15 The control building is a separate -- has
16 it's own separate foundation.

17 The foundation for firewater service
18 complex is also separate.

19 Again, the design details are included in
20 Appendix 3G.

21 So in summary, Sections 3.7 and 3.8
22 provide details of seismic analysis of the ESBWR and
23 the loads and load combinations and acceptance
24 criteria for the design of seismic Category I
25 structures for the ESBWR standard plant.

NEAL R. GROSS

COURT REPORTERS AND TRANSCRIBERS
1323 RHODE ISLAND AVE., N.W.
WASHINGTON, D.C. 20005-3701

1 CHAIRMAN CORRADINI: Thank you.

2 MR. LIU: That's all I have.

3 CHAIRMAN CORRADINI: Thank you very much.

4 MR. LIU: You're welcome.

5 CHAIRMAN CORRADINI: Questions, to the
6 Committee.

7 MR. WALLIS: Well, the worst thing that
8 could happen, probably, would be if the water
9 cavitated. You've got a big separation and then it
10 came back again, and then you've got a transient
11 impulse on the wall which would be excessive compared
12 with it just being an impact. It wouldn't just be a
13 gentle oscillation.

14 I have no idea if such a thing can happen.
15 That's the worst thing I can think of would be the
16 separation of the water from the wall, a big
17 cavitation and then a collapse.

18 CHAIRMAN CORRADINI: I think wouldn't the
19 frequency have to approach the sound speed and break
20 the wind scale for that to occur.

21 MR. WALLIS: I would think so.

22 MR. BRAVERMAN: Excuse me, could I add
23 something.

24 MR. WALLIS: You could shake it with
25 enough--

NEAL R. GROSS

COURT REPORTERS AND TRANSCRIBERS
1323 RHODE ISLAND AVE., N.W.
WASHINGTON, D.C. 20005-3701

1 MR. BRAVERMAN: Excuse me. Could I add
2 something again? My name is Joe Braverman.

3 CHAIRMAN CORRADINI: Speak.

4 MR. BRAVERMAN: I spoke earlier. I'm from
5 Brookhaven Lab.

6 Once again, the second analyses that Ai-
7 Shen Liu was talking about, which is the local effect,
8 which has been a series of equations developed over
9 the years, I think it goes back to Army Corps of
10 Engineers, that addresses your concern. It treats
11 entire water mass as two components. There's a
12 percentage of the water that acts as a rigid mass and
13 then there's another portion of the mass that acts as
14 a dynamic mass with the spring and dash pond.

15 Generally, the rigid mass is the largest
16 percentage. And a smaller mass that vibrates would
17 be--

18 MR. WALLIS: Yes. But the concern I had
19 was you cannot oscillate water by pulling on it.

20 MR. BRAVERMAN: That's right. You can
21 create a vacuum at most.

22 MR. WALLIS: It's not exceed. Negative
23 pressure must not be exceeded too much at the wall or
24 the water separates from the wall; that's the concern
25 I had. I don't know where it's i your equations.

NEAL R. GROSS

COURT REPORTERS AND TRANSCRIBERS
1323 RHODE ISLAND AVE., N.W.
WASHINGTON, D.C. 20005-3701

1 MR. BRAVERMAN: Okay. Well, again,
2 generally the water will not separate. It's going to
3 do this for horizontal excitation.

4 MR. WALLIS: Shake it enough, it will
5 separate from the wall.

6 CHAIRMAN CORRADINI: That's why I made the
7 point that you have to shake it at a frequency such as
8 you approach the sound speed or the median before you
9 cavitate. Otherwise, it's going to move.

10 MR. BRAVERMAN: I think it's going to
11 build that kind of excitation.

12 MR. WALLIS: No. There is nothing about
13 that. It's have a big enough negative pressure,
14 that's all you have to have.

15 CHAIRMAN CORRADINI: But you've got to
16 pull it at a velocity that approaches the sound speed
17 at the interface--

18 MR. WALLIS: No. No. The water just can't
19 follow that. It doesn't have to be a sound speed.

20 CHAIRMAN CORRADINI: Well, I think it
21 does.

22 MEMBER SIEBER: I think it does.

23 MEMBER BROWN: Didn't the Army Corps of
24 Engineers design structures in New Orleans for the
25 levies and --

NEAL R. GROSS

COURT REPORTERS AND TRANSCRIBERS
1323 RHODE ISLAND AVE., N.W.
WASHINGTON, D.C. 20005-3701

1 MR. WALLIS: I can do an experiment. I
2 can put water here and I can pull the wall away. You
3 don't have to move the wall at sonic speed before it--

4 CHAIRMAN CORRADINI: I guess my point is
5 if I pull the wall slowly, the water will fill. If I
6 pull the wall away very fast relative to the sound
7 speed of water, then it'll create a void and cavitate.

8 MEMBER SIEBER: A different calculation.

9 CHAIRMAN CORRADINI: Right.

10 MEMBER SIEBER: So it's a function of the
11 viscosity and it's a function of the --

12 MR. SHAMS: Mohammed Shams with the staff.

13 I'd like to add, as Joe was pointing out,
14 the equations that we have are in some respect a
15 rational conservative way of resolving a very
16 complicated issue. And they do consider both, a
17 sloshing mode as well as an impulsive mode. I got the
18 phrases, he said an impulsive mode.

19 As far as water separating from the
20 structure, we've seen that analyses of dams. And, as
21 you can imagine, there is a large body of water there.
22 And it doesn't really have to get to a -- you know, if
23 there is enough of tension, there is no attachment
24 between the water and the structure right next to it.

25 So I don't think the models that we do

NEAL R. GROSS

COURT REPORTERS AND TRANSCRIBERS
1323 RHODE ISLAND AVE., N.W.
WASHINGTON, D.C. 20005-3701

1 account for that or perhaps sophisticated enough to
2 describe that. But it could be done. But what I'm
3 trying to say from our experience in the analyses, the
4 equations that we have conservative enough to capture
5 that effect without having to go to the sophistication
6 of modeling a body of water right next to a structure.
7 If you take a conservative assumption of what the
8 portion of the water that's going to cause the
9 pressure on the wall, which is the sloshing mode, and
10 if you take another portion which will contribute to
11 the dynamic effect, that essentially captures what
12 we're looking for.

13 CHAIRMAN CORRADINI: And this is a
14 technique that has been well established?

15 MR. SHAMS: It has. And it was tested
16 considerably for dam analysis. I came from the dam
17 industry, part of my previous work was. And we
18 compared the equations, Westagard equations and the
19 other type of equations to a full dynamic analysis of
20 a water body modeled right next to a dam with all
21 sorts of sophisticated attachments to capture the
22 separation. And it worked properly.

23 CHAIRMAN CORRADINI: Okay. Thank you.

24 MR. XU: My name is Jim Xu from staff.
25 Maybe I can add some insight to this issue.

NEAL R. GROSS

COURT REPORTERS AND TRANSCRIBERS

1323 RHODE ISLAND AVE., N.W.

WASHINGTON, D.C. 20005-3701

1 CHAIRMAN CORRADINI: Please do.

2 MR. XU: I think the issue the member one
3 asked how to do it, full structure reaction phenomena.
4 And this phenomena have been researched and studied
5 for many, many years and primarily by Professor Andy
6 Velesos from Rice University. Okay.

7 And what they knew is the full containment
8 structures, okay, the response of fluid in the
9 structure has two components. One is move harmonically
10 with the structure and the other is independent
11 components and that we call slosh. Slosh mode.

12 The reason we call slosh mode is because
13 it's only the surface of the water that is needed,
14 okay, in the form and vibrate at a very low frequency.
15 And the methodology for this have been established for
16 a long time. I believe GE also used the methodology
17 established by Professor Andy Velesos. And I think
18 the cavitation issue should not be applied here
19 because the seismic excitation are generally in very
20 low frequency range between 1 and 35 Hertz. So you
21 will never have cavitation phenomena occurring in
22 this--

23 MR. WALLIS: The reason I worry about it
24 is because the seismic --

25 MR. XU: Because it's a low frequency

NEAL R. GROSS

COURT REPORTERS AND TRANSCRIBERS

1323 RHODE ISLAND AVE., N.W.

WASHINGTON, D.C. 20005-3701

(202) 234-4433

www.nealrgross.com

1 phenomena.

2 MR. WALLIS: If you had big enough
3 accelerations for enough time, you could produce
4 cavitation.

5 MR. XU: You could have a high
6 acceleration, but the acceleration would create a very
7 low frequency, therefore they will not cause
8 cavitation.

9 MR. KRESS: These empirical fractions,
10 dynamic versus the solid, seem to me ought to depend
11 on the geometry of the current. Are these for rod
12 circular cylinders? Are they all --

13 MR. XU: The study have been performed for
14 now is the geometry, it's an integral geometry,
15 rectangular and the vibration of water behave in very
16 similar fashion. Okay. And as far as interaction is
17 concerned, the impulsive mode are the part of the
18 interaction that will move with the structure. Okay.
19 The convective mode is independent mode. That means
20 nothing local phenomena and that be the portion that
21 does not interact with the structure response. Okay.

22 CHAIRMAN CORRADINI: Okay. Thank you.

23 MR. XU: So I hope I've clarified.

24 CHAIRMAN CORRADINI: Thank you. Other
25 questions by the members?

NEAL R. GROSS

COURT REPORTERS AND TRANSCRIBERS
1323 RHODE ISLAND AVE., N.W.
WASHINGTON, D.C. 20005-3701

1 Okay. We'll take a break until five
2 after. Thank you.

3 And the staff will come back and tell us
4 more.

5 (Whereupon, at 9:50 a.m. a recess until
6 10:05 a.m.)

7 CHAIRMAN CORRADINI: Okay. Let's get
8 started. I know people will catch up with us.

9 MR. PATEL: Good morning. My name is
10 Chandu Patel. I'm the lead project manager for
11 Chapter 3, again. David Jeng will present Section
12 3.7.

13 MR. JENG: Good morning. I am David Jeng.
14 I am on the staff of SED Division of Engineer, Office
15 of New Reactors. And I am the person who did review
16 Section 3.7 Seismic Design.

17 The review currently set out sections and
18 specs. I would like to start the regulations and the
19 regulatory guidance we based upon in performing our
20 Section 3.7 review.

21 The major regulations we used is the GDC
22 2, Part 50 Appendix A.

23 And we also we did use the Seismic &
24 Geologic Siting Criteria, which is a Part 100 Appendix
25 A.

NEAL R. GROSS

COURT REPORTERS AND TRANSCRIBERS
1323 RHODE ISLAND AVE., N.W.
WASHINGTON, D.C. 20005-3701

1 And in addition we applied the Earthquake
2 Engineering Criteria. This is Part 50 Appendix S.

3 There are also regulatory guides we based
4 upon in our 3.7 review. Number one is Reg. Guide
5 1.60, which the seismic response spectra for nuclear
6 plant designs. And this defines the so called
7 standardized 1.60 spectra, which has been in
8 discussion that is part of the picture GE put up
9 earlier.

10 The second reg. guide we based upon is
11 1.61. Again, this is part of a earlier discussion in
12 which the staff defines what considered the acceptable
13 range of damping barriers for different type of
14 material and stress ranges.

15 Next one is 1.92, Reg. Guide 1.92 which
16 gives guidance to how to combine the modal responses
17 in the seismic analysis. And they also give the
18 guidance on how to combine different components of
19 seismic responses either from X, Y and Z; three
20 directional components, how you go about combining
21 those effects into a design basis data or application.

22 And the last reg. guide we used is Reg.
23 Guide 1.122, which is the variance given to the public
24 in the review about how to develop for response
25 spectra given the input margin. And this provides a

NEAL R. GROSS

COURT REPORTERS AND TRANSCRIBERS
1323 RHODE ISLAND AVE., N.W.
WASHINGTON, D.C. 20005-3701

1 very detailed way of how to develop the flow of
2 response spectra, which in turn is used by a component
3 and type and designers at different floor in a
4 structure or reactor building.

5 And the last one, which is very important,
6 is the revised SRP Section 3.7. This is a Rev. 3
7 version, which has been completed March 2007. T h e
8 main implication of this revised reg. guide is we have
9 last revised earlier reg. guide provision in 1980s.
10 And then in the last two decades we have never updated
11 but, you know, we have learned and the new development
12 in technology and the analysis. So I was happy to be
13 the responsible person in revising SRP 3.7, 3.8. And
14 this encompasses all the past two decades of new
15 development, analyses, testing results as well as the
16 lessons learned. So we are very proud that GE's
17 application is being reviewed against this most
18 updated review plan, 3.7. And I think that GE did a
19 very competent job in complying to the 3.7 provisions.

20 Next, I like to review highlights.

21 Because of the nature of the ESBWR, design
22 specification is first of a kind, in a way. And also,
23 once we certify the design, this will be used almost
24 automatically for next five, ten plants. So we took
25 the very prudent posture and tried to do a very

NEAL R. GROSS

COURT REPORTERS AND TRANSCRIBERS
1323 RHODE ISLAND AVE., N.W.
WASHINGTON, D.C. 20005-3701

1 thorough job. For that reason we have performed two
2 on-site audits. The audits which took place at the GE
3 offices included discussion of the design methodology,
4 the issues raised by the NRC during the RAI processes.

5 And also we checked the summary
6 calculations and discussed their codes used and the
7 assumption of the codes.

8 So the audit not until one whole week's of
9 intense interaction between the staff and the
10 applicant, in this case GEH. And the nature of the
11 discussion and the types of interaction was quite
12 thorough. And by doing such a work, we gained
13 additional level of confidence in how the applicant is
14 doing their analysis design to compare to Commission
15 regulations.

16 And so, we believe this audit effort is
17 very proactive and very positive, particularly
18 important for design stratification type of review.

19 And in addition besides the audit, we
20 decided that we need to perform a confirmatory
21 analysis of selected subjects. This is another way of
22 trying to find out how thorough and professional job
23 that GE has done in their detail analysis and design
24 calculations.

25 So we basically took a very independent

NEAL R. GROSS

COURT REPORTERS AND TRANSCRIBERS
1323 RHODE ISLAND AVE., N.W.
WASHINGTON, D.C. 20005-3701

1 analysis of the control building. And we decided to
2 use the same stick model that GE originally adopted
3 for the control building. And we used our own SASSI
4 modeling representing the layer site. In the case
5 staff used nine layer site conditions, whereas GE only
6 used 4 layered cases. And we did an independent
7 analysis and compared the results.

8 And in the course of comparison there are
9 some differentiations between theirs and ours because
10 of some minor deviation in the way they did the stick
11 analysis compared to ours. But in the end the overall
12 result, GE has been using the design curve, which is
13 so conservative. They are forcing about a factor of
14 two safety margins over whatever the stuff came up.
15 So based on this finding and the conservatism involved
16 in their final curve, we have come to the conclusion
17 that the confirmatory analysis is consist, you know,
18 verified and reasonable within the two results. And we
19 are very happy with the outcome.

20 And this outcome further reenforces the
21 staff's confidence in being able to reach a reasonable
22 assurance that seismic design with safety related
23 subjects are well done and they should perform
24 intended safety functions. So the staff feels we are
25 very happy and with a sense of achievement.

NEAL R. GROSS

COURT REPORTERS AND TRANSCRIBERS
1323 RHODE ISLAND AVE., N.W.
WASHINGTON, D.C. 20005-3701

1 And the next one, also performed several
2 correlated development in the course of analysis. For
3 instance, how do you define so called effective
4 minimum strengths of the soil? And nowhere is the
5 soil content is defined by the shear wave velocity of
6 the soil material. And the SRP do recommend the
7 minimum allowable shear weight velocity is 1000 foot
8 per second. And there is a layer situation. So each
9 layer has different variable shear wave velocities.
10 And how you determine that this layer minimum last
11 meet the intent of 1000 foot per second.

12 And GE proposed this weighted concept.
13 They are weighting the layer, shear wave velocity
14 based on the thickness of each layers. And they
15 compute the separate *10:14 shear wave velocity, which
16 has been shown to be higher than 1000 foot per second.

17 And the staff reviewed their approach and
18 decided that the method presented by GE is very
19 reasonable and we agreed to the evaluation that
20 minimum wave velocity was meeting that provision of
21 the SRP requirements.

22 So this is one aspect of how detailed
23 their stuff cut into the design calculation and
24 checked the specificity of the numbers. So this shows
25 one level how deep we perform our independent analysis

NEAL R. GROSS

COURT REPORTERS AND TRANSCRIBERS
1323 RHODE ISLAND AVE., N.W.
WASHINGTON, D.C. 20005-3701

1 and audit.

2 So because of all this effort, the audit
3 and the interaction conference calls, which lasted
4 several months, and the resolution of all the issues,
5 difficult and some easier, we have come to a very good
6 understanding. And the overall impression the
7 applicant give us was really something to be
8 commended.

9 Now review status right now is we have
10 issued altogether 64 RAIs for 3.7. And out of that 62
11 RAI has been resolved. And right now there are two
12 RAIs open. So we are in a very good position.

13 Let me talk about the two open RAIs.

14 MEMBER ARMIJO: Just before you do that,
15 I have a quick question.

16 MR. JENG: Yes.

17 MEMBER ARMIJO: You did the confirmatory
18 analysis of the control building.

19 MR. JENG: Yes.

20 MEMBER ARMIJO: Now the reactor building
21 or the containment structure is obviously more
22 complex, at least it seems to me. Is there any reason
23 why you choose the control building instead of the
24 containment?

25 MR. JENG: We did also perform the control

NEAL R. GROSS

COURT REPORTERS AND TRANSCRIBERS
1323 RHODE ISLAND AVE., N.W.
WASHINGTON, D.C. 20005-3701

1 -- reactor building, fuel building aspect insofar as
2 the development of the input motion to ground surface
3 motion and the overall characteristics. But for more
4 detail, look at the structure design response at the
5 different floor level. We concentrated on the
6 selected basis. So we decided optimive for the
7 control building. But methodology and criteria which
8 are used identical for reactor building, fuel building
9 and control building. It's a matter of optimization
10 of the resources and the selection of some selected
11 items.

12 MEMBER ARMIJO: So you have no reason to
13 believe that had you done that same confirmatory
14 analysis on, let's say, the containment structure that
15 you would have gotten anything significantly
16 different?

17 MR. JENG: No. Based on the same computer
18 codes, same analysis methods and assumptions.

19 MEMBER ARMIJO: Okay.

20 MR. JENG: So if you had the good result
21 on one, should be equal on it.

22 MEMBER ARMIJO: Thank you. Okay.

23 MR. JENG: We do have two open items.
24 The first open RAI relates to RAI 3.7-52 and this
25 pertained to the concrete tunnels and trenches which

NEAL R. GROSS

COURT REPORTERS AND TRANSCRIBERS

1323 RHODE ISLAND AVE., N.W.

WASHINGTON, D.C. 20005-3701

(202) 234-4433

www.nealrgross.com

1 connect between the major Category I structures. And
2 in this aspect the staff wanted GE to clarify the
3 specific safety classification of these tunnels and
4 trenches. And also we want them to describe and
5 discuss more about the piping and the conduits and
6 ducts which are audited within these trenches and
7 tunnels. And this item we want GE to provide more
8 information regarding the service response, which GE
9 *10:18 foundation input response which is going to be
10 applicable for the design of the tunnels and the
11 trenches.

12 So this is a type of information I believe
13 GE should be able to timely provide. And so the
14 expectations of resolving this RAI is very good.

15 MEMBER STETKAR: Well, yesterday I
16 learned, anyway --

17 MR. JENG: Yes.

18 MEMBER STETKAR: -- about the new
19 ancillary diesel building that appears in the DCD Rev.
20 5. I'm assuming because of its location it'll have
21 underground cable tunnels to connect into the reactor
22 building. Is that part of your concerns? I know your
23 review, the building didn't exist in your review, but
24 are those the types of underground cable tunnels and
25 things that you're concerned with with that RAI?

NEAL R. GROSS

COURT REPORTERS AND TRANSCRIBERS
1323 RHODE ISLAND AVE., N.W.
WASHINGTON, D.C. 20005-3701

1 MR. JENG: Yes, exactly.

2 MEMBER STETKAR: Okay.

3 MR. JENG: At least the tunnel trenches
4 are, so called Category I tunnels and trenches they
5 encase and protect and support safety related conduit
6 and wires and so on.

7 MEMBER STETKAR: How does your analysis,
8 because I didn't read all this stuff, treat RTNSS-type
9 systems? Those are Category II, right, according
10 GEH's design?

11 MR. JENG: It's even less than Category 2.
12 Mohammed, he did review the RTNSS aspect.

13 MR. SHAMS: Mohammed Shams with the staff.

14 RTNSS components are in several bins. The
15 one that we're concerned with with regard to seismic
16 is the category B, which are the ones needed for long
17 term safety. And those were able to get GE to do them
18 in a Category II classification.

19 MEMBER STETKAR: And those Category II, is
20 that RAI the first one there, does that also apply to
21 tunnels and conduits that are -- you know, underground
22 cable tunnels that are classified as Category II, or
23 are you only --

24 MR. JENG: We are talking about the
25 Category I trenches and tunnels. Now, trenches and

NEAL R. GROSS

COURT REPORTERS AND TRANSCRIBERS

1323 RHODE ISLAND AVE., N.W.

WASHINGTON, D.C. 20005-3701

1 tunnels may -- I said may contain some Category II
2 wiring. But in general the things -- region of the
3 tunnel are hiding the conduit and ducting which are
4 safety related.

5 MEMBER STETKAR: Does GEH categorize these
6 -- again, tell me if I'm wrong. I'm assuming that
7 there are going to be underground from this ancillary
8 diesel building just because of its location and you
9 have to get somehow the cables over to the reactor
10 building. Has GEH categorized those underground
11 tunnel -- let me call them cable tunnels for the lack
12 of a better term, as Category I structures?

13 MR. LIU: This is Ai-Shen Liu, GEH.

14 Yes. We have both Category I and Category
15 II tunnels, okay. Category II tunnel for this new
16 ancillary building, diesel building we're going -- you
17 are correct. We are going to have tunnels, you know.
18 They are inevitable. Yes.

19 MEMBER STETKAR: Are those going to be
20 Category I or Category II tunnels?

21 MR. LIU: I believe they are Category II.
22 I don't think they contain any Category I components.

23 MEMBER STETKAR: I would --

24 MS. CUBBAGE: RTNSS B is Category II.

25 MR. LIU: Category II. RTNSS B is Category

NEAL R. GROSS

COURT REPORTERS AND TRANSCRIBERS
1323 RHODE ISLAND AVE., N.W.
WASHINGTON, D.C. 20005-3701

1 II. Yes.

2 MEMBER SIEBER: But structure of those --

3 MEMBER STETKAR: So if I have a large
4 earthquake that damages these tunnels and destroys the
5 cable connections from the diesels that have to supply
6 power for response after 72 hours, I won't have that
7 power supply?

8 MR. LIU: Well, the tunnel -- you know,
9 although the Category is Category II, but it's
10 designed to the same criteria as Category I.

11 MEMBER STETKAR: That was why I was asking
12 are you looking at both Category I and Category II
13 structures or only Category I. You said only Category
14 I. So you have no concerns with these tunnels because
15 they're not Category I?

16 MEMBER SIEBER: I thought Category I--

17 MR. MORANTE: Excuse me. This is Rich
18 Morante from Brookhaven.

19 The open item on this particular RAI is
20 asking GE to specifically identify which ones are
21 Category I, which ones are Category II. GE has
22 committed to seismically analyze Category II using the
23 same methods as seismic Category I. We are concerned
24 about both categories here.

25 MEMBER STETKAR: Okay. Thanks. That

NEAL R. GROSS

COURT REPORTERS AND TRANSCRIBERS
1323 RHODE ISLAND AVE., N.W.
WASHINGTON, D.C. 20005-3701

1 helps.

2 MR. JENG: That's why my question -- well,
3 first bullet is classification. We want them to
4 clarify some of the tunnels whether they're Category
5 I, Category II. It was not quite clear and we're
6 asking them to clarify.

7 MEMBER BLEY: I'm sorry, I'm still a
8 little confused on this. They're going to design them
9 to Category I criteria. Are you going to analyze --
10 are you going to review their Category II analyses?

11 MR. JENG: Okay. Once the items is
12 categorized as Category II, yes, we're planning to
13 understanding from the part of SRP that though shall
14 design to Category I, seismic requirements analysis
15 process. Only on the 2A and procurement in the
16 construction aspect they can be *10:24. But as far as
17 analysis recall the modeling and course design, it's
18 equal to and identical to category and design. That's
19 by definition of Category II.

20 MEMBER ARMIJO: But by structurally,
21 whether they're Category 1 or Category II, they're --

22 MR. JENG: Equally strong.

23 MEMBER ARMIJO: -- equally strong.

24 MR. JENG: Except --

25 MEMBER ARMIJO: But you don't have the

NEAL R. GROSS

COURT REPORTERS AND TRANSCRIBERS
1323 RHODE ISLAND AVE., N.W.
WASHINGTON, D.C. 20005-3701

1 documentation --

2 MR. JENG: Yes, sir. Not back.

3 MEMBER BLEY: It sounds to me like you're
4 saying even they're the same --

5 MEMBER ARMIJO: But PRA guidance --

6 MEMBER BLEY: -- you aren't going to redo
7 them because that review is not required by the SRP?

8 MR. JENG: Well, it's required. They have
9 committed and been required by SRP, but they use the
10 same methodology and assumptions aspect of
11 calculations that are required for Category I *10:25.
12 So they are required to review, yes.

13 MR. MORANTE: This is Rich Morante again.

14 From the review perspective Category I and
15 Category II structures would be reviewed equally.
16 There would basically be no difference. There would
17 be no difference in how we would conduct the review of
18 Category II versus Category I.

19 MEMBER STETKAR: You were pretty careful
20 to say how you would conduct a review. I think what
21 Dennis was asking is will you conduct a review of the
22 seismic Category II structures?

23 MR. JENG: Yes.

24 MR. MORANTE: As of right now we're
25 waiting for General Electric to respond to our

NEAL R. GROSS

COURT REPORTERS AND TRANSCRIBERS
1323 RHODE ISLAND AVE., N.W.
WASHINGTON, D.C. 20005-3701

1 supplement Reg. Guide RAI 3.7-52. Okay. In that
2 response we expect that they will identify the seismic
3 inputs, the seismic analysis methodologies that they
4 will apply and we will review that. Now understand
5 that as part of our review process we do not review
6 every possible calculation that General Electric has
7 before it. It's a sampling calculation review. Okay.

8 If we feel that it's appropriate after we
9 review their final response on this RAI that a
10 specific calculation on a tunnel size requalification
11 should be reviewed, then we will arrange with GE to
12 perform that review. As of right now that is
13 uncertain whether we will do a detail review of one of
14 these calculations or not.

15 MR. JENG: But I have to stress --

16 MEMBER STETKAR: But at least the Category
17 II calculations are part of your universe for your
18 sample?

19 MR. SHAMS: Absolutely.

20 MEMBER STETKAR: Okay.

21 MR. LIU: This is Ai-Shen Liu, General
22 Electric.

23 As the applicant we have a -- you know, a
24 different understanding. Our understanding is that
25 for, you know, SRP requirements only applicable to

NEAL R. GROSS

COURT REPORTERS AND TRANSCRIBERS
1323 RHODE ISLAND AVE., N.W.
WASHINGTON, D.C. 20005-3701

1 Category I as far as the design details are concerned.
2 So for Category II structures, yes, we'll commit
3 ourselves to follow the same method of analysis of
4 acceptance criteria as Category I. But it is our
5 understanding that, you know, we do not have to
6 provide the same level of details as Category I
7 structures for Category II.

8 MR. JENG: In term of qualification QA/QC
9 and procurement --

10 MR. LIU: No, that's not part of what I'm
11 asking you. For instance that for the Category I
12 structures we have a document in detail the analysis
13 performed in the DCD. Okay. It is not in our plan to
14 include the same level of details for Category II in
15 the DCD. It has been our understanding as last week
16 we commit in DCD for the requirement aspects of the
17 design, but that will be sufficient without having to
18 provide details of the analysis.

19 MR. JENG: Okay. You may already provide
20 less detail in the submittal, but you are clear that
21 your analysis method, modeling, acceptance criteria
22 for those Category analyses are identical and equal to
23 those which are required and implemented --

24 MR. LIU: Yes, that was our design --

25 MR. JENG: But are not done clear cut, right?

NEAL R. GROSS

COURT REPORTERS AND TRANSCRIBERS
1323 RHODE ISLAND AVE., N.W.
WASHINGTON, D.C. 20005-3701

1 MR. LIU: That will be our design
2 requirement.

3 MS. CUBBAGE: I think by us doing our
4 audits and our confirmatory calculations on a sample
5 and the fact that they're using the same methods would
6 give us assurance that we understand their techniques.
7 And I understand what GE is saying that they wouldn't
8 be intending to provide that level of detail in DCD.
9 Of course, the staff if we had any concerns, we have
10 the option to audit anything we need to.

11 CHAIRMAN CORRADINI: Move on.

12 MR. JENG: Okay. On RAI 63. And this one
13 pertains to the firewater surface complex. And GE
14 propose some sort of arbitrary way of trying to define
15 the surface response spectra by multiplying a vector
16 of 1.35 to the foundation input spectra as their basis
17 for their input design to the structure, service
18 firewater, service complex structure. And the staff
19 feels that we need more clarification on how this 1.35
20 can perform. So we are asking more rationale about
21 the way they jacked up this 1.35 vector. And also, we
22 want to know more about their methodology analysis
23 which are intended for the firewater service complex
24 as well as the other surface spectra plotting which we
25 think they should provide.

NEAL R. GROSS

COURT REPORTERS AND TRANSCRIBERS
1323 RHODE ISLAND AVE., N.W.
WASHINGTON, D.C. 20005-3701

1 So these are additional information we
2 have discussed with GE on the conference call earlier,
3 and they understand what is needed. And, again, as a
4 reviewer I would like to indicate that resolution of
5 this issue is not that difficult and it should
6 resolved in due course.

7 So these are the two still open RAIs. The
8 rest, 62 RAIs have been interacted and evaluated and
9 discussed and they're resolved.

10 And so this summarizes my presentation
11 about 3.7. And I am subject to your questions.

12 CHAIRMAN CORRADINI: Questions? Okay.

13 MR. JENG: Thank you very much.

14 MR. PATEL: Samir Chakrabarti is our
15 reviewer for Section 3.8. And he's going to make the
16 presentation on 3.8.

17 MR. CHAKRABARTI: Okay. Thank you,
18 Chandu.

19 I am Samir Chakrabarti. I am with NRO
20 Division of Engineering.

21 I reviewed Section 3.8 and we had
22 Brookhaven National Laboratory helping us with the
23 review and performing audits and confirmatory
24 analysis. They have been included also here with us
25 today.

NEAL R. GROSS

COURT REPORTERS AND TRANSCRIBERS
1323 RHODE ISLAND AVE., N.W.
WASHINGTON, D.C. 20005-3701

1 The regulatory guidance and standards that
2 were used for this review are listed over here, which
3 is GDC 1, 2, 4, 5, 16 and 50.

4 And the ASME Section III, Division 2,
5 "Code for Concrete Containment."

6 ASME Section III "Class MC Components"
7 were used for the steel components of the concrete
8 containment.

9 Appendix B was the quality assurance
10 criteria.

11 Regulatory Guides used 1.94, 1.57, 1.136,
12 1.142 and 1.143. And these are the guidances provided
13 for design of the concrete containment with Category
14 I structures, internal structures, et cetera.

15 ACI 349 the code for nuclear safety
16 concrete structures.

17 QA and ANSI/AISC N690 for the steel
18 structures.

19 Now the review highlights. We reviewed
20 Section 3.8 and Appendix 3G. 3.8 has the description,
21 it is there, and Appendix 3G contains the design
22 detail information.

23 Along with that we also referred to the
24 appendices that were referred in these appendices
25 Appendix 3G for getting the loads and stuff for the

NEAL R. GROSS

COURT REPORTERS AND TRANSCRIBERS
1323 RHODE ISLAND AVE., N.W.
WASHINGTON, D.C. 20005-3701

1 concrete containment and the other Category I
2 structures.

3 Section 3.8 is really a big section. It
4 documents the design for all Category I structures.
5 And we reviewed quite a few calculations. And we had
6 four design audits that we have done so far. We are
7 planning to have one more next week. And hoping to
8 get in a better shape than we are right now. I'll talk
9 about that later.

10 We also had performed a confirmatory
11 analysis of the containment basemat. We really did
12 not do a confirmatory analysis of the whole nuclear
13 island structure, but we took a small -- we took the
14 basemat up to a certain height and into TRUMPA in
15 model code analysis just because of the resources that
16 is there so you could compare the confirmatory
17 analysis.

18 One item that I would like to mention is
19 that majority of our review questions required
20 additional technical information which resulted in
21 significant enhancement of the DCD content.

22 The way when we had the first initial
23 review of the DCD the main 3.8 Section had about 51
24 pages in that section and the Appendix 3G had about
25 245 pages.

NEAL R. GROSS

COURT REPORTERS AND TRANSCRIBERS
1323 RHODE ISLAND AVE., N.W.
WASHINGTON, D.C. 20005-3701

1 When we started the review we saw that a
2 lot of information, technical information that we
3 think should go into the DCD but are not quite there.
4 So a lot of our RAIs really asked for more information
5 and more information. And GE was very good in
6 responding to those. They provided the added stuff,
7 significant in the DCD. And as of revision 5 Section
8 3.8 has 71 pages, which is 50 percent more than what
9 we had before.

10 And Appendix 3G instead 245 is now 380
11 pages. It has a lot more schedules and design results
12 included in Appendix 3G.

13 And also another thing is that in our
14 review one of the reasons that it has taken us the
15 time that it has taken is that the design has really
16 gone through some kind of evolution. As we went
17 through there were changes in the design and it had to
18 go back to review those. Some of the stuff that we
19 reviewed go back, *10:37 we had to go back and review
20 them again.

21 Examples are like we need firewater
22 service complex that was added in Revision 4 we did
23 not see before. We still have not looked at it. We
24 plan to look at it and some of the details.

25 The reclassification of the turbine

NEAL R. GROSS

COURT REPORTERS AND TRANSCRIBERS
1323 RHODE ISLAND AVE., N.W.
WASHINGTON, D.C. 20005-3701

1 building, we thought we were good with the turbine
2 building when it was called Category II. Then it was
3 categorized as nonsafety. And that brought us into
4 some of the issues of interaction of that building
5 with the other Category I structures, how it is going
6 to be addressed.

7 And changing the liner with GE which has
8 come up in Revision 5. We're just about to look
9 sometime before Revision 5 was issued. And we already
10 have some questions about this changed material.

11 The PCCS reclassification is a real issue.
12 It was not part of the containment boundary. Now it
13 has been included as part of the containment boundary
14 and that raises some questions about how this is going
15 to be handled.

16 CHAIRMAN CORRADINI: Can you expand on
17 that? I thought when we first had a presentation
18 about this that it was part of the containment
19 boundary?

20 MR. CHAKRABARTI: Before Revision 4.

21 CHAIRMAN CORRADINI: Oh, not before
22 Revision 4? Excuse me. Okay.

23 MR. CHAKRABARTI: That was done in
24 Revision 4.

25 CHAIRMAN CORRADINI: And the two questions

NEAL R. GROSS

COURT REPORTERS AND TRANSCRIBERS
1323 RHODE ISLAND AVE., N.W.
WASHINGTON, D.C. 20005-3701

1 are? It raises two questions.

2 MR. CHAKRABARTI: No. I said there are
3 questions about it how it is going to be handled, like
4 which code to apply to it.

5 CHAIRMAN CORRADINI: Oh, excuse me. I see.

6 MR. CHAKRABARTI: Yes. Now it's a
7 boundary. We have defined design requirements for the
8 containment boundary and the *10:39 internal piping
9 and all those stuff.

10 CHAIRMAN CORRADINI: Does this go back to
11 the question that I didn't understand from the staff
12 where you wanted to have isolation valves on the --

13 MR. CHAKRABARTI: No.

14 CHAIRMAN CORRADINI: Okay.

15 MS. CUBBAGE: Well, it's not his question,
16 but it's someone else's question, absolutely.

17 CHAIRMAN CORRADINI: It all revolves
18 around -- just so I'm clear.

19 MEMBER SHACK: Whether it's containment or
20 not?

21 CHAIRMAN CORRADINI: Yes. It all revolves
22 around whether it's part of containment or not, right?
23 It's philosophically in the same bailiwick?

24 MR. CHAKRABARTI: Yes, probably. We are
25 trying to find out since the containment boundary

NEAL R. GROSS

COURT REPORTERS AND TRANSCRIBERS
1323 RHODE ISLAND AVE., N.W.
WASHINGTON, D.C. 20005-3701

1 there have no requirements for special testing and
2 which code to follow. Like we usually used Class MC
3 for a containment boundary, whether that Class MC is
4 going to be used or not or some other *10:40 will be
5 used for it. Those are the issues we need to resolve.

6 CHAIRMAN CORRADINI: So this is still in
7 discussion?

8 MR. CHAKRABARTI: It's a very -- in
9 discussion.

10 MS. CUBBAGE: Right. It started with the
11 isolation --

12 MR. CHAKRABARTI: The one thing to use
13 this --

14 CHAIRMAN CORRADINI: Right. Thank you.
15 Thank you very much.

16 MS. CUBBAGE: It started with the question
17 on the isolation valves and has now migrated more into
18 this area technically because of the --

19 CHAIRMAN CORRADINI: Just for the sake of
20 those that are old and remember that, whatever
21 happened with the isolation valve part of it?

22 MS. CUBBAGE: It's still open.

23 CHAIRMAN CORRADINI: Okay. Thank you.

24 MR. CHAKRABARTI: Now the review status,
25 we had so many open items I did not list the numbers.

NEAL R. GROSS

COURT REPORTERS AND TRANSCRIBERS
1323 RHODE ISLAND AVE., N.W.
WASHINGTON, D.C. 20005-3701

1 We have total 123 RAIs. I'm sorry. The RAIs. Total
2 123 RAIs we had. We had resolved a majority of them.
3 We still have 19 RAIs that are still open. And one of
4 the purpose of the audit that we are doing next week
5 along with looking at some calculations, we want to
6 have face-to-face discussions on some of those open
7 items. Because some of them have gone through like
8 part of four supplements and I'm having a feeling that
9 we are not probably -- probably getting well. Because
10 there are aspects on some things, not getting the
11 response what we are looking for, they are writing
12 that will help resolve that and bring the open issues
13 to conclusion somehow.

14 And the confirmatory analysis has been
15 completed. And we have concluded that the computer
16 analysis GE has performed for analyzing the Category
17 I structures, they are adequate. And in general we
18 have a good conformance with our analysis and the
19 analysis that GE has performed.

20 And I talked about the issue of design
21 audit.

22 Now out of the 19 total open items I
23 didn't want to -- not all of them are really -- a lot
24 of them are on details issues and I didn't want to
25 talk about the details of why this stress did not

NEAL R. GROSS

COURT REPORTERS AND TRANSCRIBERS
1323 RHODE ISLAND AVE., N.W.
WASHINGTON, D.C. 20005-3701

1 match that, and that kind of issues we have quite a
2 few.

3 I wanted to talk about only of the major
4 ones --

5 CHAIRMAN CORRADINI: Good. We appreciate
6 that.

7 MR. CHAKRABARTI: Thank you. Major ones
8 that I think we need to discuss in this meeting.

9 RAI 3.8-107. It has a lot of other issues
10 regarding, like, the details that I talked about. But
11 the main issue that I want to talk about is the
12 applicant has done thermal analysis and a thermal
13 tracking analysis as GE already presented in their
14 section. But during our review what we noticed that
15 the thermal tracking analysis, it has reduced the
16 thermal moment significantly, which --

17 CHAIRMAN CORRADINI: Could you repeat?

18 MR. CHAKRABARTI: Thermal moments. And in
19 thermal moments, which give us the impression that
20 there has been significant nonlinear behavior in the
21 structure.

22 And then we are interested in the stresses
23 from the other loads which are calculated elastically
24 and we are using this superposition to add those
25 stresses to get the final. And our concern is, is it

NEAL R. GROSS

COURT REPORTERS AND TRANSCRIBERS
1323 RHODE ISLAND AVE., N.W.
WASHINGTON, D.C. 20005-3701

1 appropriate to use elastical linear and elastic and
2 *10:43 results with the nonlinear *10:43.

3 And GE, we asked this question. And GE has
4 provided an answer to that. We received that
5 recently. We have not yet completed review of that
6 one. We hope to discuss this during the audit.

7 I think what we had asked for they did.
8 I went to audit and did glance through it. They did
9 compare like using the other loads. I shouldn't say
10 other loads, the special loads, also they used a
11 nonlinear analysis and combined the thermal nonlinear
12 analysis and tried to show that it's not very
13 different. But on my first look I thought I saw that
14 this which we will still need to look into it.

15 So that is the kind of issue on this one.
16 The significant nonlinear. Because this thermal
17 moment they use it reduces some places in cases, but
18 major reduction.

19 RAI 3.8-79, this is about -- primarily
20 came from the reclassification of the turbine building
21 and also we had radwaste building, which is designed
22 to another Category area. This is not Category I, it
23 is not Category II. It has it's one Reg. Guide 1.143,
24 which is a different seismic design criteria which
25 says that if you design it under this criteria, it

NEAL R. GROSS

COURT REPORTERS AND TRANSCRIBERS
1323 RHODE ISLAND AVE., N.W.
WASHINGTON, D.C. 20005-3701

1 will be okay. But does not quite satisfy whether it
2 will meet the safety interaction criteria that is laid
3 out in Section 3.7. I believe it's 3.7.28 or
4 something.

5 MR. PATEL: Yes, it's 3.7.28.

6 MR. CHAKRABARTI: Yes. 3.7.28. And we
7 had a question about that one how they demonstrate
8 that because these buildings are located close towards
9 nuclear island building, safety *10:45 the turbine
10 building and the radwaste building.

11 So that is one of the issue that we plan
12 to resolve.

13 MEMBER BLEY: Let me just ask a question,
14 or ask me one. The difference between what we just
15 heard on Chapter 3.7 and what you do on Chapter 3.8 is
16 that 3.7 was a review of the analytical methods and
17 3.8 is really looking structure-by-structure to say
18 did --

19 MR. CHAKRABARTI: Absolutely.

20 MEMBER BLEY: --they apply the methods
21 appropriately to each structure? Is that fair?

22 MR. CHAKRABARTI: Little bit different.
23 What 3.7 does, like the main structure it says that
24 because of seismic determines what will be the
25 response of the structure to the ground shaking. It

NEAL R. GROSS

COURT REPORTERS AND TRANSCRIBERS
1323 RHODE ISLAND AVE., N.W.
WASHINGTON, D.C. 20005-3701

1 stops about there.

2 MEMBER BLEY: So it's the response
3 analysis, where this is --

4 MR. CHAKRABARTI: The response analysis,
5 yes. And this 3.8 designs the structure with the
6 response that is obtained from 3.7.

7 MEMBER BLEY: Okay. And it's an audit of
8 how well they follow the rules and --

9 MR. CHAKRABARTI: How they apply all the
10 rule, they obtain results of 3.7 applies those loads
11 to -- and model of the structure and determines the
12 detailed forces and moments in the structure itself.

13 MEMBER BLEY: Okay. Thanks.

14 MEMBER BROWN: How can you do the first if
15 you don't have a design?

16 MR. CHAKRABARTI: The structure response?

17 MEMBER BROWN: Yes. If you don't know what
18 the design is, how can you do what 3.7 was doing
19 before you --

20 MR. CHAKRABARTI: The action of the
21 structure, mass and stiffness properties, they have
22 actual dimensions at least. They file for completion.
23 Because to determine the response -- when you say you
24 don't have a design it's not that there is nothing
25 there. Design is the first like you *10:47 something

NEAL R. GROSS

COURT REPORTERS AND TRANSCRIBERS
1323 RHODE ISLAND AVE., N.W.
WASHINGTON, D.C. 20005-3701

1 and then verify it with the actual notice.

2 In 3.7 we assume the structure shape,
3 size, stiffness and in those discover the thermal the
4 size response.

5 MR. BRAVERMAN: Excuse me. This is Joe
6 Braverman from BNL.

7 I'd also like to add I agree with what you
8 said. When you go to the design stage and you use the
9 seismic loads and apply it to the structure and you
10 design the building, usually you're not going to
11 change your thicknesses. If it turns out the loads a
12 little too high, you may additional steel enforcement.
13 And that would not negate the assumptions in the
14 seismic analysis.

15 If it turns out you do have to make the
16 walls thicker, then you may have to iterate another
17 time.

18 MEMBER BROWN: Okay. So fundamentally the
19 building, there is a design of the building.

20 MR. BRAVERMAN: A preliminary design.

21 MEMBER BROWN: That's fine, yes. And then
22 you go do what 3.7 did and try to develop the response
23 -- the forcing functions and the spectra, blah-blah,
24 all that good stuff. Then if your responses are such
25 that the building break, then you change something. If

NEAL R. GROSS

COURT REPORTERS AND TRANSCRIBERS
1323 RHODE ISLAND AVE., N.W.
WASHINGTON, D.C. 20005-3701

1 it doesn't, then you're okay.

2 MR. BRAVERMAN: Usually you would add more
3 steel enforcement in the concrete.

4 MEMBER BROWN: All right.

5 MR. BRAVERMAN: If that's not enough, then
6 you have to change the thickness.

7 MEMBER BROWN: All right. I just lost the
8 level between 3.7 and 3.8.

9 MR. CHAKRABARTI: Yes. No. You're right.
10 If in the intend design phase we find that we cannot
11 live with what we assume, we may have to go back and
12 do the 3.7 analysis again.

13 MEMBER BROWN: Okay. So it's just a
14 little bit more of an iteration back and forth.

15 MR. CHAKRABARTI: Yes.

16 MEMBER BROWN: Okay. There's a design to
17 start with. They do the analysis. The spectra. Go
18 back and say is it okay. And you say, yes, it's okay.
19 You do nothing else. If it's not, then you --

20 MR. CHAKRABARTI: That is correct.

21 MEMBER BROWN: Okay.

22 MR. CHAKRABARTI: In RAI 3.8-94. Okay.
23 In this one what we have seen GE has come up with
24 their design and came up with a very large bearing
25 capacity requirements. And our concern was that why

NEAL R. GROSS

COURT REPORTERS AND TRANSCRIBERS
1323 RHODE ISLAND AVE., N.W.
WASHINGTON, D.C. 20005-3701

1 is it considered reasonable value that can be met at
2 potential plant sites.

3 For example, like say like for hard rock
4 the varying capacity requirement for it is 112.8 is
5 for feet per square feet. For medium 152.5 is for
6 square feet. For soft rock 56. **10:50 varying bearing
7 capacity requirements.

8 As far as we know for very hard rock sites
9 where you may be able to met it, but for medium and
10 soft soil is when these appear to be too high. And we
11 just wanted to find from them how the plant site
12 located in the medium rock or soil site, subsoil site
13 you're going to be able to use this design.

14 CHAIRMAN CORRADINI: Meaning what?

15 MR. CHAKRABARTI: Bearing capacity
16 requirements.

17 CHAIRMAN CORRADINI: Meaning that it's too
18 massive sort of for the soil it's put on? I'm not
19 still understanding your --

20 MR. CHAKRABARTI: Yes. Yes. The structure
21 that we put on the soil requires soil to have a
22 minimum bearing capacity of that much, which is not a
23 reasonable value for soft and medium soils.

24 CHAIRMAN CORRADINI: Requiring a bigger
25 footprint to make it -- okay.

NEAL R. GROSS

COURT REPORTERS AND TRANSCRIBERS
1323 RHODE ISLAND AVE., N.W.
WASHINGTON, D.C. 20005-3701

1 MR. CHAKRABARTI: Yes. To bring down the
2 soil bearing capacities, you need a bigger footprint.

3 MEMBER BROWN: You want to distribute the
4 load over a greater area?

5 MR. CHAKRABARTI: A greater area. And
6 what we are saying that for very hard rock sites
7 probably the design should be okay. But it will not
8 be useable for soft and medium soil sites. That is
9 our question. They may have an answer. We don't know.
10 We find out.

11 MEMBER BROWN: So the --

12 MR. LIU: This is Al-Shen Liu, GEH again.

13 Yes. You know, we agree with you. Our
14 bearing demand are high. Okay. Because that's the
15 price we are paying for standard design, you know.

16 And as far as the applicant -- as far as
17 whether actual -- you know, with standard high demand
18 is concerned, we have looked at our two COL FSARS
19 using ESBWR technology. One is North Anna, another
20 being Grand Gulf. North Anna is the rock site. Grand
21 Gulf is soil site.

22 Based on what information they presented
23 in the FSAR, you know, their incapacity are higher
24 than our demand values.

25 MEMBER BROWN: At which site?

NEAL R. GROSS

COURT REPORTERS AND TRANSCRIBERS
1323 RHODE ISLAND AVE., N.W.
WASHINGTON, D.C. 20005-3701

1 MR. LIU: Both. North Anna and Grand Gulf.

2 MR. CHAKRABARTI: Not that the rock site,
3 it shouldn't be a problem. Grand Gulf we have to look
4 at it. Well, it's just a question that we had. And
5 like I said, they'll have an answer.

6 MEMBER BLEY: Is this something you have
7 commented on and I missed in the SER or you intend to
8 put a condition like that on sort of --

9 MS. CUBBAGE: No. The bearing capacity is
10 a condition of the certification. It's the
11 responsibility of the COL applicant to demonstrate
12 that they fall within that criteria, the site --

13 MEMBER BLEY: In terms of the capacity,
14 not in terms of the language that we don't think this
15 is good for a soil site?

16 MS. CUBBAGE: Yes. I don't think that he
17 said that. I think that he had concerns with the site
18 parameter being bounding of the sites that would be
19 expected to try to use an ESBWR. And I think what you
20 just heard from GE is that the two COL applicants that
21 have applied, their site meets this parameter. So I
22 think GE's formally responded to this RAI--

23 MR. CHAKRABARTI: Currently a lot of sites
24 will not be able to meet these.

25 Okay. RAI 3.8-96 the staff requested GE

NEAL R. GROSS

COURT REPORTERS AND TRANSCRIBERS
1323 RHODE ISLAND AVE., N.W.
WASHINGTON, D.C. 20005-3701

1 to explain some of the assumptions made for evaluation
2 of sliding resistance of foundation. And they have
3 raised such concerns as I understand, and which we
4 have some questions like in evaluating sliding
5 resistance the -- water pressure has been considered
6 and we thought the water pressure really should not be
7 included to provide sliding resisting because it
8 probably will be both sides of the building.

9 And the assumption of static coefficient
10 of friction along passive soil resistance in our mind
11 that's not a conservative assumption because before
12 you can engage the passive resistance of the soil, you
13 probably need to have slight movement of the
14 foundation before engages passive resistance from
15 soil. And for that it's probably more appropriately
16 the dynamic coefficient of friction instead to static
17 cohesion, which is like less than static.

18 And also considering additional sliding
19 resistance due to cohesion. This part we also want to
20 talk with them like if cohesion is used for sliding
21 resistance, that probably should be also a site
22 parameter -- into the site parameter.

23 Another area, 3.8-120. GEH has recently
24 proposed the use of ASTM A-709 HPS 70W material for
25 the containment liner. This material is different

NEAL R. GROSS

COURT REPORTERS AND TRANSCRIBERS

1323 RHODE ISLAND AVE., N.W.

WASHINGTON, D.C. 20005-3701

(202) 234-4433

www.nealrgross.com

1 than what GEH had up to Revision 4, which is SA-516
2 material, which is about 38 psi and the 709 material
3 is -- has a yield of 70 psi.

4 Now because of these two, we just want to
5 ask them how it effects their analysis that they have
6 done. And also to what extent are they using. It's
7 not very clear. It looks from the -- we verified that
8 it's a generic statement of an alternate material
9 which someone can use for the internal liner.
10 Whether it is being used for the internal liner or is
11 it being used locally for attachment, which they have
12 with the main tunnel structures, A-709 structure
13 members, that's the question that we have asked them
14 asking how it impacts the analysis of the containment.

15 MEMBER ARMIJO: Well, I presume GEH has a
16 reason for proposing a stronger material. And I hope
17 it would have, presumably, good ductability, but --

18 MR. CHAKRABARTI: Yes.

19 MEMBER ARMIJO: -- can anybody tell me
20 what those reasons are?

21 MR. LIU: Yes. This is Ai-Shen Liu, GEH.

22 The reason we have to use this material
23 originally is because of the concern of using this
24 material as an attachment to the containment liner.
25 Because existing CC material list does not include

NEAL R. GROSS

COURT REPORTERS AND TRANSCRIBERS

1323 RHODE ISLAND AVE., N.W.

WASHINGTON, D.C. 20005-3701

(202) 234-4433

www.nealrgross.com

1 this particular material as a permitted attachment
2 material. And we intend to use the material for
3 measure containment internal structures. So that's
4 how we started with this code case process.

5 MEMBER ARMIJO: So that's ongoing?

6 MR. CHAKRABARTI: Yes.

7 MEMBER ARMIJO: In that code case.

8 MR. LIU: The code case is, you know,
9 supposedly to get a final approval from ASME and get
10 published in two weeks. It's getting there.

11 So in this code case we stated, you know,
12 this code case because this particular material has
13 been commonly used as a bridge material, has been
14 tested extensively. And we also did additional tests
15 to confirm the adequacy of the material behavior,
16 especially in the aspect of welding. An we determined
17 that this material does not have to do a post-weld
18 heat treatment at all.

19 So in the code case we say okay if you
20 wanted to use this material to not post-weld heat
21 treat.

22 And the application of this material as a
23 linear in all these lines very limited. We do not
24 intend to apply this material to the entire
25 containment. Because this material is quite expensive

NEAL R. GROSS

COURT REPORTERS AND TRANSCRIBERS
1323 RHODE ISLAND AVE., N.W.
WASHINGTON, D.C. 20005-3701

1 relative to 516. And we only intend to use this
2 material at two locations where the measured internal
3 structures are attached, mainly the diaphragm floor
4 and the van wall joint with the pedestal.

5 So these particular locations, the liner
6 materials not only serve as a leakage barrier for the
7 containment, the other function really is the
8 structural function to provide adequate load transfer
9 from the attachment into the concrete.

10 MEMBER ARMIJO: ASME?

11 MR. LIU: Yes, And so that's why we, you
12 know, we have this code case and we intend to use as
13 a per limited location instead of entire containment.

14 MEMBER MAYNARD: It sounds like -- is this
15 a recent change? What I'm really going to is your
16 analysis, your containment analysis, was it done with
17 the new material factored in or was it done with the
18 516?

19 MR. LIU: From analysis point of view
20 since post-516 and this A-709 are both carbon
21 material. So in analysis itself at a liner, we only
22 considered *11:01 and the Poisson's ratio. And those
23 value are identical between the two materials.

24 MEMBER MAYNARD: It's only the --

25 MR. LIU: Yes. Yes. The activity is in

NEAL R. GROSS

COURT REPORTERS AND TRANSCRIBERS

1323 RHODE ISLAND AVE., N.W.

WASHINGTON, D.C. 20005-3701

1 several analysis slightly lower than 516, you know.
2 Twenty-one percent versus 19 percent.

3 MR. CHAKRABARTI: Yes. And that was part
4 of the question that we had in this RAI. The DCD
5 Revision 5 when it was introduced to use this
6 material. It does not spell out where they are using
7 it like he explained. It probably should go in the
8 DCD.

9 And also since the analysis has not been
10 done with this material, and I agree with him if it is
11 locally used, it will not have significant or layer
12 impact of the analysis. So once they clarify those
13 things, it probably should be okay.

14 But sure enough, the analysis should
15 represent what has been used.

16 MR. BRAVERMAN: Excuse me. This is Joe
17 Braverman.

18 I just want to add one little thing there.
19 Not only does ASME code have to approve the code case,
20 but also typically the NRC reviews code cases and has
21 to endorse them. So there are several more steps to
22 go.

23 MR. CHAKRABARTI: That is true.

24 Okay. That's what I plan to present
25 today. And if there are any questions, I'll answer. If

1 I cannot, I'll seek help from BNL.

2 CHAIRMAN CORRADINI: Okay. Questions from
3 the Members? Okay.

4 Well, thank you very much.

5 MR. CHAKRABARTI: Thank you very much. I
6 appreciate.

7 CHAIRMAN CORRADINI: So this concludes the
8 day's events.

9 MS. CUBBAGE: The one thing I would ask
10 from the Committee if we could get some guidance on
11 the full Committee meeting, what topics you would be
12 interested in hearing. You obviously heard some very
13 detailed presentations from the staff and GE over the
14 last day and a half. And when we come back for full
15 Committee there's not a lot of time. And I know it's
16 been dissatisfying in the past, the level of detail
17 that was presented at the full Committee. So we'd like
18 to come with something that is satisfying. And if you
19 could identify topics you're interested in hearing,
20 that would help us.

21 CHAIRMAN CORRADINI: Are we off the
22 record? We're not. Okay. Fine. Just let it go.

23 I had a comment, which is you'll never
24 satisfy us so there's no point in trying. But I think
25 your question is a good way to go around the table to

NEAL R. GROSS

COURT REPORTERS AND TRANSCRIBERS
1323 RHODE ISLAND AVE., N.W.
WASHINGTON, D.C. 20005-3701

1 see comments by the day and suggestions relative to
2 what you want to hear in the full Committee for our
3 colleagues that haven't been here, but are probably --

4 MS. CUBBAGE: Right. Because they won't
5 have the benefit --

6 CHAIRMAN CORRADINI: -- dying to
7 understand.

8 MS. CUBBAGE: They won't the benefit of
9 the last day and a half. So we need to use the time
10 wisely at the full committee.

11 CHAIRMAN CORRADINI: Right. Jack, let me
12 start with you this time, if I may.

13 MEMBER SIEBER: Yes. I think that it would
14 be worthwhile to go through the classification
15 systems. And particularly why the various systems are
16 chosen the way they are, you know, Cat I, Category II
17 and that. And from a design standpoint why that's
18 important. And the fact that most of the issues that
19 are pointed out.

20 I also believe that the seismic issues are
21 interesting and important in light of recent events.
22 And I think that that's pretty well along and pretty
23 well understood by the applicant and the staff. And
24 so I would include that.

25 I think it would be interesting to include

1 a discussion of the steps that are being taken by GEH
2 on steam dryer integrity, not a departure from current
3 practice, it is an extension of it and has value, not
4 only for ESBWR, but for current plants.

5 And I think those are the -- you only have
6 like two hours.

7 CHAIRMAN CORRADINI: Correct.

8 MS. CUBBAGE: Right.

9 MEMBER SIEBER: And I think that would be
10 about it.

11 MS. CUBBAGE: On the dryer, I'd like to
12 propose that the staff has not issued RAIs yet on the
13 PBLE method. So it probably would be appropriate to
14 defer that to a later meeting and not attempt to get
15 into a lot of detail at the full Committee, which will
16 happen before we issue our RAIs.

17 CHAIRMAN CORRADINI: Okay. That sounds
18 fine.

19 MEMBER BROWN: Just an expansion. For an
20 electrical guy, the seismic discussion this morning
21 not only just on the categories, which you brought up,
22 but the curve, the methodology of the curves, the
23 double-hump. That was a very good -- at least, you
24 know gives me a good boundary conditions within which
25 this thing is being considered. I don't know what the

NEAL R. GROSS

COURT REPORTERS AND TRANSCRIBERS
1323 RHODE ISLAND AVE., N.W.
WASHINGTON, D.C. 20005-3701

1 expertise of the other people -- well, I know some of
2 it, but I know I'm way down the fire curve on it. So
3 that was a very good discussion relative to the
4 reasons and the questions were good. So I thought a
5 little bit of an elaboration on that along with the
6 categorizations.

7 MEMBER SIEBER: The Committee has already
8 had discussions and meetings on the characterization
9 including the soil structure underneath and the holes
10 and the impact of Charleston and liquified soil
11 findings and so forth. So the Committee does have some
12 background there and --

13 CHAIRMAN CORRADINI: Certain Members of
14 the Committee. I'm more in his camp.

15 MS. CUBBAGE: Right. But I would say that
16 the actual curve itself was presented in Chapter 2 as
17 far as that being the site parameter for anyone who
18 was there.

19 CHAIRMAN CORRADINI: For good educational
20 purposes, in other words.

21 MEMBER SIEBER: Yes. Review is not a bad
22 thing.

23 MEMBER BROWN: I'm not saying you should
24 spend two hours on it. I was really referring to the
25 summary of the double-humps and the under -- the lower

NEAL R. GROSS

COURT REPORTERS AND TRANSCRIBERS
1323 RHODE ISLAND AVE., N.W.
WASHINGTON, D.C. 20005-3701

1 curve and this .3 versus .5, whatever Bill called it,
2 anchoring on the -- at the 100 Hertz --

3 MEMBER ARMIJO: It would help a lot, I
4 think, if somebody would just make a better figure
5 showing how this double-hump is created. There are
6 actually two different spectra and they're combined.
7 And that makes it a lot easier to understand.

8 CHAIRMAN CORRADINI: That or a blackboard.

9 MEMBER STETKAR: Well, there is a figure
10 in Chapter 19 that shows that it was a finite
11 enveloping curve.

12 CHAIRMAN CORRADINI: Yes, right.

13 MEMBER STETKAR: But that piecemeal
14 assembly would kind of be nice.

15 MEMBER SIEBER: The argument though is a
16 practical curve versus a regulation curve.

17 MS. CUBBAGE: Right. The how it was
18 constructed, I'm sure that's easy.

19 MEMBER BROWN: Yes, the other we
20 understand. The other piece was the interesting
21 discussion on the pools and the impact of those pools
22 on the structure relative to the seismic response.
23 That was things they'd considered. Again, not very
24 detailed, but it has been considered and there are
25 some factors in it. If that's already done, I didn't

NEAL R. GROSS

COURT REPORTERS AND TRANSCRIBERS
1323 RHODE ISLAND AVE., N.W.
WASHINGTON, D.C. 20005-3701

1 know because I wasn't here for the previous meetings.

2 MS. CUBBAGE: No, it hasn't.

3 MEMBER BROWN: So that seemed to me a
4 different throw in relative to just these big
5 buildings that are sitting there that are getting
6 shaken and baked. That's my thing.

7 CHAIRMAN CORRADINI: Dennis?

8 MEMBER BLEY: I would like to start with
9 a thank you to GEH and staff. The last two days have
10 been very helpful for me.

11 I agree with all that's been said, and
12 there are three little things that I think if they
13 could be added in as part of the presentation, we
14 eventually got to them through questions, it might
15 make things smoother and they're going to come up
16 anyway.

17 One was eventually someone on staff gave
18 us a little story about how the staff looked to the
19 PRA and importance measures to see if equipment should
20 be added to the classification list. May as well
21 start with that, because it'll come up.

22 The other one that was finally addressed
23 was how staff verifies the EQ certification including
24 looking at the complete test histories and the
25 walkdown of the plant. I think that's a very

NEAL R. GROSS

COURT REPORTERS AND TRANSCRIBERS
1323 RHODE ISLAND AVE., N.W.
WASHINGTON, D.C. 20005-3701

1 important issue. It just ought to be right out front.

2 And I kind of hate to say it, we had the
3 little discussion on the curve that's used in the
4 seismic margins analysis and the disagreement, even
5 though that's not what this is about. That one will
6 surely come up. So if there could be a little tight
7 presentation on that and what the objections are, it
8 might save time.

9 CHAIRMAN CORRADINI: Take that under
10 advisement.

11 MEMBER BLEY: Well, yes. We have separate
12 meetings on the PRA, but it's for sure going to come
13 up if we're talking about those curves. So just get
14 on it ahead of time might save some time.

15 MEMBER BROWN: Yes, I meant to include
16 that subset that he mentioned also.

17 MEMBER BLEY: And it's not seismic PRA. It
18 is margins analysis.

19 MEMBER BROWN: No, margins analysis. It's
20 not in the PRA.

21 MEMBER SHACK: It's a PRA based seismic
22 margins analysis.

23 MEMBER STETKAR: It's a seismic margins
24 analysis. It is not --

25 MS. CUBBAGE: How about if we don't mix

NEAL R. GROSS

COURT REPORTERS AND TRANSCRIBERS
1323 RHODE ISLAND AVE., N.W.
WASHINGTON, D.C. 20005-3701

1 applies and oranges? Maybe the seismic margin
2 discussion we can come back to August.

3 MEMBER BLEY: I'm sure that's fine, but
4 it'll come up from a couple of our other Members who
5 are not here today.

6 MEMBER STETKAR: Well, because we may not
7 have time in August the way that we're planning --

8 MS. CUBBAGE: Well, we're not going to
9 have time on July 8th or 9th either.

10 MEMBER SIEBER: Well, maybe it won't come
11 up.

12 MEMBER STETKAR: Just satisfy the other
13 Members.

14 MEMBER SIEBER: Well, the Chairman will
15 decide what will be discussed.

16 MEMBER ARMIJO: I'll blame you.

17 MEMBER STETKAR: That's fine. Blame me.
18 I'll take responsibility.

19 MR. VANDER MOLEN: Dennis, could you
20 please repeat your middle point? I got your first one
21 and your third one, and I'm writing full blast here.

22 MEMBER BLEY: Toward the end yesterday,
23 and I forget who it was, one of the members of staff
24 stood up and explained how staff verifies the
25 environmental qualification including how they go to

NEAL R. GROSS

COURT REPORTERS AND TRANSCRIBERS
1323 RHODE ISLAND AVE., N.W.
WASHINGTON, D.C. 20005-3701

1 the site, they go through the complete test histories.
2 That those test histories include the failures and
3 successes and what was done to the equipment. And
4 then they walk down the site to verify that the
5 orientations are in agreement with those in the tests.

6 CHAIRMAN CORRADINI: And just to emphasize
7 the point. I can't remember the staff member either.

8 MS. CUBBAGE: It was Paul Shemanski.

9 CHAIRMAN CORRADINI: Shemanski. And his
10 point was this is one of the last things that is done
11 because you have to see it in the as-built condition.

12 MEMBER BLEY: Exactly. But that it is a
13 thorough review of all those issues.

14 CHAIRMAN CORRADINI: Okay. You got it,
15 Harold?

16 MR. VANDER MOLEN: I got it, yes.

17 I take these things independent of the
18 transcript.

19 CHAIRMAN CORRADINI: Sam?

20 MEMBER ARMIJO: I don't have anything to
21 add. I think that's plenty of comments.

22 I agree with the prior --

23 MEMBER SHACK: Yes, I mean I think it's
24 going to be very difficult to get through this. I'm
25 just trying to think how this can be done.

NEAL R. GROSS

COURT REPORTERS AND TRANSCRIBERS
1323 RHODE ISLAND AVE., N.W.
WASHINGTON, D.C. 20005-3701

1 And I think I'm sort with Dennis. I would
2 emphasize the number of audits that have been done,
3 the confirmatory calculations, the depth of the
4 review.

5 It didn't come across almost until the
6 last day here. And I think, you know, I think that
7 helps everybody's degree of confidence in the system.
8 There's an awful lot to grasp here.

9 And, again, I think the classification is
10 important. And I'd even like some clarification
11 because I don't think you used importance measures.
12 At least as I understand RTNSS requirements they're
13 not in there. That was Tom's wish list of how it would
14 have been classified, but I don't think it really was
15 done that way.

16 And I don't think that's a discussion
17 here. That's a different discussion.

18 MEMBER BLEY: One of the staff members did
19 give an example of things that they brought forward
20 and requested being appropriate, unless I
21 misunderstood what was said.

22 MEMBER SHACK: We'll find out.

23 CHAIRMAN CORRADINI: We'll find out. But
24 good luck.

25 MEMBER MAYNARD: I have no earthshaking

NEAL R. GROSS

COURT REPORTERS AND TRANSCRIBERS
1323 RHODE ISLAND AVE., N.W.
WASHINGTON, D.C. 20005-3701

1 addition to suggest.

2 MEMBER STETKAR: I don't either. Nothing.
3 Nothing. Everybody said it all. In this classification
4 that's good enough.

5 CHAIRMAN CORRADINI: I guess I wanted to
6 thank the staff and GEH for their presentations. I
7 think it was actually quite thorough.

8 I guess the one thing I was going to say
9 is that maybe it was where it sits amongst all the
10 other chapters, it came through much more clearly on
11 both the GEH side and the staff side on how much
12 you've talked, done audit calculations, done
13 comparative calculations, had a conversation about
14 things. And you apparently at least see from the most
15 part a path forward with the open items and how you
16 want to approach them, however significant they might
17 be. I guess it might be just where this is all placed
18 relative to the other chapters, but I think that came
19 through. I really appreciate it on both sides.

20 Other than that, I guess I've gotten
21 everyone else's comments. If there's additional
22 comments you want to send me as I get a draft of a
23 letter to you all about this really fun and very
24 focused chapter, let me know.

25 MS. CUBBAGE: You are right. And, again,

NEAL R. GROSS

COURT REPORTERS AND TRANSCRIBERS
1323 RHODE ISLAND AVE., N.W.
WASHINGTON, D.C. 20005-3701

1 you know the focus that we've been -- the theme for
2 the previous meetings if you have questions that you
3 don't think are being covered by RAIs or haven't been
4 covered in the review, that's what we're really trying
5 to draw out of this process and make sure they can be
6 addressed. So --

7 CHAIRMAN CORRADINI: And then I'll talk to
8 you on the side relative to the organization of it
9 with Harold. And if you have more suggestions, I'll
10 gladly take them.

11 I guess my only thought is with only two
12 hours you'll not satisfy us, so don't try. And we
13 will try to do a better job of staying on track, which
14 we never do. But we will try. Because I do think this
15 is so wide ranging, unless we're very disciplined
16 we'll go nonlinear more than the structures will.

17 So thanks. Thank you all.

18 MS. CUBBAGE: And I very much appreciate
19 the Committee's comments and feedback over the last
20 day and half.

21 CHAIRMAN CORRADINI: Okay. Thank you.

22 Meeting is adjourned.

23 (Whereupon, at 11:15 a.m. the meeting was
24 adjourned.)

25

CERTIFICATE

This is to certify that the attached proceedings
before the United States Nuclear Regulatory Commission
in the matter of: Subcommittee on ESBWR: Open

Name of Proceeding: Advisory Committee on
Reactor Safeguards

Docket Number: n/a

Location: Rockville, MD

were held as herein appears, and that this is the
original transcript thereof for the file of the United
States Nuclear Regulatory Commission taken by me and,
thereafter reduced to typewriting by me or under the
direction of the court reporting company, and that the
transcript is a true and accurate record of the
foregoing proceedings.

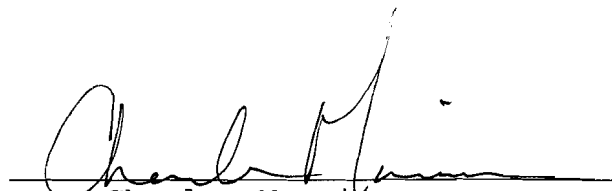
Charles Morrison
Official Reporter
Neal R. Gross & Co., Inc.

NEAL R. GROSS
COURT REPORTERS AND TRANSCRIBERS
1323 RHODE ISLAND AVE., N.W.
WASHINGTON, D.C. 20005-3701



Presentation to the ACRS Subcommittee

ESBWR Design Certification Review
Chapter 3 – Design of Structures, Components,
Equipment, and Systems
(Sections 3.7 and 3.8)

June 18, 2008



Presentation to the ACRS Subcommittee

ESBWR Design Certification Review
Chapter 3.7 – Seismic Design
David Jeng – NRO/DE/SEB2

June 18, 2008

ACRS Subcommittee Presentation

ESBWR Design Certification Review

Section 3.7 – Seismic Design

Regulations and Regulatory Guidance

- GDC 2, 10 CFR Part 50, Appendix A
- Seismic & Geologic Siting Criteria, 10 CFR 100, Appendix A
- Earthquake Engineering Criteria, 10 CFR 50, Appendix S
- Regulatory Guides 1.60, 1.61, 1.92, 1.122
- SRP 3.7, Rev. 3, March 2007

Review Highlights

- Conducted Two Design Audits at GE's Offices
- Performed Confirmatory SSI SASSI Analyses of Control Bldg (CB).
- GE and Staff Used Same Single-Stick Beam Mass Model for CB.
- GE Used DAC-3N and SASSI for Unif. And 4 Layered Sites, Respectively. Staff Used SASSI for 9 Layered Sites.
- GEH and Staff results found to be in reasonable agreement after resolution of RAIs
- 1000 Ft/Sec Min. Soil Shear Wave Velocity Met via Use of Soil Layer-Thickness Weighted Approach

Review Status

- 64 RAIs Issued
- 62 RAIs Resolved
- 2 RAIs Remain open (RAI 3.7-52 and RAI 3.7-63)

ACRS Subcommittee Presentation

ESBWR Design Certification Document Review

Section 3.7 – Seismic Design

Open Items

RAI 3.7-52

For Concrete Tunnels and Trenches, Need Clarification of (1) Seismic Classification; (2) Seismic Analysis Methodology; (3) Piping/Conduits/Ducts Housed in Tunnels and trenches; and (4) Seismic Input Motion Applied at the Surface.

RAI 3.7-63

For Layered Soil Cases, Define the Seismic Response Spectra at the Surface; Define Basis for Selecting the Surface Spectra for Analysis of the Fire Water System Complex (FWSC); Define Corresponding FWSC-Related COL Applicant Action Items.

ACRS Subcommittee Presentation

ESBWR Design Certification Document Review

Section 3.7 – Seismic Design

Open Items

RAI 3.7-52

Provide Seismic Classification and Analysis Methodology for Each Concrete Tunnel and Trench

Describe Seismic Category I FPS Yard Piping, SC I Elec. Conduits/Duct Banks, and SC RW IIa Radwaste Piping Supported in the Tunnel and Trenches.

Define Seismic input Motion at the Surface, Consistent with the Single Envelope Design Response Spectrum Defined at the Bottom of the RB/FB Foundation

ACRS Subcommittee Presentation ESBWR Design Certification Document Review Section 3.7 – Seismic Design

Open Items

RAI 3.7-63

GEH needs to submit a comparison of (1) the surface spectra derived by placing the input motion at the bottom of the RB/FB foundation to (2) the surface spectra derived by placing the input motion at the bottom of the CB foundation, for each of the 4 SASSI layered soil cases.

GEH needs to (1) re-assess its method for selecting the surface spectra for seismic design of the FWSC; (2) provide the technical basis for its selection (including the basis for the selection of 1.35 amplification factor); and (3) identify the necessary COL applicant action items to ensure the seismic adequacy of the FWSC at each site.

ACRS Subcommittee Presentation

ESBWR Design Certification Document Review

Section 3.7 – Seismic Design

Open Items

RAI 3.7-63 (continued)

GEH can define any surface spectrum it chooses to, for design certification of the FWSC. COL applicants will need to demonstrate that the site-specific surface spectrum is enveloped by the spectrum GEH has used for design certification of the FWSC.

Otherwise, a site-specific analysis of the FWSC will be required at the COL stage. This will be in addition to the required comparisons at the RB/FB and CB foundation levels.

The surface spectra used for seismic analysis of the FWSC should envelope the 8 surface spectral plots that the staff has asked GEH to submit as a supplement to its RAI 3.7-63 response.



Presentation to the ACRS Subcommittee

ESBWR Design Certification Review
Chapter 3.8 – Seismic Category I Structures
Samir Chakrabarti – NRO/DE/SEB2

June 18, 2008

ACRS Subcommittee Presentation ESBWR Design Certification Review Section 3.8 – Seismic Category I Structures

Regulations and Regulatory Guidance

- GDC 1, 2, 4, 5, 16, and 50
- ASME Section III, Division 2, Subsection CC, “Code for Concrete Reactor Vessels and Containments”
- ASME Section III, Division 1, Subsection NE, “Class MC Components”
- Appendix B to 10 CFR Part 50, “Quality Assurance Criteria for Nuclear Power Plants and Fuel Reprocessing Plants”
- Regulatory Guides 1.94, 1.57, 1.136, 1.142, 1.143
- SRP 3.8.1, 3.8.2, 3.8.3, 3.8.4, and 3.8.5
- ACI 349, “Code Requirements for Nuclear Safety related Concrete Structures”
- ANSI/AISC N690, “Specification for Safety-Related Steel Structures for Nuclear Facilities”

ACRS Subcommittee Presentation

ESBWR Design Certification Review

Section 3.8 – Seismic Category I Structures

Review Highlights

- Performed four design audits to review design reports, review calculations, and discuss open issues
- Performed confirmatory analysis of nuclear island foundation base mat
- Majority of the review questions required additional technical information which resulted in significant enhancement of the DCD content
- Review addressed ESBWR design evolution
 - Structures added (e.g. FWSC)
 - Reclassification of turbine building

Review Status

- Substantial number of issues identified during review have been resolved
- Confirmatory Analysis completed
- 19 RAI's are still open
- Additional design audit planned for week of June 23, 2008 to discuss remaining open items

ACRS Subcommittee Presentation ESBWR Design Certification Review Section 3.8 – Seismic Category I Structures

Significant Open Items

RAI 3.8-107

In view of significant nonlinear behavior of containment structure due to thermal loading, the staff questioned the appropriateness of combining results from thermal analysis with the elastically calculated results for other loads by linear superposition. GEH response is being reviewed.

RAI 3.8-79

The staff requested GEH to demonstrate that there would be no unacceptable seismic interaction between seismic category I structures and adjacent non-safety structures, e.g., Turbine Building and Radwaste Building.

ACRS Subcommittee Presentation ESBWR Design Certification Review Section 3.8 – Seismic Category I Structures

Significant Open Items (continued)

RAI 3.8-94

The staff requested GEH to explain why the extremely large bearing capacities reported in the DCD are considered reasonable values which can be met at potential plant sites.

RAI 3.8-96

The staff requested GEH to explain some of the assumptions made for evaluation of sliding resistance of foundation, e.g., considering water pressure on only one side of foundation in resisting sliding, assumption of static coefficient of friction along with passive soil pressure, considering additional sliding resistance due to cohesion.

ACRS Subcommittee Presentation

ESBWR Design Certification Review

Section 3.8 – Seismic Category I Structures

Significant Open Items (continued)

RAI 3.8-120

GEH has recently proposed to use ASTM A-709 HPS 70W material for containment liner as an alternate to ASME SA-516, Gr.-70 which is not yet approved by ASME or endorsed by NRC. Additionally, the staff requested GEH to explain how this material with much higher yield strength affects the analysis and design of the containment.

ESBWR DCD Chapter 3

Sections 3.7-3.8

Seismic Design & Seismic Category I Structures

Advisory Committee
on Reactor Safeguards

Ai-Shen Liu

Clement Rajendra

Jeffrey Waal

June 18-19, 2008

GE Hitachi Nuclear Energy

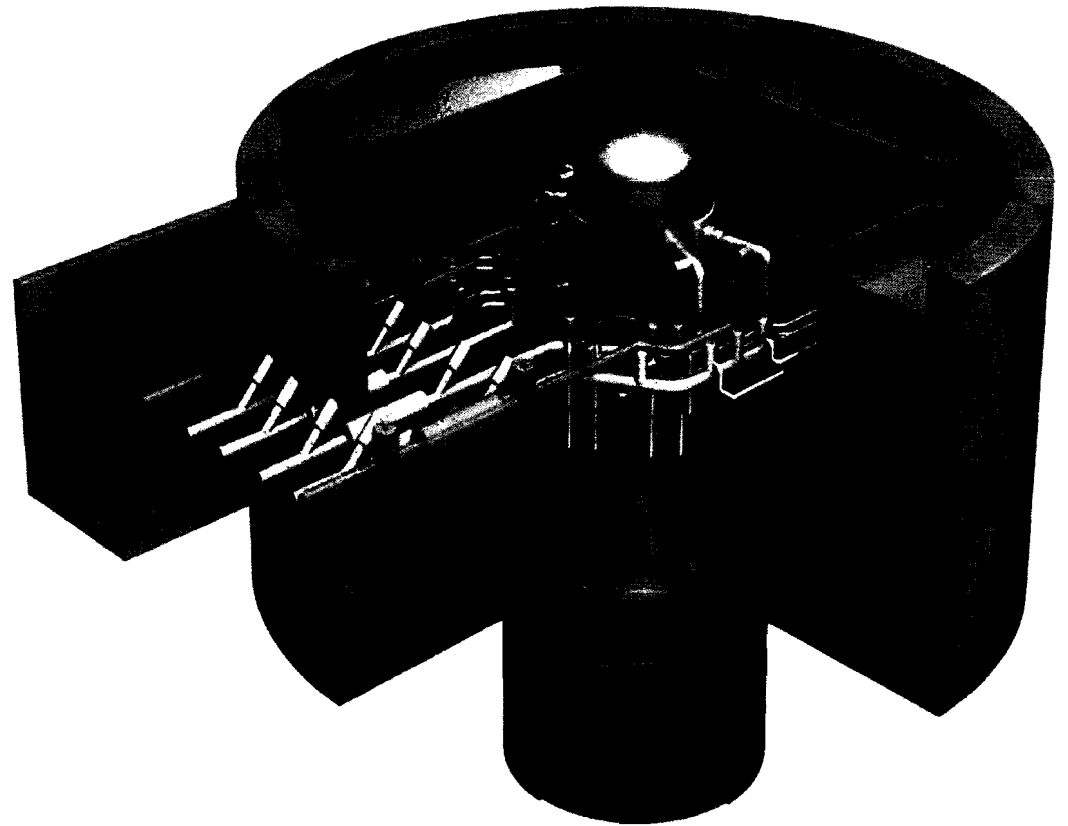

Presentation Content

- Chapter 3, Sections 3.7-3.8 Overview
- Section Descriptions
- Summary

Chapter 3, Sections 3.7 – 3.8 Overview

- Chapter 3 describes the design of structures, components, equipment and systems.
- Section 3.7 describes seismic analysis methods for designing structures, systems and components to withstand the effects of the Safe Shutdown Earthquake (SSE).
 - > The Certified Seismic Design Response Spectra (CSDRS) for the ESBWR Standard Plant is an envelope of RG 1.60 spectra and North ESP Anna site-specific spectra.
 - > The effects of Reactor Building vibrations caused by suppression pool dynamics are also considered in the Reactor Building complex design using methods applicable to seismic design.
 - > Seismic Category II structures are designed using the same methods of analysis and design as Seismic Category I structures, however, procurement, fabrication and construction are in accordance with industry practice.

Chapter 3, Sections 3.7 – 3.8 Overview

- Section 3.8 describes loads, loading combinations and Acceptance Criteria for designing Seismic Category I structures.
 - > The Seismic Category I structures include the Concrete Containment and internal structures, Reactor Building/Fuel Building, Control Building and Firewater Service Complex.

Section 3.7 – Seismic Design

- Section 3.7.1 provides seismic design parameters.
 - > The CSDRS follows RG 1.60 spectra and North Anna ESP site-specific spectra at high frequencies.
 - > North Anna spectra is representative of most severe rock sites in the Eastern US.
 - Note: No recorded seismic event contains simultaneously very high low-frequency and high-frequency motions. CSDRS is very conservative.
 - > Artificial time histories were developed to match the CSDRS spectra per NUREG/CR-6728 criteria.

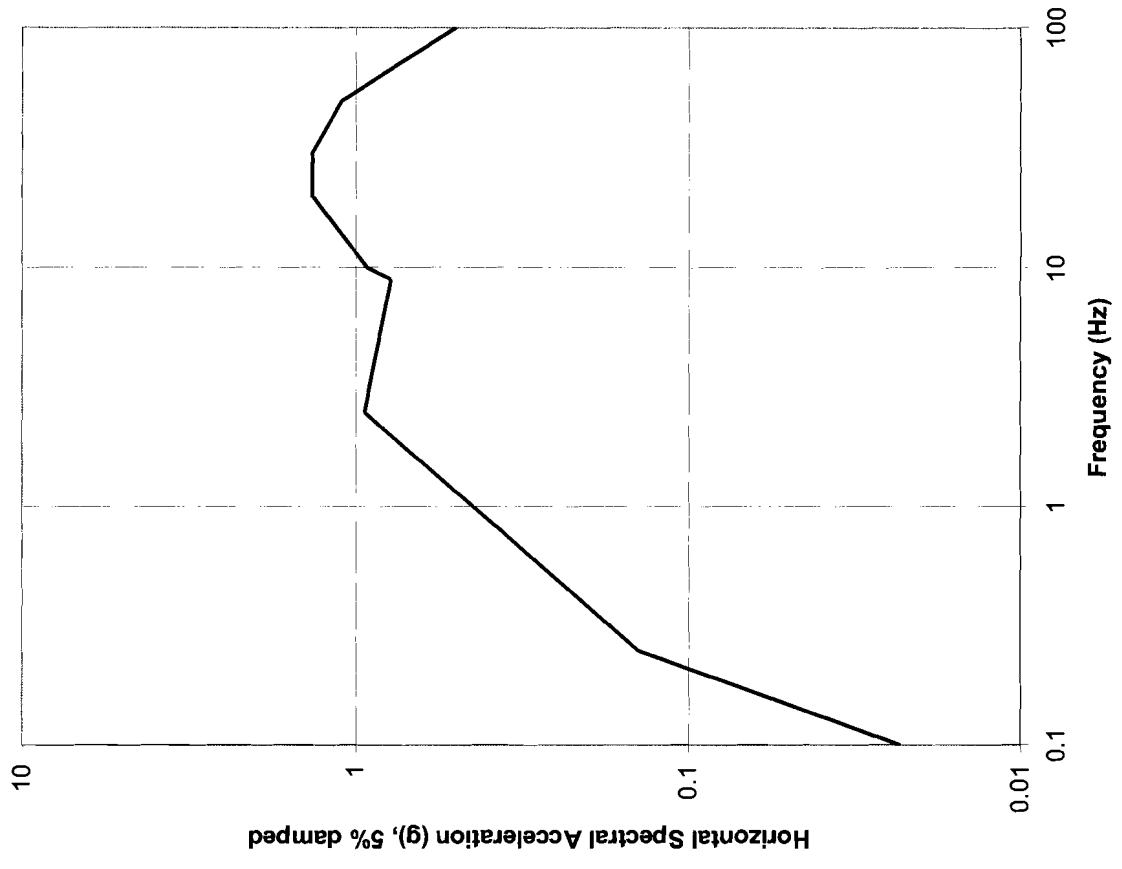

ESBWR Horizontal SSE Design Ground Spectra at Foundation Level

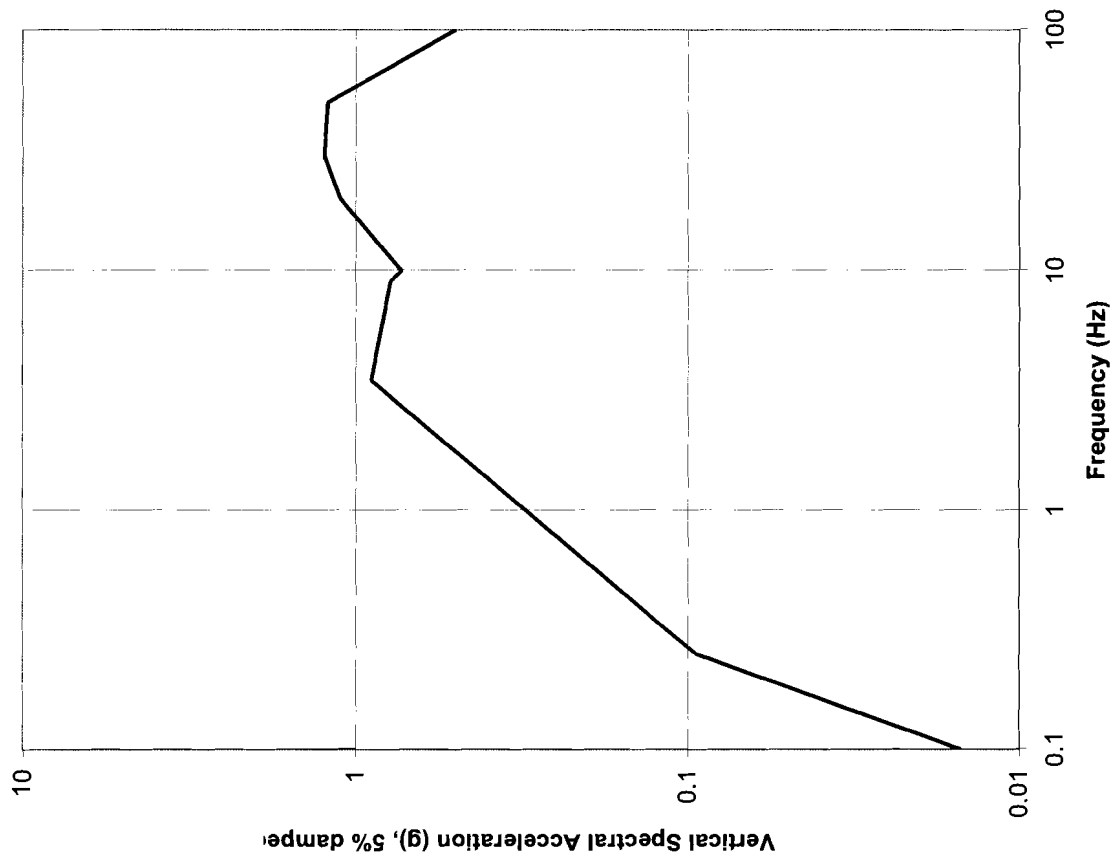

ESBWR Vertical SSE Design Ground Spectra at Foundation Level

Section 3.7 – Seismic Design

- Section 3.7.2 discusses seismic system analysis.
 - > Applies to Reactor Building, Fuel Building, Control Building and Firewater Service Complex.
 - > The Reactor Pressure Vessel is considered a part of the Reactor Building for the purpose of dynamic analysis.
 - > Lumped mass stick models are constructed of the structural systems for seismic response analysis of primary building structures. Adequacy of stick model is confirmed by a finite element model.
 - > Seismic soil-structure interaction analyses of Category I buildings are performed for a range of soil conditions and are presented in Appendix 3A.

Section 3.7 – Seismic Design

- The soils for uniform sites are represented by soil springs at base without embedment effect and SSI analysis performed using DAC3N computer code
- The soils for layered sites are represented by finite elements with embedment included and SSI analysis performed using SASSI2000 computer code.

Generic Site Properties for SSI Analysis

	Soft	Medium	Hard	Fixed Base
Shear wave velocity (m/s)	300	800	1700	>1700
Mass density (kg/m ³)	2000	2200	2500	NA
Poisson's ratio	0.478	0.40	0.35	NA
Material damping (%)	5	4	3	NA

Layered Site Cases

Layer	Shear Wave Velocity (m/s)-Depth (m)			
	CASE 1	CASE 2	CASE 3	CASE 4
Top	300/20	300/20	300/20	300/20
Middle	300/20	800/20	300/40	800/40
Bedrock	1700	1700	1700	1700

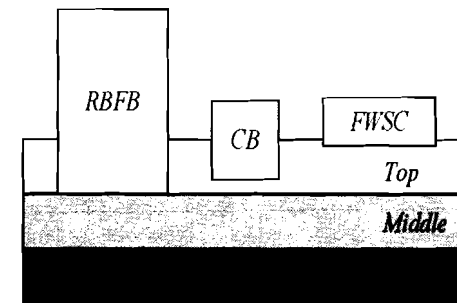

Section 3.7 – Seismic Design

- Section 3.7.3 discusses seismic subsystem analysis.
 - >Applies to Seismic Category I and II equipment and piping.
 - >Dynamic qualification can be performed by analysis, testing or a combination of both.
 - >Applicable methods of analysis are the same as those described in Section 3.7.2.
 - >Damping values are consistent with RG 1.61 Rev. 1.

Section 3.7 – Seismic Design

- Section 3.7.4 discusses seismic instrumentation.
 - >The seismic instrumentation program is consistent with RG 1.12.
 - >The procedures for plant response to earthquakes follow the guidelines of the Electric Power Research Institute (EPRI) reports NP-6695, NP-5930 and TR-100082, as permitted by RG 1.166 and RG 1.167.

Section 3.7 – Seismic Design

- Appendix 3A provides details of seismic soil-structure interaction analyses.
- Appendix 3F provides details of response of structures to containment loads.

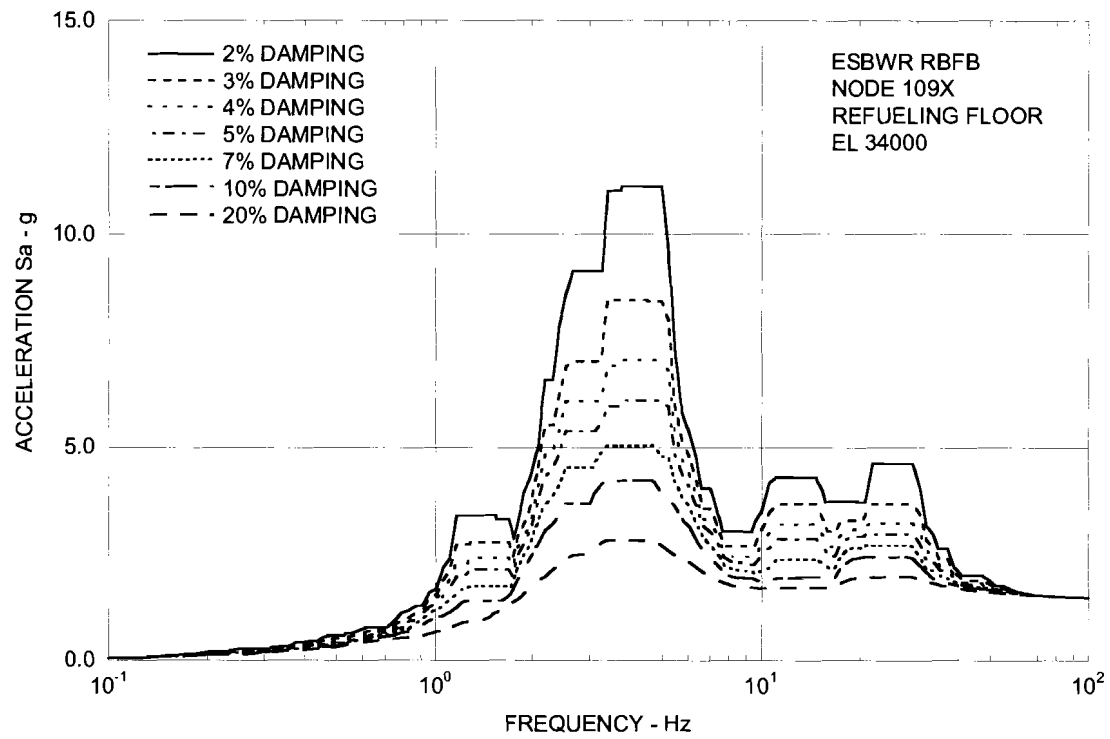

Enveloping Floor Response Spectra – RFBF Refueling Floor X

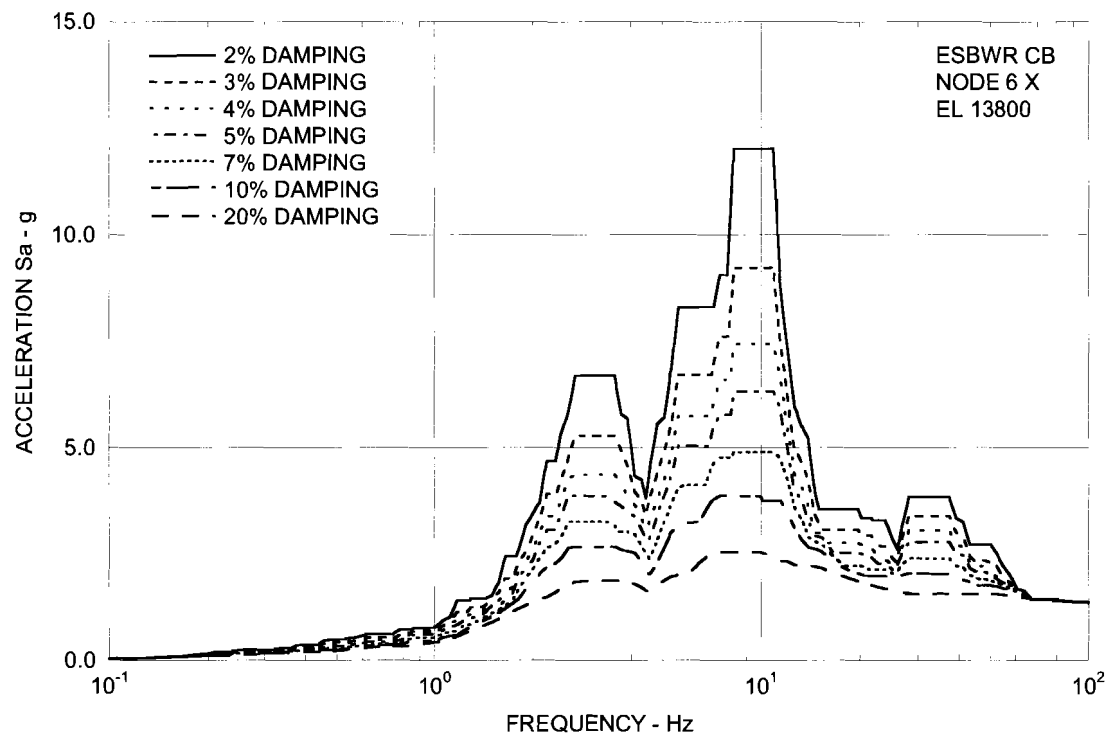

Enveloping Floor Response Spectra – CB Top X

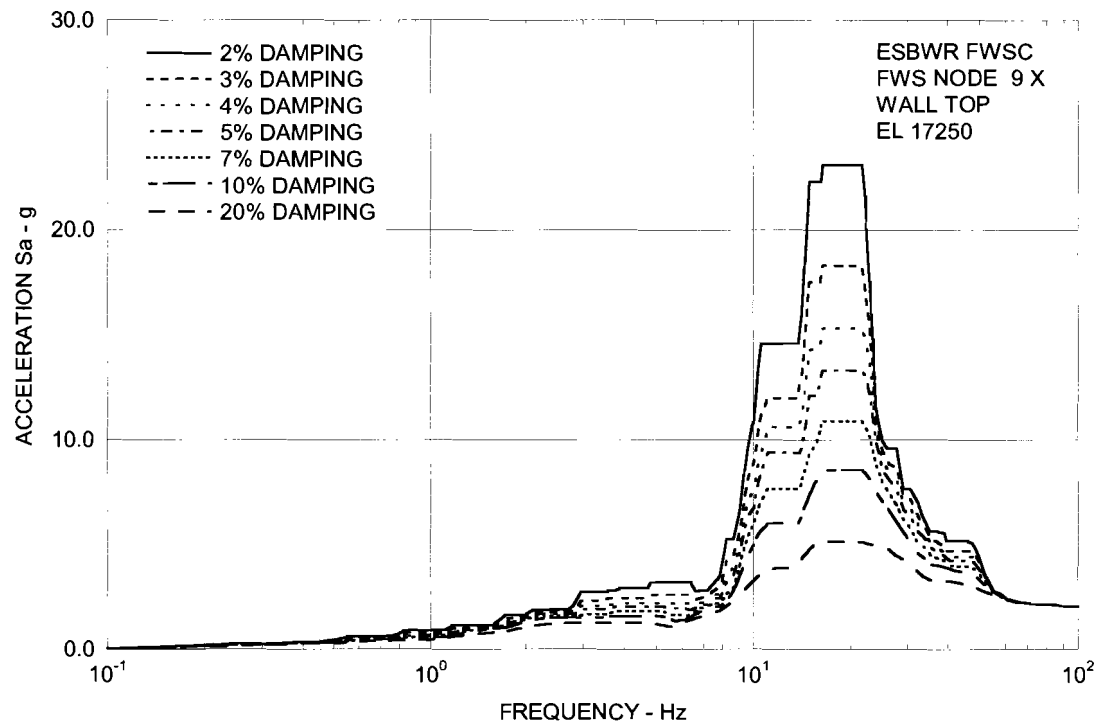

Enveloping Floor Response Spectra – FWS Wall Top X

Section 3.8 – Seismic Category I Structures

- Section 3.8.1 discusses the concrete containment.
 - > The reinforced concrete containment vessel houses the primary nuclear system and confines the potential release of radioactive material in the event of a LOCA.
 - > The containment structure is totally enclosed by and integral with the Reactor Building.
 - > Appendix 3G contains a detailed description of the containment and the analytical models, analysis methods and results.
 - > The concrete containment meets the requirements of Section III, Division 2 of the ASME Code.

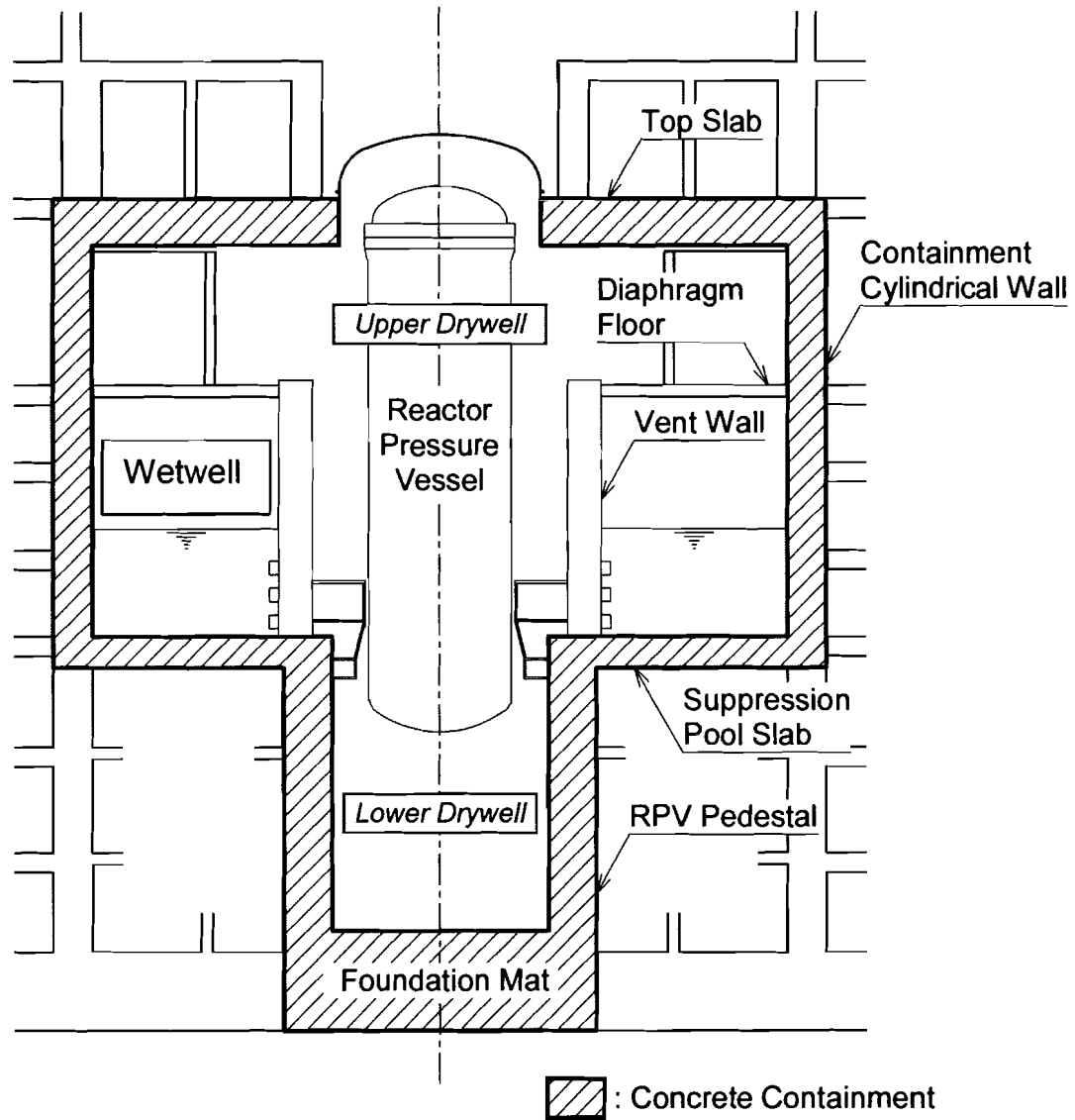

Configuration of Concrete Containment

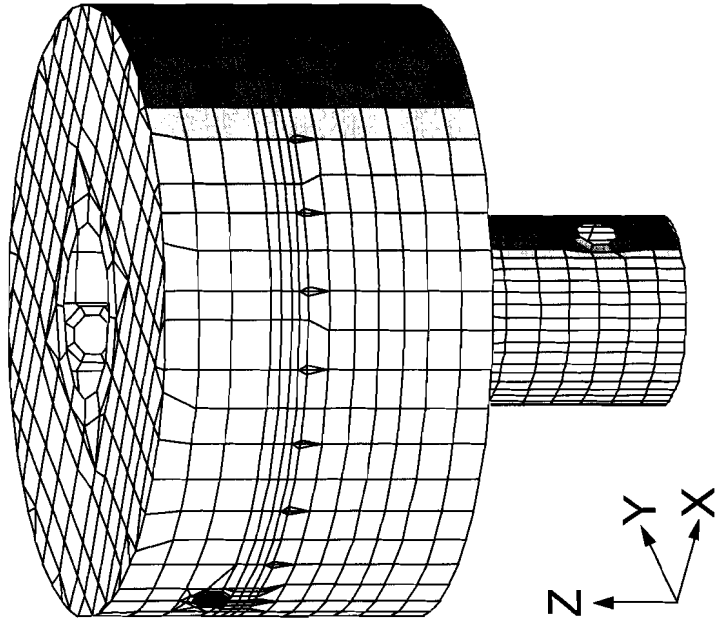

Finite Element Model of the Reinforced
Concrete Containment Vessel

Full View

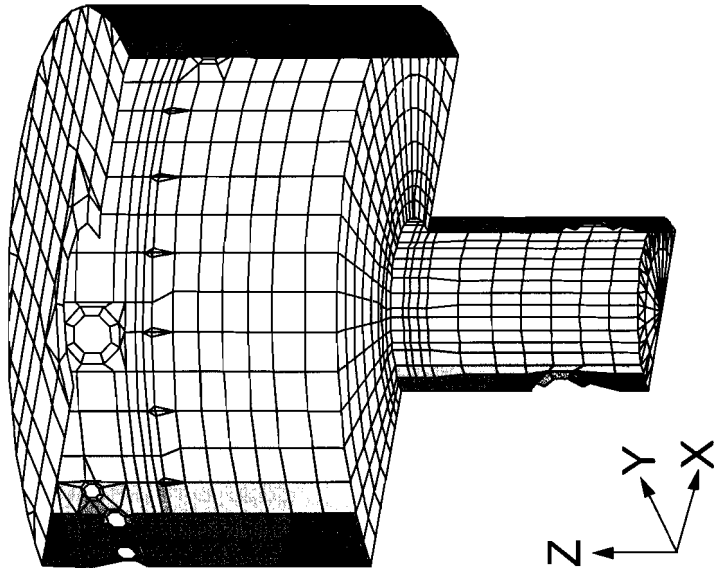

Finite Element Model of the Reinforced
Concrete Containment Vessel
Cut View

Section 3.8 – Seismic Category I Structures

- Section 3.8.2 discusses steel components of the reinforced concrete containment.
 - > Steel components of the concrete containment vessel include:
 - Personnel Air Locks
 - Equipment Hatches
 - Penetrations
 - Drywell Head
 - Passive Containment Cooling System Condenser
 - > The six PCCS Condensers form an integral part of the containment boundary.
 - > The steel components of the RCCV are designed in accordance with ASME Division 1 Subsection NE.

Section 3.8 – Seismic Category I Structures

- Section 3.8.3 discusses concrete and steel internal structures of the concrete containment.
 - > The containment internal structures include:
 - Diaphragm floor
 - Vent wall
 - Gravity Driven Cooling System pool walls
 - Reactor shield wall
 - RPV support brackets
 - Miscellaneous platforms

ESBWR Reactor Building Section B-B

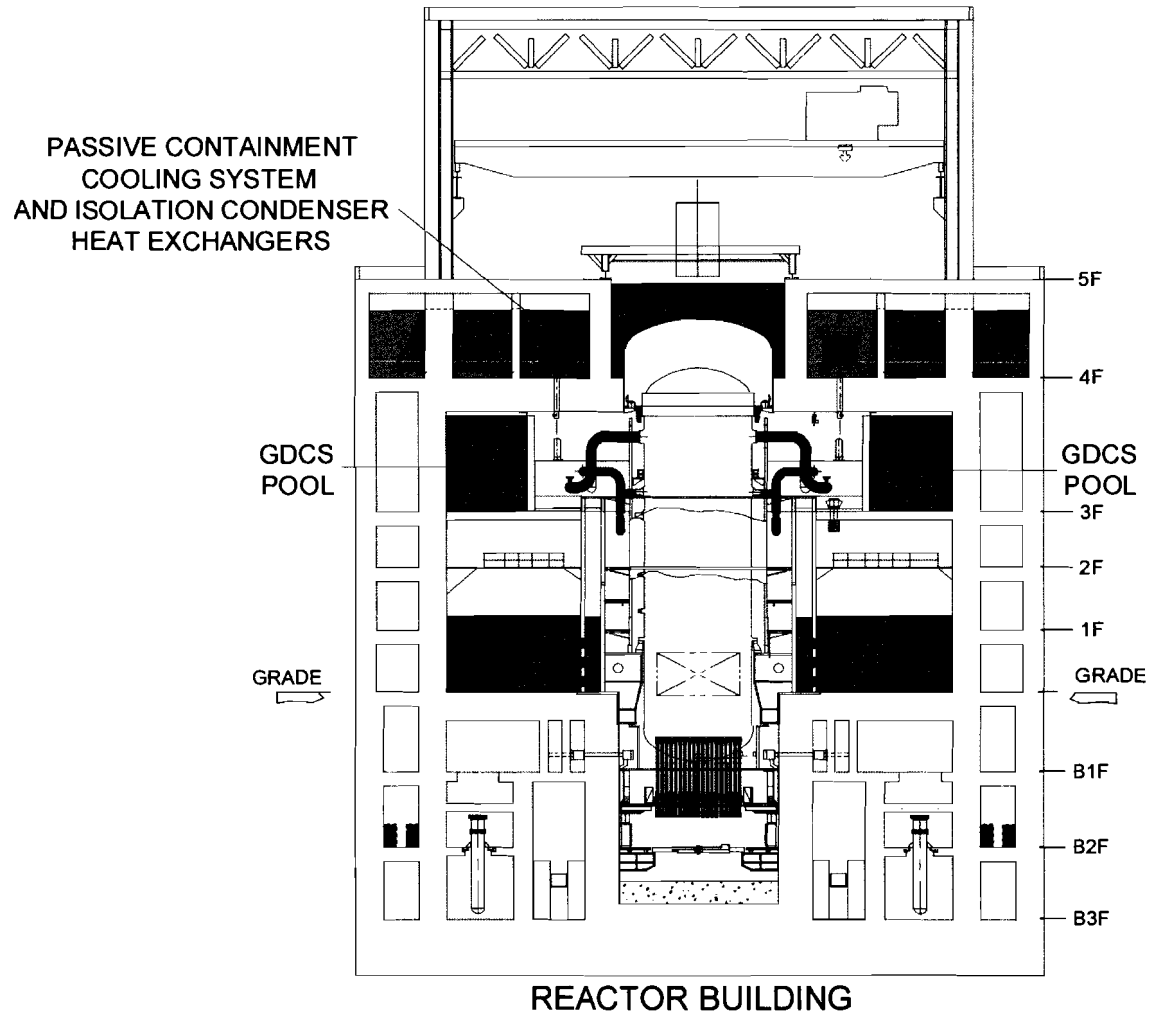

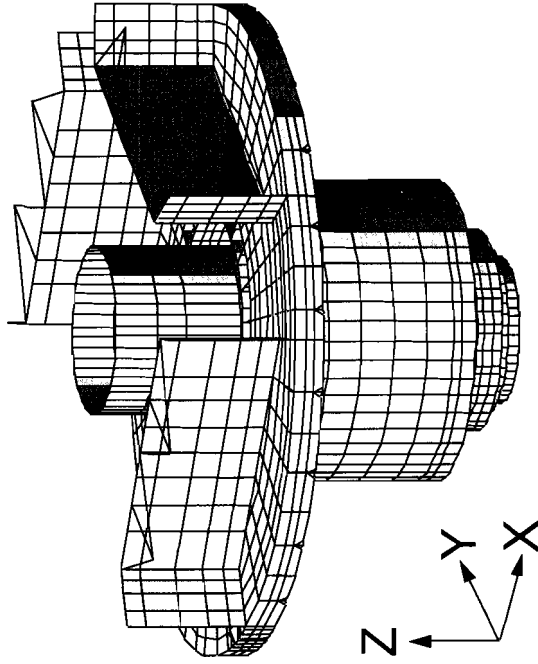

Finite Element Model
Containment Internal Structures
Full View

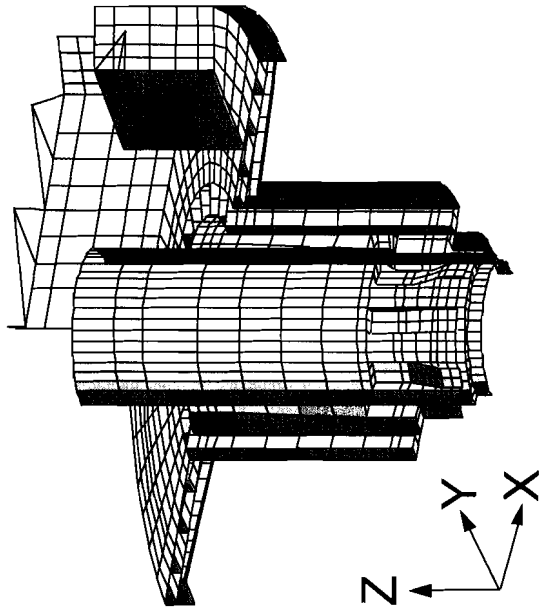

Finite Element Model
Containment Internal Structures
Cut View

Section 3.8 – Seismic Category I Structures

- Section 3.8.4 discusses other Seismic Category I structures.
 - > Other Seismic Category I structures are:
 - Reactor Building Structure/Fuel Building
 - Control Building
 - Firewater Service Complex
 - > Reactor Building and Fuel Building are integral to each other and founded on a common basemat.
 - > Design details and analysis results for the design of these structures are also included in Appendix 3G.

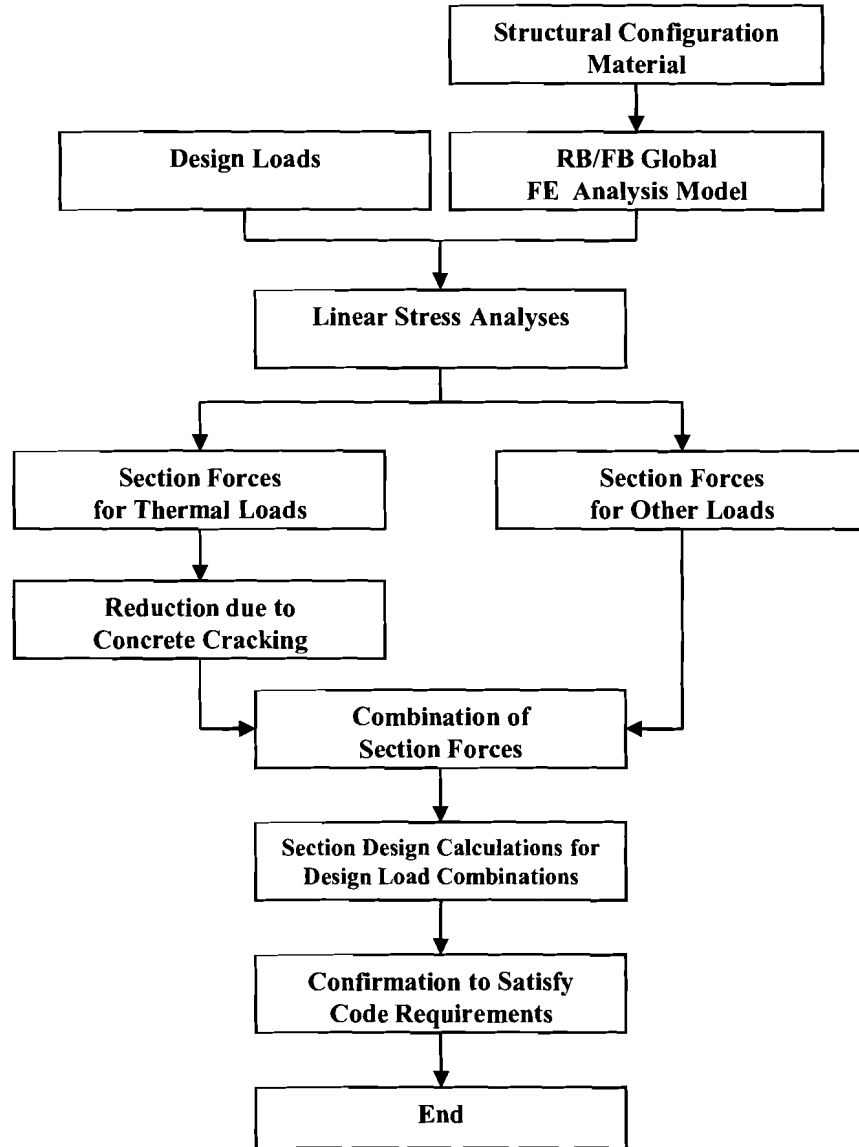

Flow Chart for Structural Analysis and Design

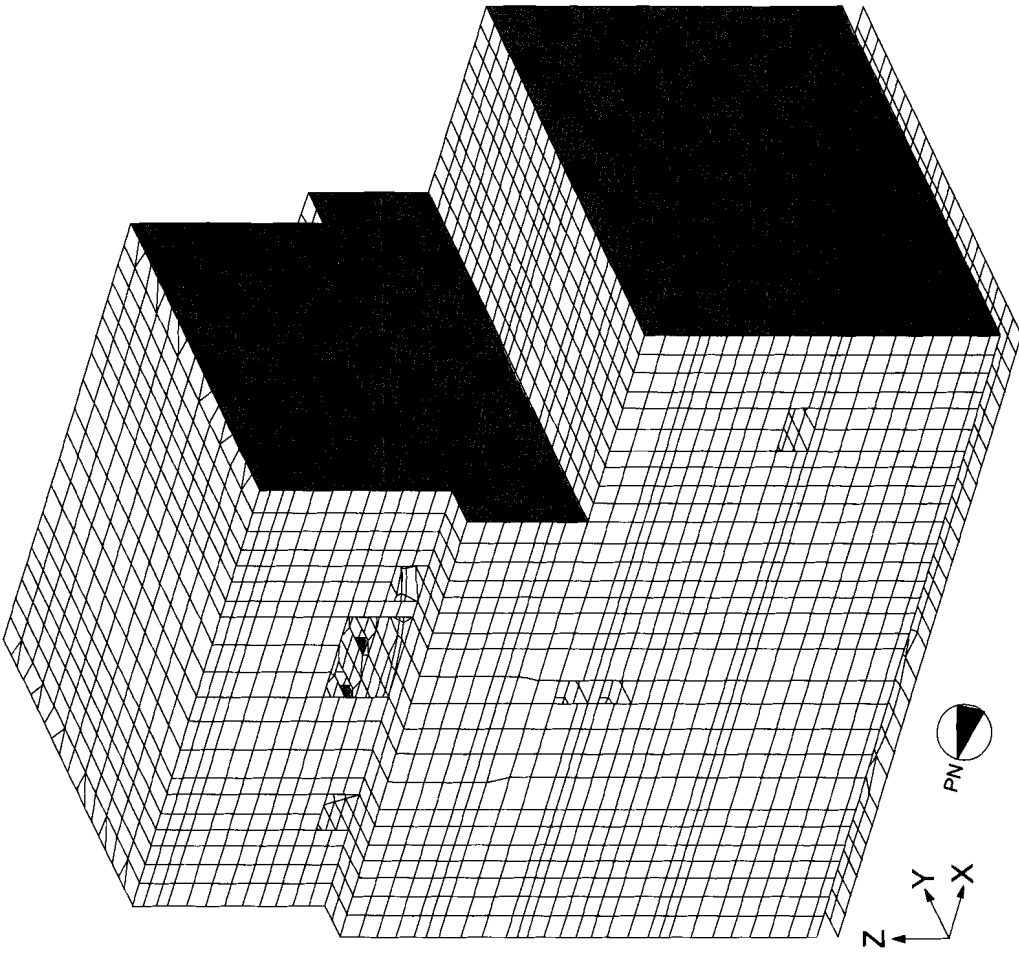

Finite Element Model of the RB/FB

Full View

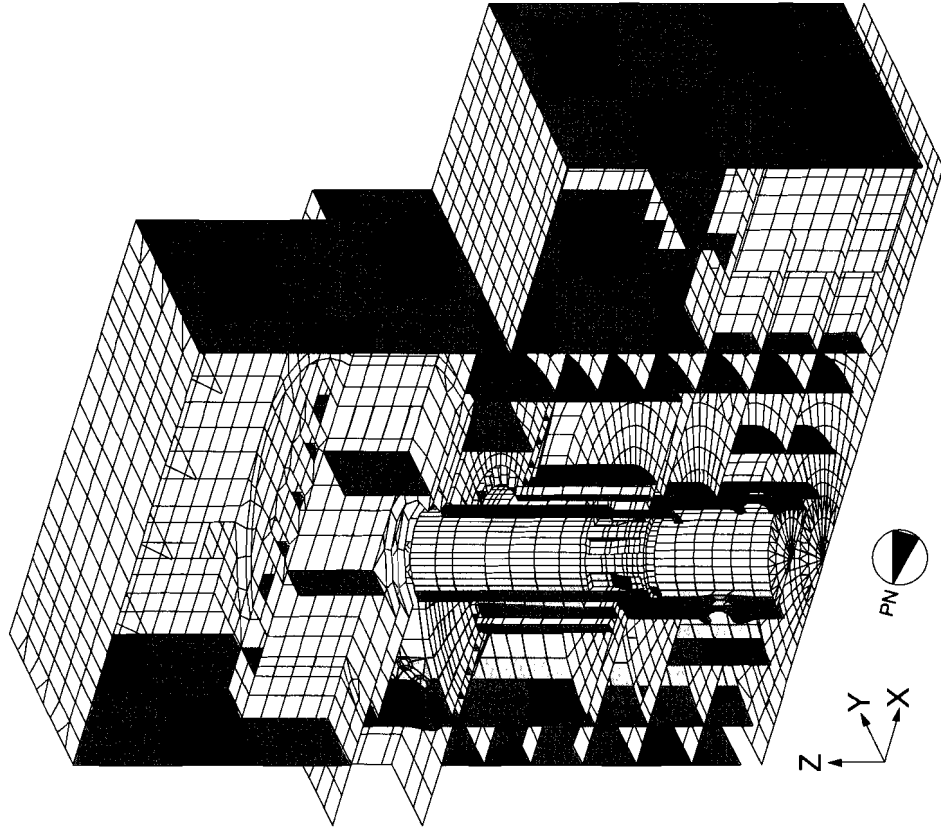

Finite Element Model of RB/FB

Cut View

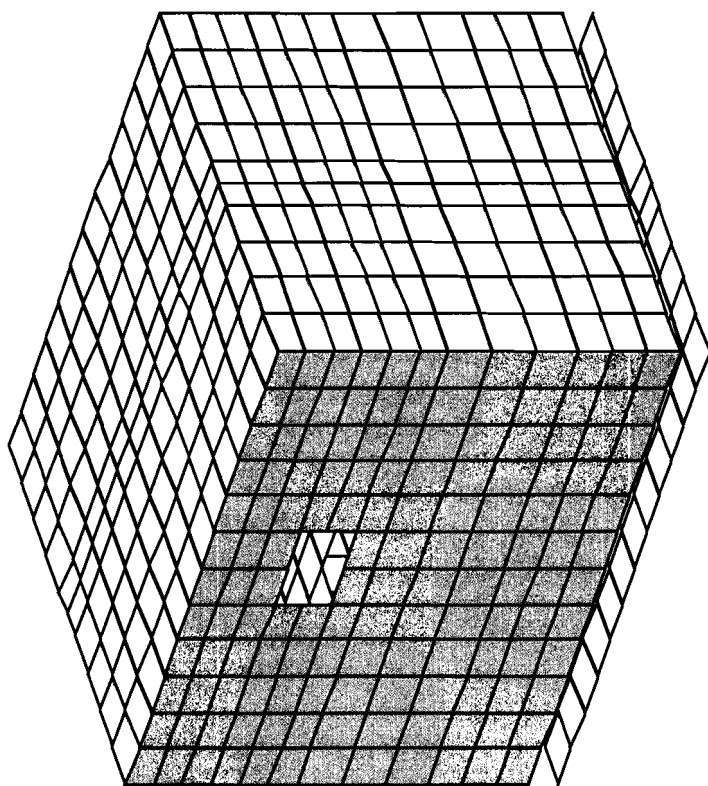

Finite Element Model of CB

Full View

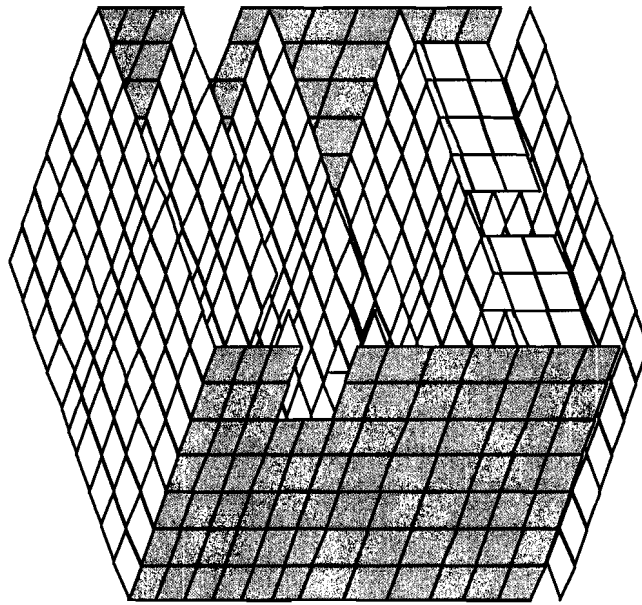

Finite Element Model of CB
Cut View

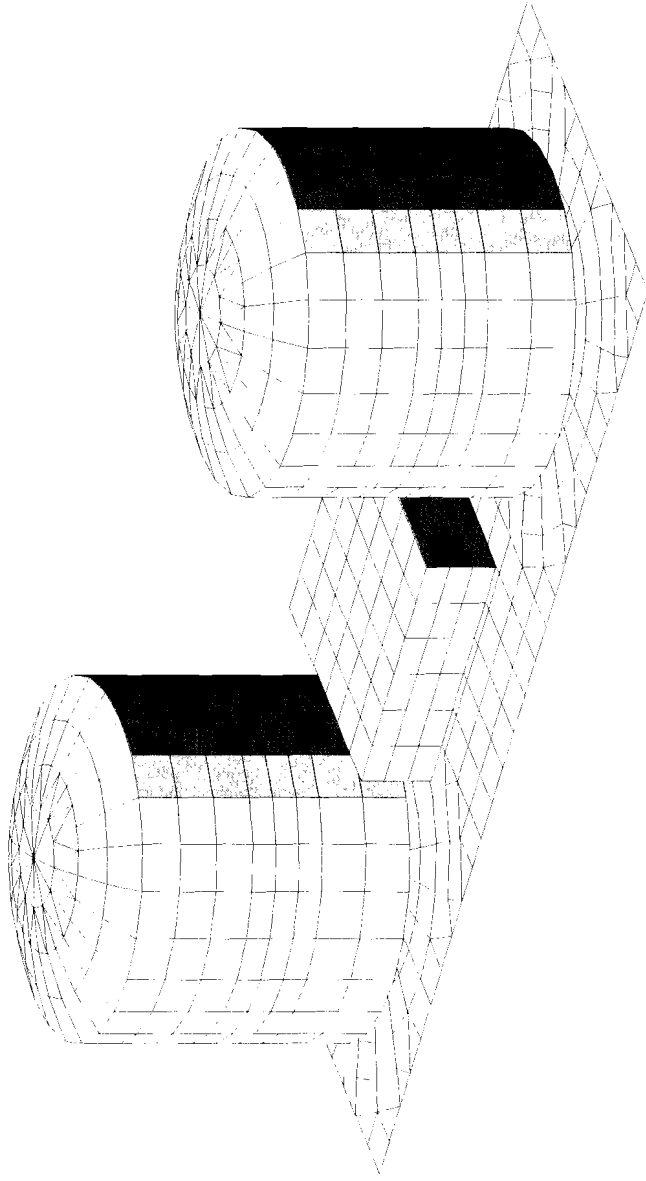

Finite Element Model of FWSC

Full View

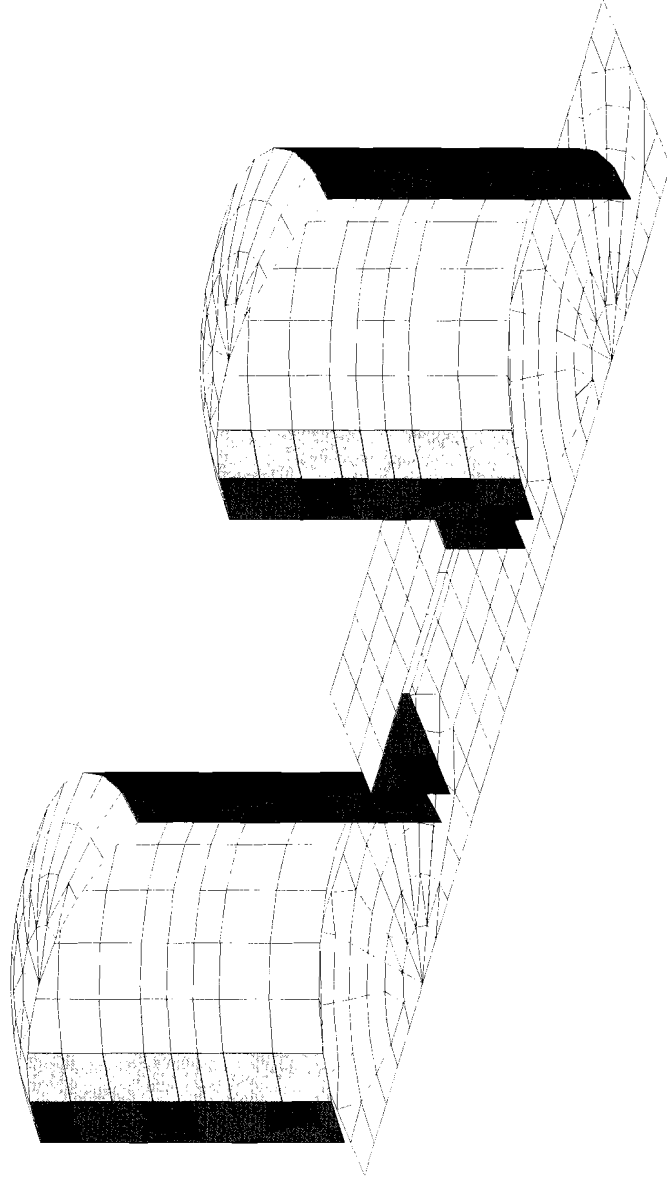

Finite Element Model of FWSC

Cut View

Section 3.8 – Seismic Category I Structures

- Section 3.8.5 discusses foundations.
 - > The Reactor Building, including the containment, and the Fuel Building are integral and built on a common foundation mat.
 - > The Control Building foundation is separate.
 - > The Firewater Service Complex foundation is also separate.
 - > Design details and analysis results for the foundations design and stability evaluations are included in Appendix 3G.

Summary

- Chapter 3, Sections 3.7 – 3.8 provide details of seismic analysis of the ESBWR and loads, loading combinations and acceptance criteria for the design of Seismic Category I structures.