

---

---

---

---

---

---

---

---



---

---

---

---

---

---

---

---

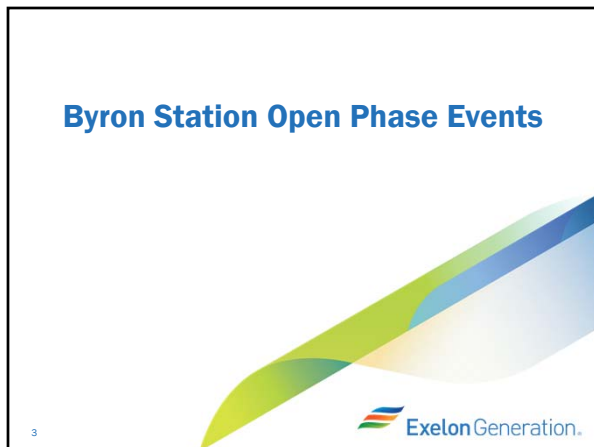

---

---

---

---

---

---

---

---

### Event Description

Unit 2	Unit 1
<ul style="list-style-type: none"><li>January 30, 2012</li><li>Mechanical failure of 345 kV under-hung porcelain insulator on system aux transformer (SAT) A-frame structure creating a line to ground fault on the SAT side</li><li>Open phase condition - protective relaying not designed to detect</li><li>Result was a reactor trip on reactor coolant pump (RCP) undervoltage</li><li>Loss of off-site power (LOOP) resulted</li><li>Unusual Event declared</li><li>Loss of all operating safety loads</li><li>Loss of RCP seal cooling for eight minutes</li><li>Manual operator action restored safety systems</li></ul>	<ul style="list-style-type: none"><li>February 28, 2012</li><li>Mechanical failure of under-hung porcelain insulator on SAT A-frame structure creating a line to ground fault on the system side</li><li>Protective relaying isolated the faulted component and transferred power to the alternate supply</li><li>Systems worked as designed and Byron station generating units remained on-line</li><li>LOOP resulted</li><li>Unusual Event declared</li></ul>

- Ohio Brass insulator manufacturing defect
- Design vulnerability - failure to automatically detect an open phase condition



---

---

---

---



---

---

---

---

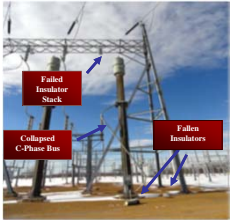
### Switchyard – Single Phase Insulator Failure

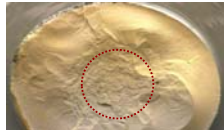
Unit 2	Unit 2 Failed Insulator
	
	

Insulator failure due to poor quality porcelain



---

---

---

---

---

---

---

---

## Design Vulnerability



---

---

---

---

---

---

---

---

**Design Vulnerability**

- Failure of Unit 2 'C' phase insulator resulted in an open circuit and voltage imbalance (high impedance ground on high side of SAT, open phase on the 345 kV side of disconnect)
  - Did not result in a fault that actuated the existing protective relay scheme
  - Voltage imbalance propagated through the SAT to the ESF buses
  - Degraded voltage relays did not initiate an EDG start signal because the relays sensed adequate voltage between 'A' and 'B' Phases (two out of two logic sensing voltage between phases)
- Plant was determined to be designed consistent with applicable regulatory requirements

7 

---

---

---

---

---

---

---

---

**Impact of Open Phase**

Grounded – Byron Unit 2

- Significant voltage imbalance due to ground
- 4.16 kV safety bus per unit (pu) voltage
  - Vab 1.0142 pu
  - Vbc 0.5912 pu
  - Vca 0.5870 pu

Ungrounded – Byron Unit 2 (Beaver Valley Scenario)

- 4.16 kV safety bus per unit voltage under light loading
  - Vab 1.0408 pu
  - Vbc 1.0407 pu
  - Vca 1.0180 pu
- Cannot detect by voltage magnitude

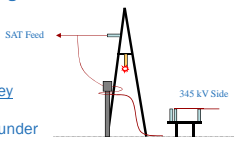

8 

---

---

---

---

---

---

---

---

**Licensing Bases**



9 

---

---

---

---

---

---

---

---

**Licensing Bases**

- Nuclear Plants were initially designed in accordance with General Design Criterion (GDC) -17 for offsite source adequacy (voltage protection) and the total loss of offsite power
- Industry operating experience identified design vulnerabilities for sustained degraded voltage – this resulted in installation of a second level of undervoltage protection
  - Information Notice 79-04
  - Generic Letter 79-36
  - Branch Technical Position (PSB-1 issued July 1981)

• Protective relaying scheme was not designed to detect open phase conditions  
• Open phase detection was not considered in the licensing process

---

10 

---

---

---

---

---

---

---

---

---

---

**Exelon Actions**



11 

---

---

---

---

---

---

---

---

---

---

**Exelon Actions**

Insulators

- Completed laboratory testing on Byron insulators
- Identified fleet scope of Ohio Brass insulators
- Performed walkdown inspections of fleet insulators
- Validated insulator preventative maintenance requirements
- Byron replaced high risk Ohio Brass insulators
- Developed risk matrix and replacement schedule for other fleet Ohio Brass insulators
- Continuing development of non-destructive technology to identify defects with insulators in service

---

12 

---

---

---

---

---

---

---

---

---

---

**Exelon Actions**

---

Design Vulnerability – Interim Actions

- Implemented compensatory measures for a LOCA coincident with this event (voltage imbalance) – Byron/Braidwood:
  - Assigned designated operators to take prompt action on indication of voltage imbalance
  - Implemented temporary changes to bus undervoltage annunciation logic to detect and alarm on phase imbalance
- Operability evaluations performed at remaining sites
  - Implemented appropriate compensatory measures based on evaluation of auxiliary power systems

---

13 

---

---

---

---

---

---

---

---

**Exelon Actions**

---

Design Solution

- Microprocessor based solution is being implemented
- Microprocessor solution requires development of unique digital relay algorithm
  - Algorithm for Wye-Wye wound transformers has been developed
  - Algorithm for Delta-Wye wound transformers under development (Limerick, Peach Bottom, Oyster Creek transformers)

---

14 

---

---

---

---

---

---

---

---

**Exelon Actions**

---

Design Solution (continued)

- Site specific Electromagnetic Transient Program (EMTP) modeling of electrical system used to establish relay settings
- Common digital relay procurement specification template developed
  - Digital relay technical requirements
  - Software quality assurance requirements
  - Cyber security requirements
- Site specific detailed designs required
- Exelon solutions are being shared with the industry

---

15 

---

---

---

---

---

---

---

---

### Exelon Actions – Byron Algorithm

- Developed for Schweitzer Engineering Laboratories (SEL) 451-5 relay
- Three detection algorithms:
  - Logic string 1 (L1): Open phase with ground if zero sequence current exceeds calculated value - limit set high enough to detect condition and low enough to prevent false actuation
  - Logic string 2 (L2): Single open phase without ground if one phase current falls to zero - security achieved by negative sequence and zero sequence current limits to block trip function for downstream faults
  - Logic string 3 (L3): Two open phases without ground if two phase currents fall to zero
- Short time delay used to coordinate with transmission system protection
- Positive sequence current limit established for L2 and L3 - security for extreme grid imbalance
- Trip output blocked if phase current is below detection capability or if relay diagnostic alarm asserts

16



---

---

---

---

---

---

---

---

---

---

### Exelon Actions – Byron Algorithm

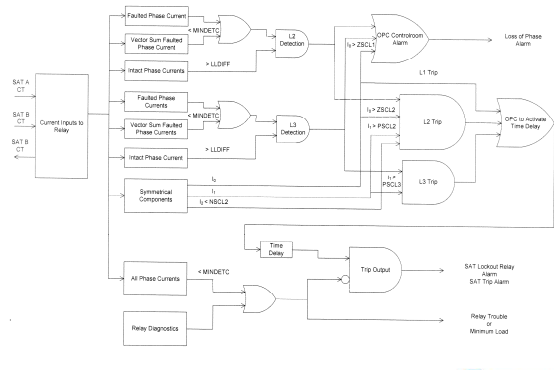

17



---

---

---

---

---

---

---

---

---

---

### Exelon Actions – Byron Relay



18

---

---

---

---

---

---

---

---

---

---



---

---

---

---

---

---

---

---

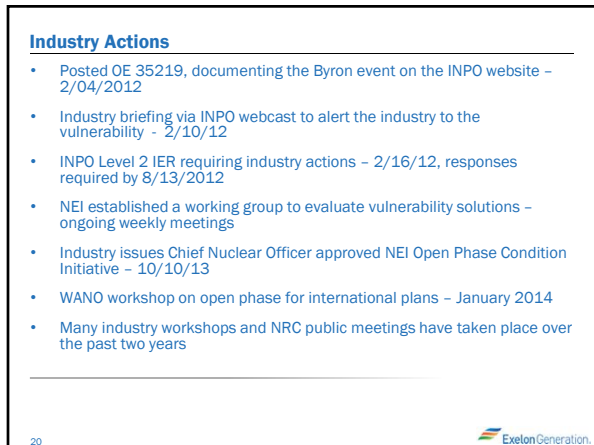

---

---

---

---

---

---

---

---



---

---

---

---

---

---

---

---

**Open Phase Condition Initiative - Goal**

An open phase condition (OPC) will not prevent functioning of important-to-safety structures, systems and components. An open phase condition is defined as an open phase, with or without a ground, which is located on the high voltage side of a transformer connecting a General Design Criterion (GDC) 17 off-site power circuit to the transmission system.

Notes:

1. The OPC initiative only applies to "active" safety features plants
2. The initiative includes requirements to address two open phases (based on the Forsmark event)
3. The initiative allows use of non-safety related circuits – technology is currently not available to allow use of safety related detection equipment

22 

---

---

---

---

---

---

---

---

**OPC Initiative Key Milestones – Operating Plants**

1. December 31, 2014 - Demonstration of compliance with the open phase condition criteria through analysis or identify appropriate actions required to demonstrate compliance.
2. December 31, 2016 - Implementation of design changes, if necessary, to comply with the open phase condition criteria. The "active" actuation features of new technology designs may be installed in a monitoring mode, with adequate justification, to demonstrate reliability.
3. December 31, 2017- If a monitoring period was deemed necessary, completion of any design adjustments identified during the monitoring period and enabling all "active" actuation features needed to demonstrate compliance with the open phase condition criteria.
4. UFSAR Updates - Completion in conjunction with the timelines noted above, but no later than December 31, 2017.

23 

---

---

---

---

---

---

---

---

**OPC Initiative Milestones – Operating Plants**

5. Technical Specification Updates - Submitted by December 31, 2017, if required. If a Technical Specification Task Force (TSTF) Traveler is available, submitted within six months of issuance of a Nuclear Regulatory Commission (NRC) approved TSTF Traveler.

**This schedule assumes License Amendments are not required to install any design changes.**

24 

---

---

---

---

---

---

---

---



**OPC Initiative Milestones – New Reactors**

1. Construction and Operating License (COL) Licensees – Complete design changes and plant modifications, as needed, prior to fuel load.
2. COL Applicants – Describe design features in the Final Safety Analysis Report (FSAR), if change to certified design is required.
3. Design Centers – Provide design features in the Design Control Document / FSAR.

25



---

---

---

---

---

---

---

---