

## RIC 2007: Advanced Reactor Designs

Eric P. Loewen Ph.D

### Advanced Reactors: NUREG-1368 Applicability to Global Nuclear Energy Partnership

March 15, 2007

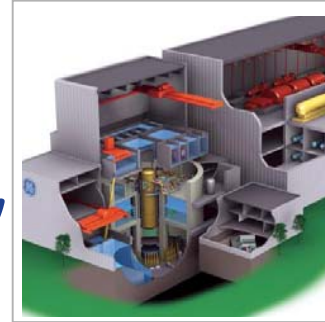
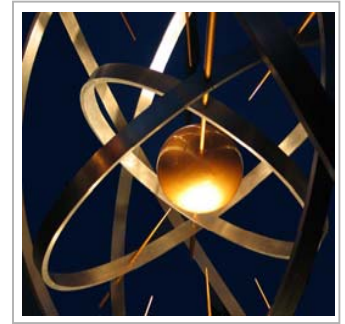
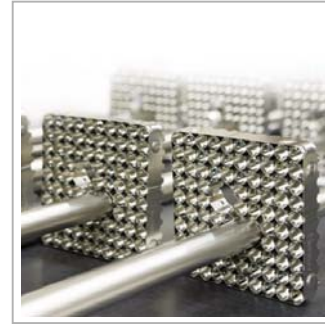

# Advanced Recycling Center (ARC)

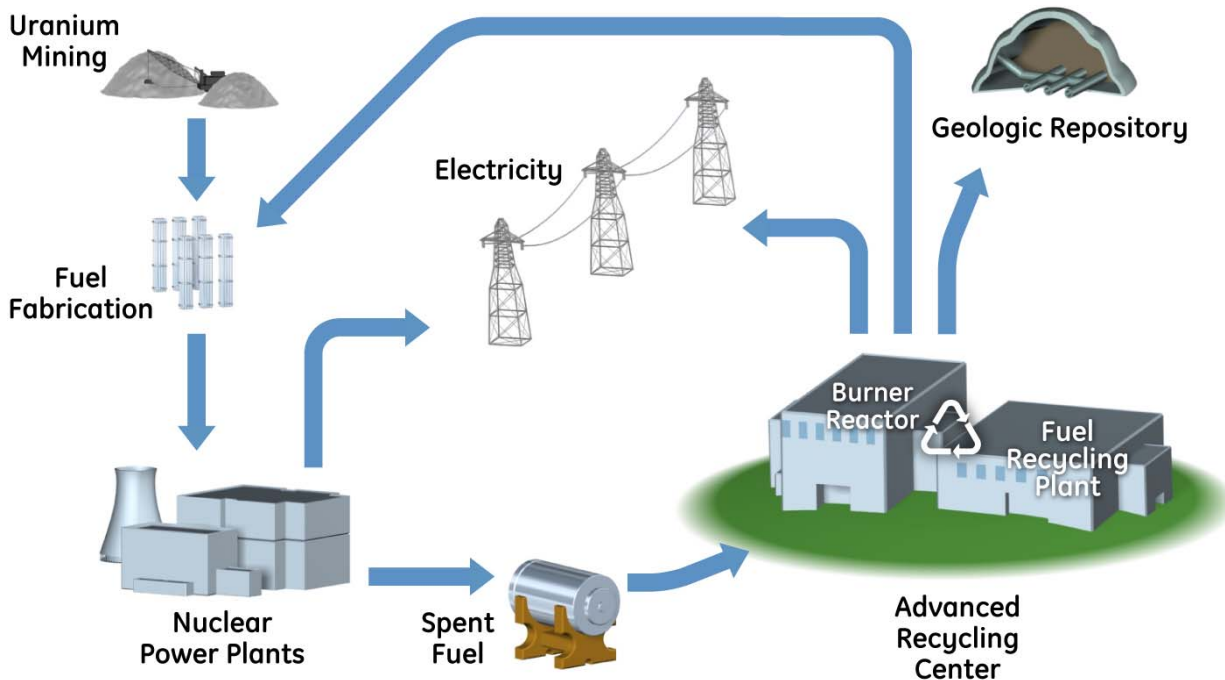

## The Advanced Recycling Center...

- Integrated ABR (PRISM) and CFTC (ER)
- Separates LWR SNF
- Fabricates ABR TRU fuel
- Converts TRU to SL isotopes
- Produces electricity & other products

## Advantages...

- Closes the fuel cycle
- Available technology
- Safe and economical
- Modular and scalable
- Proliferation resistant
- Previous USG R&D investment

## Advanced Burner Reactor

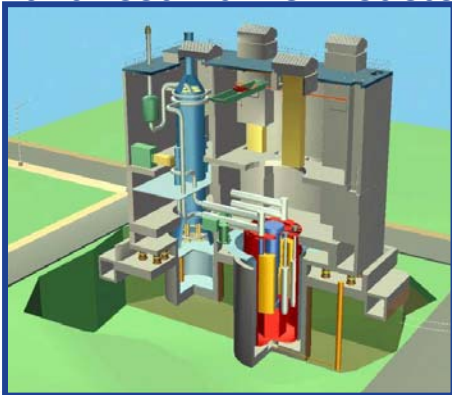

# ARC Technology Solution

## PRISM

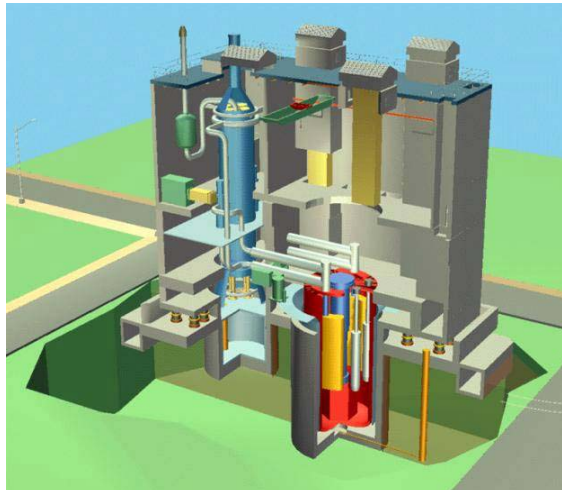

- + 840 MWth & 311 MWe
- + Na cooled fast reactor
- + Passive safety
- + Modular/scalable
- + Factory built
- + Flexible fuel cycle (broad input composition)
- + Metal or oxide fuel (metal pref.)
- + Extensive component testing

## Electro Refining

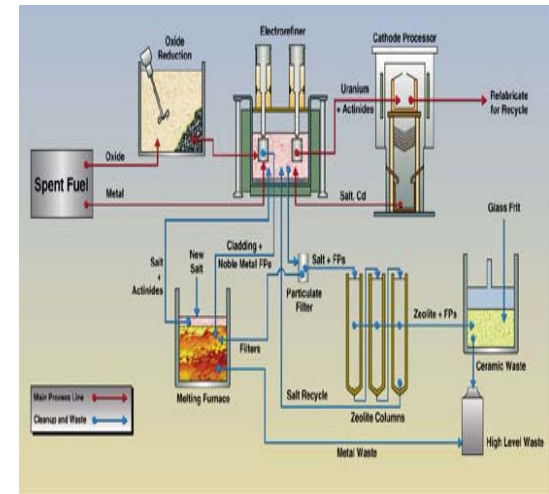

- + Modular/scalable
- + Sized to support ABR
- + Proliferation resistant
- + Removal of volatile FP through voloxidation
- + Continuous or batch process
- + Extensive testing in the U.S., Russia, Japan, and Korea
- + Used by industrial refiners

# Recycling Reactor ... PRISM

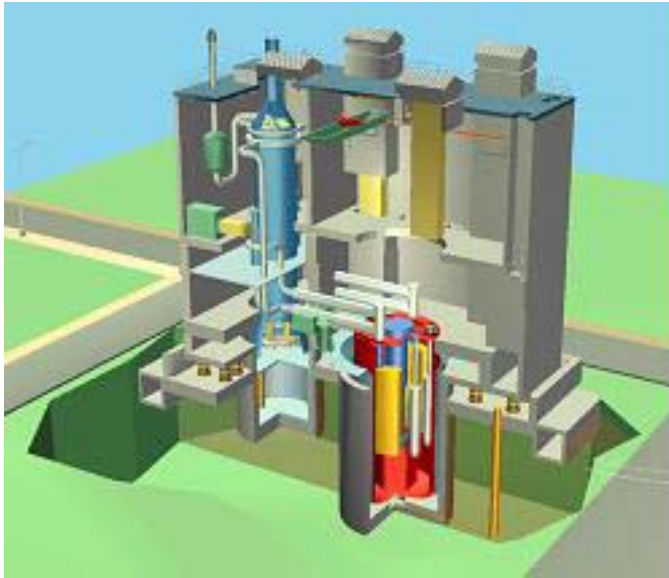

## ✓ Advanced Conceptual Design

- Already paid for by USG
- Available today
- Spent fuel is an energy asset

## ✓ Nuclear Regulatory Commission

- No obvious impediments to licensing

1981-1984  
GE Program

GE funded

1985-1987  
PRISM

DOE funded \$30M

1988  
PRDA

DOE funded \$5M

1989-1995  
ALMR

DOE funded \$42M

1995-2002  
S-PRISM

GE Funded

2007-2014



# NRC's NUREG-1368 Concluded

- No obvious impediments to licensing the PRISM (ALMR) design have been identified
- There are eight design features that deviated from LWRs
  - accident evaluation
  - calculation of source term
  - containment
  - emergency planning
  - staffing
  - heat removal
  - positive void
  - control room design





# PRISM ... Optimized for Metal Fuel

## Metal Core Advantages ...

- ✓ Fuel is denser and has a harder neutron spectrum
- ✓ Compatible with coolant, RBCB demonstrated at EBR-II
- ✓ Axial blankets are not required for break even core
- ✓ High thermal conductivity (low fuel temp.)
- ✓ Lower Doppler and harder spectrum reduce the need for GEMs for ULOF (6 versus 18)

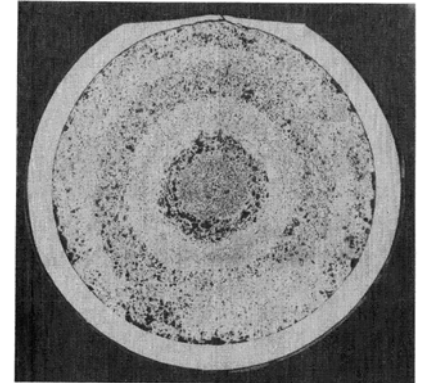

RBCB Test of Metal Fuel with 12% Burnup (ANL)

## Electro-Refining ...

- ✓ Diversion resistant
- ✓ Compact
- ✓ Less complex
- ✓ Fewer waste streams than conventional aqueous (PUREX) process

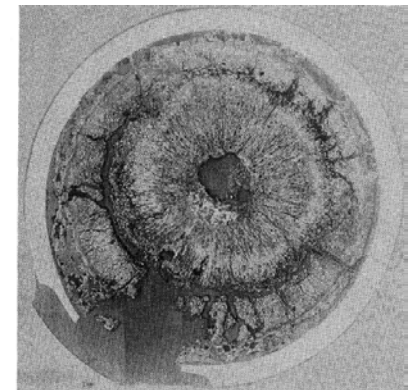

RBCB Test of Oxide Fuel with 9% Burnup (ANL)

# Size: LWR vs. FR

## 1600 MWt Sodium Cooled Fast Reactor

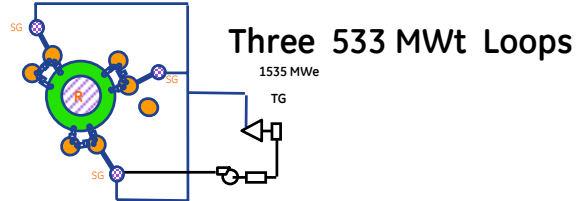

## 3600 MWt FR

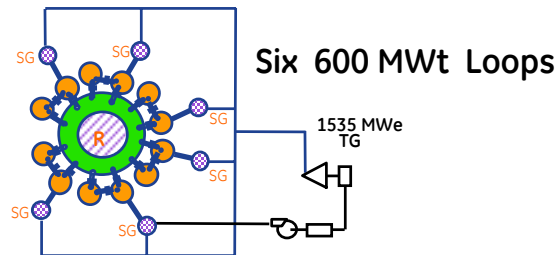

Rating Limited by:  
IHTS Piping: < 1 m diameter

## 1600 MWt Light Water Cooled Reactor

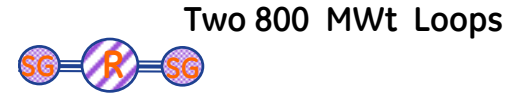

## 3600 MWt PWR

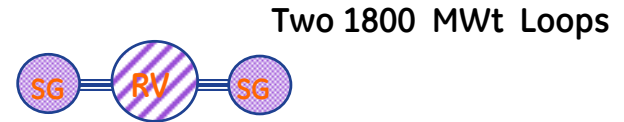

Two Loops Viable Because:  
Specific heat of water 5 x sodium  
at operating temperatures

- The complexity and availability of a PWR is essentially constant with size
- Due to the lower specific heat of sodium, six or more loops are required in a large FR.

**The Economy of Scale is Much Larger for LWRs than FBRs**

# PRISM Reactor Vessel Auxiliary Cooling System

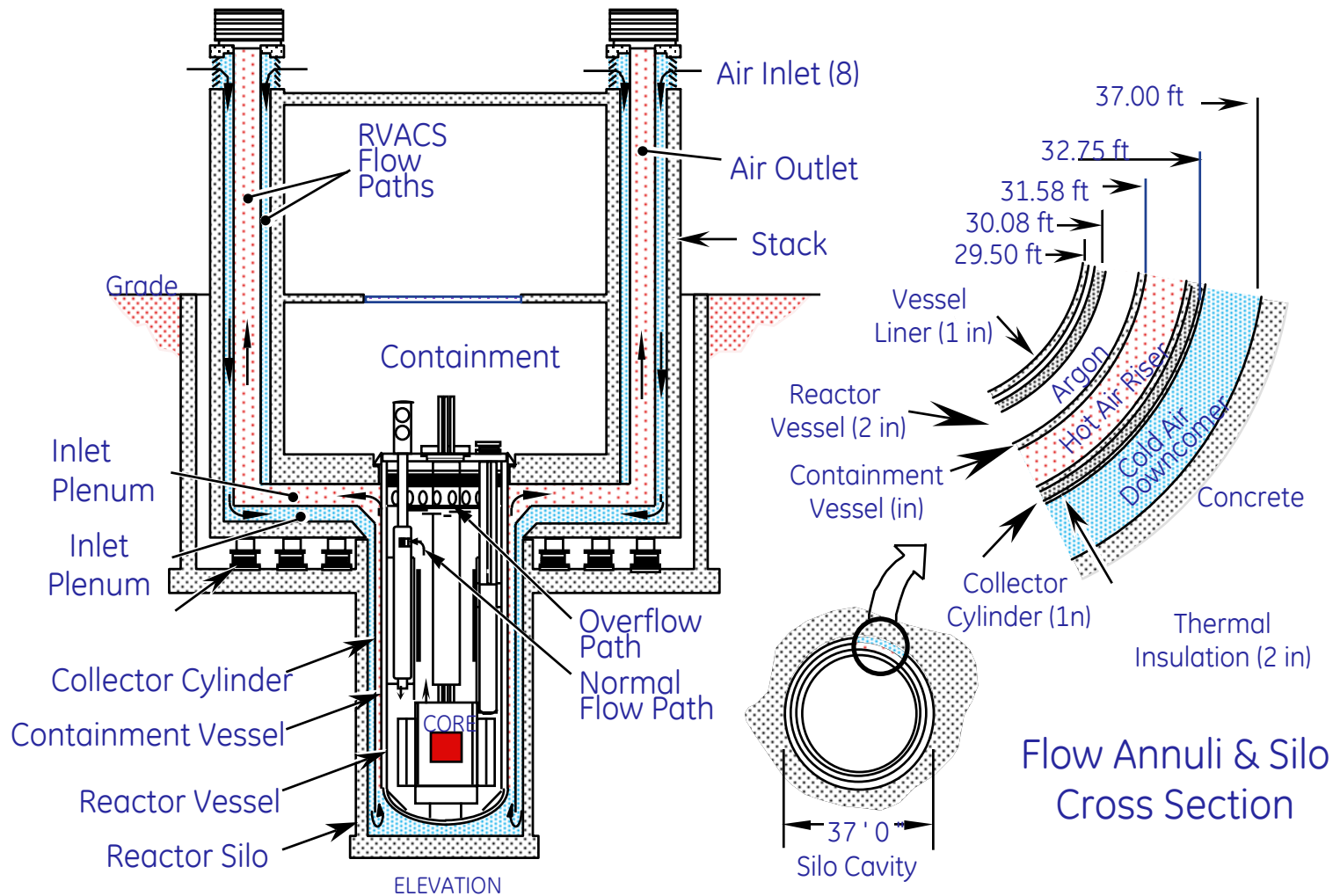

imagination at work



# High Level ARC Deployment and Licensing Plan

2006

2008

Construction

Domestic  
Deployment

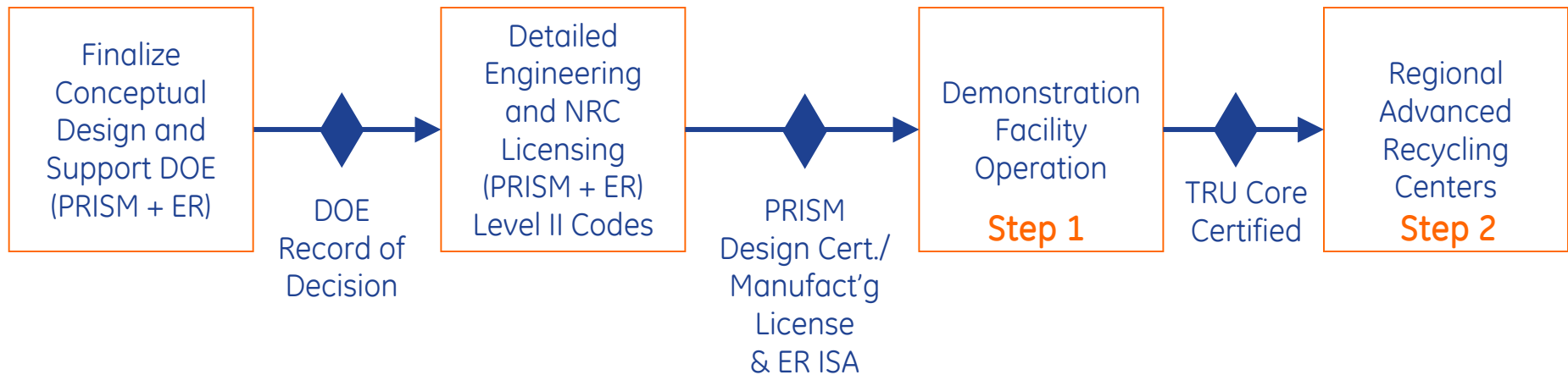

## NRC License options

### Step 1:

- Prototype technology and safety demonstration Part 50/52

### Step 2:

- Part 52 Standard Design Certification (specific site)
- Part 52 Manufacturing License
  - PRISM modules manufactured by GE,
  - CL applicants reference and purchase "off the shelf"

# PRISM Design Approach

## Simple Conservative Design

- Passive decay heat removal
- Passive accommodation of ATWS Events
- Automated safety grade actions

## Simplified O&M

- Safety grade envelope confined to NSSS
- Simple compact primary system boundary
- Low personnel radiation exposure levels

## Reduced Capital and Investment Risk

- Factory fabrication of standard certified design
- Modular Construction and seismic isolation

## Minimized Required R&D

- Low Temperature
- Small and Simple System Configuration

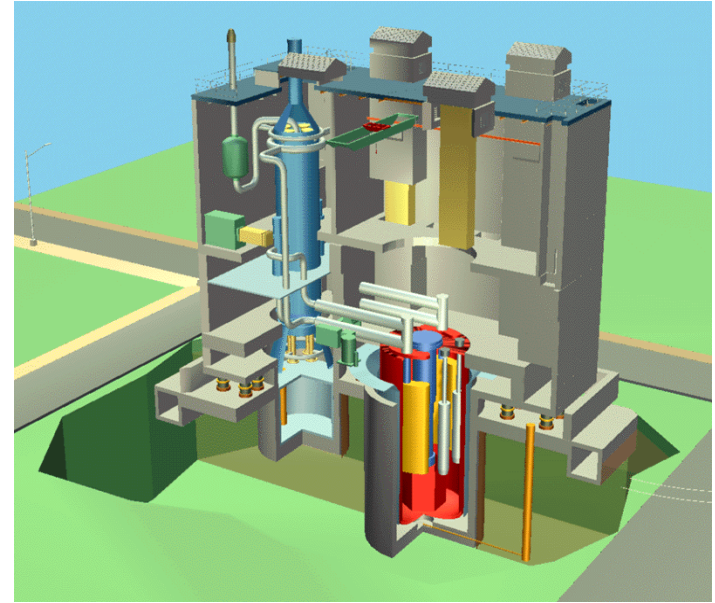

# GE's GNEP Integrated Solution

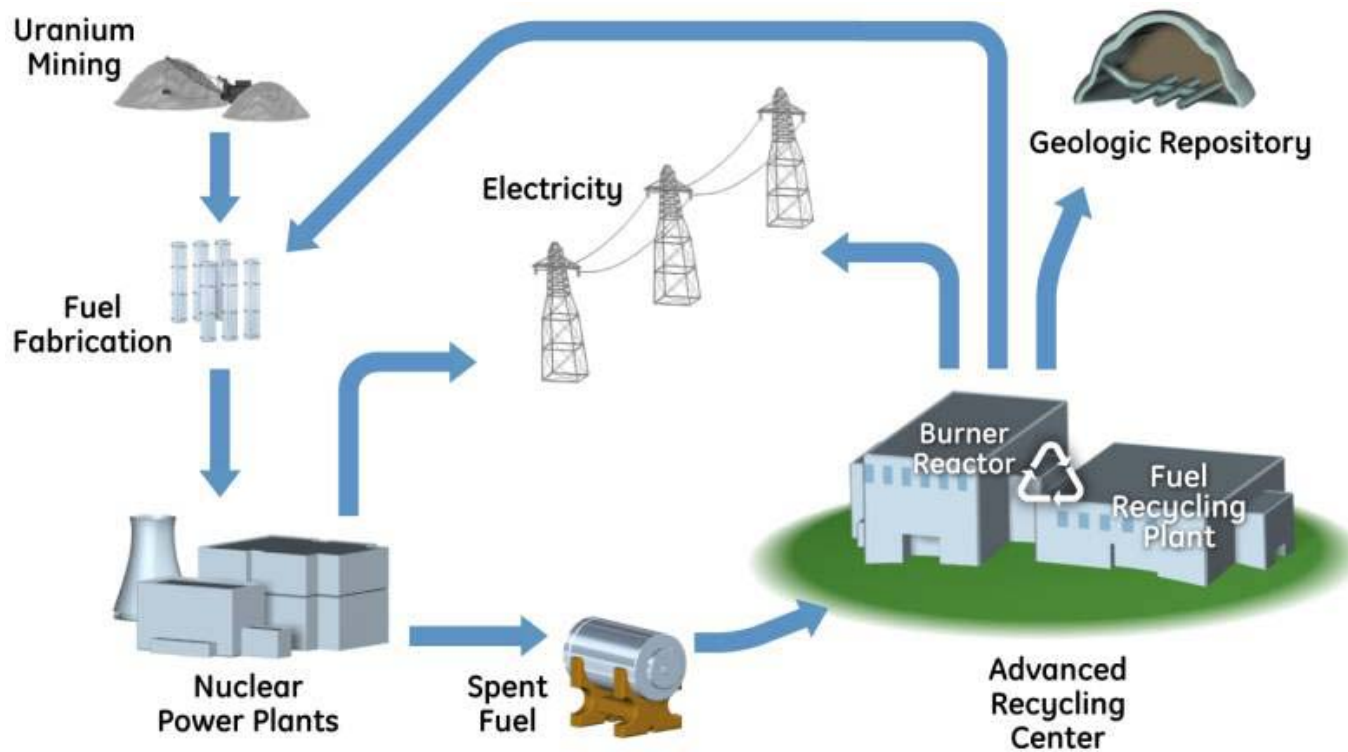

## PRISM...

- Simple Operation
- Highly Reliable and Passively Safe
- Simplified Operations and Maintenance
- Modular/Scalable Deployment

## GE's Approach...

- Integrated solution
- Available technology
- Excellent site for deployment