

LICENSING REPORT

on

The HI-STORE CIS FACILITY

by

**Holtec International
Holtec Technology Campus
One Holtec Blvd
Camden, NJ 08104, USA
(holtecinternational.com)**

**USNRC Docket # 72-1051
Holtec Project 5025
Holtec Report # HI-2167374**

Safety Category: Safety Significant

NOTICE OF PROPRIETARY & COPYRIGHTED STATUS

This document is a copyrighted intellectual property of Holtec International. All rights reserved. Proprietary information in this document is highlighted by gray shading. Excerpting any part of this document, except for public domain citations included herein, by any person or entity except the USNRC, a Holtec User Group (HUG) member company, or a foreign regulatory authority with jurisdiction over a Holtec owned or a Holtec client owned nuclear facility without an unambiguous written consent from Holtec International is unlawful.

GLOSSARY OF TERMS USED IN HI-STORE CIS FACILITY

LICENSING REPORT

Accident Condition Storage Temperature is the maximum 24 hour- average of the ambient temperature at an ISFSI site. The accident condition temperature serves as the input air temperature for a cask system to compute the accident condition peak cladding temperature for which a regulatory limit is specified in ISG11 Rev 3.

AFR is an acronym for Away from Reactor storage.

Ageing Management Program (AMP), outlined in Chapter 18, is a carefully crafted collection of processes and procedures deemed to be necessary for an effective monitoring, inspection, testing and recovery/remediation plan for the ISFSI to ensure safe operation for its entire Service life.

ALARA is an acronym for As Low- As –Reasonably- Achievable

Ambient Temperature for Short Term Operations (operations involving use of a transport cask, a Lifting device and/ or a on-site transport device) is defined as the 72 hour average of the local temperature as forecast by the National Weather Service.

Ancillary or Ancillary Equipment is the generic name of a device used to carry out “Short Term Operations.

Bulk Average Temperature is the spatially integrated average of temperatures of an entire component volume.

BWR is an acronym for Boiling Water Reactor.

Canister means an all-welded vessel containing used fuel that has been qualified to serve as a confinement boundary under the rules of 10CFR 72. The terms MPC, DSC, etc., are also used to indicate a seal-welded spent fuel canister.

Canister Transfer Facility (CTF) is a below-grade placement location where the transport cask is temporarily placed to effectuate vertical canister transfer between the transport cask and the HI-TRAC CS.

Canister Transfer means transfer operations necessary to translocate a loaded canister between a transport cask, HI-TRAC CS and/or the HI-STORM UMAX storage system.

Cask Crane is the crane installed in the Cask Transfer Building for heavy load handling activities

Cask Receiving Area is the physical location where loaded casks are received. Consists of a vehicle entrance, vehicle parking area, VCT access port, cask and cask appurtenance lifting apparatus, cask tilting apparatus, location for storage of cask transport appurtenances (e.g., personnel barrier, impact limiters, etc.), location for cask lid removal and installation, location for transfer of the cask to the VCT, cask inspection and work area. The cask receiving area may be partially or completely enclosed.

HOLTEC INTERNATIONAL COPYRIGHTED MATERIAL	
Report No. HI-2167374	Proposed Rev. 0R
i	

Cask Transfer Building (CTB) means the **reinforced concrete structure** that houses the Canister Transfer Facility (CTF) and the cask receiving area and provides storage space for ancillary equipment used in short term operations.

Cavity Enclosure Container (CEC) means a thick-walled cylindrical steel weldment that defines the storage cavity in HI-STORM UMAX for the storage of the canister.

CG is an acronym for the center- of- gravity.

Closure Lid means the METCON lid that is installed on the CEC to provide physical and shielding protection to the stored canister.

Commercial Spent Fuel (CSF) refers to nuclear fuel used to produce energy in a commercial nuclear power plant.

Confinement Boundary means the outline formed by the cylindrical enclosure of the canister shell welded to a solid baseplate, and at least one top lid to create a hermetically sealed enclosure.

Confinement System means the canister which encloses and confines the spent nuclear fuel during storage.

Container Flange means the ring flange that is welded to the upper extremity of the Container Shell.

Container Shell means the cylindrical portion of the Cavity Enclosure Container

Controlled Area means that area immediately surrounding the ISFSI over which the HI-STORE Facility owner (Holtec) exercises authority over its use and within which **ISFSI** Operations are performed.

Controlled Low-Strength Material (CLSM) is a self-compacted, cementitious material used primarily as a backfill in place of compacted fill. Many terms are currently used to describe this material, such as flowable fill, unshrinkable fill, controlled density fill, flowable mortar, flowable fly ash, fly ash slurry, plastic soil-cement and soil-cement slurry (ACI 229R-99). CLSM and lean concrete are also referred to as “*Self-hardening Engineered Subgrade (SES)*”

Cooling Time (or post-irradiation cooling time) for a spent fuel assembly is the time elapsed after its discharge from the reactor to the time it is loaded into the canister.

Critical Characteristic means a feature of a SSC that is necessary for the proper safety function of the SSC. Critical characteristics of a material are those attributes that have been identified, in the associated material specification, as necessary to render the material’s intended function.

CTB Crane is the device used in conjunction with special lifting devices that perform elements of the cask lifting operations in the Cask Receiving Area

Design Basis Earthquake (DBE) is the seismic input applicable to the cask’s long term storage on the ISFSI pad.

Design Basis Load (DBL) is a loading defined in this SAR to *bound* one or more events that are applicable to the storage system during its service life. Thus, the snow pressure loading on the cask’s lid specified in this SAR is a DBL because it is set substantially above the pressure from

HOLTEC INTERNATIONAL COPYRIGHTED MATERIAL	
Report No. HI-2167374	Proposed Rev. 0R
ii	

accumulated snow set down in the national consensus standard for the 48 contiguous United States.

Design Basis Missile (DBM) is the applicable missiles used to evaluate the safety of the storage system

Design Extended Condition Earthquake (DECE) is a beyond design basis seismic input that exceeds the 10,000 year return earthquake at the site.

Design Heat Load or Design Basis Heat Load is the computed heat rejection capacity of the HI-STORM system with a certified canister loaded with CSF stored in uniform storage with the ambient at the normal temperature and the peak cladding temperature (PCT) at 400°C. The Design Heat Load is less than the thermal capacity of the system by a suitable margin that reflects the conservatism in the system thermal analysis..

Design Life is the minimum duration for which the SSC or Facility is engineered to perform its intended function set forth in this SAR, if operated and maintained in accordance with this document.

Design Report is a document prepared, reviewed and QA validated in accordance with the provisions of 10CFR72 Subpart G. The Design Report shall demonstrate compliance with the requirements set forth in the Design Specification. A Design Report is mandatory for systems, structures, and components (SCCs) designated as Important to Safety. This SAR serves as the Design Report for the HI-STORE Facility.

Design Specification is a document prepared in accordance with the quality assurance requirements of 10CFR72 Subpart G to provide a complete set of design criteria and functional requirements for a system, structure, or component or Facility intended to be used in the operation, of the HI-STORE CIS Facility. This document serves as the Design Specification for the HI-STORE CIS Facility.

Divider Shell means a cylindrical shell bearing insulation over most of its inner or outer surface that divides the annular space between the canister and the CEC shell into two discrete regions for down- flow and up-flow of air in the HI-STORM UMAX VVM.

Dry Cask Storage System (DCSS) is a system that stores spent fuel or high level waste in a dry condition.

Enclosure Vessel means the pressure vessel defined by the cylindrical shell, baseplate, top lid and associated welds that provides confinement for the helium gas contained within the canister. The Enclosure Vessel (EV) and the fuel basket together constitute the canister.

Equivalent (or Equal) Material is a material with critical characteristics (see definition above) that meet or exceed those specified for the designated material.

Facility is used as an abbreviated name for the HI-STORE Consolidated Interim Storage facility

Fracture Toughness is a property which is a measure of the ability of a material to limit crack propagation under a suddenly applied load.

FSAR is an acronym for Final Safety Analysis Report (10CFR72).

HOLTEC INTERNATIONAL COPYRIGHTED MATERIAL	
Report No. HI-2167374	Proposed Rev. 0R
iii	

Fuel Basket means a honeycombed structural weldment with square openings which can accept a fuel assembly of the type for which it is designed.

High Burnup Fuel (HBF) refers to fuel with a burnup greater than 45,000 MWD/MTU

HI-STORE or HI-STORE CIS is the consolidated interim storage facility envisaged to be built and operated in Southeastern New Mexico.

HI-STORM VVM means the vertical ventilated module wherein the canister is stored in the upright orientation.

HI-STORM UMAX System consists of loaded canisters stored in the HI-STORM UMAX VVM under Docket Number 72-1040.

HI-STORM 100 System consists of any loaded canister model placed within any design variant of the HI-STORM overpack in Docket Number 72-1014.

HI-STORM FW System is the larger capacity, variable height counterpart of the HI-STORM 100 system certified in Docket Number 72-1032

HI-TRAC CS is the shielded transfer cask used for performing canister transfer between the transport cask and the HI-STORM UMAX system at HI-STORE.

HoltiteTM is the trademarked name of a family of neutron shield materials owned by Holtec International.

HP is an acronym for Health Physics

HS is an acronym for HI-STORE Specific, used in relation to the ancillaries at the facility.

Important to Safety (ITS) means a SSC function or condition required to store spent nuclear fuel safely; to prevent damage to spent nuclear fuel during handling and storage, and to provide reasonable assurance that spent nuclear fuel can be received, handled, packaged, stored, and retrieved without undue risk to the health and safety of the public.

Independent Spent Fuel Storage Installation (ISFSI) means a facility designed, constructed, and licensed for the interim storage of spent nuclear fuel and other radioactive materials associated with spent fuel storage in accordance with 10CFR72. An ISFSI may be located at a nuclear plant or at an AFR.

Interim Storage means an autonomous monitored canister storage facility from which the stored canister can be retrieved, if necessary.

Interfacing Components means the weldments certified in other dockets that will be used with the HI-STORM UMAX VVM assemblies for transferring and storing canisters in at the HI-STORE Facility. The canister is an Interfacing Component.

ISFSI Pad means the reinforced concrete pad that defines the top extremity of the HI-STORM UMAX VVM and provides the support surface for the cask handling device.

License Life means the duration for which the system is authorized by virtue of its certification by the U.S. NRC.

HOLTEC INTERNATIONAL COPYRIGHTED MATERIAL	
Report No. HI-2167374	Proposed Rev. 0R
iv	

Licensing Drawings or Licensing Drawing Package is an integral part of this SAR wherein the essential geometric and material information on HI-STORM UMAX is compiled to enable the safety evaluations pursuant to 10CFR72 to be carried out.

Long-term Storage means the period of passive storage in the HI-STORM UMAX VVMs at the AFR facility.

Lowest Service Temperature (LST) is the minimum metal temperature of a part for the specified service condition.

Maximum Section Average Temperature is the largest section average temperature of all sections through a component.

METCON means a steel structure fortified by plain concrete.

Mined Geological Disposal System (MGDS) is a nuclear waste repository excavated deep within a stable geologic environment

MSE is an acronym for “Most Severe Earthquake,” utilized to denote the ultra-high earthquake resistant options used in the HI-STORM UMAX generic license. These options are not currently utilized at the HI-STORE facility.

Nil Ductility Transition Temperature (NDT) is defined as the temperature at which the fracture stress in a material with a small flaw is equal to the yield stress in the same material if it had no flaws.

Neutron Absorber is a generic term used in this SAR to indicate any neutron absorber material qualified for use in the canister certified for storage in the HI-STORM UMAX VVM.

Neutron Shielding means a material used to thermalize and capture neutrons emanating from the radioactive spent nuclear fuel.

Non-Fuel Hardware (PWR) is defined as Burnable Poison Rod Assemblies (BPRAs), Thimble Plug Devices (TPDs), Control Rod Assemblies (CRAs), Axial Power Shaping Rods (APSRs), Wet Annular Burnable Absorbers (WABAs), Rod Cluster Control Assemblies (RCCAs), Control Element Assemblies (CEAs), Neutron Source Assemblies (NSAs), water displacement guide tube plugs, orifice rod assemblies, Instrument Tube Tie Rods (ITTRs), Guide Tube Anchors (GTAs), vibration suppressor inserts, and components of these devices such as individual rods.

Non-Fuel Hardware (BWR) is defined as the BWR channel. BWR control blades are not allowed in MPC-37 or MPC-89 fuel baskets.

Normal Storage Condition temperature refers to the integrated time average of the annual ambient temperature at an ISFSI site. It is used, as prescribed in ISG11Rev3 and NUREG-1536, as the reference air inlet temperature in the ventilated cask's thermal analysis for computing the fuel cladding temperature. In non-ventilated casks, it is used as the surrounding ambient temperature for the thermal analysis of the cask under the so-called normal condition of storage.

Off-Normal Storage Condition refers to the highest three- day average of ambient air temperature at an ISFSI site. The off-normal temperature serves as the air temperature for

HOLTEC INTERNATIONAL COPYRIGHTED MATERIAL	
Report No. HI-2167374	Proposed Rev. 0R
v	

computing the off-normal peak cladding temperature in a cask system for which an explicit cladding temperature limit is specified in ISG11 Rev3.

Operating Basis Earthquake is the three-dimensional seismic motion that is assumed to apply to any site activity whose duration exceeds one work shift. For conservatism, the OBE is set equal to the bounding value of 1000 year return earthquake for the HI-STORE site. (Short duration activities lasting less than a work shift are considered seismic-exempt operations)

Plain Concrete is concrete that is unreinforced by re-bars with a nominal or a range of densities specified in this document.

Post-Core Decay Time (PCDT) is synonymous with cooling time.

PWR is an acronym for pressurized water reactor.

Reactivity is used synonymously with effective neutron multiplication factor or k-effective.

Redundant Drop Protection Features are mechanical elements of a hydraulic lifting device used to prevent the uncontrolled lowering of a load in the event of a loss of power or loss of hydraulic pressure.

Safe Shutdown Earthquake (SSE) is a site's seismic input applicable to the cask's long term storage on the ISFSI pad, also called DBE.

Safety Report is a generic term to identify a SAR or any other term that connotes a compilation of all safety analyses and evaluations necessary to demonstrate compliance of a SSC to the its applicable codes and regulations.

Safety Significant is a generic term in Holtec's QA system to indicate *Safety Related* (used in 10CFR 50) and *Important- to -Safety* (Used in 10CFR71 and 10CFR72)

SAR is an acronym for Safety Analysis Report.

Section Average Temperature is the lineal average temperature through the thickness of a component.

Self-hardening Engineered Subgrade (SES) means CLSM or lean concrete in this SAR.

Service Life means the duration for which the SSC is reasonably expected to perform its intended function, if operated and maintained in accordance with the provisions of this Safety Report. Service Life may be much longer than the Design Life because of the conservatism inherent in the codes, standards, and procedures used to design, fabricate, operate, and maintain the SSC.

Severity Index is the indicator of the safety importance and operational fragility of a SSC (used in Chapter 18) which informs the level of monitoring, inspection and remediation measures required in its Aging Management Program (AMP). The canister has the highest severity index (=3); NITS items have the severity index of 0.

Shield Gate means the split-plate structure that provides the ability to open and close the bottom closure structure in the HI-TRAC CS transfer cask.

Short-term Operations means those normal operational evolutions necessary to support canister loading into or unloading from the HI-STORM UMAX storage system. These include, but are

HOLTEC INTERNATIONAL COPYRIGHTED MATERIAL	
Report No. HI-2167374	Proposed Rev. 0R
vi	

not limited to canister transfer, and onsite handling of a loaded transport cask as described in this SAR.

Single Failure Proof in order for a lifting device or special lifting device to be considered single failure proof, the design must follow the guidance in NUREG-0612, which requires that a single failure proof device have twice the normal safety margin. This designation can be achieved by either providing redundant devices (load paths) or providing twice the design factor as required by the applicable code.

SNF is an acronym for spent nuclear fuel.

Special Lifting Devices are components that meet the definition of ANSI N14.6.

SSC is an acronym for Structures, Systems and Components.

STP is an acronym Standard Temperature and Pressure conditions.

Support Foundation Pad (SFP) means the reinforced concrete pad located underground on which the CECs are situated.

Sub-Grade is the 3-D continuum adjacent to each CEC that occupies the vertical space between the SFP below and the ISFSI Pad above.

Thermal Capacity of the HI-STORM system is defined as the amount of heat the storage system, containing a canister loaded with CSF stored in *storage*, will actually reject with the ambient environment at the normal temperature and the peak fuel cladding temperature (PCT) below the ISG-11 Rev 3 limit.

Thermo-siphon is the term used to describe the buoyancy-driven natural convection circulation of helium within the canister.

Tilt Frame is the device used for tilting of the Transport Cask or HI-TRAC between the vertical and horizontal orientations.

Top-of Grade (TOG) of the ISFSI is identified as the riding surface of the cask transporter.

Traveler means the set of sequential instructions used in a controlled manufacturing program to ensure that all required tests and examinations required upon the completion of each significant manufacturing activity are performed and documented for archival reference.

UG is an acronym for HI-STORM UMAX Generic License components.

Under-grade is the space below the SFP.

Vertical Cask Transporter (VCT) is the generic name for a device that has the ability to raise or lower a cask or a canister with the built-in safety of a redundant drop protection system. A VCT may be designed to be limited in its operation space to the ISFSI pad area and/or it may have the capability to translocate the cask over a suitably engineered haul path.

VVM is an acronym for Vertical Ventilated Module

ZPA is an acronym for “zero period acceleration”.

HOLTEC INTERNATIONAL COPYRIGHTED MATERIAL	
Report No. HI-2167374	Proposed Rev. 0R
vii	

Table of Contents

CHAPTER 1: GENERAL DESCRIPTION	1-1
1.0 INTRODUCTION	1-1
1.0.1 10 CFR 72.48 Evaluations	1-3
1.1 GENERAL DESCRIPTION OF INSTALLATION	1-9
1.2 GENERAL SYSTEMS DESCRIPTION	1-11
1.2.1 HI-STORM UMAX System Overview	1-11
1.2.2 Constituents of the HI-STORM UMAX Vertical Ventilated Module and ISFSI Structures	1-13
1.2.3 Design Characteristics of the HI-STORM UMAX VVM	1-16
1.2.4 HI-TRAC CS	1-18
1.2.5 Operational Characteristics of the HI-STORM UMAX	1-19
1.2.6 Cask Contents	1-21
1.2.7 Ancillary Equipment Used at HI-STORE CIS	1-21
1.3 IDENTIFICATION OF AGENTS AND CONTRACTORS	1-30
1.4 MATERIAL INCORPORATED BY REFERENCE	1-37
1.5 LICENSING DRAWINGS	1-38
1.6 REGULATORY COMPLIANCE	1-39
CHAPTER 2: SITE CHARACTERISTICS	2-1
2.0 INTRODUCTION	2-1
2.1 GEOGRAPHY AND DEMOGRAPHY	2-2
2.1.1 Site Location	2-2
2.1.2 Site Description	2-2
2.1.3 Population Distribution and Trends	2-6
2.1.4 Land and Water Use	2-8
2.2 NEARBY INDUSTRIAL, TRANSPORTATION, AND MILITARY FACILITIES	2-47
2.2.1 Industrial Facilities	2-47
2.2.2 Pipelines	2-47
2.2.3 Air Transportation	2-48
2.2.4 Ground Transportation	2-53
2.2.5 Nuclear Facilities	2-54
2.3 METEOROLOGY	2-72

HOLTEC INTERNATIONAL COPYRIGHTED MATERIAL	
Report No. HI-2167374	Proposed Rev. 0R
viii	

2.3.1 Regional Climatology2-72

2.3.2 Local Meteorology.....2-74

2.3.3 Onsite Meteorological Measurement Program2-74

2.4 SURFACE HYDROLOGY2-83

2.4.1 Hydrologic Description.....2-83

2.4.2 Floods2-86

2.4.3 Probable Maximum Flood (PMF).....2-87

2.4.4 Potential Dam Failures (Seismically-Induced)2-89

2.4.5 Probable Maximum Surge and Seiche Flooding.....2-89

2.4.6 Probable Maximum Tsunami Flooding2-89

2.4.7 Ice Flooding2-89

2.4.8 Flood Protection Requirements.....2-89

2.4.9 Environmental Acceptance of Effluents2-89

2.5 SUBSURFACE HYDROLOGY2-108

2.6 GEOLOGY AND SEISMOLOGY2-116

2.6.1 Basic Geologic and Seismic Information.....2-116

2.6.2 Vibratory Ground Motion.....2-119

2.6.3 Surface Faulting.....2-121

2.6.4 Stability of Subsurface Materials.....2-121

2.6.5 Slope Stability.....2-123

2.6.6 Construction Excavation.....2-123

2.7 SITE SPECIFIC DATA FOR THERMAL AND STRUCTURAL ANALYSES2-148

2.8 SAFETY-RELEVANT ENVIRONMENTAL DETERMINATIONS2-151

2.9 REGULATORY COMPLIANCE2-152

CHAPTER 3: OPERATIONS AT THE HI-STORE FACILITY3-1

3.0 INTRODUCTION3-1

3.1 DESCRIPTION OF OPERATIONS.....3-3

3.1.1 Operations at Originating Nuclear Power Plant.....3-4

3.1.2 Operations Between the Originating Nuclear Power Plant and HI-STORE.....3-4

3.1.3 Operations Between the Railroad Mainline and HI-STORE3-5

3.1.4 Operations at HI-STORE.....3-5

3.1.5 Identification of Subjects for Safety Analysis3-9

HOLTEC INTERNATIONAL COPYRIGHTED MATERIAL	
Report No. HI-2167374	Proposed Rev. 0R
ix	

3.2	SPENT FUEL AND HIGH-LEVEL WASTE HANDLING SYSTEMS	3-18
3.2.1	Spent Fuel Canister Receipt, Handling, and Transfer.....	3-18
3.2.2	Spent Fuel Canister Storage.....	3-20
3.3	OTHER OPERATING SYSTEMS.....	3-22
3.4	OPERATION SUPPORT SYSTEMS	3-23
3.4.1	Instrumentation and Control Systems.....	3-23
3.4.2	System and Component Spares.....	3-23
3.5	CONTROL ROOM AND CONTROL AREA	3-24
3.6	ANALYTICAL SAMPLING	3-25
3.7	POOL AND POOL FACILITY SYSTEMS.....	3-26
3.8	REGULATORY COMPLIANCE	3-27
	CHAPTER 4: DESIGN CRITERIA FOR THE HI-STORE CIS SSCS	4-1
4.0	INTRODUCTION	4-1
4.1	MATERIALS TO BE STORED.....	4-5
4.1.1	Spent Fuel Canisters	4-5
4.1.2	High-Level Radioactive Waste.....	4-5
4.2	CLASSIFICATION OF STRUCTURES, SYSTEMS AND COMPONENTS.....	4-11
4.3	DESIGN CRITERIA FOR SSCS IMPORTANT TO SAFETY.....	4-17
4.3.1	Multi-Purpose Canisters (MPCs).....	4-17
4.3.2	VVM Components and ISFSI Structures.....	4-17
4.3.3	HI-TRAC CS	4-19
4.3.4	HI-STAR 190.....	4-20
4.3.5	Canister Transfer Facility (CTF)	4-21
4.3.6	Applicable Earthquake Loadings for the HI-STORE CIS Facility.....	4-22
4.4	ACCEPTANCE CRITERIA FOR CASK COMPONENTS.....	4-33
4.4.1	Stress and Deformation Limits	4-33
4.4.2	Thermal Limits	4-34
4.4.3	Dose Limits.....	4-34
4.5	LIFTING DEVICES (CTB CRANE & VCT, SPECIAL LIFTING DEVICES, AND MISCELLANEOUS ANCILLARIES	4-39
4.5.1	Design Requirements Applicable to Lifting Devices and Special Lifting Devices	4-39
4.5.2	Cask Transfer Building (CTB) Crane.....	4-41

HOLTEC INTERNATIONAL COPYRIGHTED MATERIAL	
Report No. HI-2167374	Proposed Rev. 0R
X	

4.5.3	Vertical Cask Transporter	4-43
4.5.4	HI-PORT	4-47
4.5.5	Miscellaneous Ancillaries	4-49
4.6	DESIGN CRITERIA FOR CASK TRANSFER BUILDING (CTB)	4-65
4.6.1	Design Features of CTB	4-65
4.6.2	CTB Slab	4-65
4.7	SUMMARY OF DESIGN CRITERIA	4-71
APP 4.A	STRESS LIMITS FOR ASME SECTION III SUBSECTION NF LINEAR STRUCTURES AND PLATE & SHELL TYPE STRUCTURES	4A-1
4.A.1	Linear Structures	4A-1
4.A.2	Stress Limit Criteria for Plate and Shell Structures	4A-5
CHAPTER 5: INSTALLATION AND STRUCTURAL EVALUATION		5-1
5.0	INTRODUCTION	5-1
5.1	CONFINEMENT STRUCTURES, SYSTEMS AND COMPONENTS	5-6
5.1.1	Description of Structural Design	5-6
5.1.2	Design Criteria	5-6
5.1.3	Material Properties	5-6
5.1.4	Structural Analyses	5-7
5.2	POOL AND POOL CONFINEMENT FACILITIES	5-8
5.3	REINFORCED CONCRETE STRUCTURES	5-9
5.3.1	HI-STORM UMAX ISFSI Pad and Support Foundation Pad	5-9
5.3.2	Canister Transfer Building	5-11
5.3.3	Canister Transfer Facility Foundation	5-17
5.4	OTHER SSCs IMPORTANT TO SAFETY	5-48
5.4.1	HI-STORM UMAX VVM	5-48
5.4.2	HI-TRAC CS	5-50
5.4.3	Cask Transfer Building Crane	5-53
5.4.4	Transport Cask Lift Yoke	5-53
5.4.5	MPC Lift Attachment	5-54
5.4.6	Other Special Lifting Devices	5-55
5.4.7	Cask Transfer Facility Steel Structure	5-56
5.5	OTHER SSCs	5-68

HOLTEC INTERNATIONAL COPYRIGHTED MATERIAL	
Report No. HI-2167374	Proposed Rev. 0R
xi	

5.5.1	Cask Tilt Frame	5-68
5.5.2	Vertical Cask Transporter	5-69
5.5.3	HI-PORT	5-70
5.5.4	HI-STAR 190SL Pedestal	5-71
5.6	REGULATORY COMPLIANCE	5-77
CHAPTER 6: THERMAL EVALUATION		6-1
6.0	INTRODUCTION	6-1
6.1	DECAY HEAT REMOVAL SYSTEMS	6-5
6.2	MATERIAL TEMPERATURE LIMITS	6-7
6.3	THERMAL LOADS AND ENVIRONMENTAL CONDITIONS	6-8
6.4	ANALYTICAL METHODS, MODELS, AND CALCULATIONS	6-10
6.4.1	Applicable Systems	6-10
6.4.2	Analysis Methodology	6-11
6.4.3	Calculations and Results	6-14
6.5	SAFETY UNDER OFF-NORMAL AND ACCIDENT EVENTS	6-38
6.5.1	Off-Normal Events	6-38
6.5.2	Accident Events	6-38
6.5.3	SSCs Important to Safety Guidance for Fire Protection Program	6-46
6.6	REGULATORY COMPLIANCE	6-53
APPENDIX 6A: HOLTEC VALIDATION OF FLUENT FOR CASK APPLICATIONS		6A-1
6A.1	INTRODUCTION	6A-1
6A.2	CODE DEVELOPER VALIDATION	6A-2
6A.3	HOLTEC VALIDATION	6A-4
CHAPTER 7: SHIELDING EVALUATION		7-1
7.0	INTRODUCTION	7-1
7.1	CONTAINED RADIATION SOURCES	7-4
7.1.1	General Specification and Approach for Neutron and Gamma Sources	7-4
7.1.2	Design Basis Assemblies	7-4
7.2	STORAGE AND TRANSFER SYSTEMS	7-12
7.2.1	Design Criteria	7-12
7.2.2	Design Features	7-12
7.3	SHIELDING COMPOSITION AND DETAILS	7-13

HOLTEC INTERNATIONAL COPYRIGHTED MATERIAL	
Report No. HI-2167374	Proposed Rev. 0R
xii	

7.3.1	Composition and Material Properties	7-13
7.3.2	Shielding Details	7-13
7.4	SHIELDING ANALYSES METHODS AND RESULTS	7-17
7.4.1	Computational Methods and Data	7-17
7.4.2	Dose and Dose Rate Estimates	7-18
7.5	SUMMARY	7-36
CHAPTER 8: CRITICALITY EVALUATION.....		8-1
8.0	INTRODUCTION	8-1
8.1	CRITICALITY DESIGN CRITERIA AND FEATURES.....	8-3
8.1.1	Criteria	8-3
8.1.2	Features.....	8-3
8.2	STORED MATERIAL SPECIFICATIONS.....	8-4
8.3	EVALUATION	8-5
8.3.1	Model Configuration.....	8-5
8.3.2	Accidental Criticality	8-5
8.4	APPLICANT CRITICALITY ANALYSIS.....	8-10
8.5	CRITICALITY MONITORING.....	8-11
CHAPTER 9: CONFINEMENT EVALUATION		9-1
9.0	INTRODUCTION	9-1
9.1	ACCEPTANCE CRITERIA.....	9-3
9.2	CONFINEMENT OF RADIOACTIVE MATERIALS.....	9-4
9.2.1	Storage Systems.....	9-4
9.2.2	Operational Activities	9-6
9.3	POOL AND WASTE MANAGEMENT FACILITIES.....	9-8
9.3.1	Pool Facilities	9-8
9.3.2	Waste Management Facilities	9-8
9.4	CONFINEMENT MONITORING	9-9
9.4.1	Storage Confinement Systems	9-9
9.4.2	Effluents.....	9-9
9.5	PROTECTION OF STORED MATERIALS FROM DEGRADATION	9-10
9.5.1	Confinement Casks or Systems	9-10
9.5.2	Pool and Waste Management Systems	9-10

HOLTEC INTERNATIONAL COPYRIGHTED MATERIAL	
Report No. HI-2167374	Proposed Rev. 0R
xiii	

9.6	SUMMARY	9-11
CHAPTER 10: CONDUCT OF OPERATIONS.....		10-1
10.0	INTRODUCTION	10-1
10.1	ORGANIZATIONAL STRUCTURE	10-2
	10.1.1 Corporate and On-site Organization	10-2
	10.1.2 Support Staff (ISFSI Specialists)	10-2
10.2	PREOPERATIONAL TESTING AND STARTUP OPERATIONS	10-6
	10.2.1 Administrative Procedures for Conducting the Test Program	10-6
	10.2.2 Preoperational Testing Plan	10-6
	10.2.3 Evaluation of Tests	10-8
	10.2.4 Corrective Actions	10-8
10.3	NORMAL OPERATIONS	10-11
	10.3.1 Procedures.....	10-11
	10.3.2 Records	10-11
	10.3.3 Conduct of Operations	10-12
	10.3.4 Maintenance Program for the HI-STORM UMAX VVM & HI-TRAC CS.....	10-19
	10.3.5 Maintenance Program for the Canister	10-21
	10.3.6 Maintenance Programs for ITS Lifting and Handling Equipment, Including VCT.....	10-21
	10.3.7 Maintenance Programs for ITS Crane Systems	10-21
	10.3.8 Maintenance Programs for HI-STAR 190 Cask	10-21
10.4	PERSONNEL SELECTION, TRAINING, AND CERTIFICATION.....	10-28
	10.4.1 Personnel Organization.....	10-28
	10.4.2 Selection and Training of Operating Personnel	10-28
	10.4.3 Selection and Training of Security Guards	10-28
	10.4.4 Selection and Training of Radiation Protection Technicians.....	10-28
10.5	EMERGENCY PLANNING	10-32
10.6	PHYSICAL SECURITY AND SAFEGUARDS CONTINGENCY PLANS	10-33
10.7	RADIATION PROTECTION PLAN	10-34
10.8	SUMMARY	10-35
CHAPTER 11: RADIATION PROTECTION EVALUATION.....		11-1
11.0	INTRODUCTION	11-1
	11.0.1 Ensuring Occupational Radiation Exposures are As Low As is Reasonably Achievable	

HOLTEC INTERNATIONAL COPYRIGHTED MATERIAL	
Report No. HI-2167374	Proposed Rev. 0R
xiv	

..... 11-1

11.1 AS-LOW-AS-REASONABLY-ACHIEVABLE (ALARA) CONSIDERATIONS..... 11-4

 11.1.1 ALARA Policies and Programs 11-4

 11.1.2 Design Considerations 11-5

 11.1.3 Operational Considerations..... 11-8

11.2 RADIATION PROTECTION DESIGN FEATURES 11-10

 11.2.1 Installation Design Features..... 11-10

 11.2.2 Access Control 11-11

 11.2.3 Radiation Shielding..... 11-12

 11.2.4 Confinement and Ventilation 11-12

 11.2.5 Area Radiation and Airborne Radioactivity Monitoring Instrumentation 11-12

11.3 DOSE ASSESSMENT..... 11-16

 11.3.1 Onsite Dose..... 11-16

 11.3.2 Offsite Dose 11-16

11.4 RADIATION PROTECTION PROGRAM..... 11-19

 11.4.1 Organizational Structure 11-19

 11.4.2 Equipment, Instrumentation, and Facilities 11-20

 11.4.3 Policies and Procedures 11-21

11.5 REGULATORY COMPLIANCE 11-23

CHAPTER 12: QUALITY ASSURANCE PROGRAM..... 12-1

12.0 INTRODUCTION 12-1

 12.0.1 Overview..... 12-1

 12.0.2 Graded Approach to Quality Assurance 12-2

12.1 REGULATORY COMPLIANCE 12-3

CHAPTER 13: DECOMMISSIONING EVALUATION 13-1

13.0 INTRODUCTION 13-1

13.1 DESIGN FEATURES..... 13-3

13.2 OPERATIONAL FEATURES 13-4

13.3 DECOMMISSIONING PLAN 13-5

 13.3.1 General Provisions 13-5

 13.3.2 Cost Estimate 13-5

 13.3.3 Financial Assurance Mechanism 13-6

HOLTEC INTERNATIONAL COPYRIGHTED MATERIAL	
Report No. HI-2167374	Proposed Rev. 0R
xv	

13.4 REGULATORY COMPLIANCE 13-7

CHAPTER 14: WASTE CONFINEMENT AND MANAGEMENT EVALUATION 14-1

14.0 INTRODUCTION 14-1

14.1 WASTE SOURCES..... 14-2

14.2 OFF-GAS TREATMENT AND VENTILATION 14-3

14.3 LIQUID WASTE TREATMENT AND RETENTION 14-4

14.4 SOLID WASTES 14-5

14.5 RADIOLOGICAL IMPACT OF NORMAL OPERATIONS 14-6

14.6 REGULATORY COMPLIANCE 14-7

CHAPTER 15: ACCIDENT ANALYSIS 15-1

15.0 INTRODUCTION 15-1

15.1 ACCEPTANCE CRITERIA..... 15-3

 15.1.1 Off-Normal Events 15-3

 15.1.2 Accident Events 15-3

15.2 OFF-NORMAL EVENTS 15-4

 15.2.1 Off-Normal Pressure..... 15-4

 15.2.2 Off-Normal Environmental Temperature 15-5

 15.2.3 Leakage of One Seal 15-5

 15.2.4 Partial Blockage of the Air Inlets and Outlets 15-6

 15.2.5 Hypothetical Non-Quiescent Wind..... 15-8

 15.2.6 Cask Drop Less Than Design Allowable Height..... 15-8

 15.2.7 Off-Normal Events Associated with Pool Facilities 15-8

 15.2.8 Safety Evaluation..... 15-8

15.3 ACCIDENTS 15-9

 15.3.1 Fire Accident..... 15-9

 15.3.2 Partial Blockage of MPC Basket Vent Holes 15-12

 15.3.3 Tornado Missiles..... 15-12

 15.3.4 Flood 15-14

 15.3.5 Earthquake 15-14

 15.3.6 100% Fuel Rods Rupture 15-15

 15.3.7 Confinement Boundary Leakage 15-16

 15.3.8 Explosion 15-16

HOLTEC INTERNATIONAL COPYRIGHTED MATERIAL	
Report No. HI-2167374	Proposed Rev. 0R
xvi	

15.3.9 Lightning..... 15-16

15.3.10 100% Blockage of Air Inlets and Outlets 15-16

15.3.11 Burial Under Debris..... 15-18

15.3.12 Extreme Environmental Temperature..... 15-18

15.3.13 Cask Tipover..... 15-18

15.3.14 Cask Drop 15-18

15.3.15 Loss of Shielding 15-19

15.3.16 Adiabatic Heatup 15-19

15.3.17 Accidents at Nearby Sites 15-19

15.3.18 Accidents Associated with Pool Facilities..... 15-19

15.3.19 Building Structural Failure onto SSCs..... 15-19

15.3.20 100% Rod Rupture Accident Coincident with Accident Events 15-20

15.4 OTHER NON-SPECIFIED ACCIDENTS 15-22

15.5 I&C SYSTEMS 15-23

15.6 REGULATORY COMPLIANCE 15-24

CHAPTER 16: TECHNICAL SPECIFICATIONS..... 16-1

16.0 INTRODUCTION 16-1

16.1 FUNCTIONAL/OPERATING LIMITS, MONITORING INSTRUMENTS, AND LIMITING CONTROL SETTINGS..... 16-3

16.2 LIMITING CONDITIONS 16-4

16.3 SURVEILLANCE REQUIREMENTS 16-5

16.4 DESIGN FEATURES..... 16-6

16.5 ADMINISTRATIVE CONTROLS 16-7

16.6 REGULATORY COMPLIANCE 16-8

APPENDIX 16.A TECHNICAL SPECIFICATIONS (LCO) BASES FOR THE HOLTEC CIS FACILITY 16.A-1

CHAPTER 17: MATERIAL CONSIDERATIONS 17-1

17.0 INTRODUCTION 17-1

17.1 MATERIAL DEGRADATION MODES 17-6

17.2 MATERIAL SELECTION..... 17-12

17.2.1 Structural Materials..... 17-12

17.2.2 Non-Structural Materials 17-13

HOLTEC INTERNATIONAL COPYRIGHTED MATERIAL	
Report No. HI-2167374	Proposed Rev. 0R
xvii	

17.3	APPLICABLE CODES AND STANDARDS.....	17-17
17.4	MATERIAL PROPERTIES	17-18
	17.4.1 Mechanical Properties.....	17-18
	17.4.2 Thermal Properties.....	17-18
	17.4.3 Protection Against Brittle Fracture of Ferritic Steel Parts	17-18
	17.4.4 Protection Against Creep	17-20
17.5	WELDING MATERIAL AND WELDING SPECIFICATION.....	17-25
17.6	BOLTS AND FASTNERS	17-27
17.7	COATINGS AND CORROSION MITIGATION	17-28
	17.7.1 Exterior Coating.....	17-28
17.8	GAMMA AND NEUTRON SHIELDING MATERIALS	17-30
	17.8.1 Plain Concrete.....	17-30
17.9	NEUTRON ABSORBING MATERIALS	17-31
17.10	SEALS	17-32
17.11	CHEMICAL AND GALVANIC REATIONS	17-33
17.12	FUEL CLADDING INTEGRITY	17-35
17.13	EXAMINATIONS AND TESTING.....	17-36
17.14	REGULATORY COMPLIANCE	17-37
	CHAPTER 18. AGING MANAGEMENT PROGRAM	18-1
18.0	INTRODUCTION	18-1
18.1	SCOPING EVALUATION AND SEVERITY INDEX	18-4
18.2	MAINTENANCE PROGRAM FOR THE HI-STORM UMAX VVM & HI-TRAC CS	18-7
18.3	MECHANISMS FOR AGING OF SSCS	18-8
18.4	UNIQUE ASPECTS OF THE HI-STORE CIS WITH NEXUS TO ITS AMP	18-14
18.5	CANISTER AGING MANAGEMENT PROGRAM.....	18-15
	18.5.1 Visual Examination.....	18-15
	18.5.2 Volumetric Examinations	18-16
	18.5.3 Accelerated Coupon Testing.....	18-16
	18.5.4 Eddy Current Testing.....	18-17
18.6	HI-TRAC CS TRANSFER CASK AGING MANAGEMENT PROGRAM.....	18-21
18.7	VVM AGING MANAGEMENT PROGRAM.....	18-23
18.8	REINFORCED CONCRETE AGING MANAGEMENT PROGRAM	18-24

HOLTEC INTERNATIONAL COPYRIGHTED MATERIAL	
Report No. HI-2167374	Proposed Rev. 0R
xviii	

18.9 HBF AGING MANAGEMENT PROGRAM 18-25

18.10 LIFTING DEVICE AGING MANAGEMENT PROGRAM..... 18-26

18.11 TILT FRAME AGING MANAGEMENT PROGRAM..... 18-27

18.12 CTF AGING MANAGEMENT PROGRAM..... 18-28

18.13 LEARNING BASED AMP 18-29

18.14 TIMING OF AGING MANAGEMENT IMPLEMENTATION..... 18-31

 18.14.1 Canisters..... 18-31

 18.14.2 All Other SSCs..... 18-31

18.15 AMELIORATING THE RISK OF CANISTER DEGRADATION OVER A LONG TERM STORAGE DURATION 18-32

18.16 RECOVERY PLAN..... 18-33

CHAPTER 19: REFERENCES 19-1

HOLTEC INTERNATIONAL COPYRIGHTED MATERIAL	
Report No. HI-2167374	Proposed Rev. 0R
xix	

CHAPTER 1: GENERAL DESCRIPTION*

1.0 INTRODUCTION

This Safety Analysis report, prepared pursuant to 10CFR72.24, provides the necessary information to justify the licensing of an Independent Spent Fuel Storage Installation (ISFSI) facility on an extensively assayed and environmentally qualified land in southeastern New Mexico. The storage facility has been named HI-STORE CIS, the acronym CIS intended to denote consolidated interim storage pursuant to the Presidential Blue Ribbon Commission report [1.0.1] subsequently adopted by the US Department of Energy (USDOE).

It is planned to situate HI-STORE CIS on a large parcel of presently unused land owned by ELEA, LLC. ELEA was formed in 2006 in accordance with an enabling legislation passed in New Mexico and consists of an alliance of (in alphabetical order) the city of Carlsbad, the county of Eddy, the city of Hobbs and the county of Lea which together, as shown in the geographical layout in Figure 1.0.1 completely surround the proposed site. (ELEA is a composite of **E**ddy and **L**ea counties which are members of the alliance). As HI-STORE CIS is an autonomous facility without any physical nexus to an operating reactor, it qualifies being referred to as an away-from-reactor (AFR) facility.

The ELEA/ Holtec compact envisages Holtec securing the site specific license pursuant to 10CFR72.6 for the HI-STORE CIS from the USNRC, carrying out the necessary detailed designs & site construction, and managing CIS' security, maintenance and ongoing operations. Thus Holtec International will serve as the operator of the HI-STORE CIS with undivided responsibility for its safety and security. Holtec International has also committed to ELEA that the storage technology deployed at the HI-STORE CIS will meet the site boundary dose limit specified in 10CFR72 [1.0.5] with substantial margins under any normal and credible accident scenarios.

The HI-STORE CIS will be built in several stages of storage system groups to correspond to the (expected) increasing need from the industry and the US government. The first stage of the storage module group and other overview information on the site germane to its intended use can be found in Table 1.0.1.

The major milestone dates for licensing, building and commissioning the HI-STORE CIS facility are presented in Table 1.0.2. This milestone schedule presumes continued DOE and NRC support and enthusiasm on the part of the utilities to avail themselves of this facility.

This license application accordingly contains the necessary information specified in Regulatory Guide 3.50 [1.0.2] and in NUREG-1567 [1.0.3] to articulate the safety case for the site specific license pursuant to 10CFR72.6. In accordance with 10CFR72.24, the site-specific license for HI-STORE CIS requires a comprehensive consideration of all aspects of the facility that bear upon its safe and ALARA installation and operation. These include:

* All references are in placed within square brackets in this report and are compiled in Chapter 19 of this report

HOLTEC INTERNATIONAL COPYRIGHTED MATERIAL	
Report No. HI-2167374	Proposed Rev. 0R
1-1	

- Siting of the AFR site and design of the storage and security system. Site-specific demonstration of compliance with regulatory dose limits. Implementation of a facility-specific ALARA program.
- An evaluation of site-specific hazards and design conditions that may exist at the AFR site or the transfer route between the plant's cask Receiving Area and the storage location. These include all naturally occurring extreme environmental phenomena that are defined as credible events in the Environmental Report[1.0.4] for the HI-STORE CIS facility
- Determination that the physical and nucleonic characteristics and the condition of the SNF assemblies to be stored meet the fuel acceptance requirements for the site.
- Detailed site-specific operating, maintenance, and inspection procedures prepared in accordance with the generic procedures and requirements provided in Chapters 3 and 10 herein.
- Performance of pre-operational testing.
- Implementation of a safeguards and accountability program in accordance with 10CFR73. Preparation of a physical security plan in accordance with 10CFR73.55.
- Essentials of the site emergency plan, quality assurance (QA) program, training program, and radiation protection program.

In addition to the sixteen chapters set forth in NUREG-1567, Chapters 17 and 18 have been added to this SAR to explicitly address material selection considerations and long term Aging Management.

This safety analysis report on the HI-STORE CIS is limited at this time to the canisters and contents approved by the NRC in the generic docket (# 72-1040) for HI-STORM UMAX **and the receipt of canisters using the licensed Transport Casks listed in Table 1.0.5**. Table 1.0.3 identifies systems, components, and/or documents submitted to and approved by the NRC in other dockets and incorporated in this application by reference. Table 1.0.3 indicates the native and subsequent adoption dockets for systems and documents incorporated by reference (including systems/components safety analyses) into this HI-STORE application.

Within this report, all figures, tables and references cited are identified by the double decimal system *m.n.i*, where *m* is the chapter number, *n* is the section number, and *i* is the table number. For a complete listing of Tables and Figure the Table of Contents should be consulted. For example, Figure 1.2.1 is the first figure in Section 1.2 of Chapter 1. Similarly, the following convention is used in the organization of chapters:

- A chapter is identified by a whole numeral, say *m* (i.e., *m*=3 means Chapter 3)
- A section is identified by one decimal separating two numerals. Thus, Section 3.1 is section 1 in Chapter 3.
- A subsection has three numerals separated by two decimals. Thus, Subsection 3.2.1 is subsection 1 in Section 3.2.
- A paragraph is denoted by four numerals separated by three decimals. Thus, Paragraph 3.2.1.1 is paragraph 1 in Subsection 3.2.1.

HOLTEC INTERNATIONAL COPYRIGHTED MATERIAL	
Report No. HI-2167374	Proposed Rev. 0R
1-2	

- e. A subparagraph has five numerals separated by four decimals. Thus, Subparagraph 3.2.1.1.1 is subparagraph 1 in Paragraph 3.2.1.1.

Tables and figures associated within a section are placed after the text narrative. The drawing packages are controlled separately within the Holtec QA program with individual revision numbers and are included in Section 1.5 of this chapter.

Finally, the Glossary contains a listing of the terminology and notation used in this SAR.

1.0.1 10 CFR 72.48 Evaluations

It is noted that the information incorporated herein by reference is based on the docketed, NRC – approved licensing basis. If any change is made to a canister under the original licensing basis using 10CFR72.48, such change will need to be evaluated against the **HI-STORE** SAR before the canister can be stored **at HI-STORE**.

Canister records must be provided to the HI-STORE facility personnel prior to shipment of a canister. These records must be reviewed and any applicable 10CFR72.48 screenings or evaluations written against the canister’s original licensing basis evaluated against the HI-STORE site specific license to determine if a change requiring NRC approval is necessary.

To facilitate evaluation and to avoid clutter in this SAR, the numerical results of the safety analyses summarized in this document are reported along with, where practicable, an “unconditionally safe threshold” value. The unconditionally safe threshold value (please see Glossary) is defined as the numerical result that defines the boundary of a materially non-consequential & insignificant change that does not require the use of a 10CFR72.48 change process avoiding the need to modify the material in the SAR; rather, the documentation of the “change” may be limited to the calculation package and other actionable project documents.

HOLTEC INTERNATIONAL COPYRIGHTED MATERIAL	
Report No. HI-2167374	Proposed Rev. 0R
1-3	

Table 1.0.1: Overview of the HI-STORE Facility		
Item	Data	Comment
Land area of the site	1045 acres	Overall land area
Maximum design capacity Envisaged in this license application (UMAX/Canisters)	10,000	Each stage is envisaged to have 500 storage cavities.
Maximum quantity of Uranium (Note 1)	173,600 MTUs	Each stage is envisaged to have 8,680 MTUs
Maximum number of stages envisaged for the HI-STORE CIS Facility to reach design capacity	Up to 20 stages	Each construction stage to take up to 1 year to complete
Capacity of the installation for the first licensing application	500	19 subsequent expansion phases to be constructed over course of 20 years and under future licensing applications
Total land area occupied by the storage system at maximum capacity	Approx. 288 acres	Includes restricted ISFSI area, parking lot, administrative building, security building and batch plant
Land area occupied by the CIS storage systems as a percentage of the total site area	Approx. 28%	See comment above.
Storage system type used at the site	HI-STORM UMAX (NRC Docket # 72-1040 [1.0.6])	Introduced in Section 1.2
Distance of the nearest permanent human settlement from the site	1.5 miles	Ranch north of the site, see Chapter 2
Distance from nearest loaded UMAX VVM to Site Boundary (Controlled Area Boundary)	400 meters (1,312 feet)	Occupancy at this distance is conservatively assumed to be 2000 hours per year, see Chapter 7
Approximate number of permanent residents in 6 miles radius from the center of the site	Less than 20 (average)	Total of five ranches, see Chapter 2
Elevation of the site above sea level, feet	3520 to 3540	Any flood risk within system design, see Chapter 2
Geological formation	Stable	No known faults in the region, see Chapter 2

HOLTEC INTERNATIONAL COPYRIGHTED MATERIAL	
Report No. HI-2167374	Proposed Rev. 0R
1-4	

Location(distance) of the existing rail terminal from the site	3.8 miles west (BNSF) 32 miles east (TNMR)	BNSF Railway Texas-New Mexico Railroad (TNMR)
Maximum excavation depth required to build the facility	Approx. 25 feet	Construction activity will not be in contact with groundwater

Note 1: Maximum quantity of uranium per loaded canister is for design basis PWR fuel assembly (MPC-37) for the HI-STORM UMAX. The quantity of uranium per loaded MPC-37 canister bounds the quantity per loaded canisters containing BWR fuel assembly.

HOLTEC INTERNATIONAL COPYRIGHTED MATERIAL	
Report No. HI-2167374	Proposed Rev. 0R
1-5	

Table 1.0.2: Projected Milestone dates for HI-STORE CIS*	
Activity	Scheduled or expected date
License Application Submitted	March 2017
License Application Approval	March 2019
Site preparation begins	June 2018
Site construction begins	December 2018
Site and ISFSI construction completed	March 2021
Protected area and security infrastructure established	June 2021
Site Specific procedures prepared, vetted and adopted	December 2021
Site QA and Safety program installed	December 2021
Facility pre-commissioning (dry run) begins	December 2021
Facility declared operational –NRC’s concurrence secured	June 2022
First batch of canisters arrives at the site’s Receiving Area	June 2022

* Pursuant to the provisions in 10CFR72.40(b), the site construction of the HI-STORE CIS facility will require regulatory approval. Additionally, in accordance with 10CFR72.22, the construction program will be undertaken only after a definitive agreement with the prospective user/payer for storing the used fuel (USDOE and/or a nuclear plant owner) at HI-STORE CIS has been established. These regulatory and contractual predicates may adversely affect the schedule dates and durations set forth in this table.

HOLTEC INTERNATIONAL COPYRIGHTED MATERIAL	
Report No. HI-2167374	Proposed Rev. 0R
1-6	

Table 1.0.3: Systems and Documents Incorporated by Reference for HI-STORE (Note 1)		
System/Document	Native Docket)	Secondary Adoption Docket
HI-STORM UMAX System	72-1040	N/A
HI-STORM FW Canisters (MPCs 37 and 89)	72-1032	72-1040
Holtec International QA Manual	71-0784	72-1040
Note 1: Where specifically incorporated by reference in this report, additional information such as report title, sections or specific analyses within reports incorporated by reference, and technical justification of applicability to HI-STORE CIS Facility are provided.		

Table 1.0.4: Canisters Allowed for Storage in HI-STORM UMAX at HI-STORE		
Canister	Native Docket	Secondary Adoption Docket
MPC-37	72-1032	72-1040
MPC-89	72-1032	72-1040

Table 1.0.5: Transport Casks Allowed for Receipt of Canisters at HI-STORE	
Transport Cask	Docket Number
HI-STAR 190	71-9373 [1.3.6]

HOLTEC INTERNATIONAL COPYRIGHTED MATERIAL	
Report No. HI-2167374	Proposed Rev. 0R
1-7	



Figure 1.0.1: Geographical Layout of Proposed HI-STORM UMAX CIS ISFSI Site

HOLTEC INTERNATIONAL COPYRIGHTED MATERIAL

Report No. HI-2167374

Proposed Rev. 0R

1-8

1.1 GENERAL DESCRIPTION OF INSTALLATION

The HI-STORE CIS Facility layout drawing in Section 1.5 provides the general arrangement of the HI-STORE CIS Facility. The facility (site) layout drawing depicts the site at design basis capacity (Table 1.0.1). However, this application is limited to the initial licensing capacity (Table 1.0.1). As shown in the layout drawing, the HI-STORE CIS consists of the following SSCs:

- a. The HI-STORM UMAX VVMs (Figure 1.2.2)
- b. Rail Spur and Cask receiving area
- c. Equipment Building to store HI-TRAC, the Vertical Cask Transporter, ancillaries and spare parts.
- d. Administrative Building to house inspection, security and administrative staff as well as access control facilities.
- e. Security Building at the entrance to **CIS Facility** to house security personnel, some health physics staff as required and some health physics or other monitoring instruments.
- f. **Additional security measures to control access to the facility including the Vehicle Barrier System (VBS), passive (e.g. concrete blocks, king tut blocks, jersey barrier, etc.) and active physical barriers (e.g. bollards, gates), turnstiles at security building entrance, a vehicle trap, and Protected Area fencing that is supplemented by intrusion detection and CCTV cameras. Additional details on these protective measures can be found in the Physical Security Plan [3.1.1].**

The following features of the Facility are important to its safety and security functions and to its emergency preparedness:

- a. Each ISFSI pad is separated from its adjacent pad by a substantial mass of earth (Table 1.1.1) to ensure that the excavation for a pad with an adjacent operating ISFSI would not introduce a geo-structural or shielding problem.
- b. As can be seen from Figure 1.2.1, there are no large obstructions in the storage region that may block the visual ability to identify an intruder.
- c. The storage pads and ISFSI at large are equipped with an efficient drainage system.
- d. Parking facility for cars, trucks and other conveyances are located far from the fuel storage area to preclude the risk of a mass fire from combustion of fuel or transmission fluid.
- e. A substantial area adjacent to the loaded ISFSI is cleared of any brush or foliage that may serve as a fire stimulant.
- f. **The passive VBS surrounding the facility shall be constructed in a manner that it consists of continuous runs with a minimum height of 3 feet. The continuous runs act as an obstruction to rainwater runoff flow entering the facility during design basis flood events.**
- g. The data in Table 1.1.1 provides additional information on the HI-STORE Facility. The HI-STORE facility systems descriptions are provided in Section 1.2.

HOLTEC INTERNATIONAL COPYRIGHTED MATERIAL	
Report No. HI-2167374	Proposed Rev. 0R
1-9	

Table 1.1.1: HI-STORE CIS General arrangement data	
Item	Value
Nominal layout of each pad	25 by 10 (2 pads per phase)
Inter-cavity pitch (minimum)	15 feet 6 inches
Pad to Pad distance	35 feet / 70 feet
Nominal Size of the Equipment Storage Building (non-safety)	60 feet by 75 feet
Nominal size of the Admin Building (non-safety)	50 feet by 75 feet
Nominal Size of the Cask Transfer Building (CTB) (Length/Width/Height)	350 x 100 x 60 (feet)
Nominal Distance Along Haul Path between CTB and ISFSI Pad	2050 feet

HOLTEC INTERNATIONAL COPYRIGHTED MATERIAL	
Report No. HI-2167374	Proposed Rev. 0R
1-10	

1.2 GENERAL SYSTEMS DESCRIPTION

1.2.1 HI-STORM UMAX System Overview

The centerpiece of the HI-STORE CIS facility is the HI-STORM UMAX canister storage system certified in NRC docket # 72-1040. HI-STORM UMAX is the subterranean version of HI-STORM FW and HI-STORM 100 of which the latter was the reference storage system for the licensed AFR site scheduled to be sited in the PFS LLC's Skull Valley, Utah licensed in 2006 in docket # 72-22. The HI-STORM UMAX stores a hermetically sealed canister containing spent nuclear fuel in a subterranean in-ground Vertical Ventilated Module (VVM). The safety evaluation of HI-STORM UMAX is maintained in USNRC docket # 72-1040. The annex identifier UMAX is an acronym of Underground MAXimum safety.

HI-STORM UMAX is a dry, in-ground spent fuel storage system consisting of any number of Vertical Ventilated Modules (VVMs) each containing one canister. The HI-STORM UMAX has all the safety attributes that are attributed to in-ground storage, such as enhanced protection from incident projectiles and threats from extreme environmental phenomena such as hurricanes, tornado borne missiles, earthquakes, tsunamis, fires, and explosions. Figure 1.2.1 provides a pictorial illustration of an array of HI-STORM UMAX systems that depicts its security-friendly diminutive profile.

The HI-STORM UMAX version that will be employed in the HI-STORE CIS is essentially the design (without the ultra-high earthquake-resistant options, referred to as MSE options) licensed in the HI-STORM UMAX docket (72-1040). The only other respect in which the HI-STORE VVM design differs from the generic FSAR design is the provision that the storage cavity depth is made fixed (not variable, as permitted in the general certification) at two discrete dimensions. The height of the lateral seismic restraint at the top of the canister is adjusted to accord with the height of the canister that will be stored in the cavity, and a second set of seismic restraints are situated between the Divider Shell and Cavity Enclosure Container (CEC) at the same height and location as the lateral seismic restraint. As a result, the structural performance of the system remains unaffected and other safety metrics such as shielding and thermal (heat rejection) are **not significantly** affected.

To differentiate this minor tweak to the HI-STORM UMAX configuration deployed in the past, the HI-STORM UMAX drawings in Section 1.5 of this chapter refer to the HI-STORE VVM as Version C. Version C's certification basis remains in docket # 72-1040; it is not a new embodiment from a certification standpoint. The drawing package for Version C is included in this SAR principally to avoid having to refer to the drawing sets in the HI-STORM UMAX FSAR, which include several geometric options not used in the Version C design.

The essential characteristics of HI-STORM UMAX that make it uniquely suitable to serve as the heart of the proposed consolidated interim storage facility are:

- a. The canister is stored below-grade which makes it essentially invulnerable to the various extreme environmental phenomena that arise in nature. The intensity of the earthquake for

HOLTEC INTERNATIONAL COPYRIGHTED MATERIAL	
Report No. HI-2167374	Proposed Rev. 0R
1-11	

which the HI-STORM UMAX system is qualified (documented in this SAR) bounds the Design Basis Earthquake for the site.

- b. The HI-STORM UMAX storage system provides an essentially inviolable protection to the stored canisters against incident missiles such as a crashing aircraft. The source of the structural protection of the canister in HI-STORM UMAX lies in the fact that the only path for an incident missile to access the canister is by piercing the thick lid which is made of a steel weldment buttressed by concrete. The lateral surface of the canister is protected by a self-hardening engineered subgrade (SES) around each canister and by the surrounding expanse of the earth beyond. While the top lid is presently designed for 10CFR72 Design Basis Missiles, it can be effortlessly swapped for an even more impregnable lid structure if the level severity of threat to the facility were to increase in the future.
- c. The storage cavity of HI-STORM UMAX is sufficiently large to accommodate *every* canister type licensed under different 10CFR72 dockets and in use in the United States at this time. Therefore, it is possible to qualify the entire universe of used fuel canisters presently deployed at the ISFSIs around the country for storage in the HI-STORM UMAX system. HI-STORM UMAX is intended to provide a safe and regulation-compliant storage for even NUHOMS canisters which are normally stored horizontally. (The safety analysis in support of LAR# 3 to the HI-STORM UMAX CoC indicates that all metrics for safe storage including decay heat rejection are maintained or improved when a canister is rotated to the vertical storage orientation in HI-STORM UMAX from its native horizontal storage in NUHOMS. LAR # 3 to the HI-STORM UMAX CoC is not a part of this application, but may be incorporated through a licensing action at a later date)
- d. Because the on-site canister transfer operation (described in Section 10.3 herein) occurs vertically (specifically, doesn't involve horizontal pushing or pulling of the heavy loaded canister against surface friction), there is no risk of gouging or scratching of the ASME code boundary of the canister. This is an important benefit at a CIS site where (presumably) thousands of canisters will be handled.
- e. As can be ascertained from the design information in this SAR, the **only HI-STORE important to safety facility that is above ground is the Cask Transfer Building**. All canister transfer facilities are below-ground.
- f. As described in the canister Aging Management Program [1.2.1], a canister installed in a HI-STORM UMAX cavity can be remotely examined to assay the state of integrity of its confinement boundary shell making its long term monitoring a low dose activity.
- g. Because of its below-ground fuel storage configuration, the HI-STORM UMAX CIS meets the site boundary accident dose limit of 10CFR72.106 with large margins, as quantified in Section 7.4 of this SAR. The minuscule accreted dose, zero effluent release, and extreme hazard-resistance features of the HI-STORM UMAX CIS facility will make its footprint on the environment vanishingly small, as described in the Environmental Report [1.0.4].
- h. The canister's confinement boundary consists of thick circular stainless steel plate-type parts at the two extremities joined by a relatively thin shell. As a result, it is the canister's

HOLTEC INTERNATIONAL COPYRIGHTED MATERIAL	
Report No. HI-2167374	Proposed Rev. 0R
1-12	

shell that has been the focus of stress corrosion cracking threat over prolonged periods of storage. Unlike horizontally disposed canister, the canister shell in HI-STORM UMAX is not in physical contact with any other structure precluding the risk of crevice corrosion, galvanic corrosion, etc.

Finally, it is instructive to note that the canister in HI-STORM UMAX is laterally confined at its top and bottom extremities inside the HI-STORM UMAX VVM cavity so that it would not significantly move or rattle under a seismic event. Thus the thermal-hydraulic flow configuration around the canister is fixed for the duration of storage. This lateral fixity feature in the HI-STORM UMAX storage system along with its subterranean disposition are key reasons that underlie its ability to withstand severe earthquakes.

All HI-STORM UMAX System components and their sub-components are categorized as ITS, as applicable, in accordance with NUREG/CR-6407 [1.2.2].

To summarize, the HI-STORM UMAX System has been engineered to:

- maximize shielding and physical protection for the canister;
- minimize the extent of handling of the SNF;
- minimize dose to operators during loading and handling;
- require minimal ongoing surveillance and maintenance by plant staff;
- facilitate SNF transfer of the loaded canister to a compatible transport overpack for transportation;

1.2.2 Constituents of the HI-STORM UMAX Vertical Ventilated Module and ISFSI Structures

The HI-STORM UMAX VVM, shown in the licensing drawing in Section 1.5 provides for storage of the canister in a vertical configuration inside a subterranean cylindrical cavity entirely below the top-of-grade (TOG) of the ISFSI. The key constituents of a HI-STORM UMAX VVM and ISFSI structures are:

- (i) VVM Components
 - a. The Cavity Enclosure Container (CEC)
 - b. The Divider Shell
 - c. The Closure Lid
- (ii) ISFSI Structures
 - d. The ISFSI Pad
 - e. The Support Foundation Pad
 - f. The Subgrade and Under-grade

A brief description of each constituent part is provided in the following:

HOLTEC INTERNATIONAL COPYRIGHTED MATERIAL	
Report No. HI-2167374	Proposed Rev. 0R
1-13	

a. Cavity Enclosure Container:

The Cavity Enclosure Container (CEC) consists of a thick walled shell integrally welded to a bottom plate. The top of the container shell is stiffened by a ring shaped flange which is also integrally welded. The constituent parts of the CEC are made of low carbon steel plate. In its installed configuration, the CEC is interfaced with the surrounding subgrade for most of its height except for the top region where it is encased in the ISFSI pad.

With the Closure Lid removed, the CEC is a closed bottom, open top, thick walled cylindrical vessel that has no penetrations or openings. Thus, groundwater has no path for intrusion into the interior space of the CEC. Likewise, any water that may be introduced into the CEC through the air passages in the top lid will not drain into the groundwater.

The CEC top contains an air plenum box which works in conjunction with the Closure Lid to channel incoming air into the down-comer flowing region of the CEC. The air plenum box also contains rigid embedded locations for securing the HI-TRAC CS against movement during Canister Transfer operations.

b. Divider Shell:

The Divider Shell is important to the thermal performance of the VVM system. The Divider Shell, as its name implies, is a removable vertical cylindrical shell concentrically situated in the CEC that divides the CEC into an inlet flow down-comer and an outlet flow passage. The Divider Shell divides the radial space between the canister and the CEC cavity into two annuli. The bottom end of the Divider Shell has cutouts to enable movement of air from the down-comer to the up-flow region around the canister. The cutouts in the Divider Shell are sufficiently tall to ensure that if the cavity were to be filled with water, the bottom region of the canister would be submerged to a depth of several inches. This design feature ensures adequate thermal performance of the system if flood water were to block air flow. The Divider Shell is not attached to the CEC which allows its convenient removal for decommissioning or for any in-service maintenance or periodic inspection.

The cylindrical surface of the Divider Shell is equipped with insulation to prevent significant preheating of the inlet air. The insulation material is selected to be water and radiation resistant as well as non-degradable under accidental wetting.

c. The Closure Lid:

The Closure Lid is a steel structure filled with plain concrete that can withstand the impact of the Design Basis Missiles defined for the site. Both the inlet and outlet vents are located at the grade level. The Closure Lid internals form segregated air channels for air inlet and outlet. A set of inlet passage located on top of the CEC provide maximum separation from the large outlet passage which is located in the center of the lid and channel the inlet air into the CEC's air plenum box. As depicted in the licensing drawings in Section 1.5, the geometry of the inlet and outlet ducts make the HI-STORM UMAX VVM essentially insensitive to the direction and speed of the wind.

The Closure Lid fulfills the following principal performance objectives:

HOLTEC INTERNATIONAL COPYRIGHTED MATERIAL	
Report No. HI-2167374	Proposed Rev. 0R
1-14	

- 1 The Closure Lid is physically constrained against horizontal movement during a Design Basis Earthquake event or a tornado missile strike.
- 2 To minimize the radiation emitted from the storage cavity, a portion of the Closure Lid extends into the cylindrical space above the canister. This cylindrical below-surface extension of the Closure Lid is also made of steel filled with shielding concrete to maximize the blockage of skyward radiation issuing from the canister.
- 3 As can be seen from the drawings in Section 1.5, the Closure Lid is substantially larger in diameter than the CEC and the canister is positioned to be at a significant vertical depth below the top of the Container Flange. These geometric provisions ensure that the Closure Lid will not fall into the canister storage cavity space and strike the canister were to accidentally drop during its handling. Because the Closure Lid is the only removable heavy load, the carefully engineered design features to facilitate recovery from its accidental drop provide added assurance that a handling accident at the ISFSI will not lead to any radiological release. This additional measure against accidental Closure Lid drop does not replace the drop prevention features mandated in this Safety Report on heavy load lifting devices (such as the cask transporter) that have been a standard and established requirement in the HI-STORM docket.

d. The ISFSI Pad:

The ISFSI Pad serves to augment shielding, to provide a sufficiently stiff riding surface for the cask transporter, to act as a barrier against gravity-induced seepage of rain or floodwater around the VVM body as well as to shield against a missile. The ISFSI pad is a monolithic reinforced concrete structure that provides the load bearing surface for the cask transporter. The appropriate requirements on the structural strength of the ISFSI pad are specified in Section 4.3.

e. The Support Foundation Pad:

The Support Foundation Pad (SFP) is the underground pad which supports the HI-STORM UMAX ISFSI. The SFP on which the VVM rests must be designed to minimize long-term settlement. The SFP and the under-grade must have sufficient strength to support the weight of all the loaded VVMs during long-term storage and earthquake conditions. As the weight of the loaded VVM is comparable to the weight of the subgrade which it replaces, the additional pressure acting on the SFP is quite small. The appropriate requirements on the structural strength of the SFP are specified in Section 4.3.

f. The Subgrade and Under-grade:

The lateral space between each CEC, the SFP and the ISFSI pad is referred to as the subgrade and is filled with a Controlled Low-Strength Material (CLSM). Alternatively, “lean concrete” may also be used.

CLSM is a self-compacted, cementitious material used primarily as a backfill in place of compacted fill. ACI 229R-99 notes several terms, such as flowable fill, unshrinkable fill, controlled density fill, flowable mortar, flowable fly ash, fly ash slurry, plastic soil-cement and soil-cement slurry to describe CLSMs. ACI 116R-00 defines lean concrete as a material with low

HOLTEC INTERNATIONAL COPYRIGHTED MATERIAL	
Report No. HI-2167374	Proposed Rev. 0R
1-15	

cementitious content. CLSM and lean concrete are also referred to as “Self-hardening Engineered Subgrade” (SES).

The subgrade material must meet the shear velocity and density requirements in Section 4.3. The space below the SFP is referred to as the under-grade.

Evaluations in Section 5.4 show that the Self-hardening Engineered Subgrade (SES) provides a stable lateral support system to the ISFSI under the Design Basis Earthquake. The interface between the SES and the native subgrade defines the radiation protection boundary of the ISFSI.

1.2.3 Design Characteristics of the HI-STORM UMAX VVM

All HI-STORM UMAX locations are alike except for their cavity depth. The design of HI-STORM UMAX cavities has been standardized into certain discrete depths as tabulated in the Licensing Drawing Package (Section 1.5). Different depth HI-STORM UMAX cavities enable canisters of different heights to be housed in the cavity of appropriate depth. The maximum HI-STORM UMAX cavity depth corresponds to that certified in docket # 72-1040.

The liberal pitch between the CEC cavities, as shown in the Licensing Drawing package, allows the Cask Transporter to traverse over any storage cavity and independently access any storage location. Thus, any canister located in any storage cavity can be independently accessed and retrieved using a qualified Vertical Cask Transporter (VCT) and a suitable transfer cask.

The essential design and operational features of the HI-STORM UMAX System are:

- a. Because of its underground staging in HI-STORM UMAX, tip-over of the canister in storage is not possible.
- b. In HI-STORM UMAX Version C, there are two fixed cavity depths referred to as Type SL and Type XL, respectively. Type SL cavity is sized to permit storage of all BWR fuel bearing canisters and PWR canisters that are shorter than the reference BWR canister. Type XL is a deeper cavity sized to accommodate the canisters that accommodate SNF from South Texas and AP-1000 plants (which are exceptionally long). The vast majority of the storage cavities will be of the “SL” type. For all canister heights, the VVM constraint at the top of the canister are positioned to engage with the structurally robust canister lid where the Divider Shell is also hardened against lateral loads.
- c. To exploit the biological shielding provided by the surrounding soil subgrade, the canister is entirely situated well below the top-of-grade level. The open plenum above the canister also acts to boost the ventilation action of the coolant air.
- d. Removal of water from the bottom of the storage cavity can be carried out by the simple expedient use of a flexible hose inserted through the air inlet or outlet passageways.
- e. All practical efforts are made to coat exposed surfaces of the VVM with proven low VOC and/or ANSI/NSF Standard 61 [1.2.3] compliant surface preservatives to preclude toxicological effects on the environment to the maximum reasonable extent.

HOLTEC INTERNATIONAL COPYRIGHTED MATERIAL	
Report No. HI-2167374	Proposed Rev. 0R
1-16	

1.2.3.1 Shielding Materials

Steel, concrete, and the subgrade are the principal shielding materials in the HI-STORM UMAX. The steel and concrete shielding materials in the Closure Lid provide additional gamma and neutron attenuation to reduce dose rates.

The fuel basket structure provides the initial attenuation of gamma and neutron radiation emitted by the radioactive contents. The canister shell, baseplate, and thick lid provide additional gamma attenuation to reduce direct radiation.

1.2.3.2 Lifting Devices

Lifting and handling devices used to load or unload a canister into the HI-STORM UMAX VVM shall be designed per Paragraph 1.2.1.5 of the HI-STORM FW FSAR (docket # 72-1032).

The lifting and handling of all heavy loads that are within 10CFR72 jurisdiction, such as the HI-TRAC (Transfer Cask) and the HI-STORM UMAX Closure Lid, shall be carried out using single failure proof (see definition in the Glossary) equipment with below-the-hook lifting devices that comply with the stress limits of ANSI N14.6 [1.2.4] and/or applicable portions of NUREG-0612 [1.2.7].

1.2.3.3 Threaded Anchor Locations

Threaded anchor locations are provided in the CEC Flange region of each CEC. These will serve as the anchoring location for the device used for canister transfer (Section 10.3). Threaded anchor locations serve no function during long term storage.

1.2.3.4 Design Life

The design life of the HI-STORM UMAX System is set forth in Table 17.0.1. This is accomplished by using materials of construction with a long proven history in the nuclear industry, specifying materials known to withstand their operating environments with little to no degradation (Section 17.2), and protecting material from corrosion by using appropriate mitigation measures.

Maintenance programs, as specified in Section 10.3, are also implemented to ensure that the service life will exceed the design life. The design considerations that assure the HI-STORM UMAX System performs as designed include the following:

HI-STORM UMAX VVM and HI-TRAC CS Transfer Cask:

- a. Exposure to Environmental Effects
- b. Material Degradation
- c. Maintenance and Inspection Provisions

Canisters:

- a. Corrosion
- b. Structural Fatigue Effects
- c. Maintenance of Helium Atmosphere

HOLTEC INTERNATIONAL COPYRIGHTED MATERIAL	
Report No. HI-2167374	Proposed Rev. 0R
1-17	

- d. Allowable Fuel Cladding Temperatures
- e. Neutron Absorber Boron Depletion

The adequacy of the materials for the designated design life is discussed in Chapter 18 of this report.

1.2.4 HI-TRAC CS

The proposed transfer cask for the HI-STORE CIS facility to carry out all on-site canister transfer operations is termed HI-TRAC CS which is a variation of the HI-TRAC VW transfer cask licensed in docket number 72-1032 for the HI-STORM FW and later adopted for HI-STORM UMAX system in docket number 72-1040. HI-TRAC CS utilizes steel and higher density concrete, meeting the requirements in Appendix 1.D of the HI-STORM 100 FSAR [1.3.3] to provide dose attenuation. HI-TRAC CS is also characterized by a split lid configuration wherein the bottom lid is in the form of two halves with both halves engineered to retract or approach symmetrically. Figure 1.2.3a shows HI-TRAC CS in fully closed and fully open bottom lid configurations.

The design and operational features of HI-TRAC CS are summarized in the following:

- a. The body of the cask features two concentric steel shells buttressed by a set of thick radial ribs that are welded to the two shells. The interstitial annular space between the two shells is filled with densified plain concrete that meets the requirements of Appendix 1.D of the HI-STORM 100 FSAR (docket # 72-1014) [1.3.3]. The appellation “CS” indicates that the transfer cask is “*concrete shielded*”.
- b. The bottom of the HI-TRAC features a pair of articulating, half-moon-shaped shield gates housed in a heavy steel weldment. The shield gates are made of multiple stacked, thick-steel plates on a low-friction bearing pad. The shield gates slide in the housing to allow the passage of the MPC from the HI-TRAC to the HI-STORM UMAX and vice versa. In the closed position, the shield gates support the weight of the MPC and provide shielding from the bottom of the loaded MPC. The major advantage of the split door configuration is that, in the fully retracted state, it does not intrude on the space occupied by the air vent projection in adjacent HI-STORM UMAX cavities and does not protrude into the canister vertical travel space. The shield gates feature air passages which allow for once-through air cooling of the canister (Figure 1.2.3b). The air cooling features of the HI-TRAC CS supplement the conductive and radiation cooling of the HI-TRAC CS. Ambient air rises through multiple Z-shaped passages in the shield gates, up through the annulus and out the open top of the HI-TRAC CS. A segmented alignment ring on the bottom of the HI-TRAC is used to concentrically align the HI-TRAC with the HI—STORM UMAX CEC during MPC transfer into the HI-STORM UMAX. The segmented alignment ring allows air to enter the region beneath the shield gates such that MPC cooling air flow is assured even if the HI-TRAC is placed flat on the ground. The air passage inlets through the shield gates passively uses the ground to shield personnel from downward-streaming radiation. The top region of the cask body features a set of lifting trunnions. The Trunnions are for lifting and handling of the HI-TRAC via the cask handling crane or VCT. The HI-TRAC bottom region also features a set of trunnions suitable for cask's tilting operations.

HOLTEC INTERNATIONAL COPYRIGHTED MATERIAL	
Report No. HI-2167374	Proposed Rev. 0R
1-18	

- c. The bottom region of the cask is outfitted with a heavy wall steel structure that houses the articulating shield gates. The shield gates ride on a low friction surface to enable them to be pulled apart (or pushed together) with a modest force to open the cask's cavity for canister transfer when needed. Shield gate opening and closure occurs via a set of hydraulic cylinders located on the outer edges of the shield gate housing.
- d. The shielding concrete in the transfer cask is installed through suitably sized openings in the cask's top closure plate which also provide the exit path for any gases that may be generated during a hypothetical fire event. The HI-TRAC concrete space is supplemented with an internal cylindrical steel ring that supplements the gamma shielding in the shield gate region.
- e. During the canister transfer operation, the transfer cask is secured to the top pad of the recipient cavity (HI-STORM UMAX ISFSI pad or the CTF pad) by a set of anchor bolts which eliminates kinematic stability concerns during the Design Basis Earthquake (DBE) event or any other credible environmental mechanical loading applicable to the site.
- f. The top of the transfer cask features a thick annular steel ring which serves to prevent an inadvertent lifting of the canister beyond the biological shielding space provided by the transfer cask and also provides shielding axially.
- g. The transfer cask is engineered to directly mate with the HI-STORM UMAX cavity as well as the Canister Transfer Facility (CTF) cavity eliminating the need for the traditional Mating Device ancillary. Elimination of the Mating Device has the salutary advantage of reducing the aggregate crew dose (i.e., promoting ALARA).

The Licensing drawing package in Section 1.5 of this chapter provides the necessary design details of HI-TRAC CS that support the required safety analyses documented in this SAR.

1.2.5 Operational Characteristics of the HI-STORM UMAX

The major operational steps to load a HI-STORM UMAX cavity consists of the following: The cask transporter carrying the transfer cask with the loaded canister aligns over the top of the HI-STORM UMAX and the HI-TRAC is placed on the HI-STORM UMAX VVM. The canister inside the transfer cask is lifted slightly by the VCT to allow the HI-TRAC's shield gates be opened. The canister is slowly lowered into the VVM cavity below. The transfer equipment is removed and the Closure Lid is installed. The principal operational characteristics of short term operations at an ISFSI are:

- a. Prior to loading the VVM, the Closure Lid or other temporary lid is removed and the Divider Shell is installed.
- b. The HI-TRAC CS cask is mounted on the VVM cavity and secured with large fasteners that are sized to protect the cask from tip- over under the site's DBE.
- c. The canister is lowered into the storage cavity.
- d. After the HI-TRAC Transfer Cask is removed then the Closure Lid is installed.

The loading operation is characterized by the following essential features:

HOLTEC INTERNATIONAL COPYRIGHTED MATERIAL	
Report No. HI-2167374	Proposed Rev. 0R
1-19	

- a. The vertical insertion (or withdrawal) of the canister eliminates the risk of gouging or binding of the canister with the CEC parts.
- b. All load handling operations are carried out using the Vertical Cask Transporter (VCT) that meets the criteria for lifting devices in Subsection 4.5.1 to preclude uncontrolled lowering of the load.

Details of the generic operational steps involving either installation or removal of the loaded canister at the HI-STORE CIS facility are provided in Section 10.3 along with reference to the safety measures that are known from experience to avert human performance errors. The visual depiction of the required operational steps in Figures 3.1.1 (a-x) provides a brief illustration of the loading steps for the HI-STORM UMAX CIS.

1.2.5.1 Design Features

The design features of the HI-STORM UMAX System are intended to meet the following principal performance characteristics under all credible modes of operation:

- a. Prevent unacceptable release of contained radioactive material at all times.
- b. Minimize occupational and site boundary dose.
- c. Permit retrievability of contents (the canister must be recoverable after accident conditions in accordance with ISGs 2 and 3 [1.2.5, 1.2.6]).

Chapter 11 identifies the many design features built into the HI-STORM UMAX System to minimize dose and maximize personnel safety. Among the design features intrinsic to the system that facilitate meeting the above objectives are:

- a. The loaded canister is always maintained in a vertical orientation during its handling at the ISFSI and is handled using ANSI N14.6 [1.2.4] compliant ancillaries.
- b. Almost all personnel activities during canister transfer occur at ground level which helps promote safety and ALARA.

1.2.5.2 Identification of Subjects for Safety and Reliability Analysis

(a) Criticality Prevention

Every canister brought over to the HI-STORE facility must be approved under a USNRC docket to store used nuclear fuel or HLW. Therefore, the criticality compliance of the canister at HI-STORE is assured, as discussed in Chapter 8 of this report.

(b) Chemical Safety

There are no chemical safety hazards associated with operations of the HI-STORM UMAX System. No chemicals are stored inside the Protected Area.

(c) Operation Shutdown Modes

The HI-STORM UMAX System is totally passive and consequently, operation shutdown modes are unnecessary.

HOLTEC INTERNATIONAL COPYRIGHTED MATERIAL	
Report No. HI-2167374	Proposed Rev. 0R
1-20	

(d) Instrumentation

As stated earlier, the HI-STORM UMAX canister, which is seal welded, non-destructively examined, and pressure tested, confines the radioactive contents. The HI-STORM UMAX is a completely passive system with appropriate margins of safety; therefore, it is not necessary to deploy any instrumentation to monitor the cask in the storage mode.

(e) Maintenance Program

Because of its passive nature, the HI-STORM UMAX System requires minimal maintenance over its lifetime. Section 10.3 describes the maintenance program set forth for the HI-STORM UMAX System.

1.2.6 Cask Contents

This sub-section contains information on the cask contents pursuant to 10CFR 72.236(a),(m).

Only those canisters certified to be stored in the HI-STORM UMAX system in Docket # 72-1040 are permitted to be stored at HI-STORE CIS Facility.

Section 4.1 provides additional details.

1.2.7 Ancillary Equipment Used at HI-STORE CIS

Ancillary equipment for the HI-STORE CIS are those that are needed to conduct cask and canister handling and transfer operations in full compliance with the safety and ALARA commitments.

The major ancillary equipment includes:

- a. Vertical Cask Transporter
- b. CTB Crane
- c. Cask Tilt Frame
- d. Special Lifting Devices
- e. HI-PORT

The above list does not include minor ancillaries that are available for procurement to the applicable ANSI standards such as common rigging, ladders, platforms, equipment stands, service and mobile cranes for handling non-critical loads, etc. The above list does not include commercial test and measurement equipment such as radiological survey equipment, leak testing equipment and cask test connectors.

The Design Criteria for the above major ancillaries are provided in Section 4.5, and analyses are presented in Sections 5.4 and 5.5; a brief description is provided below.

a. Vertical Cask Transporter

The Vertical Cask Transporter (VCT) is the principal load handling device used for transporting the HI-TRAC CS and conducting MPC transfer operations at the HI-STORM UMAX ISFSI within the HI-STORE CIS site. Used in conjunction with the special lifting devices, it provides the critical lifting and handling functions associated with the canister transfer operations at the HI-STORM

HOLTEC INTERNATIONAL COPYRIGHTED MATERIAL	
Report No. HI-2167374	Proposed Rev. 0R
1-21	

UMAX VVM locations. It is a custom-designed equipment consisting of a set of caterpillars or multiple wheels, a diesel engine with a robust gear train and transmission housed in a rugged structural frame that also supports a set of hydraulically-actuated lifting towers. Figure 1.2.4 illustrates the general configuration of a VCT. The VCT uses the same controls and redundant drop protection features used to prevent an unplanned lowering of the critical load under a loss-of-power or hydraulic system failure as used at other ISFSIs in the United States where the VCT is performing the canister transfer operations.

b. **CTB Crane:**

The Cask Handling Crane System consists of a **top running bridge**, trolley, and hoist(s). The Crane System is electrically driven and rides on crane rails which are mounted **on corbels that are integral to the CTB walls**. The trolley rides on crane rails mounted to the top of the crane girders and has at least one electric wire rope hoist for load lifting. The hoist hook will be used to lift the load and shall interface with the required rigging and below the hook lifting devices as required for the process.

The Crane System shall comply with ASME NOG-1 [3.0.1], and the latest revision of CMAA 70 [4.5.2], and OSHA. Design criteria for the **CTB** crane is in Chapter 4 of this SAR.

c. **Cask Tilt Frame:**

The Cask Tilt Frame is used in conjunction with the **CTB** Crane and its special lifting devices to transfer the Transport Cask between the vertical and horizontal orientations. The Cask Tilt Frame consist of a set of trunnion support stanchions and a cask support saddle. The trunnion support stanchions engage the cask's rotation trunnions and provide a low-friction rotation point for cask tilting. The saddle supports the upper portion of the cask when the cask reaches the horizontal orientation. A brief illustration of the upending of a Transport Cask using the Crane and Tilt Frame through insertion into the CTF is demonstrated in Chapter 3. Downending is performed in the reverse order for shipments away from the CIS.

d. **Special Lifting Devices:**

The Special Lifting Devices include those lifting components used to connect the cask or canister to the **CTB** Crane or the VCT's lift points, as illustrated in Figure 1.2.4. Special Lifting Devices are defined in ANSI N14.6 [1.2.4].

e. **HI-PORT**

The **HI-PORT** is the conveyance used for transporting the **HI-TRAC CS** (empty or loaded) from the **CTB** to the **HI-STORM UMAX ISFSI** and vice-versa. It is a custom-designed vehicle consisting of a pair of self-powered, multi-axle trailers with a drop deck spanning between the trailers. The general configuration of a **HI-PORT** is shown on the Licensing Drawing in Section 1.5. The **HI-PORT** uses the same controls and features used to transport casks at other ISFSIs in the United States.

HOLTEC INTERNATIONAL COPYRIGHTED MATERIAL	
Report No. HI-2167374	Proposed Rev. 0R
1-22	

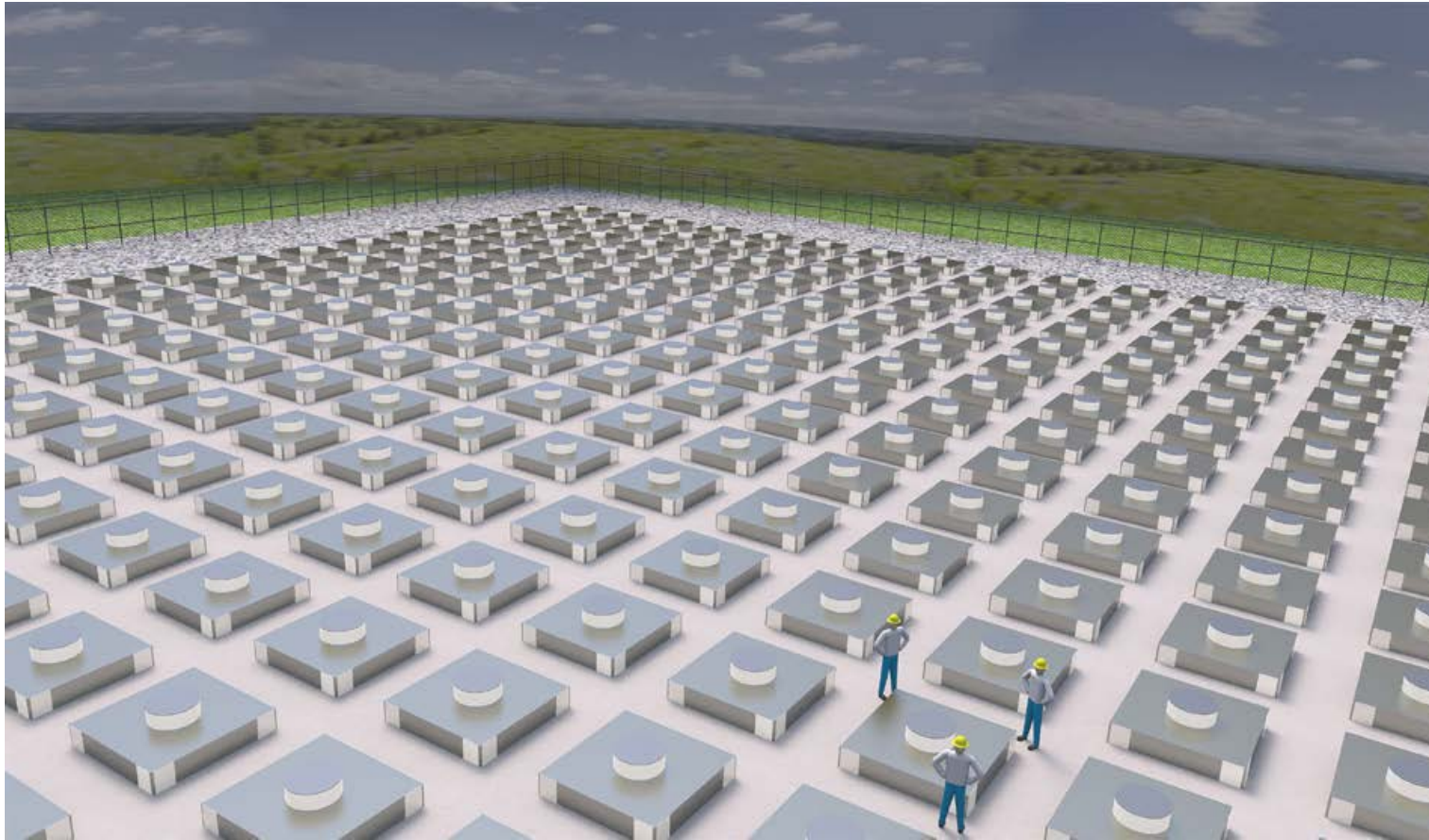


Figure 1.2.1: Illustration of an Array of HI-STORM UMAX Systems

HOLTEC INTERNATIONAL COPYRIGHTED MATERIAL

Report No. HI-2167374

Proposed Rev. 0R

1-23

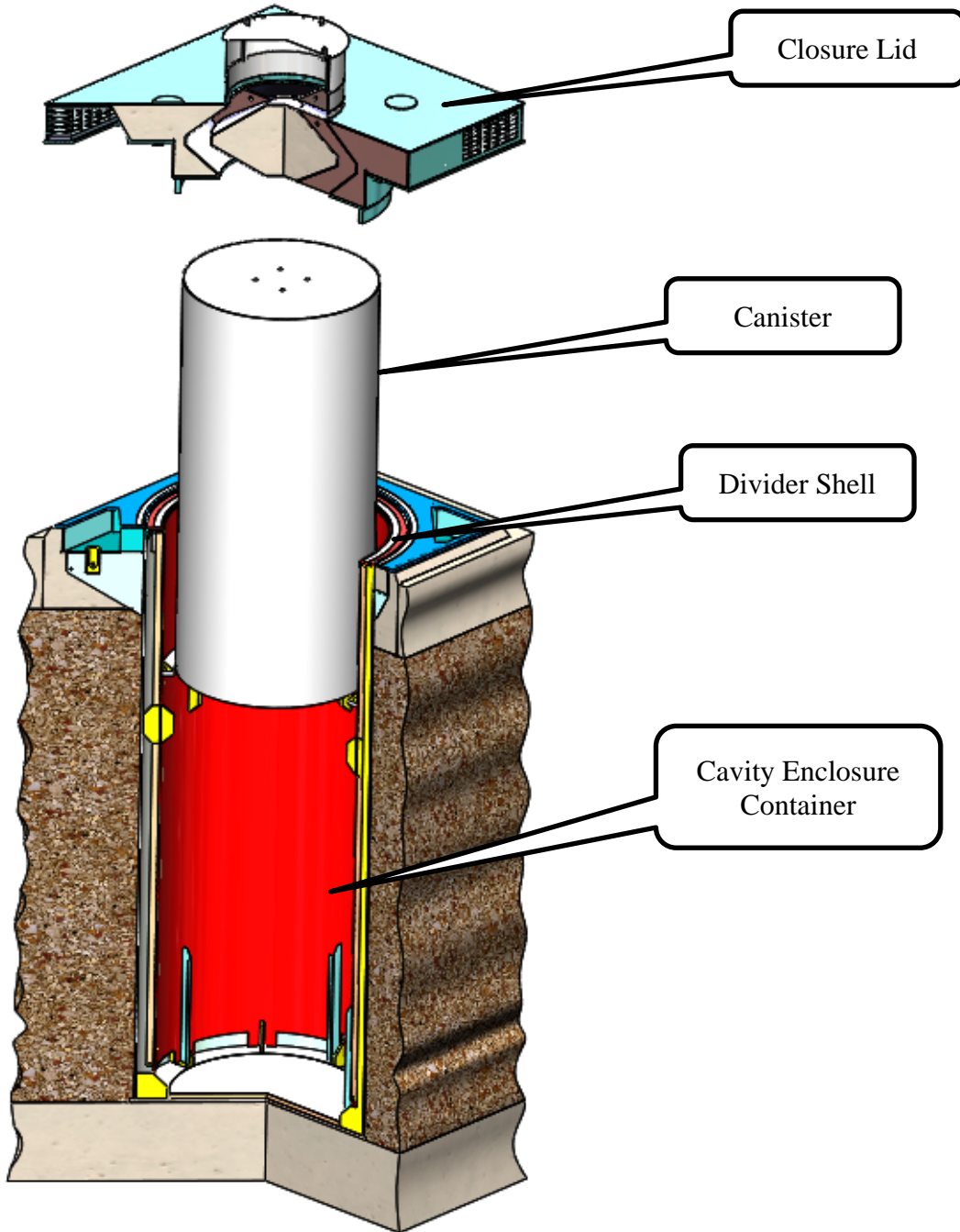


Figure 1.2.2(a): VVM Components Shown in Exploded, Cut-Away View

HOLTEC INTERNATIONAL COPYRIGHTED MATERIAL	
Report No. HI-2167374	Proposed Rev. 0R
1-24	

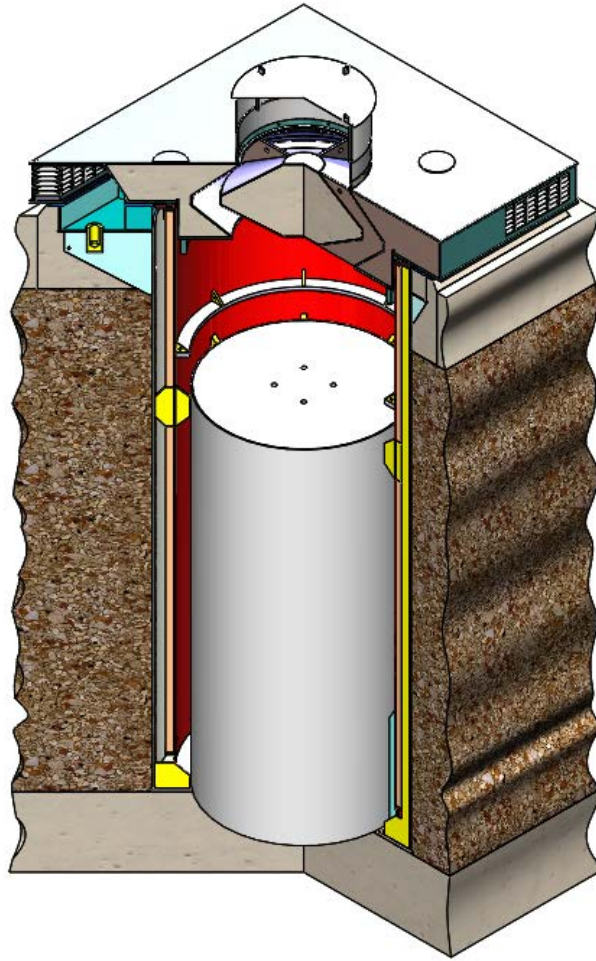


Figure 1.2.2(b): VVM Components Shown in Assembled, Cut-Away View

HOLTEC INTERNATIONAL COPYRIGHTED MATERIAL	
Report No. HI-2167374	Proposed Rev. 0R
1-25	

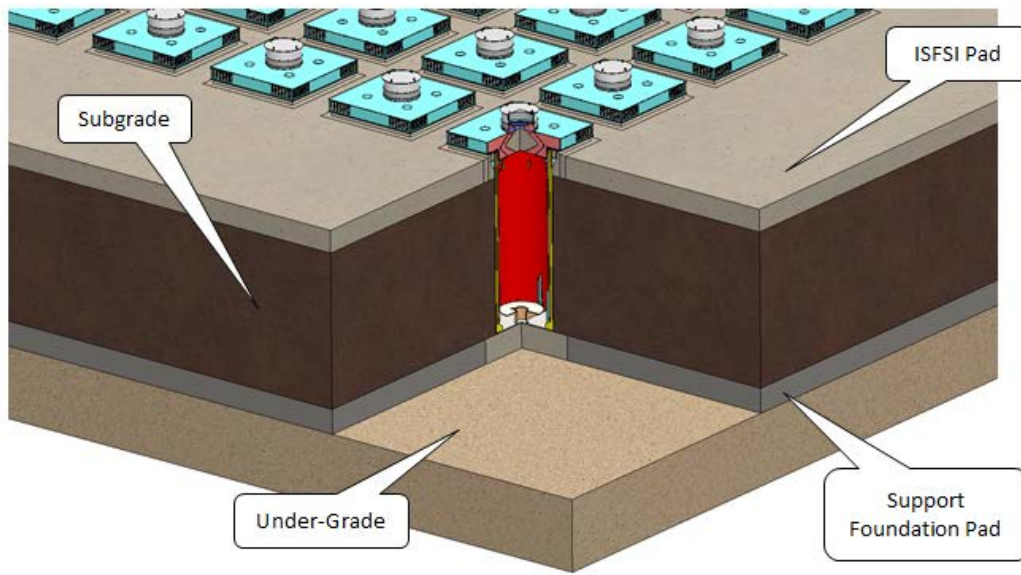


Figure 1.2.2(c): UMAX ISFSI in Partial Cut-Away View

HOLTEC INTERNATIONAL COPYRIGHTED MATERIAL	
Report No. HI-2167374	Proposed Rev. 0R
1-26	

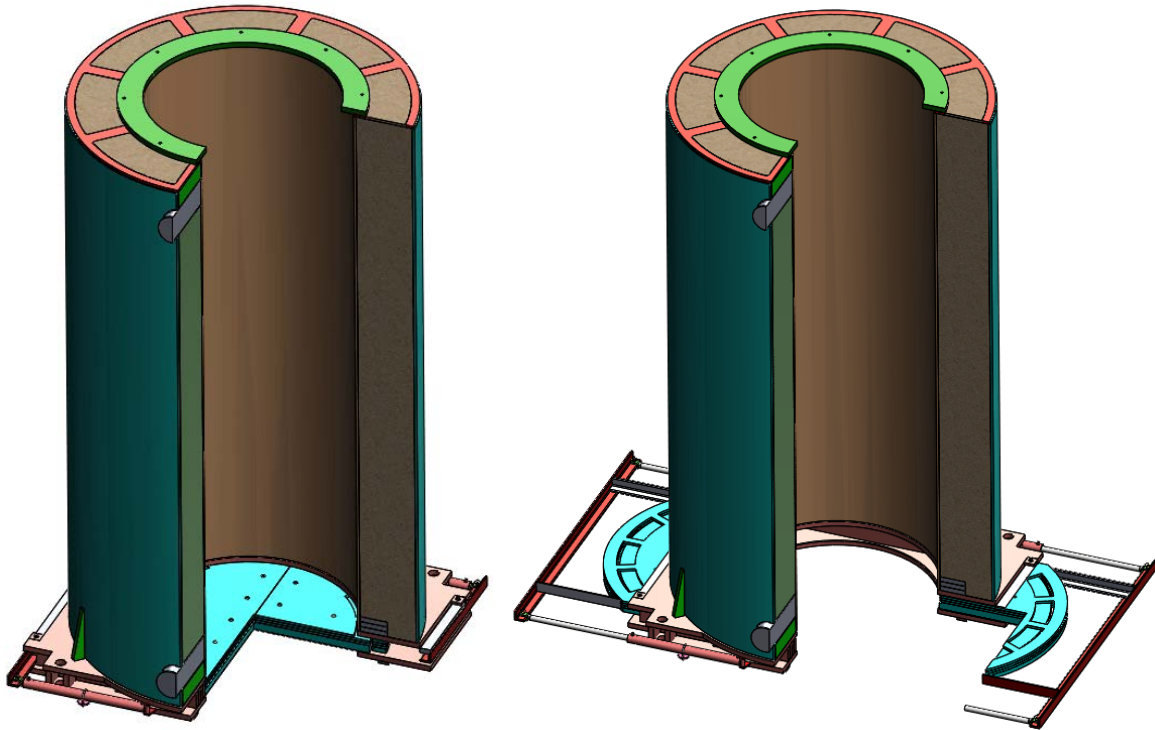


Figure 1.2.3a: HI-TRAC General Configuration Shown with Shield Gates Closed and Open

HOLTEC INTERNATIONAL COPYRIGHTED MATERIAL	
Report No. HI-2167374	Proposed Rev. 0R
1-27	

Figure 1.2.3b: [PROPRIETARY INFORMATION WITHHELD PER 10CFR2.390]

HOLTEC INTERNATIONAL COPYRIGHTED MATERIAL	
Report No. HI-2167374	Proposed Rev. 0R
1-28	

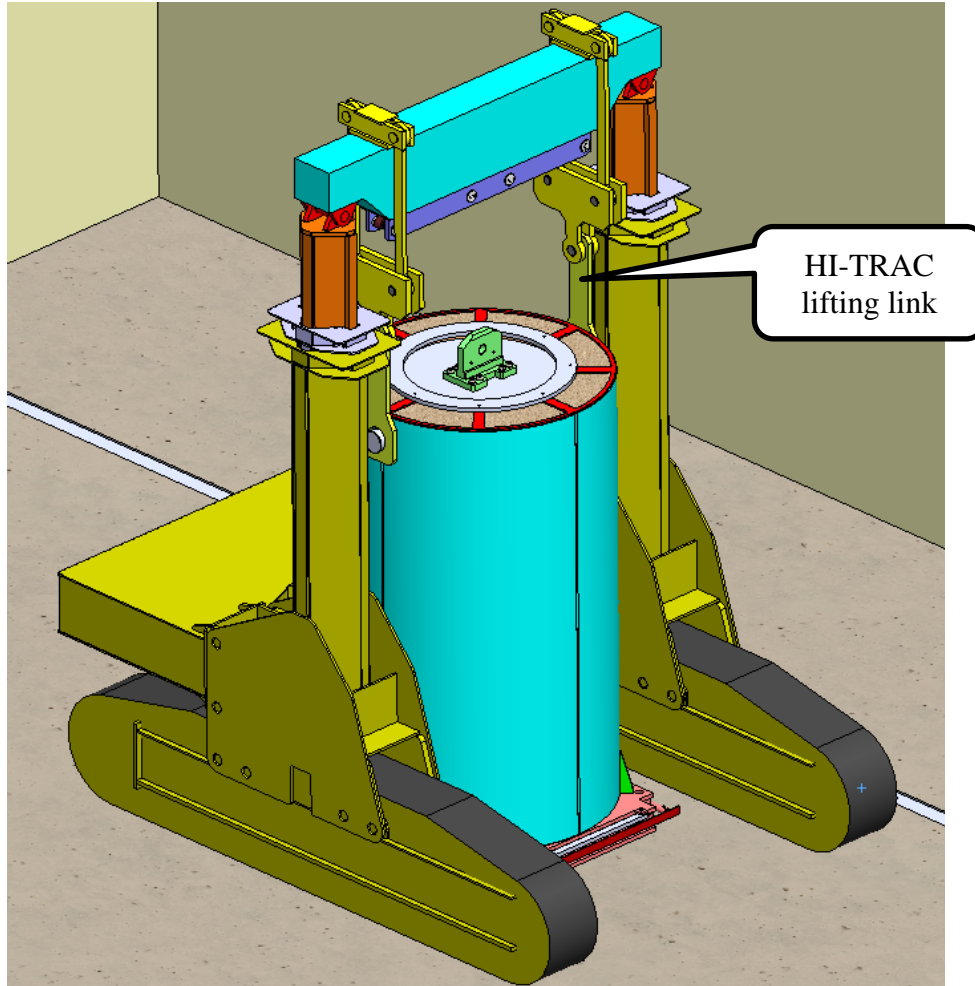


Figure 1.2.4: Vertical Cask Transporter (VCT) with loaded HI-TRAC CS Transfer Cask and Special Lifting Device

HOLTEC INTERNATIONAL COPYRIGHTED MATERIAL	
Report No. HI-2167374	Proposed Rev. 0R
1-29	

1.3 IDENTIFICATION OF AGENTS AND CONTRACTORS

This section contains the necessary information to fulfill the requirements pertaining to the qualifications of the applicant pursuant to 10CFR72.22. Holtec International, with its operation centers in Florida, New Jersey, Pennsylvania, and Ohio in The United States, is the system designer and applicant for certification of the HI-STORE CIS facility.

Holtec International is an engineering technology company with a principal focus on the power industry. Holtec International Nuclear Power Division (NPD) specializes in spent fuel storage technologies. NPD has carried out turnkey wet storage capacity expansions (engineering, licensing, fabrication, removal of existing racks, performance of underwater modifications, volume reduction of the old racks and hardware, installation of new racks, and commissioning of the fuel pool for increased storage capacity) in numerous nuclear plants around the world. Over 90 plants in the U.S., Britain, Brazil, Korea, Mexico, China and Taiwan have utilized the Company's wet storage technology to establish their state-of-the-art in-pool storage capacities.

Holtec's NPD is also a turnkey provider of dry storage and transportation technologies to nuclear plants around the globe. The company is contracted by 59 nuclear units in the U.S. and 42 overseas to provide the company's dry storage and transport systems. Utilities in Belgium, China, Korea, Spain, South Africa, Sweden, Ukraine, the United Kingdom and Switzerland are also active users of Holtec International's dry storage and transport systems.

Four U.S. commercial plants, namely, Dresden Unit 1, Trojan, Indian Point Unit 1, and Humboldt Bay have thus far been completely defueled using Holtec International's technology. For many of its dry storage clients, Holtec International provides all phases of dry storage including: the required site-specific safety evaluations; ancillary designs; manufacturing of all capital equipment; preparation of site construction procedures; personnel training; dry runs; and fuel loading. The USNRC dockets in 10CFR71 and 10CFR72 currently maintained by the Company (as of February 2017) are listed in Table 1.3.1.

Holtec International's corporate engineering consists of professional engineers and experts with extensive experience in every discipline germane to the fuel storage technologies, namely structural mechanics, heat transfer, computational fluid dynamics, and nuclear physics. Virtually all engineering analyses for Holtec's fuel storage projects (including HI-STORM UMAX) are carried out by the company's full-time staff. The Company is actively engaged in a continuous improvement program of the state-of-the-art in dry storage and transport of spent nuclear fuel. The active patents and patent applications in the areas of dry storage and transport of SNF held by the Company (ca. June 2016) are listed in Table 1.3.2. Table 1.3.3 lists Holtec patents on dry storage technologies that have been published by the US patent office but not yet granted. Many of these listed patents have been utilized in the design of the HI-STORM UMAX System.

Holtec International's quality assurance (QA) program was originally developed to meet NRC requirements delineated in 10CFR50 [1.3.1], Appendix B, and was expanded to include provisions of 10CFR71 [1.3.2], Subpart H, and 10CFR72 [1.0.5], Subpart G, for structures, systems, and components designated as important to safety. The Holtec quality assurance program, which satisfies all 18 criteria in 10CFR72, Subpart G, that apply to the design, fabrication, construction,

HOLTEC INTERNATIONAL COPYRIGHTED MATERIAL	
Report No. HI-2167374	Proposed Rev. 0R
1-30	

testing, operation, modification, and decommissioning of structures, systems, and components important to safety is incorporated by reference into this SAR. Holtec International’s QA program has been certified by the USNRC (Certificate No. 71-0784) [12.0.1].

The HI-STORM UMAX System will be fabricated by the manufacturing plants owned by Holtec International and operated under the Company’s QA program. The Company’s HMD in Pittsburgh is a long-term ASME N-Stamp holder and fabricator of nuclear components. In particular, HMD has been manufacturing HI-STORM and HI-STAR system components since the inception of Holtec International’s dry storage and transportation program in the 1990s. HMD routinely manufactures ASME code components for use in the U.S. and overseas nuclear plants. Holtec International’s engineering and manufacturing organizations have been subject to triennial inspections by the USNRC. If another fabricator is to be used for the fabrication of any part of the HI-STORM UMAX System, the proposed fabricator will be evaluated and audited in accordance with Holtec International’s QA program approved by the USNRC.

Holtec International’s Nuclear Power Division (NPD) also carries out site services for dry storage deployments at nuclear power plants. Numerous nuclear plants, such as Trojan and Waterford 3 , Waterford 3, Pilgrim and Comanche Peak have deployed dry storage at their sites using a turnkey contract with Holtec International.

The Company has considerable prior experience in the design and licensing of AFRs sites, having successfully led the licensing of PFS, LLC’s Skull Valley in Utah (2005) and the “Central Spent Fuel Storage Facility” in Ukraine (ongoing).

HOLTEC INTERNATIONAL COPYRIGHTED MATERIAL	
Report No. HI-2167374	Proposed Rev. 0R
1-31	

**Table 1.3.1:
USNRC DOCKETS ASSIGNED TO HOLTEC INTERNATIONAL**

System Name	Docket Number
HI-STORM 100 (Storage)	72-1014 [1.3.3]
HI-STAR 100 (Storage)	72-1008 [1.3.4]
HI-STAR ATB 1T (Transportation)	71-9375
HI-STAR 100 (Transportation)	71-9261 [1.3.5]
HI-STAR 180 (Transportation)	71-9325
HI-STAR 180D (Transportation)	71-9367
HI-STAR 190 (Transportation)	71-9373 [1.3.6]
HI-STAR 60 (Transportation)	71-9336
HI-STAR 80 (Transportation)	71-9374
Holtec Quality Assurance Program	71-0784 [12.0.1]
HI-STORM FW (Storage)	72-1032 [1.3.7]
HI-STORM UMAX (Storage)	72-1040 [1.0.6]

HOLTEC INTERNATIONAL COPYRIGHTED MATERIAL

Report No. HI-2167374

Proposed Rev. 0R

1-32

Table 1.3.2: Dry Storage and Transport Patents Held by Holtec International		
Item No.	Colloquial Name of the Patent	USPTO Patent Number
1.	Honeycomb Fuel Basket	5,898,747
2.	Radiation Absorbing Refractory Composition (METAMIC)	5,965,829
3.	HI-STORM 100S Overpack	6,064,710
4.	Extrusion Fabrication Process for Discontinuous Carbide Particulate Metal Matrix Composites and Super Hypereutectic Al/Si(METAMIC-CLASSIC)	6,042,779
5.	Duct Photon Attenuator	6,519,307B1
6.	HI-TRAC Operation	6,587,536B1
7.	Cask Mating Device (Hermetically Sealable Transfer Cask)	6,625,246B1
8.	Improved Ventilator Overpack	6,718,000B2
9.	Below Grade Transfer Facility	6,793,450B2
10.	HERMIT (Seismic Cask Stabilization Device)	6,848,223B2
11.	Cask Mating Device (operation)	6,853,697
12.	Davit Crane	6,957,942B2
13.	Duct-Fed Underground HI-STORM	7,068,748B2
14.	Forced Helium Dehydrator (design)	7,096,600B2
15.	Below Grade Cask Transfer Facility	7,139,358B2
16.	Forced Gas Flow Canister Dehydration (alternate embodiment)	7,210,247B2
17.	HI-TRAC Operation (Maximizing Radiation Shielding During Cask Transfer Procedures)	7,330,525
18.	HI-STORM 100U	7,330,526B2
19.	Flood Resistant HI-STORM	7,590,213B1
20.	HI-STORM 100M (Underground Manifoldded module assembly)	7,676,016B2
21.	Dew Point Temperature Based Canister Dehydration	7,707,741B2
22.	Optimized Weight Transfer Cask with Detachable Shielding	7,786,456B2
23.	VESCAP (Apparatus, System, and Method for Facilitating Transfer of High Level Radioactive Waste to and/or From a Pool)	7,820,870B2
24.	HI-STORM 100F (Counter-flow Underground Vertical Ventilated Module)	7,933,374B2
25.	Apparatus for Transporting and/or Storing Radioactive Materials Having Jacket Adapted to Facilitate Thermo-siphon Fluid Flow	7,994,380B2
26.	Method of Removing Radioactive Materials from Submerged State and/or Preparing Spent Nuclear Fuel for Dry Storage	8,067,659B2
27.	HI-STORM 100US	8,098,790B1
28.	Canister Apparatus and Basket for Transporting, Storing and/or Supporting Spent Nuclear Fuel(Double Wall Canister)	8,135,107B2

HOLTEC INTERNATIONAL COPYRIGHTED MATERIAL	
Report No.HI-2167374	Proposed Rev. 0R
1-33	

Table 1.3.2: Dry Storage and Transport Patents Held by Holtec International		
Item No.	Colloquial Name of the Patent	USPTO Patent Number
29.	Apparatus System and Method for Low Profile Translation of High Level Radioactive Waste Containment Structure (Low Profile Transporter)	8,345,813
30.	Method of Storing High Level Waste (HI-STORM 100F)	8,345,813B2
31.	Apparatus for Providing Additional Radiation Shielding to a Container Holding Radioactive Materials, and Method of Using the same to Handle and/or Process Radioactive Materials	8,415,521B2
32.	Systems and Methods for Storing Spent Nuclear Fuel	8,625,732
33.	System and Method for the Ventilated Storage of High Level Radioactive Waste in a Clustered Arrangement	8,660,230B2
34.	Method of Transferring High Level Radioactive Materials, and System for the Same	8,718,221B2
35.	Manifold System for the Ventilated Storage of High Level Waste and a Method of Using the Same to Store High Level Waste in a Below-Grade Environment	8,718,220B2
36.	Method and Apparatus for Preparing Spent Nuclear Fuel for Dry Storage	8,737,559B2
37.	Apparatus for Storing and/or Transporting High Level Radioactive Waste, and Method for Manufacturing the Same	8,798,224B2
38.	Method for Controlling Temperature of a Portion of a Radioactive Waste Storage System and for Implementing the Same	9,105,365B2
39.	Ventilated System for Storing High Level Radioactive Waste	8,905,259B2

HOLTEC INTERNATIONAL COPYRIGHTED MATERIAL	
Report No. HI-2167374	Proposed Rev. 0R
1-34	

Table 1.3.3: Holtec International Pending Patents on Fuel Storage

	Title	Submittal Date	USPTO FILE NUMBER	Publication Number
1.	System And Method For The Ventilated Storage Of High Level Radioactive Waste In A Clustered Arrangement(HIC-Storm)	22-Dec-08	12340948	US20090159550
2.	Spent Fuel Basket, Apparatus And Method Using The Same For Storing High Level Radioactive Waste (HI-STAR 180)	02-Jul-07	11772610	US20080031396
3.	System And Method For Storing Spent Nuclear Fuel Having Manifolded Underground Vertical Ventilated Module (100M)	19-Feb-10	12709094	US20100150297
4.	Cask Apparatus, System And Method For Transporting And/Or Storing High Level Waste (HI-SAFE)	28-Apr-10	12769622	US20100272225
5.	Spent Fuel Basket For Storing High Level Radioactive Waste (HEXCOMB Racks)	29-Oct-08	12260914	US20090175404
6.	Shield Transfer Canister for Inter-Unit Transfer of Spent Nuclear Fuel	16-Dec-10	12970901	US20110150164
7.	Method of Removing Radioactive Materials from a Submerged State and/or Preparing Spent Nuclear Fuel for Dry Storage	29-Nov-11	13306948	US20120142991
8.	System and Method of Storing and/or Transferring High Level Radioactive Waste	18-Apr-13	61625859	W02013158914
9.	Container and System for Handling Damaged Nuclear Fuel and Method of Making Same	19-Feb-14	61525583	W02013055445
10.	Subterranean Canister Storage System For Monitored Retrievable Storage of Nuclear Materials	10-Mar-14	61532397	US20140226777A1
11.	Vertical Ventilated Cask with Distributed Air Inlets for Storing Fissile Nuclear Materials	13-May-14	14358032	US2014329455A1
12.	A Radioactive Material Storage Canister and Method for Sealing Same	03-Jul-14	61746094	US20150340112
13.	Method of Storing High Level Radioactive Waste	07-Jul-14	13736452	US20140192946A1
14.	System and Method for Minimizing Movement of Nuclear Fuel Racks During a Seismic Event	26-Feb-15	61694058	US20150310947

HOLTEC INTERNATIONAL COPYRIGHTED MATERIAL

Report No. HI-2167374

Proposed Rev. 0R

1-35

Table 1.3.3: Holtec International Pending Patents on Fuel Storage

	Title	Submittal Date	USPTO FILE NUMBER	Publication Number
15.	System and Method for Storing and Leak Testing a Radioactive Materials Storage Canister	26-Feb-15	61695837	W02014036561
16.	High-Density Subterranean Storage System for Nuclear Fuel and Radioactive Waste	10-Dec-15	14760215	US20150357066A1
17.	System for Storing High Level Radioactive Waste	07-Jul-16	15053608	US20160196887A1
18.	Storage System for Nuclear Fuel	14-Jul-16	14912754	US20160203884A1

HOLTEC INTERNATIONAL COPYRIGHTED MATERIAL	
Report No. HI-2167374	Proposed Rev. 0R
1-36	

1.4 MATERIAL INCORPORATED BY REFERENCE

Materials incorporated by reference into this report are discussed in Section 1.0 and identified in Table 1.0.3. The majority of this information is incorporated from the HI-STORM UMAX docket, with some supplementary information from the HI-STORM FW. Each individual chapter provides a table which identifies the specific material incorporated by reference into each chapter, with specific sections and specific references.

HOLTEC INTERNATIONAL COPYRIGHTED MATERIAL	
Report No. HI-2167374	Proposed Rev. 0R
1-37	

1.5 LICENSING DRAWINGS

The licensing drawings for the HI-STORM UMAX System, the HI-TRAC Transfer Cask and other important to safety ancillary systems/components employed at the HI-STORE CIS, pursuant to the requirements of 10CFR72.24(c)(3), are provided in this section. The licensing drawings contain the necessary information to enable the margins of safety under different operating modes for the facility to be quantified in a conservative manner to support its safety case.

The drawing packages developed specifically for the proposed HI-STORE facility are listed in Table 1.5.1 and placed in their numerical sequence at the end of this chapter.

Table 1.5.1: Drawing Packages for the HI-STORE CIS Facility		Revision
Drawing Number	Caption	
10868	HI-TRAC CS	PR 2
10895	Canister Transfer Facility (CTF)	PR-2
10899	Tilt Frame	PR-2
10875	HI-STORM UMAX Vertical Ventilated Module (Version C)	PR-2
10902	Lift Yoke for HI-STAR 190	PR-2
10900	Lift Yoke for HI-TRAC CS	PR-2
10894	HI-STAR Horizontal Lift Beam	PR-2
10901	HI-TRAC CS Lift Link	PR-1
10891	MPC Lift Attachment	PR-2
10889	MPC Lifting Device Extension	PR-3
10912	Cask Transfer Building	R 0.2
10940	HI-STORE Site Plan and General Arrangement	PR-0.2
12481	HI-PORT	0
12432	HI-TRAN	0
12404	CTB Crane	0
6505	MPC-37 Enclosure Vessel	17
6512	MPC-89 Enclosure Vessel	18

[PROPRIETARY DRAWINGS WITHHELD PER 10FR2.390]

HOLTEC INTERNATIONAL COPYRIGHTED MATERIAL	
Report No. HI-2167374	Proposed Rev. 0R
1-38	

1.6 REGULATORY COMPLIANCE

This section ensures compliance with 10CFR72.18, 72.22, 72.24 and 72.44 as indicated in NUREG 1567 [1.0.3] Section 1.

10CFR72.18 discusses material incorporated by reference, which is discussed in Section 1.4.

10CFR72.22 requires that general and financial information about the applicant is provided, including age, address, description of business, estimated cost of construction and operation of the facility and decommissioning, which is discussed in Section 1.3 (with the exception as indicated below).

10CFR72.24 requires that the application includes technical information, including overview of the installation, principal characteristics of the ISFSI (dimensions, weights, and construction materials, licensing drawings), facility allowance for decommissioning (retrievability), and general description of contents to be stored at the facility. Information regarding facility systems descriptions and agents and contractors are required to be provided.

10CFR72.44 describes the license conditions, which are provided in the license document for the facility.

The chapter complies with 10CFR72 requirements above and follows the guidance of NUREG-1567 [1.0.3] with the following qualifications:

1. For proprietary reasons financial information, including cost of construction, operation and decommissioning will be submitted separately from this SAR.
2. Due to the significant quantity of material incorporated by reference into this SAR, information regarding weights will be incorporated by reference into other chapters for analysis purposes. As such, to maintain adequate configuration control, information on weights will be included in Chapter 5 (Structural) of this report. Similarly, information on contents to be stored in the HI-STORM UMAX is provided in Chapter 4 of this report.

HOLTEC INTERNATIONAL COPYRIGHTED MATERIAL	
Report No. HI-2167374	Proposed Rev. 0R
1-39	

CHAPTER 2: SITE CHARACTERISTICS*

2.0 INTRODUCTION

This chapter presents the relevant characteristics of the proposed HI-STORE Consolidated Interim Storage (CIS) Facility site (Site). The purpose of this chapter is to: (1) characterize local land and water use and population so that individuals and populations likely to be affected can be identified; (2) identify the external natural and man-induced phenomena for inclusion in design basis considerations; and (3) characterize the transport processes which could move any released contamination from the facility to the maximally exposed individuals and populations. More details regarding the environmental characteristics of the Site and surroundings is found in the Environmental Report (ER) [1.0.4].

* All references are placed within square brackets in this report and are compiled in Chapter 19 of this report

HOLTEC INTERNATIONAL COPYRIGHTED MATERIAL	
Report No. HI-2167374	Proposed Rev. 0R
2-1	

2.1 GEOGRAPHY AND DEMOGRAPHY

2.1.1 Site Location

The center of the Site is at **approximately** latitude 32.571 north and longitude 103.716 west, in Lea County, New Mexico, 32 miles east of Carlsbad and 34 miles west of Hobbs (Figure 2.1.1). **The Property is defined as the entire Section 13, Township 20 South, Range 32 East, N.M.P.M. (S13 T20S R32E). As well as portions of adjacent Section 17 and Section 18, Township 20 South, Range 33 East (T20S R33E). The HI-STORE Facility will be located within Section 13.** Larger population centers are Roswell, New Mexico, 74 miles to the northwest; Odessa, Texas, 92 miles to the southeast; and Midland, Texas, also to the southeast at 103 miles. The nearest international airport is located between Midland and Odessa, Texas 98 miles to the southeast.

2.1.2 Site Description

The Site is currently owned by the Eddy-Lea Energy Alliance (ELEA), a limited liability company owned by the cities of Carlsbad and Hobbs, and Eddy County and Lea County. In April 2016, Holtec and ELEA signed a memorandum of agreement (MOA) [2.1.1] covering the design, licensing, construction and operation of the Site. Among other things, that MOA provides the terms by which Holtec could purchase the Site. On July 19, 2016, the New Mexico Board of Finance approved the sale of the Site to Holtec [2.1.2].

The Site, **or property**, consists of mostly undeveloped land used for cattle grazing with the only boundary being a four-strand barb wire fence along the south side of the property until it nears Laguna Gatuna, where it turns south to the highway. This fence is the boundary between two grazing allotments administered by the Bureau of Land Management (BLM). The majority of allotments are grazed year-round with some type of rotational grazing. Figure 2.1.2 depicts the Site boundaries.

Rangelands comprise a substantial portion of the Site and provide forage for livestock. Pasture rotation, with some of the pastures being rested for a least a portion of the growing season, is standard management practice for grazing allotments. **Grazing allotments near the site can be seen in Figure 2.1.3.** Vegetative monitoring studies to collect data on the utilization of the land, and the amount of precipitation by pasture from each study allotment are conducted annually on Federal lands to compare production with consumption. Currently, the BLM permits nine animal unit months¹ per 640 acres [2.1.3]. Because the Site is privately held, it does not fall under the BLM range management rules, although the rules apply to most of the adjacent lands that are managed by the same rancher.

The following list of structures is shown on Figures 2.1.2, **and 2.1.5. A map of the utility infrastructure is shown on Figure 2.1.4.** An aerial view of the Site is shown in Figure 2.1.5 and several plot views of the HI-STORE CIS Facility are shown in Figures 2.1.6(a), (b), (c), and (d).

- A communications (**cell**) tower in the southwest corner of **Section 13**;
- A gas and distillate well, **Hanson State #001**, is located **between** the communications tower **and the boundary of the facility on the southern edge of Section 13**;

¹ An "animal unit month" is the amount of forage needed to feed a cow for one month.

HOLTEC INTERNATIONAL COPYRIGHTED MATERIAL	
Report No. HI-2167374	Proposed Rev. 0R
2-2	

- A small water drinker (for livestock) is located along the water pipeline in the Northeast corner of Section 13 outside the facility boundaries (water drinker to be removed and water pipeline to be relocated prior to construction of the site);
- An abandoned oil recovery facility with tanks and associated hardware left in place in the northeast corner of the property outside of Section 13;
- An oil recovery facility with tanks and associated hardware just beyond the edge of the northeast corner of the property outside of Section 13;
- An abandoned oil recovery facility in the far southeast corner of the property;
- Existing natural gas pipelines run underground along the North-South edge of Section 13 to the East of the facility, and along the East-West edge of Section 13 to the South of the facility;
- A temporary flexible pipeline for natural gas runs aboveground diagonally through the center of Section 13 (to be relocated prior to construction of the site).

As can be seen in in Figure 2.1.25 and detailed in Table 2.1.4, while there are no active wells on the HI-STORE CISF site, there are four active wells within 1 mile of the HI-STORE CISF. Three of these wells are oil wells, and 1 well is a gas and distillate well. The closest oil well is approximately 4,400 feet from the ISFSI, and the fire risk associated with these three wells is bounded by the oil recovery facility fire risk evaluation provided in Section 6.5.2. As shown by the fire risk evaluation provided in Section 6.5.2, these oil wells do not present a threat to the CIS Facility.

The closest gas and distillate well is located in the southwest corner of the Site, approximately 1,750 feet from the ISFSI, and over 500 feet from the Cask Transfer Building. There is a 6-inch low pressure pipeline approximately 387 feet from the Cask Transfer Building, and a 20-inch high pressure pipeline approximately 1280 feet from the ISFSI. As discussed further below, since the risks associated with the active gas pipelines were shown to not present a threat to the HI-STORE CISF, this gas and distillate well does not present a threat to the CIS Facility operations.

The pipelines can be seen in Figure 2.1.22. The temporary flexible water pipeline that runs aboveground through the center of the Site will be moved prior to or during the early construction phases of the CIS Facility. Once construction begins, and throughout the lifetime of the CIS Facility, temporary pipelines will no longer be allowed to traverse across Holtec owned land unless they can be shown to present no hazards to safety-related structures. The natural gas pipelines which run along the North-South edge of Section 13 to the East of the facility and along the East-West edge of Section 13 to the South of the facility are underground and not considered to present a threat to the CIS Facility operations.

No water wells are located on the Site. However, the Site has been associated with oil and gas exploration and development with at least 18 plugged and abandoned oil and gas wells located on the property. However, none of these plugged and abandoned oil and gas wells are located within the area where the ISFSI would be located or where any land would be disturbed and they are not expected to affect the construction and operation of the CIS Facility. Table 2.1.5 shows basic information for all oil and gas wells within 1 mile of the facility and Figure 2.1.25 shows their relative location. There are no active wells in the facility boundaries and there are no plans to use any of the plugged and abandoned wells on the Site.

HOLTEC INTERNATIONAL COPYRIGHTED MATERIAL	
Report No. HI-2167374	Proposed Rev. 0R
2-3	

With regard to past operations at the site involving an oil recovery facility with tanks within the CIS Facility Site boundary, it should be noted that there are no oil recovery operations presently occurring on the Site and none are reasonably foreseeable. There are 7 aboveground storage tanks (ASTs) associated with past brine disposal activities on the site. These ASTs are holding tanks that were used for storing brine and settling solids and separating residual oil from oil-field brines. The tanks range in size from 150 barrels to 250 barrels. These holding tanks or ASTs are not in use. No containers of hazardous substances have been noted in prior site visits (2007) or most recent site visits (2016). Within Section 13, which is where the CIS Facility would be located, two additional tanks (250 gallon barrels) are present at the well location in the southwest portion of the Site. One active oil/gas well, Hanson State #001, on the southwest portion of Section 13 operates at minimum production to maintain mineral rights, outside of the facility boundaries.

United States Department of Agriculture (USDA) Natural Resources Conservation Service (NRCS) Soil Survey Maps of Lea County, NM [2.1.4] were reviewed in order to identify the soil units present at the Site. A Soil Survey Map is provided as Figure 2.1.7. About 90 percent of the soils within the Site are classified as Simona-Upton association (SR) and Simona fine sandy loam (SE). Simona soils are calcareous eolian deposits derived from sedimentary rock and consist of fine sandy loam underlain by gravelly fine sandy loam and cemented material, and gravelly fine sandy loam underlain by fine sandy loam and cemented material. The remaining soils (approximately 10 percent) consist of Midessa and wink fine sandy loam (MN), Mobeetie Potter Association (MW), Stony rolling land (SY), and Mixed alluvial land (MU). Details regarding the Site soil types and characteristics were compiled from Appendix D of the ER [1.0.4], and are summarized below.

Simona-Upton Association (SR)

Simona (50 percent of soil unit)

- 0 to 8 inches: gravelly fine sandy loam; saturated hydraulic conductivity (Ksat) of 14.11 to 42.34 micrometers per second.
- 8 to 16 inches: fine sandy loam; Ksat of 14.11 to 42.34 micrometers per second.
- 16 to 26 inches: cemented material (Petrocalcic Restrictive Layer i.e. Caliche); Ksat of 0.00 to 0.42 micrometers per second.

Upton (35 percent of soil unit)

- 0 to 8 inches: gravelly loam; Ksat of 4.23 to 14.11 micrometers per second.
- 8 to 18 inches: cemented material; Ksat of 0.07 to 4.23 micrometers per second.
- 18 to 60 inches: very gravelly loam; Ksat of 4.23 to 14.11 micrometers per second.

Simona fine sandy loam (SE)

- 0 to 8 inches: fine sandy loam; Ksat of 14.11 to 42.34 micrometers per second.
- 8 to 16 inches: gravelly fine sandy loam; Ksat of 14.11 to 42.34 micrometers per second.
- 16 to 26 inches: cemented material (Petrocalcic Restrictive Layer i.e. Caliche); Ksat of 0.0 to 0.42 micrometers per second.

HOLTEC INTERNATIONAL COPYRIGHTED MATERIAL	
Report No. HI-2167374	Proposed Rev. 0R
2-4	

Midessa and wink fine sandy loams (MN)

Midessa (45 percent of soil unit)

- 0 to 4 inches: fine sandy loam; Ksat of 14.11 to 42.34 micrometers per second.
- 4 to 22 inches: clay loam; Ksat of 1.35 to 1.55 micrometers per second.
- 22 to 60 inches: clay loam; Ksat of 4.23 to 14.11 micrometers per second.

Wink (40 percent of soil unit)

- 0 to 12 inches: fine sandy loam; Ksat of 14.11 to 43.34 micrometers per second.
- 12 to 23 inches: sandy loam; Ksat of 14.11 to 43.34 micrometers per second.
- 23 to 60 inches: sandy loam; Ksat of 14.11 to 43.34 micrometers per second.

Mobeetie-Potter Association (MW)

Mobeetie (70 percent of soil unit)

- 0 to 4 inches: fine sandy loam; Ksat of 14.11 to 43.34 micrometers per second.
- 4 to 24 inches: fines sandy loam; Ksat of 14.11 to 43.34 micrometers per second.
- 24 to 60 inches: fine sandy loam; Ksat of 14.11 to 43.34 micrometers per second.

Potter (24 percent of soil unit)

- 0 to 4 inches: gravelly fine sandy loam; Ksat of 4.23 to 14.11 micrometers per second.
- 4 to 14 inches: extremely cobbly loam; Ksat of 4.23 to 42.34 micrometers per second.

Stony rolling land (SY)

Torriorthents (85 percent of soil unit)

- 0 to 20 inches: extremely gravelly sandy loam; Ksat of 14.11 to 42.34 micrometers per second.
- 20 to 60 inches: bedrock; Ksat of 0.42 to 14.00 micrometers per second.

Mixed alluvial land (MU)

Ustifluvents (85 percent of soil unit)

- 0 to 60 inches: stratified sand to loamy fine sand to loam to sandy clay loam to clay loam to clay; Ksat of 0.42 to 141.14 micrometers per second.

Appendix D of the ER [1.0.4] provides additional information regarding soil descriptions, soil features, and physical, chemical, and engineering properties, including soil salinity. Laboratory analyses of soil samples within the Site indicated chloride concentrations of 26-43,000 mg/kg in the soil [2.1.3]. The soil samples were taken in the eastern portion of the Site, in areas previously used for oilfield disposal. The highest chloride concentrations are considered to be localized and

HOLTEC INTERNATIONAL COPYRIGHTED MATERIAL	
Report No. HI-2167374	Proposed Rev. 0R
2-5	

not reflective of the concentrations where the CISF would be located [2.1.3]. A review of the available soil data, including engineering properties of the Site soils, indicates favorable conditions for foundations, utilities, surface pavement, and other improvements [2.1.3]. Removal of fill would not induce seismic activity or affect subsurface faults [1.0.4]. Section 4.3 of the ER [1.0.4] provides additional details regarding the potential impacts of the CIS Facility on soils, including a discussion of construction activities adjacent to a finished ISFSI structure.

In December of 2017, a site characterization for HI-STORE CISF Phase 1 was completed. The field explorations included borings and geophysical testing at the HI-STORE site. Figure 2.1.8 shows the location of the 9 borings and ancillary borings. Detailed profiles for these borings can be found in the Geotechnical Data Report prepared by GEI [2.1.24] or in Sections 2.5 and 2.6 of this report.

Vegetation and habitats within the Site and immediately surrounding area are common within the region. The Site does not support any vegetation of significance. Significance is defined in this document as any plant, animal, or habitat that: (1) has high public interest or economic value or both; or (2) may be critical to the structure and function of the ecosystem or provide a broader ecological perspective of the region.

The Project area is in the primary vegetation community of Desert Grasslands, which is widespread at lower elevations in southern and western New Mexico. These communities are characterized by significant amounts of grasses and less than 10 percent of total cover being forbs and shrubs [2.1.5]. Typical vegetation in Desert Grassland communities include black grama (*Bouteloua eriopoda*), blue grama (*Bouteloua gracilis*), bluestem, buffalo grass (*Bouteloua dactyloides*), western wheatgrass (*Pascopyrum smithii*), galletas (*Hilaria spp.*), tobosa (*Pleuraphis mutica*), alkali sacaton (*Sporobolus airoides*), three-awn (*Aristida spp.*), mesquite (*Prosopis spp.*), serviceberry (*Amelanchier denticulate*), skunkbush sumac (*Rhus trilobata*), sand sagebrush (*Artemisia filifolia*), Apache plume (*Fallugia paradoxa*), creosotebush (*Larrea tridentata*), and cliffrose (*Purshia mexicana*). With appropriate moisture (generally more than is typically experienced) sunflower (*Helianthus annuus*), croton (*Croton spp.*), and pigweed (*Amaranthus palmeri*) may grow in disturbed or ponded depressions.

A biological survey in October of 2016 (Appendix B in the ER [1.0.4]) also documented a variety of mesquite scrubland and very few grassland species. This further indicates that vegetation in the area has changed from a desert grassland to mesquite scrubland due to overgrazing. The dominant species documented during this survey include broom snakeweed, honey mesquite, prairie verbena (*Glandularia bipinnatifida*), prickly pear (*Opuntia engelmannii*), scarlet globemallow (*Sphaeralcea coccinea*), silverleaf nightshade (*Solanum elaeagnifolium*), tobosa grass, western peppergrass (*Lepidium montanum*), and wooly croton (*Croton capitatus*).

The topography of the Site shows a high point located on the southern border of the Site and gentle slopes leading to the two drainages (Laguna Plata and Laguna Gatuna). Both of these drainages would be able to accept a one day severe storm total within the 7.5 inch range with excess free board space. The natural drainage of the Site is useful by providing a natural area for impoundment of excess runoff during severe storms [2.1.3]. Figures 2.1.9 – 2.1.11 depict the topography for the Site and the surrounding area.

HOLTEC INTERNATIONAL COPYRIGHTED MATERIAL	
Report No. HI-2167374	Proposed Rev. 0R
2-6	

There are no United States Army Corps of Engineers (USACE) jurisdictional wetlands on the Site [2.1.3]. Additionally, there no floodplains identified or mapped for the Site or Lea County, New Mexico [2.1.6, 2.1.7].

2.1.3 Population Distribution and Trends

This section describes population distribution and trends for the 50-mile region of influence (ROI) surrounding the proposed Site including Lea and Eddy Counties in New Mexico and Andrews and Gaines Counties in Texas (see Figure 2.1.12). Lea County is primarily rural, as are the other counties in the ROI. Between 2000 and 2010, the population in the ROI has grown at a slower rate in comparison to New Mexico-wide population growth. Population estimates in the ROI are projected to grow at a slower rate than New Mexico, increasing 10 percent between 2015 and 2025 while New Mexico is projected to increase 19 percent during the same time period. Table 2.1.1 lists historical population and Table 2.1.2 lists projected population in the ROI and New Mexico and Texas.

The population in the ROI in 2015 was estimated to be 166,914 [2.1.9]. In 2015, 43 percent of the population of the ROI resided in Lea County, New Mexico. Between 2010 and 2015, the counties within the ROI all experienced an increase in population. Gaines County, Texas had the greatest increase at 14 percent, while Eddy County, New Mexico had the lowest increase at seven percent during the same time period.

The nearest residence to the Site is the Salt Lake Ranch located 1.5 miles north of the Site. There are additional residences at the Bingham Ranch, two miles to the south, and near the Controlled Recovery Inc. complex, three miles to the southwest. There is an average population of less than 20 residents among the five ranches within a six mile radius. This is a population density of less than 5 residents per square mile [2.1.3]. Table 2.1.3 presents the population density per square mile of land for the ROI in 2010. Figure 2.1.13 presents a sector map of population in segments surrounding the Site for distances of 1, 2, 3, 4, and 5 miles. As shown on that Figure, there are only 9 people living within 5 miles of the proposed Site. **As discussed in Section 3.8.1 of the ER, population estimates in the Region of influence (ROI) are projected to grow at a slower rate than New Mexico, increasing 10 percent between 2015 and 2025, while New Mexico is projected to increase 19 percent during the same time period. Assuming a 10 percent growth between 2015 and 2025, the projected population living within 5 miles of the CIS Facility would grow from 9 to 10 persons.**

With regard to transient populations within 5 miles of the CIS Facility, Holtec contacted all employers within 5 miles and determined that there are currently approximately 303 persons working within 5 miles of the CIS Facility boundary, broken down as follows:

- Land Farm (R360 Disposal): 1.9 miles southwest of the CIS Facility Site boundary; 43 full time equivalent (FTE) workers;
- Intrepid East Facility: approximately 4.9 miles southwest of the CIS Facility Site boundary; 210 FTE's;
- Intrepid North Facility: approximately 4.2 miles west of the CIS Facility Site boundary; 40 FTE's;
- Caliche Mine: 4 miles southwest of the CIS Facility Site boundary; 10 FTE's [2.1.14].

HOLTEC INTERNATIONAL COPYRIGHTED MATERIAL	
Report No. HI-2167374	Proposed Rev. 0R
2-7	

With regard to future projections, there are no reasonably foreseeable projects expected to occur within 5 miles of the CIS Facility boundary and no changes to the existing transient workforce were forecast by the employers in the area [2.1.14]. Consequently, it is assumed that the transient population of 303 workers would remain constant going forward.

The nearest local school facilities, daycare, nursing homes and hospitals are located in Hobbs, NM. The educational institutions include three colleges, a high school and an alternative high school, three middle schools, twelve elementary schools, and two private schools. The Lea Regional Medical Center is the nearest hospital. There are no school facilities or hospitals located within 5 miles of the proposed Site.

Because the only mechanism for radiological exposure would be from radiation (neutrons and gamma rays) emitted from the storage casks, the highest public dose would result from an individual located as close to the SNF casks as possible. For details on the radiation protection evaluation for the Site, see Chapter 11 of this SAR.

2.1.4 Land and Water Use

As shown on Figure 2.1.14 and 2.1.15, almost all of the land immediately surrounding the property is owned and managed by the BLM. Land uses in the area are limited to oil and gas exploration and production, oil and gas related services industries, livestock grazing, and limited recreational activity. Lands within six miles of the Site are privately owned, state lands, or BLM lands. Land use within six miles of the Site falls into two categories; livestock grazing and mineral extraction.

Within 50 miles of the Site, except for the communities located in the area, the land use and ownership is essentially the same as within the six mile radius. Along with the mining, grazing, and oil/gas activity, agriculture is a major activity [2.1.3].

Lea County is approximately 2.8 million acres in size. Property ownership is 17 percent Federal government, 31 percent state government, and 52 percent private. The Federally-owned land is primarily located in the southwestern portion of the county, the state-owned land is predominately located throughout the middle, and the privately owned land primarily extends from north to south in the county's eastern portion. Large tracts of land in Lea County are privately owned by farmers, ranchers, oil, gas, and mining companies. Urbanized areas near cities and towns include ownership of smaller tracts of land for residential, municipal, and commercial purposes. Approximately 93 percent of Lea County is used as range land for grazing, and approximately 4 percent is used for crop farming. Urban areas and the roadway system account for the remaining land use. Most of the land actively farmed in Lea County is irrigated [2.1.15].

Mineral extraction in the area consists of underground potash mining and oil/gas extraction. Both industries support major facilities on the surface, although mining surface facilities are confined to a fairly small area. Intrepid Mining LLC (Intrepid) owns two potash mines located within 6 miles of the Site. The Intrepid North facility, located approximately 5 miles to the west, is no longer actively mining potash underground. However, the surface facilities are still being used in the manufacture of potash products. The Intrepid East facility is still mining its underground potash ore [2.1.3]; however, as can be seen in Figure 2.1.23, the nearest mine workings remain approximately 2.1 miles to the southwest of the site. Mineral resources near the Site, as determined from the USGS Mineral Resources Data System and the New Mexico Mining Minerals Division,

HOLTEC INTERNATIONAL COPYRIGHTED MATERIAL	
Report No. HI-2167374	Proposed Rev. 0R
2-8	

are mapped on Figure 2.1.21. The USGS and NM MMD databases indicate that the CIS Facility is not co-located with existing mining facilities.

Potash was discovered in southeastern New Mexico in 1925 in a well that was being drilled for oil and gas. By the mid-1930s, there were 11 companies exploring for potash in southeastern New Mexico. The potash in southeastern New Mexico has been a major potash resource. The remaining potash reserves are estimated to be 500 million tons. Potash production continues in the Delaware Basin with active mining by Intrepid Mining and Mosaic Co. Although much of the high-grade zones have been mined out, exploration for commercially viable deposits continues [2.1.16].

Conventional mechanized underground mining operations are the most widely used method for the extraction of potash ore. A variety of mining techniques and equipment may be employed depending on factors such as: the orebody depth, geometry, thickness and consistency, the geological and geotechnical conditions of the ore and surrounding rock, and the presence of overlying aquifers. Methods in widespread use include variations of room and pillar, longwall, cut and fill, and open slope techniques. After the ore is extracted, it is generally transferred by bridge conveyor, shuttle cars or load-haul-dump units to a system of conveyors that carry it to underground storage bins, prior to haulage to the surface through a shaft by automated skips. On rare occasions shallow mines may use a decline and conveyor arrangement [2.1.20].

In general, potash ore zones are nearly flat lying; the potash ore is mined with slightly modified conventional coal-mining equipment. Room and pillar workings are commonly 6 feet high; as much as 60-70 percent of the ore is removed during the first stage of mining. Roof bolts are utilized for support in room and pillar mining. Some operations also use a second “pillar-robbing” mining technique, allowing overlying rock to settle slowly. In this manner, as much as 92 percent of the ore may be removed [2.1.20, 2.1.16].

When the potash to be extracted is at a depth of 3,000 feet or deeper and/or the potash is located in sedimentary rock, then solution mining provides a cost effective, efficient and safe way to extract the resource. Conventional mining involves extracting a lot of rock material to access the mineral resource resulting in large underground caverns and this excess waste material must also be stored on the surface. With solution mining, a brine is heated and injected into the deposit to dissolve the potash. The potash-rich brine is then pumped out of the cavern to the surface where the water is evaporated. Solution mining is currently used at a number of operations in New Mexico, and Intrepid Potash was approved to conduct solution mining of potash minerals at the HB Solution Mine, located over 15 miles from the site, in order to extract some of the remaining ore from suspended mines in the main potash mining area [2.1.16].

Subsidence is the phenomenon or response that occurs when an underground opening is created. In the Delaware Basin, subsidence caused by human activities largely has occurred as a result of potash mining and activities involving the withdrawal or injection of fluids for oil and gas production and brine extraction. Subsidence from mining creates voids that cause collapse of strata above the mining level. The overlying and surrounding rock or soil naturally deforms in an effort to arrive at a new and more stable overall equilibrium position. This equilibrium-seeking action can result in both vertical and horizontal ground movement, and, if not controlled or minimized, can cause damage to both surface and subsurface structures. It can result in the development of undesirable surface topography, such as surface cracking or collapse, sinkholes, blocking or

HOLTEC INTERNATIONAL COPYRIGHTED MATERIAL	
Report No. HI-2167374	Proposed Rev. 0R
2-9	

changing stream channels, and modification of drainage pathways. The rate of subsidence is largely dependent on the type of material being mined and the amount of material mined [2.1.16].

The magnitude, rate of development, and surface expression of the subsidence process are controlled by several factors, most of which are interdependent. These include mining method, depth of extraction, size and configuration of openings, rate of advance or extraction, seam thickness, topography, lithology, structure, hydrology, in situ stresses, and rock strength and deformational properties. Taken collectively, they demonstrate the complexity of the subsidence process [2.1.22].

Subsidence is expected in areas where 90 percent extraction rates occur with the room-and-pillar mining technique typically used in potash mining. Subsidence is not expected where 60-70 percent extraction rates are employed (e.g., first stage potash mining). The amount of subsidence is similar to findings concerning historic potash mining in the area where, given an average 6-foot mining extraction height, the maximum subsidence was found to be a nominal 4 feet. Subsidence fractures have been observed in the land surface above workings that have collapsed at depths of 1,000 feet or more [2.1.16].

As a general rule, the amount of maximum subsidence (i.e., the depth of subsidence) that could occur cannot exceed the thickness of the zone of mineral extracted (the mining thickness). Maximum subsidence depth, however, is seldom observed, due to one or more of the following reasons:

- Because subsidence actually spreads over an area somewhat larger than the mined area, the subsidence is proportionally less.
- Convergence, or closure of the mined area, is never fully complete or total, so some voids inevitably remain, reducing the amount of subsidence.
- The overlying rocks expand slightly in volume due to breakage as the ground moves downward into the mined area, resulting in a “bulking” effect, which contributes to a reduction in subsidence volume and depth.
- The subsidence process can be slow for rocks that creep—several hundred (or more) years may be required for ultimate subsidence to occur [2.1.16].

It is important to note that both historic data and anecdotal evidence suggest that for the southeastern New Mexico potash mines, virtual completion of the maximum surface subsidence profile occurs within just a few years (5 to 7 years) after completion of mining [2.1.16].

In some instances, surface subsidence induced by underground mining may alter river and stream drainage patterns, disrupt overlying aquifers, and damage buildings and infrastructure. The degree of subsidence depends on factors such as orebody thickness and geometry, the thickness of the overlying rock and the amount of ore recovered. The effects of subsidence have been reduced to some extent, through either: (1) the design of the ore extraction layout so as to reduce the rate and extent of subsidence, or (2) by backfilling openings with processing wastes such as salt tailings, to reduce or prevent subsidence [2.1.21].

Figure 2.1.17 shows potash that has been historically mined within 6 miles of the proposed CIS Facility. Figure 2.1.23 provides a localized view of mine working near the site. As shown on these

HOLTEC INTERNATIONAL COPYRIGHTED MATERIAL	
Report No. HI-2167374	Proposed Rev. 0R
2-10	

figures, the nearest mined potash is approximately 2.1 miles from the southwestern boundary of the CIS Facility Site. Per the Operations Manager for Intrepid Potash, potash mines in the area are generally a maximum of approximately 1,800-3,000 feet in depth, and the thickness of the zone of mineral extracted is a fraction of this total depth [2.1.19]. According to Golder and Associates, “the zone of disturbance of strata above the mine workings extends beyond the limit of the mine workings and data from the southeast New Mexico potash fields suggest that a reasonable limit for defining this zone of disturbance would be an angle of 45 degrees from the vertical” [2.1.18]. Consequently, for potash mining at a nominal 3,000-foot depth, the subsidence effects area could extend 3,000 feet beyond the edge of the mine workings [2.1.18]. Given that the nearest potash mine working is approximately 2 miles away from the CIS Facility, subsidence effects at the CIS Facility Site from past or current potash mines would not be expected to occur.

With regard to the Intrepid North Facility and associated mine workings (previously the National Potash Mine), located approximately 4.2 miles west of the Site, and shown on Figure 2.2.1 of the SAR), no deep mining has occurred at that mine since 1982. Given that surface subsidence generally occurs within 5 to 7 years after completion of mining, no further subsidence from that mine is expected. That mine is considered a surface facility and is used by Intrepid Potash as a processing, warehouse, and distribution center [2.1.19].

Regarding potential future potash mining near the CIS Facility, Figures 2.1.18 and 2.1.19 show the locations of potash core holes and potash leases within 6 miles of the CIS Facility Site. As shown on those figures, numerous potash core holes have been drilled in the areas surrounding the CIS Facility and there are potash leases surrounding the CIS Facility Site. Figure 2.1.24 shows the buffer zones as defined by Order 3324 [2.1.25] and Order R-111-P [2.1.30] that surround the site. This order is designed to ensure coordination between oil and gas drilling and potash mining. It mandates a ¼ mile buffer zone around all oil wells and a ½ mile buffer zone around all gas wells and drill islands that mining operations cannot occur. Order 3324 applies to the secretary’s potash area as defined in the Mineral Leasing Act in 1939. Potash mining around and under the proposed facility for the duration of the license is not expected due to several contributing factors: the complexity of mining potash in the vicinity of the proposed facility due to significant oil and gas operations, the distance from current potash mineworkings, and the and the economic viability of such operations in Section 13, Figure 2.1.24. Existing mineworkings would have to be extended through the narrow space between the buffer zones of the “Snoddy Federal #021H” (API 30-025-40838) well and the “Felmont Federal Com #002” (API 30-025-26302) wells, under Laguna Gatuna, and into Section 13. Alternatively, an entirely new mineshaft and surface facility would be required to be constructed in Section 13. There is reasonable assurance that potash mining will not occur around or under the proposed facility during its license period due to the complexity of mining in oil and gas fields, the distance from existing mine workings, and the cost of a new shaft if existing mine workings are not used.

Oil in southeastern New Mexico was discovered in 1909, 8 miles south of Artesia, but the well was never completed as a producer due to mechanical problems. Oil and gas production began in the New Mexico portion of the Delaware Basin in 1924 with the discovery of the Dayton-Artesia Field. Until the year 2000, 4.5 billion barrels of oil had been produced mainly from fields on the Northwest Shelf and Central Platform areas in the Delaware Basin. More than 3.5 billion barrels of the total production was extracted from Permian-age rocks. The U.S. Geological Survey (USGS) estimates that the greater Permian Basin area, including parts of southeastern New Mexico

HOLTEC INTERNATIONAL COPYRIGHTED MATERIAL	
Report No. HI-2167374	Proposed Rev. 0R
2-11	

and west Texas, contains substantial undiscovered oil and gas resources on the order of 1.3 billion barrels of oil and 41 trillion cubic feet of gas [2.1.16].

As a precaution for the potash mines in this region, the mining companies historically left protection pillars around the oil and gas boreholes. This practice is required through the buffers described in Order 3324 [2.1.25]. Well casing corrosion is a common problem in the Delaware Basin, caused by contact with the brine fluids being withdrawn or injected depending on the purpose of the well. There are documented cases where escape of unsaturated brines and dissolution of salt formations caused catastrophic collapse to the surface, not only in the Delaware Basin, but in other basins having substantial thicknesses of salt layers and numerous wells penetrating the salt for the purpose of fluid withdrawal [2.1.16].

Thousands of wells have been drilled through evaporate formations in the Delaware Basin to explore for and produce oil and gas (see Figure 2.1.20, which depicts wells immediately surrounding the CIS Facility). Because of the extent of the evaporites (salt and anhydrite), drilling and completion operations have to be conducted in a manner that prevents the dissolution of the salt and protects the well during drilling and through the productive lives of the wells, often 20 to 30 years or more. The decommissioning process of wells has similar requirements for protection of and from salts. Oil and gas exploration targets range from relatively shallow oil and gas at 3,050 feet deep in the Delaware Canyon Formation (specifically the Yates Formation) to deep gas targets in middle Paleozoic formations in excess of 16,000 feet deep [2.1.16].

Salt can be extracted from subsurface formations by using wells that inject fresh water to dissolve the salt followed by extraction of the saturated water. In the Delaware Basin, these wells are referred to as brine wells. Brine wells in the Delaware Basin are used to extract saline water for use in oil and gas well drilling and workover fluids. Recently, a few brine wells in Eddy County that were 200 to 300 feet in diameter and 100 to 200 feet deep suffered catastrophic collapse causing sinkhole development at the surface. Each of the wells associated with the collapse were former oil and gas wells converted to brine wells. At one brine well in Carlsbad, New Mexico, geophysical surveys indicated the presence of subsurface fracturing, cavities, and collapse, but no surface manifestation of collapse has occurred other than tilting of the ground surface [2.1.16]. The closest active brine well to the site, Brine state #001 (API 30-025-03154), is 22.2 miles to the northeast and is not a concern to the site.

There are several examples in the Permian Basin of catastrophic subsidence as a result of suspected oil field casing corrosion and dissolution of salt. The examples of subsidence associated with oil and gas operations include the Wink Sinks I and II and the Jal Sink. There are other similar incidents that occurred in areas underlain by salt in Texas and in Kansas. The Wink Sinks developed in the Hendrick oil field in Winkler County, Texas, near the town of Wink, which is approximately 75 miles southeast of the proposed CIS Facility Site. Wink Sink I developed in 1980 and Wink Sink II occurred in 2002 [2.1.16].

The Jal sinkhole, which developed in 2001, is located about 8 miles northwest of Jal, New Mexico and approximately 50 miles southeast of the proposed CIS facility Site. The geologic settings of the Wink and Jal sinkholes are similar to that of the CIS Facility Site as they occurred at the basin margin above the Capitan Reef. In each incident, sinkholes formed around a well location and the sinks had diameters ranging from 200 to over 700 feet. Although the exact cause of development

HOLTEC INTERNATIONAL COPYRIGHTED MATERIAL	
Report No. HI-2167374	Proposed Rev. 0R
2-12	

of these sinkholes is not known, it is suspected that casing failure allowed unsaturated water to come into contact with, and subsequently dissolve, salt layers [2.1.16]. When considering distance (Table 2.1.4 and Figure 2.1.25) and current drilling regulations, there is no risk of sinkholes affecting the CISF.

Potash deposits are located around and within the Site as shown on Figure 2.1.21.

There are active oil and gas operations in the immediate vicinity of the HI-STORE site. The Belco Tetris and Tetris Anise drill islands are located along the northern edge of Sections 22, 23, and 24, adjacent to Section 13 where the HI-STORE facility will reside. The Tetris Anise drill island was approved by the Pakse West Development Area [2.1.28]. The Egg Roll Development area [2.1.29] has been proposed which encompasses Section 13 and utilizes the Tetris Anise drill island. The Tetris Anise drill island allows for development of all oil and gas reserves north and south of the drill island to include Section 13, where the HI-STORE Site resides. As shown on Figure 2.1.20, individual oil and gas wells have also been drilled in the vicinity of the proposed facility [2.1.17]. All new wells will be drilled on drill islands per Order No. 3324 [2.1.25] and Order No. R-111-P [2.1.30]. Presently, there are 17 active or plugged wells within 1 mile of the site. All wells, active or plugged, are more than 1000 feet from the storage location and, therefore, are not a concern for the effects of subsidence, Figure 2.1.25 and Table 2.1.4. According to Order No. 3324 and Order No. R-111-P, a buffer zone of ½ mile around gas wells and drill islands and ¼ mile around oil wells and drill islands are established in which no potash mining can occur [2.1.25]. These buffer zones can be seen in Figure 2.1.24.

Water demand in Lea County increased 33 percent from 1985 to 1995 and in 1998, the demand was about 189,000 acre-feet per year. Similar increases in water use from 1985 to 1995 occurred in Irrigated Agriculture (33 percent) Public Supply (26 percent), Domestic (40 percent), Livestock (106 percent) and Commercial (21 percent) use categories. The water use by category, as a percentage of Lea County’s total, is 78 percent Irrigated Agricultural, 10 percent for Public Water Supply, 7 percent Mining, and 3 percent Power. Present water use by Domestic, Livestock, Commercial Reservoir Evaporation, and Recreation uses are all less than 1 percent of the total use [2.1.15].

The largest water use in Lea County is for non-municipal irrigation. The New Mexico Office of the State Engineer (NMOSE) has on record a total of 2,007 non-municipal wells with an associated water right of 344,600 acre-feet. The next largest user group is municipalities, with water rights of 48,000 acre-feet). The city of Hobbs is the largest water-rights holder with water rights of 20,100 acre-feet per year [2.1.15].

Over the next 40 years, if unrestrained, the water use in Lea County is estimated to increase to approximately 360,000 acre-feet, 90 percent greater than the 1995 total. The largest part of this increase is anticipated to come from Irrigated Agricultural, which is projected to require 290,000 acre-feet in 2040, in response to demands for feed from Lea County’s expanding dairy industry. All other water use categories are expected to increase in Lea County over the next 40 years. Specifically, 55 percent Public Supply, 58 percent Domestic, 364 percent Livestock, 58 percent Commercial, 134 percent Industrial, 32 percent Mining, 57 percent Power, and 55 percent Recreation are estimated above 1995 uses. These other categories account for a total of approximately 70,000 acre-feet per year of the total annual 2040 estimate [2.1.15].

HOLTEC INTERNATIONAL COPYRIGHTED MATERIAL	
Report No. HI-2167374	Proposed Rev. 0R
2-13	

Area	Census 1990	Census 2000	Census 2010	Population Estimates as of July 1				
				2011	2012	2013	2014	2015
Lea	55,765	55,528	64,727	63,690	64,670	65,681	66,876	71,180
Eddy	48,605	51,633	53,829	53,288	53,693	54,284	54,834	57,578
Andrews	14,338	13,004	14,786	14,500	15,006	15,554	16,126	18,105
Gaines	14,123	14,467	17,526	17,123	17,572	18,019	18,496	20,051
Total ROI	132,831	134,632	150,868	148,601	150,941	153,538	156,332	166,914
New Mexico	1,515,069	1,819,046	2,059,179	2,037,136	2,055,287	2,069,706	2,080,085	2,085,109
Texas	16,986,510	20,851,820	25,145,561	24,774,187	25,208,897	25,639,373	26,092,033	27,469,114

HOLTEC INTERNATIONAL COPYRIGHTED MATERIAL

Report No. HI-2167374

Proposed Rev. 0R

2-14

Table 2.1.2

POPULATION PROJECTIONS FOR THE REGION OF INFLUENCE [2.1.10, 2.1.11]					
Area	2020	2025	2030	2035	2040
Lea	78,407	85,773	93,712	102,090	110,661
Eddy	57,908	59,945	61,836	63,595	65,258
Andrews	16,450	17,244	17,973	18,695	19,378
Gaines	20,064	21,420	22,858	24,316	25,644
Total ROI	172,829	184,382	196,379	208,696	220,941
New Mexico	2,351,724	2,487,227	2,613,332	2,727,118	2,827,692
Texas	27,238,610	28,165,689	28,994,210	29,705,207	30,305,304

HOLTEC INTERNATIONAL COPYRIGHTED MATERIAL	
Report No. HI-2167374	Proposed Rev. 0R
2-15	

Table 2.1.3	
POPULATION DENSITY PER SQUARE MILE OF LAND FOR THE REGION OF INFLUENCE, 2010 [2.1.12]	
Area	2010
County	
Lea	14.7
Eddy	5.4
Andrews	9.9
Gaines	11.7
County Subdivision and Place	
Eunice City, Lea County	970.6
Hobbs City, Lea County	1,424.4
Jal City, Lea County	446.4
Lovington City, Lea County	2,320.9
Carlsbad City, Eddy County	903.3

HOLTEC INTERNATIONAL COPYRIGHTED MATERIAL	
Report No. HI-2167374	Proposed Rev. 0R
2-16	

HOLTEC INTERNATIONAL COPYRIGHTED MATERIAL	
Report No. HI-2167374	Proposed Rev. 0R
2-17	

Table 2.1.4**OIL AND GAS WELLS WITHIN 1 MILE OF THE HI-STORE FACILITY**

API	Well Name	Well Type	Well Status	Vertical Depth (ft)	Original Drilling Completion Date	Plug Date	Appr. Dist. to ISFSI (ft)
30-025-00937	Monroe #1 (PRE-ONGARD WELL #001)	Oil	Plugged (site released)	3,126	Jul-1943	Jul-1943	4,000
30-025-01708	Brooks-7 Well # 1 (PRE-ONGARD WELL #001)	Oil	Plugged (site released)	3,123	Oct-1941	Nov-1948	4,350
30-025-01748	Welch State #1 (PRE-ONGARD WELL #001)	Oil	Plugged (site released)	3,117	Sep-1945	May-1947	3,250
30-025-01751	Leonard-Welch State #1 (PRE-ONGARD WELL #001)	Oil	Plugged (site released)	3,102	Jun-1941	Mar-1947	3,250
30-025-01752	Welch State #2 (PRE-ONGARD WELL #002)	Oil	Plugged (site released)	3,104	Sep-1941	Mar-1947	2,350
30-025-01753	Welch State #3 (PRE-ONGARD WELL #003)	Oil	Plugged (site released)	3,099	Oct-1941	Feb-1948	4,200
30-025-12787	Welch State #4 (PRE-ONGARD WELL #004)	Oil	Plugged (site released)	3,087	Nov-1941	Mar-1947	3,500
30-025-20328	Bass State #1	Oil	Plugged (site released)	3,100	Sep-1963	Jun-1982	4,250
30-025-20337	Bass State #2	Oil	Plugged (site released)	3,100	Jan-1964	Jun-1982	3,350
30-025-21293	Bass State #3	Oil	Plugged (site released)	3,120	Apr-1965	Jun-1982	3,700
30-025-21294	Bass State #4 (PRE-ONGARD WELL #004)	Oil	Plugged (site released)	3,144	Aug-1965	Dec-1982	3,300
30-025-24997	Hanson State #1	Gas	Active	13,363	Aug-1975	N/A	1,750
30-025-26416	Boyd A #1 (PRE-ONGARD WELL #001)	Oil	Cancelled	N/A	N/A	N/A	3,600
30-025-26826	Belco AIA Federal #1	Oil	Active	13,250	Feb-1992	N/A	5,450
30-025-28128	Bass State #6	Oil	Plugged (site released)	3,079	Jan-1983	Aug-1998	4,200
30-025-38719	Belco AIA Federal #3H	Oil	Active	7,772	Feb-2008	N/A	5,300
30-025-43240	Rusty Anchor 7 Federal Corn #1H	Oil	Active	9,902	Dec-2016	N/A	4,400

HOLTEC INTERNATIONAL COPYRIGHTED MATERIAL

Report No. HI-2167374

Proposed Rev. 0R

2-18

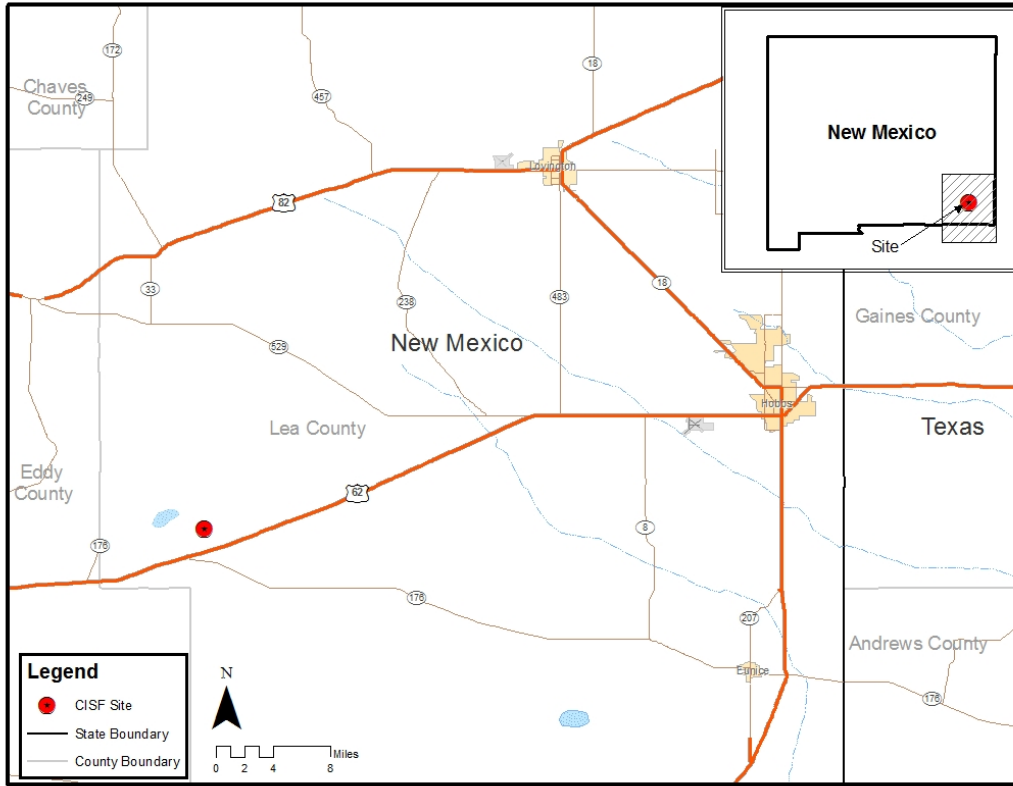


Figure 2.1.1: Location of HI-STORE

HOLTEC INTERNATIONAL COPYRIGHTED MATERIAL	
Report No. HI-2167374	Proposed Rev. 0R
2-19	



Figure 2.1.2: HI-STORE CIS Facility Site Boundaries [2.1.3]

HOLTEC INTERNATIONAL COPYRIGHTED MATERIAL		
Report No. HI-2167374		Proposed Rev. 0R
2-20		

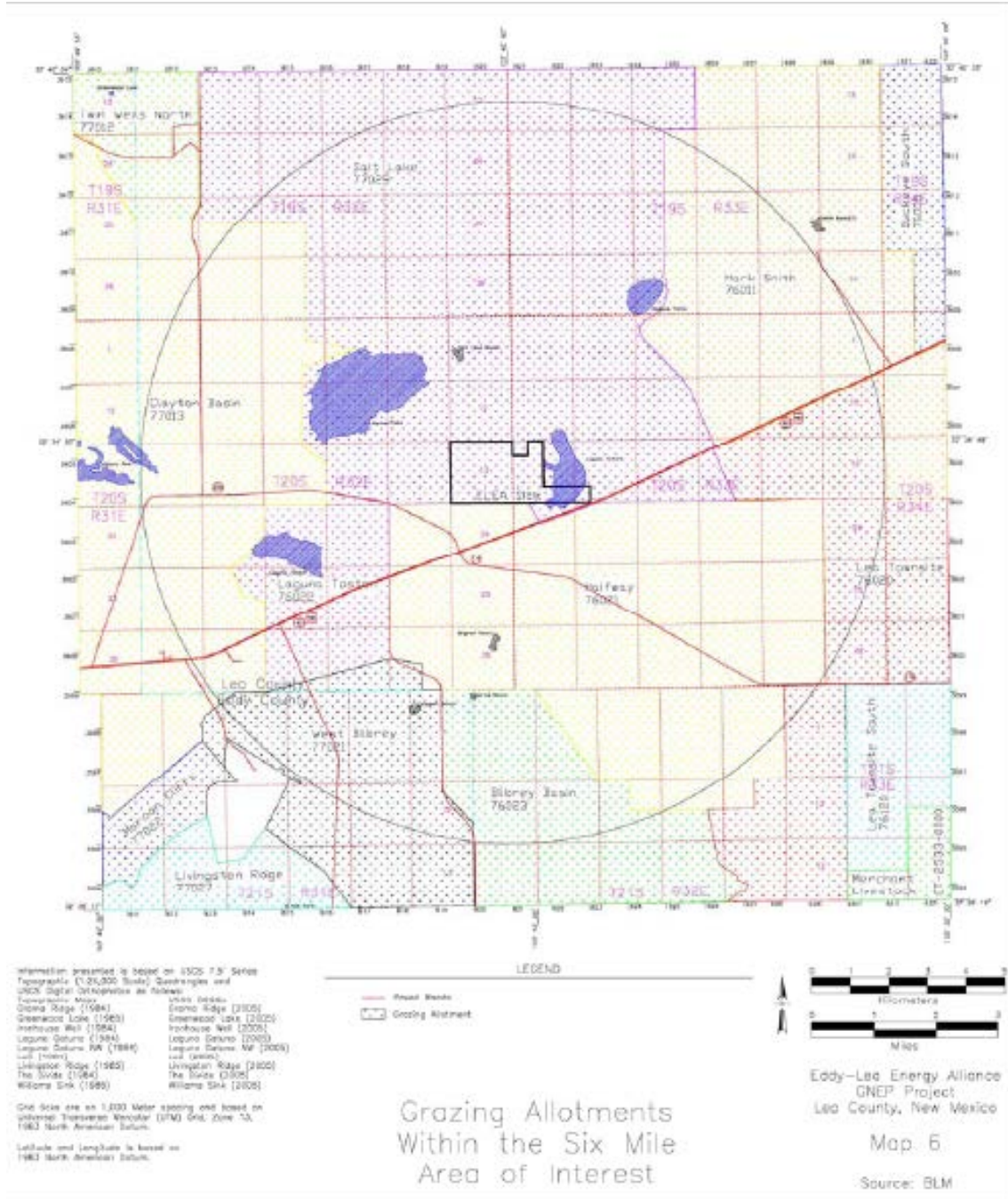


Figure 2.1.3: Grazing Allotments near the CIS Facility Site

HOLTEC INTERNATIONAL COPYRIGHTED MATERIAL		
Report No. HI-2167374		Proposed Rev. 0R
2-21		

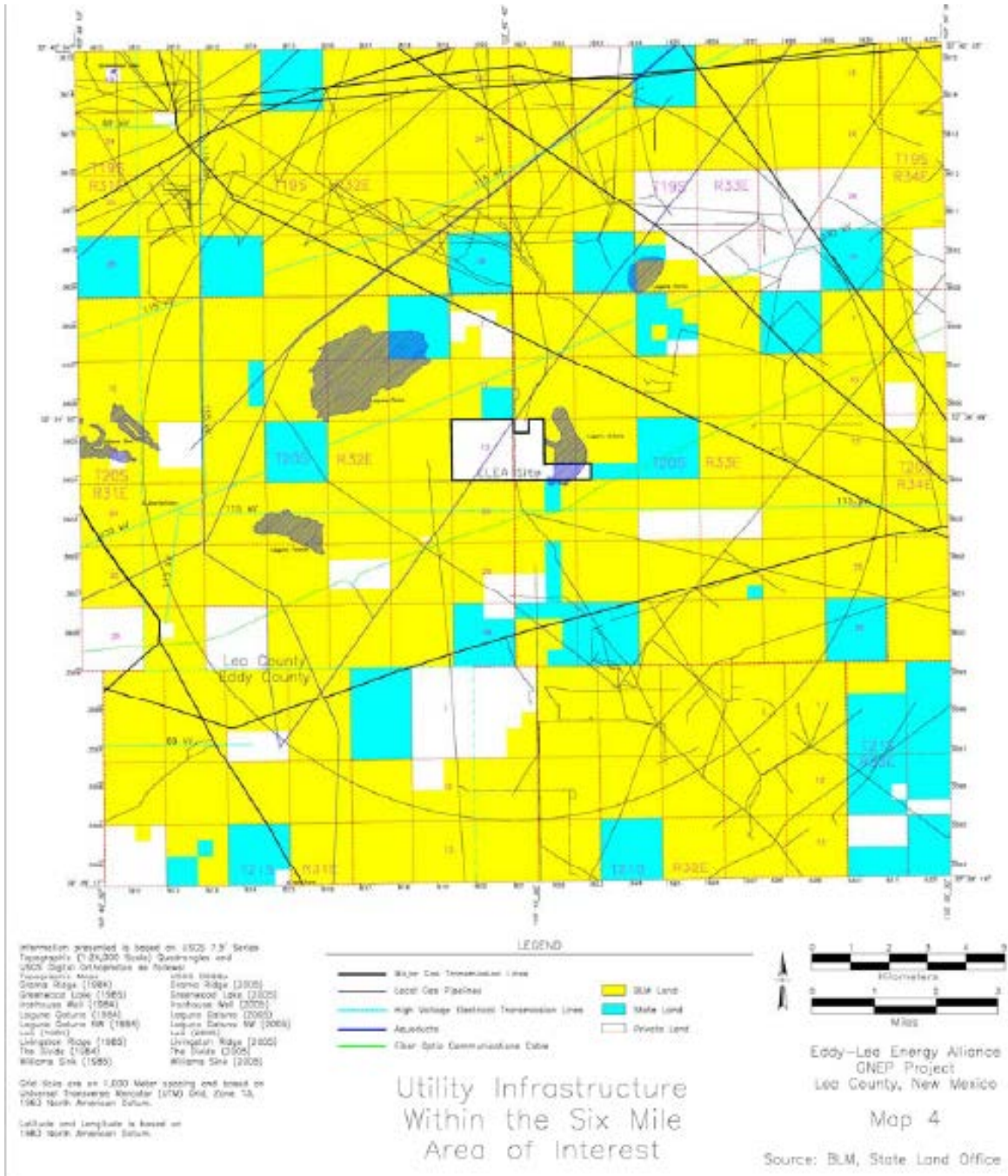


Figure 2.1.4: Utility Infrastructure near the CIS Facility Site

HOLTEC INTERNATIONAL COPYRIGHTED MATERIAL		
Report No. HI-2167374		Proposed Rev. 0R
2-22		



Figure 2.1.5: Aerial View of the Site

I HOLTEC INTERNATIONAL COPYRIGHTED MATERIAL		
Report No. HI-2167374		Proposed Rev. 0R
	2-23	

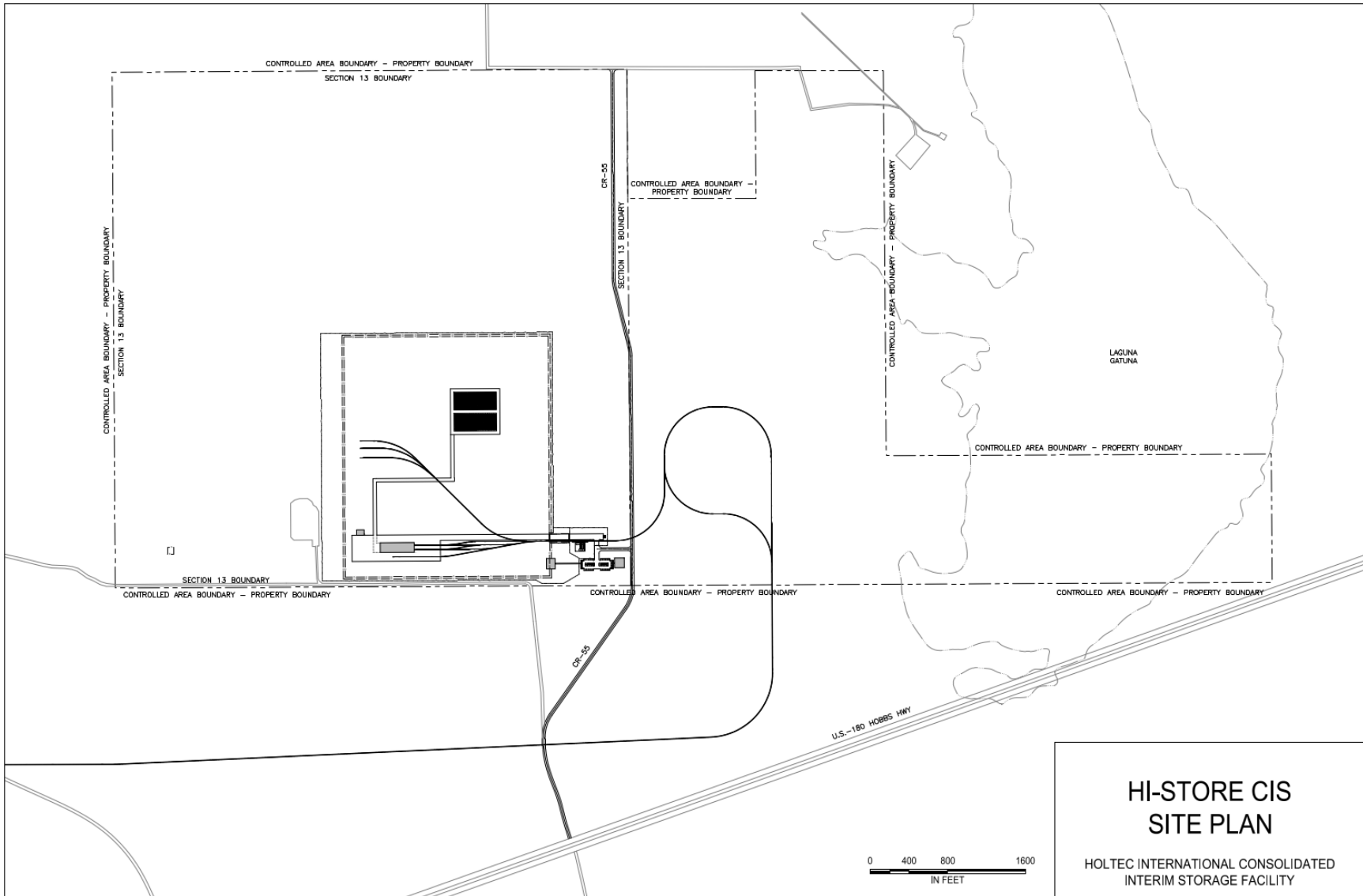


Figure 2.1.6(a): Site Layout

HOLTEC INTERNATIONAL COPYRIGHTED MATERIAL		
Report No. HI-2167374		Proposed Rev. 0R
2-24		

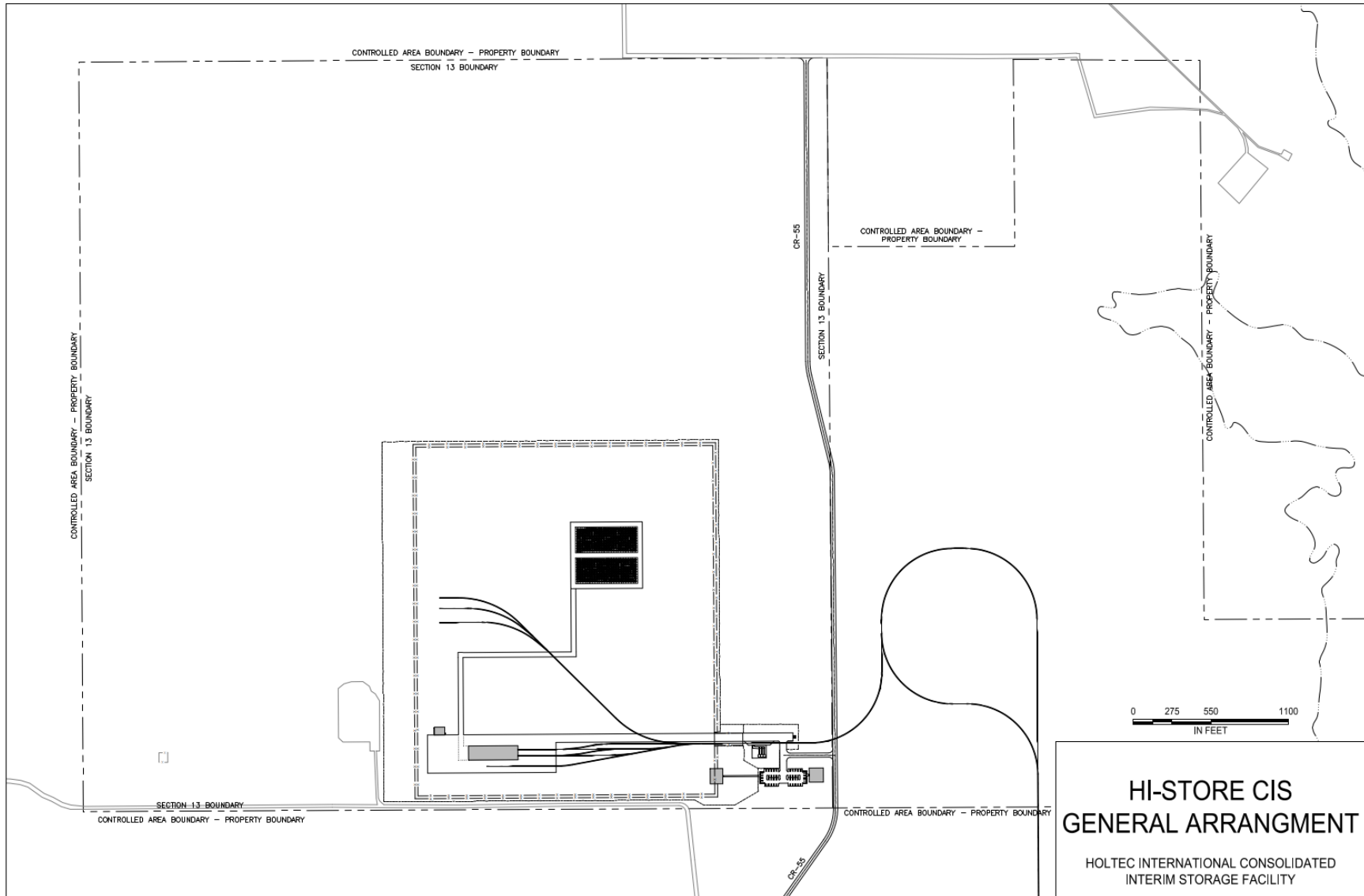


Figure 2.1.6(b): Site Layout

HOLTEC INTERNATIONAL COPYRIGHTED MATERIAL

Report No. HI-2167374

Proposed Rev. 0R

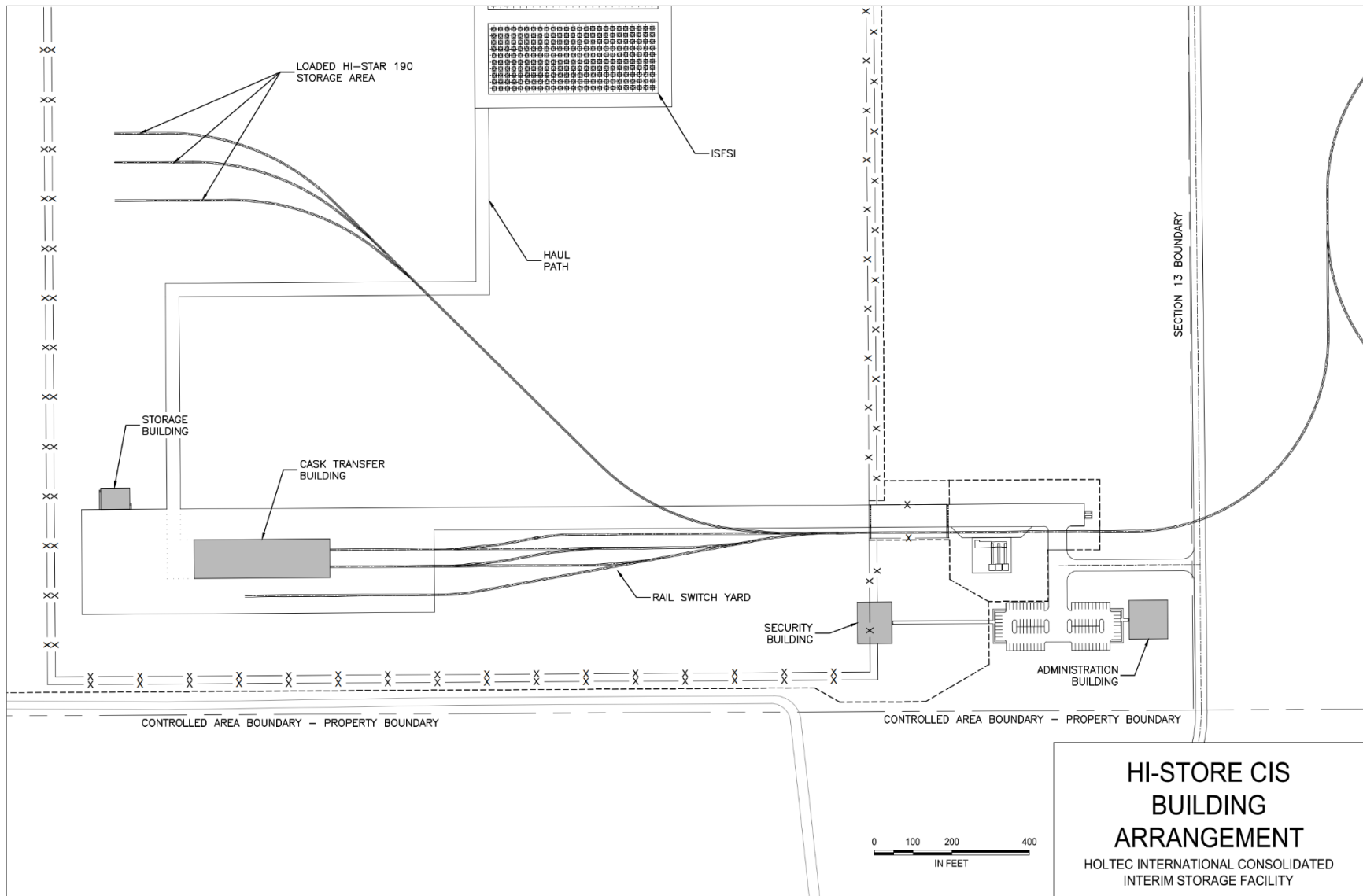


Figure 2.1.6(c): Site Layout

<p>HOLTEC INTERNATIONAL COPYRIGHTED MATERIAL</p>		
<p>Report No. HI-2167374</p>	<p>2-26</p>	<p>Proposed Rev. 0R</p>

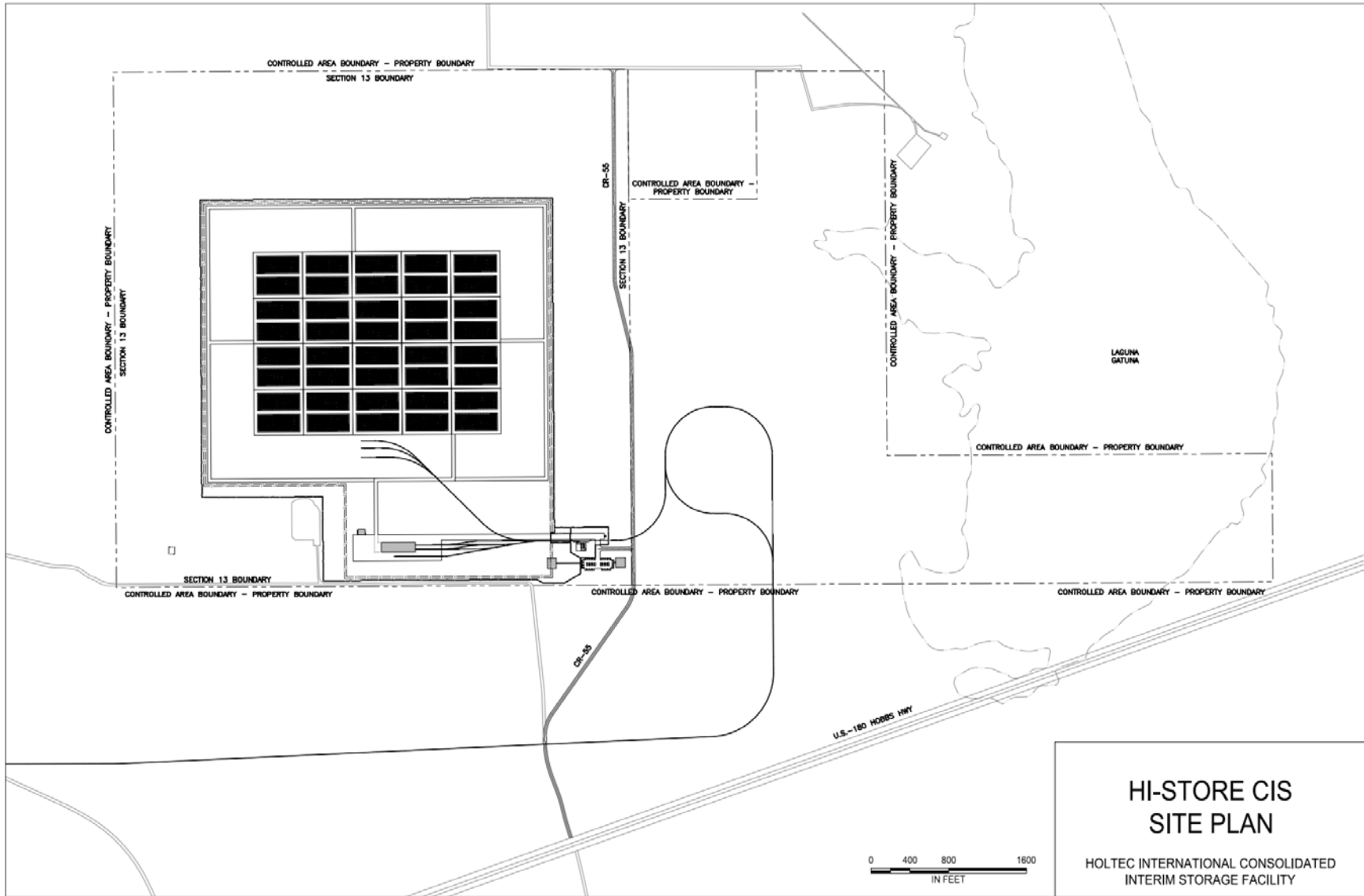


Figure 2.1.6(d): Potential Full Build Out Site Layout

HOLTEC INTERNATIONAL COPYRIGHTED MATERIAL		
Report No. HI-2167374		Proposed Rev. 0R
2-27		

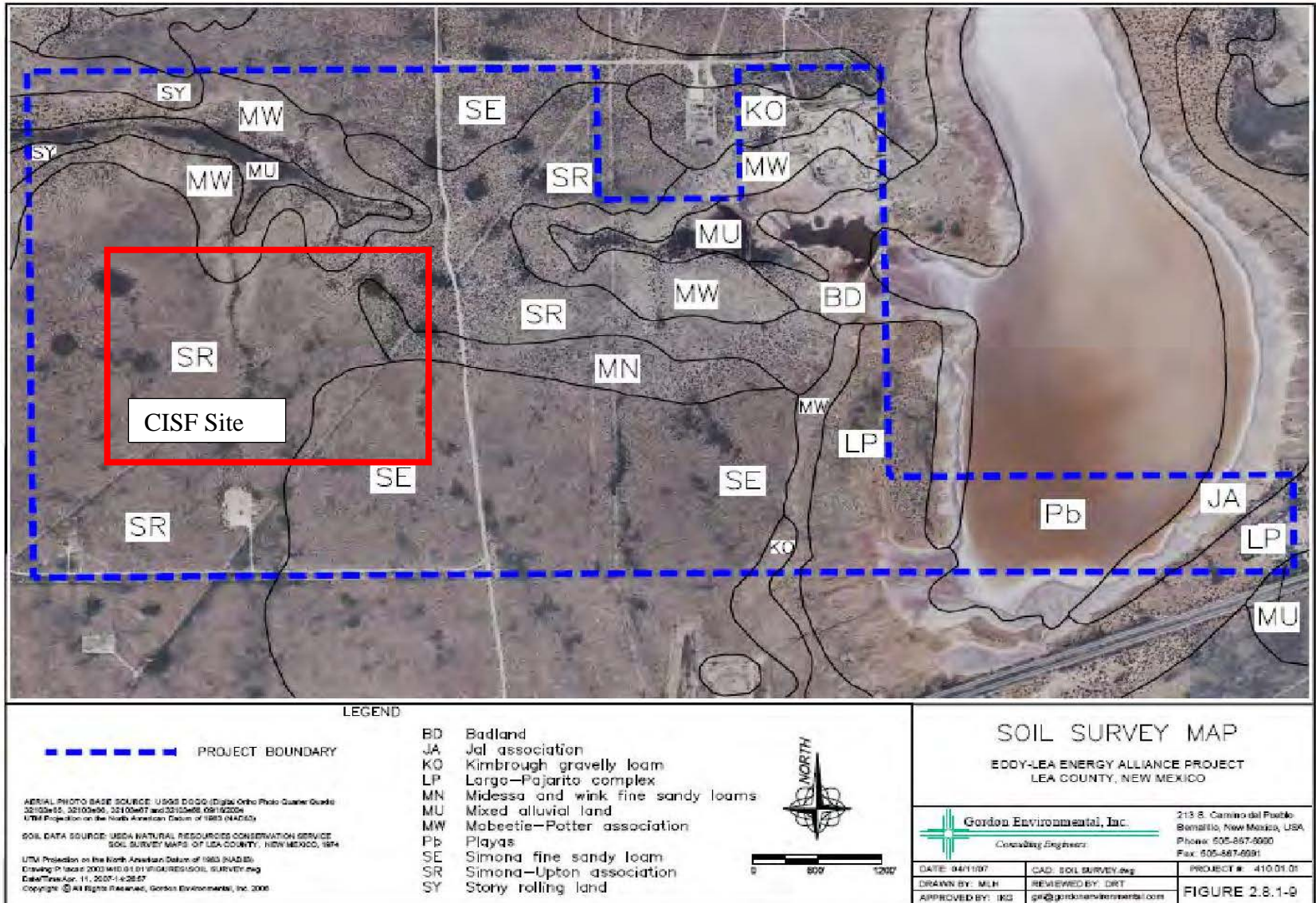


Figure 2.1.7: Soils Survey Map [2.1.3]

HOLTEC INTERNATIONAL COPYRIGHTED MATERIAL

Report No. HI-2167374

Proposed Rev. 0R

Security Related Information - Withheld under 10 CFR 2.390

Figure 2.1.8: Phase 1 Boring Location Map [2.1.24]

IHOLTEC INTERNATIONAL COPYRIGHTED MATERIAL	
Report No. HI-2167374	Proposed Rev. 0R
2-29	

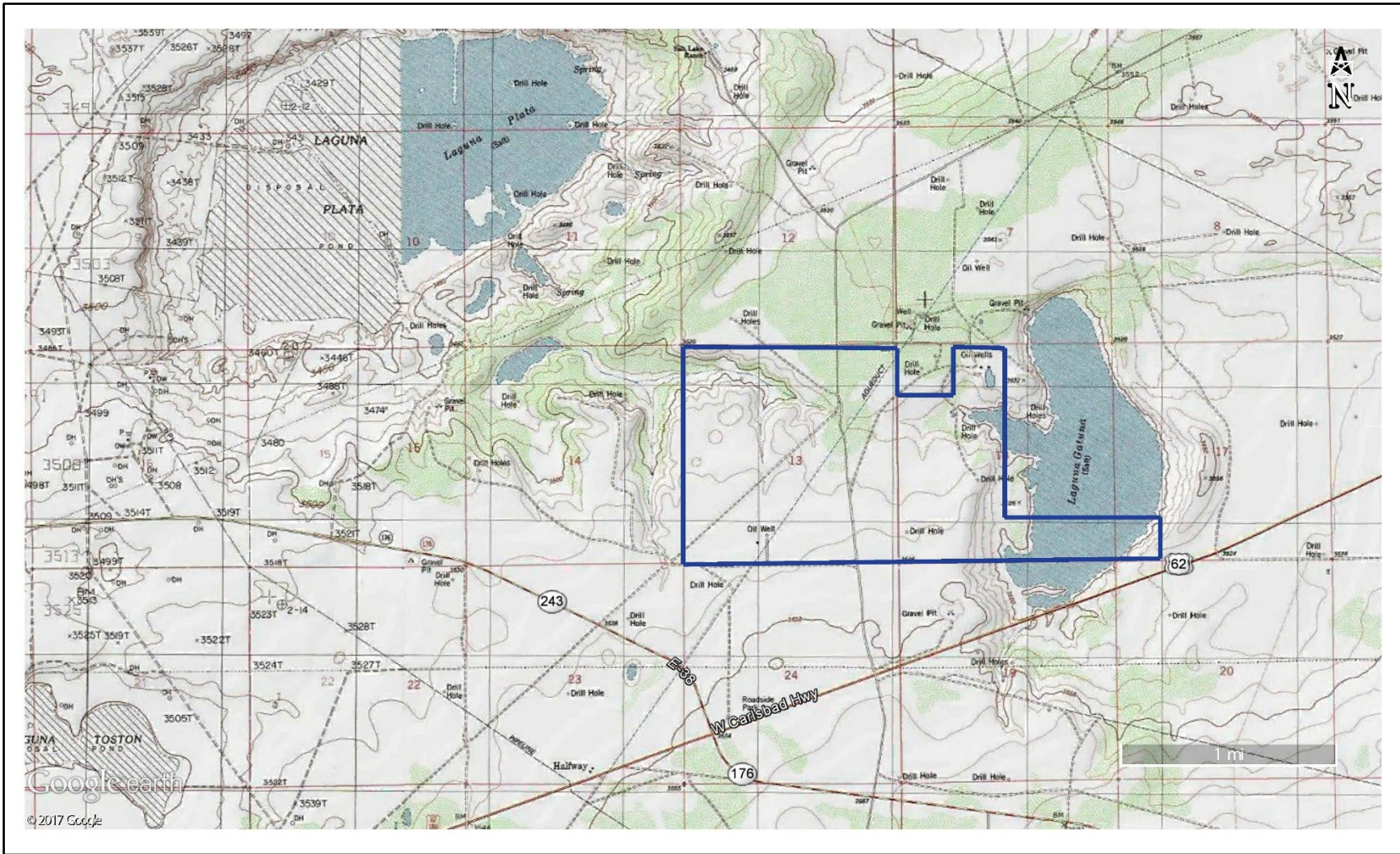


Figure 2.1.9: Topography of Site and Surrounding Area [2.1.3]

*Note that the “aqueduct” labeled on the figure refers to a water pipeline

IHOLTEC INTERNATIONAL COPYRIGHTED MATERIAL		
Report No. HI-2167374		Proposed Rev. 0R
2-30		

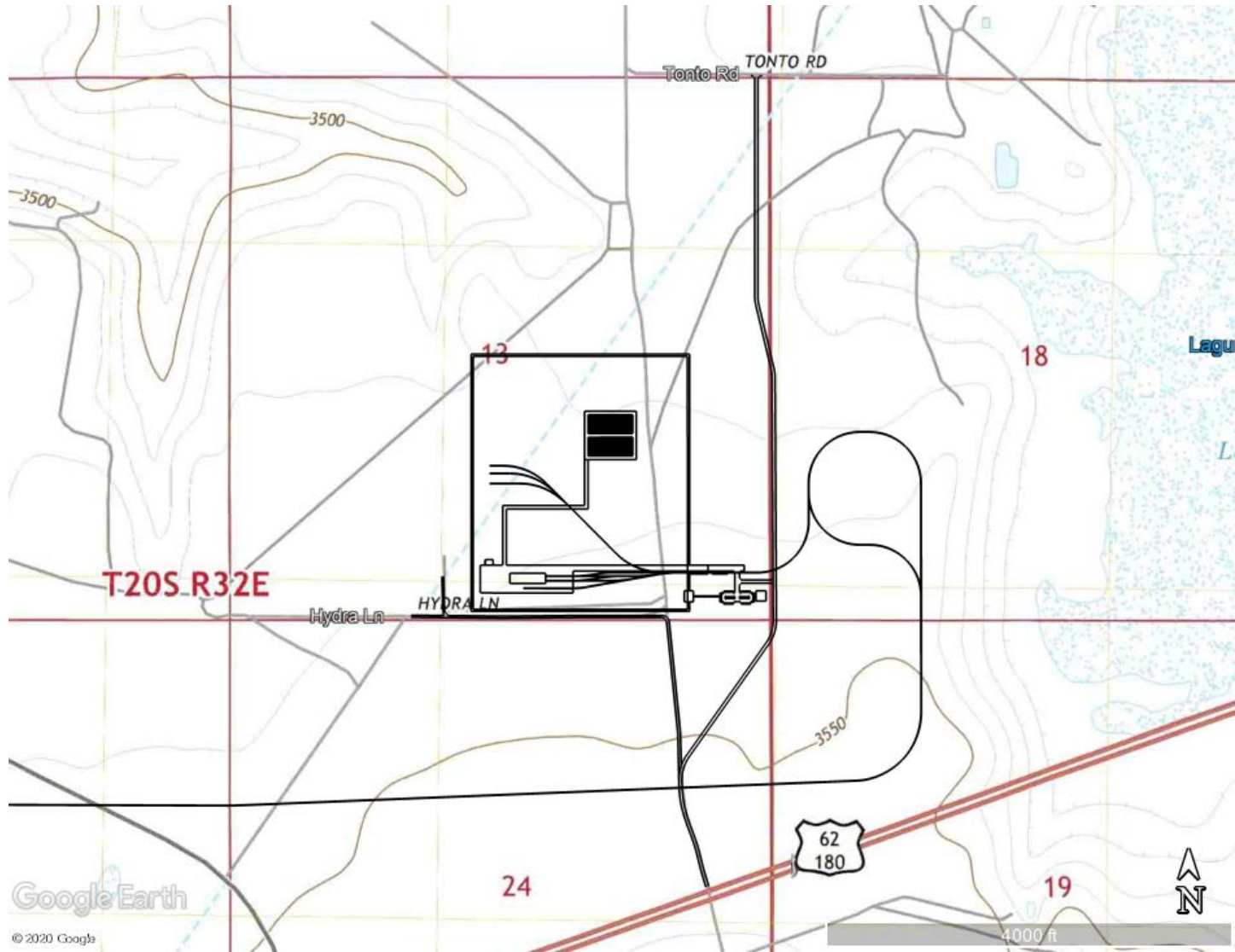


Figure 2.1.10: Topography of Site and Surrounding Area [2.1.26]

*Note that the “aqueduct” labeled on the figure refers to a water pipeline

IHOLTEC INTERNATIONAL COPYRIGHTED MATERIAL

Report No. HI-2167374

Proposed Rev. 0R

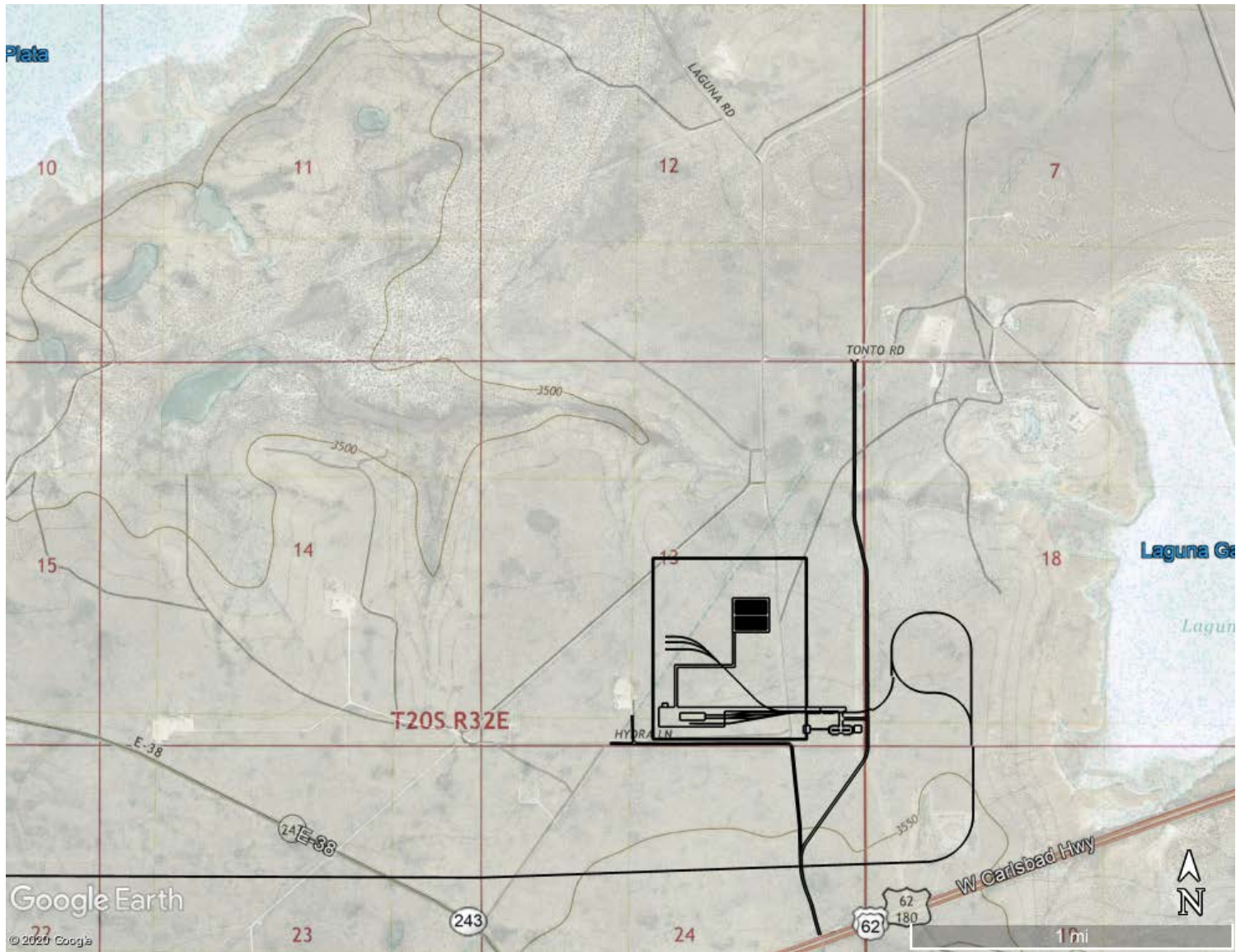


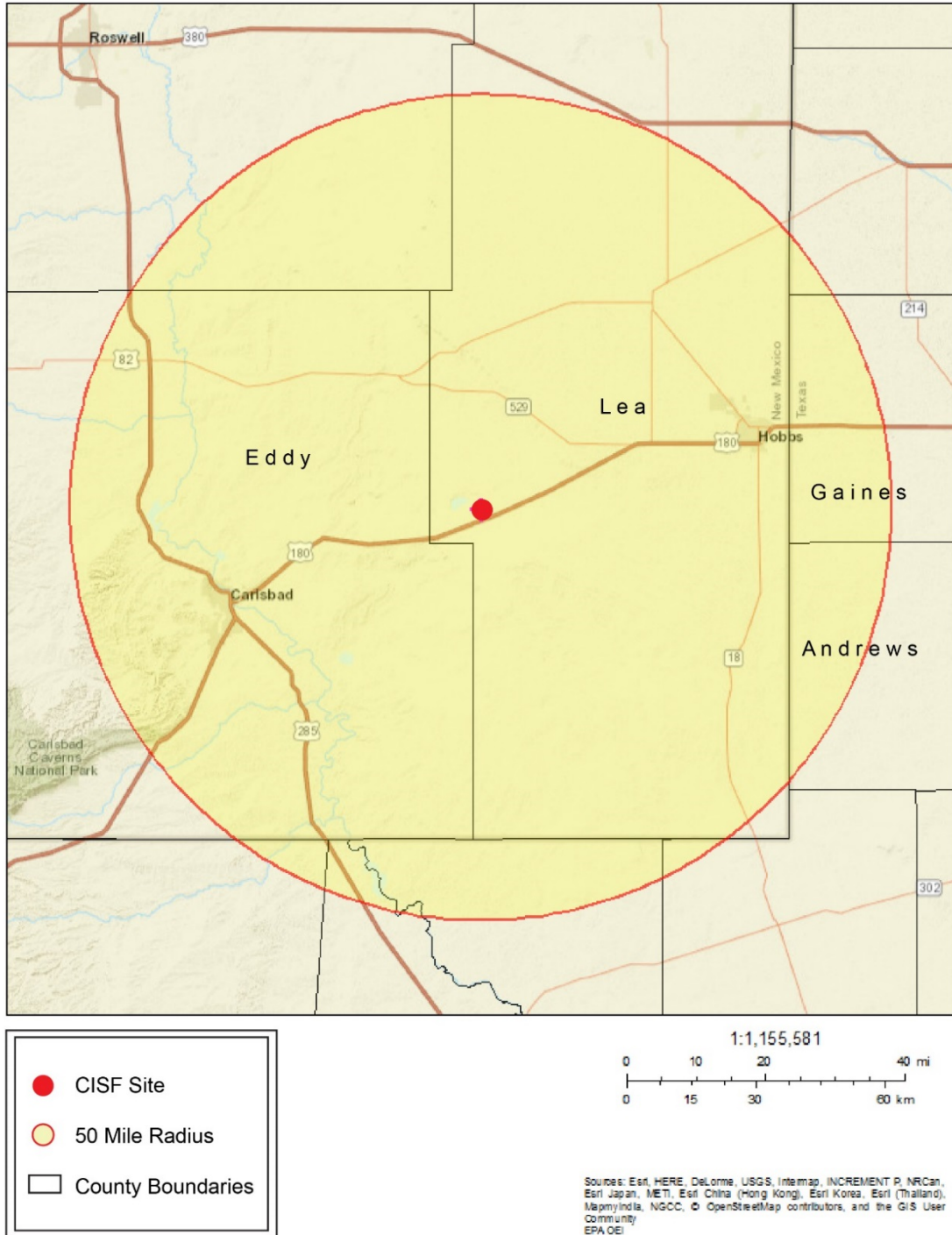
Figure 2.1.11: Topography of Site and Surrounding Area [2.1.26]

IHOLTEC INTERNATIONAL COPYRIGHTED MATERIAL

Report No. HI-2167374

Proposed Rev. 0R

50-Mile Radius



EJSCREEN 2016

Figure 2.1.12: Region of Influence with a 50-Mile Radius of the Site [2.1.13]

HOLTEC INTERNATIONAL COPYRIGHTED MATERIAL		
Report No. HI-2167374		Proposed Rev. 0R
2-33		

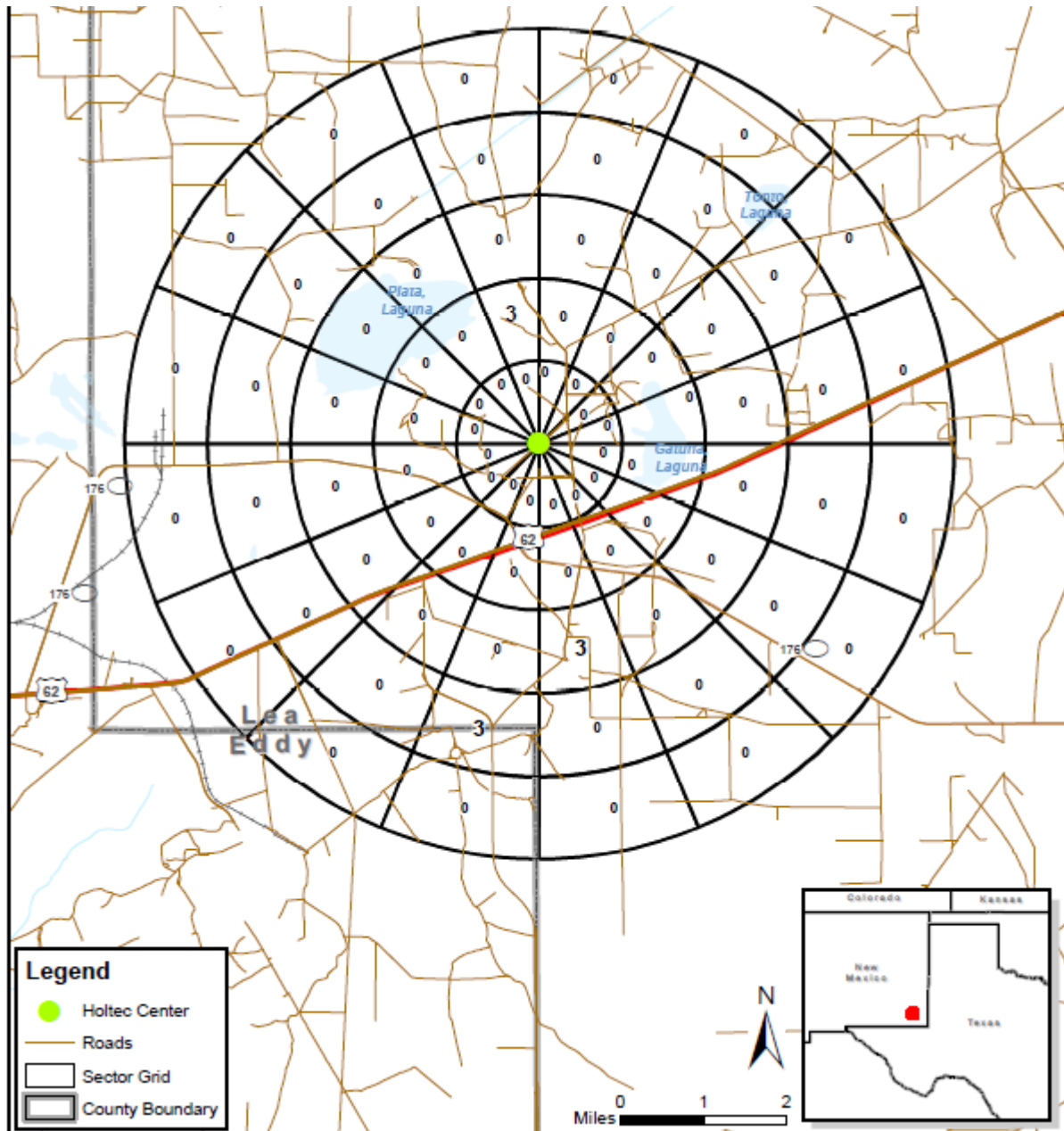


Figure 2.1.13: Sector Population Map

HOLTEC INTERNATIONAL COPYRIGHTED MATERIAL		
Report No. HI-2167374		Proposed Rev. 0R
2-34		

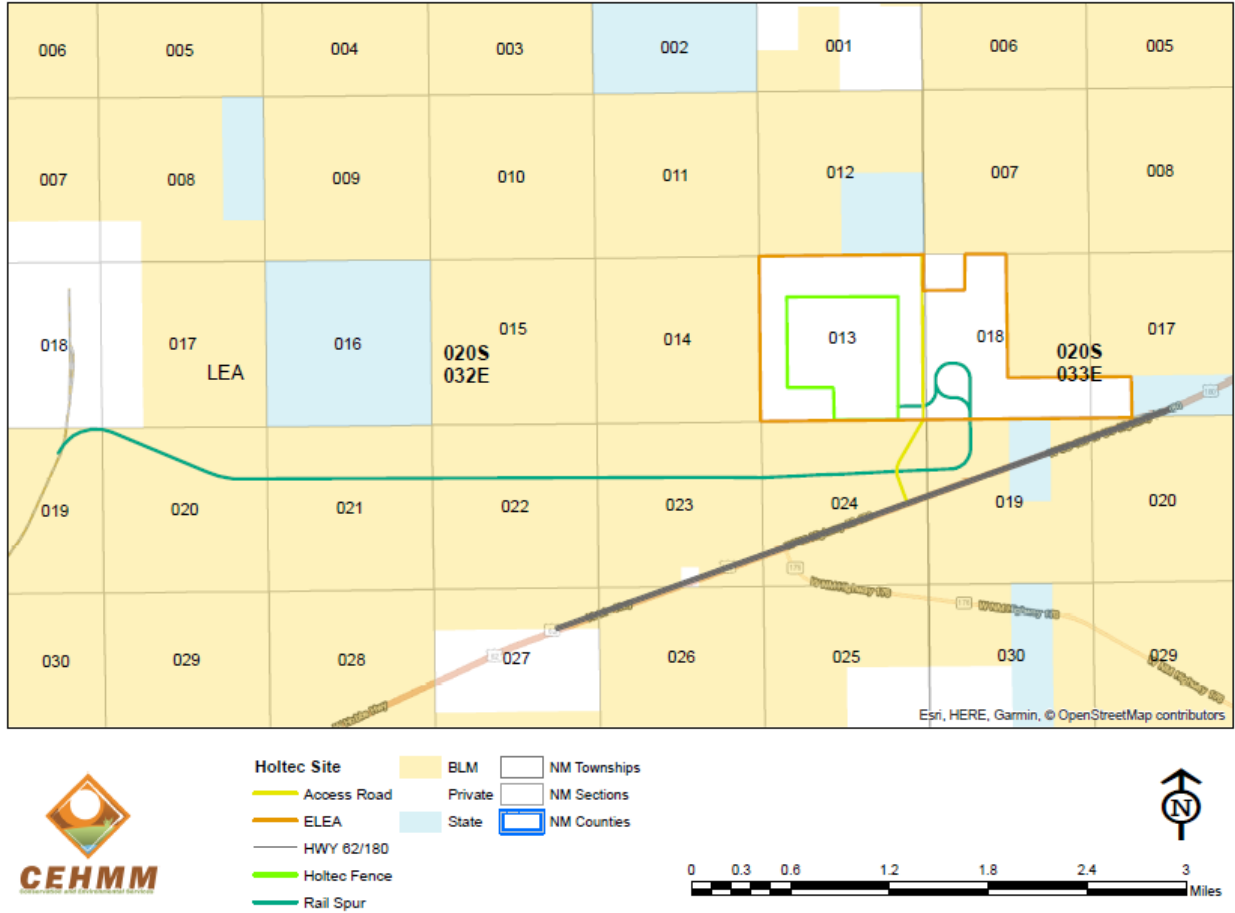


Figure 2.1.14: Surface Land Ownership in the Vicinity of the Site

HOLTEC INTERNATIONAL COPYRIGHTED MATERIAL		
Report No. HI-2167374		Proposed Rev. 0R
2-35		

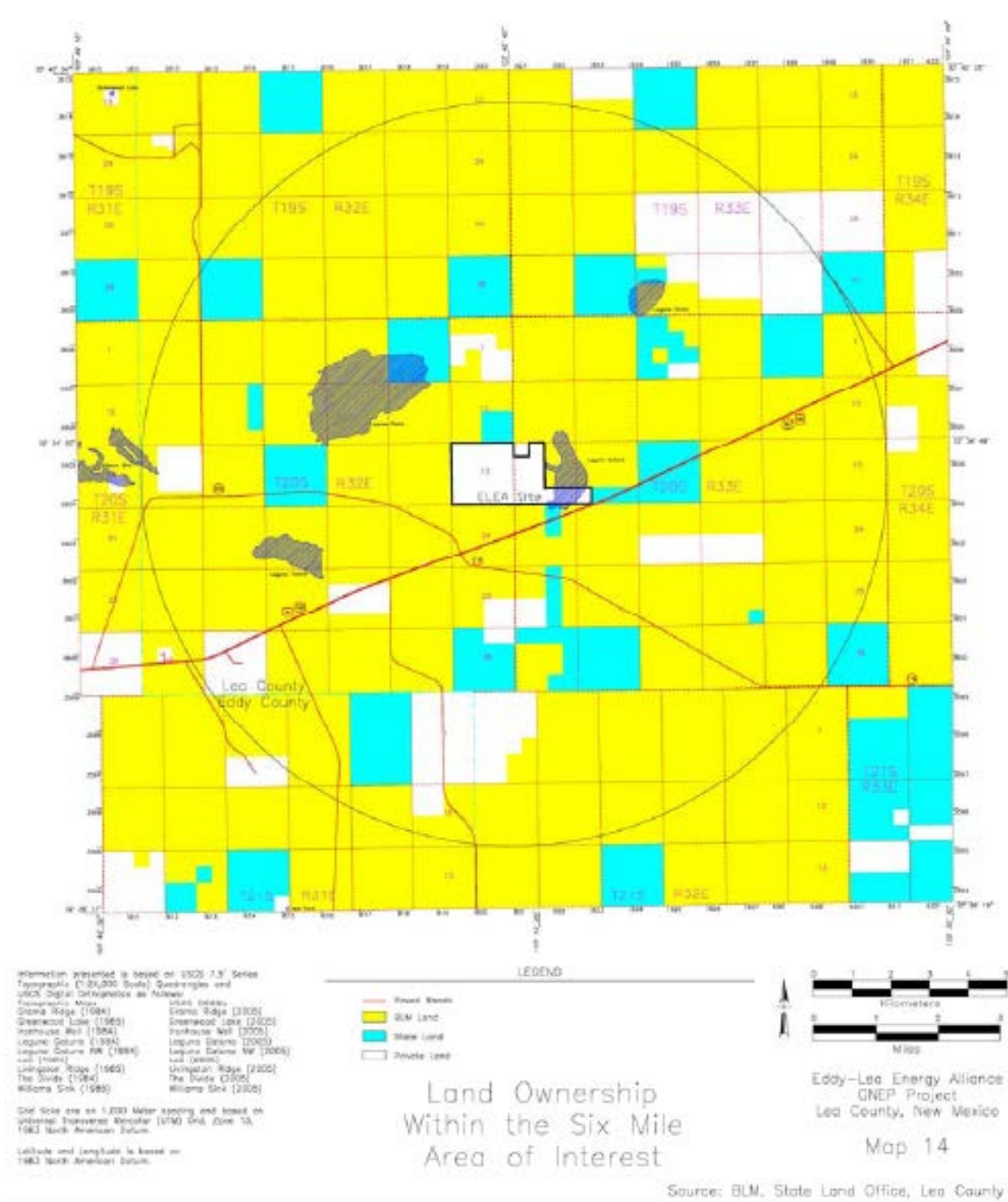


Figure 2.1.15: Land Ownership near the CIS Facility Site

HOLTEC INTERNATIONAL COPYRIGHTED MATERIAL		
Report No. HI-2167374		Proposed Rev. 0R
2-36		

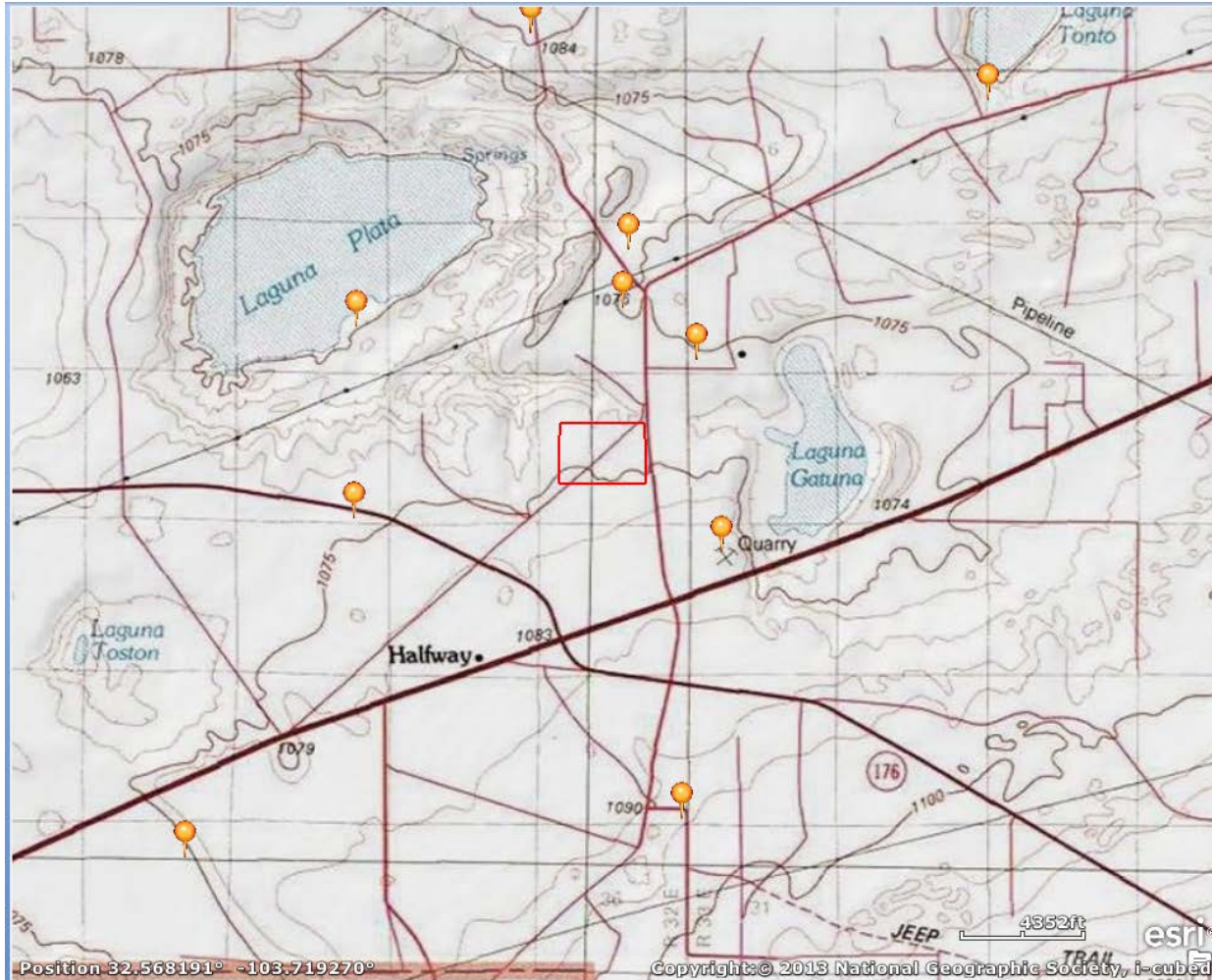


Figure 2.1.16: Mineral Resources near the Site

HOLTEC INTERNATIONAL COPYRIGHTED MATERIAL		
Report No. HI-2167374		Proposed Rev. 0R
2-37		

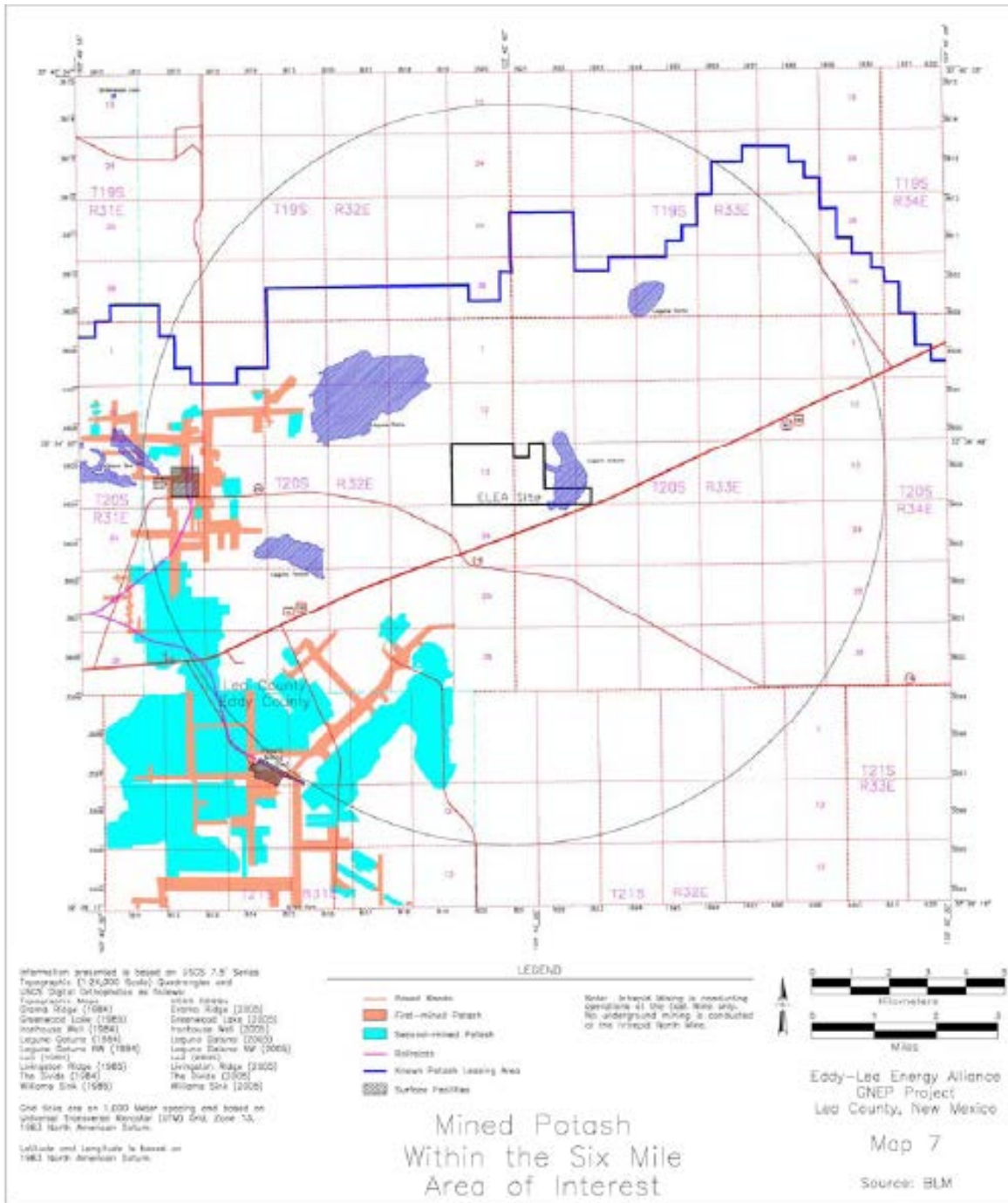


Figure 2.1.17: Mined Potash near the CIS Facility Site

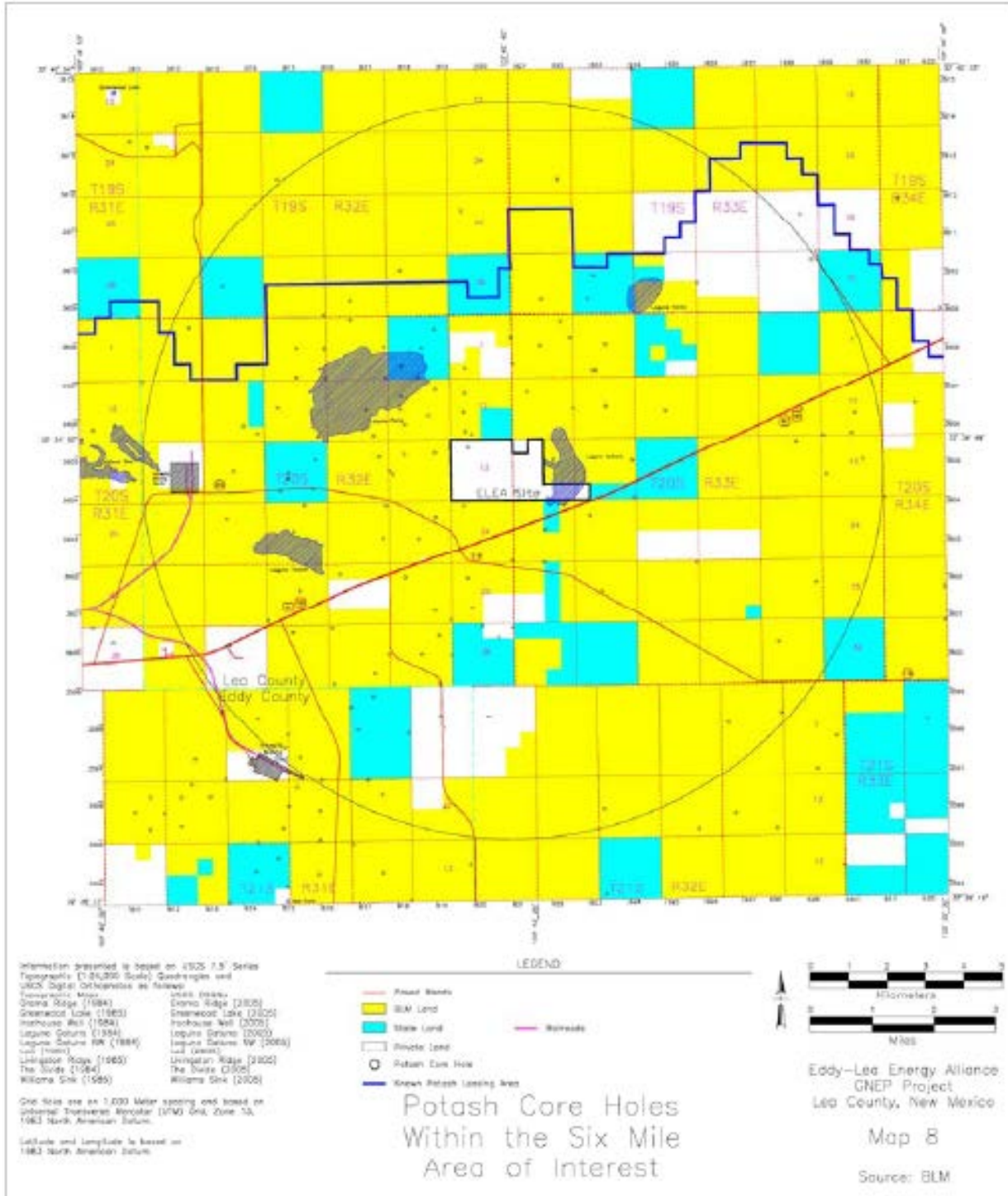


Figure 2.1.18: Potash Core Holes near the CIS Facility Site

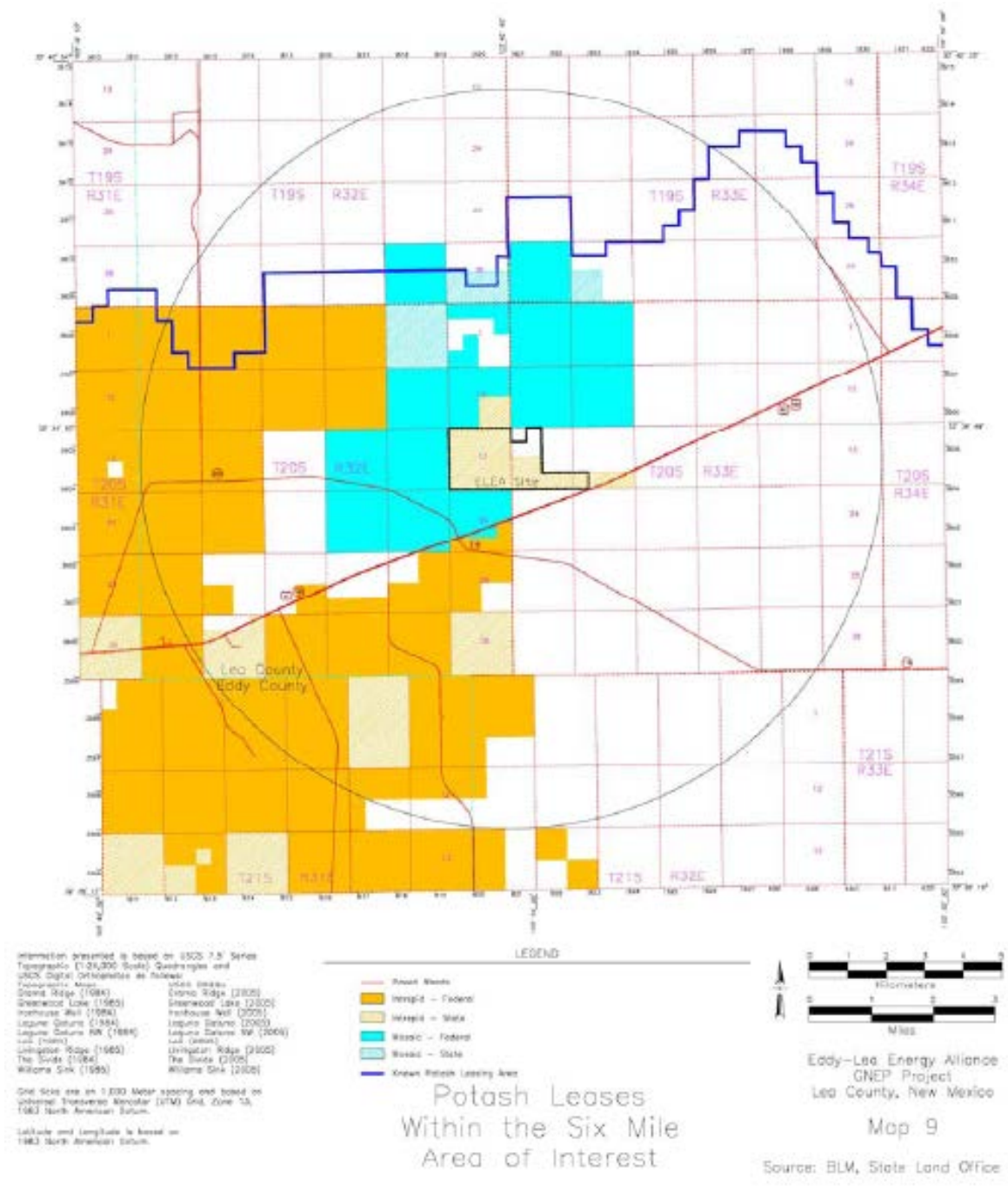


Figure 2.1.19: Potash Leases near the CIS Facility Site

HOLTEC INTERNATIONAL COPYRIGHTED MATERIAL		
Report No. HI-2167374		Proposed Rev. 0R
2-40		

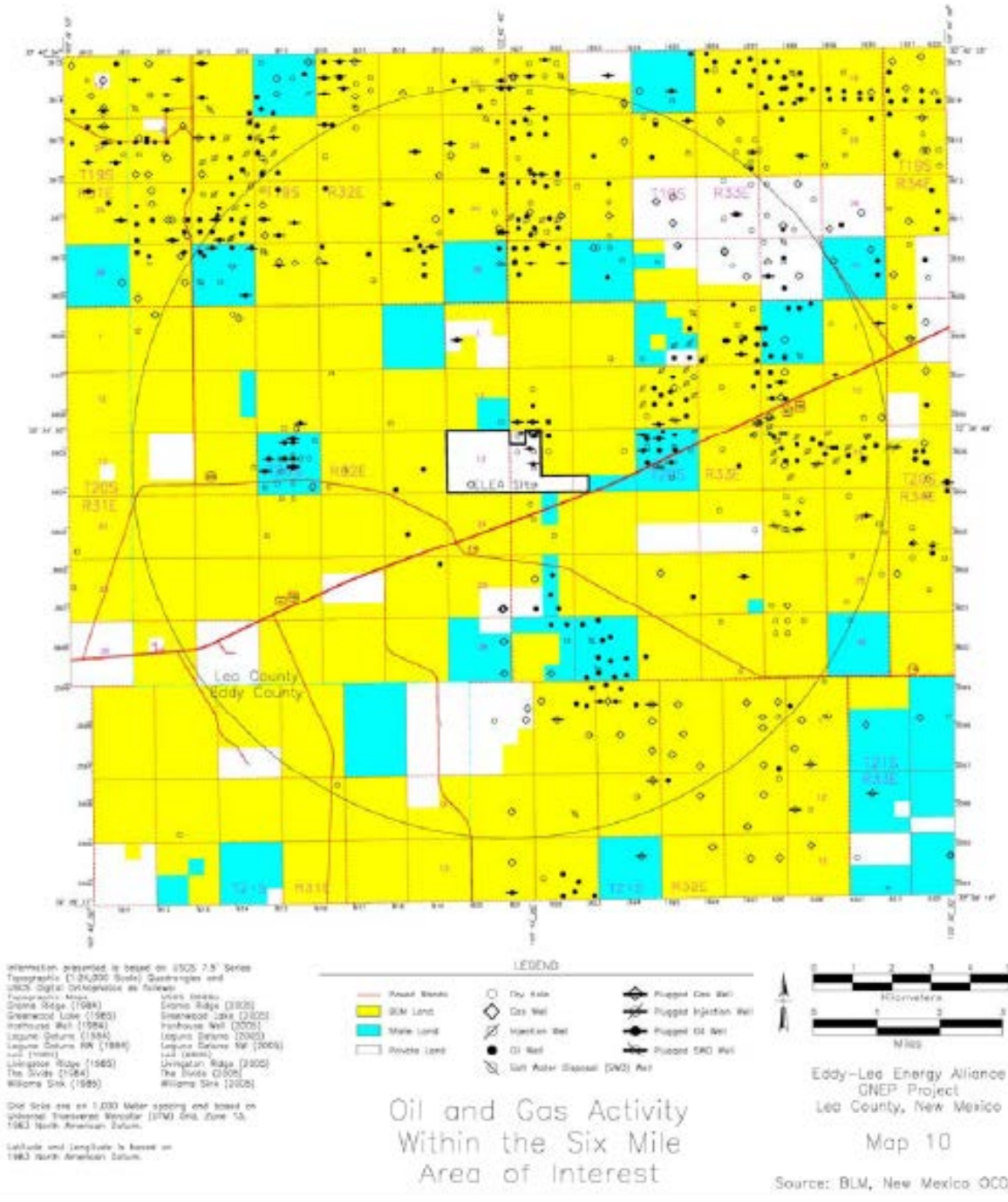


Figure 2.1.20: Oil and Gas Activity near the CIS Facility Site

HOLTEC INTERNATIONAL COPYRIGHTED MATERIAL		
Report No. HI-2167374		Proposed Rev. 0R
2-41		

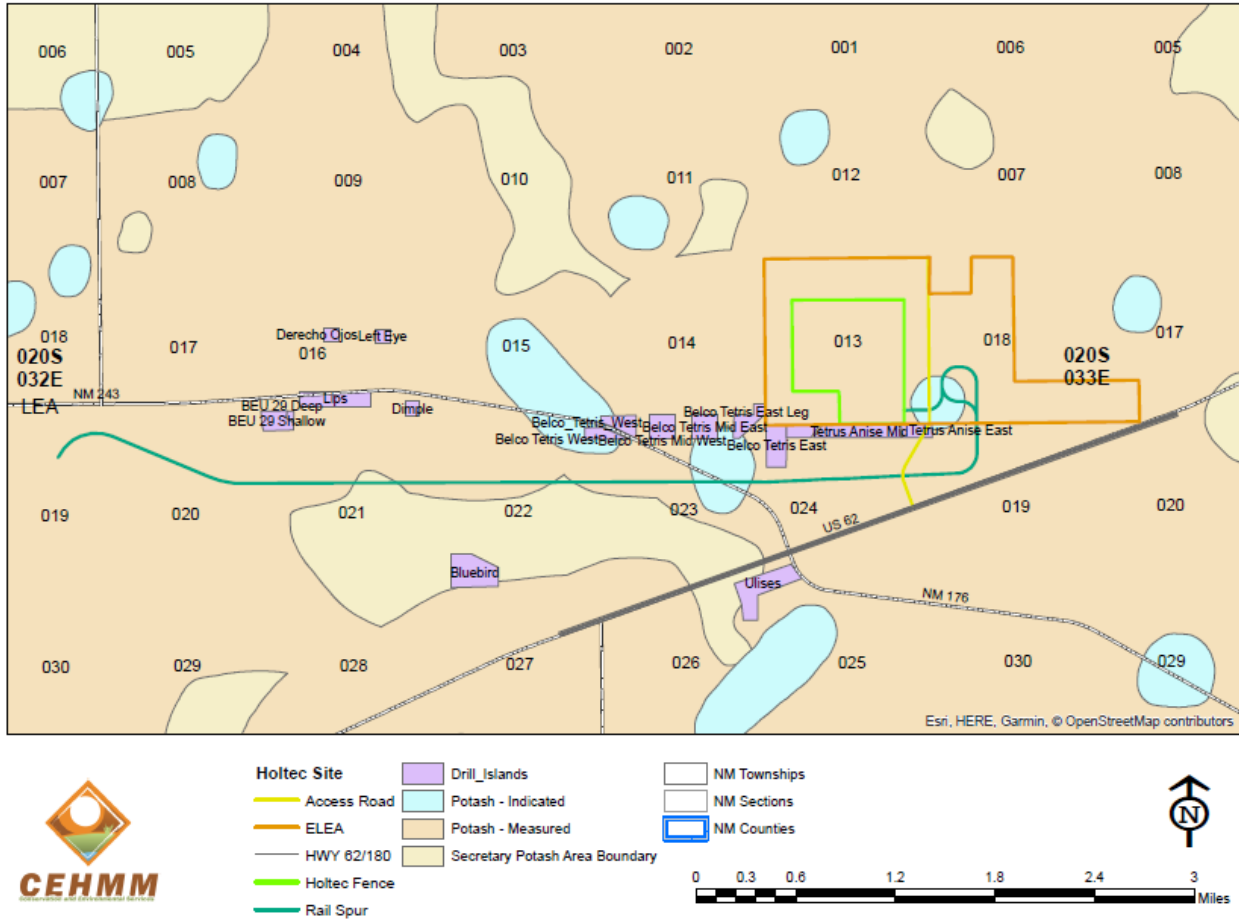


Figure 2.1.21: Potash Resources near the Site

HOLTEC INTERNATIONAL COPYRIGHTED MATERIAL		
Report No. HI-2167374		Proposed Rev. 0R
2-42		

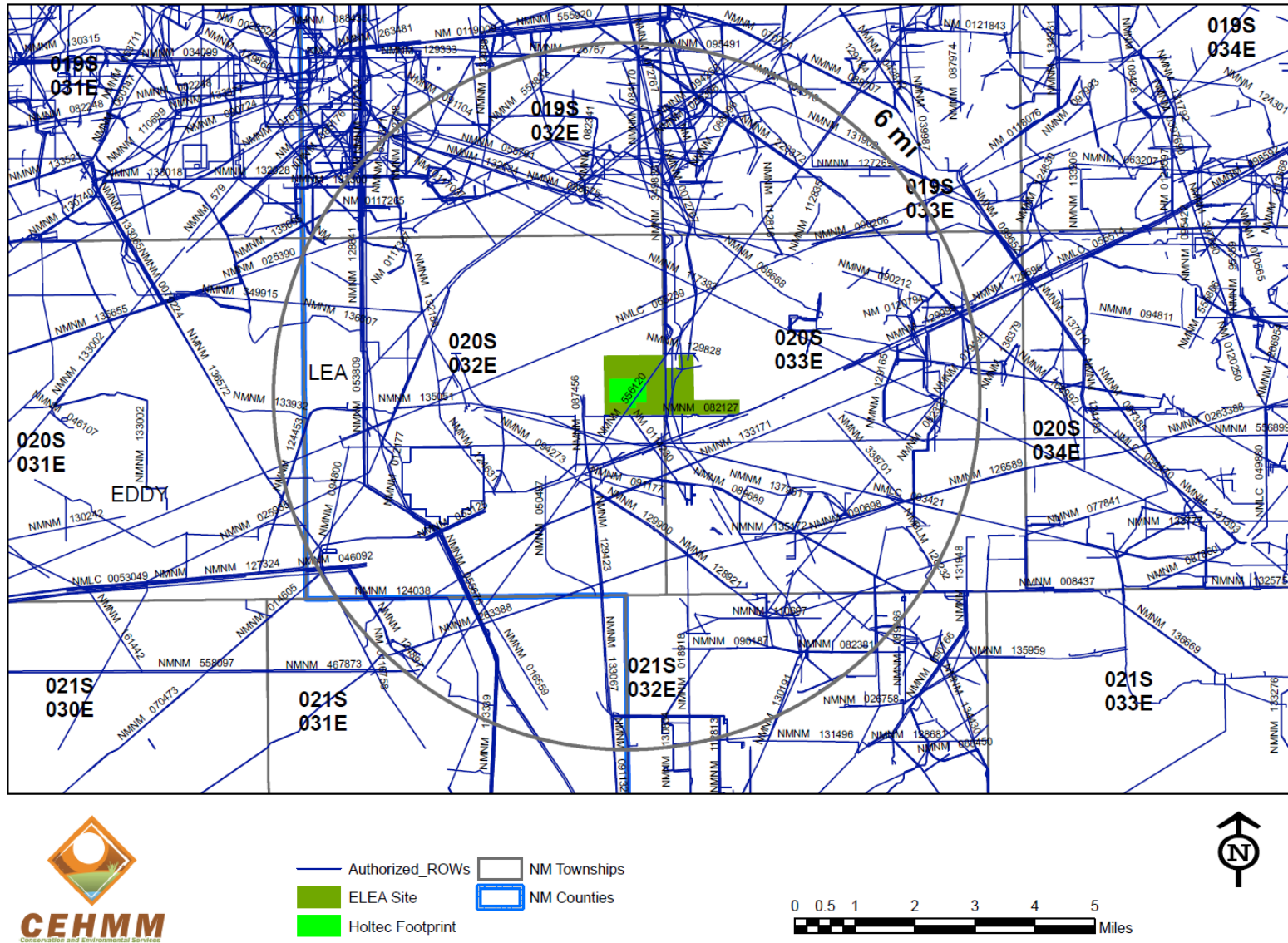


Figure 2.1.22: Pipelines in the Vicinity of the Site.

HOLTEC INTERNATIONAL COPYRIGHTED MATERIAL

Report No. HI-2167374

Proposed Rev. 0R

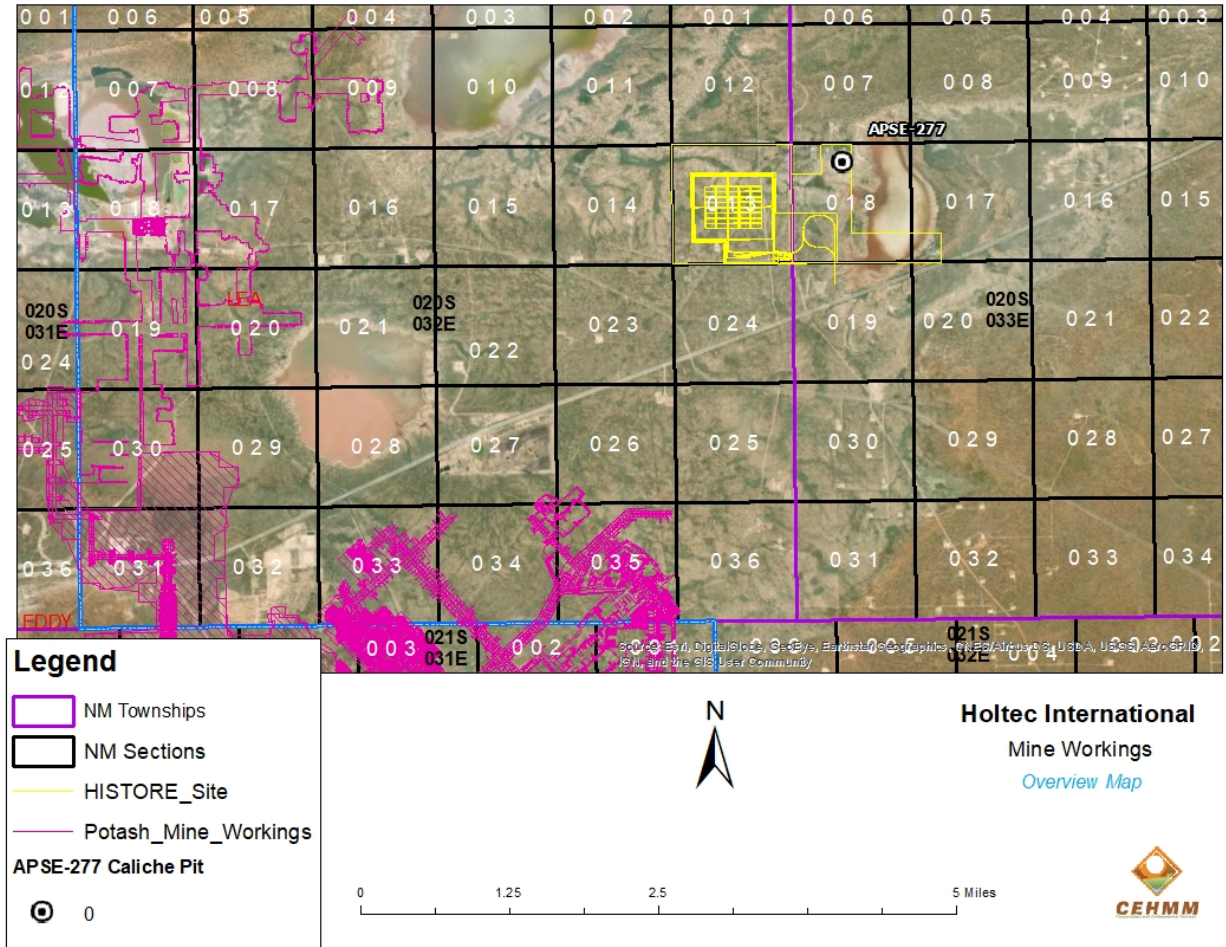


Figure 2.1.23: Potash Mines in the Vicinity of the Facility.

HOLTEC INTERNATIONAL COPYRIGHTED MATERIAL		
Report No. HI-2167374		Proposed Rev. 0R
2-44		

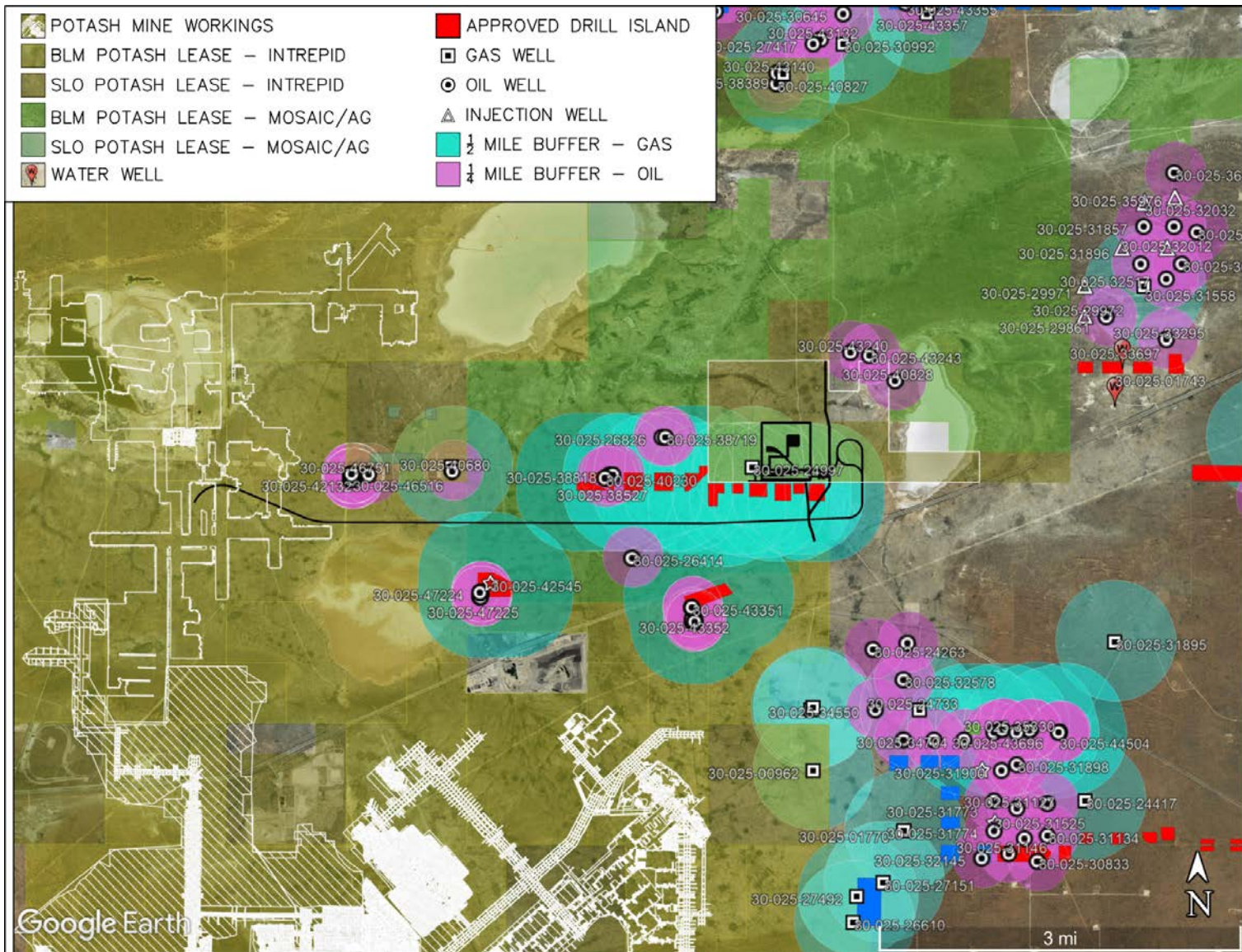


Figure 2.1.24: Order 3324 Oil & Gas Drill Island Buffer Zones [2.1.25, 2.1.27, 2.1.31, 2.1.32]

HOLTEC INTERNATIONAL COPYRIGHTED MATERIAL

Report No. HI-2167374

Proposed Rev. 0R

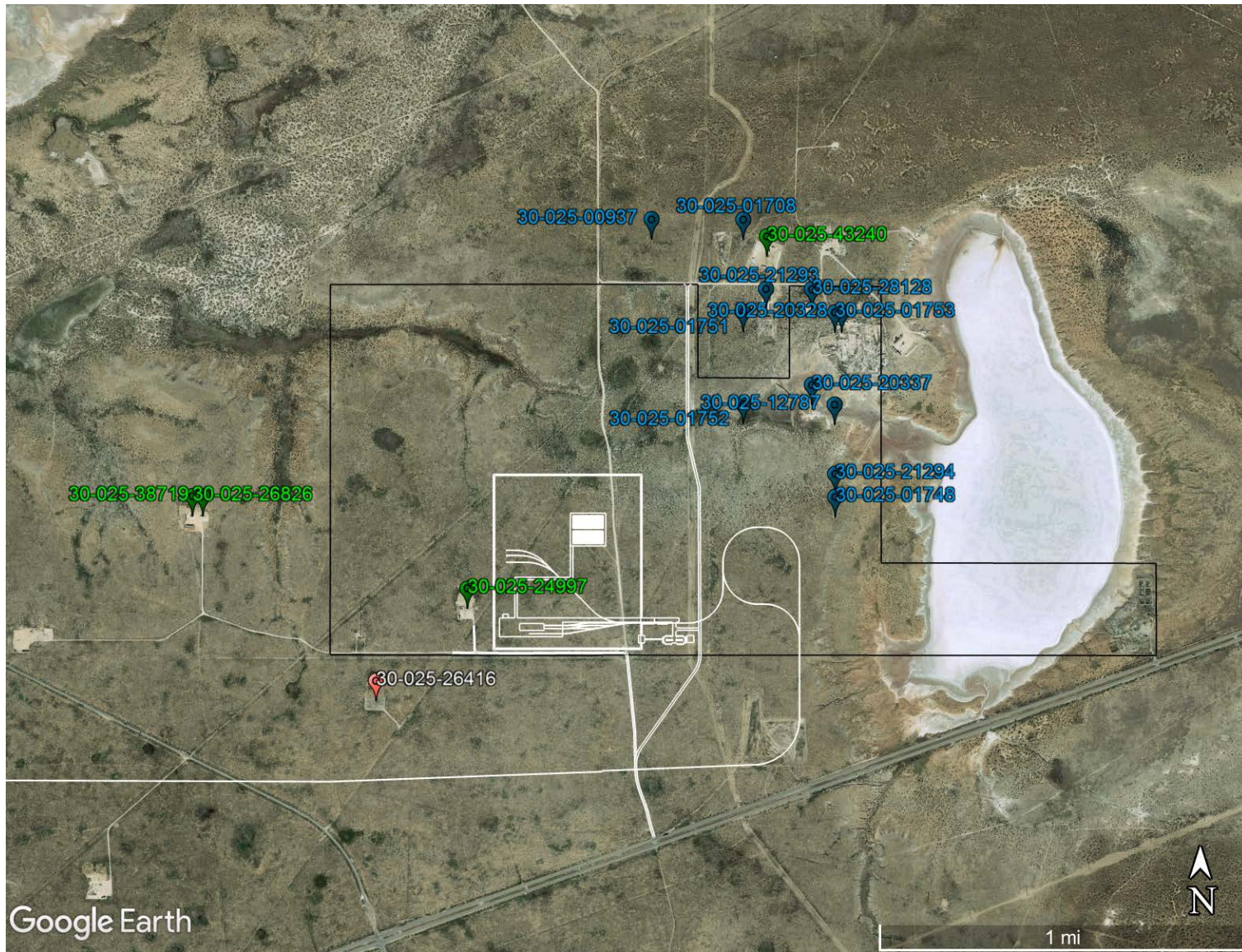


Figure 2.1.25: Oil and Gas Wells within 1 mile of HI-STORE Facility.

HOLTEC INTERNATIONAL COPYRIGHTED MATERIAL

Report No. HI-2167374

Proposed Rev. 0R

2.2 NEARBY INDUSTRIAL, TRANSPORTATION, MILITARY, AND NUCLEAR FACILITIES

2.2.1 Industrial Facilities

Figure 2.2.1 identifies industrial facilities located within approximately 5 miles of the Site. These facilities are:

1. Land Farm — oilfield waste management company that remediates contaminated soil from oil and gas operations. Located 1.9 miles southwest of the Site, contaminated soils are trucked to the facility and remediated using microbial degradation of the hazardous compounds.
2. Potash Facility — National Potash Mine, located approximately 4.2 miles west of the Site. This mine first began operations in 1957 and concluded deep mining activities. Intrepid Potash currently operates the Intrepid East Mine and has surface facilities approximately 4.2 miles west, and 4.9 miles southwest of the CIS Facility Site boundary. Potassium (mainly) is mined below surface with boring machines and lifted to the surface through shafts using hoists.
3. Transwestern — gas pipeline compressor station located approximately 5.2 miles southwest of the Site. This station consists of a small building with compressors used to compress natural gas, transporting it through the gas pipeline.
4. Caliche — mining operation located approximately 4 miles southwest of the Site. Caliche generally occurs on or near the surface or at depths of 10-20 feet. Caliche is mined using traditional excavation machinery and is used in construction applications.

None of the facilities located within 5 miles of the Site are engaged in operations that would pose a hazard to the Site or affect the design basis of the Site.

2.2.2 Pipelines

There are approximately 27,000 miles of energy-related pipelines in New Mexico that are regulated by the U.S. Department of Transportation's Pipeline and Hazardous Materials Safety Administration (PHMSA). Three pipelines are currently near the CIS Facility Site with a fourth pipeline proposed to be installed. Each pipeline is described in detail below [2.2.6].

1. A Transwestern (TW) 20-inch diameter natural gas pipeline planned to be located approximately 0.8 miles west of the western boundary of the Site.
2. A DCP Midstream (DCP) 20-inch diameter natural gas pipeline located approximately 0.16 miles east of the eastern boundary of the Site.
3. A DCP 8-inch diameter natural gas pipeline located approximately 0.17 miles east of the eastern boundary of the Site.
4. A Lucid Energy 6-inch natural gas pipeline that runs 0.16 miles east of the eastern boundary of the Site, then turns West and runs approximately 40 feet south of the southern edge of the Site to the gas compressor station southwest of the Site. When this pipeline runs parallel to the DCP 20 inch pipeline, they are approximately 50 feet apart.

HOLTEC INTERNATIONAL COPYRIGHTED MATERIAL	
Report No. HI-2167374	Proposed Rev. 0R
2-47	

The installed and the planned 20-inch pipelines are classified as high-pressure pipelines rated for a pressure of 1,180 pounds per square inch (psi), with a normal operating pressure of approximately 680 psi. The 8-inch and 6-inch pipelines are low pressure pipelines that operate at 60 psi. The minimum depth of each the pipeline is 36 inches from the top of the pipe to the ground surface, equating to a minimum of 36 inches of overburden

The rupture of a natural gas pipeline will result in the release of methane gas at high pressure as a turbulent jet with choked flow. Should this jet or the flammable vapor cloud ignite at some point, a number of consequences might ensue:

- A jet fire
- A cloud (or flash) fire or a fireball should ignition be delayed
- Vapor cloud explosions resulting from the deflagration or detonation of the methane-air cloud
- Missile generation—in addition to fires and explosion, the rupture of a pipeline might be accompanied by missile generation with fragments of the pipeline being thrown considerable distances

Pipeline rupture might result from accidents or random or seismic-induced failure of the pipeline. All these types of causes are evaluated in Holtec Report HI-2210487 “HI-STORE Gas Pipeline Risk Evaluation” [2.2.6] which determined that there would be no damage to critical operations at the proposed HI-STORE CIS Facility from a postulated pipeline rupture. Figure 2.2.2 shows the pipelines currently located in close vicinity to the Site that are evaluated in Holtec Report HI-2210487 “HI-STORE Gas Pipeline Risk Evaluation” [2.2.6].

Based on this evaluation [2.2.6] there are no credible pipeline events that have the potential to result in a peak positive incident overpressure in excess of 1.0 psi (6.9 kPa) that would impact critical operations at the proposed location of the HI-STORE CIS Facility, and pipeline hazards need not be considered a design-basis concern. In addition, the HI-STORM UMAX storage canisters that are proposed to be used at the HI-STORE CIS are designed to withstand 10 psi overpressure, which is an order of magnitude higher than the overpressure evaluated in the analysis.

2.2.3 Air Transportation

The airspace surrounding the CIS Facility is unrestricted. At any given time, the potential for commercial aircraft, military aircraft, and general aircraft to be flying at various altitudes and at various speeds, in airspace that is considered to be within the vicinity of the CIS facility is present. Commercial and general aircraft would fly in accordance with flight plans filed with the FAA and would be controlled by the national air traffic control system [2.2.18 (8260.19H)]. Military aircraft fly within designated Military Training Routes, which may or may not be flown under air traffic control, as well as within Federal Airways that are controlled by the national air traffic control system. There are several local, regional, and international airports in the general region of the HI-STORE site. All of the flights from these airports report to and are controlled by either the

HOLTEC INTERNATIONAL COPYRIGHTED MATERIAL	
Report No. HI-2167374	Proposed Rev. 0R
2-48	

Albuquerque Air Route Traffic Control Center (ARTCC) or Fort Worth ARTCC, two of the 22 ARTCCs servicing the United States. [2.2.37].

2.2.3.1 Federal Airways

Commercial and general aircraft flight plans are limited to the Federal Airways that make up the enroute airspace structure of the National Airspace System. There are multiple Federal Airways in southeast New Mexico, and those nearest the CIS Facility are listed in Table 2.2.5 [2.2.16] [2.2.17] [2.2.42].

Victor “V” Routes are low altitude airways that make up the majority of the lower stratum of the federal enroute airspace structure. Victor Routes extend from the floor of the controlled airspace up to but not including 18,000 feet above mean sea level (MSL) [2.2.18]. High altitude Jet “J” Routes and “Q” Routes make up the second stratum, which extends from 18,000 feet above MSL up to and including flight level (FL) 450 [2.2.18]. The enroute airways are defined as straight line segments between Very high frequency Omnidirectional Range (VOR) stations and are designated by the designation letter “V”, “J”, “Q”, followed by the route number. Routes have a width of 4 Nautical Miles (NM) (4.60 statute miles) on either side of the centerline when VOR stations are less than 102 NM apart, with the width increasing for VORs farther apart [2.2.18][2.2.29]. Additional information for these airways, including their distances from the site, is included in Table 2.2.5. These federal airways are illustrated on Figure 2.2.6.

2.2.3.2 Military Airspace

Airspace above the United States from the surface to 10,000 feet above sea level is limited to 250 knots (indicated airspeed) by FAA regulations, any aircraft below 10,000 feet should be travelling at speeds of less than 250 knots [2.2.34]. However, there is a military exception to this requirement. The Military Training Route (MTR) Program is a joint venture by the FAA and the Department of Defense (DOD), developed for use by military aircraft to gain and maintain proficiency in tactical "low-level" flying. These low-level training routes are generally established below 10,000 feet for speeds in excess of 250 knots [2.2.35].

Department of Defense publication AP/1B controls and defines all MTRs, which are designated either IR (Instrument Route) or VR (Visual Route), with IR routes being flown under air traffic control [2.2.19]. AP/1B provides the air speed limits for the route, which are limited to at most 540 knots [2.2.19]. Additionally, no person may operate a civil aircraft in the United States in excess of Mach 1 without prior authorization from the FAA [2.2.34].

There are four designated MTRs in the vicinity of the proposed CIS Facility: IR-128, IR-180, IR-192, and IR-194. However, these four designations represent only 2 mapped airways, as IR-128 and IR-180, and IR-192 and IR-194 share the same airway but represent opposite directions of travel (hereafter referred to IR-128/180 and IR-192/194, respectively). IR-128 and IR-192 both represent the North to South direction, while IR-180 and IR-194 represent the South to North flight direction of their respective corridors [2.2.19] [2.2.16]. The routes are individually operated by an Air Force Base (AFB). The AFB is responsible for scheduling and “owning” the route. IR-128/180 is “owned” by Dyess AFB while IR-192/194 is “owned” by Holloman AFB. The FAA requires the military to provide advance notice to other aircraft that the MTRs will be used to allow for civilian traffic to de-conflict if needed. AP/1B defines all MTRs giving coordinates of airway fixes,

HOLTEC INTERNATIONAL COPYRIGHTED MATERIAL	
Report No. HI-2167374	Proposed Rev. 0R
2-49	

or points between segments as well as the airway width different points along the route [2.2.19]. Additional information for these MTRs, including their distances from the site and widths, is included in Table 2.2.5. These Military Training Routes are also illustrated on Figure 2.2.7.

A Military Operation Area (MOA) is “airspace established outside Class A airspace to separate or segregate certain nonhazardous military activities from IFR Traffic and to identify for VFR traffic where these activities are conducted.” [2.2.21]. Examples of these activities include, but are not limited to: air combat tactics, air intercepts, aerobatics, formation training, and low-altitude tactics [2.2.35]. The nearest MOAs to the CIS facility are the Talon High East MOA, which is located north of Carlsbad, NM and the Bronco 3 MOA, which is located North of Hobbs, NM. However, the nearest edge of both MOAs is greater than 25 miles from the site [2.2.16].

2.2.3.3 Airports

There are several local and regional airports in the area surrounding (within 50 miles) the HI-STORE site. These airports include Artesia Municipal Airport, Cavern City Air Terminal, Lea County Regional Airport, and Lea County Zip Franklin Memorial Airport, none of which are considered to be within the vicinity (10 miles) of the site [2.2.37]. Of these airports, only the Lea County Regional has a Federal Aviation Administration (FAA) funded air traffic control tower. All of the flights from these airports report to and are controlled by either the Albuquerque Air Route Traffic Control Center (ARTCC) or Fort Worth ARTCC, two of the 22 ARTCCs servicing the United States [2.2.36] [2.2.20]. Also, in the general region of the CIS facility, but further away (within 100 miles) are two international airports, Midland International Air and Space Port, and Roswell International Air Center. These airports also fall under the jurisdiction of Fort Worth and Albuquerque ARTCC respectively [2.2.36].

As discussed below, most of the commercial airline operations at airports in the area of the CIS Facility involve regional jets. The largest commercial planes (Boeing 737s) are flown in and out of Midland International Air and Space. A summary of the airplane operations at airports near the CIS Facility are provided below.

Airport operation numbers have been gathered from two sources, first is the Air Traffic Activity Data System (ATADS), which contains the official National Airspace System (NAS) air traffic operations data available for public release [2.2.28]. The other is GRC Inc.’s AirportIQ 5010 (airportiq5010.com), which is a compilation of FAA form 5010-5 Airport Master Records and Reports. ATADS gives data as far back as 1990, where AirportIQ gives only the past year’s data. Additionally, ATADS only gives data for Airports that have an FAA certified Air traffic control tower, so data for some of the smaller airports has only been sourced from AirportIQ.

Artesia Municipal Airport* is a public use general aviation airport located 4 miles west of the Main Street business district or Artesia, in Eddy County, New Mexico, approximately 47 miles from the CIS Facility. The city owned airport and its 2 runways covers 1,440 acres. See Table 2.2.4 for flight information and aircraft based here during the 12 month period ending April 05, 2017 [2.2.22].

*Note that Artesia Municipal Airport does not have an FAA funded air traffic control tower, and therefore does not have data reported to ATADS.

HOLTEC INTERNATIONAL COPYRIGHTED MATERIAL	
Report No. HI-2167374	Proposed Rev. 0R
2-50	

Cavern City Air Terminal* is a public use airport in Eddy County, New Mexico, United States. It is owned by the city of Carlsbad and located five nautical miles southwest of its central business district, approximately 34 miles from the CIS Facility. The airport is served by one commercial airline. See Table 2.2.4 for flight information and aircraft based here during the 12 month period ending December 31, 2016 [2.2.23]. The holding pattern for Cavern City Air Terminal runway RNAV (GPS) RWY 21 begins at KEREY airway fix, just under 14 miles North East of the airport and is 6 NM long [2.2.30][2.2.36]. Matching this pattern is the missed approach pattern for Cavern City runway RNAV (GPS) RWY 3 [2.2.36]. Figure 2.2.6 illustrates the location of this pattern and Table 2.2.5 summarizes its distance to the site. Other holding or approach patterns associated with this airport are farther from the site than those mentioned above.

*Note that Cavern City Air Terminal does not have an FAA funded air traffic control tower, and therefore does not have data reported to ATADS

Lea County Regional Airport* is 4 miles west of Hobbs, in Lea County, NM, approximately 30 miles from the CIS Facility. The airport covers 898 acres and has three runways. It is an FAA certified commercial airport served by United Airlines' affiliate with daily regional flights. Lea County Regional Airport is the largest of the three airports owned and operated by Lea County Government. Lea County also owns and operated two general aviation airports in Lovington and Jal, New Mexico. See Table 2.2.4 for flight information and aircraft based here during the 12 month period ending April 30, 2017[2.2.24]. Average annual aircraft operations for the past 15 years data is shown in Table 2.2.6 [2.2.28]. The missed approach holding pattern for Lea County Regional runway LOC RWY 3 begins at DYETT airway fix, approximately 19 miles South West of the airport and is 6NM long [2.2.31][2.2.36]. Also matching this pattern are the missed approach patterns for Lea County Regional runways LOC BC RWY 21 and VOR or TACAN RWY 2 [2.2.36]. Figure 2.2.6 illustrates the location of this pattern and Table 2.2.5 summarizes its distance from the site. Other holding or approach patterns associated with this airport are farther from the site than those mentioned above

*Note that for Lea County Regional data reported on AirportIQ does not match the data for the same time period reported on ATADS

Lea County - Zip Franklin Memorial Airport* also known as Lovington airport is located 3 miles west of the central business district of Lovington in Lea county, NM, approximately 32 miles from the CIS Facility. See Table 2.2.4 for flight information and aircraft based here during the 12-month period ending April 3, 2017 [2.2.25].

*Note that Zip Franklin Memorial Airport does not have an FAA funded air traffic control tower, and therefore does not have data reported to ATADS.

Midland International Air and Space is located approximately midway between the Texas cities of Midland and Odessa, approximately 98 miles from the CIS Facility. It is owned and operated by the City of Midland and is licensed by the FAA to serve both scheduled airline flights and commercial human spaceflight. Midland International Air and Space Port is ranked eighth in Texas for primary commercial service airports. See Table 2.2.4 for flight information and aircraft based here during the 12 month period ending April 30, 2017 [2.2.26]. The airport has three airlines, two serving hubs with regional jets and one (Southwest) flying mainline jets (Boeing 737s) [2.2.26]. Average annual aircraft operations data is presented in Table 2.2.7 [2.2.28].

Roswell International Air Center is located 5 miles south of the central business district of Roswell,

HOLTEC INTERNATIONAL COPYRIGHTED MATERIAL	
Report No. HI-2167374	Proposed Rev. 0R
2-51	

in Chaves County, NM, approximately 68 miles from the CIS Facility. The former Air Force Base currently covers 5,029 acres and has 2 runways. It is also an FAA certified commercial airport but is served by American Airlines with daily regional flights to Dallas-Fort Worth and Phoenix. The airport is owned by the city of Roswell and also serves as a storage facility for retired aircraft. See Table 2.2.4 for flight information and aircraft based here during the 12-month period ending December 31, 2016 [2.2.27]. Average annual aircraft operations data is given in Table 2.2.8 [2.2.28].

2.2.3.4 Probabilistic Crash Assessment

In order to assure that risks from aircraft hazards are sufficiently low, a probabilistic assessment of the potential hazard posed by the nearby air transportation infrastructure, as described above, has been performed [2.2.37], following the guidance of NUREG-0800 Standard Review Plan. NUREG-0800 Section 3.5.1.6 states that only aircraft accidents impacting critical structures or operations with a probability greater than 10^{-7} per year [2.2.33] need to be considered in the design of the plant. However, on past 10 CFR Part 72 applications for storage of fuel at an ISFSI, the Commission has agreed that the risk from aircraft hazards are sufficiently low if the total probability of an aircraft crash, from all nearby air traffic sources, impacting critical structures or operations is less than an order of magnitude of 10^{-6} per year [2.2.38]. Therefore, aircraft crashes will only be considered in the design of the CIS Facility if the probability of an aircraft hazard impacting critical structures or operations at the facility is greater than 10^{-6} per year.

Holtec report HI-2188201 “HI-STORE CIS Aircraft Crash Assessment” [2.2.37] determines the probability of an accidental aircraft crash, considering all potential sources, impacting critical structures or operations at the facility. The cumulative probability per year of an aircraft crash impacting critical operations including the potential for military ordnance to impact the site is less than the 10^{-6} per year criteria. Therefore, there are no credible aircraft crash hazards to the HI-STORE CIS Facility, and aircraft hazards need not be a design-basis concern. Additional discussion regarding the individual probabilities from contributing sources can be found in the report [2.2.37].

2.2.3.5 Additional MTR Information

While aircraft munitions or ordnance are not an explicit parameter of aircraft crash probability equations for MTRs, NUREG 0800 Section 3.5.1.6 suggests that “hazardous military activities” may preclude a route from probability by inspection criteria. In order to be thorough in the assessment, aircraft munitions information was requested from the AFB owners of the MTRs in the vicinity of the facility. According to Dyess AFB, aircraft flying IR 128/180 do not carry any weapons while using the route [2.2.37]. Holloman AFB did not provide weapons information for aircraft flying IR 192/194. Conservative assumptions are made in HI-2188201 [2.2.37] to consider the potential for military ordnance originating from IR-192/194 to impact the site. Additional details including the full requests and AFB responses regarding the MTRs can be found in the report [2.2.37].

2.2.4 Ground Transportation

HOLTEC INTERNATIONAL COPYRIGHTED MATERIAL	
Report No. HI-2167374	Proposed Rev. 0R
2-52	

U.S. Highway 62/180, approximately 1 mile (greater than 2,500 feet) south of the proposed CIS Facility, is the closest and most trafficked public road. It provides a route from the state of Texas to Carlsbad, New Mexico and points further west. It is a divided highway with a maximum speed limit of 70 miles per hour in the area near the proposed CIS Facility. This, in addition to other transportation infrastructure near the site, can be seen in Figure 2.2.4. This highway is on the National Hazardous Materials Route Registry (79 FR 40844, July 14, 2014) and can be used for the transportation of radioactive waste materials to WIPP [2.2.7] (Note: as shown on Figure 2.2.5, the WIPP route is approximately 5 miles southwest of the CIS Facility. There have been instances where transuranic wastes associated with WIPP have been transported along U.S. Highway 62/180 within approximately 1 mile of the proposed CIS Facility).

Like similar roads, commercial shipments of hazardous materials are also transported over U.S. Highway 62/180. Such shipments could include a wide range of hazardous materials, including, but not limited to: gasoline, diesel fuel, acids, carbon dioxide (CO₂), nitrogen (N₂), liquid nitrogen (LN₂), chlorine (Cl) gas, refrigerants, fuel gases, oxygen (O₂), explosives, and low-level radioactive materials. Although the State of New Mexico does not keep records of hazardous material shipments via roadways, the PHMSA does maintain a database of highway incidents involving vehicles transporting hazardous materials, including the location of each incident and the type of hazardous material released as a result of each incident.

The nearest operating railroad is an industrial railroad approximately 3.8 miles west of the proposed CIS Facility and serves the local potash mines to transport ore to the refiners. The potash ore is not a hazardous material. As with highway transport, shipments by rail could include a wide range of hazardous materials, including, but not limited to: gasoline, diesel fuel, acids, CO₂, N₂, LN₂, Cl gas, refrigerants, fuel gases, O₂, explosives. Although the State of New Mexico does not keep records of hazardous material shipments via rail, the PHMSA does maintain a database of railway incidents involving rail cars transporting hazardous materials, including the location of the incident and the type of hazardous materials released as a result of each incident. All transportation infrastructure can be seen in Figure 2.2.4.

Per US NRC Regulatory Guide 1.91 [2.2.39], the maximum probable solid cargo for a single highway truck is 50,000 pounds and the maximum probable cargo in a single railroad boxcar is approximately 132,000 pounds. Considering these cargo sizes and the distances between the highway/railroad and the Facility, the potential overpressure effects from an explosion event resulting from an accident involving hazardous materials on ground transportation were evaluated in Holtec Report HI-2200797 [2.2.40]. At these distances (greater than 2,500 feet for the highway and approximately 3.8 miles for the railroad), the only heat transfer from a postulated fire to the casks would be from radiative effects. The heat exchange factor (view factor) at these distances would be so small that any effects from the fire would be negligible.

An analysis of the potential overpressure effects associated with bounding hazardous cargo transporters from ground transportation (highway and railroad) is performed in Holtec Report HI-2200797 [2.2.40]. The analysis in this report determines a conservatively low minimum pressure threshold that could affect safety-related structures at the HI-STORE Facility and then compares this with maximum overpressure values that could result from explosion of the hazardous cargo transporters. The minimum pressure threshold is determined by calculating the minimum steady-

HOLTEC INTERNATIONAL COPYRIGHTED MATERIAL	
Report No. HI-2167374	Proposed Rev. 0R
2-53	

state pressure wave that could cause the VCT carrying the HI-TRAC CS to begin to slide or tip which bounds the design basis overpressure for storage conditions in the UMAX ISFSI. This pressure threshold was determined with a steady state (continuous) pressure wave and the most bounding input parameters (component weights, component dimensions, coefficient of friction, etc.). Additionally, the hazardous cargo transporters are conservatively assumed to be completely made of TNT to determine bounding explosive overpressure values. Holtec Reports HI-2210619 [2.2.43] and HI-2210620 [2.2.44] determined the potential for a railway or highway incident involving hazardous materials to impact the critical operations at the proposed HI-STORE CIS Facility due to the hazardous material itself. Using conservative assumptions, the cumulative probability per year of a railway or highway incident involving hazardous materials impacting critical operations at the proposed HI-STORE CIS Facility was calculated to be orders of magnitude below both the Regulatory Guide 1.78 screening criteria value of 1×10^{-6} per year.

Based on these evaluations [2.2.40, 2.2.43, 2.2.44], there are no credible railway or highway incidents that have the potential to impact critical operations at the proposed location of the HI-STORE CIS Facility, and railway and highway hazards need not be considered as design-basis concerns.

2.2.5 Nuclear Facilities

With regard to nuclear facilities, Figure 2.2.5 depicts existing or planned nuclear facilities in the vicinity of the Site. As shown on that Figure, all of these facilities would be within 50-miles of the proposed Site. A brief description of these other nuclear facilities follows:

1. **Waste Isolation Pilot Plant (WIPP):** Located approximately 16 miles southwest of the proposed Site, WIPP is the nation's first underground repository permitted to safely and permanently dispose of transuranic (TRU) radioactive and mixed waste generated through defense activities and programs. WIPP, which has been operational since March 1999, stores TRU in underground salt caverns approximately 2,150 feet deep. From the first receipt of waste in March 1999 through the end of 2014, approximately 90,983 cubic meters of TRU waste has been disposed of at the WIPP facility. The environmental impacts of the WIPP are described in the *Waste Isolation Pilot Plant Disposal Phase Final Supplemental Environmental Impact Statement (DOE/EIS-0026-S2)* [2.2.11], as well as the *Waste Isolation Pilot Plant Annual Site Environmental Report for 2014* [2.2.12].
2. **National Enrichment Facility (NEF):** Located approximately 38 miles southeast of the proposed Site, the NEF is used to enrich uranium for use in manufacturing nuclear fuel for commercial nuclear power reactors. NEF enriches uranium using a gas centrifuge process. The environmental impacts of the NEF are documented in NUREG-1790 [2.2.13].
3. **Fluorine Extraction Process & Depleted Uranium De-conversion Plan (FEP/DUP):** Located approximately 23 miles northeast of the proposed Site, the FEP/DUP will de-convert depleted uranium hexafluoride (DUF6) into fluoride products for commercial resale and uranium oxides for disposal. Construction of that facility is expected to begin before the end of 2016. The environmental impacts of the FEP/DUP are documented in NUREG-2113 [2.2.14].
4. **Waste Control Specialists (WCS) CIS Facility:** In May 2016, WCS submitted a license application to the NRC to construct and operate a CIS Facility in Andrews County, Texas,

HOLTEC INTERNATIONAL COPYRIGHTED MATERIAL	
Report No. HI-2167374	Proposed Rev. 0R
2-54	

approximately 39 miles east of the Holtec proposed Site. The WCS CIS Facility would be similar to the Holtec Site, but would utilize AREVA's horizontal canister storage system (NUHOMS) at the facility. A limited number of vertical canisters supplied by NAC may also be stored. The environmental impacts of the WCS CIS Facility are documented in an ER which WCS submitted to the NRC in May 2016 [2.2.15]. In addition, the NRC is expected to prepare an EIS for the WCS CIS Facility.

HOLTEC INTERNATIONAL COPYRIGHTED MATERIAL	
Report No. HI-2167374	Proposed Rev. 0R
2-55	

Table 2.2.1 Intentionally Deleted

Table 2.2.2: Intentionally Deleted

Table 2.2.3: Intentionally Deleted

HOLTEC INTERNATIONAL COPYRIGHTED MATERIAL	
Report No. HI-2167374	Proposed Rev. 0R
2-56	

Table 2.2.4: Nearby Airports

Airports	City	Distance "D" from Site [mi]	Average Annual Operations	General Aviation	Air Taxi	Air Carrier	Military	Single-Engine	Multi-Engine	Jet	Helicopter	Ultra-Lite
Artesia Municipal (ATS)	Artesia, NM	47	14,050*	82%	-	-	18%	26	4	-	-	-
Cavern City (CNM)	Carlsbad, NM	34	6,865*	53%	4%	39%	4%	15	2	2	2	1
Lea County Regional (HOB)	Hobbs, NM	30	12,745 ⁺	67%	16%	10%	7%	41	6	4	1	-
Lea Co. Zip Franklin Mem (E06)	Lovington, NM	32	2,200*	100%	-	-	-	11	1	-	-	-
Midland Intl Air and Space Port (MAF)	Midland, TX	98	63,055	43%	14%	18%	25%	24	4	39	2	-
Roswell International (ROW)	Roswell, NM	68	25,550	23%	18%	1%	58%	31	4	3	1	-

HOLTEC INTERNATIONAL COPYRIGHTED MATERIAL

Report No. HI-2167374

Proposed Rev. 0R

2-57

Table 2.2.5: Nearby Federal Airways, Holding Patterns, and Military Training Routes

Airway or Pattern	Type	Travel Direction	Distance to Nearest Edge [mi]
Q-20	Federal	Either	8.00
Q-37	Federal	Either	16.67
J-15	Federal	Either	3.03
J-65	Federal	Either	37.05
J-66	Federal	Either	20.05
J-108	Federal	Either	25.20
V-68	Federal	Either	12.87
V-83	Federal	Either	29.86
V-102	Federal	Either	1.90
V-291	Federal	Either	7.19
CNM	Approach Pattern	N/A	11.9
HOB	Missed Approach Pattern	N/A	3.2
IR-192/ IR-194	MTR	N to S	9.5
		S to N	
IR-128/ IR-180	MTR	N to S	Over Site
		S to N	

HOLTEC INTERNATIONAL COPYRIGHTED MATERIAL	
Report No. HI-2167374	Proposed Rev. 0R
2-58	

Table 2.2.6: ATADS Standard Report for LEA County Regional Airport 2003-2017

Calendar Year	State	Facility	Itinerant					Local			Total Operations
			Air Carrier	Air Taxi	General Aviation	Military	Total	Civil	Military	Total	
2003	NM	HOB	0	3,047	8,676	167	11,890	6,138	468	6,606	18,496
2004	NM	HOB	0	3,002	6,850	200	10,052	5,224	344	5,568	15,620
2005	NM	HOB	0	2,277	5,082	77	7,436	3,660	166	3,826	11,262
2006	NM	HOB	0	2,195	4,574	72	6,841	3,694	155	3,849	10,690
2007	NM	HOB	0	2,237	5,468	62	7,767	4,006	82	4,088	13,810
2008	NM	HOB	0	2,388	5,165	85	7,638	5,240	188	5,428	17,366
2009	NM	HOB	0	2,136	10,327	171	12,634	6,884	390	7,274	19,908
2010	NM	HOB	4	2,190	9,806	280	12,280	3,991	366	4,357	16,637
2011	NM	HOB	2	1,944	6,332	137	8,415	2,011	326	2,337	10,752
2012	NM	HOB	0	2,264	5,817	157	8,238	856	176	1,032	9,270
2013	NM	HOB	2	2,341	5,622	100	8,065	738	90	828	8,893
2014	NM	HOB	0	2,358	5,153	257	7,768	511	244	755	8,523
2015	NM	HOB	0	1,979	5,336	399	7,714	1,196	304	1,500	9,214
2016	NM	HOB	0	2,115	5,351	374	7,840	818	226	1,044	8,884
2017	NM	HOB	0	1,870	5,049	157	7,076	1,097	16	1,113	8,189
Sub-Total for HOB			8	34,343	94,608	2,695	131,654	46,064	3,541	49,605	187,514
Sub-Total for NM			8	34,343	94,608	2,695	131,654	46,064	3,541	49,605	187,514
Total:			8	34,343	94,608	2,695	131,654	46,064	3,541	49,605	187,514
										15yr AVG	12,501

HOLTEC INTERNATIONAL COPYRIGHTED MATERIAL	
Report No. HI-2167374	Proposed Rev. 0R
2-59	

Table 2.2.7: ATADS Standard Report for Midland International Air and Space Port 2003-2017

Calendar Year	State	Facility	Itinerant					Local			Total Operations
			Air Carrier	Air Taxi	General Aviation	Military	Total	Civil	Military	Total	
2003	TX	MAF	9,612	14,111	23,557	17,704	64,984	4,703	22,745	27,448	92,432
2004	TX	MAF	9,603	12,264	25,137	16,555	63,559	4,149	18,401	22,550	86,109
2005	TX	MAF	9,560	13,783	24,571	16,220	64,134	4,696	18,060	22,756	86,890
2006	TX	MAF	10,309	15,615	26,352	16,197	68,473	4,463	16,563	21,026	89,499
2007	TX	MAF	9,408	14,055	17,745	13,015	54,223	4,172	16,442	20,614	84,302
2008	TX	MAF	8,613	13,827	12,608	7,747	42,795	4,129	16,369	20,498	84,037
2009	TX	MAF	8,574	12,574	18,070	10,447	49,665	2,629	9,547	12,176	61,841
2010	TX	MAF	8,196	14,935	22,290	10,587	56,008	2,792	11,766	14,558	70,566
2011	TX	MAF	8,336	12,479	23,490	12,777	57,082	2,823	14,991	17,814	74,896
2012	TX	MAF	7,903	13,850	25,202	9,972	56,927	2,466	10,345	12,811	69,738
2013	TX	MAF	7,099	16,433	25,111	10,531	59,174	2,402	10,988	13,390	72,564
2014	TX	MAF	8,987	15,464	27,562	10,181	62,194	3,390	11,093	14,483	76,677
2015	TX	MAF	11,478	11,648	22,745	10,379	56,250	4,175	9,960	14,135	70,385
2016	TX	MAF	11,033	9,370	21,423	9,878	51,704	5,471	6,733	12,204	63,908
2017	TX	MAF	11,757	8,715	23,029	6,835	50,336	5,230	6,777	12,007	62,343
Sub-Total for MAF			140,468	199,123	338,892	179,025	857,508	57,690	200,780	258,470	1,146,187
Sub-Total for TX			140,468	199,123	338,892	179,025	857,508	57,690	200,780	258,470	1,146,187
Total:			140,468	199,123	338,892	179,025	857,508	57,690	200,780	258,470	1,146,187
										15yr AVG	76,412

HOLTEC INTERNATIONAL COPYRIGHTED MATERIAL	
Report No. HI-2167374	Proposed Rev. 0R
2-60	

Table 2.2.8: ATADS Standard Report for Roswell International Air Center 2003-2017

Calendar Year	State	Facility	Itinerant					Local			Total Operations
			Air Carrier	Air Taxi	General Aviation	Military	Total	Civil	Military	Total	
2003	NM	ROW	398	8,579	13,861	13,394	36,232	9,741	12,181	21,922	58,154
2004	NM	ROW	94	9,418	18,547	13,495	41,554	12,800	13,032	25,832	67,386
2005	NM	ROW	222	9,379	16,714	12,433	38,748	7,802	13,233	21,035	59,783
2006	NM	ROW	218	8,590	19,998	15,359	44,165	7,408	15,695	23,103	67,268
2007	NM	ROW	225	8,559	14,855	11,284	34,923	6,094	18,324	24,418	66,890
2008	NM	ROW	301	6,953	8,735	5,580	21,569	4,396	9,532	13,928	50,108
2009	NM	ROW	337	6,360	12,020	11,178	29,895	6,005	12,826	18,831	48,726
2010	NM	ROW	116	6,405	9,468	10,242	26,231	4,774	20,953	25,727	51,958
2011	NM	ROW	268	6,999	8,922	7,496	23,685	4,064	7,924	11,988	35,673
2012	NM	ROW	603	6,168	7,232	8,309	22,312	4,373	7,986	12,359	34,671
2013	NM	ROW	519	6,006	6,498	13,329	26,352	2,339	24,384	26,723	53,075
2014	NM	ROW	518	6,551	7,384	12,371	26,824	3,127	16,979	20,106	46,930
2015	NM	ROW	260	5,412	6,522	8,573	20,767	2,382	12,081	14,463	35,230
2016	NM	ROW	285	6,116	6,317	8,771	21,489	1,630	11,161	12,791	34,280
2017	NM	ROW	1,652	4,718	6,593	5,252	18,215	2,301	5,030	7,331	25,546
Sub-Total for ROW			6,016	106,213	163,666	157,066	432,961	79,236	201,321	280,557	735,678
Sub-Total for NM			6,016	106,213	163,666	157,066	432,961	79,236	201,321	280,557	735,678
Total:			6,016	106,213	163,666	157,066	432,961	79,236	201,321	280,557	735,678
										15yr AVG	49,045

HOLTEC INTERNATIONAL COPYRIGHTED MATERIAL

Report No. HI-2167374

Proposed Rev. 0R

2-61

Table 2.2.9: Intentionally Deleted

HOLTEC INTERNATIONAL COPYRIGHTED MATERIAL	
Report No. HI-2167374	Proposed Rev. 0R
2-62	

Table 2.2.10: Intentionally Deleted

HOLTEC INTERNATIONAL COPYRIGHTED MATERIAL	
Report No. HI-2167374	Proposed Rev. 0R
2-63	



Figure 2.2.1: Industrial Facilities Within Approximately 5 Miles of the Proposed Site

HOLTEC INTERNATIONAL COPYRIGHTED MATERIAL		
Report No. HI-2167374	2-64	Proposed Rev. 0R

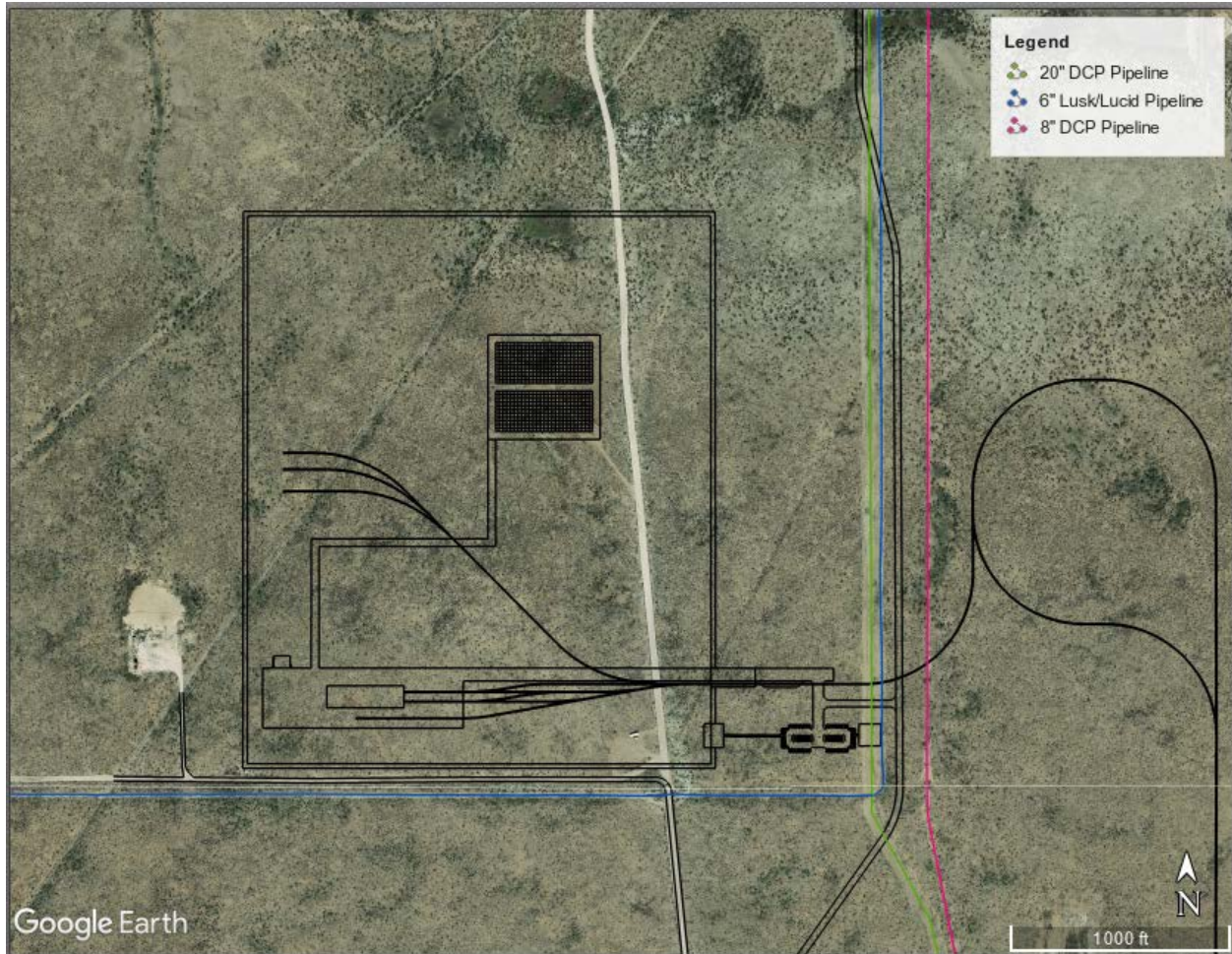


Figure 2.2.2: Pipelines in Close Vicinity to the Facility Evaluated in Reference [2.2.6]

HOLTEC INTERNATIONAL COPYRIGHTED MATERIAL	
Report No. HI-2167374	Proposed Rev. 0R
2-65	



Figure 2.2.3: WIPP Transportation Route.

HOLTEC INTERNATIONAL COPYRIGHTED MATERIAL	
Report No. HI-2167374	Proposed Rev. 0R
2-66	

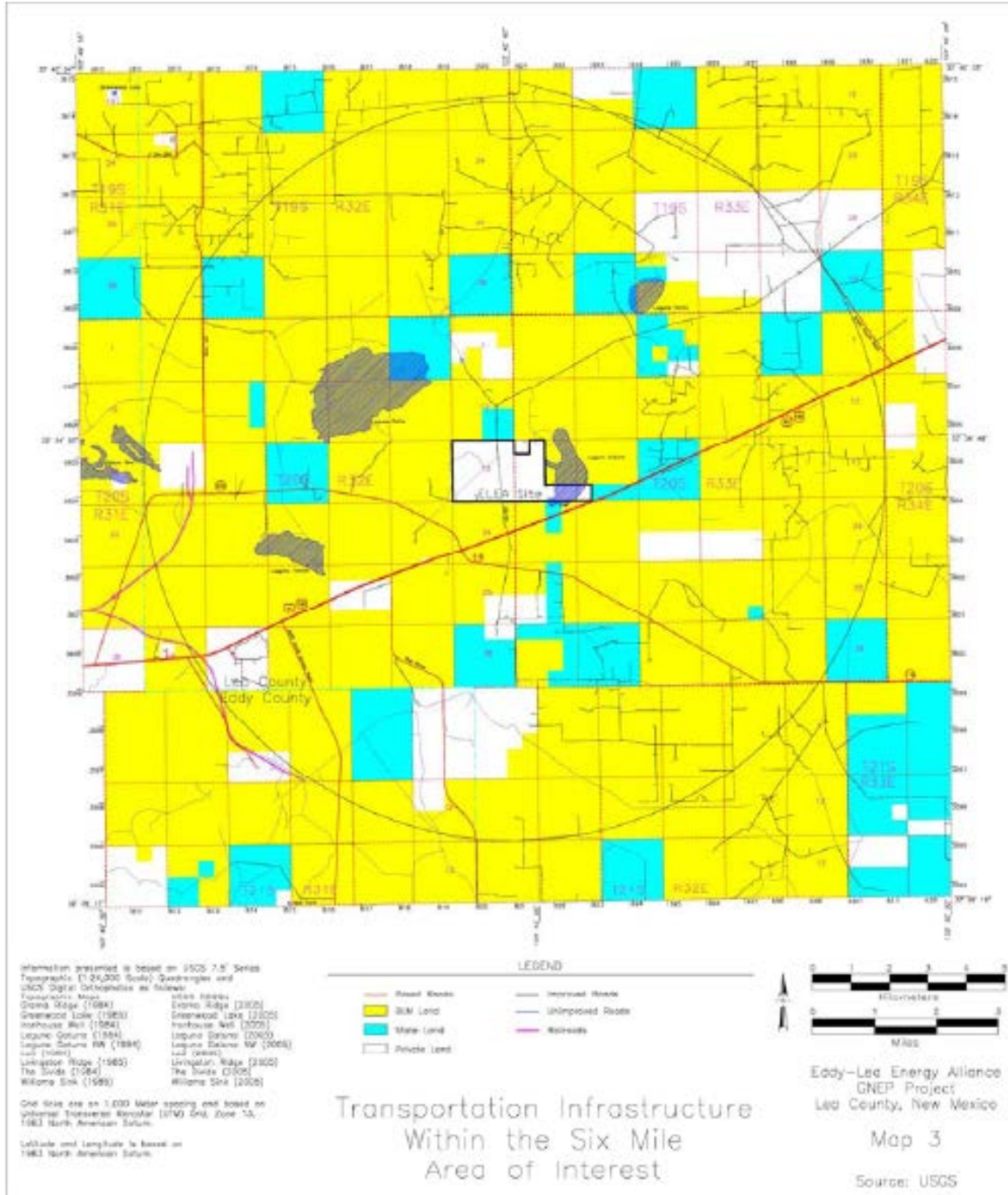


Figure 2.2.4: Transportation Infrastructure near the CIS Facility Site

HOLTEC INTERNATIONAL COPYRIGHTED MATERIAL		
Report No. HI-2167374		Proposed Rev. 0R
2-67		

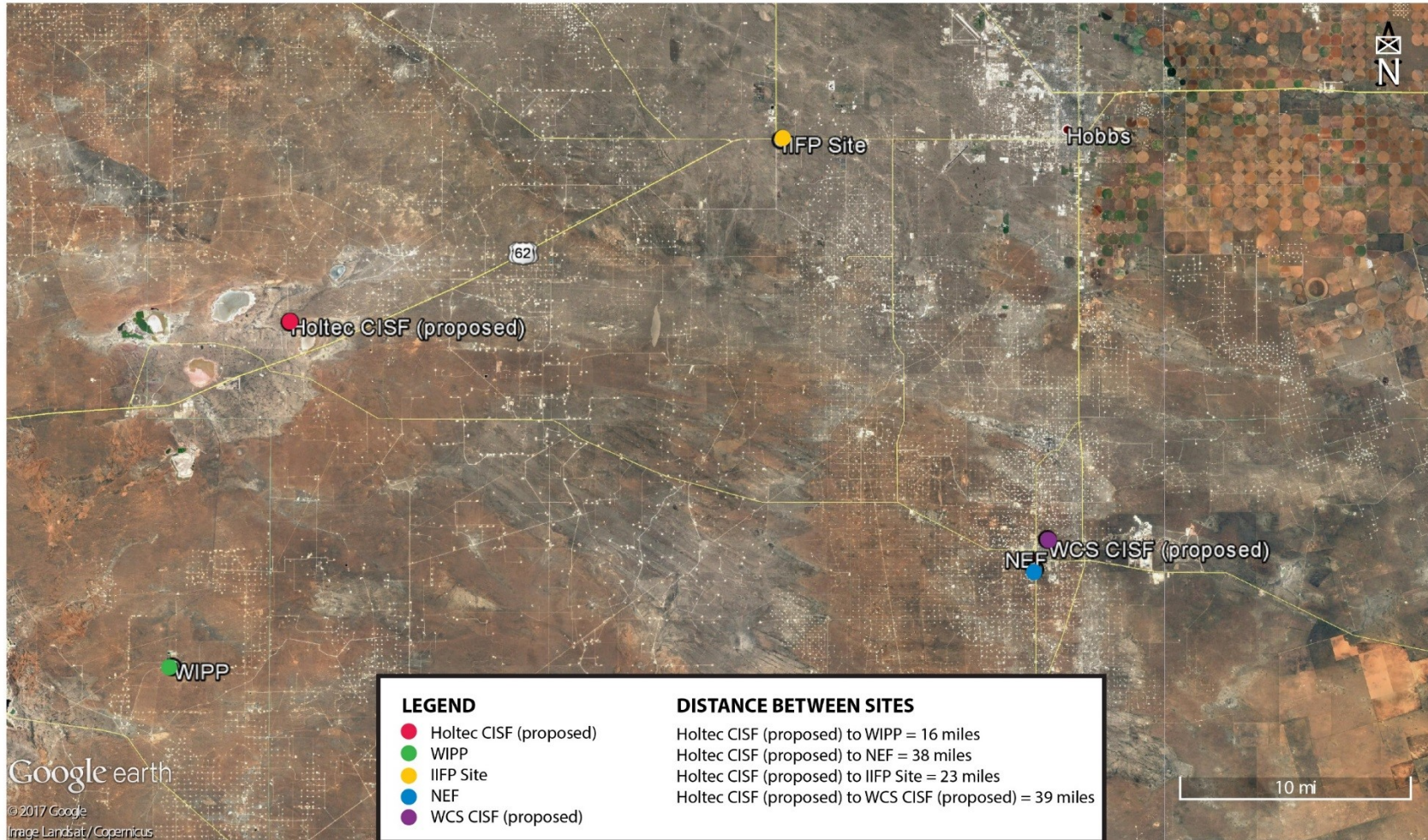


Figure 2.2.5: Existing or Planned Nuclear Facilities in the Vicinity of the Proposed Site

HOLTEC INTERNATIONAL COPYRIGHTED MATERIAL		
Report No. HI-2167374		Proposed Rev. 0R
2-68		

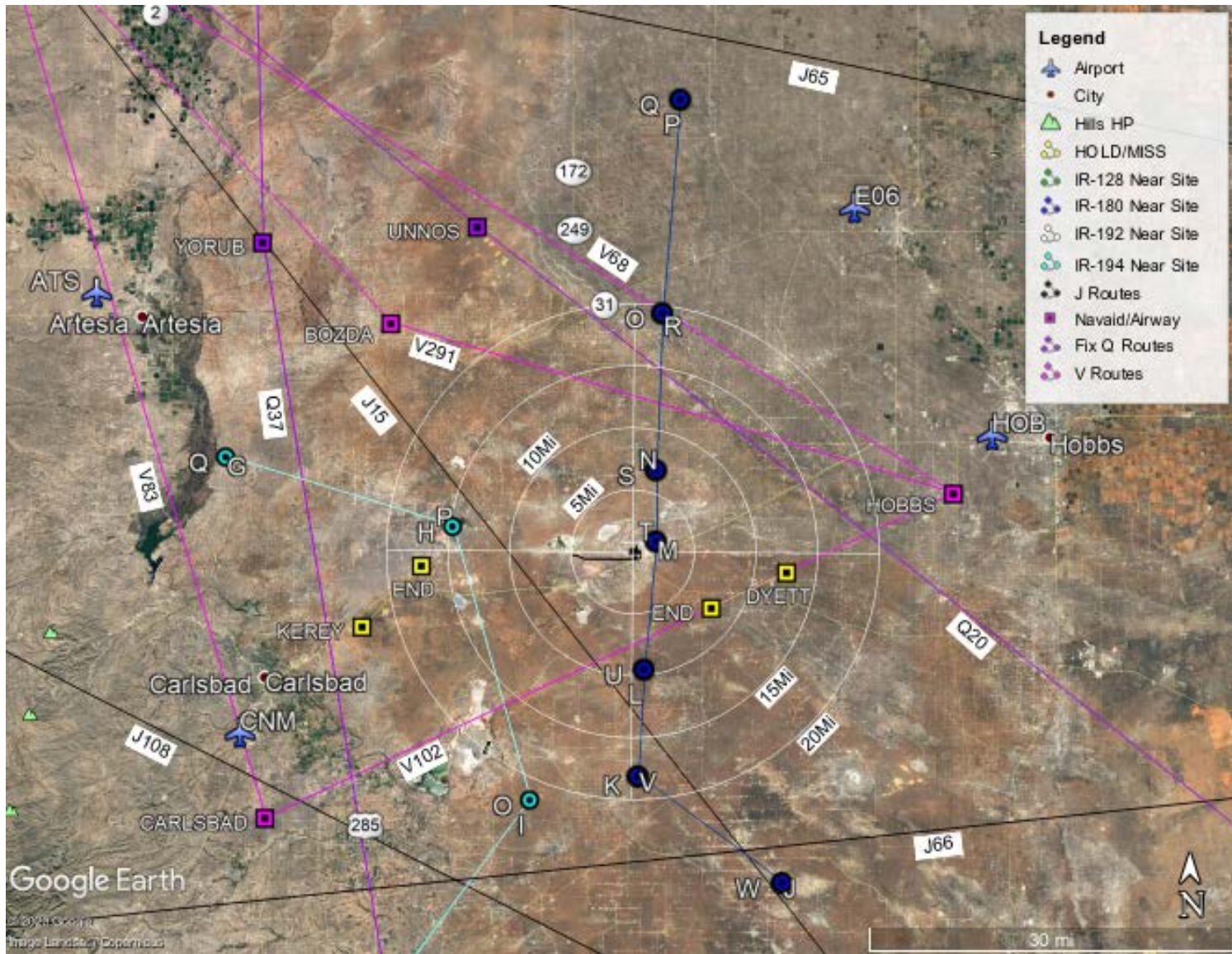


Figure 2.2.6: Federal Airways and Holding Patterns Near the CIS Facility

HOLTEC INTERNATIONAL COPYRIGHTED MATERIAL

Report No. HI-2167374

Proposed Rev. 0R

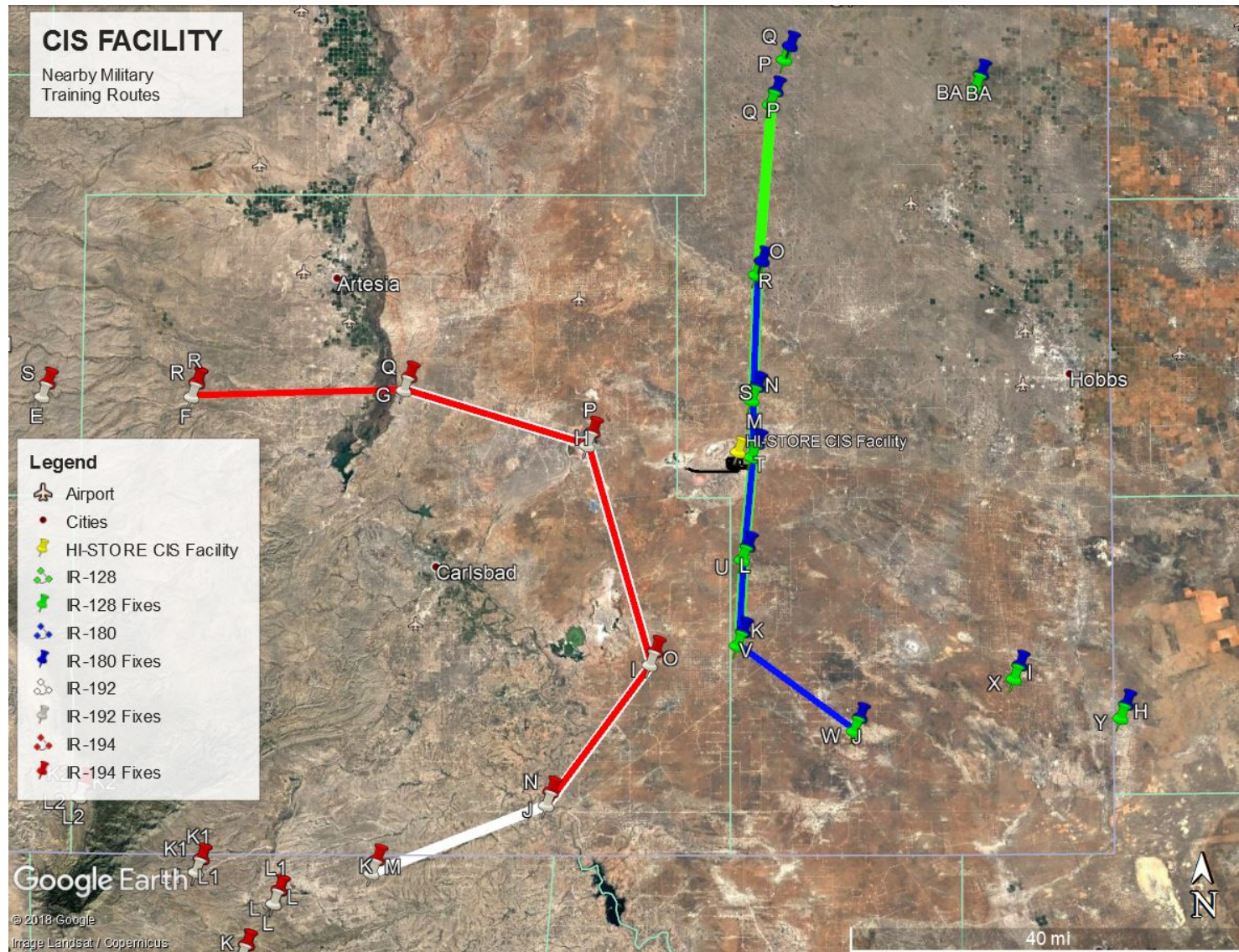


Figure 2.2.7: Military Training Routes Near the CIS Facility

HOLTEC INTERNATIONAL COPYRIGHTED MATERIAL		
Report No. HI-2167374	2-70	Proposed Rev. 0R

Figure 2.2.8: Intentionally Deleted

HOLTEC INTERNATIONAL COPYRIGHTED MATERIAL

Report No. HI-2167374

Proposed Rev. 0R

2-71

2.3 METEOROLOGY

2.3.1 Regional Climatology

The climate at the Site is typically semi-arid with generally mild temperatures, low precipitation, low humidity, and with a high evaporation rate. The winter weather typically has high pressure systems that are located in the central part of the western U.S. and low pressure systems located in north-central Mexico. In the summer, the region is typically affected by low pressure systems located over Arizona. Overall, precipitation is low and storms are infrequent. Winds during the spring may cause dust during construction periods; however, it is anticipated to be a minimal and temporary impact in comparison to the naturally occurring dust.

Meteorological information was obtained from various sources, including the Western Regional Climate Center (WRCC) and other sources as noted in this section. The use of the data from the WRCC and other sources are appropriate due to proximity to the proposed Site and are expected to have similar climates. The WRCC is a governmental department closely associated with the National Oceanic and Atmospheric Administration (NOAA) and the National Weather Service (NSW). The data from the WRCC is generally considered to be the authoritative source of meteorological data for the region (see Appendix A, Section A.2 of the ER [1.0.4] for additional details regarding the applicability of data from the WRCC).

Temperatures. Data collected over approximately the past 75 years at the Lea County Regional Airport station [2.3.1] is summarized in Table 2.3.1. The temperature data reported in this summary table includes monthly average values for the minimum, average, and maximum temperatures as well as the monthly extreme values for the minimum and maximum temperatures. Additionally, annual values for these temperature parameters are included.

A site-specific 3-day average ambient temperature is defined by evaluating local weather service records for the Lea County in which the site is situated. The results are as follows:

- Location: Lea Regional Airport
- Records Period: 1980 – 2017
- Maximum 3-Day Average Temperature: 90.7°F

Winds. Prevailing wind directions and wind speeds at the Lea County Regional Airport station are presented in Table 2.3.2 and depicted graphically in Figure 2.3.2. The average wind speed is approximately 12 miles per hour (mph) and the prevailing wind direction is from the south. Winds are typically moderate, between 1 mph and 19 mph blowing 84 percent of the time, with calm winds (winds less than 1.3 mph) occurring only approximately 8 percent of the time [2.3.1].

With respect to wind gusts, the average wind speed of all of the maximum gusts is approximately 25 mph. The prevailing wind direction for wind gusts is wind from southwest during 11 percent of the observations; however, the wind gusts are out of the south, south-southeast, and southeast during 30 percent of the observations. Typical gusts range in speed from 13 mph to 32 mph, comprising of 86 percent of the gusts. Gusts range in speed from 32 mph to 47 mph occurred during 13 percent of the observations, and less than 1 percent of the gusts observed were over 47 mph [2.3.1].

HOLTEC INTERNATIONAL COPYRIGHTED MATERIAL	
Report No. HI-2167374	Proposed Rev. 0R
2-72	

Mixing Heights. Mixing height is the height above the ground where the strong, vertical mixing of the atmosphere occurs. G.C. Holzworth developed mean annual morning and afternoon mixing heights for the contiguous United States [2.3.2]. The results of Holzworth's calculation methods for mixing heights include mean annual morning and afternoon mixing heights at the Site of approximately 1,430 feet and 6,854 feet, respectively [2.3.2]. Table 2.3.3 shows the average morning and afternoon mixing heights for Midland-Odessa, Texas, which is the nearest available area with mixing height data, located approximately 100 miles southeast.

Tornadoes. Tornadoes are typically classified by the F-Scale classification. The F-Scale classification of tornadoes is based on the appearance of the damage that the tornado causes. The six classifications range from F0 to F5 with an F0 tornado having winds of 40-72 mph and an F5 tornado having winds of 261-318 mph [2.3.3]. Note that as of February 1, 2007, an enhanced F-scale for tornado damage went into effect in the United States. The switch to the enhanced F-scale involves:

- Changing the averaging interval for wind speed estimates from the fastest quarter-mile wind speed to a maximum three-second average wind speed.
- Changing the minimum tornado wind speed from 40 mph to 65 mph.
- Changing the wind speed intervals associated with each F scale class.

The enhanced F-scale uses three-second wind gusts estimated at the point of damage based on a judgment of eight levels of damage to 28 indicators. The enhanced F-scale has six classifications, EF0 to EF5, with an EF0 tornado having three-second gusts of 65-85 mph and an EF5 tornado having three-second gusts of over 200 mph [2.3.4].

Based on a United States-wide study performed on a state by state basis, the average tornado probability for any F-scale tornado for the Site is between 1×10^{-6} and 2×10^{-4} , as is presented in Figure 2.3.3 [2.1.3]. Ninety two tornados have occurred in Eddy and Lea counties since 1954. The highest number of tornados in any given year was 15 in 1991; of which, 14 occurred over a two day period. The lowest number of tornado in a year has been zero, with a mean average of 1.5 tornados occurring in a year. Most tornados recorded were F0 in scale and occurred in the spring [2.3.5].

Hurricanes. The Site is located over 500 miles from the oceanic coast. Because hurricanes lose their intensity quickly once they pass over land, impacts from a hurricane at the Site are unlikely.

Thunderstorms. Thunderstorms can occur during every month of the year, but generally occur from March through October of each year. Thunderstorms occur an average of 39 days per year in Carlsbad, New Mexico. The seasonal averages are: 2.7 days in spring (March through May); 8.3 days in summer (June through August); 2.3 days in fall (September through November); and less than 1 day in winter (December through February) [2.3.1]. Occasionally, thunderstorms are accompanied by hail [2.1.15].

Precipitation. A summary of precipitation data collected at the Lea County Regional Airport station resulted in an annual mean average total precipitation of 10.2 inches with monthly mean average totals ranging from 0.24 inches in March to 1.9 inches in September. The monthly minimum total is 0.00 inches and the monthly maximum total is 6.2 inches. The highest daily total is 3.6 inches occurring in December of 2015. A summary of this information is presented in Table 2.3.4 and depicted graphically with monthly average total precipitation in Figure 2.3.4 [2.3.1].

HOLTEC INTERNATIONAL COPYRIGHTED MATERIAL	
Report No. HI-2167374	Proposed Rev. 0R
2-73	

A summary of snowfall data collected at the Lea County Regional Airport station resulted in an annual mean average total precipitation of 5.13 inches with monthly mean average totals ranging from 1.84 inches in February to 0.0 inches from May to October. The monthly minimum total is 0.00 inches and the monthly maximum total is 21.2 inches. The highest daily total is 10.00 inches occurring in February of 1956 [2.3.1].

Based on the season, atmospheric pressure systems can affect temperature and cause cloud formation. Clouds are formed when warm, moist air rises into the atmosphere and the droplets are cooled. When the droplets cool, the water from the air condenses into tiny droplets and forms clouds. This occurs during low pressure system. These low pressure systems typically occur during the spring and summer. Climatology data indicate the relative humidity throughout the year ranges from 45 percent to 61 percent in the region, with the highest humidity occurring during the early morning hours [2.1.15].

2.3.2 Local Meteorology

There are no on-site weather stations, however due to the proximity of the Lea County Regional Airport weather station to the Site (approximately 30 miles away), it is reasonable to say that the data presented in Section 2.3.1 adequately represents the on-site conditions for Local Meteorology. Additional details regarding the applicability of this data can be seen in Appendix A, Section A.2 of the ER [1.0.4].

2.3.3 Onsite Meteorological Measurement Program

There are no on-site weather stations, however due to the proximity of the Lea County Regional Airport weather station to the Site (approximately 30 miles away), it is reasonable to say that the data presented in Section 2.3.1 adequately represents the on-site conditions for Local Meteorology. Additional details regarding the applicability of this data can be seen in Appendix A, Section A.2 of the ER [1.0.4]. After the license is issued for the CIS Facility, Holtec will establish an on-site meteorological data collection system. That system will collect, at a minimum, temperature, precipitation, and wind data. **The program will follow the guidance of RG 1.23 [2.3.6].**

HOLTEC INTERNATIONAL COPYRIGHTED MATERIAL	
Report No. HI-2167374	Proposed Rev. 0R
2-74	

Table 2.3.1**LEA COUNTY REGIONAL AIRPORT STATION TEMPERATURE DATA (09/01/1941-06/09/2016) [2.3.1]**

Month	Average Monthly Minimum Temperature °F	Average Monthly Maximum Temperature °F	Average Monthly Temperature °F	Extreme Minimum Temperature °F	Extreme Maximum Temperature °F
January	27.72	56.25	41.98	4.00	81.00
February	30.68	61.12	45.90	-11.00	84.00
March	35.67	67.32	51.53	14.00	86.00
April	44.32	75.05	59.69	24.00	93.00
May	53.77	84.05	68.91	28.00	103.00
June	63.71	92.90	78.31	51.00	107.00
July	66.73	93.62	80.17	52.00	108.00
August	65.50	92.57	79.04	55.00	104.00
September	58.29	86.47	72.37	41.00	104.00
October	47.82	75.76	61.79	24.00	94.00
November	34.23	64.42	49.33	4.00	85.00
December	28.78	59.04	43.91	7.00	79.00
Annual	46.34	76.03	61.19	-11.00	108.0

Note: The extreme maximum temperature was recorded in July of 2000 and again in July 2001 at 108°F and the extreme minimum temperature was recorded in February of 1951 at -11°F.

HOLTEC INTERNATIONAL COPYRIGHTED MATERIAL

Report No. HI-2167374

Proposed Rev. 0R

2-75

Table 2.3.2**LEA COUNTY REGIONAL AIRPORT STATION ALL WIND DATA (12/01/1948-12/31/2014) [2.3.1]**

Wind Speed (mph)	N (%)	NNE (%)	NE (%)	ENE (%)	E (%)	ESE (%)	SE (%)	SSE (%)	S (%)	SSW (%)	SW (%)	WSW (%)	W (%)	WNW (%)	NW (%)	NNW (%)	Total (%)
1.3-4	0.1	0.1	0.2	0.1	0.2	0.2	0.2	0.2	0.3	0.2	0.2	0.1	0.1	0.1	0.1	0.1	2.5
4-8	1	0.8	0.9	0.7	1.8	1.3	1.4	1.4	2.7	1.7	1.3	0.9	0.6	0.5	0.6	0.5	18.2
8-13	2	1.5	1.7	1.5	3	2.8	3.9	4.5	6.2	3.4	2.8	2.3	1.7	1.2	1.1	0.9	40.4
13-19	1.4	1.2	1.1	0.6	1.1	1.2	2.2	2.8	2.9	1.6	1.9	1.8	1	0.7	0.6	0.5	22.7
19-25	0.5	0.4	0.2	0.1	0.1	0.1	0.3	0.6	0.4	0.4	0.7	0.7	0.4	0.3	0.2	0.2	5.6
25-32	0.2	0.1	0.1	0	0	0	0	0.1	0.1	0.1	0.2	0.3	0.1	0.1	0.1	0.1	1.7
32-39	0	0	0	0	0	0	0	0	0	0	0	0.1	0	0	0	0	0.4
39-47	0	0	0	0	0	0	0	0	0	0	0	0	0	0	0	0	0.1
47+	0	0	0	0	0	0	0	0	0	0	0	0	0	0	0	0	0
Total (%)	5.3	4.1	4.1	3.1	6.2	5.7	7.9	9.5	12.6	7.5	7.2	6.4	3.9	3	2.7	2.3	91.5
Avg. Wind Speed (mph)	12.6	12.4	11.4	10.5	10.0	10.5	11.3	11.9	11.0	11.3	12.9	14.1	12.8	13.4	11.9	12.3	10.8

NOTE: Total Calm Winds (Calm Winds is defined as less than 1.3 mph) is 8.4 percent

HOLTEC INTERNATIONAL COPYRIGHTED MATERIAL

Report No. HI-2167374

Proposed Rev. 0R

2-76

Table 2.3.3					
AVERAGE MORNING AND AVERAGE AFTERNOON MIXING HEIGHTS [2.3.2]					
	Winter (feet)	Spring (feet)	Summer (feet)	Autumn (feet)	Annual (feet)
Morning	951	1,407	1,988	1,375	1,430
Afternoon	4,186	8,035	9,003	6,191	6,854

HOLTEC INTERNATIONAL COPYRIGHTED MATERIAL

Report No. HI-2167374

Proposed Rev. 0R

2-77

Table 2.3.4

**LEA COUNTY REGIONAL AIRPORT STATION PRECIPITATION DATA
(09/01/1941-06/09/2016) [2.3.1]**

Month	Monthly Minimum Totals (Inches)	Monthly Maximum Totals (Inches)	Monthly Average Totals (Inches)	Extreme Daily Maximum Totals (Inches)
January	0.00	2.09	0.31	0.68
February	0.00	1.02	0.32	0.68
March	0.00	1.41	0.24	0.52
April	0.00	2.26	0.65	1.40
May	0.00	5.02	1.43	1.72
June	0.00	3.19	0.75	1.77
July	0.00	3.49	1.17	1.98
August	0.04	4.08	1.32	2.28
September	0.05	5.84	1.85	2.13
October	0.00	3.81	1.52	1.73
November	0.00	1.07	0.26	0.95
December	0.00	6.21	0.56	3.63
Annual	2.81	18.66	10.16	3.63

HOLTEC INTERNATIONAL COPYRIGHTED MATERIAL

Report No. HI-2167374

Proposed Rev. 0R

2-78

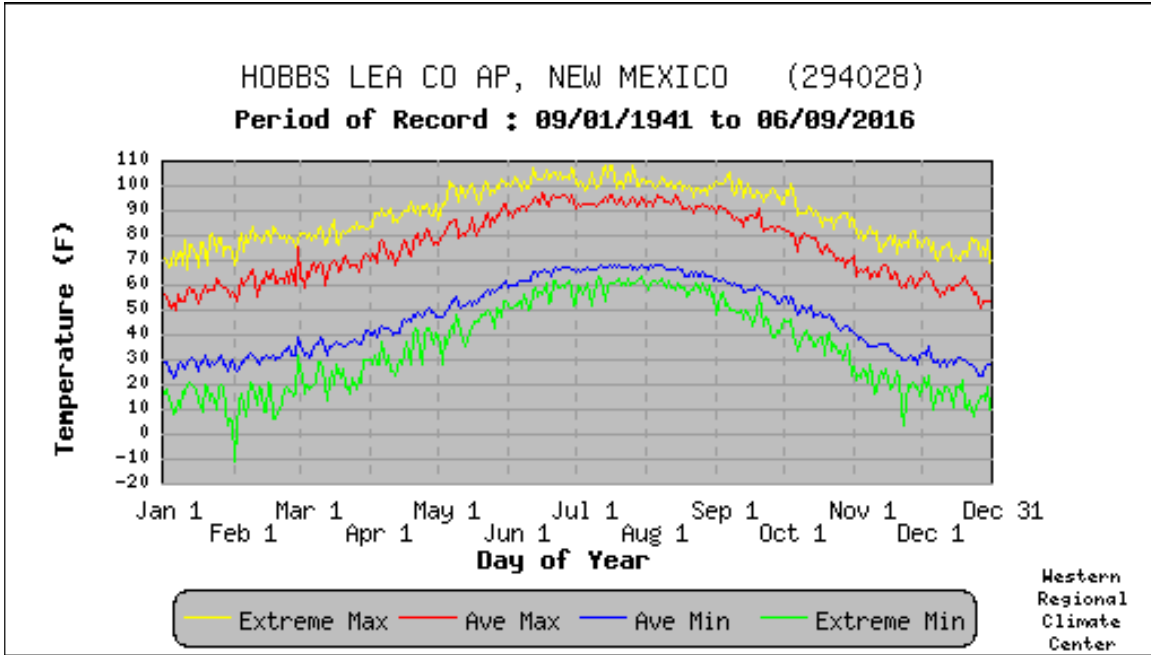


Figure 2.3.1: Lea County Regional Airport Station Temperature Data (09/01/1941-06/09/2016) [2.3.1]

HOLTEC INTERNATIONAL COPYRIGHTED MATERIAL	
Report No. HI-2167374	Proposed Rev. 0R
2-79	

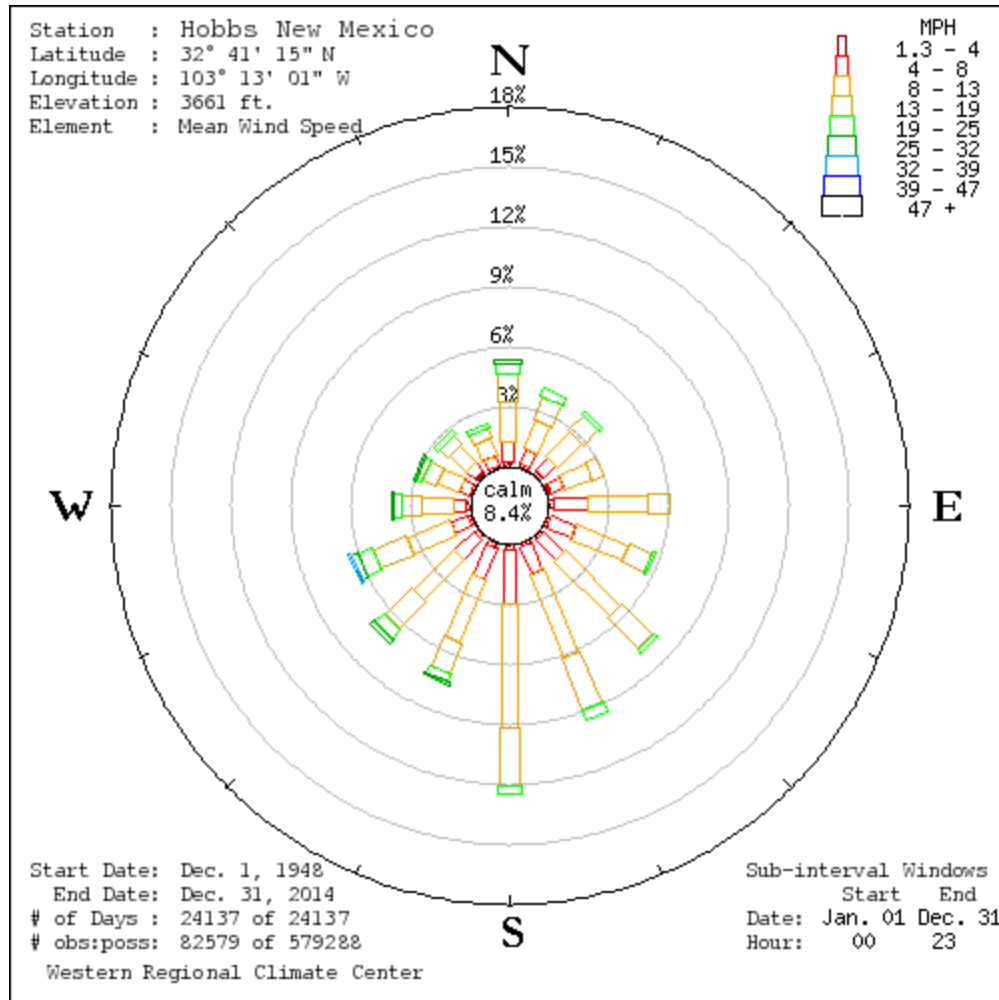


Figure 2.3.2: Lea County Regional Airport Station All Wind Rose (12/01/1948-12/31/2014)
 [2.3.1]

HOLTEC INTERNATIONAL COPYRIGHTED MATERIAL		
Report No. HI-2167374		Proposed Rev. 0R
2-80		

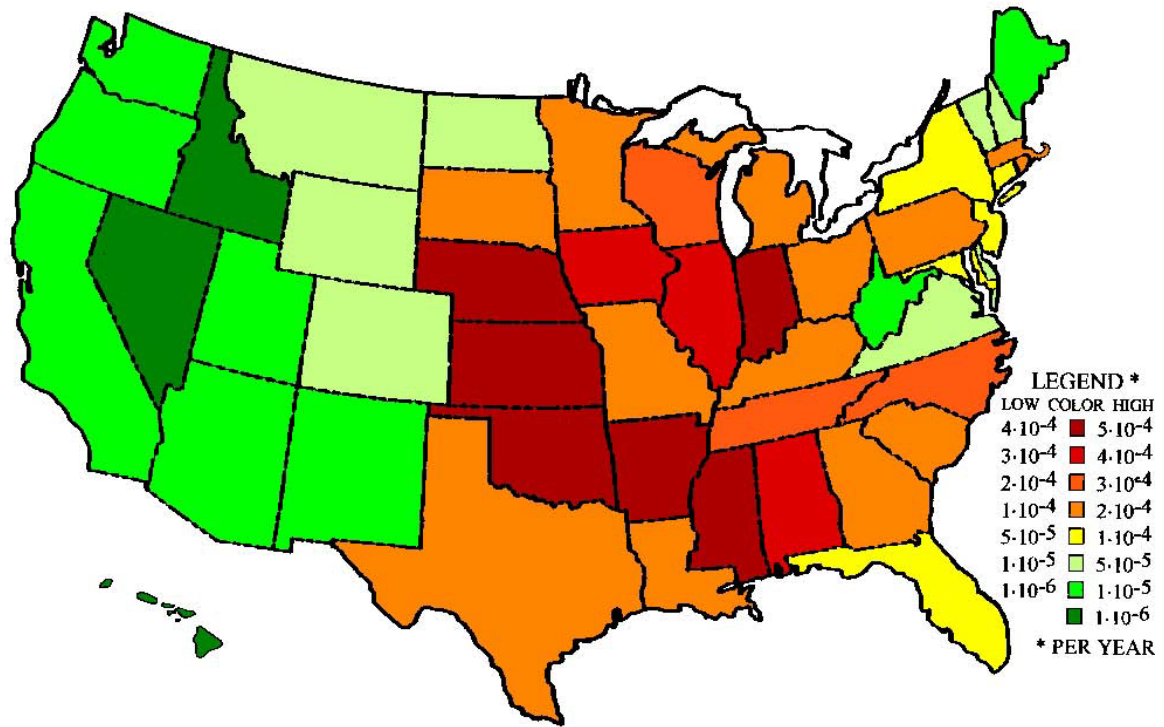


Figure 2.3.3: Tornado Probability Map [2.1.3]

HOLTEC INTERNATIONAL COPYRIGHTED MATERIAL		
Report No. HI-2167374		Proposed Rev. 0R
2-81		

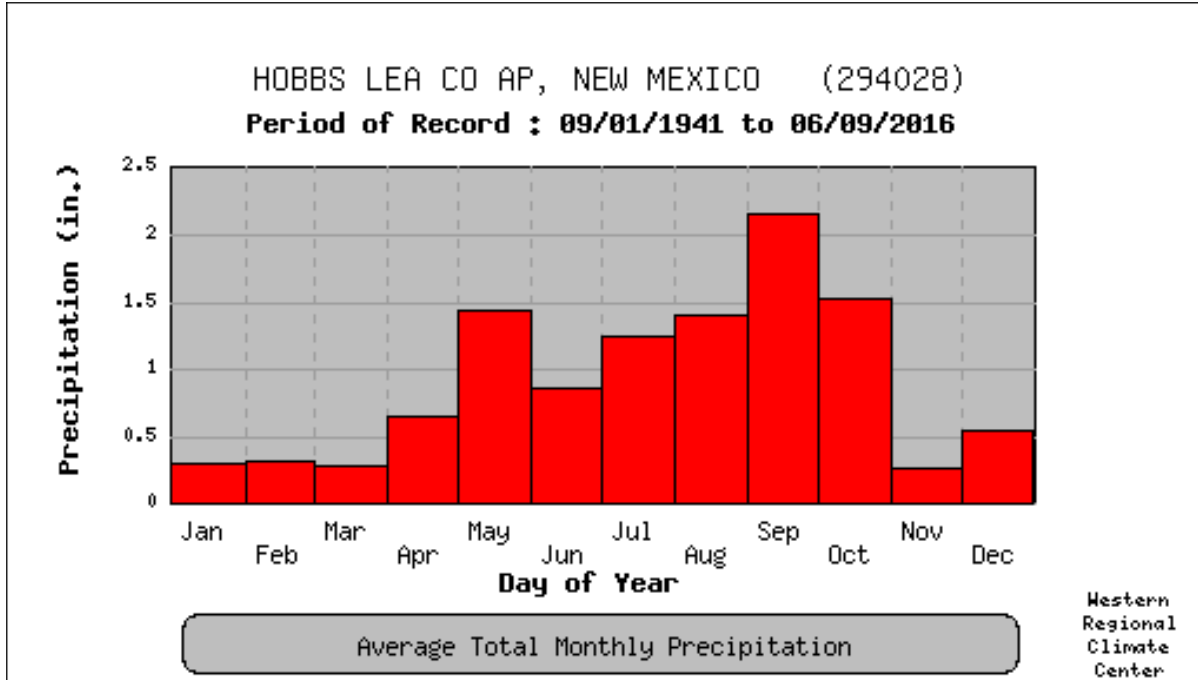


Figure 2.3.4: Monthly Average Total Precipitation Lea County Regional Airport Station (09/01/1941-06/09/2016) [2.3.1]

HOLTEC INTERNATIONAL COPYRIGHTED MATERIAL		
Report No. HI-2167374		Proposed Rev. 0R
2-82		

2.4 SURFACE HYDROLOGY

2.4.1 Hydrologic Description

The Site lies within the Pecos River Basin (see Figure 3.5.1 of the ER [1.0.4]), which has a maximum basin width of 130 miles, and a drainage area of 44,535 square miles. There are no surface-water bodies on the proposed CIS Facility Site. The Pecos River is the closest surface water feature to the Site. At its nearest approach, the distance from the Site to the Pecos River is 26 miles. In Lea County neither of the two major drainage basins, the Texas Gulf Basin in the north and east and the Pecos River Basin in the south and west, contain large-scale surface-water bodies or through-flowing drainage systems. The surface water supplies that exist are transitory and limited to quantities of runoff impounded in short drainage ways, shallow lakes, and small depressions, including various playas and lagunas. The Texas Gulf Basin contains a lake, the Llano Estacado, and the Simona Valley. The Pecos River Basin contains the Querecho Plains, the Eunice Plains, and the Antelope Ridge [2.1.3, Section 2.5.1].

The CIS Facility Site is contained within the Upper Pecos-Black watershed; however, there are no freshwater lakes, estuaries, or oceans in the vicinity of the site (Figure 2.4.1). Local surface hydrologic features in the vicinity of the site include a cluster of four saline playas that are located in the Querecho Plain area of the west-central part of the county. These playas, which retain runoff temporarily, are referred to locally as lagunas. Laguna Plata covers the largest area, about 2 square miles. Laguna Toston, the smallest of the four with a surface area of one-quarter square mile, is completely filled with sediments; the other three all contain accumulations of clastic sediments and salts (halite, gypsum) [2.4.5; 2.4.1, Section 2.5.1]. Surface runoff from the Site flows into Laguna Gatuna to the east and Laguna Plata to the northwest [2.1.3]. Surface drainage at the proposed Site is contained within these two local playa lakes that have no external drainage. These playas are generally dry, but retain runoff temporarily [2.1.3]. Runoff does not drain to any of the state's major rivers. Figures 2.4.2 and 2.4.3 show hydrologic features in the vicinity of the CIS Facility.

The lagunas help to create shallow saline ground-water which exists under much of the Querecho Plain. Surface water is lost through evaporation, resulting in high salinity conditions in soils associated with the playas. These conditions are not favorable for the development of viable aquatic or riparian habitats. The presence of the shallow saline water has been recognized to the extent that the New Mexico Oil Conservation Commission Order No. R-3221, banning the surface disposal of produced water into unlined pits within the State was amended (OCC Order No. R-3221-B, July 25, 1968) to exclude much of the area [2.4.5; 2.4.6].

Laguna Gatuna is located on the eastern boundary of the Site. Laguna Gatuna is an ephemeral playa that covers a surface area of 0.54 square miles and a total shore line of 4 miles. The lake, which sits at an elevation of 3,495 feet drains a watershed that covers 163 square miles (includes Laguna Tonto watershed). Laguna Gatuna was the site of multiple facilities for collection and discharge of brines that were co-produced from oil and gas wells in the entire area; facility permits authorized discharge of almost one million barrels of oilfield brine per month between 1969 and 1992. As a result, saturations of shallow groundwater brine have been created in a number of areas associated with the playa lakes [2.1.3, Section 2.4.2.1].

HOLTEC INTERNATIONAL COPYRIGHTED MATERIAL	
Report No. HI-2167374	Proposed Rev. 0R
2-83	

Laguna Tonto is located approximately 2.5 miles northeast of the Site. Laguna Tonto is an ephemeral playa that covers a surface area of 0.28 square miles and has a total shore line of 2 miles. The playa, which sits at an elevation of 3,531 feet, drains a watershed that covers 44 square miles.

Laguna Plata is located approximately 1.8 miles northwest of the Site. Laguna Plata is an ephemeral playa that covers a surface area of 2 square miles and has a total shore line of 6 miles. The playa, which sits at an elevation of 3,432 feet, drains a watershed that covers 254 square miles. Laguna Plata is the largest of the playas in the vicinity of the site. Laguna Plata is the topographically lowest point in the area and alluvial groundwater appears to flow toward this site [2.1.3, Section 2.4].

Laguna Toston is the smallest of the playas in the vicinity of the CIS Facility Site with a surface area of one-quarter mile. The playa is a major input point for potash refinery brine and water appears to drain radially away from this location [2.1.3, Section 2.4].

The U.S. Geological Survey (USGS) does not have permanent stream gages in Lea County which measure daily surface flows. However, peak flow rates have been spot measured at Monument Draw (near Monument) and Antelope Draw (near Jal). Each of these Draws can occasionally convey sizable flows. In June of 1972, a flow of 1280 cubic feet per second (CFS) (the highest recorded) occurred at Monument Draw. In July of 1994, a flow of 530 CFS (also the highest recorded) occurred at Antelope Draw. These flows should be considered indicative of flows that can occur at other gullies and swales in Lea County (Lea County 2016, 1999).

The proposed CIS Facility Site is not located near any floodplains. The Site is located in an area of Lea County designated as “Zone D”. The “Zone D” designation is used for areas where there are possible but undetermined flood hazards, as no analysis of flood hazards has been conducted or when a community incorporates portions of another community’s area where no map has been prepared [2.4.3]. A digital version of the map panel for the CIS Facility location in the National Flood Hazard Layer is presented in Figure 2.4.4 [2.4.3].

Other than the playas, the nearest surface water is the Pecos River which is 25 miles west of the Site. Like most rivers in New Mexico, the Pecos River is described as “extremely variable from year-to-year” due to its dependence on runoff. The principle use of Pecos River water is for agriculture. There are no sensitive or unique aquatic or riparian habitats or wetlands at the Site, nor is there surface water in the vicinity that is potable [2.1.3].

Groundwater within Lea County is provided primarily by the High Plains Aquifer composed of the Ogallala Formation. Cretaceous and Triassic rocks underlying the Ogallala Formation limit downward percolation from the Ogallala Aquifer. The region includes portions of five declared underground water basins (UWBs): Capitan, Carlsbad, Jal, Lea County, and Roswell. (A declared UWB is an area of the state proclaimed by the State Engineer to be underlain by a groundwater source having reasonably ascertainable boundaries. By such proclamation the State Engineer assumes jurisdiction over the appropriation and use of groundwater from the source.) The Jal UWB falls entirely within the Lea County region, but the other four are shared with the Lower Pecos Valley region, although only a small portion of the Lea County UWB extends into the Lower Pecos Valley region, and Lea County overlies only a small extension of the Roswell Basin [2.4.6].

HOLTEC INTERNATIONAL COPYRIGHTED MATERIAL	
Report No. HI-2167374	Proposed Rev. 0R
2-84	

The CIS Facility Site is within the Capitan UWB (Figure 2.4.5) and lies within the Upper Pecos-Black Watershed which is part of the Pecos River Basin (Figure 2.4.6). The Capitan UWB covers approximately 1,100 square miles and occupies the south-central portion of Lea County. The Capitan UWB is located within a geologic province known as the Delaware Basin, a subdivision of the Permian Basin. The Capitan UWB is aerially oriented in a northwest-southeast alignment above an arc shaped section of a formation known as the Capitan Reef Complex. The Capitan aquifer occurs within dolomite and limestone strata deposited as an ancient reef. The ground-water quality of the Capitan in Lea County is very poor. Other aquifers in the Capitan UWB are found in the overlying Rustler Formation, Santa Rosa Sandstone, and Cenozoic Alluvium. The primary uses of ground-water from the Capitan UWB are mining, oil recovery, industry, livestock, and domestic use. The towns of Eunice and Jal are located within the Capitan UWB, but currently tap beds of saturated Quaternary alluvium located within the Lea County UWB and Jal UWB respectively [2.4.5].

The site topography is irregular, with a slight slope toward the north, with elevations on the property ranging between about 3,500 and 3,550 feet above mean sea level [2.4.4] [2.1.26]. Several shallow depressions are shown along the western portions of the Site. The CIS Facility Site proper ranges from approximately 3,530 to 3,550 feet above mean sea level. The slab on grade foundations for the Administration Building, Security Building, Cask Transfer Building, and Warehouse will be located at or slightly above existing grade at approximate nominal elevations of 3545', 3545', 3540' and 3540' respectively. The top surface of the ISFSI will similarly be located at or slightly above existing grade at approximate nominal elevation of 3535'. The CISF Facilities shall be sloped and graded to generally maintain the current surface drainage pattern. Several shallow depressions are shown along the western portions of the Site. Figure 2.4.7, as well as Figures 2.1.9 through 2.1.11, illustrate local topography in the area of the proposed CIS Facility Site. A topographic high is present within the central portion of the property with ephemeral washes draining from this point; one to the west into Laguna Plata and another to the east into Laguna Gatuna.

The Project area is classified as Apacherian-Chihuahuan mesquite upland scrub [2.4.8]. This ecosystem often occurs as invasive upland shrublands such as those that are concentrated in the foothills and piedmonts of the Chihuahuan Desert [2.4.7]. Substrates are typically derived from alluvium, often gravelly without a well-developed argillic or calcic soil horizon that would limit infiltration and storage of winter precipitation in deeper soil layers. Deep-rooted shrubs are able to access the deep-soil moisture that is unavailable to grasses and cacti. Water held in storage in the soil is subsequently subject to evapotranspiration. Historical periods of high temperature and low precipitation in Lea County have resulted in high demands for irrigation water and higher open water evaporation and riparian evapotranspiration [2.4.6]. Evapotranspiration at the Site is greater than the precipitation rate, indicating that there is little infiltration of precipitation into the subsurface. Essentially all the precipitation that occurs at the Site is subject to infiltration and/or evapotranspiration.

No major surface water supplies are available in Lea County, only intermittent streams, lakes, stock ponds, and small playas that collect runoff during thunderstorms. Intermittent streams that channel runoff include Lost Draw, Sulfur Springs Draw, and Monument-Seminole Draw in the northern half of Lea County, which is part of the Texas Gulf Basin, and Landreth-Monument Draw in the southern portion of the county, which flows to the Pecos River. The Site lies within the

HOLTEC INTERNATIONAL COPYRIGHTED MATERIAL	
Report No. HI-2167374	Proposed Rev. 0R
2-85	

Pecos River Basin as depicted in Figure 2.4.6, which has a maximum basin width of 130 miles, and a drainage area of 44,535 square miles. The Pecos River generally flows year-round. The main stem of the Pecos River and its major tributaries have low flows, and the tributary streams are frequently dry. Seventy-five percent of the total annual precipitation and 60 percent of the annual flow result from intense local thunderstorms between April and September. Due to the seasonal nature of the rainfall, most surface drainage is intermittent. There are no surface-water bodies or surface-drainage features on the proposed CIS Facility Site. The intermittent surface drainages, lakes, and watersheds in Lea County are shown on Figure 2.4.6 [2.4.6].

2.4.2 Floods

Floodplains are areas of low-level ground present along rivers, stream channels, or coastal waters subject to periodic or infrequent inundation due to rain or melting snow. Risk of flooding typically depends on local topography, the frequency of precipitation events, and the size of the watershed above the floodplain. Flood potential is evaluated by the Federal Emergency Management Agency (FEMA), which defines the 100-year floodplain as an area that has a one percent chance of inundation by a flood event in any given year. Federal, state, and local regulations often limit floodplain development to passive uses such as recreational and preservation activities to reduce the risks to human health and safety. Floodplain ecosystem functions include natural moderation of floods, flood storage and conveyance, groundwater recharge, nutrient cycling, water quality maintenance, and diversification of plants and animals.

Elevations in Lea County vary from 2,900 feet in the southeast to 4,400 feet in the northwest. This relief provides two surface water drainage basins in the county. The Texas Gulf Basin, located in the northern portion of Lea County, and the Pecos River Basin, located in the southern portion of the county, are separated by the Mescalero Ridge and its extended escarpment [2.1.3].

In Lea County neither of the two major drainage basins, the Texas Gulf Basin in the north and east and the Pecos River Basin in the south and west, contain large-scale surface-water bodies or through-flowing drainage systems. The surface water supplies that exist are transitory and limited to quantities of runoff impounded in short drainage ways, shallow lakes, and small depressions, including various playas and lagunas [2.1.3].

Because there are no significant bodies of water or rivers in the vicinity of the of the Site, the only plausible flooding hazard to the Site is from stormwater runoff during rain events. To estimate the potential effects of rainfall-induced stormwater runoff, Holtec reviewed precipitation data for the area spanning more than 50-years (see Paragraph 3.6.1.7 of the Environmental Report [1.0.4]), as well as other available data developed for other nuclear facilities in the area. The highest daily precipitation in the area was 3.6 inches, which occurred in December of 2015 [1.0.4].

The topography of the CIS Facility Site is irregular, with a slight downward slope toward the north. A topographic high is present within the central portion of the property with ephemeral washes draining from this point; one to the west into Laguna Plata and another to the east into Laguna Gatuna. According to the USGS topographic map, the elevation at the Site is approximately 3,530 feet above mean sea level. Several shallow depressions are shown along the western portions of the Site. The Site is not within the 100-year and 500-year floodplains [2.1.6, 2.1.7].

HOLTEC INTERNATIONAL COPYRIGHTED MATERIAL	
Report No. HI-2167374	Proposed Rev. 0R
2-86	

2.4.3 Probable Maximum Flood (PMF)

An analysis was completed to compute the peak water surface elevations, depths, and velocities during the Probable Maximum Flood (PMF) caused by the Probable Maximum Precipitation (PMP) event. These calculations were performed and documented in the GEI Report “Probable Maximum Flood Analysis, HI-STORE CISF, Lea County, New Mexico” [2.4.15].

The report uses a conservative, deterministic analytical approach with simplified assumptions in general accordance with the hierarchical hazard assessment (HHA) presented in U.S. Nuclear Regulatory Commission (NRC) NUREG/CR-7046 titled “Design-Basis Flood Estimation for Site Characterization at Nuclear Power Plants in the United States of America” [2.4.16]. The computed peak water surface elevations, depths, and velocities are used to understand conditions at Phase I of the HI-STORE CISF and to demonstrate adequacy of the proposed project during a PMP rainfall event [2.4.15].

The approach includes hydrologic and hydraulic analyses to estimate the PMP, define watershed, channel and reservoir connectivity, and perform hydrologic modeling of precipitation and runoff. The approach uses the results of the hydrologic model as input to the hydraulic routing model to compute peak water surface elevations, depths, and velocities at the site for the PMF event for both the existing conditions and completed Phase I CISF conditions.

In accordance with the HHA stepwise procedure multiple iterations of the models were run starting with the most conservative, simplified assumptions. The first iteration as suggested by HHA considered that no precipitation losses would occur during the PMF event, and that the runoff generated in any part of the drainage basin would instantaneously be translated through the channel network and arrives at the site without delay. Reservoirs, representing storage in the Tonto, Gatuna and Plata watersheds, were also conservatively removed for this iteration. This first extremely conservative iteration resulted in unacceptable flood water depths at certain safety significant SSCs on the HI-STORE site, therefore a second iteration was performed. The second iteration the analysis was made marginally more site-specific by introducing reservoir routing in the hydrologic model, while keeping other assumptions the same. This second iteration resulted in PMF water surface elevations that did not exceed the critical elevations of any of the safety significant SSCs.

Watersheds upstream of the CISF were delineated into representative basins for the analysis using the most detailed and readily available data from United States Geological Survey (USGS) National Hydrography Dataset and Digital Elevation Model (DEM) [2.4.15]. The watersheds were developed for the following five sub basins: Laguna Gatuna Basin, Laguna Plata North Basin, Laguna Plata South Basin, Laguna Tonto Basin, and the HI-STORE Site Basin, and can be seen in Figure 2.4.12.

The PMP was calculated based on methods outlined in the “Colorado – New Mexico Regional Extreme Precipitation Study” (CO-NM) [2.4.17] and Hydrometeorological Report (HMR) Nos. 51 and 52 methods [2.4.23] [2.4.24]. Precipitation values were determined using both the CO-NM and the HMR 51/52 methods for a range of storm durations, 6-hr, 24-hr, 48-hr, and 72-hr storms, for each of the five sub-basins. In addition to optimizing the orientation of the storm, the HMR method storms were analyzed both centered on the entire watershed as well as centered on the HI-STORE site basin. Comparing the three precipitation amounts for each sub basin, a governing storm method was determined for each storm of the 6-hr, 24-hr, 48-hr, and 72-hr storm durations. These PMP rainfall values are shown in Table 2.4.2. The governing storm for each storm duration

HOLTEC INTERNATIONAL COPYRIGHTED MATERIAL	
Report No. HI-2167374	Proposed Rev. 0R
2-87	

was run through both the hydrologic and hydraulic models, for both storm centers when applicable, to determine which storm results in the greatest flood depth at the site. The results of the study indicate that the controlling storm would be the 72-hr HMR (centered on the entire watershed) and is therefore considered the PMP. Table 2.4.4 below provides flood water depths at the center of the ISFSI for each storm duration.

The results of the Hydrologic model were input to the Hydraulic model. Both models conservatively assume all culverts are blocked and not functioning. Additionally, in accordance with NUREG/CR-7046 methods, the models conservatively assume the Lagunas are in an “extreme full” condition prior to the commencement of the extreme PMP and PMF. As previously discussed in section 2.4.1, the Lagunas typically contain very little water and are frequently dry. The extreme full condition results in a water elevation greater than 20 feet higher than the typical water elevation in each of the playas. See Figure 2.4.13 for a comparison of normal full water conditions (approximately 5 ft) and the extreme full conditions for the PMP/PMF analyses. The model considers the VBS as 16 foot long blocks with 8 inch gaps between them. While the VBS was input with gaps in the hydraulic model, Section 1.1 of the FSAR commits to a continuous span of VBS to eliminate any uncertainty in the modeling representation of the VBS line and passage of water through the gaps due to the disparate mesh sizes around the modeled blocks.

Flows from the Gatuna and Tonto watersheds would join with flows from the HI-STORE Site basin downstream of the Phase I HI-STORE CISF and enter Laguna Plata. The peak flows would raise the water surface in Laguna Plata, but all flood water will flow into Laguna Plata and discharge at the downstream outlet.

The peak PMF water depth values across the site can be seen in Figure 2.4.14. The Peak PMF water velocities with associated depths can be seen in Figure 2.4.15. A summary of peak depth and velocity for key locations is provided in Table 2.4.3.

Per Table 2.3.1 of the HI-STORM UMAX FSAR [1.0.6], the HI-STORM UMAX System is able to withstand a maximum flood height of 125 ft. Therefore, all ITS components of the system can be considered safe from flooding concerns.

Minimal depths of flood water would be seen at the Cask Transfer Building during the PMF [2.4.15]. This depth is akin to rainfall runoff depths locally encountered in any heavy rainfall. The reinforced concrete walls of the building are sufficient to prevent any water infiltration. Similarly, modern overhead doors and other building penetrations would be sufficient to prevent infiltration of the minimal flood waters. If flood water of this magnitude, was to infiltrate the building, consequences of water in the building are minimal. Furthermore, as shown in Figure 2.4.16, hydrographs of the PMF flood waters indicate that there would be ample time to prepare the building for an impending flood.

The potential for surface erosion due to PMF flood waters can be determined by comparing the D₅₀ particle size classification for soil at the site [2.4.18] with critical velocities for sediment erosion as determined by the Natural Resources Conservation Service (NRCS) National Engineering Handbook [2.4.19]. The peak velocities during the PMF would likely result in erosion in the ephemeral washes and at the northeast corner of the Protected Area Fences and Vehicle Barrier System (VBS). As shown on Figure 2.4.15, the max flood velocity at all other points of interest at the site does not exceed the threshold velocity, and therefore minimal, if any, erosion at the facility would be expected.

HOLTEC INTERNATIONAL COPYRIGHTED MATERIAL	
Report No. HI-2167374	Proposed Rev. 0R
2-88	

Engineered backfill materials in CISF areas would likely have improved erosion resistance. Given the improved backfill material, depth to the base of the ISFSI, and flood water velocities (Figure 2.4.15) any potential erosion would not undermine or affect the safety of the ISFSI. After storm waters recede, any eroded materials in the CISF would be replaced and appropriately regraded.

2.4.4 Potential Dam Failures (Seismically-Induced)

The nearest dams are Brantley Dam, approximately 38 miles, and Avalon Dam, approximately 31 miles from the proposed Site. Both dams are at an elevation more than 500 feet below the Site. As a result of the large distances to the nearest bodies of water, these bodies of water do not present a credible disruptive event for the proposed Site.

2.4.5 Probable Maximum Surge and Seiche Flooding

There are no significant bodies of water or rivers within 50 miles of the Site. The potential effects of seiche in the lagunas near the site were evaluated and the site is not expected to experience conditions that would cause flooding from amplified seiche. The magnitude of the oscillation period for Laguna Gatuna, Laguna Plata, and Laguna Tonto from seiche and the oscillation period for wind are significantly different [2.4.15].

2.4.6 Probable Maximum Tsunami Flooding

The Site is approximately 500 miles from any coastal area and tsunamis are excluded as a potential flood hazard.

2.4.7 Ice Flooding

The mean annual snowfall is 5.1 inches recorded at the Hobbs weather station. The maximum recorded snow accumulation for Hobbs, NM, is 12.2 inches, and a 100-year, 2-day snowfall is 12.1 inches [2.4.14]. ~~The Site is not subject to flooding caused by ice jams. In the winter, during those periods when the playas are retaining temporary runoff, freezing of the retained water can occur.~~ The three approaches described in NUREG/CR 7046 [2.4.16] were evaluated to determine the potential for ice-induced flooding at the site. These evaluations indicate that the site does not experience conditions conducive for the formation of frazil ice (a unique form of ice and important precursor to the formation of ice jams), and ice jams or dams. There is no documented occurrence of ice jams or dams in the area of the site [2.4.20], there is no turbulent water and/or instream flow, which are necessary to for frazil ice, and the recorded air temperatures are above the frazil ice threshold value of 18°F for more than 99.6% of hourly temperature records [2.4.21, 2.4.22, 2.4.15]. The Site is not subject to flooding caused by ice jams.

2.4.8 Flood Protection Requirements

The indicated Probable Maximum Flood levels at the site do not impact the function or safety of any SSCs. The VBS line and fence line shall require a border, interior and exterior, of 5 foot width of a material of sufficient D₅₀ particle size, i.e. gravel or rip-rap, to withstand the critical velocity shown on Figure 2.4.15 [2.4.19]. This border will serve to eliminate any local erosion or undermining of the VBS and fences.

2.4.9 Environmental Acceptance of Effluents

HOLTEC INTERNATIONAL COPYRIGHTED MATERIAL	
Report No. HI-2167374	Proposed Rev. 0R
2-89	

As stated in Chapter 14, the canister storage system does not create any radioactive materials or have any radioactive waste treatment system and thus provides assurance that there are no radioactive effluents from the spent fuel storage system. Additionally, typical surface drainage at the proposed Site is contained within two local playa lakes that have no external drainage. Evapotranspiration at the Site is greater than the precipitation rate, indicating that there is little infiltration of precipitation into the subsurface. Therefore, there is little to no risk of effluents of any kind being accepted by the environment.

HOLTEC INTERNATIONAL COPYRIGHTED MATERIAL	
Report No. HI-2167374	Proposed Rev. 0R
2-90	

Table 2.4.1: Intentionally Deleted

HOLTEC INTERNATIONAL COPYRIGHTED MATERIAL	
Report No. HI-2167374	Proposed Rev. 0R
2-91	

Table 2.4.2: PMP Values and Governing Method [2.4.15]

Watershed	PMP Method	6-hr PMP	24-hr PMP	48-hr PMP	72-hr PMP
Laguna Gatuna	CO-NM	18.1	18.9	21.6	22.4
	HMR	16.1	23.0	26.4	28.5
	HMR COHSB	14.0	20.5	23.8	25.7
	Governing Method	CO-NM	HMR	HMR	HMR
Laguna Tonto	CO-NM	20.4	20.4	22.1	23.0
	HMR	18.0	25.1	28.6	30.7
	HMR COHSB	16.0	22.8	26.3	28.3
	Governing Method	CO-NM	HMR	HMR	HMR
HI-STORE Site	CO-NM	21.3	21.3	23.2	24.0
	HMR	13.1	19.5	22.8	24.8
	HMR COHSB	19.7	26.9	30.4	32.4
	Governing Method	CO-NM	HMR COHSB	HMR COHSB	HMR COHSB
Laguna Plata North	CO-NM	18.6	18.7	21.3	22.1
	HMR	16.0	22.9	26.3	28.4
	HMR COHSB	14.0	20.5	23.9	25.8
	Governing Method	CO-NM	HMR	HMR	HMR
Laguna Plata South	CO-NM	21.0	21.0	22.5	23.3
	HMR	10.3	15.9	18.8	20.6
	HMR COHSB	18.7	25.8	29.3	31.3
	Governing Method	CO-NM	HMR COHSB	HMR COHSB	HMR COHSB

Note: HMR COHSB is the HMR method storm Centered On HI-STORE Basin

HOLTEC INTERNATIONAL COPYRIGHTED MATERIAL	
Report No. HI-2167374	Proposed Rev. 0R
2-92	

Table 2.4.3: Peak PMF Depth and Velocity for key CISF Structures [2.4.15]

Hydraulic Model Point Locations (See Fig. 2.4.14 and 2.4.15)	72-hr Existing Condition			72-hr Proposed Condition		
	Max WSEL (ft)	Max Depth (ft)	Max Velocity (ft/s)	Max WSEL (ft)	Max Depth (ft)	Max Velocity (ft/s)
Phase 1 ISFSI Area	3533.2	1.9	1.9	3534.5	3.2	2.4
South Side of Phase 1 ISFSI Area	3534.2	1.7	2.1	3534.5	2.0	2.0
South Side of Security Building	3546.1	1.8	1.9	3546.1	1.8	0.4
South Side of Cask Transfer Building	3541	0.5	0.8	NA	0	0
Northeast corner of VBS	3533.6	8.3	2.9	3533.6	8.4	4.6
Haul Path Section 1	3536.9	0.3	0.7	3536.6	0	0.6
Haul Path Section 2	3536.9	0.7	1.5	3536.3	0.1	1.0
Haul Path Section 3	3535.4	1.2	2.0	3534.6	0.4	2.1
Wash to the West	3505.9	14.8	1.0	3511.2	20.2	0.2
Wash to the North	3522.1	22.5	8.8	3522.3	22.7	8.6

HOLTEC INTERNATIONAL COPYRIGHTED MATERIAL

Report No. HI-2167374

Proposed Rev. 0R

2-93

Table 2.4.4: Peak Flood Depth for Each Storm Duration at ISFSI Center [2.4.15]

PMP event	Peak Depth at Phase 1 ISFSI Area (ft)	
	Centered on Entire Watershed	Centered on HI-STORE Basin
6-hr CO-NM	2.7	NA
24-hr HMR52	3	2.6
48-hr HMR52	3.2	2.7
72-hr HMR52	3.2	2.7

HOLTEC INTERNATIONAL COPYRIGHTED MATERIAL	
Report No. HI-2167374	Proposed Rev. 0R
2-94	

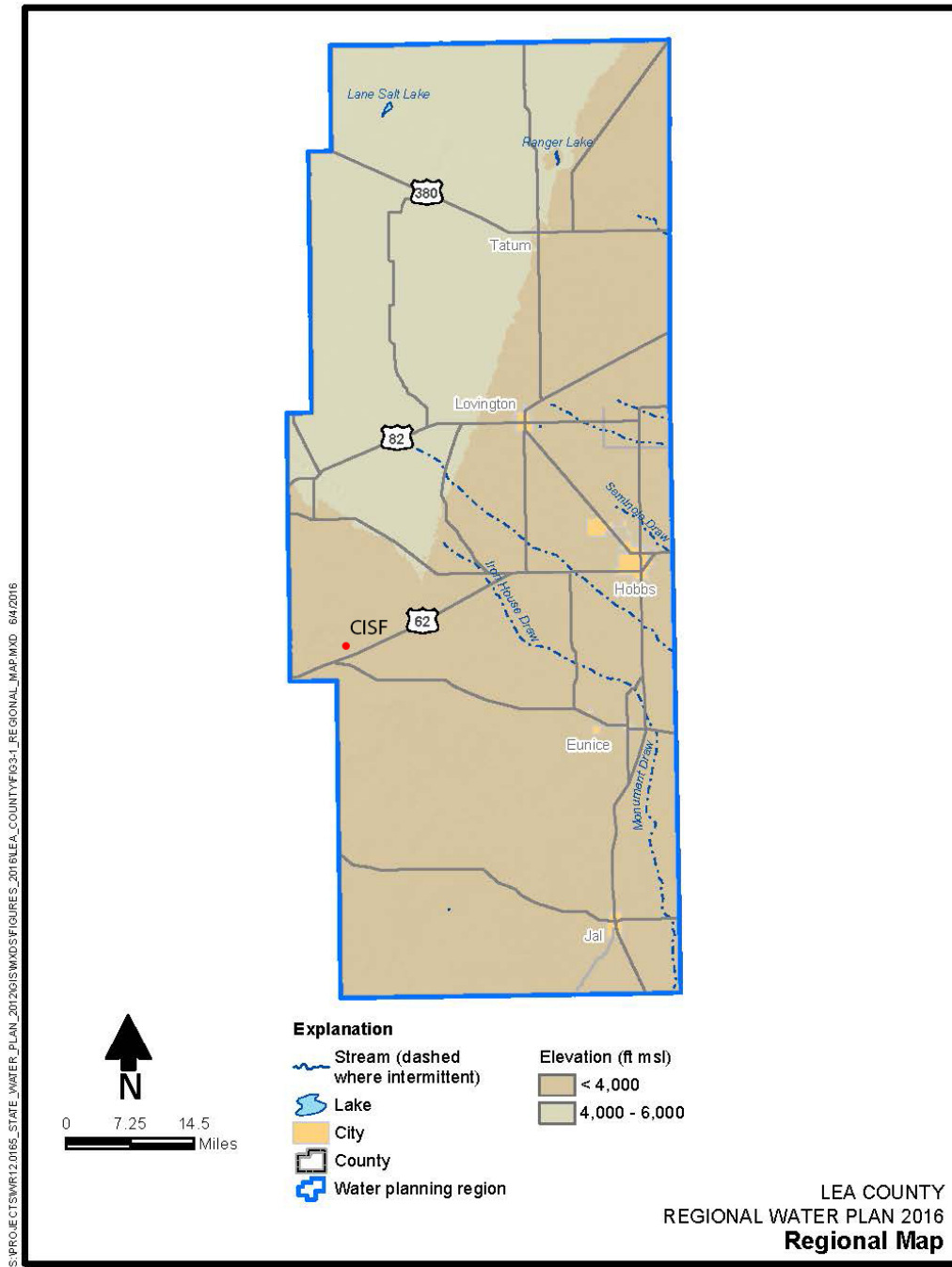


Figure 3-1

Figure 2.4.1: Regional Map [2.4.6]

HOLTEC INTERNATIONAL COPYRIGHTED MATERIAL		
Report No. HI-2167374		Proposed Rev. 0R
2-95		

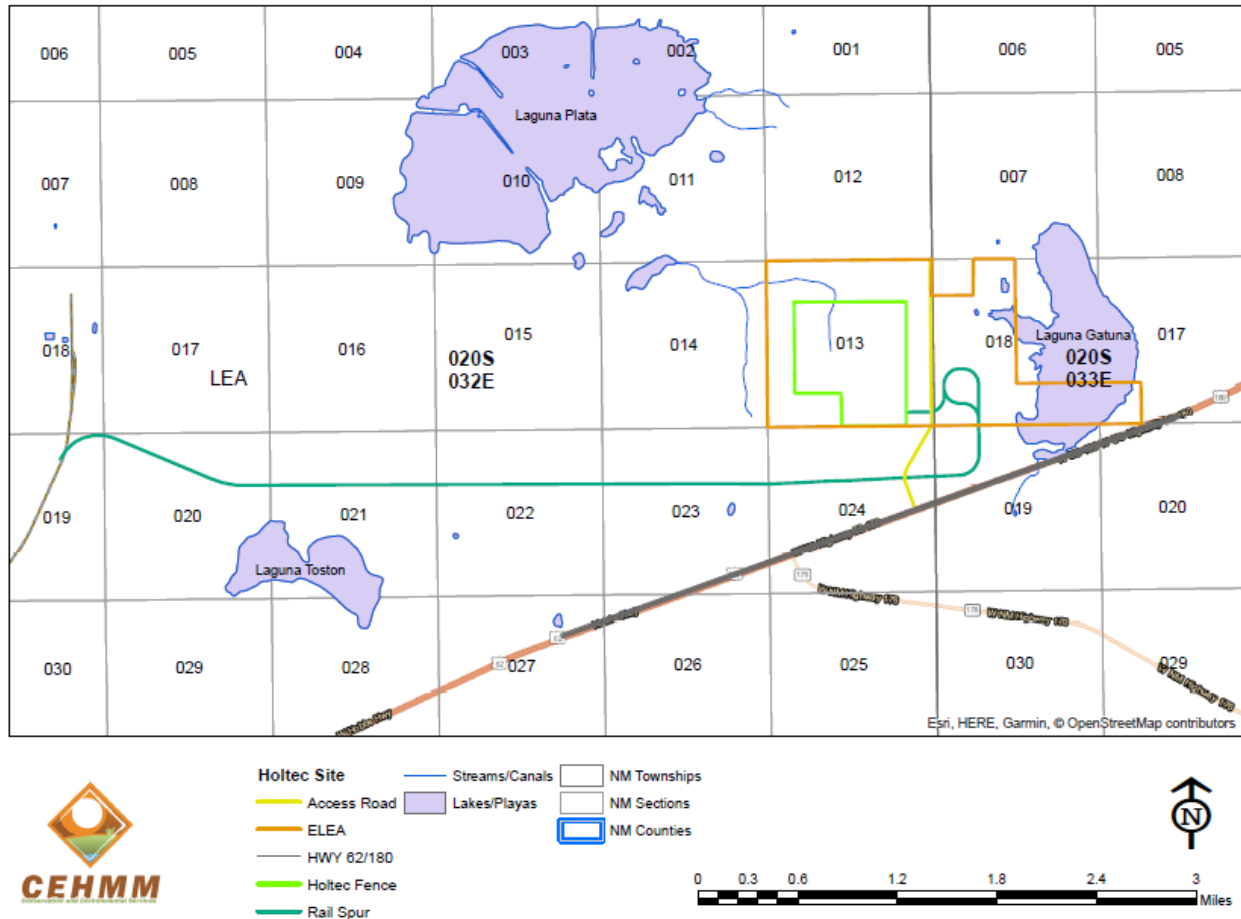


Figure 2.4.2: Location of Hydrologic Features in the Vicinity of the CIS Facility Site

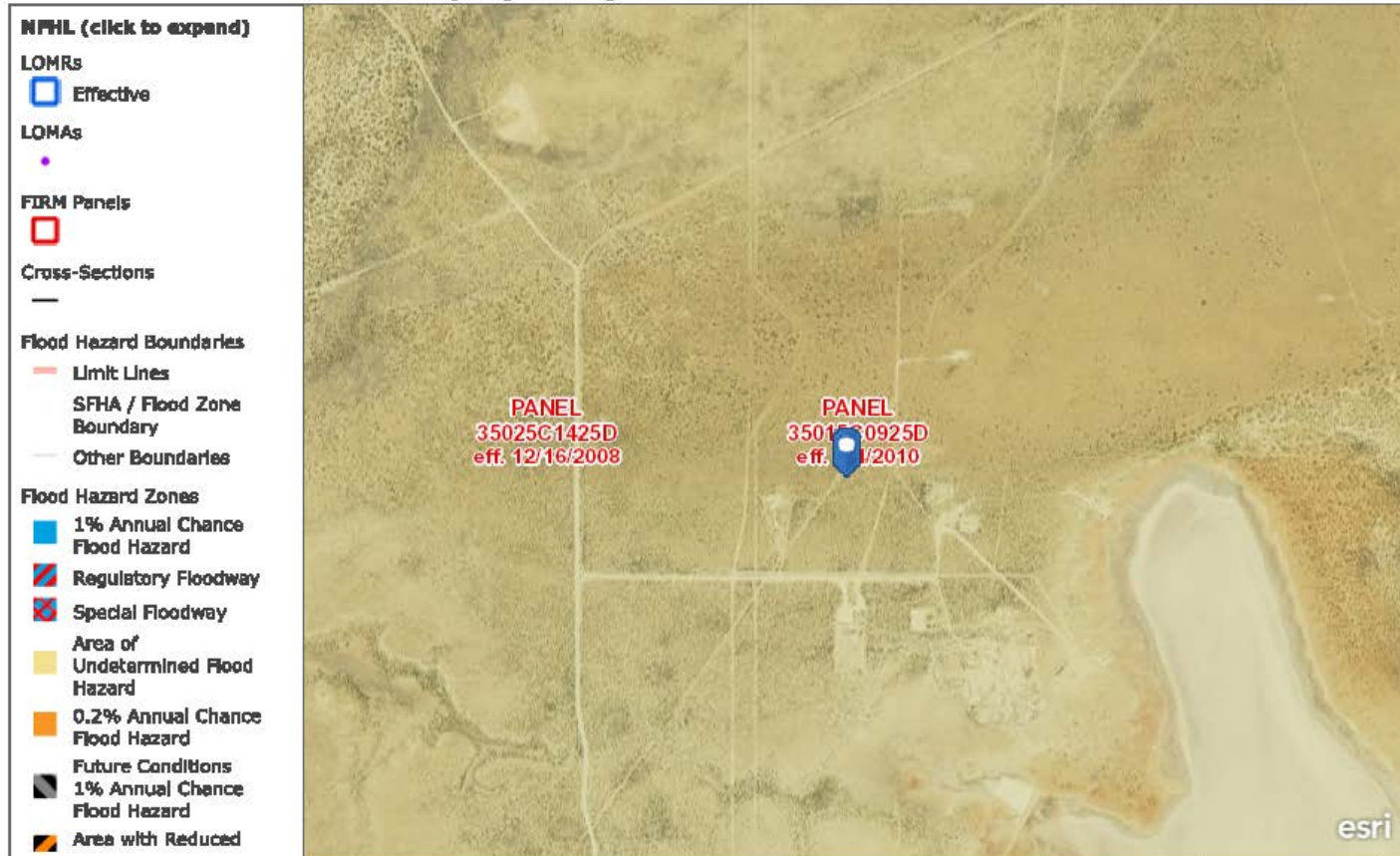
HOLTEC INTERNATIONAL COPYRIGHTED MATERIAL		
Report No. HI-2167374		Proposed Rev. 0R
2-96		



Figure 2.4.3: Lakes/Playas in the Vicinity of the CIS Facility [2.4.4]

HOLTEC INTERNATIONAL COPYRIGHTED MATERIAL	
Report No. HI-2167374	Proposed Rev. 0R
2-97	

FEMA's National Flood Hazard Layer (Official)



Data from Flood Insurance Rate Maps (FIRMs) where available digitally. New NPFL FIRMette Print app available:
<http://tinyurl.com/j4xwp5e>

USGS The National Map: Orthoimagery | National Geospatial-Intelligence Agency (NGA); Delta State University; Esri | Print here instead:
<http://tinyurl.com/j4xwp5e> Support: FEMAMapSpecialist@rskmapcds.com | USGS The National Map: Orthoimagery

Figure 2.4.4: FEMA's National Flood Hazard Layer for the CIS Facility Site [2.4.3]

HOLTEC INTERNATIONAL COPYRIGHTED MATERIAL		
Report No. HI-2167374		Proposed Rev. 0R
2-98		

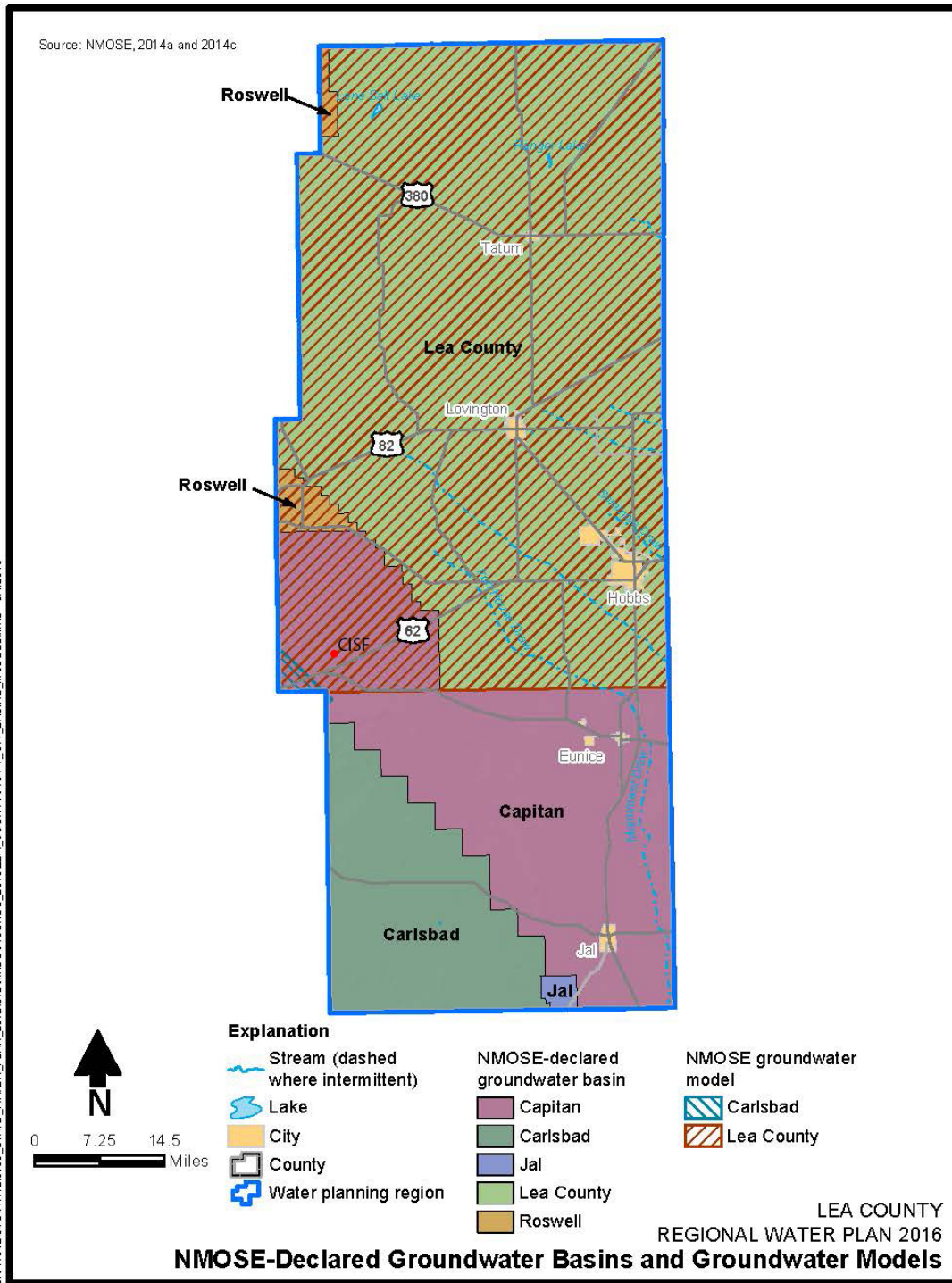


Figure 4-1

Figure 2.4.5: MNOSE-Declared Groundwater Basins and Groundwater Models [2.4.6]

HOLTEC INTERNATIONAL COPYRIGHTED MATERIAL		
Report No. HI-2167374		Proposed Rev. 0R
2-99		

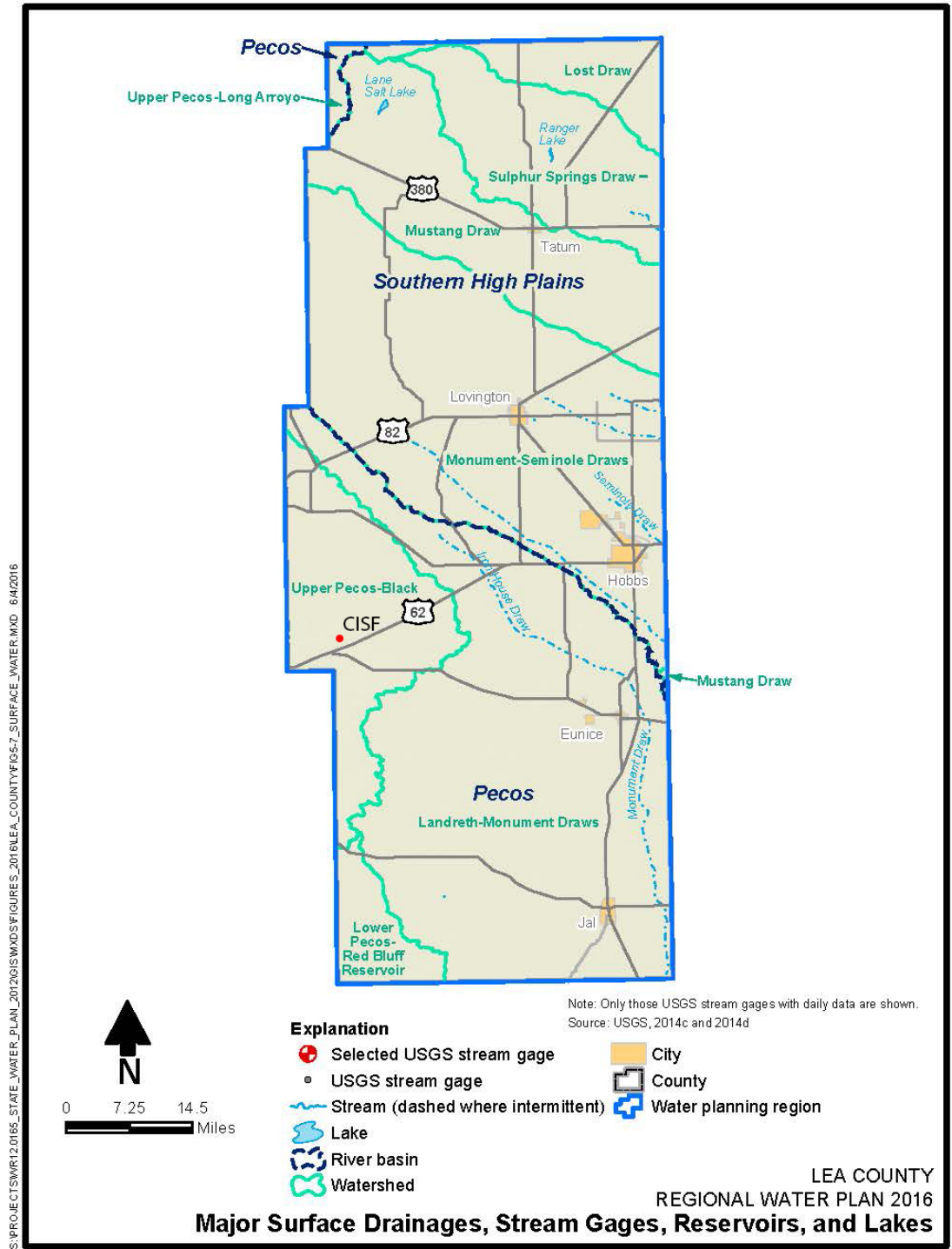


Figure 5-7

Figure 2.4.6: Major Surface Drainages, Stream Gages, Reservoirs, and Lakes
[2.4.6]

HOLTEC INTERNATIONAL COPYRIGHTED MATERIAL		
Report No. HI-2167374		Proposed Rev. 0R
2-100		

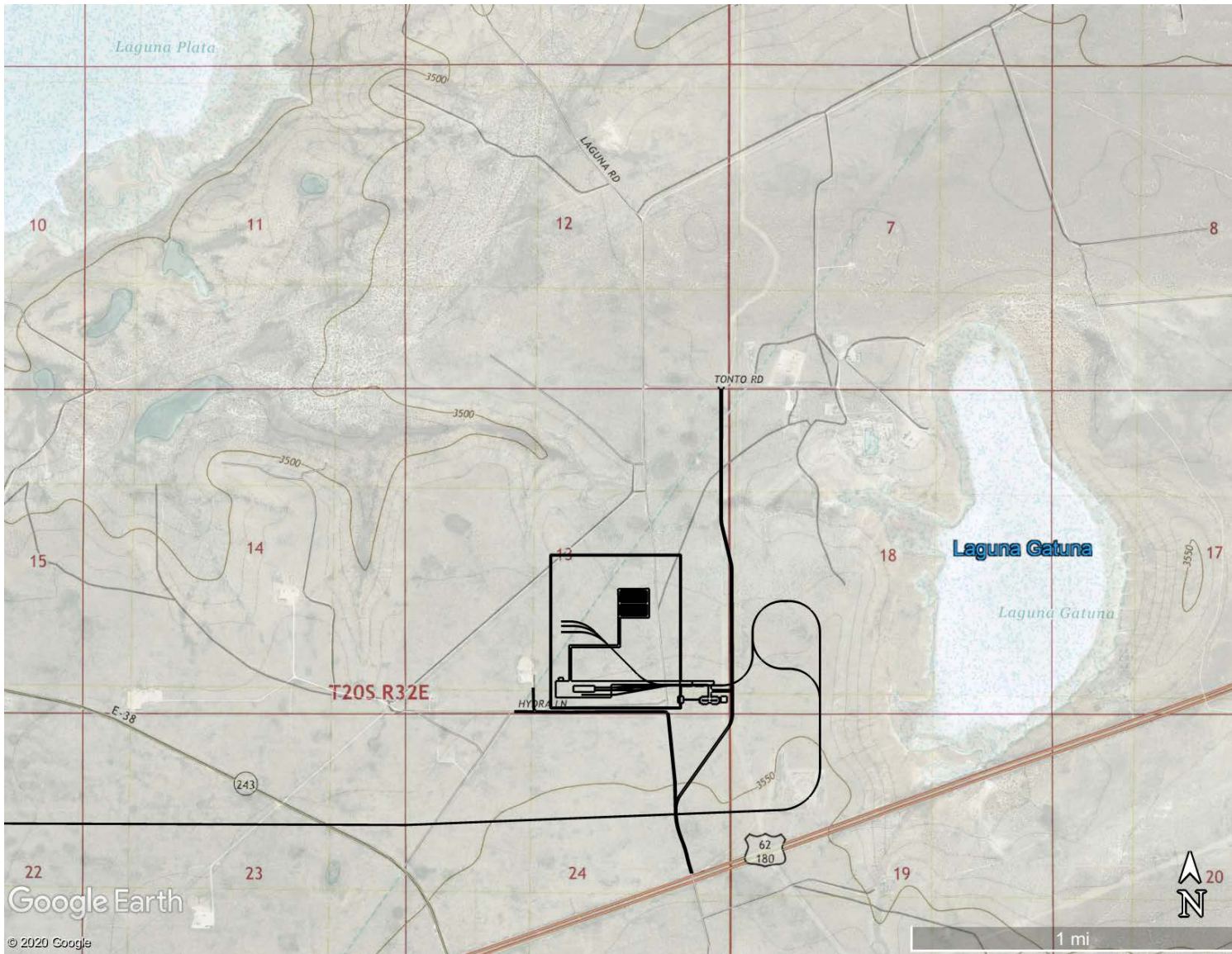


Figure 2.4.7: General Topography around the Proposed CIS Facility Site [2.1.26]

HOLTEC INTERNATIONAL COPYRIGHTED MATERIAL

Report No. HI-2167374

Proposed Rev. 0R

2-101

Figure 2.4.8: Intentionally Deleted

Figure 2.4.9: Intentionally Deleted

Figure 2.4.10: Intentionally Deleted

Figure 2.4.11: Intentionally Deleted

HOLTEC INTERNATIONAL COPYRIGHTED MATERIAL

Report No. HI-2167374

Proposed Rev. 0

2-102

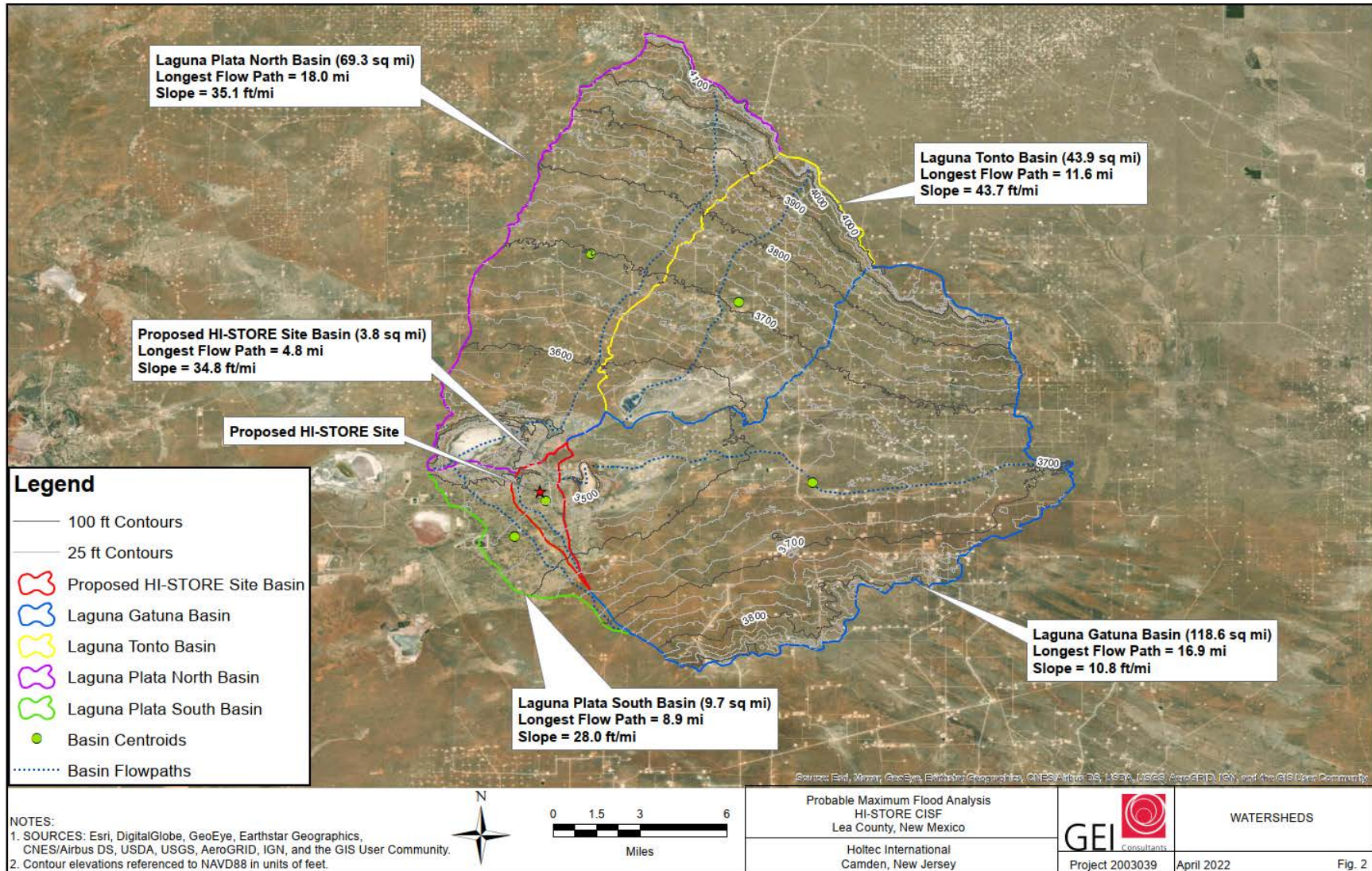


Figure 2.4.12: PMP/PMF Watersheds [2.4.15]

HOLTEC INTERNATIONAL COPYRIGHTED MATERIAL

Report No. HI-2167374

Proposed Rev. 0R

2-103

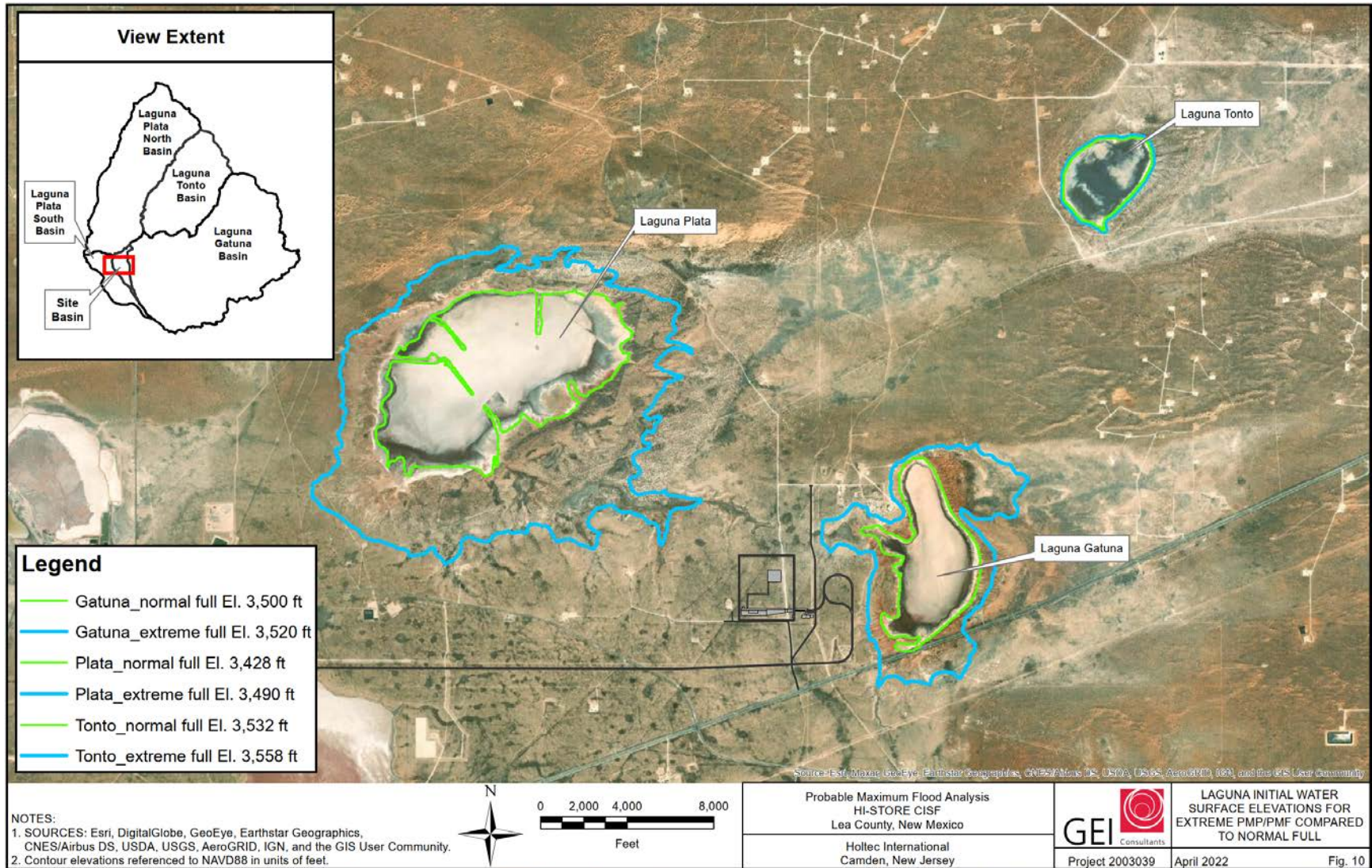


Figure 2.4.13: Laguna Extreme Full Conditions for PMP/PMF [2.4.15]

HOLTEC INTERNATIONAL COPYRIGHTED MATERIAL

Report No. HI-2167374

Proposed Rev. 0R

2-104

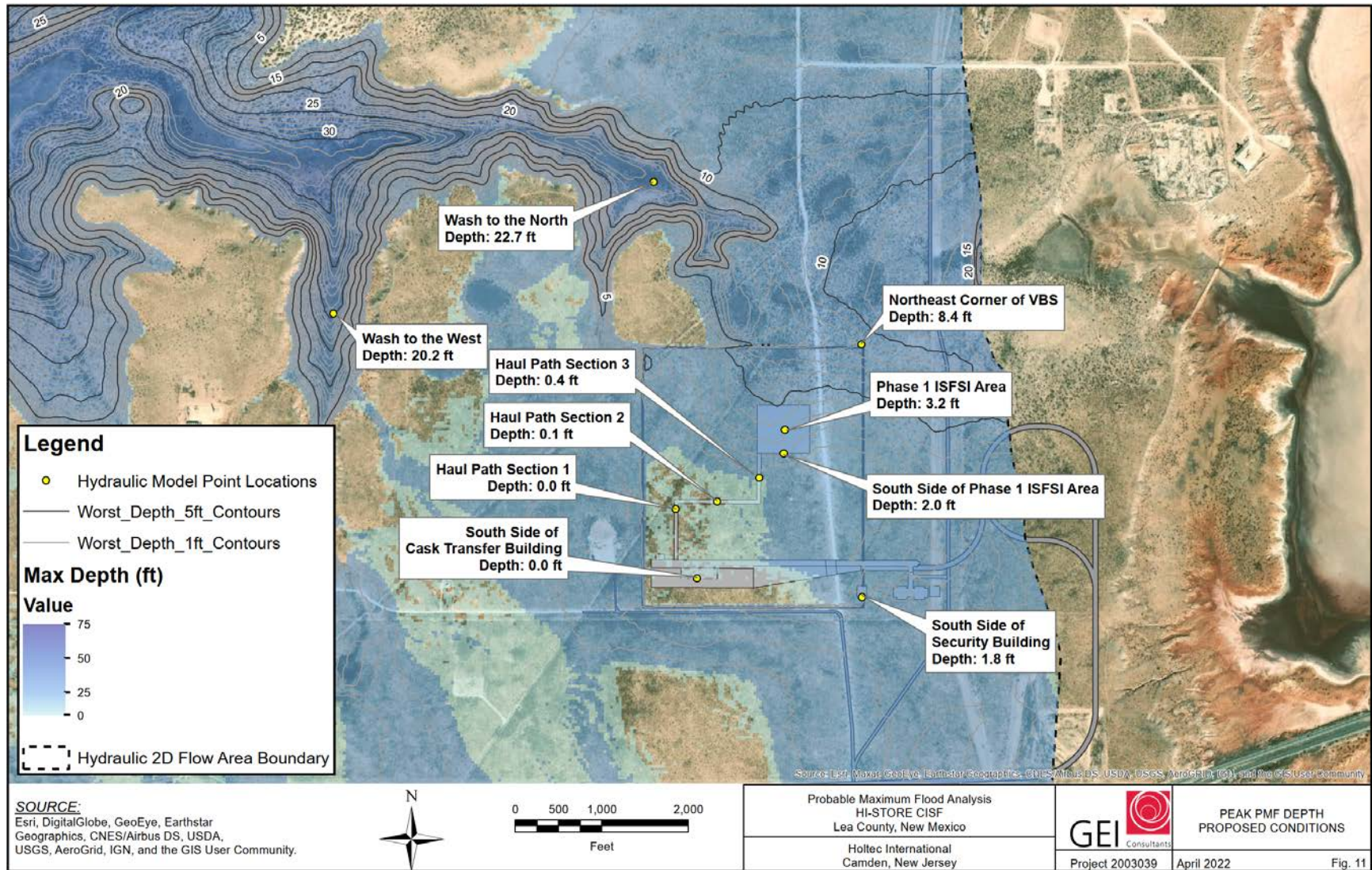


Figure 2.4.14: Peak PMF Water Depth [2.4.15]

HOLTEC INTERNATIONAL COPYRIGHTED MATERIAL		
Report No. HI-2167374		Proposed Rev. 0R
2-105		

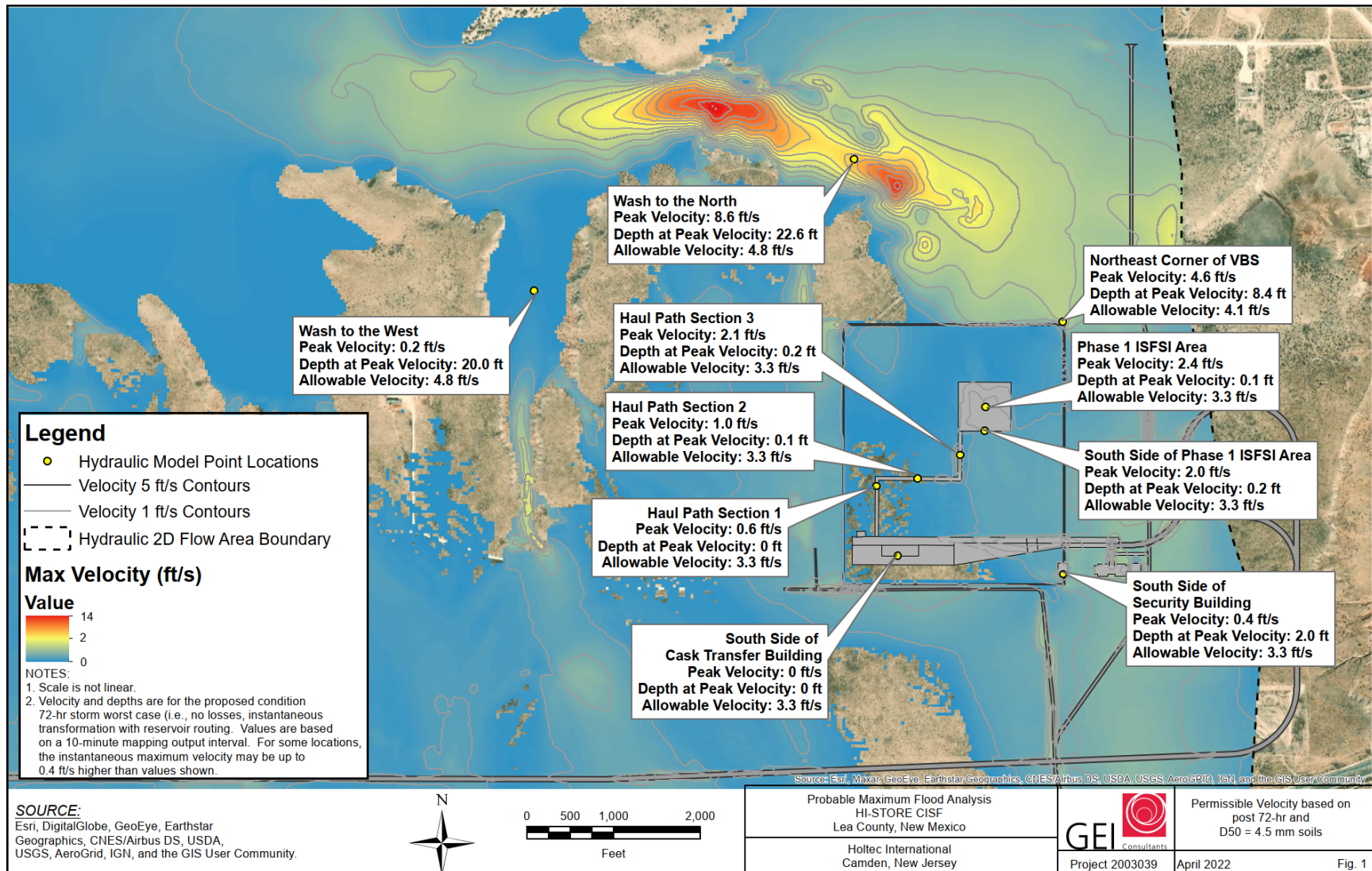


Figure 2.4.15: Peak PMF Water Velocity [2.4.15]

HOLTEC INTERNATIONAL COPYRIGHTED MATERIAL

Report No. HI-2167374

Proposed Rev. 0R

2-106

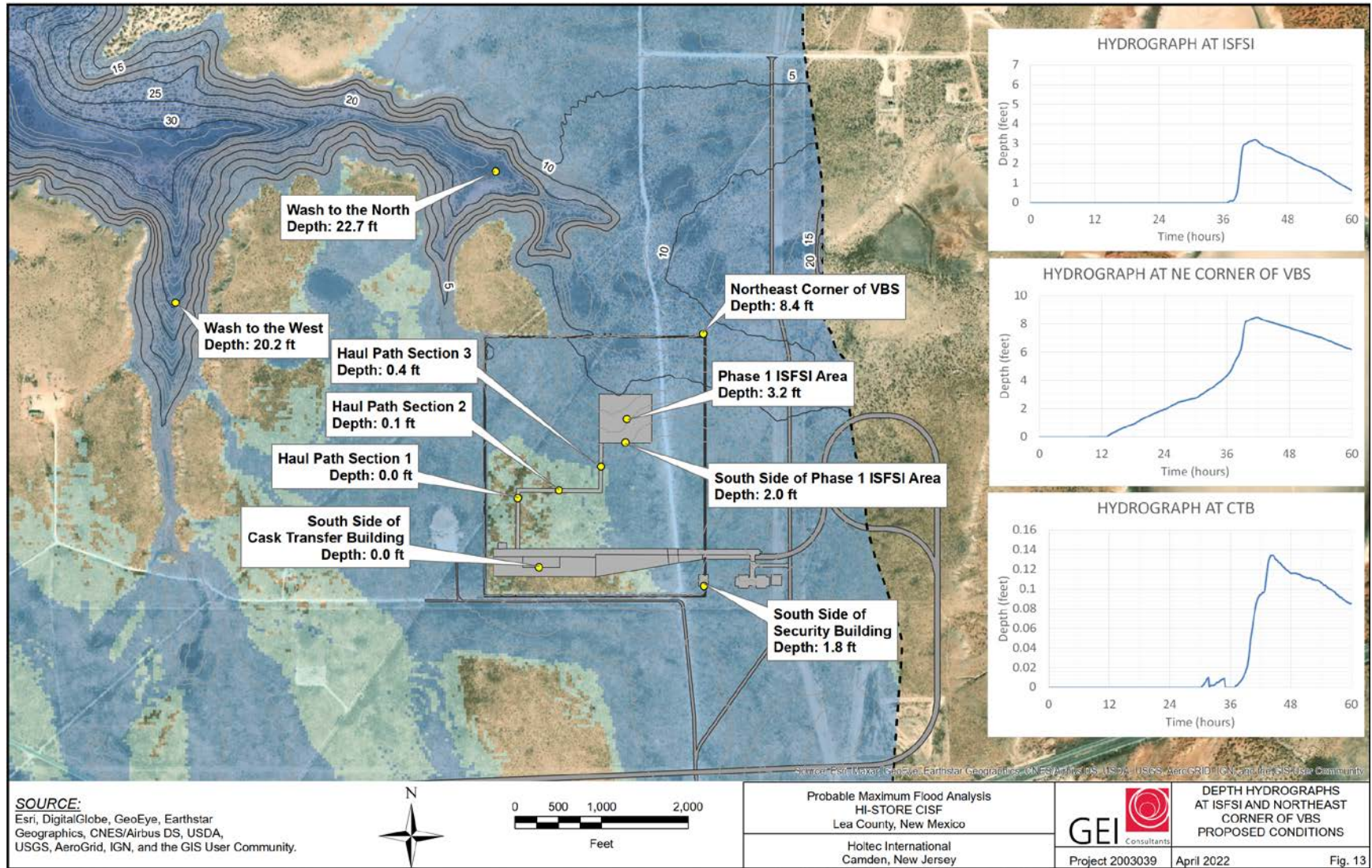


Figure 2.4.16: Peak PMF Depth Hydrographs [2.4.15]

HOLTEC INTERNATIONAL COPYRIGHTED MATERIAL		
Report No. HI-2167374		Proposed Rev. 0R
2-107		

2.5 SUBSURFACE HYDROLOGY

The Site is located in the Capitan Underground Water Basin (UWB) as shown in Figure 2.5.1 [2.5.1]. A declared groundwater basin is an area of the state proclaimed by the State Engineer to be underlying a groundwater source having reasonably ascertainable boundaries. By such proclamation, the State Engineer assumes jurisdiction over the appropriation and use of groundwater from the source. The Capitan UWB covers approximately 731,500 acres in the south-central portion of Lea County. It is located within a geologic province known as the Delaware Basin, a subdivision of the Permian Basin. The Capitan UWB is oriented in a northwest-southeast alignment above an arc-shaped section of a formation known as the Capitan Reef Complex. The Capitan aquifer occurs within dolomite and limestone strata deposited as an ancient reef. The groundwater quality of the Capitan in Lea County is very poor, with total dissolved solids ranging from 10,065 to 165,000 milligrams per liter (mg/L).

Other aquifers in the Capitan UWB are found in the overlying Rustler Formation, Santa Rosa Sandstone, Ogallala Formation, and Cenozoic alluvium and are important sources of groundwater in the Capitan UWB. The depth to the top of the Rustler Formation ranges from 900 to 1,100 feet.

Potable groundwater is available from three geologic units in southern Lea County; the Triassic Dockum shale, the Tertiary Ogallala, and Quaternary alluvium [2.5.2]. No potable groundwater is known to exist in the immediate vicinity of the Site. Shallow groundwater is present in a number of locations in the area, but water quality and quantity are marginal at best and most, if not all, shallow wells that have been drilled in the area are either abandoned or not currently in use. Potable water for the area is generally obtained from potash company pipelines that convey water to area potash refineries from the Ogallala High Plains aquifer on the caprock area of eastern Lea County. At present, water is generally obtained from these pipelines for other area users.

Much of the shallow groundwater near the Site has been directly or indirectly influenced by brine discharges from potash refining or oil and gas production. Potash mines have discharged thousands of acre-feet of near-saturated refinery process brine to Laguna Plata and to Laguna Toston for many years. But discharges ceased in Laguna Plata in the mid-1980s and in Laguna Toston by 2001. Laguna Gatuna was the site of multiple facilities for collection and discharge of brines that were co-produced from oil and gas wells in the entire area; facility permits authorized discharge of almost one million barrels of oilfield brine per month between 1969 and 1992. As a result, saturations of shallow groundwater brine have been created in a number of areas associated with the playa lakes [2.1.3].

Evapo-transpiration at the Site is five times the precipitation rate, indicating that there is little infiltration of precipitation into the subsurface. There are numerous low permeability layers between the surface and the expected groundwater level [2.1.3]. Because of the depth of groundwater, excavation during construction would not reach the groundwater. Groundwater at the Site would also not likely be impacted by any potential releases; therefore, groundwater would be unaffected by the proposed activities. The near surface water table appears to be 35-50 feet deep, where present, and is likely controlled by the water level in the playa lakes. No groundwater was encountered in the test boring on the west side of the Site in the vicinity where the ISFSI would be located [2.1.3]. Consequently, no impacts from the near surface water table would be expected. Additional information regarding groundwater can be found in Sections 3.5.2 and 4.5 of the ER [1.0.4].

HOLTEC INTERNATIONAL COPYRIGHTED MATERIAL	
Report No. HI-2167374	Proposed Rev. 0R
2-108	

Well drilling was conducted at the Site in 2007. Two wells, ELEA-1 and ELEA-2 were drilled on the Site to identify the depth and character of water-bearing rocks. The goals of the drilling investigation were to identify the potential for thin groundwater saturation in lower alluvium perched on the Triassic shale, or deeper groundwater saturation in the Triassic shale. Locations of these wells and other wells in the vicinity are shown on the well location map in Figure 2.5.2.

Piezometer ELEA-1. A small amount of water was initially detected in the well; however the water has steadily declined to within a few inches of the bottom of the well and is attributed to the small amount of bentonite hydration water that was placed in the well to seal the upper annulus during completion. Based on the data obtained from ELEA-1, no shallow groundwater saturation is present at the top of the Triassic shale at the location [2.1.3].

Piezometer ELEA-2. Water level in this well rose slowly over several days to a static depth of 34 feet below land surface (3,497 feet above mean sea level). The water-bearing zone in this well consists of either fractures or tight sandy zones between the depths of 85 and 100 feet; water in this zone is under artesian head of 50 feet. Laboratory analyses of water samples from the well indicate that the water is highly mineralized brine [2.1.3].

From the data collected from the onsite drilling, shallow alluvium is likely non water-bearing at the Site. Groundwater saturation in the Triassic shale appears to be limited to small amounts of highly mineralized water likely associated with the brine in Laguna Gatuna, where the brine is 3,500 feet above mean sea level [2.1.3].

Additional well drilling was conducted at the ISFSI site in Fall of 2017. Three monitoring wells were drilled next to borings numbered B101, B106, and B107 during the geotechnical field survey to determine the groundwater depth and elevation. The locations of these monitoring wells are shown in Figure 2.1.8. Figures 2.5.3 through 2.5.5 show Subsurface Profiles of the four soil and rock layers that were tested (details of these layers are further explained in Section 2.6.1). Monitoring well B101 (MW) was screened at the Santa Rosa foundation) while wells B106 (MW) and B107 (MW) were screened at the Chinle Foundation. Groundwater was encountered from elevations 3272 to 3282 and 3430 to 3437 at wells B101 (MW) and B107 (MW), respectively. No groundwater was found in well B106 (MW) after water was removed after drilling and wall installation. These measurements, along with the measurements present from aforementioned ELEA-2, were analyzed and tabulated in Table 2.5.1.

After field testing, it was determined that the measurement provided by well B101 (MW) is indicative of the primary groundwater aquifer at the site, whereas well B107 (MW) and ELEA-2 indicate the presence of isolated pockets of water in discontinuous aquifers above the lower permeability zones in the Chinle layer [2.1.24]. Therefore, the primary groundwater table depth is approximately 253 to 263 feet below the ground surface at the ISFSI site.

Based on this information presented in this section and the fact that there are no radioactive effluents from the proposed spent fuel storage system, it can be concluded that no buildup of radionuclides will occur in the subsurface hydrologic system. Nevertheless, as noted in the CIS Facility Environmental Report, baseline groundwater monitoring, sampling, and testing will be performed prior to construction of the facility in order to establish baseline measurements [1.0.4].

HOLTEC INTERNATIONAL COPYRIGHTED MATERIAL	
Report No. HI-2167374	Proposed Rev. 0R
2-109	

Table 2.5.1: Groundwater Elevation Data from Monitoring Wells [2.1.24]

Monitoring Well Number		B101 (MW)		B106 (MW)		B107 (MW)		ELEA-2	
		Depth	Elevation	Depth	Elevation	Depth	Elevation	Depth	Elevation
Sanded and Screened Interval ¹		377.7 - 414.4	3157.78 - 3121.08	174.3 - 203	3357.08 - 3328.38	82.4 - 107.5	3447.56 - 3422.46	53 - 98	3480.49 - 3435.49
Water Level Measurements	10/15/2017	NA	NA	199.5	3331.9	102.6	3427.4	NM	NM
	10/16/2017	NA	NA	199.5	3331.9	102.0	3428.0	NM	NM
	10/18/2017	NA	NA	199.5	3331.9	100.8	3429.2	NM	NM
	10/19/2017	NA	NA	199.5	3331.9	100.5	3429.5	NM	NM
	10/24/2017	NA	NA	199.4	3332.0	98.0	3432.0	NM	NM
	10/26/2017	263.7	3271.8	NM	NM	NM	NM	NM	NM
	10/31/2017	253.4	3282.1	NE	NE	100.0	3430.0	NM	NM
	11/1/2017	253.4	3282.1	NE	NE	99.6	3430.4	37.6	3495.9
	11/16/2017	253.6	3281.9	NE	NE	93.1	3436.9	37.7	3495.8

Notes:

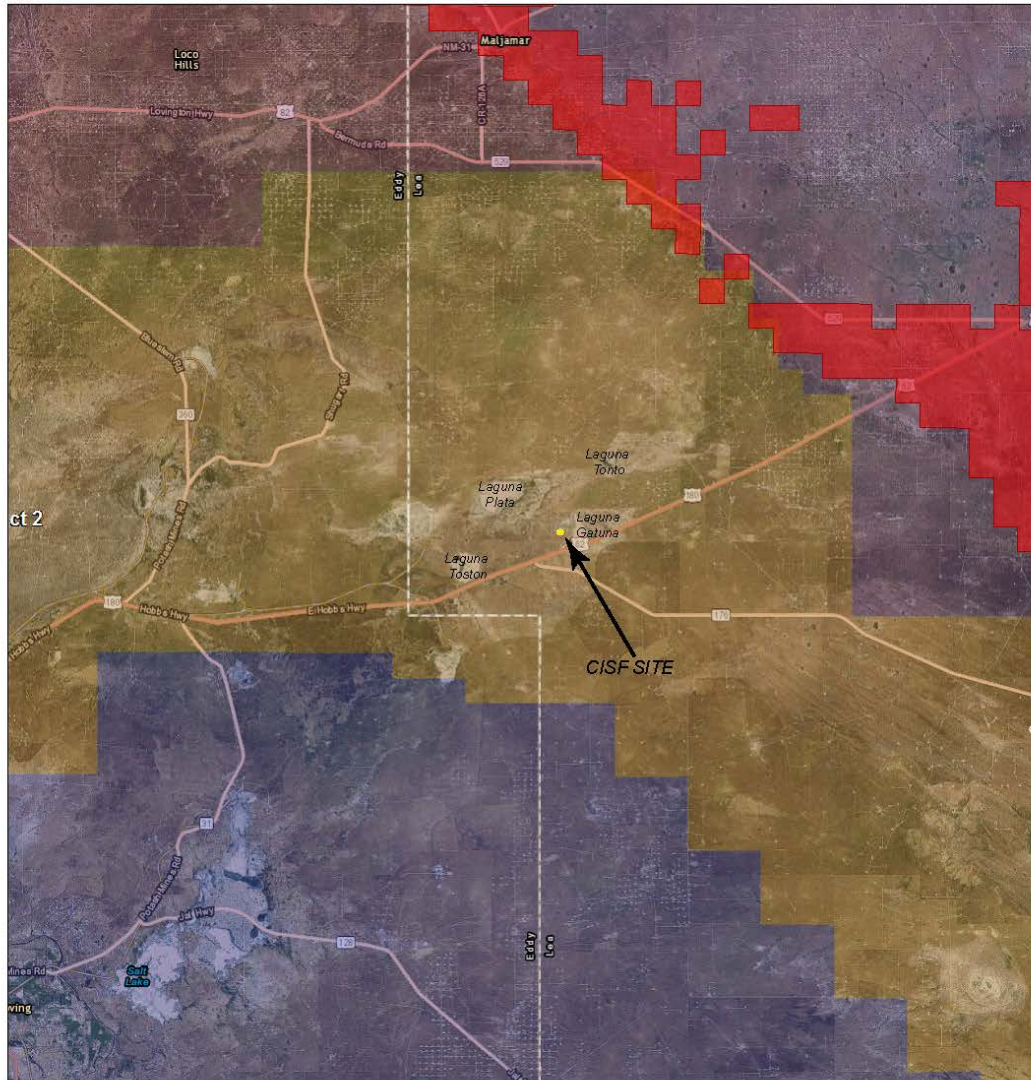
1. The sanded and screened interval corresponds to the upper and lower limits of the sanded zone.
2. Depth refers to depth below the ground surface.
3. Elevations are based on the North American Vertical Datum of 1988 (NAVD88).
4. "NA" indicates Not Applicable. Monitoring well was not installed by those dates.
5. "NM" indicates Not Measured.
6. "NE" indicates Not Encountered.
7. B107(MW) was bailed dry after 10/24/2017 water level measurement.
8. Data for B106(MW) from Oct15 to Oct24 indicate water levels below bottom of screen section, within the silt trap. These readings indicate groundwater at this
9. ELEA-2 sanded and screened interval information is based on the Drillhole Log ELEA-2 from the GNEP Eddy Lea Siting Study (2007).

HOLTEC INTERNATIONAL COPYRIGHTED MATERIAL

Report No. HI-2167374

Proposed Rev. 0R

2-110



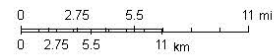
October 6, 2016

Special Condition Areas

Declared Underground Water Basins

- Capitan
- Carlsbad
- Lea County
- Roswell

1:288,895



Source: Esri, DigitalGlobe, GeoEye, Earthstar Geographics, CNES/Airbus D.S., USDA, USGS, AEX, Getmapping, Aerogrid, IGN, IGF, swisstopo, and the GIS User Community
 Esri, HERE, DeLorme, MapmyIndia, © OpenStreetMap contributors
 Esri, HERE, DeLorme, MapmyIndia, © OpenStreetMap contributors.

New Mexico Office of the State Engineer
 These maps are distributed "as is" without warranty of any kind.

Figure 2.5.1: Administrative Underground Water Basins in the State of New Mexico [2.5.1]

HOLTEC INTERNATIONAL COPYRIGHTED MATERIAL	
Report No. HI-2167374	Proposed Rev. 0R
2-111	

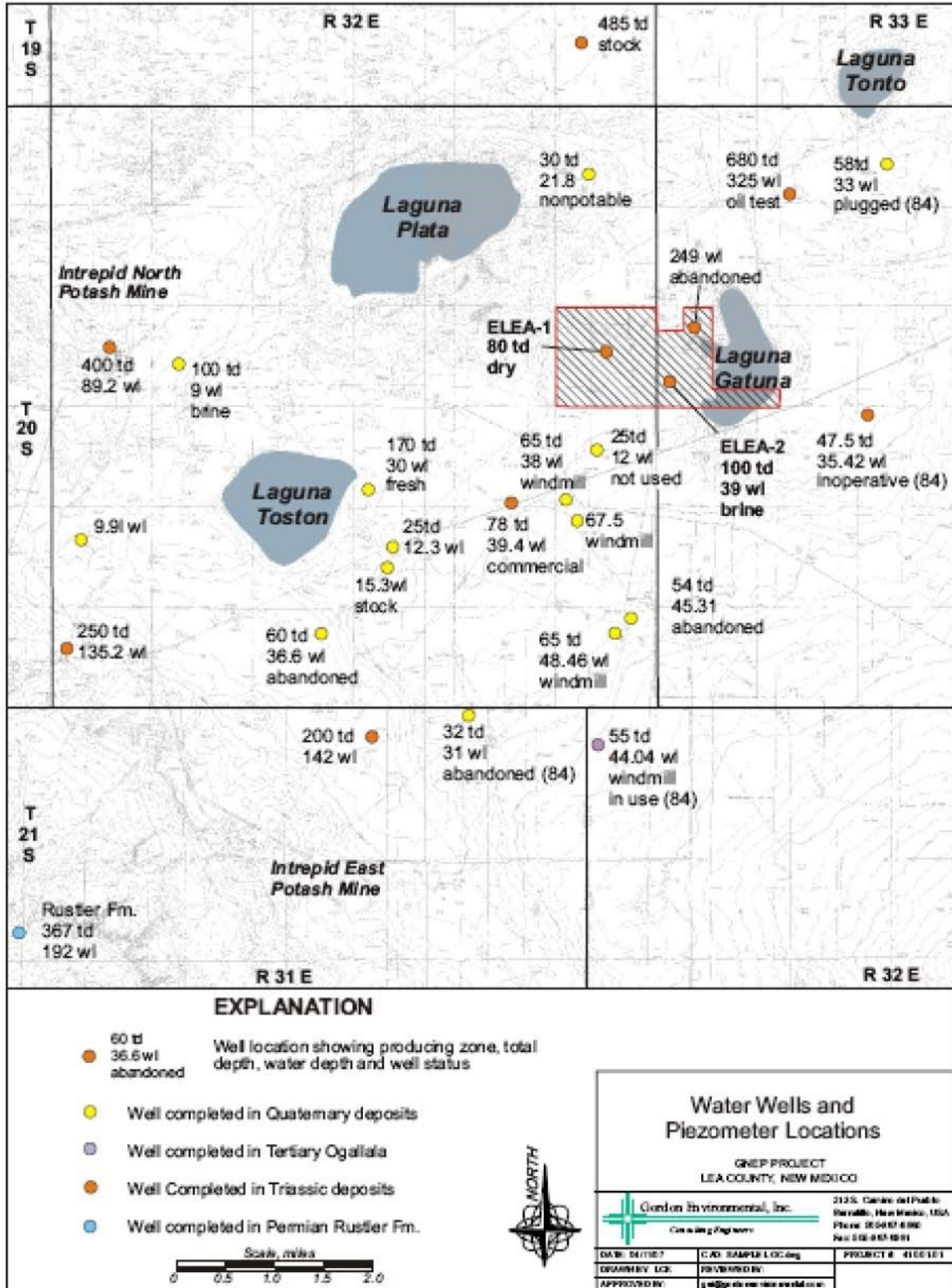


Figure 2.5.2: Water Wells and Piezometer Locations [2.1.3]

HOLTEC INTERNATIONAL COPYRIGHTED MATERIAL		
Report No. HI-2167374		Proposed Rev. 0R
2-112		

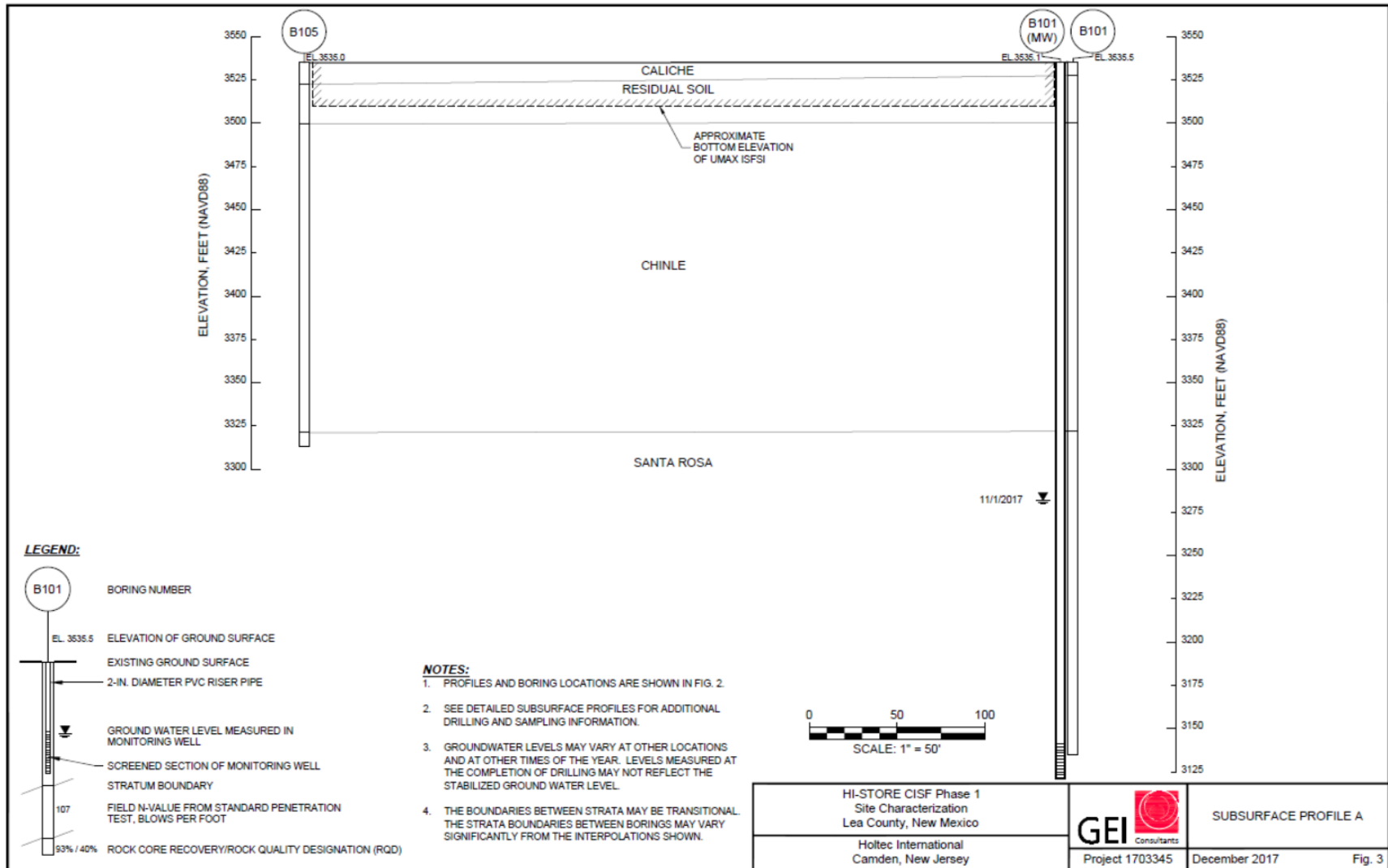


Figure 2.5.3: Subsurface Profile A [2.1.24]

HOLTEC INTERNATIONAL COPYRIGHTED MATERIAL

Report No. HI-2167374

Proposed Rev. 0R

2-113

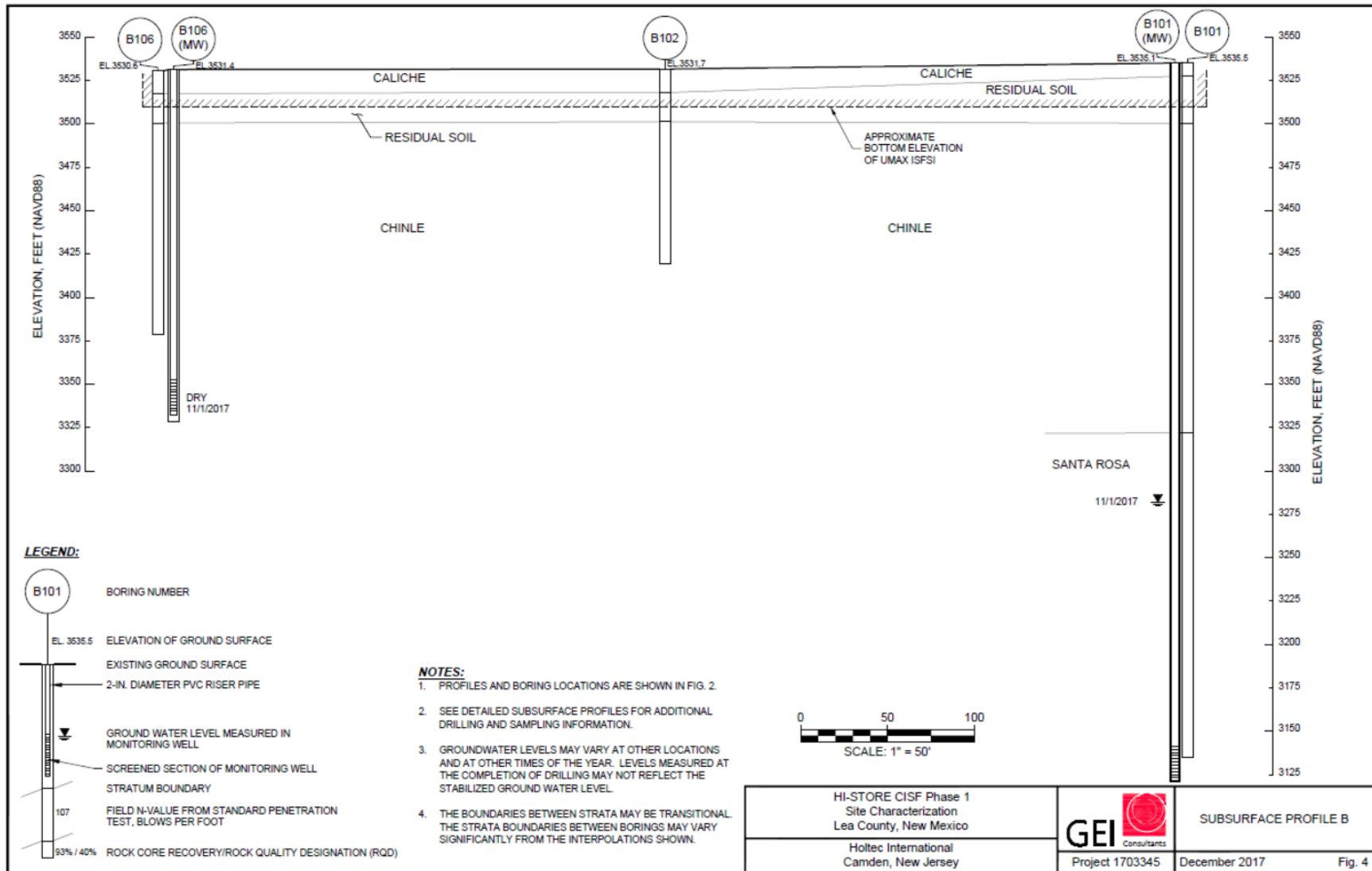


Figure 2.5.4: Subsurface Profile B [2.1.24]

HOLTEC INTERNATIONAL COPYRIGHTED MATERIAL

Report No. HI-2167374

Proposed Rev. 0R

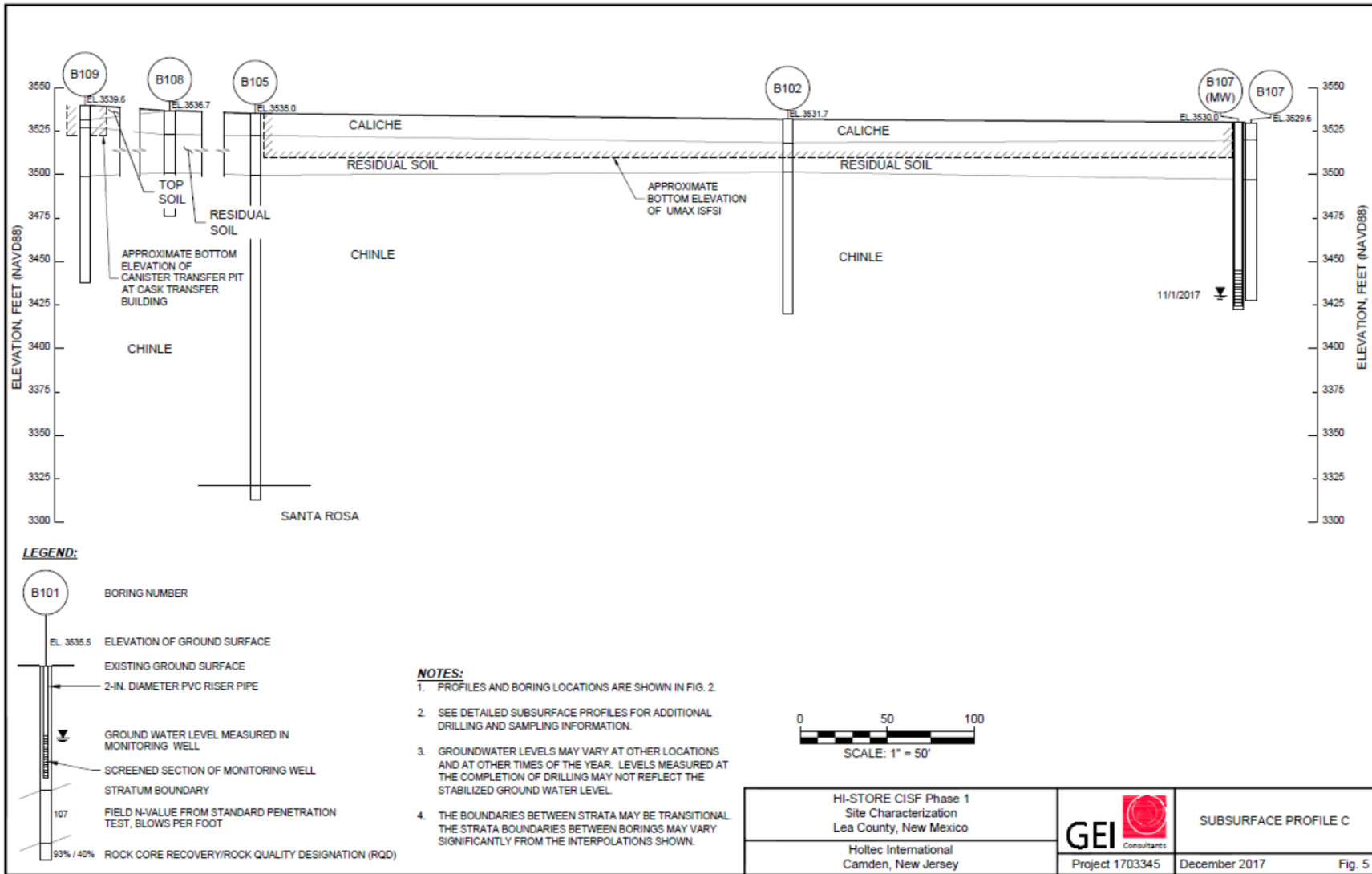


Figure 2.5.5: Subsurface Profile C [2.1.24]

HOLTEC INTERNATIONAL COPYRIGHTED MATERIAL

Report No. HI-2167374

Proposed Rev. 0R

2-115

2.6 GEOLOGY AND SEISMOLOGY

This section identifies the geological and seismological characteristics of the Site and its vicinity. The location for the proposed Site, and sites in the vicinity including the WIPP (located 16 miles southwest), and the NEF (located 38 miles southeast), have been thoroughly studied in recent years in preparation for construction of other facilities. Data are available from these investigations in the form of various reports [2.1.3, 2.1.24, 2.6.1, 2.6.2]. These documents and related material provide a substantial database and description of regional and site-specific geological conditions at the proposed Site.

2.6.1 Basic Geologic and Seismic Information

The Site is located in the northern portion of the Delaware Basin, a northerly-trending, southward plunging asymmetrical trough with structural relief of greater than 20,000 feet on top of the Precambrian basement rock. The Basin was formed by early Pennsylvanian time, followed by major structural adjustment from Late Pennsylvanian to Early Permian time. During the Triassic period, the area was uplifted, resulting in deposition of clastic continental shales (redbeds). Continuing uplift resulted in erosion and/or nondeposition until the middle to late Cenozoic period, when regional eastward tilting completed structural development of the basin as it exists today. Shallow subsurface structure at the Site consists of gently east sloping beds of Triassic age redbeds, dipping two degrees to the east. Faulting has not occurred in the northern Delaware Basin in the area of the Site. The regional geology suggests that there have been no recent, dramatic changes in geologic processes and rates in the vicinity of the Site [2.1.3].

During most of the Permian period, the Delaware Basin was the site of a deep marine canyon that extended across southeastern New Mexico and west Texas. Major structural elements of the Delaware Basin area are shown in Figure 2.6.1. The major structures of the basin include the Guadalupe Mountains on the west side, the Central Basin Platform on the east side, and the Capitan Reef Complex on the west and north sides of the basin. The reef created steep slopes toward the basin and the thickness of sediments grows precipitously toward the center of the basin from the margin of the reef. The Central Basin Platform forms an abrupt eastern terminus to the Delaware Basin; it is a steeply fault-bound uplift of basement rocks that grew through the early and middle Paleozoic period such that most of the pre-Permian sedimentary section is missing from its apex. Great thickness of organic-rich marine deposits in the basin and the presence of abrupt structures in the Capitan Reef Complex and Central Basin Platform combined to produce a prolific oil and gas province. These areas have been the focus of intense petroleum exploration and development activities since approximately 1920. Surficial geology and subsurface structure across the Delaware Basin are depicted in the maps and cross section in Figures 2.6.2 through 2.6.4. Thickness of sediments in the basin exceeds 20,000 feet, and Permian strata alone account for more than 13,000 feet of sedimentary materials [2.1.3].

The geologic formations of concern beneath the Site comprise, from oldest to youngest, consist of Permian-aged rocks (Wolfcamp series, Leonard series, Guadalupe series, Ochoa series); Triassic-aged rocks (Dockum Group); and Tertiary and Quaternary rocks (Lower Gatuna Formation, Upper Gatuna Formation); and alluvium. A stratigraphic column for the above units is provided in Figure 2.6.5.

HOLTEC INTERNATIONAL COPYRIGHTED MATERIAL	
Report No. HI-2167374	Proposed Rev. 0R
2-116	

The entire Site is underlain by Triassic bedrock consisting of shale, siltstone, and minor, fine-grained, poorly sorted sandstone. Most of the proposed operational area is relatively flat and the shale bedrock is covered by a laterally extensive veneer of 25 feet of Quaternary pediment deposits consisting of well sorted eolian sand and sandy-gravelly materials near the bedrock interface. The Mescalero Caliche unit is near the surface and is about 10 feet thick at the Site.

Most of the proposed operational area is relatively flat ranging from 3,520 feet above mean sea level (AMSL) on the northern end to 3,535 feet AMSL on the southern end. The surficial geology consists of Quaternary Pediment deposits (25 feet thick) overlying Triassic-age shale bedrock. The different soil/geologic layers are described as follows:

- Surface Soil: sandy and well-drained (0 to 2 feet below grade);
- Mescalero Caliche: well developed, naturally cemented calcium carbonate, laterally extensive, tightly bound and erosion resistant (2 to 12 feet below grade);
- Quaternary Sands: well sorted eolian sand and sandy-gravelly materials near the bedrock interface (12 to 25 feet below grade);
- Dockum Group: Triassic-age, predominantly shale, siltstone, and minor, fine-grained, poorly sorted sandstone (25 to greater than 100 feet below grade).

To determine the subsurface profile at the CIS Facility, a geotechnical survey was conducted. Nine borings, labeled B101 through B109, were drilled throughout the area: seven at the ISFSI pad, one along the haul path (B108), and one at the cask transfer building (B109). The location of each of these borings can be found in Figure 2.1.8. A summary of the boring exploration data including drilling, sampling, and field test notes, is located in Table 2.6.1. Subsurface profiles produced based on the subsurface exploration results are located in Figures 2.5.4 through 2.5.6, with more detailed subsurface profiles located in Figures 2.6.6 through 2.6.8. In addition, boring logs were developed to provide details of the subsurface geology encountered during the testing process. These boring logs can be found in Appendix C of the referenced geotechnical report [2.1.24].

At the ISFSI location (B101-B107), five primary subterranean layers were observed, Figures 2.6.6 through 2.6.8:

- Top Soil layer, which consists of clayey sand with gravel on the south corners or lean clay with sand in the center and north corners of the ISFSI site. These eolian sand deposits were found at the surface of the site and are unconsolidated and unsaturated.
- Caliche layer, which consists of silty sand with gravel for all borings, along with additional layers of narrowly graded gravel with sand and widely graded sand with silt and gravel for the northwest and southwest corners, respectively. The mescalero caliche is poorly indurated and unsaturated.
- Residual layer, which consists of various layers of clayey sand and sandy lean clay at all borings, except the northeast corner, which only included clayey sand. The center has an additional layer of clayey sand with gravel. This layer is also referred to as the Gatuna Formation in updated USGS regional nomenclature, figure 2.6.16. This layer was weathered and therefore classified as residual soil. It underlies the caliche and eolian sand deposits and is generally poorly indurated and unsaturated.

HOLTEC INTERNATIONAL COPYRIGHTED MATERIAL	
Report No. HI-2167374	Proposed Rev. 0R
2-117	

- Chinle layer, which consists of various layers of lean clay, sandy lean clay, lean clay with sand, and clayey sand. Mudstone was encountered at this layer for all borings. This layer is also referred to as the Tecovas Formation in updated USGS regional nomenclature, figure 2.6.16. This layer is poorly to moderately indurated and is unsaturated.
- Santa Rosa layer, which consists of various layers of mudstone and sandstone. Only borings B101 and B105 at the southern corners encountered this layer. This layer is well indurated and is the principal aquifer in the region in the western third of Lea County. Groundwater measurements indicated groundwater dept approximately 50 feet below the top of the Santa Rosa Formation.

These borings describe the subgrade and under-grade space makeup of Spaces B, C, and D beneath the ISFSI pad in Figure 4.3.1.

At the haul path (B108), four primary subterranean layers were tested:

- Top Soil layer which consists of clayey sand.
- Caliche layer which consists of silty sand with gravel.
- Residual layer which consists of various layers of clayey sand, sandy lean clay, and clayey sand with gravel.
- Chinle layer which consists of various layers of lean clay with sand, and then sandy lean clay before the end of boring.

At the CTF site (B109), four primary subterranean layers were tested:

- Top Soil layer which consists of lean clay with sand and sandy lean clay with gravel.
- Caliche layer which consists of clayey sand and sandy lean clay layers.
- Residual layer which consists of various layers of sandy lean clay, clayey sand, and lean clay with sand.
- Chinle layer which consists of various layers of lean clay, sandy lean clay, lean clay with sand, and clayey sand. Mudstone was encountered at this layer.

Soil properties, such as grain size, specific gravity, density, Atterberg limits, shear velocity, and water content were determined and are tabulated in Tables 2.6.2 through 2.6.4. The graphical Atterberg limit results and shear wave velocities are shown in Figures 2.6.9 and 2.6.10, respectively. All of the testing deliverables are defined in the geotechnical report [2.1.24] and are summarized in Tables 2.6.2 and 2.6.3 below. Table 2.6.5 provides locations of applicable data in the geotechnical report [2.1.24].

The Top Soil layer ranges from 3 to 4 inches deep, but was 8.1 feet thick at the CTF. The soil consists of varying loose-to-medium dense amounts of sand and clay. Next, the Mescalero Caliche layer ranges from 4.4 to 13.5 feet thick. The soil consists of varying dense-to-very dense amounts of sand and gravel with silt, with unit weights between 84.5 to 94.2 pounds per cubic foot. Finally, the Residual Soil layer ranges from 17 to 28 feet thick. The soil consists of varying very hard or very dense amounts of clayey sand or sandy clay with traces of gravel, with unit weights between 98.6 to 126.4 pounds per cubic foot [2.1.24].

HOLTEC INTERNATIONAL COPYRIGHTED MATERIAL	
Report No. HI-2167374	Proposed Rev. 0R
2-118	

The Chinle Formation layer is the first bedrock layer encountered, from a depth of 27.5 to 40.5 feet. The rock consists of varying layers of lean clay or clayey sand, classified from the SPT N-values as very dense soil to soft rock. Lastly, the Santa Rosa Formation is the last tested bedrock layer, where samples were collected at depths of 401 and 222 feet from two separate borings. The rock consists of varying ranges of fine-to-coarse grained sandstone, with minor reddish-brown siltstones and conglomerate. Details of the soil and rock layers are included in Section 5.2 of the geotechnical report [2.1.24].

Monitoring wells were drilled next to borings B101, B106, and B107 to determine the groundwater elevation at the ISFSI site. Laboratory testing was conducted on the soil and rock extracted from these borings. As stated in Section 2.5, the primary groundwater table is at 253-263 feet below grade. Excavation to a depth of 25 feet below grade is expected for facility construction; thus, the construction activity will not be in contact with the groundwater table.

The Ogallala Formation was not encountered during the 2017 subsurface explorations. The Ogallala Formation also was not encountered in drillholes NP-1 or SNL-6 in the vicinity of the Site [2.6.13, 2.6.14]. Geologic literature indicates the Mescalero Ridge delineates the western edge of the Ogallala Formation [2.6.15], approximately 12 miles east of the Site.

The Dockum Group consists of claystone, sandstone, and siltstone which compose the following units from youngest to oldest: the Redonda, Cooper Canyon, Trujillo, Tecovas, and the Santa Rosa [2.6.16]. The Redonda, Cooper Canyon, or Trujillo Formations were not identified during the 2017 subsurface explorations, Figure 2.6.5

Fractures were encountered in the rock in the Chinle and Santa Rosa Formations. The fractures were typically planar, between 0 to 30 degrees from horizontal, with most between 0 and 10 degrees, and generally formed along bedding planes. These fractures likely formed as material above eroded, relieving pressures and stress following the Triassic period. It is believed all of southeastern New Mexico has been above sea level and subjected to erosion since the Cretaceous [2.6.17]. No evidence was found of deformations or offsets in the in the subsurface profiles that suggests other geologic processes. The erosion that caused the observed fracturing is a long-term, regional process that is not expected to cause localized deformations during the operation of the site.

Slickensides were observed in B120, B105, and B106 between El. 3338-3445. Observations of similar slickensides have been made and the slickensides are referred to as pedogenic slickensides (slickensides that form during soil deposition and induration) as opposed to slickensides formed during tectonic processes [2.6.14]. Pedogenic slickensides form during expansion and contraction in clay soils. These features appear in undeformed rocks [2.6.18]. The processes that formed these pedogenic slickensides are not active and do not pose a concern for future deformation at the site.

2.6.2 Vibratory Ground Motion

Earthquakes of low to moderate magnitude have been documented within a 200 mile radius of the Site. The vast majority of the earthquake activity is located southeast of the Site in west Texas, and west/northwest of the Site in central New Mexico. The U.S. Geological Survey (USGS) earthquake database was used to query historical earthquakes within a 200 mile radius of the Site [2.6.3]. Results of the search of the 200 mile radius yielded a total of 244 historical earthquakes with magnitude 2.5 or greater between 1900 and the most recent update of the database in 2016. The results indicate the closest earthquake to the Site was 24 miles southwest with a magnitude of

HOLTEC INTERNATIONAL COPYRIGHTED MATERIAL	
Report No. HI-2167374	Proposed Rev. 0R
2-119	

3.1 that occurred on March 18, 2012. Two earthquakes with magnitudes greater than 5.0 were recorded within 200 miles of the Site. An earthquake with magnitude 6.5 occurred on August 16, 1931, located 140 miles southwest of the Site; and an earthquake with magnitude 5.7 occurred on April 14, 1995, located 165 miles south of the Site. The Eunice earthquake of January 2, 1992, located 39 miles east of the Site had a magnitude of 4.6. The results of the USGS earthquake search are plotted on a regional map in Figure 2.6.11.

There are three seismic source zones within a 200 mile radius of the Site: the northern and southern regions of the Southern Basin and Range – Rio Grande rift zone located west and southwest of the Site; and the Central Basin Platform zone located east of the Site. The most active seismic area within 200 miles of Site is the Central Basin Platform east of the Site. Large magnitude earthquakes are not occurring or have not occurred within the recent geologic past along the Central Basin platform due to the absence of Quaternary faults. The seismicity in west Texas, southeast of the Site, is hypothesized as being a result of fluid pressure build-up from fluid injection, and consequential reduction in effective stress across pre-existing fractures and associated decrease in frictional resistance to sliding. Similarly, recent records (1998 through 2005) from the WIPP seismic monitoring network indicate that the strongest events recorded annually in 1999, 2000, and 2002 through 2005 (typically of 2.5 to 4.0 magnitude during this time period) have been located about 50 miles west of the Site. This seismic activity is suspected to be induced by injection of waste water from natural gas production into deep well or wells [2.1.3].

A review of the seismic risk was based on USGS Geologic Hazards Science Center's 2009 Earthquake Probability Mapping [2.6.4], which generates maps that show the probability of a magnitude 5.0 or higher earthquake within a 30-mile radius of any location within the next 50 years. On a scale of 0.00 (the lowest probability of earthquake) to 1.00 (the highest probability), all Project facilities are within the low probability range of 0.01 to 0.02 as shown in Figure 2.6.12. Earthquake probability is dominated by seismic activity within the Central Basin Platform south and east of the Site.

Probabilistic ground motion for the Site was determined using information from the USGS [2.6.5]. Figure 2.6.13 is a probabilistic ground motion map of the Site, illustrating peak horizontal acceleration with a 2 percent probability of exceedance in 50 years (2,500 year return interval). The Peak Horizontal Ground Acceleration (PGA) value of 0.04 of the acceleration due to gravity (g) to 0.06g estimated by the regional USGS algorithm is similar to values suggested by several site-specific studies for nearby locations. The Geological Characterization Report (GCR) for the WIPP Site [2.6.1] determined acceleration of $\leq 0.06g$ for a return interval of 1,000 years, and $\leq 0.1g$ for a return interval of 10,000 years (WIPP is located approximately 16 miles southwest of the Site); the results of the GCR were reviewed and confirmed by Sanford et al. [2.6.5]), which estimated a maximum expected acceleration of 0.1g for the WIPP, and again in the Safety Evaluation Report for the WIPP [2.6.6], which describes the GCR results as conservative. The seismic hazard for the National Enrichment Facility (NEF) uranium enrichment facility predicts 0.15g for a return interval of 10,000 years [2.6.2]. The NEF facility is about 38 miles southeast of the Site [2.1.3].

Quaternary-age faulting (exhibiting movement in the past 1.6 million years) is not present in the vicinity of the Site. The nearest Quaternary-age fault is located 85 miles southwest of the Site [2.6.7]. Little is known about this fault except that it is a normal fault, 3.6 miles in length, and has a slip rate of less than 0.01 in/yr. The Guadalupe fault forms a scarp on unconsolidated Quaternary

HOLTEC INTERNATIONAL COPYRIGHTED MATERIAL	
Report No. HI-2167374	Proposed Rev. 0R
2-120	

deposits at the western base of the Guadalupe Mountains in the Basin and Range physiographic province. The same USGS database shows numerous other Quaternary-age faults within a 200-mile radius of the Site, located to the west and southwest, most of which are at the distal end of the radius and are near the Rio Grande Rift of central New Mexico. Figure 2.6.14 is a map of New Mexico and West Texas showing Quaternary-age faulting as cataloged by the USGS, and as downloaded from the database referenced above. The database contains locations and information on faults and associated folds that have been active during the Quaternary.

In all, there are a total of 27 Quaternary faults or fault zones within a 200-mile radius of the Site. A total of four “capable” faults were identified, the closest being the Guadalupe fault (85 miles to the southwest). A “capable” fault is one that has exhibited one or more of the following characteristics (10 CFR 100 [2.6.10] Appendix A.III, Definitions):

- Movement at or near the ground surface at least once within the past 35,000 years or movement of a recurring nature within the past 500,000 years.
- Macro-seismicity instrumentally determined with records of sufficient precision to demonstrate a direct relationship with the fault.
- A structural relationship to a capable fault according to the previous two characteristics such that movement on one could be reasonably expected to be accompanied by movement on the other.

For the purposes of this assessment, capable faults were identified based solely upon the first characteristic above.

2.6.3 Surface Faulting

There are no surface faults at the Site. Tectonic activity in the Delaware Basin is characterized by slow uplift relative to surrounding areas which has resulted in erosion and dissolution of rocks in the Basin. Faulting has not occurred in the northern Delaware Basin in the area of the Site. The regional geology suggests that there have been no recent, dramatic changes in geologic processes and rates in the vicinity of the Site [2.1.3].

2.6.4 Stability of Subsurface Materials

The entire Site is underlain by Triassic bedrock consisting of shale, siltstone, and minor, fine-grained, poorly sorted sandstone. Most of the proposed operational area is relatively flat and the shale bedrock is covered by a laterally extensive veneer of 25 feet of Quaternary pediment deposits consisting of well sorted eolian sand and sandy-gravelly materials near the bedrock interface. The Mescalero Caliche unit is near the surface and is about 10 feet thick at the Site.

Comparison of conditions at the Site with those conditions favorable to karst development indicates that conditions at the Site are not conducive to karst development. **The site is underlain by the dockum group and dewey lake red beds, both of which are composed of insoluble clastic rocks [2.6.19].** No thick sections of soluble rock are present at or near land surface; the shallowest soluble bedrock materials are gypsum and halite beds in the Rustler Formation, which is located at least 1,100 feet below land surface at the Site. **Since the Dockum Group and the Dewey Lake Red Beds are not soluble, and water does not move through them freely, there is no indication that conditions exist that would cause dissolution resulting in subsidence or collapse of the next few thousands of years [2.6.20].** Additionally, rainfall rates in the area are low.

HOLTEC INTERNATIONAL COPYRIGHTED MATERIAL	
Report No. HI-2167374	Proposed Rev. 0R
2-121	

Mescalero caliche is soluble and situated at or near land surface; however this unit is no more than 10 feet in thickness. **Leaching of this caliche cap and subsequent removal of the loosened material by winds are believed to be the cause of** a number of small shallow depressions in the area, **Figure 2.6.17, referred to regionally as buffalo wallows [2.6.21]**; however this is not regarded as an active or significant karst process at the Site [2.1.3].

During site reconnaissance, detailed inspection of the areas around the margins of Laguna Gatuna and tributary drainages was performed to identify any tension cracks, disrupted soils, tilting, or other evidence of rapid earth displacement. No tension cracks or other evidence of displacement was observed. Additionally, older cultural features in the area were inspected to identify evidence of tilting, offset, or displacement that could indicate recent land movement. A number of oil wells were drilled along the west flank of Laguna Gatuna beginning in the early 1940's. Most of the wells were abandoned by 1975 and well monuments were installed; several of the well monuments were identified during site reconnaissance. None of the monuments displayed evidence of tilting that might be associated with local earth movements [2.1.3].

A halite preservation and stability assessment entitled, *Report on Evaporite Stability in the Vicinity of the Proposed GNEP Site, Lea County, NM* was performed for the Site as part of the GNEP siting study [2.1.3]. This study was conducted in order assess existing data on the continuity and stability of evaporites under the Site, with special attention to data within, or adjacent to the boundaries of nearby lakes or playas. The main data sources for the project area include potash exploration drillholes and oil and gas drillholes.

Lithologic logs from potash exploration and geophysical logs from oil and gas exploration around the Site in southwestern Lea County, New Mexico, provide evidence of the extent and stability of evaporites and their possible relationship to the formation of playas in the vicinity.

An elevation map on the uppermost evaporite-bearing bed (top of Permian Rustler Formation) shows continuity across the area. General northeast slopes are revealed, with some flattened slopes associated with Laguna Plata. There are no indications of lowering of the surface by dissolution; the top of Rustler under most of Laguna Plata is actually elevated above the general trend. The surface varies locally due to variable reporting for potash drillholes of the first encounter with the uppermost sulfate bed of the Rustler.

There are no surface, drillhole, or mining indications that subsidence and collapse chimneys occur at the Site or surrounding area. These features are associated with the front of the Capitan reef, which is south of the Site, and with a hydraulic environment that is not known to exist at the Site.

Geophysical logs indicate that halite in the Rustler persists across the Site area. Dissolution from above to create lows on the uppermost Rustler is not a practical process. There is neither subsurface drillhole data nor surface features indicating a dissolution front in the vicinity of the Site. There is no evidence for either past or continuing natural processes that would cause Site instability due to halite dissolution in the near future [2.1.3].

Any future oil drilling or fracking beneath the Site would occur at greater than 3,050 feet, the depth of the Yates formation (shallowest oil and gas bearing formation) which ensures there would be no subsidence concerns.

Based on the data from the borings and analyses, the soils at the site are not susceptible to liquefaction. The soils encountered at the site were evaluated for liquefaction potential using the

HOLTEC INTERNATIONAL COPYRIGHTED MATERIAL	
Report No. HI-2167374	Proposed Rev. 0R
2-122	

methods described in Youd, et al., 2001 [2.6.12] as prescribed by Regulatory Guide 1.198 [2.6.11]. Corrected N-values greater than 30 blows per foot are too dense to liquefy in an earthquake of any size, and are therefore classified as non-liquefiable. In addition, soils above the groundwater table are not susceptible to liquefaction [2.6.12].

2.6.5 Slope Stability

The CISF Facility terrain ranges in elevation from approximately 3,530 to 3,550 feet above mean sea-level sloping gently downward from south to north. Most of the site is flat with slopes ranging from 0 to 3 percent, as shown in Figure 2.6.15. Therefore, there is no risk from slope instability (i.e. landslides) in the vicinity of the Site.

2.6.6 Construction Excavation

During the construction of Phase 1 of the HI-STORE CISF, there will be multiple areas where excavation will be required to accommodate and install the underground facilities; specifically, the Canister Transfer Facilities (CTF) which are located in the Cask Transfer Building (CTB), and the UMAX field. In both cases, the expected total excavation depth is approximately twenty-five (25) feet.

According to the geotechnical borings, there are two layers of subsurface material that will be encountered during construction excavations. The native caliche layer, which is approximately 12 feet in depth from top of existing grade, and the native residual soil layer, which makes up approximately 13 feet of depth for the remaining required excavation depth for site facilities. In no instance is it expected that construction excavations will encounter the native Chinle layer.

In order to accommodate construction vehicle access and industry wide safety standards, it is expected that construction practices will utilize a minimum 1:1 slope around the extents of the excavation pits. This method will create ~124,000 cubic yards (CY) of caliche spoils and ~121,500 CY of residual soil spoils; some of which (~24,000 CY) will be utilized to backfill the excavation area. It should be noted that the residual soil layer will be utilized for the backfill material as it meets the minimum density and shear wave velocity requirements that are required for Space B, referenced in Figure 4.3.1.

Once the areas have been excavated, the supporting soil will be prepared to receive the reinforced concrete Support Foundation Pad (SFP). The residual soil surfaces shall be proof rolled by a heavy vibrating compactor, prior to the placement of compacted fill or foundations. Careful observation shall be made by a professional engineer licensed in New Mexico or their approved representative during proof rolling in order to identify any areas of soft, yielding soils that may require over-excavation and replacement. Once the subsurface has been prepared and compacted, the supporting residual soil fill (Space C) shall be confirmed to have reached a compaction of 95 percent (minimum) of the modified Proctor maximum dry density (in accordance with ASTM D1557). The compaction should be conducted at or close to the optimum moisture content indicated by the modified Proctor test procedure (ASTM D1557).

Upon completion of subgrade preparation/compaction, placement of the reinforced concrete Support Foundation Pad (SFP) and UMAX Cavity Enclosure Containers (CECs), backfilling of Spaces A and B (Figure 4.3.1) will commence. Space A will consist of a Controlled Low Strength Material (CLSM) or lean concrete that has a minimum compressive strength and density of 1,000 psi and 120 pcf, respectively, as referenced in Table 4.3.3. Since the backfilling process is

HOLTEC INTERNATIONAL COPYRIGHTED MATERIAL	
Report No. HI-2167374	Proposed Rev. 0R
2-123	

iterative, as the fill materials are brought back up to finished grade, the sloped areas of the excavation pit that make up Space B of the UMAX lateral subgrade, will be composed of the aforementioned residual soil. Again, it is expected that for Phase 1 of the HI-STORE CISF, and all subsequent phases, ~24,000 CY of this residual soil will be required to fill out the Space B portion of the excavated area.

HOLTEC INTERNATIONAL COPYRIGHTED MATERIAL	
Report No. HI-2167374	Proposed Rev. 0R
2-124	

Table 2.6.1: Boring Exploration Data [2.1.24]

Boring Number	As-Drilled Coordinates		Ground Surface Elevation (feet)	Boring Depth (feet)	Drilling, Sampling, and Field Test Notes (1)	Purpose
	Northing (feet)	Easting (feet)				
B101	571,880.4	731,795.0	3535.5	400.6	Bulk Sampling, SPT, Rock Coring, Packer Testing	Characterize soil and rock for ISFSI Pad.
B101A	571,899.0	731,779.8	NM	30.9	SPT	Hammer energy measurement.
B101B	571,906.7	731,791.6	3535.1	414.4	Not sampled	Installed monitoring well B101(MW).
B102	572,097.9	731,585.2	3531.7	112.0	Bulk Sampling, SPT, Rock Coring	Characterize soil and rock for ISFSI Pad.
B102A	572,088.4	731,581.4	3531.4	107.9	Not sampled	Installed inclinometer casing for crosshole seismic velocity testing.
B103	572,091.3	731,567.4	3531.2	107.6	Not sampled	Installed inclinometer casing for crosshole seismic velocity testing.
B104	572,094.6	731,552.0	3531.6	107.8	Not sampled	Installed inclinometer casing for crosshole seismic velocity testing.
B105	571,879.9	731,356.8	3535.0	221.7	Bulk Sampling, SPT, Rock Coring, Packer Testing	Characterize soil and rock for ISFSI Pad.
B105A	571,865.2	731,338.5	3534.9	30.4	SPT	Hammer energy measurement.
B106	572,280.0	731,356.3	3530.6	152.0	SPT, Rock Coring, Packer Testing	Characterize soil and rock for ISFSI Pad.
B106A	572,270.0	731,364.2	3531.4	203.0	Not sampled	Installed monitoring well B106(MW).
B107	572,282.3	731,792.4	3529.6	102.0	Bulk Sampling, SPT, Rock Coring, Packer Testing	Characterize soil and rock for ISFSI Pad.
B107A	572,282.4	731,782.1	3530.0	107.5	Not sampled	Installed monitoring well B107(MW).
B108	571,660.2	731,344.9	3536.7	60.9	SPT	Characterize soil for HHP.
B109	570,681.2	730,773.3	3539.6	102.0	Bulk Sampling, SPT, Rock Coring, Packer Testing	Characterize soil and rock for CTB.

Notes:

1. Modified California samples were collected as appropriate in SPT borings.
2. Northing and Easting are based on the Modified U.S. State Plane of 1983 (NAD83), New Mexico East Zone 3001.
3. Elevations are based on the North American Vertical Datum of 1988 (NAVD88).
4. "SPT" indicates Standard Penetration Test.
5. "NM" indicates not measured.

HOLTEC INTERNATIONAL COPYRIGHTED MATERIAL

Report No. HI-2167374

Proposed Rev. 0R

2-125

Table 2.6.2: Soil Index Properties [2.1.24]

Sample Identification				Water Content (%)	Index Properties								Unit Weight			
Boring Number	Sample Number	Sample Depth (ft)	Formation		Grain Size Tests				Atterberg Limits Tests				Specific Gravity	Water Content (%)	Total Unit Weight (pcf)	Dry Unit Weight (pcf)
					Water Content (%)	Gravel (%)	Sand (%)	Fines (%)	Water Content (%)	Liquid Limit	Plastic Limit	Plasticity Index				
B101	MC1	10.0 - 11.0	Residual Soil	--	--	--	--	--	--	--	--	--	--	15.8	--	--
B101	MC2	20.0 - 21.0	Residual Soil	--	--	--	--	--	--	--	--	--	--	9.4	--	--
B101	MC3	30.0 - 30.4	Residual Soil	--	--	--	--	--	--	--	--	--	--	15.4	126.4	109.5
B101	S11	35.0 - 36.8	Chinle	--	8.7	0.0	3.6	96.4	--	--	--	--	--	--	--	--
B101	S13	45.0 - 46.8	Chinle	--	15.0	0.0	48.8	53.2	--	--	--	--	--	--	--	--
B101	S15	55.0 - 56.4	Chinle	--	13.0	0.0	35.2	64.8	--	--	--	--	--	--	--	--
B101	S19	75.0 - 76.2	Chinle	10.4	10.2	0.0	30.6	69.4	--	33	16	17	--	--	--	--
B101	S20	80.0 - 81.3	Chinle	10.4	10.8	0.0	19.4	80.6	--	--	--	--	--	--	--	--
B101	S22	90.0 - 91.4	Chinle	--	14.2	0.0	29.3	70.7	--	--	--	--	--	--	--	--
B101	S23	95.0 - 96.8	Chinle	15.9	13.9	0.0	42.1	57.9	--	40	20	20	--	--	--	--
B102	G1	0.0 - 10.0	Caliche	--	--	--	--	--	5.0	NP	NP	NP	2.67	--	--	--
B102	S13(5-17")	30.0 - 32.0	Chinle	13.6	8.6	0.0	27.6	72.4	--	--	--	--	--	--	--	--
B102	S14	35.0 - 36.3	Chinle	9.9	--	--	--	--	--	--	--	--	2.78	--	--	--
B102	S15	40.0 - 41.4	Chinle	8.0	6.6	0.0	14.7	85.3	--	--	--	--	--	--	--	--
B102	S18	45.0 - 45.9	Chinle	14.6	--	--	--	--	--	--	--	--	2.81	--	--	--
B105	MC1	10.0 - 11.0	Caliche	--	--	--	--	--	--	--	--	--	--	16.0	--	--
B105	MC2	20.0 - 20.9	Residual Soil	--	--	--	--	--	--	--	--	--	--	10.3	--	--
B105	S9	25.0 - 26.8	Residual Soil	11.5	--	--	--	--	--	--	--	--	2.74	--	--	--
B105	MC3	40.0 - 41.0	Chinle	--	--	--	--	--	--	--	--	--	--	15.8	124.2	107.3
B105	S14	50.0 - 51.4	Chinle	15.7	--	--	--	--	--	--	--	--	2.81	--	--	--
B105	S15	55.0 - 56.4	Chinle	15.0	12.9	0.0	48.8	51.2	--	--	--	--	--	--	--	--
B106	S5	10.0 - 12.0	Caliche	12.7	13.0	49.2	42.0	8.8	--	43	34	9	--	--	--	--
B106	S7(6-24")	15.0 - 17.0	Residual Soil	11.5	10.7	0.3	80.2	19.5	--	40	15	25	--	--	--	--
B106	S9	20.0 - 21.9	Residual Soil	9.6	9.2	0.0	38.3	61.7	--	40	12	28	--	--	--	--
B106	S10	22.5 - 24.5	Residual Soil	10.8	9.2	0.0	55.9	44.1	--	41	14	27	--	--	--	--
B106	S13	30.0 - 31.1	Chinle	11.0	9.9	0.0	34.3	65.7	--	40	18	22	--	--	--	--
B107	G1	0.0 - 10.0	Caliche	--	--	--	--	--	--	NP	NP	NP	2.65	--	--	--
B107	S7	15.0 - 16.9	Residual Soil	--	8.3	0.0	60.1	39.9	10.9	42	20	22	--	--	--	--
B107	S13	30.0 - 32.0	Chinle	--	11.6	0.0	10.5	89.5	12.1	45	18	27	--	--	--	--
B107	S15	40.0 - 42.0	Chinle	--	10.9	0.0	31.8	68.2	16.5	41	20	21	--	--	--	--
B107	S17	50.0 - 51.3	Chinle	--	13.3	0.0	42.7	57.3	14.9	40	21	19	--	--	--	--
B108	MC1	10.0 - 11.0	Caliche	--	--	--	--	--	--	--	--	--	--	13.3	94.2	83.2
B108	MC2	40.0 - 40.9	Chinle	--	--	--	--	--	--	--	--	--	--	14.7	123.9	108.1
B108	S14	45.0 - 47.0	Chinle	5.5	14.1	0.0	47.0	53.0	--	--	--	--	--	--	--	--
B109	MC1	10.0 - 11.0	Caliche	--	--	--	--	--	--	--	--	--	--	15.9	84.5	72.9
B109	MC2	20.0 - 20.3	Residual Soil	--	--	--	--	--	--	--	--	--	--	7.5	98.6	91.7

Notes:

1. "--" Indicates test was not assigned or performed.
2. "NP" Indicates the sample is nonplastic.
3. Total Unit Weight and Dry Unit Weights from modified california samples.
4. "ft" Indicates feet.
5. "pcf" Indicates pounds per cubic foot.
6. MC = Modified california sample; S = Standard SPT; G = Bulk sample.

HOLTEC INTERNATIONAL COPYRIGHTED MATERIAL

Report No. HI-2167374

Proposed Rev. 0R

2-126

Table 2.6.3: Rock Core Test Results [2.1.24]

Sample Identification			Formation	Test No.	Water Content (%)	Total Unit Weight (pcf)	Dry Unit Weight (pcf)	Unconfined Compressive Strength (ksf)	Strain at Failure (%)	Elastic Modulus (ksf)
Boring Number	Sample Number	Sample Depth (ft)								
B107	C6	84.0 - 85.0	Chinle	UC-1	15.2	126.5	109.8	17.4	0.75 ⁽⁶⁾	2,727
B107	C6	84.0 - 85.0	Chinle	UC-2	16.8	136.9	117.2	5.3	0.90	900
B107	C4	73.9 - 74.6	Chinle	UC-3	15.4	137.8	119.5	25.7	0.80	4,545
B101	C28	226.3 - 226.7	Santa Rosa	NA	NM	159	NM	293	1.50	28,800
B101	C31	244.5 - 244.9	Santa Rosa	NA	NM	163	NM	938	0.45	227,500
B101	C39	283.4 - 283.8	Santa Rosa	NA	NM	160	NM	696	0.74	128,300
B101	C45	309.8 - 310.2	Santa Rosa	NA	NM	156	NM	699	0.62	95,040
B101	C48	324.5 - 325.9	Santa Rosa	NA	NM	163	NM	594	0.60	124,560
B101	C55	360.7 - 361.4	Santa Rosa	NA	NM	157	NM	766	0.56	181,440
B101	C63	399.8 - 400.3	Santa Rosa	NA	NM	164	NM	1003	0.50	263,520

Notes:

1. "ft" Indicates feet.
2. "pcf" Indicates pounds per cubic foot.
3. "ksf" indicates kips per square foot
4. NM indicates not measured.
5. NA indicated not applicable.
6. Strain at failure for UC-1 adjusted to remove initial seating strain

HOLTEC INTERNATIONAL COPYRIGHTED MATERIAL

Report No. HI-2167374

Proposed Rev. 0R

2-127

Table 2.6.4: Shear Wave Velocities [2.1.24]

Depth	Measurement Elevation	Shear Wave Velocity	Formation
(ft)	(ft)	(ft/sec)	
2	3529.4	1092	Caliche
5	3526.4	1057	Caliche
10	3521.4	1019	Caliche
15	3516.4	1087	Residual Soil
20	3511.4	1906	Residual Soil
25	3506.4	1703	Residual Soil
30	3501.4	2005	Residual Soil
35	3496.4	1243	Chinle
40	3491.4	1500	Chinle
45	3486.4	1588	Chinle
50	3481.4	1637	Chinle
55	3476.4	2041	Chinle
60	3471.4	2274	Chinle
65	3466.4	2240	Chinle
70	3461.4	1867	Chinle
75	3456.4	1849	Chinle
80	3451.4	1831	Chinle
85	3446.4	1877	Chinle
90	3441.4	1812	Chinle
95	3436.4	2220	Chinle
100	3431.4	2539	Chinle
105	3426.4	2761	Chinle

Note: Shear wave velocities were measured by crosshole testing at B102A, B103, and B104.

HOLTEC INTERNATIONAL COPYRIGHTED MATERIAL

Report No. HI-2167374

Proposed Rev. 0R

2-128

Table 2.6.5: Testing Deliverable and Reference in SAR and Geotechnical Report [2.1.24]

Deliverable	Reference
Lab Testing Procedures	
No. and Locations of Borings	Table 2.6.1. <i>Boring Exploration Data</i> Figure 2.1.8. <i>Boring Location Plan</i>
Method of Sample Collection	Table 2.6.1. <i>Boring Exploration Data</i>
Types of Field & Lab Testing	Section 3.2. <i>In-Situ Soil Testing</i> in GEI Report Section 4.1. <i>Geotechnical Laboratory Testing of Soil and Rock</i> in GEI Report [2.1.24]
Soil Properties	
Grain Size Classification	<i>Grain Size Analysis</i> in Attachment H in GEI Report [2.1.24]
Atterberg Limits	Table 2.6.2. <i>Soil Index Properties</i> Figure 2.6.9. <i>Atterberg Limit Results Atterberg (Liquid and Plastic) Limits</i> in Attachment H in GEI Report [2.1.24]
Water Content	Table 2.6.2. <i>Soil Index Properties</i> Table 2.6.3. <i>Rock Core Test Results Water Content Measurement (Soil)</i> in Attachment H in GEI Report [2.1.24]
Unit Weight	Table 2.6.2. <i>Soil Index Properties</i> Table 2.6.3. <i>Rock Core Test Results Unit Weigh of Soil</i> in Attachment H in GEI Report [2.1.24]
Specific Gravity	Table 2.6.2. <i>Soil Index Properties Specific Gravity Measurement</i> in Attachment H in GEI Report [2.1.24]
Soil Classification	<i>Particle Size Analysis</i> in Attachment J in GEI Report in GEI Report [2.1.24]
Shear Strength	<i>Unconfined Compression Test</i> in Attachment I in GEI Report [2.1.24]
Shear [Young's] Modulus	Table 2.6.2. <i>Soil Index Properties Compressive Strength and Elastic Moduli of Rock</i> in Attachment K in GEI Report [2.1.24]
Poisson's Ratio	Table 2.6.2. <i>Soil Index Properties Compressive Strength and Elastic Moduli of Rock</i> in Attachment K in GEI Report [2.1.24]

HOLTEC INTERNATIONAL COPYRIGHTED MATERIAL

Report No. HI-2167374

Proposed Rev. 0R

2-129

Seismic Wave Velocities	Figure 2.6.10. <i>Shear Wave Velocities</i> Table 2.6.4. <i>Shear Wave Velocities</i>
Blow Count	<i>Boring Logs</i> in Attachment C in GEI Report [2.1.24]
Groundwater	
Groundwater El.	Table 2.5.1. <i>Groundwater Elevation Data from Monitoring Wells</i>

HOLTEC INTERNATIONAL COPYRIGHTED MATERIAL	
Report No. HI-2167374	Proposed Rev. 0R
2-130	

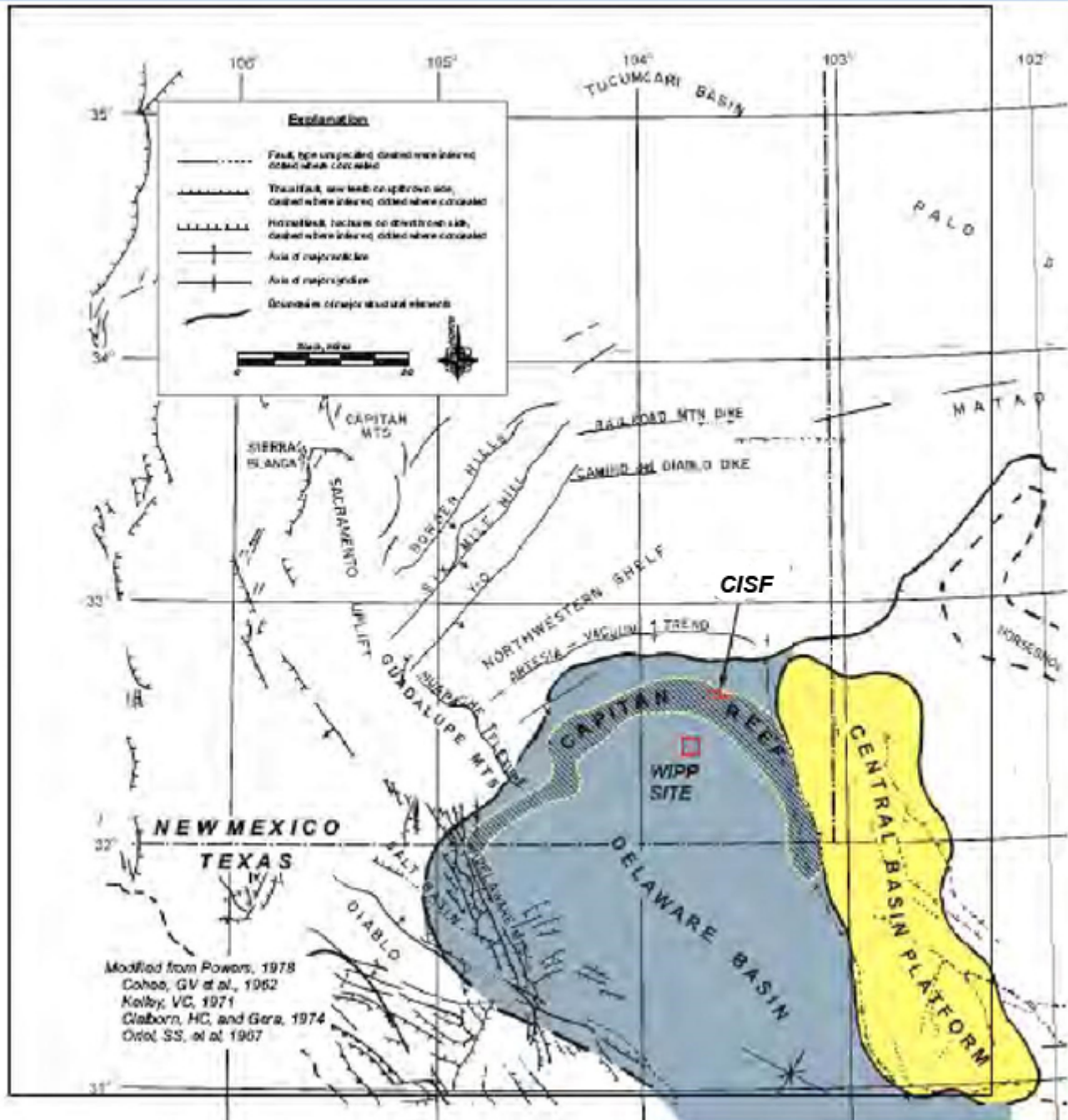


Figure 2.6.1: Major Regional Geological Structures near the Site [2.1.3]

HOLTEC INTERNATIONAL COPYRIGHTED MATERIAL		
Report No. HI-2167374		Proposed Rev. 0R
2-131		

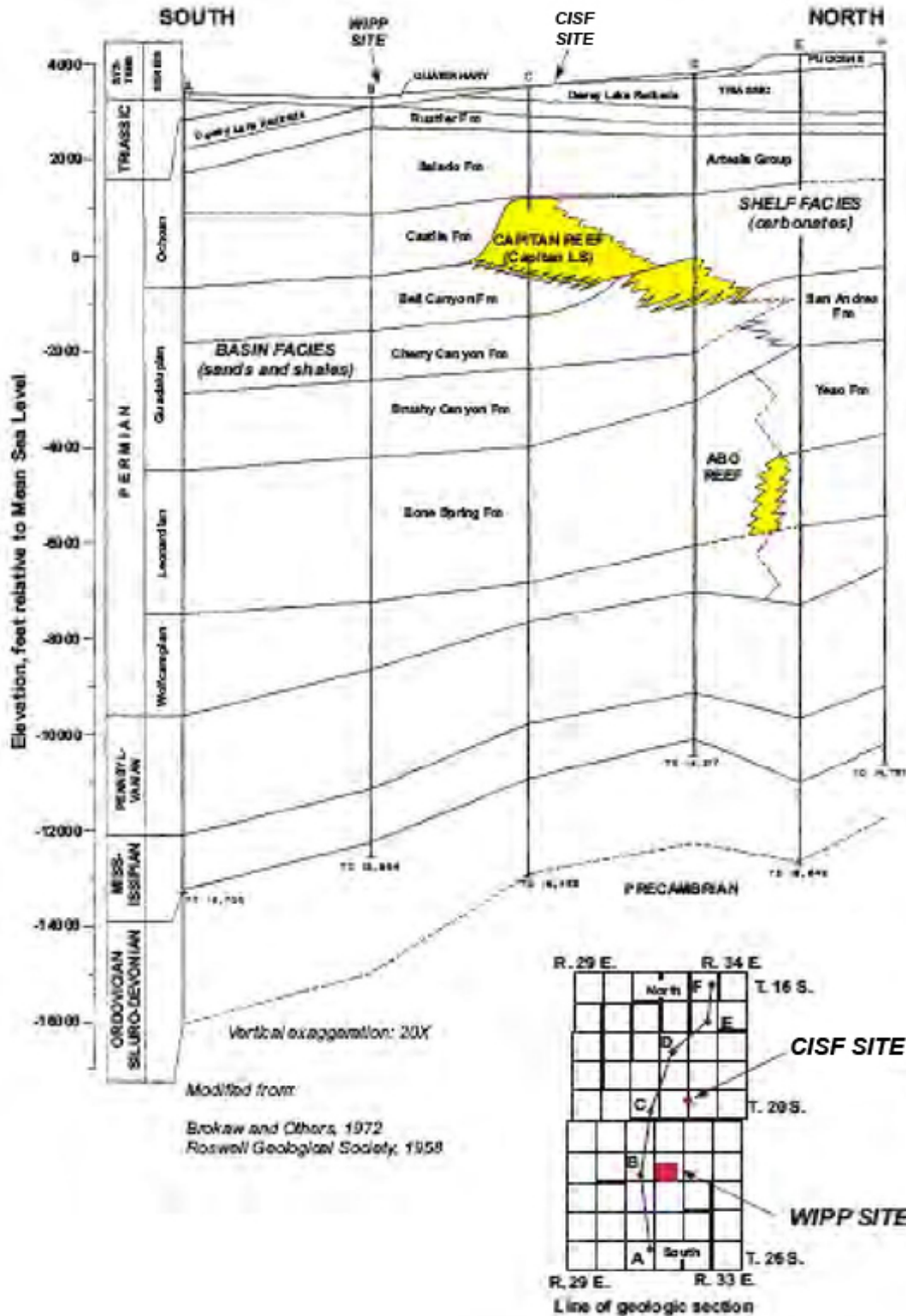


Figure 2.6.2: Geologic Cross Section through the Capitan Reef Area, Eddy and Lea Counties, NM [2.1.3]

HOLTEC INTERNATIONAL COPYRIGHTED MATERIAL		
Report No. HI-2167374		Proposed Rev. 0R
2-132		

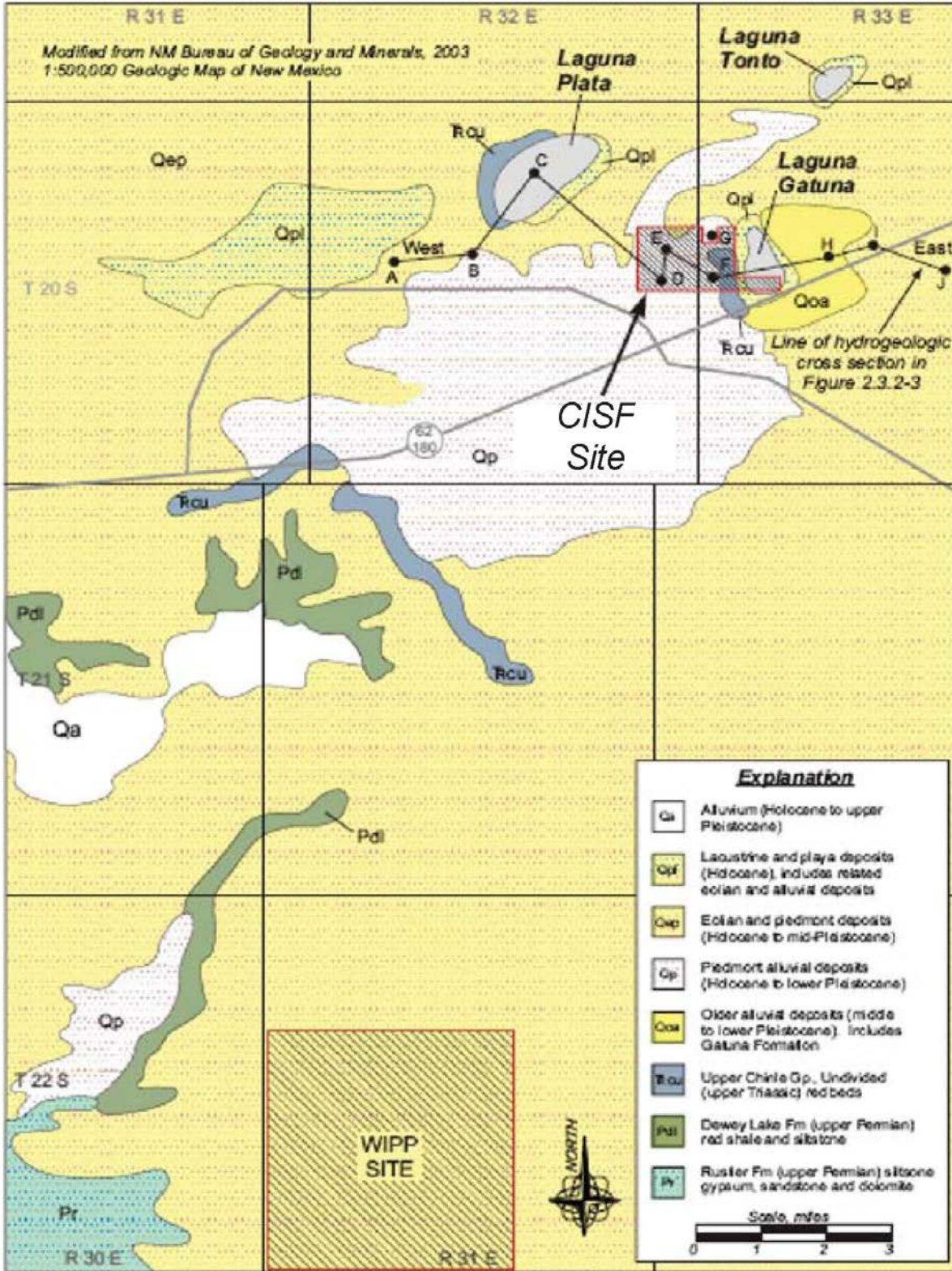


Figure 2.6.3: Surficial Geology in the Vicinity of the Site [2.1.3]

HOLTEC INTERNATIONAL COPYRIGHTED MATERIAL		
Report No. HI-2167374		Proposed Rev. 0R
2-133		

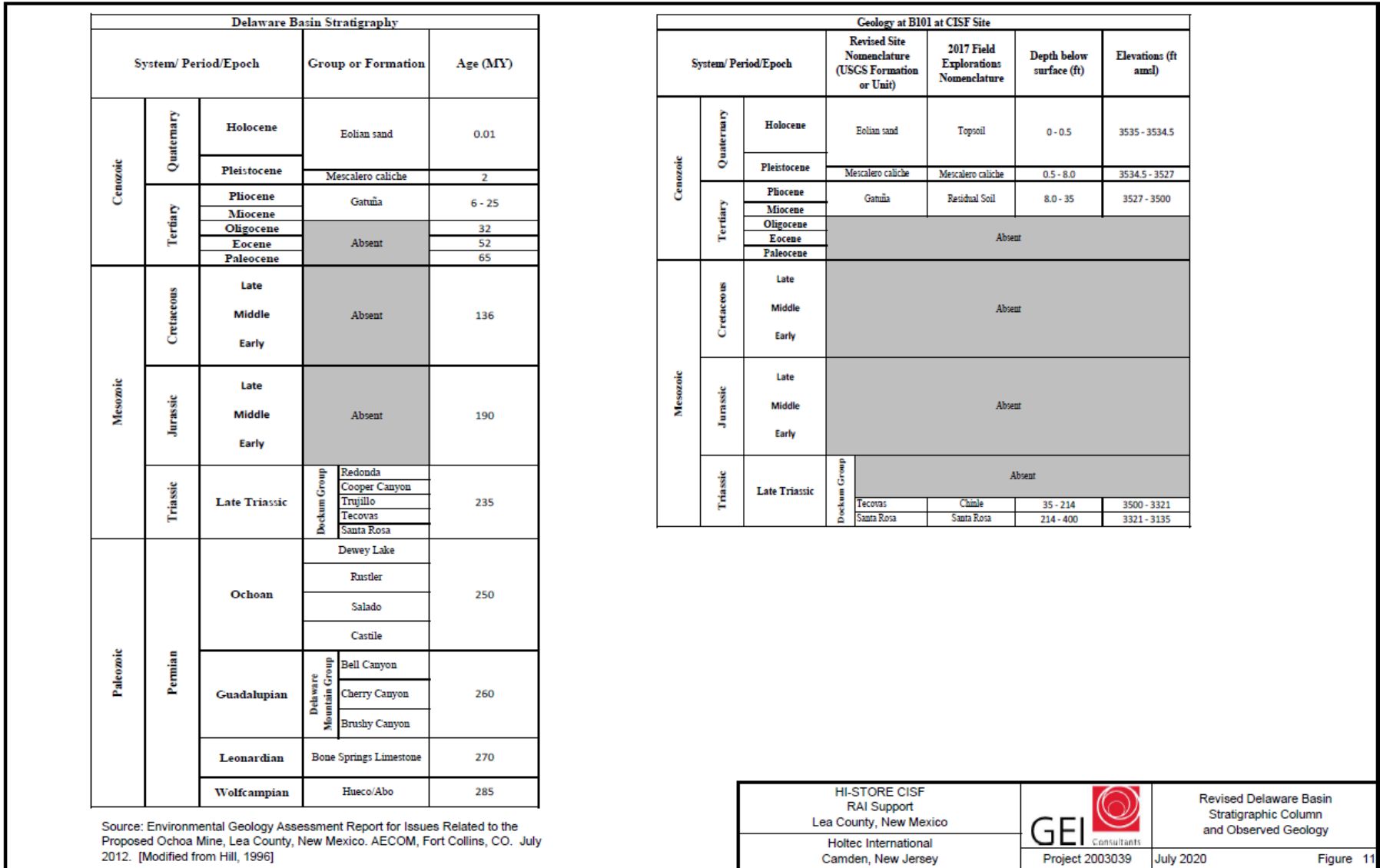


Figure 2.6.5: Stratigraphy of the Delaware Basin [2.1.3]

HOLTEC INTERNATIONAL COPYRIGHTED MATERIAL

Report No. HI-2167374

Proposed Rev. 0R

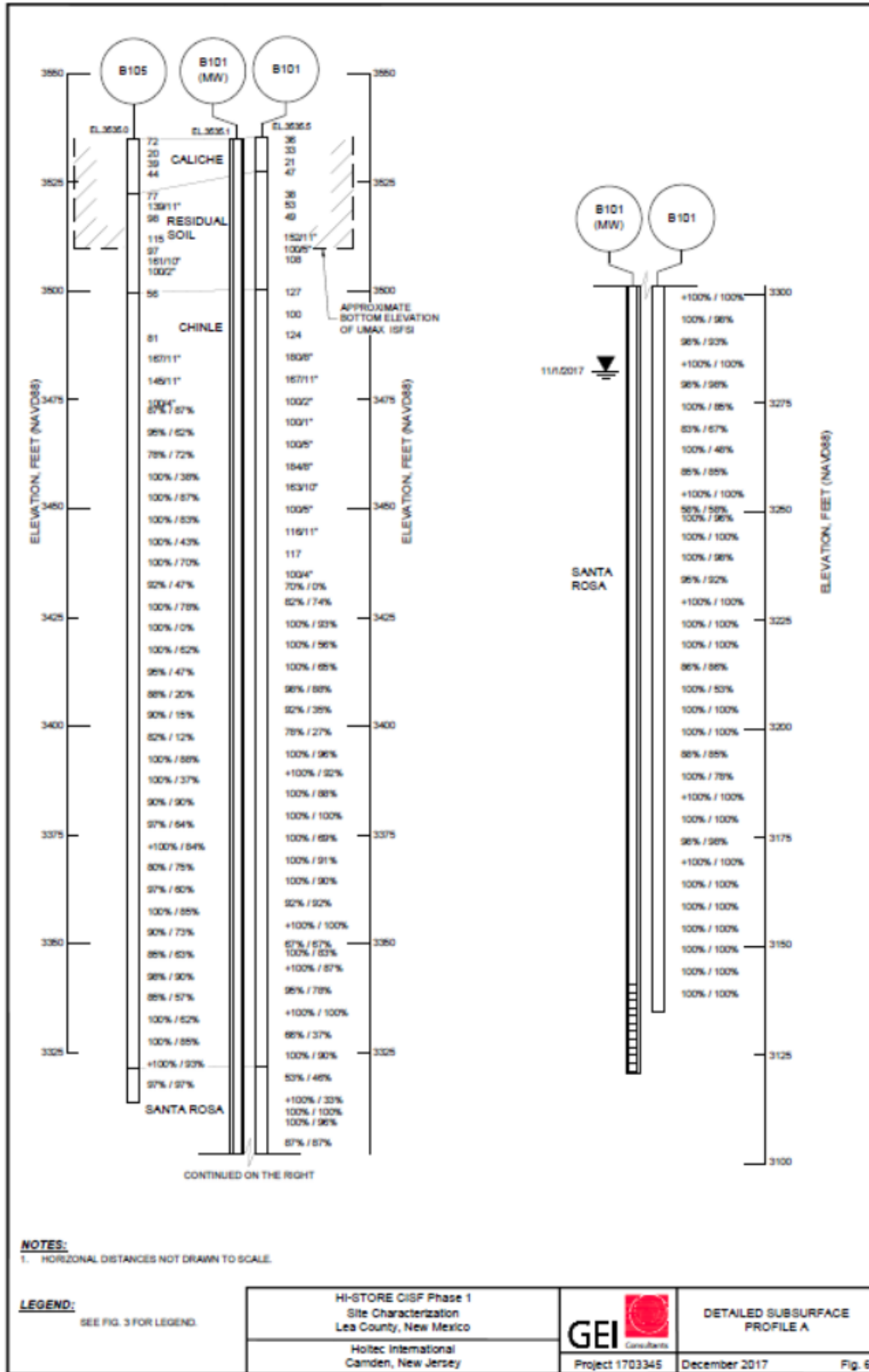


Figure 2.6.6: Phase 1 Detailed Subsurface Profile A [2.1.24]

HOLTEC INTERNATIONAL COPYRIGHTED MATERIAL		
Report No. HI-2167374	Proposed Rev. 0R	
2-136		

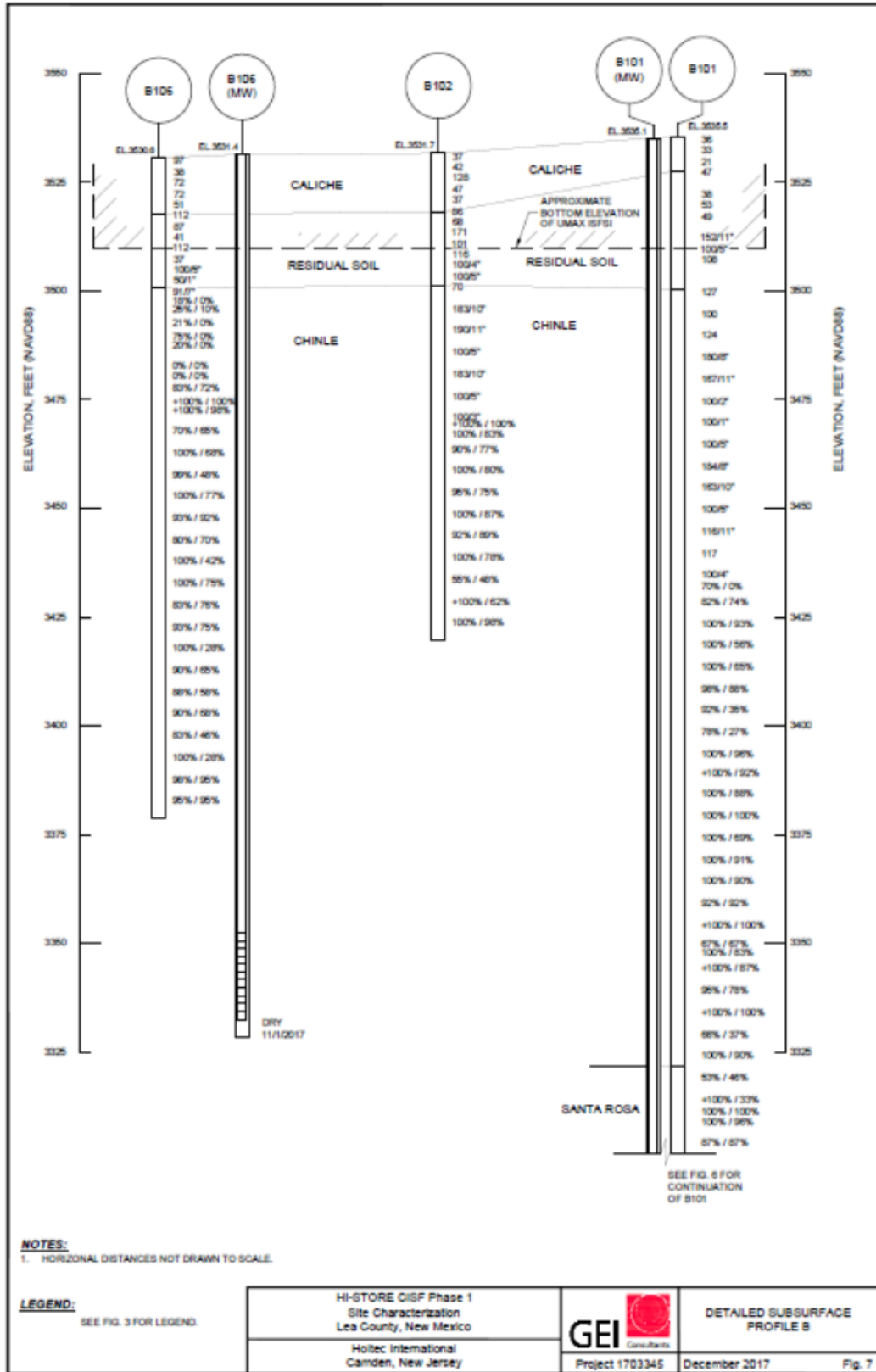


Figure 2.6.7: Phase 1 Detailed Subsurface Profile B [2.1.24]

HOLTEC INTERNATIONAL COPYRIGHTED MATERIAL	
Report No. HI-2167374	Proposed Rev. 0R
2-137	

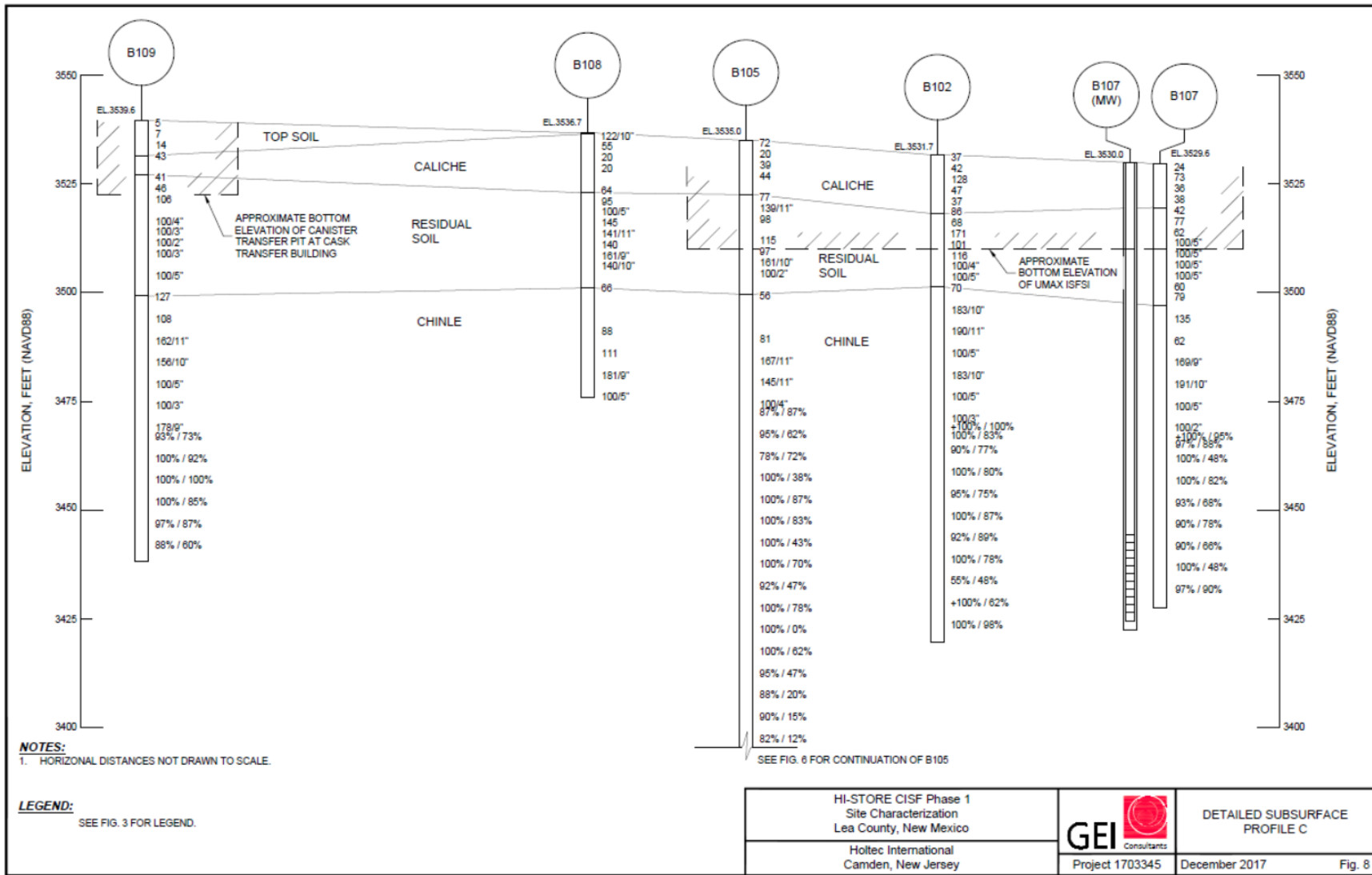


Figure 2.6.8: Phase 1 Detailed Subsurface Profile C [2.1.24]

HOLTEC INTERNATIONAL COPYRIGHTED MATERIAL

Report No. HI-2167374

Proposed Rev. 0R

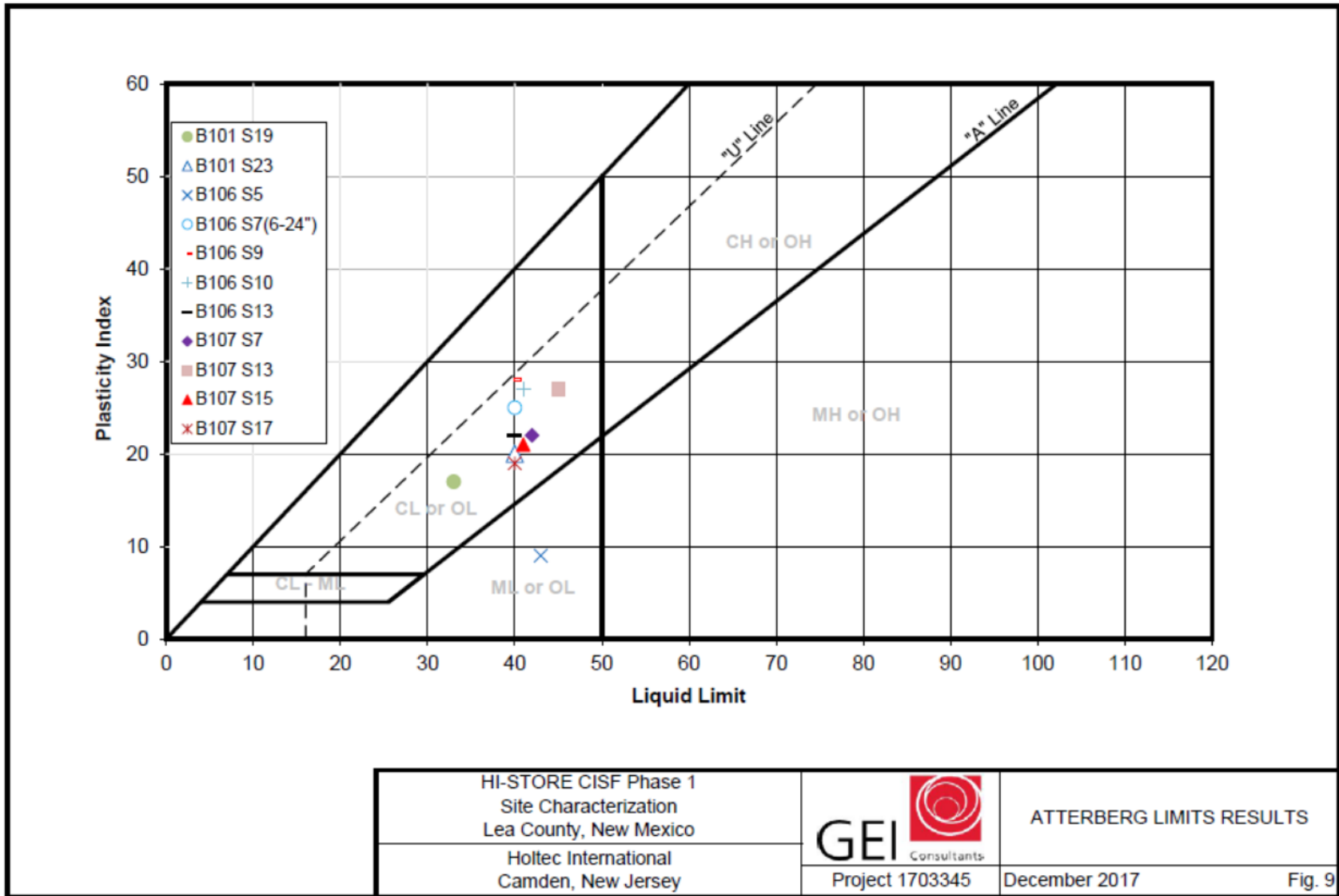


Figure 2.6.9: Phase 1 Atterberg Limit Results [2.1.24]

HOLTEC INTERNATIONAL COPYRIGHTED MATERIAL

Report No. HI-2167374

Proposed Rev. 0R

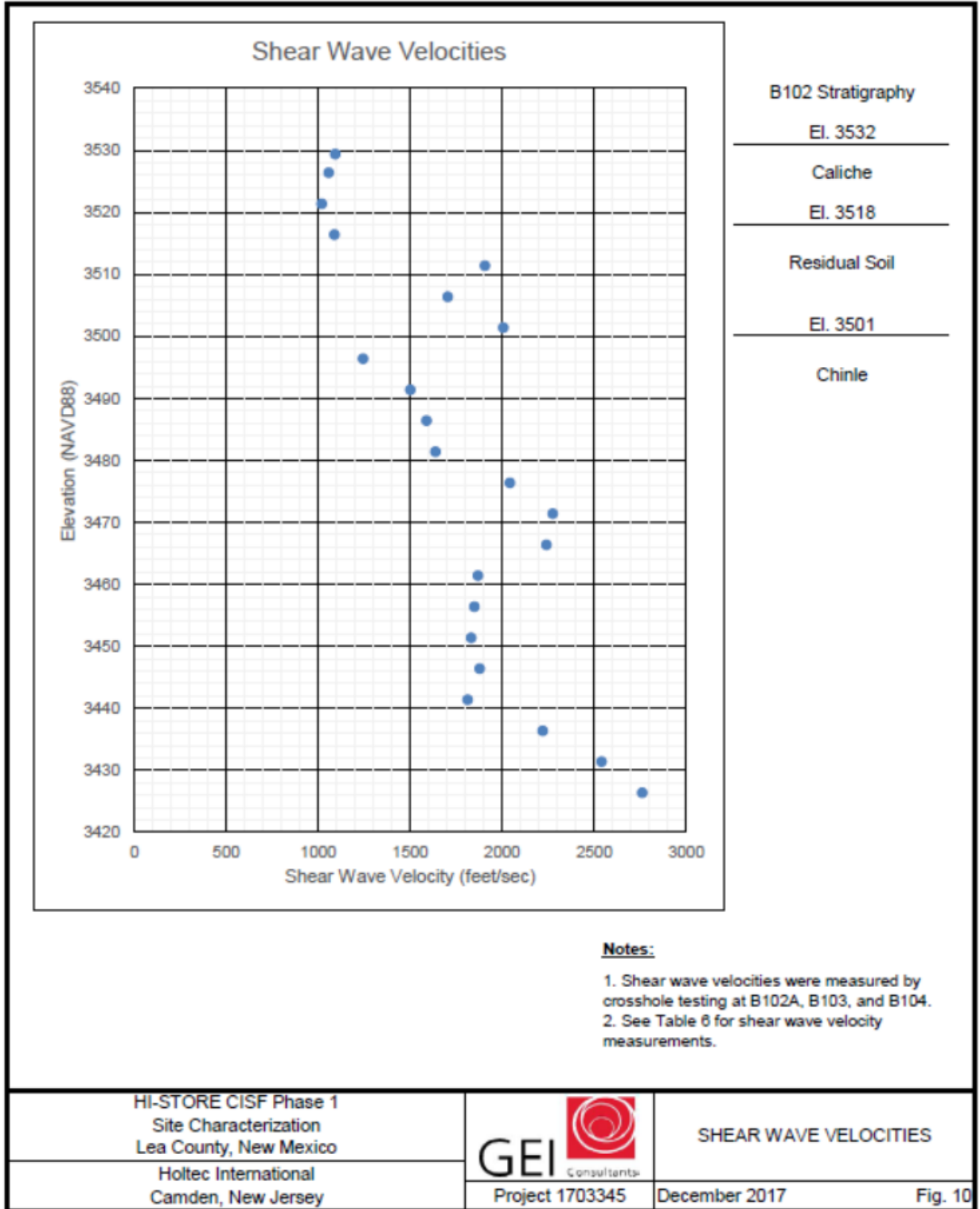


Figure 2.6.10: Phase 1 Shear Wave Velocity Results [2.1.24]

HOLTEC INTERNATIONAL COPYRIGHTED MATERIAL	
Report No. HI-2167374	Proposed Rev. 0R
2-140	

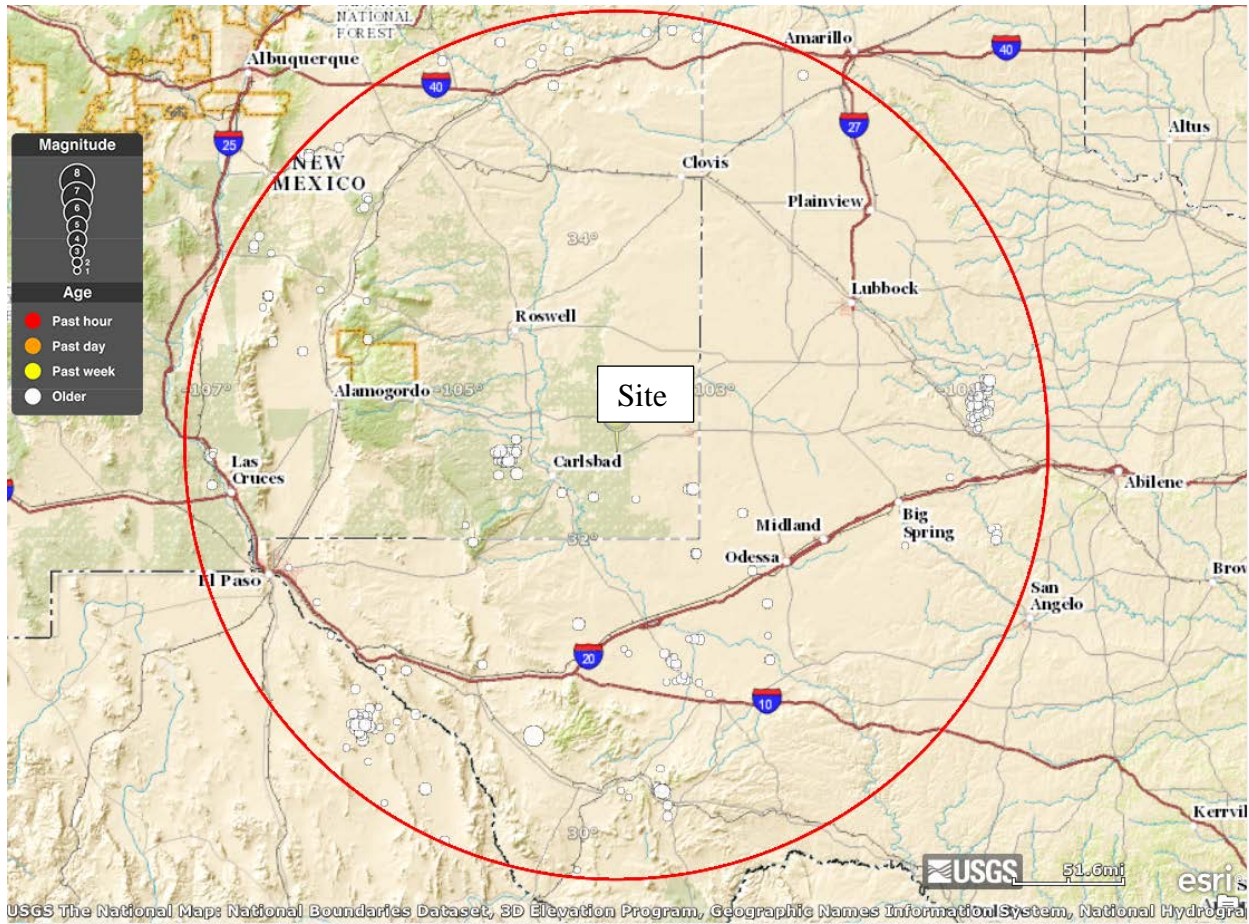
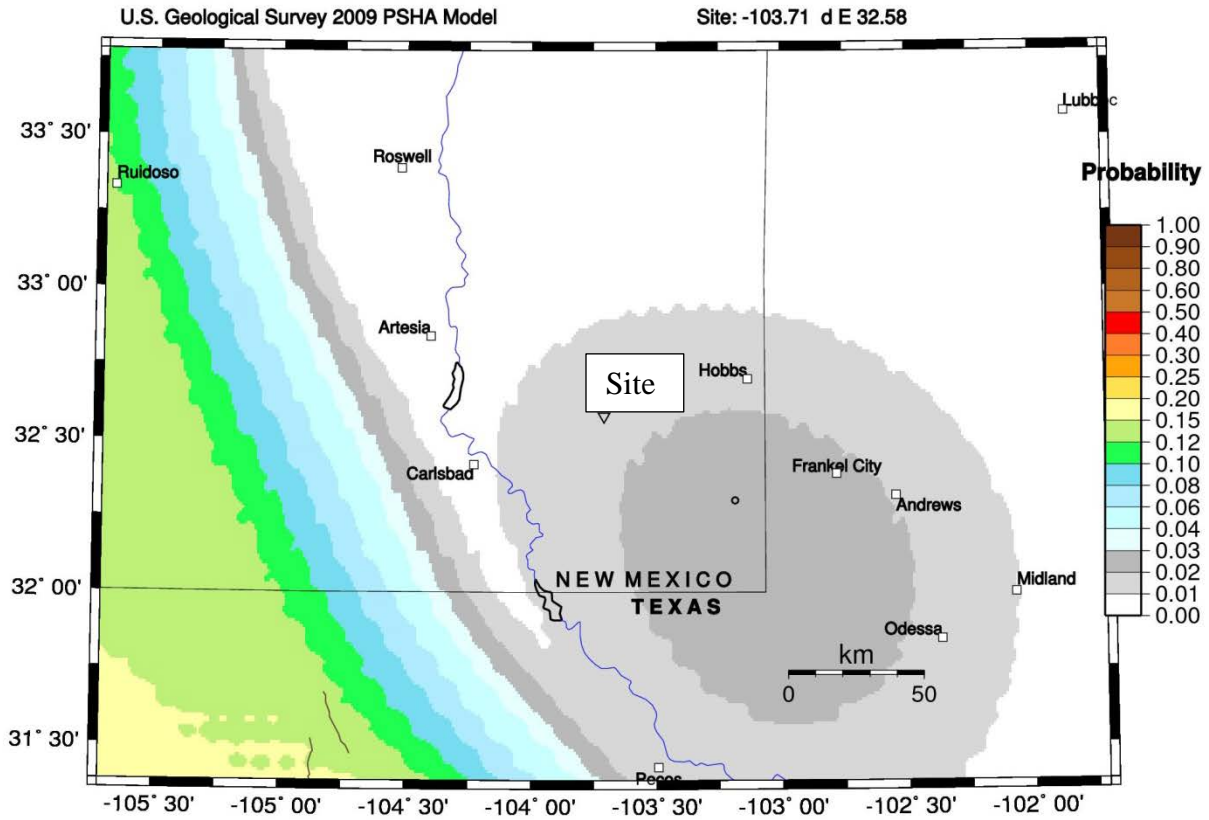


Figure 2.6.11: Earthquakes (Magnitude 2.5 or greater) within 200 miles of the Site [2.6.3]

HOLTEC INTERNATIONAL COPYRIGHTED MATERIAL	
Report No. HI-2167374	Proposed Rev. 0R
2-141	



GMT 2016 Oct 13 20:14:04 EQ probabilities from USGS OFR 08-1128 PSHA. 50 km maximum horizontal distance. Site of interest: triangle. Fault traces are brown; rivers blue. Epicenters M=5.0 circles.

Figure 2.6.12: Probability of earthquake with Magnitude greater than 5.0 within 50 years and 30 miles of the site [2.6.4]

HOLTEC INTERNATIONAL COPYRIGHTED MATERIAL	
Report No. HI-2167374	Proposed Rev. 0R
2-142	

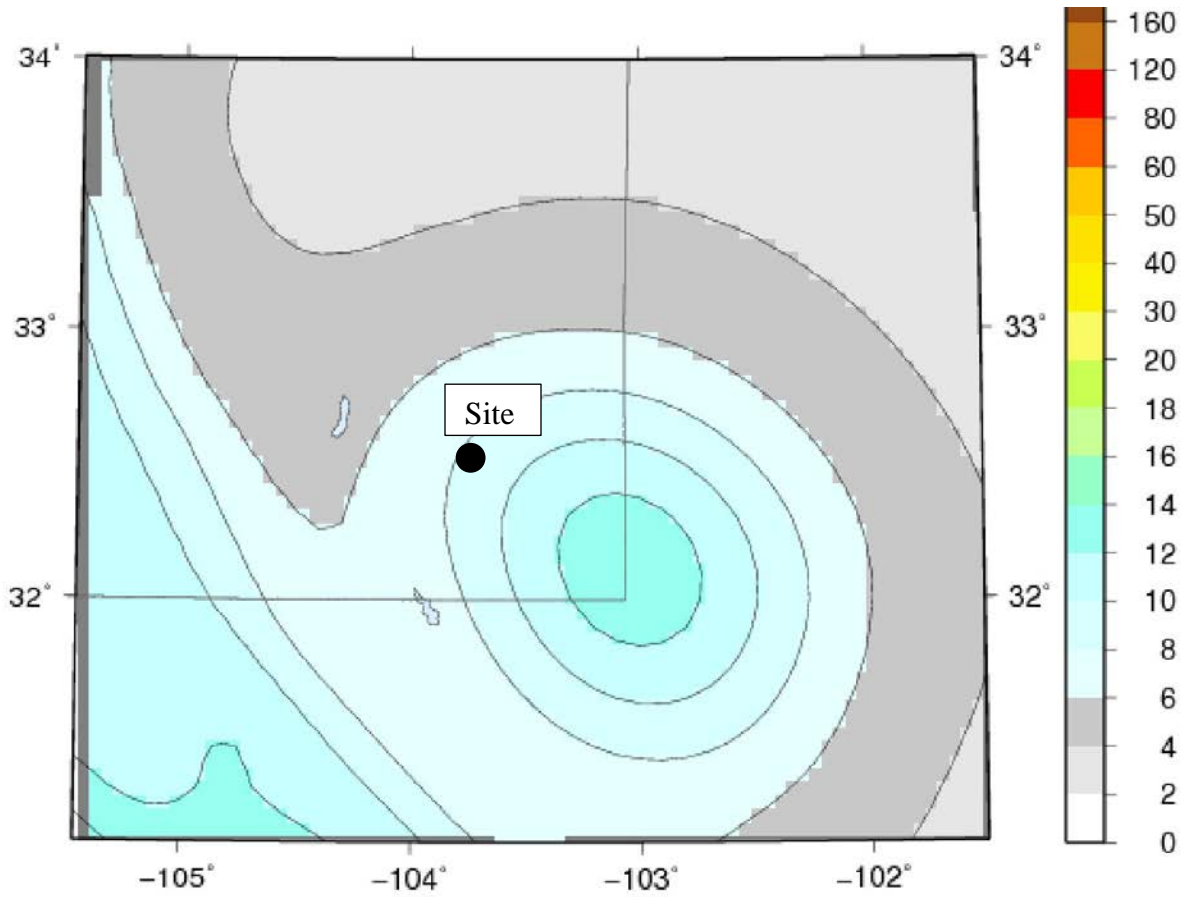


Figure 2.6.13: Peak Ground Acceleration (percent of gravity) (2,500 year return interval)
[2.6.4]

HOLTEC INTERNATIONAL COPYRIGHTED MATERIAL	
Report No. HI-2167374	Proposed Rev. 0R
2-143	

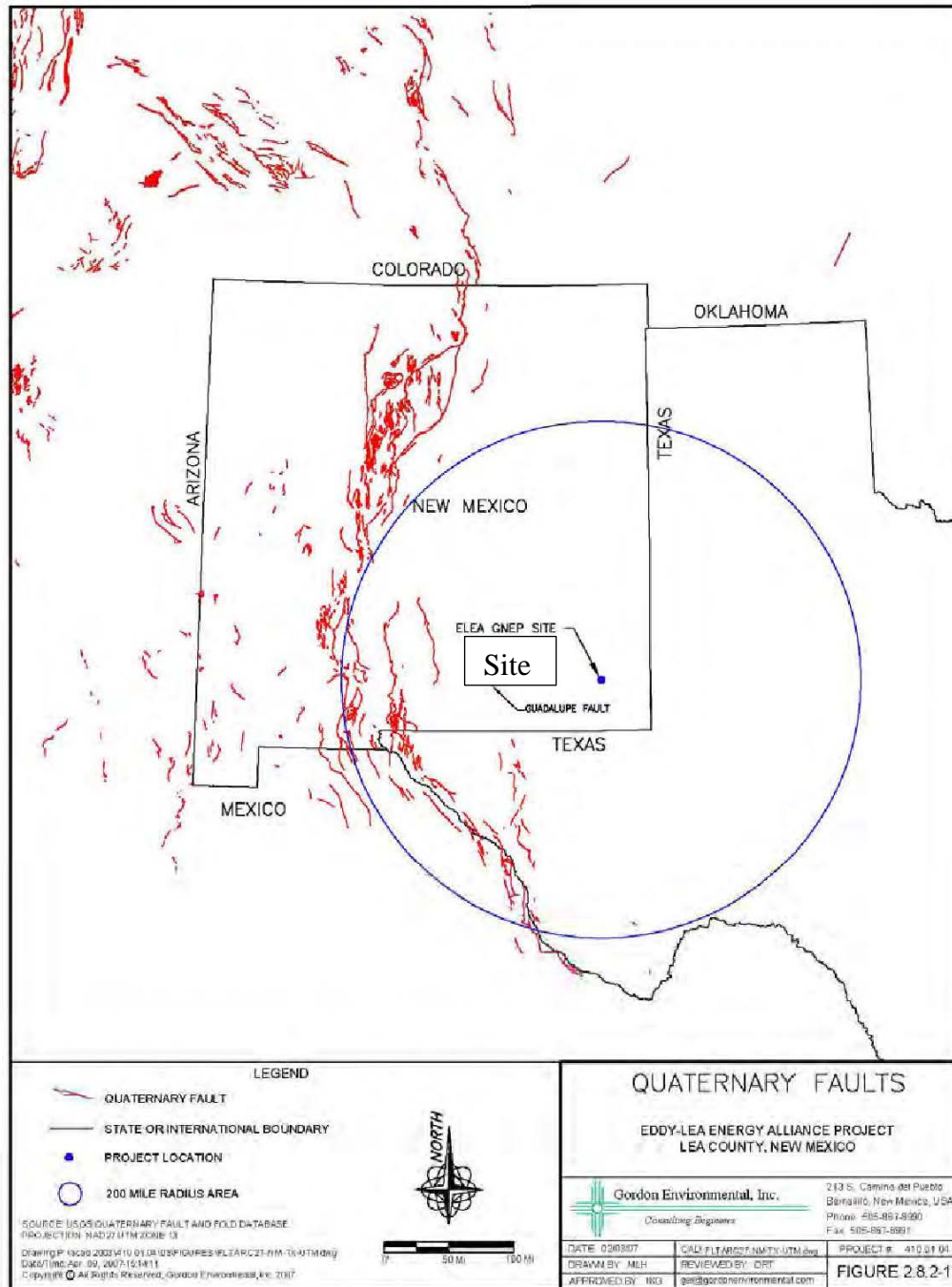


Figure 2.6.14: Quaternary faults within 200-mile radius of the site [2.6.8]

HOLTEC INTERNATIONAL COPYRIGHTED MATERIAL		
Report No. HI-2167374		Proposed Rev. 0R
2-144		

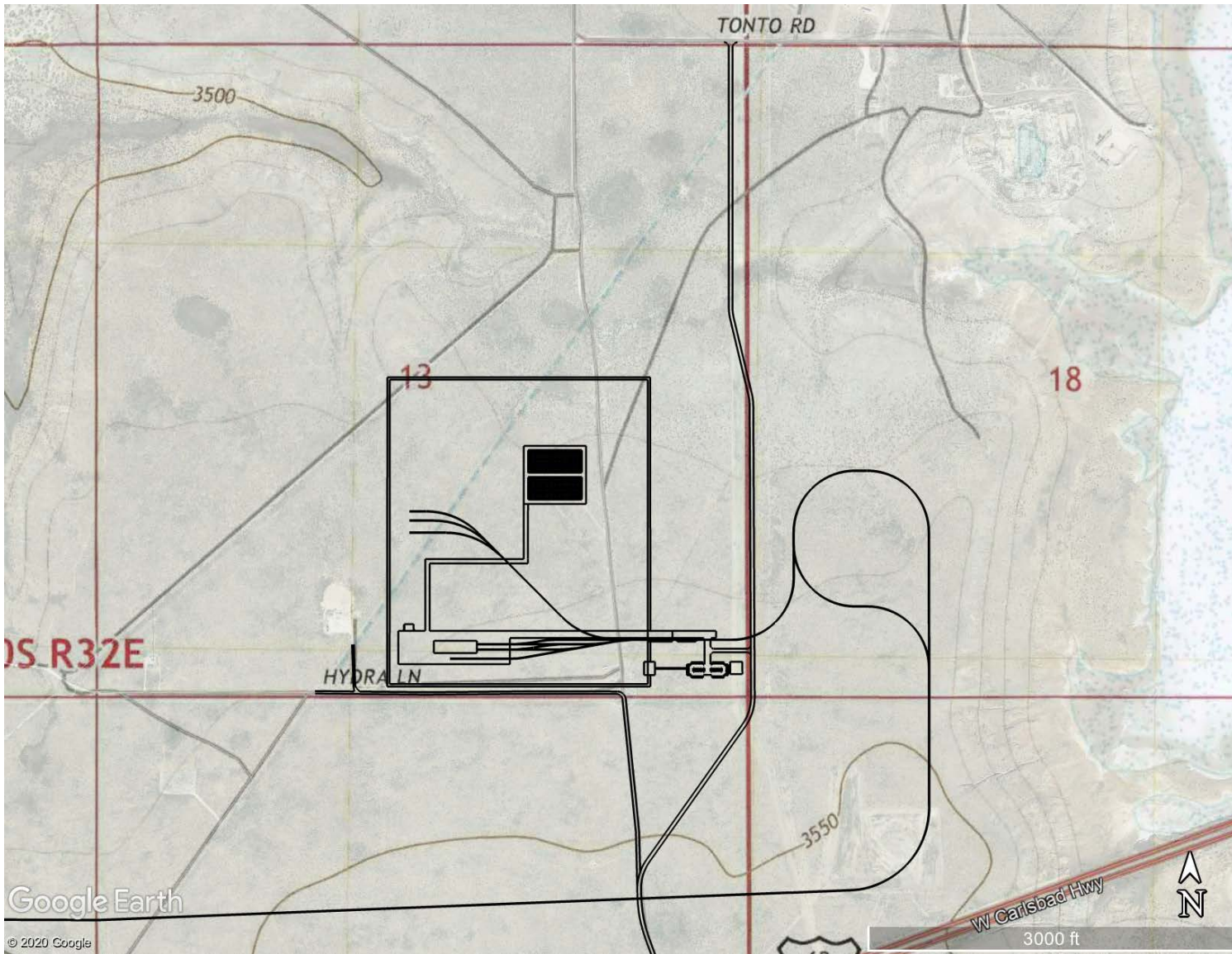


Figure 2.6.15: Elevation Contours at the Site [2.1.26]

HOLTEC INTERNATIONAL COPYRIGHTED MATERIAL

Report No. HI-2167374

Proposed Rev. 0R

2-145

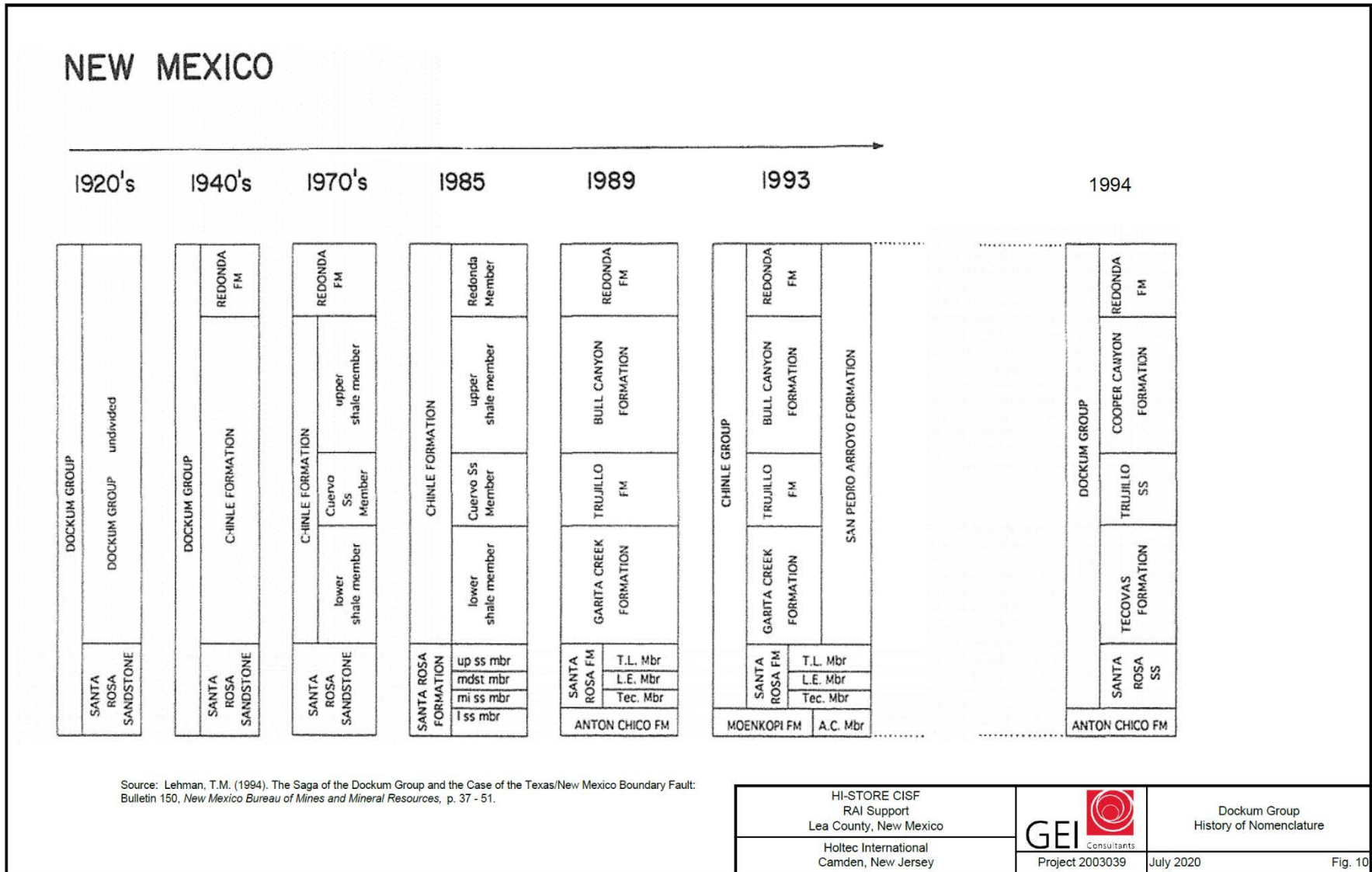


Figure 2.6.16: History of USGS Nomenclature at the Site

HOLTEC INTERNATIONAL COPYRIGHTED MATERIAL		
Report No. HI-2167374	Proposed Rev. 0R	
2-146		

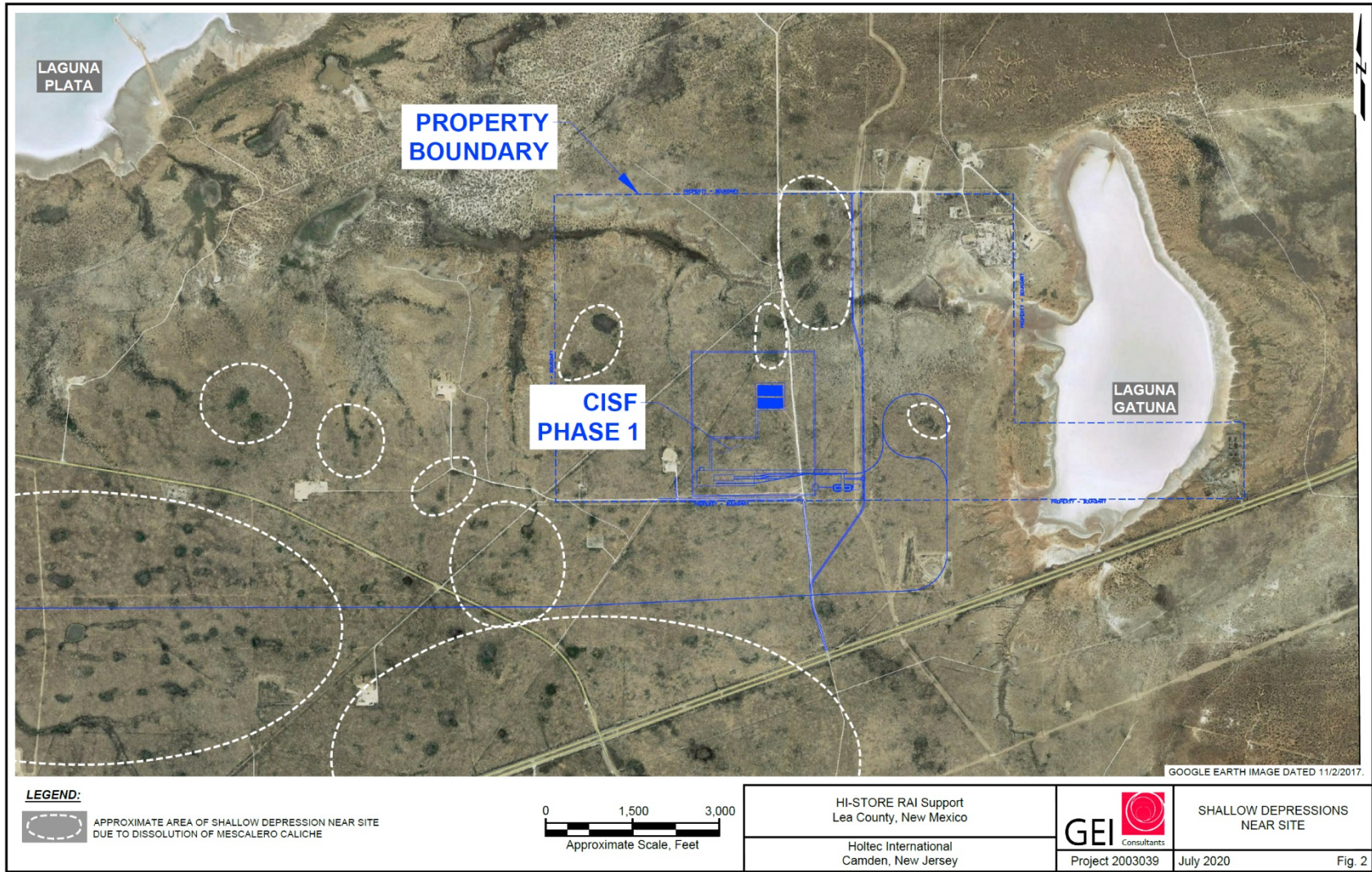


Figure 2.6.17: Circular Depression Features Near the Site (Buffalo Wallows)

HOLTEC INTERNATIONAL COPYRIGHTED MATERIAL		
Report No. HI-2167374		Proposed Rev. 0R
2-147		

2.7 SITE SPECIFIC DATA FOR THERMAL AND STRUCTURAL ANALYSES

The site characterization effort, summarized in this chapter, enables a conservative set of parameters important to thermal and structural analyses to be established. These parameters are summarized in Table 2.7.1 and are used in Chapter 5 (Structural) and Chapter 6 (Thermal). The ambient temperature in Table 2.7.1 is based on the meteorological data for the site with a small margin added for conservatism.

The 10,000-year return earthquake, adopted as the Design Basis Earthquake (DBE) for the HI-STORE facility, is bounded by the classical Reg. Guide 1.60 response spectrum with its ZPAs denoted in Table 2.7.1. Likewise, the bounding tornado missiles considered for the Site are based on the regulatory guidance and a national standard [2.7.1, 2.7.2]. These are **bounded by the missile characteristics** considered for the HI-STORM FW MPC Storage System in Docket 72-1032 and the HI-STORM UMAX Canister Storage System in Docket 72-1040.

HOLTEC INTERNATIONAL COPYRIGHTED MATERIAL	
Report No. HI-2167374	Proposed Rev. 0R
2-148	

Table 2.7.1		
SITE SPECIFIC DATA FOR THERMAL AND STRUCTURAL ANALYSIS		
Parameter	Conservatively assumed value for analysis based on site data	Comment
Normal Ambient Temperature (°F)	62	Bounding Annual Average at the Site
Normal Soil Temperature (°F)	62	Conservatively assumed to be equal to the Normal Ambient Temperature
Off-Normal Ambient Temperature (°F)	91	This temperature is based on 3-day average ambient temperature defined by evaluating local weather service records for the Lea County in which the Site is situated
Extreme Accident Level Ambient Temperature (°F)	108	This temperature value is the extreme maximum ambient temperature recorded at the Site
Reference temperature for short term operations (°F)	0 (min) and 91 (max)	This temperature is based on 3-day average ambient temperature defined by evaluating local weather service records for the Lea County in which the Site is situated
Extreme Minimum Ambient Temperature recorded in the region (°F)	See Table 2.3.1	This temperature value is used in the stress analysis of the site specific ancillaries
Extreme Maximum Ambient Temperature recorded in the region (°F)	See Table 2.3.1	This temperature value is used in the stress analysis of the site specific ancillaries
Site Elevation (feet above mean sea level)	3,520 (min) to 3,540 (max)	
Design Basis Earthquake (DBE) ZPAs in the two horizontal (X and Y) and vertical (Z) directions	See Table 4.3.3	
Design Basis Missiles and their incident velocity	See Table 2.7.2	Per Region II in [2.7.1]

HOLTEC INTERNATIONAL COPYRIGHTED MATERIAL

Report No. HI-2167374

Proposed Rev. 0R

2-149

TABLE 2.7.2;		
TORNADO GENERATED MISSILES*		
Missile Description	Mass (kg)	Velocity (fps)
Automobile	1810	112
Schedule 40 pipe (6.625 in. diameter x 15 ft. long)	130	112
Solid steel sphere (1 in. diameter)	0.07	23

*The tornado wind characteristics are provided in Table 1 of [2.7.1] for Region II

HOLTEC INTERNATIONAL COPYRIGHTED MATERIAL	
Report No. HI-2167374	Proposed Rev. 0R
2-150	

2.8 SAFETY-RELEVANT ENVIRONMENTAL DETERMINATIONS

The geotechnical information on the proposed HI-STORE CIS Facility presented in this chapter may be summarized in the following points:

- The facility will be located in one of the most sparsely populated areas in the continental United States. The nearest population centers are the cities of Carlsbad (32 miles away) and Hobbs (34 miles away).
- The topography of the land is relatively flat lending to effective intrusion detection by camera surveillance.
- The water table is sufficiently below the bottom of the subterranean HI-STORM UMAX system to preclude the possibility of any ground water intrusion in the storage cavity spaces.
- The land is fallow with limited vegetation to support cattle herds.
- The annual rainfall is meager requiring a modest water drainage infrastructure.
- The tornadic activity in the region is infrequent. The strength of the tornadoes is bounded by the national meteorological tornadic data which has been used to define the Design Basis Missiles for both the HI-STORM FW system and the HI-STORM UMAX system. Therefore, the storage system's ability to withstand the site specific tornados is axiomatically satisfied.
- There are no active volcanoes in the area.
- The area has a stable tectonic plate profile. As a result, the 10,000 year-return earthquake for the site is quite modest and well below the range for which HI-STORM UMAX as licensed in Docket 72-1040.
- There are no chemical plants in the area that would spew aggressive species into the environment. As a result, the ambient air is non-aggressive and a long service life of the stored stainless steel canisters can be predicted with confidence.
- There is no air force base or a major civilian airport in the vicinity of the site and the area is ostensibly not used for any aerial training exercises by the US military.
- The local area has a well-developed rail road infrastructure. The length of additional rail spur required for the site in less than 10 miles.

The above considerations lead to the conclusion that the proposed Site is suitable for its intended purpose.

HOLTEC INTERNATIONAL COPYRIGHTED MATERIAL	
Report No. HI-2167374	Proposed Rev. 0R
2-151	

2.9 REGULATORY COMPLIANCE

Pursuant to the guidance provided in NUREG-1567, the foregoing material in this Chapter provides:

- i. A complete description of the Geography and Demography of the Site as mandated by 10 CFR 72.24, 72.90, 72.96, 72.98, and 72.100;
- ii. A complete identification and description of key characteristics of Nearby Facilities as mandated by 10 CFR 72.24, 72.40, 72.90, 72.94, 72.96, 72.98, 72.100, and 72.122;
- iii. A complete description of the Meteorology and Surface Hydrology of the Site as mandated by 10 CFR 72.24, 72.40, 72.90, 72.92, 72.98, and 72.122;
- iv. A complete description of the Subsurface Hydrology of the Site as mandated by 10 CFR 72.24, 72.98, and 72.122;
- v. A complete description of the Geology and Seismology of the Site as mandated by 10 CFR 72.24, 72.40, 72.90, 72.92, 72.98, 72.102, and 72.122;

Therefore, it can be concluded that this SAR provides adequate description and safety assessment of the site which this ISFSI Facility is to be located, in accordance with 10 CFR 72.24(a). Additionally, it can be concluded that the proposed site complies with the criteria of 10 CFR 72 Subpart E, as required by 10 CFR 72.40(a)(2).

HOLTEC INTERNATIONAL COPYRIGHTED MATERIAL	
Report No. HI-2167374	Proposed Rev. 0R
2-152	

CHAPTER 3: OPERATIONS AT THE HI-STORE CIS FACILITY*

3.0 INTRODUCTION

This chapter describes the activities and operations antecedent to safely emplacing a loaded canister in the HI-STORM UMAX VVM at the HI-STORE CIS facility. Chapter 9 of the HI-STORM UMAX FSAR [1.0.6] and the HI-STORM FW FSAR [1.3.7] describe the operations carried out at a nuclear plant to implement on-site dry storage. While fuel loading operations are not a part of the activities at the HI-STORE CIS facility, an informational description is provided herein for reference. As the narrative in this chapter explains, the systems and operations required to effectuate transfer of canisters to the HI-STORM UMAX at HI-STORE meet the intent of 10CFR72.122 in full measure.

In particular, it is shown that the loading operations are characterized by a number of defense-in-depth measures, described in Chapter 4 and evaluated in Chapter 15, that are intended to preclude a handling accident or ALARA transgression. The defense-in-depth measures include:

- All lifting and handling devices comply with ANSI 14.6 [1.2.4] with the added requirement that the weakening effect of temperature on the strength of the lifting device is included.
- The standard lifting and handling devices, such as the Vertical Cask Transporter (VCT) comply with the added structural margin requirements set down in Chapter 4 of this SAR.
- The VCT, a key piece of equipment in heavy load handling evolutions, is equipped with a redundant drop protection features.
- The kinematic stability of the loaded equipment for every stability-vulnerable handling evolution under the site's Design Basis Earthquake (DBE) has been established by appropriate analysis.
- All lifting and handling devices are designed to maintain the CG of the lifted SSC aligned with the lift point at all times thus precluding an unstable lift.
- Custom engineered shielding accessories are utilized to meet ALARA goals.
- The crane employed at the facility is designed to be single failure proof in compliance with ASME NOG-1 [3.0.1].
- All operations will be performed in accordance with written and QA validated procedures.
- The HI-STORE CIS facility is a "start clean, stay clean" facility. This means the arriving package from the sender plant site has been assayed and declared to be free of any external contamination.

* All references are placed within square brackets in this report and are compiled in Chapter 19 in this report.

HOLTEC INTERNATIONAL COPYRIGHTED MATERIAL	
Report No. HI-2167374	Proposed Rev. 0Q
3-1	

- The HI-STORE facility is a zero effluent site; no liquid or gaseous effluents are a part of any operation at the facility.
- Even though not required to maintain stability during the site's DBE, the HI-TRAC CS transfer cask is secured by anchor bolts during all operations involving transfer of the loaded canister.

The information presented in this chapter along with the technical basis of the system design described in the canister's FSAR in its host 10CFR72 docket will be used to develop detailed operating procedures. In preparing the procedures, the conditions of the license and technical specifications, equipment-specific operating instructions, as well as the information in this chapter will be utilized to ensure that the short-term operations shall be carried out with utmost safety and ALARA.

The following generic criteria shall be used to determine whether the operating procedures developed pursuant to the guidance in this chapter are acceptable for use:

- All heavy load handling instructions are in keeping with the guidance in industry standards and Holtec's Rigging Manual.
- The procedures are in conformance with this SAR and its CoC.
- The procedures are in conformance with the canister's native FSAR (HI-STORM FW System FSAR for MPC-89 and MPC-37) [1.3.7].
- The operational steps are ALARA.
- The procedures contain provisions for documenting successful execution of all safety significant steps for archival reference.
- Procedures contain provisions for classroom and hands-on training and for a Holtec-approved personnel qualification process to ensure that all operations personnel are adequately trained.
- The procedures are sufficiently detailed and articulated to enable craft labor to execute them in literal compliance with their content.

Written procedures are required to be developed or modified to account for such items as handling and storage of systems, structures and components (SSCs) identified as important-to-safety, heavy load handling, specialized instrument calibration, special nuclear material accountability, fuel handling procedures, training, equipment, and process qualifications. The HI-STORE CIS facility management organization shall implement controls to ensure that all critical set points (e.g., Lift Weights) do not exceed the design limit of the specific equipment.

Control of the operation shall be performed in accordance with Holtec's Quality Assurance (QA) program to ensure critical steps are not overlooked and the canister has been confirmed to meet all requirements of the license before being released for on-site storage under 10CFR72.

The organization of the material and contents in this chapter follows the guidelines of NUREG-1567 [1.0.3].

HOLTEC INTERNATIONAL COPYRIGHTED MATERIAL	
Report No. HI-2167374	Proposed Rev. 0Q
3-2	

3.1 DESCRIPTION OF OPERATIONS

Operations related to the loading and closure of the canisters of spent fuel to be stored at HI-STORE are performed at the originating nuclear power plant. Spent fuel operations at the originating power plant are performed in accordance with the originating plant Owner's 10CFR50 license, any 10CFR72 site-specific and generic licenses, as well as the Technical Specification of the storage system. Transport of the spent fuel from the plant to HI-STORE is performed in accordance with the requirements of 10CFR71 [1.3.2] and 49CFR171, 172, 173, 174, and 177 [3.1.2, 3.1.3, 10.3.1, 3.1.4, 3.1.5]. The HI-STORE facility will be designed to receive fuel from any licensed canister-based transportation cask **listed in Table 1.0.5**. Storage of the spent fuel at HI-STORE is subject to the requirements of the HI-STORE CIS facility license issued pursuant to the regulations of 10CFR72. Compliance with 10CFR72 regulations [1.0.5] begins when the transportation cask enters the Cask Transfer Building (CTB).

The operations that are performed at HI-STORE include the following:

- Receipt and inspection of incoming transportation casks with canisters containing spent nuclear fuel.
- Transfer of canisters from transportation cask to the HI-TRAC CS transfer cask in the Canister Transfer Facility (CTF).
- Transfer of the HI-TRAC CS to the HI-STORM UMAX at the subterranean ISFSI.
- Surveillance of HI-STORM UMAX system.
- Security of HI-STORE.
- Health Physics at HI-STORE.
- Maintenance at HI-STORE.
- Removal of canisters from HI-STORE.
- Inventory documentation management.

Principal operations at the HI-STORE CIS facility involve activities pertaining to handling, transfer and placement of canisters in the facility's VVMs. Future removal of canisters for off-site shipment will involve the reverse of the loading operations. During storage at the HI-STORE facility, several supporting activities are required including monitoring of the storage systems and periodic maintenance of onsite equipment. Holtec International will implement detailed procedures for operating, inspecting, and testing the HI-STORE CIS facility SSCs in accordance with configuration-controlled written procedures similar to the ones employed at its existing user's ISFSIs. These procedures will ensure that the spent fuel handling and storage operations are in accordance with the HI-STORE SAR and the Company's Nuclear Safety and QA programs.

The following description provides an overview of the operational process for the spent fuel storage facility systems. Detailed step-by-step operations are described in Chapter 10.

HOLTEC INTERNATIONAL COPYRIGHTED MATERIAL	
Report No. HI-2167374	Proposed Rev. 0Q
3-3	

3.1.1 Operations at Originating Nuclear Power Plant

The spent fuel operations at the originating nuclear power plant and the transport of the loaded canisters to the HI-STORE facility are not a part of HI-STORE operations. The description provided in this subsection is for information only; for a detailed description the reader should consult the canister's host FSAR such as HI-STORM UMAX FSAR [1.0.6].

Typically, an empty canister is placed inside a transfer cask. The canister and transfer cask are placed into the spent fuel pool where the canister is loaded with spent fuel. The canister exterior is prevented from direct contact with potentially contaminated spent fuel pool water by means of a slightly-pressurized clean water annulus with an inflatable top seal. Once the fuel is loaded, the canister lid is placed on the canister and the transfer cask is removed from the spent fuel pool. The canister lid is seal welded to the canister and the canister is drained and dried. The canister is then backfilled with inert helium gas and the drain and fill ports are welded closed and leak tested. The closure ring is installed and seal welded, thereby sealing the canister. The outer surfaces of the transfer cask and the accessible areas of the canister are then checked for surface contamination and decontaminated, if necessary. **It should be noted that, when loaded in the transfer cask or transport cask, the canister top surface is considered to be representative of the canister's worst-case potential surface contamination levels, as the top surface of the canister is not protected from exposure to spent fuel pool water during the loading process.**

Most sealed canisters are placed in dry storage at the nuclear power plant.

At the time of transport, the sealed canister is recovered from storage into the transfer cask and placed in a transportation cask. The transportation cask, containing the loaded canister, is sealed using a bolted top closure lid. The transportation cask annulus is evacuated and backfilled with helium. The closure lid seals are leak tested and the transportation cask is placed horizontally on a transport frame secured to a transport vehicle. The transportation cask is fitted with impact limiters, tie-downs and a personnel barrier to protect personnel from coming in direct contact with the cask body. The transportation cask is then shipped to HI-STORE.

3.1.2 Operations Between the Originating Nuclear Power Plant and HI-STORE

The HI-STORE facility is designed to receive spent fuel waste packages shipped by rail car. Prior to shipment, the originating nuclear power plant must verify that cask storage document packages are included with the transportation cask. These document packages should contain information such as the cask's CCRs, any 10CFR72.48 documentation, aging management records and documentation of the fuel contents of the cask. These document packages will be checked once again when the cask arrives at the HI-STORE site. During transportation, the transportation cask provides a part 71-compliant containment for the canister that is qualified to withstand all applicable licensing basis accidents (10CFR71.73). The package (transportation cask and impact limiters) is licensed in accordance with the requirements of 10CFR71, "Packaging and Transportation of Radioactive Material", and complies with the requirements of 49CFR171, "General Information, Regulations, and Definitions", 49CFR172, "Hazardous Materials Tables and Hazardous Materials Communications Regulations", 49CFR173, "Shippers – General Requirements for Shipments and Packages", 49CFR174, "Carriage by Rail", and 49CFR177, "Carriage by Public Highway" [3.1.2, 3.1.3, 10.3.1, 3.1.4, 3.1.5].

HOLTEC INTERNATIONAL COPYRIGHTED MATERIAL	
Report No. HI-2167374	Proposed Rev. 0Q
3-4	

3.1.3 Operations Between the Railroad Mainline and HI-STORE

To reach the HI-STORE site, the transportation rail car is transferred to a newly constructed rail spur located along State Highway 243, where the transportation casks remain on the rail car and are transported approximately 5 miles east to the HI-STORE CIS facility.

3.1.4 Operations at HI-STORE

This section provides a summary overview of the canister handling and normal storage operations at HI-STORE CIS facility. A more detailed description is provided in Chapter 10. Radiation exposure to facility workers and the general public will be maintained as low as reasonably achievable (ALARA) during all operations in accordance with the facility's radiation protection program described in Chapter 11. Table 11.3.1 of Chapter 11 provides detailed estimates of expected durations and dose to facility workers for all canister handling operations.

3.1.4.1 Receipt and Inspection of Incoming Transportation Cask and Canister

During spent fuel transportation, the sealed canister is contained within the transportation cask, which is mounted horizontally on a rail car or heavy haul trailer. Impact limiters are mounted on both ends of the transportation cask and a personnel barrier covers the transportation cask between the impact limiters. A tie-down secures the cask to the transport vehicle. Figure 3.1.1 pictorially illustrates the cask handling operations.

When the transportation cask arrives at the HI-STORE CIS facility, the transportation cask is visually inspected for any outward indications of damage or degradation prior to entry into the Protected Area (PA). Canister records are reviewed to certify that the canister meets the material considerations of Chapter 17 and the receipt inspection requirements of Chapter 9 to ensure the canister continues to meet the no-credible-leakage criteria to which it has been certified in the HI-STORM UMAX docket [1.0.6]. Additionally, a review of the transportation documentation package, which includes verification that a pre-shipment inspection was performed and acceptable, is mandatory prior to receiving a transportation cask into the security vehicle trap.

After initial receipt approval, the cask is moved into the security vehicle trap for physical inspection by security personnel to ensure no unauthorized devices or materials enter the PA. When security clearance is complete, the shipment proceeds into the PA and into the CTB where the personnel barrier and tie-down are removed. The transportation cask, in accordance with the Part 71 requirements, is surveyed for dose rates and contamination levels.

The dose rate from the cask on arrival at the HI-STORE CIS facility must be in reasonable accord with the measured dose rate at the originating plant. An excessive discrepancy would warrant a root cause evaluation under Holtec's quality program and appropriate notification to the USNRC.

3.1.4.2 Transfer of Canister from Transportation Cask to HI-TRAC CS

The steps for transferring the sealed canister from the transportation cask to the HI-TRAC CS all occur within the CTB. Using the CTB crane, the transportation cask is lifted from the rail car horizontally and placed onto a tilt frame suitable for the transportation cask being handled. The tilt frame fully supports the cask in the horizontal orientation and allows for cask tilting between the vertical and horizontal orientations. With the transportation cask in the horizontal orientation (fully supported by the tilt frame), the impact limiters are removed and placed aside. The

HOLTEC INTERNATIONAL COPYRIGHTED MATERIAL	
Report No. HI-2167374	Proposed Rev. 0Q
3-5	

transportation cask closure lid penetration cover is removed and the annulus gas is sampled to confirm the continued effectiveness of the canister's confinement barrier. Following successful testing of the annulus gas, a canister leakage test is performed. The transportation cask is then tilted to vertical, lifted from the tilting frame and placed in the Canister Transfer Facility (CTF). An alignment plate is used to concentrically align the HI-TRAC CS to the transportation cask. The alignment plate provides shielding to personnel performing the canister transfer and allows access for examination of the canister exterior shell surface.

After the cask is installed in the CTF, the closure lid is removed and a cask seal surface protector is installed on the transportation cask's closure lid seal surface to protect it from damage. If necessary, any canister shipping spacers are removed. **With the lid of the transportation cask removed, contamination surveys are taken on accessible areas of the canister to verify that the arriving loaded canister meets the contamination limits set forth in the Technical Specifications LCO 3.2.1.** The MPC lifting attachment is then connected to the lid. Temporary shielding may be positioned as required to maintain worker dose ALARA.

The HI-TRAC CS is then placed on the CTF alignment plate with its bottom doors open. The CTF anchor studs are secured to the HI-TRAC CS bottom flange to assure the cask's seismic stability during the canister transfer process. The MPC lifting device extension is attached to the overhead crane, lowered through the HI-TRAC CS body using the CTB crane, and connected to the MPC lift attachment. The MPC is lifted into the HI-TRAC CS and the HI-TRAC CS shield gates are closed. With the canister resting on the shield gates, the MPC lifting device extension is disconnected from the MPC lift attachment. The loaded HI-TRAC CS is then lifted and placed **on to the HI-PORT**. It is at this time that the HI-TRAC CS will be surveyed for dose measurements. **The interior surfaces of the empty transport cask will be surveyed to verify that the cask is free of removable contamination, and decontamination of the surfaces will be conducted as necessary if contamination is found.**

3.1.4.3 Placement of the Canisters into the Vertical Ventilated Modules (VVMs)

The HI-TRAC CS loading is now complete and ready for transport to the designated HI-STORM UMAX VVM on the storage pad. In preparation for receiving the loaded canister, the designated VVM's CEC lid is removed and the Divider Shell is installed in the CEC. **The VCT meets HI-PORT near the VVM and connects to the HI-TRAC lifting trunnions. The HI-TRAC CS tie-downs on HI-PORT are disengaged and the VCT lifts HI-TRAC CS off the deck of HI-PORT. HI-PORT is removed from beneath the HI-TRAC CS. The HI-TRAC CS is positioned at its travel height and the restraints are attached between the HI-TRAC CS and the VCT. The restraints prevent HI-TRAC swinging during VCT movement and a seismic event. The VCT moves HI-TRAC CS to the appropriate HI-STORM UMAX location. The HI-TRAC CS is positioned over the VVM to be loaded. The restraint is disconnected and the HI-TRAC CS is lowered onto the ISFSI pad over the CEC to be loaded. Once it is lowered on the pad, the HI-TRAC CS is secured to the CEC in similar manner as at the CTF. The VCT releases from the HI-TRAC CS lifting trunnions and raises the top lift beam. The MPC lifting device extension connects the MPC lift attachment to the VCT through the VCT's top lift beam. The VCT's top lift beam is raised to tension the canister lift slings and raise the canister slightly. The HI-TRAC CS shield gates are opened and the VCT's top lift beam is lowered to lower the canister into the CEC. This continues until the canister is fully seated in the CEC. The MPC lift device extension releases from the VCT's top lift beam. The VCT reconnects to the HI-TRAC CS lifting**

HOLTEC INTERNATIONAL COPYRIGHTED MATERIAL	
Report No. HI-2167374	Proposed Rev. 0Q
3-6	

trunnions. The HI-TRAC CS shield gates are closed and the securing anchor studs and nuts are removed. HI-TRAC CS is lifted and removed from the HI-STORM UMAX location. The MPC lift attachment is unbolted from the canister lid and removed from the CEC. If necessary, the CEC-to-lid seals are installed and the HI-STORM UMAX Closure Lid is installed. The lid rigging is removed and the CEC lid vent screen is installed. Once the rigging is removed and the closure lid is installed, the VVM will be surveyed for dose measurements. **The interior surfaces of the empty HI-TRAC CS will be surveyed to verify that the HI-TRAC is free of removable contamination, and decontamination of the surfaces will be conducted as necessary if contamination is found.**

3.1.4.4 Surveillance of the HI-STORM UMAX Storage Systems

While in storage, the proper monitoring of the HI-STORM UMAX storage systems is subject to surveillance guided by written procedures. The temperature of the exiting air from the VVMs provides a telltale indication of compliance with the Technical Specifications. In addition, the cask air vent covers are visually inspected for blockages. An overall site observation surveillance is also performed on a periodic basis to monitor for adverse conditions such as the accumulation of site debris around the air vents, tearing of the vent screens and the like.

Dose rates associated with individual storage systems are measured. This is to ensure adequate shielding of the canister so that radiation exposure to the general public is minimized and occupational doses to personnel working in the vicinity of the storage casks are maintained ALARA. Radiation doses emitted from the storage casks are measured by thermoluminescent dosimeters (TLDs) located at the protected area (PA) and owner controlled area (OCA) boundaries to ensure doses are within 10CFR20.1301 and 10CFR72.104 or 40CFR191 limits.

3.1.4.5 Security Operations

Security personnel coordinate security related functions that include performing continual surveillance for intruders, responding to intrusion alarms, processing visitors and workers to HI-STORE, searching packages and vehicles, issuing badges to workers, coordinating with local law enforcement agencies, and coordination with appropriate site and off-site emergency response personnel. Security personnel are also responsible for identifying and assessing off-normal and emergency events during off-shift hours of HI-STORE operation. Details for the security personnel are discussed in the HI-STORE Physical Security Plan [3.1.1].

3.1.4.6 Health Physics Operations

The health physics (HP) personnel are responsible for measuring, monitoring and recording all radiological aspects of the HI-STORE facility. These include: taking radiation dose and contamination surveys on incoming spent fuel shipments, monitoring individual radiological exposure, issuing, monitoring and maintaining personnel dosimetry, evaluating off-site radiological conditions, placarding and establishing radiological working conditions, reporting on radiological conditions to appropriate authorities and maintenance of radiological survey equipment. In order to uphold the HI-STORE philosophy of “Start Clean/Stay Clean” HP personnel ensure that contamination levels on the canisters of incoming shipments meet site requirements.

Prior to shipment to the HI-STORE Facility, canisters must meet contamination survey limits set forth in 10 CFR 71.87(i). If canisters are subject to normal transportation conditions in route to

HOLTEC INTERNATIONAL COPYRIGHTED MATERIAL	
Report No. HI-2167374	Proposed Rev. 0Q
3-7	

the HI-STORE CIS Facility, it is highly unlikely that upon arrival a contamination survey would exceed canister contamination limits. Nevertheless, if any canisters upon arrival at the HI-STORE CIS Facility are found to exceed the contamination limits, notifications will be made in accordance with 10 CFR 20.1906(d)(1).

Accessible surfaces of the MPC will be wiped down thoroughly using a spray bottle and rag to decontaminate accessible canister surfaces. All contamination survey wipes or absorbent material, and any rags used for decontamination shall be disposed of in a secure, low specific activity (LSA) Class A waste container. Periodically, the HI-STORE CIS Facility Class A waste containers, with Class A waste contained therein, will be transported to an appropriate Class A waste disposal facility for disposal.

Following completion of decontamination of a canister that arrives on site exceeding the contamination limits, the contamination survey will be reperformed. If the canister is brought into compliance with contamination limits, processing of the canister can proceed. If the canister still does not meet the contamination limits, accessible surfaces of the MPC will be wiped down thoroughly with a spray bottle and rag a second time and the contamination survey will be performed for a third time. If the canister passes after the third contamination survey, processing of the canister can proceed. In the highly unlikely event that the canister, after the third contamination survey remains above the limit, appropriate licensing actions will be taken to proceed with processing the canister at the HI-STORE CIS Facility or reinstall the lid of the transportation cask and ship the canister back to the originating facility or another facility that meets the necessary requirements.

During the transfer process, HP personnel monitor doses to ensure that workers are not exposed to unnecessary radiation. In the event high dose rates are detected, temporary shielding, in the form of lead blankets, neutron shielding, portable shield walls, etc., are used to maintain ALARA. HP Personnel perform dose rate surveillances of the loaded storage cask to ensure requirements are met.

In addition to surveillance activities, the HP department monitors onsite and offsite radiation levels to ensure worker and offsite doses are in accordance with regulatory requirements. The HP department is also responsible for calibrating radiation protection instrumentation.

3.1.4.7 Maintenance Operations

Because of their passive nature, the HI-STORM UMAX storage system requires little maintenance over the lifetime of HI-STORE. Typical maintenance tasks may involve occasional replacement and recalibration of temperature monitoring instrumentation, repair of coatings, repair of damaged screens, and general removal of dirt and debris.

Periodic maintenance is required on the overhead bridge crane, service cranes, transfer equipment, HI-TRAC CS and transportation casks. Maintenance of SSCs, which are classified as important-to-safety, ensure that they are safe and reliable throughout the life of HI-STORE per 10CFR72.122(f). Work on these items will only occur when the equipment being maintained is in the unloaded condition.

Maintenance may also be required on the following components: the heavy haul tractor/trailer (if used), rail car and locomotive (if used), cask transporter, security systems, temperature and radiation monitoring systems, diesel generator, electrical systems, fire protection systems,

HOLTEC INTERNATIONAL COPYRIGHTED MATERIAL	
Report No. HI-2167374	Proposed Rev. 0Q
3-8	

building HVAC and site infrastructure. The CTB and Storage Building provide the facility to perform maintenance activities. Vehicles may be moved off-site to specialized facilities that are better suited to perform such activities.

Full details of the maintenance requirements are given in Chapter 10. Additional information on the Aging Management of HI-STORE SSCs can be found in Chapter 18.

3.1.4.8 Transfer of Canisters from HI-STORE Offsite

The HI-STORE CIS facility is an interim storage facility. At some point in the future, canisters may be required to be moved offsite. When such a day arrives, a 10CFR71 licensed transportation cask will transport the canisters offsite to another facility. Transfer operations will utilize the CTB to transfer the canisters from HI-TRAC CS to the transportation casks. Once loaded in a transportation cask, the spent fuel canister will be shipped to the designated facility. To accomplish this, the steps for installing the canister in the VVM are basically reversed, resulting in a loaded transportation cask ready for transport.

3.1.4.9 Sequence of Operations

Diagrams illustrating the sequence of operations for canister receipt, transfer, and placement into storage is shown in Figure 3.1.1 for the HI-STORM UMAX storage system.

The number of personnel and the time required for the various operations are provided in Table 11.3.1. This table is used to develop the occupational exposures discussed in Chapter 11.

3.1.5 Identification of Subjects for Safety Analysis

3.1.5.1 Criticality Prevention

Only canisters that have been determined to have no credible leakage shall be stored at the HI-STORE CIS facility. The determination that the canister's confinement boundary is intact and effective to prevent intrusion of any fluids including water is performed at both the plant of origin and upon its arrival at HI-STORE. Thus, while the canister is qualified to remain subcritical even in the presence of water by virtue of its fixed basket geometry and fixed neutron absorbers installed in the canister's Fuel Basket, the guaranteed absence of water inside the canister at the HI-STORE CIS facility makes any loss of criticality safety non-credible. Therefore, no additional criticality prevention measures are needed.

3.1.5.2 Chemical Safety

The HI-STORE CIS facility does not use any chemicals (even water) in its canister handling and storage operations. Therefore, there are no chemical hazards associated with the operation of HI-STORE CIS facility.

3.1.5.3 Operation Shutdown Modes

During storage, there are no operational shutdown modes associated with the HI-STORM UMAX Storage System since the system is passive and relies on natural air circulation for cooling. During canister transfer, the transfer process may be shut down at the end of the day, resuming again on a following day. A discontinuance in the transfer operation is permitted only if:

- All SSCs are in a mechanically secured state,

HOLTEC INTERNATIONAL COPYRIGHTED MATERIAL	
Report No. HI-2167374	Proposed Rev. 0Q
3-9	

- No nuclear components are in the lifted condition
- The ventilation flow of air around the canister is uninhibited, and
- The radiation dose around the cask and canister is ALARA.

In summary, all operational shutdown modes at HI-STORE are safe shutdown modes due to the design features of the facility and operational controls imposed through operating procedures.

3.1.5.4 Instrumentation

Due to the totally passive nature of the storage casks, there is no need for any instrumentation to perform safety functions. Temperature monitors are utilized as a means to monitor the cask temperature during storage. Area radiation monitors are used to measure radiation levels in the CTB during canister transfer operations. Portable radiation monitors are used to measure radiation levels during the canister transfer process. HI-STORE operators are equipped with personnel dosimeters whenever they are in the PA. The radiation dose will be monitored at the perimeters of the PA and OCA. **See Subsection 3.4.1 for the safety classification of the temperature monitors and associated instrumentation.**

3.1.5.5 Maintenance Techniques

Maintenance operations on the equipment and systems don't involve any special techniques that would require a safety analysis.

Preventative maintenance is performed on a regular basis on the overhead transfer crane, canister lifting equipment, cask transporter, heavy haul tractor/trailers, radiation detection and monitoring equipment, cask temperature monitoring equipment, security equipment, fire detection and suppression equipment, etc. Maintenance is performed in accordance with 10CFR72.122(f), ANSI N14.6 [1.2.4], and manufacturer's requirements.

HOLTEC INTERNATIONAL COPYRIGHTED MATERIAL	
Report No. HI-2167374	Proposed Rev. 0Q
3-10	

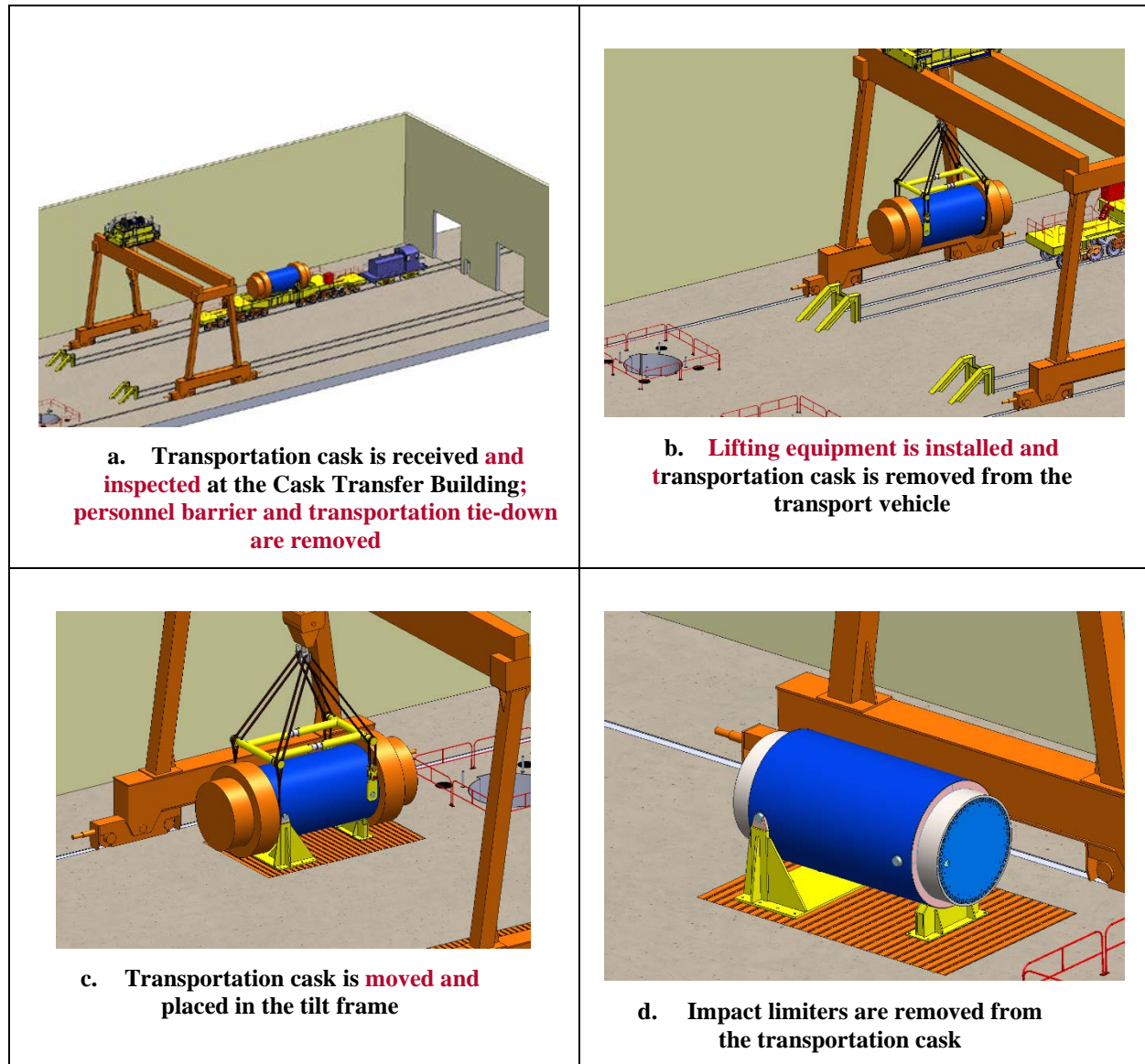


Figure 3.1.1: Cask Handling Summary Illustrations

Note these figures are intended to be for illustrative purposes only, certain details, such as the crane, may differ and are shown in on the licensing drawings in Section 1.5

HOLTEC INTERNATIONAL COPYRIGHTED MATERIAL	
Report No. HI-2167374	Proposed Rev. 0Q
3-11	

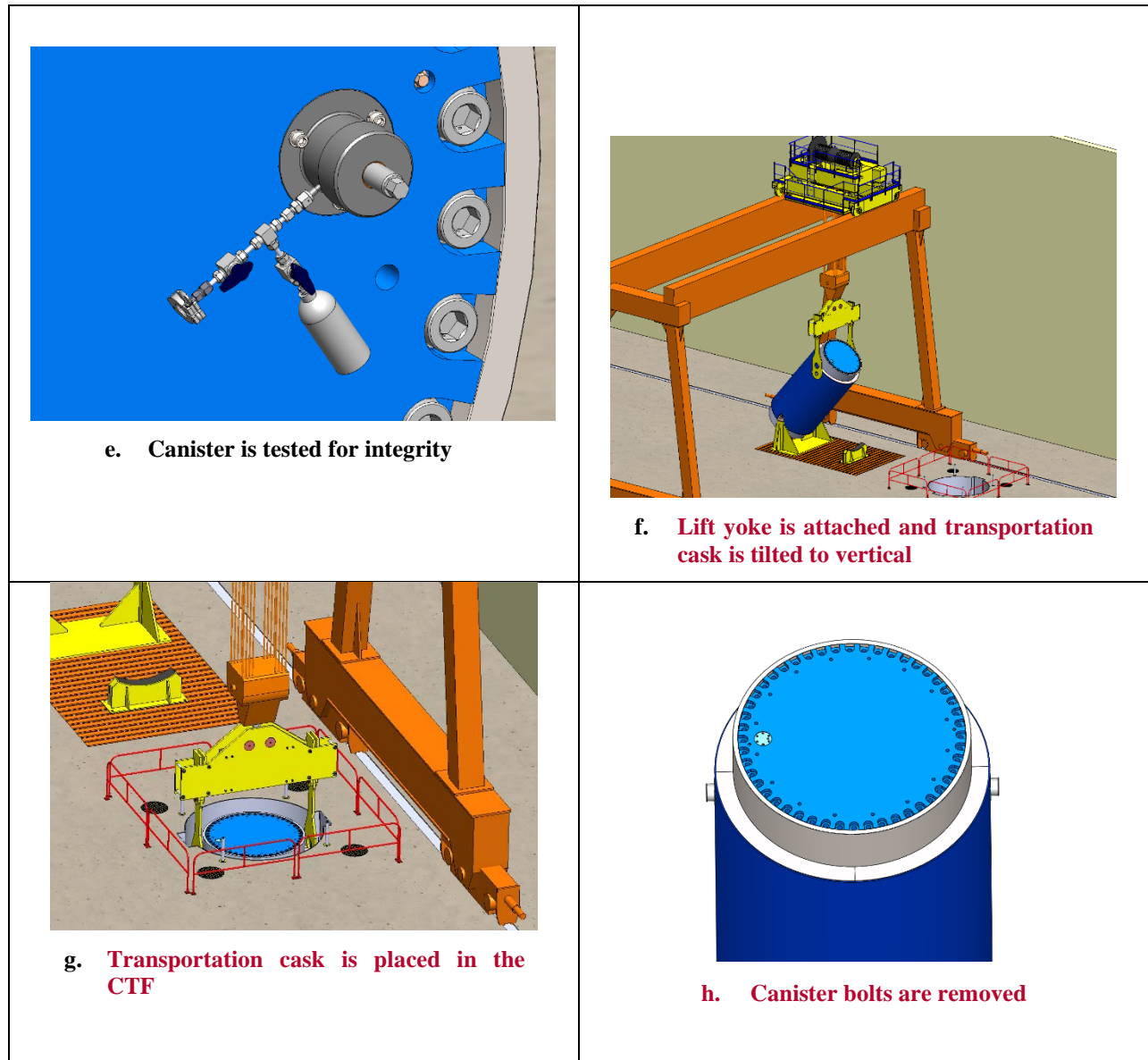


Figure 3.1.1: Cask Handling Summary Illustrations (Continued)

HOLTEC INTERNATIONAL COPYRIGHTED MATERIAL	
Report No. HI-2167374	Proposed Rev. 0Q
3-12	

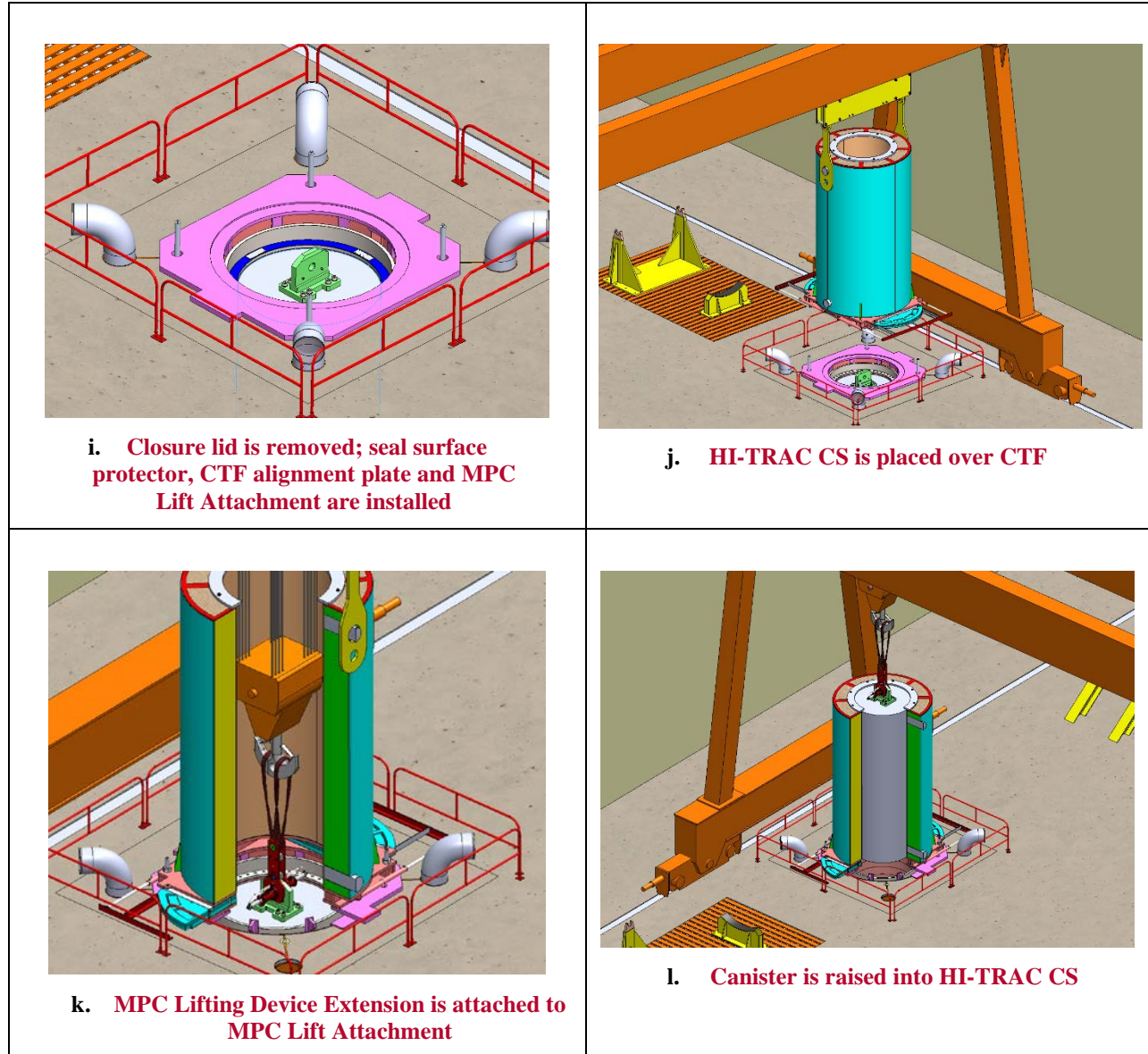


Figure 3.1.1: Cask Handling Summary Illustrations (Continued)

HOLTEC INTERNATIONAL COPYRIGHTED MATERIAL		
Report No. HI-2167374		Proposed Rev. 0Q
3-13		

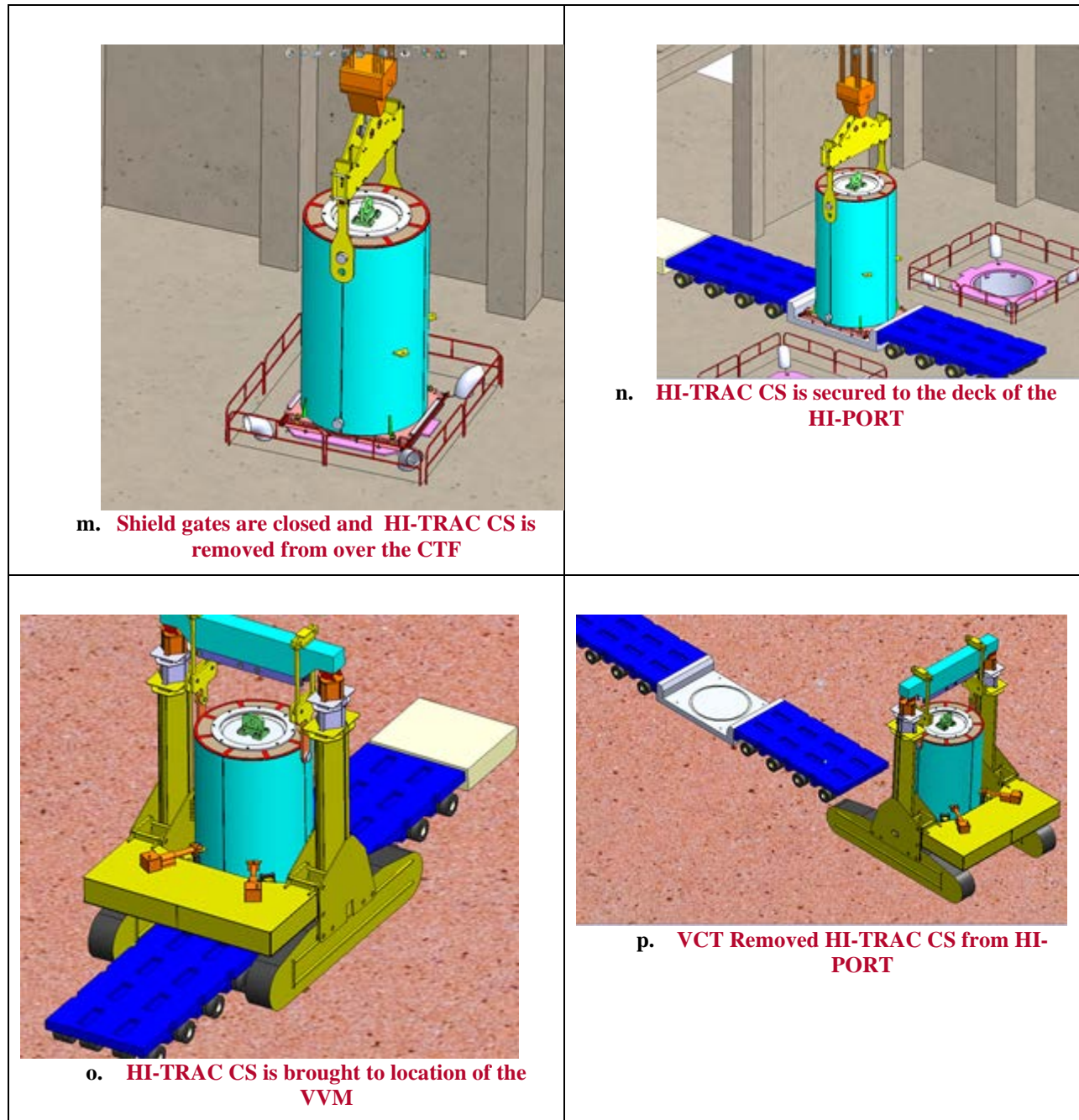


Figure 3.1.1: Cask Handling Summary Illustrations (Continued)

HOLTEC INTERNATIONAL COPYRIGHTED MATERIAL		
Report No. HI-2167374		Proposed Rev. 0Q
3-14		

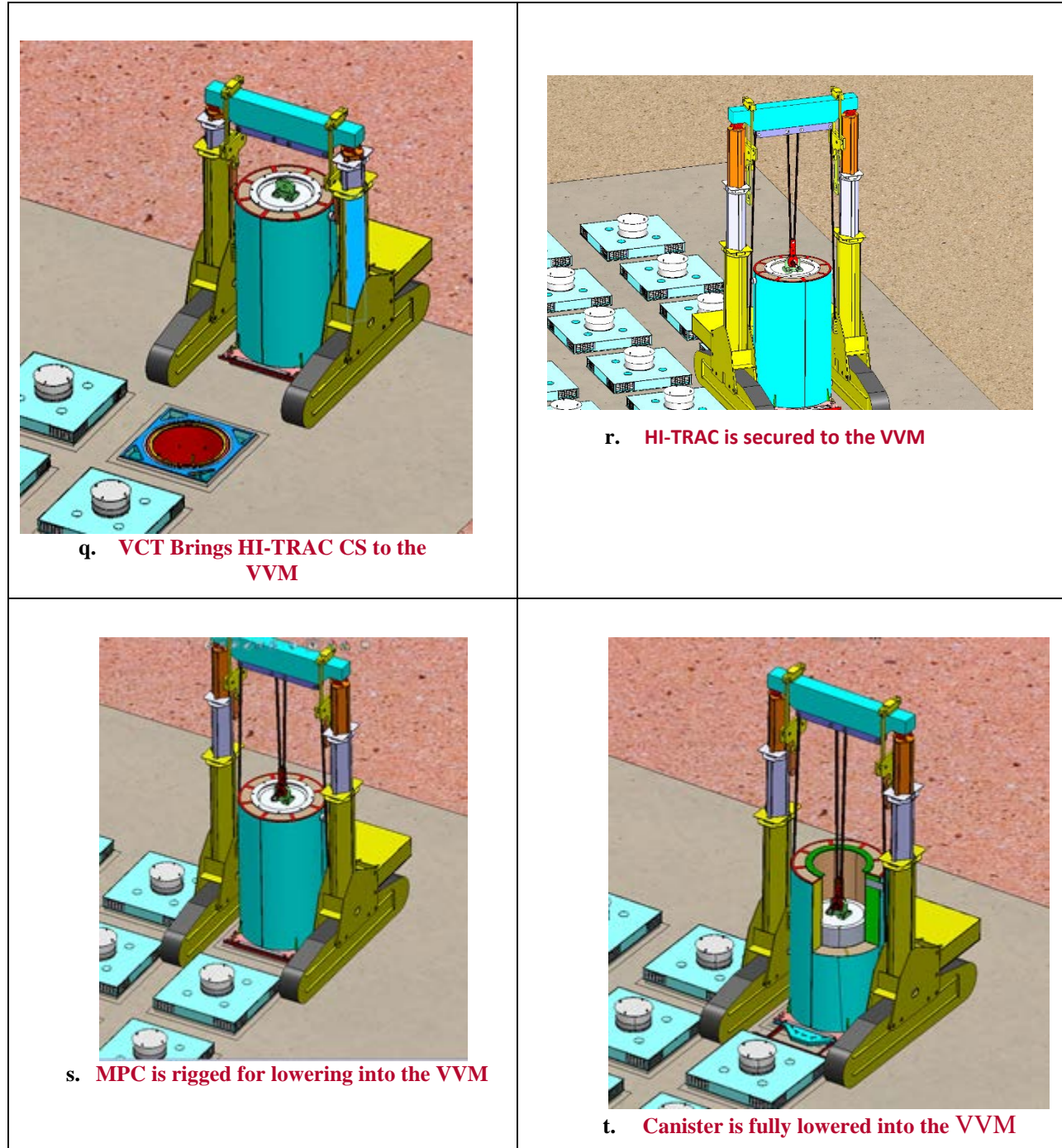


Figure 3.1.1: Cask Handling Summary Illustrations (Continued)

HOLTEC INTERNATIONAL COPYRIGHTED MATERIAL		
Report No. HI-2167374		Proposed Rev. 0Q
3-15		

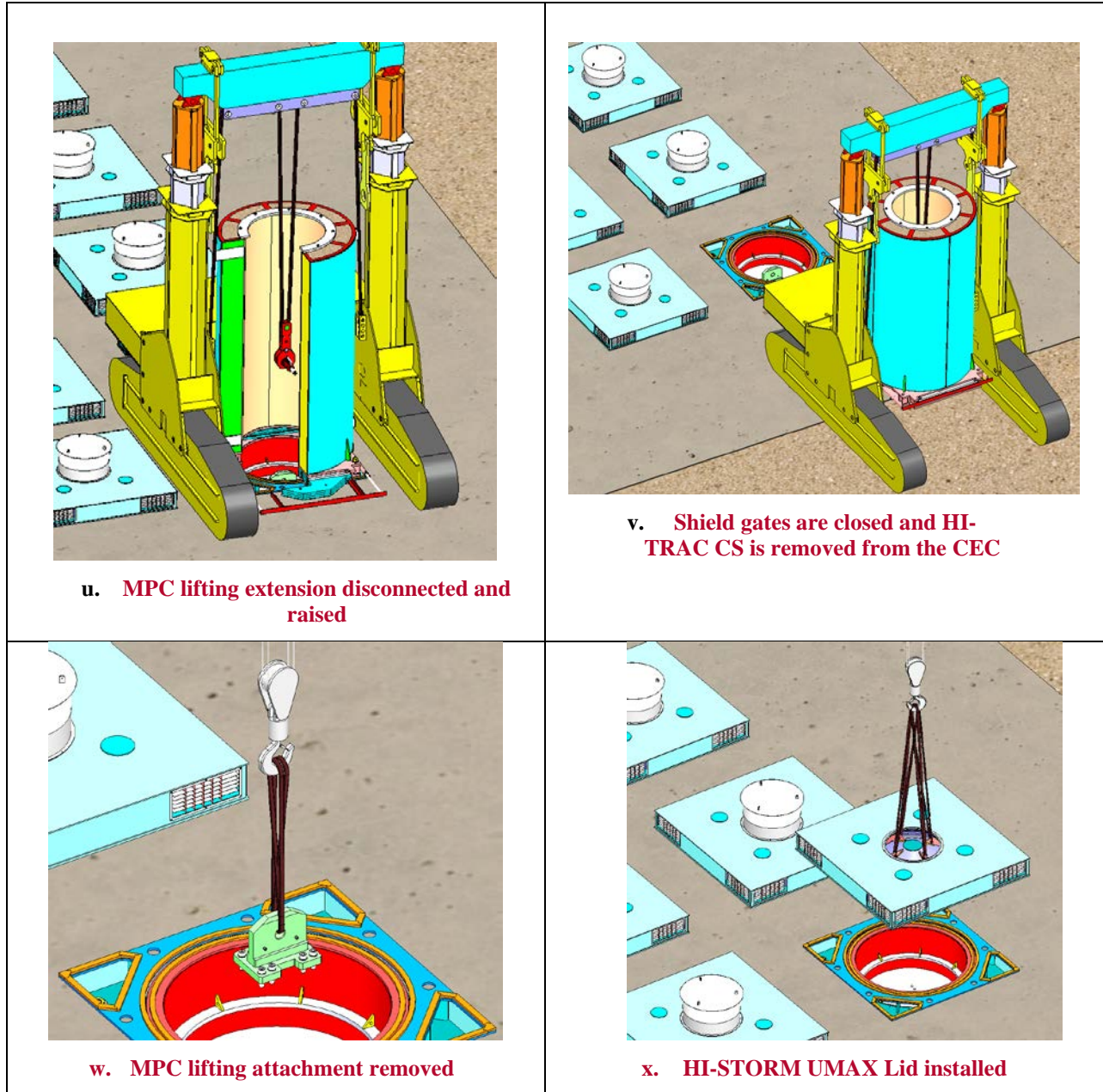


Figure 3.1.1: Cask Handling Summary Illustrations (Continued)

HOLTEC INTERNATIONAL COPYRIGHTED MATERIAL		
Report No. HI-2167374		Proposed Rev. 00Q
3-16		

Figure 3.1.2: Intentionally Deleted

HOLTEC INTERNATIONAL COPYRIGHTED MATERIAL		
Report No. HI-2167374		Proposed Rev. 0Q
3-17		

3.2 SPENT FUEL AND HIGH-LEVEL WASTE HANDLING SYSTEMS

3.2.1 Spent Fuel Canister Receipt, Handling, and Transfer

An operational description of the systems used for the receipt and transfer of spent fuel canisters is provided in the following paragraphs. Special features of these systems to ensure safe handling of the spent fuel canisters are also described.

3.2.1.1 Spent Fuel Canister Receipt

3.2.1.1.1 Functional Description

The transportation casks and impact limiters comprise the system in which the spent nuclear fuel canisters are contained when they arrive at HI-STORE. The transportation cask system protects the enclosed spent fuel canister from physical damage, provides shielding, and allows sufficient cooling of the canister while in transit to HI-STORE.

3.2.1.1.2 Safety Features

Safety features of the transport system include the impact limiters, which help protect the spent fuel inside the transportation cask during transportation. Furthermore, the design features of the transportation cask, which provides gamma and neutron shielding, conductive and radiant cooling, criticality control, and structural strength to protect the spent fuel canister. A tamper-proof device on the cask provides indication of an unauthorized attempt to obtain access to the cask. These safety features are fully described in the HI-STAR transportation cask SAR [1.3.6].

3.2.1.2 Spent Fuel Canister Handling

3.2.1.2.1 Functional Description

The cask handling crane performs handling functions inside the CTB for the transportation cask and the HI-TRAC CS. The MPC lift attachment and MPC lifting device extension connect to the overhead crane for MPC lifting and lowering in the CTB.

Cask handling components include the transportation cask and transfer cask, transport cask horizontal lift beam, lift yokes, tilt frame, **cask transporters**, cask handling crane and HI-TRAC CS lift links. The HI-TRAC CS lift links connect the VCT to the HI-TRAC CS lifting trunnions.

The canister handling components consist of the MPC lift attachment and MPC lifting device extension.

3.2.1.2.2 Safety Features

Safety features of the cask handling crane include *single-failure-proof* designs for preventing uncontrolled lowering of the load upon failure of any single component, limit switches for prevention of hook travel beyond safe operating positions, and provisions for lowering a load in the event of an overload trip. The crane is classified as ASME NOG-1 Type 1 [3.0.1]. A Type 1 crane is defined as a crane that is designed and constructed to remain in place and support a critical load during and after a seismic event and has single-failure proof features such that any credible failure of a single component will not result in the loss of capability to stop and/or hold the critical load. Design requirements for the crane include testing, inspection, and maintenance activities in accordance with 10CFR72.122(f) which, are also performed per the QA Program

HOLTEC INTERNATIONAL COPYRIGHTED MATERIAL	
Report No. HI-2167374	Proposed Rev. 0Q
3-18	

described in Chapter 12. Strict adherence to the design, testing, inspection, and maintenance criteria as noted above ensure adequate safety margins are provided to prevent damage to the transportation cask, canister, or storage cask during normal, off-normal, and accident conditions. Discussion on design criteria and the subsequent evaluations for these SSCs are found in Chapters 4 and 5, respectively. The crane design include limit switches for prevention of trolley and hook travel beyond safe operating positions, limits on trolley and hook travel speeds, and provisions for lowering a load in the event of an overload trip. Periodic inspection and testing will be performed to keep the cranes certified to ASME NOG-1 [3.0.1].

Safety features of the HI-TRAC CS handling components include single-failure-proof lift capacity or equivalent safety factor as described in this SAR. **These single-failure proof criteria are only applicable to the equipment that handles the system from above.**

The loaded HI-TRAC CS is restrained during all aspects of canister handling either by the VCT and/or the anchor studs or by the wide base of the HI-TRAC CS during switching from the cask handling crane to the VCT. Evaluation shows that the HI-TRAC CS cannot topple over during an earthquake.

Safety features associated with the VCT include redundant drop protection systems designed to withstand drops that could result from a failure associated with the transporter lift components. The transporter is designed with hydraulic counter-balance valves and anti-drop mechanical locking mechanisms which automatically engage on the loss of hydraulic pressure. Markings on the lift boom and an indicator on the operating console give indication of the lifted height. HI-TRAC CS lifting attachments are designed and tested in accordance with ANSI N14.6 [1.2.4].

The safety features of the canister handling components, slings and MPC lifting attachments, are their redundancy and the required enhanced stress safety margins as described in the HI-STORM UMAX FSAR [1.0.6].

Other components which are involved in moving the system components, but not “lifting and handling,” from above include the tilt frame and the HI-PORT. These components are required to meet the design criteria in Chapter 4 and are structurally analyzed in Chapter 5. Transporters that support the cask from below also have a limit on combustible materials as listed in the Technical Specifications.

3.2.1.3 Spent Fuel Canister Transfer

3.2.1.3.1 Functional Description

The HI-TRAC CS is used for transfer of the spent fuel canister between the transportation cask and the CEC. The HI-TRAC CS protects the spent fuel canister from physical damage and provides radiation shielding to personnel.

3.2.1.3.2 Safety Features

The HI-TRAC CS provides radiation shielding when carrying a canister loaded with spent fuel. The HI-TRAC CS lifting trunnions are designed to the single-failure proof requirements of NUREG-0612 [1.2.7] so that a load drop event involving the HI-TRAC CS is non-credible.

As described in Subsection 1.2.4, the HI-TRAC CS consists of a radially-connected pair of concentric steel shells filled with high density concrete. Two lifting trunnions and two rotation trunnions are provided for HI-TRAC CS handling. The HI-TRAC CS has a pair of thick

HOLTEC INTERNATIONAL COPYRIGHTED MATERIAL	
Report No. HI-2167374	Proposed Rev. 0Q
3-19	

movable shield gates at the bottom to allow raising the canister into the transfer cask, lowering of the canister into the storage or transportation cask, or to support the canister weight and provide shielding while in the HI-TRAC CS. The shield gates slide in steel guide rails along each side of the HI-TRAC CS. Steel pins or bolts are used to prevent inadvertent opening of the doors.

The HI-TRAC CS features a top steel ring that prevents the canister from being lifted above the top of the cask thus insuring that the canister remains within the radiation protected envelope of the transfer cask. A lifting yoke provided with the HI-TRAC CS is used to interface with the cask handling crane. **The HI-TRAC CS base can be attached to the HI-PORT cask transporter.** The VCT features lift links which connect the HI-TRAC CS trunnions to the VCT top beam for handling with the VCT.

3.2.2 Spent Fuel Canister Storage

Spent fuel storage consists of the HI-STORM UMAX storage system, which includes spent fuel canisters placed in the steel Canister Enclosure Cavity (CEC) below ground in the HI-STORM UMAX ISFSI. The storage system is entirely passive by design and is completely autonomous (i.e., it requires no support systems for its operation).

Surveillance of the HI-STORM VVM assembly to ensure its continued effectiveness involves the following principal activities:

1. Check for intrusion of foreign objects that may impair the system's thermal performance during normal operations and in the wake of an extreme environmental phenomenon.
2. Check for corrosion damage to the steel parts, namely the CECs (oldest or most vulnerable VVM shall be inspected).
3. Check for structural damage to the ISFSI after an earthquake.
4. Perform the heat removal operability surveillance as specified in the Technical Specifications.
5. Perform ISFSI Security Operations in accordance with the site's security plan.

Routine maintenance on the HI-STORM UMAX System will typically be limited to cleaning and touch-up painting of the exposed steel surfaces, repair, and replacement of damaged vent screens, and removal of vent blockages (e.g., leaves, debris), if any. The heat removal system operability surveillance should be performed after any event that may have an impact on the safe functioning of the HI-STORM UMAX system. These include, but are not limited to, wind storms, snow storms, fire inside the ISFSI, seismic activity, and/or observed animal, bird, or insect infestations. The responses to these conditions involve first assessing the dose impact to perform the corrective action (inspect the HI-STORM VVM cavity, clear the debris, check for any structural damage of the ISFSI pad, and/or replace damaged vent screens); perform the corrective action; and verify that the system is operable (check ventilation flow paths and radiation blockage capability). In the unlikely event of significant damage to the ISFSI, possibly from a Beyond-the-Design Basis earthquake, the situation may warrant removal and visual inspection of the canister, and repair or replacement of the damaged ISFSI areas.

The storage system performs its functions under normal conditions as discussed in Chapter 10 and off-normal and accident level conditions as discussed in Chapter 15. Limits of operation

HOLTEC INTERNATIONAL COPYRIGHTED MATERIAL	
Report No. HI-2167374	Proposed Rev. 0Q
3-20	

associated with various normal and off-normal conditions are contained in Chapter 16. Surveillance requirements are also contained in Chapter 16.

3.2.2.1 Safety Features

Safety features include a passive dry storage system design and administrative controls. The canister is enclosed in the cavity of the HI-STORM UMAX storage system, which protects the canister from severe natural phenomena (such as tornado-driven missiles), provides required shielding of the canister, and flow paths for natural convection cooling. Because of its underground disposition, the canister stored inside HI-STORM UMAX cannot tip-over. Safety features are discussed in greater detail in the HI-STORM UMAX FSAR [1.0.6].

HOLTEC INTERNATIONAL COPYRIGHTED MATERIAL	
Report No. HI-2167374	Proposed Rev. 0Q
3-21	

3.3 OTHER OPERATING SYSTEMS

The storage casks are passive and require no other operating systems for safe storage of the spent fuel once they are placed into storage. The HI-STORE operating systems are described in this chapter and Chapter 10.

HOLTEC INTERNATIONAL COPYRIGHTED MATERIAL	
Report No. HI-2167374	Proposed Rev. 0Q
3-22	

3.4 OPERATION SUPPORT SYSTEMS

3.4.1 Instrumentation and Control Systems

Regulation 10CFR72.122(i) requires that instrumentation and control systems be provided to monitor systems that are classified as Important to Safety. The operation of HI-STORE is passive and self-contained and therefore does not require control systems to ensure the safe operation of the system. However, temperatures of the air exiting the VVMs may be monitored to provide a means for assessing thermal performance of the storage casks. The temperature monitors are equipped with data recorders and alarms located in the Security Building. The temperature monitors are not required for safety and therefore are not subjected to important to safety criteria. **If the temperature monitors and associated temperature monitoring instrumentation are used as the sole means of surveillance, then they shall be designated important-to-safety.**

Radiation monitoring is provided to ensure doses remain ALARA and is discussed in Chapter 11. Radiation monitoring is not required to support systems that are classified as Important to Safety.

In the event of an earthquake, Holtec will contact the National Earthquake Information Center, Golden, CO to acquire seismic data for a post-earthquake performance evaluation.

No other instrumentation or control systems are necessary or are utilized. Therefore, the requirements of 10CFR72.122(i) are satisfied.

3.4.2 System and Component Spares

Spare temperature monitoring devices are maintained at the site. However, these devices are not required to maintain safe conditions at the HI-STORE facility. No other instrumentation spares are required.

HOLTEC INTERNATIONAL COPYRIGHTED MATERIAL	
Report No. HI-2167374	Proposed Rev. 0Q
3-23	

3.5 CONTROL ROOM AND CONTROL AREA

Regulation 10 CFR72.122(j) requires the control room or control area to be designed to ensure that HI-STORE is safely operated, monitored, and controlled for off-normal or accident conditions. This requirement is not applicable to HI-STORE because the spent fuel storage system is a passive system and hence does not require a control room to ensure safe operation.

HOLTEC INTERNATIONAL COPYRIGHTED MATERIAL	
Report No. HI-2167374	Proposed Rev. 0Q
3-24	

3.6 ANALYTICAL SAMPLING

No sampling is required for the safe operation of HI-STORE or to ensure that operations are within prescribed limits. Sampling of the gas inside the transportation cask is performed prior to venting and opening the cask in the CTB. Evaluation of the gas sample determines if the gas can be released to the atmosphere or if it must be filtered and the appropriate radiological protection needed when removing the transportation cask closure. Since the sampling is not required for nuclear safety of the facility, it is not classified as Important-to-Safety.

HOLTEC INTERNATIONAL COPYRIGHTED MATERIAL	
Report No. HI-2167374	Proposed Rev. 0Q
3-25	

3.7 POOL AND POOL FACILITY SYSTEMS

The HI-STORE facility does not need a pool for storage or transfer operations. Canisters are received, transferred and stored in the dry condition.

HOLTEC INTERNATIONAL COPYRIGHTED MATERIAL	
Report No. HI-2167374	Proposed Rev. 0Q
3-26	

3.8 REGULATORY COMPLIANCE

The operational steps required to place a loaded canister into a HI-STORM UMAX VVM cavity have been described in this chapter. The steps to remove a canister from a loaded VVM, which are essentially reverse of the steps in the loading sequence, have also been provided. These loading steps are sufficiently detailed to lead to the conclusion that the guidelines of safety and ALARA set down in NUREG-1567 [1.0.3] are fully satisfied. In particular, it can be concluded that:

- i. There are no radiation streaming paths from the canister during its transfer operation.
- ii. The handling operations occur near grade level thus eliminating the need for ladders/platforms and improving the human factors aspects.
- iii. There are no exterior freestanding structures in the canister transfer operations and thus there is no risk of uncontrolled load movement under a (hypothetical) extreme environmental event such as tornado or high winds.
- iv. The ventilation paths to passively cool the canister using ambient air during the transfer operation is maintained at all times thus protecting the fuel cladding from overheating and eliminating any thermally guided time limit on the duration for implementing the transfer steps.
- v. All heavy load handling is carried out by handling devices that are equipped with redundant load drop protection features.
- vi. Each storage cavity is independently accessible. Installation or removal of any canister does not have to contend with other stored canisters.
- vii. Because the canister insertion (and withdrawal) occurs in the vertical configuration with ample lateral clearances, there is no risk of scratching or gouging of the canister's external surface (Confinement Boundary). Thus the ASME Section III Class 1 prohibition against damage to the pressure retaining boundary is maintained.

It is thus concluded that the HI-STORM UMAX ISFSI is engineered to meet the safety and ALARA imperatives contemplated in 10CFR72 [1.0.5] in full measures.

HOLTEC INTERNATIONAL COPYRIGHTED MATERIAL	
Report No. HI-2167374	Proposed Rev. 0Q
3-27	

CHAPTER 4: DESIGN CRITERIA FOR THE HI-STORE CIS SYSTEMS, STRUCTURES AND COMPONENTS*

4.0 INTRODUCTION

This chapter contains safety-relevant information on the HI-STORE CIS facility in the following topical areas:

- a. Spent fuel or other high-level radioactive waste containers (canisters) authorized to be stored,
- b. Classification of structures, systems and components (SSCs) according to their *importance-to-safety*, and
- c. Design criteria and design bases for the HI-STORE CIS facility and associated SSCs during all operational modes, including normal and off-normal operations, Short Term Operations, accident conditions and extreme natural phenomena events.

Unlike the generic HI-STORM UMAX system, the Short-Term Operations at the HI-STORE facility do not involve any activity related to loading fuel into canisters: the canisters arrive at the HI-STORE CIS facility in the HI-STAR 190 (NRC docket # 71-9373). The Short Term Operations begin at the point the transport package is received at the site and end at the point the canister is placed in a HI-STORM VVM for interim storage.

As stated in Chapter 1, the HI-STORM UMAX system (NRC Docket # 72-1040) [1.0.6] is the sole storage system designated to be employed at the HI-STORE CIS facility. As the canisters certified for use in the HI-STORM UMAX system are qualified in the HI-STORM FW system (NRC Docket # 72-1032) [1.3.7], there is a direct nexus between the site specific safety analyses for HI-STORE CIS facility and the analyses that undergird the general certification in [1.0.6] and [1.3.7]. As documented in this chapter, the loadings and conditions for which the HI-STORM UMAX VVM and its canisters are certified in [1.0.6] substantially exceed their counterparts for the HI-STORE CIS facility. This safety analysis reports mandates that only those canisters that are authorized for storage in HI-STORM UMAX under its general certification can be stored at the HI-STORE CIS facility. Furthermore, even among the population of canisters authorized by the HI-STORM UMAX CoC, only those that meet the heat load limit of the transport cask can be transported to the site will be available for storage at the site. Because the transport cask has a much lower heat load capacity than the HI-STORM UMAX ventilated storage system, the limitation imposed by the transport cask winnows the number of canisters eligible for storage at the HI-STORE CIS facility significantly. It is evident that those canisters that meet the heat load limitation of the transport cask, because of the greater innate heat rejection capacity of ventilated systems, will be subject to a less severe thermal state at the HI-STORE CIS facility than that permitted under ISG-11 Rev. 3 [4.0.1] under long term storage.

The HI-STORE facility must be qualified to withstand all credible environmental or operation-related loadings without exceeding its applicable safety limits. To make this safety determination,

* All references are placed within square brackets in this report and are compiled in Chapter 19 of this report.

HOLTEC INTERNATIONAL COPYRIGHTED MATERIAL	
Report No. HI-2167374	Proposed Rev. OR
4-1	

the credible loadings under all normal, off-normal and faulted states are compared with those that have been qualified in the HI-STORM UMAX FSAR [1.0.6]. Any load that is found to exceed the pre-certified limit in the HI-STORM UMAX FSAR [1.0.6] is so identified in this chapter for further analysis.

As noted subsequently in this chapter, the site specific environmental and accident loads are fewer in number and less severe than those treated in the HI-STORM UMAX FSAR [1.0.6]. This statement applies to the Design Basis Earthquake (DBE) also where the 10,000-year return earthquake is shown to be bounded by the DBE for which the HI-STORM UMAX system is pre-certified. Much of the safety analysis material in this chapter pertains to confirming that each HI-STORE site specific loading is bounded by its counterpart treated in the HI-STORM UMAX FSAR.

Many of the Design Criteria pertaining to the loadings and components common to the HI-STORM UMAX and the HI-STORE CIS systems, such as the MPC and VVM, are incorporated by reference in this SAR, as appropriate, to the HI-STORM UMAX FSAR [1.0.6]. To facilitate convenient access to the referenced material, a list of HI-STORM UMAX FSAR sections germane to this chapter is provided in Table 4.0.1.

HOLTEC INTERNATIONAL COPYRIGHTED MATERIAL	
Report No. HI-2167374	Proposed Rev. 0R
4-2	

TABLE 4.0.1: HI-STORM UMAX FSAR MATERIAL INCORPORATED IN THIS FSAR BY REFERENCE

Location in HI-STORE SAR	Subject of the Reference	Location in HI-STORM UMAX FSAR [1.0.6]	Justification
Subsection 4.1.1	Spent Fuel to be stored	Section 2.1, with exceptions as described in Subsection 4.1 of this SAR	MPCs to be stored at HI-STORE site are limited to those included in the HI-STORM UMAX FSAR [1.0.6]; exceptions for maximum heat loads and backfill pressure imposed by transport cask are made, but are bounded by HI-STORM UMAX FSAR requirements.
Subsection 4.3.1	MPCs to be stored		
Subsection 4.3.2	Design criteria for HI-STORM UMAX VVM and ISFSI	Section 2.2, with exceptions as described in Subsection 4.3.2.1 of this SAR	Design criteria for HI-STORM UMAX VVM and ISFSI are bounded by HI-STORM UMAX FSAR, except as noted.
Table 4.3.1	MPC Internal Design Pressure	Section 2.3.2.1	Due to the lower heat load limit of the transport cask, the associated internal MPC pressure shall always be less than the MPC design basis pressure in the HI-STORM UMAX FSAR [1.0.6]
Table 4.3.1	High Winds	Section 2.3.2.7	The wind conditions at the ELEA site are bounded by the HI-STORM UMAX FSAR Design Basis Wind.
Table 4.3.1	Design Basis Flood	Section 2.4.7	The Design Basis Flood used to qualify the VVM in the HI-STORM UMAX FSAR exceeds the most severe projection of flood at the ELEA site.
Subsection 4.3.1	MPC (including fuel) temperature limits	Table 2.3.7	HI-STORM UMAX FSAR temperature limits adopted.

HOLTEC INTERNATIONAL COPYRIGHTED MATERIAL

Report No. HI-2167374

Proposed Rev. 0R

4-3

Subsection 4.3.2	VVM temperature limits	Table 2.3.7	HI-STORM UMAX FSAR temperature limits adopted.
------------------	------------------------	-------------	--

HOLTEC INTERNATIONAL COPYRIGHTED MATERIAL	
Report No. HI-2167374	Proposed Rev. 0R
4-4	

4.1 MATERIALS TO BE STORED

4.1.1 Spent Fuel Canisters

The SNF-bearing canisters that will be stored at the HI-STORE CIS facility are limited to those included in the HI-STORM UMAX FSAR [1.0.6]. No canister that is not included in the HI-STORM UMAX FSAR can be stored at the HI-STORE CIS Facility. Therefore all canisters (and the SNF specified as acceptable for storage in said canisters) to be stored at the facility are incorporated by reference herein, as follows:

- Authorized contents are incorporated by reference from Section 2.1 of the HI-STORM UMAX FSAR [1.0.6], with the following exceptions:
 - i. Maximum permissible heat loads specified in Subsection 2.1.9 of the HI-STORM UMAX FSAR [1.0.6], are replaced by more restrictive heat load imposed by the transport cask heat load requirements;
 - ii. The helium backfill pressure options of Tables 2.1.8 and 2.1.9 of the HI-STORM UMAX FSAR [1.0.6], which relate to the establishment of the permissible aggregate heat load, are supplanted by the requirements of this chapter.

Canisters to be stored at the HI-STORE CIS Facility must meet the maximum heat loads shown in Tables 4.1.1 and 4.1.2 of this SAR, in accordance with the regional loading patterns shown in Figures 4.1.1 and 4.1.2 of this SAR (item i).

Requirements for the helium backfill of all canisters to be stored at the HI-STORE CIS are in Table 4.1.3 and 4.1.4 of this SAR (item ii). Although canisters will not be backfilled at site, received canisters will be verified to meet these helium backfill requirements as a condition of acceptance.

4.1.2 High Level Radioactive Waste

This SAR does not consider safety analysis of any canister that is not certified in the HI-STORM UMAX docket [1.0.6]. Accordingly, it does not at the present time include any canister containing non-fissile High Level Radioactive Waste at the HI-STORE CIS facility.

HOLTEC INTERNATIONAL COPYRIGHTED MATERIAL	
Report No. HI-2167374	Proposed Rev. OR
4-5	

Table 4.1.1: Maximum Decay Heat Load for MPC-37 (PWR Fuel Assembly)

Pattern	Region (Note 1)	Maximum Decay Heat Load per Assembly (kW) (Note 2)	Total Heat Load for Each Pattern (kW)
1	1	0.38	31.82
	2	1.7	
	3	0.50	
2	1	0.42	32.02
	2	1.54	
	3	0.61	
3	1	0.61	32.09
	2	1.23	
	3	0.74	
4	1	0.74	32.06
	2	1.05	
	3	0.8	
5	1	0.8	32.04
	2	0.95	
	3	0.84	
6	1	0.95	31.43
	2	0.84	
	3	0.8	

Note 1: For basket region numbering scheme refer to Figure 4.1.1

Note 2: These maximum fuel storage location decay heat limits must account for decay heat from both the fuel assembly and non-fuel hardware.

HOLTEC INTERNATIONAL COPYRIGHTED MATERIAL	
Report No. HI-2167374	Proposed Rev. OR
4-6	

Table 4.1.2: Maximum Decay Heat Load MPC-89 (BWR Fuel Assembly)

Pattern	Region (Note 1)	Maximum Decay Heat Load per Location (kW) (Note 2)	Total Heat Load for Each Pattern (kW)
1	1	0.15	32.15
	2	0.62	
	3	0.15	
2	1	0.18	32.02
	2	0.58	
	3	0.18	
3	1	0.27	32.03
	2	0.47	
	3	0.27	
4	1	0.32	32.08
	2	0.41	
	3	0.32	
5	1	0.35	31.95
	2	0.37	
	3	0.35	

Note 1: For basket region numbering scheme refer to Figure 4.1.2.

Note 2: These maximum fuel storage location decay heat limits must account for decay heat from both the fuel assembly and non-fuel hardware.

HOLTEC INTERNATIONAL COPYRIGHTED MATERIAL	
Report No. HI-2167374	Proposed Rev. OR
4-7	

Table 4.1.3: MPC Backfill Pressure Requirements (Note 1)

MPC Type	Pressure Range
MPC-37	≥ 39.0 psig and ≤ 46.0 psig
MPC-89	≥ 39.0 psig and ≤ 47.5 psig

Note 1: Helium used for backfill of MPC shall have a purity of $\geq 99.995\%$. The pressure range is based on a reference temperature of 70°F.

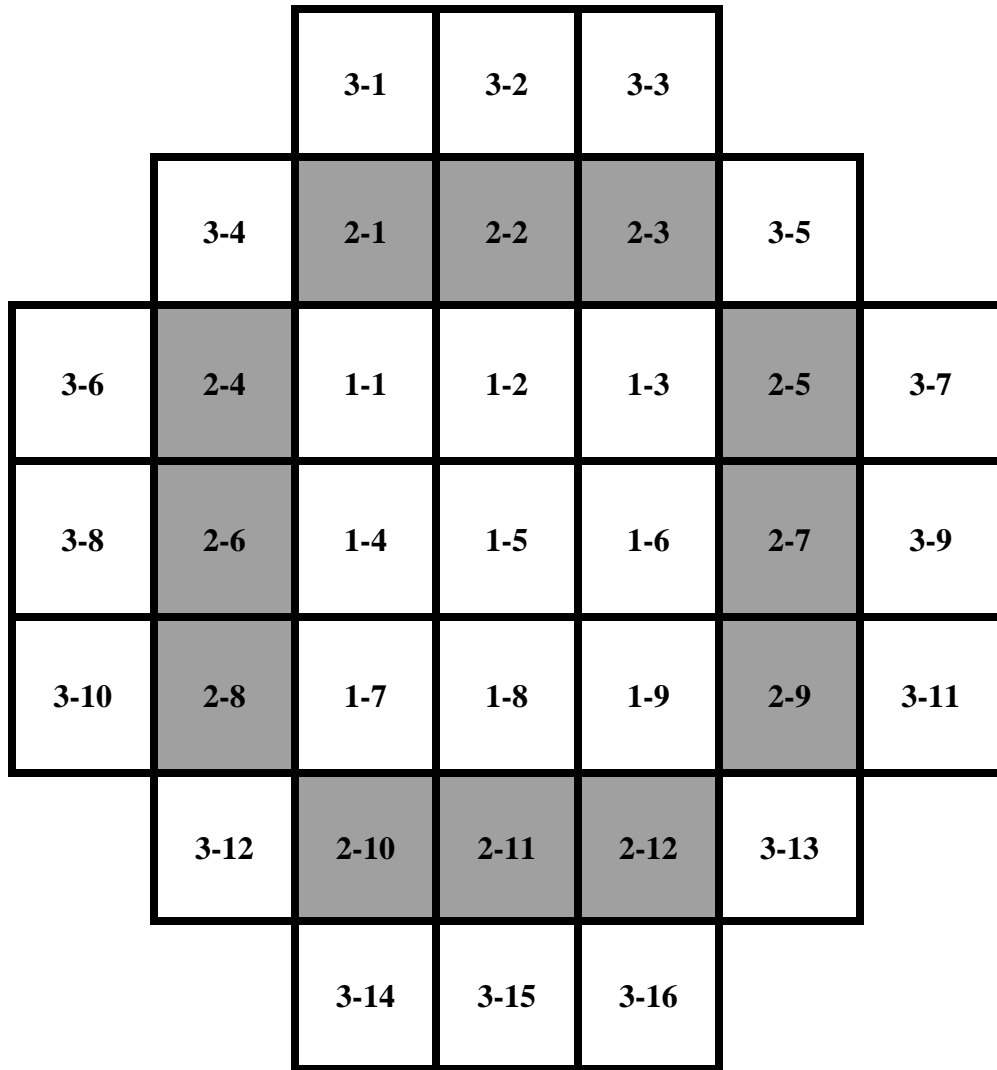
Table 4.1.4: MPC Backfill Pressure Requirements for Sub-Design Basis Heat Load (Note 1)

MPC Type	Pressure Range (Note 2)
MPC-37	≥ 39.0 psig and ≤ 50.0 psig
MPC-89	≥ 39.0 psig and ≤ 50.0 psig

Note 1: Sub-Design Basis Heat Load is defined as 80% of the design basis heat load in every storage location defined in Tables 4.1.1 and 4.1.2 for MPC-37 and MPC-89 respectively.

Note 2: Helium used for backfill of MPC shall have a purity of $>99.995\%$. The pressure range is based on a reference temperature of 70°F.

HOLTEC INTERNATIONAL COPYRIGHTED MATERIAL	
Report No. HI-2167374	Proposed Rev. OR
4-8	



Legend

Region-Cell ID

Figure 4.1.1: MPC-37 Regional-Cell Identification

HOLTEC INTERNATIONAL COPYRIGHTED MATERIAL	
Report No. HI-2167374	Proposed Rev. OR
4-9	

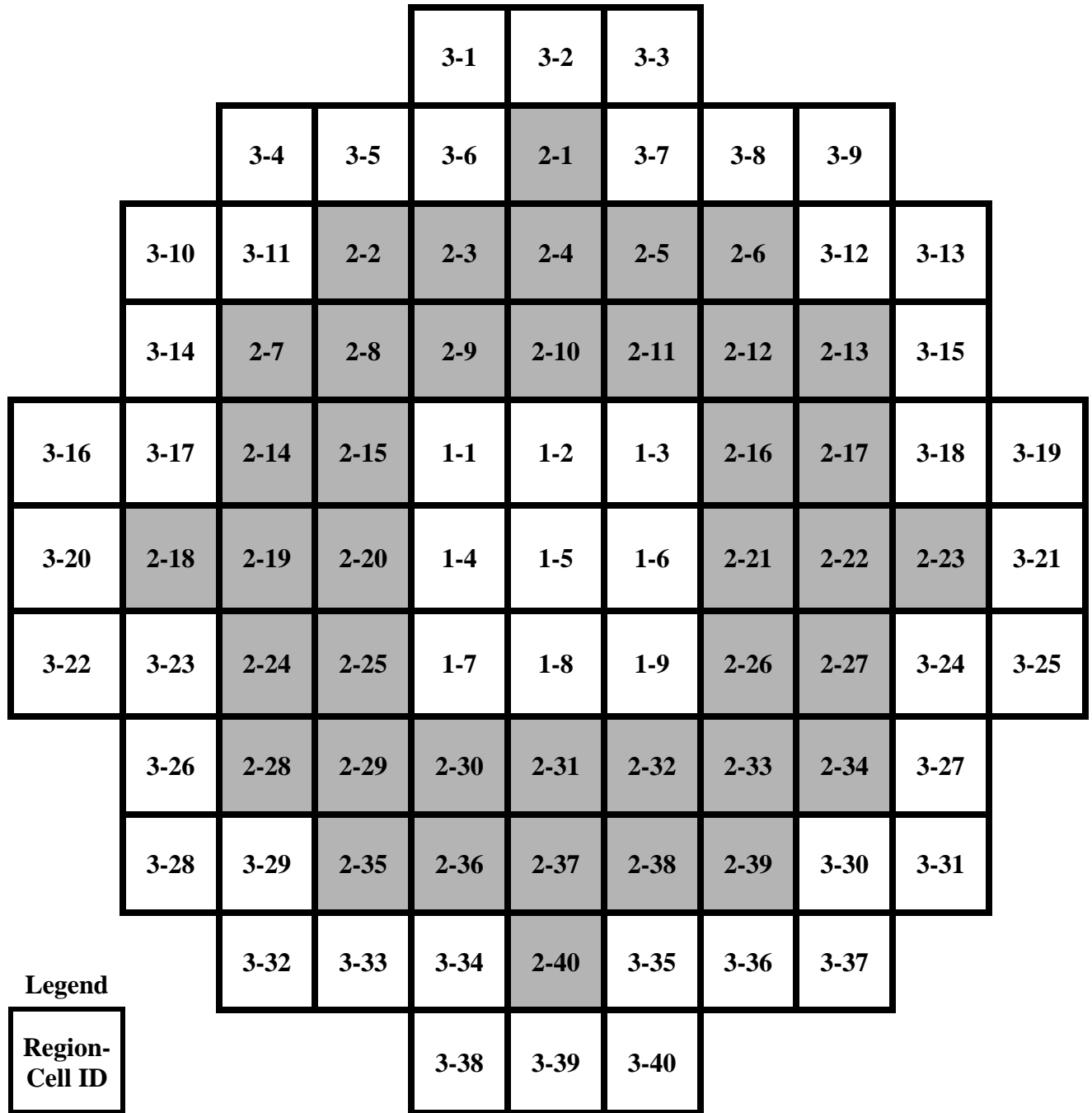


Figure 4.1.2: MPC-89 Regional-Cell Identification

HOLTEC INTERNATIONAL COPYRIGHTED MATERIAL	
Report No. HI-2167374	Proposed Rev. OR
4-10	

4.2 CLASSIFICATION OF STRUCTURES, SYSTEMS, AND COMPONENTS

The systems, structures and components (SSCs) for the HI-STORE CIS facility are designed and analyzed to ensure that they will perform their intended functions under normal, off-normal, and accident conditions to meet all regulatory requirements delineated in 10 CFR Part 72 [1.0.5]. These intended functions include:

- i. Providing radionuclide confinement/containment
- ii. Enabling heat rejection from cask components and contents to maintain their temperatures within specified regulatory limits
- iii. Attenuating emission of radiation to acceptable levels
- iv. Maintaining sub-criticality of fissile contents

References [4.2.1] & [4.2.2] provide the guidelines to determine the Important to Safety significance category in accordance with NUREG/CR-6407 [1.2.2] which are:

Category A: The failure or malfunction of a structure, component, or system could directly result in a condition adversely affecting public health and safety.

Category B: The failure or malfunction of a structure, component, or system could indirectly (i.e., in conjunction with the failure of another item) result in a condition adversely affecting public health and safety.

Category C: The failure or malfunction of a system, structure or component (SSC) that would have some effect on the packaging, but would not significantly reduce the effectiveness of the packaging and would not be likely to create a situation adversely affecting public health and safety.

Not-Important-to-Safety: The failure or malfunction of an SSC would not reduce the effectiveness of the system or packaging and would not create a situation adversely affecting public health and safety.

Thus each SSC that constitutes the HI-STORE CIS facility is classified into one of above four categories depending on the severity of consequence in the event of its failure or malfunction due to a credible adverse event.

Chapter 1 contains the description of the SSCs that comprise the HI-STORE CIS facility. The SSCs in Table 4.2.1 can be subdivided in two types, namely

- i. Those that are designed and built to meet the requirements of the HI-STORE CIS facility or are assembled at the site (HI-STORE Specific or “HS”)
- ii. Those that are pre-qualified and delivered to the site pursuant to the safety requirements in the HI-STORM UMAX docket and arrive at the site ready-for-deployment (UMAX Generic or “UG”)

HOLTEC INTERNATIONAL COPYRIGHTED MATERIAL	
Report No. HI-2167374	Proposed Rev. OR
4-11	

The ITS category for UG SSCs is defined by their classification in their native docket, principally the HI-STORM UMAX docket [1.0.6]. Those SSCs whose safety classification is not defined in other dockets (HS SSCs) are classified using [4.2.1] & [4.2.2]. Table 4.2.1 provides a compilation of the ITS classification information on *all* of the principal SSCs that are envisaged to be used at the HI-STORE CIS facility including both the “HS” and “UG” types; the latter directly excerpted from the HI-STORM UMAX FSAR [1.0.6] or a referenced docket therein, such as HI-STORM 100 FSAR [1.3.3].

HOLTEC INTERNATIONAL COPYRIGHTED MATERIAL	
Report No. HI-2167374	Proposed Rev. OR
4-12	

Table 4.2.1				
ITS Classification of SSCs that Comprise the HI-STORE CIS Facility				
Name of SSC (Note 1)	Function (See Section 1.3)	ITS Classification	Type	Source for ITS determination
Cavity Enclosure Container (CEC)	Cavity Enclosure Container; defines the Canister's storage space	ITS-C	UG	[1.0.6]
CEC Closure Lid	A removable heavy structure placed atop the HI-STORM UMAX CEC that blocks sky shine from the stored Canister.	ITS-C	UG	
CEC Divider Shell	A removable insulated shell that surrounds the stored Canister	ITS-C	UG	
Support Foundation Pad (SFP)	Supports the HI-STORM UMAX VVM	ITS-C	UG	
ISFSI pad	Defines the top surface of the VVM	ITS-C	UG	
CLSM (see Glossary)	Occupies the subterranean space between the CECs	ITS-C	UG	
SNF Canisters	Provide a leak-tight confinement and criticality control to stored fuel	ITS-A	UG	[1.3.7]
HI-TRAC CS	Serves to facilitate ALARA transfer of the Canister between the transport cask and the HI-STORM UMAX VVM cavity	ITS-A	HS	[1.0.5], [4.2.1], [4.2.2], [1.2.2]
HI-TRAC CS Lift Yoke	Means for attaching HI-TRAC CS to CTB Crane for loaded or unloaded relocation within the CTB.	ITS-A	HS	
Cask Transfer Building (CTB)	Provides weather protection and climate control for canister transfer	ITS-C	HS	

HOLTEC INTERNATIONAL COPYRIGHTED MATERIAL	
Report No. HI-2167374	Proposed Rev. OR
4-13	

Table 4.2.1				
ITS Classification of SSCs that Comprise the HI-STORE CIS Facility				
Name of SSC (Note 1)	Function (See Section 1.3)	ITS Classification	Type	Source for ITS determination
CTB Crane	Used to move, upend and down-end the transport cask (loaded and unloaded); remove the transport cask impact limiters; move and position HI-TRAC CS (loaded and unloaded); handling of other equipment	ITS-A [Note 2]	HS	[1.0.5], [4.2.1], [4.2.2], [1.2.2]
CTB Slab	Provide support for all canister receipt and loading operations within the CTB	ITS-C	HS	
Canister Transfer Facility (CTF)	Underground ventilated structure used to effectuate transfer of canister from the transport cask to the HI-TRAC CS (and reverse operation, if required)	ITS-C	HS	
HI-STAR 190 Transport Cask	Cask in which SNF canisters are received	ITS-A	UG	[1.3.6]
Transport Cask Horizontal Lift Beam	Serves to lift HI-STAR 190 transport cask (using CTB crane)	ITS-A	HS	[1.0.5], [4.2.1], [4.2.2], [1.2.2]
Transport Cask Tilt Frame	Serves to upend/downend HI-STAR 190 transport cask	ITS-C	HS	
Transport Cask Lift Yoke	Means to connect HI-STAR 190 Transport Cask to CTB crane for movement within the CTB	ITS-A	HS	
HI-PORT	Principal means to translocate the HI-TRAC CS from the CTB to the ISFSI site	ITS-C	HS	

HOLTEC INTERNATIONAL COPYRIGHTED MATERIAL	
Report No. HI-2167374	Proposed Rev. OR
4-14	

Table 4.2.1				
ITS Classification of SSCs that Comprise the HI-STORE CIS Facility				
Name of SSC (Note 1)	Function (See Section 1.3)	ITS Classification	Type	Source for ITS determination
Vertical Cask Transporter (VCT)	Principal means to translocate the HI-TRAC CS at the ISFSI site and to effectuate Canister transfer to the HI-STORM UMAX VVM	ITS-A (Note 3)	UG	[1.3.7]
MPC Lift Attachment	Means of attaching rigging to MPC for download into VVM	ITS-A	HS	[1.0.5], [4.2.1], [4.2.2], [1.2.2]
Slings	Rigging used for movement and transfer of the MPC and HI-STAR.	ITS-A	HS	
MPC Lifting Device Extension	Means of attaching MPC Lift Attachment to VCT for download of MPC into VVM	ITS-A	HS	
HI-TRAC CS Lift Link	Means of connecting the VCT to the HI-TRAC CS Lifting Trunnions	ITS-A	HS	

HOLTEC INTERNATIONAL COPYRIGHTED MATERIAL	
Report No. HI-2167374	Proposed Rev. OR
4-15	

Table 4.2.1				
ITS Classification of SSCs that Comprise the HI-STORE CIS Facility				
Name of SSC (Note 1)	Function (See Section 1.3)	ITS Classification	Type	Source for ITS determination

Note 1: The ancillaries used at the HI-STORE CIS facility are limited to those needed to transfer the arriving canisters into the HI-STORM VVMs. Thus, some ancillaries described in the HI-STORM UMAX FSAR [1.0.6], like the Forced Helium Drying System used to dry the canister internals), are not included in this table.

Note 2: The Cask crane's main girder **and all structural items in the direct load path** are ITS-category A; the main hoist, auxiliary hoist and other electrical systems are treated as 'augmented quality' under Holtec's QA program.

Note 3: The VCT is ITS-A because of the Overhead beam. Other components are as listed below (See Figure 4.5.1):

<u>VCT Component I.D.</u>	<u>ITS Category</u>
Cask restraint system	NITS
Cask restraint strap	ITS-B
Control systems	NITS
Engine and drive systems	NITS
Hydraulic system	NITS
Jacks (lift cylinders)	NITS
Lifting towers (structure)	ITS-A
MPC downloader system	ITS-B
Overhead beam	ITS-A
Tracks	NITS
Vehicle frame	NITS
Load Drop Protection System	ITS-B

HOLTEC INTERNATIONAL COPYRIGHTED MATERIAL	
Report No. HI-2167374	Proposed Rev. OR
4-16	

4.3 DESIGN CRITERIA FOR SSCS IMPORTANT TO SAFETY

4.3.1 Multi-Purpose Canisters (MPCs)

The MPCs that will be stored at the HI-STORE CIS are limited to those included in the HI-STORM UMAX FSAR [1.0.6].

4.3.1.1 Structural

The MPCs to be received and loaded at the HI-STORE CIS facility are comprised of a fuel basket within a welded enclosure vessel. As the only canisters certified for storage in the HI-STORE CIS facility are those qualified in the HI-STORM UMAX FSAR [1.0.6], the structural design criteria for the MPCs is incorporated by reference to Section 2.0.2 of [1.0.6].

4.3.1.2 Thermal

The thermal design criteria for the MPCs (including the design temperature limits of Table 2.3.7) are incorporated by reference from Section 2.0.3 (MPC Design Criteria), of the HI-STORM UMAX FSAR [1.0.6]. The portion of Section 2.0.3 of Reference [1.0.6] related to maximum permissible heat loads and helium backfill is not incorporated by reference, as it has been replaced with the information presented in Section 4.1.1 of this SAR.

4.3.1.3 Shielding

The site boundary dose requirement for the systems (including canisters) stored at HI-STORE is provided in Section 4.4. Compliance to the requirements (see Table 4.4.3) is demonstrated in Chapter 11.

4.3.1.4 Confinement

The MPC provides for confinement of all radioactive materials for all design basis **normal**, off-normal and postulated accident conditions. As the only canisters certified for storage in the HI-STORE CIS facility are those qualified in the HI-STORM UMAX FSAR [1.0.6], the confinement criteria for the MPCs is incorporated by reference from Section 2.0.6 of [1.0.6].

4.3.1.5 Criticality Control

Criticality control is maintained by the geometric spacing of the fuel assemblies and the spatially distributed B-10 isotope in the Metamic-HT basket within the canister. As the only canisters certified for storage in the HI-STORE CIS facility are those qualified in the HI-STORM UMAX FSAR [1.0.6], the criticality control criteria for the MPCs is incorporated by reference to Section 2.0.5 of [1.0.6].

4.3.2 VVM Components and ISFSI Structures

The design criteria of the HI-STORM UMAX VVM components and ISFSI structures described in Chapter 2 of the HI-STORM UMAX FSAR [1.0.6] are largely applicable to the HI-STORE CIS. The criteria of [1.0.6] that bound the HI-STORE CIS design, and are therefore excluded from

HOLTEC INTERNATIONAL COPYRIGHTED MATERIAL	
Report No. HI-2167374	Proposed Rev. OR
4-17	

further consideration in this SAR, are outlined in Table 4.3.1. Environmental conditions and constraints that differ from those bounded by [1.0.6], although minor in nature, are described in Table 4.3.2 and evaluated herein. With the following exceptions, all subsections of the HI-STORM UMAX FSAR are relevant to the HI-STORE CIS evaluation:

- 1 Criteria related to the HI-TRAC VW system. The HI-TRAC VW system is supplanted by the HI-TRAC CS system in this application, with the design criteria for the HI-TRAC CS system described herein.
- 2 Service conditions related to the used of Forced Helium Drying (FHD) described in Paragraph 2.3.3.5 of the HI-STORM UMAX FSAR. As the HI-STORE CIS facility accepts only pre-packaged canisters, operations related to internal canister drying are not applicable.

Information consistent with the regulatory requirements related to shielding, thermal performance, confinement, radiological, and operational considerations is also provided. The licensing drawing of the HI-STORM UMAX design variant used in the HI-STORE CIS application is included in Section 1.5 of this SAR. The licensing drawing provides information on the necessary critical characteristics that define the HI-STORE CIS UMAX system for this application.

4.3.2.1 Structural

The applicable loads, affected parts under each loading condition, and the applicable structural acceptance criteria related to the HI-STORM UMAX VVM and ISFSI structures that are compiled in Section 2.0 of [1.0.6] provide a complete framework for the required qualifying safety analyses in this SAR. The VVM storage system at the HI-STORE CIS ISFSI will be functionally identical to that certified in the HI-STORM UMAX docket. The conservative approach of basing the HI-STORE CIS design on the certified HI-STORM UMAX design is supported by the following:

1. The subgrade and under-grade soil properties at the HI-STORE CIS site are uniformly better than those assumed for the general certification of the HI-STORM UMAX system. **These properties can be found in the geotechnical investigation completed December 2017 [2.1.24]. HI-STORE Bearing Capacity and Settlement Calculation report HI-2188143 [4.3.5] details the methodology used to compute the bearing capacity at the site. This calculation confirms the required bearing capacity is met for the soil underneath the planned construction.**
2. The top-of-pad earthquake spectra corresponding to a 10,000-year earthquake at the HI-STORE CIS site is enveloped by that assumed for the HI-STORM UMAX in its general certification. (Subsection 4.3.6 and Table 4.3.3 provide a summary of the applicable seismic loadings for the HI-STORE CIS facility).
3. The long-term settlement at the HI-STORE CIS ISFSI is computed in [4.3.5] to be less than that assumed in the certification of the HI-STORM UMAX. **The methodology followed is stated in the calculation itself. As stated in item 1, above, soil properties at the HI-STORE CIS site are more favorable than those assumed in the HI-STORM UMAX system certification [2.1.24].**

HOLTEC INTERNATIONAL COPYRIGHTED MATERIAL	
Report No. HI-2167374	Proposed Rev. OR
4-18	

4. The load combinations for the VVM and ISFSI structure at the HI-STORE CIS are consistent with those identified in the HI-STORM UMAX evaluation. Load combinations that are bounded by the HI-STORM UMAX evaluation, and therefore excluded from further evaluation in this application, are listed in Table 4.3.1.

4.3.2.2 Thermal

The design temperatures for the VVM components and ISFSI structures are incorporated by reference from Table 2.3.7 of Reference [1.0.6].

4.3.2.3 Shielding

The site boundary dose requirement for the HI-STORM UMAX ISFSI at HI-STORE is provided in Section 4.4. Compliance to the requirements (see Table 4.4.3) is demonstrated in Chapter 11.

4.3.2.4 Confinement

The VVM and ISFSI structures do not perform any confinement function. Confinement during storage is provided by the SNF storage canisters which are protected from leak by an all-welded stainless steel confinement vessel and are certified in their native docket as subject to a non-credible risk of leakage, see Chapter 9.

4.3.2.5 Criticality Control

The VVM components and ISFSI structures do not perform any criticality control function. Criticality control is maintained during storage by the internal configuration of the SNF storage canisters, as described in Chapter 8.

4.3.3 HI-TRAC CS

The HI-TRAC provides physical protection and radiation shielding of the MPC contents during the extraction of a loaded canister from the transport cask and its subsequent transfer to the HI-STORM UMAX VVM. The design characteristics of the HI-TRAC CS are presented in Chapter 1. The HI-TRAC CS plays a central role in the Short Term Operations that are carried out to translocate the Canister from an arriving transport package to its designated HI-STORM UMAX storage cavity.

4.3.3.1 Structural

The HI-TRAC CS transfer cask includes both structural and non-structural radiation shielding components that are classified as important-to-safety. The structural steel components of the HI-TRAC CS are designed to meet the stress limits of Section III, Subsection NF, **Class 3**, of the ASME Code [4.5.1] for all operating modes. The embedded trunnions for lifting and handling of the transfer cask are designed in accordance with the requirements of NUREG-0612 [1.2.7] for interfacing lift points.

Table 4.3.4 lists the loading scenarios for HI-TRAC CS for which its structural qualification must be performed.

HOLTEC INTERNATIONAL COPYRIGHTED MATERIAL	
Report No. HI-2167374	Proposed Rev. OR
4-19	

4.3.3.2 Thermal

The HI-TRAC CS cask must reject the canister's decay heat to the environment during the normal short term operations and accident scenarios, which are established by considering the operations described in Chapter 10. The thermally-significant loadings are listed in Table 4.3.5. The permissible temperature limits for all steel and concrete used in short-term operation SSCs used at HI-STORE, including HI-TRAC CS, are provided in Table 4.4.1.

4.3.3.3 Shielding

The HI-TRAC transfer cask provides shielding to maintain occupational exposures ALARA in accordance with 10CFR20 [7.4.1]. The HI-TRAC calculated dose rates for a set of reference conditions are reported in Chapter 7. These dose rates are used to estimate the occupational exposure to the work crew for the Short-Term Operations.

Section 4.4 provides dose limits applicable to the HI-STORE CIS facility.

4.3.3.4 Confinement

The HI-TRAC CS transfer cask does not perform any confinement function.

4.3.3.5 Criticality Control

The HI-TRAC CS transfer cask does not provide any criticality control function.

4.3.4 HI-STAR 190

As discussed in Chapter 3, the HI-STAR 190 transport cask, used to deliver the loaded Canister to the CTB, participates in the Short Term Operations, albeit to a limited extent. The safety analysis of HI-STAR 190 as a transport package under 10CFR71 regulations is documented in [1.3.6]. In order to insure that the transport condition loads that underlie the transport certification of HI-STAR 190 are not exceeded, the Short Term Operations in the CTB are configured such that:

- i. The handling of the cask is always carried out using single failure proof devices and systems;
- ii. As an additional defense-in-depth, the cask remains equipped with its impact limiters during its handling from the rail car and the free fall height of the cask is maintained below its certified limit in its Part 71 docket;
- iii. The cask is kept free of any wrappings that may inhibit its heat rejection function during short term operations;
- iv. In this subsection, HI-STAR 190's safety function as a canister containment device to the requirements of Part 72 is set down as a set of design criteria.

4.3.4.1 Structural

The structural qualification of HI-STAR 190 to the loadings of 10CFR71.71 (normal condition) and 10CFR71.73 (accident condition) in [1.3.6] are clearly much more severe than those encountered during its handling in the CTB. Nevertheless, certain structural requirements are

HOLTEC INTERNATIONAL COPYRIGHTED MATERIAL	
Report No. HI-2167374	Proposed Rev. OR
4-20	

unique to the operations in the CTB that are unique to the Short Term Operations. Table 4.3.6 contains the structurally significant loadings on the HI-STAR 190 cask in the Cask Transfer Building. Acceptance criteria are provided in Section 4.4.

4.3.4.2 Thermal

The thermally-significant loadings on HI-STAR 190 that warrant safety demonstration are summarized in Table 4.3.6. The permissible temperature limits for all steel weldments in casks and structures used at HI-STORE, provided in Table 4.4.4, are applicable to the HI-STAR 190.

4.3.4.3 Shielding

HI-STAR 190 is designed to meet the dose attenuation requirements of 10CFR71 [1.3.2] which far exceed those expected of on-site transfer casks. However, HI-STAR 190's contribution to meeting the dose limits of Part 72, set down in Subsection 4.4 herein, is considered in demonstrating compliance.

4.3.4.4 Confinement

The confinement function of the canister is unaffected by the function of HI-STAR 190.

4.3.4.5 Criticality Control

HI-STAR 190 does not participate in the criticality control function.

4.3.5 Canister Transfer Facility (CTF)

The HI-STORE CTF is an underground structure used to effectuate transfer of the SNF canister from the transport cask (HI-STAR 190) to the transfer cask (HI-TRAC CS).

4.3.5.1 Structural

The CTF includes both structural and non-structural radiation shielding components that are classified as important-to-safety. The structural steel components of the CTF are designed to meet the stress limits of Section III, Subsection NF, **Class 3**, of the ASME Code [4.5.1] for normal and accident conditions, as applicable. **The CTF reinforced concrete structures shall meet the applicable strength requirements of ACI 318-05 [5.3.1].**

The CTF must withstand the loads **associated with** the weights of each of its components, including the weight of the HI-TRAC CS transfer cask with the loaded MPC stacked on top during the canister transfer, and the weight of the transport cask with the loaded MPC staged on the CTF foundation slab. **The CTF shall be capable of withstanding any loading during a seismic event as determined by the provisions of Chapter 8 of ASCE 4 [4.3.4]**

4.3.5.2 Thermal

The allowable temperatures for the CTF structural steel components are based on the maximum temperature for material properties and allowable stress values provided in Section II of the ASME

HOLTEC INTERNATIONAL COPYRIGHTED MATERIAL	
Report No. HI-2167374	Proposed Rev. OR
4-21	

Code. The allowable temperatures for the structural steel and shielding components of the CTF are provided in Table 4.4.1.

4.3.5.3 Shielding

The CTF provides shielding to maintain occupational exposures ALARA in accordance with 10CFR20 [7.4.1]. Dose rates for a set of reference conditions are reported in Chapter 7. These dose rates are used to perform a generic occupational exposure estimate for MPC transfer operations, as described in Chapter 11.

4.3.5.4 Confinement

The CTF does not perform any confinement function.

4.3.5.5 Criticality Control

The CTF does not perform any criticality control function.

4.3.6 Applicable Earthquake Loadings for the HI-STORE CIS Facility

Guided by the adjudication in the ASLB proceedings on the PFS, LLC docket [4.3.1], the Safe Shutdown Earthquake (SSE) or Design Basis Earthquake (DBE) for the HI-STORE CIS facility has been set to bound the 10,000 year return earthquake, which is discussed in Subsection 2.6.2. Similarly, the Operating Basis Earthquake (OBE) has been set to bound the 1,000 year return earthquake for the site. For additional conservatism and to overcome any potential uncertainty or future adjustments to the site seismological data, a Design Extended Condition Earthquake (DECE) has also been defined for the site, which has a ZPA value that is two-thirds greater than the DBE.

The response spectra of the bounding earthquakes are defined by the Regulatory Guide 1.60 spectra pegged to the respective ZPA values identified in Table 4.3.3. The generation of acceleration time histories, if required, shall meet the criteria specified in SRP 3.7.1 [5.4.1], which has been used to support safety analyses for HI-STORM deployments at numerous nuclear plant sites.

The DBE applies to the HI-STORM UMAX system which will serve to store the Canisters for a relatively long duration (depending on the need and licensing duration granted by the USNRC). In Chapter 5, however, the DECE is conservatively used to inform the structural evaluation of the HI-STORM UMAX system at the HI-STORE site.

The OBE applies to the Short-Term Operations required to load the arriving Canisters at HI-STORE. All equipment configurations, such as the stack-up at the Canister Transfer Facility and that at the HI-STORM UMAX VVM or the Vertical Cask Crawler (VCT) holding the HI-TRAC CS transfer cask (Figure 4.5.2), are subject to seismic qualification under the Operating Basis Earthquake. However, the seismic calculations in Chapter 5 for Short-Term Operations conservatively use the DBE as input.

HOLTEC INTERNATIONAL COPYRIGHTED MATERIAL	
Report No. HI-2167374	Proposed Rev. OR
4-22	

Table 4.3.1	
Loadings Excluded from Further Consideration in the Qualification of Storage System and Ancillaries at the HI-STORE SAR	
Internal Design Pressure	All canisters brought to the HI-STORE site in the HI-STAR 190 transport cask from operating at-plant ISFSIs must meet the transport cask heat load limit, which is much lower than the acceptable limit defined in Chapter 2 of the HI-STORM UMAX FSAR [1.0.6]. The associated internal design pressure shall therefore always be less than its design basis pressure. The canister internal pressure is incorporated by reference from the HI-STORM UMAX FSAR [1.0.6], Paragraph 2.3.2.1. The HI-TRAC transfer cask and HI-STORM UMAX VVM are not capable of retaining internal pressure due to their open design, and therefore no analysis is required.
Lightning	Lightning is considered to be innocuous to the HI-STORM UMAX ISFSI because of its underground configuration. It is therefore excluded from consideration in both the HI-STORM UMAX and HI-STORE CIS design loadings. The evaluation of the HI-STORM UMAX VVMs related to lightning is incorporated by reference from the HI-STORM UMAX FSAR [1.0.6], Section 2.3.1.
Snow and Ice	The latitude of the ELEA site makes heavy snow accumulation and the comparative low magnitude of snow loading removes snow as a Design Basis Load (DBL) <i>a priori</i> from further consideration
High Winds	Regulatory Guide 1.76 [2.7.1], ANSI 57.9 [2.7.2], and ASCE 7-05 [4.6.1] provide the wind data used to define the Design Basis Wind in the HI-STORM UMAX FSAR. The diminutive profile and heavy weight of the closure lid (over 17 tons) makes the HI-STORM UMAX facility immune from any kinematic movement under very high or tornadic wind conditions. The wind conditions at the ELEA site are considered to be bounded by the HI-STORM UMAX FSAR Design Basis Wind. The HI-STORM UMAX systems performance under high wind conditions is incorporated by reference from the HI-STORM UMAX FSAR [1.0.6], Section 2.3.2.7
Tornado Borne Missiles	The Design Basis Missiles (DBMs) analysis in the HI-STORM UMAX FSAR show large margins of safety and are considered to bound the HI-STORE CIS facility conditions. Therefore, a repetitive analysis in this SAR is unnecessary. The HI-STORM UMAX tornado borne missile analysis is incorporated by reference from the HI-STORM UMAX FSAR [1.0.6], Section 2.4.2.

HOLTEC INTERNATIONAL COPYRIGHTED MATERIAL	
Report No. HI-2167374	Proposed Rev. OR
4-23	

Table 4.3.1	
Loadings Excluded from Further Consideration in the Qualification of Storage System and Ancillaries at the HI-STORE SAR	
Flood	As shown in Table 4.3.2, the Design Basis Flood used to qualify the VVM in the HI-STORM UMAX FSAR exceeds the most severe projection of flood at the ELEA site. Therefore, flood is eliminated from consideration as a meaningful loading event for HI-STORE CIS. The HI-STORM UMAX system design basis flood evaluation is incorporated by reference from the HI-STORM UMAX FSAR [1.0.6], Section 2.4.7.
Non-Mechanistic Tip-over	Because the HI-STORM UMAX VVM is situated underground, a tip-over event is not a credible accident for this design. It has been excluded in the HI-STORM UMAX safety analysis for the same reason.
Explosion	An explosion event has not been postulated as a Design Basis Load (DBL) for the HI-STORE ISFSI. However, the HI-STORM UMAX VVM is evaluated for a design basis explosion pressure per Table 2.3.1 of [1.0.6]. In addition, the canisters are evaluated for a Design Basis external pressure, under accident conditions, per Table 2.2.1 of [1.3.7].

HOLTEC INTERNATIONAL COPYRIGHTED MATERIAL	
Report No. HI-2167374	Proposed Rev. OR
4-24	

Table 4.3.2
Environmental Data for the Licensing Basis in the HI-STORM UMAX Docket and the
HI-STORE Site for Different Service Conditions

Service Condition	Item	HI-STORM UMAX General License Data	Site Specific Data for HI-STORE CIS
Normal Condition of Storage	Temperature (defined as annual average)	80 deg. F.	62 deg. F (Table 2.7.1)
	Ambient pressure corresponding to elevation above sea level	760 mm Hg	670 mm Hg (See Note 1)
Off-Normal Condition of Storage	Off-normal temperature (defined as the maximum of the 72-hour average of the ambient temperature at an ISFSI site.)	100 deg. F.	91 deg. F (Table 2.7.1)
Accident Condition of Storage	Accident Condition (maximum average ambient temperature over a 24-hour period)	125 deg. F	108 deg. F See Chapter 2
Short Term Operations	Maximum & minimum 3-day average ambient temperature	90 deg. F 0 deg. F	91 deg. F 0 deg. F
Maximum Flood Height (faulted States)	Peak height of the flood water above the ISFSI pad	125 feet	3 feet See Chapter 2

Note 1: Ambient air pressure at 3500 ft elevation above sea level

HOLTEC INTERNATIONAL COPYRIGHTED MATERIAL	
Report No. HI-2167374	Proposed Rev. OR
4-25	

Table 4.3.3
Applicable Earthquake and Long Term Settlement data for the Certified HI-STORM UMAX System and the HI-STORE CIS Facility

#	Data	HI-STORM UMAX Generic License Value (see Note 1)	HI-STORE CIS Site Value	Comment
1	ISFSI Pad and SFP concrete density concrete compressive strength rebar yield strength concrete cover on rebar	<ul style="list-style-type: none"> • 150 lb/ft³ reference dry density • 4,500 psi minimum concrete compressive strength @ ≤ 28 days • 60,000 psi minimum rebar yield strength • minimum concrete cover on rebar per subsection 7.7.1 of ACI-318(05) 	Same as the value certified in the HI-STORM UMAX docket.	<p>See Licensing Drawings in Chapter 1 for details on concrete pad thickness.</p> <p>Grade 60 Rebar. Rebar is #11@9" (each face, each direction)</p> <p>Compressive strength, allowable bearing stress and reference dry density values for ISFSI structures are also applicable to the plain concrete used in the HI-STORM UMAX Closure Lid</p>
2	Depth averaged density of subgrade in Space A (see Figure 4.3.1)	120 lb/ft ³ minimum	120 lb/ft ³ minimum	Required for shielding and structural analysis
3	Depth averaged density of subgrade in Space B (see Figure 4.3.1)	110 lb/ft ³ minimum	110 lb/ft ³ minimum	Required for shielding analysis.
4	Depth averaged density of subgrade in Space C (see Figure 4.3.1)	120 lb/ft ³ nominal	120 lb/ft ³ nominal	Not required for shielding.
5	Depth averaged density of subgrade in Space D (see Figure 4.3.1)	120 lb/ft ³ nominal	120 lb/ft ³ nominal	This space will contain native soil. Not required for shielding.
6	Strain compatible effective shear wave velocity in Space A	1300 ft/sec minimum	1300 ft/sec minimum	This space will typically contain CLSM or lean concrete.

HOLTEC INTERNATIONAL COPYRIGHTED MATERIAL

Report No. HI-2167374

Proposed Rev. **OR**

4-26

Table 4.3.3				
Applicable Earthquake and Long Term Settlement data for the Certified HI-STORM UMAX System and the HI-STORE CIS Facility				
#	Data	HI-STORM UMAX Generic License Value (see Note 1)	HI-STORE CIS Site Value	Comment
7	Strain compatible effective shear wave velocity in Space B	450 ft/sec minimum	780 ft/sec minimum	Space will contain native soil.
8	Strain compatible effective shear wave velocity in Space C	485 ft/sec minimum	980 ft/sec minimum	Space will contain native soil.
9	Strain compatible effective shear wave velocity in Space D, V	485 ft/sec minimum	980 ft/sec minimum	Space will contain native soil.
10	Density of plain concrete in the Closure Lid (nominal)	150 lb/cubic feet	150 lb/cubic feet	Used in shielding calculations
11	Reference compressive strength of plain concrete in the Closure Lid	4,000 psi	4,000 psi	Used in analysis of mechanical loadings on the Closure Lid
12	Minimum compressive strength of SES in Space A (see Figure 4.3.1)	1,000 psi	1,000 psi	Used in tornado missile impact analysis and SSI analysis
13	Two orthogonal horizontal and one vertical ZPAs for 10,000 -year return earthquake (DBE)	-	0.15,0.15, 0.15	5% Damped Reg. Guide 1.60 spectra [4.3.2]
14	Two orthogonal horizontal and one vertical ZPAs for 1000- year return earthquake (OBE)	-	0.10, 0.10, 0.10	2% Damped Reg. Guide 1.60 spectra [4.3.2]
15	Two orthogonal horizontal and one vertical ZPAs for Design Extended Condition Earthquake (DECE)	-	0.25,0.25, 0.25	5% Damped Reg. Guide 1.60 spectra [4.3.2]

HOLTEC INTERNATIONAL COPYRIGHTED MATERIAL	
Report No. HI-2167374	Proposed Rev. OR
4-27	

Table 4.3.3				
Applicable Earthquake and Long Term Settlement data for the Certified HI-STORM UMAX System and the HI-STORE CIS Facility				
#	Data	HI-STORM UMAX Generic License Value (see Note 1)	HI-STORE CIS Site Value	Comment
16	Newmark Summation of the ZPAs at the Grade at the HI-STORE site (DECE)(Note 2)	1.3	0.45	The HI-STORM UMAX CoC uses the Newmark summation limit to indicate the severity of an earthquake event. The Newmark 100-40-40 response summation for a 3-D earthquake site is defined as: $A = a_1 + 0.4a_2 + 0.4a_3$, where a_1 , a_2 and a_3 are the site's ZPAs in three orthogonal directions and $a_1 \geq a_2 \geq a_3$. This approach is consistent with Reg. Guide 1.92 [4.3.3].

Note 1: The HI-STORM UMAX ISFSI design data is reproduced from Table 2.3.2 of the HI-STORM UMAX FSAR [1.0.6].

Note 2: The Newmark summation, A, is the weighted scalar that defines the severity of an earthquake consisting of three orthogonal (vectorial) accelerations. The magnitude of A is used to compare the relative severity of earthquakes.

HOLTEC INTERNATIONAL COPYRIGHTED MATERIAL	
Report No. HI-2167374	Proposed Rev. OR
4-28	

Table 4.3.4			
Structurally Significant Loadings (SSL) for HI-TRAC CS			
Structural Loading Case	Description of Loading	Affected part or Interfacing structure	Acceptance criterion
SSL-1	Dead weight of the loaded HI-TRAC CS	Lifting trunnions	NUREG-0612 [1.2.7]
SSL- 2	Site's OBE while the loaded cask is mounted on a HI-STORM UMAX VVM	Threaded anchors fastening the cask to the CEC structure embedded in the ISFSI pad and substrate & shell structure of the cask body loaded as a cantilever beam	ASME Section III Subsection NF [4.5.1] stress limits for Level B service condition.
SSL-3	Site's OBE while the loaded cask is mounted on the CTF surface and anchored to its Threaded Anchor Locations (TAL)	Threaded anchors fastening the cask to the CTB slab & shell structure of the cask body loaded as a cantilever beam	ASME Section III Subsection NF [4.5.1] stress limits for Level B service condition.
SSL-4	Missile from an extreme environmental phenomenon striking the cask while it is mounted on the ISFSI pad	Threaded anchors fastening the cask to the CEC structure embedded in the ISFSI pad and substrate & shell structure of the cask body loaded as a cantilever beam	ASME Section III Subsection NF stress limits for Level D service condition & the canister must be retrievable (not jammed inside the cask due to excessive diametral deformation)

HOLTEC INTERNATIONAL COPYRIGHTED MATERIAL	
Report No. HI-2167374	Proposed Rev. OR
4-29	

Table 4.3.5			
Thermally Significant Loadings (TSL) for HI-TRAC CS			
Thermally significant loading Condition	Description of condition	Ref Figure	Acceptance Criterion
TSL-1	Loaded Canister in HI-TRAC CS with its Shield Gate closed (constricted ventilation)	Figure 6.4.2	See Table 4.4.1
TSL-2	Collapse of the Cask Transfer Building (CTB) causing significant blockage of the top ventilation by the corrugated sheet metal from the roof	Further described in Subsection 6.5.2	
TSL-3	Enveloping fire	Further described in Subsection 6.5.2	

HOLTEC INTERNATIONAL COPYRIGHTED MATERIAL	
Report No. HI-2167374	Proposed Rev. OR
4-30	

Table 4.3.6			
Governing Structural and Thermal Loadings for HI-STAR 190 during Short Term Operations			
Loading ID	Loading type	Description	Acceptance Criterion
SSL-1	Structurally significant	The OBE strikes while the cask loaded with the canister is in the CTF cavity (see Figure 3.1.1g/h)	The cask's movement under the OBE must be limited such that it does not impact the internal shell of the CTF
TSL-1	Thermally Significant	The cask is seated in the CTF cavity which limits its heat rejection capacity (see Figure 6.4.1)	The maximum fuel cladding temperature must remain below the Short-Term Operation limit (Section 4.4)

HOLTEC INTERNATIONAL COPYRIGHTED MATERIAL	
Report No. HI-2167374	Proposed Rev. OR
4-31	

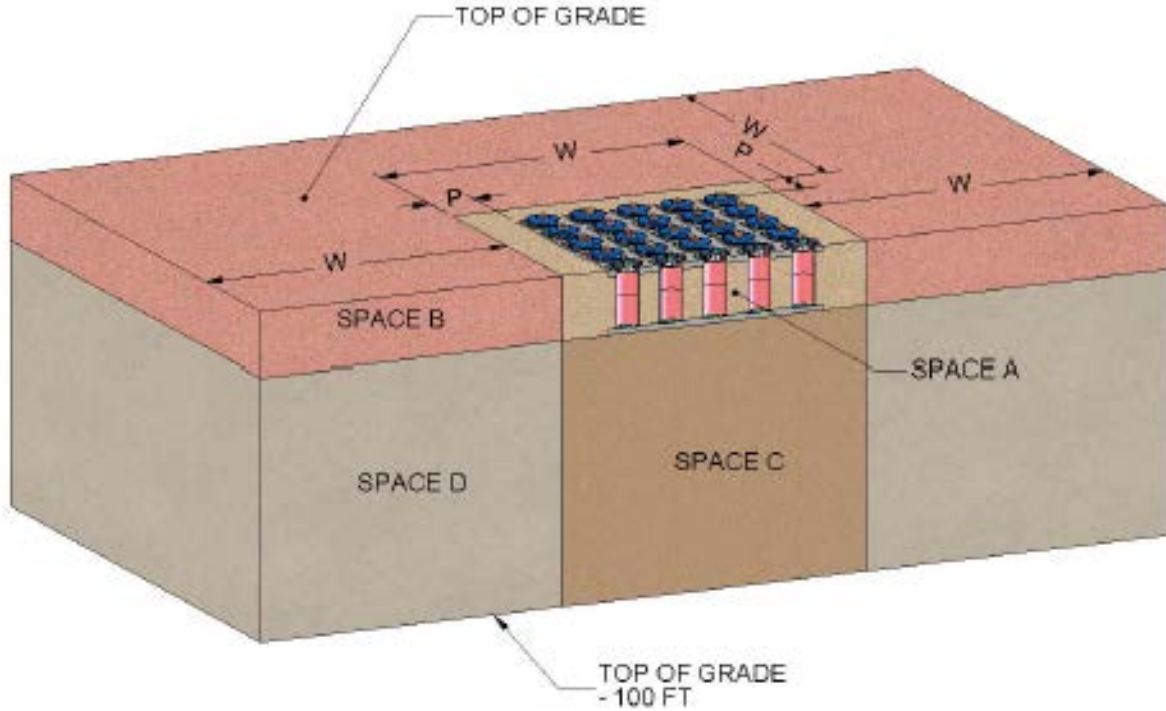


FIGURE 4.3.1: SUB-GRADE AND UNDER-GRADE SPACE NOMENCLATURE

Note 1: Space A is the lateral subgrade space in and around the VVMs which is refilled with CLSM or lean concrete after the construction of the SFP. Space B is the lateral subgrade that extends around the ISFSI. Space C is the under-grade below the SFP. Space D is the under-grade surrounding Space C. P is the distance between the outside VVMs and the edge of the ISFSI pad.

Note 2: As indicated by the title, this figure is provided to show the nomenclature for the various spaces around a HI-STORM UMAX ISFSI. This figure is not intended to provide specific dimensions or layout of the site- specific design in this SAR.

HOLTEC INTERNATIONAL COPYRIGHTED MATERIAL	
Report No. HI-2167374	Proposed Rev. OR
4-32	

4.4. ACCEPTANCE CRITERIA FOR CASK COMPONENTS

4.4.1 Stress and Deformation Limits

In the ASME Code, plant and system operating conditions are commonly referred to as normal, upset, emergency, and faulted. Consistent with the terminology in NRC documents, this SAR utilizes the terms normal, off-normal, and accident conditions.

The ASME Code defines four service conditions in addition to the Design Limits for nuclear components. They are referred to as Level A, Level B, Level C, and Level D service limits, respectively. Their definitions are provided in Paragraph NCA-2142.4 of the ASME Code. The four levels are used in this SAR as follows:

- i. Level A Service Limits are used to establish allowables for normal condition load combinations.
- ii. Level B Service Limits are used to establish allowables for off-normal conditions.
- iii. Level C Service Limits are not used.
- iv. Level D Service Limits are used to establish allowables for certain accident conditions.

The ASME Code service limits are used in the structural analyses for definition of allowable stresses and allowable stress intensities, as applicable. Allowable stresses and stress intensities of materials required for structural analyses are tabulated in Section 4.5. These service limits are matched with normal, off-normal, and accident condition loads combinations in the following subsections.

The following definitions of terms apply to the tables on stress intensity limits; these definitions are the same as those used throughout the ASME Code:

S_m : Value of Design Stress Intensity listed in ASME Code Section II, Part D, Tables 2A, 2B and 4

S_y : Minimum yield strength at temperature

S_u : Minimum ultimate strength at temperature

The following stress limits are applicable to the SSCs at the HI-STORE CIS facility:

- i. Canisters: The MPC confinement boundary is required to meet Section III, Class 1, Subsection NB stress intensity limits. Because the MPCs (canisters) are certified to loads in their native docket [1.0.6] that bound those at the HI-STORE site, it is not necessary to re-perform their stress qualifications. Accordingly, the stress intensity limits for the MPC are not presented in this SAR.
- ii. HI-STORM UMAX CEC and Closure Lid: The applicable Code for stress analysis is ASME Section III, Subsection NF. Because the HI-STORM UMAX structure has been qualified to loads that uniformly bound those at the HI-STORE site, it is not necessary to re-qualify the HI-STORM UMAX structure to the site specific loads in this SAR.

HOLTEC INTERNATIONAL COPYRIGHTED MATERIAL	
Report No. HI-2167374	Proposed Rev. OR
4-33	

- iii. Load bearing ancillaries: All structurally significant ancillaries are qualified to ASME Section III Subsection NF. The stress limits for the different service conditions are listed in Table 4.4.2. Appendix 4.A provides a summary of specific stress categories extracted from the Code for NF structures
- iv. Lifting and handling equipment: The applicable codes and requirements are provided in Section 4.5.
- v. Special handling devices: ANSI N14.6 [1.2.4] applied. Detailed requirements are provided in Section 4.5.

4.4.2 Thermal Limits

The thermal acceptance criteria for all components are identical to the design criteria described in Section 4.3.

4.4.3 Dose Limits

The off-site dose for normal operating conditions to any real individual beyond the controlled area boundary is limited by 10CFR72.104(a) for normal conditions and 10CFR72.106 for accident conditions (including contributions from all Short-Term operations) at the HI-STORE CIS facility. Table 4.4.3 provides the numerical dose limits.

HOLTEC INTERNATIONAL COPYRIGHTED MATERIAL	
Report No. HI-2167374	Proposed Rev. OR
4-34	

Table 4.4.1: Permissible Temperature Limits for HI-TRAC CS and CTF Materials (Note 4)			
ITEM	Short Term Operations, Deg. F. (Note 1)	Accident Condition, Deg. F.	Notes
Shielding Concrete	300 (section average)	<i>572</i> (local maximum)	Note 3
All steel weldments in casks and structures used at HI-STORE	600	700	Note 2; Note 3
<p>Note 1: Short term operations include all activities in the CTB and at the ISFSI to effectuate canister transfer and onsite translocation.</p> <p>Note 2: For accident conditions that involve heating of the steel structures and no mechanical loading (such as the blocked air duct accident), the permissible metal temperature of the steel parts is defined by Table 1A of ASME Section II (Part D) for Section III, Class 3 materials as 700°F</p> <p>Note 3: For the ISFSI fire event, the local temperature limit of concrete is 1100°F (HI-STORM 100 FSAR Appendix 1.D [1.3.3]), and the steel structure is required to remain physically stable (i.e., so there will be no risk of structural instability such as gross buckling, the maximum temperature shall be less than 50% of the component's melting temperature and the specific temperature limits in this table do not apply). Concrete that exceeds 1100°F shall be considered unavailable for shielding of the overpack.</p> <p>Note 4: The temperature limits of MPC components and its contents including fuel cladding under short-term operations are provided in Table 2.3.7 of the HI-STORM UMAX FSAR [1.0.6].</p>			

HOLTEC INTERNATIONAL COPYRIGHTED MATERIAL	
Report No. HI-2167374	Proposed Rev. OR
4-35	

Table 4.4.2: Stress and Acceptance Limits for Different Loading Conditions for the Primary Load Bearing Structures in the Steel Weldments of Casks

(Adapted from Table 2.2.12 of HI-STORM FW FSAR [1.3.7])

STRESS CATEGORY	DESIGN + NORMAL	OFF-NORMAL	ACCIDENT
Primary Membrane, P_m	S	$1.33 \cdot S$	See Note 1
Primary Membrane, P_m , plus Primary Bending, P_b	$1.5 \cdot S$	$1.995 \cdot S$	
Shear Stress (Average)	$0.6 \cdot S$	$0.6 \cdot S$	

Note 1: Under accident conditions, the cask must maintain its physical integrity, the loss of solid shielding (lead, concrete, steel, as applicable) shall be minimal and the Canister must remain recoverable.

Definitions:

S = Allowable Stress Value for Table 1A, ASME Section II, Part D.

S_m = Allowable Stress Intensity Value from Table 2A, ASME Section II, Part D

S_u = Ultimate Stress

HOLTEC INTERNATIONAL COPYRIGHTED MATERIAL	
Report No. HI-2167374	Proposed Rev. OR
4-36	

Table 4.4.3: Radiological Site Boundary Requirements from 10CFR72

(Reproduced from Table 2.3.1 of HI-STORM FW FSAR [1.3.7])

MINIMUM DISTANCE TO BOUNDARY OF CONTROLLED AREA (m)	100
NORMAL AND OFF-NORMAL CONDITIONS:	
-Whole Body (mrem/yr)	25
-Thyroid (mrem/yr)	75
-Any Other Critical Organ (mrem/yr)	25
DESIGN BASIS ACCIDENT:	
-TEDE (rem)	5
-DDE + CDE to any individual organ or tissue (other than lens of the eye) (rem)	50
-Lens dose equivalent (rem)	15
-Shallow dose equivalent to skin or any extremity (rem)	50

HOLTEC INTERNATIONAL COPYRIGHTED MATERIAL	
Report No. HI-2167374	Proposed Rev. OR
4-37	

Table 4.4.4
HI-STAR 190 Materials Temperature Limits

Component	Short-Term Temperature Limits^(a) °C (°F)	Accident Temperature Limits^(a) °C (°F)
Fuel Basket	500 (932) ^(b)	500 (932) ^(b)
DFC	570 (1058) ^(b)	570 (1058) ^(b)
Basket Shims and Solid Shim Plates	500 (932) ^(b)	500 (932) ^(b)
MPC Shell	427 (800) ^(b)	427 (800) ^(b)
MPC Lid	427 (800) ^(b)	427 (800) ^(b)
MPC Baseplate	427 (800) ^(b)	427 (800) ^(b)
Containment Shell	232 (450) ^(c)	371 (700) ^(d)
Containment Bottom and Top Forgings	232 (450) ^(c)	371 (700) (Structural Accidents) ^(d) 788 (1450) (Fire Accident) ^(e)
Closure Lid	232 (450) ^(c)	371 (700) (Structural Accidents) ^(d) 788 (1450) (Fire Accident) ^(e)
Remaining Cask Steel	232 (450) ^(c)	371 (700) (Structural accidents) ^(d) 788 (1450) (Fire Accident) ^(e)
Lid Seal ^(f)	120 (248)	210 (410)
Neutron Shield	204 (400)	Note (g)
Gamma Shield	316 (600)	316 (600) ^{Note (h)}

Notes

(a) The ASME Code requires that the vessel design temperature be established with appropriate consideration of internal or external heat generation. In accordance with ASME Section III Code, Para. NCA-2142 the design temperature is set at or above the structural members' section temperature defined as the maximum through thickness mean metal temperature of the part under consideration. The section temperatures of the structural members shall not exceed the temperatures limits tabulated herein.

(b) The temperature limits of MPC, fuel basket and basket shims are the same as that in HI-STORM FW FSAR [1.3.7]. The temperature limit of DFCs is the same as that in the HI-STORM UMAX FSAR [1.0.6].

(c) The normal condition temperature limits conservatively bound the ASME Code temperature limits.

(d) The accident temperatures of structural members must not exceed the ASME code temperature limits.

(e) To preclude melting the short term and fire accident temperature limits are set well below the melting temperature of structural steel.

(f) The temperature limits tabulated herein bound the manufacturers recommended limits for elastomeric seals as described in Chapter 2.

(g) Neutron shield temperature limits are applicable during normal transport and short-term operations. During fire no reduction in Holtite-B heat conduction effectiveness is assumed. During post-fire cooldown conductivity of air is assumed.

(h) To preclude melting the short term and fire accident temperature limits are set well below the melting temperature of lead.

HOLTEC INTERNATIONAL COPYRIGHTED MATERIAL	
Report No. HI-2167374	Proposed Rev. OR
4-38	

4.5 LIFTING EQUIPMENT (CTB CRANE & VCT), SPECIAL LIFTING DEVICES AND MISCELLANEOUS ANCILLARIES

Ancillaries for the HI-STORE CIS are equipment, systems or devices that are needed to carry out Short Term Operations to place the canister into interim storage or to remove the loaded canister from storage. In what follows, the design criteria for the different types of ancillaries envisaged for the HI-STORE facility are set down in sufficient detail to ensure that the resulting detailed design will fulfill their safety imperatives in full measure.

The description of principal ancillaries needed at the HI-STORE facility provided in Chapter 1 indicates that the list is quite small due to the fact that the canisters arrive in ready-to-store condition at the site and the needed operations pertain entirely to handling of the loaded canister. As a result, the ancillaries belong entirely to the class of special and standard lifting devices and certain miscellaneous equipment.

Heavy load handling device criteria summarized in the following are adopted from the HI-STORM FW FSAR [1.3.7]

4.5.1 Design Requirements Applicable to Lifting Devices and Special Lifting Devices

The lifting and handling ancillaries needed for operation of the HI-STORE CIS are classified as either “*lifting devices*” or “*special lifting devices*.”

The term *special lifting device* refers to components to which ANSI N14.6 [1.2.4] applies. As stated in ANSI N14.6 (both 1978 and 1993 versions), “This standard shall apply to *special lifting devices* that transmit the load from lifting attachments, which are structural parts of a container to the hook(s) of an overhead hoisting system.” Examples of *special lifting devices* are **MPC Lift Attachment**, **Transport Cask Horizontal Lift Beam**, and cask lift yokes.

The term *lifting device* as used in this SAR refers to components of a lifting and handling system that are not classified as *special lifting devices*. ANSI N14.6 is not applicable to these *lifting devices*. These include non-active structural components (components that bear the primary load but are not a constituent of a moving part, e.g., gear train, hydraulic cylinder) of the system.

4.5.1.1 Stress Compliance Criteria Applicable to Lifting Devices (LDs):

Examples of *lifting devices* used with Holtec’s systems include the VCT or the main girder of the crane used in the transport cask receiving area of the Cask Transfer Building (CTB).

The stress compliance criteria for *lifting devices* are taken from the code applicable to the specific component. For example, slings are required to meet the guidelines of ANSI B30.9 [4.5.6], and overhead beams in a crane are required to meet the guidelines of an applicable consensus national standard selected by the designer, such as AISC, CMAA, or ASME Code (Subsection NF [4.5.1]).

The transporter used to handle the loaded transfer cask or overpack during transport operations must be engineered to provide a high integrity handling of the load, defined as a lifting/handling operation wherein the risk of an uncontrolled lowering of the heavy load is non-credible. In handling equipment, such as a transporter, high integrity handling is achieved through (a) a body and any vertical columns designed to comply with stress limits of ASME Section III, Subsection

HOLTEC INTERNATIONAL COPYRIGHTED MATERIAL	
Report No. HI-2167374	Proposed Rev. OR
4-39	

NF, Class 3, (b) an overhead beam that is single-failure-proof, and (c) redundant drop protection features. Single failure proof handling capability is achieved by ensuring that the applicable factor of safety is 200% of that required by the reference design code or national consensus standard. It is acceptable to have certain load carrying members (such as the lifting towers in a vertical cask transporter) designed with redundant devices and others (such as the transverse beam) designed to the doubled factor of safety in order to meet the criteria set above.

4.5.1.2 Stress Compliance Criteria Applicable to Special Lifting Devices (SLDs):

The stress compliance criteria for *special lifting devices* are taken directly from ANSI N14.6 [1.2.4], which requires safety factors of three against the yield strength and five times against ultimate strength. Although not required by ANSI N14.6, Holtec International requires the yield and ultimate strengths of the primary load bearing member used in the stress analysis to be at its average metal temperature (in lieu of the ambient temperature).

Adequate material fracture toughness is demonstrated by using one of the following two methods:

- i) Demonstrate compliance with the fracture toughness requirements per NF-2300 of the ASME Code, Section III [4.5.1].
- ii) Follow the procedure given in NUREG/CR-1815 [4.5.13] for qualifying a steel specimen of known thickness and stress level for low temperature service.

Method (ii) above is comprised of four steps, which are listed below.

a) Perform a test based on an approved procedure to obtain the Charpy V-notch measurement (the energy absorbed by the specimen) in units of ft.-lb. The average of three tests shall be used. The temperature at which the test is performed shall be at or below the lowest service temperature (LST). The relation between the dynamic fracture toughness K_{ID} with units $\text{ksi}(\text{in}^{0.5})$, the Charpy V-notch measurement C_V with units ft.-lb., and the Young's Modulus E ($\times 10^6$ psi) at the test temperature is:

$$K_{ID} = (5 \times C_V \times E)^{0.5}$$

b) Determine the theoretical NDT temperature T_{NDT} in terms of the test temperature, T , and a value obtained from Figure 2 of [4.5.13] using the calculated dynamic fracture toughness K_{ID} from previous step.

c) Next, use Figure 3 from [4.5.13] to determine the value of "A" for a given test specimen thickness and the anticipated stress level during transporter operation. For Special Lifting Devices where ANSI N14.6 [1.2.4] is applicable, use a stress level of 33.3% of the material yield strength at the LST.

d) With "A" determined, a required T_{NDT} is obtained in terms of the LST and A as:

$$T_{NDT} = LST - A$$

Brittle fracture is not credible if the required NDT temperature, calculated in "Step d", is greater than the theoretical NDT temperature determined in "Step b".

HOLTEC INTERNATIONAL COPYRIGHTED MATERIAL	
Report No. HI-2167374	Proposed Rev. OR
4-40	

4.5.1.3 Single Failure Proof Criteria

In order for a *lifting device* or *special lifting device* to be considered single failure proof, the design must also follow the guidance in NUREG-0612 [1.2.7], which requires that a single failure proof device have twice the normal safety margin. This designation can be achieved by either providing redundant devices or providing twice the design safety factor as required by the applicable code. Therefore, for a *lifting device* to be considered single failure proof, the applicable code requirements should be doubled, or a redundant *lifting device* should be provided. Similarly, for a *special lifting device* to be considered single failure proof, the design safety factors in ANSI N14.6 [1.2.4] should be doubled, or a redundant *special lifting device* should be provided.

4.5.1.4 Stress Criteria and Critical Load Drop Accident

Both NUREG-0612 [1.2.7] and ANSI N14.6 [1.2.4] allow for a load drop analysis to be performed. If the consequences of that analysis are below the permissible dose rate and sub-criticality limits, the increased safety factors are not required. If the handling devices are designed to the correct stress limits, then the drop accident is non-credible.

4.5.2 Cask Transfer Building (CTB) Crane

The CTB crane is a **top running bridge crane with trolley hoist** located in the Cask Transfer Building (CTB), **as shown on the Licensing Drawing in Section 1.5**. It is the principal load handling device used to lift, upend, down-end and translocate the casks **and** other heavy loads used inside the CTB. It is the in-CTB counterpart to the Vertical Cask Transporter (VCT) which principally handles the transfer cask and other heavy loads outside the CTB. The Cask Crane renders the following repetitive operations:

1. Removal of the transport cask from the railcar
2. Removal of the transport cask impact limiters
3. Movement of the transport cask in and out of the CTF
4. **Effectuate Canister transfer between transport cask and HI-TRAC CS in CTF**
5. **Movement of HI-TRAC CS (empty and loaded) inside the CTB**
6. Movement of the transport cask (empty and loaded) inside the CTB

The ITS designation of the crane is provided in Table 4.2.1.

4.5.2.1 Structural

The CTB Crane shall be a single failure proof load handling device designed and built in accordance with the provisions of ASME NOG-1 [3.0.1].

The applicable Design Basis dead weight and seismic loadings on the CTB Crane are set down in Table 4.5.1.

- The crane shall be designed for a load capacity specified in Table 4.5.2.

HOLTEC INTERNATIONAL COPYRIGHTED MATERIAL	
Report No. HI-2167374	Proposed Rev. OR
4-41	

- For loading conditions that exceed the duration defined as seismic-exempt, a seismic analysis of the loaded crane shall be performed in accordance with the provisions of ASME NOG-1 [3.01].

4.5.2.2 Thermal

The CTB crane does not operate in an elevated temperature environment. The design temperature of the crane is conservatively specified in Table 4.5.1 to be well above the maximum ambient temperature in the CTB.

4.5.2.3 Shielding

The CTB crane does not provide a shielding function.

4.5.2.4 Confinement

The CTB crane does not provide a confinement function.

4.5.2.5 Criticality Control

The CTB crane does not perform any criticality control function.

4.5.2.6 Operational Requirements

- The crane design shall allow interfacing with all the lifting ancillaries such as MPC Lifting Device Extension, HI-TRAC CS Lifting Device, and HI-STAR 190 Lift Yoke.
- The crane design shall provide for the ability to upend and lift the HI-STAR from the railcar.
- The crane design shall meet the requirements per Table 4.5.1 and 4.5.2.
- The crane shall meet the operational requirements per ASME NOG-1 [3.0.1].

4.5.2.7 Environmental Conditions

The ambient conditions for the crane are identical to those for the VCT summarized in Table 4.5.3. In addition, the design of the crane shall preclude materials that may degrade under the radiation from casks during the crane’s service life.

4.5.2.7 Interfaces and Media Requirements

The electrical supply requirements are specified in Table 4.5.2. The crane shall have ability to receive signals from lifted equipment in order to fulfill operational requirements described in Chapter 10.

4.5.2.8 Electric Requirements

The following requirements shall be met.

The crane shall meet the electrical requirements per ASME NOG-1 [3.0.1]

- All safety relevant functions such as interlocking mechanisms, releases, selections, acceptances, and other connections shall be established via hard wire. All other functions

HOLTEC INTERNATIONAL COPYRIGHTED MATERIAL	
Report No. HI-2167374	Proposed Rev. OR
4-42	

can be realized via PLC. The operating and display elements which have no safety implications can be linked with a bus system to the PLC. The speed controllers can be linked with the PLC directly via bus system. The electrical design shall be properly configured for easy maintenance.

- Phase and voltage protection shall be provided for main power feed.
- Sufficient space shall be provided for the cable routing and buses into the electrical cabinet.
- Properly sized electrical grounding conductors shall be implemented in the cable routing of the main components.

4.5.2.9 Material Requirements

The construction materials for the CTB crane shall comply with Subsection 4200 of the ASME NOG-1 [3.0.1], including the fracture toughness requirements per paragraph 4212.

4.5.3 Vertical Cask Transporter

The Vertical Cask Transporter (VCT) is the principal load handling device used at the HI-STORE CIS ISFSI. This Subsection provides the essential design requirements that the VCT procured for the HI-STORE facility must fulfill to comply with this SAR.

The VCT is a U-shaped, tracked vehicle (also called a tracked crawler) used for handling and on-site transport of loaded and empty HI-TRAC transfer cask. The structural characteristics of the so-called “wheeled” VCT are identical and therefore are not spelled out separately. The tracked crawler configuration has been selected for the HI-STORE site because of greater in-use experience with it in the United States. Use of a wheeled crawler at a later date will require a safety evaluation pursuant to 10CFR72.48.

The VCT is used for transferring an MPC, loaded in a HI-TRAC transfer cask, at the HI-STORM UMAX cavity. The constituent parts of the VCT are illustrated in Figure 4.5.1, and they are also shown in more detail on the Licensing Drawing in Section 1.5. As shown in Figure 4.5.1, the VCT consists of the vehicle main frame, the lifting towers, an overhead crossbeam that connects between the lifting towers, a cask restraint system, the drive system and control system, and the cask lifting attachment. The transfer cask is supported by the lifting attachments that are connected to the overhead beam (Figure 4.5.2). The overhead beam is supported at the ends by a pair of lifting towers. The lifting towers transfer the cask weight directly to the vehicle frame. The lifting towers have an independent means of affording protection against uncontrolled lowering of the load. Figure 4.5.3 illustrates the dual-path MPC handling system utilized for Canister raising or lowering operations. In summary, used in conjunction with the special lifting devices, it provides the critical lifting and handling functions associated with the canister transfer operations. The VCT may also be used to transfer HI-TRAC CS from CTB to the HI-STORM UMAX ISFSI.

The ITS designation of the VCT and its constituent components is provided in Table 4.2.1.

4.5.3.1 General Design Requirements

Prevention of a cask or canister drop is afforded by design conformance with NUREG-0612 [1.2.7] and ANSI N14.6 [1.2.4] combined with the use of automatic redundant drop protection features

HOLTEC INTERNATIONAL COPYRIGHTED MATERIAL	
Report No. HI-2167374	Proposed Rev. OR
4-43	

along with hydraulic check valves and enhanced safety margins. The automatic drop protection features shall prevent an uncontrolled lowering of the load under any potential single system failure or loss of hydraulic or electric power at any time, including travel.

The VCT vehicle frame shall be designed in accordance with applicable industry standards such as ASME Section III, Subsection NF, for Class 3, linear-type supports or equivalent such as AISC [4.5.9]. The MPC downloader system shall be fully redundant and each side shall be capable of holding the entire weight of a loaded MPC (Figure 4.5.3). Overhead beam deflection shall meet the requirements of [4.5.11]

The overhead beam, lifting attachments, and MPC downloader pulley/pins and/or other attachments shall be designed in accordance with the applicable guidance of NUREG-0612, Section 5.1.6 [1.2.7], which includes ANSI N14.6 [1.2.4] for those items meeting the definition of special lifting devices. For the special lifting devices, the safety factor shall be based on the lower of 1/6th the yield strength or 1/10th the ultimate strength. The overhead beam, MPC downloader pulley/pins and other lifting devices shall be single failure proof (see definition in Glossary).

Jack/Lifting Towers (including top lugs connecting to overhead beam pins and the pins connecting the Lifting Towers to the frame) shall be designed in accordance with ASME Section III, Subsection NF, for Class 3, Linear-Type Supports [4.5.1] and ASME B30.1 [4.5.8] with design safety factors consistent with the guidance of [1.2.7], Section 5.1.6 (1)(a) for the specific load lifted.

The Load Drop Protection System shall be designed to meet the applicable stress limits of ASME Section III, Subsection NF, for Class 3, Linear-Type Supports using 115% of the design basis load.

The hydraulic fluids used in jacks or other hydraulic equipment shall be appropriate for use throughout the range of service temperatures listed in Table 4.5.1. The hydraulic fluids used in the cask transporter should have a flashpoint greater than or equal to 500°F per ASTM D92 [4.5.10]. Hydraulic fluids with flashpoints lower than 500°F may be used provided they are included as combustible material in the applicable fire analyses.

The Lifting Cylinders shall meet the requirements of ASME B30.1-2009 [4.5.8]. High-energy hydraulic lines shall be guarded or properly secured for personnel protection to ensure no personnel injuries from whipping of a ruptured line.

4.5.3.2 Fabrication

The VCT shall be designed, fabricated, inspected, and tested in accordance with the applicable guidance of NUREG-0612 [1.2.7]. All directly loaded tension and compression members shall be engineered to satisfy the enhanced safety criteria of paragraphs 5.1.6 (1) (a) and (b) of [1.2.7]. All welding shall comply with [4.5.3] or [4.5.4]. The VCT shall be manufactured in accordance with the provisions of [4.5.5]. Slings shall comply with the provisions of [4.5.6].

4.5.3.3 Structural

The following structural requirements apply to the components comprising the HI-STORE CIS facility VCT:

HOLTEC INTERNATIONAL COPYRIGHTED MATERIAL	
Report No. HI-2167374	Proposed Rev. OR
4-44	

- i. All materials used in the design of the overhead beam and lifting towers shall be ASTM or ASME approved.
- ii. Prevention of a cask or canister drop is afforded by design conformance with NUREG-0612 [1.2.7] and stress limits from ANSI N14.6 [1.2.4], where applicable, combined with enhanced safety margins and the use of redundant drop protection features, such as hydraulic check valves and a fail-safe electrical control system.
- iii. The VCT vehicle frame shall be designed in accordance with applicable industry standards such as ASME Section III, Subsection NF, for Class 3, linear-type supports or equivalent, or AISC [4.5.9].
- iv. The overhead beam, lifting attachments, and MPC downloader pulley/pins and/or other attachments shall be designed in accordance the applicable guidance of NUREG-0612 [1.2.7], Section 5.1.6 which includes ANSI N14.6 [1.2.4] for those items meeting the definition of special lifting devices. For the special lifting devices, the safety factor shall be based on the lower of 1/6th the yield strength or 1/10th the ultimate strength. The overhead beam, MPC downloader pulley/pins and other lifting devices shall be single failure proof (see definition in Glossary).
- v. Jacks shall be designed in accordance with ASME Section III, Subsection NF, for Class 3, Linear-Type Supports [4.5.1] and ASME B30.1 [4.5.8] with design safety factors consistent with the guidance of NUREG-0612 [1.2.7], Section 5.1.6 (1)(a) for the specific load lifted. Multi-stage jacks may have several rated capacities based on the extension stage. The jacks' rated capacity shall be coupled with the load based on the jack configuration for the lift of the load.
- vi. The applicable Design Basis dead weight and seismic loadings on the VCT are listed in Table 4.5.3. The VCT shall be shown to not tip-over under any specified service condition. The vehicle's lateral and transverse center of gravity shall be lower than the HI-TRAC's lateral and transverse center of gravity while transporting a loaded HI-STORM. Stability checks shall assume a 7% transverse grade in all modes for conservatism. A national consensus standard such as ASCE 43-05 [5.4.5] shall be used for stability evaluation. The seismic restraints and their attachment points on the VCT frame shall be designed to meet the Level D stress limits of ASME Subsection NF.

4.5.3.4 Functional Requirements

The VCT shall be operated and controlled by means of a control panel. The control panel shall be suitably positioned to allow for easy access and operator visibility during cask engagement, lifting, movement, and lowering. The control panels shall be enclosed or suitably protected from weather conditions. From the operator's chair, the operator shall be able to see all gauges and indicators necessary to accurately monitor the condition of both the power source and the hydraulic system at all times. The VCT shall be equipped with a dead man's throttle.

The VCT shall be equipped with an emergency stop switch tethered to the rear of the vehicle by means of a retractable cord reel. The emergency stop switch shall be easily and sagely carried and operated by ground personnel walking behind or to either side of the VCT.

HOLTEC INTERNATIONAL COPYRIGHTED MATERIAL	
Report No. HI-2167374	Proposed Rev. OR
4-45	

The VCT shall be equipped with flashing movement warning lights and audible alarm with a minimum 30' range.

The VCT shall be capable of being towed and secured against movement in the event that it becomes inoperable during transit.

The design shall ensure that any electrical malfunction in the control system, motors, or power supplies will not lead to an uncontrolled lowering of the load.

Portable fire extinguisher(s) meeting the requirements of applicable NFPA codes.

A catch pan or a double wall fuel tank with a hose connection to route spills away from the VCT shall be mounted beneath the fuel tank.

The VCT shall be equipped with auxiliary power receptacles. Voltage, frequency, amperage ratings, and receptacle shall be specified by Holtec to meet site specific requirements.

4.5.3.5 Thermal

The VCT does not operate in an elevated temperature environment. The design temperature of the VCT is conservatively specified in Table 4.5.3 to be well above the maximum ambient temperature in the CTB, on the VCT haul path, and the ISFSI pad.

4.5.3.6 Shielding

The VCT does not provide a shielding function.

4.5.3.7 Confinement

The VCT does not provide a confinement function.

4.5.3.8 Criticality Control

The VCT does not perform any criticality control function.

4.5.3.9 Material Failure Modes

All materials used in the design of the overhead beam and lifting towers shall be ASTM or ASME approved.

The material properties and allowable stress values for all structural steel members shall be taken from the applicable national consensus standard. Acceptance criteria for the Charpy testing requirements for the overhead beam, lifting towers, cask transporter lift points and MPC downloader system load bearing components shall be per ASME Section III, Subsection NF [4.5.1] or ANSI N14.6 [1.2.4]. The lowest service temperature used for developing the test parameters for Charpy testing shall be equal to 0°F for all the components mentioned above. Lateral expansion will be per Table NF-2331(a)-3 and required Cv energies shall be extrapolated from Fig. NF-2331(a)-2 for Class 3 Materials.

Fatigue failure modes of primary structural members whose failure may result in the uncontrolled lowering of the load shall be evaluated. A minimum safety factor of 2 on the number of permissible loading cycles (1000 loading cycles) for critical members shall apply.

HOLTEC INTERNATIONAL COPYRIGHTED MATERIAL	
Report No. HI-2167374	Proposed Rev. OR
4-46	

4.5.3.10 Environmental Conditions

The ambient conditions for the VCT are summarized in Table 4.5.3. The design of the VCT shall preclude materials that may degrade under the radiation from casks during the service life.

4.5.4 HI-PORT

The HI-PORT is the principal conveyance used to transport a loaded HI-TRAC CS from the CTB to the HI-STORE CIS ISFSI. This Subsection provides the essential design requirements that the HI-PORT procured for the HI-STORE facility must fulfill to comply with this SAR.

The constituent parts of the HI-PORT are shown on the Licensing Drawing in Section 1.5. The HI-PORT consists of two self-powered transport trailers with a center drop deck between the trailers. During transport, the transfer cask is oriented vertically and mechanically fastened to the drop deck at four tie-down locations. The elevated drop deck is supported at both ends by the front and back trailers. Upon arrival at the ISFSI, the transfer cask is removed from the HI-PORT using the VCT.

The ITS designation of the HI-PORT is provided in Table 4.2.1.

4.5.4.1 General Design Requirements

The HI-PORT shall be designed, fabricated, inspected, and tested in accordance with the purchase specification [4.5.14].

4.5.4.2 Fabrication

The HI-PORT structural components shall be constructed from structural or pressure vessel grades of carbon steel and must be manufactured to a national consensus standard. All welding shall comply with national consensus standards, such as AWS D1.1 [4.5.4].

4.5.4.3 Structural

The following structural requirements apply to the HI-PORT for the HI-STORE CIS facility:

- i. The drop deck shall be designed to meet the stress limits of ASME Section III, Subsection NF, Class 3.
- ii. The applicable Design Basis dead weight and seismic loadings on the HI-PORT are listed in Table 4.5.10. The HI-PORT shall be shown to not tip-over under any specified service condition. The seismic restraints and their attachment points on the HI-PORT drop deck shall be designed to meet the Level D stress limits of ASME Subsection NF.
- iii. The designated haul path for HI-PORT travel shall comply with the maximum longitudinal and lateral grade limitations in Table 4.5.10. The minimum required bearing strength for the haul path is also given in Table 4.5.10. The haul path surface can be either asphalt or hardened concrete.

4.5.4.4 Functional Requirements

HOLTEC INTERNATIONAL COPYRIGHTED MATERIAL	
Report No. HI-2167374	Proposed Rev. OR
4-47	

The HI-PORT shall be able to be operated with wireless remote control.

The HI-PORT shall be capable of being raised and lowered while under maximum transport load to clear any obstructions on the ISFSI pad.

The HI-PORT shall allow a crane or VCT to install and remove the HI-TRAC.

The HI-PORT transport trailers shall maintain operation functionality (e.g., driving, turning, stopping, etc.) when the drop deck is attached.

The HI-PORT shall have a parking brake.

The HI-PORT shall be recoverable, while under load, in the event of equipment failure or operator incapacitation. The HI-PORT shall be capable of being towed with full rated load, if necessary. Designated towing points shall be clearly identified and capable of use for towing load.

The unloaded drop deck shall be capable of resting on level ground while HI-PORT transport trailers are lowered to allow separation of the trailers from the drop deck.

4.5.4.5 Thermal

The HI-PORT does not operate in an elevated temperature environment. The design temperature of the HI-PORT is conservatively specified in Table 4.5.10 to be well above the maximum ambient temperature in the CTB, on the heavy-haul path, and at ISFSI pad.

4.5.4.6 Shielding

The HI-PORT does not provide a shielding function.

4.5.4.7 Confinement

The HI-PORT does not provide a confinement function.

4.5.4.8 Criticality Control

The HI-PORT does not perform any criticality control function.

4.5.4.9 Material Failure Modes

The HI-PORT structural components shall be constructed from structural or pressure vessel grades of carbon steel and must be manufactured to a national consensus standard. The material properties and allowable stress values for all structural steel members shall be taken from the applicable national consensus standard.

Fatigue failure modes of primary structural members whose failure may result in the uncontrolled lowering of the load shall be evaluated. A minimum safety factor of 2 on the number of permissible loading cycles for critical members shall apply.

4.5.4.10 Environmental Conditions

HOLTEC INTERNATIONAL COPYRIGHTED MATERIAL	
Report No. HI-2167374	Proposed Rev. OR
4-48	

The ambient conditions for the HI-PORT are summarized in Table 4.5.10. The design of the HI-PORT shall preclude materials that may degrade under the radiation from casks during the service life.

4.5.5 Miscellaneous Ancillaries

Miscellaneous ancillaries are those weldments that are not used in a load lifting function and do not contain or in contact with fissile material. Such ancillaries do not render a confinement or criticality function. Certain ancillaries, however, are used to reduce crew dose such as tungsten screens and lead blankets. Such non-structural ancillaries are also called “accessories” because their design is guided by ALARA, not by any regulatory regimen.

The miscellaneous ancillaries that are subject to mechanical loadings under any operating modes shall meet the following design criteria:

- i. The Design loads and associated applicable to the ancillary under normal and accident conditions (if any) shall be defined based on its function and application.
- ii. ASME Section III Subsection NF Class 3 is designated as the governing code for purposes of stress analysis of the ancillary. Specifically, Subsection NF shall be used to demonstrate:
 - a. Compliance with the Code stress limits
 - b. Absence of the risk of brittle fracture at low service conditions (See Table 2.7.1)
 - c. Absence of elastic instability effects such as buckling
 - d. Absence of the risk of fatigue failure
- iii. The load rating and maximum/minimum operating temperature for the ancillary shall be marked on the ancillary.

The stress and strength tables for common materials used in the manufacturing of ancillaries have been extracted from [1.3.3] and are provided in this subsection.

HOLTEC INTERNATIONAL COPYRIGHTED MATERIAL	
Report No. HI-2167374	Proposed Rev. OR
4-49	

Table 4.5.1		
Design Basis Loadings on the Cask Crane inside the CTB		
Item	Value	Comment
Design Basis Dead Load	200 tons	Bounds the weight of all heavy loads lifted by the crane
Operating Basis Earthquake (OBE)	See Table 4.3.3	The seismic motion is applied at the elevation of the CTB Slab
Reference temperature	150 Deg. F.	Conservative upper bound on the maximum ambient temperature

HOLTEC INTERNATIONAL COPYRIGHTED MATERIAL	
Report No. HI-2167374	Proposed Rev. OR
4-50	

Table 4.5.2
Design Parameters for the CTB Crane

Specification	Specification Description
Component Type per ASME NOG-1-2015 [3.0.1]	Main Hoist: Type I Auxiliary Hoist: Type II Bridge: Type I Trolley: Type I
Service Factor	Main Hoist, Bridge , and Trolley: To meet or exceed minimum requirements as provided in ASME NOG-1 [3.0.1]; Auxiliary Hoist: CMAA 70 [4.5.2]: CMAA Class D
Material of Construction	Load bearing members of the CTB Crane structure shall be in compliance with Subsection 4200 of ASME NOG-1 [3.0.1]; commercial winch and trolley components.
Main Hoist Capacity	200 ton minimum
Auxiliary Hoist	20 tons
Hook Type	Duplex (sister) hook with pin eye
Crane Speed (reference)	45 feet /min (infinitely variable speed control with minimum 30:1 speed range)
Trolley Speed (reference)	35 feet/min (infinitely variable speed control with minimum 30:1 speed range)
Main Hoist Speed (reference)	5 feet/min (infinitely variable speed control with minimum 100:1 speed range)
Auxiliary Hoist Speed (reference)	20 feet/min (infinitely variable speed control with minimum 100:1 speed range)
Operator Controls	Radio Control – To operate on Frequencies as allowed by local codes. Pendent backup with quick disconnect and full length festoon.
Main Hoist Reeving	Single Failure Proof reeving – True Vertical Lift
Auxiliary Hoist Reeving	Single or Double reeving. If double reeving is used, ropes must be equalized using an equalizer sheave or bar.
Motor Controls	Variable Frequency Drives with infinite speed control.

HOLTEC INTERNATIONAL COPYRIGHTED MATERIAL

Report No. HI-2167374

Proposed Rev. **OR**

4-51

Table 4.5.2
Design Parameters for the CTB Crane

Specification	Specification Description
General Additional Safety Devices	<ol style="list-style-type: none"> 1. Overload protection for critical loads and maximum capacity of each hoist. Critical load overload protection shall be field adjustable. Approximate values are provided in this document. 2. Slack Rope protection (underload) for critical loads with over-ride for lowering of the load. Settings should be field adjustable. Approximate values are provided in this document. 3. Over Speed protection for critical loads. 4. Trolley end of travel limit switches with slow down and stop. 5. Audible alarms 6. Visual alarms (lights) 7. Fail-Safe Emergency Stop (pendant, radio control, and operating floor)
Bridge Service Platform	Walkway/Service Platform mounted to one side of the crane along the entire length of the span. An entry way to be coordinated with the crane access point is to be provided for safe personnel access to the platform. All electrical control enclosures shall be serviceable from the platform.
Trolley Service Platform	Walkway/Service Platform to allow inspection and service to hoist and trolley components. Access to the platform is to be provided from the platform for safe personnel access.
Bridge Bumpers	Energy absorbing bumpers sized to decelerate and stop the while traveling without power at 40% of the rated load speed at a rate of deceleration not to exceed an average of 0.91 m/s^2 (3 ft/sec^2).
Trolley Bumpers	Energy absorbing bumpers sized to decelerate and stop the while traveling without power at 50% of the rated load speed at a rate of deceleration not to exceed an average of 1.4 m/s^2 (4.7 ft/sec^2).
Lighting	LED Crane Lighting for operators and others working under the crane.
Runway Rail and End Stops	As needed to meet hook coverage requirements and the general requirements of ASME NOG-1 [3.0.1], including all fastening hardware, splices, and end stops.
Power	3 phase, 380V, 50 Hz.
HOLTEC INTERNATIONAL COPYRIGHTED MATERIAL	
Report No. HI-2167374	Proposed Rev. OR
4-52	

Table 4.5.2	
Design Parameters for the CTB Crane	
Specification	Specification Description
Power Disconnect	Floor Mount Power Disconnect lockable in the open position
Runway Electrification	Sliding Double Shoe Collectors and Buss Bar
Coatings	ASME NOG-1 [3.0.1]; Service Level II

HOLTEC INTERNATIONAL COPYRIGHTED MATERIAL	
Report No. HI-2167374	Proposed Rev. OR
4-53	

Table 4.5.3		
Design Basis Conditions and Loadings on the Vertical Cask Transporter		
Item	Value	Comment
Design Basis Dead Load	200 tons	Bounds the weight of the loaded HI-TRAC CS along with the associated lifting hardware
Maximum Loaded MPC	110,000 lbs	Bounding weight per HI-STORM UMAX FSAR [1.0.6] Table 3.2.1
Operating Basis Earthquake (OBE)	See Table 4.3.3	The seismic motion is applied at the elevation of the Haul Path slab
Design Temperature	150 Deg. F.	Upper bound on the maximum ambient temperature
Design Life	20 years	Normal life expectancy of the VCT
Maximum permitted service temperature	125 Deg. F	Limiting environmental temperature
Minimum permitted service temperature	0 Deg. F.	Limiting environmental temperature
Relative humidity range	0 to 100%	Design Basis Relative humidity range at the site
Maximum design basis incline or grade in longitudinal (travel) direction	10%	Used to size the engine and transmission system of the VCT
Maximum design basis lateral grade	7%	

HOLTEC INTERNATIONAL COPYRIGHTED MATERIAL	
Report No. HI-2167374	Proposed Rev. OR
4-54	

Table 4.5.4: Design and Level A Stress

Code: ASME NF
Material: SA516, Grade 70, SA350-LF3, SA203-E
Service Conditions: Design and Level A
Item: Stress

Temp. (Deg. F)	Classification and Value (ksi)		
	S	Membrane Stress	Membrane plus Bending Stress
-20 to 650	17.5	17.5	26.3
700	16.6	16.6	24.9

Notes:

1. S = Maximum allowable stress values from Table 1A of ASME Code, Section II, Part D.
2. Stress classification per Paragraph NF-3260.
3. Limits on values are presented in Table 4.4.2.
4. Table reproduced from [1.3.3], Table 3.1.10

HOLTEC INTERNATIONAL COPYRIGHTED MATERIAL	
Report No. HI-2167374	Proposed Rev. OR
4-55	

Table 4.5.5: Level B Allowable Stress

Code: ASME NF
Material: SA516, Grade 70, SA350-LF3, and SA203-E
Service Conditions: Level B
Item: Stress

Temp. (Deg. F)	Classification and Value (ksi)	
	Membrane Stress	Membrane plus Bending Stress
-20 to 650	23.3	34.9
700	22.1	33.1

Notes:

1. Limits on values are presented in Table 4.4.2 with allowables from Table 4.5.4.
2. Table reproduced from [1.3.3], Table 3.1.11

HOLTEC INTERNATIONAL COPYRIGHTED MATERIAL	
Report No. HI-2167374	Proposed Rev. OR
4-56	

Table 4.5.6: Level D Stress Intensity

Code: ASME NF
Material: SA516, Grade 70
Service Conditions: Level D
Item: Stress Intensity

Temp. (Deg. F)	Classification and Value (ksi)		
	S_m	P_m	$P_m + P_b$
-20 to 100	23.3	45.6	68.4
200	23.1	41.5	62.3
300	22.5	40.4	60.6
400	21.7	39.1	58.7
500	20.5	36.8	55.3
600	18.7	33.7	50.6
650	18.4	33.1	49.7
700	18.3	32.9	49.3

Notes:

1. Level D allowable stress intensities per Appendix F, Paragraph F-1332.
2. S_m = Stress intensity values per Table 2A of ASME, Section II, Part D.
3. Table reproduced from [1.3.3], Table 3.1.12

HOLTEC INTERNATIONAL COPYRIGHTED MATERIAL	
Report No. HI-2167374	Proposed Rev. OR
4-57	

Table 4.5.7: Design and Level A Stress

Code: ASME NF
Material: SA36
Service Conditions: Design and Level A
Item: Allowable Stress

Temp. (Deg. F)	Classification and Value (ksi)		
	S	Membrane Stress	Membrane plus Bending Stress
-20 to 650	14.5	14.5	21.8
700	13.9	13.9	20.9

Notes:

1. S = Maximum allowable stress values from Table 1A of ASME Code, Section II, Part D.
2. Stress classification per Paragraph NF-3260.
3. Table reproduced from [1.3.3], Table 3.1.19

HOLTEC INTERNATIONAL COPYRIGHTED MATERIAL	
Report No. HI-2167374	Proposed Rev. OR
4-58	

Table 4.5.8: Level B Allowable Stress

Code: ASME NF
Material: SA36
Service Conditions: Level B
Item: Allowable Stress

Temp. (Deg. F)	Classification and Value (ksi)	
	Membrane Stress	Membrane plus Bending Stress
-20 to 650	19.3	28.9
700	18.5	27.7

Notes:

1. Table reproduced from [1.3.6, Table 3.1.20]

HOLTEC INTERNATIONAL COPYRIGHTED MATERIAL	
Report No. HI-2167374	Proposed Rev. OR
4-59	

Table 4.5.9: Level D Stress Intensity

Code: ASME NF
Material: SA36
Service Conditions: Level D
Item: Stress Intensity

Temp. (Deg. F)	Classification and Value (ksi)		
	S_m	P_m	$P_m + P_b$
-20 to 100	19.3	43.2	64.8
200	19.3	37.0	55.5
300	19.3	36.0	54.0
400	19.3	34.7	52.1
500	19.3	32.8	49.2
600	17.7	30.0	45.0
650	17.4	29.5	44.3
700	17.3	29.2	43.8

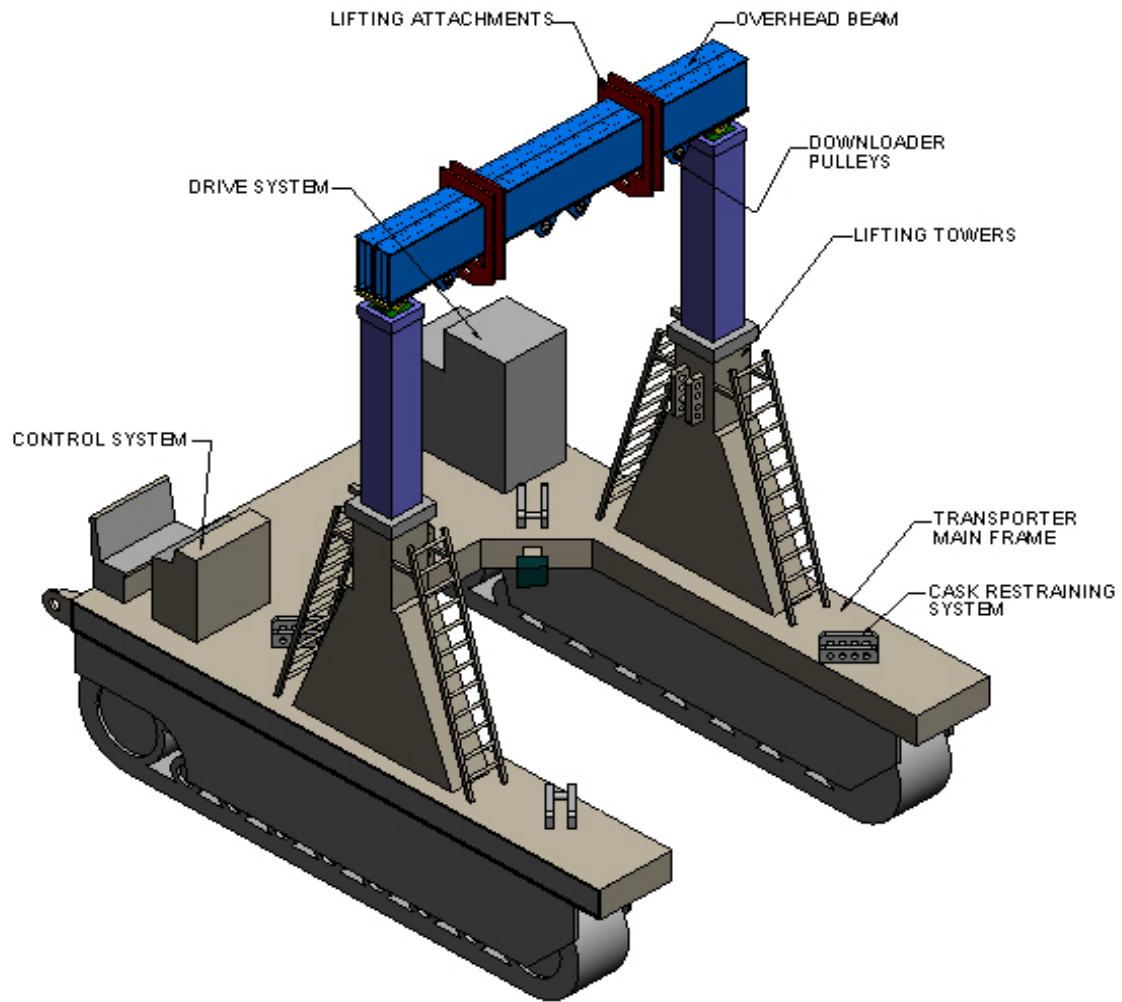
Notes:

1. Level D allowable stress intensities per Appendix F, Paragraph F-1332.
2. S_m = Stress intensity values per Table 2A of ASME, Section II, Part D.
3. Table reproduced from [1.3.3], Table 3.1.21

HOLTEC INTERNATIONAL COPYRIGHTED MATERIAL	
Report No. HI-2167374	Proposed Rev. OR
4-60	

Table 4.5.10		
Design Basis Conditions and Loadings on the HI-PORT		
Item	Value	Comment
Design Basis Dead Load	200 tons	Bounds the weight of the loaded HI-TRAC CS along with the associated lifting hardware
Operating Basis Earthquake (OBE)	See Table 4.3.3	The seismic motion is applied at the elevation of the Haul Path slab
Design Temperature	150 Deg. F.	Upper bound on the maximum ambient temperature
Design Life	15 years	Normal life expectancy of the HI-PORT
Maximum permitted service temperature	125 Deg. F	Limiting environmental temperature
Minimum permitted service temperature	0 Deg. F.	Limiting environmental temperature
Relative humidity range	0 to 100%	Design Basis Relative humidity range at the site
Maximum design basis incline or grade in longitudinal (travel) direction	8%	Used to size the engine and transmission system of the HI-PORT and to inform design of haul path
Maximum design basis lateral grade	3%	
Minimum required bearing strength of haul path	6,000 psf	Used for haul path design

HOLTEC INTERNATIONAL COPYRIGHTED MATERIAL	
Report No. HI-2167374	Proposed Rev. OR
4-61	



**FIGURE 4.5.1: VCT MAJOR COMPONENTS
(FOR ILLUSTRATION PURPOSES ONLY)**

HOLTEC INTERNATIONAL COPYRIGHTED MATERIAL		
Report No. HI-2167374		Proposed Rev. OR
4-62		

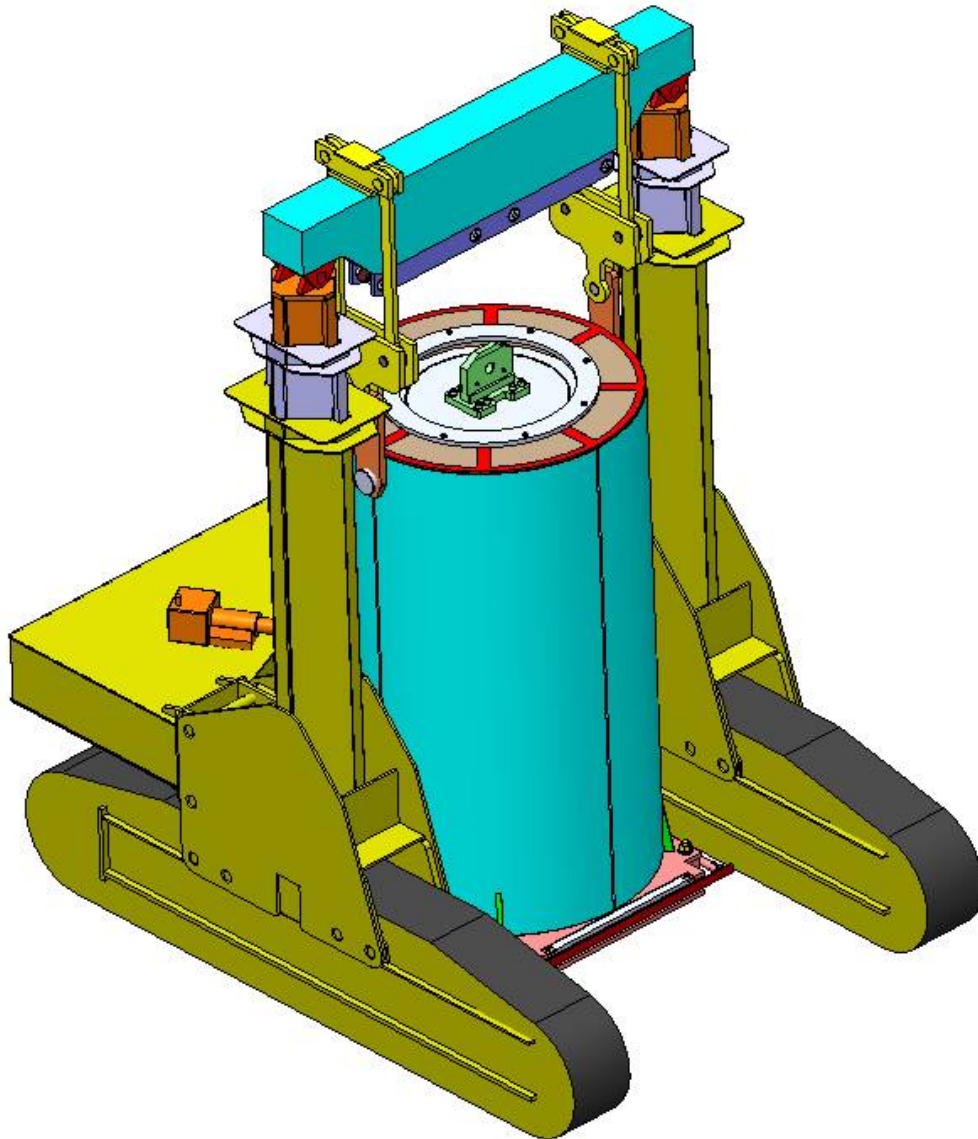


FIGURE 4.5.2: VCT CARRYING A HI-TRAC CS TRANSFER CASK

HOLTEC INTERNATIONAL COPYRIGHTED MATERIAL		
Report No. HI-2167374		Proposed Rev. OR
4-63		

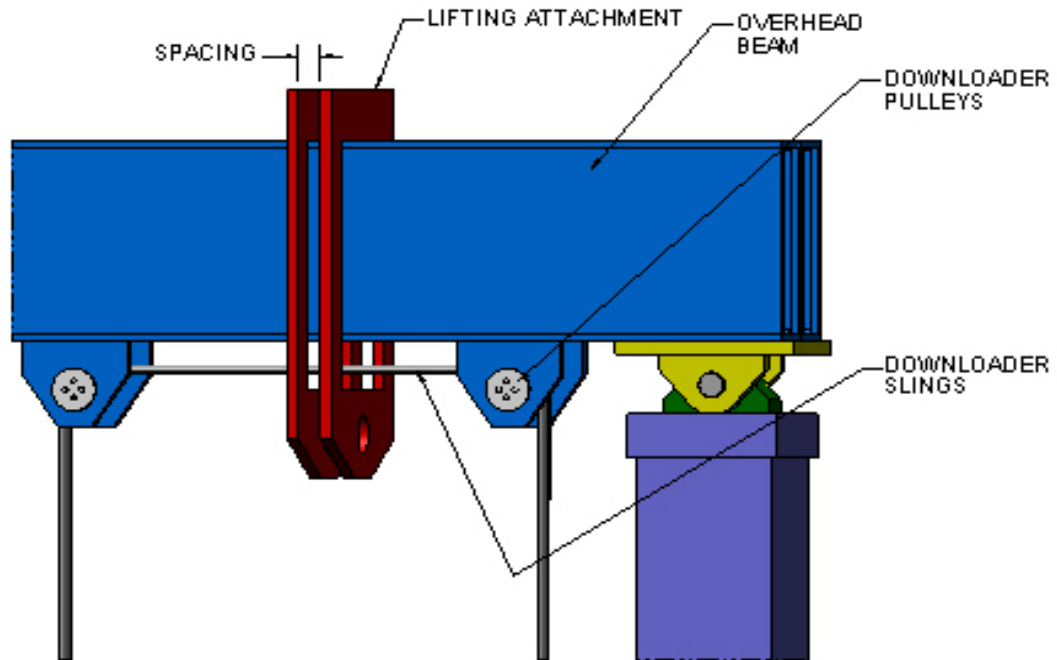


FIGURE 4.5.3: ILLUSTRATIVE VIEW OF THE VCT OVERHEAD BEAM AND CANISTER DOWNLOADER PULLEY SYSTEM

HOLTEC INTERNATIONAL COPYRIGHTED MATERIAL		
Report No. HI-2167374		Proposed Rev. OR
4-64		

4.6 DESIGN CRITERIA FOR THE CASK TRANSFER BUILDING (CTB)

4.6.1 Design Features of the CTB

The Cask Transfer Building (CTB) is an ITS-C structure at the HI-STORE CIS facility. It serves as a weather enclosure for the cask handling equipment, facilities, and structures inside the CTB, and it also provides protection against external hazards and natural phenomena. The CTB is a reinforced concrete structure, consisting of a load bearing slab-on-grade floor, reinforced concrete walls and roof, and steel framework which provides additional support for the walls and roof. The CTB Crane, summarized in Section 4.5, is a top running bridge crane mounted on a set of rails supported by the CTB walls. The CTB is founded on a thick reinforced concrete slab whose essential design data is summarized in Table 4.6.2.

The layout of the equipment and ancillaries in the CTB is provided on the Licensing Drawing in Section 1.5. Chapter 10 contains the summary of the operations that are envisaged to occur in the CTB.

4.6.2 General Design Requirements

Since the CTB is not a cask component, an ISFSI structure, nor part of a confinement system, it belongs in the category of “Other SSCs Subject to NRC Approval” per Subsection 4.5.2.2 of NUREG-2215 [4.6.6]. Accordingly, the CTB is designed to comply with the following codes and standards:

- AISC 360 [4.6.5] for steel framework and connections
- ASCE 7-10 [4.6.2] for minimum design loads
- IBC 2015 [4.6.4] for general design requirements
- ACI 318 [5.3.1] for reinforced concrete slab, walls, and roof
- AISC N690 [4.6.8] for safety-related steel structures

In addition, in Section 4.5.2 of NUREG-2215, ACI 349 [4.6.7] is listed as an acceptable reference for concrete structures important to safety that are not designed in accordance with ASME B&PV Code Section III, Division 1 or Division 2. The load combinations from all the above listed codes, as well as Table 4-3 of NUREG-2215, are surveyed, and a set of bounding load combinations is defined for the design analysis of the CTB. Table 4.6.3 lists the load combinations obtained from the referenced codes, and Table 4.6.4 lists the bounding load combinations used in the analysis. The symbols used in these tables are listed as follows:

D = Dead load of the structure and attachments including permanently installed equipment. Loads resulting from differential settlement are also included.

L = Live loads, including equipment (such as a cask or transport vehicle) not permanently installed.

L_r = Roof live load.

C_{cr} = Rated capacity of crane including impact factor.

HOLTEC INTERNATIONAL COPYRIGHTED MATERIAL	
Report No. HI-2167374	Proposed Rev. OR
4-65	

W = Wind loads per ASCE 7-10 [4.6.2]

W_t = Tornado load per Reg. Guide 1.76 [2.7.1]

S = Snow load

E = Load effects of DBE (conservatively substituted for OBE)

Lastly, the CTB design also complies with the applicable portions of New Mexico's state and local building codes.

HOLTEC INTERNATIONAL COPYRIGHTED MATERIAL	
Report No. HI-2167374	Proposed Rev. OR
4-66	

Table 4.6.1
REMOVED

HOLTEC INTERNATIONAL COPYRIGHTED MATERIAL	
Report No. HI-2167374	Proposed Rev. OR
4-67	

Table 4.6.2	
Reference Design Data for the CTB Slab	
Item	Reference value
Minimum Compressive strength of concrete	4,500 psi
Min Slab thickness	40 inches
Size of re-bars in the two orthogonal directions	#11
Re-bar nominal spacing	9 inch
Minimum concrete cover on the re-bar assembly (both faces)	3 inch
Minimum thickness of the engineered fill undergirding the slab	12 inch
Maximum weight of empty rail car	229 kips

HOLTEC INTERNATIONAL COPYRIGHTED MATERIAL	
Report No. HI-2167374	Proposed Rev. OR
4-68	

Table 4.6.3
Load Combinations from Applicable Codes

Applicable Code	D	L	C_{cr}	L_r	S⁽²⁾	W	W_t	E
ACI 349 [4.6.7]	1.4							
	1.2	1.6	1.4	0.5				
	1.2	1.6	1.4		0.5			
	1.2	0.8	1.4	1.6				
	1.2	0.8	1.4		1.6			
	1.2	1.6				1.6		
	1.0	0.8	1.0					1.0
	1.0	0.8					1.0	
ACI 318 ⁽¹⁾ [5.3.1]	1.4							
	1.2	1.6		0.5				
	1.2	1.6			0.5			
	1.2	1.0		1.6				
	1.2	1.0			1.6			
	1.2			1.6		0.5		
	1.2				1.6	0.5		
	1.2	1.0		0.5		1.0		
	1.2	1.0			0.5	1.0		
	1.2	1.0			0.2			1.0
	1.0							
AISC N690 [4.6.8]	1.4		1.4					
	1.2	1.6	1.4	0.5				
	1.2	1.6	1.4		0.5			
	1.2	0.8	1.4	1.6				
	1.2	0.8	1.4		1.6			
	1.2	0.8	1.0	0.5		1.0		
	1.2	0.8	1.0		0.5	1.0		
	1.0	0.8	1.0					1.0
	1.0	0.8					1.0	
NUREG-2215 [4.6.6]	1.4	1.7						
	1.05	1.275				1.275		
	1.0	1.0						1.0
	1.0	1.0					1.0	

Notes:

- (1) The load combinations in AISC 360 [4.6.5], ASCE 7-10 [4.6.2] and IBC-2015 [4.6.4] are identical to those in ACI 318 [5.3.1].
- (2) Per Table 4.3.1, snow load is excluded from the CTB design. Therefore, it does not need to be considered.

HOLTEC INTERNATIONAL COPYRIGHTED MATERIAL

Report No. HI-2167374

Proposed Rev. **OR**

4-69

Table 4.6.4
Bounding Load Combinations Used for CTB Analysis

Load Combination	D	L	L_r	S	W	W_t	E
1	1.4	1.7					
2	1.2	1.275	0.5		1.275		
3	1.2	1.6			1.6		
4	1.0	0.8				1.0	
5	1.2	1.0		0.2			1.0

Notes:
(1) Maximum load on crane hook is considered as live load (L) in above load combinations. Therefore, the rated capacity of the crane (C_{cr}) is not listed separately.

HOLTEC INTERNATIONAL COPYRIGHTED MATERIAL

Report No. HI-2167374

Proposed Rev. **OR**

4-70

4.7 SUMMARY OF DESIGN CRITERIA

The Design Criteria set down in this chapter seek to ensure that during any condition of storage (normal, off-normal or accident) and during canister transfer operations, the following metrics of safety will be observed:

- i. The confinement boundary is not breached.
- ii. There is no risk of exceeding the neutron multiplication factor limit of 0.95 including all uncertainties and biases.
- iii. The temperature of the used fuel remains below the limit set forth in ISG-11, Rev. 3 [4.0.1] which insures that the fuel will not undergo any significant degradation in storage.
- iv. The stresses in the primary structural members remain within the applicable ASME code limits under every condition of storage.
- v. The accreted site boundary radiation dose from the storage system meets the 72.104 & 10CFR 72.106 limits for the normal and accident conditions, respectively.
- vi. The occurrence of an accidental load drop event is rendered non-credible by the *use of single failure proof* lifting and handling devices.
- vii. There is no risk of brittle fracture of a primary load bearing member in the storage system under all storage scenarios.
- viii. There is no risk of fatigue failure in a load bearing member under all applicable storage scenarios.
- ix. There is no risk of structural instability (buckling), large deformation or similar non-linear behavior in any primary load bearing member during any (normal, off-normal and accident) condition of storage.

The above criteria are fulfilled either by reference to the HI-STORM UMAX FSAR [1.0.6] or by the safety analyses performed in support of this SAR. For the latter case, the justification for relying on the safety analysis in [1.0.6] is provided.

In particular, the information presented in this chapter shows that every loading germane to long term storage of Canisters in the HI-STORM UMAX VVM at a HI-STORM UMAX ISFSI, as described in the HI-STORM UMAX FSAR [1.0.6], either equals or bounds its site-specific counterpart for the HI-STORE CIS ISFSI. Likewise, the structural margins of safety in the short-term operations involving the HI-STAR transfer cask have been quantified in the HI-STORM UMAX FSAR for a much stronger seismic event than the Design Basis Earthquake (10,000 year return earthquake) applicable to the HI-STORE site. Finally, the Design Criteria set down in Chapter 4 of this SAR for the **ancillary equipment** such as the vertical cask transporter and special lifting devices are identical to those specified for such components in other HI-STORM dockets [1.3.3, 1.3.7].

Therefore, the safety analyses for all aspects of safe deployment and storage of HI-STORM UMAX at the HI-STORE site, including structural, criticality, thermal and confinement are

HOLTEC INTERNATIONAL COPYRIGHTED MATERIAL	
Report No. HI-2167374	Proposed Rev. OR
4-71	

substantially pre-empted by the qualifications in the HI-STORM UMAX FSAR making a re-evaluation for HI-STORE unnecessary. The only exceptions are:

- i. The site boundary dose qualification which must be performed to demonstrate compliance with the 10CFR72.104 dose limits under the maximum fuel inventory scenario, i.e., when every storage location in the ISFSI is occupied.
- ii. The temperature of the fuel within the stored canister at the HI-STORE ISFSI will meet the normal storage condition limit of ISG-11, Rev. 3. This analysis is required because the high altitude of the ISFSI (Table 2.7.1) reduces the air ventilation rate. The maximum heat load, however, is limited by the rating of the transport cask which is substantially less than the thermal capacity of HI-STORM UMAX licensed by the USNRC (Docket # 72-1040). Therefore, the ISG temperature limit is expected to be met with a large margin. Nevertheless, to support the safety case, this margin is quantified in Chapter 6.

In addition, a new transfer cask, named HI-TRAC CS has been introduced in this docket. While the design of this transfer cask is similar to the other HI-TRAC models certified in other HI-STORM dockets, viz. [1.0.6, 1.3.3, 1.3.7], there are sufficient physical differences to warrant a safety analysis of HI-TRAC CS to be performed. The applicable design criteria for such analyses are provided in this chapter.

Finally, all ancillaries must meet the design criteria presented in Section 4.5.

HOLTEC INTERNATIONAL COPYRIGHTED MATERIAL	
Report No. HI-2167374	Proposed Rev. OR
4-72	

APPENDIX 4.A: [PROPRIETARY APPENDIX WITHHELD IN ITS ENTIRETY IN ACCORDANCE WITH 10CFR2.390]

HOLTEC INTERNATIONAL COPYRIGHTED MATERIAL	
Report No. HI-2167374	Proposed Rev. OR
4A-1	

CHAPTER 5: INSTALLATION AND STRUCTURAL EVALUATION*

5.0 INTRODUCTION

The HI-STORE CIS facility utilizes the subterranean canister storage system referred to as HI-STORM UMAX certified in NRC Docket #72-1040 [1.0.6]. As the safety determination in this chapter shows, from the structural standpoint, the HI-STORM UMAX design can be adopted in its entirety from its native docket for the HI-STORE CIS facility without the need for any modification. The basis for this adoption, as elaborated in this chapter, is supported by the existing structural qualifications of the HI-STORM UMAX system that have been previously reviewed by the NRC and which bound all HI-STORE CIS site-specific loadings, **except for the weight of the site-specific transfer cask.**

However, while the safety analyses for HI-STORM UMAX can be **largely** adopted for HI-STORE, that is not the case for the ancillary systems, structures and components (SSCs) needed to operate the facility. These ancillaries are listed and their operational roles are summarized in Subsection 1.2.7. In this chapter, the structural safety qualification of each ancillary envisaged to be used at HI-STORE CIS, showing its compliance with its Design Criteria (presented in Chapter 4), is documented. The computed design margin for the ancillary SSCs under their respective design basis loads along with the safety analyses in the HI-STORM UMAX FSAR for the certified storage system underpins the safety case for the HI-STORE site.

The HI-STORM UMAX system as licensed in Docket # 72-1040 allows for a variable depth canister storage cavity to accommodate canisters of different heights. At the HI-STORE CIS site, all the storage cavities will be built to the same fixed depth, which is within the design limits of the licensed HI-STORM UMAX system. The structural qualification of HI-STORM UMAX in Docket # 72-1040 is based on the tallest and heaviest MPC-37 canisters (South Texas) because they define the bounding inertia loads. The Licensing Drawings in Section 1.5 of this SAR contain the depictions of the fixed depth HI-STORM UMAX cavity adapted from Docket #72-1040. For structural purposes, the deepest cavity to store the longest and heaviest canister defines the governing configuration. In Table 5.0.1, a comparison of the Design Basis Loads (DBLs) in its generic FSAR [1.0.6] and their site specific loading counterparts is presented to demonstrate that the Design Basis structural loads bound the site specific loads (SSLs) in every instance, **except for one. The maximum loaded weight of the HI-TRAC CS, which is used at HI-STORE CIS facility, is greater than the maximum loaded weight of the HI-TRAC VW transfer cask evaluated in the HI-STORM UMAX FSAR [1.0.6]. Consequently, the site-specific loads transmitted by the HI-TRAC CS to the HI-STORM UMAX VVM and ISFSI pad during MPC transfer operations (i.e., stack-up configuration) are explicitly analyzed in this SAR. The effects of the heavier transfer cask are mitigated by the fact that the site-specific earthquake at the top of grade elevation for the HI-STORE CIS facility is far less than the design basis spectra at the top of grade elevation per the HI-STORM UMAX FSAR, as shown in Figure 5.3.8 of this SAR. In more quantifiable terms, the peak ground acceleration (PGA) in the vertical direction evaluated**

* All references are placed within square brackets in this report and are compiled in Chapter 19 of this report.

HOLTEC INTERNATIONAL COPYRIGHTED MATERIAL	
Report No.: HI-2167374	Proposed Rev. 0S
5-1	

in the HI-STORM UMAX FSAR [1.0.6] is three times greater than the vertical PGA at the HI-STORE ISFSI pad site per Table 5.0.1. Therefore, fresh qualifying analyses for the storage system at the HI-STORE installation, in addition to those in [5.4.7], are minimal.

The bounding weights for the various dry cask storage components and ancillary equipment used at the HI-STORE CIS facility are listed in Table 5.0.2.

Finally, to facilitate convenient access to the referenced material, a list of sections germane to this chapter is provided in a tabular form. Table 5.0.3 provides a listing of the material adopted in this chapter by reference from other licensed dockets.

HOLTEC INTERNATIONAL COPYRIGHTED MATERIAL	
Report No.: HI-2167374	Proposed Rev. 0S
5-2	

Table 5.0.1: Comparison of DBLs for HI-STORM UMAX System and Site-Specific Loads for HI-STORE CIS Facility		
Load Category	Design Basis Value	Site-Specific Value
Earthquake	<p>Top of the Grade (Ground surface) spectra per Figure 2.4.1 of [1.0.6] with horizontal ZPA, a_H, and vertical ZPA, a_v scaled as follows:</p> $a_H = 1.0g$ $a_v = 0.75g$ <p>and foundation surface pad spectra per Figure 2.4.2 of [1.0.6] with horizontal ZPA, a_H, and vertical ZPA, a_v of:</p> $a_H = 0.93g$ $a_v = 0.71g$	<p>Top of the Grade spectra corresponding to 5% damped RG 1.60 earthquake [4.3.2] scaled to 0.25g (bounding) in three orthogonal directions (see Table 4.3.3 and Figure 5.3.8)</p>
Tornado Wind	Max. wind speed of 360 mph per Table 2.3.4 of [1.0.6]	Max. wind speed of 200 mph per Table 1 of Reg. Guide 1.76 [2.7.1] for Region II
Flood	Floodwater depth of 125 feet	Less than 10 feet (see Table 2.4.4)
Snow Load	100 psf	Negligible (see Table 4.3.1)
Weight of Loaded MPC	110,000 lbf per Table 3.2.1 of [1.0.6]	Refer to Table 5.0.2
Weight of Loaded HI-TRAC	270,000 lbf per Table 3.2.1 of [1.0.6]	Refer to Table 5.0.2
Contact Pressure from Loaded Transporter/VCT	38.7 psi per Table 3.2.1 of [1.0.6]	36.4 psi (see Note 1)
Long-Term Settlement of Support Foundation Pad	0.2" maximum per Table 2.3.2 of [1.0.6]	0.251" (see Note 2)
<p>Notes:</p> <ol style="list-style-type: none"> 1) Based on a maximum combined weight of VCT plus loaded HI-TRAC CS per Table 5.0.2 (635,000 lbf) and total track load bearing area per Licensing Drawing in Section 1.5 (2 x 231" x 37.75"). 2) Conservatively calculated based on full size of Support Foundation Pad at HI-STORE CIS Facility (i.e., 25x10 cask array). Maximum value given in Table 2.3.2 of [1.0.6] is associated with a smaller pad size (i.e., 5x5 cask array), and therefore it sets the maximum settlement gradient over any 5x5 pad area. The calculated long-term settlement for the same reference 5x5 ISFSI pad, coupled with the site-specific geotechnical data for the HI-STORE site, is 0.151". 		

HOLTEC INTERNATIONAL COPYRIGHTED MATERIAL

Report No.: HI-2167374

Proposed Rev. 0S

5-3

Table 5.0.2: Bounding Weights for Cask Components and Ancillary Equipment	
Component	Bounding Weight, lbf
Loaded MPC	110,000
HI-TRAC CS Transfer Cask - Empty - Loaded with MPC	[PROPRIETARY INFORMATION WITHHELD IN ACCORDANCE WITH 10CFR2.390]
HI-STAR 190 Transport Cask - Empty w/o Impact Limiters - Loaded w/o Impact Limiters - Loaded w/ Impact Limiters	261,000 371,000 414,800
HI-TRAC CS Lift Yoke	[PROPRIETARY INFORMATION WITHHELD IN ACCORDANCE WITH 10CFR2.390]
Transport Cask Lift Yoke	
Transport Cask Horizontal Lift Beam	
Transport Cask Tilt Frame	
MPC Lift Attachment	
MPC Lifting Device Extension	
HI-TRAC CS Lift Links (set of 2)	
VCT	
HI-PORT	
Notes:	
3) All structural analyses presented in Chapter 5 use the bounding weights per this table as input. Higher values may be used for additional conservatism.	
4) Bounding weight for HI-TRAN 225 VCT (tracked crawler design shown in Licensing Drawing in Section 1.5).	

HOLTEC INTERNATIONAL COPYRIGHTED MATERIAL	
Report No.: HI-2167374	Proposed Rev. 0S
5-4	

Table 5.0.3: Material Incorporated by Reference in this Chapter

Information Incorporated by Reference	Source of the Information	Location in this SAR where Material is Incorporated	Technical Justification of Applicability to HI-STORM UMAX at HI-STORE CIS
MPC-37 and MPC-89 Structural Evaluation	Section 3.4 HI-STORM FW FSAR [1.3.7]	Subsection 5.1.4	The canister is identical to the one described in the HI-STORM FW FSAR and originally approved in the referenced FSAR.
HI-STORM UMAX ISFSI Pad and SFP Structural Evaluation	Paragraph 3.4.4.1 HI-STORM UMAX FSAR [1.0.6]	Paragraph 5.3.1.4	The ISFSI Pad and SFP are identical to that described in HI-STORM UMAX FSAR and originally approved in the referenced FSAR. Also, the Design Basis Loads for the HI-STORM UMAX bound the site-specific loads applicable to the HI-STORE site as shown in Table 5.0.1.
HI-STORM UMAX VVM Structural Evaluation	Paragraph 3.4.4.1 HI-STORM UMAX FSAR [1.0.6]	Paragraph 5.4.1.4	The HI-STORM UMAX VVM is identical to that described in HI-STORM UMAX FSAR and originally approved in the referenced FSAR. Also, the Design Basis Loads for the HI-STORM UMAX bound the site-specific loads applicable to the HI-STORE site as shown in Table 5.0.1.

HOLTEC INTERNATIONAL COPYRIGHTED MATERIAL

Report No.: HI-2167374

Proposed Rev. 0S

5-5

5.1 CONFINEMENT STRUCTURES, SYSTEMS, AND COMPONENTS

The only confinement SSC that is utilized at the HI-STORE CIS facility is the Multi-Purpose Canister (MPC). There are two types of MPCs that are permitted to be stored at the HI-STORE site, namely MPC-37 and MPC-89, both of which have been previously licensed by the NRC as part of the HI-STORM FW dry storage system (Docket # 72-1032). The structural design basis for MPC-37 and MPC-89, which are used to store PWR and BWR fuel, respectively, are described in complete detail in Chapters 2 and 3 of the HI-STORM FW FSAR [1.3.7]. A brief summary of their structural design basis is provided below.

5.1.1 Description of Structural Design

The MPC enclosure vessels are cylindrical weldments with identical and fixed outside diameters. Each MPC is an assembly consisting of a honeycomb fuel basket, a baseplate, a canister shell, a lid, and a closure ring. The number of SNF storage locations in an MPC depends on the type of fuel assembly (PWR or BWR) to be stored in it. The required characteristics of the fuel assemblies to be stored in the MPC are limited in accordance with Section 4.1 of the SAR.

The MPC enclosure vessel is a fully welded enclosure, which provides the confinement for the stored fuel and radioactive material. The MPC baseplate and shell are made of stainless steel. The lid is a two-piece construction, with the top structural portion made of Alloy X. The confinement boundary is defined by the MPC baseplate, shell, lid, port covers, and closure ring. Drawings for the MPCs are provided in Section 1.5.

The MPC-37 and MPC-89 fuel baskets are assembled using interlocking Metamic-HT panels, as shown in the Licensing Drawings in Section 1.5.

5.1.2 Design Criteria

The MPC is classified as important-to-safety. The MPC structural components include the fuel basket and the enclosure vessel. The MPC enclosure vessel is designed and fabricated as a Class 1 pressure vessel in accordance with Section III, Subsection NB of the ASME Code, with certain necessary alternatives, as discussed in Section 2.2 of [1.3.7]. The MPC fuel basket is a non-Code **item**. Compliance with the ASME Code, with respect to the design and fabrication of the MPC, and the associated justification are discussed in Section 2.2 of [1.3.7]. The MPC design is analyzed for all design basis normal, off-normal, and postulated accident conditions, as defined in Section 2.2 of [1.3.7], which bound the conditions at the HI-STORE site.

5.1.3 Material Properties

The MPC shell, baseplate and lid are made of stainless steel (Alloy X, see Appendix 1.A of [1.3.7]). The properties for Alloy X are listed in Table 3.3.1 of the HI-STORM FW FSAR [1.3.7]. The minimum strength properties for Metamic-HT, which is used to fabricate the fuel baskets, are provided in Table 1.2.8 of the HI-STORM FW FSAR [1.3.7].

HOLTEC INTERNATIONAL COPYRIGHTED MATERIAL	
Report No.: HI-2167374	Proposed Rev. 0S
5-6	

5.1.4 Structural Analyses

The structural analyses for the MPC for all design basis normal, off-normal, and postulated accident conditions are documented in Chapter 3 of the HI-STORM FW FSAR [1.3.7] and further supplemented by the seismic response analysis of the MPC inside the HI-STORM UMAX presented in Subparagraph 3.4.4.1.2 of the HI-STORM UMAX FSAR [1.0.6].

The fatigue evaluations for the HI-STORM FW and HI-STORM UMAX Systems, which are found in Subsection 3.1.2.5 of their respective FSARs, remain valid for the proposed 40-year storage term at the HI-STORE CIS Facility. This is because the passive nature and the large thermal inertia of these storage systems protect the MPC enclosure vessel from significant stress cycling. In fact, the amplitude of the stress cycles is well below the endurance limit of the stainless steel MPC, which means that the MPC has infinite fatigue life under long-term storage conditions.

Moreover, as shown in Table 6.3.1 of the HI-STORE SAR, the maximum MPC heat loads and the ambient temperature conditions applicable to the HI-STORE CIS Facility are less demanding than the corresponding values for which the HI-STORM UMAX System is certified. This reduces stress amplitudes in the MPC at the HI-STORE CIS Facility and ensures that the ASME Code required fatigue evaluations that were originally performed for the UMAX and FW systems remain valid for 40 years of storage at the HI-STORE CIS Facility.

HOLTEC INTERNATIONAL COPYRIGHTED MATERIAL	
Report No.: HI-2167374	Proposed Rev. 0S
5-7	

5.2 POOL AND POOL CONFINEMENT FACILITIES

There are no pools at the HI-STORE CIS facility.

HOLTEC INTERNATIONAL COPYRIGHTED MATERIAL	
Report No.: HI-2167374	Proposed Rev. 0S
5-8	

5.3 REINFORCED CONCRETE STRUCTURES

The HI-STORE CIS facility includes the following reinforced concrete structures:

- HI-STORM UMAX ISFSI Pad and Support Foundation Pad (SFP)
- Cask Transfer Building (CTB)
- Canister Transfer Facility (CTF) Foundation

Each of these components is discussed in more detail, including their description, design criteria, material properties, and structural analyses, in the following subsections.

5.3.1 HI-STORM UMAX ISFSI Pad and Support Foundation Pad

5.3.1.1 Description of Structural Design

The HI-STORM UMAX ISFSI pad and Support Foundation Pad (SFP) are integral parts of the HI-STORM UMAX underground dry storage system, which has already been licensed in accordance with 10CFR72 requirements under NRC Docket # 72-1040. As described in Section 1.2 of this SAR, the structural performance objectives for the ISFSI pad are to provide a riding surface for the cask transporter and to serve as a missile barrier. The SFP is the foundation mat for the HI-STORM UMAX structure, and it also serves as the resting surface for the VVM array. The SFP is a continuous concrete pad of uniform thickness, whereas the ISFSI pad fills the interstitial space between the VVM at the top of grade level.

The physical design of the HI-STORM UMAX storage system at the HI-STORE CIS facility, as shown in the Licensing Drawing in Section 1.5, fully accords with the requirements and limitations of the HI-STORM UMAX FSAR [1.0.6].

In this subsection, the site-specific loads at the HI-STORE CIS facility are compared against the design basis structural loads previously used to evaluate the ISFSI pad and SFP in the HI-STORM UMAX FSAR [1.0.6]. Additional analyses are performed herein for the ISFSI pad and SFP only if the site-specific loads are not addressed or bounded by the structural analyses performed in the HI-STORM UMAX FSAR.

5.3.1.2 Design Criteria

Consistent with the HI-STORM UMAX FSAR, the SFP and the ISFSI pad are categorized as important-to-safety (ITS) structures as indicated in Table 4.2.1. The design criteria for the HI-STORM UMAX ISFSI pad and the SFP are incorporated by reference from the HI-STORM UMAX FSAR as described in Section 4.0 and Table 4.0.1. Accordingly, ACI 318-05 [5.3.1] is specified as the reference code for the design qualification of the SFP and the ISFSI pad using the load combinations specified in Table 2.4.3 of [1.0.6].

5.3.1.3 Material Properties

The ISFSI pad and SFP are reinforced concrete structures with their properties defined in Table 2.3.2 of the HI-STORM UMAX FSAR [1.0.6].

5.3.1.4 Structural Analysis

HOLTEC INTERNATIONAL COPYRIGHTED MATERIAL	
Report No.: HI-2167374	Proposed Rev. 0S
5-9	

The seismic and structural qualification of the HI-STORM UMAX storage system, including the ISFSI pad and SFP, is performed in Chapter 3 of [1.0.6]. As shown in Table 5.0.1 above, the design basis loads analyzed in the HI-STORM UMAX FSAR **almost** completely bound the site-specific loads applicable to the HI-STORE site, **except for the weight of the transfer cask**. Of particular importance, the ground motion response spectra used for the structural design and analysis of the HI-STORM UMAX storage system in Chapter 3 of [1.0.6] significantly envelope the ground motion response spectra applicable to the HI-STORE site, as shown in Figure 5.3.8. In addition, since the physical design of the HI-STORM UMAX structure at the HI-STORE CIS facility complies with the general certificate [16.0.1] and its VVM height is shorter, the dead weight of the loaded UMAX storage system (per storage location) is bounded by the dead weight analyzed in Chapter 3 of [1.0.6]. Therefore, no new structural analysis is required to qualify the ISFSI pad or the SFP for this application, **except for the following site-specific analyses:**

- i) an evaluation of the bearing capacity and the long-term differential settlement of the soil subgrade beneath the SFP;
- ii) a seismic analysis of a loaded HI-TRAC CS positioned above a VVM storage location and secured to the ISFSI pad during MPC transfer (a.k.a. stack-up analysis).

The soil subgrade evaluation (item i), which is documented in [4.3.5] and also discussed in paragraph 4.3.2.1 of this SAR, concludes that the soil bearing capacity at the site is adequate, and the long-term settlement is less than the established limit per the HI-STORM UMAX FSAR [1.0.6] (see Table 5.0.1). Table 5.3.6 summarizes the demand values and capacity limits for the soil bearing pressure at the SFP interface. The stack-up analysis (item ii) is further discussed in paragraph 5.4.1.4.

HOLTEC INTERNATIONAL COPYRIGHTED MATERIAL	
Report No.: HI-2167374	Proposed Rev. 0S
5-10	

5.3.2 Cask Transfer Building

5.3.2.1 Description of Structural Design

The Cask Transfer Building (CTB) is a reinforced concrete building comprised of four walls, a flat roof structure, and a continuous floor slab, which serves as the processing facility for inbound transport packages containing SNF canisters. The basic functions of the CTB, from a structural standpoint, are to provide:

- a foundation for the railway inside the CTB;
- a riding surface for the HI-PORT inside the CTB;
- a support system for the overhead bridge crane;
- protection for personnel and equipment inside the CTB from external hazards and natural phenomena.

The CTB has a large open interior to facilitate cask handling and conduct canister transfer operations. The east end of the CTB has two large door openings, which provide railcar access for the arriving transport packages. An overhead bridge crane runs the length of the building in the east-west direction, and it is used to offload the transport packages from the railcar upon their arrival. The crane runway is mounted on concrete corbels, which are integral to the building columns along the north and south walls. As the package travels from the east end to the west end of the CTB using the overhead crane, the external impact limiters and cask closure lid are removed before the cask is lowered into the below-grade Canister Transfer Facility (CTF). Once the canister transfer is complete, the loaded HI-TRAC CS is lifted onto the stationary HI-PORT before it exits the CTB through the single door opening at the west end of the building for final delivery to the HI-STORM UMAX storage system. A more detailed description of the operations that are undertaken inside the CTB is provided in Section 3.1 and also illustrated in Figure 3.1.1 of this SAR.

In terms of its structural design, the CTB is primarily a reinforced concrete structure with some steel framing. The CTB roof is a reinforced concrete slab, which is supported by a combination of corrugated metal decking and an array of steel beams. The entire roof system is supported vertically by a series of reinforced concrete columns, which are equally spaced around the perimeter of the CTB. The roof load is carried by the roof girders to the roof girder support beams, which run parallel to the north and south walls and rest atop the vertical columns. The roof girders and vertical columns are hinged at their connection points. The space between columns is occupied by concrete shear walls, which resist in-plane lateral forces due to wind and seismic loads. The CTB walls and columns are fixed at their base where they terminate into the slab haunch, which borders the CTB floor slab.

The complete design details of the CTB are shown on the Licensing Drawing in Section 1.5.

5.3.2.2 Design Criteria

The structural design criteria for the CTB, including the applicable loads and the governing load combinations, are provided in Subsection 4.6.2 of this SAR. The CTB is seismically designed to withstand a DBE event at the HI-STORE CIS site (see Table 4.3.3). The CTB is also designed not to collapse due to the combined effects of tornado wind and a tornado-borne missile impact.

HOLTEC INTERNATIONAL COPYRIGHTED MATERIAL	
Report No.: HI-2167374	Proposed Rev. 0S
5-11	

However, the CTB is not designed or analyzed to serve as a tornado missile barrier due primarily to its large door openings. Therefore, the HI-TRAC CS and the HI-STAR 190 have been analyzed for a direct, unmitigated missile strike on the cask exterior [5.4.6], as discussed in Subsection 5.4.2.

5.3.2.3 Material Properties

The material properties for the reinforced concrete portions of the CTB are summarized in Table 5.3.1. Per the Licensing Drawing in Section 1.5, the steel beams and girders shall conform to ASTM A572 or A992 Grade 50.

5.3.2.4 Structural Analysis

The structural analysis of the CTB to demonstrate compliance with the design criteria in Section 4.6 is performed using the finite element method in conjunction with the software program ANSYS. The following paragraphs describe the analytical model, the solution method, and the results in more detail.

5.3.2.4.1 Model Description

A complete 3-D model of the building structure, including the CTB crane, is constructed in ANSYS, as shown in Figure 5.3.1. The CTB slab, walls and roof structure are modeled using a combination of shell and beam elements with linear elastic material properties.

As shown on the licensing drawing in Section 1.5, the CTB roof is a composite structure consisting of a framework of steel girders and lateral bracing, corrugated metal roof decking, and a reinforced concrete roof slab. The roof girders and their lateral bracing are individually modeled in ANSYS using a network of beam elements. The concrete roof slab is modeled using a single layer of shell elements. Although the corrugated metal decking is not modeled explicitly, its weight is accounted for by amplifying the weight density assigned to the elements representing the concrete roof slab. The strength contribution of the corrugated metal decking is ignored in the structural analysis of the CTB. The decking, however, is sized to support the wet weight of concrete during placement of the roof slab. In addition, the density assigned to the concrete roof slab in the ANSYS model is conservatively increased by 50% to account for the mass of the metal decking, the corrugated shape of the concrete, and other uncertainties.

The ANSYS model also includes the CTB crane, including the crane runway beams, the crane bridge, and the trolley (see Figure 5.3.1). The guidance from ASME NOG-1 has been used to develop the mathematical model of the overhead crane for the purposes of the CTB structural qualification. In particular, the configuration of the crane and the connections between crane trolley and crane bridge, and between crane bridge and crane runway beams are based upon the recommendations in Figure 4154.3-1 and Table 4154.3-1 of ASME NOG-1. The CTB crane, including the runway beams, is included in the model to account for the static and dynamic loads that it transmits to the building structure. The structural qualification of the CTB crane, however, is performed via a separate analysis, which is documented in [5.4.10] (see Section 5.4.3). The design and qualification of the crane runway beams are also delegated to the crane supplier, and the final beam dimensions and properties of the beams are reflected appropriately in the CTB model. The CTB analysis described in this subsection determines the in-structure response

HOLTEC INTERNATIONAL COPYRIGHTED MATERIAL	
Report No.: HI-2167374	Proposed Rev. 0S
5-12	

spectra at the top of the corbels that support the crane runway beams, which are then used as input to the structural qualification of the CTB crane and the crane runway beams.

The CTB design also includes small lateral braces in the narrow space between the crane runway beams and the adjacent walls to prevent lateral torsion buckling, and similarly in the space between main support beams for the roof girders and north and south building walls. For the dynamic analysis involving seismic loads, these lateral braces are simulated in ANSYS using horizontal nodal constraints in order to avoid spurious frequency modes and reduce computational cost during solution. In the ANSYS static model, these lateral torsional braces are conservatively ignored since they are not in the primary load path, and their neglect insures that the full crane load is transmitted directly to building concrete columns and corbels. The stiffness of these small angle braces is also very small in comparison to the crane runway beams and roof girder support beams, so their omission has a negligible influence on the distribution of forces and moments within the CTB.

To verify that the ANSYS model of the CTB, including the overhead crane, accurately represents the total mass of the building, the mass of the FE model is compared against an independent calculation of the building mass, which is documented in [5.4.9]. The two mass values agree within approximately 5%, with the higher value associated with the ANSYS model (41,886 kips vs. 39,530 kips). This confirms the accuracy of the finite element model while maintaining a slight degree of conservatism.

The soil subgrade beneath the CTB is modeled in two different ways depending on the load being analyzed. For the static load cases (e.g., dead, live, and wind loads), the model includes a volume of soil roughly 10 times the footprint of the CTB with a depth greater than 100 feet, as depicted in Figure 5.3.2. The static soil properties are assigned based on the geotechnical data from [2.1.24]. For the dynamic load case (i.e., seismic), the 3-D soil volume is replaced by a collection of 6 discrete soil springs (3 translational and 3 rotational) located at the center of the CTB slab to account for SSI effects per the methodology in Section 5.4 of ASCE 4-16 [4.3.4]. The approach to develop the simplified soil springs is summarized below.

First, the soil deposit at the CTB location is modeled as a 1-D multi-layered soil column using the computer program SHAKE2000 [5.3.3]. The soil layers and their best estimate soil properties are defined using the data from the site geotechnical report [2.1.24], which are summarized in Table 5.3.4. The modulus reduction and damping curves assigned to the soil layers in SHAKE2000 are based on the soil descriptions and the measured properties (e.g., plasticity index) obtained from soil boring samples. Next, the design basis ground motion for the HI-STORE CISF site (see Table 4.3.3) is applied to the soil model as a rock outcrop motion at the free field surface, and the input motion is deconvoluted to the base of the soil column (i.e., bedrock) in order to obtain the strain compatible soil properties for each intermediate layer. Afterwards, the strain compatible soil properties are transferred to a 3-D ANSYS model of the soil subgrade, which is shown in Figure 5.3.3, and a series of static solutions are performed to determine the equivalent soil spring for each of the CTB displacement modes, namely vertical compression, shear in two orthogonal directions, and rotation about three principal axes. For each CTB displacement mode, a unit force (or moment) is applied to a rigid platen representing the CTB base mat, and the computed displacement (or rotation) of the platen from ANSYS, along with the applied load, is then used to manually calculate the effective soil spring. Table

HOLTEC INTERNATIONAL COPYRIGHTED MATERIAL	
Report No.: HI-2167374	Proposed Rev. 0S
5-13	

5.3.7 summarizes the soil spring stiffnesses for the six displacement modes. The complete details of the soil spring development are documented in [5.4.9].

For conservatism, the dynamic and static analyses of the CTB do not take any credit for the engineered fill layer installed beneath the CTB foundation slab (see licensing drawing in Section 1.5). Instead, the engineered fill material is ignored, and the CTB slab is modeled directly atop the much weaker in-situ soil material. The neglect of the engineered fill layer is conservative as it increases the calculated shear and flexural loads on the CTB slab due to the lower soil bearing strength. With respect to the dynamic analysis, the lower shear modulus attributed to the in-situ soil leads to greater amplification of the seismic motion transmitted to the foundation level of the CTB. The effect, however, is small since the engineered fill layer accounts for roughly 1 percent of the total soil column height.

5.3.2.4.2 Solution Method

The overall analysis of the CTB is performed in three steps. First, a dynamic analysis is performed using the mode superposition method (MSUP) in ANSYS to obtain the displacement and acceleration response throughout the building, including soil-structure interaction (SSI) effects. Next, the acceleration results from the dynamic analysis are used to inform an equivalent lateral force analysis using the procedure in Section 12.8 of ASCE 7-10 [4.6.2]. In doing so, the seismic base shear is calculated using a seismic response coefficient, C_s , that conservatively exceeds both the value determined in accordance with Section 12.8.1.1 of ASCE 7-10 and the maximum computed acceleration at the CTB foundation level from the dynamic analysis performed using ANSYS. The equivalent lateral forces are then statically applied to a separate ANSYS model (which is identified as the “static” model in [5.4.9]), along with dead and live loads (including dynamic load arising from crane operation), to obtain internal forces and moments for the CTB structure for all applicable load combinations.

The static and dynamic models are in excellent agreement as they are both ANSYS models reflecting the same building dimensions and mass properties, and they both utilize the same element types. The main difference between them is the mesh density, which affects only the element sizes. Since the dynamic analysis is a transient solution, which is computationally expensive, the dynamic model uses a coarser mesh as compared to the static model. The mesh size, however, used in the dynamic model is sufficiently small to capture the building response modes over the frequency range of interest. Specifically, the modal analysis of the CTB dynamic model, which is a prerequisite for the dynamic analysis using MSUP, extracts over 1000 mode shapes for the building structure between the frequencies of 0.2Hz and 43Hz, which envelopes with the frequency content of the seismic input motion (see Figures 5.3.4 through 5.3.6). Furthermore, the fixed base modal analysis results for the CTB are in good agreement with the lower-bound natural frequencies computed using the formula in 26.9.3 of ASCE 7-10 [4.6.2] for concrete shear wall buildings.

For the dynamic analysis, the overhead crane and trolley are initially positioned in the center of the CTB (see Figure 5.3.1) to maximize the acceleration response of the building. When the crane is in this position, the dominant vertical frequency mode of the bridge plus trolley (acting as simply supported beam with a load at center) is roughly equal to the peak response frequency of the seismic input motion in the vertical direction. Thus, this crane position maximizes the seismic amplification of the crane plus the load on the hook. For additional conservatism and to

HOLTEC INTERNATIONAL COPYRIGHTED MATERIAL	
Report No.: HI-2167374	Proposed Rev. 0S
5-14	

obtain a bounding solution, when the dynamic results (i.e., in-structure accelerations) are transferred to the static model to calculate forces and moments in the CTB structure, the trolley (w/ maximum load on hook) is re-positioned to the end of the bridge adjacent to the south wall of the CTB. By combining the maximum seismic amplification from the dynamic analysis with the offset trolley position in the static model, the vertical force transmitted by the crane to the interior building columns is further increased.

An additional location for the CTB crane, which corresponds to its parked position, has also been analyzed. The parked position for the overhead crane, which is shown in Figure 5.3.7, is at the far east end of the CTB where the railcar access doors are located (see licensing drawing in Section 1.5). Even though there is typically no load on the hook when the crane is parked, the analysis is conservatively performed assuming that (a) the trolley is positioned in the southeast corner of the building and (b) the maximum load is on the hook. Furthermore, the same peak seismic accelerations from the alternate location (w/ the crane bridge and trolley at the center of building) are conservatively applied to the CTB for this analysis.

The seismic data used as input to the dynamic analysis of the HI-STORE CTB satisfies the applicable requirements from 10 CFR 50, Appendix S, as well as the acceptance criteria for ground motion time histories per NUREG-0800, Section 3.7.1. In particular, 10 CFR 50 Appendix S requires that the horizontal free-field motion at the foundation level of the structure must be an appropriate response spectrum with a peak ground acceleration of 0.1g. From Table 4.3.3, the design basis earthquake for the HI-STORE site is a Reg. Guide 1.60 response spectra with a peak ground acceleration (PGA) of 0.15g in all three directions. As discussed in preceding subparagraph, the ground motion is deconvoluted to the base of the soil column to obtain the strain-compatible soil properties, which are in turn used to develop equivalent soil springs for the CTB displacement modes (see Table 5.3.7). In the dynamic analysis involving the coupled soil-building model, however, the 0.15g ground motion is applied to the base of the equivalent soil springs for simplicity and conservatism. To verify that the application of the free-field motion to the base of the soil column is indeed conservative, the applied motion is compared with the motion that is recovered when the same design basis free-field motion is deconvoluted to the base of the soil column. The mean spectra results (average of 5 time history solutions) are plotted in Figures 5.3.4 through 5.3.6 for the three principal directions. To enable direct comparison, all response spectrum curves in Figures 5.3.4 through 5.3.6 are generated with the damping level set at 20%, which matches the input soil damping in the CTB dynamic model. These figures clearly show that the applied Reg. Guide 1.60 motion fully envelopes the actual within layer motion at the base of the soil column over the entire frequency range, even considering soil uncertainties (i.e., lower bound, upper bound and best estimate soil properties). Moreover, it ensures that the free-field motion at the CTB foundation level is greater than 0.1g as required by 10 CFR 50 Appendix S.

Lastly, for tornado wind and missile analysis of the CTB, the analysis is conducted in ANSYS using the same static model described above. However, to account for the potential damage to the building due to a large tornado missile (such as an automobile), an enveloping 10-foot by 20-foot section of the CTB exterior wall is deleted from the model, and the capacity of the building is re-examined under the combined effects of dead, live, and tornado wind loads. For this analysis, two critical impact locations are examined as depicted in Figures 5.3.15 and 5.3.16. The first location is a missile strike near the center of the CTB long wall, and the second is a missile

HOLTEC INTERNATIONAL COPYRIGHTED MATERIAL	
Report No.: HI-2167374	Proposed Rev. 0S
5-15	

strike at a corner column location. The resulting forces and moments acting on the remaining members of the CTB are compared against their respective ACI or AISC capacity to prove that a gross building collapse is not credible.

5.3.2.4.3 Analysis Results

After the individual load cases are solved, the results are combined in ANSYS to form the governing load combinations per Subsection 4.6.2 of this SAR. The reinforced concrete portions of the CTB are designed to meet the strength requirements per ACI 318, and the steel portions of the building are designed to meet the applicable capacity limits per AISC 360 and AISC N690. Results are post-processed on an element basis such that bending and shear safety factors are computed for each discrete element that comprises the CTB model for all analyzed load combinations. The element results are then surveyed to determine the minimum overall safety factor in bending and shear for each major structural component (e.g., CTB foundation slab, roof slab, building column, etc.). The minimum calculated safety factors for the major structural components of the CTB, for all analyzed load combinations, are summarized in Table 5.3.3. All calculated safety factors for the CTB are greater than 1 thereby indicating that structural integrity is maintained, and a building collapse is not credible under the design basis normal and accident load combinations, including the combined effects of tornado wind and a large missile impact on the building exterior.

As indicated in Table 5.3.3, the maximum shear demand for the vast majority of CTB components is attributed to the seismic load combination (Load Combination 5 in Table 4.6.4). The lone exception is the CTB west wall, where the wind load (Load Combination 3 in Table 4.6.4) causes a large shear force near the corner of the wall. The maximum bending moments in the roof slab and the wall horizontal stiffeners are also caused by the seismic load combination. The maximum bending moment in the CTB foundation slab occurs, as expected, when the live load on the floor is greatest, as in Load Combinations 1 and 3 (see Table 4.6.4). The 42" deep interior columns experience their maximum moment load when the overhead trolley (w/ max. lifted load) is positioned close to the wall, and the wall is also subject to the high wind load (i.e., Load Combination 3 in Table 4.6.4). Finally, the shear and moment contour plots associated with each limiting safety factor in Table 5.3.3 are provided in Figures 5.3.17 through 5.3.28 to better visualize the heaviest loaded areas.

The in-structure response spectra at CTB foundation slab level and the crane elevation (top of corbel), which result from the dynamic analysis of the CTB, are plotted in Figures 5.3.9 through 5.3.14.

Table 5.3.5 summarizes the maximum vertical reaction force and maximum horizontal shear force acting on the concrete corbels that support the crane runway beam for each analyzed load combination. The table also gives the overall bounding values that are used to design and qualify the concrete corbels. Torsional loads on the concrete corbels are negligible since the lateral braces situated between the crane runway beams and the CTB walls prevent the runway beams from rotating out of plane from seismic and surge loads that occur during crane operation. The results in Table 5.3.5 are also used to inform the design of the crane runway beam and beam

HOLTEC INTERNATIONAL COPYRIGHTED MATERIAL	
Report No.: HI-2167374	Proposed Rev. 0S
5-16	

connections. The complete details of the structural integrity evaluation for the CTB are documented in [5.4.9].

Additional checks are performed for the CTB slab using classical solutions for a slab on grade, which are obtained from [5.3.2], to determine the internal forces and moments acting on the CTB slab for the governing load combinations in Subsection 4.6.2.

The analysis of the slab considers the live loads and seismic loads associated with the freestanding HI-TRAC CS, the restrained HI-TRAC CS at CTF, the HI-PORT (loaded with HI-TRAC CS), the tilt frame/saddle assembly (loaded with HI-STAR 190 with impact limiters), and the loaded rail car. The loads acting on the CTB slab due to the rail car are applied as concentrated forces at the wheel locations. The HI-PORT load is applied as a uniform distributed pressure over the footprint area of its wheels. The load on the tilt frame assembly is also applied as a uniformly distributed pressure.

For the seismic load combination, the weight of each component (e.g., HI-PORT, rail car) is either amplified by the vertical ZPA for the Design Basis Earthquake (DBE) or load obtained from detailed seismic analysis, which is given in Table 4.3.3. The use of the ZPA value is justified since the DBE is a low-intensity earthquake that does not cause any of the above mentioned equipment to rock/uplift (i.e., no incipient tipping). Along with the shear and moment loads, the bearing pressure on the CTB slab due to the various equipment configurations, including the restrained HI-TRAC CS at the CTF location, has been evaluated under static and dynamic (seismic) load conditions.

The calculated results for each load combination are surveyed to establish the maximum shear and moment demand on the CTB slab, which are a key determinant of the steel reinforcement design shown on the Licensing Drawing in Section 1.5. The demand loads are then compared with the ACI Code compliant section capacities to demonstrate the structural adequacy of the CTB slab. All calculated safety factors for the CTB slab are greater than 1.0 as shown in Table 5.3.2. The complete details of this additional analysis for the CTB slab are provided in the Structural Calculation Package [5.4.6].

5.3.3 Canister Transfer Facility Foundation

5.3.3.1 Description of Structural Design

The Canister Transfer Facility (CTF) is a below-ground structure used to carry out vertical MPC transfers from the transport cask to the HI-TRAC CS (or vice versa). The design enables a transport cask to be lowered into the CTF cavity (see Figure 3.1.1 (g)). With the transport cask in place, the HI-TRAC CS is then positioned above the CTF cavity opening and anchor bolts are installed to secure the HI-TRAC CS to the CTB slab at the CTF location, after which the MPC can be vertically lifted from the transport cask into the HI-TRAC CS using the CTB Crane. The general layout and key dimensions of the CTF are shown on the Licensing Drawing in Section 1.5.

At the base of the CTF cavity is a reinforced concrete slab that acts as the supporting surface for the transport cask during transfer operations. This below-grade slab is referred to as the CTF foundation, and its construction is identical to the CTB slab with respect to thickness, strength, and reinforcement details.

HOLTEC INTERNATIONAL COPYRIGHTED MATERIAL	
Report No.: HI-2167374	Proposed Rev. 0S
5-17	

The following paragraphs describe the design criteria, material properties, and the analysis method relevant to the structural design of the CTF foundation. The thermal evaluation of the transport cask inside the CTF cavity, which is identified as Loading ID TSL-1 in Table 4.3.6, is addressed in Subsection 6.4.2.

5.3.3.2 Design Criteria

The design criteria for the CTF foundation, which is an ITS component, are the same as the criteria for the CTB slab, which are provided in Subsection 4.6.2.

5.3.3.3 Material Properties

The material properties for the CTF foundation are identical to those for the CTB slab, which are given in Table 5.3.1.

5.3.3.4 Structural Analysis

The results for the structural analysis of the CTB slab, which are discussed above in Paragraph 5.3.2.4, are also bounding for the CTF foundation for the following reasons:

- a) The CTB slab and the CTF foundation **have** identical reinforcement details and minimum strength properties.
- b) **Although the CTB slab is slightly thicker than the CTF foundation, as shown on the Licensing Drawing in Section 1.5, the analysis is performed using the lesser of the two thicknesses for conservatism.**
- c) The bounding weight of a loaded HI-TRAC CS (which rests vertically on the CTB slab), used in the structural evaluation [5.4.6], is greater than the bounding weight of a loaded HI-STAR 190 transport cask without impact limiters (which rests vertically on CTF foundation). See Table 5.0.2 for bounding weight comparison.
- d) The contact footprint of the HI-TRAC CS alignment shield ring is smaller than that of the HI-STAR 190 bottom forging. The outer diameter is nearly equal but the alignment shield ring is an annular ring whereas the HI-STAR 190 bottom forging is a solid cylinder.
- e) **The CTF is equipped with lateral restraint blocks at the top and bottom of the cavity space that minimize rattling of the HI-STAR 190 during an earthquake event, and by doing so attenuates the force transmitted to the CTF foundation and precludes direct impacts between the HI-STAR 190 cask and the CTF side wall. This fulfills the acceptance criterion for Loading ID SSL-1 in Table 4.3.6.**

Based on the above, the minimum calculated safety factor for the CTB slab given in Table 5.3.2 is also a lower bound safety factor for the CTF foundation.

HOLTEC INTERNATIONAL COPYRIGHTED MATERIAL	
Report No.: HI-2167374	Proposed Rev. 0S
5-18	

Description	Value
Min. concrete compressive strength	4,500 psi
Rebar material	ASTM A706/A615
Min. rebar yield strength	60 ksi
Rebar size and spacing	See Licensing Drawing

Item	Max. Demand	Capacity	Safety Factor
Bending moment in CTB slab (kip-ft)	6,116	25,202	4.12
Shear force in CTB slab (kip)	1,441	3,425	2.38
Bearing load on CTB slab (kip)	67.5	191	2.84
Punching shear in CTB slab (kip)	67.5	1,093	16.2
Soil bearing pressure due to dead plus live loads (psf)	2,880	4,000	1.39
Notes:			
<ol style="list-style-type: none"> 1) Reported values are worst-case results from all load combinations (see Subsection 4.6.2) with the Rail Car, HI-PORT, Transport Cask, and loaded HI-TRAC CS each considered separately as the live load (L). 2) Maximum demand value for soil bearing pressure is the peak pressure at any point beneath the CTB slab per finite element solution. Linearized soil bearing pressure beneath the CTB slab is significantly lower. Therefore, the reported safety factor is very conservative. 			

HOLTEC INTERNATIONAL COPYRIGHTED MATERIAL	
Report No.: HI-2167374	Proposed Rev. 0S
5-19	

Table 5.3.3: Summary of Minimum Safety Factors for CTB Structural Analysis			
Component	SF ^{(1), (5), (6)}		IR ^{(2), (6)}
	Moment	Shear	
CTB Foundation Slab	1.72 (1.82x10 ⁵) LC3	1.06 ⁽³⁾ (5,480) LC5	---
Roof Slab	1.25 (5.69x10 ³) LC5	1.23 (318) LC5	---
42" Deep Column	1.07 ⁽³⁾ (1.03x10 ⁷) LC3	1.13 (211,764) LC5	---
Wall Horizontal Stiffener	1.66 (1.35x10 ⁶) LC5	1.41 (233,210) LC5	---
Wall Vertical Stiffener	4.36 (1.63x10 ⁶) LC4	1.20 (134,252) LC5	---
South, North, East and West Walls (Overall Minimum SFs)	1.05 ⁽³⁾ (3.73x10 ⁴) LC1	1.09 ⁽⁴⁾ (990) LC3	---
Roof Main Steel Girder W30x211	---	---	0.80 LC4
Main Steel Girder Support Beam W24x84	---	---	0.64 LC4
Notes:			
(1) SF = safety factor; SF shall be equal to or greater than 1.0.			
(2) IR = interaction ratio; IR shall be equal to or less than 1.0.			
(3) Peak force and moment results regardless of locations are directly used to compare with the capacities, which adds conservatism to minimum SF.			
(4) The location of the peak shear force (resulting in low shear safety factor) is at the side corner of the wall. The shear force from a single element adjacent to the peak value is used for conservatism. Averaged results from few adjacent elements over a length equal to at least the thickness of the wall can be used to show greater margin.			
(5) Values in parentheses are demand loads. Moments have units of lbf-in/in. Shear forces have units of lbf/in.			
(6) LC# indicates corresponding load combination number per Table 4.6.4, e.g., LC3 = Load Combination 3.			

HOLTEC INTERNATIONAL COPYRIGHTED MATERIAL

Report No.: HI-2167374

Proposed Rev. 0S

5-20

Table 5.3.4: HI-STORE CTB Soil Column Properties								
Soil Layer	Sub Layer #	Top Elevation (ft)	Thickness (ft)	Mid Layer Depth (ft)	Unit Weight (kcf)	BE Shear Wave Velocity (ft/s)	BE Shear Modulus (ksi)	Poisson's ratio
Top Soil	1	3,539	4	2	0.0845	380	379	0.25
	2	3,535	4	6	0.0845	380	379	0.25
Caliche	3	3,531	4	10	0.08935	1,078	3,228	0.35
Residual Soil	4	3,527	6	15	0.1125	1,010	3,565	0.25
	5	3,521	10	23	0.1125	1,552	8,417	0.25
	6	3,511	12	34	0.1125	1,919	12,882	0.25
Chinle Clay	7	3,499	12	46	0.124	1,509	8,776	0.25
	8	3,487	10	57	0.124	1,768	12,046	0.25
	9	3,477	10	67	0.124	2,264	19,752	0.25
Chinle Mudstone	10	3,467	12	78	0.134	1,858	14,378	0.25
	11	3,455	12	90	0.134	1,872	14,602	0.25
	12	3,443	17	104.5	0.134	2,478	25,584	0.25
Halfspace		3,426			0.134	2,761	31,749	0.25

HOLTEC INTERNATIONAL COPYRIGHTED MATERIAL

Report No.: HI-2167374

Proposed Rev. 0S

5-21

Table 5.3.5: Maximum Loads on Crane Runway Corbels		
Load Combination ⁽¹⁾	Vertical Force (lbf)	Shear Force (lbf)
1	515,680	124,270
2	406,470	99,982
3	461,360	116,880
4	277,460	75,814
5	487,110	197,620
Bounding Value ⁽²⁾	550,000	200,000
Notes:		
(1) Load combinations defined in Table 4.6.4.		
(2) Used for design and qualification of concrete corbels.		

HOLTEC INTERNATIONAL COPYRIGHTED MATERIAL	
Report No.: HI-2167374	Proposed Rev. 0S
5-22	

Load Condition	Max. Demand (ksf)	Capacity (ksf)	Safety Factor
Normal (Long-Term Storage)	3.34	5.38	1.61
Seismic (DECE Event)	4.34	8.07	1.86

Displacement Mode	Stiffness Value
Shear in X-Direction	1.615×10^8 lbf/in
Shear in Y-Direction	1.711×10^8 lbf/in
Compression in Z-Direction	4.127×10^8 lbf/in
Rotation about X-Axis	8.702×10^{11} lbf-in/deg
Rotation about Y-Axis	9.931×10^{12} lbf-in/deg
Rotation about Z-Axis	4.6×10^{12} lbf-in/deg

Notes:

(1) X-direction is East-West and parallel to the long edge of the CTB; Y-direction is North-South and parallel to the short edge of the CTB; Z-direction is vertical.

HOLTEC INTERNATIONAL COPYRIGHTED MATERIAL	
Report No.: HI-2167374	Proposed Rev. 0S
5-23	

Figure 5.3.1: [PROPRIETARY INFORMATION WITHHELD IN ACCORDANCE WITH 10CFR2.390]

HOLTEC INTERNATIONAL COPYRIGHTED MATERIAL	
Report No.: HI-2167374	Proposed Rev. 0S
5-24	

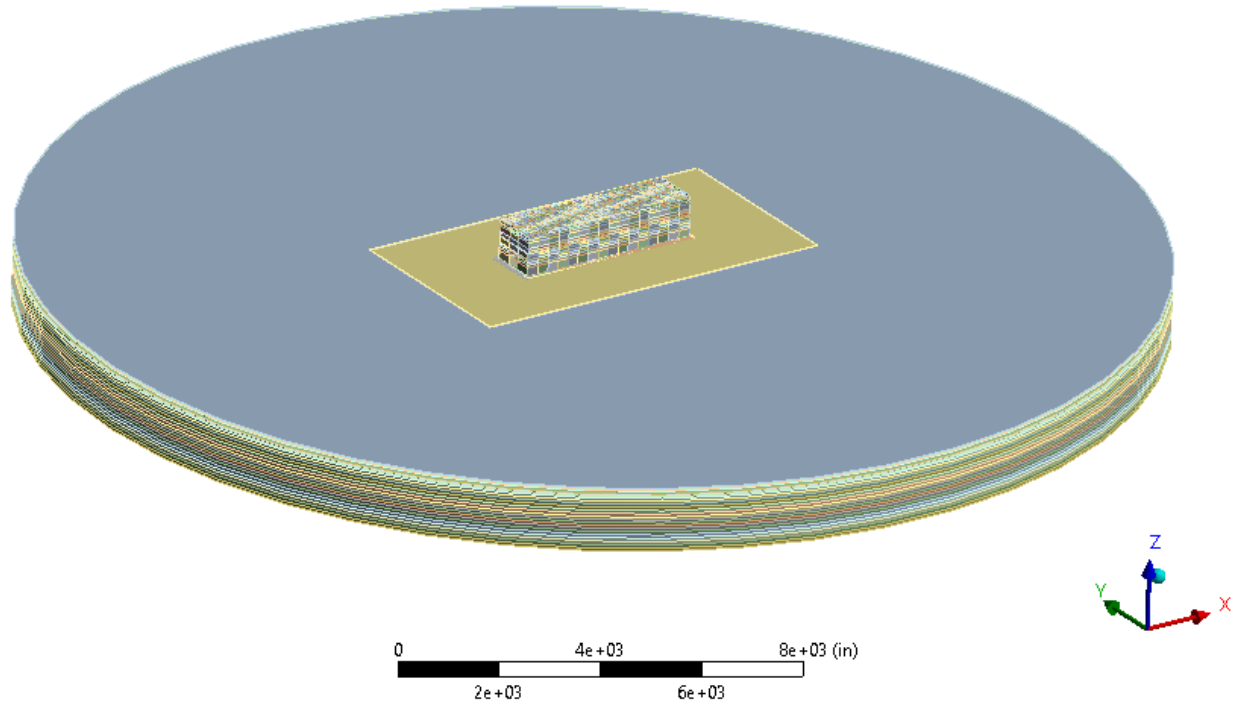


Figure 5.3.2: ANSYS Static Model of CTB plus Soil Foundation

HOLTEC INTERNATIONAL COPYRIGHTED MATERIAL	
Report No.: HI-2167374	Proposed Rev. 0S
5-25	

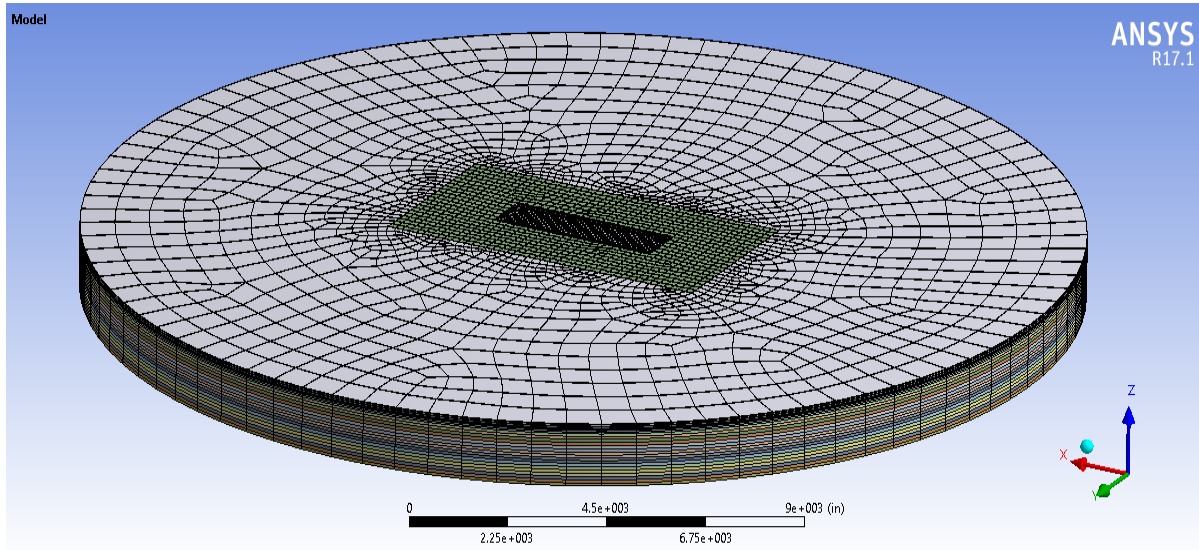


Figure 5.3.3: ANSYS Model of Soil Subgrade

HOLTEC INTERNATIONAL COPYRIGHTED MATERIAL	
Report No.: HI-2167374	Proposed Rev. 0S
5-26	

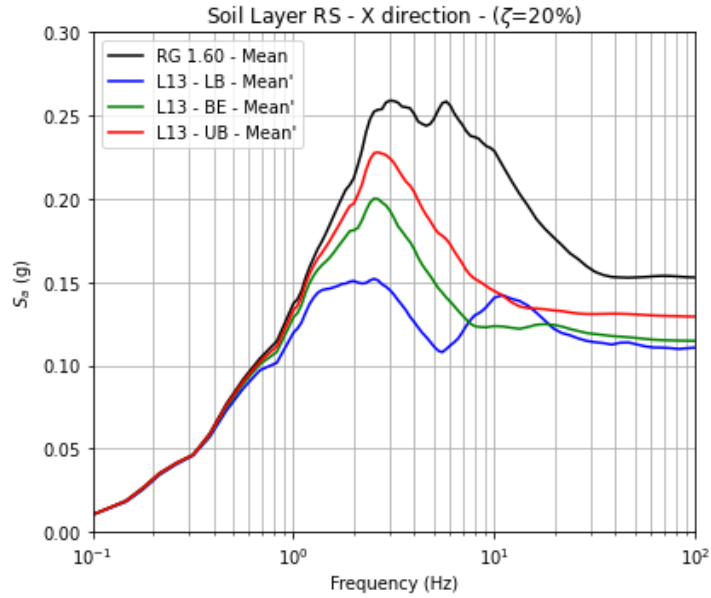


Figure 5.3.4: Response Spectra Comparison at Base of Soil Column (X-Direction)

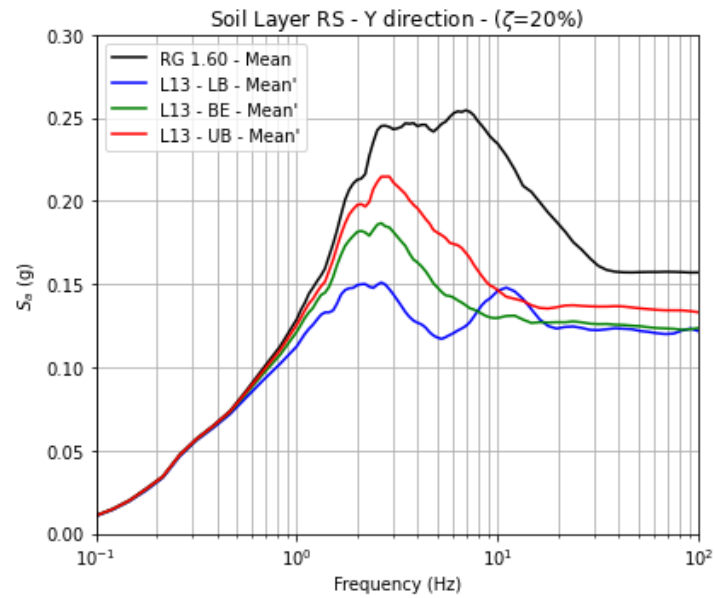


Figure 5.3.5: Response Spectra Comparison at Base of Soil Column (Y-Direction)

HOLTEC INTERNATIONAL COPYRIGHTED MATERIAL	
Report No.: HI-2167374	Proposed Rev. 0S
5-27	

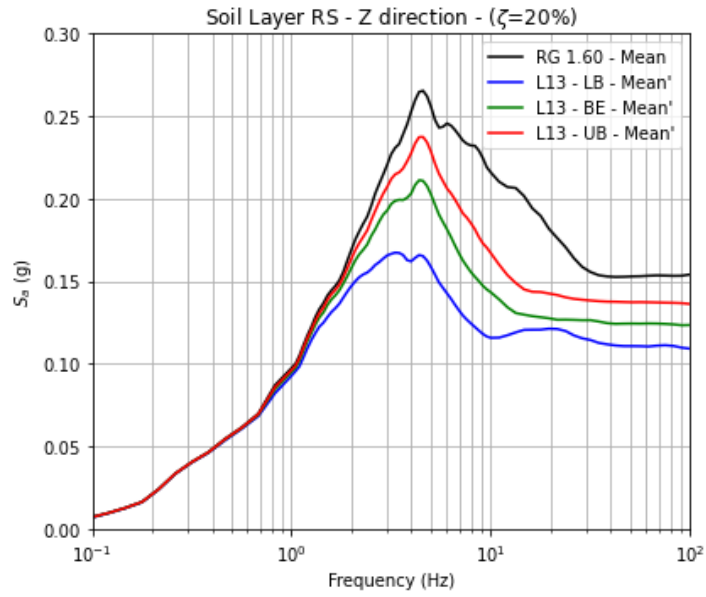
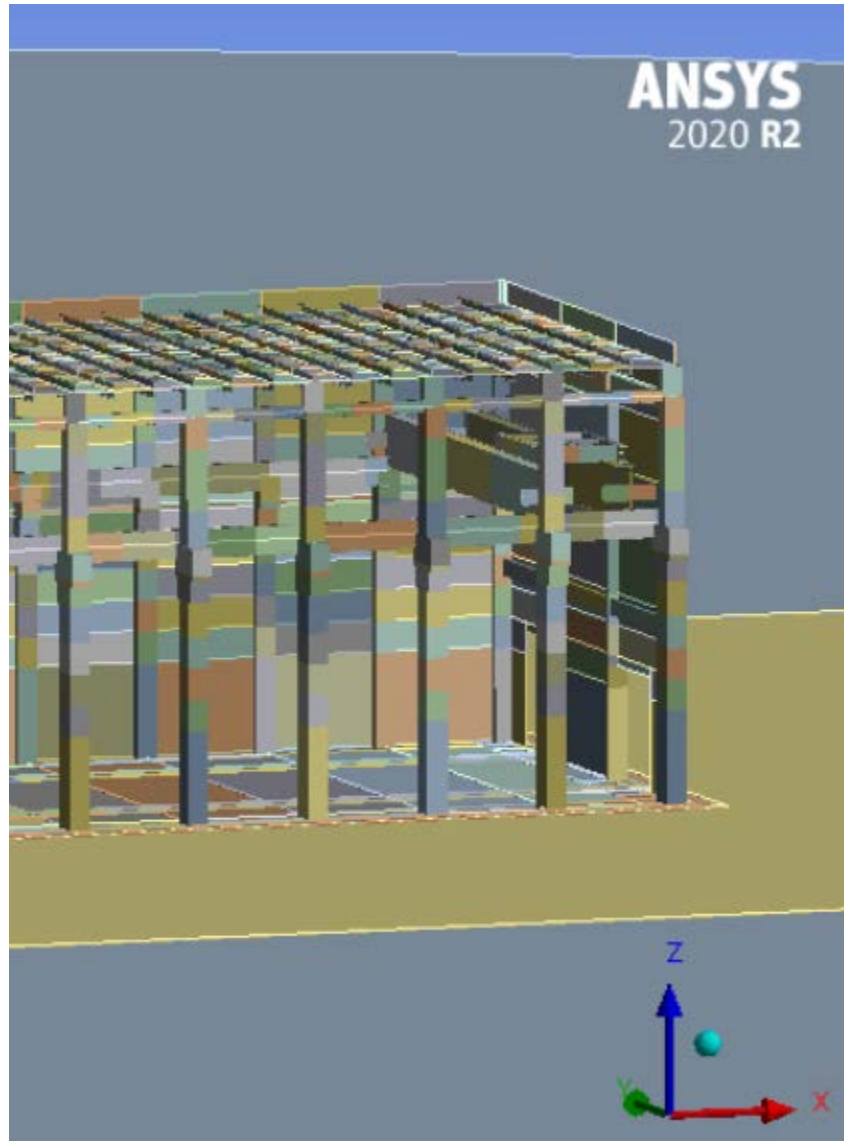


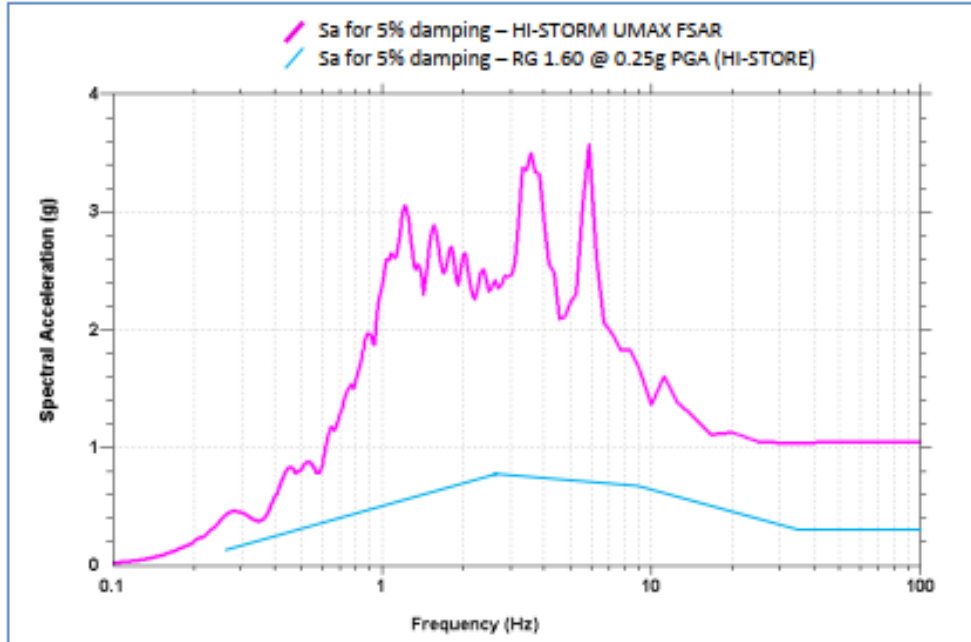
Figure 5.3.6: Response Spectra Comparison at Base of Soil Column (Z-Direction)

HOLTEC INTERNATIONAL COPYRIGHTED MATERIAL	
Report No.: HI-2167374	Proposed Rev. 0S
5-28	

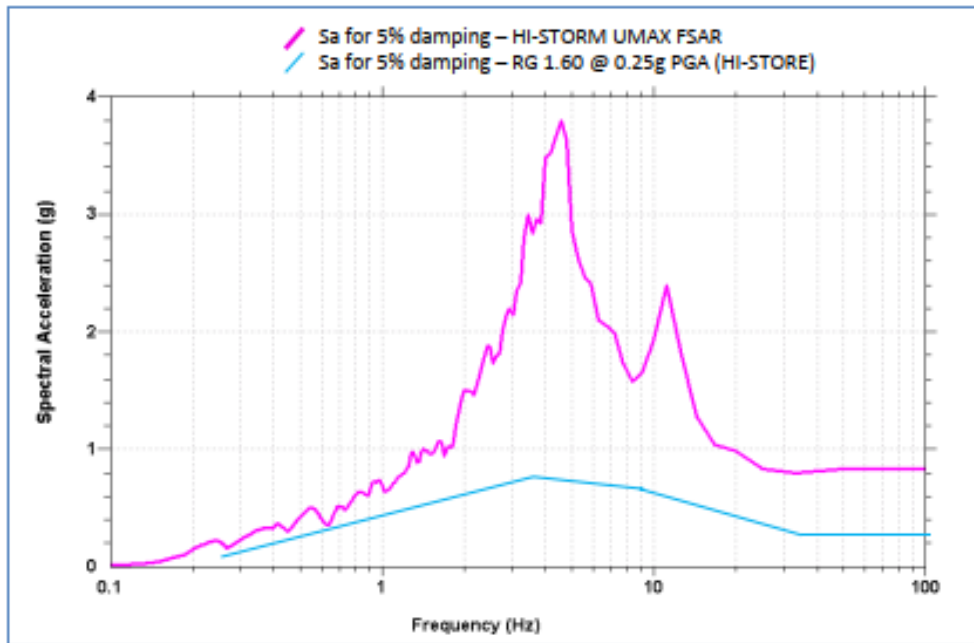


**Figure 5.3.7: ANSYS Model of CTB with Overhead Crane in Parked Position
(CTB South Wall Hidden for Clarity)**

HOLTEC INTERNATIONAL COPYRIGHTED MATERIAL	
Report No.: HI-2167374	Proposed Rev. 0S
5-29	



(a)



(b)

Figure 5.3.8: Comparison of Ground Motion Response Spectra

(a) Horizontal Direction; (b) Vertical Direction

HOLTEC INTERNATIONAL COPYRIGHTED MATERIAL	
Report No.: HI-2167374	Proposed Rev. 0S
5-30	

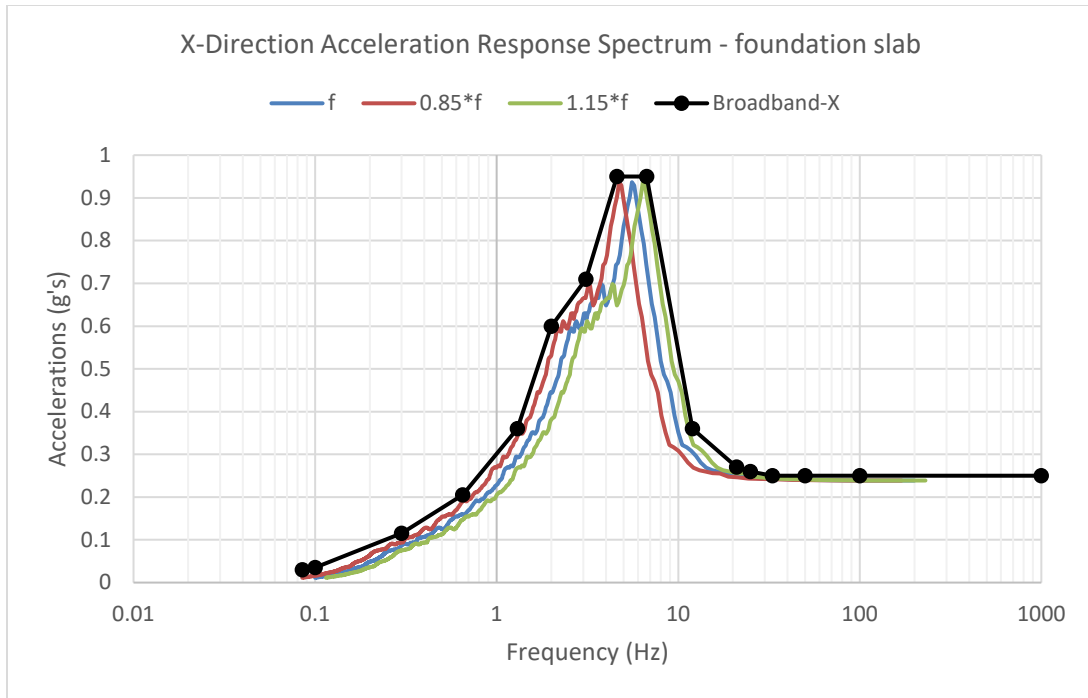


Figure 5.3.9: In-Structure Response Spectrum at CTB Foundation Slab (E-W Direction) – 5% Damping

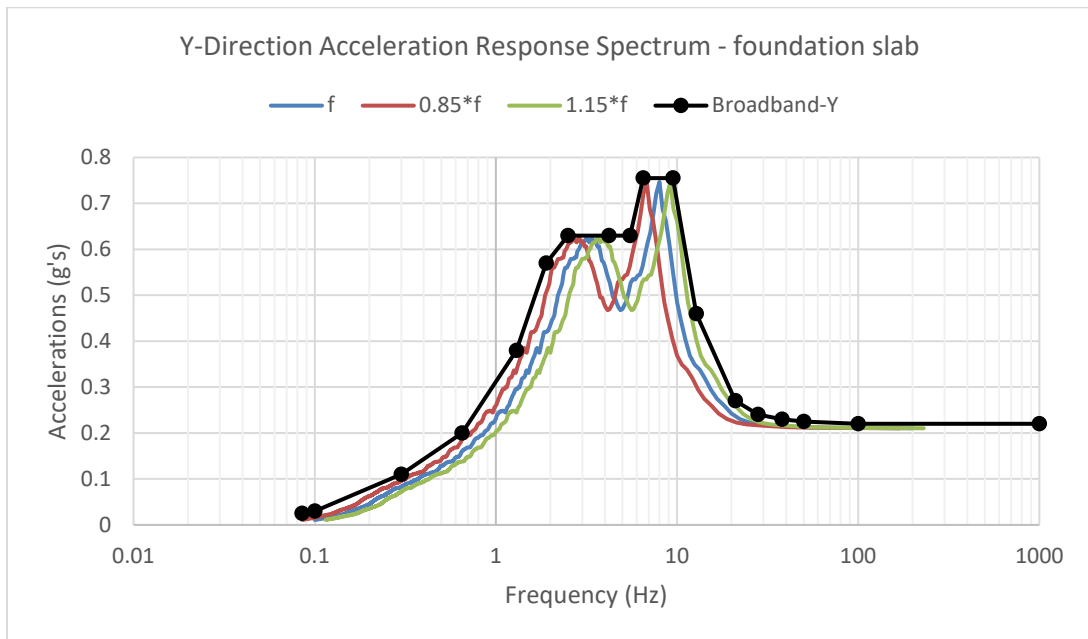


Figure 5.3.10: In-Structure Response Spectrum at CTB Foundation Slab (N-S Direction) – 5% Damping

HOLTEC INTERNATIONAL COPYRIGHTED MATERIAL	
Report No.: HI-2167374	Proposed Rev. 0S
5-31	

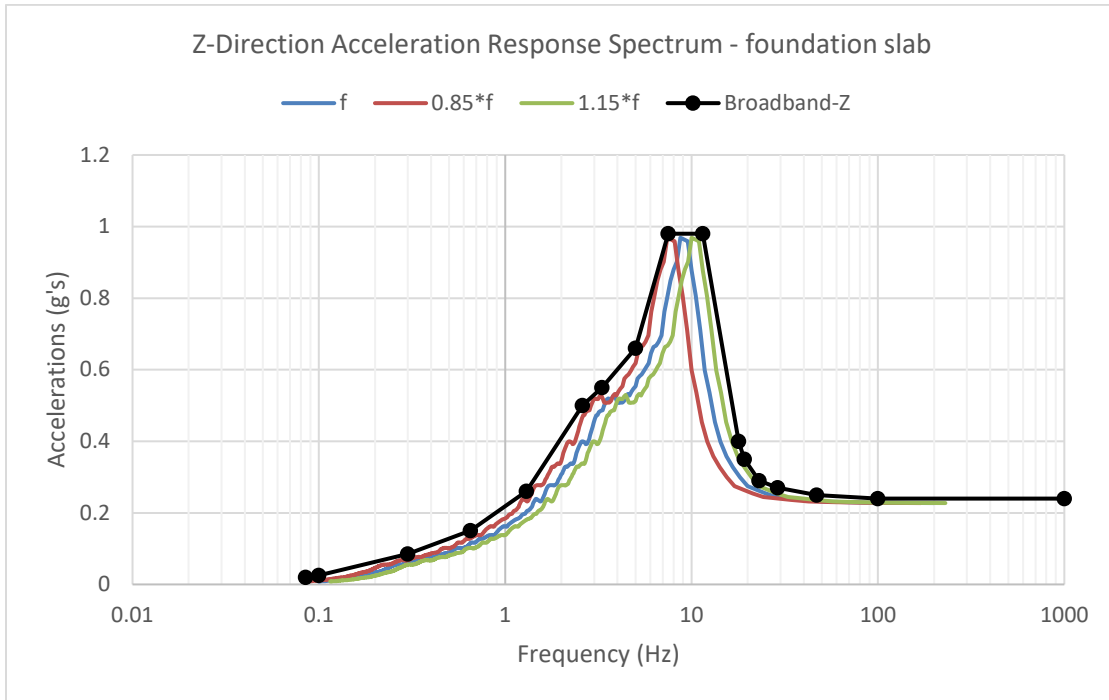


Figure 5.3.11: In-Structure Response Spectrum at CTB Foundation Slab (Vert Direction) – 5% Damping

HOLTEC INTERNATIONAL COPYRIGHTED MATERIAL	
Report No.: HI-2167374	Proposed Rev. 0S
5-32	

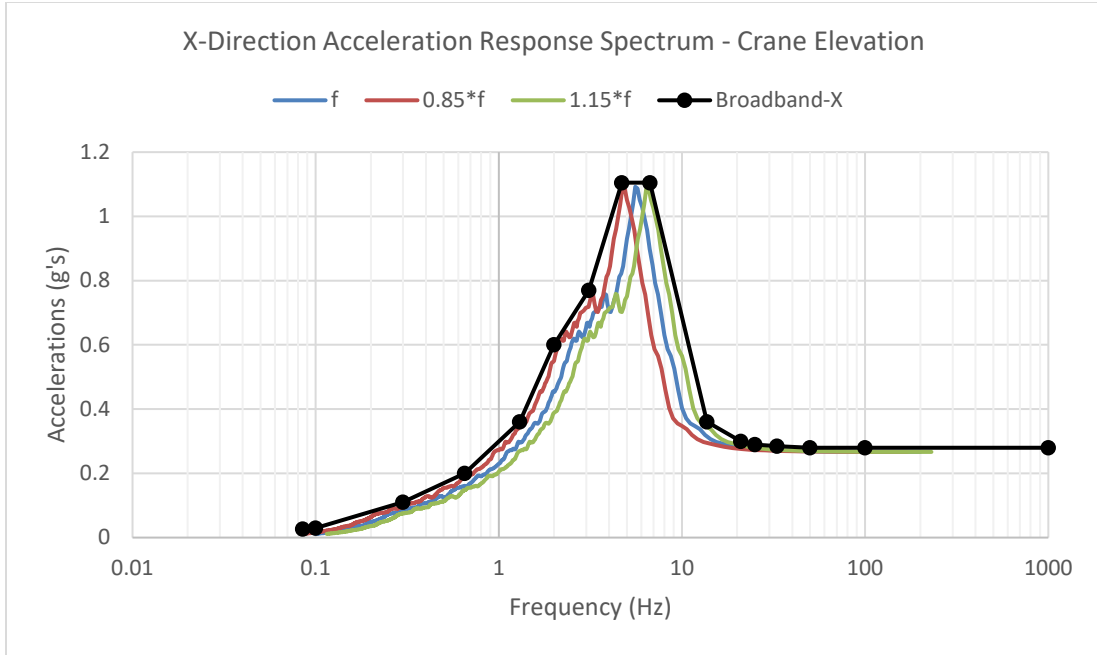


Figure 5.3.12: In-Structure Response Spectrum at Crane Corbel Elevation (E-W Direction) – 5% Damping

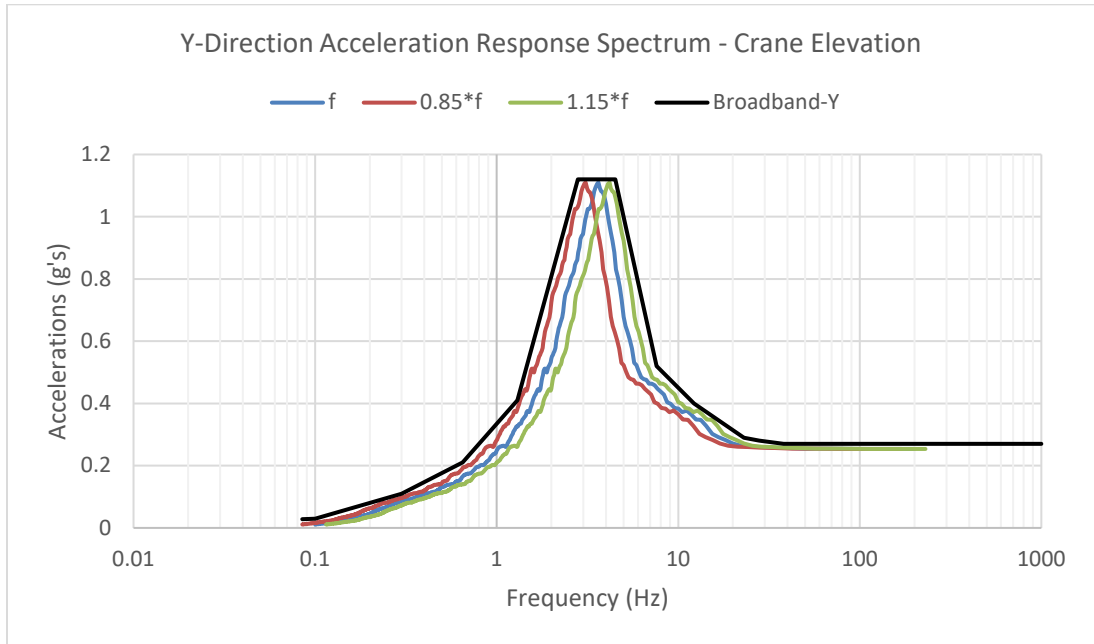


Figure 5.3.13: In-Structure Response Spectrum at Crane Corbel Elevation (N-S Direction) – 5% Damping

HOLTEC INTERNATIONAL COPYRIGHTED MATERIAL	
Report No.: HI-2167374	Proposed Rev. 0S
5-33	

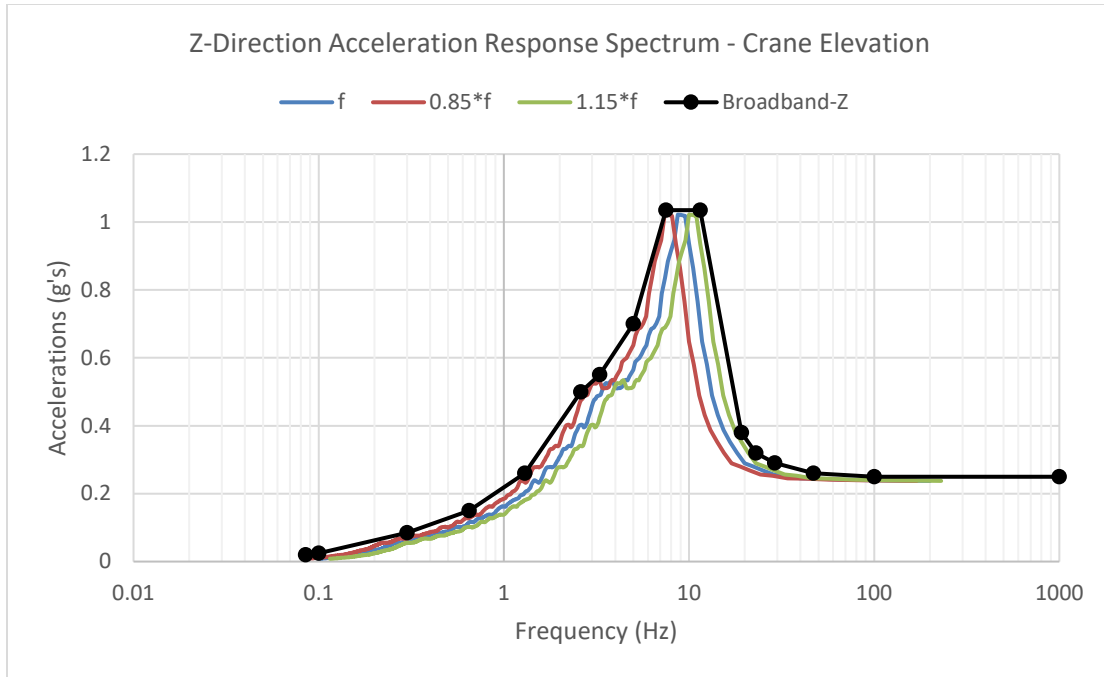


Figure 5.3.14: In-Structure Response Spectrum at Crane Corbel Elevation (Vert Direction) – 5% Damping

HOLTEC INTERNATIONAL COPYRIGHTED MATERIAL	
Report No.: HI-2167374	Proposed Rev. 0S
5-34	

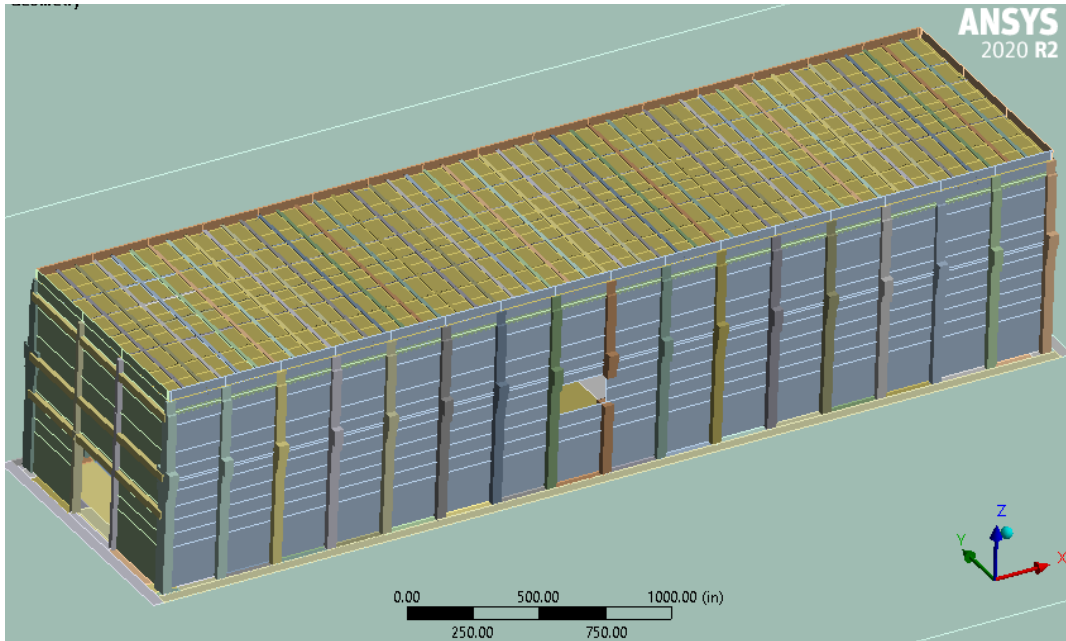


Figure 5.3.15: Large Missile Impact at Center of Long Wall

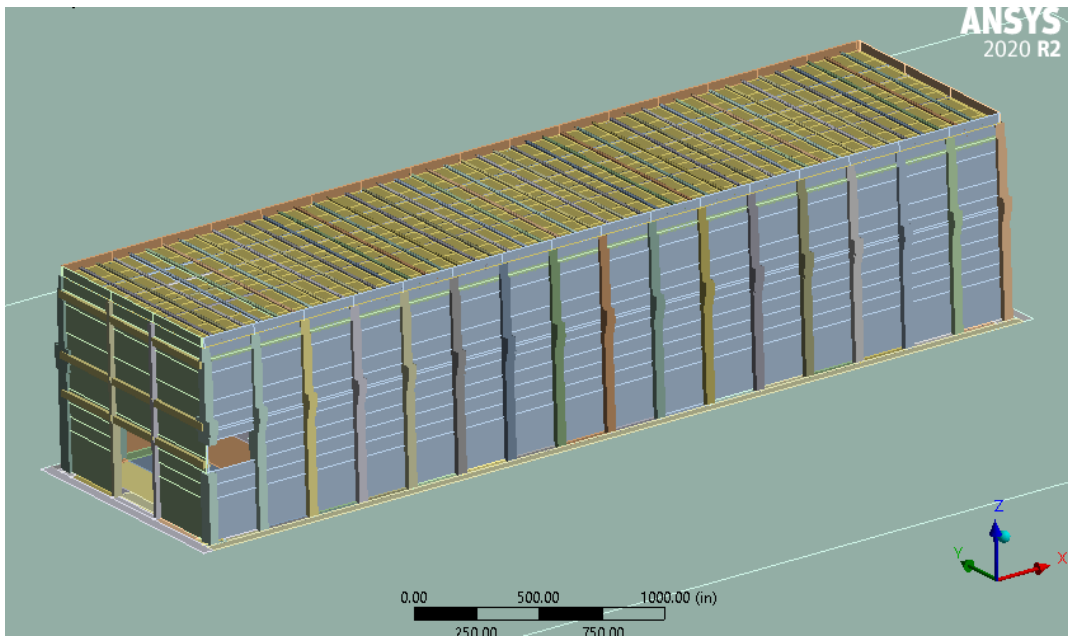


Figure 5.3.16: Large Missile Impact at Corner Column Location

HOLTEC INTERNATIONAL COPYRIGHTED MATERIAL	
Report No.: HI-2167374	Proposed Rev. 0S
5-35	

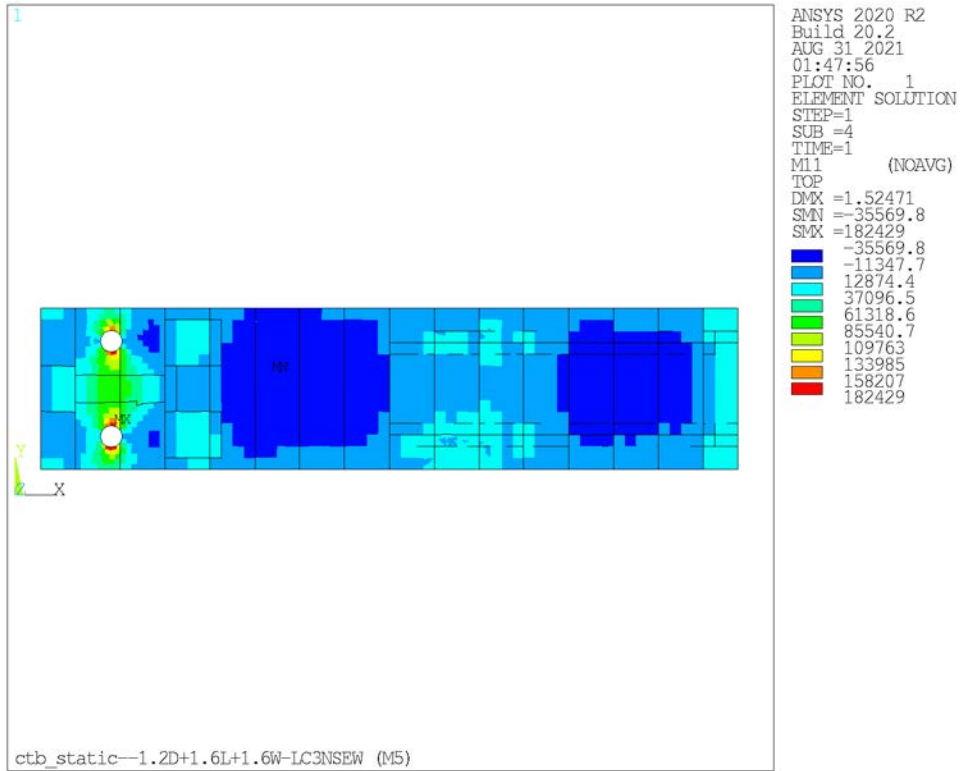


Figure 5.3.17: Moment Contour in CTB Foundation Slab

HOLTEC INTERNATIONAL COPYRIGHTED MATERIAL	
Report No.: HI-2167374	Proposed Rev. 0S
5-36	

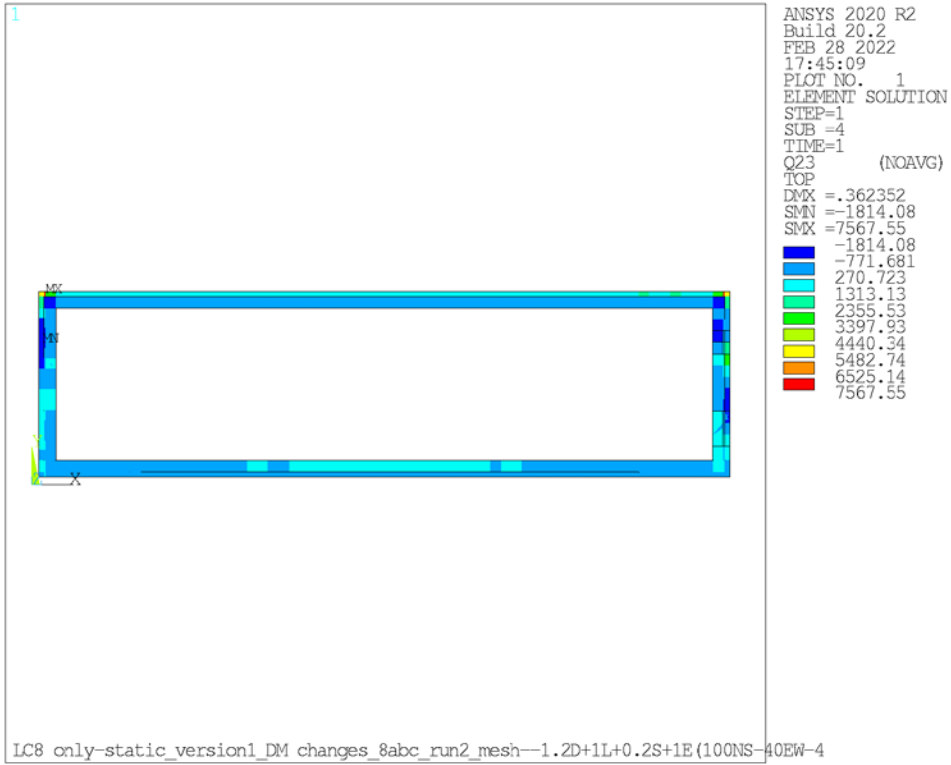


Figure 5.3.18: Shear Force Contour in CTB Foundation Slab

HOLTEC INTERNATIONAL COPYRIGHTED MATERIAL	
Report No.: HI-2167374	Proposed Rev. 0S
5-37	

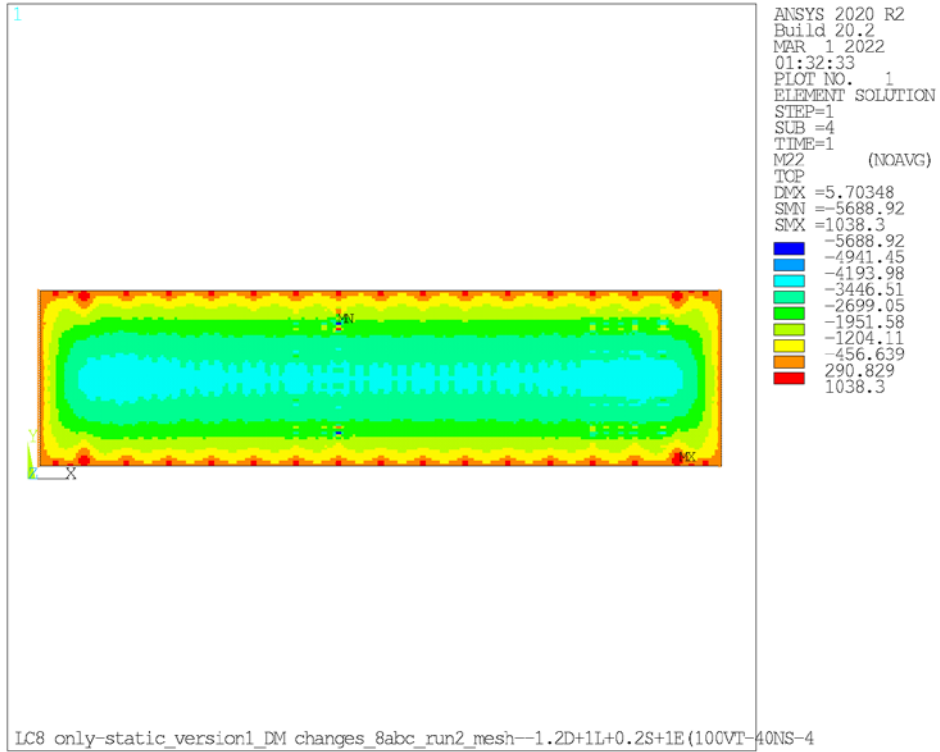


Figure 5.3.19: Moment Contour in CTB Roof Slab

HOLTEC INTERNATIONAL COPYRIGHTED MATERIAL	
Report No.: HI-2167374	Proposed Rev. 0S
5-38	

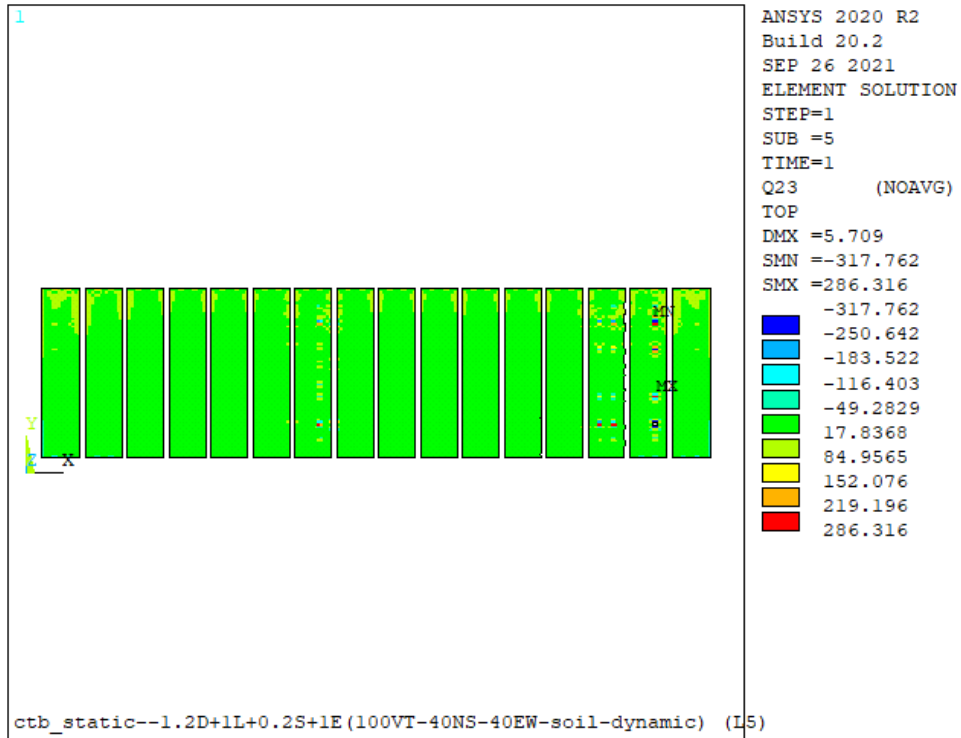


Figure 5.3.20: Shear Force Contour in CTB Roof Slab

HOLTEC INTERNATIONAL COPYRIGHTED MATERIAL	
Report No.: HI-2167374	Proposed Rev. 0S
5-39	

M: strength6-1.2D+1.6L+1.6W-LC3-NSEW

Directional Bending Moment-CLint42-Y
 Type: Directional Bending Moment(Y Axis) (Unaveraged)
 Unit: lbf-in
 Solution Coordinate System
 Time: 1
 Deformation Scale Factor: 1.0 (True Scale)
 7/29/2022 8:42 AM

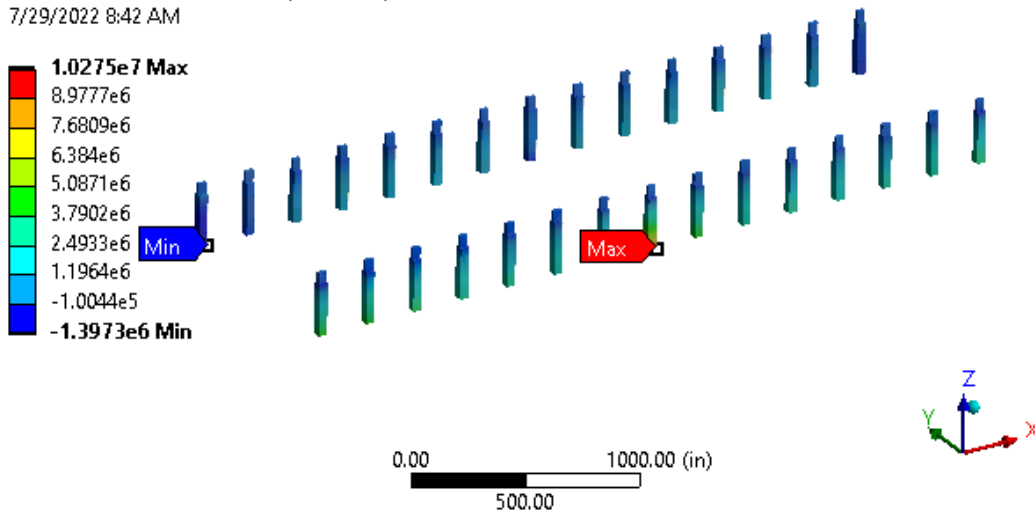


Figure 5.3.21: Moment Contour in 42” Deep CTB Columns

HOLTEC INTERNATIONAL COPYRIGHTED MATERIAL	
Report No.: HI-2167374	Proposed Rev. 0S
5-40	

C: strength13-1.2D+1.0L+0.2S+1E-100VT-40-NS-40EW-soil-dynamic

Directional Shear Force-CLint42-Y

Type: Directional Shear Force(Y Axis) (Unaveraged)

Unit: lbf

Solution Coordinate System

Time: 1

Deformation Scale Factor: 1.0 (True Scale)

7/28/2022 2:12 PM

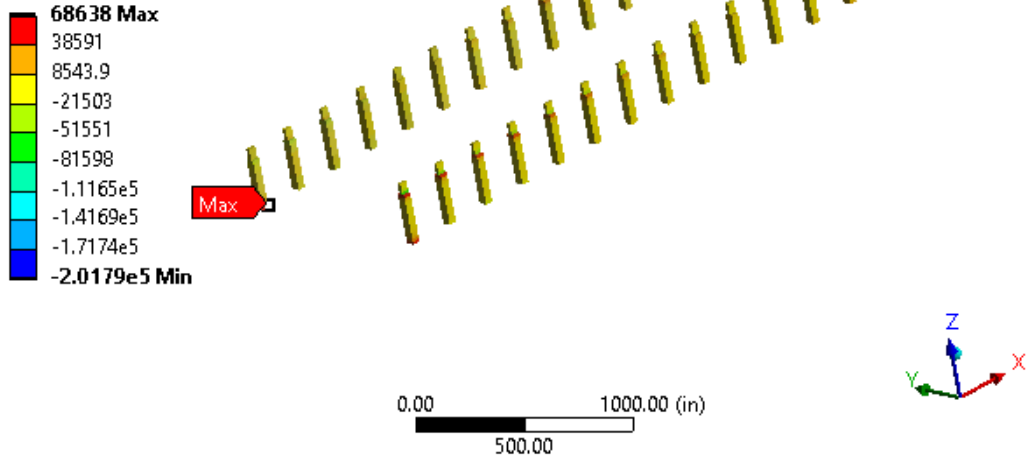


Figure 5.3.22: Shear Force Contour in 42” Deep CTB Columns

HOLTEC INTERNATIONAL COPYRIGHTED MATERIAL	
Report No.: HI-2167374	Proposed Rev. 0S
5-41	

A: strength11-1.2D+1.0L+0.2S+1E-100NS-40EW-40VT-soil-dynamic

Directional Bending Moment-wallLS-Z
 Type: Directional Bending Moment(Z Axis) (Unaveraged)
 Unit: lbf-in
 Solution Coordinate System
 Time: 1
 Deformation Scale Factor: 1.0 (True Scale)
 7/28/2022 12:04 PM

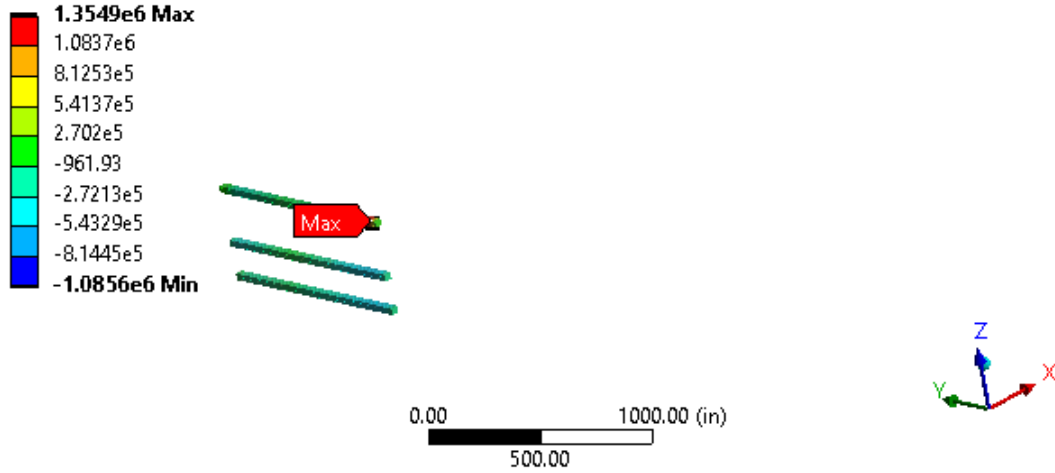


Figure 5.3.23: Moment Contour in Horizontal Wall Stiffeners

HOLTEC INTERNATIONAL COPYRIGHTED MATERIAL	
Report No.: HI-2167374	Proposed Rev. 0S
5-42	

J: strength11-1.2D+1.0L+0.2S+1E-100NS-40EW-40VT-soil-dynamic

Directional Shear Force-wallLS-Z
 Type: Directional Shear Force(Z Axis) (Unaveraged)
 Unit: lbf
 Solution Coordinate System
 Time: 1
 Deformation Scale Factor: 1.0 (True Scale)
 7/29/2022 8:50 AM

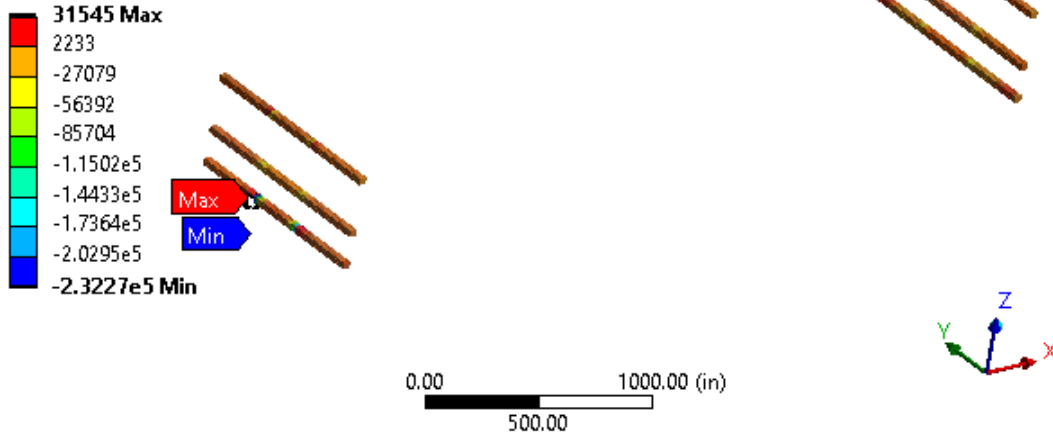


Figure 5.3.24: Shear Force Contour in Horizontal Wall Stiffeners

HOLTEC INTERNATIONAL COPYRIGHTED MATERIAL	
Report No.: HI-2167374	Proposed Rev. 0S
5-43	

S: strength9-1.0D+0.8L+1.0Wt-LC3-NSEW

Directional Bending Moment-wallVS-Z

Type: Directional Bending Moment(Z Axis) (Unaveraged)

Unit: lbf-in

Solution Coordinate System

Time: 1

Deformation Scale Factor: 1.0 (True Scale)

7/29/2022 8:55 AM

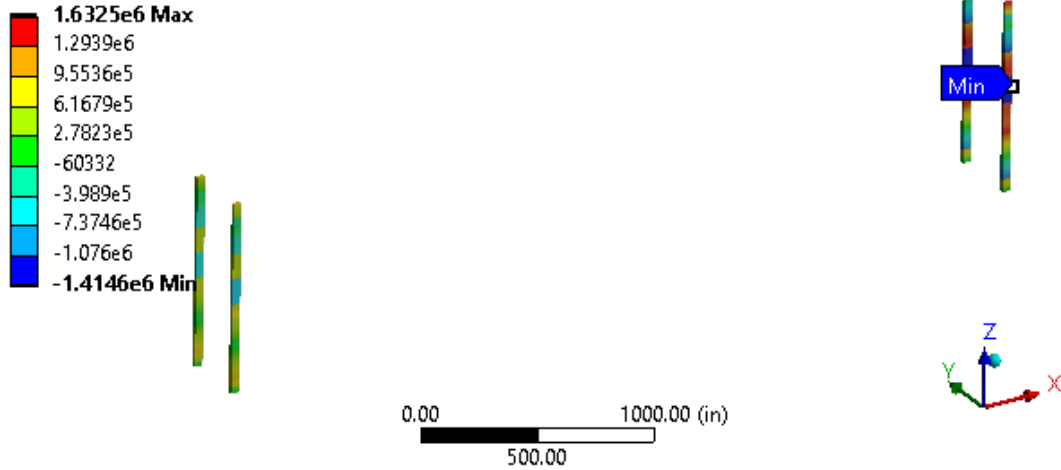


Figure 5.3.25: Moment Contour in Vertical Wall Stiffeners

HOLTEC INTERNATIONAL COPYRIGHTED MATERIAL	
Report No.: HI-2167374	Proposed Rev. 0S
5-44	

J: strength11-1.2D+1.0L+0.2S+1E-100NS-40EW-40VT-soil-dynamic
 Directional Shear Force-wall\VS-Z
 Type: Directional Shear Force(Z Axis) (Unaveraged)
 Unit: lbf
 Solution Coordinate System
 Time: 1
 Deformation Scale Factor: 1.0 (True Scale)
 7/29/2022 8:57 AM

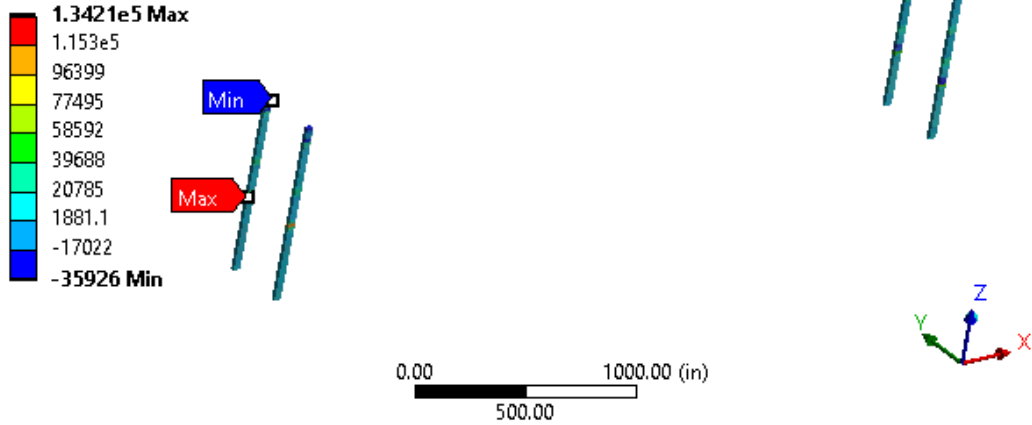


Figure 5.3.26: Shear Force Contour in Vertical Wall Stiffeners

HOLTEC INTERNATIONAL COPYRIGHTED MATERIAL	
Report No.: HI-2167374	Proposed Rev. 0S
5-45	

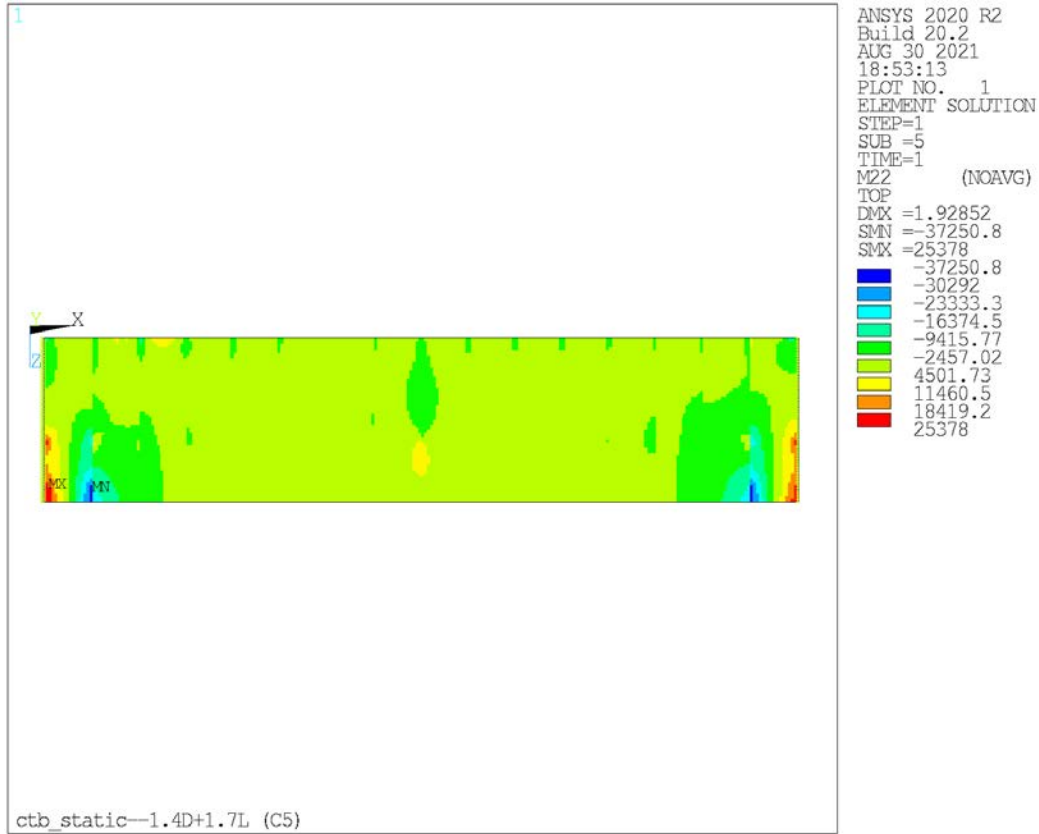


Figure 5.3.27: Moment Contour in CTB Wall

HOLTEC INTERNATIONAL COPYRIGHTED MATERIAL	
Report No.: HI-2167374	Proposed Rev. 0S
5-46	

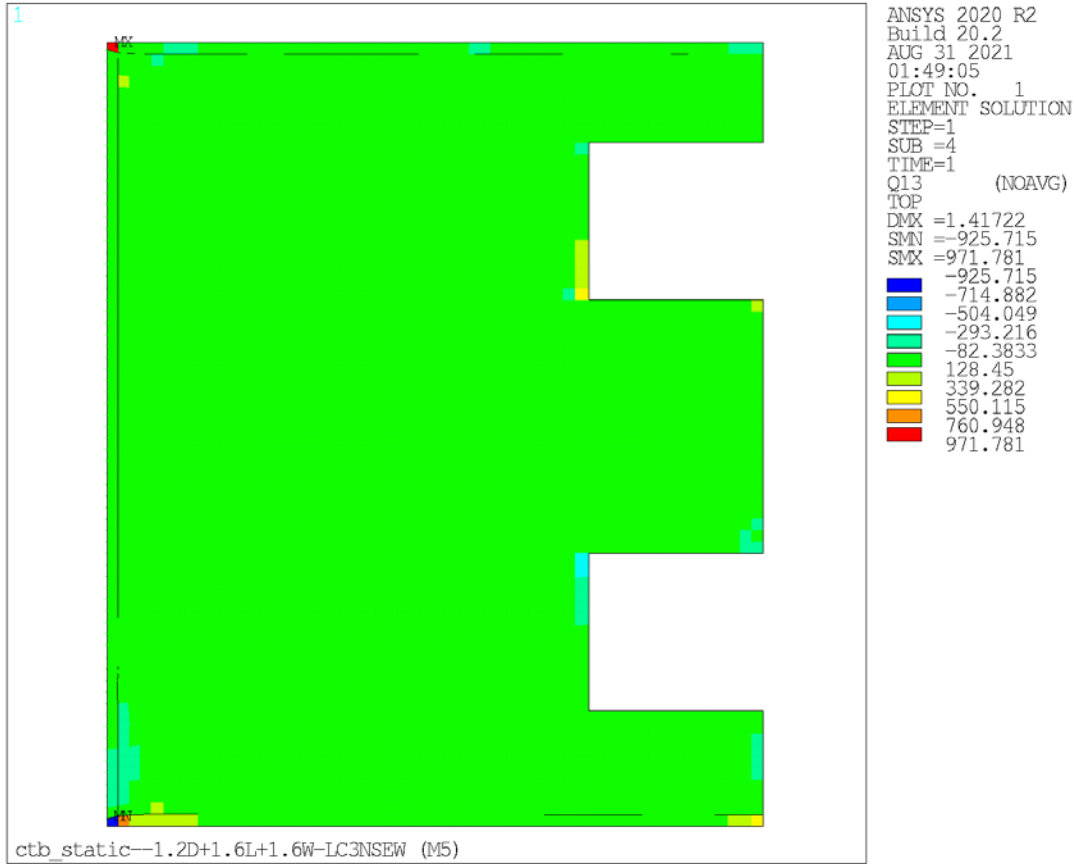


Figure 5.3.28: Shear Force Contour in CTB Wall

HOLTEC INTERNATIONAL COPYRIGHTED MATERIAL	
Report No.: HI-2167374	Proposed Rev. 0S
5-47	

5.4 OTHER SSCs IMPORTANT TO SAFETY

The HI-STORE CIS facility includes the following other SSCs that are classified as important to safety:

- HI-STORM UMAX Vertical Ventilated Module (VVM)
- HI-TRAC CS
- Cask Transfer Building Crane
- Transport Cask Lift Yoke
- MPC Lift Attachment
- Special Lifting Devices
- **Cask Transfer Facility Steel Structure**

Each of these components is discussed in more detail, including their description, design criteria, material properties, and structural analyses, in the following subsections.

5.4.1 HI-STORM UMAX VVM

5.4.1.1 Description of Structural Aspects

The HI-STORM UMAX VVM is a central component of the HI-STORM UMAX dry storage system, which has been previously licensed in accordance with 10CFR72 requirements under NRC Docket # 72-1040. The VVM provides for storage of the MPC in a vertical configuration inside a subterranean cylindrical cavity entirely below the top-of-grade (TOG) of the ISFSI pad. The VVM is comprised of the Cavity Enclosure Container (CEC) and the Closure Lid, which are both shown on the Licensing Drawing in Section 1.5. A full description of the VVM, including its subcomponents, is provided in Section 1.2 of the HI-STORM UMAX FSAR [1.0.6]. The HI-STORM UMAX VVM is licensed as a variable height system in [1.0.6]. For the HI-STORE CIS facility, however, **the cavity height is fixed at two discrete dimensions** as shown on the Licensing Drawing in Section 1.5.

5.4.1.2 Design Criteria

To serve its intended function, the HI-STORM UMAX VVM, including the CEC and Closure Lid, shall ensure physical protection, biological shielding, and allow the retrieval of the MPC under all conditions of storage (10 CFR 72.122(l)). Because the VVM is an in-ground structure, drops and tip-over of the VVM are not credible events and, therefore, do not warrant analysis. The design bases and criteria for the VVM are fully defined in Chapter 2 of the HI-STORM UMAX FSAR [1.0.6], **and they are incorporated by reference in this SAR (see Table 5.0.3)**. The load cases germane to establishing the structural adequacy of the VVM pursuant to 10 CFR 72.24(c) are compiled in Table 2.4.1 of [1.0.6].

HOLTEC INTERNATIONAL COPYRIGHTED MATERIAL	
Report No.: HI-2167374	Proposed Rev. 0S
5-48	

5.4.1.3 Material Properties

The material properties for the VVM are provided in Section 3.3 of the HI-STORM UMAX FSAR [1.0.6] in conjunction with the Licensing Drawing in Section 1.5.

5.4.1.4 Structural Analysis

The design basis structural analyses for the VVM for all applicable normal, off-normal, and accident loadings are presented in Chapter 3 of the HI-STORM UMAX FSAR [1.0.6]. As shown in Table 5.0.1 above, the design basis loads analyzed in the HI-STORM UMAX FSAR **generally** bound the site-specific loads applicable to the HI-STORE site, **except for the weight of the HI-TRAC transfer cask**, and therefore minimal structural analyses are required to qualify the VVM for this application.

The only loading event for the VVM that is not generically analyzed in the HI-STORM UMAX FSAR is a postulated earthquake during MPC transfer operations at the VVM, wherein the HI-TRAC CS is vertically stacked on top of the VVM and securely fastened in place at four anchor bolt locations. The analysis of this stack-up configuration is performed herein using the time history analysis method implemented in LS-DYNA [5.4.2]. The finite element model used for this analysis is shown in Figure 5.4.1.

The model uses a combination of solid, shell, thick shell, and discrete elements to represent various components of the stack. **The steel components are modeled in LS-DYNA as elastic-plastic materials defined by a non-linear true stress-strain curve, which is developed using the method described and benchmarked in [5.4.8].** To perform a bounding analysis, the MPC is **located** inside the HI-TRAC CS to maximize the center of gravity height of the stack. **Since the HI-STORM UMAX and the CTF are both massive, in-ground structures, and they both utilize the same anchor bolt arrangement to secure the HI-TRAC CS above the cavity opening, they are excluded from the analytical model of the stack-up configuration.** Thus, the termination point for the stack model is the CEC top plate (or the top surface of CTF alignment plate at the CTF location). A rigid layer of solid elements represents the CEC top plate and is used to drive the **anchored HI-TRAC CS based on the governing seismic motion from either stack-up location.**

Since the HI-TRAC CS is bolted in place, and therefore it is not free to slide or lift-off, the response of the system is linear and the use of a single 3-D time history input is justified. For conservatism, the stack-up analysis is performed for the Design **Basis Earthquake (DBE)** defined in Table 4.3.3, even though the MPC transfer at the VVM is a Short-Term Operation. **In addition, the stack-up analysis also accounts for soil-structure interaction (SSI) effects associated with the CTF location inside the CTB. Specifically, the driving motion for the stack-up analysis is the governing time history motion for the CTB slab at the CTF location as obtained from the SSI analysis of the CTB, which is further discussed in Subsection 5.3.2. The SSI effects are greater for the CTB versus the HI-STORM UMAX since the center of gravity of the massive CTB is well above the ground elevation, and the CTB is a more flexible structure as compared to the underground HI-STORM UMAX. Lastly, it is noted that the HI-STAR 190 has a negligible effect on the anchored HI-TRAC CS at the CTF location since the HI-STAR 190 is laterally restrained inside the CTF cavity with no mechanical connection to the HI-TRAC CS, while the HI-TRAC CS is firmly anchored to the CTB slab above the CTF cavity, as shown on Licensing Drawings in Section 1.5.**

HOLTEC INTERNATIONAL COPYRIGHTED MATERIAL	
Report No.: HI-2167374	Proposed Rev. 0S
5-49	

The results from the LS-DYNA time history analysis are used to demonstrate the kinematic stability of the stack under the DBE and qualify all structural components in the load path, including the anchor bolts, the anchor blocks, the HI-TRAC CS shield gate weldment, shield gate, and the HI-STORM UMAX ISFSI pad (or the CTB slab). The calculated stresses in the steel structures are compared with the applicable Level D stress limits per ASME Section III, Subsection NF [4.5.1]. The bearing load imposed on the ISFSI pad concrete is evaluated in accordance with ACI 318-05 [5.3.1]. The key results for this analysis are summarized in Table 5.4.1, which shows that all calculated safety factors are greater than 1.0.

The complete details of the stack-up analysis are provided in the Structural Calculation Package [5.4.6]. The minor differences of HI-STORM UMAX Version C design are addressed in [5.4.7].

A tornado-borne missile strike on the HI-TRAC CS during stack-up is not analyzed since the conduct of operations in Chapter 10 (see Paragraph 10.3.3.5) prevents the HI-TRAC CS from exiting CTB if severe weather is predicted.

5.4.2 HI-TRAC CS

5.4.2.1 Description of Structural Aspects

The HI-TRAC CS is a steel and concrete transfer cask, which is used for all on-site canister transfers. It has a cylindrical body delimited by carbon steel inner and outer shells with densified concrete occupying the space between the shells. The HI-TRAC CS has two trunnions near the top of the cask for lifting, and two optional rotation trunnions near its base for upending (or down ending) the cask. The bottom lid of the HI-TRAC CS, which is also referred to as the shield gate, is split into two halves such that they can be slid open in a symmetric manner to allow the MPC to pass through the opening (see Figure 1.2.3a). A complete description of the HI-TRAC CS is provided in Subsection 1.2.4.

5.4.2.2 Design Criteria

The design criteria for the HI-TRAC CS, which is an ITS component, are fully provided in Subsection 4.3.3.

The structural steel components of the HI-TRAC CS are designed to meet the stress limits of Section III, Subsection NF of the ASME Code [4.5.1] for all operating modes. The embedded trunnions for lifting and handling of the transfer cask are designed in accordance with the requirements of NUREG-0612 [1.2.7] for interfacing lift points.

Table 4.3.4 lists the loading scenarios for HI-TRAC CS for which its structural qualification must be performed.

5.4.2.3 Material Properties

The fabrication materials for the HI-TRAC CS are generally the same as those for the HI-STORM FW and the HI-TRAC VW, in particular SA-516 Grade 70, SA-193 B7, A36, and SB-637 N07718. The mechanical properties for these materials can be obtained from the summary tables in Section 3.3 of the certified HI-STORM FW FSAR [1.3.7], which are sourced from the Section II, Part D of ASME Code [4.6.3]. Per the Licensing Drawing in Section 1.5, the fabrication materials for the HI-TRAC CS also include SA-564 630 H1100 and A500 Grade B. The properties of these materials are summarized in Table 5.4.11 of this SAR.

HOLTEC INTERNATIONAL COPYRIGHTED MATERIAL	
Report No.: HI-2167374	Proposed Rev. 0S
5-50	

5.4.2.4 Structural Analysis

The loads on the HI-TRAC CS that are structurally significant are listed in Table 4.3.4, and the structural analysis for each of these loads is described below.

5.4.2.4.1 Lifting Analysis

[

PROPRIETARY INFORMATION WITHHELD IN ACCORDANCE WITH 10CFR2.390

]

The results for the above lifting analyses for HI-TRAC CS are summarized in Table 5.4.2, which shows that all calculated stresses are less than their applicable stress limits. The minimum safety factor is associated with the bending stress in the cantilevered lifting trunnions, which are conservatively designed to meet the stress limits per ANSI N14.6 [1.2.4]. The complete details of the HI-TRAC CS lifting analysis are provided in the Structural Calculation Package [5.4.6].

5.4.2.4.2 Seismic Analysis at CTF

The seismic analysis of the HI-TRAC CS while it is mounted atop a HI-STORM UMAX VVM is discussed in detail in Subsection 5.4.1.4, and the analysis results are summarized in Table 5.4.1. The anchorage design used to secure the HI-TRAC CS to the CTF is the same design used to anchor the HI-TRAC CS at a HI-STORM UMAX VVM location. The only difference between stack-up configurations at the CTF versus the HI-STORM UMAX VVM is the anchor bolts used to secure the HI-TRAC CS are longer for the latter configuration. The longer free length of the bolts introduces more flexibility into the system, which in turn may lead to larger rocking displacements and internal loads acting on the stack under seismic conditions. In light of this, plus the fact that the stack-up analysis for the HI-STORM UMAX VVM is conservatively performed using the bounding time history for the CTB slab including SSI effects, the results in Table 5.4.1, which address the HI-TRAC CS shield gate, the anchor bolts, the anchor blocks and its connecting welds, and the bearing stress on the concrete, are also bounding for the stack-up configuration at the CTF. The shear forces and bending moments induced in the CTB slab due to the stack-up configuration at the CTF are evaluated in Paragraph 5.3.2.4 and reflected in the results in Table 5.3.2.

HOLTEC INTERNATIONAL COPYRIGHTED MATERIAL	
Report No.: HI-2167374	Proposed Rev. 0S
5-51	

5.4.2.4.3 Tornado Missile Analysis

[

PROPRIETARY INFORMATION WITHHELD IN ACCORDANCE WITH 10CFR2.390

]

The complete details of the tornado missile analysis for the HI-TRAC CS are provided in the Structural Calculation Package [5.4.6]. The effects of a tornado missile strike on the CTB structure are discussed in Subsection 5.3.2.

5.4.2.4.4 Seismic Stability Analysis of Freestanding HI-TRAC CS

The general stability of a freestanding HI-TRAC CS (empty and fully loaded) under the DBE is evaluated for the possibility of incipient tipping and sliding, where simple dynamic equations are formulated based on force and moment equilibrium. Table 5.4.7 summarizes both the bounding parameters used as input to the seismic stability analysis and the results. As seen from the table, the cask does not uplift or slide under the DBE event. A similar analysis has also been performed for the HI-STAR 190, and the results are likewise summarized in Table 5.4.7.

5.4.2.4.5 Fatigue Evaluation

The HI-TRAC CS will be used repeatedly at the HI-STORE CIS facility to transfer canisters from arriving transport casks to VVM storage cavities. As a result, the HI-TRAC CS will be subject to both thermal and mechanical cyclic loading, which must be evaluated from a fatigue life standpoint. A fatigue life evaluation for all load bearing members of HI-TRAC CS has been performed in [5.4.6] considering both high stress low cyclic and low stress high cyclic phenomena, and the results are presented in Table 5.4.8. The maximum stress in the trunnions is conservatively set at the allowable stress limit per [1.2.7] times a stress concentration factor of 4.0 for the material. The use of stress concentration factor of 4.0 is consistent with HI-STAR 100 SAR [1.3.5]. The maximum stress in all other load bearing members of HI-TRAC CS, designed to stress limits in [4.5.1], is conservatively set at the ultimate strength of the material. The fatigue life of all load bearing materials is calculated by comparing the maximum stress value with the

HOLTEC INTERNATIONAL COPYRIGHTED MATERIAL	
Report No.: HI-2167374	Proposed Rev. 0S
5-52	

material cycle life curves defined in Appendix I of ASME Code [17.3.2]. A safety factor of 2.0 on the permissible loading cycles is imposed for additional conservatism per Subsection 4.5.3.9.

5.4.3 Cask Transfer Building Crane

5.4.3.1 Description of Structural Aspects

The Cask Transfer Building (CTB) Crane consists of a **top running bridge**, trolley, and hoist(s), **as shown on the Licensing Drawing in Section 1.5**. The CTB Crane is electrically driven and rides on crane rails, which are **secured to the walls of the CTB**. The trolley rides on crane rails mounted to the top of the **bridge** girders and has at least one electric wire rope hoist for load lifting. The hoist hook will be used to lift various loads and shall interface with the required rigging and below the hook lifting devices as required for the process.

5.4.3.2 Design Criteria

The CTB Crane **is** a single failure proof load handling device designed and built in accordance with the provisions of ASME NOG-1 [3.0.1]. The design criteria and operational requirements for the CTB Crane are further discussed in Subsection 4.5.2 of this SAR.

The applicable Design Basis loadings on the CTB Crane are set down in Table 4.5.1.

5.4.3.3 Structural Analysis

The structural analysis of the CTB Crane demonstrates compliance with the applicable requirements of ASME NOG-1 for the specified loadings in Table 4.5.1. **The complete details of the analysis are provided in [5.4.10].**

5.4.4 Transport Cask Lift Yoke

5.4.4.1 Description of Structural Aspects

The Transport Cask Lifting Device is used to lift the HI-STAR 190 transport cask inside the CTB. As shown on the Licensing Drawing in Section 1.5, the Transport Cask Lifting Device has two lift arms that connect to the pair of lifting trunnions on the HI-STAR 190 and a main strongback assembly that connects to the CTB Crane hook.

5.4.4.2 Design Criteria

The design criteria that apply to lifting devices are fully described in Section 4.5. The Transport Cask Lift Yoke is a non-redundant special lifting device, which is designed to meet the increased safety factors per ANSI N14.6 [1.2.4].

5.4.4.3 Material Properties

As shown on the Licensing Drawing in Section 1.5, the major structural components of the Transport Cask Lift Yoke are the strongback plates, the lift arms, the actuator plates, the main pins, and the actuator pins. The strongback plates, lift arms, and actuator plates are fabricated from high-strength alloy steel (A514 or equivalent). The main pins and actuator pins are fabricated from hardened nickel alloy bar material (SB-637 N07718). The minimum strength properties for these components are obtained directly from the applicable ASTM specification or from Section II, Part D of the ASME Code [4.6.3], **and they are summarized in Table 5.4.10.**

HOLTEC INTERNATIONAL COPYRIGHTED MATERIAL	
Report No.: HI-2167374	Proposed Rev. 0S
5-53	

5.4.4.4 Structural Analysis

The load bearing members of the Transport Cask Lift Yoke are analyzed using a combination of formulae from ASME BTH-1 [5.4.3] and strength of materials principles. The lifted load considered in the analysis is equal to the bounding weight of the loaded HI-STAR 190 transport cask from Table 5.0.2. The lifted load and the self-weight of the lifting device are further amplified by 15% to account for dynamic effects in accordance with the guidance in CMAA-70 [4.5.2] for low speed lifts. The results of the structural analysis for the Transport Cask Lift Yoke are summarized in Table 5.4.4, which shows that all calculated safety factors are greater than 1.0. **The Transport Cask Lift Yoke is also analyzed for the effects of seismic loading while carrying a loaded transport cask.** The complete details of the structural analysis of the Transport Cask Lift Yoke are provided in the Structural Calculation Package [5.4.6].

5.4.5 MPC Lift Attachment

5.4.5.1 Description of Structural Aspects

The MPC Lift Attachment is a one-piece lifting device (or lug) that is bolted directly to threaded anchor locations on the top surface of the MPC closure lid using a total of eight bolts (see Licensing Drawing in Section 1.5). The MPC Lift Attachment allows raising or lowering of the MPC during canister transfer operations using either the CTB Crane or the VCT.

5.4.5.2 Design Criteria

The design criteria that apply to lifting devices are fully described in Section 4.5. The MPC Lift Attachment is a non-redundant special lifting device, which is designed to meet the increased safety factors per ANSI N14.6 [1.2.4].

5.4.5.3 Material Properties

As described above, the MPC Lift Attachment consists of the lifting lug and eight attachment bolts. The lifting lug is fabricated from an alloy steel forging (A336-F6NM). The attachment bolts are fabricated from hardened nickel alloy bar material (SB-637 N07718). The minimum strength properties for these components are obtained directly from the applicable ASTM specification or from Section II, Part D of the ASME Code [4.6.3], **and they are summarized in Table 5.4.10.**

5.4.5.4 Structural Analysis

The load bearing members of the MPC Lift Attachment are analyzed using strength of materials principles together with formulae from ASME BTH-1 [5.4.3]. The lifted load considered in the analysis is equal to the bounding weight of a loaded MPC from Table 5.0.2. The lifted load and the self-weight of the lifting device are further amplified by 15% to account for dynamic effects in accordance with the guidance in CMAA-70 [4.5.2] for low speed lifts. The results of the structural analysis for the MPC Lift Attachment are summarized in Table 5.4.5, which shows that all calculated safety factors are greater than 1.0. **The MPC Lift Attachment is also analyzed for the effects of seismic loading while carrying a loaded canister.** The complete details of the structural analysis of the MPC Lift Attachment are provided in the Structural Calculation Package [5.4.6].

5.4.6 Other Special Lifting Devices

HOLTEC INTERNATIONAL COPYRIGHTED MATERIAL	
Report No.: HI-2167374	Proposed Rev. 0S
5-54	

5.4.6.1 Description of Structural Aspects

In addition to the Transport Cask Lift Yoke and MPC Lift Attachment discussed in the preceding subsections, there are other special lifting devices that will be used to connect the cask or canister to the CTB Crane or VCT at the HI-STORE CIS facility. These other special lifting devices include:

- HI-TRAC CS Lift Yoke
- HI-TRAC CS Lift Link
- Transport Cask Horizontal Lift Beam
- MPC Lifting Device Extension

All special lifting devices that will be used at the HI-STORE CIS facility are shown on the Licensing Drawings in Section 1.5.

5.4.6.2 Design Criteria

The design criteria that apply to lifting devices are fully described in Section 4.5. Special lifting devices are designed to meet the increased safety factors per ANSI N14.6 [1.2.4].

5.4.6.3 Material Properties

The fabrication materials for the special lifting devices listed above are specified on the Licensing Drawings in Section 1.5. The minimum strength properties for these materials are obtained directly from the applicable ASTM specification or from Section II, Part D of the ASME Code [4.6.3] in accordance with the Licensing Drawings. **The strength properties used to support the structural evaluations for the special lifting devices are summarized in Table 5.4.10.**

5.4.6.4 Structural Analysis

5.4.6.4.1 Lifting Analysis

The load bearing members of special lifting devices are analyzed using a combination of methods, including the finite element approach, formulae from ASME BTH-1 [5.4.3], and strength of materials principles. The lifted loads considered in the analyses are equal to the bounding weights of the loaded HI-STAR 190 transport cask, the loaded MPC, or the loaded HI-TRAC CS from Table 5.0.2, as applicable. The lifted load and the self-weight of the lifting device are further amplified by 15% to account for dynamic effects in accordance with the guidance in CMAA-70 [4.5.2] for low speed lifts. The minimum calculated safety factors for the special lifting devices, other than the Transport Cask Lift Yoke and the MPC Lift Attachment, are summarized in Table 5.4.6. **The special lifting devices identified above in Subsection 5.4.6.1 are also analyzed for the effects of seismic loading during a lifting operation.** The complete details of the structural analysis of the special lifting devices are provided in the Structural Calculation Package [5.4.6].

5.4.6.4.2 Fatigue Evaluation

The special lifting devices will be used repeatedly at the HI-STORE CIS facility to transfer canisters from arriving transport casks to VVM storage cavities. As a result, the special lifting devices will be subject to both thermal and mechanical cyclic loading, which must be evaluated

HOLTEC INTERNATIONAL COPYRIGHTED MATERIAL	
Report No.: HI-2167374	Proposed Rev. 0S
5-55	

from a fatigue life standpoint. A fatigue life evaluation for all special lifting devices has been performed in [5.4.6] **considering both high stress low cyclic and low stress high cyclic phenomena**, and the results are presented in Table 5.4.9. The maximum stress in the special lifting devices is conservatively set at the allowable stress limit per [1.2.4] times a stress concentration factor of 4.0 for the material. The use of stress concentration factor of 4.0 is consistent with HI-STAR 100 SAR [1.3.5]. The fatigue life of all load bearing materials is calculated by comparing the maximum stress value with the material cycle life curves defined in Appendix I of ASME Code [17.3.2]. A safety factor of 2.0 on the permissible loading cycles is imposed for additional conservatism per Subsection 4.5.3.9.

5.4.7 Cask Transfer Facility Steel Structure

5.4.7.1 Description of Structural Aspects

A general description of the Cask Transfer Facility (CTF) is provided in Subsection 5.3.3.1. The steel components essentially serve as concrete forms during initial construction of the CTF. The CTF steel structure is also equipped with four threaded anchor blocks, as shown on the Licensing Drawing in Section 1.5, which are used to secure the HI-TRAC CS above the CTF cavity during MPC transfer operations.

5.4.7.2 Design Criteria

The structural steel components of the CTF are designed to meet the stress limits of Section III, Subsection NF of the ASME Code [4.5.1] for all operating modes.

5.4.7.3 Material Properties

The fabrication materials for the CTF steel structure are specified on the Licensing Drawing in Section 1.5. The minimum strength properties for these materials are obtained directly from the applicable ASTM specification or from Section II, Part D of the ASME Code [4.6.3].

5.4.7.4 Structural Analysis

Under normal operating conditions, the loads on the CTF steel structure are minimal since the dead and live loads are supported by the CTB floor slab and the CTF foundation slab. The carbon steel shell and base plate that define the CTF cavity space merely act as shim plates and transfer the loads from the Transport Cask to the underlying concrete via direct thru-wall compression.

The most limiting load condition for the CTF steel structure is the accident condition wherein the site design basis earthquake is postulated to occur while the loaded HI-TRAC CS is bolted to the CTF following MPC transfer operations, which is referred to as the stack-up configuration. The analysis of this accident event, which is referred to herein as the “stack-up” analysis, is fully discussed in Subsection 5.4.1.4, and the results of the analysis, including the loads on the CTF steel structure, are summarized in Table 5.4.1. All calculated safety factors are greater than 1.0.

HOLTEC INTERNATIONAL COPYRIGHTED MATERIAL	
Report No.: HI-2167374	Proposed Rev. 0S
5-56	

Table 5.4.1: [PROPRIETARY INFORMATION WITHHELD IN ACCORDANCE WITH 10CFR2.390]
--

HOLTEC INTERNATIONAL COPYRIGHTED MATERIAL	
Report No.: HI-2167374	Proposed Rev. 0S
5-57	

Table 5.4.2: [PROPRIETARY INFORMATION WITHHELD IN ACCORDANCE WITH 10CFR2.390]

Table 5.4.3: [PROPRIETARY INFORMATION WITHHELD IN ACCORDANCE WITH 10CFR2.390]

HOLTEC INTERNATIONAL COPYRIGHTED MATERIAL

Report No.: HI-2167374

Proposed Rev. 0S

5-58

Table 5.4.4: [PROPRIETARY INFORMATION WITHHELD IN ACCORDANCE WITH 10CFR2.390]
--

HOLTEC INTERNATIONAL COPYRIGHTED MATERIAL	
Report No.: HI-2167374	Proposed Rev. 0S
5-59	

Table 5.4.5: [PROPRIETARY INFORMATION WITHHELD IN ACCORDANCE WITH 10CFR2.390]

Table 5.4.6: [PROPRIETARY INFORMATION WITHHELD IN ACCORDANCE WITH 10CFR2.390]

HOLTEC INTERNATIONAL COPYRIGHTED MATERIAL

Report No.: HI-2167374

Proposed Rev. 0S

5-60

Table 5.4.7: [PROPRIETARY INFORMATION WITHHELD IN ACCORDANCE WITH 10CFR2.390]
--

HOLTEC INTERNATIONAL COPYRIGHTED MATERIAL	
Report No.: HI-2167374	Proposed Rev. 0S
5-61	

Table 5.4.8: [PROPRIETARY INFORMATION WITHHELD IN ACCORDANCE WITH 10CFR2.390]

Table 5.4.9: [PROPRIETARY INFORMATION WITHHELD IN ACCORDANCE WITH 10CFR2.390]

HOLTEC INTERNATIONAL COPYRIGHTED MATERIAL

Report No.: HI-2167374

Proposed Rev. 0S

5-62

Table 5.4.10: Mechanical Properties for Lifting Device Materials (Note 1)		
Temperature, °F	Yield Strength, ksi	Tensile Strength, ksi
A514 ($\leq 2.5''$ Thk.)		
200	95.5	110
300	92.5	110
400	88.75	110
SB-637 N07718		
200	144	177.6
500	136.8	168.7
A336-F6NM		
500	65.35	103.87
Weldox 900E (Note 2)		
70	130 [120]	136 [123]
300	110.5 [102]	136 [123]
A500 Grade B		
200	42.17	58
A53 Grade B		
200	32.08	60
Notes:		
1) All tabulated values are obtained from [5.4.6].		
2) Strength properties are dependent on thickness of material. Values not shown in brackets ([]) are applicable to thicknesses less than or equal to 2 inches. Bracketed values are applicable to thicknesses greater than 2 inches.		

HOLTEC INTERNATIONAL COPYRIGHTED MATERIAL	
Report No.: HI-2167374	Proposed Rev. 0S
5-63	

Table 5.4.11: Mechanical Properties for HI-TRAC CS Materials		
Temperature, °F	Yield Strength, ksi	Tensile Strength, ksi
SA-564 630 (Age Hardened at 1100°F) (Note 1)		
100	115.0	140.0
200	106.3	140.0
300	101.8	140.0
400	98.3	136.1
A500 Grade B (Note 2)		
100	46	58
200	42.17	58
300	31.8	58
Notes:		
1) Values obtained from [4.6.3].		
2) Values obtained from [5.4.6]		

HOLTEC INTERNATIONAL COPYRIGHTED MATERIAL	
Report No.: HI-2167374	Proposed Rev. 0S
5-64	

Figure 5.4.1: [PROPRIETARY INFORMATION WITHHELD IN ACCORDANCE WITH 10CFR2.390]

HOLTEC INTERNATIONAL COPYRIGHTED MATERIAL	
Report No.: HI-2167374	Proposed Rev. 0S
5-65	

Figure 5.4.2: [PROPRIETARY INFORMATION WITHHELD IN ACCORDANCE WITH 10CFR2.390]

HOLTEC INTERNATIONAL COPYRIGHTED MATERIAL	
Report No.: HI-2167374	Proposed Rev. 0S
5-66	

5.5 OTHER SSCs

The HI-STORE CIS facility includes the following other SSCs:

- Transport Cask Tilt Frame
- Vertical Cask Transporter
- **HI-PORT**
- **HI-STAR 190 SL Pedestal**

Each of these components is discussed in more detail, including their description, design criteria, material properties, and structural analyses, in the following subsections.

5.5.1 Transport Cask Tilt Frame

5.5.1.1 Description of Structural Aspects

The Transport Cask Tilt Frame is used in conjunction with the CTB Crane and its special lifting devices to upend or down end the HI-STAR 190 transport cask between the vertical and horizontal orientations. The Transport Cask Tilt Frame consists of a set of trunnion support stanchions and a cask support saddle. The trunnion support stanchions engage the cask's rotation trunnions and provide a low-friction rotation point for cask tilting (see Figures 3.1.1(c-f) for illustration). The cask support saddle contacts the upper portion of the cask when the cask reaches the horizontal orientation. The trunnion support stanchion assembly is bolted to the CTB slab at its base while in use.

5.5.1.2 Design Criteria

The Transport Cask Tilt Frame is not a lifting device since it is a stationary device that provides support to the cask from below. Also, during upending or down ending operations, the cask always remains connected to the single failure proof CTB Crane via a special lifting device. Therefore, the Cask Tilt Frame is an ITS component, which is designed accordingly to meet the stress limits per ASME Section III, Subsection NF [4.5.1] for Class 3 plate- and shell-type supports.

5.5.1.3 Material Properties

As shown on the Licensing Drawing in Section 1.5, the Transport Cask Tilt Frame is fabricated from carbon steel material (SA-516 Gr. 70, A572, A500 Gr. B). The minimum strength properties for these materials are obtained directly from the applicable ASTM specification or from Section II, Part D of the ASME Code [4.6.3].

5.5.1.4 Structural Analysis

The Transport Cask Title Frame is analyzed using the finite element code ANSYS [5.5.1] and supplemented by manual calculations using strength of materials principles. [

PROPRIETARY INFORMATION WITHHELD PER 10CFR2.390

II

HOLTEC INTERNATIONAL COPYRIGHTED MATERIAL	
Report No.: HI-2167374	Proposed Rev. 0S
5-67	

[

PROPRIETARY INFORMATION WITHHELD PER 10CFR2.390

]

The results of the structural analysis for the Transport Cask Tilt Frame are summarized in Table 5.5.1, which shows that all of the calculated safety factors are above 1.0. The complete details of the structural analysis of the Transport Cask Tilt Frame are provided in the Structural Calculation Package [5.4.6].

5.5.2 Vertical Cask Transporter

5.5.2.1 Description of Structural Aspects

The Vertical Cask Transporter (VCT) is the principal load handling device used for MPC transfer operations at the HI-STORE CIS. Used in conjunction with the HI-TRAC CS lift links, it provides the critical lifting and handling functions associated with the canister transfer operations **at the HI-STORM UMAX ISFSI. As shown on the Licensing Drawing in Section 1.5, it is a custom-designed equipment consisting of a set of caterpillars or multiple wheels, a diesel engine with a robust gear train and transmission housed in a rugged structural frame that also supports a set of hydraulically-actuated lifting towers. Figure 1.2.4 illustrates the general configuration of a VCT with a suspended HI-TRAC CS.** The VCT uses the same controls and redundant drop protection features used to prevent an unplanned lowering of the critical load under a loss-of-power or hydraulic system failure as used at other ISFSIs in the United States where the VCT is used in canister transfer operations.

5.5.2.2 Design Criteria

The design criteria that apply to lifting devices, including the VCT, are fully described in Section 4.5 of this SAR. The detailed criteria that govern the design of the VCT are set down in Subsection 4.5.3.

The Design Basis loadings on the VCT are given in Table 4.5.3.

HOLTEC INTERNATIONAL COPYRIGHTED MATERIAL	
Report No.: HI-2167374	Proposed Rev. 0S
5-68	

5.5.2.3 Structural Analysis

5.5.2.3.1 Seismic Analysis

The seismic stability of the VCT (unloaded and carrying empty or fully loaded HI-TRAC CS) under the most severe DECE loading is evaluated for the possibility of incipient tipping and sliding, where simple dynamic equations are formulated based on force and moment equilibrium.
[

PROPRIETARY INFORMATION WITHHELD PER 10CFR2.390

]
The detailed stress and fatigue evaluation of the VCT in the Structural Calculation Package [5.4.6] also demonstrates compliance with the structural design criteria in Subsection 4.5.3 for the specified loadings in Table 4.5.3.

[

PROPRIETARY INFORMATION WITHHELD PER 10CFR2.390

5.5.3 HI-PORT

5.5.3.1 Description of Structural Aspects

The HI-PORT is an ITS-C ancillary used for transporting the HI-TRAC CS (empty or loaded) from the CTB to the HI-STORM UMAX ISFSI and vice-versa. It is a custom-

HOLTEC INTERNATIONAL COPYRIGHTED MATERIAL	
Report No.: HI-2167374	Proposed Rev. 0S
5-69	

designed vehicle consisting of a pair of self-powered, multi-axle trailers with a drop deck spanning between the trailers. During transport the HI-TRAC CS is fastened to the drop deck at four tie-down locations, as shown on the Licensing Drawing in Section 1.5.

5.5.3.2 Design Criteria

The design criteria for the HI-PORT are provided in Subsection 4.5.4.

5.5.3.3 Structural Analysis

5.5.3.3.1 Seismic Stability Analysis

A time-history analysis of the HI-PORT carrying a loaded HI-TRAC CS is performed using LS-DYNA to demonstrate that (a) the vehicle remains stable under the site DBE and (b) the stresses in the drop deck and its trailer connections satisfy the applicable stress limits. The analysis assumes that the ground surface satisfies the minimum bearing strength and the maximum lateral grade requirements for the haul path in Table 4.5.10. Accordingly, the ground is modeled as a rigid surface having a slope equal to the maximum lateral grade per Table 4.5.10. The complete details of the structural analysis of the HI-PORT are provided in the Structural Calculation Package [5.4.6].

[

PROPRIETARY INFORMATION WITHHELD PER 10CFR2.390

]

5.5.4 HI-STAR 190SL Pedestal

5.5.4.1 Description of Structural Aspects

The HI-STAR 190SL Pedestal is an ancillary device used to raise the elevation of the shorter HI-STAR 190SL cask when it is placed inside the CTF, so that the top flange of the cask is at the same elevation as its taller HI-STAR 190XL counterpart. The pedestal assembly, which is shown on the Licensing Drawing in Section 1.5, [

PROPRIETARY INFORMATION WITHHELD PER 10CFR2.390

HOLTEC INTERNATIONAL COPYRIGHTED MATERIAL	
Report No.: HI-2167374	Proposed Rev. 0S
5-70	

]

5.5.4.2 Design Criteria

The design criteria for the HI-STAR 190SL Pedestal are provided in Subsection 4.5.5.

5.5.4.3 Structural Analysis

The HI-STAR 190SL Pedestal is analyzed using a combination of strength of materials formulae and the finite element approach to evaluate stresses in the assembly under normal and seismic load conditions. The limiting results of the analysis are summarized in Table 5.5.3. The complete details of the structural analysis of the HI-STAR 190SL Pedestal are provided in the Structural Calculation Package [5.4.6].

HOLTEC INTERNATIONAL COPYRIGHTED MATERIAL	
Report No.: HI-2167374	Proposed Rev. 0S
5-71	

Table 5.5.1: PROPRIETARY INFORMATION WITHHELD PER 10CFR2.390

HOLTEC INTERNATIONAL COPYRIGHTED MATERIAL	
Report No.: HI-2167374	Proposed Rev. 0S
5-72	

Table 5.5.2: PROPRIETARY INFORMATION WITHHELD PER 10CFR2.390

HOLTEC INTERNATIONAL COPYRIGHTED MATERIAL	
Report No.: HI-2167374	Proposed Rev. 0S
5-73	

Table 5.5.3: PROPRIETARY INFORMATION WITHHELD PER 10CFR2.390

HOLTEC INTERNATIONAL COPYRIGHTED MATERIAL	
Report No.: HI-2167374	Proposed Rev. 0S
5-74	

[PROPRIETARY INFORMATION WITHHELD PER 10CFR2.390]

Figure 5.5.1: ANSYS Model of Transport Cask Tilt Frame

HOLTEC INTERNATIONAL COPYRIGHTED MATERIAL	
Report No.: HI-2167374	Proposed Rev. 0S
5-75	

5.6 REGULATORY COMPLIANCE

The structural compliance pursuant to the provisions of NUREG-1567 [1.0.3] for deployment of canisters certified in the HI-STORM UMAX Docket # (72-1040) has been demonstrated in this chapter. As the canisters will arrive at the HI-STORE site loaded in the transport package, the Short Term Operations on the (dry) canisters to place them in the HI-STORM UMAX VVMs and their interim storage in the HI-STORM UMAX VVMs are the subjects of safety analysis in this chapter. The information presented in this chapter confirms that:

- i. The description of confinement structures, systems and components, reinforced concrete structures, and other SSCs important to safety meet the requirements of 10CFR72.24(a) and (b), 10CFR72.82(c)(2), and 10CFR72.106(a), (b), and (c).
- ii. Suitable material properties for use in the design and construction of the SSCs, reinforced concrete structures, and other SSCs important to safety meet the requirements of 10CFR 72.24(c)(3).
- iii. The analytical and/or test reports ensuring the structural integrity of the SSCs, reinforced concrete structures, and other SSCs important to safety meet the requirements of 10CFR72.24 (d)(1), (d)(2), and (i), and 10CFR72.122 (b)(1), (b)(2), and (b)(3), (c), (d), (f), (g), (h), (i), (j), (k), and (l).

It is therefore concluded that all applicable regulatory requirements and guidelines germane to the integrity of the stored fuel and the HI-STORM UMAX storage system have been addressed and satisfied in this chapter.

HOLTEC INTERNATIONAL COPYRIGHTED MATERIAL	
Report No.: HI-2167374	Proposed Rev. 0S
5-76	

CHAPTER 6: THERMAL EVALUATION*

6.0 INTRODUCTION

HI-STORM UMAX, certified in the USNRC docket # 72-1040 is an underground vertical ventilated system with openings for air ingress and egress and internal air flow passages for ventilation cooling of loaded MPC. The licensing drawing package for the HI-STORM UMAX applicable to the HI-STORE CIS facility is provided in Section 1.5. Thermal design requirements are presented in Chapter 4.

As stated in Chapter 4, the thermal evaluation in this chapter seeks to establish that the peak fuel cladding temperature in the canisters stored in the HI-STORE CIS facility will remain below the ISG-11 Rev 3 [4.0.1] limit. Another object of the safety demonstration is that under all short-term operations summarized in Subsection 3.1.4, the peak fuel cladding temperature limit set forth in ISG-11 Rev 3 will be satisfied with robust margins.

With respect to normal storage in the HI-STORM UMAX cavities at HI-STORE, it is recognized that the maximum heat load in any canister cannot exceed the limit in the transport cask that will be used to bring the canisters to the HI-STORE CIS site. As the heat removal capacity of the ventilated HI-STORM UMAX system is substantially in excess of the (unventilated) transport cask (viz., HI-STAR 190 [1.3.6]) that will be used to transport the canisters, the ISG-11 temperature limit under the normal, off-normal and accident conditions of storage is axiomatically satisfied.

The short term operations at the HI-STORE facility involve a new transfer cask, HI-TRAC CS, which is not certified in the HI-STORM UMAX docket. As described in Subsection 1.2.4, HI-TRAC CS utilizes high density concrete (in lieu of lead, water or Holtite) to achieve enhanced structural ruggedness and for an improved dose attenuation profile. Because HI-TRAC CS is not submerged in a pool, its heat dissipation capabilities are significantly better than other HI-TRAC models that are subject to pool submergence (and hence must have a hydraulically leak-proof joint at the bottom lid suppressing the option of convective cooling of the canister). The limiting thermal scenarios with the canister in HI-TRAC CS are considered in this chapter. As described in Chapter 3, the short term operations that are performed at HI-STORE also include transfer of canisters from transportation cask (HI-STAR 190) to the HI-TRAC CS transfer cask in the Canister Transfer Facility (CTF). This thermal scenario is also considered in this chapter.

Since the Design Basis heat load is significantly lower than that in HI-STORM UMAX Docket [1.0.6] (see Table 6.3.1), the safety analyses summarized in this chapter demonstrate rather large margins to the allowable limits under all operational modes. To ensure rigorous configuration control, the information in the Licensing Drawings in Section 1.5 should be treated as the authoritative source for safety analysis at all times.

To facilitate convenient access to the material incorporated by reference, a list of sections germane to this chapter is provided in a tabular form in Table 6.0.1. Table 6.0.1 provides a listing of the material adopted in this chapter by reference from other licensed dockets.

* All references are in placed within square brackets in this report and are compiled in Chapter 19 of this report.

HOLTEC INTERNATIONAL COPYRIGHTED MATERIAL	
Report No.: HI-2167374	Proposed Rev. 0R
6-1	

Table 6.0.1: Material Incorporated by Reference in this Chapter

Information Incorporated by Reference	Source of the Information	Location in this SAR where Material is Incorporated	Technical Justification of Applicability to HI-STORM UMAX at HI-STORE CIS
Thermal Properties of materials in MPC, VVM and transfer cask	Section 4.2 of HI-STORM UMAX FSAR [1.0.6]	Subsection 6.4.1	Materials used in MPC, VVM and HI-TRAC CS transfer cask are the same as those used in HI-STORM UMAX FSAR and are therefore incorporated by reference.
MPC-37 and MPC-89 Thermal Model and Methodology	Subsection 4.4.1 of HI-STORM UMAX FSAR [1.0.6]	Paragraph 6.4.2.2	The canister is identical to the one described in the HI-STORM UMAX FSAR. So the approach, general assumptions and models established for MPCs in the HI-STORM UMAX FSAR are fully applicable to the HI-STORM UMAX utilized for HI-STORE facility. Therefore, the MPC thermal models are incorporated by reference.
HI-STORM UMAX VVM Thermal Model and Methodology	Subsection 4.4.1 of HI-STORM UMAX FSAR [1.0.6]	Paragraph 6.4.2.3	The HI-STORM UMAX VVM is identical to that described in the HI-STORM UMAX FSAR with minor differences in design details like it has two fixed cavity heights instead of variable cavity height. The thermal performance is unaffected for tallest MPC and improved for shortest MPC. Additional details of the differences and technical justification for the same are provided in Paragraph 6.4.2.3. So the approach, general assumptions and models established in the HI-STORM UMAX FSAR are fully applicable to the HI-STORM UMAX utilized for HI-STORE facility.

HOLTEC INTERNATIONAL COPYRIGHTED MATERIAL

Report No.: HI-2167374

Proposed Rev. 0R

6-2

Information Incorporated by Reference	Source of the Information	Location in this SAR where Material is Incorporated	Technical Justification of Applicability to HI-STORM UMAX at HI-STORE CIS
Minimum Temperatures	Subsection 4.4.4 of HI-STORM UMAX FSAR [1.0.6]	Paragraph 6.4.3.3	The minimum ambient temperature is bounded by that specified in the HI-STORM UMAX FSAR [1.0.6]. Accordingly the low-service temperature evaluation presented in HI-STORM UMAX FSAR [1.0.6] is applicable to the HI-STORM UMAX evaluated in this SAR and is therefore incorporated by reference.
Engineered Clearances	Subsection 4.4.6 of HI-STORM UMAX FSAR [1.0.6]	Paragraph 6.4.3.4	As the fuel, component temperatures and MPC cavity pressure during long-term storage in Subsection 6.4.3 are bounded by that presented in Subsection 4.4.4(i) of HI-STORM UMAX FSAR [1.0.6], the differential thermal expansions presented in Subsection 4.4.6 of the HI-STORM UMAX FSAR [1.0.6] is bounding and is therefore incorporated by reference.
Evaluation of Sustained Wind	Subsection 4.4.9 of HI-STORM UMAX FSAR [1.0.6]	Paragraph 6.4.3.5	The HI-STORM UMAX design is the same as the one described in the HI-STORM UMAX FSAR [1.0.6]. The effect of sustained wind on cask arrays evaluated under a worst case co-incidence of wind direction and speed is applicable to the HI-STORM UMAX evaluated in this SAR and is therefore incorporated by reference.
Off-Normal Environment Temperature	Paragraph 4.6.1.1 of HI-STORM UMAX FSAR [1.0.6]	Sub-section 6.5.1	The off-normal ambient temperature at the site is bounded by that specified in the HI-STORM UMAX FSAR [1.0.6] (see Table 6.3.1). So the temperatures and MPC cavity pressures presented in

HOLTEC INTERNATIONAL COPYRIGHTED MATERIAL

Report No.: HI-2167374

Proposed Rev. 0R

6-3

Information Incorporated by Reference	Source of the Information	Location in this SAR where Material is Incorporated	Technical Justification of Applicability to HI-STORM UMAX at HI-STORE CIS
			HI-STORM UMAX FSAR are bounding and are therefore incorporated by reference.
Deleted	Deleted	Deleted	Deleted
Extreme Environment Temperature	Paragraph 4.6.2.2 of HI-STORM UMAX FSAR [1.0.6]	Paragraph 6.5.2.4	The extreme ambient temperature at the site is the bounded by that specified in the HI-STORM UMAX FSAR [1.0.6] (see Table 6.3.1). So the temperatures and MPC cavity pressures presented in HI-STORM UMAX FSAR are bounding and is therefore incorporated by reference.
Deleted	Deleted	Deleted	Deleted
Flood	Paragraph 4.6.2.5 of HI-STORM UMAX FSAR [1.0.6]	Paragraph 6.5.2.6	The Design Basis Flood scenarios used to qualify the VVM in the HI-STORM UMAX FSAR are independent of the flood height discussed in Chapter 2 . Therefore, flood evaluation presented in Paragraph 4.6.2.5 of HI-STORM UMAX FSAR [1.0.6] is bounding and is therefore incorporated by reference.

HOLTEC INTERNATIONAL COPYRIGHTED MATERIAL	
Report No.: HI-2167374	Proposed Rev. 0R
6-4	

6.1 DECAY HEAT REMOVAL SYSTEMS

Rejection of heat from the used nuclear fuel at the HI-STORE CIS facility occurs through three types of casks, namely:

- i. The HI-STAR 190 transport cask
- ii. The HI-TRAC CS transfer cask
- iii. The HI-STORM UMAX vertical ventilated module

The heat dissipation mechanisms in each of the above cask systems are summarized below:

- (i) The HI-STAR 190 transport cask: The HI-STAR 190 transport cask is used only during the short term operations at the HI-STORE site. The HI-STAR 190 transport cask, illustrated in Figure 6.4.1, is a metal cask whose safety analysis is summarized in the SAR [1.3.6] in NRC Docket# 71-9373. HI-STAR rejects the decay heat produced by its contents through natural convection from its external surface and by radiation. In its standard transport configuration, HI-STAR 190 is horizontally disposed. Its thermal performance in the horizontal orientation is documented in the cask's SAR [1.3.6].
- (ii) At the HI-STORE facility, however, the HI-STAR cask is staged vertically inside the Canister Transfer Facility (CTF) which is a subterranean pit with a set of inlet vents located near its bottom. The heat dissipation mechanism inside the CTF is evidently different from that in the transport mode analyzed in [1.3.6]. Therefore, a thermal analysis of this configuration is required. A thermal model of this configuration is constructed and details are provided in Section 6.4.2.
- (iii) The HI-TRAC CS transfer cask: The HI-TRAC is used only during the short term operations at the HI-STORE facility. The HI-TRAC CS transfer cask, illustrated in Figure 6.4.2 and described in Section 1.2, is a ventilated dual shell steel weldment with high density concrete installed in its inter-shell space for neutron and gamma shielding. HI-TRAC CS is not intended for use in fuel pool service; it is used solely for dry handling of the canisters arriving at the HI-STORE facility. As described in Chapter 3, the loaded canister is transferred to the HI-TRAC CS transfer cask in the Canister Transfer Facility (CTF) through a vertical stack up process. As shown in Figure 6.4.3, in this configuration, the canister is cooled by a direct convective action of ventilation air over a tall column of the stack. This convection effect would be much less pronounced when the canister is installed in the transfer cask and its retractable segmented shield gate is fully closed (Figure 1.2.3a). An examination of the canister loading steps outlined in Subsection 1.2.5 indicates that the limiting thermal condition involves the scenario where the canister is loaded in the transfer cask and its shield gate is closed. Figures 1.2.3a, 1.2.3b and 6.4.2 show the retractable shield gate in perspective view. As can be seen from this figure, HI-TRAC CS has a built-in ventilation feature which provides for limited ventilation even when the shield gate is fully closed. The thermal analysis in this chapter seeks to quantify the margins to the fuel cladding temperature and other material limits for this thermally limiting configuration. A thermal model of this configuration is constructed and details are provided in Section 6.4.2.

HOLTEC INTERNATIONAL COPYRIGHTED MATERIAL	
Report No.: HI-2167374	Proposed Rev. 0R
6-5	

(iv) The HI-STORM UMAX VVMs: The interim storage of the canisters will occur in the HI-STORM UMAX VVMs. The thermal-hydraulic configuration of the HI-STORM UMAX VVMs at HI-STORE is essentially identical to that certified in the HI-STORM UMAX docket. Therefore, its heat rejection capacity would be virtually identical under identical conditions to that analyzed and certified in [1.0.6] under all operation modes. However, as can be inferred from Table 6.3.1, the Design Basis heat load and the ambient temperature metrics for the HI-STORE ISFSI are less challenging than those for which the system is certified in [1.0.6]. Therefore, it is concluded that the heat rejection performance of the canisters at the HI-STORE ISFSI will have even greater margins to the regulator-prescribed limit than that established in [1.0.6]. To ascertain this, long-term storage of canisters in HI-STORM UMAX with site-specific conditions from Table 6.3.1 is evaluated in this chapter. A thermal model of the HI-STORM UMAX VVM containing MPC is constructed and details are provided in Section 6.4.2.

The decay heat removal of HI-STORM UMAX VVMs under normal, off-normal and accident conditions is evaluated in this chapter. Similarly, thermal performance of HI-TRAC CS transfer cask and HI-STAR 190 cask under short-term and accident conditions are also evaluated in this chapter.

HOLTEC INTERNATIONAL COPYRIGHTED MATERIAL	
Report No.: HI-2167374	Proposed Rev. 0R
6-6	

6.2 MATERIAL TEMPERATURE LIMITS

Material temperature limits are provided in Section 4.4 of Chapter 4. All material considerations including material degradation modes applicable to HI-STORM UMAX are evaluated in Chapter 17 of this SAR. If the canister arrives at HI-STORE at a date greater than 20 years from the date of first being placed on a storage pad, the canister is added to the list of canisters undergoing aging management immediately, a more detailed description of which is provided in Chapter 18 of this SAR.

HOLTEC INTERNATIONAL COPYRIGHTED MATERIAL	
Report No.: HI-2167374	Proposed Rev. 0R
6-7	

6.3 THERMAL LOADS AND ENVIRONMENTAL CONDITIONS

The thermal loads and applicable environmental conditions are summarized in Table 6.3.1. This table also contains the corresponding values for which the HI-STORM UMAX system is certified in its FSAR [1.0.6]. It can be noted from this table that the site normal, off-normal and accident ambient temperatures are lower than that adopted on a generic basis in the HI-STORM UMAX FSAR [1.0.6]. The design basis normal ambient temperature used in this SAR will be exceeded only for brief periods as suggested by the ambient temperature data in Chapter 2. Inasmuch as the sole effect of the normal temperature is on the computed fuel cladding temperature to establish long-term fuel integrity, it should not lie below the time averaged yearly mean for the site. Previously licensed cask systems have employed yearly averaged normal temperatures (USNRC Dockets 72-1014, 72-1032 and 72-1040) for evaluation of long-term storage.

HOLTEC INTERNATIONAL COPYRIGHTED MATERIAL	
Report No.: HI-2167374	Proposed Rev. 0R
6-8	

Table 6.3.1: Thermally Significant Parameters for the HI-STORM UMAX ISFSI at HI-STORE and Corresponding Certified Value in the System FSAR [1.0.6]				
Thermally significant ISFSI parameter	Certified value from the HI-STORM UMAX FSAR and table reference		Value applicable to the HI-STORE ISFSI and reference source	
	Data	Table I.D.	Data	Source
Maximum Aggregate Heat Load for MPC-37, kW	37.06*	Table 2.1.8 of [1.0.6]	32.09	Table 4.1.1
MPC-37 Initial Helium Backfill Specification at 70°F reference temperature, psig	39 – 46	Table 4.4.6 of [1.0.6]	39 – 46	Table 4.1.3
Maximum Aggregate Heat Load for MPC-89, kW	36.72*	Table 2.1.9 of [1.0.6]	32.15	Table 4.1.2
Initial Helium Backfill Specification at 70°F reference temperature, psig	39 – 46 [†]	Table 4.4.6 of [1.0.6]	39 – 47.5 [†]	Table 4.1.3
Normal Ambient Temperature (See Glossary), °F	80	Table 2.3.6 of [1.0.6]	62	Table 2.7.1
Minimum Ambient Temperature (See Glossary), °F	-40	Table 2.3.6 of [1.0.6]	-11	Table 2.3.1
Off-normal Ambient Temperature (See Glossary), °F	100	Table 2.3.6 of [1.0.6]	91	Table 2.7.1
Accident Ambient Temperature (See Glossary), °F	125	Table 2.3.6 of [1.0.6]	108	Table 2.7.1

* The maximum total heat load permissible in the HI-STORM UMAX 72-1040 CoC is presented herein. The actual total heat load adopted for thermal evaluations in the HI-STORM UMAX FSAR [1.0.6] is significantly higher.

[†] It is recognized that the initial helium backfill specification are consistent with the limits in the transport cask [1.3.6] that will be used to bring the canisters to the HI-STORE CIS site.

HOLTEC INTERNATIONAL COPYRIGHTED MATERIAL	
Report No.: HI-2167374	Proposed Rev. 0R
6-9	

6.4 APPLICABLE SYSTEMS, ANALYTICAL METHODS, MODELS AND CALCULATIONS

6.4.1 Applicable Systems

As explained in Subection 1.2.1, HI-STORM UMAX Version C is deployed at HI-STORE CIS. This design is identical to the design licensed in HI-STORM UMAX docket# 72-1040 except the following:

- The ultra-high earthquake-resistant options, referred to as MSE options, are not present.
- The storage cavity depth is made fixed (not variable, as permitted in the general certification) at two discrete dimensions and are referred to as types SL and XL (see drawing Section 1.5).

As a result of the above, the thermal performance of the system remains either unaffected or improved depending on the height of the canister being stored. The safety analysis of the HI-STORM UMAX ISFSI at HI-STORE will be bounded by the generic analysis in the HI-STORM UMAX docket [1.0.6] since the Design Basis heat load and the ambient temperature metrics for the HI-STORE ISFSI are less challenging than those for which the system is certified in [1.0.6] (see Table 6.3.1). To provide further assurance, a thermal evaluation of normal long-term storage of HI-STORM UMAX Version C VVMs under governing scenario is performed in this section to demonstrate safety compliance.

Additionally, there are two safety analyses that pertain to short term operations that warrant quantification of their safety margin. These are:

- The HI-STAR 190 transport cask situated in the CTF illustrated in Figure 6.4.1: The HI-STAR 190 cask is analyzed in its Part 71 docket [1.3.6] wherein its compliance with the ISG-11 Rev 3 thermal limit under transport is demonstrated. A similar demonstration for the configuration in Figure 6.4.1 is provided in Subsection 6.4.2.
- HI-TRAC CS transfer cask containing a loaded canister with its shield gates closed: In this configuration, as shown in Figure 6.4.2, the canister inside the transfer cask has limited ventilation assistance. In comparison, the configuration wherein the transfer cask is mounted on top of the HI-STORM UMAX cavity or HI-STAR 190 cavity with its shield gates wide open (see Figure 6.4.3) has maximum ventilation cooling action and is therefore ruled out as a governing thermal condition. Thermal model and analysis methodology of normal onsite transfer in HI-TRAC CS is described in Subsection 6.4.2.

Table 6.4.1 provides the principal input data used in the thermal analysis performed for the above two short term operation scenarios. Thermal properties of materials used in MPC and VVM storage system are incorporated by reference from Section 4.2 of HI-STORM UMAX FSAR [1.0.6]. Materials present in HI-TRAC CS transfer cask include steel and concrete, thermal properties of which are also provided in Section 4.2 of HI-STORM UMAX FSAR [1.0.6]. Similarly properties of materials used in HI-STAR 190 cask are incorporated by reference from Section 3.3 of HI-STAR 190 SAR [1.3.6].

HOLTEC INTERNATIONAL COPYRIGHTED MATERIAL	
Report No.: HI-2167374	Proposed Rev. 0R
6-10	

6.4.2 Analysis Methodology

6.4.2.1 Computer Code

The analysis vehicle for prediction of thermal performance of the systems in this SAR is the computer code FLUENT [6.4.1]. FLUENT has been benchmarked and validated for use in cask systems [6.4.2] since 1990s and has been used in the thermal qualification of every storage and transport cask developed by Holtec since 1995. A summary of pre-qualification benchmarking of FLUENT is included in Appendix 6.A herein for reference purposes. In Table 6.4.2, a listing of the licenses or license amendments issued by the USNRC and other regulatory authorities on both transport and ventilated cask types that utilize FLUENT is summarized. Several cask models listed in Table 6.4.2 have received numerous licensing amendments over the years. Thus, from this table, it can be inferred that Holtec's FLUENT models for simulating ventilated and metal casks have been repeatedly endorsed by the NRC and other national regulatory authorities.

As in all other HI-STORM docket, the FLUENT solutions reported in this SAR have been vetted for numerical stability and grid sensitivity [6.4.3, 6.4.4] (Subsection 4.4.2 of the HI-STORM UMAX FSAR [1.0.6]).

6.4.2.2 MPC Thermal Model

The thermal analysis model of MPC is incorporated by reference from Section 4.4 of the HI-STORM UMAX FSAR [1.0.6].

6.4.2.3 HI-STORM UMAX VVM Thermal Model

The HI-STORM UMAX storage VVM used in HI-STORE CIS is slightly modified compared to the version documented in the HI-STORM UMAX FSAR [1.0.6]. A geometrically accurate 3D thermal model of the HI-STORM UMAX VVM Version C is constructed in the manner of HI-STORM UMAX in docket # 72-1040. The scenario of short MPC-37 placed in HI-STORM UMAX Version C Type SL is thermally governing for the following reasons and is therefore evaluated in this chapter:

- a. As demonstrated in Section 4.4 of HI-STORM UMAX FSAR [1.0.6], thermal evaluations of MPC-89 are bounded by MPC-37. Since the heat load patterns provided in Section 4.1 of this SAR are bounded by those adopted in the generic HI-STORM UMAX FSAR [1.0.6] for both MPCs, MPC-37 is the governing canister at HI-STORE also.
- b. MPC-37 with short fuel results in highest PCT and component temperatures as demonstrated in Section 4.4 of HI-STORM UMAX FSAR [1.0.6].
- c. Active fuel height of short PWR fuel is lowest among short, reference and long fuel assemblies. For the same heat load, lower active height results in higher heat load density.

The thermal modeling of the HI-STORM UMAX VVM is incorporated by reference from Section 4.4 of HI-STORM UMAX FSAR [1.0.6]. The quarter symmetric model for the VVM assembly seeks to represent the essential geometry details of the physical system as depicted in the Licensing Drawings in Section 1.5 and utilizes the same conservative assumptions as summarized in Section 4.4 of [1.0.6].

HOLTEC INTERNATIONAL COPYRIGHTED MATERIAL	
Report No.: HI-2167374	Proposed Rev. 0R
6-11	

Sectional and isometric views of the HI-STORM UMAX VVM quarter symmetric 3D thermal model are presented in Figures 6.4.4 and 6.4.5 respectively.

[

PROPRIETARY INFORMATION WITHHELD IN ACCORDANCE WITH 10CFR2.390

]

6.4.2.4 HI-STAR 190 Thermal Model

[

PROPRIETARY INFORMATION WITHHELD IN ACCORDANCE WITH 10CFR2.390

]

To accommodate all PWR and BWR canisters, the HI-STAR 190 cask is available in two discrete lengths – version SL (standard length) and version XL (extended length), as described in Chapter 1 of HI-STAR 190 SAR [1.3.6]. The HI-STAR 190 Version XL has a larger external surface area for heat dissipation than that of HI-STAR 190 Version SL. Therefore, the thermal performance of HI-STAR 190 Version XL is bounded by that of HI-STAR 190 Version SL. The

HOLTEC INTERNATIONAL COPYRIGHTED MATERIAL	
Report No.: HI-2167374	Proposed Rev. 0R
6-12	

thermal performance of short MPC-37 bounds that of MPC-89 for similar decay heats as has been demonstrated in Section 3.3 of HI-STAR 190 SAR [1.3.6], Sections 4.4 of the HI-STORM UMAX FSAR [1.0.6] and HI-STORM FW FSAR [1.3.7].

[

PROPRIETARY INFORMATION WITHHELD IN ACCORDANCE WITH 10CFR2.390

]

Table 6.4.1 provides the principal input data used in the thermal analysis performed for this short term operation scenario. Sectional and isometric views of the HI-STAR 190 in CTF quarter symmetric 3D thermal model are presented in Figures 6.4.6 and 6.4.7 respectively. The computational results for this scenario are presented in Subsection 6.4.3.

6.4.2.5 HI-TRAC CS Transfer Cask Thermal Model

The HI-TRAC CS is a dry use only cask designed specifically for the HI-STORE CIS facility. HI-TRAC CS has large cavities to accommodate various heights of MPCs. As described above, short MPC-37 is the governing thermal scenario and is therefore evaluated to demonstrate safety. Its thermal model, implemented on FLUENT has the following key attributes:

HOLTEC INTERNATIONAL COPYRIGHTED MATERIAL	
Report No.: HI-2167374	Proposed Rev. 0R
6-13	

[

PROPRIETARY INFORMATION WITHHELD IN ACCORDANCE WITH 10CFR2.390

]

Sectional and isometric views of the HI-TRAC quarter symmetric 3D thermal model are presented in Figures 6.4.8 and 6.4.9 respectively. The computational results for this scenario are presented in Subsection 6.4.3.

6.4.3 Calculations and Results

6.4.3.1 Maximum Temperatures

A steady state thermal analysis of the governing “thermal configurations” (meaning the combination of canister type, regionalized loading pattern and fuel type that produces highest fuel cladding temperature) was performed using the 3-D FLUENT model described in Subsection 6.4.2 to quantify the thermal margins under long term storage conditions. Thermal

HOLTEC INTERNATIONAL COPYRIGHTED MATERIAL	
Report No.: HI-2167374	Proposed Rev. 0R
6-14	

analyses of the MPC-37 with short fuel under heat load pattern 1 specified in Table 4.1.1 is performed.

The maximum spatial values of the computed temperatures of the fuel cladding, the fuel basket material, the divider shell, the closure lid concrete, the MPC lid, the MPC shell and the average air outlet temperature are summarized in Table 6.4.3. The following conclusions are reached from the solution data:

- a. The PCT is below the temperature limit set forth in ISG-11 Rev 3 [4.0.1].
- b. The maximum temperatures of all MPC and VVM constituent parts are below their respective limits set down in Section 4.4.
- c. The temperatures are below the licensed temperatures obtained and presented in Chapter 4 of HI-STORM UMAX FSAR [1.0.6].

It is therefore concluded that the HI-STORM UMAX system provides a thermally acceptable storage environment for the eligible MPCs.

Thermal evaluations in Section 3.3.5 of HI-STAR 190 SAR [1.3.6] demonstrate that the predicted temperatures and cavity pressures under sub-design basis heat loads* is bounded by those under design basis maximum heat loads. Therefore, the safety conclusions made for design basis heat loads also remain applicable to sub-design basis heat loads also.

6.4.3.2 MPC Cavity Pressures

The MPC from HI-STAR 190 is already filled with dry pressurized helium. During normal storage in HI-STORM UMAX VVM and during short-term operations in HI-TRAC CS and HI-STAR 190, the gas temperature within the MPC rises to its maximum operating basis temperature. The gas pressure inside the MPC will also increase with rising temperature. The pressure rise is determined using the ideal gas law. The MPC gas pressure is also subject to substantial pressure rise under hypothetical rupture of fuel rods.

The MPC maximum gas pressure is computed for a postulated release of fission product gases from fuel rods into this free space. For these scenarios, the amounts of each of the release gas constituents in the MPC cavity are summed and the resulting total pressures determined from the ideal gas law. A concomitant effect of rod ruptures is the increased pressure and molecular weight of the cavity gases with enhanced rate of heat dissipation by internal helium convection and lower cavity temperatures. As these effects are substantial¹ under large rod ruptures the 100% rod rupture accident is conservatively evaluated without credit for increased heat dissipation under increased pressure and molecular weight of the cavity gases. Based on fission gases release fractions (NUREG 1567 criteria), rods' net free volume and initial fill gas pressure, maximum gas pressures with 1% (normal), 10% (off-normal) and 100% (accident condition) rod rupture are given in Table 6.4.4. The maximum calculated gas pressures reported in Table 6.4.4

* MPC helium initial backfill specification and sub-design basis heat load is defined in Table 4.1.4.

¹ Rod rupture gases boost helium density and coincident mass of internal convection flows by virtue of their large molecular weights (Argon, Krypton and Xenon are 10, 21 and 33 times heavier than helium). As internal convection cooling is an effective means of dissipating heat relative to conduction heat transfer in gases it more than offsets reduced conductivity of helium due to rod rupture gases.

HOLTEC INTERNATIONAL COPYRIGHTED MATERIAL	
Report No.: HI-2167374	Proposed Rev. 0R
6-15	

are all below the MPC internal design pressures for normal, off-normal and accident conditions specified in Chapter 4.

6.4.3.3 Minimum Temperatures

The minimum temperature evaluation for HI-STORM UMAX at HI-STORE is bounded by that in Subsection 4.4.4 of the HI-STORM UMAX FSAR [1.0.6] due to the following:

- The minimum ambient temperature at HI-STORE site is bounded by that defined in HI-STORM UMAX FSAR [1.0.6] (see Table 6.3.1).

Therefore, Subsection 4.4.4(ii) of the HI-STORM UMAX FSAR [1.0.6] is incorporated by reference into this document.

6.4.3.4 Engineered Clearances to Eliminate Thermal Interfaces

The differential thermal expansion between MPC and cask components for HI-STORM UMAX at HI-STORE is bounded by that in Sub-section 4.4.6 of the HI-STORM UMAX FSAR [1.0.6] due to the following:

- The MPC and VVM component temperatures at HI-STORE are lower than that presented for the same MPC presented in Section 4.4.4(i) of the HI-STORM UMAX FSAR under normal long-term storage condition [1.0.6].

Therefore, Subsection 4.4.6 of the HI-STORM UMAX FSAR [1.0.6] is incorporated by reference into this document.

6.4.3.5 Evaluation of Sustained Wind

This scenario corresponds to a postulated event where a sustained wind of *a fixed velocity in a fixed direction* acts for a sufficiently long time to bring the array of HI-STORE storage systems to thermal equilibrium. The horizontal wind has two potential thermal-hydraulic effects on the HI-STORE Systems:

Effect #1: Horizontal wind may decrease the ventilating air flow entering the passageway inside HI-STORM UMAX cavity.

Effect #2: Horizontal wind may blow the heated air exiting the upwind modules into the inlet vents of down-stream modules, thus increasing their air inlet temperature.

PROPRIETARY INFORMATION WITHHELD IN ACCORDANCE WITH 10CFR2.390

]

HOLTEC INTERNATIONAL COPYRIGHTED MATERIAL	
Report No.: HI-2167374	Proposed Rev. 0R
6-16	

[

PROPRIETARY INFORMATION WITHHELD IN ACCORDANCE WITH 10CFR2.390

] The results tabulated in Table 6.4.9 support the following conclusions:

- a. The PCT complies with temperature limit set forth in ISG-11 Rev 3 [4.0.1] with robust margins.
- b. The maximum temperatures of all MPC and VVM constituent parts are well below their respective limits set down in Section 4.4.
- c. The temperatures are below the licensed temperatures in Chapter 4 of HI-STORM UMAX FSAR [1.0.6].
- d. The MPC pressures are below the design pressures under normal, off-normal and accident conditions specified in Chapter 4.

HOLTEC INTERNATIONAL COPYRIGHTED MATERIAL	
Report No.: HI-2167374	Proposed Rev. 0R
6-17	

6.4.3.6 Evaluation of HI-STAR 190 in CTF

The calculations performed [6.4.7] using the 3-D FLUENT model described in Subsection 6.4.2 provided steady state results that are summarized in Table 6.4.5. By comparing the results in the above tables with the acceptable limits in Chapter 4 yield the following conclusions:

- i) The peak cladding temperature is considerably below the limit corresponding to short term operations.
- ii) There is a large margin to the limit for the metal temperature of the steel in the cask.
- iii) The temperatures of the gamma and neutron blockage materials in the transport cask have considerable margins to their respective limits.
- iv) MPC cavity pressure during this short-term operation is below the design pressure limit (see Chapter 4).

In summary, the temperatures of all HI-STAR 190 components are well within their prescribed limits.

6.4.3.7 Evaluation of Normal Onsite Transfer in HI-TRAC CS

The calculations performed using the 3-D FLUENT model described in Subsection 6.4.2 provided steady state results that are summarized in Table 6.4.6. By comparing the results in the above tables with the acceptable limits in Chapter 4 yield the following conclusions:

- (i) The peak cladding temperature is considerably below the limit corresponding to short term operations.
- (ii) There is a large margin to the limit for the metal temperature of the steel in the cask.
- (iii) The section average temperature of shielding concrete in HI-TRAC CS is also well within the permitted limit.
- (iv) MPC cavity pressure during this short-term operation is below the design pressure limit (see Chapter 4).

In summary, the temperatures in every constituent part of HI-TRAC CS are well within their prescribed regulatory limits.

6.4.3.8 Evaluation of HI-TRAC CS to HI-STORM UMAX Transfer

Transfer of the loaded MPC from the HI-TRAC CS to the HI-STORM UMAX is performed as described in Paragraph 10.3.3.5. The HI-TRAC containing the MPC is placed atop the UMAX and the MPC is lowered down through the shield gates on the bottom of the HI-TRAC. As described in Step 10 of Paragraph 10.3.3.5, the HI-TRAC shield gates are closed prior to removing the now-empty HI-TRAC. To prevent overheating of the fuel, MPC and UMAX while the closed shield gates restrict the cooling air flow the HI-TRAC must be removed from atop the UMAX in an expeditious manner.

HOLTEC INTERNATIONAL COPYRIGHTED MATERIAL	
Report No.: HI-2167374	Proposed Rev. 0R
6-18	

This condition is bounded by the burial under debris event in Paragraph 4.6.2.3 of the HI-STORM UMAX FSAR, which provides an equation for determining an allowable duration. That equation is used to determine the allowable duration for the HI-TRAC removal.

m = mass of HI-STORM UMAX = 46000 kg from HI-STORM UMAX FSAR Table 4.6.8

c_p = carbon steel heat capacity = 419 J/(kg×°C) from HI-STORM UMAX FSAR Table 4.6.8

ΔT = minimum temperature rise is for the fuel cladding, which is the difference between the calculated value from Table 6.4.6 and the limit of 390°C (400°C from ISG-11 Rev. 3 minus 10°C per Section 6.0) = 734°F – 669°F = 65°F or 36°C

Q = maximum decay heat load = 32.15 kW from Table 4.1.2

$$\Delta\tau = \frac{46000 \text{ kg} \times 419 \frac{\text{J}}{\text{kg} \times ^\circ\text{C}} \times 36^\circ\text{C}}{32150 \text{ W}} = 21582 \text{ sec} = 6.0 \text{ hr}$$

For specific individual MPCs it is also acceptable to calculate the allowable time for that MPC using the actual specific MPC decay heat load in place of the maximum decay heat load used above. Alternatively, it is also acceptable to perform a transient evaluation using the CFD models and methodologies described earlier in this chapter to determine the allowable time.

If the HI-TRAC cannot be removed within this time it would be an accident condition. The appropriate time available for remedial action would correspond to the 100% vent blockage event (see Paragraph 6.5.2.5).

HOLTEC INTERNATIONAL COPYRIGHTED MATERIAL	
Report No.: HI-2167374	Proposed Rev. 0R
6-19	

Table 6.4.1: Thermal Input Data for Analysis of Governing Scenarios During Short Term Operations		
PARAMETER	HI-STAR 190	HI-TRAC CS
Ambient Temperature, °F (Note 1)	91	91
Ambient pressure, psia (Note 2)	12.2	12.2
Canister (Note 3)	Short MPC-37	Short MPC-37
Nominal Cask Cavity Height, inch	190.81 (Note 4)	215.25
Heat Load, kW	(Note 5)	(Note 5)
Location	Canister Transfer Building	Inside or Outside Canister Transfer Building
Configuration	Figure 6.4.1	Figure 6.4.2
<p>Note 1: The 3-day average ambient temperature is defined in Table 2.7.1.</p> <p>Note 2: The ambient pressure is assumed to be based on an altitude of 5000 feet above the Mean Sea Level [6.4.5]; the actual elevation cited in Table 2.7.1, is much lower.</p> <p>Note 3: The thermal analyses reported in Section 4.1 of HI-STORM UMAX FSAR [1.0.6] shows that short MPC-37 with PWR fuel provides the most challenging thermal case.</p> <p>Note 4: The cavity height of short SL version reported herein.</p> <p>Note 5: The thermal analyses reported in Section 3.3 of HI-STAR 190 SAR [1.3.6] shows that Heat Load Pattern 1 specified in Appendix 7.C of HI-STAR 190 SAR [1.3.6] is the governing heat load distribution and is adopted herein for thermal evaluations.</p>		

HOLTEC INTERNATIONAL COPYRIGHTED MATERIAL	
Report No.: HI-2167374	Proposed Rev. 0R
6-20	

Table 6.4.2: List of Holtec's Licensing Basis FLUENT Models Previously Used in Storage and Transport Casks			
Cask name	Type	Regulator	Docket No.
HI-STAR 100	Metal transport cask	USNRC	71-9261
HI-STAR 100	Metal storage cask	USNRC	72-1008
HI-STORM 100	Ventilated storage cask	USNRC	72-1014
HI-STAR 180	Metal transport cask	USNRC	71-9325
HI-STAR 60	Metal transport cask	USNRC	71-9336
HI-STAR 180D	Metal transport cask	USNRC	71-9367
HI-STORM FW	Ventilated storage cask	USNRC	72-1032
HI-STORM UMAX	Ventilated storage cask	USNRC	72-1040

HOLTEC INTERNATIONAL COPYRIGHTED MATERIAL

Report No.: HI-2167374

Proposed Rev. 0R

6-21

Table 6.4.3: Normal Long-Term Storage Temperatures for MPC-37 in HI-STORM UMAX at HI-STORE CIS	
Component	Temperature, °F
Fuel Cladding	613
Fuel Basket	552
Basket Shims	435
MPC Shell	372
MPC Lid ²	369
MPC Baseplate ¹	304
Divider Shell	273
CEC Shell	111
Closure Lid Concrete ¹	156
Average Air Outlet	153
Note: MPC cavity pressures under normal long term storage tabulated in Table 6.4.4.	

² Maximum section average temperature is reported.

HOLTEC INTERNATIONAL COPYRIGHTED MATERIAL	
Report No.: HI-2167374	Proposed Rev. 0R
6-22	

Table 6.4.4: MPC Cavity Pressure During Normal Long-Term Storage in HI-STORM UMAX VVM		
Component	Pressure, psig	Cavity Average Temperature [°F]
Normal Condition - No Rod Rupture - 1% Rod Rupture	88.2 89.2	439
Off-Normal Condition (10% Rod Rupture)	98.3	
Accident Condition (100% Rod Rupture)	188.7	

HOLTEC INTERNATIONAL COPYRIGHTED MATERIAL

Report No.: HI-2167374

Proposed Rev. 0R

6-23

Table 6.4.5: Maximum Component Temperatures and MPC Cavity Pressure for HI-STAR 190 in CTF Short-Term Operation	
Component	Temperature, °F
Fuel Cladding	716
Fuel Basket	667
Basket Shims	558
MPC Shell	504
MPC Lid ³	495
MPC Baseplate ¹	396
Containment Shell	385
Holtite	385
Enclosure Shell	336
Closure Lid ¹	252
Containment Bottom Forging ⁴	320
Containment Top Forging ²	264
MPC Cavity Average Temperature	561
	Pressure, psig
MPC Cavity Pressure	102.3

³ Maximum section average temperature is reported.

⁴ Bulk average temperature is reported.

HOLTEC INTERNATIONAL COPYRIGHTED MATERIAL	
Report No.: HI-2167374	Proposed Rev. 0R
6-24	

Table 6.4.6: Normal On-Site Transfer Temperatures and MPC Cavity Pressure in HI-TRAC CS	
Component	Temperature, °F
Fuel Cladding	669
Fuel Basket	615
Basket Shims	507
MPC Shell	461
MPC Lid ⁵	416
MPC Baseplate ¹	343
HI-TRAC Inner Shell	352
HI-TRAC Concrete ¹	271
HI-TRAC Outer Shell	200
MPC Cavity Average Temperature	507°F
	Pressure, psig
MPC Cavity Pressure	96.0

⁵ Maximum section average temperature is reported.

HOLTEC INTERNATIONAL COPYRIGHTED MATERIAL	
Report No.: HI-2167374	Proposed Rev. 0R
6-25	

Table 6.4.7: Effects of Wind on Peak Cladding Temperature in a Single HI-STORM UMAX System		
Wind Speed MPH	UMAX FSAR^{Notes 1,3} °F	HI-STORE UMAX^{Notes 2,3} °F
2	7	3
5	18	9
7	19	7
9	21	-4 (Note 4)
10	18	-9 (Note 4)

Note 1: PCT rise due to sustained wind obtained for the standard UMAX version from Table 4.4.12 of the UMAX FSAR [1.0.6].

Note 2: PCT rise due to sustained wind obtained for UMAX Version C presented in Section 1.5.

Note 3: Effect of wind calculated at conservatively higher decay heat load than that presented in Table 4.1.1.

Note 4: Negative temperature rise in PCT indicate wind has a positive impact i.e. it results in decrease in PCT compared to no wind scenario.

HOLTEC INTERNATIONAL COPYRIGHTED MATERIAL	
Report No.: HI-2167374	Proposed Rev. 0R
6-26	

Table 6.4.8: Combined Effect of Wind on Component Temperatures in HI-STORM UMAX System	
PCT Rise (Notes 1,2)	34°F
<p>Note 1: PCT rise due to sustained wind obtained for the standard UMAX version from Tables 4.4.15 and 4.4.2 of the UMAX FSAR [1.0.6].</p> <p>Note 2: PCT rise is conservatively adopted as the temperature rise for all MPC and VVM components in HI-STORE UMAX.</p> <p>Note 3: Combined effect of wind obtained at conservatively higher decay heat load than that presented in Table 4.1.1.</p>	

HOLTEC INTERNATIONAL COPYRIGHTED MATERIAL	
Report No.: HI-2167374	Proposed Rev. 0R
6-27	

Table 6.4.9: Maximum HI-STORE Long-Term Storage Temperatures and Pressures Under Wind Conditions	
Component	Temperature, °F
Fuel Cladding	647
Fuel Basket	586
Basket Shims	469
MPC Shell	406
MPC Lid ⁶	403
MPC Baseplate ¹	338
Divider Shell	307
CEC Shell	145
Closure Lid Concrete ¹	190
Average Air Outlet	187
MPC Cavity Average Temperature	473
	Pressure, psig
Normal Condition	
- No Rod Rupture	92.2
- 1% Rod Rupture	93.2
Off-Normal Condition (10% Rod Rupture)	102.6
Accident Condition (100% Rod Rupture)	196.4
Note 1: Temperatures obtained by conservatively adding temperature rise due to wind effects (Table 6.4.8) to Table 6.4.3.	

⁶ Maximum section average temperature is reported.

HOLTEC INTERNATIONAL COPYRIGHTED MATERIAL	
Report No.: HI-2167374	Proposed Rev. 0R
6-28	

Figure 6.4.1: [PROPRIETARY INFORMATION WITHHELD IN ACCORDANCE WITH 10CFR2.390]

HOLTEC INTERNATIONAL COPYRIGHTED MATERIAL	
Report No.: HI-2167374	Proposed Rev. 0R
6-29	

Figure 6.4.2: [PROPRIETARY INFORMATION WITHHELD IN ACCORDANCE WITH 10CFR2.390]

HOLTEC INTERNATIONAL COPYRIGHTED MATERIAL	
Report No.: HI-2167374	Proposed Rev. 0R
6-30	

Figure 6.4.3: [PROPRIETARY INFORMATION WITHHELD IN ACCORDANCE WITH 10CFR2.390]

HOLTEC INTERNATIONAL COPYRIGHTED MATERIAL	
Report No.: HI-2167374	Proposed Rev. 0R
6-31	

Figure 6.4.4: [PROPRIETARY INFORMATION WITHHELD IN ACCORDANCE WITH 10CFR2.390]

HOLTEC INTERNATIONAL COPYRIGHTED MATERIAL	
Report No.: HI-2167374	Proposed Rev. 0R
6-32	

Figure 6.4.5: [PROPRIETARY INFORMATION WITHHELD IN ACCORDANCE WITH 10CFR2.390]

HOLTEC INTERNATIONAL COPYRIGHTED MATERIAL	
Report No.: HI-2167374	Proposed Rev. 0R
6-33	

Figure 6.4.6: [PROPRIETARY INFORMATION WITHHELD IN ACCORDANCE WITH 10CFR2.390]

HOLTEC INTERNATIONAL COPYRIGHTED MATERIAL	
Report No.: HI-2167374	Proposed Rev. 0R
6-34	

Figure 6.4.7: [PROPRIETARY INFORMATION WITHHELD IN ACCORDANCE WITH 10CFR2.390]

HOLTEC INTERNATIONAL COPYRIGHTED MATERIAL	
Report No.: HI-2167374	Proposed Rev. 0R
6-35	

Figure 6.4.8: [PROPRIETARY INFORMATION WITHHELD IN ACCORDANCE WITH 10CFR2.390]

HOLTEC INTERNATIONAL COPYRIGHTED MATERIAL	
Report No.: HI-2167374	Proposed Rev. 0R
6-36	

Figure 6.4.9: [PROPRIETARY INFORMATION WITHHELD IN ACCORDANCE WITH 10CFR2.390]

HOLTEC INTERNATIONAL COPYRIGHTED MATERIAL	
Report No.: HI-2167374	Proposed Rev. 0R
6-37	

6.5 SAFETY UNDER OFF-NORMAL AND ACCIDENT EVENTS

6.5.1 Off-Normal Events

To support evaluation of off-normal events in Section 15.2, the following off-normal events are evaluated herein:

- i) Off-Normal Environment Temperature
- ii) Partial Blockage of Air Inlets and Outlets
- iii) Off-Normal Pressure

Thermal evaluation of off-normal event (i) is bounded by the evaluation reported in Sub-section 4.6.1 of the HI-STORM UMAX FSAR [1.0.6] since the PCT and component temperatures of MPC stored in HI-STORM UMAX at HI-STORE are lower than those of the same MPC presented in Section 4.4.4(i) of the HI-STORM UMAX FSAR under normal long-term storage condition [1.0.6]. Therefore, Subsection 4.6.1 of the HI-STORM UMAX FSAR [1.0.6] is incorporated by reference into this document.

For off-normal event (ii), the HI-STORM UMAX system is designed with debris screens installed on the inlet and outlet openings. These screens ensure the air passages are protected from entry and blockage by foreign objects. However, it is conservatively postulated that the HI-STORM UMAX air inlet vents and outlet vents are both 50% blocked simultaneously. The resulting decrease in flow area increases the flow resistance of the inlet and outlet ducts. The effect of the increased flow resistance on fuel temperature is analyzed assuming that steady state conditions have been reached. The computed temperatures and pressures are reported in Table 6.5.5. The results are confirmed to be below off-normal condition allowable limits for both internal pressure and temperature presented in Tables 2.3.5 and 2.3.7 of the HI-STORM UMAX FSAR [1.0.6], respectively.

Thermal evaluation of off-normal event (iii) is presented in Subsection 6.4.3. The off-normal MPC cavity pressure is below the limit defined in Table 4.3.1 with positive margins.

6.5.2 Accident Events

6.5.2.1 Bounding Fire Event

(a) HI-STORM UMAX Fire Accident: The FSARs of both the HI-STORM UMAX [1.0.6] and the HI-STORM FW system [1.3.7] contain the fire consequence analysis for a 50 gallon fire at a generic ISFSI and demonstrate that all of the safety metrics of the storage system will be met. However, since a transporter with potentially larger volume of combustibles is used on site to transfer MPCs from HI-TRAC CS transfer cask to HI-STORM UMAX VVM storage module, a conservative fire event has been considered herein. The amount of combustibles is conservatively considered equal to that specified in Table 6.5.1. Thermal evaluation of an all engulfing fire of the aboveground HI-STORM FW System for the same amount of combustibles is presented in a Holtec report [6.5.3]. The results demonstrate that the fuel and MPC confinement integrity is assured under this severe fire accident. Based on this, it is safe to conclude that the MPC and its contents are also safe in HI-STORM UMAX at HI-STORE under transporter fire accident due to the following:

HOLTEC INTERNATIONAL COPYRIGHTED MATERIAL	
Report No.: HI-2167374	Proposed Rev. 0R
6-38	

- The initial PCT and component temperatures of MPC stored in HI-STORM UMAX at HI-STORE are lower than that of the same MPC in the HI-STORM FW system [6.5.3].
- MPC decay heat is significantly lower in HI-STORM UMAX.
- HI-STORM UMAX system has much lesser surface directly exposed to fire than that of above-ground system.

Consequently, the conclusion that PCT and components' temperatures and MPC pressure are below temperature and pressure limits for transporter fire event drawn in Holtec report [6.5.3] remain valid for the HI-STORM UMAX system at HI-STORE site.

(b) HI-TRAC CS Fire Accident: The case of fire in the Cask Transfer Building (CTB) where the HI-TRAC CS cask is used to handle the arriving canister, however, is not addressed in the above referenced FSARs. While the probability of a fire event in the CTB is quite low due to the lack of combustible materials, except the fuel in the Vertical Cask Transporter's tank (procedurally limited to **volume listed in Table 6.5.1**) and the combustibles from HI-PORT (procedurally limited to **value listed in Table 6.5.3**), conservative fire events have been assumed herein and analyzed.

(b.1) VCT Fire Accident

Under a postulated fuel tank fire, the outer layers of HI-TRAC CS cask will be heated for the duration of fire by the incident thermal radiation and forced convection heat fluxes. **This subsection presents the evaluation of a postulated fire from VCT alone.**

To make the fire event even more severe, the quantity of combustible fluid in the VCT has been conservatively increased to as adopted in Table 6.5.1. The fuel tank fire is conservatively assumed to surround the HI-TRAC CS cask thus exposing the entire external to heating by radiation and convection heat transfer. Following the 10 CFR 71 guidelines [1.3.2], the following fire parameters are assumed:

[

PROPRIETARY INFORMATION WITHHELD IN ACCORDANCE WITH 10CFR2.390

HOLTEC INTERNATIONAL COPYRIGHTED MATERIAL	
Report No.: HI-2167374	Proposed Rev. 0R
6-39	

[]

PROPRIETARY INFORMATION WITHHELD IN ACCORDANCE WITH 10CFR2.390

HOLTEC INTERNATIONAL COPYRIGHTED MATERIAL	
Report No.: HI-2167374	Proposed Rev. 0R
6-40	

]

The results of the fire and post-fire events are reported in Table 6.5.2. These results demonstrate the following:

- The fire event has a minor effect on the fuel cladding temperature. The peak cladding temperature remains below the applicable ISG-11 Rev 3 [4.0.1] limit.
- The internal pressure in the canister remains below its accident condition limit.
- Localized regions of shielding concrete in the body of HI-TRAC CS up to less than 0.25 inch depth are exposed to temperatures in excess of accident temperature limit set forth in Chapter 4, Table 4.4.1. The bulk of the concrete remains well below the accident temperature limit.
- The metal temperature of the steel weldment of the HI-TRAC CS cask is also well within the applicable limit in Table 4.4.1.

It is thus concluded that the suitability of the HI-TRAC CS cask to render its canister transfer function will remain essentially unimpaired after the VCT fire event postulated in the foregoing.

(b.2) Combined VCT and HI-PORT Fire Accident

As discussed in Chapter 1, HI-PORT is a custom designed vehicle to transport the HI-TRAC CS from the CTB to the ISFSI pad. It consists of multi-axle trailers with a drop deck to support the HI-TRAC. The HI-PORT uses diesel fuel, and also contains hydraulic oil, and rubber tires that are combustible. Therefore, a fire accident due to the presence of combustibles on the HI-PORT is postulated. During loading operations, it is possible that both HI-PORT and VCT are present near the HI-TRAC CS cask. Therefore, a bounding combined fire event resulting from VCT and HI-PORT combustibles together is postulated and evaluated in this subsection.

The methodology and the thermal model adopted for this evaluation is the same as that in the VCT only fire accident described above. However, due to the presence of additional combustibles from the HI-PORT, the fire duration is longer than that evaluated for the VCT only fire in subsection (b.1). In addition to the liquid combustibles, the impact of the fire from HI-PORT rubber tires is also included in this evaluation. [

HOLTEC INTERNATIONAL COPYRIGHTED MATERIAL	
Report No.: HI-2167374	Proposed Rev. 0R
6-41	

PROPRIETARY INFORMATION WITHHELD IN ACCORDANCE WITH 10CFR2.390

]

The results of the fire and post-fire events are reported in Table 6.5.4. These results demonstrate the following:

- The fire event has a minor effect on the fuel cladding temperature. The peak cladding temperature remains below the applicable ISG-11 Rev 3 [4.0.1] limit.
- The internal pressure in the canister remains below its accident condition limit.

HOLTEC INTERNATIONAL COPYRIGHTED MATERIAL	
Report No.: HI-2167374	Proposed Rev. 0R
6-42	

- Approximately 1% of shielding concrete in the body of HI-TRAC CS is exposed to temperatures in excess of accident temperature limit set forth in Chapter 4, Table 4.4.1. The bulk of the concrete remains well below the accident temperature limit.
- The metal temperature of the steel weldment of the HI-TRAC CS cask is also within the applicable limit in Table 4.4.1.

It is thus concluded that the suitability of the HI-TRAC CS cask to render its canister transfer function will remain essentially unimpaired after the bounding combined fire event postulated in the foregoing.

(c) HI-STAR 190 Fire Accident: All loading/lifting operations related to HI-STAR 190 transport cask after arriving at the facility is performed using CTB crane (see Section 10.3). The CTB crane does not have sources of combustibles to cause a potential fire hazard. The HI-TRAC CS transfer cask is also operated using the crane and placed on the CTF alignment plate for MPC transfer from HI-STAR 190 to HI-TRAC CS. The transporter is only used for transfer operations with HI-TRAC CS, which is always distant from the CTF or HI-STAR 190 cask. Any potential hazard from transporter fire is bounded by the 30 minute fire evaluation in Section 3.4 of the HI-STAR 190 SAR [1.3.6] and is therefore incorporated by reference.

(d) Potential Fire Hazards: Site survey in Subsection 2.1.2 yields potential hazards which are evaluated herein. These are the presence of an oil recovery facility and underground run natural gas pipelines at the **recovery** facility. There are no active oil wells **within the boundary of the HI-STORE facility** and there are no plans to use any of the plugged and abandoned wells on **the Property**. This section reviews the potential fire hazards from these sources that could affect spent fuel storage operations at storage pad and/or cask transfer operations along the haul path. The identified hazards from oil well and natural gas pipelines are evaluated for credibility and severity.

As stated in Table 2.1.4, the oil recovery facility or oil well is at a substantial distance from any cask structure either on the storage pad or haul path to cause a significant impact on fuel cladding temperature or cask structures. In an unlikely event oil well catches fire, emergency response plans are in place to mitigate the fire. If the oil well catches fire during transfer of MPC in HI-TRAC CS on the haul path, transfer cask shall be moved either to the storage pad or the cask transfer building.

The temporary flexible pipelines that run aboveground through the center of the site will be moved prior to or during the early construction phases of the CIS facility, as described in Subsection 2.1.2. Therefore, they do not present a fire hazard. The natural gas pipelines that run underground along the north-south axis to the east of the site do not present a real fire hazard.

(e) Range-Land Fires and Fire-Jump Hazards: Rangeland fires do not pose a credible threat to the safety of spent nuclear fuel stored at the HI-STORE CIS facility as justified below:

- Fuel stored in an underground cavity having no line of sight for radiation heating.
- The HI-STORE CIS facility is designed and operated as a vegetation-free storage area within the controlled area boundary.

HOLTEC INTERNATIONAL COPYRIGHTED MATERIAL	
Report No.: HI-2167374	Proposed Rev. 0R
6-43	

- The ISFSI layout includes a substantial distance (over 500 ft) from the storage pads to the controlled area boundary.
- Site includes suitable width of vegetation cleared land around the controlled area boundary.
- Due to large distances separating potential vegetation fires and UMAX storage modules fire heating reasonably bounded by design basis fire accidents evaluated herein as all-engulfing fires.
- As evaluated above the HI-STORE CIS designed as a vegetation free facility renders fire-jump hazards non-credible.

6.5.2.2 Explosion Event

There are no credible internal explosive events at the HI-STORE ISFSI since all materials are compatible with the various operating environments, as discussed in Chapter 17, or appropriate preventive measures are taken to preclude internal explosive events (see Table 4.3.1). The canister is composed of non-explosive materials and maintains an inert gas environment. Thus explosion during long term storage is not credible. Likewise, the mandatory use of the protective measures at the HI-STORE site to prevent fires and explosions and the absence of any need for an explosive material during loading and unloading operations eliminates the scenario of an explosion as a credible event. Furthermore, because the MPC is internally pressurized, any short-term external pressure from explosion will act to reduce the tensile state of stress in the enclosure vessel. Nevertheless, a design basis external pressure (Table 4.3.1) has been defined as a design basis loading event wherein the internal pressure is non-mechanistically assumed to be absent. The ability of the canister to withstand loads due to an explosion event is evaluated in Chapter 3 of HI-STORM FW FSAR [1.3.7].

6.5.2.3 Burial under Debris

(a) Burial of HI-STORM UMAX VVM

There are no structures that loom over the HI-STORE HI-STORM UMAX ISFSI whose collapse could bury the VVMs in debris. A substantial distance from the ISFSI to the nearest ISFSI security fence (see Drawing in Section 1.5) precludes the close proximity of substantial amount of vegetation (native vegetation is low lying scrub). Thus, there is no credible mechanism for the HI-STORM UMAX system to become completely buried under debris.

(b) Collapse of the CTB

The CTB, where the canister transfer operations are performed is a reinforced concrete building. As demonstrated in Section 5.3.2, collapse of CTB is non-credible. Therefore, there are no credible mechanisms for HI-TRAC CS, HI-STAR 190 or the CTF structure to become partially or completely buried under debris

6.5.2.4 Extreme Environmental Temperature

The extreme environmental accident evaluation for HI-STORM UMAX at HI-STORE is bounded by that in Paragraph 4.6.2.2 of the HI-STORM UMAX FSAR [1.0.6] due to the following:

HOLTEC INTERNATIONAL COPYRIGHTED MATERIAL	
Report No.: HI-2167374	Proposed Rev. 0R
6-44	

- The PCT and component temperatures of MPC stored in HI-STORM UMAX at HI-STORE are lower than that of the same MPC presented in Section 4.4.4(i) of the HI-STORM UMAX FSAR under normal long-term storage condition [1.0.6].
- The extreme environment temperature at HI-STORE site is lower than that defined in HI-STORM UMAX FSAR [1.0.6] (see Table 6.3.1).

Therefore, Paragraph 4.6.2.2 of the HI-STORM UMAX FSAR [1.0.6] is incorporated by reference into this document.

6.5.2.5 100% Blockage of Air Vents

This event is defined as a postulated complete blockage of all inlet and outlet ducts for a specified duration. The immediate consequence of a complete blockage of the air inlets and outlets is that the normal circulation of air for cooling the MPC is interrupted. A small amount of heat will continue to be removed by localized air circulation patterns in the VVM annulus, and the MPC will continue to dissipate heat to the relatively cooler subgrade. As the temperatures of the MPC and its contents rise, the rate of heat rejection will increase correspondingly. Nevertheless, under this condition, the temperatures of the storage system including the MPC and the stored fuel assemblies will rise monotonically as a function of time.

As a result of the considerable inertia of the storage overpack, a significant temperature rise is possible if the inlets and outlets are substantially blocked for extended durations. This accident condition is, however, a short duration event that is identified and corrected through scheduled periodic surveillance. Nevertheless, this event is conservatively analyzed assuming a substantial duration of blockage. The inlet and outlet ducts in the HI-STORM UMAX thermal model are assumed to have become impervious to air flow. Using this model, a transient thermal solution of the HI-STORM UMAX system starting from normal storage conditions is obtained. The results of the 32 hours blocked ducts transient analysis are presented in Table 6.5.6 and compared against the accident temperature limits (Table 2.3.7 of the HI-STORM UMAX FSAR [1.0.6]). The co-incident MPC pressure is also computed and compared with the accident design pressure (Table 2.3.5 of the HI-STORM UMAX FSAR [1.0.6]). All computed results are found to remain well below their respective limits under the postulated 32 hours blockage duration.

6.5.2.6 Flood

The flood accident evaluation is bounded by that in Paragraph 4.6.2.5 of the HI-STORM UMAX FSAR [1.0.6] due to the following:

- The design bases flood scenarios used to qualify the VVM in the HI-STORM UMAX FSAR [1.0.6] are independent of the flood height discussed in Chapter 2.
- The initial condition of the PCT and component temperatures of MPC stored in HI-STORM UMAX at HI-STORE is lower than that of the same MPC presented in Section 4.4.4(i) of the HI-STORM UMAX FSAR under normal long-term storage condition [1.0.6].

Therefore, Paragraph 4.6.2.5 of the HI-STORM UMAX FSAR [1.0.6] is incorporated by reference into this document.

HOLTEC INTERNATIONAL COPYRIGHTED MATERIAL	
Report No.: HI-2167374	Proposed Rev. 0R
6-45	

6.5.3 SSCs Important to Safety Guidance for Fire Protection Program

There are no combustible or explosive materials associated with the HI-STORM UMAX System. Combustible materials will not be stored within the ISFSI. Additionally, all fixed locations with combustible materials at the HI-STORE Facility (e.g., diesel generators and storage tanks) are not located in areas that could impact radioactive materials. However, for conservatism, a hypothetical fire accident has been analyzed as a bounding condition for HI-STORM UMAX System. The evaluation of the HI-STORM UMAX System fire accident is discussed in Subsection 6.5.2. Similarly, there are no credible internal explosive events at the HI-STORE ISFSI since all materials are compatible with the operating environments, or appropriate preventive measures are taken to preclude explosions. The canister is composed of non-explosive materials and maintains an inert gas environment. Thus, explosion during long term storage is not credible. Likewise, the mandatory use of the protective measures at the HI-STORE site to prevent fires and explosions and the absence of any need for an explosive material during loading and unloading operations eliminates the scenario of an explosion as a credible event. An emergency response plan is in place as described in emergency response plan report [10.5.1]. The Holtec CISF Emergency Response Plan [10.5.1] evaluates and describes the necessary and sufficient emergency response capabilities for managing fire emergency conditions associated with the operation of the HI-STORE facility. The plan meets all requirements of 10CFR72.32 (a).

Measures for fire prevention, fire detection, fire suppression, and fire containment for the protection of the spent fuel assemblies and cask structures important to safety are provided in emergency response plan [10.5.1]. The fire detection and suppression systems are contained within the Canister Transfer Building. The construction materials of the Canister Transfer Building do not support combustion, and the fire-prone materials are limited to diesel fuel. Additionally, the very small amount of low-level solid radioactive wastes to be temporarily stored on site, as discussed in Subsection 14.4 of this SAR, are located within flammable storage cabinets/containers to protect them from any fires at the CIS facility. Therefore, the low-level solid radioactive wastes will neither be affected by nor contribute to any fire events. Fires are analyzed for all casks in Subsection 6.5.2 of this SAR. The area surrounding the storage pads and Canister Transfer Building includes a gravel-covered fire break with vegetation control to limit potential fuel for fires. The nonflammable nature of the materials of construction, other passive design features, and the limited fuel sources at the Facility lead to the conclusion that the fire detection and suppression systems are correctly classified as not important to safety.

The design of the Facility is such that all structures, systems, and components are located within a region covered with crushed rock. Therefore, there is no credible wildfire load on structures, systems, and components important to safety. A range of onsite fire scenarios has been evaluated. Bounding fire events are based on the volume of combustibles in the transporter, as given in Table 6.5.1. Operational restrictions are in place to ensure that these levels are not exceeded. The cask structures are designed so that they can continue to perform their safety functions under credible fire and explosion exposure conditions. Additionally, the cask structures containing spent fuel are located at significant distances from potential fire hazards identified on site.

HOLTEC INTERNATIONAL COPYRIGHTED MATERIAL	
Report No.: HI-2167374	Proposed Rev. 0R
6-46	

HOLTEC INTERNATIONAL COPYRIGHTED MATERIAL	
Report No.: HI-2167374	Proposed Rev. 0R
6-47	

Table 6.5.1: Cask Transporter Combustible Quantities and Fire Duration	
Description	Value
Volume of Combustibles, gallon	430
Fuel Area around HI-TRAC CS Cask, ft ²	291.6
Depth of Combustibles, inch	2.366
Fuel consumption rate, in/min [6.5.1]	0.15
Fire Duration, seconds	946 (Note 1)
Note 1: Thermal evaluations of HI-TRAC CS fire conservatively performed for a larger duration.	

HOLTEC INTERNATIONAL COPYRIGHTED MATERIAL	
Report No.: HI-2167374	Proposed Rev. 0R
6-48	

Table 6.5.2: HI-TRAC CS Fire and Post-Fire Accident Results		
Component	Temperature, °F	
	End of Fire	Post-Fire^{Note 1}
Fuel Cladding	670	701
Fuel Basket	615	650
Basket Shims	508	537
MPC Shell	512	512
MPC Lid ⁷	474	474
MPC Baseplate ¹	426	527
HI-TRAC Inner Shell	886	886
HI-TRAC Concrete	1380 (Note 2)	1380 (Note 2)
HI-TRAC Outer Shell ⁸	1092	1092
MPC Cavity Average Temperature	509	543
	Pressure, psig	
MPC Cavity Pressure	96.2	100.2
<p>Note 1: Maximum temperatures are reported during the fire event.</p> <p>Note 2: An extremely small area of concrete skin towards the top of the HI-TRAC is unavailable for shielding since it exceeds the temperature limit specified in Table 4.4.1.</p>		

⁷ Maximum section average temperature is reported.

⁸ Bulk temperature is reported.

HOLTEC INTERNATIONAL COPYRIGHTED MATERIAL	
Report No.: HI-2167374	Proposed Rev. 0R
6-49	

Table 6.5.3: HI-PORT Combustible Quantities and Fire Duration	
Description	Value
Volume of Liquid Combustibles, gallon	528
Mass of Solid Combustibles (rubber) lb	4479
Depth of Combustibles, inch	3.205
Fuel consumption rate, in/min [6.5.1]	0.15
Fire Duration due to HI-PORT Combustibles, seconds	1282
Total Combined Fire Duration (VCT+HI-PORT Combustibles)	2277 (Note 1)
Note 1: The total duration of the combined fire is a summation of the durations computed for the HI-PORT combustibles in this table and VCT combustibles in Table 6.5.1.	

HOLTEC INTERNATIONAL COPYRIGHTED MATERIAL	
Report No.: HI-2167374	Proposed Rev. 0R
6-50	

Table 6.5.4: HI-TRAC CS Combined VCT and HI-PORT Fire and Post-Fire Accident Results		
Component	Temperature, °F	
	End of Fire	Post-Fire^{Note 1}
Fuel Cladding	669	730
Fuel Basket	615	680
Basket Shims	487	540
MPC Shell	588	673
MPC Lid ¹¹	541	552
MPC Baseplate ¹	649	718
HI-TRAC Inner Shell	1218	1238
HI-TRAC Concrete	1443 ^{Note 2}	1447 ^{Note 2}
HI-TRAC Outer Shell ¹²	1310	1310
MPC Cavity Average Temperature	513	576
	Pressure, psig	
MPC Cavity Pressure	96.7	103.9
<p>Note 1: Maximum temperatures are reported during the fire event. Note 2: An extremely small area of concrete skin towards the top of the HI-TRAC is unavailable for shielding since it exceeds the temperature limit specified in Table 4.4.1.</p>		

¹¹ Maximum section average temperature is reported.

¹² Bulk temperature is reported.

HOLTEC INTERNATIONAL COPYRIGHTED MATERIAL	
Report No.: HI-2167374	Proposed Rev. 0R
6-51	

Table 6.5.5: Maximum Temperatures for MPC-37 in HI-STORM UMAX at HI-STORE CIS During 50% Inlet and 50% Outlet Vent Blockage	
Component	Temperature, °F
Fuel Cladding	626
Fuel Basket	567
Basket Shims	424
MPC Shell	374
MPC Lid ¹⁷	381
MPC Baseplate ¹	318
Divider Shell	284
CEC Shell	111
Closure Lid Concrete ¹	174
MPC Cavity Average Temperature	480
	Pressure, psig
MPC Cavity Pressure	92.9

HOLTEC INTERNATIONAL COPYRIGHTED MATERIAL

Report No.: HI-2167374

Proposed Rev. 0R

6-52

Table 6.5.6: Maximum Temperatures for MPC-37 in HI-STORM UMAX at HI-STORE CIS During 32-hour 100% Inlet and 100% Outlet Vent Blockage	
Component	Temperature, °F
Fuel Cladding	810
Fuel Basket	759
Basket Shims	635
MPC Shell	606
MPC Lid ¹⁸	503
MPC Baseplate ¹	522
Divider Shell	581
CEC Shell	414
Closure Lid Concrete ¹	426
MPC Cavity Average Temperature	684
	Pressure, psig
MPC Cavity Pressure	116.2

HOLTEC INTERNATIONAL COPYRIGHTED MATERIAL

Report No.: HI-2167374

Proposed Rev. 0R

6-53

6.6 REGULATORY COMPLIANCE

The thermal compliance pursuant to the provisions of NUREG-1567 [1/0/3] and ISG-11 [4.0.1] for deployment of canisters certified in the HI-STORM UMAX docket number (72-1040) has been demonstrated in this chapter. As the canisters will arrive at the HI-STORE site loaded in the transport package, the Short Term Operations on the (dry) canisters to place them in the HI-STORM UMAX VVMs and their interim storage in the VVMs are the subjects of safety analysis in this chapter.

Following the guidance of ISG-11 [4.0.1], the fuel cladding temperature at the beginning of dry storage at HI-STORE will be below the anticipated damage-threshold temperatures for normal conditions of storage for the licensed life of the HI-STORM UMAX System. Maximum fuel cladding temperatures for long-term storage conditions are reported in Section 6.4. The large margin to the ISG-11 limit for the fuel cladding temperature at the HI-STORE ISFSI provides added assurance that the breach of fuel cladding in storage is extremely unlikely.

Following the guidance of NUREG-1567, the system is passively cooled. All heat rejection mechanisms described in this chapter, including conduction, natural convection, and thermal radiation, are completely passive.

During Short Term Operations, the ISG-11 requirement to ensure that maximum cladding temperatures be below 400°C (752°F) for high burnup fuel and below 570°C (1058°F) for moderate burnup fuel is satisfied with ample margin.

Events of extremely low probability such as an enveloping fire and an extreme environmental phenomenon leading to burial of the transfer or transport cask in debris have been analyzed for their compliance with the temperature limits set down for fuel cladding, structural weldments and shielding materials. The results show ample margins of safety against regulatory limits.

It is therefore concluded that all applicable regulatory requirements and guidelines germane to the integrity of the stored fuel and the HI-STORM UMAX storage system have been addressed and satisfied in this chapter.

HOLTEC INTERNATIONAL COPYRIGHTED MATERIAL	
Report No.: HI-2167374	Proposed Rev. 0R
6-54	

**APPENDIX 6A: [PROPRIETARY APPENDIX WITHHELD IN
ITS ENTIRETY IN ACCORDANCE WITH 10CFR2.390]**

HOLTEC INTERNATIONAL COPYRIGHTED MATERIAL	
Report No.: HI-2167374	Proposed Rev. 0R
6.A-1	

CHAPTER 7: SHIELDING EVALUATION*

7.0 INTRODUCTION

The shielding evaluations for the HI-STORE CIS Facility are presented in this chapter, including dose and dose rate calculations to show that the facility is in compliance with the applicable regulatory requirements.

Specifically, evaluations and calculations are presented here for the following conditions and configurations:

- Owner Controlled Area boundary and nearest residence beyond the controlled area boundary, with dose rates and annual dose for the locations closest to the ISFSI.
 - An ISFSI with 500 loaded HI-STORM UMAX VVMs, consistent with the description in Section 1.1, is used for the evaluations, and conservative assumptions on the content of each canister.
 - The HI-TRAC CS dose rate versus distance model.
 - The HI-TRAC CS inside the Canister Transfer Building (CTB), crediting shielding provided by the concrete walls and roof of the CTB, dose rate versus distance (outside the CTB).
 - The HI-STAR 190 dose rate versus distance model.
- Occupational dose rates at the surface and 1 meter from a single HI-STORM UMAX.
- Occupational dose rates at the surface, 0.5 meters, 1 meter, and 2 meters from the HI-TRAC CS

The HI-STORE CIS Facility utilizes the HI-STORM UMAX storage system (Docket #72-1040), and only canisters approved for that system and listed in Table 1.0.3 are permitted for storage in the facility. Therefore, the principal calculational approach, including principal assumptions and methodologies, are directly taken from the HI-STORM UMAX FSAR, and are incorporated by reference. Table 7.0.1 lists all sections from the HI-STORM UMAX FSAR that are incorporated by reference, together with a technical justification. However, some additional shielding evaluation that is different from that in the HI-STORM UMAX FSAR is required specifically for the HI-STORE CIS Facility, due to site-specific considerations. These additional shielding evaluations are clearly identified in the following sections. In brief, they contain the following:

- The dose analyses in the HI-STORM UMAX FSAR focus on dose rates around a single VVM, and only a few hypothetical ISFSI configurations were analyzed. In the evaluations presented here, the full ISFSI as described in Section 1.1 is used as the basis of the evaluation.
- The HI-STORM UMAX storage VVM used here is slightly modified compared to the version documents in the HI-STORM UMAX FSAR [1.0.6], with lower doses and other

* All references are in placed within square brackets in this report and are compiled in Chapter 19 (References)

HOLTEC INTERNATIONAL COPYRIGHTED MATERIAL	
Report No.: HI-2167374	Proposed Rev. 0Q
7-1	

improvements not related to the shielding analyses. General details of this version are presented in Section 1.2. This is considered in the dose evaluations presented here.

- The HI-STORM UMAX FSAR assumes the use of a generic transfer cask (HI-TRAC VW) suitable for canister loading in a spent fuel pool. Since wet loading of canisters is not part of the operation of the HI-STORE CIS facility, a different HI-TRAC, termed HI-TRAC CS, with improved shielding and improved operational characteristics is used. Details of this HI-TRAC CS are presented in Section 1.2. Dose rate evaluations for this transfer cask are presented in this chapter.
- The dose estimates for loading operations consider the operational sequence for canister loading at the HI-STORE facility, which includes the unloading of the transport cask, stackup operation between the transport cask and the HI-TRAC CS, transfer movement to the HI-STORM UMAX VVM ISFSI, and downloading of the canister into the HI-STORM UMAX VVM.

HOLTEC INTERNATIONAL COPYRIGHTED MATERIAL	
Report No.: HI-2167374	Proposed Rev. 0Q
7-2	

Table 7.0.1: Material Incorporated by Reference in this Chapter

Information Incorporated by Reference	Source of the Information	NRC Approval of Material Incorporated by Reference	Location in this SAR where Material is Incorporated	Technical Justification of Applicability
HI-STORM UMAX Evaluation Methodologies	Sections 5.1, 5.2, 5.3, and 5.4; Reference [1.0.6]	SER HI-STORM UMAX Amendments 0, 1, and 2 References [7.0.1, 7.0.2, 7.0.3]	Sections 7.1, 7.2, 7.3, and 7.4	<p>The general HI-STORM UMAX design is the same from a shielding perspective as the one described in the HI-STORM UMAX FSAR with minor differences in design details, so the approaches, general assumptions and methods established in the HI-STORM UMAX FSAR are fully applicable to the HI-STORM UMAX utilized for the HI-STORE facility.</p> <p>Note that the HI-STORM UMAX FSAR includes references to the HI-STORM FW FSAR, since both share the same canister models. However, since the HI-STORM UMAX FSAR includes relevant excerpts from the HI-STORM FW FSAR, no part of the HI-STORM FW FSAR needs to be incorporated by reference into the HI-STORE SAR in this chapter.</p>
HI-STAR 190 Source Terms	Section 5.2 and Appendix 7.C of Reference [1.3.6]	SER HI-STAR 190 Package Revisions 0, 1 References [7.0.4, 7.0.5]	Sections 7.1, 7.2, 7.3, and 7.4	Source terms bounding what is allowed in the HI-STAR 190 SAR (Section 5.2 and Appendix 7.C of Reference [1.3.6]) are considered for dose rate calculations in this chapter and in Section 11.3 of this SAR. HI-STORE CIS Facility source terms are developed in Reference [7.1.1] using a 3 region bounding loading pattern that selects a bounding neutron or gamma source strength for each energy group using all burnup, initial enrichment, and cooling time combinations allowed in Reference [1.3.6] Appendix 7.C.

HOLTEC INTERNATIONAL COPYRIGHTED MATERIAL

Report No.: HI-2167374

Proposed Rev. 0Q

7-3

7.1 CONTAINED RADIATION SOURCES

7.1.1 General Specification and Approach for Neutron and Gamma Sources

The HI-STORE CIS Facility is designed for spent fuel and associated hardware in sealed canisters. The principal description of the source terms for the fuel, together with the calculations methodologies, is presented in Section 5.2 of the HI-STORM UMAX FSAR [1.0.6], which is incorporated here by reference. As spent fuel canisters are delivered to the site using the HI-STAR 190 transport cask, source terms bounding what is allowed in the HI-STAR 190 SAR (Section 5.2 and Appendix 7.C of Reference [1.3.6]) are considered for dose rate calculations in this chapter and in Section 11.3 of this SAR. The only additional discussion needed here is the justification of the design basis assembly assumption presented below.

7.1.2 Design Basis Assemblies

The design basis assemblies in [1.0.6] are industry standard 17x17 PWR assemblies,. HI-STORE CIS Facility source terms are developed in Reference [7.1.1] using a 3 region bounding loading pattern that selects a bounding neutron or gamma source strength for each energy group using all burnup, initial enrichment, and cooling time combinations allowed in Reference [1.3.6] Appendix 7.C. These parameters while conservative for HI-STORM UMAX systems loaded on ISFSIs at Nuclear Power Plant sites, far exceed the allowable heat load of the HI-STAR 190 (Table 7.C.7 of Reference [1.3.6]); additionally, these source term parameters exceed the burnup, enrichment, and cooling time combination specified in Table 5.0.1 of the HI-STORM UMAX FSAR [1.0.6]. The HI-STORE CISF source terms are based on the fuel specifications for the HI-STAR 190 transport cask, presented in Tables 7.C.7 through 7.C.10 of the HI-STAR 190 SAR [1.3.6]. Specifically, for each basket loading region of the MPC-37 and MPC-89 baskets, all the applicable burnup, enrichment and cooling time combinations in Tables 7.C.8 and 7.C.10 of the HI-STAR 190 SAR are considered, and the maximum source strength for each energy group of neutrons/gammas and the maximum cobalt activity are determined using the design basis fuel assembly types. The established artificial but conservative source terms that encompass the entire fuel specification up to the maximum allowable burnup are presented in Tables 7.1.2 through 7.1.5 and are used in the shielding analysis for the HI-STORE CISF. High burnup fuel, as it is allowed in the regionalized loading patterns in the HI-STAR 190 SAR Appendix 7.C [7.1.1], is considered in the HI-STORE CISF shielding analyses.

A number of conservative assumptions are applied throughout the HI-STORE CIS Facility shielding calculations. These assumptions assure that actual dose rates will always be below the calculated dose rates, and below regulatory limits. Selected key assumptions are:

[

PROPRIETARY INFORMATION WITHHELD PER 10CFR2.390

]

HOLTEC INTERNATIONAL COPYRIGHTED MATERIAL	
Report No.: HI-2167374	Proposed Rev. 0Q
7-4	

[

PROPRIETARY INFORMATION WITHHELD PER 10CFR2.390

]

These represent significant conservatisms, which provide sufficient margin to cover conditions not explicitly analyzed, such as:

- PWR fuel assemblies that differ from HI-STORM UMAX FSAR [1.0.6] design basis fuel assemblies
- The MPC-89 canister with BWR fuel.
 - Calculations for the HI-STORM FW [1.3.7] show that the results for the MPC-37 and MPC-89 are comparable.

HOLTEC INTERNATIONAL COPYRIGHTED MATERIAL	
Report No.: HI-2167374	Proposed Rev. 0Q
7-5	

Table 7.1.1:

Bounding Burnup, Initial Enrichment, and Cooling Time combination is taken on a per energy group basis, using HI-STAR 190 Fuel Specifications in Appendix 7.C [1.3.6] with more details on determination of bounding HI-STORE CISF source terms provided in Reference [7.1.1].

Table 7.1.2(A)

**CALCULATED PWR FUEL GAMMA SOURCE PER ASSEMBLY FOR DESIGN BASIS
BOUNDING SOURCE TERMS [7.1.1]**

Lower Energy	Upper Energy	Region 1	Region 2	Region 3
(MeV)	(MeV)	(Photons/s)	(Photons/s)	(Photons/s)
0.45	0.7	2.65E+15	5.14E+15	2.80E+15
0.7	1	7.16E+14	1.89E+15	5.21E+14
1	1.5	1.12E+14	2.67E+14	9.81E+13
1.5	2	9.07E+12	1.56E+13	4.45E+12
2	2.5	1.14E+13	1.47E+13	4.42E+12
2.5	3	5.98E+11	9.25E+11	2.70E+11
Total		3.50E+15	7.33E+15	3.43E+15

Table 7.1.2 (B)

**CALCULATED BWR FUEL GAMMA SOURCE PER ASSEMBLY FOR DESIGN BASIS
BURNUP AND COOLING TIME**

Lower Energy	Upper Energy	Bounding Source Terms		
		Region 1	Region 2	Region 3
(MeV)	(MeV)	(Photons/s)	(Photons/s)	(Photons/s)
0.45	0.7	8.09E+14	1.63E+15	8.09E+14
0.7	1	1.64E+14	4.60E+14	1.64E+14
1	1.5	2.84E+13	6.85E+13	2.84E+13
1.5	2	1.12E+12	4.59E+12	1.12E+12
2	2.5	1.54E+12	4.55E+12	1.54E+12
2.5	3	7.53E+10	2.83E+11	7.53E+10
Total		1.00E+15	2.17E+15	1.00E+15

HOLTEC INTERNATIONAL COPYRIGHTED MATERIAL

Report No.: HI-2167374

Proposed Rev. 0Q

7-6

Table 7.1.3(A)	
SCALING FACTORS USED IN CALCULATING THE ⁶⁰ Co SOURCE	
Region	PWR
Handle	N/A
Upper End Fitting	0.1
Gas Plenum Spacer	0.1
Expansion Springs	N/A
Gas Plenum Springs	0.2
Incore Grid Spacer	1.0
Lower End Fitting	0.2

Table 7.1.3(B)	
SCALING FACTORS USED IN CALCULATING THE ⁶⁰ Co SOURCE	
Region	BWR
Handle	0.05
Upper End Fitting	0.1
Gas Plenum Spacer	N/A
Expansion Springs	0.1
Gas Plenum Springs	0.2
Incore Grid Spacers	1
Lower End Fitting	0.15

HOLTEC INTERNATIONAL COPYRIGHTED MATERIAL	
Report No.: HI-2167374	Proposed Rev. 0Q
7-7	

Table 7.1.4(A) CALCULATED ^{60}Co SOURCE PER ASSEMBLY FOR DESIGN BASIS PWR FUEL AT DESIGN BASIS BOUNDING SOURCE TERMS [7.1.1]			
Location	Bounding Source Terms		
	Region 1 (curies)	Region 2 (curies)	Region 3 (curies)
Lower End Fitting	73.70	107.81	66.71
Gas Plenum Springs	14.37	21.01	13.00
Gas Plenum Spacer	10.21	14.94	9.24
Incore Grid Spacers	306.05	447.70	277.03
Upper End Fitting	49.03	71.72	44.38

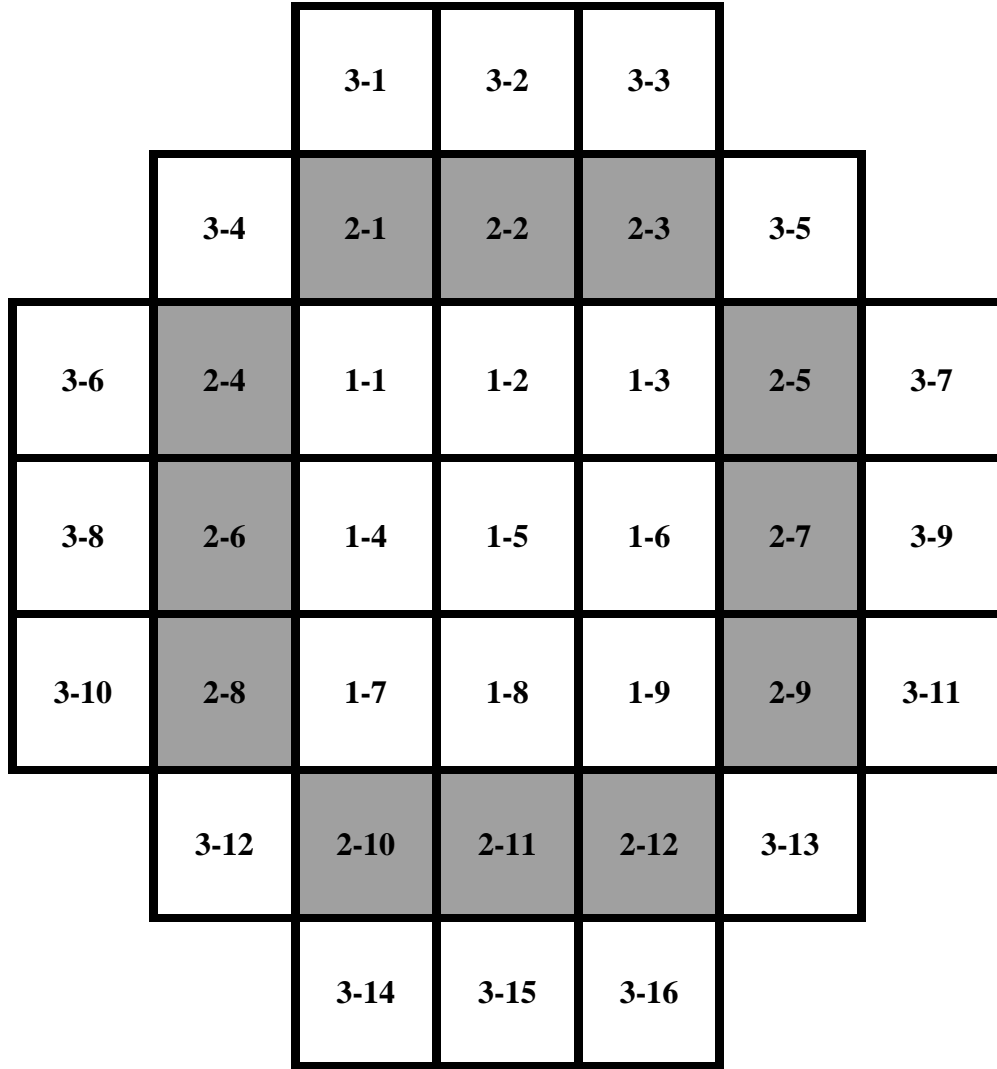
Table 7.1.4(B) CALCULATED ^{60}Co SOURCE PER ASSEMBLY FOR DESIGN BASIS BWR FUEL AND BOUNDING SOURCE TERMS [7.1.1]			
Location	Bounding Source Terms		
	Region 1 (curies)	Region 2 (curies)	Region 3 (curies)
Lower End Fitting	39.31	59.58	39.31
Gas Plenum Springs	12.01	18.20	12.01
Expansion Springs	2.18	3.31	2.18
Incore Grid Spacers	18.02	27.31	18.02
Upper End Fitting	10.92	16.55	10.92
Handle	1.37	2.07	1.37

HOLTEC INTERNATIONAL COPYRIGHTED MATERIAL	
Report No.: HI-2167374	Proposed Rev. 0Q
7-8	

Table 7.1.5(A) CALCULATED PWR NEUTRON SOURCE PER ASSEMBLY FOR DESIGN BASIS BOUNDING SOURCE TERMS [7.1.1]				
Lower Energy (MeV)	Upper Energy (MeV)	Bounding Source Terms		
		Region 1 (Neutrons/s)	Region 2 (Neutrons/s)	Region 3 (Neutrons/s)
1.00E-01	4.00E-01	4.73E+07	8.29E+07	5.21E+07
4.00E-01	9.00E-01	1.03E+08	1.81E+08	1.14E+08
9.00E-01	1.4	1.03E+08	1.81E+08	1.14E+08
1.4	1.85	8.22E+07	1.44E+08	9.07E+07
1.85	3	1.53E+08	2.68E+08	1.68E+08
3	6.43	1.39E+08	2.44E+08	1.54E+08
6.43	20	1.33E+07	2.35E+07	1.47E+07
Totals		6.41E+08	1.12E+09	7.07E+08

Table 7.1.5(B) CALCULATED BWR NEUTRON SOURCE PER ASSEMBLY FOR BOUNDING SOURCE TERMS [7.1.1]				
Lower Energy (MeV)	Upper Energy (MeV)	Bounding Source Terms		
		Region 1 (Neutrons/s)	Region 2 (Neutrons/s)	Region 3 (Neutrons/s)
1.00E-01	4.00E-01	1.24E+07	3.23E+07	1.24E+07
4.00E-01	9.00E-01	2.69E+07	7.05E+07	2.69E+07
9.00E-01	1.4	2.69E+07	7.04E+07	2.69E+07
1.4	1.85	2.15E+07	5.61E+07	2.15E+07
1.85	3	4.00E+07	1.04E+08	4.00E+07
3	6.43	3.63E+07	9.51E+07	3.63E+07
6.43	20	3.46E+06	9.19E+06	3.46E+06
Totals		1.67E+08	4.38E+08	1.67E+08

HOLTEC INTERNATIONAL COPYRIGHTED MATERIAL	
Report No.: HI-2167374	Proposed Rev. 0Q
7-9	



Legend

Region-Cell ID

Figure 7.1.1

MPC-37 REGION-CELL IDENTIFICATION

HOLTEC INTERNATIONAL COPYRIGHTED MATERIAL	
Report No.: HI-2167374	Proposed Rev. 0Q
7-10	

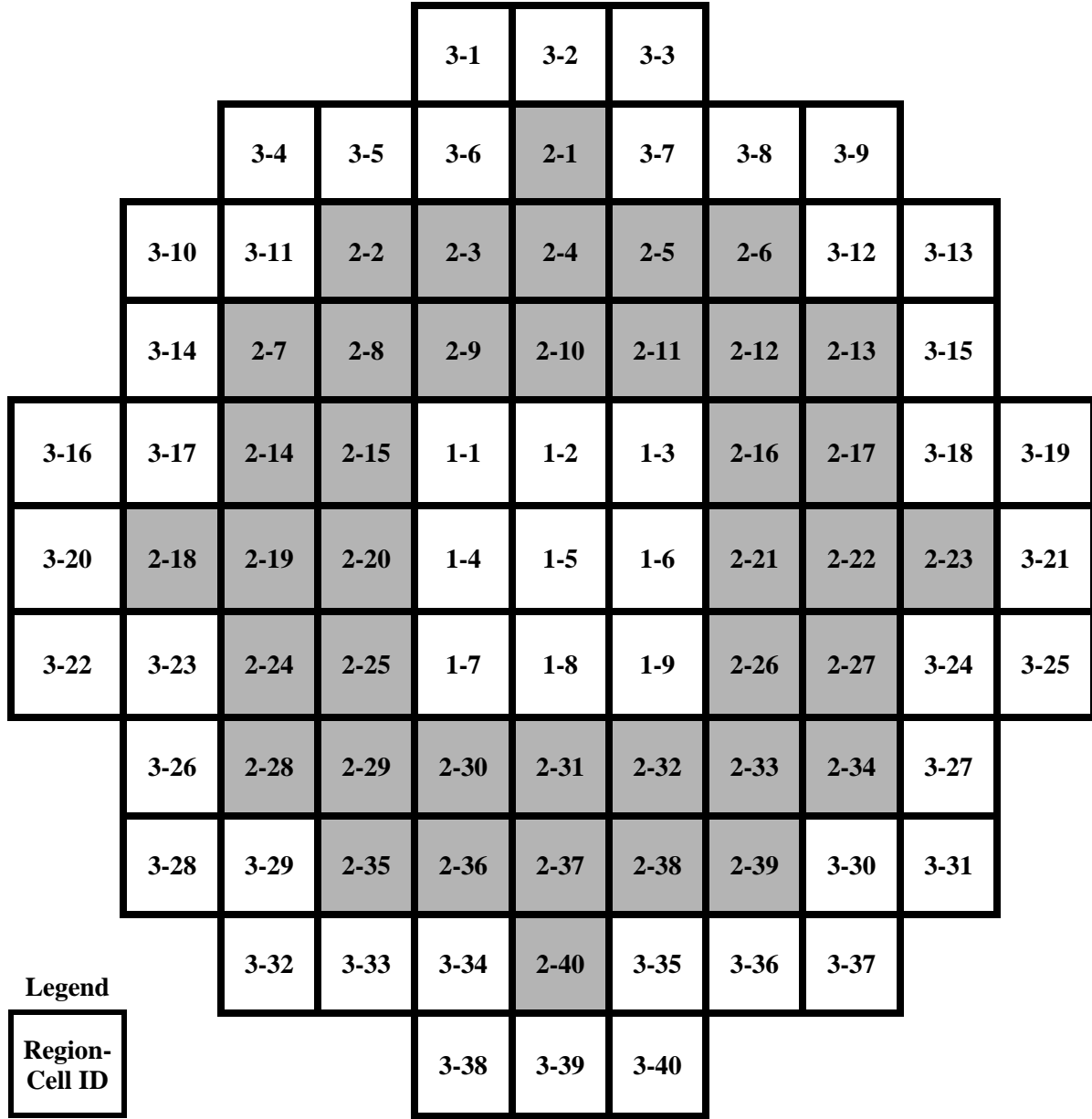


Figure 7.1.2

MPC-89 REGION-CELL IDENTIFICATION

HOLTEC INTERNATIONAL COPYRIGHTED MATERIAL	
Report No.: HI-2167374	Proposed Rev. 0Q
7-11	

7.2 STORAGE, TRANSFER, AND TRANSPORT SYSTEMS

7.2.1 Design Criteria

The design criteria, namely the relevant regulatory dose and dose rate, and ALARA requirements are presented in Chapter 4.

7.2.2 Design Features

7.2.2.1 Storage System

The version of the HI-STORM UMAX storage system used here is slightly different from that described in [1.0.6]. However, the differences are minor, and do not affect the principal design features of the system. A discussion of the shielding design features of the storage system see Subsection 5.1.1 in [1.0.6]. This Subsection is incorporated here by reference.

The storage system design is based on a metal canister that is sealed by welding for spent fuel confinement, preventing release of radionuclides from inside the canister. Radioactive effluents are thus precluded by design. This meets the intent of 10CFR72.24(e) and 10CFR72.126(d) [1.0.5], which requires that the ISFSI design provide means to limit the release of radioactive materials in effluents during normal operations to levels that are ALARA. There are no radioactive effluents released from the CIS Facility during normal operations. This passive system design also requires minimum maintenance and surveillance requirements by personnel.

7.2.2.2 Transfer Cask HI-TRAC CS

As discussed before, the HI-STORE facility uses a different transfer cask, HI-TRAC CS, than used in the operation of the generic HI-STORM UMAX and HI-STORM FW system. Instead of lead and steel for gamma shielding, and water for neutron shielding, it uses steel and concrete for both gamma and neutron shielding, and has an integrated bottom door for operational purposes. A detailed description of the HI-TRAC CS design is presented in Subsection 1.2.4. With its higher weight and integrated bottom shield gates, it provides significant advantages in dose rates and operational doses compared to the lead and water design.

7.2.2.3 Transport Cask HI-STAR 190

Spent fuel canisters at the HI-STORE facility arrive by rail in a transportation cask certified by USNRC, with many of the arrivals packaged in the HI-STAR 190 (Docket #71-9373). The HI-STAR 190 transport system principle design features are the MPC, the cask body, and the cask lid. Primarily, the shielding of the contents is provided by the body of the cask. The primary gamma shielding components in the cask are steel and lead. Holtite neutron absorber is utilized for primary neutron shielding. Radially, the Holtite neutron absorber is placed near the outer surface of the cask. A detailed description of the HI-STAR 190 transportation cask is presented in Reference [1.3.6].

HOLTEC INTERNATIONAL COPYRIGHTED MATERIAL	
Report No.: HI-2167374	Proposed Rev. 0Q
7-12	

7.3 SHIELDING COMPOSITION AND DETAILS

7.3.1 Composition and Material Properties

The composition and material properties for the concrete and soil used in the MCNP model of the HI-STORM UMAX System is provided in Table 7.3.1. The material compositions and material properties of the storage system are provided in Subsection 5.3.2 and Table 5.3.2 in [1.0.6]. This section and table are incorporated by reference into this document.

The material compositions and properties for the materials used for the HI-TRAC CS are the same as those for the corresponding materials in Table 5.3.2 in [1.0.6], except for the concrete in the transfer cask body, which is specified in Table 7.3.1 at the end of this subsection.

7.3.2 Shielding Details

For shielding details of the canisters see Section 5.3 in [1.0.6]. This section is incorporated by reference into this document.

Chapter 1 provides the drawings that describe the HI-STORM UMAX System including the HI-TRAC CS transfer cask. These drawings, using nominal dimensions, were used to create the MCNP models used in the radiation transport calculations for the transfer cask. Figure 7.4.1 shows a cross sectional view of the HI-TRAC CS with the MPC-37. Figure 7.4.2 shows the HI-STORM UMAX Version C as modeled in MCNP. These figures were created in the visual editor provided with MCNP, and are drawn to scale.

Conservatively the walls of the HI-TRAC CS are shorter than the dimensions shown in Section 1.5 Licensing Drawings and the optional Annulus Shield Ring is not credited.

HOLTEC INTERNATIONAL COPYRIGHTED MATERIAL	
Report No.: HI-2167374	Proposed Rev. 0Q
7-13	

Table 7.3.1 (Sheet 1 of 3)			
COMPOSITION OF THE MATERIALS – HI-STORE CIS FACILITY			
Component	Density (g/cm³)	Elements	Mass Fraction (%)
HI-TRAC CS Concrete	Normal Conditions 3.05	O	53.2
	Accident Conditions* 2.40	Si	33.7
		Ca	4.4
	Ground (Concrete below HI-TRAC CS) 2.30 Canister Transfer Building Walls and Roof Concrete 2.24	Al	3.4
		Na	2.9
		Fe	1.4
	H*	1.0	
HI-STORM UMAX Concrete	Lid 2.40	O	53.2
	C.E.C Plenum Shield 2.16	Si	33.7
		Ca	4.4
		Al	3.4
	ISFSI Pad 2.16	Na	2.9
		Fe	1.4
	Support Foundation Pad 1.92	H	1.0
Soil	Ground 1.92	H	0.962
		O	54.361
	Beneath VVM 1.7	Al	12.859
		Si	31.818

Notes:

* Hydrogen is removed from the HI-TRAC CS concrete under accident conditions

[PROPRIETARY INFORMATION WITHHELD PER 10CFR2.390]

HOLTEC INTERNATIONAL COPYRIGHTED MATERIAL	
Report No.: HI-2167374	Proposed Rev. 0Q
7-14	

Table 7.3.1 (Sheet 2 of 3)			
COMPOSITION OF THE MATERIALS - HI-STORE CIS FACILITY			
Component	Density (g/cm³)	Elements	Mass Fraction (%)
Metamic-HT	[PROPRIETARY INFORMATION PER 10CFR2.390]		
Carbon steel	7.82	Fe	99.0
		C	1.0
SS304	7.94	Cr	19.0
		Mn	2.0
		Fe	69.5
		Ni	9.5
Neutron Shield / Holtite (HI-STAR 190)	1.053	C	62.802
		H	9.592
		B-10	0.304
		B-11	1.344
		N	12.117
		O	13.841
Lead (HI-STAR 190)	11.3	Pb	99.9
		Cu	0.08
		Ag	0.02

HOLTEC INTERNATIONAL COPYRIGHTED MATERIAL	
Report No.: HI-2167374	Proposed Rev. 0Q
7-15	

Table 7.3.1 (Sheet 3 of 3)			
COMPOSITION OF THE MATERIALS – HI-STORE CIS FACILITY			
Component	Density (g/cm³)	Elements	Mass Fraction (%)
PWR Fuel Region Mixture	3.769 (5.0 wt% U-235)	²³⁵ U	3.709
		²³⁸ U	70.474
		O	9.972
		Zr	15.565
		Cr	0.016
		Fe	0.033
		Sn	0.230
Lower End Fitting (PWR)	1.849	SS304	100
Gas Plenum Springs (PWR)	0.23626	SS304	100
Gas Plenum Spacer (PWR)	0.33559	SS304	100
Upper End Fitting (PWR)	1.8359	SS304	100

HOLTEC INTERNATIONAL COPYRIGHTED MATERIAL	
Report No.: HI-2167374	Proposed Rev. 0Q
7-16	

7.4 SHIELDING ANALYSES METHODS AND RESULTS

7.4.1 Computational Methods and Data

Computational methods and associated data are provided in Section 5.4 in [1.0.6]. This section is incorporated by reference into this document.

Since MCNP is a statistical code, there is an uncertainty associated with the calculated values. In MCNP the uncertainty is expressed as the relative error that is defined as the standard deviation of the mean divided by the mean. The standard deviations of the various results were statistically combined to determine the standard deviation of the total dose in each dose location. The estimated variance of the total dose rate, S^2_{total} , is the sum of the estimated variances of the individual dose rates S^2_i . The estimated total dose rate, estimated variance, and relative error are derived according to Equations within Section 5.4 in [1.0.6]. The calculational uncertainty from MCNP is expressed as total relative error in percent for one standard deviation. The total relative error for the MCNP total dose rates presented in this chapter is typically less than 5% [7.4.2], [7.4.3], [7.4.5].

The combined MCNP uncertainty that is added to annual dose totals in Tables 7.4.7 and 7.4.8 use the root sum of squares method using the equation 7.4.1.

$$\text{Equation 7.4.1: } u_c(y) = \sqrt{u_1^2 + u_2^2 + \dots + u_i^2}$$

For doses and dose rates from the entire ISFSI, the contribution from each individual VVM is calculated, considering the distance of the VVM to the selected dose location, and then the results for all VVMs are added.

Soil is used to represent Self-hardening Engineering Subgrade in the MCNP models in the areas between and around the modules with a composition and density shown in Table 7.3.1. This is conservative since the areas between and around the modules would contain engineered fill with a typical density higher than soil. Furthermore, the dose rates around the VVM are dominated by the streaming through the inlet and outlet vents, and not by direct radiation through the soil and concrete. The use of soil as the subgrade backfill material in MCNP is consistent with previous Holtec submittals to the NRC for UMAX with further justification provided in Section 5.4 of Reference [1.0.6]. Radiation escapes the VVM in locations where the shielding material is the least thick, i.e. through the ventilated UMAX lid and immediately adjacent to the lid; Areas in the MCNP shielding model of the UMAX VVM where soil is modeled rather than CLSM or lean concrete underground are areas of substantial thickness (substantial areal density) between the source and the external environment.

HOLTEC INTERNATIONAL COPYRIGHTED MATERIAL	
Report No.: HI-2167374	Proposed Rev. 0Q
7-17	

7.4.2 Dose and Dose Rate Estimates

7.4.2.1 Normal Conditions

Dose rates around a HI-TRAC CS and around a single HI-STORM UMAX storage module, loaded with the MPC-37 and design basis fuel, are presented in Table 7.4.1 and 7.4.2 respectively. It can be concluded from the shielding analysis and results that the HI-TRAC CS and HI-STORM UMAX provide suitable shielding in accordance with 10CFR72.128(a)(2) [1.0.5].

Dose rates, and annual dose from 500 loaded HI-STORM UMAX VVMs at the ISFSI for various distances are presented in Table 7.4.3. Figure 7.4.3 shows ISFSI dose rates as a function of distance. The site specific geometry used in the shielding calculation is provided in Figure 7.4.4.

When transportation casks, like the HI-STAR 190 arrive on site by rail, any transport casks that are not immediately delivered into the Canister Transfer Building (CTB) shall be located in a rail yard “parking area” as shown in Figure 11.2.1 (rail switchyard area labeled a “radiation area”). Dose versus distance results for a single HI-STAR 190 transportation cask in a horizontal orientation, 2 meters above ground are provided in Table 7.4.6. Transportation casks are not a permanent fixture of the HI-STORE CISF, so a differing number of casks may be present at any given time.

Operations inside the Canister Transfer Building (CTB) are accounted for using a HI-TRAC CS surrounded by the concrete walls and concrete roof of the CTB with dose rate results shown in Table 7.4.5. Dose rates from the loaded HI-TRAC CS at 100 meters bound the dose rates from the loaded HI-STAR 190 cask at 100 meters (Table 7.4.6), and therefore the HI-TRAC CS within the CTB is conservatively considered in the annual dose evaluations. Within the CTB, the loaded canisters are shielded at all times by a shipping or transfer cask. The operational steps to load a single storage module, together with the estimated duration and dose rate for each step, and the cumulative crew dose for the entire operation, is presented in Chapter 11 (Radiation Protection).

Occupational doses to individuals are administratively controlled to ensure that they are maintained below 10CFR20.1201(a)(1) annual limits [7.4.1] i.e. the more limiting of:

- i. The total effective dose equivalent being equal to 5 rem (0.05 Sv); or
- ii. The sum deep-dose equivalent and the committed dose equivalent to any individual organ or tissue other than the lens of the eye being equal to 50 rem (0.5 Sv).

Operational controls ensure the total effective dose equivalent to individual members of the public from the licensed operation does not exceed 0.1 rem (1 mSv) in accordance with 10CFR20.1301(a)(1) [7.4.1] and that the dose in any unrestricted area from external sources does not exceed 2 mrem (0.02 mSv) in any one hour 10CFR20.1301(a)(2) [7.4.1].

The HI-TRAC CS is used to move MPC canisters from the CTB to the UMAX VVM ISFSI. Dose rates versus distance calculations are provided for a single HI-TRAC CS in Table 7.4.5. Additionally, the HI-TRAC CS will at times be loaded in the CTB; dose rates versus distance for the loaded HI-TRAC CS within the CTB, with the CTB concrete walls and concrete roof credited for shielding, are also provided in Table 7.4.5. The CTB is designed to be able to

HOLTEC INTERNATIONAL COPYRIGHTED MATERIAL	
Report No.: HI-2167374	Proposed Rev. 0Q
7-18	

process two canisters simultaneously, and therefore there could be 0, 1, or 2 loaded HI-TRAC CS transfer casks on site at any given time. Loaded HI-TRAC CS transfer casks are not a permanent fixture of the HI-STORE CISF site, and will spend time empty (with no spent fuel loaded inside).

TLDs are located at the Restricted Area fence and at the Controlled Area Boundary in accordance with 10CFR20.1302 [7.4.1] to show compliance with the annual dose limit in 10CFR20.1301 [7.4.1].

The dose rate versus distance as a result of C-14 production from a HI-STORM UMAX system is documented in Reference [7.4.4]. The effect of C-14 dose on site boundary dose and occupational dose is negligible, considering the number of loaded casks and occupancy time.

Two scenarios are selected to demonstrate compliance with the dose requirements in 10 CFR 72.104(a) through calculations of the expected dose. In each scenario, calculations are performed for specified bounding location, and a corresponding identified real individual, in accordance with NUREG-1567 [1.0.3] and ISG-13 [7.4.6]. For both scenarios, the evaluations are additionally based on significant conservatisms in the assumptions. The details for both scenarios are further discussed below.

The dose location for the first scenario is a unique single location on the OCA boundary closest to the CTB, as indicated in the site plan in Section 1.5. This location is at least 100 m from the CTB, at least 400 m from the HI-STORM UMAX ISFSI, and at least 400 m from the loaded HI-STAR storage area, as shown in the site plan in Section 1.5. This is a unique bounding location, since it is closest to both the CTB and the ISFSI. Other locations on the OCA boundary may be at a similar distance from the ISFSI or the HI-STAR storage area, but would be much further from the building, hence the contribution from the building would be lower at those locations. Also note that based on the information in the site plan, the distance from the ISFSI to the selected dose location would be 487 m (1600 ft), which would result in a further reduction in dose rates as indicated by the results in Table 7.4.3. However, for simplification, a conservative distance of 400 m from the nearest loaded UMAX VVM to the OCA boundary is used in the HI-STORE shielding analysis.

The dose contributions from the loaded UMAX systems, HI-STARs waiting to be unloaded, and HI-TRACs being loaded in the building and being in the process to move the MPCs from the CTB to the ISFSI are considered. For the ISFSI with the loaded UMAX systems, it is assumed all 500 systems are filled with MPCs containing the bounding fuel. This is conservative, since loading all those would take time, so by the time all systems are filled, some of the fuel would already have some additional cooling time, with a corresponding reduction of the dose contribution.

Transport casks arrive by train, with a maximum of 10 casks per train, which are then successively transferred into the UMAX storage systems. It is conservatively assumed that a new train loaded with 10 casks arrives as soon as the last of the previous 10 casks has been processed. Under this assumption, an average of 5 casks, or 10 casks with an occupancy factor of 50%, will be present at any time. Assuming this back-to-back operation is very conservative since it would require a significant number of casks, based on the fact that up to 20 casks may be present at the

HOLTEC INTERNATIONAL COPYRIGHTED MATERIAL	
Report No.: HI-2167374	Proposed Rev. 0Q
7-19	

facility (10 of them empty), that 10 additional casks would be in transit back to plants to be loaded, that 10 additional casks would be in the process of being loaded at some plants, and that 10 additional casks would have to be in transit back to the facility.

For the transfer cask, two principally different locations and contributions are considered, namely inside and outside of the building. For the location inside the building, essentially continuous loading operation is considered, with one canister in the building at any given time, either in a HI-TRAC or a transport cask (which is bounded by the HI-TRAC). While the building can accommodate up to two HI-TRACs, one would be on its way to or at the pad loading the canister into the UMAX, hence it is not realistic to assume two loaded HI-TRACs or transport casks to be in the building at the same time all the time. The second condition of the HI-TRAC is on its way to the ISFSI and during the download of the canister into the UMAX system. To cover this operation, several distances with different occupancy times were selected, with the highest occupancy time for the location of the HI-TRAC at the ISFSI for the download of the canister.

The other important factor in determining the dose is the occupancy time of the individual at the selected dose location. Full occupancy, i.e. a person residing just outside the OCA boundary permanently, 24 hours every day, is not possible at that location, since the existing BLM and state land designations preclude homes from being built within 1 mile of the HI-STORE CIS facility. Hence a second option is used, identifying a maximally exposed real individual for the location just outside the OCA boundary. The real individual is considered a person performing work in the location identified above, just outside the OCA boundary. The corresponding occupancy is then the normal working hours, i.e. 50 weeks per year and 40 hours/week, or a total of 2000 hours per year. Note that this is still a very conservative assumption for the identified unique location, since the maximum exposure would only occur in a narrow area of the OCA boundary close to the CTB. Having a person working in this small area for an entire year is considered unlikely, although not impossible. In summary, an occupancy time of 2000 hours per year is therefore used as a conservative assumption.

The results of the calculations for this location and the identified real individual are presented in Table 7.4.7, and show that the dose is expected to be below the regulatory limit established in 10 CFR 72.104 (a).

At larger distances, slightly more than a mile from the HI-STORE CIS Facility, some parcels of land are not controlled by the BLM or state, so residential facilities could exist or be built, where residents may be present 24 hours a day for every day in the year. However, the dose rates from the various contributors drop off quickly with even modest increases in the distance, as can be observed in the information provided in tables 7.4.3, 7.4.5 and 7.4.6, and that will easily offset the increase in occupancy time from the 2000 hours assumed at the OCA boundary to full occupancy. As stated before, the BLM and state land designations control the land up to about 1 mile from the facility. Conservatively, a distance of 1000 m is used in the analyses, with annual dose results for full occupancy of a real individual presented in Table 7.4.8. The results show that at that distance, and assuming full occupancy, the annual dose is below the limit in 10 CFR 72.104 with a significant margin. Note that the current closest resident is even further away from the facility, about 1.5 miles (about 2500 m).

HOLTEC INTERNATIONAL COPYRIGHTED MATERIAL	
Report No.: HI-2167374	Proposed Rev. 0Q
7-20	

The evaluations in tables 7.4.7 and 7.4.8 show that it is expected that the dose to the public at any location outside the OCA boundary will be below the regulatory limit with sufficient margin, even when based on significant conservatisms in the evaluations. During the operation of the facility, dose measurements will be performed and recorded, providing actual doses, which are expected to be well below those conservatively predicted dose values reported here. However, should any of the conditions and assumptions taken here and listed above ever change, or should higher than expected dose values be recorded, then additional measures will be implemented to ensure that the regulatory limits are always met. Accordingly, an entry has been added to the list of maintenance and inspection activities in Table 10.3.1.

7.4.2.2 Off-Normal and Accident Conditions

The only off-normal or accident condition applicable to the HI-STORM UMAX storage system is the missile impact during construction next to a loaded canister. This condition is analyzed and modeled in Section 5.1 and 5.3 of the HI-STORM UMAX FSAR [1.0.6]. The evaluation of this missile impact event, which is the bounding accident case from a shielding perspective affecting the UMAX VVM, shows that the regulatory dose limits are met for this condition. The respective sections are hereby incorporated by reference into this document.

The HI-TRAC CS is always carried with single failure proof equipment when loaded with a canister, hence any drop accident that could result in an increase in does rates is not credible. Further, unlike the HI-TRAC VW used in the HI-STORM UMAX FSAR, the HI-TRAC CS does not contain any water as neutron absorber. A loss of water accident is therefore not possible. However, under the accident condition, some areas of the cask would heat up significantly, and while the outer steel shell would assure the overall integrity of the cask, and hence prevent any significant loss of shielding function, the areas exceeding concrete temperature limits may experience some degradation and water loss. To model this in an analysis, shielding calculations are performed in which the density of the HI-TRAC CS concrete is assumed to be substantially degraded as shown in Table 7.3.1 and assume a total loss of hydrogen in the concrete. The resultant areal density (g/cm^2) of the concrete shielding assumed for accident conditions is conservatively lower than the areal density of the concrete shielding remaining post-thermal accident, taking into account degradation, as described in Reference [6.5.4]. Results of the HI-TRAC CS accident analyses are presented in Table 7.4.4, with the resulting accident dose (assuming a 30 day accident duration) at 100 m from the cask showing compliance with the requirements of 10CFR72.106 [1.0.5].

HOLTEC INTERNATIONAL COPYRIGHTED MATERIAL	
Report No.: HI-2167374	Proposed Rev. 0Q
7-21	

Table 7.4.1: Dose Rates from the HI-TRAC CS MPC-37 Design Basis Fuel [7.4.3] with Bounding Source Terms from Reference [7.1.1]			
Dose Point Location¹	Gamma Dose Rate² (mrem/hr)	Neutron Dose Rate (mrem/hr)	Total Dose Rate (mrem/hr)
Surface of HI-TRAC CS			
Bottom Duct	82.4	105	187
60 inches below Mid-Height	114	3.6	117
Mid-Height	115	3.2	118
60 inches above Mid-Height	68.1	0.6	69
Center of Top Lid	1168	307	1475
0.5 meters from HI-TRAC CS			
Bottom Duct	31.8	28.4	61
60 inches below Mid-Height	66.6	3.4	70
Mid-Height	73.0	2.3	75
60 inches above Mid-Height	43.6	0.7	44
1 meter from HI-TRAC CS			
Bottom Duct	35.4	11.5	47
60 inches below Mid-Height	46.8	3.3	50
Mid-Height	53.6	1.8	55
60 inches above Mid-Height	31.4	0.8	32
2 meters from HI-TRAC CS			
Bottom Duct	23.6	5.2	29
60 inches below Mid-Height	28.1	2.2	30
Mid-Height	34.0	1.2	35
60 inches above Mid-Height	20.7	0.7	21

¹ Refer to Figure 7.4.1.

² Dose rate from gammas include gammas generated by neutron capture, fuel gammas, Co-60 gammas and BPRA gammas.

HOLTEC INTERNATIONAL COPYRIGHTED MATERIAL	
Report No.: HI-2167374	Proposed Rev. 0Q
7-22	

Table 7.4.2: Dose Rates Adjacent to and 1 Meter from the HI-STORM UMAX Module for Normal Conditions MPC-37 Design Basis Zircaloy Clad Fuel [7.4.3] with Bounding Source Terms [7.1.1]			
Dose Point Location¹	Gamma Dose Rate² (mrem/hr)	Neutron Dose Rate (mrem/hr)	Total Dose Rate (mrem/hr)
Surface of Closure Lid			
1	3.40	1.40	4.81
2	5.30	2.90	8.21
3	5.22	2.54	7.76
4	6.36	3.09	9.45
5	30.97	9.58	40.55
One Meter from Closure Lid			
1	0.96	0.52	1.48
2	1.08	0.82	1.90
3	1.45	0.55	2.00
4	1.75	0.59	2.34
5	3.91	1.04	4.96

¹ Refer to Figure 7.4.2 for dose point locations.

² Dose rate from gammas include gammas generated by neutron capture, fuel gammas, Co-60 gammas, and BPRA gammas.

HOLTEC INTERNATIONAL COPYRIGHTED MATERIAL	
Report No.: HI-2167374	Proposed Rev. 0Q
7-23	

Table 7.4.3: Dose Rates as a Function of Distance from 500 Loaded HI-STORM UMAX VVMs for Fuel Assemblies [7.4.2] with Bounding Source Terms from Reference [7.1.1]

Distance (m)	Total Dose Rate (mrem/hr)	2000 hour/year Occupancy	8760 hour/year Occupancy
		Total Dose (mrem/yr)	Total Dose (mrem/yr)
10	1.09E+00	2.18E+03	9.56E+03
20	7.36E-01	1.47E+03	6.45E+03
30	5.44E-01	1.09E+03	4.76E+03
40	4.15E-01	8.30E+02	3.64E+03
50	3.26E-01	6.52E+02	2.85E+03
75	1.91E-01	3.82E+02	1.67E+03
100	1.19E-01	2.39E+02	1.05E+03
150	5.11E-02	1.02E+02	4.47E+02
200	2.40E-02	4.80E+01	2.10E+02
250	1.20E-02	2.40E+01	1.05E+02
300	6.29E-03	1.26E+01	5.51E+01
350	3.41E-03	6.82E+00	2.99E+01
400	1.91E-03	3.82E+00	1.67E+01
450	1.11E-03	2.21E+00	9.69E+00
500	6.59E-04	1.32E+00	5.78E+00
600	2.55E-04	5.09E-01	2.23E+00
700	1.10E-04	2.19E-01	9.61E-01
800	5.22E-05	1.04E-01	4.57E-01
900	2.65E-05	5.30E-02	2.32E-01
1000	1.86E-05	3.73E-02	1.63E-01

HOLTEC INTERNATIONAL COPYRIGHTED MATERIAL

Report No.: HI-2167374

Proposed Rev. 0Q

7-24

Table 7.4.4	
Dose at 100 Meters from a Single HI-TRAC CS with MPC-37 Loaded with Design Basis Fuel for Accident Condition¹ [7.4.2] with Bounding Source Terms [7.1.1]	
Dose (Rem)	10 CFR 72.106 [1.0.5] Accident Dose Limit (Rem)
0.211	5

¹ Accident duration is assumed to be 30 days.

HOLTEC INTERNATIONAL COPYRIGHTED MATERIAL	
Report No.: HI-2167374	Proposed Rev. 0Q
7-25	

Table 7.4.5 Dose Rate versus Distance from a Single HI-TRAC CS [7.4.2] with Bounding Source Terms [7.1.1]		
Distance (m)	Single HI-TRAC CS Total Dose Rate (mrem/hr)	Single HI-TRAC CS in Canister Transfer Building* Total Dose Rate (mrem/hr)
10	4.27E+00	Tally inside Building
25	8.63E-01	6.22E-02
50	2.22E-01	1.23E-02
75	9.51E-02	5.47E-03
100	5.02E-02	2.97E-03
150	1.86E-02	1.13E-03
200	8.35E-03	5.13E-04
250	4.14E-03	2.54E-04
300	2.19E-03	1.35E-04
350	1.21E-03	7.55E-05
400	6.88E-04	4.38E-05
450	4.05E-04	2.62E-05
500	2.47E-04	1.60E-05
600	9.63E-05	6.54E-06
700	4.04E-05	2.90E-06
800	1.80E-05	1.38E-06
900	8.42E-06	6.90E-07
1000	4.09E-06	3.60E-07

Notes:

*Inside Canister Transfer Building, 12 inch (30 cm) thick concrete walls, 12 meter high walls, 6 inch (15 cm) thick concrete roof. HI-TRAC CS dose rates, which bound the HI-STAR 190 at the 100 meter distance, are provided.

HOLTEC INTERNATIONAL COPYRIGHTED MATERIAL	
Report No.: HI-2167374	Proposed Rev. 0Q
7-26	

Table 7.4.6	
Dose Rate versus Distance from a Single HI-STAR 190 [7.4.5] using Bounding Source Terms [7.1.1]	
Distance (meters)	Dose Rate for Single HI-STAR 190 Cask (mrem/hr)
10	2.47E+00
25	4.27E-01
50	1.07E-01
75	4.55E-02
100	2.36E-02
150	8.55E-03
200	3.76E-03
250	1.87E-03
300	9.89E-04
350	5.58E-04
400	3.26E-04
450	1.95E-04
500	1.20E-04
600	4.94E-05
700	2.22E-05
800	1.08E-05
900	5.45E-06
1000	2.89E-06

HOLTEC INTERNATIONAL COPYRIGHTED MATERIAL	
Report No.: HI-2167374	Proposed Rev. 0Q
7-27	

Table 7.4.7 Annual Dose to a Real Individual at Nearest Controlled Area Boundary						
Number of loaded Casks	Radiation Source	Distance (meters)	Occupancy Factor of loaded Casks	Occupancy of Real Individual Beyond Controlled Area Boundary (hours/year)	Dose Rate [‡] (mrem/hr)	Annual Dose (mrem/yr)
500	UMAX VVMs	400	100%	2000	1.91E-03	3.82E+00
10	HI-STAR 190 transport casks	400	50%	2000	3.26E-04	3.26E+00
2	Canister Transfer Building*, MPCs in HI-TRAC CS or HI-STAR 190	100	50%	2000	2.97E-03	5.94E+00
2	HI-TRAC CS transfer casks	100	2%	2000	5.02E-02	4.02E+00
		200	2%	2000	8.35E-03	6.68E-01
		300	2%	2000	2.19E-03	1.75E-01
		400	19%	2000	6.88E-04	5.23E-01
Total						1.84E+01
Combined MCNP Uncertainties						4.37E-02
Total + Combined MCNP Uncertainties						1.85E+01

Notes:

*Inside Canister Transfer Building, 12 inch (30 cm) thick concrete walls, 12 meter high walls, 6 inch (15 cm) thick concrete roof. HI-TRAC CS dose rates, which bound the HI-STAR 190 at the 100 meter distance, are provided.

[‡] Dose rates are for 500 UMAX VVMs (cask array), a single HI-STAR 190 cask, and a single HI-TRAC CS.

[‡] The HI-STORE CISF UMAX ISFSI is located 400 meters from the nearest controlled area boundary, as shown in Figure 7.4.4. It is conservatively assumed that a worker, not affiliated with HI-STORE CISF, could be located at the controlled area boundary for 2000 hours per year.

HOLTEC INTERNATIONAL COPYRIGHTED MATERIAL	
Report No.: HI-2167374	Proposed Rev. 0Q
7-28	

Table 7.4.8 Annual Dose to a Real Individual at Nearest Residence [¥] Beyond Controlled Area Boundary						
Number of loaded Casks	Radiation Source	Distance (meters)	Occupancy Factor of loaded Casks	Occupancy of Real Individual Beyond Controlled Area Boundary at Nearest Residence (hours/year)	Dose Rate [‡] (mrem/hr)	Annual Dose (mrem/yr)
500	UMAX VVMs	1000	100%	8760	1.86E-05	1.63E-01
10	HI-STAR 190 transport casks	1000	50%	8760	2.89E-06	1.27E-01
2	Canister Transfer Building*, MPCs in HI-TRAC CS or HI-STAR 190	1000	50%	8760	3.60E-07	3.15E-03
2	HI-TRAC CS transfer casks	1000	25%	8760	4.09E-06	1.79E-02
Total						3.11E-01
Combined MCNP Uncertainties						8.48E-03
Total + Combined MCNP Uncertainties						3.19E-01

Notes:

[¥] The nearest residence is 1.5 miles from the HI-STORE CIS Facility; annual dose results provided at 1000 meters are conservative for the nearest residence.

*Inside Canister Transfer Building, 12 inch (30 cm) thick concrete walls, 12 meter high walls, 6 inch (15 cm) thick concrete roof. HI-TRAC CS dose rates, which bound the HI-STAR 190 at the 100 meter distance, are provided.

[‡] Dose rates in this column are for 500 UMAX VVMs (cask array), a single HI-STAR 190 cask, and a single HI-TRAC CS.

HOLTEC INTERNATIONAL COPYRIGHTED MATERIAL	
Report No.: HI-2167374	Proposed Rev. 0Q
7-29	

[PROPRIETARY INFORMATION WITHHELD PER 10CFR2.390]

Figure 7.4.1 Dose Locations for the HI-TRAC CS

HOLTEC INTERNATIONAL COPYRIGHTED MATERIAL	
Report No.: HI-2167374	Proposed Rev. 0Q
7-30	

Figure 7.4.2. [PROPRIETARY INFORMATION WITHHELD PER 10CFR2.390]

HOLTEC INTERNATIONAL COPYRIGHTED MATERIAL	
Report No.: HI-2167374	Proposed Rev. 0Q
7-31	

Figure 7.4.2. [PROPRIETARY INFORMATION WITHHELD PER 10CFR2.390]

HOLTEC INTERNATIONAL COPYRIGHTED MATERIAL	
Report No.: HI-2167374	Proposed Rev. 0Q
7-32	

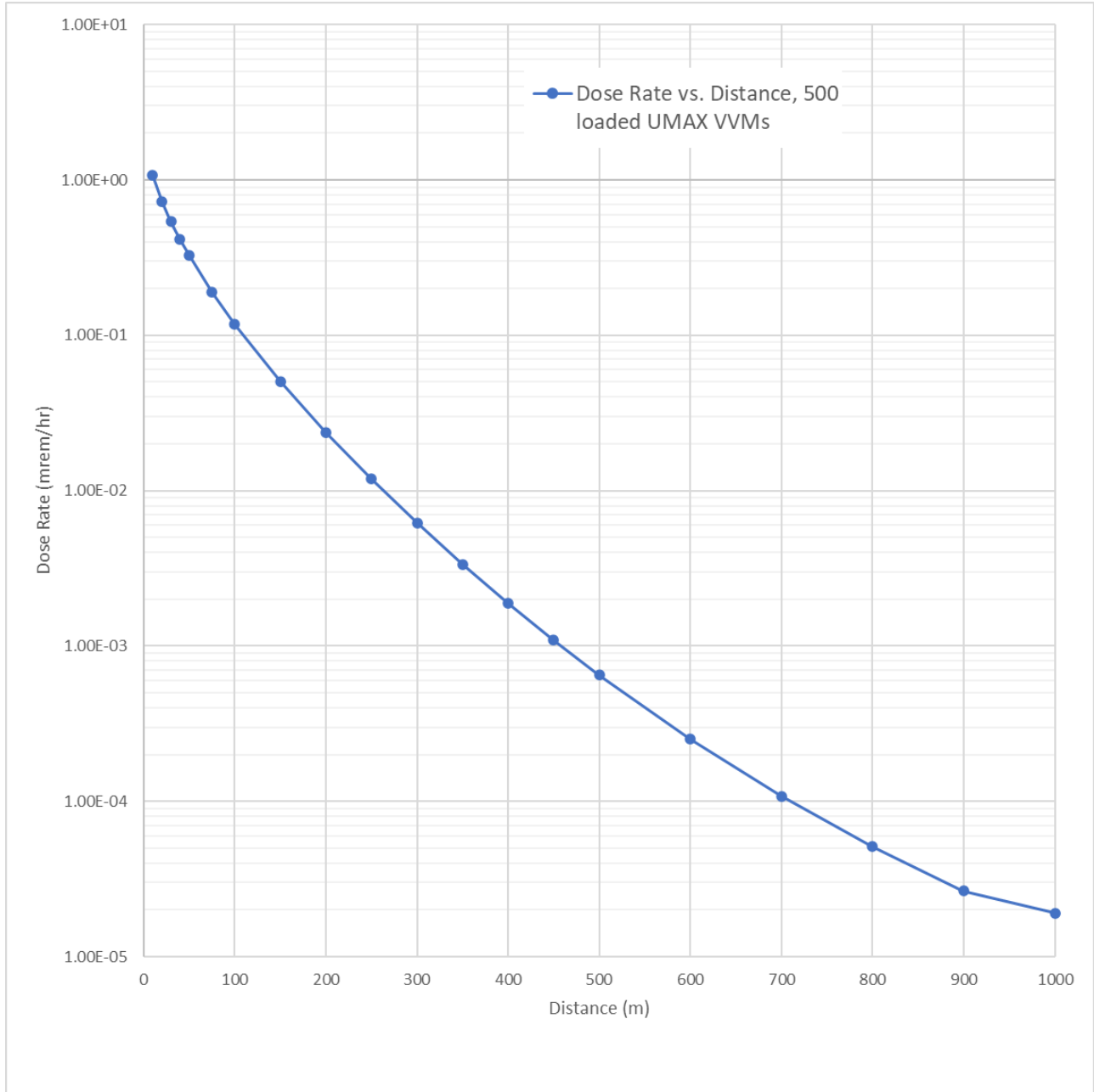


Figure 7.4.3. HI-STORE CIS Facility HI-STORM UMAX VVM ISFSI Dose Rates as a Function of Distance (500 loaded HI-STORM UMAX VVMs)

HOLTEC INTERNATIONAL COPYRIGHTED MATERIAL	
Report No.: HI-2167374	Proposed Rev. 0Q
7-33	

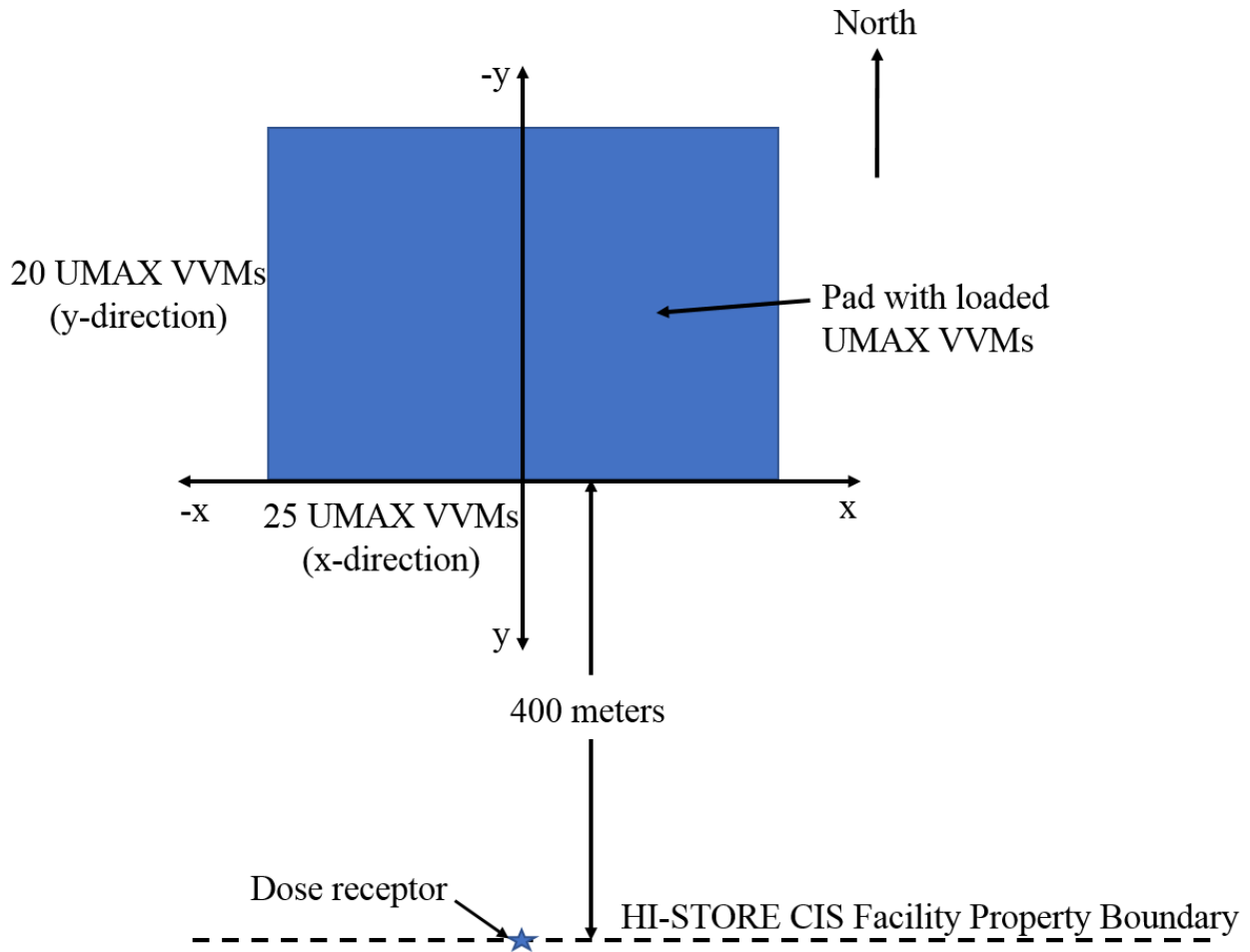


Figure 7.4.4. HI-STORE CIS Facility Layout - 500 Loaded HI-STORM UMAX VVMs considered in Dose vs. Distance Shielding Analysis

Notes:

1. UMAX VVM center-to-center inter-cavity pitch is provided in Table 1.1.1.
2. Dose receptor pictured in Figure 7.4.4 indicates location of maximum dose rates at the property boundary for the given ISFSI geometry. Maximum dose rates at various distances (for any orientation) are reported in Table 7.4.3. The dose receptor pictured in Figure 7.4.4 is at the coordinate pair (0, 400) in units of meters, with modeling and calculational details provided in Reference [7.4.2].

HOLTEC INTERNATIONAL COPYRIGHTED MATERIAL	
Report No.: HI-2167374	Proposed Rev. 0Q
7-34	

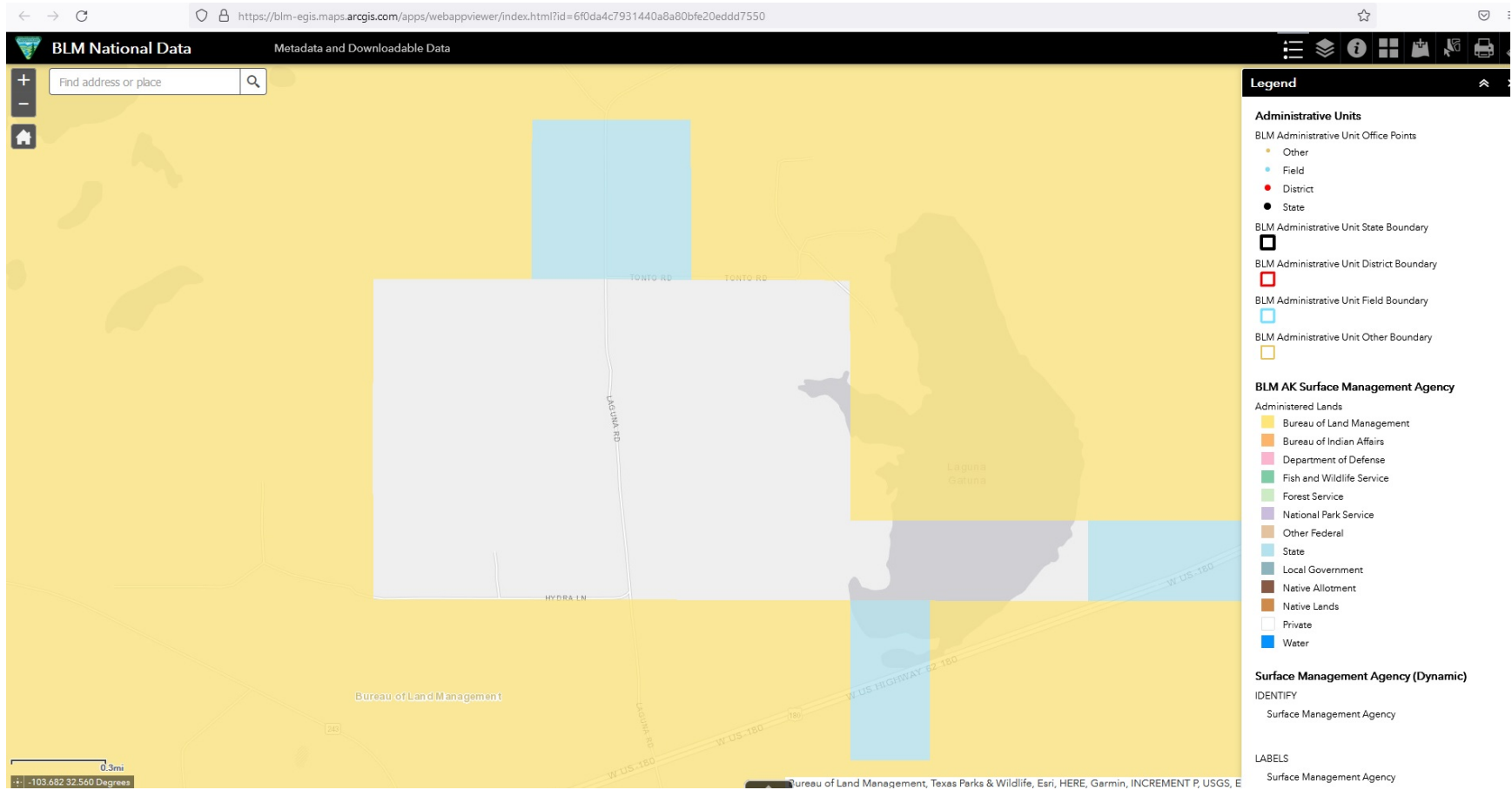


Figure 7.4.5. HI-STORE CISF Site and Adjacent Land Administration Designations

Note 1: Additional Figures showing Federal Bureau of Land Management (BLM) and State Land Administrative designations adjacent to HI-STORE CISF site are provided in Section 2.1 of this SAR.

Note 2: The existing land use designations preclude a home from being built within a mile of the HI-STORE CIS Facility.

HOLTEC INTERNATIONAL COPYRIGHTED MATERIAL	
Report No.: HI-2167374	Proposed Rev. 0Q
7-35	

7.5 SUMMARY

In summary, the design of the facility satisfies all regulatory criteria and limits for radiological protection, and provides acceptable means for limiting the exposure of the public to direct and scattered radiation.

HOLTEC INTERNATIONAL COPYRIGHTED MATERIAL	
Report No.: HI-2167374	Proposed Rev. 0Q
7-36	

CHAPTER 8: CRITICALITY EVALUATION*

8.0 INTRODUCTION

The criticality safety qualification of the canisters for installation at the HI-STORE CIS facility is considered in this chapter. An essential commitment in this SAR is that only those canisters that have been certified and loaded under the HI-STORM UMAX docket (#72-1040) may be stored at the HI-STORE facility. Reactivity of the stored fuel in a canister depends foremost on the configuration of the fuel basket and to a lesser extent on the circumscribing Enclosure Vessel around the basket. Because the canister shipped from the originating site has already been designed, built, loaded and certified to an NRC-issued Technical Specification, the subcriticality of the canister is pre-established. Thus, for example, for the canisters denoted as MPC-37 and MPC-89, the substantiating criticality safety demonstration is in the HI-STORM FW FSAR [1.3.7]. This qualification has also been utilized in the regulatory review and certification for storage in the HI-STORM UMAX system in docket # 72-1040. Since the same HI-STORM UMAX system is proposed to be deployed at HI-STORE, the criticality safety determination by the NRC in docket # 72-1040 remains applicable. This axiomatic qualification of the canisters will remain valid unless the canister and its fuel basket are physically altered during their transport or handling to the HI-STORE facility which will summarily disqualify them from storage under the HI-STORE CIS docket.

* All references are placed within square brackets in this report and are compiled in Chapter 19 (last chapter)

HOLTEC INTERNATIONAL COPYRIGHTED MATERIAL	
Report No.: HI-2167374	Proposed Rev. 0Q
8-1	

Table 8.0.1: Material Incorporated by Reference in this Chapter

Information Incorporated by Reference	Source of the Information	NRC Approval of Material Incorporated by Reference	Location in this SAR where Material is Incorporated	Technical Justification of Applicability
MPC-37 and MPC-89 Criticality Evaluation	Sections 6.1, 6.2, 6.3, 6.4, and 6.5; Appendices 6.A and 6.B of Reference [1.3.7]	SER HI-STORM FW Amendments 0, 1, and 2 References [8.0.1, 8.0.2, and 8.0.3]	Sections 8.1, 8.3, and 8.4	The canister is the same as the one described in the FW FSAR and originally approved in the referenced SER. There is no change to the fuel basket, and canister integrity is ensured by the acceptance test criteria established in this SAR.
Applicability of HI-STORM FW criticality evaluation to HI-STORM UMAX system	Section 6.2 of Reference [1.0.6]	SER HI-STORM UMAX Amendments 0, 1, and 2 References [7.0.1, 7.0.2, 7.0.3]	Sections 8.3, and 8.4	The HI-STORM UMAX design is the same from a criticality perspective as the one described in the HI-STORM UMAX FSAR and so the conclusions established therein that the HI-STORM FW criticality analysis is fully applicable to the HI-STORM UMAX, remain unchanged in this SAR.
HI-STAR 190 Criticality Evaluations	Chapter 6 of Reference [1.3.6]	SER HI-STAR 190 Package Revisions 0, 1 References [7.0.4, 7.0.5]	Sections 8.3 and 8.5	The HI-STAR 190 SAR [1.3.6] criticality safety analyses provide a bounding case for the HI-STORE criticality safety and demonstrate that the ISFSI design meets 10 CFR 72.124(a), i.e., the double contingency requirement.

HOLTEC INTERNATIONAL COPYRIGHTED MATERIAL

Report No.: HI-2167374

Proposed Rev. 0Q

8-2

8.1 CRITICALITY DESIGN CRITERIA AND FEATURES

8.1.1 Criteria

The acceptance criteria for criticality evaluations for the HI-STORM UMAX system utilized at the HI-STORE facility are presented in Chapter 4 of this SAR.

8.1.2 Features

Section 6.1 of the HI-STORM FW FSAR [1.3.7] is incorporated by reference into this SAR, and describes all the criticality design features of the canisters which maintain the stored fuel in a sub-critical condition.

HOLTEC INTERNATIONAL COPYRIGHTED MATERIAL	
Report No.: HI-2167374	Proposed Rev. 0Q
8-3	

8.2 STORED MATERIAL SPECIFICATIONS

The fuel assemblies allowable for storage in the HI-STORM UMAX VVMs at the HI-STORE facility are described in Section 4.1.

HOLTEC INTERNATIONAL COPYRIGHTED MATERIAL	
Report No.: HI-2167374	Proposed Rev. 0Q
8-4	

8.3 EVALUATION

During storage conditions in the HI-STORM UMAX system, the maximum k_{eff} will be significantly below the limiting maximum k_{eff} since the MPC is internally dry. Under this condition, the configuration is very similar in all other HI-STORM models, which consists of an internally dry MPC, an air gap between the MPC and the overpack, a steel shell or shells and concrete (above-ground) or soil (underground). Results for the HI-STORM UMAX VVM would therefore be practically identical to the results listed for storage conditions in Chapter 6 of the canister's native FSAR (such as the HI-STORM FW FSAR [1.3.7] for the canisters subsequently certified under the HI-STORM UMAX FSAR [1.0.6], which are now included in this site-specific license. Any small differences in results would not affect the principal conclusions, since the maximum k_{eff} under storage conditions (dry inert environment) is substantially below the regulatory limit. It should be noted that the analysis for the canisters in the various HI-STORM models conservatively assumes that the gap between the canister and the HI-STORM is flooded with water, thus increasing the neutron reflection compared to a dry cavity [8.0.1, Section 7]. Flooding under accident conditions of the HI-STORM UMAX is therefore also covered by the calculations for the HI-STORM FW (see also Subsection 8.3.2 below). All other normal, off-normal and accident conditions in the HI-STORM UMAX system at HI-STORE are identical to or less severe than invoked for certification in the generic dockets (such as HI-STORM FW) which consider bounding loadings for the entire continental United States.

In summary, the limiting condition for storage of the canisters certified in the generic docket for HI-STORM UMAX (Docket # 72-1040) is identical to their storage in HI-STORM UMAX at HI-STORE from a criticality perspective, and all other normal, off-normal and accident conditions are identical or equivalent between the two dockets from a criticality perspective. Therefore, the criticality safety of the canisters certified in docket # 72-1040 is *a priori* ensured for storing those canisters at HI-STORE. No additional calculations to demonstrate criticality safety are required for storing such canisters in the HI-STORM UMAX system at HI-STORE.

8.3.1 Model Configuration

The model configuration including material properties for the criticality analysis is incorporated by reference from Section 6.3 of [1.3.7], as described in Table 8.0.1 of this SAR.

8.3.2 Accidental Criticality

10CFR72.124(a) requires that at least two unlikely events (changes) must occur before a criticality accident is possible. It is discussed in Paragraph 6.4.2.5 of the HI-STORM FW FSAR [1.3.7] that the damage due to design basis accidents has no adverse effect on the design parameters important to criticality safety, and the HI-STORM FW system is in full compliance with the requirement of 10CFR72.124(a). The conclusions established therein remain applicable to the HI-STORM UMAX system, as well as the HI-STORM UMAX design at the HI-STORE facility which is the same from a criticality perspective as that described in the HI-STORM UMAX FSAR [1.0.6]. As shown in Table 8.3.1, all the credible accident events for the HI-STORM UMAX system at the HI-STORE facility discussed in Section 15.3 are bounded by those discussed in the HI-STORM UMAX FSAR. Therefore, the damage resulting from the accidents is limited to the minor damage to the concrete radiation shield for the HI-STORM

HOLTEC INTERNATIONAL COPYRIGHTED MATERIAL	
Report No.: HI-2167374	Proposed Rev. 0Q
8-5	

UMAX storage cask, which would only have impact on the cask lid but not the MPC and fuel basket integrity. It should be noted that unlike the HI-TRAC VW used in the HI-STORM UMAX FSAR, the HI-TRAC CS used for the HI-STORE CIS facility does not contain any water as neutron shield, a loss of water accident is therefore not possible.

The HI-STORM UMAX implementation at the HI-STORE facility would in fact require **two unlikely** events before an accident is possible, and is therefore in compliance with the abovementioned regulation. The **two unlikely** events applicable to the facility are as follows:

- The Probable Maximum Flood (PMF) for the HI-STORE site, which considers the theoretically largest flood resulting from a combination of the most severe meteorological and hydrologic conditions that could conceivably occur in a given area, is discussed in Chapter 2. Though a flooding of the CECs outside of the PMF is unlikely because the pads are designed and constructed so that rainwater will run off and not accumulate (see [1.0.6], Section 10.3) and a water spray was performed on the first HI-STORM UMAX systems installed at site to demonstrate this after installation; during PMF conditions the flood has water levels high enough to enter the CEC. However, even if a CEC would be flooded, the internal cavity of the canister with the basket and fuel would remain dry, and hence the reactivity would remain very low. The canister is seal-welded, and the integrity of the canister is verified during the acceptance tests when it enters the site. For the initially licensed period of each canister, this gives assurance that a leak of the canister that would allow ingress of water is unlikely. For longer storage times beyond the initially licensed period, an aging management program is applied, designed to detect and mitigate any such leaks, making water inleakage also an unlikely event.
- Finally, the fact that canisters are not loaded on-site, but always be delivered to the site in a 10CFR71 approved transportation cask, together with the acceptance tests for each transport cask, presents the third barrier, which would prevent a criticality accident even in the unlikely event that both the CEC and the canister would be flooded:
 - The transport regulations require that the package remains subcritical under normal conditions when flooded with pure water.
 - For BWR fuel that is essentially met by default, since canisters are loaded in a pool with fresh water.
 - For PWR fuel, the requirements for transportation in the HI-STAR 190 require burnup credit so that the same requirement is met, i.e. subcriticality when flooded with fresh water (see [1.3.6], Subsection 6.1.1).
 - The transportation cask to be used for the approved canisters (HI-STAR 190) will also be qualified for High Burnup Fuel, where fuel damage is possible. In that case, the criticality safety evaluation for the package does not assume flooding of the canister. However, the acceptance tests for the acceptance of the canister on site excludes canisters from transports that have undergone any accident condition, as described in the Facility Technical Specifications. This scenario is therefore not applicable here.

Based on this, even for a flooded canister, accidental criticality is unlikely.

HOLTEC INTERNATIONAL COPYRIGHTED MATERIAL	
Report No.: HI-2167374	Proposed Rev. 0Q
8-6	

Overall, at least **two** unlikely (or non-credible) events would be required before accidental criticality could be possible at the HI-STORE facility. The facility is therefore in compliance with 10CFR72.124(a).

HOLTEC INTERNATIONAL COPYRIGHTED MATERIAL	
Report No.: HI-2167374	Proposed Rev. 0Q
8-7	

Table 8.3.1: Comparison of Accident Events between the HI-STORM UMAX FSAR and the HI-STORE SAR

Accident	HI-STORE SAR Subsection	UMAX FSAR Subsection	Note
Fire Accident	15.3.1	12.2.1	Fire accident does not affect the safe operation.
Partial Blockage of MPC Basket Vent Holes	15.3.2	12.2.2	Event evaluation incorporated by UMAX FSAR subsection.
Tornado Missiles	15.3.3	12.2.3	Tornado accident does not affect the safe operation.
Flood	15.3.4	12.2.4	Flood hazards are bounded by UMAX FSAR subsection.
Earthquake	15.3.5	12.2.5	Earthquake accident does not affect the safe operation of HI-TRAC CS, the hazards of HI-STORM UMAX are bounded by UMAX FSAR subsection.
100% Fuel Rods Rupture	15.3.6	12.2.6	The rupture of every fuel rod inside the Canister is postulated as a non-mechanistic event.
Confinement Boundary Leakage	15.3.7	12.2.7	Event evaluation incorporated by UMAX FSAR subsection.
Explosion	15.3.8	12.2.8	Event evaluation incorporated by UMAX FSAR subsection.
Lightning	15.3.9	12.2.9	Event evaluation incorporated by UMAX FSAR subsection.
100% Blockage of Air Inlet and Outlet Ducts	15.3.10	12.2.10	Event evaluation incorporated by UMAX FSAR subsection.
Burial Under Debris	15.3.11	12.2.11	Burial accident is not credible for HI-STORM UMAX, HI-TRAC CS is covered by Subsection 15.3.19.
Extreme Environmental Temperature	15.3.12	12.2.12	Event is bounded by the UMAX FSAR
Cask Tipover	15.3.13	-	Event is not a credible accident.
Cask Drop	15.3.14	12.2.13	Event is not a credible accident.
Loss of Shielding	15.3.15	-	Event is not a credible accident.
Adiabatic Heatup	15.3.16	-	Event is not a credible accident.
Accidents at Nearby Sites	15.3.17	-	No adverse effect on storage and transport casks.
Accidents Associated with Pool Facilities	15.3.18	-	Not applicable to HI-STORE.
Building Structural Failure onto SSCs	15.3.19	-	Accident does not affect the safe operation

HOLTEC INTERNATIONAL COPYRIGHTED MATERIAL

Report No.: HI-2167374

Proposed Rev. 0Q

8-8

Accident	HI-STORE SAR Subsection	UMAX FSAR Subsection	Note
100% Rod Rupture Accident Coincident with Accident Events	15.3.20	-	100% Rod Rupture is not to be combined with any accident supported by quote from NRC SER.

HOLTEC INTERNATIONAL COPYRIGHTED MATERIAL	
Report No.: HI-2167374	Proposed Rev. 0Q
8-9	

8.4 APPLICANT CRITICALITY ANALYSIS

The criticality analysis for the MPC-37 and MPC-89 is incorporated by reference from Section 6.4 of [1.3.7], as described in Table 8.0.1 of this SAR, including the computer program utilized, multiplication factor, and benchmark comparison. The discussion of how these HI-STORM FW results apply to the HI-STORM UMAX system is incorporated by reference from Section 6.2 of [1.0.6]. The configuration and confinement of the canisters are unchanged based on the discussion in Chapter 9, so the existing analysis is fully applicable to the HI-STORE CIS Facility.

HOLTEC INTERNATIONAL COPYRIGHTED MATERIAL	
Report No.: HI-2167374	Proposed Rev. 0Q
8-10	

8.5 CRITICALITY MONITORING

10CFR72.124(c) requires criticality monitoring during operations unless the fuel is already packaged in the storage configuration. At the HI-STORE facility, no wet fuel operations are performed, and fuel will always be in the dry and sealed canisters, i.e. in the storage configuration. Hence criticality monitoring per 10CFR72.124(c) is not required.

HOLTEC INTERNATIONAL COPYRIGHTED MATERIAL	
Report No.: HI-2167374	Proposed Rev. 0Q
8-11	

CHAPTER 9: CONFINEMENT EVALUATION*

9.0 INTRODUCTION

The confinement safety of the HI-STORE CIS facility is considered in this chapter. In accordance with NUREG-1567 [1.0.3] the following areas are addressed

- Potential of the release of radioactive material
- Monitoring systems
- Protection of stored materials from degradation

The evaluation of any potential release considers both the storage systems and the operational activities.

Additionally, for the storage systems, aspects of receipt inspections for systems delivered to the site, and long-term aging are briefly addressed, with full details presented in other chapters of this SAR and referenced appropriately.

With respect to the storage systems themselves, only radioactive materials in seal-welded canisters are accepted and placed into storage in this facility. Further, this is limited to those canisters that are certified for storage in the HI-STORM UMAX docket (Docket #72-1040). **The HI-STORM UMAX FSAR references the HI-STORM FW docket (Docket # 72-1032).** Hence this chapter contains references to sections of the FSAR of the HI-STORM UMAX **and sections of FSAR of the HI-STORM FW.** The sections that are included by reference from the HI-STORM UMAX FSAR **and HI-STORM FW** are listed in Table 9.0.1.

* All references are in placed within square brackets in this report and are compiled in Chapter 19 (last chapter)

HOLTEC INTERNATIONAL COPYRIGHTED MATERIAL	
Report No.: HI-2167374	Proposed Rev. 0P
9-1	

Table 9.0.1: Material Incorporated by Reference in this Chapter

Information Incorporated by Reference	Source of the Information	NRC Approval of Material Incorporated by Reference	Location in this SAR where Material is Incorporated	Technical Justification of Applicability to HI-STORM UMAX
HI-STORM UMAX Confinement Evaluation	Chapter 7 of [1.0.6]	SER HI-STORM UMAX Amendments 0, 1, and 2 References [7.0.1, 7.0.2, 7.0.3]	Section 9.2.1	<p>Only canisters approved for use in HI-STORM UMAX under its certificate are permitted for storage in the HI-STORE facility. Further, the storage system used for storage of the canisters at the HI-STORE CIS is principally the same as that in the HI-STORM UMAX FSAR. Additionally, the conditions, namely the environmental temperatures, and canister heat loads, for the HI-STORE facility are bounded by the values that the canisters are qualified for in the HI-STORM UMAX FSAR. Hence the containment evaluation in the HI-STORM UMAX FSAR is fully applicable to the HI-STORM UMAX utilized for the HI-STORE facility.</p> <p>The details of the canisters approved for use in the HI-STORM UMAX, confinement design and requirements, for normal, off-normal and accident conditions are provided in the HI-STORM FW FSAR .</p>
HI-STORM FW Confinement Evaluation	Chapter 7 of [1.3.7]	SER HI-STORM FW Amendments 0, 1, and 2 References [8.0.1, 8.0.2, 8.0.3]	Section 9.2.1	

HOLTEC INTERNATIONAL COPYRIGHTED MATERIAL

Report No.: HI-2167374

Proposed Rev. 0P

9-2

9.1 ACCEPTANCE CRITERIA

The acceptance criteria for confinement evaluations are referenced in Section 4.3 of this SAR.

HOLTEC INTERNATIONAL COPYRIGHTED MATERIAL	
Report No.: HI-2167374	Proposed Rev. 0P
9-3	

9.2 CONFINEMENT OF RADIOACTIVE MATERIALS

9.2.1 Storage Systems

Continued Storage

Only canisters approved for use in HI-STORM UMAX under its certificate are permitted for storage in the HI-STORE facility. **Table 1.0.4 identifies the canisters approved for storage in this docket.** Further details on the canisters and the applicability of the containment evaluations from the HI-STORM UMAX FSAR to the HI-STORE facility are discussed below.

Confinement of all radioactive materials in all HI-STORM vertical ventilated modules is provided by the canister's Enclosure Vessel which has no mechanical joints, flanges, gaskets and the like that may be subject to leakage. The confinement boundary as defined in Paragraph 2.3.3.4 in the HI-STORM UMAX FSAR[1.0.6] consists of the MPC shell, MPC baseplate, MPC lid, port cover plates, closure ring, and associated welds. The pressure boundary of the canister consists of radiographed weld seams and ultrasonically tested plate and forging stock. Only high ductility stainless steel alloy with excellent fracture strength properties at low service temperatures are used in the manufacture of the canisters eligible for storage at HI-STORE.

All normal, off-normal and accident conditions relevant to confinement integrity for which the canister is certified in the HI-STORM UMAX docket are equal to or less severe at the HI-STORE facility. A summary of the design basis site-specific off-normal and accident conditions that could challenge the integrity of the canister confinement system is provided in Chapter 15 and incorporates by reference the evaluated off-normal and accident events considered in the HI-STORM UMAX FSAR. Chapter 15 concludes that as a result of the design basis off-normal or accident conditions that could challenge the integrity of the confinement system, there is no effect on the confinement function of the MPC, and all pressure boundary stresses remain within allowable ASME Code values. With respect to the applicability of the containment evaluation from the HI-STORM UMAX note that the continued confinement integrity of a canister is influenced by the stress field that exists in its Enclosure Vessel during its storage state and by the occurrence of any stress-inducing mechanical loading event. These are discussed below:

- The stresses that the canister will experience at the HI-STORE facility will be bounded by those for which it is certified in the HI-STORM UMAX docket because:
 - The Design Basis Heat load (see Tables 4.1.1 and 4.1.2) for all canisters eligible for storage in HI-STORE is lower than that for the canisters certified in Docket # 72-1040 (see Tables 2.1.8 and 2.1.9 in the HI-STORM UMAX FSAR[1.0.6]). It follows that the internal gas temperature in the former will be less than the latter.
- **Per Table 5.0.3 of this SAR, the certification basis for the structural qualification of the HI-STORE canisters is adopted from Section 3.4 of the HI-STORM FW FSAR [1.3.7]. Due to the higher heat load limits for the MPC-37 and MPC-89 associated with HI-STORM FW CoC (which exceed those for HI-STORE and HI-STORM UMAX), the MPC internal pressure and the metal temperatures evaluated in Section 3.4 of the HI-STORM FW FSAR are much greater than the values for the HI-STORE CIS facility notwithstanding the higher ambient temperature conditions. As in the HI-STORM UMAX FSAR, all lifting and handling operations involving canisters at the HI-STORE facility are performed with single**

HOLTEC INTERNATIONAL COPYRIGHTED MATERIAL	
Report No.: HI-2167374	Proposed Rev. 0P
9-4	

failure proof equipment. Hence there are no additional mechanical loading events that would affect the confinement function of the canisters.

In summary, the storage conditions at the HI-STORE site are identical to, or more benign (less challenging) than the certification-basis conditions for the canisters in the generic HI-STORM UMAX docket (# 72-1040). Therefore, the safety conclusions reached with respect to the system confinement integrity in the HI-STORM UMAX FSAR [1.0.6] also apply to the canisters stored at HI-STORE.

Confinement safety of the canisters in this docket is therefore demonstrated by reference to the confinement determination reached in the HI-STORM UMAX FSAR [1.0.6].

Receipt Inspection

The canister must meet the following criteria that pertain to its continued condition of no-credible-leakage upon arrival at the HI-STORE facility:

- The canister records must be provided to the HI-STORE facility personnel prior to shipment of a canister. These records must be reviewed and any applicable 10CFR72.48 screenings or evaluations written against the canister’s original licensing basis evaluated against the HI-STORE site specific license to determine if a change requiring NRC approval is necessary.
- The canister was not subject to any incident beyond the normal conditions which the package has been qualified to pursuant to 10CFR71.71.
- The canister passes the leak test and other receipt inspections set forth in Chapter 10 of this SAR at the HI-STORE receiving area.

A canister that meets the above conditions is deemed to continue to meet the no-credible-leakage criteria to which it has been certified in the HI-STORM UMAX docket (# 72-1040). Although the HI-STORM UMAX confinement boundary includes the MPC lid to shell weld, this weld is covered with a redundant closure ring. Therefore, the leak testing described is performed on that redundant closure ring and the confinement boundary lid to shell weld together. However, due to the restrictions on no transport incident and the fact that the storage conditions have been demonstrated to pose no challenge to the confinement boundary, confirmation that the combination of closure ring and lid to shell weld is intact provides reasonable assurance that the inner lid-to-shell weld remains a fully qualified confinement boundary.

Prior to shipment, the canister storage operation is bounded by the onsite storage system FSAR. During transportation to the HI-STORE, canister transportation operations are bounded by the HI STAR 190 SAR, Chapter 4 (Sections 4.5 – 4.7) [1.3.6]. Adherence to these criteria demonstrates confinement safety prior to receipt at the HI-STORE. Additionally, once the canister are on-site (prior to and during the receipt inspection) they are maintained in their transportation casks. As stated above, these transportation casks demonstrate that confinement of the canister is maintained while it is within the transportation cask. The transportation cask lid is not removed until after the receipt inspection is performed.

Long Term Storage and Aging Management

HOLTEC INTERNATIONAL COPYRIGHTED MATERIAL	
Report No.: HI-2167374	Proposed Rev. 0P
9-5	

While a canister is still within its originally licensed period in accordance with the certificate it was originally approved to, no further confinement considerations are necessary, since the canister retains its no-credible-leakage status based on the original confinement evaluation and the receipt inspection discussed above. However, it is expected that canisters will be stored at the HI-STORE CIS facility beyond this initial period. Any canister where the storage life exceeds 20 years will need to comply with the aging management requirements outlined in Chapter 18 of this SAR. Compliance with these requirements will ensure that any conditions that could be detrimental to the confinement function of the canister **will be** identified, and, if necessary, mitigated.

9.2.2 Operational Activities

With respect to the confinement of the radioactive material, the operational activities can be grouped into the following three steps/conditions

- MPC is still inside the intact containment boundary of the transportation cask that it **is** delivered in
- Receipt inspection activities on each canister, and, if the inspection criteria are met, opening of the transport cask containment boundary.
- Operational activities to place the accepted canister into storage

These steps are discussed in further detail below.

While the canister is still inside the transportation cask, the canister is still considered the confinement boundary for the material. However, the receipt inspections need to be passed to confirm that the confinement boundary has not degraded during the transport phase. Until this is concluded, the containment boundary of the transportation cask serves as **an** additional measure to assure confinement of the material in the canisters.

During the receipt inspection and opening of each transportation cask, the activities that are performed, and the possibility (or lack thereof) of any release of radioactive material is as follows:

- The transportation cask's **closure lid access port** is opened to allow access to the small free volume between the canister and the cask. For this activity, the port is covered by appropriate means, so that in the unlikely event that the volume would contain any radioactive material, **it** would not be released into the local work area (transfer building), but appropriately collected.
- A gas sample is taken from this volume and tested for the presence of fission products, namely Krypton-85.
 - If any fission products are detected, the port will be resealed, and the cask will be classified as “not acceptable”. All gas samples containing fission products will be collected and tracked in accordance with Section 10.3. **Cask transfer operations will be terminated for casks not meeting the acceptance criteria.** For further processing of casks that are not acceptable see Section 10.3.
 - Full details of the receipt inspection test including instrumentation and acceptance criteria are outlined in **Section 10.3.**

HOLTEC INTERNATIONAL COPYRIGHTED MATERIAL	
Report No.: HI-2167374	Proposed Rev. 0P
9-6	

- If the acceptance criteria outlined in **Section 10.3** are not met the transportation cask is not opened and is not accepted at the HI-STORE facility
- If no fission products are detected, the free volume is evacuated, flushed with nitrogen and then tested for traces of helium that could be an indication of any leakage of the helium-filled canister in the cask.
 - If the **leak** tightness of the canister cannot be ascertained the port will be resealed and the cask will be classified as “not acceptable”. For further processing of casks that are not acceptable see Subsection 10.3.3.

From this step, even in the unlikely event that fission products were detected, these would only be small amounts from the small free space between the cask and the canisters, and the process is designed to ensure that those are collected. A release into the building or the environment is therefore not considered credible.

As discussed in Subsection 9.2.1 above, all radioactive material is stored and handled in seal welded canisters, and as presented in Chapter 1, all handling operations are performed either with single-failure-proof cranes, or using suitable impact limiters. **Once the canisters have passed the receipt inspection, also discussed in Subsection 9.2.1, the design basis site-specific off-normal or accident conditions that could challenge the integrity of the canister confinement system are evaluated in Chapter 15, Accident Analysis. Chapter 15 concludes that as a result of the design basis off-normal or accident conditions that could challenge the integrity of the confinement system, there is no effect on the confinement function of the MPC, and all pressure boundary stresses remain within allowable ASME Code values.**

Overall, from all operational activities, no credible events are identified that would result in a release of any radioactive materials into the work areas or the environment.

HOLTEC INTERNATIONAL COPYRIGHTED MATERIAL	
Report No.: HI-2167374	Proposed Rev. 0P
9-7	

9.3 POOL AND WASTE MANAGEMENT FACILITIES

9.3.1 Pool Facilities

HI-STORE CIS contains no pool or any other water-based storage or handling facility.

9.3.2 Waste Management Facilities

No specific facilities are needed for the management of radioactive waste at the HI-STORE facility, since no, or only insignificant amounts of, radioactive waste is generated in the facility, as discussed in the following:

- All fuel is handled in seal-welded canisters with no credible leakage, and all activities and operations with the canisters are designed to maintain this condition
- The transportation casks received with the canisters at the site would almost certainly have been loaded with canisters in a dry facility, hence contamination of the casks is not expected.
 - Nevertheless, transport casks are checked for contamination upon receipt and during processing and extraction of the canisters, and in the unlikely event that any contamination would be detected, this would be removed with standard methods, and any materials related to this operation would be separately collected, and transported off-site for appropriate disposal.
- Small gas samples are taken during the receipt inspection of the canisters. The samples will be kept in closed containers until the measurements have confirmed the absence of any fission gases. In the unlikely event that fission gases would be detected, the gas samples will be transported off-site for appropriate disposal.
- There is no other radioactive material that is being handled openly throughout the facility.

HOLTEC INTERNATIONAL COPYRIGHTED MATERIAL	
Report No.: HI-2167374	Proposed Rev. 0P
9-8	

9.4 CONFINEMENT MONITORING

9.4.1 Storage Confinement Systems

9.4.1.1 Closure Seal Monitoring System

All radioactive material is stored in seal-welded canisters, and consistent with its operation and approval under the initial certificate that those canisters are loaded under, no monitoring of the closure seals is required for the initial licensing period. The continuous confinement of the canisters beyond their initial licensing period is addressed in the Aging Management Program in Chapter 18, which uses a Canister Aging Management Program to inspect and monitor, as described in Section 18.5.

9.4.1.2 Continuous Monitoring System

All material at the ISFSI is stored in seal welded canisters, qualified to have no credible leakage per ISG-18. Hence no monitoring of airborne radiation is needed in and around the storage area.

For the canister transfer inside the CTB, there is also no expectation that any release of radioactivity would occur, so no monitoring of airborne radiation is required. Nevertheless, radiation detectors able to detect airborne radiation may be used in the CTB as additional measure.

9.4.2 Effluents

The HI-STORE CIS facility does not generate any radioactive effluent hence no effluent monitoring system is required.

Additionally, in the absence of any effluent, there is no potential for transport of radioactive materials to the environment through any aquifer under the site.

HOLTEC INTERNATIONAL COPYRIGHTED MATERIAL	
Report No.: HI-2167374	Proposed Rev. 0P
9-9	

9.5 PROTECTION OF STORED MATERIALS FROM DEGRADATION

9.5.1 Confinement Casks or Systems

All radioactive material is stored in seal-welded canisters, in an inert atmosphere, and consistent with its operation and approval under the initial certificate that those canisters are loaded under, no degradation of its content is to be expected. Any potential degradation beyond the **previously approved canister licensed life** is addressed in the Aging Management Program in **Sections 18.5, 18.11, 18.13 and 18.15.**

9.5.2 Pool and Waste Management Systems

HI-STORE CIS contains no pool or any other water-based storage or handling facility.

HOLTEC INTERNATIONAL COPYRIGHTED MATERIAL	
Report No.: HI-2167374	Proposed Rev. 0P
9-10	

9.6 SUMMARY

In summary,

- This chapter describes confinement structures, systems and components, and their evaluation and effectiveness.
- The confinement of all radioactive material is provided by seal-welded canisters, loaded and closed under their original certificates. **The confinement is verified upon receipt inspection through leak testing to the leaktight criteria in accordance with Section 10.3.**
- The operation of the HI-STORE CIS facility generates no radioactive effluents. There is no potential for transport of radioactive materials to the environment through any aquifer.
- No release of any radioactive material is expected from the facility and its operation, hence no additional dose from released material is considered in the evaluations in Chapter 11.
- No radiation monitoring system is required.
- The stored material is protected against degradation due to its storage in an inert atmosphere.
- The confinement systems will reasonably maintain confinement under normal, off-normal and accident conditions.

HOLTEC INTERNATIONAL COPYRIGHTED MATERIAL	
Report No.: HI-2167374	Proposed Rev. 0P
9-11	

CHAPTER 10: CONDUCT OF OPERATIONS EVALUATION*

10.0 INTRODUCTION

This chapter discusses the organization and procedures established by Holtec International (Holtec) for the operation and decommissioning of an Independent Spent Fuel Storage Installation (ISFSI) at the HI-STORE CIS site. Included are descriptions of organizational structure, testing, training programs, normal operations, emergency planning, and security safeguards.

* All references are placed within square brackets in this report and are compiled in Chapter 19 of this report.

HOLTEC INTERNATIONAL COPYRIGHTED MATERIAL	
Report No. HI-2167374	Proposed Rev. 0R
10-1	

10.1 ORGANIZATIONAL STRUCTURE

This section describes the organization that is responsible for long term storage of spent nuclear fuel at the HI-STORE CIS facility. Lines of authority, responsibility, and communication shall be defined and established throughout highest management levels, intermediate levels, and all operating organization positions. These relationships shall be documented and updated, as appropriate, in organizational charts, functional descriptions of departmental responsibilities and relationships, and job descriptions for key personnel positions, or in equivalent forms of documentation. This chapter is included in this SAR to fulfill the requirements in 10CFR72.24(h) and 72.28(c).

10.1.1 Corporate and On-Site Organization

The Holtec Corporate Executive responsible for the HI-STORE CIS facility (hereafter referred to as the Corporate Executive) has overall responsibility for safe operation of the site.

The Holtec HI-STORE CIS Site Manager (hereafter referred to as the Site Manager) reports to the Corporate Executive. The Site Manager is responsible for safe operation of the site, maintaining personnel trained and qualified in accordance with the HI-STORE Site Specialist Training Program [10.1.1], day-to-day implementation of the Holtec Quality Assurance Manual [12.0.1], and operation of all HI-STORE CIS facility structures, systems and components that are important to safety. This position provides direction for the safe operation, maintenance, radiation protection, training and qualification, and security of the site and personnel.

To assure continuity of operation and organizational responsiveness to off-normal situations, a normal order of succession and delegation of authority will be established. The Site Manager will designate, in writing, personnel who are qualified to act in his/her absence.

The organization charts shown in Figures 10.4.1 and 10.4.2 represent the planned organizational relationships throughout the life of the facility.

10.1.2 Support Staff (ISFSI Specialists)

Support staff will be available by either corporate staff, on-site staff or contract personnel to provide support and expertise to the Site Manager in the following areas:

- **Quality Assurance:** Responsible for the implementation of the requirements of the Holtec Quality Assurance Manual [12.0.1], including the maintenance of appropriate records. The staff will ensure that the appropriate steps are added to site procedures for operation and maintenance to ensure that all activities are performed in accordance with the site license;
- **Engineering:** The site nuclear compliance engineer is responsible for the oversight of the facility modifications. Engineering support staff, either on or off-site, is provided to support the site nuclear engineer.
- **Radiation Protection Manager:** Responsible for radiation safety at the HI-STORE CIS facility, for the planning and direction of the facility radiation protection and ALARA programs and procedures, as well as the operation of the health physics laboratory.

HOLTEC INTERNATIONAL COPYRIGHTED MATERIAL	
Report No. HI-2167374	Proposed Rev. 0R
10-2	

- **Operating Personnel:** Responsible for the receipt, inspection and transfer of canisters arriving onsite in accordance with site procedures.
- **Maintenance:** Responsible for mechanical, electrical and instrument maintenance for buildings, fencing, mechanical equipment and all other site equipment. Also provide operations coverage for those periods of time in which loaded canisters are handled and routine site maintenance and surveillance when canisters are not being handled. May also provide maintenance as needed for operation of railroad locomotives from the railroad mainline. Shall be responsible for ensuring that appropriate records are maintained in accordance with Subsection 10.3.2 of this Chapter and the site licensing requirements.
- **Security:** Responsible to maintain the security of special nuclear materials that are within the physical confines of the site, including providing initial responses to security intrusions as described in the Site Security Plan [3.1.1].
- **Records:** Responsible for the maintenance of records in accordance with Subsection 10.3.2 of this Chapter and the site licensing requirements.
- **Site Administrative:** Responsible for site administrative functions, including the maintenance of records in accordance with Subsection 10.3.2 of this Chapter and the site licensing requirements, as well as site business records and contracts. Also responsible for ensuring appropriate hiring standards are followed in the selection of staff members.

The Site Manager, **Radiation Protection Manager** and Specialists are qualified as described in Table 10.1.1.

HOLTEC INTERNATIONAL COPYRIGHTED MATERIAL	
Report No. HI-2167374	Proposed Rev. 0R
10-3	

Table 10.1.1: Staffing Qualifications and Operation Organization	
Site Manager	<p>The Site Manager, at the time of appointment to the position, shall have a minimum of five years of nuclear power plant or comparable experience, with relevant experience in the management of nuclear facility operations. The ISFSI Manager will be trained and certified in accordance with the HI-STORE CISF Specialist Training Program [10.1.1], and shall meet or exceed the minimum qualifications of ANSI N18.1-1971 [10.1.2] for a comparable position.</p> <p>In addition to the above specified requirements, the Site Manager will also be required to be qualified as an Independent Safety Reviewer (ISR) as described below.</p>
Radiation Protection Manager	<p>The Radiation Protection Manager, at the time of appointment, shall have a minimum of ten years in radiation protection within the nuclear industry. A maximum of four years of this 10 years of experience may be fulfilled by related technical or academic training. The RP Manager shall have a Bachelor or higher degree in radiation protection or a related field. The Radiation Protection Manager will be trained and certified in accordance with the HI-STORE CISF Specialist Training Program [10.1.1], and shall meet or exceed the minimum qualifications of ANSI N18.1-1971 [10.1.2] for a comparable position.</p> <p>In addition to the above specified requirements, the Radiation Protection Manager will also be required to be qualified as an Independent Safety Reviewer (ISR) as described below.</p>
Specialists/Radiation Protection Technicians	<p>The ISFSI Specialists, at the time of appointment to the position, shall have a High School diploma or successfully completed the General Education Development (GED) test. Operation of equipment and controls that are identified as important to safety shall be limited to personnel who are trained and certified in accordance with the Certified ISFSI Specialist Training Program[10.1.1] or personnel who are under the direct visual supervision of a person who is trained and certified in accordance with the Certified ISFSI Specialist Training Program. Specialists will be trained and certified in accordance with the Holtec Certified ISFSI Specialist Training Program and the Holtec HI-STORE Site Security Plan training and qualification requirements, and shall meet or exceed the minimum qualifications of ANSI/ANS 3.1-2014 for a comparable position. At the time of completion of training and appointment to the position,</p>

HOLTEC INTERNATIONAL COPYRIGHTED MATERIAL	
Report No. HI-2167374	Proposed Rev. 0R
10-4	

	<p>the Certified ISFSI Specialist shall have a minimum of two years of nuclear facility experience. Radiation Protection Technicians will be trained and certified in accordance with the Holtec Radiation Protection Technician Training Program, which is based on the requirements of ANSI/ANS 3.1-2014, and the Holtec HI-STORE Site Security Plan training and qualification requirements.</p>
<p>Independent Safety Reviewers</p>	<p>The Independent Safety Reviewer (ISR) shall be an individual not having direct involvement in the performance of the activities under review, but who may be from the same functionally cognizant organization as the individuals performing the original work. The ISR shall have five years of professional level experience and either A Bachelor’s Degree in Engineering or the Physical Sciences or equivalent in accordance with ANSI/ANS-3.1-1981. The Holtec Corporate Executive shall designate the qualified ISRs in writing.</p>

<p>HOLTEC INTERNATIONAL COPYRIGHTED MATERIAL</p>	
<p>Report No. HI-2167374</p>	<p>Proposed Rev. 0R</p>
<p>10-5</p>	

10.2 PREOPERATIONAL TESTING AND STARTUP OPERATIONS

Prior to operation of the HI-STORE CIS facility, a preoperational test, a startup test, and other tests and inspections will be performed to verify that the storage system satisfied the design criteria described in this SAR. Tests and inspections will also be completed prior to initial loading of the ISFSI to ensure that the storage system handling equipment satisfied the design criteria stated in Chapter 4. The results of such tests and inspections will be maintained in accordance with regulatory recordkeeping requirements and will be available at the ISFSI site.

Several of the tests and inspections of equipment involved with loading the storage system will be performed (e.g., load testing the CTB crane). These tests and inspections are not pre-operational or startup tests of the storage system, but are discussed below due to their importance to the safe loading and operation of the storage system.

10.2.1 Administrative Procedures for Conducting the Test Program

The development, approval, and performance of pre-operational and startup test procedures will meet the requirements of the Holtec Quality Assurance Manual [12.0.1]. The procedures that govern testing will specify how the test results will be evaluated, documented, and approved. Test results must be shown to be within the acceptance criteria specified in test procedures.

The procedure that governs testing will specify the process for identifying needed system modifications that are recognized during testing. Also, the procedure will require evaluation of whether retesting is required after a needed modification has been implemented.

10.2.2 Preoperational Testing Plan

The test program is divided into two parts: preoperational testing and startup testing. Other tests and inspections which are not pre-operational or startup tests, are also briefly discussed in this section because of their importance to the proper operation and integrity of the storage system and handling equipment. The preoperational, startup, and other tests are described in this section and a summary is provided in Table 10.2.1.

The VVM storage system uses passive cooling, and therefore has no “operating” systems, other than the optional air outlet temperature monitoring system, to test prior to the loading of spent nuclear fuel (i.e., pre-operational testing). However, the other tests and inspections described below are performed to ensure the storage system will function in accordance with the design.

Startup testing is performed for each VVM after loading with a spent nuclear fuel canister. Startup testing confirms that the actual dose rates are less than the maximum expected dose rates determined in Chapter 11 of this SAR, such that estimated personnel exposures are bounded by the safety analyses.

In addition to the tests and inspections described in this section, all safety significant equipment will be inspected prior to use to ensure that these components are fabricated in accordance with the design drawings. Materials used specifically for shielding will be tested for shielding effectiveness. Steel properties will be verified by review of appropriate test reports. Structural and shielding adequacy of concrete will be determined by testing during construction.

HOLTEC INTERNATIONAL COPYRIGHTED MATERIAL	
Report No. HI-2167374	Proposed Rev. 0R
10-6	

10.2.2.1 Pre-Operational Testing of Equipment

The operations associated with the physical transfer of an MPC from receipt to installation in the VVM will be completed and verified using a full size, full weight dummy MPC. In addition to evaluating component function, pre-operational tests will also evaluate adequacy of procedural controls, communication, personnel safety and all other processes and controls that affect operations. Relevant operations include the following:

1. Receipt of the loaded HI-STAR 190 transport cask
2. Removal of the loaded HI-STAR 190 from the shipping railcar;
3. Canister integrity testing, including cavity gas sampling for Krypton-85, cavity evacuation, flushing and potential backfill, and MPC leakage testing while in the HI-STAR 190.
4. Preparation of the loaded HI-STAR 190 for unloading, including unpadding and placement in the CTF;
5. Removal of the HI-STAR 190 closure lid;
6. Installation of the CTF alignment plate;
7. Installation of rigging and lifting apparatus on the MPC;
8. Installation and alignment of the HI-TRAC transfer cask;
9. Loading of the dummy MPC into the HI-TRAC, and associated tasks for preparation for transfer to the VVM;
10. Transfer of the dummy MPC into the VVM;
11. Installation of the VVM closure lid and other associated components.

10.2.2.2 Startup Testing

A startup testing will consist of the measurement of external radiation dose rates for each VVM after it is loaded with spent nuclear fuel to confirm that the actual dose rates are less than the maximum expected dose rates defined in Chapter 11 of this SAR. This will confirm that the estimates of personnel exposures are bounded by the safety analysis.

10.2.2.3 Other Testing

Load tests: The following components are loaded test prior to pre-operational testing as part of fabrication acceptance requirements:

1. CTB crane
2. VCT lift brackets and structure
3. HI-STAR 190 lifting trunnions
4. Lift yoke for HI-STAR 190
5. Tilt frame

HOLTEC INTERNATIONAL COPYRIGHTED MATERIAL	
Report No. HI-2167374	Proposed Rev. 0R
10-7	

6. Transport cask horizontal lift beam
7. HI-TRAC lifting trunnions
8. HI-TRAC lower shield gates
9. Lift yoke for HI-TRAC
10. MPC lift attachment
11. MPC lifting device extension
12. HI-TRAC CS lift links

Functional testing of HI-TRAC: The efficient and dependable operation of the HI-TRAC cask is paramount to achieving ALARA operations while transferring the MPC from its transport cask to its VVM storage location. Before pre-operational testing, post-fabrication operational testing of the HI-TRAC shield gates will be performed to ensure the gates repeatedly function as designed, both prior to and after repeated application of a load representative of the worst-case MPC weight that will be transported by the HI-TRAC.

Sampling equipment validation: Equipment used for sampling gas from the HI-STAR 190 transport cask annulus will be calibrated by qualified personnel using a NIST-traceable validation source in accordance with NRC Regulatory Guide 1.21 [10.2.1]. Equipment will be functionally tested to both ensure repeatable operation and evaluate, and improve, the efficiency of the sampling operations.

Leak test equipment calibration: Equipment used for leak testing will be calibrated per the requirements of ANSI N14.5-2014 [10.3.3] before and after leak test measurements.

RTD monitoring system tests: Acceptance testing of the optional RTD monitoring system will be performed prior to pre-operational tests to ensure proper performance of the system. Prior to the installation of an MPC into each VVM, operational tests of each RTD monitoring component relevant to its VVM will be checked against an appropriate standard temperature source.

10.2.3 Evaluation of Tests

The tests will be deemed successful if the acceptance criteria provided in the test procedures are achieved safely and without damage to any of the components or associated equipment.

10.2.4 Corrective Actions

Modifications to equipment or components will be performed, should they become necessary, to ensure that the acceptance criteria are achieved. The modified equipment or components will be retested to confirm that the modification is sufficient. If required, pre-operational test procedure changes will be incorporated into the appropriate operating procedures.

HOLTEC INTERNATIONAL COPYRIGHTED MATERIAL	
Report No. HI-2167374	Proposed Rev. 0R
10-8	

Table 10.2.1		
Pre-Operational, Startup, and Other Tests		
Component	Type	Test Purpose / Objective(s)
Railcar transfer into CTB	Pre-Op	Operational clearances are confirmed and sequence/efficiency of operational steps is evaluated.
CTB crane test	Other	Receipt inspection and testing per requirements of ASME NOG-01[3.0.1]
Load test of HI-TRAC horizontal lift beam	Other	Load test in accordance with requirements of ANSI N14.6 [1.2.4]. Verify fitup and clearance of all associated lift equipment.
Transfer of HI-STAR 190 from railcar to tilting frame	Pre-Op	Check clearances and interferences of components. Evaluate sequence/efficiency of operational steps. Confirm alignment of tilting frame
Removal of HI-STAR 190 impact limiters	Pre-Op	Evaluate efficiency of rigging operations. Check clearances and interferences
HI-STAR 190 cask cavity sampling	Pre-Op	Evaluate functionality of equipment. Optimize sampling process. Verify calibration of equipment.
HI-STAR 190 cask cavity evacuation and backfill	Pre-Op	Optimize procedure. Evaluate time and steps required for backfill.
MPC leak test in HI-STAR 190 cavity	Pre-Op	Evaluate functionality of equipment. Optimize sampling process. Verify calibration of equipment.
CTF preparations	Pre-Op	Check fitup of alignment fixture on CTF
Load test of HI-STAR 190 lift yoke	Other	Load test in accordance with requirements of ANSI 14.6 [1.2.4]. Verify fitup and clearance of all associated lift equipment.
Transfer of HI-STAR 190 to CTF	Pre-Op	Check clearances and operational steps. Evaluate efficiency of rigging operations
HI-STAR 190 closure lid removal in CTF	Pre-Op	Evaluate ergonomics of rigging/removal.

HOLTEC INTERNATIONAL COPYRIGHTED MATERIAL	
Report No. HI-2167374	Proposed Rev. 0R
10-9	

Table 10.2.1		
Pre-Operational, Startup, and Other Tests		
Component	Type	Test Purpose / Objective(s)
Load test of MPC lift attachment	Other	Load test to demonstrate ability to safely lift a fully loaded MPC in accordance with requirements of ANSI 14.6 [1.2.4]. Verify fitup and clearance of all associated lift equipment.
Installation of MPC lift attachment	Pre-Op	Check fit up with MPC lid and CTF.
Acceptance test of HI-TRAC shield gates	Other	Demonstrate proper operation of gates after supporting the weight equivalent to 150% of design load.
Installation of CTF Adapter Plate	Pre-Op	Check fit up with transport cask and CTF.
Installation of HI-TRAC on CTF	Pre-Op	Check fit up with transport cask and CTF adapter plate.
Transfer Cask lifting trunnions	Other	300% load test to demonstrate ability to safely lift a loaded Transfer Cask.
Load test of HI-TRAC CS Lift Yoke	Other	Check fit up with Transfer Cask and crane. 150% load test to demonstrate ability to safely lift a loaded Transfer Cask.
Transfer of MPC into HI-TRAC	Pre-Op	Check for interferences. Evaluate operation and seating of MPC on HI-TRAC shield gates.
Transfer of HI-TRAC (with MPC) to ISFSI site	Pre-Op	Evaluate ability to maneuver haul path, review operational steps for efficiency,
Mating of HI-TRAC with HI-STORM UMAX VVM	Pre-Op	Check fit up and alignment. Evaluated procedure for installation of tie-down studs.
Transfer of MPC into HI-STORM UMAX VVM	Pre-Op	Check for interferences. Evaluate operation of VCT and HI-TRAC.
VVM air outlet temperature monitoring system components	Pre-op	Demonstrate proper operation of the temperature monitoring system components prior to placing a loaded MPC into the VVM
Installation of CEC closure lid	Other	Check fit up and lifting/handling operations.

HOLTEC INTERNATIONAL COPYRIGHTED MATERIAL	
Report No. HI-2167374	Proposed Rev. 0R
10-10	

10.3 NORMAL OPERATION

This section describes the administrative controls and conduct of operations associated with activities considered important to safety. Also described in this section is the management system for maintaining records related to the operation of the ISFSI.

10.3.1 Procedures

Activities affecting quality are accomplished in accordance with approved and documented instructions, procedures, or drawings. Written procedures will be used for site operations, maintenance, and testing activities that are quality-related as defined in the Holtec Quality Assurance Manual [12.0.1]. Procedures will be used to implement the Fire Protection Program and training and certification of personnel. The review and approval process for procedures, and changes thereto, will be procedurally controlled. The Site Manager or his designee will approve procedures and changes prior to implementation. Temporary changes to procedures are allowed if the intent of the existing procedure is not altered and the change is approved by the Site Manager or his/her designee.

Site procedures will require that any changes to facilities, equipment or procedures will be reviewed for safety impact to ensure that the proposed change does not require prior NRC approval pursuant to 10CFR72.48.

10.3.2 Records

Administrative procedures will be established and maintained to ensure quality assurance records are identifiable and retrievable. In addition to quality assurance records, the following records will also be maintained in accordance with 10CFR72.174:

1. Operating records, including maintenance and modifications.
2. Records of off-normal occurrences.
3. Events associated with radioactive releases.
4. Environmental survey records.
5. Personnel Training and Qualification Records.
6. Records of ISFSI design changes made pursuant to 10CFR72.48.
7. Records showing the receipt, inventory (including location), disposal, acquisition, and transfer of spent fuel and related nuclear material as required by 10CFR72.72(a).
8. Records of material control and inventory procedures to account for material in storage as required by 10CFR72.72.
9. Records detailing the provisions of the radiation protection program and any audits of its content or implementation.
10. Records detailing results of radiation surveys and occupational dose monitoring on site.

HOLTEC INTERNATIONAL COPYRIGHTED MATERIAL	
Report No. HI-2167374	Proposed Rev. 0R
10-11	

11. Records that demonstrate compliance with the dose limits outlined in 10CFR20.1301 for individual members of the public.

12. Copies of the updated SAR or FSAR.

Records of site procedure changes, and tests and experiments, conducted pursuant to 10CFR72.48 will be maintained in accordance with 10CFR72.48. Storage of the above records will be in accordance with the requirements of the Holtec Quality Assurance Manual [12.0.1].

Security records, including security training and qualification records, will be maintained in accordance with the HI-STORE Site Security Plan [3.1.1].

10.3.3 Conduct of Operations

The information presented in this section will be used to develop detailed operating procedures for the receipt of MPC transport casks and the safe transfer of the MPCs to their storage location at the HI-STORE site. In preparing the procedures, the user must consult the conditions of the Technical Specifications, equipment-specific operating instructions, and the HI-STORE site’s working procedures as well as the information in this chapter to ensure that the short-term operations shall be carried out with utmost safety and ALARA.

The following generic criteria shall be used to determine whether the HI-STORE site operating procedures developed pursuant to the guidance in this chapter are acceptable for use:

- All heavy load handling instructions are in keeping with the guidance in industry standards and Holtec-provided instructions.
- The procedures are in conformance with this SAR and its Technical Specifications.
- The procedures are in conformance with the HI-STORM UMAX FSAR [1.0.6] and HI-STORM FW System FSAR [1.3.7] where applicable.
- The operational steps are ALARA.
- The procedures contain provisions for documenting successful execution of all safety significant steps for archival reference.
- Procedures contain provisions for classroom and hands-on training and for a Holtec-approved personnel qualification process to ensure that all operations personnel are adequately trained.
- The procedures are sufficiently detailed and articulated to enable craft labor to execute them in literal compliance with their content.

Independent safety reviews will be performed and documented by qualified Independent Safety Reviewers (ISR) prior to the performance of any operations. The independent safety reviews shall confirm that changes to the facility, changes to operating procedures, and the performance of tests and experiments not described in the Safety Analysis Report are safe and do not require prior NRC approval pursuant to 10CFR72.48.

HOLTEC INTERNATIONAL COPYRIGHTED MATERIAL	
Report No. HI-2167374	Proposed Rev. 0R
10-12	

10.3.3.1 Receipt and Inspection of Transportation Cask and Canister

Prior to shipment of the loaded transport cask to the site, records shall be reviewed to confirm the following:

- a) The incoming spent fuel canister shall meet the requirements of Section 2.1 of the site Technical Specifications for its approved contents, fuel specifications and loading conditions. Upon delivery of the canister at the facility, and prior to performing receipt and inspection activities, site personnel shall verify that accompanying paperwork matches the paperwork provided for initial approval of the shipment.
- b) Inspection of quality records from originating site including operating, maintenance, inspection and aging management records.
- c) Adoption of the HI-STAR 190 SAR Table 8.A.1 [1.3.6] inspection checklist as a mandatory requirement for all MPCs including those not containing high-burnup fuel.

The following operational steps are used to receive and inspect the transportation cask in the HI-STORE CTB. The steps also include

Caution Note:

If the HI-STAR 190 needs to be set down at any point during the following steps it must be further than 1 inch from the edge of any slab to avoid any contact due to sliding.

1. The HI-STAR 190 packaging is visually receipt inspected to verify that there are no outward visual indications of impaired physical conditions except for superficial marks and dents. Any issues are identified to site management.
2. The HI-STAR 190 transportation package is moved into the CTB building security trap, where it is inspected by HI-STORE site security personnel to ensure no unauthorized devices enter the CTB building.
3. The HI-STAR 190 transportation package is moved into the CTB.
4. The personnel barrier, if used, is removed and the security seal installed on the top impact limiter is inspected to verify there was no tampering and that it matches the corresponding shipping documents.
5. The HI-STAR 190 tie-downs are removed. The radial shims are removed from the top and bottom of the cask.
6. Radiological surveys are performed in accordance with 10CFR20.1906 [7.4.1], with removable surface contamination acceptance criteria per 49CFR173.443 [10.3.1]. External radiation levels must meet the limits of Section 71.47 of 10CFR Part 71[1.3.2] and be in reasonable accord with the measured dose rates at the originating plant. Any issues are identified to site management. If necessary, the overpack is decontaminated as directed by site radiation protection. Appropriate notifications are made as detailed in the surveillance requirements, in accordance with the requirements of 10CFR20.1906 [7.4.1].

HOLTEC INTERNATIONAL COPYRIGHTED MATERIAL	
Report No. HI-2167374	Proposed Rev. 0R
10-13	

Note:

Any transport cask that does not meet the radiation dose rates specified in the applicable transportation regulations will not be accepted at the HI-STORE CISF and will be returned to the nuclear plant of origin or other facility licensed to perform fuel loading procedures. Radiological controls will be established to reduce the dose rates to permissible site limits, the NRC Operations Center shall be notified, and a root cause investigation initiated in accordance with the site QA program to identify the cause of the problem and to develop contingency actions.

7. Any road dirt is washed off and any foreign material is removed.
8. The HI-STAR 190 is rigged and transferred to the tilt frame using the CTB building crane.

ALARA Warning:

Dose rates around the bottom end of the HI-STAR 190 cask may be higher than other locations around the cask. After the impact limiter is removed, the cask should be upended promptly. Personnel should remain clear of the bottom of the unshielded cask and exercise other appropriate ALARA controls.

9. The HI-STAR 190 impact limiters are rigged and removed using the CTB crane and a second visual inspection to verify that there are no outward visual indications of impaired physical condition is performed.
10. The neutron shield relief devices are inspected to confirm that they are installed, intact, and not covered by tape or any other covering.
11. As a safety precaution, the HI-STAR 190 closure lid access port cover is removed and sampling equipment is attached to test for the presence of Krypton-85. The sampling equipment consists of a cover flange that allows remote opening of the closure lid port plug to ensure there is no release of radioactive material. The cover flange and gas sample canister is evacuated prior to opening the port plug to ensure the sample accurately reflects the cask cavity contents. The cask cavity gas sample is handled in accordance with Radiation Protection directions by qualified personnel. Testing is performed per pre-approved procedure, using appropriately calibrated equipment that has been qualified for testing at expected concentration limits, to confirm that the sample meets the acceptance criteria of Table 10.3.3. In the unlikely event that the Krypton-85 concentration exceeds the acceptance criteria, the canister transfer operations are terminated and site management is informed for disposition. The cask is returned to a safe condition for transport in accordance with its applicable Part 71 requirements. This includes measurement of helium backfill gas pressure and addition of helium gas of the requisite purity, as necessary, to ensure the backfill gas pressure is within the required limits for transport. The cask access port cover and impact limiters shall be re-installed, the cask shall be rigged and transferred back to the railcar, restored to its shipping configuration (tie-downs, radial shims and

HOLTEC INTERNATIONAL COPYRIGHTED MATERIAL	
Report No. HI-2167374	Proposed Rev. 0R
10-14	

personnel barrier installed) and moved to a designated staging area prior to off-site transport. Operations to receive the cask are terminated, a root cause investigation shall be initiated, and the cask shall be prepared for return to the nuclear plant of origin or other facility licensed to perform fuel loading procedures.

Operational Limit:

Prior to performing evacuation, flushing, and leak testing of the MPC within the HI-STAR 190 cask, an evaluation based on the specific transportation cask conditions, canister conditions (including heat load), and leak test conditions shall be performed using a methodology previously approved by the NRC to establish a canister-specific time limit for all operations performed without helium in the cask annulus. A previously performed bounding evaluation may also be utilized. Process steps shall be stopped before reaching the thermal time limit, and the helium backfill shall be re-established per the requirements of Table 10.3.4 before continuing.

12. The sampling equipment is isolated, and the HI-STAR 190 annulus space is evacuated and flushed with nitrogen using the sampling equipment connector. This process may be repeated several times, as determined by process experience and required by the approved test procedure, to ensure residual helium is flushed from the annulus space. Refer to Table 10.3.4 for process pressure limits.
13. The mass spectrometer leak test apparatus is attached to the sampling equipment connector and a leak test of the MPC is performed. Leakage rate testing is performed per procedures written and approved in accordance with the requirements of ANSI N14.5-2014 [10.3.3]. All testing is performed by personnel qualified in accordance with the Holtec QA program and certified in accordance with Recommended Practice No. SNT-TC-1A [10.3.2]. The written and approved test procedures shall clearly define the test equipment arrangement. Leakage rate testing procedures shall be approved by personnel certified by the ASNT as a Level III examiner for leakage testing. The applicable recommended guidelines of Recommended Practice No. SNT-TC-1A [10.3.2] shall be considered as minimum requirements. Canister leakage test specifications are listed in Table 10.3.2. If a canister leak is detected, the canister transfer operations are terminated and site management is informed for disposition. The cask is returned to a safe condition for transport in accordance with its applicable Part 71 requirements. This includes the addition of helium

HOLTEC INTERNATIONAL COPYRIGHTED MATERIAL	
Report No. HI-2167374	Proposed Rev. 0R
10-15	

gas of the requisite purity, as necessary, to ensure the backfill gas pressure is within the required limits for transport. The cask access port cover and impact limiters shall be re-installed, the cask shall be rigged and transferred back to the railcar, restored to its shipping configuration (tie-downs, radial shims and personnel barrier installed) and moved to a designated staging area prior to off-site transport. Operations to receive the cask are terminated, a root cause investigation shall be initiated, and the cask shall be prepared for return to the nuclear plant of origin or other facility licensed to perform fuel loading procedures.

14. The CTF is inspected and prepared for receipt of the HI-STAR 190 transportation cask.
15. The HI-STAR 190 is upended, removed from the tilting frame and transferred to the CTF using a lift yoke attached to the cask trunnions and the CTB crane.

10.3.3.2 Transfer of Canister from Transportation Cask to HI-TRAC

1. Using the CTB crane, the HI-TRAC alignment plate is installed on the CTF over the HI-TRAC cask.
2. The HI-STAR 190 closure lid bolts are removed and the closure lid is removed using the CTB crane.

ALARA Warning:
Personnel should remain clear of the open end of the unshielded cask and exercise other appropriate ALARA controls. Dose rates around open end of the HI-STAR 190 cask may be higher than other locations around the cask. Temporary shielding may be installed to reduce worker dose ALARA.

3. A contamination survey is taken on the accessible areas of the canister lid to verify that the canister is free of removable contamination, per the limits of LCO 3.2.1. If required, decontamination to be performed in accordance with LCO 3.2.1.
4. A cask seal surface protector is installed on the closure lid sealing surface to protect it from damage.
5. The MPC lifting attachment is connected to the threaded holes on the MPC closure lid. The lifting attachment bolts are tightened hand-tight.
6. Using the CTB crane, the HI-TRAC is placed on the HI-TRAC alignment plate with the shield gates open. The CTF studs are secured to the HI-TRAC and the nuts are tightened wrench-tight.
7. The MPC lifting extension is attached to the CTB crane, lowered through the HI-TRAC body, and engaged with the MPC lift attachment.
8. Using the CTB crane, the MPC is lifted into the HI-TRAC.
9. The HI-TRAC shield gates are closed, and the MPC is lowered to rest on the gates.

HOLTEC INTERNATIONAL COPYRIGHTED MATERIAL	
Report No. HI-2167374	Proposed Rev. 0R
10-16	

10. The MPC lifting extension is disconnected and removed using the CTB crane.
11. The HI-TRAC lift yoke is connected to CTB crane and the HI-TRAC lift trunnions.
12. The CTF stud nuts are removed.
13. The HI-TRAC is lifted using the CTB crane and secured to the HI-PORT.
14. The HI-TRAC lift yoke is disengaged and removed.

10.3.3.4 Preparation of VVM for Receipt of MPC

1. Prior to receipt of the MPC, install or confirm installation of the appropriate divider shell in the appropriate VVM for the planned MPC. Installation and verification shall be procedurally controlled and reviewed to ensure correct VVM component designs are specified so that licensing requirements are met.
2. If not already removed, remove the closure lid using a crane or other equivalent lifting device.
3. Install the HI-TRAC restraint studs in the VVM threaded anchors.

Operations Note:

In addition to securing the HI-TRAC to the VVM, the restraint studs also provide alignment while positioning the HI-TRAC on the VVM.

10.3.3.5 Placement of Canisters in the CEC

CAUTION NOTE

Before transporting the HI-PORT with a loaded HI-TRAC out of the CTB, site personnel will check the weather. If a tornado watch or warning, high wind watch or warning, extreme wind warning, or flood watch or warning is predicted for the site area within the expected time to complete steps 1 through 16 below, the process shall not be started. If any of the above occur while in the middle of the below steps, the loaded HI-TRAC will be returned to the building or placed in the VVM and lid installed, whichever can be done in the shortest amount of time.

Caution Note:

If the HI-TRAC needs to be set down at any point during the following steps it must be further than 1 inch from the edge of any slab to avoid any contact due to sliding. Additionally, the loaded HI-TRAC must be carried at a height of 1 foot or less.

1. The HI-PORT transports the HI-TRAC along a designated haul path to an area near the VVM to be loaded, for transfer to the VCT.
2. The VCT is positioned over the HI-TRAC on the HI-PORT, and is connected to the HI-

HOLTEC INTERNATIONAL COPYRIGHTED MATERIAL	
Report No. HI-2167374	Proposed Rev. 0R
10-17	

TRAC lifting trunnions using the HI-TRAC CS lift links.

3. The HI-TRAC tie-downs on the HI-PORT are disengaged and HI-TRAC is lifted from the HI-PORT.
4. The VCT seismic restraints are engaged to secure the HI-TRAC to the VCT.

Operations Note:

If required for transport of the loaded HI-TRAC to the designated VVM, the outlet air vent extensions for previously loaded or unloaded VVMs may be temporarily removed (if installed) to minimize the required lift height for the HI-TRAC. **When any vent extension is removed the resultant opening will be covered by a low-profile Temporary Cover Screen assembly that prevents debris from entering the outlet without blocking airflow.** For previously loaded VVMs, the outlet air vent extensions shall be expeditiously re-installed to restore the VVMs to its normal condition of storage. **During transport with the VCT, the HI-TRAC shall be lowered to within several inches of the ground to minimize radiation dose to workers ALARA.**

5. Using the VCT, transport the loaded HI-TRAC to the ISFSI and place the loaded HI-TRAC on the VVM, using the HI-TRAC restraint studs (previously installed) to ensure proper alignment.
6. Disconnect the HI-TRAC CS lift links from the HI-TRAC and rig the MPC lifting attachment to the VCT using the MPC lifting extension.
7. Raise the MPC slightly to remove the weight of the MPC from the HI-TRAC Shield Gate.

ALARA Warning:

Temporary shielding may be used to reduce personnel dose during MPC transfer operations. If used, temporary shielding must not restrict air flow into CEC inlet vent openings. If ALARA considerations dictate that temporary shielding not be used, personnel must remain clear of the immediate area around the HI-TRAC Shield Gates during MPC downloading.

8. Open the HI-TRAC Shield Gate. At the user's discretion, install temporary shielding to cover the potential streaming paths around the HI-TRAC Shield Gates.
9. Lower the MPC into the VVM.
10. Verify that the MPC is fully seated in the VVM.

HOLTEC INTERNATIONAL COPYRIGHTED MATERIAL	
Report No. HI-2167374	Proposed Rev. 0R
10-18	

Caution:

Operations steps that occur with the MPC in the VVM with the HI-TRAC Shield Gate closed must be performed in an expeditious manner to avoid excessive heating of the MPC and fuel. The HI-TRAC must be removed or the shield gate opened to establish air cooling within the time limits described in Paragraph 6.4.3.8. In the event of equipment malfunction that results in the blockage of air flow, corrective actions must occur within the time limits of the burial accident condition.

11. Disconnect the MPC lifting attachment from the MPC and remove using the lifting extension and the VCT.
12. Remove any temporary shielding and close the HI-TRAC Shield Gates.

ALARA Warning:

Personnel should remain clear (to the maximum extent practicable) of the VVM annulus when HI-TRAC is being removed to comply with ALARA requirements.

13. Remove the HI-TRAC transfer cask from the top of the VVM.
14. Install plugs in the empty MPC bolt holes.

Guidance:

The VVM closure lid shall be preferably kept less than 2 feet above the top surface of the VVM while over the MPC. This lift limit action is purely a defense-in-depth measure because the Closure Lid cannot fall and impact the MPC because of geometric constraints.

15. Install the VVM closure lid. Check that the rigging (in its specific configuration) is rated to lift the load (rated to lift two times the load per NUREG 0612).
16. Remove the VVM closure lid rigging equipment and re-install the outlet vent cover (if previously removed).
17. Install the VVM temperature monitoring elements (if used).
18. Ensure records showing the receipt, inventory (including location), disposal, acquisition, and transfer of the canister, as required by 10CFR72.72(a), are complete.

10.3.3.6 Removal of Canisters from the CEC

If necessary, canisters are recovered from the HI-STORM UMAX VVM and returned to the transport cask in accordance with the steps described in this Section, except that the order is basically reversed.

HOLTEC INTERNATIONAL COPYRIGHTED MATERIAL	
Report No. HI-2167374	Proposed Rev. 0R
10-19	

10.3.4 Maintenance Program for the HI-STORM UMAX VVM Systems

An ongoing maintenance program shall be defined and incorporated into the HI-STORM UMAX system Operations and Maintenance Manual for the HI-STORE CIS facility. This document shall delineate the detailed inspections, testing, and parts replacement necessary to ensure continued structural, thermal performance, and radiological safety in accordance with 10CFR72 regulations, the conditions in the Technical Specifications, and the design requirements and criteria contained in this SAR.

The HI-STORM UMAX system is totally passive by design and requires minimal preventive maintenance to ensure that it will render its intended design functions satisfactorily. Periodic surveillance (via temperature monitoring or visual or camera-aided inspection of air passages) is required to ensure that the air passage in the VVM is not blocked. Preventive or remedial painting of the exposed steel surfaces as part of the user's preventive maintenance program is recommended to mitigate corrosion.

In-service inspection shall be performed by visual inspection of accessible areas of the HI-STORM UMAX VVM. **Additional in-service inspection activities will be performed to visually inspect for interior and below-grade degradation.** The frequency and scope of these visual in-service inspections are described in Table 10.3.1. **Acceptance criteria for visual inspections shall be based on confirmation that the components continue to meet the licensing basis design requirements.**

Among the QA commitments are performance of maintenance by trained personnel by written procedures and written documentation of the maintenance work performed and of the results obtained. Table 10.3.1 provides a listing of the minimum maintenance activities on the HI-STORM UMAX VVM.

In summary, the HI-STORM UMAX System is totally passive by design: There are no active components or monitoring systems required to assure the performance of its safety functions. As a result, only minimal maintenance will be required over its lifetime, and this maintenance would primarily result from the effects of weather. Typical of such maintenance would be the reapplication of corrosion inhibiting materials on accessible external surfaces. Visual inspection of the vent screens is required to ensure the air flow passages are free from obstruction

Maintenance activities shall be performed under Holtec's NRC-approved quality assurance program. Maintenance activities shall be administratively controlled and the results documented.

10.3.4.1 Structural Capacity Verification

Prior to each MPC loading, a visual examination in accordance with a written procedure shall be required of the Closure Lid lift lugs and the HI-TRAC trunnions, bottom lid bolts, and bolt holes. The examination shall inspect for indications of overstress such as cracks, deformation, wear marks, corrosion, etc. Repairs in accordance with written and approved procedures shall be required if an unacceptable condition is identified.

10.3.4.2 Shielding Capacity

HOLTEC INTERNATIONAL COPYRIGHTED MATERIAL	
Report No. HI-2167374	Proposed Rev. 0R
10-20	

The gamma and neutron shielding materials in HI-TRAC CS are not subject to measurable degradation over time or as a result of usage. The radiation shielding capacity of the HI-STORM UMAX System is expected to remain undiminished over time. Therefore, unless the VVM is subjected to an extreme environmental event that imparts stresses or temperatures beyond-the-design-basis limits for the system (i.e., prolonged fire or impact from a beyond-the-design basis large energetic projectile) with the plausible potential to degrade the shielding effectiveness of the VVM, no shielding effectiveness tests beyond that required by the HI-STORE's Radiation Protection Program are required over the life of the AFR facility.

Radiation monitoring of the ISFSI in accordance with 10CFR72.104(c) will provide ongoing evidence and confirmation of shielding integrity and performance. If increased radiation doses are indicated by the facility monitoring program, additional surveys of the ISFSI shall be performed to determine the cause of the increased dose rates.

10.3.4.3 Thermal Capacity

In order to assure that the HI-STORM UMAX System continues to provide effective thermal performance during storage operations, surveillance of the air vents (or alternatively, by temperature monitoring) shall be performed in accordance with written procedures.

10.3.5 Maintenance Program for the Canister

The canister is an all-welded stainless steel pressure vessel that does not require an in-service maintenance unless a disruptive occurrence such as deposition of flood-borne foreign materials on the canister's surface occurs. The Aging Management Program described in Chapter 18, however, will require monitoring and inspection activities, and possibly remedial actions, if so determined.

10.3.6 Maintenance Programs for ITS Lifting and Handling Equipment, Including VCT

Maintenance, inspection and testing of lifting equipment designed to ANSI 14.6 [1.2.4] shall per the requirements of ANSI 14.6. Equipment designed the requirements of ASME Section III, Subsection NF [4.5.1] shall be functionally tested prior to initial use and visually inspected for any degradation or damage prior to each cask transfer.

10.3.7 Maintenance Programs for ITS Crane Systems

Maintenance, inspection and testing of crane systems designed to ASME NOG-1 [3.0.1] shall be per the requirements of ASME B30.2 [4.5.11] and manufacturer's recommendations.

10.3.8 Maintenance Program for HI-STAR 190 Cask

The maintenance program for the HI-STAR 190 Cask shall be as specified in the HI-STAR 190 SAR [1.3.6].

HOLTEC INTERNATIONAL COPYRIGHTED MATERIAL	
Report No. HI-2167374	Proposed Rev. 0R
10-21	

Table 10.3.1			
Maintenance and Inspection Activities for the HI-STORM UMAX VVM Systems			
	Activity	Frequency	Purpose
1.	Visual Inspection of CEC Cavity	Prior to MPC installation	To ensure that VVM internal components are properly aligned, the surface preservatives on all exposed surfaces are undamaged (including Divider Shell), the insulation on the Divider Shell is undamaged and the cavity is free of visible foreign material.
2.	Closure Lid Examination	Prior to MPC installation	Ensure that the preservatives on the external surfaces are in good condition and the lid is free of dents and rust stains.
3.	VVM Inlet/Outlet Vent Screen Inspection	Prior to installation of the flanged screen assembly and monthly when in use	Ensure that the screen is present and undamaged.
4.	ISFSI pad	Annually	Ensure that the ISFSI Pad (raised areas near the VVM) is free of visible cracks or repaired as appropriate, the interface between the ISFSI Pad and the CEC Flange is grouted (or caulked) if necessary, the ISFSI drain system is functional, the ground water collection and removal system (if used) is in working order. Ensure that the subgrade settlement is minimal and unsightly surface cracks in the ISFSI pad have not developed. Implement counter measures to prevent the opening of surface cracks and excessive pad settlement, if observed.
5.	Shielding Effectiveness Test	As required by the Radiation Protection Program described in Chapter 11	Ensure ALARA conditions are maintained per Technical Specifications

HOLTEC INTERNATIONAL COPYRIGHTED MATERIAL	
Report No. HI-2167374	Proposed Rev. 0R
10-22	

Table 10.3.1 (continued)			
Maintenance Activities for the HI-STORM UMAX VVM Systems			
	Activity	Frequency	Purpose
6.	ISFSI Settlement	Every five years	Confirm that the VVM settlement is within the range of its design basis.
7.	VVM Air Temperature Monitoring System	Continuous monitoring with alarms	Ensure design basis cooling of canister is maintained.
8.	VVM In-Service Inspection	Annually	Ensure that the vent screen assembly fasteners or weldments remain coated with preservative, the screen is present and undamaged, all visible external surfaces are free from significant corrosion and identification markings remain legible.
9.	VVM plenum inspection for accumulation of foreign materials	Annually or following a severe weather event that may introduce significant foreign materials material.	Visually verify inlet/outlet plenums are free of significant foreign material and air passages are not degraded.
10.	Additional VVM In-Service Inspection for Long-Term Interior and Below-grade Degradation	Every five years.	Visual inspection of accessible exterior and interior surfaces of the VVM to determine the general condition of the system and assess long-term degradation. Condition of surface coatings, divider shell insulation and internal passages shall be evaluated and corrected as needed. Inspection and removal of accumulated foreign material, if any, shall be performed if required. CEC interior surfaces shall be inspected for corrosion and visible wall thinning. VVM may be inspected using remote devices such as a borescope.

HOLTEC INTERNATIONAL COPYRIGHTED MATERIAL	
Report No. HI-2167374	Proposed Rev. 0R
10-23	

11.	Visual Inspection of HI-TRAC CS	Prior to each handling campaign	Verify surface coatings of interior and exterior surfaces of the cask (including internal hole surfaces, etc.) and all shield gate components are intact. Verify shield gate operation mechanism appears undamaged and functional. Inspect tie-down stud threads for damage or wear. Lifting trunnions shall be inspected for indications of overstress such as cracking, deformation or wear marks.
12.	Visual Inspection of CTF	Prior to each handling campaign	Verify flow passages are free of significant foreign material. Verify surface coatings of accessible surfaces of CTF are intact
13.	Testing and Inspection of HI-TRAC CS Upper Trunnions	Per requirements of ANSI 14.6 [1.2.4].	Verify continuing compliance with ANSI 14.6 [1.2.4]. Identify cracks and/or permanent deformation indicating a need for trunnion replacement.
14.	Testing and Inspection of Special Lifting Devices	Per requirements of ANSI 14.6 [1.2.4].	Verify continuing compliance with ANSI 14.6 [1.2.4]
15.	CTB Crane Maintenance	Annually	Maintenance per requirements of ASME B30.2 [4.5.11] and manufacturer's recommendations
16.	CTF Floor Slab Inspection	Annually	Visual inspection of all accessible surfaces for cracking, loss of material, permeability and integrity.
17.	Transport Cask Tilt Frame Inspection	Annually	Visual inspection of all accessible surfaces for corrosion and integrity, including evaluation of dents, scratches, gouges or other damage.

HOLTEC INTERNATIONAL COPYRIGHTED MATERIAL	
Report No. HI-2167374	Proposed Rev. 0R
10-24	

18	Shielding occupancy assumption confirmation	Annually	Confirm that no change in ownership of land surrounding the HI-STORE facility has occurred that would impact the “real individual” considered in Chapter 7.
----	---	----------	---

HOLTEC INTERNATIONAL COPYRIGHTED MATERIAL	
Report No. HI-2167374	Proposed Rev. 0R
10-25	

Table 10.3.2 Canister Leakage Test Performance Specifications	
Reference Helium Leakage Rate (L_R) Acceptance Criterion	1.85×10^{-7} ref-cm ³ /s helium (Leaktight as defined by ANSI N14.5-2014[10.3.3], using helium as tracer gas)
Leakage Rate Test Sensitivity	9.2×10^{-8} ref-cm ³ /s helium ($\frac{1}{2}$ of the leakage rate acceptance criterion per ANSI N14.5-2014 [10.3.3], using helium as tracer gas)
Type of Leakage Rate Test	A.5.4, per ANSI N14.5 [10.3.3], App. A
Instrument used	Helium mass spectrometer

HOLTEC INTERNATIONAL COPYRIGHTED MATERIAL	
Report No. HI-2167374	Proposed Rev. 0R
10-26	

Table 10.3.3	
Acceptance Criteria for Testing of Shipping Cask Gas Sample	
Radionuclide	Concentration Limit (Note 1)
Krypton-85	10^{-4} $\mu\text{Ci/cc}$ (Note 2)

Note 1: Concentration measurement is performed using equipment specifically designed to detect gamma emission from Krypton-85 in the gas sample. Equipment shall be suitably designed and calibrated to correlate the rate of Krypton-85 radioisotope disintegration to volumetric concentration.

Note 2: Acceptance criteria based on occupational derived air concentration limits for Krypton-85 of Appendix B to 10 CFR Part 20 [7.4.1].

Table 10.3.4		
Transport Cask Flushing/Backfill Requirements		
Process	Gas	Limit
Cask Backfill	99.9% Helium (recommended)	41 kPa (6 psig) to 103 kPa (15 psig)
Cask Flushing (Note 1)	99.7% Nitrogen (or greater)	\leq 103 kPa (15psig)

Note 1: Requirements applicable only for transport cask in horizontal orientation, on tilt frame.

HOLTEC INTERNATIONAL COPYRIGHTED MATERIAL	
Report No. HI-2167374	Proposed Rev. 0R
10-27	

10.4 PERSONNEL SELECTION, TRAINING, AND CERTIFICATION

10.4.1 Personnel Organization

The personnel organization is shown in the organization charts in Figures 10.4.1 and 10.4.2.

10.4.2 Selection and Training of Operating Personnel

The main objective of the training program is to provide personnel with the specialized training necessary to operate and maintain the site in a safe manner.

All individuals requiring unescorted access to the site will receive training in the following areas: Radiation Protection, Security, Radiological Emergency Plan, Quality Assurance, Fire Protection, Chemical Safety, OSHA compliance, and the Policy statement on worker responsibility for safe operation of the ISFSI. All individuals requiring continued unescorted access will receive refresher training on these topics annually.

Individuals performing quality-related activities in support of the site will receive training on the QA Program, QA policies, and if applicable, site procedures and organization as necessary to ensure that suitable proficiency is maintained.

Operation of equipment and controls that are identified as important to safety for the ISFSI shall be limited to personnel who are trained and certified in accordance with the HI-STORE Specialist Training Program [10.1.1] or personnel who are under the direct visual supervision of a person who is trained and certified in accordance with the HI-STORE Specialist Training Program [10.1.1].

On-site workers will receive radiation protection training commensurate with their responsibilities in accordance with 10 CFR 19, “Notices, Instructions and Reports to Workers: Inspection and Investigations.” [11.1.1]

Records will be maintained on the status of trained personnel, training of new employees, and refresher training of present personnel.

10.4.3 Selection and Training of Security Guards

Security training will be provided in accordance with the training and qualification requirements outlined in the HI-STORE Site Security Plan [3.1.1].

10.4.4 Selection and Training of Radiation Protection Technicians

Radiation Protection Technicians will be trained and certified in accordance with the HI-STORE Radiation Protection Technician Training Program. The main objective of the training program is to provide personnel with the specialized training necessary to implement the procedures associated with the Radiation Protection Program. Radiation Protection Technicians will receive training in the use and calibration of radiation survey equipment, RWP generation and implementation, ALARA principles, verifying proper packaging of radioactive material, and proper response in the event of an emergency in accordance with the Radiological Emergency Plan.

HOLTEC INTERNATIONAL COPYRIGHTED MATERIAL	
Report No. HI-2167374	Proposed Rev. 0R
10-28	

In addition, Radiation Protection Technicians will receive training in the following areas: Security, Quality Assurance, Fire Protection, Chemical Safety, OSHA compliance, and the Policy statement on worker responsibility for safe operation of the ISFSI. Individuals requiring continued unescorted access will receive refresher training on these topics annually.

Records will be maintained on the status of trained personnel, training of new employees, and refresher training of present personnel.

HOLTEC INTERNATIONAL COPYRIGHTED MATERIAL	
Report No. HI-2167374	Proposed Rev. 0R
10-29	

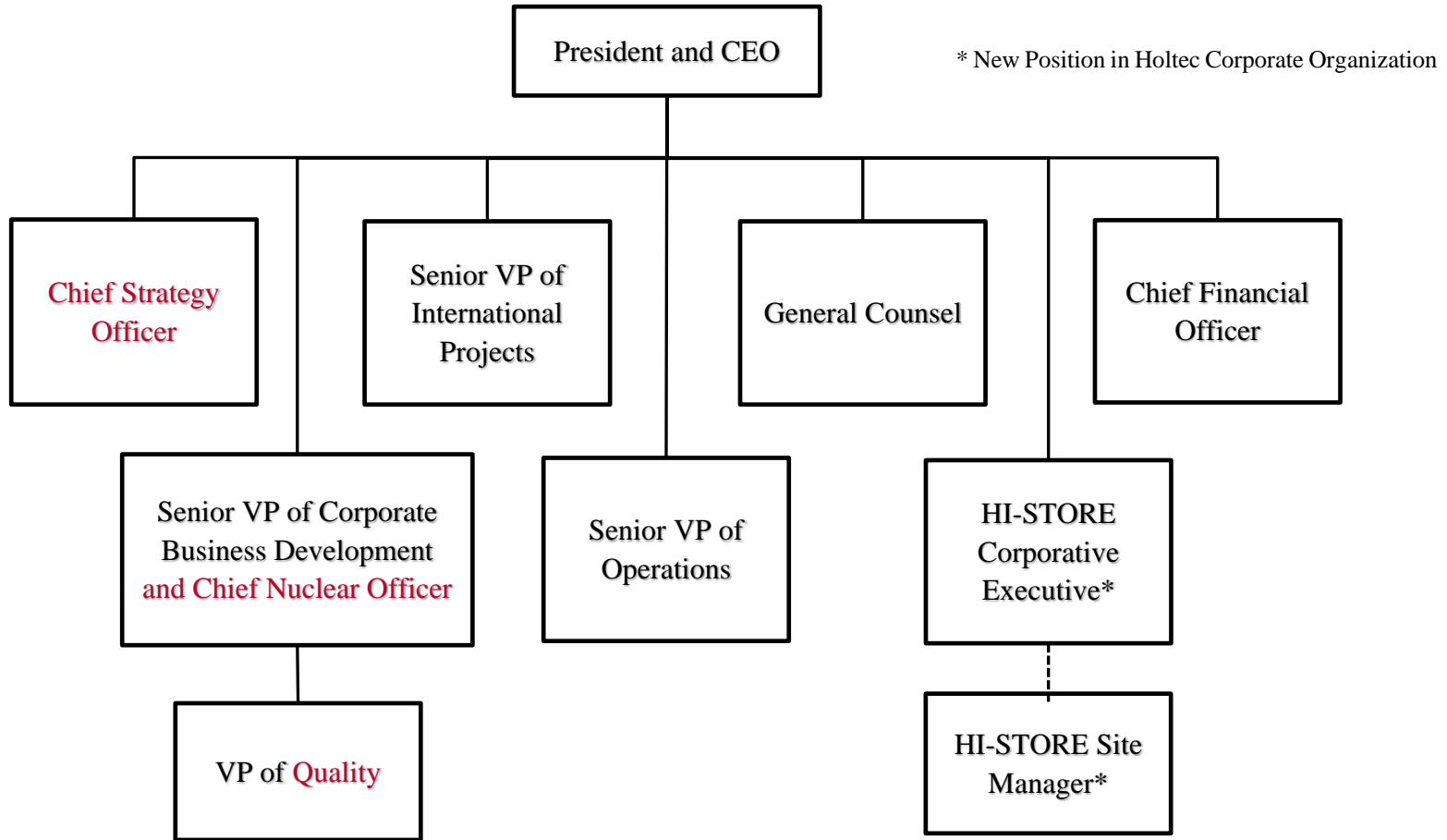


Figure 10.4.1: Holtec Corporate Organization

HOLTEC INTERNATIONAL COPYRIGHTED MATERIAL		
Report No. HI-2167374		Proposed Rev. OR
10-30		

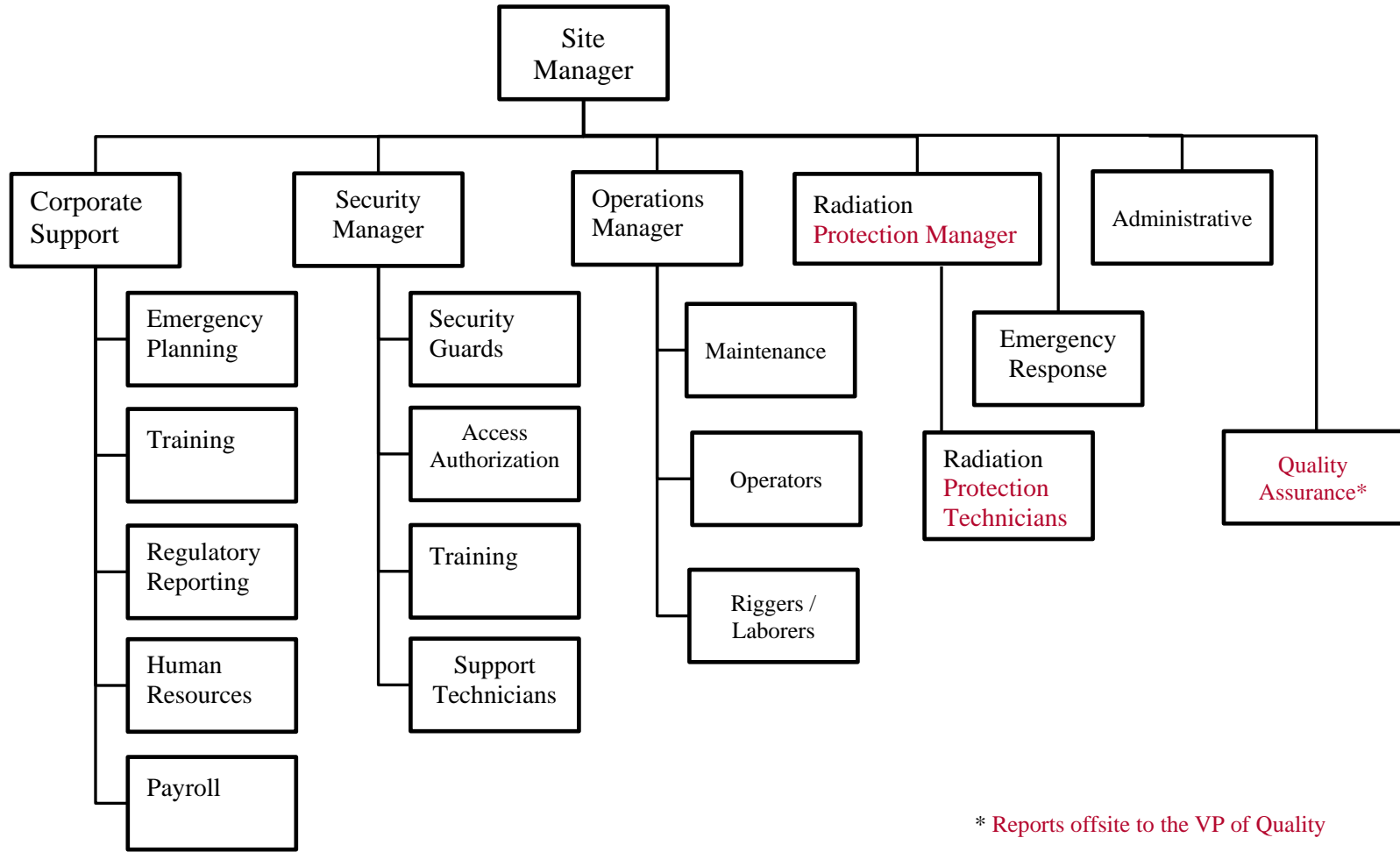


Figure 10.4.2: HI-STORE Site Organization

HOLTEC INTERNATIONAL COPYRIGHTED MATERIAL		
Report No. HI-2167374	Proposed Rev. OR	
10-31		

10.5 EMERGENCY PLANNING

The Holtec CISF Emergency Response Plan [10.5.1] evaluates and describes the necessary and sufficient emergency response capabilities for managing all reasonably anticipated emergency conditions associated with the operation of the HI-STORE facility. The plan meets all requirements of 10CFR72.32(a).

HOLTEC INTERNATIONAL COPYRIGHTED MATERIAL	
Report No. HI-2167374	Proposed Rev. OR
10-32	

10.6 PHYSICAL SECURITY AND SAFEGUARDS CONTINGENCY PLANS

The HI-STORE Site Security Plan [3.1.1] contains a detailed plan for security measures for physical protection of the site. In addition, this plan contains contingencies for responding to threats and potential radiological sabotage. This plan complies with the requirements of 10CFR72, Subpart H, “Physical Protection.”

HOLTEC INTERNATIONAL COPYRIGHTED MATERIAL	
Report No. HI-2167374	Proposed Rev. 0R
10-33	

10.7 RADIATION PROTECTION PLAN

Chapter 11 contains a detailed plan for radiation protection measures for the site. This plan complies with the requirements of 10CFR72, Subpart H, “Physical Protection.” A Radiation Protection Program is implemented at the CIS Facility in accordance with requirements of 10CFR72.126, 10CFR20.1101, and 10CFR19.12 [1.0.5], [7.4.1], and [11.1.1].

The CIS Facility is committed to a strong ALARA program. The ALARA program follows the guidelines of Regulatory Guides 8.8 [11.1.2] and 8.10 [11.1.3] and the requirements of 10 CFR 20 [7.4.1].

HOLTEC INTERNATIONAL COPYRIGHTED MATERIAL	
Report No. HI-2167374	Proposed Rev. OR
10-34	

10.8 SUMMARY

The conduct of operations described in this chapter fulfills the requirements of NUREG-1567 [1.0.3], Section 10, by providing the following information:

- 1 A plan for conduct of operations at the HI-STORE CIS site in compliance with 10CFR72.24(h).
- 2 Detailed description of the HI-STORM UMAX storage system operations which, based on successful previous experience, is concluded to be largely demonstrated and in compliance with 10CFR72.24(i).
- 3 Detailed description of the program covering preoperational testing and initial operations, in compliance with 10CFR72.24(p).
- 4 The provision of acceptable technical qualifications, including training and experience, for personnel who will be engaged in the proposed activities, in compliance with 10CFR72.28(a).
- 5 A description of a personnel training program to comply with 10CFR72,Subpart I.
- 6 A description of the operating organization, delegations of responsibility and authority, and the minimum skills and experience qualifications relevant to the various levels of responsibility and authority, in compliance with 10CFR72.28(c).
- 7 A commitment to maintain an adequate complement of trained and certified installation personnel before receipt of spent fuel or high-level radioactive waste for storage, in compliance with 10CFR72.28(d).
- 8 Assurance of qualification by reason of training and experience to conduct the operations covered by the regulations in 10 CFR 72, in compliance with 10CFR72.40(a)(4).
- 9 Assurance with regard to the management, organization, and planning for preoperational testing and initial operations that the activities authorized by the license can be conducted without endangering the health and safety of the public, in compliance with 10CFR72.40(a)(13).

HOLTEC INTERNATIONAL COPYRIGHTED MATERIAL	
Report No. HI-2167374	Proposed Rev. 0R
10-35	

CHAPTER 11: RADIATION PROTECTION EVALUATION*

11.0 INTRODUCTION

11.0.1 Ensuring Occupational Radiation Exposures are As Low As is Reasonably Achievable

The objective for the Centralized Interim Storage (CIS) Facility Radiation Protection Program is to keep radiation exposures to facility workers and the general public as low as is reasonably achievable (ALARA). Subsection 11.1.1 describes the policy and procedures that ensure that ALARA occupational exposures are achieved. Subsection 11.1.2 describes the ALARA design considerations and Subsection 11.1.3, the ALARA operational considerations.

The HI-STORE CIS Facility utilizes the HI-STORM UMAX storage system (Docket #72-1040) [1.0.6], and only canisters approved for that system and listed in Table 1.0.3 are permitted for storage in the facility. Therefore, the principal radiation protection evaluation is directly taken from the HI-STORM UMAX FSAR, and is incorporated by reference. Table 11.0.1 lists all sections from the HI-STORM UMAX FSAR that are incorporated by reference, together with a technical justification. However, some additional radiation protection evaluation that is different from that in the HI-STORM UMAX FSAR is required specifically for the HI-STORE CIS Facility, due to site-specific considerations. These additional radiation protection evaluations are clearly identified in the following sections.

* All references are in placed within square brackets in this report and are compiled in Chapter 19 (References)

HOLTEC INTERNATIONAL COPYRIGHTED MATERIAL	
Report No.: HI-2167374	Proposed Rev. 0P
11-1	

Table 11.0.1: Material Incorporated by Reference in this Chapter (Sheet 1 of 2)

Information Incorporated by Reference	Source of the Information	NRC Approval of Material Incorporated by Reference	Location in this SAR where Material is Incorporated	Technical Justification of Applicability to HI-STORM UMAX
Ensuring that Occupational Radiation Exposures are As-Low-As-Reasonably-Achievable (ALARA)	Section 11.1 of Reference [1.0.6]	SER HI-STORM UMAX Amendments 0, 1, and 2, References [7.0.1, 7.0.2, and 7.0.3]	Section 11.1	From the radiation protection perspective, the HI-STORM UMAX system at the HI-STORE CIS Facility is the same as the one described in the HI-STORM UMAX FSAR and originally approved in the referenced SER. The generic radiation protection policy considerations, radiation exposure criteria, operational considerations, and auxiliary/temporary shielding measures established in this SAR are also applicable for the site-specific HI-STORE CIS Facility license.
Radiation Protection Features in the HI-STORM UMAX System Design	Section 11.2 of Reference [1.0.6]	SER HI-STORM UMAX Amendments 0, 1, and 2, References [7.0.1, 7.0.2, and 7.0.3]	Section 11.2	The HI-STORM UMAX radiation protection design features are the same as described in the HI-STORM UMAX FSAR and therefore the conclusions established therein that the radiation protection features ensure that the occupational dose as well as off-site dose from the ISFSI will be ALARA, remain unchanged in this SAR.

HOLTEC INTERNATIONAL COPYRIGHTED MATERIAL

Report No.: HI-2167374

Proposed Rev. 0P

11-2

Table 11.0.1: Material Incorporated by Reference in this Chapter (Sheet 2 of 2)

Information Incorporated by Reference	Source of the Information	NRC Approval of Material Incorporated by Reference	Location in this SAR where Material is Incorporated	Technical Justification of Applicability to HI-STORM UMAX
Estimated On-Site Cumulative Dose Assessment - Excavation Activities and accident site boundary dose limits.	Subsection 11.3.2 of Reference [1.0.6]	SER HI-STORM UMAX Amendments 0, 1, and 2, References [7.0.1, 7.0.2, and 7.0.3]	Subsection 11.3.1	In the event it is desired to expand the HI-STORE CIS Facility's HI-STORM UMAX VVM ISFSI, radiation protection of the excavation activities is achieved on a site-specific level using the same prescription as in the generic case (i.e. prescribing a minimum distance between the excavation area and the loaded VVMs, as well as radiological monitoring of the excavation area. The shielding design basis accident dose presented in the HI-STORM UMAX FSAR for the HI-STORM UMAX system demonstrates compliance with 10CFR72.106 [1.0.5] for the HI-STORE CIS Facility. All 500 UMAX VVMs will be constructed prior to loading any canisters into these storage systems. If at some point in the future, the facility plans to expand beyond 500 UMAX VVMs, an updated license application will be required to be filed with the NRC, which will consider radiation protection of the excavation activities.
Estimated Exposures for Surveillance and Maintenance	Subsection 11.3.4 of Reference [1.0.6]	SER HI-STORM UMAX Amendment 0, 1, and 2, Reference [7.0.1, 7.0.2, and 7.0.3]	Subsection 11.3.1	Security surveillance and maintenance activities for the HI-STORM UMAX ISFSI are addressed in the HI-STORM UMAX FSAR. The HI-STORM UMAX ISFSI at the HI-STORE CIS Facility utilizes electronic temperature monitoring of the HI-STORM UMAX modules, which significantly lowers personnel dose accumulated from security and surveillance measures.

HOLTEC INTERNATIONAL COPYRIGHTED MATERIAL

Report No.: HI-2167374

Proposed Rev. 0P

11-3

11.1 AS LOW AS REASONABLY ACHIEVABLE CONSIDERATIONS

11.1.1 ALARA Policies and Programs

A Radiation Protection Program is implemented at the CIS Facility in accordance with requirements of 10CFR72.126, 10CFR20.1101, and 10CFR19.12 [1.0.5], [7.4.1], and [11.1.1]. The program draws upon the experience and expertise of programs and personnel of Holtec International and utilities that plan to transport radioactive waste to the CIS Facility.

Section 11.1 of the HI-STORM UMAX FSAR [1.0.6] is incorporated by reference into this SAR, and describes radiation protection policy considerations, radiation exposure criteria, operational considerations, and auxiliary/temporary shielding measures applicable to the HI-STORE CIS Facility, as described in Table 11.0.1 of this SAR.

The primary goal of the Radiation Protection Program is to minimize exposure to radiation such that the individual and collective exposure to personnel in all phases of operation and maintenance are kept ALARA. This is accomplished by integrating ALARA concepts into design, construction, and operation of the facility.

Trained personnel develop and conduct the Radiation Protection Program and will assure that procedures are followed to meet CIS Facility and regulatory requirements. Training programs in the basics of radiation protection and exposure control is provided to all facility personnel whose duties require working in radiation areas.

Basic objectives of the ALARA program are:

- 1 Protection of personnel, including surveillance and control over internal and external radiation exposure to maintain individual exposures within permissible limits and ALARA, and to keep the annual integrated (collective) dose to facility personnel ALARA.
- 2 Protection of the public, including surveillance and control over all conditions and operations that may affect the health and safety of the public.

The radiation protection staff is responsible for and has the appropriate authority to maintain occupational exposures as far below the specified limits as reasonably achievable. Ongoing reviews are performed to determine how exposures might be reduced. The program ensures that CIS Facility personnel receive sufficient training and that radiation protection personnel have sufficient authority to enforce safe facility operation. Periodic training and exercises are conducted for management, radiation workers, and other site employees in radiation protection principles and procedures, protective measures, and emergency responses. Revisions to operating and maintenance procedures and modifications to CIS Facility equipment and facilities are made when the proposed revisions will substantially reduce exposures at a reasonable cost. The program also ensures that adequate equipment and supplies for radiation protection work are provided.

The CIS Facility is committed to a strong ALARA program. The ALARA program follows the guidelines of Regulatory Guides 8.8 [11.1.2] and 8.10 [11.1.3] and the requirements of 10 CFR 20 [7.4.1]. Management is committed to compliance with regulatory requirements regarding control of personnel exposures and establishes and maintain a comprehensive program at the CIS

HOLTEC INTERNATIONAL COPYRIGHTED MATERIAL

ort No.: HI-2167374

Proposed Rev

11-4

Facility to keep individual and collective doses ALARA. Management will assure that each staff member integrates appropriate radiation protection controls into work activities. CIS Facility personnel are trained and updated on ALARA practices and dose reduction techniques to assure that each individual understands and follows procedures to maintain his/her radiation dose ALARA. Design, operation, and maintenance activities are reviewed to ensure ALARA criteria are met.

The ALARA program ensures that:

- 1 An effective ALARA program is administered at the CIS Facility that appropriately integrates management philosophy and NRC regulatory requirements and guidance.
- 2 CIS Facility design features, operating procedures, and maintenance practices are in accordance with ALARA program guidelines. Formal periodic reviews of the Radiation Protection Program will assure that objectives of the ALARA program are attained.
- 3 Pertinent information concerning radiation exposure of personnel is reflected in design and operation.
- 4 Appropriate experience gained during the operation of nuclear power stations relative to radiation control is factored into procedures, and revisions of procedures, to assure that the procedures continually meet the objectives of the ALARA program.
- 5 Necessary assistance is provided to ensure that operations, maintenance, and decommissioning activities are planned and accomplished in accordance with ALARA objectives.
- 6 Trends in CIS Facility personnel and job exposures are reviewed to permit corrective actions to be taken with respect to adverse trends.
- 7 When it is not practicable to apply process controls or other engineering controls, dose reduction techniques such as access control, limitation of exposure times, and other controls in accordance with 10CFR20.1702 [7.4.1] may be used.

CIS Facility personnel are responsible for ensuring that activities are planned and accomplished in accordance with the objectives of the ALARA program. Staff will ensure that procedures and their revisions are implemented in accordance with the objectives of the ALARA program, and that radiation protection staff is consulted as necessary for assistance in meeting ALARA program objectives. Individual radiation doses, and collective doses associated with tasks controlled by radiation work permits, are tracked to identify trends and support development of alternative procedures that result in lower doses.

11.1.2 Design Considerations

ALARA considerations have been incorporated into the CIS Facility design, in accordance with 10CFR72.126(a) [1.0.5], based upon the layout of the CIS Facility area and the type of spent fuel storage system selected. The following summarizes the design considerations:

- The HI-STORM UMAX ISFSI is located at least 400 meters (1312 feet) to the controlled area boundary. This provides an acceptable distance from radiation sources to offsite personnel to ensure dose rates at the controlled area boundary are minimized and maintained within specified limits.

HOLTEC INTERNATIONAL COPYRIGHTED MATERIAL

Report No.: HI-2167374

Proposed Revision

11-5

- The HI-STORM UMAX ISFSI has been sized to allow adequate spacing between Vertically Ventilated Modules (VVMs) to permit workers to function efficiently during loading/unloading operations at the ISFSI and during performance of maintenance (e.g. clearing blockage from the inlet ducts and surveillances. Adequate work space helps to minimize time spent by workers in the vicinity of storage casks, limiting worker dose.
- The storage system design is based on a metal canister that is sealed by welding for spent fuel confinement, preventing release of radionuclides from inside the canister. Radioactive effluents are thus precluded by design. This meets the intent of 10CFR72.24(e)(1) and 10CFR72.126(d) [1.0.5], which requires that the ISFSI design provide means to limit the release of radioactive materials in effluents during normal operations to levels that are ALARA. There are no radioactive effluents released from the CIS Facility during normal operations. This passive system design also requires minimum maintenance and surveillance requirements by personnel.
- The data acquisition of the VVM temperature monitoring system enables remote readout of temperatures representative of cask thermal performance, avoiding time spent by CIS staff to perform daily walkdowns, or take measurements, or read instrumentation in the vicinity of the HI-STORM UMAX ISFSI.
- Holtec International, the vendor of the spent fuel storage system, has incorporated a number of design features to provide ALARA conditions during transportation, handling, and storage as described in its HI-STORM UMAX Final Safety Analysis Report [1.0.6].
- Where practical, power operated wrenches are used to reduce the times associated with tasks involving bolt insertion and removal during transport cask receipt and canister transfer operations. This minimizes times spent in radiation fields. Temporary shielding is used where it is determined to be effective in reducing total dose for a task (considering doses to personnel involved in its installation and removal).

Regulatory Position 2 of Regulatory Guide 8.8 [11.1.2] is incorporated into design considerations, as described below:

- Regulatory Position 2a on access control is met by use of a fence with a locked gate that surrounds the HI-STORM UMAX ISFSI and prevents unauthorized access.
- Regulatory Position 2b on radiation shielding is met by the heavy shielding of the shipping, storage, and transfer casks, which minimizes personnel exposures during transport cask reception, canister transfer, canister storage, and offsite shipment operations. The designs of the storage cask air inlet and outlet ducts prevent direct radiation streaming. The Canister Transfer Building is positioned a substantial distance (as shown in [the site plan drawing in Section 1.5](#)) from the HI-STORM UMAX ISFSI to minimize dose from the ISFSI to personnel during operations taking place in the Canister Transfer Building. The designs of the shipping, storage, transfer casks and auxiliary equipment assure adequate shielding for personnel inside the Cask Transfer Building.
- The Security and Administrative Buildings is also positioned a substantial distance (as shown in [the site plan drawing in Section 1.5](#)) from the HI-STORM UMAX ISFSI to minimize dose from the ISFSI to personnel residing in this building.

HOLTEC INTERNATIONAL COPYRIGHTED MATERIAL

Report No.: HI-2167374

Proposed Rev

11-6

- Regulatory Position 2c on process instrumentation is met since the cask temperature monitoring system utilizes a data acquisition system to record cask temperature instrumentation readings, avoiding time spent by CIS Facility staff to make daily cask vent blockage surveillances and to read instrumentation in the vicinity of the storage casks.
- Regulatory Position 2d on control of airborne contaminants is not applicable because gaseous releases are precluded by the sealed canister design. No significant surface contamination is expected on the outer surfaces of the canister since process controls are maintained during fuel loading into the canister at the originating nuclear power plants. Additionally, the nuclear power plant shipping the cask is required to demonstrate compliance with 49CFR173.443 [10.3.1], which places strict controls on non-fixed contamination.
- Regulatory Position 2e on crud control is not applicable to the CIS Facility because there are no systems at the CIS Facility that could produce crud.
- Regulatory Position 2f on decontamination is met because the internal surfaces of shipping, transfer, and storage casks have hard surfaces that lend themselves to decontamination by wiping. Interior surfaces of the Canister Transfer Building are painted with a special paint that is easily decontaminated.
- Regulatory Position 2g on radiation monitoring is met with the use of area radiation monitors in the Canister Transfer Building for monitoring general area dose rates from the casks and canisters during canister transfer operations, and with thermoluminescent dosimeters (TLDs) along the perimeters of the RA and OCA to provide information on radiation doses. Continuous air monitors, if deemed necessary, are located in the exhaust of the Canister Transfer Building (Subsection 11.2.5) and/or available as portable air samplers.
- Regulatory Position 2h on resin treatment systems is not applicable to the CIS Facility because there are not any radioactive systems containing resins.
- Applicable portions of Regulatory Position 2i concerning other miscellaneous ALARA items is met because CIS Facility features provide a favorable working environment and promote efficiency (Paragraph 2i(13)) [11.1.2]. These include:
 - Adequate lighting in the Canister Transfer Building, and HI-STORM UMAX ISFSI; adequate ventilation in the Canister Transfer Building;
 - Adequate working space in the Canister Transfer Building and at the HI-STORM UMAX ISFSI; and accessibility – with platforms or scaffolding and ladders that facilitate ready access to the tops of the transport casks and storage casks and to the transfer cask doors where operators need to perform tasks during canister transfer operations.
 - Regulatory Position 2i(15) is met because the emergency lighting system is adequate to permit prompt egress from any high radiation areas that could possibly exist in the vicinity of the canister/casks during canister transfer operations.

 HOLTEC INTERNATIONAL COPYRIGHTED MATERIAL

Report No.: HI-2167374

Proposed Rev

11-7

11.1.3 Operational Considerations

Specific CIS Facility operational considerations to achieve ALARA conditions are as follows:

- Fuel loading operations take place at the originating nuclear power plants, away from the CIS Facility. There are no assembly handling operations at the CIS Facility.
- No significant surface contamination is expected on the canisters as the result of controls applied during the fuel loading operations at the originating nuclear power plants. Workers therefore are not exposed to significant surface contamination or airborne contamination during canister transfer operations.
- Canister transfer between the transport cask and the HI-STORM UMAX VVM will take place within a shielded transfer cask.
- Prior to canister transfer operations, “dry runs” are performed to train personnel on canister transfer procedures, discuss methods to minimize exposures, and refine procedures to achieve minimum probable exposures.
- The CIS Facility procedures and work practices reflect ALARA lessons learned from other ISFSIs that use VVMs, as applicable.
- Operations research is performed to determine types of tools, portable shielding, and equipment that helps to minimize exposures to workers involved in canister transfer operations.
- The crane located in the Canister Transfer Building is single-failure proof and is designed to withstand the design basis ground motion, as described in Chapter 5. The crane, whose range of travel covers the length and width of the Canister Transfer Building, handles the transport casks and moves the transport casks from a horizontal orientation on the inbound rail car to a vertical orientation where it can be placed in the Canister Transfer Facility (indoor pit).
- The Vertical Cask Transporter (VCT) is used to move the HI-TRAC CS (transfer cask) from the Canister Transfer Building to the HI-STORM UMAX ISFSI. The VCT requires minimum personnel and allows for quick and accurate placement of a storage cask.
- The storage systems do not require any systems that process liquids or gases or contain, collect, store, or transport radioactive liquids. Therefore, there are no such systems to be maintained or operated.

Regulatory Position 4 of Regulatory Guide 8.8 is met with the use of area radiation monitors in the Canister Transfer Building and TLDs around the Restricted Area fence and the Controlled Area boundary. In addition, radiation protection personnel use portable monitors during transport cask receipt, inspection, and canister transfer operations, and the operating staff will have personal dosimetry (Subsection 11.4.2). The access control point is at the Security Building, as described in Subsection 11.4.2.

Protective equipment, that may include anti-contamination clothing and respirators, is available in the Security Building and controlled by radiation protection personnel. Airborne monitoring is performed using portable monitors as needed.

HOLTEC INTERNATIONAL COPYRIGHTED MATERIAL

ort No.: HI-2167374

Proposed Rev

11-8

Regulatory Guide 8.10 [11.1.3] is incorporated into the CIS Facility operational considerations as described below:

- 1 Facility personnel are made aware of management's commitment to keep occupational exposures ALARA.
- 2 Ongoing reviews are performed to determine how exposures might be lowered.
- 3 There is a well-supervised radiation protection capability with specific, defined responsibilities.
- 4 Facility workers receive sufficient training.
- 5 Sufficient authority to enforce safe facility operation is provided to radiation protection personnel.
- 6 Modification to operating and maintenance procedures and to equipment and facilities are made where they substantially reduce exposures at a reasonable cost.
- 7 The radiation protection staff understands the origins of radiation exposures in the facility and seeks ways to reduce exposures.
- 8 Adequate equipment and supplies for radiation protection work are provided.

11.2 RADIATION PROTECTION DESIGN FEATURES

The HI-STORM UMAX radiation protection design features are incorporated by reference from Section 11.2 of [1.0.6], as described in Table 11.0.1 of this SAR.

11.2.1 Installation Design Features

A description of the CIS Facility layout and design is provided in Section 2.1. The CIS Facility layout and design are in accordance with the facility and equipment design features identified in Position 2 of Regulatory Guide 8.8 [11.1.2], as described in Subsection 11.1.2.

The CIS Facility has the following design features that ensure that exposures are ALARA:

- The site is located far from population centers [1.0.4].
- The nearest resident is 1.5 miles (2.41 km) north of the site, as shown in Table 1.0.1.
- The only sources of radiation at the CIS Facility are the sealed canisters containing spent fuel assemblies. These canisters are always shielded by shipping, storage, or by transfer casks during canister transfer operations.
- Measures are taken at the originating nuclear power plants to prevent loose surface contamination levels on the exterior of the canisters. Controls assure that canisters are not transported to the CIS Facility unless contamination levels are within specified limits.
- The canisters are sealed by welding, eliminating the potential for release of radioactive gases or particles.
- The canisters are never opened, nor will spent fuel assemblies be unloaded at the CIS Facility.
- The fuel assemblies are stored dry inside the canisters, so that no radioactive liquid is available for release.
- The shipping, transfer, and HI-STORM UMAX VVMs are heavily shielded to minimize external dose rates.
- The CIS Facility site layout provides substantial distance between the HI-STORM UMAX ISFSI and the Controlled Area boundary, as shown in Table 1.0.1, minimizing radiation exposures to individuals outside the controlled area boundary and assuring offsite dose rates are below the 10CFR72.104 [1.0.5] criteria.
- The location of the Canister Transfer Building inside the Restricted Area (RA) minimizes the route between the Canister Transfer Building and the HI-STORM UMAX ISFSI, provides for minimal other traffic on the route, and maintains substantial distance from the Controlled Area boundary.
- There are no radioactive liquid wastes associated with the CIS Facility.

The CIS Facility building ventilation systems are not designed for any special radiological considerations since there is no credible scenario for which a significant radioactive release would occur. Shielding of the canister is provided by the HI-STORM UMAX systems and by the shipping and transfer casks during canister receipt, transfer, and offsite shipping operations.

HOLTEC INTERNATIONAL COPYRIGHTED MATERIAL

Report No.: HI-2167374

Proposed Revision

11-10

The general area inside the RA fence is a Restricted Area, as defined by 10CFR20 [7.4.1], and is controlled in accordance with applicable requirements of 10CFR20, with personnel dosimetry required. Certain areas within the Restricted Area are designated as Radiation Areas, and specific locations within the RA have the potential to be High Radiation Areas, and are posted and controlled in accordance with applicable requirements of 10CFR20 [7.4.1]. The cask load/unload bay, crane bay, cask transporter bay, and canister transfer cells inside the Canister Transfer Building are designated as Radiation Areas whenever loaded canisters are present in these areas, since the potential exists for dose rates to exceed 5 mrem/hr in these areas. Upon removal of the impact limiters from the transport casks in the Canister Transfer Building, the potential exists for dose rates in the vicinity of the top and or bottom of the casks to exceed 100 mrem/hr in localized areas, and these localized areas will be posted as High Radiation Areas, with necessary controls applied. Due to distances from the transport casks when their impact limiters are removed, dose rates outside the Canister Transfer Building are well below 100 mrem/hr.

The Protected Area perimeter is marked as Restricted Area. The Cask Transfer Building is marked as a radiation area or high radiation area per 10 CFR 20 limits. The “parking area” for the loaded transportation casks, and the UMAX VVM ISFSI are marked as radiation areas. HI-STAR Access controls is used to prevent unauthorized access to the Restricted Area for the purpose of radiation protection. Physical barriers such as fencing and gates are used to prevent access to the Restricted Area with details outlined in the Physical Security Plan [3.1.1]. The provisions of 10 CFR 20.203 (b) or 10 CFR 20.1902 (a) (b) [7.4.1] require that each radiation area and high radiation area be conspicuously posted with a sign or signs bearing the radiation caution symbol and the words: "CAUTION, RADIATION AREA" or “CAUTION, HIGH RADIATION AREA”, respectively. The restricted area and radiation areas are shown in Figures 11.2.1 and 11.2.2.

11.2.2 Access Control

The CIS Facility is designed to provide access control in accordance with 10CFR72. Access control to the RA is provided for both personnel radiological protection and facility physical protection. The physical protection program is covered in the Security Plan, which is classified and submitted as part of the License Application under separate cover.

The access control boundary for the restricted area are established along the security fence lines (see [the site plan drawing in Section 1.5](#)). The RA is that space which is controlled for purposes of protecting individuals from exposure to radiation or radioactive materials and for providing facility physical security. Operational controls ensure the total effective dose equivalent to individual members of the public from the licensed operation does not exceed 0.1 rem in accordance with 10CFR20.1301(a)(1) [7.4.1]. The boundary for the RA is the security fence where the dose rate is less than 2 mrem/hr, in accordance with 10CFR20.1301(a)(2) [7.4.1]. The controlled area is the area inside the site boundary. The dose rate beyond the controlled area is less than 25 mrem/year, in accordance with 10CFR72.104 [1.0.5].

Access to the RA is controlled through a single access point in the Security Building (See [the site plan drawing in Section 1.5](#)). Personal dosimetry is issued and controlled in this building to individuals entering the Restricted Area (RA). Provisions exist in this building for donning and removing personal protective equipment, such as anti-contamination clothing and/or respirators

HOLTEC INTERNATIONAL COPYRIGHTED MATERIAL

ort No.: HI-2167374

Proposed Rev

11-11

if deemed necessary, in the event of contamination in the Canister Transfer Building as a result of off-normal or accident conditions. Provisions for personnel decontamination are also contained in the Security Building. The Restricted Area also includes the cask storage area and Canister Transfer Building. In accordance with the CIS Facility Radiation Protection Program (Section 11.4), radiation protection personnel monitor radiation levels in the RA and establish access requirements as needed.

11.2.3 Radiation Shielding

The HI-STORM UMAX VVMs are designed to maintain radiation exposures ALARA. No low-level radioactive waste (LLW) materials are expected to be generated on site, and there are no special design provisions for low-level radioactive waste materials are not required.

In the unlikely event that low level waste is generated on site such as for smears, disposable clothing, tape, blotter paper, rags, and related health physics material, this material will be processed and temporarily stored on-site while awaiting removal to a licensed LLW disposal facility. The material will be packaged and stored in sealed LLW containers. The LLW containers provide necessary shielding, and dose rates on the outside surfaces of the drums are expected to be negligible. In the unlikely event that LLW materials are stored on-site with significant activity levels, temporarily located shielding may be used to maintain dose rates in the area ALARA, as determined by radiation protection personnel.

11.2.3.1 Shielding Configurations

Chapter 5 of the HI-STORM UMAX FSAR [1.0.6] identifies the shielding materials and geometries of the HI-STORM UMAX system and describes the codes used to model shielding and assess cask dose rates. Further descriptions of site specific shielding configurations are provided in Chapter 7 of this SAR.

11.2.4 Confinement and Ventilation

10CFR72.122(h)(3) [1.0.5] requires that ventilation systems and off-gas systems be provided where necessary to ensure the confinement of airborne radioactive particulate materials during normal or off-normal conditions. However, there are no special ventilation systems installed at the CIS Facility buildings. There are no credible scenarios that would require installation of ventilation systems to protect against off-gas or particulate filtration.

11.2.5 Area Radiation and Airborne Radioactivity Monitoring Instrumentation

10CFR72.122(h)(4) [1.0.5] requires the capability for continuous monitoring of the storage system to enable the licensee to determine when corrective action needs to be taken to maintain safe storage conditions. This is not applicable to the CIS Facility because the canisters are sealed by welding and with the canisters in HI-STORM UMAX systems, there are no credible events that could result in releases of radioactive material from within the canisters or unacceptable increases in direct radiation levels, as described in Chapter 9. Area radiation and airborne radioactivity monitors are therefore not needed at the storage pads. However, TLDs are used to record dose rates in the Restricted Area and along the Controlled Area boundary. TLDs provide a passive means for continuous monitoring of radiation levels and provide a basis for assessing the potential impact on the environment.

HOLTEC INTERNATIONAL COPYRIGHTED MATERIAL

ort No.: HI-2167374

Proposed Rev

11-12

TLDs are located at the Restricted Area fence and at the Controlled Area Boundary in accordance with 10CFR20.1302 [7.4.1]. Additionally, TLDs are located at strategic locations inside the Canister Transfer Building, Security Building, and Administration Building where personnel are normally working. These TLDs serve as a backup for monitoring personnel radiation exposure and maintaining this exposure ALARA. For redundancy, each TLD location mentioned above house a set of two TLDs. The TLDs are retrieved and processed quarterly. The TLDs primarily detect gamma radiation and have a lower limit of sensitivity of (0.02 mrem). The storage system design is based on a metal canister that is sealed by welding for spent fuel confinement, preventing release of radionuclides from inside the canister. Radioactive effluents are thus precluded by design.

Local radiation monitors with audible alarms are installed in the Canister Transfer Building. These provide warning to personnel involved in the canister transfer operation of abnormal radiation levels that could possibly occur during transfer operations. Because of measures taken at the originating nuclear power plants to minimize loose surface contamination levels on the exterior of the canisters during fuel loading operations, as discussed in Subsection 11.1.3, it is unlikely that canister transfer operations would generate significant levels of airborne contaminants. Local continuous air monitors include alarms to warn operating personnel in the unlikely event of an airborne release, remote alarm in the Security Building alarm station to ensure coverage at all times, and charting capability to provide data necessary to quantify any release. The radiological alarm systems are designed with provisions for calibration and operability testing. There are no liquid or gaseous effluent releases from the CIS Facility. This satisfies the requirements of 10CFR72.24(e)(1) and 10CFR72.126(b)(c) [1.0.5].

HOLTEC INTERNATIONAL COPYRIGHTED MATERIAL

Report No.: HI-2167374

Proposed Revision

11-13

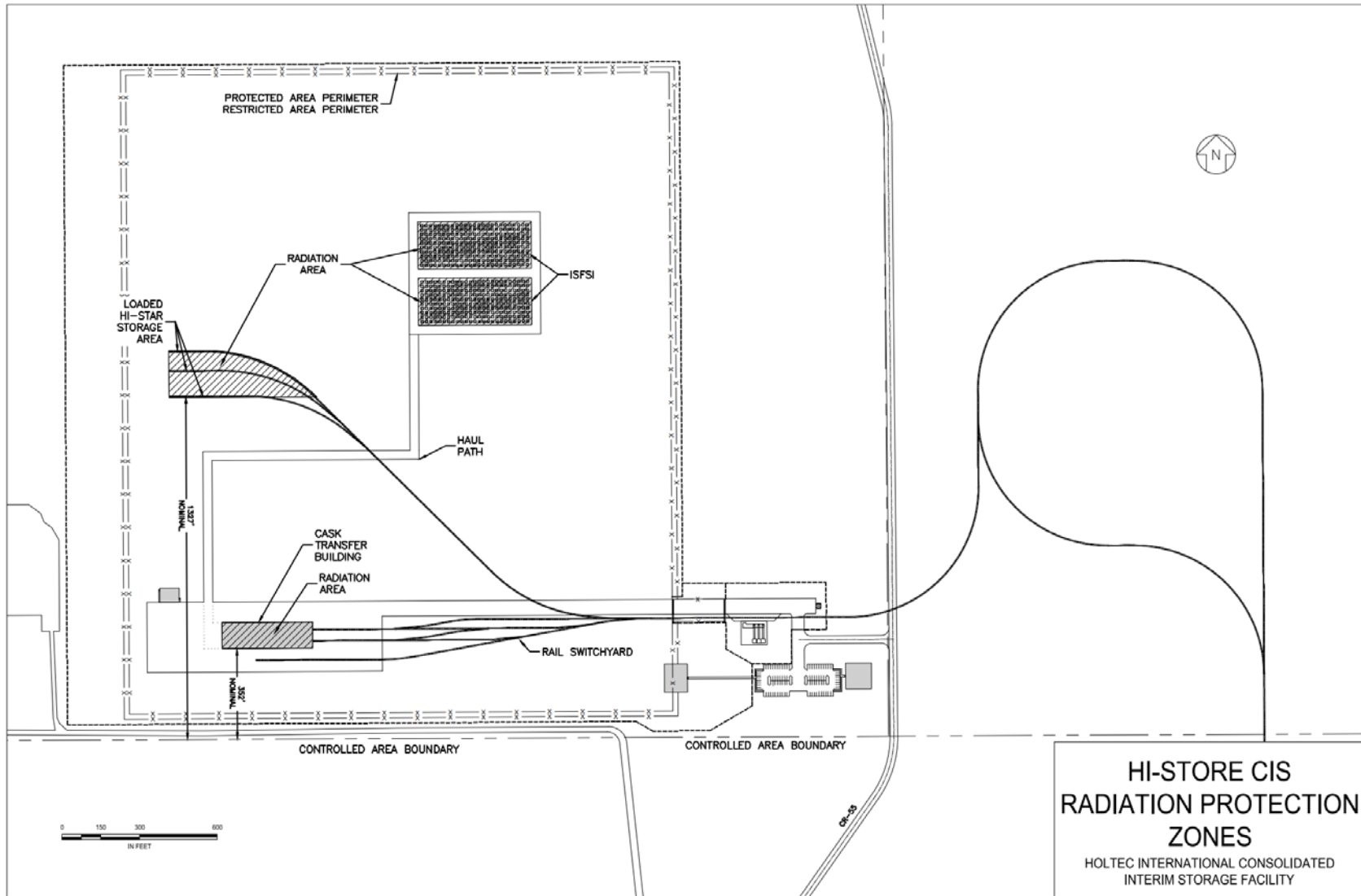
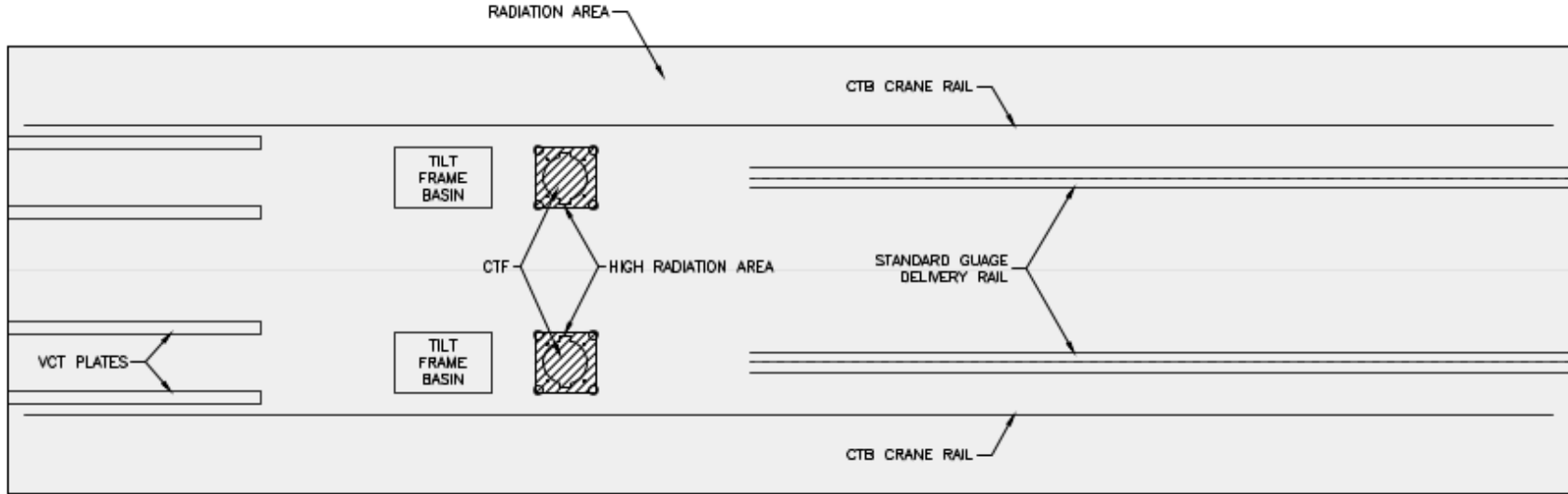


Figure 11.2.1
HI STORE CIS Facility Radiation Protection Zones

HOLTEC INTERNATIONAL COPYRIGHTED MATERIAL

Report No.: HI-2167374

Proposed Rev. 0P



CTB FLOOR PLAN
RADIATION AREA

Figure 11.2.2
HI STORE Canister Transfer Building (CTB) Radiation Protection Zones

HOLTEC INTERNATIONAL COPYRIGHTED MATERIAL		
Report No.: HI-2167374		Proposed Rev. 0P
11-15		

11.3 DOSE ASSESSMENT

11.3.1 Onsite Dose

The shipping, transfer, and storage casks are designed to limit dose rates to ALARA levels for operators, inspectors, maintenance, and radiation protection personnel when the canisters are being transferred from the shipping to the transfer casks, when the transfer cask is being moved to the ISFSI, and while the canisters are transferred from the transfer cask to the HI-STORM UMAX VVMs.

HI-TRAC CS dose rates at the surface, 0.5 meter, 1 meter, and 2 meter distances are presented in Table 7.4.1. HI-STORM UMAX Version C dose rates at the surface and at 1 meter are presented in Table 7.4.2.

Table 11.3.1 shows the estimated occupational exposures to CIS Facility personnel during receipt of the transport cask and transfer of the canister from the transport cask to the HI-STORM UMAX using the HI-TRAC CS transfer cask. The operational sequence for these operations is also described in Chapter 3.

Dose rate values include both gamma and neutron flux components, and are based on design basis PWR fuel as shown in Table 7.1.1. Fuel with these characteristics is considered to conservatively represent fuel assemblies that are contained in canisters handled at the CIS Facility, and dose estimates based on fuel with these characteristics are considered to be realistic and reflect expected personnel exposures.

Occupational doses to individuals are administratively controlled to ensure that they are maintained below 10 CFR 20.1201 limits. Temporarily positioned shielding is used during transfer operations to reduce dose rates from streaming paths or relatively high radiation areas where its use results in a net reduction in worker exposures. Conservatively, the effects of temporarily positioned shielding are not considered in the Table 11.3.1 dose estimates for canister transfer operations. It is expected the actual crew dose per loading would be significantly less than what is presented in Table 11.3.1, and operational experience gained with each loading also has been shown to lower crew dose on subsequent loadings.

The shielding design basis accident dose analysis for the HI-STORM UMAX system presented in Subsection 11.3.2 of Reference [1.0.6] is incorporated by reference as described in Table 11.0.1. Additionally, in the event it is desired to expand the HI-STORE CIS Facility's HI-STORM UMAX VVM ISFSI, radiation protection of excavation activities is incorporated by reference from Section 11.3.2 of Reference [1.0.6] as described in Table 11.0.1.

Occupational exposures are also estimated to security personnel and CIS Facility personnel that conduct inspections, surveillances, and maintain the storage systems. Subsection 11.3.4 of the HI-STORM UMAX FSAR [1.0.6], which addresses estimated exposures for security surveillance and maintenance, is incorporated by reference into this SAR as described in Table 11.0.1.

11.3.2 Offsite Dose

The offsite dose evaluation is provided in Section 7.4, with results in Table 7.4.3 and Table 7.4.4.

HOLTEC INTERNATIONAL COPYRIGHTED MATERIAL	
Report No.: HI-2167374	Proposed Rev. 0P
11-16	

Table 11.3.1: Estimated Personnel Exposures for Loading Operations of One Canister at the HI-STORE CIS Facility**(Sheet 1 of 2)**

OPERATION	OPERATION FIGURE 3.1.1	NUMBER OF PERSONNEL	DURATION (MINS)	OCCUPANCY FACTOR (%)	DOSE RATE (mrem/hr)	CREW DOSE (mrem)
RECEIVE HI-STAR 190	a	2	120	20	50	40.0
PERFORM HI-STAR 190 INSPECTION	a	2	30	50	50	25.0
REMOVE PERSONNEL BARRIER	a	2	20	50	10	3.3
REMOVE TIE-DOWN	a	2	20	70	10	4.7
ATTACH HORIZONTAL LIFT BEAM	b	2	25	30	50	12.5
MOVE HI-STAR 190 TO TILT FRAME	c	2	25	70	10	5.8
REMOVE IMPACT LIMITERS	d	2	30	90	10	9.0
PERFORM ANNULUS SAMPLE	e	2	60	20	200	80.0
REMOVE LID BOLTS	f	2	80	90	10	24.0
ATTACH LIFT YOKE TO HI-STAR 190	g	1	20	30	10	1.0
TILT HI-STAR 190 TO VERTICAL	g	2	10	80	10	2.7
PLACE HI-STAR 190 IN CTF	h	2	20	80	10	5.3
REMOVE HI-STAR 190 CLOSURE LID	i	2	20	70	50	23.3
INSTALL SEAL SURFACE PROTECTOR	i	2	10	80	369	98.3
INSTALL MPC LIFTING ATTACHMENT	i	2	20	90	369	221.3
PLACE ALIGNMENT PLATE ON HI-STAR 190	i	2	25	80	74	49.2
PLACE HI-TRAC ON CTF	j	2	20	90	29	17.3
GRAPPLE MPC LIFTING ATTACHMENT	k	1	15	100	29	7.2
RAISE MPC INTO HI-TRAC	l	2	5	100	29	4.8
CLOSE HI-TRAC SHIELD GATES	m	2	5	100	61	10.2

HOLTEC INTERNATIONAL COPYRIGHTED MATERIAL

Report No.: HI-2167374

Proposed Rev. 0P

11-17

Table 11.3.1: Estimated Personnel Exposures for Loading Operations of One Canister at the HI-STORE CIS Facility

(Sheet 2 of 2)

OPERATION	OPERATION FIGURE 3.1.1	NUMBER OF PERSONNEL	DURATION (MINS)	OCCUPANCY FACTOR (%)	DOSE RATE (mrem/hr)	CREW DOSE (mrem)
MOVE HI-TRAC TO VCT PICK UP AREA	n	2	30	90	29	26.0
CONNECT VCT TO HI-TRAC	o	3	20	100	29	28.8
REMOVE CEC LID	p	3	120	50	7.5	22.6
INSTALL DIVIDER SHELL	p	3	120	50	7.5	22.6
TRANSPORT HI-TRAC TO CEC	q	2	120	100	35	140.6
PLACE HI-TRAC ON CEC	r	3	20	100	35	35.2
CONNECT MPC LIFTING EXTENSION TO MPC LIFTING ATTACHMENT	r	1	15	100	35	8.8
OPEN HI-TRAC SHIELD GATES	s	2	5	100	61	10.2
LOWER MPC INTO CEC	t	1	10	100	35	5.9
DISCONNECT MPC LIFTING EXTENSION	u	1	5	100	35	2.9
REMOVE HI-TRAC FROM CEC	v	3	60	90	35	94.9
REMOVE MPC LIFTING ATTACHMENT	w	2	15	40	738	147.5
INSTALL CEC LID	x	2	60	100	14	27.9
TOTAL						1218.5

HOLTEC INTERNATIONAL COPYRIGHTED MATERIAL

Report No.: HI-2167374

Proposed Rev. 0P

11-18

11.4 RADIATION PROTECTION PROGRAM

11.4.1 Organizational Structure

The CIS Facility Radiation Protection Manager reports to the Site Manager (Figure 10.4.2) and is responsible for administering the radiation protection program and for the radiation safety of the facility. Minimum qualification requirements are set forth in Chapter 10.

Responsibilities of the CIS Facility Radiation Protection Manager include the following:

- Administer the Radiation Protection program policies and procedures
- Review and approve radiation protection procedures
- Coordinate radiation protection group activities with operations and maintenance personnel
- Ensure adequate staffing, facilities, and equipment are available to perform the functions assigned to radiation protection personnel
- Establish goals for the Radiation Protection program
- Initiate and implement exposure control program that factors dosimetry results into operational planning
- Issue or rescind “stop work” orders as appropriate
- Ensure that locations, operations, and/or conditions that have potential for causing significant exposures to radiation are identified and controlled
- Review and approve training programs related to work in radiological areas or involving radioactive material
- Administer shipments (if necessary) of solid radioactive waste offsite for disposal
- Review root causes and corrective actions for incidents and deficiencies associated with Radiation Protection
- Ensure an effective ALARA program is maintained, in accordance with the guidance provided in Regulatory Guides 8.8 [11.1.2] and 8.10 [11.1.3]
- Supervise the collection, analysis and evaluation of data obtained from radiological surveys and monitoring activities in accordance with 10CFR20.1501 [7.4.1]
- Participate in the event of an emergency, as required

Radiation protection technicians report to the Radiation Protection Manager. Responsibilities of the radiation protection technicians include the following:

- Conduct radiation, contamination, and airborne surveys and prepare complete and accurate records
- Prepare Radiation Work Permits to control access to and activities in radiologically controlled areas

HOLTEC INTERNATIONAL COPYRIGHTED MATERIAL	
Report No.: HI-2167374	Proposed Rev. 0P
11-19	

- Identify and post radiation, contamination, hot particle, airborne and radioactive material areas in accordance with 10 CFR 20 [7.4.1] requirements
- Monitor CIS Facility operations to assure good radiological work practices
- Implement ALARA program requirements
- Maintain and calibrate portable monitoring instruments
- Issue “stop work” orders whenever activities have the potential to jeopardize the health and safety of workers, visitors, or the general public
- Verify proper packaging of any radioactive material
- Participate in the event of an emergency, as required

11.4.2 Equipment, Instrumentation, and Facilities

A sufficient inventory and variety of operable and calibrated portable and fixed radiological instrumentation is maintained to allow for effective measurement and control of radiation exposure and radioactive material and to provide back-up capability for inoperable equipment. Equipment is ensured to be appropriate to enable the assessment of sources of gamma, neutron, beta, and alpha radiation, including the capability to measure dose rates and radioactivity concentrations expected. Radiation protection procedures govern instrument calibration, instrument inventory and control, and instrument operation.

Portable survey and personnel monitoring instrumentation, if deemed necessary during normal, off-normal, or accident conditions, will include, but not be limited to, the following:

- Low-level contamination meters
- Beta/gamma portable survey meters
- Alarming beta/gamma personnel friskers
- Portable air samplers

Area radiation monitors are utilized in the Canister Transfer Building since the operations performed in this building (transport cask receipt, inspection, and canister transfer operations) pose the greatest risk to the operating staff for radiation exposure. These monitors have audible alarms to warn operating personnel of abnormal radiation levels. Area radiation monitors are not utilized outside the Canister Transfer Building since these areas have relatively low area radiation levels and there are no operations performed in these areas which could result in rapid change in radiation level and pose a risk for over-exposure of personnel.

The Restricted Area is surrounded by a chain link security fence and an outer chain link nuisance fence with an isolation zone and intrusion detection system between the two fences. Access to the Restricted Area is controlled through a single access point in the Security Building (see **the site plan drawing in Section 1.5**). Personal dosimetry is issued and controlled in this building to individuals entering the Restricted Area. External radiation dose monitoring is accomplished through the use of thermoluminescent dosimeters (TLDs) and self-reading dosimeters (SRDs) or digital alarming dosimeters (DADs). During transfer operations inside the Canister Transfer Building alarming dosimeters shall be used to warn of excessively high direct radiation to

HOLTEC INTERNATIONAL COPYRIGHTED MATERIAL	
Report No.: HI-2167374	Proposed Rev. 0P
11-20	

maintain exposures ALARA, thereby providing assurance that occupational exposures do not exceed the limits of 10 CFR Part 20. The official record of external dose to beta and gamma radiations is normally obtained from the TLDs with SRDs or DADs used as a means for tracking dose between TLD processing periods as a backup to TLDs. Self-reading dosimeters are administered in accordance with the guidance in Regulatory Guide 8.4 [11.4.1].

Provisions exist in the Security Building for donning and removing personal protective equipment, such as anti-contamination clothing, which could be necessary in the event of contamination in the Canister Transfer Building due to off-normal or accident conditions. A respiratory protection program, if deemed necessary, will be established in accordance with 10 CFR 20 and consistent with the guidance of NUREG-0041 [11.4.2].

Provisions for personnel decontamination are contained in the Security Building. Contamination of equipment or personnel is not expected to occur under normal conditions of operation. In accordance with the CIS Facility policy of preventing generation of liquid radioactive waste, any necessary decontamination of equipment and personnel will be conducted using methods that produce only solid radioactive waste. Decontamination methods would typically include wiping the contaminated item with rags or paper wipes.

Drain sumps are provided in the cask load/unload bay of the Canister Transfer Building which catch and collect water that drips from transport casks (e.g. from melting snow) onto the floor. Water collected in the cask load/unload bay drain sumps is sampled and analyzed to verify it is not contaminated prior to its release. In the event contaminated water is detected, it will be collected in a suitable container, solidified by the addition of an agent such as cement or “Aquaset” so that it qualifies as solid waste, staged on-site while awaiting shipment offsite, and transported to a LLW disposal facility, in accordance with Radiation Protection procedures.

No process or effluent monitors are necessary because of the design of the CIS Facility storage system, in which spent fuel assemblies are stored in welded canisters. During routine storage operations at the CIS Facility, the only radiological instrumentation in use in the storage area are the TLDs, as described in Subsection 11.2.5. Routine radiological surveys use instruments that are controlled by the Radiation Protection Program and governed by existing procedures. Calibration procedures for radiological instrumentation are established and applied to instruments used at the CIS Facility.

11.4.3 Policies and Procedures

Radiation protection requirements for all radiological work at the CIS Facility are governed by radiation protection procedures. Radiation protection practices for cask loading and unloading operations, canister transfer, canister storage, and monitoring are also based on these procedures, as well as on anticipated conditions when the task is to be performed. These procedures, if deemed necessary, include, but are not limited to, the following:

- Procedure for performing badging functions for access authorization to the Restricted Area.
- Procedure for issuing personnel dosimetry, and monitoring, recording, and tracking individual exposures.
- Procedure for performing radiological safety training and refresher training.

HOLTEC INTERNATIONAL COPYRIGHTED MATERIAL	
Report No.: HI-2167374	Proposed Rev. 0P
11-21	

- Procedure for performing ALARA reviews of plant procedures and monitoring of operations.
- Procedure for determining radiation doses on a periodic basis at the Restricted Area and Controlled Area boundaries using TLDs.
- Procedure for issuing, revising, and terminating radiation work permits and standing radiation work permits.
- Procedure for roping off, barricading, and posting radiation control zones.
- Procedure for decontaminating personnel, equipment, and areas.
- Procedure for performing radiation surveys in accordance with 10CFR20.1501.
- Procedure for smear swab sampling, counting, and calculation.
- Procedure for calibrating detection, monitoring, and dosimetry instruments.
- Procedure for quantifying airborne radioactivity.
- Procedure for maintaining records of the radiation protection program, including audits and other reviews of program content and implementation; radiation surveys; instrument calibrations; individual monitoring results; and records required for decommissioning.

Implementation of the Radiation Protection Program procedures ensures that occupational doses are below the limits required by 10 CFR 20.1201 [7.4.1]. Area radiation monitors in the Canister Transfer Building have audible alarms and warn operating personnel of abnormal radiation levels. While area radiation monitors are not installed in the Restricted Area, measures are in place to ensure personnel in the Restricted Area do not exceed dose limits. Process and engineering controls at the HI-STORE CIS Facility ensures that contamination is non-existent or minimized, that controls are in place to ensure air concentrations of radioactive material is non-existent or insignificantly low, and that there is no or minimal generation of radioactive waste on-site in accordance with 10CFR20.1406 and 10CFR20.1701 [7.4.1].

As discussed in Subsection 11.2.2, access to the Restricted Area is controlled through a single access point in the Security Building where personal dosimetry is issued to individuals entering the Restricted Area. Periodic radiation surveys are conducted of areas inside the Restricted Area and maps are generated showing the radiation levels in all areas. Radiation work permits (RWPs) are completed by qualified radiation protection personnel prior to any entry and serve to identify normal and unusual radiation readings. Workers are required to read, understand and sign that they are aware of the conditions or unknowns. Personnel are trained to use the appropriate radiation detection instruments or are required to have a qualified radiation protection technician with them at all times while in the areas. Training includes responses to unusual readings and off-scale conditions. The Radiation Protection program will provide for the immediate reading of any individual’s TLD if an unusual reading or off-scale condition occurs.

HOLTEC INTERNATIONAL COPYRIGHTED MATERIAL	
Report No.: HI-2167374	Proposed Rev. 0P
11-22	

11.5 REGULATORY COMPLIANCE

The HI-STORM UMAX System at the HI-STORE CIS Facility provides radiation shielding and confinement features that are sufficient to meet the requirements of 10CFR72.104 and 10CFR72.106 [1.0.5].

Occupational radiation exposures satisfy the limits of 10CFR20 [7.4.1] and meet the objective of maintaining exposures ALARA.

The design of the HI-STORM UMAX System is in compliance with 10CFR72 [1.0.5] and applicable design and acceptance criteria have been satisfied. The radiation protection system design provides reasonable assurance that the HI-STORM UMAX System at the HI-STORE CIS Facility allows safe storage of spent fuel.

HOLTEC INTERNATIONAL COPYRIGHTED MATERIAL	
Report No.: HI-2167374	Proposed Rev. 0P
11-23	

CHAPTER 12: QUALITY ASSURANCE PROGRAM*

12.0 INTRODUCTION

12.0.1 Overview

This chapter provides a summary of the quality assurance program implemented by Holtec International for activities related to the design, qualification analyses, material procurement, fabrication, assembly, testing and use of structures, systems, and components of the Company's dry storage/transport systems including the HI-STORM UMAX System and other equipment at the HI-STORE CIS facility. This chapter is included in this SAR to fulfill the requirements in 10CFR72.140(c)(2) as elaborated in NUREG-1567[1.0.3].

Important-to-safety activities related to construction and deployment of the HI-STORM UMAX System and other equipment at the HI-STORE CIS Facility are controlled under the NRC-approved Holtec Quality Assurance Program. The Holtec QA program manual [12.0.1][†] is approved by the NRC under Docket 71-0784. The Holtec QA program satisfies the requirements of 10CFR72, Subpart G and 10CFR71, Subpart H. In accordance with 10CFR72.140(d), this approved 10CFR71 QA program will be applied to spent fuel storage cask activities at HI-STORE under 10CFR72. The additional recordkeeping requirements of 10CFR72.174 are addressed in the Holtec QA program manual and must also be complied with.

The Holtec QA program is implemented through a hierarchy of procedures and documentation, listed below.

1. Holtec Quality Assurance Program Manual [12.0.1]
2. Holtec Quality Assurance Procedures
3. Miscellaneous Documents including, but not limited to:
 - a. Holtec Standard Procedures
 - b. Holtec Project Procedures
 - c. Project Specifications
 - d. Drawing packages
 - e. Project Bill-of-Materials
 - f. Inspection and testing procedures
 - g. Welding procedure Specifications
 - h. Calculation packages
 - i. Technical Reports (generic and project specific)
 - j. Position Papers and Technical Memos

* All references are in placed within square brackets in this report and are compiled in Chapter 19 of this report

[†] Holtec QA manual [12.0.1] is incorporated by reference in its entirety in this chapter. Format and content of QA manual is in accordance with NUREG 1567 [1.0.3] and Regulatory Guide 3.50 [1.0.2].

HOLTEC INTERNATIONAL COPYRIGHTED MATERIAL	
Report No.: HI-2167374	Proposed Rev. 0A
12-1	

- k. Corporate Documents that include Corporate Governance, Safety and other manuals
- l. A series of databases including the Lessons Learned database

Quality activities performed by others on behalf of Holtec are governed by the supplier's quality assurance program or Holtec's QA program extended to the supplier. The type and extent of Holtec QA control and oversight is specified in the procurement documents for the specific item or service being procured. The fundamental goal of the supplier oversight portion of Holtec's QA program is to provide the assurance that activities performed in support of the supply of safety-significant items and services are performed correctly and in compliance with the procurement documents.

12.0.2 Graded Approach to Quality Assurance

Holtec International uses a graded approach to quality assurance on all safety-related or important-to-safety projects. This graded approach is controlled by Holtec Quality Assurance (QA) program documents as described in Subsection 12.0.1.

NUREG/CR-6407 [1.2.2] provides descriptions of quality categories A, B and C. Using the guidance in NUREG/CR-6407, Holtec International assigns a quality category to each individual, important-to-safety component of the HI-STORM UMAX System and HI-TRAC transfer cask. The ITS categories assigned to the HI-STORM UMAX cask components and for other equipment deployed at the HI-STORE CIS Facility, and equipment needed to deploy the HI-STORM UMAX System at HI-STORE CIS are provided in Chapter 4 using the guidelines of NUREG/CR-6407 [1.2.2].

Activities affecting quality will be defined by Holtec's Purchase Specifications and/or written instructions/procedures for use of the HI-STORM UMAX System under the license provisions of 10CFR72, Subpart C at the HI-STORE CIS independent spent fuel storage installation (ISFSI). These activities include any or all of the following: design, procurement, fabrication, handling, shipping, storing, cleaning, assembly, inspection, testing, operation, maintenance, repair, monitoring and aging management of HI-STORM UMAX and other HI-STORE CIS Facility equipment structures, systems, and components (SSCs) that are important-to-safety.

The quality assurance program described in the Holtec QA Program Manual fully complies with the requirements of 10CFR72 Subpart G and the intent of NUREG-1567 [1.0.3]. However, NUREG-1567 does not explicitly address incorporation of a QA program manual by reference. Therefore, invoking the NRC-approved QA program in this SAR constitutes a literal deviation from NUREG-1567. This deviation is acceptable since important-to-safety activities are implemented in accordance with the latest revision of the Holtec QA program manual and implementing procedures. Further, incorporating the QA Program Manual by reference in this SAR avoids duplication of information between the implementing documents and the SAR and any discrepancies that may arise from simultaneous maintenance to the two program descriptions governing the same activities. The Holtec Quality Assurance Manual has been included as one of the documents incorporated by reference in this SAR (Table 1.0.3).

HOLTEC INTERNATIONAL COPYRIGHTED MATERIAL	
Report No.: HI-2167374	Proposed Rev. 0A
12-2	

12.1 REGULATORY COMPLIANCE

The chapter complies with the quality assurance requirements of 10CFR72. As indicated in Table 1.0.3, Holtec's NRC-approved QA program, is adopted herein for 10CFR72 activities performed at the HI-STORE CIS Facility. The QA program applies to the docketed listed in Table 1.3.1 of this SAR. The QA program covers activities affecting important to safety components identified in this report for the HI-STORE CIS Facility.

The format and content of the Quality Assurance Program Manual [12.0.1] is in accordance with NUREG-1567 [1.0.3] and Regulatory Guide 3.50 [1.0.2].

HOLTEC INTERNATIONAL COPYRIGHTED MATERIAL	
Report No.: HI-2167374	Proposed Rev. 0A
12-3	

CHAPTER 13: DECOMMISSIONING EVALUATION*

13.0 INTRODUCTION

This chapter contains the information for the design and operational features of the HI-STORE CIS Facility that will allow for eventual decontamination and decommissioning of the site. Also, described in this chapter is the financial assurance mechanisms that will fund the decommissioning effort.

* All references are in placed within square brackets in this report and are compiled in Chapter 19 of this report.

HOLTEC INTERNATIONAL COPYRIGHTED MATERIAL	
Report No.: HI-2167374	Proposed Rev. 0A
13-1	

Table 13.0.1: Material Incorporated By Reference

Information Incorporated by Reference	Source of the Information	NRC Approval of Material Incorporated by Reference	Location in this SAR where Material is Incorporated	Technical Justification of Applicability to HI-STORM UMAX
HI-STORM UMAX Decommissioning Considerations	HI-STORM UMAX FSAR Chapter 2.11 [1.0.6]	SER HI-STORM UMAX Amendments 0, 1, and 2 [7.0.1, 7.0.2, 7.0.3]	Section 13.1	The ISFSI structure is the same as the one described in the HI-STORM UMAX FSAR and the same Decommissioning Considerations would apply at the HI-STORE CIS Facility.

HOLTEC INTERNATIONAL COPYRIGHTED MATERIAL

Report No.: HI-2167374

Proposed Rev. 0A

13-2

13.1 DESIGN FEATURES

Section 2.11 of the HI-STORM UMAX FSAR [1.0.6] is incorporated by reference into this SAR, and describes all the design features of the ISFSI which are considered for the decommissioning of the Site. The CTF and other auxiliary SSCs, as described in Chapter 4, support decommissioning processes similar to those used for the HI-STORM UMAX VVM structures.

HOLTEC INTERNATIONAL COPYRIGHTED MATERIAL	
Report No.: HI-2167374	Proposed Rev. 0A
13-3	

13.2 OPERATIONAL FEATURES

The layout and design of the HI-STORE CIS Facility will facilitate rapid, safe, and economical decommissioning of the Site. As described in Chapter 2 of the HI-STORM UMAX FSAR [1.0.6], the VVM components are designed to allow the retrieval of the MPC under all conditions of storage. The MPC, which holds the SNF assemblies, is engineered to be suitable as a waste package for permanent internment in a deep Mined Geological Disposal System (MGDS). Towards that end, the loaded MPC has been designed with the objective to transport it in a transportation cask, which is an *a priori* assumption for receipt of the canisters at the Site.

The HI-STORE CIS Facility will be operated as a “clean” facility. All components of the facility including the transport casks and storage canisters are designed to minimize the potential for any contamination. Canisters are already welded shut and sealed to prevent leaks at the generator facility. All procedures controlling handling and storage operations of the canisters will emphasize minimizing any potential contamination at the Site. Dose rate surveys will be performed throughout the operations for site receiving and loading of canisters as discussed in Chapter 3 of this SAR. The dose requirements for these surveys are discussed in Chapter 7 of this SAR.

Pursuant to 10 CFR 72.30(f), records of importance to the decommissioning of the HI-STORE CIS Facility will be maintained until the site is released for unrestricted use. Records will include:

- Records of spills or other unusual occurrences involving the spread of contamination in and around the facility, equipment, or site.
- Records on contamination that may have spread to inaccessible areas.
- As-built drawings and modifications of structures and equipment used in the storage of radioactive materials.
- A list containing all areas designated as a restricted area.
- The decommissioning funding plan, cost estimate, and records of the funding method used for assuring funds are available for decommissioning.

HOLTEC INTERNATIONAL COPYRIGHTED MATERIAL	
Report No.: HI-2167374	Proposed Rev. 0A
13-4	

13.3 DECOMMISSIONING PLAN

13.3.1 General Provisions

A Preliminary Decommissioning Plan for the HI-STORE CIS Facility is provided in Holtec Report HI-2177558 [13.3.1]. A summary of this preliminary plan and is presented below.

The objective of decommissioning activities at the HI-STORE CIS Facility is to verify that any potential radioactive contamination is below established release limits, and in the unlikely event of contamination, to identify and remove radioactive contamination that is above the NRC release limits, so that the site may be released for unrestricted use and the NRC license terminated.

Residual radioactive contamination is not anticipated at the HI-STORE CIS Facility for several reasons:

- Canisters are surveyed and decontaminated at the generator facility, prior to shipment, to ensure the outer surfaces are clean. This is repeated at the HI-STORE CIS Facility to ensure dose rate and contamination requirements are met.
- Canisters are welded shut and sealed to prevent leaks.
- Canisters will not be opened during transportation to the Site or during transfer, handling, or storage operations at any time.
- Radiological activation of the VVM and concrete pad materials is expected to be insignificant with radiation levels below the applicable NRC criteria for unrestricted release.

An insignificant amount of radioactive wastes are expected to be generated at the HI-STORE CIS Facility from normal operations of the Site. Conventional decontamination techniques will be used to minimize the volume of waste generated. Any waste generated will be sent to a licensed facility for disposal. Gaseous and liquid wastes are not generated at the HI-STORE CIS Facility. Small volumes of solid radioactive waste may be produced from routine operations involving contamination surveys and decontamination activities involving incoming and outgoing transportation casks and equipment. Potential solid waste streams are collected and temporarily stored at the Site until offsite shipping, processing, and disposal methods are available.

A Final Decommissioning Plan detailing activities and procedures for decommissioning will be provided once all of the canisters are removed from the facility. The Final Decommissioning Plan will address final status survey of the site and termination of the license. The final plan will evaluate NRC criteria for decommissioning to ensure all requirements are satisfied. Decommissioning activities will be planned using ALARA principles and in a manner that protects the public and environment during the process.

13.3.2 Cost Estimate

Pursuant to 10 CFR 72.30, a decommissioning cost estimate was prepared and is presented in Holtec Report HI-2177565 [13.3.2]. This report discusses the decommissioning cost estimate and financial funding assurance per 10 CFR 72.30(b)(2). The decommissioning cost estimate follows

HOLTEC INTERNATIONAL COPYRIGHTED MATERIAL	
Report No.: HI-2167374	Proposed Rev. 0A
13-5	

the guidance of NUREG-1757 [13.3.3, 13.3.4] for activities that will allow the NRC license to be terminated and the remaining facility and site may be released for unrestricted use.

The cost estimating method used for developing the overall decommissioning cost estimate is based on resource costing. The resource costing is based on the resources and duration to estimate the costs associated with radiological surveys and decontamination activities. The estimated labor costs are based on an R.S. Means 2017 [13.3.5] that will allow an independent third party to assume the responsibility and carry out the decommissioning project. Non-labor costs include equipment and security.

The decommissioning cost estimate is based on the following key assumptions:

- All costs associated with removing the canisters from the site is not included.
- Four crews will be used to perform the radiological survey within a one year time frame.
- No subsurface material is assumed to require remediation regarding radionuclides.
- No canisters will be opened at the CIS Facility
- Nuclear activation of the VVMs and concrete pads are anticipated to be below the release limits, however for the purposes of the cost estimate, it is assumed that removal and remediation of the VVMs will be necessary
- There is no subsurface soil containing residual radioactivity that will require remediation.
- The decommissioning tasks are assumed to be completed in a two year time frame.
- All costs used in the estimates were current on January 2017.

The decommissioning cost estimate will be updated a minimum of every three years, adjusting the estimated cost for current prices of services, inflation (as necessary), and approach. The key assumptions will be also be revisited and adjusted as warranted.

13.3.3 Financial Assurance Mechanism

The method of financial assurance as specified in 10 CFR 72.30(e)(3) will be met by Holtec International. Expected decommissioning costs for Phase 1 of the HI-STORE CIS Facility are presented in Holtec Report HI-2177565 [13.3.2]. A decommissioning fund will be established by setting aside a fixed dollar amount per MTU stored at the HI-STORE facility. These funds, plus earnings on such funds calculated at a fixed rate of return over the life of the facility, will cover the estimated cost to complete decommissioning.

HOLTEC INTERNATIONAL COPYRIGHTED MATERIAL	
Report No.: HI-2167374	Proposed Rev. 0A
13-6	

13.4 REGULATORY COMPLIANCE

Pursuant to the guidance provided in NUREG-1567 [1.0.3], the foregoing material in this Chapter provides:

- i. A complete description of the Design Features of the Site which facilitate decommissioning as mandated by 10CFR72.24, 72.30, and 72.130;
- ii. A complete description of the Operational Features of the Site which facilitate decommissioning as mandated by 10CFR72.24, 72.30, and 72.130;
- iii. A complete description of the Decommissioning Plan for the Site including the Decommissioning Cost Estimate and Decommissioning Funding Plan as mandated by 10CFR72.24, 72.30, and 72.130;

Therefore, it can be concluded that this SAR provides adequate information to assure that decommissioning issues for the ISFSI facility have been adequately characterized, so that the site will ultimately be available for unrestricted use for any private or public purpose. Additionally, it can be concluded that this SAR provides adequate information to estimate the costs of decommissioning activities as well as sufficient financial assurance mechanisms to provide reasonable assurance that adequate funds will be available to decommission the facility so that the site will ultimately be available for unrestricted use for any private or public purpose.

HOLTEC INTERNATIONAL COPYRIGHTED MATERIAL	
Report No.: HI-2167374	Proposed Rev. 0A
13-7	

CHAPTER 14: WASTE CONFINEMENT AND MANAGEMENT EVALUATION*

14.0 INTRODUCTION

Significant quantities of radioactive wastes are not expected to be generated as a result of handling and storage operations for spent fuel or high-level waste (HLW) at the HI-STORE CIS site. Small volumes of solid low-level radioactive waste may be produced from routine contamination surveys and potential decontamination of transportation casks and other equipment surfaces. The canisters bearing SNF and other approved contents for storage in HI-STORM UMAX systems at the HI-STORE CIS serves as the confinement system during storage and related operations, as noted in Chapter 9 of this report. There is no breaching or opening of the confinement canister during storage operations. The integrity of the confinement system has been proven via analysis to be maintained during normal, off-normal and hypothetical accident conditions as discussed in Chapters 9 and 15 of this report.

* All references are in placed within square brackets in this report and are compiled in Chapter 19 of this report.

HOLTEC INTERNATIONAL COPYRIGHTED MATERIAL	
Report No. 2167374	Proposed Rev. 0R
14-1	

14.1 WASTE SOURCES

Radioactive wastes typically generated during operations at an ISFSI fall into the categories (a and b) below. As discussed in Sections 14.3, 14.4 and 14.5, the HI-STORE CIS has the potential to generate small volumes of low-level solid radioactive waste from contamination surveys conducted during operations. There are no other sources for significant radioactive wastes. The HI-STORE CIS complies with the radioactive wastes and radiological impact criteria in 10CFR20 and 10CFR72, as gaseous or liquid effluents are not generated onsite and provisions are made for the packaging of site-generated low-level solid waste in a form suitable for storage onsite awaiting transfer to disposal sites.

- a) Effluents (gaseous and liquid), and
- b) Wastes (solid or solidified)

In addition to the radioactive waste types above, NUREG-1567 [1.0.3] also recommends evaluation of exposure of radioactive wastes to non-radioactive wastes such as combustion products and chemical wastes.

Combustion Products

An explosion within the protected area of the ISFSI is unlikely, since explosive materials are generally prohibited within the site boundary. However, an explosion as a result of combustible fluid contained in the VCT is possible (Subsection 6.5.2). Due to the quantity of combustible fluid and the structurally robust construction materials of the HI-TRAC transfer cask, HI-STORM UMAX VVM and the canister, the effects of a fire is minimal, and the confinement boundary of the canister is not compromised (Subsection 6.5.2). The canister is in the HI-TRAC during transfer by the VCT to the HI-STORM UMAX VVM, which provides protection to the canister during an explosion. The effect of an explosion on the canister is further reduced after loading into a HI-STORM UMAX. Canisters in a HI-STORM UMAX system are protected from an explosion by the robust lid of the HI-STORM UMAX, the ISFSI pad, the subgrade and HI-STORM UMAX VVM. Thus, explosions due to combustion products will not compromise canisterized wastes being transferred to the VVM or in the VVM, and therefore have no radiological impact. There is also no credible mechanism through which radioactive wastes will come into contact with the fuel prior to or after loading into the VCT, which could potentially result in unplanned releases as exhausts effluents from the VCT's engine during operations.

Chemical Wastes

There are no chemical wastes generated at the HI-STORE CIS Facility.

HOLTEC INTERNATIONAL COPYRIGHTED MATERIAL	
Report No. 2167374	Proposed Rev. 0R
14-2	

14.2 OFF-GAS TREATMENT AND VENTILATION

The HI-STORE CIS is not a waste treatment facility. Canisters loaded and welded shut at the waste site of origin remain closed during transfer operations and storage at the HI-STORE CIS. The canister confinement boundary is not procedurally opened during operations upon arrival at the HI-STORE CIS. Furthermore, upon arrival at the HI-STORE CIS and prior to opening the transport cask containment boundary, the transport cask and the loaded canister are leak tested to ANSI N14.5 (Subsection 10.3.3) “leaktight” criteria to ensure the confinement boundary of the canister was not compromised during transport to the HI-STORE CIS. If a breach of the loaded canister is detected during the leakage test, the loaded transport cask is transported off-site to a facility authorized to perform contents unloading operations or transported back to the site of origin of the radioactive wastes without opening its transport cask containment boundary.

Therefore, since a) breach of the confinement canisters is deemed non-credible under analyzed conditions, b) opening of the confinement boundary of canisters is procedurally prohibited at the HI-STORE CIS, and c) the HI-STORE CIS is not a waste treatment facility, the generation or presence of gaseous effluents, either due to contamination cleanup or other activities is non-credible, and negates the need for off-gas treatment and ventilation systems.

HOLTEC INTERNATIONAL COPYRIGHTED MATERIAL	
Report No. 2167374	Proposed Rev. 0R
14-3	

14.3 LIQUID WASTE TREATMENT AND RETENTION

The HI-STORE CIS is designed for passive storage of HI-STORM UMAX Systems that require no further handling once canisters are loaded into the VVM. Liquid wastes, radioactive or non-radioactive, are not generated at the HI-STORE CIS during handling and or storage operations. Therefore, treatment and retention systems for liquid wastes are not required.

Fuel and HLW loaded canisters are inspected prior to transport to the HI-STORE CIS. Upon arrival at the HI-STORE CIS, the transport cask or overpack is inspected for damage and is also leak tested along with the loaded canister. In the unlikely scenario that leakage is detected or damage is observed to a degree that may compromise the long term integrity of the canister, the transport cask with the loaded canister is returned to the waste site of origin or other authorized facility for decontamination, which may involve a washdown, followed by canister unloading. Washdowns or decontamination activities of the transport cask and canisters, if required, will not occur at the HI-STORE CIS. This prevents generation of liquid radioactive or non-radioactive wastes at the CIS. Furthermore, the CIS has no labs or other facilities that may produce liquid wastes, that may become susceptible to contamination, radiologically or otherwise.

Furthermore, the ISFSI pads are designed to ensure drainage of rain water or other spilled liquids away from the HI-STORM UMAX VVMs. Radioactive contamination of drained liquids from the ISFSI pad is unlikely since all radioactive wastes onsite are in canisters. The canister design, as approved by the NRC, precludes a breach of its steel weldment construction under all analyzed conditions (Chapters 9 and 15) during storage in the HI-STORM UMAX systems. Therefore, leakage of radioactive material from the canisters is non-credible.

HOLTEC INTERNATIONAL COPYRIGHTED MATERIAL	
Report No. 2167374	Proposed Rev. 0R
14-4	

14.4 SOLID WASTES

As explained in Subsection 14.3, liquid waste (radioactive or non-radioactive) is not generated as a result of facility normal operations and off-normal events as defined in Chapters 9 and 15 of this report. As such, solidified wastes **resulting** from liquid waste stream(s) are not generated at the HI-STORE CIS.

Transportation casks and canisters received at the site are expected to be free of loose surface contamination, but are nonetheless surveyed for confirmation. Although unlikely, solid low-level radioactive wastes may therefore be generated at the HI-STORE CIS, typically consisting of paper or cloth swipes, paper towels, protective clothing, and other similar solid materials. Subsequent to contamination surveys and confirmation of canister integrity during receipt, **canisters are** transferred to the HI-STORM UMAX VVM using a process that at no time requires the canister **to be** opened and waste handled or treated. If breach of the canister is detected during **receipt** leak testing of the transport cask and loaded canister, the package is transported back to the site of origin or other site authorized to handle the radioactive contents of the package for unloading and other remediation activities. Therefore, **it is not expected that any** solid radioactive wastes **will be** generated as a result of CIS facility operations. However, any low-level solid radioactive wastes that might be generated will be collected in containers and temporarily stored in an appropriate repository in the CTB. Small volumes of solid radioactive wastes are anticipated. While on site at the CIS facility, these temporarily stored containers with low-level solid radioactive wastes will be located within flammable storage cabinets/containers to protect them from any incidental fires that occur onsite. As such, in case of a fire at the HI-STORE CIS, there would be no impact on the low-level solid radioactive wastes. These low activity wastes will be transported to, and disposed of at, a low-level waste disposal facility licensed in accordance with 10CFR61, and in compliance with other applicable federal and state regulations.

HOLTEC INTERNATIONAL COPYRIGHTED MATERIAL	
Report No. 2167374	Proposed Rev. 0R
14-5	

14.5 RADIOLOGICAL IMPACT OF NORMAL OPERATIONS

There are no radioactive wastes generated during normal operations of the HI-STORE CIS Facility. The radiological impact of the HI-STORE CIS Facility is provided in Chapter 11 of this report, and is in compliance with 10CFR20 [7.4.1] and 10CFR72 [1.0.5] effluents and dose criteria.

HOLTEC INTERNATIONAL COPYRIGHTED MATERIAL	
Report No. 2167374	Proposed Rev. 0R
14-6	

14.6 REGULATORY COMPLIANCE

In accordance with NUREG-1567 [1.0.3], this chapter should comply with 10CFR20 Appendix B Table 2, 10CFR72.24(l) and (f), 10CFR72.40(a)(13), 10 CFR72.104, 72.122(h), 10 CFR 72.126(c) and (d), and 10CFR72.128(a)(5) and (b).

10CFR20 Appendix B, Table 2 gaseous or liquid effluents radionuclide concentration limits shall not be exceeded at the HI-STORE CIS Facility.

10CFR72.24(f) requires this report to include features of the ISFSI design and operating modes that reduce to the extent practicable radioactive waste volumes generated at the installation.

10CFR72.24(l) requires description of instruments that maintain control over radioactive materials in gaseous and liquid effluents produced during normal operations and expected operational occurrences.

10CFR72.40(a)(13) requires that this report provide reasonable assurance that (i) the activities authorized by the license can be conducted without endangering the health and safety of the public, and (ii) the activities be conducted in compliance with applicable regulations of this chapter.

10CFR72.104 doses shall not be exceeded.

10CFR72.122(h)(3) requires that ventilation systems and off-gas systems must be provided where necessary to ensure the confinement of airborne radioactive particulate materials during normal or off-normal conditions.

10CFR72.126(c) requires as appropriate for handling and storage systems that effluent monitoring system be provided, and direct radiation monitoring system be provided in and around areas containing radioactive materials.

10CFR72.126(d) requires the ISFSI be designed to provide means to limit as low as reasonably achievable the release of radioactive materials in effluents during normal operations; and control the release of radioactive materials under accident conditions. Show via analysis that releases to the environment will be within the exposure limits given in 10 CFR 72.104 for normal conditions and 10 CFR 72.106 for design basis accident conditions.

10CFR72.128(a)(5) requires spent fuel and other radioactive wastes handling and storage systems must be designed to minimize the quantity of radioactive wastes generated.

10CFR 72.128(b) radioactive waste treatment facilities must be provided. Provisions must be made for the packing of site-generated low-levels wastes in a form suitable for storage onsite awaiting transfer to disposal sites.

This chapter ensures that the HI-STORE CIS Facilities complies with the applicable waste confinement and management regulatory requirements of 10 CFR 20 and 72. The HI-STORE CIS Facility is designed to receive welded canisters containing SNF and related hardware. No radioactive wastes (gaseous or liquid effluents) will be generated at the ISFSI site, and the canisters will arrive welded and remain welded throughout the storage duration at the HI-STORE CIS ISFSI. The canisters are classified as “leaktight” in accordance with ANSI N14.5 (Subsection 10.3.3), and release to the environment or impact on public health and safety is

HOLTEC INTERNATIONAL COPYRIGHTED MATERIAL	
Report No. 2167374	Proposed Rev. 0R
14-7	

considered non credible or negligible. Therefore, no effluents monitoring system are provided. Radiation monitoring equipment are provided at the HI-STORE CIS Facility as discussed in the Radiation Protection chapter (11).

As noted in Section 2.2 of this report, four nuclear facilities exist or are planned to be built within 50 miles of the proposed site for the HI-STORE CIS Facility. The closest nuclear facility is located 16 miles southwest of the proposed site for the HI-STORE CIS Facility. As such, there is no concern of the cumulative impact from operation of the HI-STORE CIS Facility and nearby facilities on the public. The environmental impacts of other nuclear facilities are in impact statements in Section 2.2 of this report.

HOLTEC INTERNATIONAL COPYRIGHTED MATERIAL	
Report No. 2167374	Proposed Rev. 0R
14-8	

CHAPTER 15: ACCIDENT ANALYSIS¹

15.0 INTRODUCTION

This chapter is focused on the safety evaluation of all off-normal and accident events germane to the HI-STORE CIS facility. For each postulated event, the event cause, means of detection, consequences, and corrective actions, as applicable, are discussed and evaluated. For other miscellaneous events (i.e., those not categorized as either design basis off-normal or accident condition events), a similar outline for safety analysis is followed. As applicable, the evaluation of consequences includes the impact on the structural, thermal, shielding, criticality, confinement, and radiation protection performance of the system due to each postulated event.

As the HI-STORE facility deploys the NRC licensed HI-STORM UMAX System for long term storage of spent fuel the applicable off-normal and accident events addressed in the HI-STORM UMAX FSAR [1.0.6] are incorporated herein by reference. A roadmap of applicable HI-STORM UMAX material is tabulated in Table 15.0.1.

The structural, thermal, shielding, criticality, and confinement features and performance of the HI-STORM UMAX system under the short-term operations and various conditions of storage are discussed in Chapters 5, 6, 7, 8 and 9. The evaluations provided in this chapter are based on the safety analyses reported therein. The accidents considered in this chapter follow guidance in NUREG-1567 [1.0.3] and NUREG-1536 [15.3.1].

¹ All references are in placed within square brackets in this report and are compiled in Chapter 19 (last chapter).

HOLTEC INTERNATIONAL COPYRIGHTED MATERIAL	
Report No.: HI-2167374	Proposed Rev. 0Q
15-1	

Table 15.0.1: Material Incorporated by Reference in this Chapter				
Information Incorporated by Reference	Source of the Information	NRC Approval of Material Incorporated by Reference	Location in this SAR where Material is Incorporated	Technical Justification of Applicability to HI-STORM UMAX
Off-Normal Events	Section 12.1, Reference [1.0.6]	SER HI-STORM UMAX Amendments 0,1,2 References [7.0.1, 7.0.2, 7.0.3]	Section 15.2	See Note 1
Accident Events	Sections 12.2 and 12.3, Reference [1.0.6]	SER HI-STORM UMAX Amendments 0,1,2 References [7.0.1, 7.0.2, 7.0.3]	Section 15.3	See Note 1
Note 1: As the HI-STORM UMAX Version C System is essentially the same as the version approved for use in the HI-STORM UMAX Docket ² and the severity of events are no greater than off-normal and accident events evaluated in the HI-STORM UMAX FSAR [1.0.6] it follows that the consequences evaluated in it are bounding.				

² Minor changes introduced in Version C have no adverse effect on the analyses performed for the generic license version.

HOLTEC INTERNATIONAL COPYRIGHTED MATERIAL	
Report No.: HI-2167374	Proposed Rev. 0Q
15-2	

15.1 ACCEPTANCE CRITERIA

15.1.1 Off-Normal Events

Criticality

In accordance with 10CFR72.124(a) regulations spent fuel sub-criticality must be maintained with k_{eff} equal to or less than 0.95.

Confinement

In accordance with 10CFR72.128(a)(3) regulations systems important to safety must be evaluated to reasonably ensure radioactive material remains confined under off-normal and accident events.

Retrievability

In accordance with 10CFR72.122(l) storage systems must allow safe retrieval of the stored spent fuel without endangering public health and safety or undue exposure to workers.

Instrumentation

In accordance with 10 CFR72.122(i) and 72.128(a)(1) the SAR must identify all instruments and control systems required to remain operational under accident conditions.

15.1.2 Accident Events

In addition to Subsection 15.1.1 criteria, dose rates to individuals located at or beyond controlled area boundary must meet 10CFR72.106(b) limits under design basis accidents.

HOLTEC INTERNATIONAL COPYRIGHTED MATERIAL	
Report No.: HI-2167374	Proposed Rev. 0Q
15-3	

15.2 OFF-NORMAL EVENTS

In this section, design events pertaining to off-normal operation under expected operational occurrences are considered and evaluated.

The following off-normal events are applicable to the HI-STORE CIS facility:

- Off-Normal Pressure
- Off-Normal Environmental Temperature
- Leakage of One MPC Seal
- Partial Blockage of Air Inlet and Outlet Ducts
- Hypothetical Non-Quiescent Wind³
- Cask Drop Less Than Design Allowable Height
- Off-Normal Events Associated with Pool Facilities
- Off-Normal Events Associated with Cask Transfer Building

15.2.1 Off-Normal Pressure

The sole pressure boundary in the HI-STORM UMAX storage System is the MPC enclosure vessel. The off-normal pressure condition is specified in Section 6.4 and evaluated in Section 6.5. The off-normal pressure for the MPC internal cavity is a function of the initial helium fill pressure and the steady state temperature reached within the MPC cavity under normal ambient temperature. The MPC internal pressure under the off-normal condition is evaluated with 10% of the fuel rods ruptured and with 100% of ruptured rods fill gas and 30% of ruptured rods fission gases released to the cavity.

15.2.1.1 Postulated Cause of Off-Normal Pressure

Fuel rods rupture is a non-mechanistic event postulated as a defense-in-depth measure and evaluated.

15.2.1.2 Detection of Off-Normal Pressure

The HI-STORM UMAX system is designed to withstand the MPC off-normal internal pressure without any effects on its ability to meet its safety requirements. There is no requirement or safety imperative for detection of off-normal pressure and, therefore, no monitoring is required.

15.2.1.3 Analysis of Effects and Consequences of Off-Normal Pressure

The MPC off-normal internal pressure is analyzed in Section 6.4. The analysis shows that the MPC pressure remains below Off-Normal limit.

15. Structural

³ Hypothetical non-quiescent wind intends to evaluate HI-STORM UMAX under a sustained persistent wind of a constant magnitude and direction to maximize disruption of the thermal performance.

HOLTEC INTERNATIONAL COPYRIGHTED MATERIAL	
Report No.: HI-2167374	Proposed Rev. 0Q
15-4	

Structural integrity of the MPC enclosure vessel is not affected as the pressure computed under this event remains below the MPC Off-Normal pressure limit as qualified by the structural design of the MPC in Section 3.1 of the HI-STORM UMAX FSAR [1.0.6] and incorporated herein by reference.

ii. Thermal

The MPC internal pressure under off-normal conditions is evaluated in Section 6.5. The computed pressure remains below Off-Normal pressure limit.

iii. Shielding

There is no effect on the shielding performance of the system as a result of this off-normal event.

iv. Criticality

There is no effect on the criticality control features of the system as a result of this off-normal event.

v. Confinement

There is no effect on the confinement function of the MPC as a result of this off-normal event. As discussed in the structural evaluation above, all pressure boundary stresses remain within allowable ASME Code values, assuring Confinement Boundary integrity.

vi. Radiation Protection

As shielding and confinement functions are not affected as evaluated above, there is no adverse effect on occupational or public exposures as a result of this off-normal event.

15.2.1.4 Corrective Action for Off-Normal Pressure

The HI-STORM UMAX system is designed to withstand the off-normal pressure without any effects on its ability to maintain safe storage conditions. Therefore, there is no corrective action requirement for off-normal pressure.

15.2.1.5 Radiological Impact of Off-Normal Pressure

The event of off-normal pressure has no radiological impact because the confinement barrier and shielding integrity are not affected.

15.2.1.6 Conclusion

Based on this evaluation, it is concluded that the off-normal pressure does not affect the safe operation of the HI-STORM UMAX system.

15.2.2 Off-Normal Environmental Temperature

As evaluated in Subsection 6.5.1 this event is bounded by HI-STORM UMAX FSAR [1.0.6]. Event evaluation incorporated by reference. See Table 15.0.1 and HI-STORM UMAX FSAR Subsection 12.1.2 [1.0.6].

15.2.3 Leakage of one MPC seal

HOLTEC INTERNATIONAL COPYRIGHTED MATERIAL	
Report No.: HI-2167374	Proposed Rev. 0Q
15-5	

The MPC confinement boundary is defined by MPC shell, baseplate, lid, vent and drain port covers, closure ring and associated welds. Leakage of an MPC seal weld evaluated in HI-STORM UMAX FSAR Subsection 12.1.3 [1.0.6] is incorporated by reference.

15.2.4 Partial Blockage of the Air Inlets and Outlets

The HI-STORM UMAX inlet and outlet vents are designed with debris screens. These screens protect the openings from the incursion of foreign objects. However, it is conservatively assumed that 50% of the air inlets and outlets are blocked simultaneously. The scenario of the partial blockage of air inlets and outlets is evaluated with a normal ambient temperature, full solar insolation, and Design Basis SNF decay heat. This condition is analyzed in Subsection 6.5.1 4 to demonstrate the acceptability of the system thermal performance during this event.

15.2.4.1 Postulated Cause of Partial Blockage of Air Inlets and Outlets

The presence of screens prevents foreign objects from entering the openings and the screens are either inspected periodically or the system temperature field is monitored per the Technical Specifications. It is, however, possible that blowing debris may partially block the inlets and outlets for a short time until the openings are cleared of debris.

15.2.4.2 Detection of Partial Blockage of Air Inlets and Outlets

The detection of the partial blockage of air inlets and outlets will occur during routine visual inspection of the screens or temperature monitoring of the outlet air, required by the Technical Specifications. The frequency of inspection is based on an assumed complete blockage of all air inlets and outlets (see Subsection 15.3.10). There is no inspection requirement as a result of the postulated partial inlet and outlet blockage because the complete blockage of all air inlets and outlets is bounding.

15.2.4.3 Analysis of Effects and Consequences of Partial Blockage of Air Inlets and Outlets

i. Structural

The effect of partial blockage of the air inlets and outlets is an increase in cask component and fuel cladding temperatures and an increase in MPC internal pressure with a corresponding increase in pressure boundary stresses. However, the resultant temperatures and pressures are below the off-normal design limits as discussed in the thermal effects evaluation below. The MPC stresses resulting from the partial blockage of air inlets and outlets are confirmed to be bounded by the applicable pressure boundary stress limits. Therefore, there is no effect on structural function.

In summary, there are no structural consequences as a result of this off-normal event since the HI-STORM UMAX components do not exceed the off-normal temperature limits (Table 2.3.7 of the HI-STORM UMAX FSAR [1.0.6]) and the MPC internal pressure does not exceed the off-normal pressure limit (Table 2.3.5 of the HI-STORM UMAX FSAR [1.0.6]).

ii. Thermal

The thermal evaluation of partial blockage of air inlets and outlets is discussed in Subsection 6.5.1. The calculated bounding temperatures, conservatively evaluated as a

HOLTEC INTERNATIONAL COPYRIGHTED MATERIAL	
Report No.: HI-2167374	Proposed Rev. 0Q
15-6	

50% blockage of both inlets and outlets for a sufficient duration to reach the asymptotic maximum (steady-state) temperature field, are reported in Table 6.5.5 and are below the MPC and VVM off-normal design temperature limits (Table 2.3.7 of the HI-STORM UMAX FSAR [1.0.6]). Additionally, the increased temperatures generate an elevated MPC internal pressure, reported in Table 6.5.5, which is less than the off-normal design pressure limit (Table 2.3.5 of the HI-STORM UMAX FSAR [1.0.6]). The temperatures and pressures resulting from the partial blockage of air inlets and outlets are confirmed to be bounded by the applicable system temperature and pressure limits. Therefore, there is no adverse effect on the system's thermal function.

iii. Shielding

There is no adverse effect on the function of shielding features of storage the system as a result of this off-normal event.

iv. Criticality

There is no effect on the criticality control features of the system as a result of this off-normal event.

v. Confinement

There is no effect on the confinement function of the MPC as a result of this off-normal event.

vi. Radiation Protection

Since there is no degradation in shielding or confinement capabilities as discussed above, there is no predicted adverse effect on occupational or public exposures as a result of this off-normal event.

15.2.4.4 Corrective Action for Partial Blockage of Air Inlets and Outlets

The corrective action for the partial blockage of air inlets and outlets is the removal, cleaning, and replacement of the affected mesh screens. After clearing of the blockage, the storage module temperatures will return to the normal temperatures reported in Chapter 6. Partial blockage of air inlets and outlets does not affect the safe operation of the HI-STORM UMAX System.

Periodic inspection of the HI-STORM UMAX air inlet and outlet screens is required per the Technical Specifications. Alternatively, per the Technical Specifications, the outlet air temperature is monitored. The frequency of inspection is based on an assumed blockage of all air inlet openings evaluated in Subsection 15.3.10.

15.2.4.5 Radiological Impact of Partial Blockage of Air Inlets and Outlets

The off-normal event of partial blockage of the air inlets and outlets has no radiological impact because the confinement barrier is not breached and the system's shielding effectiveness is not diminished.

15.2.4.6 Conclusion

Based on the above evaluation, it is concluded that the off-normal partial blockage of air inlets and outlets does not affect the safe operation of the HI-STORM UMAX VVM.

HOLTEC INTERNATIONAL COPYRIGHTED MATERIAL	
Report No.: HI-2167374	Proposed Rev. 0Q
15-7	

15.2.5 Hypothetical Non-Quiescent Wind

As evaluated in Subsection 6.4.3 this event is bounded by HI-STORM UMAX FSAR [1.0.6]. Event evaluation incorporated by reference. See Table 15.0.1 and HI-STORM UMAX FSAR Subsection 12.1.5 [1.0.6].

15.2.6 Cask Drop Less Than Design Allowable Height

HI-STORM UMAX VVM

Not applicable as HI-STORM UMAX VVM is a permanently installed underground structure.

HI-TRAC CS

HI-TRAC CS drop not credible as heavy load handling requires redundant drop protection. See Chapter 4, Subsections 4.5.1, 4.5.2 and 4.5.3.

HI-STAR 190

HI-STAR 190 drop not credible as heavy load handling requires redundant drop protection. See Chapter 4, Subsections 4.5.1, 4.5.2 and 4.5.3.

15.2.7 Off-Normal Events Associated with Pool Facilities

Not applicable to HI-STORE CIS facility as pool facilities are not required to support operations.

15.2.8 Off-Normal Events Associated with Cask Transfer Building

There are no specific off-normal events associated with activities inside the CTB for the following reasons. When a HI-STAR 190 transport cask arrives at the CTB, its impact limiters are installed and they remain in place until the HI-STAR 190 package is lowered onto the tilt frame. Thus, there is no credible risk to the HI-STAR 190 cask or its contents while the impact limiters are in place, as demonstrated by the qualifying analyses in the HI-STAR 190 SAR [1.3.6]. After the impact limiters are removed from the HI-STAR 190 cask, the loaded MPC either remains in a static resting position, inside a HI-STAR 190 or HI-TRAC CS, with support from below (i.e., tilt frame or CTB/CTF slab) or it is being lifted (raised or lowered) using the single-failure-proof overhead crane in combination with ANSI N14.6 compliant handling devices. Therefore, an off-normal drop event is not credible, as indicated in Subsection 15.2.6.

15.2.9 Safety Evaluation

Off-Normal event analyses support the conclusion that HI-STORM UMAX robustly withstands impact of off-normal events and complies with Section 15.1 Acceptance Criteria and Chapter 4 Design Limits.

HOLTEC INTERNATIONAL COPYRIGHTED MATERIAL	
Report No.: HI-2167374	Proposed Rev. 0Q
15-8	

15.3 ACCIDENTS

Accidents, in accordance with ANSI/ANS-57.9 [2.7.2], are either infrequent events that could reasonably be expected to occur during the lifetime of the cask or events postulated because their consequences may affect public health and safety. Accidents germane to the safety evaluation of HI-STORM UMAX system are considered and evaluated herein.

The following accident events are applicable to the HI-STORE CIS facility:

- Fire Accident
- Partial Blockage of MPC Basket Vent Holes
- Tornado Missiles
- Flood
- Earthquake
- 100% Fuel Rods Rupture
- Confinement Boundary Leakage
- Explosion
- Lightning
- 100% Blockage of Air Inlet and Outlet Ducts
- Burial Under Debris
- Extreme Environmental Temperature
- Cask Tipover
- Cask Drop
- Loss of Shielding
- Adiabatic Heatup
- Accidents at Nearby Sites
- Accidents Associated with Pool Facilities
- Building Structural Failure onto SSCs
- 100% Rod Rupture Accident Coincident with Accident Events

15.3.1 Fire Accident

The potential of a fire accident is extremely remote by ensuring that there are no significant combustible materials in the area. The only credible concern is related to a transport vehicle fuel tank fire engulfing a loaded HI-STORM UMAX VVM or a HI-TRAC CS transfer cask. Fire accident involving the HI-STORM UMAX VVM, HI-TRAC CS or HI-STAR 190 fire is evaluated in the following.

HOLTEC INTERNATIONAL COPYRIGHTED MATERIAL	
Report No.: HI-2167374	Proposed Rev. 0Q
15-9	

15.3.1.1 Fire Analysis

(a) HI-STORM UMAX VVM Fire

The analysis for the fire accident including the methodology is articulated in Subsection 6.5.2. The transport vehicle fuel tank fire is analyzed to evaluate the storage overpack heating by the incident thermal radiation and forced convection heat fluxes and fuel cladding and MPC temperatures.

i. Structural

As evaluated in Subsection 6.5.2 there are no structural consequences of the fire accident condition as the short-term temperature limit on great majority of the concrete is not exceeded and component temperatures remain within Chapter 4 temperature limits. The MPC structural boundary remains within normal condition internal pressure and temperature limits.

ii. Thermal

Based on a conservative analysis articulated in Subsection 6.5.2 and computed response under the hypothetical event, it is concluded that the fire event does not affect the temperature of the MPC or contained fuel. Furthermore, the ability of the HI-STORM UMAX System to maintain cooling of the spent nuclear fuel within temperature limits during and after fire is not compromised.

iii. Shielding

With respect to limited damage to the outer layers of concrete subject to direct fire flux, NUREG-1536 (4.0,V,5.b) states: “the loss of a small amount of shielding material is not expected to cause a storage system to exceed the regulatory requirements in 10 CFR 72.106 and, therefore, need not be estimated or evaluated in the FSAR.”

iv. Criticality

There is no effect on the criticality control features of the system as a result of this event.

v. Confinement

There is no effect on the confinement function of the MPC as a result of this event as the structural integrity of the confinement boundary is unaffected.

vi. Radiation Protection

As there is minimal reduction, if any, in shielding and no effect on the confinement capabilities as discussed above, there is no effect on occupational or public exposures as a result of this accident event.

As supported by evaluation above, it is concluded that the design basis fire does not affect the safe operation of the HI-STORM UMAX System.

(b) HI-TRAC CS Fire

The HI-TRAC CS must withstand elevated temperatures under the Design Basis Fire event defined Chapter 6. The acceptance criteria for the fire accident are specified in Design Criteria Chapter 4.

HOLTEC INTERNATIONAL COPYRIGHTED MATERIAL	
Report No.: HI-2167374	Proposed Rev. 0Q
15-10	

i. Structural

The effect of the fire accident on the HI-TRAC CS is an increase in fuel cladding and system component temperatures and MPC internal pressure and thus an increase in MPC pressure boundary stresses. The resultant temperatures and pressures are below the accident design limits as evaluated below. The MPC pressures resulting from the fire accident event are bounded by the applicable pressure boundary limits; therefore, there is no effect on structural function.

ii. Thermal

As evaluated in Section 6.5, the effect of the fire does not result in any system component or the contained fuel to exceed temperature limits set in this SAR. The Design Basis Fire has a minor impact on MPC pressure. The temperatures and pressures resulting from the fire accident event are to be bounded by the applicable system temperature and pressure limits; therefore, there is no deleterious effect on the system's thermal function. With respect to limited damage to the outer layers of concrete subject to direct fire flux, NUREG-1536 (4.0,V,5.b) states: "the loss of a small amount of shielding material is not expected to cause a storage system to exceed the regulatory requirements in 10 CFR 72.106 and, therefore, need not be estimated or evaluated in the FSAR."

iii. Shielding

Under the fire accident condition, the outside of the cask would heat up significantly, and while the outer steel shell would assure the overall integrity of the cask, and hence prevent any significant loss of shielding function, the outer area of the shielding concrete may experience some degradation. To model this in an analysis, shielding calculations are performed in which the density of the HI-TRAC CS concrete is substantially degraded as shown in Table 7.3.1. Results of the analyses are presented in Table 7.4.4, demonstrating compliance with 10CFR72.106.

iv. Criticality

There is no effect on the criticality control features of the system as a result of this event.

v. Confinement

There is no effect on the confinement function of the MPC as a result of this event as the structural integrity of the confinement boundary is unaffected.

vi. Radiation Protection

There is no effect on the confinement capabilities as evaluated above, and the site boundary shielding accident dose limits in 10CFR72.106 are not exceeded thereby ensuring occupational and public safety.

(c) HI-STAR 190 Fire

As evaluated in Subsection 6.5.2 HI-STAR 190 fire accident under HI-STORE CIS deployment is bounded by the HI-STAR 190 SAR transport fire accident [1.3.6]. The accident Section 3.4 is incorporated by reference.

HOLTEC INTERNATIONAL COPYRIGHTED MATERIAL	
Report No.: HI-2167374	Proposed Rev. 0Q
15-11	

15.3.1.2 Fire Accident Corrective Actions

Upon detection of a fire appropriate fire protection actions are initiated in accordance with facility Emergency Response Plan [10.5.1] to extinguish the fire. Following the termination of the fire, a visual and radiological inspection of the equipment shall be performed.

If damage to HI-STORM UMAX VVM, HI-TRAC CS or HI-STAR 190 warrant, and/or radiological conditions require (based on dose rate measurements), the MPC shall be transferred to HI-TRAC CS in accordance with procedures set down in Chapter 3. The HI-STORM UMAX VVM, HI-TRAC CS or HI-STAR 190 may be returned to service after appropriate restoration (reapplication of coatings, etc.) and if there is no significant increase in the measured dose rates (i.e., the shielding effectiveness of overpack is confirmed) and if visual inspection is satisfactory.

15.3.1.3 Conclusion

Based on the above evaluation, it is concluded that the Design Basis Fire accident does not affect the safe operation of the HI-STORM UMAX, HI-TRAC CS and HI-STAR 190 casks.

15.3.2 Partial Blockage of MPC Basket Vent Holes

Event evaluation incorporated by reference. See Table 15.0.1 and UMAX FSAR Subsection 12.2.2.

15.3.3 Tornado Missiles

HI-STORM UMAX VVM

Site specific tornado hazards are identified in Chapter 2, Section 2.3. These hazards are bounded by HI-STORM UMAX FSAR [1.0.6] as justified in Chapter 4, Table 4.3.1. Accordingly, HI-STORM UMAX FSAR tornado accident Subsection 12.2.3 [1.0.6] is incorporated by reference.

HI-TRAC CS

See discussion below.

HI-STAR 190

HI-STAR 190 damage from tornado missile impacts are bounded by the more onerous 1-meter puncture drop accident evaluated in the HI-STAR 190 SAR [1.3.6].

CTB

The CTB is designed for the design basis tornado winds and missiles, so there are no consequences from a tornado accident on operations within the building.

VCT and HI-PORT

Following the previously certified HI-STORM UMAX as described in Table 15.0.1, the tornado analysis from the HI-STORM FW FSAR[1.3.7] is incorporated by reference. The HI-STORM FW FSAR specifically states that because the HI-TRAC is handled by equipment that meets the single failure proof criteria, impacts from the tornado missile is not credible, and further analyses were not required. However for additional assurance, as described in Chapter 5, the impact of the tornado accident on the VCT and HI-PORT is evaluated.

HOLTEC INTERNATIONAL COPYRIGHTED MATERIAL	
Report No.: HI-2167374	Proposed Rev. 0Q
15-12	

As further defense in depth, the operations in Chapter 10 require that prior to moving a transporter out of the building, the weather will be considered and if severe weather is predicted, appropriate actions will be taken.

15.3.3.1 Cause

Tornado and high winds are principally caused by the uneven heating of the earth's atmosphere, coupled with gravitational forces and the rotation of the earth. The HI-TRAC CS involves deployment in an open area environment and thus will be subject to extreme environmental conditions throughout the storage period.

15.3.3.2 Tornado Analysis

A tornado event is characterized by high wind velocities and tornado-generated missiles. The reference missiles considered in this SAR are of three sizes: small, medium, and large. A small projectile, upon collision with a cask, would tend to penetrate it. A large projectile, such as an automobile, on the other hand, would tend to cause deformation.

The tornado analysis for a HI-TRAC CS transfer cask is evaluated in Chapter 5, including while o the VCT and HI-PORT. The evaluation is summarized below.

i. Structural

There is no effect on the structural function of HI-TRAC CS as a result of this accident event.

ii. Thermal

There is no effect on the function of HI-TRAC CS heat transfer features as a result of this accident event. Tornado borne missile may cause localized damage. Global heat dissipation characteristics are unaffected.

iii. Shielding

Tornado borne missile may cause localized damage. Dose consequences of the localized damage are bounded by accident analysis in Shielding Chapter 7

iv. Criticality

There is no effect on the criticality control features of the MPC as a result of this accident event.

v. Confinement

There is no effect on the confinement function of the MPC as a result of this accident event.

15.3.3.3 Radiation Protection and Consequences

There is no adverse effect on confinement functions. Controlled area boundary accident dose limits in 10CFR72.106 are not exceeded.

HOLTEC INTERNATIONAL COPYRIGHTED MATERIAL	
Report No.: HI-2167374	Proposed Rev. 0Q
15-13	

15.3.3.4 Tornado Accident Corrective Action

Following a tornado accident visual and radiological inspection shall be performed in accordance with site Emergency Response Plan and appropriate restoration measures undertaken if localized damage results in a significant increase in measured dose.

15.3.3.5 Conclusion

Based on the above evaluation, it is concluded that the Design Basis tornado accident will not affect the safe operation of the HI-STORM UMAX, HI-TRAC CS and HI-STAR 190 casks.

15.3.4 Flood

Site specific flood hazards are identified in Chapter 2, Section 2.4.3. These hazards are bounded by HI-STORM UMAX FSAR [1.0.6] as justified in Chapter 4, Table 4.3.1. Moderator exclusion under flood accident is evaluated in Chapter 8. HI-STORM UMAX FSAR flood accident Subsection 12.2.4 [1.0.6] is incorporated by reference.

15.3.5 Earthquake

HI-STORM UMAX

Site specific earthquake hazards are identified in Chapter 4, Subsection 4.3.2. These hazards are bounded by HI-STORM UMAX FSAR [1.0.6] as justified in Chapter 4, Table 4.3.1. HI-STORM UMAX FSAR earthquake accident Subsection 12.2.5 [1.0.6] is incorporated by reference.

HI-TRAC CS

See discussion below.

HI-STAR 190

HI-STAR 190 g-loads under earthquake events are reasonably bounded by the 10CFR Part 71 10-meter drop accident evaluated in the HI-STAR 190 SAR [1.3.6]. In addition, the seismic stability of freestanding HI-STAR 190 under site specific earthquake is evaluated in Chapter 5.

15.3.5.1 Cause of Event

Earthquake is a terrestrial instability event cause by relative movements in the mantle of the earth. The only concern is under a stack up of HI-TRAC CS in the CTB during canister transfer operations. This event is analyzed under site earthquake loading in Chapter 5 and evaluated below.

15.3.5.2 Analysis of the Effect of Site-Specific Earthquake

i. Structural

The stack-up scenario of the HI-TRAC CS has been fully evaluated in Chapter 5. Due to the robust configuration of the HI-TRAC CS and its earthquake resistant bolting design, it has been demonstrated that there are no structural concerns with the HI-TRAC CS under an earthquake event.

ii. Thermal

HOLTEC INTERNATIONAL COPYRIGHTED MATERIAL	
Report No.: HI-2167374	Proposed Rev. 0Q
15-14	

There is no effect on the function of HI-TRAC CS heat transfer features as a result of this accident event because no constriction of the air flow passages within the system is computed to occur and vertical configuration is not compromised as evaluated in the structural analysis above. Thus, the cooling effectiveness of the HI-TRAC CS remains undiminished in under an earthquake event.

iii. Shielding

There is no adverse effect on the function of shielding features of the system as a result of this accident event.

iv. Criticality

There is no effect on the criticality control features of the MPC as a result of this accident event.

v. Confinement

There is no effect on the confinement function of the MPC as a result of this accident event. Structural evaluation shows stresses remain within design criteria, assuring confinement boundary integrity.

vi. Radiation Protection and Consequences

As there is no effect on shielding or confinement functions as evaluated above, there is no radiological consequence (from effluents and direct radiation) as a result of this accident event. A minor increase to occupational exposures for the performance of corrective actions is expected.

15.3.5.3 Earthquake Accident Corrective Action

Following a seismic event HI-TRAC CS must be inspected for localized damage. Visual inspection shall be performed as follows:

- Visual inspection to confirm the extent of damage (if any) to the MPC shell is negligible.
- Visual inspection to verify the extent of damage (if any) to HI-TRAC CS components important-to-safety is negligible.
- Visual inspection to confirm air flow passages are clear of obstructions.

Corrective actions shall be implemented based on the results of the inspection.

15.3.5.4 Conclusion

Based on the above evaluation, it is concluded that the Design Basis Earthquake will not affect the safe operation of HI-TRAC CS. Corrective actions may be necessary to restore the system to the pre-seismic condition.

15.3.6 100% Fuel Rods Rupture

The rupture of every fuel rod inside the Canister is postulated as a *non-mechanistic event* in NUREG -1536 [15.3.1]. In other words, simultaneous failure of all fuel rods in a Canister is a counter-factual event whose actuation mechanism cannot be articulated but it is nevertheless postulated to ascertain the robustness of the Confinement boundary. (A similar non-credible

HOLTEC INTERNATIONAL COPYRIGHTED MATERIAL	
Report No.: HI-2167374	Proposed Rev. 0Q
15-15	

event requiring safety assessment in NUREG-1536 is the "non-mechanistic tip-over" of above-ground storage casks). Because the rods are assumed to have failed *a priori*, the 100% rod rupture event does not require satisfaction of a specific fuel cladding temperature limit. Rather, the acceptance criterion focuses on demonstrating the integrity of the Confinement Boundary. This accident is analyzed in Subsection 6.4.3 and integrity of the Canister's pressure boundary evaluated to ensure the internal pressure in the Canister remains below the Chapter 4 accident design pressure.

From a thermal perspective 100% percent rod rupture event is not adverse to heat transfer because internal convection heat transfer in the Canister is significantly boosted by the release of the plenum gases in the rods (due to their rupture), thus spatial temperature field in the Canister is moderated (reduced in magnitude).

15.3.7 Confinement Boundary Leakage

Event evaluation incorporated by reference. See Table 15.0.1 and HI-STORM UMAX FSAR Subsection 12.2.7 [1.0.6].

15.3.8 Explosion

Accident event is bounded by HI-STORM UMAX FSAR [1.0.6]. See site specific explosion evaluation in Chapter 4, Table 4.3.1 and Chapter 6, Subsection 6.5.2. HI-STORM UMAX FSAR explosion accident Subsection 12.2.8 [1.0.6] is incorporated by reference.

15.3.9 Lightning

Event evaluation incorporated by reference. See Table 15.0.1 and HI-STORM UMAX FSAR Subsection 12.2.9 [1.0.6].

15.3.10 100% Blockage of Air Inlets and Outlets

A complete blockage of all VVM inlets and outlets cannot be realistically postulated to occur at the HI-STORE site. However, this event is conservatively defined as a complete blockage of all VVM inlets and outlets.

15.3.10.1 100% Blockage of Air Inlets and Outlets Analysis

The immediate consequence of a complete blockage of the air inlets and outlets is that the normal circulation of air for cooling the MPC is stopped. An amount of heat will continue to be removed by localized air circulation patterns in the cooling passages and the system will continue to reject heat to the relatively cooler soil surrounding the VVM. As the temperatures of the MPC and its contents rise, the rate of heat rejection will increase correspondingly. Under this condition, the temperatures of the HI-STORM UMAX VVM, the MPC and the stored fuel assemblies will rise as a function of time.

As a result of the large mass and correspondingly large thermal capacity of the HI-STORM UMAX VVM, it is expected that a significant temperature rise is only possible if the blocked condition is allowed to persist for an extended duration. This accident condition is, however, a short duration event that will be identified by the ISFSI staff, at worst, during scheduled periodic surveillance at the ISFSI site and corrected using the site's event response procedure or equivalent.

HOLTEC INTERNATIONAL COPYRIGHTED MATERIAL	
Report No.: HI-2167374	Proposed Rev. 0Q
15-16	

i. Structural

The effect of complete blockage of the air inlets and outlets is an increase in component and fuel cladding temperatures and MPC internal pressure (with a corresponding increase in pressure boundary stresses). However, the resultant temperatures and pressures are below the accident design limits as discussed in the thermal effects evaluation below. The MPC stresses resulting from the complete blockage of air inlets and outlets are confirmed to be bounded by the applicable pressure boundary stress limits. Therefore, there is no effect on structural function.

In summary, there are no structural consequences as a result of this accident event since the HI-STORM UMAX components do not exceed the accident condition temperature limits (Table 2.3.7 of the HI-STORM UMAX FSAR [1.0.6]) and the MPC internal pressure does not exceed the accident condition pressure limit (Table 2.3.5 of the HI-STORM UMAX FSAR [1.0.6]).

ii. Thermal

A thermal analysis is performed in Subsection 6.5.2.5 to determine the effect of a complete blockage of all inlets and outlets for an extended duration. For this event, both the fuel cladding and component temperatures (see Table 6.5.6) remain below their accident temperature limits (Table 2.3.7 of the HI-STORM UMAX FSAR [1.0.6]) for the evaluated duration of the event. The MPC internal pressure for this event is evaluated and reported in Table 6.5.6 and is bounded by the design basis internal pressure for accident conditions (Table 2.3.5 of the HI-STORM UMAX FSAR [1.0.6]).

iii. Shielding

The above thermal results indicate insignificant loss of material and, therefore, the effect of this event on the shielding capacity would be negligible.

iv. Criticality

There is no effect on the function of criticality control features of the MPC as a result of this accident event.

v. Confinement

There is no effect on the confinement function of the MPC as a result of this accident event.

vi. Radiation Protection and Consequences

Since there is no effect on shielding or confinement functions as discussed above, there is no radiological consequence (from effluents and direct radiation) as a result of this event. A negligible-to-minor increase to occupational exposures for the performance of corrective actions is expected.

15.3.10.2 Corrective Action

Analysis of the 100% blockage of air inlets and outlets shows that the temperatures for system components and fuel cladding are within the accident temperature limits if the blockage is cleared within the maximum elapsed period between scheduled surveillance inspections. Upon

HOLTEC INTERNATIONAL COPYRIGHTED MATERIAL	
Report No.: HI-2167374	Proposed Rev. 0Q
15-17	

detection of the complete blockage of the air inlets and outlets, the blockage shall be removed with mechanical and manual means as necessary. After clearing the VVM openings, the system shall be visually and radiologically inspected for any damage. If exit air temperature monitoring is performed in lieu of direct visual inspections, the difference between the ambient air temperature and the exit air temperature will be the basis for the assurance that the temperature limits are not exceeded.

15.3.10.3 Conclusion

Based on the above evaluation, it is concluded that the 100% blockage of air inlets and outlets does not affect the safe operation of the HI-STORM UMAX System, if the blockage is removed in the specified time period.

15.3.11 Burial Under Debris

HI-STORM UMAX

As evaluated in Chapter 6, Subsection 6.5.2 burial accident is not credible.

HI-TRAC CS

See Subsection 15.3.19.

15.3.12 Extreme Environmental Temperature

This event is bounded by the HI-STORM UMAX FSAR [1.0.6] as the site extreme ambient temperature and cask heat loads are bounded by HI-STORM UMAX (See Table 6.3.1). Accordingly the event evaluation is incorporated by reference. See Table 15.0.1 and HI-STORM UMAX FSAR Subsection 12.2.12 [1.0.6].

15.3.13 Tip-over

Because the HI-STORM UMAX VVM is situated underground, a tip-over event is not a credible accident for this design. See Table 4.3.1.

HI-TRAC CS cask and HI-STAR 190 cask tip-over is not credible as demonstrated in Chapter 5.

15.3.14 Cask Drop

HI-STORM UMAX VVM

Not applicable as HI-STORM UMAX VVM is a permanently installed underground structure.

HI-TRAC CS

HI-TRAC CS drop not credible as heavy load handling requires redundant drop protection. See Chapter 4, Subsections 4.5.1, 4.5.2 and 4.5.3.

HI-STAR 190

HI-STAR 190 drop not credible as heavy load handling requires redundant drop protection. See Chapter 4, Subsections 4.5.1, 4.5.2 and 4.5.3.

HOLTEC INTERNATIONAL COPYRIGHTED MATERIAL	
Report No.: HI-2167374	Proposed Rev. 0Q
15-18	

15.3.15 Loss of Shielding

Loss of shielding rendered not-credible under an array of challenging off-normal and accident events wherein shielding function is concluded to result in *no-impact*.

15.3.16 Adiabatic Heat-up

Accident not credible as this requires a counter-factual postulate choking all means of heat dissipation including conduction, convection and radiation.

15.3.17 Accidents at Nearby Sites

To ensure HI-STORE CIS facility is not under undue risk from off-site facilities the surrounding area must be assessed for potential hazards such as military installations, gas and oil processing or storage facilities, oil or gas pipelines, chemicals, fireworks or explosives factories.

A survey of surrounding areas evaluated in Sections 2.1 and 2.2 yields one fire hazard that warrants attention. The fire hazard is evaluated in Section 6.5 concluding no adverse effect on the HI-STORM UMAX storage casks or on-site transfer operations involving the HI-TRAC CS and HI-STAR 190.

15.3.18 Accidents Associated with Pool Facilities

Not applicable to HI-STORE CIS as pool facilities not required to support operations.

15.3.19 Building Structural Failure onto SSCs

15.3.19.1 Cause of Building Collapse

The CTB is an ITS structure and is designed to strict building codes as outlined in the Technical Specifications, therefore building collapse is non-credible. However, as defense in depth, and because the accident may bound other scenarios the below description is maintained.

This accident is defined as a postulated structural collapse of CTB building roof and burial under it of canister bearing HI-TRAC CS and HI-STAR 190 casks. The event is analyzed in Section 5.4 and Section 6.5, for structural and thermal considerations, respectively.

15.3.19.2 Building Collapse Analysis

Burial of casks under debris adversely affects ventilation cooling because debris will block the inflow of air. A thermal analysis is undertaken in Section 6.5 to compute steady state maximum cask temperatures and co-incident MPC pressures. The results are evaluated below.

i. Structural

The effect of burial under collapsed debris on the MPC is an increase in component and fuel cladding temperatures and internal pressure and thus an increase in pressure boundary stresses. The resultant temperatures and pressures obtained in Subsection 6.5.2 remain below accident limits. In addition, the HI-TRAC CS and HI-STAR 190 casks are structurally analyzed to evaluate the damage due to a potential building collapse in Section 5.4.

ii. Thermal

HOLTEC INTERNATIONAL COPYRIGHTED MATERIAL	
Report No.: HI-2167374	Proposed Rev. 0Q
15-19	

The fuel cladding and MPC integrity is evaluated in Section 6.5. The evaluation supports the conclusion that fuel cladding and confinement function of the MPC is not compromised.

iii. Shielding

HI-TRAC CS

The thermal results support the conclusion there is no material loss in the shielding capacity of the HI-TRAC CS cask.

HI-STAR 190

Limited reduction in shielding effectiveness is possible as Holtite neutron shield temperature limits are nominally exceeded. These effects are reasonably bounded by Holtite loss under the 10CFR Part 71 fire accident evaluated in HI-STAR 190 SAR [1.3.6].

iv. Criticality

Criticality control function is not affected under this event.

v. Confinement

Confinement function is not affected under this event.

vi. Radiation Protection and Consequences

As shielding and confinement functions as evaluated above are not affected, there is no radiological consequence. A negligible-to-minor increase to occupational exposures for the performance of corrective actions is expected.

15.3.19.3 Corrective Action

Analysis of building collapse accident shows that fuel, components and MPC pressures remain below accident limits. Under building collapse accident, operator shall remove the debris from around loaded casks in accordance with facility Emergency Response Plan [10.5.1]. Upon debris removal flow passages shall be visually inspected to verify air flow path is free of obstructions. The site's emergency action plan shall include provisions for the implementation of this corrective action.

15.3.19.4 Conclusion

Based on the above evaluation, it is concluded that the burial-under-debris accident event does not affect the safe operation of canister bearing casks in the CTB.

15.3.20 100% Rod Rupture Accident Coincident with Accident Events

The rupture of every fuel rod inside the Canister is postulated as a *non-mechanistic event* in NUREG -1536 [15.3.1]. In other words, simultaneous failure of all fuel rods in a Canister is a counter-factual event whose actuation mechanism cannot be articulated but it is nevertheless postulated to ascertain the robustness of the Confinement boundary. (A similar non-credible event requiring safety assessment in NUREG-1536 is the "non-mechanistic tip-over" of above-ground storage casks). Because the rods are assumed to have failed *a' priori*, the 100% rod

HOLTEC INTERNATIONAL COPYRIGHTED MATERIAL	
Report No.: HI-2167374	Proposed Rev. 0Q
15-20	

rupture event does not require satisfaction of a specific fuel cladding temperature limit. Rather, the acceptance criterion focuses on demonstrating the integrity of the Confinement Boundary. The integrity of the Canister's pressure boundary is satisfied if the internal pressure in the Canister remains below the Chapter 4 accident design pressure.

From a thermal perspective 100% percent rod rupture event is not adverse to heat transfer because internal convection heat transfer in the Canister is significantly boosted by the release of the plenum gases in the rods (due to their rupture), thus spatial temperature field in the Canister is moderated (reduced in magnitude).

Because the 100% rod rupture is a hypothetical postulate, the standard safety analysis practice as licensed in the Part 72 docket (viz 72-1008, 72-1014, 72-1032, 72-1040) is to treat it as a stand-alone event, not to be combined with any accident such as fire near the HI-STORM UMAX ISFSI. The above position is supported by quote from the NRC Safety Evaluation Report as shown in the text highlighted below for emphasis:

HI-STORM 100 SER⁴:

“The HI-STORM 100 Cask System postulated accidents are described in Chapter 11 of the proposed FSAR and include:

1. HI-TRAC Transfer Cask Handling Accident
2. HI-STORM 100 Overpack Handling Accidents
3. Tip Over
4. Fire Accident
5. Partial Blockage of MPC Basket Vent Holes
6. Tornado
7. Flood
8. Earthquake
9. 100% Fuel Rod Rupture
10. Confinement Boundary Leakage
11. Lightning
12. Explosion
13. 100% Blockage of Air Inlets
14. Burial Under Debris
15. Extreme Environmental Temperature
16. SCS Failure”

⁴ “Final Safety Evaluation Report Docket No. 72-1014 Holtec International HI-STORM 100 Cask System Certificate of Compliance No. 1014 Amendment No. 5”, pp. 11-2 & 11-3.

HOLTEC INTERNATIONAL COPYRIGHTED MATERIAL	
Report No.: HI-2167374	Proposed Rev. 0Q
15-21	

15.4 OTHER NON-SPECIFIED ACCIDENTS

This section addresses miscellaneous events, which are placed in the category of “other events” since they cannot be categorized as off-normal or accident events. The following “other events” are discussed in this chapter:

- Hazards during Construction Proximate to existing VVMs

This situation will arise if the facility owner decides to expand storage capacity by adding VVMs adjacent to operating VVMs. Evaluation of this event is incorporated by reference to HI-STORM UMAX FSAR Subsection 12.3.1 [1.0.6]. See Table 15.0.1. The results of the evaluations demonstrate that loaded HI-STORM UMAX VVMs can withstand the effects of “other events” without affecting safety function.

HOLTEC INTERNATIONAL COPYRIGHTED MATERIAL	
Report No.: HI-2167374	Proposed Rev. 0Q
15-22	

15.5 I&C SYSTEMS

The HI-STORM UMAX System does not rely on instruments or control systems for safety limits compliance under accident conditions.

HOLTEC INTERNATIONAL COPYRIGHTED MATERIAL	
Report No.: HI-2167374	Proposed Rev. 0Q
15-23	

15.6 REGULATORY COMPLIANCE

The accident compliance pursuant to the provisions of NUREG-1567 for deployment of canisters certified in the HI-STORM UMAX docket (#72-1040) has been demonstrated in this chapter.

As required by 10CFR72.124(a) the spent fuel sub-criticality is maintained under all design basis off-normal and accident events.

As required by 10CFR72.128(a)(3) confinement barrier integrity is maintained under all design basis off-normal and accident events.

As required by 10CFR72.122(l) spent fuel retrievability defined as the capability of returning stored radioactive material to a safe condition without endangering public health and safety is not compromised under all design basis off-normal and accident conditions.

As required by 10CFR72.106(b) regulations dose rates to individuals located at or beyond controlled area boundaries do not exceed specified accident limits under all design basis accidents.

In accordance with 10CFR72.122(i) and 72.128(a)(1) regulations instruments and control systems required to be operational under accident conditions are identified herein.

HOLTEC INTERNATIONAL COPYRIGHTED MATERIAL	
Report No.: HI-2167374	Proposed Rev. 0Q
15-24	

CHAPTER 16: TECHNICAL SPECIFICATIONS*

16.0 INTRODUCTION†

This chapter defines the operating controls and limits (i.e., Technical Specifications) including their supporting bases for deployment and storage of approved MPCs in a HI-STORM UMAX VVM at the HI-STORE CIS Facility ISFSI. The technical specifications define the conditions that are deemed necessary and sufficient for safe ISFSI use, and are in Appendix A to the HI-STORE CIS Facility license (No. SNM-1051) [16.0.2]. The technical specifications are required by 10CFR72.44(c) to include functional/operating limits, monitoring instruments, limiting control settings, limiting conditions, surveillance requirements, design features, and administrative controls. Technical specifications for a Part 72 storage facility, specifically the HI-STORE CIS Facility, shall be necessary to maintain subcriticality, confinement, shielding, heat removal, and structural integrity under normal, off-normal, and accident conditions. The technical specifications for the HI-STORE CIS Facility, contained herein, are supported by analyses. However, since the HI-STORE CIS Facility is designed for dry storage of MPCs loaded and shipped from a licensed 10CFR72 or 10CFR50 facility, and MPCs are not opened at the HI-STORE CIS Facility, technical specifications LCOs and their bases outside the scope of this SAR, but related to fuel loading and unloading of the MPC, including drying operations and criticality control and surface contamination surveys, shall be complied with prior to transport and storage at the HI-STORE CIS Facility in a HI-STORM UMAX System.

Table 16.0.1 contains material incorporated by reference from the HI-STORM UMAX FSAR and CoC that are applicable to the HI-STORE CIS Facility.

* All references are in placed within square brackets in this report and are compiled in Chapter 19 of this report.

† This chapter is based on the format and content of NUREG 1567 [1.0.3] and Regulatory Guide 3.50, Rev. 2 [1.0.2].

HOLTEC INTERNATIONAL COPYRIGHTED MATERIAL	
Report No. 2167374	Proposed Rev. 0P
16-1	

Table 16.0.1 : Material Incorporated by Reference in this chapter

Information Incorporated by Reference	Source of the Information	NRC Approval of Material Incorporated by Reference	Location in this SAR where Material is Incorporated	Technical Justification of Applicability to HI-STORM UMAX
MPCs 37 and 89 Confinement Analysis	Section 7.0 of Reference [1.0.6]	HI-STORM UMAX SER Amendments 0, 1 and 2 of Reference [7.0.1, 7.0.2, 7.0.3]	Section 16.6 of this chapter	The canister was originally qualified for the HI-STORM FW and incorporated by reference into the HI-STORM UMAX FSAR and subsequently this HI-STORE SAR by reference. See Table 1.0.3 of this SAR.
MPC Design Codes and Standards (including alternatives)	HI-STORM UMAX CoC, Appendix B (Section 3.3), Amendment 0,1 and 2, Reference [16.0.1]	HI-STORM UMAX SER Amendments 0, 1 and 2, Reference [7.0.1, 7.0.2, 7.0.3]	Section 16.4 of this chapter	MPC design codes and standards (including alternatives) approved by NRC in the generic CoC (No. 1040) for the HI-STORM UMAX System are unchanged in this application and therefore are applicable during deployment of the HI-STORM UMAX System at the HI-STORE CIS facility.

HOLTEC INTERNATIONAL COPYRIGHTED MATERIAL

Report No. 2167374

Proposed Rev. 0P

16-2

16.1 FUNCTIONAL/OPERATING LIMITS, MONITORING INSTRUMENTS, AND LIMITING CONTROL SETTINGS

This section provides a discussion of the operating controls and limits, monitoring instruments, and limiting control settings for the HI-STORM UMAX system to assure long-term performance consistent with the conditions analyzed in this SAR.

Functional and operating limits, monitoring instruments, and limiting control settings include limits placed on fuel, waste handling, and storage conditions to protect the integrity of the fuel and MPC, to maintain radiation workers exposure to radiation at the storage facility ALARA, and to guard against the uncontrolled release of radioactive materials.

As discussed in Section 16.0, loading and unloading of MPC contents occurs at a 10CFR72 license facility or a Part 50 license facility, in accordance with QA'd program procedures, prior to shipment to the HI-STORE CIS Facility. Therefore fuel loadings are verified and records maintained. Waste handling (fuel loading and MPC handling) at the site of origin is performed by individuals appropriately trained and qualified. Upon arrival at the HI-STORE CIS Facility, MPC handling shall be performed by personnel trained under the HI-STORE CIS Facility QA program. The controls and limits apply to operating parameters and conditions which are observable, detectable, and/or measurable. The HI-STORM UMAX system is completely passive during storage and requires no monitoring instruments. A temperature monitoring system or visual inspection of the vent screens to verify operability of the VVM heat removal system may be employed in accordance with Technical Specification Limiting Condition for Operation (LCO) 3.1.1 (Appendix 16.A) .

HOLTEC INTERNATIONAL COPYRIGHTED MATERIAL	
Report No. 2167374	Proposed Rev. 0P
16-3	

16.2 LIMITING CONDITIONS

Limiting Conditions for Operation (LCO) specify the minimum capability or level of performance that is required to assure that the HI-STORM UMAX system at the HI-STORE CIS can fulfill its safety functions. Limiting Conditions are supported by analyses in this SAR (Chapters 5 – 9) and provided in Appendix A of the proposed license (No. SNM-1051 Rev. 0), and their bases are contained herein Appendix 16.A to this chapter.

HOLTEC INTERNATIONAL COPYRIGHTED MATERIAL	
Report No. 2167374	Proposed Rev. 0P
16-4	

16.3 SURVEILLANCE REQUIREMENTS

The analyses in this SAR show that the HI-STORE CIS Facility fulfills its safety functions, provided that the Technical Specifications in Appendix A of the proposed license (No. SNM-1051 Rev. 0) are met. Surveillance requirements during storage operations at the HI-STORE CIS Facility are provided in the Technical Specifications. Surveillance is required to ensure LCOs are not violated.

HOLTEC INTERNATIONAL COPYRIGHTED MATERIAL	
Report No. 2167374	Proposed Rev. 0P
16-5	

16.4 DESIGN FEATURES

This subsection describes design features at the HI-STORE CIS Facility that are Important to Safety. These features require design controls and fabrication controls. The design features, detailed in this SAR and in Section 4.0 of Appendix A to the Proposed HI-STORE CIS Facility license (No. SNM-1051), are established in specifications and drawings which are controlled through the quality assurance program. Fabrication controls and inspections are in place to ensure that the HI-STORE CIS Facility and important to safety systems are fabricated or constructed in accordance with the licensing drawings in Section 1.5.

The HI-STORE and HI-STORM UMAX system and its components, as appropriate, have been analyzed for specified normal, off-normal, and accident conditions, including extreme environmental conditions. Analysis has shown that no credible condition or event prevents the important to safety systems at from performing their function. As a result, there is no threat to public health and safety from any postulated accident condition or analyzed event. When all equipment are tested and placed into service in accordance with procedures developed for the ISFSI, no failure of the system to perform its safety function is expected to occur.

Design codes and standards for the MPC, including alternatives, are incorporated by reference in Section 3.3 of the NRC issued HI-STORM UMAX CoC No. 1040 Amendments 0, 1 and 2. Criticality control features of the MPC are referenced from Section 3.2 of the HI-STORM UMAX CoC No. 1040 Amendments 0, 1 and 2. Design codes and standards, and criticality control features are incorporated by reference into this chapter in accordance with Table 16.0.1.

The cask lifting equipment to be used at the HI-STORE CIS Facility, which includes specially designed lifting devices, the Cask Transfer Building Crane, and the Vertical Cask Transporter, have design features to render cask drops non-credible. These design features are described in Section 4.5 of this SAR, and captured in Section 4.0 of Appendix A to the Proposed HI-STORE CIS Facility Technical Specifications (No. SNM-1051).

Criteria and analyses (as applicable) for design features, including important to safety components of drawings in Section 1.5 and ancillaries in Subsection 1.2.7, are provided in Chapters 4 – 9 of this SAR.

HOLTEC INTERNATIONAL COPYRIGHTED MATERIAL	
Report No. 2167374	Proposed Rev. 0P
16-6	

16.5 ADMINISTRATIVE CONTROLS

Administrative control is established through the development of organizational and management procedures, recordkeeping, review and audit systems, and reporting necessary to ensure that the HI-STORE CIS Facility is managed in a safe and reliable manner. Administrative action, in accordance with written procedures, shall be taken in the event of non-compliance.

Administrative controls for the HI-STORE CIS Facility in Appendix A to proposed HI-STORE license No. SNM-1051 Rev. 0 is in alignment with Conduct of Operations in Chapter 10 of this Safety Analysis Report.

HOLTEC INTERNATIONAL COPYRIGHTED MATERIAL	
Report No. 2167374	Proposed Rev. 0P
16-7	

16.6 REGULATORY COMPLIANCE

This chapter ensures regulatory compliance with 10CFR72.24, 72.26 and 72.44(a)(c) and (d).

10CFR72.24(g) requires identification and justification for the selection of those subjects that will be probable license conditions and technical specifications

10CFR72.26 requires that each application under this part include proposed technical specifications.

10CFR72.44(a) requires that each license includes license conditions

10CFR72.44(c) requires that each license includes technical specifications that must include requirements in the following categories:

1. Functional and operating limits and monitoring instruments and limiting control settings.
2. Limiting conditions.
3. Surveillance requirements.
4. Design features
5. Administrative Controls

10CFR72.44(d) states that each license must include an annual report that specifies the quantity of each of the principal radionuclides released to the environment.

This chapter discusses the technical specifications and LCO bases as applicable for the HI-STORE CIS Facility or incorporated by reference. The Technical Specifications are license conditions. Therefore, compliance with 10CFR72.44(c) is by extension compliance with 10CFR72.24(g) and 10CFR72.26. Technical specifications noted in 10CFR72.44(a) and (c) are discussed in this chapter. 10CFR72.44(d) requirement for an annual report that specifies the quantity of each of the principal radionuclides released to the environment is not discussed in the chapter and not required for the HI-STORE CIS Facility. Analysis (Table 16.0.1) of the MPCs confirms it remains intact and welds are not breached under normal, off-normal and accident conditions. Since the MPC meets the ANSI N14.5 leaktight criteria (Subsection 10.3.3), release of effluents from MPCs are on an order of magnitude to be considered negligible and with no impact on public health and safety.

HOLTEC INTERNATIONAL COPYRIGHTED MATERIAL	
Report No. 2167374	Proposed Rev. 0P
16-8	

HI-STORE CIS Facility SAR
APPENDIX 16.A
TECHNICAL SPECIFICATION (LCOs) BASES
FOR THE HOLTEC HI-STORE CIS Facility

HOLTEC INTERNATIONAL COPYRIGHTED MATERIAL	
Report No. 2167374	Proposed Rev. 0P
HI-STORE SAR Revision 0S	Page 60A of 717

BASES TABLE OF CONTENTS

B 3.0 LIMITING CONDITION FOR OPERATION (LCO) APPLICABILITY 16.A-3

B 3.0 SURVEILLANCE REQUIREMENT (SR) APPLICABILITY 16.A-6

B 3.1 SFSC INTEGRITY 16.A-11

B 3.1.2 SFSC Heat Removal System 16.A-11

B.3.2 SFSC RADIATION PROTECTION 16.A-14

B.3.2.1 CANISTER Surface Contamination 16.A-14

HOLTEC INTERNATIONAL COPYRIGHTED MATERIAL	
Report No. 2167374	Proposed Rev. 0P
HI-STORE SAR Revision 0S	Page 61 of 717

B 3.0 LIMITING CONDITION FOR OPERATION (LCO) APPLICABILITY

BASES

LCOs	LCO 3.0.1, 3.0.2, 3.0.4, and 3.0.5 establish the general requirements applicable to all Specifications and apply at all times, unless otherwise stated.
LCO 3.0.1	LCO 3.0.1 establishes the Applicability statement within each individual Specification as the requirement for when the LCO is required to be met (i.e., when the facility is in the specified conditions of the Applicability statement of each Specification).
LCO 3.0.2	<p>LCO 3.0.2 establishes that upon discovery of a failure to meet an LCO, the associated ACTIONS shall be met. The Completion Time of each Required Action for an ACTIONS Condition is applicable from the point in time that an ACTIONS Condition is entered. The Required Actions establish those remedial measures that must be taken within specified Completion Times when the requirements of an LCO are not met. This Specification establishes that:</p> <p>a. Completion of the Required Actions within the specified Completion Times constitutes compliance with a Specification; and</p> <p>b. Completion of the Required Actions is not required when an LCO is met within the specified Completion Time, unless otherwise specified.</p> <p>There are two basic types of Required Actions. The first type of Required Action specifies a time limit in which the LCO must be met. This time limit is the Completion Time to restore a system or component or to restore variables to within specified limits. Whether stated as a Required Action or not, correction of the entered Condition is an action that may always be considered upon entering ACTIONS. The second type of Required Action specifies the remedial measures that permit continued operation that is not further restricted by the Completion Time. In this case, compliance with the Required Actions provides an acceptable level of safety for continued operation.</p>

(continued)

BASES

LCO 3.0.2 (continued) Completing the Required Actions is not required when an LCO is met or is no longer applicable, unless otherwise stated in the individual Specifications.

The Completion Times of the Required Actions are also applicable when a system or component is removed from service intentionally. The reasons for intentionally relying on the ACTIONS include, but are not limited to, performance of Surveillances, preventive maintenance, corrective maintenance, or investigation of operational problems. Entering ACTIONS for these reasons must be done in a manner that does not compromise safety. Intentional entry into ACTIONS should not be made for operational convenience.

LCO 3.0.3 This specification is not applicable to a dry storage cask system because it describes conditions under which a power reactor must be shut down when an LCO is not met and an associated ACTION is not met or provided. The placeholder is retained for consistency with the power reactor technical specifications.

LCO 3.0.4 LCO 3.0.4 establishes limitations on changes in specified conditions in the Applicability when an LCO is not met. It precludes placing the HI-STORM UMAX System in a specified condition stated in that Applicability (e.g., Applicability desired to be entered) when the following exist:

- a. Facility conditions are such that the requirements of the LCO would not be met in the Applicability desired to be entered; and
- b. Continued noncompliance with the LCO requirements, if the Applicability were entered, would result in being required to exit the Applicability desired to be entered to comply with the Required Actions.

Compliance with Required Actions that permit continuing with dry fuel storage activities for an unlimited period of time in a specified condition provides an acceptable level of safety for continued operation. This is without regard to the status of the dry storage system. Therefore, in such cases, entry into a specified condition in the Applicability may be made in accordance with the provisions of the Required Actions. The provisions of this Specification should not be interpreted as endorsing the failure to exercise the good practice of restoring systems or components before entering an associated specified condition in the Applicability.

(continued)

HOLTEC INTERNATIONAL COPYRIGHTED MATERIAL	
Report No. 2167374	Proposed Rev. 0P
HI-STORE SAR Revision 0S	Page 612 of 717
December 2022 - NonProprietary Version	

 BASES

LCO 3.0.4 (continued) The provisions of LCO 3.0.4 shall not prevent changes in specified conditions in the Applicability that are required to comply with ACTIONS. In addition, the provisions of LCO 3.0.4 shall not prevent changes in specified conditions in the Applicability that are related to the unloading of an SFSC.

Exceptions to LCO 3.0.4 are stated in the individual Specifications. Exceptions may apply to all the ACTIONS or to a specific Required Action of a Specification.

HOLTEC INTERNATIONAL COPYRIGHTED MATERIAL	
Report No. 2167374	Proposed Rev. 0P
HI-STORE SAR Revision 0S	Page 61 of 717
December 2022 - NonProprietary Version	

BASES

LCO 3.0.5 LCO 3.0.5 establishes the allowance for restoring equipment to service under administrative controls when it has been removed from service or determined to not meet the LCO to comply with the ACTIONS. The sole purpose of this Specification is to provide an exception to LCO 3.0.2 (e.g., to not comply with the applicable Required Action(s)) to allow the performance of testing to demonstrate:

The equipment being returned to service meets the LCO; or

Other equipment meets the applicable LCOs.

The administrative controls ensure the time the equipment is returned to service in conflict with the requirements of the ACTIONS is limited to the time absolutely necessary to perform the allowed testing. This Specification does not provide time to perform any other preventive or corrective maintenance.

HOLTEC INTERNATIONAL COPYRIGHTED MATERIAL

Report No. 2167374

Proposed Rev. 0P

HI-STORE SAR Revision 0S

Page 614 of 717

December 2022 - NonProprietary Version

B 3.0 SURVEILLANCE REQUIREMENT (SR) APPLICABILITY

BASES

SRs	SR 3.0.1 through SR 3.0.4 establish the general requirements applicable to all Specifications and apply at all times, unless otherwise stated.
-----	--

SR 3.0.1	SR 3.0.1 establishes the requirement that SRs must be met during the specified conditions in the Applicability for which the requirements of the LCO apply, unless otherwise specified in the individual SRs. This Specification is to ensure that Surveillances are performed to verify that systems and components meet the LCO and variables are within specified limits. Failure to meet a Surveillance within the specified Frequency, in accordance with SR 3.0.2, constitutes a failure to meet an LCO.
----------	--

Systems and components are assumed to meet the LCO when the associated SRs have been met. Nothing in this Specification, however, is to be construed as implying that systems or components meet the associated LCO when:

- a. The systems or components are known to not meet the LCO, although still meeting the SRs; or
- b. The requirements of the Surveillance(s) are known to be not met between required Surveillance performances.

Surveillances do not have to be performed when the HI-STORM UMAX System is in a specified condition for which the requirements of the associated LCO are not applicable, unless otherwise specified.

Surveillances, including Surveillances invoked by Required Actions, do not have to be performed on equipment that has been determined to not meet the LCO because the ACTIONS define the remedial measures that apply. Surveillances have to be met and performed in accordance with SR 3.0.2, prior to returning equipment to service. Upon completion of maintenance, appropriate post-maintenance testing is required. This includes ensuring applicable Surveillances are not failed and their most recent performance is in accordance with SR 3.0.2. Post maintenance testing may not be possible in the current specified conditions in the Applicability due to the necessary dry storage cask system parameters not having been established. In these situations, the equipment may be considered to meet the LCO provided testing has been satisfactorily completed to the extent possible and the equipment is not otherwise believed to be incapable of performing its function. This will allow dry fuel storage activities to proceed to a specified condition where other necessary post maintenance tests can be completed.

(continued)

HOLTEC INTERNATIONAL COPYRIGHTED MATERIAL	
Report No. 2167374	Proposed Rev. 0P
HI-STORE SAR Revision 0S	Page 61A of 717
December 2022 - NonProprietary Version	

BASES

SR 3.0.2 SR 3.0.2 establishes the requirements for meeting the specified Frequency for Surveillances and any Required Action with a Completion Time that requires the periodic performance of the Required Action on a "once per..." interval.

SR 3.0.2 permits a 25% extension of the interval specified in the Frequency. This extension facilitates Surveillance scheduling and considers facility conditions that may not be suitable for conducting the Surveillance (e.g., transient conditions or other ongoing Surveillance or maintenance activities).

The 25% extension does not significantly degrade the reliability that results from performing the Surveillance at its specified Frequency. This is based on the recognition that the most probable result of any particular Surveillance being performed is the verification of conformance with the SRs. The exceptions to SR 3.0.2 are those Surveillances for which the 25% extension of the interval specified in the Frequency does not apply. These exceptions are stated in the individual Specifications as a Note in the Frequency stating, "SR 3.0.2 is not applicable."

As stated in SR 3.0.2, the 25% extension also does not apply to the initial portion of a periodic Completion Time that requires performance on a "once per..." basis. The 25% extension applies to each performance after the initial performance. The initial performance of the Required Action, whether it is a particular Surveillance or some other remedial action, is considered a single action with a single Completion Time. One reason for not allowing the 25% extension to this Completion Time is that such an action usually verifies that no loss of function has occurred by checking the status of redundant or diverse components or accomplishes the function of the affected equipment in an alternative manner.

The provisions of SR 3.0.2 are not intended to be used repeatedly merely as an operational convenience to extend Surveillance intervals or periodic Completion Time intervals beyond those specified.

(continued)

BASES

SR 3.0.3 SR 3.0.3 establishes the flexibility to defer declaring affected equipment as not meeting the LCO or an affected variable outside the specified limits when a Surveillance has not been completed within the specified Frequency. A delay period of up to 24 hours or up to the limit of the specified Frequency, whichever is less, applies from the point in time that it is discovered that the Surveillance has not been performed in accordance with SR 3.0.2, and not at the time that the specified Frequency was not met.

This delay period provides adequate time to complete Surveillances that have been missed. This delay period permits the completion of a Surveillance before complying with Required Actions or other remedial measures that might preclude completion of the Surveillance.

The basis for this delay period includes consideration of HI-STORM UMAX System conditions, adequate planning, availability of personnel, the time required to perform the Surveillance, the safety significance of the delay in completing the required Surveillance, and the recognition that the most probable result of any particular Surveillance being performed is the verification of conformance with the requirements. When a Surveillance with a Frequency based not on time intervals, but upon specified facility conditions, is discovered not to have been performed when specified, SR 3.0.3 allows the full delay period of 24 hours to perform the Surveillance.

SR 3.0.3 also provides a time limit for completion of Surveillances that become applicable as a consequence of changes in the specified conditions in the Applicability imposed by the Required Actions.

Failure to comply with specified Frequencies for SRs is expected to be an infrequent occurrence. Use of the delay period established by SR 3.0.3 is a flexibility which is not intended to be used as an operational convenience to extend Surveillance intervals.

(continued)

BASES

SR 3.0.3 (continued) If a Surveillance is not completed within the allowed delay period, then the equipment is considered to not meet the LCO or the variable is considered outside the specified limits and the Completion Times of the Required Actions for the applicable LCO Conditions begin immediately upon expiration of the delay period. If a Surveillance is failed within the delay period, then the equipment does not meet the LCO, or the variable is outside the specified limits and the Completion Times of the Required Actions for the applicable LCO Conditions begin immediately upon the failure of the Surveillance.

Completion of the Surveillance within the delay period allowed by this Specification, or within the Completion Time of the ACTIONS, restores compliance with SR 3.0.1.

SR 3.0.4 SR 3.0.4 establishes the requirement that all applicable SRs must be met before entry into a specified condition in the Applicability.

This Specification ensures that system and component requirements and variable limits are met before entry into specified conditions in the Applicability for which these systems and components ensure safe conduct of dry fuel storage activities.

The provisions of this Specification should not be interpreted as endorsing the failure to exercise the good practice of restoring systems or components before entering an associated specified condition in the Applicability.

However, in certain circumstances, failing to meet an SR will not result in SR 3.0.4 restricting a change in specified condition. When a system, subsystem, division, component, device, or variable is outside its specified limits, the associated SR(s) are not required to be performed per SR 3.0.1, which states that Surveillances do not have to be performed on equipment that has been determined to not meet the LCO. When equipment does not meet the LCO, SR 3.0.4 does not apply to the associated SR(s) since the requirement for the SR(s) to be performed is removed. Therefore, failing to perform the Surveillance(s) within the specified Frequency does not result in an SR 3.0.4 restriction to changing specified conditions of the Applicability. However, since the LCO is not met in this instance, LCO 3.0.4 will govern any restrictions that may (or may not) apply to specified condition changes.

(continued)

 BASES

SR 3.0.4 The provisions of SR 3.0.4 shall not prevent changes in specified conditions in the Applicability that are required to comply with ACTIONS. In addition, the provisions of LCO 3.0.4 shall not prevent changes in specified conditions in the Applicability that are related to the unloading of an SFSC.

(continued)

The precise requirements for performance of SRs are specified such that exceptions to SR 3.0.4 are not necessary. The specific time frames and conditions necessary for meeting the SRs are specified in the Frequency, in the Surveillance, or both. This allows performance of Surveillances when the prerequisite condition(s) specified in a Surveillance procedure require entry into the specified condition in the Applicability of the associated LCO prior to the performance or completion of a Surveillance. A Surveillance that could not be performed until after entering the LCO Applicability would have its Frequency specified such that it is not "due" until the specific conditions needed are met. Alternately, the Surveillance may be stated in the form of a Note as not required (to be met or performed) until a particular event, condition, or time has been reached. Further discussion of the specific formats of SRs' annotation is found in Section 1.4, Frequency.

HOLTEC INTERNATIONAL COPYRIGHTED MATERIAL	
Report No. 2167374	Proposed Rev. 0P
HI-STORE SAR Revision 0S	Page 61A of 717

December 2022 - NonProprietary Version

B 3.1 SFSC Integrity

B 3.1.1 SFSC Heat Removal System

BASES

BACKGROUND The SFSC Heat Removal System is a passive, air-cooled, convective heat transfer system that ensures heat from the MPC canister is transferred to the environs by the chimney effect. Air is drawn into the inlet ducts and travels down the space between the Cavity Enclosure Container (CEC) and the Divider Shell, through the cut-outs at the bottom of the Divider Shell, up the space between the Divider Shell and the MPC, and out through the outlet duct. The MPC transfers its heat from its surface to the air via natural convection. The buoyancy created by the heating of the air creates a chimney effect.

APPLICABLE SAFETY ANALYSIS The thermal analyses of the SFSC take credit for the decay heat from the spent fuel assemblies being ultimately transferred to the ambient environment surrounding the VVM. Transfer of heat away from the fuel assemblies ensures that the fuel cladding and other SFSC component temperatures do not exceed applicable limits. Under normal storage conditions, the inlet and outlet duct screens are unobstructed and full air flow occurs.

Analyses have been performed for half and complete obstruction of the inlet **and outlet** duct screens. Blockage of half of the inlet **and outlet** ducts reduces air flow through the VVM and decreases heat transfer from the MPC. Under this off-normal condition, no SFSC components exceed the shortterm temperature limits.

The complete blockage of all inlet **and outlet** air ducts stops normal air cooling of the MPC. The MPC will continue to radiate heat to the relatively cooler subgrade. With the loss of normal air cooling, the SFSC component temperatures will increase toward their respective short-term temperature limits. None of the components reach their temperature limits over the duration of the analyzed event.

(continued)

BASES

LCO

The SFSC Heat Removal System must be verified to be operable to preserve the assumptions of the thermal analyses. Operability is defined as 50% or more of the inlet and outlet vent duct areas are unblocked and available for flow. Operability of the heat removal system ensures that the decay heat generated by the stored fuel assemblies is transferred to the environs at a sufficient rate to maintain fuel cladding and other SFSC component temperatures within design limits.

The intent of this LCO is to address those occurrences of air duct screen blockage that can be reasonably anticipated to occur from time to time at the ISFSI (i.e., Design Event I and II class events per ANSI/ANS-57.9). These events are of the type where corrective actions can usually be accomplished within one 8-hour operating shift to restore the heat removal system to operable status (e.g., removal of loose debris).

This LCO is not intended to address low frequency, unexpected Design Event III and IV class events (ANSI/ANS-57.9) such as design basis accidents and extreme environmental phenomena that could potentially block one or more of the air ducts for an extended period of time (i.e., longer than the total Completion Time of the LCO). This class of events is addressed site-specifically as required by Section 4.2.4 of Appendix A to the license (SNM-1051).

APPLICABILITY

The LCO is applicable during STORAGE OPERATIONS. Once a VVM containing an MPC loaded with spent fuel has been placed in storage, the heat removal system must be operable to ensure adequate dissipation of the decay heat from the fuel assemblies.

ACTIONS

A note has been added to the ACTIONS which states that, for this LCO, separate Condition entry is allowed for each SFSC. This is acceptable since the Required Actions for each Condition provide appropriate compensatory measures for each SFSC not meeting the LCO. Subsequent SFSCs that don't meet the LCO are governed by subsequent Condition entry and application of associated Required Actions.

(continued)

HOLTEC INTERNATIONAL COPYRIGHTED MATERIAL

Report No. 2167374

Proposed Rev. 0P

HI-STORE SAR Revision 0S

Page 62 of 177

December 2022 - NonProprietary Version

 BASES

 ACTIONS

(continued)

A.1

Although the heat removal system remains operable, the blockage should be cleared expeditiously.

B.1

If the heat removal system has been determined to be inoperable, it must be restored to operable status within eight hours. Eight hours is a reasonable period of time to take action to remove the obstructions in the air flow path.

C.1

If the heat removal system cannot be restored to operable status within eight hours, the VVM and the fuel may experience elevated temperatures. Therefore, dose rates are required to be measured to verify the effectiveness of the radiation shielding provided by the concrete. This Action must be performed immediately and repeated every twelve hours thereafter to provide timely and continued evaluation of the effectiveness of the concrete shielding. As necessary, the system user shall provide additional radiation protection measures such as temporary shielding. The Completion Time is reasonable considering the expected slow rate of deterioration, if any, of the concrete under elevated temperatures.

C.2.1

In addition to Required Action C.1, efforts must continue to restore cooling to the SFSC. Efforts must continue to restore the heat removal system to operable status by removing the air flow obstruction(s) unless optional Required Action C.2.2 is being implemented.

This Required Action must be complete in 24 hours. The Completion Time is consistent with the thermal analyses of this event, which show that all component temperatures remain below their short-term temperature limits up to 32 hours after event initiation.

 (continued)

BASES

ACTIONS

(continued)

C.2.1 (continued)

The Completion Time reflects the 8 hours to complete Required Action B.1 and the appropriate balance of time consistent with the applicable analysis results. The event is assumed to begin at the time the SFSC heat removal system is declared inoperable. This is reasonable considering the low probability of all inlet **and outlet** ducts becoming simultaneously blocked.

C.2.2

In lieu of implementing Required Action C.2.1, transfer of the MPC into a TRANSFER CASK will place the MPC in an analyzed condition and ensure adequate fuel cooling until actions to correct the heat removal system inoperability can be completed. Transfer of the MPC into a TRANSFER CASK removes the SFSC from the LCO Applicability since STORAGE OPERATIONS does not include times when the MPC resides in the TRANSFER CASK.

An engineering evaluation must be performed to determine if any deterioration which prevents the VVM from performing its design function. If the evaluation is successful and the air inlet **and outlet** duct screens have been cleared, the VVM heat removal system may be considered operable and the MPC transferred back into the VVM. Compliance with LCO 3.1.1 is then restored. If the evaluation is unsuccessful, the user must transfer the MPC into a different, fully qualified VVM to resume STORAGE OPERATIONS and restore compliance with LCO 3.1.1

In lieu of performing the engineering evaluation, the user may opt to proceed directly to transferring the MPC into a different, fully qualified VVM.

The Completion Time of 24 hours reflects the Completion Time from Required Action C.2.1 to ensure component temperatures remain below their short-term temperature limits for the respective decay heat loads.

(continued)

HOLTEC INTERNATIONAL COPYRIGHTED MATERIAL

Report No. 2167374

Proposed Rev. 0P

HI-STORE SAR Revision 0S

Page 623 of 717

December 2022 - NonProprietary Version

 BASES

 SURVEILLANCE
REQUIREMENTS

SR 3.1.2

The long-term integrity of the stored fuel is dependent on the ability of the SFSC to reject heat from the MPC to the environment. There are two options for implementing SR 3.1.1, either of which is acceptable for demonstrating that the heat removal system is OPERABLE.

Visual observation that all air inlet duct screens are unobstructed ensures that the SFSC is operable. If greater than 50% of the air inlet and outlet duct screens are blocked the heat removal system is inoperable and this LCO is not met. While 50% or less blockage of the total air inlet and outlet duct screen area does not constitute inoperability of the heat removal system, corrective actions should be taken promptly to remove the obstruction and restore full flow.

As an alternative, for VVMs with air temperature monitoring instrumentation installed in the air outlets, the temperature difference between the outlet air (average) and the ambient air may be monitored to verify operability of the heat removal system. Blocked air duct screens will reduce air flow and increase the outlet duct air temperature. Based on the analyses, if the temperature difference between the ambient air (see Table 2.7.1) and the outlet duct air (see Table 6.4.3) meets the criteria in the LCO, adequate air flow is occurring to provide assurance of long term fuel cladding integrity. The reference ambient temperature used to perform this Surveillance shall be measured at the ISFSI facility.

The Frequency of 24 hours is reasonable based on the time necessary for SFSC components to heat up to unacceptable temperatures assuming design basis heat loads, and allowing for corrective actions to take place upon discovery of blockage of air ducts.

 REFERENCES

1. SAR Chapter 6
 2. ANSI/ANS 57.9-1992
-

B 3.2 SFSC Radiation Protection

B 3.2.1 CANISTER Surface Contamination

BASES

BACKGROUND The HI-STORE facility is a “start clean, stay clean,” facility, so canisters have been decontaminated before loading into the transportation casks to be shipped to HI-STORE. Therefore, it is extremely unlikely for any contamination to be on the outside of a canister. However, for extra assurance, this lack of contamination is confirmed in this LCO. This allows dry fuel storage activities to proceed without additional radiological controls to prevent the spread of contamination and reduces personnel dose due to the spread of loose contamination or airborne contamination. This is consistent with ALARA practices.

APPLICABLE SAFETY ANALYSIS The radiation protection measures are based on the assumption that the exterior surfaces of the MPC have been decontaminated, and were not altered during the course of transportation. Failure to decontaminate the surfaces of the CANISTER could lead to higher-than-projected occupational doses.

LCO Removable surface contamination on the top surface of the CANISTER is limited to 1000 dpm/100 cm² from beta and gamma sources and 20 dpm/100 cm² from alpha sources. These limits are taken from the guidance in IE Circular 81-07 (Ref. 1) and are based on the minimum level of activity that can be routinely detected under a surface contamination control program using direct survey methods. Only loose contamination is controlled, as fixed contamination will not result from the transfer process.

(continued)

HOLTEC INTERNATIONAL COPYRIGHTED MATERIAL	
Report No. 2167374	Proposed Rev. 0P
HI-STORE SAR Revision 0S	Page 625 of 717
December 2022 - NonProprietary Version	

BASES

LCO (continued) Experience has shown that these limits are low enough to prevent the spread of contamination to clean areas and are significantly less than the levels which would cause significant personnel skin dose. LCO 3.2.1 requires removable contamination to be within the specified limits for the top surface of the CANISTER. The location and number of surface swipes used to determine compliance with this LCO are determined based on standard industry practice for objects of this size. The objective is to determine a removable contamination value representative of the entire upper circumference of the MPC, while implementing sound ALARA practices.

APPLICABILITY Verification that the surface contamination is less than the limit in the LCO is performed during transfer of the CANISTER between the transportation overpack and TRANSFER CASK. This occurs before TRANSPORT OPERATIONS, when the LCO is applicable.

ACTIONS A note has been added to the ACTIONS which states that, for this LCO, separate Condition entry is allowed for each CANISTER. This is acceptable since the Required Actions for each Condition provide appropriate compensatory measures for each CANISTER not meeting the LCO.

A.1

If the removable surface contamination of a CANISTER, which has been loaded with spent fuel is not within the LCO limits, action must be initiated to decontaminate the CANISTER and bring the removable surface contamination to within limits. The Completion Time of 7 days is appropriate given that sufficient time is needed to prepare for, and complete the decontamination once the LCO is determined not to be met.

(continued)

HOLTEC INTERNATIONAL COPYRIGHTED MATERIAL	
Report No. 2167374	Proposed Rev. 0P
HI-STORE SAR Revision 0S	Page 626 of 717
December 2022 - NonProprietary Version	

BASES

**SURVEILLANCE
REQUIREMENTS**

This SR verifies that the removable surface contamination on the top surface of the CANISTER is less than the limits in the LCO. The Surveillance is performed using smear surveys to detect removable surface contamination. The Frequency requires performing the verification during CANISTER transfer in order to confirm that the CANISTER can be moved to the ISFSI without spreading loose contamination.

REFERENCES 1. NRC IE Circular 81-07.

HOLTEC INTERNATIONAL COPYRIGHTED MATERIAL	
Report No. 2167374	Proposed Rev. 0P
HI-STORE SAR Revision 0S	Page 62 of 717
December 2022 - NonProprietary Version	

CHAPTER 17: MATERIAL EVALUATION

17.0 INTRODUCTION

This chapter presents an assessment of the materials selected for use in the HI-STORM UMAX system [1.0.6] components that are envisaged to be deployed at the HI-STORE CIS facility. The assessment of the materials selected for use in the MPCs is provided in the previously licensed HI-STORM FW system FSAR [1.3.7]. The fuel loading, dewatering, drying and welding of the canister occur at the nuclear plant site, the material selection decisions for the canister are comprehensively covered in [1.3.7]. The canisters will arrive at the HI-STORE site in *ready-to-store* condition; no material selection decision vis-à-vis the canisters will be made at the HI-STORE site. Because the environmental conditions and design criteria for the MPCs for use at HI-STORE are completely bounded by those in the HI-STORM FW (and HI-STORM UMAX) dockets, reference is made to the material selection considerations for the MPCs (canisters) in their native docket (HI-STORM FW FSAR). The information on the suitability of the MPC for the local environmental conditions at HI-STORE CIS, however, underpins the Aging Management program presented in Chapter 18.

The HI-STORM UMAX components must withstand the environmental conditions experienced during normal operation, off-normal conditions, and accident conditions for the entire service life of the interim storage facility (please see Table 17.0.1).

Chapter 1 provides a general description of the HI-STORM UMAX System including information on materials of construction. The ITS categories of the principal materials of construction in the HI-STORM UMAX VVM and ISFSI system are identified in the drawing package provided in Section 1.5.

Nevertheless, for completeness, it is necessary that the material considerations applicable to HI-STORM UMAX be independently evaluated for compliance with the ISG-15 [17.0.1] which contains the latest NRC position in this matter. The principal purpose of ISG-15 is to evaluate the dry cask storage system to ensure adequate material performance of components deemed to be important-to-safety at an independent spent fuel storage installation (ISFSI) under normal, off-normal, and accident conditions.

ISG-15 sets down the following general acceptance criteria for material evaluation:

- The safety analysis report should describe all materials used for dry spent fuel storage components important-to-safety, and should consider the suitability of those materials for their intended functions in sufficient detail to evaluate their effectiveness in relation to all safety functions.
- The dry spent fuel storage system should employ materials that are compatible with wet and dry spent fuel loading and unloading operations and facilities. These materials should not degrade to the extent that a safety concern is created.

* All references are in placed within square brackets in this report and are compiled in Chapter 19 of this report.

HOLTEC INTERNATIONAL COPYRIGHTED MATERIAL	
Report No.: HI-2167374	Proposed Rev. 0N
17-1	

The information compiled in this chapter seeks to address the above acceptance criteria in full measure for the HI-STORM UMAX VVM and ISFSI. To perform the material suitability evaluation, it is necessary to characterize the following for each component: (i) the applicable environment, (ii) potential degradation modes and (iii) potential hazards to continued effectiveness of the selected material.

The material evaluation presented in this chapter is intended to be complete, even though *a priori* conclusion of the adequacy of the materials can be made on the basis of the following facts:

- i. The materials used in HI-STORM UMAX VVM are identical to those used in the widely deployed HI-STORM 100 System (Docket No. 72-1014) [1.3.3] including its underground VVM denoted as HI-STORM 100U and the HI-STORM FW system (Docket No. 72-1032) [1.3.7].
- ii. As can be ascertained from Table 2.7.1, the thermal environment in the HI-STORM UMAX system at the HI-STORE site is bounded by the design basis for its generic certification in the HI-STORM UMAX docket [1.0.6].

In this chapter, the significant mechanical, thermal, radiological, and metallurgical properties of materials identified for use in the components of the HI-STORM UMAX System and ISFSI are presented. The material evaluation effort is directed towards the interim storage at HI-STORE CIS for its intended service life and its consequences to the system's continued safety. Table 17.0.1 provides the expected licensing, design and service life data for the HI-STORE CIS facility.

Because the materials designated to be used at the HI-STORE CIS facility have a long pedigree of usage in other HI-STORM dockets, their mechanical and thermos-physical properties are well documented in the prior FSARs approved by the NRC. The identification of such sections/appendices/tables that are adopted by reference herein is summarized in Table 17.0.2.

HOLTEC INTERNATIONAL COPYRIGHTED MATERIAL	
Report No.: HI-2167374	Proposed Rev. 0N
17-2	

Item	Definition	Value in Years
License Life	The period for which the NRC is expected to grant the initial license	40
Design Life	A conservative estimate of the useable life of the system in full compliance with the regulations and ALARA expectations	80
Service Life	The expected life of the facility for which it will continued to meet all safety requirements if the aging management program described in this SAR is implemented without limitation	120

HOLTEC INTERNATIONAL COPYRIGHTED MATERIAL	
Report No.: HI-2167374	Proposed Rev. 0N
17-3	

Table 17.0.2: Material Incorporated By Reference

Information Incorporated by Reference	Source of the Information	NRC Approval of Material Incorporated by Reference	Location in this SAR where Material is Incorporated	Technical Justification of Applicability to HI-STORE
Mechanical Properties of materials	Section 3.3 of [1.0.6]	SER HI-STORM UMAX Amendments 0, 1, and 2 References [7.0.1, 7.0.2,7.0.3]	Subsection 17.4.1	The materials used in the canisters and components at the HI-STORE CIS Facility are identical to those used in the HI-STORM UMAX Generic License FSAR.
Summary of Thermal Properties of materials	Section 4.2 of [1.0.6]	SER HI-STORM UMAX Amendments 0, 1, and 2 References [7.0.1, 7.0.2,7.0.3]	Subsection 17.4.2	The materials used in the canisters and components at the HI-STORE CIS Facility are identical to those used in the HI-STORM UMAX Generic License FSAR.
Alloy X Description	Appendix 1.A of [1.3.7]	SER HI-STORM FW Amendments 0, 1, and 2 References [8.0.1, 8.0.2,8.0.3]	Sub-section 17.4.3	The materials used in the canisters and components at the HI-STORE CIS Facility are identical to those used in the HI-STORM UMAX Generic License FSAR.
MPC Material Selection Information	Section 8.2 of [1.3.7]	SER HI-STORM FW Amendments 0, 1, and 2 References [8.0.1, 8.0.2, 8.0.3]	Section 17.2	The MPCs are identical to those loaded under the HI-STORM UMAX and FW generic licenses, and therefore the same material selection criteria apply.
Metamic-HT	Paragraph 1.2.1.4 of [1.3.7]	SER HI-STORM FW Amendments 0, 1, and 2 References [8.0.1, 8.0.2, 8.0.3]	Section 17.9	The materials used in the canisters and components at the HI-STORE CIS Facility are identical to those used in the HI-STORM UMAX Generic License FSAR.
Fuel Integrity Evaluation	Section 8.13 of [1.3.7]	SER HI-STORM FW Amendments 0, 1, and 2 References [8.0.1, 8.0.2, 8.0.3]	Section 17.12	The fuel remains in seal welded canisters, with lower temperatures and pressures than originally licensed, therefore the fuel integrity evaluation is still applicable.

HOLTEC INTERNATIONAL COPYRIGHTED MATERIAL

Report No.: HI-2167374

Proposed Rev. 0N

17-4

Table 17.0.2: Material Incorporated By Reference

Information Incorporated by Reference	Source of the Information	NRC Approval of Material Incorporated by Reference	Location in this SAR where Material is Incorporated	Technical Justification of Applicability to HI-STORE
Examination and Testing	Section 8.13 of [1.0.6],	SER HI-STORM UMAX Amendments 0, 1, and 2 References [7.0.1, 7.0.2, 7.0.3]	Section 17.12	The canisters to be stored at the HI-STORE facility must fully meet the fabrication examination and testing requirements that are in the HI-STORM UMAX FSAR.
Acceptable Coatings	Section 8.7.2 and Appendix 8.A of [1.3.7]	SER HI-STORM FW Amendments 0, 1, and 2 References [8.0.1, 8.0.2, 8.0.3]	Section 17.7	Surface preservative requirements are identical to those defined for HI-STORM FW system; coatings defined for the HI-STORM FW system are therefore applicable.

HOLTEC INTERNATIONAL COPYRIGHTED MATERIAL

Report No.: HI-2167374

Proposed Rev. 0N

17-5

17.1 MATERIAL DEGRADATION MODES

Tables 17.1.1, 17.1.2 and 17.1.3 provide a summary of the environmental states, potential degradation modes, and hazards applicable to the HI-STORM UMAX modules and other ITS SSCs that are specific to HI-STORE CIS facility. The facility specific SSCs employ similar materials as to those employed in HI-STORM UMAX modules. These components include HI-TRAC CS, CTB Crane, Lift Yokes (Transfer Cask and Transport Cask), MPC Lift Attachments, Special Lifting devices, Transport Cask Lift Beams and Tilt Frames. Table 17.1.4 provides the listing of material types that are important to safety and are subject to the ambient environmental of the HI-STORE Facility.

To provide a proper context for the subsequent evaluations, the potential degradation mechanisms applicable to the ventilated systems are summarized in Table 17.1.5. The degradation mechanisms listed in Table 17.1.5 are considered in the suitability evaluation presented in this chapter.

HOLTEC INTERNATIONAL COPYRIGHTED MATERIAL	
Report No.: HI-2167374	Proposed Rev. 0N
17-6	

Table 17.1.1: Considerations Germane to Performance of Materials used in the MPCs in Long Term Storage in HI-STORM UMAX	
Consideration	Environment
Environment	MPC's internal environment is hot ($\leq 752^{\circ}\text{F}$), inertized and dry. Temperature of the MPC internals cycles vary gradually due to changes in the environmental temperature.
Potential degradation modes	Corrosion of the external surfaces of the MPC (stress, corrosion, cracking, pitting, etc.).
Potential hazards to effective performance	Blockage of ventilation ducts under an extreme environmental phenomenon leading to a rapid heat-up of the MPC internals.

HOLTEC INTERNATIONAL COPYRIGHTED MATERIAL	
Report No.: HI-2167374	Proposed Rev. 0N
17-7	

Table 17.1.2: Considerations Germane to the HI-STORM UMAX VVM Material Performance	
Consideration	Performance Data
Environment	Cool ambient air is progressively (but marginally) heated as it flows up the annulus between the Divider Shell and the MPC heating the inside surface of the cask and cooling the outside surface of the MPC. The heated air has reduced relative humidity the warmer it gets. As a result, the bottom external surface of the Closure Lid is heated and the top external surfaces are in contact with ambient air, rain, and snow, as applicable. The exterior surfaces of the CEC are in contact with either engineered fill or concrete (concrete encasement or “free-flow “concrete”).
Potential degradation modes	Peeling or perforation of surface preservatives on steel surfaces and corrosion of exposed steel surfaces.
Potential hazards to effective performance	Blockage of ducts by debris leading to overheating of the concrete in the ISFSI pad, scorching of the cask by proximate fire, lightning.

HOLTEC INTERNATIONAL COPYRIGHTED MATERIAL	
Report No.: HI-2167374	Proposed Rev. 0N
17-8	

Table 17.1.3: Considerations Germane to the Other SSCs Material Performance	
Consideration	Performance Data
Environment	The components and their external surfaces are in contact with ambient air, rain, and snow, as applicable.
Potential degradation modes	Peeling or perforation of surface preservatives on steel surfaces and corrosion of exposed steel surfaces.
Potential hazards to effective performance	None, as all components and surfaces are accessible for repair and/or replaceable as required.

HOLTEC INTERNATIONAL COPYRIGHTED MATERIAL	
Report No.: HI-2167374	Proposed Rev. 0N
17-9	

Table 17.1.4: *Material Types in the HI-STORE CIS Facility Components Exposed to the Long-Term Ambient Environment		
	Material Type	Components and Their Surfaces Exposed to Ambient Environment
1.	Low carbon steel	<ul style="list-style-type: none"> • All surfaces of the closure lid • Internal surfaces of the CEC (expose to air) • External surfaces of the CEC (exposed to CLSM) or subgrade • Internal and External surfaces of the Divider shell • All external surfaces of HI-TRAC CS, CTB Crane, Lift Yokes, Lift Beams & Attachments, Tilt Frames and Special Lifting Devices.
2.	Shielding concrete	<ul style="list-style-type: none"> • The outside surface of the ISFSI pad • The embedded densified concrete in HI-TRAC CS
3.	Alloy X Austenitic Stainless Steel (Defined in Appendix 1A of the HI-STORM 100 FSAR [1.3.3] and used in all HI-STORM docket).	<ul style="list-style-type: none"> • External surfaces of the stored MPC • MPC Guides and MPC support surfaces inside the CEC. • Surfaces of the closure lid • Internal surfaces of the CEC • External surfaces of the CEC Internal External surfaces of the Divider shell (optional per Section 1.5)
4.	Elastomeric Gasket	<ul style="list-style-type: none"> • Closure Lid Seal • Divider Shell Seal

* Specific material grades used at the HI-STORE ISFSI will comply with the requirements set forth in Subsection 8.2.3 of [1.3.7] which provides the conditions to establish material equivalence.

HOLTEC INTERNATIONAL COPYRIGHTED MATERIAL	
Report No.: HI-2167374	Proposed Rev. 0N
17-10	

Table 17.1.5: Failure and Degradation Mechanisms*				
	Mechanism	Area of Performance Affected	Vulnerable Parts	Location of Discussion
1.	General Corrosion	Structural Integrity	All carbon steel parts	Section 18.3
2.	Stress Corrosion Cracking	Structural Integrity	Austenitic Stainless Steel	Section 18.3
3.	Galling	Equipment handling and deployment	Threaded Fasteners	Section 17.6
4.	Fatigue	Structural Integrity	Fuel Cladding & Bolting	Section 18.3
5.	Brittle Fracture	Structural Integrity	Thick Steel Parts	Section 17.4.3
6.	Boron Depletion	Criticality Control	Neutron Absorber	Section 18.3
7.	Creep	Structural Integrity	All steel parts	Section 17.4.4
8.	Galvanic Corrosion	Structural integrity	All carbon steel parts	Section 17.11

* This table lists all potential (generic) mechanisms, whether they are credible for the HI-STORM UMAX System or not. The viability of each failure mechanism is discussed later in this chapter and/or chapter 18.

HOLTEC INTERNATIONAL COPYRIGHTED MATERIAL	
Report No.: HI-2167374	Proposed Rev. 0N
17-11	

17.2 MATERIAL SELECTION

The acceptance criteria for the materials subject to long-term storage conditions in HI-STORM UMAX are extracted from ISG-15 [17.0.1] as follows:

- a. The material properties of a dry spent fuel storage component should meet its service requirements in the proposed cask system for the duration of the licensing period.
- b. The materials that comprise the dry spent fuel storage should maintain their physical and mechanical properties during all conditions of operations. The spent fuel should be readily retrievable without posing operational safety problems.
- c. Over the range of temperatures expected prior to and during the storage period, any ductile-to-brittle transition of the dry spent fuel storage materials, used for structural and nonstructural components, should be evaluated for its effects on safety.
- d. Dry spent fuel storage gamma shielding materials should not experience slumping or loss of shielding effectiveness to an extent that compromises safety. The shield should perform its intended function throughout the licensed service period.
- e. Dry spent fuel storage materials used for neutron absorption should be designed to perform their safety function.
- f. Dry spent fuel storage protective coatings should remain intact and adherent during all loading and unloading operations within wet or dry spent fuel facilities, and during long-term storage.

The qualification of the materials used in the MPC types is documented in Section 8.2 of the HI-STORM FW FSAR [1.3.7] incorporated herein by reference. The material selection opportunities for the HI-STORM UMAX system, therefore, are limited to the HI-TRAC CS and the VVM module assembly components and the reinforced concrete structures that support or surround them.

However, to obviate the need for any new material qualification effort, the materials permitted for the HI-STORM UMAX system are limited to those certified in other HI-STORM 100 and HI-STORM FW docket. The material qualification information presented in this chapter is accordingly adapted from Docket Number 72-1032 [1.3.7].

17.2.1 Structural Materials

17.2.1.1 Cask Components and Their Constituent Materials

The major structural material that is used in the HI-STORM UMAX VVM is steel. The concrete in the VVM Closure Lid does not play a major structural role but is present in large quantity for the main purpose of shielding. The major structural materials in the ISFSI structures are the concrete and rebars in the Support Foundation Pad, the ISFSI Pad and the Self-hardening Engineered Subgrade in the inter-CEC space.

17.2.1.2 Synopsis of Structural Materials

- i. Carbon Steel, Low-Alloy Steel

HOLTEC INTERNATIONAL COPYRIGHTED MATERIAL	
Report No.: HI-2167374	Proposed Rev. 0N
17-12	

Materials for the HI-STORM UMAX VVM are selected to preclude brittle fracture. Details of discussions are provided in Section 17.4 herein.

ii. Reinforced Concrete

All reinforced concrete load bearing structures (concrete and rebar) in the HI-STORM UMAX ISFSI will conform to stress criteria of ACI-318(2005) [5.3.1]. Section 3.3 in the HI-STORM UMAX FSAR [1.0.6] provides properties for reinforced concrete to be used for the HI-STORM UMAX interfacing ISFSI structures. The service life of the ISFSI structures is specified to be the same as that of the HI-STORM UMAX VVM.

iii. Self-hardening Engineered Subgrade

The SES material (i.e., lean concrete or CLSM) used in the HI-STORM UMAX ISFSI will conform to the stress criteria of ACI-318(2005) or ACI-229(1999). Tables 2.3.2 and 3.3.4 in the HI-STORM UMAX FSAR [1.0.6] provide the critical properties for the SES material used for HI-STORM UMAX ISFSI safety analyses. In the interest of a reliably robust design and long service life, additional performance properties of CLSM are listed in table below. The service life for the SES is the same as that of the VVM and ISFSI reinforced concrete.

iv. Austenitic Stainless Steel

Austenitic stainless steel may be used for certain components of the HI-STORM UMAX VVM. Chapter 5 provides the structural evaluation for the HI-STORM UMAX VVM using the governing structural materials. Since stainless steel materials do not undergo a ductile-to-brittle transition in the minimum permissible service temperature range of the HI-STORM UMAX System, brittle fracture is not a concern for stainless steel components. It is recognized that austenitic stainless steels are qualified for use with other HI-STORM UMAX System components (namely Alloy X for the MPC) by the HI-STORM FW FSAR.

Chapter 5 discusses the structural evaluations of the HI-STORM UMAX System components and ISFSI structures. It is demonstrated that the structural steel components of the HI-STORM UMAX VVM and the SFP concrete meet the allowable stress limits for normal, off-normal, and accident loading conditions as applicable. The analyses documented in Chapter 5 also demonstrate that the SES remains stable under the Design Basis Earthquake condition and provides sufficient protection to the stored MPC even if any side of the self-hardening sub-grade (SES) is fully exposed during excavation for ISFSI expansion.

17.2.2 Non-Structural Materials

i. Plain Concrete

Plain concrete is specified for the VVM Closure Lid for its shielding properties and also as an encasement around the exterior of the VVM CEC shell, if required, for its corrosion mitigation properties. The requirements on the shielding concrete are specified in Table 4.3.3.

The shielding performance of the plain concrete is maintained by ensuring that the minimum concrete density is met during construction and the allowable concrete temperature limits are not exceeded. The durability and thermal analyses for normal and off-normal conditions are carried out in this SAR to ensure that the plain concrete does not exceed the allowable long term temperature limit provided in Chapter 4. The strength analysis is carried out in Chapter 5 of this SAR.

HOLTEC INTERNATIONAL COPYRIGHTED MATERIAL	
Report No.: HI-2167374	Proposed Rev. 0N
17-13	

ii. Insulation

The Divider Shell is lined with insulation on its outer surface to prevent excessive heating of the ISFSI pad. The insulation selected shall be suitable for high temperature and high humidity operation and shall be foil faced, jacketed, or otherwise made water-resistant to ensure the required thermal resistance is maintained in accordance with Chapter 6. The high zinc content present in the coating of the Divider Shell provides protection for the jacketing or foil from the potential of galvanic corrosion. To ensure adequate radiation resistance, the insulation blanket does not contain any organic binders. The damage threshold for ceramics is known to be approximately 1×10^{10} Rads. Chloride corrosion is not a concern since chloride leachables are limited and sufficiently low. Stress corrosion cracking of the foil or jacketing, whether made from stainless steel or other material, is not an applicable corrosion mechanism due to minimal stresses derived from self-weight. The foil or jacketing and attachment hardware shall either have sufficient corrosion resistance (e.g., stainless steel, aluminum, or galvanized steel) or shall be protected with a suitable surface preservative. The insulation is adequately secured to prevent blockage of the ventilation passages in case of failure of a single attachment (strap, clamp, bolt or other attachment hardware). Table 17.2.2 provides the acceptance criteria for the selection of insulation material for the VVM assembly and ranks them in order of importance.

HOLTEC INTERNATIONAL COPYRIGHTED MATERIAL	
Report No.: HI-2167374	Proposed Rev. 0N
17-14	

Table 17.2.1: Additional CLSM Performance Properties*		
Performance Property	Test Property	Nominal Value
Corrosive Resistance	pH Resistivity Permeability	7.5 – 11.5 > 279000 ohm-cm < 10 ⁻⁵ cm/sec
Flowability	Flow	6” – 8” (ASTM D 6103)
Excavatability	Unconfined Compressive Strength	Not excavatable since compressive strength is greater than 300 psi
Permeability	Water Permeability	< 10 ⁻⁵ cm/sec
Strength	Penetration Resistance	> 650
Acidity/Alkalinity	pH	7.5 – 11.5
Note: * These properties are not used in HI-STORM UMAX safety analyses; nominal values obtained from References [17.2.1], [17.2.2], and [17.2.3] are tabulated for information only.		

HOLTEC INTERNATIONAL COPYRIGHTED MATERIAL	
Report No.: HI-2167374	Proposed Rev. 0N
17-15	

Table 17.2.2: Acceptance Criteria for the Selection of the Insulation Material^{Note 1}	
Rank	Criteria
1	Adequate thermal resistance
2	Adequate high temperature resistance
3	Adequate humidity resistance
4	Adequate radiation resistance
5	Adequate resistance to the ambient environment
6	Sufficiently low chloride leachables
7	Adequate integrity and resistance to degradation and corrosion during long-term storage

Note 1: Kaowool® ceramic fiber insulation [17.2.1] is selected as one that satisfies the acceptance criteria to the maximum degree. The Kaowool® insulation material provides excellent resistance to chemical attack and is not degraded by oil or water. It has been used in all HI-STORM UMAX ISFSIs thus far. Equivalent materials that meet the above criteria are also commercially available.

HOLTEC INTERNATIONAL COPYRIGHTED MATERIAL	
Report No.: HI-2167374	Proposed Rev. 0N
17-16	

17.3 APPLICABLE CODES AND STANDARDS

The design, material selection, manufacturing, inspection and testing of the SSCs for the HI-STORM UMAX system are undergirded by national codes and consensus standards to ensure the longest possible service life. The principal codes and standards applied to the HI-STORM UMAX System components are the ASME Code Section II [17.3.1], the ACI code [5.3.1], the ASTM Standards, and the ANSI standards.

The Codes and standards for the ISFSI pad are discussed in Chapter 5.

Allowable stresses and stress intensities for various materials for the HI-STORM UMAX structures are extracted from ASME Section III Subsection NF for various service conditions. “NF” is also invoked to establish fracture toughness test requirements for low service temperature conditions. Mechanical properties of materials are extracted from applicable ASME sections [17.3.1], [17.3.2] and are tabulated for various materials used in HI-STORM UMAX System. Concrete properties are from ACI 318-2005 [5.3.1] code.

In order to meet the requirements of the codes and standards the materials must conform to the minimum acceptable physical strengths and chemical compositions and the fabrication procedures must satisfy the prescribed requirements of the applicable codes.

Additional codes and standards applicable to welding are discussed in Section 17.5 and those for the bolts and fasteners are discussed in Section 17.6.

Review of the above shows that the identified codes and standards are appropriate for the material control of major components. Additional material control is identified in material specifications. Material selections are appropriate for environmental conditions to be encountered during loading, unloading, transfer, and storage operations. The materials and fabrication of major components are suitable based on the applicable codes of record.

HOLTEC INTERNATIONAL COPYRIGHTED MATERIAL	
Report No.: HI-2167374	Proposed Rev. 0N
17-17	

17.4 MATERIAL PROPERTIES

This section provides discussions on material properties that mainly include mechanical and thermal properties. The material properties used in the design and analysis of the HI-STORM UMAX System are obtained from established industry sources such as the ASME Boiler and Pressure Vessel Code [17.3.1], ASTM publications, handbooks, textbooks, other NRC-reviewed SARs, and government publications, as appropriate.

17.4.1 Mechanical Properties

Section 3.3 of the HI-STORM UMAX FSAR [1.0.6], incorporated herein by reference, provides mechanical properties of all ITS materials used in the HI-STORM UMAX System at HI-STORE. **Section 5.4 in Chapter 5 of HI-STORE SAR provides a detailed description of structural aspects, design criteria and material properties of the other SSCs that are classified as ITS components.** The structural materials include Alloy X, carbon steel, low-alloy and nickel-alloy steel, bolting materials, and weld materials. The properties include yield stress, mean coefficient of thermal expansion, ultimate stress, and Young's modulus of these materials and their variations with temperature. Certain mechanical properties are also provided for nonstructural materials such as concrete used for shielding.

The discussion on mechanical properties of materials in Chapter 3 of [1.0.6] provides reasonable assurance that the class and grade of the structural materials are acceptable under the applicable construction code of record. Selected parameters such as the temperature dependent values of stress allowables, modulus of elasticity, Poisson's ratio, density, thermal conductivity, and thermal expansion have been appropriately defined in conjunction with other disciplines. The material properties of all code materials are guaranteed by procuring materials from Holtec-approved vendors through the so-called "material dedication" process*, if necessary.

17.4.2 Thermal Properties

Section 4.2 of [1.0.6], incorporated herein by reference, presents thermal properties of materials used in the MPC such as Alloy X, Metamic-HT, aluminum shims and helium gas; materials present in HI-STORM UMAX such as carbon steel, stainless steel and concrete; and materials present in HI-TRAC transfer cask that include carbon steel and plain concrete. The properties include density, thermal conductivity, heat capacity, and surface emissivity/absorptivity. Variations of these properties with temperature are also provided in tabular forms.

The thermal properties of fuel (UO₂) and fuel cladding are also reported in Section 4.2 of [1.0.6]. Thermal properties are obtained from standard handbooks or established text books.

17.4.3 Protection Against Brittle Fracture of Ferritic Steel Parts

The risk of brittle fracture in the HI-STORM UMAX **VVM** components **at the HI-STORE CIS facility** is eliminated by utilizing materials that maintain high fracture toughness under "cold" conditions (-40 degrees F). **The Lowest Service Temperature that is used to define fracture toughness testing requirements for the HI-TRAC CS, the Cask Transfer Facility, and the Tilt**

* Dedication is a term of art in nuclear quality assurance.

HOLTEC INTERNATIONAL COPYRIGHTED MATERIAL	
Report No.: HI-2167374	Proposed Rev. 0N
17-18	

Frame is set at 0°F, which corresponds to the minimum reference temperature for short-term operations per Table 2.7.1.

The MPC canister is constructed from a menu of stainless steels termed Alloy X (Appendix 1A of HI-STORM 100 FSAR, incorporated herein by reference). These stainless steel materials do not undergo a ductile-to-brittle transition in the minimum service temperature range of the HI-STORM UMAX system. Therefore, brittle fracture is not a concern for the MPC components. Such an assertion cannot be made *a priori* for the HI-STORM UMAX VVM and HI-TRAC CS transfer cask that contain ferritic steel parts. In general, the impact testing requirement for the VVM and the transfer cask is a function of two parameters: the Lowest Service Temperature (LST)* and the normal stress level. The significance of these two parameters, as they relate to impact testing of the VVM is discussed below.

In normal storage mode, the LST of the VVM structural members may reach the minimum ambient temperature in the limiting condition wherein the spent nuclear fuel (SNF) in the contained MPCs emits no (or negligible) heat. The minimum service temperature of the storage VVM and HI-TRAC CS steel components is conservatively set at a temperature that is 10 degrees F below the 24-hour average for any day at the HI-STORE site recorded for the site in the previous year. This temperature restriction also applies to other SSCs and the heavy load handling operations at the ISFSI. All load bearing parts are deemed to have the necessary level of protection against brittle fracture if the NDT (nil ductility transition) temperature of the part meets ASME Section III Subsection NF requirements.

It is well known that the NDT temperature of steel is a strong function of its composition, manufacturing process (viz., fine grain vs. coarse grain practice), thickness, and heat treatment. For example, it is well known that increasing the carbon content in carbon steels from 0.1% to 0.8% leads to the change in NDT from -50°F to approximately 120°F. Likewise, lowering of the normalizing temperature in the ferritic steels from 1200°C to 900°C may lower the NDT from 10°C to -50°C. It therefore follows that the fracture toughness of steels can be varied significantly within the confines of the ASME Code material specification set forth in Section II of the Code. For example, SA516 Gr. 70 can have a maximum carbon content of up to 0.3% in plates up to four inches thick. Section II further permits normalizing or quenching followed by tempering to enhance fracture toughness. Manufacturing processes that have a profound effect on fracture toughness, but little effect on tensile or yield strength of the material, are also not specified with the degree of specificity in the ASME Code to guarantee a well-defined fracture toughness. In fact, the Code relies on actual coupon testing of the part to ensure the desired level of protection against brittle fracture. For Section III, Subsection NF Class 3 parts, the desired level of protection is considered to exist if the lowest service temperature is equal to or greater than the NDT temperature (per NF 2311(b)(10)).

The fracture toughness requirements for the HI-STORM UMAX VVM are provided in Table 3.1.9 of the HI-STORM UMAX FSAR [1.0.6]. The fracture toughness requirements for the ferritic steel portions of the HI-TRAC CS, the Canister Transfer Facility, the Tilt Frame, and the Vertical Cask Transporter are summarized in Tables 17.4.1, 17.4.2, 17.4.3, and 17.4.4 of this SAR, respectively.

* LST (Lowest Service Temperature) is defined as the daily average for the host ISFSI site

HOLTEC INTERNATIONAL COPYRIGHTED MATERIAL	
Report No.: HI-2167374	Proposed Rev. 0N
17-19	

17.4.4 Protection Against Creep

Creep, a visco-elastic and visco-plastic effect in metals, manifests itself as a monotonically increasing deformation if the metal part is subjected to stress under elevated temperature. Since certain parts of the HI-STORM UMAX system, notably the fuel basket, operate at relatively high temperatures, creep resistance of the fuel basket is an important property. Creep resistance of the MPC internals is discussed in the HI-STORM FW FSAR [1.3.7]. Creep is not a concern in the Enclosure Vessel, the HI-STORM UMAX, the HI-TRAC steel weldment **or the other ITS SSCs at the HI-STORE CIS facility** because of the operating metal temperatures, stress levels and material properties. Steels used in ASME Code pressure vessels have a high threshold temperature at which creep becomes a factor in the equipment design. The ASME Code Section II material properties provide the acceptable upper temperature limit for metals and alloys acceptable for pressure vessel service.

In the selection of steels for the HI-STORM UMAX system, a critical criterion is to ensure that the sustained (normal) metal temperature of the part made of the particular steel type shall be less than the Code permissible temperature for pressure vessel service. This criterion guarantees that excessive creep deformation will not occur in the steels used in the HI-STORM UMAX system.

HOLTEC INTERNATIONAL COPYRIGHTED MATERIAL	
Report No.: HI-2167374	Proposed Rev. 0N
17-20	

Table 17.4.1

FRACTURE TOUGHNESS TEST REQUIREMENTS FOR HI-TRAC CS

Material	Test Requirement	Test Temperature	Acceptance Criterion
Ferritic steel with nominal section thickness of 5/8" or less	Not required per NF-2311(b)(1)	-	-
Normalized SA516/A516 Gr. 70 (thicknesses 2-1/2" and less)	Not required per NF-2311(b)(10)	-	-
As rolled SA516/A516 Gr. 70 (greater than 5/8") used for HI-TRAC CS inner and outer shells, top plate, annulus shield ring, shield gate gusset, shield gate alignment shield ring, shield gate shield block	Not required per NF-2311(b)(7)	-	-
SA36/A36 used for HI-TRAC CS ribs, shield gate spacer supports (type I, II and III)	Not required per NF-2311(b)(7)	-	-
As rolled SA516/A516 Gr. 70 used for HI-TRAC CS shield gate top flange, bottom flange, door weldment (thickness greater than 5/8")	Per NF-2331	0°F (Also must meet ASME Section IIA requirements)	Table NF-2331(a)-3 or Figure NF-2331(a)-2 (Also must meet ASME Section IIA requirements)
Bolting (SA193 B7)	Per NF-2333	0°F (Also must meet ASME Section II.A requirements)	Table NF-2333-1 (Also must meet ASME Section II.A requirements)
Weld material	Test per NF-2430 if: (1) either of the base materials of the production weld requires impact testing, or; (2) either of the base materials is A516 Gr. 70 with nominal section thickness greater than 5/8".	0°F	Per NF-2331

Note:

1. Required NDT temperature = 0 deg. F for all "NF" materials in the HI-TRAC CS.

HOLTEC INTERNATIONAL COPYRIGHTED MATERIAL

Report No.: HI-2167374

Proposed Rev. 0N

17-21

Table 17.4.2

FRACTURE TOUGHNESS TEST REQUIREMENTS FOR CASK TRANSFER FACILITY

Material	Test Requirement	Test Temperature	Acceptance Criterion
Ferritic steel with nominal section thickness of 5/8" or less	Not required per NF-2311(b)(1)	-	-
Normalized SA516/A516 Gr. 70 (thicknesses 2-1/2" and less)	Not required per NF-2311(b)(10)	-	-
SA516/A516 Gr. 70 (greater than 5/8") used for CTF shell, base plate, studding outlet plate, pipe flange plate, adapter plate, support plates (type 1 and 2) ; and also used for pedestal top plate, ring, base plate, center gusset, bearing plate gusset.	Not required per NF-2311 (b)(7)	-	-
SA350 LF2 used for CTF bolt anchor	Per NF-2331	0°F (Also must meet ASME Section IIA requirements)	Table NF-2331(a)-3 or Figure NF-2331(a)-2 (Also must meet ASME Section IIA requirements)
Bolting (SA193 B7)	Per NF-2333	0°F (Also must meet ASME Section II.A requirements)	Table NF-2333-1 (Also must meet ASME Section II.A requirements)
Weld material	Test per NF-2430 if: (1) either of the base materials of the production weld requires impact testing, or; (2) either of the base materials is A516 Gr. 70 with nominal section thickness greater than 5/8".	0°F	Per NF-2331

Note:

1. Required NDT temperature = 0 deg. F for all "NF" materials in the Cask Transfer Facility.

HOLTEC INTERNATIONAL COPYRIGHTED MATERIAL

Report No.: HI-2167374

Proposed Rev. 0N

17-22

Table 17.4.3

FRACTURE TOUGHNESS TEST REQUIREMENTS FOR TILT FRAME

Material	Test Requirement	Test Temperature	Acceptance Criterion
Ferritic steel with nominal section thickness of 5/8" or less	Not required per NF-2311(b)(1)	-	-
Normalized SA516/A516 Gr. 70 (thicknesses 2-1/2" and less)	Not required per NF-2311(b)(10)	-	-
SA516/A516 Gr. 70 (greater than 5/8") used for tilt frame base plate, tilt frame lifting plate, tilt frame gusset plates (I, II, III and IV), tilt frame beam side plate, tilt frame trunnion support block, saddle base plate, saddle web plate, saddle pad plate, saddle side plates (I and II), saddle gusset plates (I, II and III)	Not required per NF-2311 (b)(7)	-	-
A572 used for tilt frame beam	Not required per NF-2311 (b)(7)	-	-
As rolled SA516/A516 Gr. 70 used for tilt frame block mounting plate, tilt frame gusset plate-V (thickness greater than 5/8")	Per NF-2331	0°F (Also must meet ASME Section IIA requirements)	Table NF-2331(a)-3 or Figure NF-2331(a)-2 (Also must meet ASME Section IIA requirements)
Weld material	Test per NF-2430 if: (1) either of the base materials of the production weld requires impact testing, or; (2) either of the base materials is A516 Gr. 70 with nominal section thickness greater than 5/8".	0°F	Per NF-2331

HOLTEC INTERNATIONAL COPYRIGHTED MATERIAL

Report No.: HI-2167374

Proposed Rev. 0N

17-23

Table 17.4.4

FRACTURE TOUGHNESS TEST REQUIREMENTS FOR VERTICAL CASK TRANSPORTER

Material	Test Requirement	Test Temperature	Acceptance Criterion
Ferritic steel with nominal section thickness of 5/8" or less	Not required per NF-2311(b)(1)	-	-
Normalized SA516/A516 Gr. 70 (thicknesses 2-1/2" and less)	Not required per NF-2311(b)(10)	-	-
SA516/A516 Gr. 70 (as-rolled), A572 Gr. 50, or A514 (thickness greater than 5/8") SA193/A193 B7	Per NF-2300	0°F	Table NF-2331(a)-3 or Figure NF-2331(a)-2
Weld material	Test per NF-2430 if: (1) either of the base materials of the production weld requires impact testing, or; (2) either of the base materials is A516 Gr. 70 with nominal section thickness greater than 5/8".	0°F	Per NF-2331

HOLTEC INTERNATIONAL COPYRIGHTED MATERIAL

Report No.: HI-2167374

Proposed Rev. 0N

17-24

17.5 WELDING MATERIAL AND WELDING SPECIFICATION

No welding operations are expected to occur on the system components at the HI-STORE CIS site. Nevertheless, the requirements on welding are set down in this section to ensure that the SSCs manufactured at a remote fabrication plant (such as Holtec's plants in Camden, NJ, Orrville, OH or Pittsburgh, PA) comply with the essential provisions specified below.

Welds in the HI-STORM UMAX system **and the other ITS SSCs** are divided into two broad categories:

- i. Structural welds
- ii. Non-structural welds

Structural welds are those that are essential to withstand mechanical and inertial loads exerted on the component under normal storage and handling.

Non-structural welds are those that are subject to minor stress levels and are not critical to the safety function of the part. Non-structural welds are typically located in the redundant parts of the structure. The guidance in the ASME Code Section NF-1215 for secondary members may be used to determine whether the stress level in a weld qualifies it to be categorized as non-structural.

Both structural and non-structural welds must satisfy the material considerations listed in Tables 8.1.1 and 8.1.2 of [1.0.6] for the MPC and the HI-STORM UMAX VVM, respectively. In addition, the welds must not be susceptible to any of the applicable failure modes listed in Table 17.1.5.

The welding material and welding specification considerations for the MPC and HI-TRAC are discussed in Section 8.5 of the HI-STORM FW FSAR [1.3.7].

To ensure that all structural welds in the HI-STORM UMAX system **and the other ITS SSCs** shall render their intended function, the following requirements are observed:

- i. The welding procedure specifications comply with ASME Section IX for every Code material used in the system.
- ii. The quality assurance requirements applied to the welding process correspond to the highest ITS classification of the parts being joined.
- iii. The non-destructive examination of every weld is carried out using quality procedures that comply with ASME Section V.

The welding operations are performed in accordance with the requirements of codes and standards depending on the design and functional requirements of the components.

The selection of the weld wire, welding process, range of essential and non-essential variables*, and the configuration of the weld geometry has been carried out to ensure that each weld will have:

- i. Greater mechanical strength than the parent metal.
- ii. Acceptable ductility, toughness, and fracture resistance.

* Please refer to Section IX of the ASME Code for the definition and delineation of essential and non-essential variables.

HOLTEC INTERNATIONAL COPYRIGHTED MATERIAL	
Report No.: HI-2167374	Proposed Rev. 0N
17-25	

- iii. Corrosion resistance properties comparable to the parent metal.
- iv. No risk of crack propagation under the applicable stress levels.

The welding procedures implemented in the manufacturing of all HI-STORM UMAX SSCs are intended to fulfill the above performance expectations.

The weld filler material shall comply with requirements set forth in the applicable Welding Procedure Specifications qualified to ASME Section IX at the manufacturer’s facility. Only those Welding Procedures that have been qualified to the Code are permitted in the manufacturing of HI-STORE CIS facility components.

The weld procedure qualification record specifies the requirements for fracture control (e.g., post weld heat treatment). The HI-STORM UMAX module assembly does not require any post weld heat treatment due to the material combinations and provisions in the applicable codes and standards.

Non-structural welds shall meet the following requirements:

1. The welding procedure shall comply with Section IX of the ASME Code or AWS D1.1.
2. The welder shall be qualified, at minimum, to the commercial code such as ASME Section VIII, Div.1, or AWS D1.1.
3. The weld shall be visually examined by the weld operator or a Q.C. inspector qualified to Level 1 (or above) per ASNT (American Society for Nondestructive Testing) designation, in accordance with SNT-TC-1A.

HOLTEC INTERNATIONAL COPYRIGHTED MATERIAL	
Report No.: HI-2167374	Proposed Rev. 0N
17-26	

17.6 BOLTS AND FASTENERS

The HI-STORM UMAX VVM assembly does not employ any ITS bolts or fasteners. However, during the MPC transfer into the HI-STORM UMAX, the HI-TRAC is attached to the VVM assembly to prevent tip-over during a seismic event. **The MPC Lift Attachment is a one-piece lifting device that is bolted directly to threaded anchor locations on the top surface of the MPC closure lid which allows the raising or lowering of MPC during canister transfer operations using either the CTB or the VCT.** Likewise, the HI-TRAC CS cask is bolted to the CTF (located in the Cask Transfer Building) during the canister transfer operation. These bolts used to secure the HI-TRAC against tip-over, the bolts and anchor location material are classified as ITS and are procured in accordance with the Holtec QA program. Bolt and anchor location material must meet either an ASME or ASTM specification.

The only bolts employed in the HI-STORM UMAX VVM system are those used to secure the vent flue to the inlet and outlet plenums. All bolts and fasteners are made of alloy materials which are not expected to experience any significant corrosion and/or SCC in the operating environment.

All threaded surfaces are treated with a preservative to prevent corrosion. The O&M program for the storage system calls for all bolts to be monitored for corrosion damage and replaced, as necessary.

The coefficient of thermal expansion (CTE) describes how the size of an object changes with a change in temperature. Bolts and fasteners used in HI-STORE CIS systems, used only for short term operations, will have a CTE that is similar to the CTE of the materials being bolted together. In case of dissimilar material bolting, the temperature gradient is not high enough to alter the size of the bolts, and it is not credible that the bolts will lose their intended functions.

HOLTEC INTERNATIONAL COPYRIGHTED MATERIAL	
Report No.: HI-2167374	Proposed Rev. 0N
17-27	

17.7 COATINGS AND CORROSION MITIGATION

In order to provide reasonable assurance that the VVM will meet its intended Design Life (Table 17.0.1) and perform its intended safety function(s), chemical and galvanic reactions and other potentially degrading mechanisms must be accounted for in its design and construction.

It should be noted that, although the CEC is a buried steel structure it is substantially sequestered from the native soil through two engineered features:

- a. A thick reinforced concrete Enclosure Wall surrounds the VVM array and, along with the Support Foundation pad, provides a physical separation (water intrusion protection) to the CECs.
- b. The subgrade in contact with the CECs is either a “free flow” concrete or an engineered fill selected to provide a non-aggressive environment around the CECs.

The above engineered features provide an environmentally benign condition for the CECs. The above said, although the CEC is not a part of the MPC confinement boundary, it should not corrode to the extent where localized in-leakage of water occurs or where gross general corrosion prevents the component from performing its primary safety function. In the following, considerations in the VVM’s design and construction consistent with the applicable guidance provided in ISG-15 [17.0.1] are summarized.

All VVM components are protected from galvanic corrosion by appropriate designs. Except for the CEC exterior surfaces (exterior CEC surface coating requirements discussed separately), all carbon steel surfaces of the VVM are lined and coated with the same or equivalent surface preservative that is used in the aboveground HI-STORM FW and HI-STORM 100 overpacks. **Acceptable coatings are fully characterized in the HI-STORM FW FSAR [1.3.7] in Paragraph 8.7.2 and Appendix 8.A, which are incorporated herein by reference [see Table 17.0.2]. The same is true for all the other ITS SSCs and care is taken to avoid the formation of corrosion products by deposition of appropriate coatings, as necessary.** The pre-approved surface preservative is a proven zinc-rich inorganic/metallic (may also be an organic zinc rich coating) material that protects galvanically and has self-healing characteristics for added protection. **The coating also meets the emissivity requirements of Table 4.2.4 of [1.0.6], which is incorporated by reference into Section 6.4.1 of this FSAR, for the interior surface of the CEC divider shell.** All exposed surfaces interior to the VVM are accessible for the reapplication of surface preservative, if necessary.

The native soil excavated at the ISFSI site shall not be used as subgrade at the HI-STORE CIS ISFSI. Instead, CLSM will be used to provide corrosion protection and enhanced shielding.

17.7.1 Exterior Coating

The CEC exterior shall be coated with a radiation resistant surface preservative designed for below-grade and/or immersion service. Inorganic and/or metallic coatings are sufficiently radiation-resistant for this application; therefore, radiation testing is not required. Organic coatings such as epoxy, however, must have proven radiation resistance or must be tested without failure to at least 10^7 Rad. Radiation testing shall be performed in accordance with ASTM D 4082 [17.7.4] or equivalent.

HOLTEC INTERNATIONAL COPYRIGHTED MATERIAL	
Report No.: HI-2167374	Proposed Rev. 0N
17-28	

The coating should be conservatively treated as a Service Level II coating as described in Reg. Guide 1.54 [17.7.1]. As such, the coating shall be subjected to appropriate quality assurance in accordance with the applicable guidance provided by ASTM D 3843-00 [17.7.2]. The coating should preferably be shop-applied in accordance with manufacturer's instructions and, if appropriate, applicable guidance from ANSI C 210-03 [17.7.3]. The following table provides the acceptance criteria for the selection of coatings for the exterior surfaces of the CEC and ranks them in order of importance.

Acceptance Criteria for the Selection of Coatings	
Rank	Criteria
1	suitable for immersion and/or below grade service
2a	compatible with the ICCPS (if used) <ul style="list-style-type: none"> • adequate dielectric strength • adequate resistance to cathodic disbondment
2b	compatible with concrete encasement (if used) <ul style="list-style-type: none"> • adequate resistance to high alkalinity
3	adequate radiation resistance
4	adequate adhesion to steel
5	adequate bendability/ductility/cracking resistance/abrasion resistance
6	adequate strength to resist handling abuse and substrate stress

HOLTEC INTERNATIONAL COPYRIGHTED MATERIAL	
Report No.: HI-2167374	Proposed Rev. 0N
17-29	

17.8 GAMMA AND NEUTRON SHIELDING MATERIALS

Gamma and neutron shield materials in the HI-STORM UMAX VVM system are discussed in Section 1.2. The primary shielding materials used in the HI-STORM UMAX VVM system, as listed in Table 17.1.4, are plain concrete, reinforced concrete, and steel.

The plain concrete provides the main shielding function in the HI-STORM UMAX lids to minimize sky shine.

17.8.1 Plain Concrete

Unlike the above ground HI-STORM models, the use of plain concrete for shielding purposes in the underground VVMs is limited to the VVM Closure Lid. The critical characteristics of concrete used in the Closure Lid are its density and compressive strength. Table 2.3.2 in the HI-STORM UMAX FSAR provides reference properties of plain concrete used in the Closure Lid.

The density of plain concrete within the HI-STORM UMAX VVM is subject to a minor decrease due to long-term exposure to elevated temperatures. The reduction in density occurs primarily due to liberation of unbonded water by evaporation.

HOLTEC INTERNATIONAL COPYRIGHTED MATERIAL	
Report No.: HI-2167374	Proposed Rev. 0N
17-30	

17.9 NEUTRON ABSORBING MATERIALS

The neutron absorber material is permanently installed inside the Canisters for reactivity control. Metamic-HT is the neutron absorber material utilized the MPC-37 and MPC-89 -Canisters initially certified in the HI-STORM FW docket (#72-1032). The properties of Metamic-HT are fully characterized in the HI-STORM FW FSAR [1.3.7] in Paragraph 1.2.1.4 which is incorporated herein by reference [see Table 17.0.2].

Because Metamic-HT is enclosed in a helium environment and is subject to no interaction with the environment, its service life is not subject to attrition in storage.

HOLTEC INTERNATIONAL COPYRIGHTED MATERIAL	
Report No.: HI-2167374	Proposed Rev. 0N
17-31	

17.10 SEALS

The HI-STORM UMAX VVM assembly does not utilize any gaskets that seal against a large pressure differential.

The only external gasket used in the system is the soft gasket at the Closure lid-CEC Flange interface that helps prevent the ingress of moisture and insects (through the small crack that may exist due to weld distortion in the fabrication of interfacing fabricated steel weldment surfaces) into the module cavity space.

The Divider shell is sealed against the Closure lid using a pliable, non-organic seal material that is suitable for long-term ambient air application up to 300 degree F.

BISCO® BF-1000 Extra Soft Cellular Silicone gasket material [17.10.1] is selected as one that satisfies the acceptance criteria to the maximum degree. The seal/gasket material provides excellent compressibility, softness, and durability to adapt to various environments, making it an ideal choice for sealing Closure Lid. It has been used in all HI-STORM UMAX ISFSIs thus far. Equivalent materials that meet the above criteria are also commercially available.

HOLTEC INTERNATIONAL COPYRIGHTED MATERIAL	
Report No.: HI-2167374	Proposed Rev. 0N
17-32	

17.11 CHEMICAL AND GALVANIC REACTIONS

The materials used in the HI-STORM UMAX System **and all other ITS SSCs** are examined to establish that these materials do not participate in any chemical or galvanic reactions when exposed to the various environments during all normal operating conditions and off-normal and accident events. Chemical and galvanic reactions related to the MPC are discussed in Section 8.12 of the HI-STORM FW FSAR.

The following acceptance criteria for chemical and galvanic reactions are extracted from ISG-15 [17.0.1] for use in HI-STORM UMAX VVM components.

- a. The DCSS should prevent the spread of radioactive material and maintain safety control functions using, as appropriate, noncombustible and heat resistant materials.
- b. A review of the DCSS, its components, and operating environments (wet or dry) should confirm that no operation (e.g., short-term loading/unloading or long-term storage) will produce adverse chemical and/or galvanic reactions, which could impact the safe use of the storage cask.
- c. Components of the DCSS should not react with one another, or with the cover gas or spent fuel, in a manner that may adversely affect safety. Additionally, corrosion of components inside the containment vessel should be effectively prevented.
- d. Potential problems from general corrosion, pitting, stress corrosion cracking, or other types of corrosion, should be evaluated for the environmental conditions and dynamic loading effects that are specific to the component.

The materials and their ITS pedigree are listed in the drawing package provided in Section 1.5 of **Chapter 1**. The compatibility of the selected materials with the operating environment and to each other for potential galvanic reactions is discussed in this section.

- External atmosphere – During long-term storage the casks are exposed to outside atmosphere, air with temperature variations, solar radiation, rain, snow, ice, etc.

As discussed herein, the **ITS** components of the HI-STORM UMAX System **and other SSCs** have been engineered to ensure that the environmental conditions expected to exist at nuclear power plant installations do not prevent the cask components from rendering their respective intended functions.

The principal operational considerations that bear on the adequacy of the VVM for the service life are addressed as follows:

Exposure to Environmental Effects

All exposed surfaces of the HI-STORM UMAX VVM components are made from stainless steels or ferritic steels that are readily painted. **The same is true for all the other ITS SSCs and care is taken to avoid the formation of galvanic cells by deposition of appropriate coatings, as necessary, in case dissimilar materials are joined together.** Concrete, which serves strictly as a shielding material in the VVM Closure Lid, is encased in steel. Therefore, the potential of environmental vagaries such as spalling of concrete are ruled out for HI-STORM UMAX VVM. Under normal storage conditions, the bulk temperature of the HI-STORM UMAX storage overpack will change

HOLTEC INTERNATIONAL COPYRIGHTED MATERIAL	
Report No.: HI-2167374	Proposed Rev. 0N
17-33	

very gradually with time because of its large thermal inertia. Therefore, material degradation from rapid thermal ramping conditions is not credible for the HI-STORM UMAX VVM. Similarly, corrosion of structural steel embedded in the concrete structures due to salinity in the environment at coastal sites is not a concern for HI-STORM UMAX VVM because it does not rely on rebars (indeed, it contains no rebars). The configuration of the storage VVM assures resistance to freeze-thaw degradation. In addition, the storage system is specifically designed for a full range of enveloping design basis natural phenomena that could occur over the service life of the storage system as catalogued in Section 2.2 and evaluated in Chapter 15.

The ISFSI pad, which is exposed to the elements, shall be subject to a surveillance program to monitor its potential degradation, as discussed in Chapter 10.

Material Degradation

The relatively low neutron flux to which the VVM is subjected cannot produce measurable degradation of the cask's material properties and impair its intended safety function. Exposed carbon steel components are coated to prevent corrosion. The ambient environment of the ISFSI storage pad mitigates damage due to exposure to corrosive and aggressive chemicals that may be produced at other industrial plants in the surrounding area.

Maintenance and Inspection Provisions

The requirements for periodic inspection and maintenance of **all the ITS SSCs at HI-STORE CIS facility** throughout **their** service life **is** defined in Chapter 10. These requirements include provisions for routine inspection of the exterior **surfaces of equipment** and periodic visual verification that the ventilation flow paths are free and clear of debris **in the VVM**. In addition, the HI-STORM UMAX system is designed for easy retrieval of the MPC from the VVM should it become necessary to perform more detailed inspections and repairs on the storage system.

The above findings are consistent with those of the NRC's Continued Storage of Spent Nuclear Fuel Decision [17.11.1], which concluded that dry storage systems designed, fabricated, inspected, and operated in accordance with such requirements are adequate for the design and service life expectations set down in Table 17.0.1.

HOLTEC INTERNATIONAL COPYRIGHTED MATERIAL	
Report No.: HI-2167374	Proposed Rev. 0N
17-34	

17.12 FUEL CLADDING INTEGRITY

The discussion related to the fuel cladding integrity during short term operations is incorporated by reference from Section 8.13 of the HI-STORM FW FSAR and is not repeated here.

HOLTEC INTERNATIONAL COPYRIGHTED MATERIAL	
Report No.: HI-2167374	Proposed Rev. 0N
17-35	

17.13 EXAMINATION AND TESTING

Examination and testing are integral parts of manufacturing of the HI-STORM UMAX System and other ITS components that will be used at the HI-STORE CIS facility. The requirements for HI-STORM UMAX system are incorporated by reference from HI-STORM UMAX FSAR [1.0.6], Section 8.13.

Post-fabrication inspections are discussed in Chapter 10 of this SAR as part of the HI-STORM UMAX VVM System maintenance program. Inspections are conducted prior to fuel loading or prior to each fuel handling campaign. Other periodic inspections are conducted during storage.

The HI-STORM UMAX VVM is a passive device with no moving parts. The vent screens are inspected on scheduled intervals for damage, holes, etc. All the other ITS SSCs are inspected per scheduled intervals (Table 18.6.1) for general corrosion and/or mechanical damage.

The external surface of the VVM and the other ITS SSCs at the site, including identification markings, is visually examined on a periodic basis in accordance with the ISFSI's surveillance plan. The temperature monitoring system, if used, is inspected per the licensee's QA program and manufacturer's recommendations.

HOLTEC INTERNATIONAL COPYRIGHTED MATERIAL	
Report No.: HI-2167374	Proposed Rev. 0N
17-36	

17.14 REGULATORY COMPLIANCE

The preceding sections describe the materials used in important-to-safety SSCs and the suitability of those materials for their intended functions in the HI-STORM UMAX System at the HI-STORE CIS facility.

The requirements of 10CFR72.122(a) are met: The material properties of SSCs important to safety conform to quality standards commensurate with their safety functions.

The requirements of 10CFR72.104(a), 106(b), 124, and 128(a)(2) are met: Materials used for shielding are adequately designed and specified to perform their intended function.

The requirements of 10CFR72.122(h)(1) are met: The design of the DCSS and the selection of materials adequately protect the spent fuel cladding against degradation that might otherwise lead to gross rupture of the cladding by ensuring that the cladding temperature remains below the ISG-11 Rev 3 limits.

The requirements of 10CFR72.122(i) are met: The material properties of SSCs important-to-safety will be maintained during normal, off-normal, and accident conditions of operation as well as short-term operations so the spent fuel can be readily retrieved without posing operational safety problems.

The requirements of 10CFR72.122(f) are met: The material properties of SSCs important-to-safety will be maintained during all conditions of operation so the spent fuel can be safely stored for the specified service life and maintenance can be conducted as required.

The requirements of 10CFR72.1226(b) are met: The HI-STORM UMAX System employs materials that are not vulnerable to degradation over time or react with one another during long-term storage.

HOLTEC INTERNATIONAL COPYRIGHTED MATERIAL	
Report No.: HI-2167374	Proposed Rev. 0N
17-37	

CHAPTER 18: AGING MANAGEMENT PROGRAM*

18.0 INTRODUCTION

This chapter contains the essentials of the Aging Management Programs (AMP) for the HI-STORE CIS ISFSI which is intended to possess a long Service life (Table 17.0.1). An effective AMP is considered an imperative for an ISFSI that may ultimately house thousands of canisters containing spent nuclear fuel. For such a facility, a well-construed program to thwart gradual weakening of the safety margins associated with aging of the facility with potentially adverse consequences to important-to-safety structures, systems and components (SSCs) is a necessity. AMPs monitor and control the degradation of storage system's SSCs, so that the aging effects will not result in loss of their safety-significant function during their service life in interim storage. An effective AMP prevents, mitigates, or detects the aging effects and provides for the prediction of the extent of the effects of aging and timely corrective actions before there is a loss of intended function.

It is recognized that the HI-STORE ISFSI will store canisters most of which have been previously stored at an ISFSI at an operating or shuttered nuclear plant site. An AMP has not been required as a part of the initial licensing cycle of an ISFSI which has historically been 20 years. An acceptable AMP is required, however, at the end of the initial licensed life as a regulatory predicate for life extension of the storage license. At HI-STORE CIS, Holtec International plans to implement a state-of-the-art AMP that incorporates certain innovative approaches pioneered by the Company which are founded on the fundamentals of material degradation mechanisms. The architecture of the Program is informed by the published regulatory and industry literature as synopsized below.

NUREG-1927 [18.0.1] sets down an AMP containing 10 elements to manage the effects of aging. This document emphasizes the operating experience of all operating units to be documented and reviewed. Periodic future reviews of operating experience are required to confirm the effectiveness of AMP, or identify a need to enhance/modify the AMP. Managing aging mechanisms and effects in a "learning" manner articulated in [18.0.1] means ISFSI owners would monitor both the known SSC degradation mechanisms and the symptoms that would be indicators of a potential unknown SSC degradation mechanism.

The AMP set down in this chapter consists of four major components, namely

- Monitoring for emerging signs of potential degradation
- Periodic inspection and testing to uncover onset of the SSC's degradation
- Implementation of preventive measures (barriers) to arrest degradation
- Recovery and remedial measures if all barriers were to fail

Each of the above constituents of the AMP is summarized in the following sections.

* All references are in placed within square brackets in this report and are compiled in Chapter 19 (last chapter)

HOLTEC INTERNATIONAL COPYRIGHTED MATERIAL	
Report No. HI-2167374	Proposed Rev. 0P
18-1	

Nuclear Energy Institute (NEI) publication #14-03, Revision 1 [18.0.2] elaborates on [18.0.1] providing an explicit set of expectations from a well implemented AMP. The NEI espoused program calls for the AMP to have the following attributes:

- safety-focused
- operations-based
- implemented within existing corrective action and operating experience programs
- qualitatively risk-informed based on relevant failure modes and effects
- forward-looking
- proactive
- responsive to condition-based monitoring.

NEI 14-03 [18.0.2] provides a framework for AMP through the use of tollgates, defined as periodic points within the period of extended operation when licensees would be required to evaluate aggregate feedback and perform and document a safety assessment that confirms the safe storage of spent fuel. Tollgates are an additional set of in-service assessments beyond the normal continual assessment of operating experience, research, monitoring, and inspections on component performance that is part of normal ISFSI operations for licensees during the initial license period as well as the renewal period.

The concept of operations-based aging management is to manage aging mechanisms and timeframes (duration to loss of intended function) that are either not known or not well understood. Known aging mechanisms will be managed using existing corrective action and operating experience programs with the objective of preventing loss of intended safety functions due to aging effects. Because some postulated aging mechanisms and/or timeframes for in-scope SSCs are not well-characterized by operating data, aging management should be implemented in a manner that feeds information back in a timely fashion to the licensees. This feedback will be used to perform corrective actions on components to preclude the loss of safety function over the renewed operating period.

Operations-based aging management programs should include the following attributes for the known and unknown degradation mechanisms and time frames:

- recognition and evaluation (key technical issues)
- storage system inspections
- monitoring and operational inspections
- analysis and assessment
- tollgate assessment
- feedback and corrective actions (mitigation/repair and/or analysis).

HOLTEC INTERNATIONAL COPYRIGHTED MATERIAL	
Report No. HI-2167374	Proposed Rev. 0P
18-2	

The AMP outlined in this chapter incorporates the above elements of [18.0.1 and 18.0.2] and is termed a “progressively enhanced plan” (PEP) that is shaped and guided by fundamental technical principles and ongoing operating experience. **The aging management information provided in this chapter is elaborated in the aging management report HI-2167378 [1.2.1].**

All the important-to-safety (ITS) SSCs scoped for aging management were granted a 20 year initial license under the HI-STORM UMAX license. HI-STORE SAR will be requesting a 40 year license. To ensure an uninterrupted performance of these ITS SSCs and their intended functions through the 40 year license period, all such ITS SSCs will be inspected and monitored per their respective AMP, and a concern-free service life of those SSCs will be established. Additional AMPs are also included for those SSCs that are not part of the HI-STORM UMAX generic license. Typical aging mechanisms and quantitative and/or qualitative analyses are discussed in Section 18.3 below.

HOLTEC INTERNATIONAL COPYRIGHTED MATERIAL	
Report No. HI-2167374	Proposed Rev. 0P
18-3	

18.1 SCOPING EVALUATION AND SEVERITY INDEX

The HI-STORE CIS ISFSI consists of (i) the MPC, (ii) the VVM, and (iii) other support SSCs. These components were evaluated using the two scoping criteria in NUREG-1927 [18.0.1]. In summary, these criteria are (1) an SSC that is Important to Safety (ITS) or (2) an SSC that supports SSC safety functions.

Because the canister provides the confinement protection and reactivity control, its AMP is the most critical activity and is accordingly the central focus of the program. The VVM which includes the top pad (ISFSI pad) is the other critical component. As a steel and concrete structure that is limited to providing dose attenuation, the aging management demands on the VVM are different in nature from those on the MPC and are also somewhat less severe. Furthermore, the top lid (Closure Lid) of the VVMs is a removable item which can be replaced with a new lid, if needed, making the aging management demands on it less consequential. (The VVM body is integral to the ISFSI and cannot be replaced). The HI-TRAC CS transfer cask is used only during loading operations; it does not store any used Fuel. The AMP for the Transfer cask is accordingly informed by its functional requirement. An assessment of the VVM, MPCs, HI-TRAC CS Transfer Cask, ISFSI pad, and other SSCs is documented in [1.2.1] which identifies the necessary inspection and monitoring activities to provide reasonable assurance that the SSCs will perform their intended functions for the duration of their License life. A summary of the SSCs that warrant an AMP along with the severity of the consequence of each SSC's degradation is provided in Table 18.1.1 (partially adapted from [1.2.1]). The Severity index is essentially a graded approach to defining AMP requirements: A Severity Index of 3 is the highest, 2 means moderate severity, 1 is minor impact on SSC, and 0 means the SSC is not subject to an AMP.

HOLTEC INTERNATIONAL COPYRIGHTED MATERIAL	
Report No. HI-2167374	Proposed Rev. 0P
18-4	

Table 18.1.1: Summary of SSCs Requiring Aging Management & Their Severity Index

SSC	Scoping Results		In-Scope SSC	Severity of the consequence of degradation (3 most severe, 2 moderately severe, 1 Minor; 0 not severe and not-included)
	Criterion 1 ¹	Criterion 2 ²		
MPC	Yes	N/A	Yes	3
HI-TRAC CS Transfer Cask	Yes	N/A	Yes	1
VVM	Yes	N/A	Yes	2
Fuel Assembly	Yes	N/A	Yes	3
ISFSI Pad	Yes	No	Yes	2
SFP	Yes	No	Yes	1
CTB Crane	Yes	No	Yes	1
CTB Slab	Yes	No	Yes	1
CTF	Yes	No	Yes	1
HI-TRAC CS Lifting Device (Lift Yoke)	Yes	No	Yes	1
MPC Lift Attachment	Yes	No	Yes	1
MPC Lifting Device Extension	Yes	No	Yes	1
VCT	Yes	No	Yes	1
Special Lifting Devices	Yes	No	Yes	1
Transport Cask Horizontal Lift Beam	Yes	No	Yes	1
Transport Cask Tilt Frame	Yes	No	Yes	1
Transport Cask Lift Yoke	Yes	No	Yes	1
CLSM	Yes	No	Yes	1
CTB	No	No	No	0
CTF Adapter Plate	No	No	No	0

HOLTEC INTERNATIONAL COPYRIGHTED MATERIAL

Report No. HI-2167374

Proposed Rev. 0P

18-5

ISFSI Security Equipment	No	No	No	0
--------------------------	----	----	----	---

Notes:

(1) SSC is Important to Safety (ITS)

(2) SSC is Not Important to Safety (NITS), but its failure could prevent an ITS function from being fulfilled

HOLTEC INTERNATIONAL COPYRIGHTED MATERIAL	
Report No. HI-2167374	Proposed Rev. 0P
18-6	

18.2 MAINTENANCE PROGRAM FOR THE HI-STORM UMAX VVM & HI-TRAC CS

The maintenance program is an essential element of a comprehensive AMP. The essentials of the maintenance program for the HI-STORE ISFSI SSCs are summarized in Chapter 10. The relationship of aging management to the maintenance program is discussed in Section 18.14.

HOLTEC INTERNATIONAL COPYRIGHTED MATERIAL	
Report No. HI-2167374	Proposed Rev. 0P
18-7	

18.3 MECHANISMS FOR AGING OF SSCS

In this section, the fundamental mechanisms that underlie aging of a dry storage SSC are summarized to serve as the guide in evolving an effective aging management program. The principal effects that can cause aging of an SSC are:

- i. Cyclic fatigue from thermal and pressure transients
- ii. Creep
- iii. Erosion
- iv. General Corrosion
- v. Boron depletion (of neutron absorbing or shielding materials)
- vi. Crack propagation
- vii. Repetitive mechanical loading (of trunnions and threaded anchor locations)
- viii. Stress corrosion cracking (SCC)

Each mechanism is discussed below in the context of its potential role in aging of the HI-STORE SSCs.

i. Cyclic Fatigue:

Cyclic fatigue is caused by thermal or pressure transients in a SSC. The necessary condition for fatigue expenditure in metals is a rapid pulsation of large amplitude stress which is only possible in the dry storage SSCs if the environmental conditions were to change drastically (hundreds of °F change) in a matter of seconds and such changes were to occur repeatedly (thousands of cycles). Because such cyclic conditions are not realistic for any terrestrial environment, cyclic fatigue of dry storage components and structures is not a credible mechanism for their degradation.

Quantitative analysis of long term fatigue on HI-TRAC CS, **Transport Cask lift beams** and other lifting ancillaries (**lift yokes, etc.**) is discussed in Chapter 5 of this SAR.

It summarizes a cyclic loading fatigue evaluation of the HI-TRAC CS Transfer Cask, **Transport Cask lift beams** and other lifting ancillaries which concludes that stresses are well below the endurance limit of the trunnion material. Thus, trunnion fatigue is not an issue during the aging management period. It is conservatively assumed that the HI-TRAC CS, **Transport Cask lift beams** and other lifting ancillaries are utilized for all lifts of the ISFSI MPCs. However, the allowable number of lifting cycles far exceeds the number of lifts that will be needed. Therefore, no additional aging management plan is needed to address fatigue failure of the HI-TRAC CS, **Transport Cask lift beams** and other lifting ancillaries.

The Transport Cask Tilt Frame is not a lifting device since it is a stationary device that provides support to the cask from below. Also, during upending or down ending operations, the cask always remains connected to the single failure proof CTB Crane via a special lifting device. Structural analysis of tilt frame is summarized in Chapter 5 of this SAR.

HOLTEC INTERNATIONAL COPYRIGHTED MATERIAL	
Report No. HI-2167374	Proposed Rev. 0P
18-8	

ii. Creep:

Creep is a time-dependent effect that produces ever-increasing deformation under a sustained load. Creep is a factor in components that operate at a high temperature and are subject to an elevated state of stress. Creep effects are negligible in most metals at moderate temperature (below 600°F) and stress levels (less than half of the material's Yield Strength). Creep, therefore, is a concern only for the fuel assembly rods inside the canisters. Because the fuel rods are thin walled pressurized tubes and operate at elevated temperatures, the incidence of damage from creep cannot be ruled out. In this respect, the high thermal capacity of the HI-STORM UMAX system provides an effective protection against creep. A quantitative estimate of the benefit accrued by HI-STORM UMAX to the canisters brought in at a substantially lower heat load (Section 4.1) can be obtained by using the creep rate equation for fuel cladding from [18.3.1]:

$$\phi = \frac{d\epsilon}{dt} = \alpha \exp\left(-\frac{\zeta}{R(T+273)}\right) \sinh(\gamma\sigma) \beta \tau^{\beta-1}$$

Where

ϕ = Creep Rate (% / hr)

α = Rate Constant (2.4×10^7)

ζ = Activation Energy (120,000 J/gmol)

R = Gas Constant (8.31 J/gmol)

γ = Stress Exponent (0.022 MPa^{-1})

σ = Cladding Stress (MPa)

β = Creep Constant (0.4)

T = Temperature (°C)

The creep rate corresponding to the maximum heat load in HI-STORM UMAX to that if the fuel rod were at the ISG-11 Rev 3 limit temperature can be obtained by assuming the cladding hoop stress is directly proportional to the absolute temperature of the cladding material. Using the cladding temperature result from Table 18.3.1, the ratio is determined and presented in Table 18.3.1. As can be seen from this result, the high thermal capacity of the HI-STORM VVMs has the effect of reducing the creep rate by several orders of magnitude.

Of course, as the canister ages, its heat load decreases, causing a corresponding decrease in the creep rate, reaching vanishing small values after a few years. Therefore, the threat of creep damage to the fuel recedes to a negligible range as the canisters will age in interim storage at HI-STORE.

Appendix D of NUREG-1927 [18.0.1] provides supplemental guidance for the use of a demonstration program as a surveillance tool for confirmation of integrity of High Burnup Fuel (HBF) during the period of extended operation. The technical discussion and guidance provided by the demonstration program will be used for learning purposes and the results obtained from

HOLTEC INTERNATIONAL COPYRIGHTED MATERIAL	
Report No. HI-2167374	Proposed Rev. 0P
18-9	

the program will be analyzed. All appropriate actions shall be taken at the HI-STORE facility, as needed, based on the demonstration program results.

iii. Erosion:

Erosion is a mechanical action wherein the impinging particles carried by a fluid medium on a surface causes the target surface to release fine surface matter. Erosion requires a high fluid velocity to cause noticeable material loss. Contemporary design practice in tubular heat exchanger thermal design holds that the incident velocity must be high enough so that E defined by $\rho v^2 > 500$, where ρ is density of the fluid carrier in lb/cubic feet, and v is the flow velocity orthogonal to the target surface in feet/sec.

The evident area on the canister's surface potentially vulnerable to erosion would be the surface facing the inlet ducts through which ventilation air enters. The value of in-duct air velocity from the FLUENT analysis is used for comparison purposes. The key computed data is summarized in the unnumbered table below which shows that the minimum required threshold value is orders of magnitude larger than the actual value.

Empirical correlation for the rate of erosion states that the rate varies as 4.5 power of velocity. Using this correlation gives the computed factor of safety against the onset of erosion on the canister's surface.

Computing the margin against erosion on the canister's surface	
Ventilation air velocity in the HI-STORM UMAX cavities from FLUENT at the maximum allowed canister heat load at the site, ft/sec	6 ft/s
Reference air density used in the calculation, lb/cubic feet	0.075
Threshold velocity of impingement based on $\rho v^2 = 500$	81.65 ft/s
Ratio of the threshold velocity to the actual impingement velocity value (Velocity ratio)	$81.65 / 6 = 13.61 \sim 14$
Factor of safety for the onset of impingement erosion (4.5 power of the velocity ratio)	$4.5^{14} = 1.4 \times 10^9$

Therefore, erosion is ruled out as an actuating mechanism to cause damage to the stored canister at the HI-STORE facility.

iv. General Corrosion & Spalling of the ISFSI concrete surface:

General corrosion of painted carbon steel surfaces in the HI-STORE CIS is expected and dealt with in the maintenance program described in the foregoing. Because the ambient air is relatively dry, the incidence of peeling of the coating is expected to be much more subdued.

Likewise spalling of the ISFSI concrete surface around the VVM due to freeze/thaw cycles following water infiltration is prevented by keeping the surface coating in good condition through preventive maintenance.

HOLTEC INTERNATIONAL COPYRIGHTED MATERIAL	
Report No. HI-2167374	Proposed Rev. 0P
18-10	

v. Boron depletion:

The theoretical risk of boron depletion applies to the neutron absorber panels in the canister's Fuel Basket wherein the B-10 isotope in the material serves to capture thermalized neutrons produced by the radioactive decay of the used fuel. Calculations performed on a typical canister show that the fraction of boron atoms consumed during the service life of the MPC (Table 17.0.1) will be a small fraction of boron available in the Fuel Basket.

A quantitative analysis on Boron depletion has been discussed in Section 3.4.8 of HI-STORM FW FSAR [1.3.7]. The analysis demonstrates that the Boron depletion in Metamic-HT material is negligible over a 60 year duration. Thus, sufficient levels of Boron are present in the fuel basket neutron absorbing material to maintain criticality safety functions over the license life of the MPC.

Therefore, aging management of the canister to insure adequate boron-10 isotope in the Fuel Basket is not necessary; the canister does not run a credible risk of boron depletion below the needed level to maintain subcriticality.

vi. Crack propagation:

Every material has flaws at microscopic level. Those components whose load bearing materials are volumetrically examined are less apt to have hidden flaws but the existence of imperfections that can propagate over time can't be entirely ruled out. In order to ensure that any pre-existing flaw will not propagate and lead to sudden failure, the following design measures will be implemented in the design and manufacturing of the SSCs for HI-STORE:

- In high strength materials, such as those used in lift rigs, the maximum primary stress in the material during lifting and handling operations is required to be less than 1/6th of the material Yield Strength which is generally considered to be the limit at which a pre-existing crack may propagate.
- In high ductility materials, such as austenitic stainless steel (used in the canister), the maximum stress is required to meet the limit in Reg Guide 3.61. Furthermore, the primary stress in the canister under normal storage condition is required to meet the limit for ASME Section III Class 1 components.

Observing the above restrictions eliminates the threat of crack propagation in critical equipment at the HI-STORM ISFSI and hence the need for any prophylactic measures to avoid their occurrence.

vii. Repetitive Mechanical Loading:

The design measure employed by Holtec requires the maximum primary stress in a trunnion or threaded anchor location under the maximum lifted load to be below the "endurance strength" of the material. Observing the endurance limit criterion eliminates the threat of cyclic fatigue failure *a priori*. Quantitative analysis of long term fatigue on lifting ancillaries is discussed in Chapter 5 in the SAR.

viii. Stress Corrosion Cracking (SCC):

Unique to austenitic and duplex stainless steels, SCC causes cracking at the intergranular or transgranular level in the material. It is a serious threat to the canister's confinement boundary

HOLTEC INTERNATIONAL COPYRIGHTED MATERIAL	
Report No. HI-2167374	Proposed Rev. 0P
18-11	

which is exposed to the ambient environment at the ISFSI. The incidence of SCC requires three essential conditions to be present concurrently:

- a. Significant tensile stress at the surface exposed to the environment, and
- b. Halides in the environment, and
- c. Relative humidity in excess of 20%

At the HI-STORE site, the halide content in the air is negligible as mentioned in Chapter 2, therefore an essential requirement for SCC is not satisfied and the incidence of SSC becomes a remote possibility. Nevertheless, the risk of SCC cannot be entirely ruled out and the AMP must provide for a way to anticipate it. Accordingly, the monitoring method for the canister proposed in this SAR assumes that the threat of SCC is real and possible.

HOLTEC INTERNATIONAL COPYRIGHTED MATERIAL	
Report No. HI-2167374	Proposed Rev. 0P
18-12	

Table 18.3.1: Calculation of Creep Rate Attenuation Under HI-STORM UMAX Storage Baselined to ISG-11 Revision 3 Limit

Property	Value
Bounding Cladding Stress (σ_{\max})	144.7 MPa @ $T_{\text{ref}} = 387^{\circ}\text{C}$ ¹
Baseline Cladding Temperature (T_{cb})	400°C
Max. Cladding Temperature under HI-STORM UMAX Storage (T_{cs})	330°C ²
Cladding Stress (σ_{b}) @ T_{cb} ($\sigma_{\max} * (T_{\text{cb}} + 273) / (T_{\text{ref}} + 273)$)	147.6 MPa
Cladding Stress (σ_{s}) @ T_{cs} ($\sigma_{\max} * (T_{\text{cs}} + 273) / (T_{\text{ref}} + 273)$)	132.2 MPa
Creep Rate Ratio (ϕ @ T_{cs} / ϕ @ T_{cb})	0.04

¹ Data adopted from Appendix 4.A for bounding PWR fuel rods [18.3.1]

² Data adopted from Chapter 6, Section 6.4 of the HI-STORE SAR.

HOLTEC INTERNATIONAL COPYRIGHTED MATERIAL	
Report No. HI-2167374	Proposed Rev. 0P
18-13	

18.4 UNIQUE ASPECTS OF THE HI-STORE CIS WITH NEXUS TO ITS AMP

The following aspects of the HI-STORE ISFSI are relevant to developing a sound AMP for the site:

- i. Because the storage system is subterranean, the extent of the exposed metal surface of the VVM is quite small compared to the above-ground storage systems.
- ii. The relatively thin wall of the exposed surface of the canister (the canister's shell which is made of austenitic stainless steel) is disposed vertically which, as expected, discourages the deposition of aggressive species from accumulating on the shell surface. (An EPRI/Holtec measurement program at Diablo Canyon and Salem/Hope Creek ISFSIs showed that the deposition on the shell surface is significantly less than that on the horizontal surface [18.4.1]). It is well known that the deposition of solutes on the surface of stainless steel directly correlates with the risk of generation of nucleation sites where stress corrosion cracking (SCC) may initiate. Reduced deposition rate on the thin wall of the canister is a positive feature for an extended service life.
- iii. As described in Chapter 2, the ambient environment at the HI-STORE site has minuscule amount of salts and other airborne particulates known to be injurious to stainless steel. The minuscule concentration of halides in the air starves the canister's surface of an essential ingredient for initiating SCC.
- iv. There is no location for contaminant hide-out (such as crevice or gouge) on the surface of the vertically arrayed canister (in contrast to the condition where the canister is horizontally stored), where halide-bearing particles may concentrate enabling SCC to take hold.
- v. The settling of moisture on the canister's shell during cool hours followed by warm hours causing the moisture to evaporate leaving behind the particulate residue is the principal means for salts to accumulate on the canister's surface. In the high desert of south-eastern New Mexico, the relative humidity in the air is low, making the delivery of salts to the canister's surface less effective.

In light of the above, it is reasonable to expect that the canisters stored at HI-STORE CIS will have a substantially longer service life than that projected in Table 17.0.1. Nevertheless, a progressively enhanced plan for Aging Management has been adopted in this SAR as explained in this Chapter.

HOLTEC INTERNATIONAL COPYRIGHTED MATERIAL	
Report No. HI-2167374	Proposed Rev. 0P
18-14	

18.5 MPC AGING MANAGEMENT PROGRAM

The welded canisters need inspections and enhanced monitoring programs in order to detect localized corrosion and potential chloride-induced stress corrosion cracking (CISCC) initiation and propagation prior to through wall crack growth. To identify these aging mechanisms SCC in canisters at HI-STORE CIS prior to a loss of function, a set of criteria and associated canister ranking values will be developed per EPRI Report [18.5.1]. This ranking may be used to assess welded MPCs at the site with regard to selecting more susceptible canisters for inspections. The criteria for canister selection for inspection is presented in Element 4 of MPC AMP in [1.2.1].

[18.5.1] also mentions additional factors that should be considered for prioritizing canisters among a population of canisters with the same rank. The canister ranking criteria are designed to rank individual canisters at HI-STORE site based on the anticipated level of chloride accumulation, the contribution of the material alloy to CISCC susceptibility, and the surface regions where deliquescence could occur. The chloride accumulation/deposition criterion provides a rank factor based on the previous site and the time elapsed since the canister was emplaced in the overpack. The material criterion provides a ranking factor based on resistance to SCC. The decay heat criterion provides a ranking factor relating current canister residual decay heat to the prevalence of deliquescent conditions on the canister surface using surface temperatures from available thermal models. The results of the canister ranking will be used in the canister inspection selection criteria and in the development of the learning based AMP/operating experience. The detailed aging management program for the MPC is provided in [1.2.1].

18.5.1 Visual Examination

The MPC AMP involves monitoring the exterior surface of the selected MPC(s), including visual inspection of the MPC surface for signs of degradation. A minimum of one canister from each originating site shall be selected for visual inspection. The canisters with the highest susceptibility for SCC should be selected for inspection. The selection criteria include oldest and coldest canisters with a potential for accumulation and deliquescence of deposited salts that may promote localized corrosion and/or SCC. The selection criteria for inspection of the installed canisters at the site will be re-evaluated as and when additional canisters are installed. The visual inspection frequency has been outlined per Table 18.6.1. All the accessible weld areas of the canister(s) will be covered for SCC inspection/monitoring and the canisters selected for inspection will be visually inspected for conditions listed below.

The monitored conditions include, but are not limited to:

- Localized corrosion pits, stress corrosion cracking, etching, or deposits
- Discrete colored corrosion products, especially those adjacent to welds and weld heat affected zones
- Linear appearance of corrosion products parallel to or traversing welds or weld heat affected zones

HOLTEC INTERNATIONAL COPYRIGHTED MATERIAL	
Report No. HI-2167374	Proposed Rev. 0P
18-15	

- Red-orange colored corrosion products combined with deposit accumulations in any location
- Red-orange colored corrosion tubercles of any size

18.5.2 Volumetric Examination

Additional assessment is necessary for suspected areas of localized corrosion or stress corrosion cracking. Volumetric and surface examinations are conducted to characterize the extent and severity of localized corrosion and stress corrosion cracking. Volumetric examinations of pits is conducted within 25 mm (1 inch) of welds or 25 mm (1 inch) of an area where a temporary attachment was known to be located.

18.5.3 Accelerated Coupon Testing

As defense in depth, small coupons pre-stressed to varying levels installed in the cold (air inlet) region of the VVM cavity annulus are planned to be used at the HI-STORE CIS site to serve as an early warning system for predicting the onset of stress corrosion cracking or any other anomalous behavior. The coupons shall be installed after evaluation, in VVMs that contain oldest and coldest canisters, where inspections are expected. In addition to oldest and coldest canisters, U-bend coupons will also be installed in hottest canister. Hottest canister is expected to have the highest airflow of the VVM. Coupons withdrawn for testing shall not be reused. This program contemplates inspection and monitoring of U-bend coupons installed inside the HI-STORM UMAX over an extended period of time. The selection criteria for coupon installation in additional VVMs at the site will be re-evaluated as and when additional canisters are installed. The U-bend test coupon will be prepared in accordance to ASTM G30 [18.5.2].

The coupon schematic and dimensions are shown in Figure 18.5.1.

As per [18.5.2], any dimensional characteristics enlisted in the unnumbered table below can be chosen for preparing a U-bend coupon.

Monitoring and inspecting U-bend coupons is an accelerated approach of predicting degradation of MPC material. Prior to exposure, all coupons must be inspected by Penetrant Testing (PT) to ensure that the coupons are free from cracks. The post exposure inspection of the coupons will be performed as a part of MPC AMP. Optical metallography examinations will be conducted at 20X and 100X magnifications to identify cracks per ASTM G1 [18.5.3], and PT testing will be carried out per ASME Section V requirement [18.5.4] on U-bend coupons post exposure in accordance to inspection frequency mentioned in Table 18.6.1.

This program will develop track record in terms of pitting, stress corrosion and/or on any other form of material degradation. Thus, the program will provide insight and data on long term aging behavior of the material which will help prognosticate the risk of crack initiation and propagation in the canisters over their Service Life. The visual and volumetric inspections described in Subsection 18.5.1 and 18.5.2 are the credited aging management program for the canister, but the coupons provide information for learning and evaluating the program effectiveness.

18.5.2.1 Frequency of Coupon Testing and Canister Sample Size

HOLTEC INTERNATIONAL COPYRIGHTED MATERIAL	
Report No. HI-2167374	Proposed Rev. 0P
18-16	

As MPC degradation is a long term process with no known or observed mechanisms that would lead to rapid thru-wall breach a suitable coupon testing plan must be fashioned to maximize learning thru an expanding database of experience and knowledge. To this end initial coupon test plan is defined in Table 18.5.1.

18.5.4 Eddy Current Testing:

If the U-bend coupon indicates any kind of defect and/or anomaly, the external surface of the representative canister may be tested using an Eddy current NDE technique developed by EDF Energy and Holtec to ensure the quality and integrity of the canister.

The Eddy Current testing on a canister is performed by staging the HI-TRAC CS transfer cask over the VVM cavity with a custom engineered “Eddy current probe system” housed in shielded enclosure interposed between the two. The probe system consists of the Eddy Current inspection ring and the shielding ring (Figure 18.5.2 – The shielding ring surrounding the inspection ring is not shown for clarity).

The surface of the MPC is circumferentially assayed as it is progressively raised from the VVM cavity. Eddy current testing is capable of identifying surface defect of maximum allowable depth of 2mm anywhere on the external cylindrical surface of the canister. Any flaw that exceeds the maximum allowable depth will require further investigation. **Similar to the coupons, the eddy current testing is used as a defense in depth option if further information about the canister is needed.**

HOLTEC INTERNATIONAL COPYRIGHTED MATERIAL	
Report No. HI-2167374	Proposed Rev. 0P
18-17	

Table 18.5.1: Initial Coupon Testing Protocol

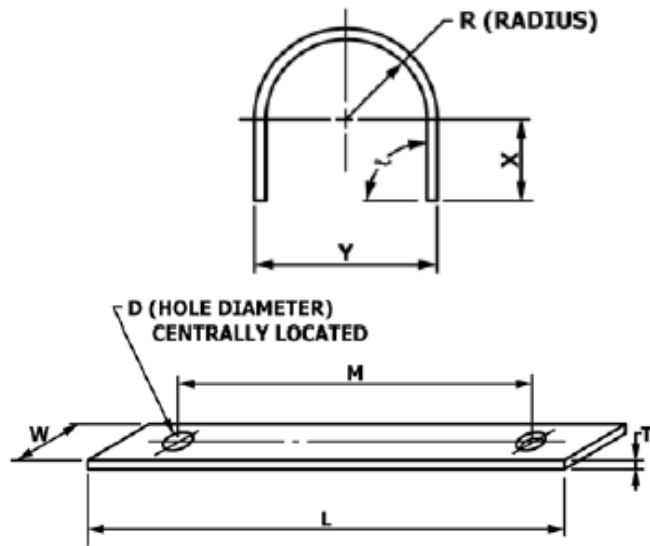
Test Item	Count	Remarks
Test Coupons/canister (Note 3)	Four Coupons	One in each quadrant located near the inlets
Coupon Testing Frequency	Once Every Five Years	Frequency aligns with visual inspections (See Table 18.6.1).
<p>Note 1: Coupon testing must not be solely relied as a basis for acceptable performance.</p> <p>Note 2: Coupon evaluation must be coordinated with eddy current and visual inspection results to provide a comprehensive and informed basis for future inspections.</p> <p>Note 3: Coldest and hottest canisters are selected for coupon testing as defined in Section 18.5.3.</p>		

HOLTEC INTERNATIONAL COPYRIGHTED MATERIAL

Report No. HI-2167374

Proposed Rev. 0P

18-18



Example	L (mm)	M (mm)	W (mm)	T (mm)	D (mm)	X (mm)	Y (mm)	R (mm)	α , rad
a	80	50	20	2.5	10	32	14	5	1.57
b	100	90	9	3	7	25	38	16	1.57
c	120	90	20	1.5	8	35	35	16	1.57
d	130	100	15	3	6	32	32	13	1.57
e	150	140	15	0.8	3	20	20	9	1.57
f	310	250	25	13	13	90	90	32	1.57
g	510	460	25	6.5	13	165	165	76	1.57
h	102	83	19	3.2	9.6	16	16	4.8	1.57

Figure 18.5.1: Coupon Schematic and Dimensions

HOLTEC INTERNATIONAL COPYRIGHTED MATERIAL	
Report No. HI-2167374	Proposed Rev. 0P
18-19	

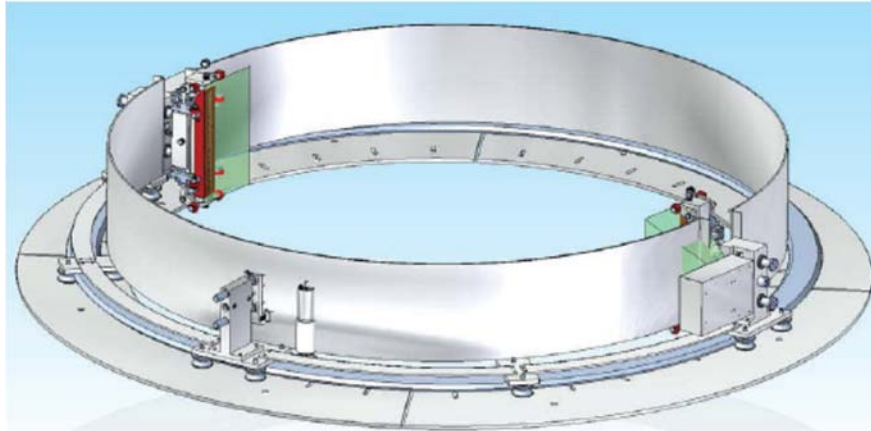


Figure 18.5.2: Representative Eddy Current Inspection Ring

HOLTEC INTERNATIONAL COPYRIGHTED MATERIAL	
Report No. HI-2167374	Proposed Rev. 0P
18-20	

18.6 HI-TRAC CS TRANSFER CASK AGING MANAGEMENT PROGRAM

The HI-TRAC CS Transfer Cask Aging Management Program utilizes inspections to ensure that the transfer cask maintains its intended function throughout its Service Life by performing a visual inspection for degradation of the external surfaces of the Transfer Cask and trunnions. This inspection is performed prior to use of the Transfer Cask per Table 18.6.1. **A detailed aging management program for the HI-TRAC CS Transfer Cask is provided in [1.2.1].**

The visual inspection will include the following:

- All painted surfaces for corrosion and paint integrity
- All surfaces for dents, scratches, gouges, or other damage
- Lifting trunnions for deformation, cracks, damage, corrosion, and galling

HOLTEC INTERNATIONAL COPYRIGHTED MATERIAL	
Report No. HI-2167374	Proposed Rev. 0P
18-21	

Table 18.6.1: Periodic Inspection Frequency of HI-STORE CIS ISFSI Components

Components	Periodic Inspection Frequency
MPC	Every 5 years
HI-TRAC CS Transfer Cask	Pre-Use and Once every year while in use
VVM	Every 5 years
ISFSI Pad and SFP	Once every year
CTB Crane	Pre-Use and Once every year while in use
CTB Slab	Once every year
Lifting Devices (HI-TRAC CS Lift Yoke, VCT, MPC Lift Attachment, MPC Lifting Device Extension, Transport Cask Lift Yoke, Horizontal Lift Beam)	Pre-Use and Once every year while in use
Transport Cask Tilt Frame	Pre-Use and Once every year while in use
CTF	Every 5 years

HOLTEC INTERNATIONAL COPYRIGHTED MATERIAL	
Report No. HI-2167374	Proposed Rev. 0P
18-22	

18.7 VVM AGING MANAGEMENT PROGRAM

The Vertical Ventilated Module (VVM) AMP utilizes condition monitoring to manage aging effects of the Cavity Enclosure Container (CEC), Divider Shell, and the Closure Lid as set down in the maintenance program in the foregoing. **All VVMs that contain the MPCs used for the MPC AMP shall be inspected.** The initial frequency of inspection is set down in Table 18.6.1 which is subject to change depending on the ‘tollgate’ protocol explained in Section 18.13. **A detailed aging management program for the VVM is provided in [1.2.1].**

The visual inspection of the steel components and structures will include the following:

- All internal surfaces for corrosion and integrity
- All other surfaces for dents scratches, gouges, or other damage.

HOLTEC INTERNATIONAL COPYRIGHTED MATERIAL	
Report No. HI-2167374	Proposed Rev. 0P
18-23	

18.8 REINFORCED CONCRETE AGING MANAGEMENT PROGRAM

The ISFSI pad, SFP and Cask Transfer Building (CTB) slab are examples of reinforced concrete structures at the HI-STORE CIS facility. The AMP includes periodic visual inspections by personnel qualified to monitor reinforced concrete for applicable aging effects, and evaluate identified aging effects against acceptance criteria derived from the design bases. The initial frequency of inspection is set down in Table 18.6.1. **The reinforced concrete aging management program is also applicable to the CLSM, which does not include steel reinforcement but is subject to the same aging mechanisms as the higher strength concrete used in the ISFSI pad, SFP and CTB slab.**

The program also includes periodic sampling and testing of groundwater, and the need to assess the impact of any changes in its chemistry on the concrete structures underground. Additional activities may include periodic inspections to ensure the air convection vents are not blocked. **A detailed aging management program for the reinforced concrete is provided in [1.2.1].**

The inspection of the reinforced concrete structures will include the following:

- All accessible surfaces for cracking, loss of material, permeability and integrity
- Groundwater chemistry monitoring to identify conditions conducive to underground aging mechanisms such as corrosion of steel and degradation due to chemical attack.

HOLTEC INTERNATIONAL COPYRIGHTED MATERIAL	
Report No. HI-2167374	Proposed Rev. 0P
18-24	

18.9 HBF AGING MANAGEMENT PROGRAM

This is a program that monitors and assesses data and other information regarding HBF performance, to confirm that the design-bases HBF configuration is maintained during the period of extended operation. The HBF AMP relies on a surrogate demonstration program to provide data on HBF performance. Guidance to support HBF AMP is given in Appendix D of NUREG-1927.

The aging management review is not expected to identify any aging effects that could lead to fuel reconfiguration, as long as the HBF is stored in a dry inert environment, temperature limits are maintained, and thermal cycling is limited. Short term testing and scientific analyses examining the performance of HBF have provided a foundation for the technical basis that storage of HBF in the period of extended operation may be performed safely and in compliance with regulations. However, there has been relatively little operating experience, to date, with dry storage of HBF.

Therefore, the purpose of HBF AMP is to monitor and assess data and other information regarding HBF performance to confirm there is no degradation of HBF that would result in an unanalyzed configuration during the period of extended operation. **A detailed aging management program for the HBF is provided in [1.2.1].**

The parameters (maximum assembly-average burnup, cladding type, peak cladding temperatures, vent gases during drying, cask cavity atmosphere for fission products, oxidizing gas, hydrogen content and moisture content, and cask pressure) of the demonstration program are applicable to the design-bases HBF at HI-STORE.

HOLTEC INTERNATIONAL COPYRIGHTED MATERIAL	
Report No. HI-2167374	Proposed Rev. 0P
18-25	

18.10 LIFTING DEVICE AGING MANAGEMENT PROGRAM

Ancillaries for the HI-STORE CIS are equipment, systems or devices that are needed to carry out Short Term Operations to place the canister into interim storage or to remove the loaded canister from storage. The lifting and handling ancillaries needed for operation of the HI-STORE CIS are classified as either “lifting devices” or “special lifting devices”. The design requirements and stress compliance criteria applicable for such devices are located in Section 4.5 of this SAR.

The term *lifting device* as used in this SAR refers to components of a lifting and handling system that are not classified as *special lifting devices*. ANSI N14.6 is not applicable to these *lifting devices*. Examples of *lifting devices* used with Holtec’s systems include the VCT used in the transport cask receiving area of the Cask Transfer Building (CTB).

The term *special lifting device* refers to components to which ANSI N14.6 [1.2.4] applies. As stated in ANSI N14.6 (both 1978 and 1993 versions), “This standard shall apply to *special lifting devices* that transmit the load from lifting attachments, which are structural parts of a container to the hook(s) of an overhead hoisting system.” Examples of *special lifting devices* are **MPC Lift Attachment**, **HI-TRAC CS Lifting Device (Lift Yoke)**, **Transport Cask Lift Yoke and Transport Cask Horizontal Lift Beam**.

The Lifting Device AMP utilizes condition monitoring to manage aging effects of the Cask Transfer Building (CTB) Crane, Vertical Cask Transporter (VCT), MPC Lift Attachment, MPC Lifting Device Extension, HI-TRAC CS Lift Yoke, **HI-TRAC CS Lift Link**, **Transport Cask Lift Yoke and Horizontal Lift Beam** as set down in the maintenance program in the foregoing. The initial frequency of inspection is set down in Table 18.6.1 which is subject to change depending on the “tollgate” protocol explained in **Section 18.13**. **A detailed aging management program for the Lifting Device has been provided in [1.2.1]**.

The visual inspection of the steel components and structures will include the following:

- All **external surfaces for corrosion, dents, scratches, gouges, or other signs of damage which may be adverse to the structural integrity of the component.**

HOLTEC INTERNATIONAL COPYRIGHTED MATERIAL	
Report No. HI-2167374	Proposed Rev. 0P
18-26	

18.11 TILT FRAME AGING MANAGEMENT PROGRAM

The Tilt Frame AMP utilizes condition monitoring to manage aging effects of the Transport Cask Tilt Frame as set down in the maintenance program in the foregoing. Visual inspections are performed to ensure that the external surfaces of the Tilt Frame maintain its intended function throughout its service life without degradation. The initial frequency of inspection is set down in Table 18.6.1 which is subject to change depending on the ‘tollgate’ protocol explained in Section 18.13. A detailed aging management program for the Tilt Frame has been provided in [1.2.1].

The visual inspection of the steel components and structures will include the following:

- All accessible surfaces for corrosion and integrity, dents scratches, gouges, or other damage.

HOLTEC INTERNATIONAL COPYRIGHTED MATERIAL	
Report No. HI-2167374	Proposed Rev. 0P
18-27	

18.12 CTF AGING MANAGEMENT PROGRAM

The Canister Transfer Facility (CTF) AMP utilizes condition monitoring to manage aging effects of the components of the CTF. The initial frequency of inspection is set down in Table 18.6.1 which is subject to change depending on the ‘tollgate’ protocol explained in Section 18.13. A detailed aging management program for the CTF is provided in [1.2.1].

The visual inspection of the steel components and structures will include the following:

- All internal surfaces for corrosion and integrity
- All other surfaces for dents scratches, gouges, or other damage.

HOLTEC INTERNATIONAL COPYRIGHTED MATERIAL	
Report No. HI-2167374	Proposed Rev. 0P
18-28	

18.13 LEARNING BASED AMP

The “tollgate” approach is based on NEI’s report [18.0.2]. Tollgates are established to evaluate aging management feedback and perform a safety assessment that confirms the safe storage of spent nuclear fuel. The impact of the aggregate feedback will be assessed as it pertains to components at the ISFSI and actions taken as necessary, such as:

- Adjustment of aging-related degradation monitoring and inspection programs in AMPs described in the foregoing
- Modification of testing frequency based on operating experience
- Performance of mitigation activities

Each tollgate assessment should address the following elements:

- Utilize the performance criteria outlined below to evaluate the aging management program
- Correlate the performance criteria in the license application with one or more of the applicable ten program elements. It is not necessary to evaluate all ten elements; however, particular attention should be focused on the detection of aging effects (element 4), corrective action (element 7), and operating experience (element 10) as a minimum
- Perform a review of plant-specific and industry operating experience to confirm the effectiveness of aging management programs, utilizing the INPO database described below
- Use the following criteria to arrive at a conclusion regarding “effective”
 - Aging management program implementing activities are completed as scheduled
 - Industry and site-specific operating experience is routinely evaluated and program adjustments are made as necessary
 - Self-assessments are conducted and program adjustments are made as necessary.
 - No significant findings are identified from external assessments or internal audits.
- Ineffective programs or ineffective elements of programs would be addressed in the site’s corrective action program
- Document the results of the effectiveness reviews, summarize in a tollgate assessment, and maintain as records available for audit and NRC inspection.

ISFSI’s tollgates are shown in Table 18.13.1. Note that the implementation of these tollgates does not infer that ISFSI will wait until one of these designated times to evaluate information. ISFSI will continue to follow existing processes for addressing emergent issues, including the use of the corrective action program on site. These tollgates are specific times where an aggregate of information will be evaluated as a whole.

HOLTEC INTERNATIONAL COPYRIGHTED MATERIAL	
Report No. HI-2167374	Proposed Rev. 0P
18-29	

Table 18.13.1: Tollgate Assessments for HI-STORE ISFSI

Tollgate	Year	Assessment
1	See Note ¹	Perform an assessment of the AMP effectiveness considering the criteria in the license renewal application. It is not necessary to evaluate all ten elements; however, particular attention should be focused on the detection of aging effects (element 4), corrective action (element 7), and operating experience (element 10) as a minimum. This assessment should include information from the INPO AMID.
2	Tollgate 1 Year + 5	Evaluate additional information gained from the AMID and subsequent AMP inspections to update the assessment listed in Tollgate 1, to ensure continued AMP effectiveness.
3	Tollgate 2 Year + 5	Evaluate additional information gained from the AMID and subsequent AMP inspections to update the assessment listed in Tollgate 2, to ensure continued AMP effectiveness.
4	Tollgate 3 Year + 5	Evaluate additional information gained from the AMID and subsequent AMP inspections to update the assessment listed in Tollgate 3, to ensure continued AMP effectiveness.
5	Tollgate 4 Year + 5	Evaluate additional information gained from the AMID and subsequent AMP inspections to update the assessment listed in Tollgate 4, to ensure continued AMP effectiveness.
6	Tollgate 5 Year + 5	Evaluate additional information gained from the AMID and subsequent AMP inspections to update the assessment listed in Tollgate 5, to ensure continued AMP effectiveness.
7	Tollgate 6 Year + 5	Evaluate additional information gained from the AMID and subsequent AMP inspections to update the assessment listed in Tollgate 6, to ensure continued AMP effectiveness.
8	Tollgate 7 Year + 5	Evaluate additional information gained from the AMID and subsequent AMP inspections to update the assessment listed in Tollgate 7, to ensure continued AMP effectiveness.

Notes:

(1) The calendar year when the first MPC (37 or 89) completes 20 years of service life. If the first canister at HI-STORE already exceeds 20 years of service life, then the calendar year is the year of first canister placed in a VVM at HI-STORE.

HOLTEC INTERNATIONAL COPYRIGHTED MATERIAL	
Report No. HI-2167374	Proposed Rev. 0P
18-30	

18.14 TIMING OF AGING MANAGEMENT IMPLEMENTATION

18.14.1 Canisters

Based on the fact that canisters will be arriving at the HI-STORE CIS that may have been stored for extended period of time at other sites, it is important to identify when aging management will be performed. Regardless of when aging management begins, the canisters will still be required to undergo the acceptance testing described in Chapters 3 and 10.

Canister Age Less than 20 Years

If the canister arrives at HI-STORE at a date less than 20 years from the date of first being placed on a storage pad, aging management is not required. Once the canister reaches 20 years from first being placed on a storage pad, the aging management activities described in this chapter are implemented. The canister is added to all other canisters undergoing aging management and the selection criteria given in this chapter are utilized to determine which canisters need to be inspected.

Canister Age Greater than 20 Years

If the canister arrives at HI-STORE at a date greater than 20 years from the date of first being placed on a storage pad, the canister is added to the list of canisters undergoing aging management immediately. The selection criteria given in this chapter are utilized to determine which canisters need to be inspected.

18.14.2 All Other SSCs

For all other SSCs, which are constructed exclusively for the HI-STORE facility, the aging management activities described in this chapter are implemented once the SSC reaches 20 years from use for first loading. These may be separate dates for groups of HI-STORM UMAX VVMs, as the construction of HI-STORE is designed to be performed in stages.

Chapter 10 of HI-STORE SAR discusses the operations and maintenance procedures established for the equipment and lifting ancillaries used at HI-STORE CIS facility. The preoperational and startup testing programs, and other tests and inspections of ISFSI equipment are located in Section 10.2.2, and the normal operations and maintenance procedures are located in Section 10.3 of Chapter 10. Maintenance activities will be performed on brand new equipment and devices for 20 years prior to introduction of aging management, and it will be a combination of maintenance and aging management from thereon.

As mentioned earlier, maintenance activities at the ISFSI will be carried out on dates of different frequency. Overlapping of maintenance activity and aging management program may be expected at a future date. Hence, if aging management is scheduled within 1 year of a maintenance program, certain inspection activities may not need to be repeated, but the conditions of the SSC/device will have to meet the acceptance criteria per AMP.

HOLTEC INTERNATIONAL COPYRIGHTED MATERIAL	
Report No. HI-2167374	Proposed Rev. 0P
18-31	

18.15 AMELIORATING THE RISK OF CANISTER DEGRADATION OVER A LONG-TERM STORAGE DURATION

Industry data on SCC attack on austenitic stainless steels indicates that wet surfaces are more vulnerable to attack than dry surfaces. Maintaining the proximate air's relative humidity below 20%, as noted above, helps mitigate the risk of SCC. Noting that the canister's internal heat generation rate will decrease exponentially with the passage of time, its surface will get progressively cooler. After a long period in storage, the canister's surface may cool off sufficiently to allow moisture to reside on it. From the SCC perspective, this is not a welcome situation. To address this perverse effect of canister cool down, Holtec proposes to seek a license amendment at a later date that will permit the inlet and/or outlet ventilation passages to be progressively constricted so that the canister's surface remains warm and moisture free.

This approach is a part of the long-term AMP (many decades from now) that Holtec International expects to formalize and submit to the NRC for review.

HOLTEC INTERNATIONAL COPYRIGHTED MATERIAL	
Report No. HI-2167374	Proposed Rev. 0P
18-32	

18.16 RECOVERY PLAN

The AMP described in this chapter has been configured to provide an advance warning of the potential of loss of Confinement integrity in a loaded canister. The accelerated coupon testing and, if the coupon testing indicates onset of nucleation on the canister surface, then a comprehensive canister wall integrity determination using eddy current testing provide a reliable strategy to predict the risk of leakage well before such a problem would materialize.

Nevertheless, it is deemed prudent to have the ability to isolate an at-risk canister before leakage occurs. Towards this end, Holtec will insure that a HI-STAR 190 transport cask can be brought to the HI-STORE CIS site within 30 days after the site's Emergency Response organization identifies such a need.

Finally, it should be noted that there is adequate cross sectional and vertical space available in the VVM cavity to accommodate a highly conductive sequestration canister with a gasketed lid that can be used to isolate a leaking canister from the environment. Such a sequestration canister can be installed using the canister Transfer Facility using a set of steps that are ALARA. This sequestration canister will provide a defense-in-depth measure (in addition to the transport cask which provides a high integrity containment boundary) for dealing with an extenuating situation involving the likelihood of an impending canister leak at the HI-STORE CIS site.

HOLTEC INTERNATIONAL COPYRIGHTED MATERIAL	
Report No. HI-2167374	Proposed Rev. 0P
18-33	

CHAPTER 19: CONSOLIDATED REFERENCES

References cited throughout this SAR are compiled in this chapter. Each reference may be cited multiple times in multiple chapters. The context of the citation delineates the extent of reliance in this SAR on any particular reference. No reference, unless so stated, is invoked in its entirety. Each reference is identified by a decimal system (its native chapter, Section, and numeric sequence) and is enclosed in square brackets throughout this document. All Holtec origin documents are proprietary subject to 10CFR2.390 protection from dissemination except for Safety Analysis Reports which are available in redacted version in the Public Document Room. The unabridged version of any referenced Holtec document is shared with the USNRC upon request.

- [1.0.1] Report to the Secretary of Energy, “Blue Ribbon Commission on America’s Nuclear Future”, January 2012.
(https://energy.gov/sites/prod/files/2013/04/f0/brc_finalreport_jan2012.pdf)
- [1.0.2] USNRC Regulatory Guide 3.50 “Standard Format and Content for a Specific License Application for an Independent Spent Fuel Storage Installation or Monitored Retrievable Storage Facility”, Revision 2, September 2014.
- [1.0.3] USNRC NUREG-1567, “Standard Review Plan for Spent Fuel Dry Storage Facilities”, March 2000.
- [1.0.4] “Environmental Report on The HI-STORE CIS Facility”, Holtec Report 2167521, dated **November 2020**
- [1.0.5] 10 CFR Part 72, “Licensing Requirements for the Independent Storage of Spent Nuclear Fuel, High-level Radioactive Waste, and Reactor-Related Greater than Class C Waste”, Title 10 of the Code of Federal Regulations- Energy, Office of the Federal Register, Washington, D.C.
- [1.0.6] USNRC Docket 72-1040, “Final Safety Analysis Report on The HI-STORM UMAX Canister Storage System”, Holtec Report No. HI-2115090, Revision 3. Submitted with Holtec Letter 5021032 (ML16193A336), dated June 30, 2016
- [1.2.1] “Aging Assessment and Management Program for HI-STORE CIS”, Holtec Report 2167378, Revision 5, dated **June 2021**
- [1.2.2] NUREG/CR-6407, “Classification of Transportation Packaging and Dry Spent Fuel Storage System Components According to Importance to Safety”, U.S. Nuclear Regulatory Commission, February 1996.
- [1.2.3] ANSI/NSF Standard 61, “Drinking Water System Components – Health Effects”, 2013.
- [1.2.4] ANSI N14.6-1993, “American National Standard for Radioactive Materials - Special Lifting Devices for Shipping Containers Weighing 10,000 Pounds (4,500 Kg) or More”, American National Standards Institute, Inc., Washington D.C., June 1993.

HOLTEC INTERNATIONAL COPYRIGHTED MATERIAL	
Report No. HI-2167374	Proposed Rev. 0S
19-1	

- [1.2.5] Interim Staff Guidance (ISG) – 2, “Fuel Retrievability”, Revision 1, February 22, 2010.
- [1.2.6] Interim Staff Guidance (ISG) – 3, “Post Accident Recovery and Compliance with 10 CFR 72.122(l)”
- [1.2.7] NUREG 0612, “Control of Heavy Loads at Nuclear Power Plants”, U.S. Nuclear Regulatory Commission, Washington, D.C., July 1980.
- [1.3.1] 10 CFR Part 50, “Domestic Licensing of Production and Utilization Facilities”, Title 10 of the Code of Federal Regulations, Office of the Federal Register, Washington, D.C.
- [1.3.2] 10CFR Part 71, “Packaging and Transportation of Radioactive Material”, Title 10 of the Code of Federal Regulations, Office of the Federal Register, Washington, D.C.
- [1.3.3] USNRC Docket 72-1014, “Final Safety Analysis Report for the HI-STORM 100 Cask System”, Holtec Report No. HI-2002444, Revision 14.
- [1.3.4] USNRC Docket 72-1008, “Final Safety Analysis Report for the HI-STAR 100 Cask System”, Holtec Report No. HI-2012610, Revision 3.
- [1.3.5] USNRC Docket 71-9261, “Safety Analysis Report on the HI-STAR 100 Cask System”, Holtec Report No. 951251, Revision 15.
- [1.3.6] USNRC Docket 71-9373, “Safety Analysis Report on the HI-STAR 190 Package”, Holtec Report No. 2146214, Revision 3.
- [1.3.7] USNRC Docket 72-1032, “Final Safety Analysis Report on the HI-STORM FW System”, Holtec Report No. HI-2114830, Revision 4.
- [2.1.1] Eddy-Lea Energy Alliance. *Memorandum of Agreement with Holtec International*. April 2016.
- [2.1.2] New Mexico Board of Finance. “Action Taken: Board of Finance Meeting.” Governor’s Cabinet Room – Fourth Floor, State Capitol Building – Santa Fe, New Mexico. July 19, 2016.
- [2.1.3] Eddy-Lea Energy Alliance. *GNEP Siting Study*. 2007. (https://curie.ornl.gov/system/files/EDDY_LEA_Siting_Study_ML102440738.pdf)
- [2.1.4] United States Department of Agriculture, Natural Resources Conservation Service (USDA/NRCS). 2016. Soil Survey Geographic (SSURGO) Database for Lea County, New Mexico. Soil Survey Staff, Natural Resources Conservation Service, United States Department of Agriculture. Available at: <http://websoilsurvey.sc.egov.usda.gov/App/WebSoilSurvey.aspx> , Accessed September 30, 2016.
- [2.1.5] Dick-Peddie, W.A., W.H. Moir, and R. Spellberg. *New Mexico Vegetation: Past, Present and Future*. Albuquerque, NM: University of New Mexico Press.

HOLTEC INTERNATIONAL COPYRIGHTED MATERIAL	
Report No. HI-2167374	Proposed Rev. 0S
19-2	

- [2.1.6] Federal Emergency Management Agency (FEMA). Flood Insurance Study, Lea County, New Mexico and Incorporated Areas. December 16, 2008.
- [2.1.7] FEMA. FEMA Flood Map Service Center. Available at: <http://msc.fema.gov/portal/search?AddressQuery=Lea%20County%2C%20new%20mexico#searchresultsanchor>. Accessed October 2016.
- [2.1.8] Holtec International. *Data Call for the CISF Environmental Report*. September 2016.
- [2.1.9] U.S. Census Bureau (USCB). Table B01003, Total Population, American Community Survey 5-Year Estimates. Available at: http://factfinder.census.gov/bkmk/Table/1.0/en/ACS/11_5YR/B01003/0400000US35|0400000US48|0500000US35015|0500000US35025|0500000US48003|0500000US48165. Accessed on October 19, 2016.
- [2.1.10] New Mexico Department of Workforce Solutions (NMDWS). New Mexico Annual Social and Economic Indicator, Statistical Abstract for Data Users, 2015. Available at: https://www.dws.state.nm.us/Portals/0/DM/LMI/ASEI_2015.pdf.
- [2.1.11] Texas Demographic Center (Texas). Texas Population Projections. Available at: <http://txsdc.utsa.edu/data/TPEPP/Projections/Index>. Accessed on October 19, 2016.
- [2.1.12] U.S. Census Bureau (USCB). Table GCT-PH1, Population, Housing Units, Area, and Density: 2010 – County, 2010 Census Summary File 1. Available at: http://factfinder.census.gov/bkmk/Table/1.0/en/DEC/10_SF1/GCTPH1.CY07/0500000US35015|0500000US35025|0500000US48003|0500000US48165.
- [2.1.13] Environmental Justice Screen (EJSCREEN). EPA’s Environmental Justice Screening and Mapping Tool (Version 2016). Location with 50-mile buffer. Available at: <https://ejscreen.epa.gov/mapper/>. Accessed on October 14, 2016.
- [2.1.14] CEHMM. “Transient Employment.” Email from Doug Lynn, Executive Director CEHMM, to Tetra Tech on July 27, 2017.
- [2.1.15] International Isotopes Fluorine Products, Inc. (IIFP). Fluorine Extraction Process & Depleted Uranium De-conversion Plant (FEP/DUP) Environmental Report. December 27, 2009.
- [2.1.16] AECOM. “Environmental Geology Assessment Report for Issues Related to the Proposed Ochoa Mine, Lea County, New Mexico.” July 2012.
- [2.1.17] CEHMM. “Oil and Gas Information.” E-mail from Doug Lynn, Executive Director CEHMM, to Tetra Tech on July 31, 2017.
- [2.1.18] Golder and Associates. Report to USDOJ and USGS on Recommendations on Abandonment of the Will-Weaver Mine and Shafts. Prepared for the U.S. Geological Survey by Golder and Associates, November 1979.

HOLTEC INTERNATIONAL COPYRIGHTED MATERIAL	
Report No. HI-2167374	Proposed Rev. 0S
19-3	

- [2.1.19] Intrepid Potash LLC. “Phone conversation with Mr. Robert Baldrige, Operations Manager for Intrepid Potash, and Jay Rose, Tetra Tech.” July 25, 2017.
- [2.1.20] New Mexico Bureau of Mines and Minerals Resources (NMBMMR). “Potash in New Mexico.” February 1980.
- [2.1.21] United Nations Environment Programme (UNEP). “Environmental Aspects of Phosphate and Potash Mining. 2001.
- [2.1.22] U.S. Geological Survey (USGS). “Geological Survey Circular 876-- Subsidence from Underground Mining: Environmental Analysis and Planning Considerations.” 1983.
- [2.1.23] CEHMM. “Holtec HI-Store Facility Area GIS Conflict Analysis.” October 7, 2016.
- [2.1.24] GEI Consultants (GEI). “Geotechnical Data Report: HI-STORE CISF Phase 1 Site Characterization.” February 2018.
- [2.1.25] Secretary of the Interior, “Order No. 3324 – Oil, Gas, And Potash Leasing and Development within the Designated Potash Area of Eddy and Lea Counties, New Mexico.” 2012.
- [2.1.26] U.S Geological Survey, Laguna Gatuna Quadrangle, New Mexico, 7.5-Minute Series, 1:24,000
- [2.1.27] Bureau of Land Management, “Carlsbad Field Office Drill Islands Map.” Carlsbad, New Mexico, 8/25/2019
- [2.1.28] Bureau of Land Management, “Designation of the Pakse West Development Area” Letter, August 2, 2021
- [2.1.29] Titus Oil & Gas Production, “Designation of Development Area, Egg Roll Development Area” Letter, December 4, 2020
- [2.1.30] State of New Mexico Energy, Minerals, and Natural Resources Department Oil Conservation Commission, “Order R-111-P”, 1988
- [2.1.31] Bureau of Land Management, Carlsbad Office Spatial Data, https://www.nm.blm.gov/shapeFiles/cfo/carlsbad_spatial_data.html, Accessed August 2021
- [2.1.32] New Mexico State Land Office, GIS Data, <https://www.nmstatelands.org/maps-gis/gis-data-download/> , Accessed August 2021.
- [2.2.1] Not Used
- [2.2.2] C-FER Technologies, Stephens, Mark. “A Model for Sizing High Consequence Areas Associated with Natural Gas Pipelines.” October 2000.

HOLTEC INTERNATIONAL COPYRIGHTED MATERIAL	
Report No. HI-2167374	Proposed Rev. 0S
19-4	

- [2.2.3] National Transportation Safety Board (NTSB). "Pipeline Accident Report PAR-03-01, dated August 19, 2000." Available at: NTSB.gov. Accessed July 2017.
- [2.2.4] Pipeline and Hazardous Materials Safety Administration (PHMSA). "Pipeline Safety." Available at: <https://www.phmsa.dot.gov/>. Accessed July 2017.
- [2.2.5] Not Used
- [2.2.6] Holtec International Report HI-2210487, "HI-STORE Gas Pipeline Risk Evaluation" Latest Revision
- [2.2.7] National Hazardous Materials Route Registry (NHMRR). U.S. Department of Transportation. Available at: www.fmcsa.dot.gov/regulations/hazardous-materials/national-hazardous-materials-route-registry-state. Accessed on July 18, 2017.
- [2.2.8] Not Used
- [2.2.9] Not Used
- [2.2.10] NMDOT. "New Mexico Freight Plan." Available at: dot.state.nm.us/content/dam/nmdot/planning/nm_2040_plan-freight_plan.pdf. August 2015.
- [2.2.11] Department of Energy (DOE). *Waste Isolation Pilot Plant Disposal Phase Final Supplemental Environmental Impact Statement*. DOE/EIS-0026-S2. September. Available at: <http://energy.gov/nepa/eis-0026-s2-waste-isolation-pilot-plant-disposal-phase-carlsbad-new-mexico>.
- [2.2.12] DOE. *Waste Isolation Pilot Plant Annual Site Environmental Report for 2014*. DOE/WIPP-15-8866. September 2015.
- [2.2.13] NRC. *Environmental Impact Statement for the Proposed National Enrichment Facility in Lea County, New Mexico*. NUREG-1790. June 2005.
- [2.2.14] NRC. *Environmental Impact Statement for the Proposed Fluorine Extraction Process and Depleted Uranium Deconversion Plant in Lea County, New Mexico*. NUREG-2113. August 2012.
- [2.2.15] Waste Control Specialists. "WCS Consolidated Interim Spent Fuel Storage Facility Environmental Report." May 2016. (Compiled from ADAMS Numbers: ML16133A137, ML16133A161, ML16133A158, ML16133A139, ML16133A162, ML16133A153, ML16133A151, ML16133A146, ML16133A145, ML16133A144, ML16133A143, ML16133A142, ML16133A099)
- [2.2.16] U.S. Department of Transportation Federal Aviation Administration, Albuquerque VFR Sectional Chart, 106th Edition, 9/10/2020

HOLTEC INTERNATIONAL COPYRIGHTED MATERIAL	
Report No. HI-2167374	Proposed Rev. 0S
19-5	

- [2.2.17] U.S. Department of Transportation Federal Aviation Administration, Order JO 7400.11B “Airspace Designations and Reporting Points”, 8/3/2017
- [2.2.18] U.S. Department of Transportation Federal Aviation Administration, Order 8260.19H “Flight Procedures and Airspace”, 7/20/2017
- [2.2.19] U.S. Department of Defense National Geospatial-Intelligence Agency, AP/1B “Flight Information Publication: Area Planning: Military Training Routes: North and south America”, 3/29/2018
- [2.2.20] U.S. Department of Transportation Federal Aviation Administration, “Aeronautical Information Services: Aeronautical Chart User’s Guide”, 3/29/2018
- [2.2.21] 14 CFR Part 1.1, “Aeronautics and Space Definitions and Abbreviations”, Title 14 of the Code of Federal Regulations – Transportation, Federal Aviation Administration, Washington, D.C.
- [2.2.22] U.S. Department of Transportation Federal Aviation Administration, FAA Form 5010-1 “FAA Airport Master Record for ATS” Available at: <http://www.gcr1.com/5010web/airport.cfm?Site=ATS&AptSecNum=2> , Accessed on 5/18/2018.
- [2.2.23] U.S. Department of Transportation Federal Aviation Administration, FAA Form 5010-1 “FAA Airport Master Record for CNM” Available at: <http://www.gcr1.com/5010web/airport.cfm?Site=CNM&AptSecNum=2> , Accessed on 5/18/2018.
- [2.2.24] U.S. Department of Transportation Federal Aviation Administration, FAA Form 5010-1 “FAA Airport Master Record for HOB” Available at: <http://www.gcr1.com/5010web/airport.cfm?Site=HOB&AptSecNum=2> , Accessed on 5/18/2018.
- [2.2.25] U.S. Department of Transportation Federal Aviation Administration, FAA Form 5010-1 “FAA Airport Master Record for E06” Available at: <http://www.gcr1.com/5010web/airport.cfm?Site=E06&AptSecNum=2> , Accessed on 5/18/2018.
- [2.2.26] U.S. Department of Transportation Federal Aviation Administration, FAA Form 5010-1 “FAA Airport Master Record for MAF” Available at: <http://www.gcr1.com/5010web/airport.cfm?Site=MAF&AptSecNum=2> , Accessed on 5/18/2018.
- [2.2.27] U.S. Department of Transportation Federal Aviation Administration, FAA Form 5010-1 “FAA Airport Master Record for ROW” Available at: <http://www.gcr1.com/5010web/airport.cfm?Site=ROW&AptSecNum=2> , Accessed on 5/18/2018.

HOLTEC INTERNATIONAL COPYRIGHTED MATERIAL	
Report No. HI-2167374	Proposed Rev. 0S
19-6	

- [2.2.28] U.S. Department of Transportation Federal Aviation Administration, Air Traffic Activity Data System (ATADS)
- [2.2.29] U.S. Department of Transportation Federal Aviation Administration, Order 8260.3D “United States Standard for Terminal Instrument Procedures (TERPS)”, 2/16/2018
- [2.2.30] Jeppesen, Instrument Approach Chart 12-3, CNM Cavern City Air Terminal, RNAV (GPS) Runway 21
- [2.2.31] Jeppesen, Instrument Approach Chart 11-1, HOB Lea County Regional Airport, ILS or LOC Runway 3, 12/29/2017
- [2.2.32] Not Used
- [2.2.33] NUREG 0800, “Standard Review Plan for the Review of Safety Analysis Reports for Nuclear Power Plants”, U.S. Nuclear Regulatory Commission, Washington, D.C., March 2010
- [2.2.34] 14 CFR Part 91, “General Operating and Flight Rules”, Title 14 of the Code of Federal Regulations – Transportation, Federal Aviation Administration, Washington, D.C.
- [2.2.35] U.S. Department of Transportation Federal Aviation Administration, “ENR 5.2 Military Exercise and Training Areas”, Aeronautical Information Publication, 24th edition, 3/29/2018
- [2.2.36] AirNav, LLC, AirNav Airport Information Database, <https://www.airnav.com/airport/>
- [2.2.37] Holtec International, “HI-STORE CIS Aircraft Crash Assessment”, Holtec Report No. HI-2188201, Latest Revision
- [2.2.38] Memorandum for John F. Cordes, Director, Office of Commission Appellate Adjudication, dated November 14, 2001, Subject: Staff Requirements – Affirmation Session, 8:55 A.M., Wednesday, November 14, 2001, Reference M011114A.
- [2.2.39] USNRC Regulatory Guide 1.91, “Evaluations of Explosions Postulated to Occur on Transportation Routes Near Nuclear Power Plants,” Revision 2.
- [2.2.40] Holtec International Report HI-2200797, “Hazards Assessment of Ground Transportation Routes near HI-STORE”, Revision 1.
- [2.2.41] Not Used
- [2.2.42] U.S. Department of Transportation Federal Aviation Administration, High Altitude Enroute (U.S.) Cart H-6, EHUS6 Effective 12/31/2020
- [2.2.43] Holtec International Report HI-2210619, “HI-STORE Railway Hazardous Chemicals Risk Evaluation”, Revision 2.

HOLTEC INTERNATIONAL COPYRIGHTED MATERIAL	
Report No. HI-2167374	Proposed Rev. 0S
19-7	

- [2.2.44] Holtec International Report HI-2210620, “HI-STORE Highway 62/180 Hazardous Chemicals Risk Evaluation”, Revision 1.
- [2.3.1] Western Regional Climate Center Hobbs, Lea County Airport data. Available at: <http://www.wrcc.dri.edu/cgi-bin/cliMAIN.pl?nm4028>. Accessed on October 14, 2016.
- [2.3.2] Holzworth, G.C. Mixing Heights, Wind Speeds, and Potential for Urban Air Pollution Throughout The Contiguous United States. January 1972.
- [2.3.3] Greer. American Meteorological Society. Glossary of Weather and Climate. 1996.
- [2.3.4] National Oceanic and Atmospheric Administration (NOAA). Enhanced F Scale for Tornado Damage. Available at: <http://www.spc.noaa.gov/faq/tornado/ef-scale.html>. Accessed on October 14, 2016.
- [2.3.5] Tornado history. Available at: <http://www.tornadohistoryproject.com/tornado/New-Mexico/>. October 14, 2016.
- [2.3.6] NRC Regulatory Guide 1.23, “Meteorological Monitoring Programs for Nuclear Power Plants,” Revision 1, March 2007.
- [2.4.1] Not Used
- [2.4.2] CEHMM. “Holtec Hi-Store Facility Area GIS Conflict Analysis.” October 7, 2016.
- [2.4.3] Federal Emergency Management Agency (FEMA). FEMA Flood Map Service Center. Available at: <https://msc.fema.gov/portal>.
- [2.4.4] “Hydrologic Features.” 32.583, -103.708. Google Earth. February 1, 2017. Accessed on: July 21, 2017.
- [2.4.5] State of New Mexico Interstate Stream commission, Office of the State Engineer. Lea County Regional Water Plan 1999. Available at: http://www.ose.state.nm.us/Planning/RWP/region_16.php.
- [2.4.6] State of New Mexico Interstate Stream commission, Office of the State Engineer. Lea County Regional Water Plan 2016. Available at: http://www.ose.state.nm.us/Planning/RWP/Regions/16_Lea%20County/2016/Reg%2016_Lea%20County_Regional%20Water%20Plan%202016_December%202016.pdf
- [2.4.7] NatureServe. International Ecological Classification Standard: Terrestrial Ecological Classifications. NatureServe Central Databases. Arlington, VA. U.S.A. 2009.
- [2.4.8] NatureServe. Madrean Archipelago Rapid Ecoregional Assessment Pre-Assessment Report. Arlington, Virginia. 2013.
- [2.4.9] U.S. Geological Survey (USGS), National Geospatial Program. 3D Elevation Program Digital Elevation Model Resolution 1/3 arc second (10 meters). <https://nationalmap.gov>

HOLTEC INTERNATIONAL COPYRIGHTED MATERIAL	
Report No. HI-2167374	Proposed Rev. 0S
19-8	

- [2.4.10] New Mexico Resource Geographic Information System. Hydrologic Unit Boundary “New Mexico HUC-12 Boundaries”, <http://rgis.unm.edu/>
- [2.4.11] U.S. Department of Agriculture, National Resources Conservation Service. NRCS Web Survey. <https://websoilsurvey.sc.egov.usda.gov/App/WebSoilSurvey.aspx>
- [2.4.12] U.S. Fish and Wildlife Service. National Wetlands Inventory, Wetlands-Data. Available at: <https://www.fws.gov/wetlands/data/Google-Earth.html>.
- [2.4.13] NOAA. NOAA Atlas 14 Point Precipitation Frequency Estimates: NM. Available at: https://hdsc.nws.noaa.gov/hdsc/pfds/pfds_map_cont.html
- [2.4.14] Bonnin, M., D. Martin, B. Lin, T. Parzybok, M. Yekta, and D. Riley, “Precipitation Frequency Atlas of the United States: NOAA Atlas 14, Volume 1: Semiarid Southwest (Arizona, Southeast California, Nevada, New Mexico, Utah),” Version 5.0, Silver Spring, MD: U.S. Department of Commerce, National Oceanic and Atmospheric Administration, National Weather Service, 2011.
- [2.4.15] GEI Report CIS-RP 003-03, “Probable Maximum Flood Analysis, HI-STORE CISF, Lea County, New Mexico” April 2022
- [2.4.16] NUREG/CR-7046, “Design-Basis Flood Estimation for Site Characterization at Nuclear Power Plants in the United States of America”, U.S. Nuclear Regulatory Commission, Washington, D.C., November 2011
- [2.4.17] Colorado Division of Water Resources, Department of Natural Resources. “Colorado – New Mexico Regional Extreme Precipitation Study, Summary Report, Volume II. Deterministic Regional Probable Maximum Precipitation Estimation.” November 30.
- [2.4.18] GEI Report CIS-RP 001-01, “Geotechnical Data Report HI-STORE CISF Phase 1 Site Characterization, Lea County, New Mexico” February 2018
- [2.4.19] Natural Resources Conservation Service (NRCS), National Engineering Handbook Hydrology Chapters. Accessed multiple dates from: <https://www.nrcs.usda.gov/wps/portal/nrcs/detailfull/national/water/manage/hydrology/?cid=STELPRDB1043063>
- [2.4.20] U.S. Army Corps of Engineers (USACE) (2022). Ice Jam Database. Accessed March 21, 2022, from <https://icejam.sec.usace.army.mil/ords>
- [2.4.21] National Oceanic and Atmospheric Administration (NOAA) (2022a). National Centers for Environmental Information. Accessed March 22, 2022, from <https://www.ncdc.noaa.gov/cdo-web/datasets/GHCND/stations/GHCND:USC00294028/detail>.
- [2.4.22] National Oceanic and Atmospheric Administration (NOAA) (2022b). Station Locations. Accessed March 22, 2022, from <https://www.ncei.noaa.gov/maps/lcd>.

HOLTEC INTERNATIONAL COPYRIGHTED MATERIAL	
Report No. HI-2167374	Proposed Rev. 0S
19-9	

- [2.4.23] National Oceanic and Atmospheric Administration (NOAA) (1980). “Probable Maximum Precipitation Estimates – United States East of the 105th Meridian, Hydrometeorological Report Number 51 (HMR-51),” National Oceanic and Atmospheric Administration, August.
- [2.4.24] National Oceanic and Atmospheric Administration (NOAA) (1982). “Application of Probable Maximum Precipitation Estimates – United States East of the 105th Meridian, Hydrometeorological Report Number 52 (HMR-52),” National Oceanic and Atmospheric Administration, August.
- [2.5.1] New Mexico Office of the State Engineer (NMOSE). Declared Underground Water Basins Map. Available at: <http://www.ose.state.nm.us/GIS/maps.php>. Accessed October 2016.
- [2.5.2] Nicholson, Alexander Jr. and Alfred Clebsch, Jr. 1963. Ground-water Report 6, Geology and Ground-water Condition in Southern Lea County, New Mexico. State Bureau of Mines and Mineral Resources, New Mexico Institute of Mining and Technology. 1963.
- [2.6.1] Powers, D. W., Lambert, S. J., Shaffer, S. E., Hill, L. R., and Weart, W. D., eds., 1978, Geological Characterization Report for the Waste Isolation Pilot Plant (WIPP) Site, Southeastern New Mexico. SAND78-1596, Vols. I and II. Sandia National Laboratories.
- [2.6.2] Nuclear Regulatory Commission (NRC). Safety Evaluation Report for the National Enrichment Facility in Lea County, New Mexico, Louisiana Energy Services (NUREG-1827), Available at: <http://www.nrc.gov/reading-rm/doc-collections/nuregs/staff/sr1827/>, Accessed October 28, 2016.
- [2.6.3] United States Geological Survey (USGS). Earthquake Archive Search. Available at: <http://earthquake.usgs.gov/earthquakes/search/>. Accessed on September 29, 2016.
- [2.6.4] USGS. Earthquake Probability Mapping, 2009 PSHA Model. United States Geological Survey. Available at: <http://geohazards.usgs.gov/eqprob/2009/>. Accessed on October 13, 2016.
- [2.6.5] Sanford A., Balch, R., and Delap S., 1993, Report 68: A Review of the Seismicity and Seismic Risk at the WIPP Site, Geoscience Department and Geophysical Research Center, New Mexico Tech. Available at: <https://www.ees.nmt.edu/images/ees/Geop/nmquakes/R68/R68.HTM> Accessed October 24, 2016.
- [2.6.6] Safety Evaluation Report for Approval of DOE/WIPP 07-3372, Waste Isolation Pilot Plant Documented Safety Analysis, Revision 5 and DOE/WIPP 07-3373, Waste Isolation Pilot Plant Technical Safety Requirements, Revision 5
- [2.6.7] USGS. Quaternary Faults in Google Earth. Available at: <http://earthquake.usgs.gov/hazards/qfaults/google.php> . Accessed on September 29, 2016.

HOLTEC INTERNATIONAL COPYRIGHTED MATERIAL	
Report No. HI-2167374	Proposed Rev. 0S
19-10	

- [2.6.8] USGS. Geologic Hazards Map. Available at: [http://geohazards.usgs.gov/hazards/apps/cmapps/](http://geohazards.usgs.gov/hazards/apps/cmmaps/) . Accessed September on 30, 2016.
- [2.6.9] Deleted
- [2.6.10] 10 CFR Part 100, “Reactor Site Criteria”, Title 10 of the Code of Federal Regulations, Office of the Federal Register, Washington, D.C.
- [2.6.11] USNRC Regulatory Code 1.198, “Procedures and Criteria for Assessing Seismic Liquefaction at Nuclear Power Sites”, November 2003.
- [2.6.12] Youd, T.L., et al. “Liquefaction Resistance of Soils: Summary Report from the 1996 NCEER and 1998 NCEER/NSF Workshops on Evaluation of Liquefaction Resistance of Soils.” American Society of Civil Engineers, Journal of Geotechnical and Geoenvironmental Engineering, October 2001.
- [2.6.13] Powers, Dennis W. “Basic Data report for Drillhole SNL-6 & -6A (CP-3151)(Waste Isolation Pilot Plant)”, 2010
- [2.6.14] Powers, Dennis W. “Basic Data Report for Drillhole NP-1 (CP-1163). Section 1, T19S, R32E, Lea County, New Mexico”, 2014.
- [2.6.15] Lowry, T. S., Schuhen, M. D., Roberts, B. L., Arnold, B. W., McKenna, S. A., & Kirby, C. L. “BLM Lea County Water Study for the Dewey Lake and Santa Rosa Formations: Final Report.” Sandia National Laboratories, 2015.
- [2.6.16] Lehman, T. M. “The saga of the Dockum Group and the Case of the Texas/New Mexico Boundary Fault.” Bulletin 150, New Mexico Bureau of Mines and Mineral Resources, 1994.
- [2.6.17] Bachman, G. R. “Regional Geology and Cenozoic History of Pecos Region, Southeastern New Mexico.” United States Department of the Interior Geological Survey, 1971.
- [2.6.18] Gray, M. B. & Nickelsen, R. P. “Pedogenic Slickensides, Indicators of Strain and Deformation Processes in Redbed Sequences of the Appalachian Foreland.” Geology, 17(1), 1989.
- [2.6.19] Bachman, G. O. “Assessment of Near-Surface Dissolution at and Near the Waste Isolation Pilot Plant, Southeastern New Mexico.” 1985.
- [2.6.20] Powers, D. W. “Report on Evaporite Stability in the Vicinity of the Proposed GNEP Site, Lea County, New Mexico.” 2007.
- [2.6.21] Turner, M. T. et al. “Soil Survey of Lea County New Mexico” United States Department of Agriculture, Soil Conservation Service, 1974.
- [2.7.1] Regulatory Guide 1.76, “Design Basis Tornado and Tornado Missiles for Nuclear Power Plants,” United States Nuclear Regulatory Commission, March 2007.

HOLTEC INTERNATIONAL COPYRIGHTED MATERIAL	
Report No. HI-2167374	Proposed Rev. 0S
19-11	

- [2.7.2] ANSI/ANS 57.9-1992, "Design Criteria for an Independent Spent Fuel Storage Installation (Dry Type)", American Nuclear Society, LaGrange Park, IL, May 1992.
- [3.0.1] ASME NOG-1, Rules for Construction of Overhead and Gantry Cranes (Top Running Bridge, Multiple Girder), American Society of Mechanical Engineers, New York, 2010.
- [3.1.1] Holtec International & Eddy Lea Energy Alliance (ELEA) Underground Consolidated Interim Storage Facility – Physical Security Plan, Holtec Report HI-2177559, Latest Revision.
- [3.1.2] 49 CFR 171, “General Information, Regulations, and Definitions,” Title 49 of the Code of Federal Regulations – Transportation, Office of the Federal Register, Washington, D.C.
- [3.1.3] 49 CFR 172, “Hazardous Materials Table, Special Provisions, Hazardous Materials Communications, Emergency Response Information, Training Requirements, and Security Plans,” Title 49 of the Code of Federal Regulations – Transportation, Office of the Federal Register, Washington, D.C.
- [3.1.4] 49 CFR 174, “Carriage by Rail,” Title 49 of the Code of Federal Regulations – Transportation, Office of the Federal Register, Washington, D.C.
- [3.1.5] 49 CFR 177, “Carriage by Public Highway,” Title 49 of the Code of Federal Regulations – Transportation, Office of the Federal Register, Washington, D.C.
- [4.0.1] ISG-11, “Cladding Considerations for the Transport and Storage of Spent Fuel,” USNRC, Washington, DC, Revision 3, November 17, 2003.
- [4.2.1] Holtec Position Paper DS-381, “Guidelines for Specifying ITS Categories,” Revision 0, dated October 8, 2012
- [4.2.2] Holtec Standard Procedure HSP 345, Important-to-Safety Classification Procedure.
- [4.3.1] ASLB Hearings, Private Fuel Storage, LLC, Docket # 72-22-ISFSI, ASLBP 97-732-02-ISFSI, February 2005.
- [4.3.2] U.S. Nuclear Regulatory Commission, Regulatory Guide 1.60, “Design Response Spectra for Seismic Design of Nuclear Power Plants,” Revision 1, 1973.
- [4.3.3] U.S. Nuclear Regulatory Commission, Regulatory Guide 1.92, “Combining Modal Responses and Spatial Components in Seismic Response Analysis,” Revision 2, 2006.
- [4.3.4] ASCE 4-16, “Seismic Analysis of Safety-Related Nuclear Structures,” American Society of Civil Engineers, 2017.
- [4.3.5] “HI-STORE Bearing Capacity and Settlement Calculations”, Holtec Report HI-2188143, Revision 5.

HOLTEC INTERNATIONAL COPYRIGHTED MATERIAL	
Report No. HI-2167374	Proposed Rev. 0S
19-12	

- [4.5.1] ASME Boiler and Pressure Vessel Code, Section III, Division 1, Subsection NF - Supports, 2010.
- [4.5.2] Crane Manufacturer's Association of America (CMAA), Specification #70, 1988, Section 3.3.
- [4.5.3] ASME Boiler and Pressure Vessel Code, Welding, Section IX, 2010.
- [4.5.4] AWS D1.1:2006 Structural Welding Code – Steel, 2008.
- [4.5.5] ISO 9001:2008, Quality Management Systems.
- [4.5.6] American Society of Mechanical Engineers, American National Standard, Safety Standards, “Slings”, ASME B30.9, 1971
- [4.5.7] Deleted
- [4.5.8] American Society of Mechanical Engineers, American National Standard, Safety Standards, “Jacks”, ASME B30.1-2009.
- [4.5.9] American Institute for Steel Construction (AISC), Specification for Structural Steel Buildings, Allowable Stress Design and Plastic Design, 13th Edition.
- [4.5.10] ASTM D92, “Standard Test Method for Flash and Fire Points”.
- [4.5.11] American National Standard Institute, “Overhead and Gantry Cranes (Top Running Bridge, Single or Multiple Girder, Top Running Trolley Hoist)”, ANSI B30.2, 1976.
- [4.5.12] Deleted
- [4.5.13] NUREG/CR-1815, “Recommendations for Protecting Against Failure by Brittle Fracture in Ferritic Steel Shipping Containers Up to Four Inches Thick”, June 1981.
- [4.5.14] Holtec Project Specification PS-5025-0001, “Purchase Specification for the HI-STORE HI-PORT”, Revision 0.
- [4.6.1] ANSI/ASCE 7-05 (formerly ANSI A58.1), “Minimum Design Loads for Buildings and Other Structures,” American Society of Civil Engineers, 2006.
- [4.6.2] ASCE 7-10, “Minimum Design Loads for Building and Other Structures,” American Society of Civil Engineers, 2013.
- [4.6.3] ASME Boiler and Pressure Vessel Code, Section II, Part D, Properties, 2010.
- [4.6.4] International Building Code (IBC), International Code Council, 2015.
- [4.6.5] AISC 360-10, “Specification for Structural Steel Buildings”, American Institute of Steel Construction, 2010.

HOLTEC INTERNATIONAL COPYRIGHTED MATERIAL	
Report No. HI-2167374	Proposed Rev. 0S
19-13	

- [4.6.6] NUREG-2215, “Standard Review Plan for Spent Fuel Dry Storage Systems and Facilities – Final Report,” April 2020
- [4.6.7] ACI-349 (2006), Code Requirements for Nuclear Safety Related Concrete Structures (ACI 349-06) and Commentary (ACI 349R-06), American Concrete Institute, 2006.
- [4.6.8] AISC N690-12, “Specification for Safety-Related Steel Structures for Nuclear Facilities”, American Institute of Steel Construction, 2012.
- [5.3.1] ACI-318 (2014), Building Code Requirements for Structural Concrete (ACI 318-14) and Commentary (ACI 318R-14), American Concrete Institute, 2014.
- [5.3.2] Boresi, A. et al., Advanced Mechanics of Materials, John Wiley and Sons, Third Edition.
- [5.3.3] SHAKE2000, GeoMotions, Version 9.99.99, 2016.
- [5.4.1] U.S. Nuclear Regulatory Commission, “Standard Review Plan Chapter 3.7.1 – Seismic Design Parameters”, Revision 3, March 2007.
- [5.4.2] LS-DYNA, Version 971, Livermore Software Technology, 2012.
- [5.4.3] ASME BTH-1-2011, Design of Below-the-Hook Lifting Devices, January 2012.
- [5.4.4] “Regulatory Guide 1.60 Time Histories Using EZ-FRISK”, Holtec Report HI-2146083, Revision 4.
- [5.4.5] ASCE/SEI 43-05, Seismic Design Criteria for Structures, Systems, and Components in Nuclear Facilities, American Society of Civil Engineers, 2005.
- [5.4.6] “Structural Calculation Package for HI-STORE CIS Facility”, Holtec Report HI-2177585, Revision 3.
- [5.4.7] “Structural Calculation Package for the HI-STORM UMAX System”, Holtec Report HI-2125228, Revision 9.
- [5.4.8] “Benchmarking of Material Stress-Strain Curves in LS-DYNA”, Holtec Report HI-2210251, Revision 0.
- [5.4.9] “Structural Analysis of HI-STORE Cask Transfer Building (CTB)”, Holtec Report HI-2210576, Revision 1.
- [5.4.10] “Static, Seismic Analysis and Mechanical Calculations for HI-STAR Crane”, Meloni Document No. 722118_3, Revision 0.
- [5.5.1] ANSYS (Versions up to 17.1), SAS IP, Inc., 2016.

HOLTEC INTERNATIONAL COPYRIGHTED MATERIAL	
Report No. HI-2167374	Proposed Rev. 0S
19-14	

- [6.4.1] FLUENT Computational Fluid Dynamics Software, Fluent, Inc., Centerra Resource Park, 10 Cavendish Court, Lebanon, NH 03766.
- [6.4.2] “Topical Report on the HI-STAR/HI-STORM Thermal Model and its Benchmarking with Full-Size Cask Test Data,” Holtec Report HI-992252, Revision 1, Holtec International, Marlton, NJ, 08053.
- [6.4.3] “Standard for Verification and Validation in Computational Fluid Dynamics and Heat Transfer”, ASME V&V 20-2009.
- [6.4.4] “Procedure for Estimating and Reporting of Uncertainty due to Discretization in CFD Applications”, I.B. Celik, U. Ghia, P.J. Roache and C.J. Freitas (Journal of Fluids Engineering Editorial Policy on the Control of Numerical Accuracy).
- [6.4.5] Perry, Robert.H., Perry’s Chemical Engineers’ Handbook, Sixth Edition, Texas: McGraw-Hill, pg. 3-167, 1984.
- [6.4.6] “Fuel, Weather and Considerations”, United States Department of Agriculture, Forest Service Southern Region, February 1989; Technical Publication R8-TP 11.
- [6.4.7] “HI-STORE CTF Thermal Evaluation”, Holtec Report HI-2177597, Rev. 2.
- [6.5.1] Gregory, J.J. et. al., “Thermal Measurements in a Series of Large Pool Fires”, SAND85-1096, Sandia National Laboratories, (August 1987).
- [6.5.2] Jakob, M. and Hawkins, G.A., “Elements of Heat Transfer,” John Wiley & Sons, New York, (1957).
- [6.5.3] “Evaluation of Effects of Tracked VCT Fire on HI-STORM FW System”, Holtec Report HI-2135677, Latest Revision.
- [6.5.4] “Thermal Analysis of HI-TRAC CS Transfer Cask”, Holtec Report HI-2177553, Revision 3.
- [6A.1] Darr, J.H., and S.P. Vanka, "Separated flow in a driven trapezoidal cavity", Physics Fluids A, 3, 3, 385-392, (March 1991).
- [6A.2] Young, D.F. and F.Y. Tsai, "Flow characteristics in models of arterial stenoses-I steady flow", Journal of Biomechanics, 6, 395-410, (1973).
- [6A.3] Coutanceau, M. and J.R. Defaye, "Circular cylinder wake configurations - A flow visualization survey", Applied Mechanics Review, 44, 6, (June 1991).
- [6A.4] Braza, M.P. Chassaing and H.H. Minh, "Numerical study and physical analysis of the pressure and velocity fields in the near wake of a circular cylinder", Journal of Fluid Mechanics, 165, 79-130, (1986).

HOLTEC INTERNATIONAL COPYRIGHTED MATERIAL	
Report No. HI-2167374	Proposed Rev. 0S
19-15	

- [6A.5] Hayes, R.E., K. Nandkumar and H. Nasr-El-Din, "Steady laminar flow in a 90 degree planar branch", *Computers and Fluids*, 17, 4, 537-553, (1989).
- [6A.6] Kuehn, T.H. and R.J. Goldstein, "An experimental study of natural convection heat transfer in concentric and eccentric horizontal cylinder annuli", *Journal of Heat Transfer*, 100, 635-640, (1978).
- [6A.7] Yucel, A., S. Acharya and M.L. Williams, "Natural convection and radiation in a square enclosure", *Numerical Heat Transfer, Part A*, 15, 261-278, (1989).
- [6A.8] Sorensen, J.N. and T.P. Loc, "Higher-order axisymmetric Navier-Stokes Code: Description and evolution of boundary conditions", *International Journal for Numerical Methods in Fluids*, 9, 1517-1537, (1989).
- [6A.9] Michelsen, J.A., "Modelling of laminar incompressible rotating fluid flow", AFM 86-05, Ph.D. dissertation, Department of fluid mechanics, Technical University of Denmark, (1986).
- [6A.10] Eidelman, S., P. Collela and R.P. Shreeve, "Application of the Godunov method and its second-order extension to cascade flow modelling", *AIAA Journal*, 22, 1609-1615, (1984).
- [6A.11] Karki, K.C., "A calculational procedure for viscous flows at all speeds in complex geometries", Ph.D. Thesis, U. of Minnesota, (1986).
- [6A.12] Vogel, J.C. and J.K. Eaton, "Combined heat transfer and fluid dynamic measurements downstream of a backward facing step", *Journal of Heat Transfer*, 107, 922-929, (1985).
- [6A.13] Antonopoulos, K.A., "The prediction of turbulent inclined flow in rod bundles", *Computers and Fluids*, 14, 4, 361-378, (1986).
- [6A.14] Humphrey, T.A.C., A.M.K. Taylor and J.H. Whitelaw, "Laminar flow in a square duct of strong curvature", *Journal of Fluid Mechanics*, 83, 509-527, (1977).
- [6A.15] Rogers, S.E., D. Kwak and C. Kiris, "Steady and Unsteady Solutions of the Incompressible Navier-Stokes Equations", *AIAA Journal*, 29, 4, 603-610, (April 1991).
- [6A.16] Yeo, R.N., P.E. Wood and A.N. Hrymak, "A numerical study of laminar 90-degree bend duct flow with different discretization schemes", *Journal of Fluid Engineering*, 113, 563-568, (December 1991).
- [6A.17] Bradley, D., L.A. Kwa, A.K.C. Lau, M. Missaghi and S.B. Chin, "Laminar Flamelet modelling of recirculating premixed methane and propane-air combustion", *Combustion and Flame*, 71, 109-122, (1988).
- [6A.18] Kakac, S., R.K. Shah and W. Aung, "Handbook of single-phase convective heat transfer", Wiley interscience, NY, (1987).

HOLTEC INTERNATIONAL COPYRIGHTED MATERIAL	
Report No. HI-2167374	Proposed Rev. 0S
19-16	

- [6A.19] Stanitz, J.D., W.M. Osborn and Mizisin, “An experimental investigation of secondary flow in an accelerating rectangular elbow with 90 degree turning”, NACA-TN-30150, (1953).
- [6A.20] EPRI, "The TN-24P PWR Spent Fuel Storage Cask: Testing and Analyses, EPRI ND-5128, April 1987.
- [6A.21] “Topical Report on the HI-STAR/HI-STORM Thermal Model and its Benchmarking with Full-Size Cask Test Data”, Holtec Report HI-992252, Revision 1.
- [7.0.1] Safety Evaluation Report for the HI-STORM UMAX System, Amendment 0, dated April 2, 2015, ML15093A510.
- [7.0.2] Safety Evaluation Report for the HI-STORM UMAX System, Amendment 1, dated September 8, 2015, ML15252A423.
- [7.0.3] Safety Evaluation Report for the HI-STORM UMAX System, Amendment 2, dated January 6, 2017, ML16341B129.
- [7.0.4] Safety Evaluation Report for the HI-STAR 190 Package, Revision 0, dated August 8, 2017, ML17222A083.
- [7.0.5] Safety Evaluation Report for the HI-STAR 190 Package, Revision 1, dated November 27, 2018, ML18332A029.
- [7.1.1] Bounding Source Terms for the HI-STORE CIS Facility. HI-2201004 Revision 0. Holtec International
- [7.4.1] 10 CFR Part 20 “Standards for Protection Against Radiation,” Title 10, of the Code of Federal Regulations – Energy, Office of the Federal Register, Washington, D.C.
- [7.4.2] HI-STORE CIS Facility Site Boundary Dose Rates Calculations for HI-STORM UMAX System. HI-2177599 Revision 4. Holtec International.
- [7.4.3] HI-STORE CIS Facility Occupational Dose Calculation. HI-2177600 Revision 3. Holtec International.
- [7.4.4] HI-STORM UMAX C-14 Dose Rate versus Distance. HI-2200954 Revision 2. Holtec International.
- [7.4.5] Dose Versus Distance Calculations for the HI-STAR 190 at the HI-STORE CIS Facility. HI-2201053 Revision 0. Holtec International.
- [7.4.6] ISG-13, “Real Individual” NRC Spent Fuel Project Office. May, 17 2000.

HOLTEC INTERNATIONAL COPYRIGHTED MATERIAL	
Report No. HI-2167374	Proposed Rev. 0S
19-17	

- [8.0.1] Safety Evaluation Report for the HI-STORM FW System, Amendment 0, dated July 14, 2011, ML111950325.
- [8.0.2] Safety Evaluation Report for the HI-STORM FW System, Amendment 1, dated December 17, 2014, ML14351A475.
- [8.0.3] Safety Evaluation Report for the HI-STORM FW System, Amendment 2, dated October 25, 2016, ML16280A302.
- [10.1.1] HI-STORE CISF Specialist Training Program, [HI-2177562 latest revision](#).
- [10.1.2] ANSI N18.1. “Selection and Training of Nuclear Power Plant Personnel”, American National Standards Institute, Inc., Washington D.C., 1971.
- [10.1.3] [HI-STORE CISF Radiation Protection Technician Training Program](#).
- [10.2.1] [U.S. Nuclear Regulatory Commission, "Measuring, Evaluating, and Reporting Radioactive Material in Liquid and Gaseous Effluents and Solid Waste", Regulatory Guide 1.21, Revision 2, June 2009.](#)
- [10.3.1] 49 CFR 173, “Shippers – General Requirements for Shipments and Packagings,” Title 49 of the Code of Federal Regulations – Transportation, Office of the Federal Register, Washington, D.C.
- [10.3.2] American Society for Nondestructive Testing, “Personnel Qualification and Certification in Nondestructive Testing,” Recommended Practice No. SNT-TC-1A, December 2006.
- [10.3.3] ANSI N14.5, American National Standard for Radioactive Materials – Leakage Tests on Packages for Shipment, 2014.
- [10.5.1] Holtec CISF Emergency Response Plan, Holtec Report HI-2177535, dated [June 2020](#).
- [11.1.1] *U.S. Code of Federal Regulations*, Title 10, “Energy” Part 19 “Notices, Instructions and Reports to Workers: Inspection and Investigations”.
- [11.1.2] U.S. Nuclear Regulatory Commission “Information Relevant to Ensuring that Occupational Radiation Exposures at Nuclear Power at Nuclear Power Stations will be As Low As Reasonably Achievable”, Regulatory Guide 8.8, June 1978.
- [11.1.3] U.S. Nuclear Regulatory Commission, "Operating Philosophy for Maintaining Occupational and Public Radiation Exposures As Low As is Reasonably Achievable", Regulatory Guide 8.10, Revision 2, August 2016.
- [11.4.1] U.S. Nuclear Regulatory Commission “Personnel Monitoring Device – Direct-Reading Pocket Dosimeters” Regulatory Guide 8.4, Revision 1. June 2011.
- [11.4.2] NUREG/CR-0041, “Manual of Respiratory Protection Against Airborne Radioactive Material” U.S. Nuclear Regulatory Commission, Revision 1. January 2001.

HOLTEC INTERNATIONAL COPYRIGHTED MATERIAL	
Report No. HI-2167374	Proposed Rev. 0S
19-18	

- [12.0.1] Holtec International Quality Assurance Program, Latest Approved Revision on Docket 71-0784.
- [13.3.1] Holtec Report HI-2177558, “Holtec International & Eddy Lea Energy Alliance (ELEA) Underground Consolidated Interim Storage Facility - Decommissioning Plan,” dated March 2017
- [13.3.2] Holtec Report HI-2177565, “Holtec International & Eddy Lea Energy Alliance (ELEA) CIS Facility - Decommissioning Cost Estimate and Funding Plan”.
- [13.3.3] NUREG-1757 Volume 1, “Consolidated Decommissioning Guidance”.
- [13.3.4] NUREG-1757 Volume 3, “Consolidated Decommissioning Guidance, Financial Assurance, Recordkeeping and Timeliness”.
- [13.3.5] R.S. Means, Construction Cost Data, 2017.
- [15.3.1] NUREG-1536, “Standard Review Plan for Spent Fuel Dry Storage Systems at a General License Facility”, Rev 1, U.S. Nuclear Regulatory Commission, Washington, DC.
- [16.0.1] HI-STORM UMAX CoC, Amendments 0, 1, 2, Issued April 6, 2015, September 8, 2015 and January 9, 2017 respectively.
- [16.0.2] Proposed HI-STORE CIS Facility License SNM-1051, Appendix A (Technical Specifications), Revision 0, March 2022.
- [17.0.1] ISG-15, “Materials Evaluation,” USNRC, Washington D.C., dated January 10, 2001
- [17.2.1] Morgan Thermal Ceramics Inc., Product Data Sheet for Blanket Products (Kaowool® Blanket).
- [17.2.2] “Properties, Behavior and Construction Use of Controlled Low Strength Material (CLSM) (U),” Engineering Studies Research Report K-ESG-G-00004, Revision 1.0, September 2002, Geotechnical Engineering Group.
- [17.2.3] “Guide Specification for Controlled Low Strength Materials (CLSM)”, National Ready Mixed Concrete Association, Silver Spring, MD.
- [17.3.1] ASME Boiler and Pressure Vessel Code, Section II, Part A – Ferrous Material Specifications,” American Society of Mechanical Engineers, New York, NY, 2010 Edition.
- [17.3.2] ASME Boiler and Pressure Vessel Code, Section III, Appendices, 2010 Edition.
- [17.7.1] Reg. Guide 1.54, “Service Level I, II, and III Protective Coatings Applied to Nuclear Power Plants”, Revision 2, US Nuclear Regulatory Commission, Washington, DC.
- [17.7.2] ASTM D 3843-00, “Standard Practice for Quality Assurance for Protective Coatings Applied to Nuclear Facilities”, ASTM International, West Conshohocken, PA.

HOLTEC INTERNATIONAL COPYRIGHTED MATERIAL	
Report No. HI-2167374	Proposed Rev. 0S
19-19	

- [17.7.3] ANSI C 210-03, “Liquid Epoxy Coating Systems for the Interior and Exterior of Steel Water Pipes”.
- [17.7.4] ASTM D4082-10, “Standard Test Method for Effects of Gamma Radiation on Coatings for use in Nuclear Power Plants”, ASTM International, West Conshohocken, PA.
- [17.10.1] Rogers Corporation, Product Data Sheet for BISCO® Silicones (BF-1000 – Extra Soft Cellular Silicone).
- [17.11.1] SECY-14-0072, “Final Rule: Continued Storage of Spent Nuclear Fuel,” dated July 14, 2014, as supported by NUREG-2157, “Generic Environmental Impact Statement for Continued Storage of Spent Nuclear Fuel”.
- [18.0.1] NUREG-1927, “Standard Review Plan for Renewal of Specific Licenses and Certificates of Compliance for Dry Storage of Spent Nuclear Fuel” Revision 1 – USNRC 2016 ADAMS # ML16179A148.
- [18.0.2] NEI 14-03, “Format, Content and Implementation Guidance for Dry Cask Storage Operations-Based Aging Management for Dry Cask Storage” Revision 1 – NEI 2015 ADAMS # ML15272A329.
- [18.3.1] USNRC Docket 72-1014, “Final Safety Analysis Report on the HI-STORM 100 Cask System”, Holtec Report No. HI-2002444, Revision 1.
- [18.4.1] “MPC Surface Inspection of Diablo Canyon Power Plant”, Holtec Report No. HI-2146301, Revision 2.
- [18.5.1] “Susceptibility Assessment Criteria for Chloride-Induced Stress Corrosion Cracking (CISCC) of Welded Stainless Steel Canisters for Dry Cask Storage Systems”, EPRI Report No. 3002005371, 2015.
- [18.5.2] ASTM G 30, “Standard Practice for Making and Using U-Bend Stress Corrosion Test Specimens”, ASTM ,100 Barr Harbor Drive, W Conshohocken, PA 19428-2959, 1997.
- [18.5.3] ASTM G 1, “Standard Practice for Preparing, Cleaning, and Evaluating Corrosion Test Specimens”, ASTM 100 Barr Harbor Drive, W Conshohocken, PA 19428, 2011.
- [18.5.4] ASME Section V, “Nondestructive Examination”, Two Park Avenue, New York, NY 10016, 2015.
- [18.5.5] ASME Code Case N-860, “Inspection Requirements and Evaluation Standards for Spent Nuclear Fuel Storage and Transportation Containment Systems”, Latest Revision.

HOLTEC INTERNATIONAL COPYRIGHTED MATERIAL	
Report No. HI-2167374	Proposed Rev. 0S
19-20	