

REV 13 4/06



VOGTLE
ELECTRIC GENERATING PLANT
UNIT 1 AND UNIT 2

REACTOR CAVITY PRESSURE
RESPONSE - NODE E15

FIGURE 6.2.1-15 (SHEET 15 OF 65)

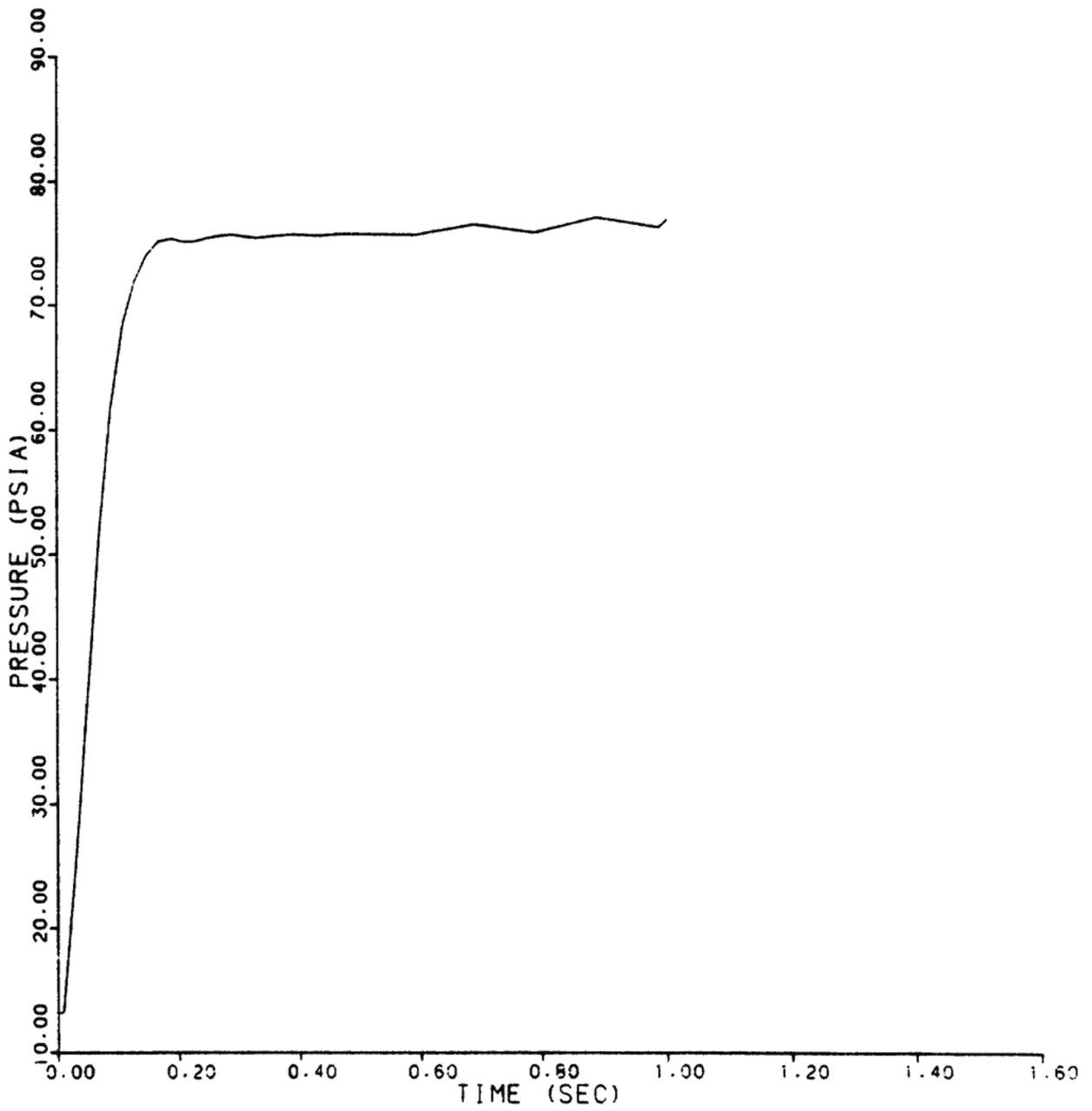

REV 13 4/06



VOGTLE
ELECTRIC GENERATING PLANT
UNIT 1 AND UNIT 2

REACTOR CAVITY PRESSURE
RESPONSE - NODE E16

FIGURE 6.2.1-15 (SHEET 16 OF 65)

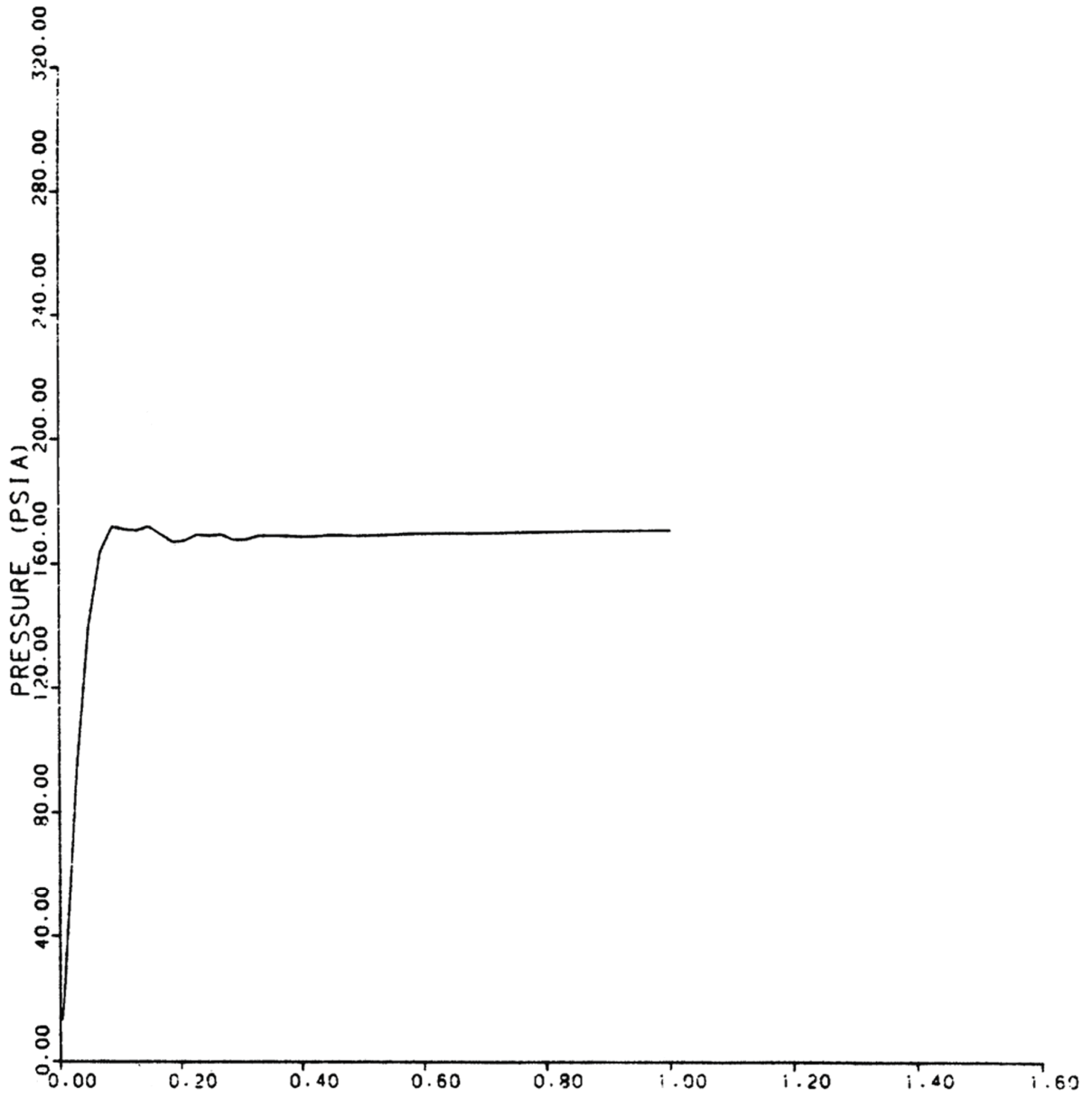

REV 13 4/06



VOGTLE
ELECTRIC GENERATING PLANT
UNIT 1 AND UNIT 2

REACTOR CAVITY PRESSURE
RESPONSE - NODE E17

FIGURE 6.2.1-15 (SHEET 17 OF 65)

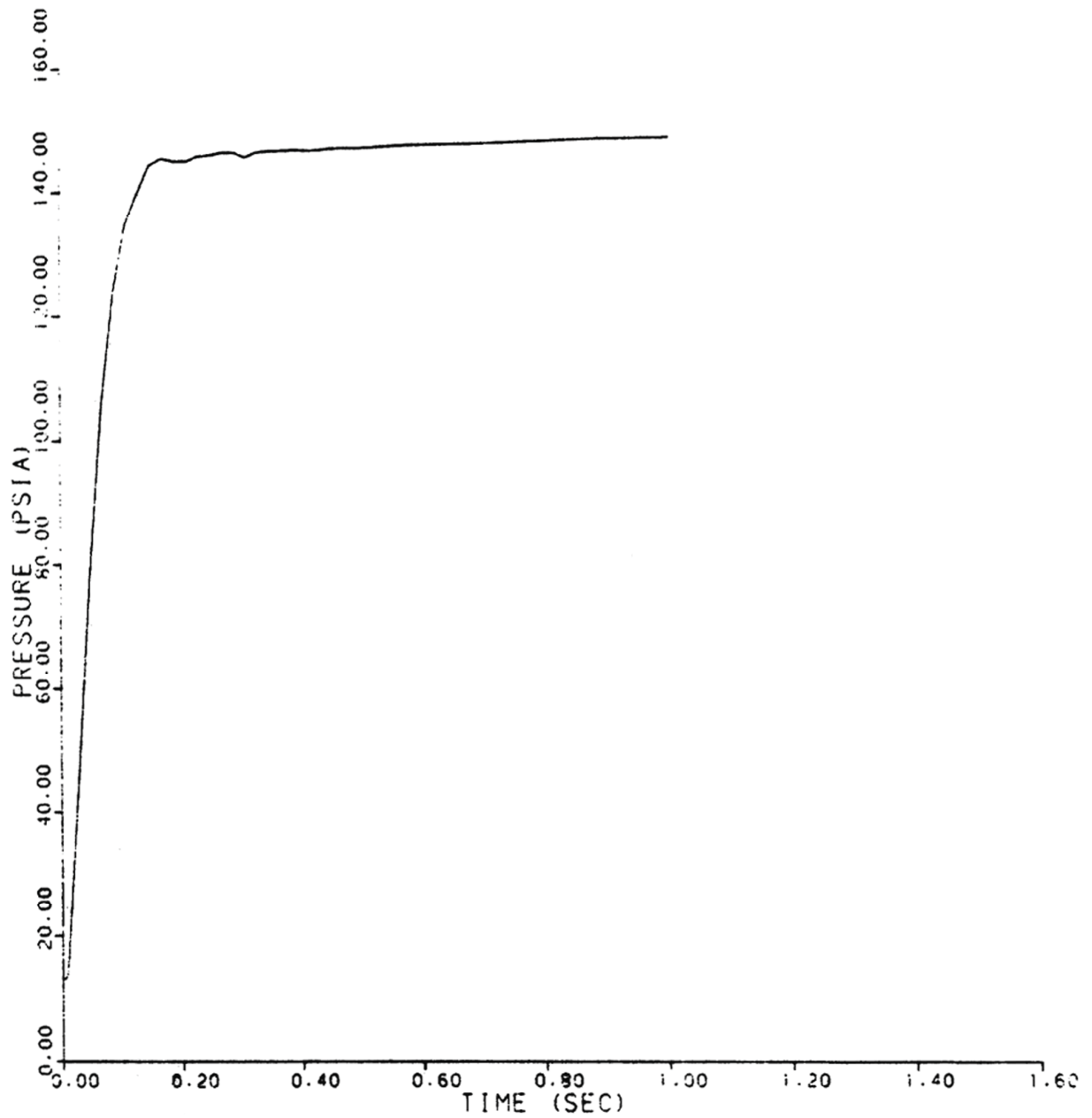

REV 13 4/06



VOGTLE
ELECTRIC GENERATING PLANT
UNIT 1 AND UNIT 2

REACTOR CAVITY PRESSURE
RESPONSE - NODE E18

FIGURE 6.2.1-15 (SHEET 18 OF 65)

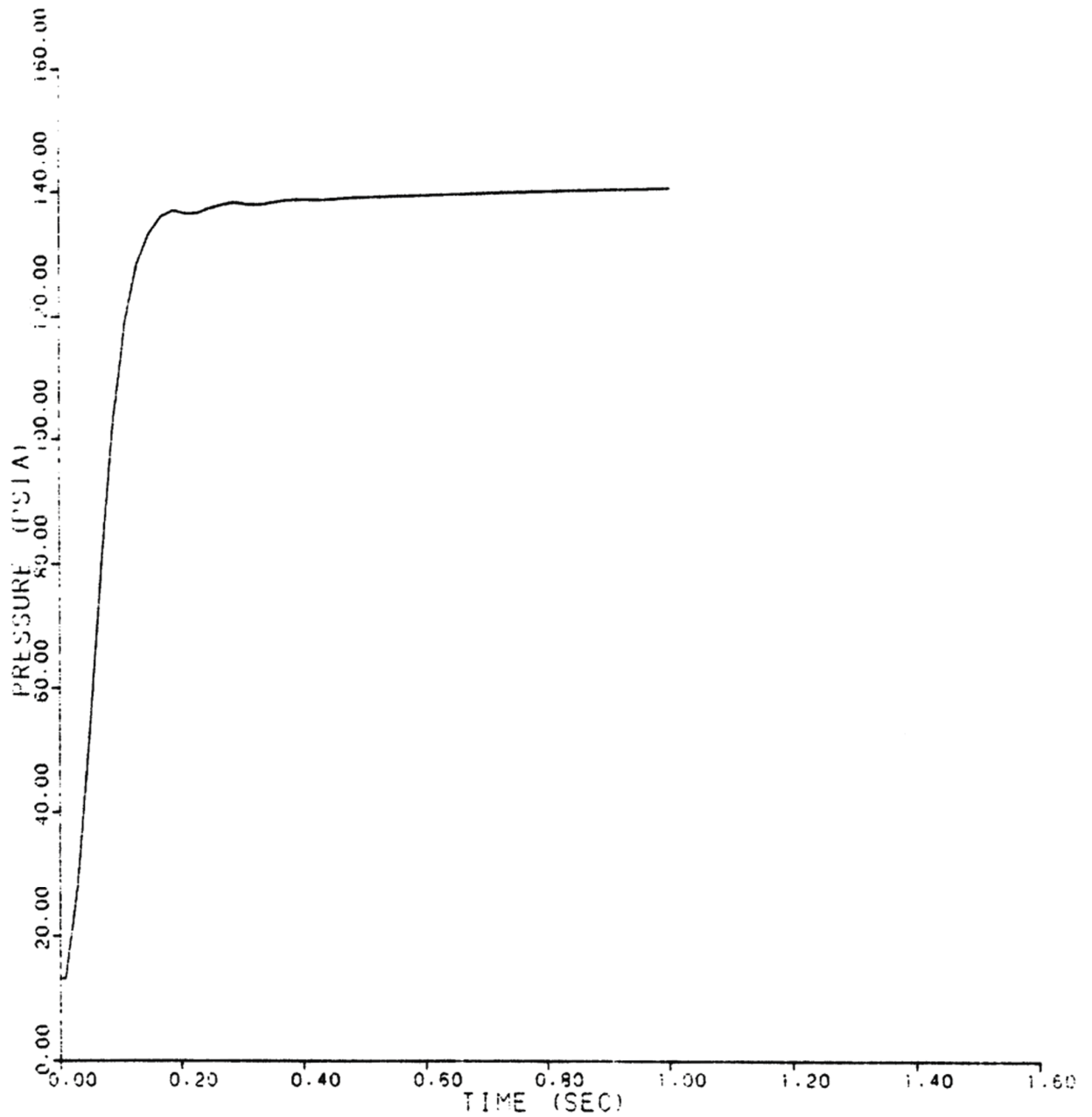

REV 13 4/06



VOGTLE
ELECTRIC GENERATING PLANT
UNIT 1 AND UNIT 2

REACTOR CAVITY PRESSURE
RESPONSE – NODE E19

FIGURE 6.2.1-15 (SHEET 19 OF 65)

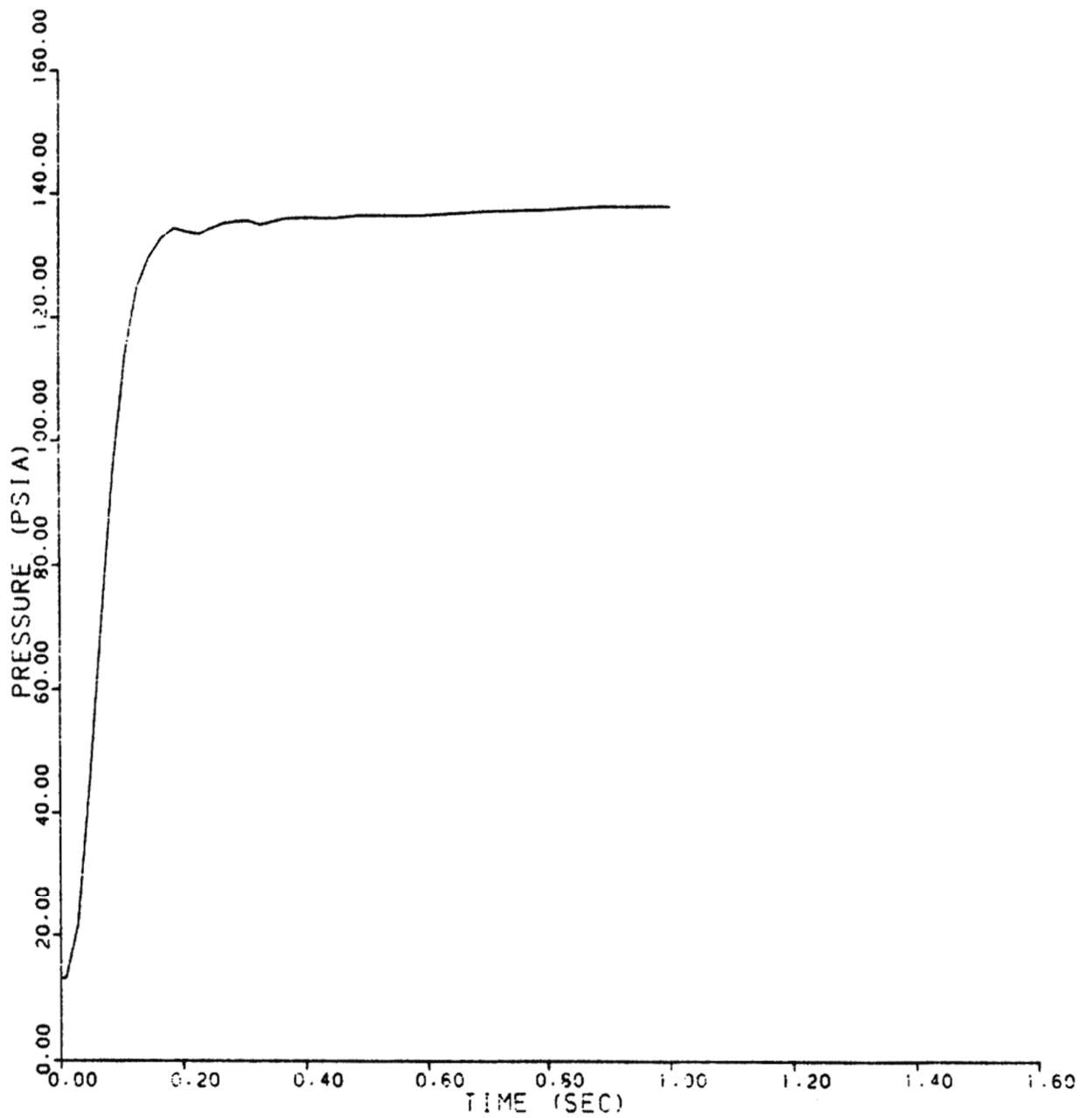

REV 13 4/06



VOGTLE
ELECTRIC GENERATING PLANT
UNIT 1 AND UNIT 2

REACTOR CAVITY PRESSURE
RESPONSE - NODE E20

FIGURE 6.2.1-15 (SHEET 20 OF 65)

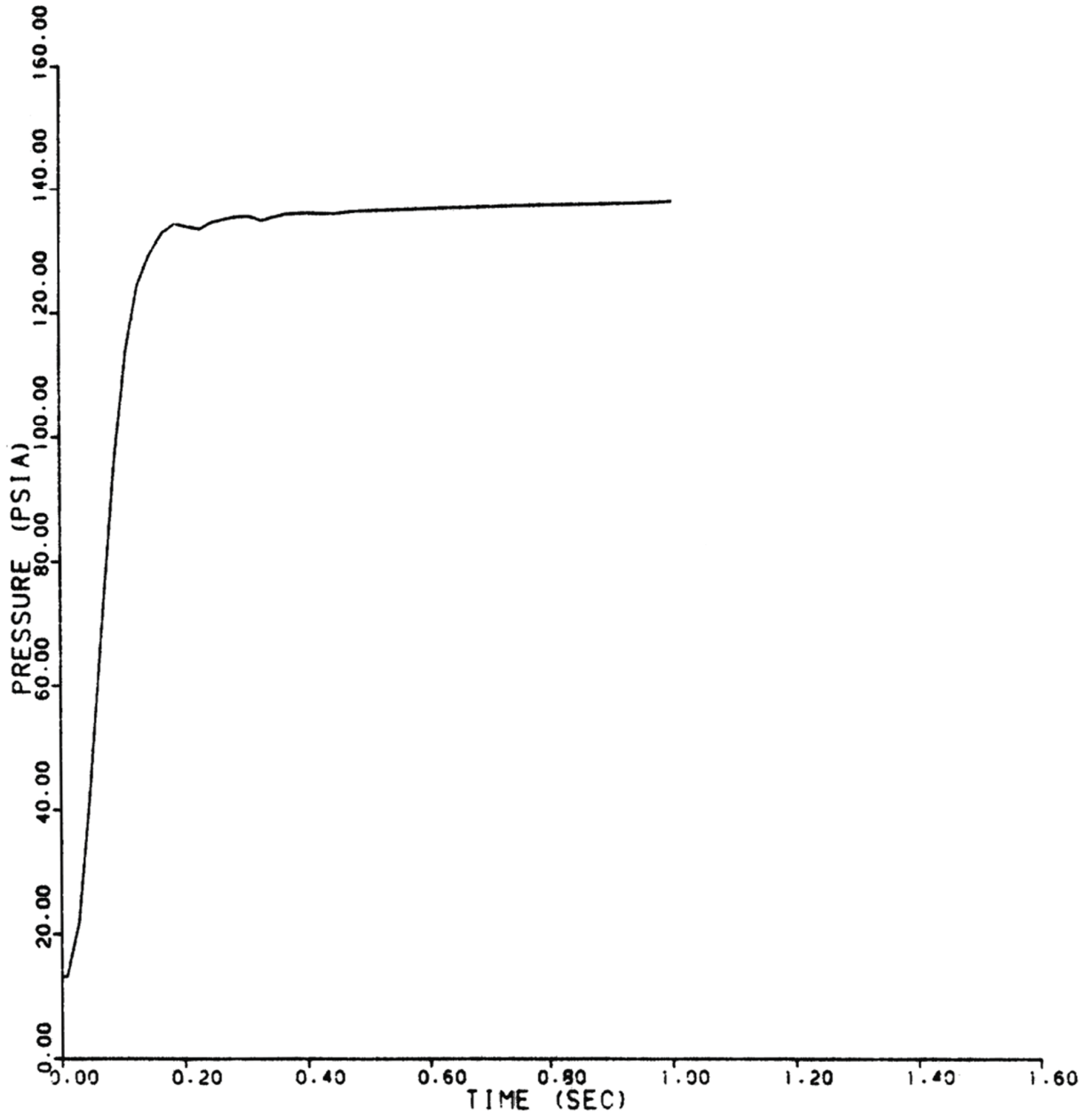

REV 13 4/06



VOGTLE
ELECTRIC GENERATING PLANT
UNIT 1 AND UNIT 2

REACTOR CAVITY PRESSURE
RESPONSE - NODE E21

FIGURE 6.2.1-15 (SHEET 21 OF 65)

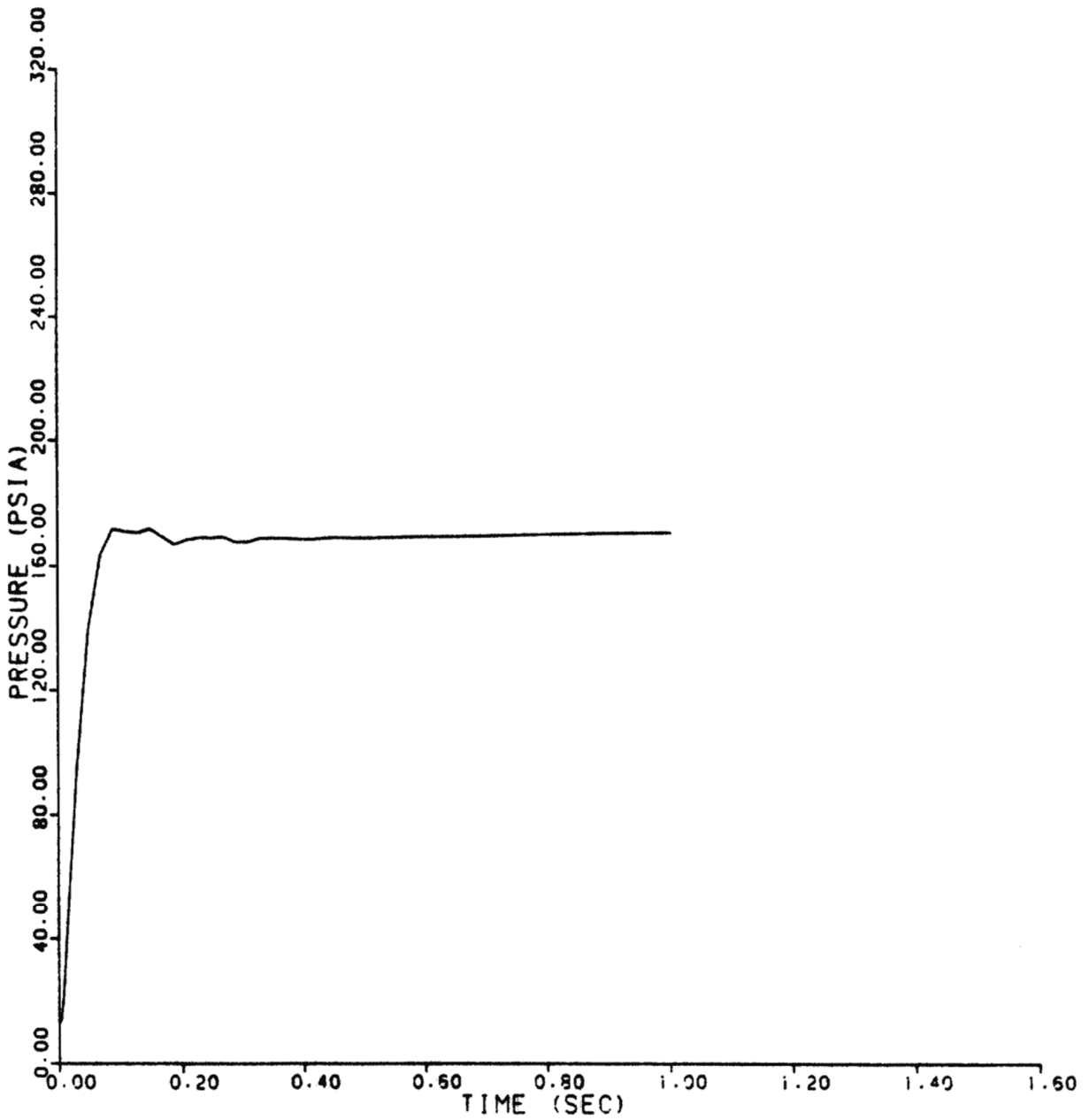

REV 13 4/06



VOGTLE
ELECTRIC GENERATING PLANT
UNIT 1 AND UNIT 2

REACTOR CAVITY PRESSURE
RESPONSE - NODE E22

FIGURE 6.2.1-15 (SHEET 22 OF 65)

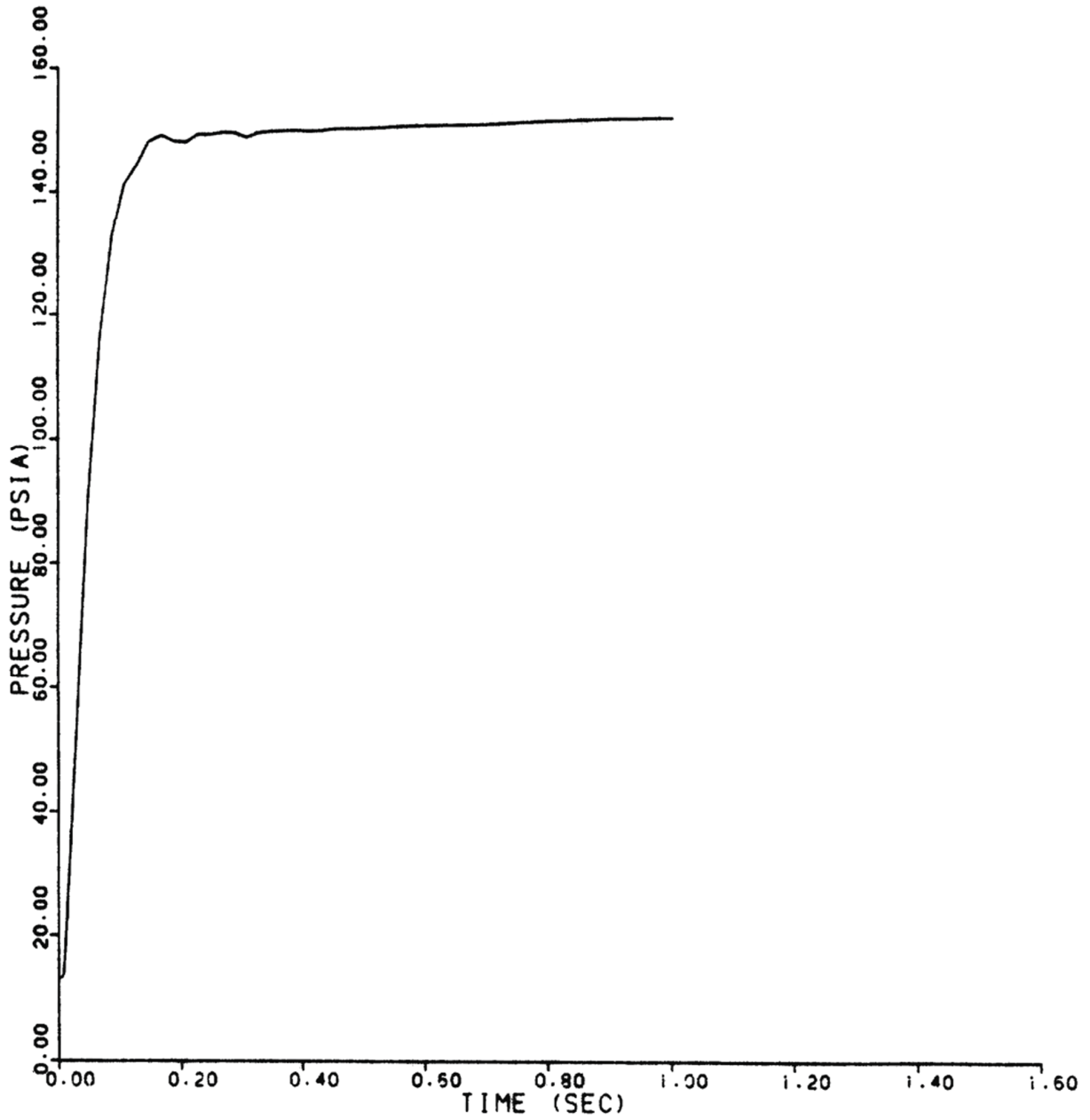

REV 13 4/06



VOGTLE
ELECTRIC GENERATING PLANT
UNIT 1 AND UNIT 2

REACTOR CAVITY PRESSURE
RESPONSE – NODE E23

FIGURE 6.2.1-15 (SHEET 23 OF 65)

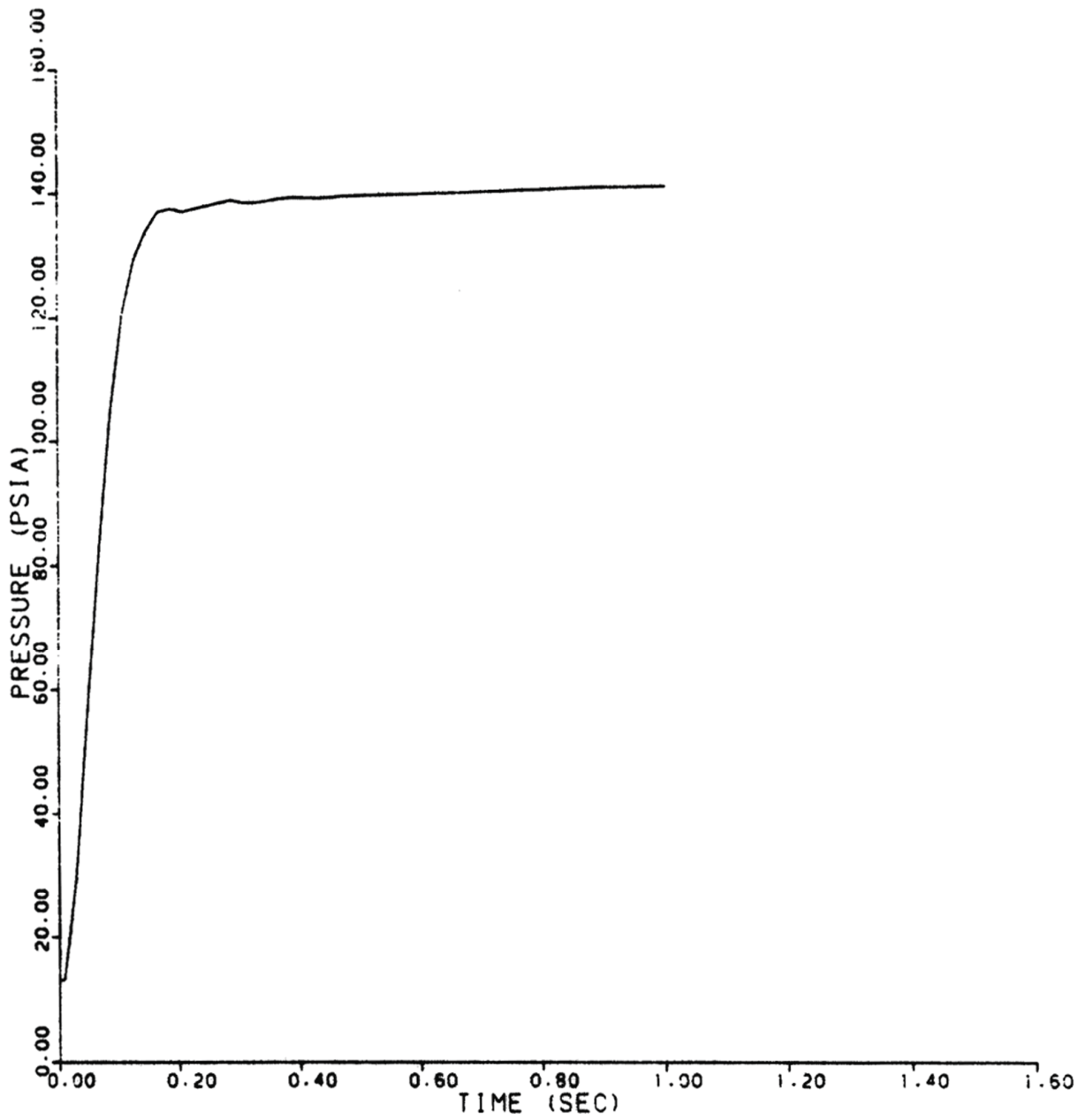

REV 13 4/06



VOGTLE
ELECTRIC GENERATING PLANT
UNIT 1 AND UNIT 2

REACTOR CAVITY PRESSURE
RESPONSE - NODE E24

FIGURE 6.2.1-15 (SHEET 24 OF 65)

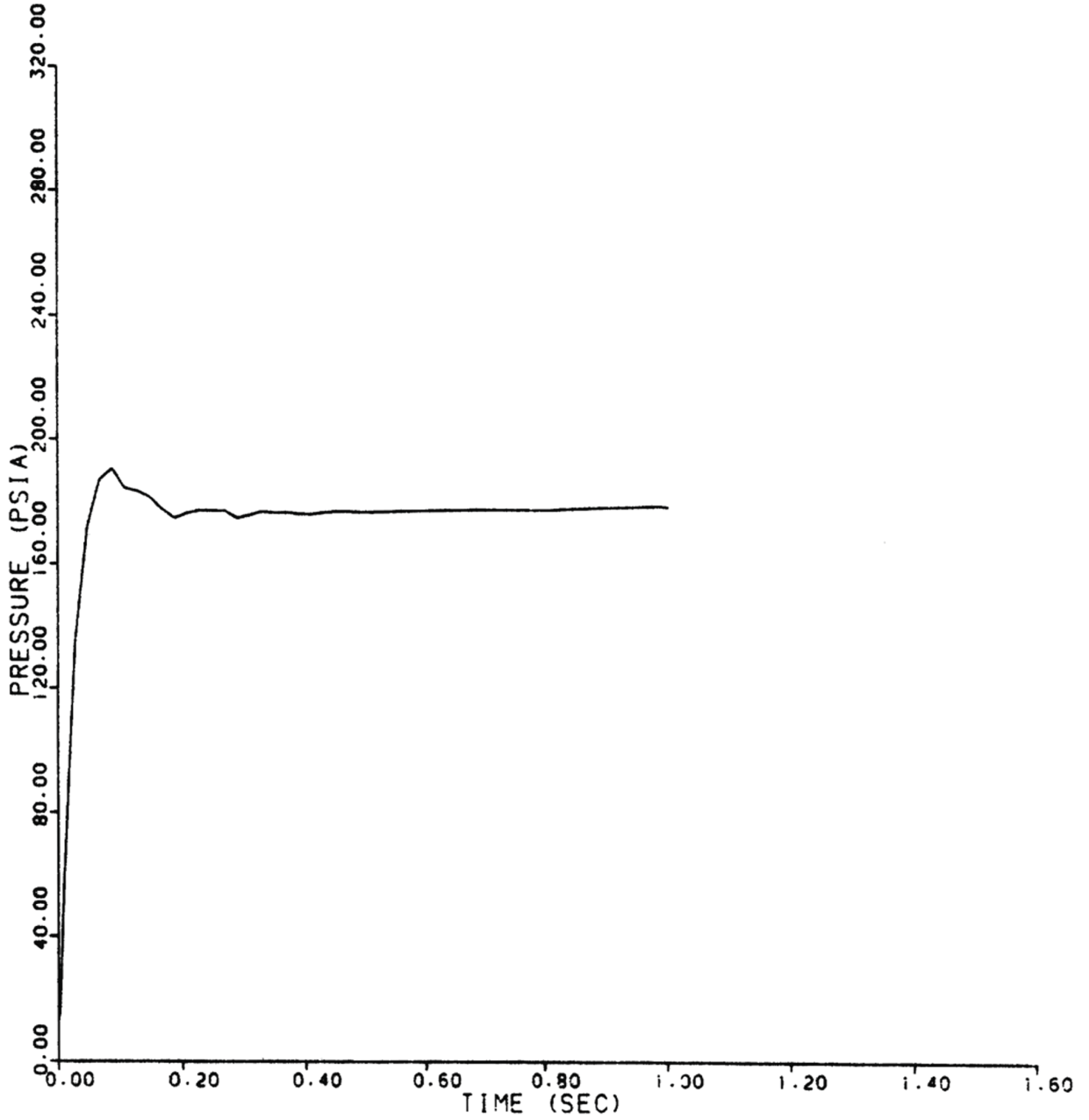

REV 13 4/06



VOGTLE
ELECTRIC GENERATING PLANT
UNIT 1 AND UNIT 2

REACTOR CAVITY PRESSURE
RESPONSE - NODE E25

FIGURE 6.2.1-15 (SHEET 25 OF 65)

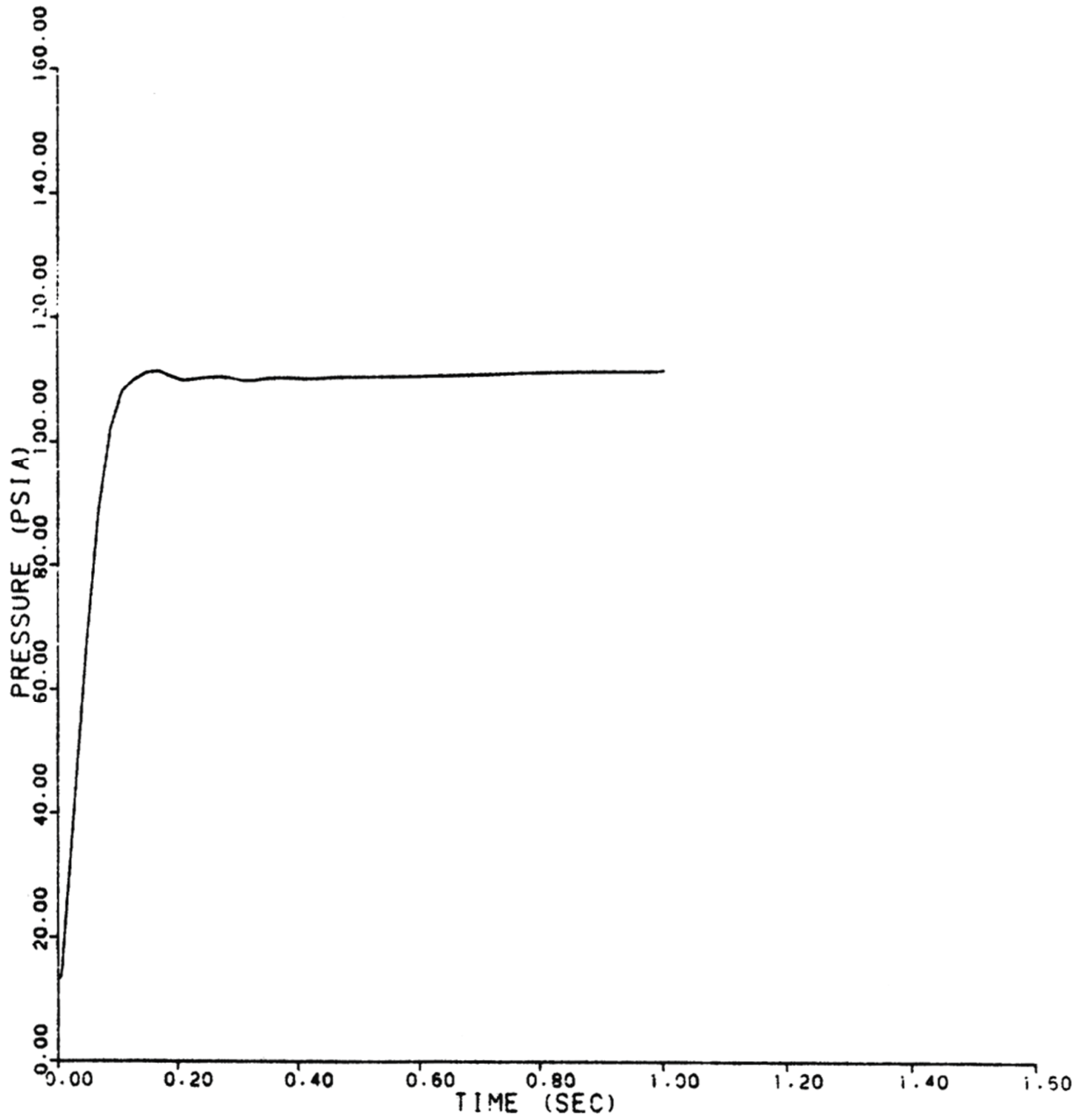

REV 13 4/06



VOGTLE
ELECTRIC GENERATING PLANT
UNIT 1 AND UNIT 2

REACTOR CAVITY PRESSURE
RESPONSE - NODE E26

FIGURE 6.2.1-15 (SHEET 26 OF 65)

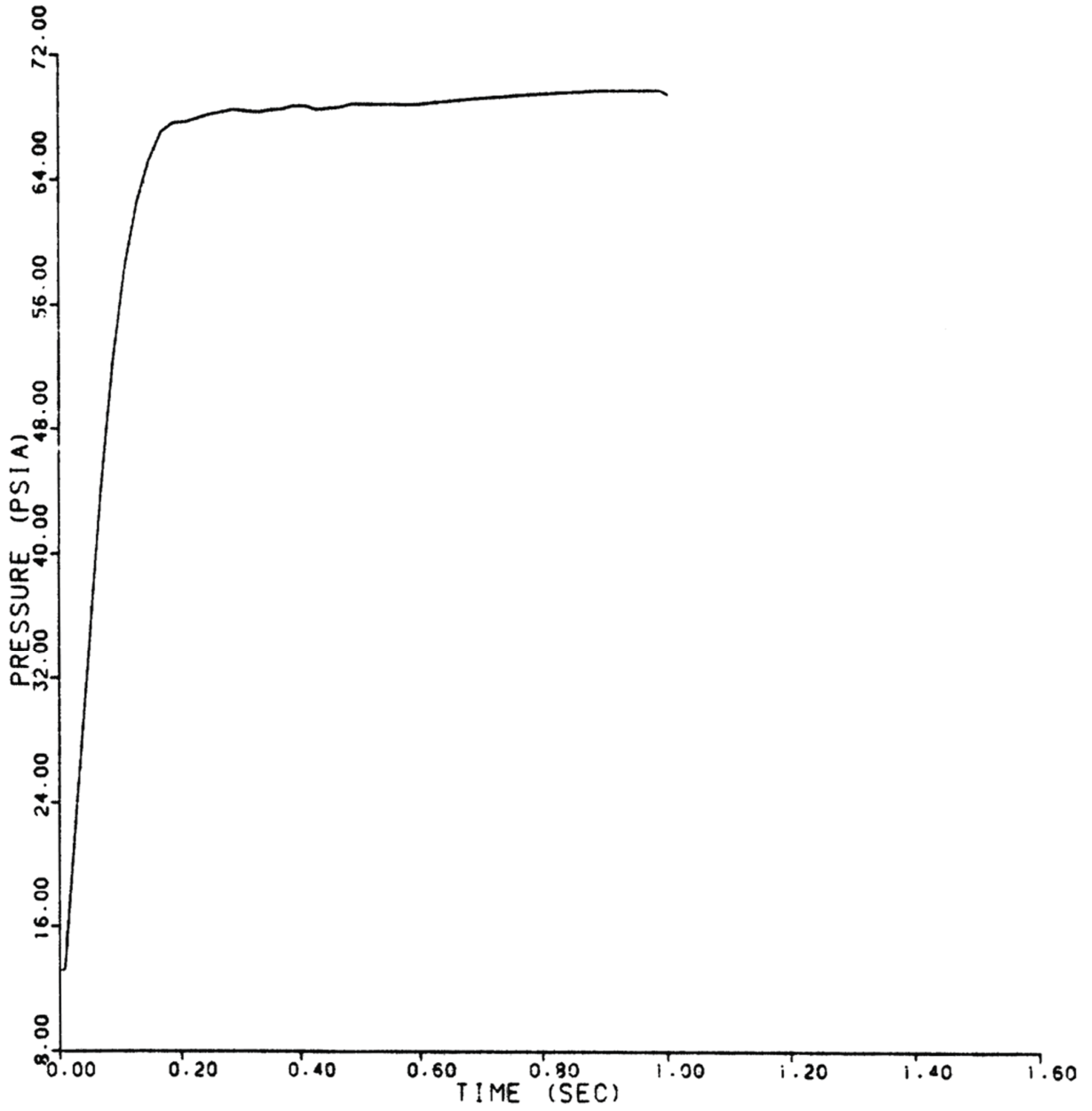

REV 13 4/06



VOGTLE
ELECTRIC GENERATING PLANT
UNIT 1 AND UNIT 2

REACTOR CAVITY PRESSURE
RESPONSE - NODE E27

FIGURE 6.2.1-15 (SHEET 27 OF 65)

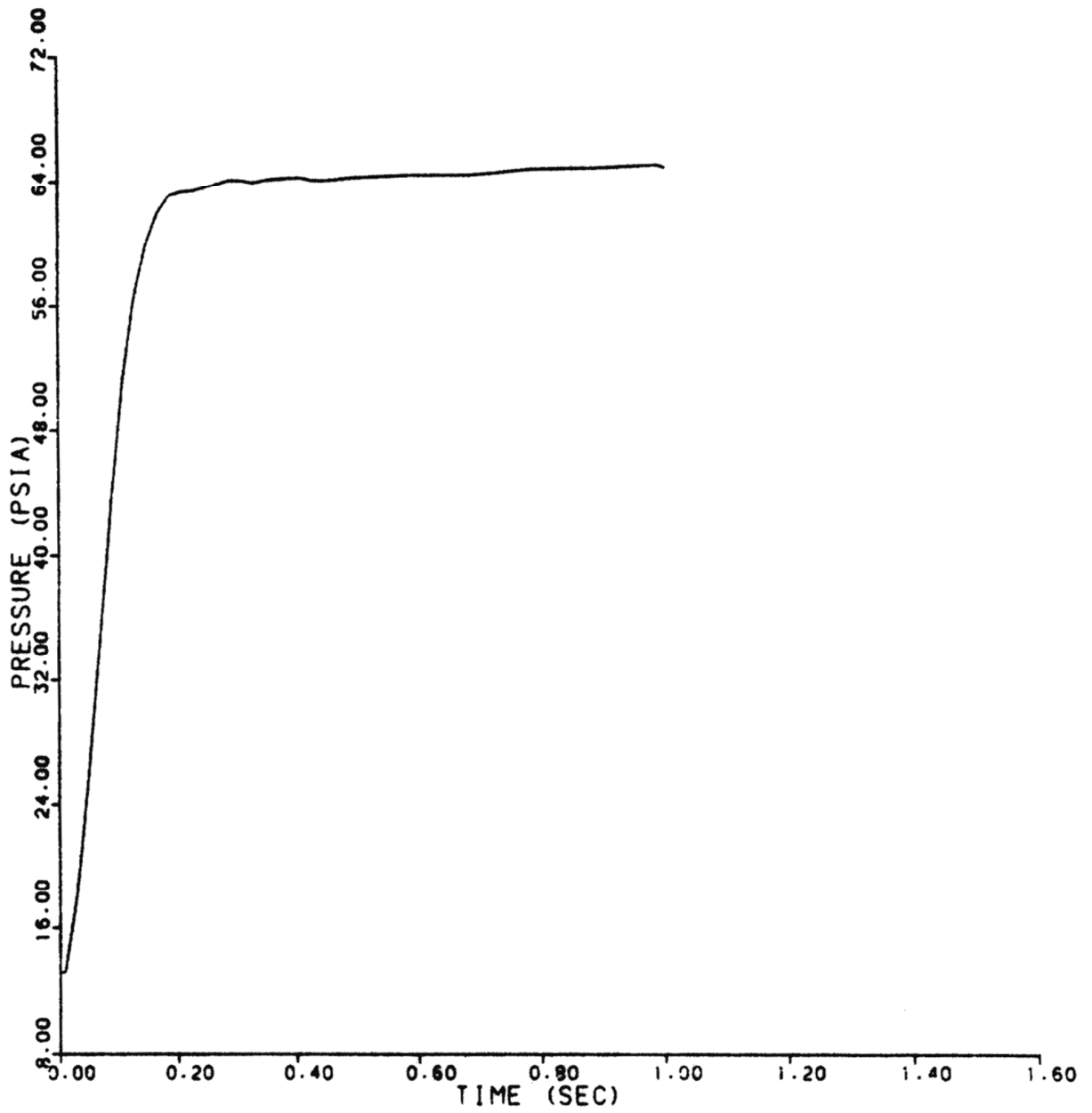

REV 13 4/06



VOGTLE
ELECTRIC GENERATING PLANT
UNIT 1 AND UNIT 2

REACTOR CAVITY PRESSURE
RESPONSE - NODE E28

FIGURE 6.2.1-15 (SHEET 28 OF 65)

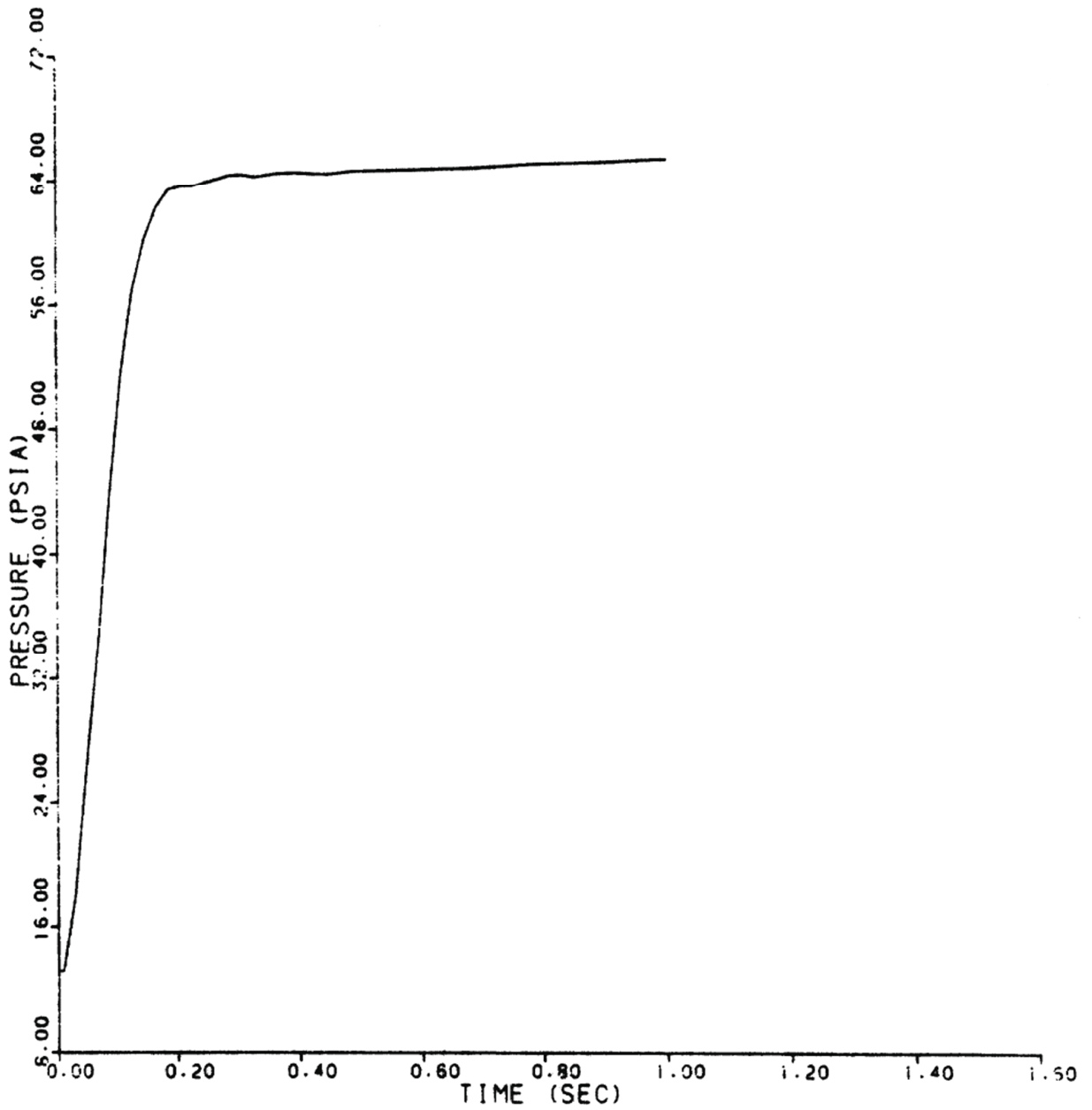

REV 13 4/06



VOGTLE
ELECTRIC GENERATING PLANT
UNIT 1 AND UNIT 2

REACTOR CAVITY PRESSURE
RESPONSE - NODE E29

FIGURE 6.2.1-15 (SHEET 29 OF 65)

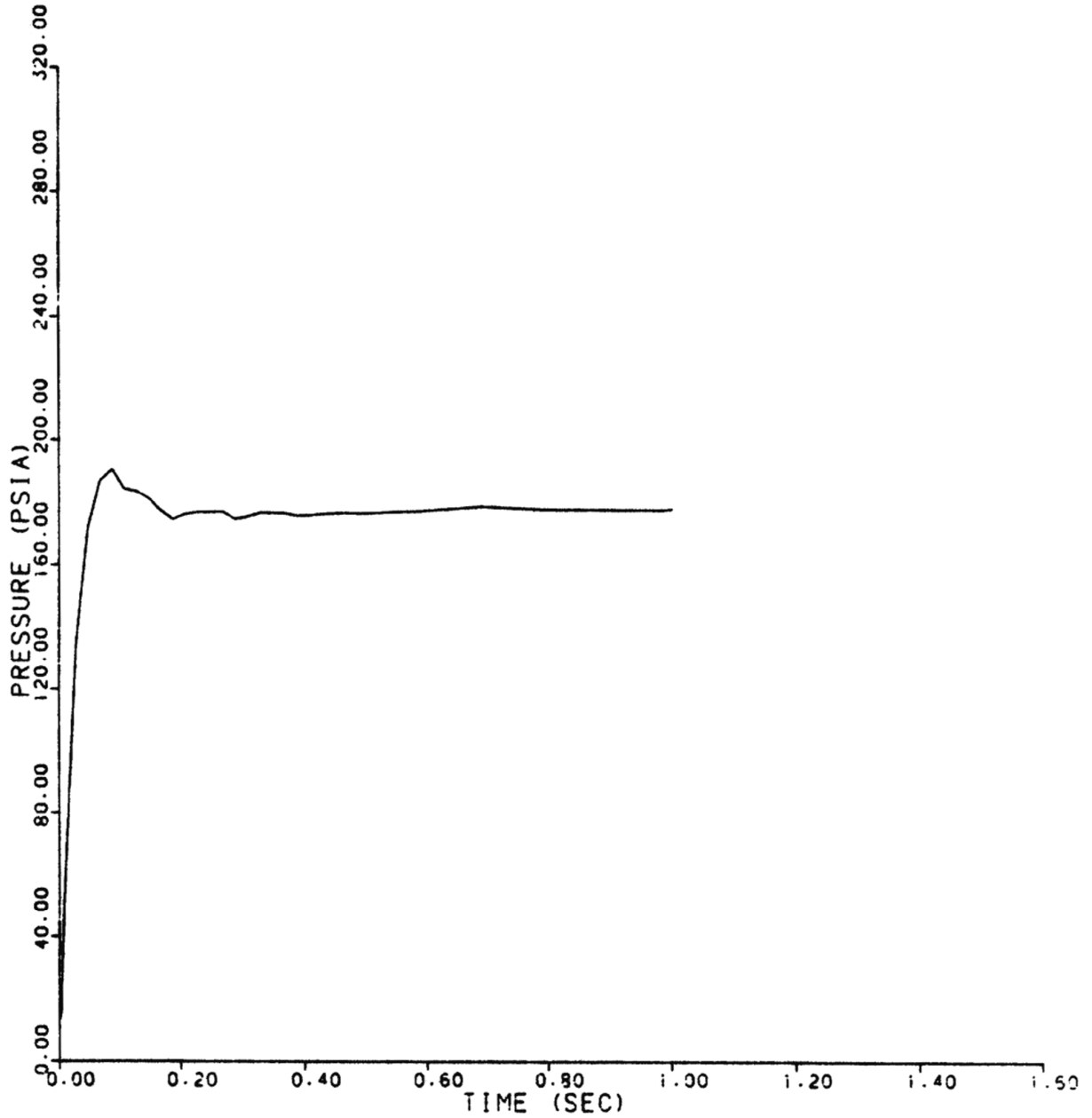

REV 13 4/06



VOGTLE
ELECTRIC GENERATING PLANT
UNIT 1 AND UNIT 2

REACTOR CAVITY PRESSURE
RESPONSE - NODE E30

FIGURE 6.2.1-15 (SHEET 30 OF 65)

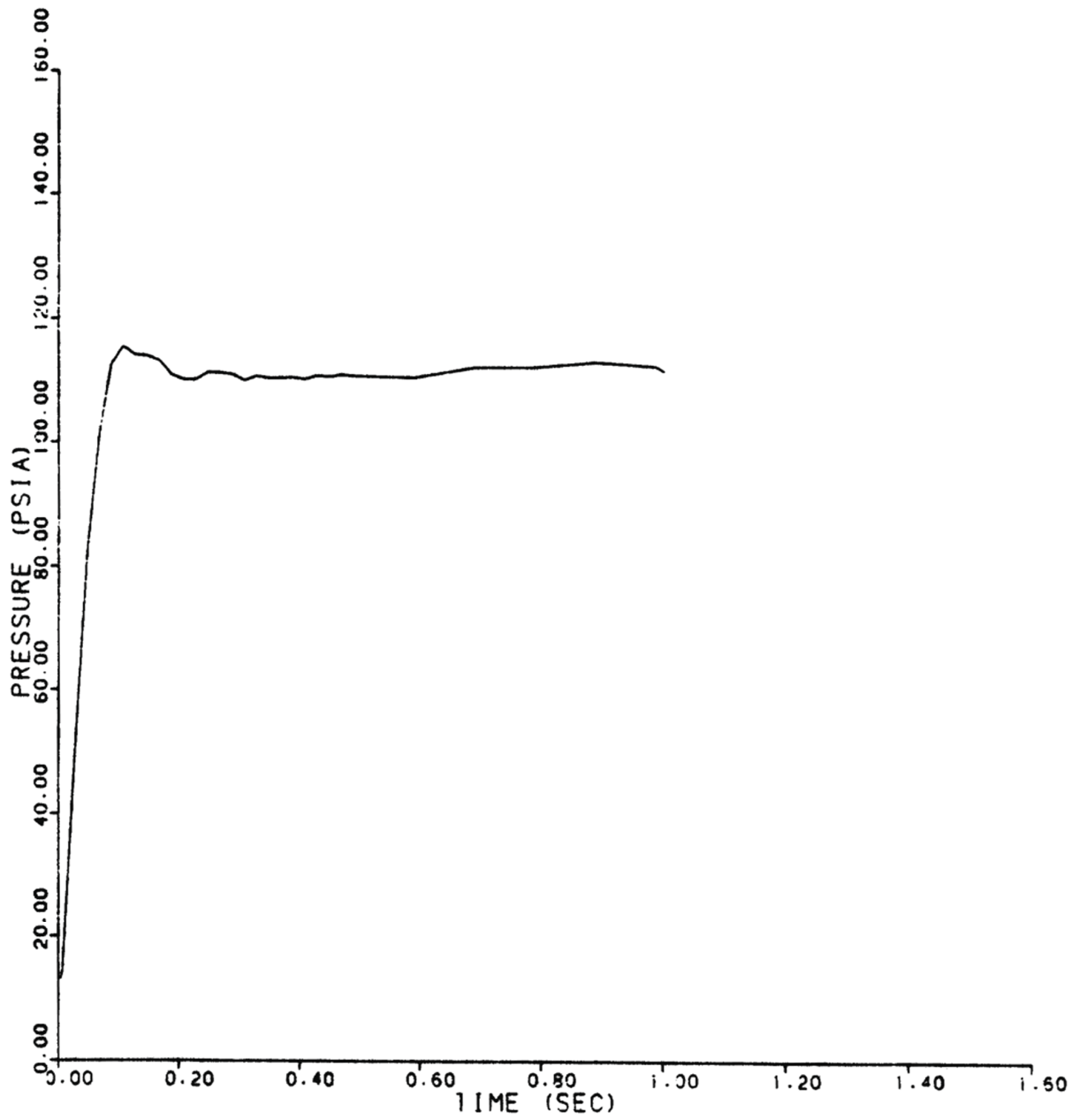

REV 13 4/06



VOGTLE
ELECTRIC GENERATING PLANT
UNIT 1 AND UNIT 2

REACTOR CAVITY PRESSURE
RESPONSE - NODE E31

FIGURE 6.2.1-15 (SHEET 31 OF 65)

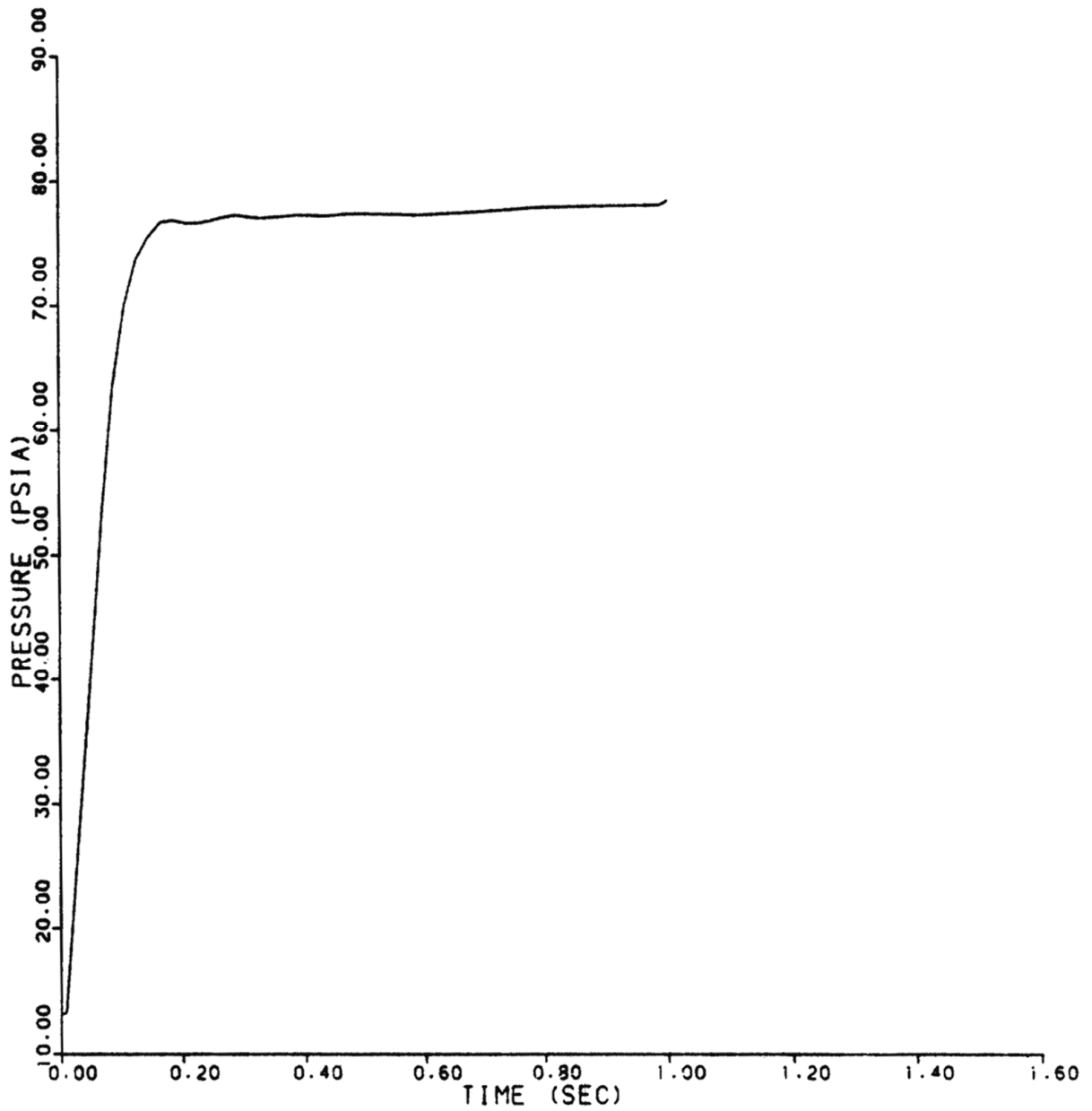

REV 13 4/06



VOGTLE
ELECTRIC GENERATING PLANT
UNIT 1 AND UNIT 2

REACTOR CAVITY PRESSURE
RESPONSE - NODE E32

FIGURE 6.2.1-15 (SHEET 32 OF 65)

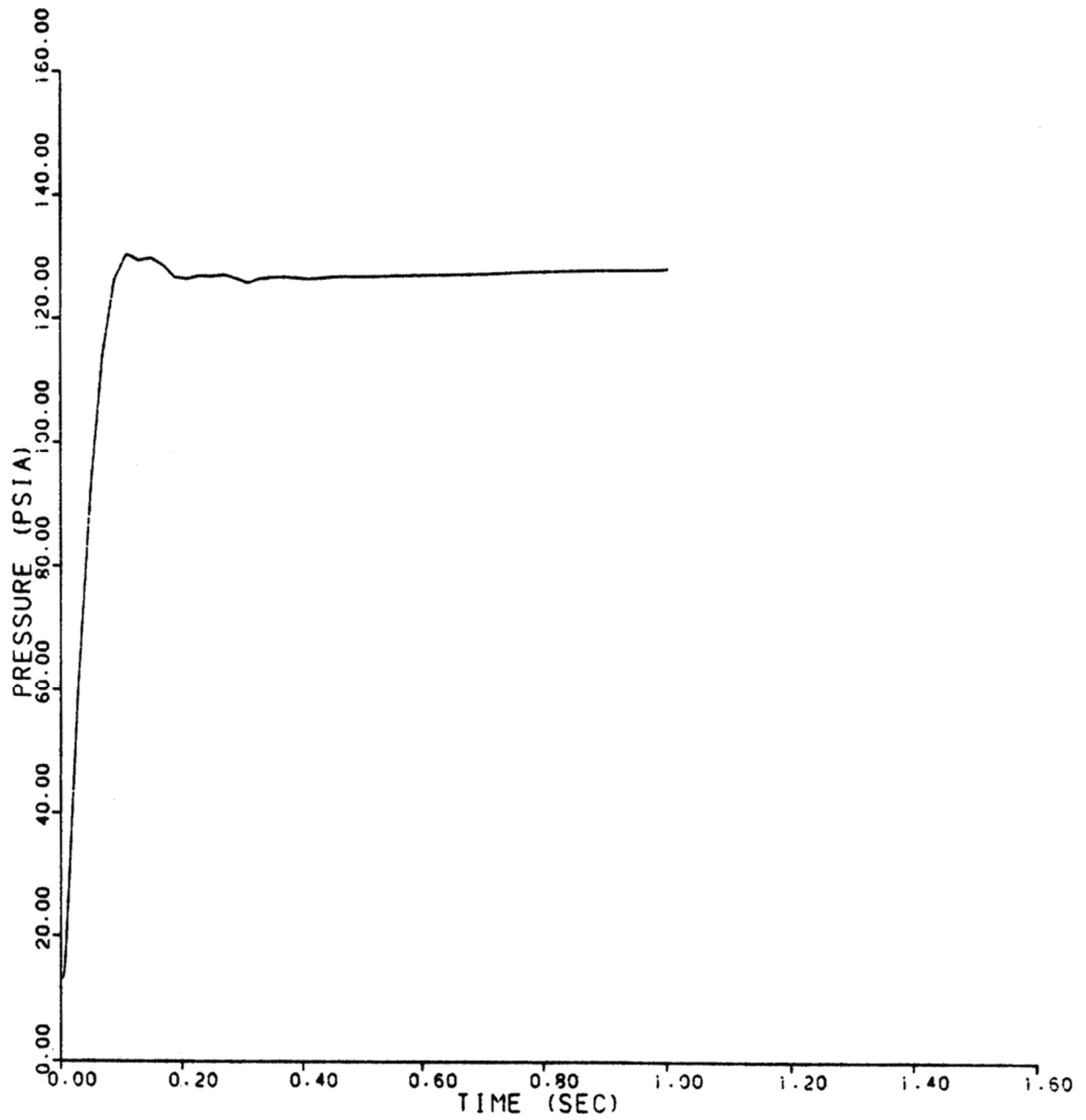

REV 13 4/06



VOGTLE
ELECTRIC GENERATING PLANT
UNIT 1 AND UNIT 2

REACTOR CAVITY PRESSURE
RESPONSE - NODE E33

FIGURE 6.2.1-15 (SHEET 33 OF 65)

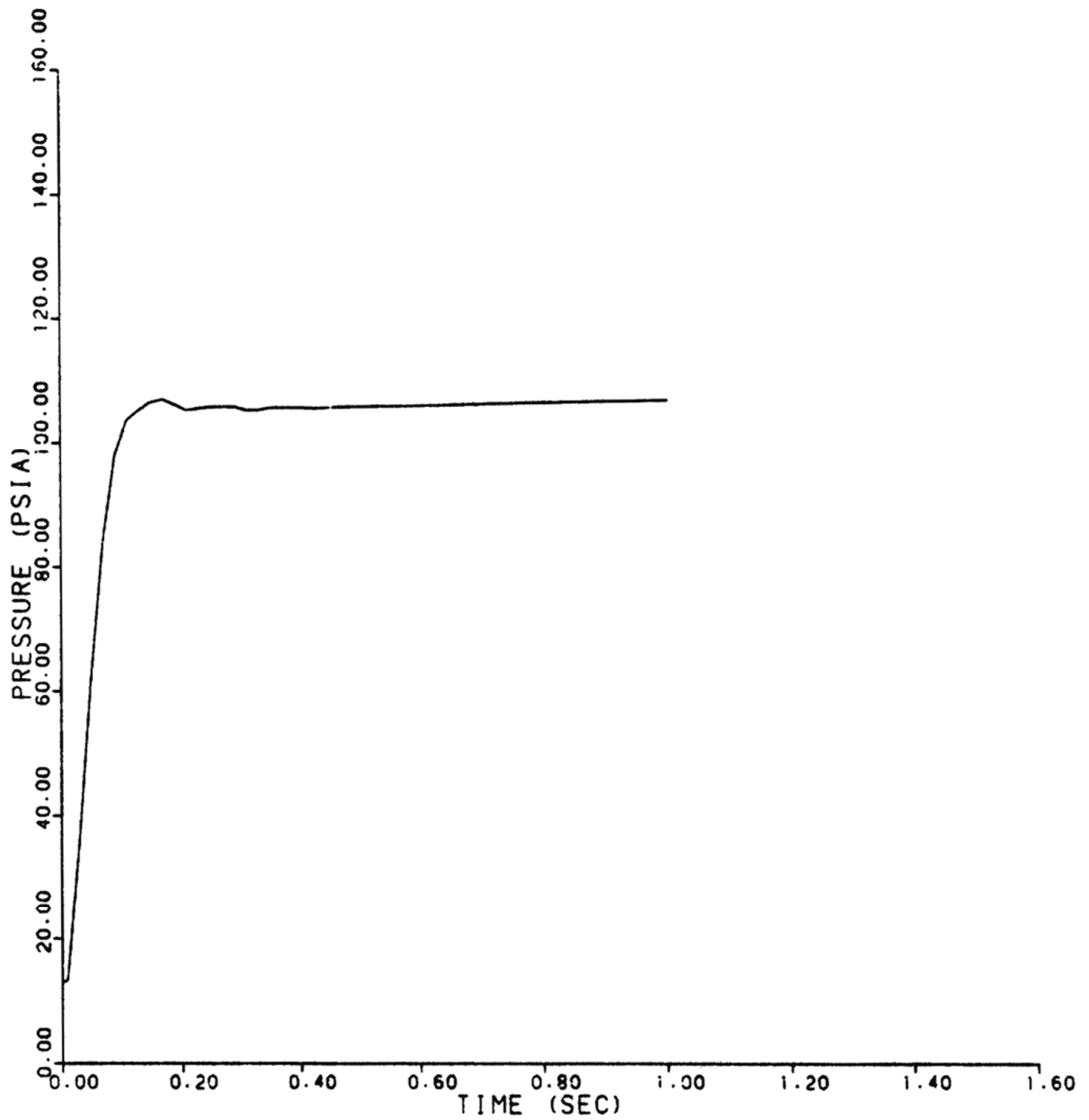

REV 13 4/06



VOGTLE
ELECTRIC GENERATING PLANT
UNIT 1 AND UNIT 2

REACTOR CAVITY PRESSURE
RESPONSE - NODE E34

FIGURE 6.2.1-15 (SHEET 34 OF 65)

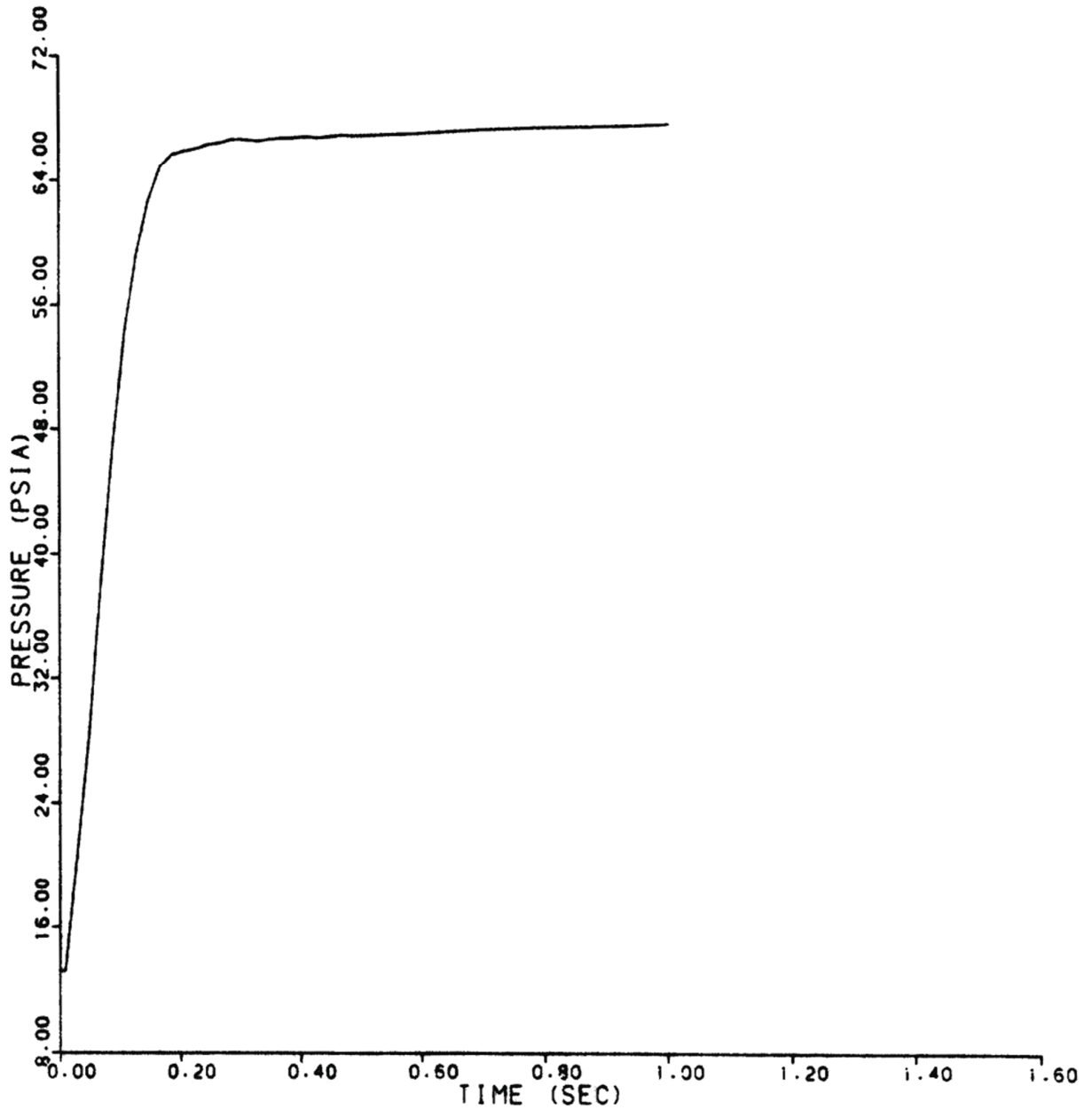

REV 13 4/06



VOGTLE
ELECTRIC GENERATING PLANT
UNIT 1 AND UNIT 2

REACTOR CAVITY PRESSURE
RESPONSE - NODE E35

FIGURE 6.2.1-15 (SHEET 35 OF 65)

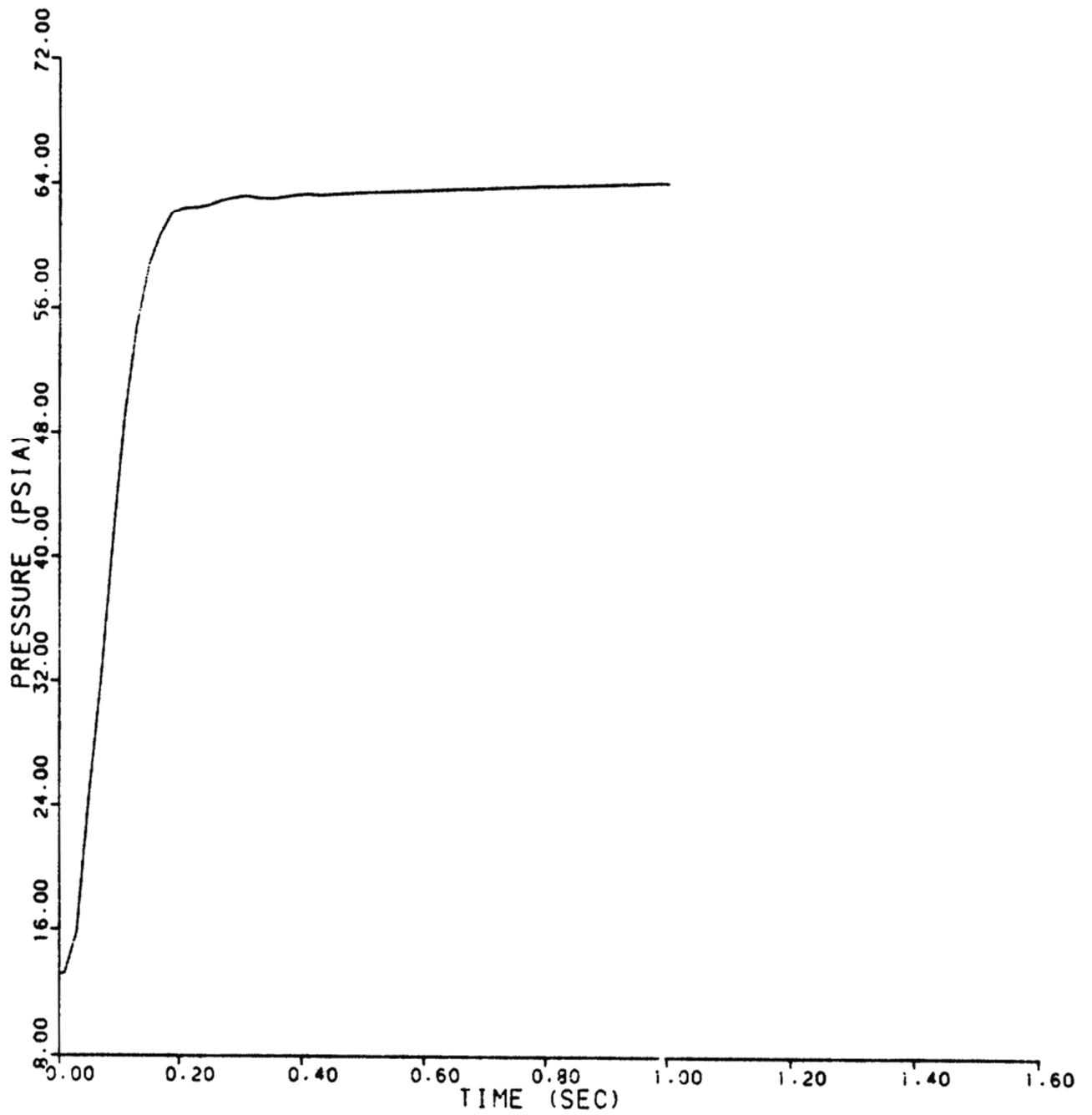

REV 13 4/06



VOGTLE
ELECTRIC GENERATING PLANT
UNIT 1 AND UNIT 2

REACTOR CAVITY PRESSURE
RESPONSE - NODE E36

FIGURE 6.2.1-15 (SHEET 36 OF 65)

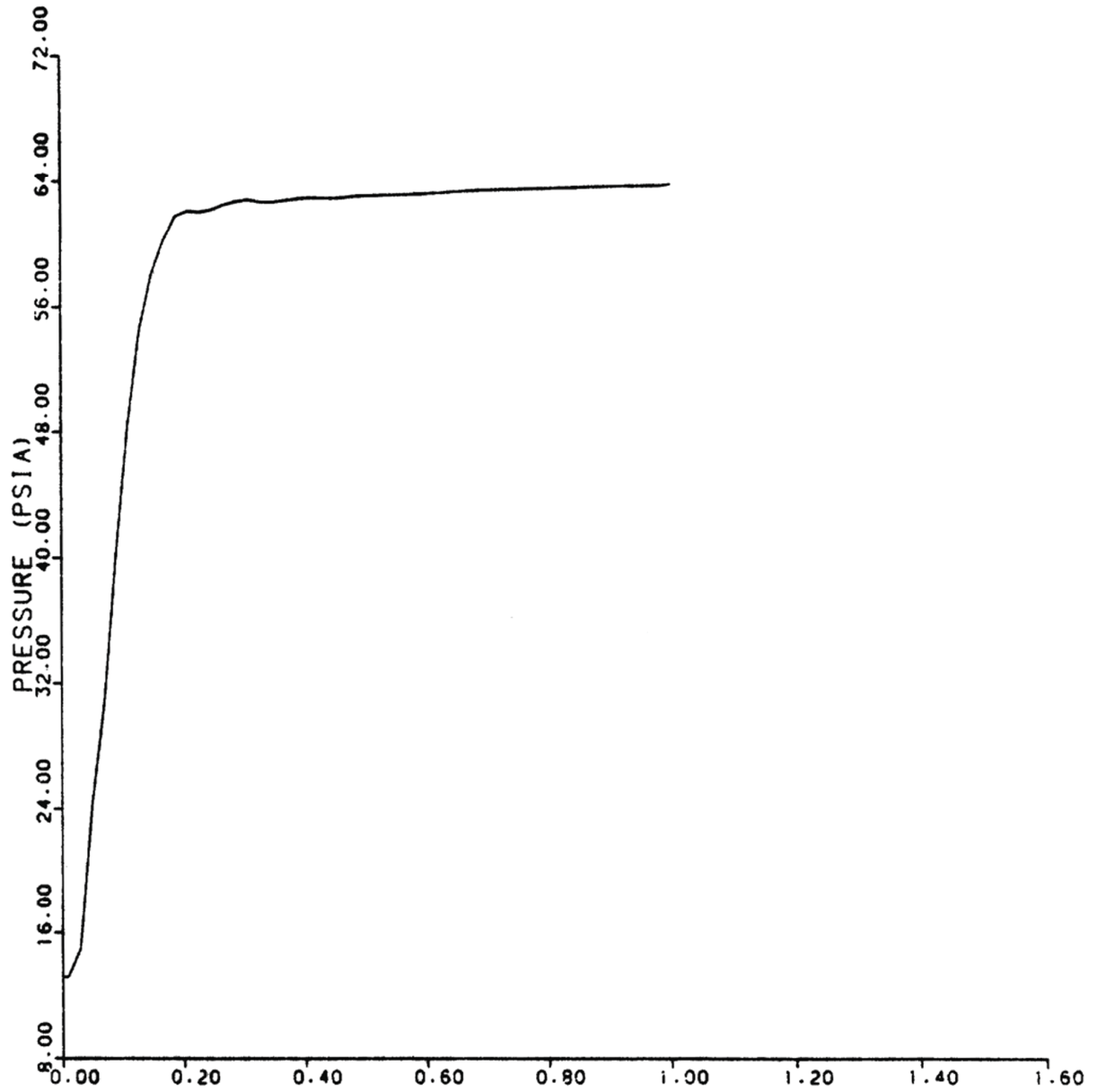

REV 13 4/06



VOGTLE
ELECTRIC GENERATING PLANT
UNIT 1 AND UNIT 2

REACTOR CAVITY PRESSURE
RESPONSE - NODE E37

FIGURE 6.2.1-15 (SHEET 37 OF 65)

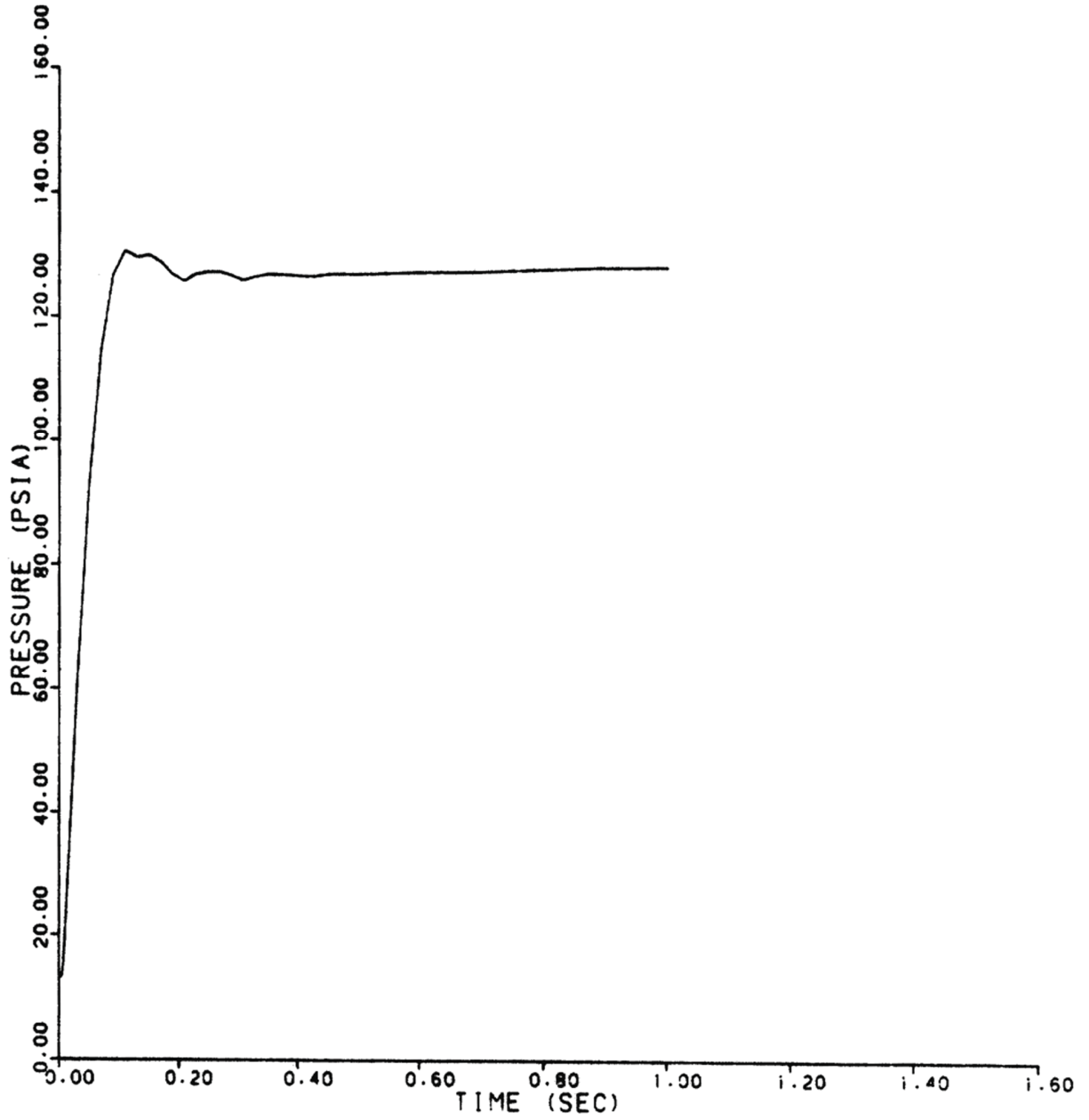

REV 13 4/06



VOGTLE
ELECTRIC GENERATING PLANT
UNIT 1 AND UNIT 2

REACTOR CAVITY PRESSURE
RESPONSE - NODE E38

FIGURE 6.2.1-15 (SHEET 38 OF 65)

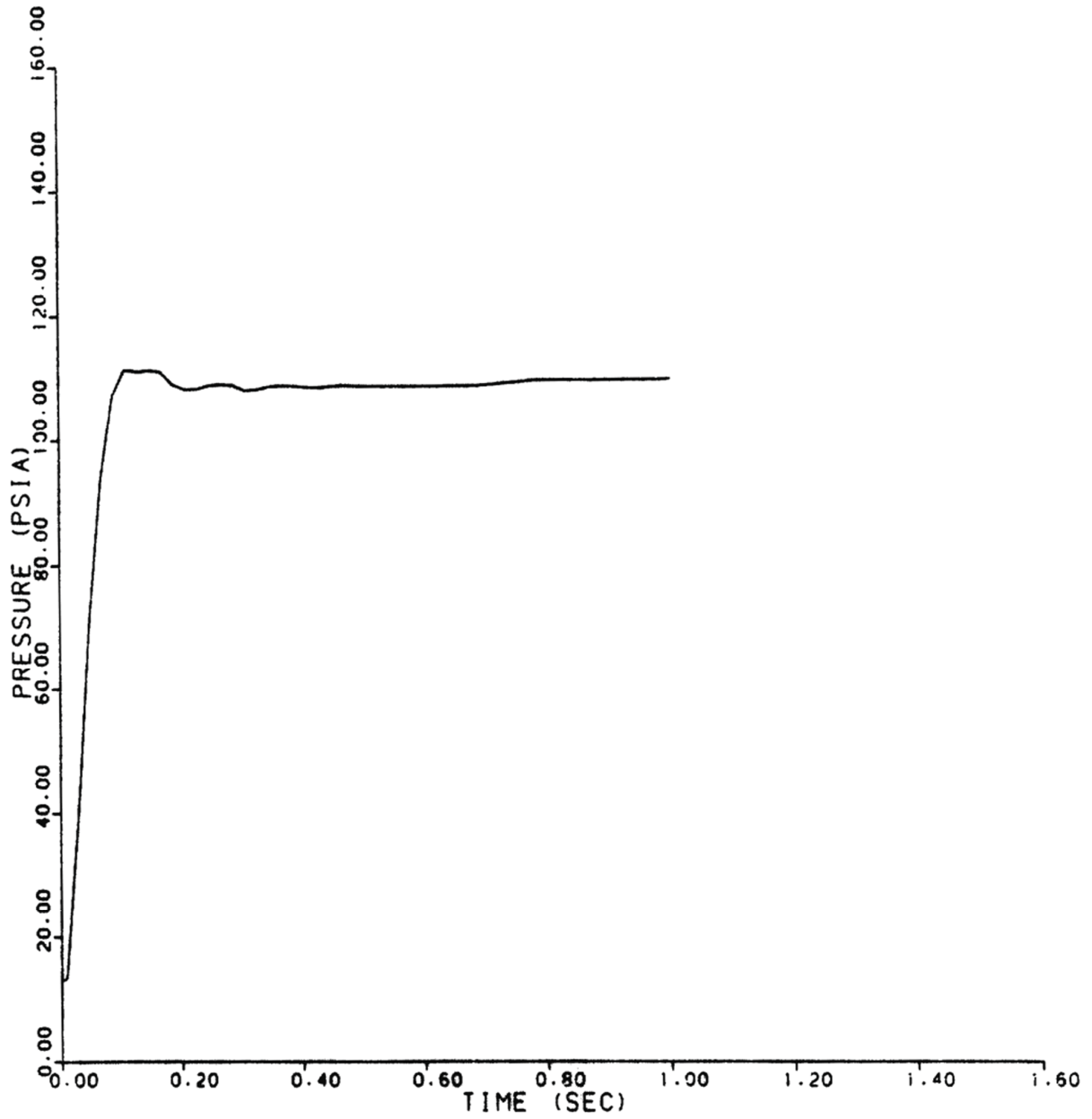

REV 13 4/06



VOGTLE
ELECTRIC GENERATING PLANT
UNIT 1 AND UNIT 2

REACTOR CAVITY PRESSURE
RESPONSE - NODE E39

FIGURE 6.2.1-15 (SHEET 39 OF 65)

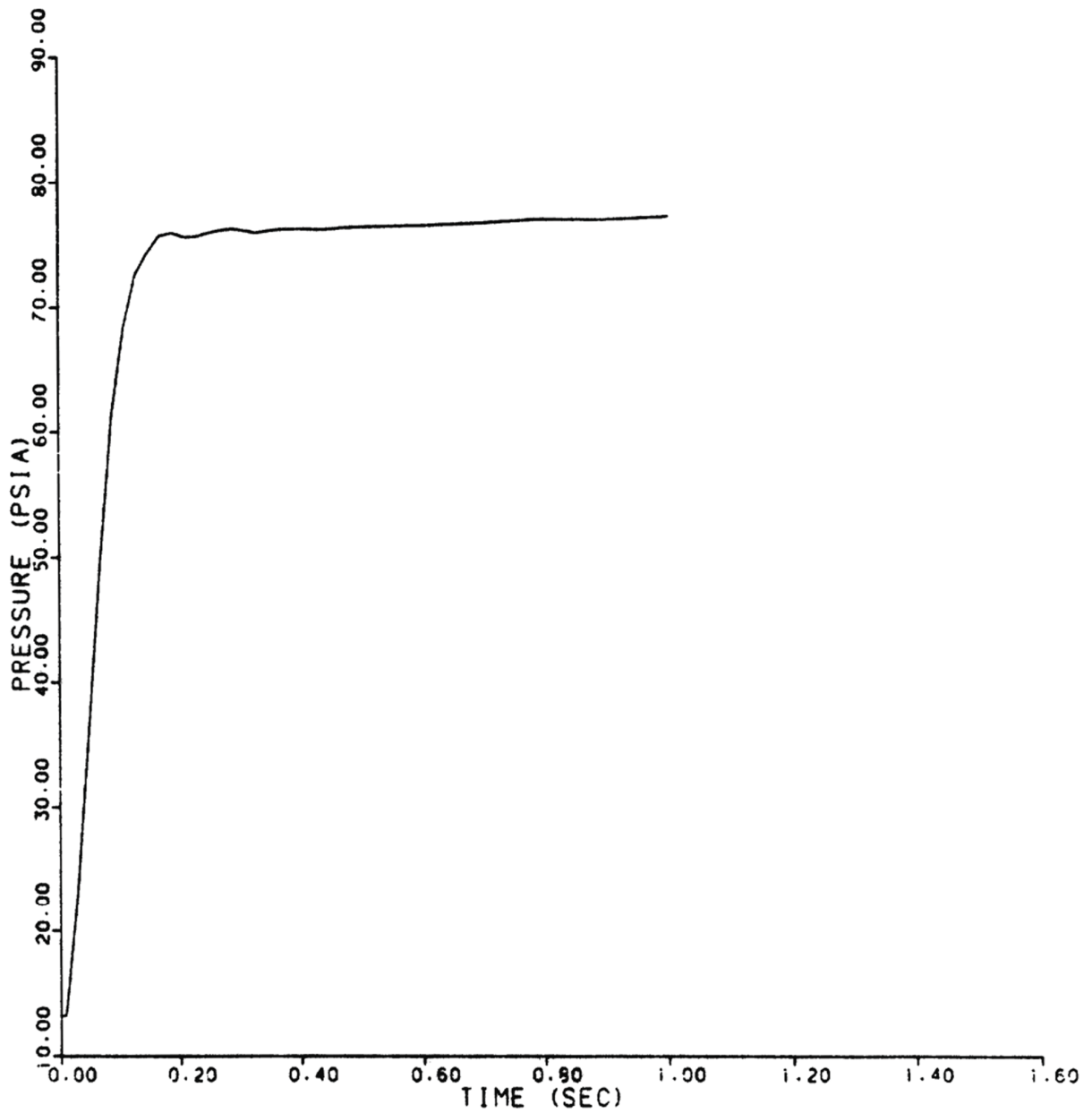

REV 13 4/06



VOGTLE
ELECTRIC GENERATING PLANT
UNIT 1 AND UNIT 2

REACTOR CAVITY PRESSURE
RESPONSE - NODE E40

FIGURE 6.2.1-15 (SHEET 40 OF 65)

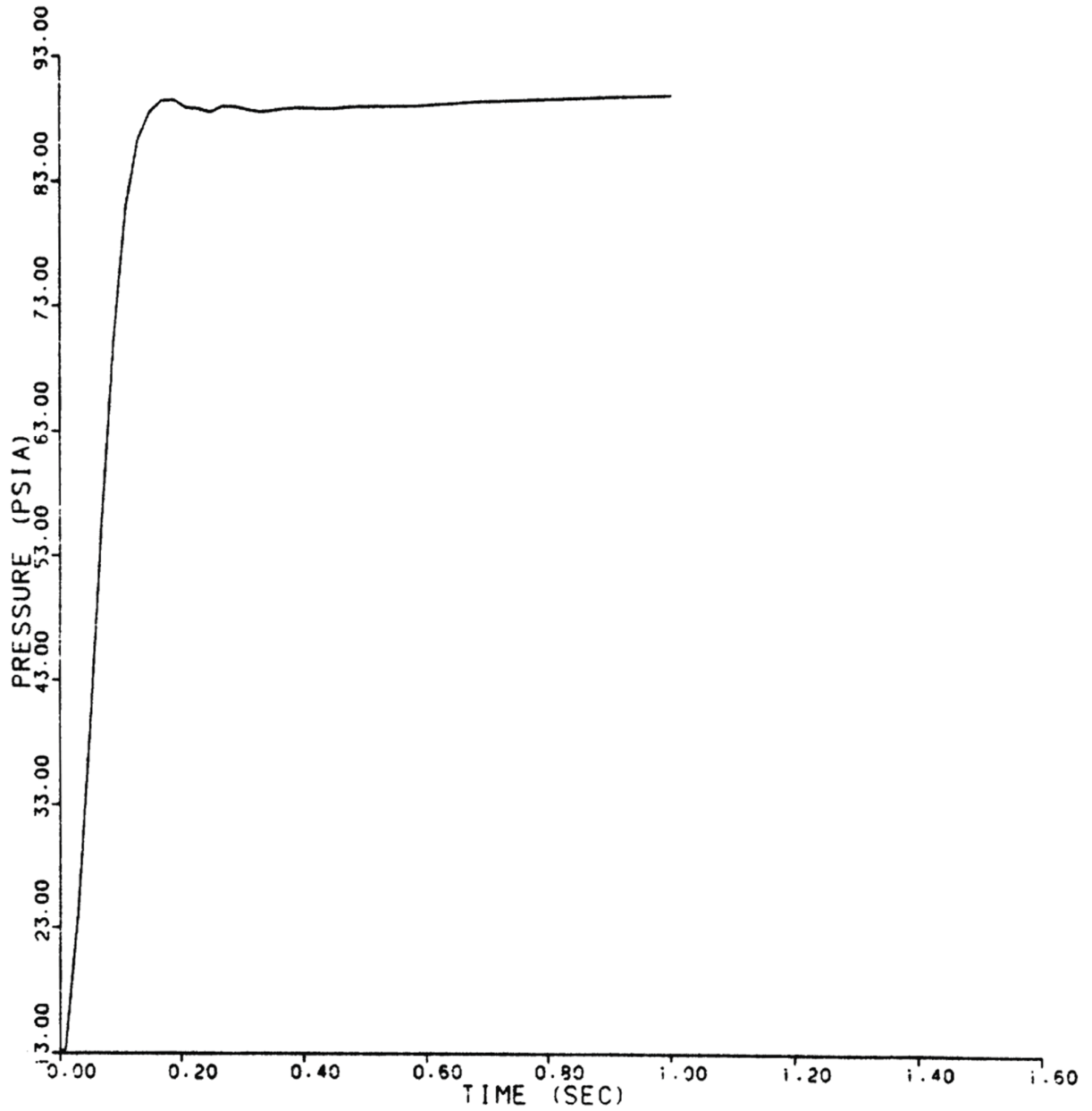

REV 13 4/06



VOGTLE
ELECTRIC GENERATING PLANT
UNIT 1 AND UNIT 2

REACTOR CAVITY PRESSURE
RESPONSE - NODE E41

FIGURE 6.2.1-15 (SHEET 41 OF 65)

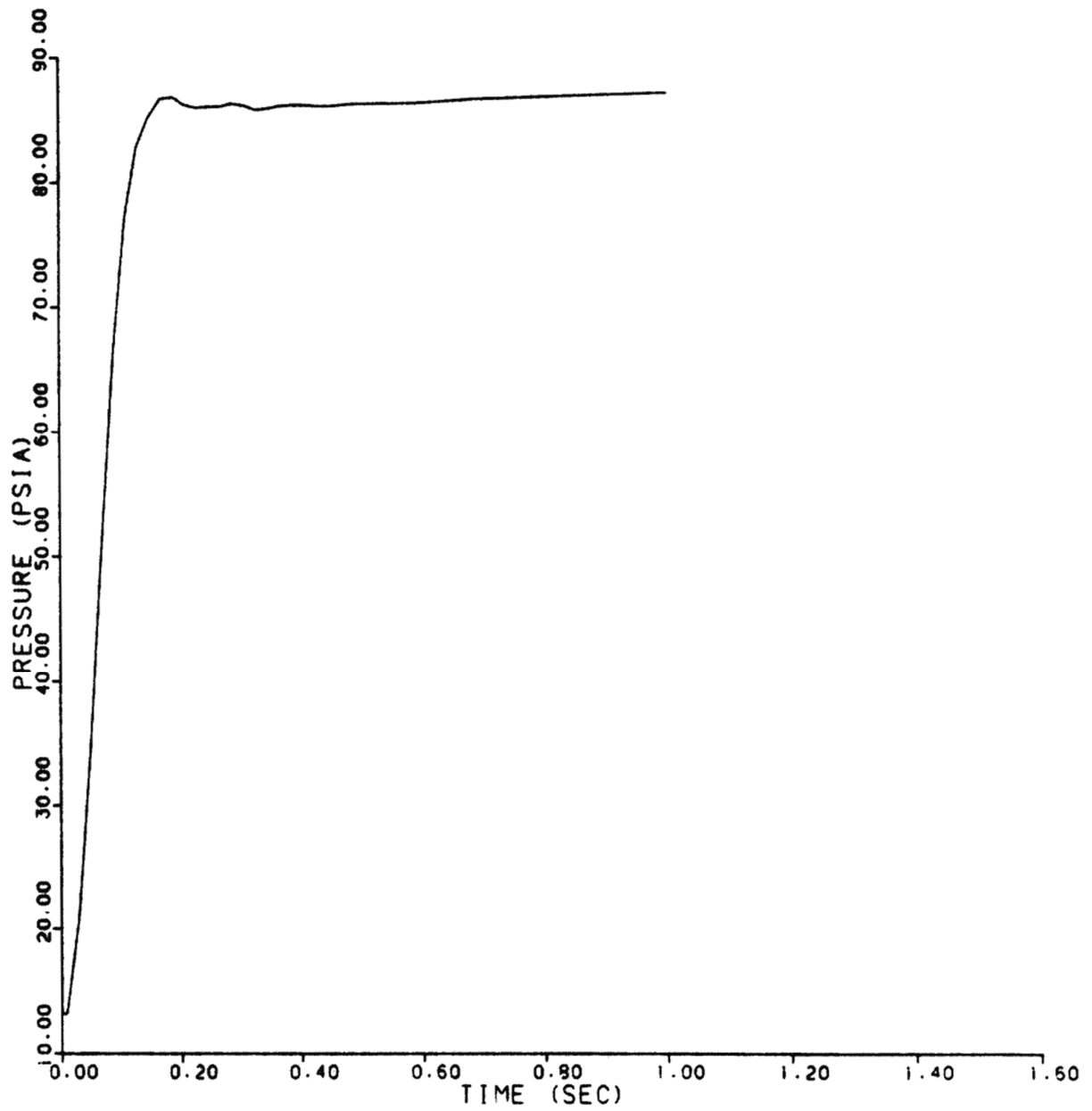

REV 13 4/06



VOGTLE
ELECTRIC GENERATING PLANT
UNIT 1 AND UNIT 2

REACTOR CAVITY PRESSURE
RESPONSE - NODE E42

FIGURE 6.2.1-15 (SHEET 42 OF 65)

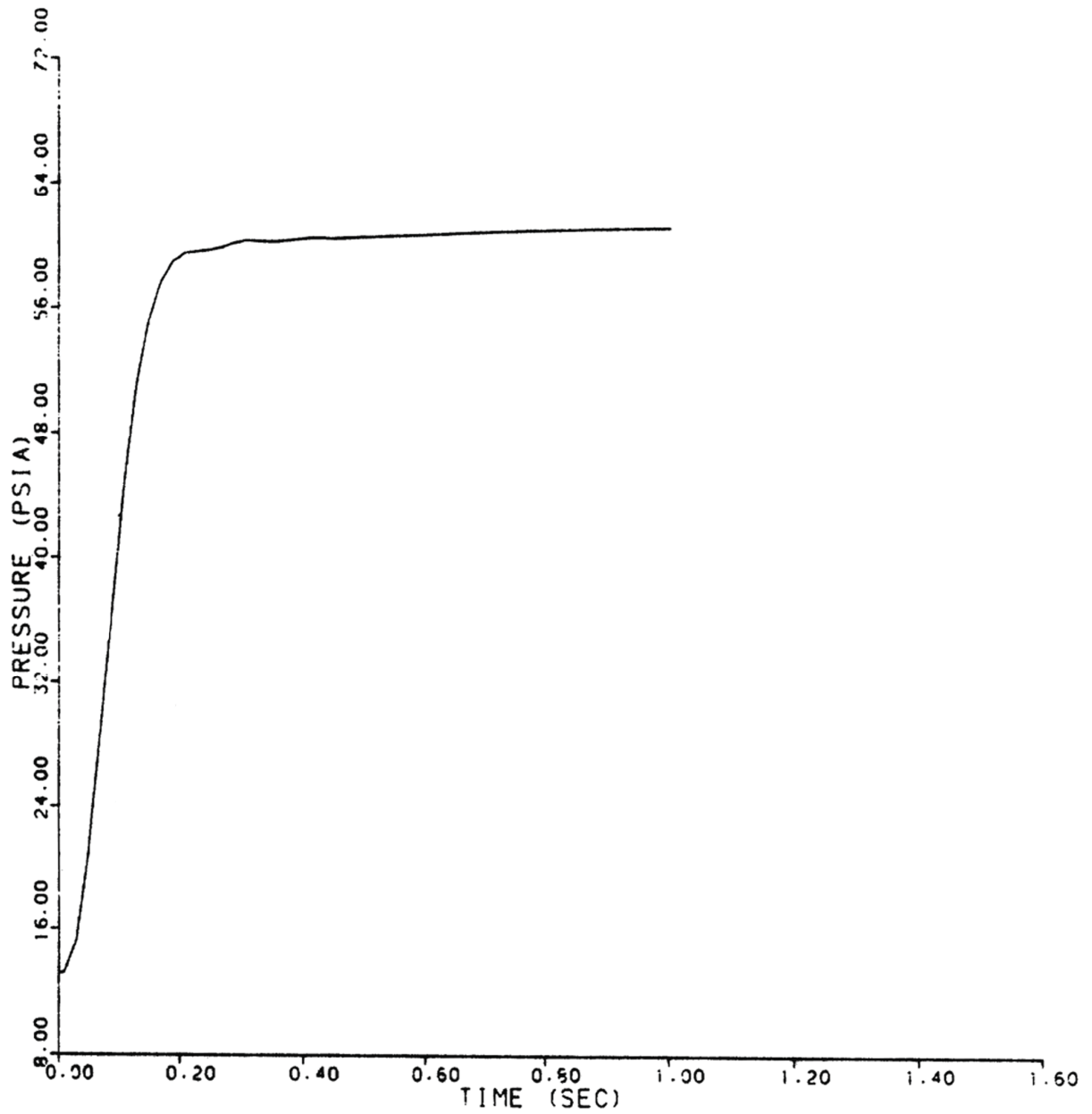

REV 13 4/06



VOGTLE
ELECTRIC GENERATING PLANT
UNIT 1 AND UNIT 2

REACTOR CAVITY PRESSURE
RESPONSE - NODE E43

FIGURE 6.2.1-15 (SHEET 43 OF 65)

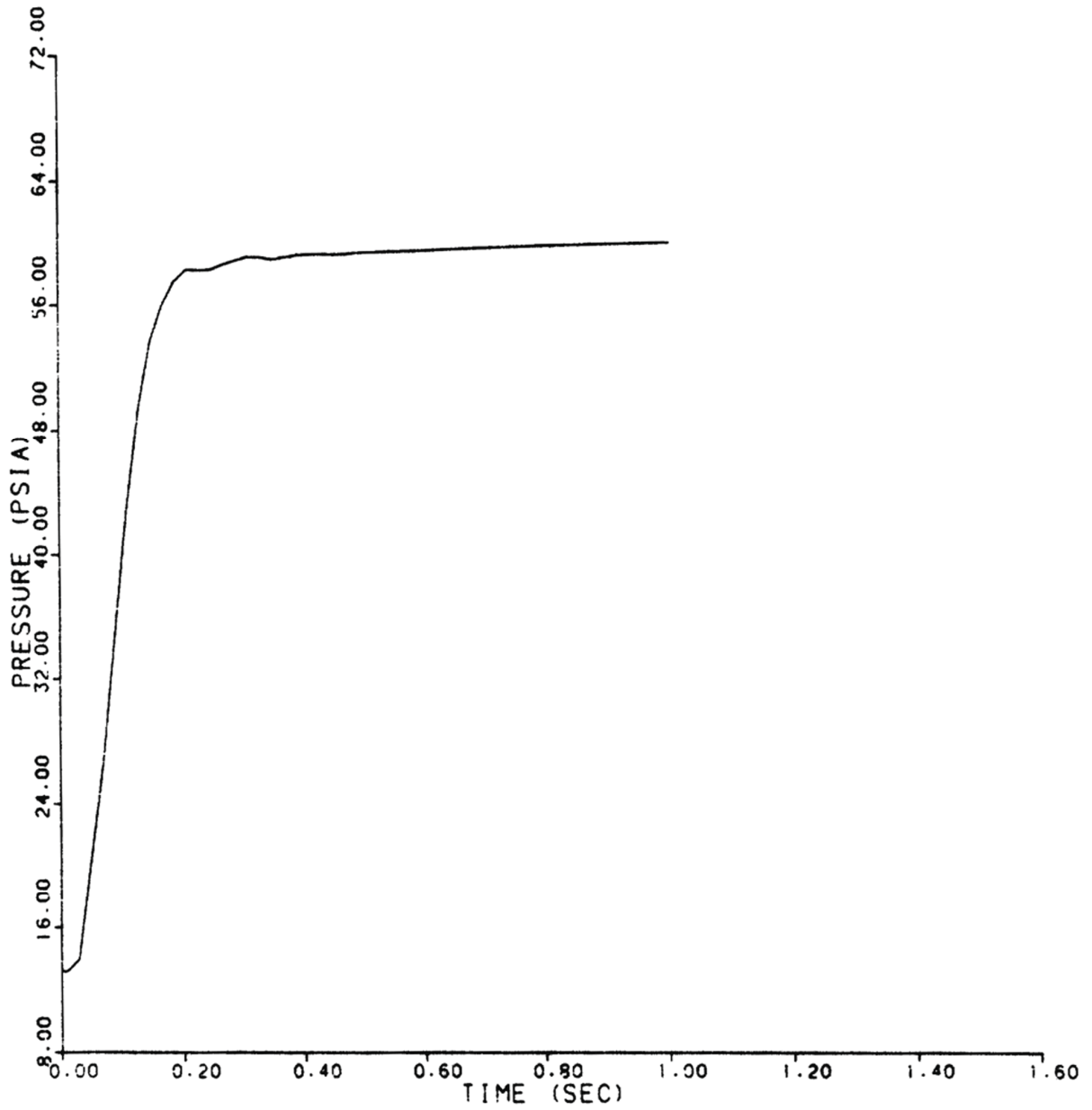

REV 13 4/06



VOGTLE
ELECTRIC GENERATING PLANT
UNIT 1 AND UNIT 2

REACTOR CAVITY PRESSURE
RESPONSE - NODE E44

FIGURE 6.2.1-15 (SHEET 44 OF 65)

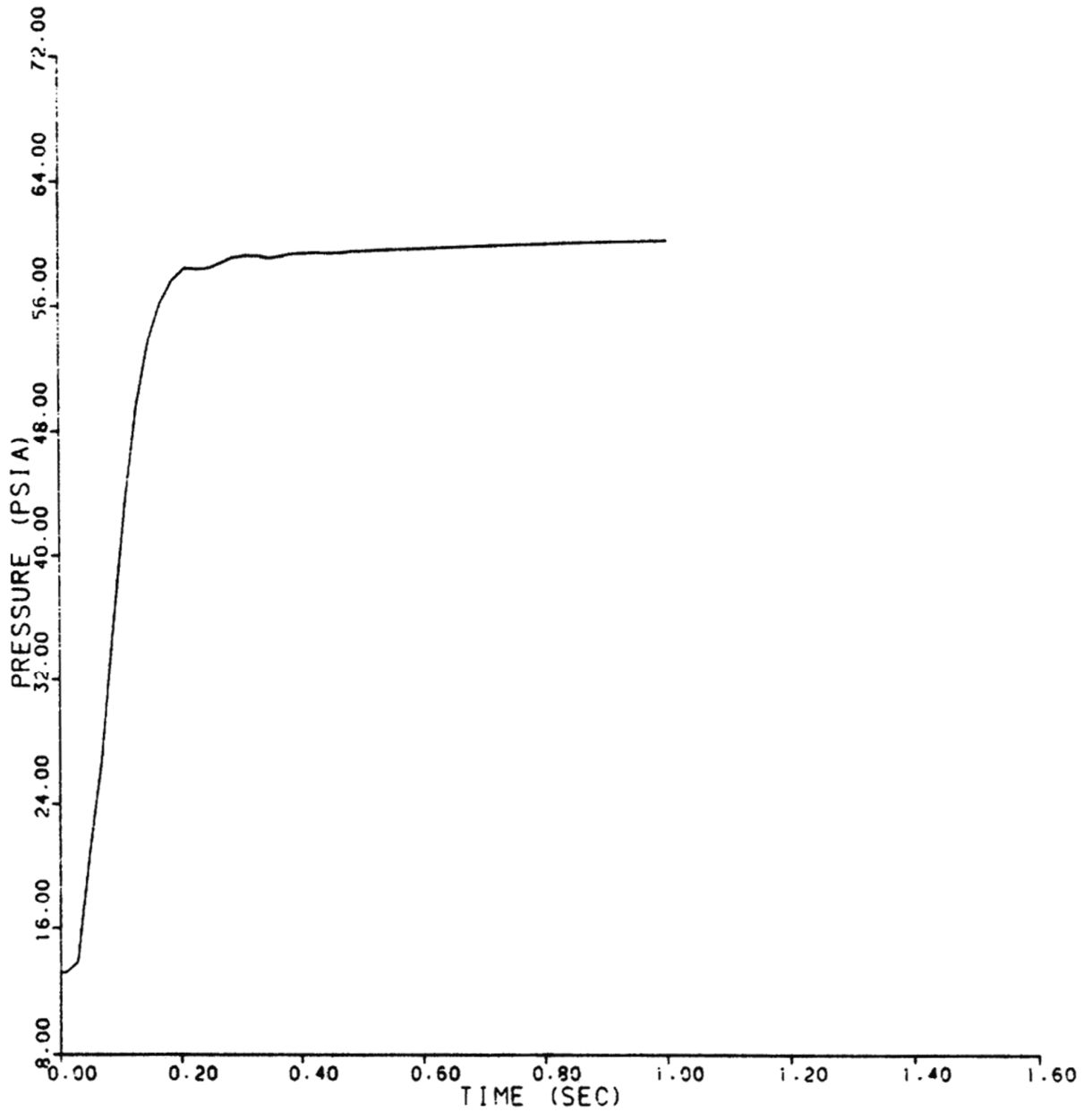

REV 13 4/06



VOGTLE
ELECTRIC GENERATING PLANT
UNIT 1 AND UNIT 2

REACTOR CAVITY PRESSURE
RESPONSE - NODE E45

FIGURE 6.2.1-15 (SHEET 45 OF 65)

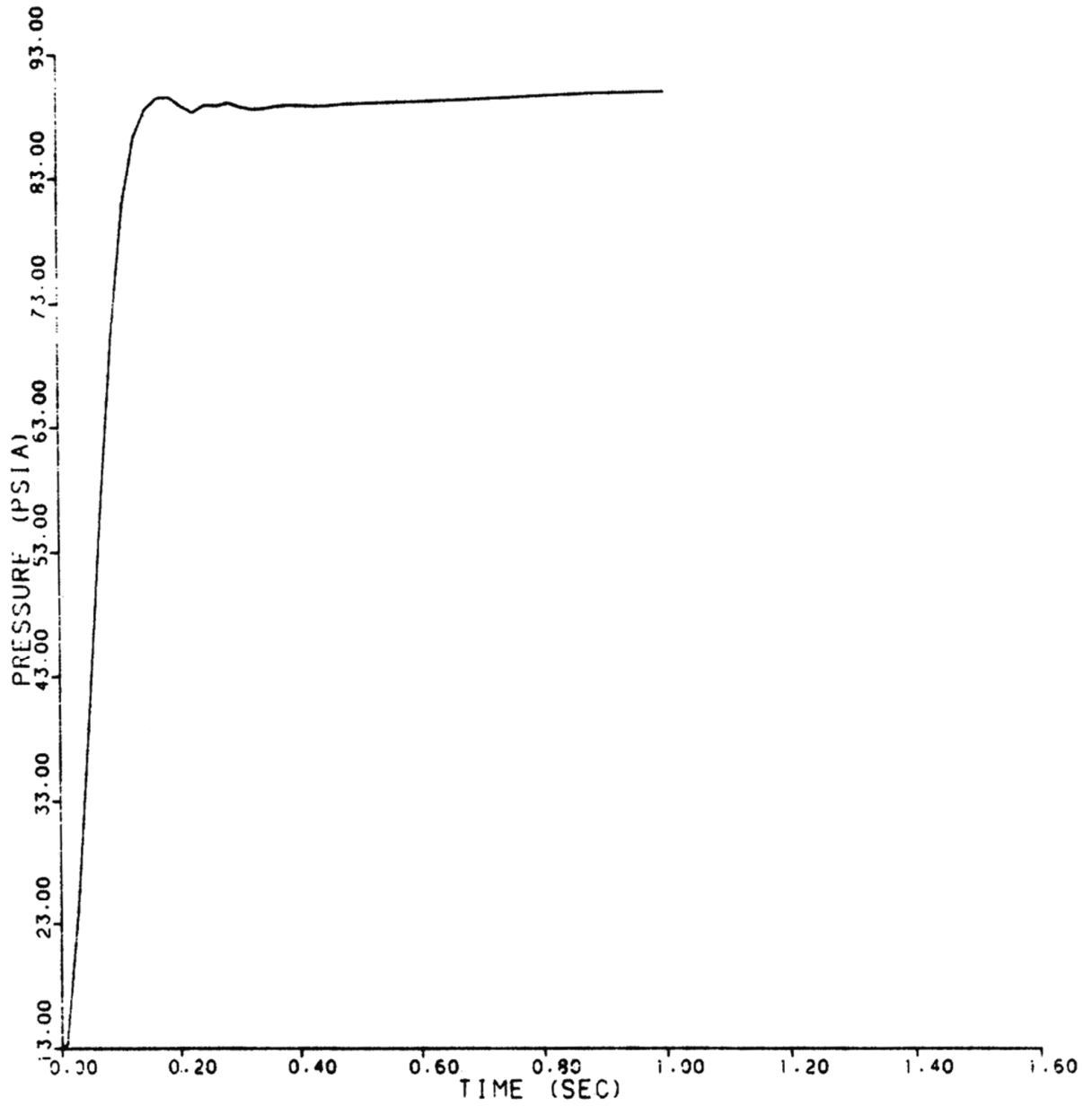

REV 13 4/06



VOGTLE
ELECTRIC GENERATING PLANT
UNIT 1 AND UNIT 2

REACTOR CAVITY PRESSURE
RESPONSE – NODE E46

FIGURE 6.2.1–15 (SHEET 46 OF 65)

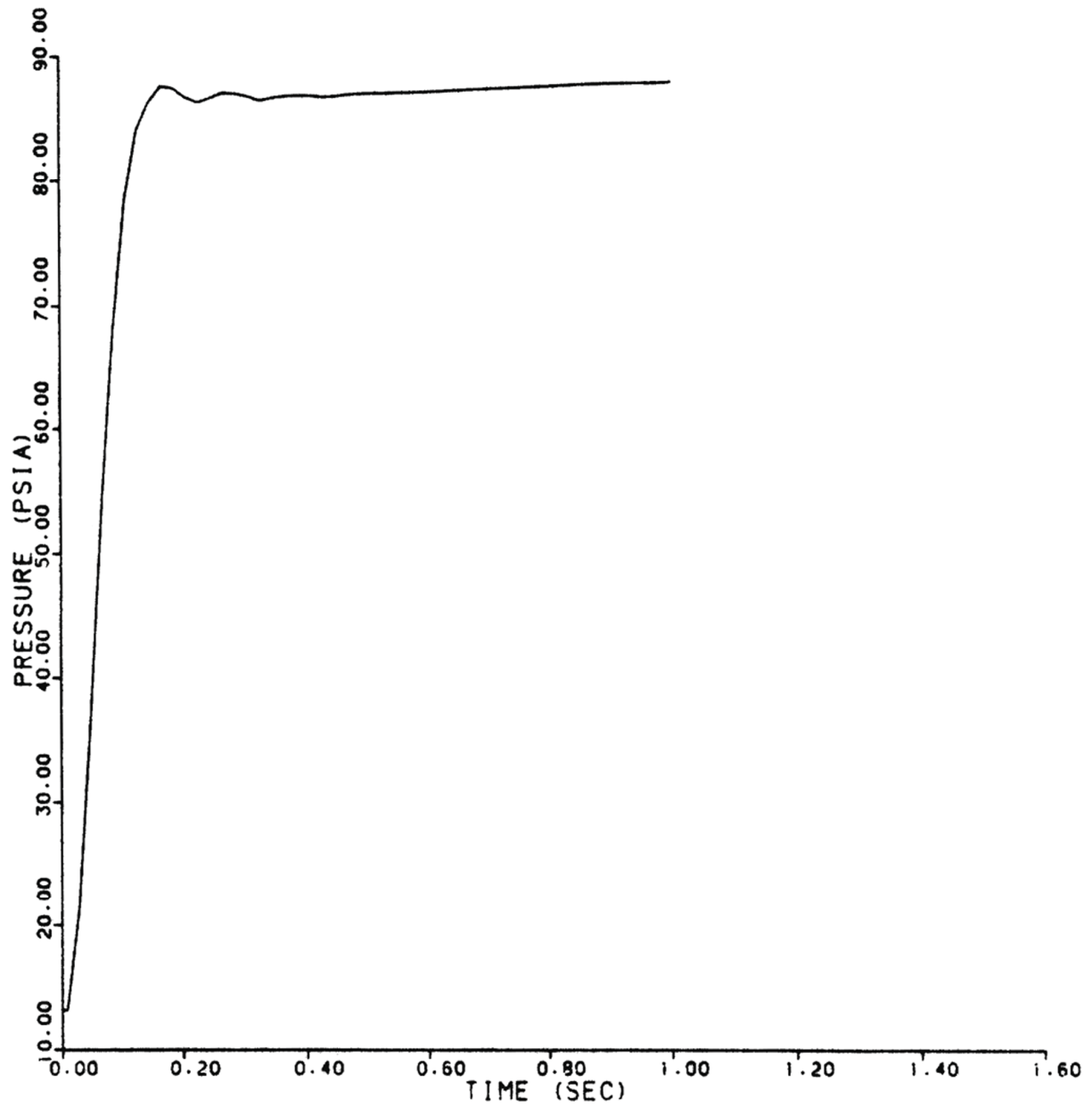

REV 13 4/06



VOGTLE
ELECTRIC GENERATING PLANT
UNIT 1 AND UNIT 2

REACTOR CAVITY PRESSURE
RESPONSE - NODE E47

FIGURE 6.2.1-15 (SHEET 47 OF 65)

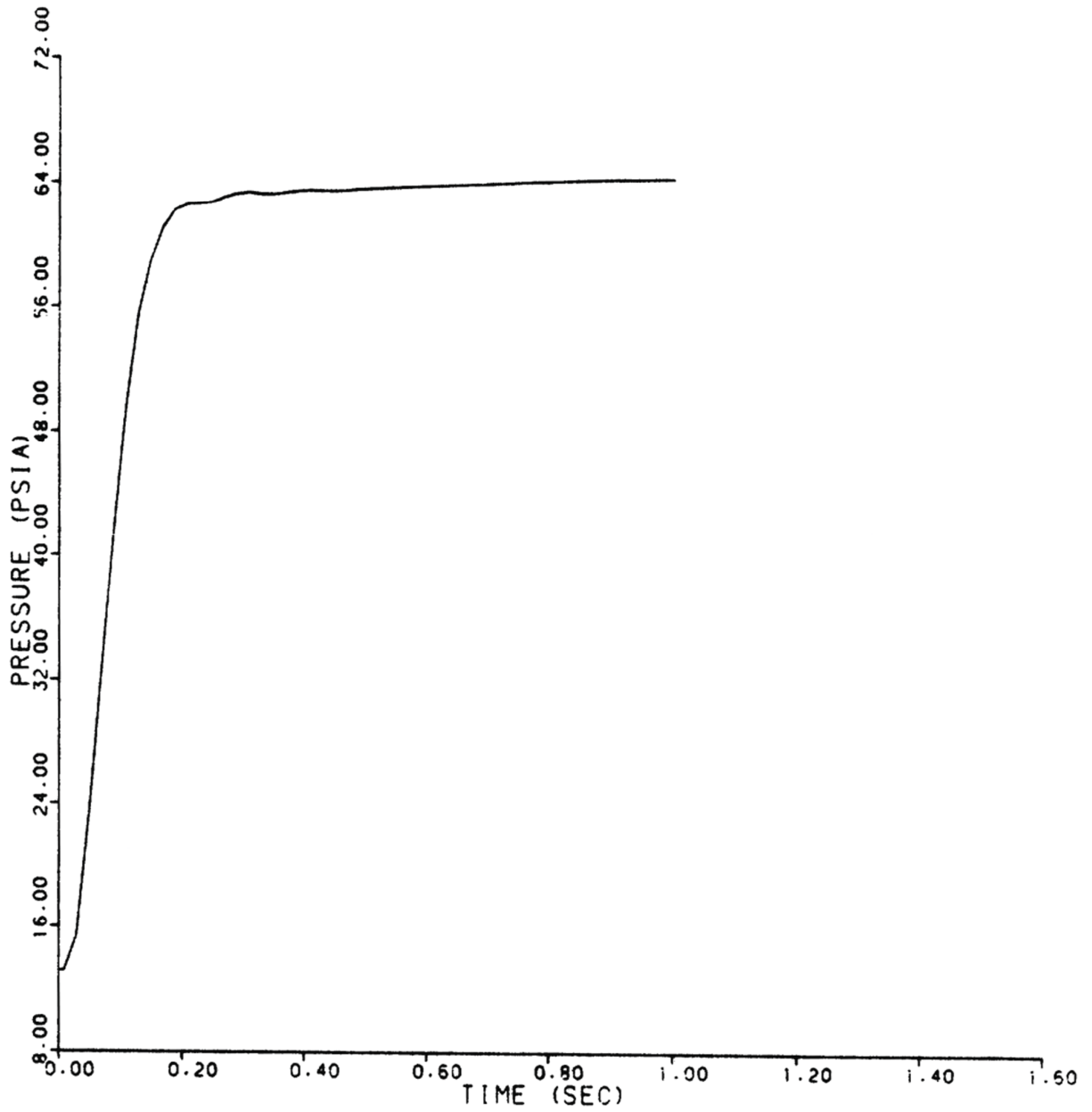

REV 13 4/06



VOGTLE
ELECTRIC GENERATING PLANT
UNIT 1 AND UNIT 2

REACTOR CAVITY PRESSURE
RESPONSE - NODE E48

FIGURE 6.2.1-15 (SHEET 48 OF 65)

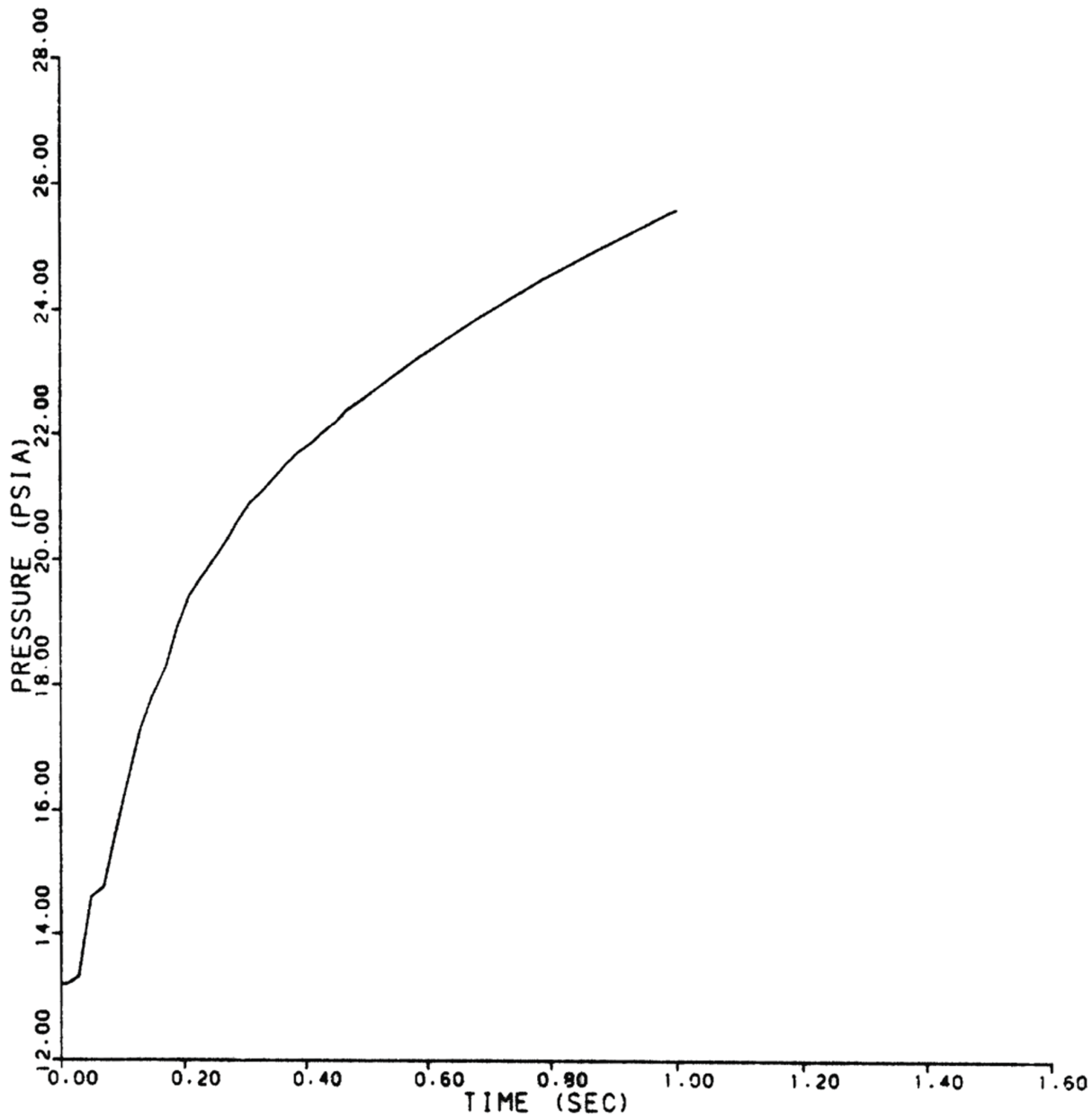

REV 13 4/06



VOGTLE
ELECTRIC GENERATING PLANT
UNIT 1 AND UNIT 2

REACTOR CAVITY PRESSURE
RESPONSE - NODE E49

FIGURE 6.2.1-15 (SHEET 49 OF 65)

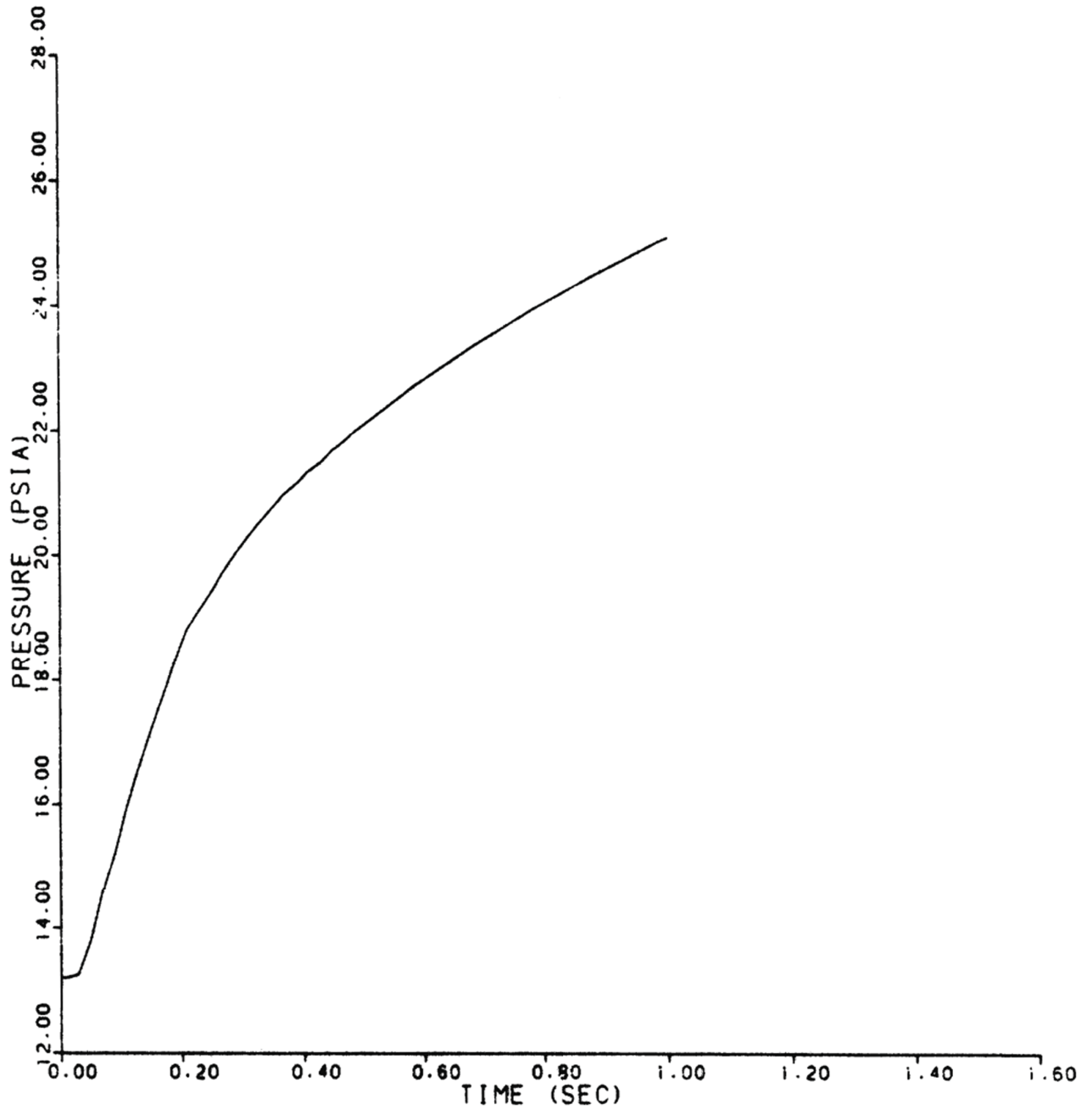

REV 13 4/06



VOGTLE
ELECTRIC GENERATING PLANT
UNIT 1 AND UNIT 2

REACTOR CAVITY PRESSURE
RESPONSE - NODE E50

FIGURE 6.2.1-15 (SHEET 50 OF 65)

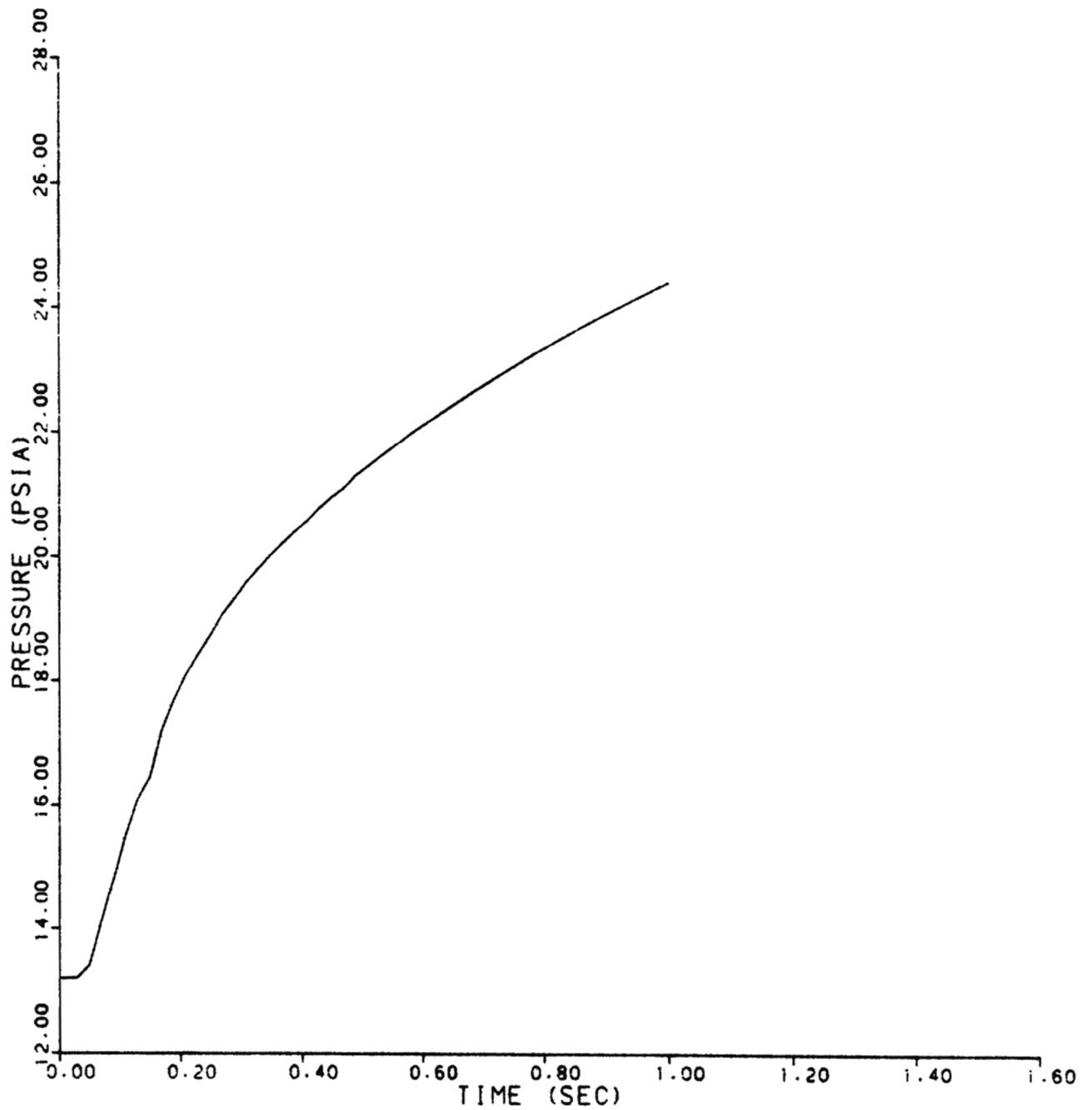

REV 13 4/06



VOGTLE
ELECTRIC GENERATING PLANT
UNIT 1 AND UNIT 2

REACTOR CAVITY PRESSURE
RESPONSE - NODE E51

FIGURE 6.2.1-15 (SHEET 51 OF 65)

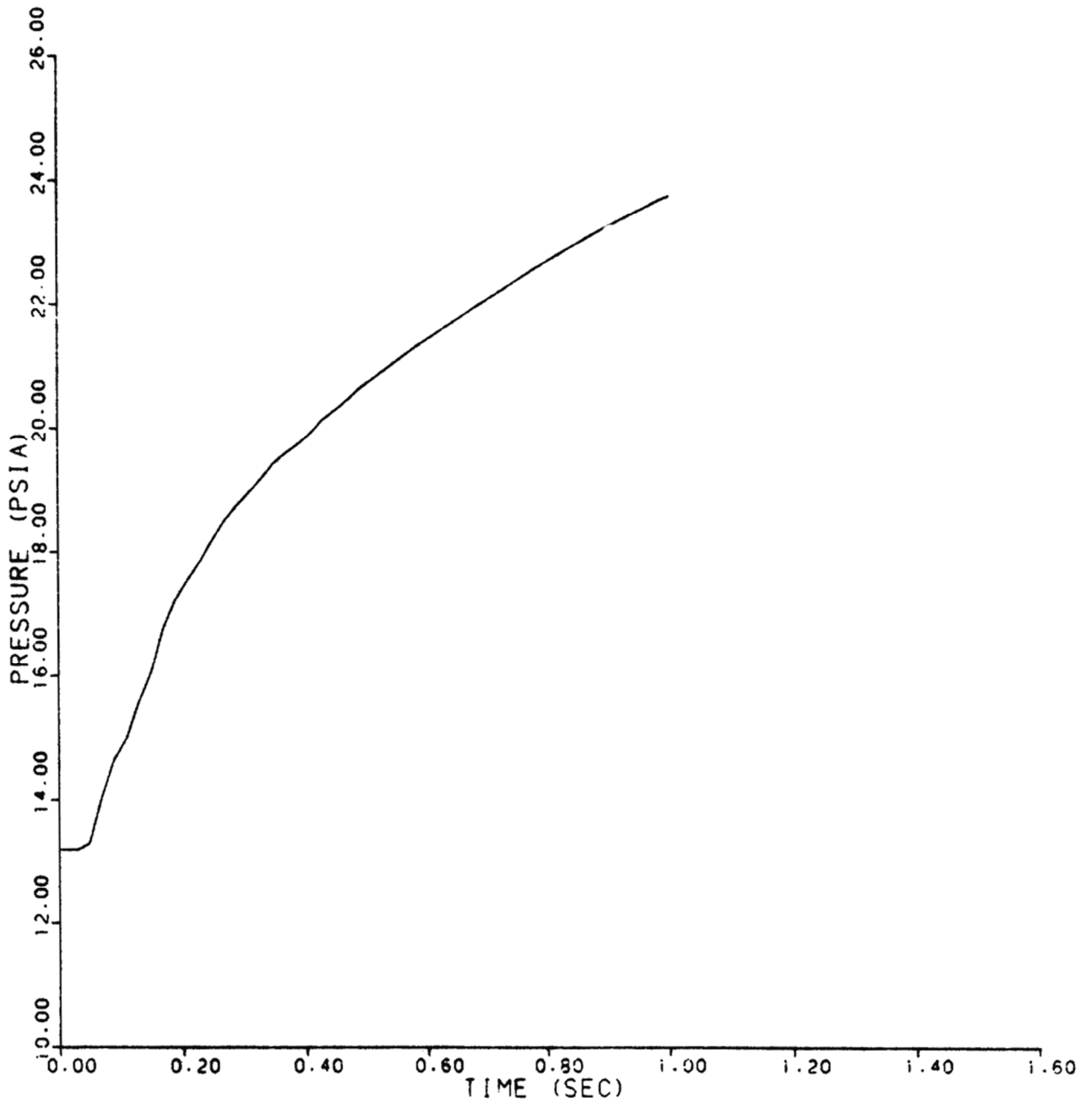

REV 13 4/06



VOGTLE
ELECTRIC GENERATING PLANT
UNIT 1 AND UNIT 2

REACTOR CAVITY PRESSURE
RESPONSE - NODE E52

FIGURE 6.2.1-15 (SHEET 52 OF 65)

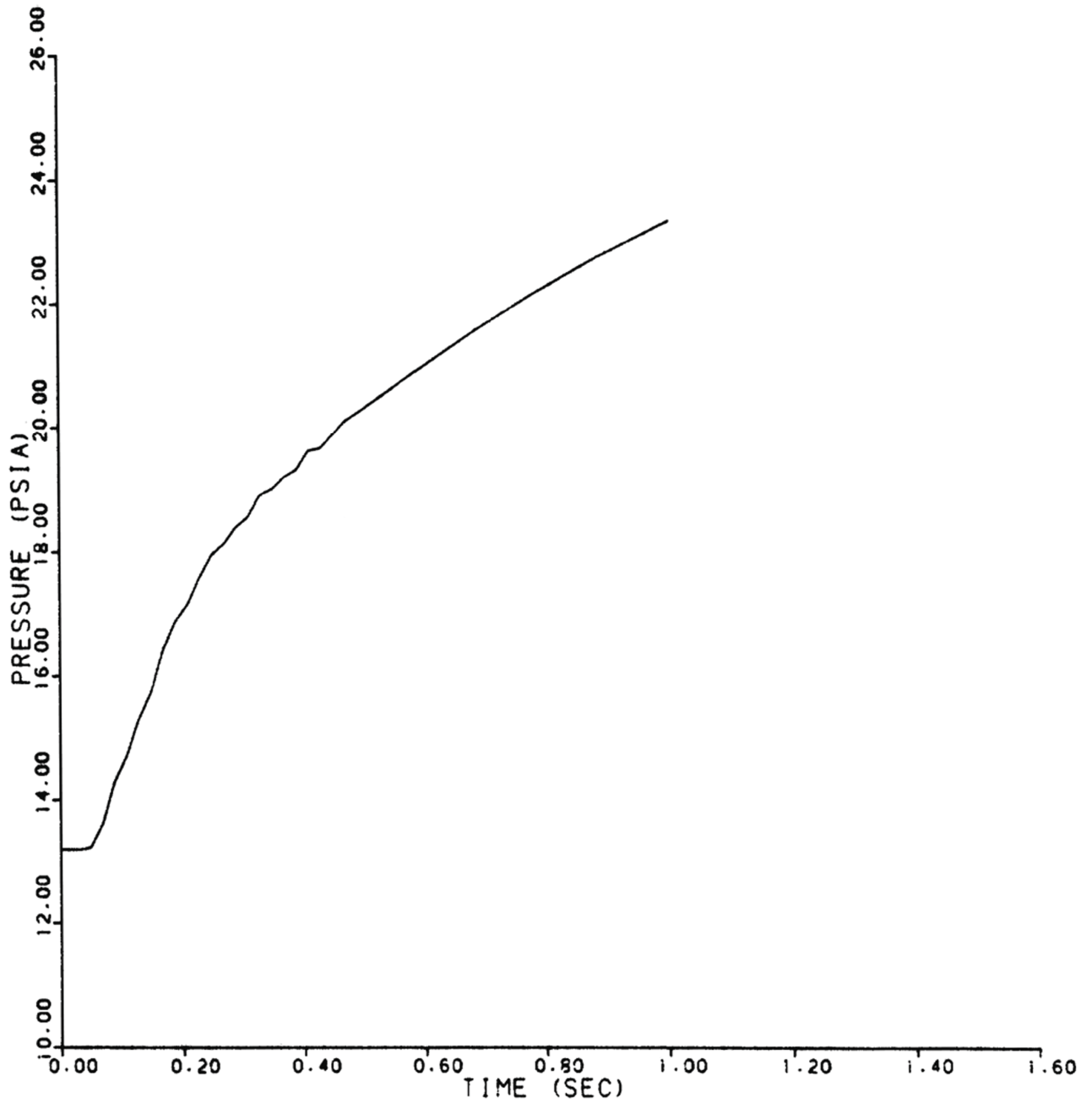

REV 13 4/06



VOGTLE
ELECTRIC GENERATING PLANT
UNIT 1 AND UNIT 2

REACTOR CAVITY PRESSURE
RESPONSE – ODE E53

FIGURE 6.2.1–15 (SHEET 53 OF 65)

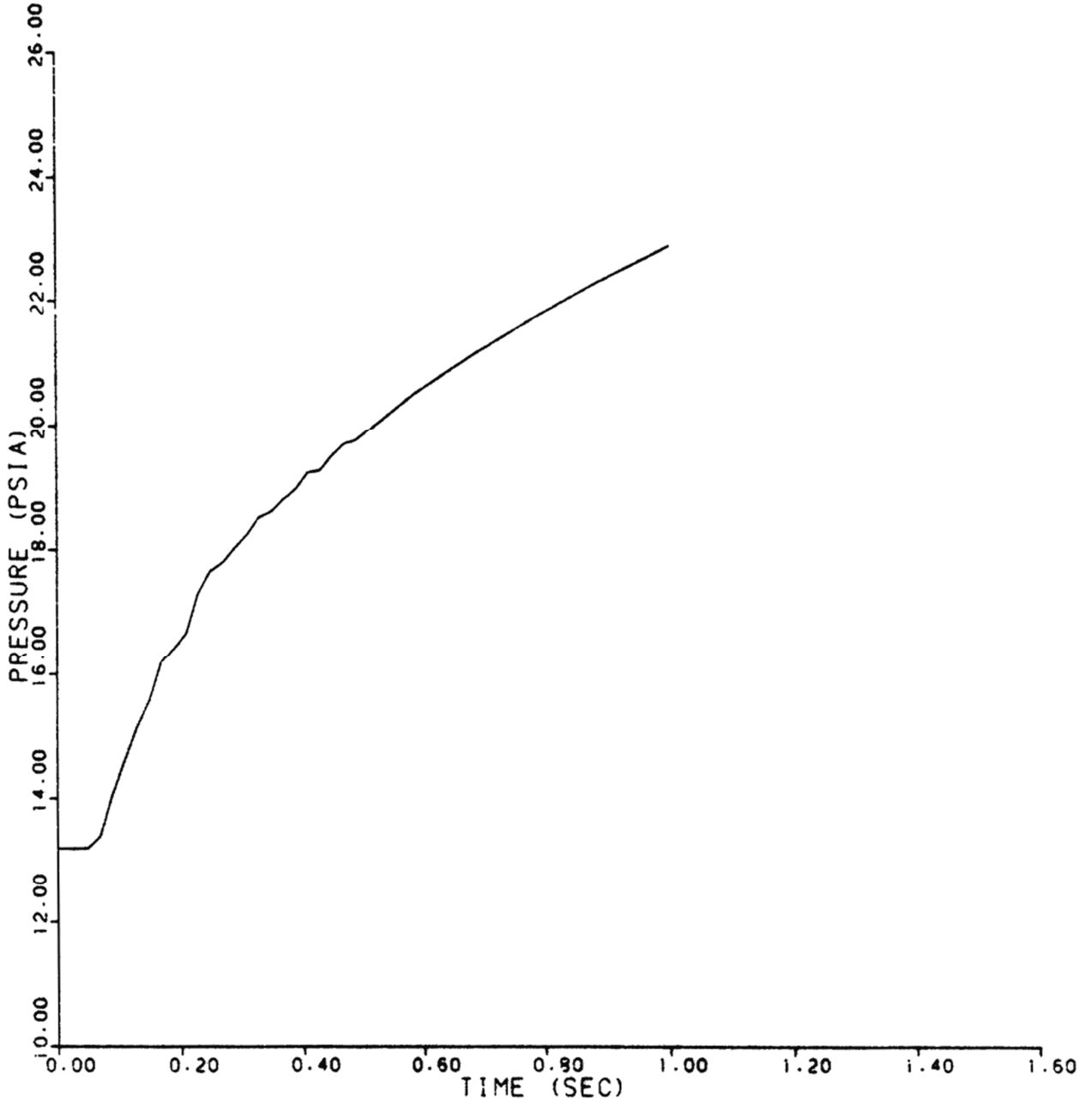

REV 13 4/06



VOGTLE
ELECTRIC GENERATING PLANT
UNIT 1 AND UNIT 2

REACTOR CAVITY PRESSURE
RESPONSE - NODE E54

FIGURE 6.2.1-15 (SHEET 54 OF 65)

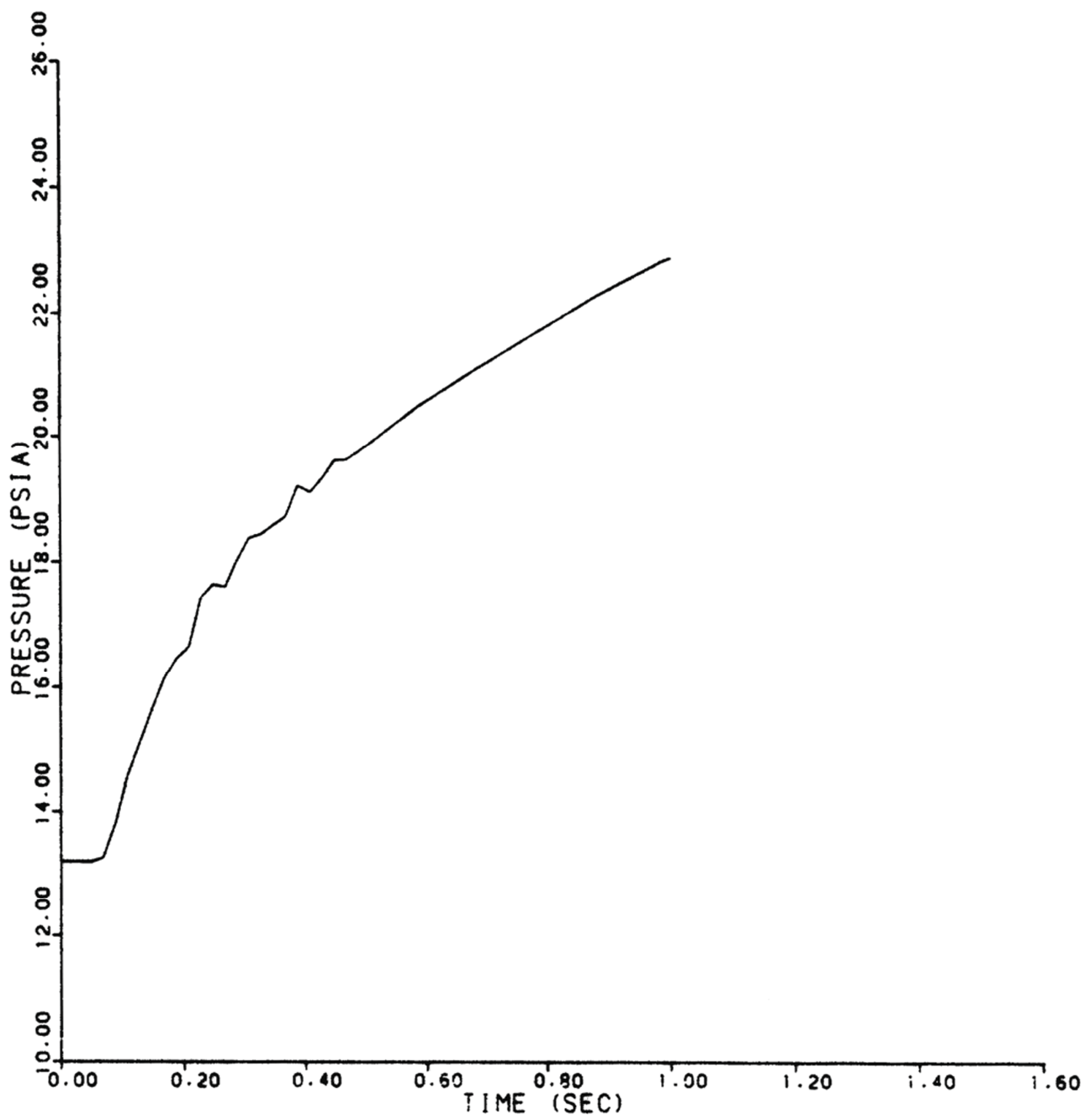

REV 13 4/06



VOGTLE
ELECTRIC GENERATING PLANT
UNIT 1 AND UNIT 2

REACTOR CAVITY PRESSURE
RESPONSE - NODE E55

FIGURE 6.2.1-15 (SHEET 55 OF 65)

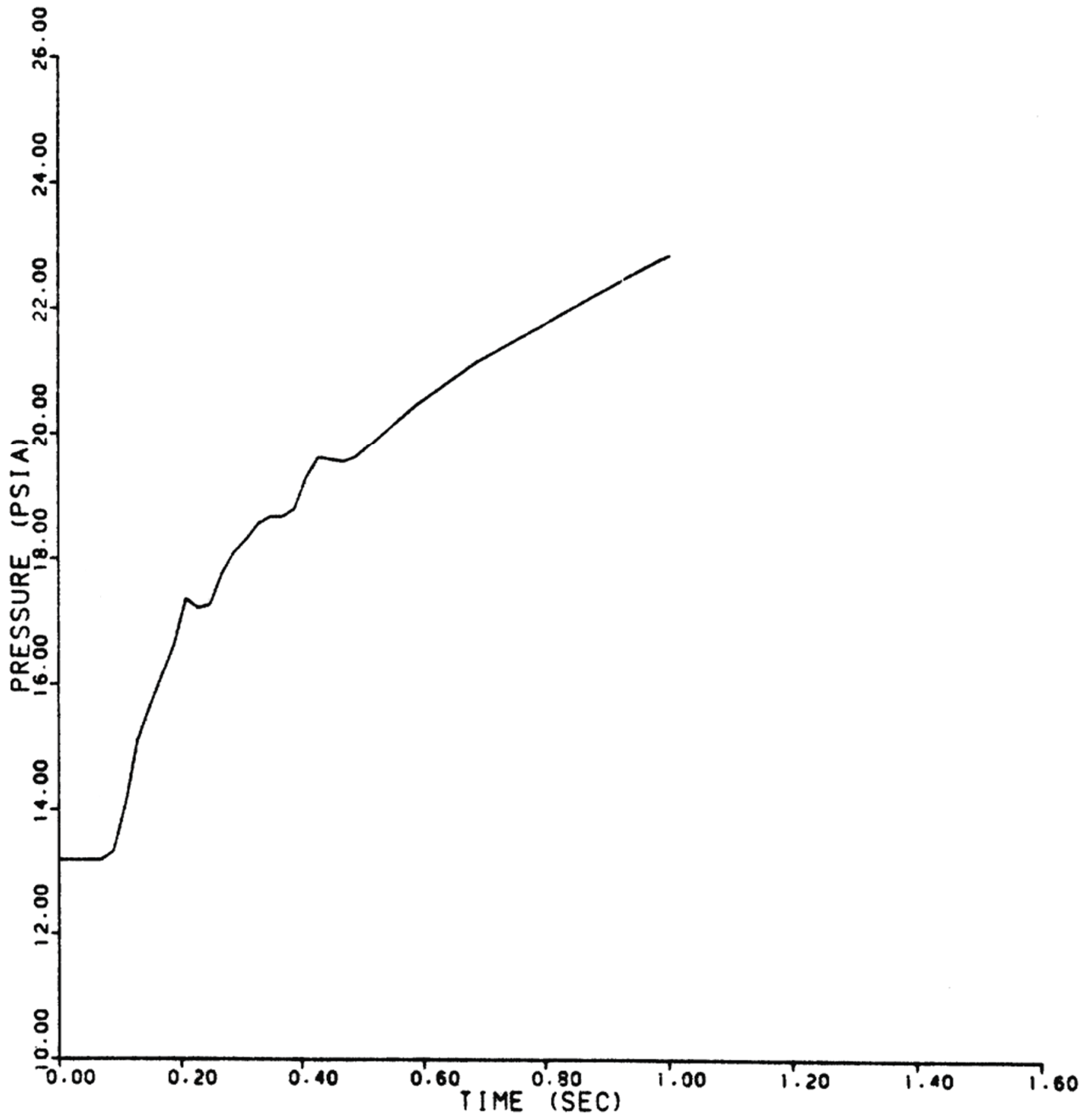

REV 13 4/06



VOGTLE
ELECTRIC GENERATING PLANT
UNIT 1 AND UNIT 2

REACTOR CAVITY PRESSURE
RESPONSE - NODE E56

FIGURE 6.2.1-15 (SHEET 56 OF 65)

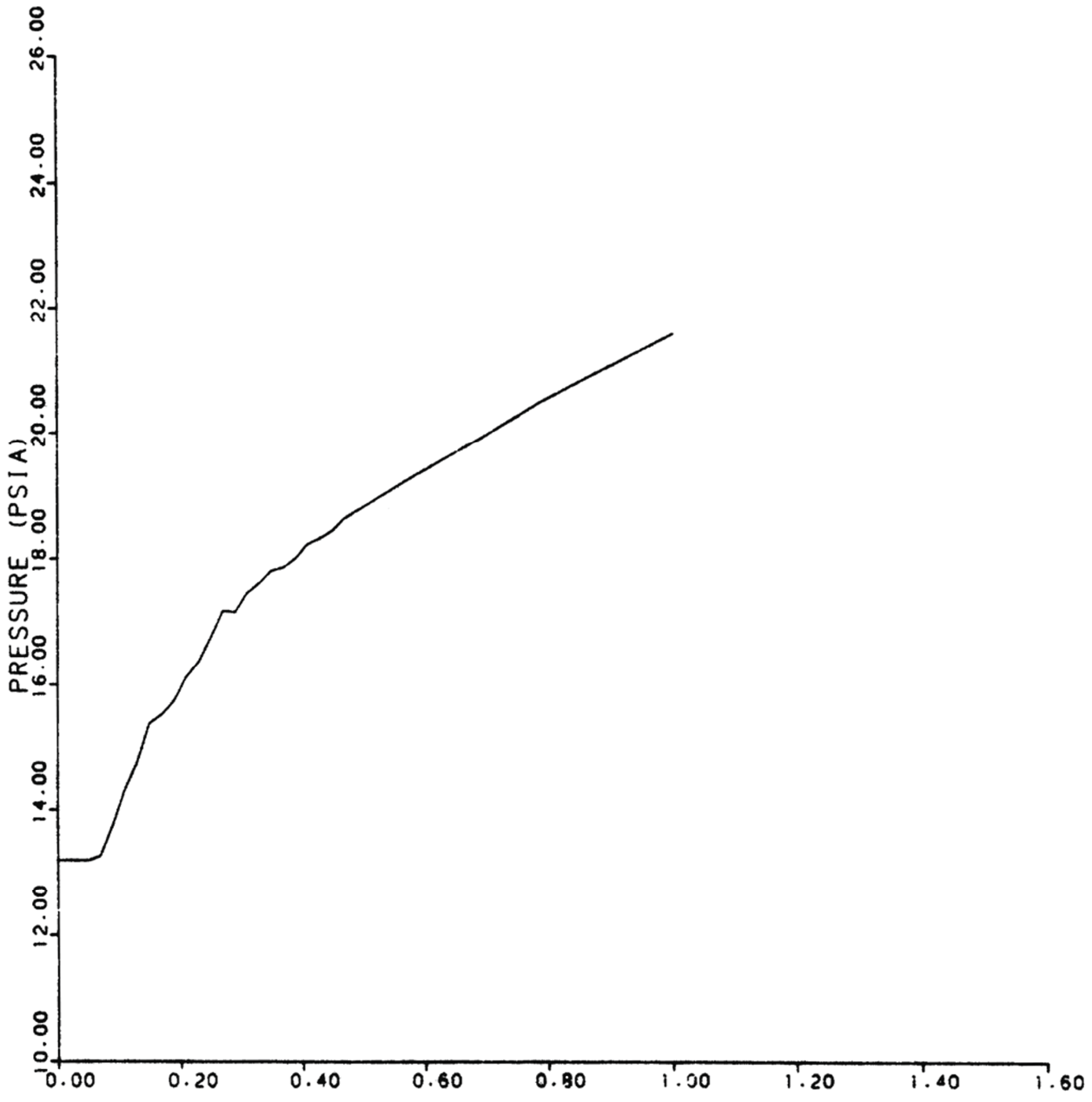

REV 13 4/06



VOGTLE
ELECTRIC GENERATING PLANT
UNIT 1 AND UNIT 2

REACTOR CAVITY PRESSURE
RESPONSE – NODE E57

FIGURE 6.2.1-15 (SHEET 57 OF 65)

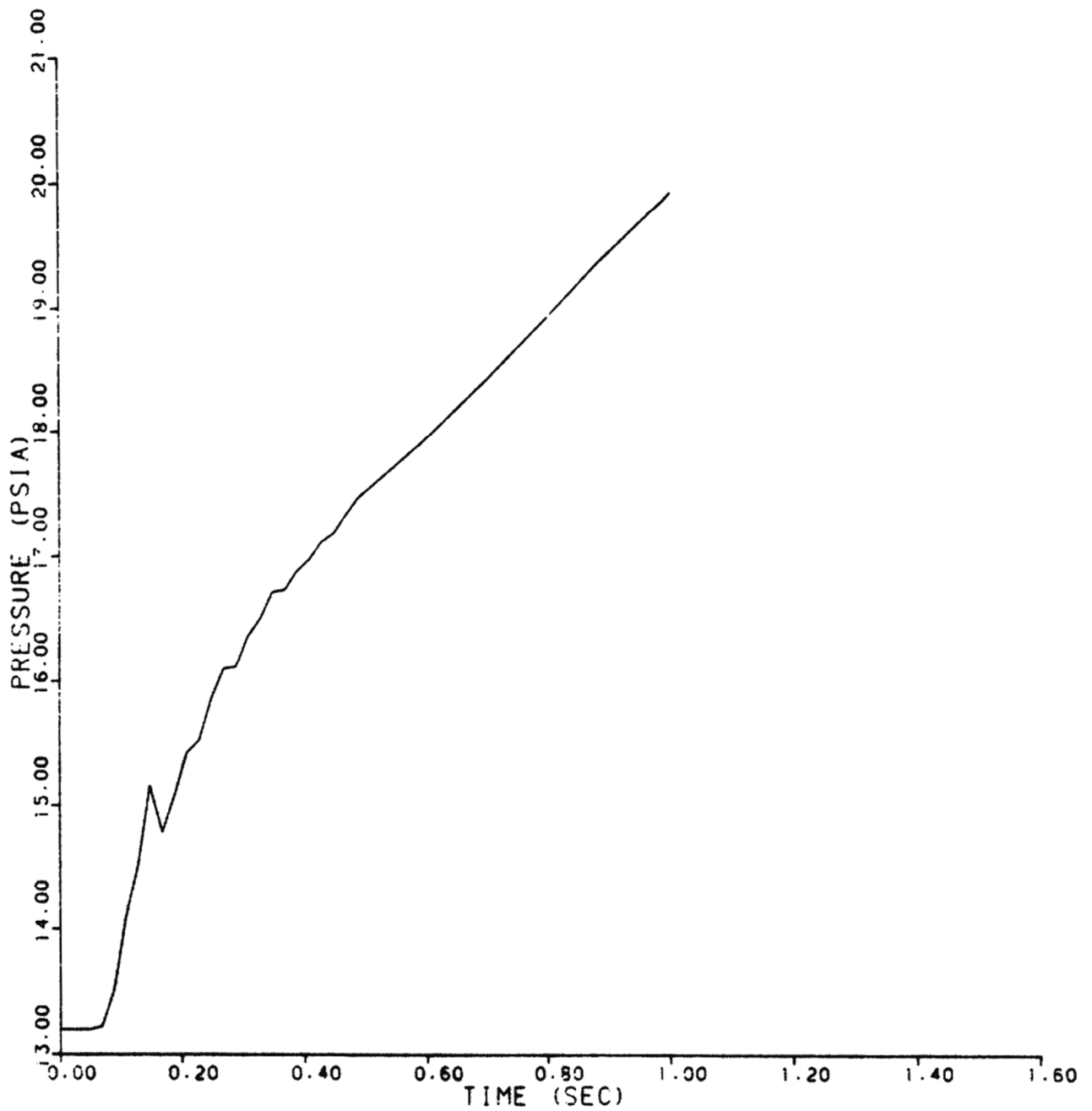

REV 13 4/06



VOGTLE
ELECTRIC GENERATING PLANT
UNIT 1 AND UNIT 2

REACTOR CAVITY PRESSURE
RESPONSE – NODE E58

FIGURE 6.2.1-15 (SHEET 58 OF 65)

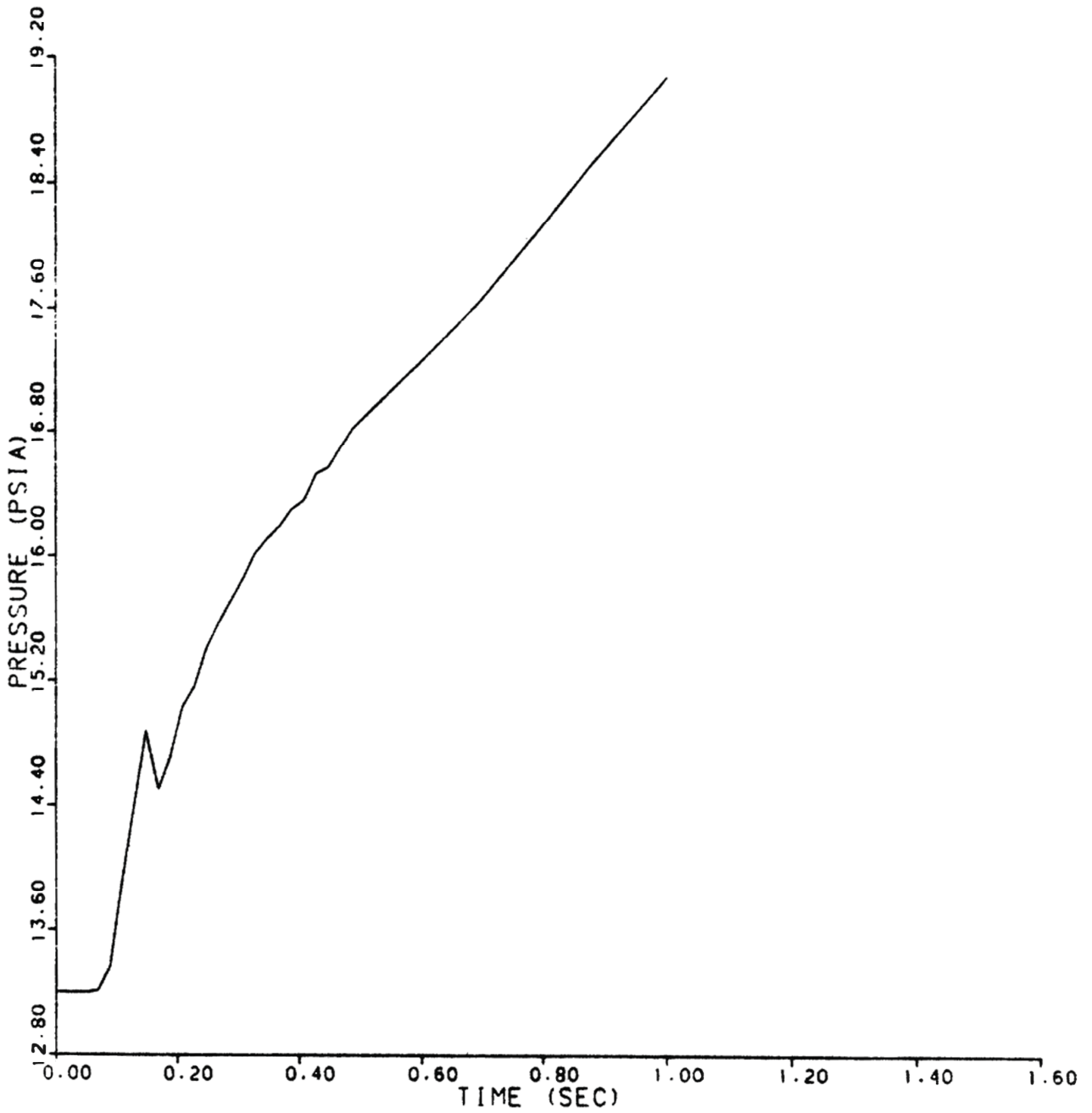

REV 13 4/06



VOGTLE
ELECTRIC GENERATING PLANT
UNIT 1 AND UNIT 2

REACTOR CAVITY PRESSURE
RESPONSE – NODE E59

FIGURE 6.2.1-15 (SHEET 59 OF 65)

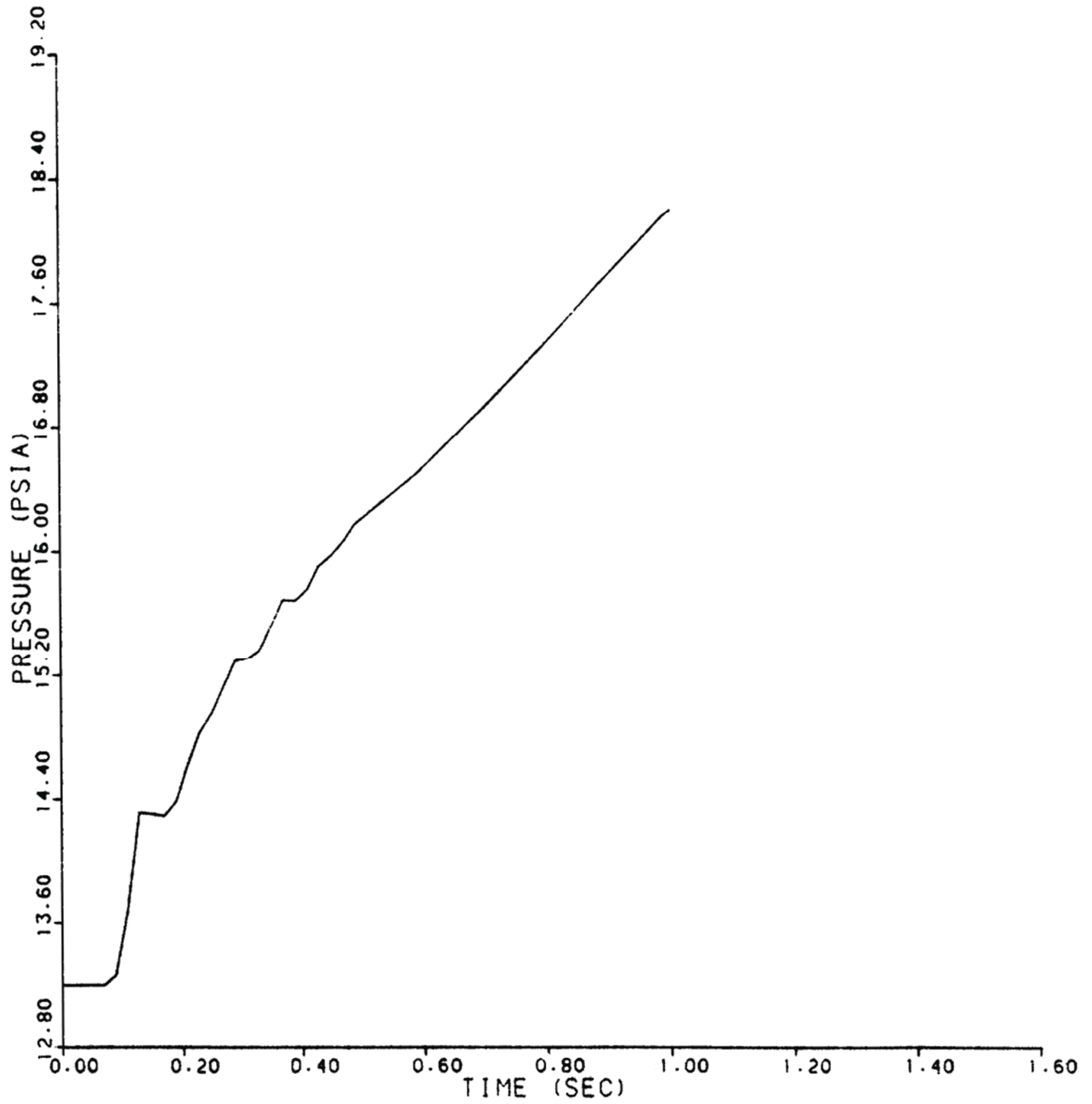

REV 13 4/06



VOGTLE
ELECTRIC GENERATING PLANT
UNIT 1 AND UNIT 2

REACTOR CAVITY PRESSURE
RESPONSE – NODE E60

FIGURE 6.2.1–15 (SHEET 60 OF 65)

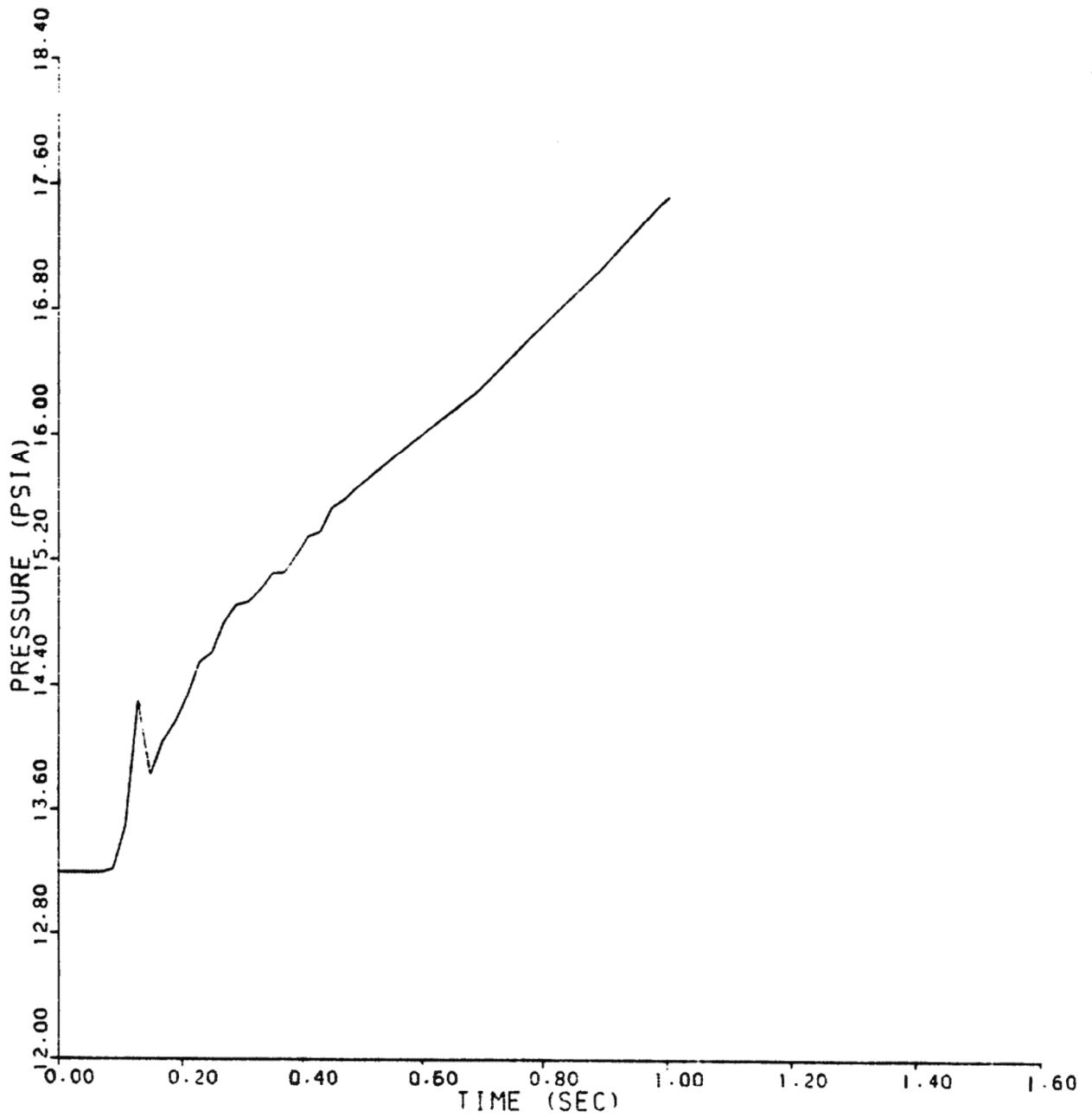

REV 13 4/06



VOGTLE
ELECTRIC GENERATING PLANT
UNIT 1 AND UNIT 2

REACTOR CAVITY PRESSURE
RESPONSE - NODE E61

FIGURE 6.2.1-15 (SHEET 61 OF 65)

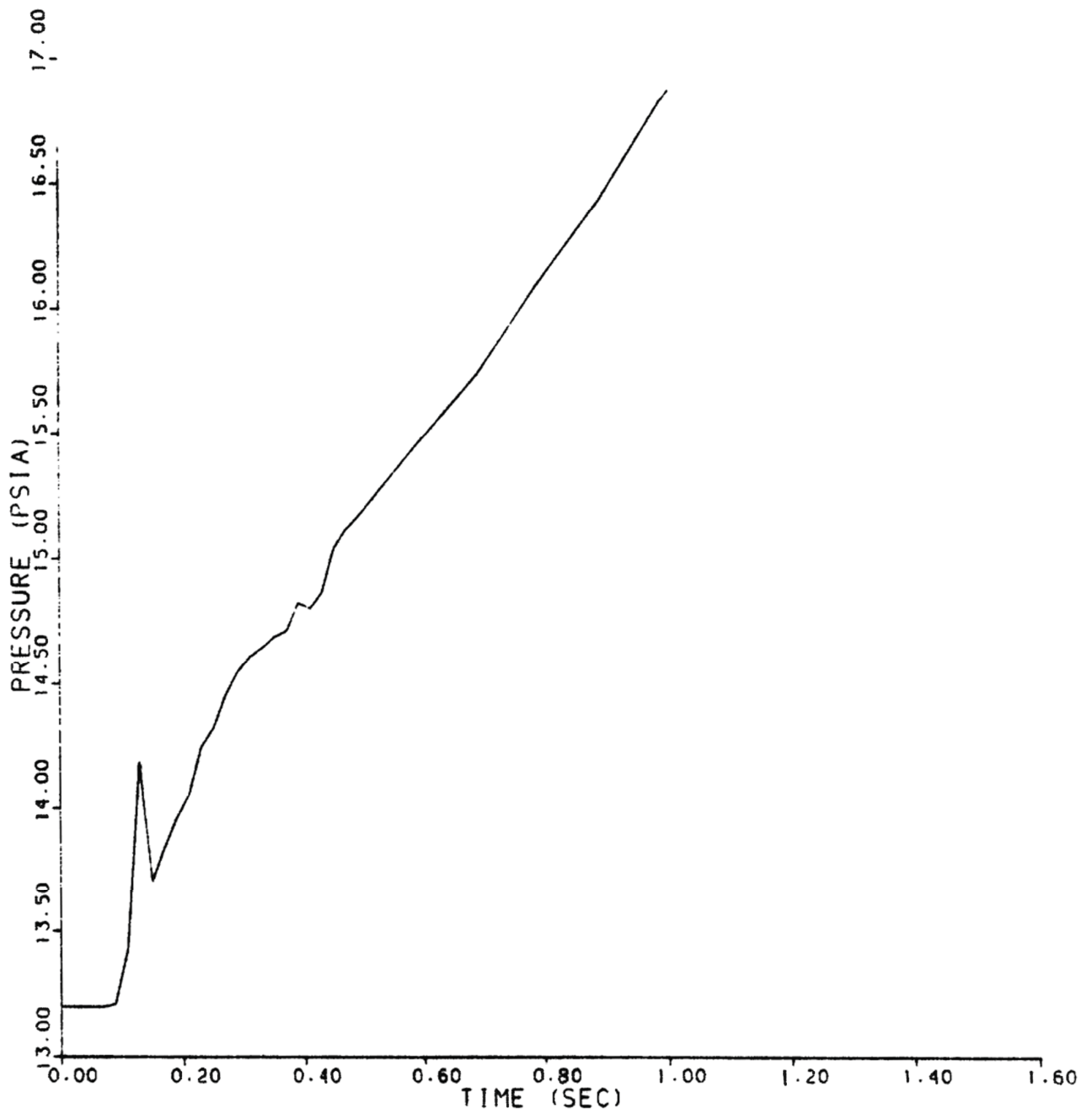

REV 13 4/06



VOGTLE
ELECTRIC GENERATING PLANT
UNIT 1 AND UNIT 2

REACTOR CAVITY PRESSURE
RESPONSE – NODE E62

FIGURE 6.2.1–15 (SHEET 62 OF 65)

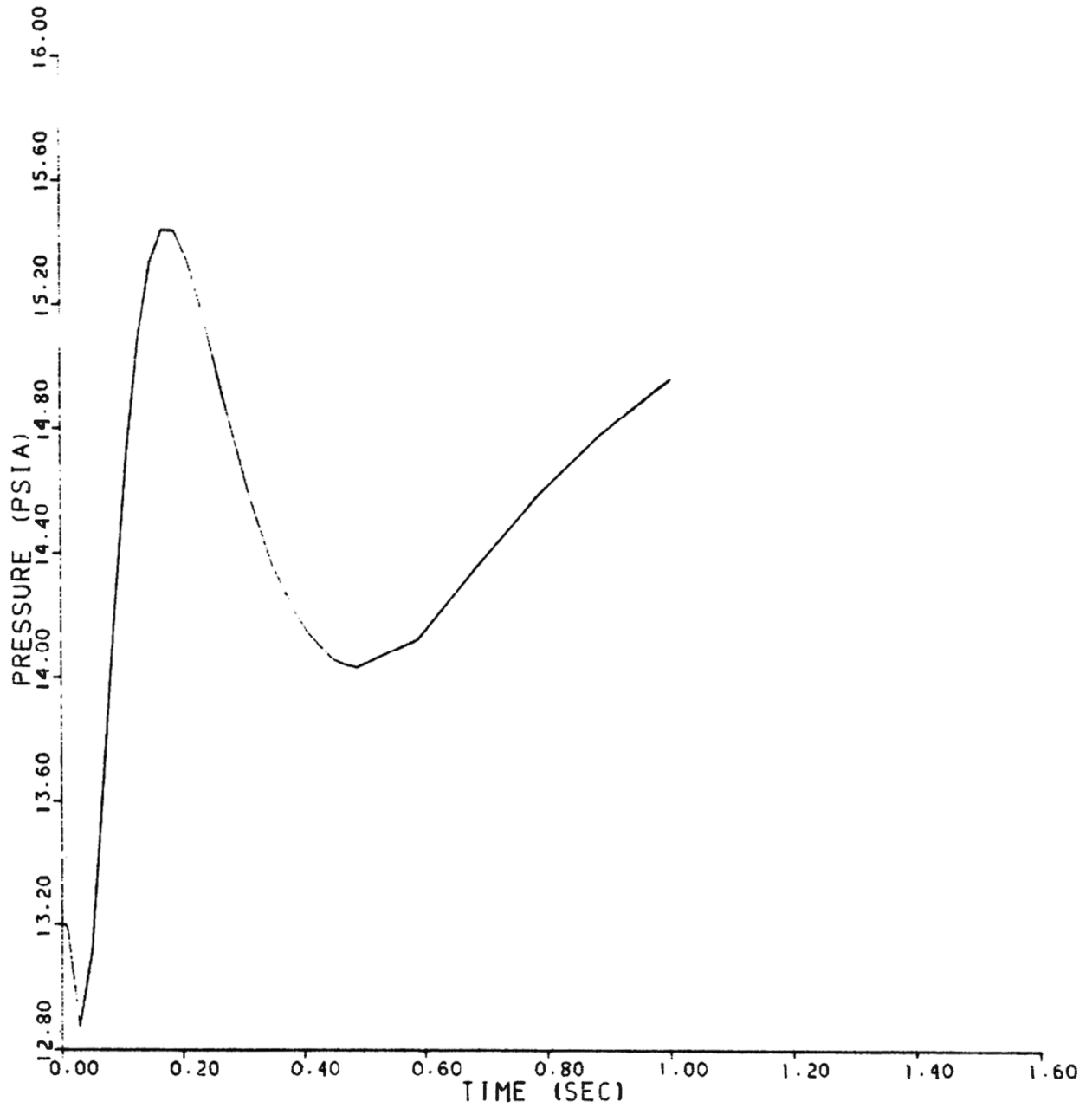

REV 13 4/06



VOGTLE
ELECTRIC GENERATING PLANT
UNIT 1 AND UNIT 2

REACTOR CAVITY PRESSURE
RESPONSE - NODE E63

FIGURE 6.2.1-15 (SHEET 63 OF 65)

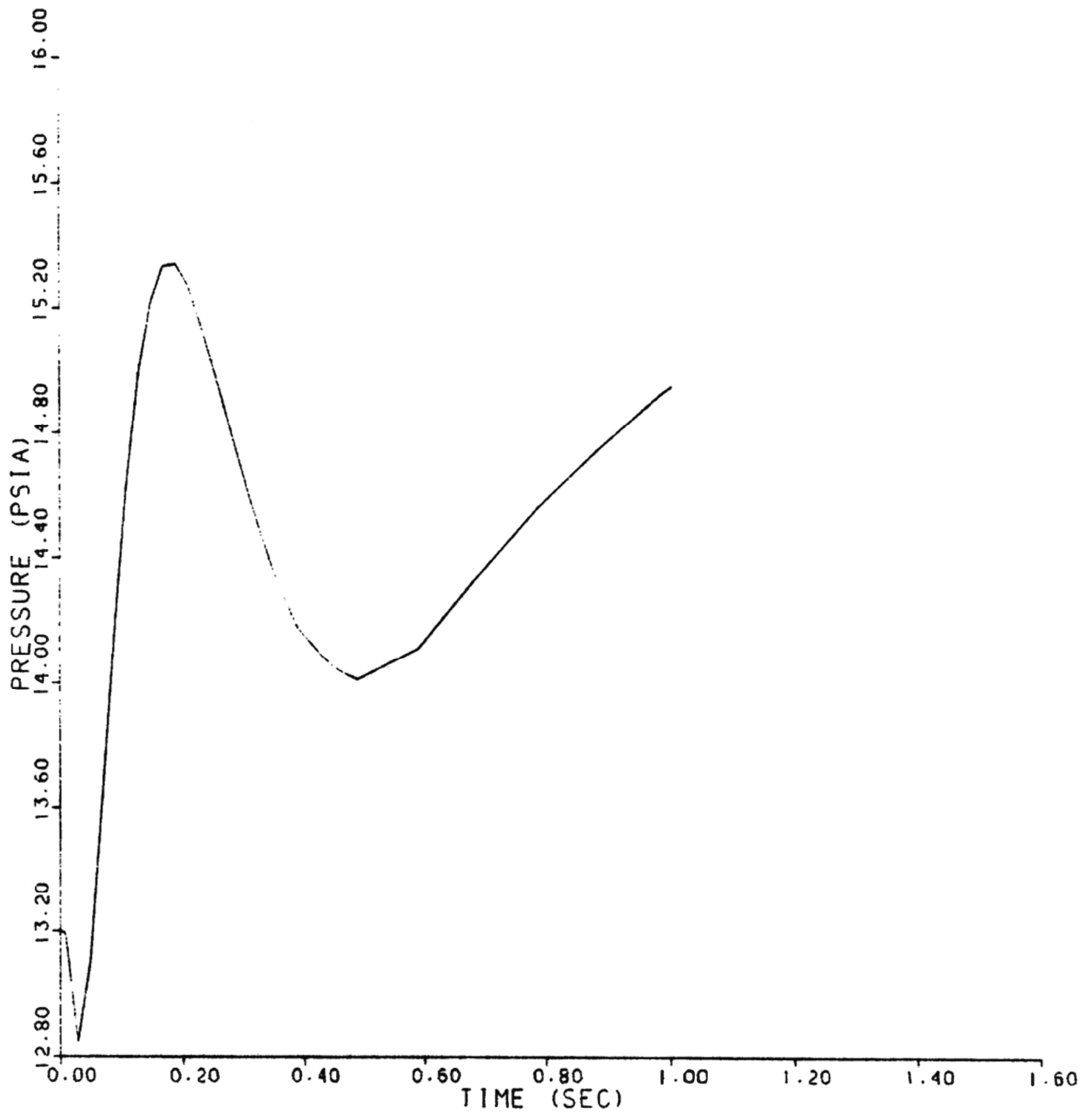

REV 13 4/06



VOGTLE
ELECTRIC GENERATING PLANT
UNIT 1 AND UNIT 2

REACTOR CAVITY PRESSURE
RESPONSE - NODE E64

FIGURE 6.2.1-15 (SHEET 64 OF 65)

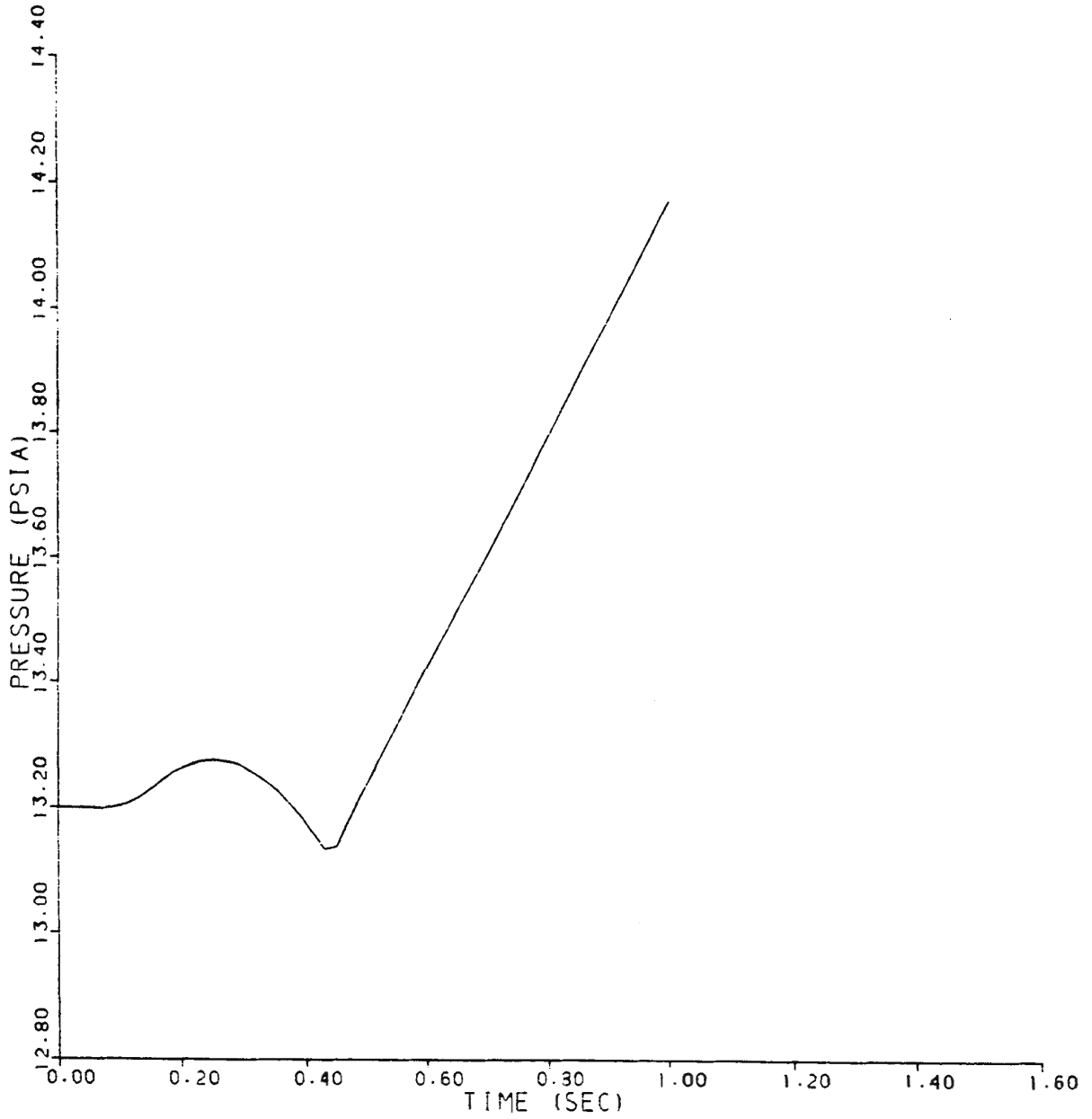

REV 13 4/06



VOGTLE
ELECTRIC GENERATING PLANT
UNIT 1 AND UNIT 2

REACTOR CAVITY PRESSURE
RESPONSE – NODE E65

FIGURE 6.2.1-15 (SHEET 65 OF 65)

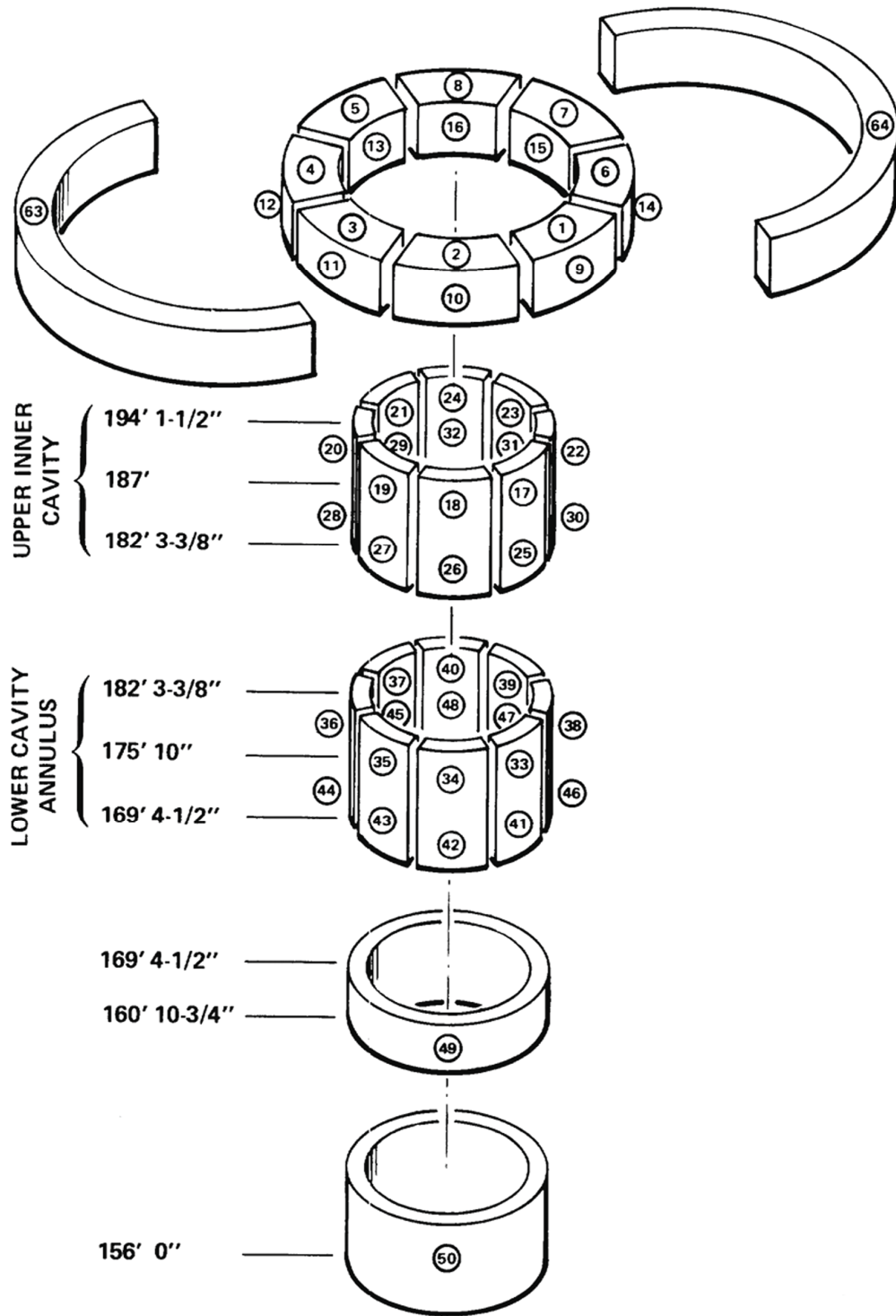

NODES SURROUNDING VESSEL

REV 13 4/06



VOGTLE
ELECTRIC GENERATING PLANT
UNIT 1 AND UNIT 2

REACTOR CAVITY MODEL

FIGURE 6.2.1-16 (SHEET 1 OF 3)

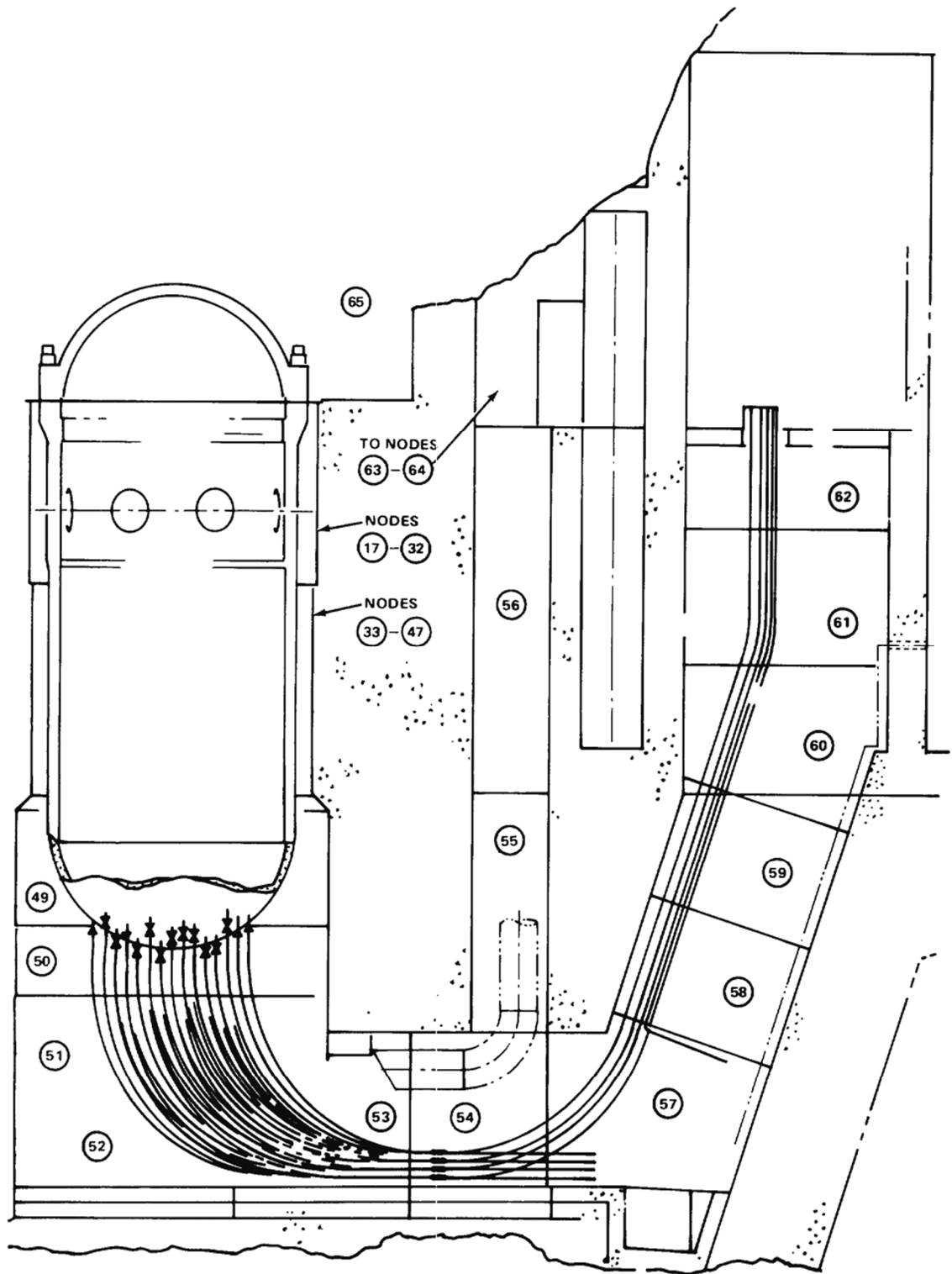

REV 13 4/06



VOGTLE
ELECTRIC GENERATING PLANT
UNIT 1 AND UNIT 2

REACTOR CAVITY MODEL

FIGURE 6.2.1-16 (SHEET 2 OF 3)

(I) INSPECTION ANNULUS (360°)

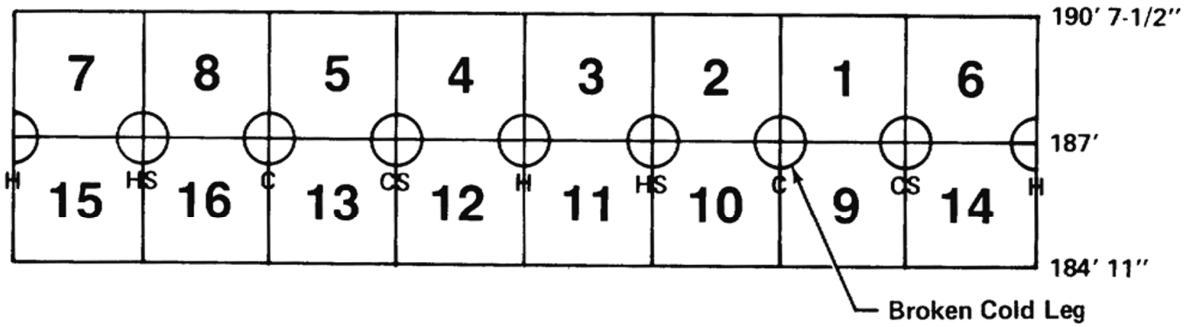

(II) UPPER INNER CAVITY

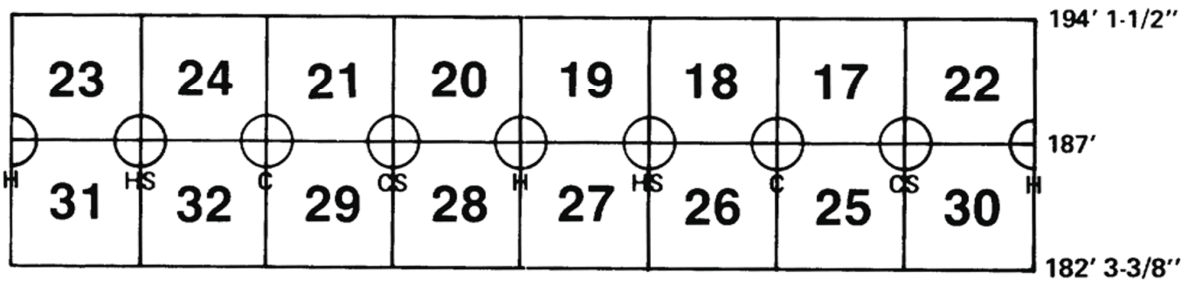

(III) LOWER CAVITY ANNULUS

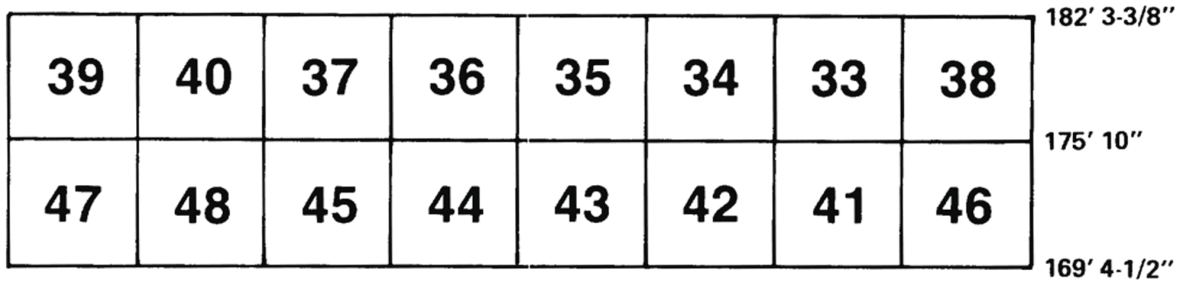

- * C = COLD LEG
- H = HOT LEG
- CS = COLD LEG WITH SUPPORT
- HS = HOT LEG WITH SUPPORT

REV 13 4/06



VOGTLE
ELECTRIC GENERATING PLANT
UNIT 1 AND UNIT 2

REACTOR CAVITY MODEL

FIGURE 6.2.1-16 (SHEET 3 OF 3)

STEAM GENERATOR DOGHOUSE (TOP VIEW)
NODALIZATION

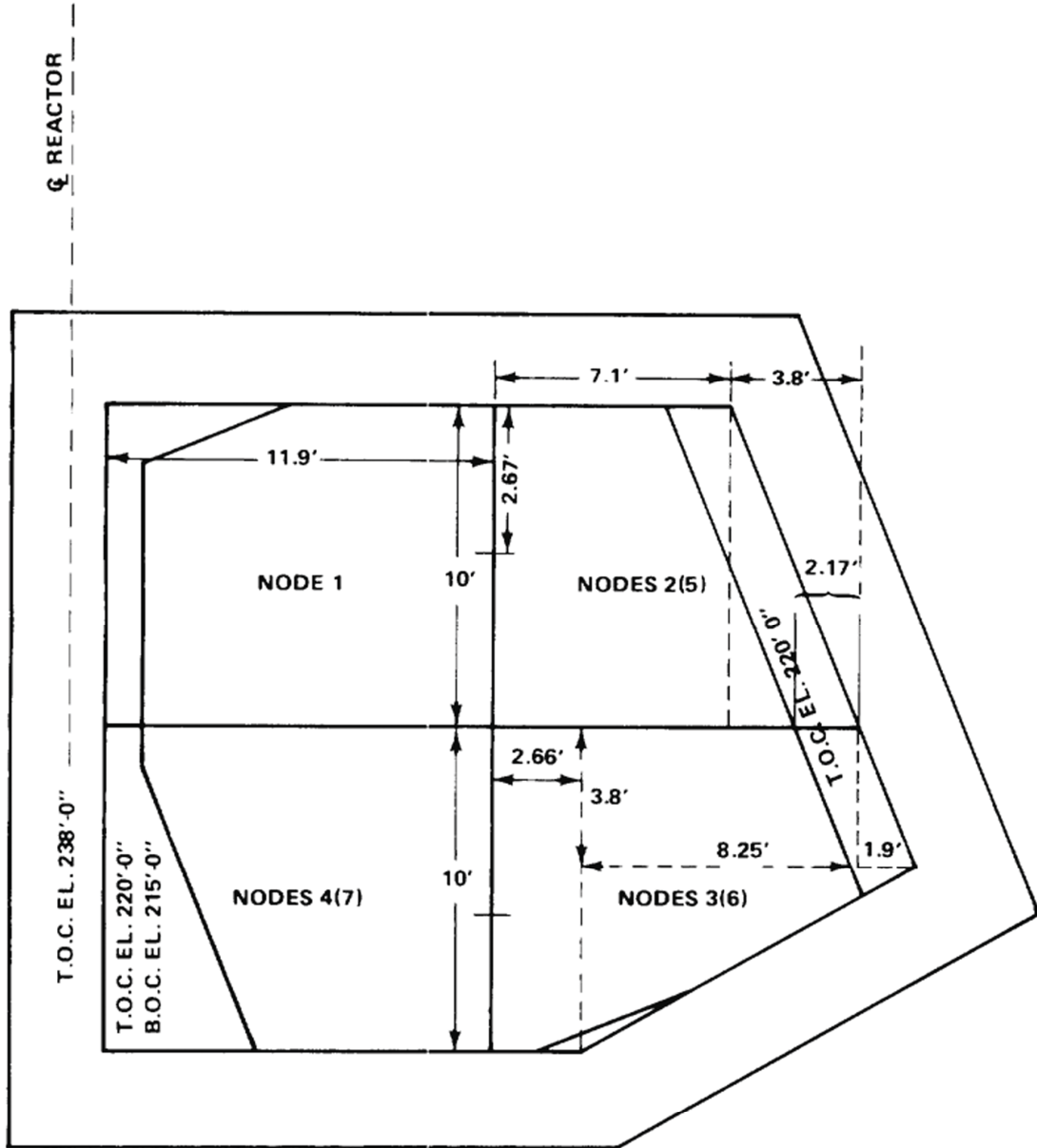

NODE NUMBERS IN PARENTHESES ARE THE NODES BELOW ANOTHER NODE.

REV 13 4/06



VOGTLE
ELECTRIC GENERATING PLANT
UNIT 1 AND UNIT 2

STEAM GENERATOR COMPARTMENT
MODEL (PIPE BREAK ABOVE el. 220 ft.)

FIGURE 6.2.1-16A (SHEET 1 OF 3)

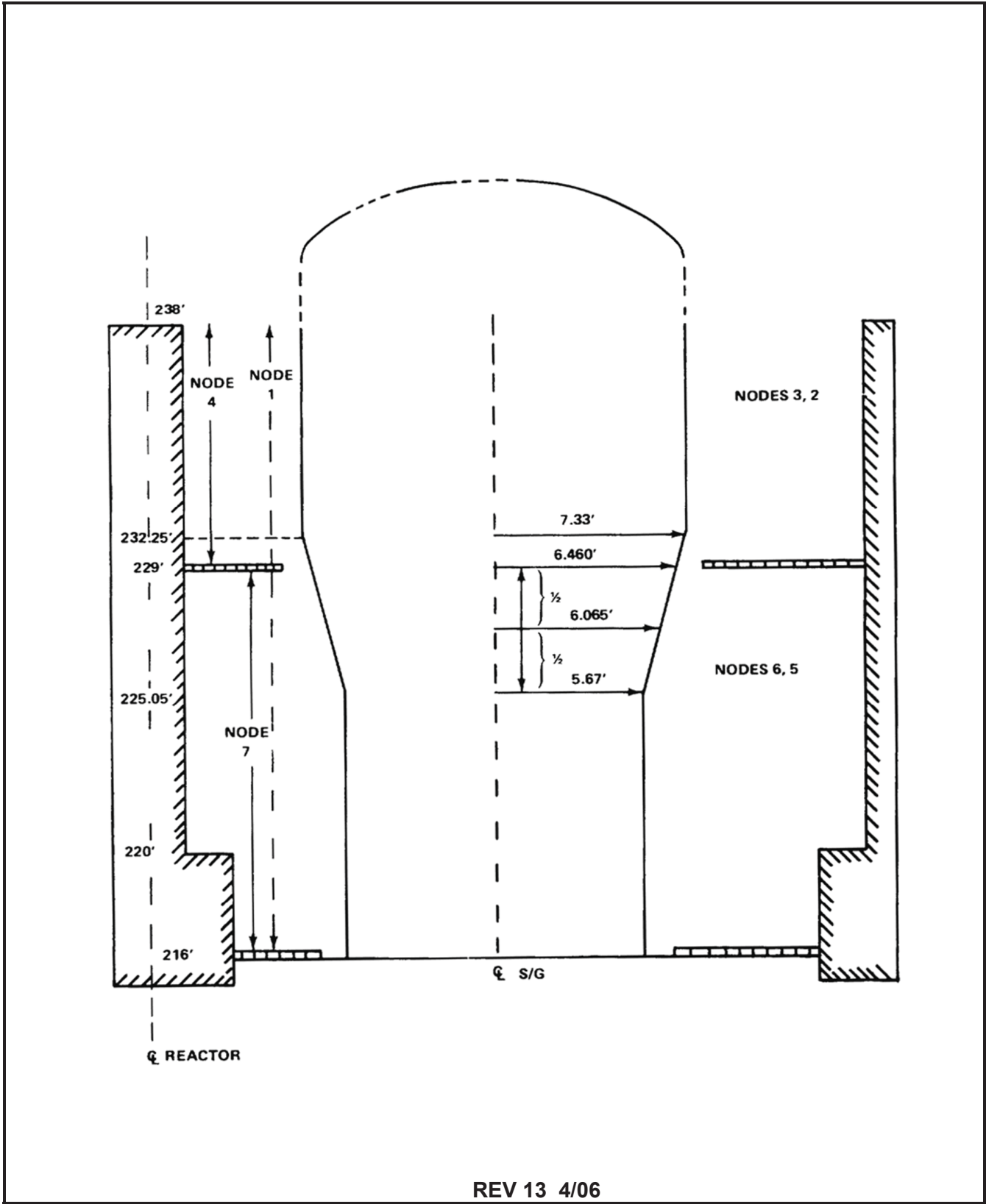

REV 13 4/06



VOGTLE
ELECTRIC GENERATING PLANT
UNIT 1 AND UNIT 2

STEAM GENERATOR COMPARTMENT MODEL
(PIPE BREAK ABOVE el. 220 ft.)

FIGURE 6.2.1-16A (SHEET 2 OF 3)

☉ REACTOR

NODALIZATION (el. 200 ft. to 216 ft.)

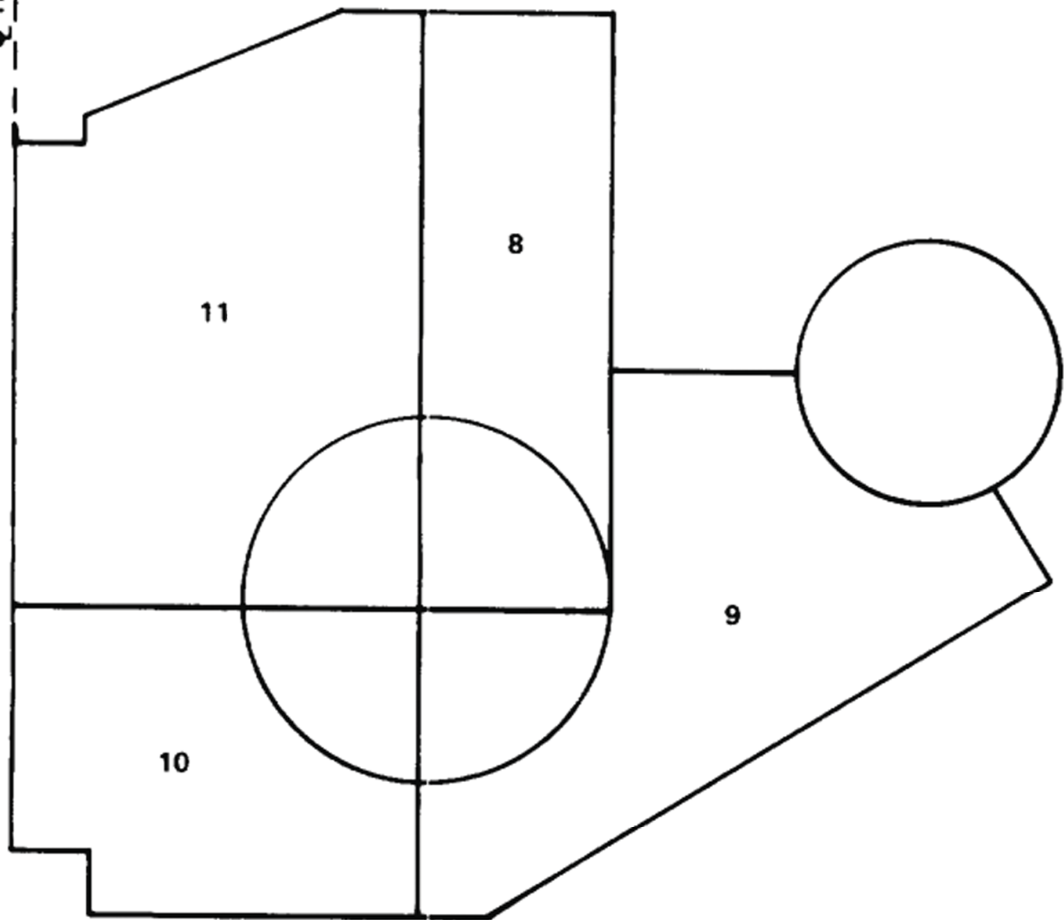

REV 13 4/06



VOGTLE
ELECTRIC GENERATING PLANT
UNIT 1 AND UNIT 2

STEAM GENERATOR COMPARTMENT MODEL
(PIPE BREAK ABOVE el. 220 ft.)

FIGURE 6.2.1-16A (SHEET 3 OF 3)

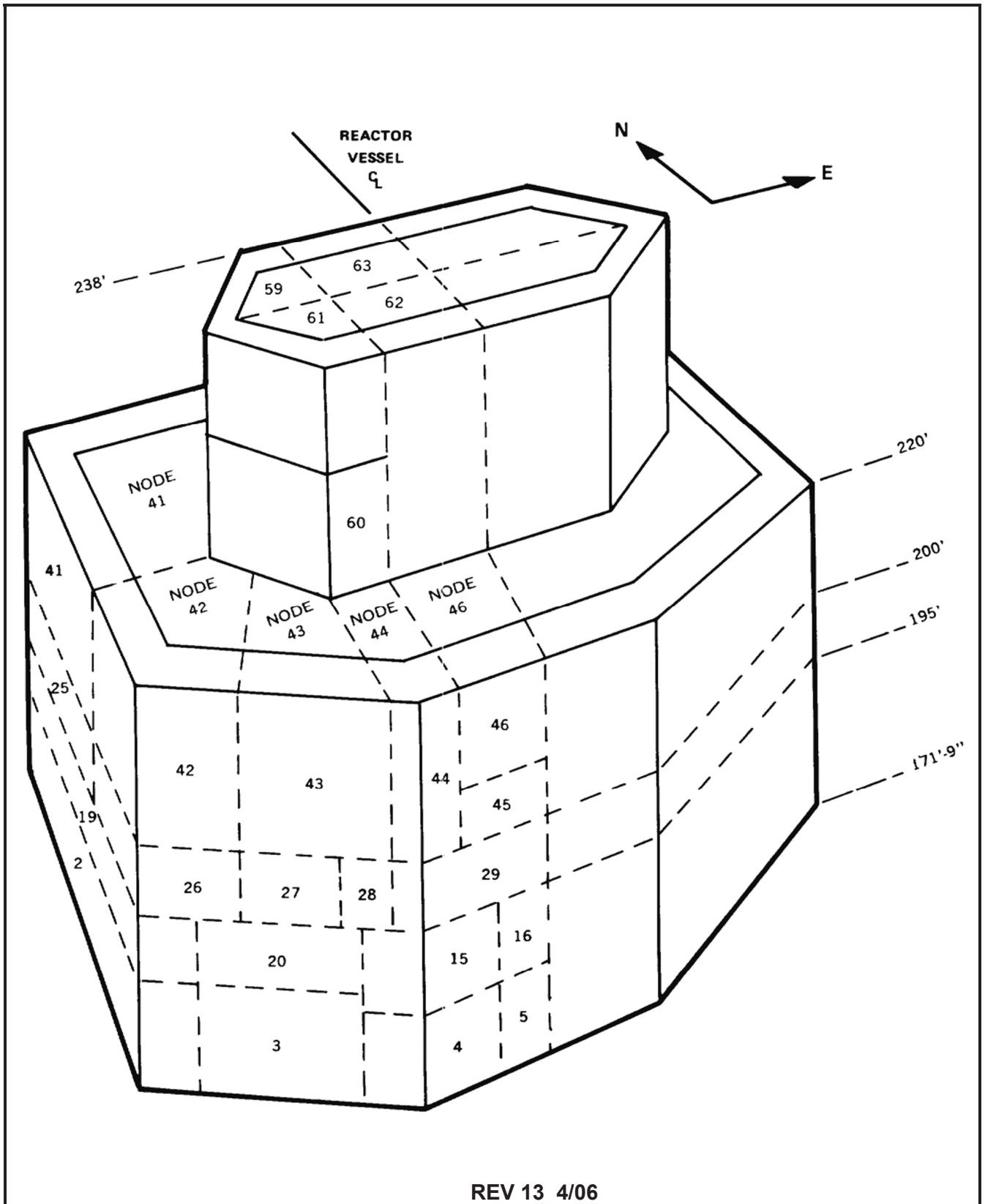

REV 13 4/06



VOGTLE
ELECTRIC GENERATING PLANT
UNIT 1 AND UNIT 2

STEAM GENERATOR COMPARTMENT MODEL
(PIPE BREAK BELOW el.220 ft.)

FIGURE 6.2.1-17 (SHEET 1 OF 6)

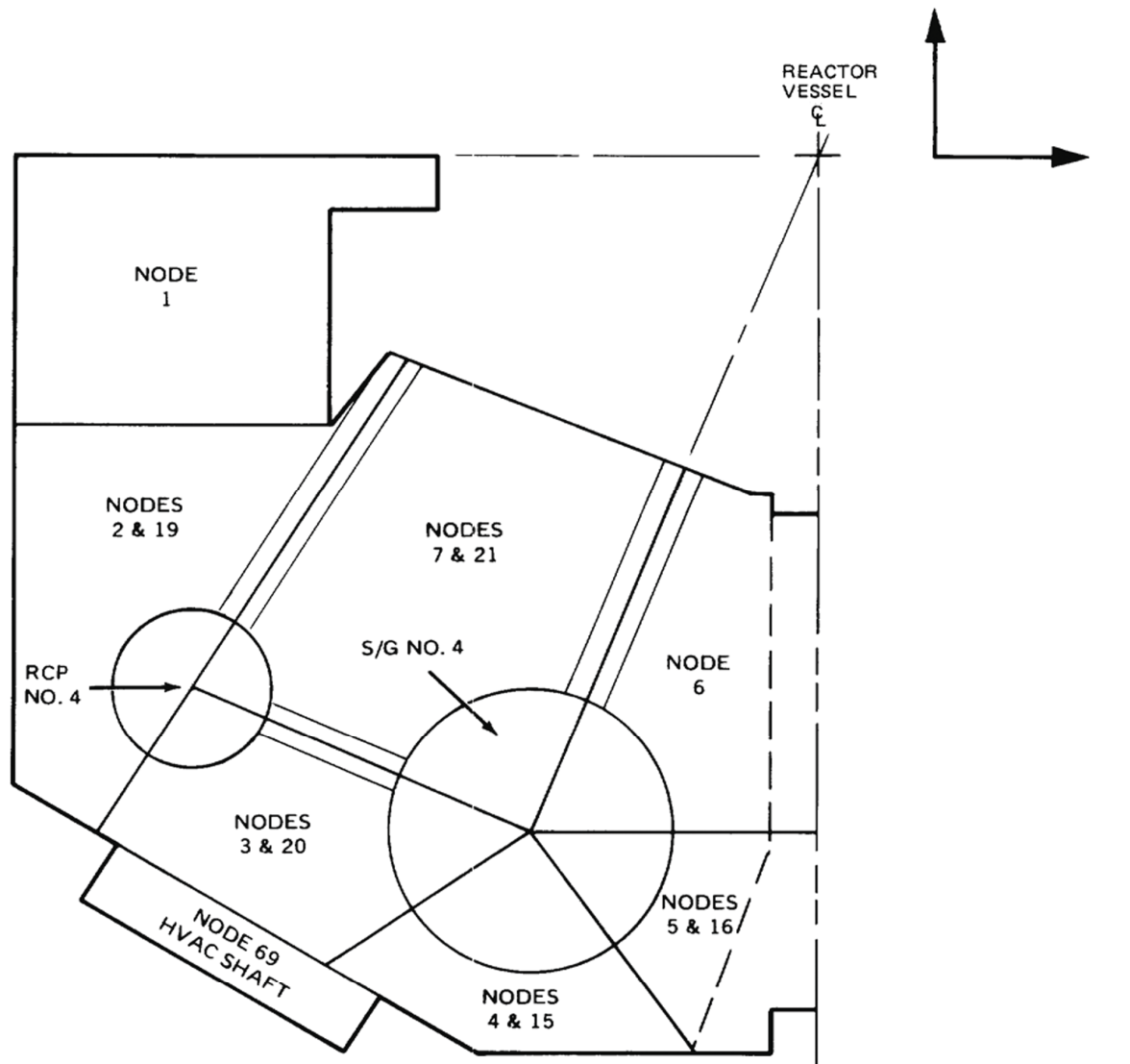

NOTE:
1. SKETCH HAS NO SCALE.

NODES	BOTTOM ELEVATION	TOP ELEVATION
1	171' 9"	178' 3 3/4"
4, 5	171' 9"	183' 0"
2, 3, 7	171' 9"	187' 0"
15, 16	183' 0"	195' 0"
19, 20, 21	187' 0"	195' 0"
6	171' 9"	195' 0"

REV 13 4/06



VOGTLE
ELECTRIC GENERATING PLANT
UNIT 1 AND UNIT 2

STEAM GENERATOR COMPARTMENT MODEL
(PIPE BREAK BELOW el. 220 ft.) LEVEL 1
(LEFT HALF TOP VIEW)

FIGURE 6.2.1-17 (SHEET 2 OF 6)

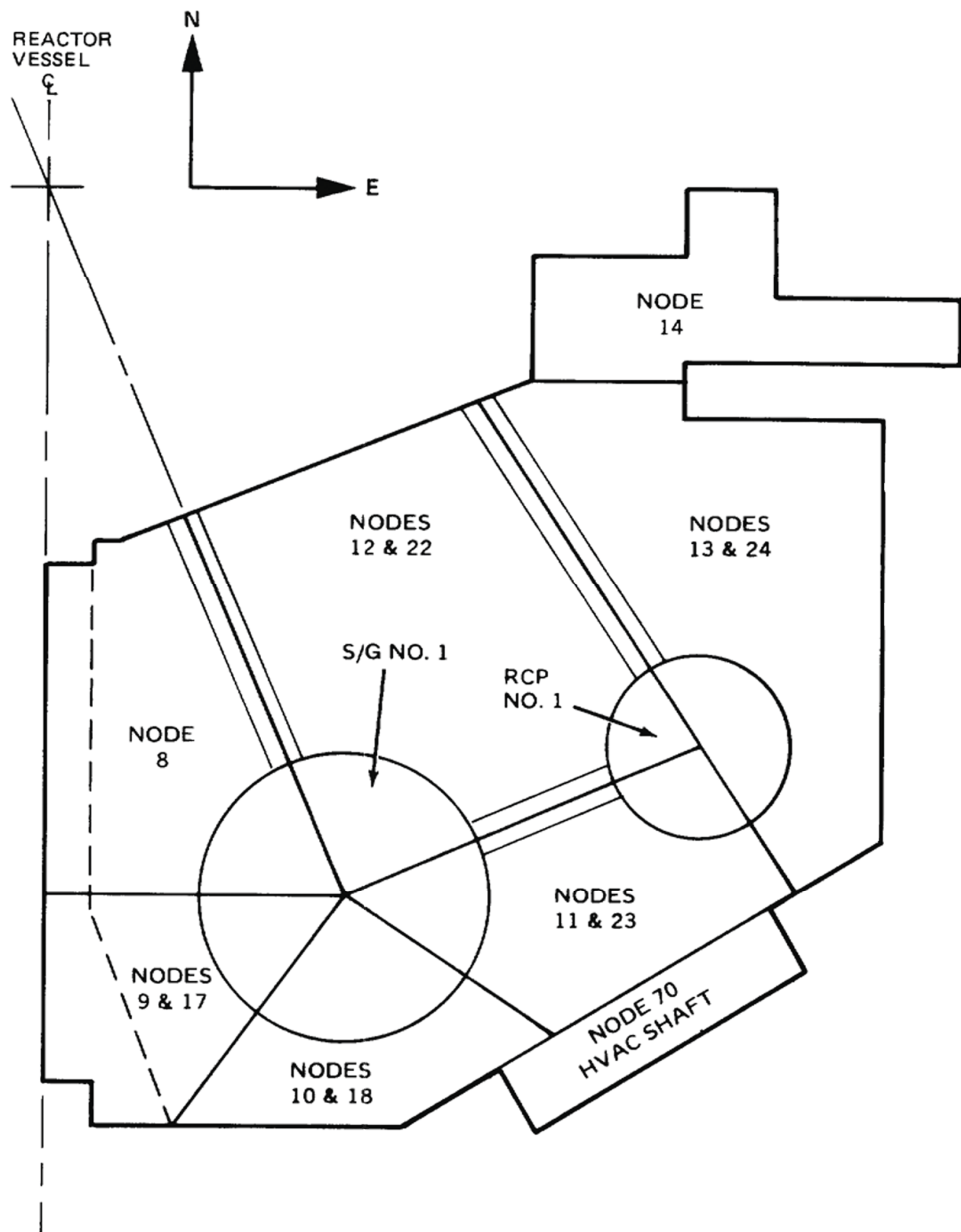

<u>NODES (SYMMETRIC)</u>	<u>BOTTOM ELEVATION</u>	<u>TOP ELEVATION</u>
9 (5), 10 (4)	171' 9"	183' 0"
11 (3), 13 (2), 12 (7)	171' 9"	187' 0"
17 (16), 18 (15)	183' 0"	195' 0"
22 (21), 23 (20), 24 (19)	187' 0"	195' 0"
14 (1 APPROX.)	171' 9"	192' 0"
8 (6)	171' 9"	195' 0"

REV 13 4/06



VOGTLE
ELECTRIC GENERATING PLANT
UNIT 1 AND UNIT 2

STEAM GENERATOR COMPARTMENT MODEL
(PIPE BREAK BELOW el. 220 ft.) LEVEL 1
(RIGHT HALF TOP VIEW)

FIGURE 6.2.1-17 (SHEET 3 of 6)

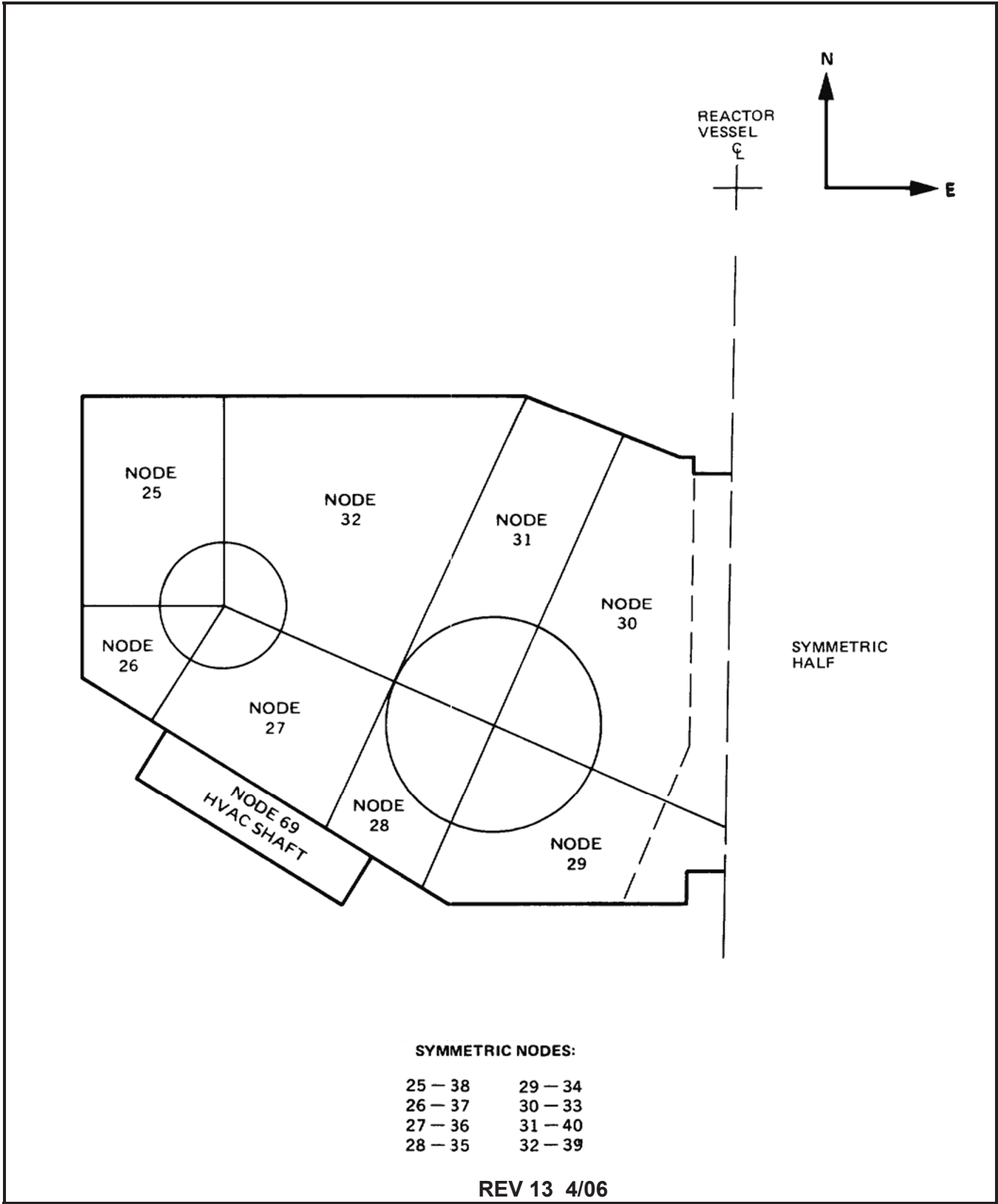

SYMMETRIC NODES:

25 - 38	29 - 34
26 - 37	30 - 33
27 - 36	31 - 40
28 - 35	32 - 39

REV 13 4/06



**VOGTLE
ELECTRIC GENERATING PLANT
UNIT 1 AND UNIT 2**

**STEAM GENERATOR COMPARTMENT MODEL
(PIPE BREAK BELOW el. 220445 ft.) LEVEL 2,
EL. 195 TO 200 ft. (TOP VIEW)**

FIGURE 6.2.1-17 (SHEET 4 OF 6)

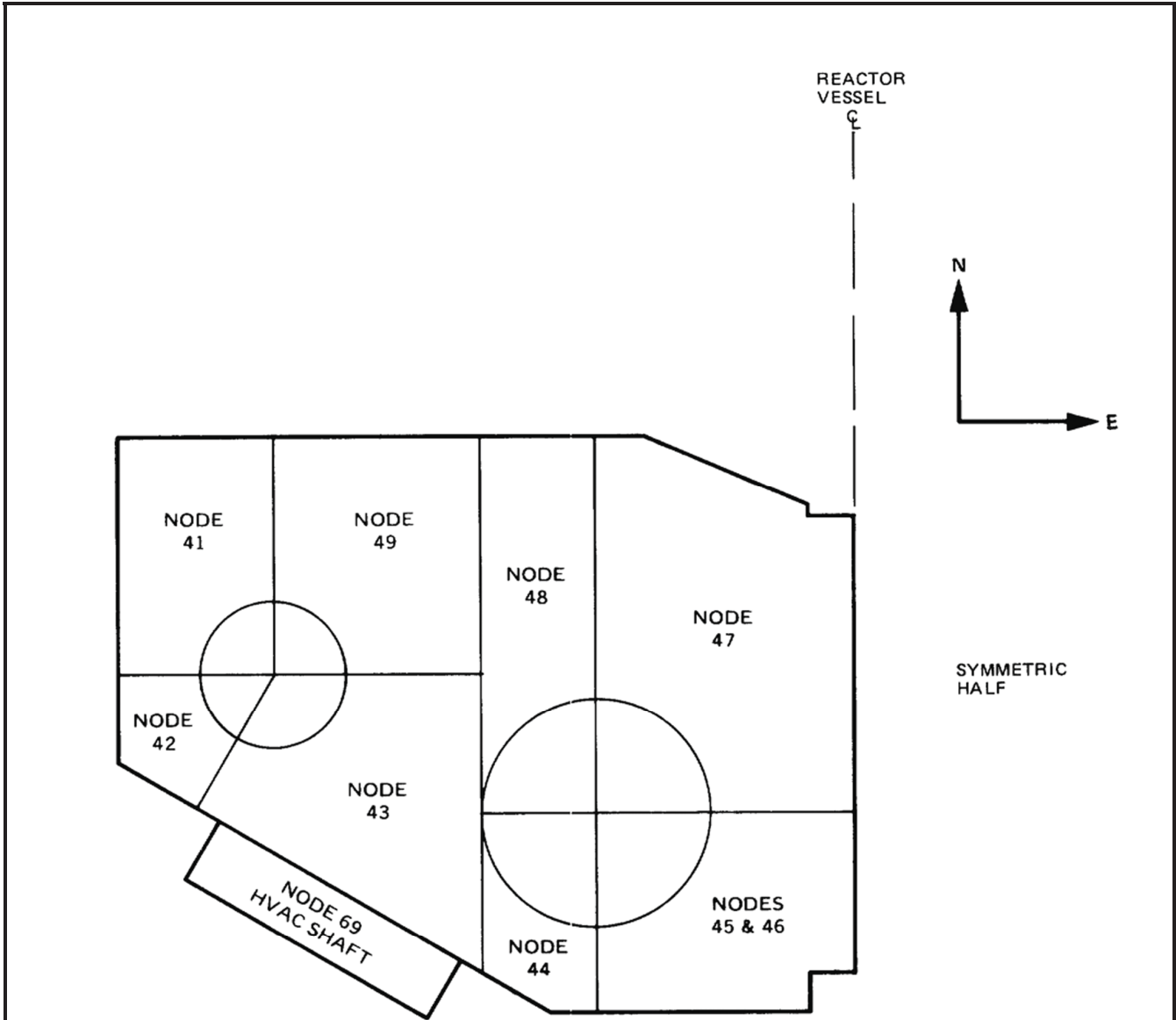

NOTE:

1. SKETCH HAS NO SCALE.
 200' TO 207' (NODE 45)
 207' TO 215' (NODE 46)
 200' TO 215' (NODES 44, 47, 48)
 200' TO 220' (NODES 41, 42, 43, 49)

SYMMETRIC NODES

41 - 56	45 - 51
42 - 55	46 - 52
43 - 54	47 - 50
44 - 53	48 - 58
	49 - 57

REV 13 4/06



**VOGTLE
ELECTRIC GENERATING PLANT
UNIT 1 AND UNIT 2**

**STEAM GENERATOR COMPARTMENT MODEL
(PIPE BREAK BELOW el. 220 ft.)
LEVEL 3 (TOP VIEW)**

FIGURE 6.2.1-17 (SHEET 5 OF 6)

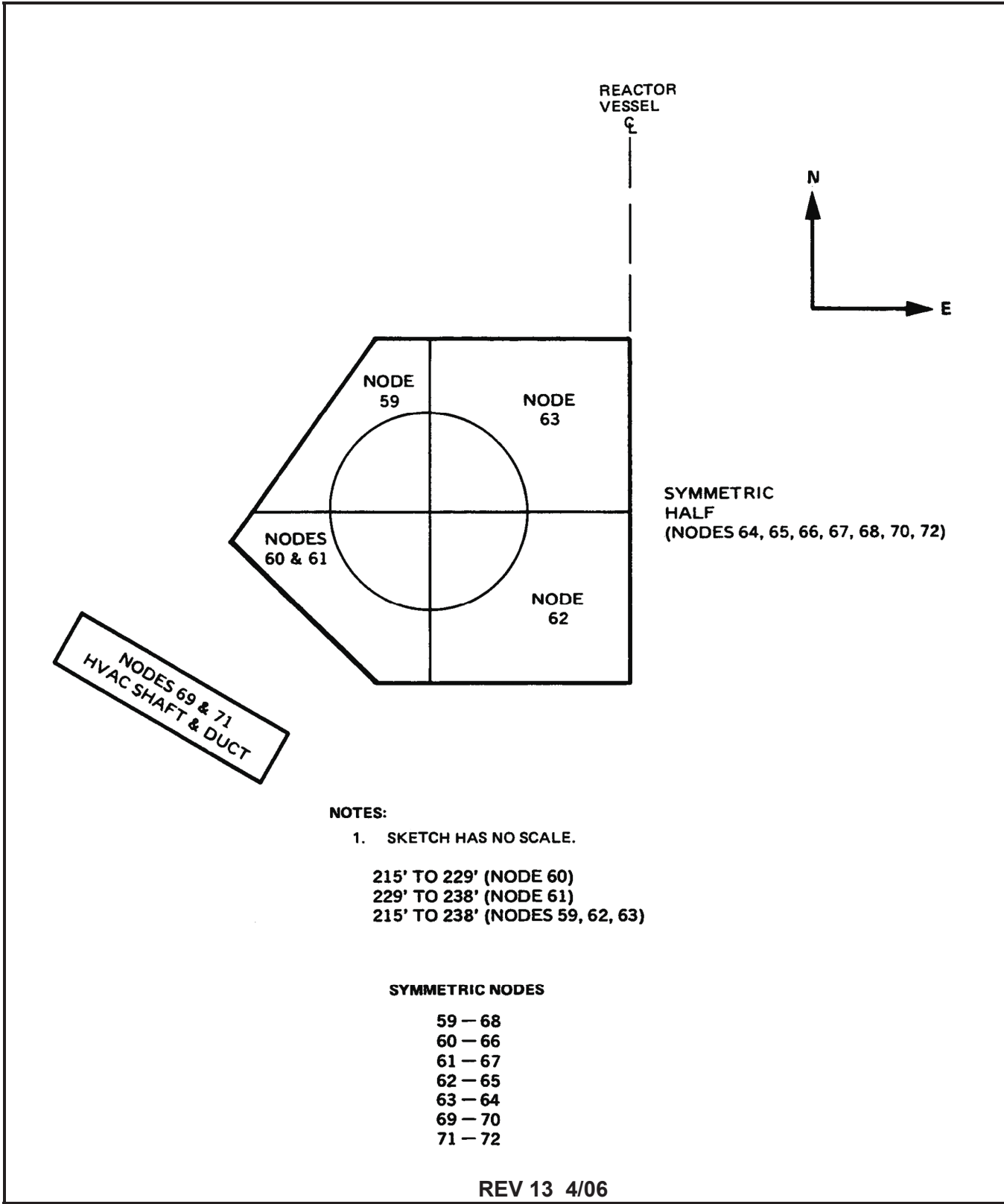

NODES 69 & 71
HVAC SHAFT & DUCT

NOTES:

1. SKETCH HAS NO SCALE.

215' TO 229' (NODE 60)
229' TO 238' (NODE 61)
215' TO 238' (NODES 59, 62, 63)

SYMMETRIC NODES

- 59 - 68
- 60 - 66
- 61 - 67
- 62 - 65
- 63 - 64
- 69 - 70
- 71 - 72

REV 13 4/06



VOGTLE
ELECTRIC GENERATING PLANT
UNIT 1 AND UNIT 2

STEAM GENERATOR COMPARTMENT MODEL
(PIPE BREAK BELOW el. 220 ft.)
LEVEL 4 (TOP VIEW)

FIGURE 6.2.1-17 (SHEET 6 OF 6)

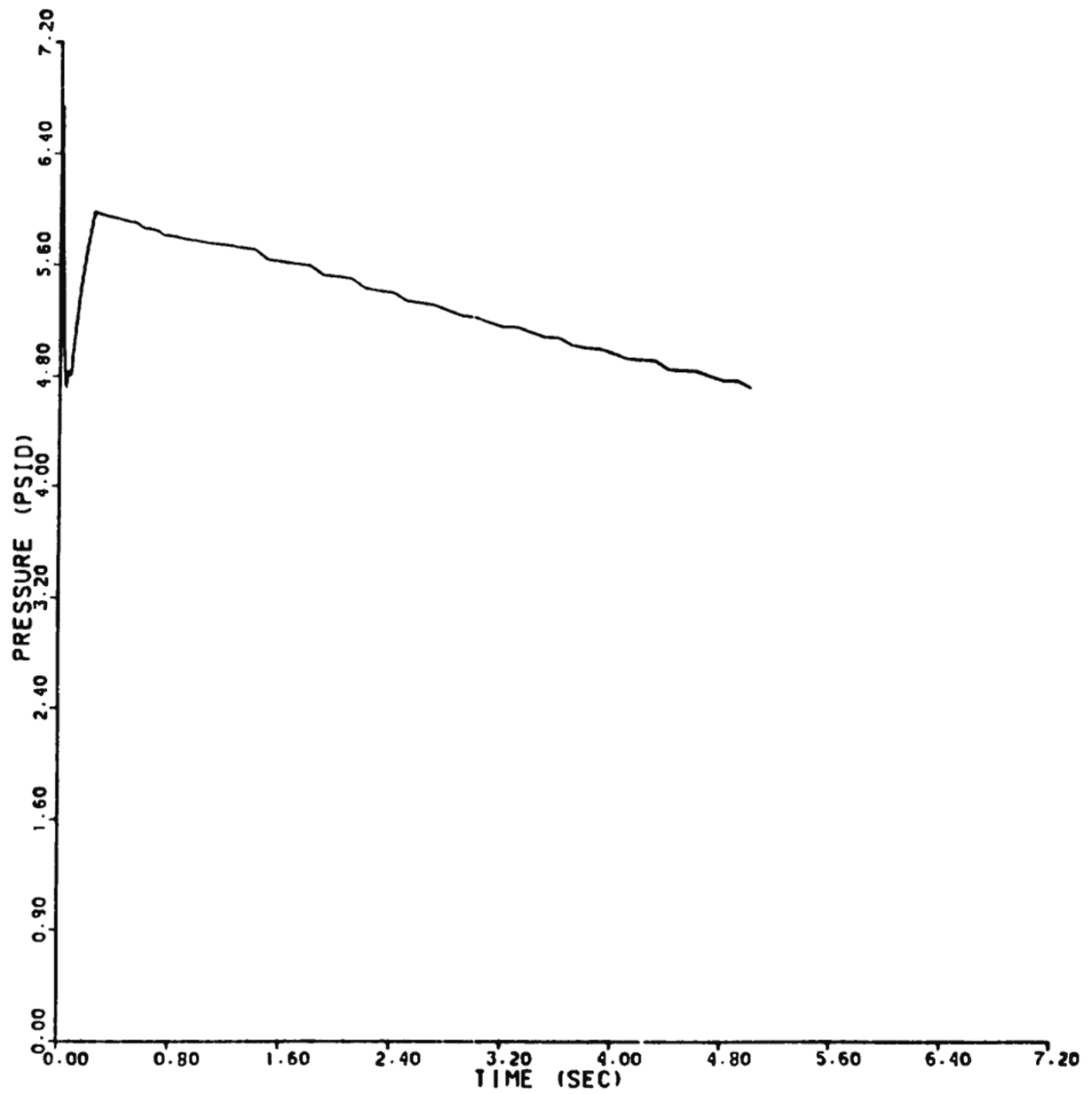

REV 13 4/06



VOGTLE
ELECTRIC GENERATING PLANT
UNIT 1 AND UNIT 2

STEAM GENERATOR COMPARTMENTS
DIFFERENTIAL PRESSURE RESPONSE
ACROSS DOGHOUSE WALL (144.5 in² MAIN
FEEDWATER LINE BREAK)

FIGURE 6.2.1-17A

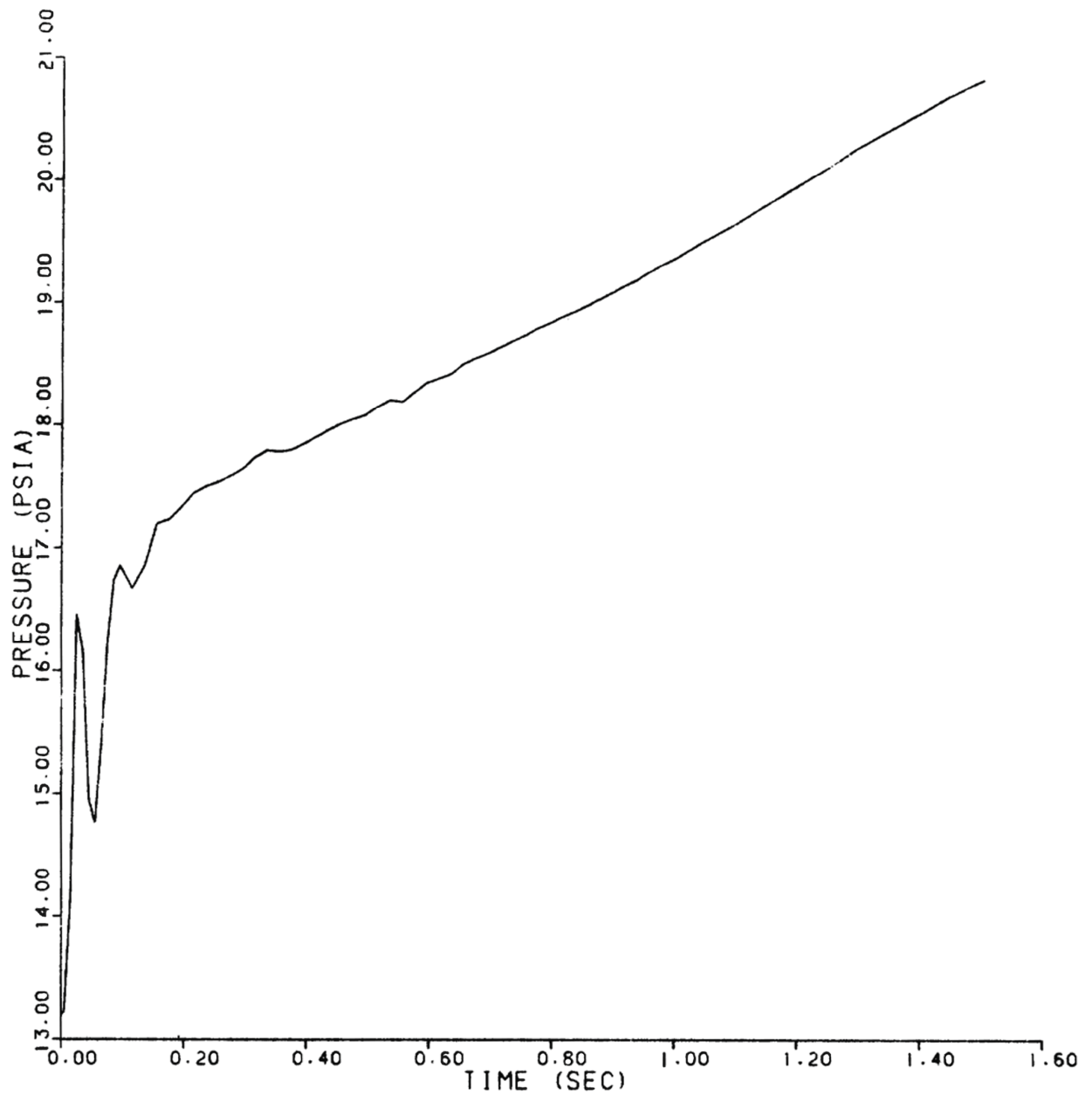

REV 13 4/06



VOGTLE
ELECTRIC GENERATING PLANT
UNIT 1 AND UNIT 2

STEAM GENERATOR COMPARTMENT
PRESSURE RESPONSE - NODE E1
(236-in.² BREAK AREA)

FIGURE 6.2.1-18 (SHEET 1 OF 74)

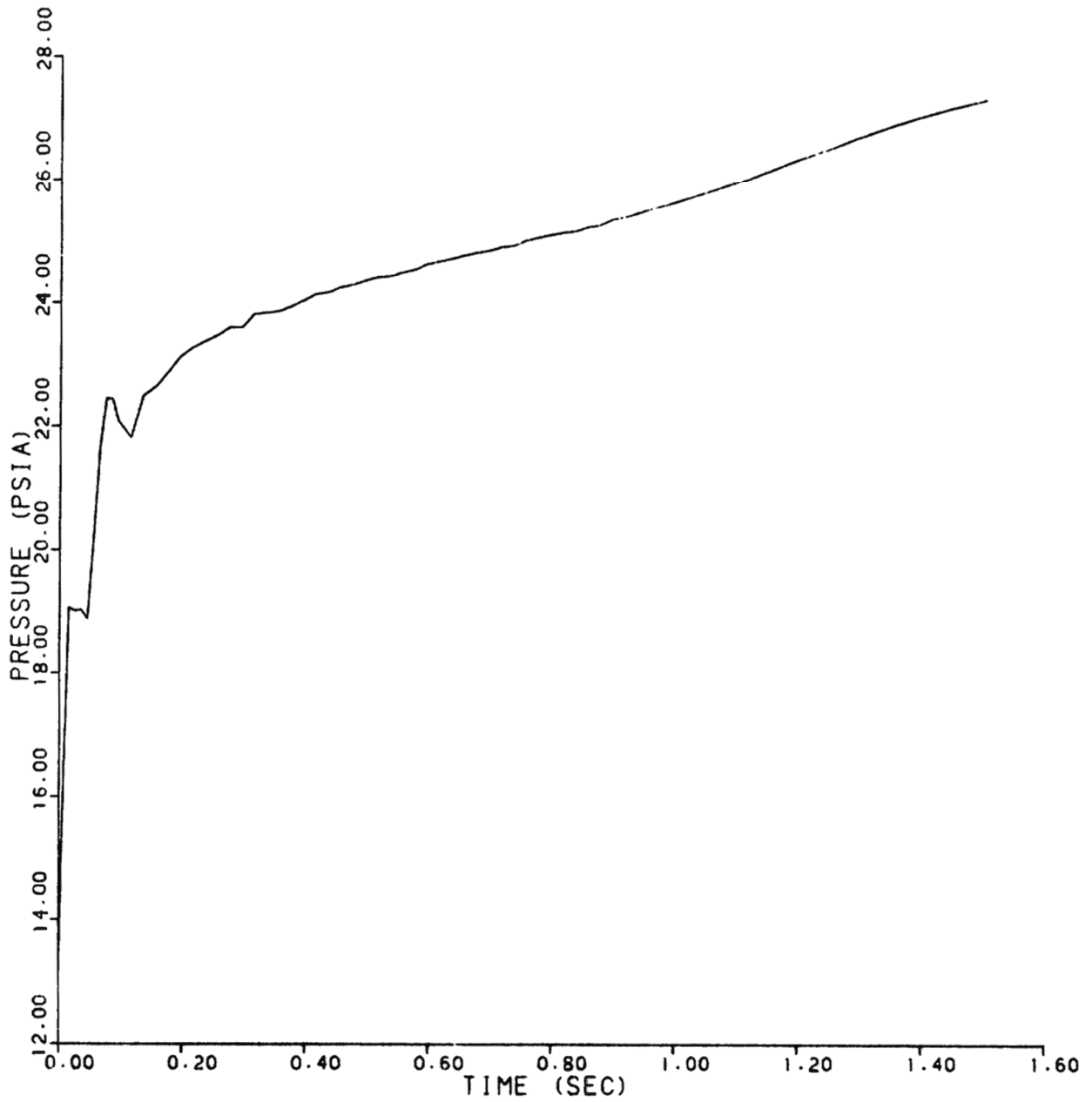

REV 13 4/06



VOGTLE
ELECTRIC GENERATING PLANT
UNIT 1 AND UNIT 2

STEAM GENERATOR COMPARTMENT
PRESSURE RESPONSE - NODE E2
(236-in.² BREAK AREA)

FIGURE 6.2.1-18 (SHEET 2 OF 74)

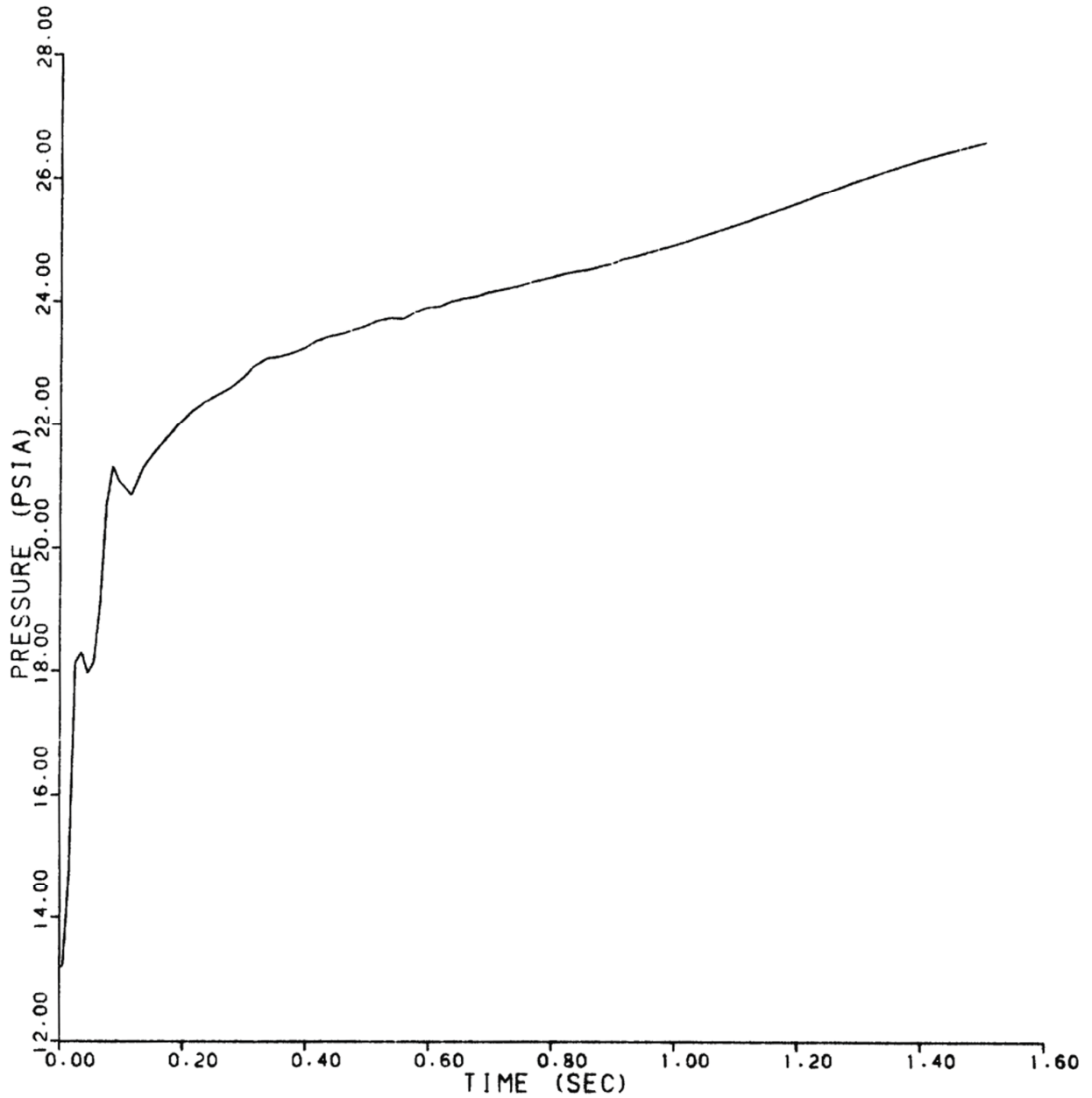

REV 13 4/06



VOGTLE
ELECTRIC GENERATING PLANT
UNIT 1 AND UNIT 2

STEAM GENERATOR COMPARTMENT
PRESSURE RESPONSE - NODE E3
(236-in.² BREAK AREA)

FIGURE 6.2.1-18 (SHEET 3 OF 74)

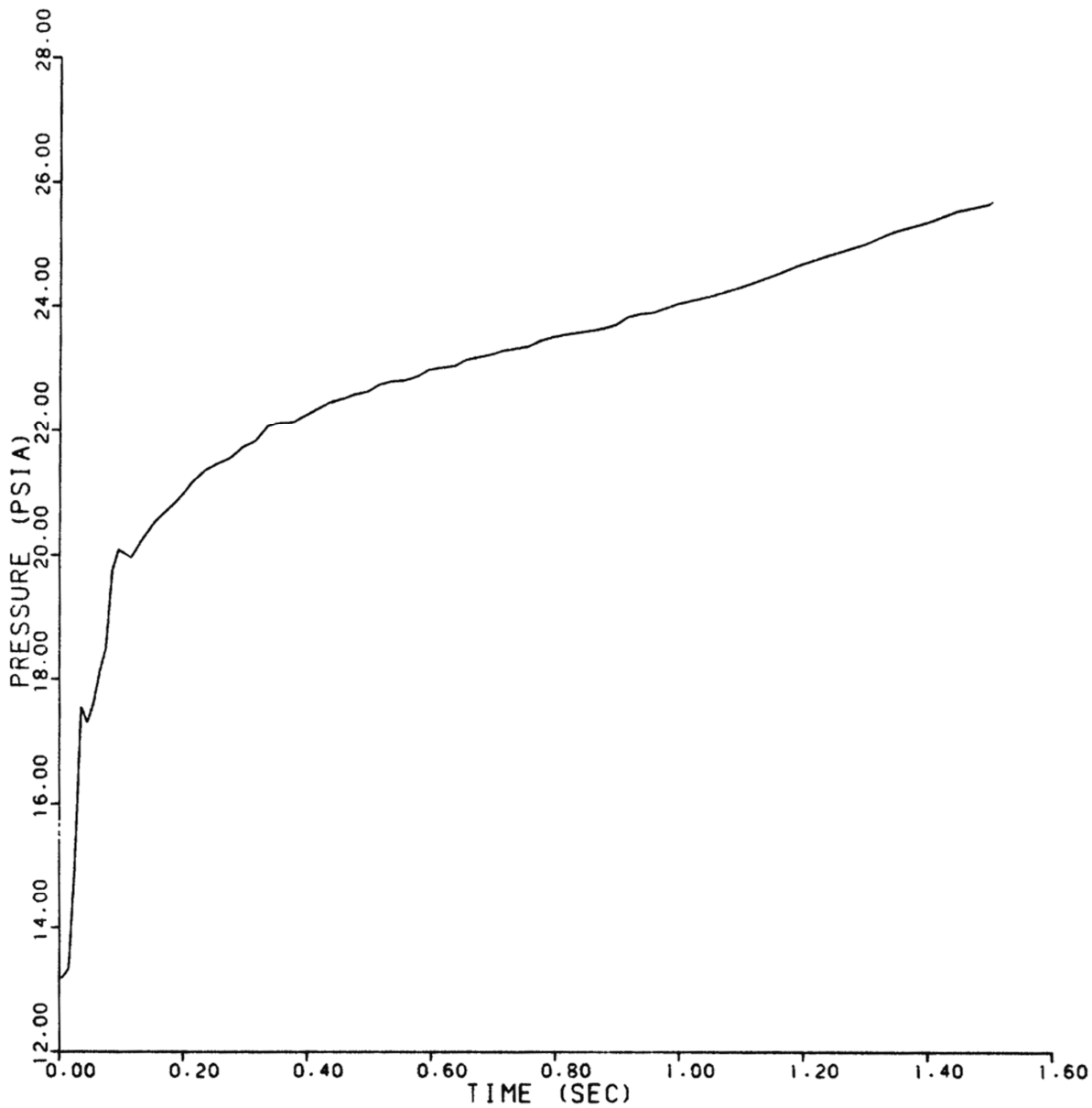

REV 13 4/06



VOGTLE
ELECTRIC GENERATING PLANT
UNIT 1 AND UNIT 2

STEAM GENERATOR COMPARTMENT
PRESSURE RESPONSE – NODE E4
(236-in.² BREAK AREA)

FIGURE 6.2.1-18 (SHEET 4 OF 74)

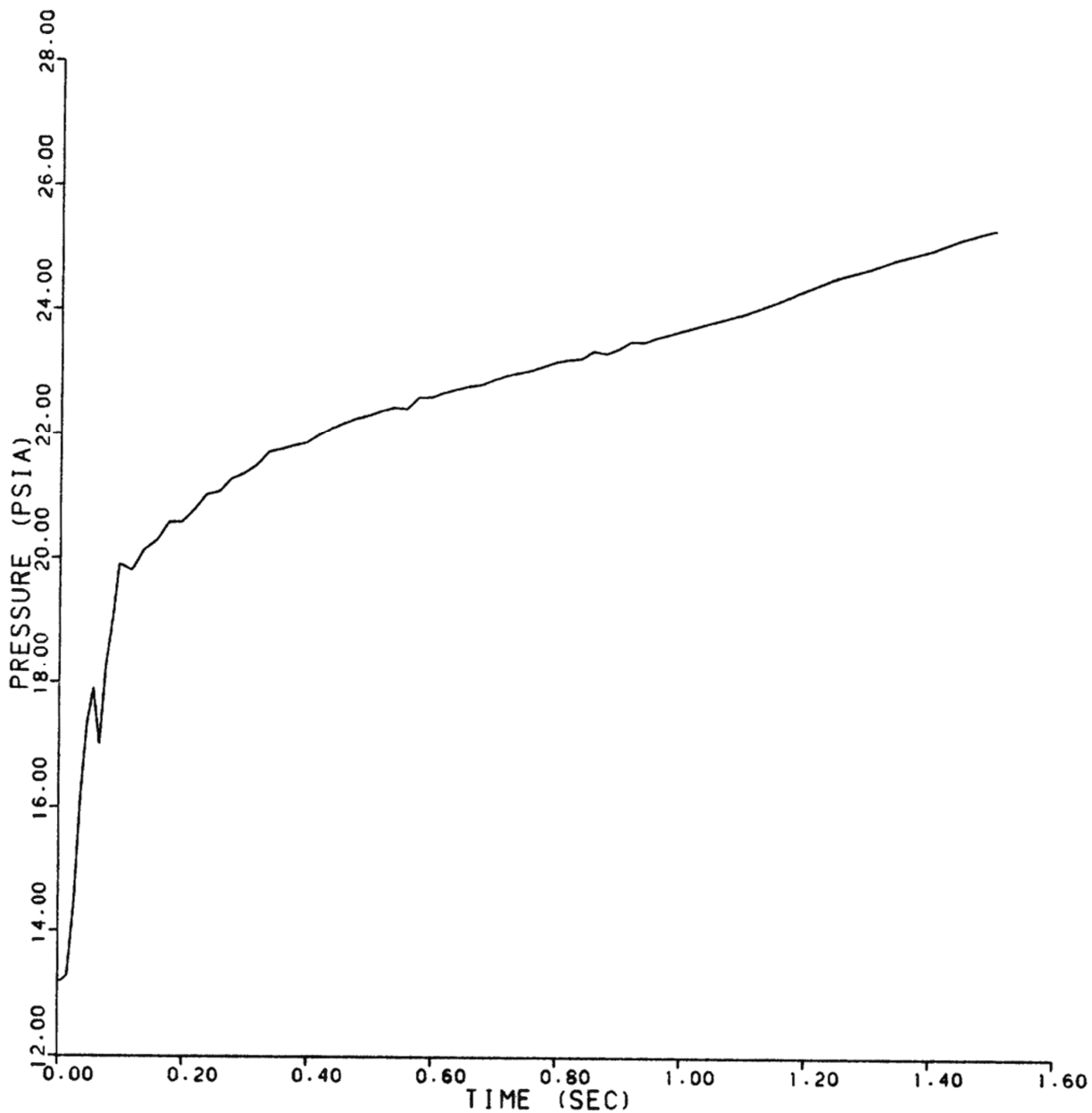

REV 13 4/06



VOGTLE
ELECTRIC GENERATING PLANT
UNIT 1 AND UNIT 2

STEAM GENERATOR COMPARTMENT
PRESSURE RESPONSE – NODE E5
(236-in.² BREAK AREA)

FIGURE 6.2.1-18 (SHEET 5 OF 74)

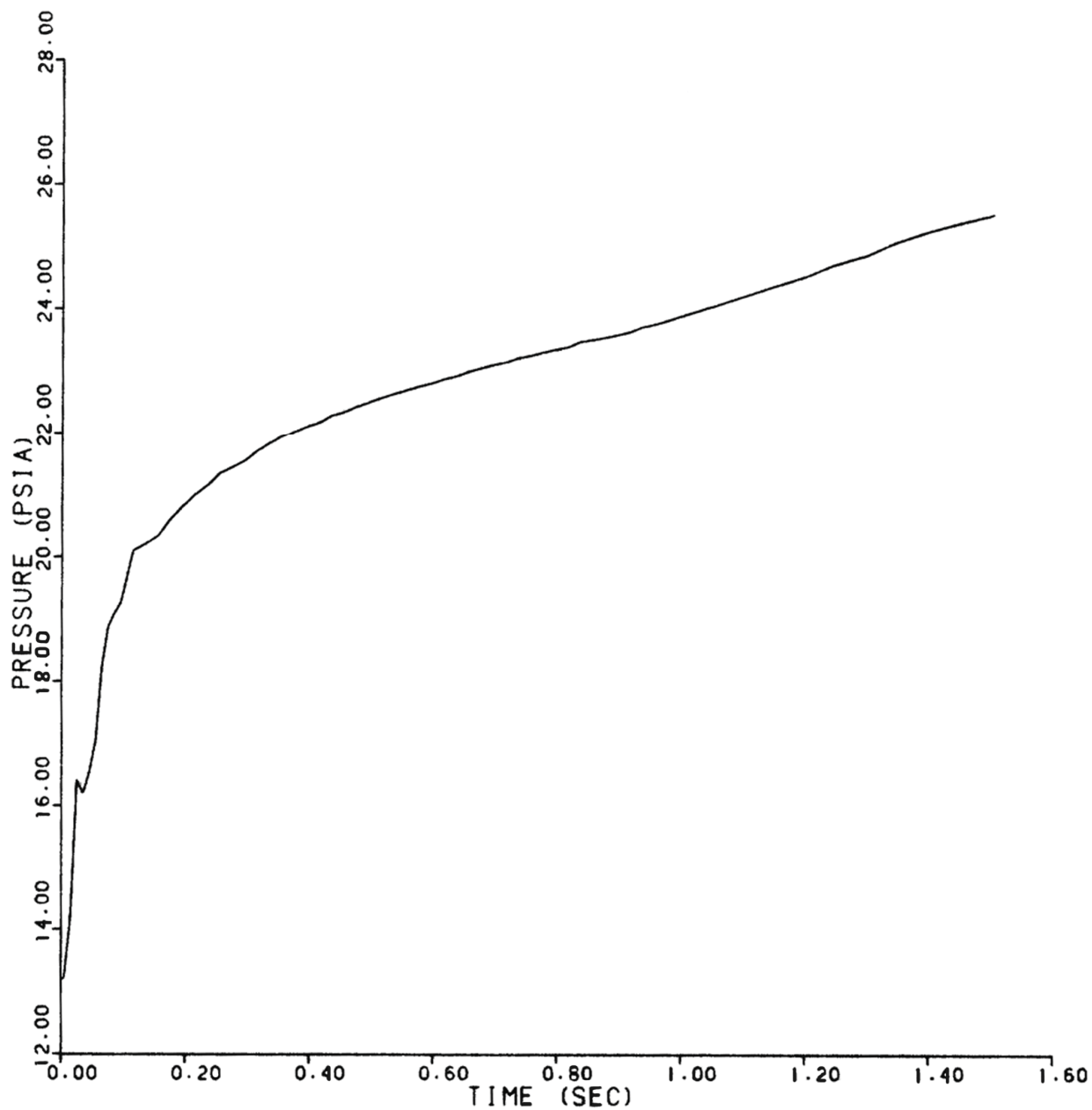

REV 13 4/06



VOGTLE
ELECTRIC GENERATING PLANT
UNIT 1 AND UNIT 2

STEAM GENERATOR COMPARTMENT
PRESSURE RESPONSE – NODE E6
(236-in.² BREAK AREA)

FIGURE 6.2.1-18 (SHEET 6 OF 74)

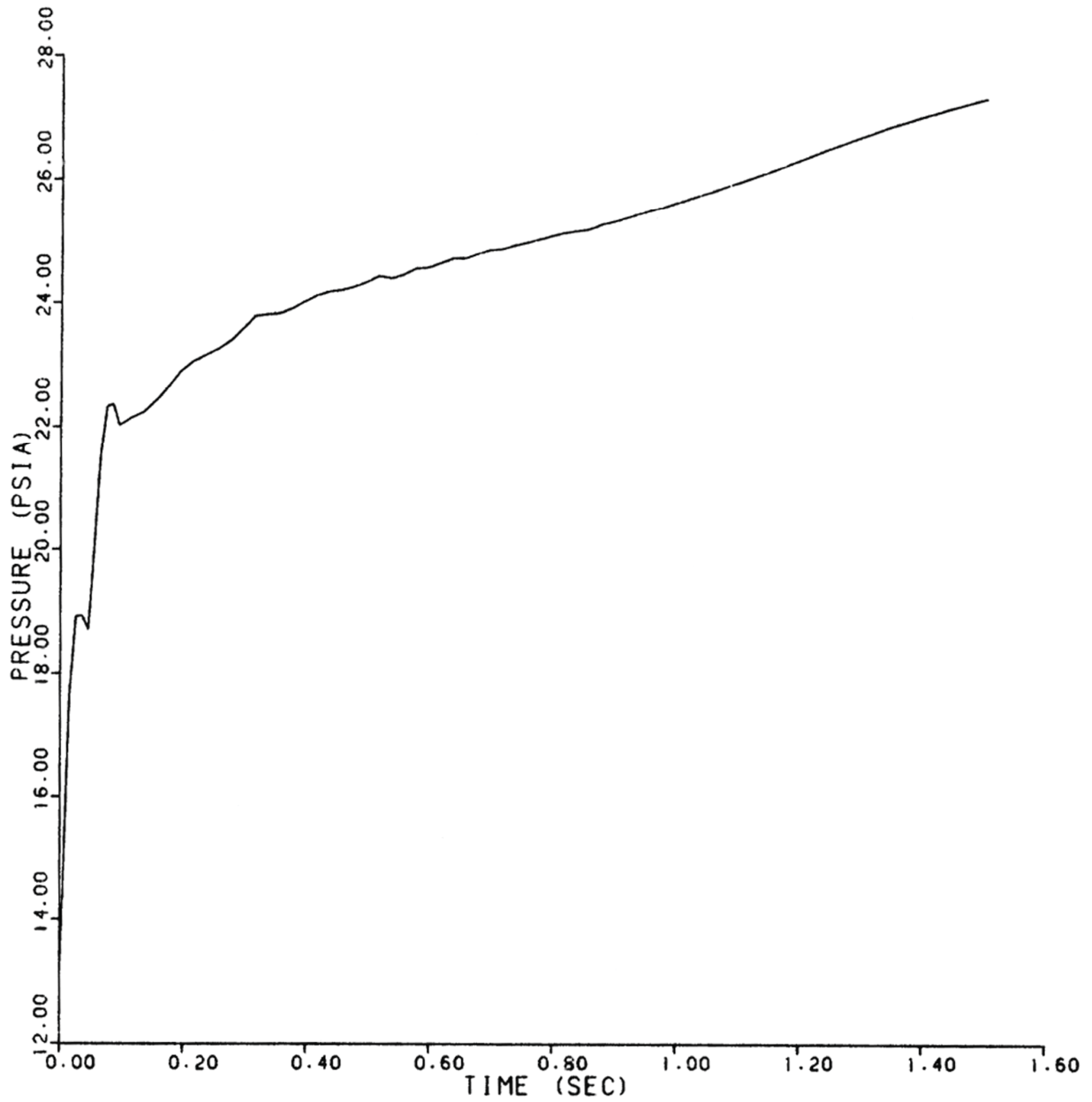

REV 13 4/06



VOGTLE
ELECTRIC GENERATING PLANT
UNIT 1 AND UNIT 2

STEAM GENERATOR COMPARTMENT
PRESSURE RESPONSE – NODE E7
(236-in.² BREAK AREA)

FIGURE 6.2.1-18 (SHEET 7 OF 74)

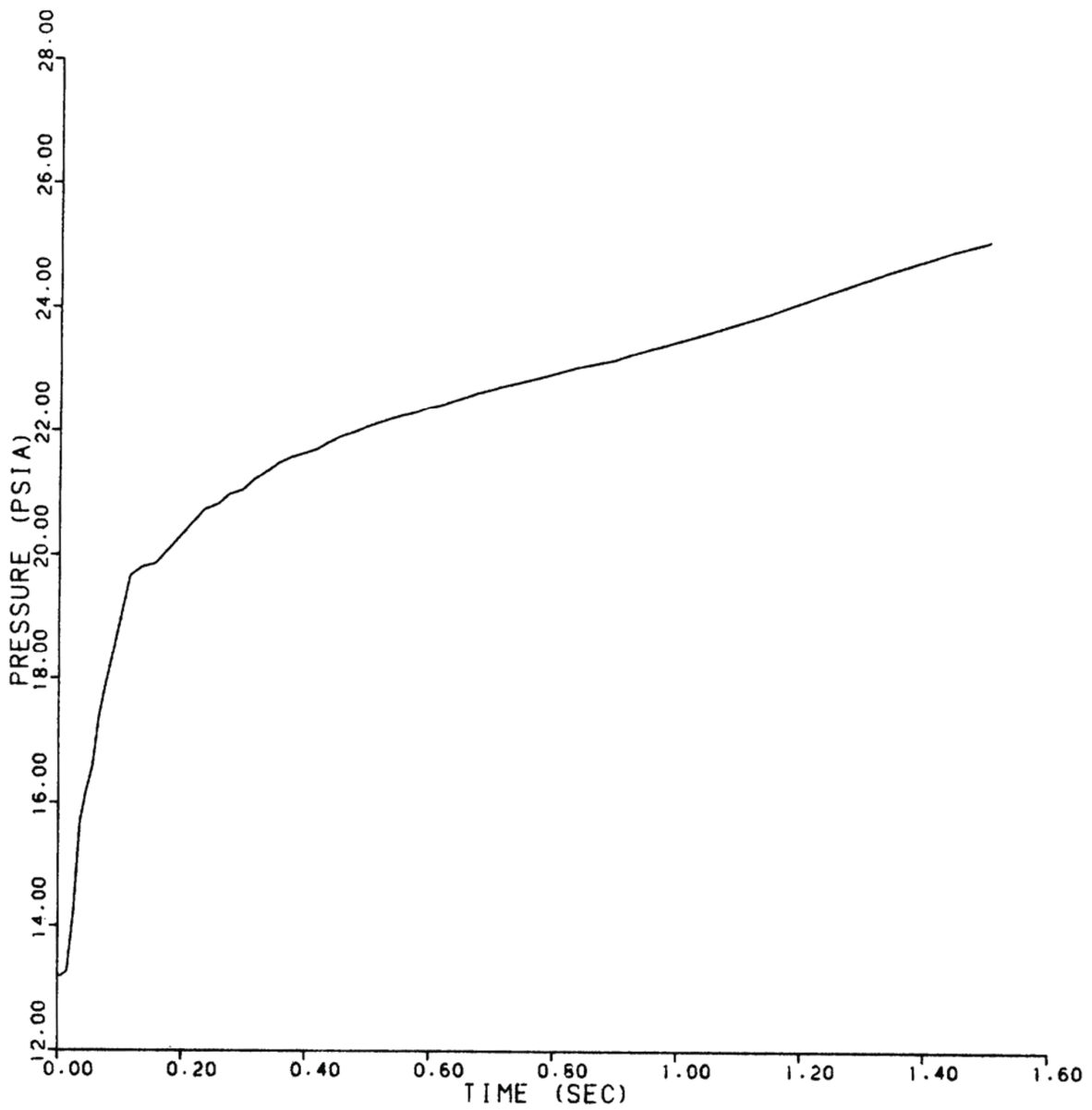

REV 13 4/06



VOGTLE
ELECTRIC GENERATING PLANT
UNIT 1 AND UNIT 2

STEAM GENERATOR COMPARTMENT
PRESSURE RESPONSE – NODE E8
(236-in.² BREAK AREA)

FIGURE 6.2.1-18 (SHEET 8 OF 74)

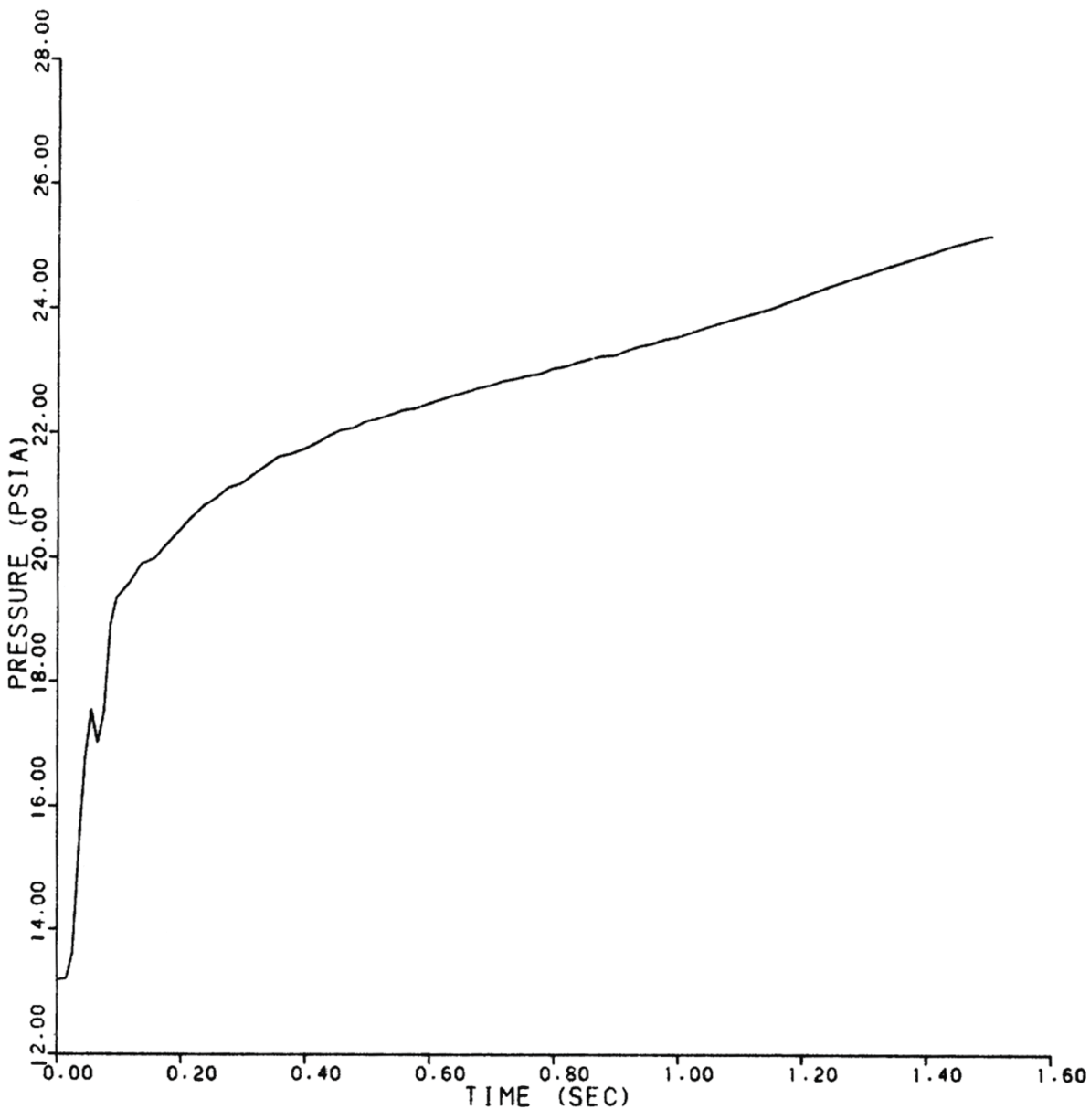

REV 13 4/06



VOGTLE
ELECTRIC GENERATING PLANT
UNIT 1 AND UNIT 2

STEAM GENERATOR COMPARTMENT
PRESSURE RESPONSE – NODE E9
(236-in.² BREAK AREA)

FIGURE 6.2.1-18 (SHEET 9 OF 74)

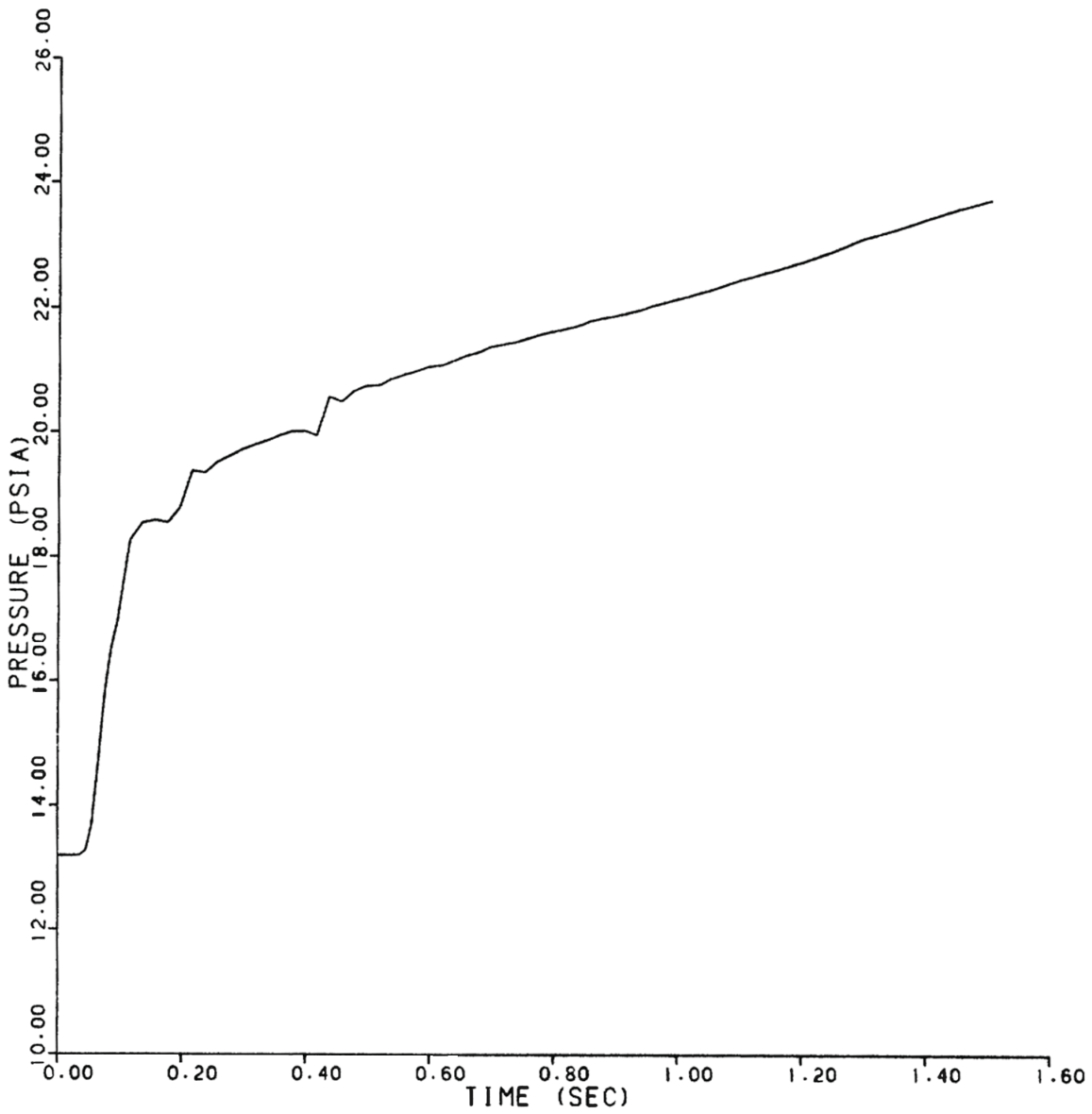

REV 13 4/06



VOGTLE
ELECTRIC GENERATING PLANT
UNIT 1 AND UNIT 2

STEAM GENERATOR COMPARTMENT
PRESSURE RESPONSE – NODE E10
(236-in.² BREAK AREA)

FIGURE 6.2.1-18 (SHEET 10 OF 74)

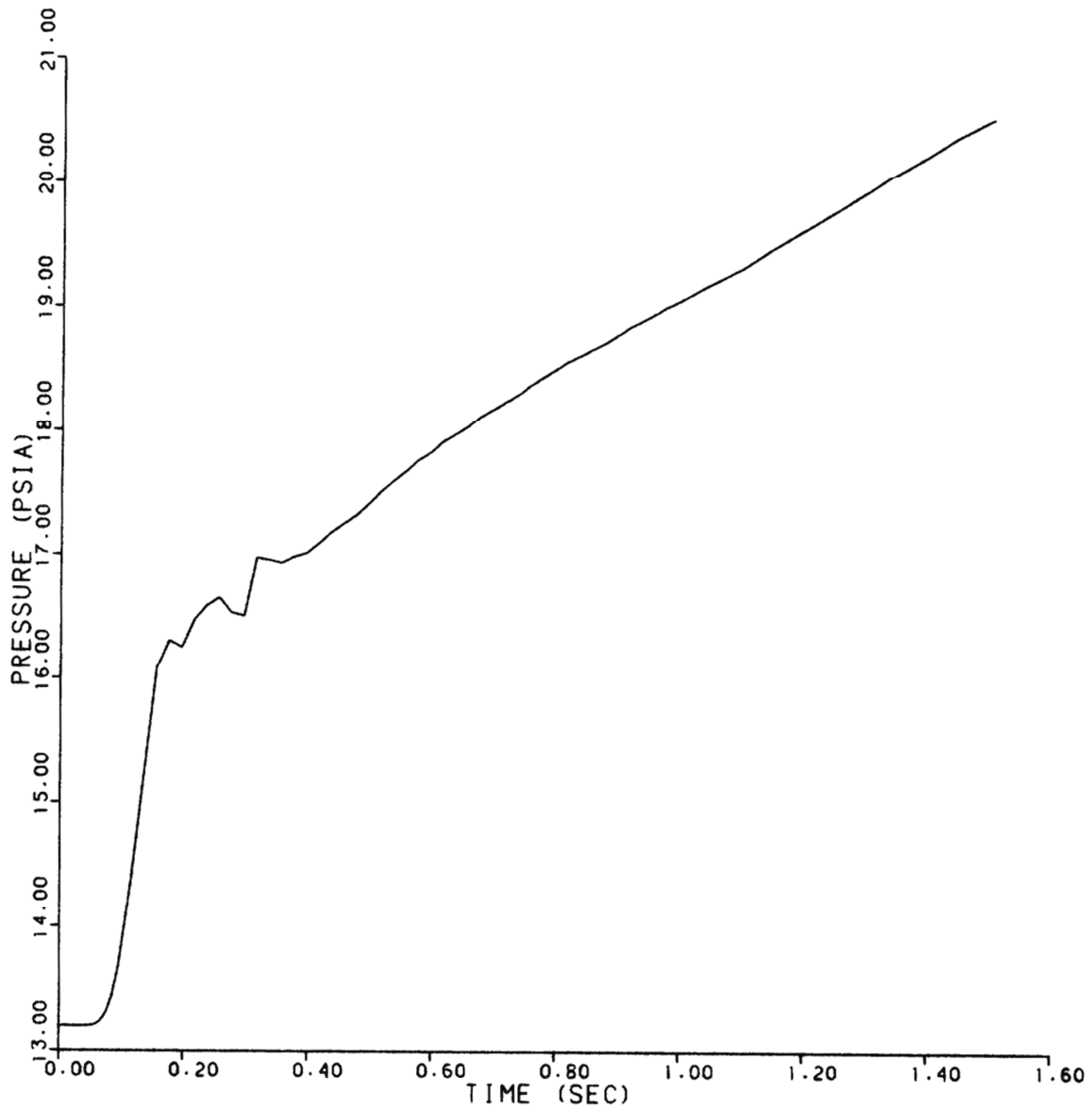

REV 13 4/06



VOGTLE
ELECTRIC GENERATING PLANT
UNIT 1 AND UNIT 2

STEAM GENERATOR COMPARTMENT
PRESSURE RESPONSE – NODE E11
(236-in.² BREAK AREA)

FIGURE 6.2.1-18 (SHEET 11 OF 74)

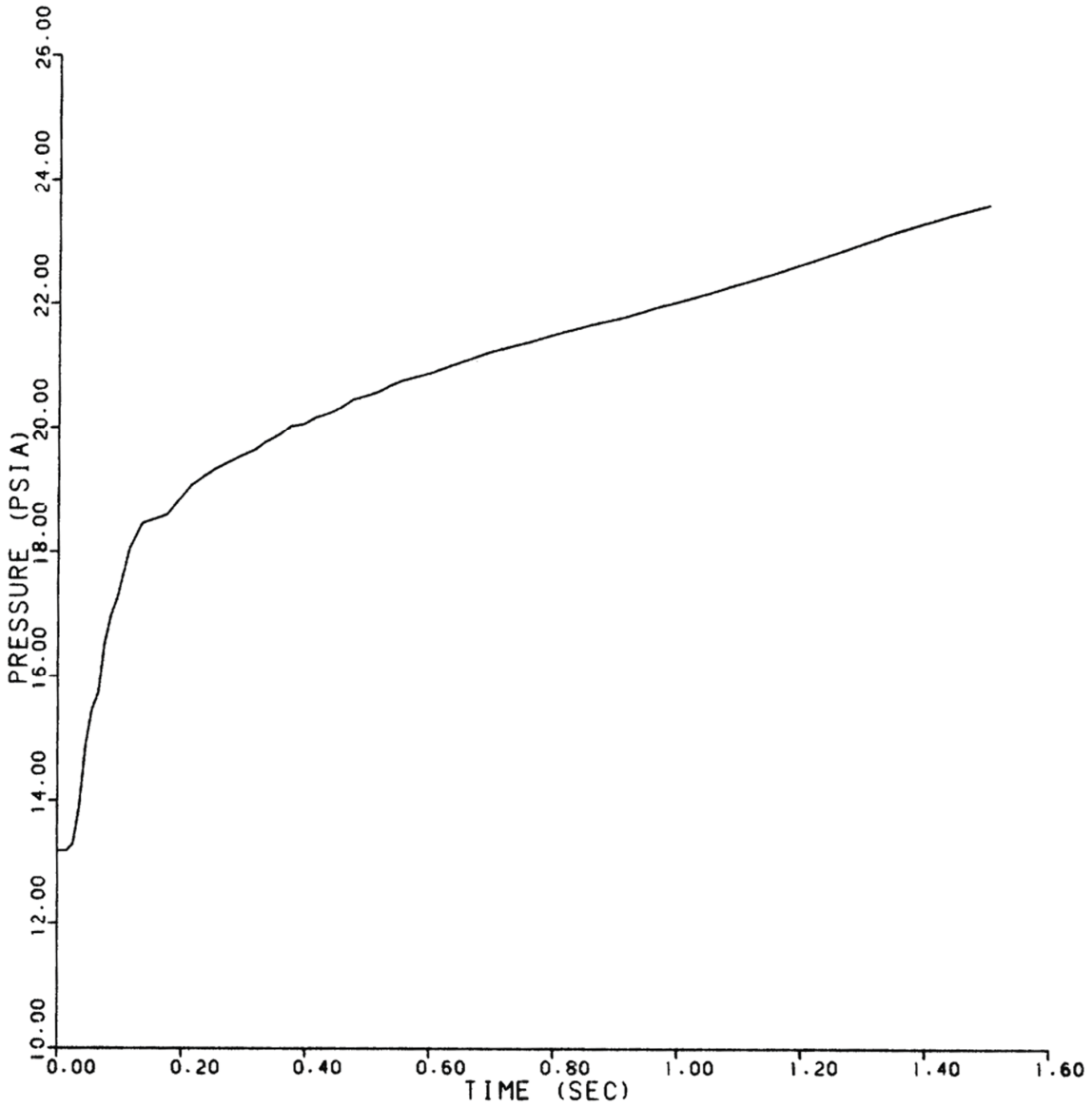

REV 13 4/06



VOGTLE
ELECTRIC GENERATING PLANT
UNIT 1 AND UNIT 2

STEAM GENERATOR COMPARTMENT
PRESSURE RESPONSE – NODE E12
(236-in.² BREAK AREA)

FIGURE 6.2.1-18 (SHEET 12 OF 74)

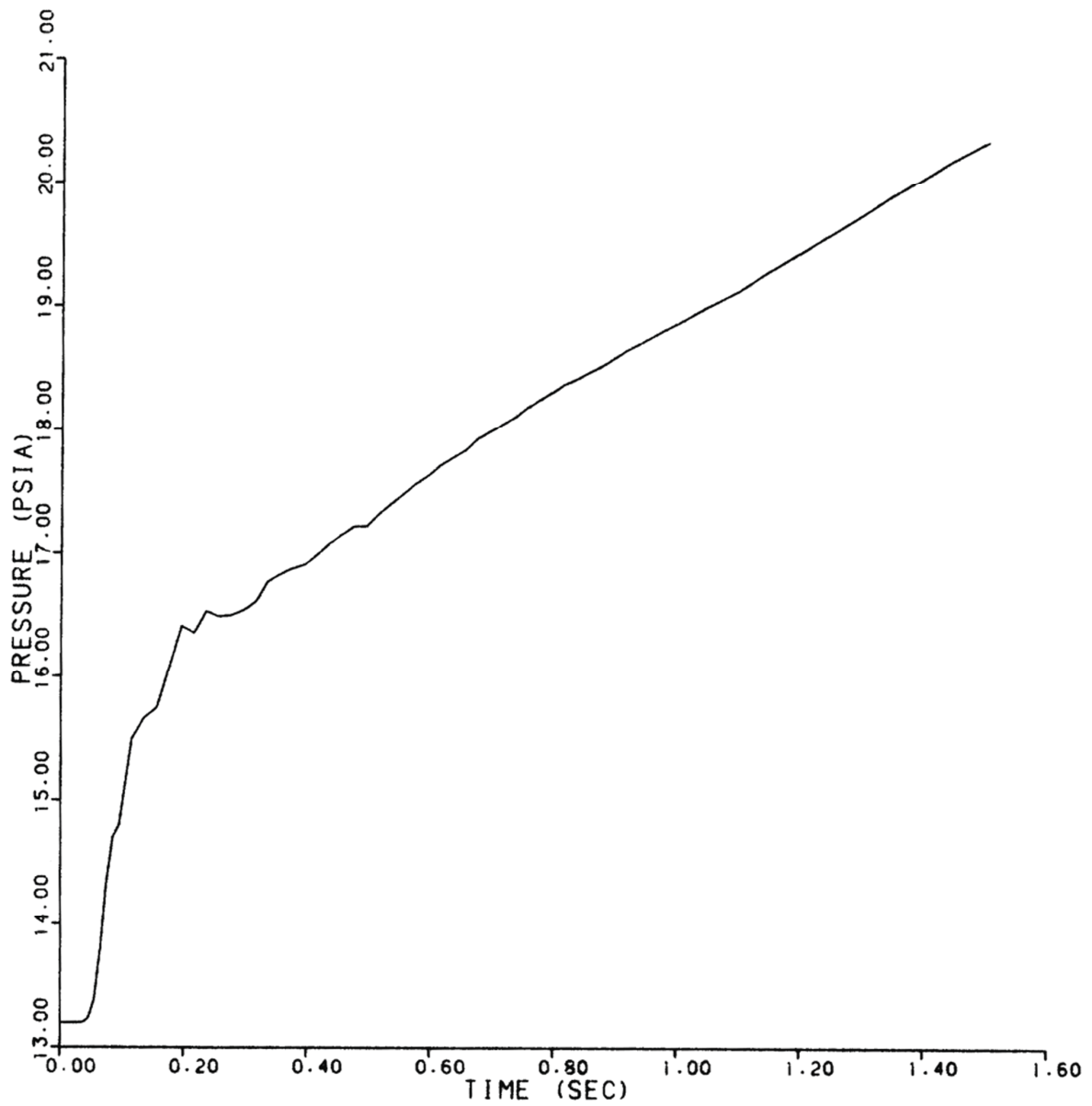

REV 13 4/06



VOGTLE
ELECTRIC GENERATING PLANT
UNIT 1 AND UNIT 2

STEAM GENERATOR COMPARTMENT
PRESSURE RESPONSE – NODE E13
(236-in.² BREAK AREA)

FIGURE 6.2.1–18 (SHEET 13 OF 74)

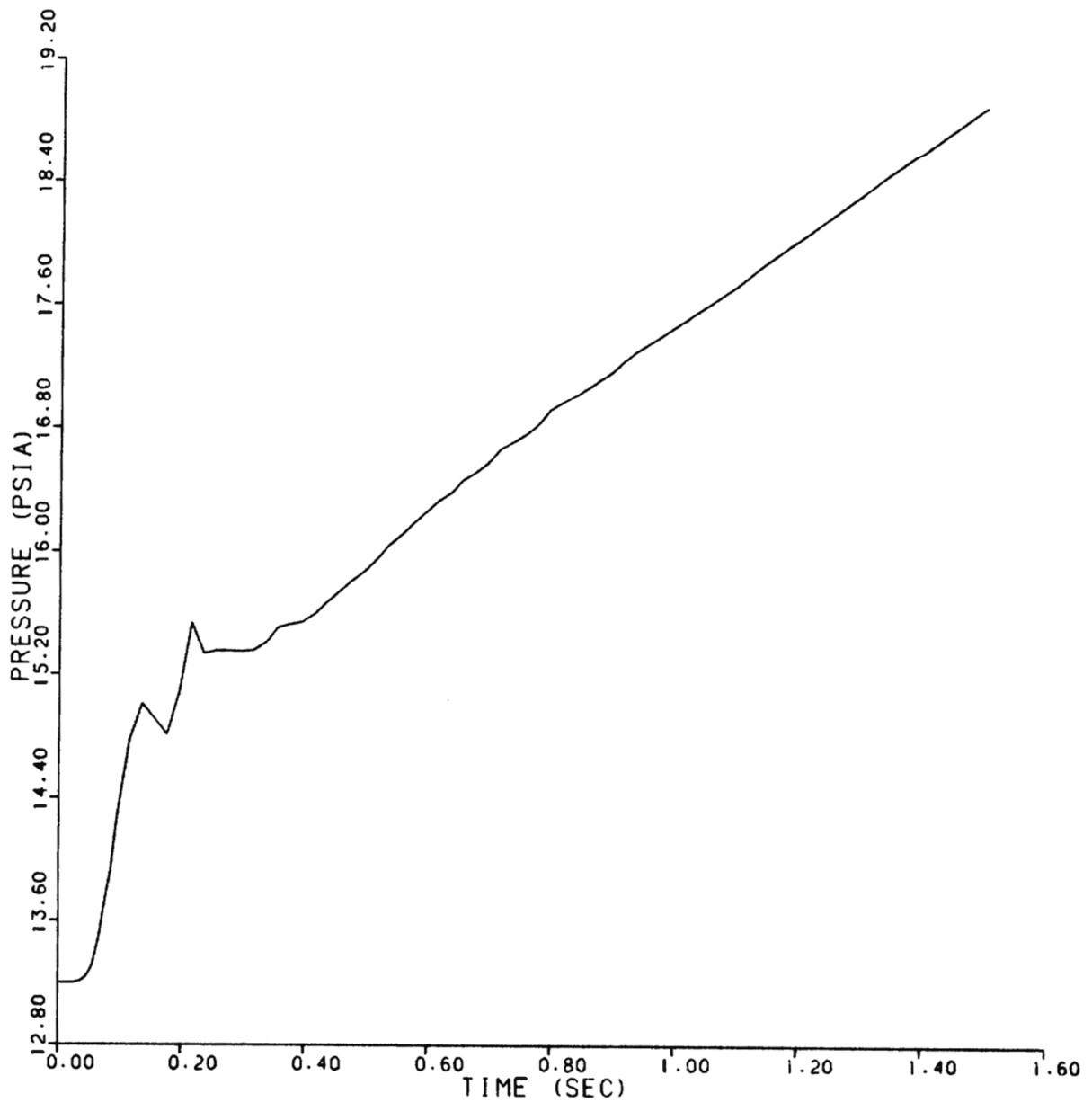

REV 13 4/06



VOGTLE
ELECTRIC GENERATING PLANT
UNIT 1 AND UNIT 2

STEAM GENERATOR COMPARTMENT
PRESSURE RESPONSE – NODE E14
(236-in.² BREAK AREA)

FIGURE 6.2.1-18 (SHEET 14 OF 74)

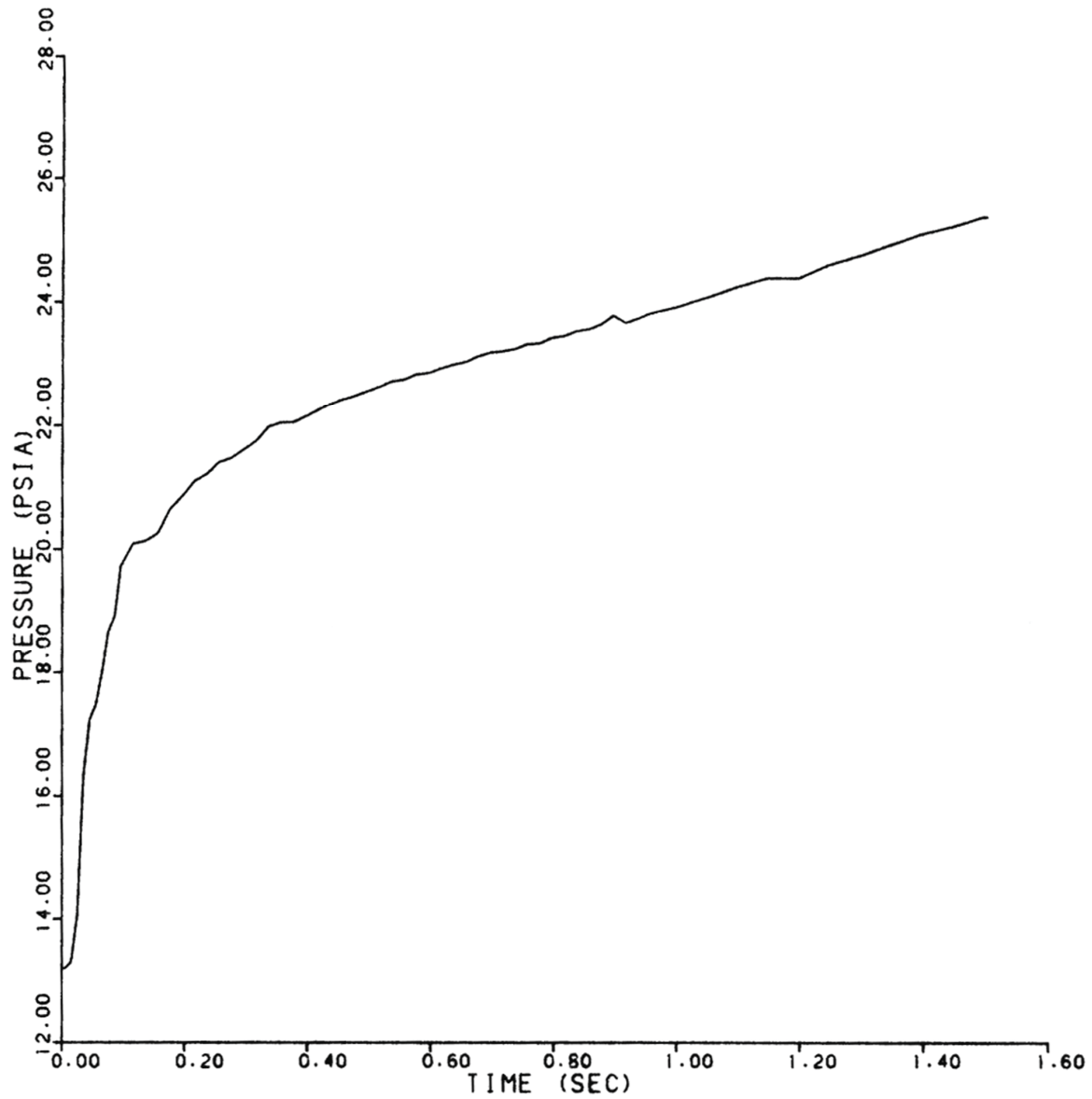

REV 13 4/06



VOGTLE
ELECTRIC GENERATING PLANT
UNIT 1 AND UNIT 2

STEAM GENERATOR COMPARTMENT
PRESSURE RESPONSE – NODE E15
(236-in.² BREAK AREA)

FIGURE 6.2.1-18 (SHEET 15 OF 74)

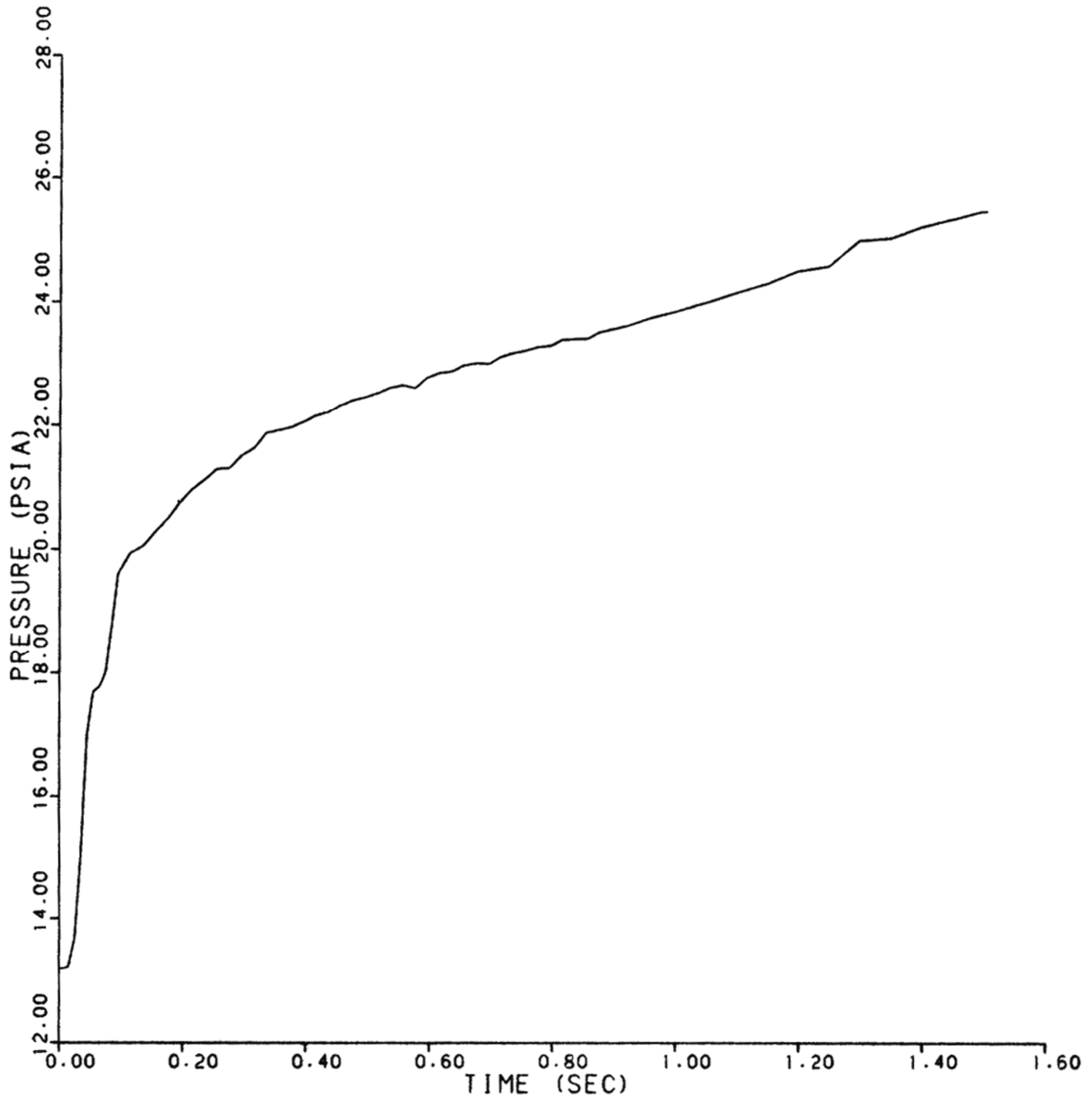

REV 13 4/06



VOGTLE
ELECTRIC GENERATING PLANT
UNIT 1 AND UNIT 2

STEAM GENERATOR COMPARTMENT
PRESSURE RESPONSE – NODE E16
(236-in.² BREAK AREA)

FIGURE 6.2.1–18 (SHEET 16 OF 74)

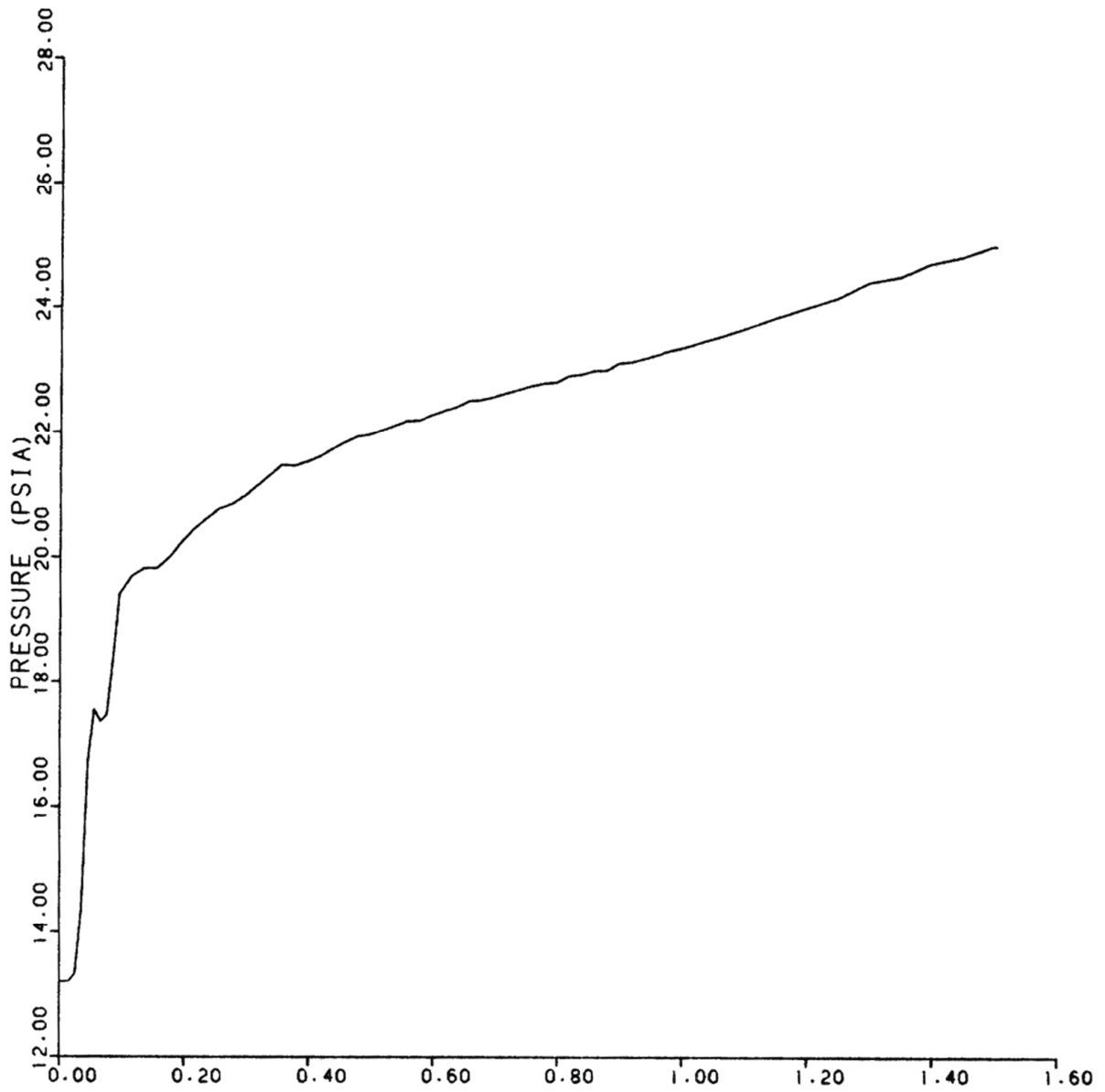

REV 13 4/06



VOGTLE
ELECTRIC GENERATING PLANT
UNIT 1 AND UNIT 2

STEAM GENERATOR COMPARTMENT
PRESSURE RESPONSE – NODE E17
(236-in.² BREAK AREA)

FIGURE 6.2.1–18 (SHEET 17 OF 74)

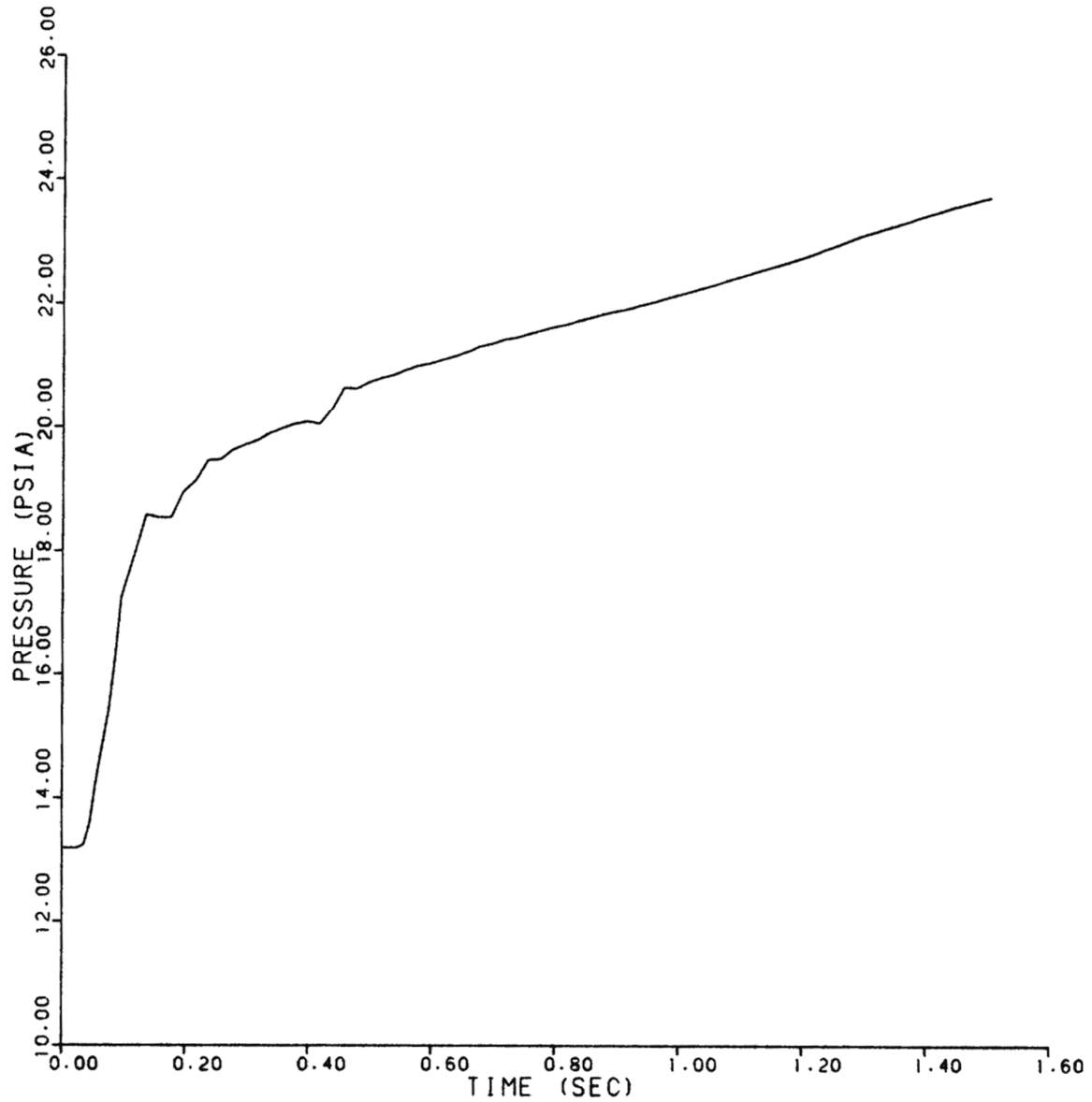

REV 13 4/06



VOGTLE
ELECTRIC GENERATING PLANT
UNIT 1 AND UNIT 2

STEAM GENERATOR COMPARTMENT
PRESSURE RESPONSE – NODE E18
(236-in.² BREAK AREA)

FIGURE 6.2.1-18 (SHEET 18 OF 74)

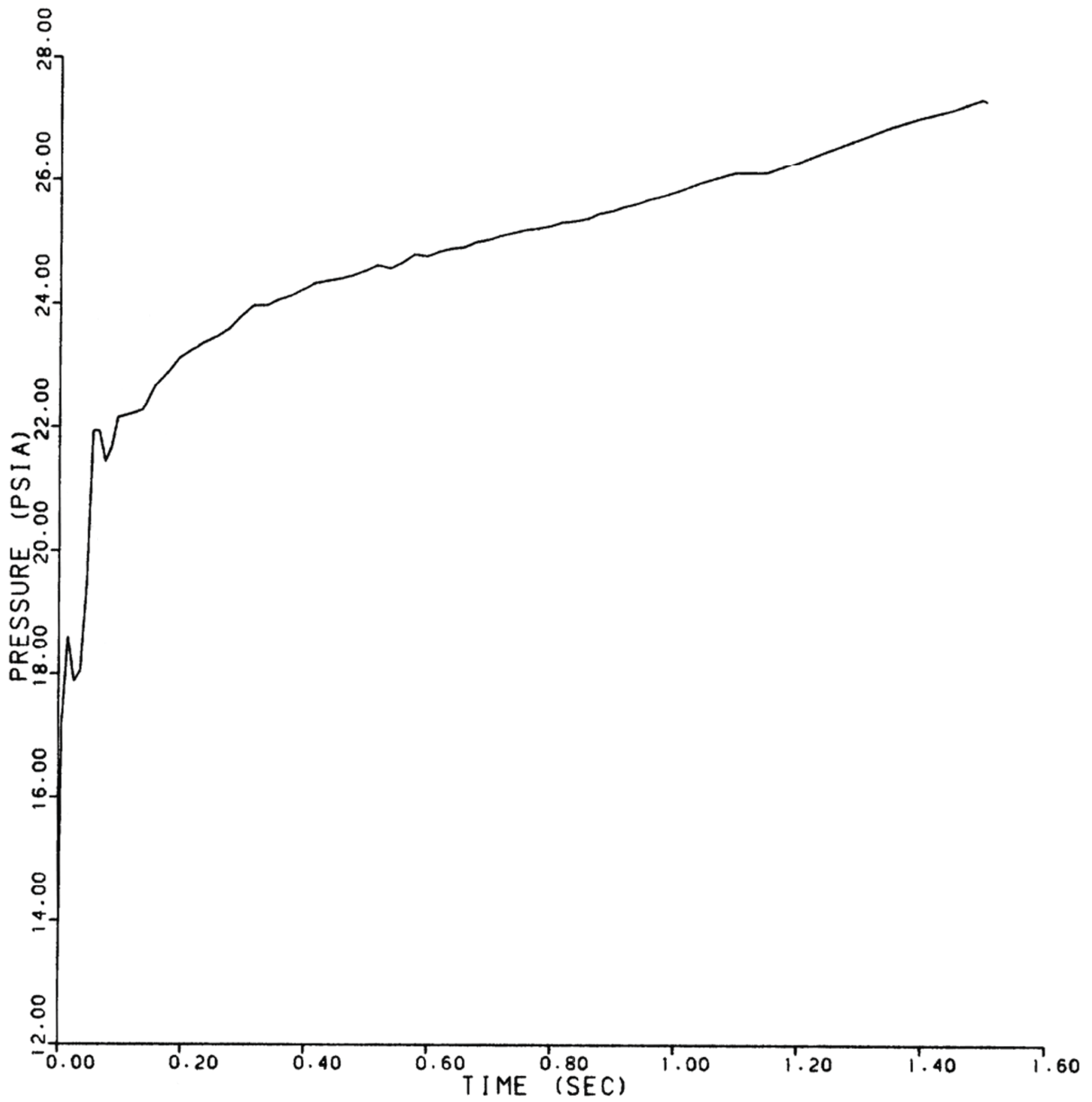

REV 13 4/06



VOGTLE
ELECTRIC GENERATING PLANT
UNIT 1 AND UNIT 2

STEAM GENERATOR COMPARTMENT
PRESSURE RESPONSE – NODE E19
(236-in.² BREAK AREA)

FIGURE 6.2.1-18 (SHEET 19 OF 74)

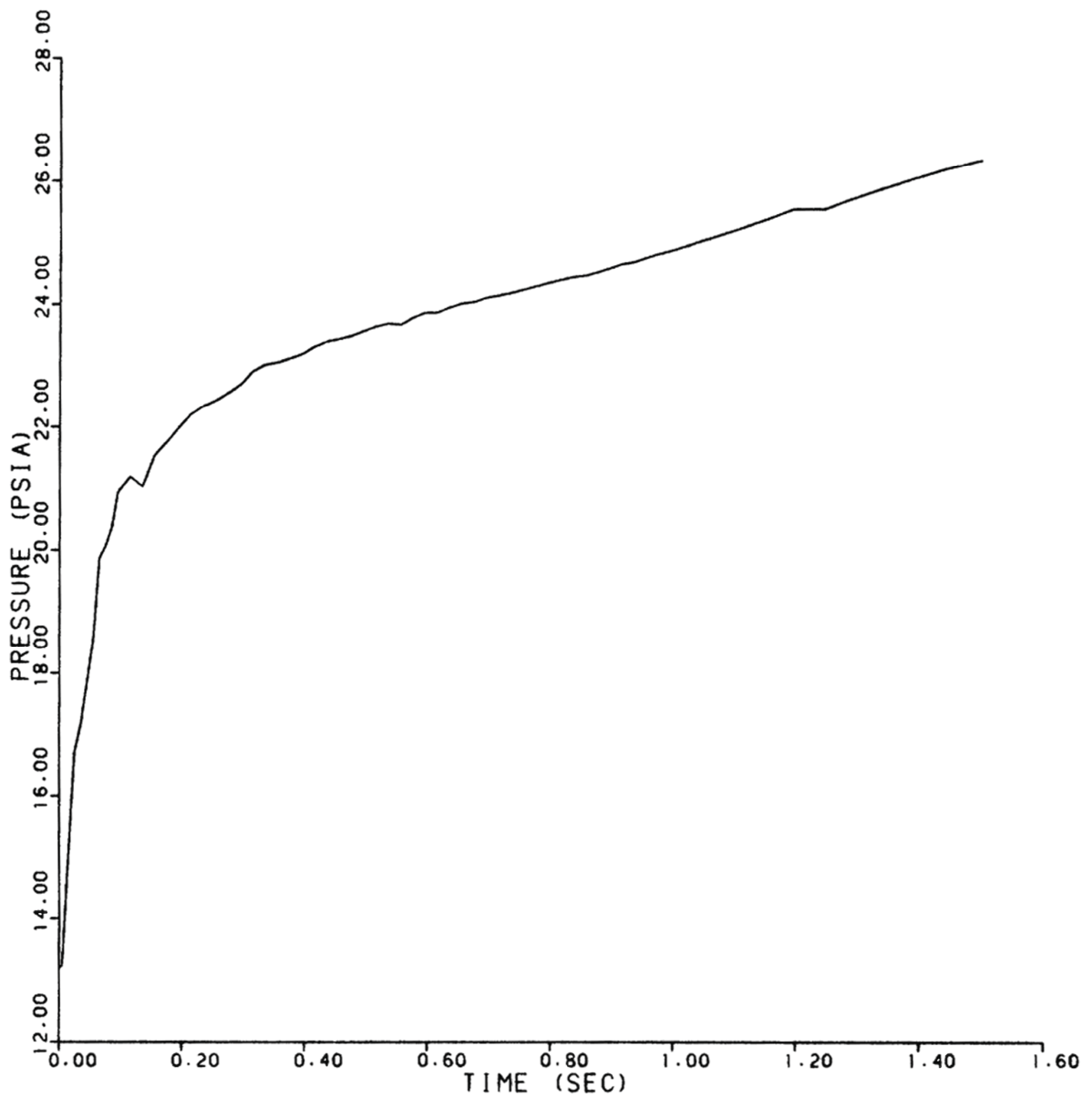

REV 13 4/06



VOGTLE
ELECTRIC GENERATING PLANT
UNIT 1 AND UNIT 2

STEAM GENERATOR COMPARTMENT
PRESSURE RESPONSE – NODE E20
(236-in.² BREAK AREA)

FIGURE 6.2.1-18 (SHEET 20 OF 74)

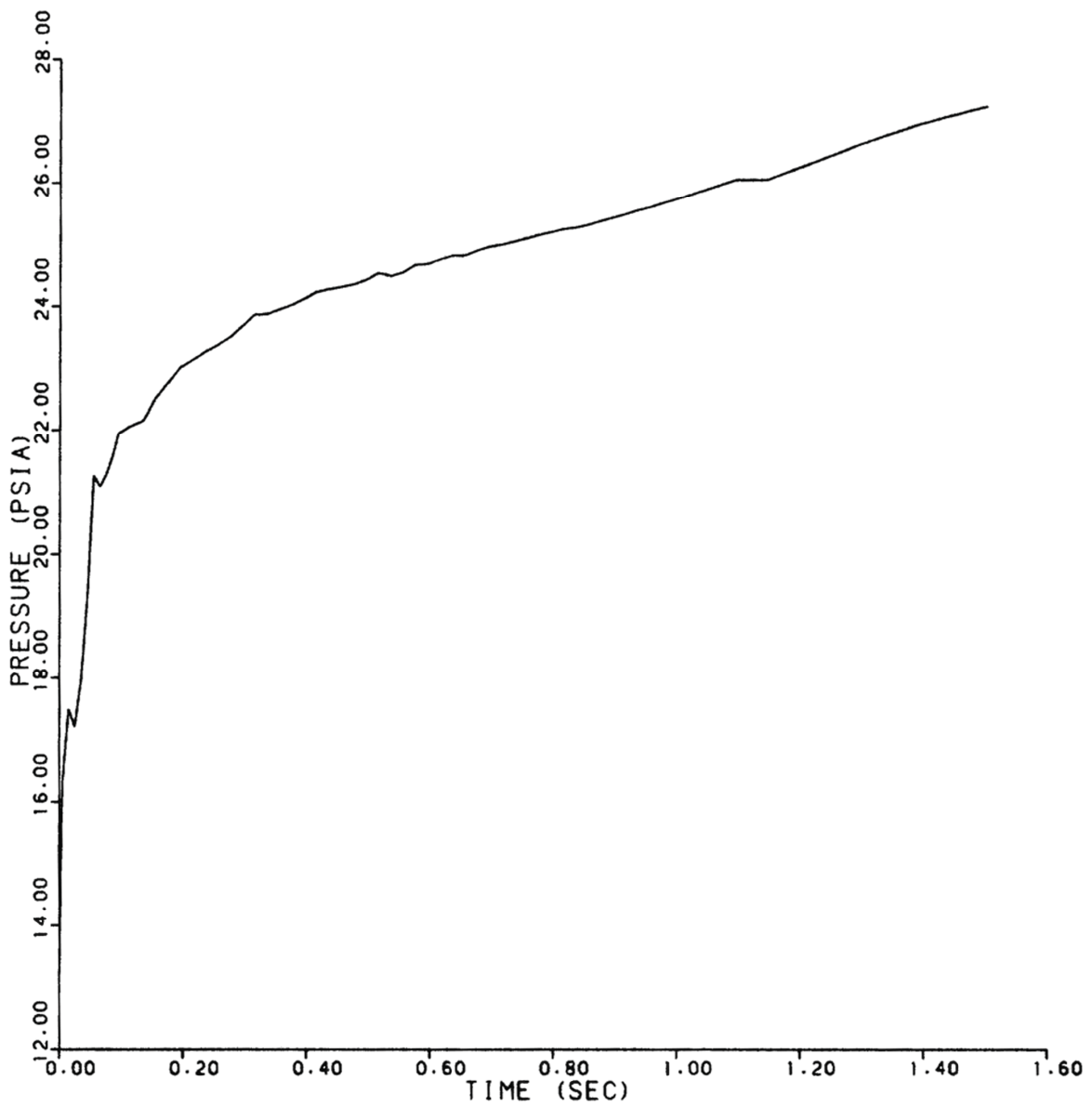

REV 13 4/06



VOGTLE
ELECTRIC GENERATING PLANT
UNIT 1 AND UNIT 2

STEAM GENERATOR COMPARTMENT
PRESSURE RESPONSE - NODE E21
(236-in.² BREAK AREA)

FIGURE 6.2.1-18 (SHEET 21 OF 74)

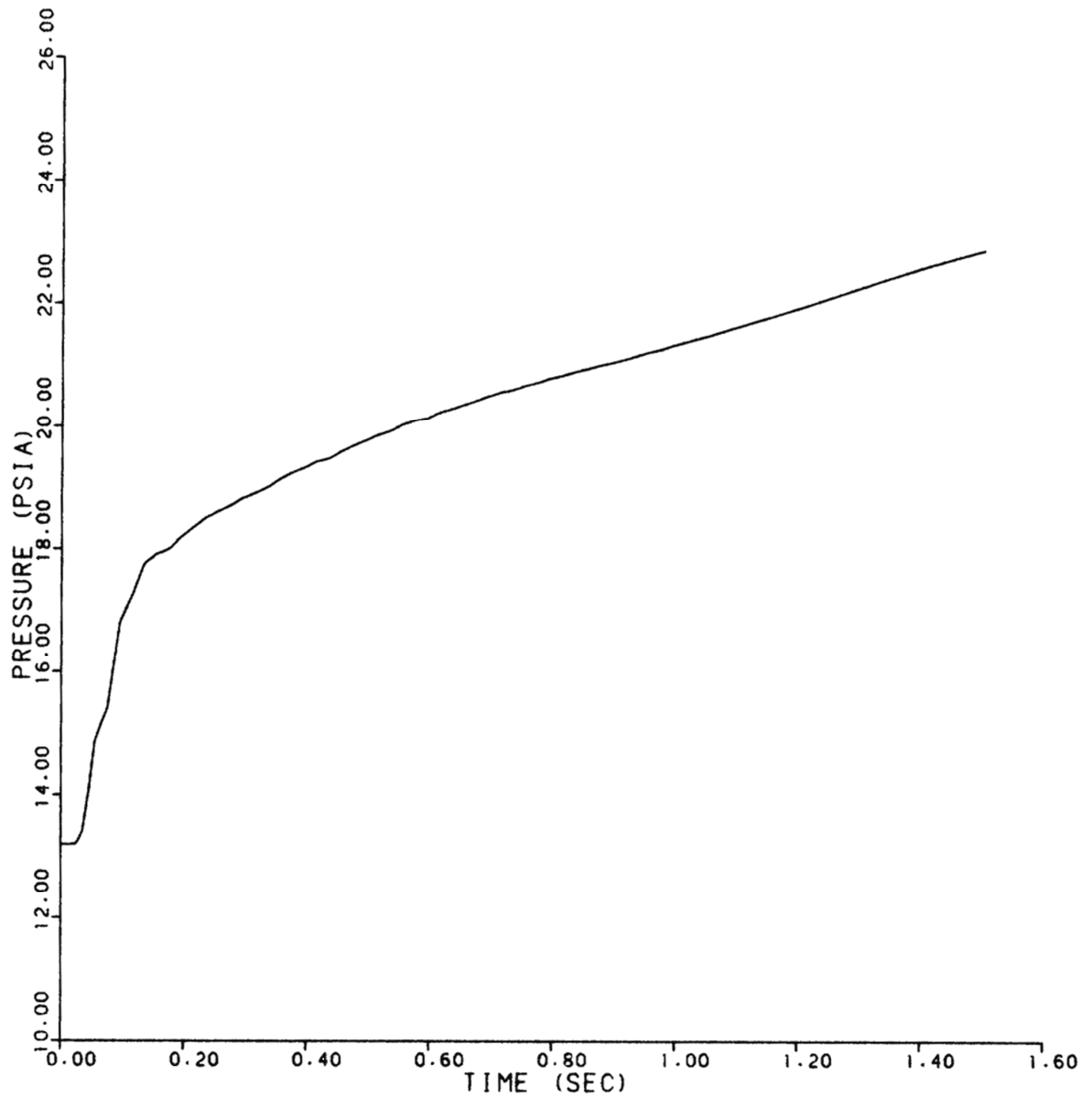

REV 13 4/06



VOGTLE
ELECTRIC GENERATING PLANT
UNIT 1 AND UNIT 2

STEAM GENERATOR COMPARTMENT
PRESSURE RESPONSE – NODE E22
(236-in.² BREAK AREA)

FIGURE 6.2.1-18 (SHEET 22 OF 74)

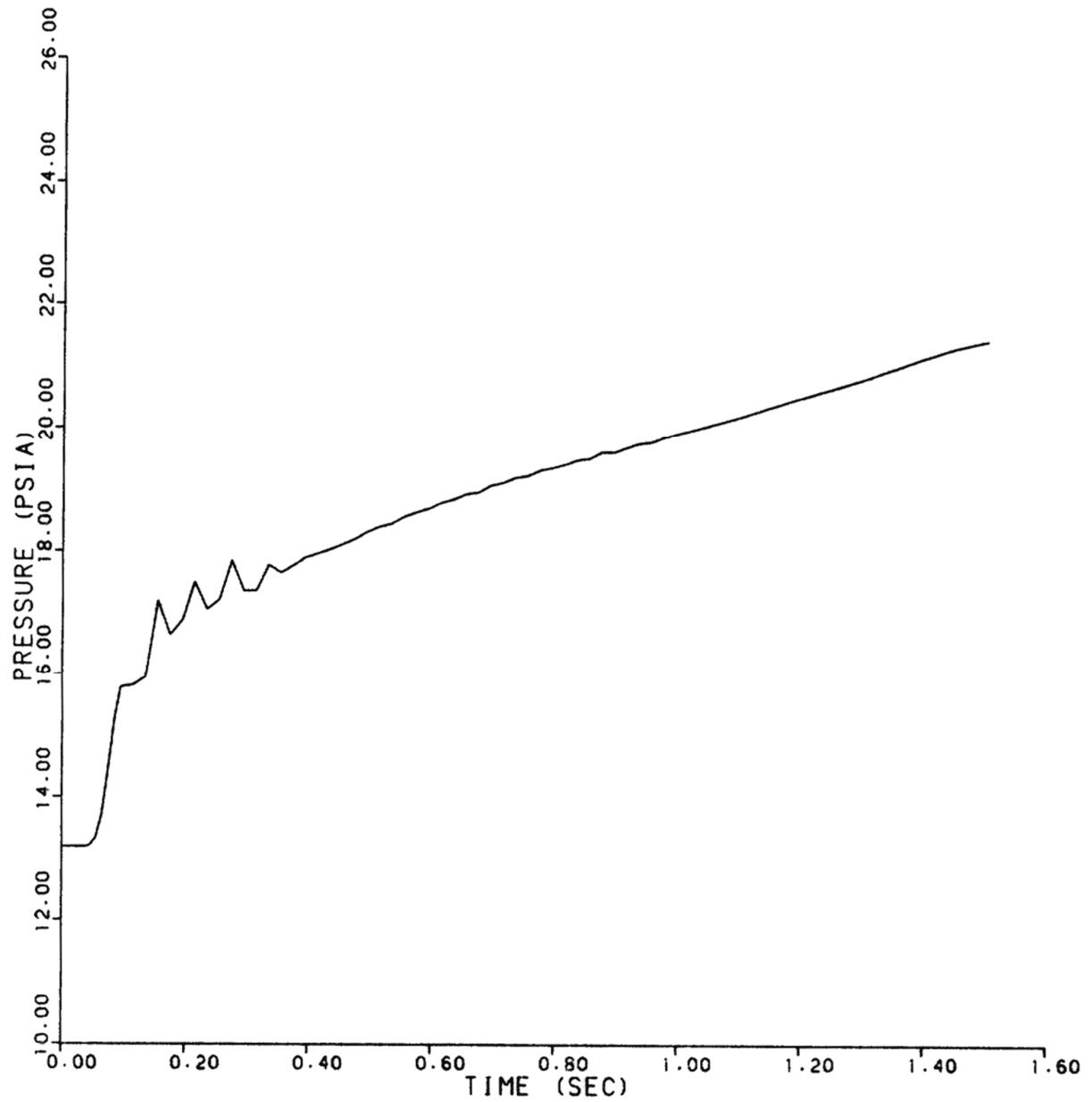

REV 13 4/06



VOGTLE
ELECTRIC GENERATING PLANT
UNIT 1 AND UNIT 2

STEAM GENERATOR COMPARTMENT
PRESSURE RESPONSE - NODE E23
(236-in.² BREAK AREA)

FIGURE 6.2.1-18 (SHEET 23 OF 74)

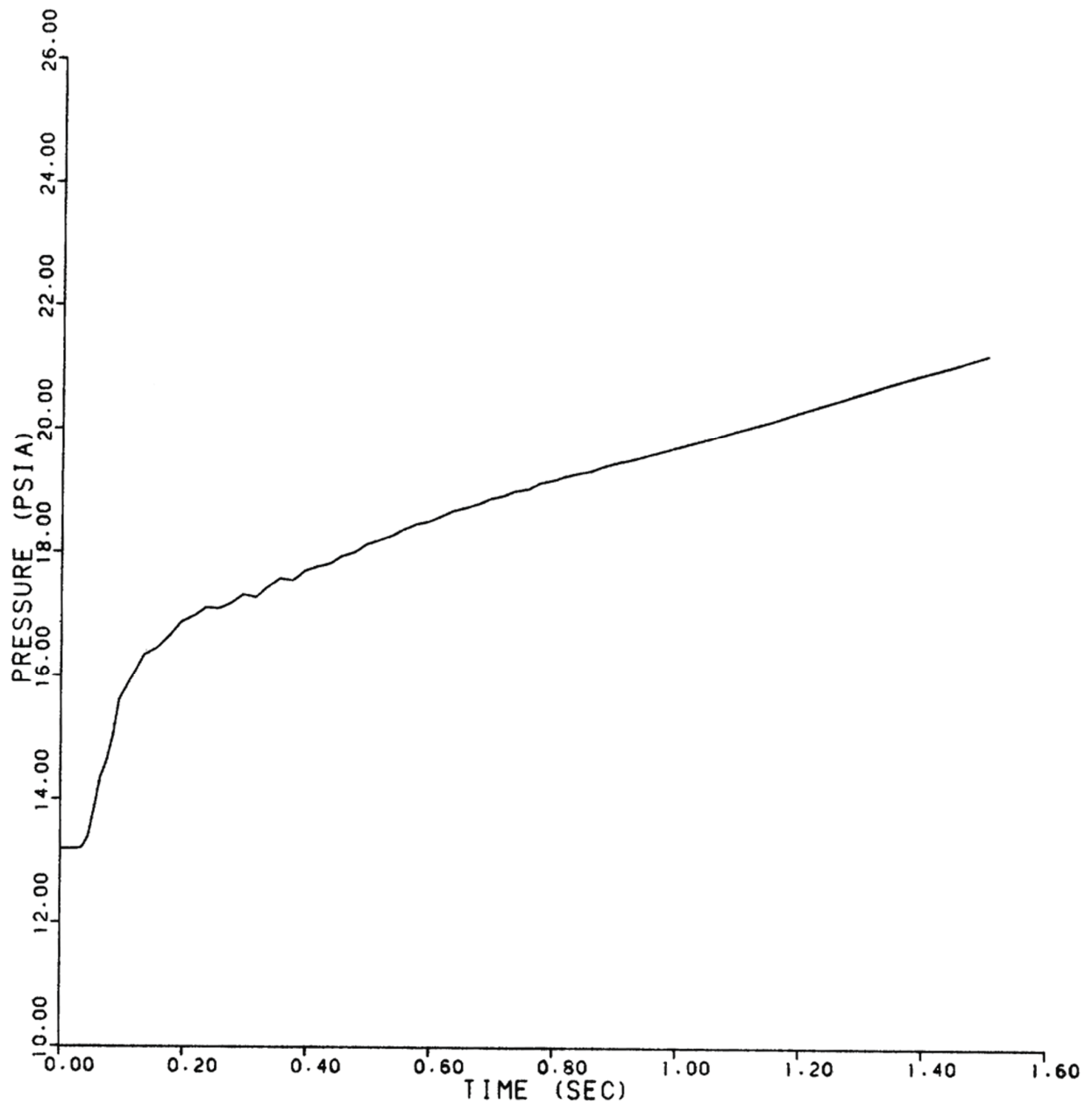

REV 13 4/06



VOGTLE
ELECTRIC GENERATING PLANT
UNIT 1 AND UNIT 2

STEAM GENERATOR COMPARTMENT
PRESSURE RESPONSE – NODE E24
(236-in.² BREAK AREA)

FIGURE 6.2.1–18 (SHEET 24 OF 74)

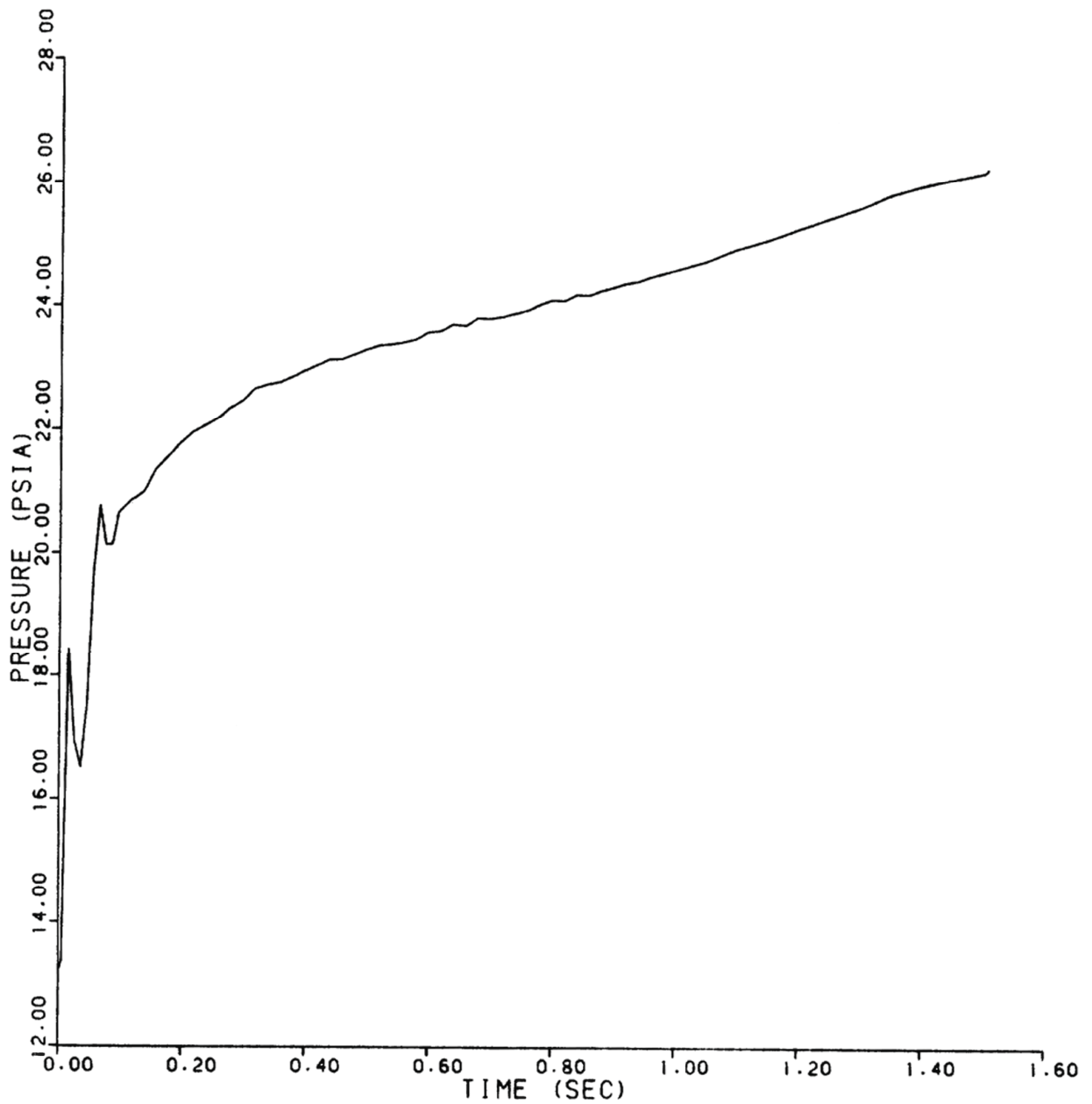

REV 13 4/06



VOGTLE
ELECTRIC GENERATING PLANT
UNIT 1 AND UNIT 2

STEAM GENERATOR COMPARTMENT
PRESSURE RESPONSE – NODE E25
(236-in.² BREAK AREA)

FIGURE 6.2.1-18 (SHEET 25 OF 74)

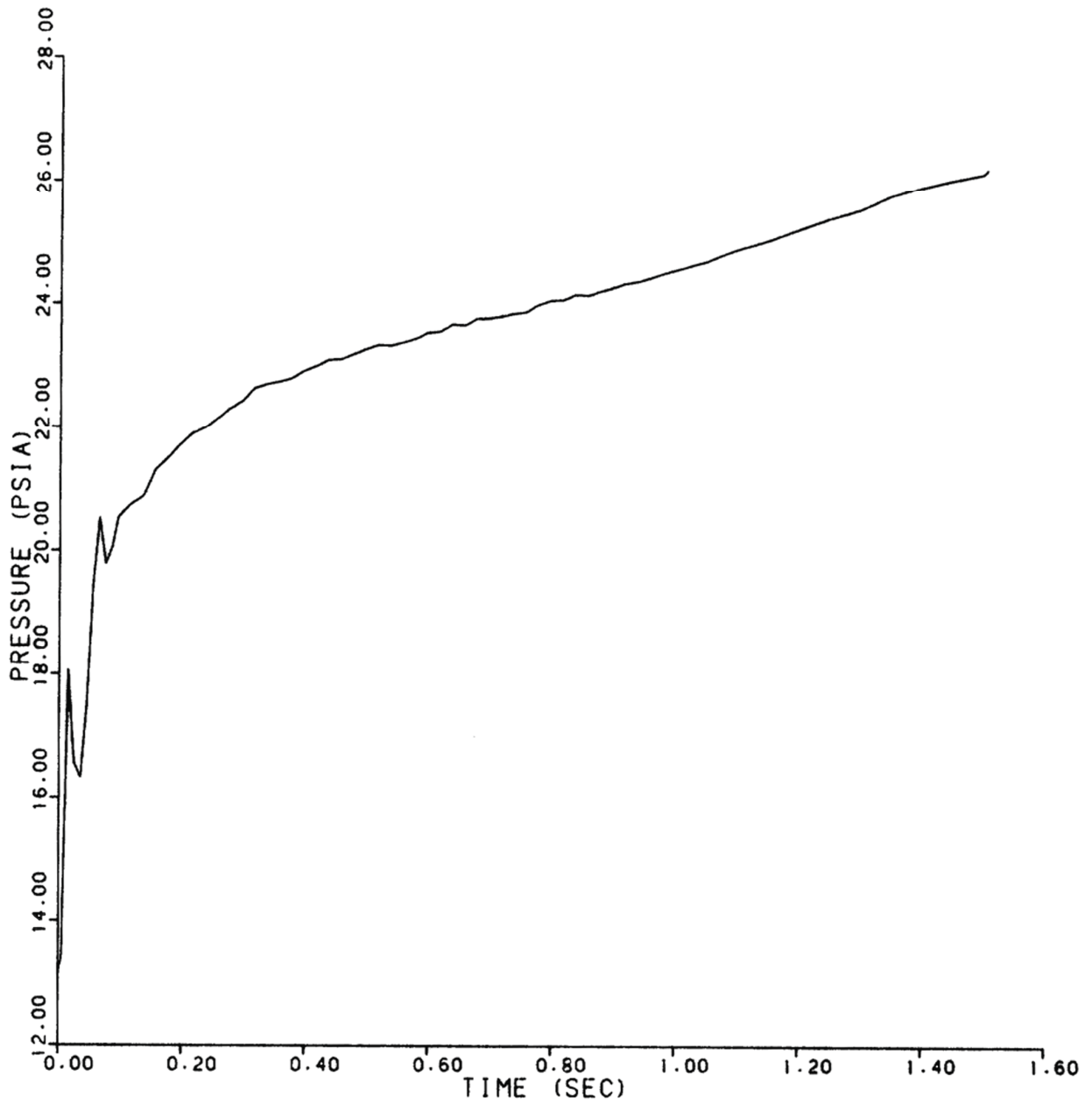

REV 13 4/06



VOGTLE
ELECTRIC GENERATING PLANT
UNIT 1 AND UNIT 2

STEAM GENERATOR COMPARTMENT
PRESSURE RESPONSE – NODE E26
(236-in.² BREAK AREA)

FIGURE 6.2.1–18 (SHEET 26 OF 74)

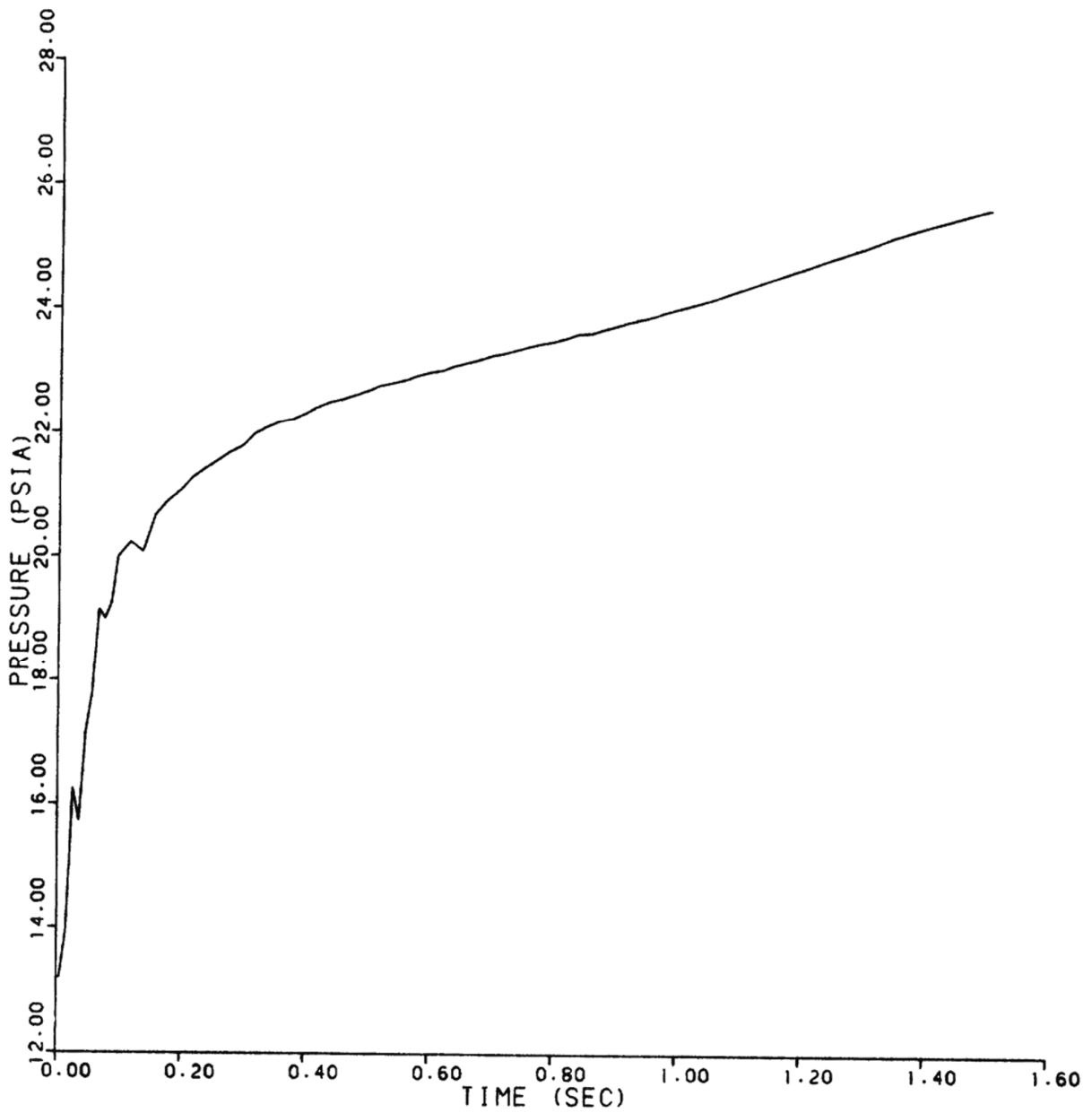

REV 13 4/06



VOGTLE
ELECTRIC GENERATING PLANT
UNIT 1 AND UNIT 2

STEAM GENERATOR COMPARTMENT
PRESSURE RESPONSE – NODE E27
(236-in.² BREAK AREA)

FIGURE 6.2.1-18 (SHEET 27 OF 74)

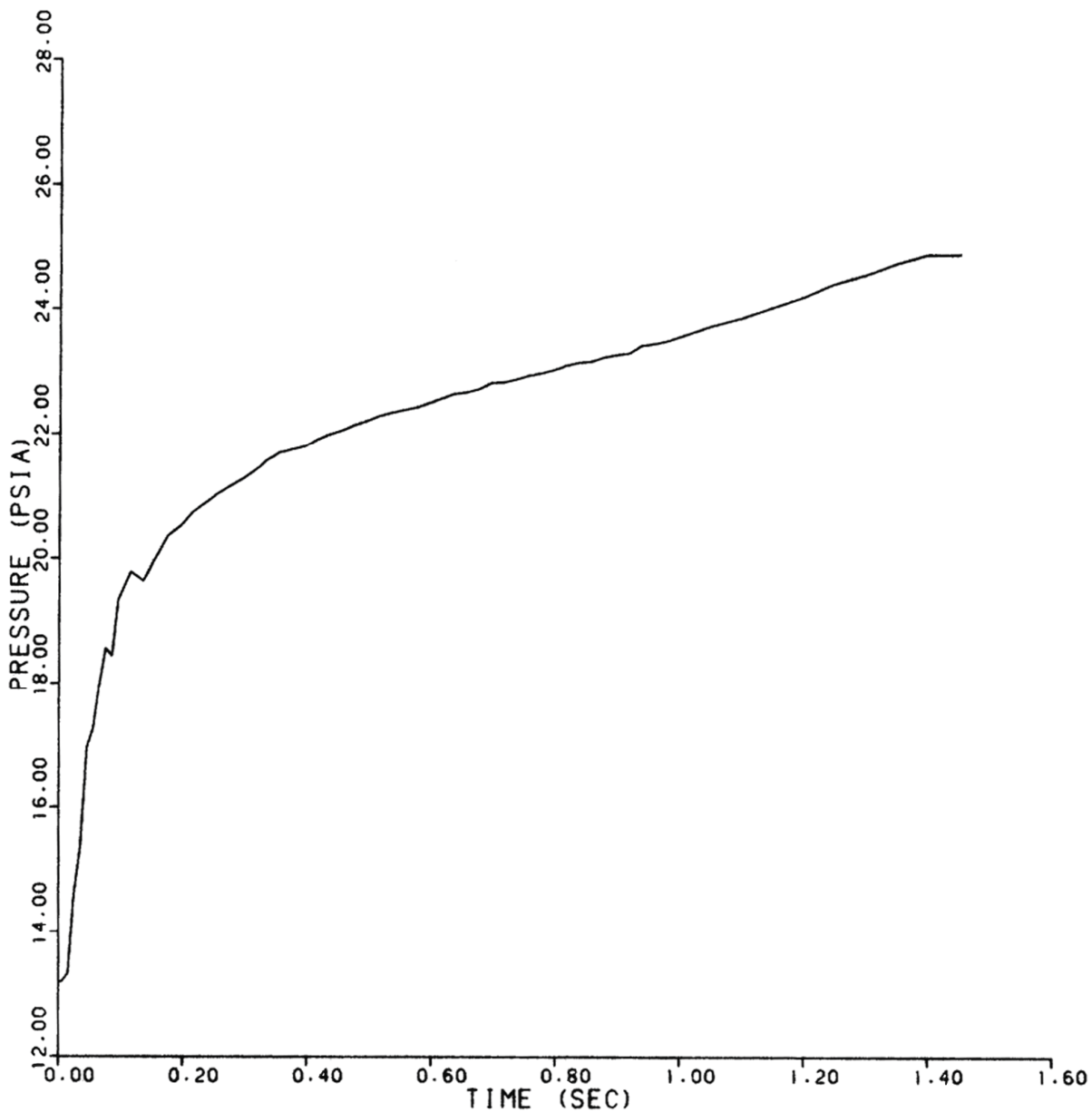

REV 13 4/06



VOGTLE
ELECTRIC GENERATING PLANT
UNIT 1 AND UNIT 2

STEAM GENERATOR COMPARTMENT
PRESSURE RESPONSE – NODE E28
(236-in.² BREAK AREA)

FIGURE 6.2.1-18 (SHEET 28 OF 74)

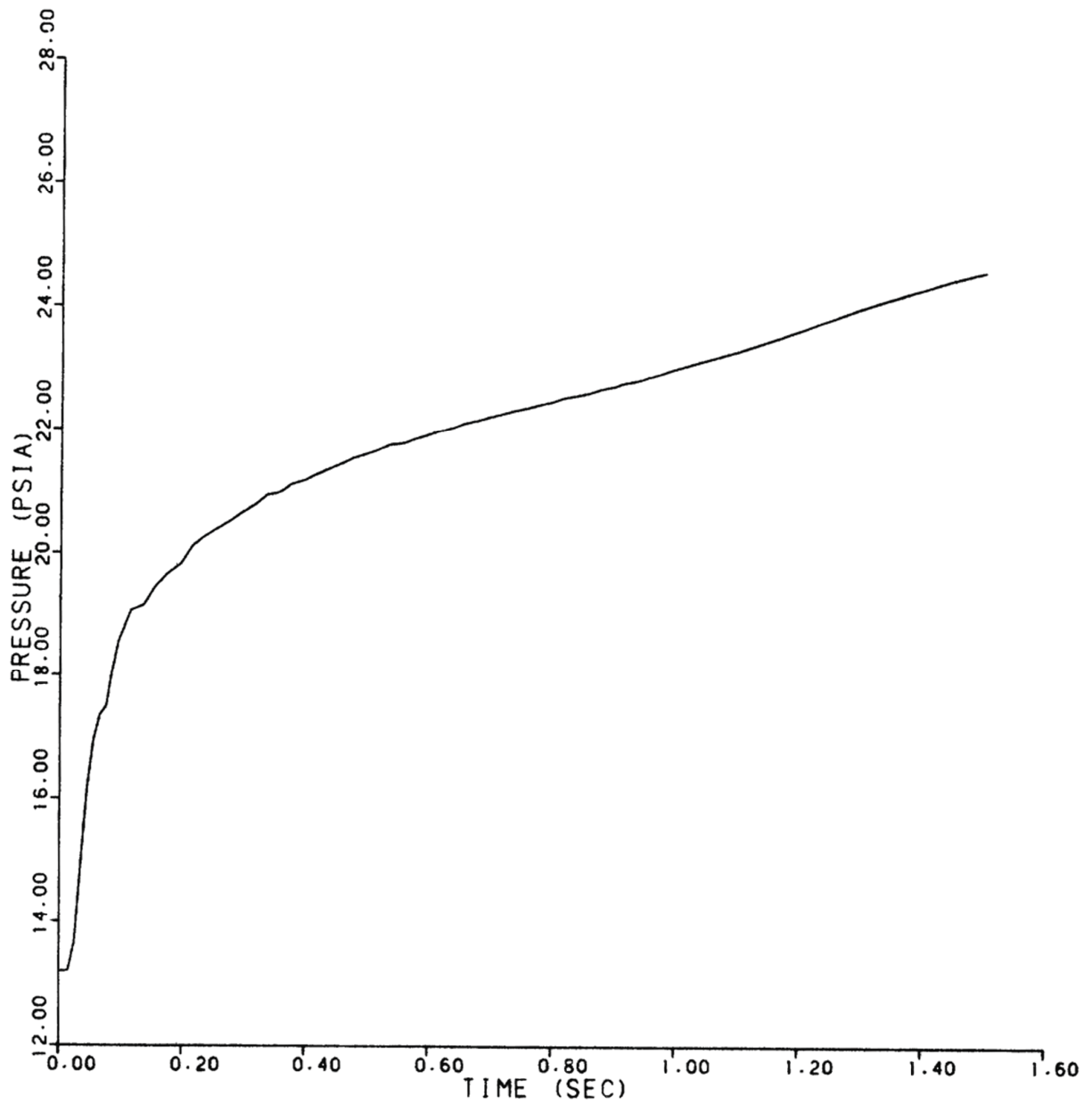

REV 13 4/06



VOGTLE
ELECTRIC GENERATING PLANT
UNIT 1 AND UNIT 2

STEAM GENERATOR COMPARTMENT
PRESSURE RESPONSE - NODE E29
(236-in.² BREAK AREA)

FIGURE 6.2.1-18 (SHEET 29 OF 74)

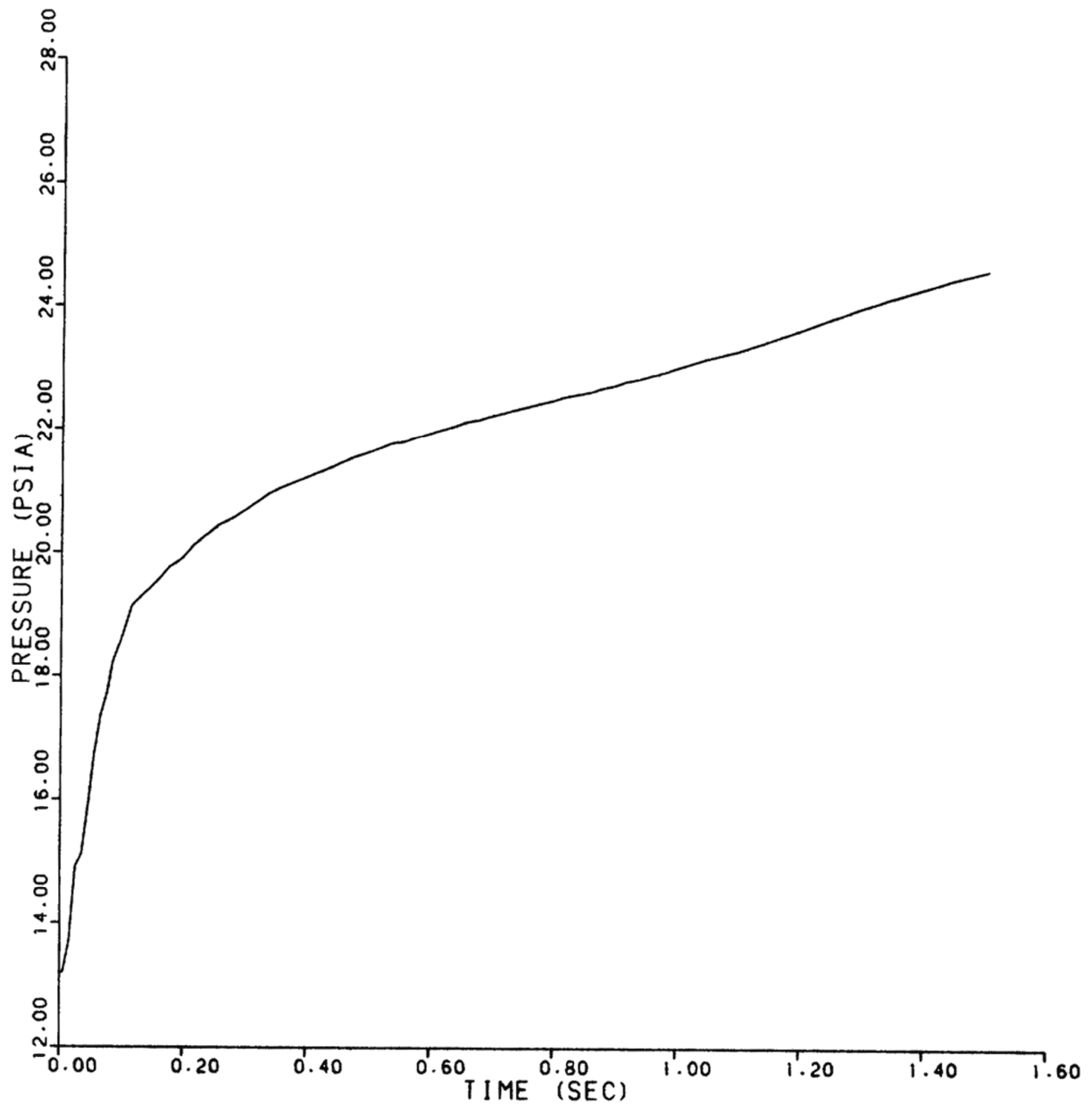

REV 13 4/06



VOGTLE
ELECTRIC GENERATING PLANT
UNIT 1 AND UNIT 2

STEAM GENERATOR COMPARTMENT
PRESSURE RESPONSE – NODE E30
(236-in.² BREAK AREA)

FIGURE 6.2.1-18 (SHEET 30 OF 74)

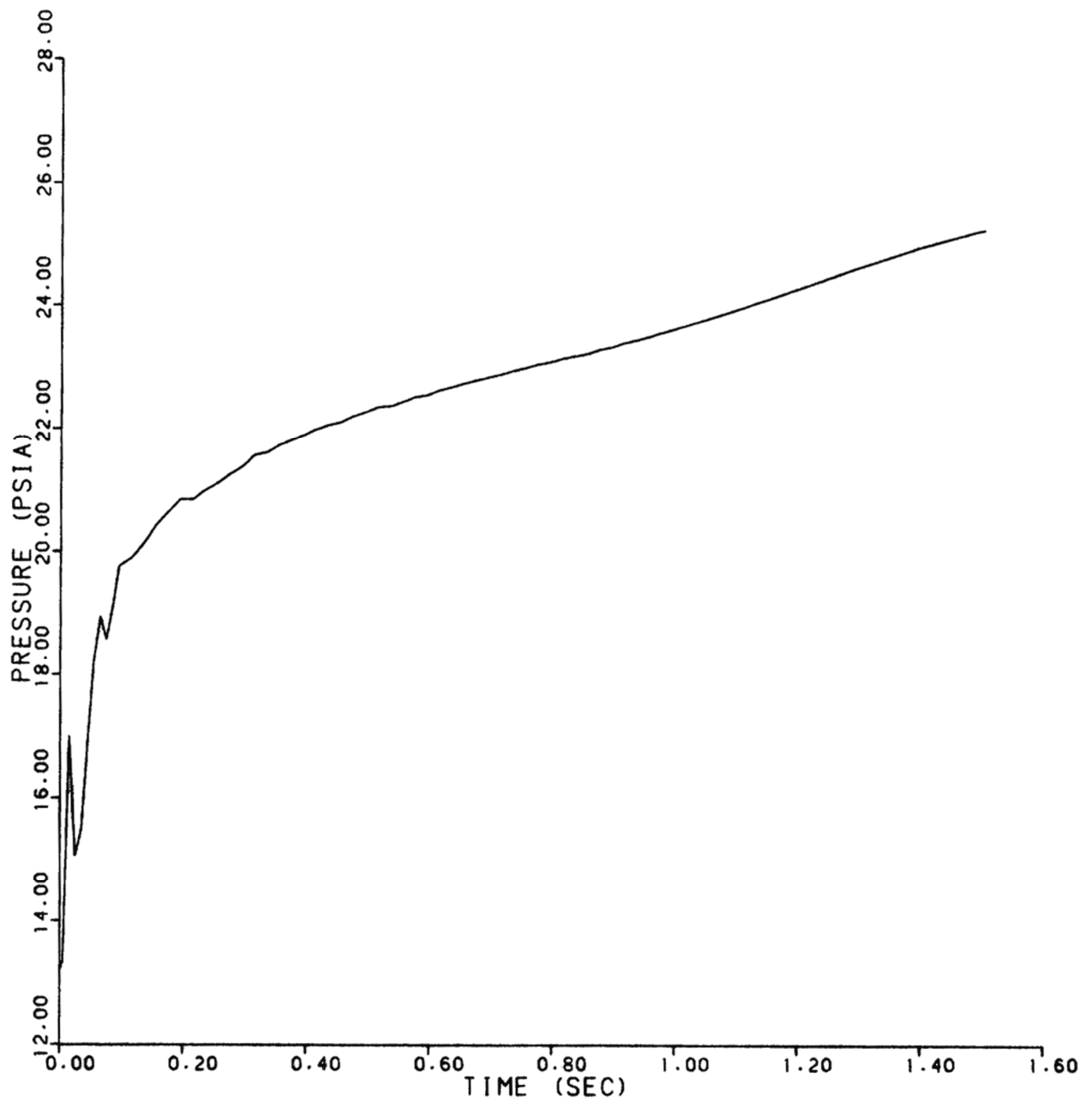

REV 13 4/06



VOGTLE
ELECTRIC GENERATING PLANT
UNIT 1 AND UNIT 2

STEAM GENERATOR COMPARTMENT
PRESSURE RESPONSE – NODE E31
(236-in.² BREAK AREA)

FIGURE 6.2.1-18 (SHEET 31 OF 74)

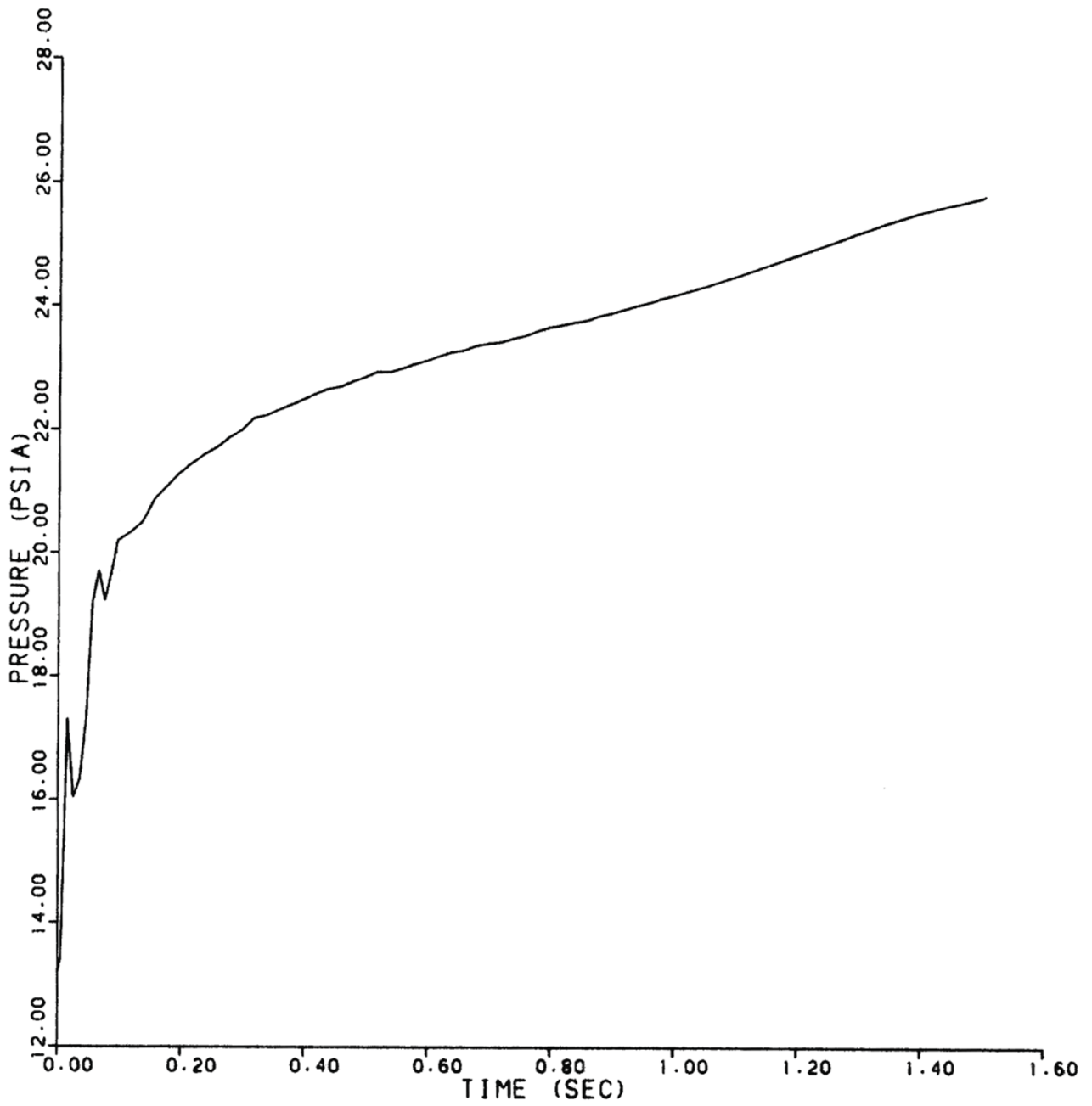

REV 13 4/06



VOGTLE
ELECTRIC GENERATING PLANT
UNIT 1 AND UNIT 2

STEAM GENERATOR COMPARTMENT
PRESSURE RESPONSE – NODE E32
(236-in.² BREAK AREA)

FIGURE 6.2.1-18 (SHEET 32 OF 74)

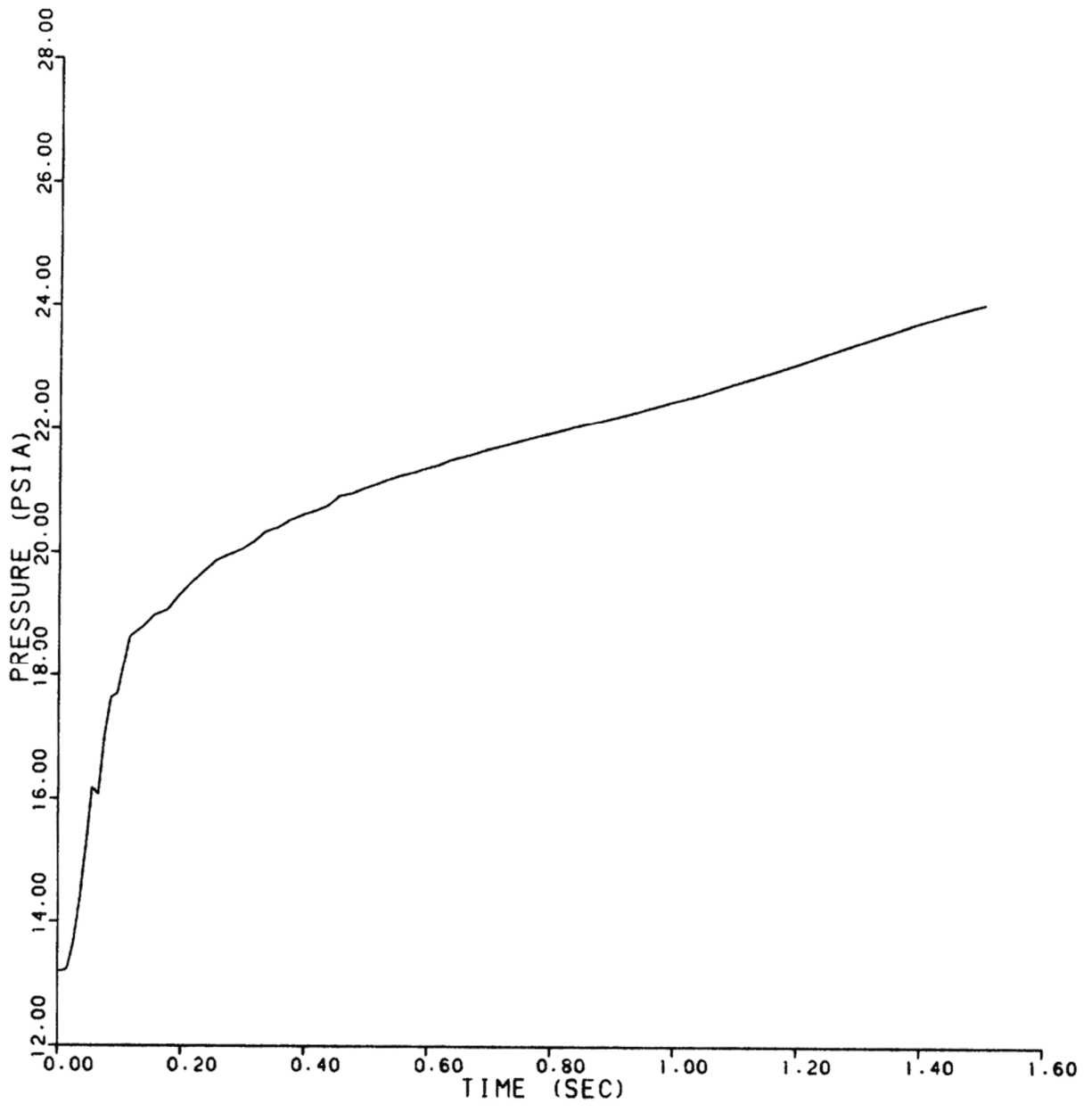

REV 13 4/06



VOGTLE
ELECTRIC GENERATING PLANT
UNIT 1 AND UNIT 2

STEAM GENERATOR COMPARTMENT
PRESSURE RESPONSE – NODE E33
(236-in.² BREAK AREA)

FIGURE 6.2.1-18 (SHEET 33 OF 74)

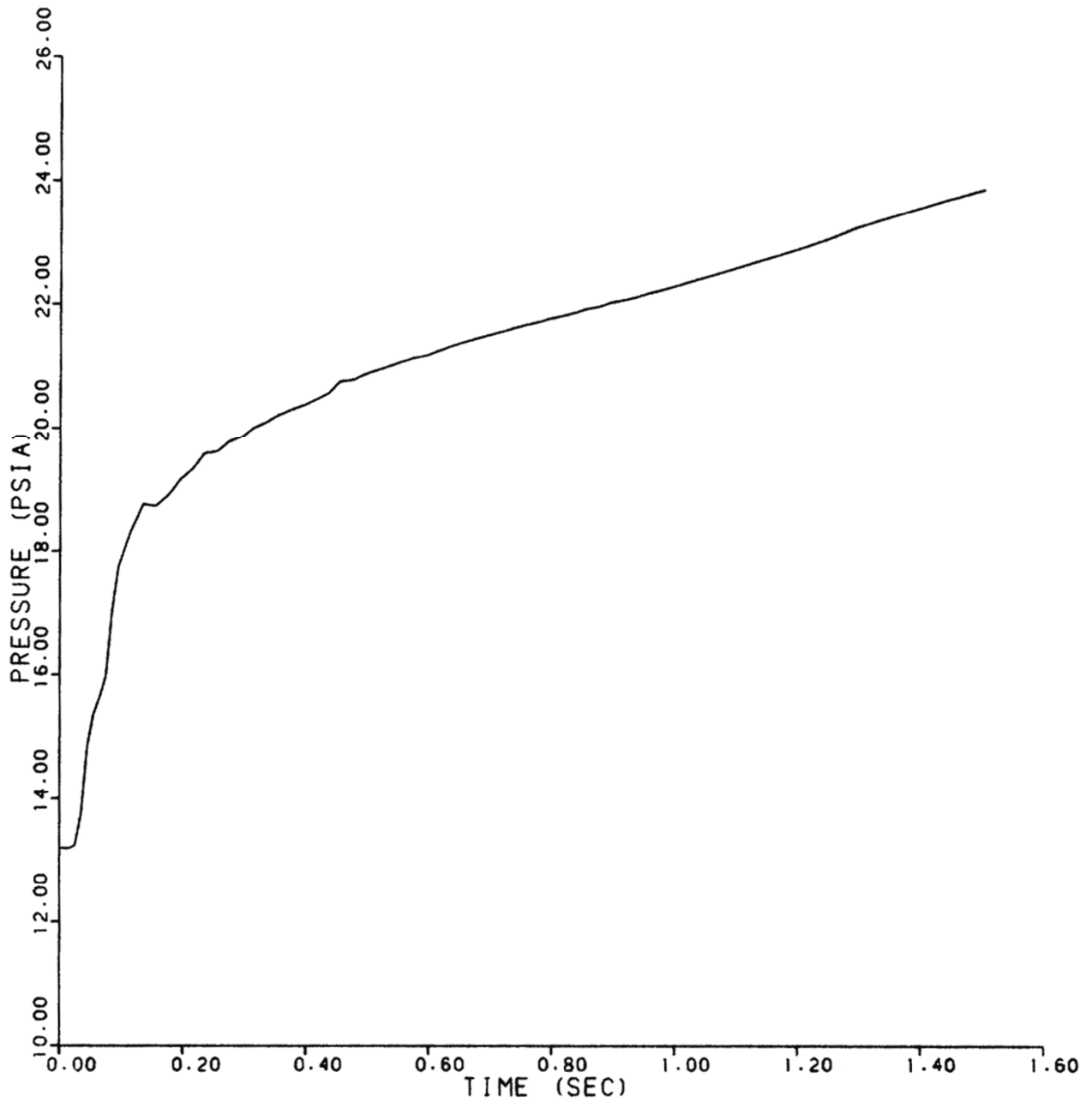

REV 13 4/06



VOGTLE
ELECTRIC GENERATING PLANT
UNIT 1 AND UNIT 2

STEAM GENERATOR COMPARTMENT
PRESSURE RESPONSE – NODE E34
(236-in.² BREAK AREA)

FIGURE 6.2.1–18 (SHEET 34 OF 74)

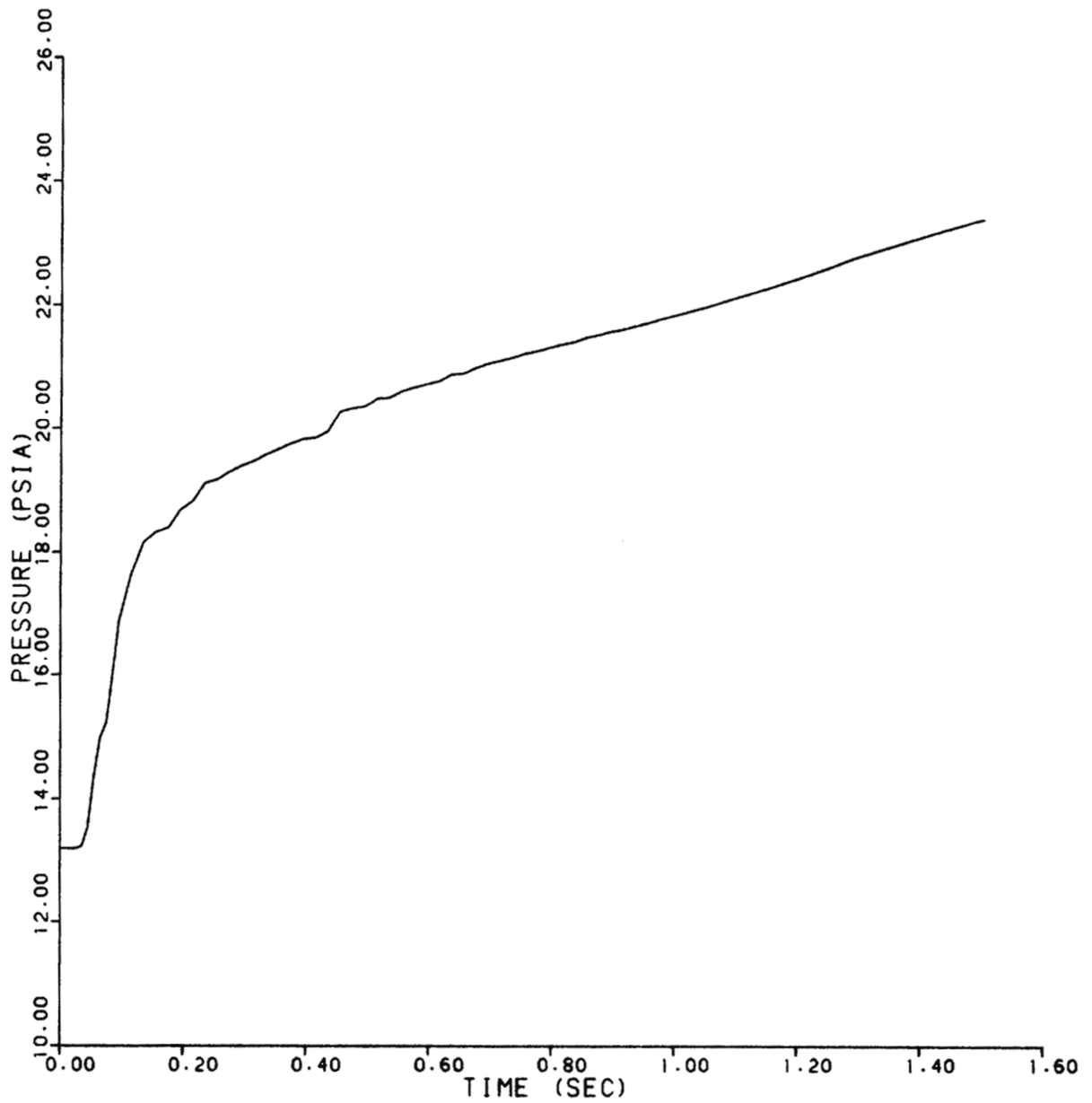

REV 13 4/06



VOGTLE
ELECTRIC GENERATING PLANT
UNIT 1 AND UNIT 2

STEAM GENERATOR COMPARTMENT
PRESSURE RESPONSE – NODE E35
(236-in.² BREAK AREA)

FIGURE 6.2.1–18 (SHEET 35 OF 74)

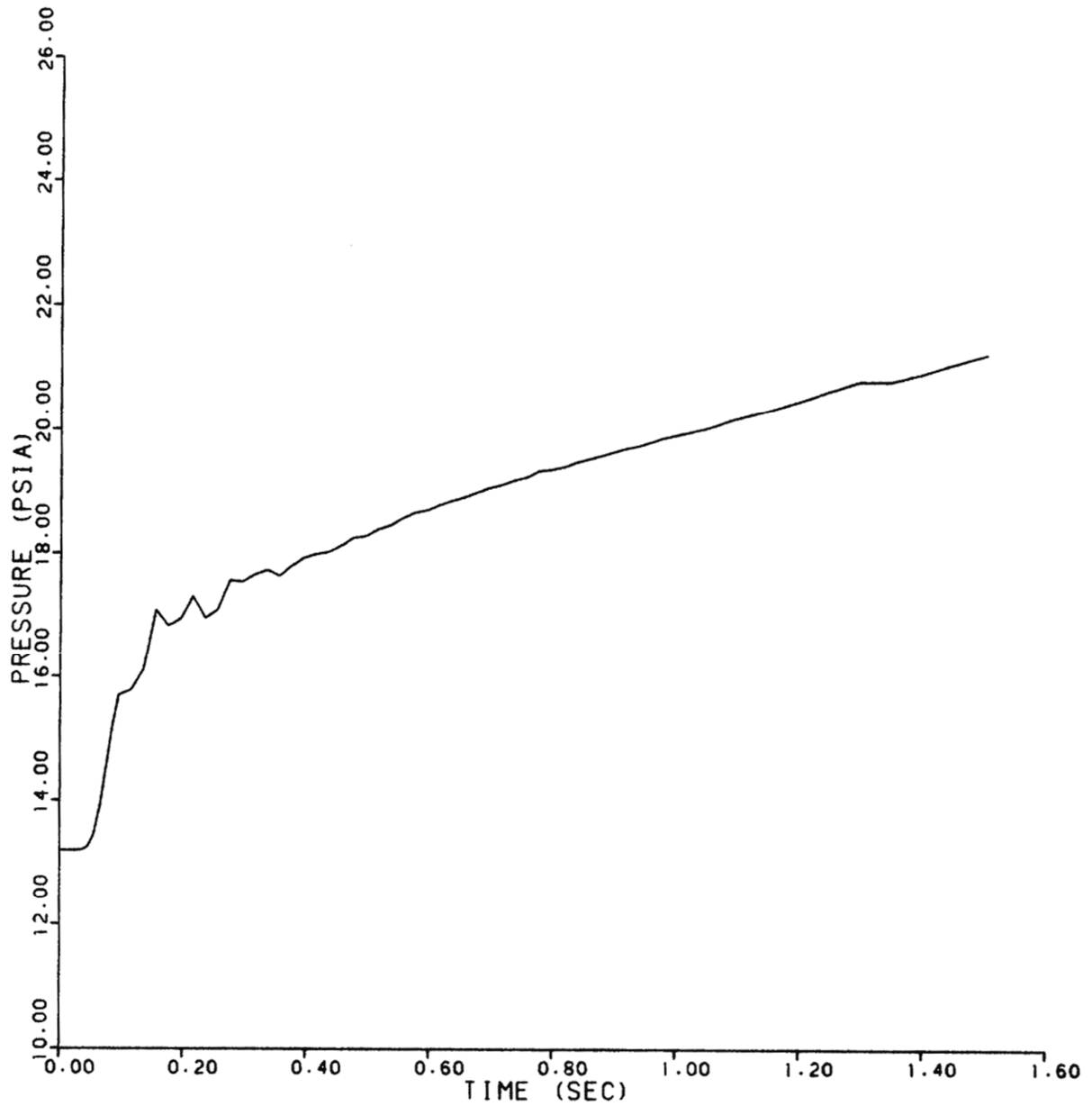

REV 13 4/06



VOGTLE
ELECTRIC GENERATING PLANT
UNIT 1 AND UNIT 2

STEAM GENERATOR COMPARTMENT
PRESSURE RESPONSE – NODE E36
(236-in.² BREAK AREA)

FIGURE 6.2.1-18 (SHEET 36 OF 74)

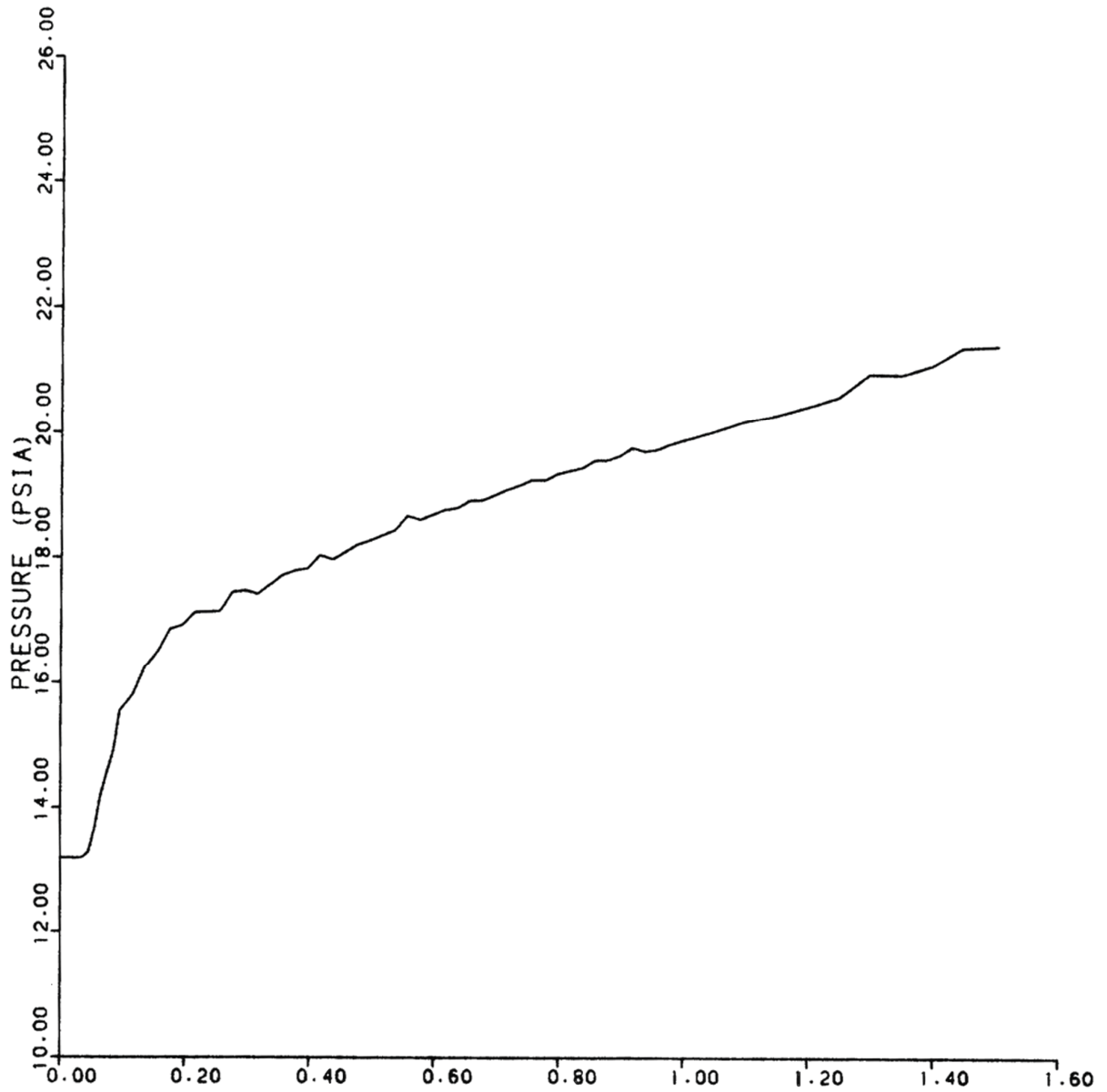

REV 13 4/06



VOGTLE
ELECTRIC GENERATING PLANT
UNIT 1 AND UNIT 2

STEAM GENERATOR COMPARTMENT
PRESSURE RESPONSE – NODE E37
(236-in.² BREAK AREA)

FIGURE 6.2.1–18 (SHEET 37 OF 74)

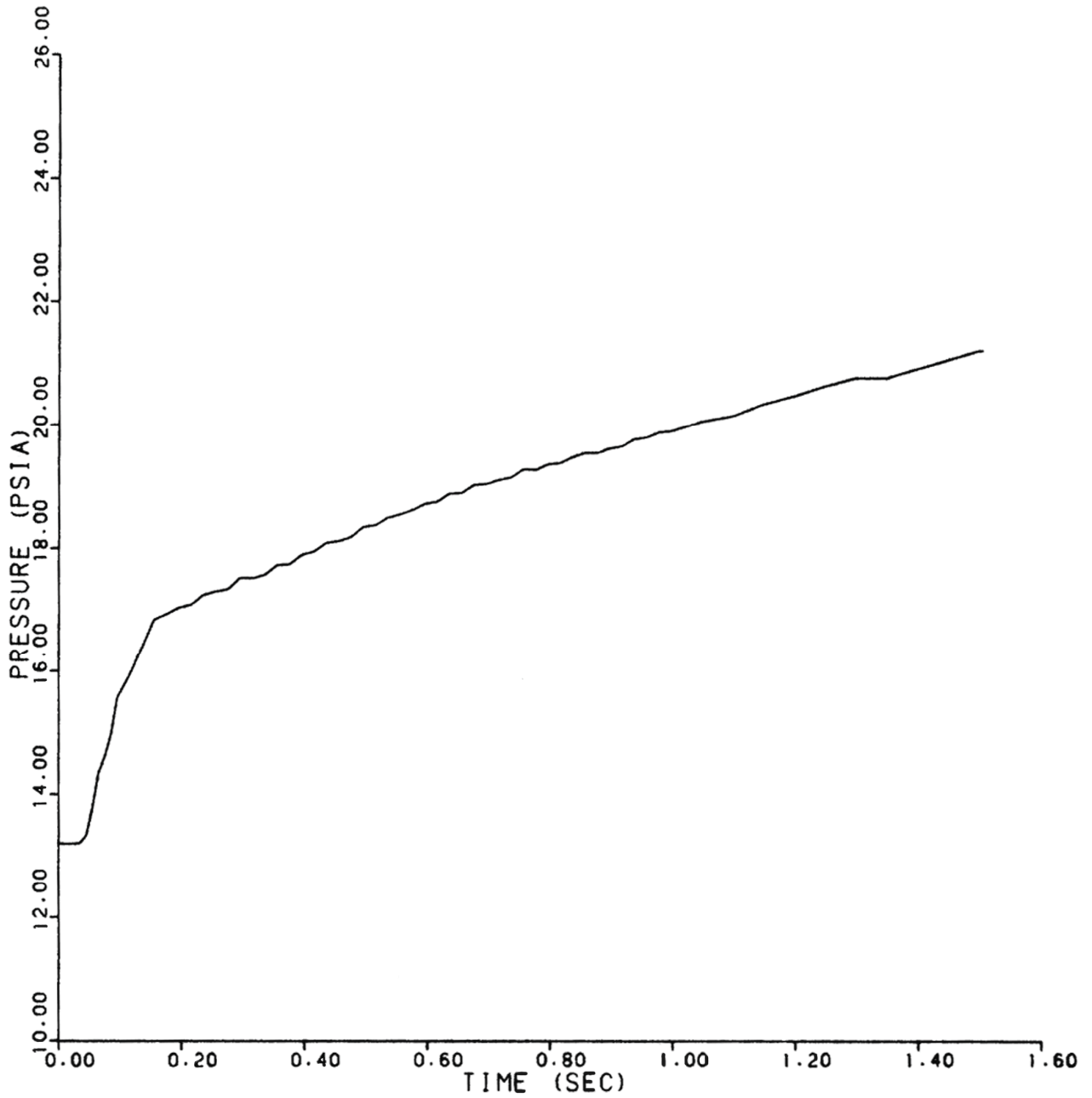

REV 13 4/06



VOGTLE
ELECTRIC GENERATING PLANT
UNIT 1 AND UNIT 2

STEAM GENERATOR COMPARTMENT
PRESSURE RESPONSE – NODE E38
(236-in.² BREAK AREA)

FIGURE 6.2.1–18 (SHEET 38 OF 74)

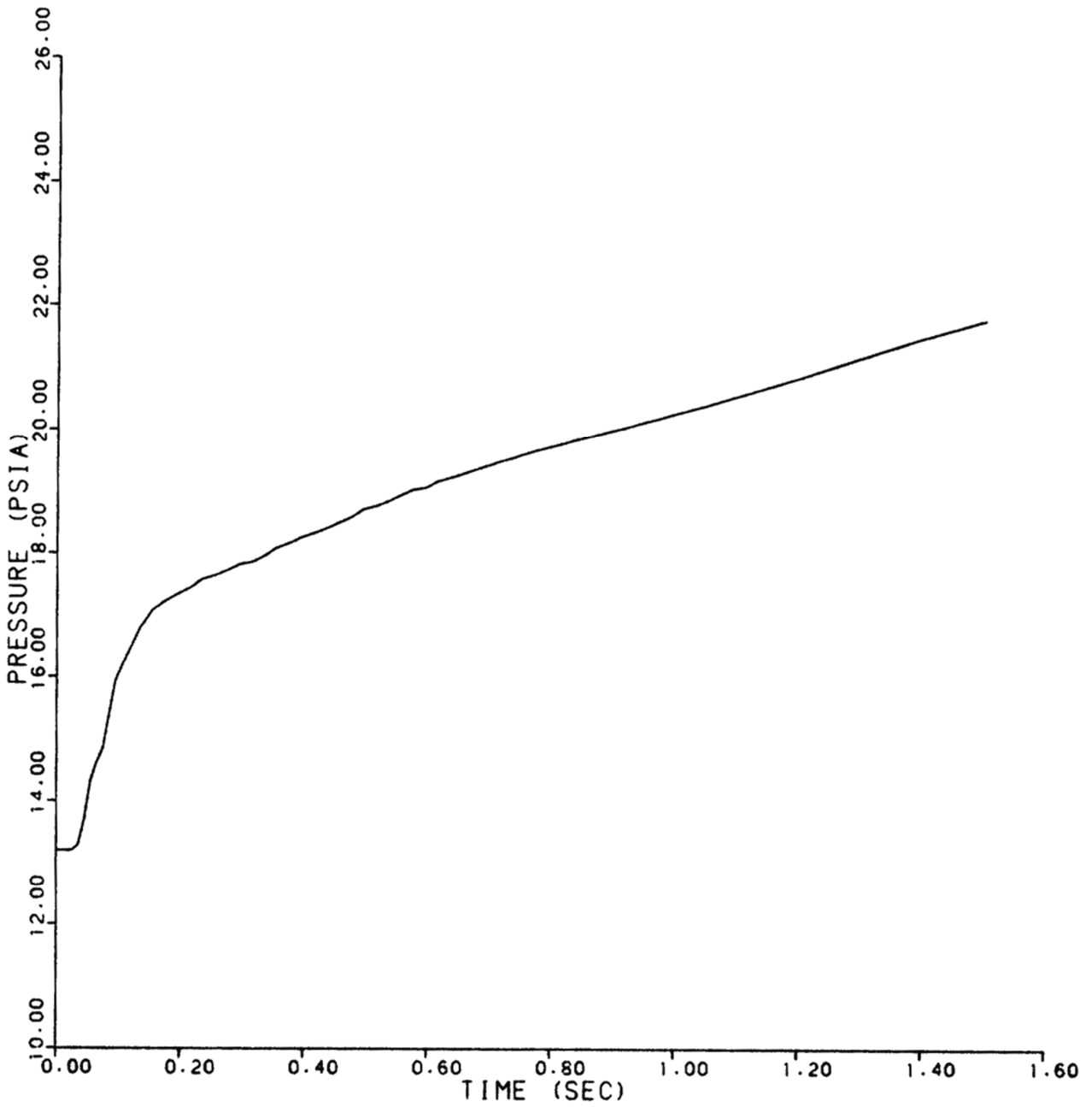

REV 13 4/06



VOGTLE
ELECTRIC GENERATING PLANT
UNIT 1 AND UNIT 2

STEAM GENERATOR COMPARTMENT
PRESSURE RESPONSE – NODE E39
(236-in.² BREAK AREA)

FIGURE 6.2.1-18 (SHEET 39 OF 74)

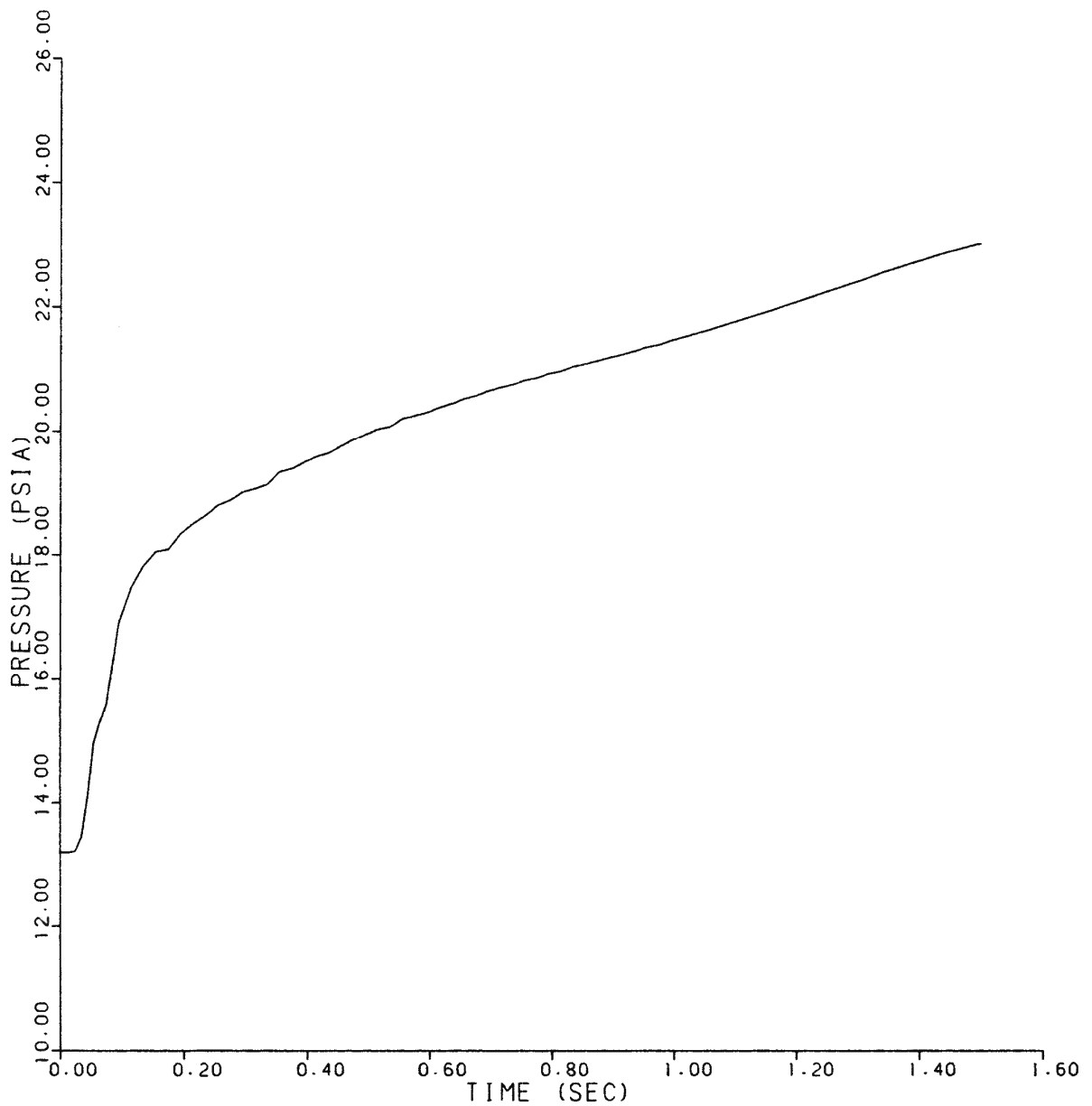

REV 13 4/06



VOGTLE
ELECTRIC GENERATING PLANT
UNIT 1 AND UNIT 2

STEAM GENERATOR COMPARTMENT
PRESSURE RESPONSE – NODE E40
(236-in.² BREAK AREA)

FIGURE 6.2.1-18 (SHEET 40 OF 74)

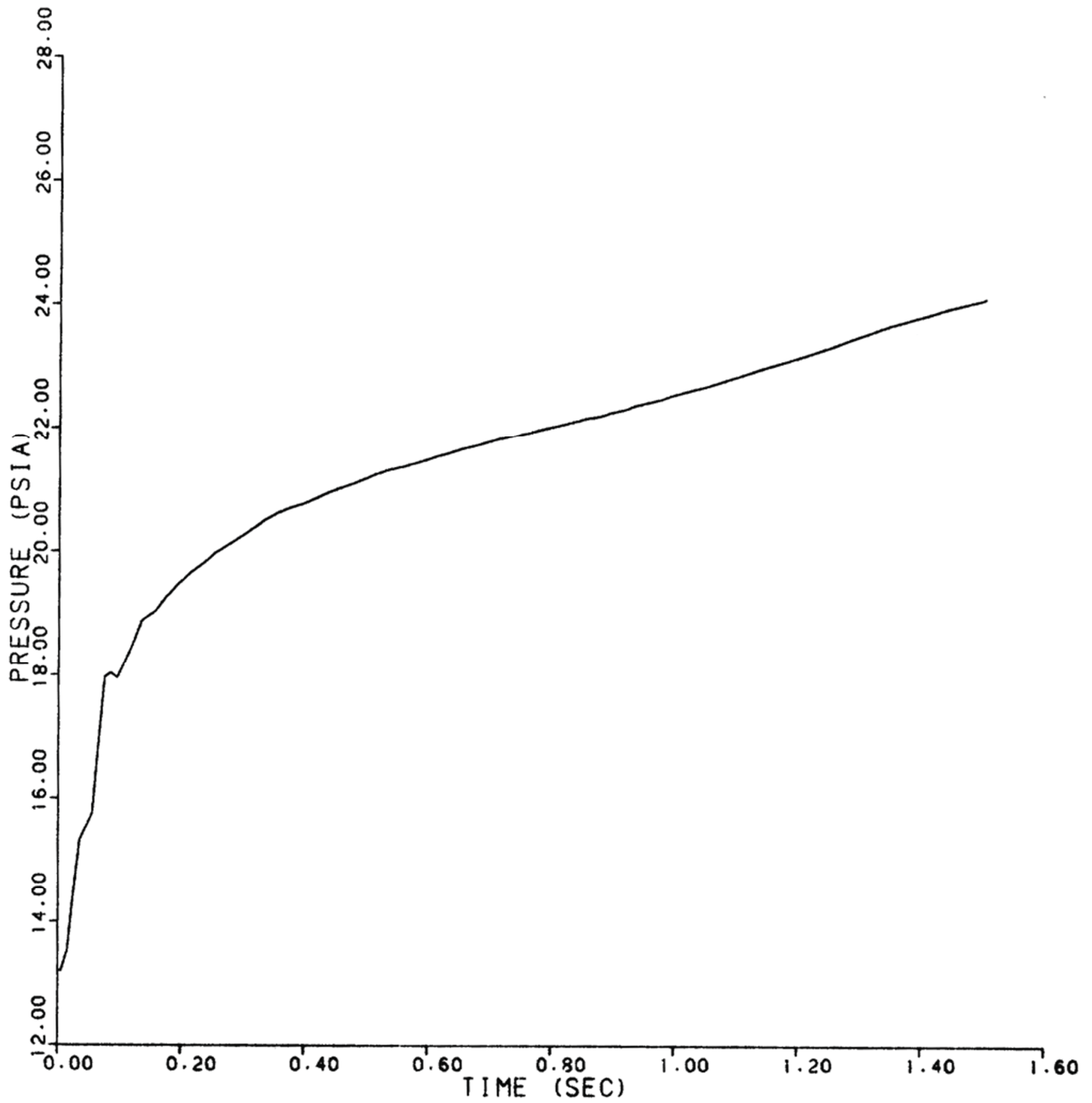

REV 13 4/06



VOGTLE
ELECTRIC GENERATING PLANT
UNIT 1 AND UNIT 2

STEAM GENERATOR COMPARTMENT
PRESSURE RESPONSE - NODE E41
(236-in.² BREAK AREA)

FIGURE 6.2.1-18 (SHEET 41 OF 74)

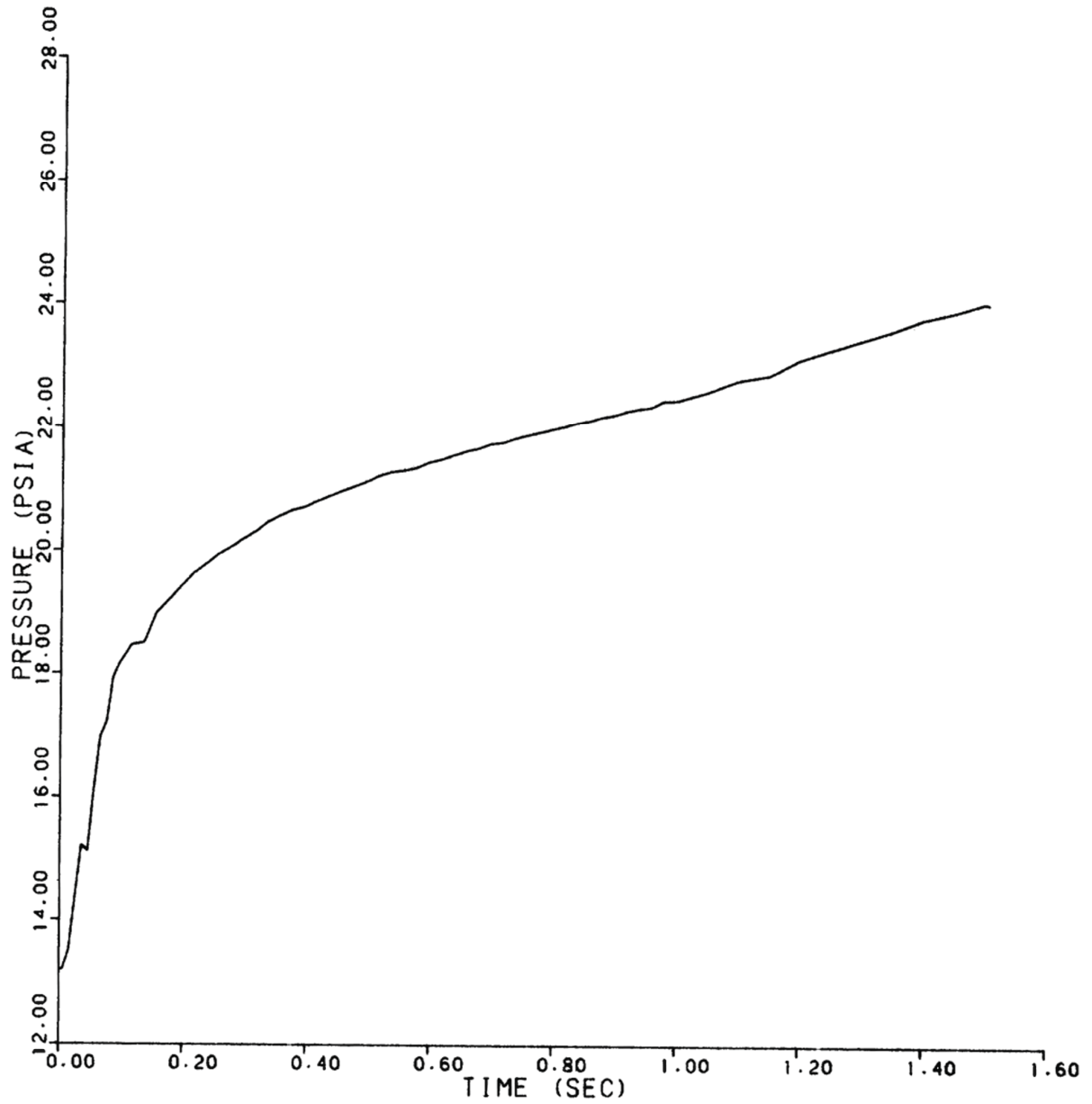

REV 13 4/06



VOGTLE
ELECTRIC GENERATING PLANT
UNIT 1 AND UNIT 2

STEAM GENERATOR COMPARTMENT
PRESSURE RESPONSE – NODE E42
(236-in.² BREAK AREA)

FIGURE 6.2.1-18 (SHEET 42 OF 74)

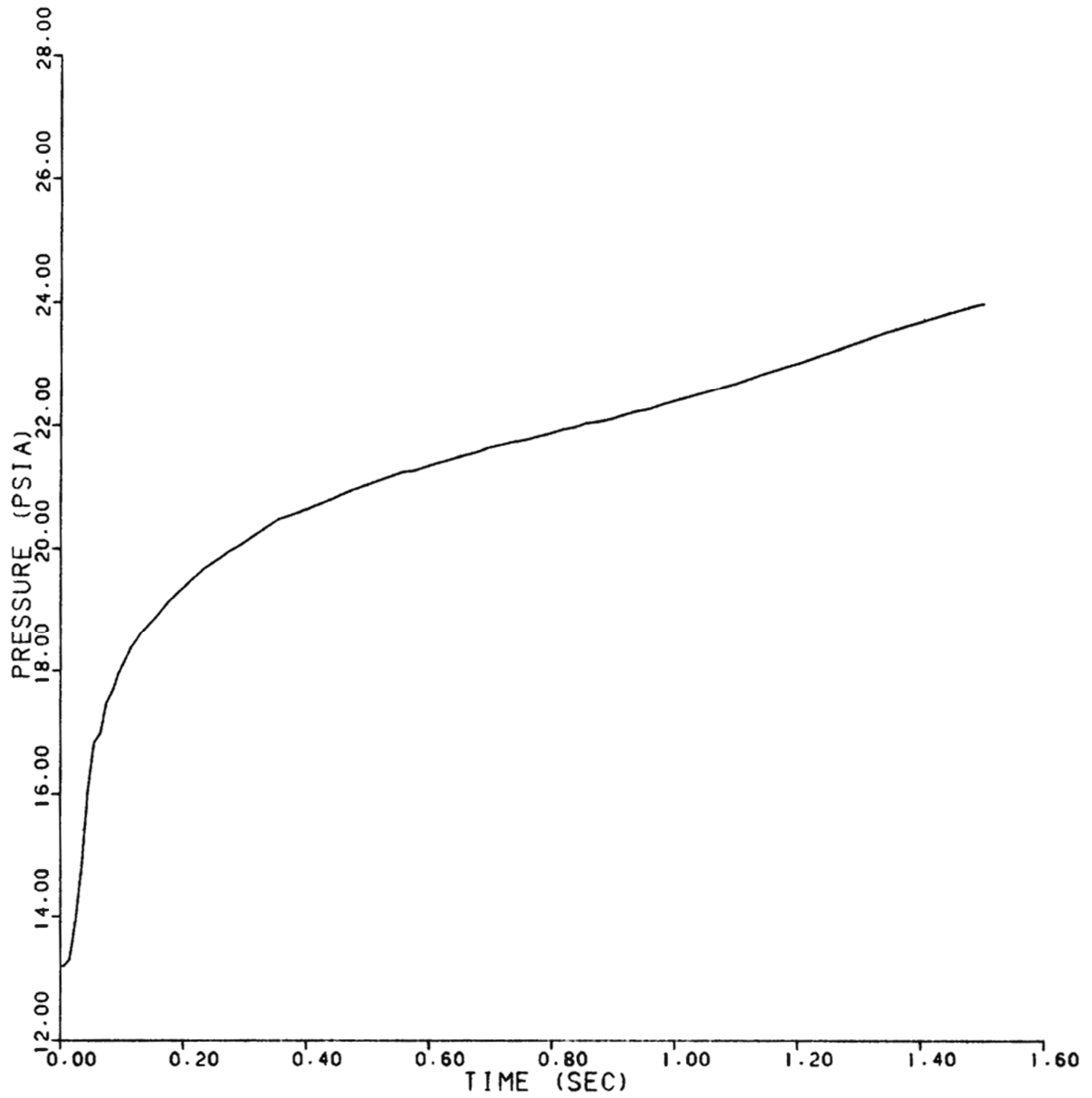

REV 13 4/06



VOGTLE
ELECTRIC GENERATING PLANT
UNIT 1 AND UNIT 2

STEAM GENERATOR COMPARTMENT
PRESSURE RESPONSE – NODE E43
(236-in.² BREAK AREA)

FIGURE 6.2.1-18 (SHEET 43 OF 74)

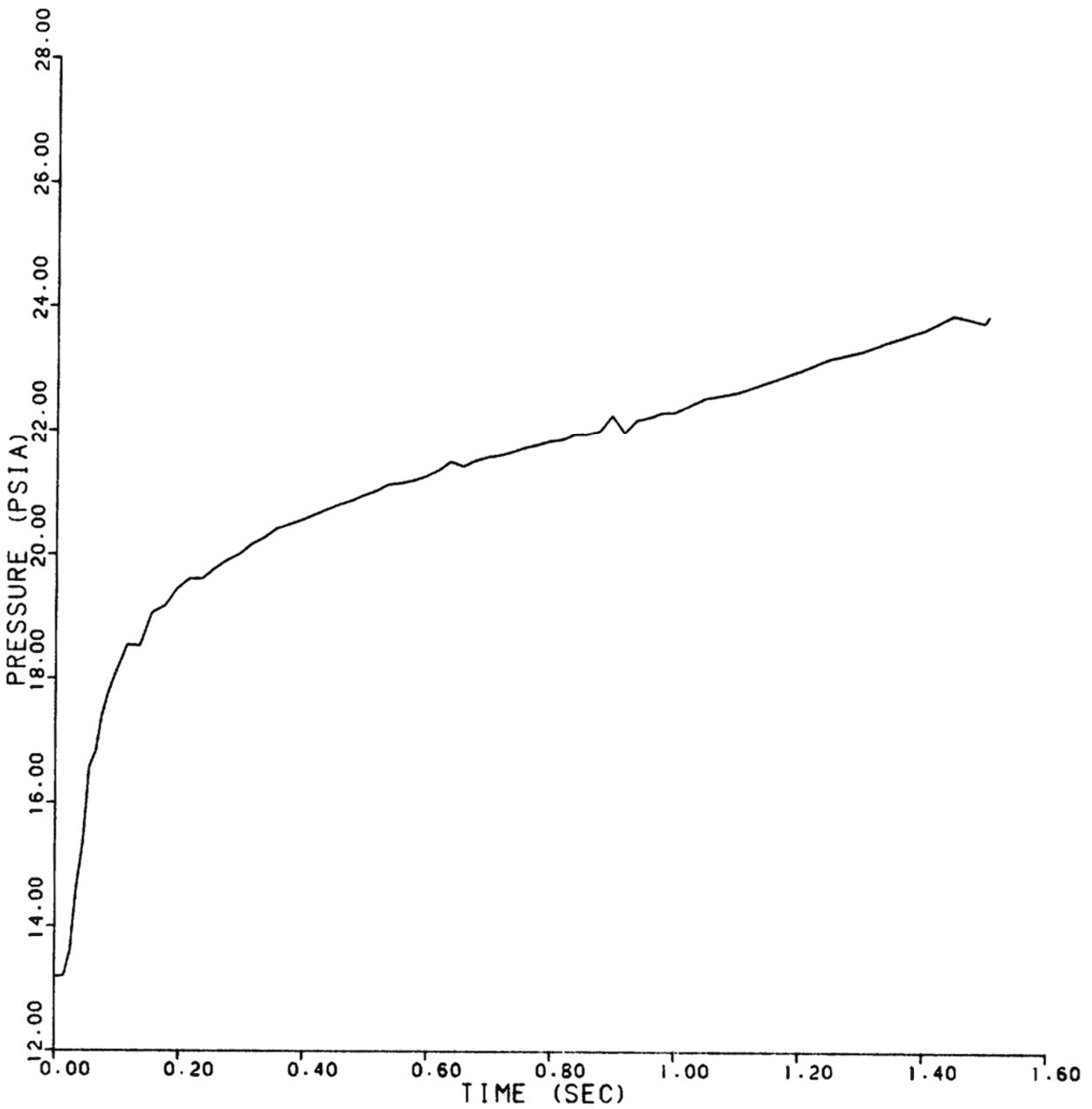

REV 13 4/06



VOGTLE
ELECTRIC GENERATING PLANT
UNIT 1 AND UNIT 2

STEAM GENERATOR COMPARTMENT
PRESSURE RESPONSE – NODE E44
(236-in.² BREAK AREA)

FIGURE 6.2.1–18 (SHEET 44 OF 74)

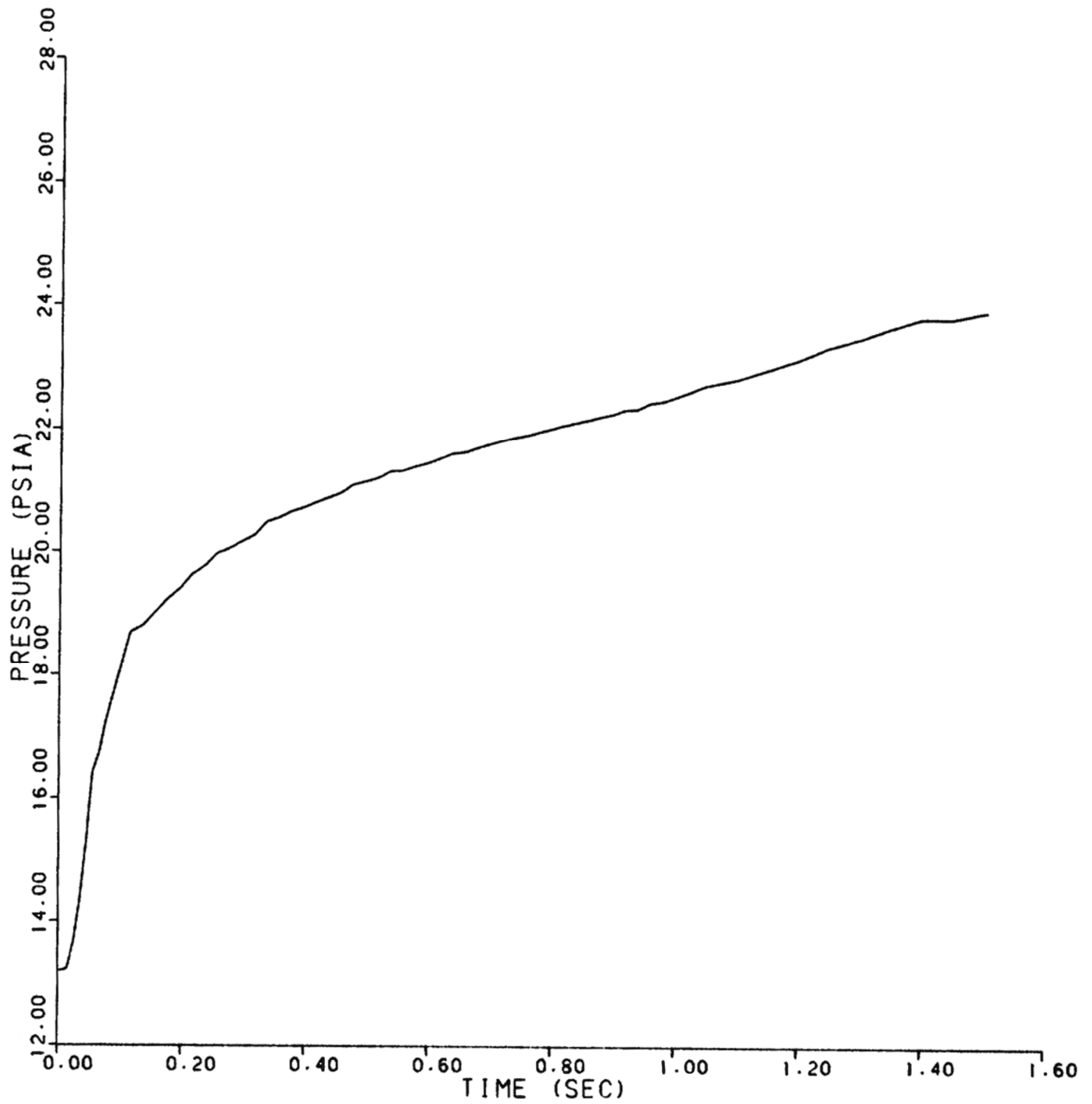

REV 13 4/06



VOGTLE
ELECTRIC GENERATING PLANT
UNIT 1 AND UNIT 2

STEAM GENERATOR COMPARTMENT
PRESSURE RESPONSE – NODE E45
(236-in.² BREAK AREA)

FIGURE 6.2.1–18 (SHEET 45 OF 74)

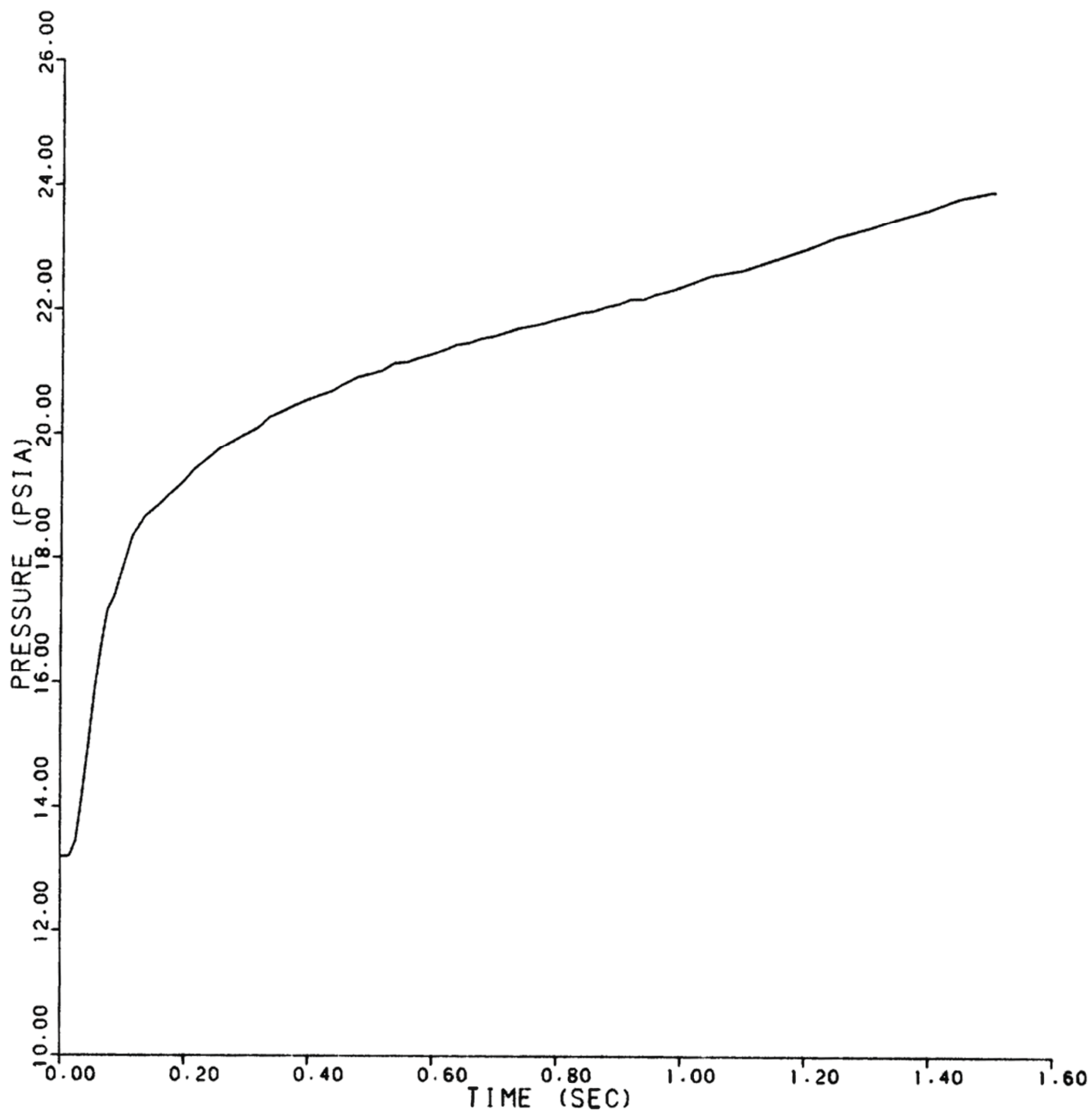

REV 13 4/06



VOGTLE
ELECTRIC GENERATING PLANT
UNIT 1 AND UNIT 2

STEAM GENERATOR COMPARTMENT
PRESSURE RESPONSE – NODE E46
(236-in.² BREAK AREA)

FIGURE 6.2.1–18 (SHEET 46 OF 74)

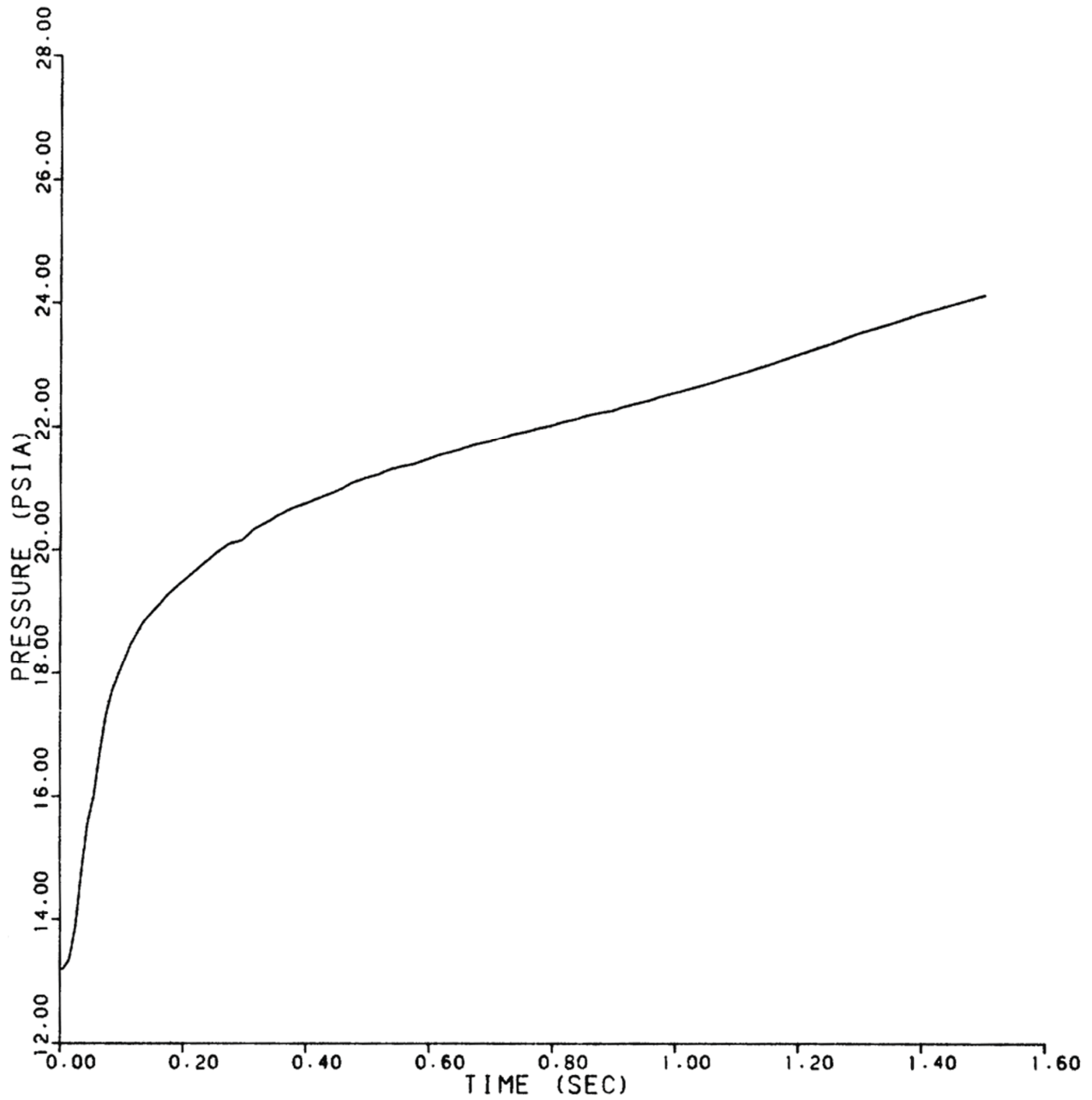

REV 13 4/06



VOGTLE
ELECTRIC GENERATING PLANT
UNIT 1 AND UNIT 2

STEAM GENERATOR COMPARTMENT
PRESSURE RESPONSE – NODE E47
(236-in.² BREAK AREA)

FIGURE 6.2.1-18 (SHEET 47 OF 74)

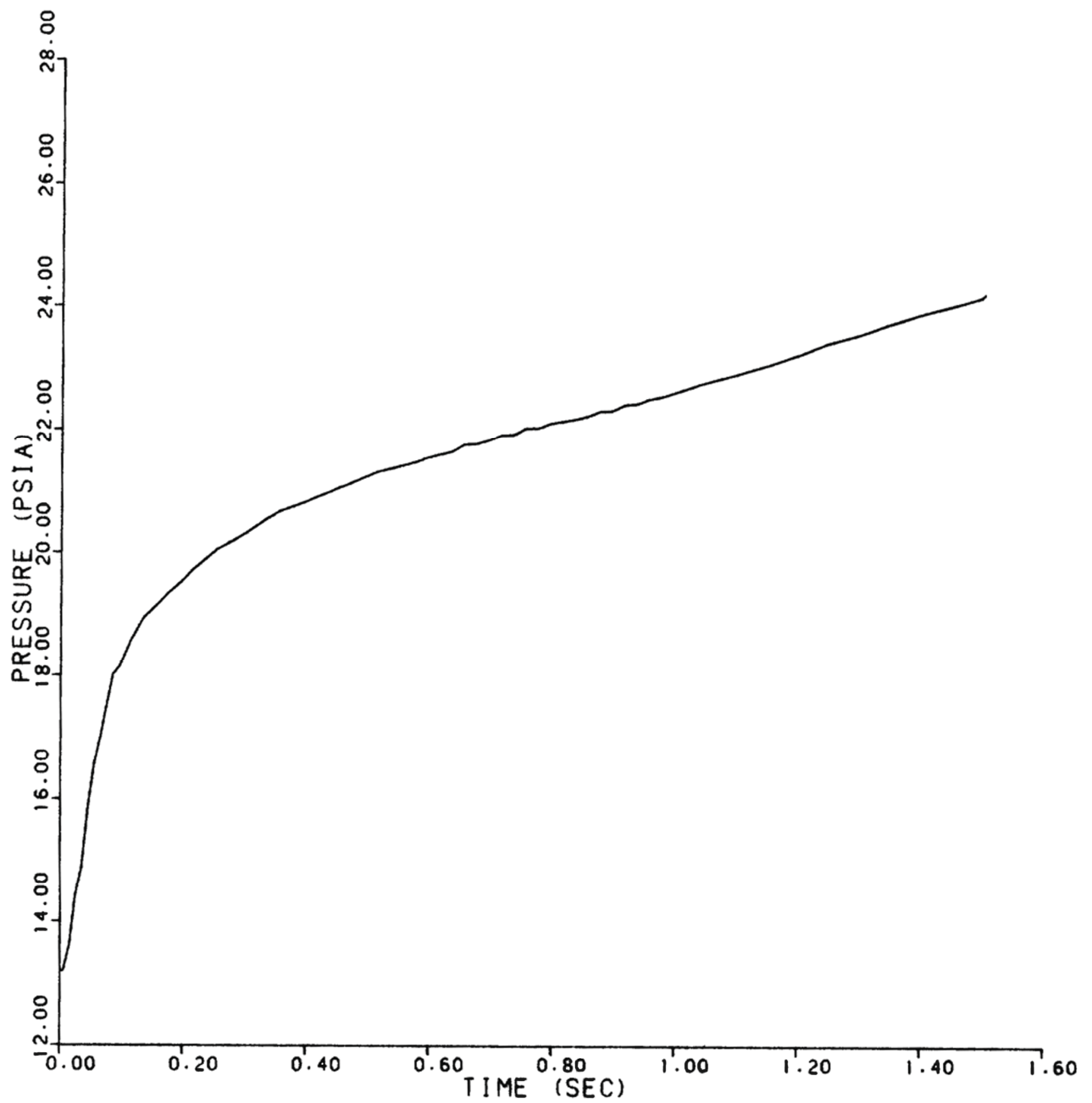

REV 13 4/06



VOGTLE
ELECTRIC GENERATING PLANT
UNIT 1 AND UNIT 2

STEAM GENERATOR COMPARTMENT
PRESSURE RESPONSE – NODE E48
(236-in.² BREAK AREA)

FIGURE 6.2.1–18 (SHEET 48 OF 74)

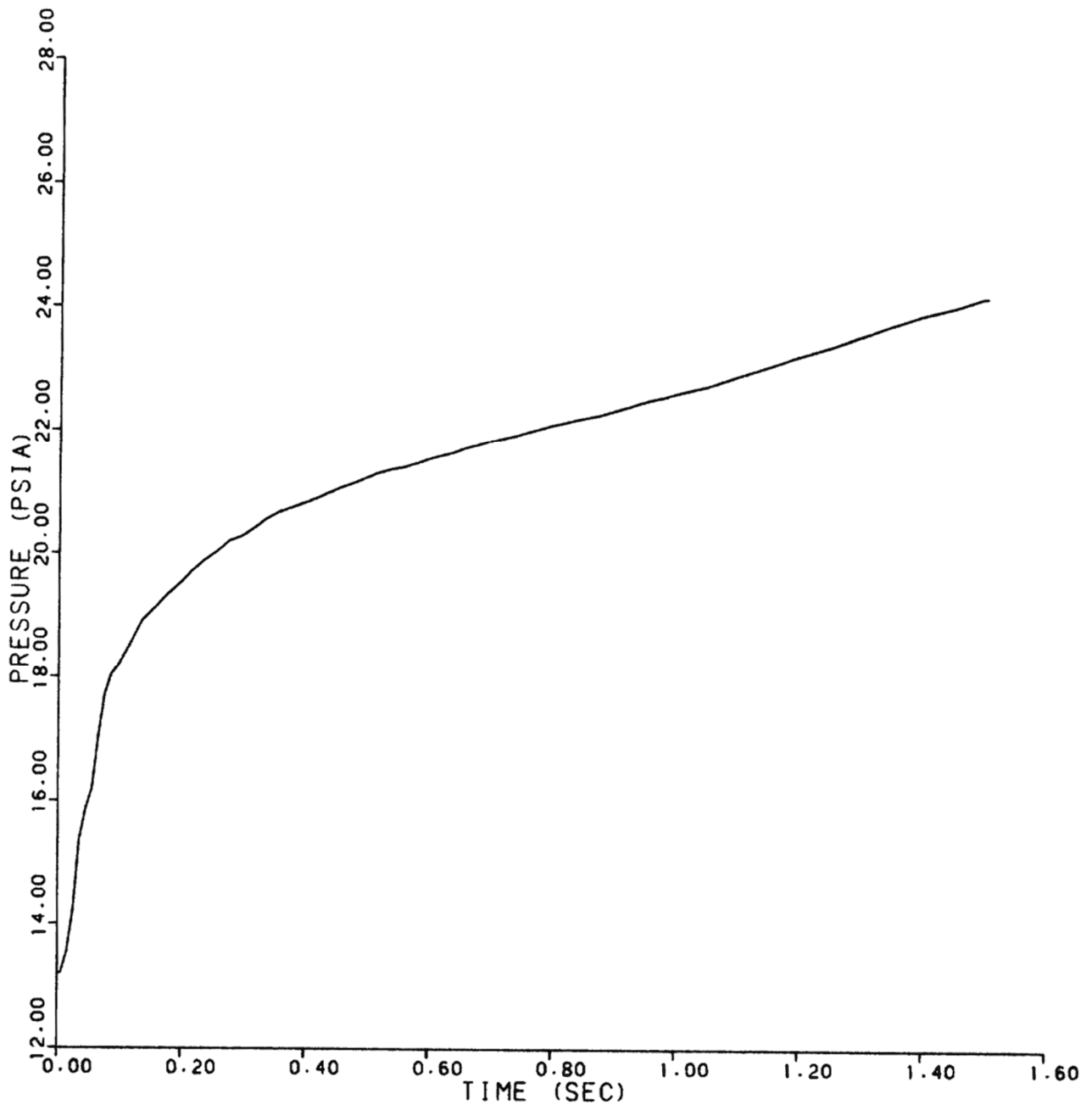

REV 13 4/06



VOGTLE
ELECTRIC GENERATING PLANT
UNIT 1 AND UNIT 2

STEAM GENERATOR COMPARTMENT
PRESSURE RESPONSE – NODE E49
(236-in.² BREAK AREA)

FIGURE 6.2.1–18 (SHEET 49 OF 74)

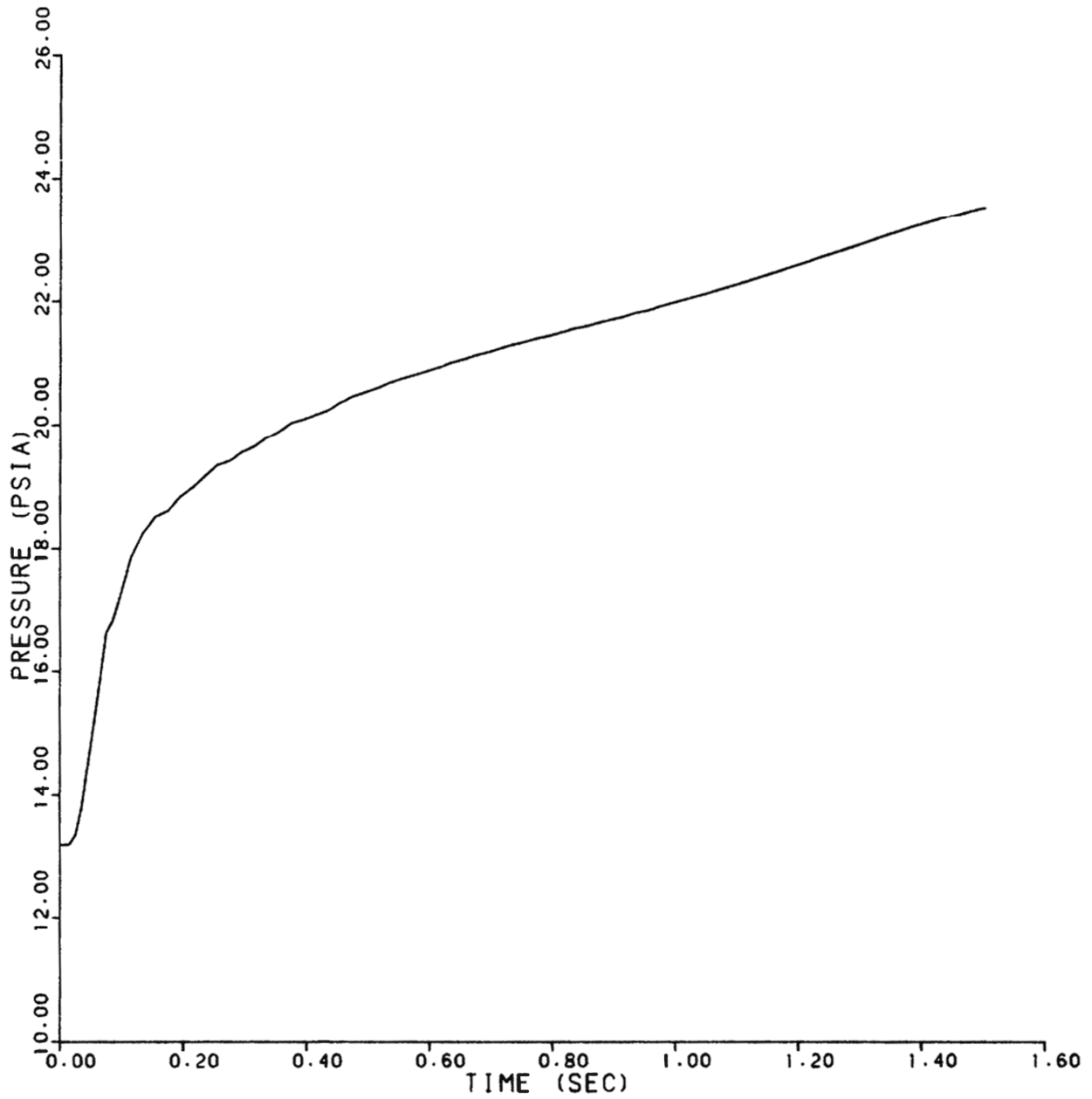

REV 13 4/06



VOGTLE
ELECTRIC GENERATING PLANT
UNIT 1 AND UNIT 2

STEAM GENERATOR COMPARTMENT
PRESSURE RESPONSE – NODE E50
(236-in.² BREAK AREA)

FIGURE 6.2.1–18 (SHEET 50 OF 74)

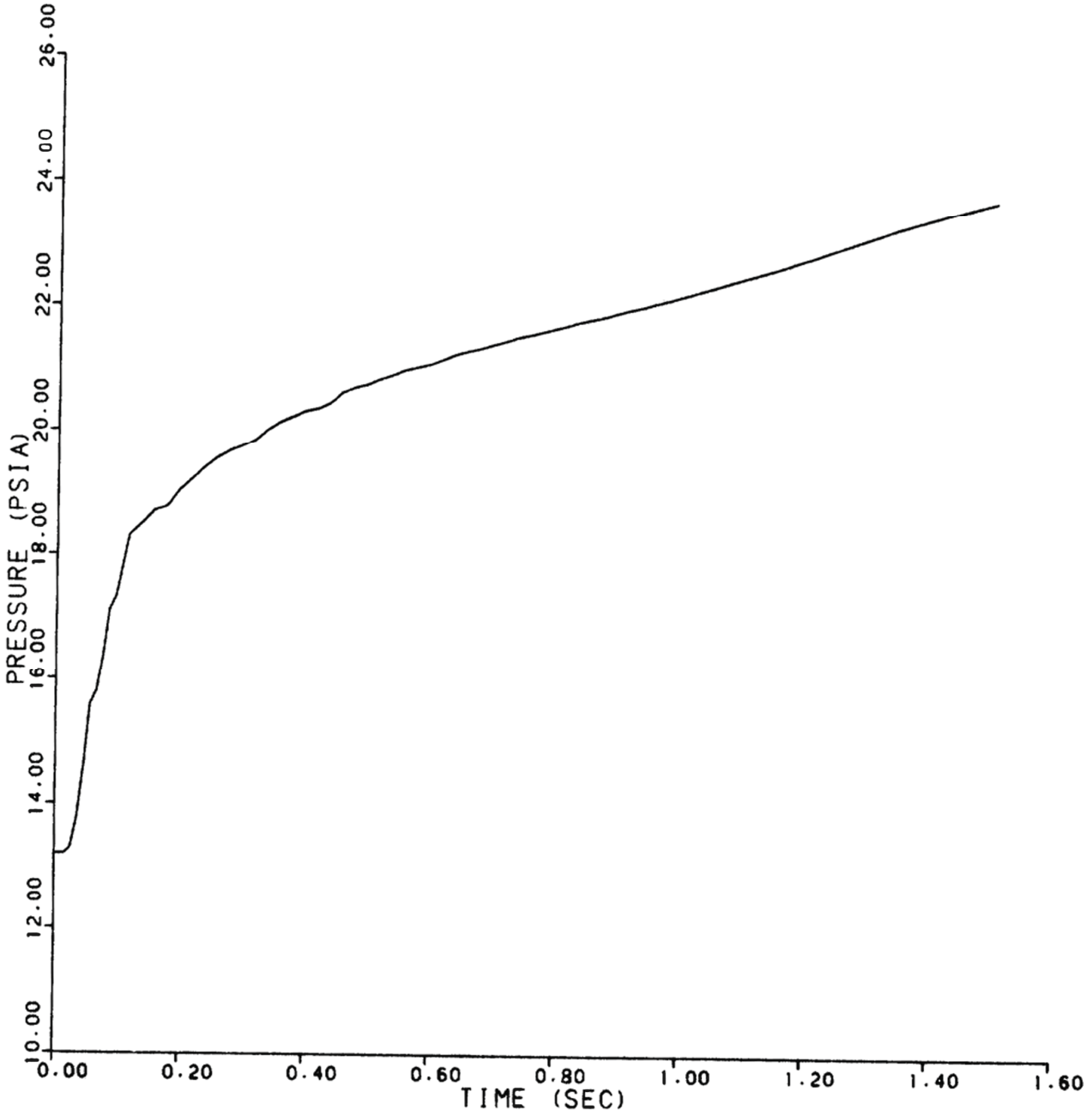

REV 13 4/06



VOGTLE
ELECTRIC GENERATING PLANT
UNIT 1 AND UNIT 2

STEAM GENERATOR COMPARTMENT
PRESSURE RESPONSE – NODE E51
(236-in.² BREAK AREA)

FIGURE 6.2.1-18 (SHEET 51 OF 74)

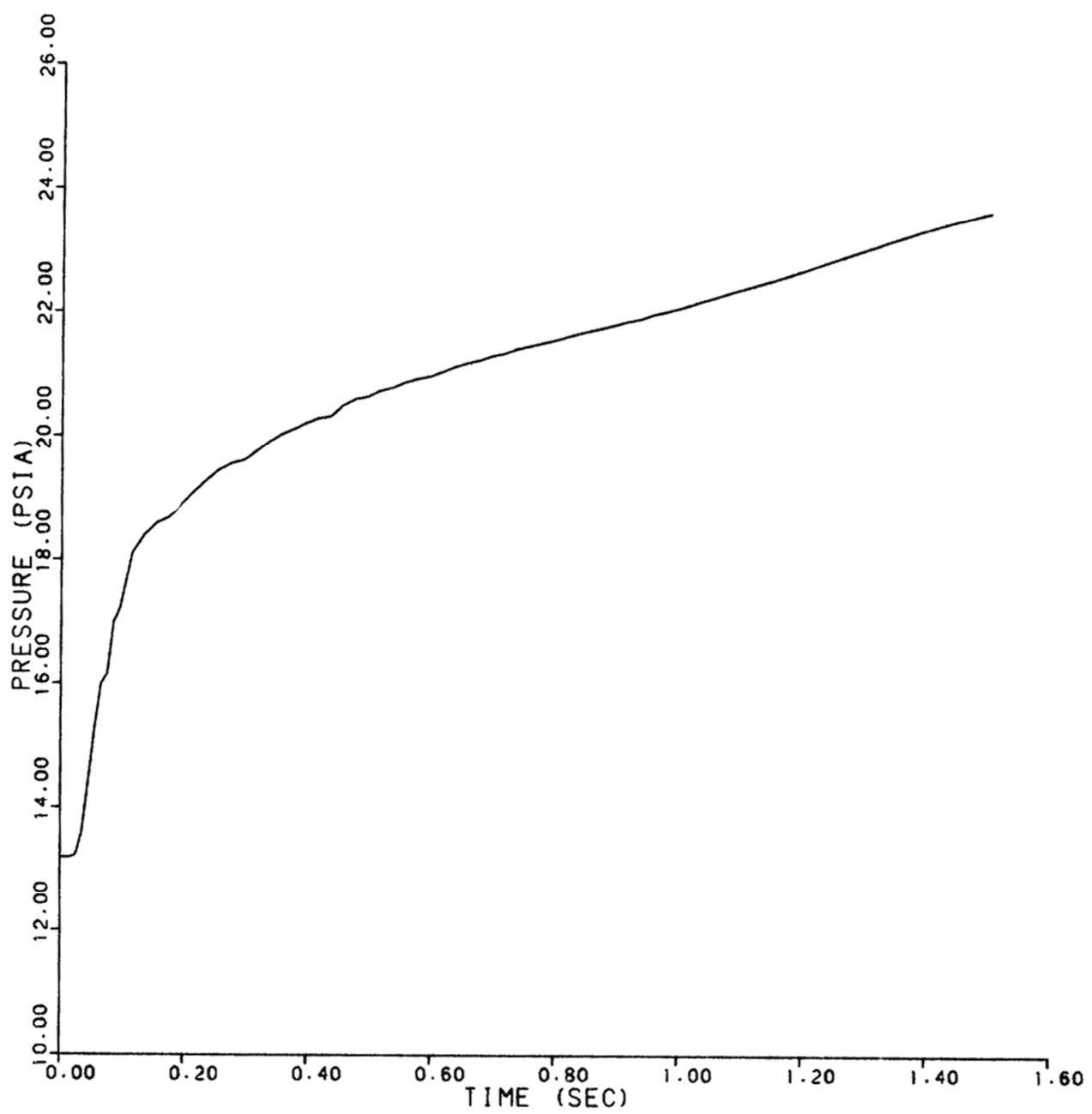

REV 13 4/06

STEAM GENERATOR COMPARTMENT
 PRESSURE RESPONSE – NODE E52
 (236-in.² BREAK AREA)

FIGURE 6.2.1–18 (SHEET 52 OF 74)



VOGTLE
 ELECTRIC GENERATING PLANT
 UNIT 1 AND UNIT 2

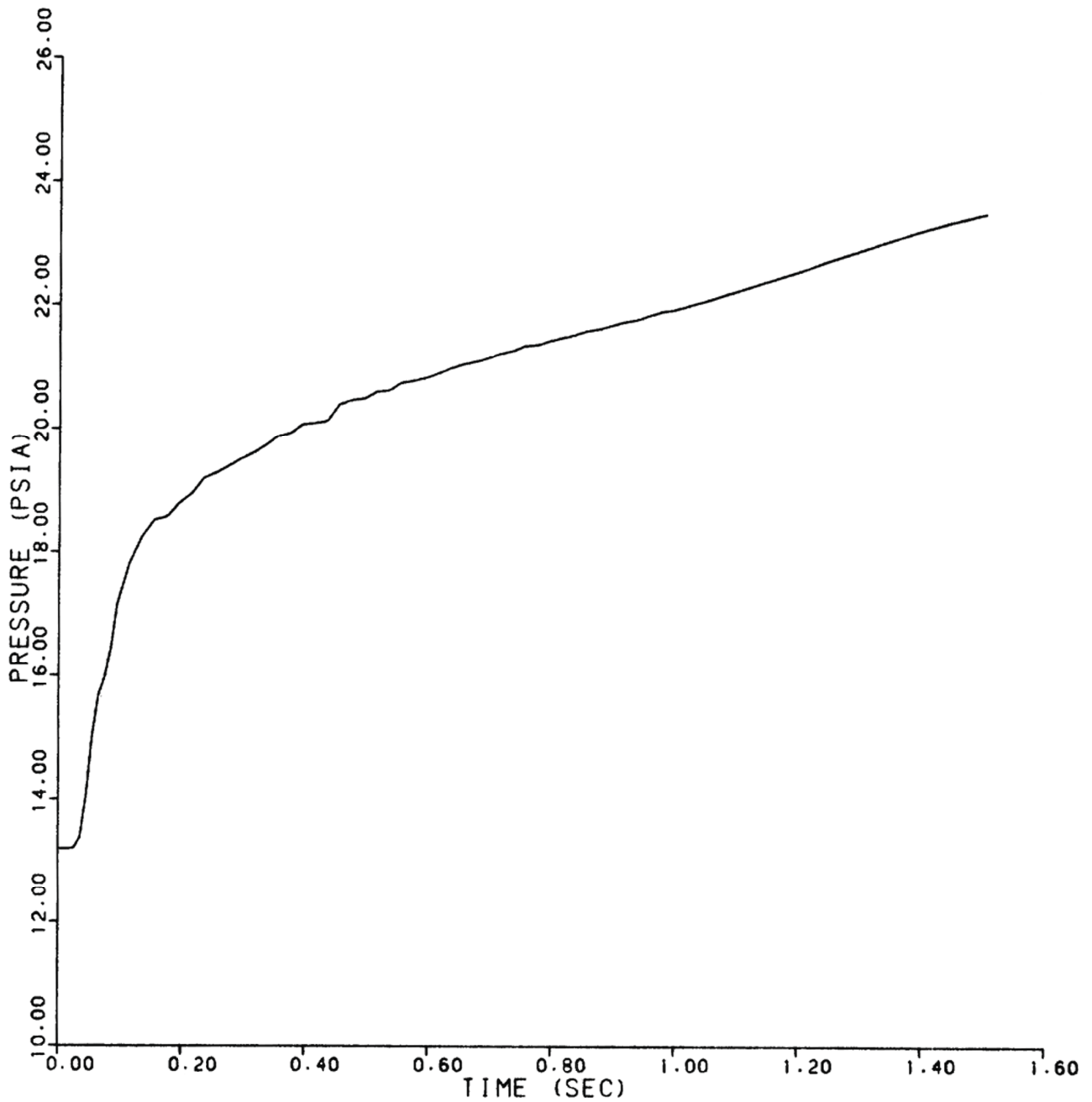

REV 13 4/06



VOGTLE
ELECTRIC GENERATING PLANT
UNIT 1 AND UNIT 2

STEAM GENERATOR COMPARTMENT
PRESSURE RESPONSE – NODE E53
(236-in.² BREAK AREA)

FIGURE 6.2.1–18 (SHEET 53 OF 74)

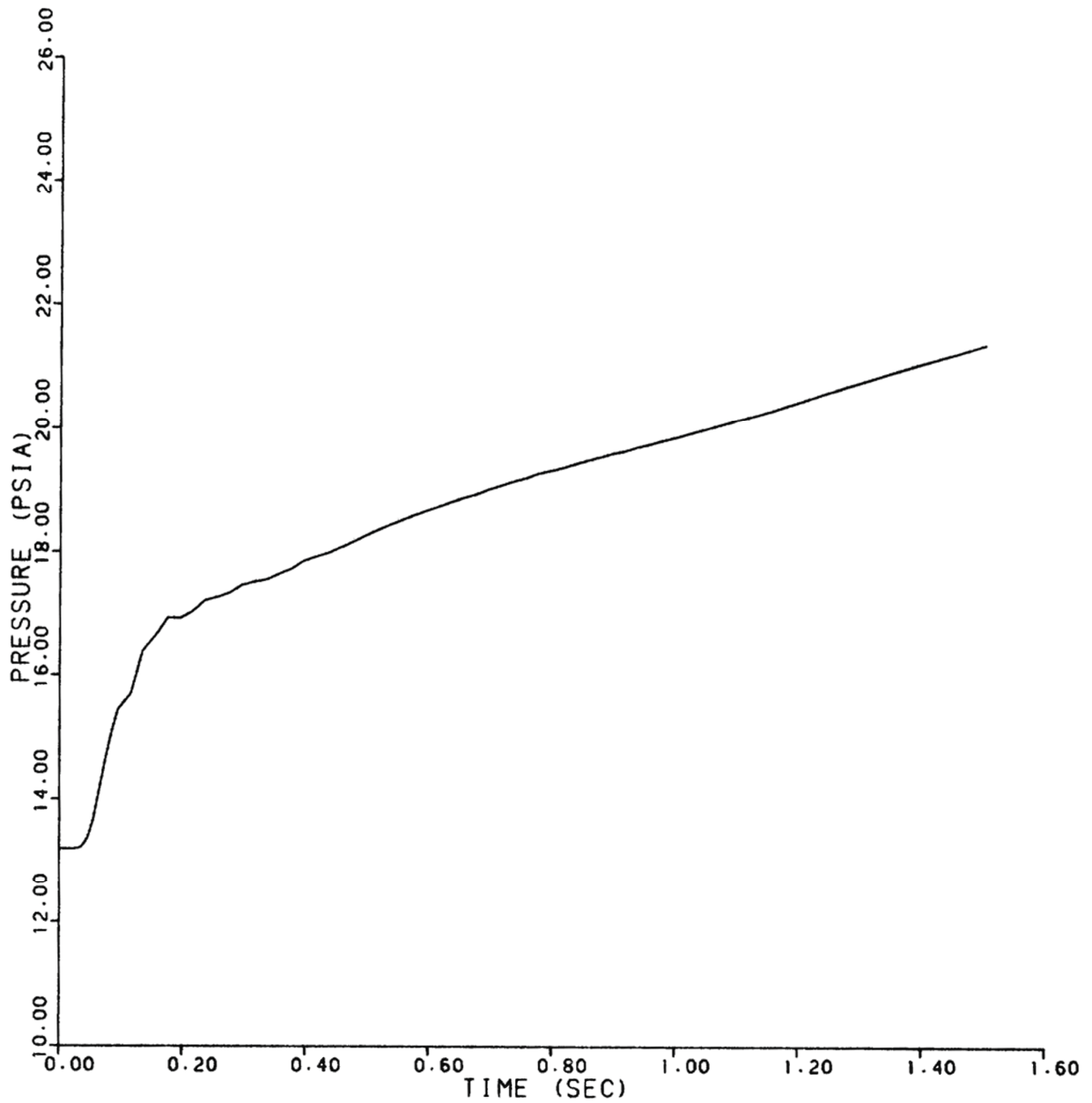

REV 13 4/06



VOGTLE
ELECTRIC GENERATING PLANT
UNIT 1 AND UNIT 2

STEAM GENERATOR COMPARTMENT
PRESSURE RESPONSE – NODE E54
(236-in.² BREAK AREA)

FIGURE 6.2.1-18 (SHEET 54 OF 74)

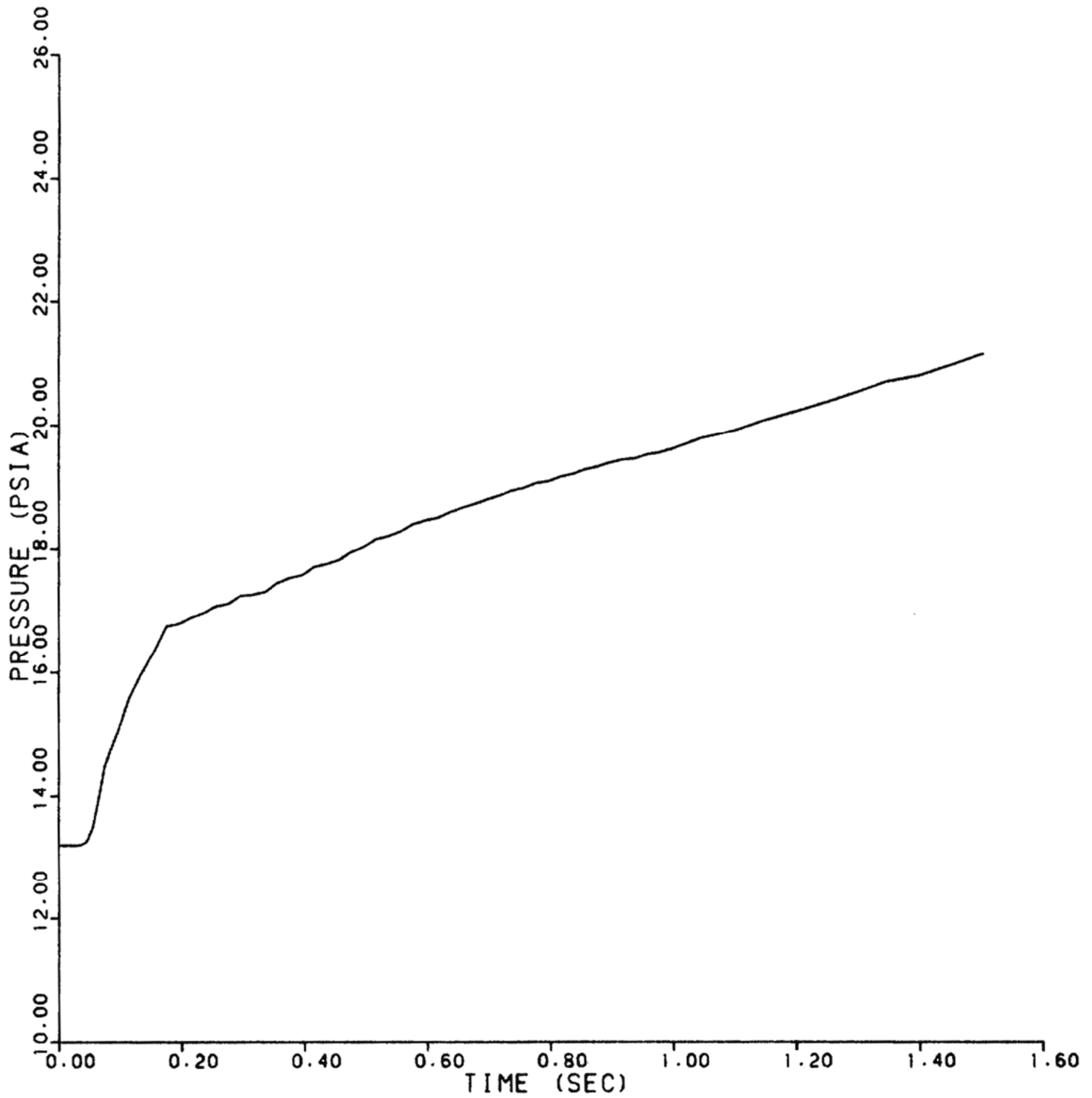

REV 13 4/06



VOGTLE
ELECTRIC GENERATING PLANT
UNIT 1 AND UNIT 2

STEAM GENERATOR COMPARTMENT
PRESSURE RESPONSE - NODE E55
(236-in.² BREAK AREA)

FIGURE 6.2.1-18 (SHEET 55 OF 74)

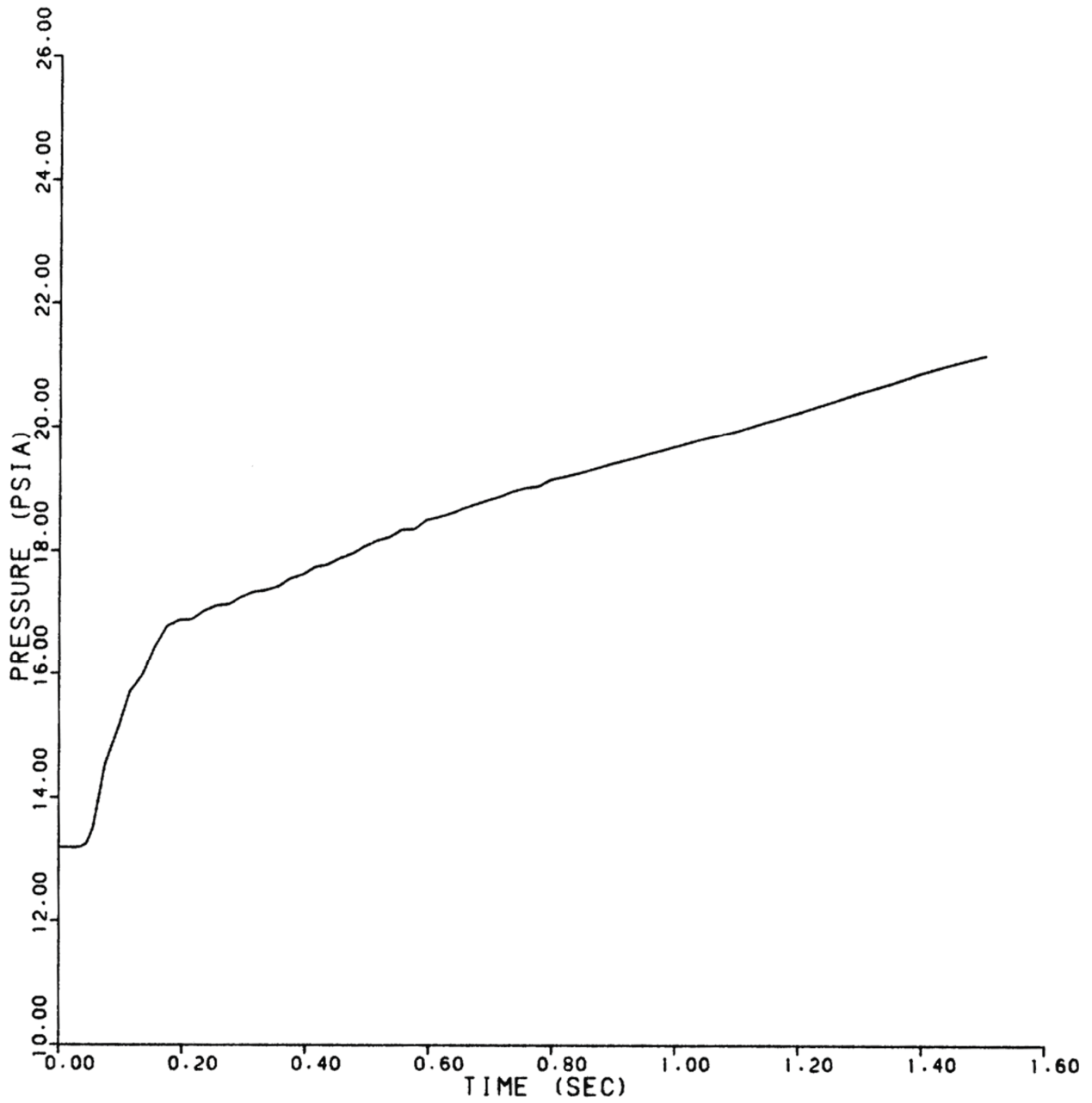

REV 13 4/06



VOGTLE
ELECTRIC GENERATING PLANT
UNIT 1 AND UNIT 2

STEAM GENERATOR COMPARTMENT
PRESSURE RESPONSE – NODE E56
(236-in.² BREAK AREA)

FIGURE 6.2.1-18 (SHEET 56 OF 74)

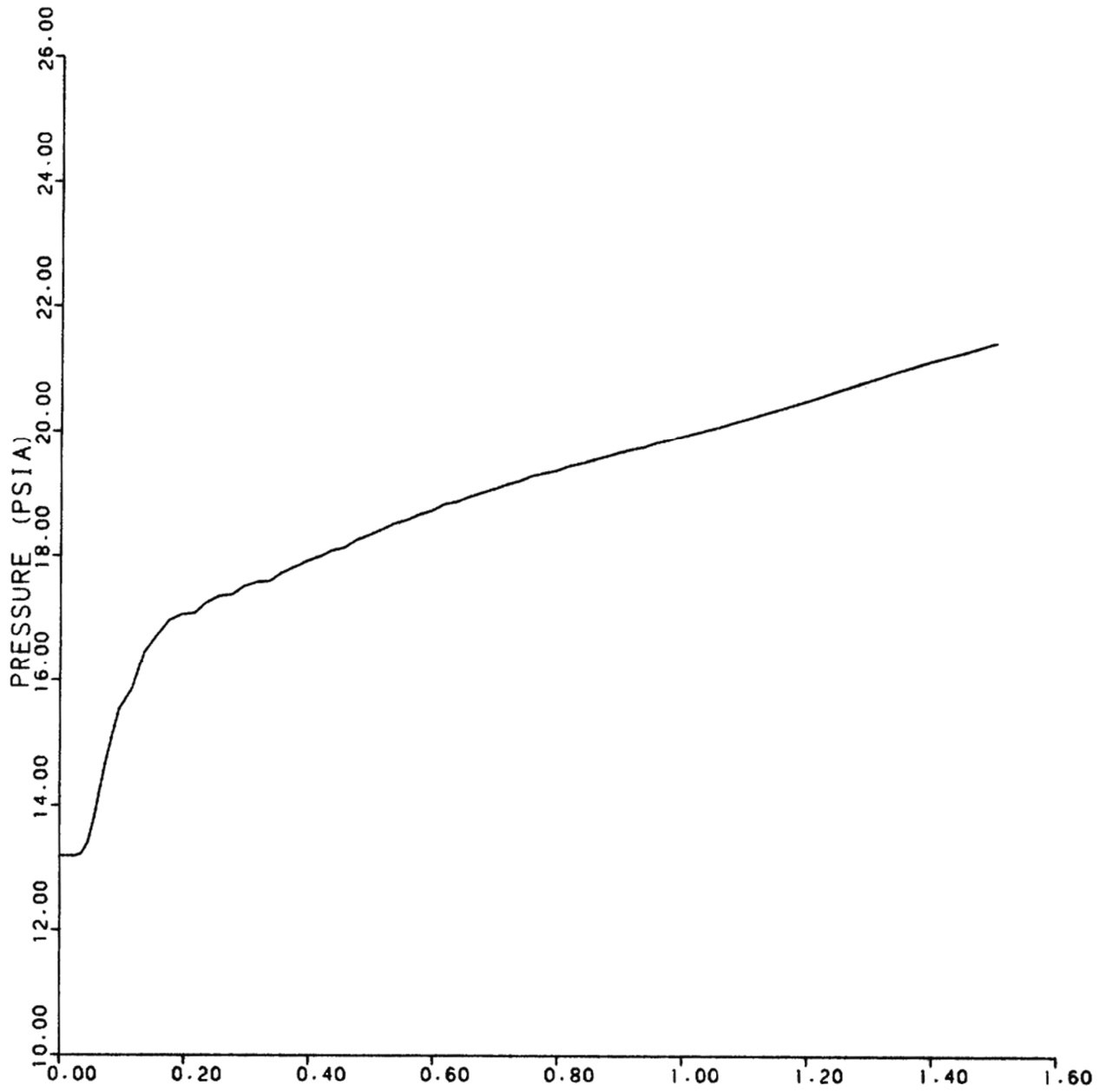

REV 13 4/06



VOGTLE
ELECTRIC GENERATING PLANT
UNIT 1 AND UNIT 2

STEAM GENERATOR COMPARTMENT
PRESSURE RESPONSE – NODE E57
(236-in.² BREAK AREA)

FIGURE 6.2.1-18 (SHEET 57 OF 74)

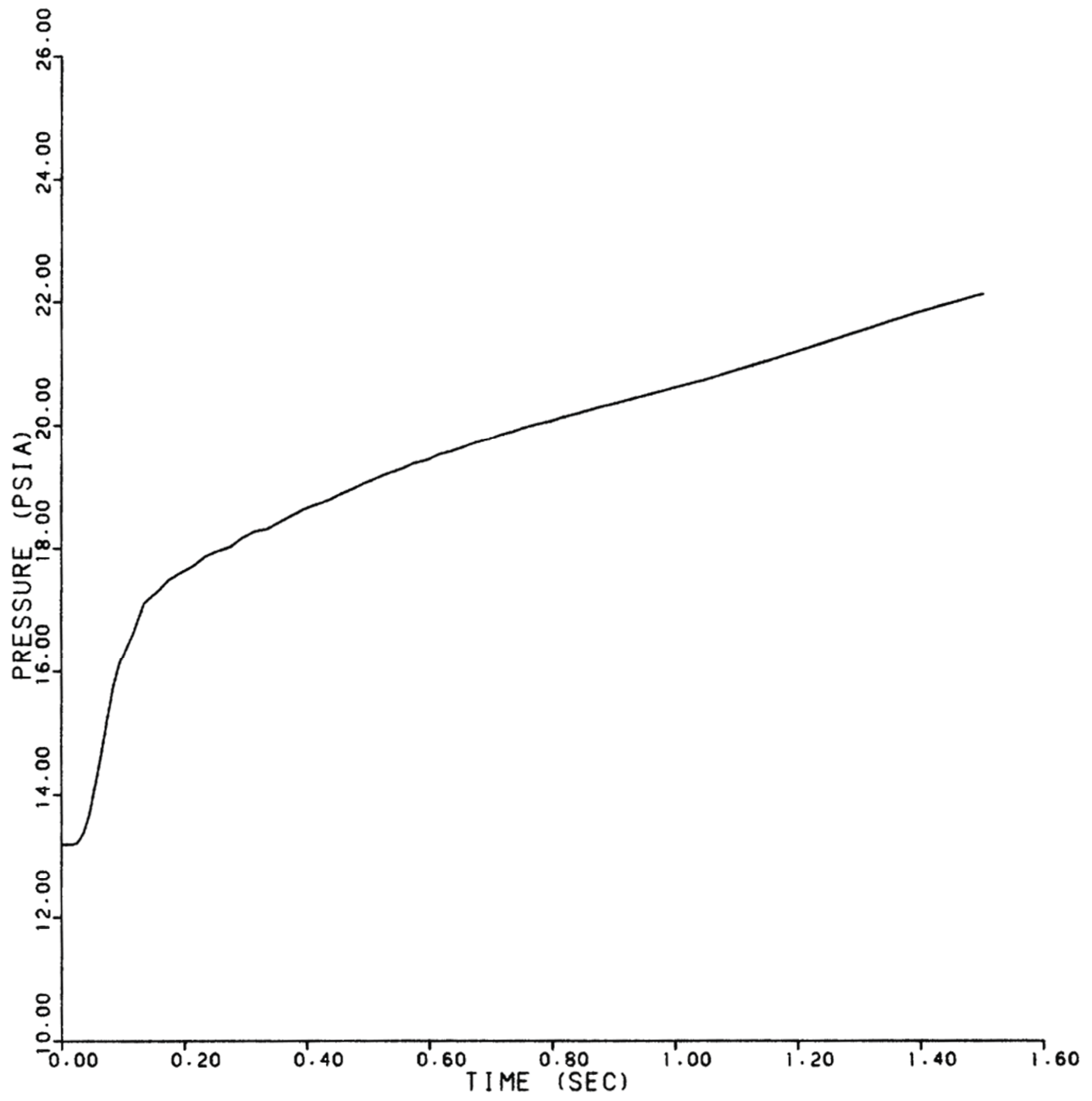

REV 13 4/06



VOGTLE
ELECTRIC GENERATING PLANT
UNIT 1 AND UNIT 2

STEAM GENERATOR COMPARTMENT
PRESSURE RESPONSE - NODE E58
(236-in.² BREAK AREA)

FIGURE 6.2.1-18 (SHEET 58 OF 74)

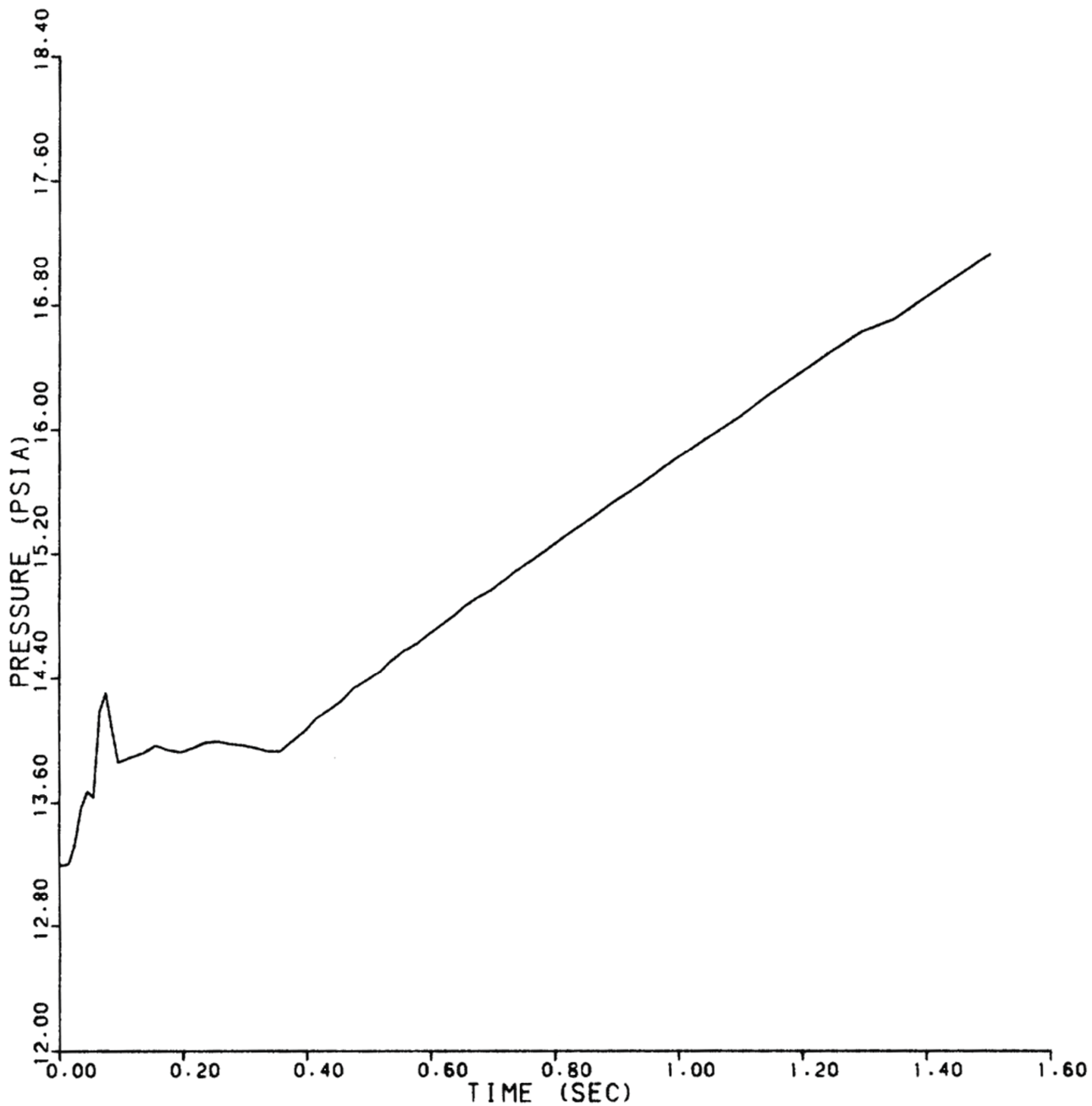

REV 13 4/06



VOGTLE
ELECTRIC GENERATING PLANT
UNIT 1 AND UNIT 2

STEAM GENERATOR COMPARTMENT
PRESSURE RESPONSE – NODE E59
(236-in.² BREAK AREA)

FIGURE 6.2.1–18 (SHEET 59 OF 74)

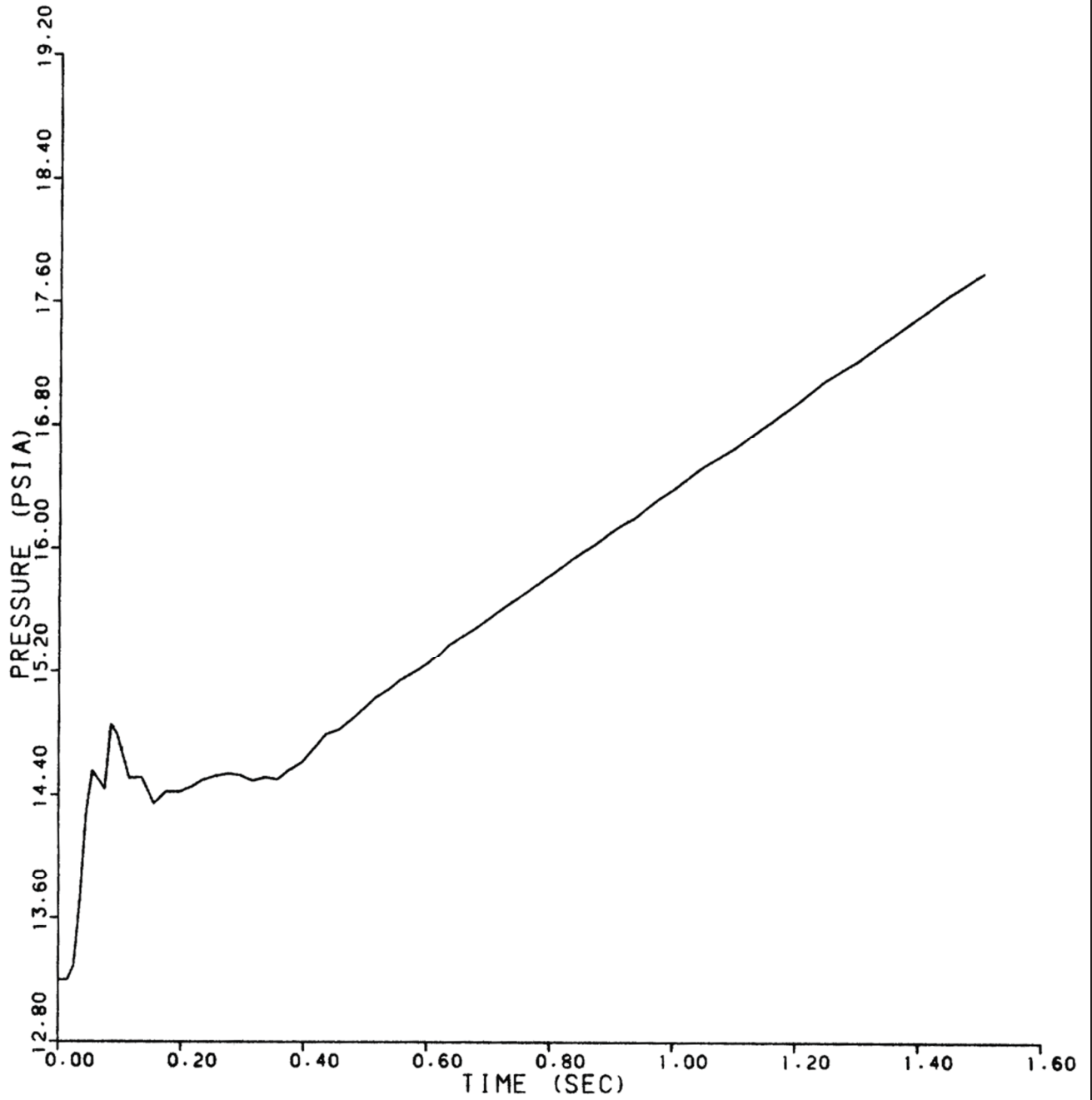

REV 13 4/06



VOGTLE
ELECTRIC GENERATING PLANT
UNIT 1 AND UNIT 2

STEAM GENERATOR COMPARTMENT
PRESSURE RESPONSE - NODE E4
(236-in.² BREAK AREA)

FIGURE 6.2.1-18 (SHEET 60 OF 74)

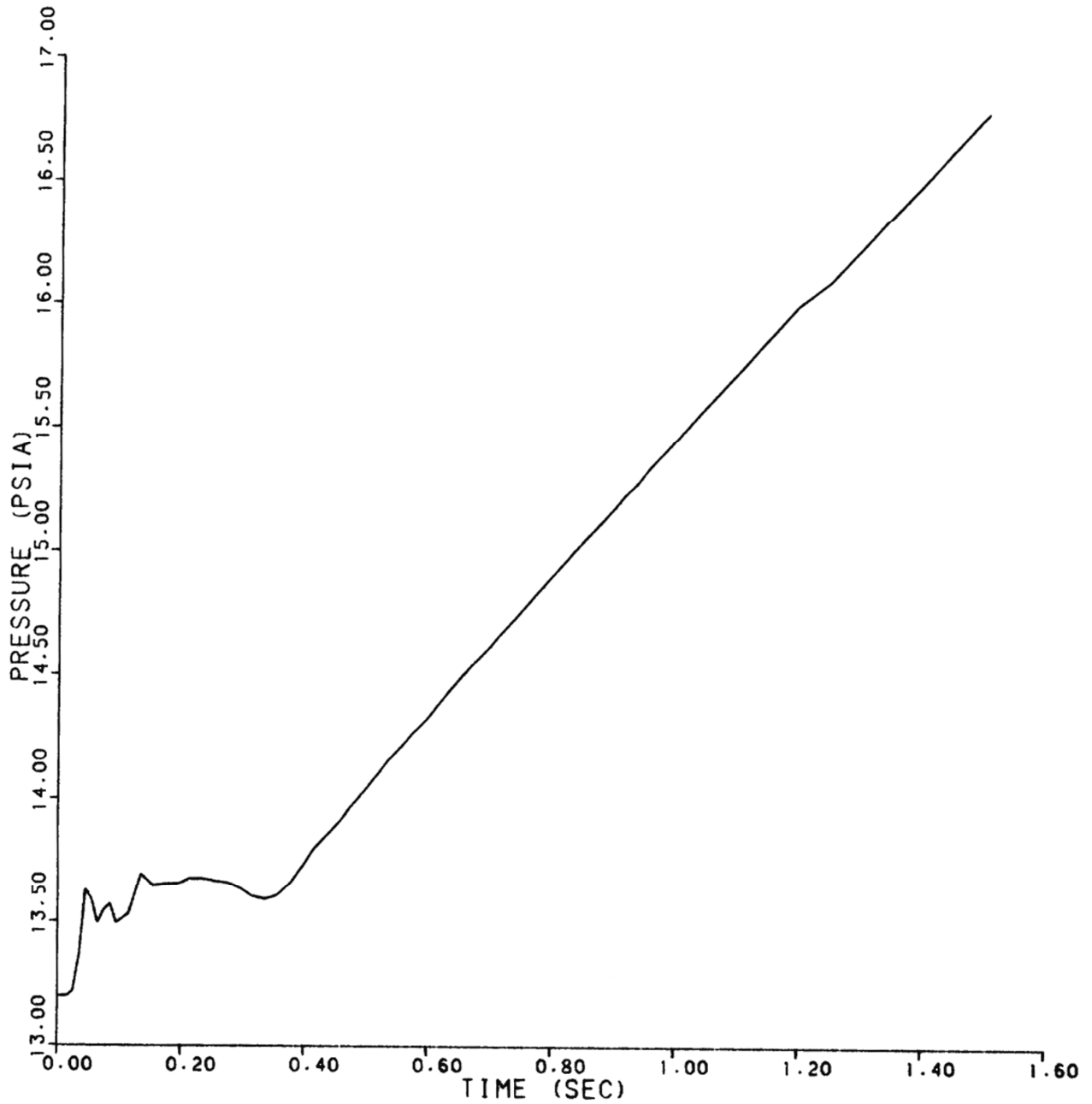

REV 13 4/06



VOGTLE
ELECTRIC GENERATING PLANT
UNIT 1 AND UNIT 2

STEAM GENERATOR COMPARTMENT
PRESSURE RESPONSE – NODE E61
(236-in.² BREAK AREA)

FIGURE 6.2.1–18 (SHEET 61 OF 74)

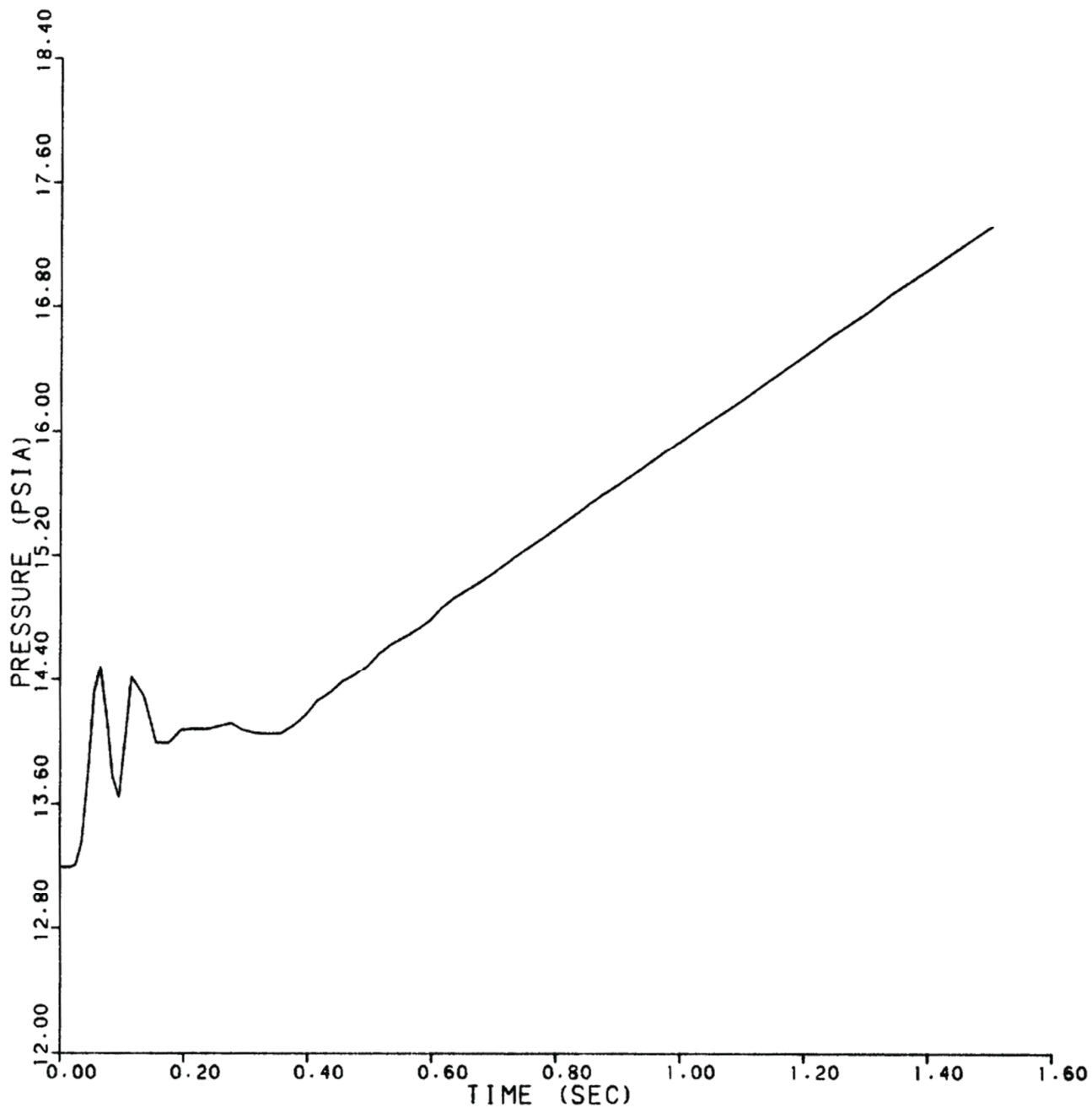

REV 13 4/06



VOGTLE
ELECTRIC GENERATING PLANT
UNIT 1 AND UNIT 2

STEAM GENERATOR COMPARTMENT
PRESSURE RESPONSE – NODE E62
(236-in.² BREAK AREA)

FIGURE 6.2.1–18 (SHEET 62 OF 74)

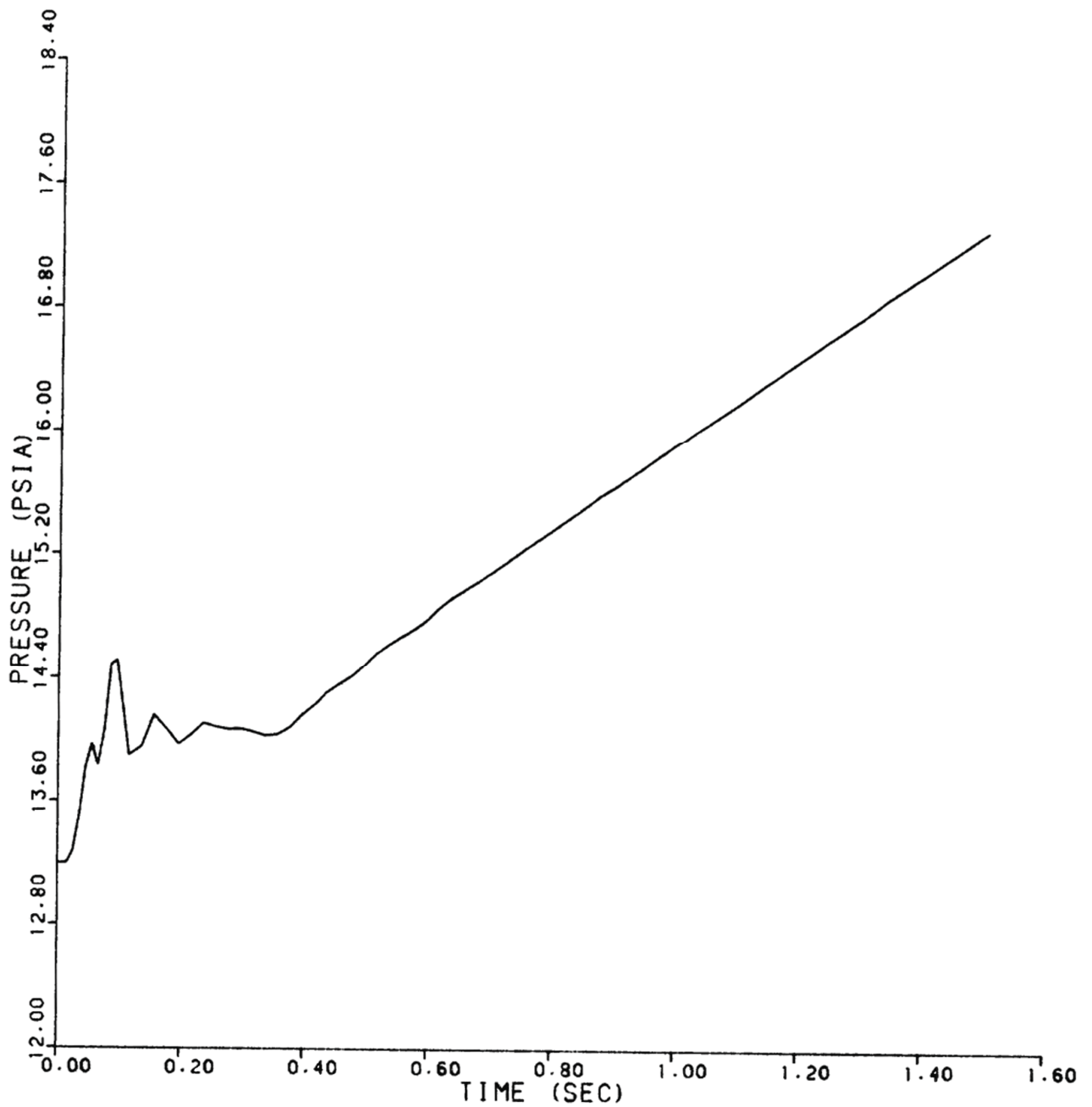

REV 13 4/06

STEAM GENERATOR COMPARTMENT
 PRESSURE RESPONSE – NODE E63
 (236-in.² BREAK AREA)



VOGTLE
 ELECTRIC GENERATING PLANT
 UNIT 1 AND UNIT 2

FIGURE 6.2.1-18 (SHEET 63 OF 74)

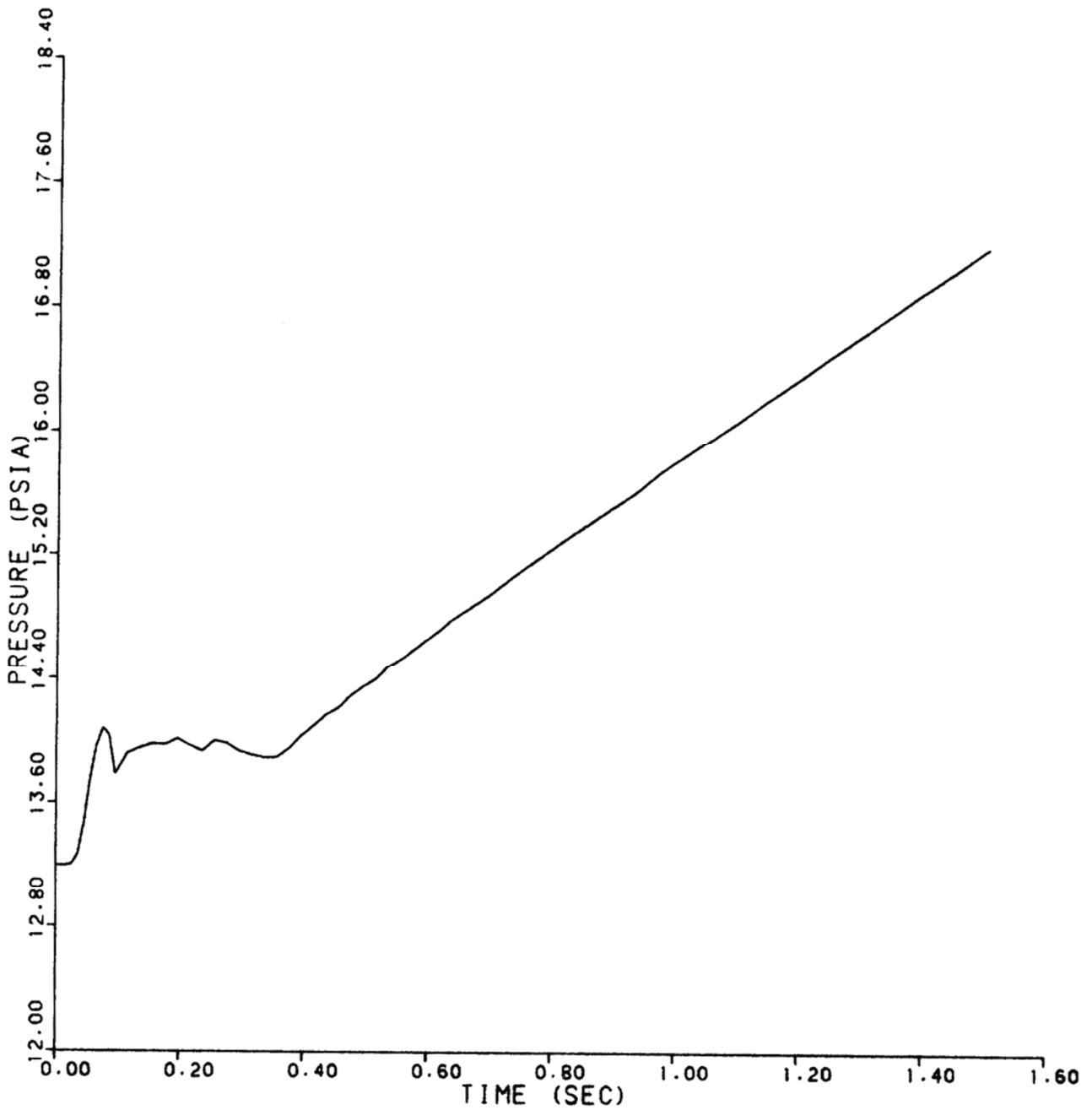

REV 13 4/06



VOGTLE
ELECTRIC GENERATING PLANT
UNIT 1 AND UNIT 2

STEAM GENERATOR COMPARTMENT
PRESSURE RESPONSE – NODE E64
(236-in.² BREAK AREA)

FIGURE 6.2.1-18 (SHEET 64 OF 74)

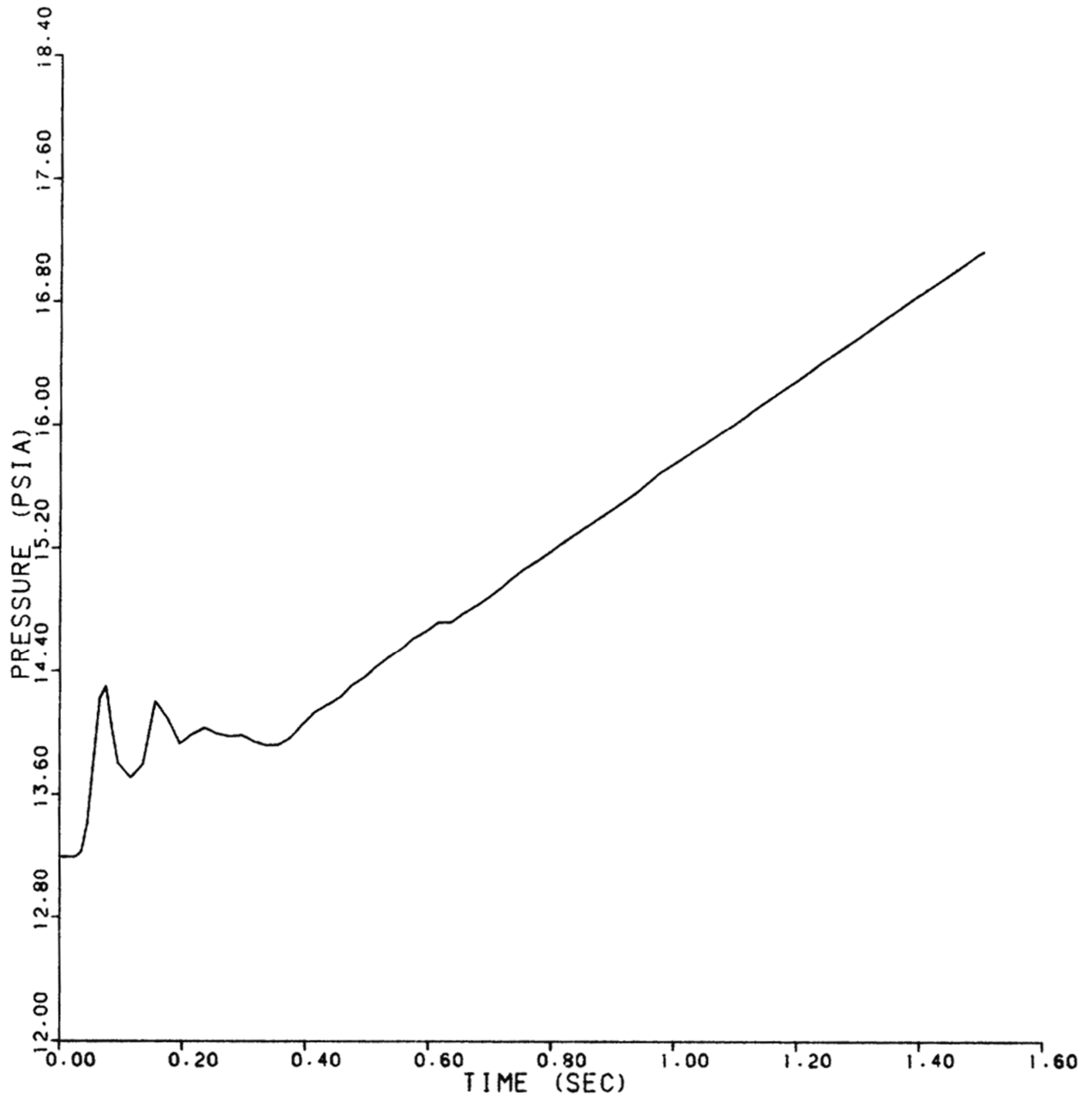

REV 13 4/06



VOGTLE
ELECTRIC GENERATING PLANT
UNIT 1 AND UNIT 2

STEAM GENERATOR COMPARTMENT
PRESSURE RESPONSE – NODE E65
(236-in.² BREAK AREA)

FIGURE 6.2.1–18 (SHEET 65 OF 74)

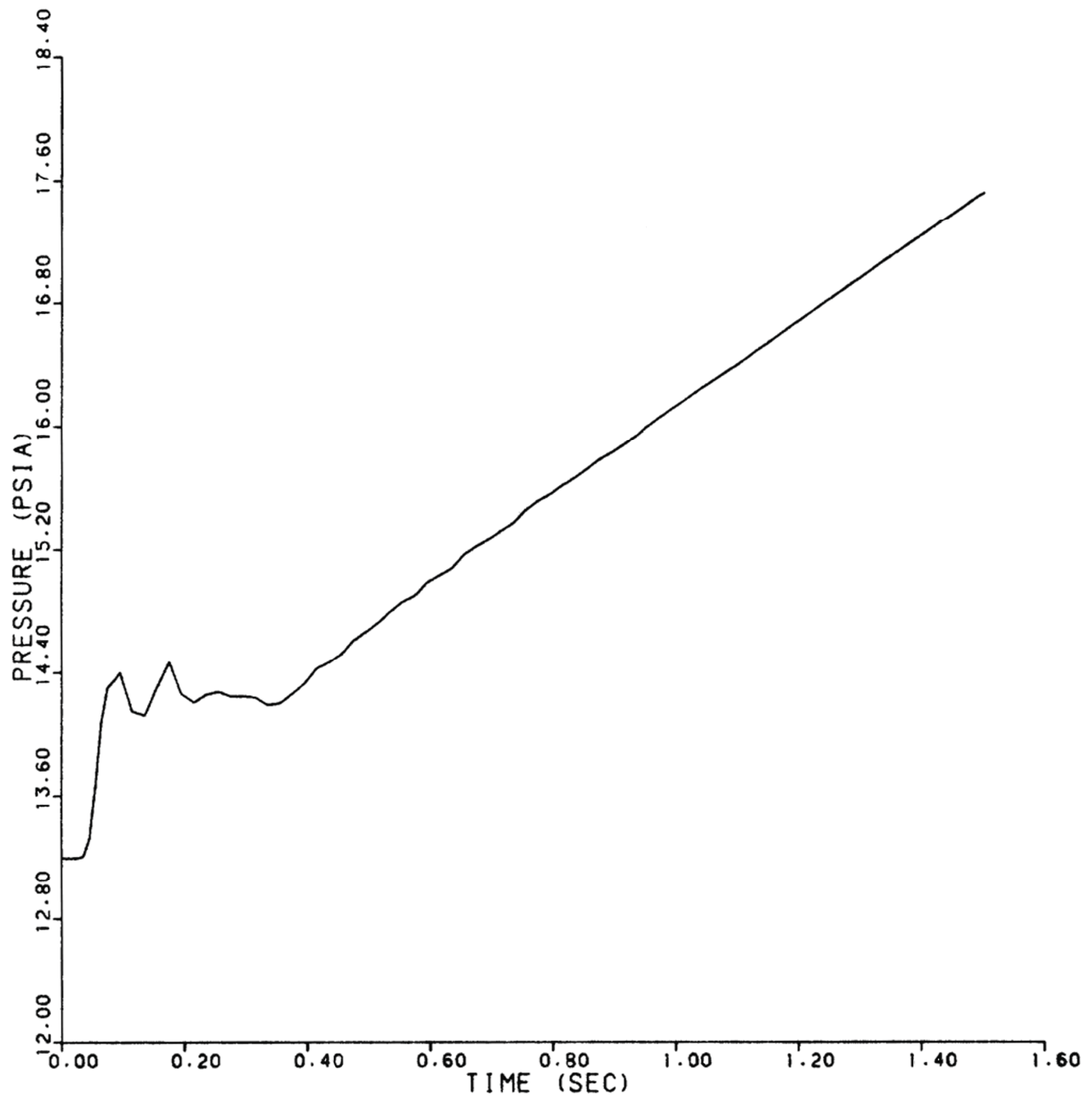

REV 13 4/06



VOGTLE
ELECTRIC GENERATING PLANT
UNIT 1 AND UNIT 2

STEAM GENERATOR COMPARTMENT
PRESSURE RESPONSE – NODE E66
(236-in.² BREAK AREA)

FIGURE 6.2.1–18 (SHEET 66 OF 74)

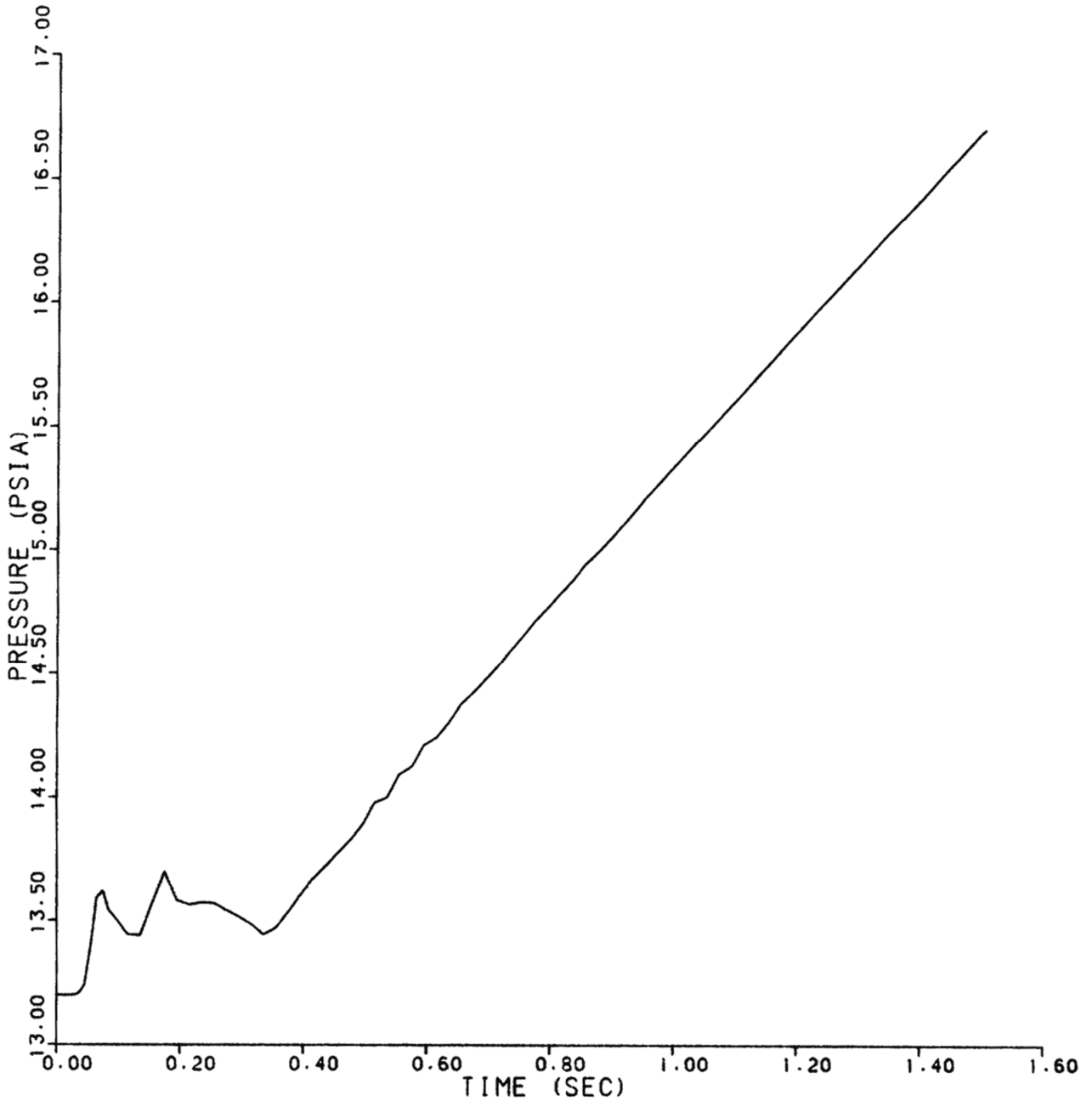

REV 13 4/06



VOGTLE
ELECTRIC GENERATING PLANT
UNIT 1 AND UNIT 2

STEAM GENERATOR COMPARTMENT
PRESSURE RESPONSE – NODE E67
(236-in.² BREAK AREA)

FIGURE 6.2.1-18 (SHEET 67 OF 74)

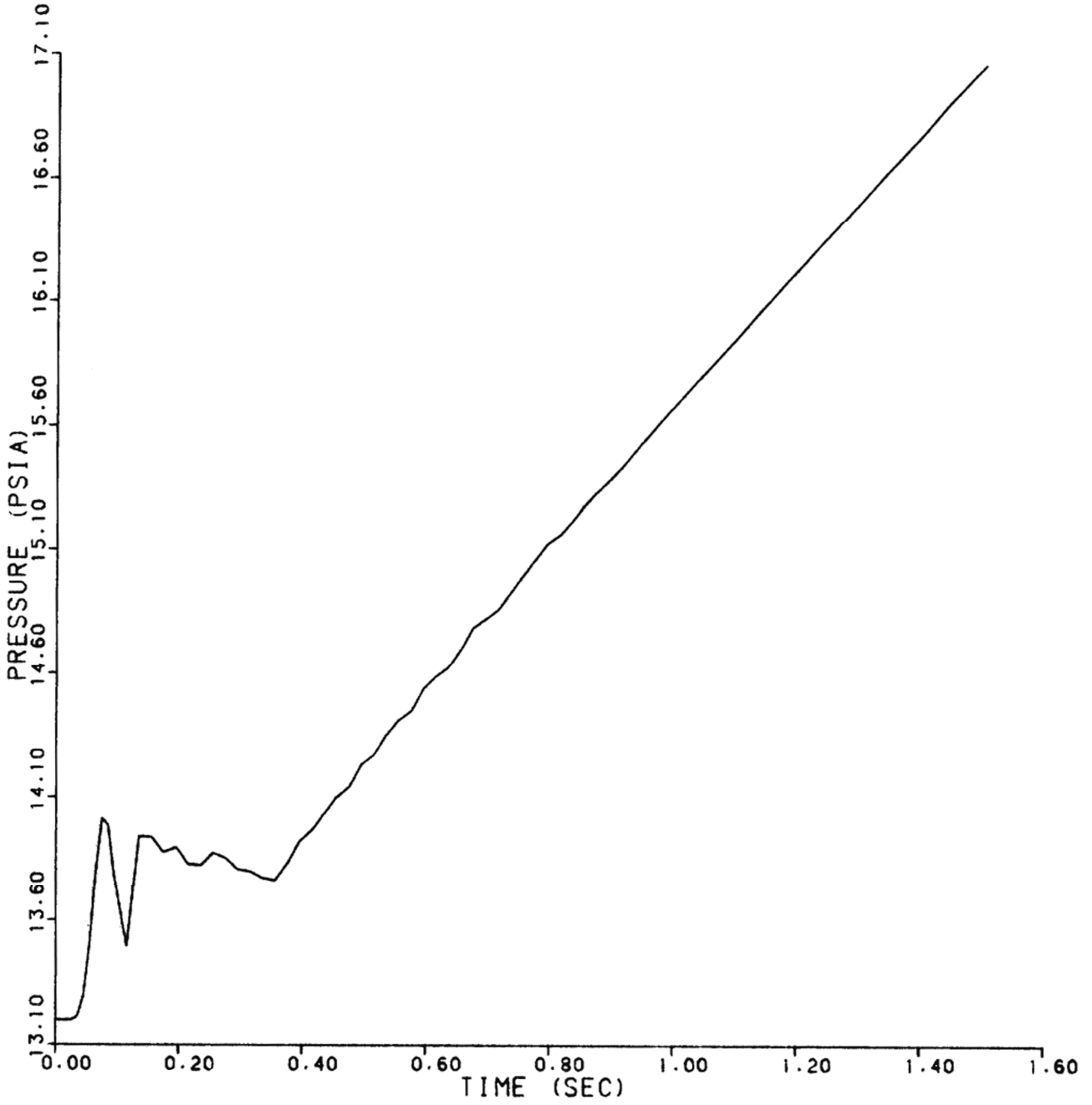

REV 13 4/06



VOGTLE
ELECTRIC GENERATING PLANT
UNIT 1 AND UNIT 2

STEAM GENERATOR COMPARTMENT
PRESSURE RESPONSE – NODE E68
(236-in.² BREAK AREA)

FIGURE 6.2.1–18 (SHEET 68 OF 74)

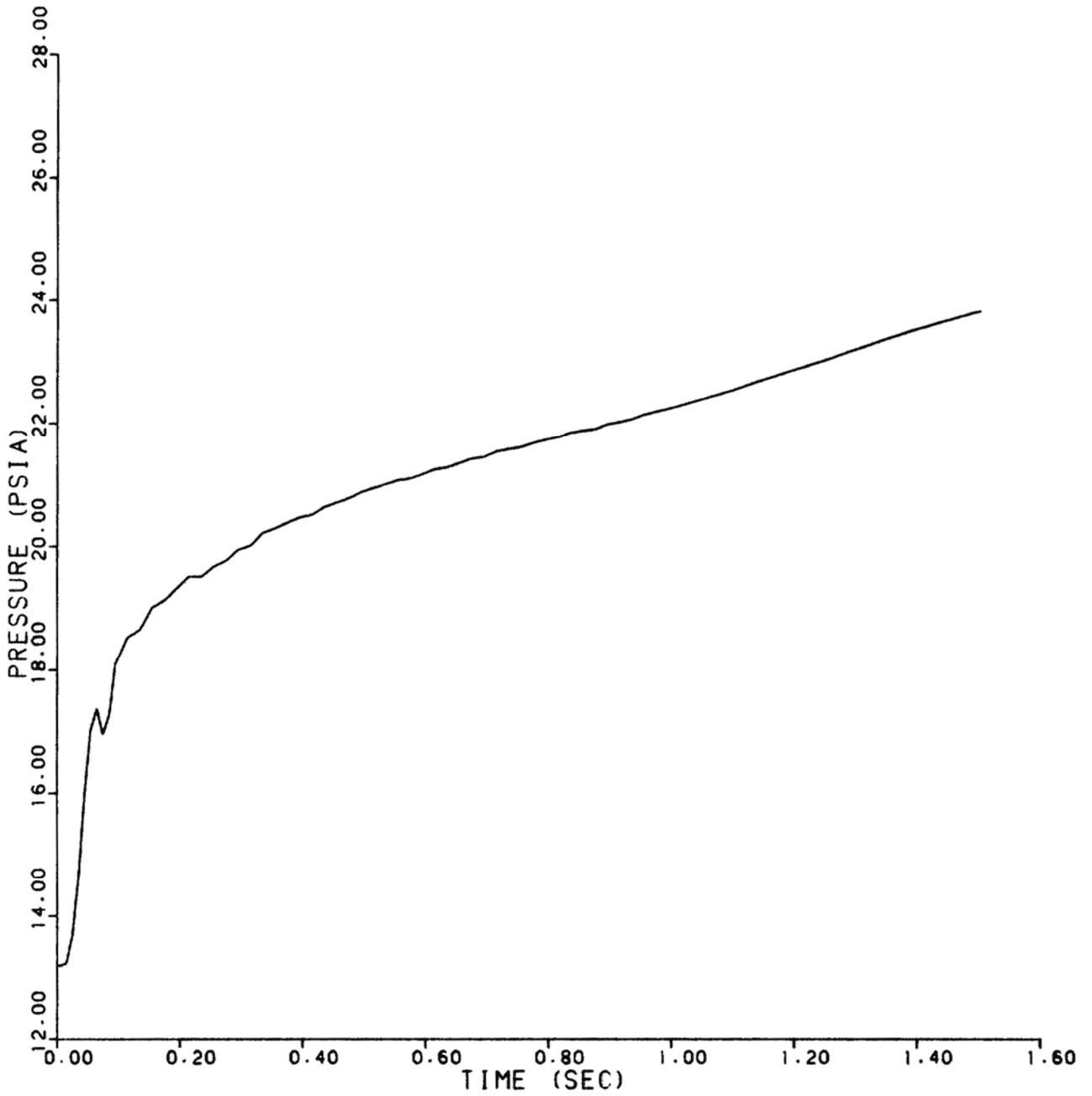

REV 13 4/06



VOGTLE
ELECTRIC GENERATING PLANT
UNIT 1 AND UNIT 2

STEAM GENERATOR COMPARTMENT
PRESSURE RESPONSE – NODE E69
(236-in.² BREAK AREA)

FIGURE 6.2.1-18 (SHEET 69 OF 74)

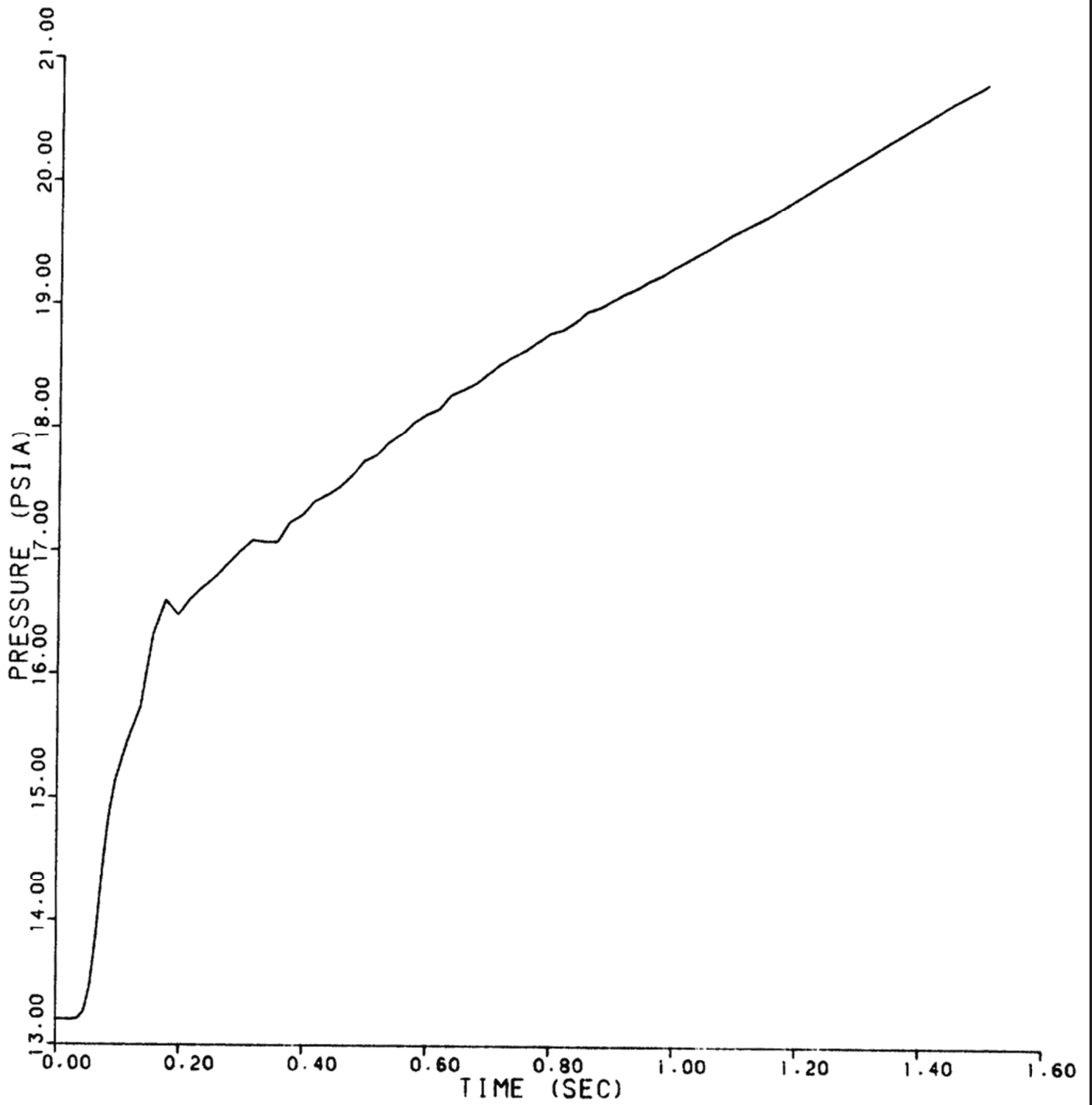

REV 13 4/06



VOGTLE
ELECTRIC GENERATING PLANT
UNIT 1 AND UNIT 2

STEAM GENERATOR COMPARTMENT
PRESSURE RESPONSE – NODE E70
(236-in.² BREAK AREA)

FIGURE 6.2.1–18 (SHEET 70 OF 74)

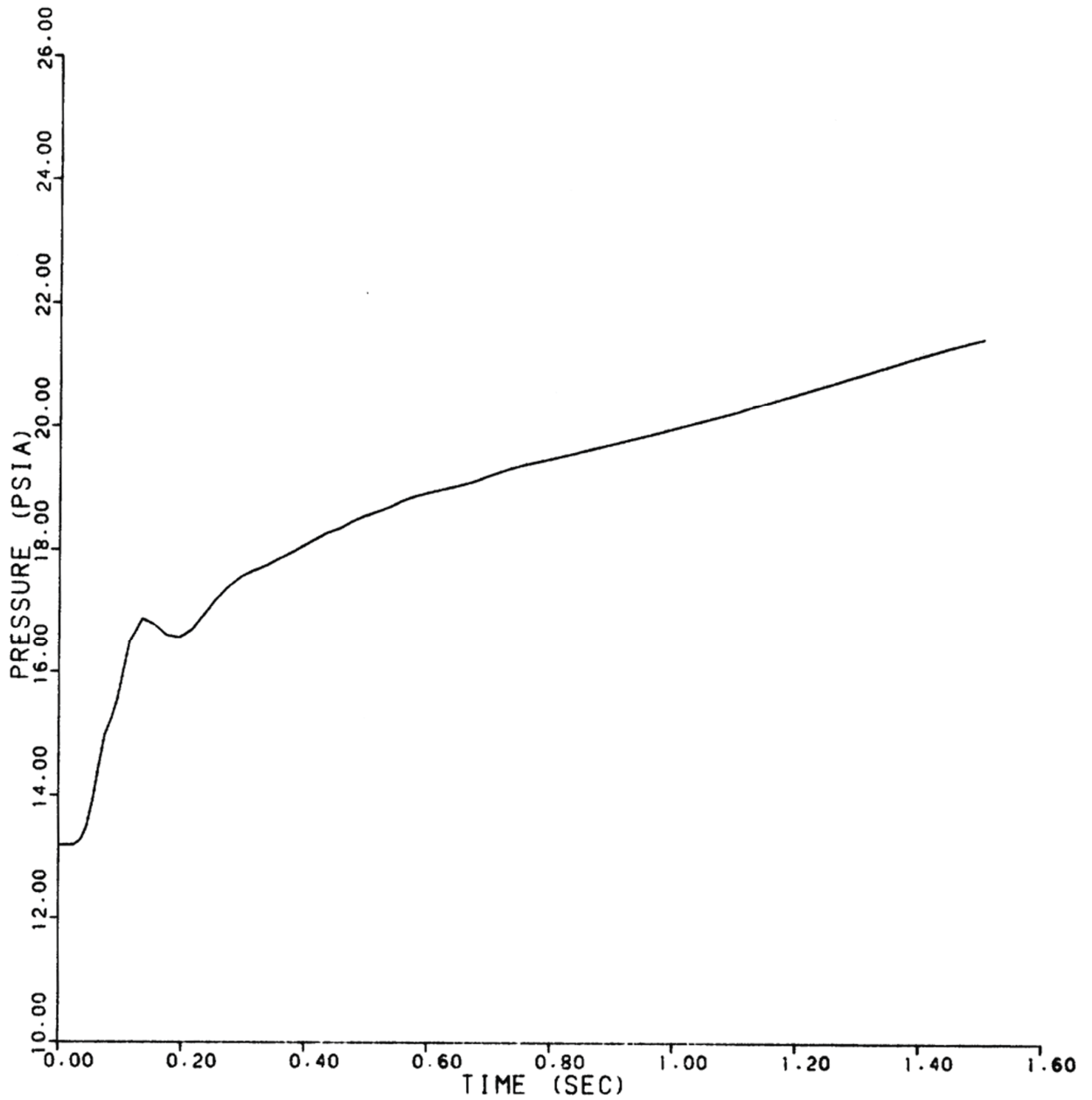

REV 13 4/06



VOGTLE
ELECTRIC GENERATING PLANT
UNIT 1 AND UNIT 2

STEAM GENERATOR COMPARTMENT
PRESSURE RESPONSE – NODE E71
(236-in.² BREAK AREA)

FIGURE 6.2.1-18 (SHEET 71 OF 74)

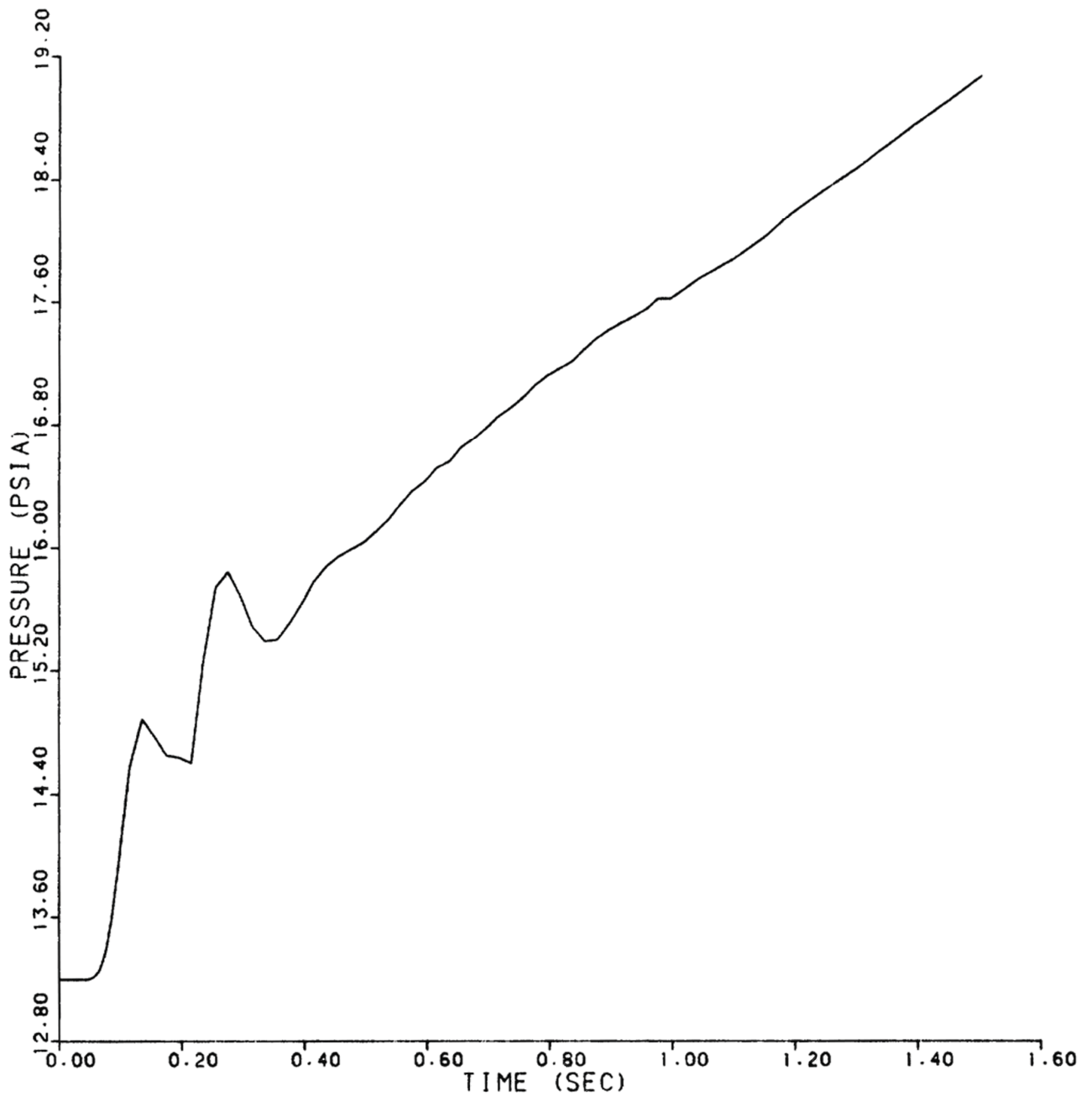

REV 13 4/06



VOGTLE
ELECTRIC GENERATING PLANT
UNIT 1 AND UNIT 2

STEAM GENERATOR COMPARTMENT
PRESSURE RESPONSE - NODE E72
(236-in.² BREAK AREA)

FIGURE 6.2.1-18 (SHEET 72 OF 74)

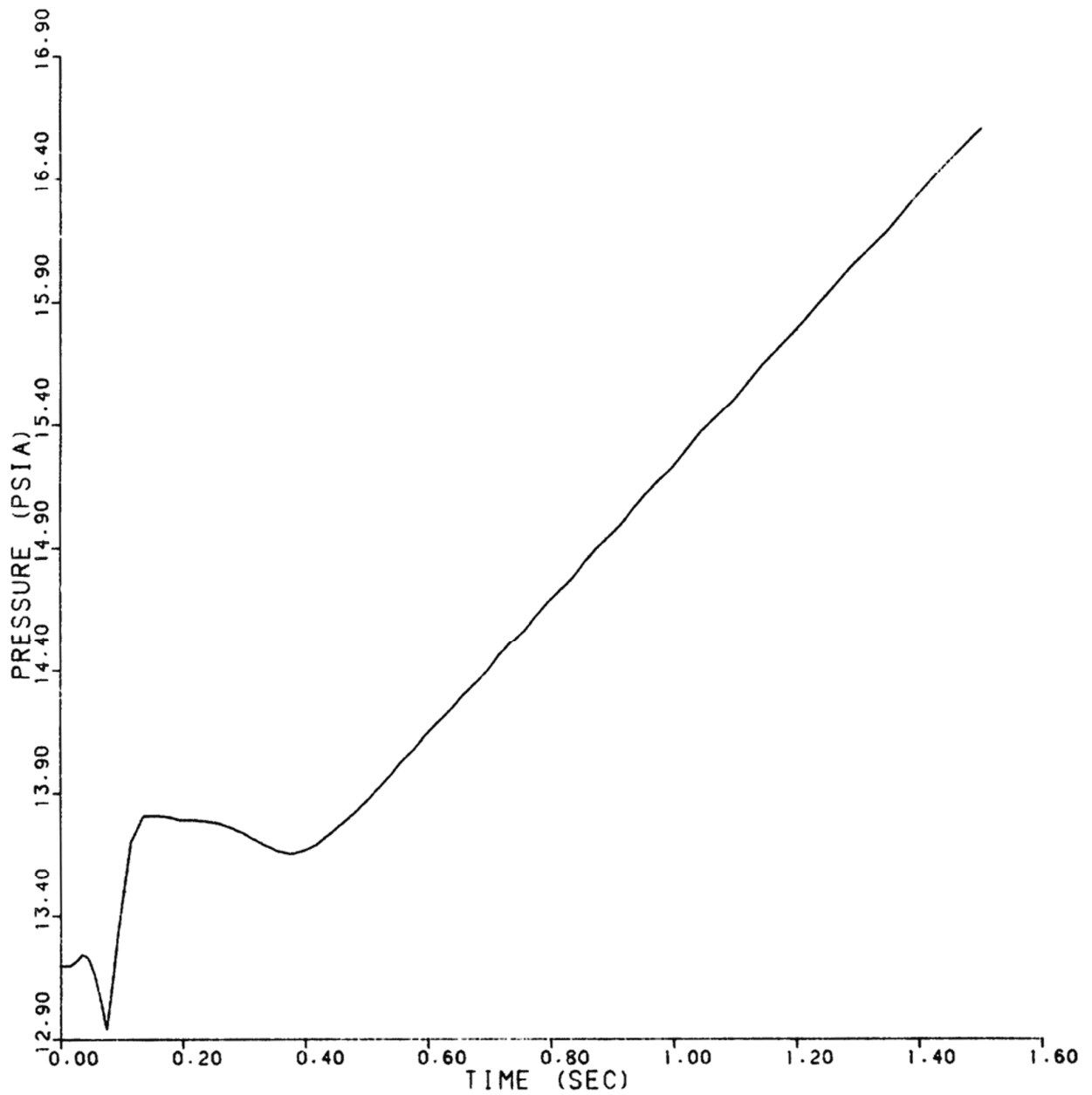

REV 13 4/06



VOGTLE
ELECTRIC GENERATING PLANT
UNIT 1 AND UNIT 2

STEAM GENERATOR COMPARTMENT
PRESSURE RESPONSE – NODE E73
(236-in.² BREAK AREA)

FIGURE 6.2.1–18 (SHEET 73 OF 74)

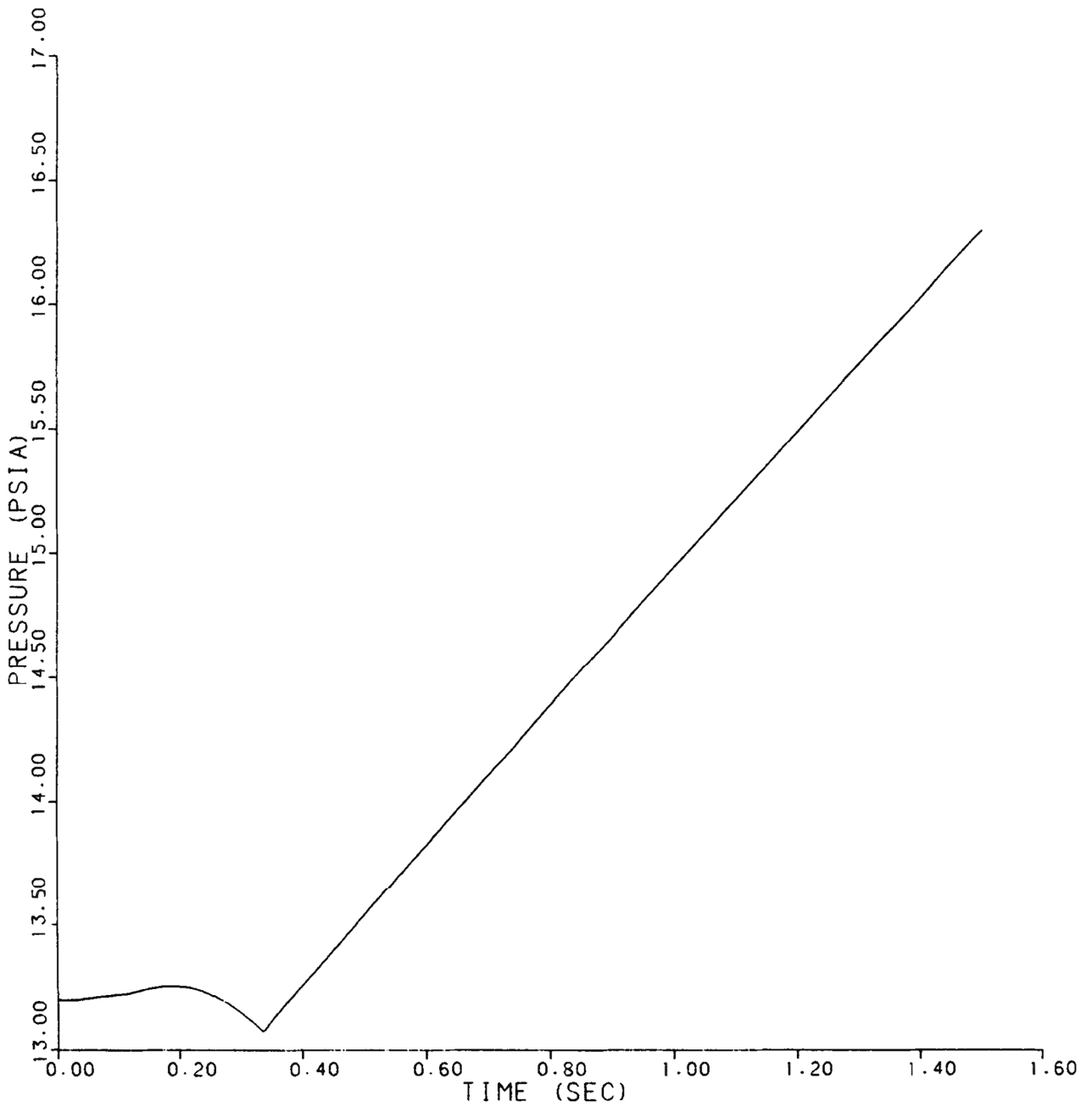

REV 13 4/06



VOGTLE
ELECTRIC GENERATING PLANT
UNIT 1 AND UNIT 2

STEAM GENERATOR COMPARTMENT
PRESSURE RESPONSE – NODE E74
(236-in.² BREAK AREA)

FIGURE 6.2.1–18 (SHEET 74 OF 74)

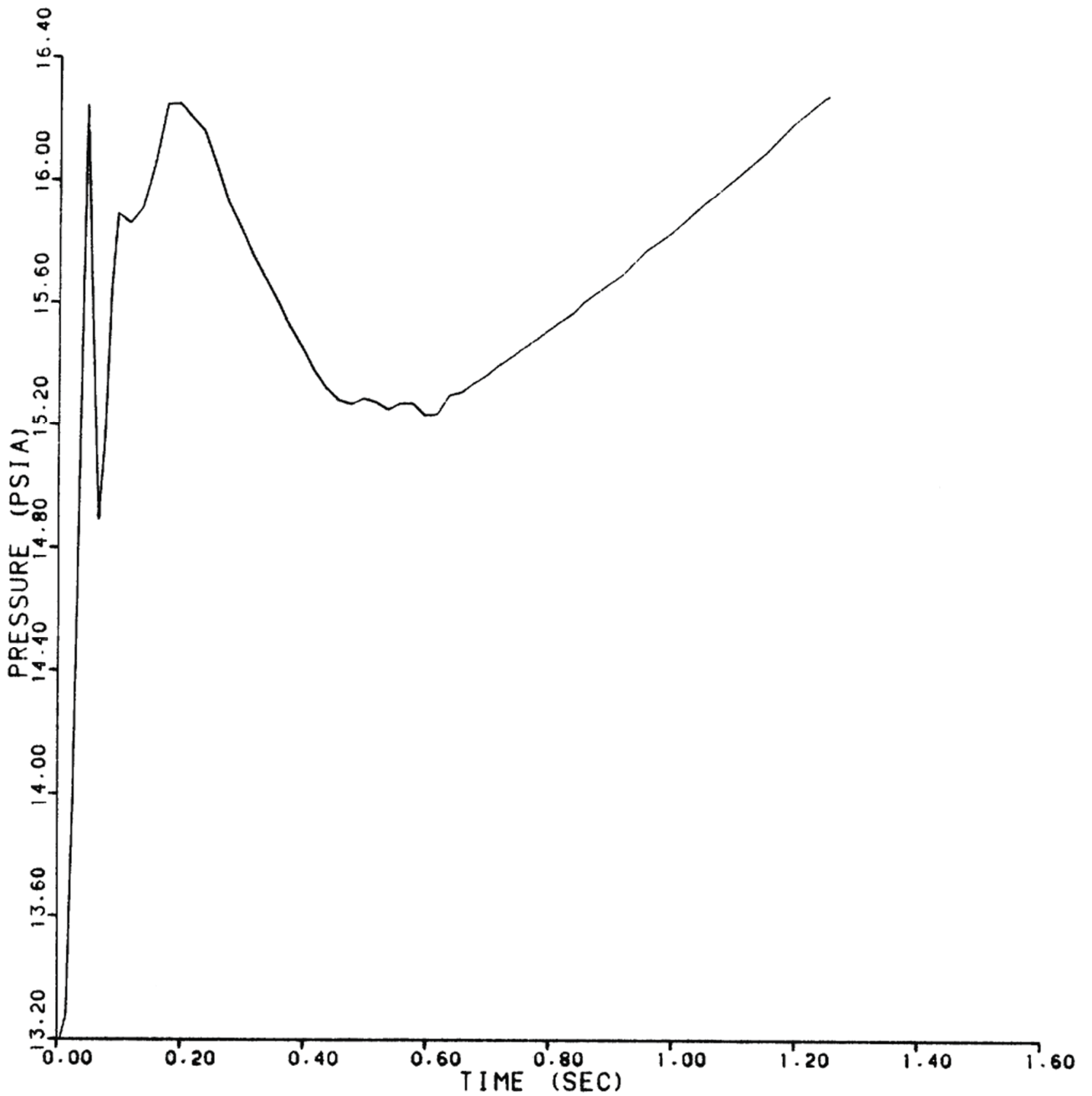

REV 13 4/06



VOGTLE
ELECTRIC GENERATING PLANT
UNIT 1 AND UNIT 2

STEAM GENERATOR INLET NOZZLE
NODE - E1
(306-in.² BREAK AREA)

FIGURE 6.2.1-19 (SHEET 1 OF 74)

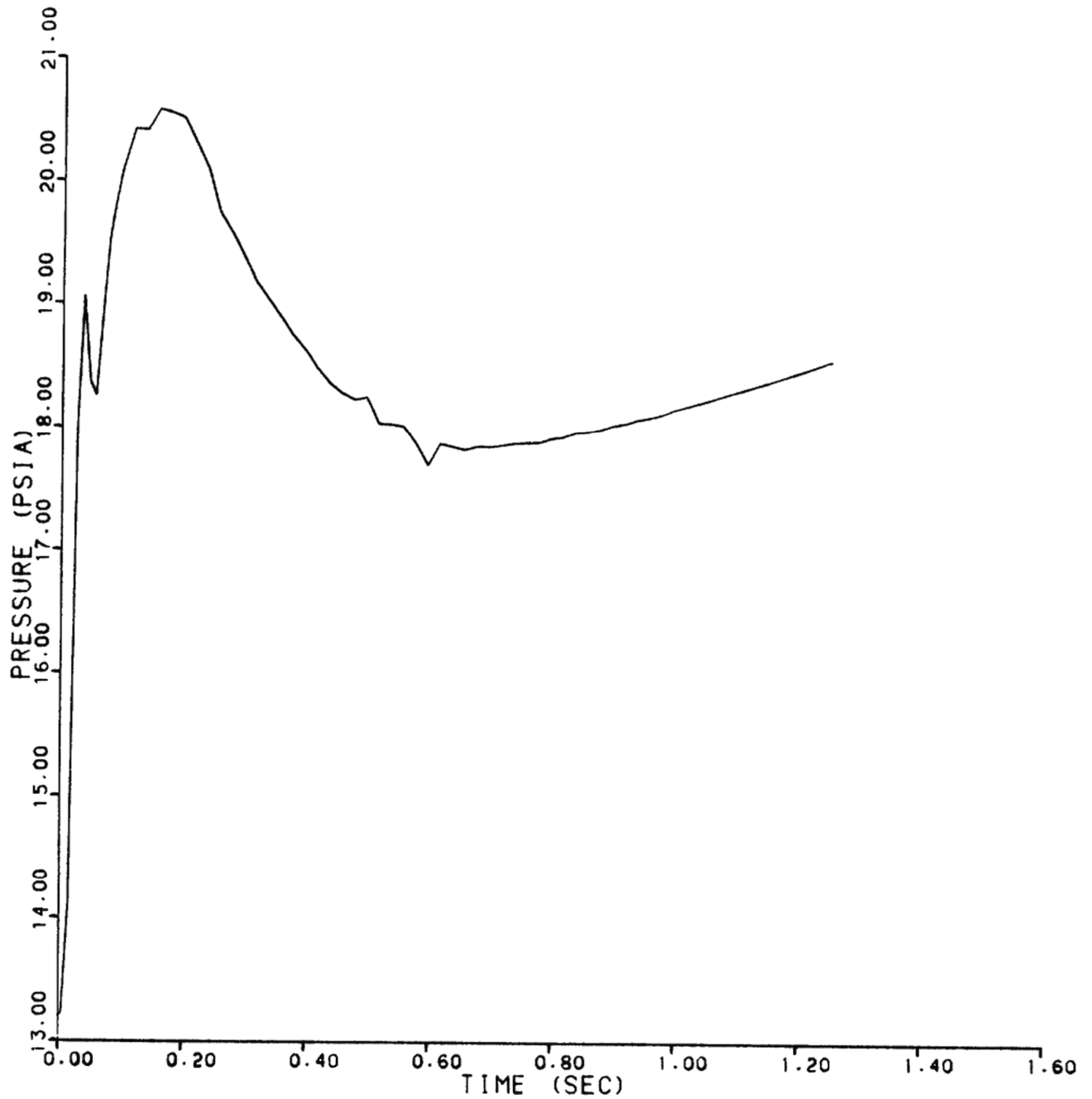

REV 13 4/06



VOGTLE
ELECTRIC GENERATING PLANT
UNIT 1 AND UNIT 2

STEAM GENERATOR INLET NOZZLE
NODE - E2
(306-in.² BREAK AREA)

FIGURE 6.2.1-19 (SHEET 2 OF 74)

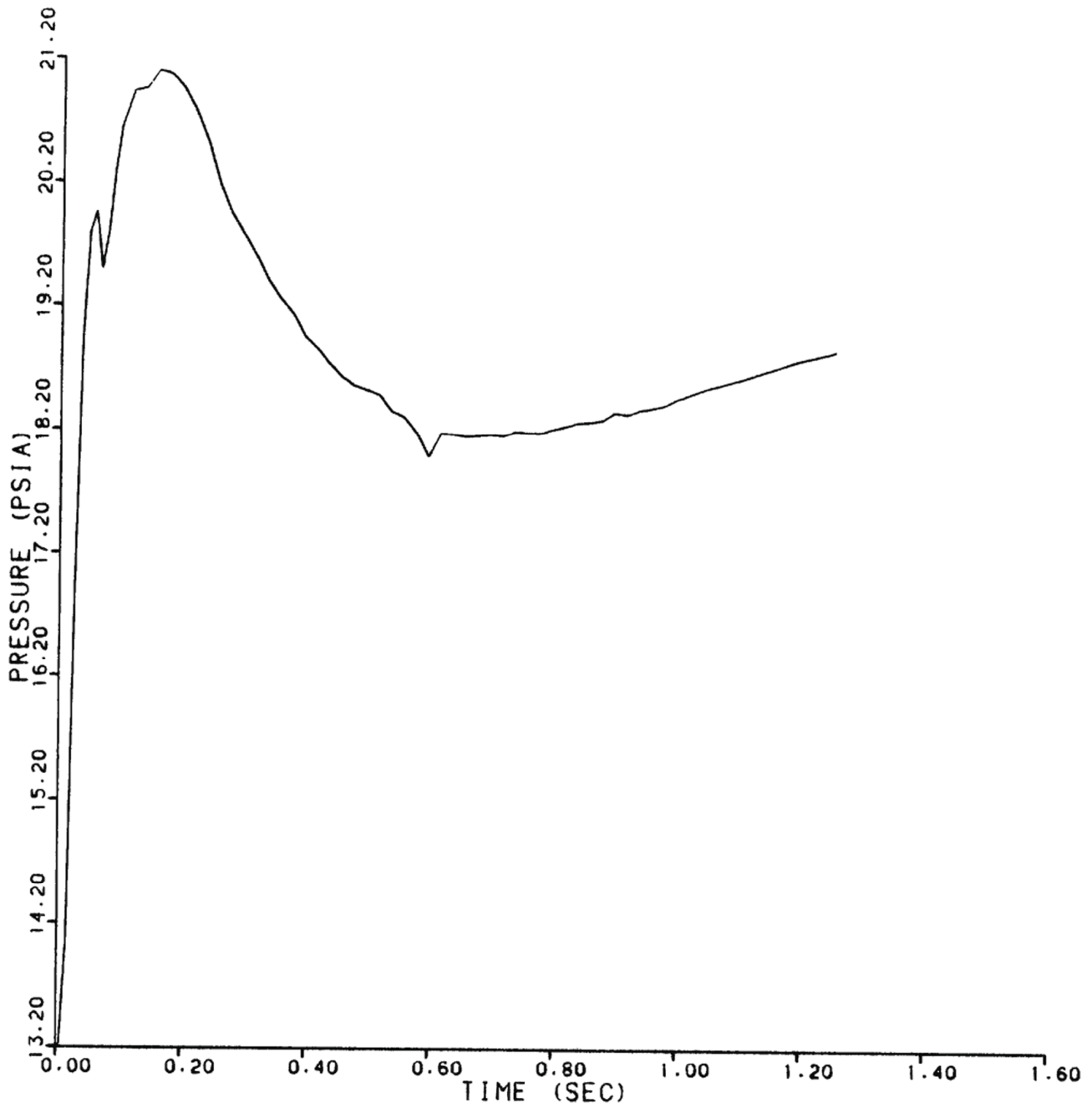

REV 13 4/06



VOGTLE
ELECTRIC GENERATING PLANT
UNIT 1 AND UNIT 2

STEAM GENERATOR INLET NOZZLE
NODE - E3
(306-in.² BREAK AREA)

FIGURE 6.2.1-19 (SHEET 3 OF 74)

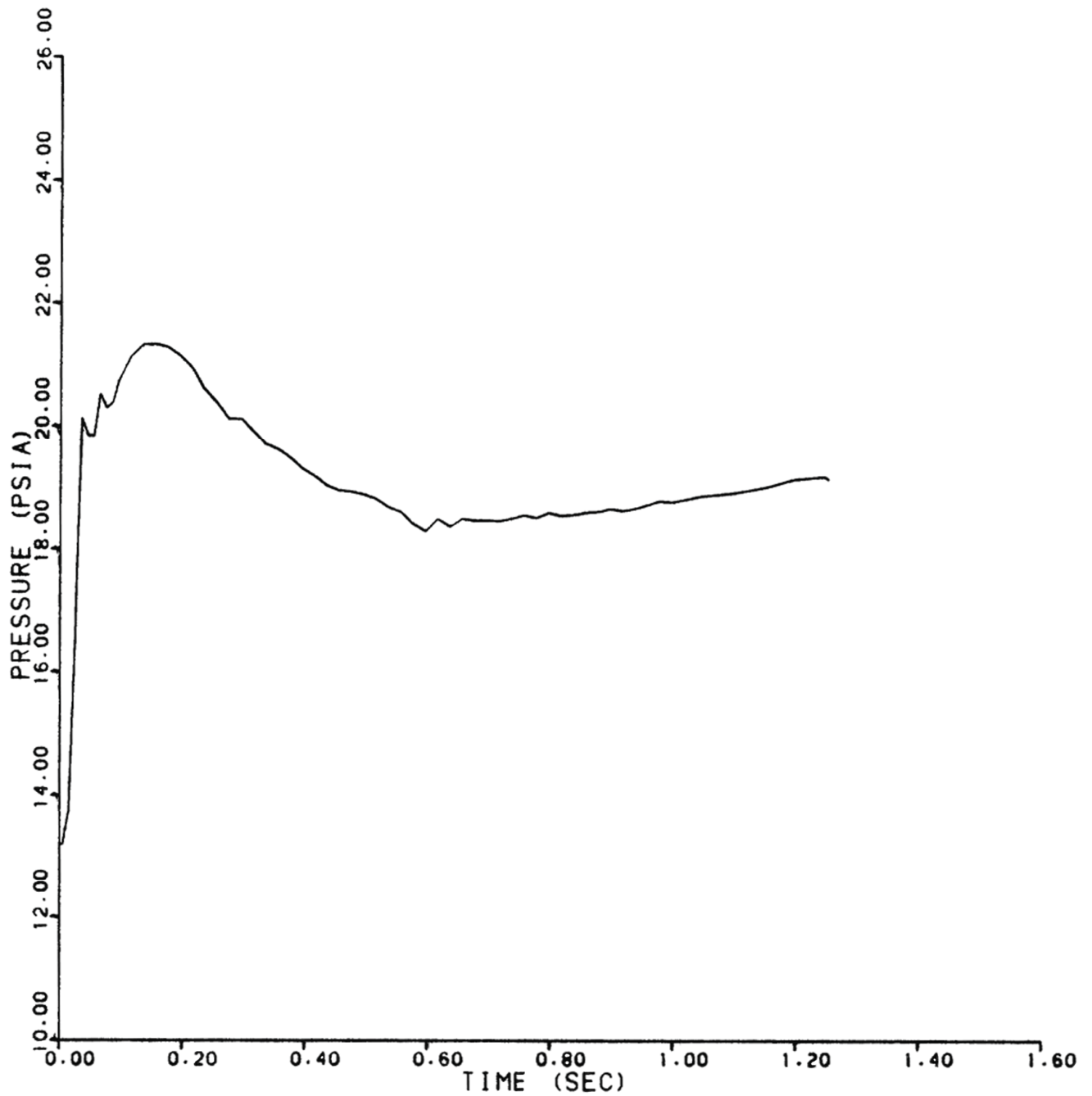

REV 13 4/06



VOGTLE
ELECTRIC GENERATING PLANT
UNIT 1 AND UNIT 2

STEAM GENERATOR INLET NOZZLE
NODE - E4
(306-in.² BREAK AREA)

FIGURE 6.2.1-19 (SHEET 4 OF 74)

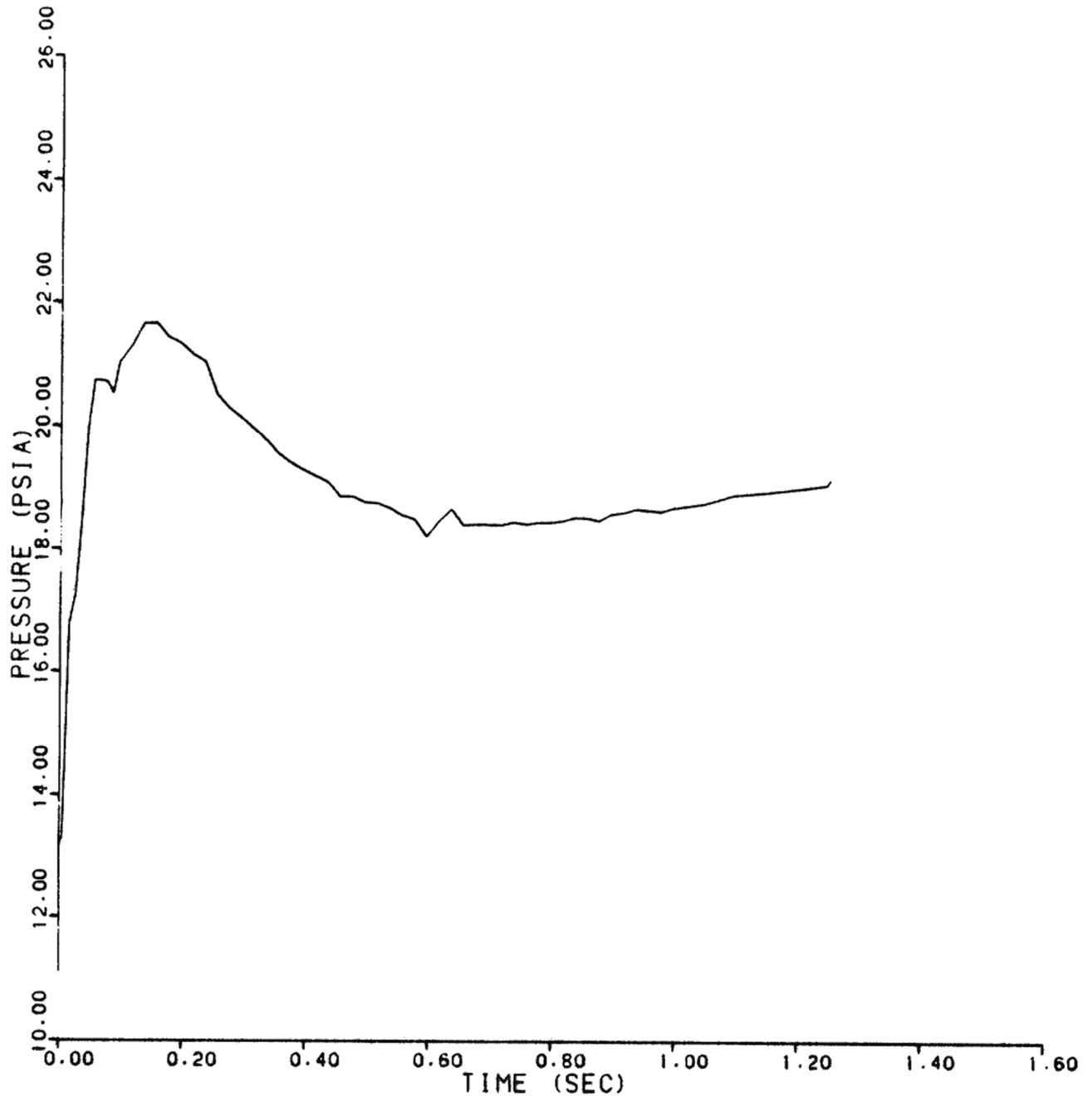

REV 13 4/06



VOGTLE
ELECTRIC GENERATING PLANT
UNIT 1 AND UNIT 2

STEAM GENERATOR INLET NOZZLE
NODE - E5
(306-in.² BREAK AREA)

FIGURE 6.2.1-19 (SHEET 5 OF 74)

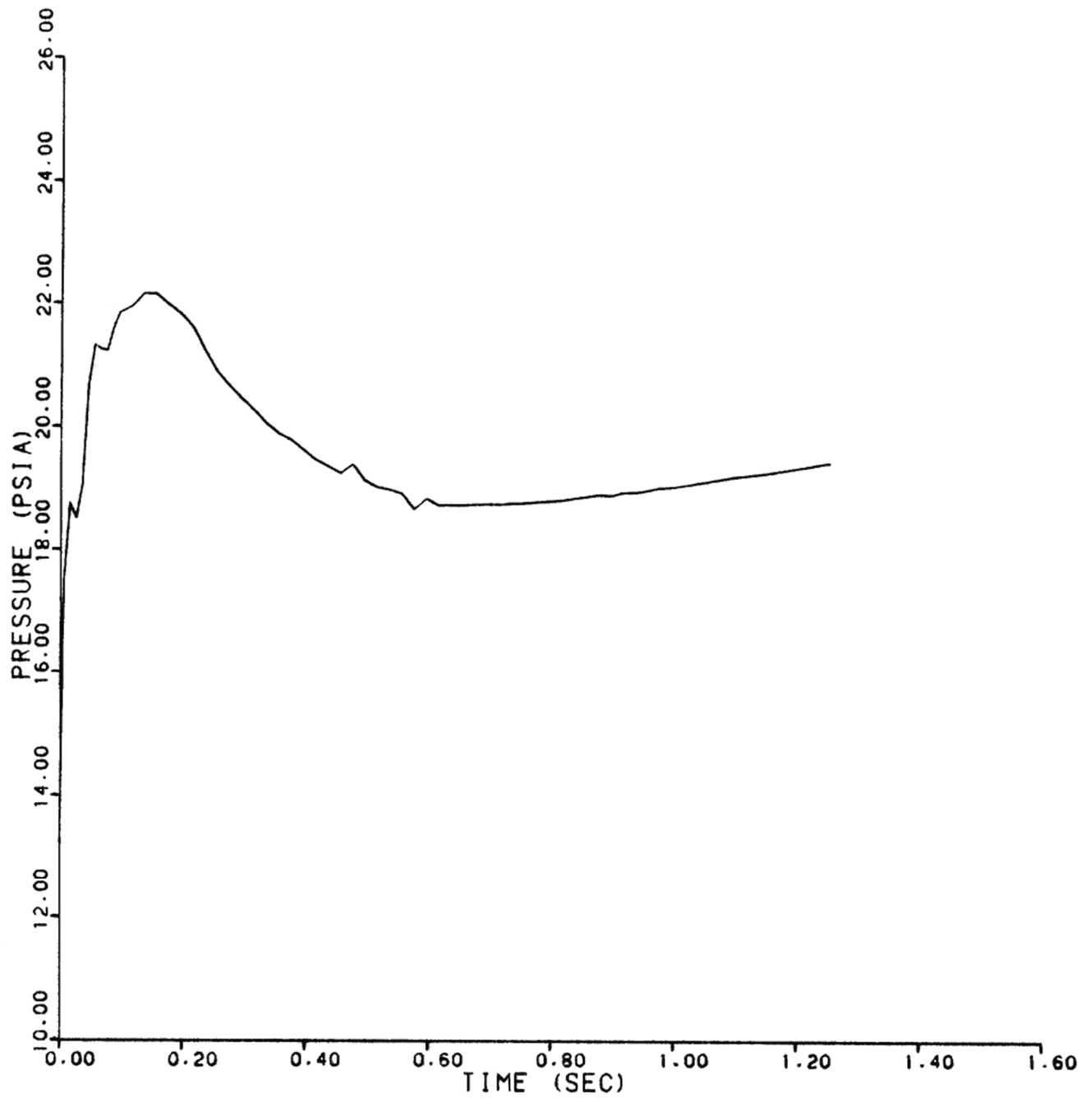

REV 13 4/06



VOGTLE
ELECTRIC GENERATING PLANT
UNIT 1 AND UNIT 2

STEAM GENERATOR INLET NOZZLE
NODE - E6
(306-in.² BREAK AREA)

FIGURE 6.2.1-19 (SHEET 6 OF 74)

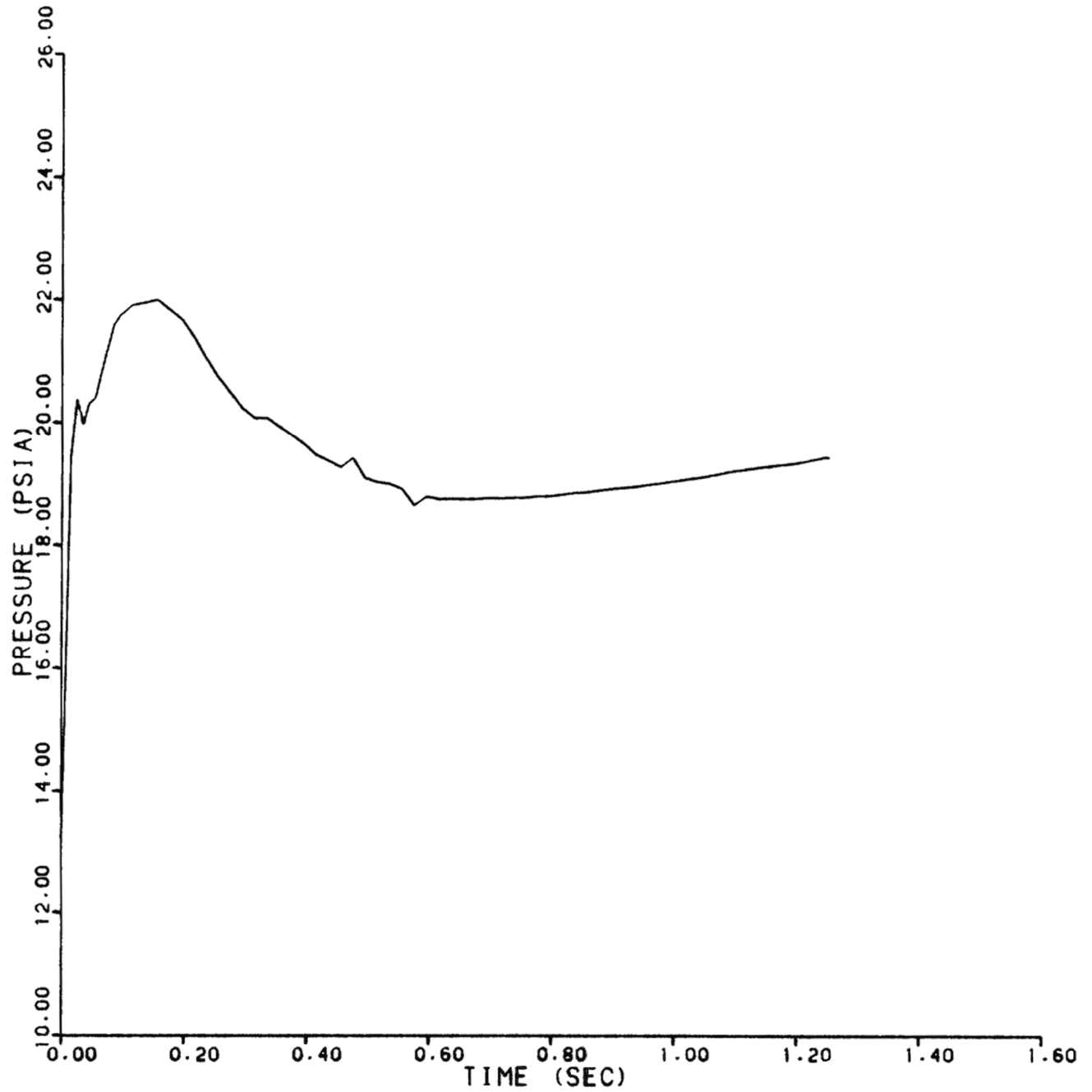

REV 13 4/06



VOGTLE
ELECTRIC GENERATING PLANT
UNIT 1 AND UNIT 2

STEAM GENERATOR INLET NOZZLE
NODE - E7
(306-in.² BREAK AREA)

FIGURE 6.2.1-19 (SHEET 7 OF 74)

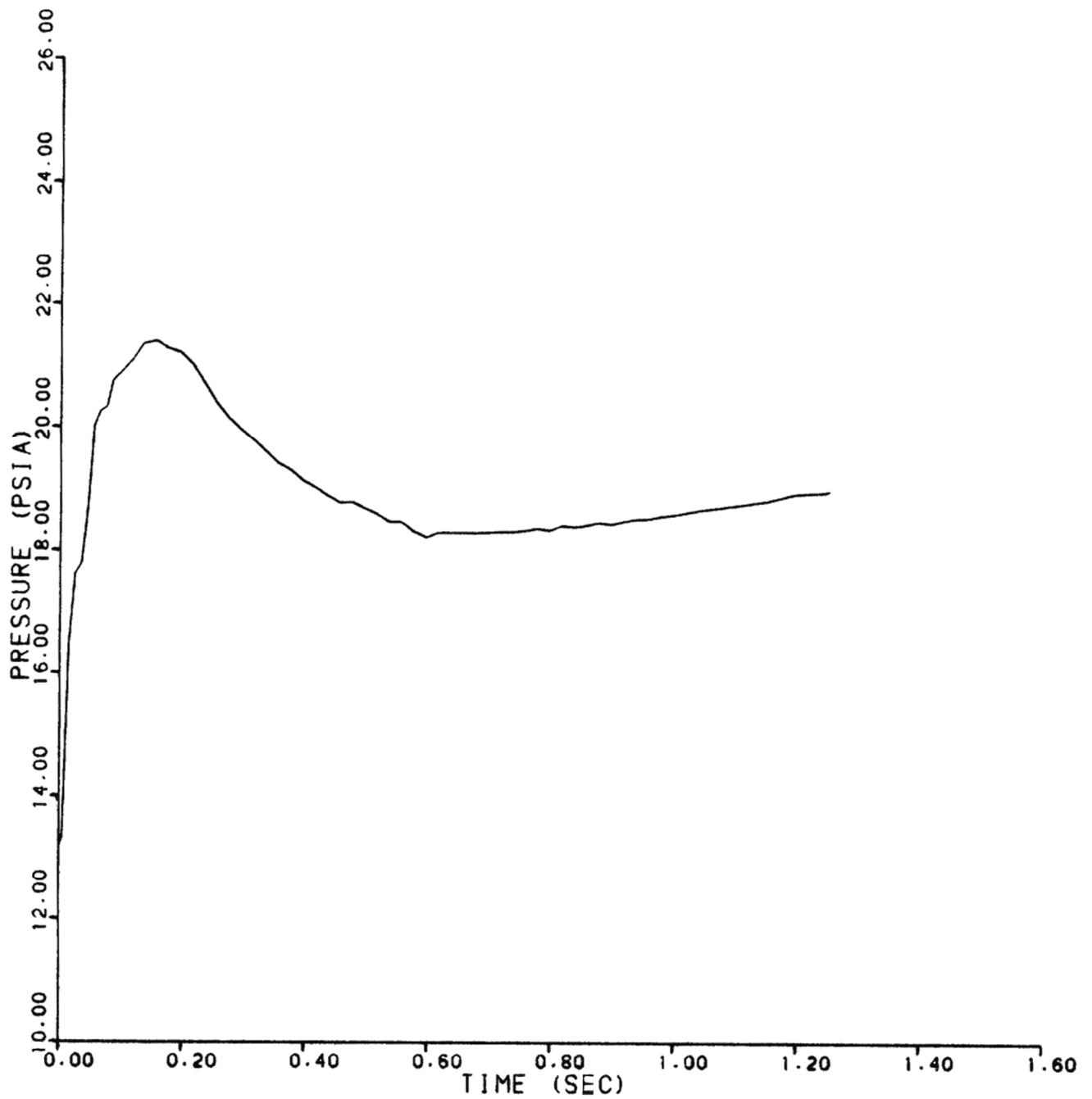

REV 13 4/06



VOGTLE
ELECTRIC GENERATING PLANT
UNIT 1 AND UNIT 2

STEAM GENERATOR INLET NOZZLE
NODE - E8
(306-in.² BREAK AREA)

FIGURE 6.2.1-19 (SHEET 8 OF 74)

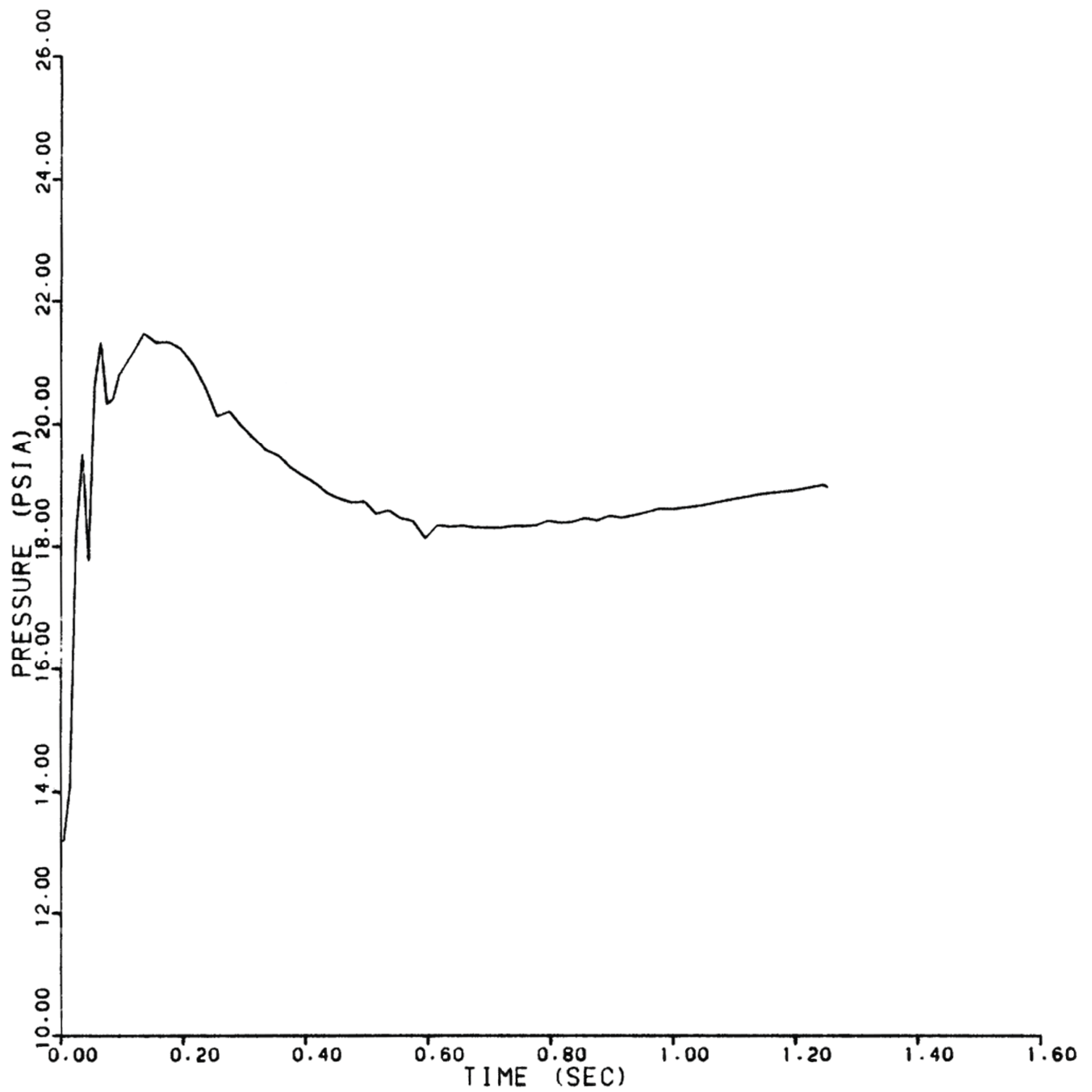

REV 13 4/06



VOGTLE
ELECTRIC GENERATING PLANT
UNIT 1 AND UNIT 2

STEAM GENERATOR INLET NOZZLE
NODE - E9
(306-in.² BREAK AREA)

FIGURE 6.2.1-19 (SHEET 9 OF 74)

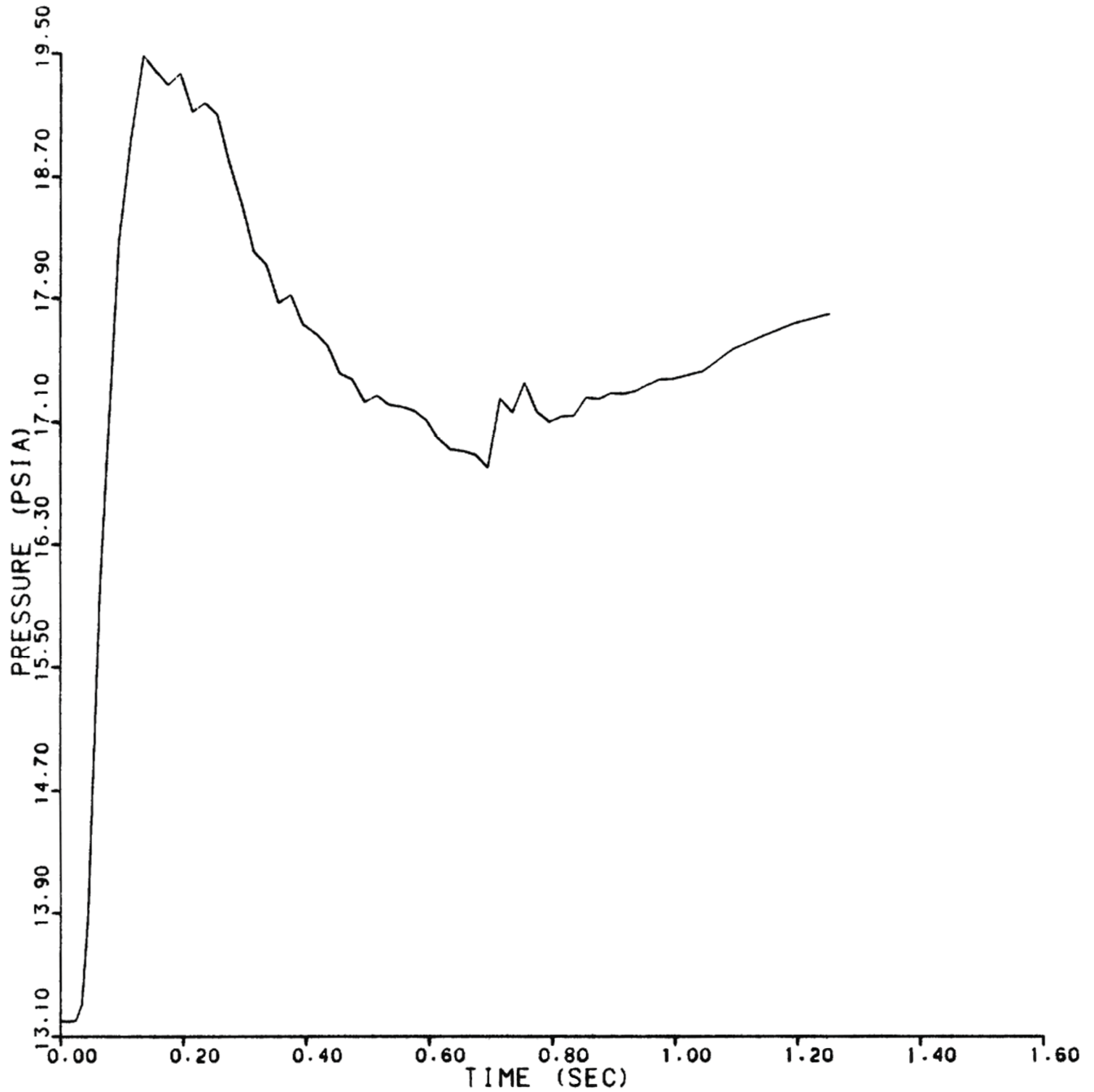

REV 13 4/06



VOGTLE
ELECTRIC GENERATING PLANT
UNIT 1 AND UNIT 2

STEAM GENERATOR INLET NOZZLE
NODE - E10
(306-in.² BREAK AREA)

FIGURE 6.2.1-19 (SHEET 10 OF 74)

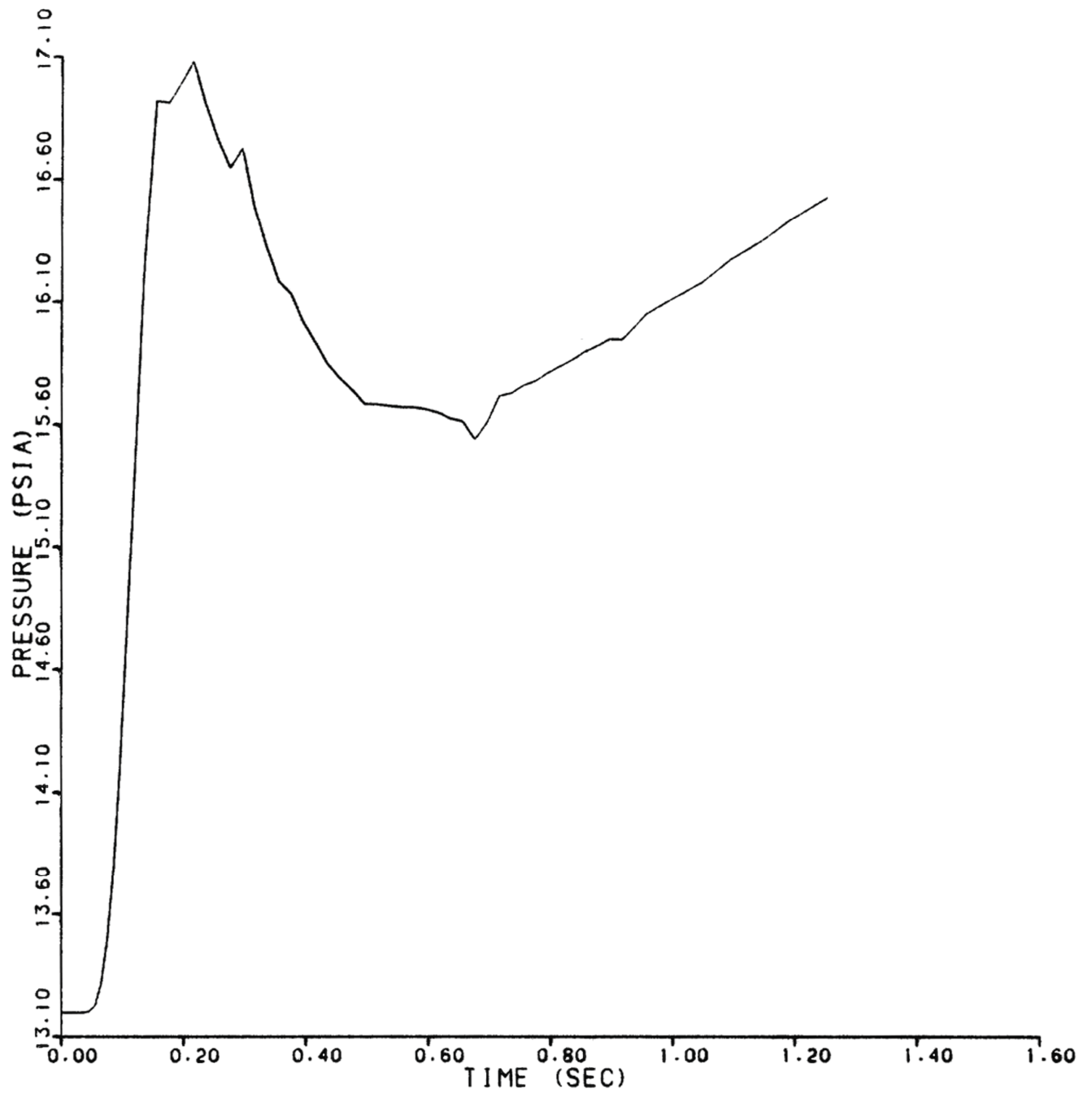

REV 13 4/06



VOGTLE
ELECTRIC GENERATING PLANT
UNIT 1 AND UNIT 2

STEAM GENERATOR INLET NOZZLE
NODE - E11
(306-in.² BREAK AREA)

FIGURE 6.2.1-19 (SHEET 11 OF 74)

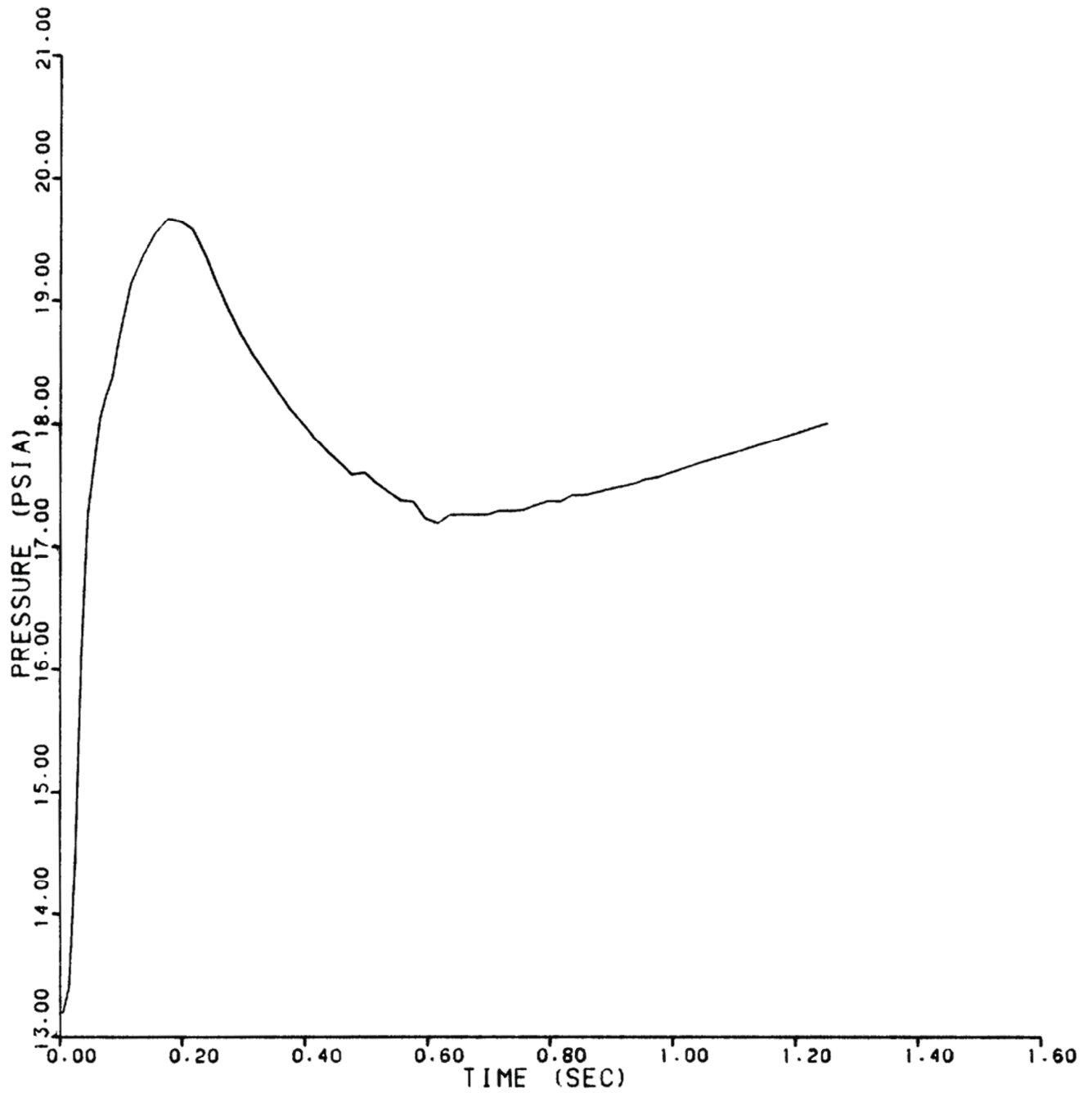

REV 13 4/06



VOGTLE
ELECTRIC GENERATING PLANT
UNIT 1 AND UNIT 2

STEAM GENERATOR INLET NOZZLE
NODE - E12
(306-in.² BREAK AREA)

FIGURE 6.2.1-19 (SHEET 12 OF 74)

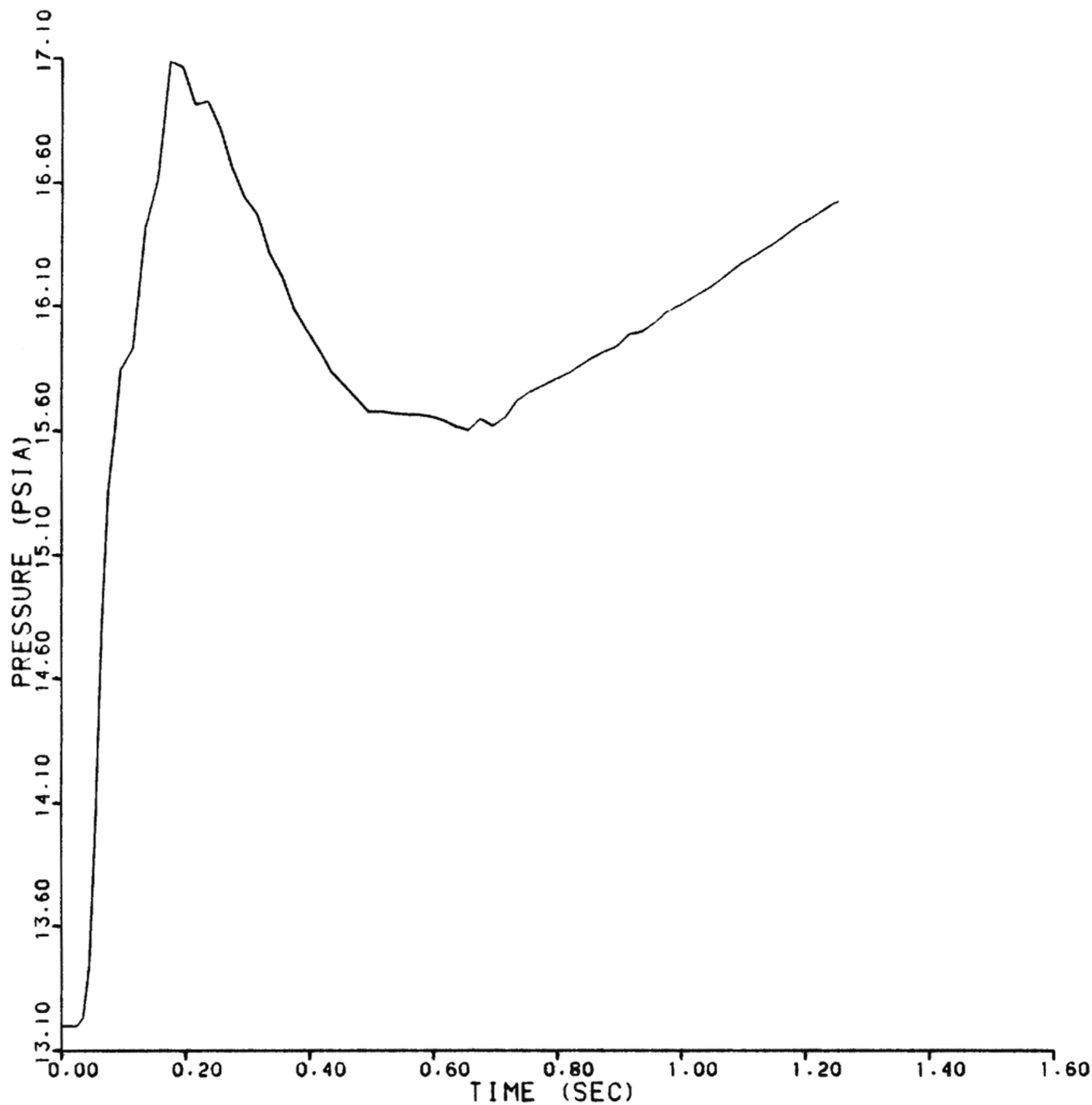

REV 13 4/06

STEAM GENERATOR INLET NOZZLE
 NODE - E13
 (306-in.² BREAK AREA)



VOGTLE
 ELECTRIC GENERATING PLANT
 UNIT 1 AND UNIT 2

FIGURE 6.2.1-19 (SHEET 13 OF 74)

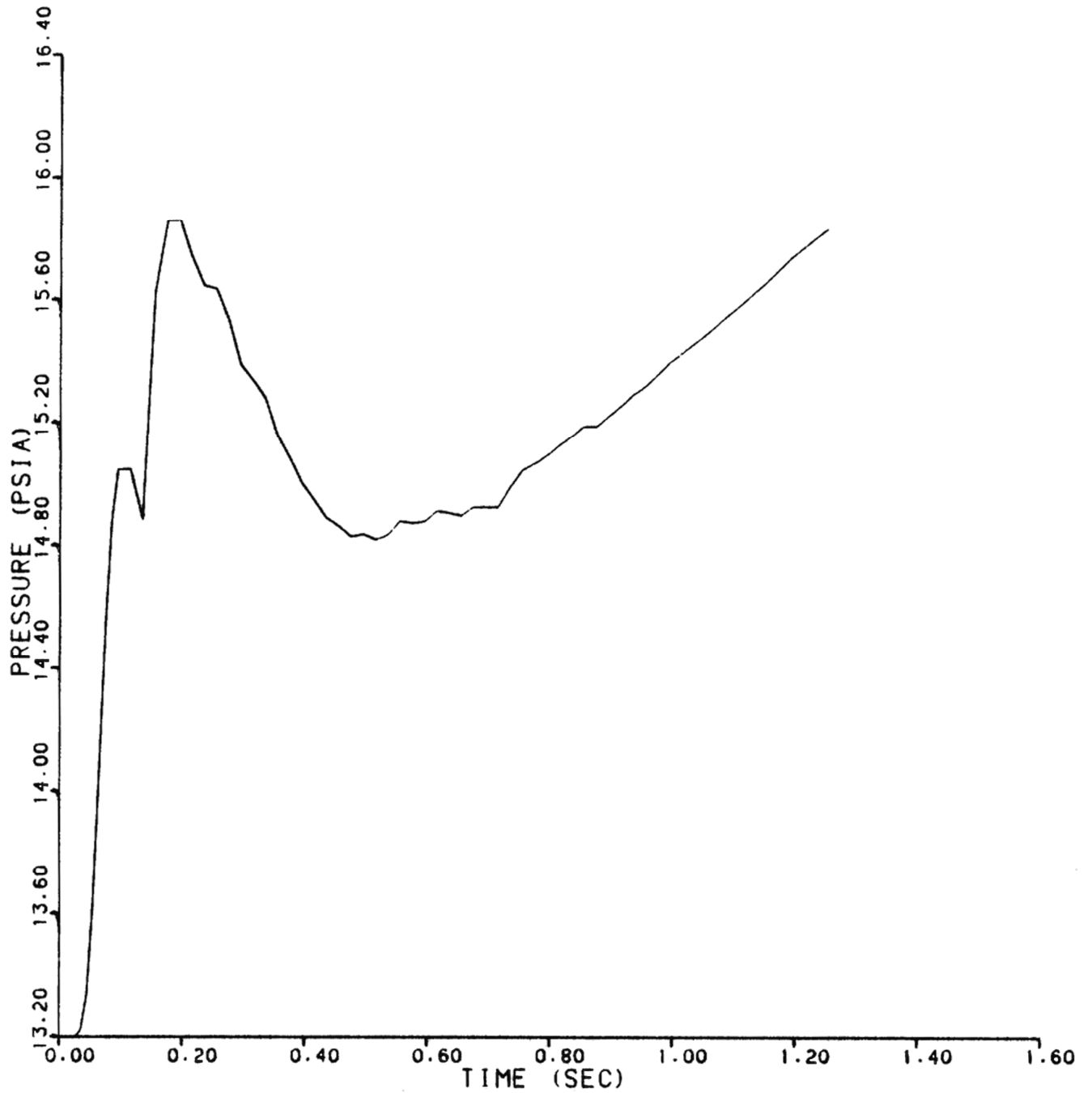

REV 13 4/06



VOGTLE
ELECTRIC GENERATING PLANT
UNIT 1 AND UNIT 2

STEAM GENERATOR INLET NOZZLE
NODE - E14
(306-in.² BREAK AREA)

FIGURE 6.2.1-19 (SHEET 14 OF 74)

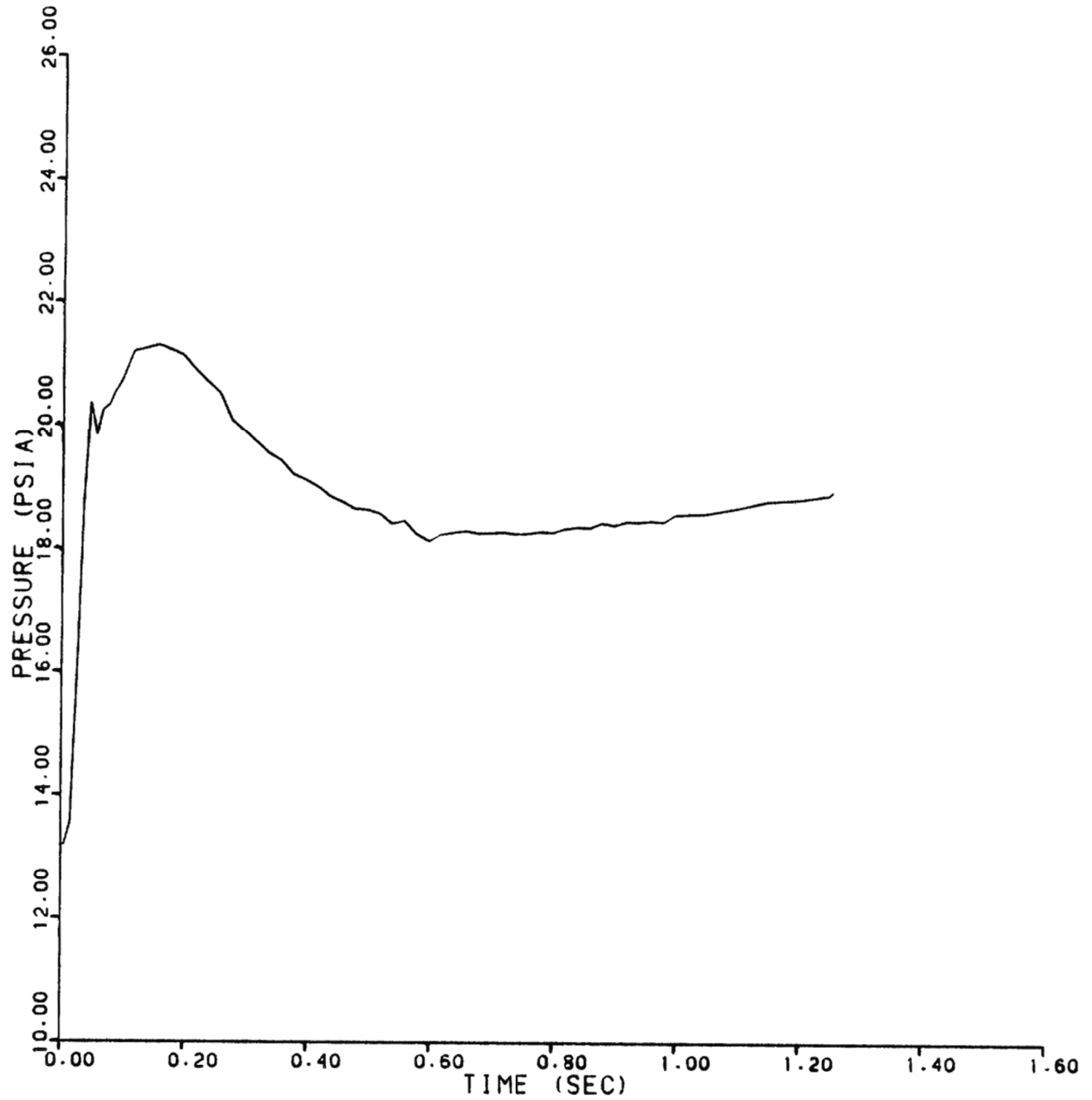

REV 13 4/06



VOGTLE
ELECTRIC GENERATING PLANT
UNIT 1 AND UNIT 2

STEAM GENERATOR INLET NOZZLE
NODE - E15
(306-in.² BREAK AREA)

FIGURE 6.2.1-19 (SHEET 15 OF 74)

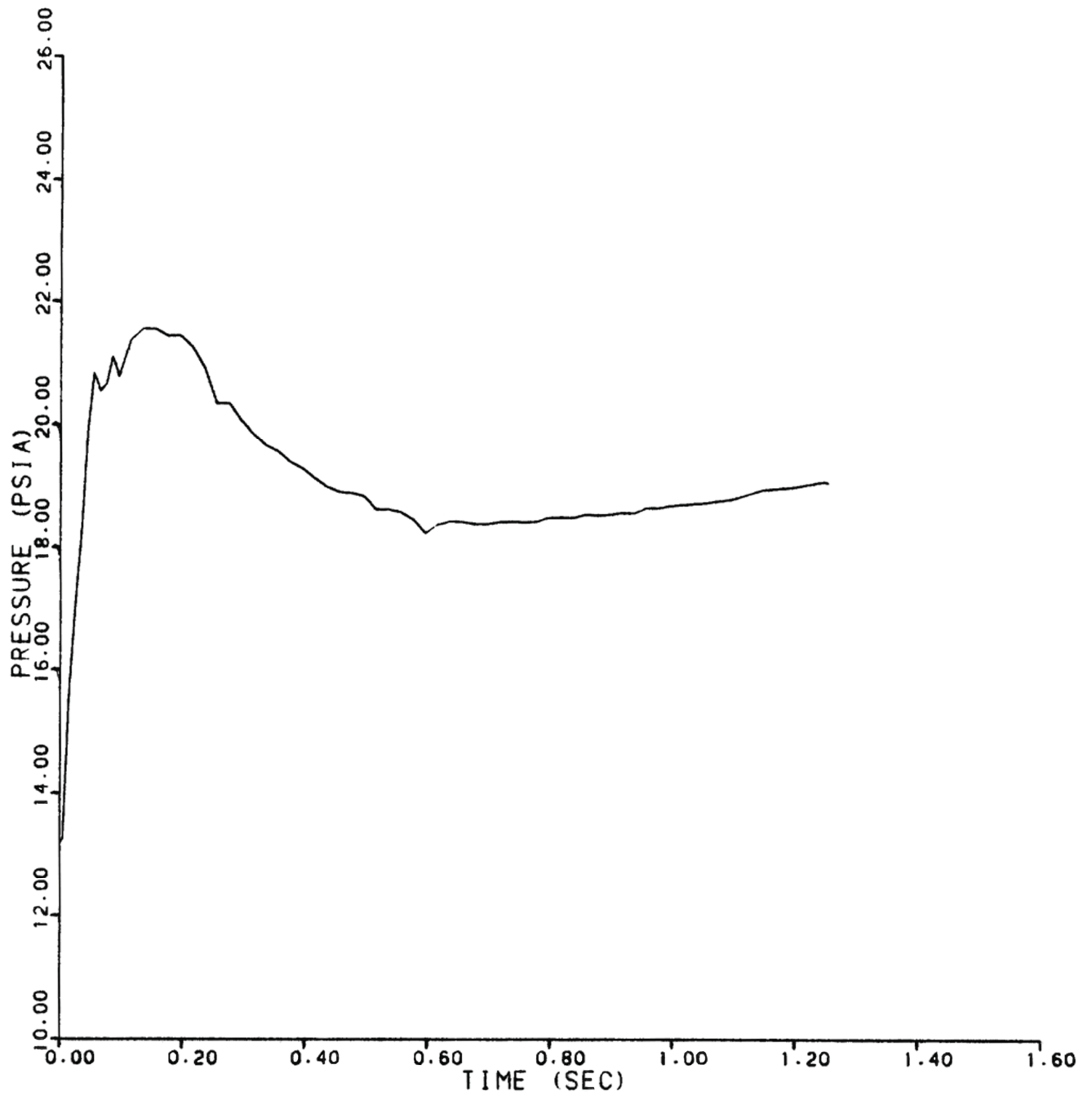

REV 13 4/06



VOGTLE
ELECTRIC GENERATING PLANT
UNIT 1 AND UNIT 2

STEAM GENERATOR INLET NOZZLE
NODE - E16
(306-in.² BREAK AREA)

FIGURE 6.2.1-19 (SHEET 16 OF 74)

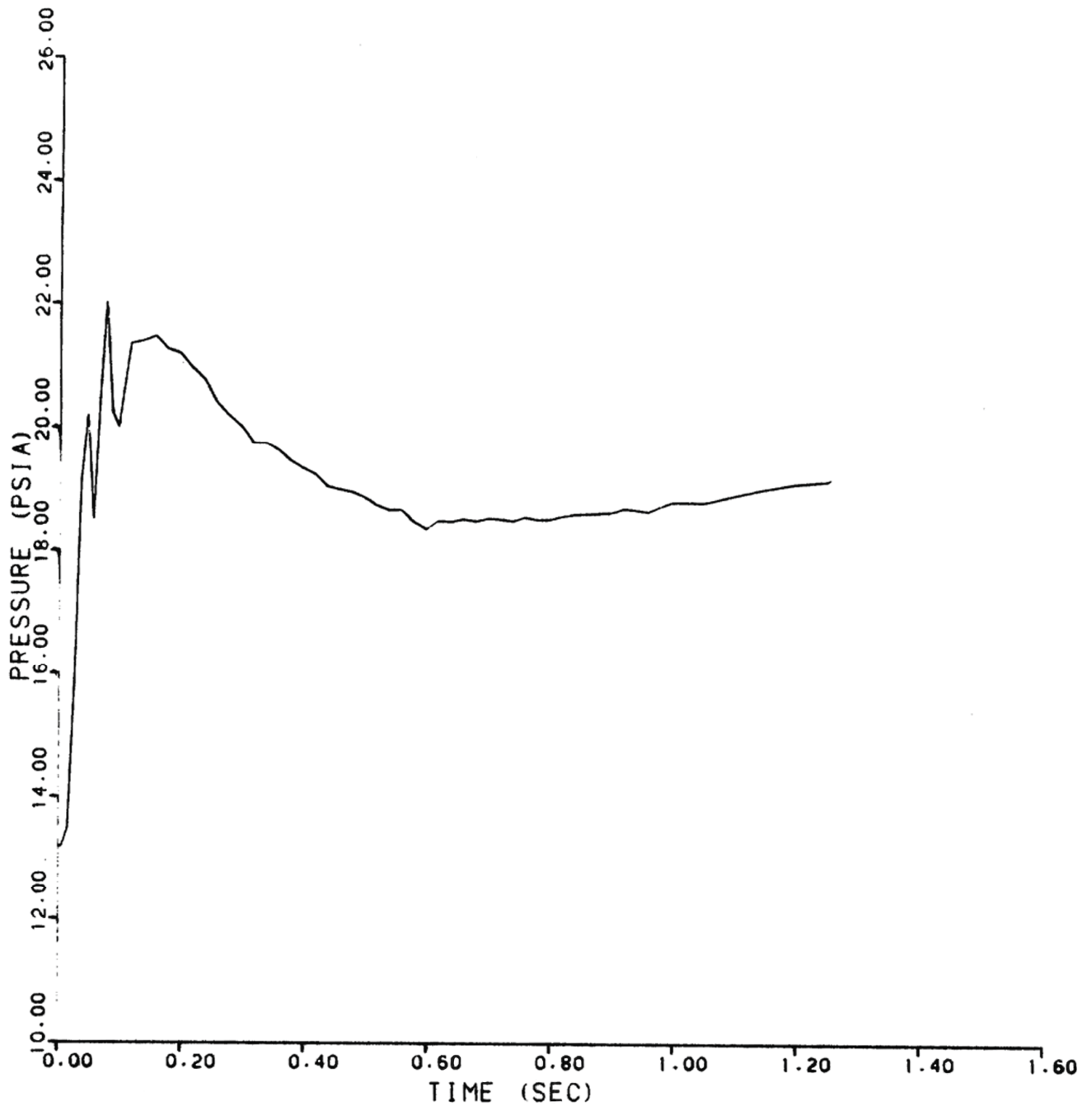

REV 13 4/06



VOGTLE
ELECTRIC GENERATING PLANT
UNIT 1 AND UNIT 2

STEAM GENERATOR INLET NOZZLE
NODE - E17
(306-in.² BREAK AREA)

FIGURE 6.2.1-19 (SHEET 17 OF 74)

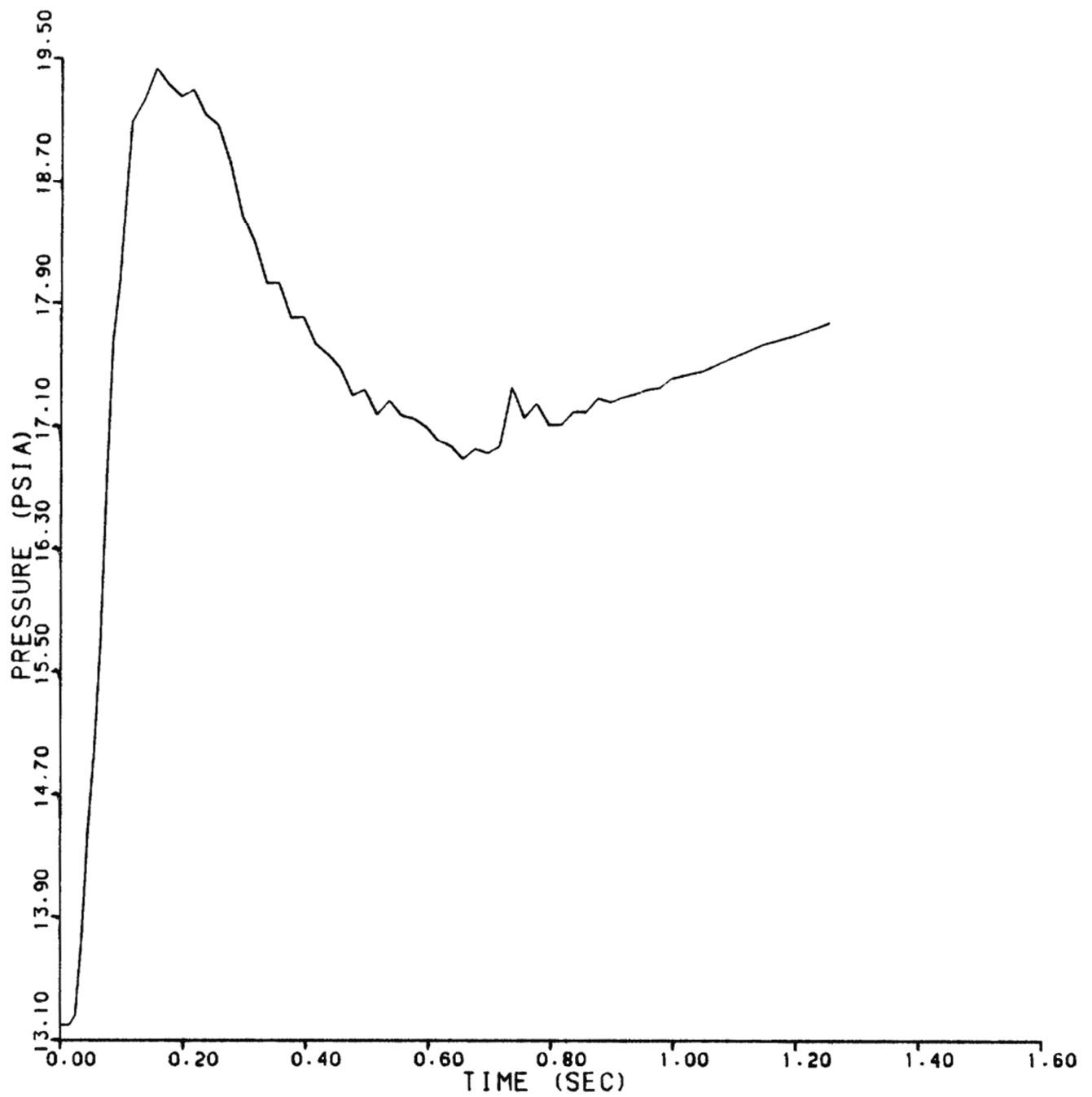

REV 13 4/06



VOGTLE
ELECTRIC GENERATING PLANT
UNIT 1 AND UNIT 2

STEAM GENERATOR INLET NOZZLE
NODE - E18
(306-in.² BREAK AREA)

FIGURE 6.2.1-19 (SHEET 18 OF 74)

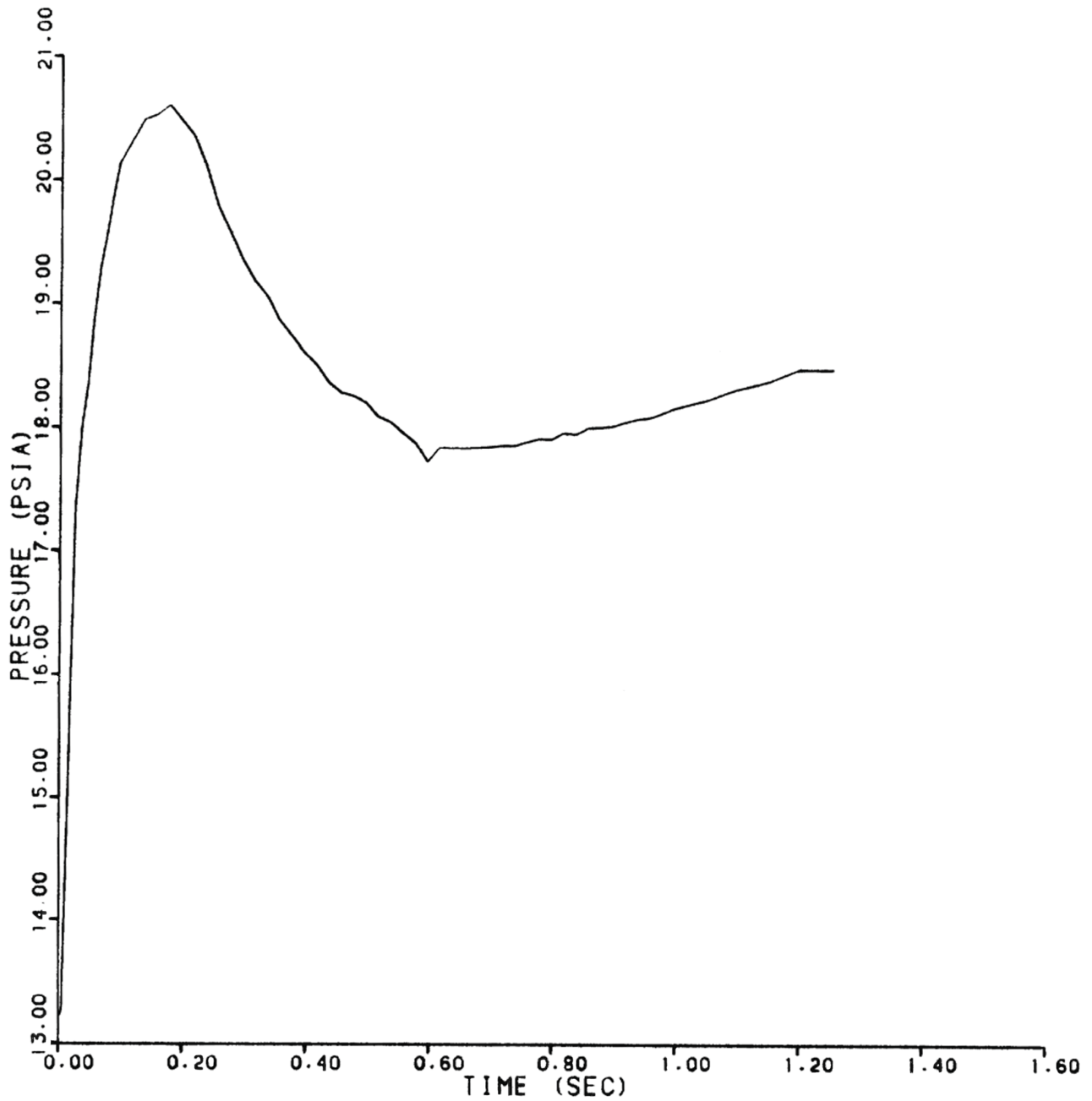

REV 13 4/06



VOGTLE
ELECTRIC GENERATING PLANT
UNIT 1 AND UNIT 2

STEAM GENERATOR INLET NOZZLE
NODE - E19
(306-in.² BREAK AREA)

FIGURE 6.2.1-19 (SHEET 19 OF 74)

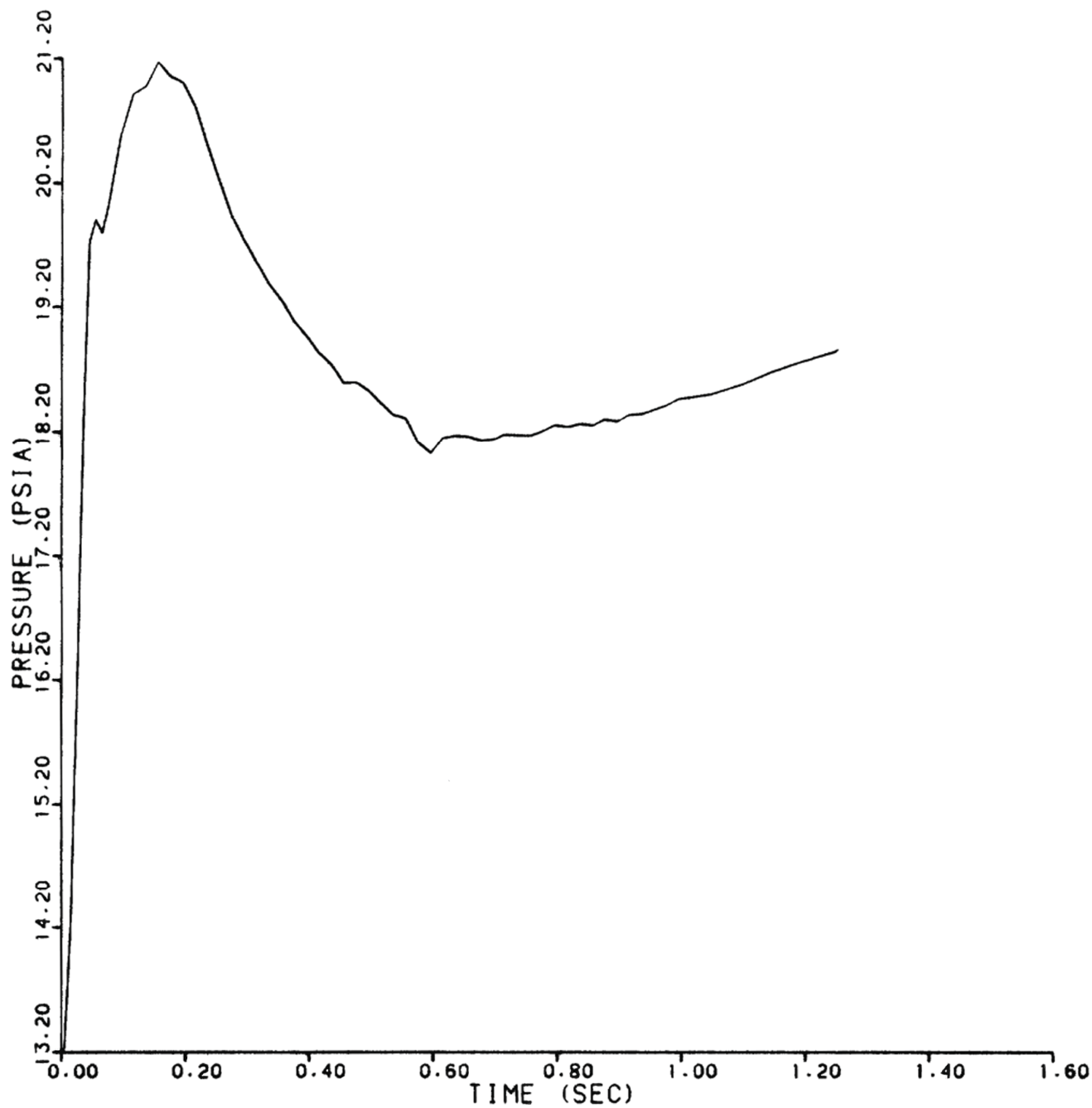

REV 13 4/06



VOGTLE
ELECTRIC GENERATING PLANT
UNIT 1 AND UNIT 2

STEAM GENERATOR INLET NOZZLE
NODE - E20
(306-in.² BREAK AREA)

FIGURE 6.2.1-19 (SHEET 20 OF 74)

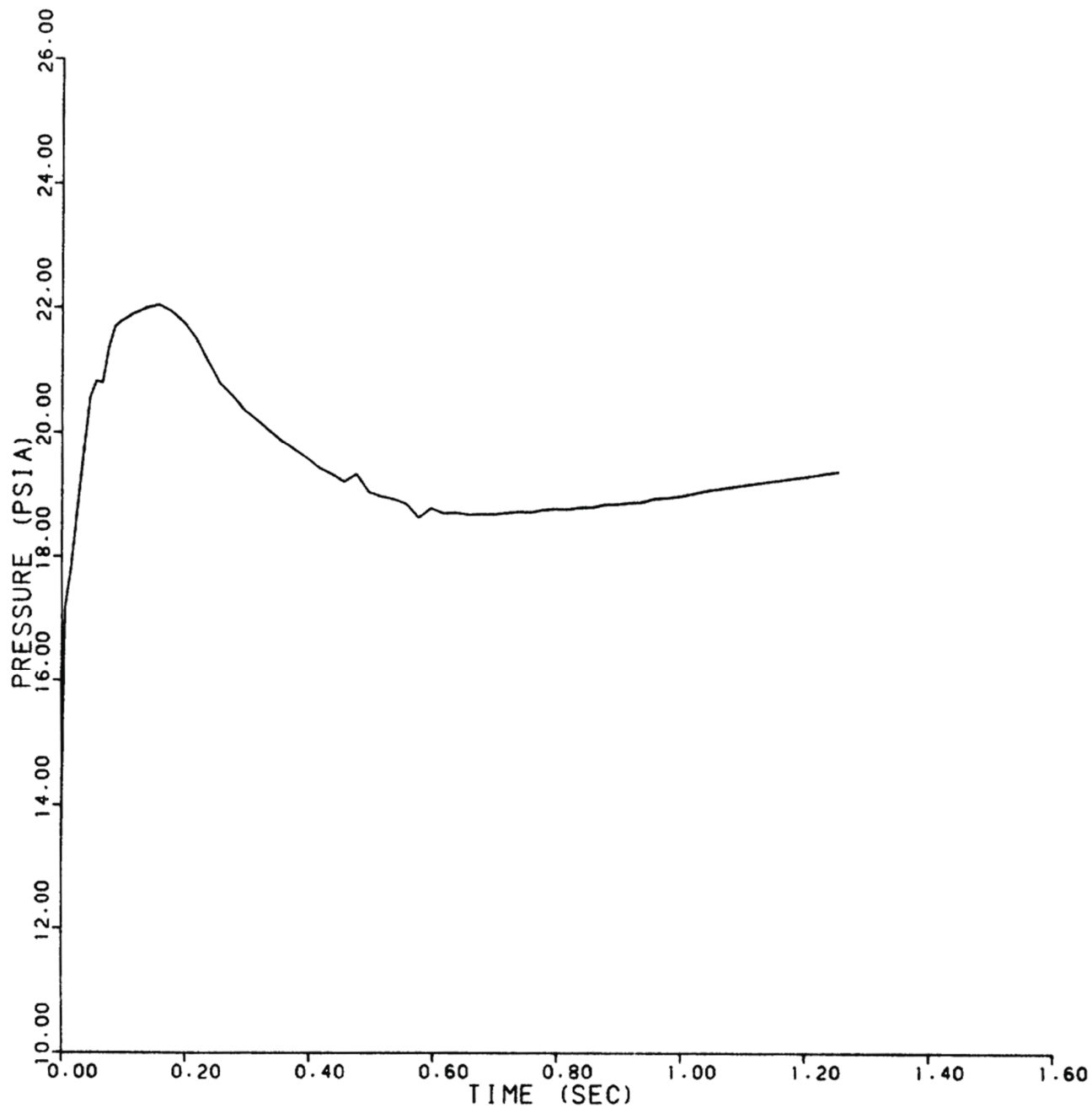

REV 13 4/06



VOGTLE
ELECTRIC GENERATING PLANT
UNIT 1 AND UNIT 2

STEAM GENERATOR INLET NOZZLE
NODE - E21
(306-in.² BREAK AREA)

FIGURE 6.2.1-19 (SHEET 21 OF 74)

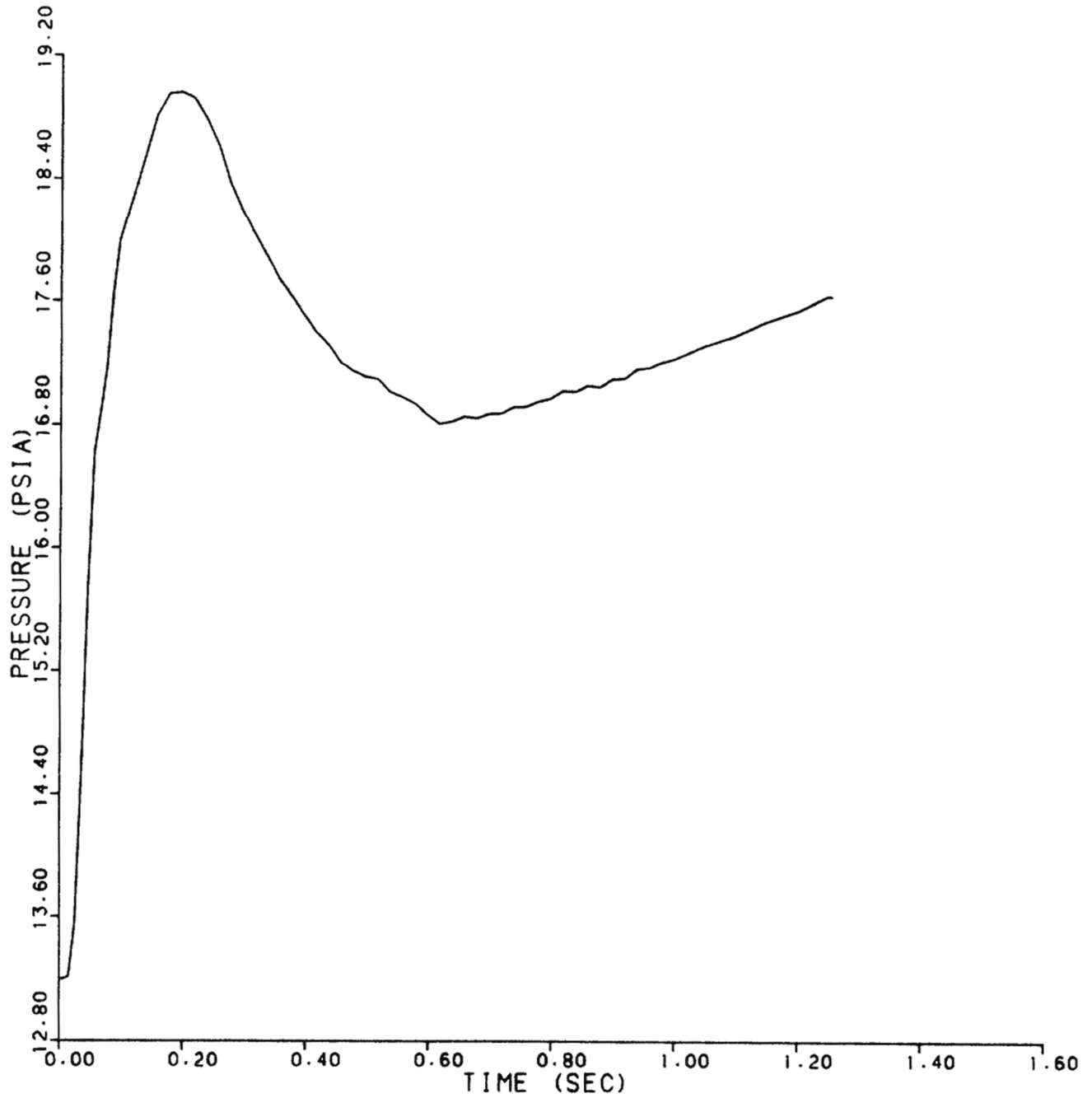

REV 13 4/06



VOGTLE
ELECTRIC GENERATING PLANT
UNIT 1 AND UNIT 2

STEAM GENERATOR INLET NOZZLE
NODE - E22
(306-in.² BREAK AREA)

FIGURE 6.2.1-19 (SHEET 22 OF 74)

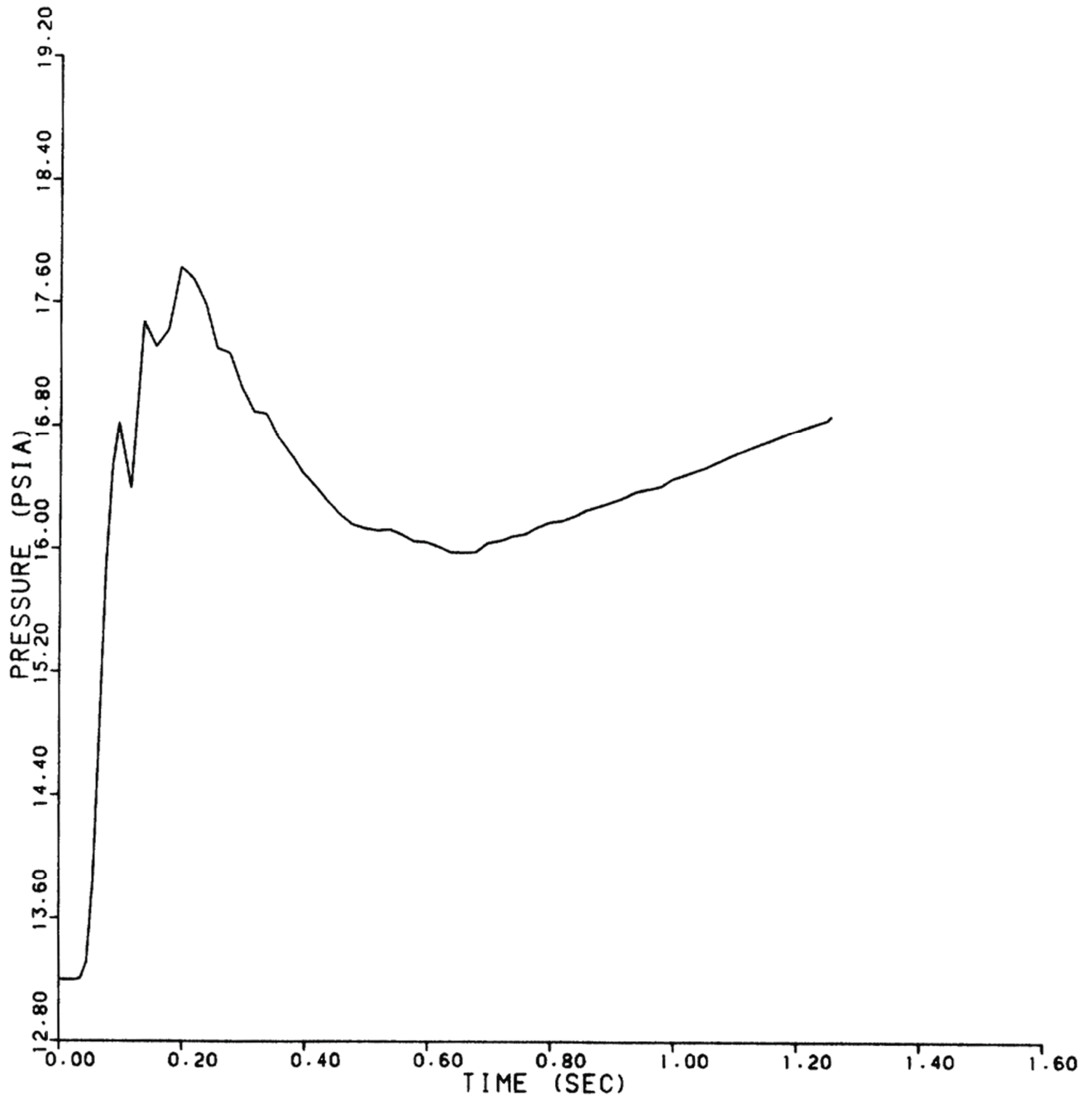

REV 13 4/06



VOGTLE
ELECTRIC GENERATING PLANT
UNIT 1 AND UNIT 2

STEAM GENERATOR INLET NOZZLE
NODE - E23
(306-in.² BREAK AREA)

FIGURE 6.2.1-19 (SHEET 23 OF 74)

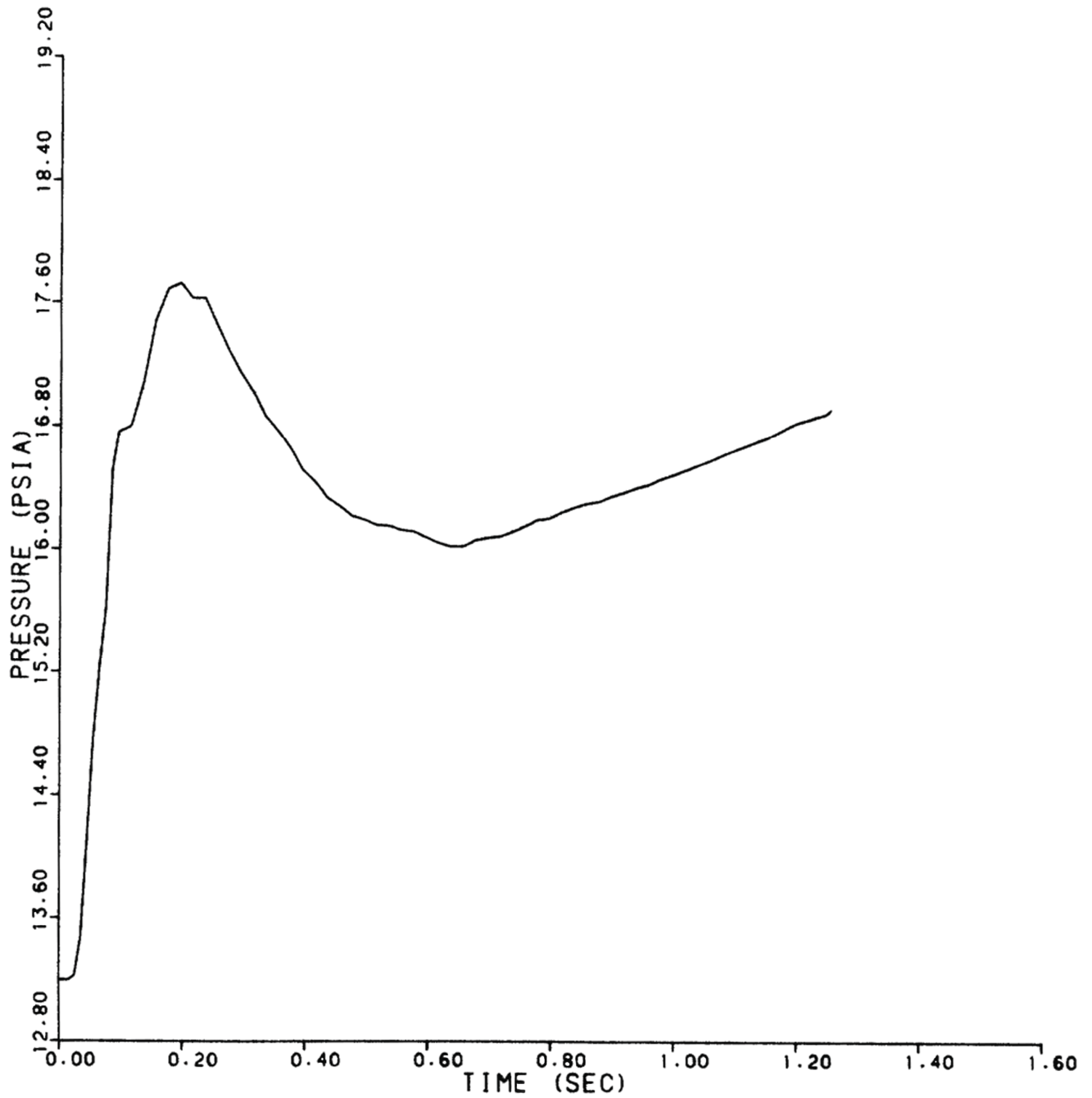

REV 13 4/06



VOGTLE
ELECTRIC GENERATING PLANT
UNIT 1 AND UNIT 2

STEAM GENERATOR INLET NOZZLE
NODE - E24
(306-in.² BREAK AREA)

FIGURE 6.2.1-19 (SHEET 24 OF 74)

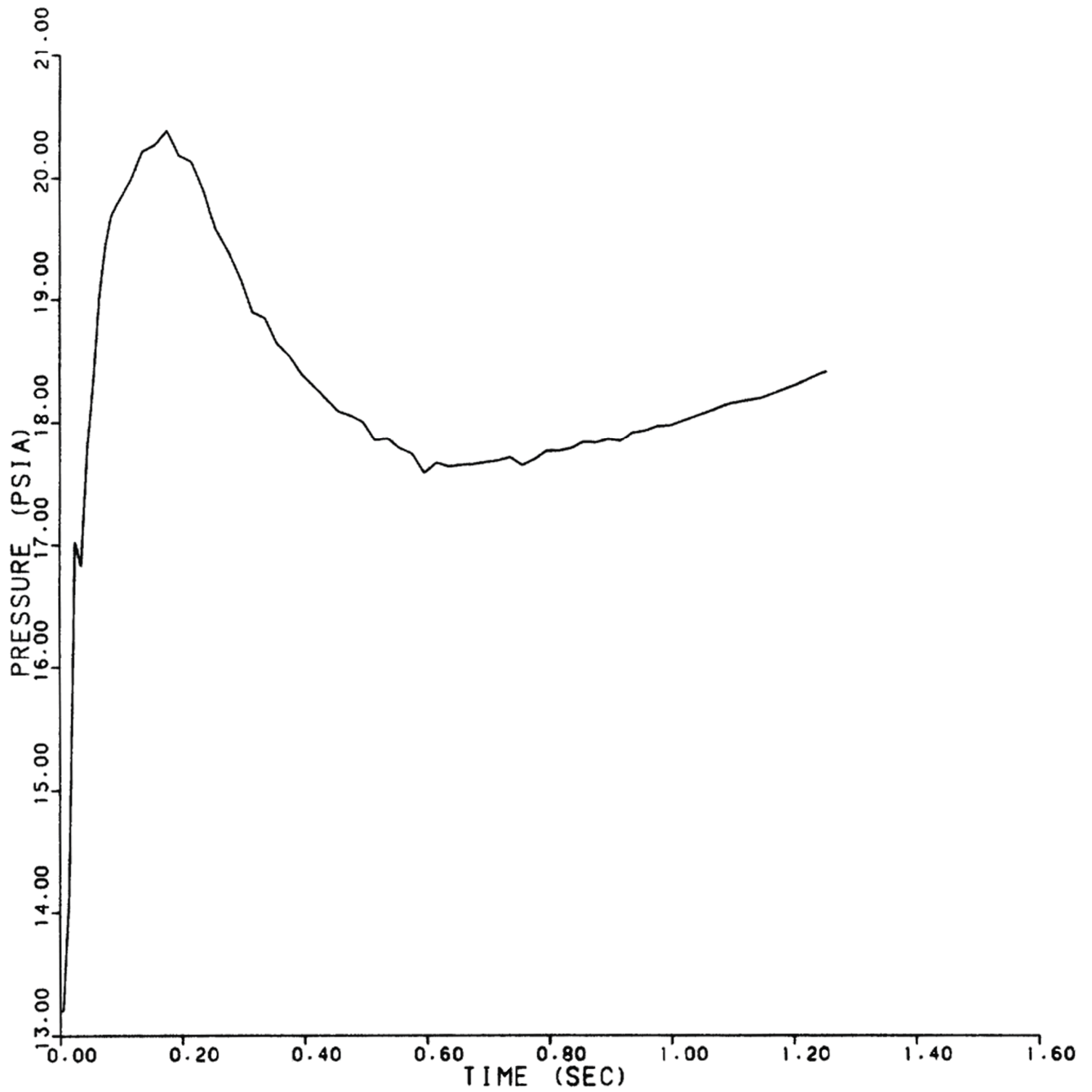

REV 13 4/06



VOGTLE
ELECTRIC GENERATING PLANT
UNIT 1 AND UNIT 2

STEAM GENERATOR INLET NOZZLE
NODE - E25
(306-in.² BREAK AREA)

FIGURE 6.2.1-19 (SHEET 25 OF 74)

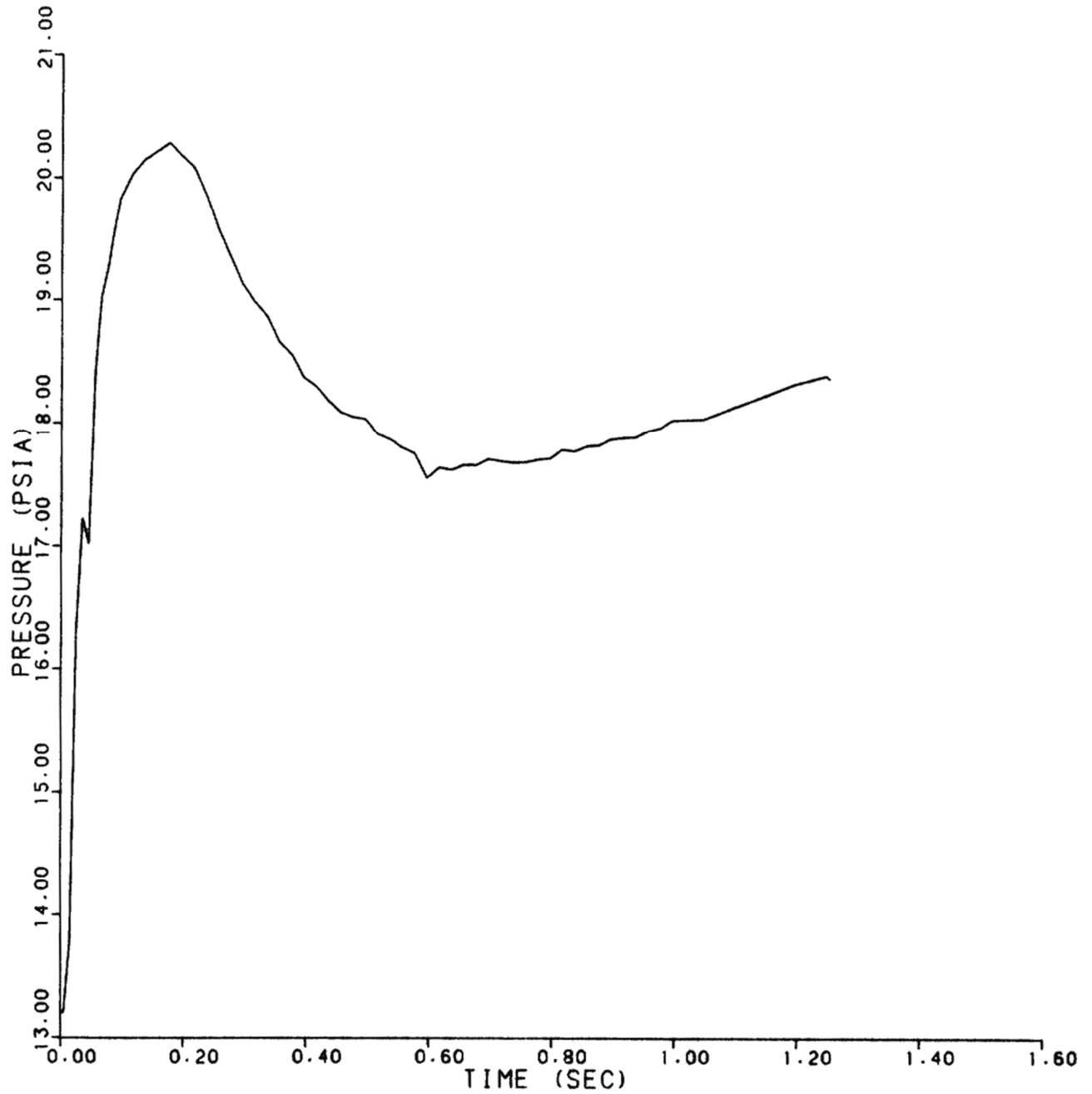

REV 13 4/06



VOGTLE
ELECTRIC GENERATING PLANT
UNIT 1 AND UNIT 2

STEAM GENERATOR INLET NOZZLE
NODE - E26
(306-in.² BREAK AREA)

FIGURE 6.2.1-19 (SHEET 26 OF 74)

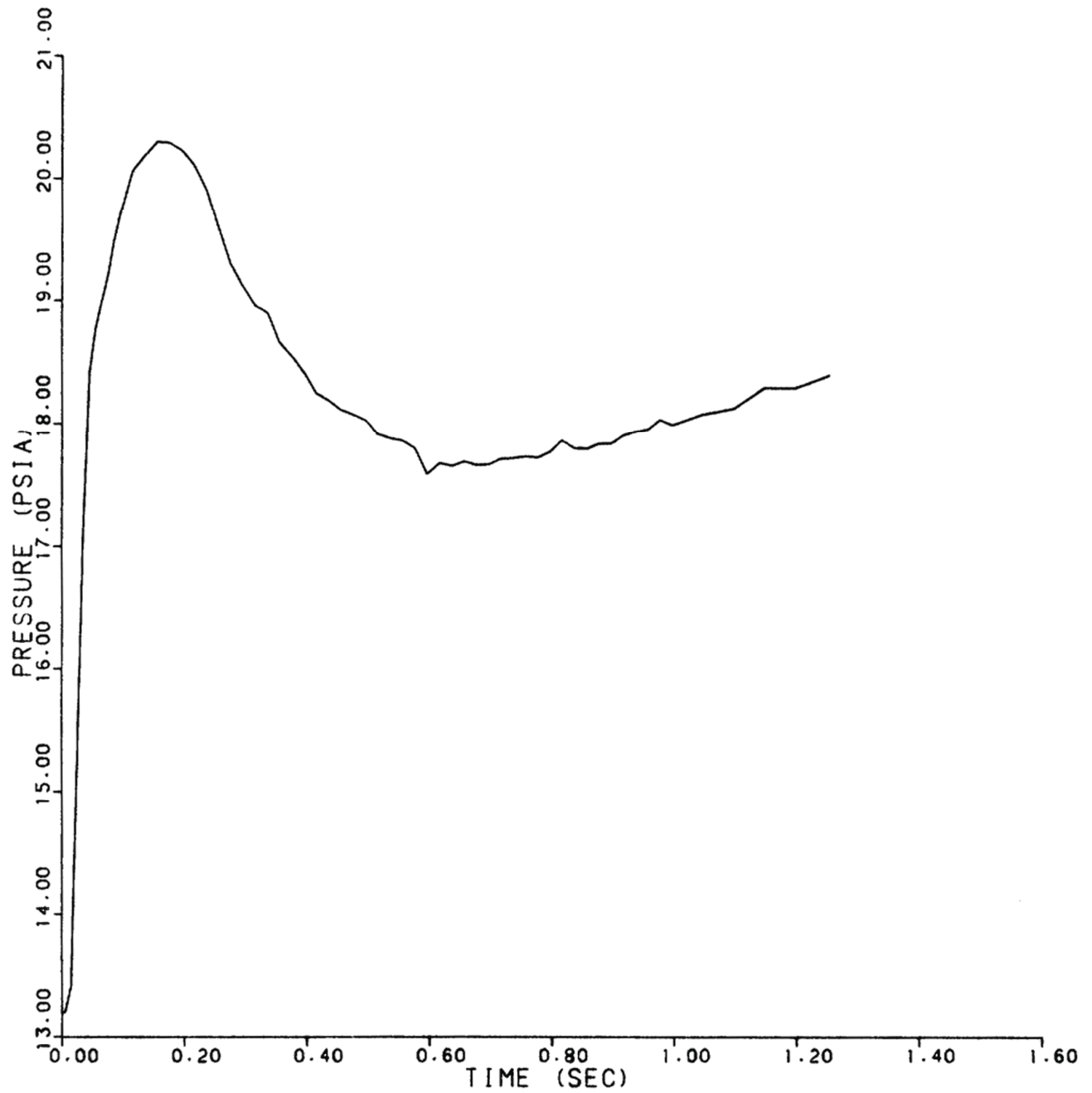

REV 13 4/06



VOGTLE
ELECTRIC GENERATING PLANT
UNIT 1 AND UNIT 2

STEAM GENERATOR INLET NOZZLE
NODE - E27
(306-in.² BREAK AREA)

FIGURE 6.2.1-19 (SHEET 27 OF 74)

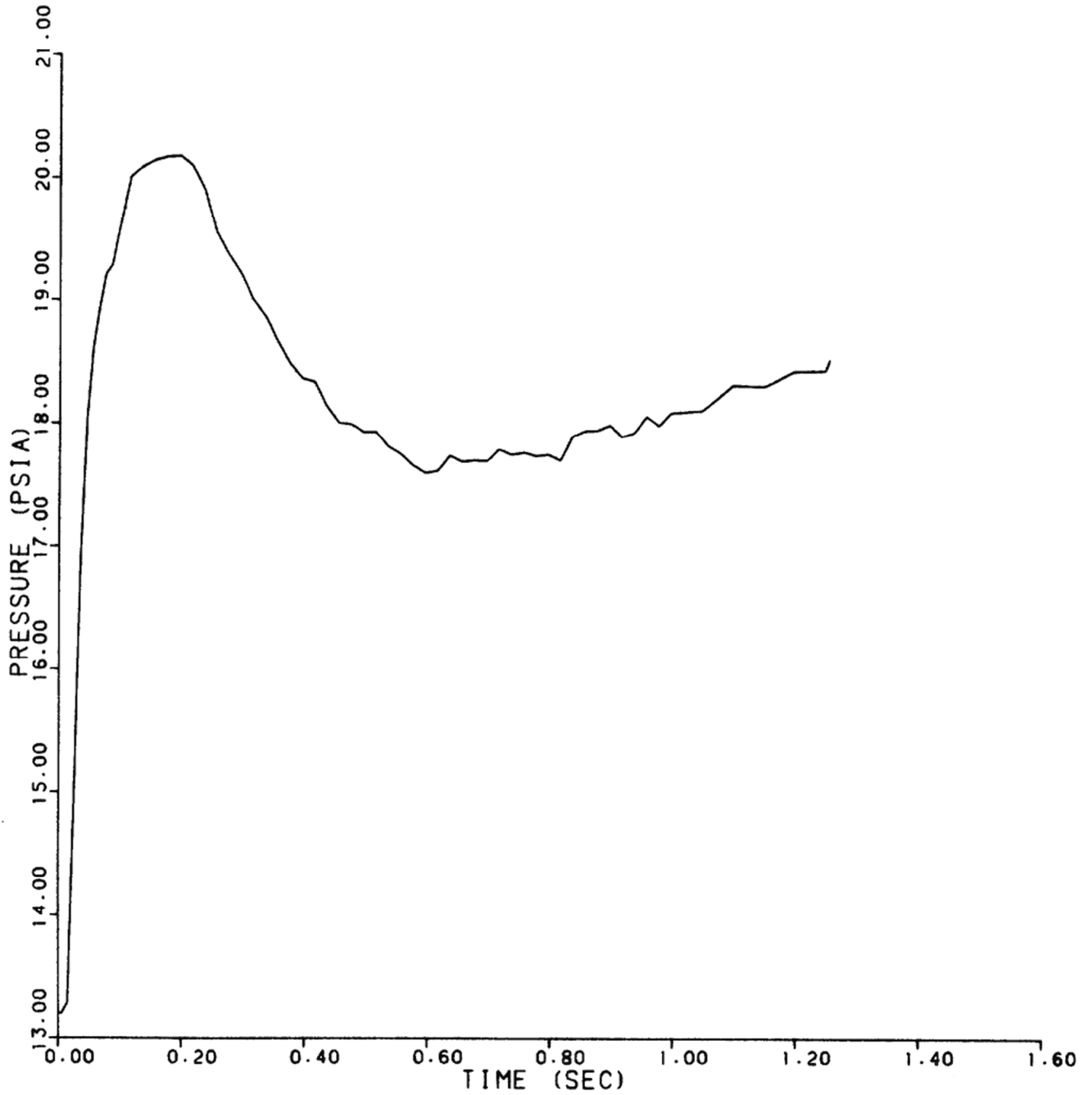

REV 13 4/06



VOGTLE
ELECTRIC GENERATING PLANT
UNIT 1 AND UNIT 2

STEAM GENERATOR INLET NOZZLE
NODE - E28
(306-in.² BREAK AREA)

FIGURE 6.2.1-19 (SHEET 28 OF 74)

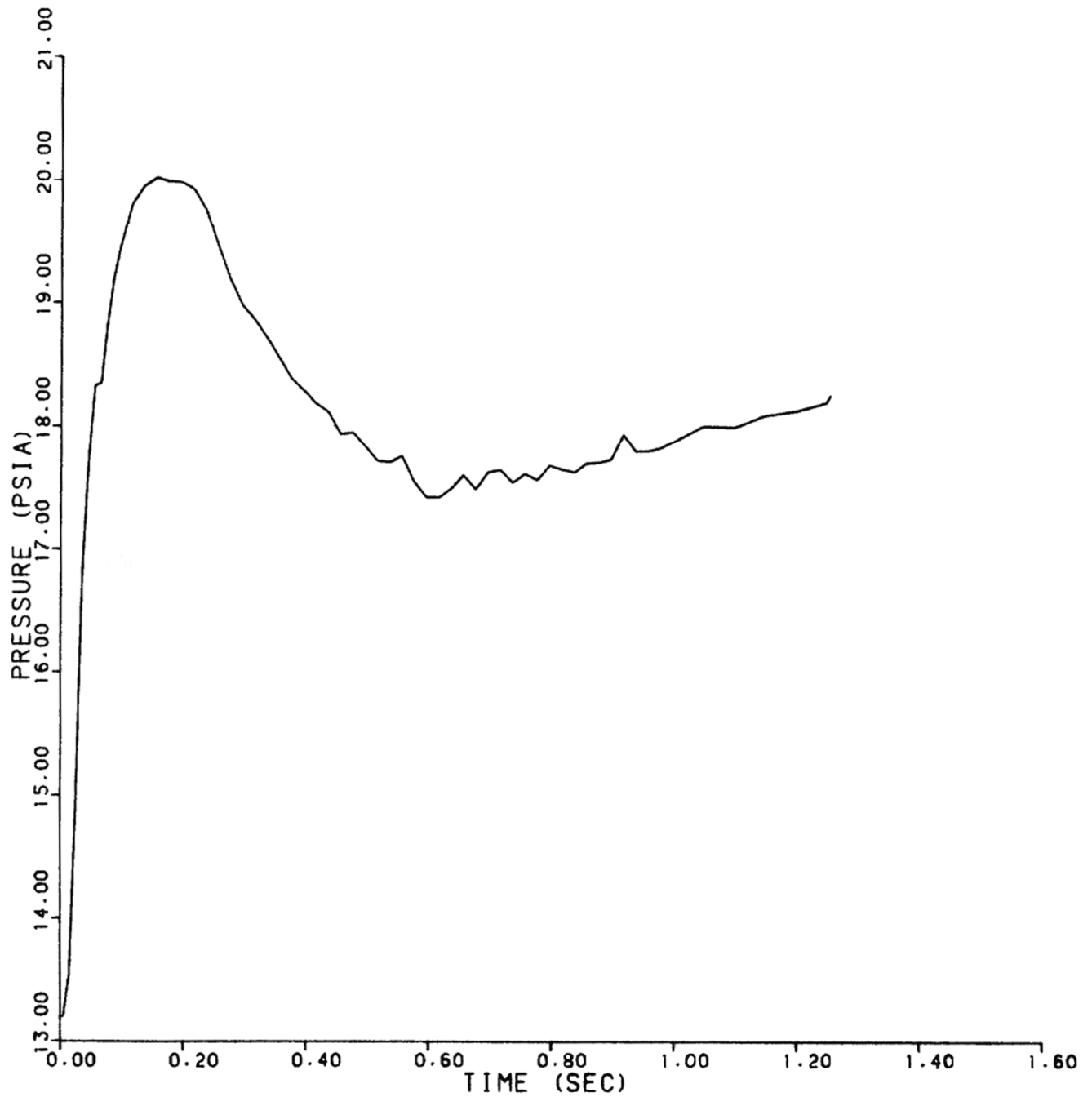

REV 13 4/06



VOGTLE
ELECTRIC GENERATING PLANT
UNIT 1 AND UNIT 2

STEAM GENERATOR INLET NOZZLE
NODE - E29
(306-in.² BREAK AREA)

FIGURE 6.2.1-19 (SHEET 29 OF 74)

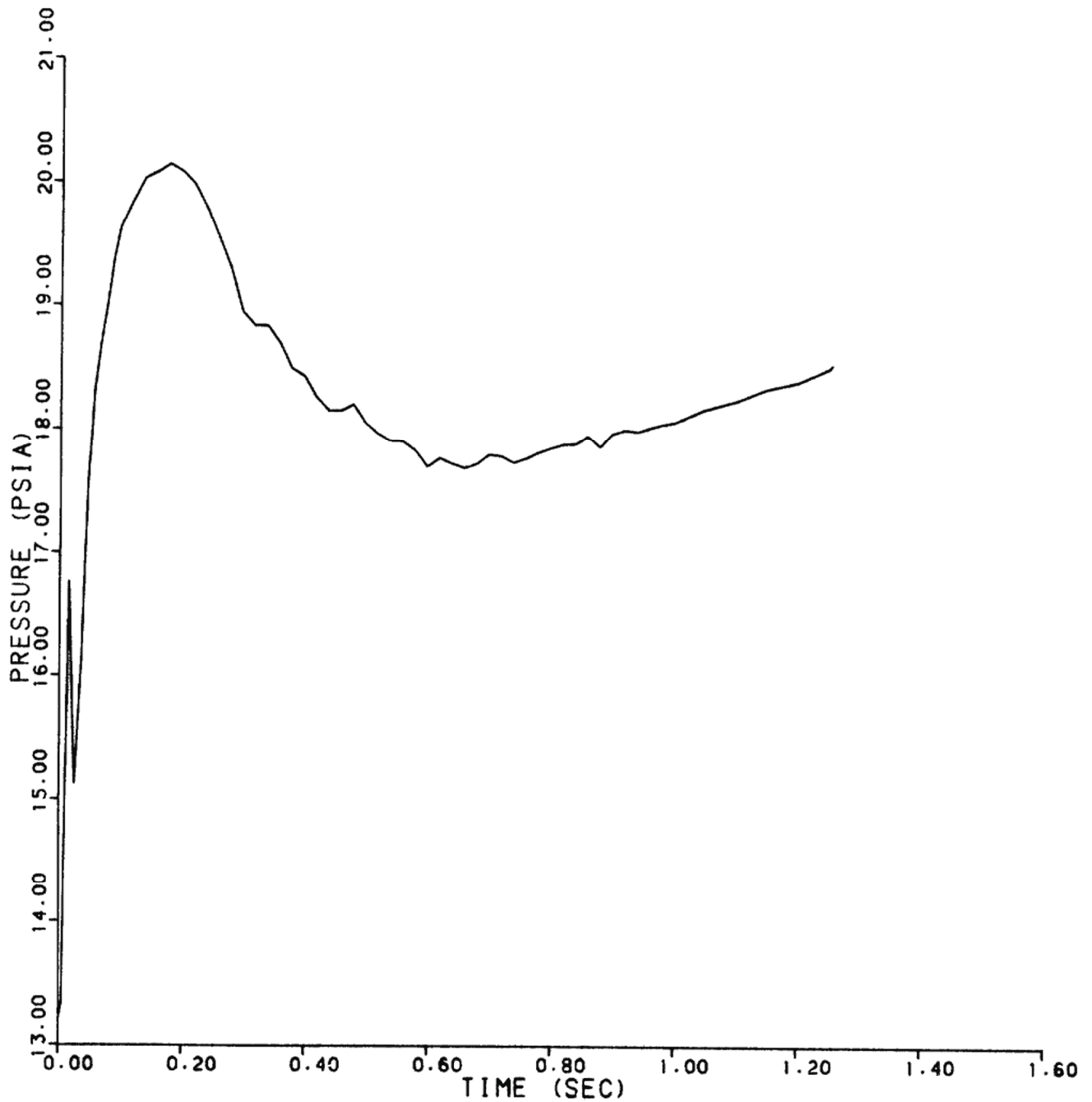

REV 13 4/06



VOGTLE
ELECTRIC GENERATING PLANT
UNIT 1 AND UNIT 2

STEAM GENERATOR INLET NOZZLE
NODE - E30
(306-in.² BREAK AREA)

FIGURE 6.2.1-19 (SHEET 30 OF 74)

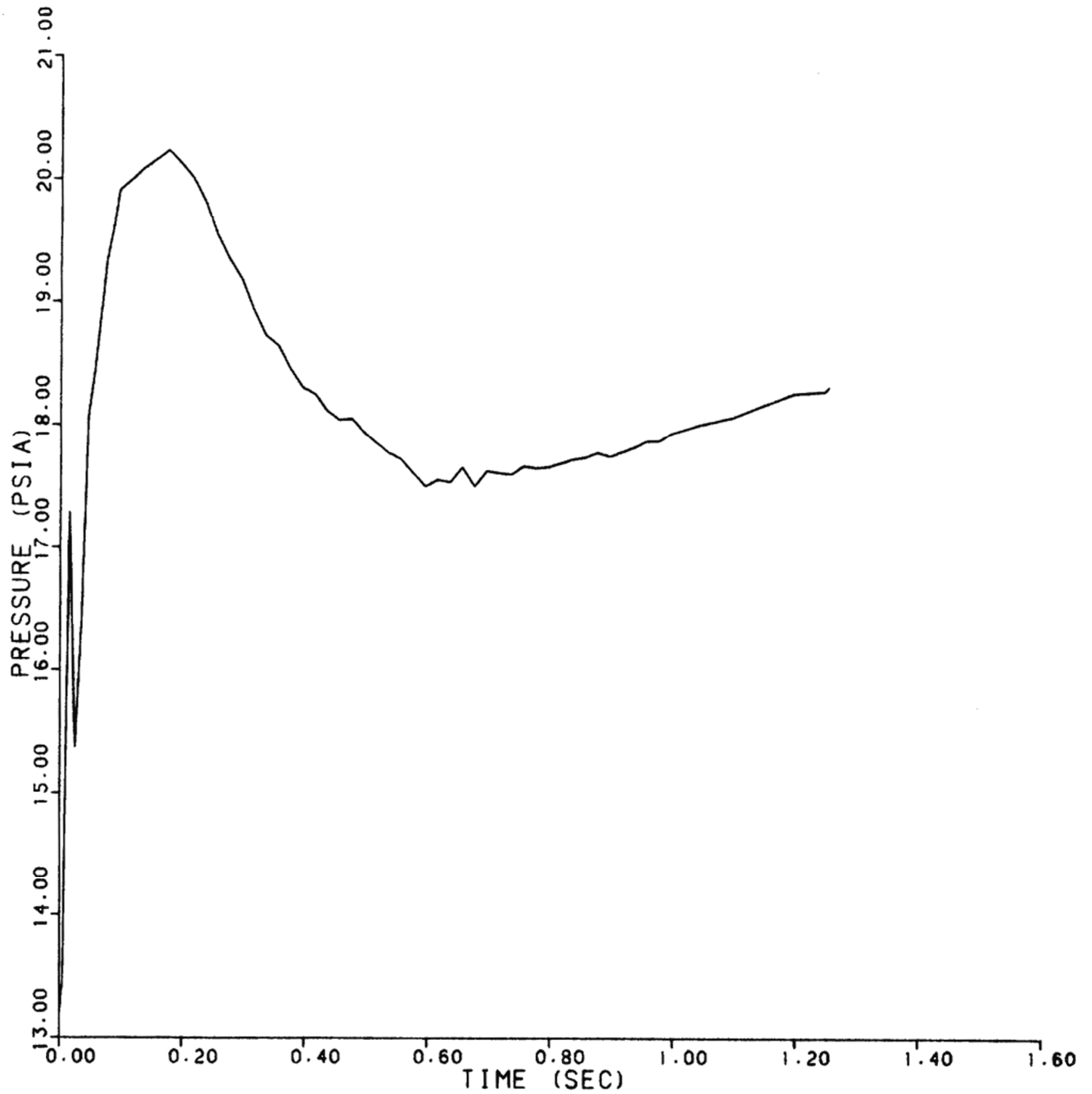

REV 13 4/06



VOGTLE
ELECTRIC GENERATING PLANT
UNIT 1 AND UNIT 2

STEAM GENERATOR INLET NOZZLE
NODE - E31
(306-in.² BREAK AREA)

FIGURE 6.2.1-19 (SHEET 31 OF 74)

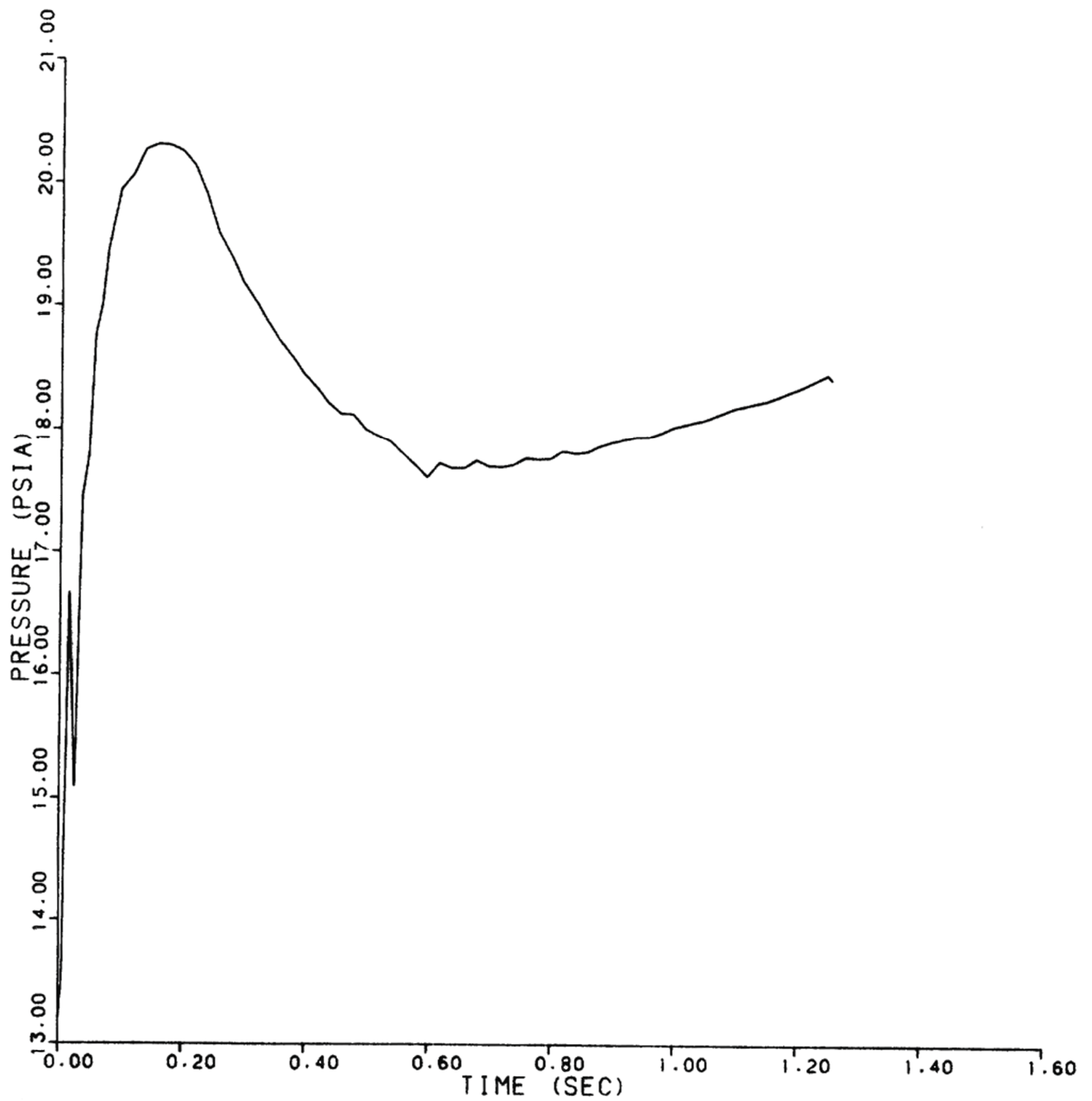

REV 13 4/06



VOGTLE
ELECTRIC GENERATING PLANT
UNIT 1 AND UNIT 2

STEAM GENERATOR INLET NOZZLE
NODE - E32
(306-in.² BREAK AREA)

FIGURE 6.2.1-19 (SHEET 32 OF 74)

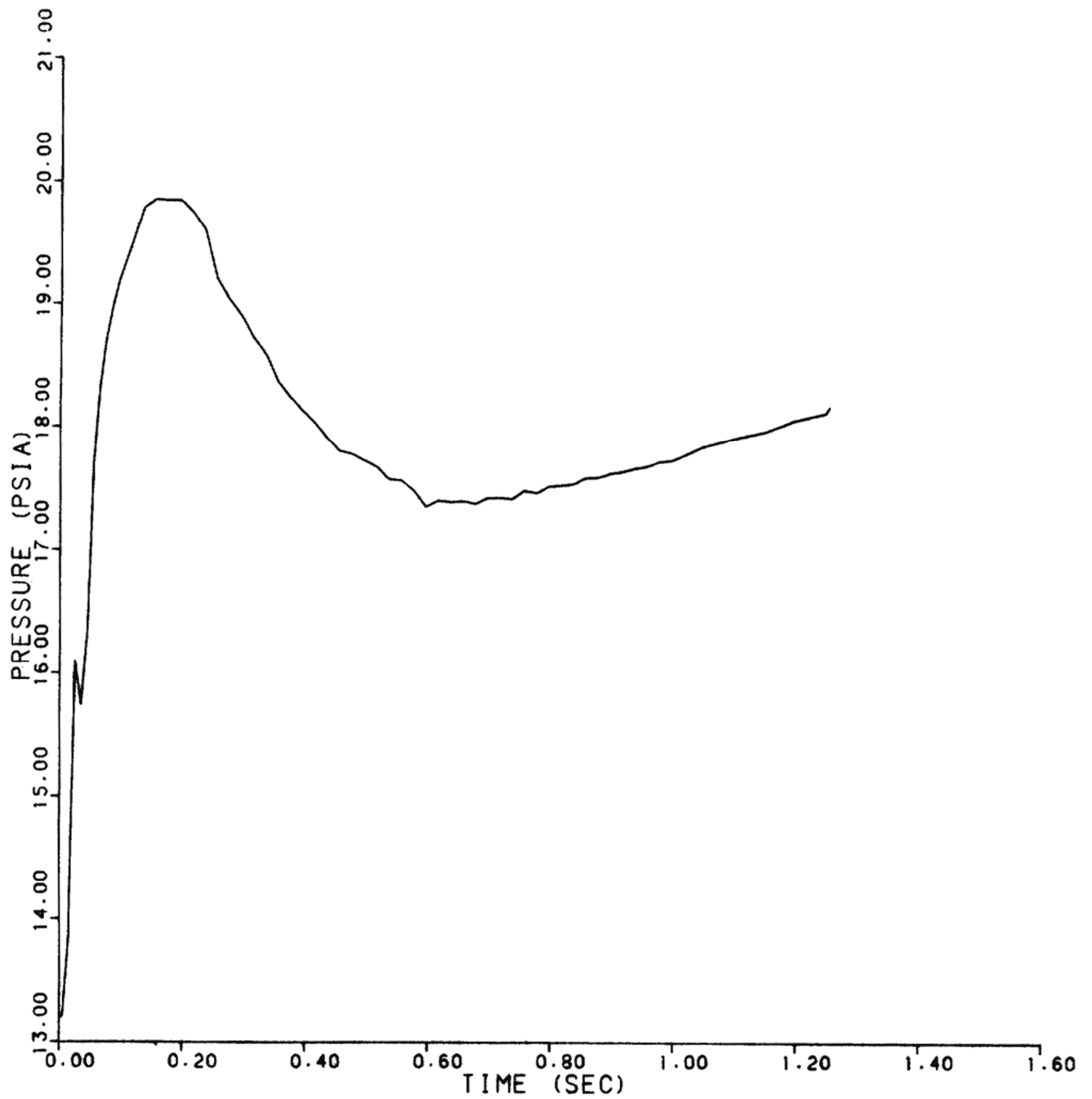

REV 13 4/06



VOGTLE
ELECTRIC GENERATING PLANT
UNIT 1 AND UNIT 2

STEAM GENERATOR INLET NOZZLE
NODE - E33
(306-in.² BREAK AREA)

FIGURE 6.2.1-19 (SHEET 33 OF 74)

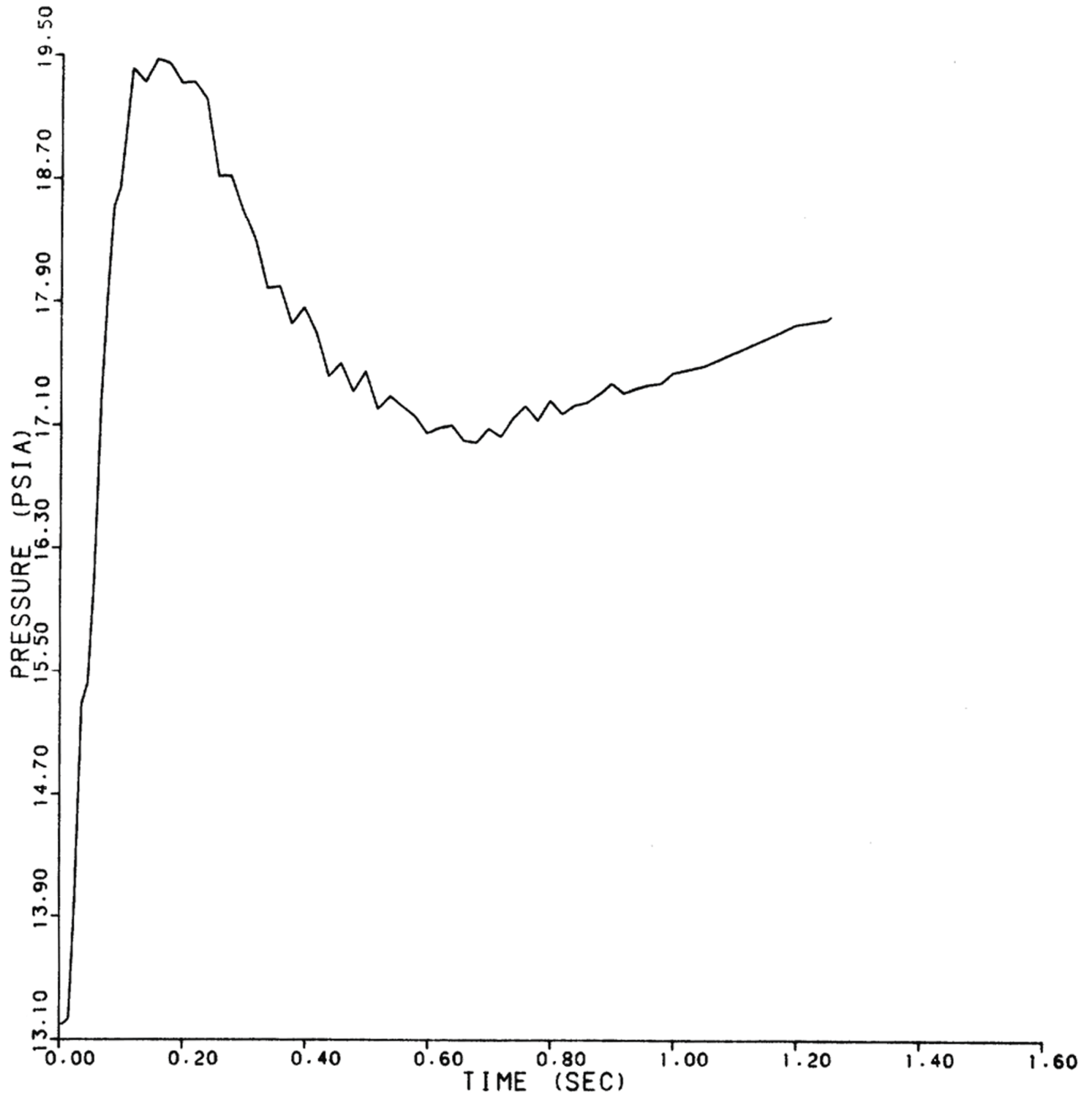

REV 13 4/06



VOGTLE
ELECTRIC GENERATING PLANT
UNIT 1 AND UNIT 2

STEAM GENERATOR INLET NOZZLE
NODE - E34
(306-in.² BREAK AREA)

FIGURE 6.2.1-19 (SHEET 34 OF 74)

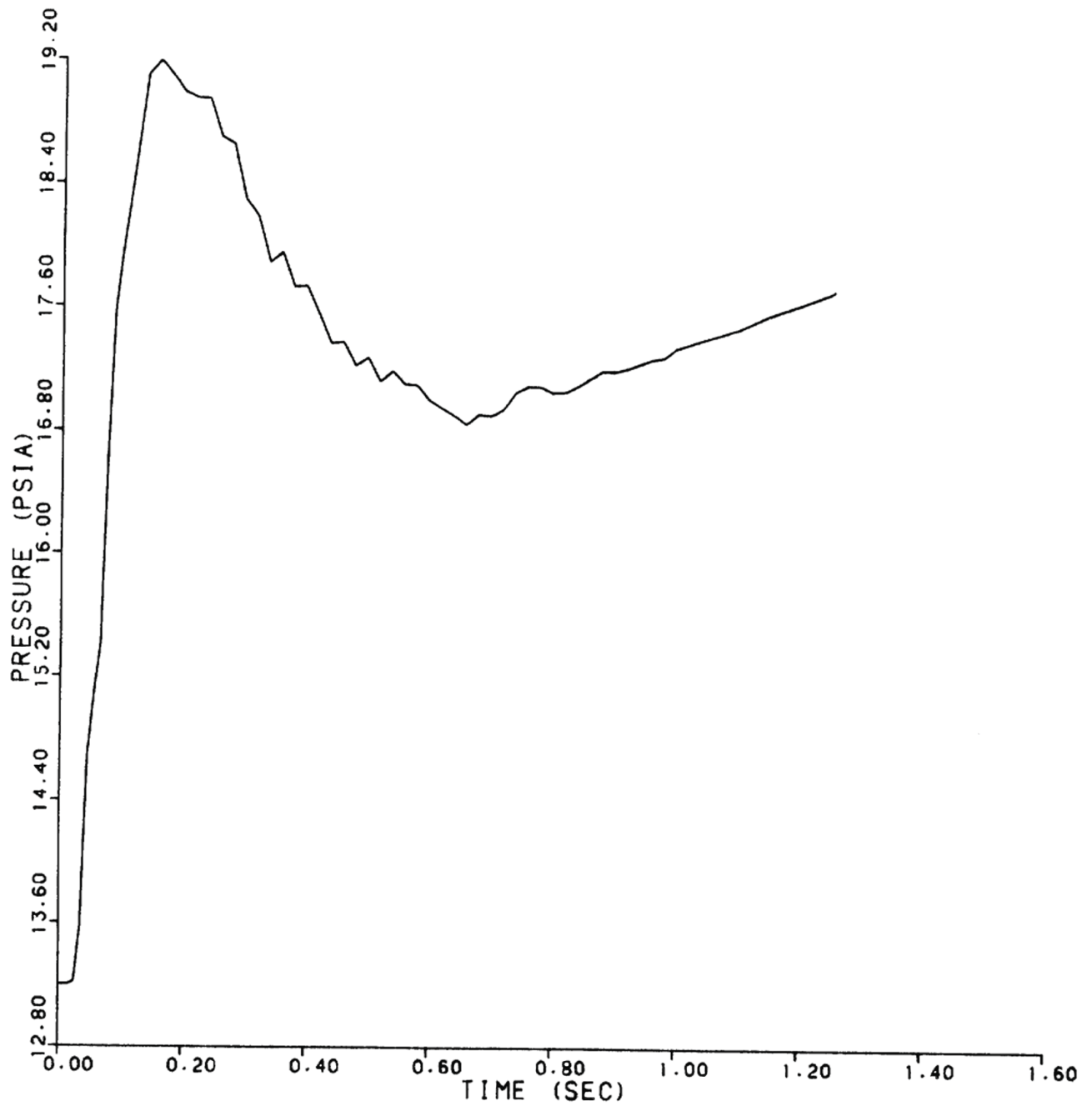

REV 13 4/06



VOGTLE
ELECTRIC GENERATING PLANT
UNIT 1 AND UNIT 2

STEAM GENERATOR INLET NOZZLE
NODE - E35
(306-in.² BREAK AREA)

FIGURE 6.2.1-19 (SHEET 35 OF 74)

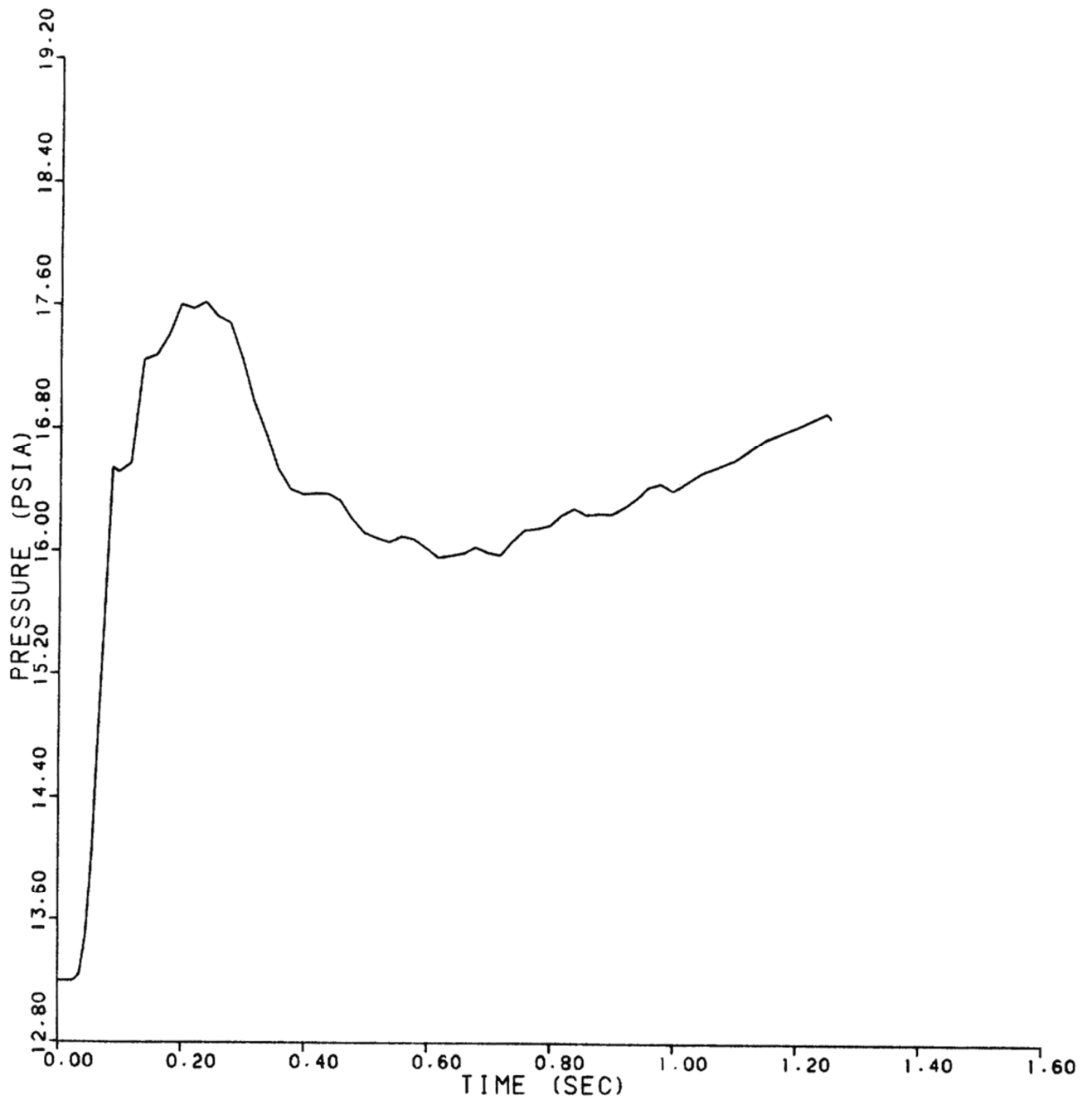

REV 13 4/06



VOGTLE
ELECTRIC GENERATING PLANT
UNIT 1 AND UNIT 2

STEAM GENERATOR INLET NOZZLE
NODE - E36
(306-in.² BREAK AREA)

FIGURE 6.2.1-19 (SHEET 36 OF 74)

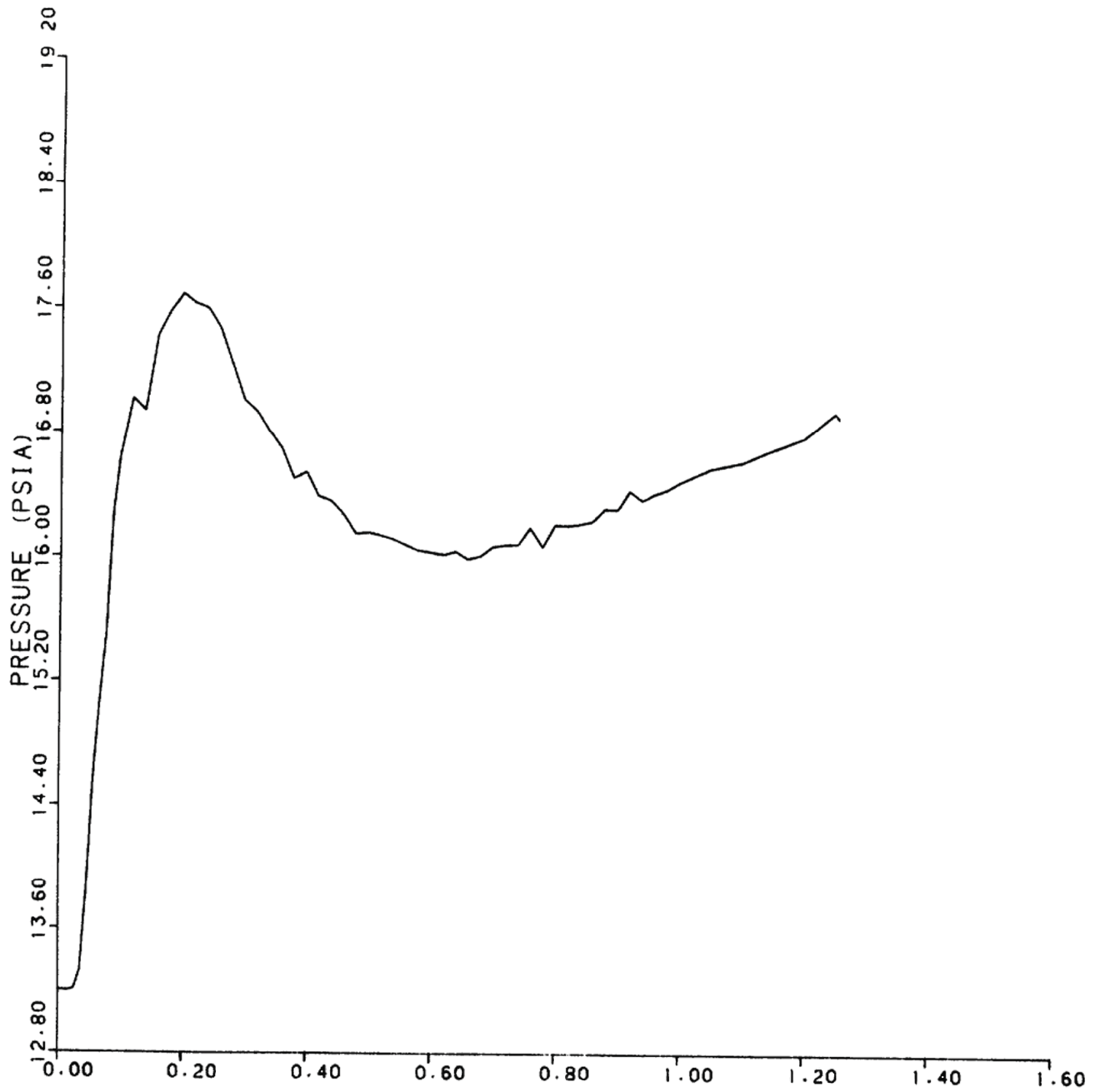

REV 13 4/06



VOGTLE
ELECTRIC GENERATING PLANT
UNIT 1 AND UNIT 2

STEAM GENERATOR INLET NOZZLE
NODE - E37
(306-in.² BREAK AREA)

FIGURE 6.2.1-19 (SHEET 37 OF 74)

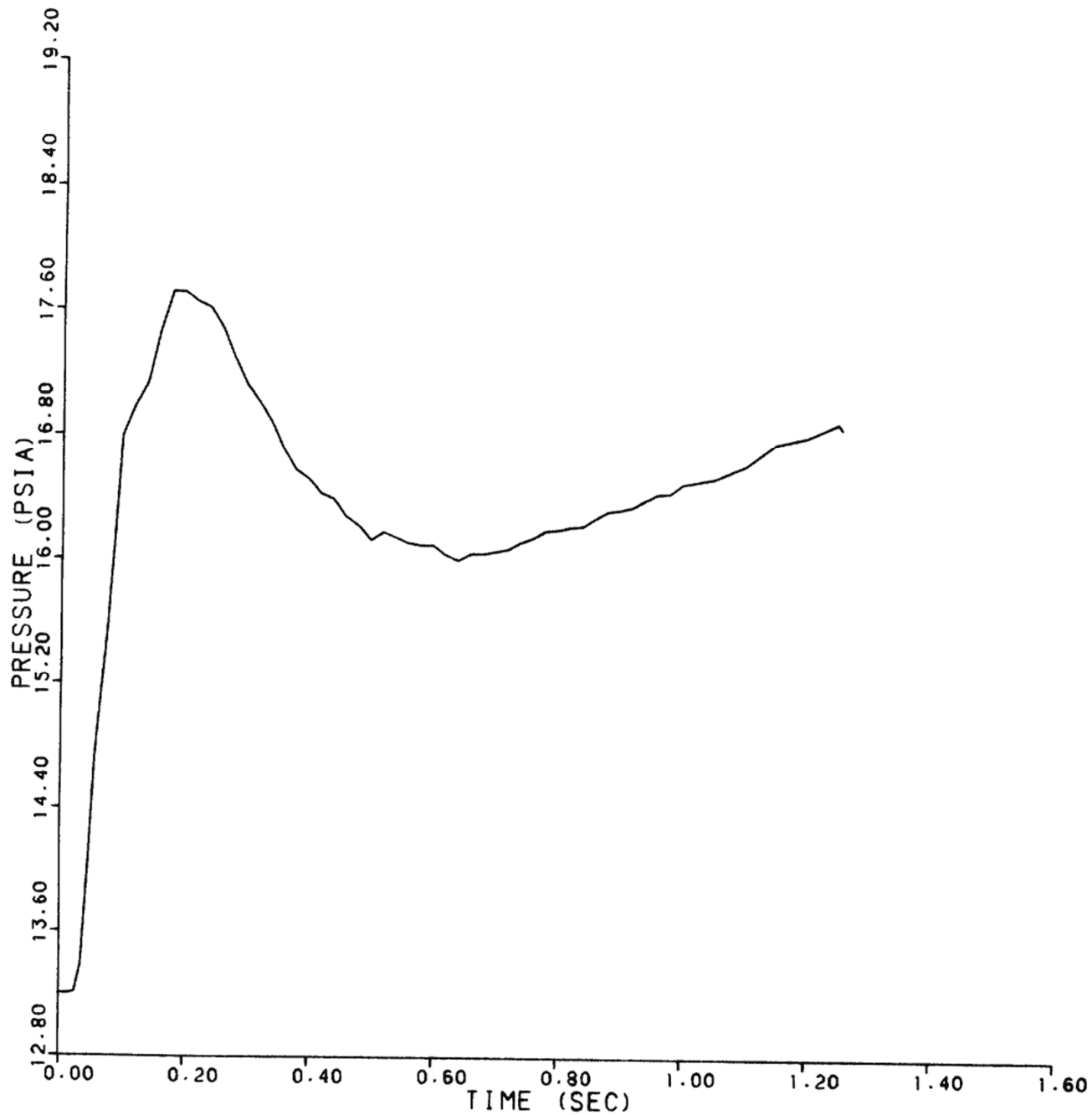

REV 13 4/06



VOGTLE
ELECTRIC GENERATING PLANT
UNIT 1 AND UNIT 2

STEAM GENERATOR INLET NOZZLE
NODE - E38
(306-in.² BREAK AREA)

FIGURE 6.2.1-19 (SHEET 38 OF 74)

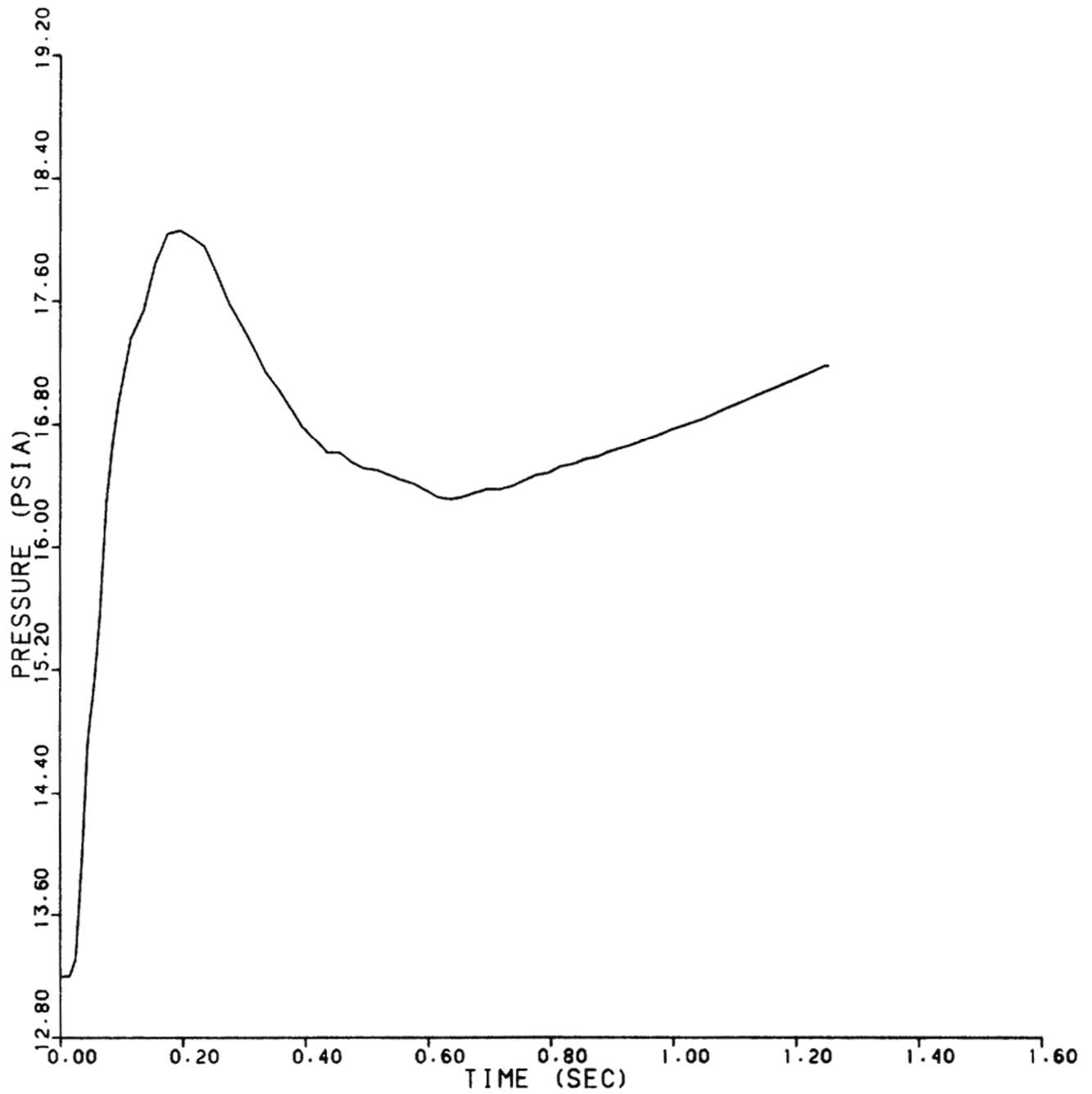

REV 13 4/06



VOGTLE
ELECTRIC GENERATING PLANT
UNIT 1 AND UNIT 2

STEAM GENERATOR INLET NOZZLE
NODE - E39
(306-in.² BREAK AREA)

FIGURE 6.2.1-19 (SHEET 39 OF 74)

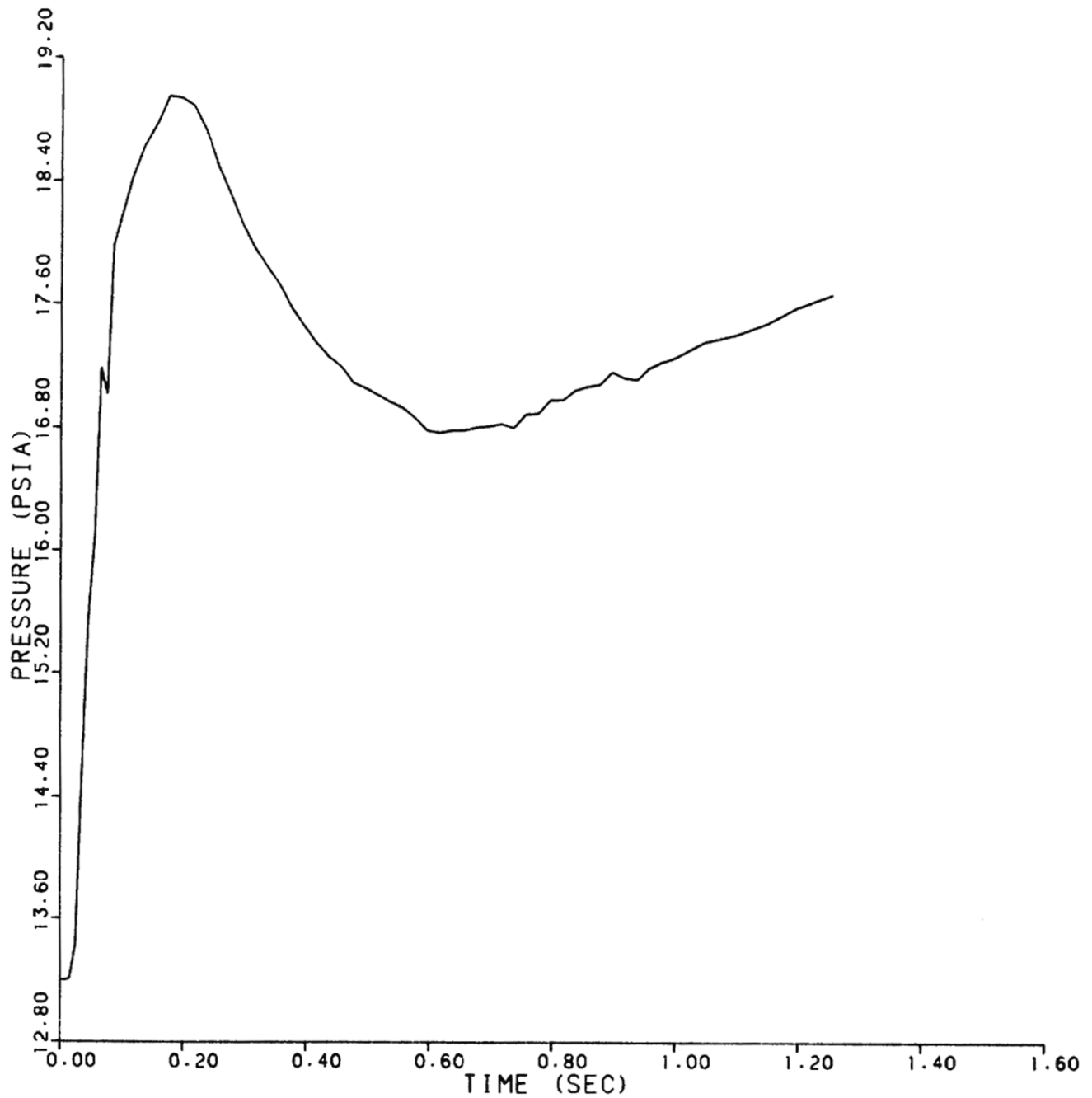

REV 13 4/06

STEAM GENERATOR INLET NOZZLE
 NODE - E40
 (306-in.² BREAK AREA)



VOGTLE
 ELECTRIC GENERATING PLANT
 UNIT 1 AND UNIT 2

FIGURE 6.2.1-19 (SHEET 40 OF 74)

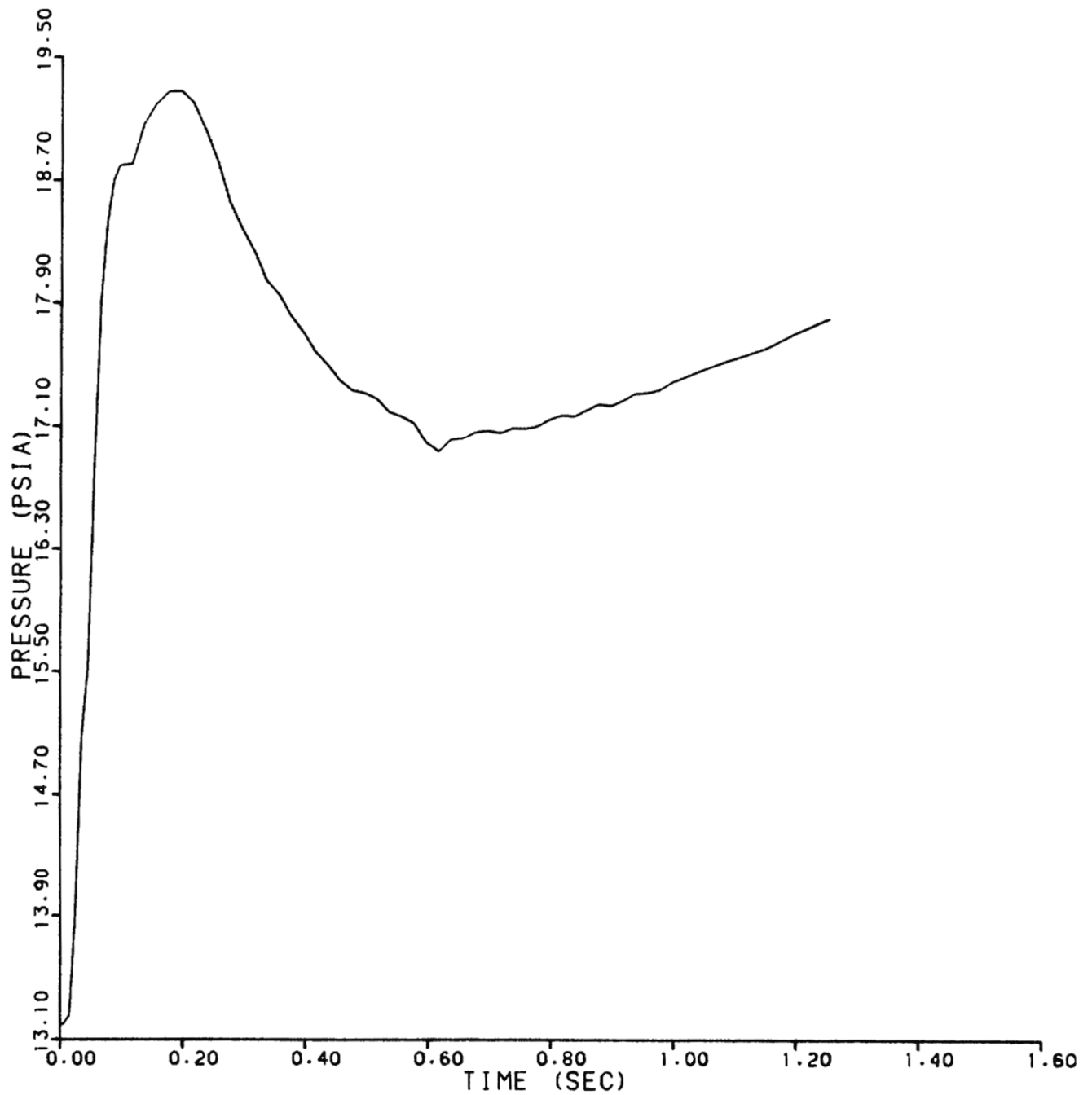

REV 13 4/06

STEAM GENERATOR INLET NOZZLE
 NODE - E41
 (306-in.² BREAK AREA)



VOGTLE
 ELECTRIC GENERATING PLANT
 UNIT 1 AND UNIT 2

FIGURE 6.2.1-19 (SHEET 41 OF 74)

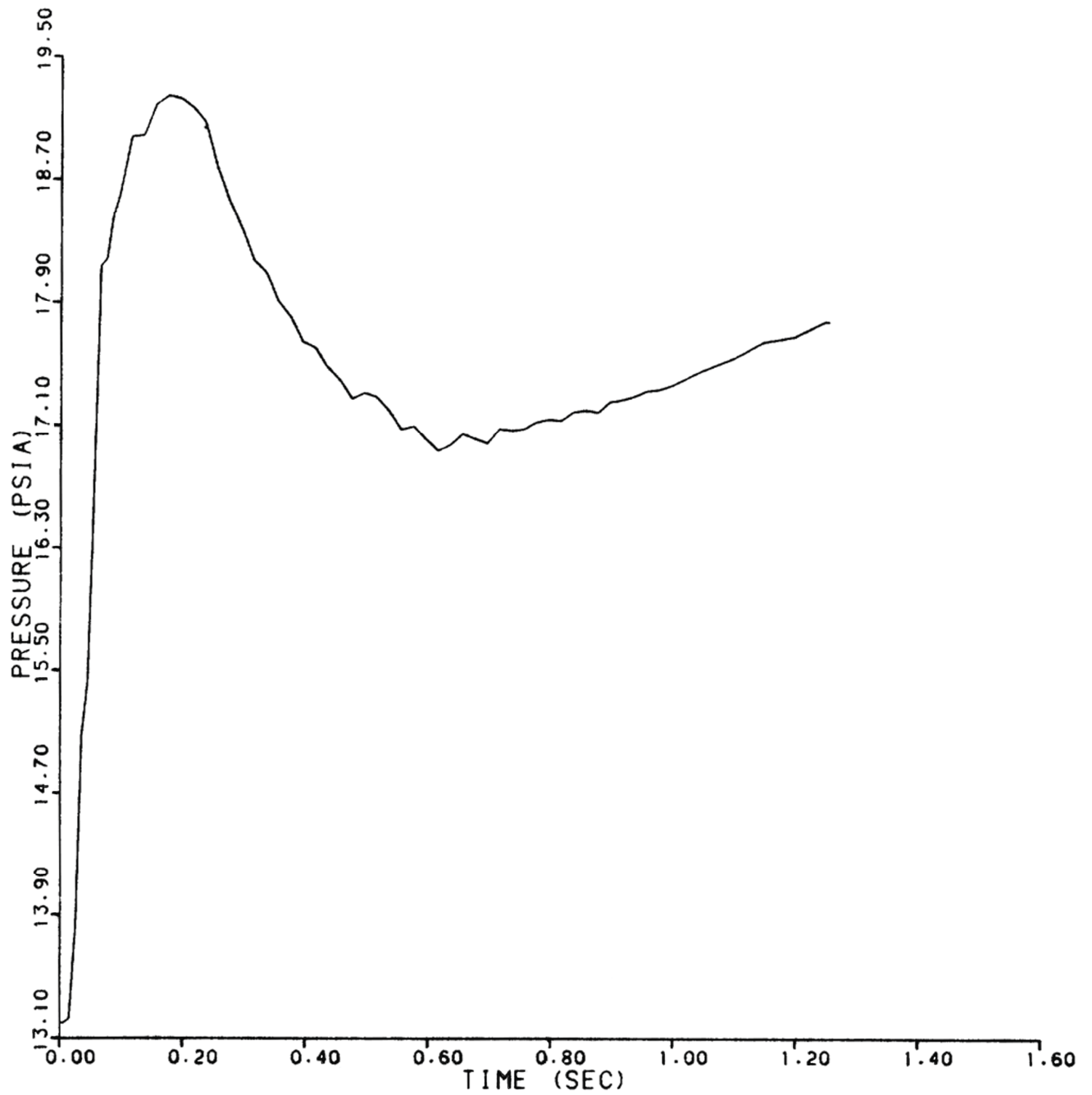

REV 13 4/06



VOGTLE
ELECTRIC GENERATING PLANT
UNIT 1 AND UNIT 2

STEAM GENERATOR INLET NOZZLE
NODE - E42
(306-in.² BREAK AREA)

FIGURE 6.2.1-19 (SHEET 42 OF 74)

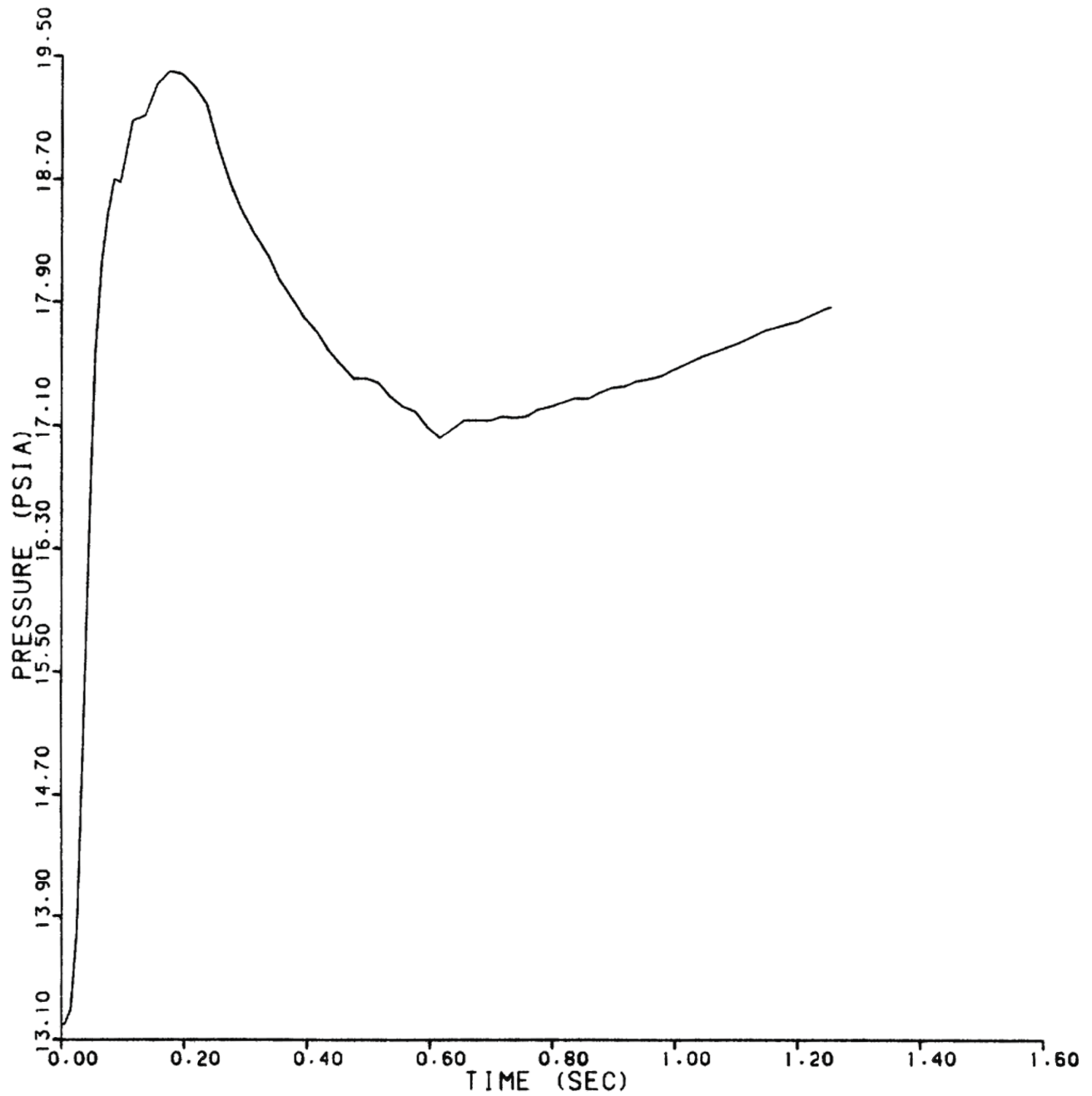

REV 13 4/06



VOGTLE
ELECTRIC GENERATING PLANT
UNIT 1 AND UNIT 2

STEAM GENERATOR INLET NOZZLE
NODE - E43
(306-in.² BREAK AREA)

FIGURE 6.2.1-19 (SHEET 43 OF 74)

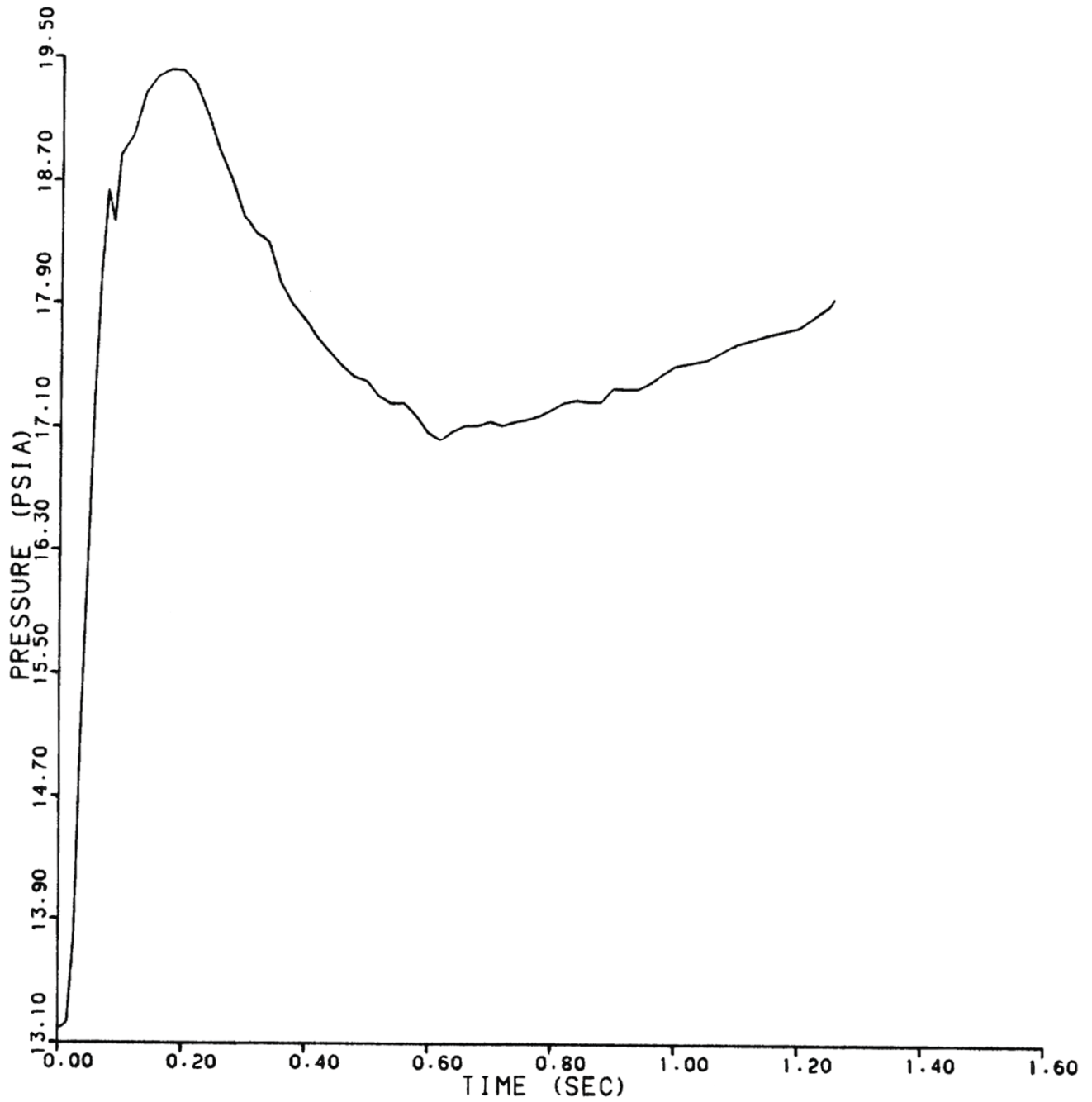

REV 13 4/06



VOGTLE
ELECTRIC GENERATING PLANT
UNIT 1 AND UNIT 2

STEAM GENERATOR INLET NOZZLE
NODE - E44
(306-in.² BREAK AREA)

FIGURE 6.2.1-19 (SHEET 44 OF 74)

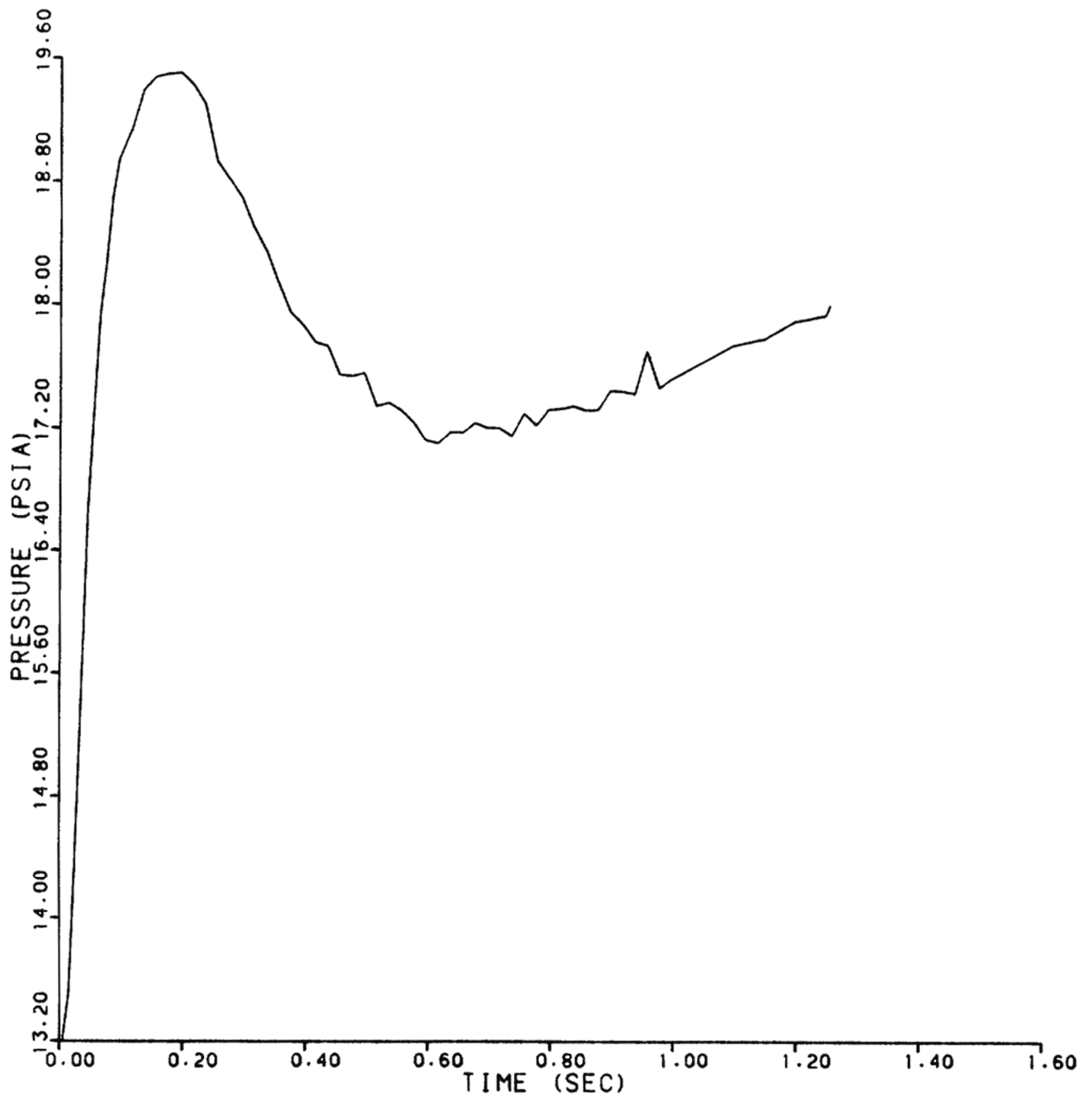

REV 13 4/06



VOGTLE
ELECTRIC GENERATING PLANT
UNIT 1 AND UNIT 2

STEAM GENERATOR INLET NOZZLE
NODE - E45
(306-in.² BREAK AREA)

FIGURE 6.2.1-19 (SHEET 45 OF 74)

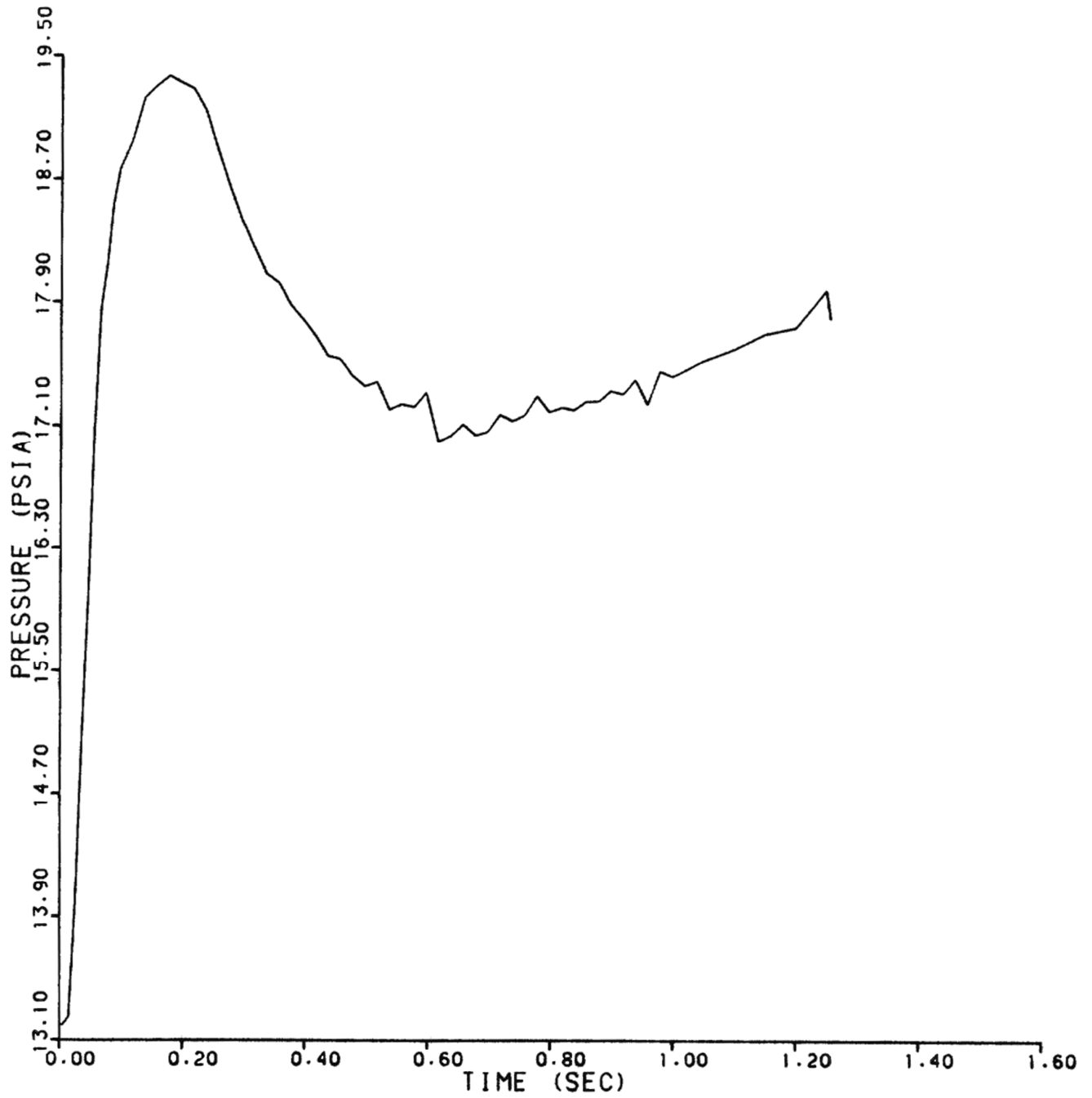

REV 13 4/06



VOGTLE
ELECTRIC GENERATING PLANT
UNIT 1 AND UNIT 2

STEAM GENERATOR INLET NOZZLE
NODE - E46
(306-in.² BREAK AREA)

FIGURE 6.2.1-19 (SHEET 46 OF 74)

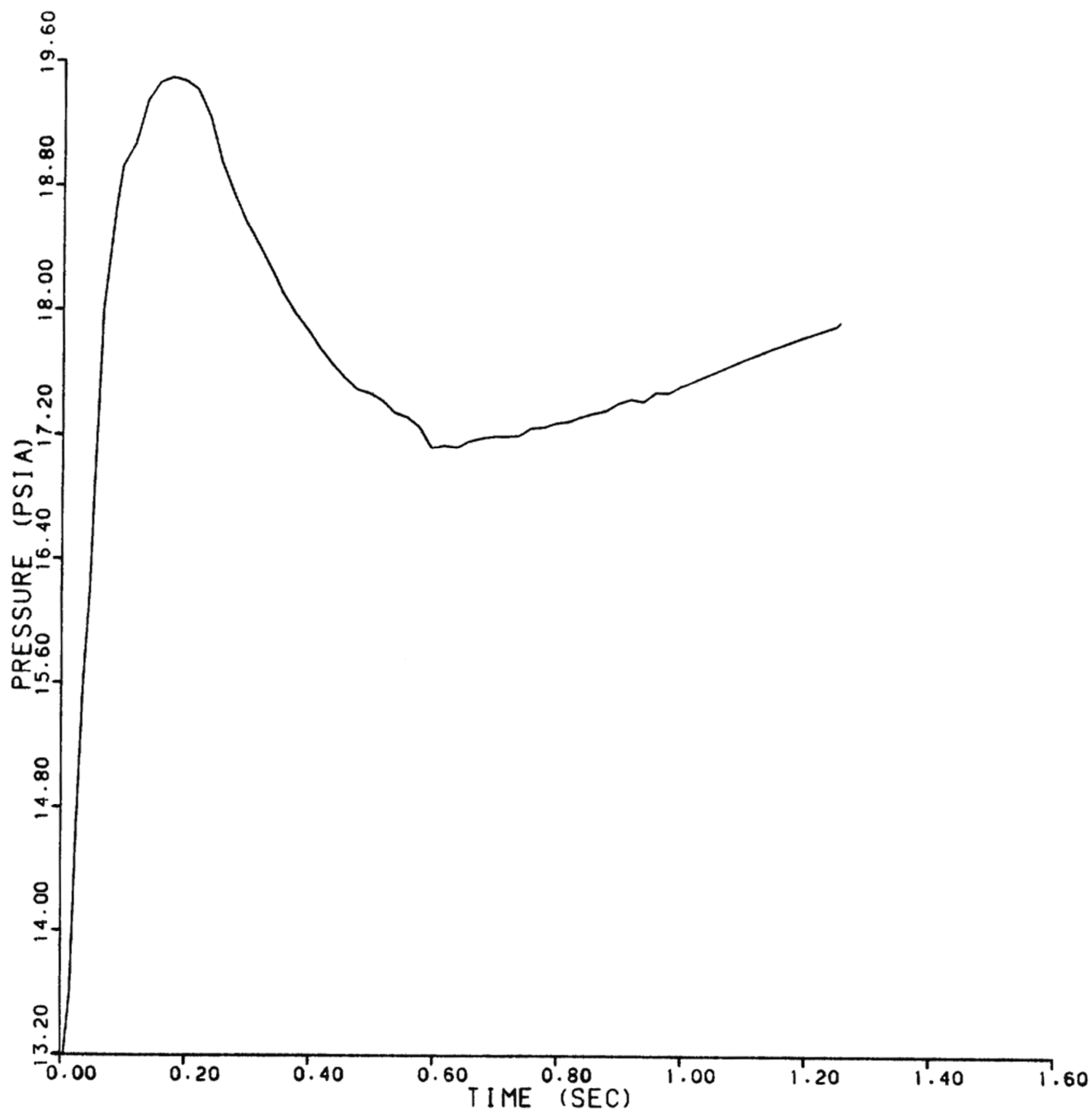

REV 13 4/06



VOGTLE
ELECTRIC GENERATING PLANT
UNIT 1 AND UNIT 2

STEAM GENERATOR INLET NOZZLE
NODE - E47
(306-in.² BREAK AREA)

FIGURE 6.2.1-19 (SHEET 47 OF 74)

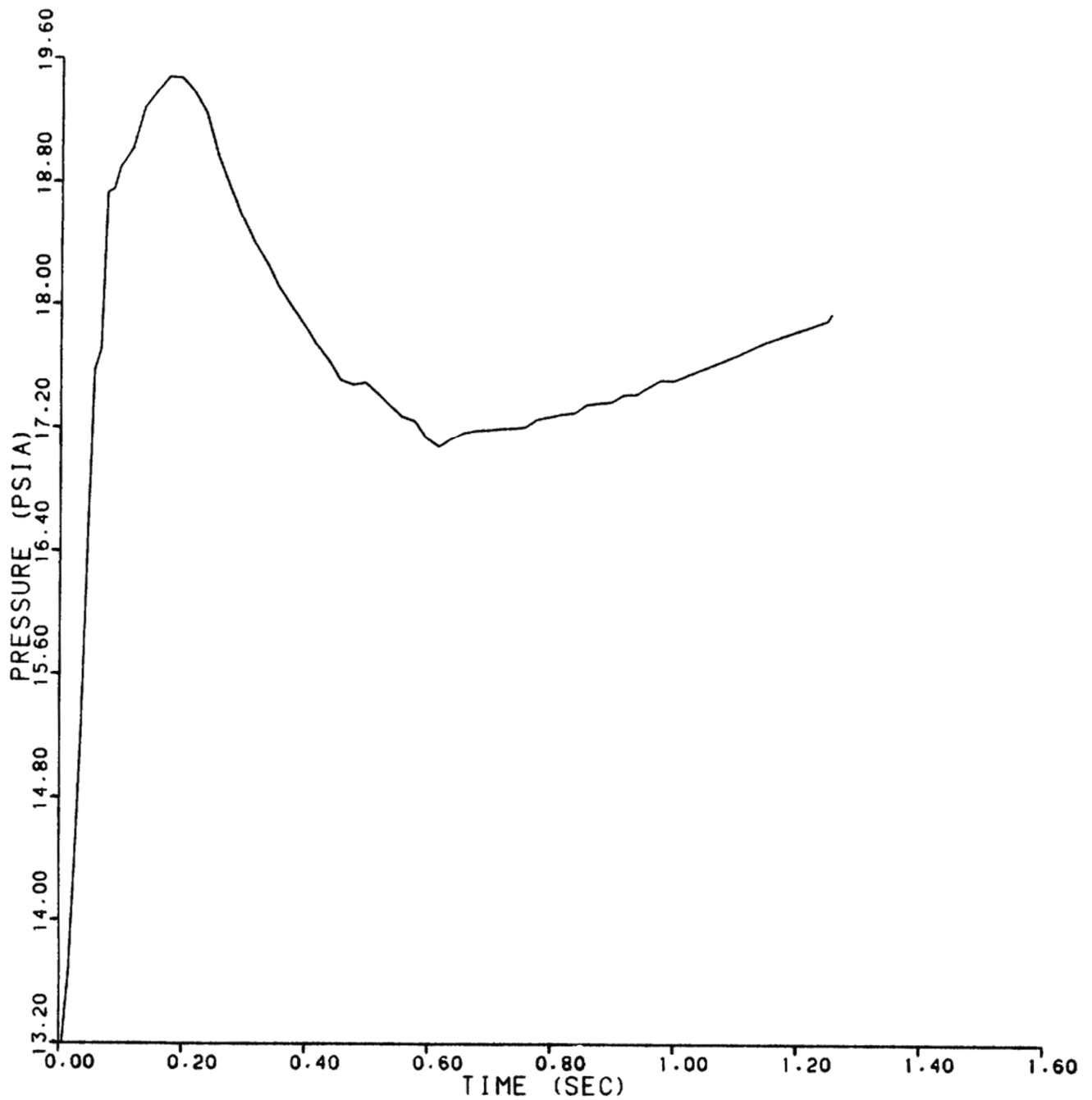

REV 13 4/06



VOGTLE
ELECTRIC GENERATING PLANT
UNIT 1 AND UNIT 2

STEAM GENERATOR INLET NOZZLE
NODE - E48
(306-in.² BREAK AREA)

FIGURE 6.2.1-19 (SHEET 48 OF 74)

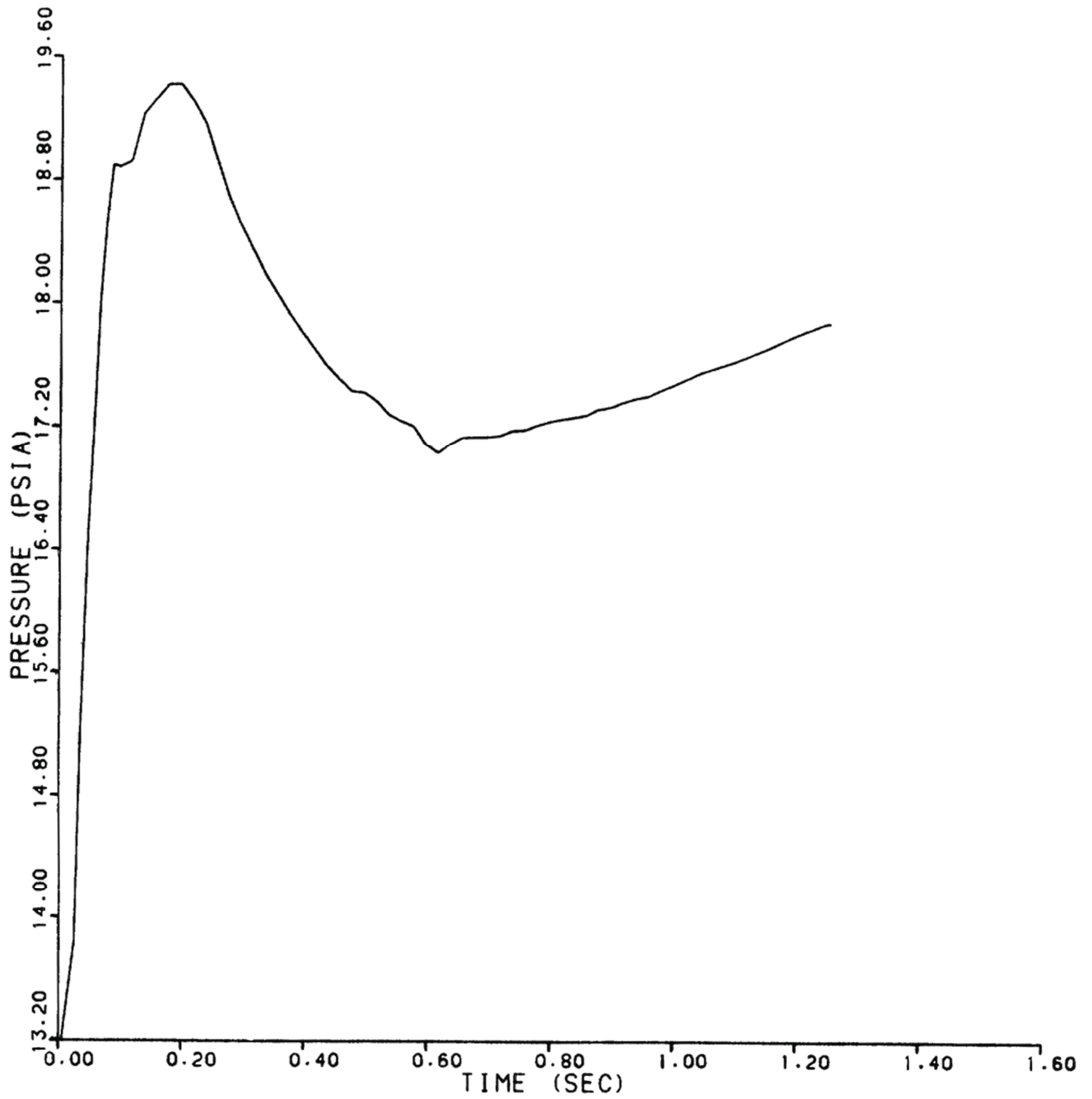

REV 13 4/06



VOGTLE
ELECTRIC GENERATING PLANT
UNIT 1 AND UNIT 2

STEAM GENERATOR INLET NOZZLE
NODE - E49
(306-in.² BREAK AREA)

FIGURE 6.2.1-19 (SHEET 49 OF 74)

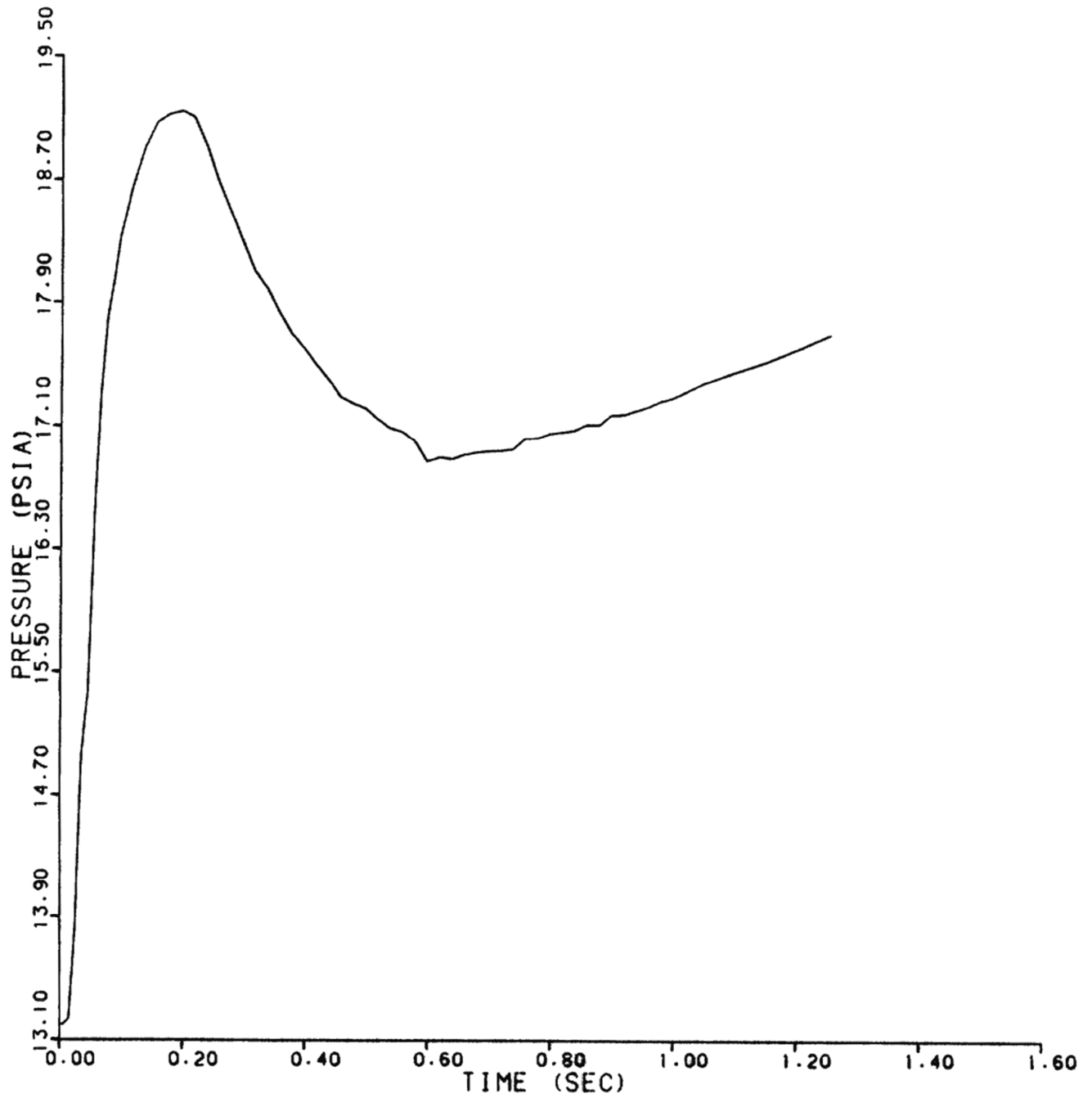

REV 13 4/06



VOGTLE
ELECTRIC GENERATING PLANT
UNIT 1 AND UNIT 2

STEAM GENERATOR INLET NOZZLE
NODE - E50
(306-in.² BREAK AREA)

FIGURE 6.2.1-19 (SHEET 50 OF 74)

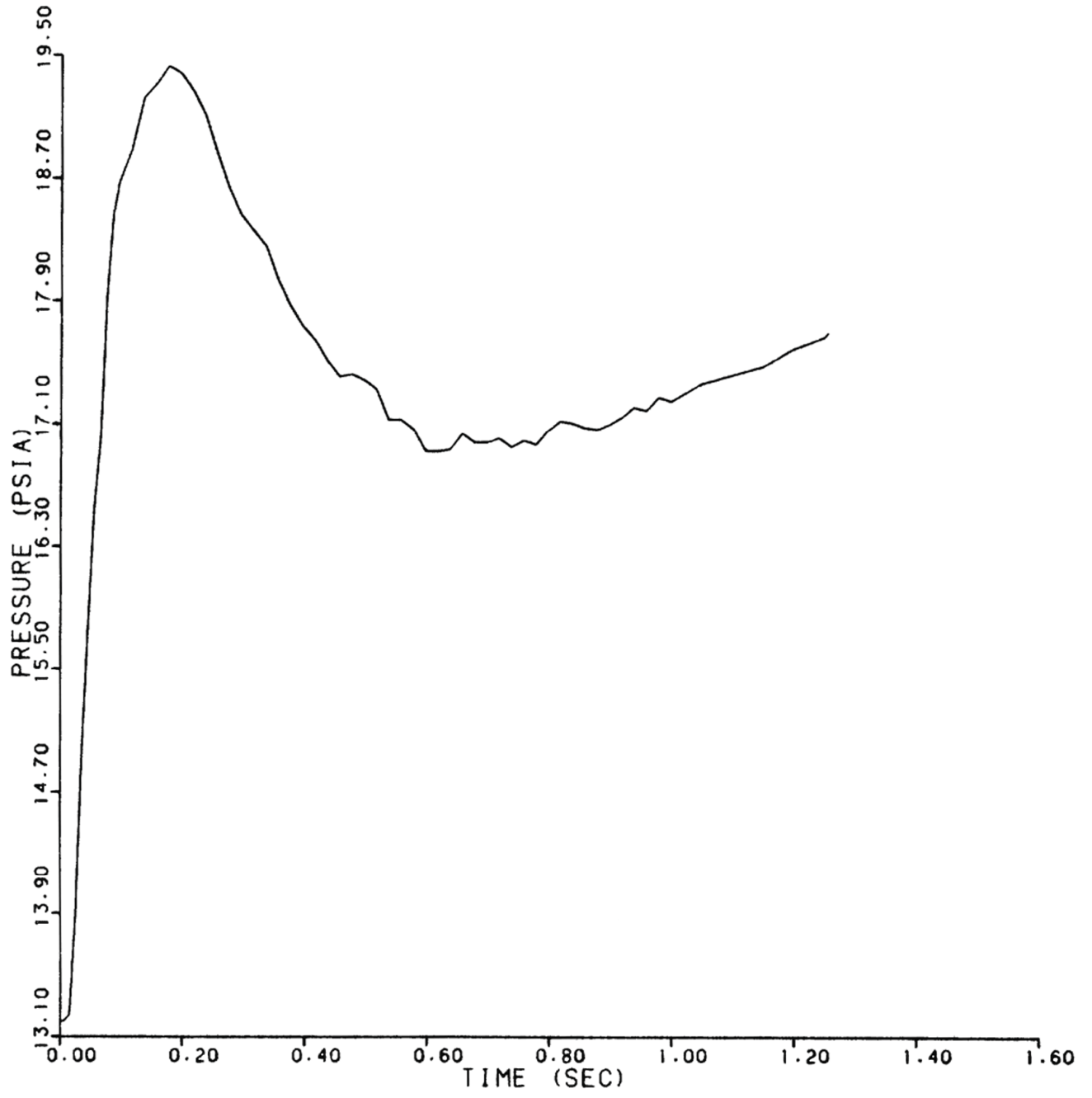

REV 13 4/06



VOGTLE
ELECTRIC GENERATING PLANT
UNIT 1 AND UNIT 2

STEAM GENERATOR INLET NOZZLE
NODE - E51
(306-in.² BREAK AREA)

FIGURE 6.2.1-19 (SHEET 51 OF 74)

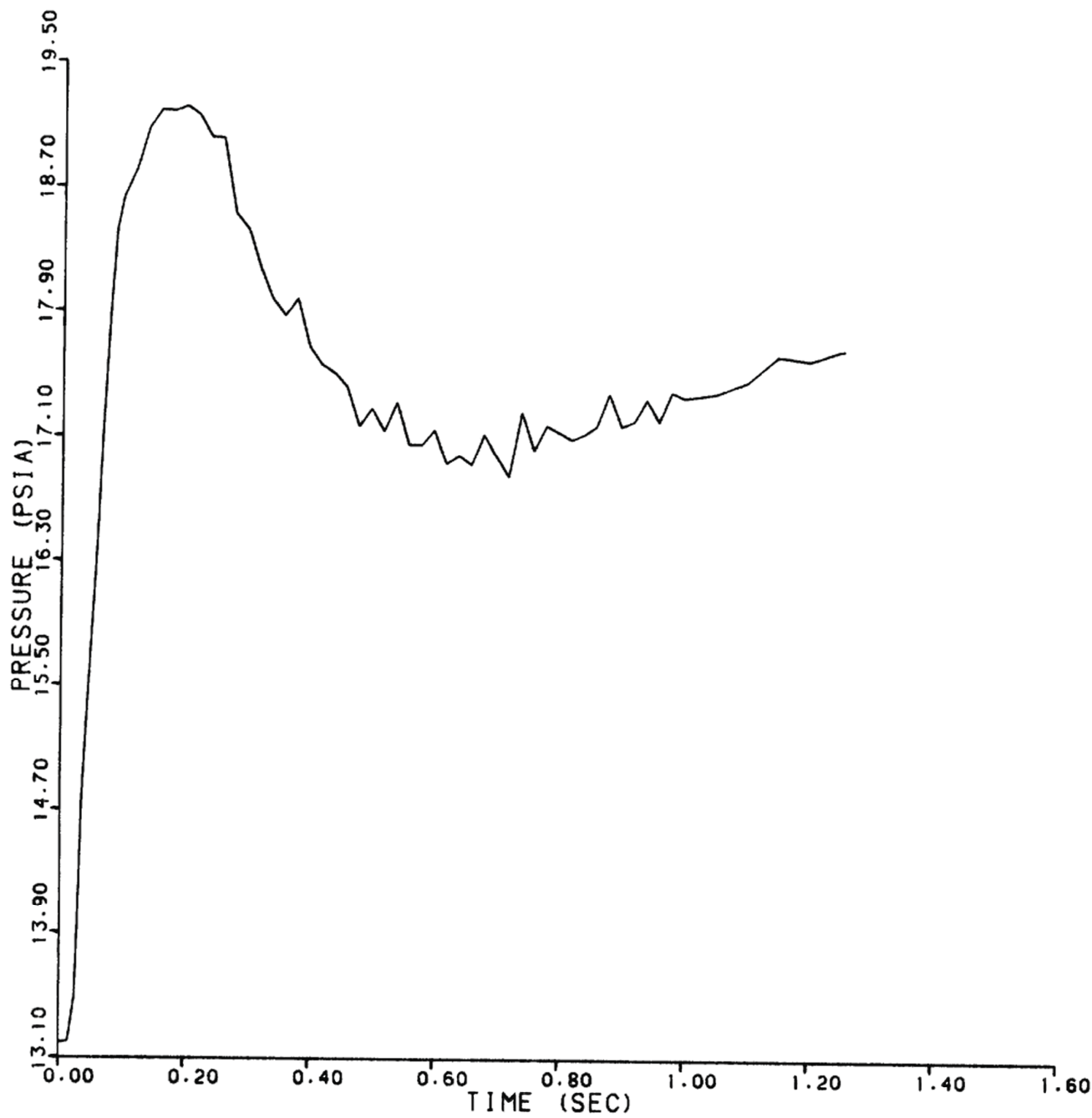

REV 13 4/06



VOGTLE
ELECTRIC GENERATING PLANT
UNIT 1 AND UNIT 2

STEAM GENERATOR INLET NOZZLE
NODE - E52
(306-in.² BREAK AREA)

FIGURE 6.2.1-19 (SHEET 52 OF 74)

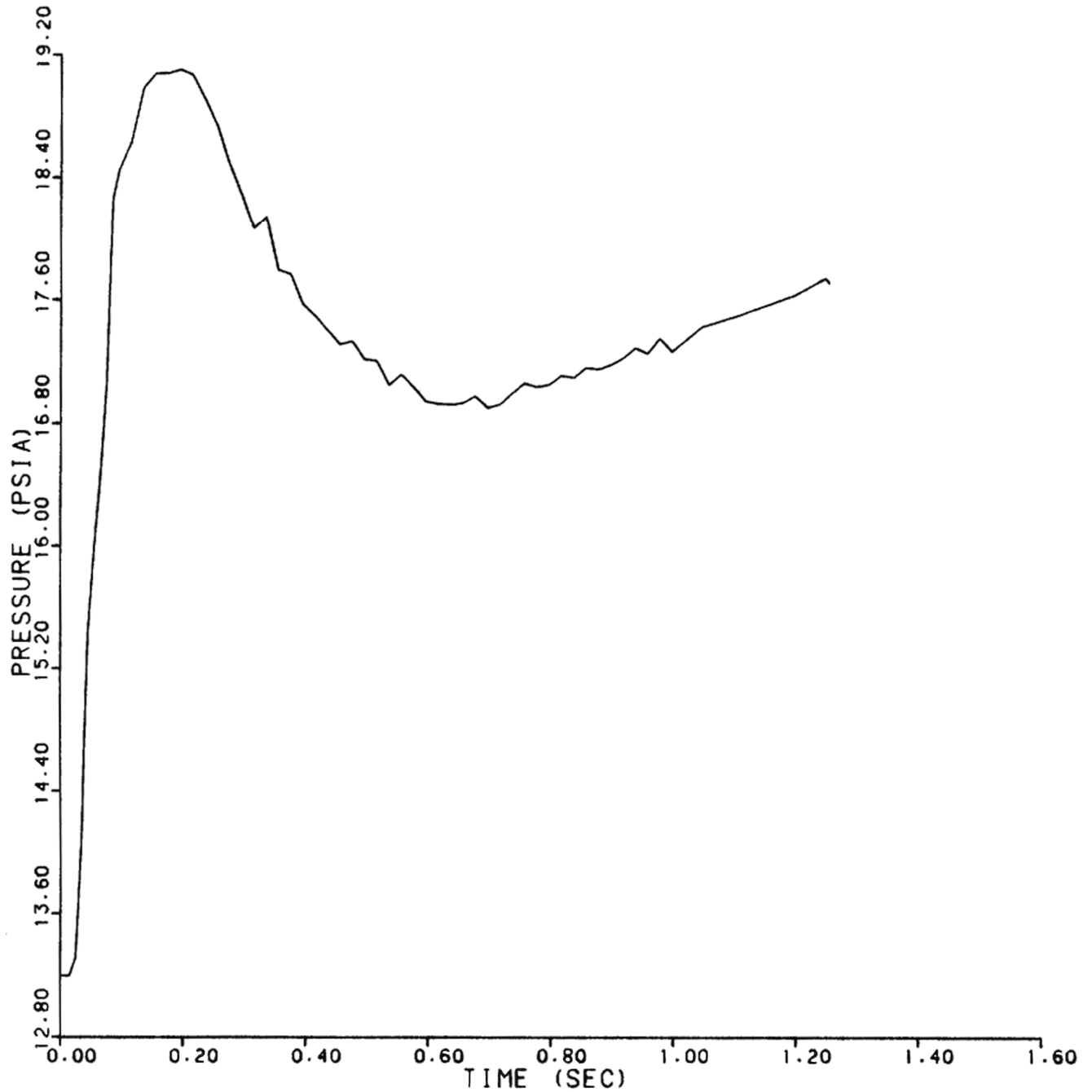

REV 13 4/06



VOGTLE
ELECTRIC GENERATING PLANT
UNIT 1 AND UNIT 2

STEAM GENERATOR INLET NOZZLE
NODE - E53
(306-in.² BREAK AREA)

FIGURE 6.2.1-19 (SHEET 53 OF 74)

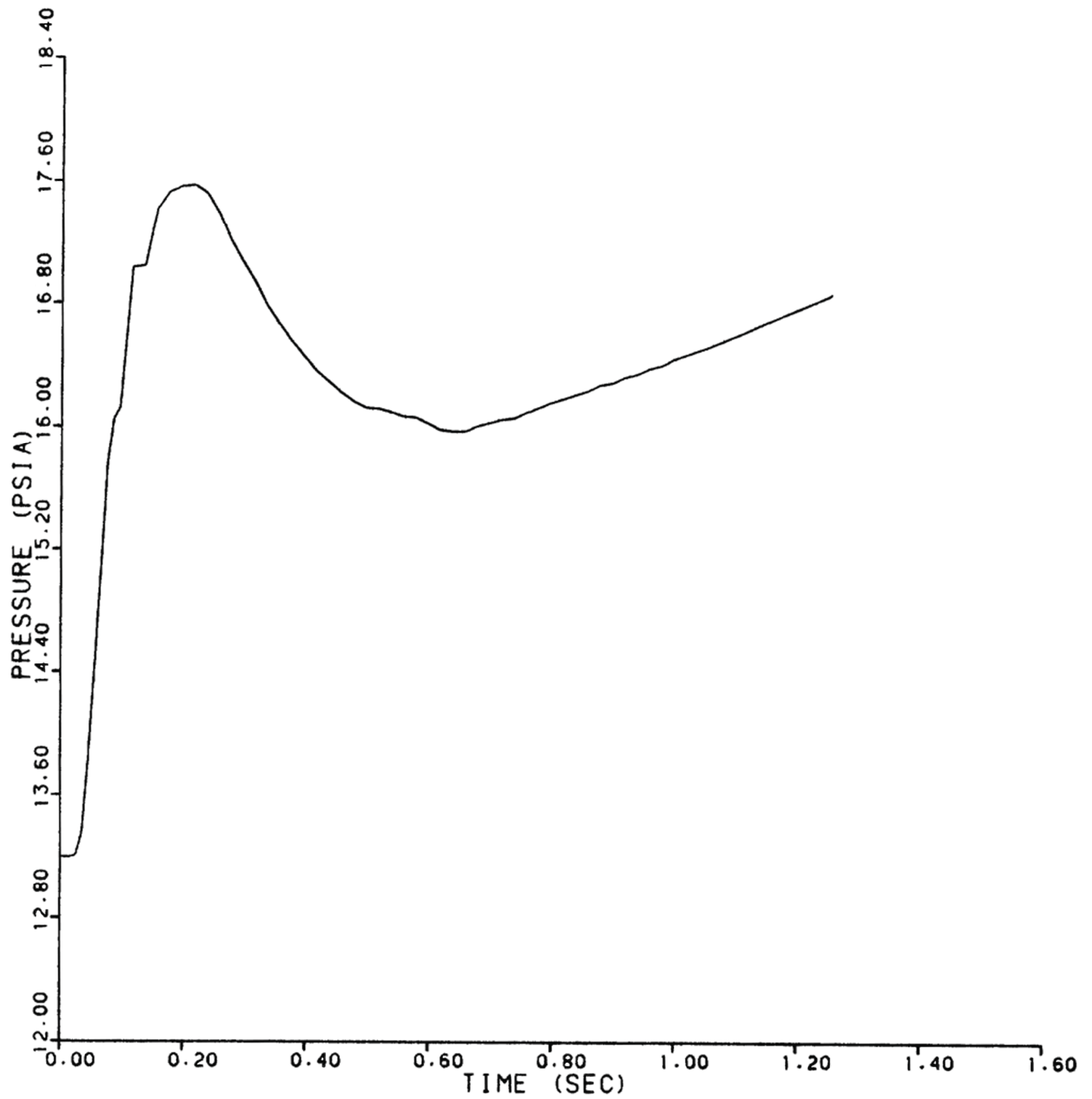

REV 13 4/06



VOGTLE
ELECTRIC GENERATING PLANT
UNIT 1 AND UNIT 2

STEAM GENERATOR INLET NOZZLE
NODE - E54
(306-in.² BREAK AREA)

FIGURE 6.2.1-19 (SHEET 54 OF 74)

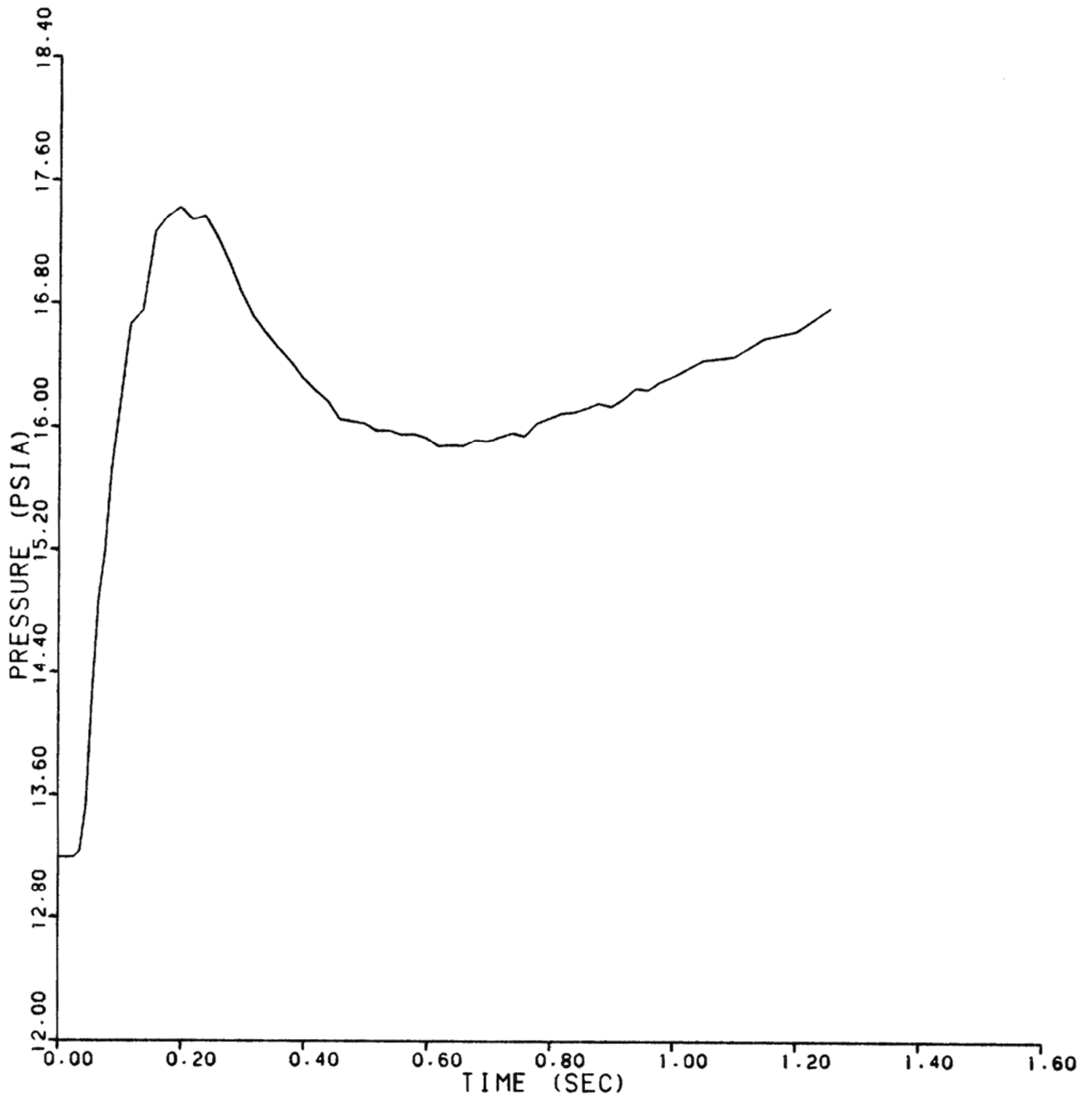

REV 13 4/06



VOGTLE
ELECTRIC GENERATING PLANT
UNIT 1 AND UNIT 2

STEAM GENERATOR INLET NOZZLE
NODE - E55
(306-in.² BREAK AREA)

FIGURE 6.2.1-19 (SHEET 55 OF 74)

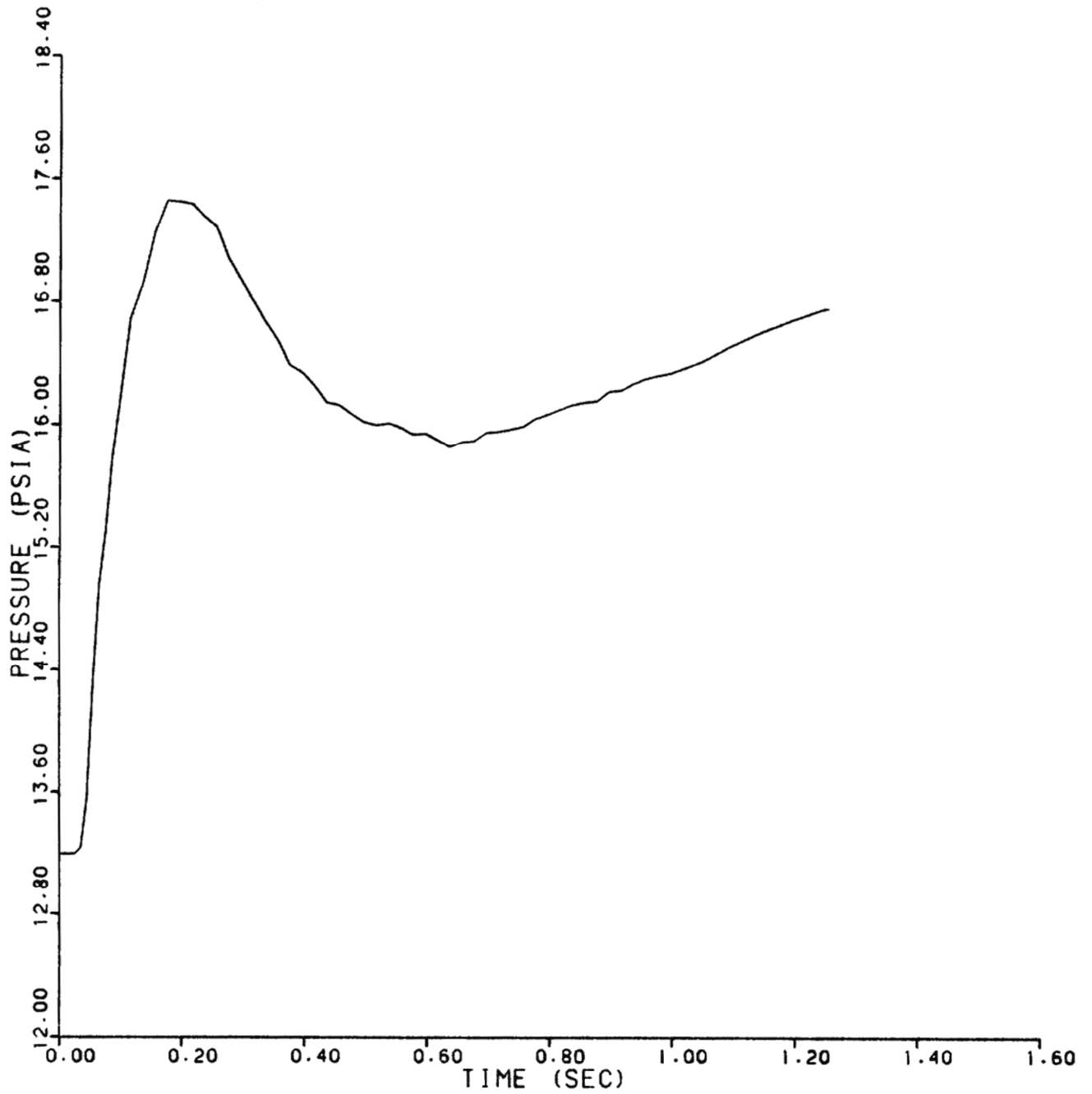

REV 13 4/06



VOGTLE
ELECTRIC GENERATING PLANT
UNIT 1 AND UNIT 2

STEAM GENERATOR INLET NOZZLE
NODE - E56
(306-in.² BREAK AREA)

FIGURE 6.2.1-19 (SHEET 56 OF 74)

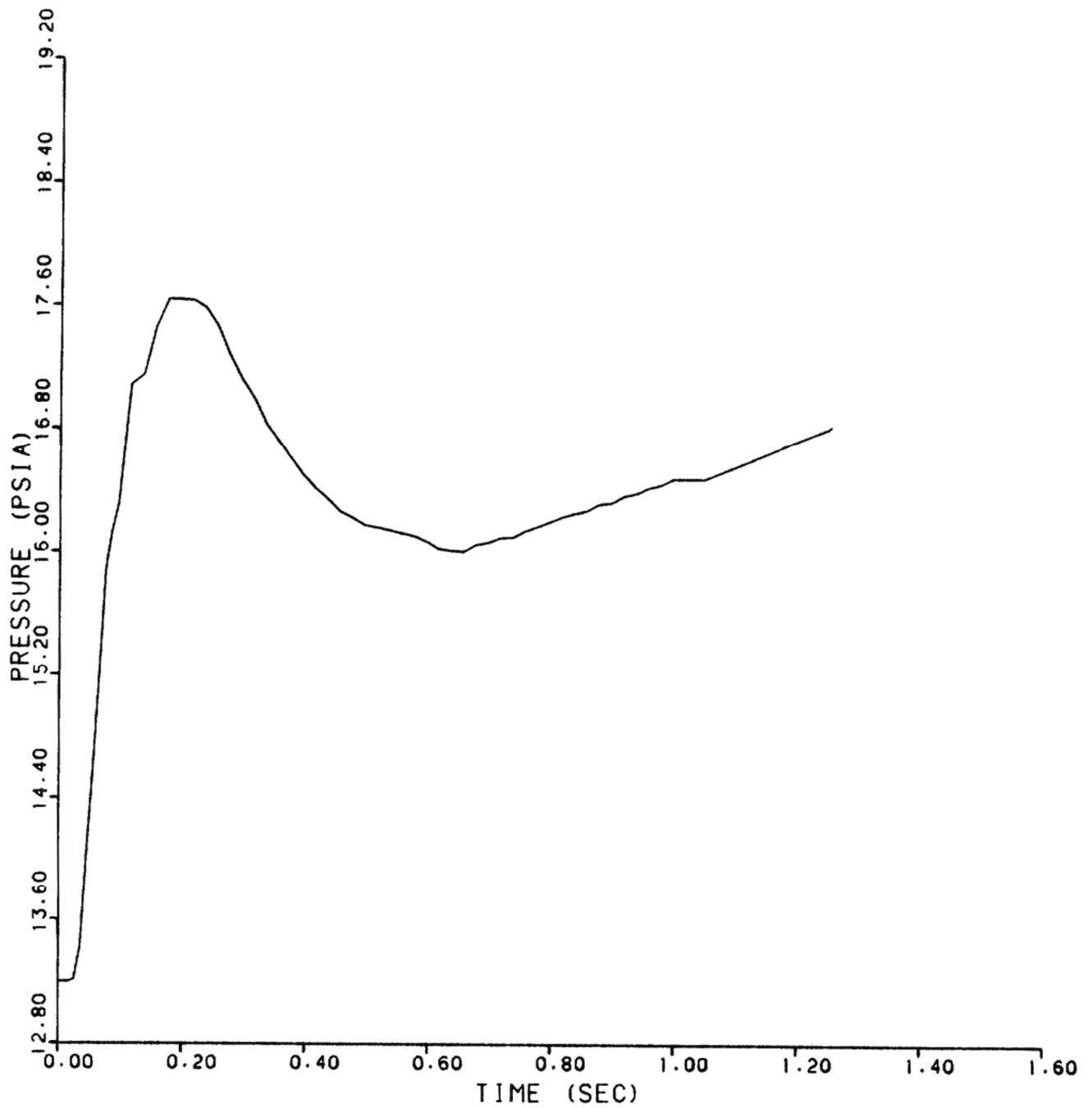

REV 13 4/06



VOGTLE
ELECTRIC GENERATING PLANT
UNIT 1 AND UNIT 2

STEAM GENERATOR INLET NOZZLE
NODE - E57
(306-in.² BREAK AREA)

FIGURE 6.2.1-19 (SHEET 57 OF 74)

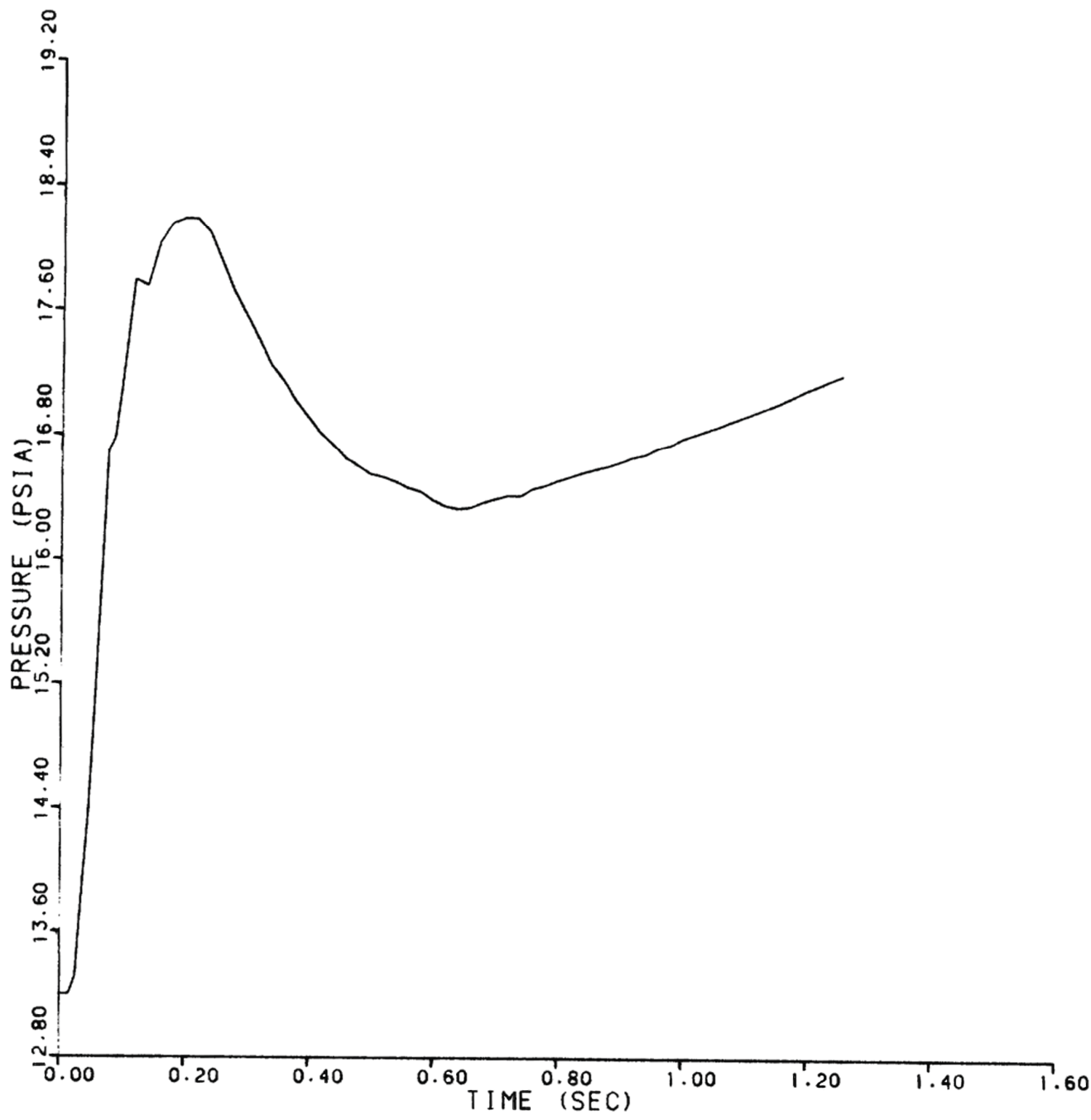

REV 13 4/06



VOGTLE
ELECTRIC GENERATING PLANT
UNIT 1 AND UNIT 2

STEAM GENERATOR INLET NOZZLE
NODE - E58
(306-in.² BREAK AREA)

FIGURE 6.2.1-19 (SHEET 58 OF 74)

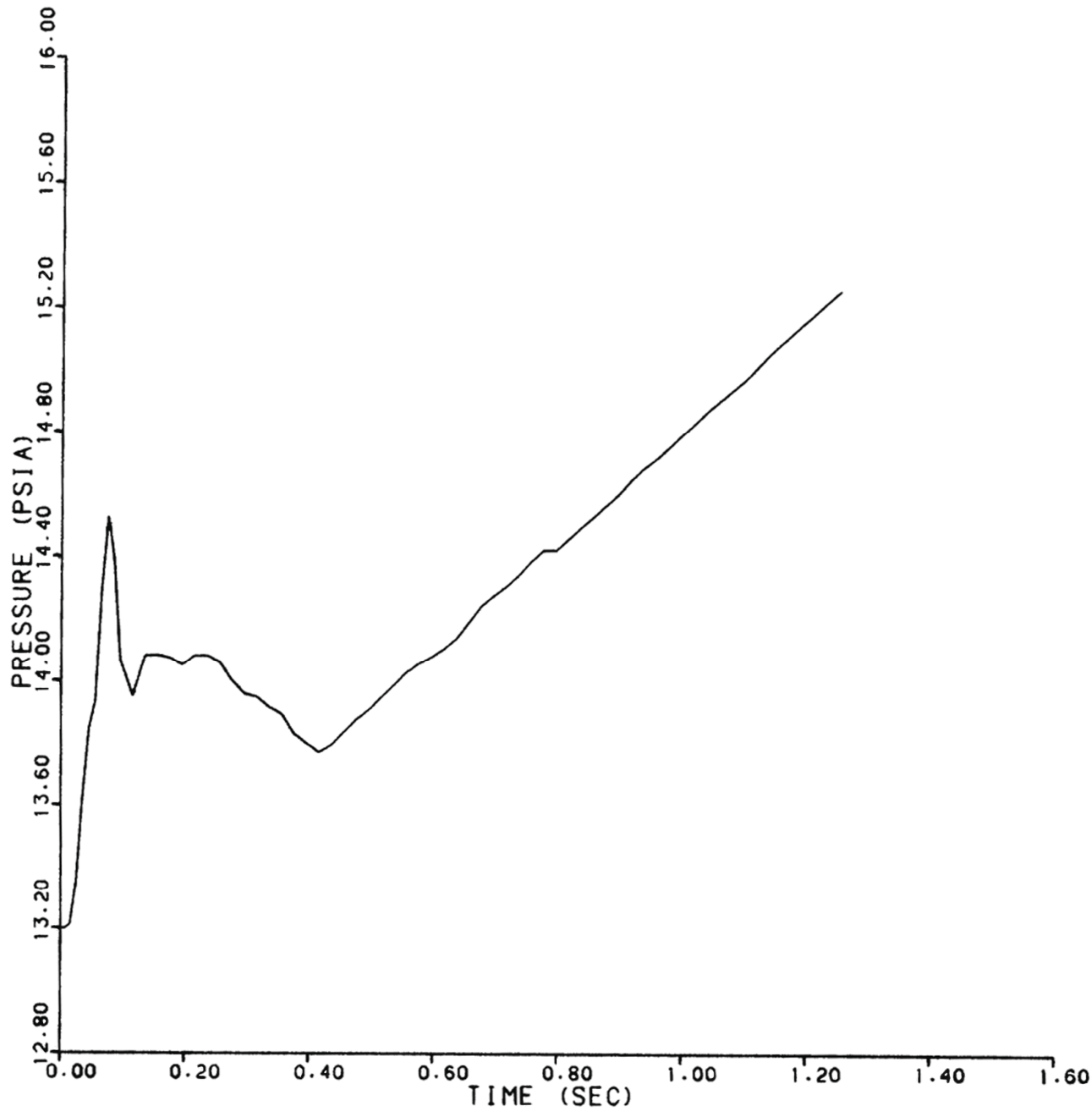

REV 13 4/06



VOGTLE
ELECTRIC GENERATING PLANT
UNIT 1 AND UNIT 2

STEAM GENERATOR INLET NOZZLE
NODE - E59
(306-in.² BREAK AREA)

FIGURE 6.2.1-19 (SHEET 59 OF 74)

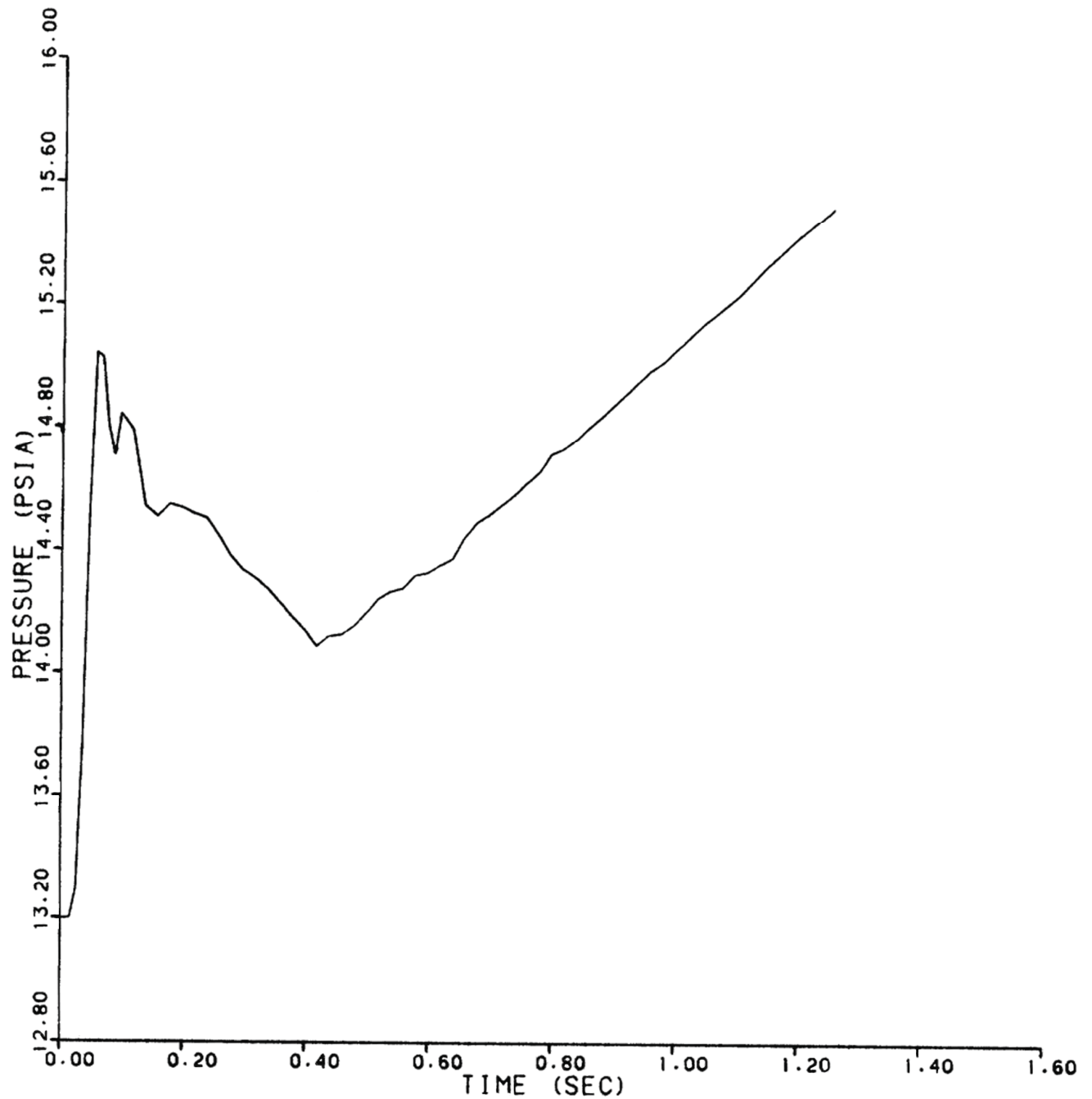

REV 13 4/06



VOGTLE
ELECTRIC GENERATING PLANT
UNIT 1 AND UNIT 2

STEAM GENERATOR INLET NOZZLE
NODE - E60
(306-in.² BREAK AREA)

FIGURE 6.2.1-19 (SHEET 60 OF 74)

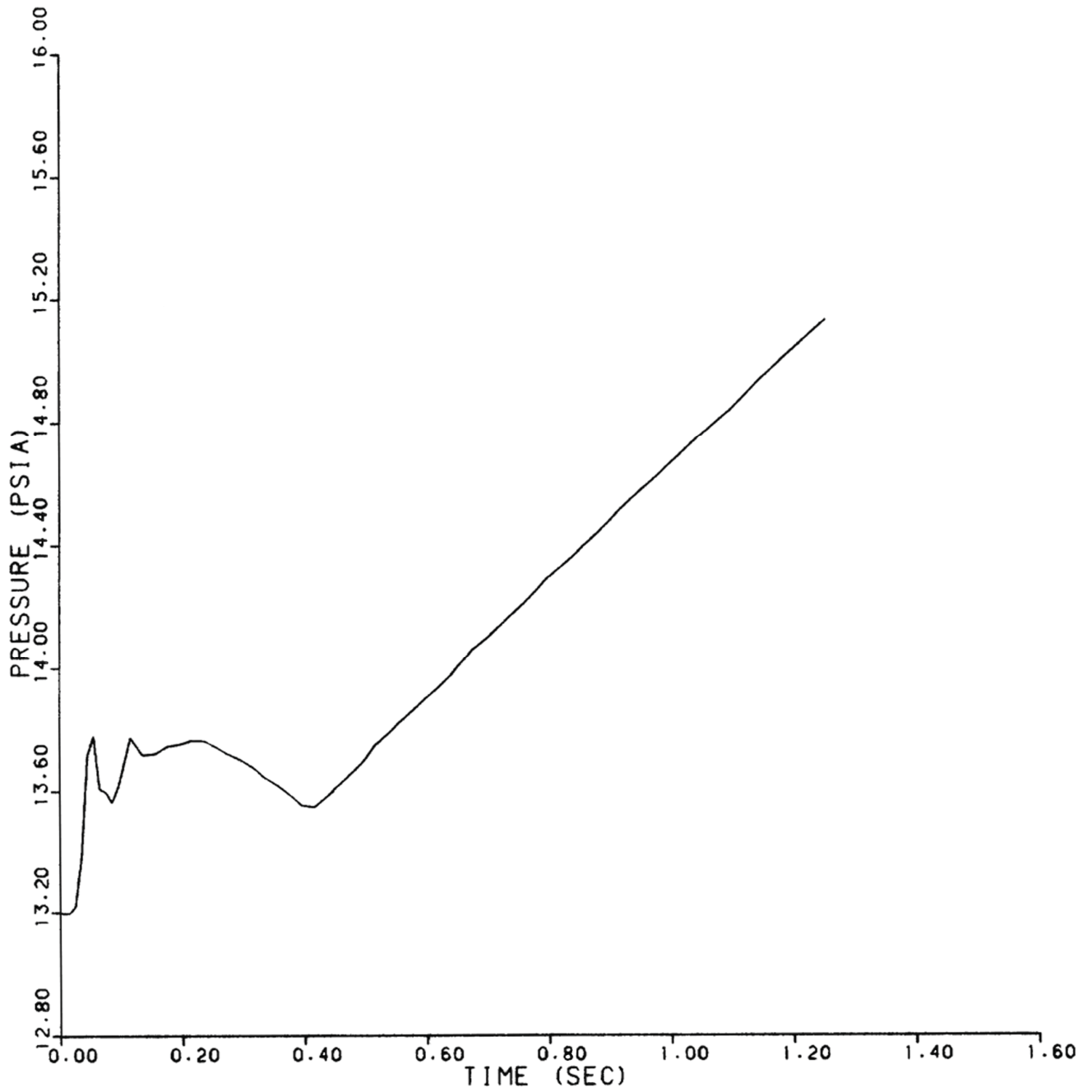

REV 13 4/06



VOGTLE
ELECTRIC GENERATING PLANT
UNIT 1 AND UNIT 2

STEAM GENERATOR INLET NOZZLE
NODE - E61
(306-in.² BREAK AREA)

FIGURE 6.2.1-19 (SHEET 61 OF 74)

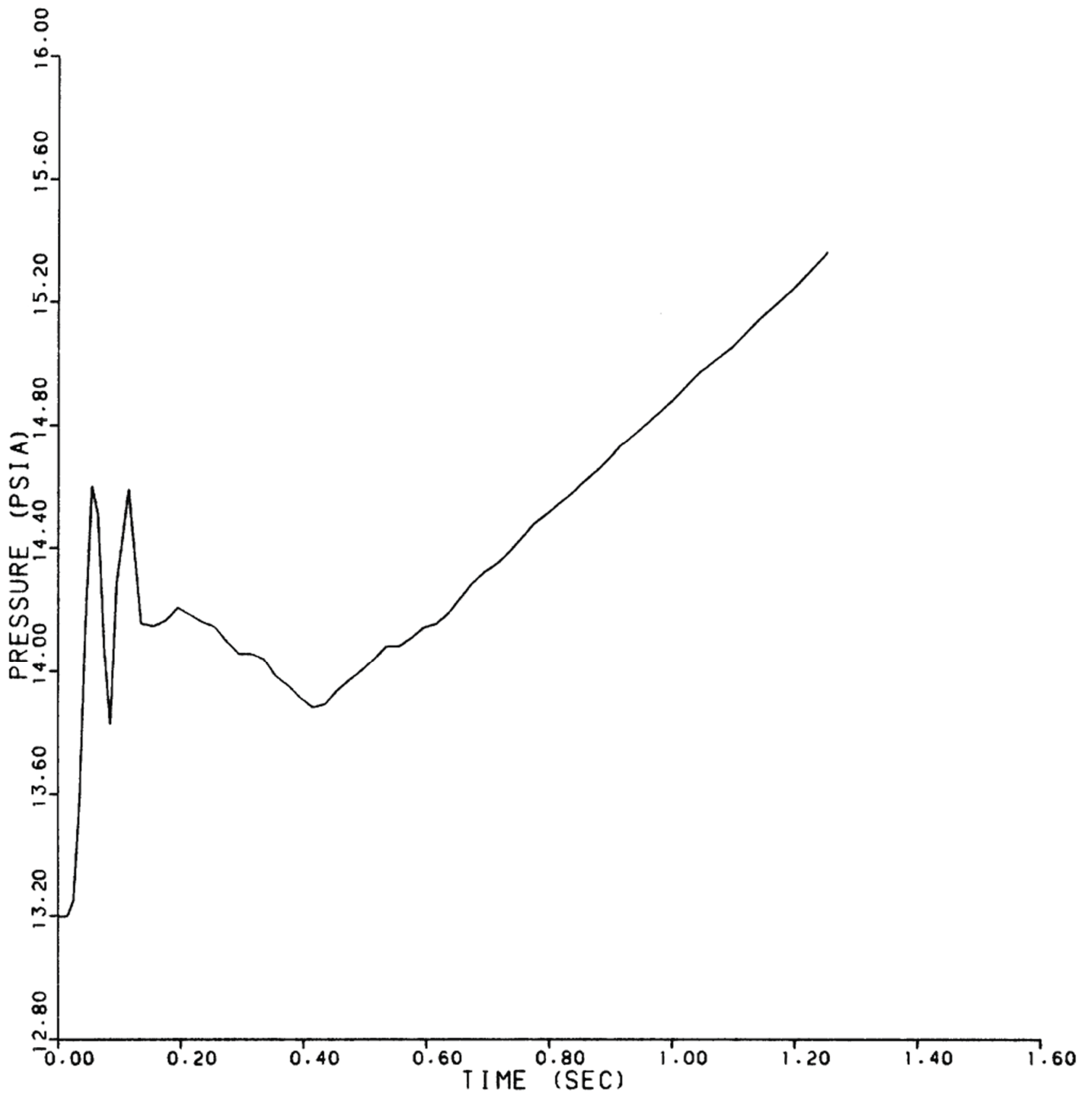

REV 13 4/06



VOGTLE
ELECTRIC GENERATING PLANT
UNIT 1 AND UNIT 2

STEAM GENERATOR INLET NOZZLE
NODE - E62
(306-in.² BREAK AREA)

FIGURE 6.2.1-19 (SHEET 62 OF 74)

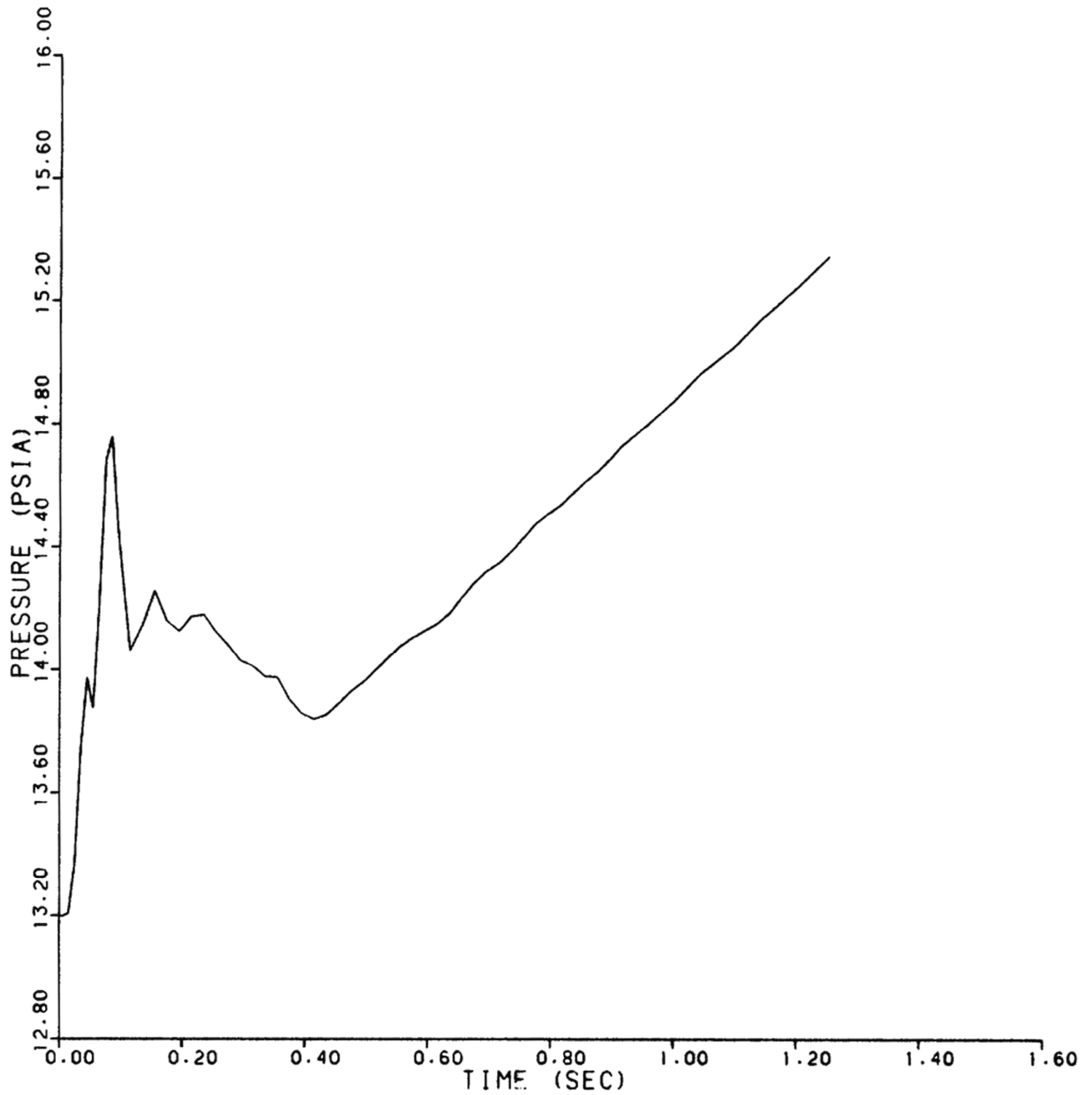

REV 13 4/06



VOGTLE
ELECTRIC GENERATING PLANT
UNIT 1 AND UNIT 2

STEAM GENERATOR INLET NOZZLE
NODE - E63
(306-in.² BREAK AREA)

FIGURE 6.2.1-19 (SHEET 63 OF 74)

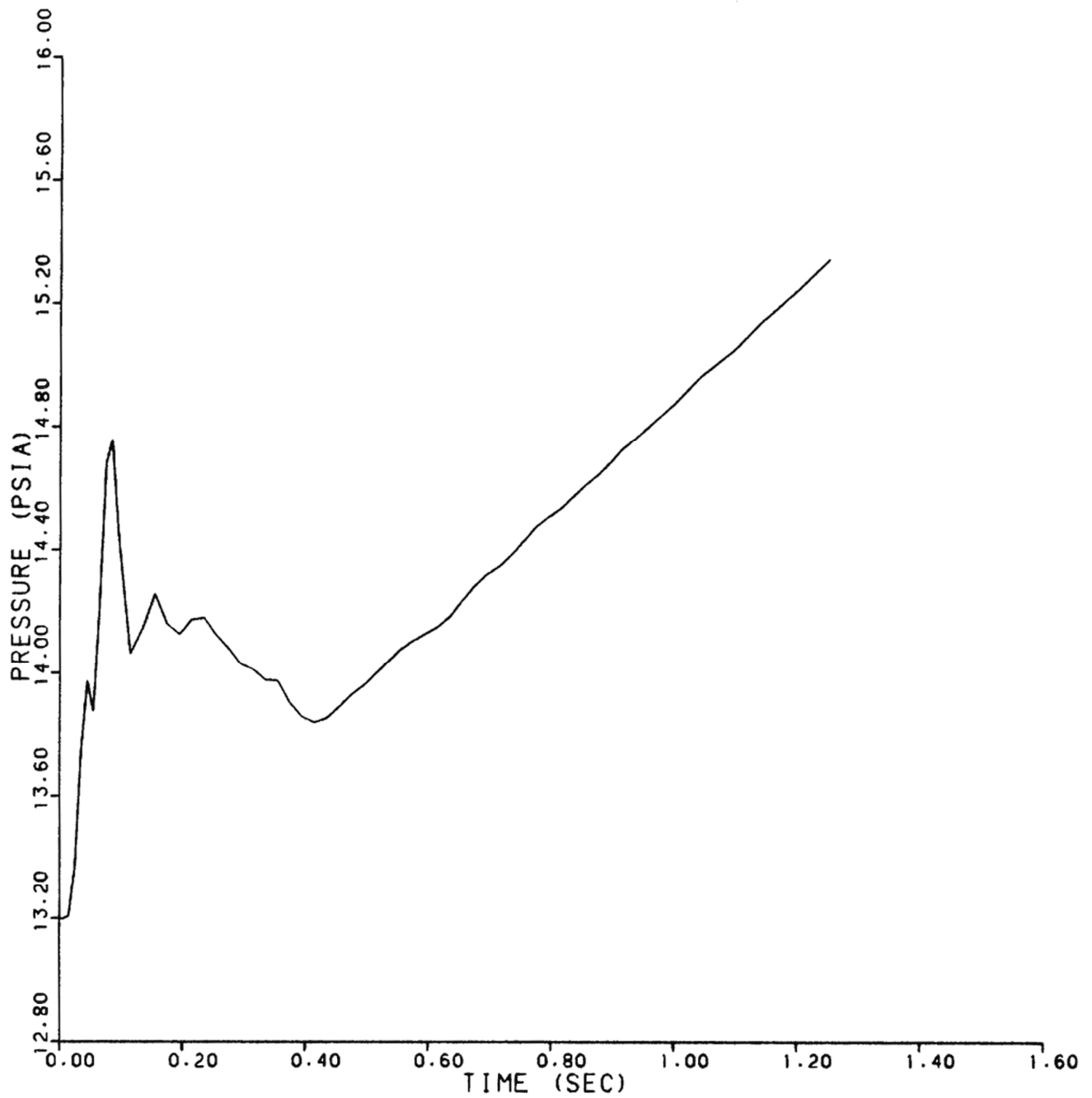

REV 13 4/06



VOGTLE
ELECTRIC GENERATING PLANT
UNIT 1 AND UNIT 2

STEAM GENERATOR INLET NOZZLE
NODE - E64
(306-in.² BREAK AREA)

FIGURE 6.2.1-19 (SHEET 64 OF 74)

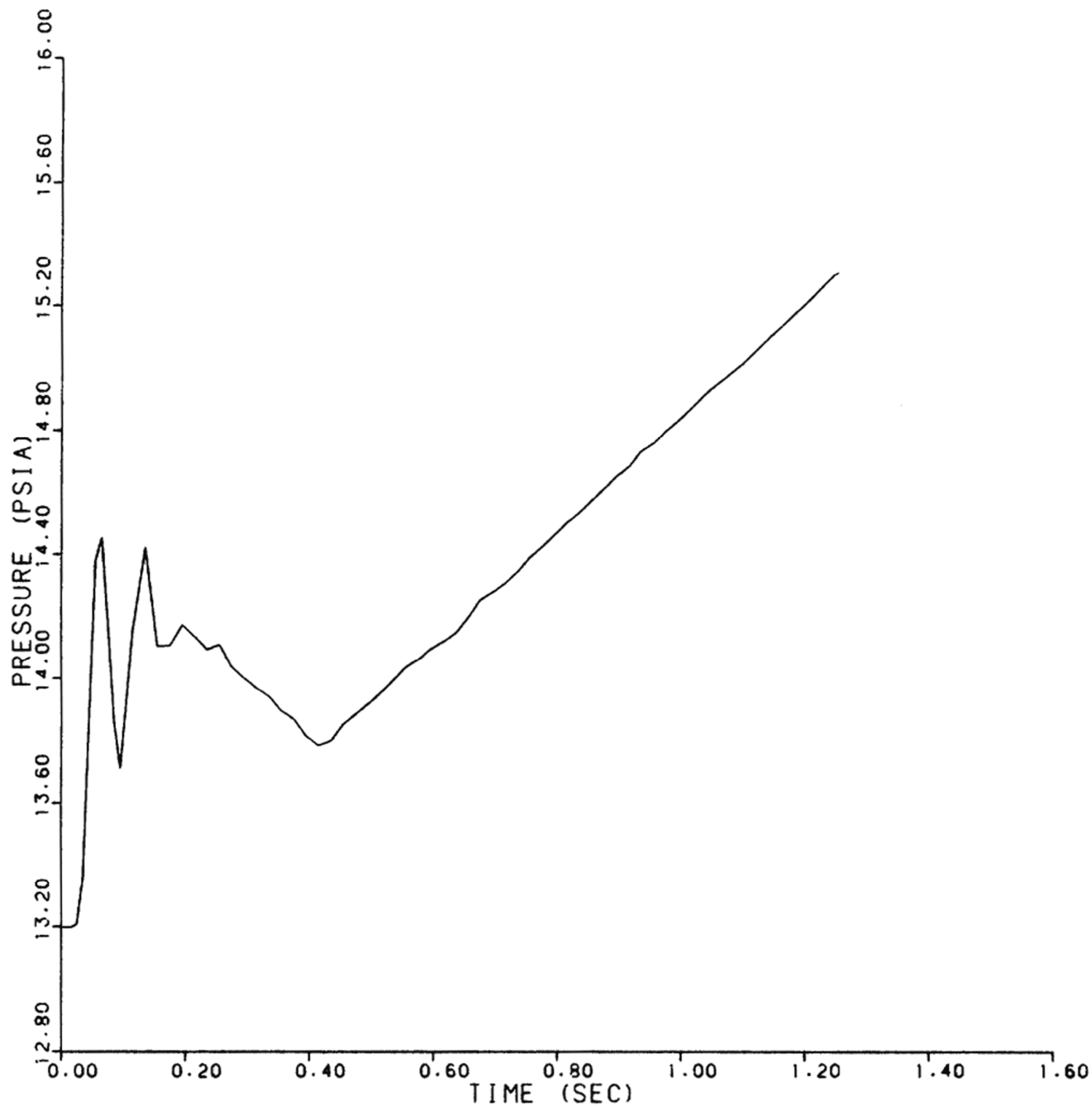

REV 13 4/06



VOGTLE
ELECTRIC GENERATING PLANT
UNIT 1 AND UNIT 2

STEAM GENERATOR INLET NOZZLE
NODE - E65
(306-in.² BREAK AREA)

FIGURE 6.2.1-19 (SHEET 65 OF 74)

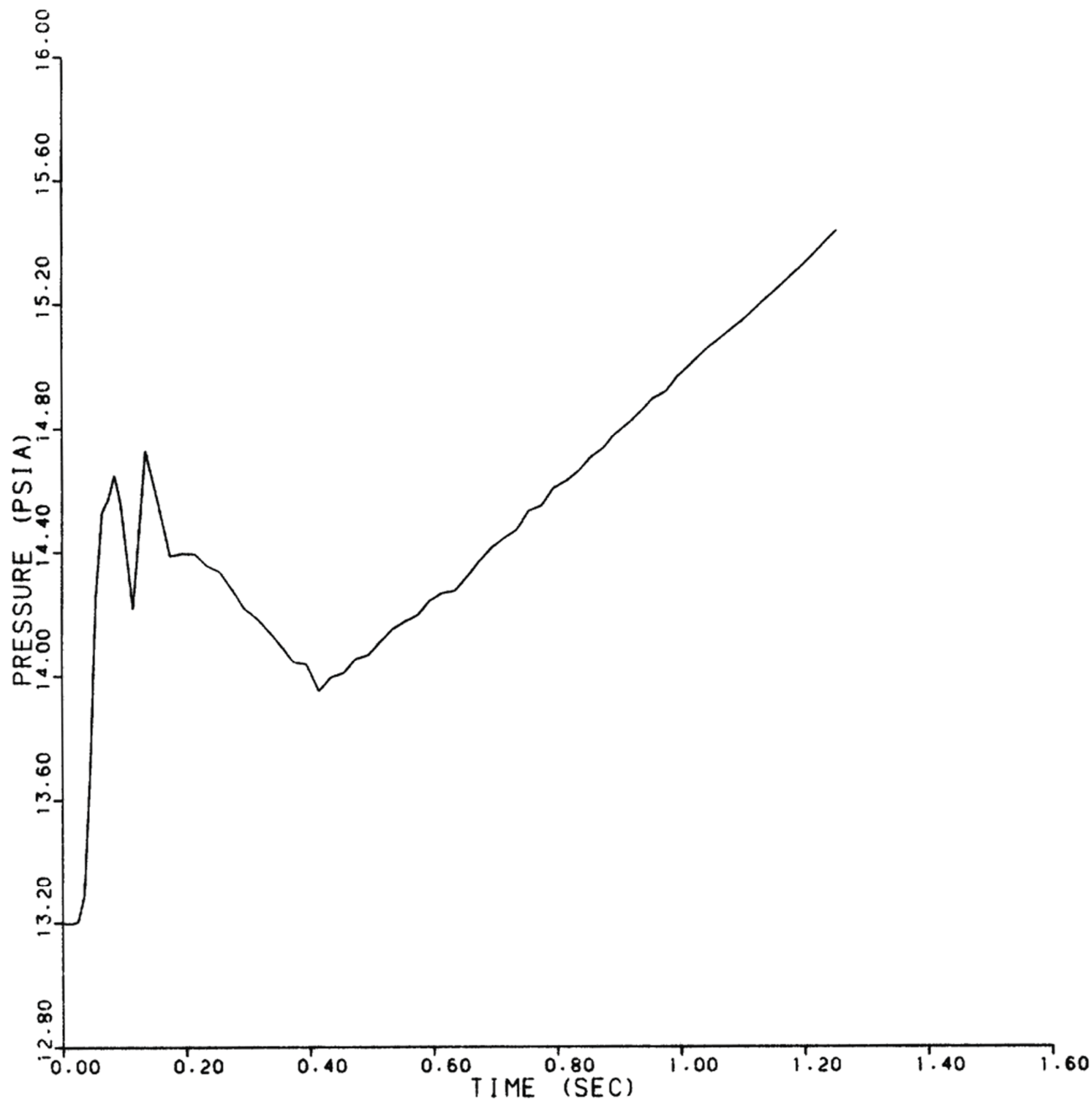

REV 13 4/06



VOGTLE
ELECTRIC GENERATING PLANT
UNIT 1 AND UNIT 2

STEAM GENERATOR INLET NOZZLE
NODE - E66
(306-in.² BREAK AREA)

FIGURE 6.2.1-19 (SHEET 66 OF 74)

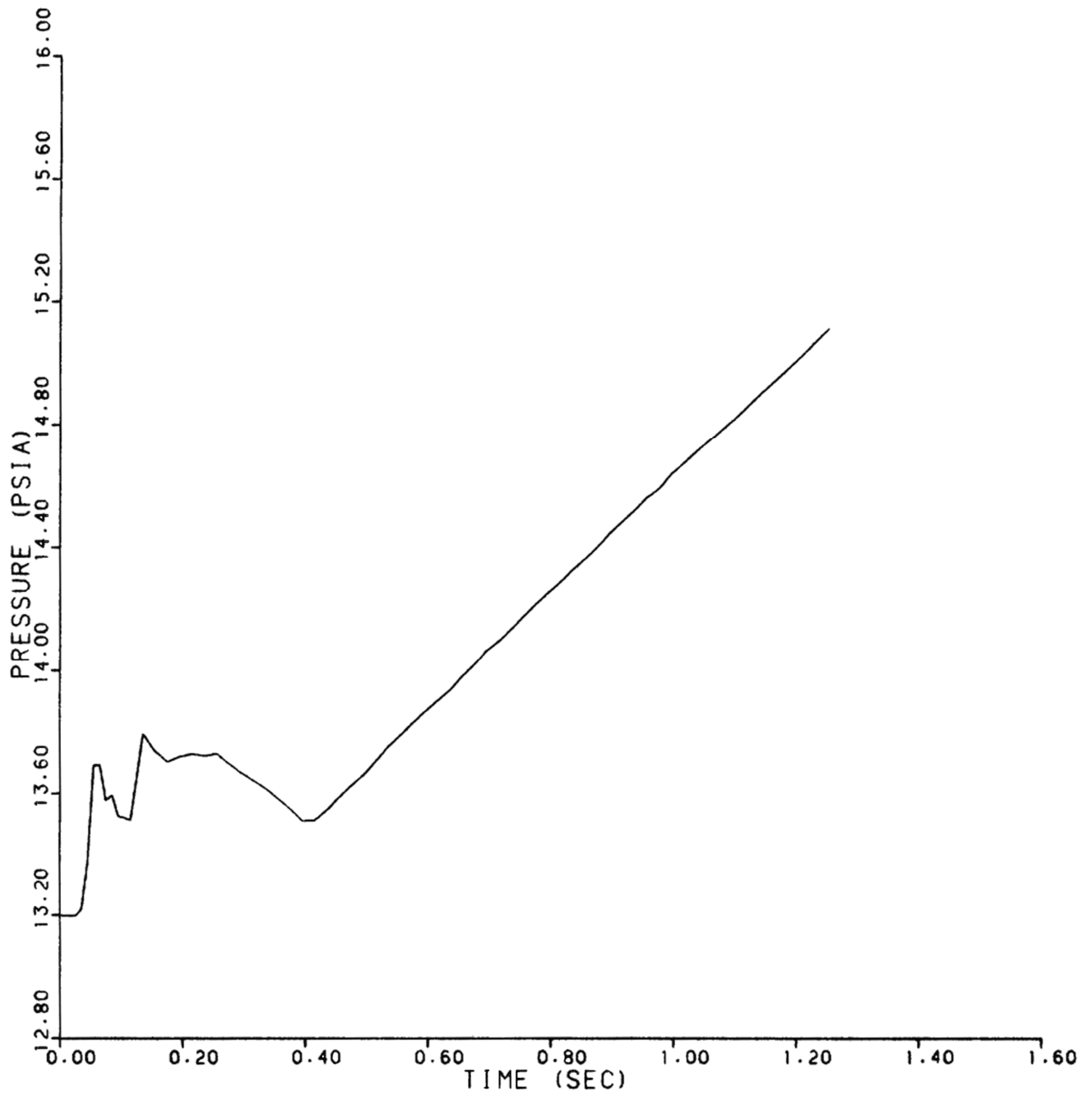

REV 13 4/06



VOGTLE
ELECTRIC GENERATING PLANT
UNIT 1 AND UNIT 2

STEAM GENERATOR INLET NOZZLE
NODE - E67
(306-in.² BREAK AREA)

FIGURE 6.2.1-19 (SHEET 67 OF 74)

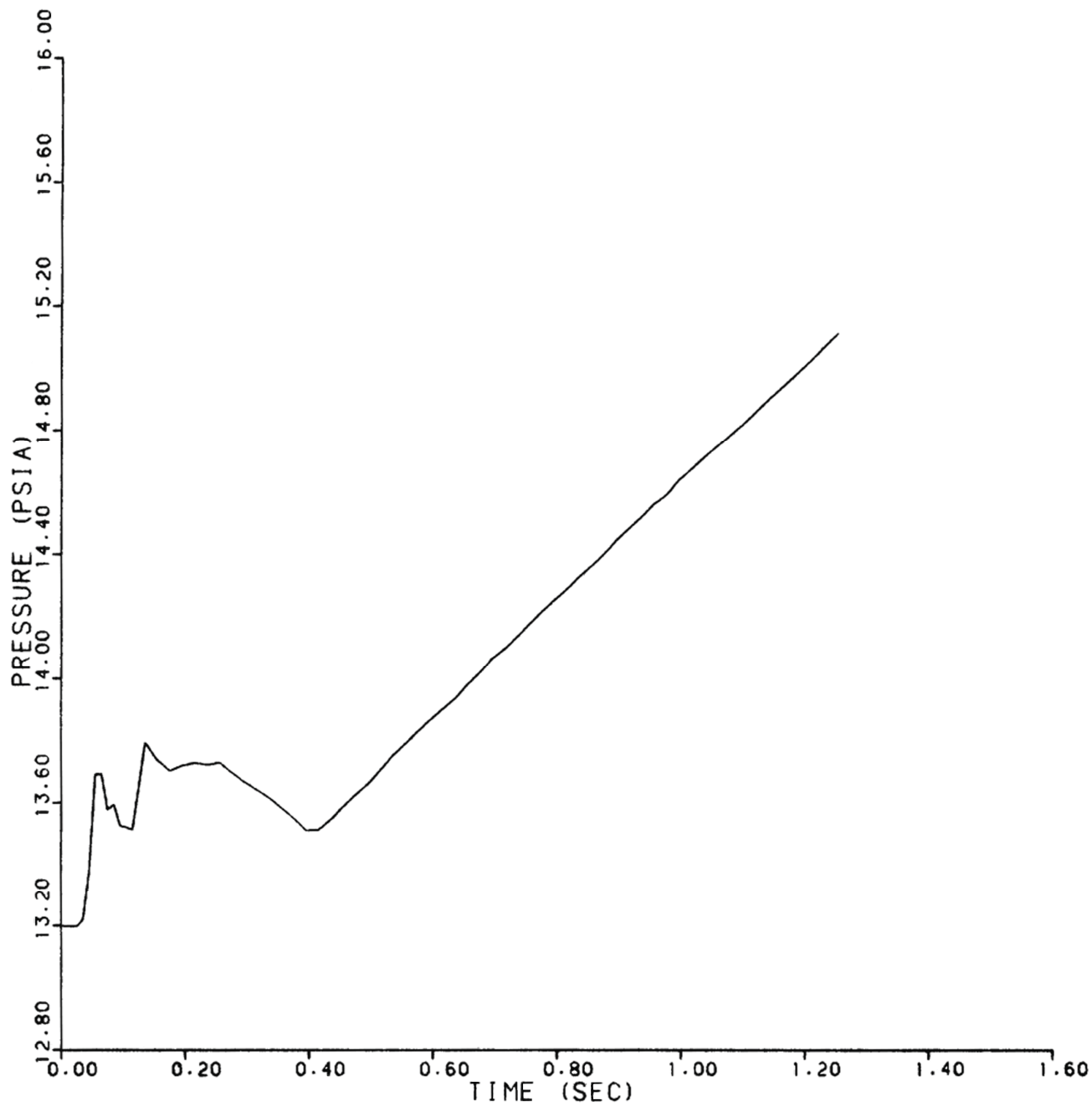

REV 13 4/06

STEAM GENERATOR INLET NOZZLE
 NODE - E68
 (306-in.² BREAK AREA)

FIGURE 6.2.1-19 (SHEET 68 OF 74)



VOGTLE
 ELECTRIC GENERATING PLANT
 UNIT 1 AND UNIT 2

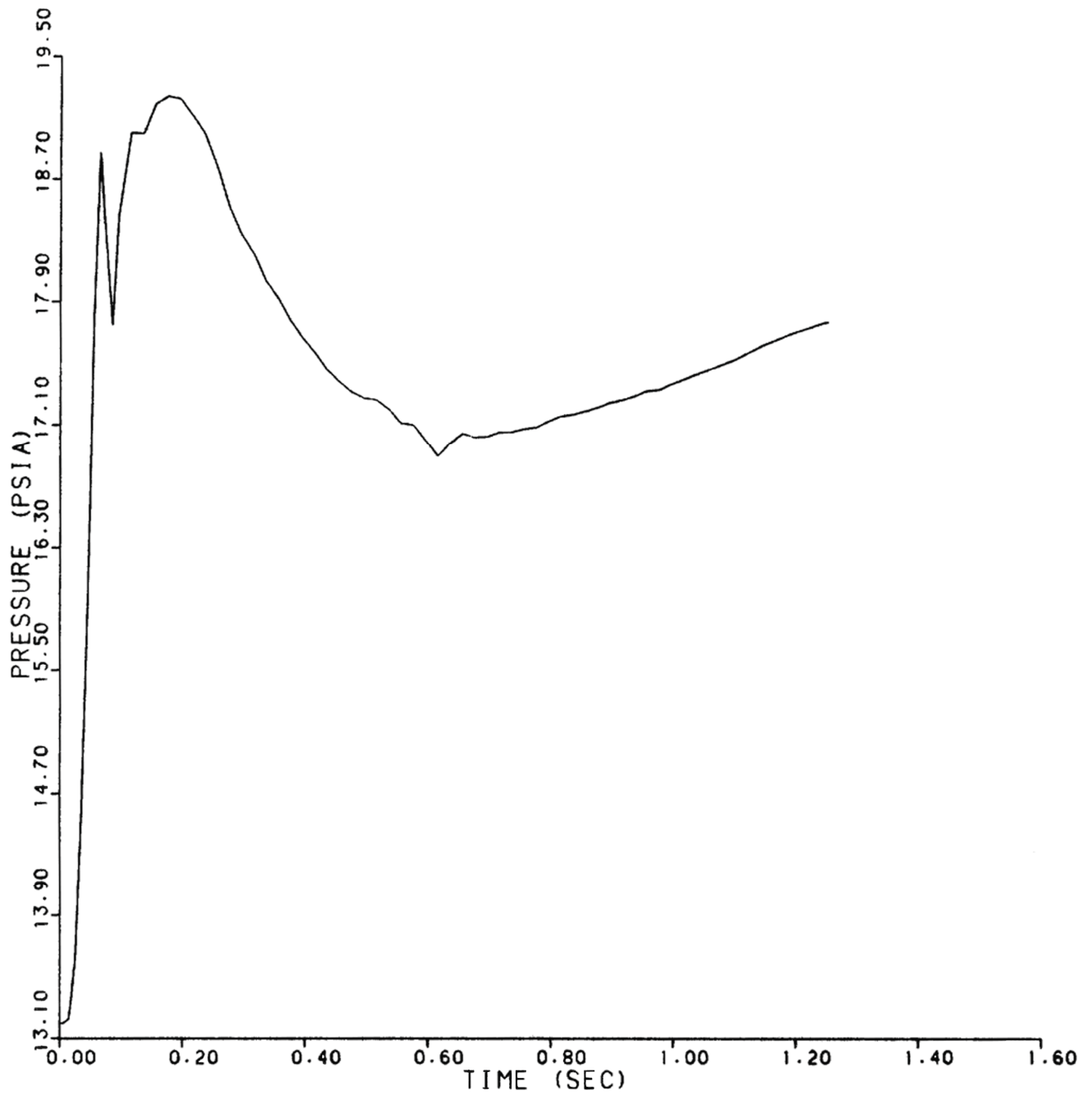

REV 13 4/06



VOGTLE
ELECTRIC GENERATING PLANT
UNIT 1 AND UNIT 2

STEAM GENERATOR INLET NOZZLE
NODE - E69
(306-in.² BREAK AREA)

FIGURE 6.2.1-19 (SHEET 69 OF 74)

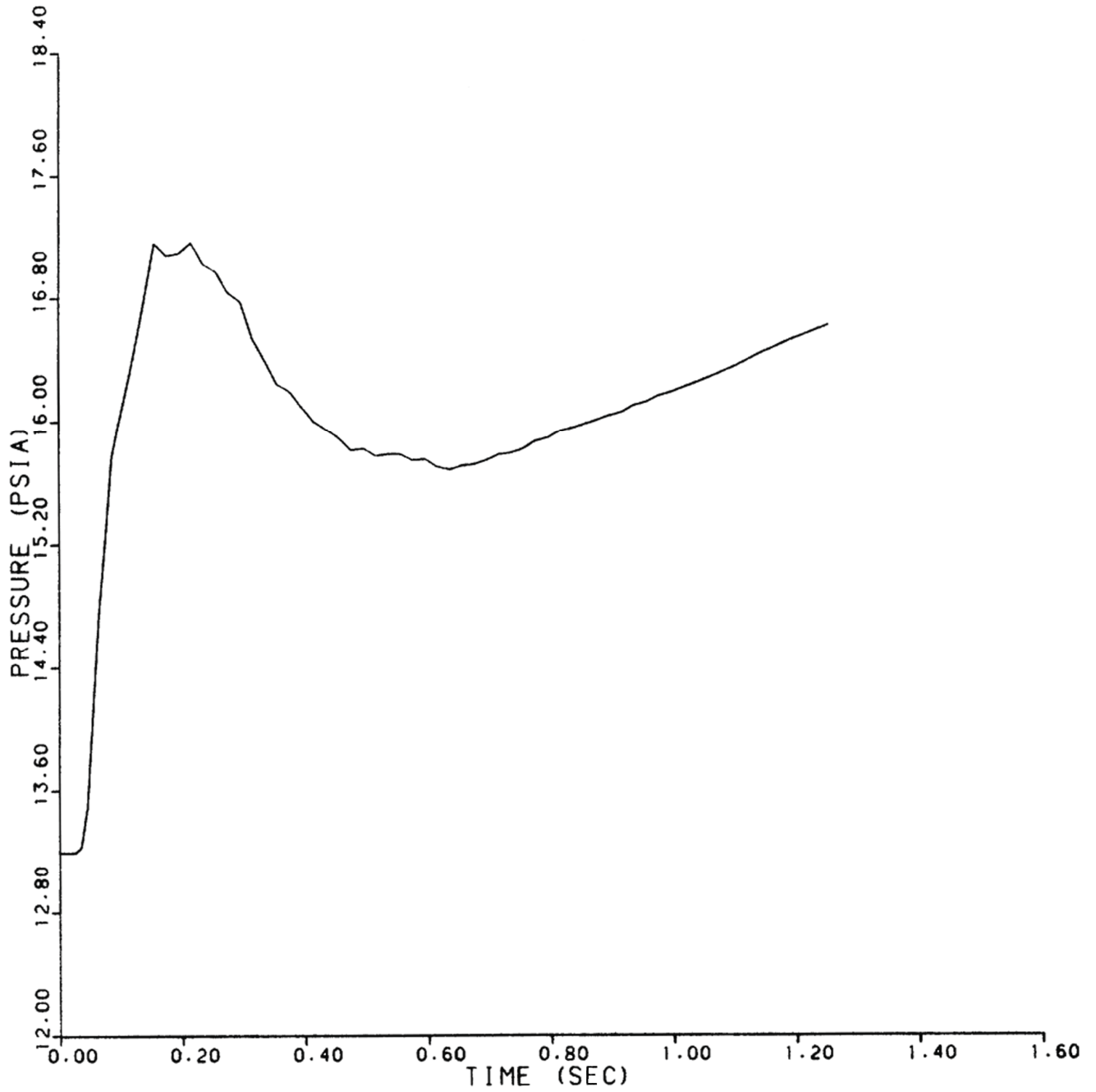

REV 13 4/06



VOGTLE
ELECTRIC GENERATING PLANT
UNIT 1 AND UNIT 2

STEAM GENERATOR INLET NOZZLE
NODE - E70
(306-in.² BREAK AREA)

FIGURE 6.2.1-19 (SHEET 70 OF 74)

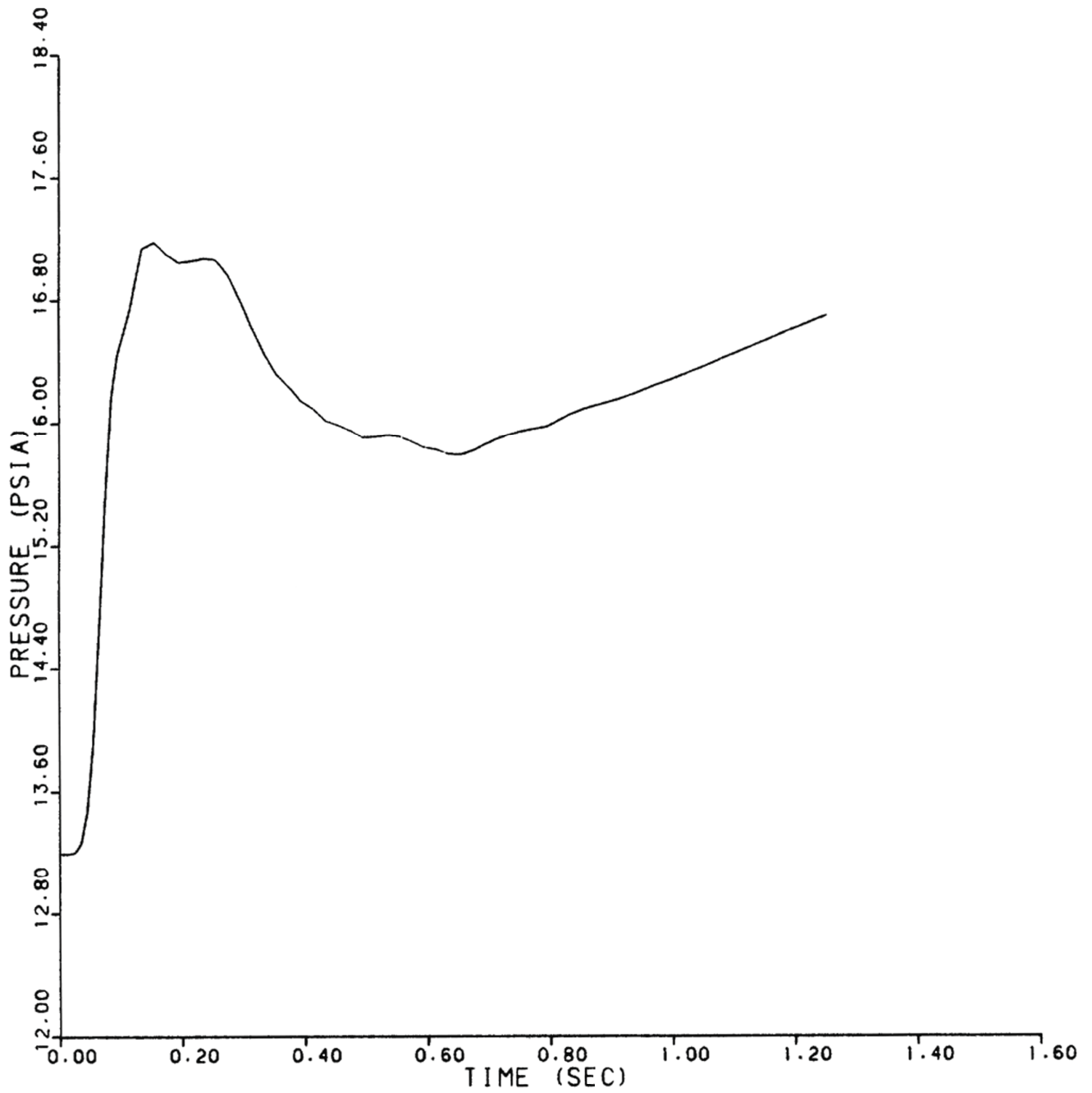

REV 13 4/06



VOGTLE
ELECTRIC GENERATING PLANT
UNIT 1 AND UNIT 2

STEAM GENERATOR INLET NOZZLE
NODE - E71
(306-in.² BREAK AREA)

FIGURE 6.2.1-19 (SHEET 71 OF 74)

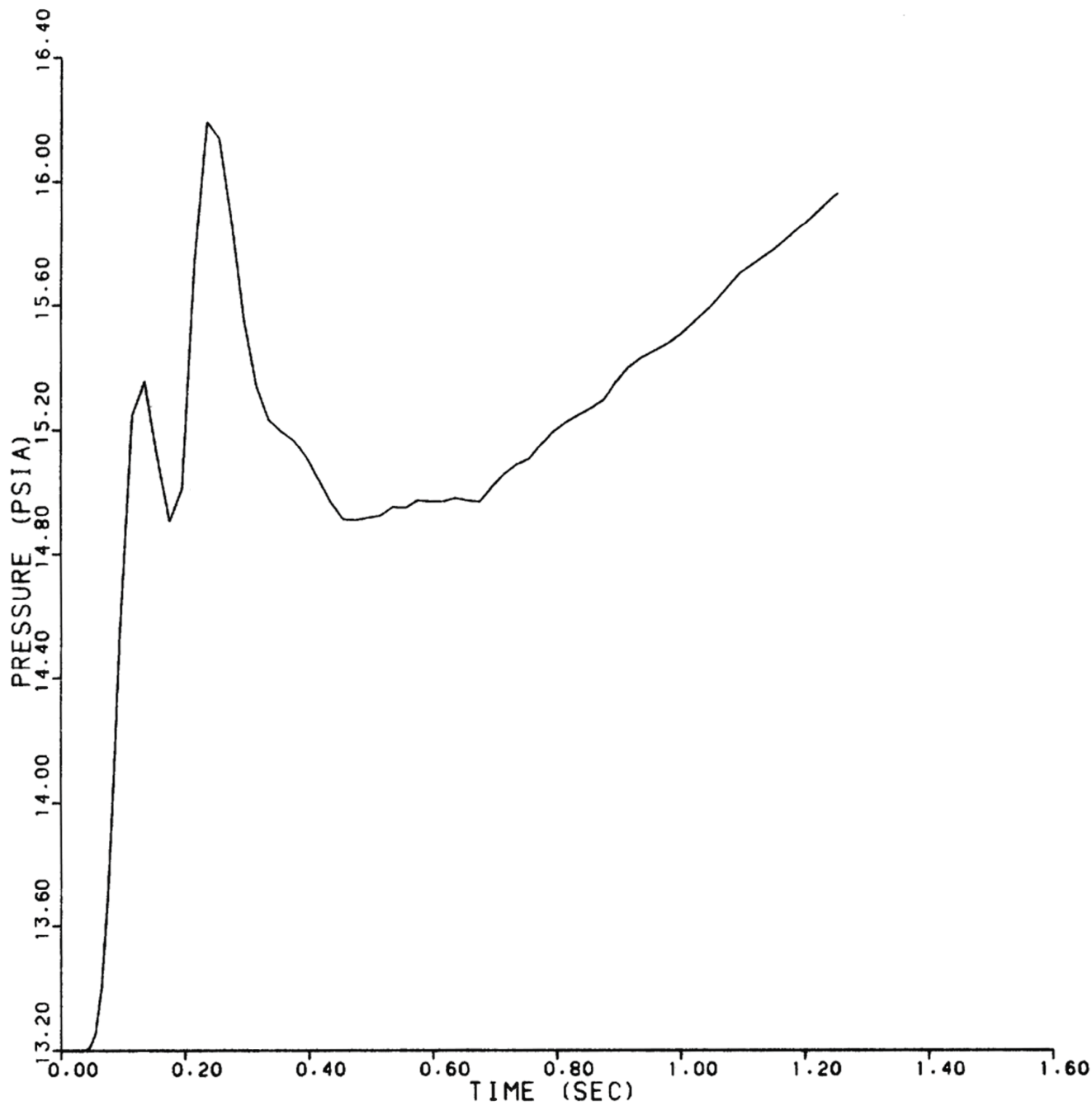

REV 13 4/06



VOGTLE
ELECTRIC GENERATING PLANT
UNIT 1 AND UNIT 2

STEAM GENERATOR INLET NOZZLE
NODE - E72
(306-in.² BREAK AREA)

FIGURE 6.2.1-19 (SHEET 72 OF 74)

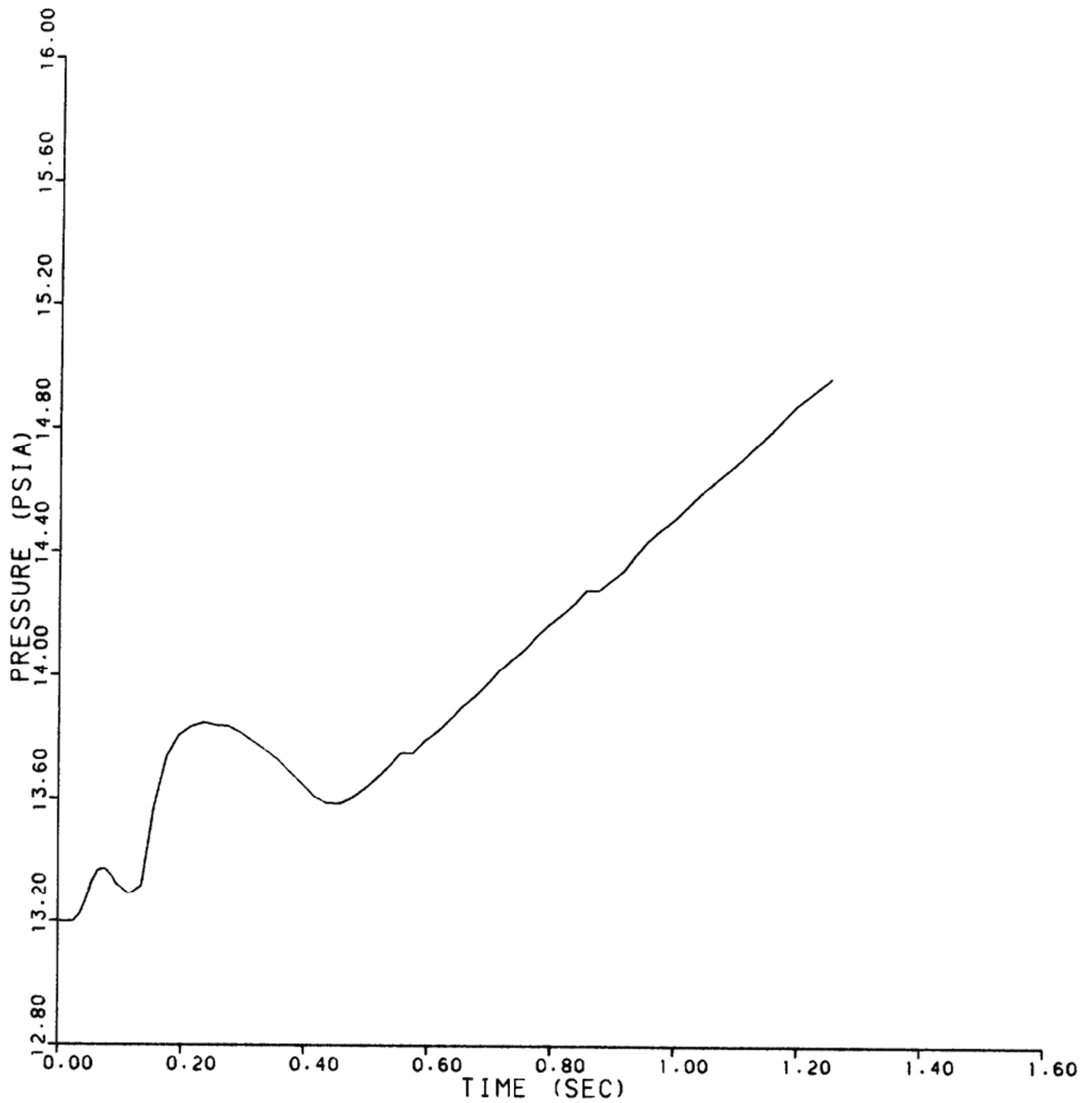

REV 13 4/06



VOGTLE
ELECTRIC GENERATING PLANT
UNIT 1 AND UNIT 2

STEAM GENERATOR INLET NOZZLE
NODE - E73
(306-in.² BREAK AREA)

FIGURE 6.2.1-19 (SHEET 73 OF 74)

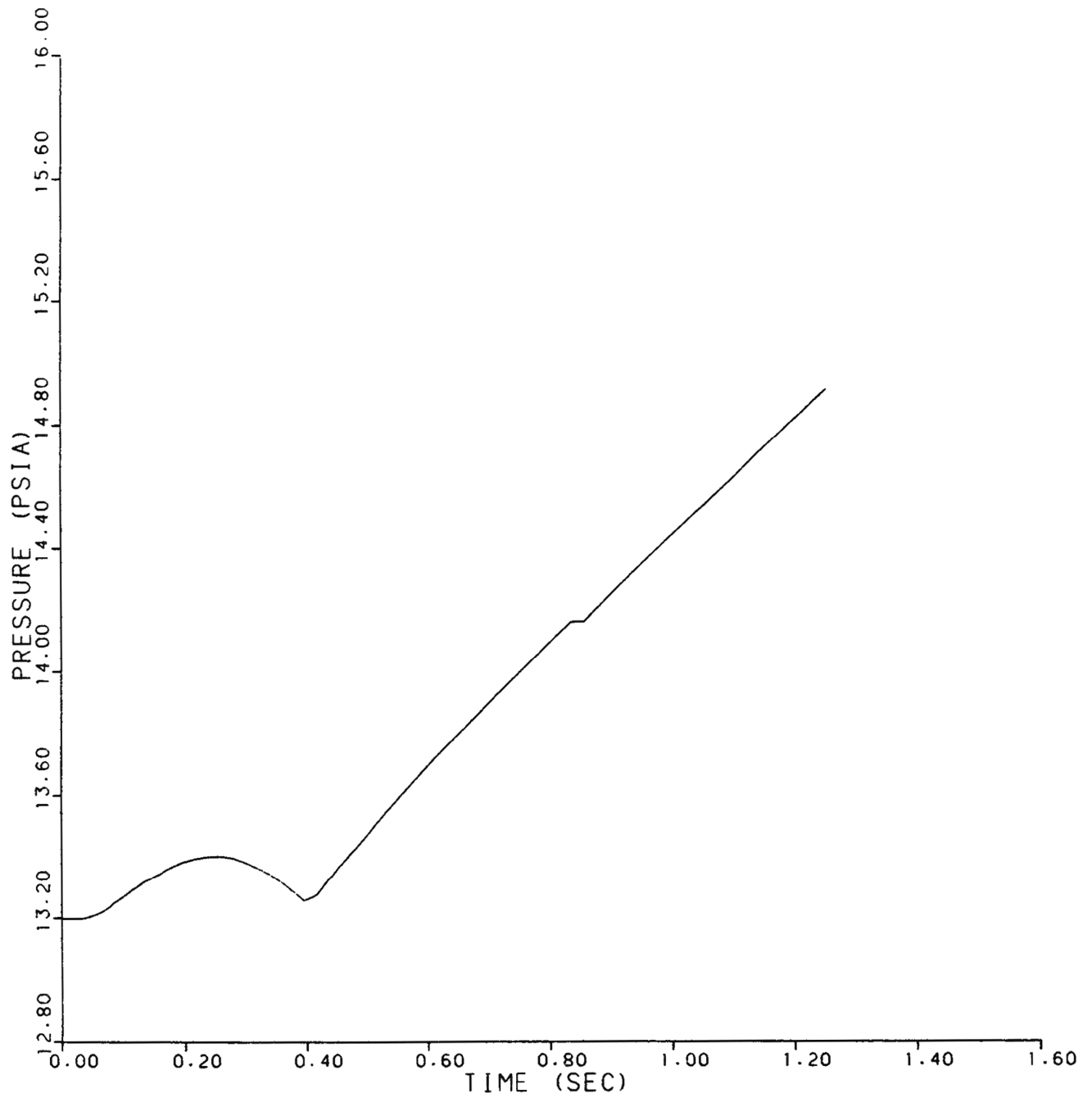

REV 13 4/06



VOGTLE
ELECTRIC GENERATING PLANT
UNIT 1 AND UNIT 2

STEAM GENERATOR INLET NOZZLE
NODE - E74
(306-in.² BREAK AREA)

FIGURE 6.2.1-19 (SHEET 74 OF 74)

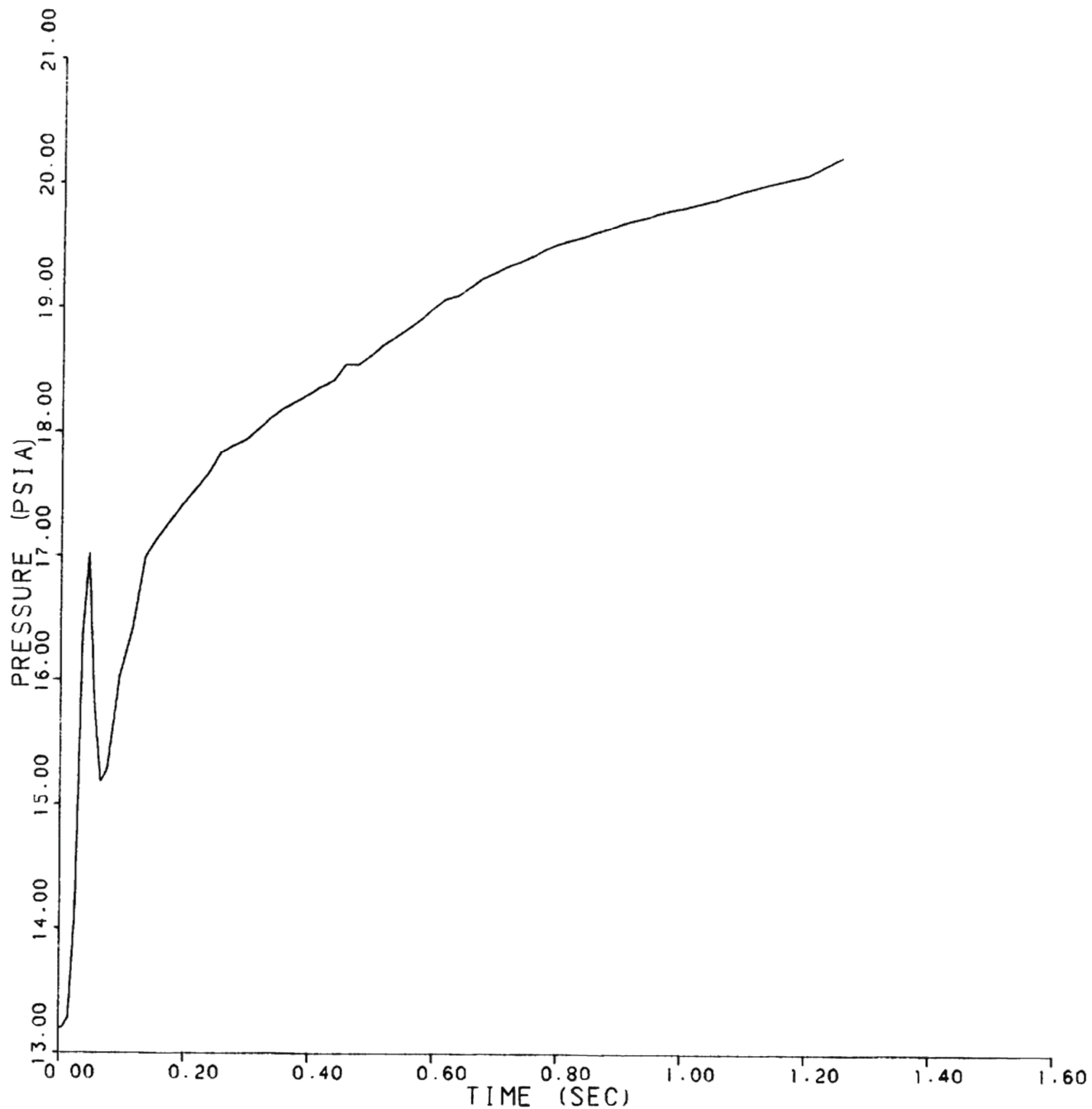

REV 13 4/06



VOGTLE
ELECTRIC GENERATING PLANT
UNIT 1 AND UNIT 2

REACTOR COOLANT PUMP
INLET NOZZLE - NODE E1
(336-in.² BREAK AREA)

FIGURE 6.2.1-20 (SHEET 1 OF 74)

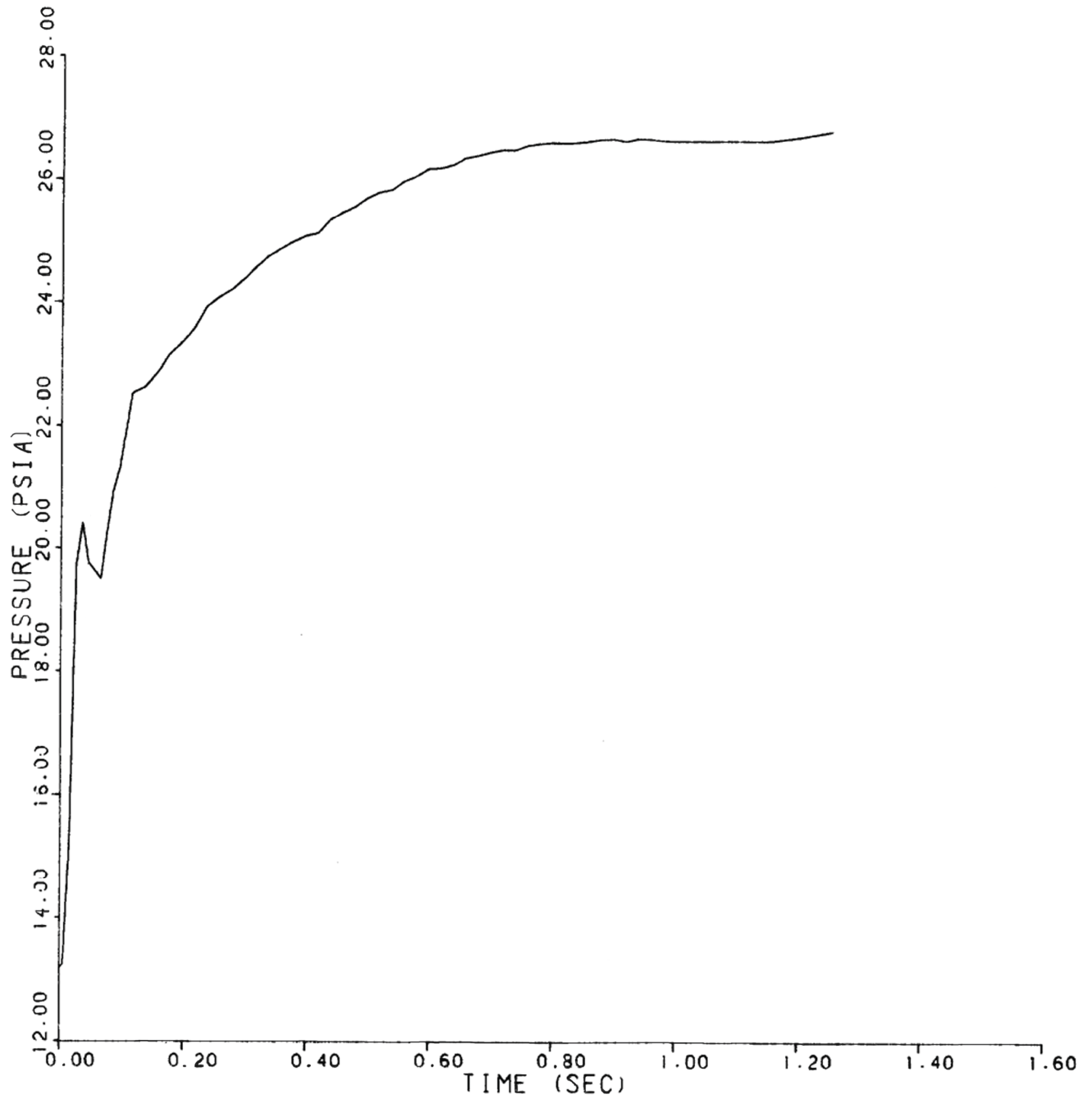

REV 13 4/06



VOGTLE
ELECTRIC GENERATING PLANT
UNIT 1 AND UNIT 2

REACTOR COOLANT PUMP
INLET NOZZLE - NODE E2
(336-in.² BREAK AREA)

FIGURE 6.2.1-20 (SHEET 2 OF 74)

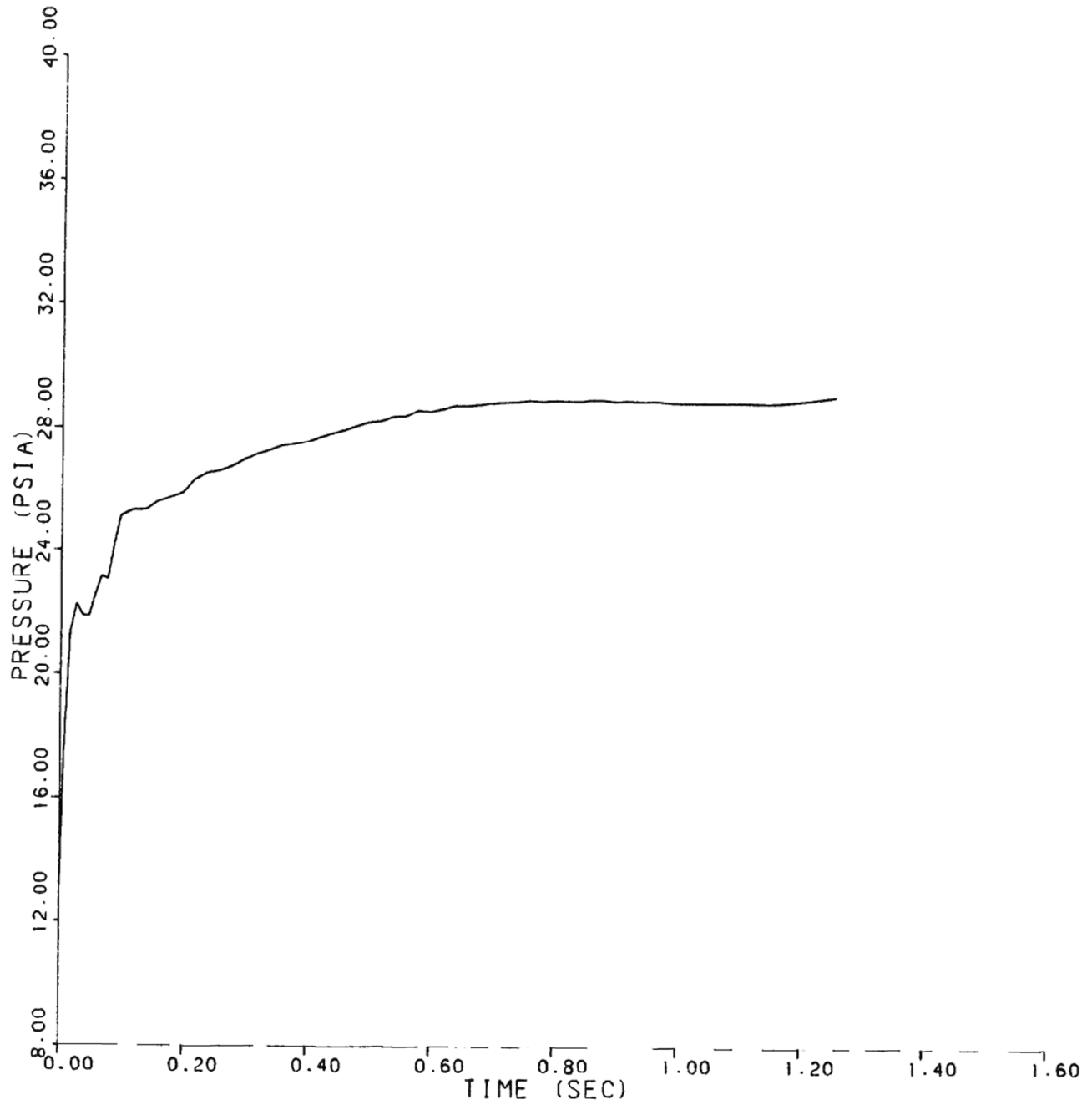

REV 13 4/06



VOGTLE
ELECTRIC GENERATING PLANT
UNIT 1 AND UNIT 2

REACTOR COOLANT PUMP
INLET NOZZLE - NODE E3
(336-in.² BREAK AREA)

FIGURE 6.2.1-20 (SHEET 3 OF 74)

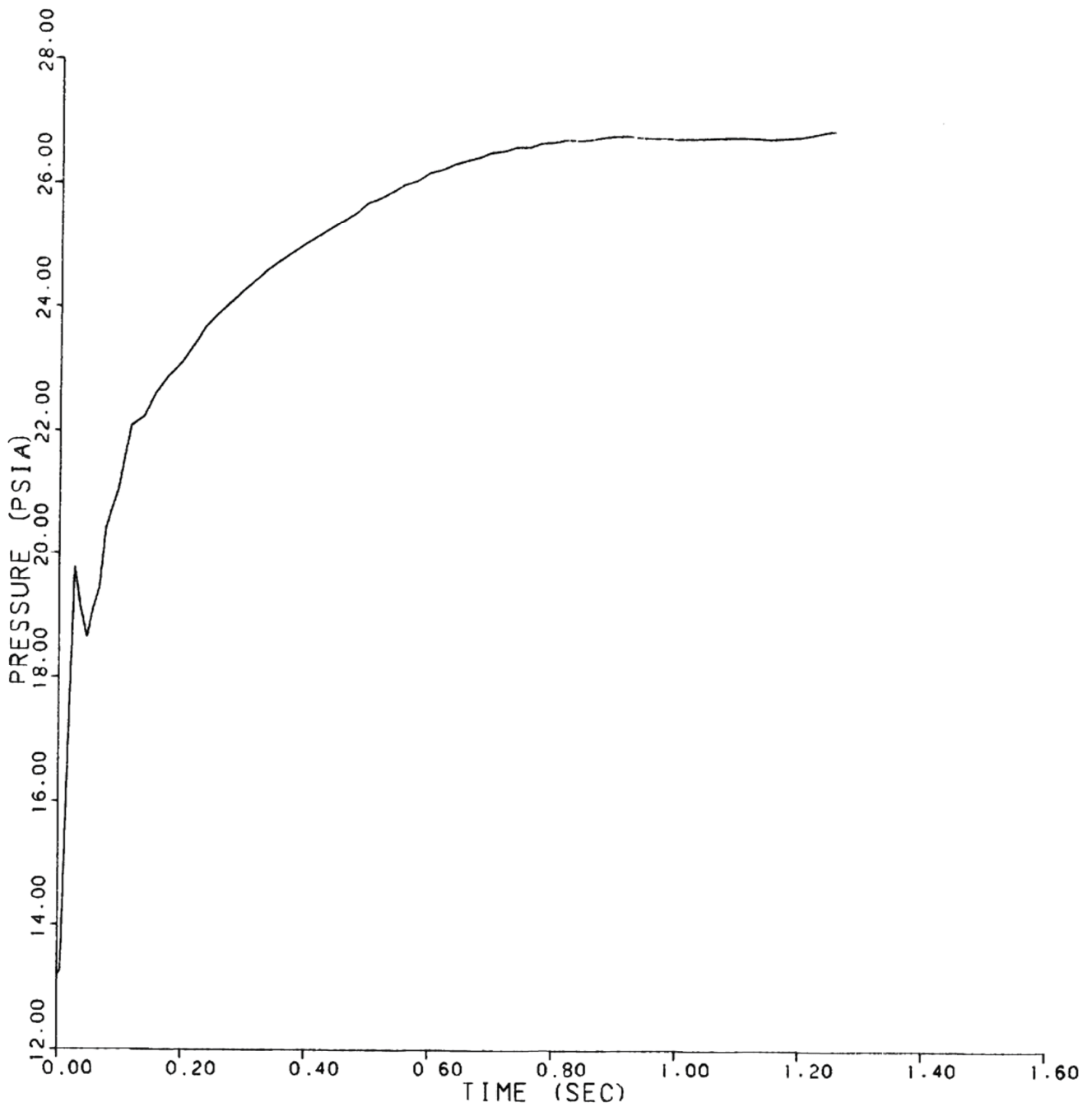

REV 13 4/06



VOGTLE
ELECTRIC GENERATING PLANT
UNIT 1 AND UNIT 2

REACTOR COOLANT PUMP
INLET NOZZLE - NODE E4
(336-in.² BREAK AREA)

FIGURE 6.2.1-20 (SHEET 4 OF 74)

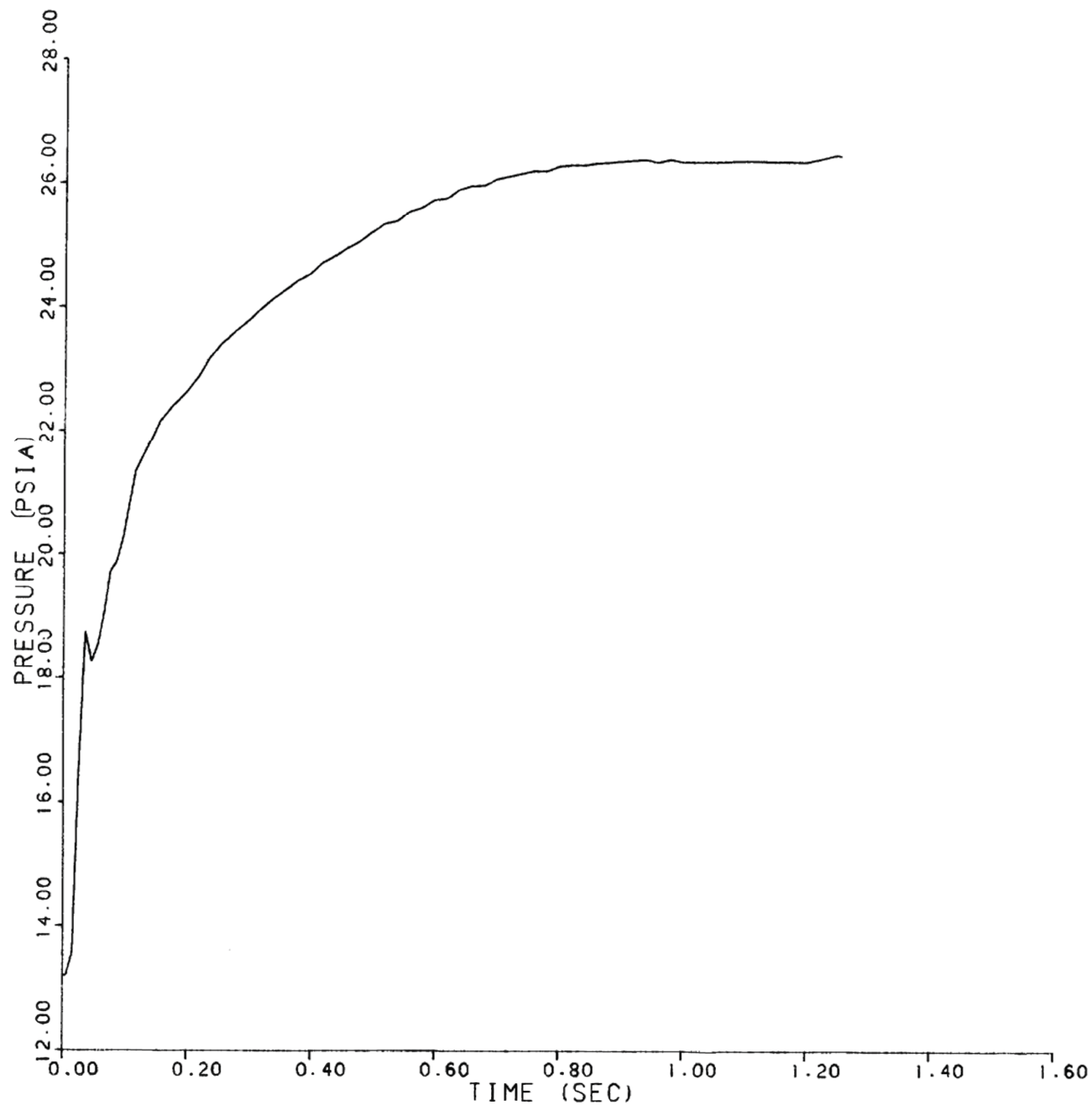

REV 13 4/06



VOGTLE
ELECTRIC GENERATING PLANT
UNIT 1 AND UNIT 2

REACTOR COOLANT PUMP
INLET NOZZLE - NODE E5
(336-in.² BREAK AREA)

FIGURE 6.2.1-20 (SHEET 5 OF 74)

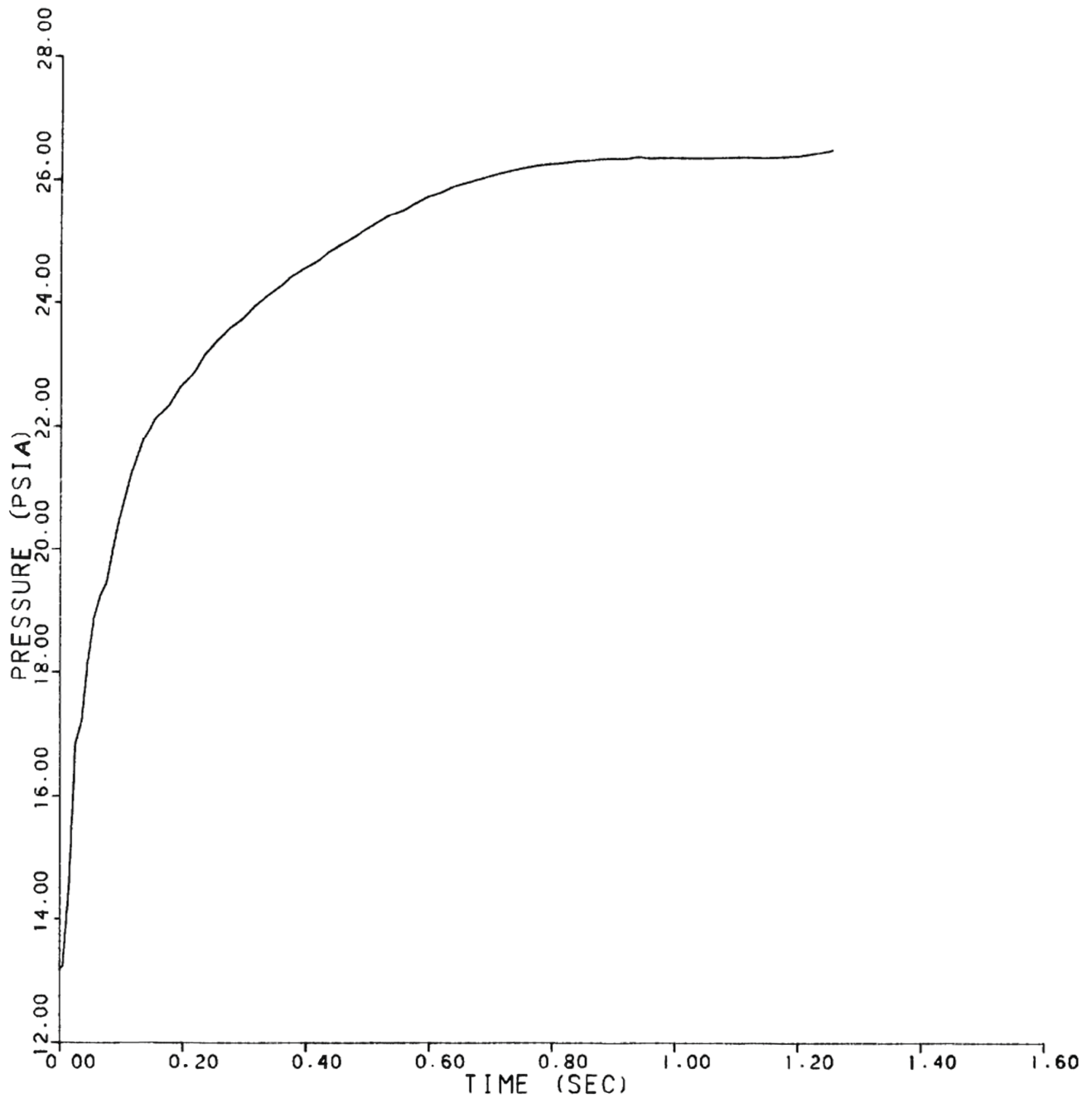

REV 13 4/06



VOGTLE
ELECTRIC GENERATING PLANT
UNIT 1 AND UNIT 2

REACTOR COOLANT PUMP
INLET NOZZLE - NODE E6
(336-in.² BREAK AREA)

FIGURE 6.2.1-20 (SHEET 6 OF 74)

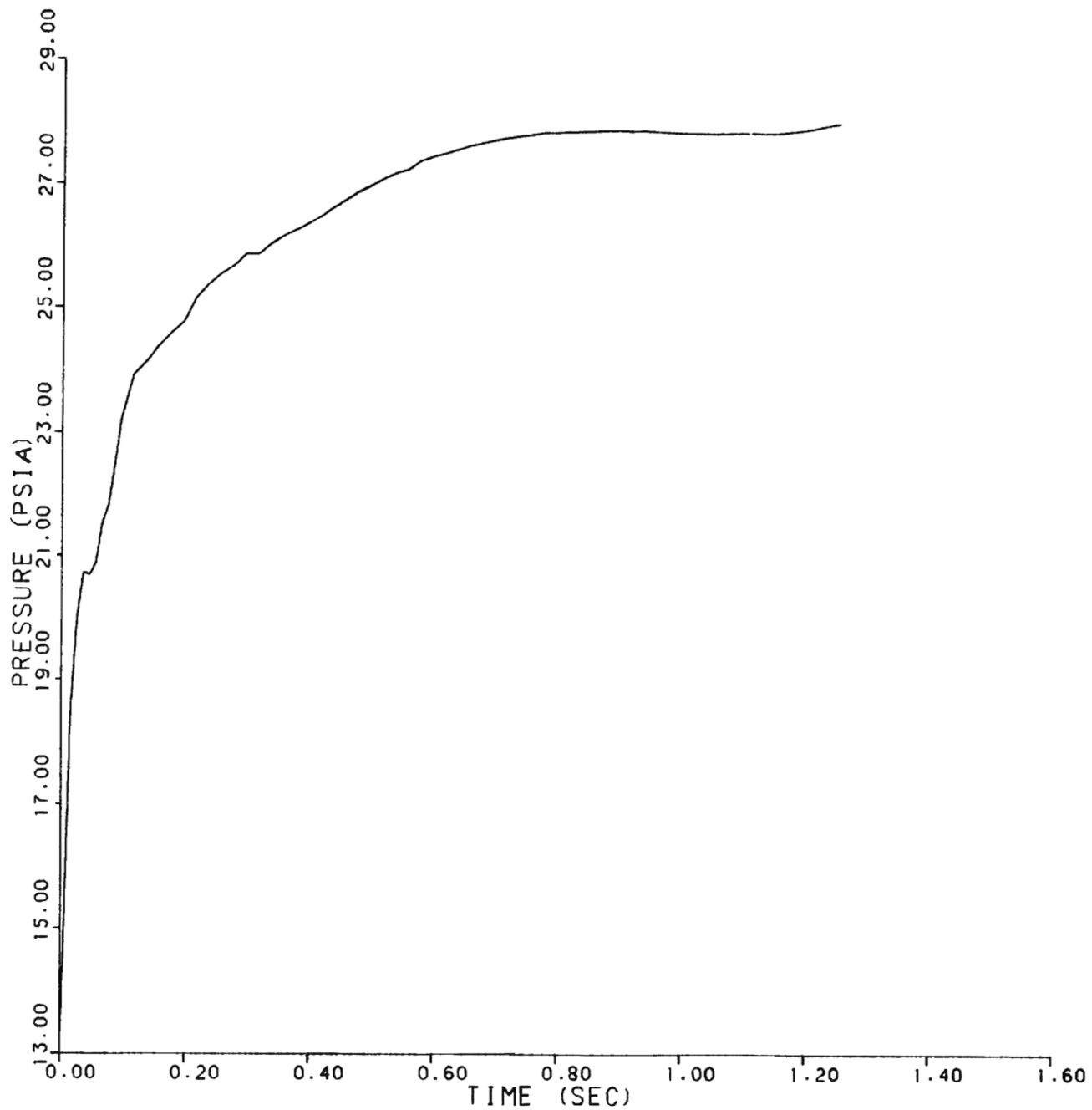

REV 13 4/06



VOGTLE
ELECTRIC GENERATING PLANT
UNIT 1 AND UNIT 2

REACTOR COOLANT PUMP
INLET NOZZLE - NODE E7
(336-in.² BREAK AREA)

FIGURE 6.2.1-20 (SHEET 7 OF 74)

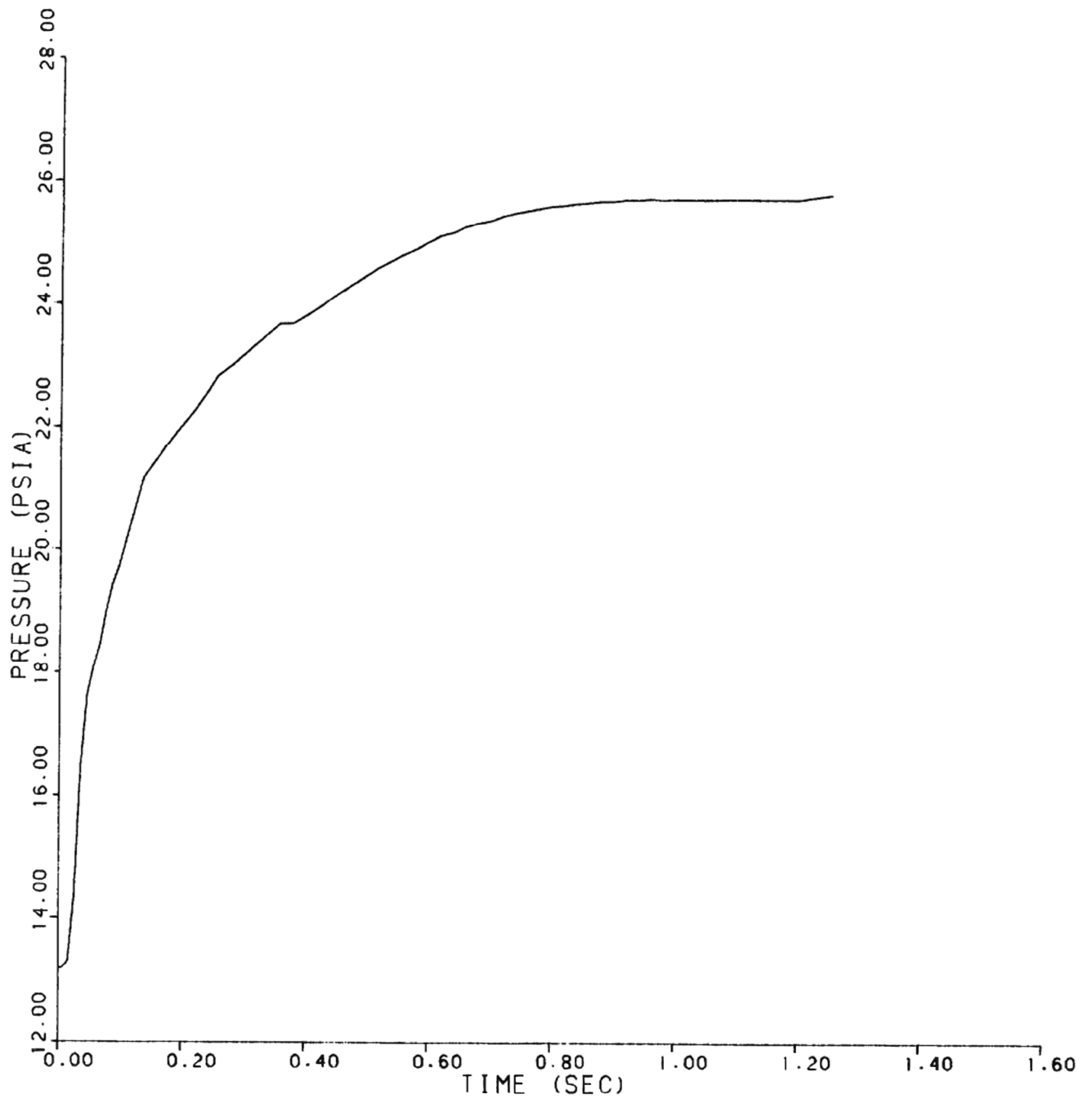

REV 13 4/06



VOGTLE
ELECTRIC GENERATING PLANT
UNIT 1 AND UNIT 2

REACTOR COOLANT PUMP
INLET NOZZLE - NODE E8
(336-in.² BREAK AREA)

FIGURE 6.2.1-20 (SHEET 8 OF 74)

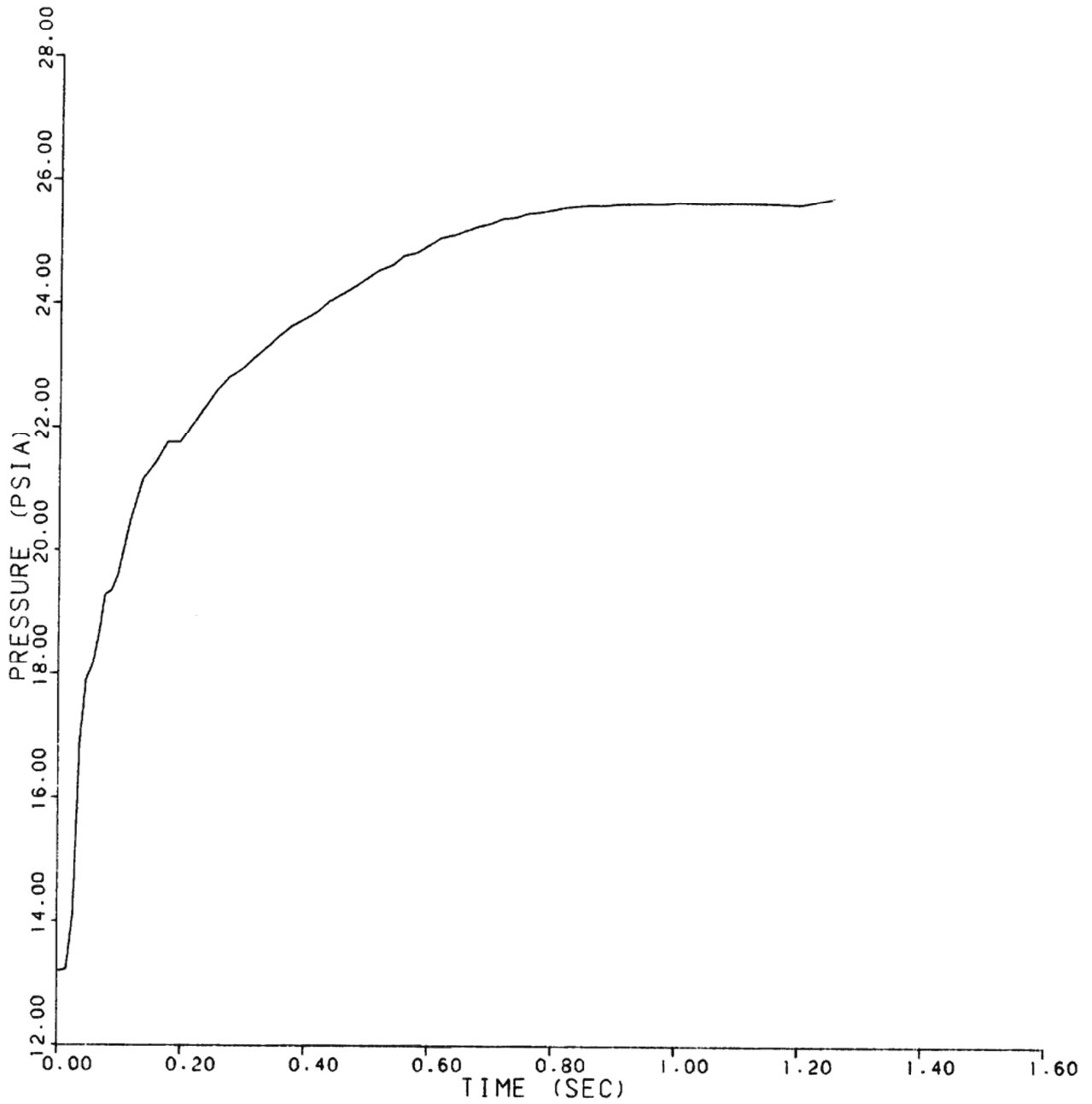

REV 13 4/06



VOGTLE
ELECTRIC GENERATING PLANT
UNIT 1 AND UNIT 2

REACTOR COOLANT PUMP
INLET NOZZLE - NODE E9
(336-in.² BREAK AREA)

FIGURE 6.2.1-20 (SHEET 9 OF 74)

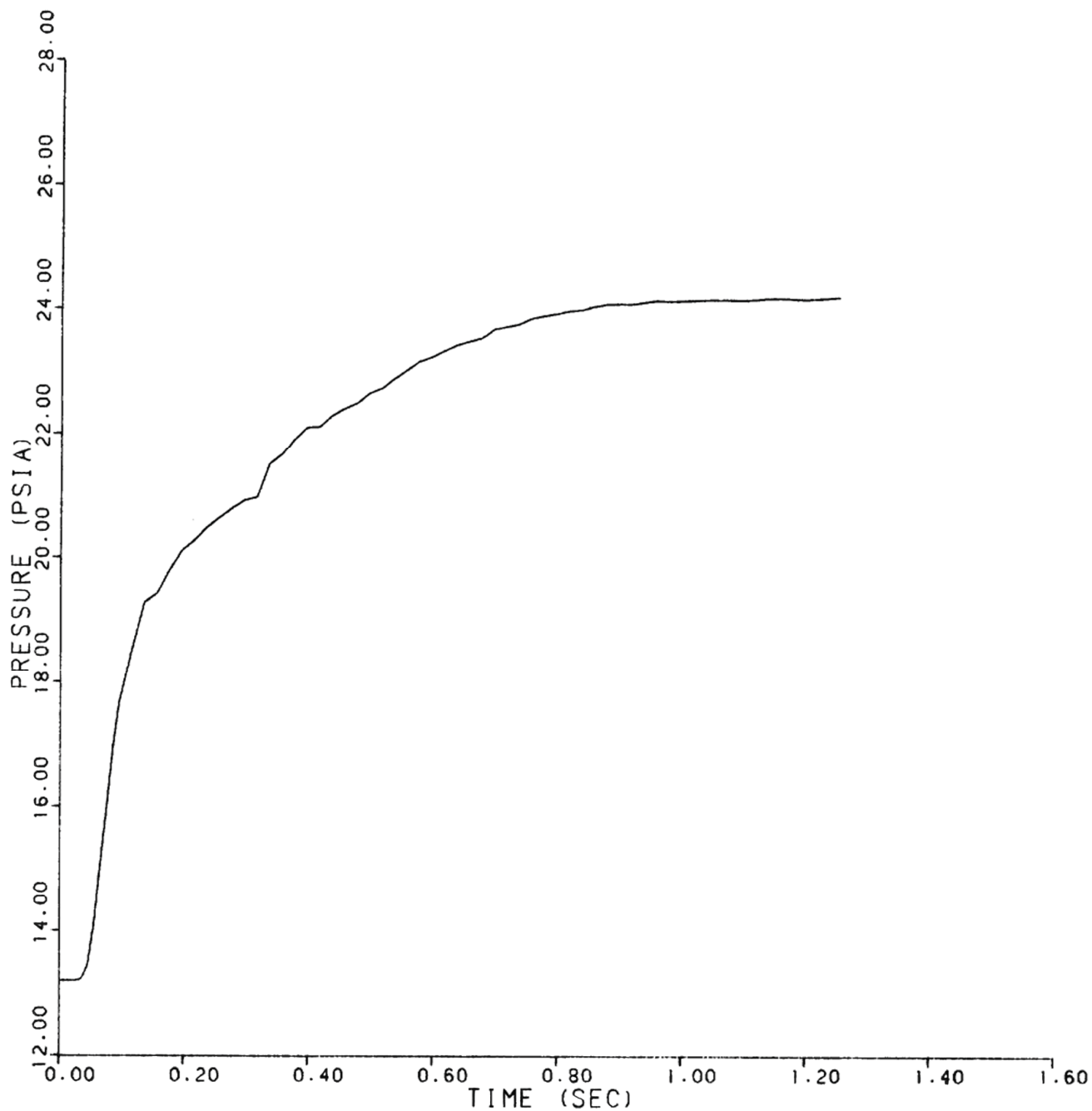

REV 13 4/06



VOGTLE
ELECTRIC GENERATING PLANT
UNIT 1 AND UNIT 2

REACTOR COOLANT PUMP
INLET NOZZLE - NODE E10
(336-in.² BREAK AREA)

FIGURE 6.2.1-20 (SHEET 10 OF 74)

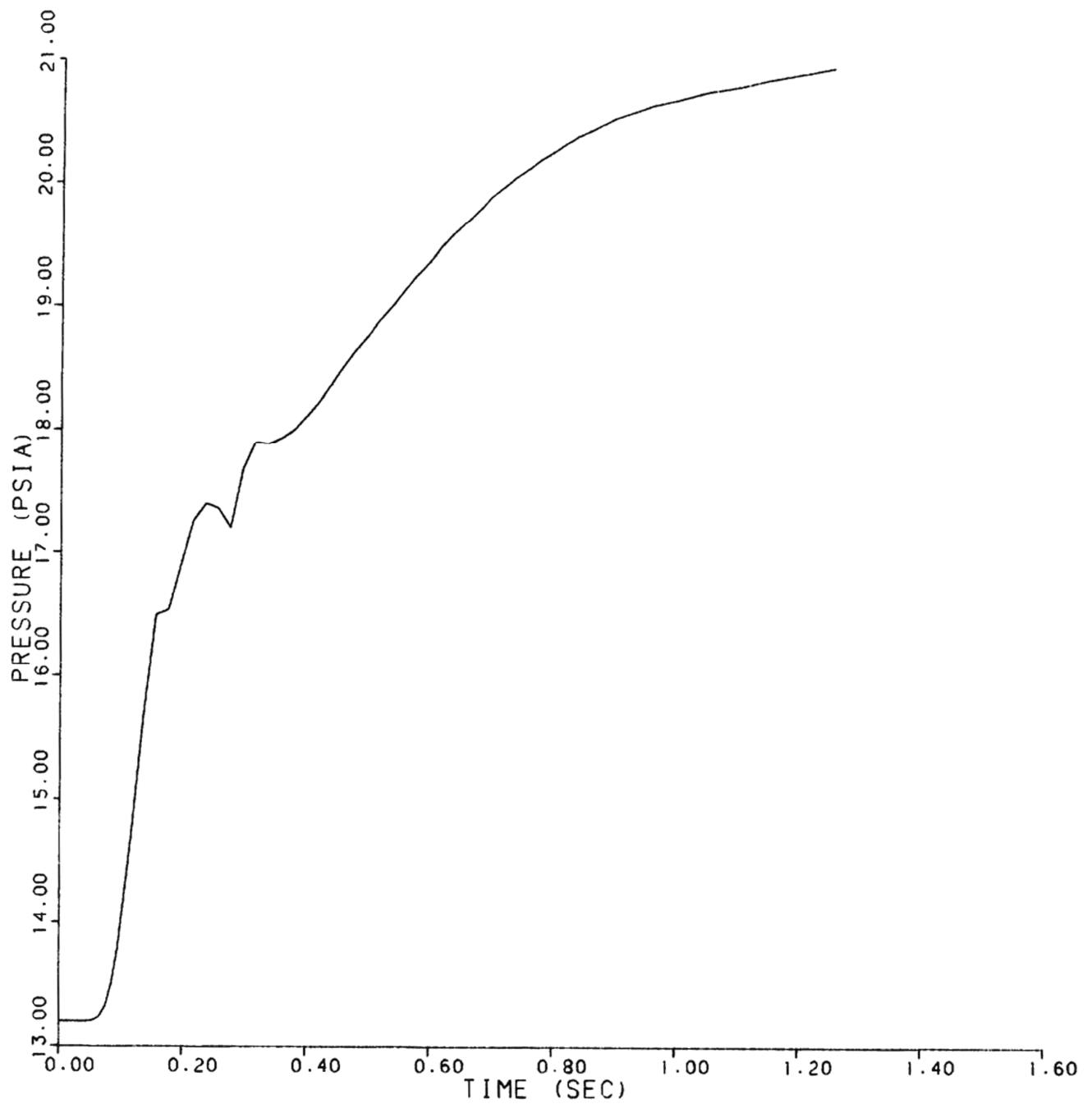

REV 13 4/06



VOGTLE
ELECTRIC GENERATING PLANT
UNIT 1 AND UNIT 2

REACTOR COOLANT PUMP
INLET NOZZLE - NODE E11
(336-in.² BREAK AREA)

FIGURE 6.2.1-20 (SHEET 11 OF 74)

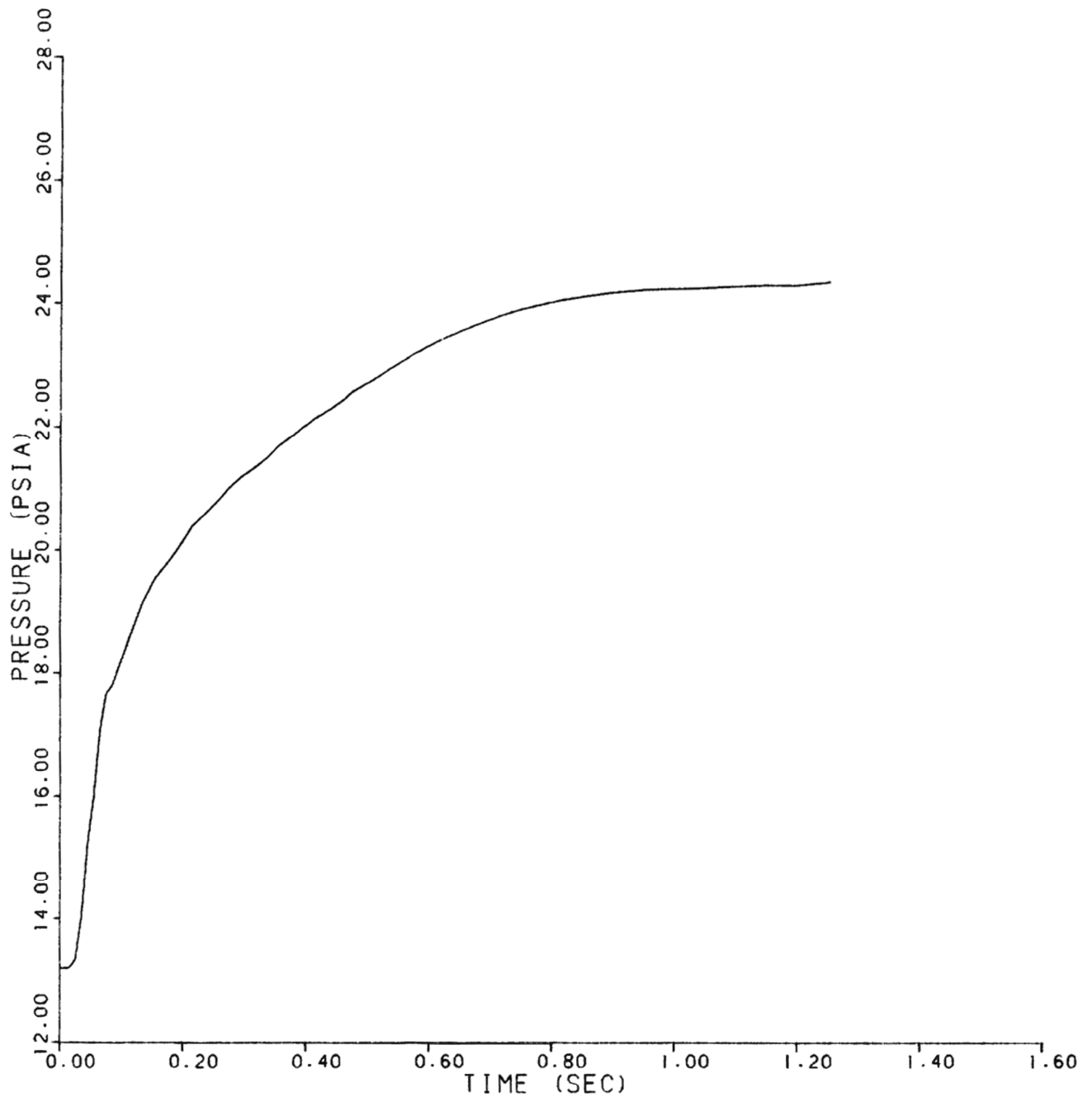

REV 13 4/06



VOGTLE
ELECTRIC GENERATING PLANT
UNIT 1 AND UNIT 2

REACTOR COOLANT PUMP
INLET NOZZLE - NODE E12
(336-in.² BREAK AREA)

FIGURE 6.2.1-20 (SHEET 12 OF 74)

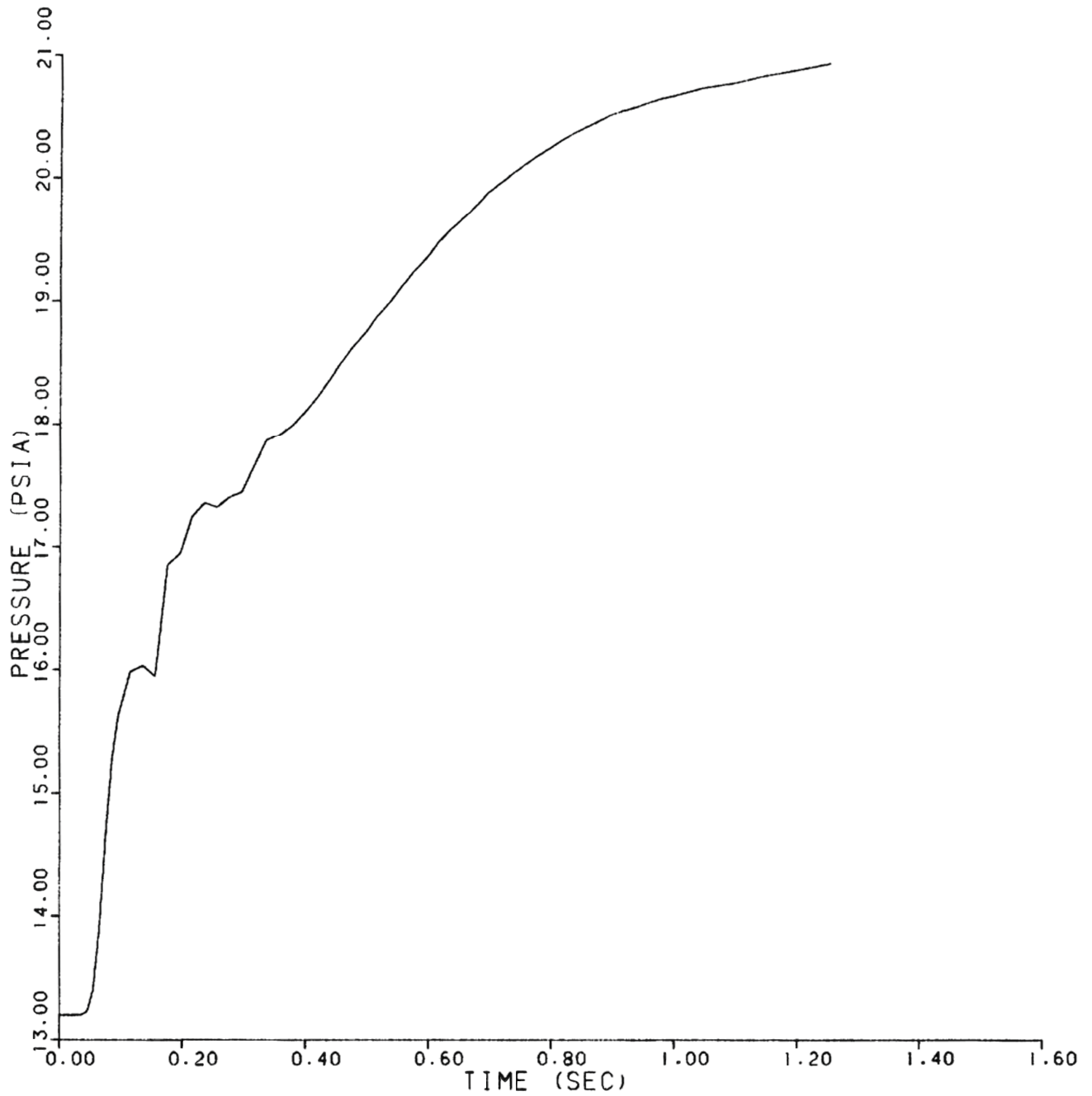

REV 13 4/06



VOGTLE
ELECTRIC GENERATING PLANT
UNIT 1 AND UNIT 2

REACTOR COOLANT PUMP
INLET NOZZLE - NODE E13
(336-in.² BREAK AREA)

FIGURE 6.2.1-20 (SHEET 13 OF 74)

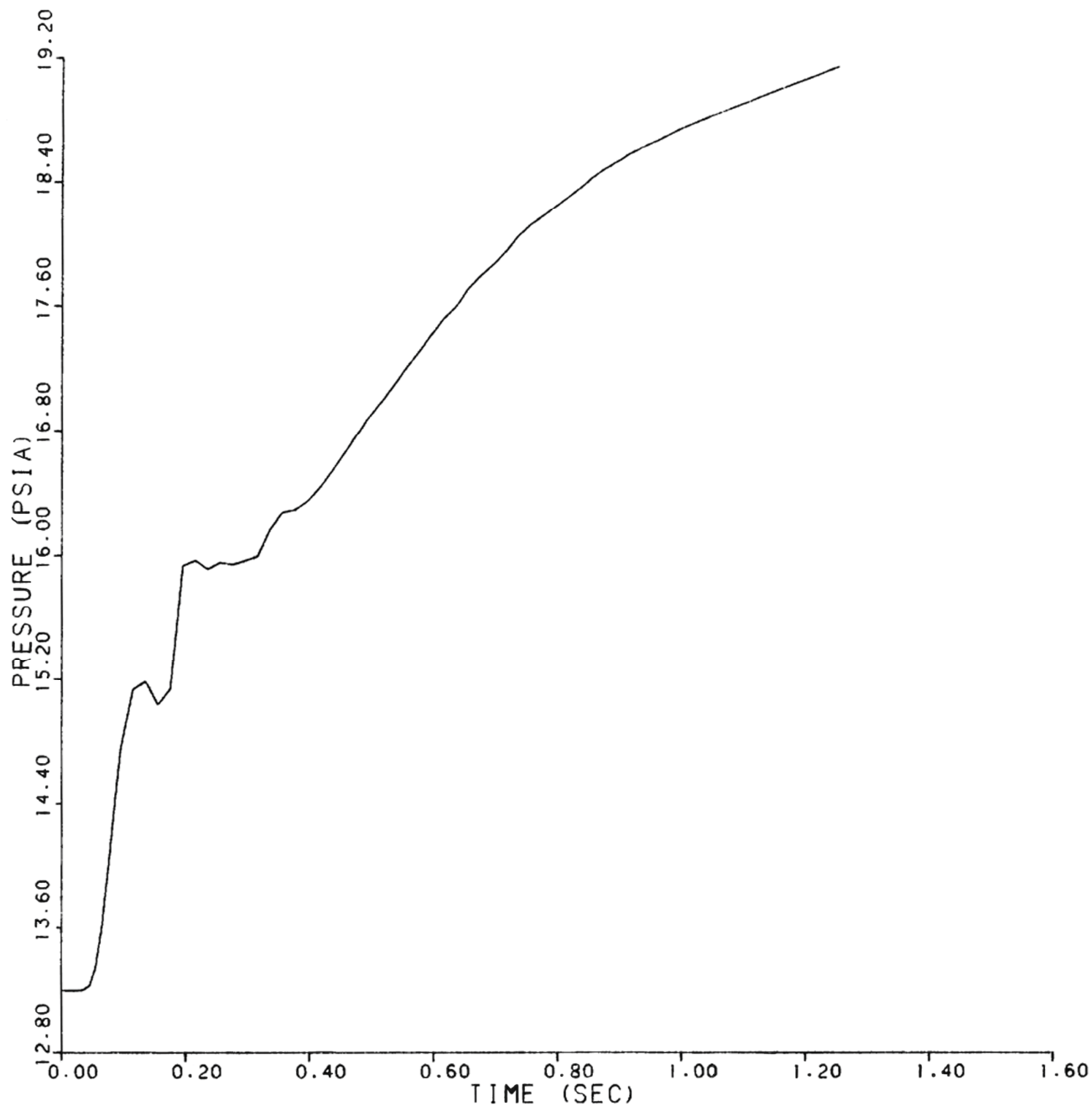

REV 13 4/06



VOGTLE
ELECTRIC GENERATING PLANT
UNIT 1 AND UNIT 2

REACTOR COOLANT PUMP
INLET NOZZLE - NODE E14
(336-in.² BREAK AREA)

FIGURE 6.2.1-20 (SHEET 14 OF 74)

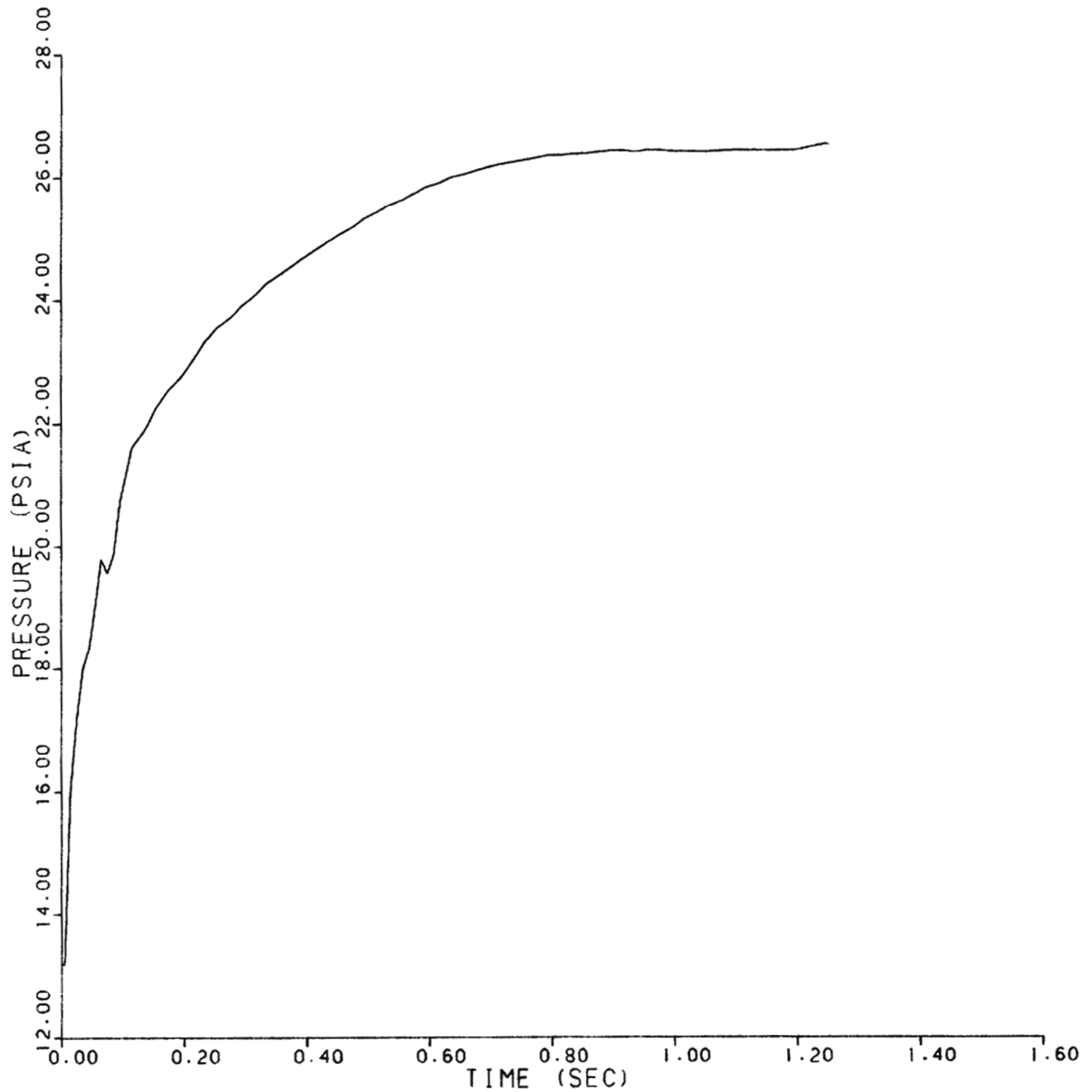

REV 13 4/06



VOGTLE
ELECTRIC GENERATING PLANT
UNIT 1 AND UNIT 2

REACTOR COOLANT PUMP
INLET NOZZLE - NODE E15
(336-in.² BREAK AREA)

FIGURE 6.2.1-20 (SHEET 15 OF 74)

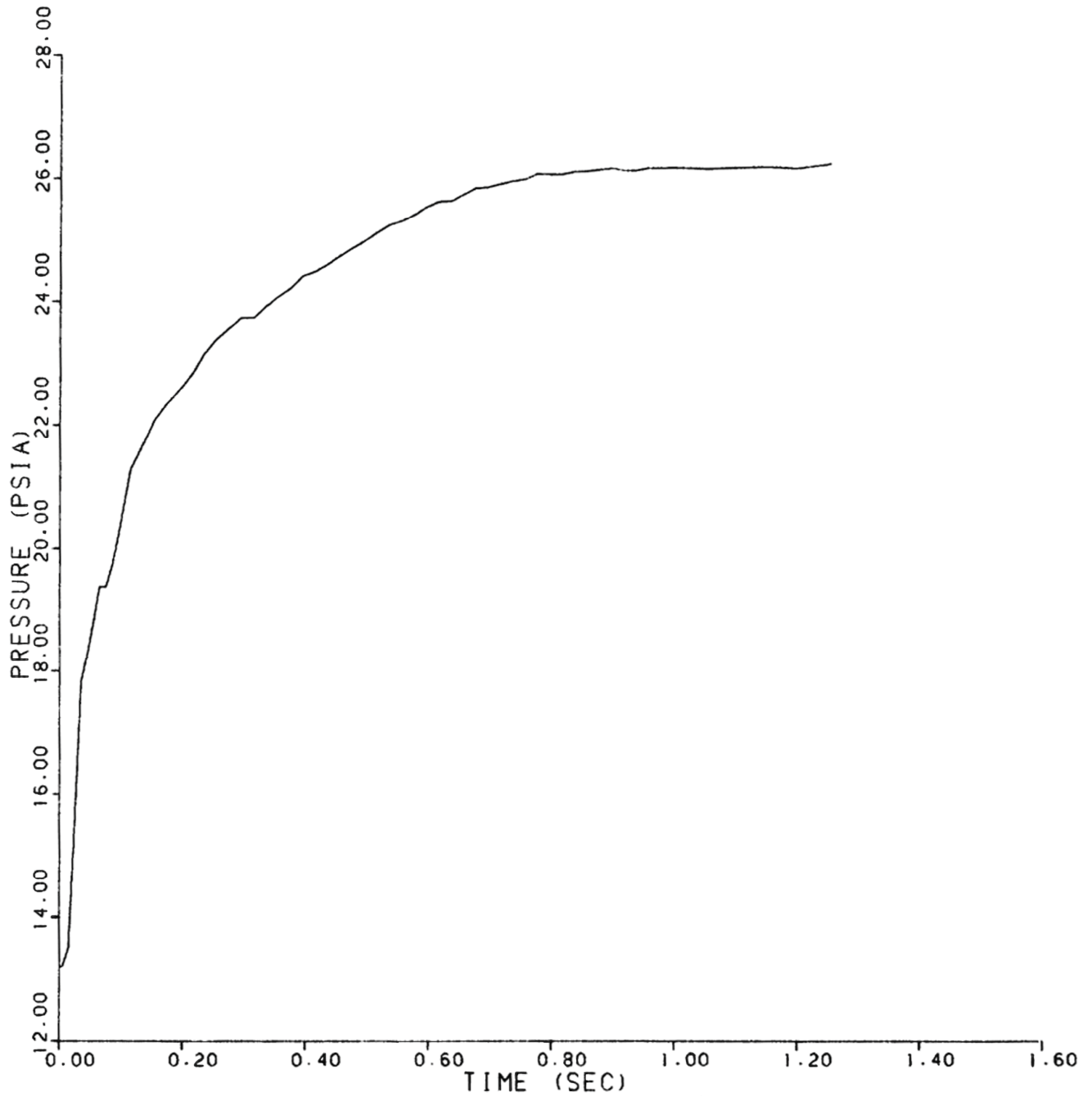

REV 13 4/06



VOGTLE
ELECTRIC GENERATING PLANT
UNIT 1 AND UNIT 2

REACTOR COOLANT PUMP
INLET NOZZLE - NODE E16
(336-in.² BREAK AREA)

FIGURE 6.2.1-20 (SHEET 16 OF 74)

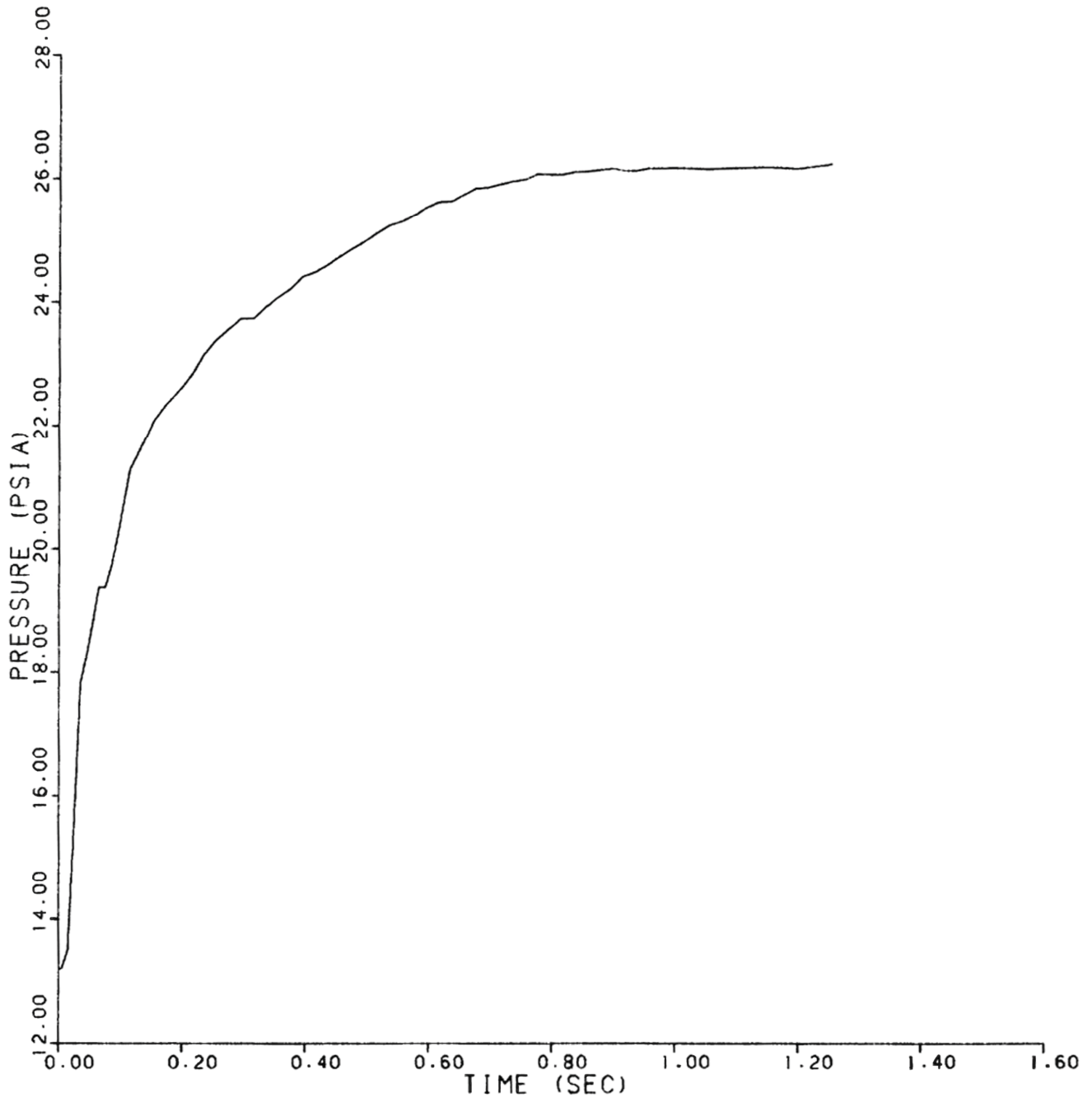

REV 13 4/06



VOGTLE
ELECTRIC GENERATING PLANT
UNIT 1 AND UNIT 2

REACTOR COOLANT PUMP
INLET NOZZLE - NODE E17
(336-in.² BREAK AREA)

FIGURE 6.2.1-20 (SHEET 17 OF 74)

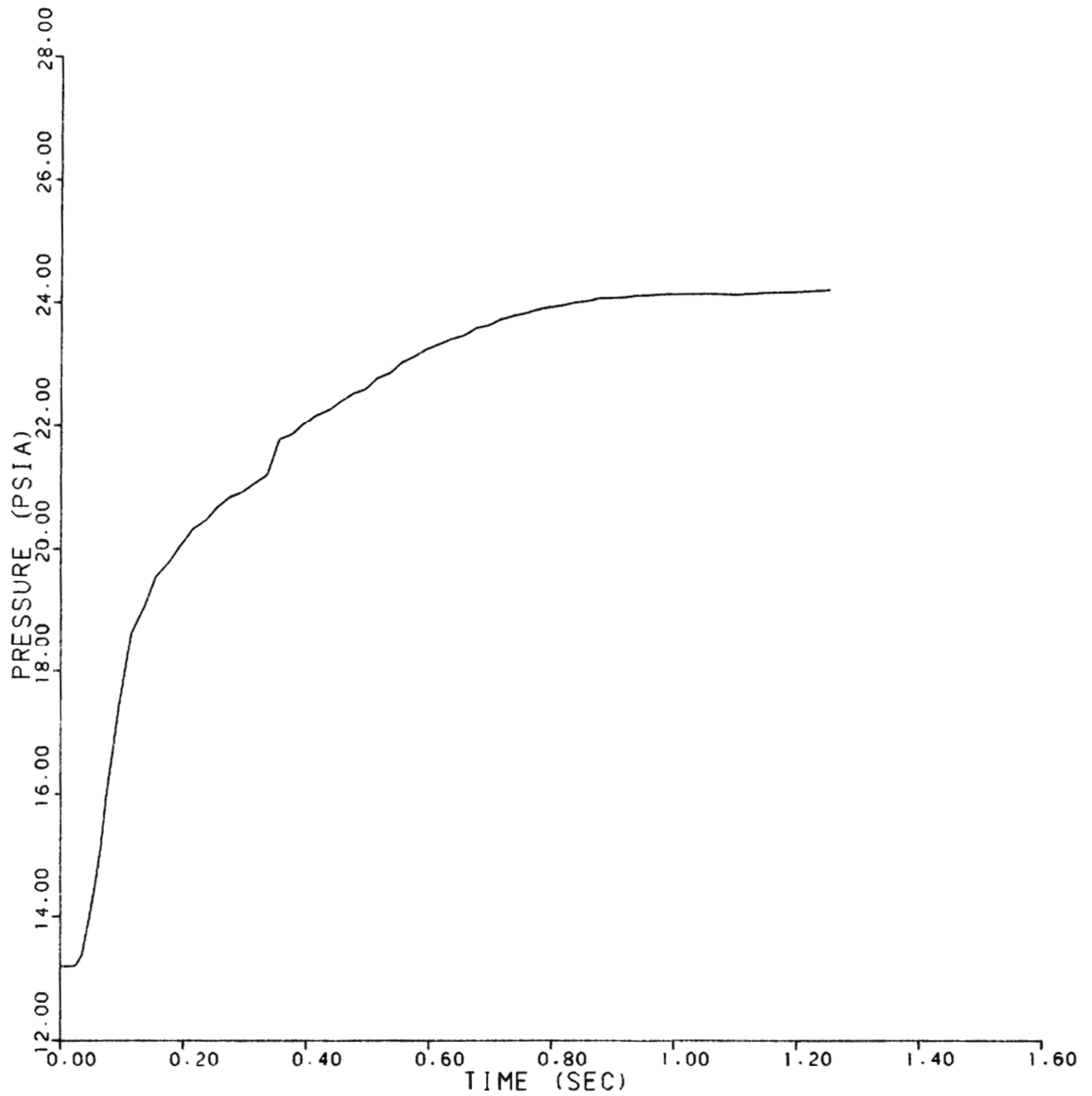

REV 13 4/06



VOGTLE
ELECTRIC GENERATING PLANT
UNIT 1 AND UNIT 2

REACTOR COOLANT PUMP
INLET NOZZLE - NODE E18
(336-in.² BREAK AREA)

FIGURE 6.2.1-20 (SHEET 18 OF 74)

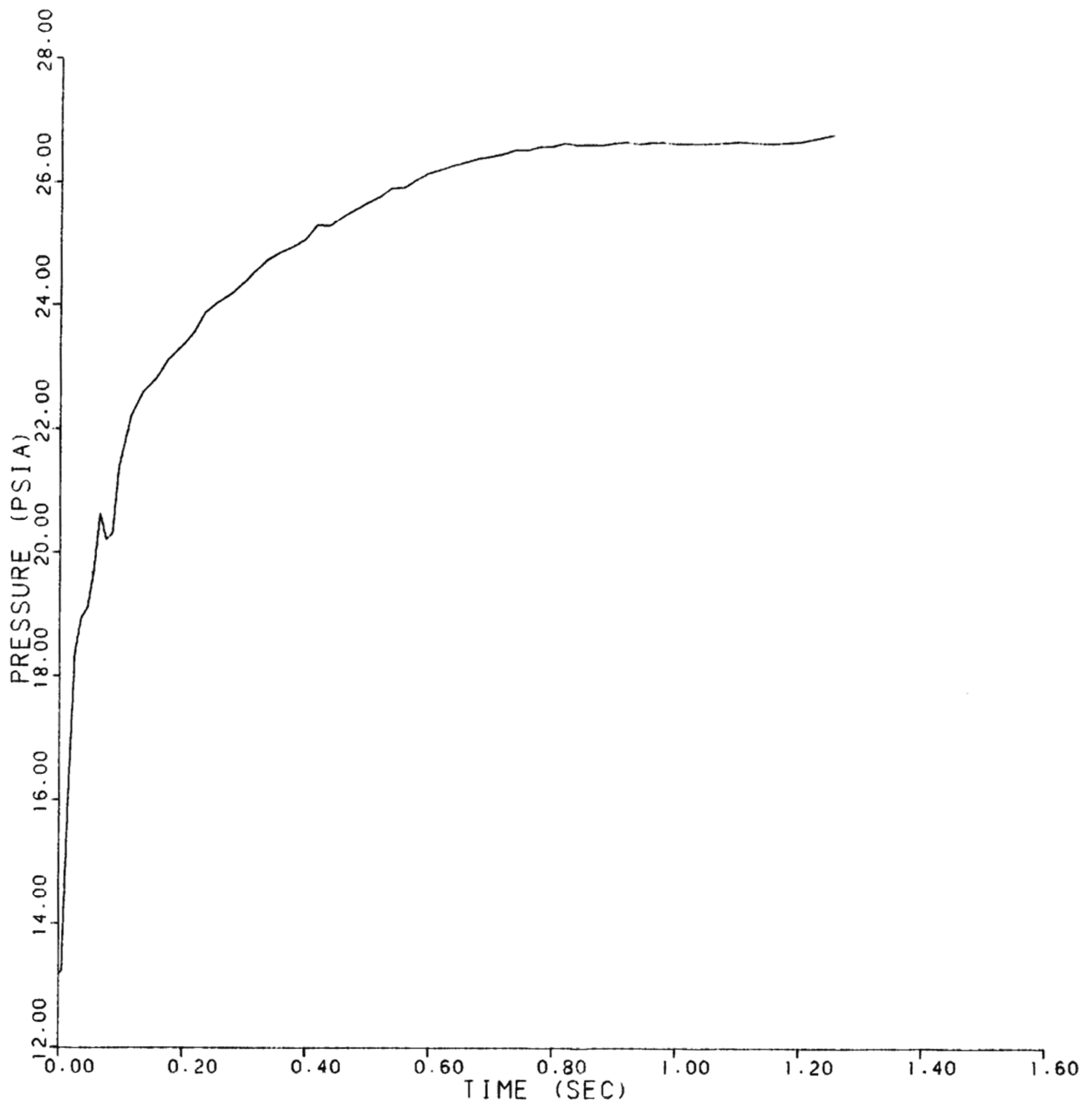

REV 13 4/06



VOGTLE
ELECTRIC GENERATING PLANT
UNIT 1 AND UNIT 2

REACTOR COOLANT PUMP
INLET NOZZLE - NODE E19
(336-in.² BREAK AREA)

FIGURE 6.2.1-20 (SHEET 19 OF 74)

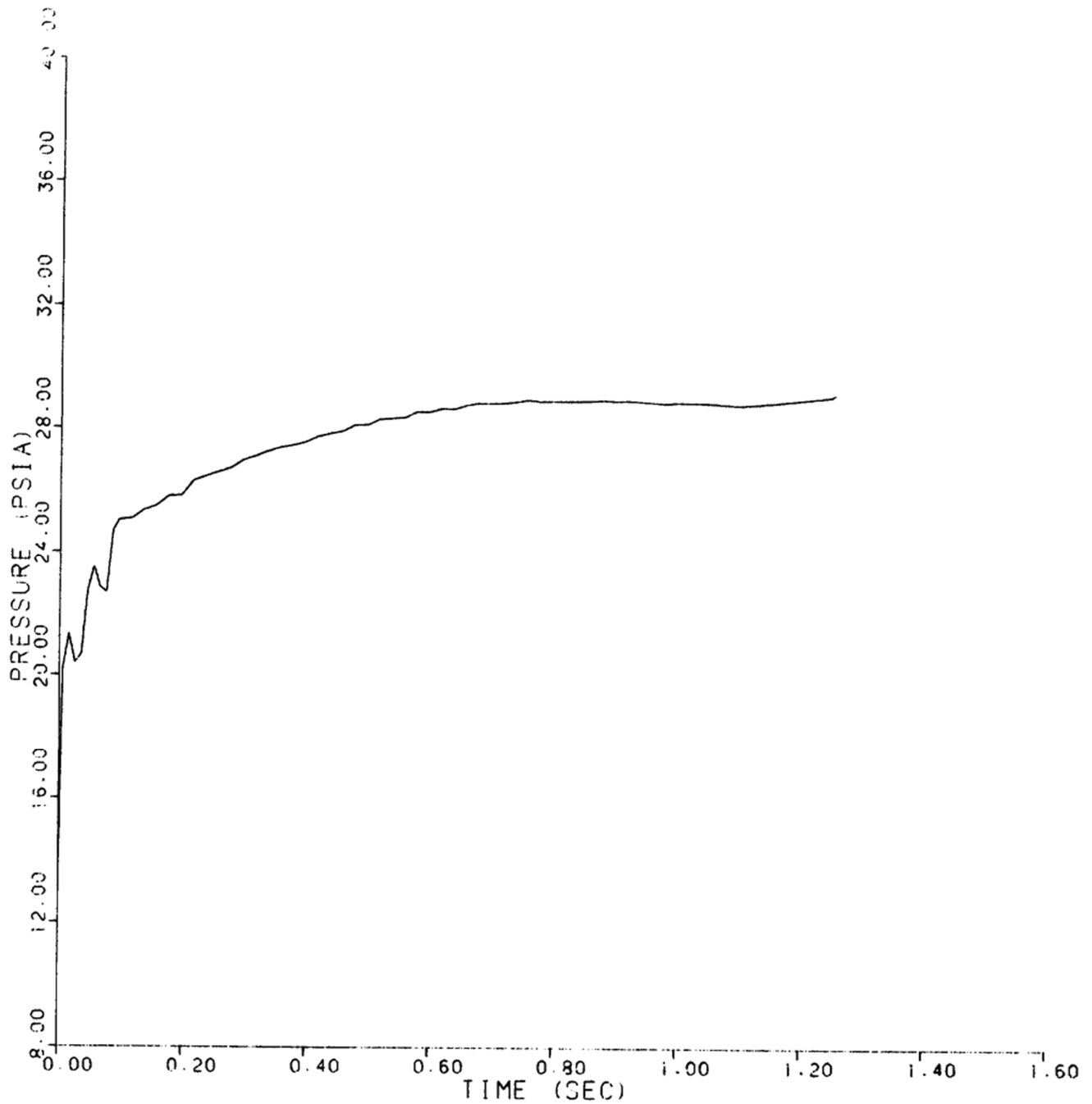

REV 13 4/06



VOGTLE
ELECTRIC GENERATING PLANT
UNIT 1 AND UNIT 2

REACTOR COOLANT PUMP
INLET NOZZLE - NODE E20
(336-in.² BREAK AREA)

FIGURE 6.2.1-20 (SHEET 20 OF 74)

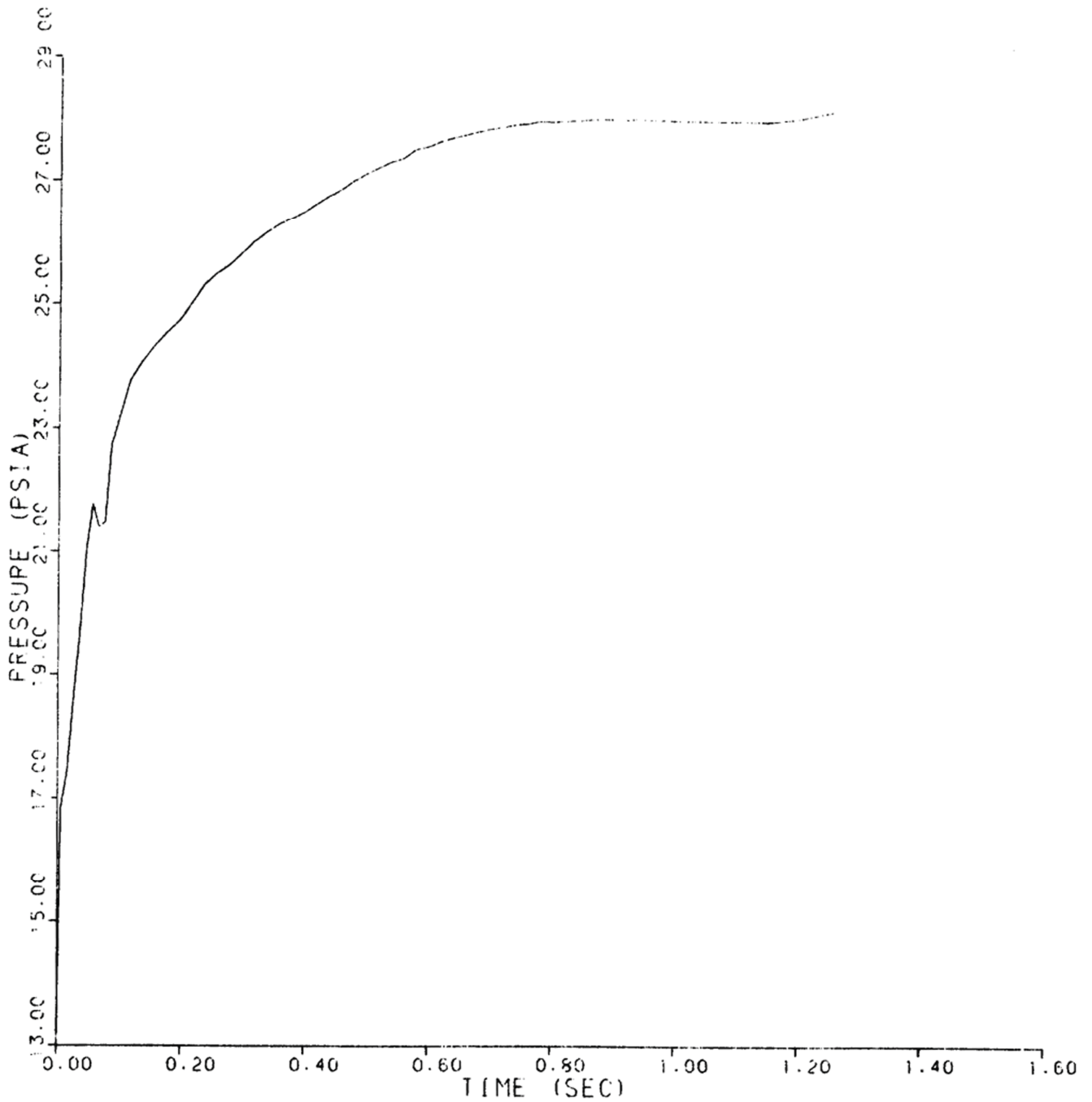

REV 13 4/06



VOGTLE
ELECTRIC GENERATING PLANT
UNIT 1 AND UNIT 2

REACTOR COOLANT PUMP
INLET NOZZLE - NODE E21
(336-in.² BREAK AREA)

FIGURE 6.2.1-20 (SHEET 21 OF 74)

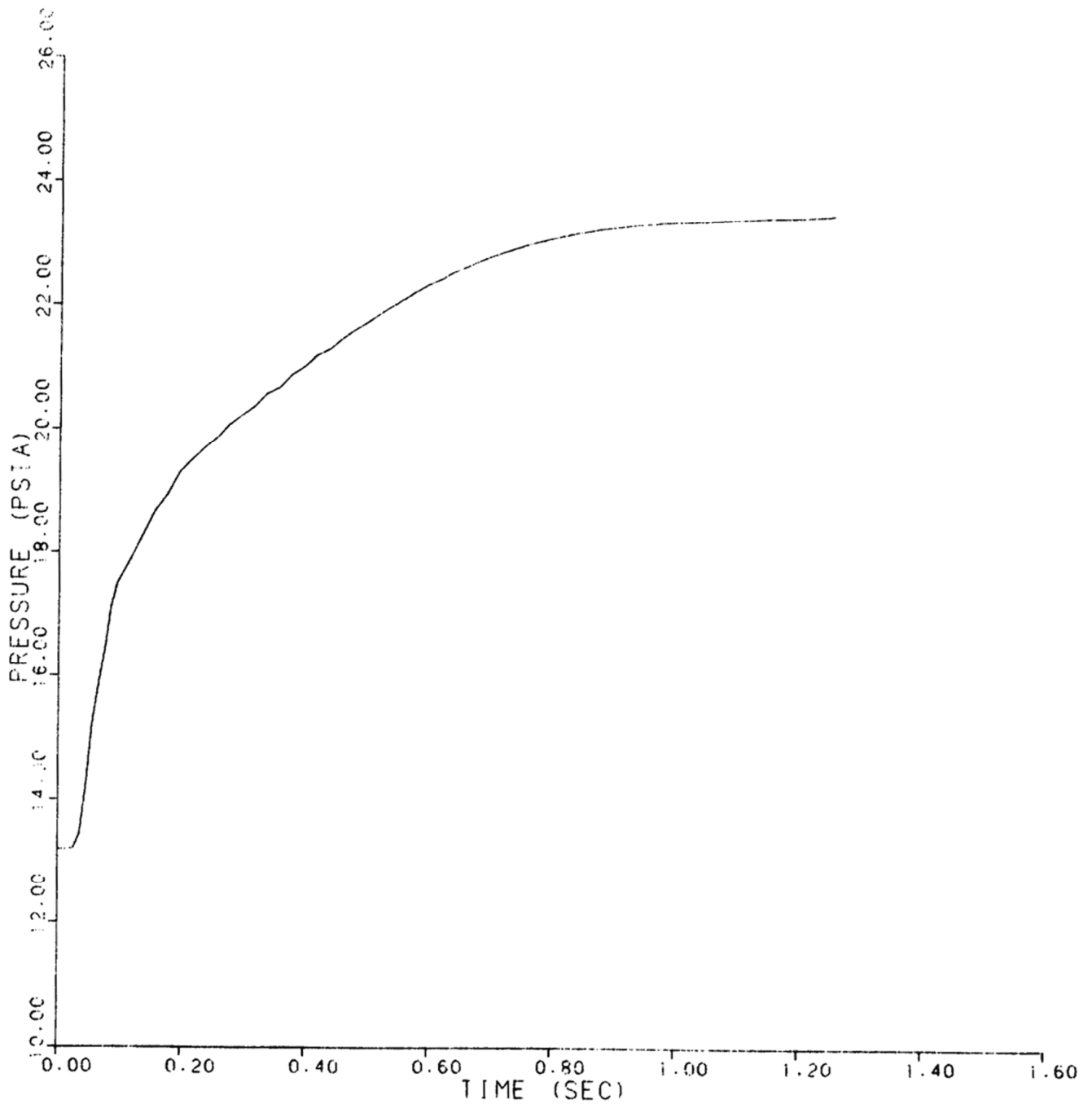

REV 13 4/06



VOGTLE
ELECTRIC GENERATING PLANT
UNIT 1 AND UNIT 2

REACTOR COOLANT PUMP
INLET NOZZLE - NODE E22
(336-in.² BREAK AREA)

FIGURE 6.2.1-20 (SHEET 22 OF 74)

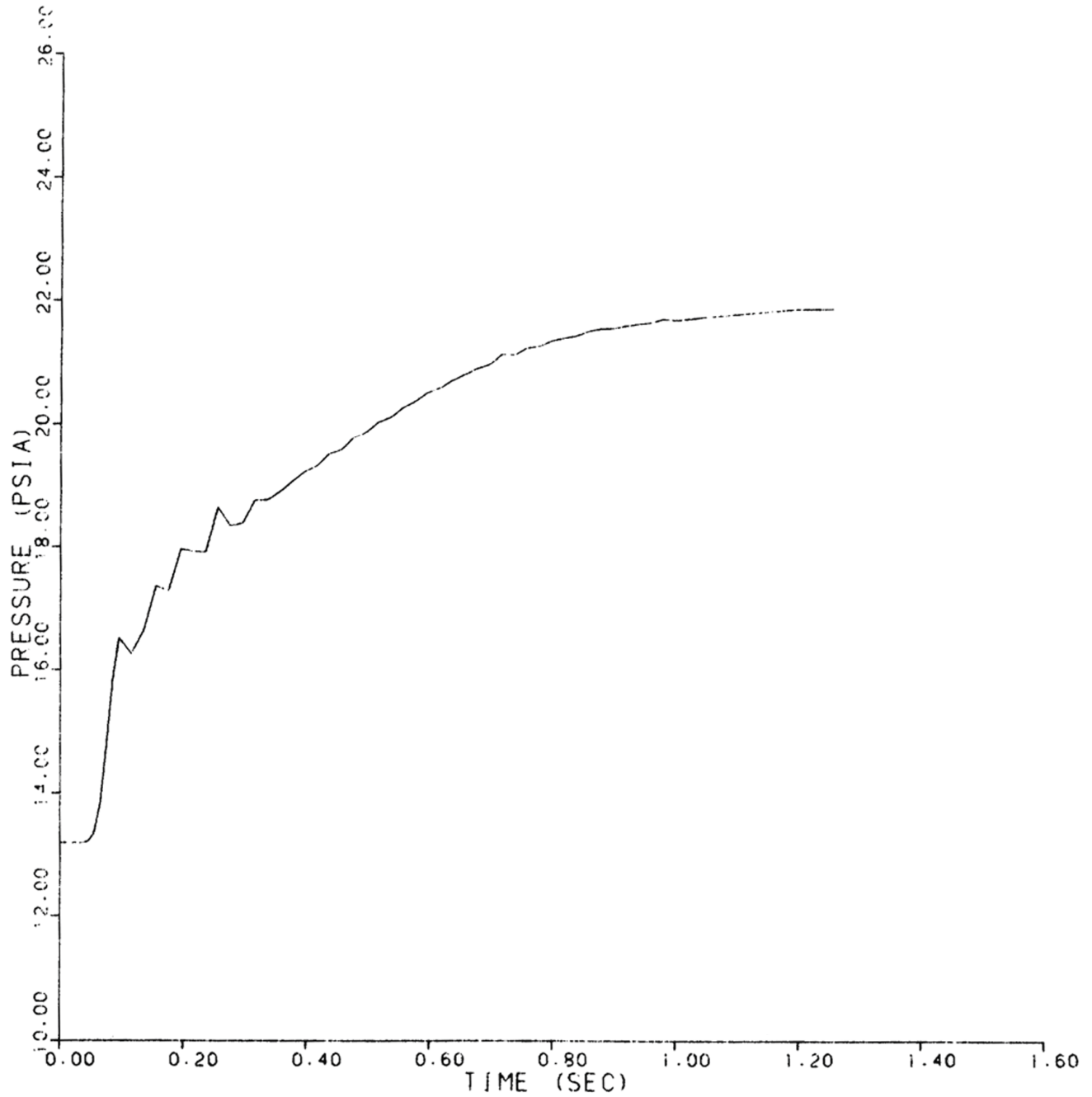

REV 13 4/06



VOGTLE
ELECTRIC GENERATING PLANT
UNIT 1 AND UNIT 2

REACTOR COOLANT PUMP
INLET NOZZLE - NODE E23
(336-in.² BREAK AREA)

FIGURE 6.2.1-20 (SHEET 23 OF 74)

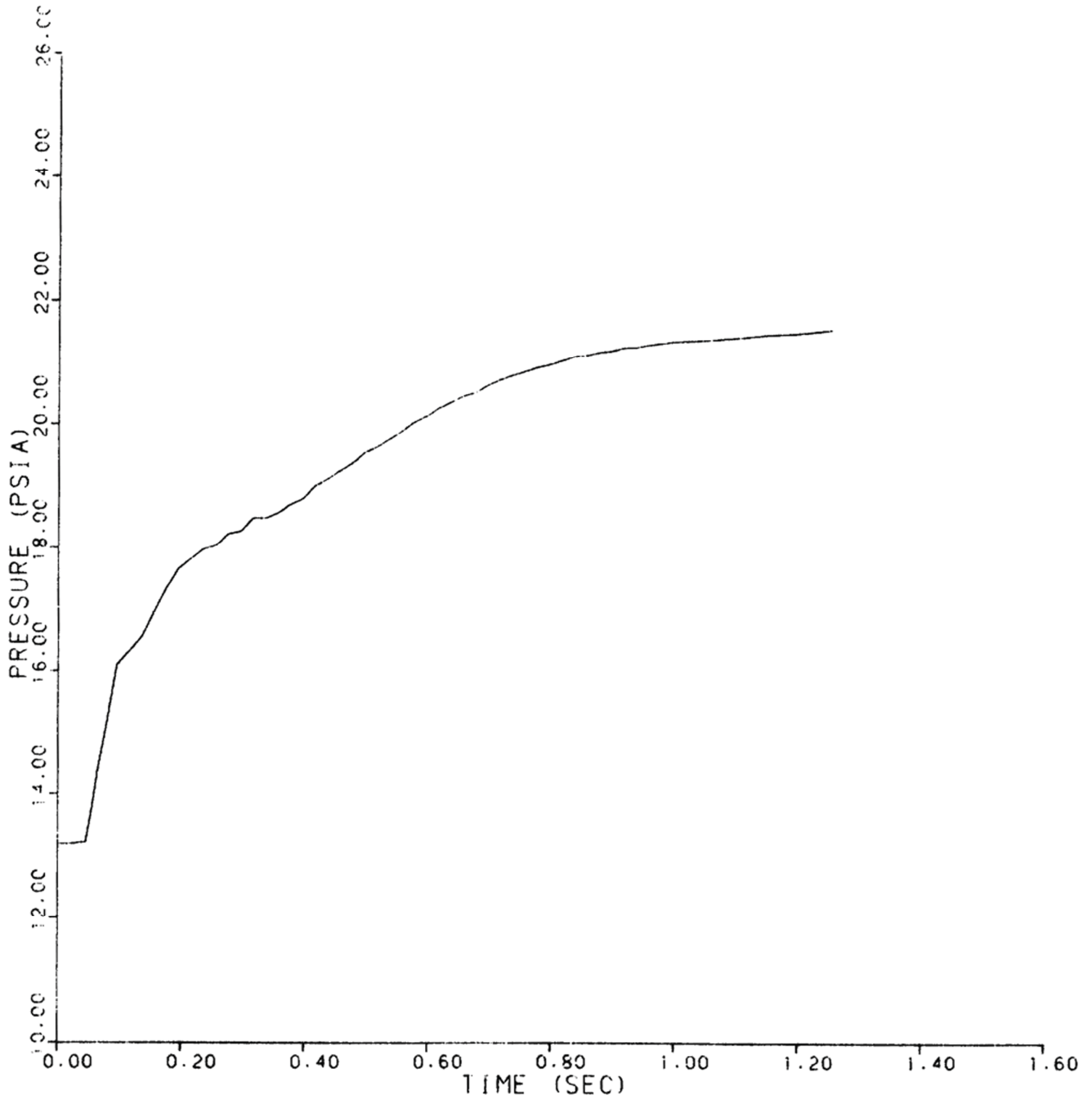

REV 13 4/06



VOGTLE
ELECTRIC GENERATING PLANT
UNIT 1 AND UNIT 2

REACTOR COOLANT PUMP
INLET NOZZLE - NODE E24
(336-in.² BREAK AREA)

FIGURE 6.2.1-20 (SHEET 24 OF 74)

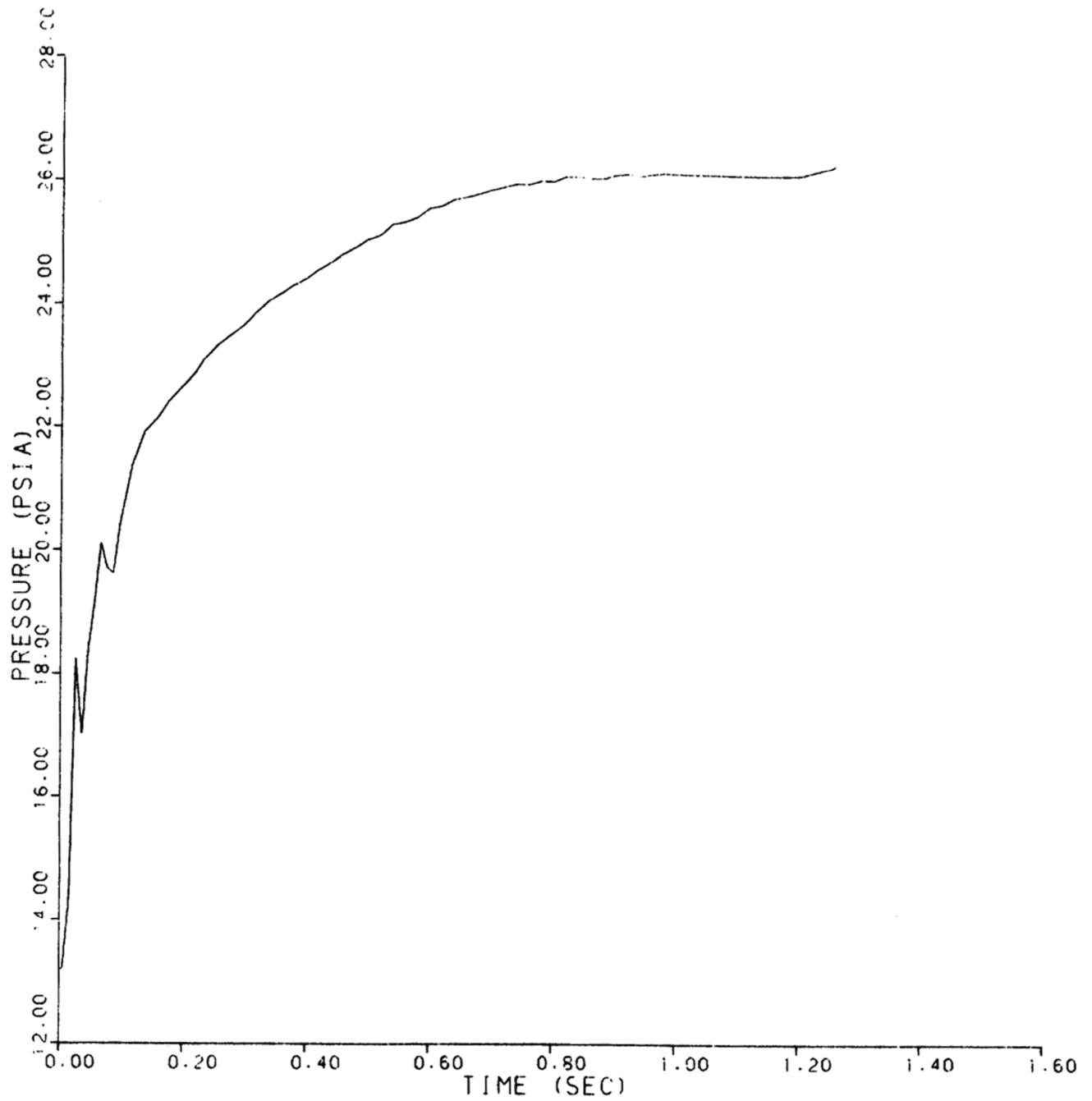

REV 13 4/06



VOGTLE
ELECTRIC GENERATING PLANT
UNIT 1 AND UNIT 2

REACTOR COOLANT PUMP
INLET NOZZLE - NODE E25
(336-in.² BREAK AREA)

FIGURE 6.2.1-20 (SHEET 25 OF 74)

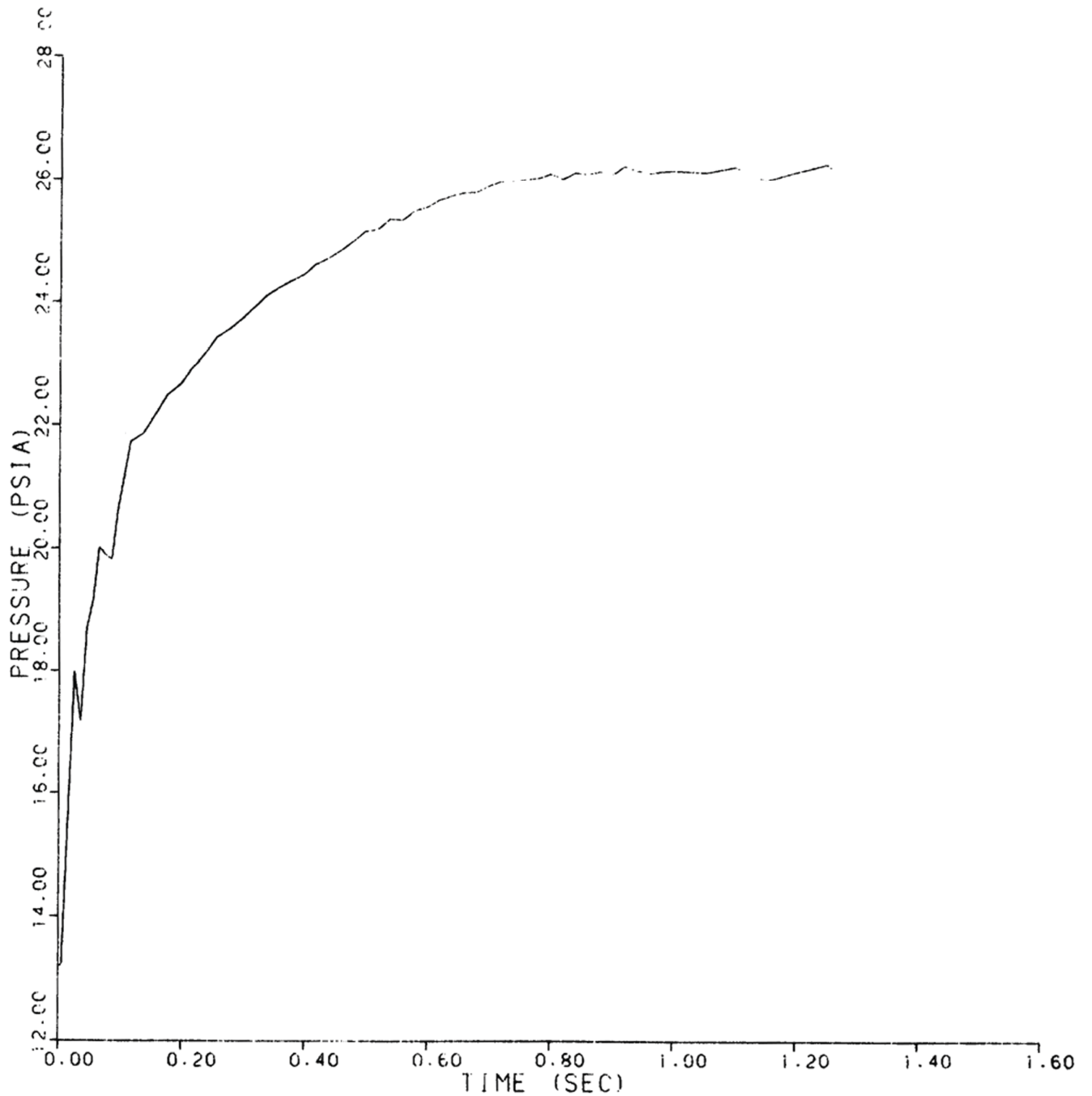

REV 13 4/06



VOGTLE
ELECTRIC GENERATING PLANT
UNIT 1 AND UNIT 2

REACTOR COOLANT PUMP
INLET NOZZLE - NODE E26
(336-in.² BREAK AREA)

FIGURE 6.2.1-20 (SHEET 26 OF 74)

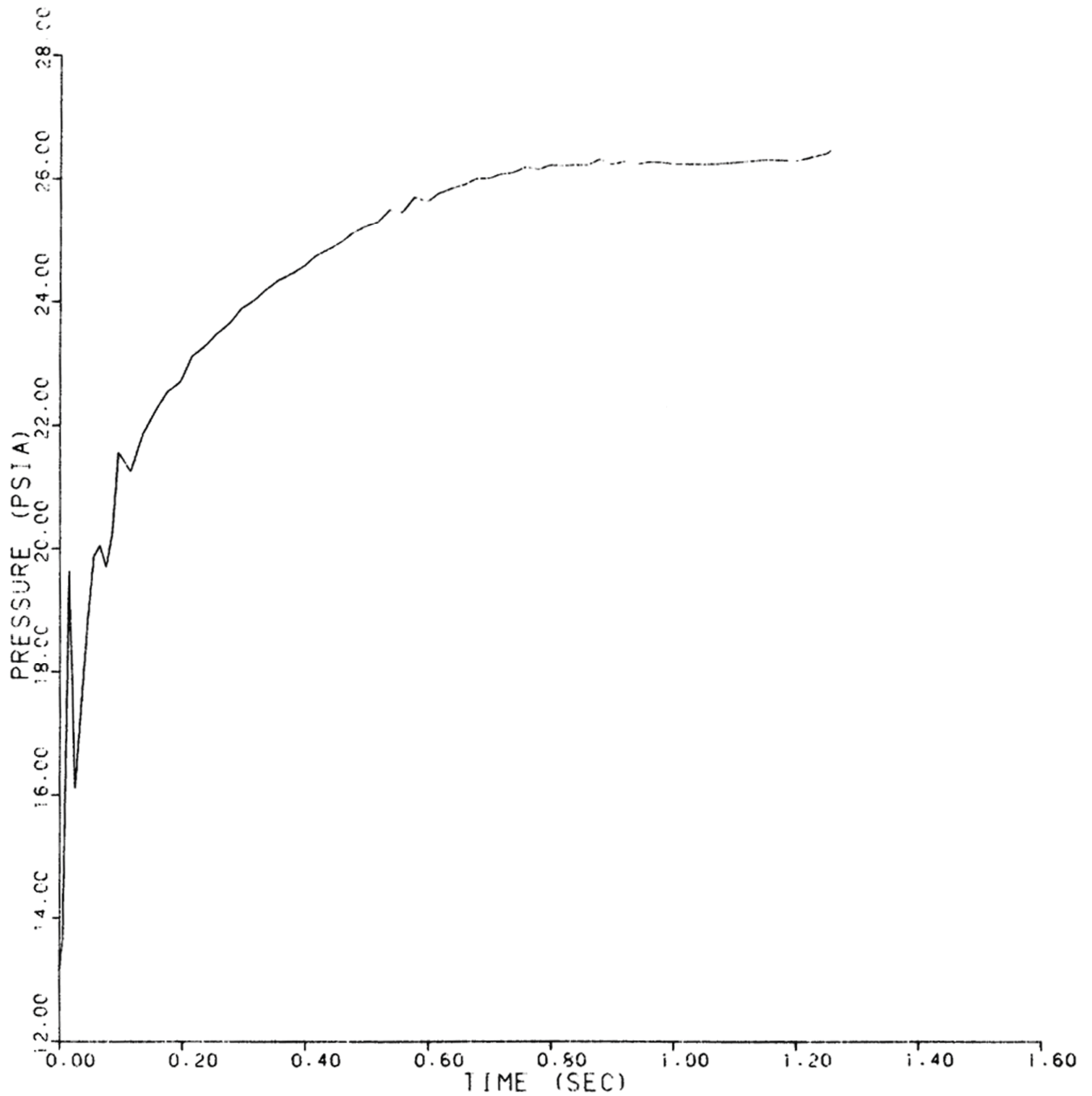

REV 13 4/06



VOGTLE
ELECTRIC GENERATING PLANT
UNIT 1 AND UNIT 2

REACTOR COOLANT PUMP
INLET NOZZLE - NODE E27
(336-in.² BREAK AREA)

FIGURE 6.2.1-20 (SHEET 27 OF 74)

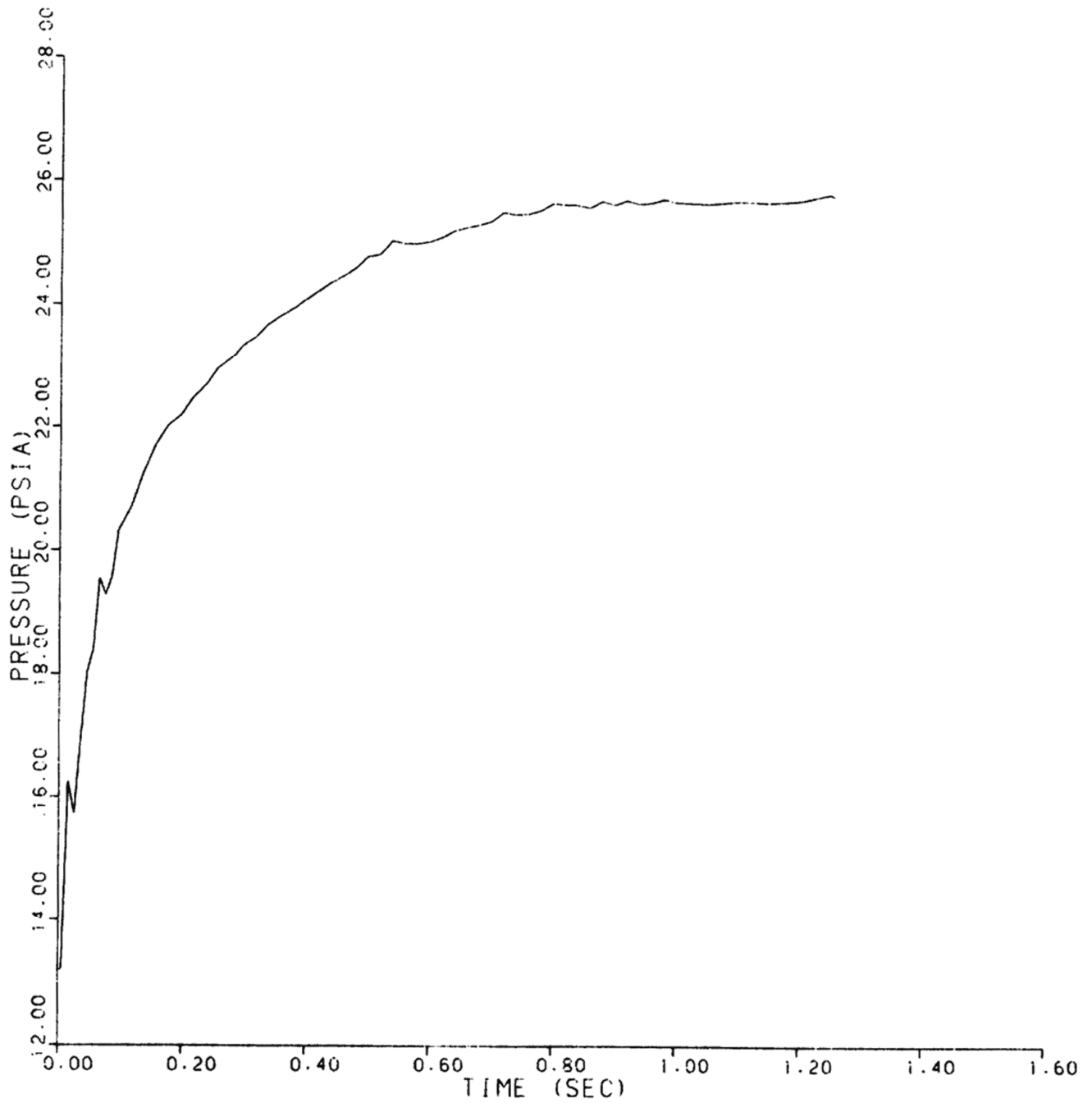

REV 13 4/06



VOGTLE
ELECTRIC GENERATING PLANT
UNIT 1 AND UNIT 2

REACTOR COOLANT PUMP
INLET NOZZLE - NODE E28
(336-in.² BREAK AREA)

FIGURE 6.2.1-20 (SHEET 28 OF 74)

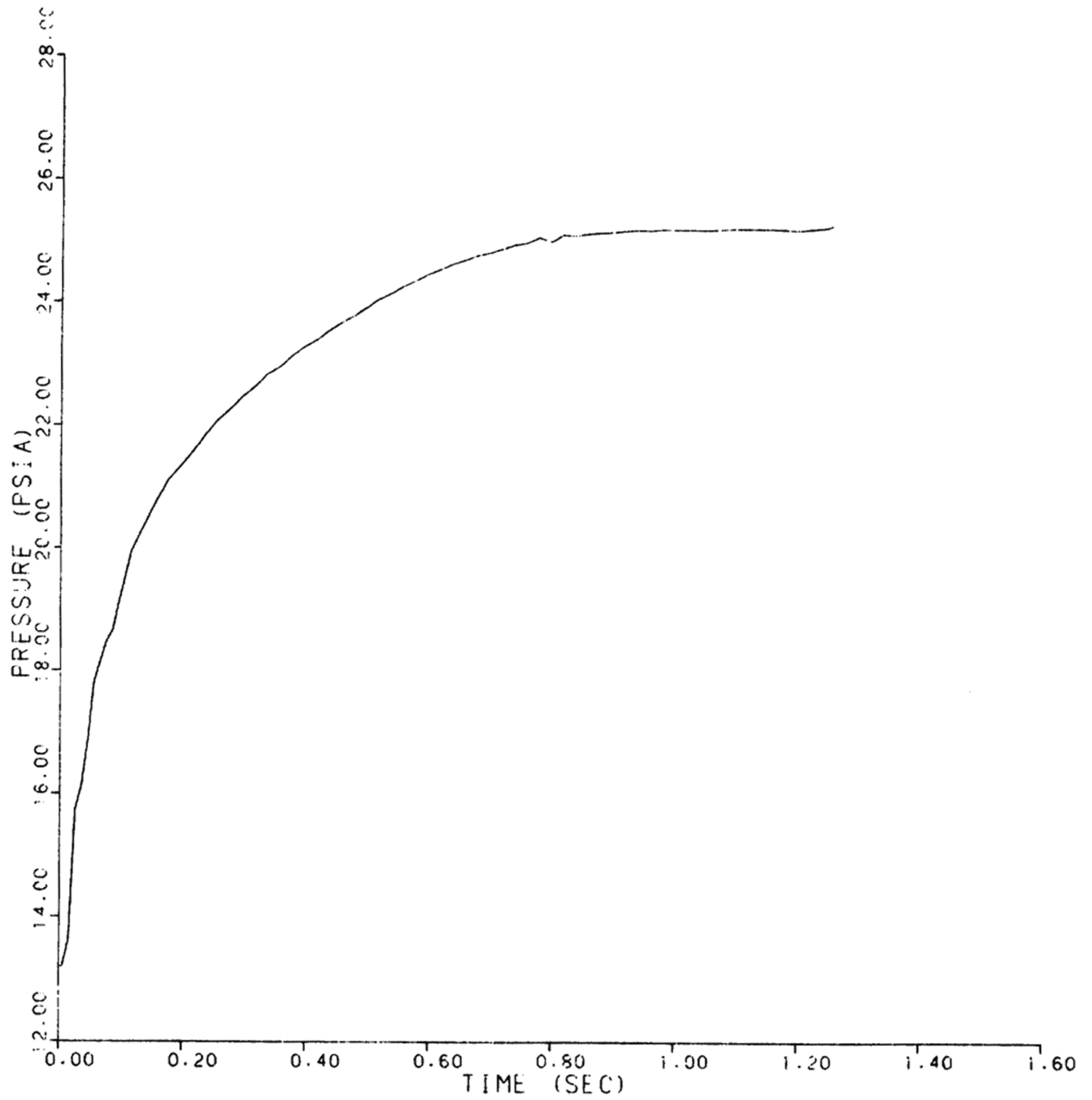

REV 13 4/06



VOGTLE
ELECTRIC GENERATING PLANT
UNIT 1 AND UNIT 2

REACTOR COOLANT PUMP
INLET NOZZLE - NODE E29
(336-in.² BREAK AREA)

FIGURE 6.2.1-20 (SHEET 29 OF 74)

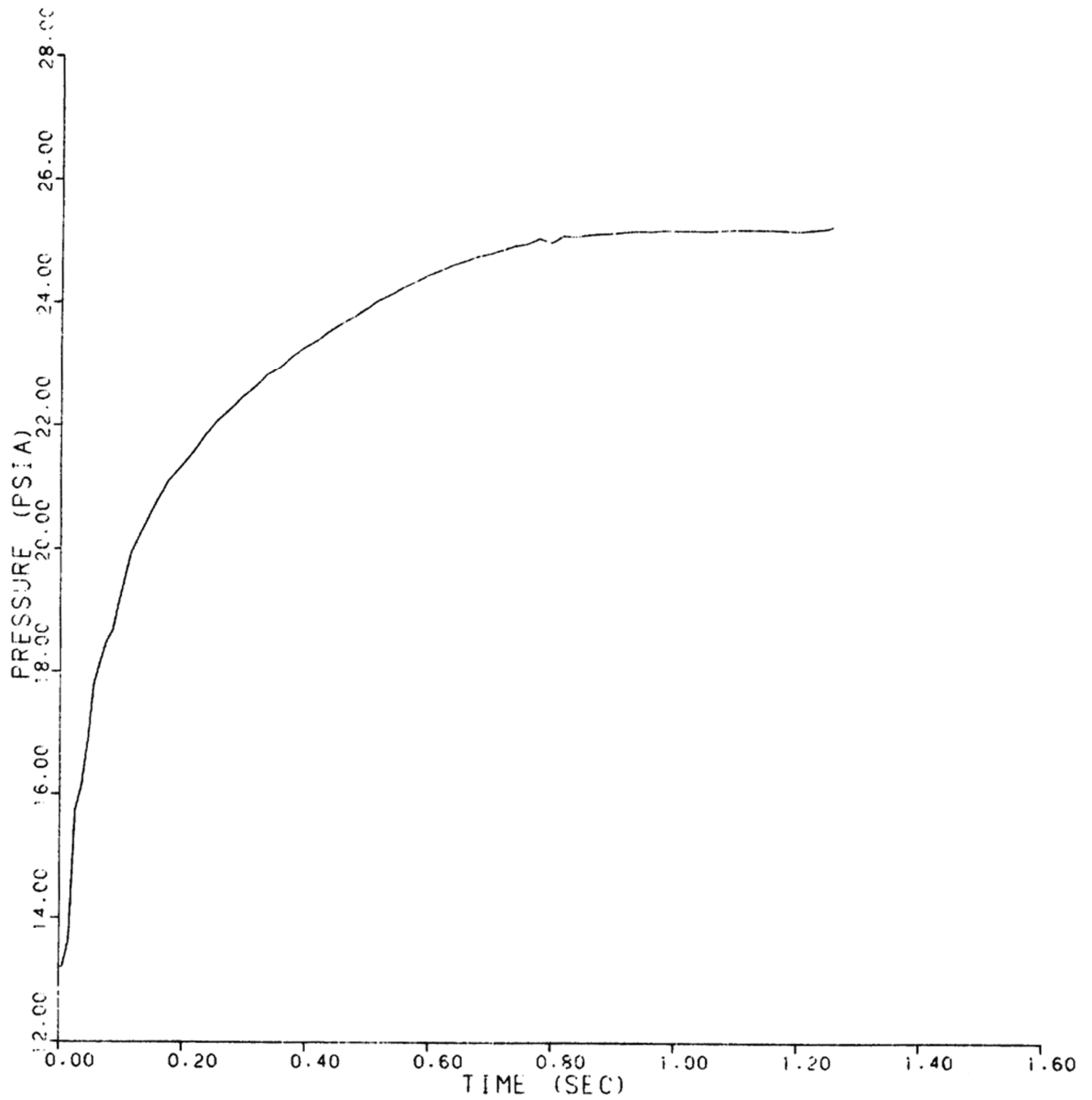

REV 13 4/06



VOGTLE
ELECTRIC GENERATING PLANT
UNIT 1 AND UNIT 2

REACTOR COOLANT PUMP
INLET NOZZLE - NODE E30
(336-in.² BREAK AREA)

FIGURE 6.2.1-20 (SHEET 30 OF 74)

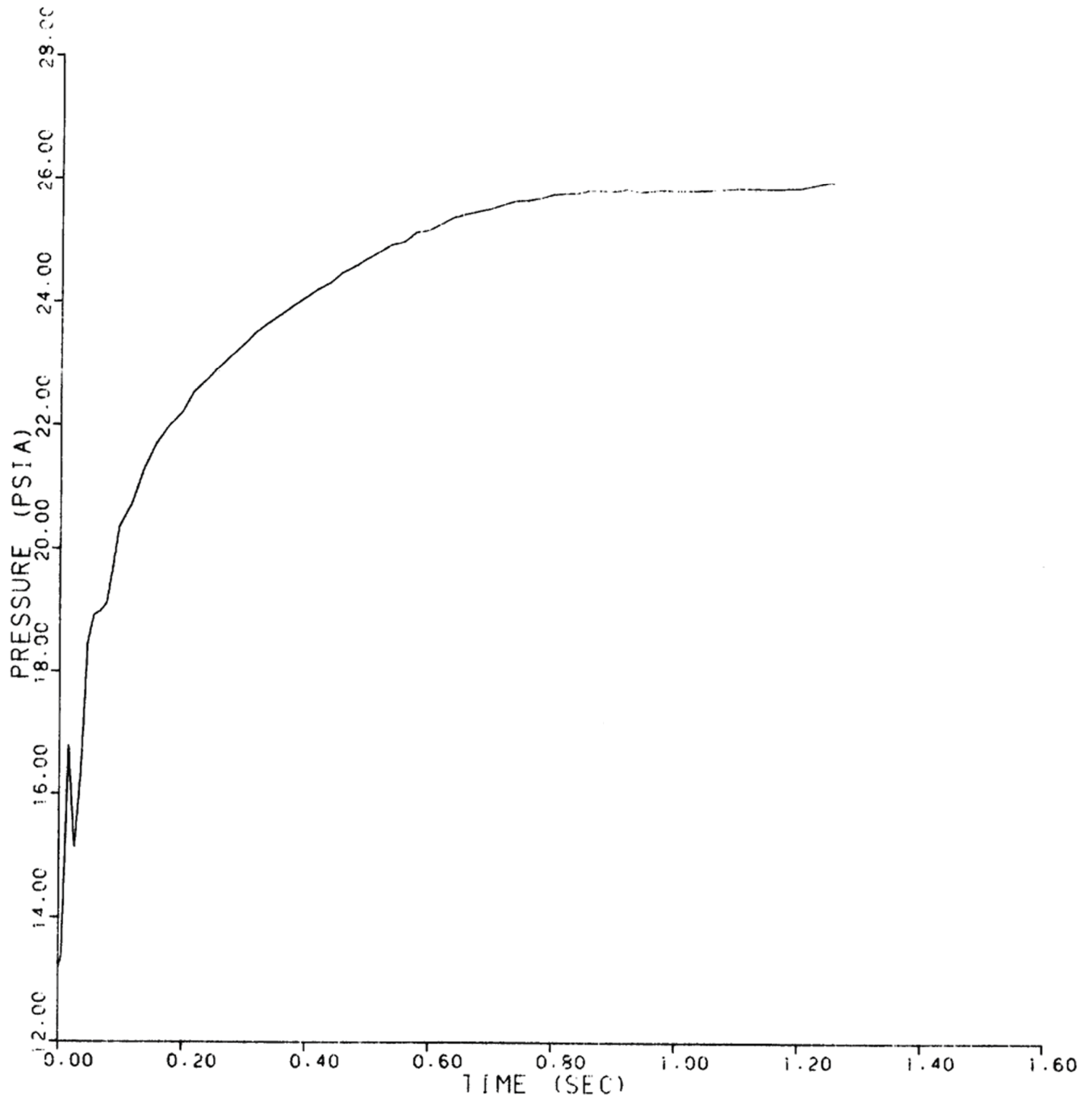

REV 13 4/06



VOGTLE
ELECTRIC GENERATING PLANT
UNIT 1 AND UNIT 2

REACTOR COOLANT PUMP
INLET NOZZLE - NODE E31
(336-in.² BREAK AREA)

FIGURE 6.2.1-20 (SHEET 31 OF 74)

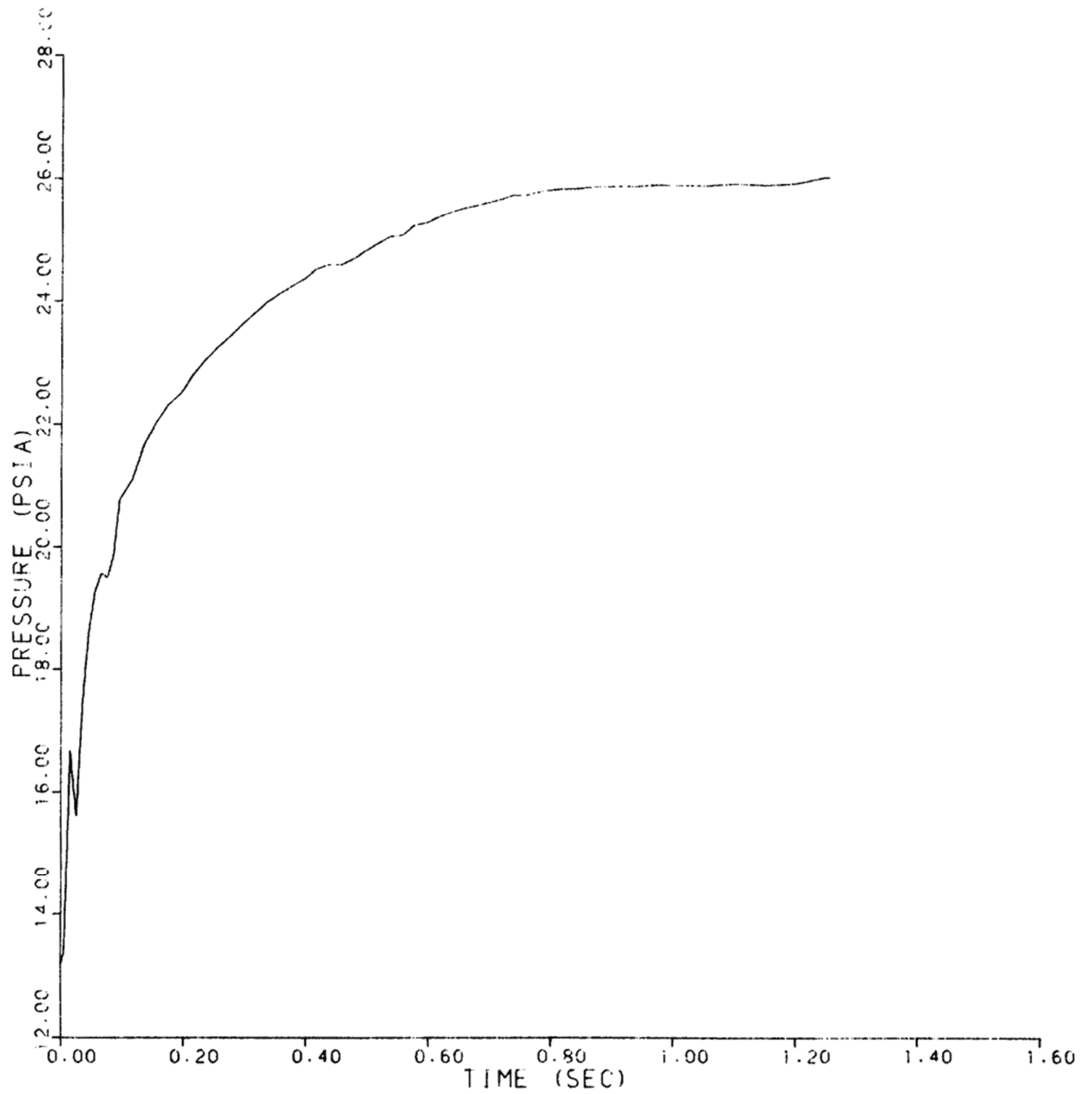

REV 13 4/06



VOGTLE
ELECTRIC GENERATING PLANT
UNIT 1 AND UNIT 2

REACTOR COOLANT PUMP
INLET NOZZLE - NODE E32
(336-in.² BREAK AREA)

FIGURE 6.2.1-20 (SHEET 32 OF 74)

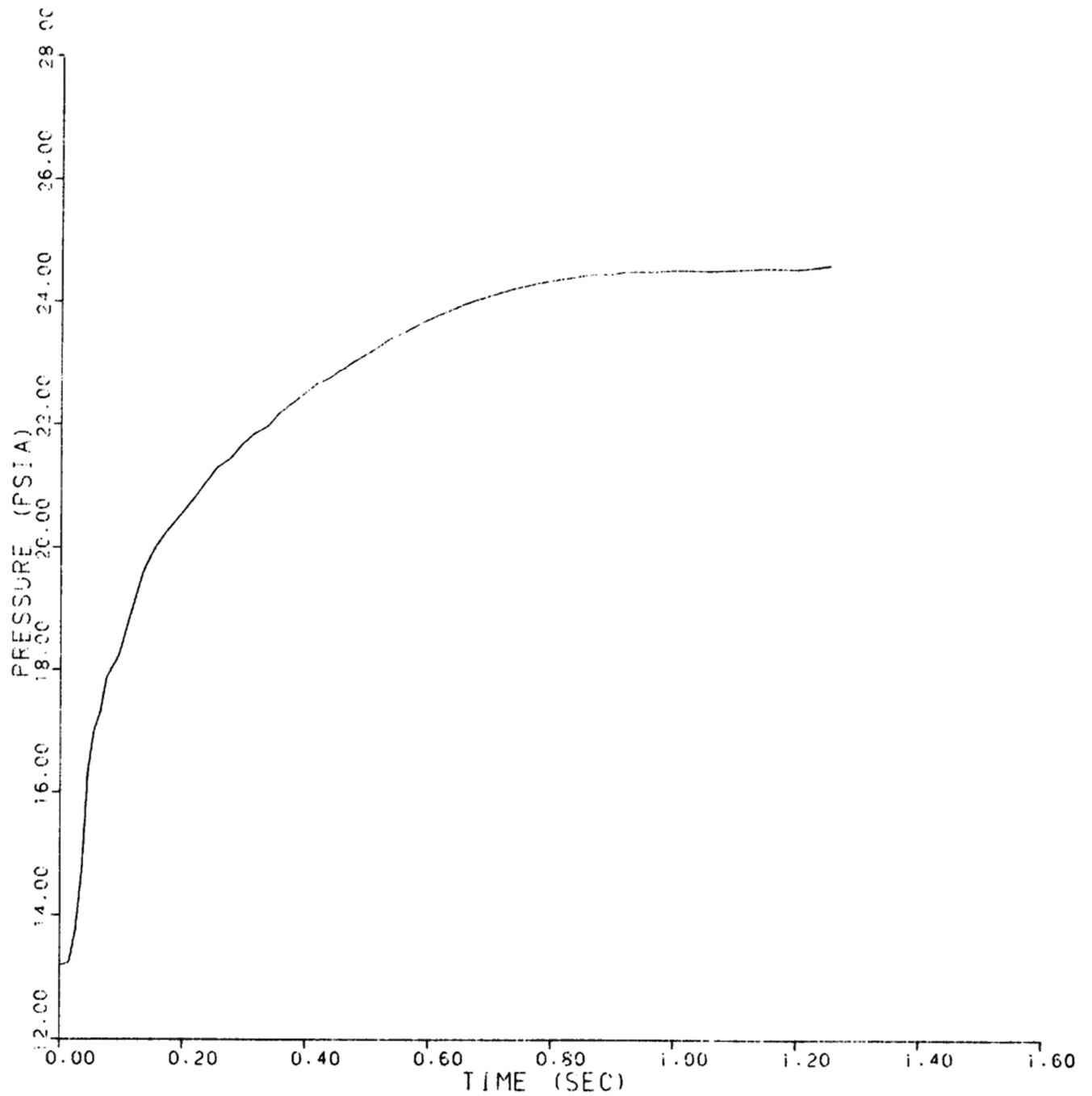

REV 13 4/06



VOGTLE
ELECTRIC GENERATING PLANT
UNIT 1 AND UNIT 2

REACTOR COOLANT PUMP
INLET NOZZLE - NODE E33
(336-in.² BREAK AREA)

FIGURE 6.2.1-20 (SHEET 33 OF 74)

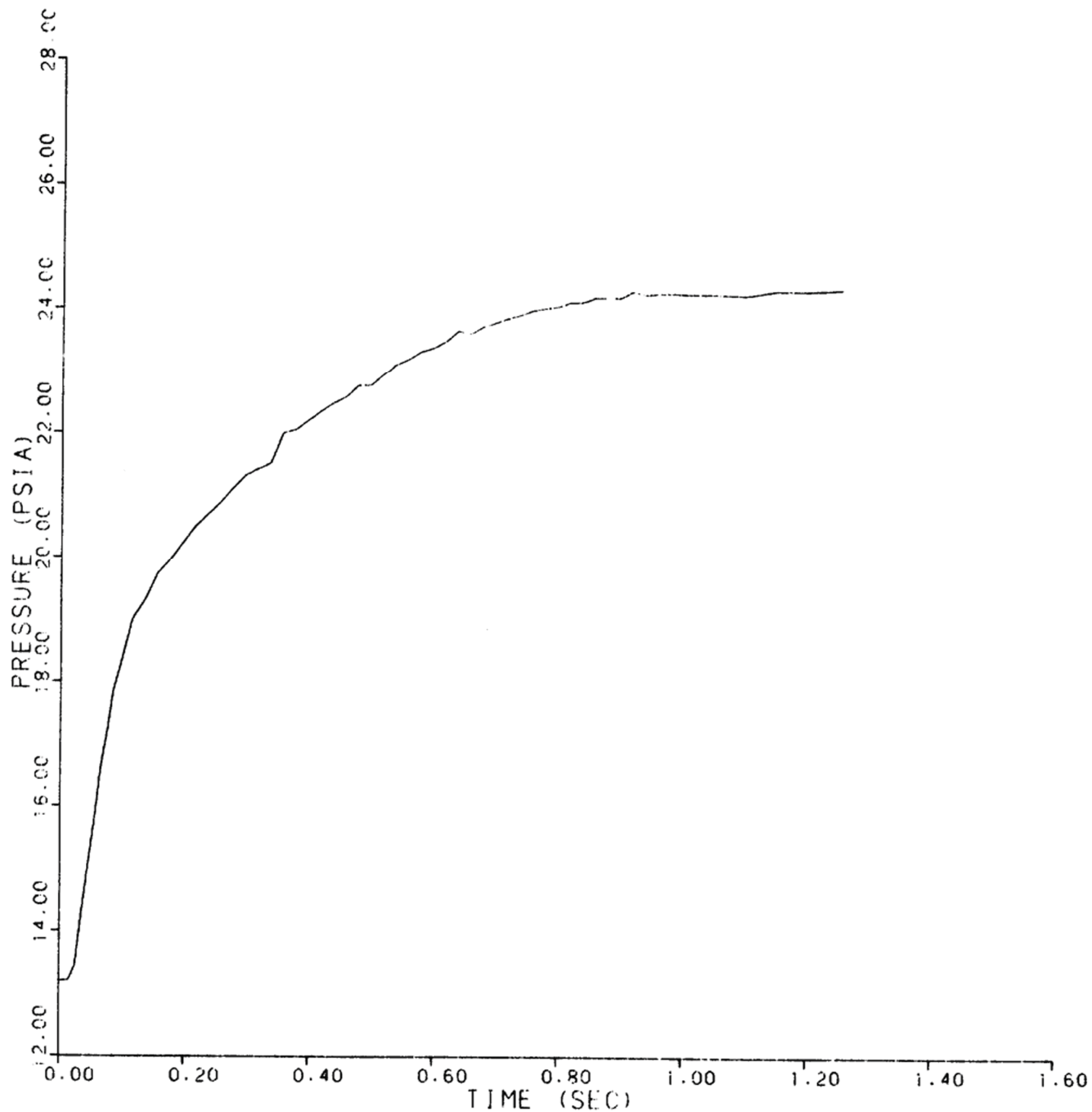

REV 13 4/06



VOGTLE
ELECTRIC GENERATING PLANT
UNIT 1 AND UNIT 2

REACTOR COOLANT PUMP
INLET NOZZLE - NODE E34
(336-in.² BREAK AREA)

FIGURE 6.2.1-20 (SHEET 34 OF 74)

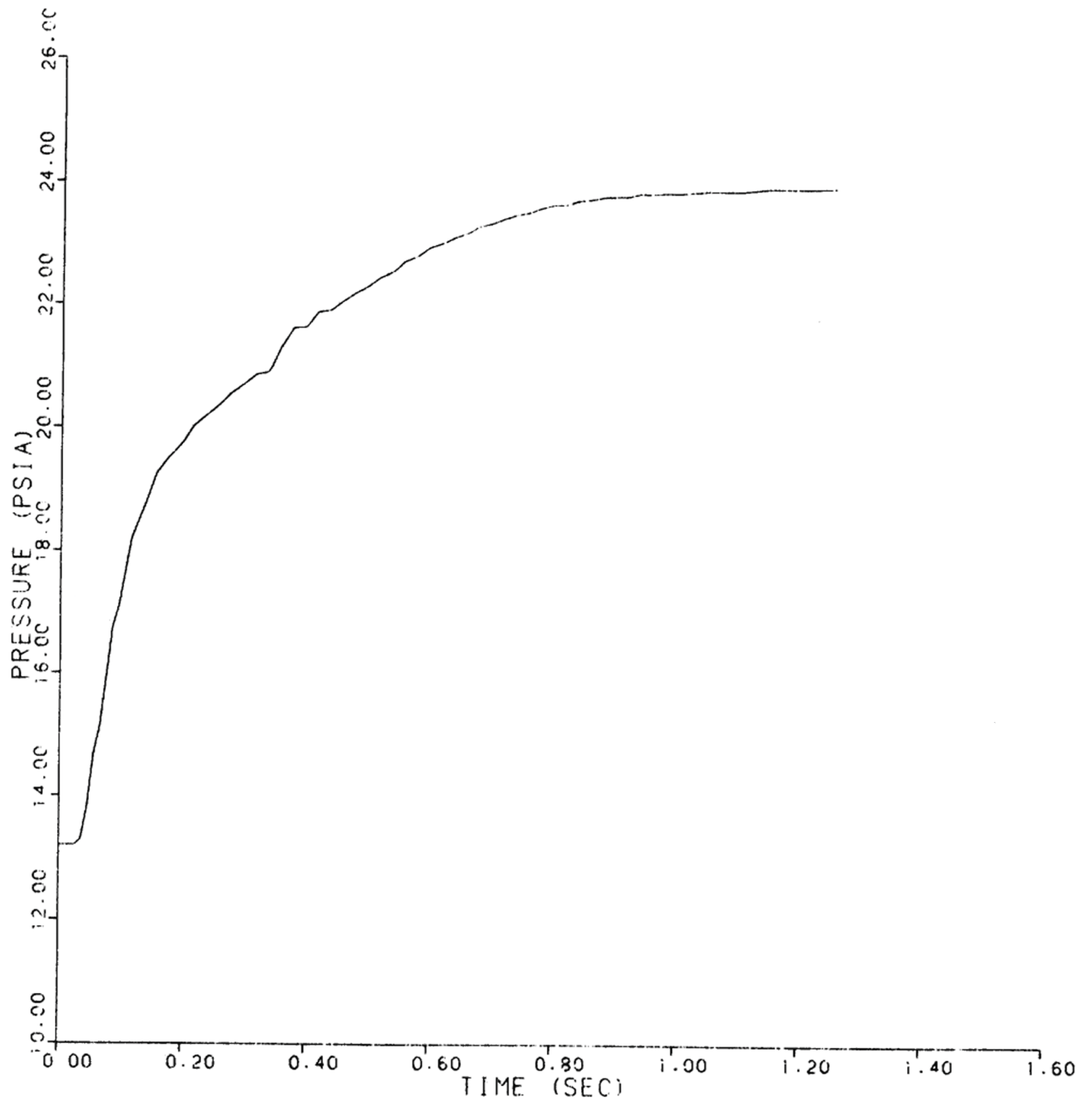

REV 13 4/06



VOGTLE
ELECTRIC GENERATING PLANT
UNIT 1 AND UNIT 2

REACTOR COOLANT PUMP
INLET NOZZLE - NODE E35
(336-in.² BREAK AREA)

FIGURE 6.2.1-20 (SHEET 35 OF 74)

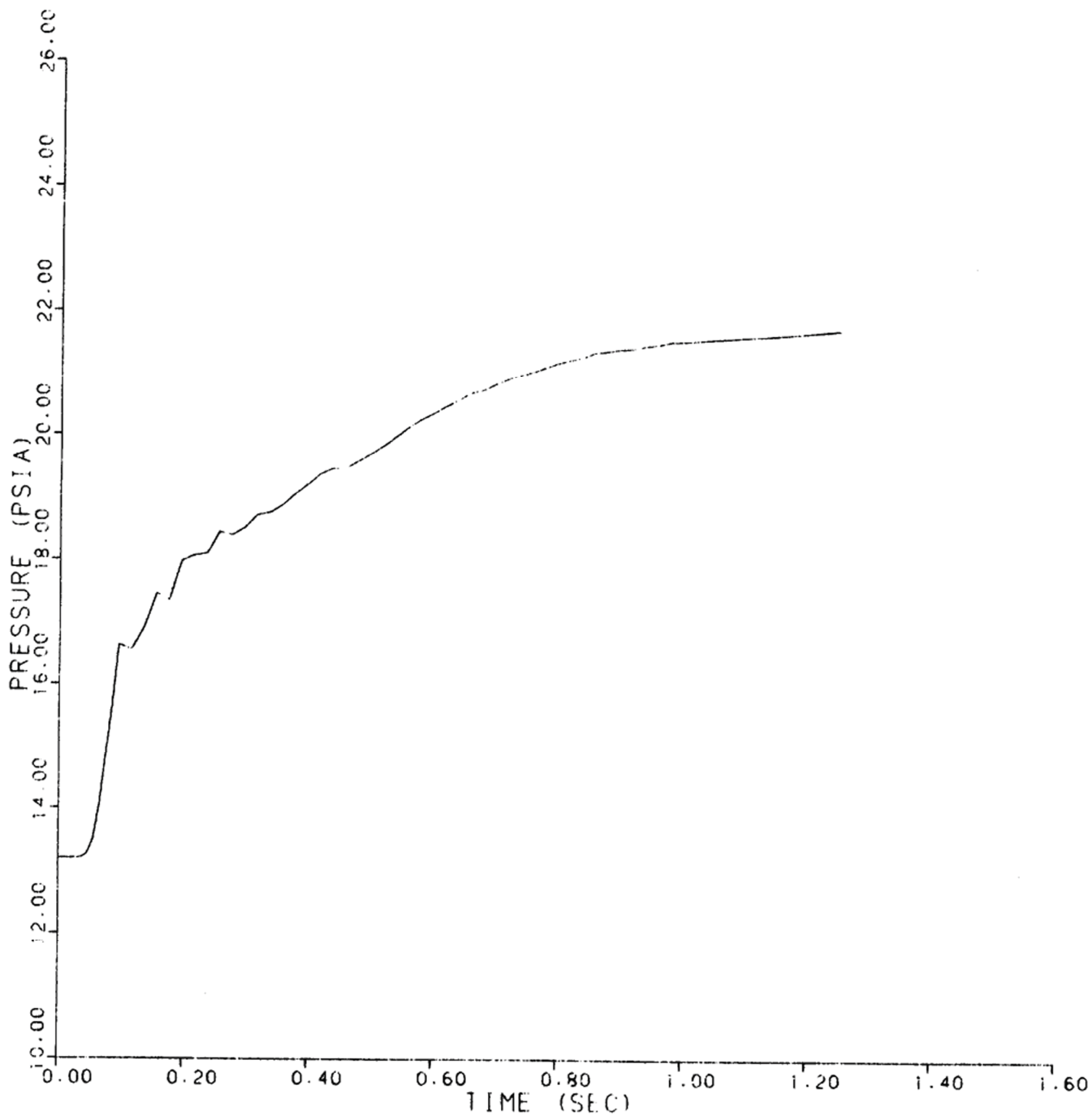

REV 13 4/06



VOGTLE
ELECTRIC GENERATING PLANT
UNIT 1 AND UNIT 2

REACTOR COOLANT PUMP
INLET NOZZLE - NODE E36
(336-in.² BREAK AREA)

FIGURE 6.2.1-20 (SHEET 36 OF 74)

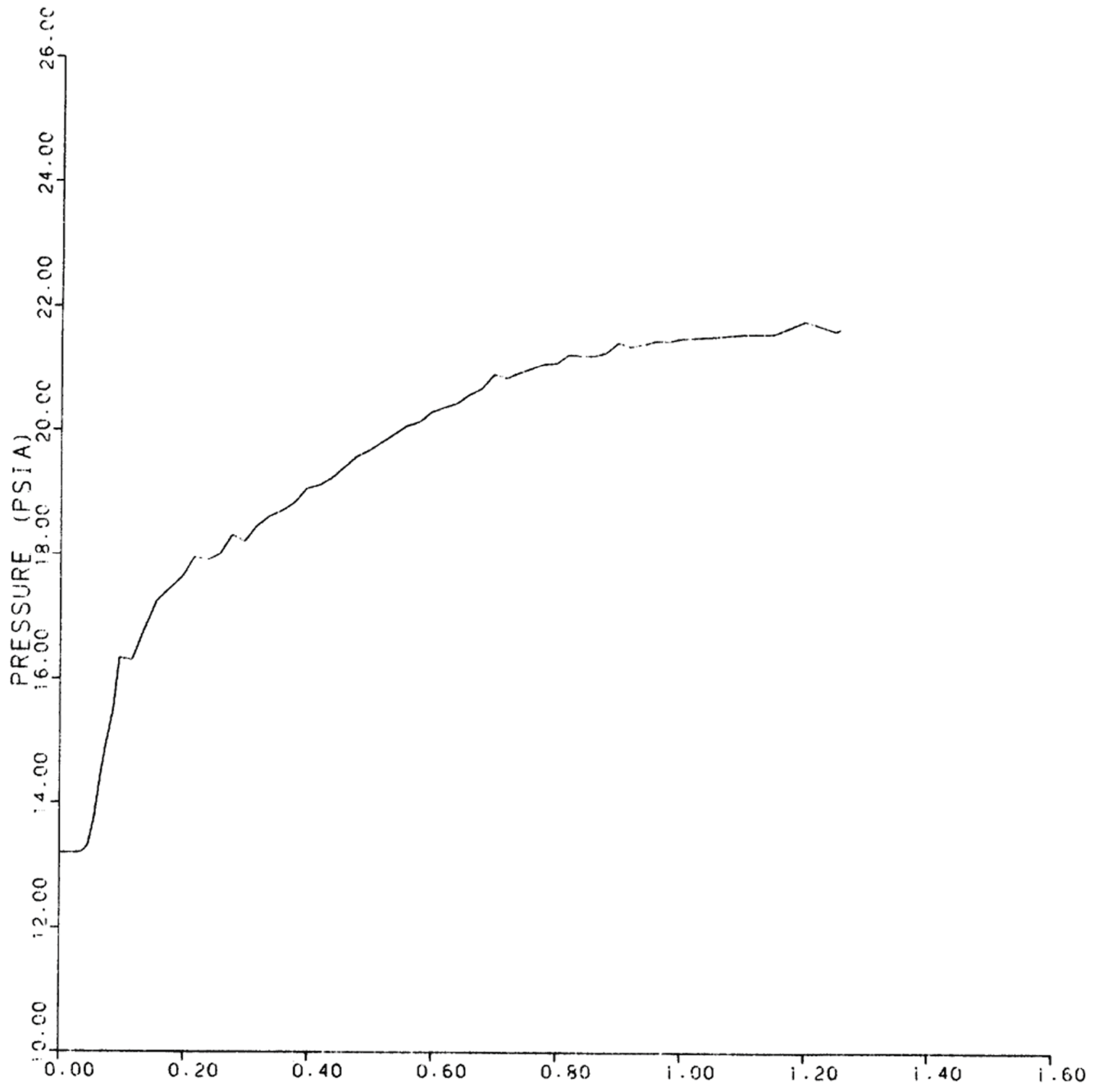

REV 13 4/06



VOGTLE
ELECTRIC GENERATING PLANT
UNIT 1 AND UNIT 2

REACTOR COOLANT PUMP
INLET NOZZLE - NODE E37
(336-in.² BREAK AREA)

FIGURE 6.2.1-20 (SHEET 37 OF 74)

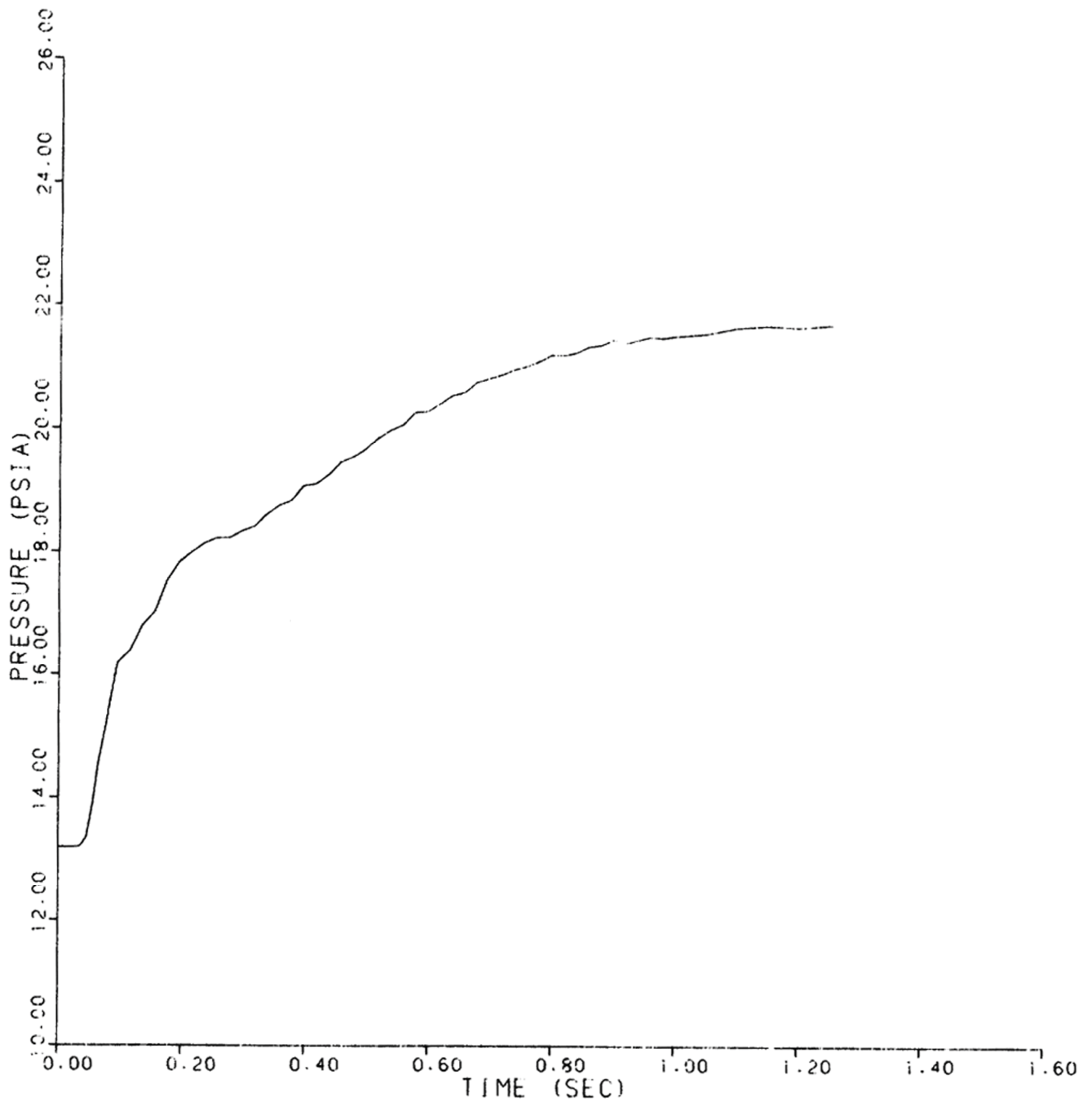

REV 13 4/06



VOGTLE
ELECTRIC GENERATING PLANT
UNIT 1 AND UNIT 2

REACTOR COOLANT PUMP
INLET NOZZLE - NODE E38
(336-in.² BREAK AREA)

FIGURE 6.2.1-20 (SHEET 38 OF 74)

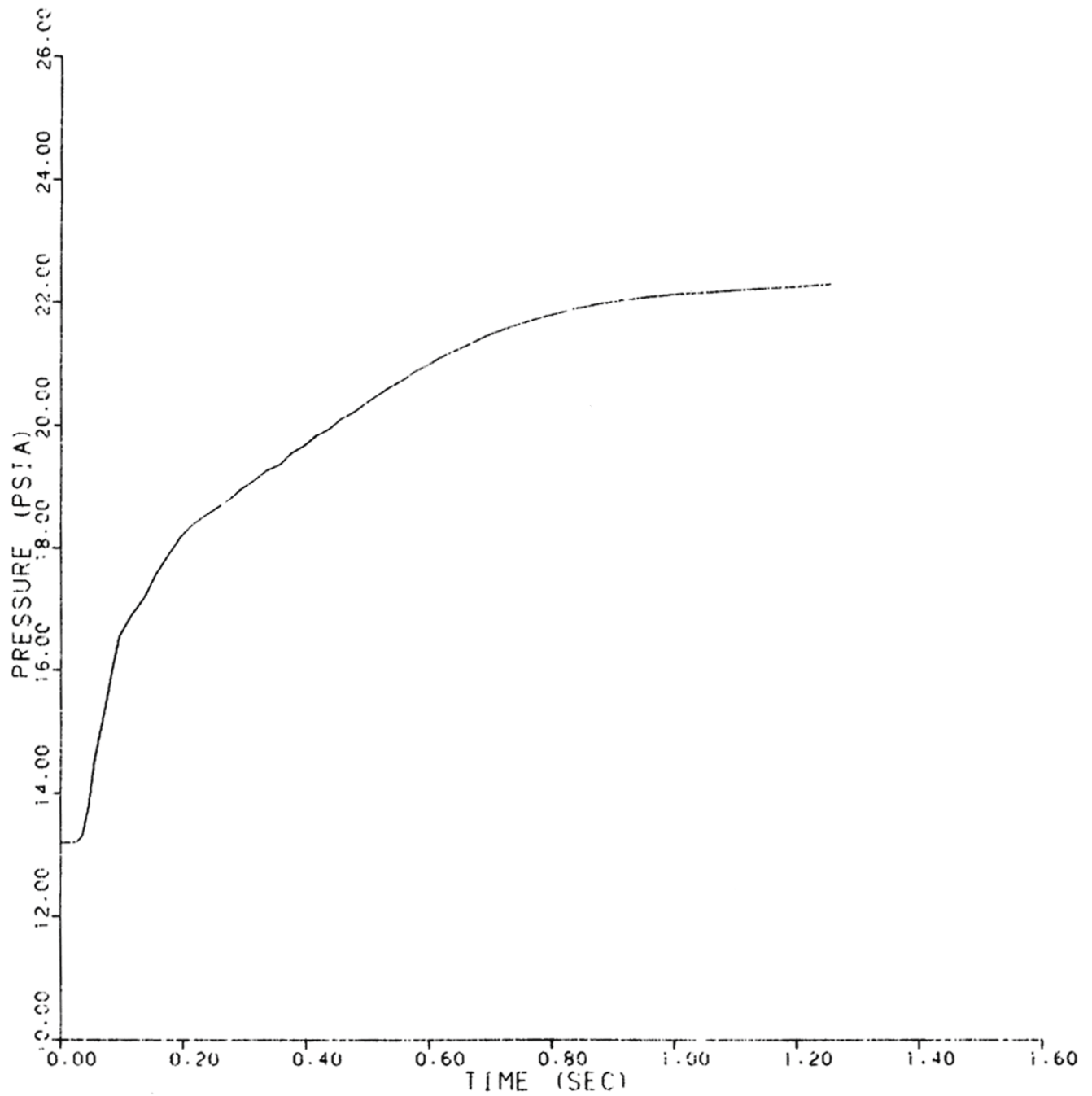

REV 13 4/06



VOGTLE
ELECTRIC GENERATING PLANT
UNIT 1 AND UNIT 2

REACTOR COOLANT PUMP
INLET NOZZLE - NODE E39
(336-in.² BREAK AREA)

FIGURE 6.2.1-20 (SHEET 39 OF 74)

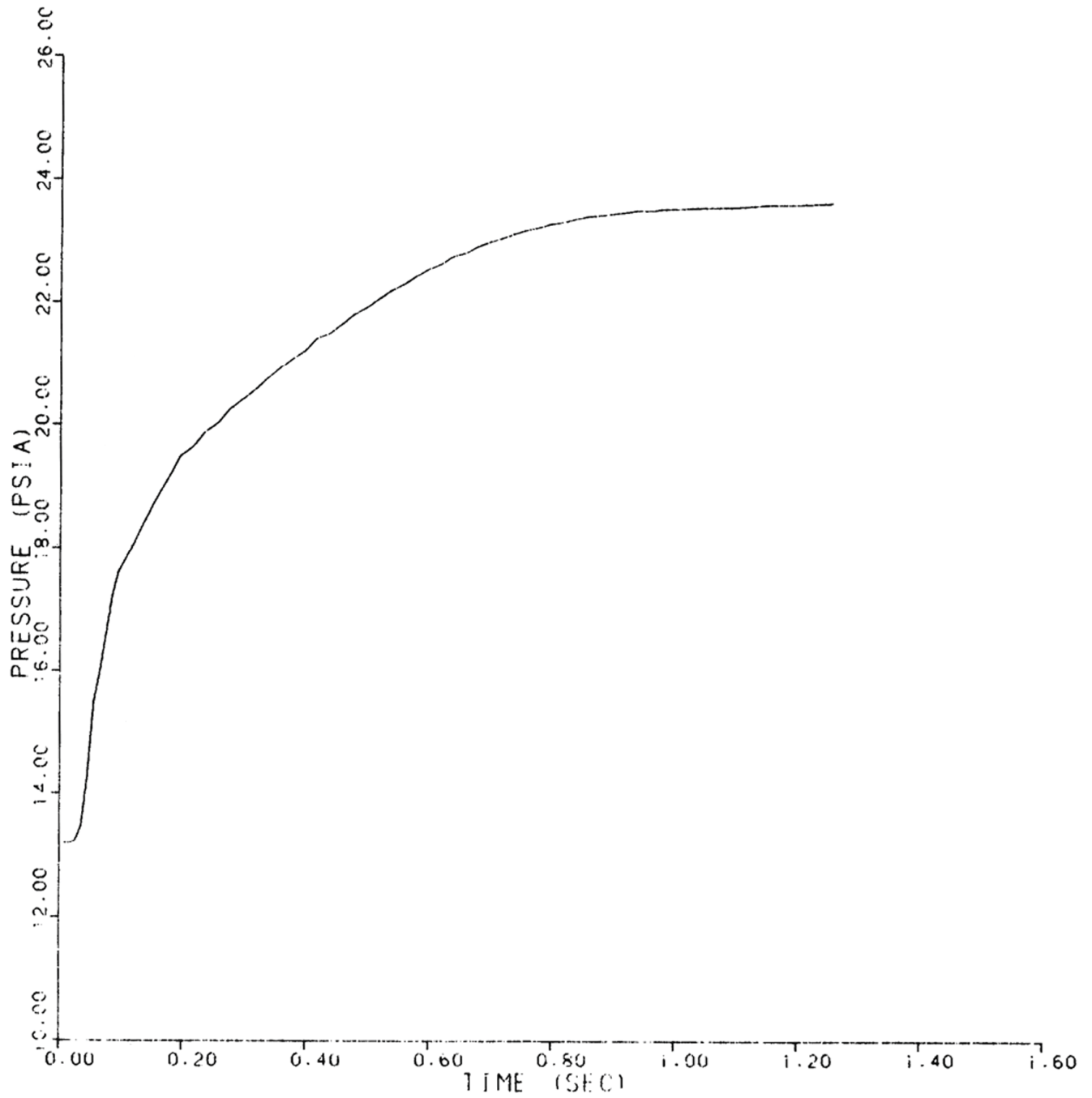

REV 13 4/06



VOGTLE
ELECTRIC GENERATING PLANT
UNIT 1 AND UNIT 2

REACTOR COOLANT PUMP
INLET NOZZLE - NODE E40
(336-in.² BREAK AREA)

FIGURE 6.2.1-20 (SHEET 40 OF 74)

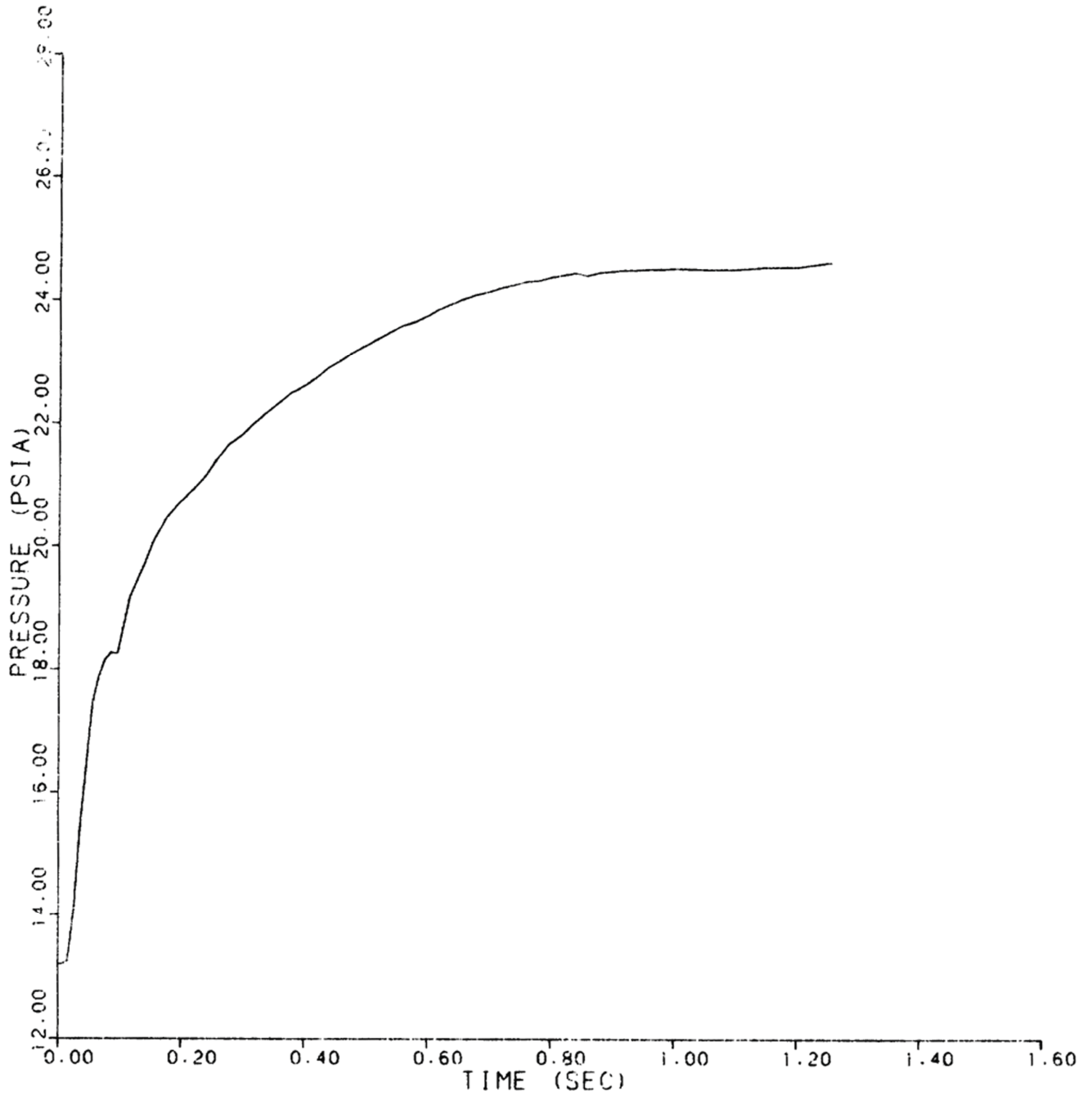

REV 13 4/06



VOGTLE
ELECTRIC GENERATING PLANT
UNIT 1 AND UNIT 2

REACTOR COOLANT PUMP
INLET NOZZLE - NODE E41
(336-in.² BREAK AREA)

FIGURE 6.2.1-20 (SHEET 41 OF 74)

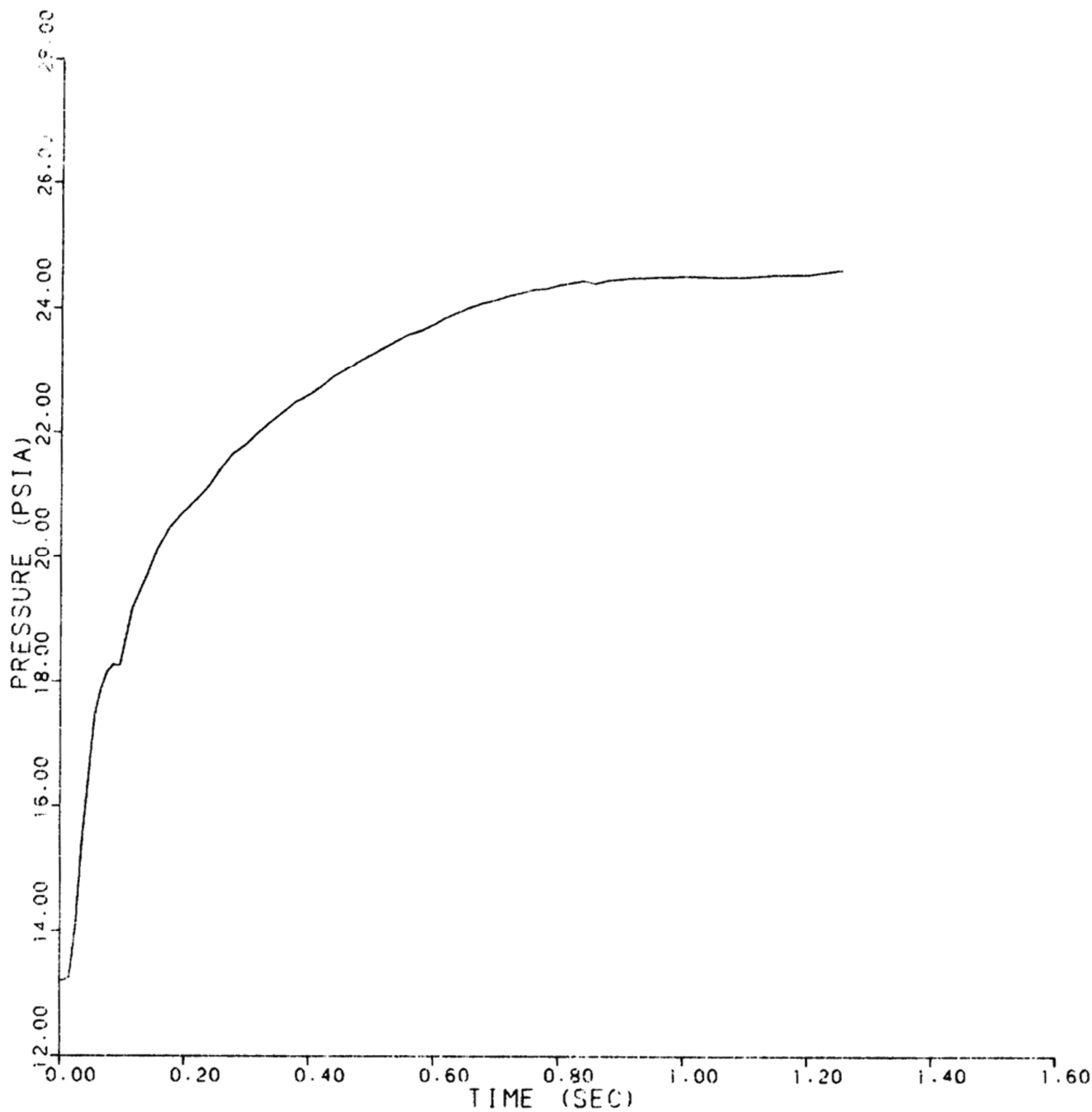

REV 13 4/06



VOGTLE
ELECTRIC GENERATING PLANT
UNIT 1 AND UNIT 2

REACTOR COOLANT PUMP
INLET NOZZLE - NODE E42
(336-in.² BREAK AREA)

FIGURE 6.2.1-20 (SHEET 42 OF 74)

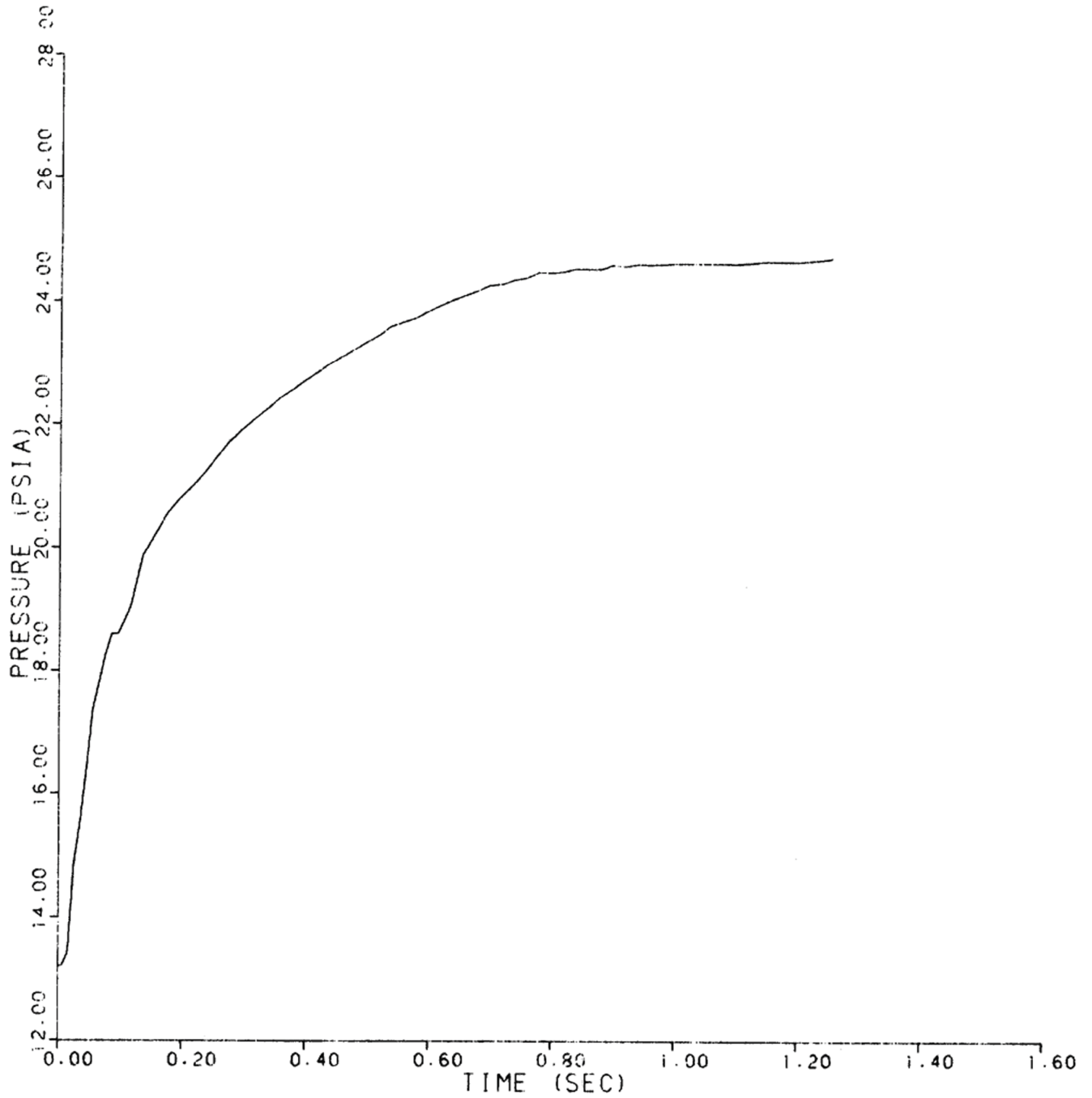

REV 13 4/06



VOGTLE
ELECTRIC GENERATING PLANT
UNIT 1 AND UNIT 2

REACTOR COOLANT PUMP
INLET NOZZLE - NODE E43
(336-in.² BREAK AREA)

FIGURE 6.2.1-20 (SHEET 43 OF 74)

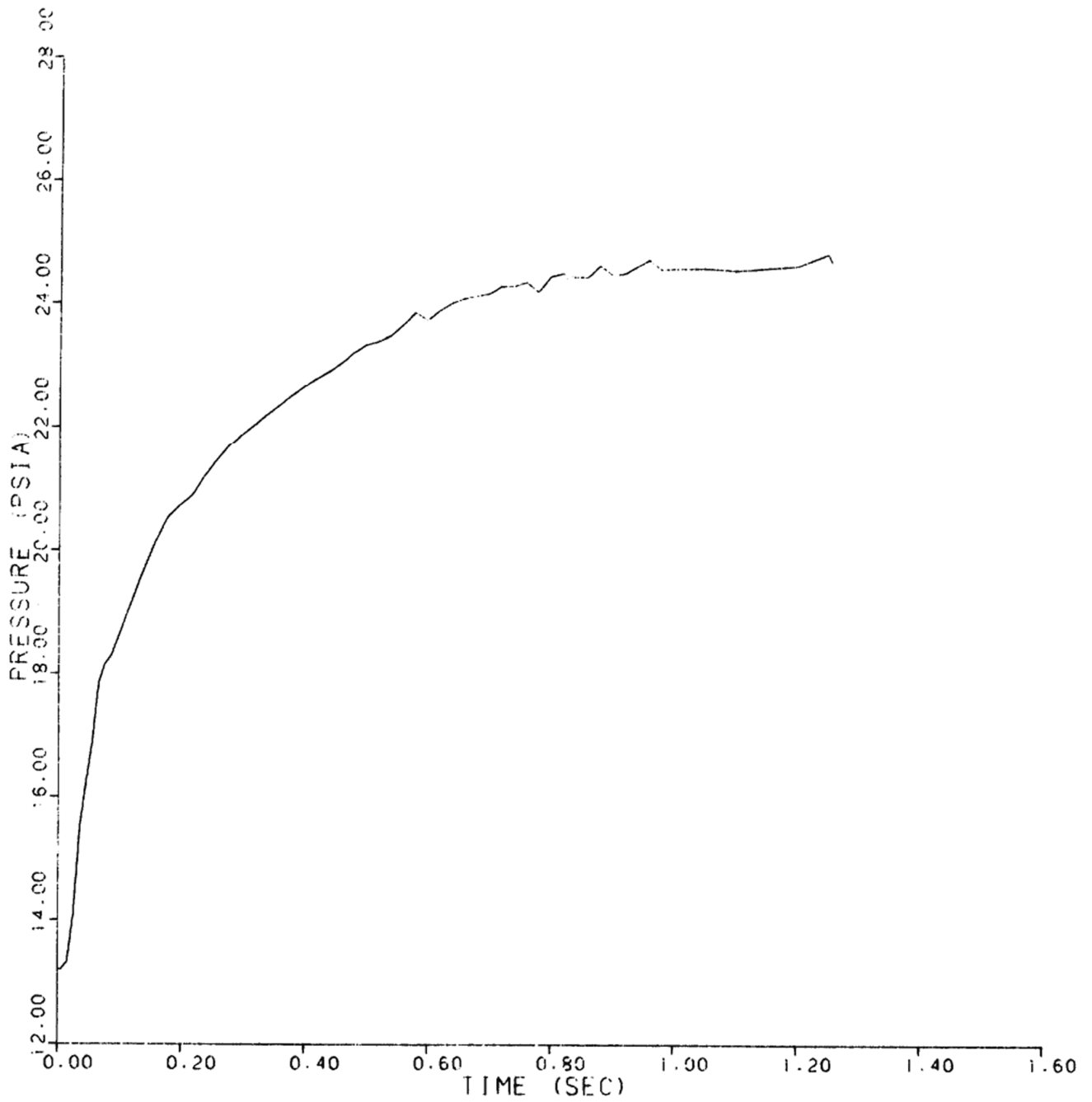

REV 13 4/06



VOGTLE
ELECTRIC GENERATING PLANT
UNIT 1 AND UNIT 2

REACTOR COOLANT PUMP
INLET NOZZLE - NODE E44
(336-in.² BREAK AREA)

FIGURE 6.2.1-20 (SHEET 44 OF 74)

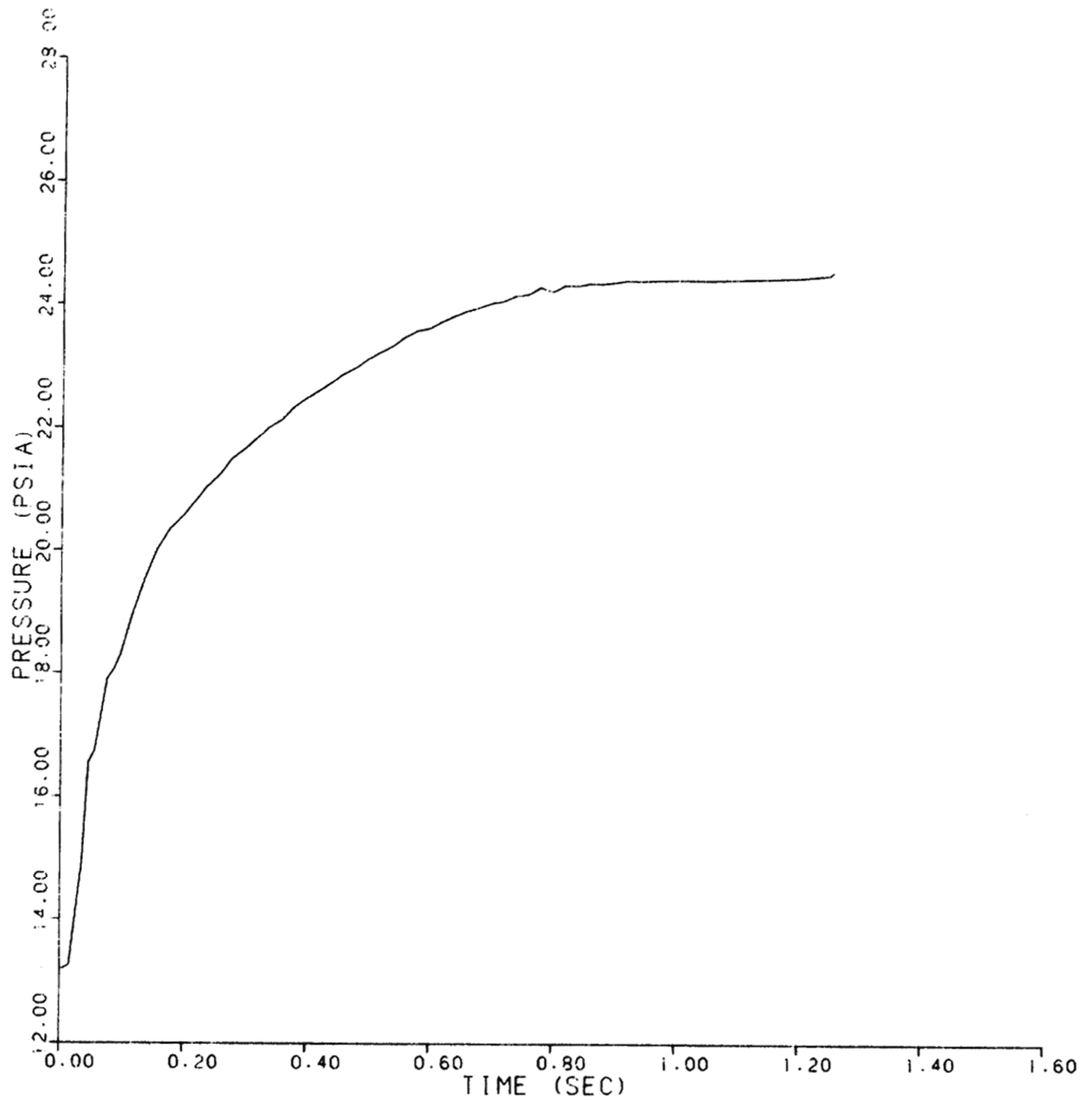

REV 13 4/06



VOGTLE
ELECTRIC GENERATING PLANT
UNIT 1 AND UNIT 2

REACTOR COOLANT PUMP
INLET NOZZLE - NODE E45
(336-in.² BREAK AREA)

FIGURE 6.2.1-20 (SHEET 45 OF 74)

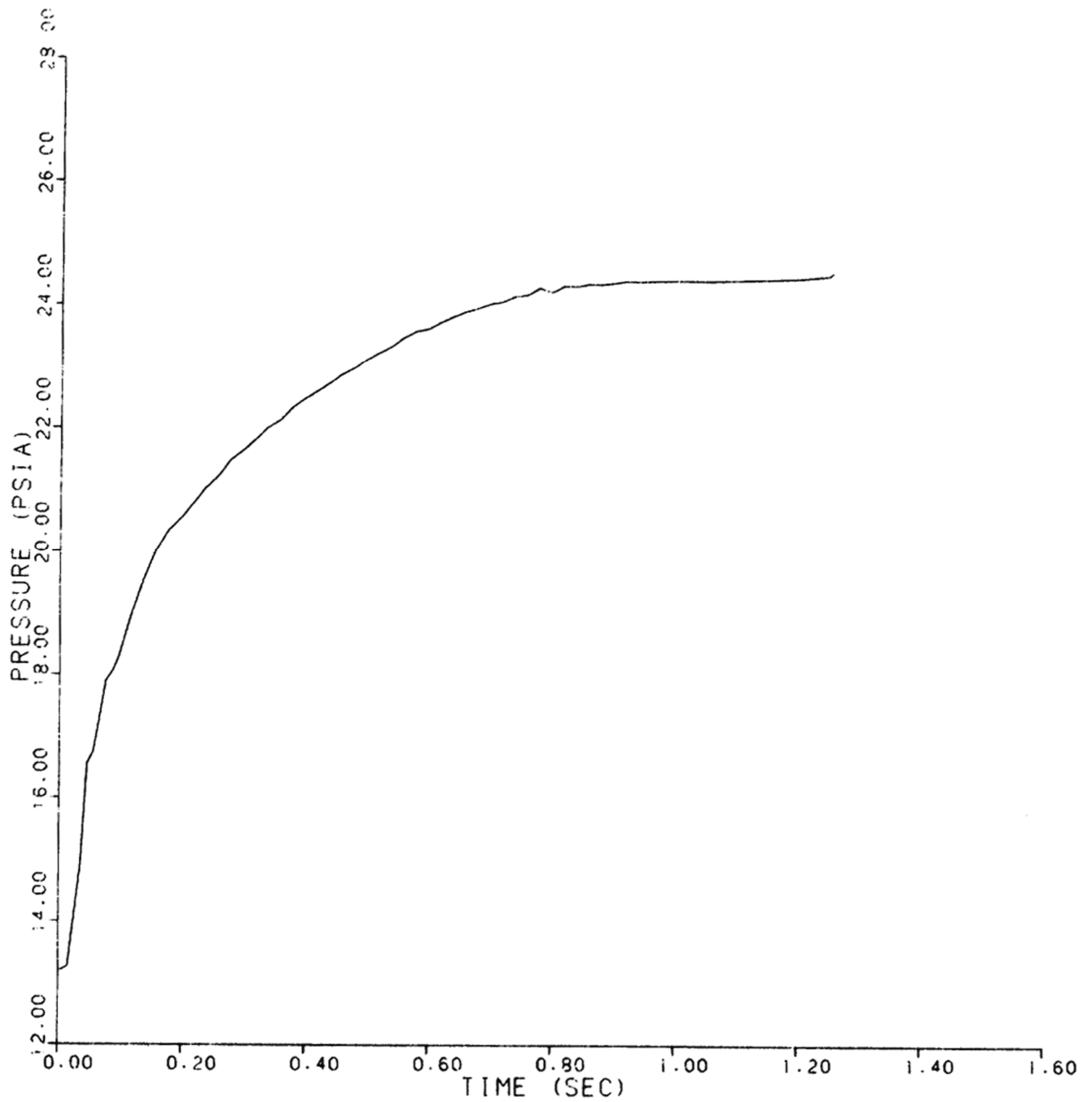

REV 13 4/06



VOGTLE
ELECTRIC GENERATING PLANT
UNIT 1 AND UNIT 2

REACTOR COOLANT PUMP
INLET NOZZLE - NODE E46
(336-in.² BREAK AREA)

FIGURE 6.2.1-20 (SHEET 46 OF 74)

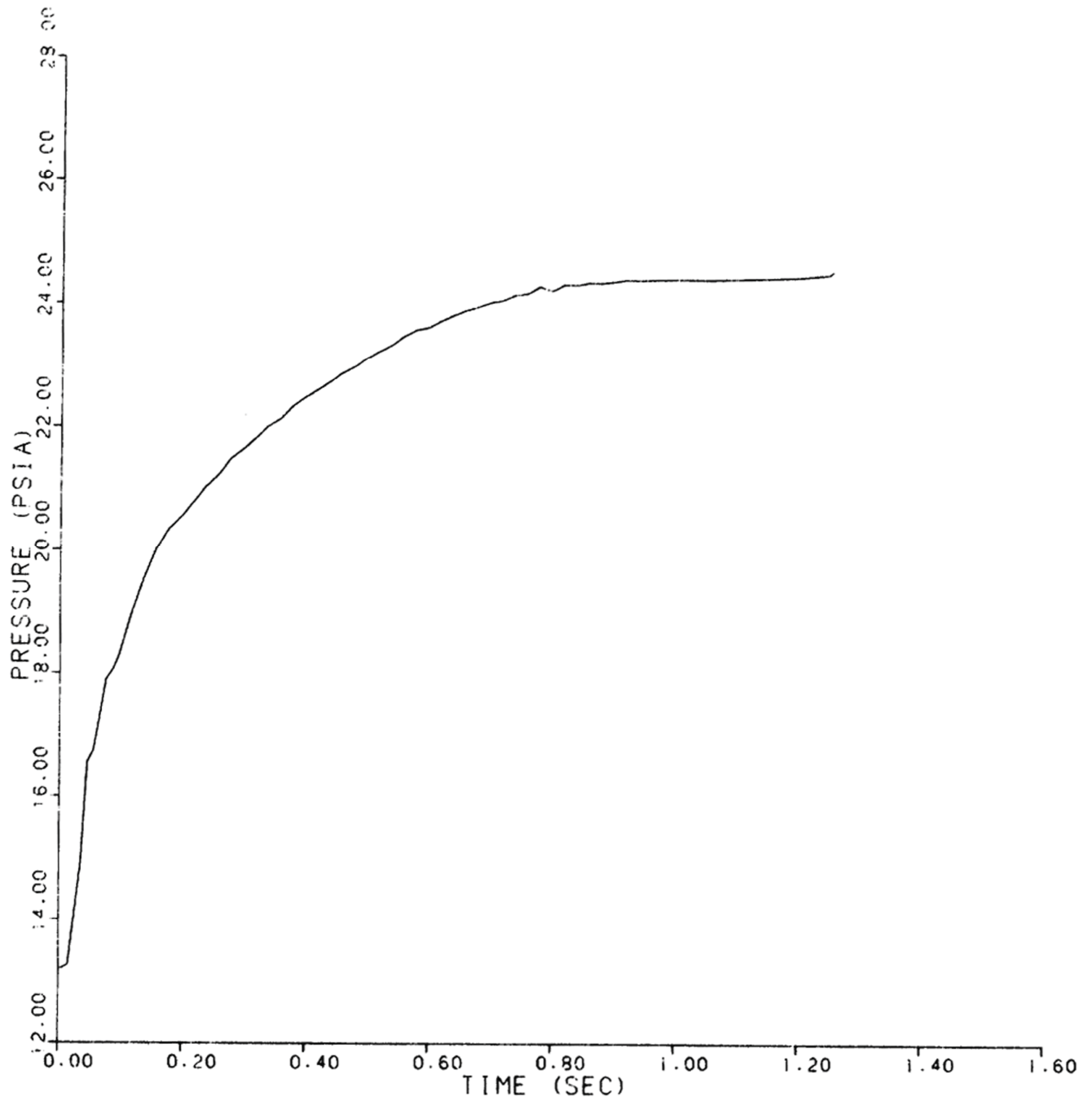

REV 13 4/06



VOGTLE
ELECTRIC GENERATING PLANT
UNIT 1 AND UNIT 2

REACTOR COOLANT PUMP
INLET NOZZLE - NODE E47
(336-in.² BREAK AREA)

FIGURE 6.2.1-20 (SHEET 47 OF 74)

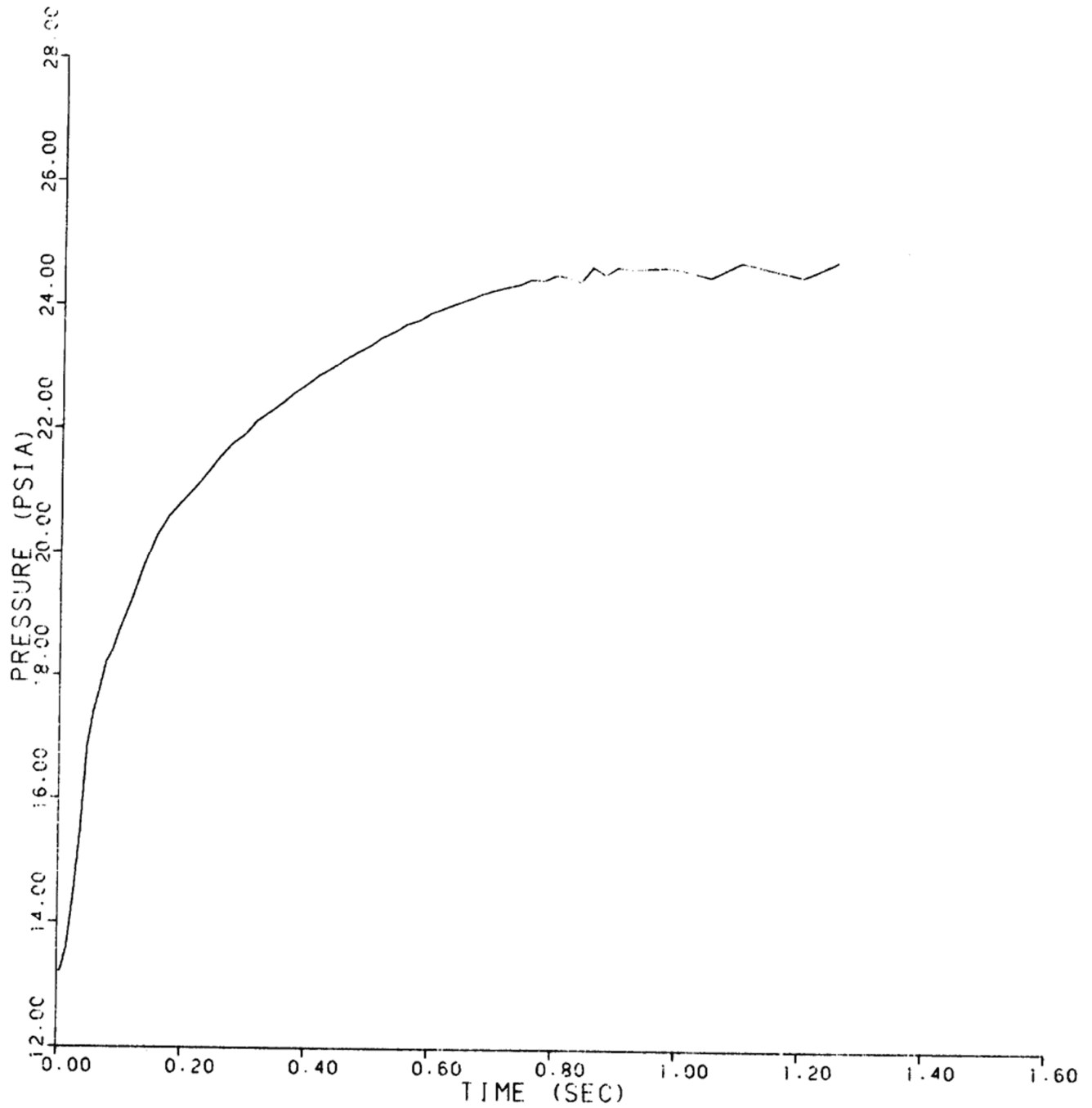

REV 13 4/06



VOGTLE
ELECTRIC GENERATING PLANT
UNIT 1 AND UNIT 2

REACTOR COOLANT PUMP
INLET NOZZLE - NODE E48
(336-in.² BREAK AREA)

FIGURE 6.2.1-20 (SHEET 48 OF 74)

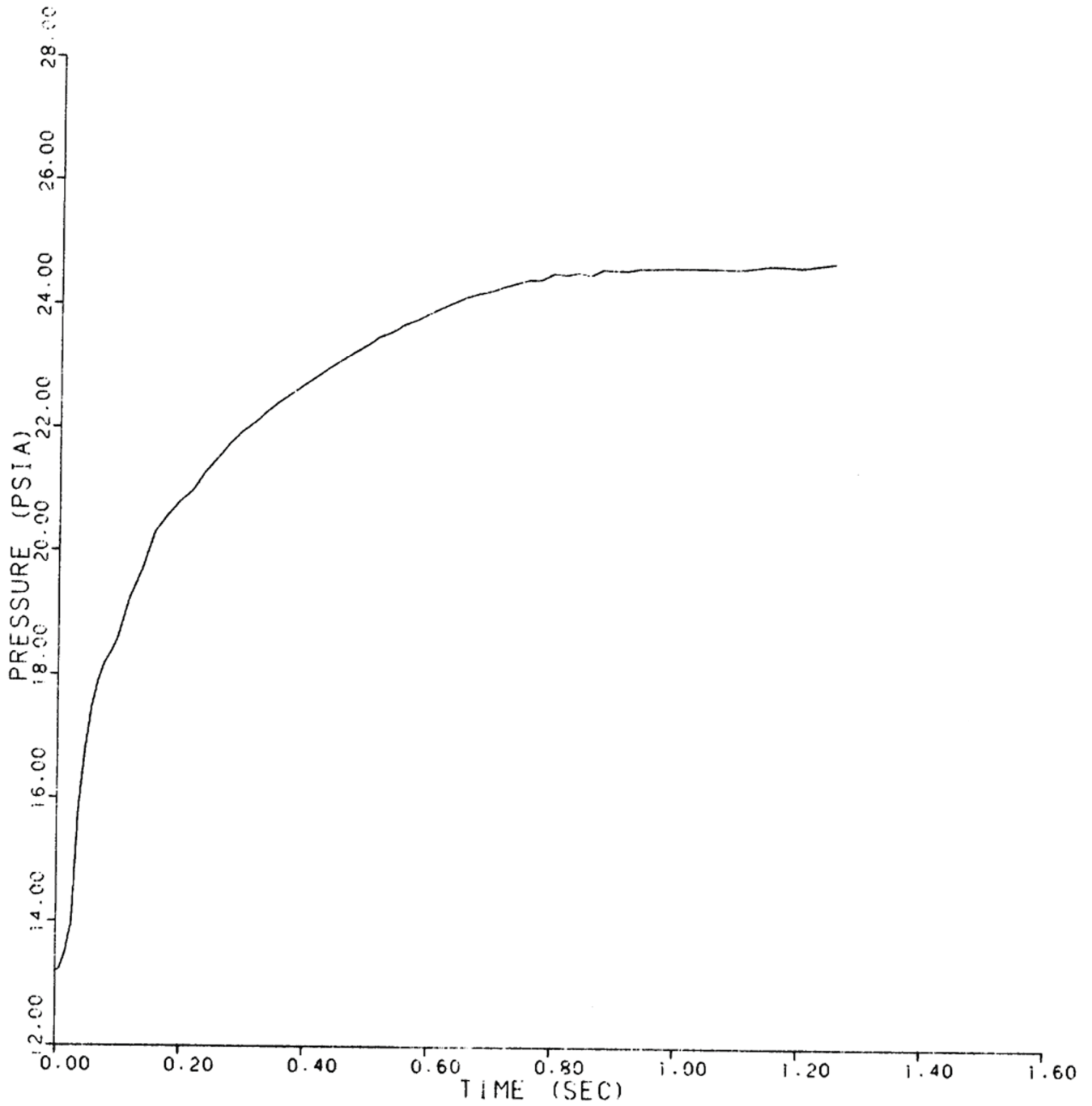

REV 13 4/06



VOGTLE
ELECTRIC GENERATING PLANT
UNIT 1 AND UNIT 2

REACTOR COOLANT PUMP
INLET NOZZLE - NODE E49
(336-in.² BREAK AREA)

FIGURE 6.2.1-20 (SHEET 49 OF 74)

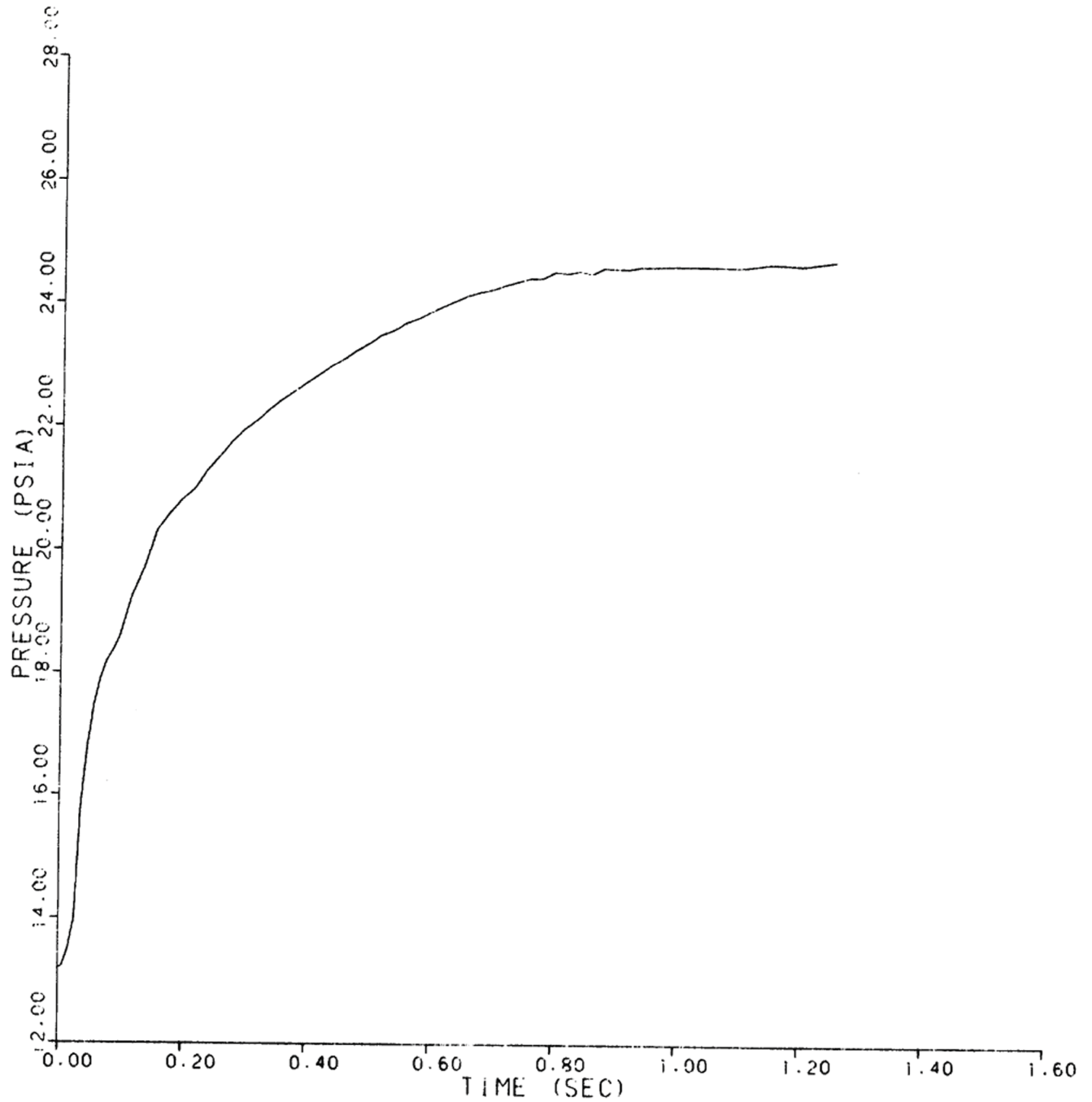

REV 13 4/06



VOGTLE
ELECTRIC GENERATING PLANT
UNIT 1 AND UNIT 2

REACTOR COOLANT PUMP
INLET NOZZLE - NODE E50
(336-in.² BREAK AREA)

FIGURE 6.2.1-20 (SHEET 50 OF 74)

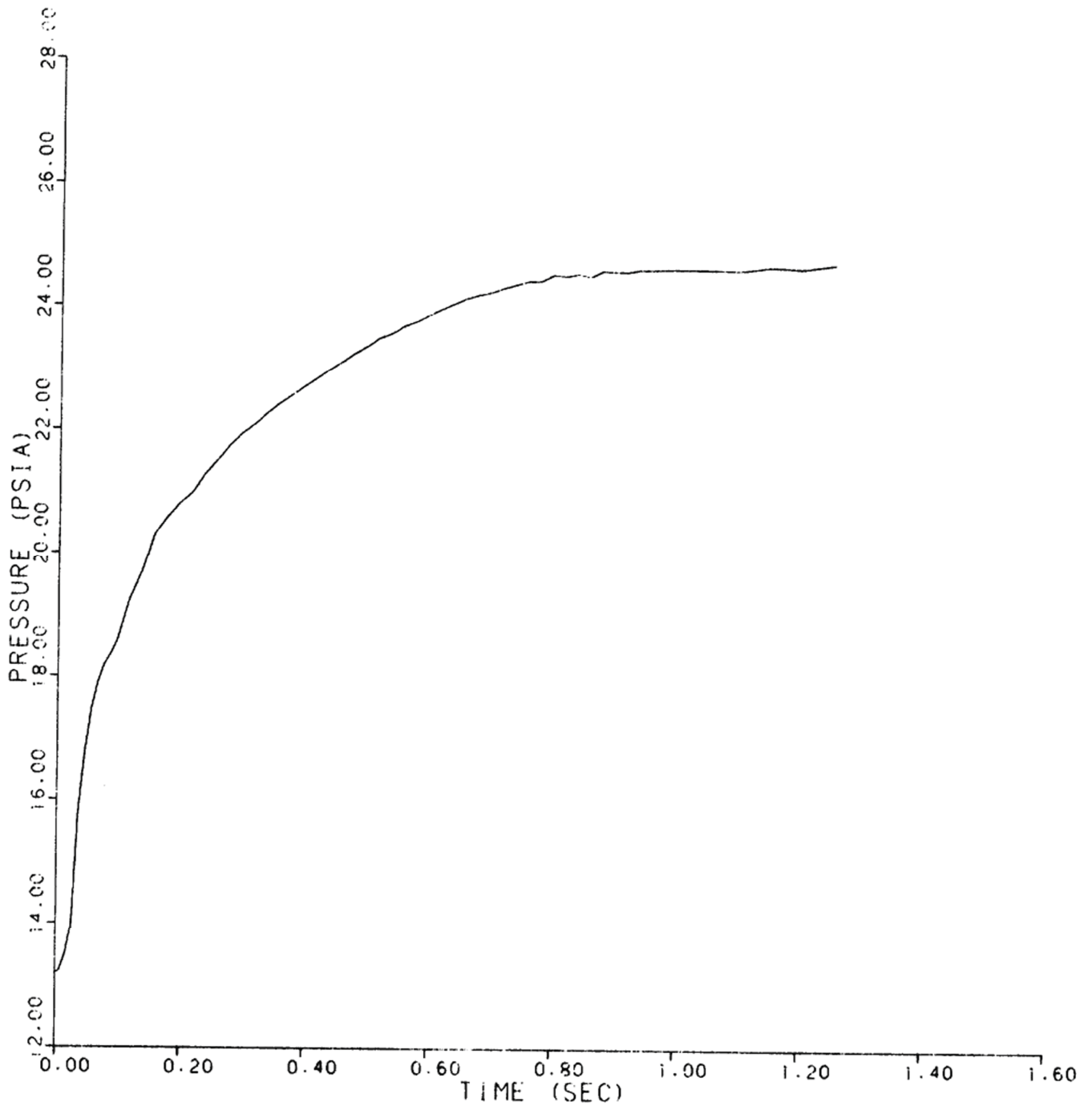

REV 13 4/06



VOGTLE
ELECTRIC GENERATING PLANT
UNIT 1 AND UNIT 2

REACTOR COOLANT PUMP
INLET NOZZLE - NODE E51
(336-in.² BREAK AREA)

FIGURE 6.2.1-20 (SHEET 51 OF 74)

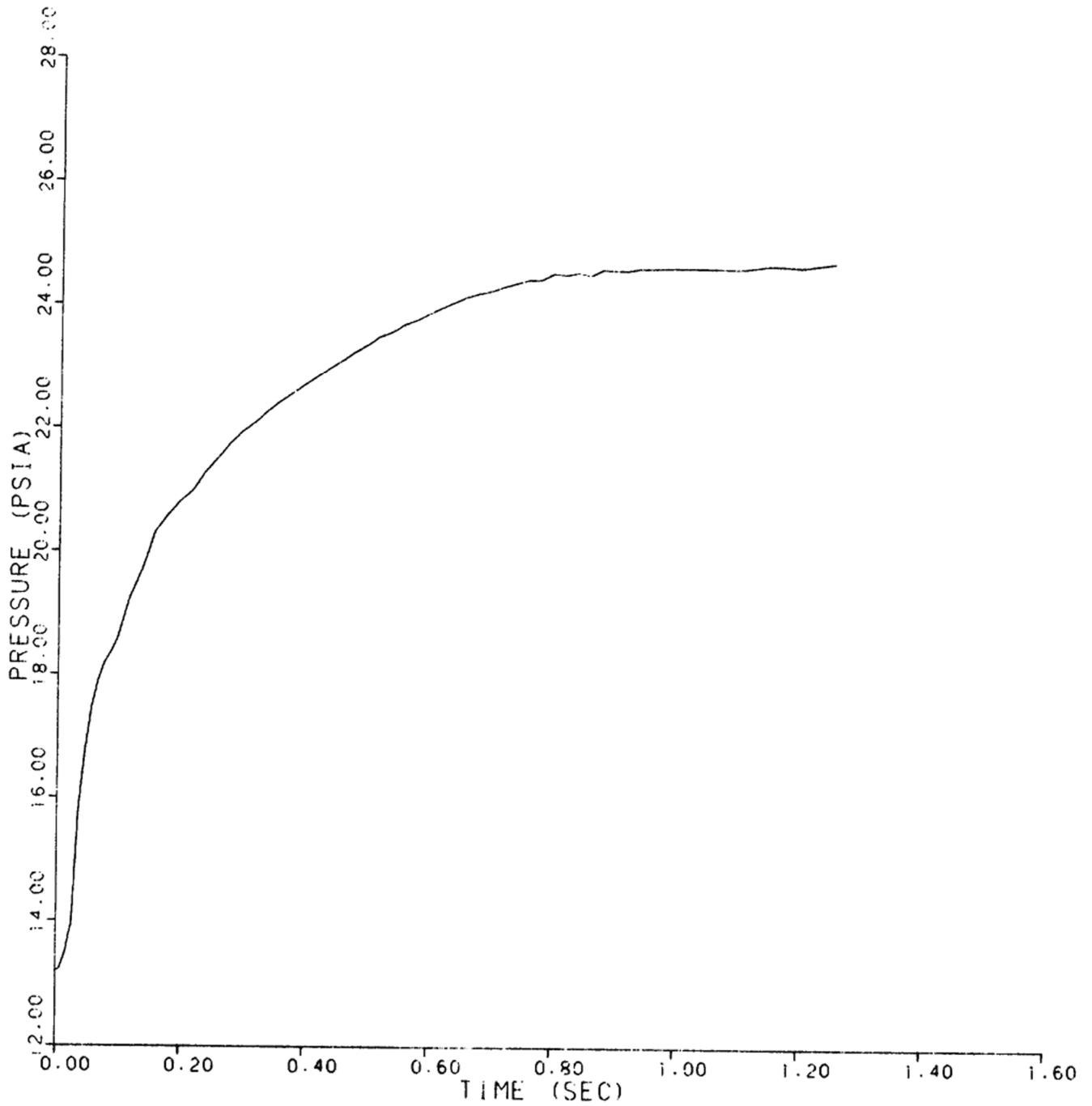

REV 13 4/06



VOGTLE
ELECTRIC GENERATING PLANT
UNIT 1 AND UNIT 2

REACTOR COOLANT PUMP
INLET NOZZLE - NODE E52
(336-in.² BREAK AREA)

FIGURE 6.2.1-20 (SHEET 52 OF 74)

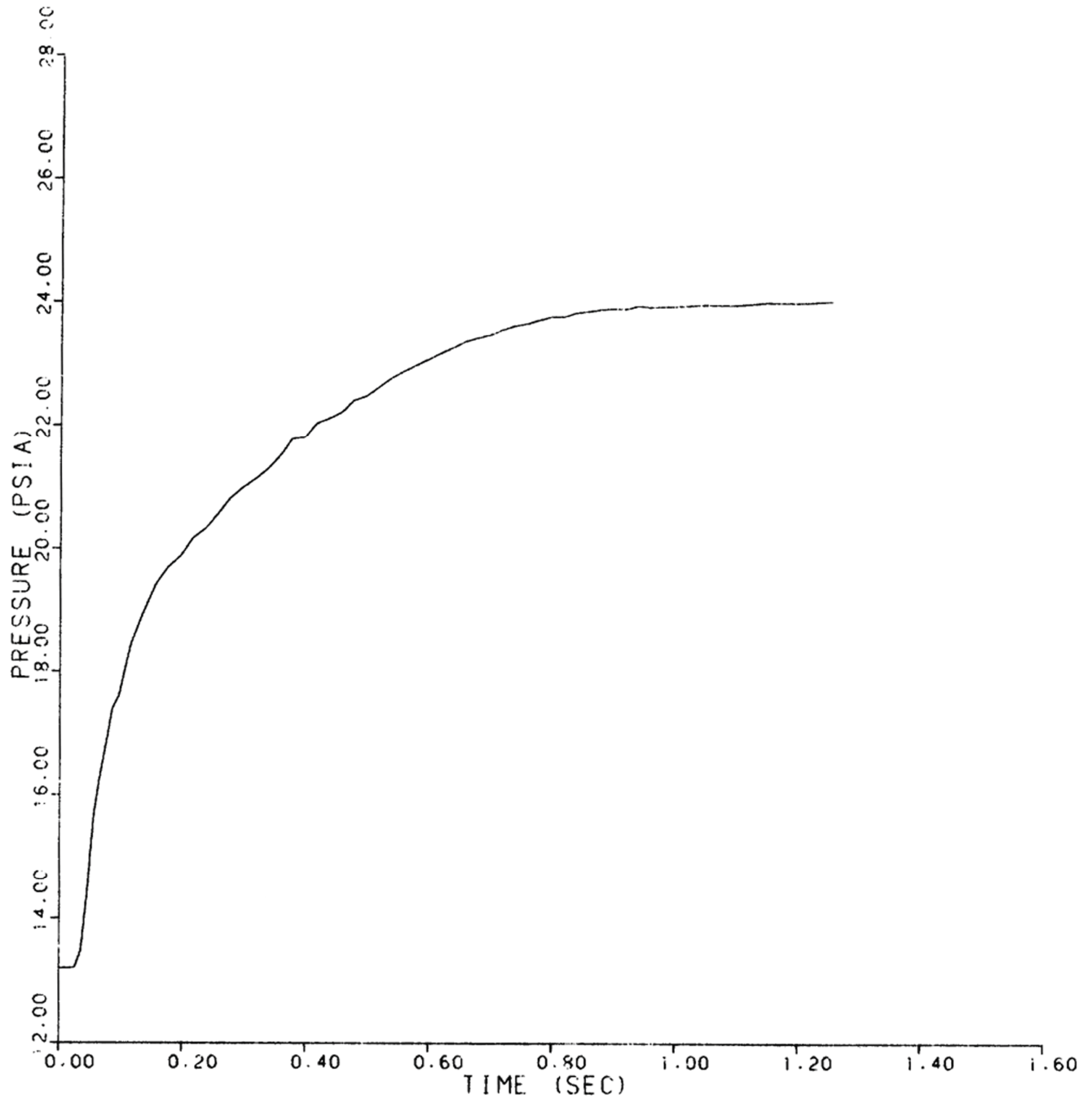

REV 13 4/06



VOGTLE
ELECTRIC GENERATING PLANT
UNIT 1 AND UNIT 2

REACTOR COOLANT PUMP
INLET NOZZLE - NODE E53
(336-in.² BREAK AREA)

FIGURE 6.2.1-20 (SHEET 53 OF 74)

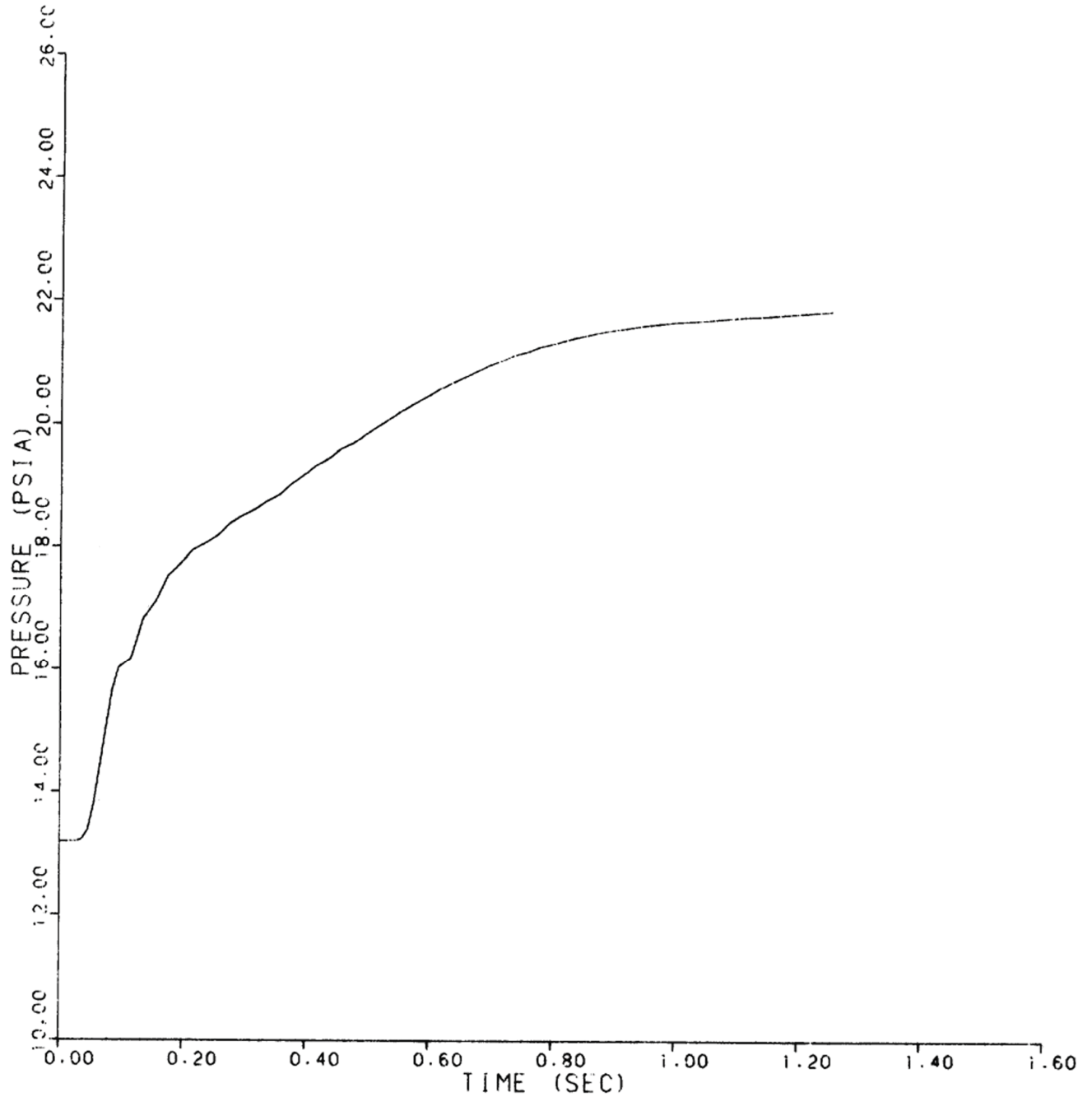

REV 13 4/06



VOGTLE
ELECTRIC GENERATING PLANT
UNIT 1 AND UNIT 2

REACTOR COOLANT PUMP
INLET NOZZLE - NODE E54
(336-in.² BREAK AREA)

FIGURE 6.2.1-20 (SHEET 54 OF 74)

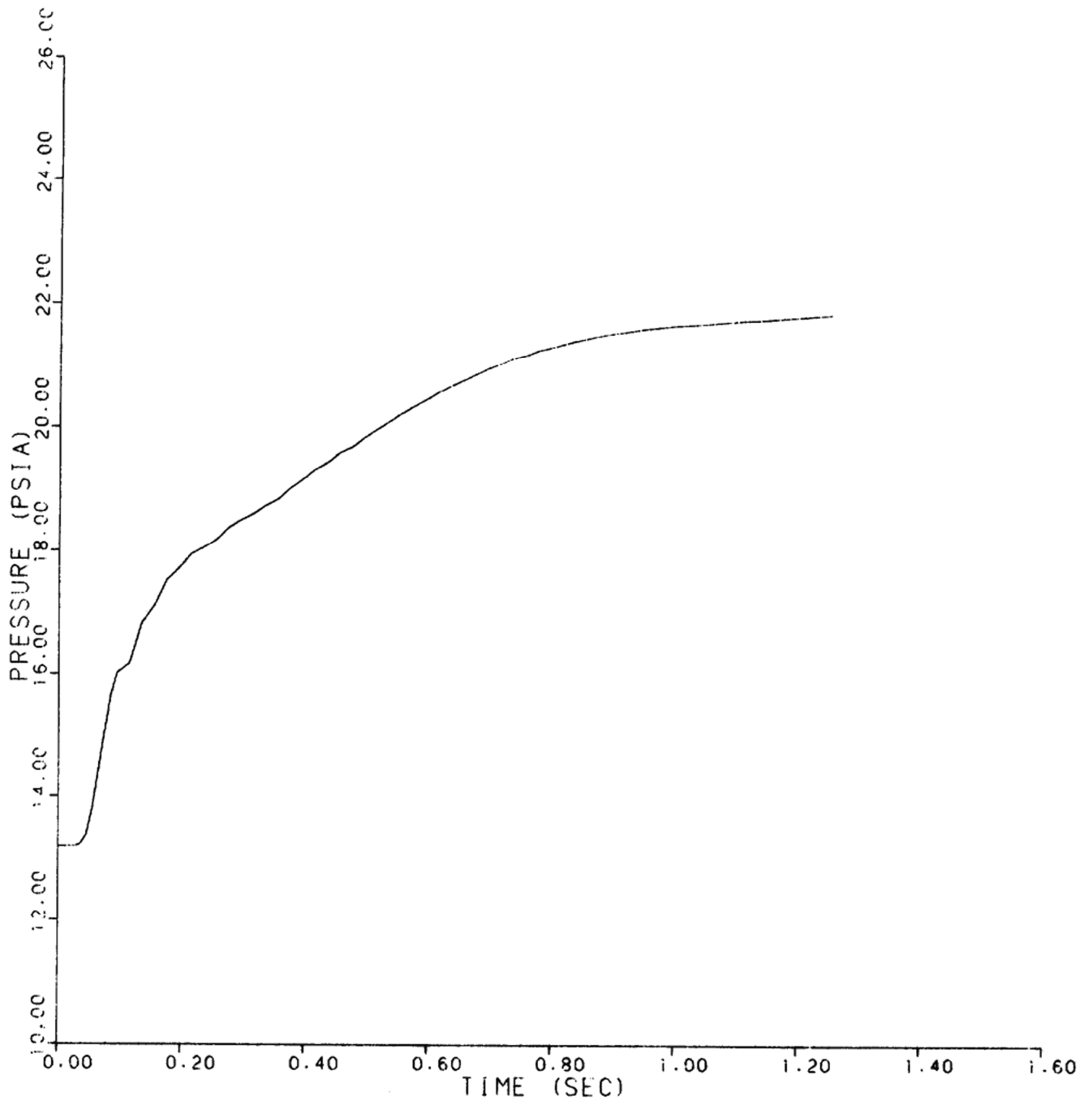

REV 13 4/06



VOGTLE
ELECTRIC GENERATING PLANT
UNIT 1 AND UNIT 2

REACTOR COOLANT PUMP
INLET NOZZLE - NODE E55
(336-in.² BREAK AREA)

FIGURE 6.2.1-20 (SHEET 55 OF 74)

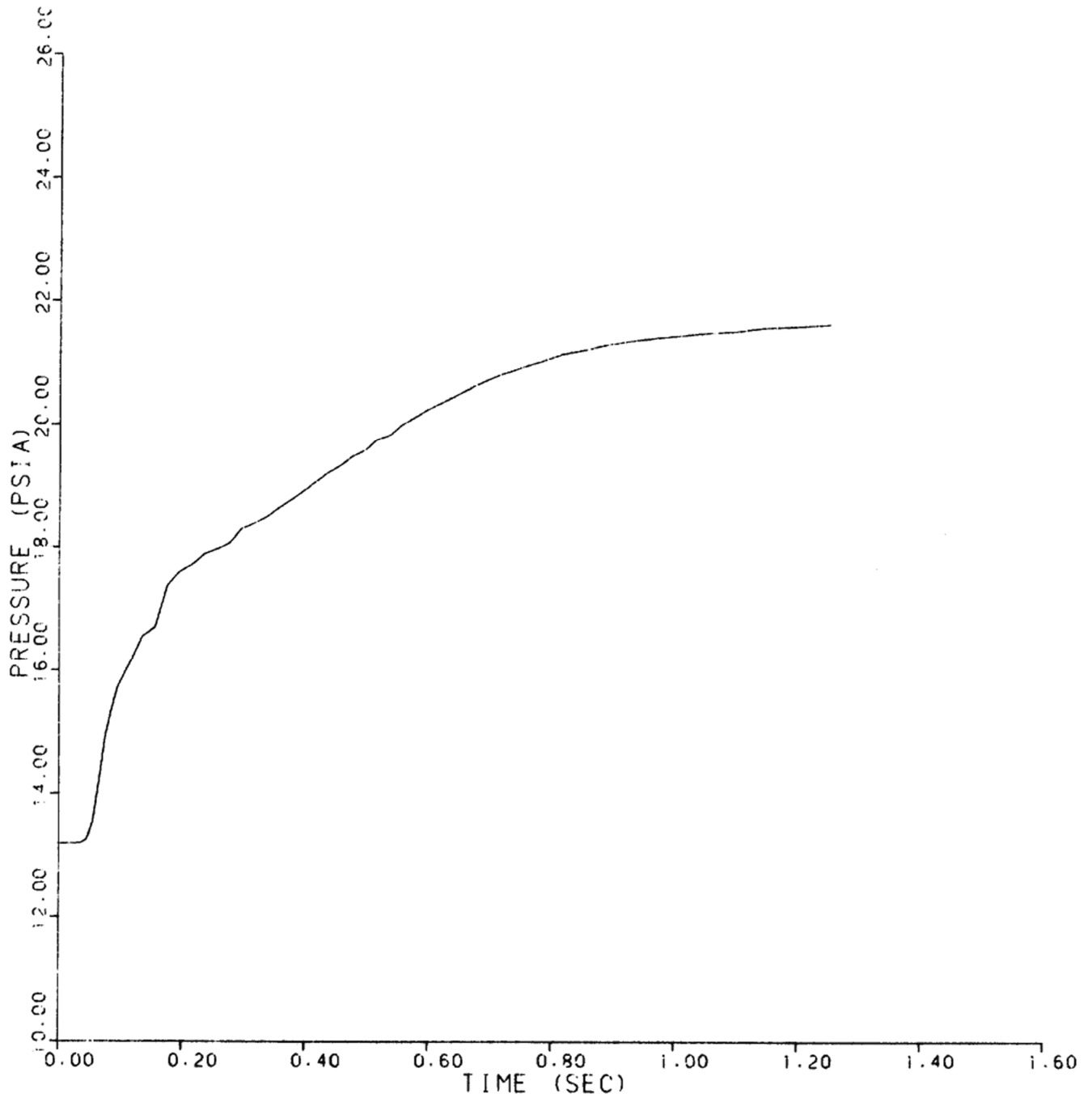

REV 13 4/06



VOGTLE
ELECTRIC GENERATING PLANT
UNIT 1 AND UNIT 2

REACTOR COOLANT PUMP
INLET NOZZLE - NODE E56
(336-in.² BREAK AREA)

FIGURE 6.2.1-20 (SHEET 56 OF 74)

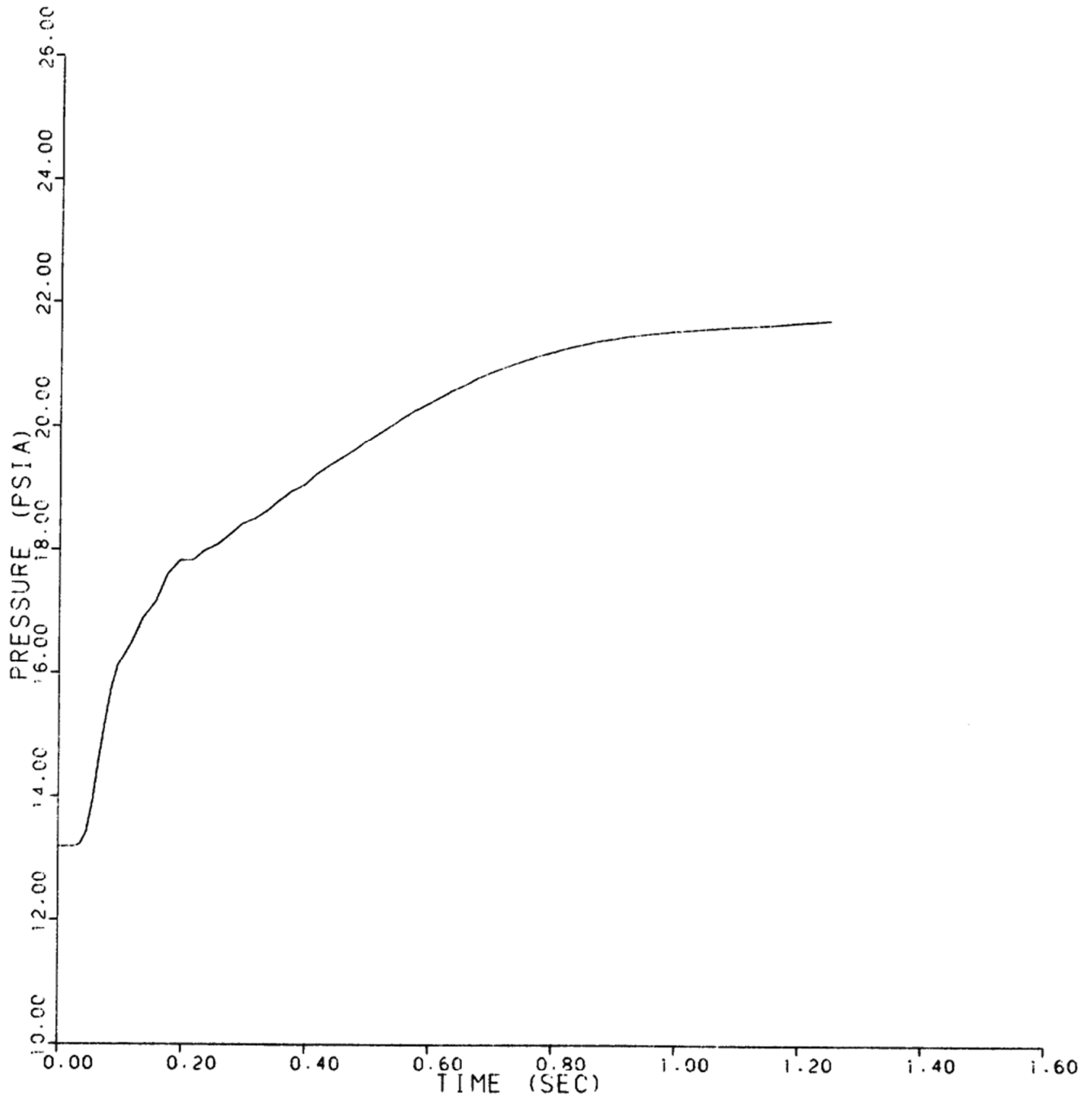

REV 13 4/06



VOGTLE
ELECTRIC GENERATING PLANT
UNIT 1 AND UNIT 2

REACTOR COOLANT PUMP
INLET NOZZLE - NODE E57
(336-in.² BREAK AREA)

FIGURE 6.2.1-20 (SHEET 57 OF 74)

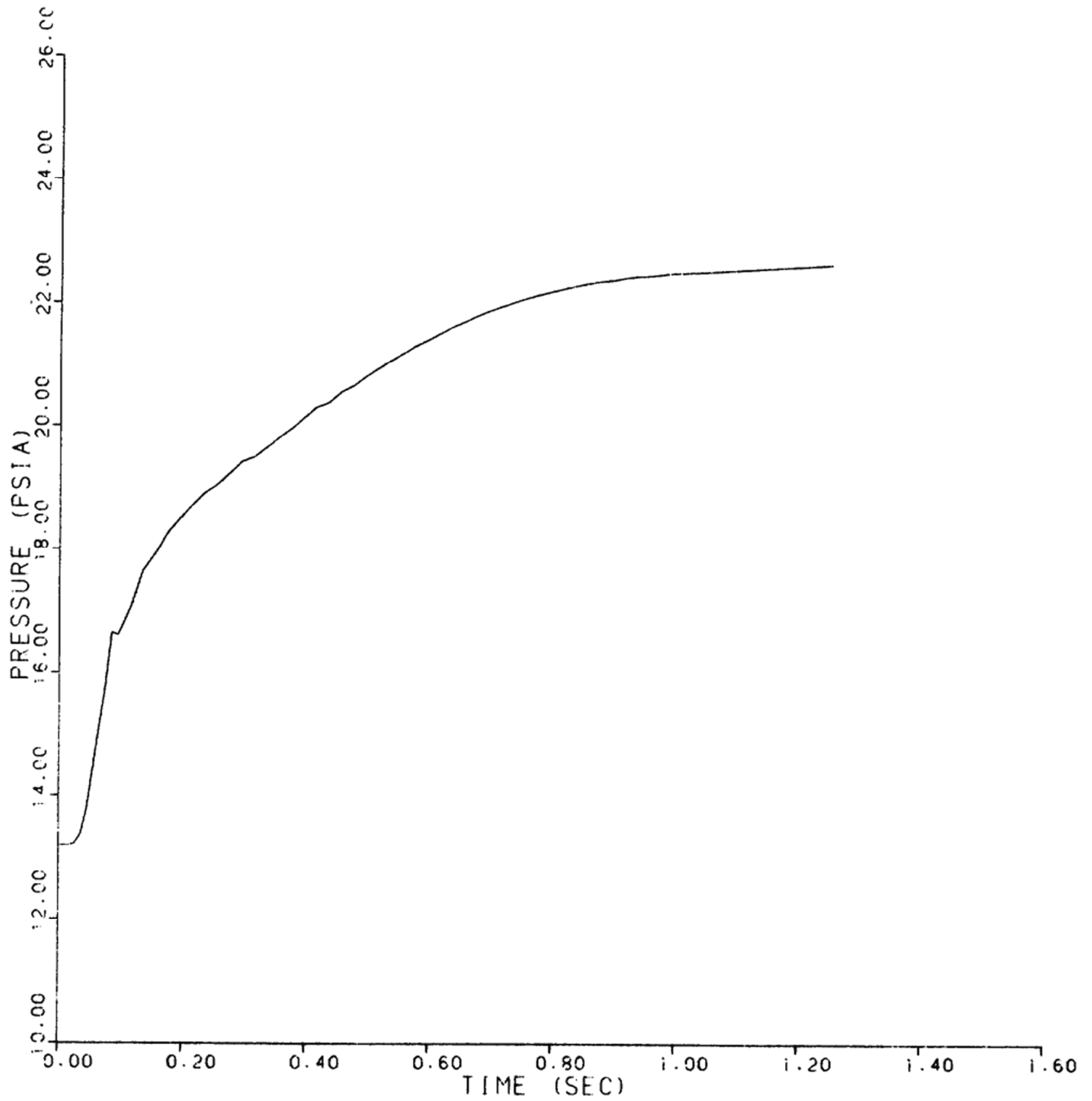

REV 13 4/06



VOGTLE
ELECTRIC GENERATING PLANT
UNIT 1 AND UNIT 2

REACTOR COOLANT PUMP
INLET NOZZLE - NODE E58
(336-in.² BREAK AREA)

FIGURE 6.2.1-20 (SHEET 58 OF 74)

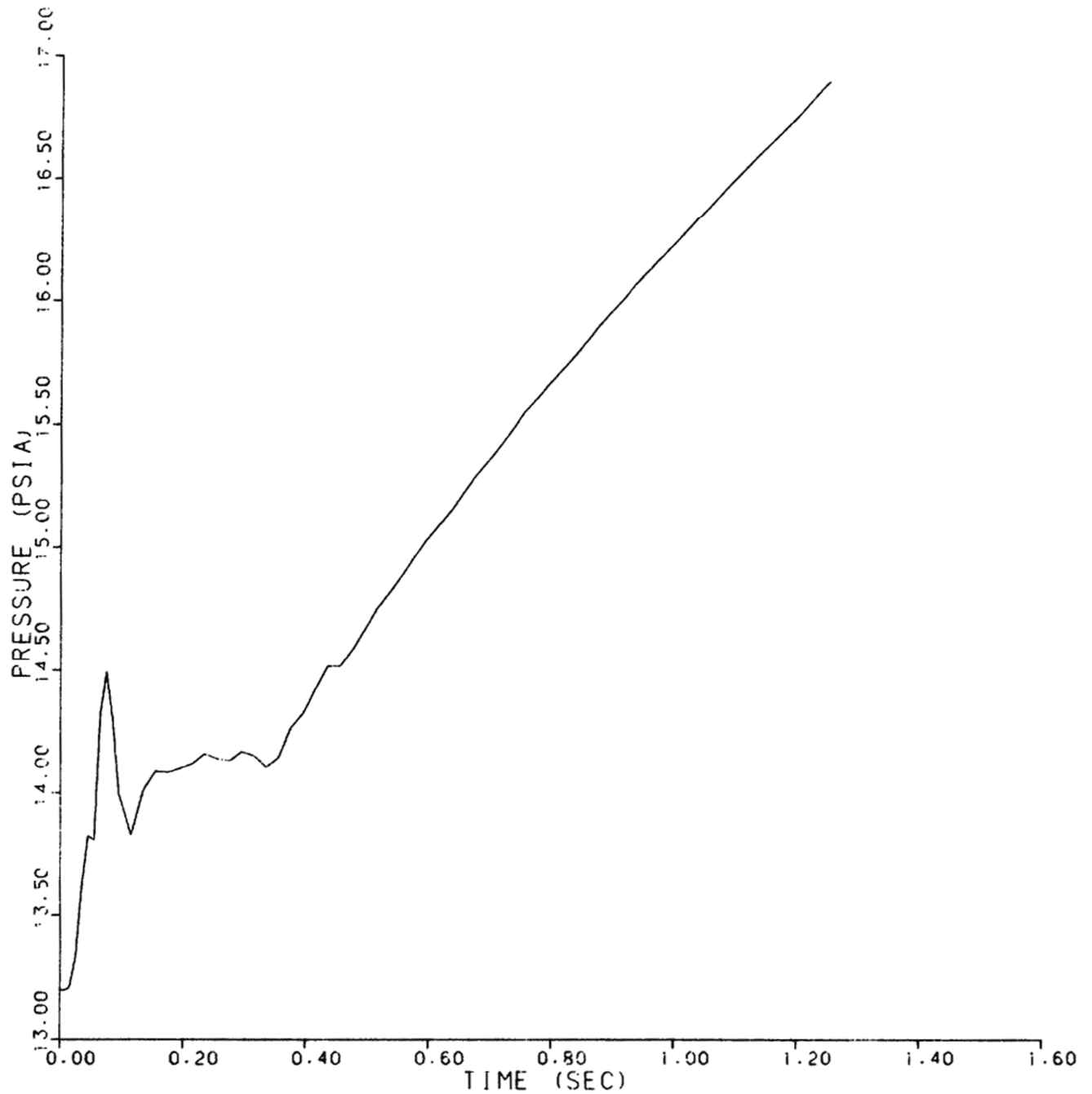

REV 13 4/06



VOGTLE
ELECTRIC GENERATING PLANT
UNIT 1 AND UNIT 2

REACTOR COOLANT PUMP
INLET NOZZLE - NODE E59
(336-in.² BREAK AREA)

FIGURE 6.2.1-20 (SHEET 59 OF 74)

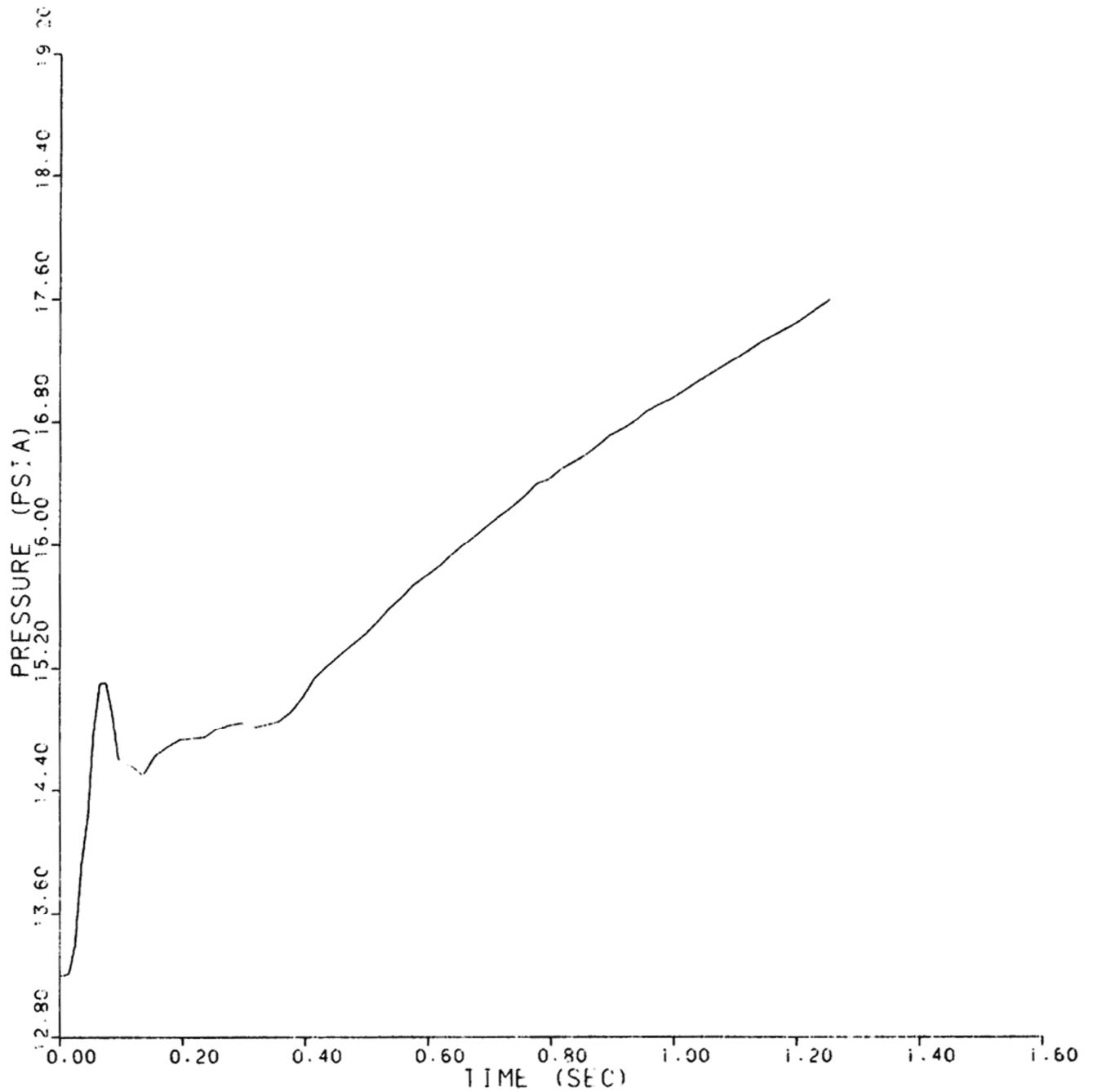

REV 13 4/06



VOGTLE
ELECTRIC GENERATING PLANT
UNIT 1 AND UNIT 2

REACTOR COOLANT PUMP
INLET NOZZLE - NODE E60
(336-in.² BREAK AREA)

FIGURE 6.2.1-20 (SHEET 60 OF 74)

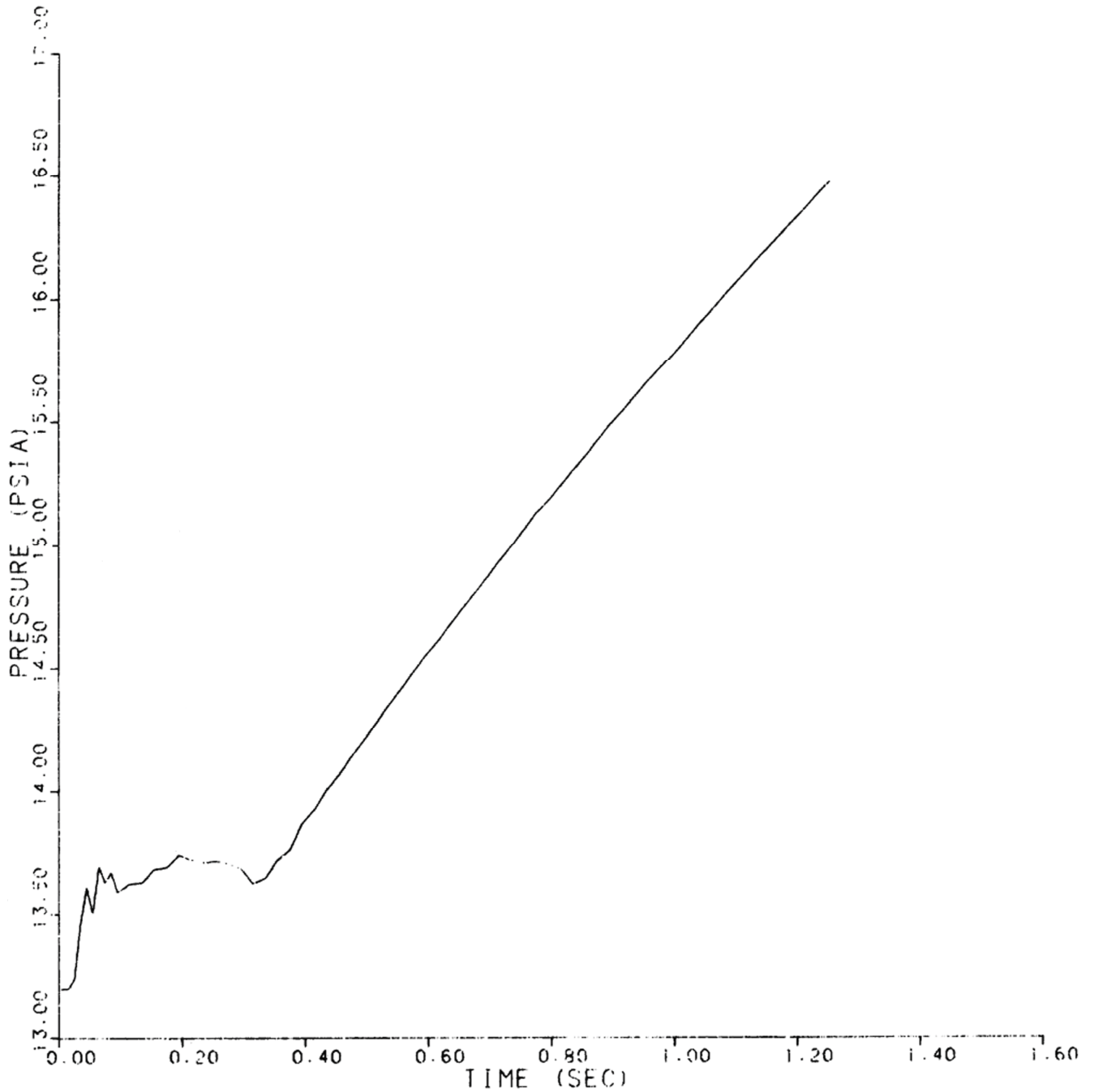

REV 13 4/06



VOGTLE
ELECTRIC GENERATING PLANT
UNIT 1 AND UNIT 2

REACTOR COOLANT PUMP
INLET NOZZLE - NODE E61
(336-in.² BREAK AREA)

FIGURE 6.2.1-20 (SHEET 61 OF 74)

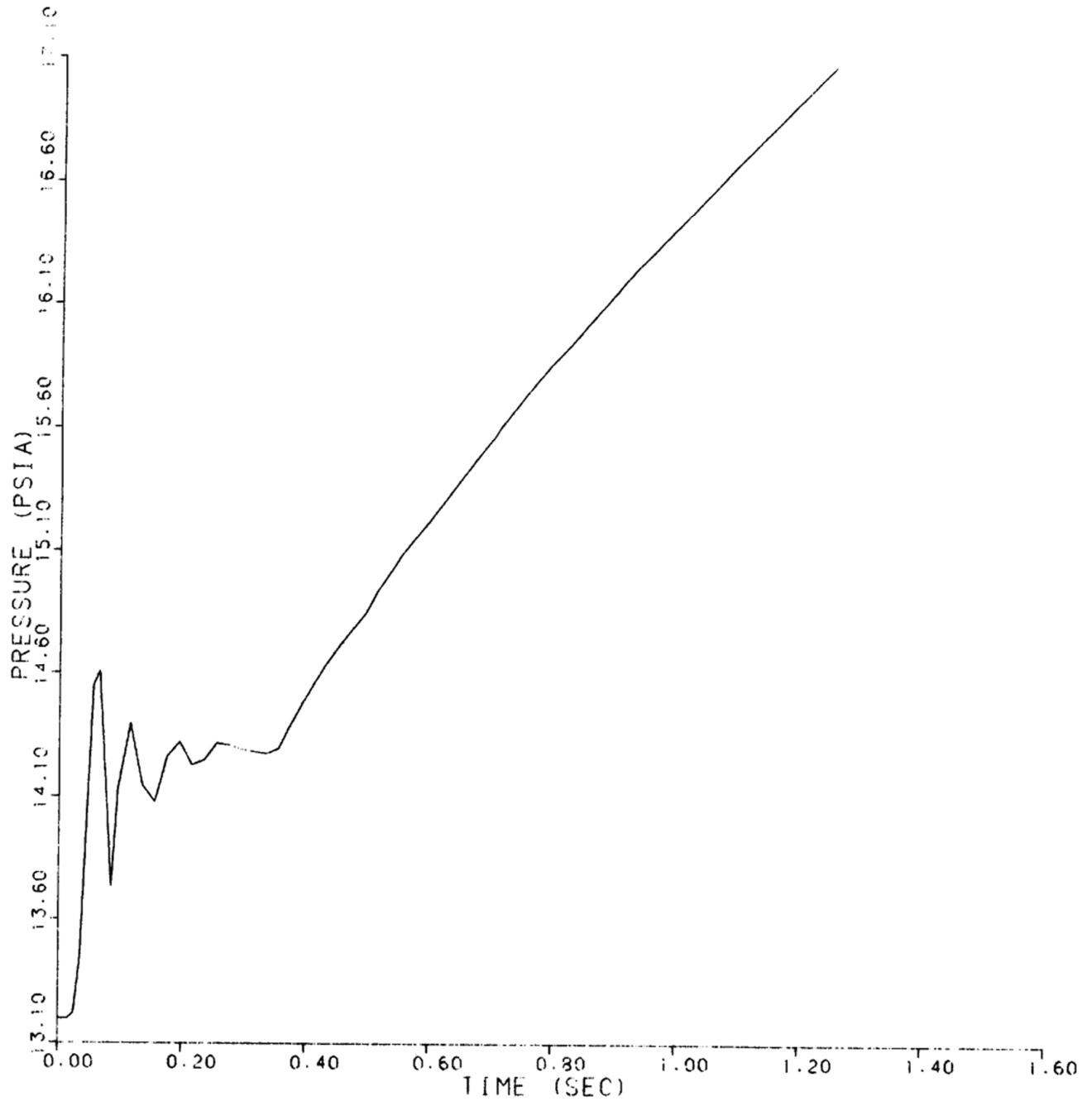

REV 13 4/06



VOGTLE
ELECTRIC GENERATING PLANT
UNIT 1 AND UNIT 2

REACTOR COOLANT PUMP
INLET NOZZLE - NODE E62
(336-in.² BREAK AREA)

FIGURE 6.2.1-20 (SHEET 62 OF 74)

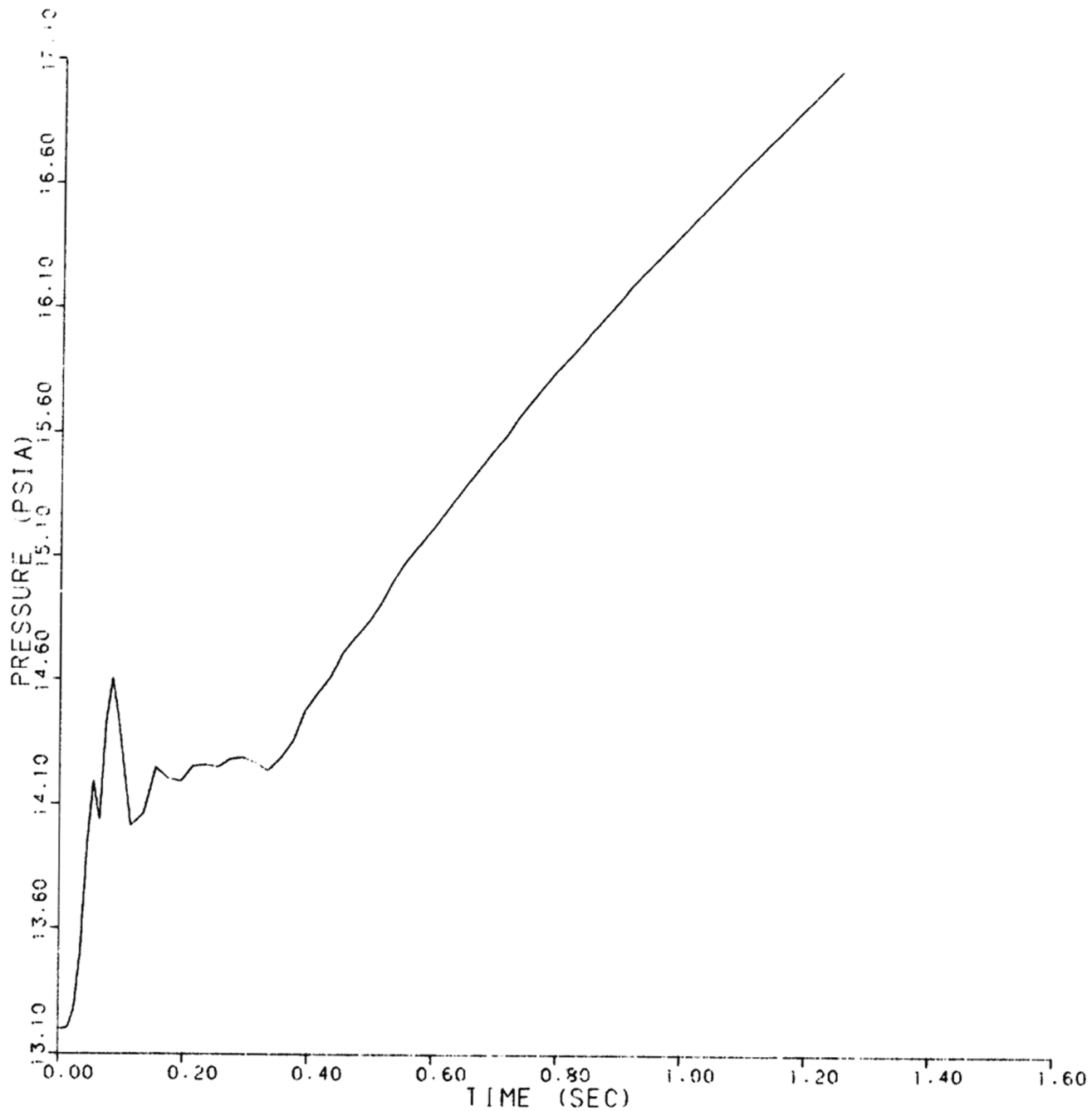

REV 13 4/06



VOGTLE
ELECTRIC GENERATING PLANT
UNIT 1 AND UNIT 2

REACTOR COOLANT PUMP
INLET NOZZLE - NODE E63
(336-in.² BREAK AREA)

FIGURE 6.2.1-20 (SHEET 63 OF 74)

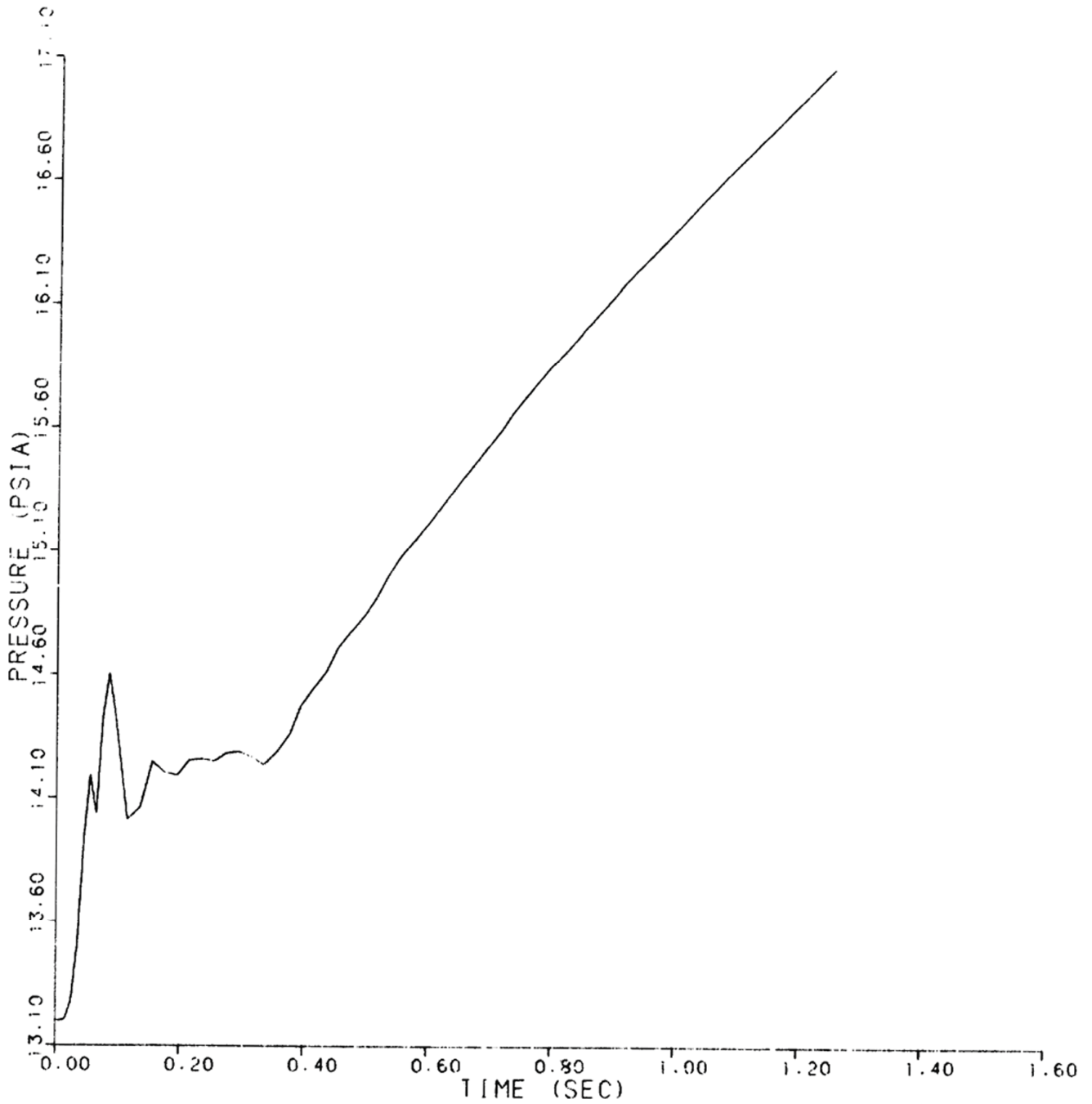

REV 13 4/06



VOGTLE
ELECTRIC GENERATING PLANT
UNIT 1 AND UNIT 2

REACTOR COOLANT PUMP
INLET NOZZLE - NODE E64
(336-in.² BREAK AREA)

FIGURE 6.2.1-20 (SHEET 64 OF 74)

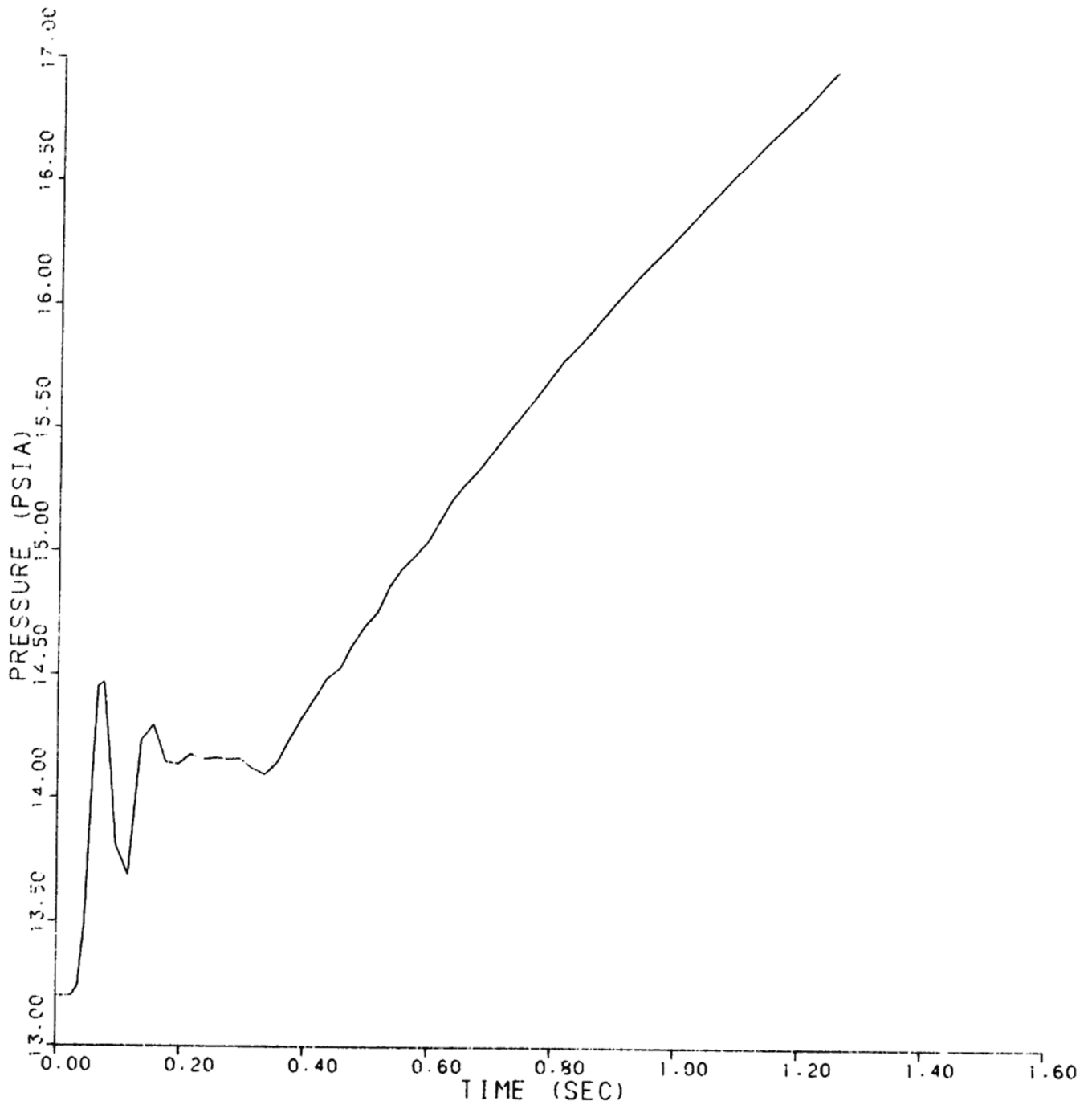

REV 13 4/06



VOGTLE
ELECTRIC GENERATING PLANT
UNIT 1 AND UNIT 2

REACTOR COOLANT PUMP
INLET NOZZLE - NODE E65
(336-in.² BREAK AREA)

FIGURE 6.2.1-20 (SHEET 65 OF 74)

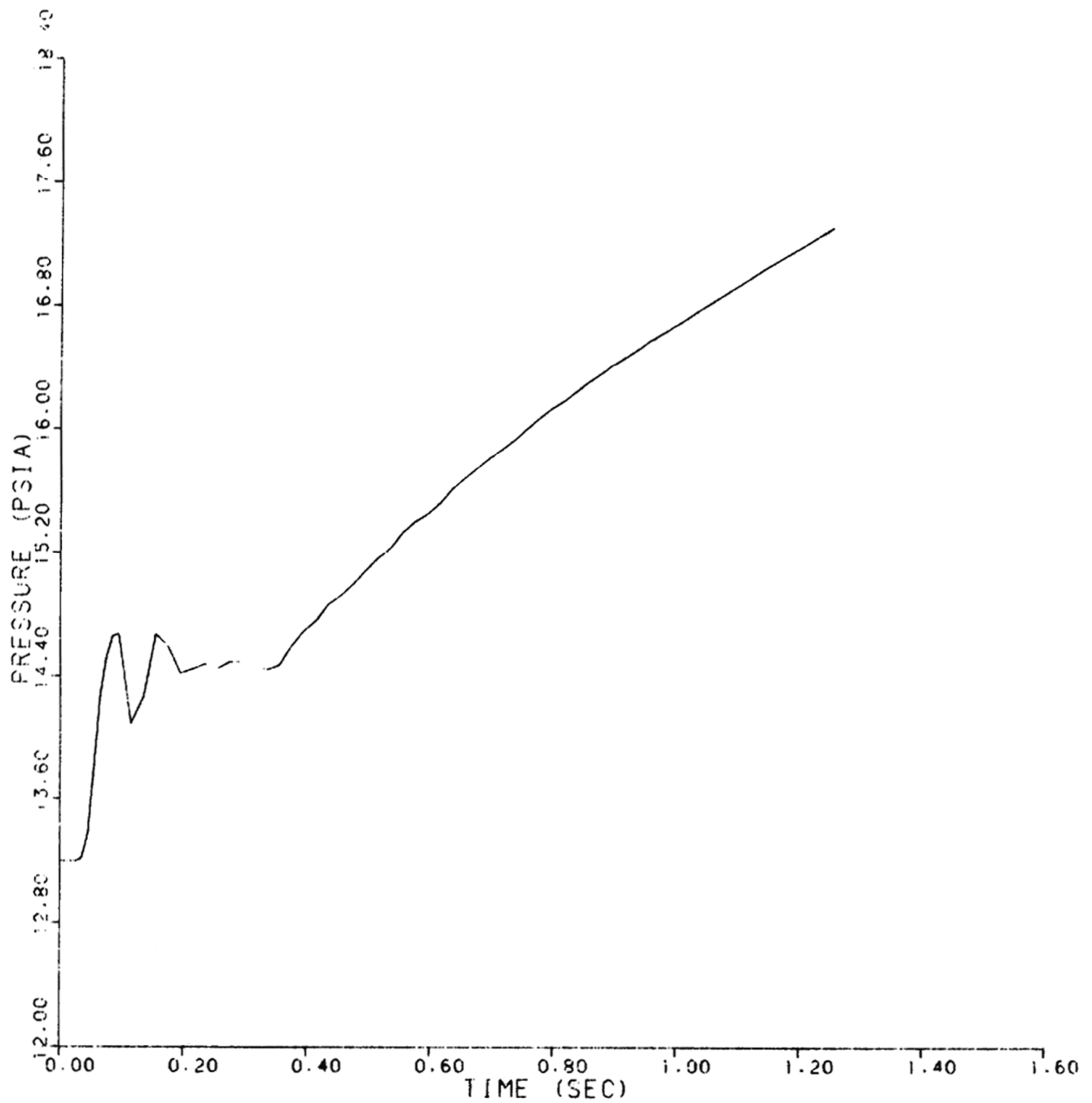

REV 13 4/06



VOGTLE
ELECTRIC GENERATING PLANT
UNIT 1 AND UNIT 2

REACTOR COOLANT PUMP
INLET NOZZLE - NODE E66
(336-in.² BREAK AREA)

FIGURE 6.2.1-20 (SHEET 66 OF 74)

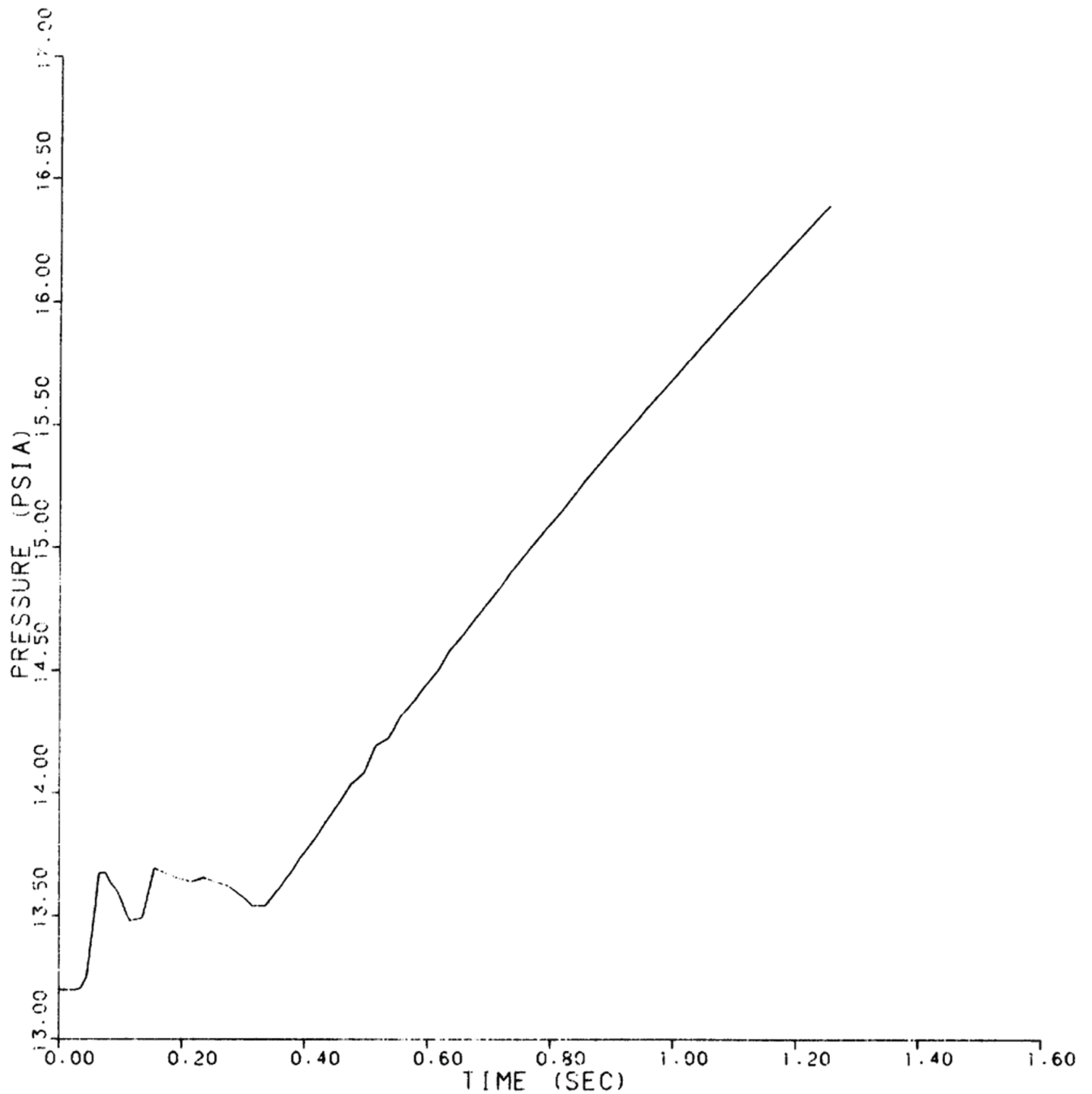

REV 13 4/06



VOGTLE
ELECTRIC GENERATING PLANT
UNIT 1 AND UNIT 2

REACTOR COOLANT PUMP
INLET NOZZLE - NODE E67
(336-in.² BREAK AREA)

FIGURE 6.2.1-20 (SHEET 67 OF 74)

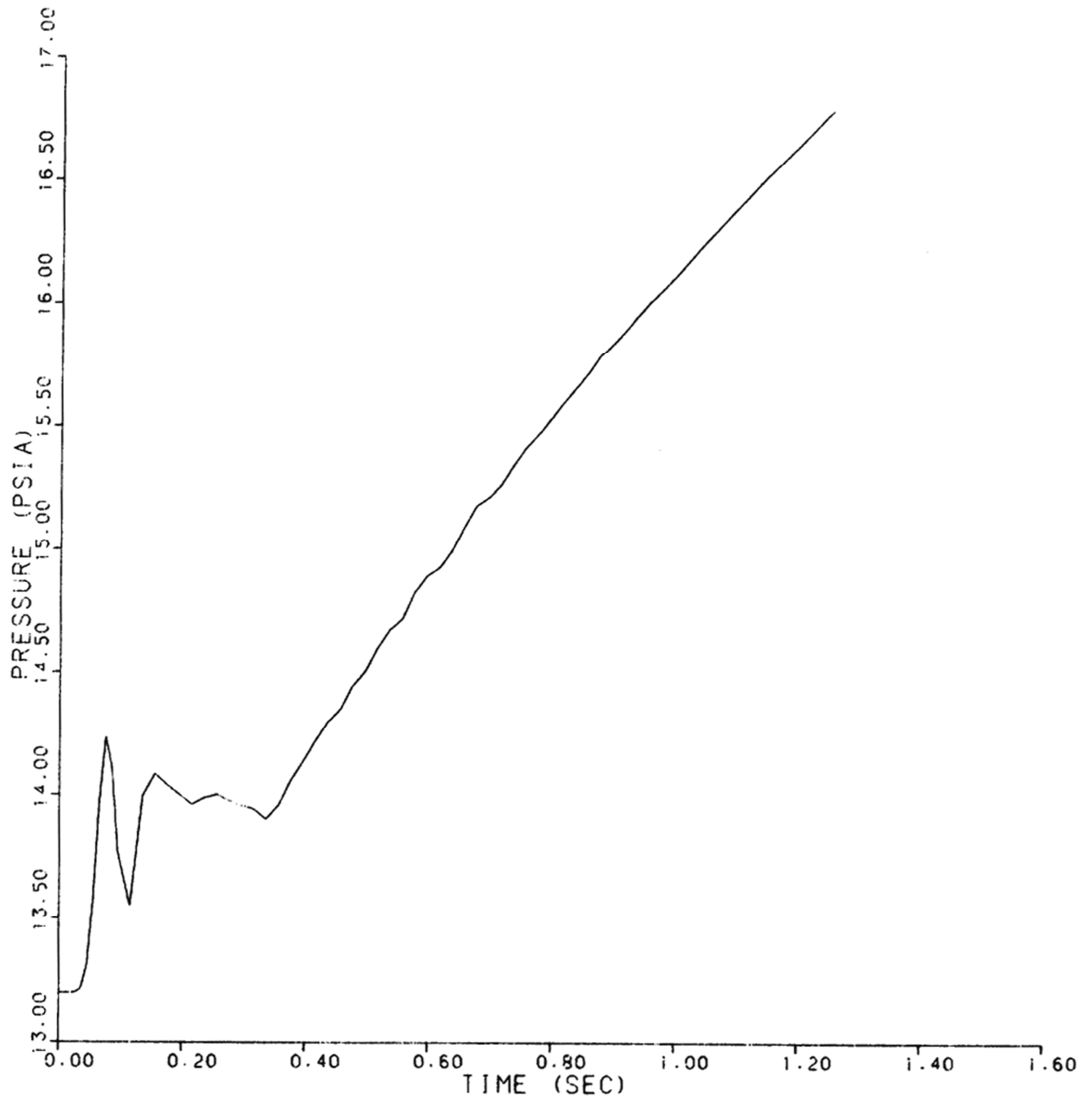

REV 13 4/06



VOGTLE
ELECTRIC GENERATING PLANT
UNIT 1 AND UNIT 2

REACTOR COOLANT PUMP
INLET NOZZLE - NODE E68
(336-in.² BREAK AREA)

FIGURE 6.2.1-20 (SHEET 68 OF 74)

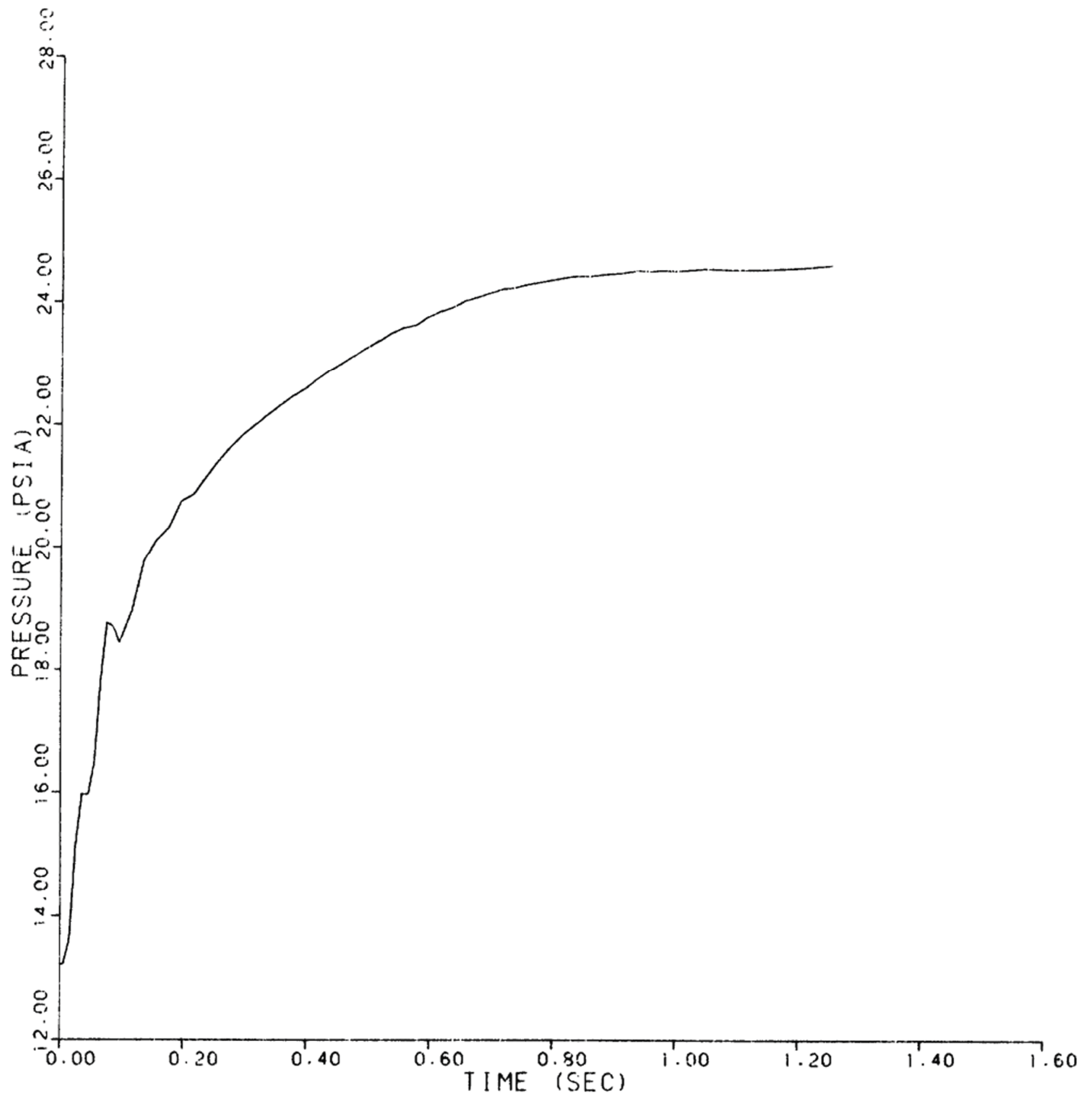

REV 13 4/06



VOGTLE
ELECTRIC GENERATING PLANT
UNIT 1 AND UNIT 2

REACTOR COOLANT PUMP
INLET NOZZLE - NODE E69
(336-in.² BREAK AREA)

FIGURE 6.2.1-20 (SHEET 69 OF 74)

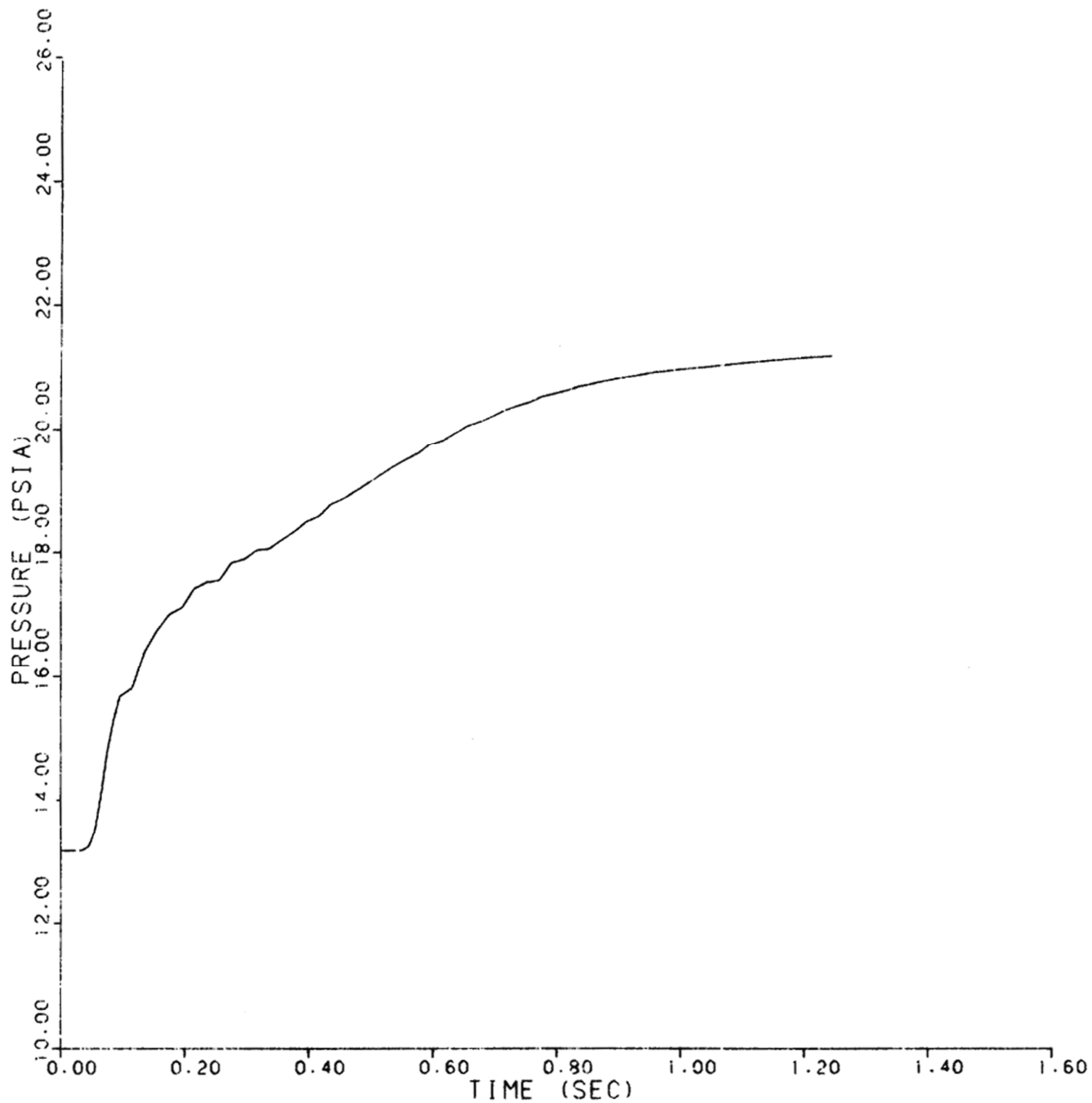

REV 13 4/06



VOGTLE
ELECTRIC GENERATING PLANT
UNIT 1 AND UNIT 2

REACTOR COOLANT PUMP
INLET NOZZLE - NODE E70
(336-in.² BREAK AREA)

FIGURE 6.2.1-20 (SHEET 70 OF 74)

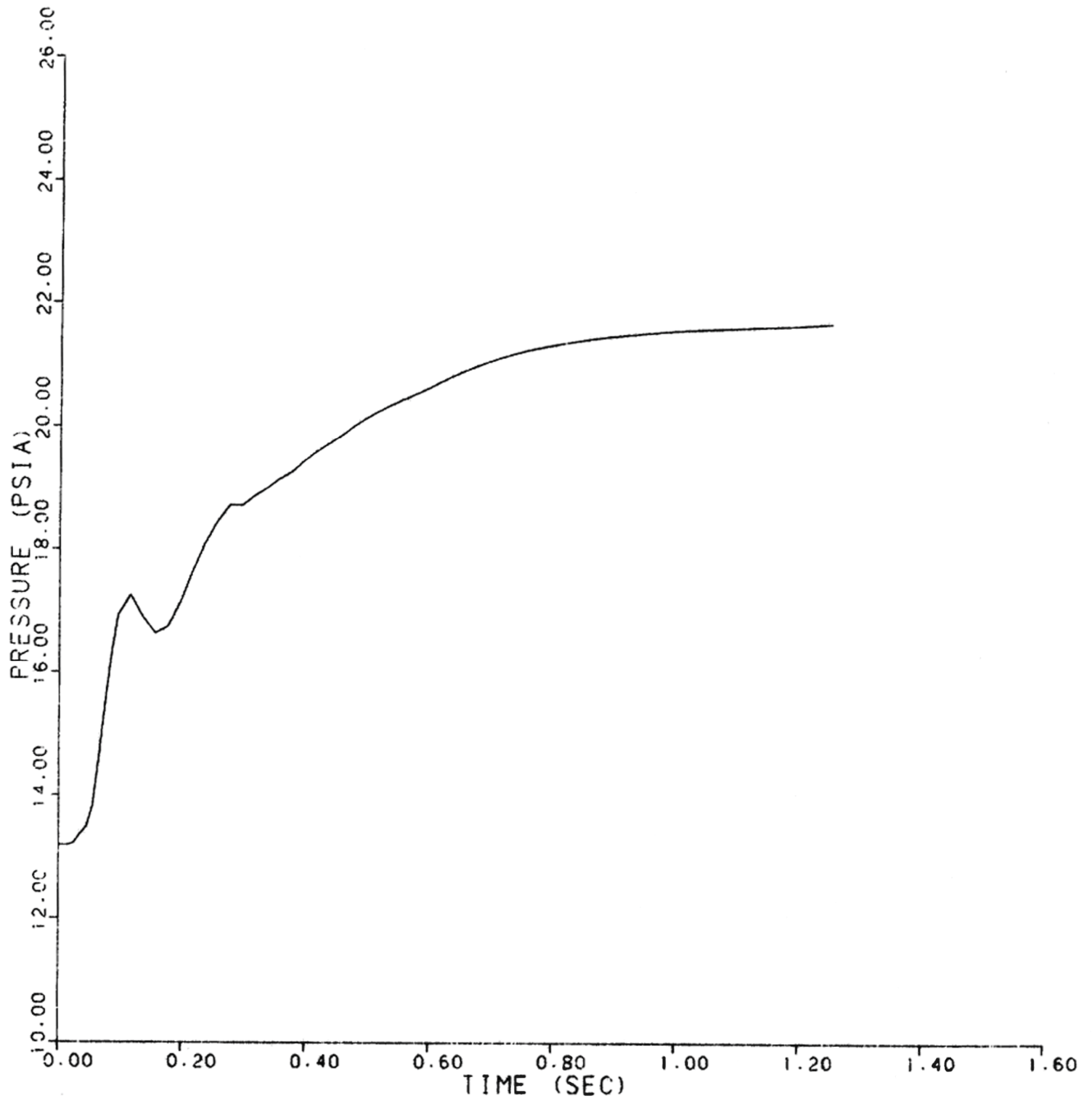

REV 13 4/06



VOGTLE
ELECTRIC GENERATING PLANT
UNIT 1 AND UNIT 2

REACTOR COOLANT PUMP
INLET NOZZLE - NODE E71
(336-in.² BREAK AREA)

FIGURE 6.2.1-20 (SHEET 71 OF 74)

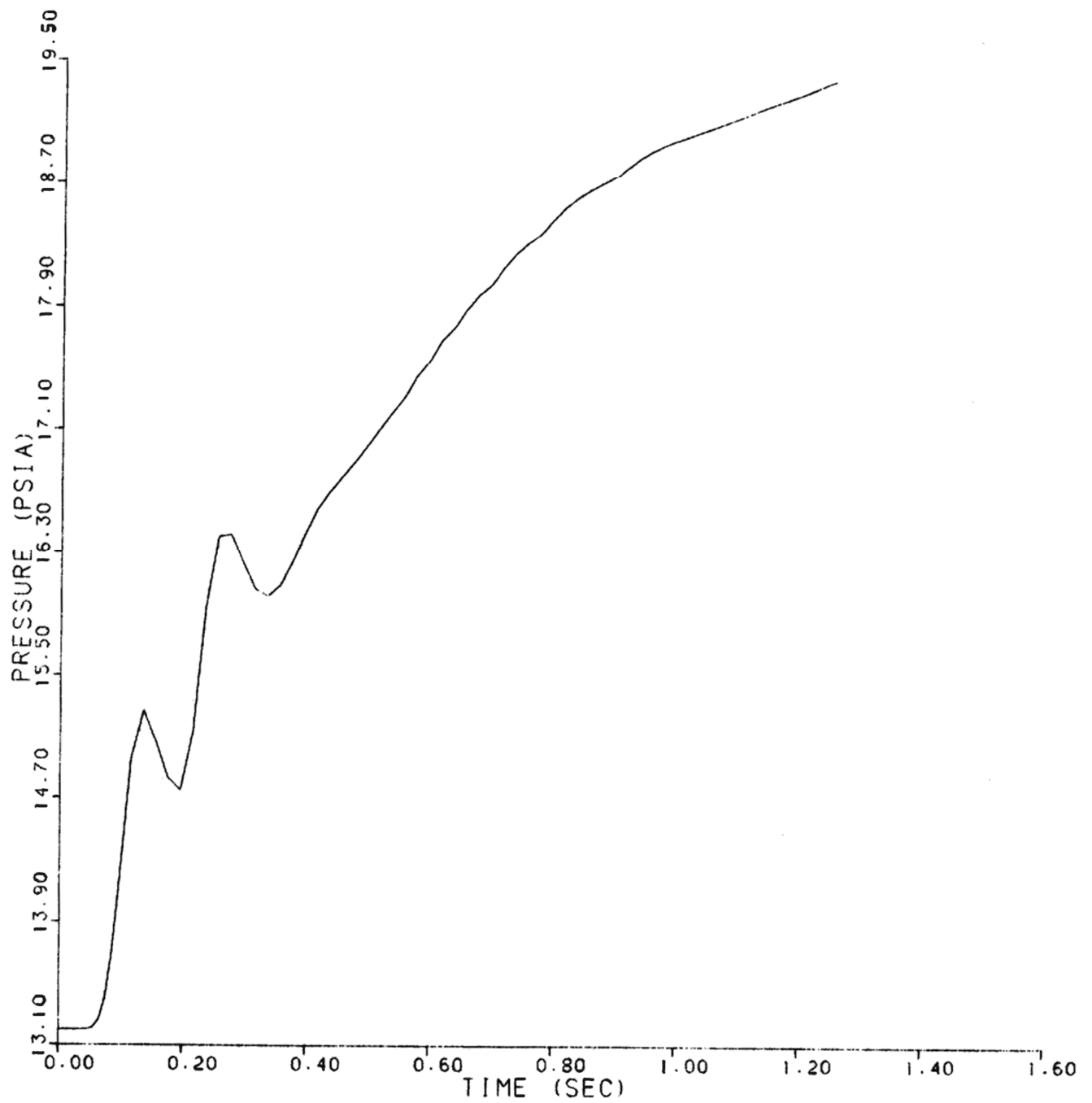

REV 13 4/06



VOGTLE
ELECTRIC GENERATING PLANT
UNIT 1 AND UNIT 2

REACTOR COOLANT PUMP
INLET NOZZLE - NODE E72
(336-in.² BREAK AREA)

FIGURE 6.2.1-20 (SHEET 72 OF 74)

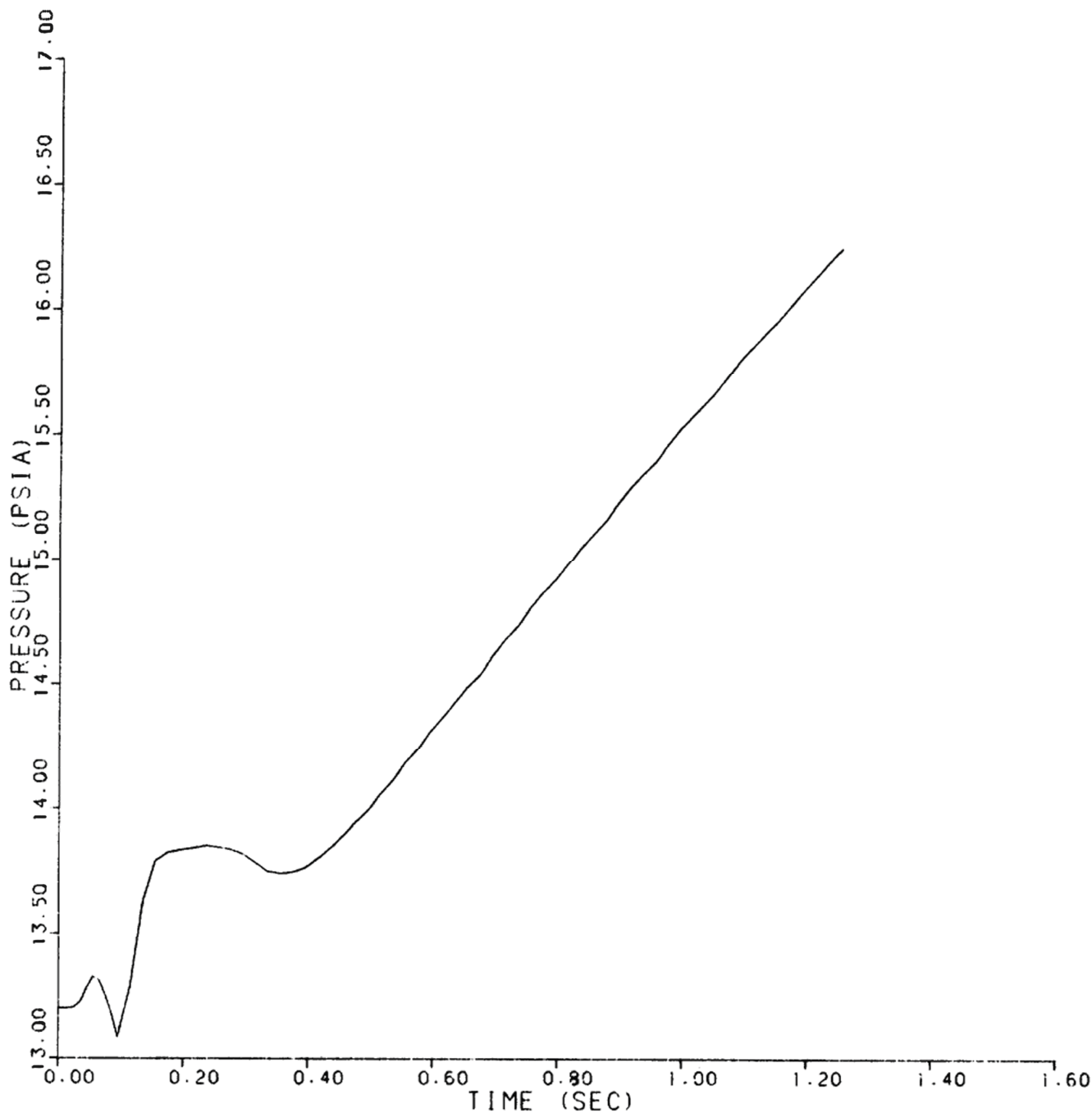

REV 13 4/06



VOGTLE
ELECTRIC GENERATING PLANT
UNIT 1 AND UNIT 2

REACTOR COOLANT PUMP
INLET NOZZLE - NODE E73
(336-in.² BREAK AREA)

FIGURE 6.2.1-20 (SHEET 73 OF 74)

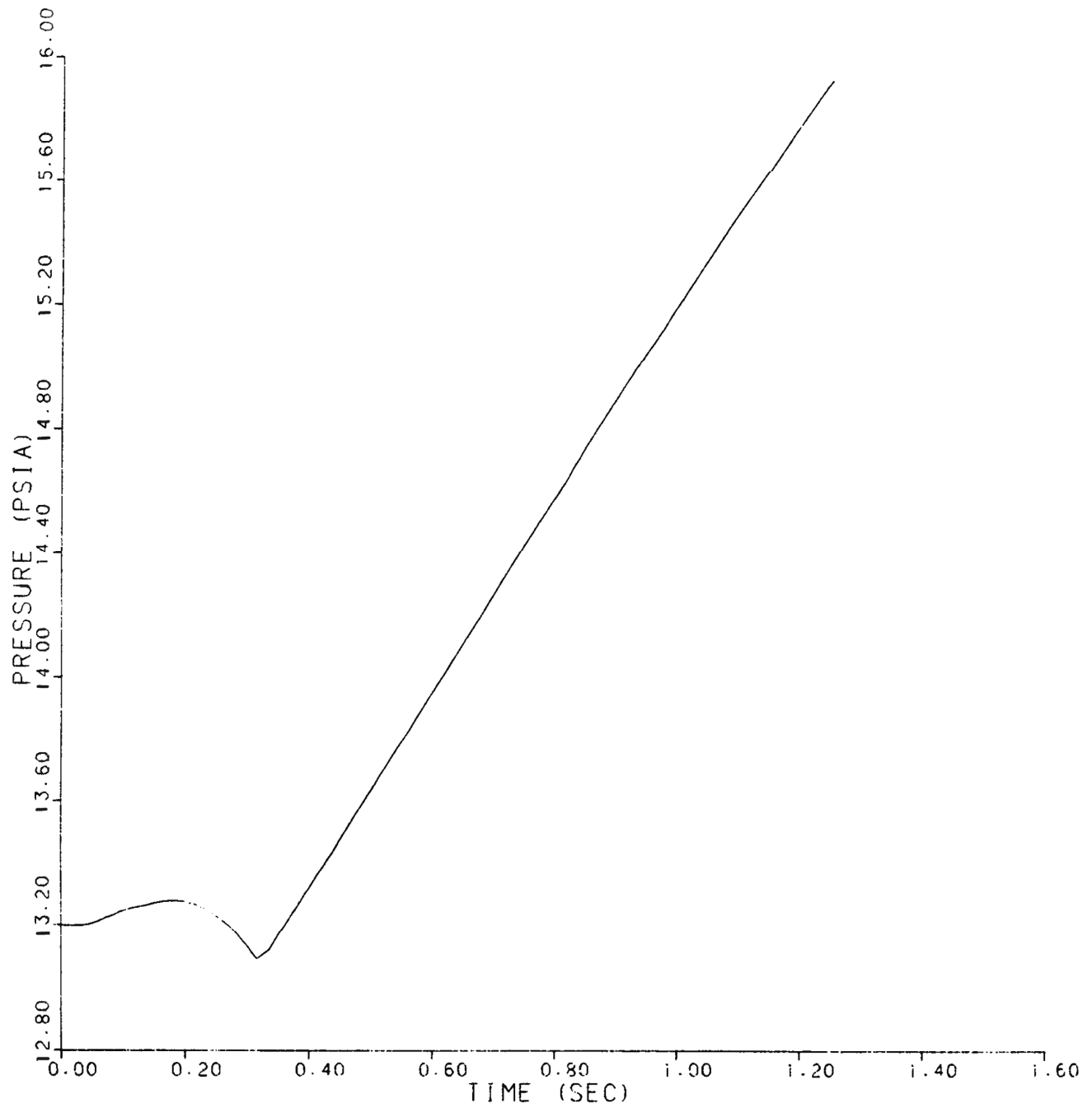

REV 13 4/06



VOGTLE
ELECTRIC GENERATING PLANT
UNIT 1 AND UNIT 2

REACTOR COOLANT PUMP
INLET NOZZLE - NODE E74
(336-in.² BREAK AREA)

FIGURE 6.2.1-20 (SHEET 74 OF 74)

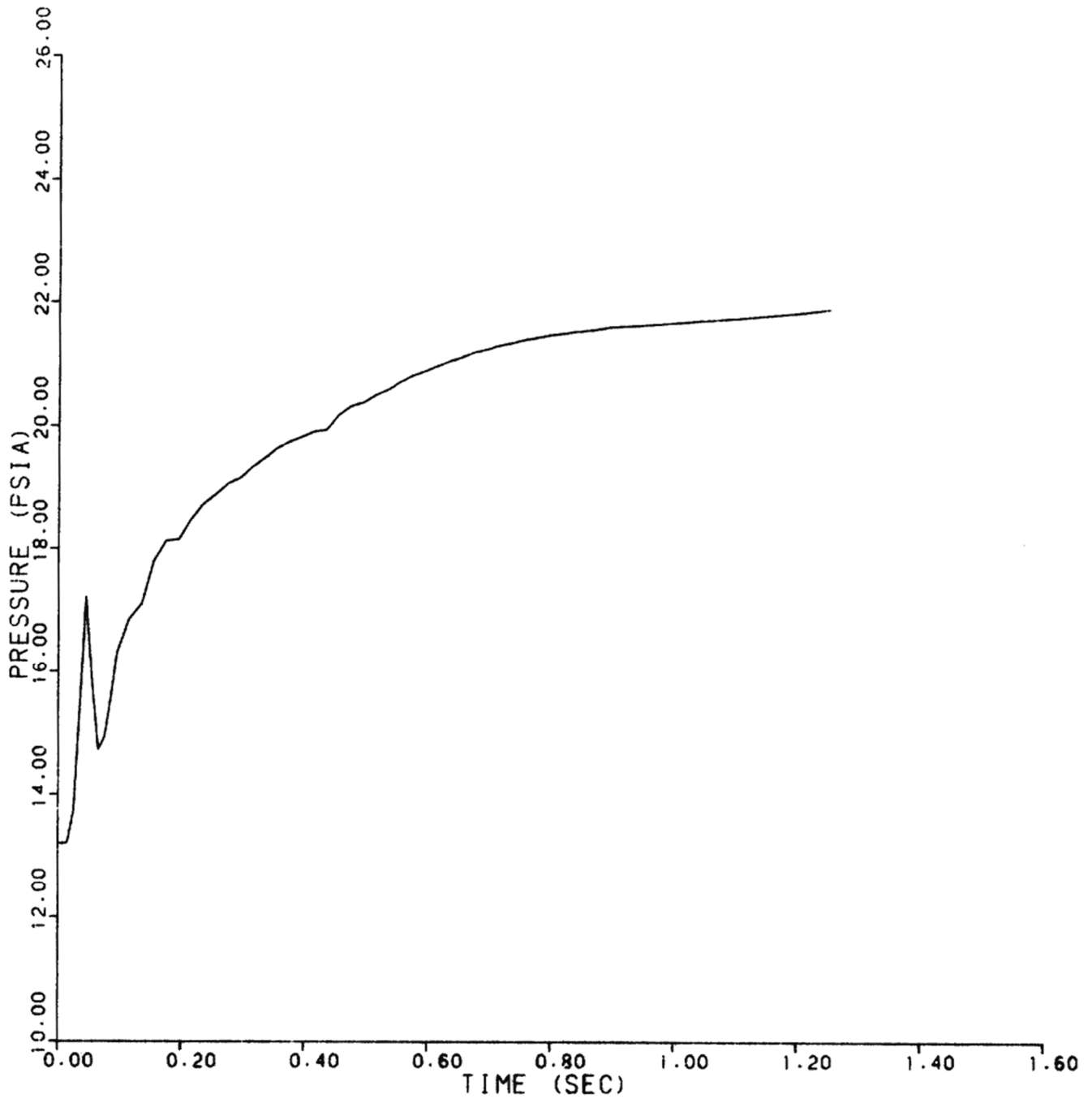

REV 13 4/06



VOGTLE
ELECTRIC GENERATING PLANT
UNIT 1 AND UNIT 2

STEAM GENERATOR OUTLET NOZZLE
NODE - E1
(436-in.² BREAK AREA)

FIGURE 6.2.1-21 (SHEET 1 OF 74)

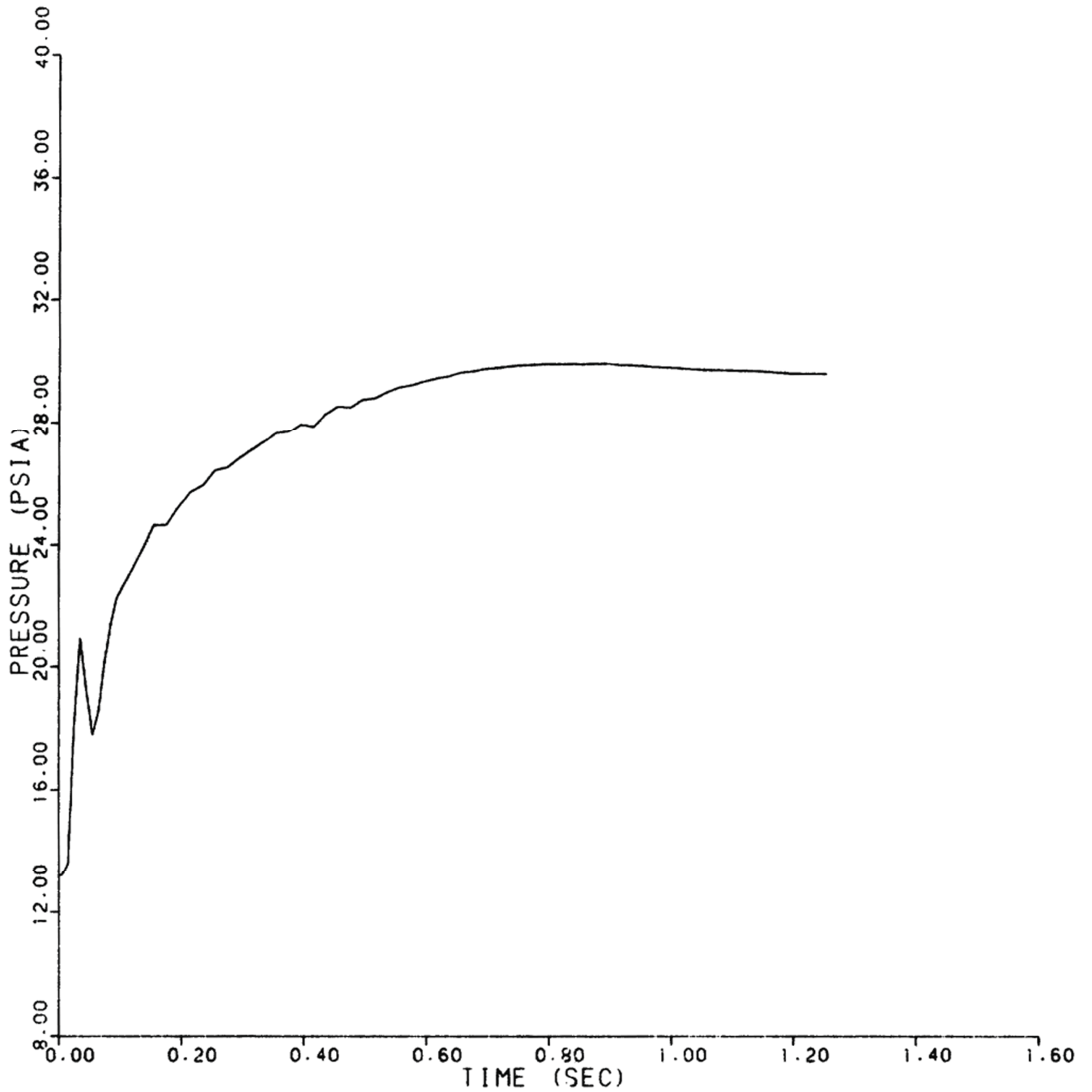

REV 13 4/06



VOGTLE
ELECTRIC GENERATING PLANT
UNIT 1 AND UNIT 2

STEAM GENERATOR OUTLET NOZZLE
NODE - E2
(436-in.² BREAK AREA)

FIGURE 6.2.1-21 (SHEET 2 OF 74)

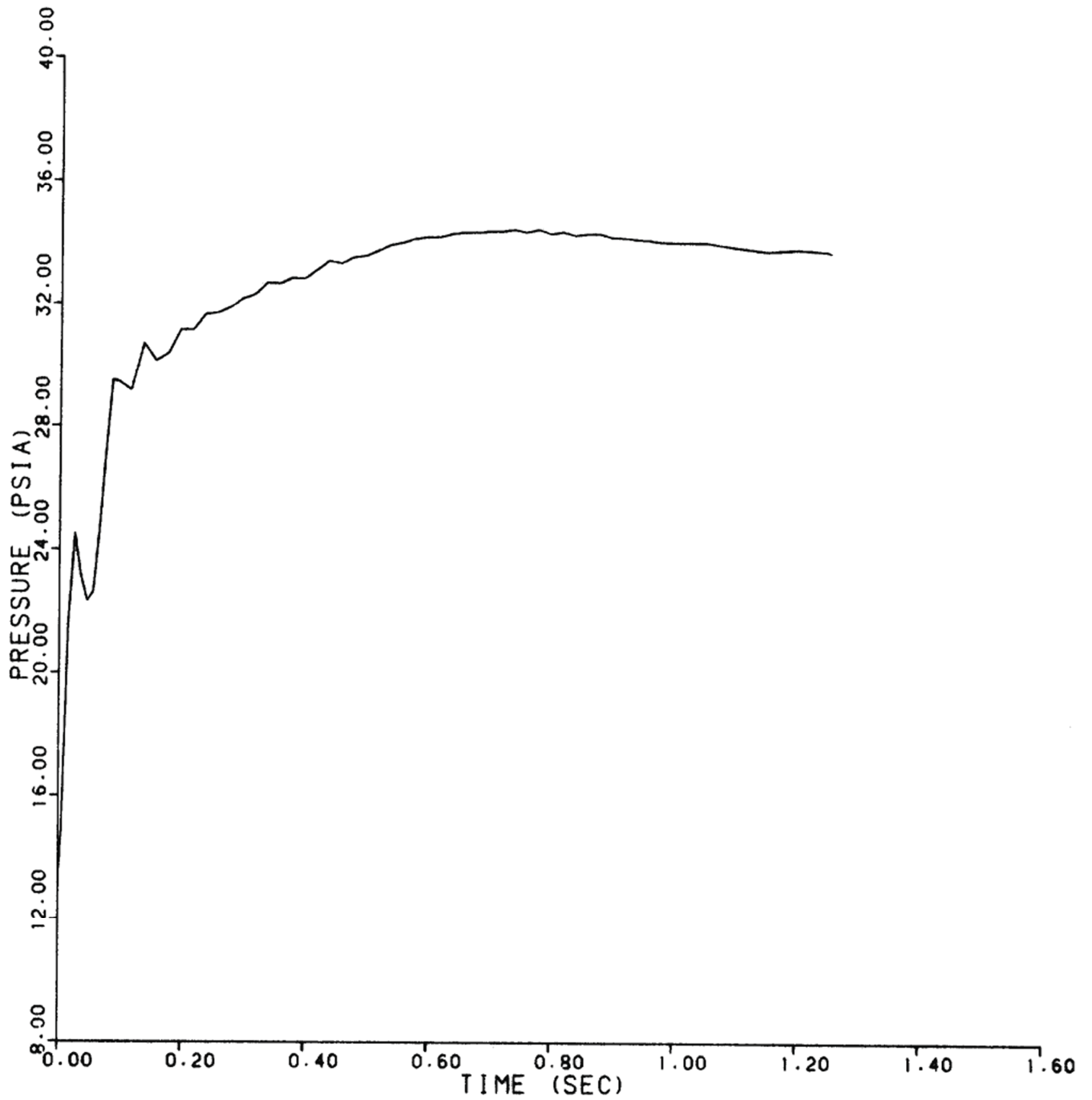

REV 13 4/06



VOGTLE
ELECTRIC GENERATING PLANT
UNIT 1 AND UNIT 2

STEAM GENERATOR OUTLET NOZZLE
NODE - E3
(436-in.² BREAK AREA)

FIGURE 6.2.1-21 (SHEET 3 OF 74)

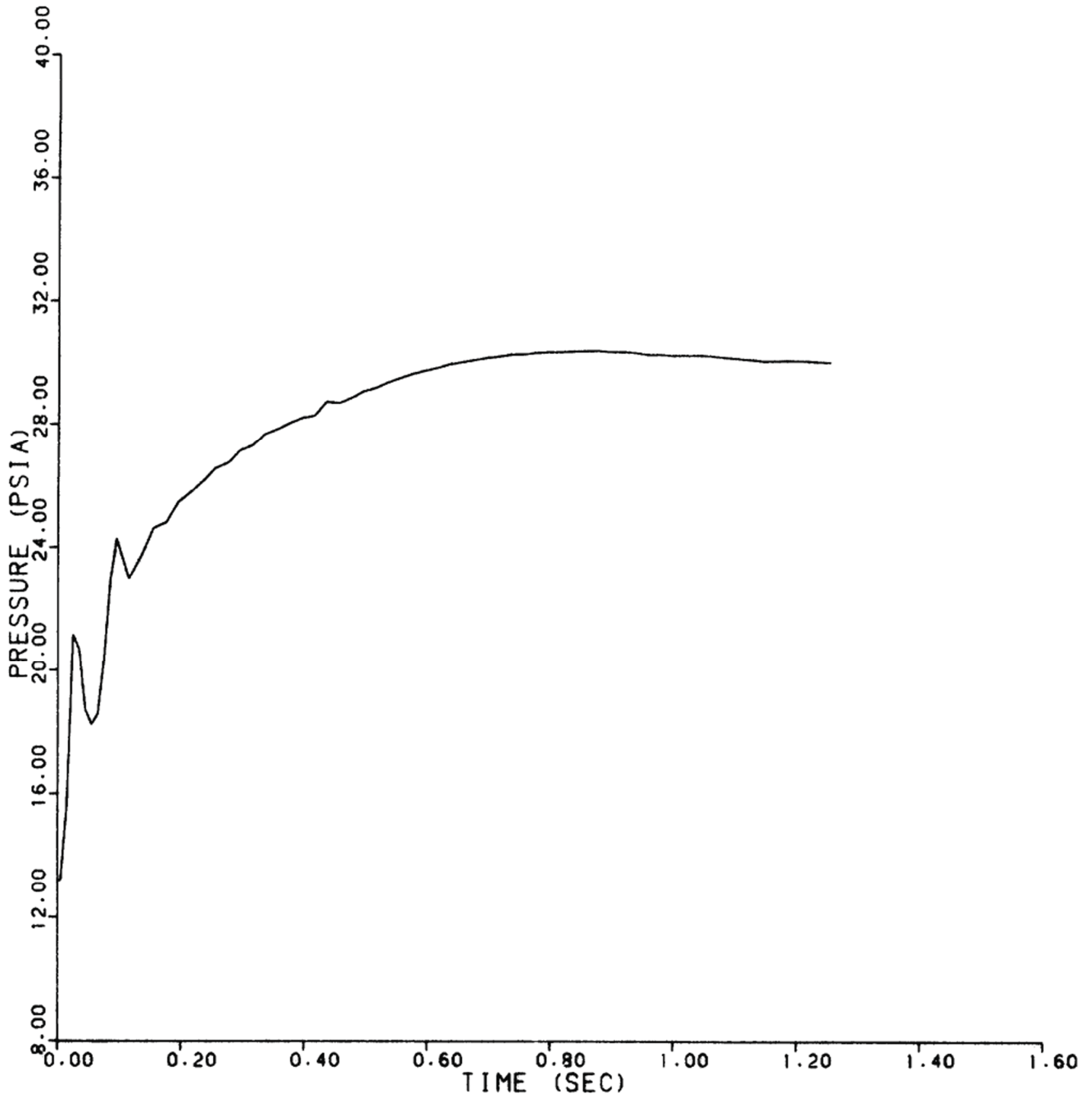

REV 13 4/06



VOGTLE
ELECTRIC GENERATING PLANT
UNIT 1 AND UNIT 2

STEAM GENERATOR OUTLET NOZZLE
NODE - E4
(436-in.² BREAK AREA)

FIGURE 6.2.1-21 (SHEET 4 OF 74)

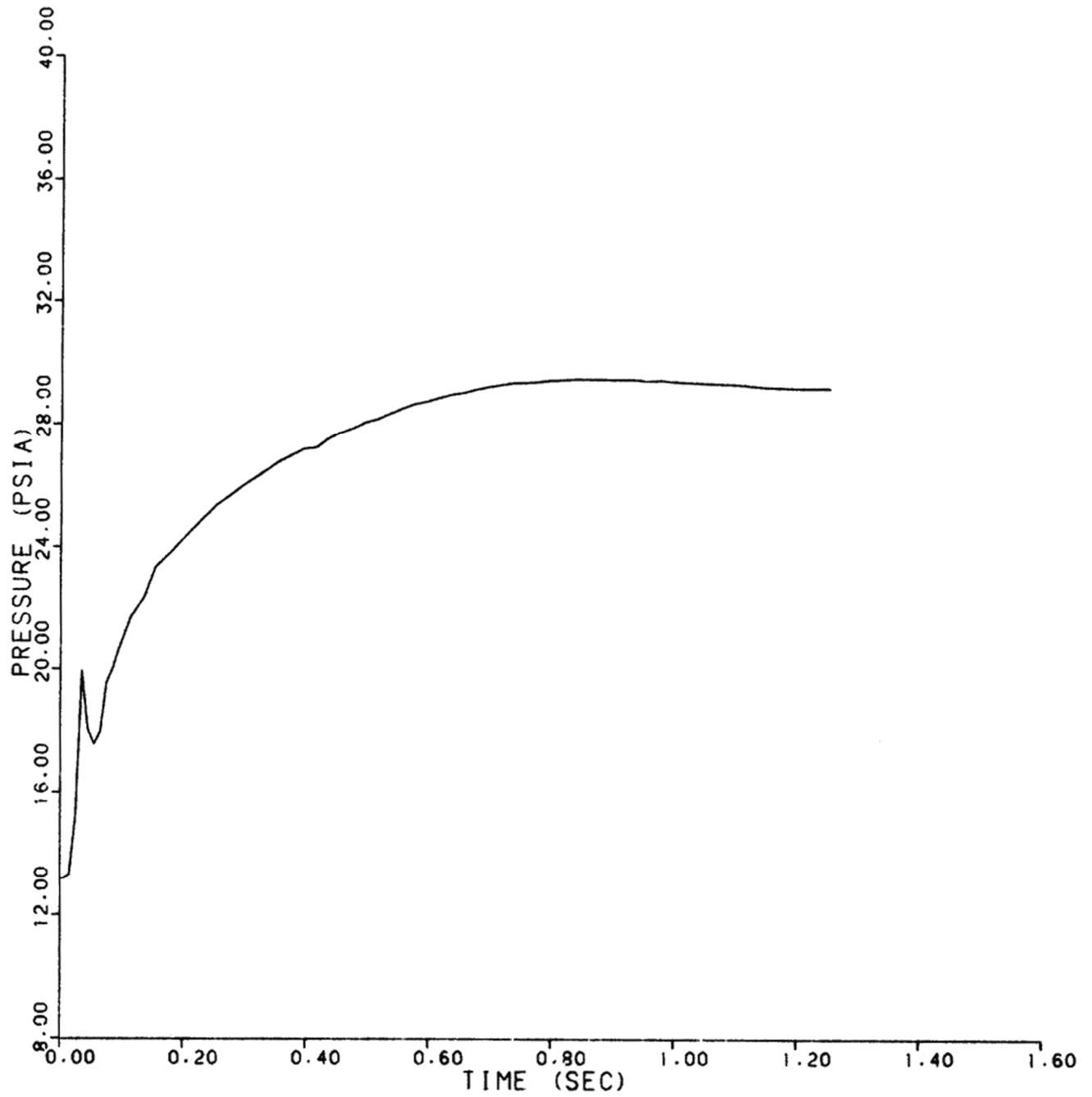

REV 13 4/06



VOGTLE
ELECTRIC GENERATING PLANT
UNIT 1 AND UNIT 2

STEAM GENERATOR OUTLET NOZZLE
NODE - E5
(436-in.² BREAK AREA)

FIGURE 6.2.1-21 (SHEET 5 OF 74)

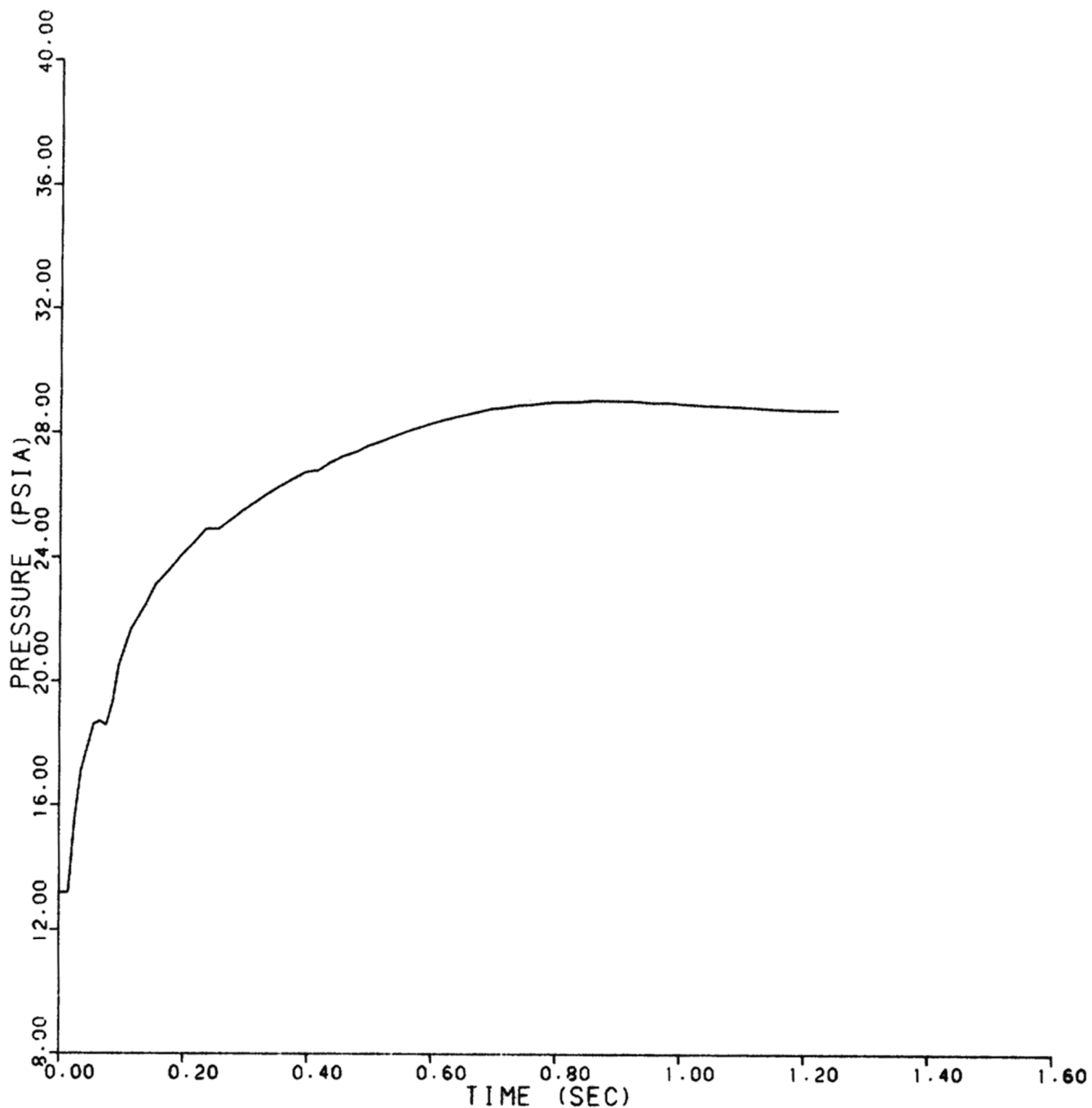

REV 13 4/06



VOGTLE
ELECTRIC GENERATING PLANT
UNIT 1 AND UNIT 2

STEAM GENERATOR OUTLET NOZZLE
NODE - E6
(436-in.² BREAK AREA)

FIGURE 6.2.1-21 (SHEET 6 OF 74)

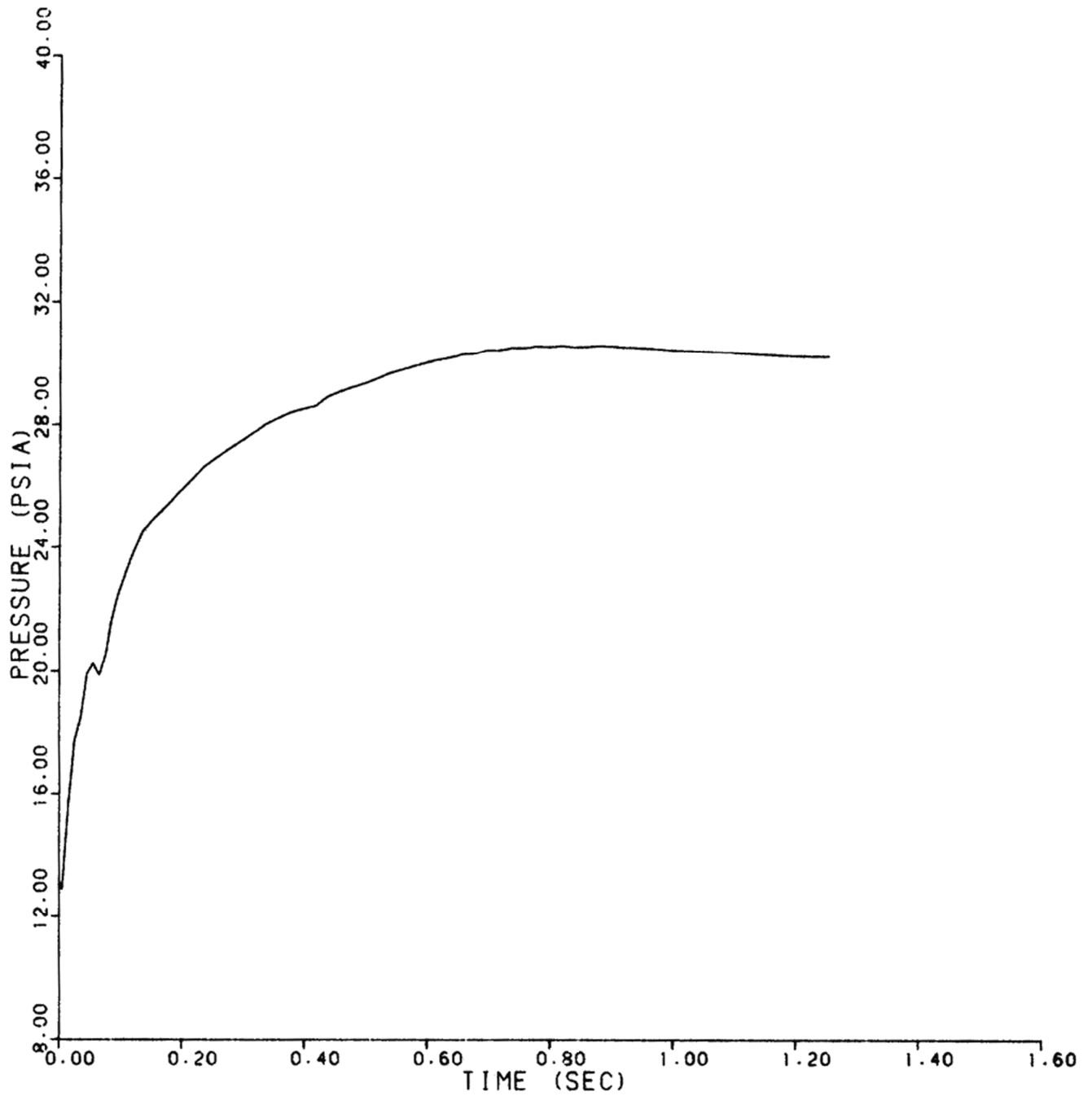

REV 13 4/06



VOGTLE
ELECTRIC GENERATING PLANT
UNIT 1 AND UNIT 2

STEAM GENERATOR OUTLET NOZZLE
NODE - E7
(436-in.² BREAK AREA)

FIGURE 6.2.1-21 (SHEET 7 OF 74)

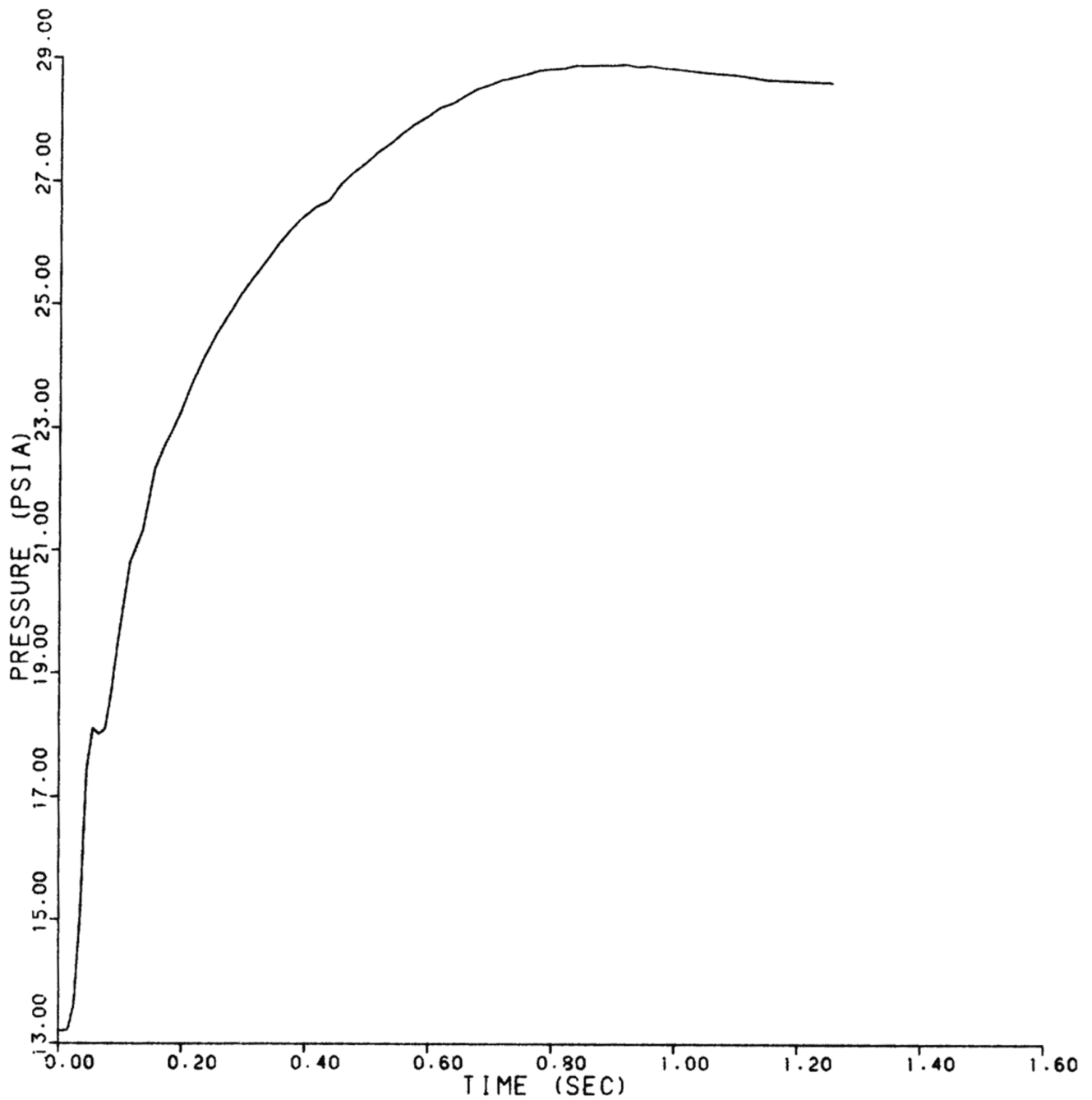

REV 13 4/06



VOGTLE
ELECTRIC GENERATING PLANT
UNIT 1 AND UNIT 2

STEAM GENERATOR OUTLET NOZZLE
NODE - E8
(436-in.² BREAK AREA)

FIGURE 6.2.1-21 (SHEET 8 OF 74)

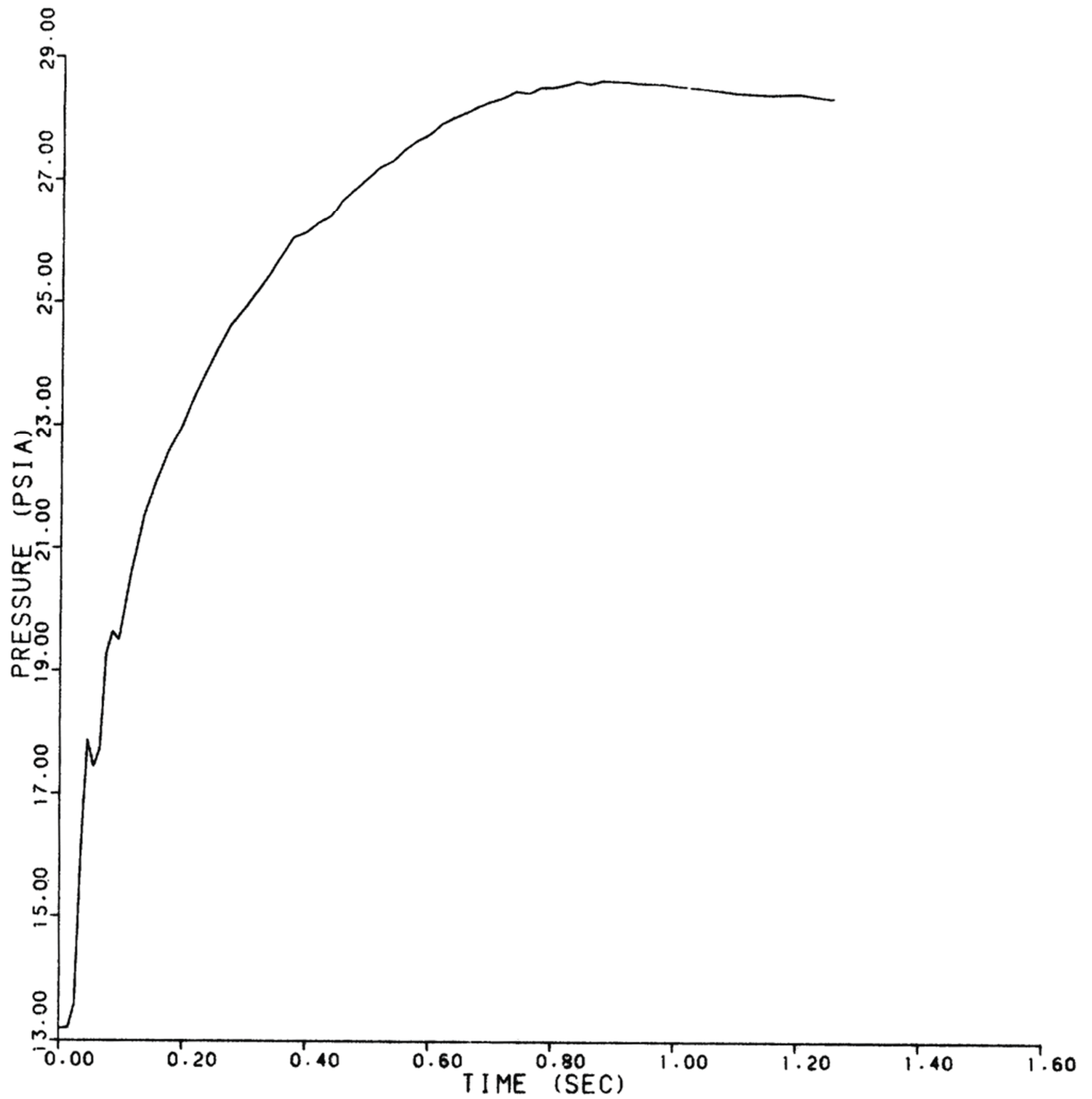

REV 13 4/06



VOGTLE
ELECTRIC GENERATING PLANT
UNIT 1 AND UNIT 2

STEAM GENERATOR OUTLET NOZZLE
NODE - E9
(436-in.² BREAK AREA)

FIGURE 6.2.1-21 (SHEET 9 OF 74)

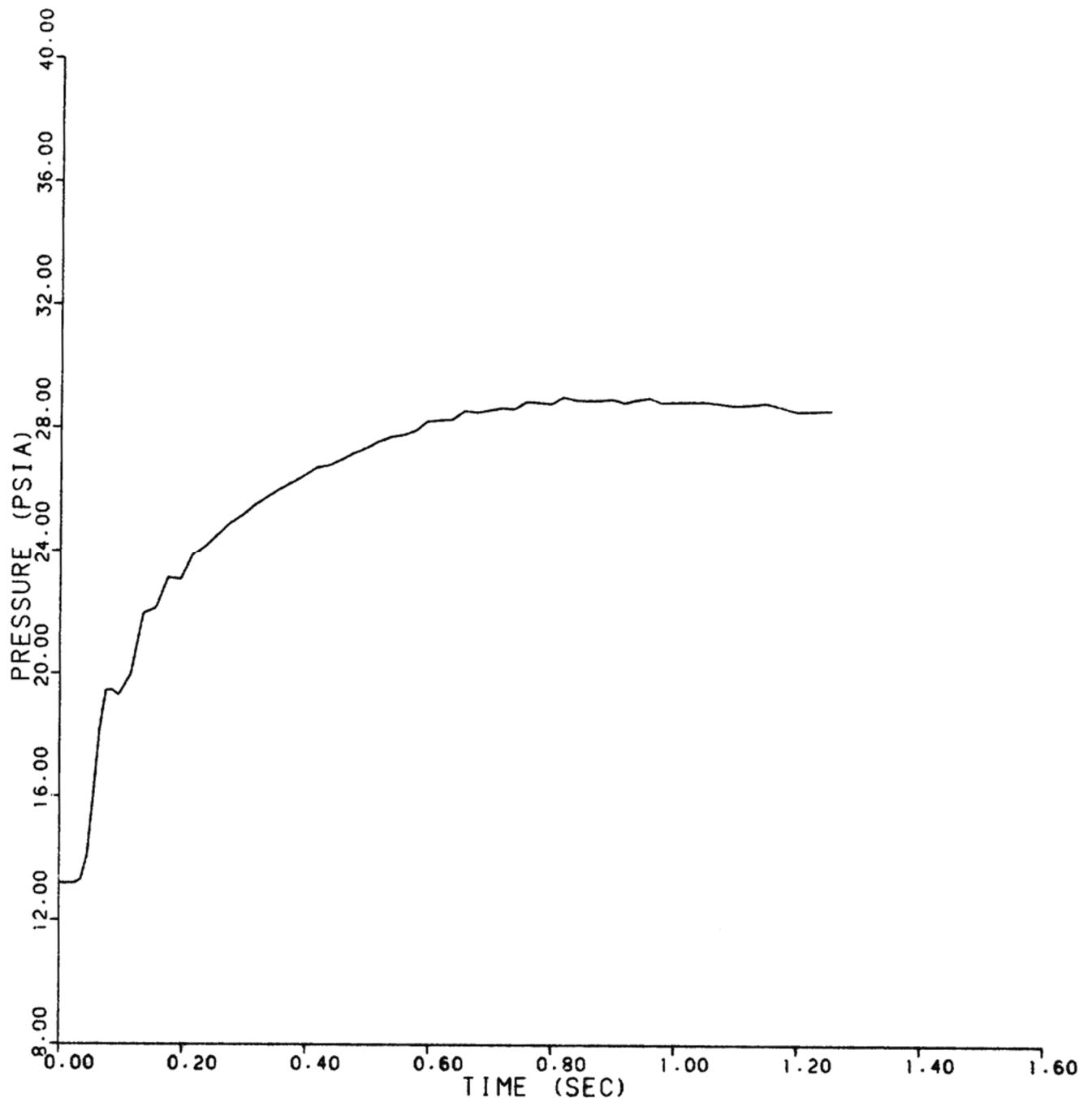

REV 13 4/06



VOGTLE
ELECTRIC GENERATING PLANT
UNIT 1 AND UNIT 2

STEAM GENERATOR OUTLET NOZZLE
NODE - E10
(436-in.² BREAK AREA)

FIGURE 6.2.1-21 (SHEET 10 OF 74)

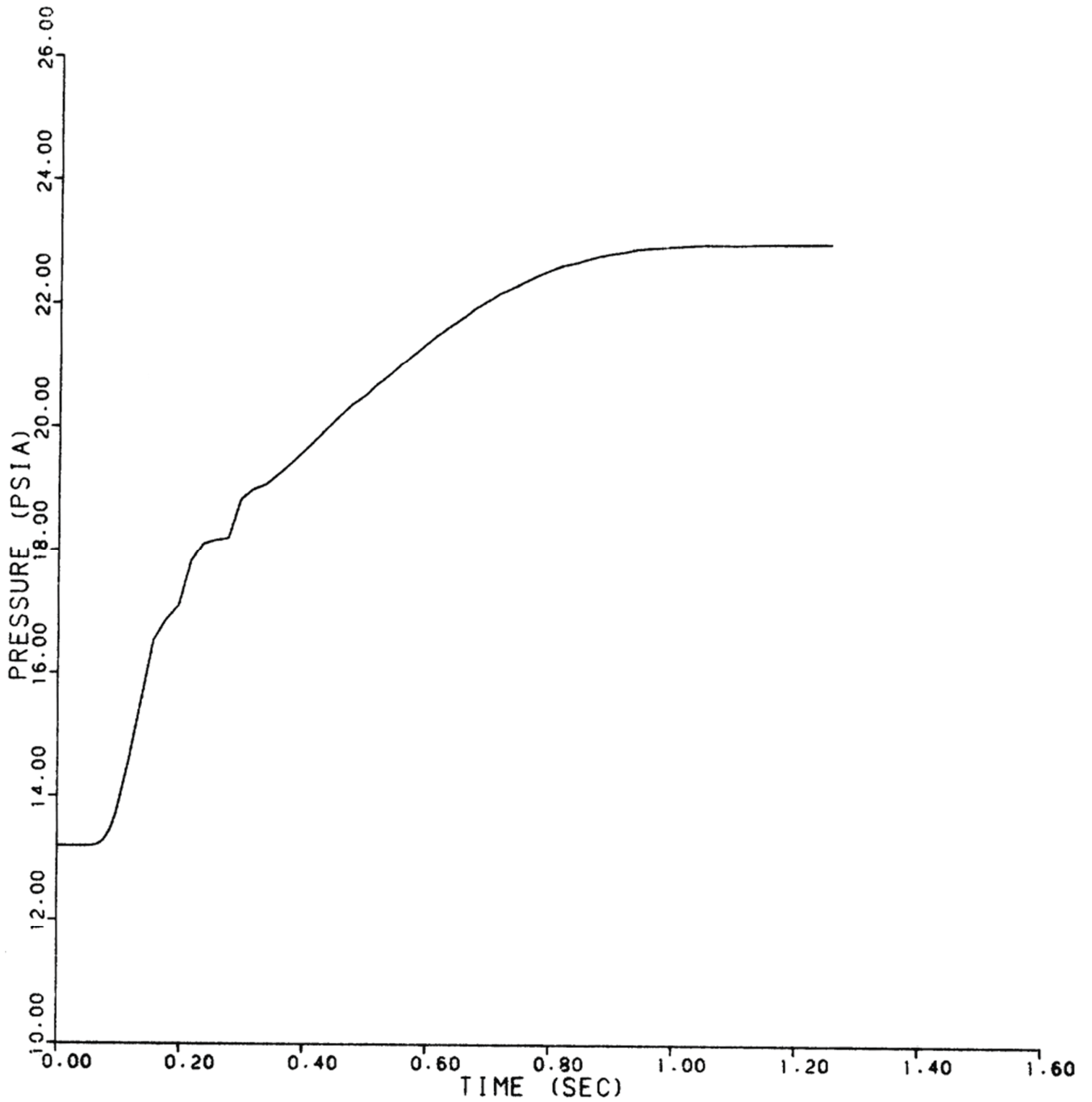

REV 13 4/06



VOGTLE
ELECTRIC GENERATING PLANT
UNIT 1 AND UNIT 2

STEAM GENERATOR OUTLET NOZZLE
NODE - E11
(436-in.² BREAK AREA)

FIGURE 6.2.1-21 (SHEET 11 OF 74)

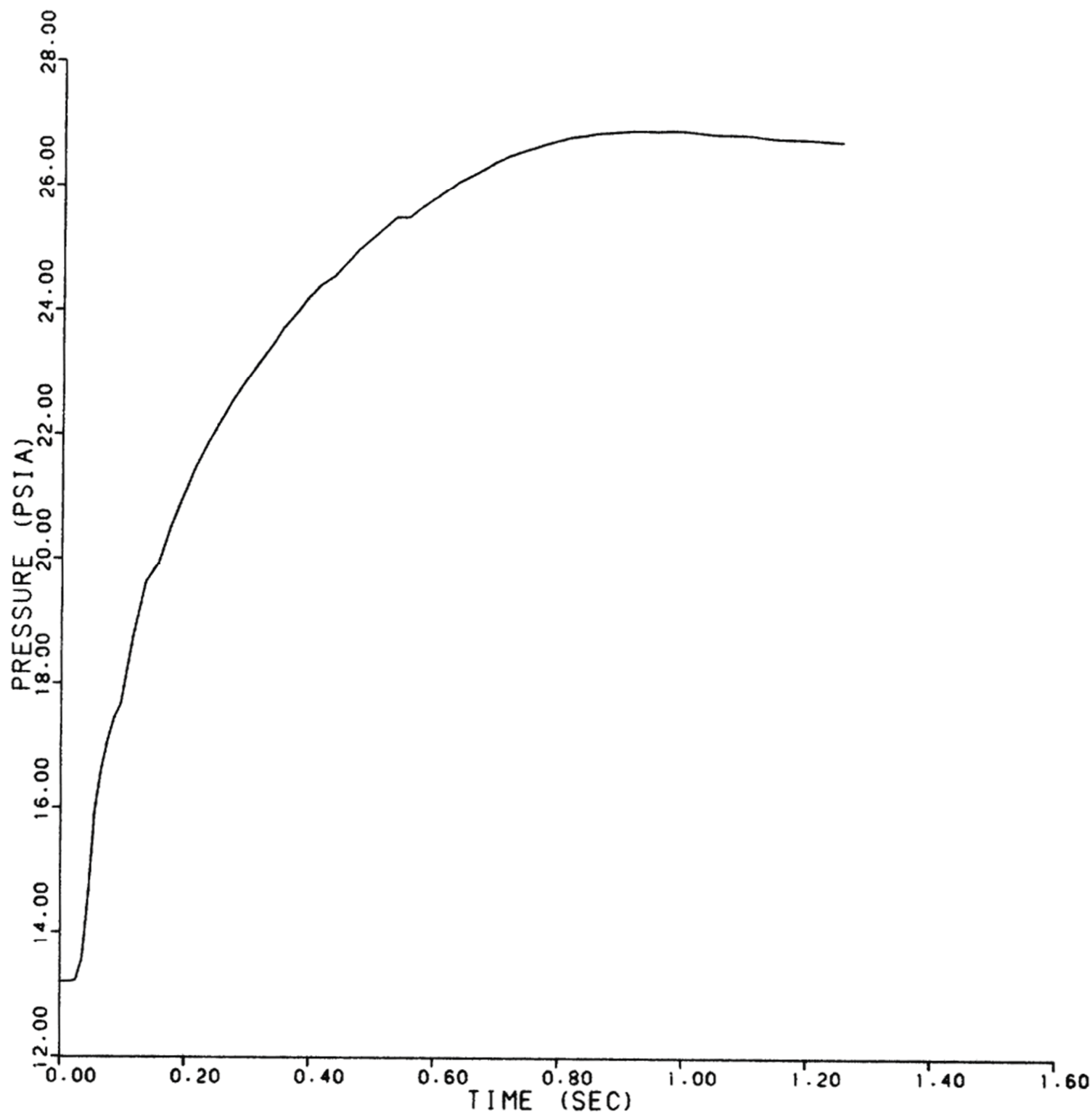

REV 13 4/06



VOGTLE
ELECTRIC GENERATING PLANT
UNIT 1 AND UNIT 2

STEAM GENERATOR OUTLET NOZZLE
NODE - E12
(436-in.² BREAK AREA)

FIGURE 6.2.1-21 (SHEET 12 OF 74)

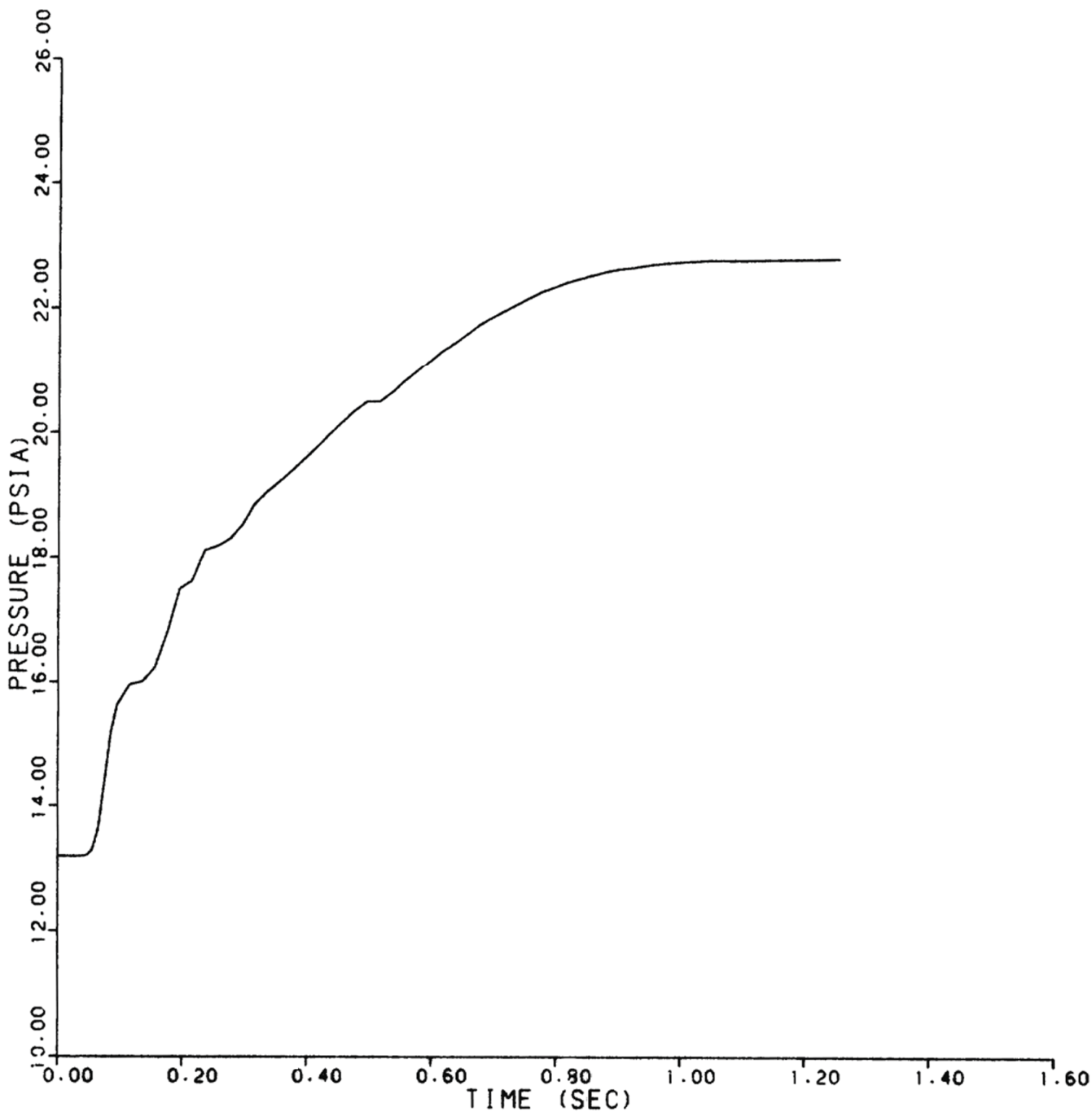

REV 13 4/06



VOGTLE
ELECTRIC GENERATING PLANT
UNIT 1 AND UNIT 2

STEAM GENERATOR OUTLET NOZZLE
NODE - E13
(436-in.² BREAK AREA)

FIGURE 6.2.1-21 (SHEET 13 OF 74)

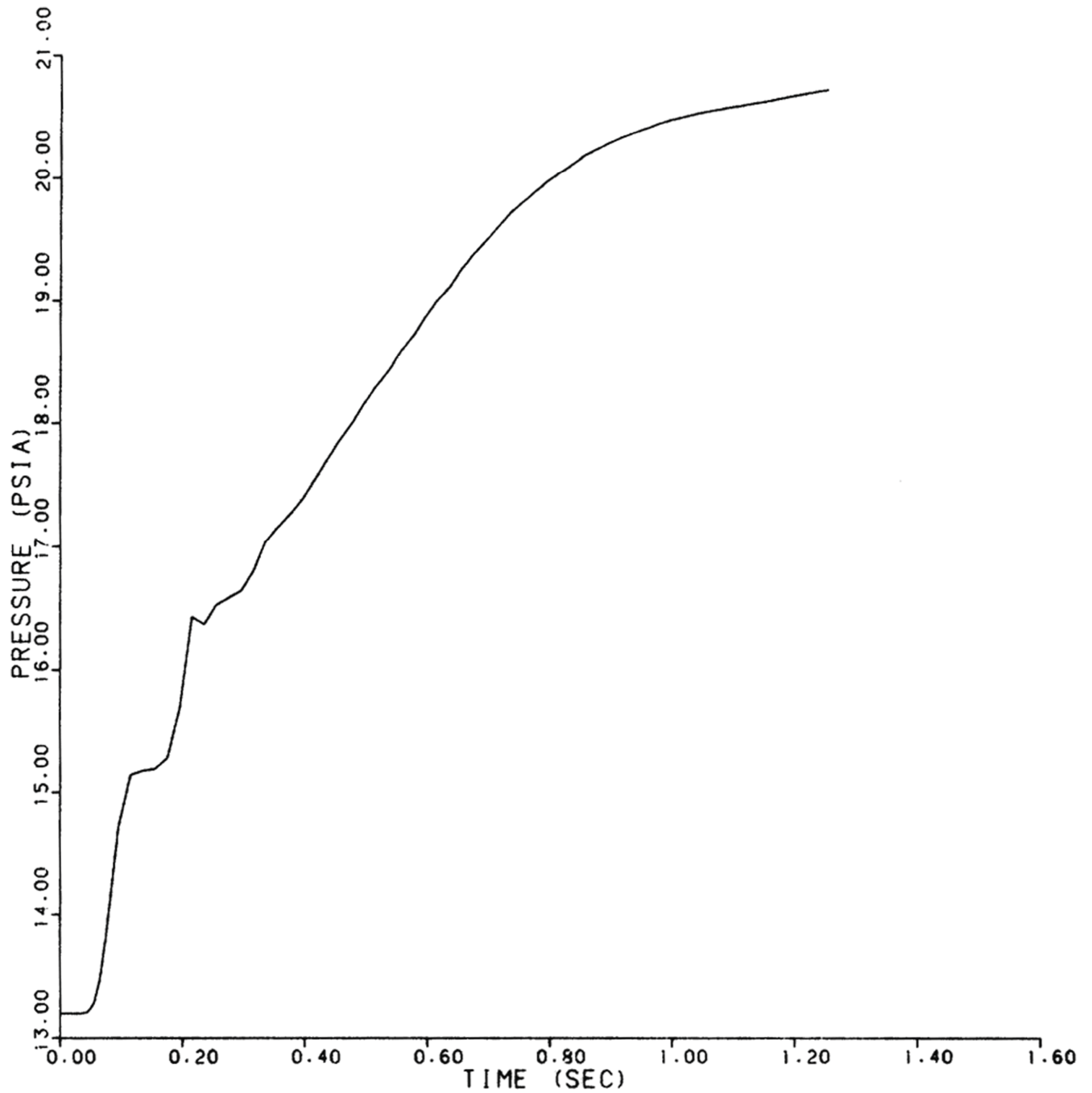

REV 13 4/06



VOGTLE
ELECTRIC GENERATING PLANT
UNIT 1 AND UNIT 2

STEAM GENERATOR OUTLET NOZZLE
NODE - E14
(436-in.² BREAK AREA)

FIGURE 6.2.1-21 (SHEET 14 OF 74)

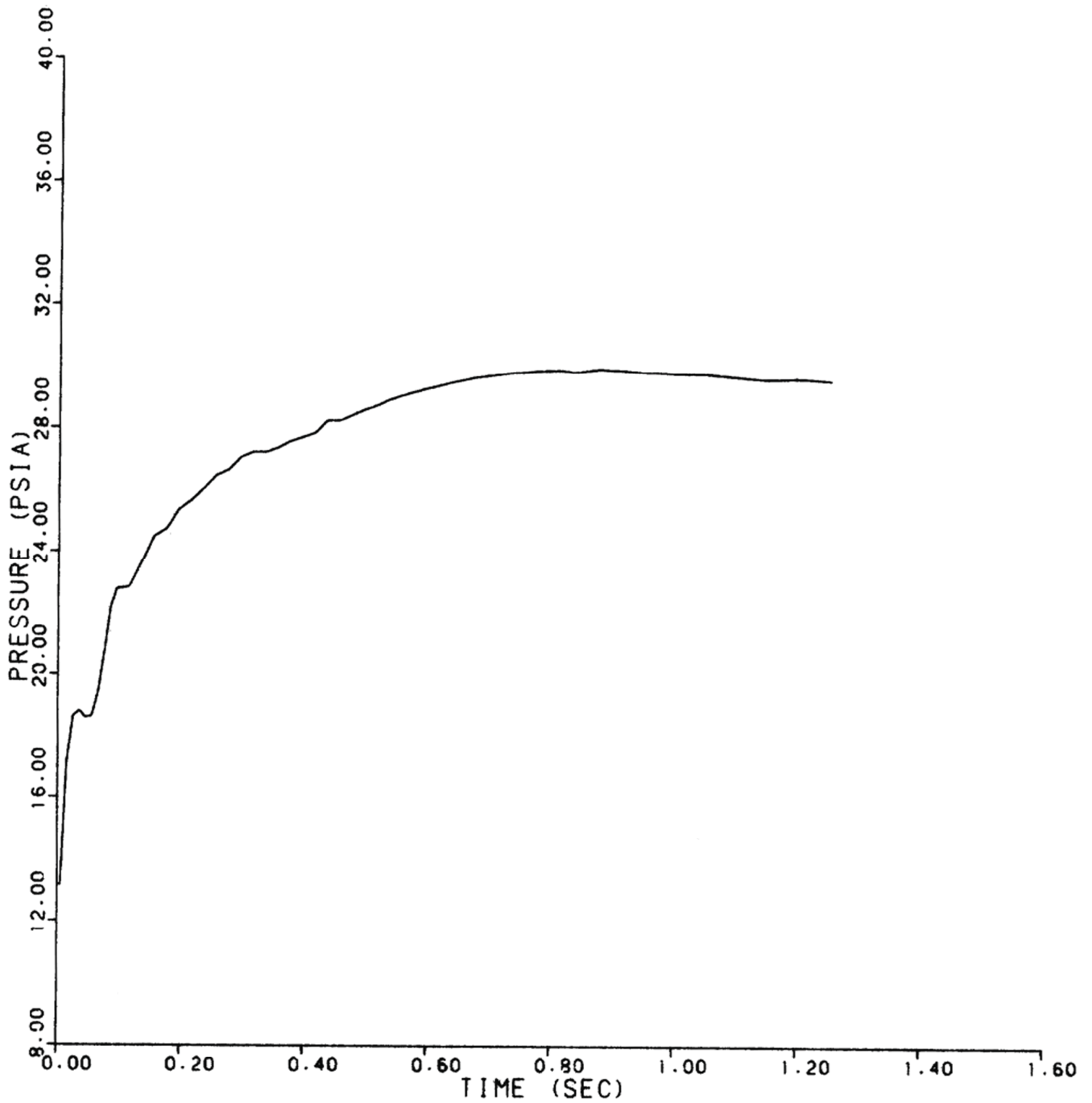

REV 13 4/06



VOGTLE
ELECTRIC GENERATING PLANT
UNIT 1 AND UNIT 2

STEAM GENERATOR OUTLET NOZZLE
NODE - E15
(436-in.² BREAK AREA)

FIGURE 6.2.1-21 (SHEET 15 OF 74)

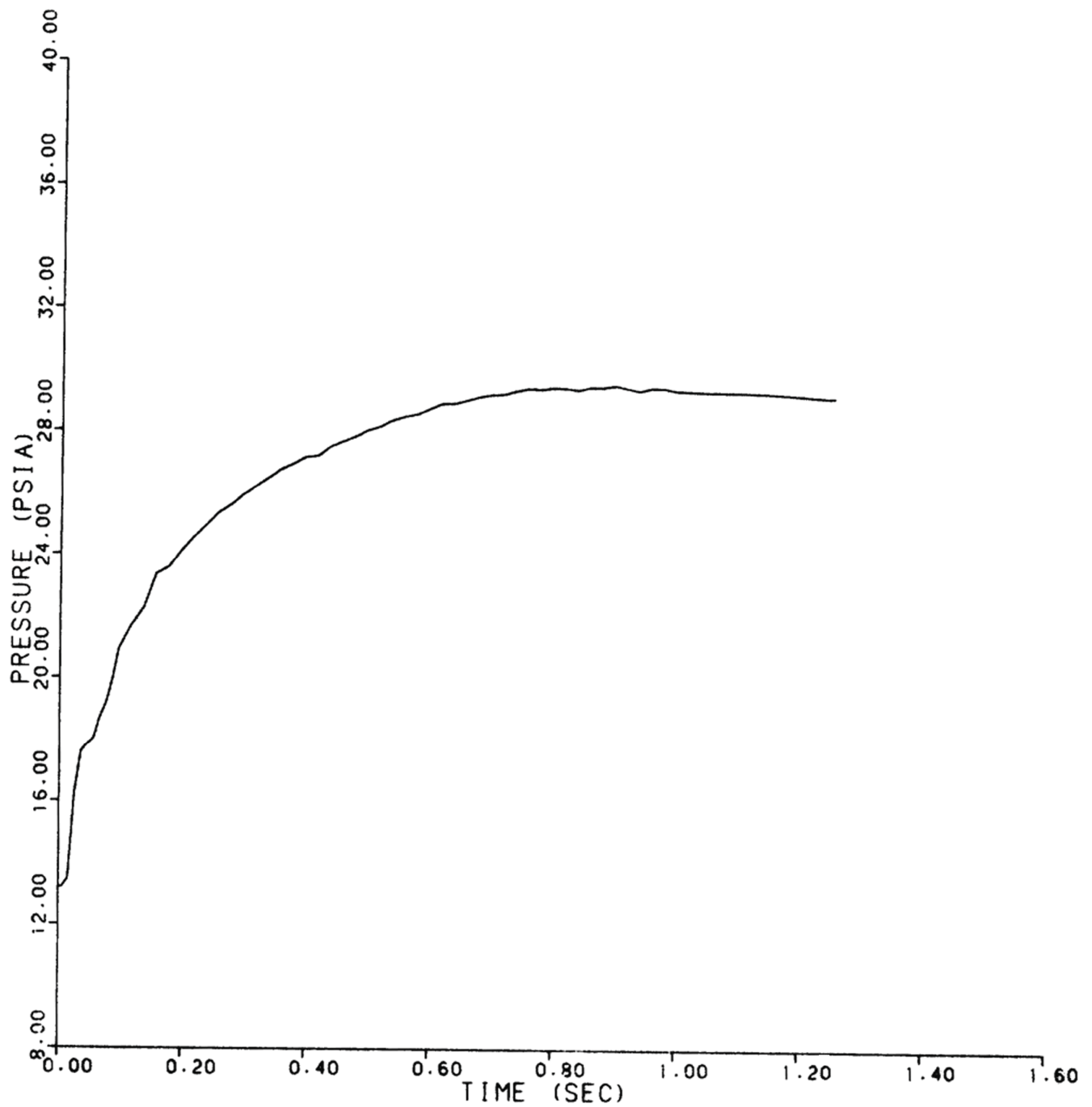

REV 13 4/06



VOGTLE
ELECTRIC GENERATING PLANT
UNIT 1 AND UNIT 2

STEAM GENERATOR OUTLET NOZZLE
NODE - E16
(436-in.² BREAK AREA)

FIGURE 6.2.1-21 (SHEET 16 OF 74)

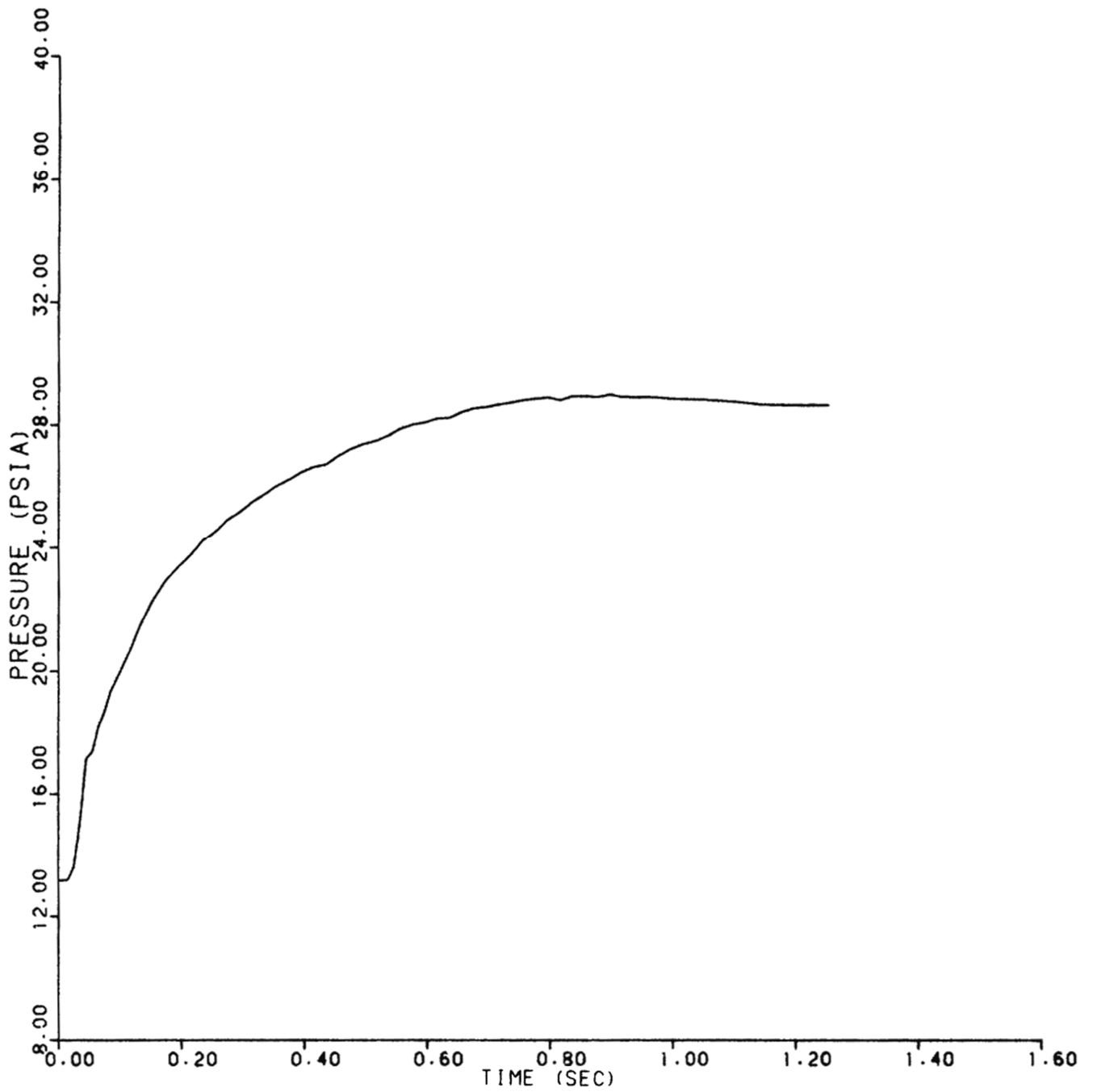

REV 13 4/06



VOGTLE
ELECTRIC GENERATING PLANT
UNIT 1 AND UNIT 2

STEAM GENERATOR OUTLET NOZZLE
NODE - E17
(436-in.² BREAK AREA)

FIGURE 6.2.1-21 (SHEET 17 OF 74)

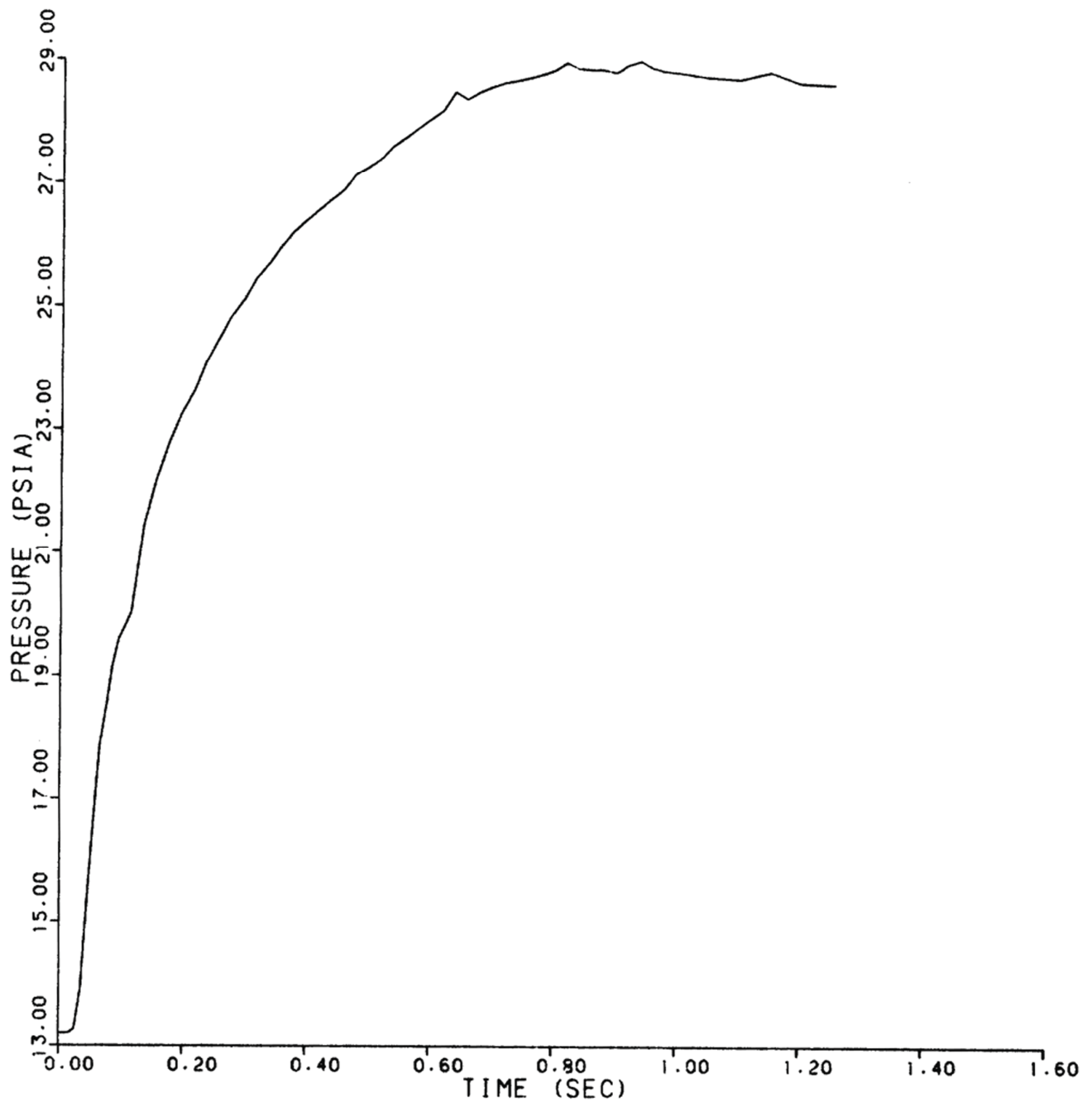

REV 13 4/06



VOGTLE
ELECTRIC GENERATING PLANT
UNIT 1 AND UNIT 2

STEAM GENERATOR OUTLET NOZZLE
NODE - E18
(436-in.² BREAK AREA)

FIGURE 6.2.1-21 (SHEET 18 OF 74)

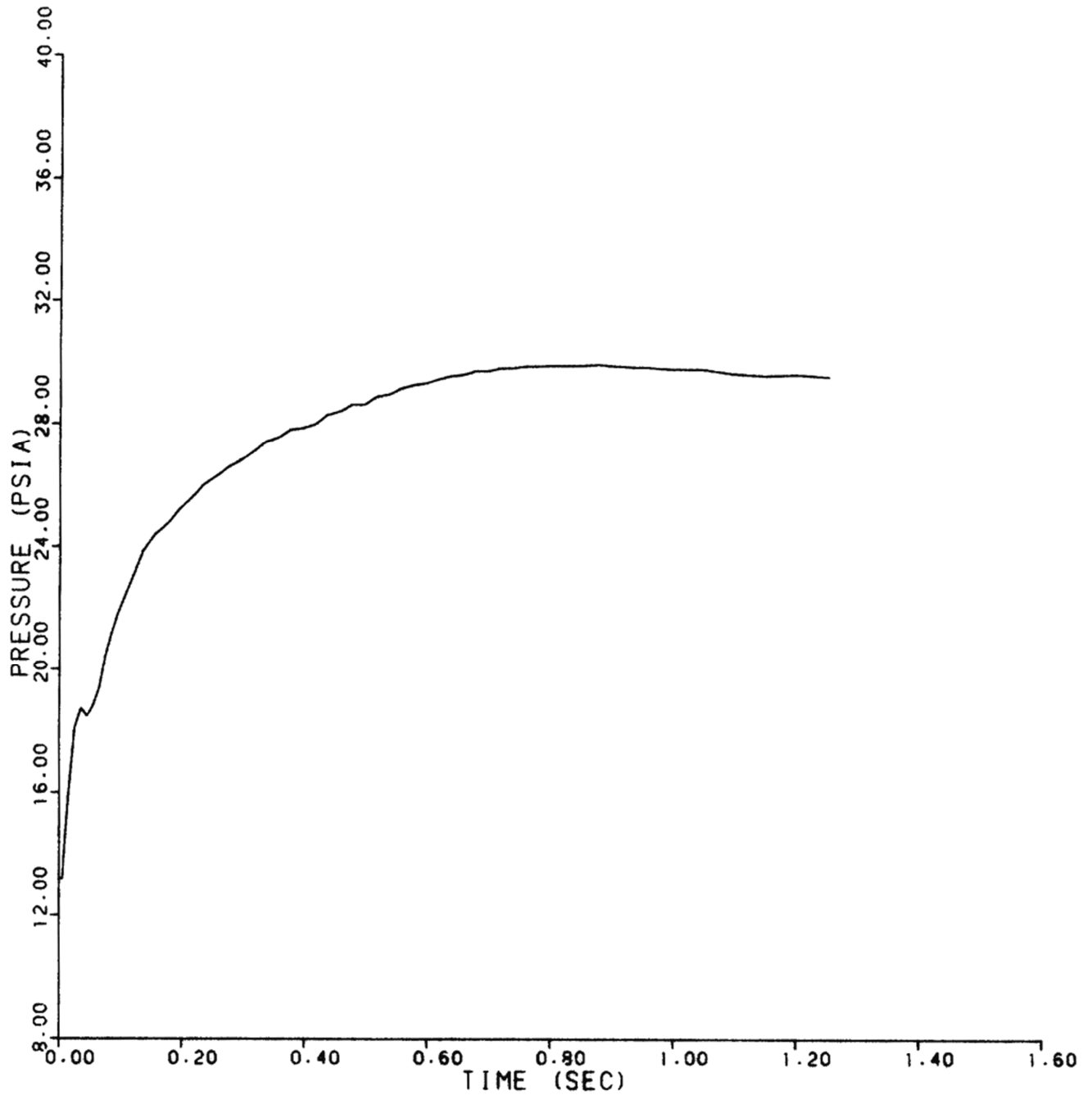

REV 13 4/06



VOGTLE
ELECTRIC GENERATING PLANT
UNIT 1 AND UNIT 2

STEAM GENERATOR OUTLET NOZZLE
NODE - E19
(436-in.² BREAK AREA)

FIGURE 6.2.1-21 (SHEET 19 OF 74)

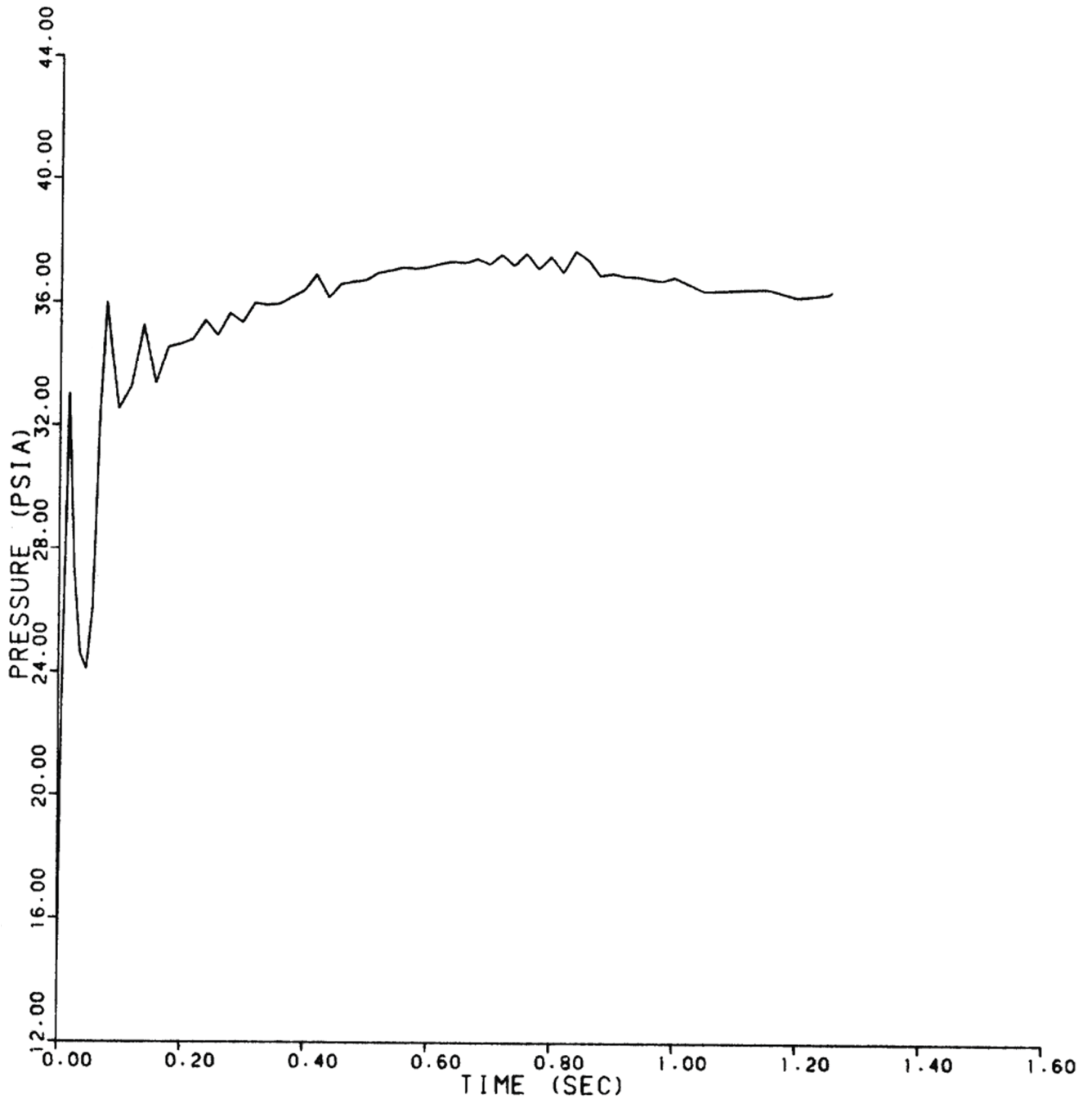

REV 13 4/06



VOGTLE
ELECTRIC GENERATING PLANT
UNIT 1 AND UNIT 2

STEAM GENERATOR OUTLET NOZZLE
NODE - E20
(436-in.² BREAK AREA)

FIGURE 6.2.1-21 (SHEET 20 OF 74)

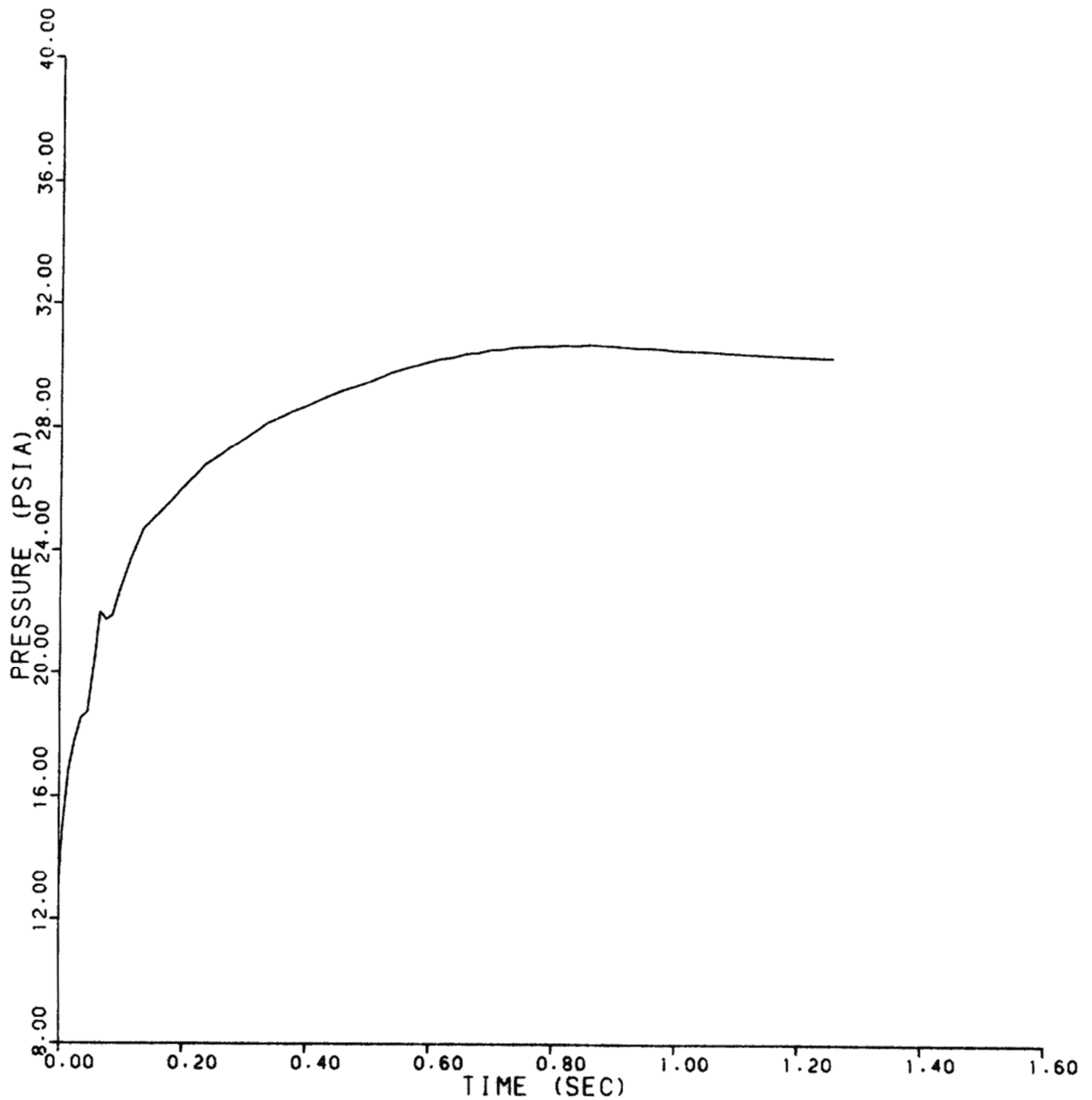

REV 13 4/06



VOGTLE
ELECTRIC GENERATING PLANT
UNIT 1 AND UNIT 2

STEAM GENERATOR OUTLET NOZZLE
NODE - E21
(436-in.² BREAK AREA)

FIGURE 6.2.1-21 (SHEET 21 OF 74)

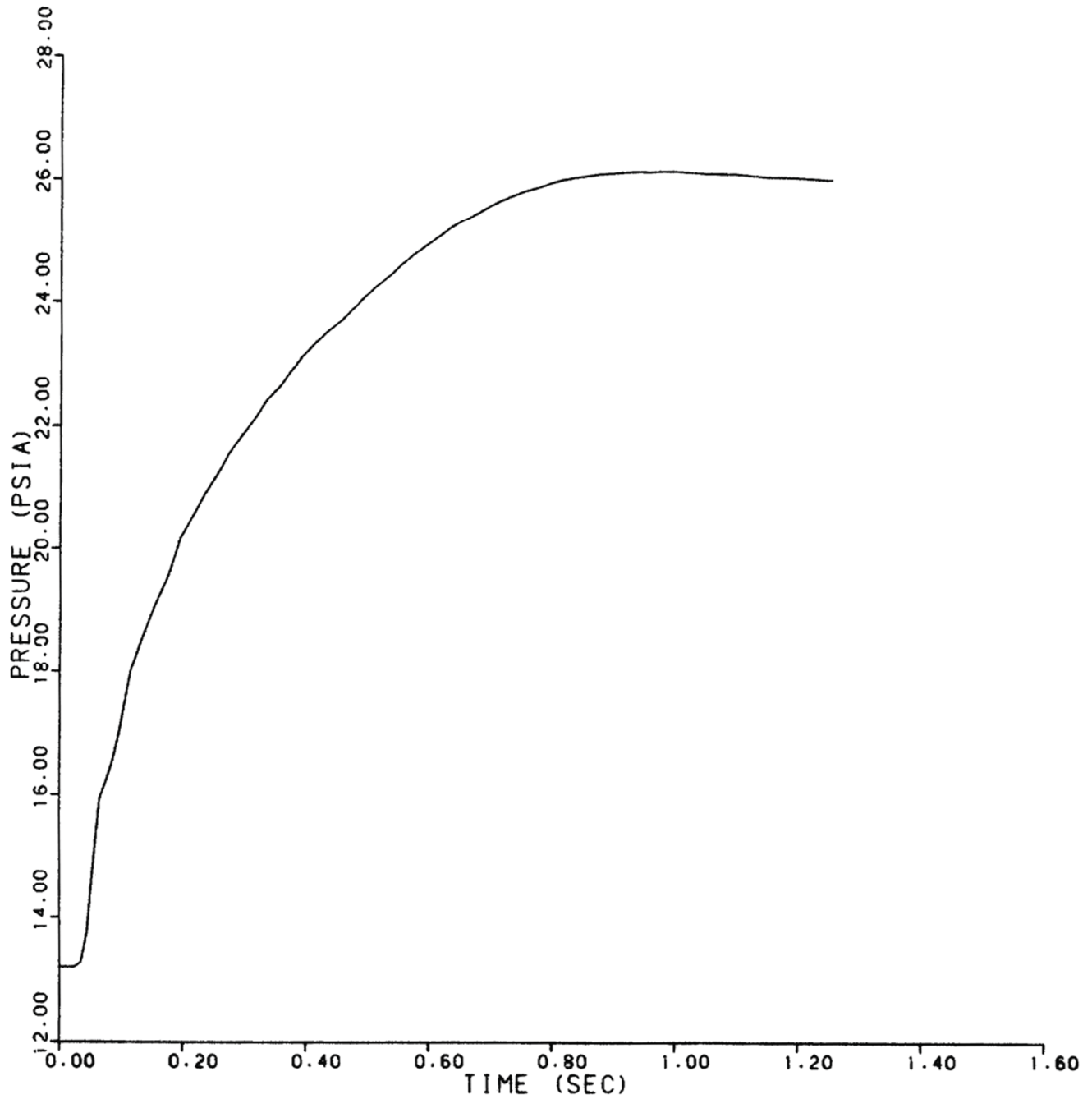

REV 13 4/06



VOGTLE
ELECTRIC GENERATING PLANT
UNIT 1 AND UNIT 2

STEAM GENERATOR OUTLET NOZZLE
NODE - E22
(436-in.² BREAK AREA)

FIGURE 6.2.1-21 (SHEET 22 OF 74)

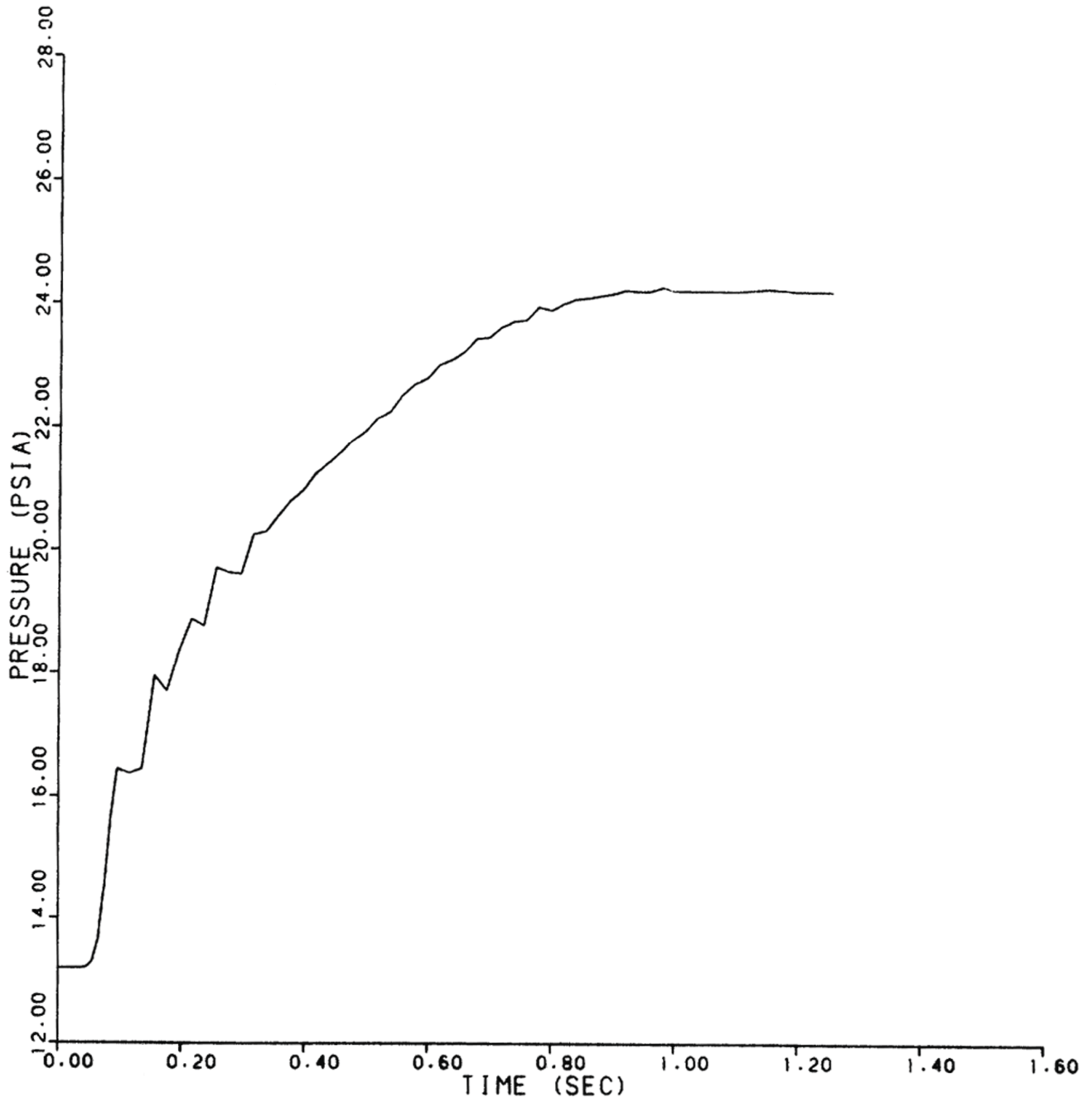

REV 13 4/06



VOGTLE
ELECTRIC GENERATING PLANT
UNIT 1 AND UNIT 2

STEAM GENERATOR OUTLET NOZZLE
NODE - E23
(436-in.² BREAK AREA)

FIGURE 6.2.1-21 (SHEET 23 OF 74)

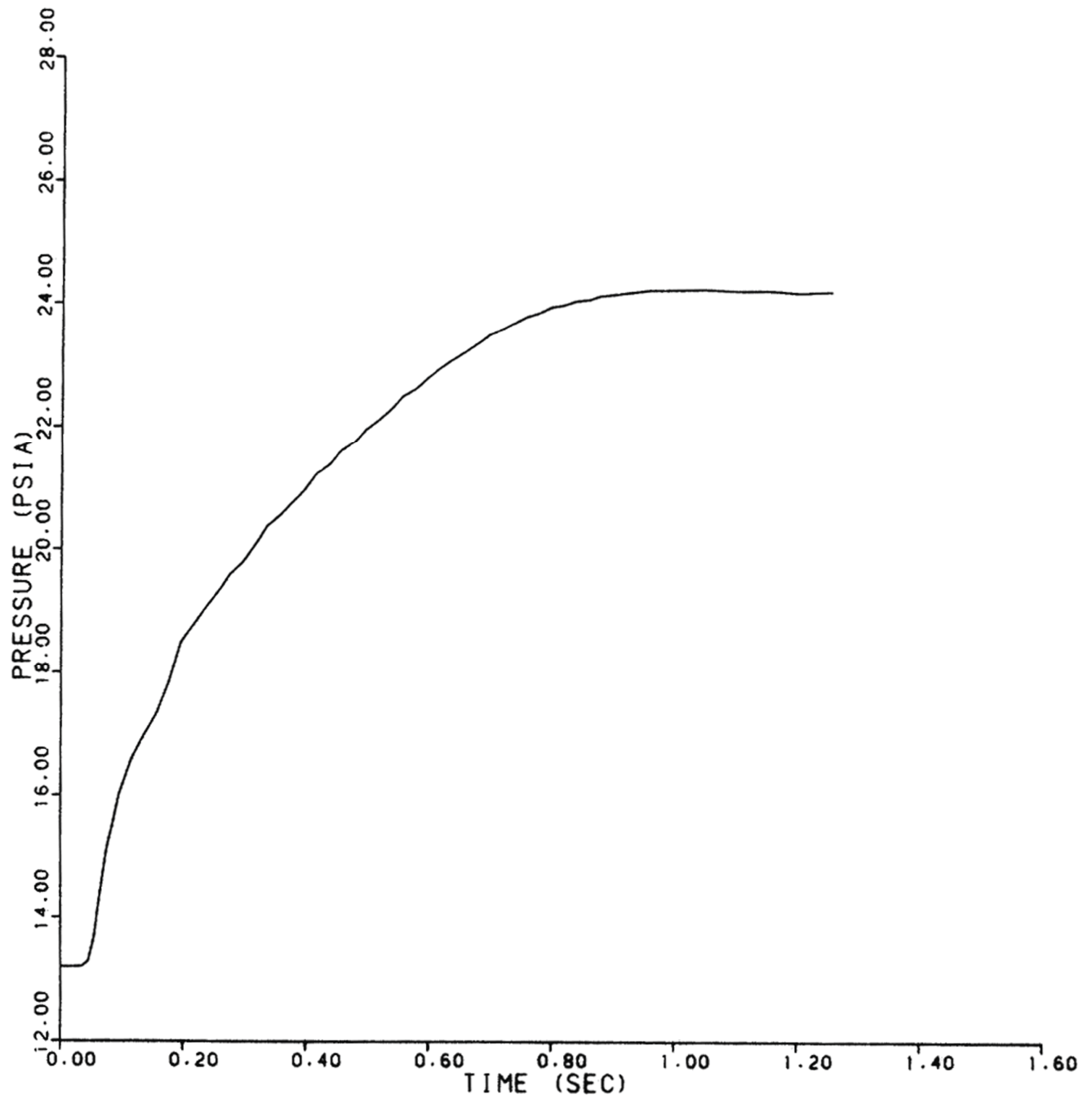

REV 13 4/06



VOGTLE
ELECTRIC GENERATING PLANT
UNIT 1 AND UNIT 2

STEAM GENERATOR OUTLET NOZZLE
NODE - E24
(436-in.² BREAK AREA)

FIGURE 6.2.1-21 (SHEET 24 OF 74)

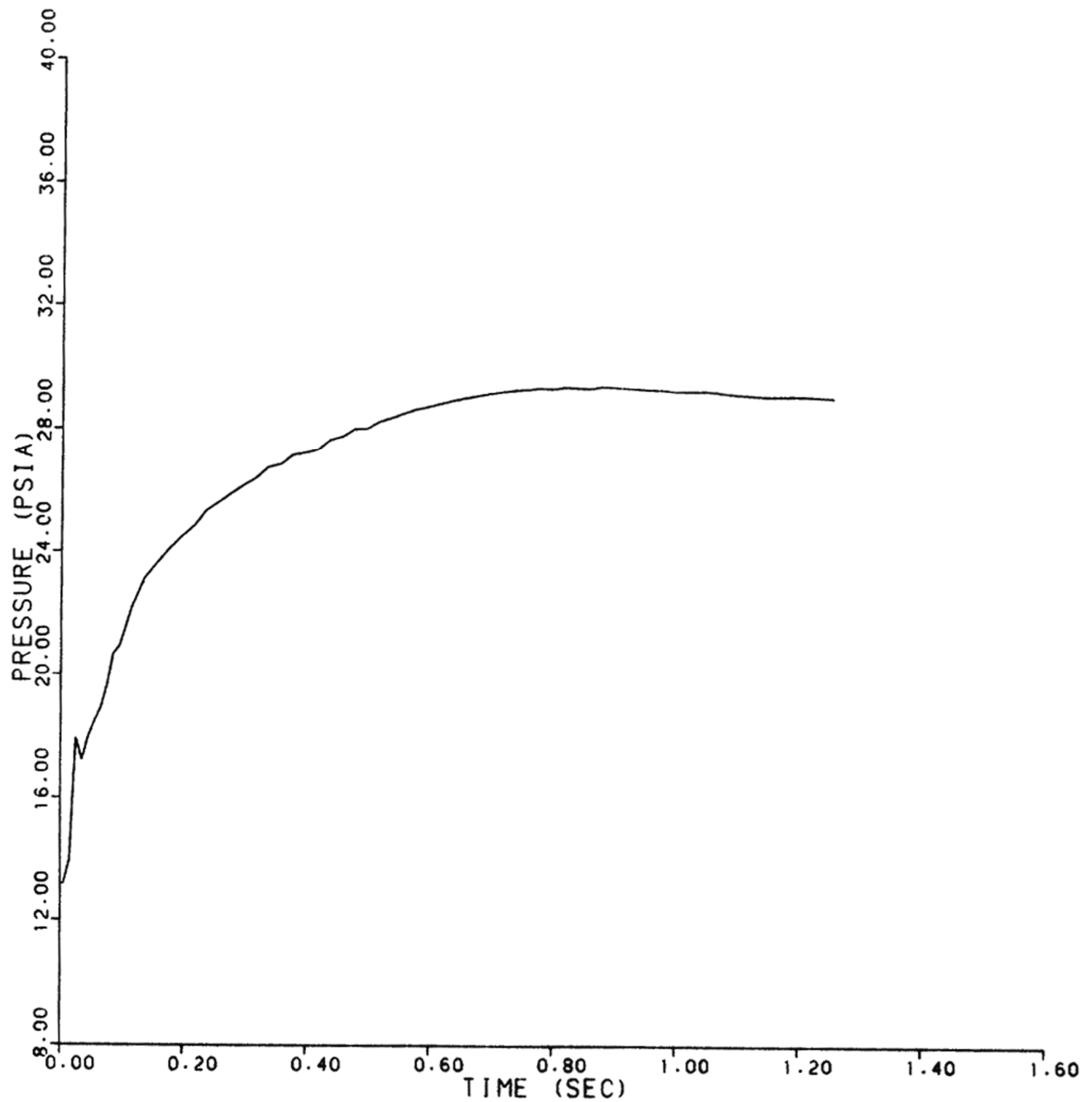

REV 13 4/06



VOGTLE
ELECTRIC GENERATING PLANT
UNIT 1 AND UNIT 2

STEAM GENERATOR OUTLET NOZZLE
NODE - E25
(436-in.² BREAK AREA)

FIGURE 6.2.1-21 (SHEET 25 OF 74)

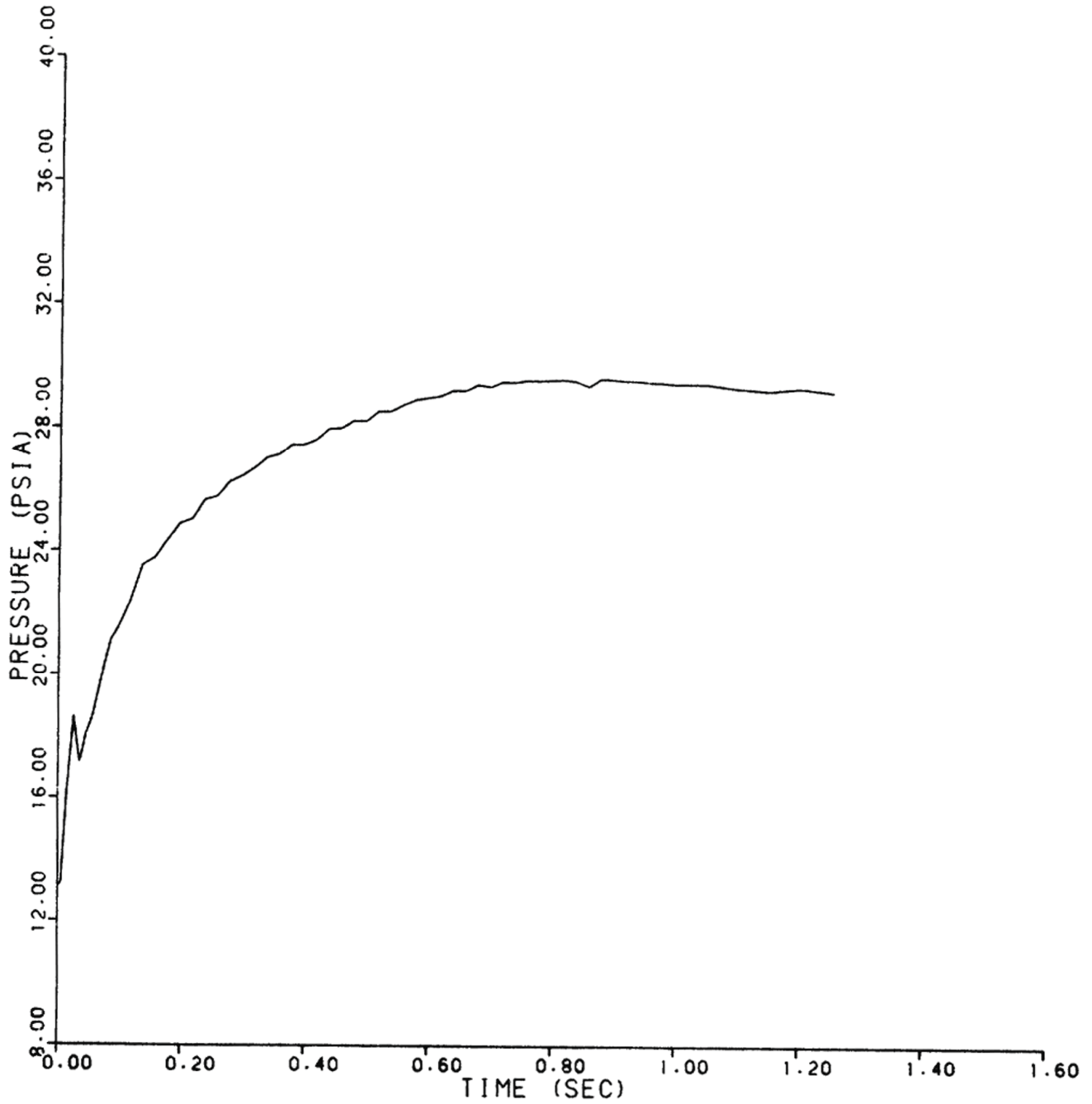

REV 13 4/06



VOGTLE
ELECTRIC GENERATING PLANT
UNIT 1 AND UNIT 2

STEAM GENERATOR OUTLET NOZZLE
NODE - E26
(436-in.² BREAK AREA)

FIGURE 6.2.1-21 (SHEET 26 OF 74)

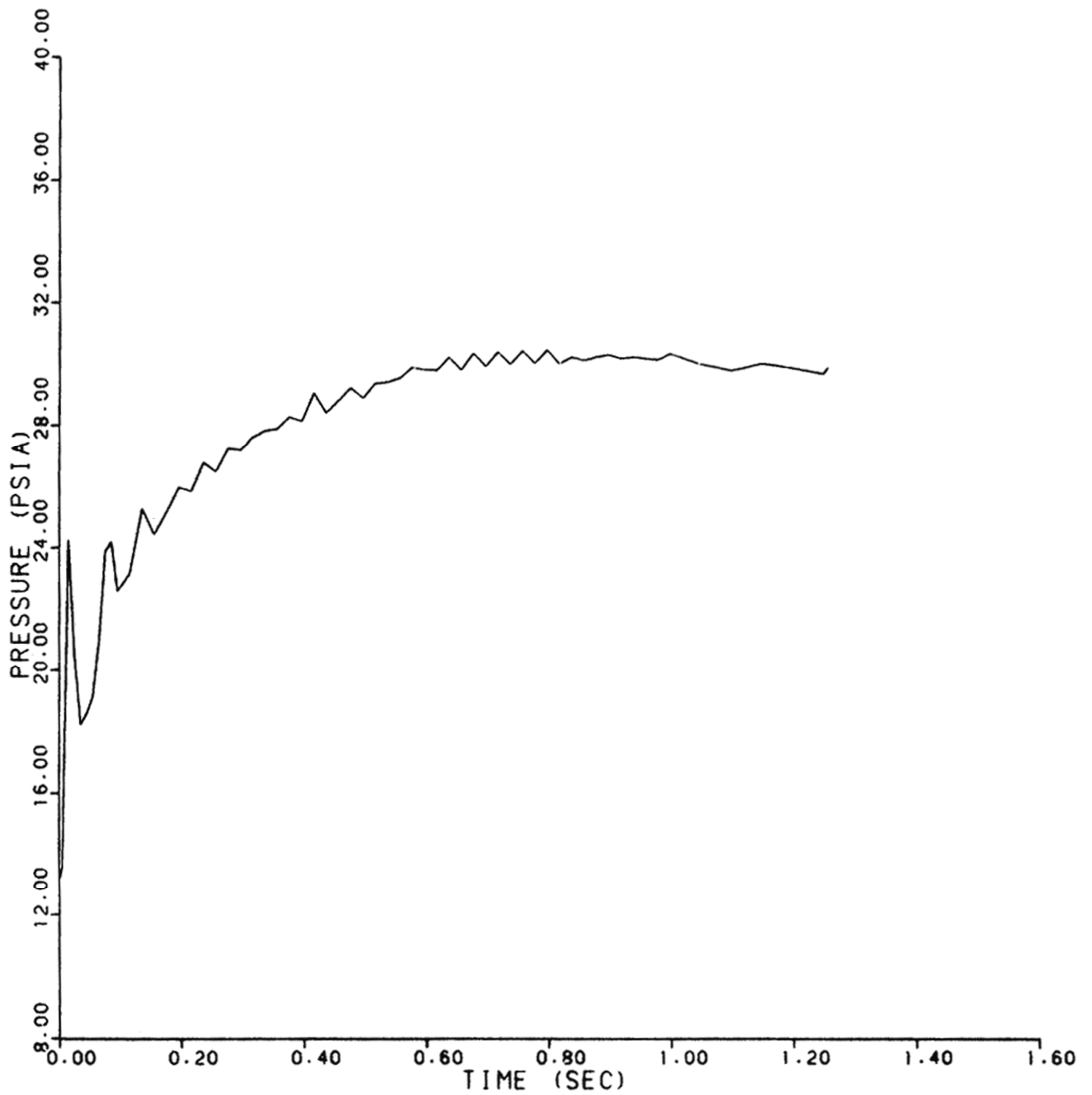

REV 13 4/06



VOGTLE
ELECTRIC GENERATING PLANT
UNIT 1 AND UNIT 2

STEAM GENERATOR OUTLET NOZZLE
NODE - E27
(436-in.² BREAK AREA)

FIGURE 6.2.1-21 (SHEET 27 OF 74)

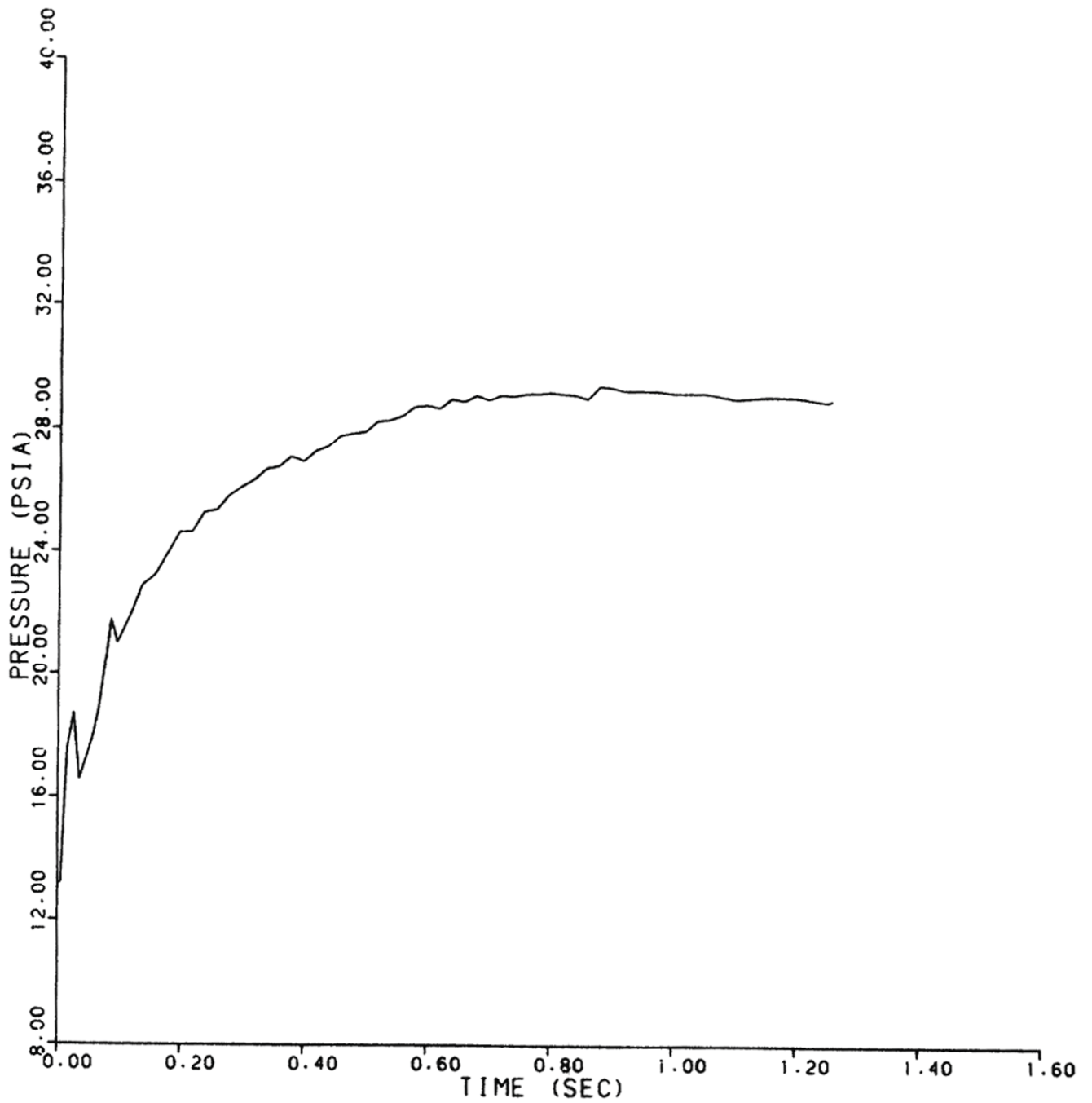

REV 13 4/06



VOGTLE
ELECTRIC GENERATING PLANT
UNIT 1 AND UNIT 2

STEAM GENERATOR OUTLET NOZZLE
NODE - E28
(436-in.² BREAK AREA)

FIGURE 6.2.1-21 (SHEET 28 OF 74)

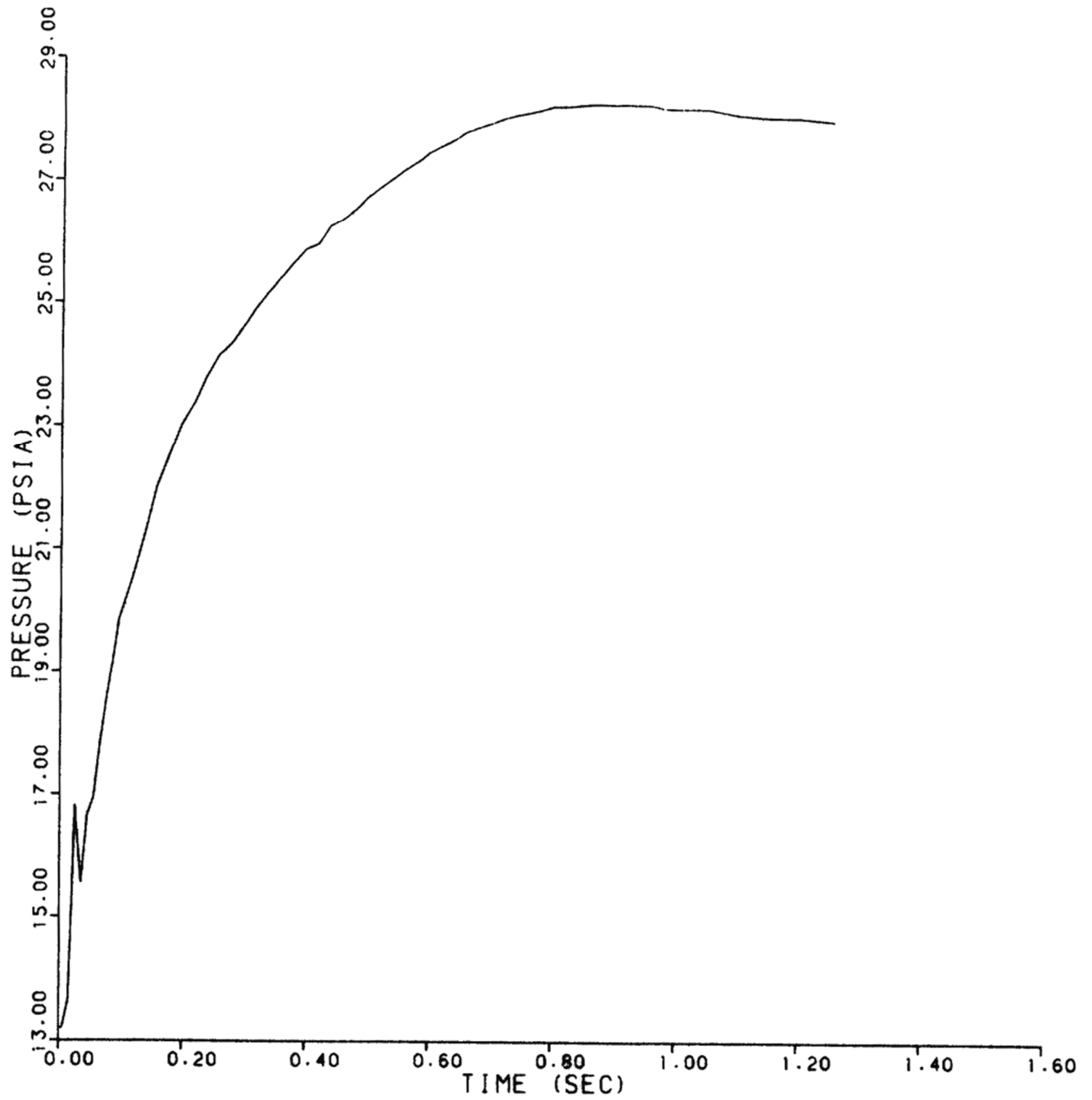

REV 13 4/06



VOGTLE
ELECTRIC GENERATING PLANT
UNIT 1 AND UNIT 2

STEAM GENERATOR OUTLET NOZZLE
NODE - E29
(436-in.² BREAK AREA)

FIGURE 6.2.1-21 (SHEET 29 OF 74)

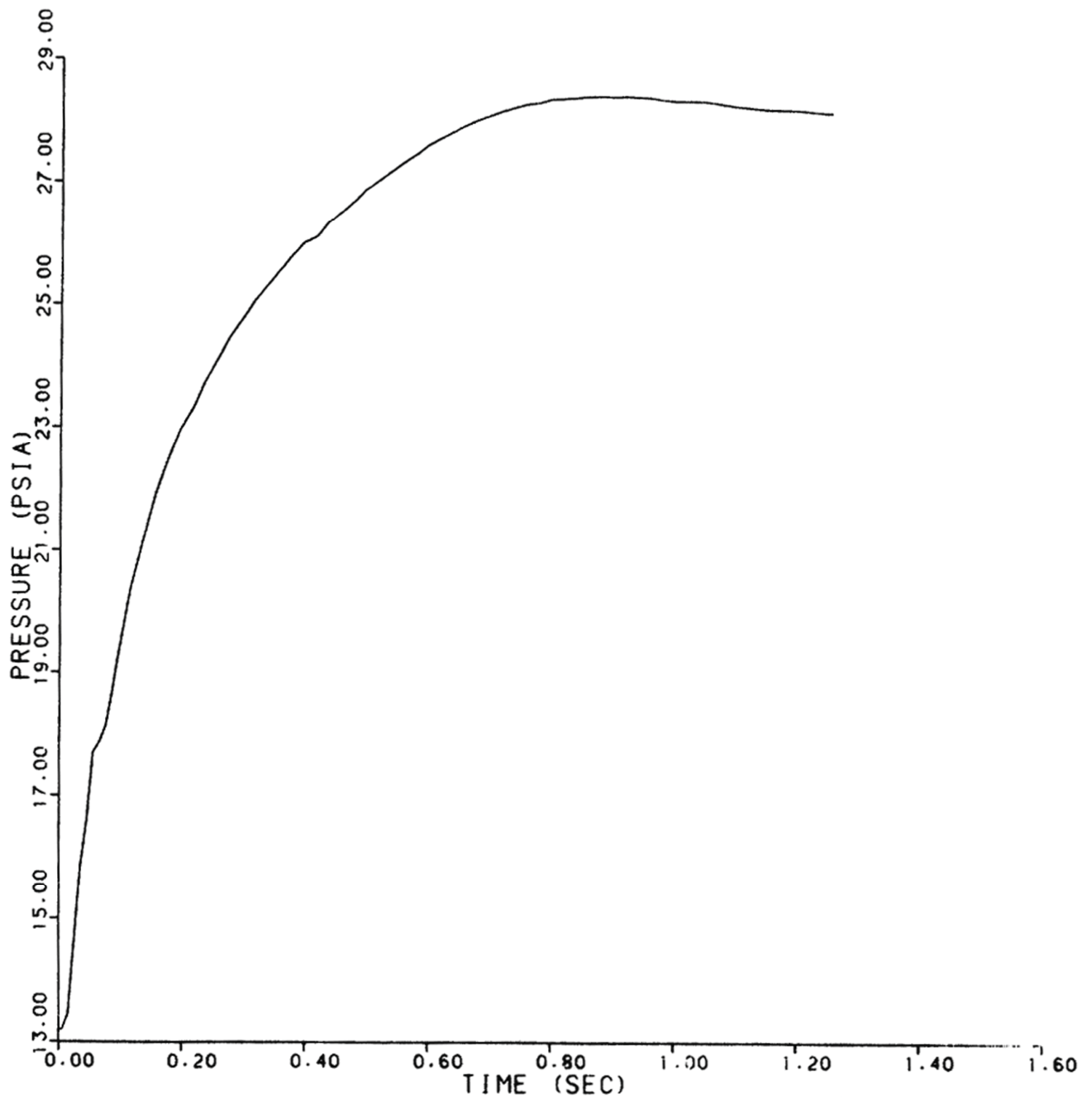

REV 13 4/06



VOGTLE
ELECTRIC GENERATING PLANT
UNIT 1 AND UNIT 2

STEAM GENERATOR OUTLET NOZZLE
NODE - E30
(436-in.² BREAK AREA)

FIGURE 6.2.1-21 (SHEET 30 OF 74)

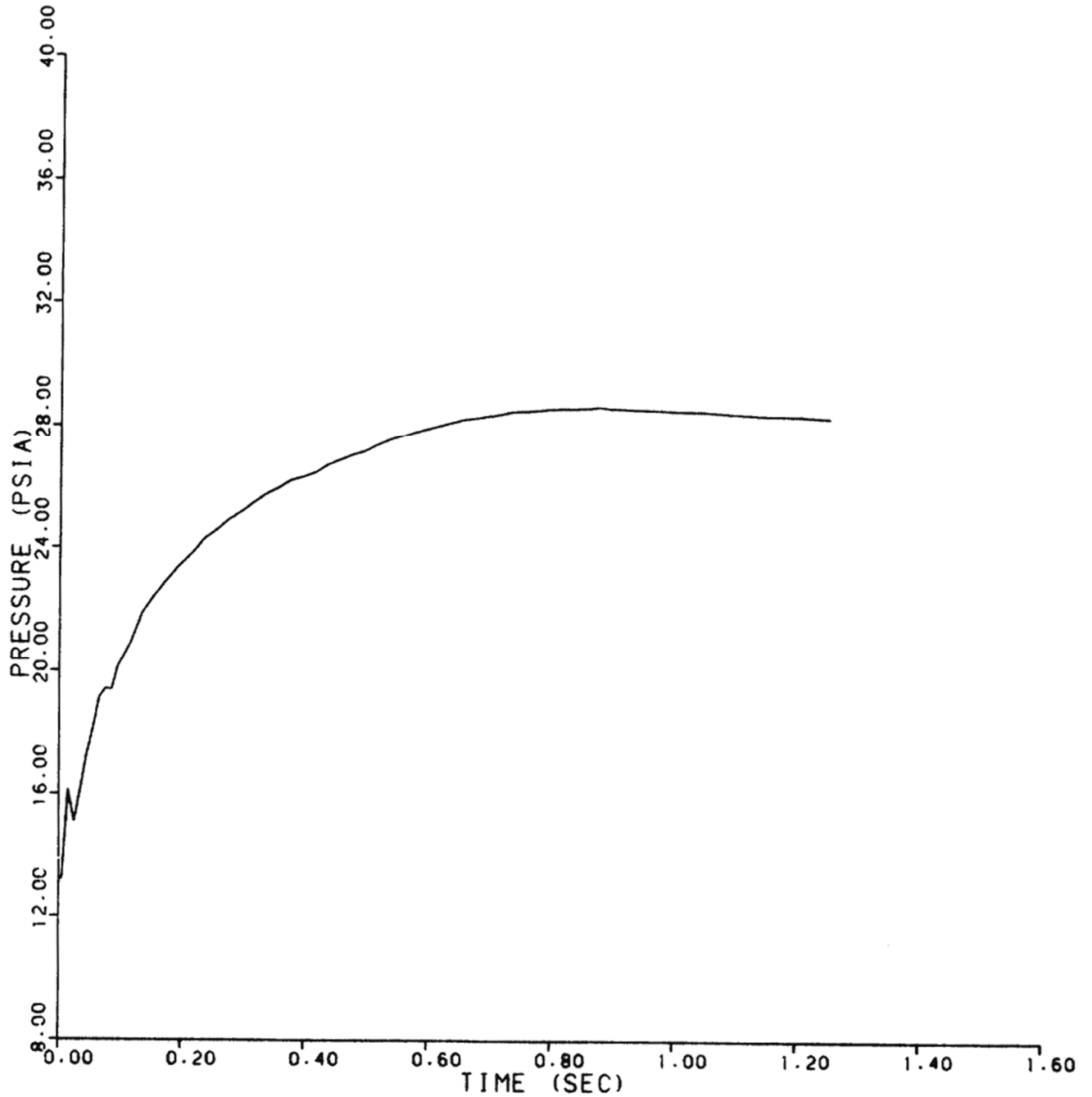

REV 13 4/06



VOGTLE
ELECTRIC GENERATING PLANT
UNIT 1 AND UNIT 2

STEAM GENERATOR OUTLET NOZZLE
NODE - E31
(436-in.² BREAK AREA)

FIGURE 6.2.1-21 (SHEET 31 OF 74)

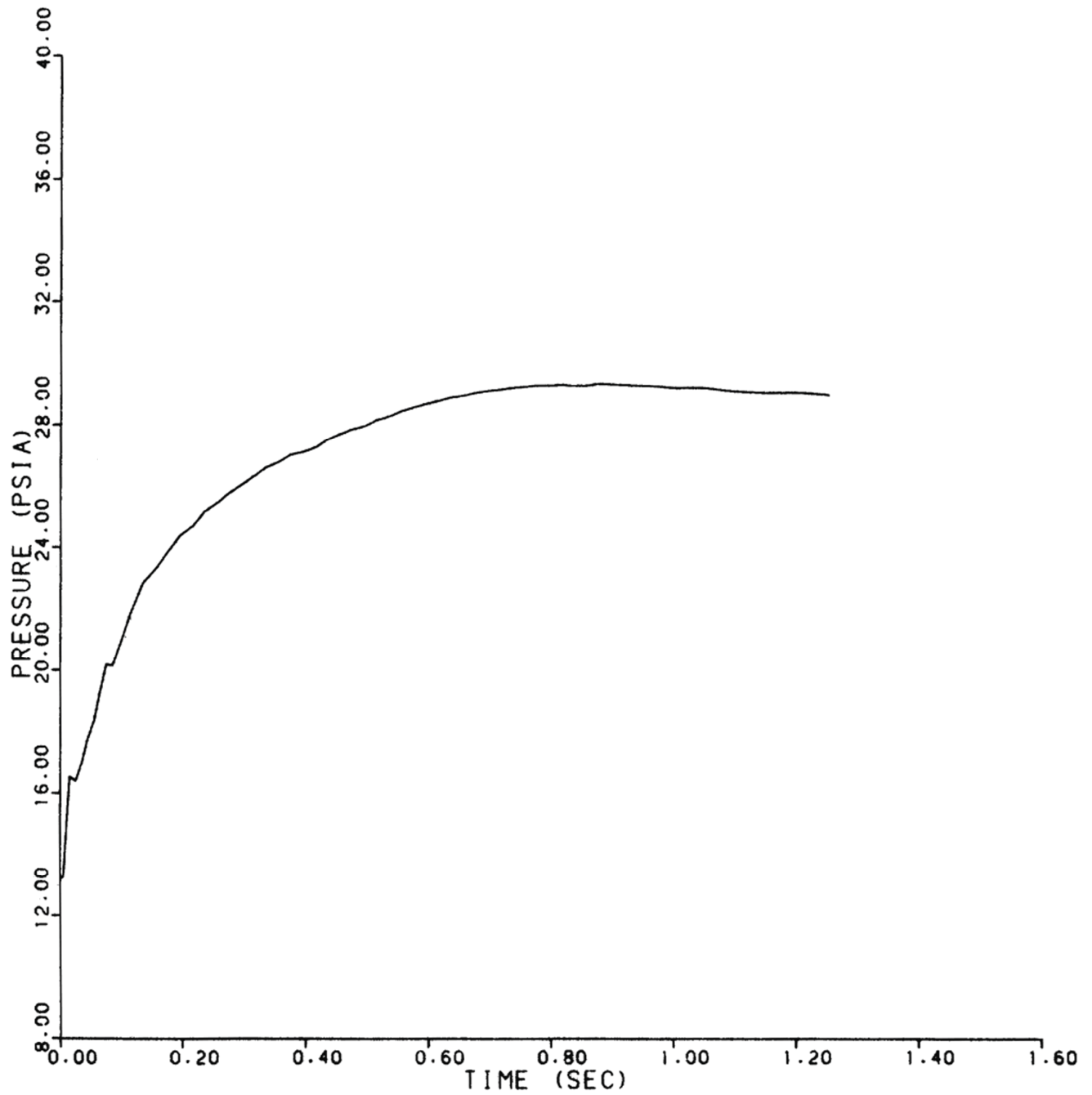

REV 13 4/06



VOGTLE
ELECTRIC GENERATING PLANT
UNIT 1 AND UNIT 2

STEAM GENERATOR OUTLET NOZZLE
NODE - E32
(436-in.² BREAK AREA)

FIGURE 6.2.1-21 (SHEET 32 OF 74)

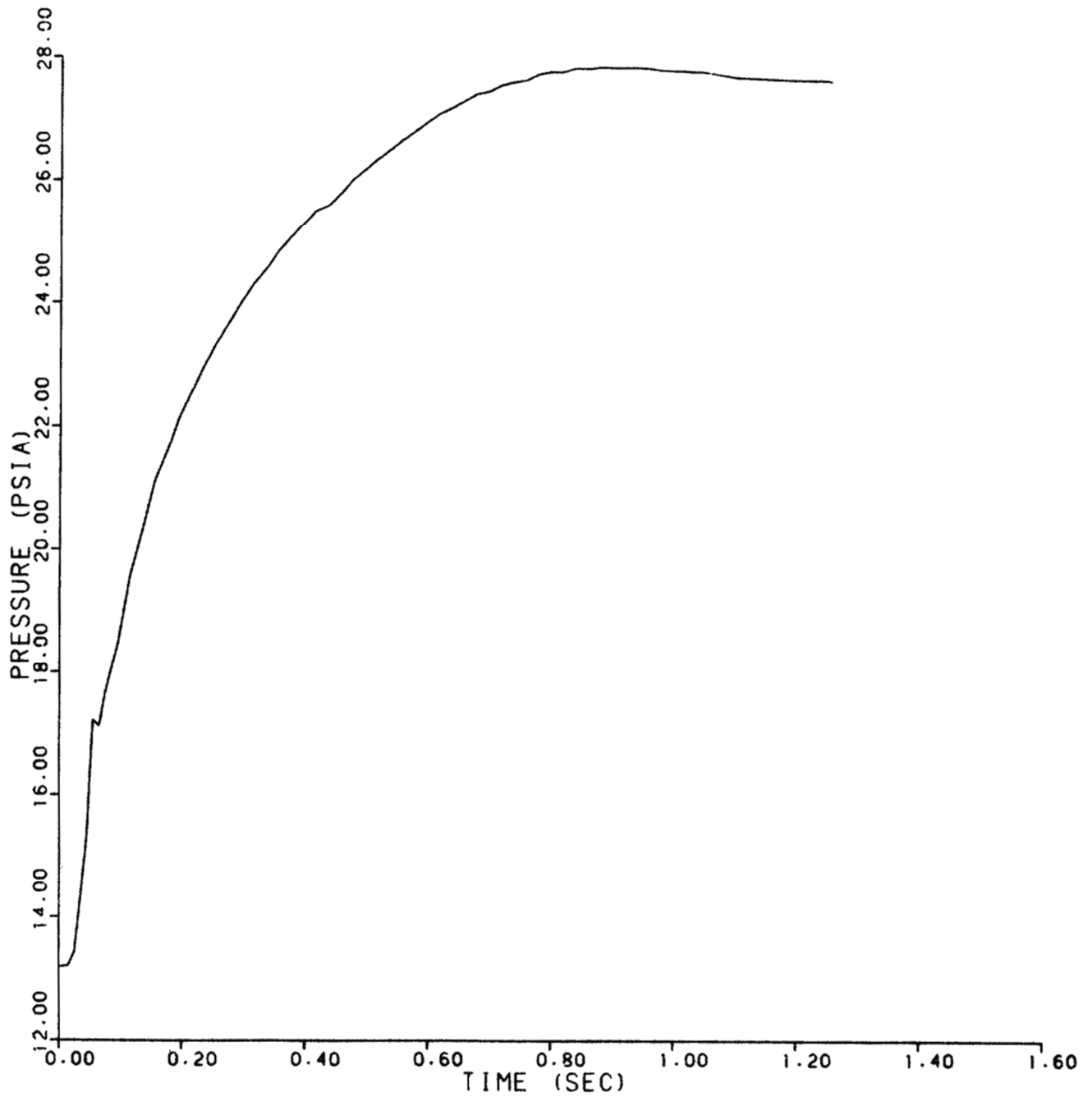

REV 13 4/06



VOGTLE
ELECTRIC GENERATING PLANT
UNIT 1 AND UNIT 2

STEAM GENERATOR OUTLET NOZZLE
NODE - E33
(436-in.² BREAK AREA)

FIGURE 6.2.1-21 (SHEET 33 OF 74)

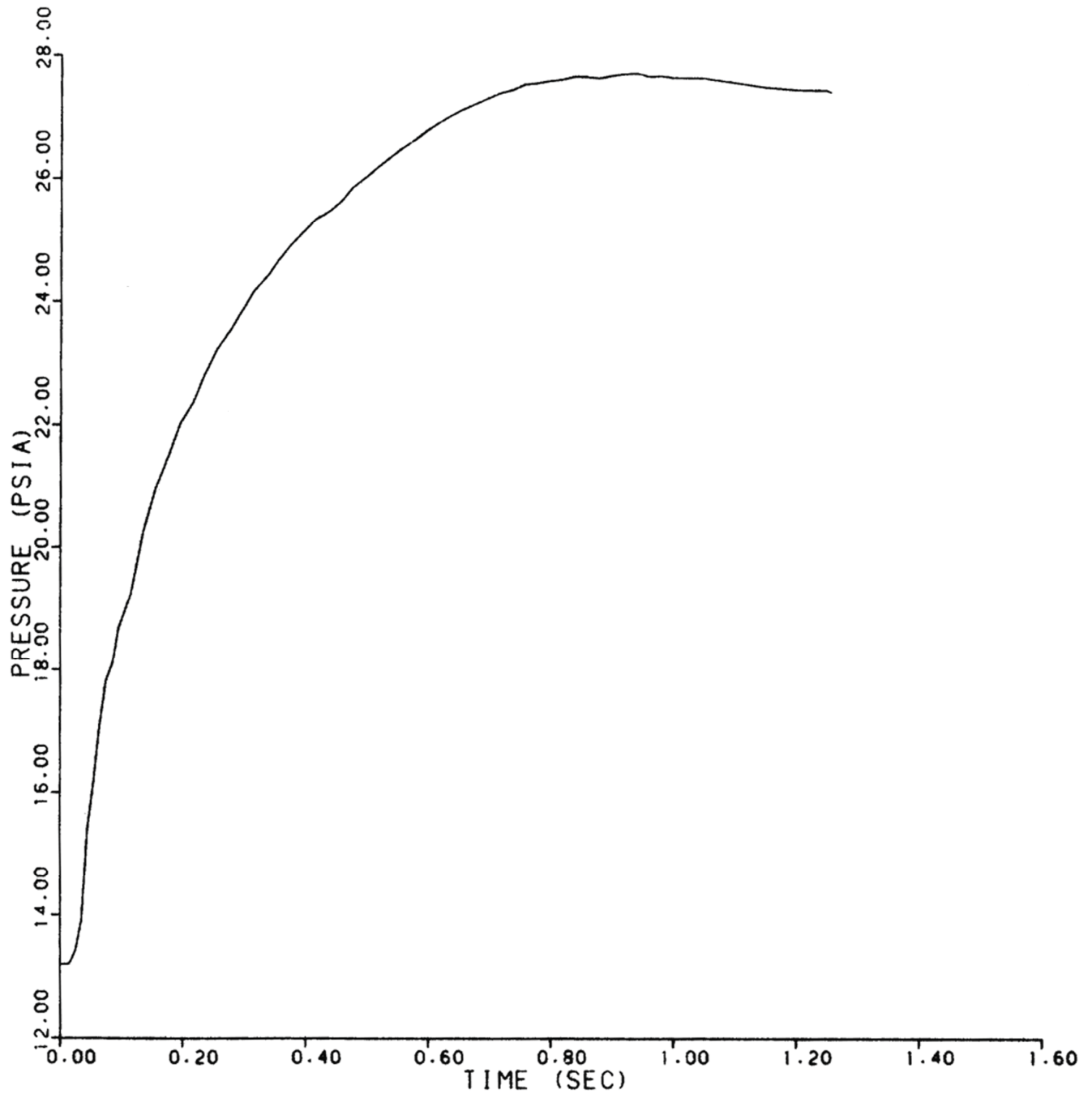

REV 13 4/06



VOGTLE
ELECTRIC GENERATING PLANT
UNIT 1 AND UNIT 2

STEAM GENERATOR OUTLET NOZZLE
NODE - E34
(436-in.² BREAK AREA)

FIGURE 6.2.1-21 (SHEET 34 OF 74)

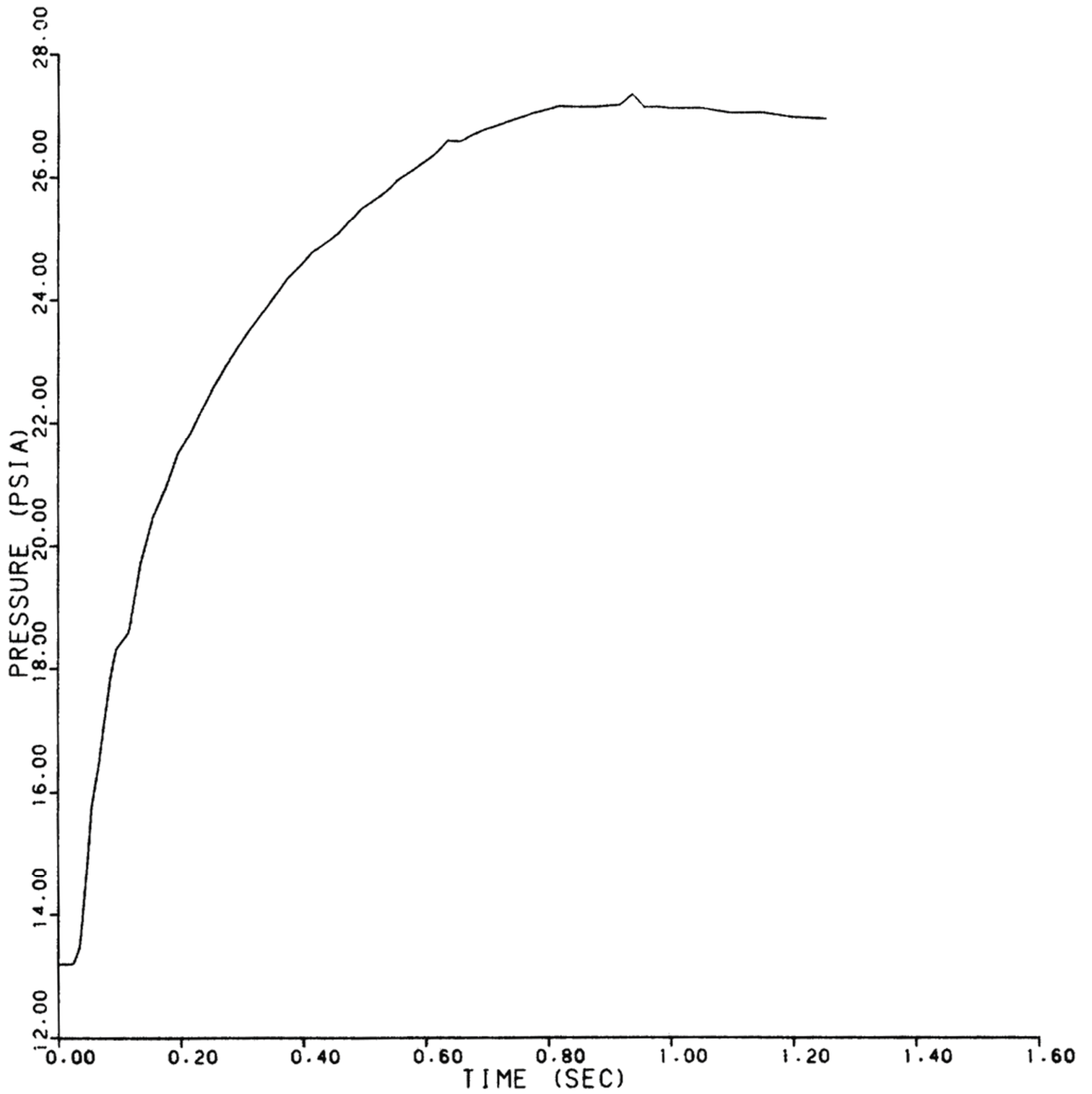

REV 13 4/06



VOGTLE
ELECTRIC GENERATING PLANT
UNIT 1 AND UNIT 2

STEAM GENERATOR OUTLET NOZZLE
NODE - E35
(436-in.² BREAK AREA)

FIGURE 6.2.1-21 (SHEET 35 OF 74)

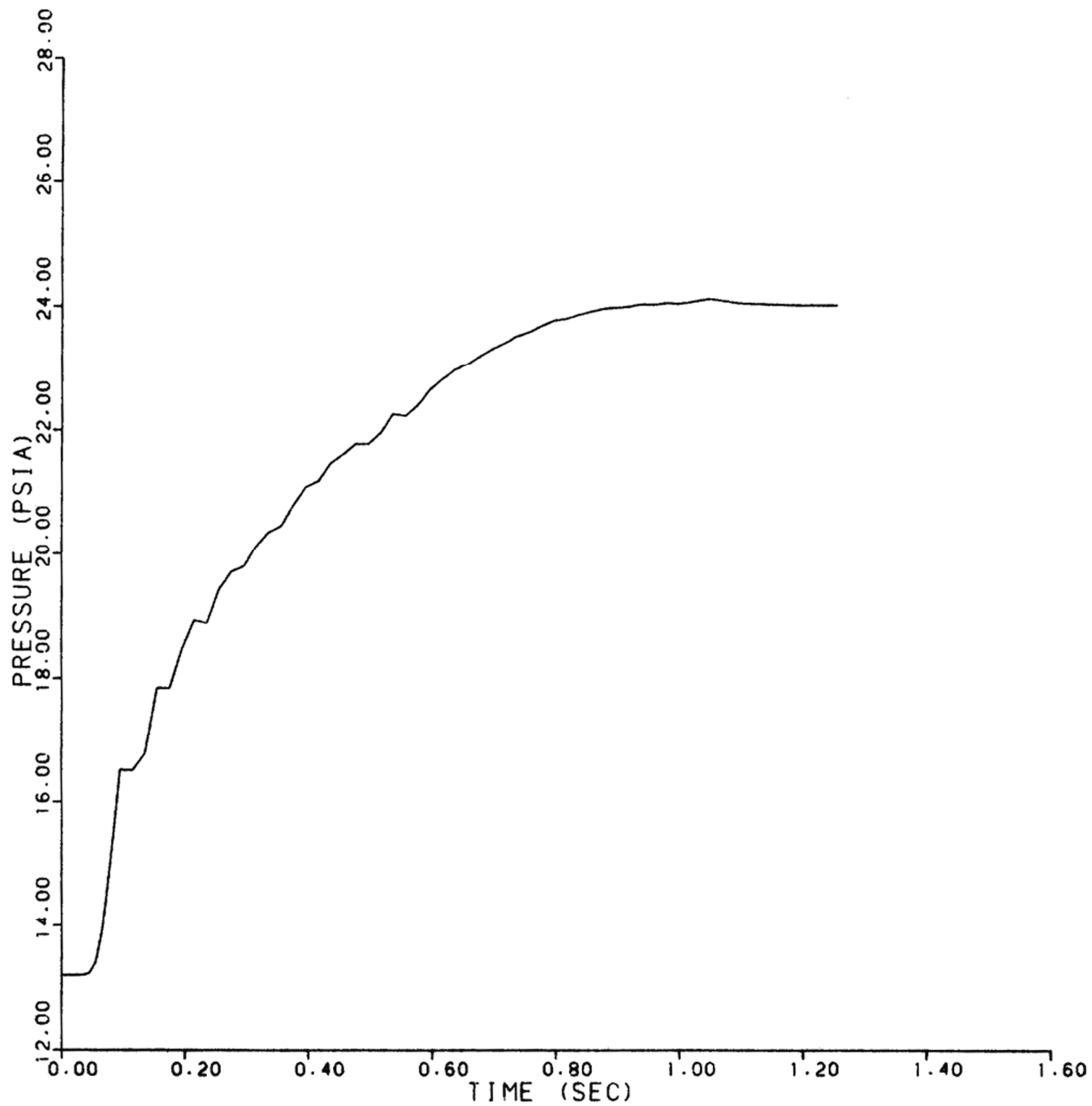

REV 13 4/06



VOGTLE
ELECTRIC GENERATING PLANT
UNIT 1 AND UNIT 2

STEAM GENERATOR OUTLET NOZZLE
NODE - E36
(436-in.² BREAK AREA)

FIGURE 6.2.1-21 (SHEET 36 OF 74)

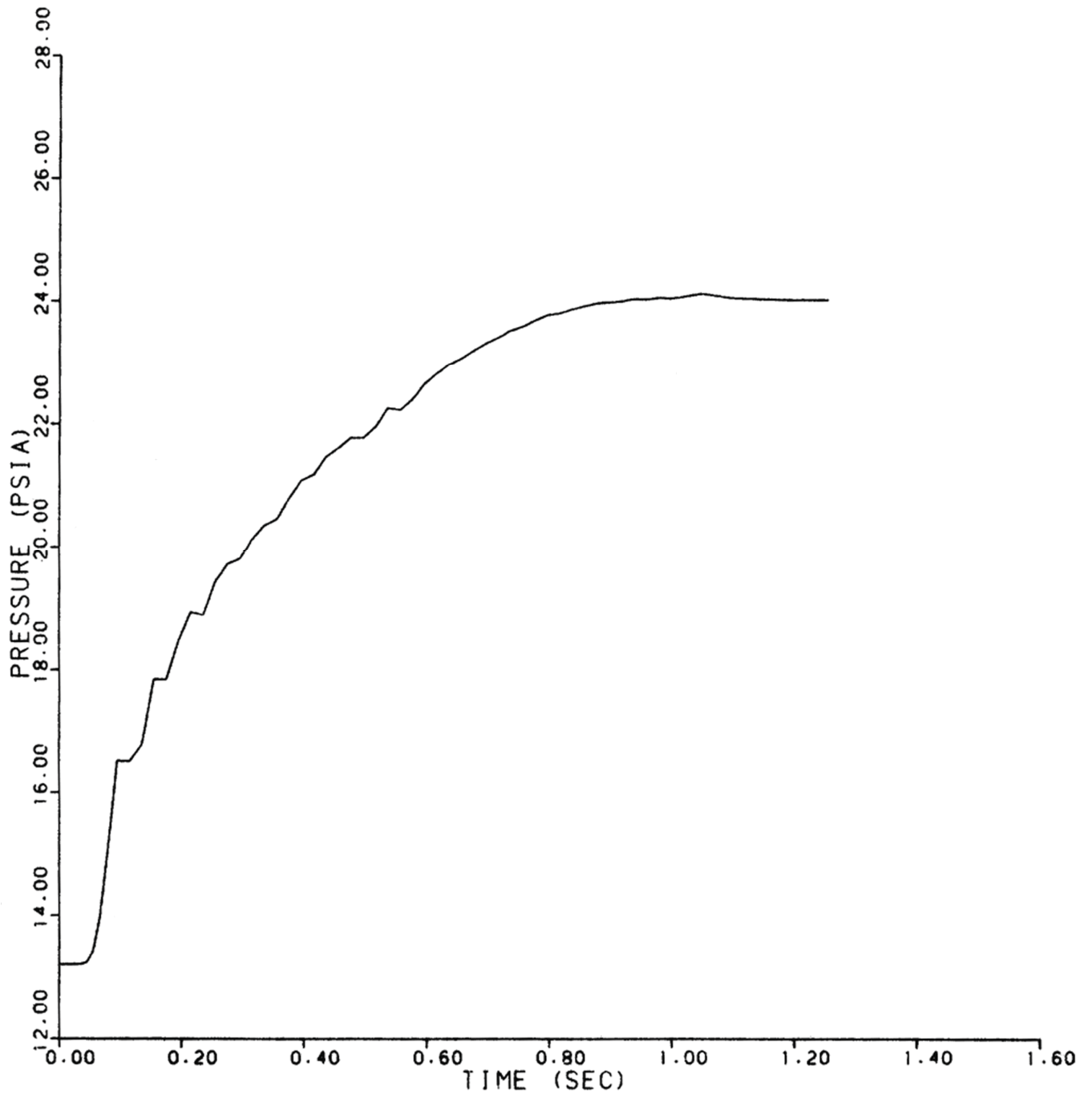

REV 13 4/06



VOGTLE
ELECTRIC GENERATING PLANT
UNIT 1 AND UNIT 2

STEAM GENERATOR OUTLET NOZZLE
NODE - E37
(436-in.² BREAK AREA)

FIGURE 6.2.1-21 (SHEET 37 OF 74)

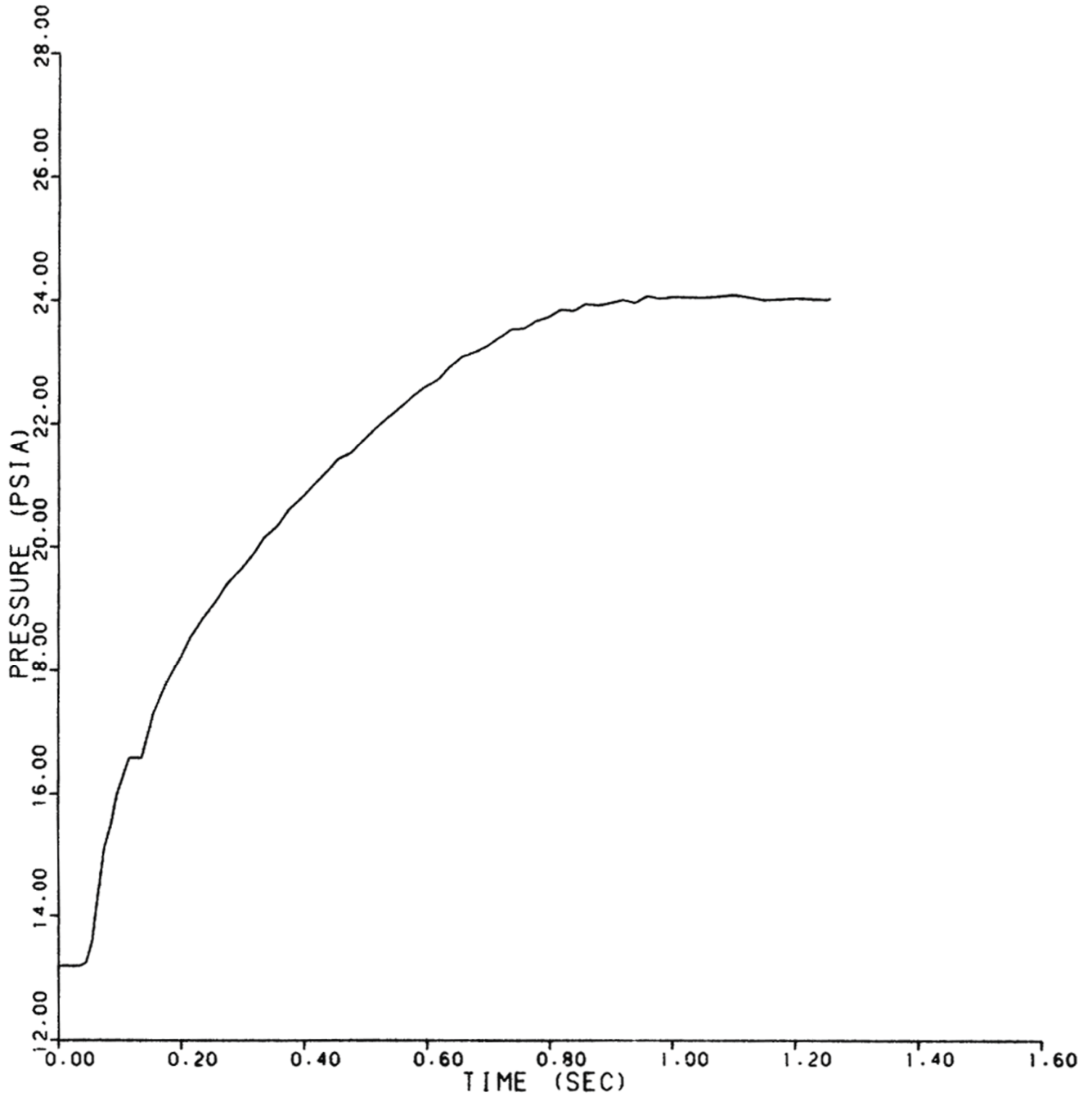

REV 13 4/06



VOGTLE
ELECTRIC GENERATING PLANT
UNIT 1 AND UNIT 2

STEAM GENERATOR OUTLET NOZZLE
NODE - E38
(436-in.² BREAK AREA)

FIGURE 6.2.1-21 (SHEET 38 OF 74)

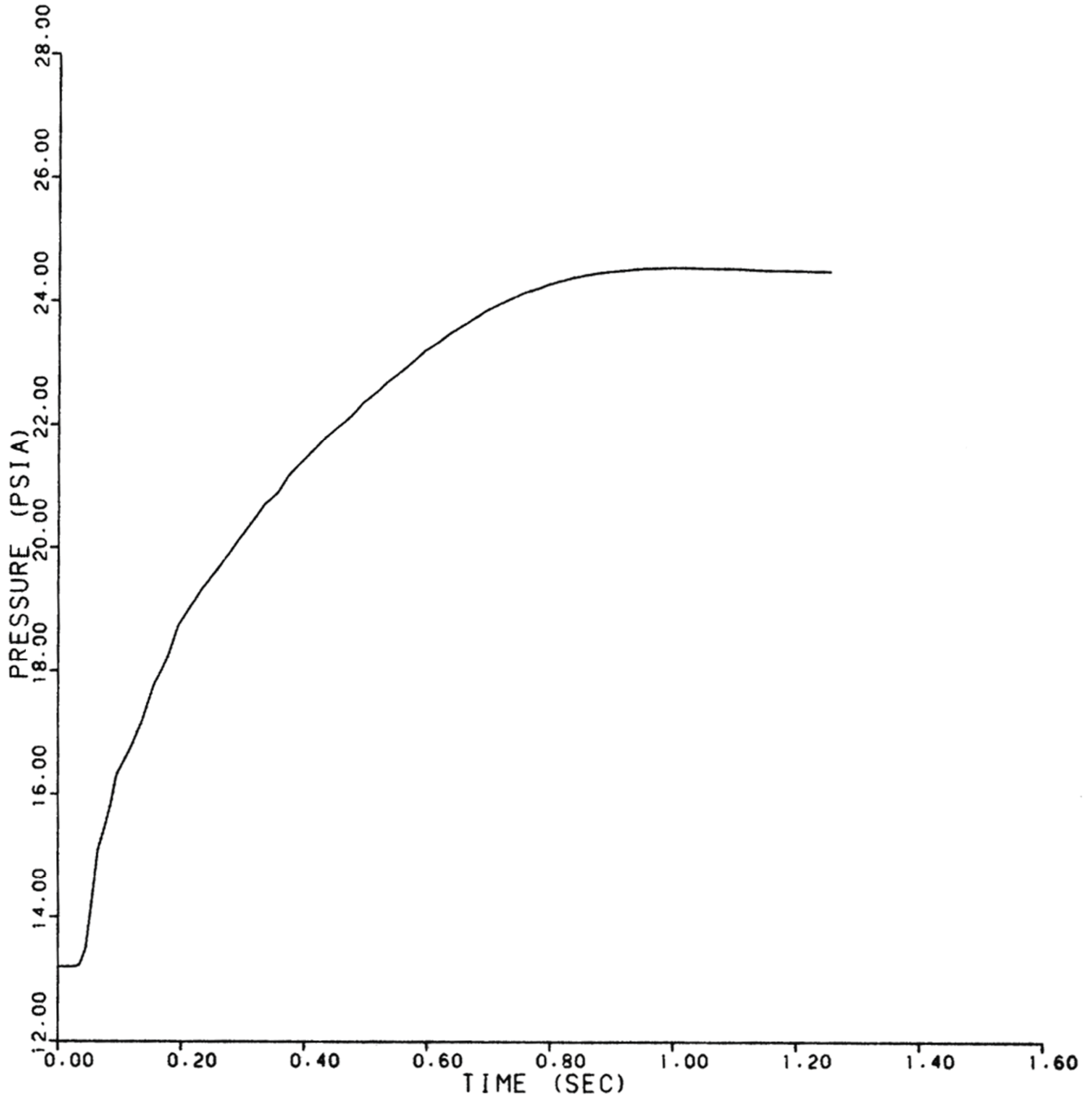

REV 13 4/06



VOGTLE
ELECTRIC GENERATING PLANT
UNIT 1 AND UNIT 2

STEAM GENERATOR OUTLET NOZZLE
NODE - E39
(436-in.² BREAK AREA)

FIGURE 6.2.1-21 (SHEET 39 OF 74)

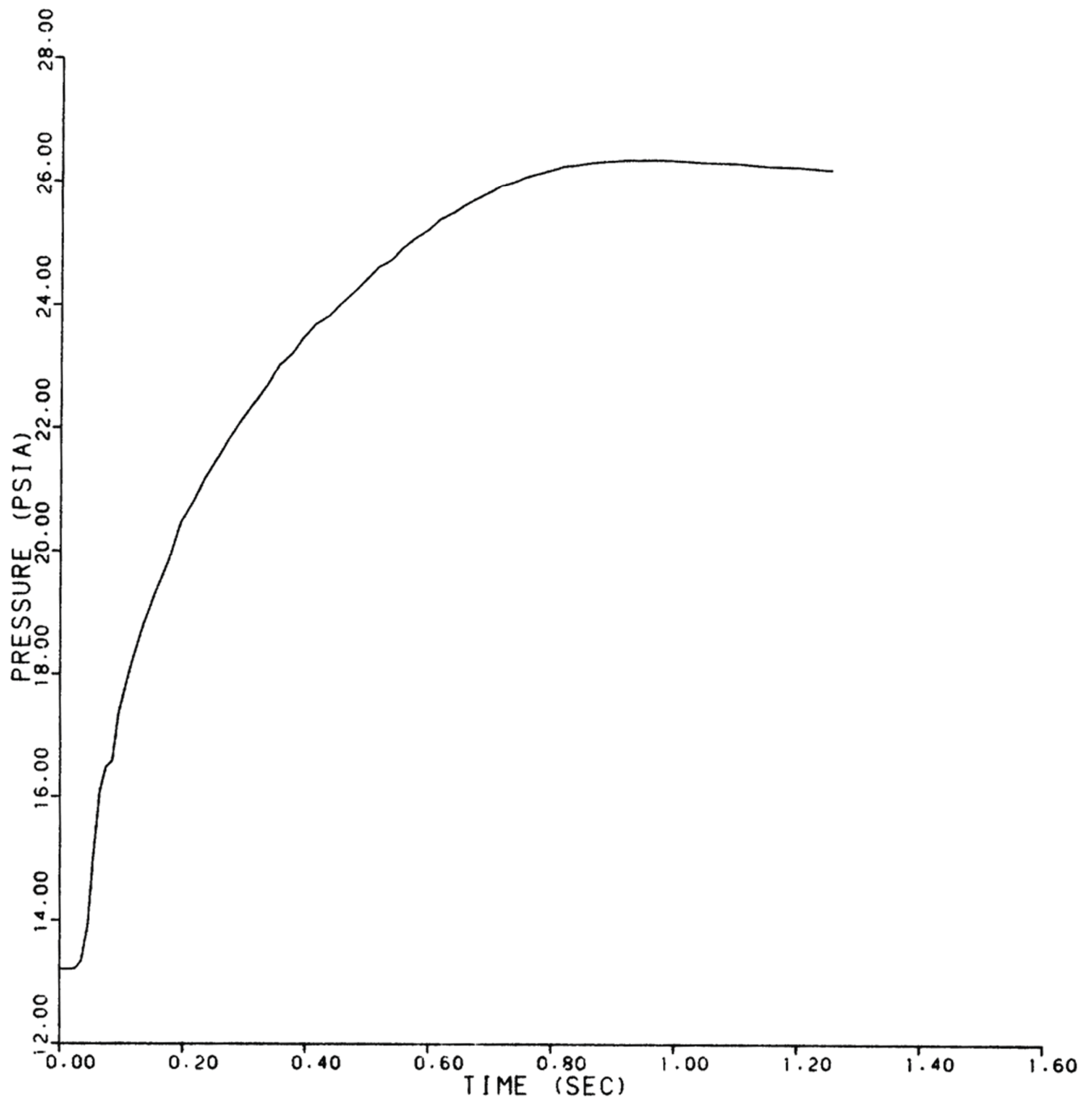

REV 13 4/06



VOGTLE
ELECTRIC GENERATING PLANT
UNIT 1 AND UNIT 2

STEAM GENERATOR OUTLET NOZZLE
NODE - E40
(436-in.² BREAK AREA)

FIGURE 6.2.1-21 (SHEET 40 OF 74)

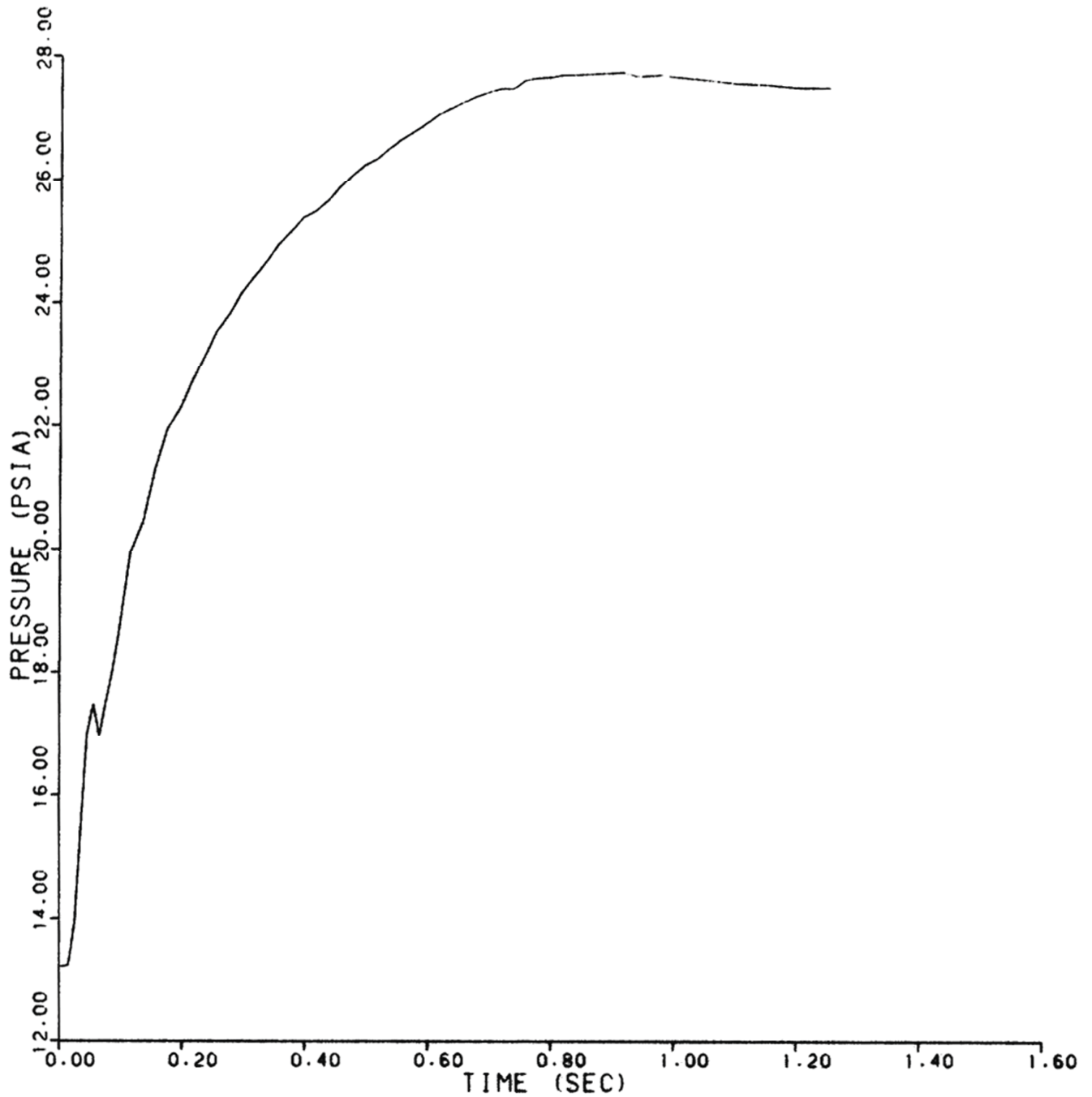

REV 13 4/06



VOGTLE
ELECTRIC GENERATING PLANT
UNIT 1 AND UNIT 2

STEAM GENERATOR OUTLET NOZZLE
NODE - E41
(436-in.² BREAK AREA)

FIGURE 6.2.1-21 (SHEET 41 OF 74)

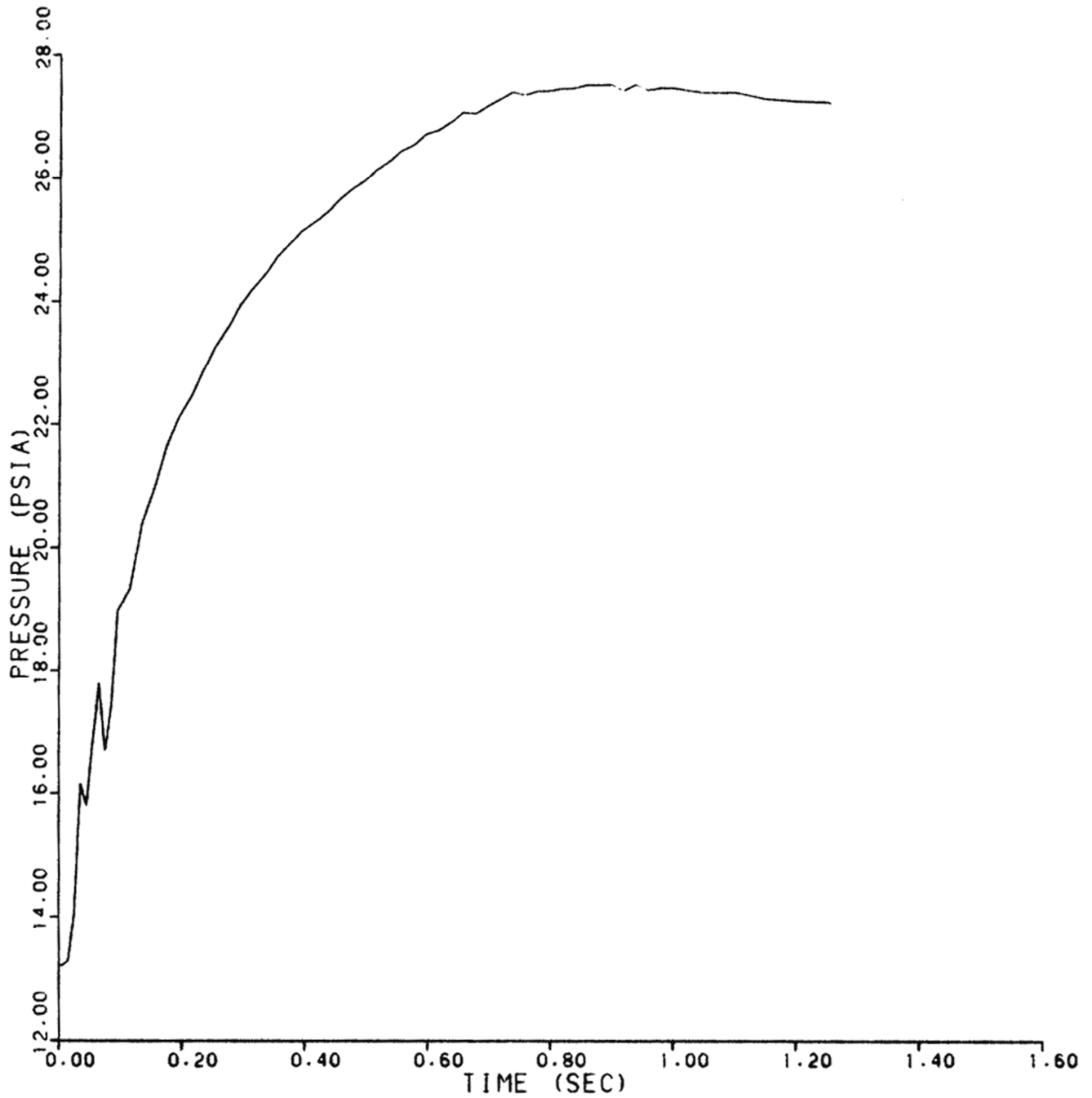

REV 13 4/06



VOGTLE
ELECTRIC GENERATING PLANT
UNIT 1 AND UNIT 2

STEAM GENERATOR OUTLET NOZZLE
NODE - E42
(436-in.² BREAK AREA)

FIGURE 6.2.1-21 (SHEET 42 OF 74)

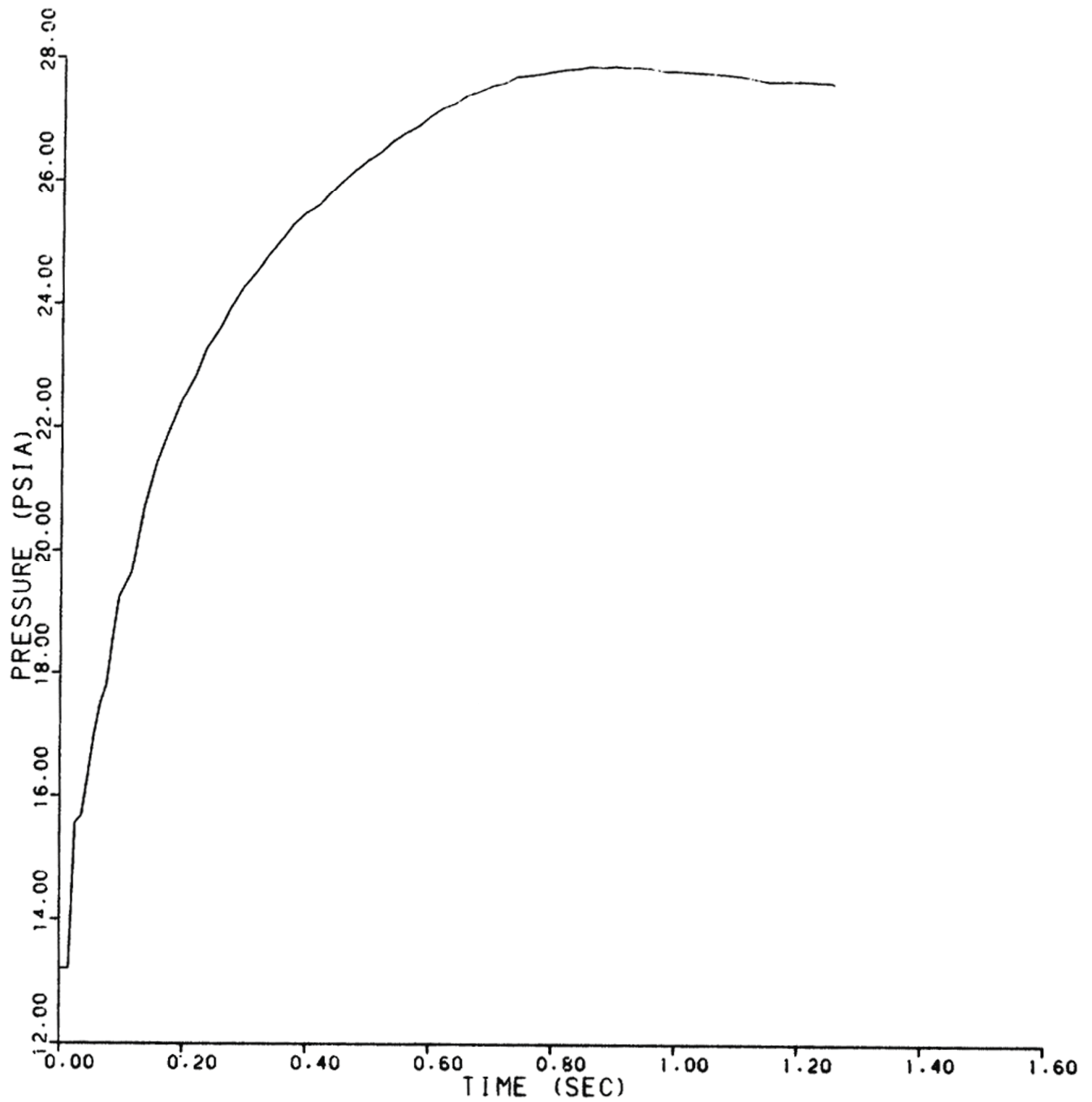

REV 13 4/06



VOGTLE
ELECTRIC GENERATING PLANT
UNIT 1 AND UNIT 2

STEAM GENERATOR OUTLET NOZZLE
NODE - E43
(436-in.² BREAK AREA)

FIGURE 6.2.1-21 (SHEET 43 OF 74)

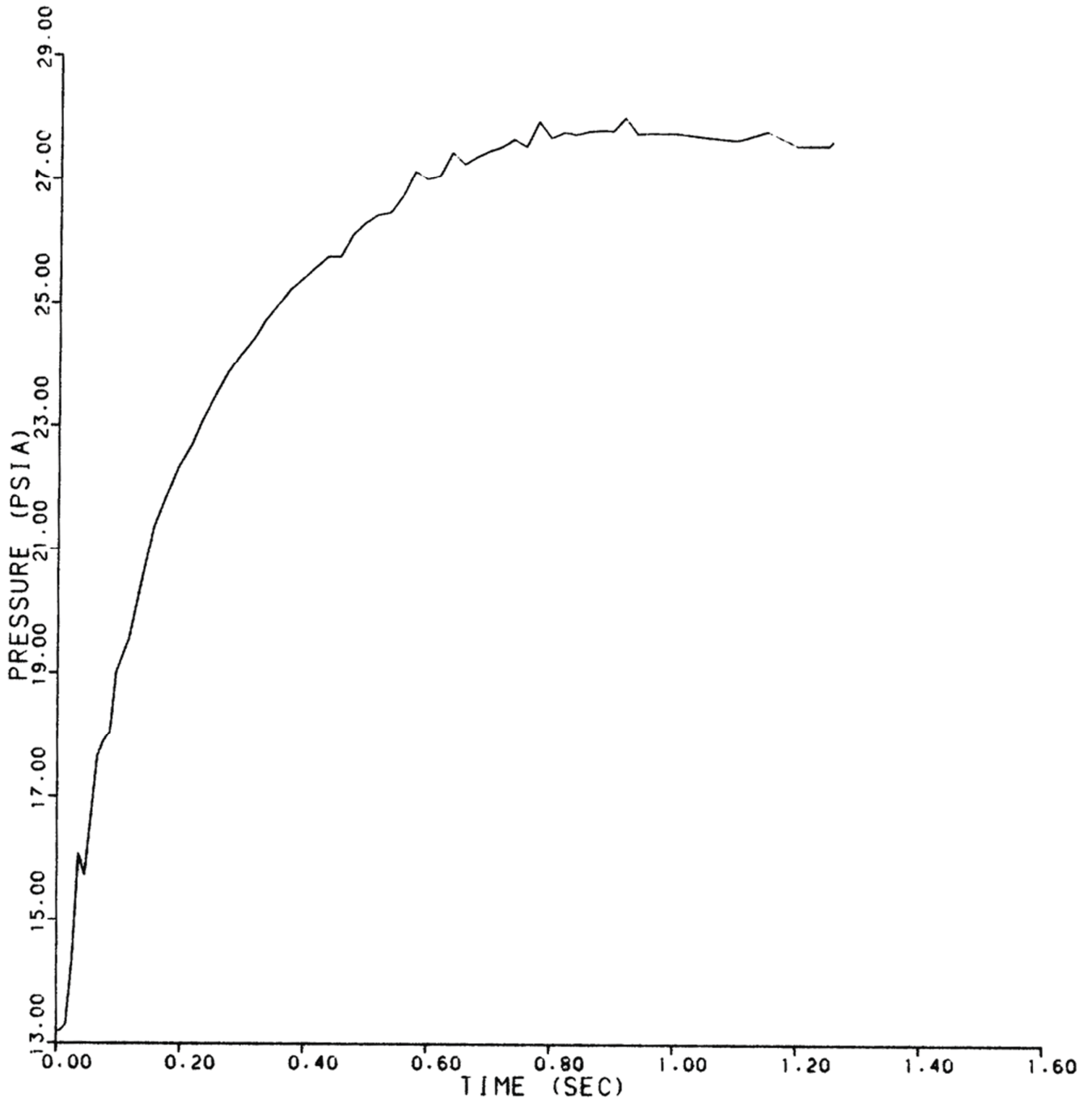

REV 13 4/06



VOGTLE
ELECTRIC GENERATING PLANT
UNIT 1 AND UNIT 2

STEAM GENERATOR OUTLET NOZZLE
NODE - E44
(436-in.² BREAK AREA)

FIGURE 6.2.1-21 (SHEET 44 OF 74)

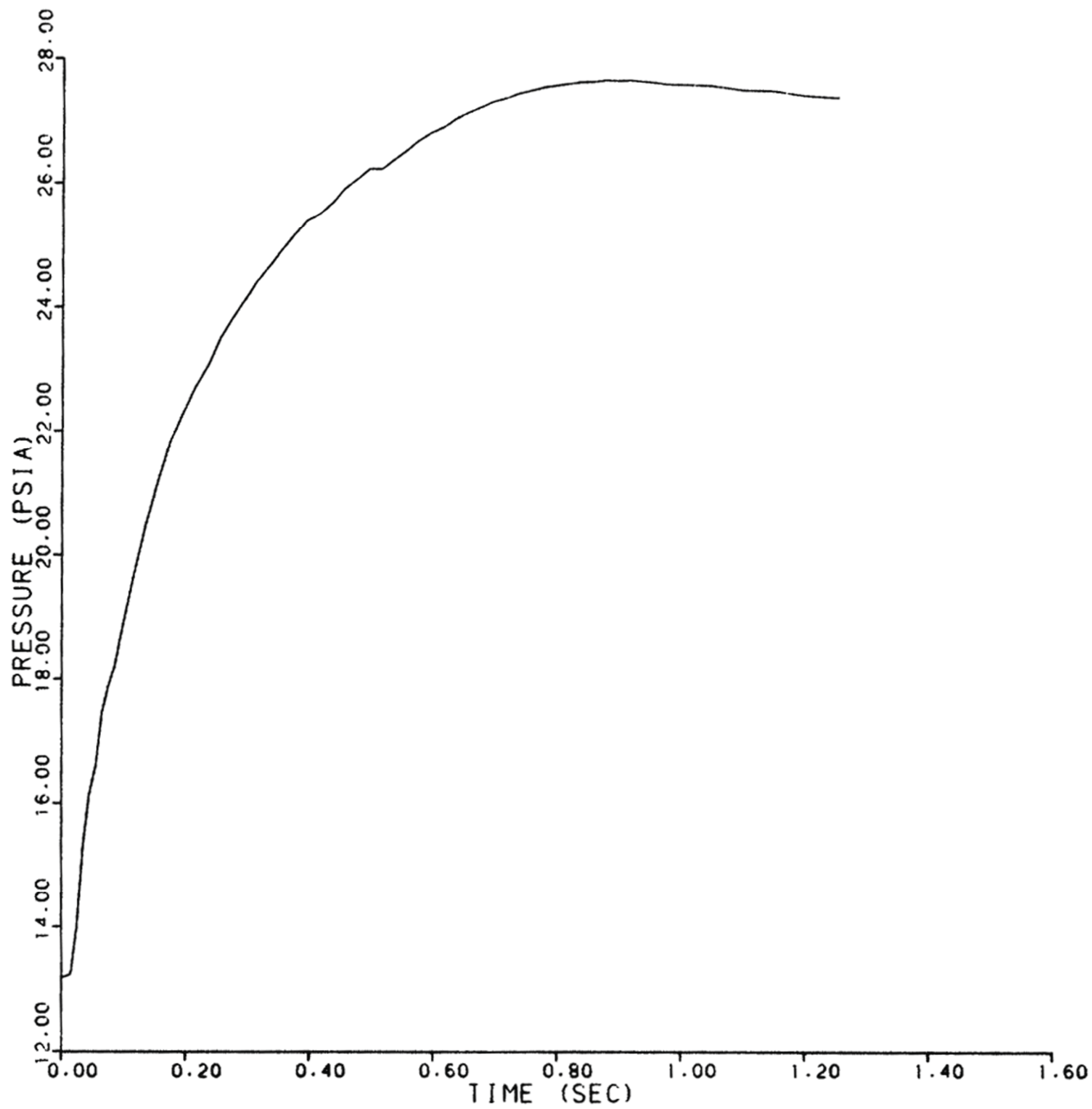

REV 13 4/06



VOGTLE
ELECTRIC GENERATING PLANT
UNIT 1 AND UNIT 2

STEAM GENERATOR OUTLET NOZZLE
NODE - E45
(436-in.² BREAK AREA)

FIGURE 6.2.1-21 (SHEET 45 OF 74)

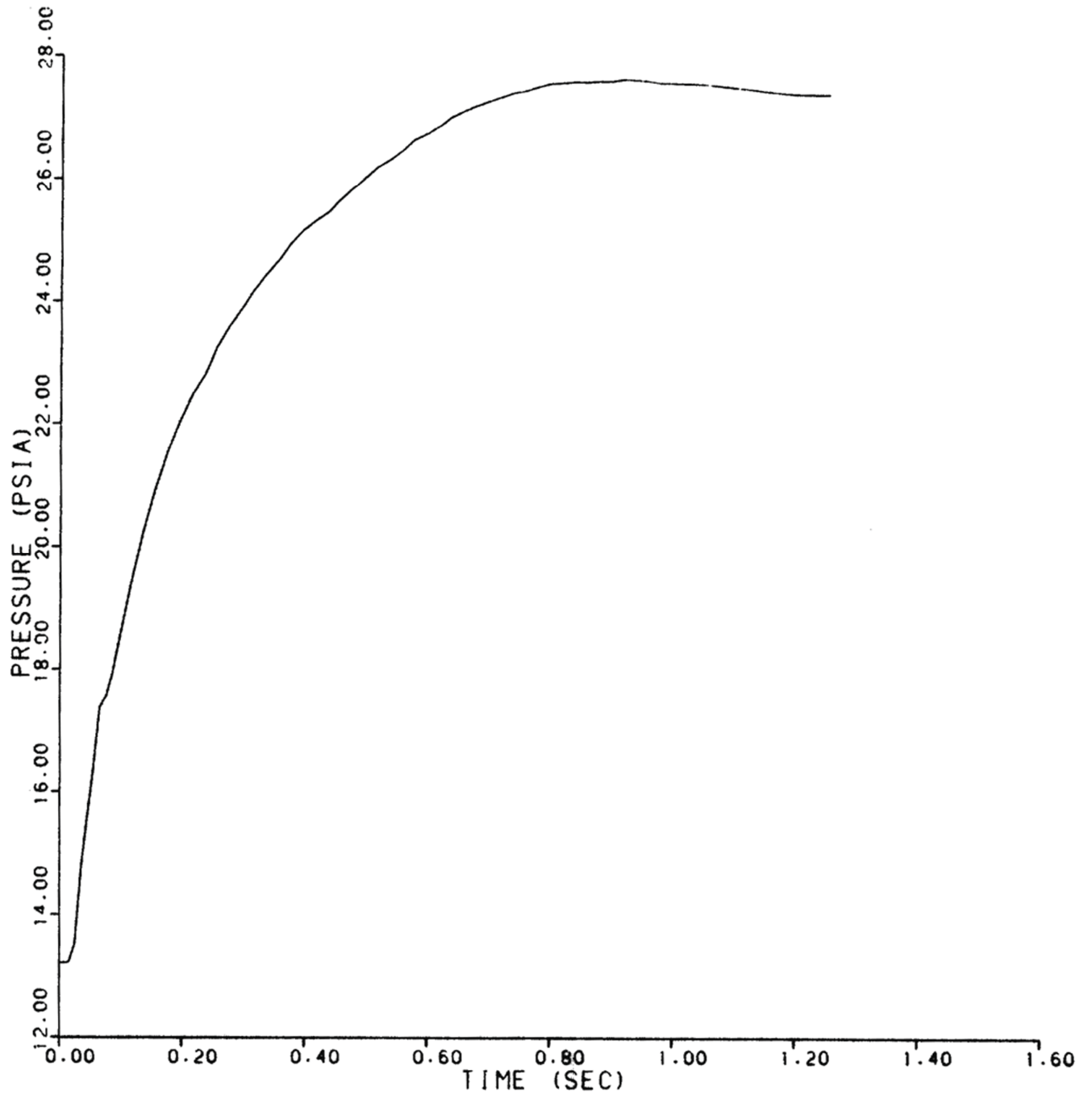

REV 13 4/06



VOGTLE
ELECTRIC GENERATING PLANT
UNIT 1 AND UNIT 2

STEAM GENERATOR OUTLET NOZZLE
NODE - E46
(436-in.² BREAK AREA)

FIGURE 6.2.1-21 (SHEET 46 OF 74)

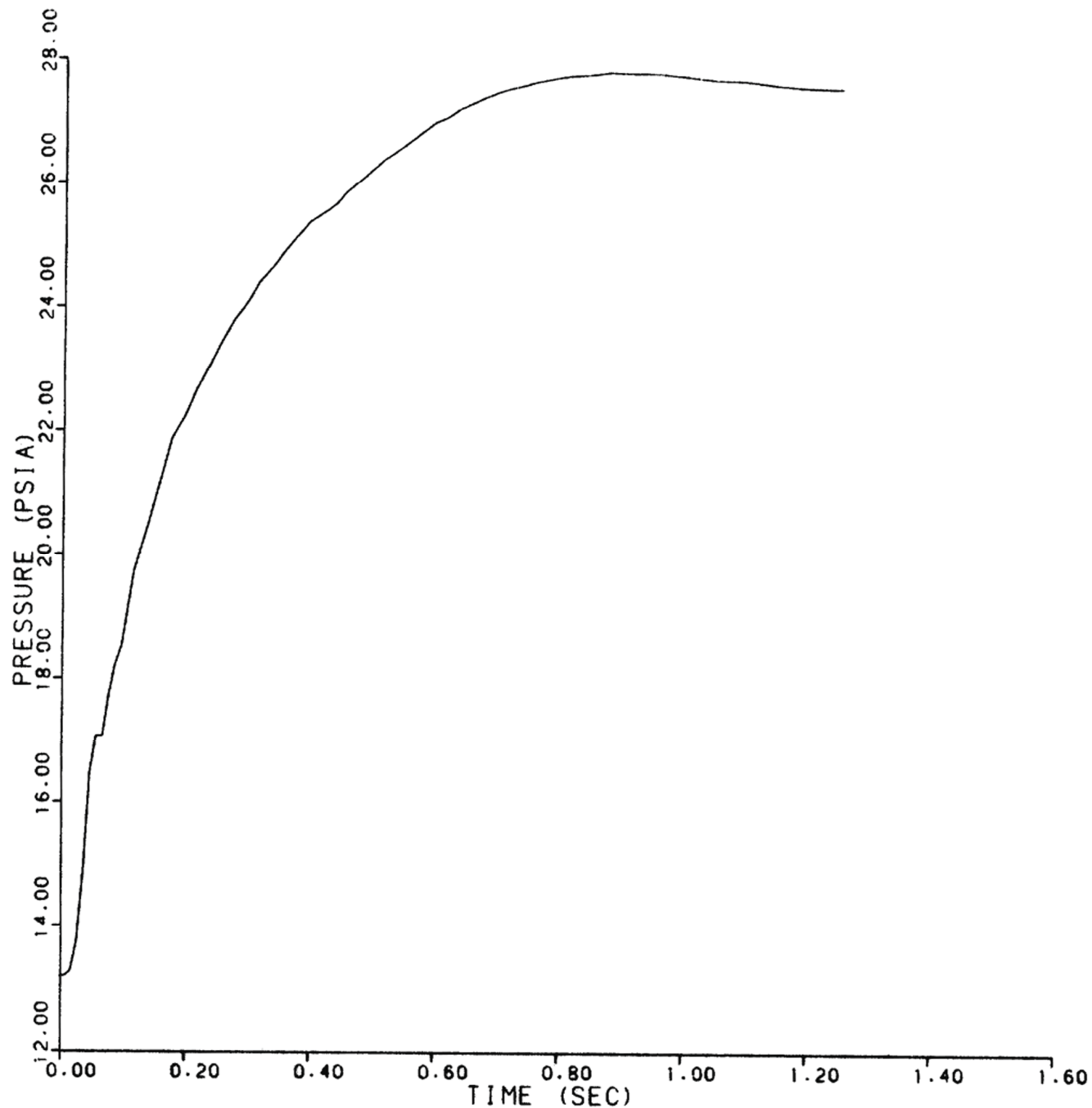

REV 13 4/06



VOGTLE
ELECTRIC GENERATING PLANT
UNIT 1 AND UNIT 2

STEAM GENERATOR OUTLET NOZZLE
NODE - E47
(436-in.² BREAK AREA)

FIGURE 6.2.1-21 (SHEET 47 OF 74)

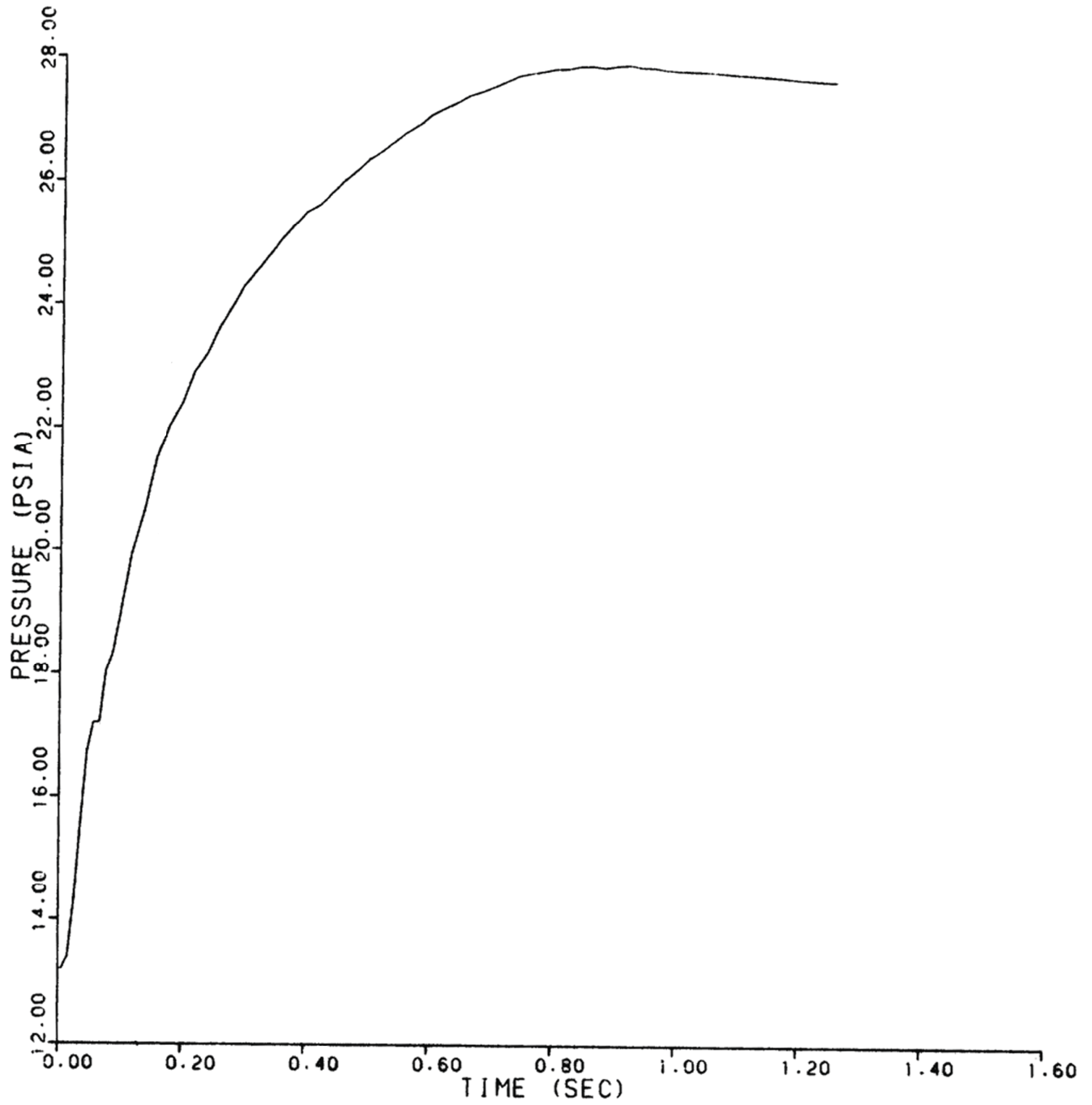

REV 13 4/06



VOGTLE
ELECTRIC GENERATING PLANT
UNIT 1 AND UNIT 2

STEAM GENERATOR OUTLET NOZZLE
NODE - E48
(436-in.² BREAK AREA)

FIGURE 6.2.1-21 (SHEET 48 OF 74)

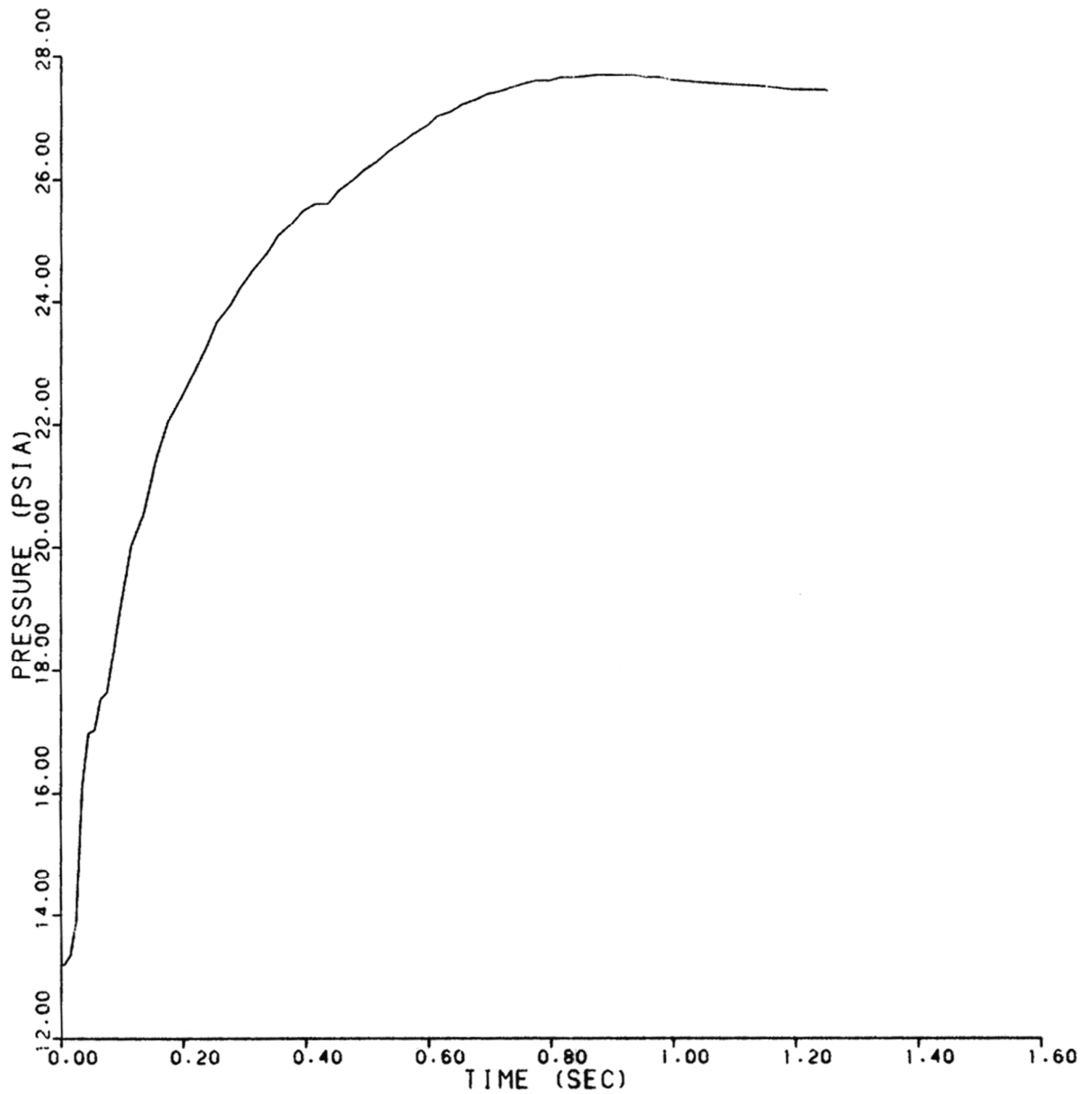

REV 13 4/06



VOGTLE
ELECTRIC GENERATING PLANT
UNIT 1 AND UNIT 2

STEAM GENERATOR OUTLET NOZZLE
NODE - E49
(436-in.² BREAK AREA)

FIGURE 6.2.1-21 (SHEET 49 OF 74)

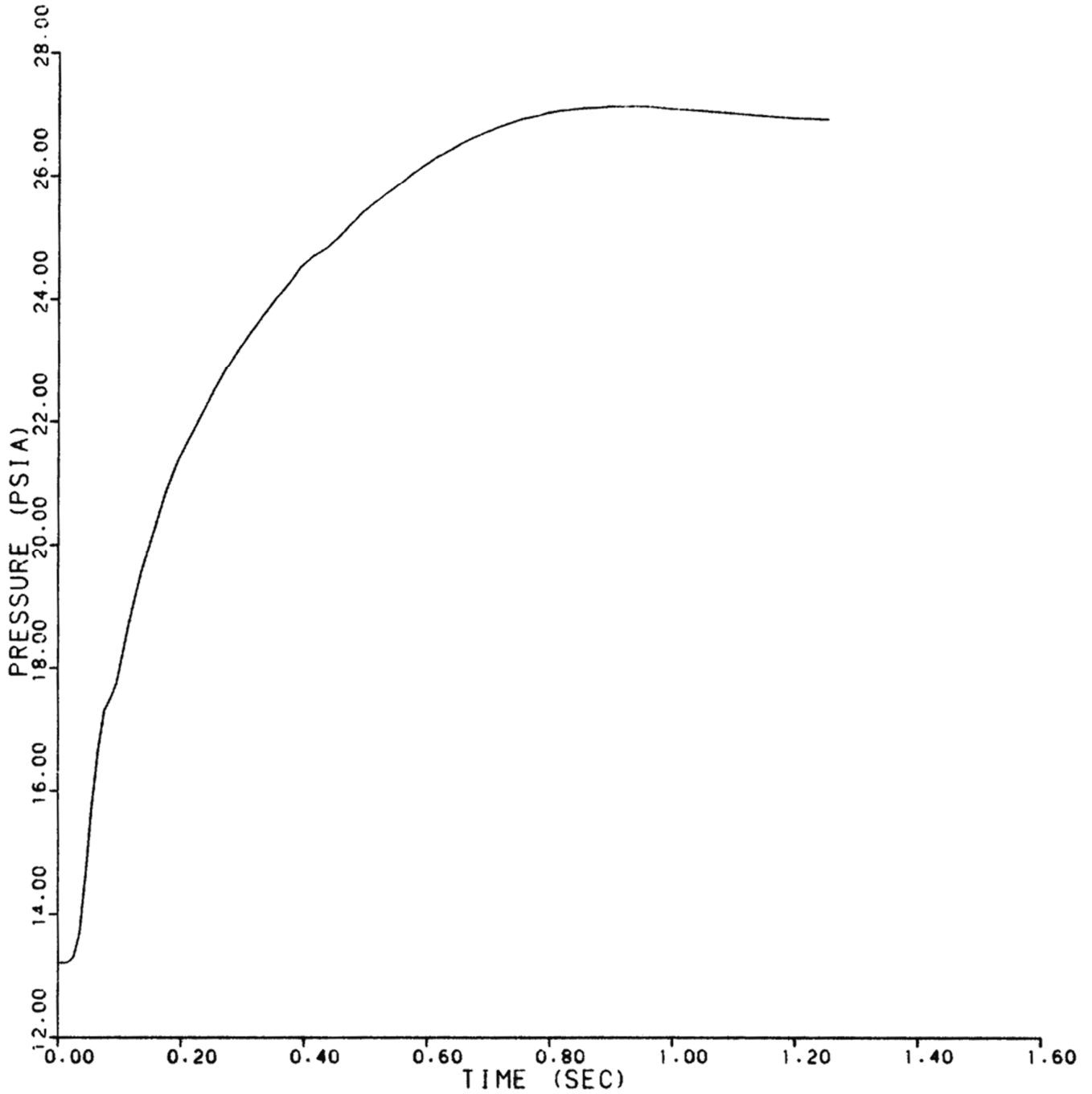

REV 13 4/06



VOGTLE
ELECTRIC GENERATING PLANT
UNIT 1 AND UNIT 2

STEAM GENERATOR OUTLET NOZZLE
NODE - E50
(436-in.² BREAK AREA)

FIGURE 6.2.1-21 (SHEET 50 OF 74)

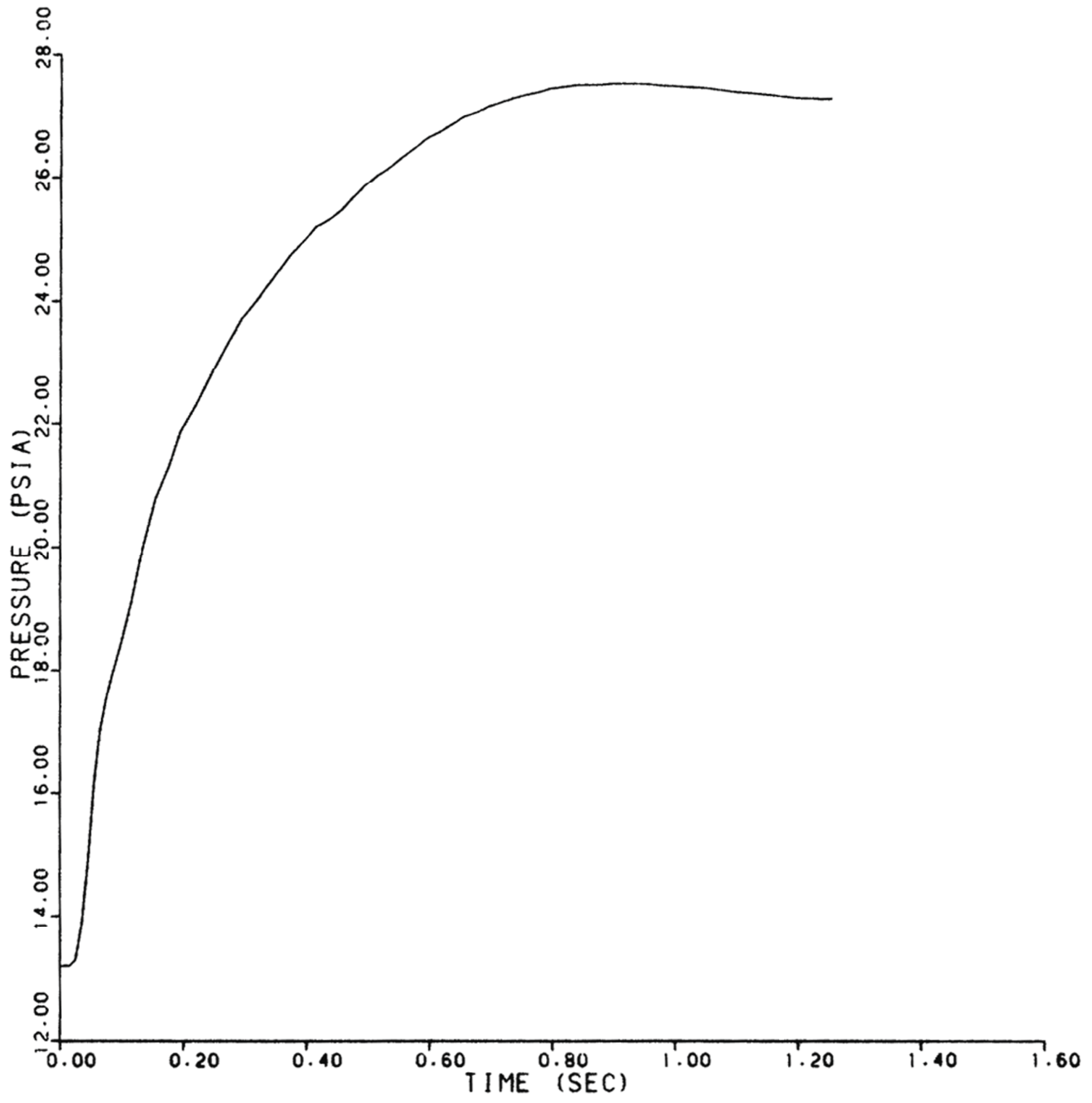

REV 13 4/06



VOGTLE
ELECTRIC GENERATING PLANT
UNIT 1 AND UNIT 2

STEAM GENERATOR OUTLET NOZZLE
NODE - E51
(436-in.² BREAK AREA)

FIGURE 6.2.1-21 (SHEET 51 OF 74)

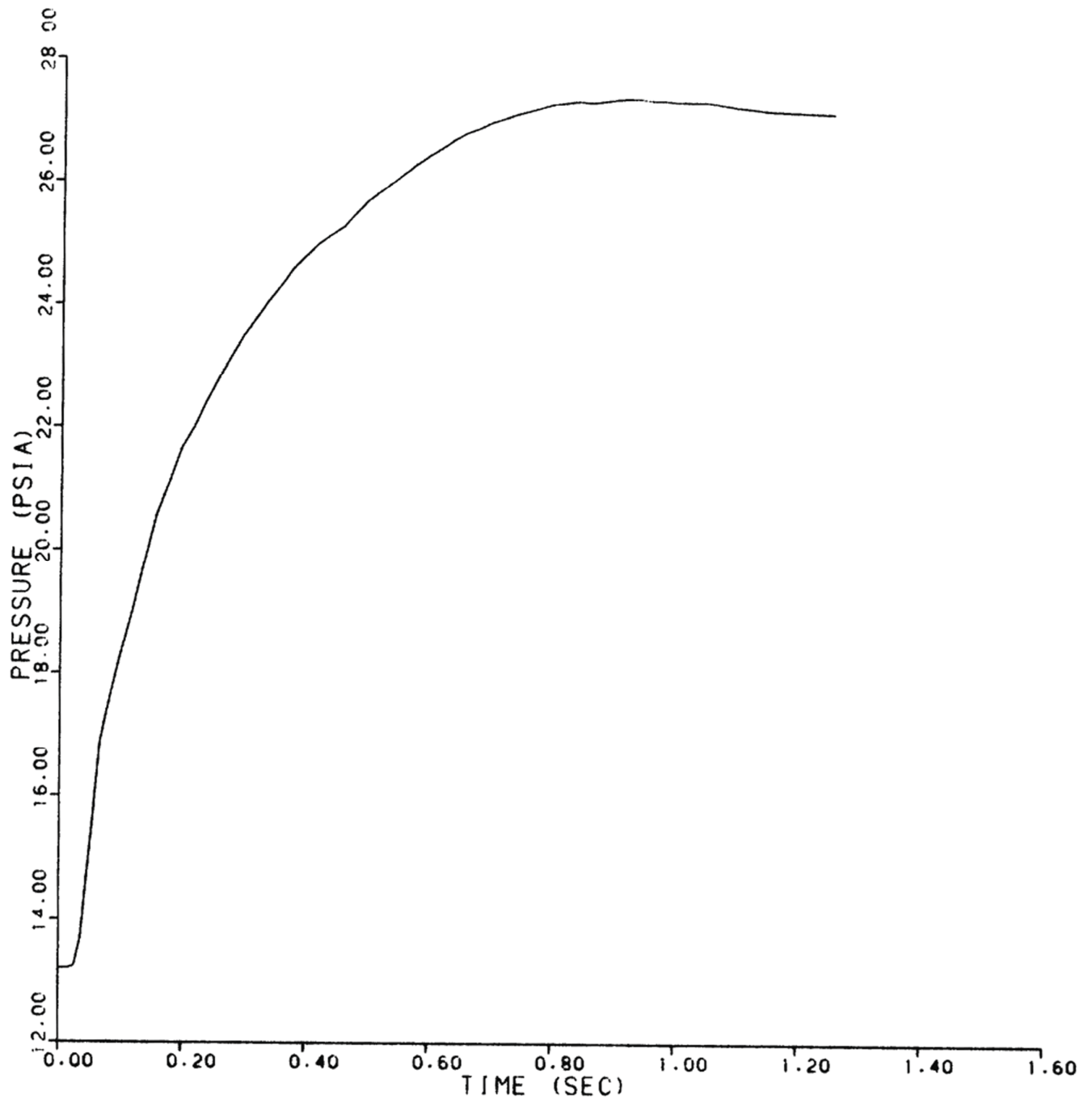

REV 13 4/06



VOGTLE
ELECTRIC GENERATING PLANT
UNIT 1 AND UNIT 2

STEAM GENERATOR OUTLET NOZZLE
NODE - E52
(436-in.² BREAK AREA)

FIGURE 6.2.1-21 (SHEET 52 OF 74)

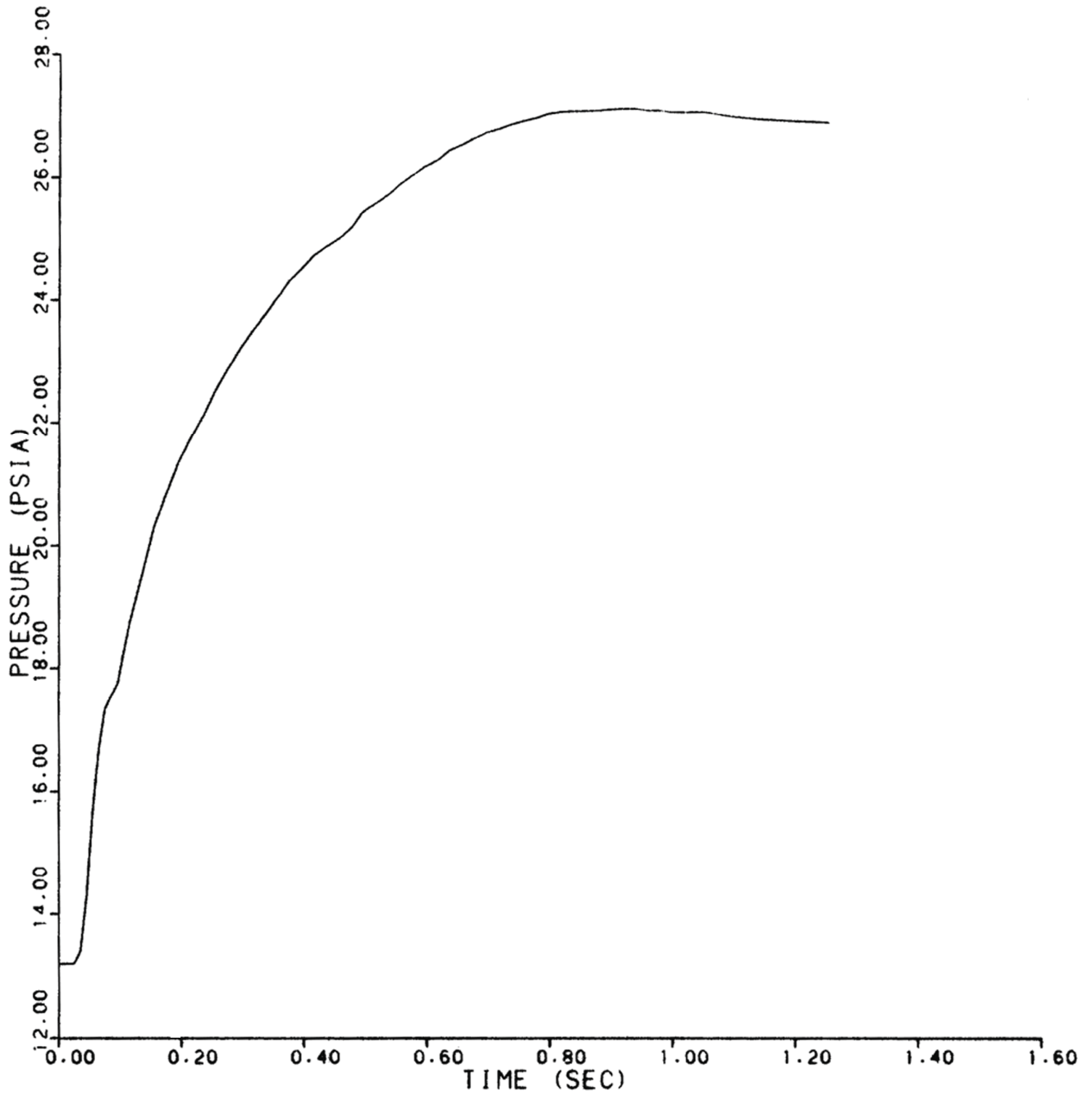

REV 13 4/06



VOGTLE
ELECTRIC GENERATING PLANT
UNIT 1 AND UNIT 2

STEAM GENERATOR OUTLET NOZZLE
NODE - E53
(436-in.² BREAK AREA)

FIGURE 6.2.1-21 (SHEET 53 OF 74)

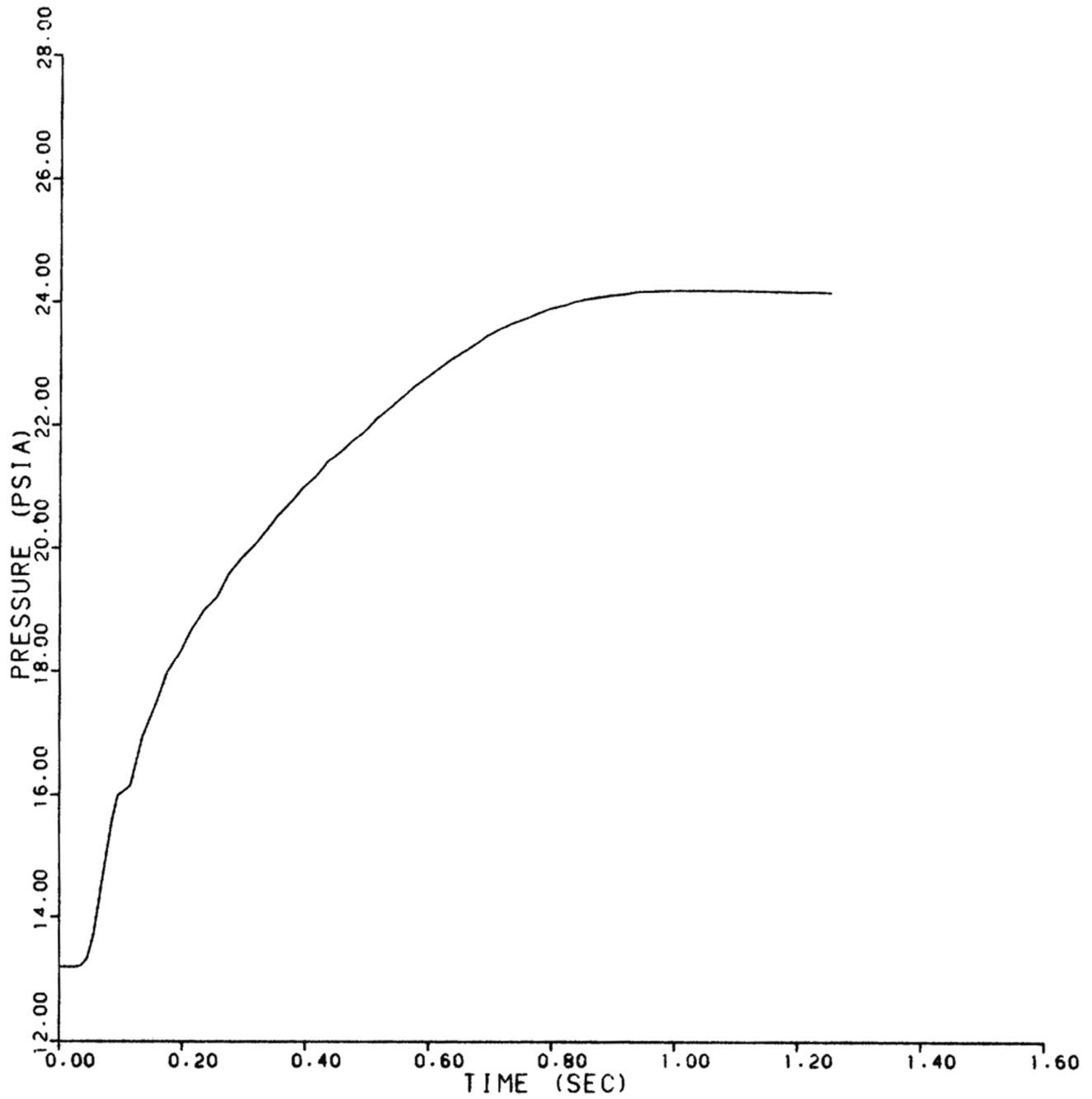

REV 13 4/06



VOGTLE
ELECTRIC GENERATING PLANT
UNIT 1 AND UNIT 2

STEAM GENERATOR OUTLET NOZZLE
NODE - E54
(436-in.² BREAK AREA)

FIGURE 6.2.1-21 (SHEET 54 OF 74)

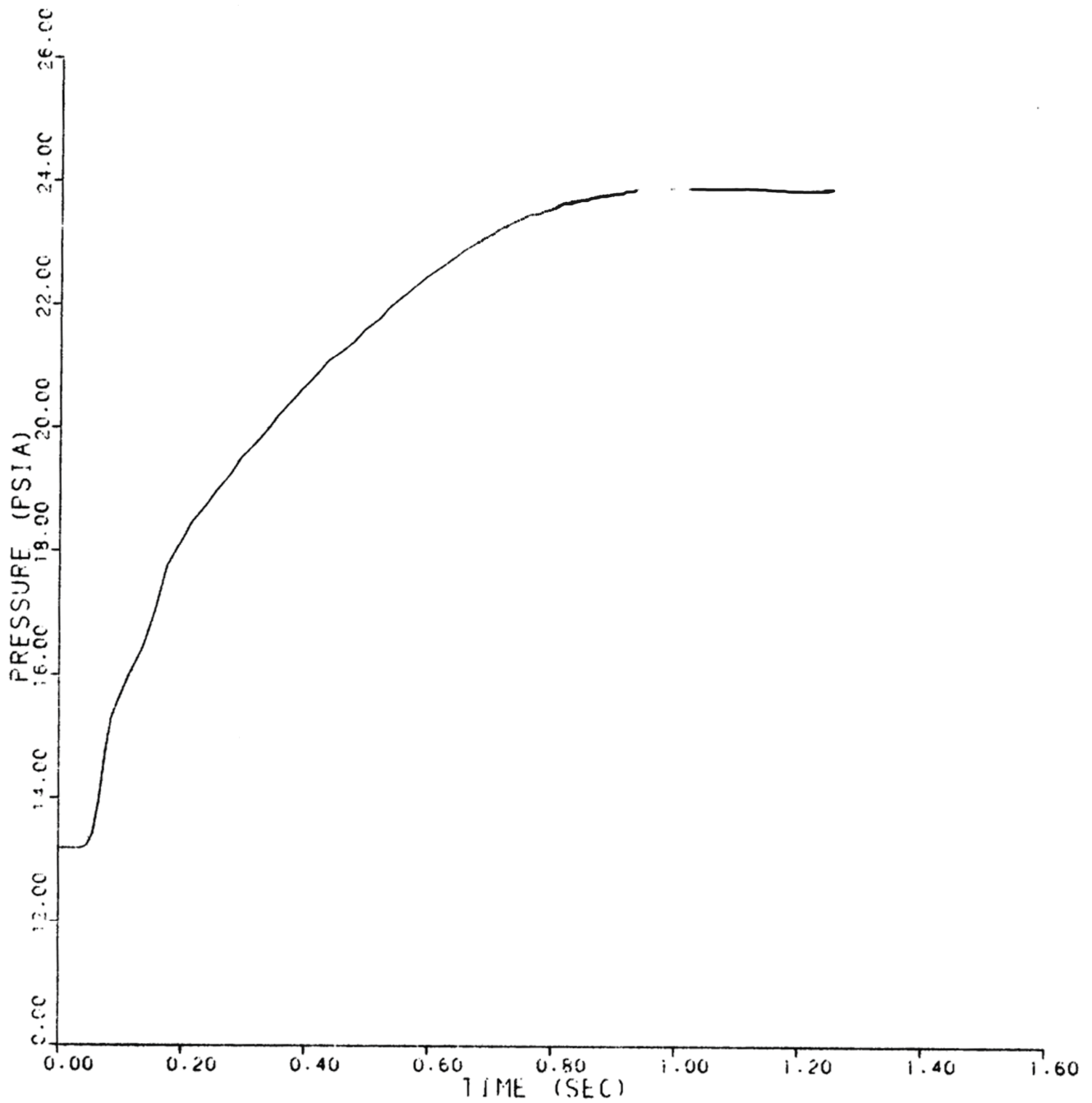

REV 13 4/06



VOGTLE
ELECTRIC GENERATING PLANT
UNIT 1 AND UNIT 2

STEAM GENERATOR OUTLET NOZZLE
NODE - E55
(436-in.² BREAK AREA)

FIGURE 6.2.1-21 (SHEET 55 OF 74)

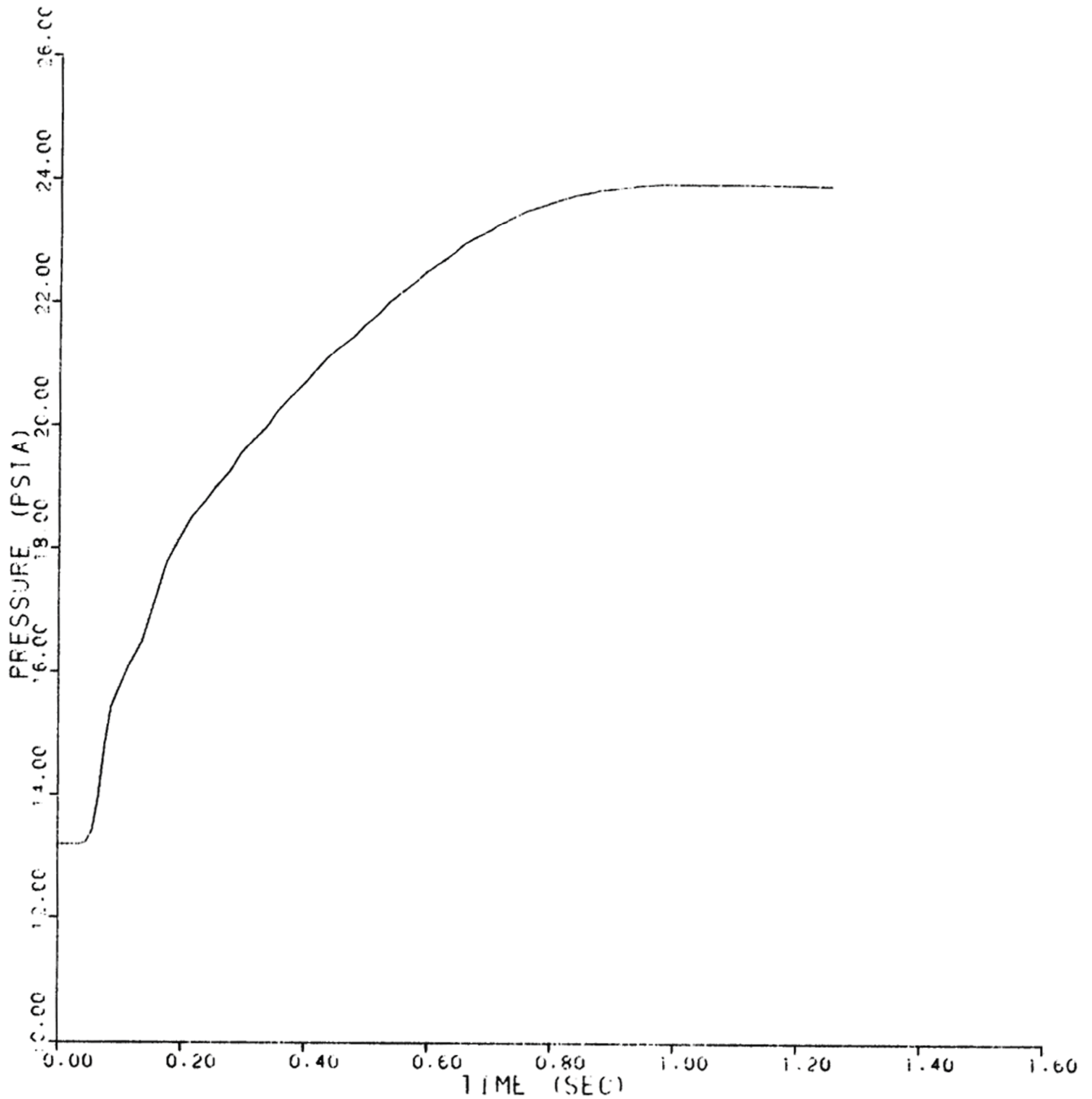

REV 13 4/06



VOGTLE
ELECTRIC GENERATING PLANT
UNIT 1 AND UNIT 2

STEAM GENERATOR OUTLET NOZZLE
NODE - E56
(436-in.² BREAK AREA)

FIGURE 6.2.1-21 (SHEET 56 OF 74)

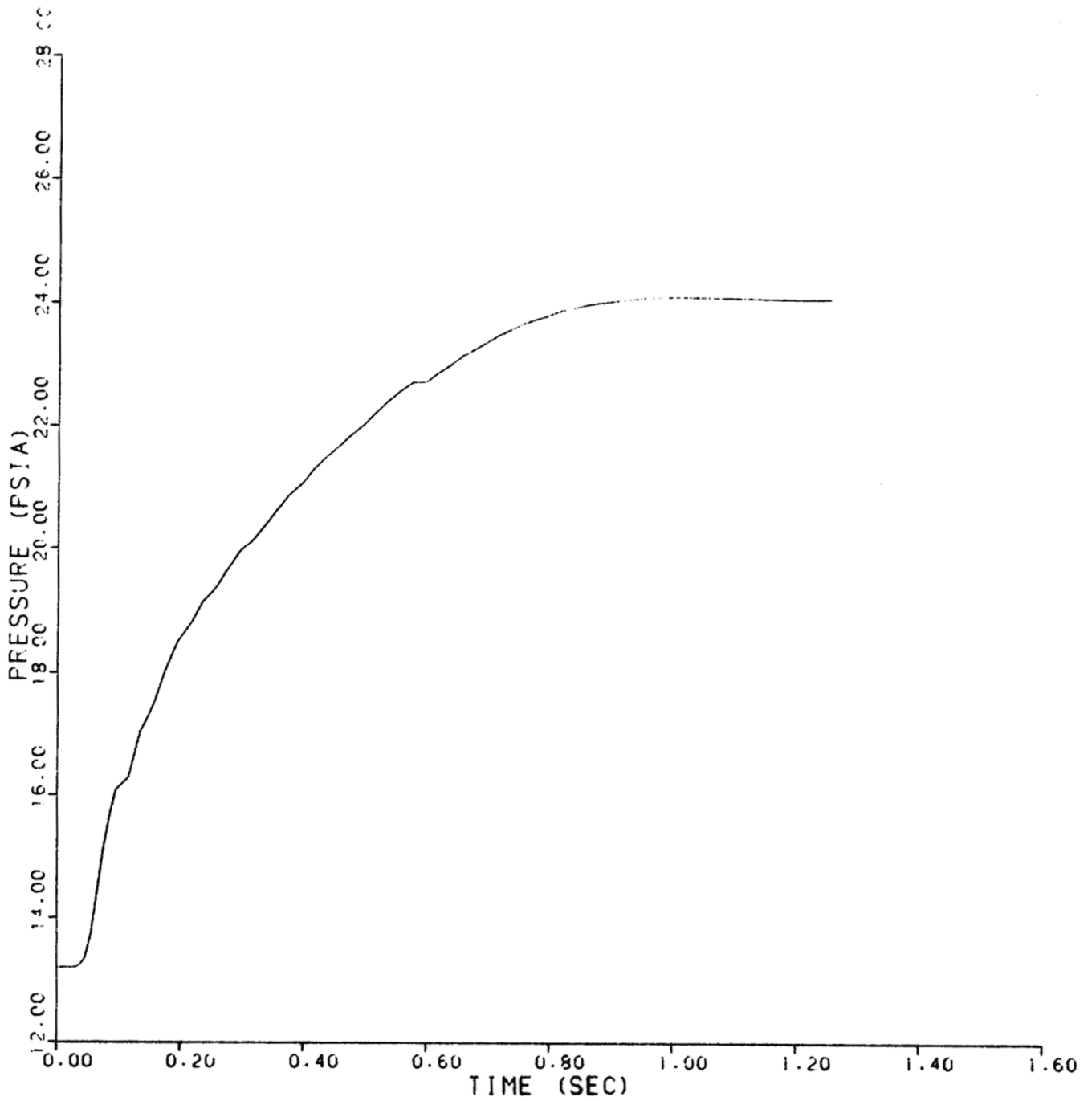

REV 13 4/06



VOGTLE
ELECTRIC GENERATING PLANT
UNIT 1 AND UNIT 2

STEAM GENERATOR OUTLET NOZZLE
NODE - E57
(436-in.² BREAK AREA)

FIGURE 6.2.1-21 (SHEET 57 OF 74)

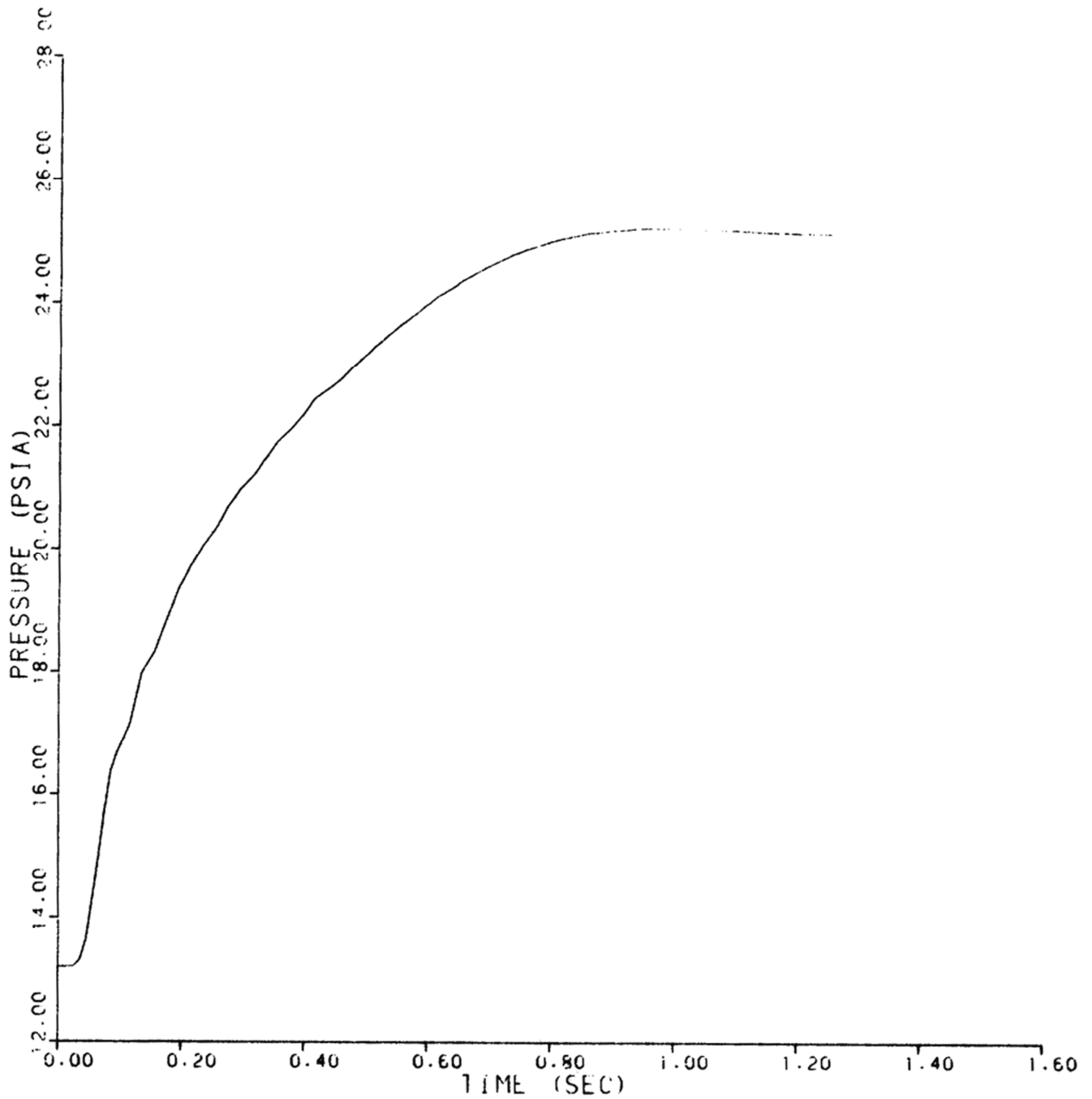

REV 13 4/06



VOGTLE
ELECTRIC GENERATING PLANT
UNIT 1 AND UNIT 2

STEAM GENERATOR OUTLET NOZZLE
NODE - E58
(436-in.² BREAK AREA)

FIGURE 6.2.1-21 (SHEET 58 OF 74)

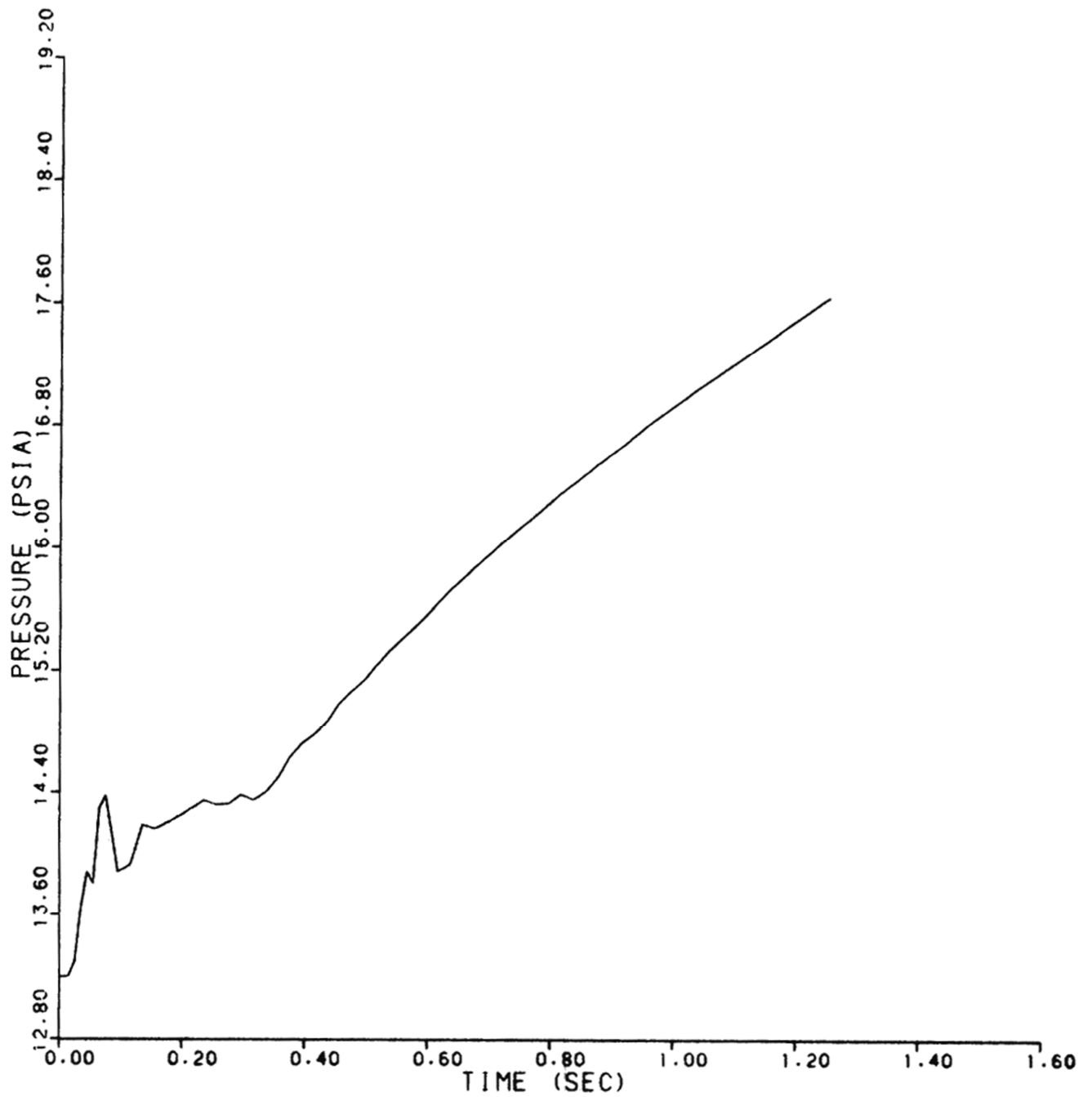

REV 13 4/06



VOGTLE
ELECTRIC GENERATING PLANT
UNIT 1 AND UNIT 2

STEAM GENERATOR OUTLET NOZZLE
NODE - E59
(436-in.² BREAK AREA)

FIGURE 6.2.1-21 (SHEET 59 OF 74)

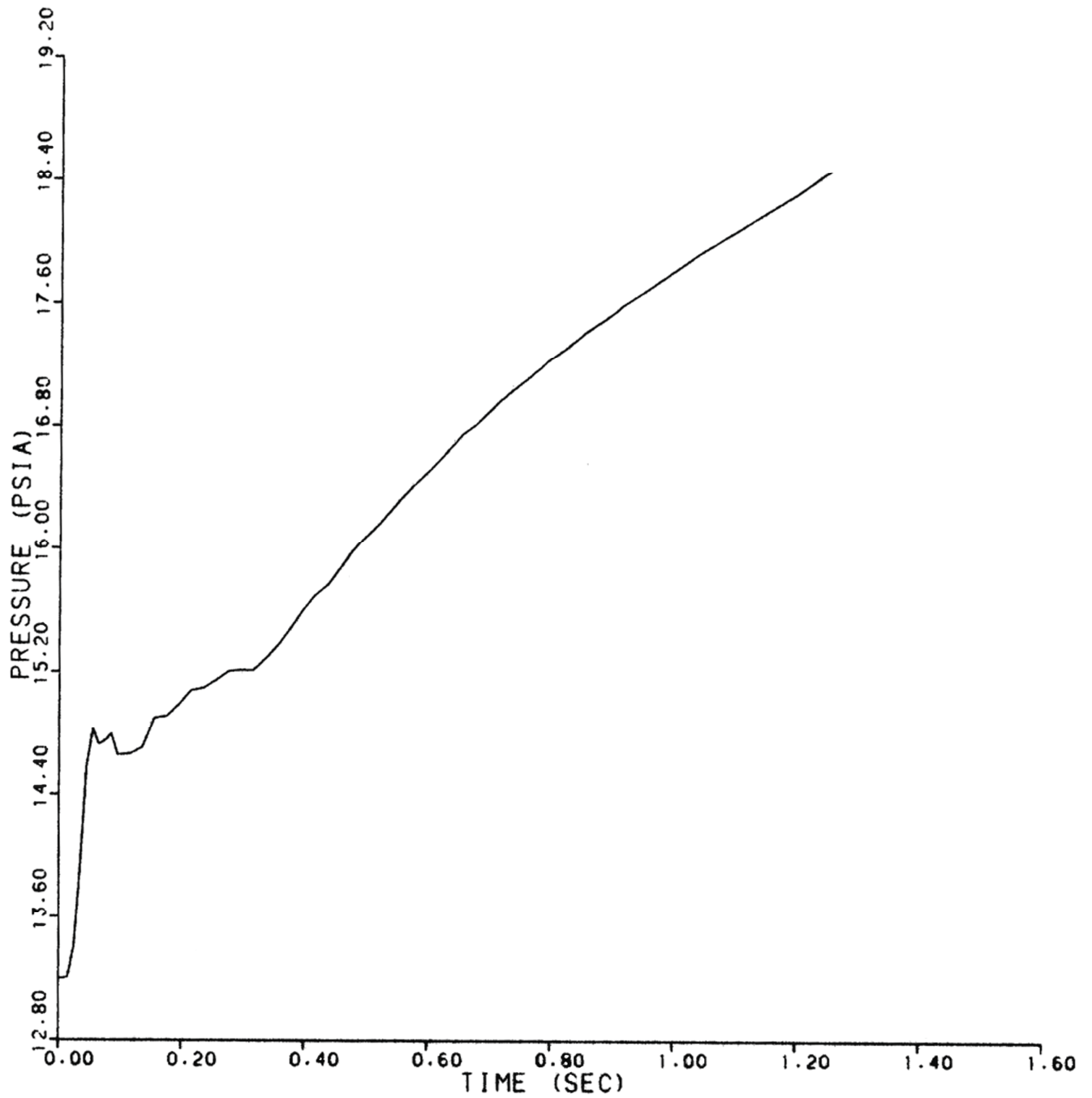

REV 13 4/06



VOGTLE
ELECTRIC GENERATING PLANT
UNIT 1 AND UNIT 2

STEAM GENERATOR OUTLET NOZZLE
NODE - E60
(436-in.² BREAK AREA)

FIGURE 6.2.1-21 (SHEET 60 OF 74)

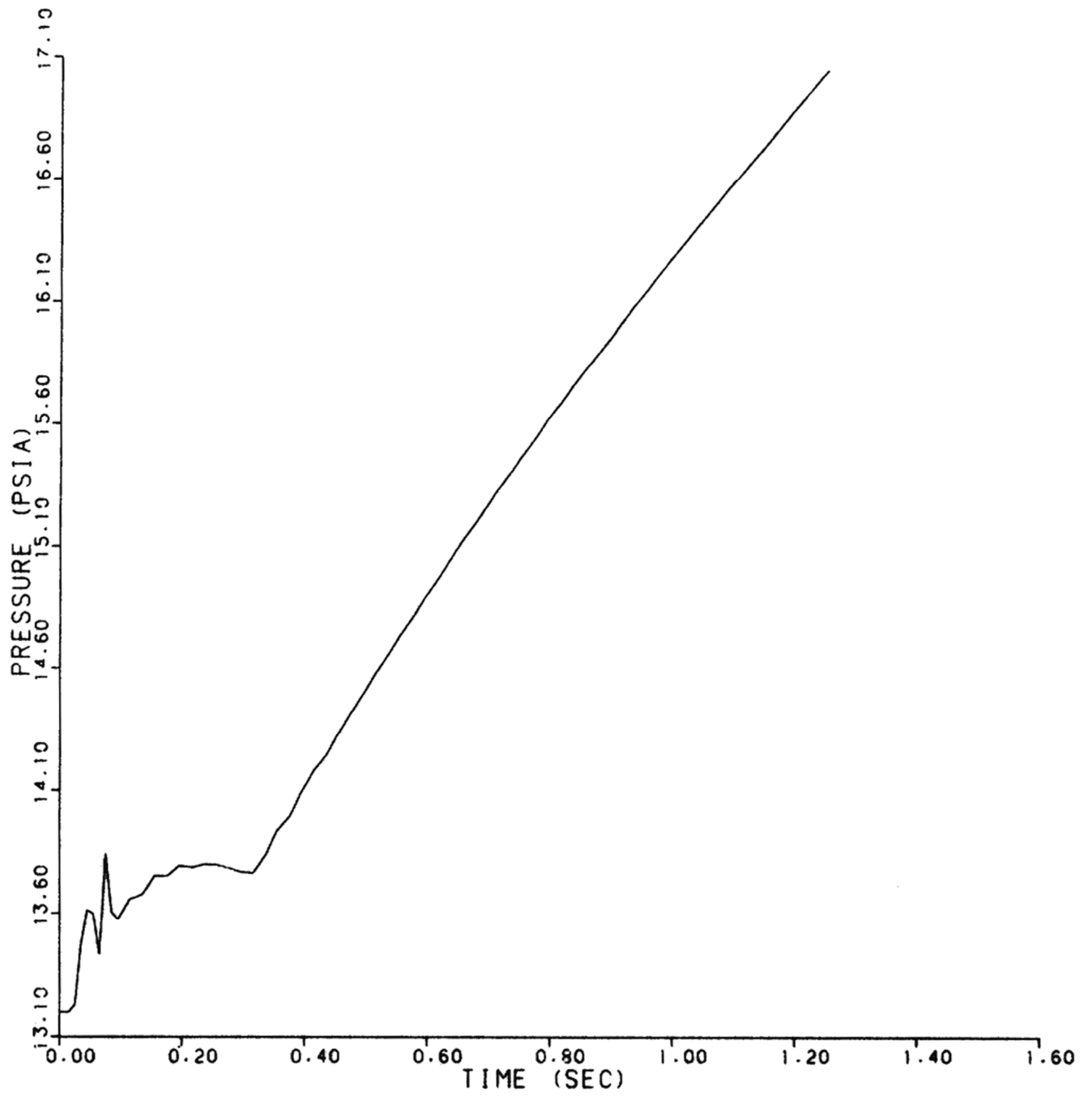

REV 13 4/06



VOGTLE
ELECTRIC GENERATING PLANT
UNIT 1 AND UNIT 2

STEAM GENERATOR OUTLET NOZZLE
NODE - E61
(436-in.² BREAK AREA)

FIGURE 6.2.1-21 (SHEET 61 OF 74)

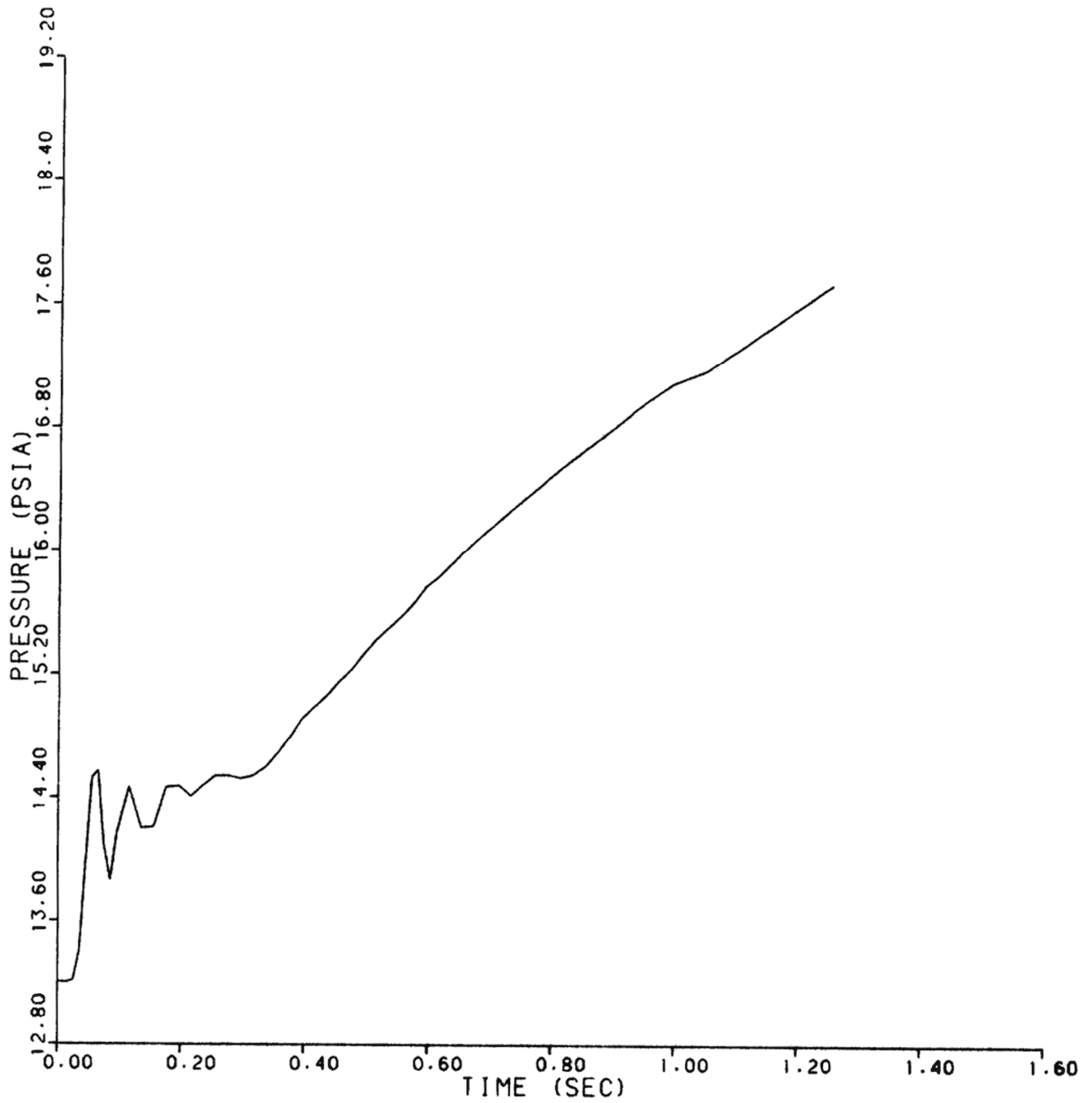

REV 13 4/06



VOGTLE
ELECTRIC GENERATING PLANT
UNIT 1 AND UNIT 2

STEAM GENERATOR OUTLET NOZZLE
NODE - E62
(436-in.² BREAK AREA)

FIGURE 6.2.1-21 (SHEET 62 OF 74)

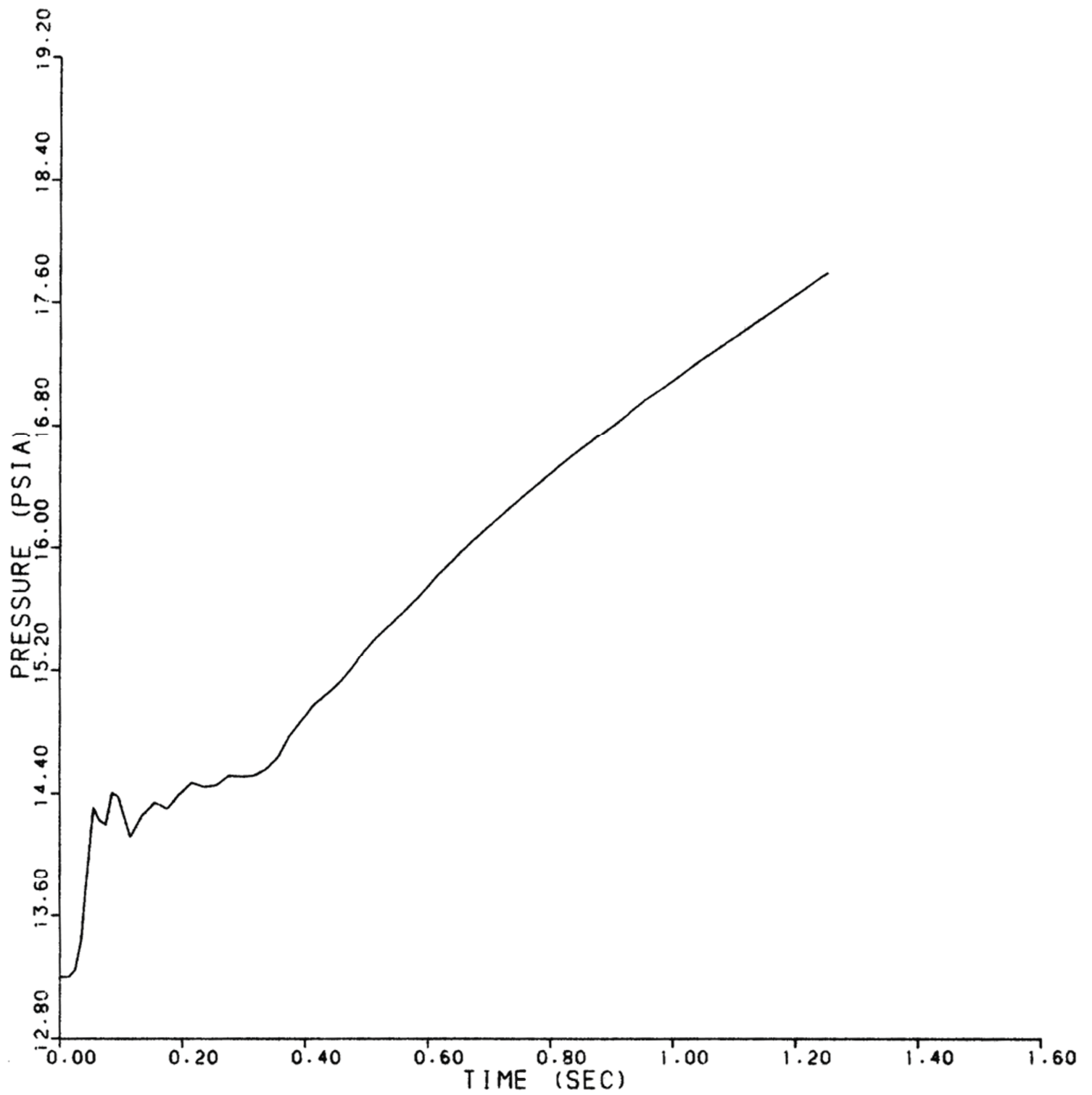

REV 13 4/06



VOGTLE
ELECTRIC GENERATING PLANT
UNIT 1 AND UNIT 2

STEAM GENERATOR OUTLET NOZZLE
NODE - E63
(436-in.² BREAK AREA)

FIGURE 6.2.1-21 (SHEET 63 OF 74)

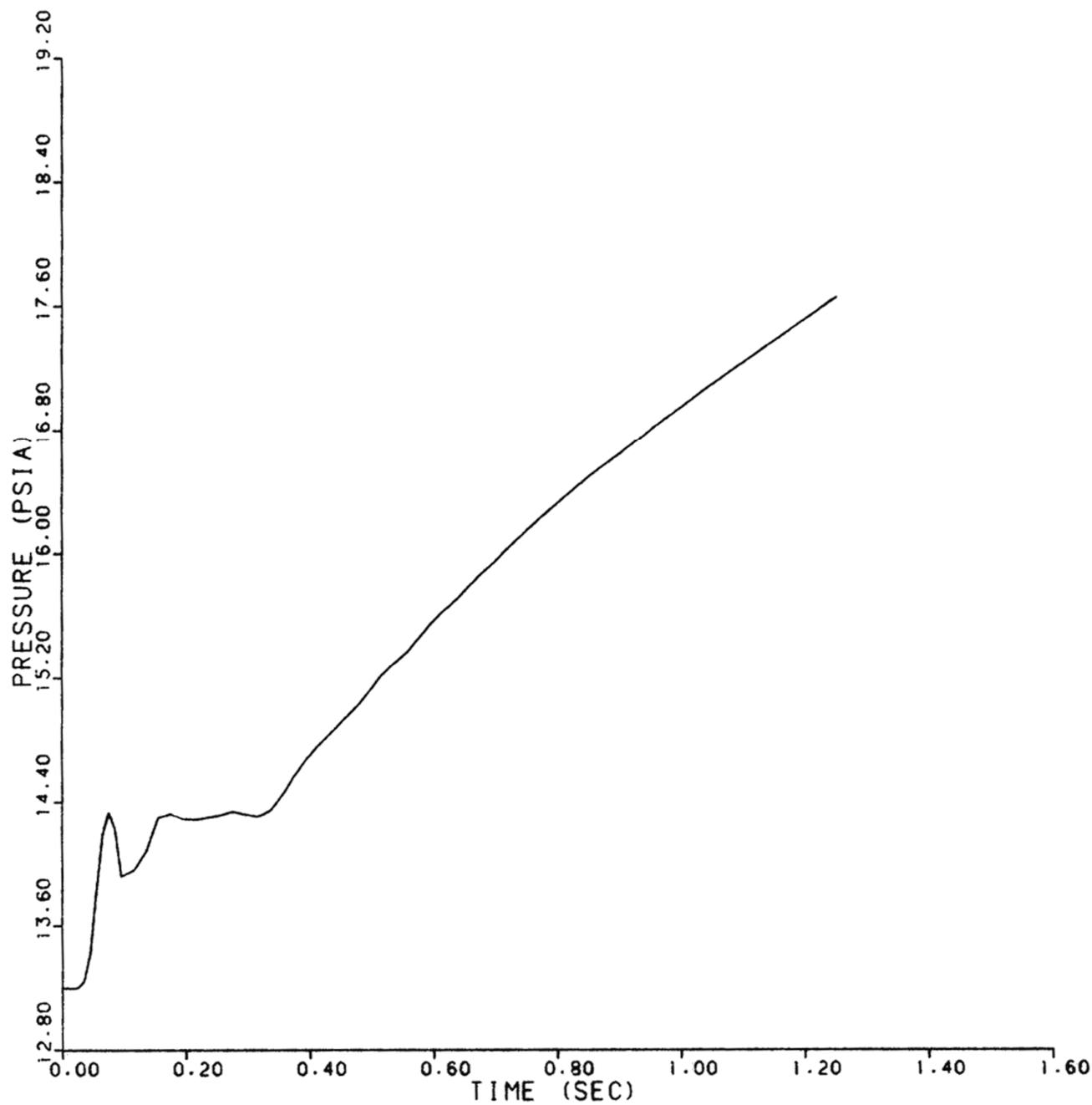

REV 13 4/06



VOGTLE
ELECTRIC GENERATING PLANT
UNIT 1 AND UNIT 2

STEAM GENERATOR OUTLET NOZZLE
NODE - E64
(436-in.² BREAK AREA)

FIGURE 6.2.1-21 (SHEET 64 OF 74)

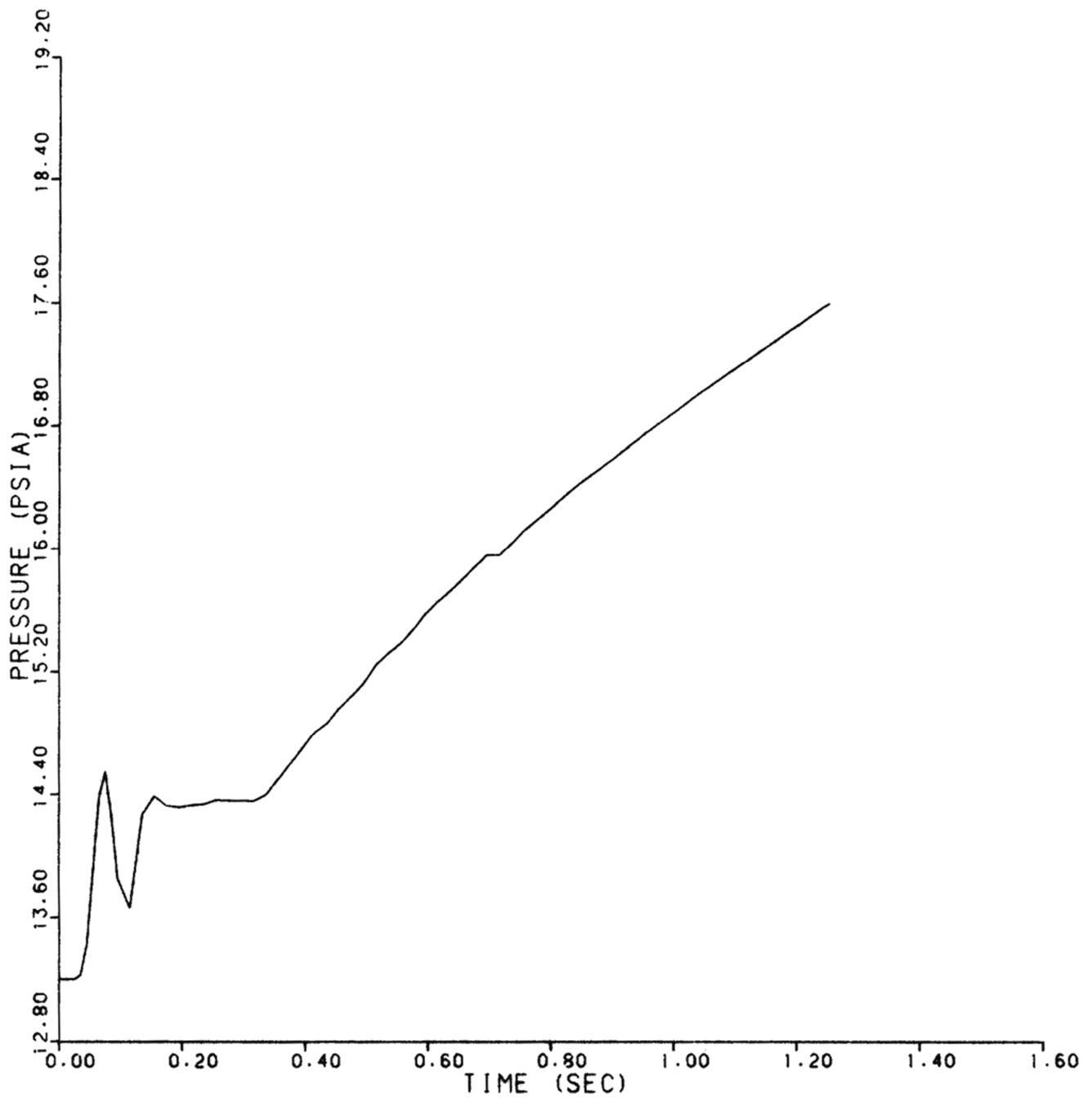

REV 13 4/06



VOGTLE
ELECTRIC GENERATING PLANT
UNIT 1 AND UNIT 2

STEAM GENERATOR OUTLET NOZZLE
NODE - E65
(436-in.² BREAK AREA)

FIGURE 6.2.1-21 (SHEET 65 OF 74)

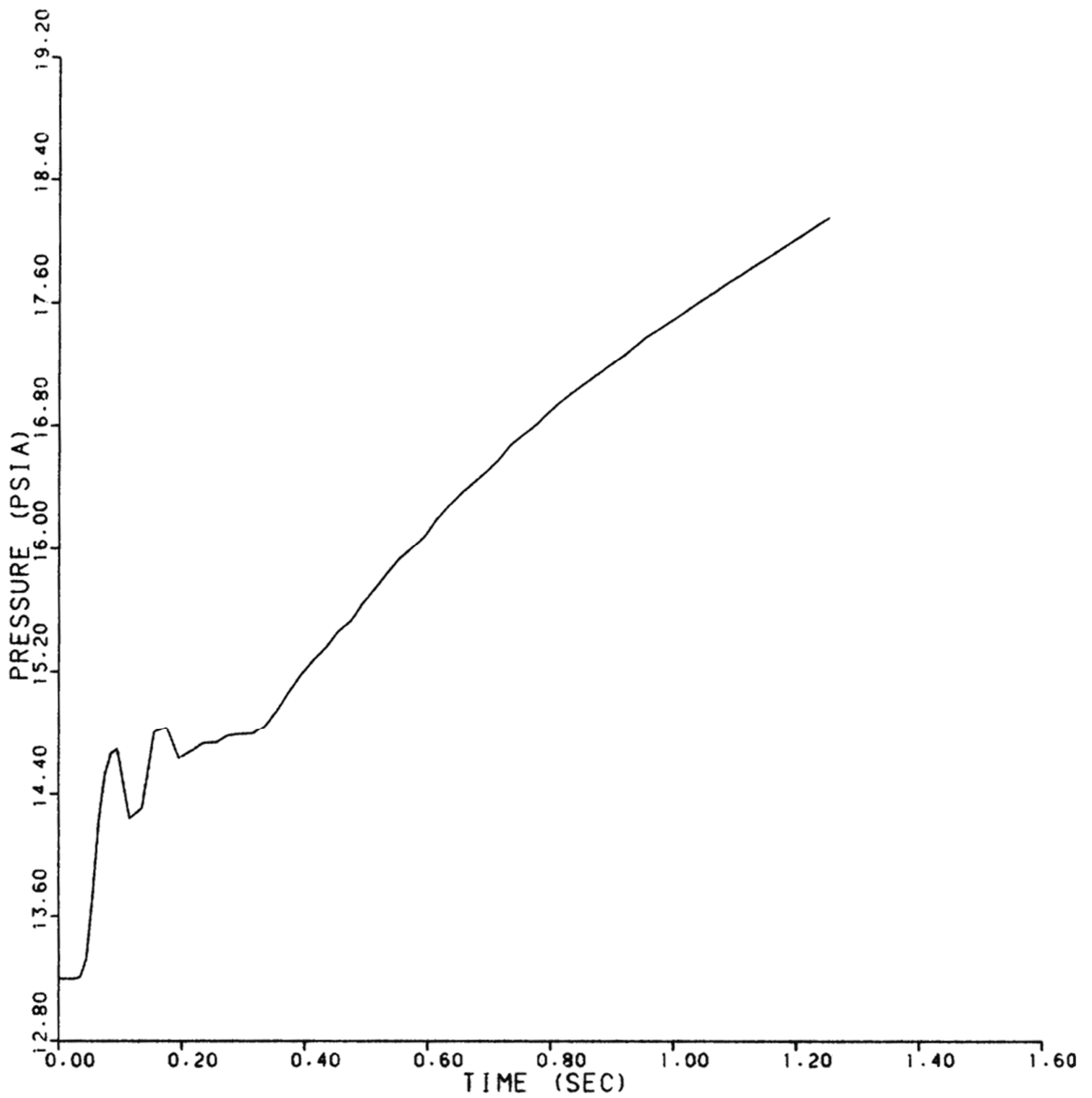

REV 13 4/06



VOGTLE
ELECTRIC GENERATING PLANT
UNIT 1 AND UNIT 2

STEAM GENERATOR OUTLET NOZZLE
NODE - E66
(436-in.² BREAK AREA)

FIGURE 6.2.1-21 (SHEET 66 OF 74)

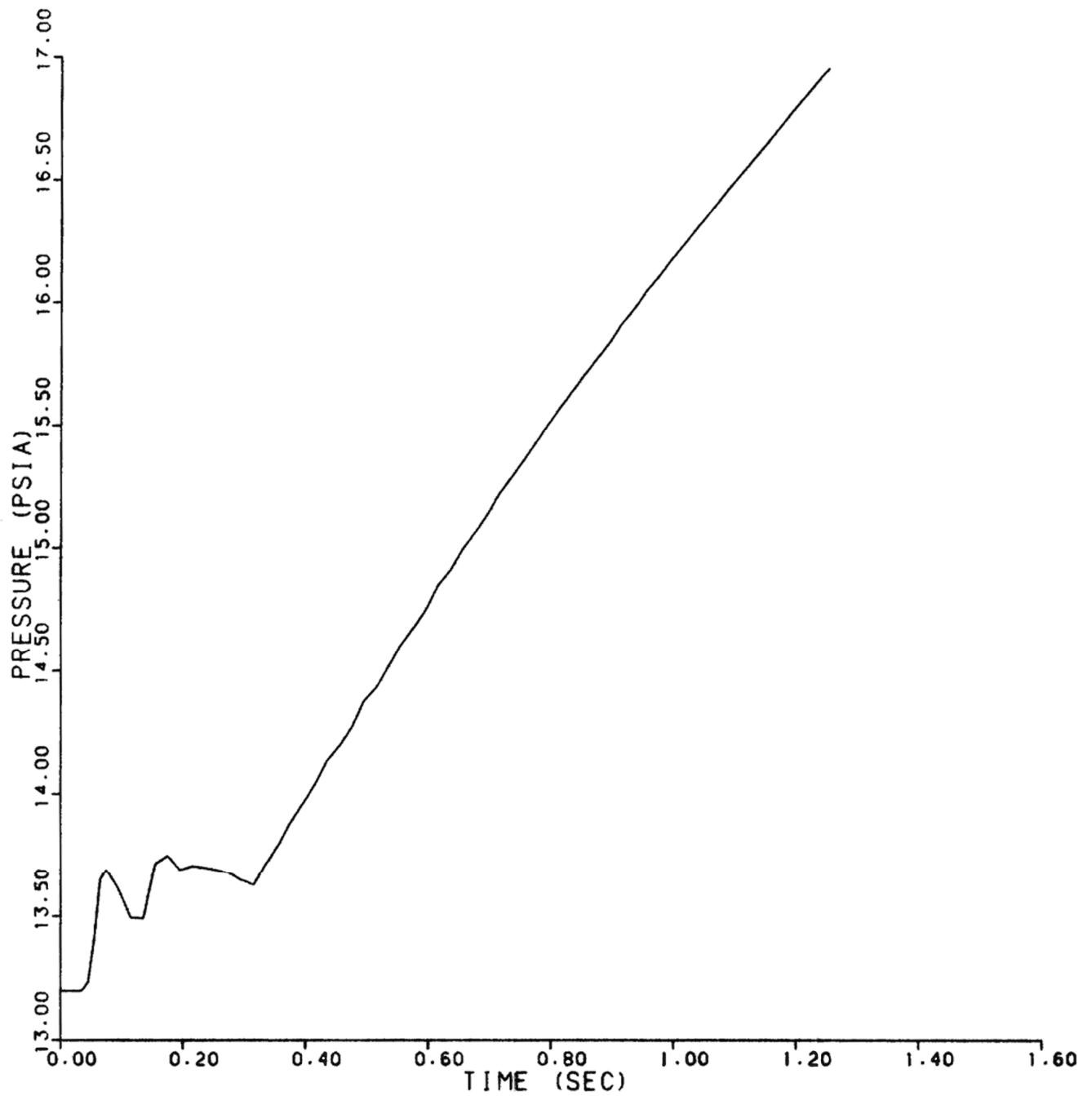

REV 13 4/06



VOGTLE
ELECTRIC GENERATING PLANT
UNIT 1 AND UNIT 2

STEAM GENERATOR OUTLET NOZZLE
NODE - E67
(436-in.² BREAK AREA)

FIGURE 6.2.1-21 (SHEET 67 OF 74)

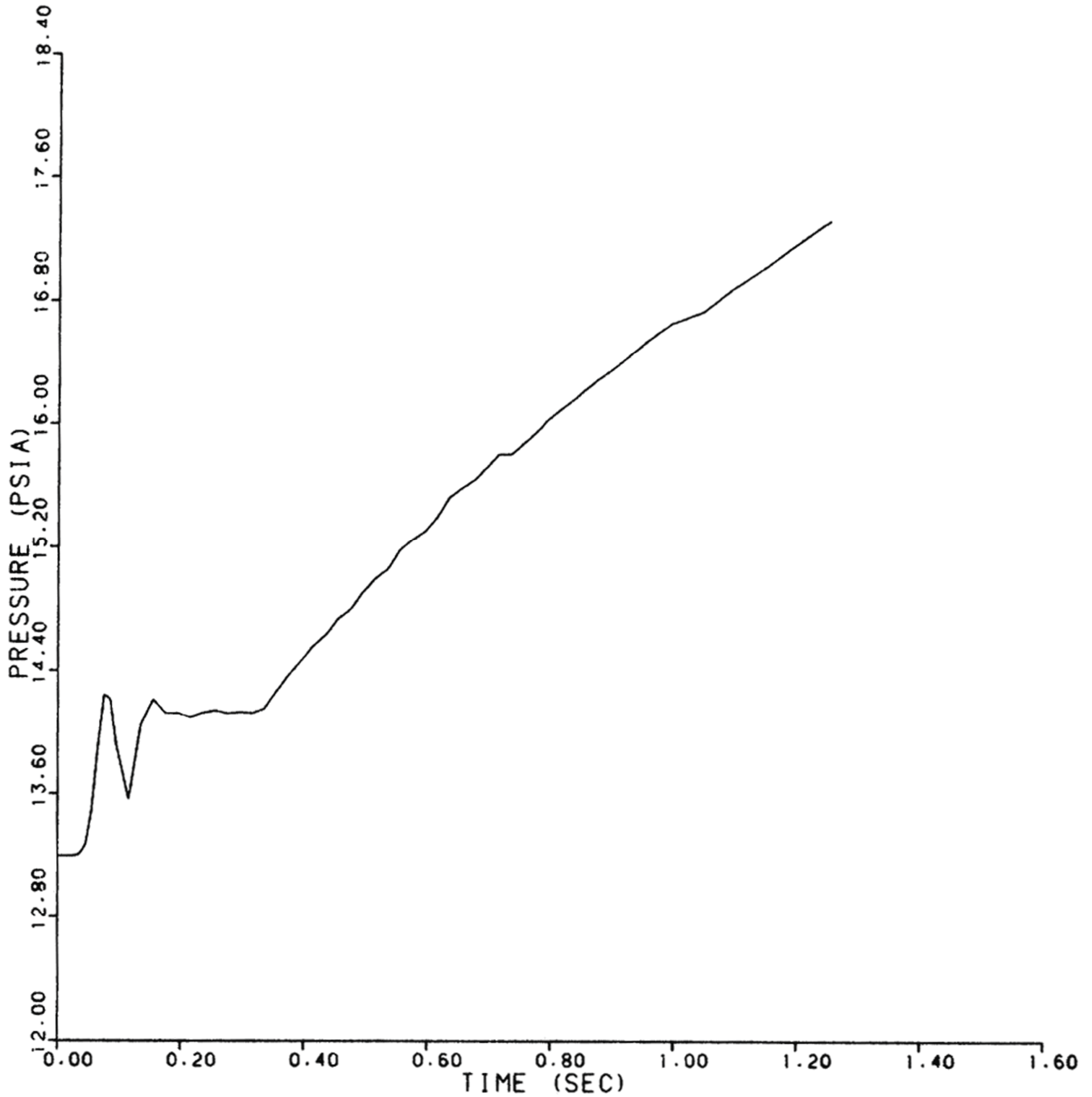

REV 13 4/06



VOGTLE
ELECTRIC GENERATING PLANT
UNIT 1 AND UNIT 2

STEAM GENERATOR OUTLET NOZZLE
NODE - E68
(436-in.² BREAK AREA)

FIGURE 6.2.1-21 (SHEET 68 OF 74)

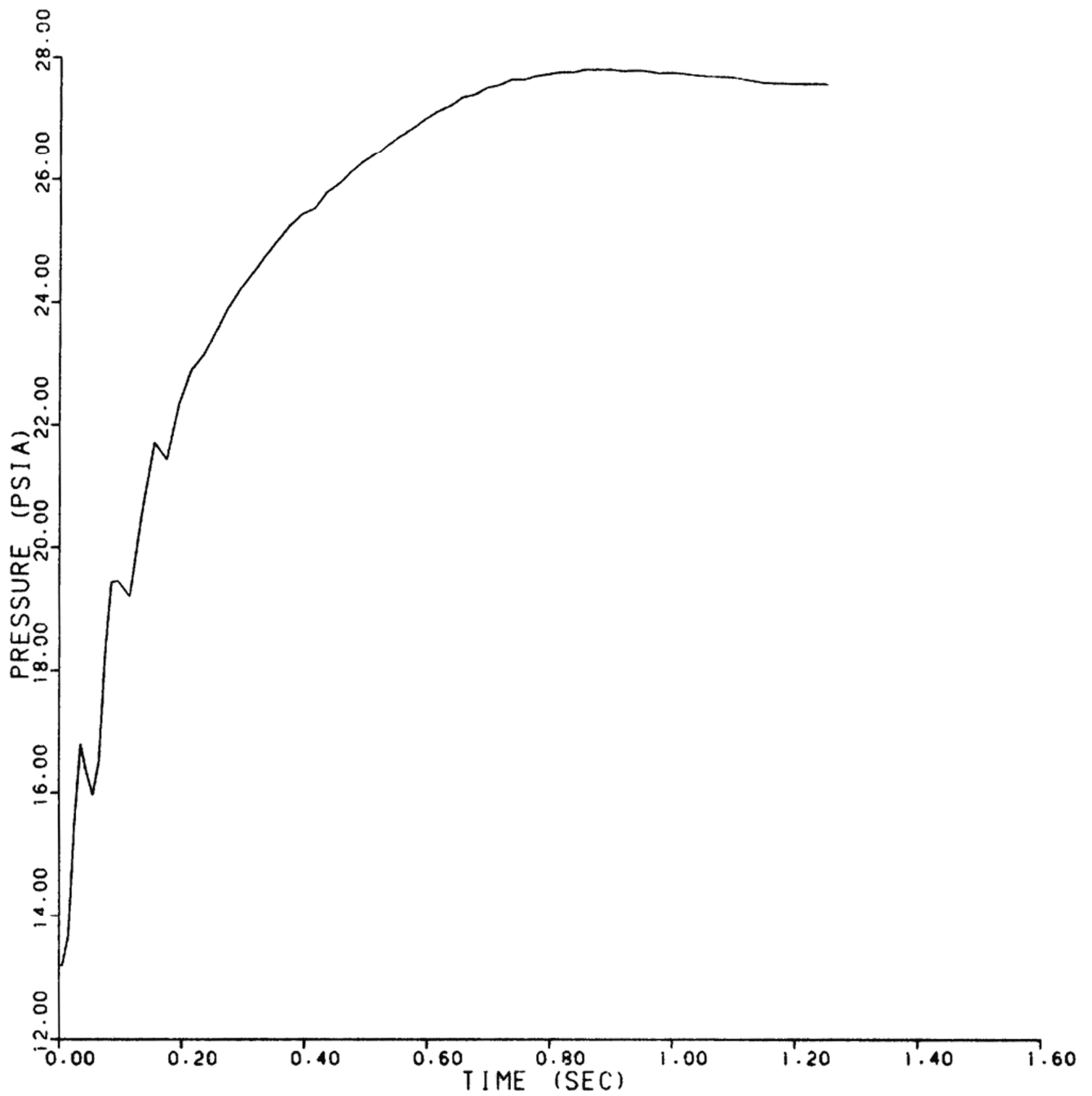

REV 13 4/06



VOGTLE
ELECTRIC GENERATING PLANT
UNIT 1 AND UNIT 2

STEAM GENERATOR OUTLET NOZZLE
NODE - E69
(436-in.² BREAK AREA)

FIGURE 6.2.1-21 (SHEET 69 OF 74)

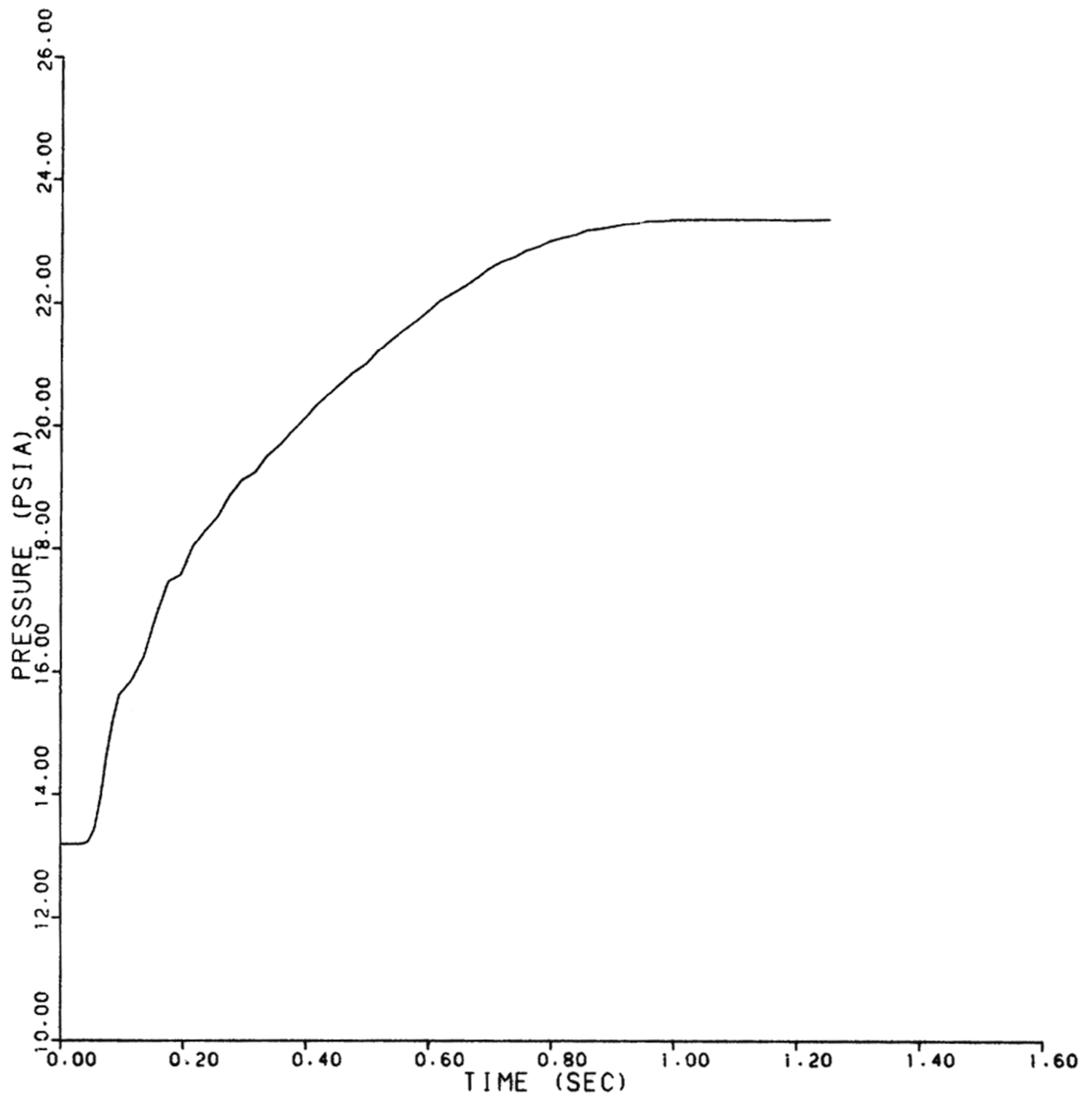

REV 13 4/06



VOGTLE
ELECTRIC GENERATING PLANT
UNIT 1 AND UNIT 2

STEAM GENERATOR OUTLET NOZZLE
NODE - E70
(436-in.² BREAK AREA)

FIGURE 6.2.1-21 (SHEET 70 OF 74)

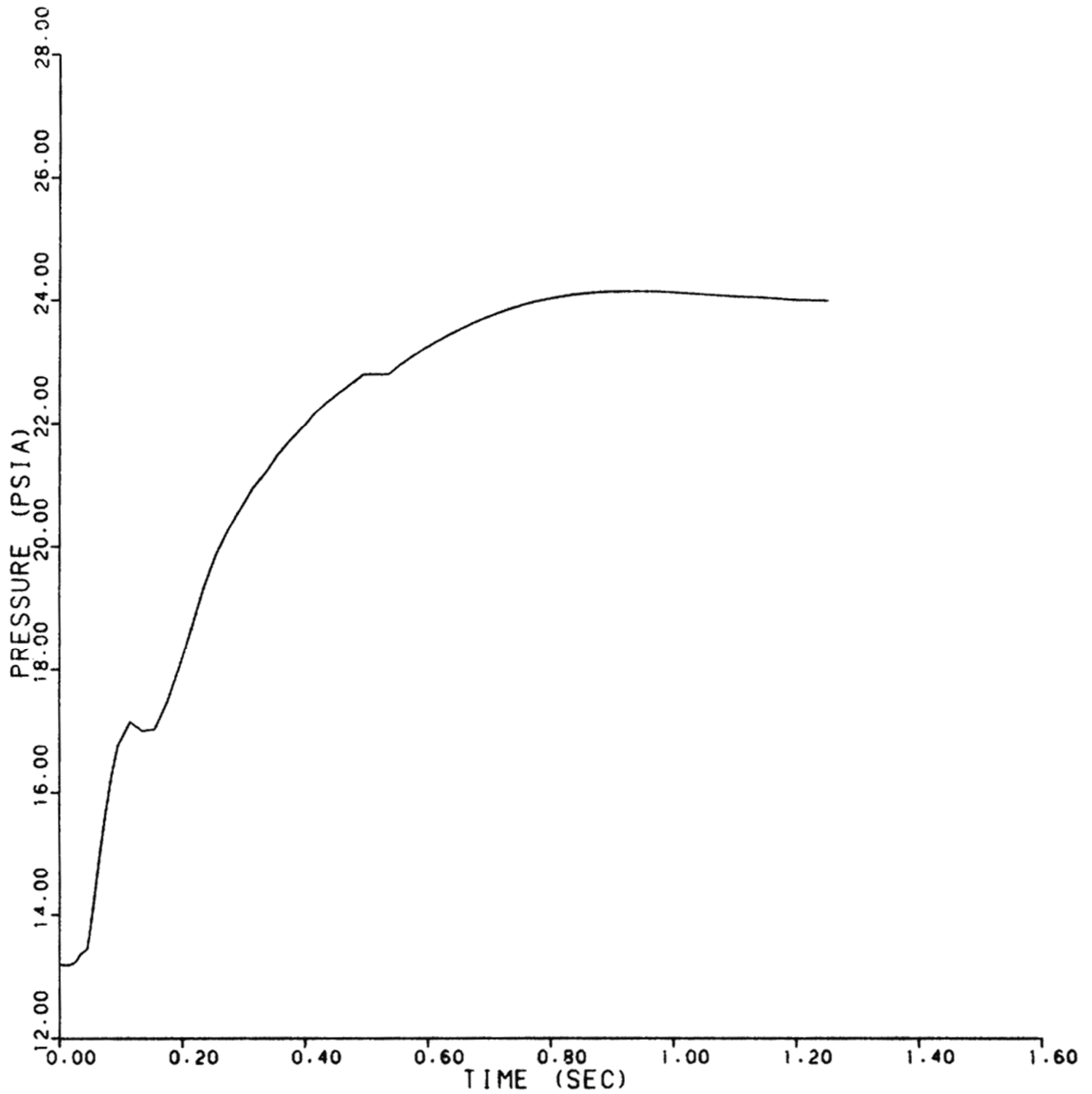

REV 13 4/06



VOGTLE
ELECTRIC GENERATING PLANT
UNIT 1 AND UNIT 2

STEAM GENERATOR OUTLET NOZZLE
NODE - E71
(436-in.² BREAK AREA)

FIGURE 6.2.1-21 (SHEET 71 OF 74)

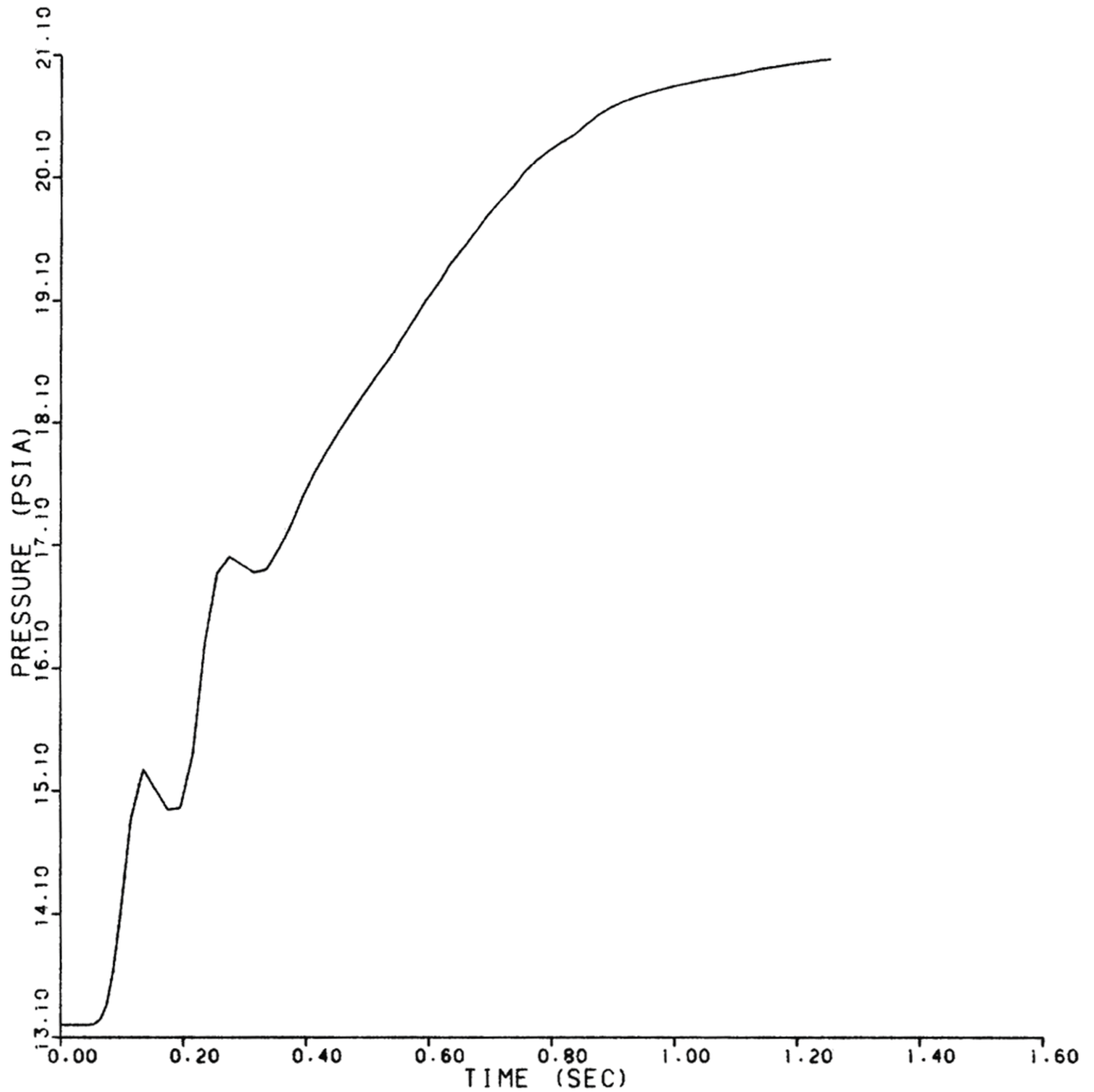

REV 13 4/06



VOGTLE
ELECTRIC GENERATING PLANT
UNIT 1 AND UNIT 2

STEAM GENERATOR OUTLET NOZZLE
NODE - E72
(436-in.² BREAK AREA)

FIGURE 6.2.1-21 (SHEET 72 OF 74)

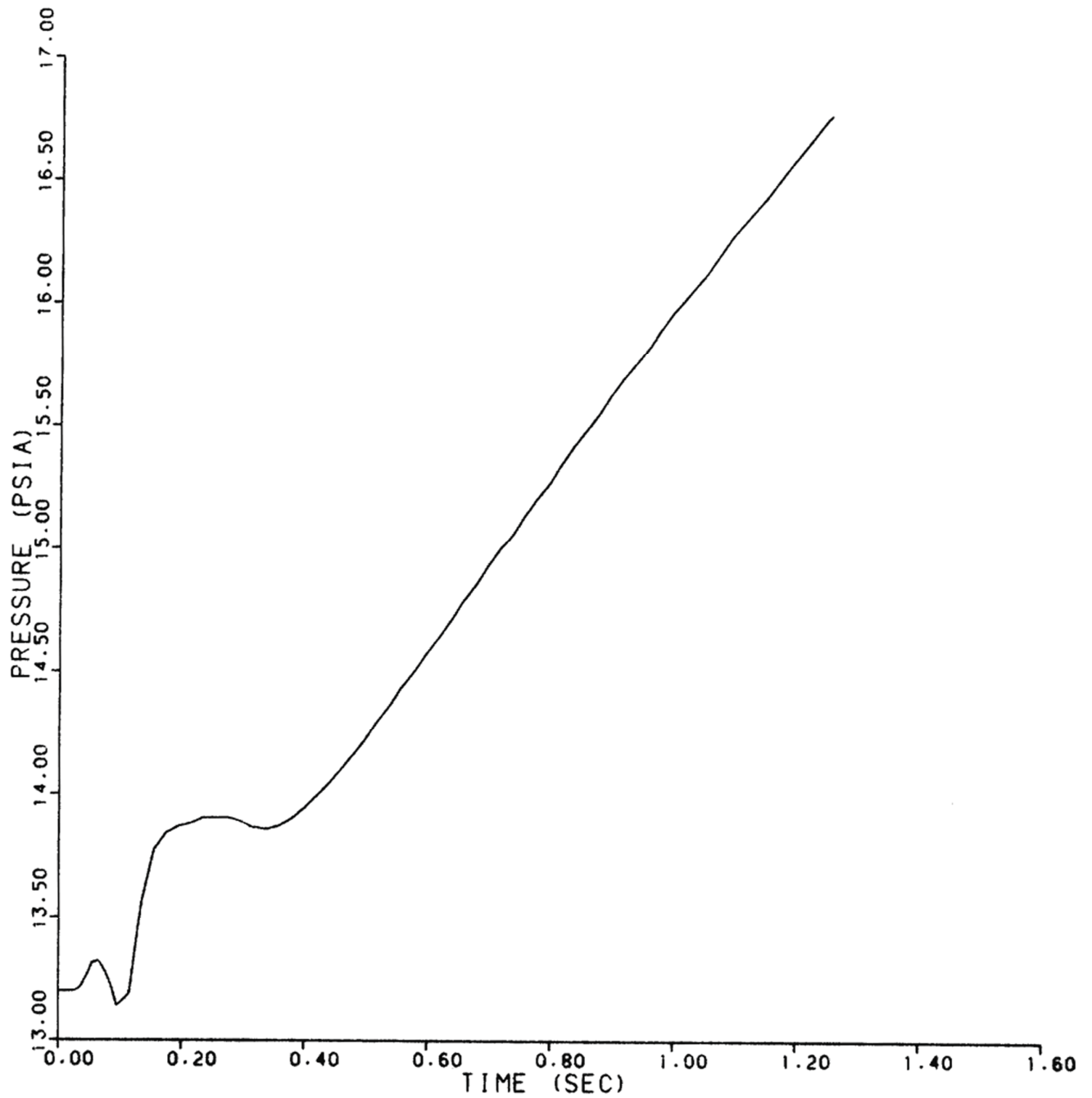

REV 13 4/06



VOGTLE
ELECTRIC GENERATING PLANT
UNIT 1 AND UNIT 2

STEAM GENERATOR OUTLET NOZZLE
NODE - E73
(436-in.² BREAK AREA)

FIGURE 6.2.1-21 (SHEET 73 OF 74)

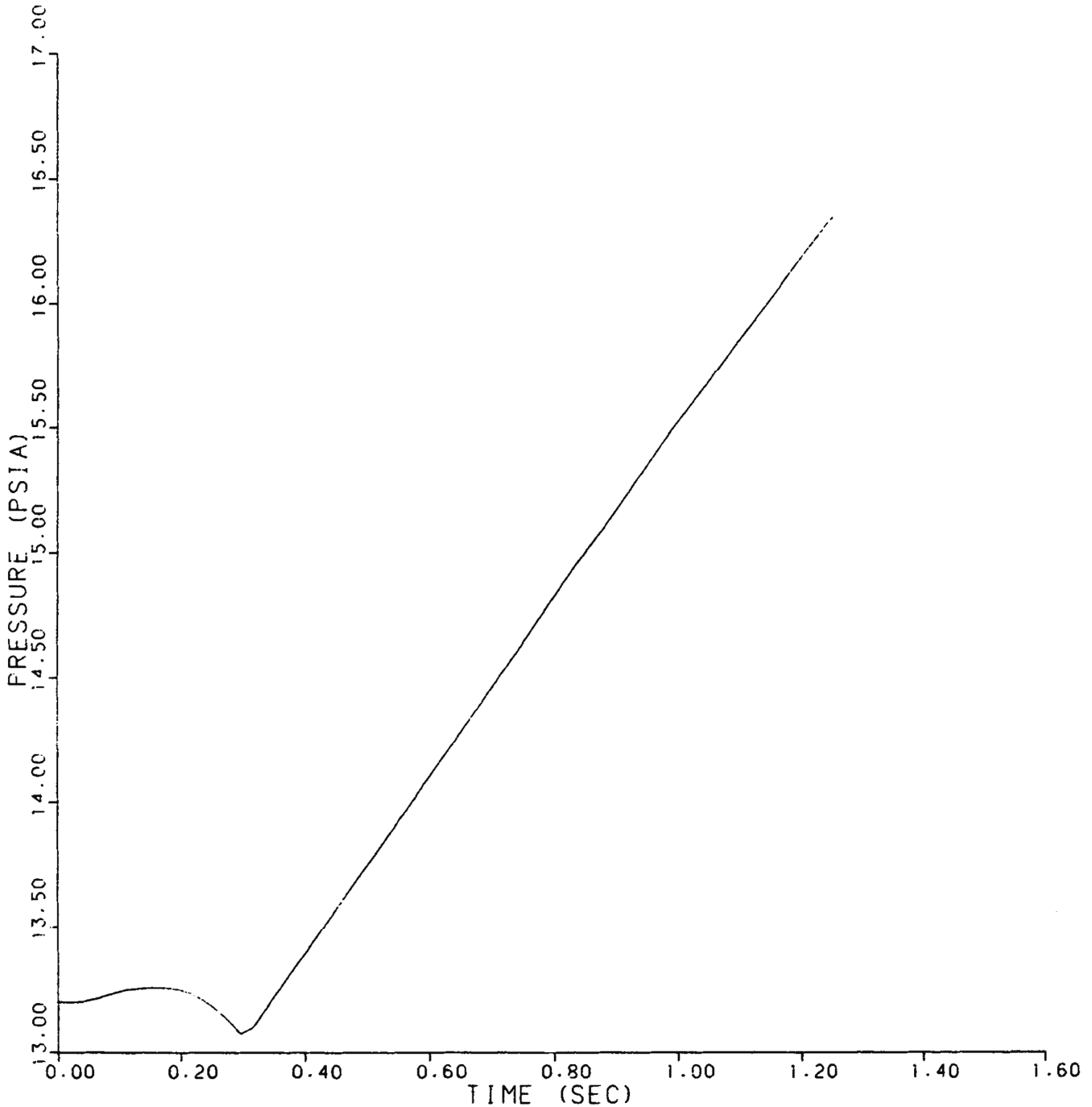

REV 13 4/06



VOGTLE
ELECTRIC GENERATING PLANT
UNIT 1 AND UNIT 2

STEAM GENERATOR OUTLET NOZZLE
NODE - E74
(436-in.² BREAK AREA)

FIGURE 6.2.1-21 (SHEET 74 OF 74)