

GRAND GULF NUCLEAR GENERATING STATION
Updated Final Safety Analysis Report (UFSAR)

TABLE OF CONTENTS

CHAPTER 9 AUXILIARY SYSTEMS

9.1	FUEL STORAGE AND HANDLING	9.1-1
9.1.1	New Fuel Storage	9.1-1
9.1.1.1	Design Bases	9.1-1
9.1.1.2	Facilities Description	9.1-3
9.1.1.3	Safety Evaluation	9.1-4
9.1.2	Spent Fuel Pool Storage	9.1-6
9.1.2.1	Design Bases	9.1-6
9.1.2.2	Facilities Description	9.1-8
9.1.2.3	Safety Evaluation	9.1-9
9.1.2.4	Dry Spent Fuel Storage	9.1-22
9.1.3	Fuel Pool Cooling and Cleanup System	9.1-23
9.1.3.1	Design Bases	9.1-23
9.1.3.2	System Description	9.1-24
9.1.3.3	Safety Evaluation	9.1-26
9.1.3.4	Inspection and Testing Requirements	9.1-30
9.1.3.5	Radiological Considerations	9.1-30
9.1.4	Fuel Handling System	9.1-31
9.1.4.1	Design Bases	9.1-31
9.1.4.2	System Description	9.1-32
9.1.4.3	Safety Evaluation, Fuel Handling System	9.1-67
9.1.4.4	Inspection and Testing Requirements	9.1-69
9.1.4.5	Instrumentation Requirements	9.1-71
9.1.5	References	9.1-72
9.2	WATER SYSTEMS	9.2-1
9.2.1	Standby Service Water System	9.2-1
9.2.1.1	Design Bases	9.2-1
9.2.1.2	System Description	9.2-2
9.2.1.3	Safety Evaluation	9.2-4
9.2.1.4	Tests and Inspections	9.2-20
9.2.1.5	Instrumentation Requirements	9.2-21

GRAND GULF NUCLEAR GENERATING STATION
Updated Final Safety Analysis Report (UFSAR)

TABLE OF CONTENTS

9.2.1.6	References	9.2-22
9.2.2	Component Cooling Water System	9.2-22
9.2.2.1	Power Generation Design Bases	9.2-22
9.2.2.2	System Description	9.2-22
9.2.2.3	Safety Evaluation	9.2-24
9.2.2.4	Test and Inspection	9.2-25
9.2.2.5	Instrumentation Application	9.2-25
9.2.3	Makeup Water Treatment System	9.2-26
9.2.3.1	Design Bases	9.2-26
9.2.3.2	System Description	9.2-26
9.2.3.3	Safety Evaluation	9.2-28
9.2.3.4	Tests and Inspections	9.2-28
9.2.3.5	Instrument Application	9.2-28
9.2.4	Domestic Water System and Sanitary Waste Water System	9.2-29
9.2.4.1	Power Generation Design Bases	9.2-29
9.2.4.2	System Description	9.2-29
9.2.4.3	Safety Evaluation	9.2-30
9.2.4.4	Inspection and Testing	9.2-30
9.2.4.5	Instrumentation Application	9.2-30
9.2.5	Ultimate Heat Sink	9.2-30
9.2.5.1	Design Bases	9.2-30
9.2.5.2	System Description	9.2-31
9.2.5.3	Safety Evaluation	9.2-32
9.2.5.4	Tests and Inspections	9.2-32
9.2.5.5	Instrumentation Application	9.2-32
9.2.6	Condensate and Refueling Water Storage and Transfer System	9.2-32
9.2.6.1	Power Generation Design Bases	9.2-32
9.2.6.2	System Description	9.2-33
9.2.6.3	Safety Evaluation	9.2-34
9.2.6.4	Tests and Inspections	9.2-35

GRAND GULF NUCLEAR GENERATING STATION
Updated Final Safety Analysis Report (UFSAR)

TABLE OF CONTENTS

9.2.6.5	Instrumentation Requirements	9.2-36
9.2.7	Plant Chilled Water System	9.2-36
9.2.7.1	Power Generation Design Basis	9.2-36
9.2.7.2	System Description	9.2-36
9.2.7.3	Safety Evaluation	9.2-37
9.2.7.4	Tests and Inspections	9.2-38
9.2.7.5	Instrumentation Application	9.2-38
9.2.8	Plant Service Water System	9.2-39
9.2.8.1	Power Generation Design Bases	9.2-39
9.2.8.2	System Description	9.2-40
9.2.8.3	Safety Evaluation	9.2-41
9.2.8.4	Testing and Inspection	9.2-42
9.2.8.5	Instrumentation Requirements	9.2-42
9.2.9	Turbine Building Cooling Water System (TBCWS) .	9.2-43
9.2.9.1	Power Generation Design Bases	9.2-43
9.2.9.2	System Description	9.2-43
9.2.9.3	Safety Evaluation	9.2-44
9.2.9.4	Tests and Inspections	9.2-44
9.2.9.5	Instrumentation Application	9.2-44
9.2.10	Plant Service Water Radial Well System	9.2-44
9.2.10.1	Power Generation Design Basis	9.2-44
9.2.10.2	System Description	9.2-45
9.2.10.3	Safety Evaluation	9.2-45
9.2.10.4	Testing and Inspection Requirements	9.2-46
9.2.10.5	Instrumentation Requirements	9.2-46
9.2.11	Drywell Chilled Water System	9.2-46
9.2.11.1	Power Generation Design Basis	9.2-46
9.2.11.2	System Description	9.2-46
9.2.11.3	Safety Evaluation	9.2-47
9.2.11.4	Test and Inspections	9.2-48
9.2.11.5	Instrumentation Application	9.2-48

GRAND GULF NUCLEAR GENERATING STATION
Updated Final Safety Analysis Report (UFSAR)

TABLE OF CONTENTS

9.3	PROCESS AUXILIARIES	9.3-1
9.3.1	Compressed Air Systems	9.3-1
9.3.1.1	Design Bases	9.3-1
9.3.1.2	System Description	9.3-1
9.3.1.3	Safety Evaluation	9.3-3
9.3.1.4	Tests and Inspections	9.3-4
9.3.1.5	Instrumentation Application	9.3-4
9.3.2	Process Sampling System	9.3-5
9.3.2.1	Design Bases	9.3-5
9.3.2.2	System Description	9.3-6
9.3.2.3	Safety Evaluation	9.3-11
9.3.2.4	Tests and Inspection	9.3-12
9.3.2.5	Instrumentation Applications	9.3-12
9.3.3	Floor and Equipment Drainage Systems	9.3-12
9.3.3.1	Design Bases	9.3-12
9.3.3.2	System Description	9.3-14
9.3.3.3	Safety Evaluation	9.3-18
9.3.3.4	Tests and Inspections	9.3-19
9.3.3.5	Instrumentation Application	9.3-19
9.3.4	Chemical and Volume Control System	9.3-19
9.3.5	Standby Liquid Control System	9.3-20
9.3.5.1	Design Bases	9.3-20
9.3.5.2	System Description	9.3-21
9.3.5.3	Safety Evaluation	9.3-24
9.3.5.4	Testing and Inspection Requirements	9.3-29
9.3.5.5	Instrumentation Requirements	9.3-30
9.3.6	Suppression Pool Cleanup System	9.3-30
9.3.6.1	Design Bases	9.3-30
9.3.6.2	System Description	9.3-31
9.3.6.3	Safety Evaluation	9.3-33

GRAND GULF NUCLEAR GENERATING STATION
Updated Final Safety Analysis Report (UFSAR)

TABLE OF CONTENTS

9.3.6.4	Tests and Inspections	9.3-33
9.3.6.5	Instrumentation Requirements	9.3-34
9.4	HEATING, VENTILATION, AND AIR CONDITIONING SYSTEMS	
9.4.1	Control Room HVAC System	9.4-1
9.4.1.1	Design Bases	9.4-1
9.4.1.2	System Description	9.4-3
9.4.1.3	Safety Evaluation	9.4-4
9.4.1.4	Inspection and Testing Requirements	9.4-5
9.4.1.5	Instrumentation Application	9.4-6
9.4.2	Fuel-Handling Area Ventilation System	9.4-7
9.4.2.1	Design Bases	9.4-7
9.4.2.2	System Description	9.4-8
9.4.2.3	Safety Evaluation	9.4-12
9.4.2.4	Tests and Inspections	9.4-13
9.4.2.5	Instrumentation Application	9.4-13
9.4.3	Radwaste Building Ventilation System	9.4-14
9.4.3.1	Design Bases	9.4-14
9.4.3.2	System Description	9.4-15
9.4.3.3	Safety Evaluation	9.4-16
9.4.3.4	Tests and Inspections	9.4-16
9.4.3.5	Instrumentation Application	9.4-17
9.4.4	Turbine Building Ventilation System	9.4-17
9.4.4.1	Design Bases	9.4-17
9.4.4.2	System Description	9.4-18
9.4.4.3	Safety Evaluation	9.4-20
9.4.4.4	Tests and Inspections	9.4-20
9.4.4.5	Instrumentation Application	9.4-20
9.4.5	Miscellaneous Safety-Related Ventilation and Cooling Systems	9.4-21
9.4.5.1	Design Bases	9.4-22
9.4.5.2	System Description	9.4-23
9.4.5.3	Safety Evaluation	9.4-26

GRAND GULF NUCLEAR GENERATING STATION
Updated Final Safety Analysis Report (UFSAR)

TABLE OF CONTENTS

9.4.5.4	Tests and Inspections	9.4-27
9.4.5.5	Instrumentation Application	9.4-27
9.4.6	Auxiliary Building Ventilation System	9.4-31
9.4.6.1	Design Bases	9.4-31
9.4.6.2	System Description	9.4-32
9.4.6.3	Safety Evaluation	9.4-33
9.4.6.4	Tests and Inspections	9.4-34
9.4.6.5	Instrumentation Application	9.4-34
9.4.7	Containment Cooling System	9.4-35
9.4.7.1	Design Bases	9.4-35
9.4.7.2	System Description	9.4-36
9.4.7.3	Safety Evaluation	9.4-42
9.4.7.4	Tests and Inspections	9.4-43
9.4.7.5	Instrumentation Application	9.4-43
9.4.8	Drywell Cooling System	9.4-44
9.4.8.1	Power Generation Design Bases	9.4-44
9.4.8.2	System Description	9.4-45
9.4.8.3	Safety Evaluation	9.4-47
9.4.8.4	Inspection and Testing	9.4-48
9.4.8.5	Instrumentation Application	9.4-48
9.4.9	Miscellaneous Buildings Nonsafety-Related Ventilation Systems	9.4-49
9.4.9.1	Design Bases	9.4-49
9.4.9.2	System Description	9.4-51
9.4.9.3	Safety Evaluation	9.4-53
9.4.9.4	Tests and Inspections	9.4-53
9.4.9.5	Instrumentation Application	9.4-54
9.4.10	Control Building Ventilation System	9.4-54
9.4.10.1	Power Generation Design Bases	9.4-55
9.4.10.2	System Description	9.4-56
9.4.10.3	Safety Evaluation	9.4-58
9.4.10.4	Tests and Inspections	9.4-58

GRAND GULF NUCLEAR GENERATING STATION
Updated Final Safety Analysis Report (UFSAR)

TABLE OF CONTENTS

9.4.10.5	Instrumentation Application	9.4-58
9.5	OTHER AUXILIARY SYSTEMS	9.5-1
9.5.1	Fire Protection System	9.5-1
9.5.1.1	Design Bases	9.5-1
9.5.1.2	System Description	9.5-3
9.5.1.3	Safety Evaluation	9.5-16
9.5.1.4	Inspection and Testing Requirements	9.5-19
9.5.1.5	Personnel Qualification and Training	9.5-19
9.5.1.6	Equipment Operability	9.5-19
9.5.2	Communications Systems	9.5-21
9.5.2.1	Design Bases	9.5-21
9.5.2.2	System Description	9.5-22
9.5.2.3	Inspection and Testing	9.5-25
9.5.3	Lighting Systems	9.5-25
9.5.3.1	Design Bases	9.5-25
9.5.3.2	System Description	9.5-26
9.5.3.3	Safety Evaluation	9.5-27
9.5.3.4	Tests and Inspections	9.5-28
9.5.4	Diesel Generator Fuel Oil System	9.5-28
9.5.4.1	Design Bases	9.5-28
9.5.4.2	Description	9.5-29
9.5.4.3	Safety Evaluation	9.5-32
9.5.4.4	Tests and Inspections	9.5-36
9.5.4.5	Instrumentation Application	9.5-36
9.5.5	Diesel Generator Cooling Water System	9.5-37
9.5.5.1	Safety Design Bases	9.5-37
9.5.5.2	System Description	9.5-37
9.5.5.3	Safety Evaluation	9.5-39
9.5.5.4	Tests and Inspections	9.5-41
9.5.5.5	Instrumentation Application	9.5-41

GRAND GULF NUCLEAR GENERATING STATION
Updated Final Safety Analysis Report (UFSAR)

TABLE OF CONTENTS

9.5.6	Diesel Generator Starting System	9.5-42
9.5.6.1	Design Bases	9.5-42
9.5.6.2	System Description	9.5-42
9.5.6.3	Safety Evaluation	9.5-47
9.5.6.4	Tests and Inspections	9.5-50
9.5.6.5	Instrumentation Application	9.5-50
9.5.7	Diesel Engine Lubrication System	9.5-50
9.5.7.1	Safety Design Bases	9.5-50
9.5.7.2	System Description	9.5-51
9.5.7.3	Safety Evaluation	9.5-54
9.5.7.4	Tests and Inspections	9.5-54
9.5.7.5	Instrumentation Application	9.5-55
9.5.8	Diesel Generator Combustion Air Intake and Exhaust System	9.5-55
9.5.8.1	Design Bases	9.5-55
9.5.8.2	System Description	9.5-56
9.5.8.3	Safety Evaluation	9.5-56
9.5.8.4	Tests and Inspections	9.5-59
9.5.8.5	Instrumentation Application	9.5-59
9.5.9	Auxiliary Steam System	9.5-59
9.5.9.1	Design Bases	9.5-59
9.5.9.2	System Description	9.5-59
9.5.9.3	Safety Evaluation	9.5-60
9.5.10	Hydrogen Water Chemistry System	9.5-60
9.5.10.1	Design Basis	9.5-60
9.5.10.2	System Description	9.5-61
9.5.10.3	Safety Evaluation	9.5-63
9.5.10.4	Tests and Inspections	9.5-66
9.5.10.5	Instrument Application	9.5-66
9.5.11	Referemces	9.5-67

GRAND GULF NUCLEAR GENERATING STATION
Updated Final Safety Analysis Report (UFSAR)

TABLE OF CONTENTS

APPENDIX 9A	FIRE HAZARD ANALYSIS REPORT	9A-1
APPENDIX 9B	FIRE PROTECTION PROGRAM	
9B.1	Scope and Applicability	9B-1
9B.2	Organizations and Responsibilities	9B-2
9B.2.1	Organizations and Responsibilities	9B-2
9B.2.1.1	Corporate Management	9B-2
9B.2.1.2	Deleted	9B-2
9B.2.1.3	Director, Nuclear Safety Assurance	9B-2
9B.2.1.4	Director, Engineering	9B-2
9B.2.1.5	Plant Fire Chief (Fire Protection Coordinator) ...	9B-3
9B.2.1.6	Manager, Quality Assurance	9B-3
9B.2.1.7	Fire Departments	9B-3
9B.2.1.8	General Manager, Plant Operations	9B-3
9B.2.1.9	Shift Fire Chief (Shift Manager)	9B-4
9B.2.1.10	Fire Brigade	9B-4
9B.2.1.11	Manager, Training & Development	9B-4
9B.2.1.12	Manager, Maintenance	9B-5
9B.2.1.13	Maintenance Discipline Superintendents	9B-5
9B.2.1.14	Administrative Services Superintendent	9B-5
9B.2.2	Deleted	9B-5
9B.3	Qualifications of Personnel	9B-5
9B.4	Fire Protection Evaluation	9B-6
9B.5	Program Implementation	9B-6
9B.6	Administrative Controls	9B-7

GRAND GULF NUCLEAR GENERATING STATION
Updated Final Safety Analysis Report (UFSAR)

TABLE OF CONTENTS

9B.7	Fire Brigade	9B-9
9B.7.1	Fire Brigade Personnel	9B-9
9B.7.2	Fire Brigade Equipment	9B-10
9B.8	Training	9B-10
9B.8.1	Instructions for Members of the Fire Brigade	9B-10
9B.8.2	Practice for Fire Brigades	9B-11
9B.8.3	Instruction for All Station Employees	9B-12
9B.8.4	Special Fire Protection Training	9B-12
9B.8.5	Program Administration	9B-12
9B.9	Fire Brigade Drills and Practices	9B-12
9B.9.1	Types of Fire Brigade Drills and Practices	9B-12
9B.9.2	Guidelines for Fire Brigade Drills and Practices	9B-13
9B.10	Quality Assurance	9B-14
9B.11	Systems	9B-15
9B.12	Fire Hazards Analysis	9B-15
9B.13	Analysis of Safe Shutdown in the Event of a Major Fire	9B-15
APPENDIX 9C	ANALYSIS OF SAFE SHUTDOWN IN THE EVENT OF A MAJOR FIRE	
9C.1	Identification of Causes and Frequency Classification	9C-1
9C.1.1	Identification of Causes	9C-1
9C.1.2	Frequency Classification	9C-1
9C.2	Sequence of Events and System Operation	9C-1
9C.2.1	Identification of Operator Actions	9C-1

GRAND GULF NUCLEAR GENERATING STATION
Updated Final Safety Analysis Report (UFSAR)

TABLE OF CONTENTS

9C.2.2	Systems Operation	9C-2
9C.2.3	The Effect of Single Failures and Operator Errors	9C-2
9C.3	Core and System Performance	9C-3
9C.3.1	Mathematical Model	9C-3
9C.3.2	Input Parameters and Initial Conditions	9C-3
9C.3.3	Results	9C-4
9C.3.4	Assumptions	9C-4
9C.4	Barrier Performance	9C-5
9C.5	Conformance with 10CFR50 Appendix R Performance Criteria	9C-5
9C.6	References	9C-8
APPENDIX 9D	GGNS COMPLIANCE WITH NUREG-0612, "CONTROL OF HEAVY LOADS AT NUCLEAR POWER PLANTS"	
9D.1	Scope of NUREG-0612	9D-1
9D.2	Initial Compliance	9D-2
9D.2.1	GGNS Submittals for Phase I & II	9D-2
9D.2.2	NRC Response to GGNS Submittals	9D-3
9D.2.3	Summary of GGNS Phase I Actions	9D-3
9D.3	Continuing Compliance	9D-7
9D.3.1	Containment Hatchway Crane Evaluation	9D-7
9D.4	References	9D-9

GRAND GULF NUCLEAR GENERATING STATION
Updated Final Safety Analysis Report (UFSAR)

LIST OF TABLES

Table 9.1-1	Tools and Servicing Equipment (2 Sheets)
Table 9.1-2	Fuel Servicing Equipment
Table 9.1-3	Reactor Vessel Servicing Equipment
Table 9.1-4	Under-Reactor Vessel Servicing Equipment and Tools
Table 9.1-5	Cask Handling Passive Failure Analysis
Table 9.1-6	Cask Handling Active Failure Analysis
Table 9.1-7	Containment Polar Crane Load Drop (2 Sheets)
Table 9.1-8	Deleted
Table 9.1-9	Deleted
Table 9.1-10	Fuel Loading Cycles
Table 9.1-11	Unit 1 High Density Spent Fuel Storage Module Data
Table 9.1-12	Maximum Fuel Pool Heat Load
Table 9.1-13	Deleted
Table 9.2-1	Standby Service Water System Passive Failure Analysis
Table 9.2-2	Standby Service Water System Active Failure Analysis
Table 9.2-3	Standby Service Water System (2 Sheets)
Table 9.2-4	Standby Service Water System Component Description (2 Sheets)
Table 9.2-5	Deleted
Table 9.2-5a	Standby Service Water Cooling Towers Grand Gulf Nuclear Station Worst One Day Analysis Alternate Shutdown Cooling
Table 9.2-5b	Standby Service Water Cooling Towers Grand Gulf Nuclear Station Worst One Day Analysis Recirculation Line Break
Table 9.2-6	Deleted
Table 9.2-6a	Standby Service Water Cooling Towers Grand Gulf Nuclear Station Analysis Based on Maximum 30-day Average Wet Bulb

GRAND GULF NUCLEAR GENERATING STATION
Updated Final Safety Analysis Report (UFSAR)

LIST OF TABLES

	(2 Sheets)
Table 9.2-6b	Standby Service Water Cooling Towers Grand Gulf Nuclear Station Analysis Based on Maximum 30-day Average Wet Bulb (2 Sheets)
Table 9.2-7	Component Cooling Water System Component Description
Table 9.2-8	Makeup Water Treatment System Component Description (5 Sheets)
Table 9.2-9	Domestic Water System and Sanitary Waste Water System Component Description
Table 9.2-10	Condensate and Refueling Water Storage and Transfer Facility Component Description
Table 9.2-11	Plant Chilled Water System Component Description (3 Sheets)
Table 9.2-12	Turbine Building Cooling Water System Component Description
Table 9.2-13	Deleted
Table 9.2-14	Deleted
Table 9.2-15	Deleted
Table 9.2-15A	Total Integrated Heat Rejected from Basin A
Table 9.2-15B	Total Integrated Heat Rejected from Basins
Table 9.2-16	Unit 1 - Standby Service Water System Cooling Duty Loads Following a DBA (LOCA with Loss of Offsite Power and Failure of Standby Diesel Generator B) (4 Sheets)
Table 9.2-16A	Unit 1 - Standby Service Water System Cooling Duty Loads Following a DBA (LOCA with Loss of Offsite Power)
Table 9.2-17	Unit 1 - Time Dependent Standby Service Water System Cooling Duty Loads Following a DBA (LOCA with Loss of Offsite Power and Single Active Failure) (2 Sheets)
Table 9.2-17A	Unit 1 - Time Dependent Standby Service Water System Cooling Duty Loads Following a DBA (LOCA with Loss of Offsite Power and Single Active Failure) (2 Sheets)

GRAND GULF NUCLEAR GENERATING STATION
Updated Final Safety Analysis Report (UFSAR)

LIST OF TABLES

Table 9.2-18	Deleted
Table 9.2-19	Deleted
Table 9.2-20	Deleted
Table 9.2-21	Deleted
Table 9.2-22	Drywell Chilled Water System Component Description
Table 9.3-1	Pneumatically Operated Valves Which Have a Safety Function (4 Sheets)
Table 9.3-2	Single Failure Analysis of Components Which Perform a Safety Function and are Served by Compressed Air System (8 Sheets)
Table 9.3-3	List of Sampling Points (9 Sheets)
Table 9.3-4	Standby Liquid Control System Operating Pressure/Temperature Conditions (2 Sheets)
Table 9.4-1	Control Room Heating, Ventilating, and Air-Conditioning System Component Description (3 Sheets)
Table 9.4-2	Control Room Heating, Ventilating, and Air-Conditioning System Failure Analysis
Table 9.4-3	Fuel-Handling-Area Ventilation System Component Descriptions (3 Sheets)
Table 9.4-4	Radwaste Building Ventilation/Air-Conditioning System (6 Sheets)
Table 9.4-5	Radwaste Building Ventilation System Failure Analysis
Table 9.4-6	Turbine Building Ventilation System (2 Sheets)
Table 9.4-7	Miscellaneous Safety-Related Ventilation and Cooling System Component Description (6 Sheets)
Table 9.4-8	Miscellaneous Safety-Related Ventilation and Cooling Systems Failure Analysis (4 Sheets)
Table 9.4-9	Auxiliary Building HVAC System Component Descriptions (3 Sheets)
Table 9.4-10	Containment Ventilating, Cooling, and Purge System Component Description (8 Sheets)
Table 9.4-11	Drywell Cooling System Component Description

GRAND GULF NUCLEAR GENERATING STATION
Updated Final Safety Analysis Report (UFSAR)

LIST OF TABLES

Table 9.4-12	Miscellaneous Buildings Ventilation Systems Component Description (6 Sheets)
Table 9.4-13	Control Building HVAC Systems Component Description (5 Sheets)
Table 9.4-14	Comparison of Normal Ventilation Filter Trains to Branch Technical Position ETSB No. 11-2, "Design, Testing and Maintenance Criteria for Normal Ventilation Exhaust System Air Filtration and Adsorption Units of Light-Water-Cooled Nuclear Power Reactor Plants" (9 Sheets)
Table 9.5-1	Diesel Generator Fuel Oil System Component Data (2 Sheets)
Table 9.5-2	Failure Analysis of Diesel Generator Fuel Oil System (2 Sheets)
Table 9.5-3	Diesel Generator Cooling Water System Component Data (3 Sheets)
Table 9.5-4	Component and System Heat Rejection Rates
Table 9.5-5	Diesel Generators Starting Air Systems Components (2 Sheets)
Table 9.5-6	Diesel Generators Lubrication System Components (3 Sheets)
Table 9.5-7	Diesel Generators Combustion Air Intake and Exhaust System Components (2 Sheets)
Table 9.5-8	Failure Analysis for Standby Diesel Generator Cooling Water System
Table 9.5-9	Failure Analysis for Standby Diesel Generator Starting Air System
Table 9.5-10	Failure Analysis for Diesel Generator Lubrication System (2 Sheets)
Table 9.5-11	Fire Protection Program Comparison with NRC Requirements (32 Sheets)
Table 9.5-12	Fire Protection Program Comparison with Appendix R to 10 CFR 50 (8 Sheets)
Table 9.5-13	Standby Diesel Generator Fuel Oil Drip Return Piping
Table 9.5-14	Working Stations Communication Systems (6 Sheets)

GRAND GULF NUCLEAR GENERATING STATION
Updated Final Safety Analysis Report (UFSAR)

LIST OF TABLES

Table 9.5-15	Lighting System Tabulation (2 Sheets)
Table 9.5-16	Deleted
Table 9.5-17	Hydrogen Water Chemistry System Malfunctions/ Effects (3 Sheets)
Table 9C-1	Sequence of Events for Safe Shutdown in the Event of a Major Fire (Initial Core Analysis)

GRAND GULF NUCLEAR GENERATING STATION
Updated Final Safety Analysis Report (UFSAR)

LIST OF FIGURES

Figure 9.1-1	New Fuel Storage
Figure 9.1-2	Top View High Density Fuel Rack - Unit 1
Figure 9.1-2a	High Density Fuel Rack Array of Cells(4x4) - Unit 1
Figure 9.1-2b	High Density Spent Fuel Rack Cruciform Element - Unit 1
Figure 9.1-2c	High Density Fuel Rack Typical Cell Elevation - Unit 1
Figure 9.1-2d	Typical High Density Spent Fuel Rack - Unit 1
Figure 9.1-2e	Control Rod Storage Rack
Figure 9.1-3	Eccentric Fuel Positioning
Figure 9.1-4	Fuel Stored in Control Rod Racks
Figure 9.1-5	Deleted
Figure 9.1-6	Fuel Preparation Machine Shown Installed in Facsimile Fuel Pool
Figure 9.1-7	New Fuel Inspection Stand
Figure 9.1-8	Channel Bolt Wrench
Figure 9.1-9	Channel Handling Tool
Figure 9.1-10	Fuel Pool Sipper
Figure 9.1-11	Channel Gauging Fixture
Figure 9.1-12	General Purpose Grapple
Figure 9.1-13	Deleted
Figure 9.1-14	Channel Handling Boom
Figure 9.1-15	Transfer Tube
Figure 9.1-16	Plant Refueling and Servicing Sequence
Figure 9.1-17	Fuel Transfer
Figure 9.1-18	Drywell Head Removal Sequence GE Standard Plant
Figure 9.1-19	Reactor Vessel Head Removal Sequence GE Standard Plant
Figure 9.1-20	Steam Dryer Removal Sequence GE Standard Plant
Figure 9.1-21	Steam Separator Removal Sequence GE Standard

GRAND GULF NUCLEAR GENERATING STATION
Updated Final Safety Analysis Report (UFSAR)

LIST OF FIGURES

	Plant
Figure 9.1-22	Fuel Bundle Transfer Sequence GE Standard Plant
Figure 9.1-23	Fuel Bundle Laydown Areas (GE Standard Plant)
Figure 9.1-24	Containment Building Laydown Areas (GE Standard Plant)
Figure 9.1-25	Spent Fuel Cask
Figure 9.1-26	Fuel Pool Cooling and Cleanup System (2 Sheets)
Figure 9.1-27	Fuel Pool Cooling and Cleanup System
Figure 9.1-28	Filter Demineralizer System
Figure 9.1-29	System Flow Diagram Filter/Demineralizer System (F.P.C. & C.U.) Unit 1
Figure 9.1-30	System Flow Diagram Fuel Pool Cooling and Cleanup System Unit 1
Figure 9.1-31	Vessel Outline
Figure 9.1-32	Outline Head Strongback Carousel Reactor Vessel Servicing Equip.
Figure 9.1-33	Containment Upper Containment Pool Gates Sections and Details Unit 1
Figure 9.1-34	Outline Steam Dryer Standard Plant
Figure 9.1-35	Outline Shroud Head and Separators Standard Plant
Figure 9.1-36	Outline Dryer and Separator Strongback R Factor Vessel Service Equip.
Figure 9.1-37	Study, Portable Radiation Shield
Figure 9.1-38	Spent Fuel Pool Liner Plate Details
Figure 9.1-39	Reactor Vessel Top Head General Arrangement
Figure 9.1-40	Deleted
Figure 9.1-40a	High-Density Spent Fuel Racks Arrangement Unit 1
Figure 9.1-41	Deleted
Figure 9.1-42	Deleted
Figure 9.2-1	Standby Service Water System

GRAND GULF NUCLEAR GENERATING STATION
Updated Final Safety Analysis Report (UFSAR)

LIST OF FIGURES

Figure 9.2-2	Standby Service Water System
Figure 9.2-3	Standby Service Water System
Figure 9.2-4	Standby Service Water System
Figure 9.2-5	Deleted
Figure 9.2-6	Deleted
Figure 9.2-6A	Total Heat Rejection Rate Basin A (Loop A and Loop C) Time Period - 0 to 30 Days
Figure 9.2-6B	Total Heat Rejection Rate Basin A (SSW Loop A and HPCS SW Loop C) Basin B (SSW Loop B) Time Period - 0 to 30 Days
Figure 9.2-7	Deleted
Figure 9.2-7A	Standby Service Water Cooling Towers, Worst One-Day Performance Alternate Shutdown Cooling
Figure 9.2-7B	Standby Service Water Cooling Towers, Worst One-Day Performance Alternate Recirculation Line Break
Figure 9.2-8	Deleted
Figure 9.2-8A	Standby Service Water Cooling Towers, Worst 30-Days Performance SSW - Loop A and HPCS SW - Loop C
Figure 9.2-8B	Standby Service Water Cooling Towers, Worst 30-Days Performance SSW - Loops A & B and HPCS SW - Loop C Operating
Figure 9.2-9	Component Cooling Water System
Figure 9.2-10	Component Cooling Water System
Figure 9.2-11	Make Up Water Treatment System
Figure 9.2-12	Makeup Water Treatment System
Figure 9.2-13	Domestic Water System
Figure 9.2-14	Domestic Water System
Figure 9.2-15	Unit 1 Control Bldg Sump and Sewage Lift Station
Figure 9.2-16	Condensate and Refueling Water Storage, Transfer System
Figure 9.2-17	Plant Chilled Water System, Part I
Figure 9.2-18	Plant Chilled Water System

GRAND GULF NUCLEAR GENERATING STATION
Updated Final Safety Analysis Report (UFSAR)

LIST OF FIGURES

Figure 9.2-19	Plant Chilled Water System
Figure 9.2-20	Plant Chilled Water System
Figure 9.2-21	Plant Chilled Water System
Figure 9.2-21a	Plant Chilled Water System
Figure 9.2-22	Plant Service Water System
Figure 9.2-23	Plant Service Water System (2 Sheets)
Figure 9.2-23a	Plant Service Water System, Unit 1
Figure 9.2-23b	Plant Service Water System, Part 4
Figure 9.2-23c	P&I Diagram Plant Service Water System, Unit 1
Figure 9.2-24	Turbine Bldg. Cooling Water System
Figure 9.2-25	Turbine Bldg. Cooling Water System
Figure 9.2-26	Turbine Building Cooling Water System
Figure 9.2-26a	Turbine Building Cooling Water System, Unit 1
Figure 9.2-27	Plant Service Water Radial Well System (3 Sheets)
Figure 9.2-28	Deleted
Figure 9.2-29	Deleted
Figure 9.2-30	Deleted
Figure 9.2-31	Deleted
Figure 9.2-32	Deleted
Figure 9.2-33	Deleted
Figure 9.2-34	Deleted
Figure 9.2-35	Heat Rejection Rate for Unit 1 Loop C Time Period - 0 to 20 Hours
Figure 9.2-36	Deleted
Figure 9.2-37	Deleted
Figure 9.2-37A	Total Integrated Heat Rejected Basin A - Loop A and Loop C Time Period - 0 to 30 Days
Figure 9.2-37B	Total Integrated Heat Rejected Basin A - Loop A and Loop C Basin B - Loop B Time Period - 0 to 30 Days

GRAND GULF NUCLEAR GENERATING STATION
Updated Final Safety Analysis Report (UFSAR)

LIST OF FIGURES

Figure 9.2-38	Deleted
Figure 9.2-39	Deleted
Figure 9.2-40	Heat Rejection Rate Unit 1 Loop B Station Auxiliary Loads Time Period - 0 to 30 Days
Figure 9.2-41	Deleted
Figure 9.2-42	Heat Rejection Rate Unit 1 Loop B RHR Heat Exchanger Time Period - 0 to 30 Days
Figure 9.2-43	Total Integrated Heat Rejected by RHR Heat Exchangers (Per Unit) for Post-LOCA Shutdown Only
Figure 9.2-44	Deleted
Figure 9.2-45	Deleted
Figure 9.2-46	Deleted
Figure 9.2-47	Simplified SSW System Schematic
Figure 9.2-48	Drywell Chilled Water System Unit 1
Figure 9.2-49	Drywell Chilled Water System
Figure 9.2-50	P&I Diagram Drywell Chilled Water System
Figure 9.3-1	Instrument Air System
Figure 9.3-2	Instrument Air System
Figure 9.3-2a	Deleted
Figure 9.3-2b	Instrument Air System
Figure 9.3-2c	P&I Diagram Instrument Air System Auxiliary Building - Unit 1
Figure 9.3-2D	P&ID Diagram Instrument Air System Turbine Building - Unit 1
Figure 9.3-2e	P&I Diagram Instrument Air System Turbine Building Unit 1
Figure 9.3.2f	P&I Diagram Instrument Air System Unit 1
Figure 9.3-2g	Instrument Air System
Figure 9.3-2h	Instrument Air System
Figure 9.3-3	Service Air System (3 Sheets)
Figure 9.3-4	Service Air System

GRAND GULF NUCLEAR GENERATING STATION
Updated Final Safety Analysis Report (UFSAR)

LIST OF FIGURES

Figure 9.3-5	Process Sampling System
Figure 9.3-6	Process Sampling System
Figure 9.3-7	Process Sampling System
Figure 9.3-7a	Process Sampling System
Figure 9.3-8	Deleted
Figure 9.3-8a	Process Sampling System Part 4
Figure 9.3-9	Floor and Equipment Drains System
Figure 9.3-10	Floor and Equipment Drains System
Figure 9.3-11	Floor and Equipment Drains System
Figure 9.3-12	Floor and Equipment Drains System
Figure 9.3-13	Embedded and Suspended Drains Radwaste Building
Figure 9.3-14	Embedded and Suspended Drains Radwaste Building
Figure 9.3-14a	Embedded and Suspended Dr. Radwaste Pipe Tunnel and Waste Treatment Building Units 1 and 2
Figure 9.3-15	Embedded and Suspended Floor Drains, Aux. Bldg.
Figure 9.3-16	Embedded and Suspended Floor Drains, Auxiliary Building
Figure 9.3-17	Embedded and Suspended Floor Drains, Turbine Bldg.
Figure 9.3-18	Embedded and Suspended Floor Drains, Turbine Bldg.
Figure 9.3-19	Embedded and Suspended Floor Drains, Turbine and Ctmt Bldg
Figure 9.3-20	Embedded and Suspended Floor Drains, Turbine and Ctmt Bldg.
Figure 9.3-21	Embedded and Suspended Floor Drains, Ctmt Bldg and Drywell
Figure 9.3-22	Embedded and Suspended Floor Drains, Ctmt Bldg and Drywell
Figure 9.3-23	Suppression Pool Cleanup System
Figure 9.3-24	Standby Liquid Control System
Figure 9.3-25	System Flow Diagram Standby Liquid Control

GRAND GULF NUCLEAR GENERATING STATION
Updated Final Safety Analysis Report (UFSAR)

LIST OF FIGURES

	System
Figure 9.3-26	Sodium Pentaborate (NaBO 16*10HO) Volume-Concentration Requirements
Figure 9.3-27	Saturation Temperature of Sodium Pentaborate Solution
Figure 9.3-28	System Flow Diagram Floor and Equipment Drains System Unit 1
Figure 9.3-29	System Flow Diagram Floor & Equipment Drains System Unit 1
Figure 9.3-30	Normal Natural Circulation
Figure 9.3-31	Plant Air System
Figure 9.3-32	Plant Air System
Figure 9.4-1	Control Room HVAC System
Figure 9.4-2	Fuel Handling Area Ventilation System
Figure 9.4-3	Fuel Handling Area Ventilation System, Part 2
Figure 9.4-4	Radwaste Building Ventilation System, Part 1
Figure 9.4-5	Radwaste Building Ventilation System
Figure 9.4-5b	Radwaste Building Ventilation System
Figure 9.4-6	P&I Diagram Turbine Building Ventilation System, Unit 1
Figure 9.4-7	Turbine Bldg. Ventilation System
Figure 9.4-7a	Turbine Bldg. Ventilation System, Unit 1
Figure 9.4-8	Deleted
Figure 9.4-8a	Safeguard Switchgear and Battery Rooms Ventilation System
Figure 9.4-8b	Safeguard Swgr. and Battery Rooms Ventilation System - Unit 1
Figure 9.4-9	Deleted
Figure 9.4-9a	Diesel Generator, ECCS, ESF, Electrical Swgr, SSW, and Circ. Water Pumphouse Ventilation System
Figure 9.4-9b	Diesel Generator, ECCS, ESF, Electrical Switchgear, SSW, and Cir. Water Pump House Ventilation System
Figure 9.4-10	Auxiliary Bldg. Ventilation System

GRAND GULF NUCLEAR GENERATING STATION
Updated Final Safety Analysis Report (UFSAR)

LIST OF FIGURES

Figure 9.4-11	Containment Cooling System
Figure 9.4-12	Containment Cooling System
Figure 9.4-13	Drywell Cooling System
Figure 9.4-14	Miscellaneous Building Ventilation System
Figure 9.4-15	Miscellaneous Building Ventilation System
Figure 9.4-15a	Miscellaneous Building Ventilation System
Figure 9.4-16	Deleted
Figure 9.4-16a	Control Building HVAC System
Figure 9.4-16b	P&I Diagram Control Building HVAC System
Figure 9.4-16c	Hot Machine Shop HVAC System
Figure 9.5-1	Fire Protection System, Unit 1
Figure 9.5-2	Fire Protection System, Part 2
Figure 9.5-3	Deleted
Figure 9.5-4	Fire Protection System
Figure 9.5-5	Fire Protection System
Figure 9.5-6	Fire Protection System
Figure 9.5-7	Fire Protection System
Figure 9.5-8	Fire Protection System Part 8
Figure 9.5-8a	Fire Protection System
Figure 9.5-8b	P&I Diagram Fire Protection System
Figure 9.5-8c	P&I Diagram Fire Protection System
Figure 9.5-8d	Deleted
Figure 9.5-8e	P&I Diagram Fire Protection System, Units 1 & 2
Figure 9.5-9	Deleted
Figure 9.5-9a	Deleted
Figure 9.5-9b	Public Address System, Sound Power Telephone and Warning Light Diagram El 93' - 0" & El 103' - 0"
Figure 9.5-9c	Public Address System, Sound Power Telephone and Warning Light Diagram El 133' - 0", 113' - 0", 118' - 0" and Partial Plan El 111' - 0"
Figure 9.5-9D	Public Address System, Sound Power Telephone

GRAND GULF NUCLEAR GENERATING STATION
Updated Final Safety Analysis Report (UFSAR)

LIST OF FIGURES

	and Warning Light Diagram El 133' - 0", 136' - 0", 139' - 0", 13' - 4" and Partial Plan El 148' - 0"	
Figure 9.5-9E	Public Address System, Sound Power Telephone and Warning Light Diagram El 166' - 0", 161' - 0", Partial Plans El 166' - 0" & El 177' - 0"	
Figure 9.5-9f	Public Address System, Sound Power Telephone and Warning Light Diagram El 185' - 0", 189' - 0" and Partial Plan El 208' - 10"	
Figure 9.5-9g	Public Address System, Sound Power Telephone and Warning Light Diagram Site Plan	
Figure 9.5-9h	Public Address System Administration Building	
Figure 9.5-9i	Public Address System, Sound Power Telephone and Warning Light Diagram El 93' - 0" & El 103' - 0"	
Figure 9.5-10	Deleted	
Figure 9.5-11	Standby Diesel Generator System	
Figure 9.5.11a	Standby Diesel Generator System	
Figure 9.5-12	Standby Diesel Generator System	
Figure 9.5.12a	Standby Diesel Generator System Part 2	
Figure 9.5-13	HPCS Diesel Generator System	
Figure 9.5-13a	HPCS Diesel Generator System	
Figure 9.5-13b	HPCS Diesel Generator System	
Figure 9.5-14	HPCS Fuel Oil System	
Figure 9.5-15	HPCS Jacket Cooling Water System	
Figure 9.5-16	HPCS Air Start System	
Figure 9.5-17	HPCS Air Start System	
Figure 9.5-18	HPCS Lubrication System	
Figure 9.5-19	Deleted	
Figure 9.5-20	Auxiliary Steam System (2 Sheets)	
Figure 9.5-20a	P&I Diagram Auxiliary Steam System Units 1 and 2	
Figure 9.5-21	Diesel Generator Building	
Figure 9.5-22	Diesel Generator Building Roof	

GRAND GULF NUCLEAR GENERATING STATION
Updated Final Safety Analysis Report (UFSAR)

LIST OF FIGURES

Figure 9.5-23	Diesel Generator Fuel Oil System Plan View
Figure 9.5-24	Diesel Generator Fuel Oil System Section View
Figure 9.5-25	Reactor Recirculation Pump Motor Assembly
Figure 9.5-26	Reactor Recirculation Pump Motor Assembly
Figure 9.5-27	Typical Sprinkler Arrangement for Systems Covering Redundant Safe Shutdown-Related Raceways
Figure 9.5-28	Square Concrete Test Specimen with Simulated Seismic Gaps
Figure 9B-1	Fire Protection Organization
Figure 9C-1	Safe Shutdown in the Event of a Major Fire (Initial Core Analysis)

GRAND GULF NUCLEAR GENERATING STATION
Updated Final Safety Analysis Report (UFSAR)

CHAPTER 9.0 AUXILIARY SYSTEMS

9.1 FUEL STORAGE AND HANDLING

9.1.1 New Fuel Storage

9.1.1.1 Design Bases

9.1.1.1.1 Safety Design Bases

9.1.1.1.1.1 Safety Design Bases - Structural

- a. The new fuel storage racks containing a full complement of fuel assemblies are designed to withstand all credible static and dynamic loadings to prevent damage to the structure of the racks, and therefore the contained fuel, and to minimize distortion of the racks arrangement (see Table 3.9-2(s)).
- b. The racks are designed to protect the fuel assemblies from excessive physical damage which may mitigate the release of radioactive materials in excess of 10 CFR 20 requirements under normal or abnormal conditions.
- c. The racks are constructed in accordance with the Quality Assurance Requirements of 10 CFR 50, Appendix B.
- d. The new fuel storage racks are categorized as safety Class 2 and seismic Category I.
- e. The building containing the new fuel storage vault (auxiliary building) is a seismic Category I structure and is designed to Regulatory Guides 1.13 and 1.29 which precludes any deleterious effects on fuel storage (fuel rack) integrity due to natural phenomena such as earthquakes, tornadoes, hurricanes, tornado missiles, and floods. The new fuel storage facility is designed in accordance with General Design Criteria 61, 62, and 63.

9.1.1.1.1.2 Safety Design Bases - Nuclear

- a. The new fuel storage racks are designed and maintained with sufficient spacing between the new fuel assemblies to assure that the array, when racks are fully loaded, shall be subcritical, by at least 5 percent Δk , including allowance for calculational biases and uncertainties. In

GRAND GULF NUCLEAR GENERATING STATION
Updated Final Safety Analysis Report (UFSAR)

the calculations performed to assure that $k_{\text{eff}} \leq 0.95$, the standard lattice methods* used at GEH are employed. Confirmatory analyses are performed for new fuel designs to demonstrate that the 0.95 acceptance criterion continues to be satisfied. Under conditions where diffusion theory is valid, it is used in calculations (i.e., conditions where the fuel is flooded with water at a density of between 0.7 and 1.0 g/cc).

GGNS submitted GEH topical report NEDC-33621P, "Grand Gulf Nuclear Station, Fuel Storage Criticality Safety Analysis of Spent and New Fuel Storage Racks". NEDC-33621P calculated an in-rack k_{eff} less than 0.9 for the new fuel storage, (Reference 30). This value meets the Tech Spec requirement that the k_{eff} of the new fuel storage racks, fully loaded with unborated water is not to exceed 0.95 including an allowance for uncertainties as described in UFSAR Section 9.1.1. NRC acceptance of the GGNS Criticality Safety Analysis is described in Reference 32, and Reference 33 is the final version of the approved analysis. Reference 34 performed a criticality safety analysis for the GNF3 fuel design, and Reference 31 showed that the Reference 33 analysis bounded the GNF3 fuel design.

It is assumed that the storage array is infinite in all directions. Since no credit is taken for leakage, the values reported as effective neutron multiplication factors are in reality infinite neutron multiplication factors.

The biases between the calculated results and experimental results as well as the uncertainty involved in the calculations are taken into account as part of the calculational procedure to assure that the specified k_{eff} limits are met.

9.1.1.1.2 Power Generation Design Bases

- a. New fuel storage racks are supplied for 38 percent of the full core fuel load.
- b. New fuel storage racks are designed and arranged so that the fuel assemblies can be handled efficiently during refueling operations.

GRAND GULF NUCLEAR GENERATING STATION
Updated Final Safety Analysis Report (UFSAR)

9.1.1.2 Facilities Description

The location of the new fuel storage facility within the station complex is shown in Figure 1.2-6. Each new storage rack (Figure 9.1-1) holds up to 10 channeled or unchanneled assemblies in a row.

*S. A. Richards (NRC) to G.A. Watford (GE), "Amendment 26 to GE Licensing Topical Report NEDE-24011-P-A, GESTAR II Implementing Improved GE Steady-State Methods," (TAC No. MA6481), November 10, 1999.

Fuel spacing (7 inches nominal center-to-center within a rack, 12 inches nominal center-to-center between adjacent racks) within the rack and from rack-to-rack limits the effective multiplication factor of the array (k_{eff}) to not more than 0.95. The fuel assemblies are loaded into the rack through the top. Each hole for a fuel assembly has adequate clearance for inserting or withdrawing the assembly, channeled or unchanneled. Sufficient guidance is provided to preclude damage to the fuel assemblies. The upper tie plate of the fuel element rests against the rack to provide lateral support. The design of the racks prevents accidental insertion of the fuel assembly in a position not intended for the fuel. This is achieved by abutting the sides of each casting to the adjacently installed casting. In this way, the only spaces in the assembly are those into which it is intended to insert fuel. The weight of the fuel assembly is supported by the lower tie plate which is seated in a chamfered hole in the base casting.

The floor of the new fuel storage vault is sloped to a drain located at the low point. This drain removes any water that may be accidentally and unknowingly introduced into the vault. The drain is part of the equipment drain subsystem of the liquid radwaste system.

The radiation monitoring equipment for the new fuel storage area is described in subsection 12.3.4.

9.1.1.3 Safety Evaluation

9.1.1.3.1 Criticality Control

The calculations of k_{eff} are based upon the geometrical arrangements of the fuel array and subcriticality does not depend upon the presence of neutron absorbing materials. The arrangement of fuel assemblies in the fuel storage racks results in k_{eff} below 0.95 in a dry condition or completely flooded with water which has a density of 1 g/cc. To meet the requirements of General Design Criterion 62, geometrically-safe configurations of fuel stored in the new fuel array are employed to assure that k_{eff} will not exceed 0.95 if fuel is stored in the dry condition or if the abnormal condition of flooding (water with a density of 1 g/cc) occurs. In the dry condition, k_{eff} is maintained ≤ 0.95 due to undermoderation. In the flooded condition, the geometry of the fuel storage array assures the k_{eff} will remain ≤ 0.95 due to overmoderation. Administrative controls are used to prohibit the introduction of sources of optimum moderation in the fuel storage areas and to ensure the use of solid noncombustible covers over the fuel whenever possible.

No limitation is placed on the size of the new fuel storage array from a criticality standpoint since all calculations are performed on an infinite basis. Confirmatory analyses are performed for new fuel designs to demonstrate that the 0.95 acceptance criterion continues to be satisfied.

9.1.1.3.2 New Fuel Rack Design

- a. The new fuel storage vault contains 30 sets of castings which may contain up to 10 fuel assemblies; therefore a maximum of 300 fuel assemblies may be stored in the fuel vault.
- b. There are three tiers of castings which are positioned by fixed box beams. This holds the fuel assemblies in a vertical position supported at the lower and upper tie plate with additional lateral support at the center of gravity of the fuel assembly.
- c. The lower casting supports the weight of the fuel assembly and restricts the lateral movement; the center and top casting restricts lateral movement only of the fuel assembly.

GRAND GULF NUCLEAR GENERATING STATION
Updated Final Safety Analysis Report (UFSAR)

- d. The new fuel storage racks are made from aluminum. Materials used for construction are specified in accordance with the latest issue of applicable ASTM specifications. The material choice is based on a consideration of the susceptibility of various metal combinations to electrochemical reaction. When considering the susceptibility of metals to galvanic corrosion, aluminum and stainless steel are relatively close together insofar as their coupled potential is concerned. The use of stainless steel fasteners in aluminum to avoid detrimental galvanic corrosion is a recommended practice and has been used successfully for many years by the aluminum industry.
- e. The minimum center-to-center spacing for the fuel assembly between rows is 11.875 inches. The minimum center-to-center spacing within the rows is 6.535 inches. Fuel assembly placement between rows is not possible.
- f. Lead-in and lead-out of the casting provides guidance of the fuel assembly during insertion or withdrawal.
- g. The rack is designed to withstand the impact force of 4000 ft-lbs while maintaining the safety design basis. This impact force could be generated by the vertical free fall of a fuel assembly from the height of 6 feet.
- h. The storage rack is designed to withstand the pull-up force of 4000 pounds and a horizontal force of 1000 pounds. The racks are designed with lead-outs to prevent sticking. However, in the event of a stuck fuel bundle, the Fuel Handling Platform main or auxiliary hoists jam cutoff or the New Fuel Bridge Crane hoist jam cutoff will preclude damage to the rack. There are no readily available horizontal forces in excess of 1,000 pounds.
- i. The storage rack is designed to withstand horizontal combined loads up to 222,000 lbs, well in excess of expected loads.
- j. The maximum stress in the fully loaded rack in a faulted condition is shown in Table 3.92(S). This is significantly lower than the allowable stress.

GRAND GULF NUCLEAR GENERATING STATION
Updated Final Safety Analysis Report (UFSAR)

- k. The fuel storage rack is designed to handle non-irradiated, low emission radioactive fuel assemblies. The expected radiation levels are well below the design levels.
- l. The fuel storage rack is designed using non-combustible materials. Plant procedures and inspections assure that combustible materials are restricted from this area. Fire prevention by elimination of combustible materials and fluids is regarded as the prudent approach rather than fire accommodation and the need for fire suppressant materials which could inhibit or negate criticality control assurances. Therefore, fire accommodation is not considered a problem.
- m. The fuel storage racks are provided protection from adverse environmental effects by proper design of the new fuel storage facility (see subsection 9.1.1.3.3).

9.1.1.3.3 Protection Features of Fuel Storage Facilities

The new fuel storage vault is provided with a removable cover to ensure a watertight facility. Subsection 9.1.1.1.1 discusses additional protection features for the new fuel storage facility.

9.1.2 Spent Fuel Pool Storage

9.1.2.1 Design Bases

9.1.2.1.1 Safety Design Bases

9.1.2.1.1.1 Safety Design Bases - Structural

- a. The Unit 1 spent fuel storage racks in the auxiliary building and containment are designed to withstand all credible static and dynamic loadings to prevent damage to the structure of the racks, and therefore the contained fuel, and to minimize distortion of the racks arrangement (see Table 3.9-2s). These loads are described in more detail in subsection 9.1.2.3.2.1.
- b. The racks are designed to protect the fuel assemblies from excessive physical damage which may mitigate the release of radioactive materials in excess of 10 CFR 20 requirements under normal or abnormal conditions.

GRAND GULF NUCLEAR GENERATING STATION
Updated Final Safety Analysis Report (UFSAR)

- c. The racks are constructed in accordance with the Quality Assurance Requirements of 10 CFR 50, Appendix B.
- d. The spent fuel storage racks are categorized as safety Class 2 and seismic Category I.
- e. The spent fuel pool storage facility is housed within a seismic Category I structure and is designed to Regulatory Guides 1.13 and 1.29.
- f. The spent fuel pool storage facility is designed in accordance with General Design Criteria 61, 62, and 63.

9.1.2.1.1.2 Safety Design Bases - Nuclear

The fuel array in the fully loaded spent fuel racks is designed to be subcritical by at least 5 percent Δk . Geometrically safe configurations of fuel stored in the spent fuel array are employed to assure that k_{eff} will not exceed 0.95 under all normal and abnormal storage conditions.

9.1.2.1.2 Power Generation Design Bases

- a. The Unit 1 spent fuel storage racks are designed with storage space sufficient for the following:
 - Upper Containment Pool - Approximately 89% of one full core fuel load
 - Spent Fuel Pool - 543% of one full core fuel load
- b. The shielding provided for spent fuel and the administrative controls on the placement of spent fuel are sufficient to assure that radiation levels noted in Section 12.3 are not exceeded. The administrative controls regulate the placement of spent fuel in rack locations close to the spent fuel pool walls such that the dose rate contributions due to spent fuel in the Auxiliary Building are maintained below 2.5 mR/hr.
- c. Adequate cooling to maintain acceptable fuel cladding temperatures is provided.
- d. [HISTORICAL INFORMATION] [The historical information in this section was moved to Section 9.1.2.3.1 to increase clarity and avoid repetition.]

9.1.2.2 Facilities Description

Spent fuel storage racks provide a place in the fuel pool for storing spent fuel received from the reactor vessel. These are top entry racks designed to maintain the spent fuel in a space geometry that precludes the possibility of criticality under normal and abnormal conditions. The spent fuel storage racks provide continuous lateral support to the fuel element.

9.1.2.2.1 Unit 1

The location of the spent fuel storage facility within the station complex is shown in Figure 1.2-6. High density spent fuel racks are installed in the auxiliary building spent fuel pool and in the upper containment fuel pool. One end of the Upper Containment Pool may be used to permanently store components such as control rods, control rod guide tubes, empty defective fuel storage canisters, blade guides, and fuel sipping containers. The Upper Containment Pool is also used for interim storage and cooling of spent fuel assemblies and defective fuel storage containers (with fuel) during refueling operations. The spent fuel assemblies are transferred to the spent fuel pool in the auxiliary building for long-term storage. No fuel is contained in the upper containment fuel pool during normal power operation of the plant. The spent fuel pool is also designed to handle storage of control rods, control rod blade guides and defective fuel storage canisters. To support plant operation and refueling, spent fuel pool and upper

GRAND GULF NUCLEAR GENERATING STATION
Updated Final Safety Analysis Report (UFSAR)

containment pools are used for temporary storage of nuclear instrumentation and other irradiated plant components and materials.

The spent fuel pool contains 16 high density fuel rack modules in 5 different module sizes. The module types are labeled A, B, C, D and H on Figure 9.1-40a, which also shows their relative placement. There are a total of 4348 fuel storage locations in the spent fuel pool. With current physical, load, and criticality restrictions only 3919 fuel storage locations are available in the spent fuel pool.

The upper containment pool contains 7 high density fuel rack modules in 3 different module sizes. The module types are labeled E, F and G on Figure 9.1-40a, which also shows their relative placement. There are a total of 710 fuel storage locations in the upper containment pool. With current physical and load restrictions only 584 fuel storage locations are available in the upper containment pool.

9.1.2.2.2 Unit 2

[HISTORICAL INFORMATION] [As noted in Section 1.1.1, after Unit 1 had received its Commercial Operating License, Entergy Operations, Inc. formally requested the NRC to return the Construction Permit and officially cancel the second unit at the Grand Gulf Nuclear Station. The Construction Permit for Grand Gulf Unit 2 was revoked by the NRC in August 1991. Therefore, this section is deleted.]

9.1.2.3 Safety Evaluation

9.1.2.3.1 Criticality Control

The design of the spent fuel storage racks provides for a subcritical multiplication factor (k_{eff}) for both normal and abnormal storage conditions. For normal and abnormal conditions, k_{eff} is equal to or less than 0.95. Normal conditions exist when the fuel storage racks are located in the pool and are covered with a normal depth of water (about 23 ft above the stored fuel) for radiation shielding and with the maximum number of fuel assemblies or bundles in their design storage position. The spent fuel is covered with water at all times by a minimum depth required to provide sufficient shielding. An abnormal condition may result from accidental dropping of equipment or damage caused by the horizontal movement of fuel handling equipment without first disengaging the fuel from the hoisting equipment. To meet

GRAND GULF NUCLEAR GENERATING STATION
Updated Final Safety Analysis Report (UFSAR)

the requirements of General Design Criterion 62, geometrically safe configurations of fuel stored in the spent fuel array, in combination with neutron absorbing material are employed to assure that k_{eff} does not exceed 0.95 under all normal and abnormal storage conditions. The design of the Unit 1 high density spent fuel storage racks employs double-walled stainless steel boxes with Boraflex neutron absorber sheets in the space between the walls.

[HISTORICAL INFORMATION] [The unit 1 spent fuel storage racks were originally designed to provide storage for standard 8 x 8 fuel assemblies containing fuel rods with a uniform enrichment of 3.5 wt% U-235. Design adequacy for enrichments greater than 3.5 wt% U-235 and for 9x9 fuel was subsequently addressed in References 10 and 17. These analyses were supplemented by References 20 and 23, which address fuel containing 4.80 wt% U-235 uniformly distributed in the central enriched region of a 10x10 fuel pin array. This assembly was confirmed to bound the 8x8 and 9x9 configurations previously analyzed for GGNS. The Reference 23 analysis also confirms the reference assembly bounds the ARTRIUM-10 fuel design. Reference 28 confirmed that the reference assembly bounds the Cycle 18 GNF2 reload fuel design and the GE14 fuel design and Reference 29 confirmed the reference assembly bounds the Cycle 19 GNF2 reload fuel design. The most reactive fuel geometry is achieved with the fuel assembly centered in the fuel storage cell.

Standard criticality calculations using the AMPX-KENO and CASMO assembly computer package were performed in the Reference 20 and 23 analyses to assure that K_{eff} does not violate the 0.95 criteria for all of the normal and abnormal storage conditions described below:

- a. Normal positioning in the spent fuel storage array
- b. The eccentric positions evaluated consisted of (1) adjacent fuel assemblies (each assumed to be located on one side of its cell with the zirconium fuel channel touching the stainless steel - Boraflex plate) creating an infinite series of two-assembly clusters separated only by the stainless steel - Boraflex plate, (2) fuel assemblies moved into the corner of the storage rack cell creating a four-assembly cluster at the closest approach, and (3) abnormal positioning of a fuel assembly outside the fuel storage rack. This includes (but is not necessarily

GRAND GULF NUCLEAR GENERATING STATION
Updated Final Safety Analysis Report (UFSAR)

limited to) when a fuel assembly is inadvertently placed either (a) between the fuel storage racks and either the spent fuel or containment pool equipment racks or (b) between two fuel storage racks (References 24 and 25).

- c. Pool water temperature increases to 212°F
- d. The effects of Zirconium fuel channel distortion
- e. The initial core loading in a dry condition subsequent cycles of reload fuel are not confirmed at dry conditions

GRAND GULF NUCLEAR GENERATING STATION
Updated Final Safety Analysis Report (UFSAR)

- f. Lateral motion of a fuel storage rack which causes the water gap between racks to close
- g. Degradation of the Boraflex, including both B4C loss due to washout and shrinkage of the Boraflex sheets.

The current GGNS criticality safety analysis of record is documented in Reference 33 and NRC acceptance of the analysis is described in Reference 32. The submittal included a Tech Spec change to add a standard cold core geometry k-infinity limit of 1.26 on the fuel assemblies to ensure the existing Tech Spec limit of an in-rack k_{eff} of 0.95 was protected. This analysis used a base GE14 (10x10) assembly design containing 4.9 wt% U-235 with bounding amounts of gadolinia. This assembly was confirmed to bound all fuel already utilized at GGNS and any planned GE14 or GNF2 assemblies. The analysis uses MCNP and GNF's lattice physics code (TGBLA06P). It includes a distribution of various Boraflex gap sizes and locations in the analyzed array, and it assumes all Boraflex panels have an areal density of 0.0133 g/cm², which is 70% of the minimum certified areal density of 0.0190 g/cm². Details of the method are proprietary and can be found in Reference 33. An additional analysis was performed in Reference 34 using a GNF3 fuel assembly design, and Reference 31 confirmed the GNF3 fuel assembly design was bounded by the existing analysis in Reference 33.

Each new batch of fuel assemblies are compared against the standard cold core geometry k-infinity limit of 1.26 to ensure they are bounded by the analysis.

No limitation is placed on the size of the Region I spent fuel storage array from a criticality standpoint since all calculations are performed on an infinite basis. The Region II array size is discussed in 9.1.2.3.2.1.p.

9.1.2.3.2 Spent Fuel Storage Design

The fuel storage facilities are designed to seismic Category I requirements to prevent earthquake damage to the stored fuel.

From the analyses, it is concluded that the spent fuel storage arrangement and design meet the safety design bases and satisfy the intent of Regulatory Guides 1.13 and 1.29, which precludes any deleterious effects on spent fuel storage integrity due to natural phenomena such as earthquakes, tornadoes, hurricanes, and floods. The fuel storage pools have adequate water shielding for

GRAND GULF NUCLEAR GENERATING STATION
Updated Final Safety Analysis Report (UFSAR)

the stored spent fuel. Adequate shielding for transporting the fuel is also provided. Liquid level sensors are installed to detect a low-pool water level, and adequate makeup water is available to assure that the fuel is not uncovered should a leak occur.

The stainless steel liner plate (1/4-in. thick) is utilized as permanent formwork and serves as a leaktight membrane that has an inherent ductile capability to resist damage from abrasion, impact, and cracking of the integral concrete floor and walls. The wall liner plate assembly with its welded carbon steel stiffeners (6 in. deep, 1/4-in. thick) forms a rigid panel and is securely attached to the concrete walls by means of the stiffeners embedded in concrete (Figure 9.1-38).

The pool floor liner is a 1/4-inch-thick stainless steel plate continuously welded on embedded channels in concrete and spaced at approximately 6 ft-5 in. center-to-center.

The pool concrete walls and slabs are designed as a Category I structure to withstand all of the loading associated with the safe shutdown earthquake, without regard to the strength provided by the liner plate. A leak chase system is provided so that any pool water leakage is drained into a leak detection system. See Figure 9.1-38 for liner plate details.

GRAND GULF NUCLEAR GENERATING STATION
Updated Final Safety Analysis Report (UFSAR)

An analysis of the liner plate has been performed for seismic conditions. The results of this analysis show that the function of the liner plate as a leaktight membrane will not be compromised during an SSE, nor will it dislodge from the concrete wall and fall on top of the fuel racks.

Since the fuel racks are made of noncombustible material and are stored under water, there is no potential fire hazard. The large water volume also protects the spent fuel storage racks from potential pipe breaks and associated jet impingement loads.

9.1.2.3.2.1 Spent Fuel Rack Design, Unit 1

- a. The spent fuel storage racks are constructed of SA240, Type 304 stainless steel.
- b. The spent fuel storage racks consist of individual cells with a 6-inch-square cross section, each of which accommodates a single BWR fuel assembly. The cell walls consist of a neutron absorber (Boraflex) sandwiched between sheets of stainless steel. The cells are arranged in modules of varying numbers of cells with a center-to-center spacing of 6.26 inches (nominal).
- c. The spent fuel storage racks are designed to store:

Upper containment fuel pool - 710 fuel assemblies

Spent fuel pool - 4348 fuel assemblies, 27 control rods, 9 control rod blade guides and 9 defective fuel storage canisters.

Due to limited storage capacity for control rod blades in the storage racks, additional Control Rod Blades can be stored in the Spent Fuel Pool from Curb Hangers. Curb Hangers are attached along the Spent Fuel Pool east and west walls and are designed to hang one blade per hanger. The curb hangers are individually analyzed and approved by engineering. The stresses in the hangers are designed to meet AISC allowables for Seismic II/I loading conditions.

- d. The spent fuel storage racks are free standing; that is, they are not anchored to the pool floor or connected to the pool walls through snubber or lateral restraints.

GRAND GULF NUCLEAR GENERATING STATION
Updated Final Safety Analysis Report (UFSAR)

They are made as wide as possible within the constraints of transportation and site handling to obtain the largest width to height aspect ratio to provide the greatest margin against rigid body tipping.

- e. Adequate clearance between the spent fuel storage racks and other hardware in the pool is provided. This clearance assures that the possibility of inter-rack impact or a collision between a storage rack and other hardware in the pool is precluded.
- f. The bottom of the spent fuel storage rack cruciform assembly (Figure 9.1-2b) has 7-7/8 inch high stainless steel strips to ensure against the downward slippage of the Boraflex "poison" material due to gravitational loads or operating conditions.
- g. The central hole in the spent fuel storage rack baseplate provides the coolant flow path for heat removal from the fuel assembly cladding. Lateral holes (Nominal diameter = 3/4 inch) in the cell walls (Figure 9.1-2c) provide a redundant coolant flow path in the unlikely event that the baseplate hole becomes blocked.
- h. The defective fuel storage rack module is 150 inches high which allows a portion of the defective fuel container to be above the module. Redundant coolant flow paths (2 lateral holes, 1 inch in diameter in each cell) are provided to provide cooling should the main coolant flow path become blocked.
- i. Spent fuel storage module data and rack construction details are shown in Table 9.1-11 and Figures 9.1-2 through 9.1-2d, respectively.
- j. The spent fuel storage racks are designed to maintain a K_{eff} equivalent of less than or equal to 0.95 when flooded with unborated water. The maximum calculated reactivity includes a statistically summed set of uncertainty calculations related to the reactivity calculations, a statistically summed set of storage rack and fuel assembly mechanical tolerance calculations, and a sum of positive bias calculations such that the true K_{eff} will be equal to or less than 0.95 with a 95% probability at a 95% confidence level (Reference 33). The evaluation of the

GRAND GULF NUCLEAR GENERATING STATION
Updated Final Safety Analysis Report (UFSAR)

the GGNS historical Blackness Test Campaign data shows continued accelerated Boraflex degradation for those panels receiving the highest doses in the shortest time frame (the designated Blackness Test Area). Analysis of the data confirms the EPRI model is valid until panel dose levels reach a threshold dose. Beyond this dose, Boraflex gapping can accelerate. The analysis indicates that an equilibrium condition for this case is likely not attainable or if equilibrium condition is attainable, it is at a high level of Boraflex panel gapping. This high level of gapping reduces the effectiveness of the Boraflex material to maintain criticality control.

In order to accommodate known and possible future Boraflex degradation and maintain the K_{eff} criterion of less than or equal to 0.95, the GGNS fuel pool racks are allocated into Region I and Region II locations. The Region I rack locations are those locations which are above the Boraflex panel areal density limit and below the dose threshold for accelerated gapping and are bounded by the EPRI model for shrinkage. The Region II rack locations are those locations which are below the Boraflex panel areal density limit or at or above the dose threshold for accelerated gapping and no credit is taken for the Boraflex panels in the criticality analysis in these locations.

- k. The stresses for the spent fuel storage rack components are calculated from a seismic analysis (time history and stress analysis) and are found to be within the allowable limits given in Table 3.9-2s. The load cases listed below were considered:

SRP Designation	ASME Designation
1. D + L	Level A
2. D + L + T _o	Level A
3. D + L + T _o + E	Level B
4. D + L + T _a + E	Level B
5. D + L + T _o + P _f	Level D

GRAND GULF NUCLEAR GENERATING STATION
Updated Final Safety Analysis Report (UFSAR)

SRP Designation

ASME Designation

6. $D + L + T_a + E'$

Level D

7. $D + L + F_d$

Level D

These loads have the following connotation with respect to the fuel rack analysis:

D = Dead load of rack and contained fuel assemblies

L = Live load = 0

T_o = Stresses due to differential thermal expansion in the body of the rack

E = Operating basis earthquake

T_a = Identical to T_o

E' = Safe shutdown earthquake

P_f = Upward force on the racks caused by a postulated stuck fuel assembly

F_d = Force caused by accidental drop of the heaviest load from the maximum possible height (See 9.1.2.3.2.1.0)

1. The effects of a fuel assembly (weight - 630 lbs) dropped from a height of 36 inches (i) above a storage location and impacting the base and (ii) above a rack and impacting the top of the rack, have been determined to be within the applicable design stress levels and rack integrity criteria. Load handling restrictions are based on accident analyses that address SFP criticality and fuel damage radiological consequences. These analyses are discussed in Sections 3.1.2.6 and 15.7.4.

- m. The storage rack is designed to withstand the pull-up force of 4,000 pounds and a horizontal force of 1,000 pounds applied at the top of the rack at the weakest storage location. In the event of a stuck fuel assembly,

GRAND GULF NUCLEAR GENERATING STATION
Updated Final Safety Analysis Report (UFSAR)

the Refueling Platform main hoist jam cutoff, Fuel Handling Platform main or auxiliary hoists jam cutoff, or the New Fuel Bridge Crane hoist jam cutoff will preclude damage to the racks. There are no readily available horizontal forces in excess of 1,000 pounds.

- n. The fuel storage racks are designed to handle irradiated fuel assemblies. The expected radiation levels are well below the design levels.
- o. The fuel storage rack design precludes the buckling of the rack under the impact of the fuel transfer canal gate (weight-7000 lbs) from a height of 15 inches above the rack. However, administrative procedures are in place which prevent the movement of the transfer canal gate over storage locations which contain spent fuel.
- p. The Boraflex neutron poison material used in the Unit 1 high density spent fuel storage racks consists of boron carbide powder in a rubber-like silicone polymeric matrix. The space containing the Boraflex is vented to the pool to allow any gas generated from the silicone polymer binder during heating and irradiation of the rack to escape. This will prevent bulging or swelling of the stainless steel tube containing the Boraflex. To provide added assurance that no unexpected corrosion or degradation of the materials will compromise the integrity of the racks, a long-term Boraflex monitoring program has been implemented.

In order to verify acceptability of the GGNS Fuel Pool racks for storage of nuclear fuel and ensure the K_{eff} criterion of less than or equal to 0.95 is met, the GGNS Upper Containment Pool and Spent Fuel Pool racks are allocated into Region I and Region II locations. The GGNS rack monitoring program shall consist of RACKLIFE, or an equivalent methodology, which will be used to track panel dose and boron carbide (B_4C) loss and to define each rack location as either a Region I or Region II location.

GRAND GULF NUCLEAR GENERATING STATION
Updated Final Safety Analysis Report (UFSAR)

Region II spent fuel pool rack locations are defined in TS 4.3.1.1.e. Region I spent fuel pool rack locations represent the remaining spent fuel storage locations. Monitoring of Boraflex panel dose shall be performed with RACKLIFE, or an equivalent methodology, to ensure that these limits continue to be met for each Region I location. Spent fuel pool silica data is obtained prior to the receipt of each new fuel batch for input into RACKLIFE calculations. Each RACKLIFE assessment includes projections to confirm acceptable Boraflex performance through the next evaluation period.

Any location which is determined by the monitoring program to meet the criteria for a Region II location, either currently or as projected through the current monitoring period, is assigned to Region II (described below). Isolated storage cell locations that do not meet the Region I requirements, and do not meet all Region II requirements, are physically and administratively blocked from storing any fuel assembly.

Region II storage locations are grouped in a minimum 4x4 arrays which shall have selected storage locations physically and administratively blocked in a "8 of 16 blocked" configuration. Region II storage locations may be arranged in any configuration/combination of "8 of 16 blocked" provided the following requirements are met.

- a. Each 4x4 group is not offset, i.e. the straight line connecting the centers of two 4x4 groups align with the outer edge of all of the storage locations along this line. The orientation of the 4x4 groups may not be rotated with respect to each other.
- b. Region II rack locations, which cannot be allocated to a 4x4 group and classified as Region II for any reason, are physically blocked from storing any fuel assembly.
- c. In order to prevent a fuel misloading error in the 4x4 arrays, the required blocked locations are confirmed to be properly located and blocked prior to storing fuel assemblies in the 4x4 arrays.

Past Blackness Test data is sufficient to fully characterize those GGNS rack locations (Region I) that remain below the Boraflex panel dose threshold for

GRAND GULF NUCLEAR GENERATING STATION
Updated Final Safety Analysis Report (UFSAR)

accelerated gapping. The remainder of the rack locations (Region II) are above the Boraflex panel dose threshold for accelerated gapping and conservatively no longer receive credit for the Boraflex in these panels in the criticality analysis. Since previous Blackness Testing campaigns have gathered the data needed to fully satisfy the requirements of Reference 21, Blackness Testing is no longer being performed.

In order to ensure the criticality Safety Analysis (CSA) assumptions remain bounding, areal density and gap size measurements of the Boraflex neutron absorbing material are performed periodically as part of the monitoring program. These measurements are performed on at least a five-year frequency using Boron-10 Areal Density Gage for Evaluating Racks (BADGER) testing. The measurements are only performed for the spent fuel pool since the Boraflex used in these racks will experience long term irradiation. No measurement is performed for the Boraflex used in the upper containment pool racks, because these racks are planned to be used for interim (short term) storage of spent fuels, and the condition of the Boraflex in the spent fuel pool will bound that of the upper containment pool. [HISTORICAL INFORMATION] [The first BADGER test campaign was completed in 2007, the next was in 2013, and subsequent ones are completed on a five-year frequency.

- q. The spent fuel pool storage racks have the capability of also storing 27 control rods, 9 defective fuel containers and 9 control rod guide-tubes. For criticality concerns, it is necessary to maintain a minimum of 12 inches between any fuel stored in the Control Blade/Defective Fuel Storage Rack and the surrounding high-density spent fuel pool storage racks. Fuel sipping canisters and containers containing defective fuel can be placed into interior rack locations only.
- r. The consequences of Boraflex gap redistribution due to the downward motion of segments of Boraflex are bounded by criticality analysis assumptions. Due to the close tolerances between the Boraflex sheets and the rack structural material, no appreciable slumping and downward motion of segments of Boraflex (except for closing the gaps) is considered. Additional surveillance and analysis following a seismic event exceeding the postulated

GRAND GULF NUCLEAR GENERATING STATION
Updated Final Safety Analysis Report (UFSAR)

Operating Basis Earthquake (OBE) will be performed to determine any changes in Boraflex positions and criticality analysis.

9.1.2.3.2.2 Spent Fuel Rack Design, Unit 2

[HISTORICAL INFORMATION] [As noted in section 1.1.1, after Unit 1 had received its Commercial Operating License, Entergy Operations, Inc. formally requested the NRC to return the

GRAND GULF NUCLEAR GENERATING STATION
Updated Final Safety Analysis Report (UFSAR)

Construction Permit and officially cancel the second unit at the Grand Gulf Nuclear Station. The Construction Permit for Grand Gulf Unit 2 was revoked by the NRC in August 1991. Therefore, this section is deleted.]

GRAND GULF NUCLEAR GENERATING STATION
Updated Final Safety Analysis Report (UFSAR)

Page Deleted

GRAND GULF NUCLEAR GENERATING STATION
Updated Final Safety Analysis Report (UFSAR)

9.1.2.3.2.3 Control Rod Storage Rack, Unit 1

- a. The Control Rod Storage Rack is a free standing modular type rack which minimizes the effective center-to-center spacing of cells and optimizes available floor space in the Upper Containment Fuel Pool.

The Control Rod Storage Rack is located in the northwest corner of the Upper Containment Fuel Pool and is constructed of SA240, Type 304; SA312, Type 304; and SA193, Grade B8 stainless steel.

- b. The rack has four supports which rest directly on the pool's liner plate or on intermediate bearing pads and are self leveling. The rack is not attached to the pool's liner plate.
- c. The Control Rod Storage consists of 20 individual cells with tapered lead-in edges. There are 4 - 12" o.d. tubes used for storage of Control Rod Guide tubes and 16 - 10¹" o.d. tubes used for storage of control rods, defective fuel storage canisters, and fuel "sipping" containers.
- d. Control Rod storage module data and rack construction details are shown in Table 9.1-11 and Figure 9.1-2e, respectively.
- e. Adequate clearance between the Control Rod Storage Rack and other hardware in the pool is provided. This clearance assures that the possibility of a collision between the rack and other hardware is precluded.
- f. The Control Rod Storage Rack is designed to withstand the applicable Containment seismic and hydrodynamic loads. It is also designed to withstand a maximum pull-up force of 4000 pounds and a maximum horizontal force of 1000 pounds.
- g. The rack is designed to withstand a minimum impact force of 4000 foot-pounds generated by any one of the following cases:
- (1) Vertical free fall of a channeled fuel bundle to the baseplate of the rack
 - (2) Inclined impact of a channeled fuel bundle to the top of the rack (i.e. leading edge)

GRAND GULF NUCLEAR GENERATING STATION
Updated Final Safety Analysis Report (UFSAR)

- (3) Horizontal impact of a channeled fuel bundle to the top of the rack; and
 - (4) Miscellaneous objects (e.g., gates, consolidated canisters, etc.) to the top of the rack.
- h. The effects of this rack and its stored components on pool thermal hydraulics and criticality have been evaluated and determined to be acceptable.

9.1.2.3.3 Protection Features of Spent Fuel Storage Facilities

The spent fuel and other safety-related components in the auxiliary building are protected from the consequences of a cask drop by restriction of the limits of cask crane travel as discussed in subsections 9.1.4.1 and 9.1.4.2.2.2. The limits of cask travel are shown in Figure 1.2-7.

Subsection 9.1.2.1.1.1 discusses additional protection features for the spent fuel storage facility.

9.1.2.4 Dry Spent Fuel Storage

The other fuel storage system utilized is Holtec International's HI-STORM dry fuel storage system. The HI-STORM system is comprised of a cylindrical enclosure containing a metal basket, the Multi-Purpose Canister (MPC) that contains the fuel, an onsite transfer cask (HI-TRAC 125D), and a concrete and steel storage container (HI-STORM 100S). These components are classified as important to safety (ITS) as described in the NRC approved FSAR and Certificate of Compliance (CoC) (Reference 26) for the Holtec dry fuel storage cask system licensed under 10 CFR 72.214. These components are treated as safety related.

Since the dry fuel storage cask system has been independently reviewed and approved for use by the NRC apart from the site reactor licenses, the full description of the system is in other documents. These documents include the Holtec CoC, Holtec Final Safety Analysis Report (FSAR), NRC Safety Evaluation Reports (SER) and the Entergy Nuclear South 10CFR72.212 Evaluation Report (Reference 27).

Major support ancillaries consist of:

GRAND GULF NUCLEAR GENERATING STATION
Updated Final Safety Analysis Report (UFSAR)

- 1) Forced helium dehydration (FHD) system (Not ITS) including a chiller and various pumps, valves, pressure indicators and hoses mounted on a skid to facilitate preparing the MPC for storage operations,
- 2) Low profile transporter (LPT) (Not ITS) used to transport the loaded HI-STORM overpack from the Auxiliary Building outdoors to the VCT for movement to the ISFSI pad,
- 3) HI-TRAC Lift Yoke (ITS) for lifting and moving the HI-TRAC,
- 4) MPC lifting cleats (ITS) for lowering the MPC into the HI-STORM, and
- 5) Vertical cask transporter (VCT) (Not ITS) used to transport the loaded HI-STORM overpack from outside the Auxiliary Building to the ISFSI pad.

The GGNS ISFSI cask storage pad for the Holtec system, classified as not important to safety (non-safety related), is seismically designed and qualified to support the worst case cask loading conditions. The free standing casks are to be stored on the first of two (phase 2 to be completed later) pads with the casks arranged in a 4 x 11 array providing an initial space for a 44 cask total storing capacity. The ISFSI pad is a reinforced concrete slab 196 feet long by 61 feet wide and approximately 36 inches thick. The GGNS ISFSI is located in the protected area beginning approximately 250 feet north of the abandoned Unit-2 Containment Building.

9.1.3 Fuel Pool Cooling and Cleanup System

9.1.3.1 Design Bases

9.1.3.1.1 Safety Design Bases - Nuclear

The safety related functions of the fuel pool cooling and cleanup (FPCC) system include:

- a. Remove the decay heat from spent fuel assemblies to maintain the pool bulk water temperature at or below 150 F.

GRAND GULF NUCLEAR GENERATING STATION
Updated Final Safety Analysis Report (UFSAR)

- b. Monitor fuel pool water level and maintain a water level above the fuel sufficient to provide radiation shielding for building occupancy.

The FPCC system provides the primary means of decay heat removal from the spent fuel pool. The FPCC system also incorporates the necessary components to maintain a satisfactory pool water level and sustain recirculation through the FPCC cooling system.

9.1.3.1.2 Power Generation Design Bases

The power generating design bases of the fuel pool cooling and cleanup system include:

- a. Minimize corrosion product buildup and control water clarity so that the fuel assemblies can be handled underwater efficiently.
- b. Minimize fission product concentration in the water which could be released from the pools to the auxiliary and containment building environment.

FPCC maintains the upper containment pools, the spent fuel and cask storage pools, and the fuel transfer pool at an acceptable degree of clarity necessary to transfer and service the reactor internals and fuel bundles. The system can also remove heat transferred from the drywell to the containment pools through the drywell head.

9.1.3.2 System Description

The major portion of FPCC equipment is located in the auxiliary building except for the valves, piping, and instrumentation associated with the containment pools.

During normal plant operation, the FPCC system (Figures 9.1-26 through 9.1-30) transfers decay heat released to the spent fuel pool to the component cooling water (CCW) system via the FPCC heat exchanger(s). The spent fuel pool water temperature is normally maintained below 140 F.

Water is normally routed through at least one heat exchanger and one filter-demineralizer (F/D) circuit before returning to the pool. Spent fuel pool water is normally circulated by means of one two 1100 gpm parallel pumps to provide the normal flow rate of

GRAND GULF NUCLEAR GENERATING STATION
Updated Final Safety Analysis Report (UFSAR)

1100 gpm. The pumps are controlled from a local panel and suitable for continuous duty operation. The pumps are also controlled from the control room.

Water overflows from the pool into skimmers or scuppers around the periphery of the pools and is collected in the fuel pool drain tank. The fuel pool drain tank is sized to contain the volume of water above the skimmer weirs which drains from the pools following a temporary loss of circulation. To preclude tank overflow, the fuel pool drain tank vent extends to an elevation above the maximum possible water level in the pools.

The FPCC system is designed to remove suspended or dissolved impurities from the pool water. The following are typical sources:

- a. Dust or other airborne particles;
- b. Surface dirt dislodged from equipment immersed in the pool;
- c. Crud and fission products emanating from the reactor during refueling;
- d. Debris from inspection or disposal operations;
- e. Residual cleaning chemicals or flush water.

Clarity and purity of the pool water are maintained by a combination of filtering and ion exchange. The filter-demineralizers maintain water chemistry for compatibility with the Unit 1 stainless steel fuel storage racks.

The FPCC flow rate is designed to be approximately that required for two complete water changes per day for the fuel transfer and storage pools. Water may be returned to the condensate storage tank after being filtered and demineralized.

The F/D units are located separately in shielded cells with enough clearance to permit removing filter elements from the vessels. The F/D units are controlled from a local panel. Suitable alarms, differential pressure indicators, and flow indicators monitor the condition of the F/D. Further details of radiological considerations for this system are described in Chapter 12.

GRAND GULF NUCLEAR GENERATING STATION
Updated Final Safety Analysis Report (UFSAR)

9.1.3.3 Safety Evaluation

The spent fuel storage facility was designed so that no single active failure of FPCC equipment or components will cause an inability to:

- 1) maintain irradiated fuel submerged in water; or
- 2) re-establish normal fuel pool water level; or
- 3) remove decay heat from the pool.

The spent fuel pool structure and auxiliary building were designed to seismic Category I requirements in accordance with Regulatory Guides 1.13 and 1.29 as discussed in Section 9.1.2. In addition, the auxiliary building is a controlled leakage structure and features the standby gas treatment system to confine and process airborne contamination and radioactive gases.

The cooling portion of the FPCC system also was designed to seismic Category I up to and including the isolation valves for the F/D units. The bypass around the F/D units was designed to seismic Category I requirements. These attributes assure that the integrity of the spent fuel pool structure and associated equipment will be maintained intact, therefore sustaining the pool inventory. The heat removal function of FPCC would not be affected if the filter-demineralizer portion sustained damage by a seismic event. Portions of the FPCC system were designed to seismic Category I requirements and are depicted in Table 3.2-1. Section 3.9 provides additional discussion of FPCC component seismic qualification.

The spent fuel pool design at Grand Gulf also incorporates the capability of RHR Divisions 1 or 2 to provide sufficient cooling capacity to maintain an acceptable spent fuel pool water temperature. Section 5.4.7 discusses the RHR system. Divisions 1 and 2 of RHR can be aligned to supplement FPCC or provide total heat removal capacity. RHR can be aligned such that suction can be taken from the reactor vessel or the spent fuel pool as depicted in Figures 5.4-016-01, 5.4-017, and 9.1-026 Sheets 1 and 2. The RHR system can be aligned to return water to the reactor vessel and/or the spent fuel pool. The volume of water in the storage pool is such that there is enough heat absorption capability to allow sufficient time for switching over to the RHR system for emergency cooling. Connecting piping from the fuel storage pool to the RHR system was designed to seismic Category I requirements

GRAND GULF NUCLEAR GENERATING STATION
Updated Final Safety Analysis Report (UFSAR)

and installed completely independent of FPCC system piping. These connections may also be utilized during shutdown condition to assure cooling of the spent fuel regardless of FPCC system availability.

Pool water level instrumentation and a makeup water system are provided to replace evaporative and leakage losses. Level switches are located in the containment and auxiliary building pools. The water level in the spent fuel storage pool is maintained at a height which is sufficient to provide the iodine decontamination factors specified in Appendix B to Regulatory Guide 1.183 in the event of a fuel handling accident. This requires that a minimum level of 23 feet of water be maintained over irradiated fuel at all times. With the high density spent fuel racks installed, this level equates to an elevation of 204' 1-3/8". Lines terminating below this level are equipped with siphon breakers, check valves, or other suitable means to prevent inadvertent pool drainage. This minimum level also ensures sufficient water to provide shielding for building occupancy. Whenever the water levels are too high or too low, an alarm and indicator light are activated in the control room.

Makeup water during normal operation is supplied from the condensate and refueling water storage and transfer system. Emergency makeup water is available from standby service water system or the suppression pool water through the RHR system.

Decay heat loads analyzed for spent fuel stored in the spent fuel pool were based on the anticipated batch reload quantities specified in Table 9.1-10. Decay heat loads may be calculated using either Branch Technical Position ASB 9-2 or the ORIGEN2 computer code with appropriate consideration of power measurement uncertainties. For conservatism, the decay heat loads were calculated using BTP ASB 9-2 based on full-power operation and 24 month fuel cycles.

The normal maximum heat load and abnormal maximum heat loads were analyzed for the spent fuel pool. The normal maximum heat load was defined to occur when the spent fuel pool is filled to capacity with the freshly discharged batch. The abnormal maximum heat load was defined to occur when the spent fuel pools is filled to capacity with a complete core offload. The projected spent fuel pool heat loads associated with those conditions are depicted in Table 9.1-12.

GRAND GULF NUCLEAR GENERATING STATION
Updated Final Safety Analysis Report (UFSAR)

FPCC heat removal capacity may be insufficient to maintain the spent fuel pool temperature below 150 F during the early stages of a complete core offload. In this case, RHR would be aligned to remove decay heat from the spent fuel pool for the complete core offload condition.

EPU increased the heat load on the FPCC system during and after RFOs because of the increase in decay heat. Therefore, to increase the operating margin, the heat exchangers were replaced.

FPCC heat exchangers utilize component cooling water (CCW) during normal operation as depicted in Figure 9.2-009. However, essential cooling water for accident conditions is provided by SSW as depicted in Figure 9.2-002. Interconnections to the standby service water (SSW) system provide emergency cooling water when required and are discussed in Sections 7.1.2.1.32 and 7.6.1.10.

In general, although cooled by CCW during normal operation, heat removal capacities of FPCC were analyzed with SSW providing the cooling water. In addition, the residual heat removal (RHR) system can supplement the FPCC system to provide additional cooling capacity when necessary.

The heat transferred to SSW by FPCC for the normal maximum decay heat load was analyzed for the bounding condition of SSW. The LOOP/LOCA event postulated to occur upon resuming reactor operation after a refueling outage is depicted in Table 9.2-17. Since SSW provides the essential cooling water to FPCC, SSW must be capable of removing the decay heat of spent fuel stored in the spent fuel pool in addition to the heat from the reactor core via the residual heat removal (RHR) system.

The bounding analysis for SSW assumed that the LOOP/LOCA occurred upon the onset of reactor power operation after refueling. Although the bounding analysis for SSW postulated that the LOOP/LOCA occurred 15 days post-shutdown, the implied limit in that analysis was that the FPCC decay heat load was equivalent to the spent fuel pool normal maximum heat load. Each FPCC train has a heat removal capacity of 22.0 E6 Btu/hr with spent fuel pool water temperature at 150°F. The SSW System and UHS were evaluated at 22.08 E6 Btu/hr (see section 9.2.1), which conservatively assumes the pool is initially at 150°F, and neglects the decreased heat rejection rate during pool heatup from 140°F. Thus, unit startups

GRAND GULF NUCLEAR GENERATING STATION
Updated Final Safety Analysis Report (UFSAR)

following reactor refuelings are limited by the actual decay heat loads of spent fuel stored in the spent fuel pool coincident with a given unit startup.

Reduced SSW flow rates to FPCC heat exchangers that were predicted to occur as a result of SSW basin reduction during the 30 days following accident initiation have less impact on FPCC heat removal capacity than the expected reduction of the time dependent spent fuel pool decay heat load.

RHR can also be used to supplement FPCC under the normal maximum heat load condition as defined in Subsection 9.1.3.3, but reactor heatup can not be resumed until FPCC can sustain the spent fuel pool bulk water temperature below the design temperature limit. Furthermore, the reactor will not be restarted should either the fuel pool water temperature exceed 140°F or a portion of RHR is needed to cool the spent fuel pool.

The alternate decay heat removal (ADHR) system can also remove decay heat from the spent fuel pool during refueling conditions with the reactor cavity flooded as discussed in Section 5.4.7.5.

The FPCC circulating pump motors are powered from their corresponding unit shutdown board supplied by the Class 1E power source. FPCC circulating pump motor loads are considered nonessential loads and are operated as required under accident conditions. Class 1E loads are discussed in Section 8.1.3.

In the event that one FPCC train fails or becomes unavailable during the early stages of a refueling outage, one FPCC pump supplying flow to two FPCC heat exchangers in parallel resulted in a heat removal capacity sufficient to reject the normal maximum decay heat load.

A loss of all power event during refueling operations will require certain contingency measures to be executed to prevent pool water from boiling. The required actions include using the station fire truck or fire water system, a diesel driven fire pump, and manual valve manipulations to provide feed and bleed cooling of the pools.

The FPCC system is protected from potential plant hazards such as internally generated missiles, pipe breaks, and fire as discussed in Sections 3.5, 3,6, and the Fire Hazards Analysis Report, respectively.

GRAND GULF NUCLEAR GENERATING STATION
Updated Final Safety Analysis Report (UFSAR)

System instrumentation and controls are provided for both automatic and remote-manual operations. Temperature elements are provided to record pool temperature in the main control room. Instrumentation and controls associated with the FPCC system are described in Section 7.6.

In order to limit the possibility of pool leakage around pool penetrations, the pool is lined with stainless steel. Details of the liner plate are shown in figure 9.1-38. In addition to providing a high degree of integrity, the lining is designed to withstand abuse that might occur when equipment is moved about. No inlets, outlets, or drains are provided that might permit the pool to be drained below a safe radiation shielding level.

Interconnected drainage paths are provided behind the liner welds. These paths are designed to prevent the uncontrolled loss of contaminated pool water to other relatively cleaner locations within the containment and auxiliary building fuel handling area, and to provide expedient liner leak detection and measurement. These drainage paths are formed by welding channels behind the liner weld joints and are designed to permit free gravity drainage to leak detection and radwaste systems.

From the foregoing analysis, it is concluded that the fuel pool cooling and cleanup system meets its design bases and satisfies the requirements of Regulatory Guide 1.13.

9.1.3.4 Inspection and Testing Requirements

At least one pump, one heat exchanger, and one filter-demineralizer are normally operating during power operation while spent fuel is stored in the spent fuel pool. The alternate train is operated periodically to ensure its operation or to transfer increased spent fuel pool decay heat loads. Routine visual inspection of the system components, instrumentation, and trouble alarms is adequate to verify operability of most system components. Some FPCC components including the pumps, heat exchangers, and certain valves are included in periodic testing programs to ensure satisfactory performance or function. Additional discussion can be found in Section 3.9.6.

9.1.3.5 Radiological Considerations

The water level in the spent fuel storage pool is maintained at a height which is sufficient to provide shielding for normal building occupancy. Radioactive particulates removed from the

GRAND GULF NUCLEAR GENERATING STATION
Updated Final Safety Analysis Report (UFSAR)

fuel pool are collected in the filter-demineralizer units which are located in shielded cells. For these reasons, the exposure of plant personnel to radiation from the FPCC system is minimal. Further details of radiological considerations for this and other systems are described in Chapters 11, 12, and 15.

9.1.4 Fuel Handling System

9.1.4.1 Design Bases

The fuel handling system is designed to provide a safe and effective means for transporting and handling fuel from the time it reaches the plant until it leaves the plant after post-irradiation cooling.

Safe handling of fuel includes design considerations for maintaining occupational radiation exposures as low as practicable during transportation and handling.

Design criteria for major fuel handling system equipment is provided in Tables 9.1-2 through 9.1-4 which list the safety class, quality group, and seismic category. Where applicable, the appropriate ASME, ANSI, industrial, and electrical codes are identified. Additional design criteria is shown below and expanded further in subsection 9.1.4.2.

The transfer of new fuel assemblies in the fuel handling area up to the point of the fuel preparation machine is normally accomplished using the 5-ton new fuel bridge crane equipped with an appropriate grapple.

From this point on, the fuel is either handled by the telescoping grapples on the fuel handling platform or on the refueling platform, and is transported between the containment and auxiliary buildings by the fuel transfer system.

These platforms are safety Class 2 and seismic Category I from a structural standpoint in accordance with Federal Register 10 CFR 50, Appendices A and B. Allowable stress due to safe shutdown earthquake loading is 120 percent of yield or 70 percent of ultimate, whichever is least. A dynamic analysis is performed on the structures using the response spectrum method with load contributions resulting from each of three earthquakes being combined by the RMS procedure. Working loads of the platform structures are in accordance with the AISC Manual of Steel Construction. All parts of the hoist systems are designed to have

GRAND GULF NUCLEAR GENERATING STATION
Updated Final Safety Analysis Report (UFSAR)

a safety factor of 5 based on the ultimate strength of the material. A redundant load path is incorporated in the fuel hoists so that no single component failure could result in a fuel bundle drop. Maximum deflection limitations are imposed on the main structures to maintain relative stiffness of the platform. Welding of the platforms is in accordance with AWS D14-1 or ASME Code Section IX. Gears and bearings meet AGMA Gear Classification Manual and ANSI STD B3.5. Materials used in construction of load bearing members are to ASTM specifications. For personnel safety, OSHA Part 1910-179 is applied. Electrical equipment and controls meet ANSI CI, National Electric Code, and NEMA Publication No. IC1, MG1.

The main telescoping fuel grapples have redundant lifting features and an indicator which confirms positive grapple engagement.

The fuel grapple is used for lifting and transporting fuel bundles. It is designed as a telescoping grapple that can extend to the proper work level and in its fully retracted state still maintains adequate water shielding over fuel.

On the auxiliary hoists, redundant electrical normal-up interlocks preclude the possibility of raising radioactive material out of the water. These auxiliary hoists also incorporate an electrical maximum-up interlock to stop the hoists at a preset distance below the mechanical (full-up) jam-stop.

Provision of a separate cask storage pool, capable of being isolated from the spent fuel pool, eliminates the potential accident of dropping the cask and rupturing the spent fuel pool structure and its contents. Furthermore, limitation of the travel of the crane handling the cask precludes transporting the cask over the spent fuel pool. Refer to Chapter 15 for accident considerations and to subsection 9.1.4.2.2.2 for details on crane travel limitations.

9.1.4.2 System Description

Table 9.1-1 is a listing of typical tools and servicing equipment supplied with the nuclear system. The following paragraphs describe the use of some of the major tools and servicing equipment and address safety aspects of the design where applicable.

GRAND GULF NUCLEAR GENERATING STATION
Updated Final Safety Analysis Report (UFSAR)

9.1.4.2.1 Spent Fuel Cask

9.1.4.2.1.1 Spent Fuel Shipping Cask

The designs of cask storage and handling facilities are based on a design cask weighing approximately 125 tons with approximate dimensions 21 feet long by 10 feet in diameter. This size cask is expected to accommodate 24 to 32 fuel bundles. A flatbed takes the cask to and from the auxiliary building. The flatbed is equipped with a cask cooling system and storage area for the cask yoke. Overland offsite transportation of the cask conforms to transportation rules and regulations of 49 CFR 173.

The cask is handled by means of a yoke which is attached to the cask lifting trunnions. The yoke is provided with sufficient component redundancy and design safety features to assure that, for all postulated credible component failures, a cask drop is precluded. A failure analysis of the cask handling yoke is presented in Table 9.1-5.

The cask is equipped with two energy-absorbing crash cones (see Figure 9.1-25), one on each end. The crash cones are constructed of a stainless steel honeycomb encased in aluminum. The performance of the crash cone complies with the requirements of 49 CFR 173.

9.1.4.2.1.2 Dry Fuel Storage Transfer Cask

The Holtec transfer cask (HI-TRAC) is utilized for transporting spent fuel from the cask storage pool to the HI-STORM storage container. The dimensions and loaded weight of the HI-TRAC are encompassed by those of the described shipping cask. The spent fuel contained within the sealed multi-purpose canister (MPC) is transferred from the HI-TRAC to the HI-STORM in the Auxiliary Building for storage at the ISFSI pad.

The design of HI-TRAC transfer cask system is based on a design loaded cask weighing approximately 125 tons with approximate dimensions 17 feet long by 8 feet in diameter. This transfer cask accommodates a sealed enclosure (MPC) containing 68 fuel assembly bundles. After transfer of the MPC to the HI-STORM storage overpack, the low profile transporter (LPT) and tracked vehicle (VCT) sequentially transport the loaded cask (HI-STORM) to the storage area (ISFSI).

GRAND GULF NUCLEAR GENERATING STATION
Updated Final Safety Analysis Report (UFSAR)

In the Auxiliary Building the HI-TRAC is handled by means of a yoke attached to the cask lifting trunnions. The yoke is provided with sufficient component redundancy and design safety margin to assure that, for all postulated credible component failures, a cask drop is precluded. The two lifting trunnions for the HI-TRAC are spaced at 180 degrees. The trunnions are designed for a two-point lift in accordance with NUREG-0612 criteria. The lifting analysis presented in the HI-STORM 100 system FSAR demonstrates that the stresses in the HI-TRAC trunnions and yoke comply with NUREG-0612 and ANSI N14.6 critical lift provisions.

9.1.4.2.2 Cranes

9.1.4.2.2.1 Containment Polar Crane

The containment polar crane is designed as seismic Category I equipment. The crane consists of two crane girders and a trolley. The circular runway (rails) which supports the crane girders is supported from the containment walls at elevation 235'-0" (Figure 1.2-8) and provides for 360° rotation of the crane girders. The trolley travels laterally on the crane girders. The hoisting equipment (main - 125 ton capacity; auxiliary - 35 ton capacity) is located on the trolley.

The containment polar crane is used to move all of the major components (reactor vessel head, shroud head and separator, and dryer assembly) as required by operations. The crane is also used for the erection of major pieces of equipment during the construction phase. The containment polar crane is not used for fuel handling purposes.

The principal design criteria for the containment polar crane is as follows:

- a. The crane generally conforms to specifications for electric overhead traveling Class A1-cranes in Crane Manufacturing Association of America (CMAA) Specification 70; ANSI STD B30.2.0-1967 Safety Code for Cranes; applicable portions of 29 CFR 1910.179 and Regulations for Construction Title 29, Chapter VII, Part 1926; and in accordance with the following standards, codes, and regulations: AFBMA, AGMA, AISE, ASCE, ASTM, AWS, IEEE, NEC, NEMA, OSHA, and SAE.

- b. The allowable stresses under earthquake loading are as follows:

GRAND GULF NUCLEAR GENERATING STATION
Updated Final Safety Analysis Report (UFSAR)

1. Normal operating conditions:

Condition	Stress Limit
$D + L + T_o$	F_s
$D + L + T_o + E$	$1.25 F_s$
$D + L + T_o + W$	$1.33 F_s$

2. For structural elements carrying mainly earthquake forces:

$$D + L + T_o + E \qquad F_s$$

3. Design accident and extreme environmental conditions:

$$D + L + (T_o T_a) + E' + P \qquad \text{In no case shall the allowable stress exceed } 0.90F_y \text{ in bending, } 0.85F_y \text{ in axial tension, and } 0.50F_y \text{ in shear. Where } F_y \text{ is governed by requirements of stability (local or lateral buckling), } f_s \text{ shall not exceed } 1.5F_s.$$

4. Notations are as follows:

- F_s = Allowable stress for structural steel
- f_s = Calculated stress in structural steel
- F_y = Yield strength for steel
- E' = Load due to safe shutdown earthquake
- E = Load due to operating basis earthquake
- D = Dead load of structure and equipment plus any other permanent loads
- L = Live loads expected to be present when plant is operating
- P = Loss-of-coolant accident pressure load
- T_o = Thermal loads due to operating conditions; including liner plate expansions, pipe reactions and thermal gradient

GRAND GULF NUCLEAR GENERATING STATION
Updated Final Safety Analysis Report (UFSAR)

T_a = Added thermal loads due to accident conditions, and which correspond to the factored design accident pressure

- c. The bridge and trolley will not derail as a result of abnormal conditions and/or seismic conditions and are provided with earthquake restrainers.
- d. The equipment is capable of withstanding, without damage, the containment internal test pressure.
- e. In the event of loss of power, the equipment and its load, will remain in a safe condition.
- f. The crane hoist is equipped with an adjustable load-limiting device for 125 tons.

A containment polar crane load drop analysis has been performed. Results of this analysis have shown that such postulated occurrences would not affect the ability of the plant to remain shutdown (note: the plant was assumed to have been shutdown when the postulated load drops occurred), or result in the release of significant amounts of radioactive materials. This load drop analysis was performed during the initial preparation of NUREG 0612, Phase II. However it is not a design basis requirement since the NRC eliminated Phase II compliance in GL 85-11. The RPV Head drop onto the RPV flange analysis was subsequently required by RIS 08-28 endorsement of NEI 08-05, "Industry Initiative on Control of Heavy Loads," and the GGNS accepted response outlining compliance with NUREG-0612, section 5.1, is summarized in section 9.1.4.2.2.5 and in Appendix D. Specifically, the following were considered in the load drop analysis:

- a. Dropping the reactor vessel head from its highest lift point onto the open reactor vessel.
- b. Dropping the steam dryer assembly from its highest lift point into the open reactor vessel.
- c. Dropping the shroud head/steam separator assembly from its highest lift point into the open reactor vessel.
- d. Dropping the portable radiation shield from its highest lift point into the reactor vessel with the dryer and separator installed.

GRAND GULF NUCLEAR GENERATING STATION
Updated Final Safety Analysis Report (UFSAR)

- e. Dropping the RPV head insulation with support structure from its highest lift point, during transport to or from storage area, onto the grating part of the refueling floor (note: RHR system piping is located beneath this floor).
- f. Dropping of the upper containment fuel pool/transferpool gate from its highest lift point, during transport to or from its storage area into the steam dryer storage area.
- g. Dropping of the reactor well/steam dryer storage area gate from its highest lift point, during transport to or from its storage area, into the steam dryer storage area.
- h. Dropping of the drywell head from its highest lift point, during transport to or from its storage area, (1) onto the refueling floor, or (2) into the reactor well.
- i. Dropping of the RPV head, strongback, nuts and washers from the highest lift point, during transport of this equipment to or from the RPV head storage, stud tensioner storage, and decontamination station, onto the refueling floor.

The RPV head drop analysis was divided into two phases, first the RPV head drop onto the reactor vessel and secondly, the RPV head drop onto the refueling floor slab, the suppression pool wall, and the grating floor on top of the refueling floor bulkhead.

For the RPV head drop onto the reactor vessel, an analysis was performed to determine the structural consequences of dropping the vessel head during maintenance operations. It was postulated that the vessel head would be dropped from a height of approximately 40 feet above the vessel-head flange, and that at impact, the head would be rotated 90° from the in-place orientation causing a point impact on the vessel.

The vessel loads due to the postulated impact were determined by dynamic elastic-perfectly plastic finite element analysis.

The most serious consequence resulting from an accidental drop of vessel head would be severe plastic deformations of the vessel top flange. This accident will not produce any vessel leaks or result in the release of radioactive material.

GRAND GULF NUCLEAR GENERATING STATION
Updated Final Safety Analysis Report (UFSAR)

For the RPV head drop analysis onto the refueling floor slab, the suppression pool wall, and the grating floor, the load path of the RPV head is along a line from the centerline of the RPV head in its normal position to its centerline in the stored position (see Figure 9.1-24).

The 4'-0"-thick reinforced concrete slab of the refueling floor El. 208'-10" was analyzed for the effects of a maximum height drop (level position) of the RPV head. The slab was first checked for penetration using the methods of Ref. 1. These calculations showed the penetration of the slab by the RPV head to be approximately 4-1/2" which was much less than the 4'-0" overall slab thickness. The ultimate capacity of the slab was then found by using the equations of ultimate strength design. The slab was checked for two cases of end restraint in order to simplify the calculations but envelop the problem. First assuming one-way action with simply supported edges, the natural frequency of the slab was calculated. From impulse and momentum equations, a triangular load pulse diagram was generated. Using this information and the graphs and equations of Ref. 2, the ductility ratio was found to be less than the allowable ductility ratio. Assuming one-way action with fixed edges, a similar procedure was followed with the ductility ratio calculated to be within the allowable limits. It was therefore concluded that although the slab would suffer damage by partial penetration of the RPV head, no gross failure of the slab would occur.

From inspection, it was concluded that if the RPV head dropped on the pool boundary walls or impacted the grating floor on top of the refueling bulkhead, leaktightness of the upper pool walls or the refueling bellows may be impaired, but watertightness at these boundaries is not a concern in maintaining the reactor in a safe shutdown condition.

9.1.4.2.2.2 Containment Hatchway Crane

The containment hatchway crane is a general service crane located on the containment 208'-10" refueling floor. The primary purpose of the crane is to handle loads in the hatchway area over the containment and drywell equipment hatches. The approximate lift range is from elevation 93' to elevation 265'. The crane is a base mounted hydraulic telescoping crane attached to the structural steel floor at 208'-10". It's capacity varies from 600 lbs. to 8,400 lbs. over its 47 ft. horizontal reach range. Typical lifts include main steam safety relief valves, local power range

GRAND GULF NUCLEAR GENERATING STATION
Updated Final Safety Analysis Report (UFSAR)

monitor casks, and other miscellaneous loads such as equipment, tools, and supplies required to support outage maintenance and modification work. If necessary, the crane may also be used to handle miscellaneous loads on the 208'-10" floor over the spent fuel pool, the reactor vessel, and the drywell head storage slab. The crane is not used for fuel handling.

Load restrictions are imposed and/or evaluations of load drops have been conducted over the full operating range of the crane on the refueling floor to eliminate the potential for damaging safety related equipment in the event an actual load drop occurred. Loads handled over the reactor vessel and the spent fuel pool are limited to 1140 lbs. This restriction applies at all times in modes 4 and 5, whether or not fuel is present and exposed to potential load drops in the pool and the reactor vessel. Operation of the crane in modes 1, 2, and 3, is further restricted to 1000 lbs. and may only be handled North of an E-W line through the crane operating center. All load drop consequences are enveloped by consequences associated with Containment Polar Crane postulated load drops (see also Section 9.1.4.3).

The crane and its support structure are designed such that structural integrity is maintained in the anticipated seismic/hydrodynamic events.

Provisions are made to contain hydraulic fluid leaks even though adverse consequences are not predicted due to a fluid leak to the containment pools. The fluid utilized is a non-flammable water glycol mixture.

9.1.4.2.2.3 Spent Fuel Cask Crane

The primary purpose of the spent fuel cask crane is to facilitate onsite handling of the fuel cask. This is a bridge-type crane, supported by reinforced concrete columns, which spans the width of the fuel handling area. Its range of service includes the cask handling hatch, cask storage pool, and cask washdown area. The cask crane rails do not extend over any portion of the spent fuel pool; thus, the cask cannot be transported over the spent fuel storage racks. Figure 1.2-7 details the limits of the crane hook approach. The crane is provided with limit switches which will interrupt the current to the drive motors and deenergize the coil of the parking brake, thus stopping the motion of the crane when

GRAND GULF NUCLEAR GENERATING STATION
Updated Final Safety Analysis Report (UFSAR)

the crane approaches its limit of travel. If the limit switches fail, the crane has end stops which will absorb the impact energy associated with full speed entry.

The crane lift system has a dual load path design, with the exception of the main drum, so that no single component failure results in a cask drop. A failure analysis of the spent fuel cask crane lift system is presented in Tables 9.1-5 and 9.1-6. The failure of the main drum is not considered credible since the drum is designed with a high factor of safety. If the drum were to fail, the most likely point of failure would be the drum shaft because it receives the greatest stress concentration during loading. If the shaft failed, the drum would be restrained in position by a structural barrier supporting the hub and maintaining gear mesh so that the drum would not spin uncontrollably.

The 150-ton capacity cask crane is designed to handle a fuel shipping cask or dry fuel storage transfer cask weighing approximately 125 tons. An outline drawing of the cask showing its principal dimensions and the location of the center of gravity is shown in Figure 9.1-25.

The total cask weight includes the lifting yoke and is approximately 67 percent of the preoperational test load. In addition to the fuel shipping cask and dry fuel storage transfer cask, the cask crane may be used to handle the recirculation pump motor, weighing approximately 30 tons, and the HPCS pump motor, weighing approximately 18 tons. These weights are 16 and 10 percent of the preoperational test loads, respectively. These loads are handled using slings which attach to eye bolts on the loads.

Administrative controls ensure the cask is raised at least 9 inches above the operating floor during movements of the cask except when lowering or raising the cask at the washdown pit, cask storage pool or Hi-Storm.

The hoist, trolley, and bridge speeds are step variable. These speeds are administratively controlled for the different modes of operation, and the control design is such that the speeds cannot be operated out of the increasing or decreasing sequence. The cask crane design and operation complies with the requirements of Regulatory Guide 1.13, 29 CFR 1910.179, and NUREG 0554.

GRAND GULF NUCLEAR GENERATING STATION
Updated Final Safety Analysis Report (UFSAR)

9.1.4.2.2.4 New Fuel Bridge Crane

The new fuel bridge crane is the general service crane in the fuel handling area. Its range includes the entire fuel handling area. It is a 5-ton capacity crane controlled by an operator on the floor. The primary service of the new fuel bridge crane is the handling of the new fuel from the time it arrives in the fuel handling area until it is placed in the fuel preparation machine. The crane rails run below the cask crane rails and above the fuel handling area platform rails. They are supported by reinforced concrete columns and wall supports. The crane and its supporting structures comply with seismic Category I requirements.

9.1.4.2.2.5 Compliance with NUREG-0612

The Containment Polar Crane, Containment Hatchway Crane, Spent Fuel Cask Crane, and the New Fuel Bridge Crane are all capable of handling heavy loads defined to weigh more than 1140 lbs. The GGNS position on handling of heavy loads in accordance with NUREG-0612 is summarized below. Appendix 9D contains an outline of the development of Grand Gulf's position. Section 9.1.4.3 discusses administrative controls for loads less than 1140 lbs.

Due to the many different load-handling situations for these cranes, safe load paths are neither required nor prudent for every situation, and would unnecessarily restrict plant operations and maintenance activities. Further, safe load paths for these four cranes cannot be defined strictly in accordance with Section 5.1.1(1) of NUREG-0612 because their loads must be carried over irradiated fuel or safe shutdown equipment. For these cases, load safety classes have been defined, along with the actions required for handling heavy loads, as follows:

Safety Class 1: Load must be carried directly over (i.e., no intervening structures such as floors) spent fuel, the reactor vessel, or safe shutdown equipment.

Action: Procedurally limit time and height load is carried over the area of concern.

Safety Class 2: Load could be carried directly over spent fuel, the reactor vessel or safety shutdown equipment, i.e., load can be handled during the time when spent fuel or the reactor vessel is exposed or safe shutdown equipment is required

GRAND GULF NUCLEAR GENERATING STATION
Updated Final Safety Analysis Report (UFSAR)

to be operable and there are no physical means (such as interlocks or mechanical stops) available to restrict load movement over these objects.

Actions: Procedurally define an area over which loads shall not be carried so that if load is dropped, it will not result in damage to spent fuel or operable safe shutdown equipment or compromise reactor vessel integrity.

Safety Class 3: Load can be carried over spent fuel, or safe shutdown equipment, but the fuel or equipment is not directly exposed to the load drop, i.e., intervening structures such as floors provide some protection.

Action: See 3A and 3B

Safety Class 3A: Preliminary evaluation indicates that intervening structures will protect spent fuel or safe shutdown equipment.

Action: No load travel path is required at this time. General precautions limiting load travel height is prudent.

Safety Class 3B: Preliminary evaluation cannot conclusively demonstrate that intervening structures will protect spent fuel or safe shutdown equipment.

Action: Define safe load paths that follow, to the extent practical, structural floor members. Limit load travel height to minimum height practical.

Safety Class 4: Load cannot be carried over spent fuel or safe shutdown equipment when such equipment is required to be operable, i.e., design or operational limitations prohibit movement.

Action: No safe load path required.

Table 9.1-7 lists the appropriate Safety Classes for Containment Polar Crane loads. The heavy load paths are defined in procedures and shown on drawings. The cranes are match marked for proper

GRAND GULF NUCLEAR GENERATING STATION
Updated Final Safety Analysis Report (UFSAR)

alignment during heavy lifts. In addition, supervision is present during heavy load lifts to enforce procedural requirements. Deviations from defined load paths require the approval of the On-Site Safety Review Committee.

Grand Gulf's use of "Load Safety Classes" in lieu of explicit safe load path determinations involving load drop analyses was accepted by the NRC in Supplement 5 to the Grand Gulf SER.

This acceptance, in effect, superseded the original load drop analyses described in Section 9.1.4.2.2.1, and established the use of these Classes as the binding guidance for handling heavy loads.

9.1.4.2.3 Fuel Servicing Equipment

The fuel servicing equipment described below has been designed in accordance with the criteria listed in Table 9.1-2.

9.1.4.2.3.1 Fuel Preparation Machine

The fuel preparation machine, Figure 9.1-6, is mounted on the wall of the fuel storage pools and is used for stripping reusable channels from the spent fuel and for rechanneling fuel. The machine is also used with the fuel inspection fixture to provide an underwater inspection capability. During new fuel receipt one of the fuel preparation machines is used to facilitate new fuel insertion in the spent fuel pool.

The fuel preparation machine consists of a work platform, a frame, and a moveable carriage. The frame and moveable carriage are located below the normal water level in the fuel storage pool, thus providing a water shield for the fuel assemblies being handled. The fuel preparation machine carriage has an up-travel-stop to prevent raising fuel above a safe water shield level. The design of the up-travel-stop allows for the repositioning to a new fuel stop location. The new fuel stop location allows for inserting new fuel into the fuel preparation machine such that the new fuel bail handle is exposed above the normal water level to facilitate new fuel insertion. After new fuel receipt the up-travel-stop is repositioned back to its normal stop location. The normal stop location prevents raising irradiated fuel above its safe water shield level. The repositioning of the up-travel-stop and insertion of fuel bundles is controlled by administrative controls. The moveable carriage is operated by a foot pedal controlled air hoist.

9.1.4.2.3.2 New Fuel Inspection Stand

The new fuel inspection stand, Figure 9.1-7, serves as a support for the new fuel bundles undergoing receiving inspection and provides a working platform for technicians engaged in performing the inspection.

The new fuel inspection stand consists of a vertical guide column, a lift unit to position the work platform at any desired level, bearing seats and upper clamps to hold the fuel bundles in position.

9.1.4.2.3.3 Channel Bolt Wrench

The channel bolt wrench, Figure 9.1-8, is a manually operated device approximately 12 feet (3.6 meters) in overall length. The wrench is used for removing and installing the channel fastener assembly while the fuel assembly is held in the fuel preparation machine.

The channel bolt wrench has a socket which mates and captures the channel fastener capscrew.

9.1.4.2.3.4 Channel Handling Tool

The channel handling tool, Figure 9.1-9, is used in conjunction with the fuel preparation machine to remove, install, and transport fuel channels in the fuel storage pool.

The tool is composed of a handling bail, a lock/release knob, extension shaft, angle guides, and clamp arms which engage the fuel channel. The clamps are actuated (extended or retracted) by manually rotating lock/release knob.

The channel handling tool is suspended by its bail from a spring balancer on the channel handling boom located on the fuel pool periphery.

9.1.4.2.3.5 Fuel Pool Sipper

The fuel pool sipper, Figure 9.1-10, provides a means of isolating a fuel assembly in demineralized water in order to concentrate fission products in relation to a controlled background.

The fuel pool sipper consists of a control panel assembly and a sipping container cover to the tank.

9.1.4.2.3.6 Channel Gauging Fixture

The channel gauging fixture, Figure 9.1-11, is a go/no-go gauge used to evaluate the condition of a fuel channel, prior to rechanneling or when one is difficult to install.

The channel gauging fixture consists basically of a frame, gauging plate and gauging block. The gauging plate is shimmed to correspond to the outside dimension of a usable fuel channel. The gauging block conforms to the inside dimension of lower end of a usable fuel channel.

The channel gauging fixture is installed in the vertical position, between the two fuel preparation machines and hangs from the fuel storage pool curb.

9.1.4.2.3.7 General Purpose Grapple

The general purpose grapple, Figure 9.1-12, is a handling tool used generally with the fuel.

9.1.4.2.3.8 Deleted

9.1.4.2.3.9 Fuel Handling Platform

Refer to subsection 9.1.4.2.7.3 for fuel handling platform.

9.1.4.2.3.10 Channel Handling Boom

A channel handling boom, Figure 9.1-14, with a spring-loaded balance reel is used to assist the operator in supporting a portion of the weight of the channel after it is removed from the fuel assembly. The boom is set between the fuel preparation machines. With the channel handling tool attached to the reel, the channel may be conveniently moved between fuel preparation machines.

9.1.4.2.3.11 Fuel Transfer System

Fuel, control rods, and other small items are transferred between the containment and auxiliary buildings by way of a horizontal, water filled, cylindrical transfer tube as shown in Figure 9.1-15. The transfer is accomplished by placing fuel or other items in a carrier which fits within the transfer tube. Pulling the carrier through the tube is done by means of a winch and cable system. The transfer system consists of the transfer tube (36-inch O.D.

GRAND GULF NUCLEAR GENERATING STATION
Updated Final Safety Analysis Report (UFSAR)

stainless steel pipe), a carrier with rollers, an insert for two fuel assemblies, two tilting mechanisms (upender), a dual winch drive assembly, two control panels with associated switches and wiring for logic control, a 36-inch knife gate valve, and a containment penetration closure.

The tube is welded at the containment pool penetration to a seal ring and is simply supported at the auxiliary building penetration by a seismic brace which provides lateral and vertical restraints. The containment penetration closure is welded to the seal ring and along with the tube bellows provides the required containment isolation boundary. The 36-inch gate valve is mounted on the auxiliary building end of the transfer tube and is only provided for water shutoff during maintenance operations. The upending devices are at each terminus to bring the carrier inserts to the vertical position for loading and unloading cargo and to return the insert to the horizontal position for transfer.

In the containment and auxiliary buildings, the pool area in which the transfer tube terminus is located is physically separated from the fuel storage area by a concrete wall which serves as a positive barrier to prevent fuel in the storage area from being uncovered in the event of loss of pool water through the transfer system. In addition, these walls, both with gates, allow drainage of the transfer pool areas for maintenance and/or removal of the transfer tube and components.

The transfer control system functions on a semiautomatic basis with provision made for manual override. Automatic sequencing is accomplished by use of an electronic control system located in the auxiliary building. The control system monitors the step-by-step procedure of installation or removing cargo from the carrier and assures proper sequencing of the transfer operation. Control panels are provided in both the containment and auxiliary buildings. The transfer mechanism is equipped with sensors and instrumentation appropriate for confirming the successful completion of each step and signaling the control system which automatically initiates the next step. The completion of a transfer operation is signaled at the control panels. When the HFTS system is in operation, interlocks or equivalent administrative controls are provided to prevent incorrect operation. Interlocks and/or administrative controls assure the correct operational sequence of the transfer system components and fuel handling equipment.

GRAND GULF NUCLEAR GENERATING STATION
Updated Final Safety Analysis Report (UFSAR)

The transfer tube, its support, and the containment penetration closure are designed to seismic Category I requirements. The carrier, insert, upenders, valve, and other related hardware are non-seismic Category I.

The transfer tube, tube support, tube penetration sleeve, tube bellows assembly, and the containment penetration closure are designated as quality group B and are designed, fabricated, tested, and inspected in accordance with the ASME Boiler and Pressure Vessel Code as follows:

Transfer Tube, Support and Penetration Sleeve	ASME Code Section III Class-2
Containment Penetration Closure and Transfer Tube Bellows	ASME Code Section III Class-MC

The transfer tube, its support, and the containment penetration closure are designed to the following load conditions:

<u>Normal</u>	<u>Upset</u>	<u>Faulted</u>
Deadweight	Deadweight	Deadweight
Normal Pressure	Maximum Pressure	Maximum Pressure
Normal Temperature	Maximum Temp. OBE	Maximum Temp. SSE

The refueling interlocks, instrumentation and control, and other control safety aspects of the refueling system are described and evaluated in subsections 7.6.1.1 and 7.6.2.1.

Refer to Table 9.1-2 for component identification, essential classifications, safety classifications, quality groups, and seismic categories.

9.1.4.2.3.12 New Fuel Channeling Air Tugger

The New Fuel Channeling Air Tugger is used for the purpose of installing only new channels on new fuel bundles while positioned on the New Fuel Inspection Stand. This allows channeling of new

GRAND GULF NUCLEAR GENERATING STATION
Updated Final Safety Analysis Report (UFSAR)

fuel to be accomplished without working in the spent fuel pool. Channeling of new fuel with irradiated channels is not done with the New Fuel Channeling Air Tugger. This is accomplished in the spent fuel pool as described in Section 9.1.4.2.10.2.1.2.1.

9.1.4.2.4 Servicing Aids

General area underwater lights are provided with suitable reflectors for illumination. Suitable light support brackets are furnished to support the lights in the reactor vessel to allow the lights to be positioned over the area being serviced independent of the platform. Local area underwater lights are small diameter lights for additional illumination. Drop lights are used for illumination where needed.

A radiation hardened designed portable underwater closed circuit television camera is provided. The camera may be lowered into the reactor vessel and/or fuel storage pools to assist in the inspection and/or maintenance of these areas. The camera lens is capable of pitching ninety degrees which allows infinite scanning of three hundred and sixty degrees, solid angle.

A general purpose, plastic viewing aid is provided to float on the water surface to provide better visibility. The sides of the viewing aid are brightly colored to allow the operator to observe it in the event of filling with water and sinking. A portable, submersible type, underwater vacuum cleaner is provided to assist in removing crud and miscellaneous particulate matter from the pool floors or the reactor vessel. The pump and the filter unit are completely submersible for extended periods. The filter "package" is capable of being remotely changed, and the filters fit into a standard shipping container for offsite burial. Fuel pool tool accessories are also provided to meet servicing requirements. A fuel sipper is provided. This is to be used to detect defective fuel assemblies during open vessel periods while the fuel is in the core. The fuel sipper head isolates individual fuel assemblies by sealing the top of the fuel channel and pumping water from the bottom of the fuel assembly, through the fuel channel, to a sampling station, and return to the primary coolant system. After a "soaking" period, a water sample is obtained and is radiochemically analyzed.

9.1.4.2.5 Reactor Vessel Servicing Equipment

The essentiality and safety classifications, the quality group, and the seismic category for this equipment are listed in Table 9.1-3. Following is a description of the equipment designs in reference to that table.

9.1.4.2.5.1 Reactor Vessel Service Tools

These tools are used when the reactor is shut down and the reactor vessel head is being removed or reinstalled. Tools in this group are:

- Stud handling tool
- Stud wrench
- Nut runner
- Stud thread protector
- Thread protector mandrel
- Bushing wrench
- Seal surface protector
- Stud elongation measuring rod
- Dial indicator elongation measuring device
- Head guide cap

These tools are designed for a 40-year life in the specified environment. Lifting tools are designed for a safety factor of 5 or better with respect to the ultimate strength of the material used. When carbon steel is used, it is either hard chrome plated, parkerized, or coated with an approved paint per Regulatory Guide 1.54.

9.1.4.2.5.2 Steam Line Plugs

The steam line plugs are used during reactor refueling or servicing; they are inserted in the steam outlet nozzles from inside the reactor vessel to prevent a flow of water from the reactor well into the main steam line during servicing of safety relief valves, main isolation valves, or other components of the main steam lines, while the reactor water level is at the refueling level. The steam line plug design provides two seals of different types. Each one is independently capable of holding full head pressure. The equipment is constructed of non-corrosive materials. All calculated safety factors are 5 or better. The plug body is designed in accordance with the "Aluminum Construction Manual" by the Aluminum Association.

GRAND GULF NUCLEAR GENERATING STATION
Updated Final Safety Analysis Report (UFSAR)

9.1.4.2.5.3 Shroud Head Bolt Wrench

This is a hand held tool for operation of the shroud head bolts. It is designed for a 40-year life and is made of aluminum to be easy to handle and to resist corrosion. Testing has been performed to confirm the design.

9.1.4.2.5.4 Head Holding Pedestals

Three pedestals are provided for mounting on the refueling floor to support the reactor vessel head and strongback/ carousel during periods of reactor service. The pedestals have studs which engage three evenly spaced stud holes in the head flange. The flange surface rests on replaceable wear pads made of aluminum. When resting on the pedestals, the head flange is approximately 3 ft above the floor to allow access to the seal surface for inspection and O-ring replacement.

The pedestal structure is a carbon steel weldment coated with an approved paint. It has a base with bolt holes for mounting it to the concrete floor.

A seismic analysis was made to determine the seismic forces imposed on the pedestals floor anchors using the floor response spectrum method. The structure is designed to withstand these calculated forces and meet the requirements of AISC.

9.1.4.2.5.5 Head Stud Rack

The head stud rack is used for transporting and storage of 8 reactor pressure vessel studs. It is suspended from the containment polar crane hook when lifting studs from the reactor well to the operating floor.

The rack is made of aluminum to resist corrosion and is designed for a safety factor of 5 with respect to the ultimate strength of the material.

The structure is designed in accordance with the "Aluminum Construction Manual" by the Aluminum Association.

9.1.4.2.5.6 Dryer and Separator Strongback

The dryer and separator strongback is a lifting device used to transport the steam dryer or the shroud head with the steam separators between the reactor vessel and the storage pools. The

GRAND GULF NUCLEAR GENERATING STATION
Updated Final Safety Analysis Report (UFSAR)

strongback is a cruciform shaped I beam structure which has a hook box with two hook pins in the center for engagement with the containment polar crane sister hook. It has a socket with a pneumatically operated pin on the end of each arm to engage it to the four lift eyes on the steam dryer or shroud head.

The strongback has been designed so that one hook pin and one main beam of the cruciform will be capable of carrying the total load and so that no single component failure will cause the load to drop or swing uncontrollably out of an essentially level attitude. The safety factor of all lifting members is 5 or better in reference to the ultimate breaking strength of the material.

The structure is designed in accordance with "The Manual of Steel Construction" by AISC. The completed assembly is proof tested at 125 percent of rated load and all structural welds are magnetic particle inspected after load test.

9.1.4.2.5.7 Head Strongback/Carousel

The RPV head strongback/carousel is an integrated piece of equipment consisting of a cruciform shaped strongback, a circular monorail, and a circular storage tray.

The strongback is a box beam structure which has a hook box with two hook pins in the center for engagement with the containment polar crane sister hook. On each arm it has a lift rod for engagement to the lift lugs on the RPV head. The monorail is mounted on extensions of the strongback arms and four additional arms equally spaced between the strongback arms. The monorail circle matches the stud circle of the reactor vessel and serves to suspend stud tensioners and nut handling devices. The storage tray is suspended from the ends of the same eight arms and surrounds the RPV flange. A manifold is mounted underneath the hook box to distribute hydraulic and pneumatic pressures to equipment traveling on the monorail. The head strongback/carousel serves the following functions:

a. Lifting of Vessel Head

The strongback, when suspended from the containment polar crane main hook, will transport the RPV head plus the carousel with all its attachments between the reactor vessel and storage on the pedestals.

b. Tensioning of Vessel Head Closure

GRAND GULF NUCLEAR GENERATING STATION
Updated Final Safety Analysis Report (UFSAR)

The carousel, when supported on the RPV head on the vessel, will carry eight tensioners, its own weight, the strongback, storage of nuts, washers, thread protectors, and associated tools and equipment. The eight tensioners are suspended from a monorail above the vessel stud circle. Each tensioner has an air-operated hoist with individual controls.

c. Storage with RPV

The carousel, when stored with the RPV head on the head holding pedestals, carries the same load as b above. When in storage position, it accommodates nut cleaning and inspection.

d. Storage without RPV Head

During reactor operation, the carousel is stored on the refueling floor, straddling the three pedestals. Support cradles with a flat base are provided to support the four carousel legs on the floor.

The strongback with its lifting components is designed to meet the Crane Manufacturers Association of America specification No. 70; the design provides a 15 percent impact allowance and a safety factor of 5 in reference to the ultimate strength of the material used. After completion of welding and before painting, the lifting assembly is proof load tested and all load-affected welds and lift pins are magnetic particle inspected.

The steel structure is designed in accordance with "The Manual of Steel Construction" by AISC. Aluminum structures are designed in accordance with the "Aluminum Construction Manual" by the Aluminum Association.

The strongback is designed in accordance with ASME, American National Standard, for overhead hoists ANSI STD B30.16 - 1973, Paragraph 16-1.2.2.2 so that one hook pin and one main beam of the structure is capable of carrying the total load, and so that no single component failure will cause the load to drop or swing uncontrollably out of an essentially level attitude.

GRAND GULF NUCLEAR GENERATING STATION
Updated Final Safety Analysis Report (UFSAR)

The steel structure is coated with an approved paint per Regulatory Guide 1.54. Components fabricated from aluminum remain unpainted.

9.1.4.2.6 In-Vessel Servicing Equipment

The instrument handling tool is attached to the refueling platform auxiliary hoist and is used to remove and install neutron source holders. Each in-core instrumentation guide tube is sealed by an O-ring on the flange. In the event that the seal needs replacing, an in-core guide tube sealing tool is provided. The tool is inserted into an empty guide tube and sits on the beveled guide tube entry in the vessel. When the drain on the water seal cap is opened, hydrostatic pressure seats the tool. The flange can then be removed for seal replacement.

The auxiliary hoist on the refueling platform is used with appropriate grapples to handle control rods, flux monitor dry tubes, sources, and other internals of the reactor. Interlocks on both the grapple hoists and auxiliary hoist are provided for safety purposes; the refueling interlocks are described and evaluated in subsection 7.6.1.1.

9.1.4.2.7 Refueling Equipment

Fuel movement and reactor servicing operations are performed from platforms which span the refueling, servicing, and storage cavities. The containment building is supplied with a refueling platform for fuel movement and servicing, an auxiliary platform for servicing operations from the refueling floor level, and a vessel platform for reactor servicing from the vessel flange level. The auxiliary building is supplied with a fuel handling platform for fuel movement and servicing.

9.1.4.2.7.1 Refueling Platform

The refueling platform is a gantry crane which is used to transport fuel and reactor components to and from pool storage and the reactor vessel. The platform spans the fuel storage and vessel pools on bedded tracks in the refueling floor. A telescoping mast and grapple suspended from a trolley system is used to lift and orient fuel bundles for core, storage rack, and upender placement. Control of the platform is from an operator station on the main trolley. A position indicating system and travel limit computer is provided to locate the grapple over the vessel core and minimize the potential of collisions with pool obstacles. Two

GRAND GULF NUCLEAR GENERATING STATION
Updated Final Safety Analysis Report (UFSAR)

1,000-pound capacity auxiliary hoists, one main trolley-mounted and one auxiliary monorail trolley-mounted, are provided for in-core servicing such as detector module replacement, fuel support replacement, jet pump servicing, and control rod blade replacement. The main grapple in its fully retracted position provides 7 ft 9 in. minimum water shielding over the active fuel during transit. Interlocks on the platform prevent unsafe operation over the vessel during control rod movements, prevent collision with the auxiliary platform, avoid unsafe operation in the transfer tube upender zone, limit travel of the fuel grapple, and verify grapple hook engagement.

The safety-related components of the Refueling Platform are as follows.

1. Load supporting structural members of the mast.
2. Load supporting structural members of the bridge.
3. Load supporting structural members of the trolley.
4. Supporting frame for frame mounted and monorail auxiliary hoists.

The following assemblies and components should be considered non-safety related:

1. Pneumatic system-air compressor, associated piping and hoses.
2. Frame mounted auxiliary hoist.
3. Monorail auxiliary hoist.
4. Main hoist.
5. Hoisting cables for all hoists.
6. Brake assemblies for all hoists.
7. Main fuel grapple.
8. Drive train for bridge, trolley, and monorail.
9. All electrical control components, wiring, relays, brushes, limit switches, etc.

9.1.4.2.7.2 Auxiliary and Vessel Platforms

An auxiliary platform is provided to allow versatility of operations. This platform operates over the upper containment pools and provides an additional work area for reactor servicing. A 500-pound capacity hoist is provided for reactor servicing tasks. Part of the auxiliary platform is used as the vessel flange level service platform.

GRAND GULF NUCLEAR GENERATING STATION
Updated Final Safety Analysis Report (UFSAR)

The reactor level servicing platform provides a reactor flange level working surface for in-vessel inspection and reactor internals servicing, and permits servicing access for the full vessel diameter. Typical operations to be performed are in-service inspection and jet pump servicing. No hoisting equipment is provided with this platform as this function can be obtained from the refueling platform or auxiliary platform. The platform operates on tracks at the reactor vessel flange level and is lowered into position by the containment polar crane using the dryer/separator strongback or 4 matched-length, 20 ft., wire rope slings. The platform weighs approximately 4,000 lbs and features 5 ft wide work areas and motorized travel. The platform power is supplied by a cable from the refueling floor elevation.

9.1.4.2.7.3 Fuel Handling Platform

The fuel handling platform is a gantry crane which is used to transport fuel within the auxiliary building storage pools. The platform spans the fuel storage and transfer tube upender pools and the cask storage pool on tracks embedded in the auxiliary building floor. A telescoping mast and grapple is used to lift and orient fuel bundles for storage rack or upender placement. Control of the platform is from an operator station on the main trolley. A vertical position indicating system is provided for the grapple. Limit switches are located on the platform frame to interlock the platform and minimize the potential of the main fuel mast from running into pool walls or obstacles. Two 1000-pound capacity auxiliary hoists, one main trolley-mounted and one auxiliary monorail trolley-mounted, are provided to move control rods and other materials within the pool areas. Both auxiliary hoists are normally limited to 500-pounds, however, the monorail trolley-mounted auxiliary hoist contains a load over-ride switch (1000-pounds maximum) to allow for handling new fuel. The main fuel hoist has redundant load paths so that no single component failure will result in a fuel bundle drop. The auxiliary monorail hoist is operated using a single cable during non-fuel loading; but is fitted with two cables to provide a redundant load path during movement of new fuel. During transfer of fuel, the main grapple in its fully retracted position provides 7 ft 9 in. minimum water shielding over the active fuel. In order to use the auxiliary hoists when the main fuel mast is removed from the water and stored, it may be necessary to override or bypass the platform travel limit switch interlocks. Appropriate administrative controls will be used to ensure that the mast is protected and no irradiated fuel assemblies are moved in the spent fuel pool under these conditions.

9.1.4.2.7.4 Portable Radiation Shield

The portable radiation shield is a temporary shielding device that is installed prior to transfer of spent fuel bundles from the reactor to the spent fuel pool. The fuel bundles are passed through the shield which reduces radiation levels in the upper drywell area. The shield is handled by the containment polar crane. In the installed position, one end of the shield is supported by the reactor vessel flange and the other end is supported from the floor at El. 184-3. Following its use, the shield is decontaminated and stored in the containment building.

9.1.4.2.8 Storage Equipment

Specially designed equipment storage racks are provided. Additional storage equipment is listed on Table 9.1-1. For fuel storage racks description and fuel arrangement, see subsections and 9.1.2.

GRAND GULF NUCLEAR GENERATING STATION
Updated Final Safety Analysis Report (UFSAR)

Depending on the condition and integrity of the defective fuel assembly, it may be placed in a defective fuel storage container prior to storage in the defective fuel storage rack. These containers may be used to isolate leaking or defective fuel while in the fuel pool and during shipping.

Defective fuel storage containers can be picked up and moved with a fuel bundle in them. Channels can also be removed from the fuel bundle while in a defective fuel storage container.

The fuel pool sipper may be used for out-of-core wet sipping at any time. It is used to detect a defective fuel bundle while circulating water through the fuel bundle in a closed system. The containers cannot be used for transporting a fuel bundle. The bail on the container head is designed not to fit into the fuel grapple.

9.1.4.2.9 Under-Reactor Vessel Servicing Equipment

The primary function of the under-reactor vessel servicing equipment is to: (1) remove and install control rod drives;

(2) service thermal sleeve and control rod guide tube; and (3) install and remove the neutron detectors. Table 9.1-4 lists the equipment and tools required for servicing.

The control rod drive handling equipment is powered pneumatically and is designed for the removal and installation of the control rod drives from their housings. This equipment is used in conjunction with the equipment handling platform. It is designed in accordance with manufacturer's standards and proven design techniques that may not be explicitly defined in industry codes and standards.

The equipment handling platform is powered electrically and provides a working surface for equipment and personnel in the under vessel area. It is a polar structure capable of rotating 360°. This equipment is designed in accordance with the applicable requirements of OSHA (Vol. 37, No. 202, Part 1910N) and AISC, ANSI - C-1 (National Electrical Code).

The seal cap is designed to prevent leakage of primary coolant from in-core detector housings during detector replacement. It is designed to industrial codes and manufactured from noncorrosive material.

GRAND GULF NUCLEAR GENERATING STATION
Updated Final Safety Analysis Report (UFSAR)

The thermal sleeve installation tool locks, unlocks, and lowers the thermal sleeve from the control rod drive guide tube.

The in-core flange seal test plug is used to determine the pressure integrity of the in-core flange O-ring seal. It is constructed of noncorrosive material.

The key bender is designed to install and remove the antirotation key that is used on the thermal sleeve.

9.1.4.2.10 Description of Fuel Transfer

The fuel handling system provides a safe and effective means for transporting and handling fuel from the time it reaches the plant until it leaves the plant after post-irradiation cooling. The following paragraphs describe the integrated fuel transfer system which ensures that the design bases of the fuel handling system and the requirements of Regulatory Guide 1.13 are satisfied.

9.1.4.2.10.1 Arrival of Fuel on Site

The new fuel arrives at the site in shipping containers. Each container contains two fuel bundles, both enclosed in an inner metal container which supports the entire length of the bundles. The outer containers are then removed. The containers are then transferred to the fuel handling area of the auxiliary building and laid horizontally on the floor. The new fuel bridge crane then raises the containers individually to the vertical position. Access to the fuel bundles is gained by opening the top and one side of the container. Subsection 9.1.4.2.10.2.1 further discusses the preparation of the new fuel.

9.1.4.2.10.2 Refueling Procedure

A typical plant refueling and servicing sequence diagram is shown in Figure 9.1-16. Many of the steps in Figure 9.1-16 are explained in detail in this section. The order of the steps is typical and may change slightly from one outage to the next. Fuel handling procedures are shown in Figures 9.1-17 through 9.1-24 and described below. Typical auxiliary and containment building layouts are shown in Figures 9.1-23 and 9.1-24, and component drawings of the principal fuel handling equipment are shown in Figures 9.1-6 through 9.1-15.

GRAND GULF NUCLEAR GENERATING STATION
Updated Final Safety Analysis Report (UFSAR)

Assurance of refuel with suitable fuel is provided through plant operations procedures, compliance with 10CFR50 App. B and other regulatory requirements. While refueling, at least two individuals verify the correct bundle is located in the proper location. Once each fuel assembly is in its final position for plant restart, a core verification check is made to ensure that the bundle is in its proper location (by serial number), oriented properly, and is seated. Verification activities may begin prior to completion of all core alterations provided that all fuel is verified correctly loaded prior to vessel reassembly.

9.1.4.2.10.2.1 New Fuel Preparation

9.1.4.2.10.2.1.1 Receipt and Inspection of New Fuel

The incoming new fuel is delivered to a receiving station within the protected area. The containers are unloaded from the transport vehicle and examined for damage during shipment. The container dimensions are approximately 30 x 30 x 200 inches. Each outer container contains two fuel bundles supported by an inner metal container. Shipping weight of each unit is approximately 3,500 pounds. The receiving station includes a separate area where the container cover and the inner metal container are removed. The inner and outer shipping containers are reusable. Handling during unpacking is accomplished by use of appropriate handling methods. Fuel handling activities comply with the requirements of 10CFR50.68 in lieu of maintaining a monitoring system capable of detecting a criticality as described in 10 CFR 70.24. Specifically, plant procedures prohibit handling and storage at any one time of more fuel assemblies than have been determined to be safely sub-critical under the most adverse moderation conditions feasible by unborated water. The new fuel bridge crane hoist or the freight elevator is used to lift the inner container up to the fuel handling area. The container is supported in a vertical position while the fuel bundles are unstrapped and transported to storage in the new fuel storage racks or to the new fuel inspection stand.

The actual inspection of the new fuel is normally deferred until two fuel assemblies are inserted into the new fuel inspection stand. At that time, the individual fuel bundles are dimensionally and visually inspected. The new fuel inspection stand accommodates two fuel assemblies at one time.

9.1.4.2.10.2.1.2 Channeling New Fuel

9.1.4.2.10.2.1.2.1 Channeling New Fuel With Irradiated Channels

New fuel is unloaded from the new fuel vault or new fuel inspection stand and transported to the fuel racks in the fuel pool. Usually channeling new fuel is done concurrently with de-channeling spent fuel*. Two fuel preparation machines are located in the fuel pool; one is used for de-channeling spent fuel and the other to channel new fuel. The procedure is as follows: Using the fuel handling platform in the auxiliary building, a spent fuel bundle is transported to the fuel prep machine. The channel is unbolted from the bundle using the channel bolt wrench. The channel handling tool is fastened up to the top of the channel, and the fuel prep machine carriage is lowered, removing the fuel from the channel. The channel is then positioned over a new fuel bundle located in fuel prep machine No. 2 and the process is then reversed. The channeled new fuel is stored in the pool storage racks ready for insertion into the reactor.

9.1.4.2.10.2.1.2.2 Channeling New Fuel With Non-Irradiated Channels

Channeling of new fuel with new channels is accomplished per Section 9.1.4.2.10.2.1.2.1 or as follows. While new fuel is positioned on the new fuel inspection stand, new channels are hoisted into place with the New Fuel Channeling Air Tugger and bolted to the new fuel bundles.

9.1.4.2.10.2.1.2.3 Channeling Irradiated Fuel With New Channels

Irradiated fuel is unloaded from the fuel racks in the fuel pool and moved to one of the two fuel preparation machines. The irradiated channel is unbolted from the bundle using the channel bolt wrench. A channel handling tool is fastened to the top of the channel, and the fuel prep machine carriage is lowered, removing the fuel from the channel. The channel is then moved to the spent fuel rack or to the channel storage area. The new channel is positioned over the irradiated bundle at the fuel prep machine. The prep machine is raised and the channel is bolted to the bundle using the channel bolt wrench.

* As stated in Section 15.7.4.3.1 the handling of irradiated fuel over unchanneled fuel is prohibited.

GRAND GULF NUCLEAR GENERATING STATION
Updated Final Safety Analysis Report (UFSAR)

The channeled fuel is removed from the prep machine using the fuel handling platform and stored in the spent pool storage racks. The discarded irradiated fuel channels are stored in the spent fuel pool.

9.1.4.2.10.2.2 Reactor Shutdown

The reactor is shut down according to a prescribed procedure detailed in other documentation. During cooldown, the reactor pressure vessel is vented and filled to above flange level to promote cooling. The drywell head cavity is deflooded during this time in preparation for drywell and vessel head removal.

9.1.4.2.10.2.2.1 Drywell Head Removal

Immediately after cooldown and deflooding, the work to release the drywell head can begin. The drywell head is coupled by 36 securing pin assemblies. The securing pins are fully retracted with wrenches. The drywell head lifting frame is lowered into place by the overhead polar crane and attached to the drywell head lifting lugs. The drywell head is now lifted to its appointed storage space on the refueling floor by the overhead polar crane. The drywell seal surface protector is installed before any other activity proceeds in the reactor well area.

9.1.4.2.10.2.2.2 Reactor Well Servicing

When the drywell head has been removed, an array of piping is exposed that must be serviced. Various vent piping penetrations through the reactor well must be removed and the penetrations made watertight. Vessel head piping is stored on the head insulation and a common lift is used to transport them to storage on the refueling floor.

Water level in the vessel is lowered to flange level in preparation for head removal.

9.1.4.2.10.2.3 Reactor Vessel Opening

9.1.4.2.10.2.3.1 Vessel Head Removal

The combination head strongback and carousel stud tensioner is transported by the containment polar crane and positioned on the reactor vessel head.

GRAND GULF NUCLEAR GENERATING STATION
Updated Final Safety Analysis Report (UFSAR)

Each stud is tensioned and its nut loosened in a series of 2 to 3 passes. Finally, when the nuts are loose, they are backed off using a nut runner until only a few threads engage. The nut is hand rotated free from the stud and the nuts and washers are placed in the racks provided for them on the carousel. When all the nuts and washers are removed, the vessel head guide caps are installed.

The head, strongback, and carousel are transported by the containment polar crane to the head holding pedestals on the refueling floor. The head holding pedestals keep the vessel head elevated to facilitate inspection and O-ring replacement.

The seven studs in line with the fuel transfer canal are removed from the vessel and placed in the rack provided for them. The loaded rack is transported to the refueling floor for storage. Removal of these studs provides a path for fuel movement.

9.1.4.2.10.2.3.2 Dryer Removal

The dryer-separator strongback is lowered by the containment polar crane and attached to the dryer lifting lugs. The dryer is lifted from the reactor vessel and transported to its storage location in the dryer storage pool adjacent to the reactor well. The dryer is not expected to be highly radioactive and, therefore, is transported in air.

9.1.4.2.10.2.3.3 Installation of Portable Radiation Shield

The portable radiation shield is lowered into place by the auxiliary hook of the containment polar crane.

9.1.4.2.10.2.3.4 Separator Removal

In preparation for the separator removal, the separator is unbolted and unlatched from the shroud using the four shroud head bolt wrenches furnished for this purpose. These wrenches are used from the vessel flange area. When the unbolting is accomplished, the dryer-separator strongback is lowered into the vessel and attached to the separator lifting lugs. Normally, the reactor cavity level is raised to the weir wall level as the separator is simultaneously lifted from the cavity and the separator is transferred to its allotted storage place in the pool. Alternate separator transfer processes (e.g., "Dry-Transfers") are also utilized to allow for scheduling flexibility during refueling outages.

9.1.4.2.10.2.3.5 Fuel Bundle Sampling

During reactor operation, the core offgas radiation level is monitored. If a rise in offgas activity has been noted, a process can be undertaken to determine the location, approximate size, and approximate number of fuel cladding failures. By comparing changes to local power densities corresponding to control rod movement during planned power maneuvers, offgas samples and pre-treatment radiation monitor readings can be used to identify the potential location of the fuel cladding failure in the core. During the next refueling outage, fuel sipping equipment can be placed on the Refueling Platform to determine the exact fuel assembly or assemblies that have failed cladding. Fuel sipping is a process by which individual fuel assemblies can be sampled for the fission products that would escape as a result of a cladding failure.

One method used to perform this sampling is the Telescope Sipping method. This telescope Sipping system is used to identify leaking fuel assemblies based on the detection of gaseous soluble fission products. These fission products are released from a leaking fuel assembly due to inner gas expansion resulting from the change in the pressure head of water when the assembly is grappled and elevated to a higher level. The measurements are based on counting for nuclides such as Xe 133 and Kr 85 in the gas phase drawn from the subject assembly.

An alternate (or backup) means of sampling for fuel defects is the vacuum canister method where the fuel assembly is placed in a special canister container and the container is subjected to a vacuum with special equipment and vacuum pump (as opposed to elevation change above) to draw off gas phase including fission products that would be present if the cladding has failed. This vacuum sipping method must be performed outside the reactor vessel in spent fuel and equipment storage areas.

If a defective fuel assembly is detected, it is transferred to the spent fuel pool for possible inspection and storage. Depending on the condition of the defective fuel assembly, the fuel assembly or the individual defective fuel rods may be stored in a special defective fuel storage container to minimize background activity and the release of activity in the spent fuel pool.

GRAND GULF NUCLEAR GENERATING STATION
Updated Final Safety Analysis Report (UFSAR)

9.1.4.2.10.2.4 Refueling and Reactor Servicing

To allow refueling of the reactor, the gate isolating the containment pool from the reactor well is removed, thereby interconnecting the containment pool, the reactor well, and the fuel transfer area.

9.1.4.2.10.2.4.1 Refueling

During a typical equilibrium outage, approximately 25 to 33 percent of the fuel is removed, replaced and the remainder of the fuel is shuffled in the core. The actual fuel handling is done with the refueling platform. It is used as the principal means of transporting fuel assemblies between the reactor well and the containment pool; it also serves as a hoist and transport device. It provides an operator with work surface for almost all the other servicing operations. The platform travels on track extending along each side of the reactor well and pool, and supports the refueling grapple and auxiliary hoists. The platform design permits travel over safety railings placed around the pools. The grapple is suspended from a trolley that can transverse the width of the platform. Platform movement is controlled from an operator station on the trolley. Railing is provided to keep all unauthorized personnel from entering the platform area or the inside of the refueling platform track area.

The refueling platform has two 1/2-ton auxiliary hoists. One auxiliary hoist is mounted on the reactor side of the refueling platform and projects approximately two feet from the frame. This hoist normally can be used with appropriate grapples to handle control rods, guide tubes, fuel support pieces, sources, and other internals of the core. The auxiliary hoist can also serve as a means of handling other equipment within the pool. The second auxiliary hoist is mounted on the platform trolley.

The platform control system permits variable-speed, simultaneous operation of all three platform motions. Maximum speeds are:

Bridge	60 fpm
Trolley	40 fpm
Grapple hoist	50 fpm

GRAND GULF NUCLEAR GENERATING STATION
Updated Final Safety Analysis Report (UFSAR)

A single operator can control all the motions of the platform required to handle the fuel assemblies during refueling. Interlocks on the fuel grapple prevent hoisting of a fuel assembly over the core with a control rod withdrawn; interlocks also prevent withdrawal of a blade with a fuel assembly over the core attached to the fuel grapple. Interlocks block travel over the reactor in the startup mode.

The refueling platform contains a system that indicates position of the fuel grapple over the core. The readout, in the operator's cab, matches the core arrangement cell identification numbers. The position indicator is accurate within 1/4 inch, relative to actual core position, and minimizes jogging required to correctly place the grapple over the core.

To move fuel, the fuel grapple is aligned over the fuel assembly, lowered, and attached to the fuel bundle bail. The fuel bundle is raised out of the core, moved through the refueling slot to the containment pool and is positioned over the storage rack and lowered into the rack or is placed in the fuel transfer system for transfer to the spent fuel pool. Fuel is shuffled and the new fuel is moved from the containment pool to the reactor vessel in the same manner.

9.1.4.2.10.2.5 Vessel Closure

The following steps, when performed, return the reactor to operating condition. The procedures are normally the reverse of those described in the preceding sections. Some steps may be performed in parallel and/or not in order listed.

- a. Install pool gate.
- b. Core verification. The core position of each fuel assembly must be verified to assure the desired core configuration has been attained.
- c. Control rod drive tests. The control rod drive timing, friction, and scram tests are performed as required.
- d. Replace separator.
- e. Drain separator storage pool and reactor well.
- f. Bolt separator and remove the four steam line plugs.

GRAND GULF NUCLEAR GENERATING STATION
Updated Final Safety Analysis Report (UFSAR)

- g. Remove drywell seal surface covering.
- h. Open drywell vents, install vent piping.
- i. Remove portable radiation shield.
- j. Replace steam dryer.
- k. Replace vessel studs.
- l. Install reactor vessel head.
- m. Install vessel head piping and insulation.
- n. Hydro-test vessel, if required.
- o. Install drywell head. Leak check.
- p. Flood reactor well.
- q. Startup tests The reactor is returned to full power operation. Power is increased gradually in a series of steps until the reactor is operating at rated power. At specific steps during the approach to power, the in-core flux monitors are calibrated.

9.1.4.2.10.3 Departure of Fuel from Site

The empty shipping cask arrives at the auxiliary building on a specially designed shipping flatbed. The personnel shipping barrier is removed and stored in the auxiliary building near the flatbed entrance. If inspection shows that the radioactivity level of the cask exceeds 10 CFR 20 limits, the cask is washed with demineralized water. When the cask crane is in operation, administrative controls assure that the New Fuel Bridge Crane and the Fuel Handling Area Platform are not operated (in operation) in the cask handling area. Cask crane is considered to be in operation any time the crane hoist, or bridge, or trolley are in motion. Cask handling operations are not performed during reactor refueling.

The front cask crash cone is removed and stored near the flatbed. The cask yoke is then removed from its flatbed storage area and attached to the cask trunnions. The cask crane then upends the cask, raises it to the fuel handling area, and transfers it to the cask storage pool. It is not necessary to move the flatbed during these operations. Although it is possible for the cask to pass

GRAND GULF NUCLEAR GENERATING STATION
Updated Final Safety Analysis Report (UFSAR)

over the new fuel storage vault, a cask drop accident on the new fuel storage racks, though costly, is not a nuclear safety concern. The normal path of cask travel does not include the new fuel storage vault and administrative controls assure that the normal path of travel is followed.

As the cask is lowered into the pool, the water is drained so that the water level is maintained just below the yoke crossbar. After the cask is set on the storage pool floor, the yoke and head seal are removed and stored near the hatch. The cask storage pool is then refilled and the two pool separation gates are opened, using the new fuel bridge crane where necessary.

Once the cask is loaded, the gates are closed and the water level lowered to the top of the cask. The head seal and yoke are reattached to the cask. As the cask is raised, the water level is maintained just below the top of the cask until the pool is filled and the cask is out of the water.

For normal operation, no cooling is necessary for the cask during transfer to the flatbed. The cask design is such that cooling can be delayed for 8 to 12 hours before the heat generation exceeds allowable limits. This situation can occur when power to the crane drive is lost or the drive itself becomes inoperative. Should a cask crane hoist malfunction cause such a delay that it appears that the heat generation may exceed allowable limits, cooling water may be readily supplied to the cask at any point along its path of travel by connecting a flexible hose between the cask and a demineralizer water supply nozzle, located in the washdown area.

A flexible return line discharges the heated water to the washdown area. Should the cask crane hoist become inoperative while handling a load, it is possible to safely lower the load by releasing the two redundant drum shaft holding brakes according to operational instructions.

9.1.4.2.10.4 Storage of Fuel at the Independent Spent fuel Storage Installation (ISFSI)

Spent Fuel is stored in a dry configuration in HI-STORM casks at the ISFSI in accordance with 10CFR72. Similar to the shipping cask loading, though, some dry spent fuel storage activities take place in the Auxiliary Building and are governed by 10CFR50.

GRAND GULF NUCLEAR GENERATING STATION
Updated Final Safety Analysis Report (UFSAR)

The Spent Fuel Cask Crane is required to lift and handle the HI-TRAC transfer cask and MPC fuel canister loaded with spent fuel in support of dry storage cask loading. The combined maximum lifted weight, including rigging and lift yoke does not exceed 125 tons.

Once fuel assemblies have been loaded into the MPC within the HI-TRAC in the cask storage pool, the MPC lid is installed under water the HI-TRAC transfer cask is lifted by the Spent Fuel Cask Crane and placed in the cask washdown pit to allow MPC closure activities. The MPC lid is welded and the canister is drained, dried and backfilled with helium in accordance with the Holtec CoC and FSAR governed by 10CFR72. The HI-TRAC transfer cask containing the sealed MPC is decontaminated, lifted out of the cask washdown pit, and moved by the Spent Fuel Cask Crane to the Auxiliary Building train bay. The HI-TRAC is lowered through the elevation 208, 185, and 166 hatch openings where it is placed on top of a mating device attached to an empty storage overpack sitting on the low profile transporter (LPT) in the train bay. The MPC is lowered into the overpack and the loaded HI-STORM cask is transported to the ISFSI.

Figure 9.1-25 depicts a shipping cask as it would appear during shipment. This configuration is not applicable for the ISFSI dry storage cask operations as the LPT and VCT are used to move the HI-STORM in a vertical orientation to the ISFSI.

9.1.4.3 Safety Evaluation, Fuel Handling System

Safety aspects (evaluation) of the fuel servicing equipment are discussed in subsection 9.1.4.2.3 and safety aspects of the refueling equipment are discussed throughout subsection 9.1.4.2.7. A description of fuel transfer, including appropriate safety features, is provided in subsection 9.1.4.2.10. In addition, the following summary safety evaluation of the fuel handling system is provided.

During new fuel receipt the fuel prep machine is used to facilitate new fuel insertion in the spent fuel pool. During fuel channeling operations with the fuel prep machine, the fuel prep machine removes and installs channels with all parts remaining underwater. Mechanical stops prevent the carriage from lifting a fuel bundle or assembly above its safe water shield level. Irradiated channels, as well as small parts such as bolts and

GRAND GULF NUCLEAR GENERATING STATION
Updated Final Safety Analysis Report (UFSAR)

springs, are stored underwater. The spaces in the channel storage rack have center posts which prevent the loading of fuel bundles into this rack.

There are no nuclear safety problems associated with the handling of new fuel bundles, singly or in pairs. Equipment and procedures prevent an accumulation of more than two bundles in any location.

The refueling platform is designed to prevent it from toppling into the pools during an SSE. Redundant safety interlocks are provided as well as limit switches to minimize the potential of accidentally running the grapple into the pool walls. The grapple utilized for fuel movement is on the end of a telescoping mast. At full retraction of the mast, the grapple is approximately 7 feet below water surface, so there is no chance of raising a fuel assembly to the point where it is inadequately shielded by water. The grapple is hoisted by redundant cables inside of the mast and is lowered by gravity. A digital readout is displayed to the operator, showing him the exact coordinates of the grapple over the core.

The mast is suspended and gimbaled from the trolley, near its top, so that the mast can be swung about the axis of platform travel in order to remove the grapple from the water for servicing and for storage.

The grapple has two independent hooks each operated by an air cylinder. Engagement is indicated to the operator. Interlocks prevent grapple disengagement until a "slack cable" signal from the lifting cables indicates that the fuel assembly is seated.

In addition to the main hoist on the trolley, there is an auxiliary hoist on the trolley, and another hoist on its own monorail. These three hoists are precluded from operating simultaneously, because control power is available to only one of them at a time. The two auxiliary hoists have load cells with interlocks which prevent the hoists from moving anything as heavy as a fuel bundle.

The Refueling platform auxiliary monorail hoist and main trolley framemounted auxiliary hoist load cell interlock setpoints were initially set via the original GE Specification 21A3545 "Refueling Platform" to a value of 500 lbs that effectively prevented the auxiliary hoists from lifting a fuel bundle with a weight of approximately 630 lbs. To fully utilize the

GRAND GULF NUCLEAR GENERATING STATION
Updated Final Safety Analysis Report (UFSAR)

capabilities of the auxiliary hoists for handling non-fuel items, including control rod blades, temporary blade guides, fuel support pieces, guide tubes, neutron flux monitors dry tubes, sources, and other non-fuel reactor internals, the load cell interlock setpoints have been adjusted to allow hoist operation more fully within the full 1000 lb rated capacity of the auxiliary hoist, with an appropriate accounting for measurement uncertainty. The use of the auxiliary hoists in this manner has been determined to be within the analyzed bounds of the FSAR Section 15.7.4 Fuel Handling Accident. Administrative and procedural controls and other physical restrictions of the refueling special tools shall effectively preclude the inadvertent lifting of a fuel bundle from the reactor core when using the refueling platform auxiliary hoists, which remains strictly prohibited. Fuel bundles are only to be moved using the refueling platform main mast and fuel grapple.

The two auxiliary hoists have redundant electrical normal-up interlocks which prevent the lifting of their loads higher than approximately 7 feet below the surface of the water. During control blade or irradiated fuel channel movements, the water coverage over the control blade or fuel channel must be at least 6 feet 2 inches. A mechanical interlock and administrative controls may be used in lieu of the electrical normal-up interlocks to

GRAND GULF NUCLEAR GENERATING STATION
Updated Final Safety Analysis Report (UFSAR)

ensure that the minimum water shielding is maintained. The auxiliary hoists also incorporate an electrical maximum-up interlock to stop the hoists at a preset distance below the mechanical (full-up) jam-stop.

Provisions have been made to minimize the potential for a heavy load handling operation that results in damage to irradiated fuel or safety related equipment. The applicable design criteria, construction standards, and operational procedures have been reviewed and found adequate to the extent that this potential is reduced to an acceptable level. Information regarding this review is contained in Appendix 9D. In addition, the handling of loads less than 1140 pounds over irradiated fuel is administratively controlled to ensure that in the unlikely event of a load drop, the radiological results are well within the guidelines of 10CFR100. These controls establish limits on loads when Secondary Containment/Standby Gas Treatment Systems are available or when unavailable. In either case, analyses have been performed to show that postulated load drops within the established limits will maintain radiological results within the acceptance criteria.

In summary, the fuel handling system complies with Regulatory Guides 1.13, General Design Criteria 2, 3, 4, 5, 61, 62, and 63, and applicable portions of 10CFR100.

A system-level, qualitative-type failure mode and effects analysis relative to this system is discussed in subsection 15.A.6.5.

The safety evaluation of the new and spent fuel storage is presented in subsections 9.1.1.3 and 9.1.2.3.

9.1.4.4 Inspection and Testing Requirements

9.1.4.4.1 Inspection

Refueling and servicing equipment is subject to the strict controls of quality assurance, incorporating the requirements of federal regulation 10 CFR 50, Appendix B. Components defined as essential to safety, such as the fuel storage racks, refueling platform, and horizontal fuel transfer tube, have an additional set of engineering specified, "quality requirements" that identify safety-related features which require specific QA verification of compliance to drawing requirements.

GRAND GULF NUCLEAR GENERATING STATION
Updated Final Safety Analysis Report (UFSAR)

For components classified as American Society of Mechanical Engineers (ASME) Section III, the shop operation must secure and maintain an ASME "N" stamp, which requires the submittal of an acceptable ASME quality plan and a corresponding procedural manual.

Additionally, the shop operation must submit to frequent ASME audits and component inspections by resident state code inspectors.

Prior to shipment, every component inspection item is reviewed by QA supervisory personnel and combined into a summary product quality checklist (PQL). By issuance of the PQL, verification is made that all quality requirements have been confirmed and are on record in the product's historical file.

9.1.4.4.2 Testing

Prior to multi-unit fabrication, major pieces of refueling or servicing equipment are fabricated and tested as prototype units. These units are tested to specifications defined by the responsible design engineer and implemented by a test engineering organization. In many cases, a full design review of the product is conducted before and after the testing cycle.

Any design changes affecting function, that are made after the design review of the qualification testing has been completed, are reverified by test or calculation.

When the unit is received at the site, it is inspected by quality assurance personnel to ensure that no damage has occurred during transit or storage. Prior to site operation, the refueling or servicing equipment undergoes a sequence of preoperational functional tests, as defined by a site preoperational test specification.

There is an operation and maintenance instruction manual for each tool that additionally requires a series of functional checks each time the unit is operated for reactor refueling or servicing.

Fuel handling and vessel servicing equipment preoperational tests are described in subsection 14.2.12.1.12.

9.1.4.5 Instrumentation Requirements

The majority of the refueling and servicing equipment is manually operated and controlled by the operator's visual observations. This type of operation does not necessitate the need for a dynamic instrumentation system.

However, there are several components that are essential to prudent operation that do have instrumentation and control systems.

9.1.4.5.1 Refueling Platform

The refueling platform has a non-safety-related X-Y-Z position indicator system that informs the operator which core fuel cell the fuel grapple is accessing. Interlocks and control room monitor are provided to prevent the fuel grapple from operating in a fuel cell where the control rod is not in the proper orientation for refueling. Refer to subsection 7.6.1.1 for discussion of refueling interlocks.

Additionally, there is a series of mechanically activated switches and relays that provides monitor indications on the operator's console for grapple limits, hoist and cable load conditions, and confirmation that the grapple's hook is either engaged or released.

A series of load cells is installed to provide automatic shutdown whenever threshold limits are exceeded on either the fuel grapple or the auxiliary hoist units.

9.1.4.5.2 Fuel Support Grapple

Although the fuel support grapple is not essential to safety, it has an instrumentation system consisting of mechanical switches and indicator lights. This system provides the operator with a positive indication that the grapple is properly aligned and oriented and that the grappling mechanism is either extended or retracted. Proper seating and grappling of the fuel support maybe verified using underwater camera and weight verification in lieu of the indicating lights.

9.1.4.5.3 Other

Refer to Table 9.1-1 for additional refueling and servicing equipment not requiring instrumentation.

GRAND GULF NUCLEAR GENERATING STATION
Updated Final Safety Analysis Report (UFSAR)

9.1.4.5.4 Radiation Monitoring

The radiation monitoring equipment for the refueling and servicing equipment is described and evaluated in subsections 7.6.1.2 and 7.6.2.2, respectively.

9.1.5 References

1. R. P. Kennedy, "A Review of Procedures for the Analysis and Design of Concrete Structures to Resist Missile Impact Effects," Report No. NSS5-940.1, September 1975.
2. J. M. Biggs, "Introduction to Structural Dynamics," McGraw-Hill Book Co., 1964.
3. Deleted
4. Deleted
5. Deleted
6. Deleted
7. Deleted
8. Deleted
9. Deleted
10. MAEC-88/0386, "Criticality Analysis for Cycle 4 Fuel", L. L. Kintner, NRC, to W. T. Cottle, SERI, December 12, 1988. Deleted
11. Deleted
12. Deleted
13. Deleted
14. Deleted
15. Deleted
16. Deleted
17. "Issuance of Amendment No. 73 to Facility Operating License No. NPF-29 - Grand Gulf Nuclear Station, Unit 1, Regarding Fuel Cycle 5 Reload (TAC No. 76992)," L. L. Kintner to W. T. Cottle, November 15, 1990.

GRAND GULF NUCLEAR GENERATING STATION
Updated Final Safety Analysis Report (UFSAR)

18. Deleted
19. Deleted
20. CEO-97/00037, F. H. Smith to M. D. Withrow, "GGNS Spent Fuel Rack Criticality Analysis, dated March 3, 1997."
21. GNRO-96/00118, "Response to Generic Letter 96-04, Boraflex Degradation In Spent Fuel Pool Storage Racks, October 16, 1996."
22. Deleted
23. CEO-2000/00056, "GGNS Spent Fuel Pool Criticality Evaluation."
24. CEO-2002/00157, "Criticality Safety Evaluation Of Misplaced Fuel Assembly in GGNS Fuel Storage Racks -GGNS Condition Report, CR-GGNS-2002-00772," July 12, 2002.
25. NEAD-SR-2002/045, Revision 0, "Criticality Safety Analysis of GGNS Fuel Storage Racks with Misplaced Assembly," July 15, 2002.
26. Certificate of Compliance For Spent Fuel Storage Casks, Certificate 1014 Issued to Holtec International Docket 72-1014 Dated 05/31/00.
27. Entergy Operations 10 CFR 72.212 Evaluation Report for Independent Spent Fuel Storage Installations Using the Holtec International HI-STORM 100 Cask System.
28. EC20182, "GGNS Cycle 18 Fuel Receipt and Storage."
29. EC32221, "GGNS Cycle 19 Fuel Receipt and Storage."

GRAND GULF NUCLEAR GENERATING STATION
Updated Final Safety Analysis Report (UFSAR)

30. GE-Hitachi Nuclear Energy Americas, LLC, "Grand Gulf Nuclear Station, Fuel Storage Criticality Safety Analysis of Spent and New Fuel Storage Racks," NEDC-33621P, Revision 0, November 2010 (not publicly available - proprietary) public version designated as NEDO-33621, Revision 0, November 2010 (ADAMS Accession No. ML 103330093).

31. EC84881, "GGNS C23 Fuel Receipt and Storage." |

32. GNRI2013-00160 "Grand Gulf Nuclear Station, Unit 1 - Issuance of Amendment RE: Changes to the Nuclear Criticality Safety Analysis (TAC NO. ME7111)." |

33. ECH-NE-19-00038, "GGNS Fuel Storage Criticality Safety Analysis of Spent and New Fuel Storage Racks" |

34. ECH-NE-19-00039, "GNF3 Fuel Design Cycle Independent Fuel Storage Criticality Safety Analysis for GGNS" |

GRAND GULF NUCLEAR GENERATING STATION
Updated Final Safety Analysis Report (UFSAR)

TABLE 9.1-1 TOOLS AND SERVICING EQUIPMENT

<u>Fuel Servicing Equipment</u>	<u>In-Vessel Servicing Equipment</u>
Channel handling boom	Instrument strongback
Fuel preparation machines	Control rod grapple
New fuel inspection stand	Control rod guide tube grapple
Channel bolt wrenches	Fuel support grapple
Channel handling tool	Grid guide
Fuel pool sipper	Control rod latch tool
Channel gauging fixture	Instrument handling tool
General purpose grapples	Control rod guide tube seal
Fuel handling platform	In-core guide tube seals
Fuel transfer system	Blade guides
New fuel channeling air tugger	Fuel bundle sampler
	Peripheral orifice grapple
	Orifice holders
	Peripheral fuel support plug
	REM TAKE-2
<u>Servicing Aids</u>	<u>Refueling Equipment</u>
Pool tool accessories	Refueling platform
Actuating poles	Auxiliary platform
General area underwater lights	Fuel handling platform
Local area underwater lights	
Drop lights	
Underwater TV monitoring system	
Underwater vacuum cleaner	
Viewing aids	
Light support brackets	
Underwater viewing tube	

GRAND GULF NUCLEAR GENERATING STATION
Updated Final Safety Analysis Report (UFSAR)

TABLE 9.1-1 TOOLS AND SERVICING EQUIPMENT

Reactor Vessel Servicing
Equipment

Reactor vessel servicing tools
Steam line plugs and
installation tools
Head holding pedestals
Head stud rack
Dryer-separator strongback
Head strongback/carousel
(incl. stud tensioners)

Storage Equipment

Fuel storage racks
Channel storage racks
Control rod storage rack
Defective fuel storage
containers
In-vessel racks
Defective fuel storage racks
Control rod guide tube rack
HFTS insert storage rack
Control Rod Blade Storage
Hanger

Under-Reactor Vessel Servicing
Equipment

Control rod drive servicing
tools
CRD hydraulic system tools
Water seal cap
Control rod drive handling
equipment
Equipment handling platform
Thermal sleeve installation
tool
In-core flange seal test plug
Key bender

TABLE 9.1-2 FUEL SERVICING EQUIPMENT

Component No. Identification	Essential Classification	Safety Classification	Quality Group	Seismic Category
	(a)	(b)	(c)	(d)
1. Fuel prep machine	PE	3	E	I
2. New fuel inspection stand	PE	3	E	I
3. Channel bolt wrench	NE	0	E	NA
4. Channel handling tool	NE	0	E	NA
5. Fuel pool sipper	NE	0	E	NA
6. Channel gauging fixture	NE	0	E	NA
7. General purpose grapple	PE	2	E	I
8. Fuel handling platform	PE	2	E	I
9. Channel handling boom	NE	0	E	NA
10. New fuel channeling air tugger	NE	0	E	NA

Table Notes

a. NE Non-essential
 PE passive essential

b. 0 Other

c. B ASME Code, Section III, Class-2
 D ANSI B31.1
 E Industrial code applies
 I Electrical codes apply

d. NA No seismic requirements

TABLE 9.1-3 REACTOR VESSEL SERVICING EQUIPMENT

Component No. Identification	Essential Classification	Safety Classification	Quality Group	Seismic Category
	(a)	(b)	(c)	(d)
1. Reactor vessel servicing tools	NE	0	E	NA
2. Steam line plug	NE	0	E	NA
3. Shroud head bolt wrench	NE	0	E	NA
4. Head holding pedestal	PE	0	E	I
5. Head stud rack	NE	0	E	NA
6. Dryer and separator strongback	PE	0	E	NA
7. Head strongback carousel	PE	3	E	I*
8. Drywell Head Lifting Frame	3	E	I**	

Table Notes

a. NE Non-essential
PE Passive essential

c. B ASME Code, Section III, Class-2
D ANSI STD B31.1
E Industrial

b. 0 Other
I Electrical codes apply

d. NA No seismic requirements

* Dynamic analysis methods for seismic loading are not applicable, as this equipment is supported by the containment polar crane. Lifting devices have been designed with a minimum safety factor of 5 and undergo proof testing.

** Dynamic analysis methods for seismic loading are not applicable, as this equipment is supported by the containment polar crane. Lifting device has been designed with maximum allowables per AISC and undergoes proof testing.

GRAND GULF NUCLEAR GENERATING STATION
Updated Final Safety Analysis Report (UFSAR)

TABLE 9.1-4 UNDER-REACTOR VESSEL SERVICING EQUIPMENT AND TOOLS

Equipment/Tool	Classification	Safety Class	Seismic Category
1. CRD Handling equipment	Non-essential	"Other"	NA
2. Equipment handling platform	Non-essential	"Other"	NA
3. Water seal cap	Non-essential	"Other"	NA
4. Thermal sleeve removal tool	Non-essential	"Other"	NA
5. In-core flange seal test plug	Non-essential	"Other"	NA
6. Key bender	Non-essential	"Other"	NA

NA - No seismic requirements

GRAND GULF NUCLEAR GENERATING STATION
Updated Final Safety Analysis Report (UFSAR)

TABLE 9.1-5 CASK HANDLING PASSIVE FAILURE ANALYSIS

Single Passive Failure	Analysis
Failure of one shipping cask trunnion	Total shipping cask weight is supported by redundant pair of trunnions
Failure of any member of primary cask yoke assembly	Total load will be supported by redundant yoke assembly and precludes cask drop
Failure of dry fuel storage transfer cask trunnions or yoke	Note a credible failure
Failure of cask crane sister hook center hole support	Redundant sister hook supports total design load (cask plus yoke)
Failure of crane rope	Redundant rope supports total design load
Failure of main drum	Not a credible failure (see subsection 9.1.4.2.2.2 for design analysis)
Failure of hoist gear teeth	Redundant gear train supports total design load

GRAND GULF NUCLEAR GENERATING STATION
Updated Final Safety Analysis Report (UFSAR)

TABLE 9.1-6 CASK HANDLING ACTIVE FAILURE ANALYSIS

Single Active Failure	Analysis
Failure of holding brake on loss of offsite power	Redundant holding brake precludes a cask drop

TABLE 9.1-7 CONTAINMENT POLAR CRANE LOAD DROP

Load	Weight	Drop Area	Load Safety Class	Drop Height	Transport Medium	Load Reference Figure	Crane Speeds (Based on Full Load), fpm			
							Main Hoist Lift (Max)	Auxiliary Hoist Lift (Max)	Trolley Traveling (Max)	Bridge Traveling
A. RPV head	117 tons	Reactor vessel	1	40 ft.	Air	Figure 9.1-31 Figure 9.1-32	5	-	25	65
B. Steam dryer	60 tons	Reactor vessel	1	40 ft. 11 ft. (Note 2)	Air Water Air	Figure 9.1-34	5	-	25	65
C. Shroud head/Steam separator	68 tons	Reactor vessel	1	50 ft. (Note 1)	Water	Figure 9.1-35	5	-	25	65
D. Portable radiation shield	12 tons	Reactor vessel	2	43 ft. 11 ft.	Air Water	Figure 9.1-37	5	20	25	65
E. RPV head insulation with support structure	10.5 tons	Refueling floor grating	1/3A	5 ft.	Air	Figure 9.1-39 (Note 3)	-	20	25	65
F. Upper ctmt. fuel pool/transfer pool gate	3.5 tons	Steam dryer storage area	2/3A	24 ft.	Water	Figure 9.1-33	-	20	25	65
G. Reactor well/steam dryer stor. area gate	3.5 tons	Steam dryer storage area	2/3A	24 ft.	Water	Figure 9.1-33	-	20	25	65
H. Drywell head B. Reactor well	61.5 tons	A. Refueling floor	1/3B	5 ft. 30 ft.	Air	Figure 3.8-59	5	-	25	65
I. RPV head	117 tons	A. Refueling floor	3B	5 ft.	Air	Figure 9.1-31 Figure 9.1-32	5	-	25	65
J. Steam dryer	60 tons	Steam dryer storage area	2/3B	23 ft.	Air	Figure 9.1-34 Figure 9.1-36	5	-	25	65
K. Shroud head/Steam separator	68 tons	Steam separator storage area	3B	17 ft.	Water	Figure 9.1-35 Figure 9.1-36	5	-	25	65

9.1-82

Revision 2016-00

L. Portable radiation shield 12 tons Refueling floor 3A 5 ft. Air Figure 9.1-37 5 20 25 65

NOTES:

1. Assumed to impact at terminal velocity.
2. The kinetic energy of the steam dryer at impact is less than that for the shroud head/steam separator assembly and, therefore, the load drop analysis for the shroud head assembly is conservative for the steam dryer as the drop impact areas are comparable for each piece of equipment.
3. The kinetic energy of the RPV head insulation with support structure is less than that for the drywell head and, therefore, the load drop analysis for the drywell head is conservative for the drop of the RPV head insulation with support structure.

GRAND GULF NUCLEAR GENERATING STATION
Updated Final Safety Analysis Report (UFSAR)

TABLE 9.1-8: DELETED

GRAND GULF NUCLEAR GENERATING STATION
Updated Final Safety Analysis Report (UFSAR)

TABLE 9.1-9: DELETED

GRAND GULF NUCLEAR GENERATING STATION
Updated Final Safety Analysis Report (UFSAR)

TABLE 9.1-10 PROJECTED FUEL LOADING CYCLES

Discharge Batch*	Number of Assemblies	Percentage of Core
N-11	168	21
N-10	380	47.5
N-9	380	47.5
N-8	380	47.5
N-7	380	47.5
N-6	380	47.5
N-5	380	47.5
N-4	380	47.5
N-3	380	47.5
N-2	380	47.5
N-1	380	47.5
N	380	47.5

*Batch N is the discharge batch that completely fills the spent fuel pool.

GRAND GULF NUCLEAR GENERATING STATION
Updated Final Safety Analysis Report (UFSAR)

TABLE 9.1-11: UNIT 1 HIGH DENSITY SPENT FUEL STORAGE MODULE DATA

Type	Quantity	Pool	Number of Cells/ Module	Array Size	Approximate Weight lbs/module
A	12	SFP†	304	19x16	32,400
B	1	SFP	256	16x16	27,360
C	1	SFP	216	12x18	23,160
D	1	SFP	228	12x19	24,420
E	3	UCP††	90	9x10	9,930
F	2	UCP	99	9x11	10,880
G	2	UCP	121	11x11	13,190
H	1	SFP	45†††	9x5	11,300
J	1	UCP	20††††	5x4	4,300

† Spent Fuel Pool (SFP)

†† Upper Containment Pool (UCP)

††† Designated for storage of 27 control rods, 9 control rod blade guides and 9 defective fuel storage canisters

†††† Designated for storage of control rods, control rod guide tubes, defective fuel storage containers, & fuel sipping containers.

GRAND GULF NUCLEAR GENERATING STATION
Updated Final Safety Analysis Report (UFSAR)

TABLE 9.1-12 MAXIMUM FUEL POOL HEAT LOAD

Shutdown Time (Days)	Normal Maximum Decay Heat (MBtu/hr) *	Abnormal Maximum Decay Heat Load (MBtu/hr) *
1	48.67	106.15
2	40.92	89.69
3	36.06	79.32
4	32.62	71.95
5	30.13	66.56
6	28.27	62.52
6.25	27.88	61.67
7	26.85	59.39
8	25.72	56.90
9	24.81	54.86
10	24.04	53.14
11	23.38	51.65
12	22.81	50.33
13	22.29	49.14
14	21.82	48.06
15	21.40	47.06
16	21.00	46.13
17	20.62	46.25
18	20.27	44.43
19	19.94	43.64
20	19.63	42.90
22	19.04	41.51
24	18.51	40.23
26	18.02	39.06
28	17.56	37.97
30	17.15	36.96

*The normal and abnormal maximum heat loads are associated with a fuel pool that is completely filled by discharge of a normal reload batch and a full core offload, respectively.

GRAND GULF NUCLEAR GENERATING STATION
Updated Final Safety Analysis Report (UFSAR)

TABLE 9.1-13: DELETED

GRAND GULF NUCLEAR GENERATING STATION
Updated Final Safety Analysis Report (UFSAR)

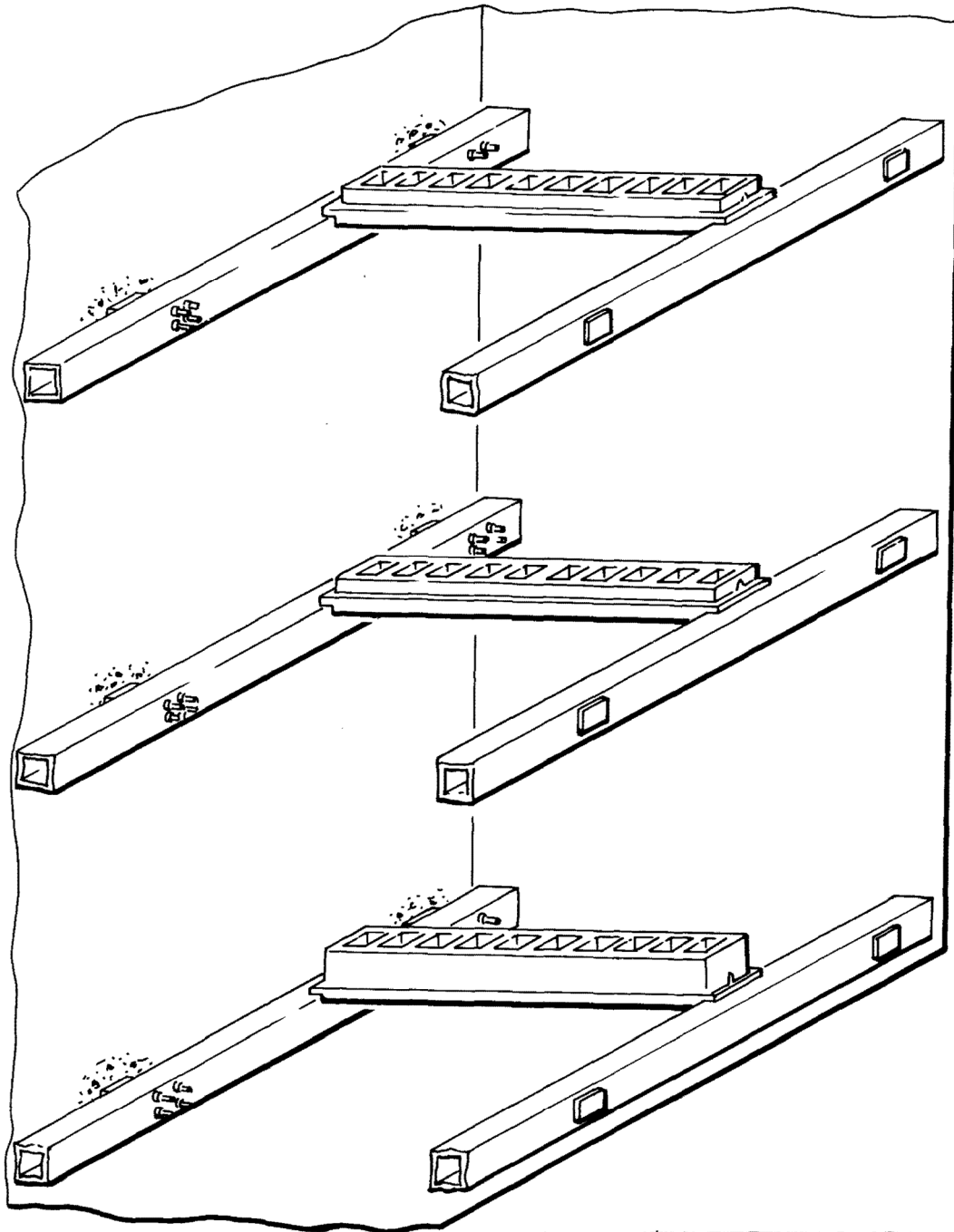

<p>MISSISSIPPI POWER & LIGHT COMPANY GRAND GULF NUCLEAR STATION UNITS 1 & 2 UPDATED FINAL SAFETY ANALYSIS REPORT</p>	<p>NEW FUEL STORAGE FIGURE 9.1-1</p>
--	---

GRAND GULF NUCLEAR GENERATING STATION
 Updated Final Safety Analysis Report (UFSAR)

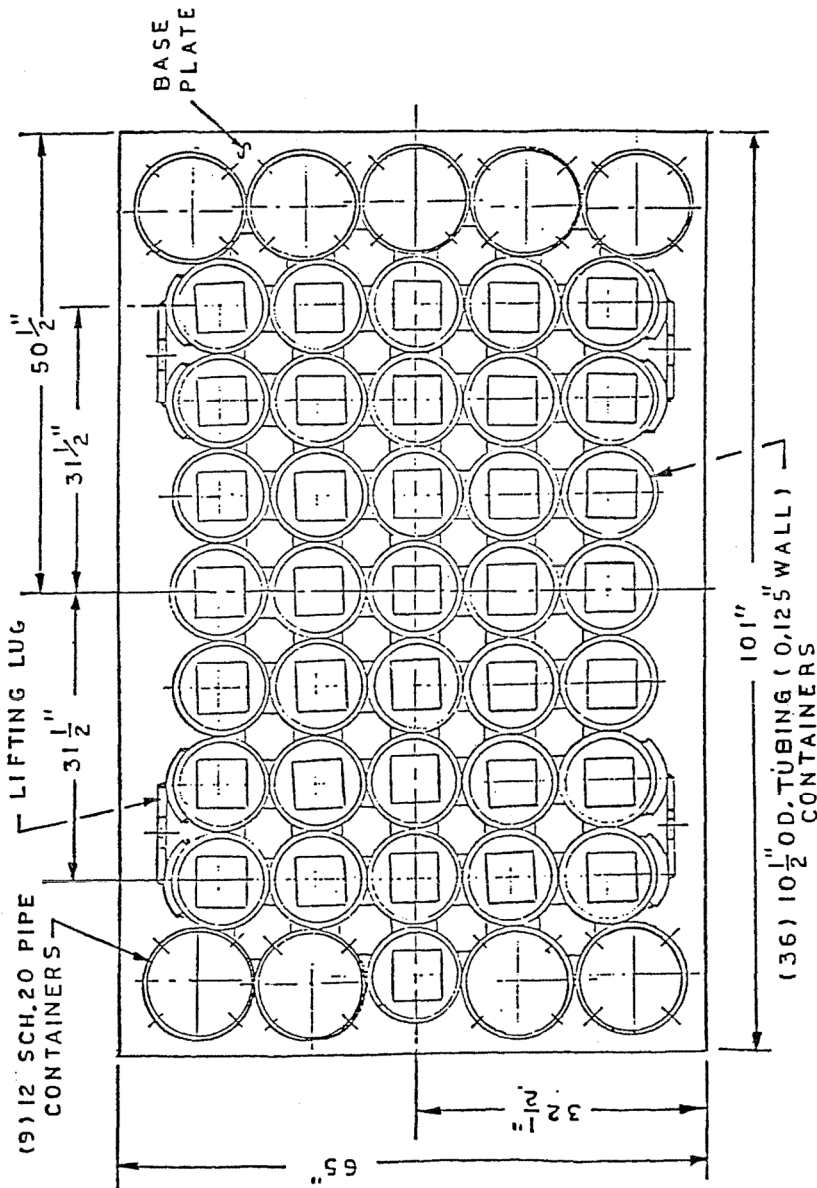

TOP VIEW HIGH DENSITY FUEL RACK
 UNIT 1
 FIGURE 9.1-2

SYSTEM ENERGY RESOURCES, INC.
 GRAND GULF NUCLEAR STATION
 UNITS 1 & 2
 UPDATED FINAL SAFETY ANALYSIS REPORT

GRAND GULF NUCLEAR GENERATING STATION
Updated Final Safety Analysis Report (UFSAR)

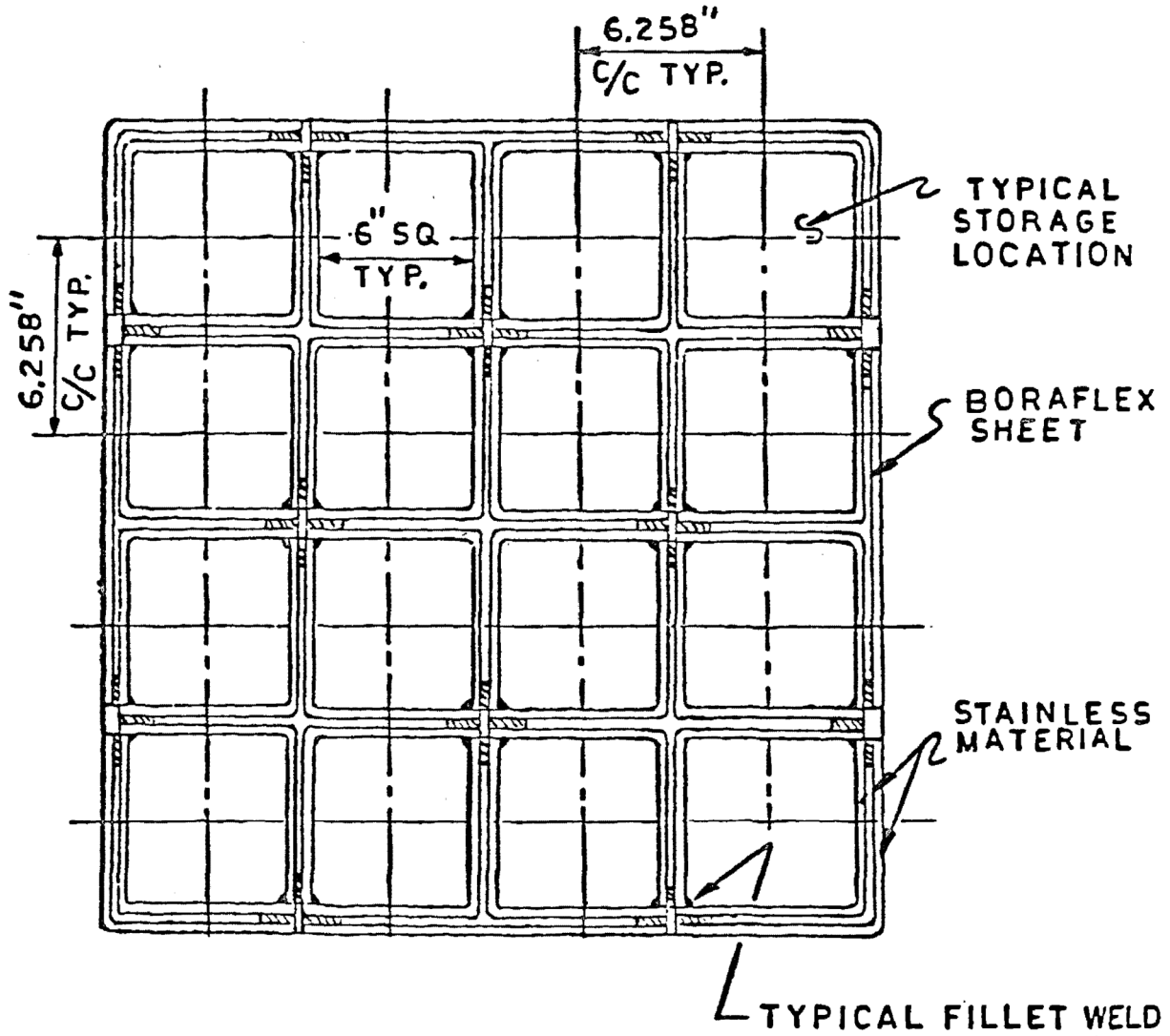

<p>SYSTEM ENERGY RESOURCES, INC. GRAND GULF NUCLEAR STATION UNITS 1 & 2 UPDATED FINAL SAFETY ANALYSIS REPORT</p>	<p>HIGH DENSITY FUEL RACK ARRAY OF CELLS (4 x 4) UNIT 1 FIGURE 9.1-2a</p>
--	---

GRAND GULF NUCLEAR GENERATING STATION
Updated Final Safety Analysis Report (UFSAR)

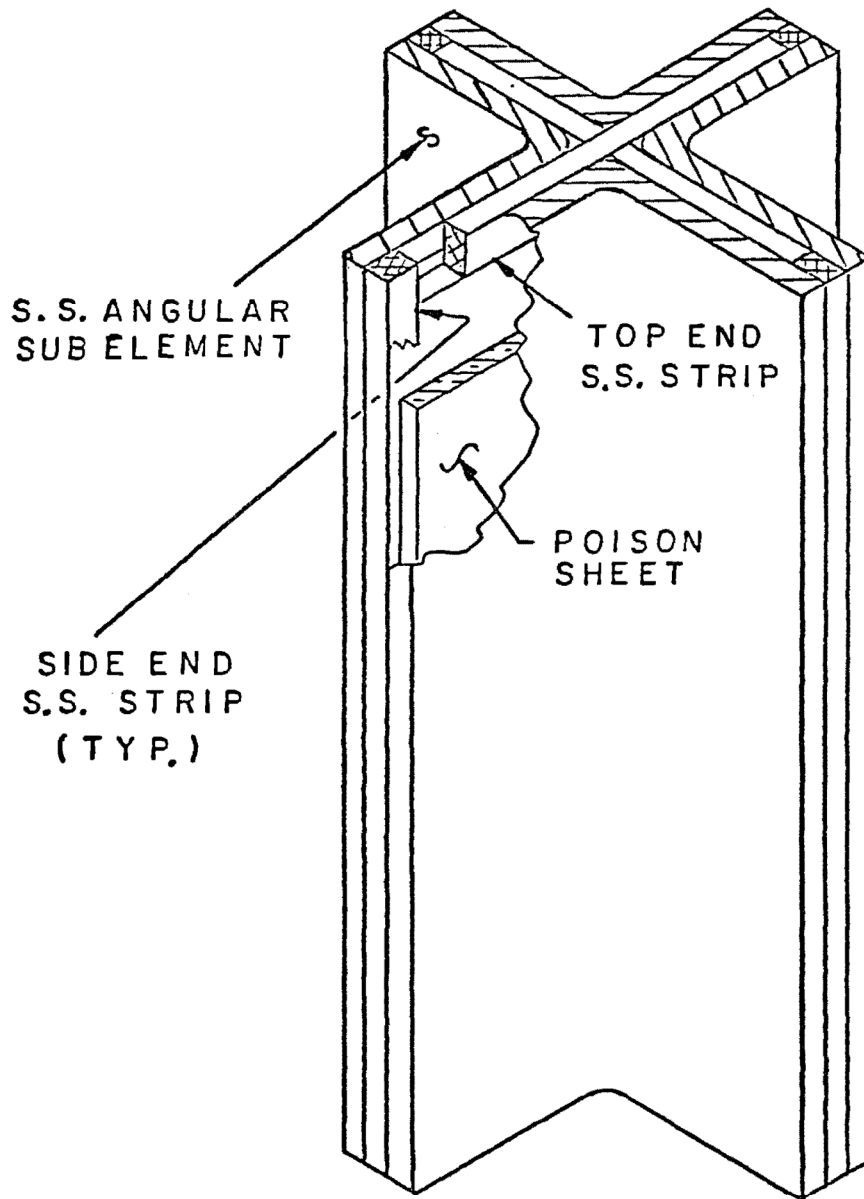

<p>SYSTEM ENERGY RESOURCES, INC. GRAND GULF NUCLEAR STATION UNITS 1 & 2 UPDATED FINAL SAFETY ANALYSIS REPORT</p>	<p>HIGH DENSITY FUEL RACK CRUCIFORM ELEMENT UNIT 1 FIGURE 9.1-2b</p>
--	--

GRAND GULF NUCLEAR GENERATING STATION
 Updated Final Safety Analysis Report (UFSAR)

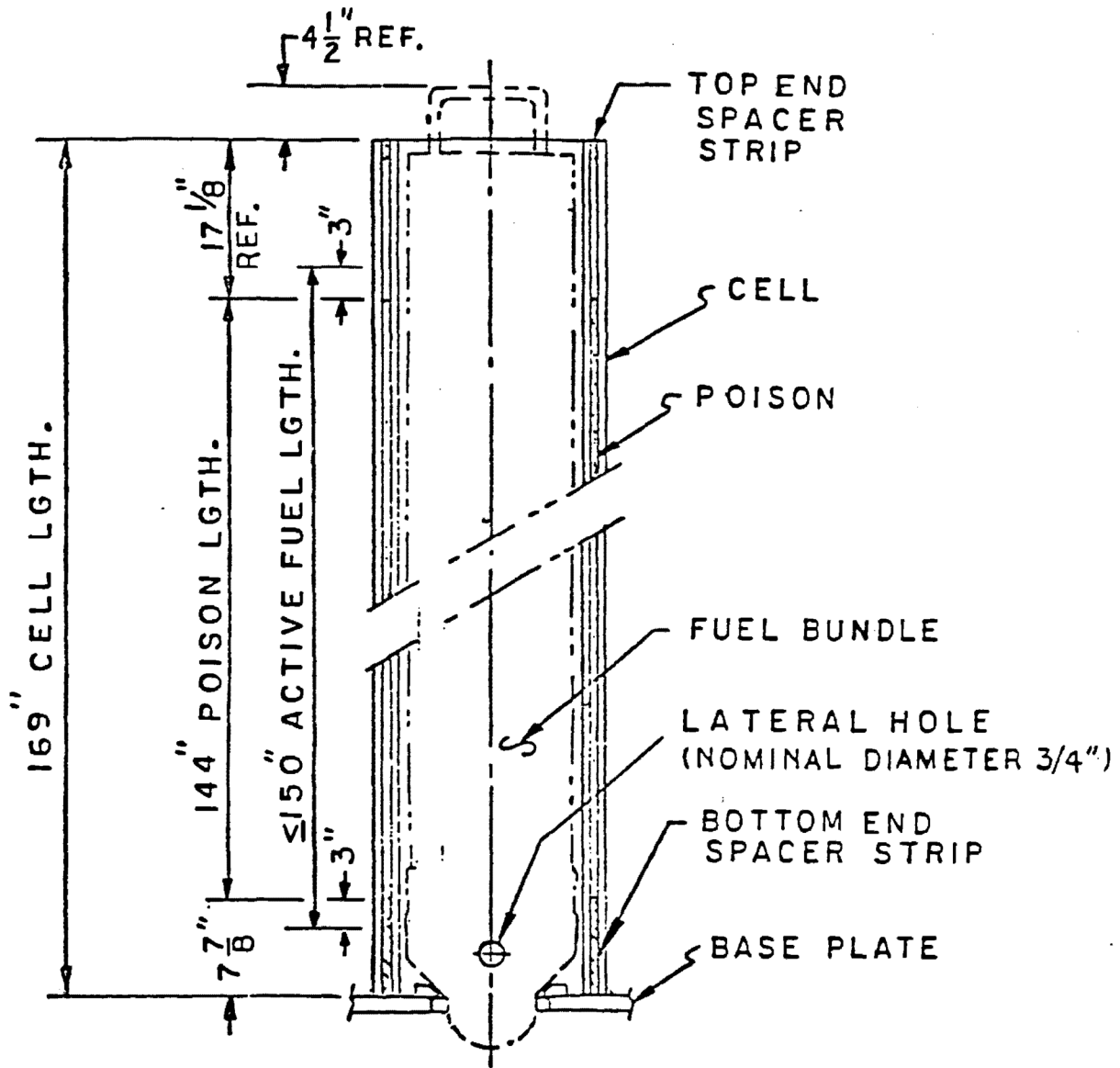

GRAND GULF NUCLEAR STATION UNIT 1 UPDATED FINAL SAFETY ANALYSIS REPORT	HIGH DENSITY FUEL RACK TYPICAL CELL ELEVATION FIGURE 9.1-2c
---	---

GRAND GULF NUCLEAR GENERATING STATION
 Updated Final Safety Analysis Report (UFSAR)

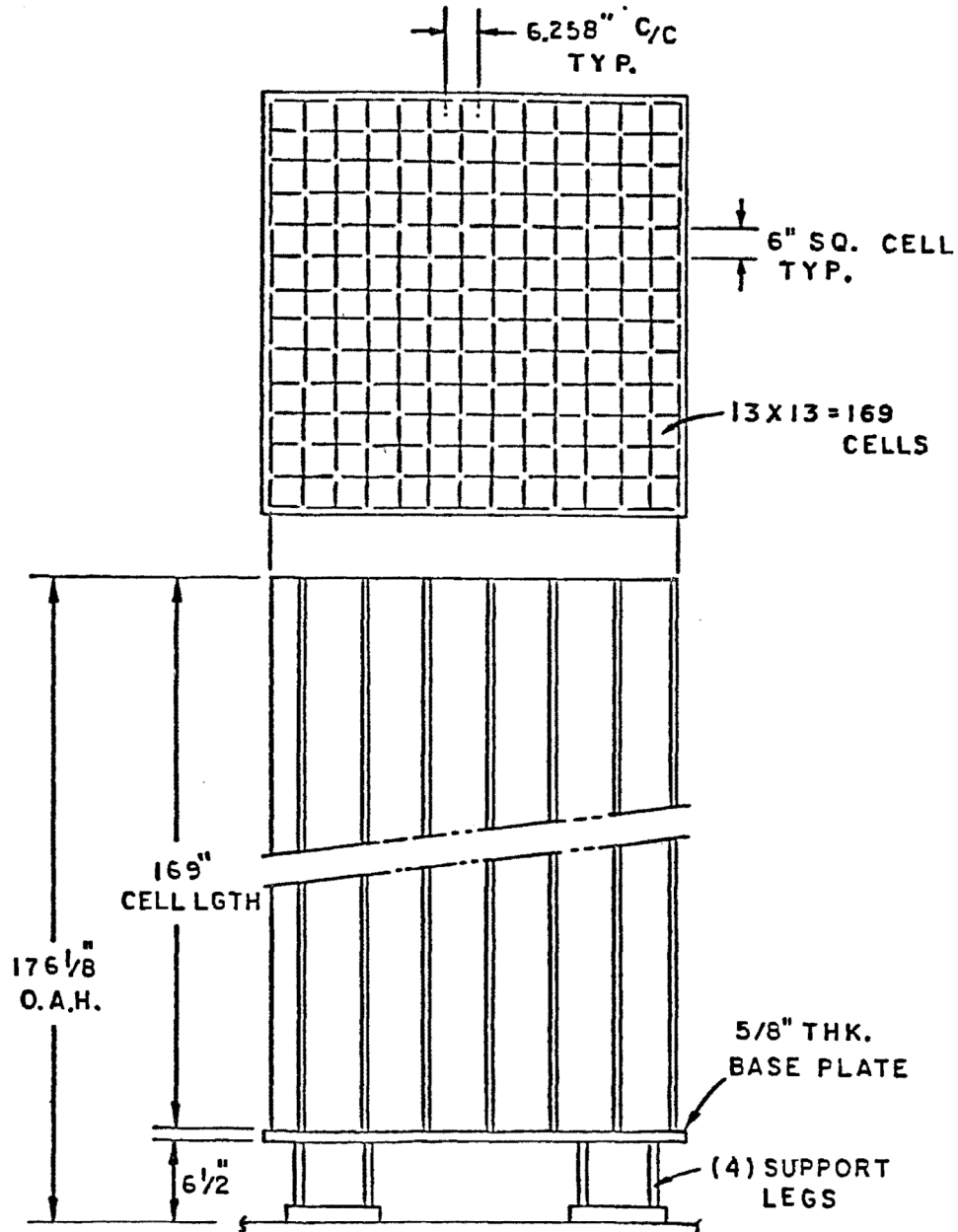

<p>SYSTEM ENERGY RESOURCES, INC. GRAND GULF NUCLEAR STATION UNITS 1 & 2 UPDATED FINAL SAFETY ANALYSIS REPORT</p>	<p>TYPICAL HIGH DENSITY SPENT FUEL RACK UNIT 1 FIGURE 9.1-2d</p>
---	---

GRAND GULF NUCLEAR GENERATING STATION
Updated Final Safety Analysis Report (UFSAR)

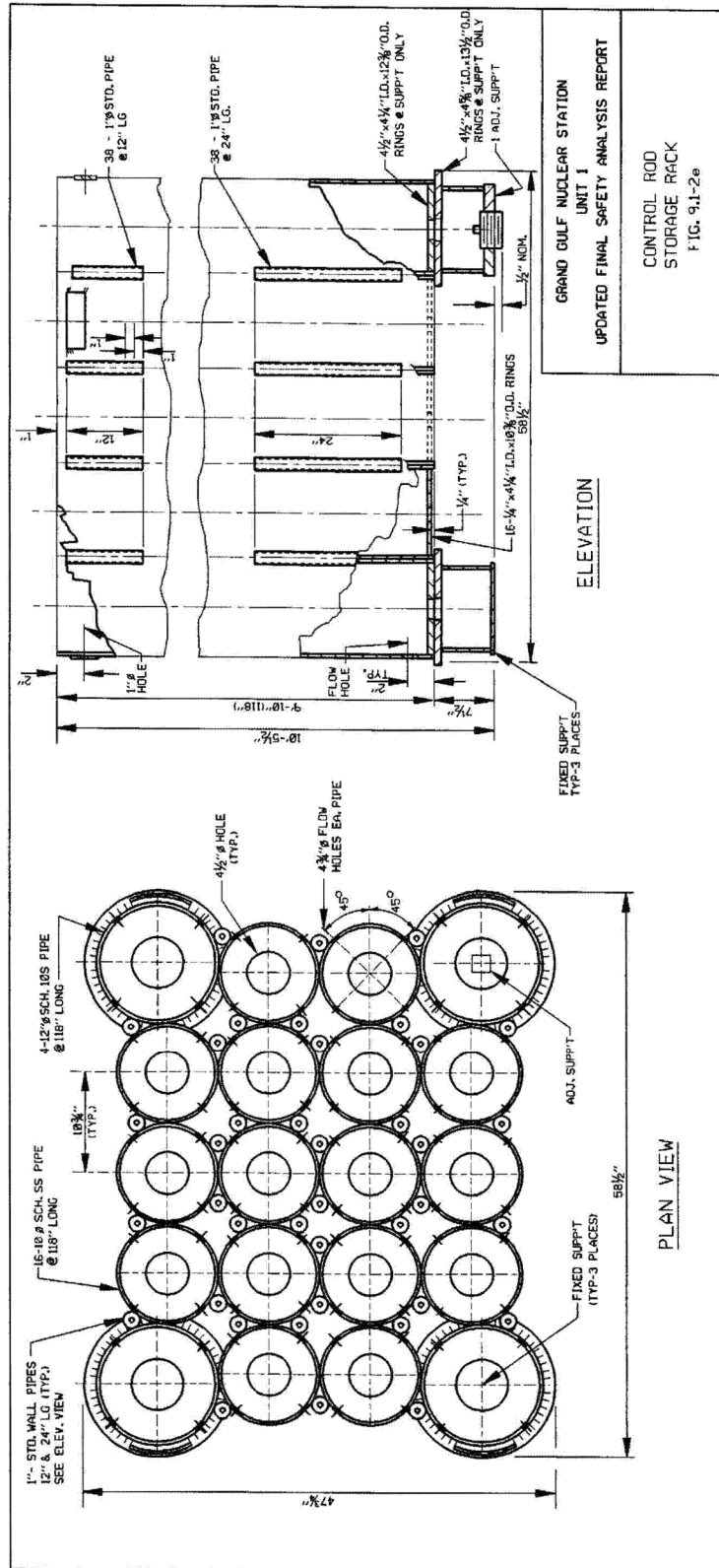
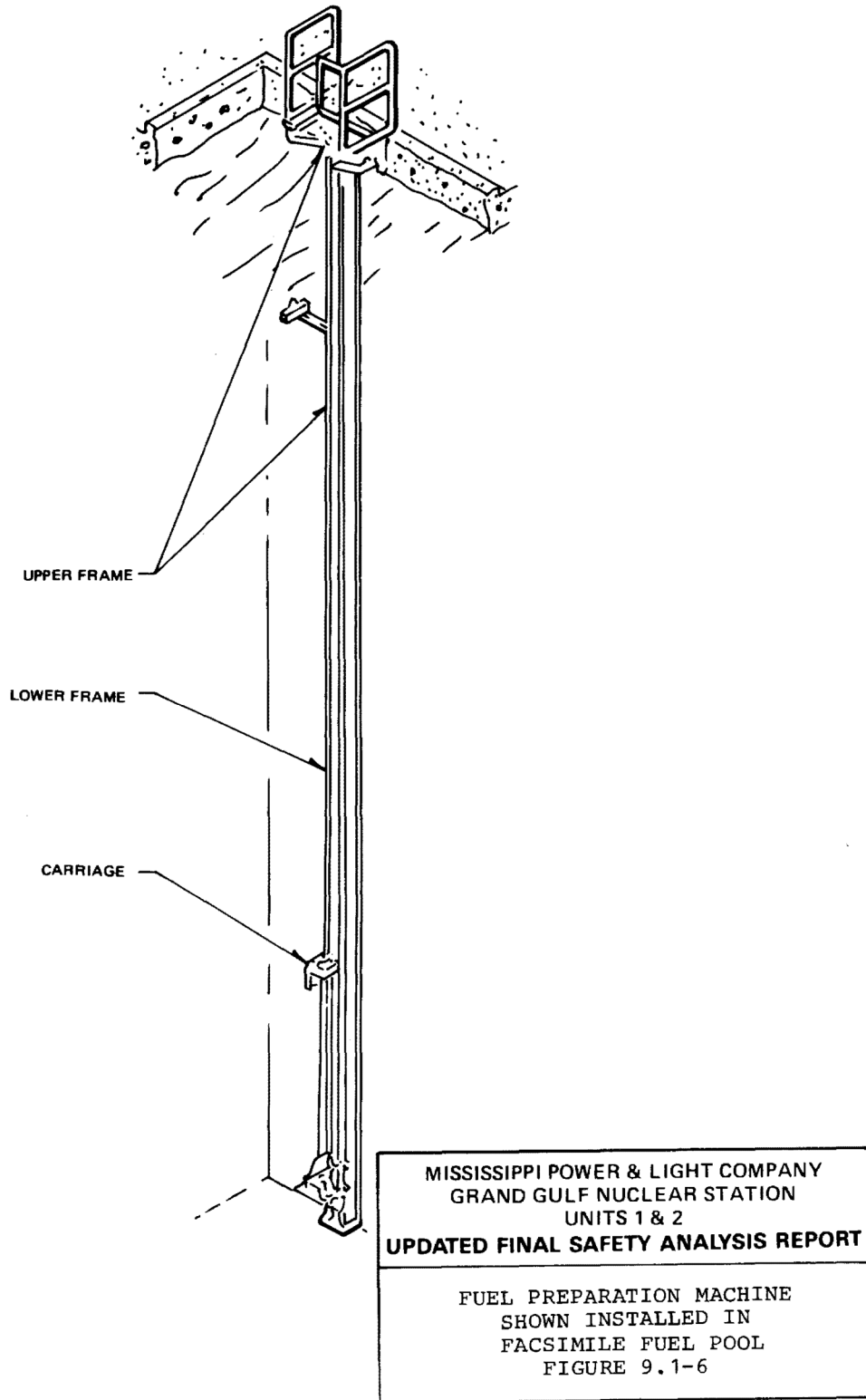

Figure 9.1-3 has been deleted.

Figure 9.1-4 has been deleted

Figure 9.1-5 has been deleted.

GRAND GULF NUCLEAR GENERATING STATION
Updated Final Safety Analysis Report (UFSAR)



GRAND GULF NUCLEAR GENERATING STATION
Updated Final Safety Analysis Report (UFSAR)

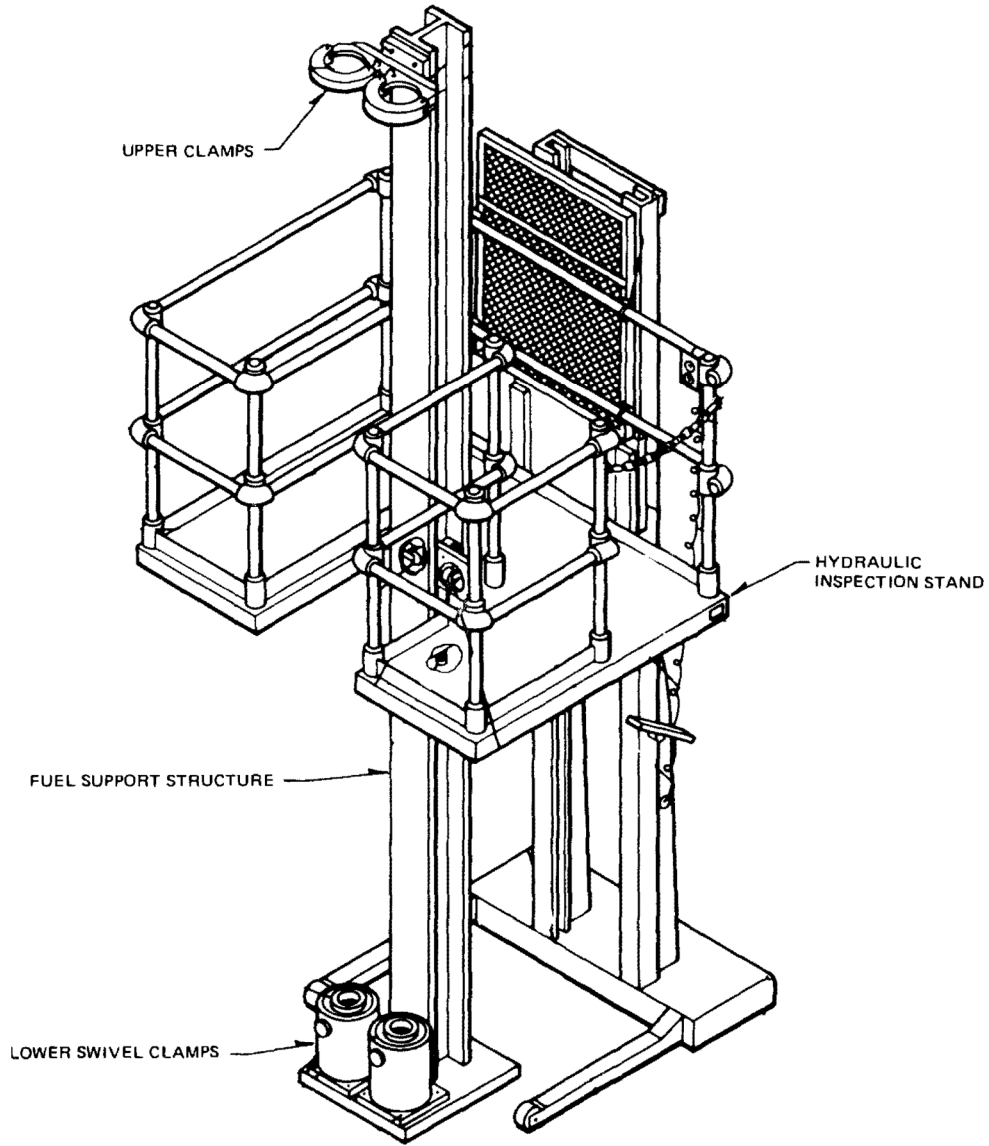

MISSISSIPPI POWER & LIGHT COMPANY
GRAND GULF NUCLEAR STATION
UNITS 1 & 2
UPDATED FINAL SAFETY ANALYSIS REPORT

NEW FUEL
INSPECTION STAND

FIGURE 9.1-7

GRAND GULF NUCLEAR GENERATING STATION
Updated Final Safety Analysis Report (UFSAR)

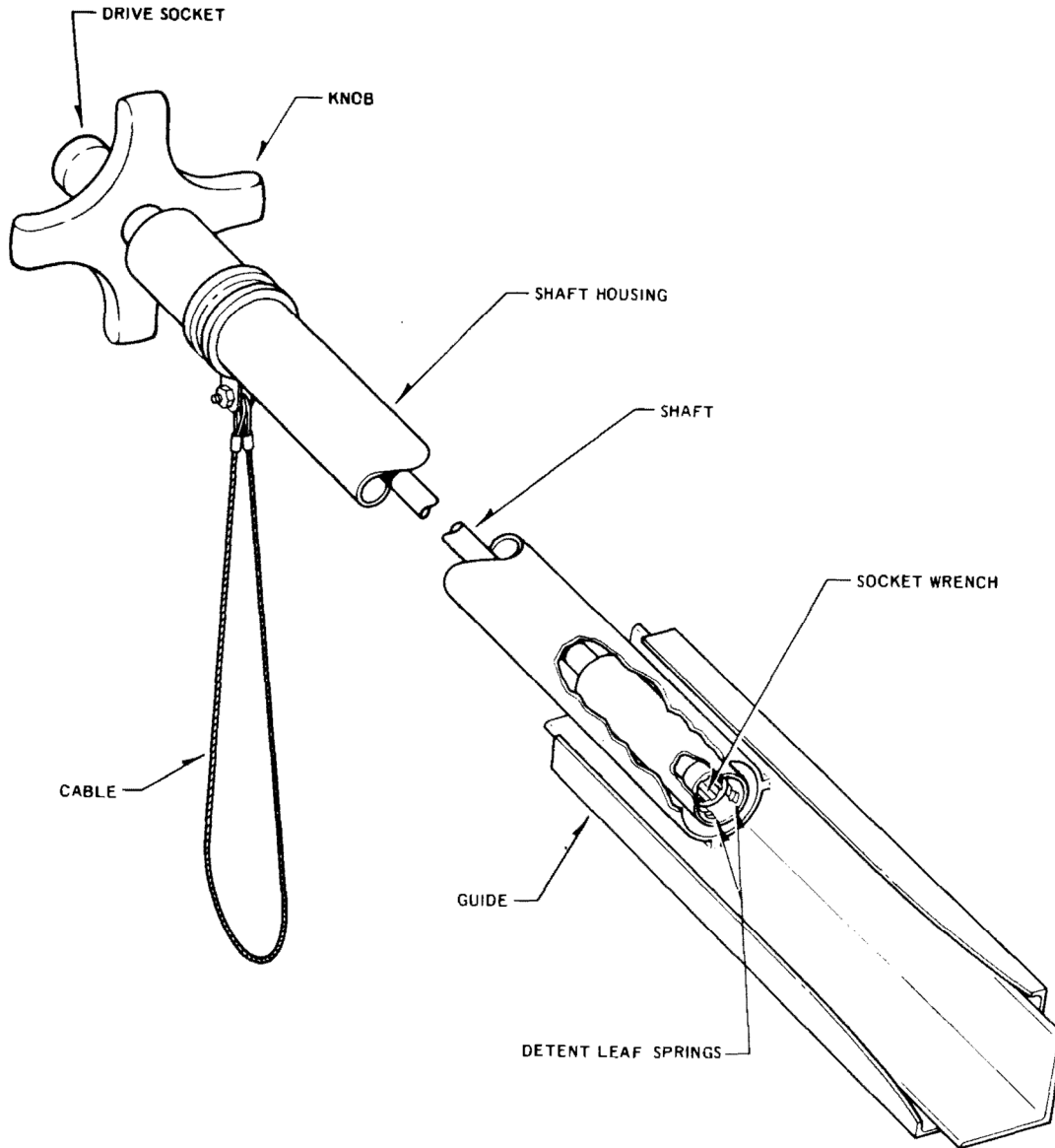

MISSISSIPPI POWER & LIGHT COMPANY
GRAND GULF NUCLEAR STATION
UNITS 1 & 2
UPDATED FINAL SAFETY ANALYSIS REPORT

CHANNEL
BOLT WRENCH

FIGURE 9.1-8

GRAND GULF NUCLEAR GENERATING STATION
Updated Final Safety Analysis Report (UFSAR)

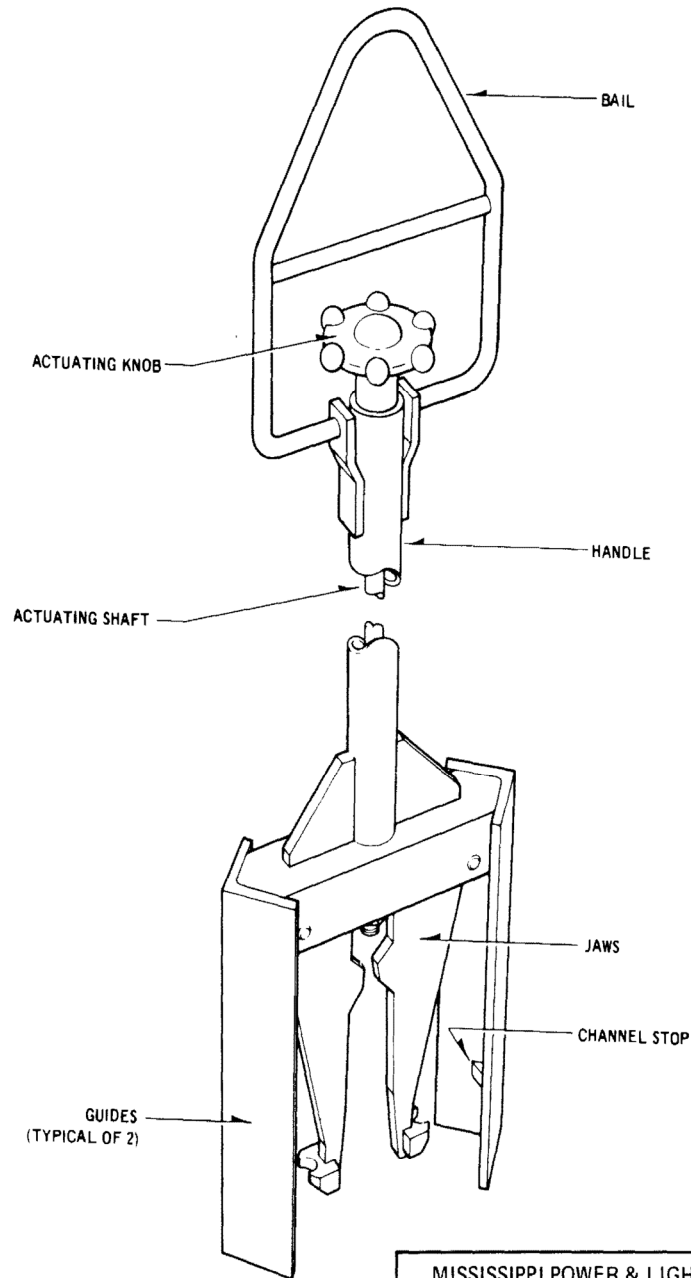

MISSISSIPPI POWER & LIGHT COMPANY GRAND GULF NUCLEAR STATION UNITS 1 & 2 UPDATED FINAL SAFETY ANALYSIS REPORT
CHANNEL HANDLING TOOL
FIGURE 9.1-9

GRAND GULF NUCLEAR GENERATING STATION
 Updated Final Safety Analysis Report (UFSAR)

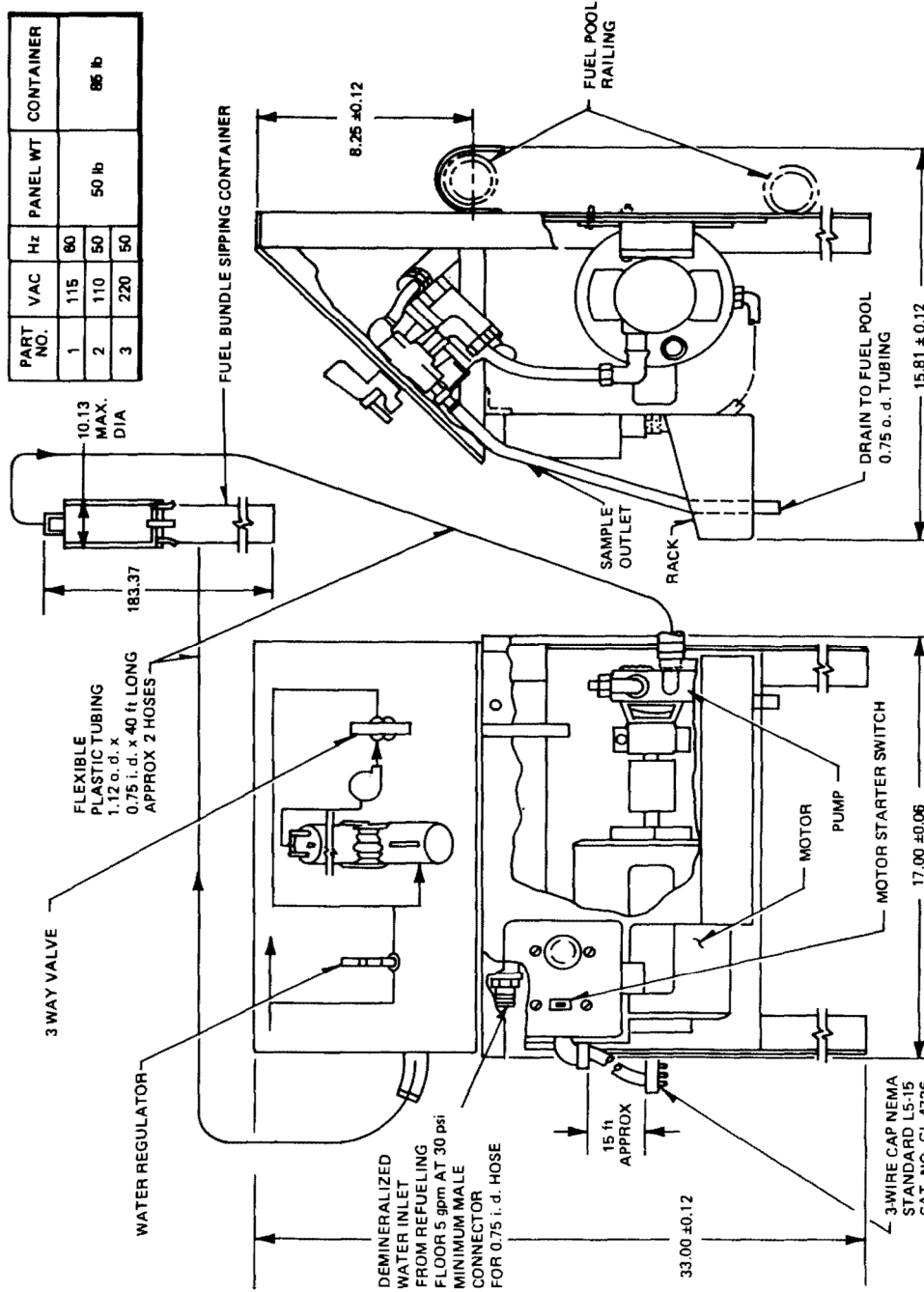

MISSISSIPPI POWER & LIGHT COMPANY
 GRAND GULF NUCLEAR STATION
 UNITS 1 & 2
 UPDATED FINAL SAFETY ANALYSIS REPORT

FUEL POOL SIPPER

FIGURE 9.1-10

GRAND GULF NUCLEAR GENERATING STATION
 Updated Final Safety Analysis Report (UFSAR)

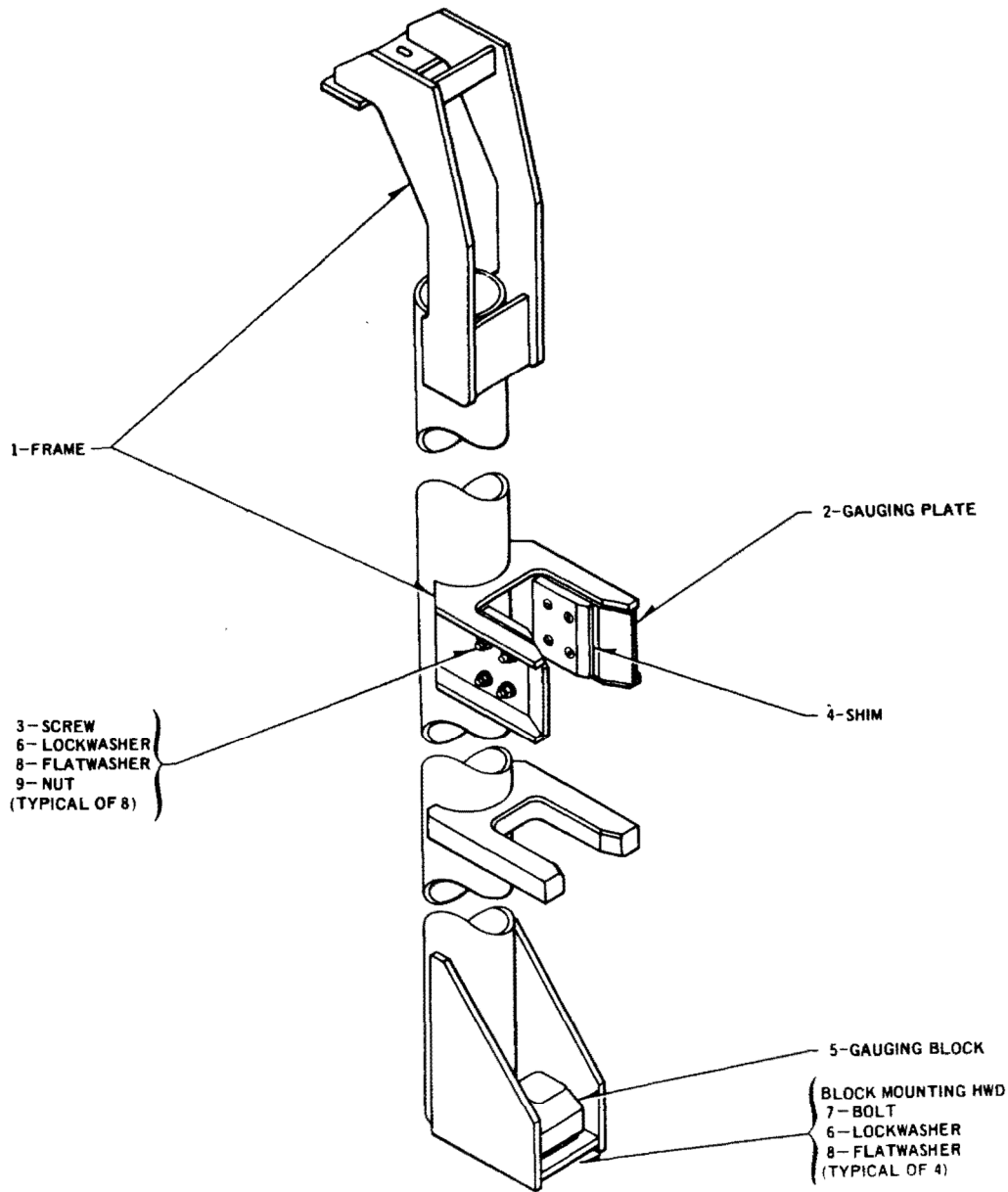

MISSISSIPPI POWER & LIGHT COMPANY
 GRAND GULF NUCLEAR STATION
 UNITS 1 & 2
 UPDATED FINAL SAFETY ANALYSIS REPORT

CHANNEL GAUGING FIXTURE

FIGURE 9.1-11

GRAND GULF NUCLEAR GENERATING STATION
Updated Final Safety Analysis Report (UFSAR)

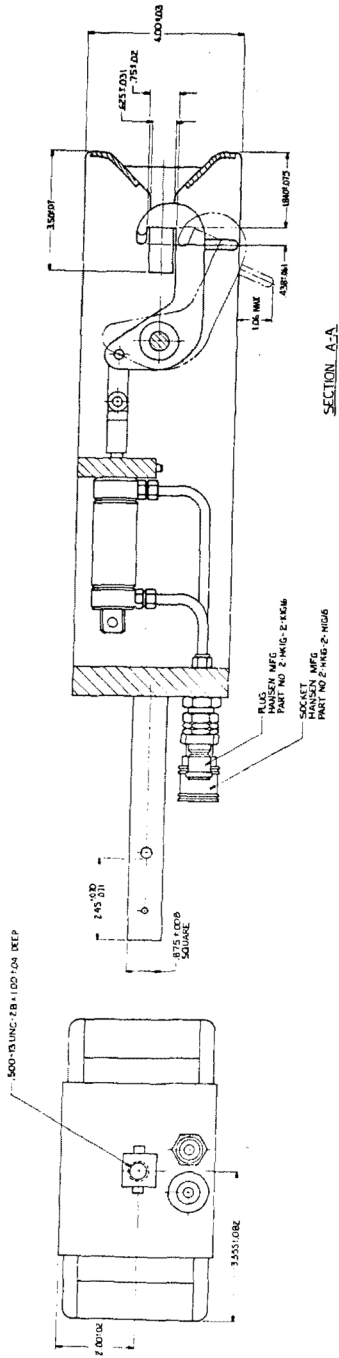
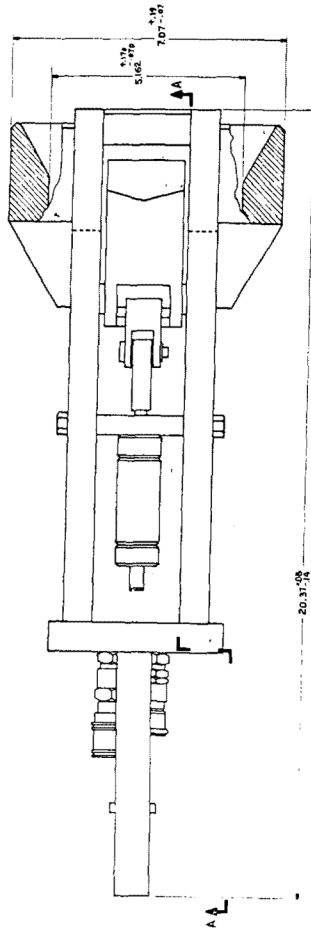

① APPROX WEIGHT 45 LB
 OPERATING AIR PRESSURE 80-100 PSI

MISSISSIPPI POWER & LIGHT COMPANY GRAND GULF NUCLEAR STATION UNITS 1 & 2 UPDATED FINAL SAFETY ANALYSIS REPORT
GENERAL PURPOSE GRAPPLE
FIGURE 9.1-12

Figure 9.1-13 is deleted.

GRAND GULF NUCLEAR GENERATING STATION
 Updated Final Safety Analysis Report (UFSAR)

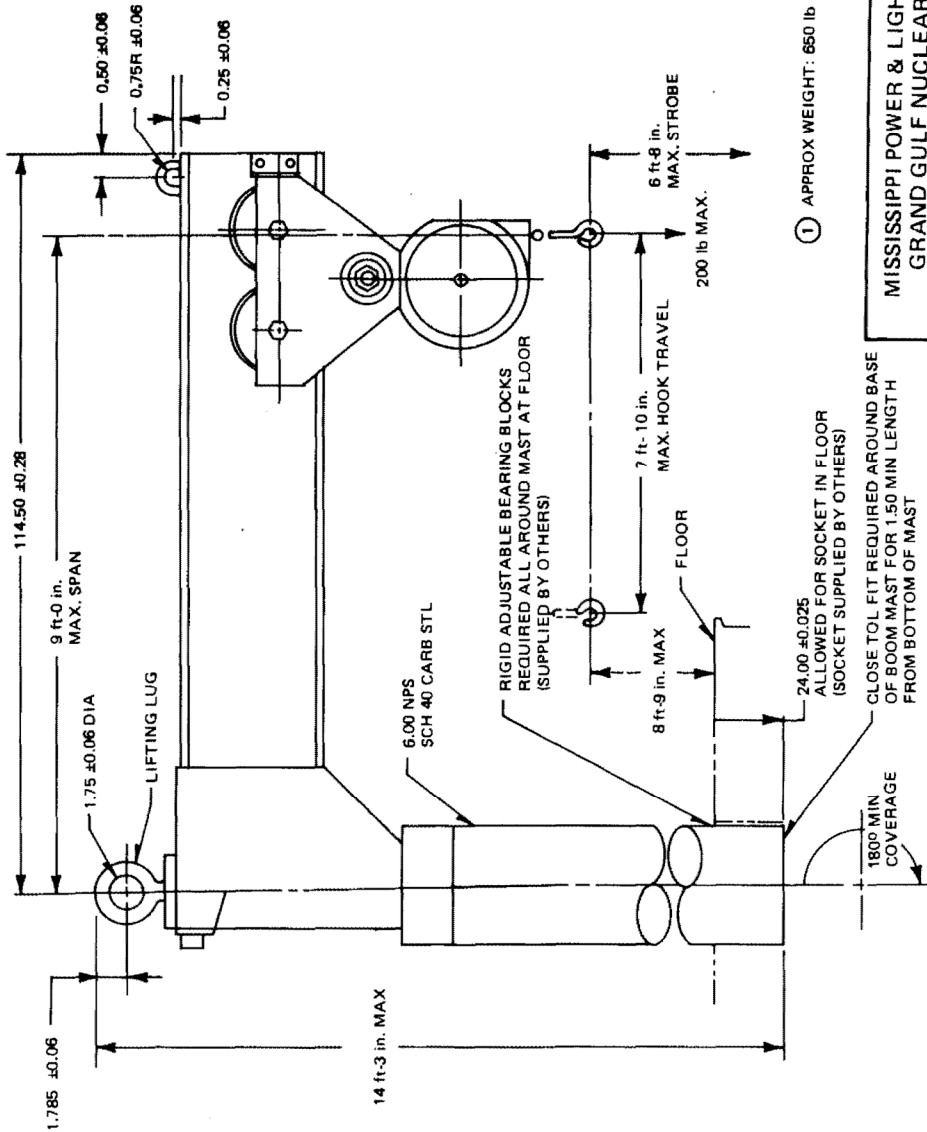

① APPROX WEIGHT: 650 lb

MISSISSIPPI POWER & LIGHT COMPANY
 GRAND GULF NUCLEAR STATION
 UNITS 1 & 2
 UPDATED FINAL SAFETY ANALYSIS REPORT

CHANNEL HANDLING BOOM

FIGURE 9.1-14

GRAND GULF NUCLEAR GENERATING STATION
Updated Final Safety Analysis Report (UFSAR)

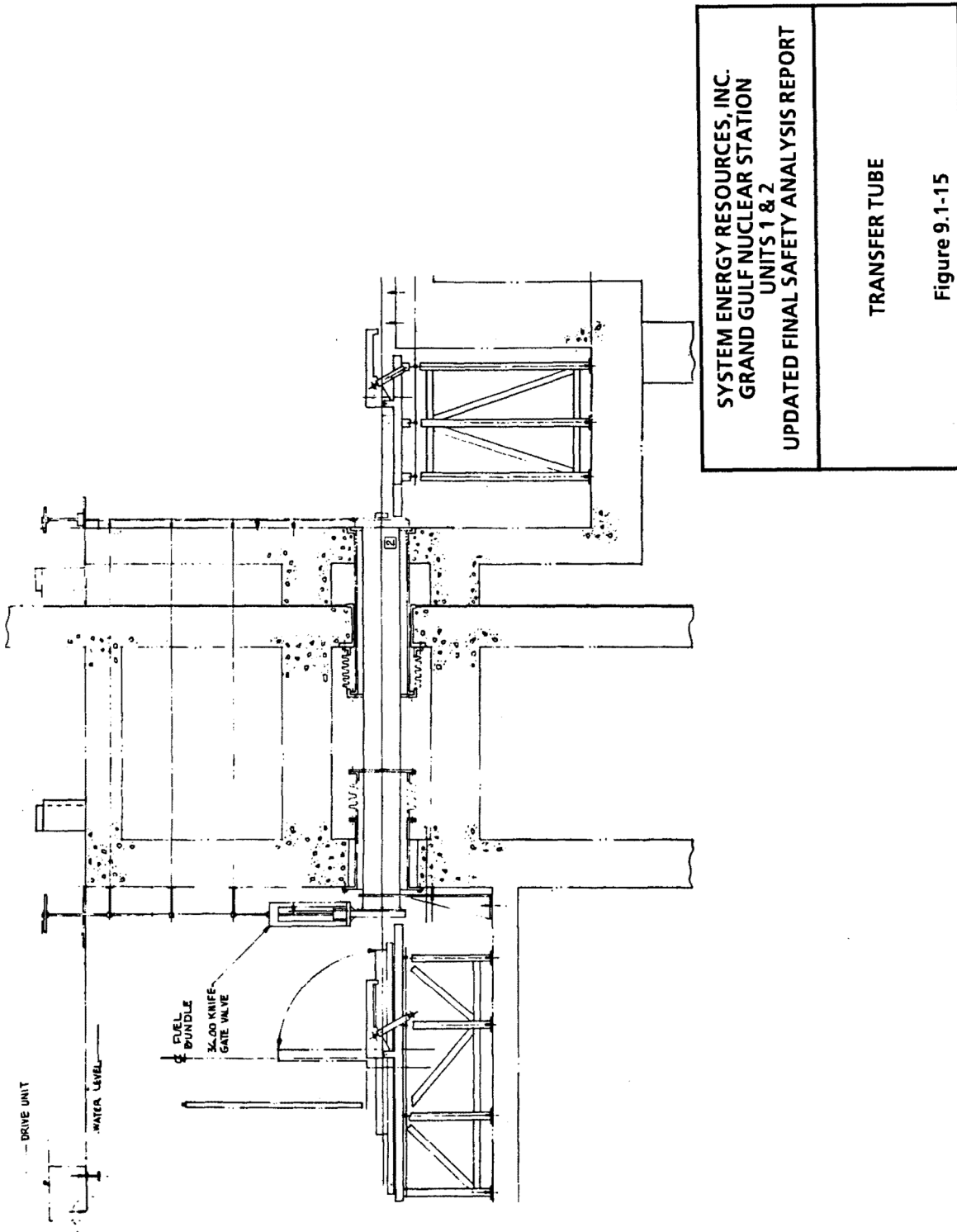

SYSTEM ENERGY RESOURCES, INC.
GRAND GULF NUCLEAR STATION
UNITS 1 & 2
UPDATED FINAL SAFETY ANALYSIS REPORT

TRANSFER TUBE

Figure 9.1-15

GRAND GULF NUCLEAR GENERATING STATION
Updated Final Safety Analysis Report (UFSAR)

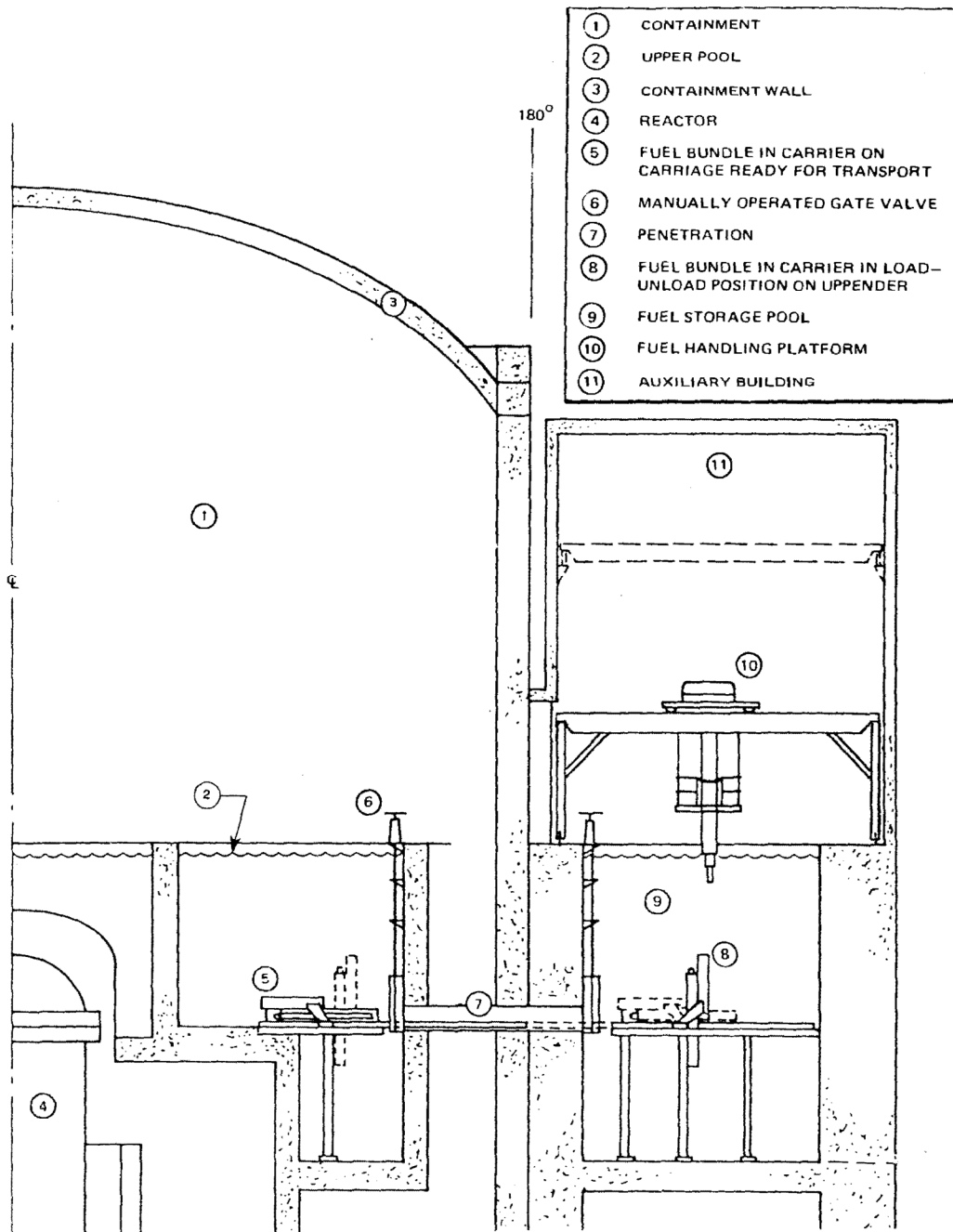

<p align="center">MISSISSIPPI POWER & LIGHT COMPANY GRAND GULF NUCLEAR STATION UNITS 1 & 2 UPDATED FINAL SAFETY ANALYSIS REPORT</p>	<p align="center">FUEL TRANSFER FIGURE 9.1-17</p>
--	---

GRAND GULF NUCLEAR GENERATING STATION
Updated Final Safety Analysis Report (UFSAR)

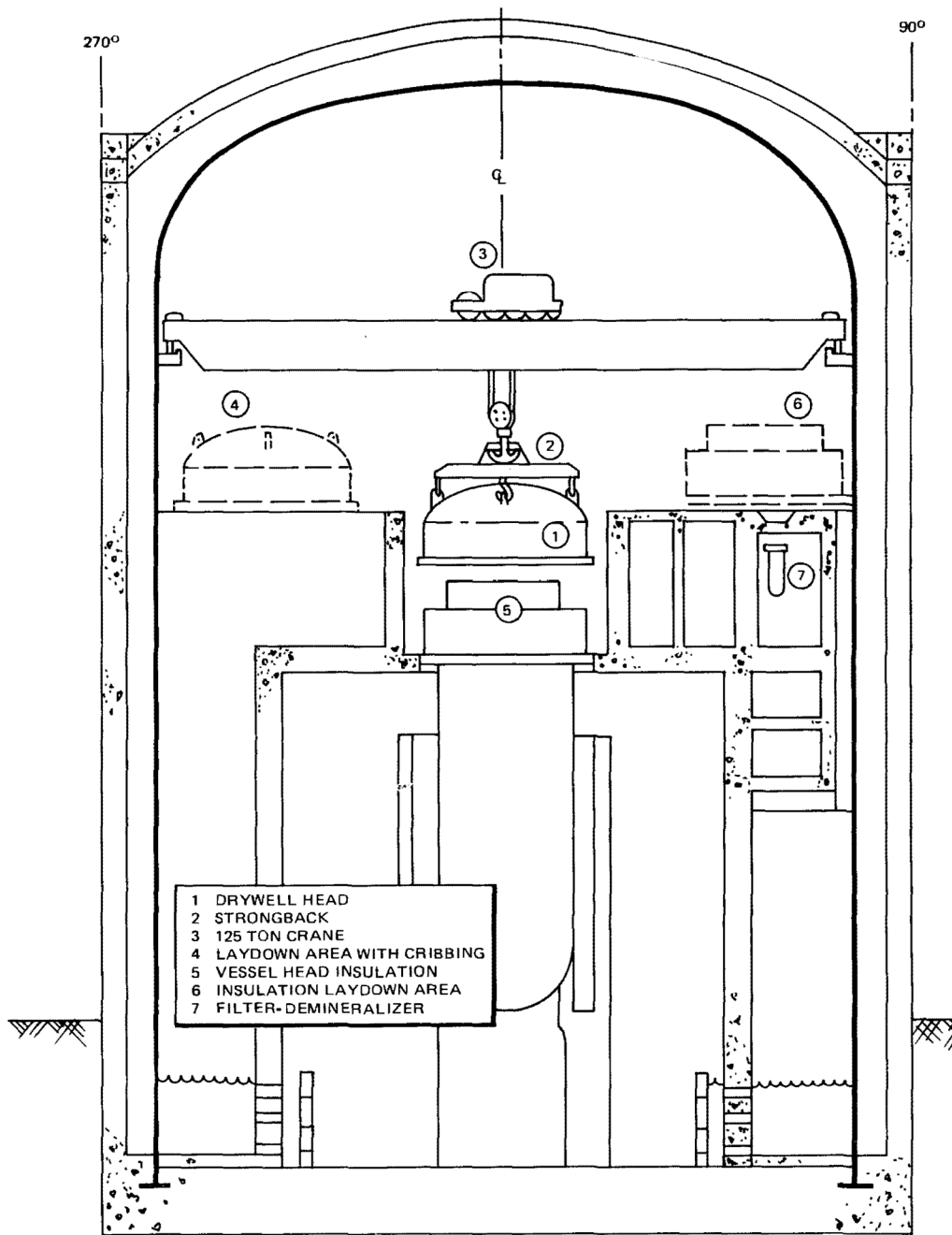

MISSISSIPPI POWER & LIGHT COMPANY
GRAND GULF NUCLEAR STATION
UNITS 1 & 2
UPDATED FINAL SAFETY ANALYSIS REPORT

DRYWELL HEAD REMOVAL SEQUENCE
GE STANDARD PLANT

FIGURE 9.1-18

GRAND GULF NUCLEAR GENERATING STATION
Updated Final Safety Analysis Report (UFSAR)

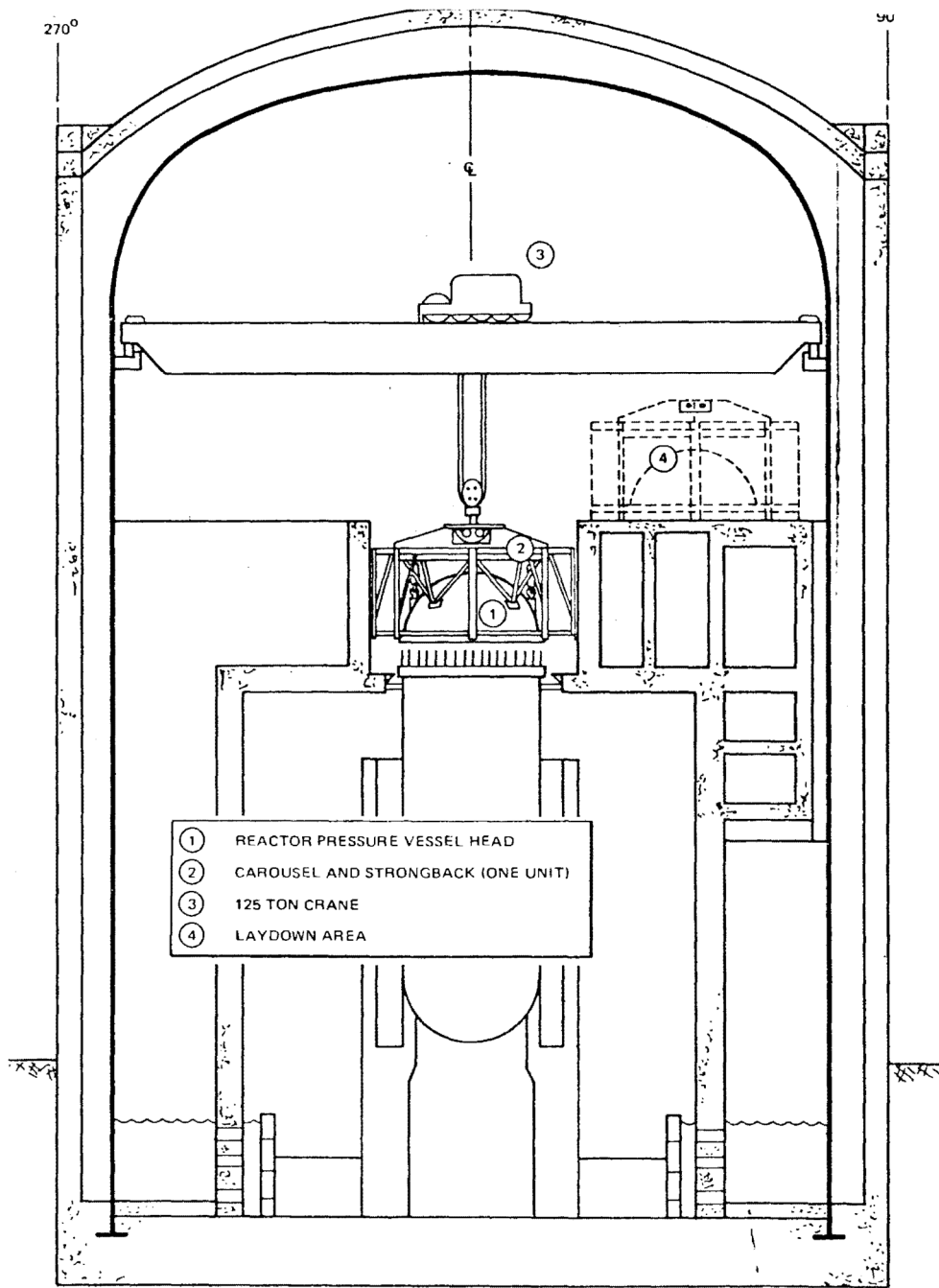

<p>MISSISSIPPI POWER & LIGHT COMPANY GRAND GULF NUCLEAR STATION UNITS 1 & 2 UPDATED FINAL SAFETY ANALYSIS REPORT</p>	<p>REACTOR VESSEL HEAD REMOVAL SEQUENCE GE STANDARD PLANT FIGURE 9.1-19</p>
--	---

GRAND GULF NUCLEAR GENERATING STATION
Updated Final Safety Analysis Report (UFSAR)

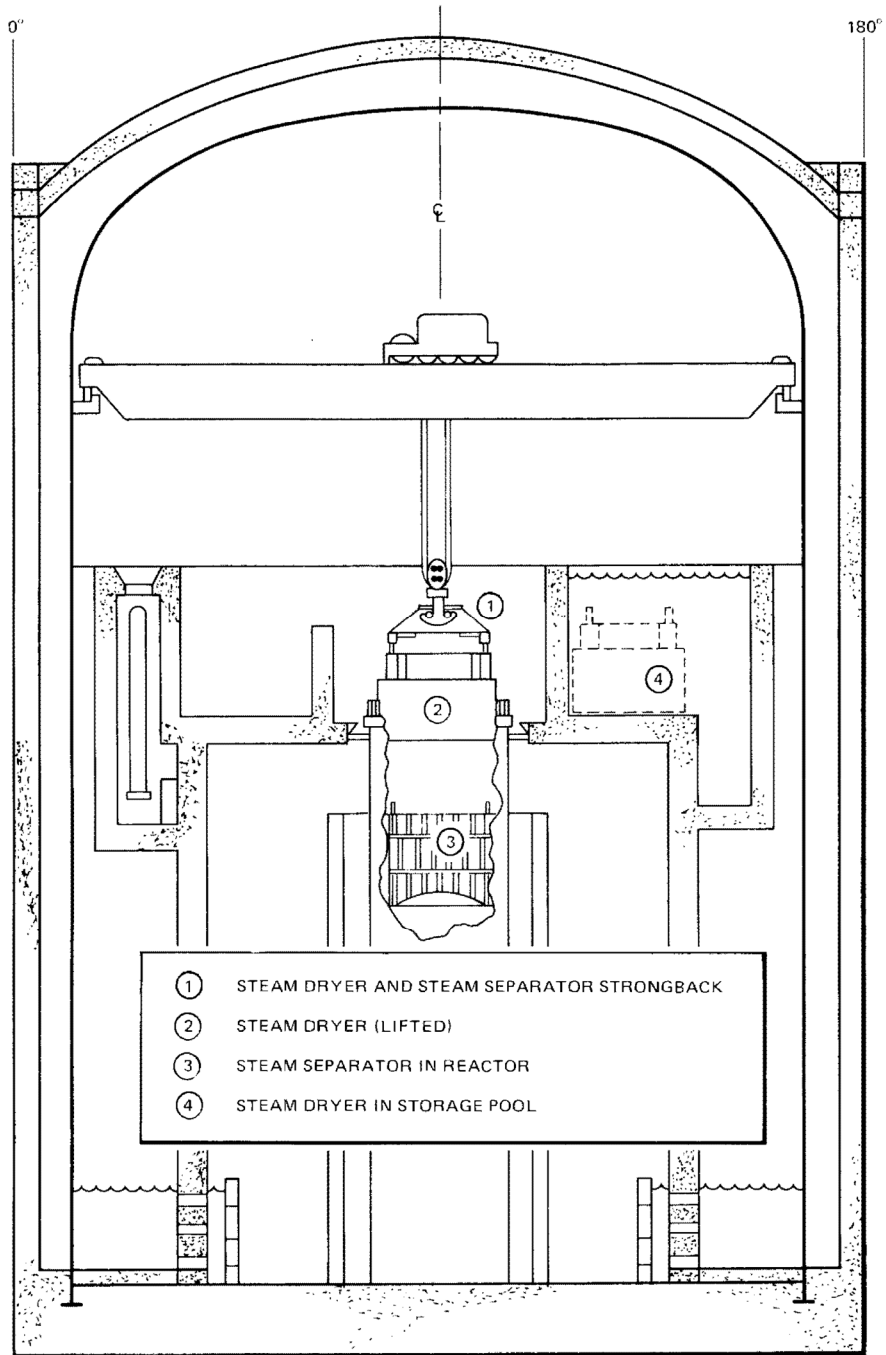

MISSISSIPPI POWER & LIGHT COMPANY
GRAND GULF NUCLEAR STATION
UNITS 1 & 2
UPDATED FINAL SAFETY ANALYSIS REPORT

STEAM DRYER
REMOVAL SEQUENCE
GE STANDARD PLANT
FIGURE 9.1-20

GRAND GULF NUCLEAR GENERATING STATION
Updated Final Safety Analysis Report (UFSAR)

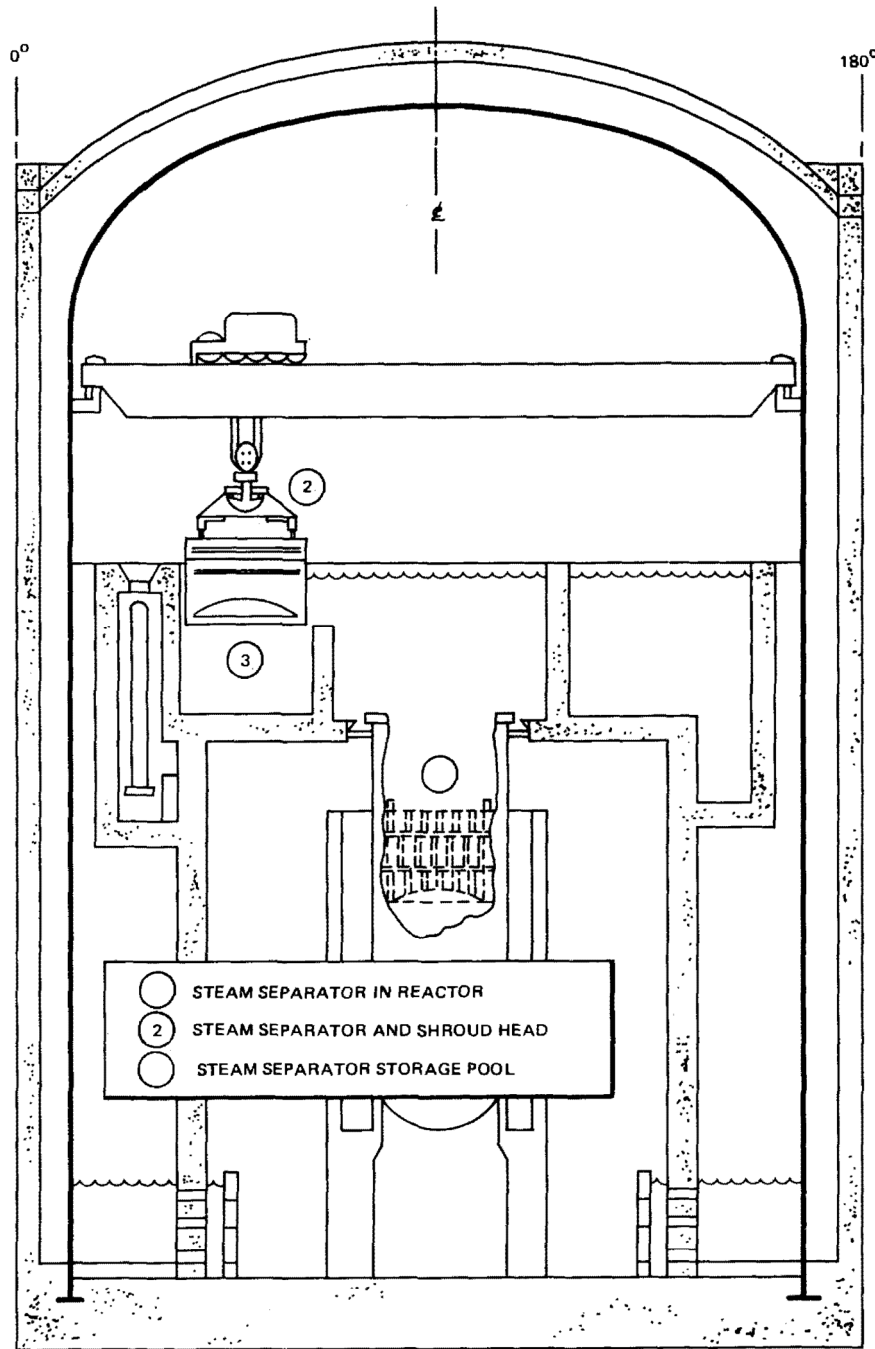

<p>MISSISSIPPI POWER & LIGHT COMPANY GRAND GULF NUCLEAR STATION UNITS 1 & 2 UPDATED FINAL SAFETY ANALYSIS REPORT</p>	<p>STEAM SEPARATOR REMOVAL SEQUENCE GE STANDARD PLANT FIGURE 9.1-21</p>
--	---

GRAND GULF NUCLEAR GENERATING STATION
 Updated Final Safety Analysis Report (UFSAR)

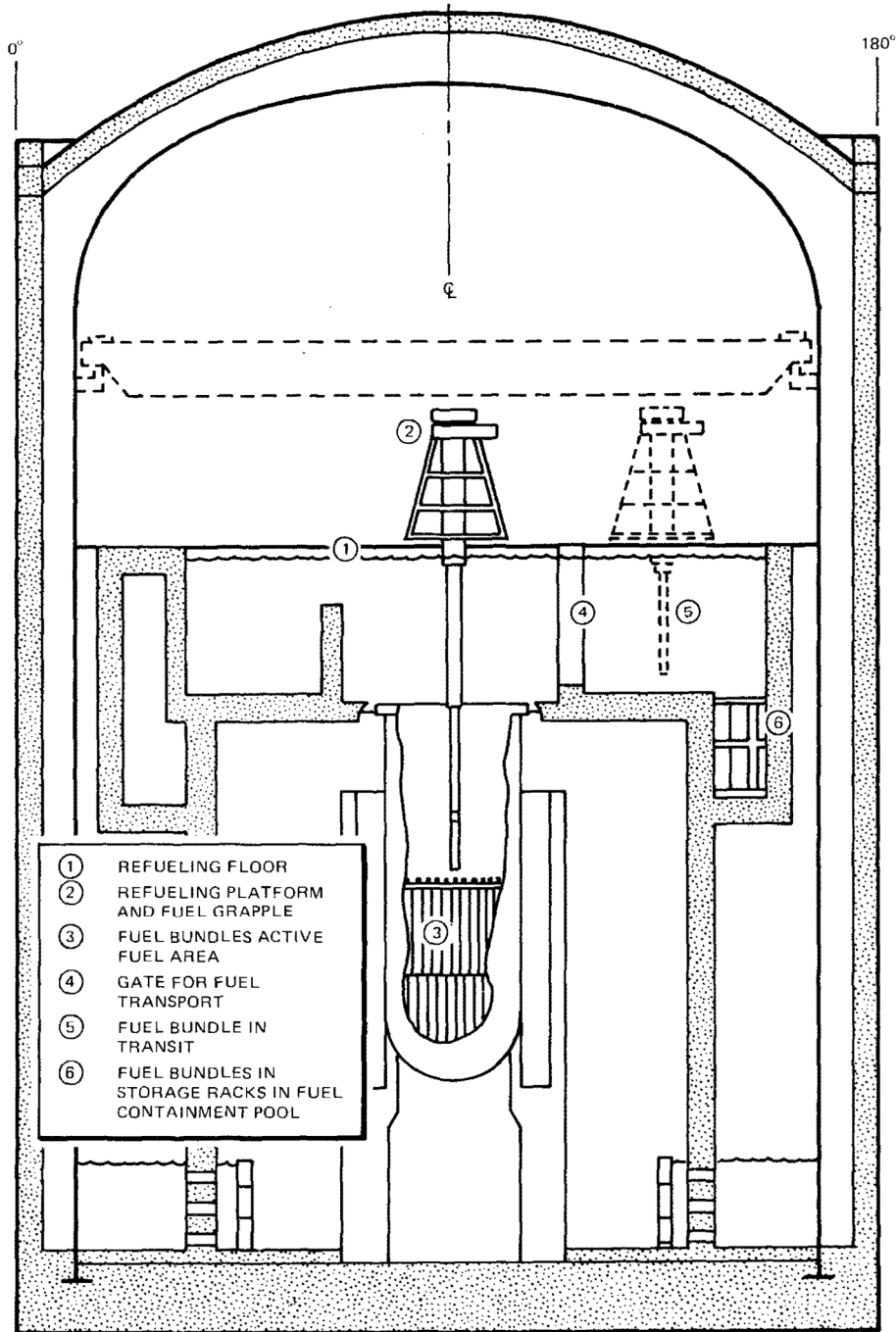

<p align="center">MISSISSIPPI POWER & LIGHT COMPANY GRAND GULF NUCLEAR STATION UNITS 1 & 2 UPDATED FINAL SAFETY ANALYSIS REPORT</p>	<p align="center">FUEL BUNDLE TRANSFER SEQUENCE GE STANDARD PLANT FIGURE 9.1-22</p>
--	--

GRAND GULF NUCLEAR GENERATING STATION
Updated Final Safety Analysis Report (UFSAR)

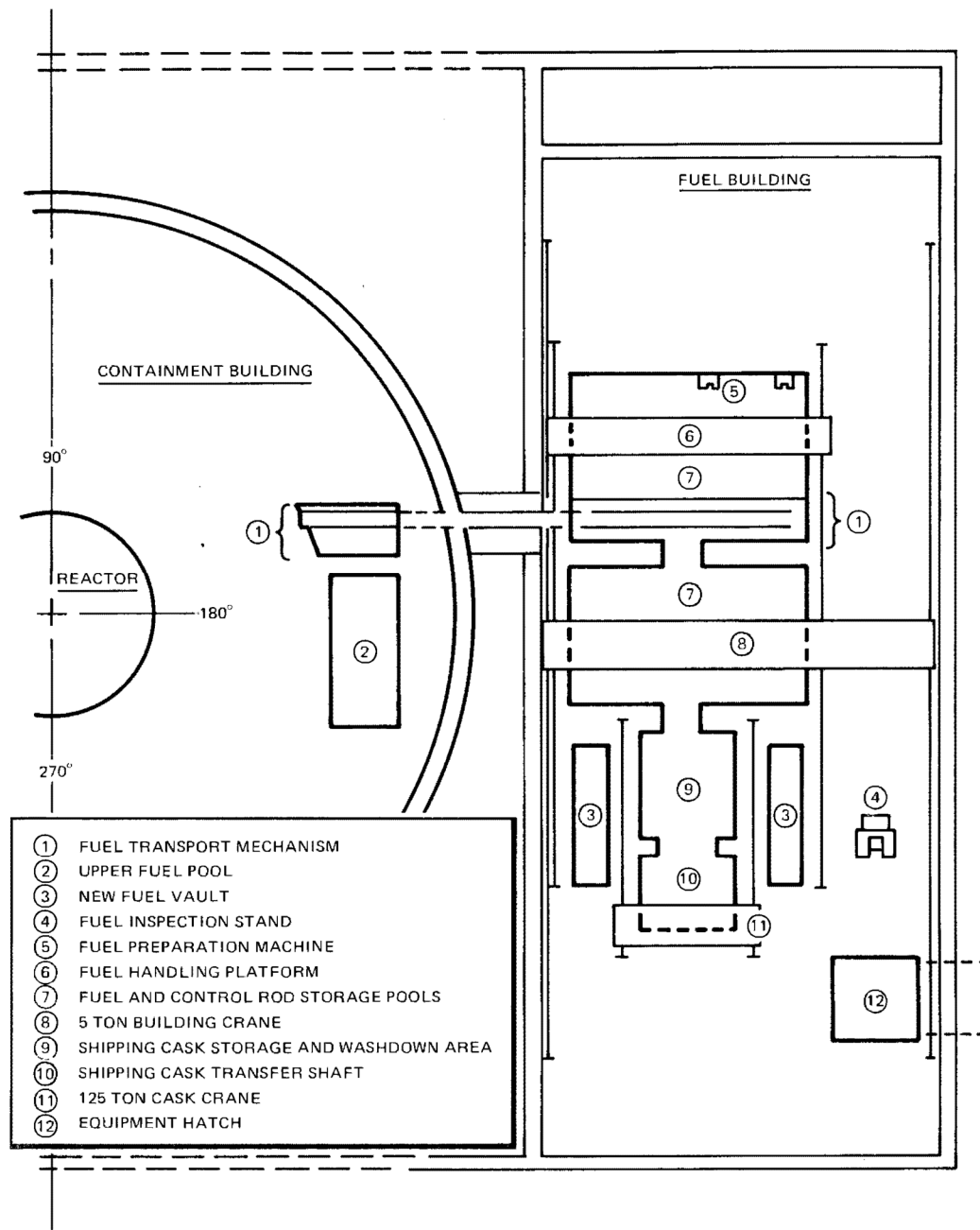

<p align="center">MISSISSIPPI POWER & LIGHT COMPANY GRAND GULF NUCLEAR STATION UNITS 1 & 2 UPDATED FINAL SAFETY ANALYSIS REPORT</p>	<p align="center">FUEL BUNDLE LAYDOWN AREAS (GE STANDARD PLANT)</p> <p align="center">FIGURE 9.1-23</p>
--	--

GRAND GULF NUCLEAR GENERATING STATION
Updated Final Safety Analysis Report (UFSAR)

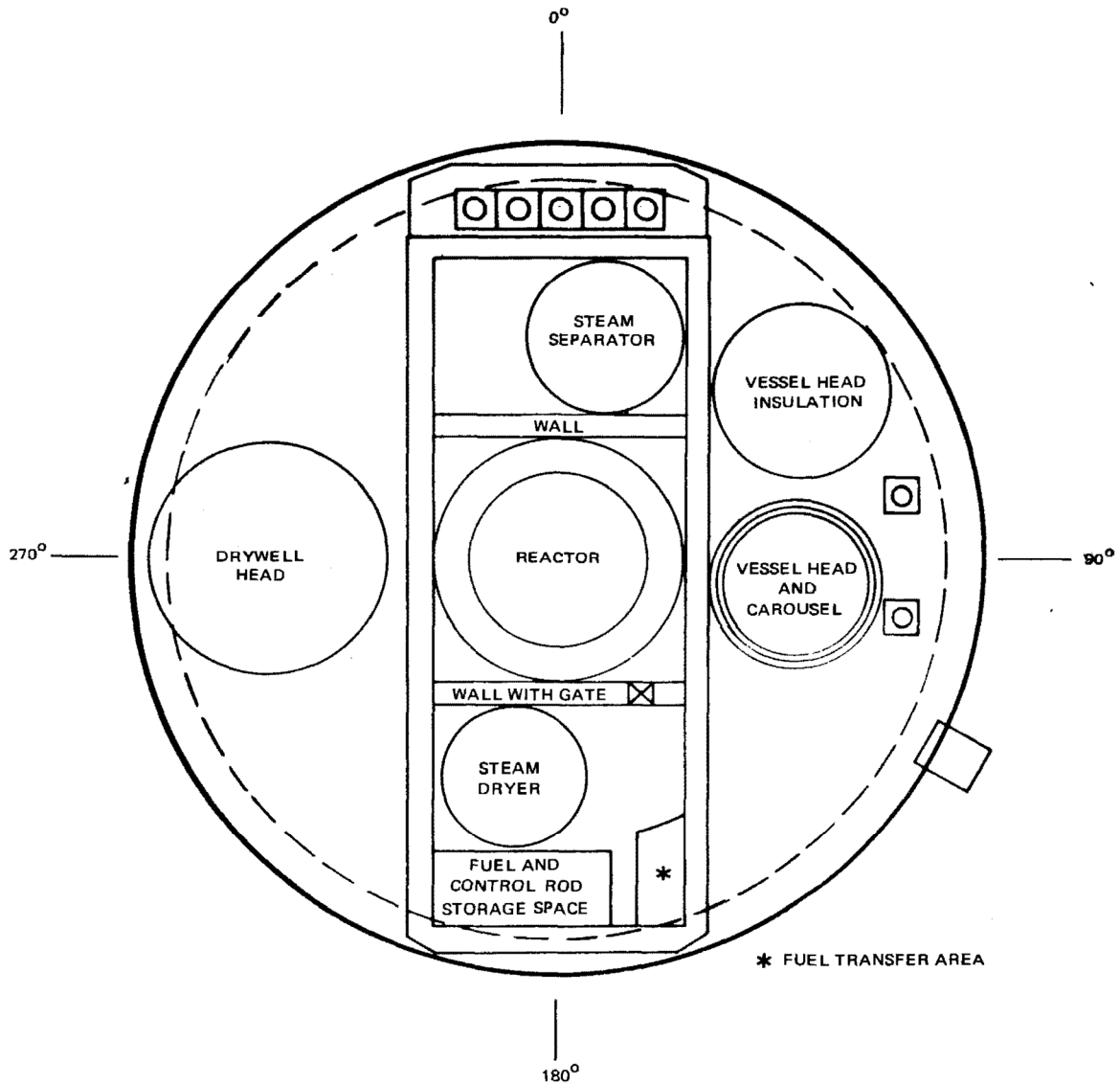

<p align="center">MISSISSIPPI POWER & LIGHT COMPANY GRAND GULF NUCLEAR STATION UNITS 1 & 2 UPDATED FINAL SAFETY ANALYSIS REPORT</p>	<p align="center">CONTAINMENT BUILDING LAYDOWN AREAS (GE STANDARD PLANT) FIGURE 9.1-24</p>
--	---

GRAND GULF NUCLEAR GENERATING STATION
 Updated Final Safety Analysis Report (UFSAR)

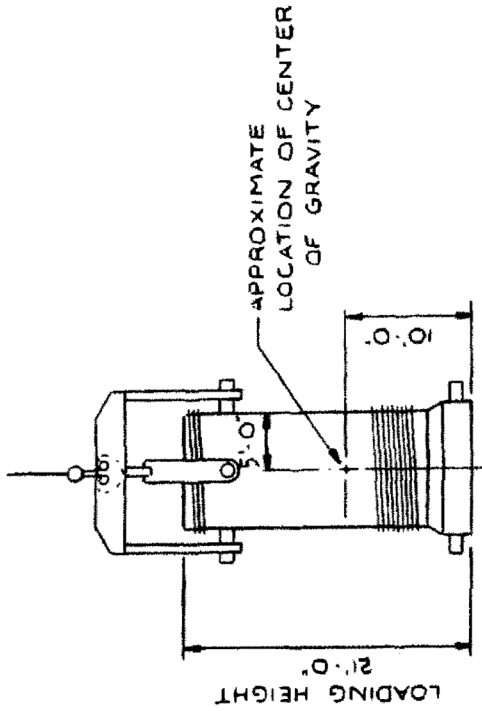

CASK, AS IT WOULD APPEAR DURING ONSITE HANDLING
 FRONT CRASH CONE REMOVED, CASK CRANE YOKE
 ATTACHED

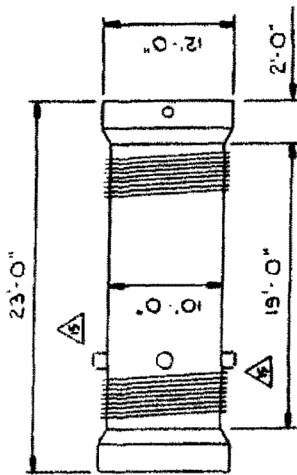

CASK, AS IT WOULD APPEAR DURING SHIPMENT

MISSISSIPPI POWER & LIGHT COMPANY GRAND GULF NUCLEAR STATION UPDATED FINAL SAFETY ANALYSIS REPORT
SPENT FUEL SHIPPING CASK FIGURE 9.1-25

GRAND GULF NUCLEAR GENERATING STATION

Updated Final Safety Analysis Report (UFSAR)

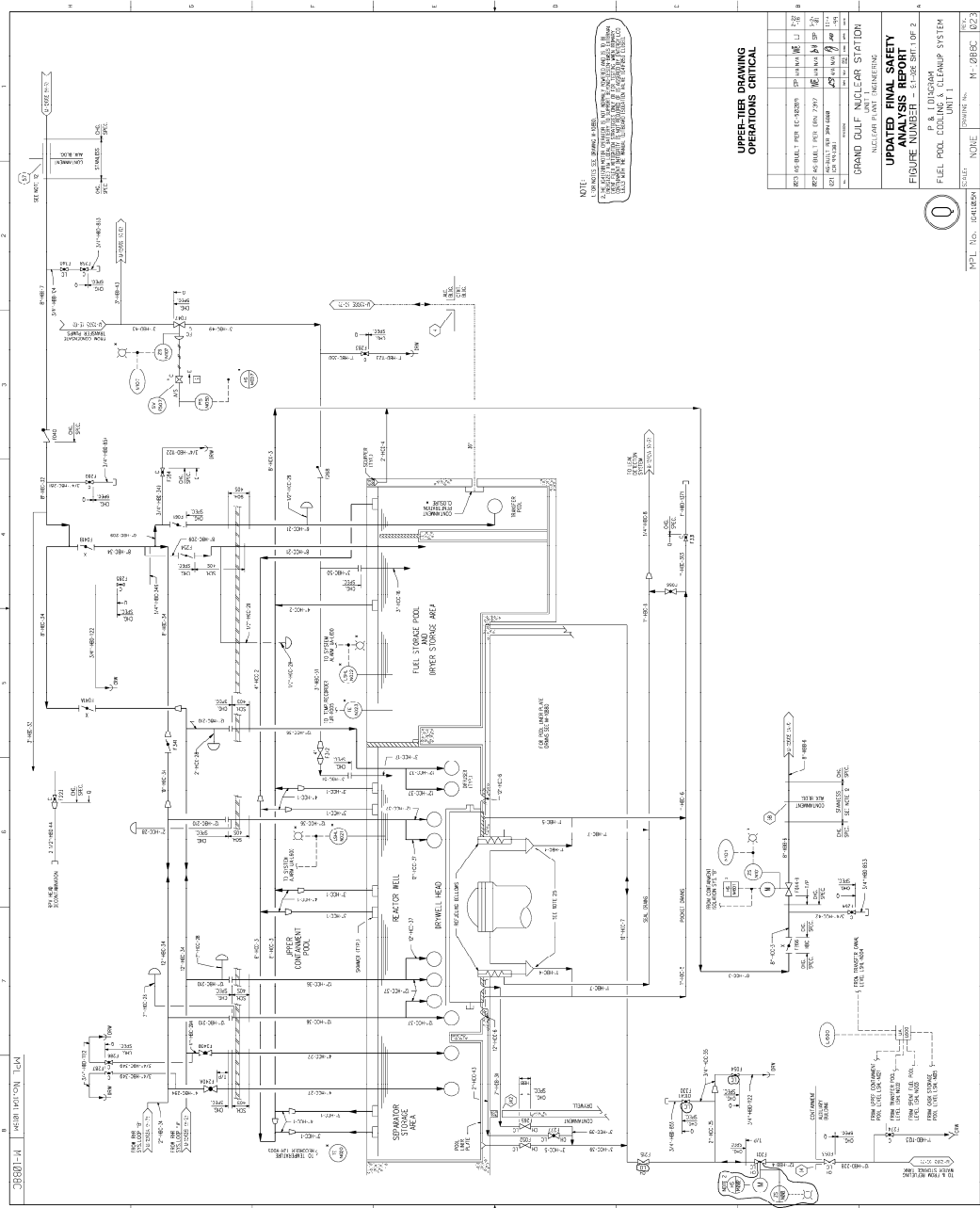

**UPPER-TIER DRAWING
OPERATIONS CRITICAL**

REV	DESCRIPTION	DATE	BY	CHKD
1	ISSUED FOR CONSTRUCTION	11/15/88	J. L. BROWN	J. L. BROWN
2	REVISED TO REFLECT CHANGES TO THE SYSTEM	03/15/90	J. L. BROWN	J. L. BROWN
3	REVISED TO REFLECT CHANGES TO THE SYSTEM	03/15/90	J. L. BROWN	J. L. BROWN
4	REVISED TO REFLECT CHANGES TO THE SYSTEM	03/15/90	J. L. BROWN	J. L. BROWN
5	REVISED TO REFLECT CHANGES TO THE SYSTEM	03/15/90	J. L. BROWN	J. L. BROWN
6	REVISED TO REFLECT CHANGES TO THE SYSTEM	03/15/90	J. L. BROWN	J. L. BROWN
7	REVISED TO REFLECT CHANGES TO THE SYSTEM	03/15/90	J. L. BROWN	J. L. BROWN
8	REVISED TO REFLECT CHANGES TO THE SYSTEM	03/15/90	J. L. BROWN	J. L. BROWN
9	REVISED TO REFLECT CHANGES TO THE SYSTEM	03/15/90	J. L. BROWN	J. L. BROWN
10	REVISED TO REFLECT CHANGES TO THE SYSTEM	03/15/90	J. L. BROWN	J. L. BROWN

**UPPER-TIER DRAWING
OPERATIONS CRITICAL**

**UPDATES FINAL SAFETY
ANALYSIS REPORT**

FIGURE NUMBER - 51-208 SHIT. OF 2

P. & I. DIAGRAM

FUEL POOL COOLING & CLEANUP SYSTEM

UNIT 1

SCALE: NONE

MPL No. 0488509

Sheet No. M-088C 023

Date: 08/28/88

Drawn: M-088C/023

GRAND GULF NUCLEAR GENERATING STATION

Updated Final Safety Analysis Report (UFSAR)

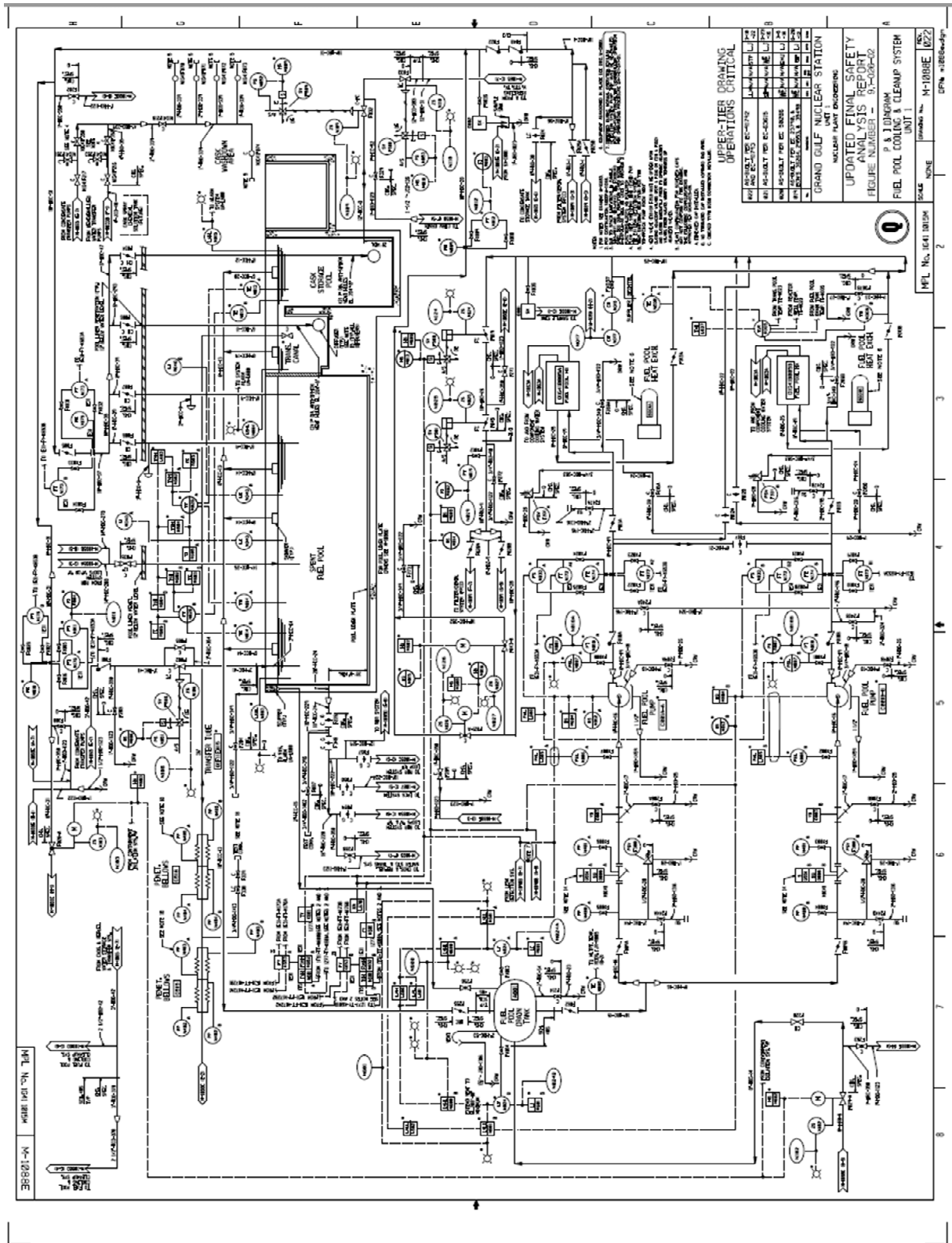

NO.	DESCRIPTION	DATE	BY	CHKD.
1	ISSUED FOR DESIGN	11/11/88
2	ISSUED FOR CONSTRUCTION
3	ISSUED FOR OPERATION
4	ISSUED FOR MAINTENANCE
5	ISSUED FOR REVISION
6	ISSUED FOR REVISION
7	ISSUED FOR REVISION
8	ISSUED FOR REVISION

OPERATIONS CRITICAL

UPDATED FINAL SAFETY ANALYSIS REPORT
FIGURE NUMBER
GRAND GULF NUCLEAR STATION
FUEL POOL COOLING CLEANUP SYSTEM
UNIT 1

HFL No. 1041 01038
 M-12888

GRAND GULF NUCLEAR GENERATING STATION

Updated Final Safety Analysis Report (UFSAR)

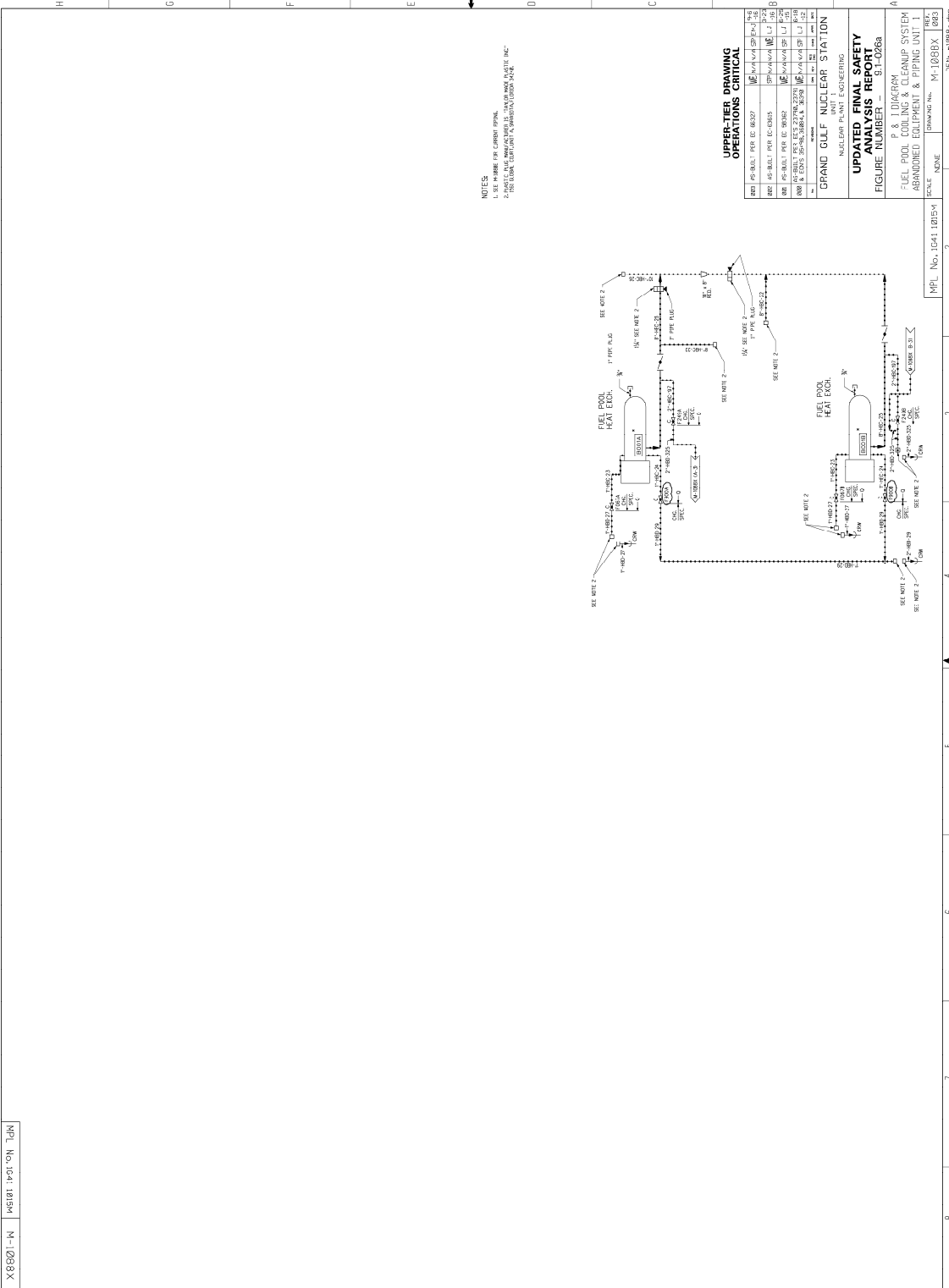

**GRAND GULF NUCLEAR GENERATING STATION
Updated Final Safety Analysis Report (UFSAR)**

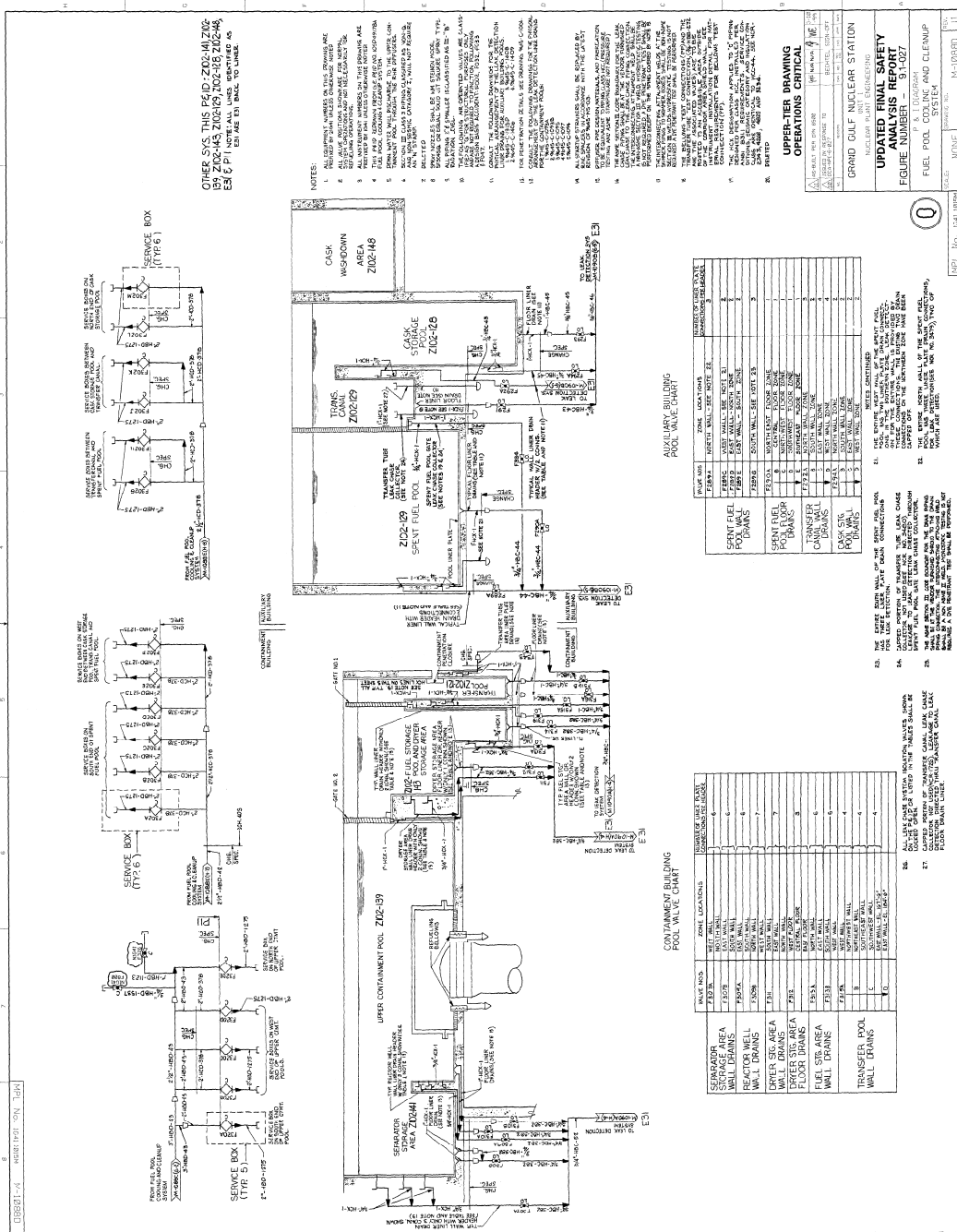

GRAND GULF NUCLEAR GENERATING STATION

Updated Final Safety Analysis Report (UFSAR)

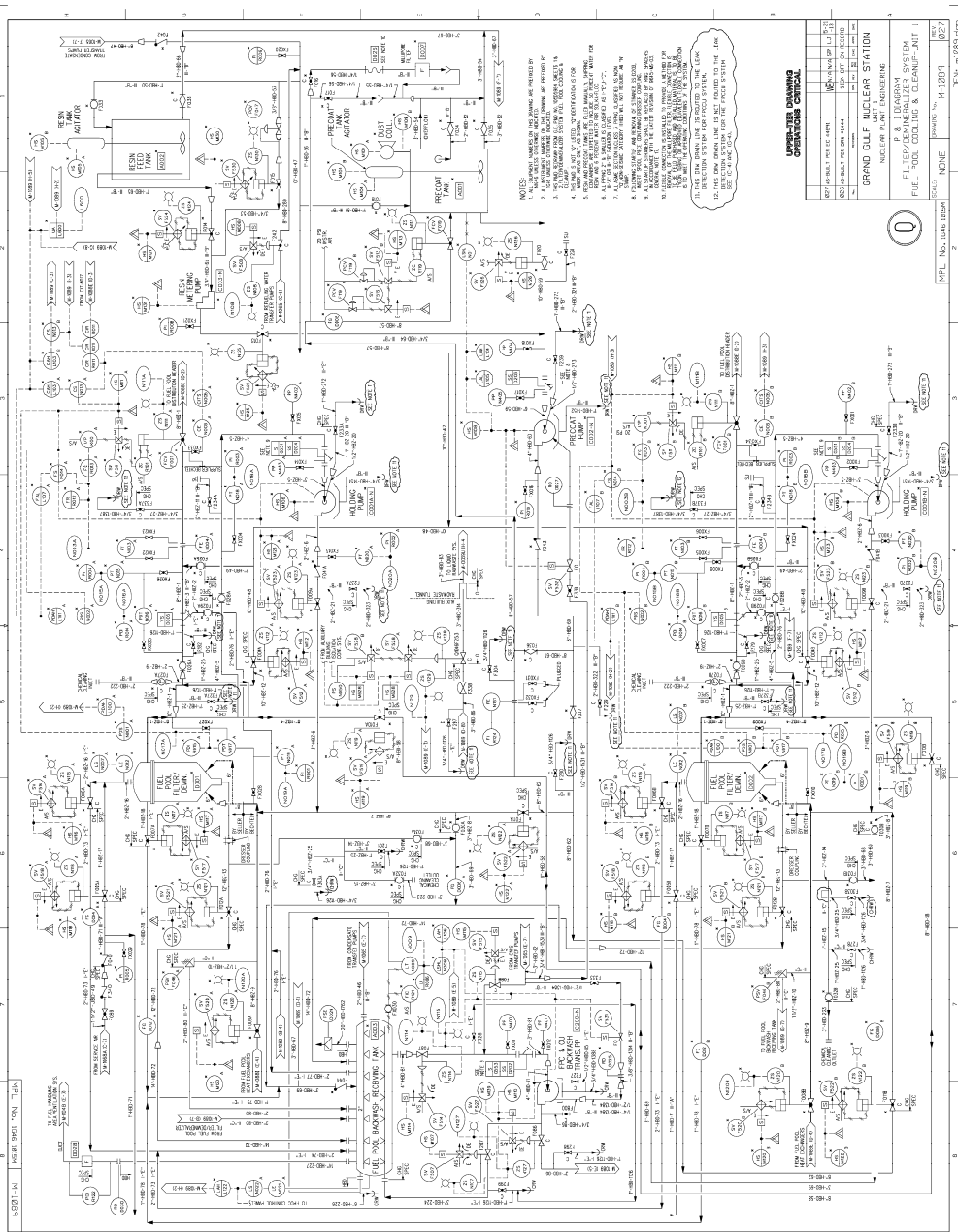

GRAND GULF NUCLEAR GENERATING STATION
Updated Final Safety Analysis Report (UFSAR)

ITEM	ELEV. ±	DIAM. ±	THICKNESS ±	DESCRIPTION
N1	172.5/16	160.7/12	2.4	FLG
N2	171.5/16	161.3/16	2.9	FLG
N3	64.8	164.3/12	13.1/4	FLG
N4	4.93 1/2	162.1/8	13.1/4	FLG
N5	4.79 1/4	161.5/8	13.1/4	FLG
N6	4.19	160.7/2	13.1/4 3/12	FLG
N7	SEE ELEV	6" IPS	1500#	FLG
N8	SEE ELEV	6" IPS	1500#	FLG
N9	156	148	4 1/16 3/12	FLG
N10	44.8 1/2	150 1/16	3.5/4	FLG
N11	SEE ELEV		1.86 ± .08	FLG
N12	366	141 1/2	1.86 ± .08	FLG
N13	517	141 1/2	1.86 ± .08	FLG
N14	599	141 1/2	1.86 ± .08	FLG
N15	SEE ELEV		2.56 ± 2.010	FLG
N16	64.8	8" IPS	900#	FLG
N17	64.5 3/4		1.86 ± .08	FLG
N18	SEE ELEV		1.86 ± .08	FLG

* UNLESS OTHERWISE NOTED

NOTES

- INSIDE FORMING DIMENSIONS ARE NOMINAL. TOLERANCES BETWEEN MAXIMUM & MINIMUM VESSEL DIAMETERS SHALL NOT EXCEED 1/2" IN ANY ONE PLANE, AS DEFINED IN ASME SECTION III.
- AZIMUTH LOCATIONS OF NOZZLES N1 THRU N6, N9 & N10, N12 THRU N14 & N16 SHALL BE WITHIN ± 0° 15' OF TRUE AZIMUTH POSITION.
- TOP HEAD LIFT LUGS LOCATED @ 0°, 90°, 180° & 270° WITHIN ± 2" TOTAL OF TRUE AZIMUTH POSITION.
- N8 - SPARE.
- TOP HEAD WEIGHT 181,200 LB
VESSEL WEIGHT = 15,256,000 LB
VESSEL VOLUME = 2,3005 CU FT

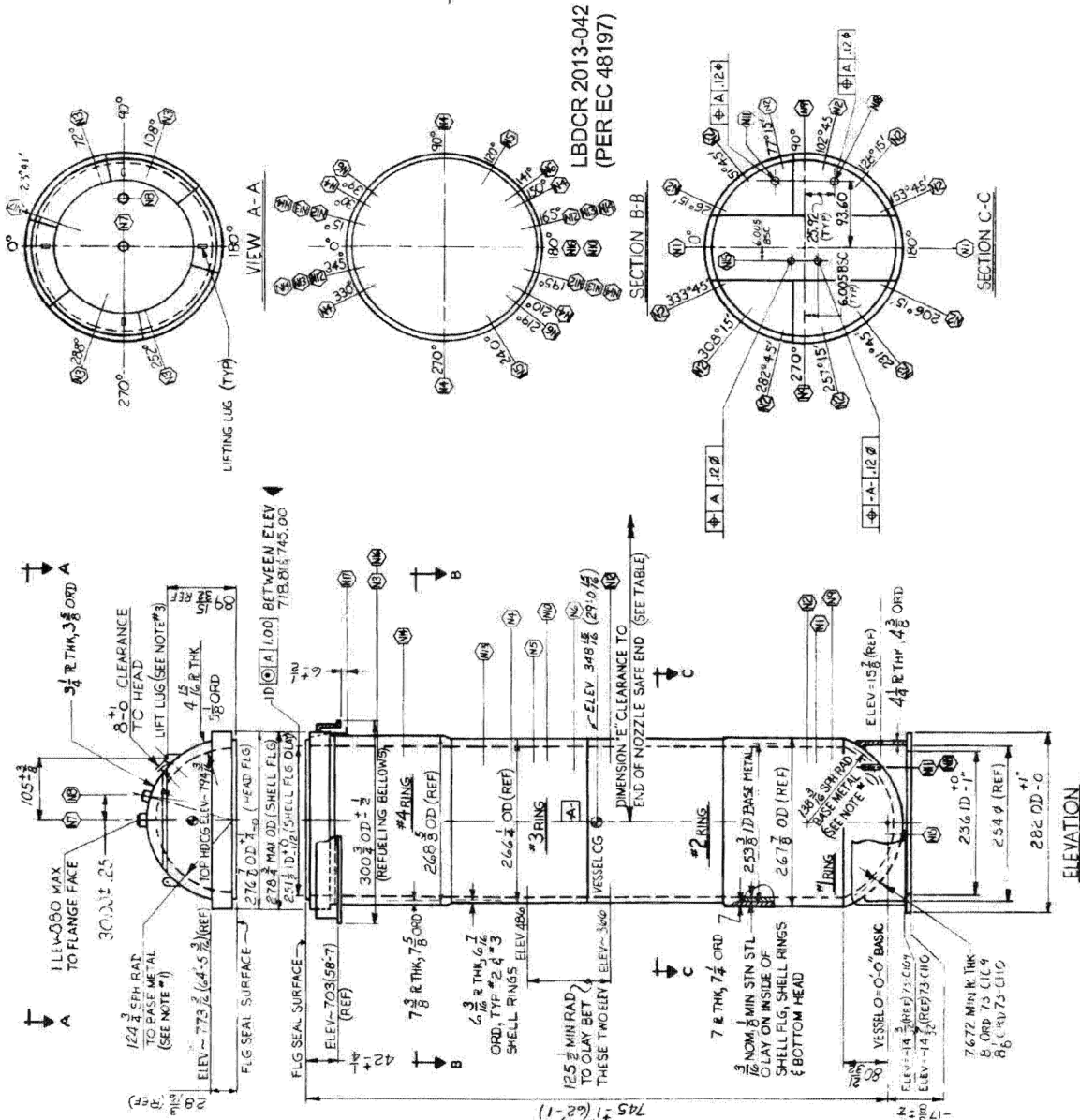

MISSISSIPPI POWER & LIGHT COMPANY
 GRAND GULF NUCLEAR STATION
 UNITS 1 & 2
 UPDATED FINAL SAFETY ANALYSIS REPORT
 VESSEL OUTLINE
 FIGURE 9.1-31

GRAND GULF NUCLEAR GENERATING STATION Updated Final Safety Analysis Report (UFSAR)

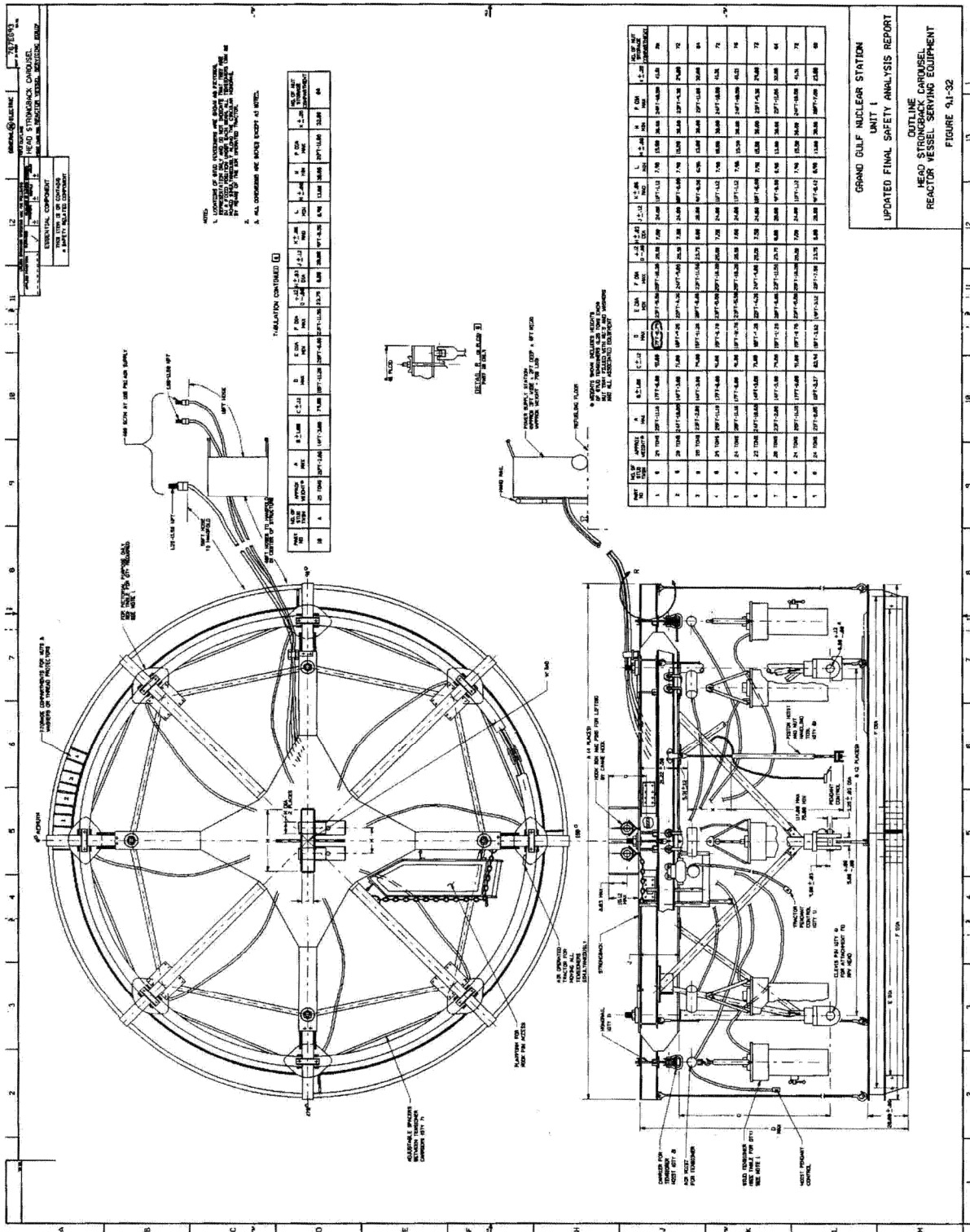

GRAND GULF NUCLEAR GENERATING STATION
 Updated Final Safety Analysis Report (UFSAR)

INFLATABLE SEALS (2 PER GATE)

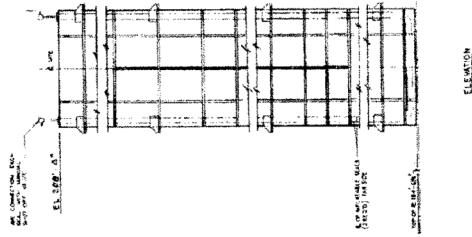
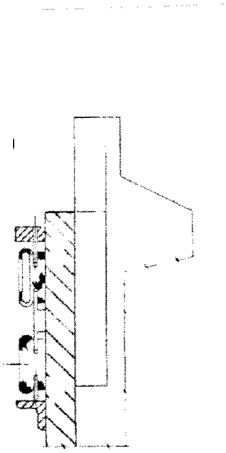

SYSTEM ENERGY RESOURCES, INC.
 GRAND GULF NUCLEAR STATION
 UNITS 1 & 2
 UPDATED FINAL SAFETY ANALYSIS REPORT
 CONTAINMENT
 UPPER CONTAINMENT POOL GATES
 SECTIONS AND DETAILS
 UNIT 1
 FIGURE 9.1-33

REV. 3

9601-C-1096

GRAND GULF NUCLEAR GENERATING STATION

Updated Final Safety Analysis Report (UFSAR)

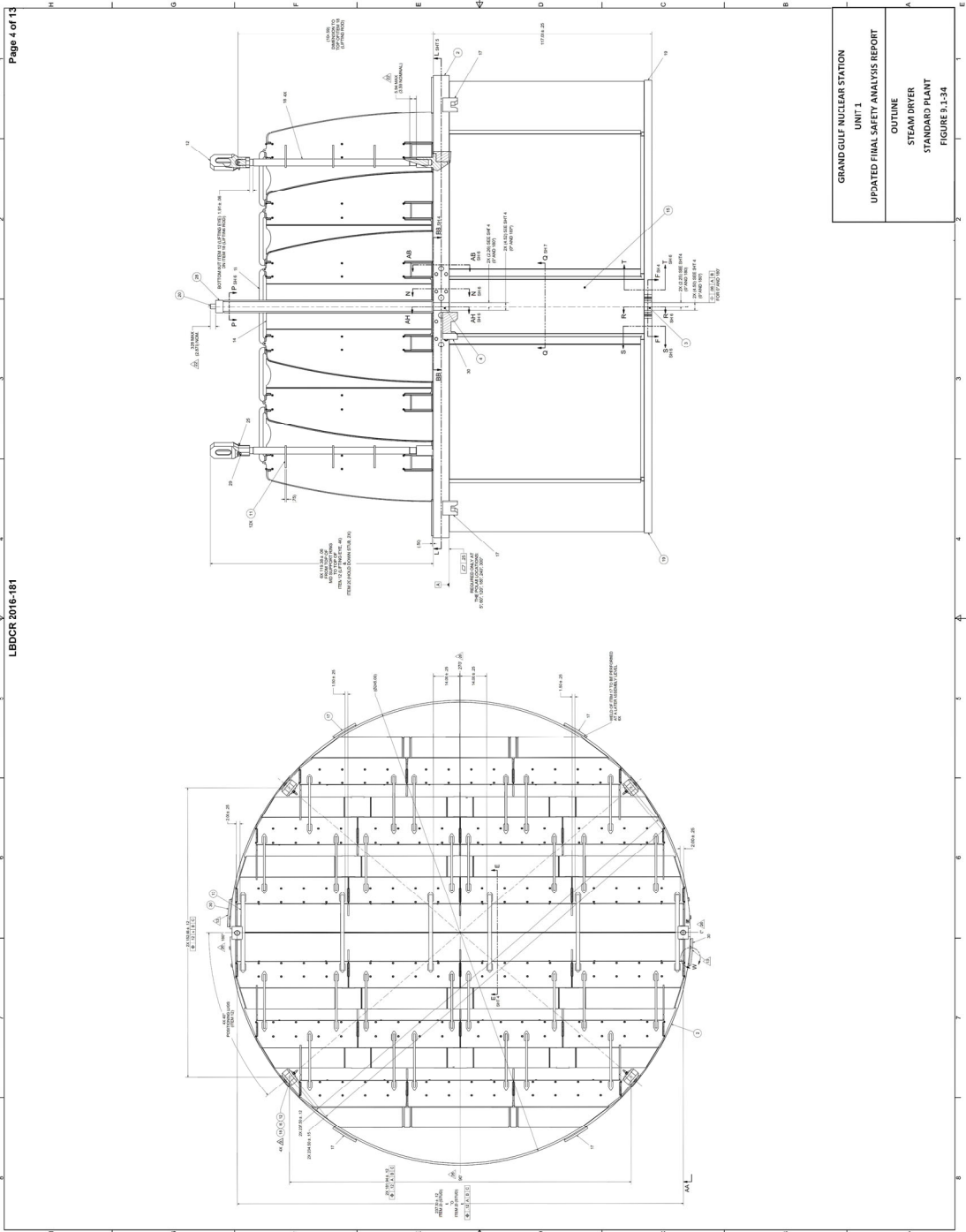

GRAND GULF NUCLEAR GENERATING STATION

Updated Final Safety Analysis Report (UFSAR)

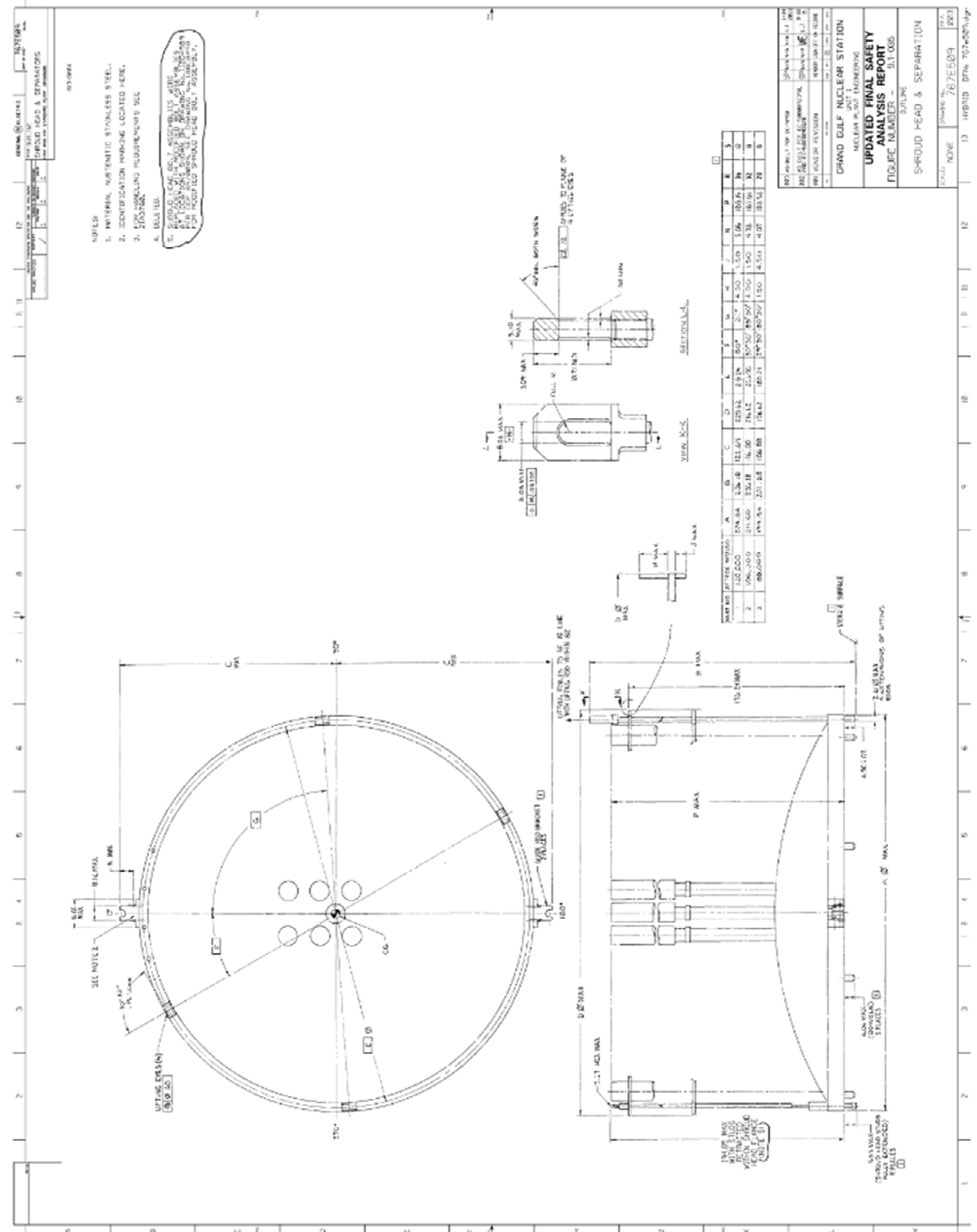

GRAND GULF NUCLEAR GENERATING STATION
Updated Final Safety Analysis Report (UFSAR)

Page 5 of 13

LBDCR 2016-181

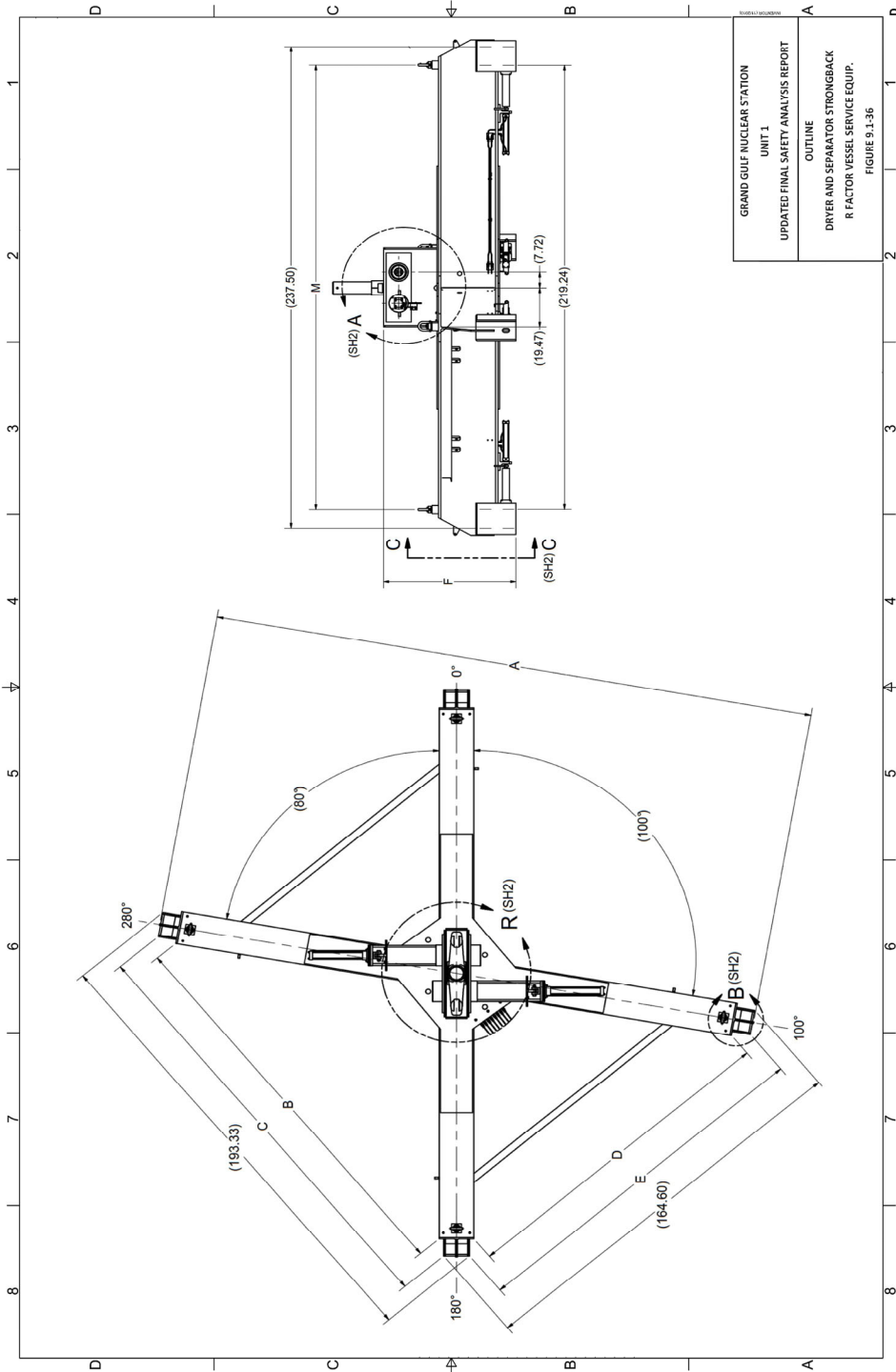

GRAND GULF NUCLEAR GENERATING STATION
Updated Final Safety Analysis Report (UFSAR)

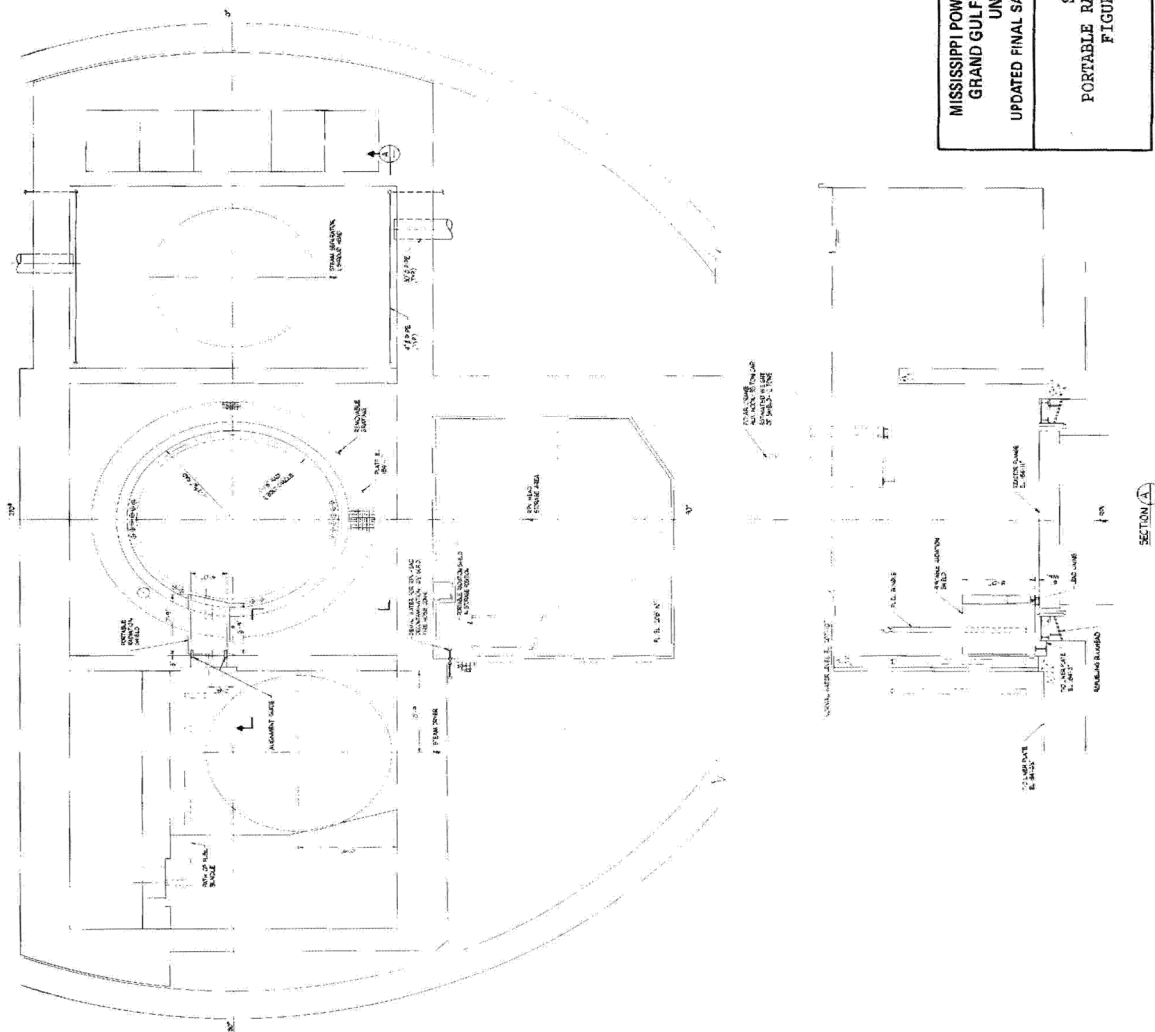

MISSISSIPPI POWER & LIGHT COMPANY GRAND GULF NUCLEAR STATION UNITS 1 & 2 UPDATED FINAL SAFETY ANALYSIS REPORT	STUDY PORTABLE RADIATION SHIELD FIGURE 9.1-37
--	---

GRAND GULF NUCLEAR GENERATING STATION
Updated Final Safety Analysis Report (UFSAR)

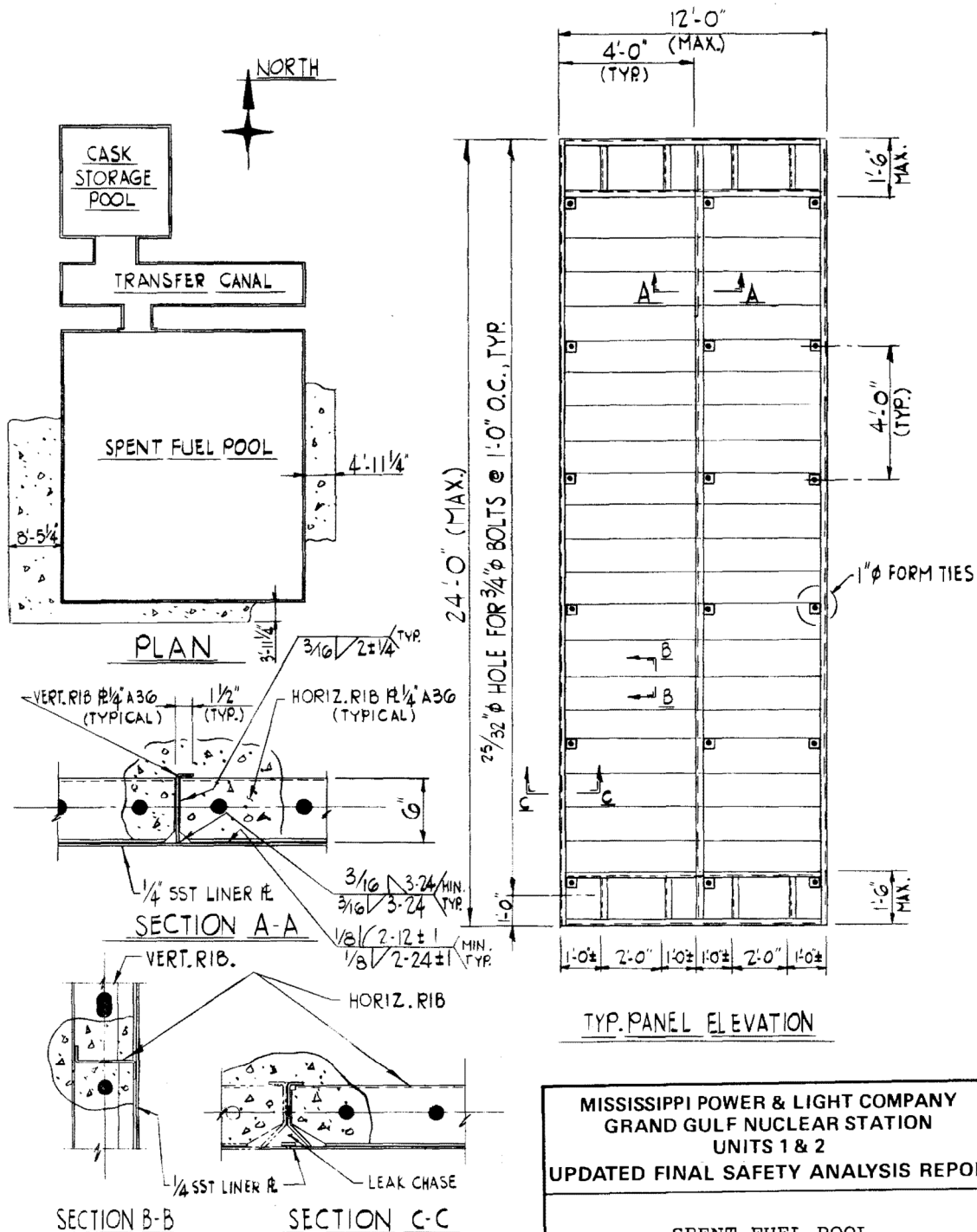

MISSISSIPPI POWER & LIGHT COMPANY
 GRAND GULF NUCLEAR STATION
 UNITS 1 & 2
 UPDATED FINAL SAFETY ANALYSIS REPORT

SPENT FUEL POOL
 LINER PLATE DETAILS

FIGURE 9.1-38

GRAND GULF NUCLEAR GENERATING STATION

Updated Final Safety Analysis Report (UFSAR)

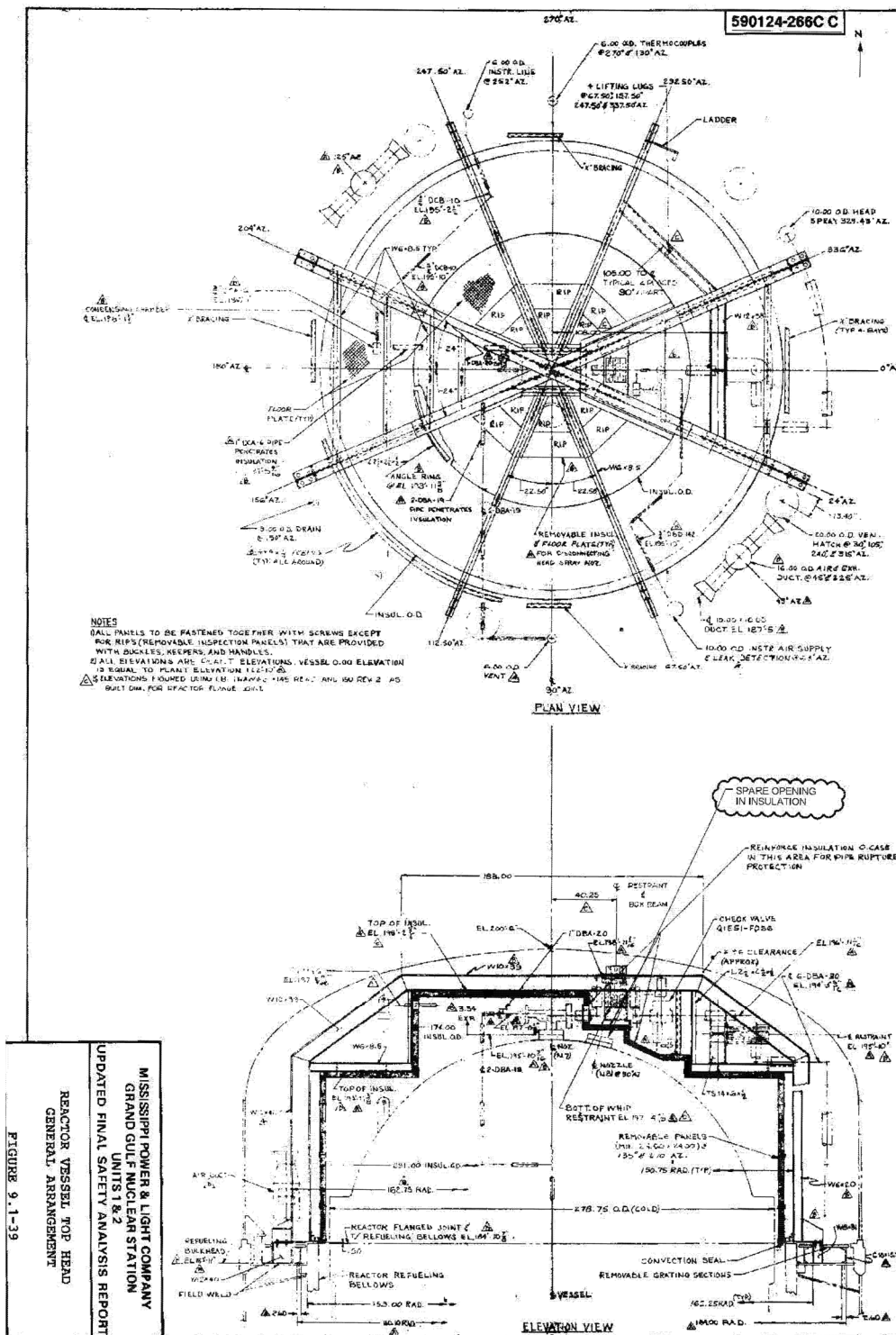
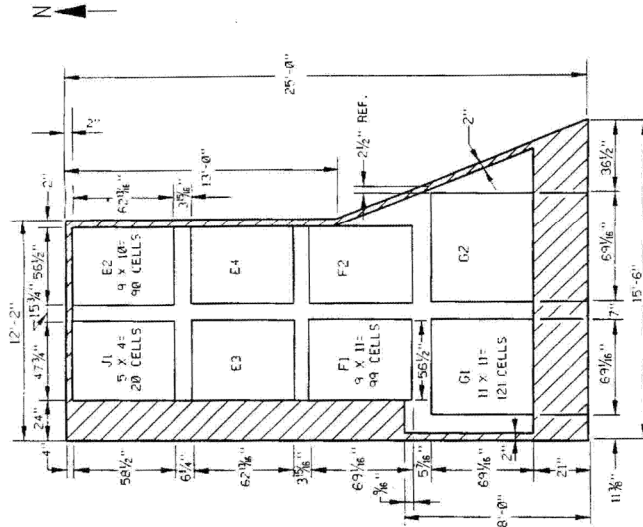

Figure 9.1-40

Deleted

GRAND GULF NUCLEAR GENERATING STATION
 Updated Final Safety Analysis Report (UFSAR)



CONTAINMENT FUEL POOL
 RACK ARRANGEMENT
 730 STORAGE SPACES

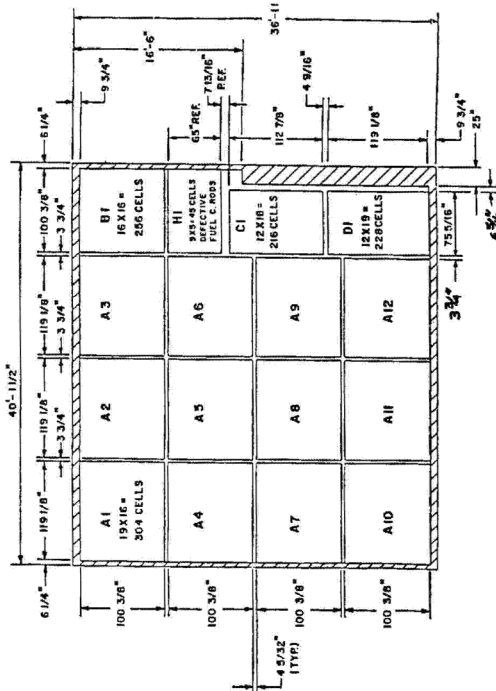

SPENT FUEL POOL RACK
 ARRANGEMENT
 4393 STORAGE SPACES

GRAND GULF NUCLEAR STATION
 UNIT 1
 UPDATED FINAL SAFETY ANALYSIS REPORT
 HIGH DENSITY SPENT FUEL
 RACKS ARRANGEMENT
 FIGURE 9.1-40b

Figure 9.1-41

Deleted

Figure 9.1-42

DELETED

GRAND GULF NUCLEAR GENERATING STATION
Updated Final Safety Analysis Report (UFSAR)

9.2 WATER SYSTEMS

9.2.1 Standby Service Water System

9.2.1.1 Design Bases

9.2.1.1.1 Safety Design Bases

- a. The standby service water (SSW) system, containing the plant ultimate heat sink, is an essential auxiliary supporting system which is designed to remove heat from plant auxiliaries that are required for a safe reactor shutdown. The capacity of the ultimate heat sink has been increased by 15% for EPU.
- b. The SSW system is designed to minimize leakage to the environment of radioactive contamination that may enter the SSW system from the residual heat removal (RHR) system.
- c. The SSW system provides a means of flooding the drywell and containment, if required, during the post-LOCA period.
- d. The SSW system is designed to perform its cooling function following a LOCA, automatically and without operator action, assuming a single active or passive¹ failure coincident with a loss of offsite power.
- e. Portions of the SSW system essential to a safe shutdown are designed to meet seismic Category I requirements. Two-valve isolation is provided between the nonseismic - seismic interfaces.
- f. The SSW system is protected from extreme natural phenomena, missiles, and the effects of pipe whip, jet impingement or water spray damage from high and moderate energy line breaks.

-
1. Credible non-electrical passive failures post-accident are a leakage crack, as defined in SRP Section 3.6.2, from 30 minutes to 24 hours post-LOCA, and pump or valve seal leakage after 24 hours post-LOCA. Noted in subsection 9.2.1.6, References 2, 3, and 4.

GRAND GULF NUCLEAR GENERATING STATION
Updated Final Safety Analysis Report (UFSAR)

- g. Nonseismic pipe, ductwork, or components are evaluated to ensure that their physical collapse during an SSE will not adversely affect essential components.
- h. A fire hazards analysis was performed to ensure that both divisions "A" and "B" of the SSW system would not be rendered inoperable due to the effects of a fire.

9.2.1.1.2 Power Generation Design Bases

The SSW system provides cooling to plant components, as required, during normal, reactor shutdown, and reactor isolation modes.

9.2.1.2 System Description

The SSW system consists of redundant cooling water trains comprised of cooling towers, pumps, piping, valves, and instrumentation as shown on Figures 9.2-1 through 9.2-4. The system components are designed to the requirements of Table 3.2-1, Section XXIV.

The locations of the cooling towers with their basins and pumps are shown in Figure 1.2-1. The locations of the components that are cooled by the SSW system are shown on Figures 1.2-1 through 1.2-8. The SSW cooling towers are shown on Figures 3.8-89 through 100. Component performance data is given in Table 9.2-4.

A minimum water depth of 2 feet 1 inch is required in each of the two SSW cooling tower basins to provide adequate submergence of the protective debris screen. The basin floors are at El. 82'-6" (see Figure 3.8-92, SSW Cooling Tower Basin Wall Elevations and Details). The sump area in which the pump suction is located is not included as part of the available basin volume. The pump suction bells are at El. 78'-0".

Cooling water is pumped from the cooling tower basins by two redundant SSW pumps and one HPCS service water pump to the essential components through the two main redundant SSW supply headers (loops A and B) and the HPCS service water supply header (loop C). After removing heat from the components, the coolant is returned back to the cooling towers where the heat is rejected through direct contact with ambient air. A simplified system schematic diagram is shown on Figure 9.2-47.

GRAND GULF NUCLEAR GENERATING STATION
Updated Final Safety Analysis Report (UFSAR)

The standby service water system supplies cooling water to each component listed in Table 9.2-3 through branches from the associated main supply headers and the HPCS service water supply header. During certain modes of system operation not all of the components listed in Table 9.2-3 are supplied with cooling water from the SSW system.

The control room air conditioning units and the ESF electrical switchgear room coolers are also connected to the plant service water (PSW) system for cooling during normal plant operation. The fuel pool heat exchangers are connected to the component cooling water (CCW) system for cooling during normal plant operation. The remaining SSW system components are isolated from the PSW and CCW systems. These components are maintained full of water via the SSW fill tank during normal plant operation.

The SSW system provides cooling to the component cooling water heat exchangers, plant air compressors, and two drywell chillers only during a loss of offsite power and shutdown of the unit.

Suitable isolation capability is provided to separate all nonessential systems from the SSW system to assure that the SSW system safety function can be accomplished assuming a single failure.

Each SSW cooling tower is provided with chemical treatment that prevents biological fouling and scaling and system corrosion by the addition of chemicals. A portion of the system coolant may be blown down, when makeup water is available, if the accumulation of fouling agents has occurred.

In order to prohibit debris, which may enter the SSW basin through the cooling tower openings, from entering the piping system, a screen is provided over the sump from which the SSW and HPCS service water pumps take suction. The screen openings are sized to filter any debris which could block a system flowpath and prevent adequate cooling water from reaching a heat exchanger.

Normal makeup for each SSW cooling tower basin is provided automatically by a connection with the PSWRW system which provides filtered well water during shutdown and reactor isolation conditions. Since the PSW system may not be operable for a period of time following a LOCA, the SSW cooling tower basins are sized to have sufficient water inventory to provide all plant post-LOCA cooling for the required 30-day period with no external makeup water source. SSW cooling tower basin water is the source

GRAND GULF NUCLEAR GENERATING STATION
Updated Final Safety Analysis Report (UFSAR)

of supply to the SSW system and does not perform any other function. A passive interconnecting line is also provided to transfer water between the SSW basins.

The UHS can operate indefinitely without exceeding the design service water temperature. The basin water volume must be replenished as required with water which may be cooler than the design service water temperature of 90 F.

The impact of long-term corrosion for the service water piping is compensated for by appropriate corrosion allowances. In addition, the buried piping is protected from corrosion by external wrapping.

9.2.1.3 Safety Evaluation

The standby service water system is an essential auxiliary supporting system which provides a reliable source of cooling for plant auxiliaries that are essential to a safe reactor shutdown following a design-basis, loss-of-coolant accident (LOCA). Either of the two main supply headers, in conjunction with the HPCS service water supply header, or both main supply headers provide adequate cooling water to meet safe shutdown requirements. The entire system is adequately protected to withstand adverse environmental occurrences, as required.

The two main redundant trains and the HPCS service water train of the SSW system are separated and protected to the extent necessary to assure that, in the event of any one of the following events, sufficient equipment remains operational to permit safe shutdown of the unit:

- a. Flooding or steam release from equipment failure such as pipe or tank rupture
- b. Pipe whip and jet forces resulting from pipe rupture
- c. Missiles resulting from equipment failure
- d. Fire

The ability of the SSW system to withstand explosions, fires, airplane crashes, and icing is described in subsections 2.2.3 and 3.5.1 and the Fire Hazards Analysis Report. Two redundant cooling towers with their associated makeup basins provide shutdown cooling for the unit. The cooling capacity of the cooling towers

GRAND GULF NUCLEAR GENERATING STATION
Updated Final Safety Analysis Report (UFSAR)

was increased to ensure that the towers maintain the temperature of the water supplied within the maximum design basis temperature of 90°F during all modes of required operation, including single failure. The usable water inventory in the basins for EPU was increased to ensure a 30-day post-accident operating period without makeup. Each tower is located on a separate basin. The combined basin volume is sized to provide supply to the SSW system for a minimum period of 30 days following a LOCA. (Refer to subsection 9.2.5 for a discussion of compliance of the SSW system with the requirements of NRC Regulatory Guide 1.27, Rev. 2.) The two SSW pumps or either of the two SSW pumps in conjunction with the HPCS service water pump are sized to provide cooling water to safely shut down the unit following a LOCA. To ensure the availability of a 30-day water supply, an interconnecting line is provided below grade to transfer water between the basins. Depending on the water level in the basins, the line either equalizes the levels or siphons water from one basin to the other. The transferring capability of the interconnecting line is limited to a low water level of approximately Elevation 92' in the basins. The SSW and HPCS service water pumps have sufficient NPSH available at the low basin water level. The required NPSH for the pumps is listed in Table 9.2-4. The SSW system is designed to withstand a single active or passive¹ failure coincident with a loss of offsite power without losing its capability to shut down the reactor safely following an accident. A single failure analysis is given in Tables 9.2-1 and 9.2-2.

The SSW system is designed to perform its required function for all modes of system operation. Analysis of system operation for the various modes listed below has determined that Mode IV is the critical mode for evaluating the capability of the SSW system to perform its safety function.

Mode I - Normal shutdown with offsite power

Mode II - Normal shutdown without offsite power

-
1. Credible non-electrical passive failures post-accident are a leakage crack, as defined in SRP Section 3.6.2, from 30 minutes to 24 hours post-LOCA, and pump or valve seal leakage after 24 hours post-LOCA. Noted in subsection 9.2.1.6, References 2, 3, and 4.

GRAND GULF NUCLEAR GENERATING STATION
Updated Final Safety Analysis Report (UFSAR)

Mode III - Two unit analysis deleted due to Unit 2 cancellation.

Mode IV - LOCA coincident with worst single active failure and total loss of offsite power.

The system operation analysis for Mode IV is based on the following operating cases:

- a. Operation of one loop of SSW and the HPCS SW loop.
- b. Operation of both loops of SSW and the HPCS SW loop.

The following assumptions are applicable to Case a. where one loop of SSW and the HPCS SW loop are running:

- a. LOCA occurs.
- b. Total loss of offsite power.
- c. The worst single active failure, which for this analysis is the loss of one of the two standby diesel generators which removes one of the standby service water loops from operation. The B standby diesel generator is assumed to fail.
- d. No makeup water is available to the SSW cooling tower basins for 30 days.
- e. Worst 30-day site meteorology for heat rejection.

The following assumptions are applicable to Case b. where both loops of SSW and the HPCS SW loop are running:

- a. LOCA occurs.
- b. Total loss of offsite power.
- c. Both loops of SSW and the HPCS SW loop run for 30 days.
- d. Worst single active failure, i.e., RHR heat exchanger bypass valve failure leading to increased heat load on the suppression pool.

GRAND GULF NUCLEAR GENERATING STATION
Updated Final Safety Analysis Report (UFSAR)

- e. No makeup water is available to the SSW cooling tower basins for 30 days.
- f. Worst 30-day site meteorology for heat rejection.

These assumptions will result in the greatest heat rejection rate for the ultimate heat sink during the most severe meteorology for cooling tower heat rejection. All other modes are less severe with respect to heat rejection from the UHS and are considered to be enveloped by this analysis.

Mode IV cooling requirements for shutdown of the unit are satisfied by the operation of either one loop of SSW and the HPCS Service Water loop or both loops of SSW and the HPCS SW loop. Both cooling water loops operate continuously from the time of system initiation.

The Mode IV design cooling duty requirements for each of the operating cooling water loops are given in Tables 9.2-16 and 9.2-16a.

Tables 9.2-17 and 9.2-17a give the Mode IV time dependent heat loads for each operating cooling water loop.

The day-by-day tabulations of the Mode IV integrated heat rejection from the SSW basin are given in Tables 9.2-15a and 9.2-15b.

The Mode IV total heat rejection curves for the SSW basin are shown on Figures 9.2-6a and 9.2-6b.

Figures 9.2-35, 9.2-37a, 9.2-37b, 9.2-40, 9.2-42 and 9.2-43 present heat rejection rate and integrated heat rejection curves for the operating cooling water loops. Included are curves showing the station auxiliary loads and the RHR loads individually.

As a conservative approach to the heat rejection analysis, the entire energy input from the pumps to the SSW system was assumed to be a sensible heat input. This approach is conservative as there would actually be a significant portion of the energy input accountable to pump work, thus reducing the sensible heat load.

The cooling tower and meteorological models which were used to analyze the ultimate heat sink cooling tower performance are described below.

GRAND GULF NUCLEAR GENERATING STATION
Updated Final Safety Analysis Report (UFSAR)

Deleted

GRAND GULF NUCLEAR GENERATING STATION
Updated Final Safety Analysis Report (UFSAR)

Deleted

Mode IV Cooling Tower Model

The following assumptions were used to simplify the STBY SSW cooling tower model:

- o The tower effluent air is assumed saturated, and
- o The temperature of the water-gas interface is assumed to be the same as that as the bulk water temperature.

The following assumptions were used to simplify the HPCS SSW cooling tower model:

- o The tower effluent air is assumed saturated, and
- o The temperature of the water gas interface is calculated based on design heat loads and cooling water flow water.
- o The heat load was assumed to be constant over the first 30 day period.
- o The basin water temperature was assumed to be 90°F.

GRAND GULF NUCLEAR GENERATING STATION
Updated Final Safety Analysis Report (UFSAR)

- o The total HPCS SSW cooling tower flow rate was assumed to be 1000 GPM, with 500 GPM flow being distributed evenly to each of the two cells, with two cells in natural draft operation.

The heat balance for the cooling tower is given as follows:

$$G(h_2 - h_1) = L(T_1 - T_2) + [(G) (W_2 - W_1) (T_2 - 32)]$$

or

$$L/G = [(h_2 - h_1) - [(G) W_2 - W_1) (T_2 - 32)] / (T_1 - T_2) \quad (1)$$

and

$$\text{RANGE} = T_1 - T_2 = (\text{HEAT LOAD}) / (C_p) (L) (60) \quad (2)$$

where

HEAT LOAD = Heat rejection rate, Btu/hr

L = Circulating water flow rate, lb/min

C_p = Specific heat, Btu/lb-F

G = Effluent air mass flow rate, lb/min

h₂ = Enthalpy of the saturated air at the effluent air temperature, Btu/lb dry air

h₁ = Enthalpy of the ambient air, Btu/lb dry air

T₁ = Hot water temperature, F

T₂ = Cold water temperature, F

W₁ = Water vapor content of entering air, lb water/lb dry air

W₂ = Water vapor content of exit air, lb water/lb dry air

The design liquid-to-gas ratio, L/G, and the design cooling tower performance characteristic, KaV/L, are specified for the cooling tower based on the following parameters (design point):

- a. Maximum heat rejection rate required,

GRAND GULF NUCLEAR GENERATING STATION
Updated Final Safety Analysis Report (UFSAR)

- b. Hot water temperature,
- c. Cold water temperature,
- d. Dry bulb temperature, and
- e. Wet bulb temperature.

The specified L/G and performance characteristic based on the STBY SSW design point are 1.02769 and 1.74823, respectively.

The specified L/G and performance characteristic based on the HPCS SSW design point are 0.948 and 1.633, respectively.

The following data were used in the STBY SSW analysis.

- a. Heat rejection rates for every 3-hour period (for corresponding 3-hour meteorological condition) during the first day of LOCA conditions, Btu/hr.
- b. Daily average heat rejection rates for the following 30 days of LOCA conditions, Btu/hr.
- c. The worst single day and the worst 30-day period of meteorological conditions with reference to wet bulb temperature.

The following data were used in the HPCS SSW analysis:

- a. Heat rejection rates were evaluated for a constant worst case meteorological condition of 79°F Wet Bulb and 100°F Dry Bulb, BTU/Hr.
- b. A constant HPCS SSW post LOCA average heat rejection load of 12,000,000 BTU/Hr.

Evaporation and drift are calculated as:

$$\text{EVAP} = G (X_1 - X_o) \quad (3)$$

and

$$\text{DRIFT} = L \times \text{PCT} \quad (4)$$

respectively, so that

$$\text{WATER CONSUMPTION} = \text{EVAP} + \text{DRIFT} \quad (5)$$

GRAND GULF NUCLEAR GENERATING STATION
Updated Final Safety Analysis Report (UFSAR)

where

X_0 = lb water vapor/lb dry air at ambient conditions

X_1 = lb water vapor/lb dry air at tower exit conditions

PCT = Drift loss as percent of the circulating water

EVAP and DRIFT are evaporation and drift rates in lb/min, and L and G have the same meaning as previously.

An iterative procedure relating the exit air temperature, cold water temperature and range to wet bulb temperature, L/G ratio, and the cooling tower performance characteristic is used to determine the cold water temperature. The iterative procedure, based on the Cooling Tower Institute's "Acceptance Test Code for Water-Cooling Towers" (CTI Code ATC-105), involves setting the performance characteristic equal to the integral of the inverse enthalpy potential difference over the range of cold water temperatures. Successive iterations result in the range which satisfies the equality.

Justification that the cooling tower manufacturer has used conservative heat transfer values in the design of the Grand Gulf SSW towers is contained in the Ceramic Cooling Tower Report NCT-647-37. The report represents test and design data for cooling towers of various sizes and cooling capacities design by Ceramic. The results of the tests performed in accordance with Cooling Tower Institute Code ATC/ATP-105, Acceptance Test for Water-Cooling Towers found that each tower performed at or above the design cooling rate for the test conditions.

STBY SSW Meteorological Model

The controlling meteorological parameters required for the analysis of wet mechanical draft cooling tower performance are wet bulb temperature and coincident dry bulb temperature. The meteorological data presented below were developed in accordance with the requirements of Regulatory Guide 1.27, Revision 2.

The meteorological data base used for synthesizing the worst 1-day and 30-day periods of wet bulb and coincident dry bulb temperatures was 28 years (1948-1975) of weather data for Jackson, Mississippi, obtained from the National Climatological Center (NCC); 4 years (1996-2000) of weather data for Vicksburg, Mississippi, obtained from NCDC Local Climatological data; and

GRAND GULF NUCLEAR GENERATING STATION
Updated Final Safety Analysis Report (UFSAR)

2001-2003 GGNS Site Meteorological Data. The 36 years of meteorological data is representative of the site for the ultimate heat sink analysis. Several computer programs were utilized in processing the meteorological data. Two different methods were used to calculate the daily averages of the wet and dry bulb temperatures. One method was used for processing hourly data and a second for 3-hourly data. When calculating the daily averages using hourly data, occasionally missing or erroneous data were found. If 3 or more hours of data were missing or erroneous, the daily average for that particular parameter was not calculated. If less than 3 hours of data were missing or erroneous, the missing data were linearly interpolated, and the interpolated values were used to calculate the daily average. When calculating the daily averages using 3-hourly data, instead of interpolating the missing or erroneous data, the bad data were eliminated for the average calculation. If more than two observations were missing for a given parameter, no average was calculated for that day.

The worst 1-day and worst 30-day periods were found to be as follows:

a. Worst 1-day period

The worst 1 day for Jackson, Mississippi, was August 1, 1998, which gives the highest daily average wet bulb temperature.

b. Worst 30-day period

The first 30 consecutive daily average wet bulb temperatures were summed and divided by 30 to calculate the first 30-day average. Then the 31st day value was added to the sum and the first day value subtracted. This new sum was divided by 30 to get the second 30-day average. This process was repeated consecutively until all the data were exhausted. By keeping running track of the highest average calculated, the maximum average was determined giving the worst 30-day period. The worst 30 day period, as shown in Table 2.3-20, is July 4, 1998 to August 2, 1998.

With one loop of SSW and the HPCS SW loop running, the results of the Mode IV design performance analysis for the one standby service water cooling tower experiencing the greatest heat load, i.e., LOCA/LOP, for the worst one-day and 30-day meteorology,

GRAND GULF NUCLEAR GENERATING STATION
Updated Final Safety Analysis Report (UFSAR)

based on the manufacturer guaranteed performance characteristics, are shown on Figures 9.2-7a and 9.2-8a, respectively. The tabulated results for this analysis are shown in Tables 9.2-5a and 9.2-6a, respectively.

The cooling tower cold water return temperatures in Table 9.2-5a are based on 3-hour average heat rejection rates for the design accident. In each 3-hour period, the SSW pump suction temperature was assumed to be in near equilibrium with the tower cold water return temperature for the heat rejection rate at that time. In the initial 0 to 3-hour period of Mode IV the cold water temperature of 86.2 F was based on an SSW pump suction temperature also of 86.2 F. Likewise, for the highest Mode IV CWT of 91.4 F, a pump suction temperature of 91.4 F was assumed. A similar methodology was used for the Mode IV 30-day analysis, as shown in Table 9.2-6a, using daily average heat rates. In all cases no credit was taken for the actual cooler basin water temperatures throughout the analysis.

With both loops of SSW and the HPCS SW loop running, the results of the Mode IV design performance analysis for the one standby service water cooling tower experiencing the greatest heat load, i.e., LOCA/LOP, for the worst one-day and 30-day meteorology, based on the manufacturer guaranteed performance characteristics, are shown on Figures 9.2-7b and 9.2-8b, respectively. The tabulated results for this analysis are shown in Tables 9.2-5b and 9.2-6b, respectively.

The cooling tower cold water return temperatures in Table 9.2-5b are based on 3-hour average heat rejection rates for the design accident. In each 3-hour period, the SSW pump suction temperature was assumed to be in near equilibrium with the tower cold water return temperature for the heat rejection rate at that time. In the initial 0 to 3-hour period of Mode IV the cold water temperature of 87.2 F was based on an SSW pump suction temperature also of 87.2 F. Likewise, for the highest Mode IV CWT of 91.6 F, a pump suction temperature of 91.6 F was assumed. A similar methodology was used for the Mode IV 30-day analysis, as shown in Table 9.2-6a, using daily average heat rates. In all cases no credit was taken for the actual cooler basin water temperatures throughout the analysis.

GRAND GULF NUCLEAR GENERATING STATION
Updated Final Safety Analysis Report (UFSAR)

HPCS SSW METEOROLOGICAL MODEL

As noted in the assumptions for the HPCS SSW cooling tower model, the cooling tower cold water return temperature is based on a constant HPCS SSW heat rejection rate for the design accident. The HPCS SSW pump suction temperature was assumed to be a constant 90°F. No credit was taken for the actual cooler basin water temperatures in the analysis.

The cold water return temperature will not actually be as high as indicated in Tables 9.2-5a or 9.2-5b for the worst one-day analyses. The worst one day of UHS cooling tower demand occurs on the first day of the 30-day period following a LOCA. The actual basin water temperature is at its lowest on this day and will be at a maximum initial temperature of 78.7 F, assuming the highest average daily wet bulb temperature for the 30 day period. Hot water coming from the plant is cooled by the tower and then mixes with the large basin water volume, resulting in a lower actual SSW pump suction temperature to the plant. As the basin level decreases due to drift and evaporation, both the SSW and the HPCS SSW flow rates will decrease. The lower HPCS SSW flow rate will improve the overall performance of the HPCS SSW natural draft cooling tower. The lower HPCS SSW flow rate will increase the HPCS SSW return hot water temperature and will increase the induced natural air flow through the tower, resulting in an overall colder water temperature returning to the basin. Lower SSW flow rates will not appreciably alter the SSW cold water return temperatures due to the fixed air flow rate provided by mechanical draft towers. The Mode IV 30-day performance analysis also verifies that even with a gradually depleting basin water inventory due to evaporation and drift, the cold water temperature will still not exceed the design temperature of 90 F.

Losses from the SSW cooling tower basins inventory result from cooling tower drift, system leakage, and evaporation. The maximum losses occur if both loops of SSW and the HPCS SW loop operate continuously for 30 days. For a 30-day period of operation following plant shutdown at design conditions, the Mode IV total integrated water losses resulting from cooling tower drift from both cooling towers will be approximately 205,000 gallons. The drift loss estimates were determined using the cooling tower manufacturer's guaranteed maximum drift loss rate, 0.02 percent of the circulating water flow. This estimate for drift loss from the Grand Gulf SSW cooling towers has been supported by drift eliminator performance tests conducted by an independent testing

GRAND GULF NUCLEAR GENERATING STATION
Updated Final Safety Analysis Report (UFSAR)

firm. The tests were performed on both a test cell and an actual operating cell whose size and design are similar to those for the Grand Gulf SSW towers. The drift eliminators used on the cells tested were of the same zig-zag design as those used on the Grand Gulf towers. The test results found the drift losses to be less than 0.000018 percent. Based on the results of the tests conducted on the drift eliminators, the 0.02 percent estimated drift loss from the Grand Gulf towers is conservative. The drift and evaporate losses demonstrated by the independent testing firm are considered very conservative for the natural draft HPCS SSW cooling tower since the losses are based on drift eliminator geometry, air flow rate, water temperature, and meteorological conditions.

The natural draft HPCS SSW cooling tower utilizes the same drift eliminator design tested for the mechanical draft towers, has a lower air flow rate than the mechanical draft towers, and operates with similar system return water temperatures under identical meteorological conditions. The Mode IV total integrated loss of water inventory resulting from system leakage will be approximately 637,000 gallons. The Mode IV total integrated loss of water inventory resulting from evaporation for the same period and conditions will be approximately 10,870,000 gallons. The evaporative losses have been determined using the cooling tower and meteorological models described above. For Mode IV, the combined basin volume for the plant is approximately 13.27×10^6 gallons. With Mode IV total evaporative, leakage, and drift losses estimated to be 11.71×10^6 gallons, there will be approximately 1.567×10^6 gallons of water left at the end of the 30-day period. A minimum of 300,000 gallons (2-foot depth) is required in each of the two SSW cooling tower basins to provide adequate submergence of the protective debris screen. (This value was originally derived based on two unit operation, i.e., two SSW and one HPCS Service Water pumps operating in each basin, and has not been derived for single unit operation since the value for two unit operation is conservative). For Mode IV, the net usable volume of water is reduced by 300,000 gallons so that there is approximately 1,267,000 gallons of usable water following the Mode IV scenario. This amount of water will also result in a water level in each basin which assures that adequate submergence (NPSH) is available to permit proper operation of both the SSW and HPCS service water pumps. No water will be drawn from the basins for fire-fighting purposes. In the event the normal makeup from

GRAND GULF NUCLEAR GENERATING STATION
Updated Final Safety Analysis Report (UFSAR)

the plant service water radial well (PSWRW) system is unavailable at the end of 30 days, sufficient time is available to take the following action:

- a. Transport an alternate water supply from offsite
- b. Install a temporary pump and piping system utilizing the water contained in the main cooling tower basin, onsite construction wells, storm drains, or the Mississippi River

The design of the SSW cooling towers and basins has been based on a wet bulb temperature of 79 F and a dry bulb temperature of 100 F. The SSW cooling tower design is such that variations in wind speed do not affect tower performance. For the 30-day period following initiation of a design basis shutdown, the maximum heat loads can be rejected by the cooling tower based on the above design temperatures. Both design temperatures are the highest daily average temperatures based on 36 years of real data collected at Jackson, Mississippi, Vicksburg, Mississippi, and the site. In addition, the design wet bulb temperature has been exceeded only one percent of the time.

During the peak heat load period of SSW cooling tower operation, the basin water is at a temperature lower than the maximum allowable water temperature. Because the basins contain a large volume of water, any short period of air temperatures higher than the design air temperatures will not cause the basin water temperature to exceed the design limit.

Radiation monitors are provided to detect radioactive contamination resulting from a leak in the SSW system. Upon detection of radioactive leakage in one of the RHR heat exchangers, that exchanger is isolated by operator action in the control room, and the cooling requirements are met by the RHR heat exchanger of the redundant main service water train and the HPCS service water train. The motor-operated isolation valves can also be manually actuated locally. Consequently, radioactive contamination released in the SSW system to the environment will not exceed allowable limits.

Sumps and pumps are located throughout the plant as required, including each ECCS pump room, to detect system leakage (refer to subsection 9.3.3). Excessive leakage to a particular sump is indicated by a high-high level alarm and the operation of the standby sump pump. The plant computer monitors the high-high level switch status and the pump operating status. All essential

GRAND GULF NUCLEAR GENERATING STATION
Updated Final Safety Analysis Report (UFSAR)

equipment is protected from flooding due to a passive failure. Should a large break occur in a SSW pipeline located outside of the plant buildings, a low-pressure switch in the associated SSW pump discharge header signals the operator that this condition exists.

Discharge flow from each of the SSW pumps and return flow to the SSW cooling towers is measured and compared. A high differential between these variables indicates system leakage and is annunciated in the control room.

An intertie with the RHR system is provided from loop B of the SSW system supply header. The intertie contains two remote manually operated isolation valves that can be opened from the control room in the event containment and drywell flooding is required.

The SSW cooling towers, basins, and pump houses are designed to withstand, without a loss of functional capability, the following natural phenomena:

- a. Safe shutdown earthquake as discussed in Section 3.7
- b. Maximum probable flood elevation of +103 feet above mean sea level as discussed in Section 3.4
- c. Tornado wind forces and tornado-borne missiles as discussed in subsections 3.3.2 and 3.5.1.4

The SSW cooling towers, basins, and pump houses are constructed of concrete walls and roofs at least 2 feet thick. The SSW cooling tower fans are provided with debris protectors as discussed in Section 3.8 to prevent simultaneous failure of the fans from tornado entrained debris.

Design and construction of all portions of the standby service water system, including instrument air supply, and blowdown subsystems, are in accordance with seismic Category I requirements; ASME Code Section III, Class 2 or 3 and ANSI B31.1 Code (for instrument air and blowdown system piping); and IEEE 279-1971 criteria, where applicable.

The system has been evaluated for consequences of moderate energy line breaks in accordance with the guidelines given in Section 3.6.

GRAND GULF NUCLEAR GENERATING STATION
Updated Final Safety Analysis Report (UFSAR)

The components (and supporting structures) of any system, equipment, or structure that is not seismic Category I and whose collapse could result in loss of a required function of the standby service water system through either impact or flooding are analytically checked to determine that they will not collapse when subjected to seismic loading. [HISTORICAL INFORMATION] [

9.2.1.4 Tests and Inspections

The SSW system was hydrostatically tested prior to initial startup and is designed to permit periodic tests and inspections of all components to assure the integrity and capability of the system.] The system design incorporates provisions to permit inservice inspection in accordance with the requirements of ASME Code Section XI. The tests and inspections will include the following:

- a. Pumps and Drive Motors - Each pump is started and run for sufficient time to assure its proper operability in accordance with the requirements of ASME OM Code for Operation and Maintenance of Nuclear Power Plants. The operator records discharge pressures, basin levels, and flow rates, calculates differential pressures, and measures for abnormal vibration in accordance with the requirements of ASME OM Code.
- b. Cooling Towers - The operator runs each fan for sufficient time to assure its proper operability. Inspection for abnormal vibration is performed and maintenance is provided for as required. Any accumulation of foreign matter is removed.
- c. Manual Valves - The manual valves are tested as required in accordance with the GGNS IST Pump and Valve Test Program.
- d. Check Valves - The check valves are tested as required in accordance with the GGNS IST Pump and Valve Test Program.
- e. Control Valves - Each control valve is operated through its complete range of movement.
- f. Level Controllers - These are inspected for working condition. A simulated signal is sent to level switches and level valves to assure that the system works.

GRAND GULF NUCLEAR GENERATING STATION
Updated Final Safety Analysis Report (UFSAR)

- g. Power-Operated Containment Isolation Valves - These are tested to assure that they are capable of opening and closing by operating manual switches in the control room and observing the valve position lights. Testing will be in accordance with the provisions specified in subsection 6.2.4.
- h. Leak Detection Systems - Each leak detection sump pump and high-high alarm is checked.

In addition to the test and inspection of individual system components, periodic functional testing is performed to assure the operability of the system as a whole. The tests assure, under conditions as close to design as practical, the performance of the full operational sequence that brings the system into operation for reactor shutdown and for loss-of-coolant accidents, including operation of applicable portions of the protection system and the transfer between normal and standby power sources.

9.2.1.5 Instrumentation Requirements

The standby service water system operation following a LOCA or other faulted conditions is initiated automatically and requires no operator action. Initiation of operation for normal shutdown is manual from the control room.

If a LOCA occurs, all cooling tower fans, SSW pumps, and HPCS service water pumps will start. If a loss of offsite power occurs during a LOCA, the pumps and fans will momentarily stop until transfer to standby diesel-generator power is completed and the pumps and fans are restarted automatically according to the diesel loading sequence. At the same time, the plant service water lines to the standby service water components that are required during normal operation are isolated automatically, and the respective SSW system lines are opened to these components.

The cooling water return line from each SSW loop contains a radiation monitor to detect any radioactive contamination resulting from a leak in the SSW system. When contamination is detected, an alarm sounds in the control room.

The SSW system has local temperature and pressure test points for evaluation of the performance of the system coolers. Local indicators are provided for determination of the pump discharge pressures. Level indication for the cooling tower basins is provided in the control room. Normal makeup to these basins from

GRAND GULF NUCLEAR GENERATING STATION
Updated Final Safety Analysis Report (UFSAR)

the PSWRW system is controlled automatically. Refer to subsections 7.3.1.1.7, and 7.3.2.7 for a further discussion of instrumentation and controls for the SSW system.

9.2.1.6 References

1. Deleted
2. NUREG-0138, Staff Discussion of Fifteen Technical Issues Listed in Attachment to November 3, 1976 Memorandum from Director, NRR to NRR Staff, Issue No. 7, Passive Failures Following a Loss-of-Coolant Accident, November, 1976.
3. SECY-77-439, NRC Information Paper on Single Failure Criterion, August 17, 1977.
4. "Grand Gulf Nuclear Station, Unit 1 - Issuance of Amendment RE: Revise the Standby Service Water Passive Failure Methodology in the Updated Final Safety Analysis Report," September, 2013 (Amendment 196).

9.2.2 Component Cooling Water System

9.2.2.1 Power Generation Design Bases

- a. The component cooling water (CCW) system is designed to cool auxiliary plant equipment over the full range of reactor operation during normal operating and normal shutdown conditions. Cooling water will also be provided for some components during a loss of offsite power. The design basis cooling water supply temperature is 95 F.
- b. The CCW system is designed to provide a closed cooling water loop between certain systems that are potentially radioactive and the plant service water used for cooling. This provides an additional barrier between the contaminated systems and the cooling water discharged to the environment.
- c. The CCW system is designed in a manner which prevents long-term corrosion that may degrade system performance.

9.2.2.2 System Description

The CCW system is a closed-loop system that provides parallel-flow cooling to auxiliary equipment in the containment, drywell,

GRAND GULF NUCLEAR GENERATING STATION
Updated Final Safety Analysis Report (UFSAR)

and auxiliary buildings. The system consists of pumps, heat exchangers, tanks, piping, valves, and instrumentation as shown on Figures 9.2-9 and 9.2-10. Each of the three pumps and three heat exchangers are half capacity, based on maximum normal cooling requirements. Heat is removed from the CCW system by the plant service water system during normal operation. The service water is passed through the tube side of the CCW heat exchangers, and the closed-loop water is passed through the shell side. A mechanical heat exchanger tube cleaning system circulates cleaning balls through the plant service water side of the CCW heat exchangers, one heat exchanger at a time. System component performance data is shown in Table 9.2-7.

In the event of a loss of offsite power, the following components will be automatically isolated from the rest of the CCW system:

- a. Reactor water cleanup (RWCU) heat exchangers
- b. Fuel pool heat exchangers

One of the CCW pumps will operate during this plant condition to continue cooling the remaining system components. The operating CCW pump is powered from an engineered safety features bus. An intertie between the plant service water system and the standby service water (SSW) system is provided to automatically supply cooling water to the CCW heat exchangers. In addition, each fuel pool heat exchanger is provided with an independent intertie connection to and from the SSW system to supply emergency cooling water to these components. The switchover to the SSW system is manually initiated. Refer to subsection 9.2.1 for further details concerning the SSW system.

A chemical-addition system is provided to inject a corrosion inhibitor into the closed-loop water. Corrosion inhibition will be accomplished by running the system with demineralized water only, or with a corrosion inhibitor added. System water level and volume control, and the CCW pump's net positive suction head (NPSH) are maintained by an atmospheric head tank. Makeup to the CCW system is supplied from the makeup water treatment system.

System containment penetrations and isolation valves are designed to meet seismic Category I and ASME Code, Section III, Class 2 requirements. The penetrations are designed to 140 psig and 185 F, whereas the isolation valves are designed to 150 psig and 500 F. (F035 valve is designed for 267 F.) The fuel pool heat exchangers and associated process piping out to and including the component

GRAND GULF NUCLEAR GENERATING STATION
Updated Final Safety Analysis Report (UFSAR)

isolation valves are designed to meet seismic Category I and ASME Code, Section III, Class 3, requirements. The remainder of the system is not designed to meet seismic Category I requirements: it is designed to ANSI B31.1, TEMA, NEMA, API, and ASME Code, Section VIII codes and standards, as applicable, and for a pressure of 125 psig. The system will operate at a maximum pressure of 120 psig and a maximum temperature of 180 F.

9.2.2.3 Safety Evaluation

Piping and valves associated with fuel pool heat exchangers and piping and valves forming a part of containment boundary are safety-related and designed to seismic Category I requirements as discussed in Section 3.2. The remaining system has no safety-related function or required for a safe shutdown of the reactor and it is not designed to seismic Category I requirements. Failure of the system will not compromise any safety-related system or component and will not prevent safe reactor shutdown. Refer to subsection 5.5.2.1 for a discussion of loss of component cooling water (CCW) to the reactor recirculation pumps.

The CCW system provides a barrier between systems that are potentially radioactive and the service water discharged to the environment. A radiation monitor is provided in the CCW system to indicate inleakage to this system from a contaminated system (refer to Section 11.5). Should a break occur in the CCW system, cooling water leakage will be collected in floor drains and sumps and piped to the radwaste system for processing (refer to Section 11.2). Excessive leakage, indicative of a large break in the system, will be detected by pressure instrumentation in the system supply headers downstream of the CCW pumps. Smaller leaks will be detected by observing an abnormally high number of makeup cycles to the CCW surge tank. Piping for the CCW system is routed so that a pipe break will not flood or damage any safety-related equipment.

Portions of the CCW system that penetrate the containment and drywell are provided with isolation valves that can be remotely actuated by the operator in the control room.

Emergency cooling water is available to the fuel pool heat exchangers from either of the redundant loops of the SSW system in the event the CCW system is inoperable.

9.2.2.4 Test and Inspection

Pumps in the CCW system are proven operable by their use during normal plant operation. Motor-operated isolation valves can be tested to assure that they are capable of opening and closing by operating manual switches in the control room and observing the position lights. The components of the CCW system listed in Table 9.2-7 and associated instrumentation are accessible for visual examination. Routine inspection of these items will be adequate to verify the proper operating conditions of the system.

[HISTORICAL INFORMATION] [The system piping and components were hydrostatically tested prior to initial startup.]

9.2.2.5 Instrumentation Application

The CCW system is a balanced, constant-flow system. Local pressure and temperature test points are provided for the system coolers to measure pressure drop and temperature rise. Pressure downstream of the component cooling water pumps is transmitted to the control room. A temperature switch downstream of the CCW heat exchangers actuates an alarm in the control room on high water temperature. The standby pump is brought on line if the other two pumps cannot maintain pressure in the system. The standby pump is started, and a low pressure alarm is actuated in the control room by means of a pressure switch in the cooling water header. Should system pressure continue to drop after the standby pump is started, another pressure switch actuates a low-low pressure alarm in the control room.

The system cooling water level is maintained from the makeup water treatment system by a high-low level switch in the system head tank.

The portion of the cooling water system that penetrates the containment and drywell can be isolated by operator action in the control room.

In the event of a low component cooling water flow to the fuel pool heat exchangers, the heat exchangers are automatically isolated from the CCW system and the low flow condition is annunciated in the control room. Manual initiation of the SSW system is required to supply cooling water from that system. The controls and instrumentation for this feature are discussed in detail in subsection 7.6.1.10.

9.2.3 Makeup Water Treatment System

9.2.3.1 Design Bases

9.2.3.1.1 Safety Design Basis

Containment and auxiliary building penetrations and isolation valves are designed and built in accordance with the ASME Code, Section III, and to the requirements of seismic Category I.

9.2.3.1.2 Power Generation Design Bases

- a. The makeup water treatment system is designed to provide high-quality water for preoperational tests, startup, and normal operation.
- b. The makeup water treatment system will maintain the makeup water quality, as a minimum, as follows:

Conductivity, $\mu\text{mho/cm}$	≤ 3.0 at 25 C
Chlorides, as Cl, ppm	≤ 0.05
Dissolved silica, as SiO_2 , ppm	≤ 0.01
Total Dissolved Solids, as CaCO_3 , ppm	≤ 1.2
pH	5.3 to 7.5 @ 25 C

Conductivity limit applies after correction for dissolved CO_2 .

9.2.3.2 System Description

The makeup water treatment system is shown on Figures 9.2-11 and 9.2-12.

Water is supplied to the makeup water treatment system from the radial wells by means of the plant service water system where the water is stored in the clearwell tank. The well water is passed through activated carbon filters then through a vendor provided water treatment trailer. The permanently installed plant water treatment equipment consisting of a layered-bed cation exchanger and a layered-bed anion exchanger is not normally used. The processed water is stored in the demineralized water storage tank. From the storage tank, demineralized water is distributed, as required, to the following plant equipment and systems:

GRAND GULF NUCLEAR GENERATING STATION
Updated Final Safety Analysis Report (UFSAR)

- a. Condensate storage tank (startup only)
- b. Main condenser
- c. Fuel pool cooling and cleanup system
- d. Component cooling water system
- e. Standby liquid-control system
- f. Diesel generators
- g. Auxiliary boiler condensate return storage tank
- h. Condensate cleanup system
- i. Sample laboratories
- j. Liquid radwaste system
- k. Plant chilled water system
- l. Chlorination system
- m. Residual heat removal systems
- n. Decontamination stations
- o. Standby service water system
- p. Turbine building cooling water system
- q. Offgas System
- r. Drywell chilled water system
- s. Refuel floor booster pump and hose connections

There are two trains of permanent plant ion exchangers (retired/abandoned in place). The performance data for system components is provided in Table 9.2- 8.

Rainwater runoff is captured in the regeneration waste neutralizing tank.

The majority of the permanent plant makeup water treatment system is in the water treatment building adjacent to the radwaste building (retired/abandoned in place). The sulfuric acid storage and transfer facilities are located in a reinforced concrete dike to prevent uncontrolled release of acid to the ground. The bottom of the dike is covered with limestone to neutralize any spilled acid.

The piping carrying dilute acid or sodium hydroxide is lined with either saran, polypropylene, or polyvinylidene fluoride. Piping carrying concentrated acid is either carbon steel or nickel-iron-chromium alloy.

GRAND GULF NUCLEAR GENERATING STATION
Updated Final Safety Analysis Report (UFSAR)

9.2.3.3 Safety Evaluation

The system has no safety-related function as defined in Section 3.2. Failure of the system will not compromise any safety-related system or component and will not prevent safe reactor shutdown.

The Makeup water treatment system has been designed to preclude the entry of potentially radioactive water into the system. System features to preclude the entry of contaminated water include:

- a. The distribution piping for the makeup water treatment system is pressurized by the demineralized water jockey pump during all modes of system operation.
- b. The distribution piping for the makeup water treatment system normally discharges into vented storage or fill tanks at atmospheric pressure.
- c. Interconnections with pressurized, potentially contaminated water systems normally have multiple isolation valves, a check valve and isolation valve, or other positive means of isolation.

The MWT system has been evaluated as a moderate energy system for pipe breaks outside the containment in accordance with Section 3.6 of this report.

9.2.3.4 Tests and Inspections

The makeup water treatment system is proved operable by its use during normal plant operation. Portions of the system normally closed to flow can be tested to ensure operability and integrity of the system. A sample station is provided for routine chemical analysis. On-line instrumentation is provided to monitor regeneration and normal operation.

9.2.3.5 Instrument Application

The quality of the demineralized water is continuously monitored by conductivity measuring devices that indicate and alarm on the local and control room panels.

The flow through each carbon filter is recorded and totalized.

9.2.4 Domestic Water System and Sanitary Waste Water System

GRAND GULF NUCLEAR GENERATING STATION
Updated Final Safety Analysis Report (UFSAR)

9.2.4.1 Power Generation Design Bases

- a. The domestic water system and sanitary waste water system are designed to provide domestic water supplies and sewage treatment necessary for normal plant operation and shutdown periods.
- b. The domestic water system is designed to produce and maintain the quality of water required by the authorities having jurisdiction.
- c. The sanitary waste water system is designed to produce an effluent quality required by local and state regulations.

9.2.4.2 System Description

Treated water from the construction water system is supplied to the domestic system. The domestic water distribution system consists of pumps, hot water heaters, and interconnecting piping and valves as shown on Figures 9.2-13 and 9.2-14. Sodium hypochlorite solution is added prior to distribution via the hypochlorinator.

The sanitary water system consists of a prefabricated, aerobic, digestion-type sewage-treatment plant, capable of treating approximately 100,000 gpd of domestic sewage. The plant includes a comminutor and clarifier in addition to the aeration chamber.

GRAND GULF NUCLEAR GENERATING STATION
Updated Final Safety Analysis Report (UFSAR)

The Unit 1 Control Bldg Sump and Sewage Lift Station equipment arrangement is shown on Figure 9.2-15. The quality of effluent meets, as a minimum, the standards established by the authorities having jurisdiction. System component performance data is given in Table 9.2-9.

There are no cross-connections between the domestic water system and any potentially radioactive system.

9.2.4.3 Safety Evaluation

The domestic water and sanitary waste water systems have no safety-related functions. Failure of the system will not compromise any safety-related equipment or component and will not prevent safe shutdown of the plant.

However, the systems incorporate some features that will assure reliable operation over the full range of normal plant operation. These features consist primarily of instrumentation that will monitor and/or control its respective process.

9.2.4.4 Inspection and Testing

The domestic and sanitary water systems are proven operable by their use during normal plant operation.

9.2.4.5 Instrumentation Application

The domestic water and sanitary waste water systems are furnished with instrumentation that will permit local and/or remote monitoring and/or control of each respective process. This instrumentation includes all meters, switches, indicators, pressure gauges, transmitters, controllers, and valves required for service operation and for the protection of plant personnel and equipment.

9.2.5 Ultimate Heat Sink

9.2.5.1 Design Bases

9.2.5.1.1 Safety Design Bases

The ultimate heat sink (UHS) is capable of providing sufficient cooling for at least 30 days without makeup to permit safe shutdown and cooldown of the unit and to maintain it in a safe shutdown condition, and to mitigate the effects of an accident.

GRAND GULF NUCLEAR GENERATING STATION
Updated Final Safety Analysis Report (UFSAR)

In conformance with Regulatory Guide 1.27, Rev. 2, the UHS structure consists of at least one highly reliable water source with a capability to perform the safety function during and after the following postulated design basis events:

- a. The most severe natural phenomena including the safe shutdown earthquake, tornado and tornado missiles, and flood taken individually
- b. Reasonably probable combinations of less severe phenomena and/or site related events
- c. Any credible single mechanistic failure of a man-made structure

9.2.5.1.2 Power Generation Design Bases

The UHS removes the heat rejected to the standby service water system by various plant components that operate during normal, reactor shutdown, and reactor isolation modes.

9.2.5.2 System Description

Cooling water required for the dissipation of residual heat after reactor shutdown and after a postulated accident is supplied from the UHS. The UHS consists of two cooling towers (each with four independent cells) and two concrete makeup water basins of the standby service water system. The system is described in detail in subsection 9.2.1. The basin and cooling tower structure are described in detail in Section 3.8. The UHS has been designed and constructed in accordance with codes and standards as listed in Table 3.2-1, item XLVI.

The cooling capacity of the cooling towers was increased to ensure that the towers can maintain the temperature of the water supplied within the maximum design basis temperature of 90°F during all modes of required operation, including consideration of single failure as a result of EPU (reference PUSAR Section 2.5.3.4). The modification involved replacement of the original ceramic block fill material with high efficiency stainless steel fill material, (reference Amendment 191NRC letter number GNRI-2012/00153).

9.2.5.3 Safety Evaluation

The ultimate heat sink structure is capable of withstanding the effects of the most severe natural phenomena associated with the plant location, other applicable site-related events, reasonably probable combinations of less severe phenomena, and any credible single failure of any man-made structural features without loss of the sink capability to provide the heat rejection necessary to meet the requirements of the safety design bases. In addition, there is an extremely low probability of losing the capability of the makeup water basin that provides makeup to the cooling system. The design of the UHS complies with Regulatory Guide 1.27, Rev. 2, with the clarifications as given in Appendix 3A. The UHS component failure analysis is given in Tables 9.2-1 and 9.2-2. The heat rate input to the ultimate heat sink is based on the GEH methodology of the ANS standard, ANS/ANSI 5.1 1979 for RHR as part of the SHEX methodology and ANS/ANSI 5.1 1994 for the fuel pool. Total heat rejection to the standby service water cooling towers is shown on Figures 9.2-6a and 9.2-6b. The heat input from the auxiliary systems is given in Tables 9.2-16, 9.2-16a, 9.2-17, and 9.2-17a. A detailed safety evaluation is presented in subsection 9.2.1.3.

9.2.5.4 Tests and Inspections

The tests and inspections applicable to the UHS are described in subsection 9.2.1.4.

9.2.5.5 Instrumentation Application

The instrumentation applicable to the UHS is described in subsection 9.2.1.5.

9.2.6 Condensate and Refueling Water Storage and Transfer System

9.2.6.1 Power Generation Design Bases

- a. The condensate storage and transfer subsystem is designed to pump and store condensate for the reactor core isolation cooling (RCIC) and high pressure core spray (HPCS) systems, maintain the level of condensate in the condenser hotwell, and provide condensate to other plant systems, where required.

GRAND GULF NUCLEAR GENERATING STATION
Updated Final Safety Analysis Report (UFSAR)

- b. The refueling water storage and transfer subsystem is designed to handle water during refueling and fuel shipping cask loading operations.

9.2.6.2 System Description

The condensate and refueling water storage and transfer (CRWST) system is shown on Figure 9.2-16. The CRWST system is designed in accordance with the codes and standards of Table 3.2-1, Item XXXII. The condensate storage and transfer subsystem consists of a stainless steel storage tank with a capacity of 300,000 gallons, two condensate transfer pumps, and necessary piping, valves, and instrumentation. System component performance data are given in Table 9.2-10.

The condensate storage tank will provide suction for the HPCS and RCIC pumps during emergency conditions and for normal testing. The condensate storage and transfer subsystem also provides makeup to the fuel pool cooling and cleanup system, liquid radwaste system, reactor water cleanup system and control rod drive hydraulic system, the condensate and refueling water storage and transfer system will provide fire protection inside the containment, as required. The primary source of makeup to the condensate storage tank will be the liquid radwaste system effluent. One pump continuously operates during normal plant operation.

The refueling water storage and transfer subsystem consists of a stainless steel refueling water storage tank with a capacity of 350,000 gallons, two refueling water transfer pumps, and necessary piping, valves, and instrumentation. This subsystem provides the water handling requirements for the upper containment pool during refueling and for the cask storage pool during cask loading. The refueling water storage tank is normally empty. This subsystem also provides water handling requirements for the suppression pool cleanup system during normal plant operation. During normal plant operation one or both of the refueling water transfer pumps takes suction from the suppression pool and transfers the water to the suppression pool cleanup system.

GRAND GULF NUCLEAR GENERATING STATION
Updated Final Safety Analysis Report (UFSAR)

The CRWST system can be used for the handling of suppression pool water should the emptying of the suppression pool be required for maintenance and/or inspection. Overflow from the refueling water and condensate storage tanks is routed to the waste surge tanks for processing by the liquid radwaste system.

9.2.6.3 Safety Evaluation

The system has no safety-related function as discussed in Section 3.2. Failure of the system will not compromise any safety-related system or component and will not prevent safe shutdown of the reactor.

The CST level is normally maintained above 25 ft and has a low level alarm at 22 ft. Standpipes inside the CST ensure that the non-safety systems cannot draw the CST below an 18.9 ft indicated level. This remainder of the CST volume is reserved specifically for RCIC and HPCS. The intent was to reserve a minimum of 170,000 gallons of clean condensate grade water which would make the injection of non condensate grade suppression pool water less likely. The CST level transmitters for HPCS and RCIC are tapped off of the CST suction line in lieu of a static sensing line. As a result of friction losses, the low CST suction swaps to the suppression pool are dependent on flow and occur higher than intended, resulting in less usable volume.

Less usable volume is not an issue since the suppression pool is the normally credited water source. The CST is only credited for station blackout and for vessel drain down during Modes 4 and 5 when HPCS is required and HPCS suction from the suppression pool is not available. If the HPCS suction from the suppression pool is not available, the automatic swap to the suppression pool would be defeated by necessity. If the automatic suction swap is defeated the usable reserve volume is reduced because of the potential for vortexing. The low CST level setpoints were intentionally set high enough to prevent vortex formation. However, if the automatic swap is disabled, Operations must manually swap suction to the suppression pool above the level that vortexing could occur. For station blackout only 136,014 gallons is required to cope with a 4 hr SBO event. At 800 gpm flow with the auto swap defeated there is a usable reserve volume of approximately 177,000 gallons. At 800 gpm flow with the auto swap enabled there is a usable reserve volume 143,000 gallons. For a vessel drain down event in Modes 4 and 5 there is no specific CST volume requirement. The usable reserve volume at 8175 gpm flow with the

GRAND GULF NUCLEAR GENERATING STATION
Updated Final Safety Analysis Report (UFSAR)

auto swap disabled is 145,000 gallons. The usable reserve volume at 8175 gpm flow with the auto swap enabled is 109,000 gallons. This volume should allow sufficient time for operators to attempt to terminate the inventory loss prior to fuel uncovering.

The Seismic Category 1 Quality Group B portion of the suction piping upstream of the motor operated isolation (CST suction) valves has a sufficient volume of water to permit automatic transfer of the HPCS and RCIC pump suction to the suppression pool prior to the loss of adequate suction pressure when a catastrophic failure of the CST, or a break in the non-safety related portion of suction piping is detected by the HPCS and RCIC CST level transmitters.

To preclude an uncontrolled release of the contents of the condensate and refueling water storage tanks, the tanks are located within a reinforced concrete retaining basin. The retaining dike is sized to retain the full capacity of both tanks.

The CRWST system has been classified in accordance with the requirements of Table 3.2-1.

A condensate dike sump pump is provided to transfer rainwater from the dike to the storm drainage system. To preclude the uncontrolled release of radioactive contaminants to the environment, the sump pump will only be started after the activity of the collected water is determined to be within 10 CFR 20 limits when pumping to the storm drainage system.

[HISTORICAL INFORMATION] [

9.2.6.4 Tests and Inspections

The condensate storage tank and refueling water storage tank bottom plates and first shell course were vacuum tested after they were welded in place on the foundations. When erection was complete, the tanks were filled and visually inspected for leakage. In addition, the specifications for the condensate storage tank required (1) 100 percent surface examination of the side wall to bottom joint, and (2) 100 percent volumetric examination of the side wall weld joints. The CRWST system piping and components were hydrostatically tested prior to initial startup.]

9.2.6.5 Instrumentation Requirements

A level detection system is provided for both the condensate storage and refueling water storage tanks which provide continuous level indication and level alarms in the control room. Temperature controls are not necessary for the condensate and refueling water storage tanks because water is continuously circulated to and from the condensate storage tank and is only periodically stored in the refueling water storage tank. A temperature sensor has been installed on the condensate storage tank to monitor the temperature of the water and provide local temperature indications to prevent injection of water below +65 F through the train "B" feedwater flued head during RCIC system initiation. Heat tracing has been installed on the exposed RCIC suction line from the condensate storage tank to prevent RCIC injection of water below +65 F. Heat tracing is provided for the instruments mounted on the tanks and instrument lines to and from the tanks to prevent freezing. An alarm is provided to warn of an increasing level in the condensate storage tank dike sump.

9.2.7 Plant Chilled Water System

9.2.7.1 Power Generation Design Basis

The plant chilled water system is designed to provide 44 F chilled water to the nonsafety-related turbine building, control building, radwaste building, auxiliary building, diesel

generator building, and containment fan coil units for space cooling and dehumidification. Area ambient temperatures to be maintained are given in subsections 9.4.2, 9.4.3, 9.4.4, 9.4.5, 9.4.6, 9.4.7, and 9.4.10. The plant chillers also supply cooling water for the sample coolers located throughout the plant and for the thrust bearing on the main circulating water pumps.

9.2.7.2 System Description

The plant chilled water system is shown on Figures 9.2-17 through 9.2-21. The major system components and associated fabrication and performance data are given in Table 9.2-11.

The system consists of a primary loop containing three 1200-ton chillers, two primary chilled water pumps, and piping. A chemical addition tank is available to chemically treat the system to prevent corrosion and; an expansion tank is provided to pressurize the system. Corrosion inhibition will be accomplished

GRAND GULF NUCLEAR GENERATING STATION
Updated Final Safety Analysis Report (UFSAR)

by running the system with demineralized water only, or with corrosion inhibitor added. The chillers are centrifugal type, and are piped in parallel. The chillers use R-134a refrigerant. The number of chillers placed in service is determined by the heat load on the system. A chiller not in operation can be placed in standby, available for automatic operation. The plant chilled water system also includes a refrigerant recovery system for maintenance purposes. The recovery system, consisting of a storage tank and integral compressor, is mounted in the vicinity of the chillers. The recovery system is not connected to the chillers unless refrigerant is required to be removed from a chiller for maintenance activities. The recovery system can hold a full chiller charge of refrigerant. The chilled water is circulated to the three secondary loops, the steam tunnel cooler (outside containment) and the radwaste building fan coil unit by two full-capacity, horizontal split-case, centrifugal pumps connected in parallel to a primary loop.

The secondary loops serve the auxiliary building and containment, the turbine building, and the control building respectively. Each secondary loop contains two pumps, fan coil units, sample coolers, and piping. The secondary loop pumps are full-capacity, horizontal, split-case, centrifugal pumps connected in parallel to the secondary loop.

The radwaste building and the control building are served by the plant chilled water system.

During winter shutdown conditions, the turbine building secondary loop is valved off from the rest of the system, and an auxiliary steam heat exchanger, along with an expansion tank, is placed on the line. The system is then used for space heating in the turbine building (see subsection 9.4.4). The area fan coil units not required for heating are automatically shut down during this mode of operation.

9.2.7.3 Safety Evaluation

The auxiliary building and containment penetrations of the chilled-water system are of seismic Category I design and are equipped with redundant isolation valves to satisfy single-failure criteria.

GRAND GULF NUCLEAR GENERATING STATION
Updated Final Safety Analysis Report (UFSAR)

Other than the above, the system has no safety-related function as defined in Section 3.2. Failure of the system will not compromise any safety-related system or component and will not prevent safe reactor shutdown.

Failure of the system due to moderate energy line breaks is discussed in Section 3.6. However, the system incorporates some features that will assure its reliable operation over the full range of operation. These features include the installation of redundant components for equipment such as chillers, pumps, and some fan coil units. Additional features include fail-safe positions on the system controls and equipment safety controls.

Some heat loads on the Plant Chilled Water System are power-dependent and potentially increased by power uprate, such as piping temperatures and pump motor heat loads. It was determined of all serviced heat loads at EPU that the Plant Chilled Water System is adequate for operation at EPU.

[HISTORICAL INFORMATION] [

9.2.7.4 Tests and Inspections

The initial testing of the system includes performance testing of the chillers, pumps, and coils for conformance with design tonnages, water flows, and heat-transfer capabilities. An integrity test will be performed on the system upon completion.]

Provision is made for periodic inspection of major components to ensure the capability and integrity of the system. Local display devices or test connections are provided to indicate all vital parameters required in testing and inspections.

9.2.7.5 Instrumentation Application

A regulated supply of makeup water for the plant chilled water system is provided by a level switch and control valve.

The primary and secondary loop chilled water pumps are controlled from the control room. The standby pump automatically starts upon failure of the operating pump.

The chillers can be controlled individually by a local switch or by a temperature controller in the common return header. High water temperature in the common return header initiates operation of a standby chiller. A low water temperature signal from the same

GRAND GULF NUCLEAR GENERATING STATION
Updated Final Safety Analysis Report (UFSAR)

temperature sensor will shut down the standby chiller. Chilled water temperature is controlled by the number of chiller units in operation.

A temperature controller and flow switch continuously monitor the discharge of each evaporator. If the temperature of the chilled water drops below a specified level, the controller automatically adjusts the temperature of the water. The flow switch prohibits the chiller from operating unless there is water flow through the evaporator.

Chilled water penetrations of the containment and the auxiliary building are provided with isolation valves that close automatically on isolation signal.

Fan coil units are provided with three-way temperature control valves to control the flow of water to the coils to maintain space temperatures.

Temperature and/or pressure test connections and relief valves are provided throughout the system for monitoring and protection.

The turbine building hot water system controls function to maintain 140 F supply water temperature from the heat exchangers. Additionally, local controls function to shut down the hot water flow through the area fan coil units not required for heating.

9.2.8 Plant Service Water System

9.2.8.1 Power Generation Design Bases

The plant service water (PSW) system is designed to:

- a. Cool plant auxiliary equipment over the full range of reactor operation during normal operating and normal shutdown conditions.
- b. Provide makeup water to the circulating water system cooling tower, the standby service water system, and the fire protection system during normal operating and normal shutdown conditions.
- c. Provide makeup to the makeup water treatment system for plant domestic and demineralized water requirements.

GRAND GULF NUCLEAR GENERATING STATION
Updated Final Safety Analysis Report (UFSAR)

- d. Provide backup cooling for the turbine building sampling station during plant shutdown and startup periods when chilled water may not be available in the turbine building.

9.2.8.2 System Description

The plant service water system consists of piping, valves, and instrumentation as shown in Figures 9.2-22, 9.2-23, 9.2-23b, and 9.2-23c. The plant service water system receives well water from the plant service water radial well system (subsection 9.2.10) and provides cooling and makeup water to components located throughout the plant.

The plant service water system provides the cooling for various systems including the component cooling water and turbine building cooling water heat exchangers, plant chillers, drywell chillers, mechanical vacuum pump water jacket coolers, ESF electrical switchgear room coolers, control room air conditioners, SJAE intercondensers, a containment leak rate test system compressor aftercooler, and alternate decay heat removal heat exchangers and air conditioner. Additionally, the plant service water system provides lube water for the circulating water pumps cutless rubber bearings. A mechanical heat exchanger tube cleaning system circulates cleaning balls through the plant service water side of the CCW heat exchangers, one heat exchanger at a time.

For the control room air conditioner and ESF electrical switchgear room coolers, an intertie with the standby service water system has been included to provide cooling during an emergency shutdown when plant service water is not available.

For the component cooling water heat exchangers and two drywell chillers, an intertie with the standby service water system has been provided to provide cooling during a non-emergency loss of offsite power condition.

In the plant service water system, a bypass line is provided with control valves to operate in parallel with the heat exchanger loops and in response to the water level in the circulating water cooling tower basin. If circulating water system demand exceeds heat exchanger demand, additional water will be bypassed to the circulating water system. If the heat exchanger demand exceeds circulating water makeup requirements, the excess water will be bypassed directly to the discharge basin.

GRAND GULF NUCLEAR GENERATING STATION
Updated Final Safety Analysis Report (UFSAR)

Organic fouling is controlled by periodic injections of a sodium hypochlorite solution upstream of the heat exchangers. Controls are provided to stop chlorination of the service water when the bypass valve to the discharge basin is open. Alternately, organic fouling may be controlled by continuous or intermittent injection of a non-oxidizing biocide at a concentration at or below the allowable environmental discharge limit.

To prevent scale formation and to minimize the deposition of iron oxide and suspended solids in system heat exchangers, a dispersant is injected on a continuous basis and other approved chemical treatment products are injected as required at a metered rate dependent on plant service water flow rate.

9.2.8.3 Safety Evaluation

The PSW system has no safety design basis as defined in Section 3.2.

Should a break occur in the PSW system inside the auxiliary building, cooling water leakage is collected in floor drains and sumps and piped to the radwaste system for processing (refer to Section 11.2). An excessively high level in any sump that is caused by inleakage greater than the capacity of a single pump will actuate an alarm in the control room and will be monitored by the plant computer. The operating status of the sump pumps is monitored by the plant computer allowing the operator to evaluate if an abnormal leak has occurred. Non-safety related piping for the PSW system is routed so that a pipe break will not flood or damage any safety-related equipment.

Portions of the PSW system that interface with the standby service water (SSW) system as discussed above and in subsection 9.2.8.2 are not classified as safety-related unless the failure of these interfaces would affect the operation of the SSW system. In the latter case, ASME Code, Section III, Class 3 double isolation valves are provided for isolation of the SSW system. Refer to subsection 9.2.1 for details on the instrumentation to the isolation valves.

PSW piping serving the ADHRS, including the manual isolation valves at the common supply and return lines from the PSW header, and isolation valves at the ADHRS room cooler, are designated as safety-related and ASME Section III, Class 3.

[HISTORICAL INFORMATION] [

GRAND GULF NUCLEAR GENERATING STATION
Updated Final Safety Analysis Report (UFSAR)

9.2.8.4 Testing and Inspection

System piping and components were hydrostatically tested prior to initial startup. For non-nuclear piping, other methods of testing may have been used as permitted by the applicable codes. In addition, the system was hydraulically balanced and its cooling capability verified prior to initial plant startup.]

Motor-operated isolation valves can be tested to ensure that they are capable of opening and closing by operating manual switches in the control room and observing the position lights. Routine visual inspection of the system components, instrumentation, and trouble alarms are adequate to verify system operability.

9.2.8.5 Instrumentation Requirements

Continuous pressure indication and alarm sensors are provided to verify plant service water system operation. For larger components, flow points or flow indicators are provided to permit system balancing. Temperature and pressure points are also provided where occasional heat exchanger performance evaluation is desirable.

A radiation monitor is provided on the PSW return line from the ADHRS heat exchangers to detect any radioactive contamination that could result from a tube leak in the ADHRS heat exchangers during modes 4 and 5. If contamination is detected, an alarm sounds in the control room.

Within 30 days of placing the ADHRS into operation for the removal of decay heat, the ADHRS may be unisolated from interfacing plant systems during Modes 1, 2, and 3 under administrative controls for the purpose of valve surveillance testing and filling, venting, and flushing of the primary and PSW sides of the ADHRS. During filling, venting, and flushing of the PSW side of the ADHRS heat exchangers the PSW radiation monitor on the PSW return line from the ADHRS heat exchangers is placed into service.

9.2.9 Turbine Building Cooling Water System (TBCWS)

9.2.9.1 Power Generation Design Bases

- a. The turbine building cooling water system (TBCWS) is designed to cool auxiliary plant equipment located in the turbine, radwaste, and water treatment buildings over the full range of normal plant operation. The design basis cooling water supply temperature is 95 F.
- b. The design of the piping and valves for the TBCWS is in accordance with the Power Piping Code, ANSI B31.1. The miscellaneous equipment conforms to the applicable codes and standards of TEMA, NEMA, API, and ASME Section VIII.
- c. Deleted
- d. Deleted
- e. The TBCWS provides cooling for plant air compressors.

9.2.9.2 System Description

The TBCWS is a closed cooling water system consisting of recirculation pumps, heat exchangers, coolers, a chemical-addition tank, a surge tank, and associated piping, valves, and controls. The TBCWS is as shown on Figures 9.2-24 through 9.2-26a. The system water level and volume control, and the TBCWS pump NPSH are maintained by the surge tank. The inleakage of potentially radioactive contaminants is prevented by the operation of the TBCW system at a higher pressure than the interfacing systems. System component performance data is shown in Table 9.2-12.

For the instrument air compressors, an intertie with the standby service water system has been provided to provide cooling during a non-emergency loss of offsite power condition.

The system incorporates some features that will assure its reliable operation over the full range of normal plant operations. These features include the installation of redundant components for equipment, such as pumps and heat exchangers, and chemical treatment of the water for the prevention of long-term corrosion and scaling in the piping. Corrosion inhibition will be accomplished by running the system with demineralized water only, or with a corrosion inhibitor added.

GRAND GULF NUCLEAR GENERATING STATION
Updated Final Safety Analysis Report (UFSAR)

9.2.9.3 Safety Evaluation

The system has no safety-related function as discussed in Section 3.2. Failure of the system will not compromise any safety-related system or component and will not prevent safe reactor shutdown. The increase in heat load from EPU to the TBCW system can be accommodated by the margin in the system heat exchangers and the system pumps have sufficient capacity to accommodate any minor increases from potential changes in localized flows to affected components.

9.2.9.4 Tests and Inspections

A special test program for the pumps in the TBCWS is not required as they are proven operable by their use during normal plant operation. The components of the TBCW system given in Table 9.2-12 and associated instrumentation are accessible for visual examination. Routine inspection of these items will be adequate to verify the proper operating condition of the system. [HISTORICAL INFORMATION] [The system piping and components were hydrostatically tested prior to initial startup.]

9.2.9.5 Instrumentation Application

The standby pump is brought on line by low pressure as monitored by a pressure switch in the pump discharge header if the other two pumps cannot maintain pressure. During this condition, an alarm is activated in the control room. Another pressure switch alarms in the control room if the pressure continues to drop. All of the parallel legs are balanced to absorb the available pressure drop. Several of the legs have temperature control to control the cooling in the respective leg. The system has many local temperature and pressure/test points for temperature gain and pressure drop determination. The proper volume of water in the system is maintained by the surge tank with a high/low level switch for makeup control.

9.2.10 Plant Service Water Radial Well System

9.2.10.1 Power Generation Design Basis

The plant service water radial well (PSWRW) system is designed to provide well water to the plant service water (PSW) system over the full range of reactor operation during normal operating and normal shutdown conditions.

GRAND GULF NUCLEAR GENERATING STATION
Updated Final Safety Analysis Report (UFSAR)

9.2.10.2 System Description

The radial well system consists of five wells, pumps, recirculation line at each well, valves, instrumentation, and piping as shown on Figure 9.2-27.

The radial wells are large reinforced concrete caissons, installed vertically, that extend into the alluvial sediments adjacent to the Mississippi River. Water is derived from the Mississippi River via induced infiltration and enters the caisson through horizontal screened pipes, called laterals, that extend radially from the caisson into the alluvial sediments. This naturally filtered water is pumped to the plant by two vertical plant service water pumps installed on the operating floor of each well which is located at an elevation that is above the site 100-year flood elevation of 93.1 feet.

Water is collected in the radial wells and pumped, during normal operation, into a single underground main header which supplies the plant service water system. The Unit 2 header terminates at the first isolation valve. In addition, supply makeup water to the standby service water cooling towers and service water to the administration building is provided by the radial wells. During the start-up of the first pump (one of the two pumps) at the wells, the radial collector well flow may be diverted to the river via the recirculation line to purge any sand and/or sediment collected in wells from the laterals.

During normal operation, as many wells and pumps as required will be operating to meet the plant demand. The makeup requirements for the circulating water system are expected to be the primary demand.

9.2.10.3 Safety Evaluation

The radial well system has no safety-related function as defined in Section 3.2. Failure of the system will not compromise any safety-related system or component and will not prevent safe reactor shutdown.

For all modes of normal operation, the PSW radial well system provides makeup to the standby service water system cooling tower basins, but this makeup capability is not required to safely shutdown the reactor following a LOCA (Refer to subsection 9.2.1). [HISTORICAL INFORMATION] [

GRAND GULF NUCLEAR GENERATING STATION
Updated Final Safety Analysis Report (UFSAR)

9.2.10.4 Testing and Inspection Requirements

Prior to initial plant startup, the radial wells were tested to verify the following:

- a. Radial well collector capacity
- b. Pump performance]

In addition, the system piping was hydrostatically tested. For non-nuclear piping, other methods of testing have been used as permitted by the applicable codes.

9.2.10.5 Instrumentation Requirements

Operation of PSW pumps may be controlled locally or remotely from the control room by use of the enable/disable switch. The pumps may be controlled locally when switch is in disable and remotely from the control room when switch is in enable. The pump discharge flow rate, pump discharge header pressure and the pumping level are monitored in the control room. The pump discharge flow and pressure are limited to prevent excessive flow from being drawn into the caisson laterals and to protect the piping from over-pressurization.

9.2.11 Drywell Chilled Water System

9.2.11.1 Power Generation Design Basis

The drywell chilled water system is designed to provide 50 F chilled water to the drywell coolers and to the steam tunnel cooler inside containment. Area ambient temperatures to be maintained are given in subsection 9.4.7 and 9.4.8. The system is also designed to allow operation of two drywell chillers and one chilled water pump if normal offsite ac power is not available.

9.2.11.2 System Description

The drywell chilled water system is shown on Figure 9.2-48, 9.2-49 and 9.2-50. The major system components and associated fabrication and performance data are given in Table 9.2-22.

The system consists of four 50-percent-capacity chillers and two 100-percent-capacity chilled water pumps. An expansion section and a chemical feed tank are provided to pressurize and to protect the system from corrosion and scale deposits. Corrosion

GRAND GULF NUCLEAR GENERATING STATION
Updated Final Safety Analysis Report (UFSAR)

inhibition will be accomplished by running the system with demineralized water only, or with a corrosion inhibitor added. The chillers are hermetic rotary screw type using refrigerant R-22. Normally, two chillers and one pump are in operation. The two standby chillers automatically start in case of high chilled water supply temperature to the drywell coolers. The chilled water is circulated to the drywell coolers and the inside containment steam tunnel cooler by one of the two horizontal split-case centrifugal pumps connected in parallel to the chilled water loop. Cooling water to the drywell chillers is provided by the Plant Service Water System with an intertie to the Standby Service Water System in the event of a loss of offsite power.

9.2.11.3 Safety Evaluation

The supply and return chilled water lines for the drywell coolers penetrate the containment and drywell Isolation valves are provided for these lines in accordance with NRC General Design Criterion 56 (refer to subsection 6.2.4). The valves can be remotely actuated by the operator in the control room or close automatically upon receiving an isolation signal.

Other than the above, the system has no safety-related function as defined in Section 3.2. Failure of the system will not compromise any safety-related system or component and will not prevent safe reactor shutdown.

Failure of the system due to moderate energy line breaks is discussed in Section 3.6.

Following a LOCA, the drywell chilled water system is not required to maintain the Class 1E equipment located inside the drywell within the temperature range for which it is qualified to operate. However, the system incorporates some features that will assure its reliable operation over the full range of normal plant operations. These features include the installation of redundant principal system components. Additional features include fail-safe positions on the system controls, equipment safety controls and provisions to supply two drywell chillers and one chilled water pump from a Class 1E power source for all non-LOCA conditions. [HISTORICAL INFORMATION] [

Although some heat loads are power-dependent and are potentially increased by power uprate, such as piping temperatures, it was determined that the DW Chilled Water system is adequate at EPU.

9.2.11.4 Test and Inspections

The initial testing of the system includes performance testing of the chillers, pumps and coils for conformance with design tonnages, water flows, and heat-transfer capabilities. An integrity test was performed on the system upon completion.]

Provision is made for periodic inspection of major components to assure the capability and integrity of the system. Local display devices or test connections are provided to indicate all vital parameters required in testing and inspections.

9.2.11.5 Instrumentation Application

Flow switches are installed in the discharge line of the pumps to automatically start the standby pump upon failure of the operating pump.

The chillers can be controlled by local switches or by switches located in the control room. The two standby chillers automatically start in case of high chilled water temperature in the common supply header to the drywell coolers. Flow switches in the chilled water return line prohibit the chillers from starting unless there is enough water flow through the evaporators.

A temperature controller in the return chilled water line controls a valve in the bypass line from chilled water supply to the chilled water return line. This limits the temperature of the return water going to the chillers and thus prevents the chillers from shutting down due to overloading.

Pressure controllers on the shell side of the condenser regulate the refrigerant pressure by opening or closing the control valves in the service water line inlet to the condensers.

A regulated amount of makeup water is provided for the drywell chilled water system by a level switch and a control valve.

GRAND GULF NUCLEAR GENERATING STATION
Updated Final Safety Analysis Report (UFSAR)

TABLE 9.2-1 STANDBY SERVICE WATER SYSTEM PASSIVE FAILURE ANALYSIS

<u>Single Passive Failure</u>	<u>Consequences</u>
Failure of an UHS cooling tower	This is not a credible failure due to the design requirements for the towers.
Failure of PSWRW system makeup line to cooling tower basin	Adequate UHS system water inventory is stored in the SSW cooling tower basins to provide cooling water for a minimum of 30 days for all plant conditions.
Failure of HPCS service water supply header or return header	The cooling requirements for the UHS system are met by main SSW supply headers.
Failure of any single service water supply or return header	The cooling requirements for the UHS system are met by the remaining two SSW trains.
Failure of a cooling tower basin	This is not a credible failure due to the design requirements for the basins.
Failure of the SSW pressure boundary due to a leakage crack, as defined in SRP Section 3.6.2, from 30 minutes to 24 hours and pump or valve seal leakage.	The SSW system has been designed with sufficient redundancy (separate, redundant SSW Loops) to withstand any single failures of these components.
Failure of any manual i.e., valve fails closed contrary position	The SSW system has been valve, designed with sufficient open or redundancy (separate, to its normal redundant SSW loops) to withstand any single failure of these components.

GRAND GULF NUCLEAR GENERATING STATION
Updated Final Safety Analysis Report (UFSAR)

TABLE 9.2-2 STANDBY SERVICE WATER SYSTEM ACTIVE FAILURE ANALYSIS

Single Active Failure	Analysis
Either standby diesel generator fails or failure of all power on bus	Power available from redundant diesel generator to redundant SSW train
Failure of one nonessential service water systems intertie lines isolation valve	Redundant isolation valve will prevent loss of coolant from SSW system
Failure of SSW pump	Remaining two pumps will meet cooling requirements
Failure of cooling tower fan	Redundant cooling tower will meet cooling requirements
Loss of all offsite power	All SSW pumps, HPCS service water pump, and cooling tower fans will stop momentarily and restart according to diesel generator loading sequence

GRAND GULF NUCLEAR GENERATING STATION
Updated Final Safety Analysis Report (UFSAR)

**TABLE 9.2-3: COMPONENTS SERVED BY STANDBY SERVICE
WATER SYSTEM**

Loop A

- a. RHR heat exchanger A
- b. Standby diesel generator A jacket water cooler
- c. RHR pump A seal cooler
- d. RHR A room cooler
- e. LPCS room cooler
- f. Fuel pool heat exchanger A
- g. RCIC room cooler
- h. Control room A/C unit A
- i. ESF electrical switchgear room coolers
- j. Drywell purge compressor A
- k. SSW pump A motor cooler
- l. SSW pump A work
- m. Fuel pool cooling and cleanup pump room cooler

Loop B

- a. RHR heat exchanger B
- b. Standby diesel generator B jacket water cooler
- c. RHR pump B seal cooler
- d. RHR pump C seal cooler
- e. RHR B room cooler
- f. RHR C room cooler
- g. Fuel pool heat exchanger B
- h. Control room A/C unit B
- i. Drywell chiller
- j. Component cooling water heat exchangers
- k. Plant air compressors
- l. Drywell purge compressor B
- m. ESF electrical switchgear room coolers
- n. SSW pump B motor cooler
- o. SSW pump B work
- p. Fuel pool cooling and cleanup pump room cooler

GRAND GULF NUCLEAR GENERATING STATION
Updated Final Safety Analysis Report (UFSAR)

TABLE 9.2-3: COMPONENTS SERVED BY STANDBY SERVICE
WATER SYSTEM (CONTINUED)

Loop C

- a. HPCS diesel generator jacket water coolers
- b. HPCS room cooler
- c. HPCS service water pump work

GRAND GULF NUCLEAR GENERATING STATION
Updated Final Safety Analysis Report (UFSAR)

**TABLE 9.2-4: STANDBY SERVICE WATER SYSTEM
 COMPONENT DESCRIPTION**

SSW Pumps

Type	Vertical, centrifugal
Quantity	2, 100% capacity each
Capacity, each, gpm	12,000
TDH, ft	270
Driver, hp	1250
NPSH required, ft	38.3
Minimum NPSH available, ft	38.7

SSW Cooling Towers

For Loops A & B (STBY SSW)

Type	Mechanically induced draft
Quantity of cells	4/tower, total No. of cells 2/tower A, Loop A, Mech Draft 2/tower A, Loop C, Nat. Draft 2/tower B, Loop B, Mech. Draft 2/tower B, Spare, Mech. Draft

Duty per cell, Btu/hr	138 x 10 ⁶
Quantity of towers	2
Flow per cell, gpm	5,922 (Except Loop C)
Design wet bulb temperature, F	79
Cold water temperature, F	90
Maximum range, F	41
Maximum inlet water temp, F	131
Structure type	Concrete
Fan, hp	150/cell

For Loop C (HPCS SSW)

Type	Natural Draft
Quantity of cells	2/tower A
Duty per cell, Btu/hr	5.84 x 10 ⁵

GRAND GULF NUCLEAR GENERATING STATION
Updated Final Safety Analysis Report (UFSAR)

**TABLE 9.2-4: STANDBY SERVICE WATER SYSTEM
COMPONENT DESCRIPTION (CONTINUED)**

Quantity of towers	1
Flow per cell, gpm	500
Design wet bulb temperature, F	79
Cold water temperature, F	90
Maximum range, F	31
Maximum inlet water temp, F	121
Structure type	Concrete
Fan, hp	NA/0
 <u>HPCS Service Water Pump</u>	
Quantity	One
Type	Vertical, centrifugal
Capacity, gpm	1300
TDH, ft	173
Driver, hp	100
NPSH required, ft	11.2
Minimum NPSH available, ft	34.6
 <u>SSW Fill Tank</u>	
Quantity	One
Capacity, gal	550 Design
pressure/temperature, F	Atm/200

GRAND GULF NUCLEAR GENERATING STATION
Updated Final Safety Analysis Report (UFSAR)

TABLE 9.2-5: DELETED

GRAND GULF NUCLEAR GENERATING STATION
Updated Final Safety Analysis Report (UFSAR)

**TABLE 9.2-5A: STANDBY SERVICE WATER COOLING TOWERS
 GRAND GULF NUCLEAR STATION
 WORST ONE DAY ANALYSIS
 ALTERNATE SHUTDOWN COOLING**

HR	WBT F	DBT F	Avg. Heat Load 10 ⁷ BTU/HR	Evaporation GPM	Cold Water Temperature F
00	78.0	78.0	17.59	272.71	86.53
03	78.0	78.0	25.82	409.81	88.33
06	80.0	81.0	24.29	389.79	89.27
09	83.0	91.0	22.14	377.38	90.76
12	83.0	96.0	20.82	369.01	90.49
15	85.0	96.0	19.66	346.83	91.63
18	83.0	88.0	18.89	314.57	90.15
21	80.0	82.0	18.19	290.73	87.99
			Average	346.35	89.39

Basic Assumptions and Conditions

Number of Towers 1

Number of Cells per Tower 4

Number of Cells in Operation 4

LOCA/LOP

SSW Loops A & C Operational, Loop B Inop

Evaporation losses do not include drift losses

SSW Loop C Heat Load assumed to be constant for the entire period.

SSW Basin water temp. assumed to be 90°F for the entire period.

GRAND GULF NUCLEAR GENERATING STATION
Updated Final Safety Analysis Report (UFSAR)

TABLE 9.2-5B: STANDBY SERVICE WATER COOLING TOWERS
GRAND GULF NUCLEAR STATION
WORST ONE DAY ANALYSIS
RECIRCULATION LINE BREAK

Hour	Dry Bulb Temp °F	Wet Bulb Temp °F	Avg. Heat Load 10 ⁷ BTU/hr	Evaporation Rate GPM	Cold Water Temperature °F
00	78	78	21.51	337.42	87.48
03	78	78	24.57	388.61	88.10
06	81	80	23.66	379.06	89.15
09	91	83	22.68	386.31	90.85
12	96	83	21.72	384.06	90.65
15	96	85	20.80	365.85	91.84
18	88	83	20.12	335.14	90.40
21	82	80	19.49	312.27	88.30
			Average	361.09	89.60

Basic Assumptions and Conditions

Number of Towers 1

Number of Cells per Tower 4

Number of Cells in Operation 4

LOCA/LOP

SSW Loops A & C Operational, Loop B Inop

Evaporation losses do not include drift losses

SSW Loop C Heat Load assumed to be constant for the entire period.

SSW basin water temperature assumed to be 90°F for the entire period.

GRAND GULF NUCLEAR GENERATING STATION
Updated Final Safety Analysis Report (UFSAR)

TABLE 9.2-6: DELETED

GRAND GULF NUCLEAR GENERATING STATION
Updated Final Safety Analysis Report (UFSAR)

**TABLE 9.2-6A: STANDBY SERVICE WATER COOLING TOWERS GRAND GULF
 NUCLEAR STATION ANALYSIS BASED ON MAXIMUM 30-DAY AVERAGE WET BULB
 SSW LOOP A AND HPCS SW LOOP C OPERATING FOR 30 DAYS**

Tower / Basin A

Day	Dry Bulb Temp °F	Wet Bulb Temp °F	Avg. Heat Load 10^7 BTU/ hr	Evaporation Rate GPM	Cold Water Temperature °F
1	81.7	78.3	21.84	352.91	87.72
2	82.3	79.0	17.72	285.40	87.20
3	85.5	80.2	16.33	269.87	87.64
4	86.3	80.6	15.41	256.42	87.66
5	86.7	80.6	14.53	243.22	87.41
6	86.8	79.6	14.04	237.46	86.55
7	85.8	79.9	13.67	228.06	86.65
8	81.8	77.6	13.31	215.00	84.91
9	80.1	77.0	12.93	205.00	84.35
10	77.8	76.5	12.60	194.03	83.88
11	78.5	77.0	12.37	191.51	84.15
12	81.9	78.8	12.09	193.57	85.34
13	82.5	78.5	12.00	194.43	85.08
14	81.3	76.8	11.91	192.75	83.82
15	82.2	76.2	11.82	195.05	83.34
16	83.5	77.8	11.73	194.32	84.46
17	84.5	78.7	11.64	194.05	85.09
18	79.3	76.3	11.55	182.17	83.32
19	80.7	76.9	11.46	183.65	83.71
20	82.7	78.4	11.36	185.10	84.77
21	83.3	77.8	11.27	186.57	84.29
22	81.0	77.5	11.18	179.05	84.04
23	81.6	77.8	11.09	178.77	84.22
24	83.6	79.1	11.00	180.57	85.15
25	85.8	80.1	10.91	183.52	85.86
26	84.4	78.4	10.82	181.40	84.55
27	85.4	79.1	10.73	181.47	85.03
28	85.7	79.0	10.64	181.11	84.92

GRAND GULF NUCLEAR GENERATING STATION
Updated Final Safety Analysis Report (UFSAR)

TABLE 9.2-6A: STANDBY SERVICE WATER COOLING TOWERS GRAND GULF NUCLEAR STATION ANALYSIS BASED ON MAXIMUM 30-DAY AVERAGE WET BULB SSW LOOP A AND HPCS SW LOOP C OPERATING FOR 30 DAYS (CONTINUED)

29	86.3	81.0	10.55	177.38	86.41
30	84.8	80.0	10.45	173.60	85.61
			Average	206.58	85.24

Basic Assumptions and Conditions

Number of Towers 1

Number of Cells per Tower 4

Number of Cells in Operation 2 - Loop A, 2 - Loop C

LOCA/LOP

SSW Loops A Operational, HPCS SW Loop Operational

Evaporation losses do not include drift losses

SSW Loop C Heat Load assumed to be constant for the entire period

SSW basin water temperature assumed to be 90°F for the entire period

**TABLE 9.2-6B: STANDBY SERVICE WATER COOLING TOWERS GRAND GULF NUCLEAR STATION ANALYSIS
 BASED ON MAXIMUM 30-DAY AVERAGE WET BULB SSW LOOPS A & B AND HPCS SW LOOP C OPERATING
 FOR 30 DAYS**

Day	Tower/ Basin A				Tower/ Basin B			
	Dry Bulb Temp °F	Wet Bulb Temp °F	Avg. Heat Load 10 ⁷ BTU/hr	Evaporation Rate GPM	Cold Water Temperature	Avg. Heat Load 10 ⁷ BTU/hr	Evaporation Rate GPM	Cold Water Temperature °F
1	81.7	78.3	21.84	352.91	87.72	2.14	41.26	79.87
2	82.3	79.0	17.72	285.40	87.20	2.14	41.11	80.53
3	85.5	80.2	16.33	269.87	87.64	2.14	47.36	81.64
4	86.3	80.6	15.41	256.42	87.66	2.14	48.64	82.01
5	86.7	80.6	14.53	243.22	87.41	2.14	49.84	82.01
6	86.8	79.6	14.04	237.46	86.55	2.14	52.92	81.07
7	85.8	79.9	13.67	228.06	86.65	2.14	49.08	81.35
8	81.8	77.6	13.31	215.00	84.91	2.14	43.49	79.22
9	80.1	77.0	12.93	205.00	84.35	2.14	40.06	78.67
10	77.8	76.5	12.60	194.03	83.88	2.14	34.52	78.21
11	78.5	77.0	12.37	191.51	84.15	2.14	35.24	78.67
12	81.9	78.8	12.09	193.57	85.34	2.14	40.46	80.34
13	82.5	78.5	12.00	194.43	85.08	2.14	43.10	80.06
14	81.3	76.8	11.91	192.75	83.82	2.14	44.22	78.47
15	82.2	76.2	11.82	195.05	83.34	2.14	48.59	77.91
16	83.5	77.8	11.73	194.32	84.46	2.14	48.04	79.40
17	84.5	78.7	11.64	194.05	85.09	2.14	48.54	80.23
18	79.3	76.3	11.55	182.17	83.32	2.14	39.60	78.01
19	80.7	76.9	11.46	183.65	83.71	2.14	42.14	78.57
20	82.7	78.4	11.36	185.10	84.77	2.14	43.98	79.96

9.2-61

LBDCR 2017-007

GRAND GULF NUCLEAR GENERATING STATION
 Updated Final Safety Analysis Report (UFSAR)

**TABLE 9.2-6B: STANDBY SERVICE WATER COOLING TOWERS GRAND GULF NUCLEAR STATION ANALYSIS
 BASED ON MAXIMUM 30-DAY AVERAGE WET BULB SSW LOOPS A & B AND HPCS SW LOOP C OPERATING
 FOR 30 DAYS (CONTINUED)**

Day	Dry Bulb Temp °F	Wet Bulb Temp °F	Avg. Heat Load 10 ⁷ BTU/hr	Evaporation Rate GPM	Cold Water Temperature	Avg. Heat Load 10 ⁷ BTU/hr	Evaporation Rate GPM	Cold Water Temperature °F
21	83.3	77.8	11.27	186.57	84.29	2.14	47.44	79.40
22	81.0	77.5	11.18	179.05	84.04	2.14	41.37	79.13
23	81.6	77.8	11.09	178.77	84.22	2.14	42.33	79.41
24	83.6	79.1	11.00	180.57	85.15	2.14	44.73	80.62
25	85.8	80.1	10.91	183.52	85.86	2.14	48.53	81.54
26	84.4	78.4	10.82	181.40	84.55	2.14	49.07	79.95
27	85.4	79.1	10.73	181.47	85.03	2.14	50.12	80.61
28	85.7	79.0	10.64	181.11	84.92	2.14	51.30	80.51
29	86.3	81.0	10.55	177.38	86.41	2.14	47.53	82.39
30	84.8	80.0	10.45	173.60	85.61	2.14	45.82	81.45
			Average	206.58	85.24	Average	45.01	80.04

Basic Assumptions and Conditions

Number of Towers 1
 Number of Cells per Tower 4
 Number of Cells in Operation 2 - Loop A, 2 - Loop B, 2 - Loop C
 LOCA/LOP
 SSW Loop A Operational, HPCS SW Loop Operational
 Evaporation losses do not include drift losses
 SSW Loop C Heat Load assumed to be constant for the entire period
 SSW basin water temperature assumed to be 90°F for the entire period

GRAND GULF NUCLEAR GENERATING STATION
Updated Final Safety Analysis Report (UFSAR)

**TABLE 9.2-7: COMPONENT COOLING WATER SYSTEM
COMPONENT DESCRIPTION**

CCW Pumps

Quantity	3, 50% capacity each
Type	Horizontal, centrifugal
Capacity, each, gpm	1,987
TDH, ft	150
Driver, hp	100

CCW Heat Exchangers

Quantity	3, 50% capacity each
Type	TEMA, CFN
Duty, each, Btu/hr	19.2 x 10 ⁶ exponent

Shell Side:

Fluid	Inhibited demineralized water
No. of passes	Two
Flow rate, gpm	1807
Temperature in/out, F	116.3/95

Tube Side:

Fluid	Plant service water
No. of passes	Two
Flow rate, gpm	1536
Temperature in/out, F	75/100

CCW Surge Tank

Capacity, gal	550
Design pressure, psig	Atmospheric
Design temperature, F	200

CCW Chemical Addition Tank

Capacity, gal	50
Design pressure, psig	150
Design temperature, F	200

GRAND GULF NUCLEAR GENERATING STATION
Updated Final Safety Analysis Report (UFSAR)

**TABLE 9.2-8: MAKEUP WATER TREATMENT SYSTEM
COMPONENT DESCRIPTION**

Clearwell Transfer Pumps

Quantity	2, 50% capacity each
Type	Horizontal, centrifugal
Capacity, each, gpm	270
TDH, ft	190
Driver, hp	25

Clearwell Tank

Quantity, type	1, horizontal
Capacity, gal	10,000
Design pressure	Atmospheric

Layered-Bed Cation Exchanger
(retired/abandoned in place)

Quantity	2
Capacity, each, gpm	150
Resin type	Rohm & Haas 84/Rohm & Haas 122
Design pressure, psig	100

Demineralized Water Transfer Pumps

Quantity	2, 50% capacity each
Type	Horizontal, centrifugal
Capacity, each, gpm	165
TDH, ft	132
Driver, hp	15

Demineralized Water Jockey Pump

Type	Horizontal, centrifugal
Quantity	One, 100% capacity each
Capacity, gpm	70
TDH, ft	132
Driver, hp	5

GRAND GULF NUCLEAR GENERATING STATION
Updated Final Safety Analysis Report (UFSAR)

**TABLE 9.2-8: MAKEUP WATER TREATMENT SYSTEM
COMPONENT DESCRIPTION
(CONTINUED)**

Water Treatment Building Sump Pumps

Type	Vertical, centrifugal
Quantity	2, 100% capacity each
Capacity, gpm	100
TDH, ft	45
Driver, hp	3

Caustic Dilution Water Heater
(retired/abandoned in place)

Quantity	1
Storage capacity, gal	4900
Design pressure, psig	100

Acid Injection Pump
(retired/abandoned in place)

Quantity	2, 100% capacity each
Type	Positive displacement, diaphragm
Capacity, each, gph	84
Discharge pressure, rated, psig	95
Driver, hp	1/2

Caustic Injection Pump
(retired/abandoned in place)

Quantity	2, 100% capacity each
Type	Sump
Capacity, each, gpm	50
Total differential head, ft	50

GRAND GULF NUCLEAR GENERATING STATION
Updated Final Safety Analysis Report (UFSAR)

Driver, hp 10

**TABLE 9.2-8: MAKEUP WATER
TREATMENT SYSTEM COMPONENT
DESCRIPTION (CONTINUED)**

Acid Feed Pump Skid (adjacent to cooling tower)
retired/abandoned in place)

Quantity	2, 100% capacity each
Type	Positive displacement, diaphragm
Capacity, each, gph	132
Discharge pressure, rated, psig	100 (max)
Driver, hp	1/3

Acid Feed Pump (retired/abandoned in place)

Quantity	2 per unit, 100% capacity each
Type	Positive displacement, diaphragm
Capacity, each, gph	197
Discharge pressure, rated, psig	100
Driver, hp	3/4

Acid Transfer Pump (retired/abandoned in place)

Quantity	2
Type	Horizontal, centrifugal
Capacity, gpm	5
Total differential head, ft	30
Motor, hp	1/2

GRAND GULF NUCLEAR GENERATING STATION
Updated Final Safety Analysis Report (UFSAR)

**TABLE 9.2-8: MAKEUP WATER
TREATMENT SYSTEM COMPONENT
DESCRIPTION (CONTINUED)**

Acid Dike Sump Pump (retired/abandoned in place)

Quantity	1
Type	Sump
Capacity, gpm	55
Total differential head, ft	36
Driver, hp	2

Caustic Storage Tank
(retired/abandoned in place)

Quantity	1
Type	Horizontal
Capacity, gal	20,000
Design pressure, psig	

Acid Storage Tanks (adjacent to cooling tower)

Quantity	3
Type	Vertical
Capacity, each, gal	10,000 (3 tanks)
Design pressure, psig	Atmospheric (3 tanks),

Acid Storage Tank (retired/abandoned in place)

Quantity	3
Type	Horizontal
Capacity, each, gal	40,000
Design pressure, psig	15

GRAND GULF NUCLEAR GENERATING STATION
Updated Final Safety Analysis Report (UFSAR)

**TABLE 9.2-8: MAKEUP WATER TREATMENT SYSTEM
COMPONENT DESCRIPTION (CONTINUED)**

Regeneration Waste Neutralizing Tank

Quantity	1
Type	Vertical, open top
Capacity, gal	30,000
Design pressure, psig	Atmospheric

Acid Day Tank (retired/abandoned in place)

Quantity	1
Type	Vertical
Capacity, gal	150
Design pressure, psig	Atmospheric

Layered-Bed Anion
Exchanger (retired/abandoned in place)

Quantity	2
Capacity, each, gpm	150
Type of resin	Rohm & Haas 93/Rohm & Haas 402
Design pressure, psig	100

Demineralized Water Storage Tank

Quantity, type	1, vertical
Capacity, gal	100,000
Design pressure	Atmospheric

Activated Carbon Filter

Quantity	2
Capacity, each, gpm	250
Design pressure, psig	100

GRAND GULF NUCLEAR GENERATING STATION
Updated Final Safety Analysis Report (UFSAR)

**TABLE 9.2-9: DOMESTIC WATER SYSTEM AND SANITARY WASTE WATER
SYSTEM COMPONENT DESCRIPTION**

Domestic Water Storage Tank

Quantity	One
Capacity, gal	13,800
Design pressure	Atmospheric

Domestic Water Pumps

Quantity	2, 100% capacity each
Type	Horizontal, centrifugal
Capacity, each, gpm	210
TDH, ft	210
Driver, hp	25

Sewage Lift Station Pumps

Quantity	2, 100% capacity, each
Type	Vertical
Capacity, each, gpm	125
TDH, ft	45
Driver, hp	2

HP Area Sink Drain Pump

Quantity	1, 100% capacity
Type	Vertical
Capacity, gpm	32 gpm
TDH, ft	20
Driver, hp	1/3

GRAND GULF NUCLEAR GENERATING STATION
Updated Final Safety Analysis Report (UFSAR)

**TABLE 9.2-10: CONDENSATE AND REFUELING WATER STORAGE AND TRANSFER
FACILITY COMPONENT DESCRIPTION**

Condensate Transfer Pumps

Quantity	2, 100% each
Type	Horizontal, centrifugal
Capacity, each, gpm	600
TDH, ft	220
Driver, hp	50

Refueling Water Transfer Pumps

Quantity	2, 50% each
Type	Horizontal, centrifugal
Capacity, each, gpm	1250
TDH, ft	214
Driver, hp	100

Condensate Storage Tank

Quantity	1
Capacity, gal	300,000
Design pressure	Atmospheric

Refueling Water Storage Tank

Quantity	1
Capacity, gal	350,000
Design pressure	Atmospheric

Condensate Dike Sump Pump

Quantity	1
Type	Vertical, centrifugal
Capacity, gpm	55
TDH, ft	36
Driver, hp	2

GRAND GULF NUCLEAR GENERATING STATION
Updated Final Safety Analysis Report (UFSAR)

**TABLE 9.2-11: PLANT CHILLED WATER SYSTEM
COMPONENT DESCRIPTION**

Plant Chillers

Type	Centrifugal
Quantity	3
Capacity, tons	1200
Chilled-water flow, gpm	1020
Chilled-water supply, temperature, F	44
Condenser water flow, gpm	1250
Condenser water supply, temperature, F	75
Cooling media	R-134a
Control	Inlet guide vane
Motor horsepower, hp	1200
Condenser	Two-pass shell and tube
Evaporator	Three-pass shell and tube

Primary Plant Chilled-Water Pumps

Type	Horizontal, split-case centrifugal
Quantity	2
Capacity, gpm	2464
Total differential head, ft	133
Motor horsepower, hp	100

Control Building Secondary Chilled-Water Pumps

Type	Horizontal, split-case centrifugal
Quantity	2
Capacity, gpm	193
Total differential head, ft	66
Motor horsepower, hp	5

GRAND GULF NUCLEAR GENERATING STATION
Updated Final Safety Analysis Report (UFSAR)

TABLE 9.2-11: PLANT CHILLED WATER SYSTEM
COMPONENT DESCRIPTION (CONTINUED)

Auxiliary Building Secondary Chilled-Water Pumps

Type	Horizontal, split-case centrifugal
Quantity	2
Capacity, gpm	721
Total differential head, ft	75
Motor horsepower, hp	20

Turbine Building Secondary-Chilled Water Pumps

Type	Horizontal, split-case centrifugal
Quantity	2
Capacity, gpm	1333
Total differential head, ft	80
Motor horsepower, hp	40

Turbine Building Heating Heat Exchanger

Type	Shell and tube
Quantity	1
Capacity, Btu/hr	3,337,000

Chilled-Water Chemical Feed Tank

Type	Horizontal
Quantity	1
Capacity, gal	10
Material	Carbon steel

Chilled-Water Expansion Tank

Type	Vertical
Quantity	1
Capacity, gal	550
Material	Carbon steel

GRAND GULF NUCLEAR GENERATING STATION
Updated Final Safety Analysis Report (UFSAR)

TABLE 9.2-11: PLANT CHILLED WATER SYSTEM
COMPONENT DESCRIPTION (CONTINUED)

Hot Water Expansion Tank

Type	Vertical
Quantity	1
Capacity, gpm	550
Material	Carbon steel

GRAND GULF NUCLEAR GENERATING STATION
Updated Final Safety Analysis Report (UFSAR)

TABLE 9.2-12: TURBINE BUILDING COOLING WATER SYSTEM COMPONENT DESCRIPTION

TBCW Pumps

Type	Horizontal, centrifugal
Quantity	3, 50% capacity each
Capacity, gpm	10,500
TDH, ft	100
Driver, hp	350

TBCW Heat Exchangers

Quantity	3, 50% capacity
Type	TEMA, CGN
Duty, each, Btu/hr	70.7 x 10 ⁶

Shell Side:

Fluid	Inhibited demineralized water
No. of passes	Two, divided
Flow rate, gpm	9,724
Temperature in/out, F	110/95

Tube Side:

Fluid	Plant service water
No. of passes	Four
Flow rate, gpm	5,656
Temperature in/out, F	75/100

TBCW Surge Tank

Capacity, gal	550
Design pressure/temperature, F	Atm./200

TBCW Chemical Addition Tank

Capacity, gal	50
Design pressure, psig	150
Design temperature, F	200

GRAND GULF NUCLEAR GENERATING STATION
Updated Final Safety Analysis Report (UFSAR)

TABLE 9.2-13: DELETED

GRAND GULF NUCLEAR GENERATING STATION
Updated Final Safety Analysis Report (UFSAR)

TABLE 9.2-14: DELETED

GRAND GULF NUCLEAR GENERATING STATION
Updated Final Safety Analysis Report (UFSAR)

TABLE 9.2-15: DELETED

GRAND GULF NUCLEAR GENERATING STATION
Updated Final Safety Analysis Report (UFSAR)

**TABLE 9.2-15A: TOTAL INTEGRATED HEAT REJECTED FROM BASIN A
SSW LOOP A AND HPCS SW LOOP OPERABLE**

Day	Basin A Integrated Heat (10^{10} BTU)
1	0.52
2	0.95
3	1.34
4	1.71
5	2.06
6	2.40
7	2.72
8	3.04
9	3.35
10	3.66
11	3.95
12	4.24
13	4.53
14	4.82
15	5.10
16	5.38
17	5.66
18	5.94
19	6.21
20	6.49
21	6.76
22	7.03
23	7.29
24	7.56
25	7.82
26	8.08
27	8.34
28	8.59
29	8.84
30	9.09

GRAND GULF NUCLEAR GENERATING STATION
Updated Final Safety Analysis Report (UFSAR)

**TABLE 9.2-15B: TOTAL INTEGRATED HEAT REJECTED FROM BASINS SSW
 LOOPS A & B AND HPCS SW LOOP OPERABLE**

Day	Basin A Integrated Heat (10 ¹⁰ BTU)	Basin B Integrated Heat (10 ¹⁰ BTU)
1	0.52	0.05
2	0.95	0.10
3	1.34	0.15
4	1.71	0.21
5	2.06	0.26
6	2.40	0.31
7	2.72	0.36
8	3.04	0.41
9	3.35	0.46
10	3.66	0.51
11	3.95	0.56
12	4.24	0.62
13	4.53	0.67
14	4.82	0.72
15	5.10	0.77
16	5.38	0.82
17	5.66	0.87
18	5.94	0.92
19	6.21	0.98
20	6.49	1.03
21	6.76	1.08
22	7.03	1.13
23	7.29	1.18
24	7.56	1.23
25	7.82	1.28
26	8.08	1.34
27	8.34	1.39
28	8.59	1.44
29	8.84	1.49
30	9.09	1.54

TABLE 9.2-16: STANDBY SERVICE WATER SYSTEM COOLING DUTY LOADS FOLLOWING A DBA (LOCA WITH LOSS OF OFFSITE POWER AND FAILURE OF STANDBY DIESEL GENERATOR B)

Component	Loop A			Loop B			Loop C		
	Duty	Flow	ΔT	Duty	Flow+	ΔT	Duty	Flow	ΔT
RHR Heat Exch A	188.78 ⁽¹⁾	7900	37	--	--	--	--	--	--
RHR Heat Exch B	--	--	--	--	--	--	--	--	--
Stby. D.G.J.W. Cooler A	19.14 ⁽²⁾	2400	--	--	--	--	--	--	--
Stby. D.G.J.W. Cooler B	--	--	--	--	--	--	--	--	--
RHR Pump A Seal Clr.	0.3	20	30	--	--	--	--	--	--
RHR Pump B Seal Clr.	--	--	--	--	--	--	--	--	--
RHR Pump C Seal Clr.	--	--	--	--	--	--	--	--	--
RHR A Room Cooler	0.424	31	34	--	--	--	--	--	--
RHR B Room Cooler	--	--	--	--	--	--	--	--	--
RHR C Room Cooler	--	--	--	--	--	--	--	--	--
-----	--	--	--	--	--	--	--	--	--
LPCS Room Cooler	0.322	27	--	--	--	--	--	--	--
Fuel Pool Heat Exch. A	22.08 ⁽³⁾	1000	--	--	--	--	--	--	--
Fuel Pool Heat Exch. B	--	--	--	--	--	--	--	--	--
RCIC Room Cooler	0.041	17	--	--	--	--	--	--	--
HPCS D.G.J.W. Cooler 'A'	--	--	--	--	--	--	5.108	365	30
HPCS D.G.J.W. Cooler 'B'	--	--	--	--	--	--	5.108	365	30

9.2-80

LBDCR 2022-005

TABLE 9.2-16: STANDBY SERVICE WATER SYSTEM COOLING DUTY LOADS FOLLOWING A DBA (LOCA WITH LOSS OF OFFSITE POWER AND FAILURE OF STANDBY DIESEL GENERATOR B) (CONTINUED)

Component	<u>Loop A</u>			<u>Loop B</u>			<u>Loop C</u>		
	Duty	Flow	ΔT	Duty	Flow+	ΔT	Duty	Flow	ΔT
Fuel Pool Cooling and Cleanup Pump Room Cooler B	0.077	17	12	--	--	--	--	--	--
HPCS Room Cooler	--	--	--	--	--	--	0.544	35	31
Control Rm. A/C - B	--	--	--	--	--	--	--	--	--
Blowdown	--	--	--	--	--	--	--	--	--
CCW Heat Exch.	--	--	--	--	--	--	--	--	--
Drywall Chillers	--	--	--	--	--	--	--	--	--
ESF Elec. Swgr. Clr. S-East 166'	0.016	15	2	--	--	--	--	--	--
ESF Elec. Swgr. Clr. S-East 119'	0.032	15	4	--	--	--	--	--	--
ESF Elec. Swgr. Clr. S-West 119'	0.063	40	5	--	--	--	--	--	--
ESF Elec. Swgr. Clr. S-East 139'	0.089	40	6	--	--	--	--	--	--
ESF Elec. Swgr. Clr. S-West 139'	0.033	15	6	--	--	--	--	--	--
ESF Elec. Swgr. Clr. N-East 166'	--	--	--	--	--	--	--	--	--
ESF Elec. Swgr. Clr. N-East 119'	--	--	--	--	--	--	--	--	--
ESF Elec. Swgr. Clr. N-West 119'	--	--	--	--	--	--	--	--	--
ESF Elec. Swgr. Clr. N-East 139'	--	--	--	--	--	--	--	--	--

9.2-81

LBDCR 2022-005

GRAND GULF NUCLEAR GENERATING STATION
 Updated Final Safety Analysis Report (UFSAR)

TABLE 9.2-16: STANDBY SERVICE WATER SYSTEM COOLING DUTY LOADS FOLLOWING A DBA (LOCA WITH LOSS OF OFFSITE POWER AND FAILURE OF STANDBY DIESEL GENERATOR B) (CONTINUED)

Component	<u>Loop A</u>			<u>Loop B</u>			<u>Loop C</u>		
	Duty	Flow	ΔT	Duty	Flow+	ΔT	Duty	Flow	ΔT
ESF Elec. Swgr. Clr. N-West 139'	--	--	--	--	--	--	6	--	--
Plant Air Compressors	--	--	--	--	--	--	--	--	--
SSW Pump A Mtr. Cooler	0.06	4	--	--	--	--	--	--	--
SSW Pump B Mtr. Cooler	--	--	--	--	--	--	--	--	--
Drywell Purge Compressor Oil Cooler	0.875	20	--	--	--	--	--	--	--
Drywell Purge Compressor Aftercooler	--	50	--	--	--	--	--	--	--
SSW Pump A Pump Work	3.18	--	--	--	--	--	--	--	--
SSW Pump B Pump Works	--	--	--	--	--	--	--	--	--
HPCS SW Pump Work	--	--	--	--	--	--	0.255	--	--

Duty - x 10⁶ Btuh, Flow - gpm, ΔT - °F

1. Maximum duty for this mode.
2. The diesel generator heat load of 19.14 x 10⁶ Btuh was based on the actual loading of the diesel generator following a LOCA. This load is less than the full rated load of the diesel generator.

TABLE 9.2-16: STANDBY SERVICE WATER SYSTEM COOLING DUTY LOADS FOLLOWING A DBA (LOCA WITH LOSS OF OFFSITE POWER AND FAILURE OF STANDBY DIESEL GENERATOR B) (CONTINUED)

3. For Mode IV analysis, a fuel pool heat exchanger design load of 22.08×10^6 Btuh was used. This pool heat load was based on 11 off-loads and 24 month fuel cycles, with the most recent off-load being 15 days since shutdown.

+ Nominal design flow unless otherwise noted.

**TABLE 9.2-16A: STANDBY SERVICE WATER SYSTEM COOLING DUTY LOADS
FOLLOWING A DBA (LOCA WITH LOSS OF OFFSITE POWER)
SSW - LOOPS A & B AND HPCS SW - LOOP C OPERATING**

Component	Loop A			Loop B			Loop C		
	Duty	Flow	ΔT	Duty	Flow+	ΔT	Duty	Flow	ΔT
RHR Heat Exch A	188.78 ⁽¹⁾	7900	37	--	--	--	--	--	--
RHR Heat Exch B	--	--	--	188.78	7900	37	--	--	--
Stby. D.G.J.W. Cooler A	19.14 ⁽⁴⁾	2400	--	--	--	--	--	--	--
Stby. D.G.J.W. Cooler B	--	--	--	14.73 ⁽²⁾	2400	--	--	--	--
HR Pump A Seal Clr.	0.3	20	30	--	--	--	--	--	--
RHR Pump B Seal Clr.	--	--	--	0.30	20	30	--	--	--
RHR Pump C Seal Clr.	--	--	--	0.30	20	30	--	--	--
RHR A Room Cooler	0.424	31	34	--	--	--	--	--	--
RHR B Room Cooler	--	--	--	0.383	33	32	--	--	--
RHR C Room Cooler	--	--	--	0.293	17.3	34	--	--	--
-----	--	--	--	--	--	--	--	--	--
LPCS Room Cooler	0.322	27	--	--	--	--	--	--	--
Fuel Pool Heat Exch.A	22.08 ⁽³⁾	1000	--	--	--	--	--	--	--
Fuel Pool Heat Exch.B	--	--	--	--	--	--	--	--	--
RCIC Room Cooler	0.041	17	--	--	--	--	--	--	--
HPCS D.G.J.W. Cooler 'A'	--	--	--	--	--	--	5.108	365	30
HPCS D.G.J.W. Cooler 'B'	--	--	--	--	--	--	5.108	365	30
Fuel Pool Cooling and Cleanup Pump Room Cooler A	0.077	17	12	--	--	--	--	--	--
Fuel Pool Cooling and Cleanup Pump Room Cooler B	--	--	--	--	--	--	--	--	--
HPCS Room Cooler	--	--	--	--	--	--	0.528	40	26
Control Rm. A/C - A	0.966	161	12	--	--	--	--	--	--
Control Rm. A/C - B	--	--	--	0.966	161	12	--	--	--
Blowdown	--	--	--	--	--	--	--	--	--

9.2-84

LBDCR 2022-005

GRAND GULF NUCLEAR GENERATING STATION
Updated Final Safety Analysis Report (UFSAR)

TABLE 9.2-16A: STANDBY SERVICE WATER SYSTEM COOLING DUTY LOADS FOLLOWING A DBA (LOCA WITH LOSS OF OFFSITE POWER) SSW - LOOPS A & B AND HPCS SW - LOOP C OPERATING (CONTINUED)

Component	Duty	Flow	ΔT	Duty	Flow+	ΔT	Duty	Flow	ΔT
CCW Heat Exch.	--	--	--	--	--	--	--	--	--
Drywell Chillers	--	--	--	--	--	--	--	--	--
ESF Elec. Swgr. Clr. S-East 166'	0.016	15	2	--	--	--	--	--	--
ESF Elec. Swgr. Clr. S-East 119'	0.032	15	4	--	--	--	--	--	--
ESF Elec. Swgr. Clr. S-West 119'	0.063	40	5	--	--	--	--	--	--
ESF Elec. Swgr. Clr. S-East 139'	0.089	40	6	--	--	--	--	--	--
ESF Elec. Swgr. Clr. S-West 139'	0.033	15	6	--	--	--	--	--	--
ESF Elec. Swgr. Clr. N-East 166'	--	--	--	0.014	15	2	--	--	--
ESF Elec. Swgr. Clr. N-East 119'	--	--	--	0.042	15	4	--	--	--
ESF Elec. Swgr. Clr. N-West 119'	--	--	--	0.058	40	5	--	--	--
ESF Elec. Swgr. Clr. N-East 139'	--	--	--	0.088	40	6	--	--	--
ESF Elec. Swgr. Clr. N-West 139'	--	--	--	0.030	15	6	--	--	--
Plant Air Compressors	--	--	--	--	--	--	--	--	--
SSW Pump A Mtr. Cooler	0.06--	4-	--	--	--	--	--	--	--
SSW Pump B Mtr. Cooler	--	--	--	--	4	--	--	--	--
Drywell Purge Compressor Oil Cooler A	0.875	20	--	--	--	--	--	--	--
Drywell Purge Compressor Aftercooler A	--	50	--	--	--	--	--	--	--

9.2-85

LBDCR 2019-068

TABLE 9.2-16A: STANDBY SERVICE WATER SYSTEM COOLING DUTY LOADS FOLLOWING A DBA (LOCA WITH LOSS OF OFFSITE POWER) SSW - LOOPS A & B AND HPCS SW - LOOP C OPERATING (CONTINUED)

Component	Duty	Flow	ΔT	Duty	Flow+	ΔT	Duty	Flow	ΔT
Drywell Purge Compressor Oil Cooler B				0.150	20	15	--	--	--
Drywell Purge Compressor Aftercooler B				0.748	50	30	--	--	--
SSW Pump A Pump Work	3.18	--	--	--	--	--	--	--	--
SSW Pump B Pump Work	--	--	--	3.18	--	--	--	--	--
HPCS SW Pump Work	--	--	--	--	--	--	0.255	--	--

Duty - x 10⁶ Btuh, Flow - gpm, ΔT - °F

1. Maximum duty for this mode.
2. The diesel generator heat load of 14.73 x 10⁶ Btuh was based on the actual loading of the diesel generator following a LOCA. This load is less than the full rated load of the diesel generator.
3. For Mode IV analysis, a fuel pool heat exchanger design load of 22.08 x 10⁶ Btuh was used. This pool heat load was based on 11 off-loads and 24 month fuel cycles, with the most recent off-load being 15 days since shutdown.
4. The diesel generator heat load of 19.14 x 10⁶ Btuh was based on the actual loading of the diesel generator following a LOCA. This load is less than the full rated load of the diesel generator.

+Nominal design flow unless otherwise noted.

**TABLE 9.2-17: UNIT 1
TIME DEPENDENT STANDBY SERVICE WATER SYSTEM COOLING DUTY LOADS FOLLOWING A DBA
(LOCA WITH LOSS OF OFFSITE POWER AND SINGLE ACTIVE FAILURE)**

		LOOP A		LOOP C	
	TIME	COMPONENT	DUTY ⁺ (10 ⁶ Btuh)	COMPONENT	DUTY ⁺ (10 ⁶ Btuh)
(1)	0-30 minutes	Stby. DG JW Cooler	19.14 ⁽¹⁾	HPCS Diesel Generator Jacket Water Cooler 'A'	5.108
				HPCS Diesel Generator Jacket Water Cooler 'B'	5.108
		RHR Pump A Seal Clr	0.30	HPCS Room Cooler	0.544
	0.255	RHR Pump A Room Clr	0.424	HPCS Service Water Pump Work	0.255
		Fuel Pool HX	22.08 ⁽³⁾		
		LPCS Room Cooler	0.322		
		RCIC Room Cooler	0.041		
		Control Rm A/C	0.97		
		ESF Elec Swgr Rm Clrs	0.232		
		Drywell Purge Compressors	0.875		
		SSW Pump A Motor Clrs	0.06		
		SSW Pump A Pump Work	3.18		
		Fuel Pool Cooling and Cleanup Pump Room Clr	0.077		
		Total	47.70	Total	11.69
(2)	30 min. - 6 hr	- Same as 0-30 min., plus RHR A HX	Same as 0-30 min. plus 188.78 ⁽²⁾	Same as 0-30 min.	Same as 0-30 min.
(3)	6 hr - 24 hr	- Same as 30 min. - 6 hr	Same as 30 min. - 6 hr	Same as 30 min. - 6 hr	Same as 30 min. - 6 hr

9.2-87

LBDCR 2022-005

GRAND GULF NUCLEAR GENERATING STATION
Updated Final Safety Analysis Report (UFSAR)

TABLE 9.2-17: UNIT 1
TIME DEPENDENT STANDBY SERVICE WATER SYSTEM COOLING DUTY LOADS FOLLOWING A DBA
(LOCA WITH LOSS OF OFFSITE POWER AND SINGLE ACTIVE FAILURE) (CONTINUED)

(4)	24 hr - Same as 6 hr - 24 hr 30 days	Same as 6 hr - 24 hr	Same as 6 hr - 24 hr	Same as 6 hr - 24 hr	Same as 6 hr - 24 hr
-----	---	----------------------	----------------------	----------------------	-------------------------

Notes:

- (1) The diesel generator heat load of 19.14×10^6 Btuh was based on the actual loading of the diesel generator following a LOCA. This load is less than the full rated load of the diesel generator.
- (2) The A RHR heat exchanger was assumed, for Mode IV analysis, to reject heat to standby service water system for time period of T = 30 minutes (1800 seconds) to 30 days. Load shown is maximum duty for this mode. Refer to Figure 9.2-42.
- (3) For Mode IV analysis, a fuel pool heat exchanger design load of 22.08×10^6 Btuh was used. This pool heat load was based on 11 off-loads and 24 month fuel cycles, with the most recent off-load being 15 days since shutdown.
- + Nominal cooling duty loads unless otherwise noted.

TABLE 9.2-17A: UNIT 1
TIME DEPENDENT STANDBY SERVICE WATER SYSTEM COOLING DUTY LOADS FOLLOWING A DBA (LOCA WITH LOSS OF OFFSITE POWER) SSW - LOOPS A & B AND HPCS SW - LOOP C OPERATING DELAYED SINGLE FAILURE

TIME	LOOP A	DUTY ⁺	LOOP B	DUTY ⁺	LOOP C	DUTY ⁺
	COMPONENT	(10 ⁶ Btuh)	COMPONENT	(10 ⁶ Btuh)	COMPONENT	(10 ⁶ Btuh)
(1) 0-30 minutes	Stby. DG JW Cooler	19.14 ⁽¹⁾	Stby. DG JW Cooler	14.73 ⁽¹⁾	HPCS Diesel Generator Jacket Water Cooler 'A'	5.108
					HPCS Diesel Generator Jacket Water Cooler 'B'	5.108
	RHR Pump A Seal Clr	0.30	RHR Pump B Seal Clr	0.30	HPCS Room Cooler	0.544
	RHR Pump A Room Clr	0.424	RHR Pump B Room Clr	0.383	HPCS ServiceWater Pump Work	0.255
	Fuel Pool HX	22.08 ⁽³⁾	Fuel Pool HX			
	LPCS Room Cooler	0.322	RHR Pump C Seal Clr	0.30		
	RCIC Room Cooler	0.041	RHR Pump C Room Clr	0.293		
	Control Rm A/C	0.97	Control Rm A/C	0.97		
	HPCS Diesel Generator Jacket	0.232	ESF Elect Swgr Rm Clrs	0.233		
	Water Cooler 'A' Compressors	0.875	Drywell Purge Compressors	0.90		
	SSW Pump A Motor Clrs	0.06	SSW Pump B Motor Clrs	0.01		
	SSW Pump A Pump Work	3.18	SSW Pump B Pump Clrs	3.18		

TABLE 9.2-17A: UNIT 1
TIME DEPENDENT STANDBY SERVICE WATER SYSTEM COOLING DUTY LOADS FOLLOWING A DBA (LOCA
WITH LOSS OF OFFSITE POWER) SSW - LOOPS A & B AND HPCS SW -
LOOP C OPERATING DELAYED SINGLE FAILURE (CONTINUED)

	Fuel Pool Cooling and Cleanup Pump Room Clr	0.077	Fuel Pool Cooling and Cleanup Pump Room Clr			
	Total	47.70	Total	20.69	Total	11.69
(2) 30 min. - 6 hr	Same as 0-30 min. plus RHR A HX	Same as 0-30 min. plus 188.78 ⁽²⁾	Same as 0 - 30 min.	Same as 0 - 30 min.	Same as 0 - 30 min.	
(3) 6 hr - 24 hr	Same as 30 min. 6 hr	Same as 30 min. 6 hr	Same as 30 min. 6 hr	Same as 30 min. 6 hr	Same as 30 min. 6 hr	
(4) 24 hr - 30 days	Same as 6 hr - 24 hr	Same as 6 hr - 24 hr	Same as 6 hr - 24 hr	Same as 6 hr - 24 hr	Same as 6 hr - 24 hr	

Notes:

- (1) The diesel generator heat load of 14.73×10^6 Btuh was based on the actual loading of the diesel generator following a LOCA. This load is less than the full rated load of the diesel generator.
 - (2) The A RHR heat exchanger was assumed, for Mode IV analysis, to reject heat to standby service water system for time period of $T = 30$ minutes (1800 seconds) to 30 days. Load shown is maximum duty for this mode. Refer to Figure 9.2-42.
 - (3) For Mode IV analysis, a fuel pool heat exchanger design load of 22.08×10^6 Btuh was used. This pool heat load was based on 11 off-loads and 24 month fuel cycles, with the most recent off-load being 15 days since shutdown.
 - (4) The diesel generator heat load of 19.14×10^6 Btuh was based on the actual loading of the diesel generator following a LOCA. This load is less than the full rated load of the diesel generator.
- + Nominal cooling duty loads unless otherwise noted.

GRAND GULF NUCLEAR GENERATING STATION
Updated Final Safety Analysis Report (UFSAR)

TABLE 9.2-18: DELETED

GRAND GULF NUCLEAR GENERATING STATION
Updated Final Safety Analysis Report (UFSAR)

TABLE 9.2-19: DELETED

GRAND GULF NUCLEAR GENERATING STATION
Updated Final Safety Analysis Report (UFSAR)

TABLE 9.2-20: DELETED

GRAND GULF NUCLEAR GENERATING STATION
Updated Final Safety Analysis Report (UFSAR)

TABLE 9.2-21: DELETED

GRAND GULF NUCLEAR GENERATING STATION
Updated Final Safety Analysis Report (UFSAR)

**TABLE 9.2-22: DRYWELL CHILLED WATER SYSTEM
COMPONENT DESCRIPTION**

Drywell Chillers

Type	Rotary screw
Quantity	4
Capacity, tons	310
Chilled water flow, gpm	300
Chilled water supply temperature, F	50
Condenser water flow, gpm	650
Condenser water supply temperature, F	75
Cooling media	R-22
Control	Hydraulic - slide valves
Condenser	Two-pass shell and tube
Evaporator	Two-pass shell and tube

Drywell Chilled Water Pumps

Type	Horizontal, split-case centrifugal
Quantity	2
Capacity, gpm	600
Total differential head, ft	330
Motor horsepower, hp	100

Chilled Water Chemical Feed Tank

Type	Horizontal
Quantity	1
Capacity, gal	10
Material	Carbon steel

Chilled Water Expansion Section

Type	Vertical
Quantity	1
Capacity, gal	80
Material	Carbon steel

GRAND GULF NUCLEAR GENERATING STATION

Updated Final Safety Analysis Report (UFSAR)

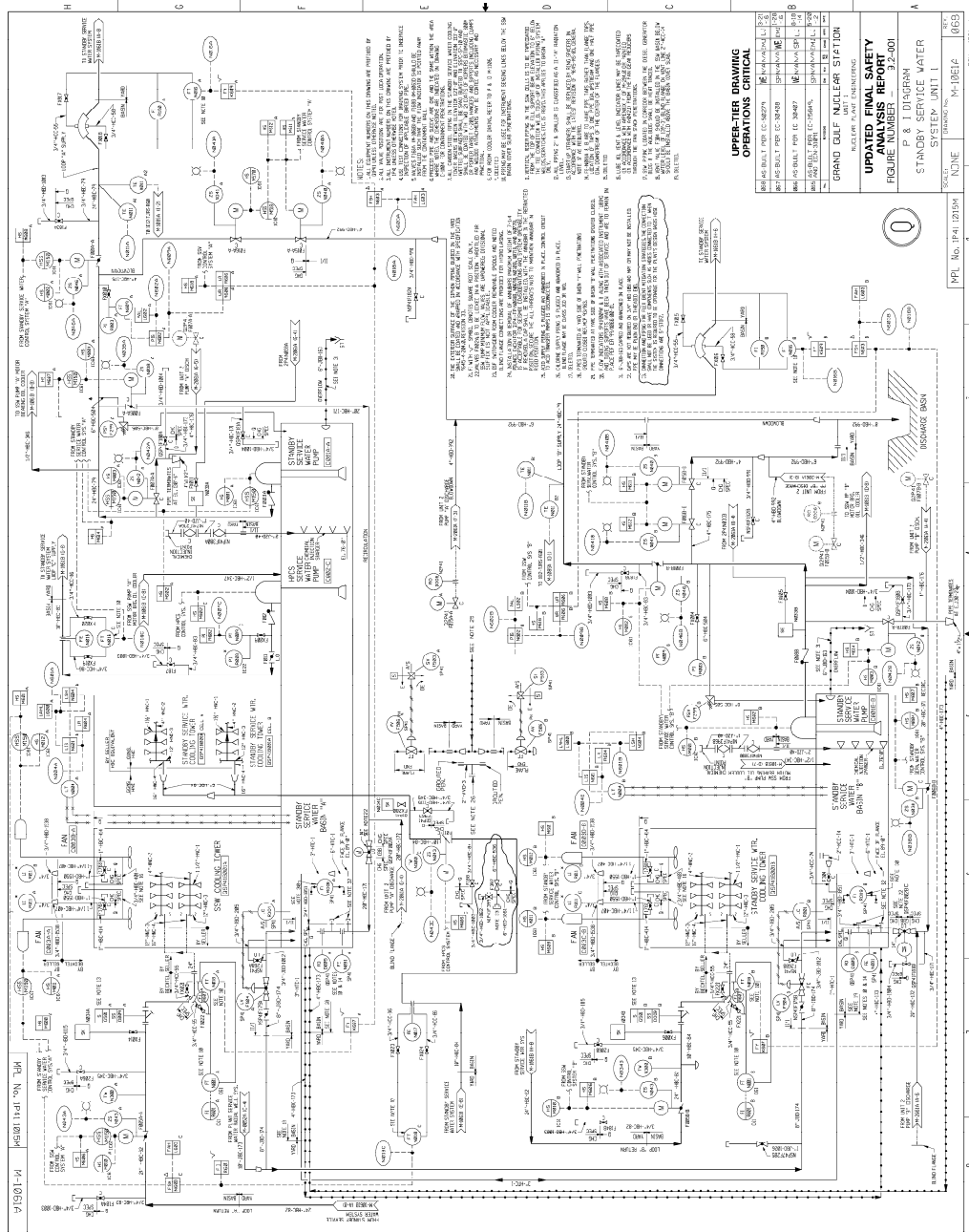

GRAND GULF NUCLEAR GENERATING STATION

Updated Final Safety Analysis Report (UFSAR)

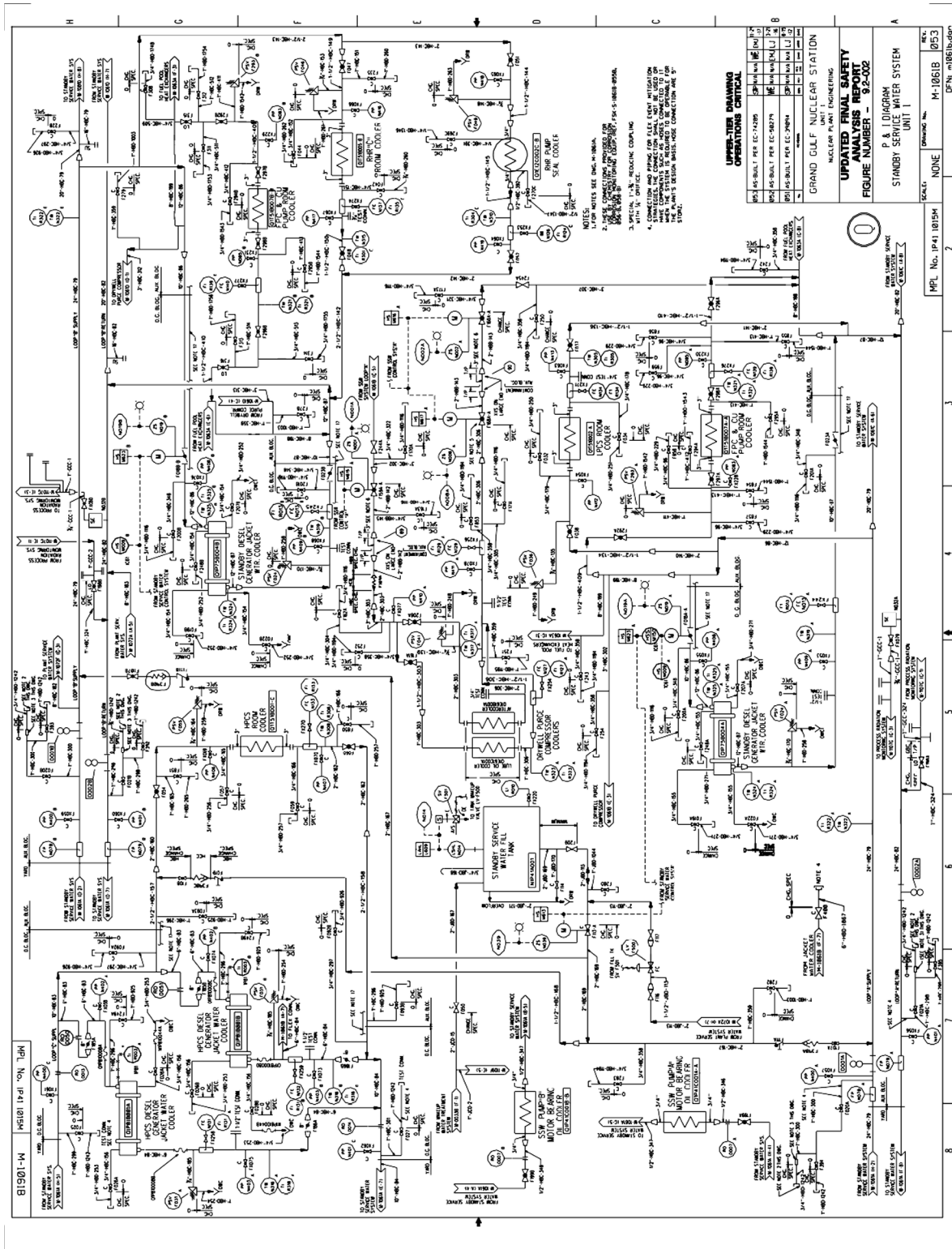

GRAND GULF NUCLEAR GENERATING STATION

Updated Final Safety Analysis Report (UFSAR)

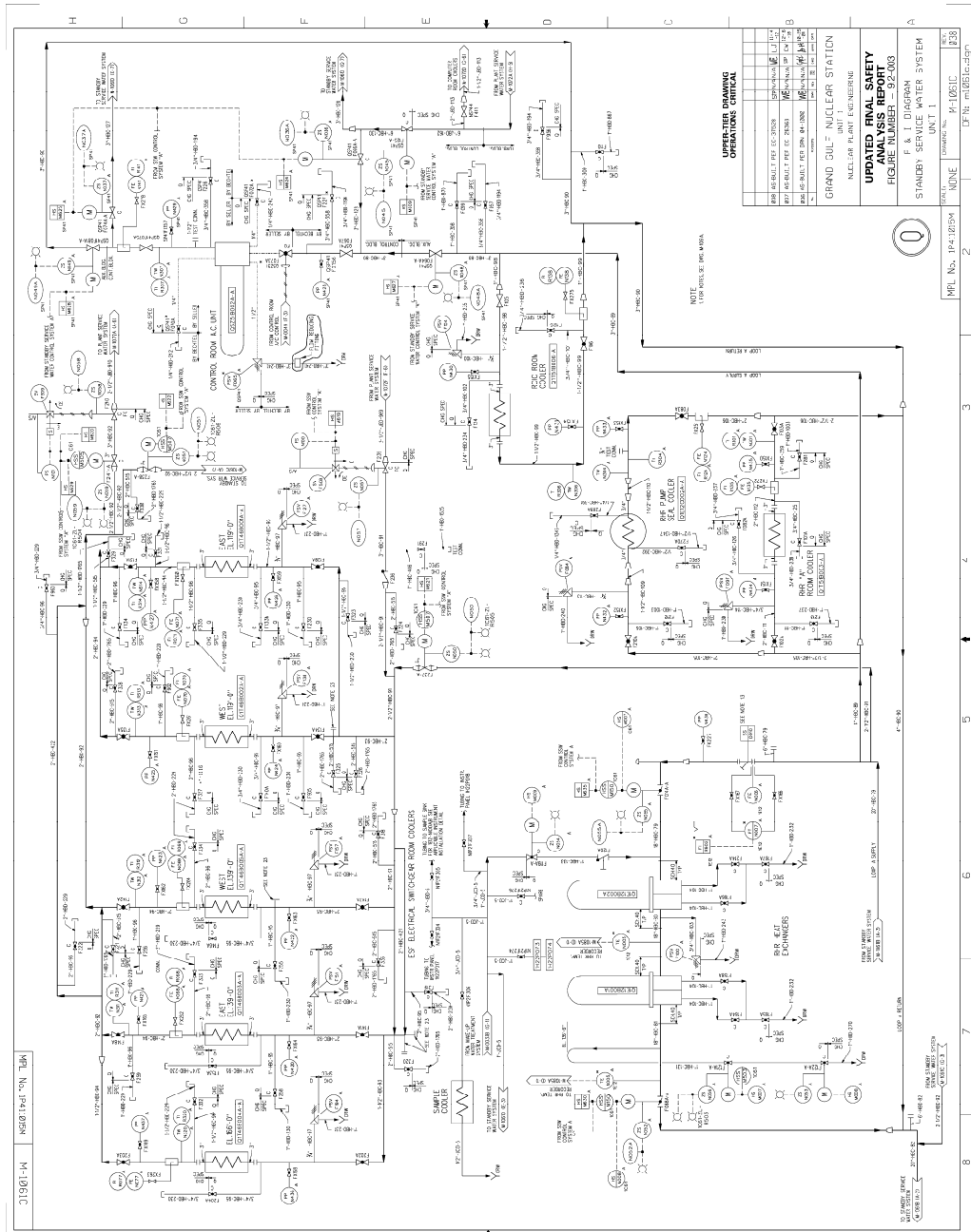

GRAND GULF NUCLEAR GENERATING STATION

Updated Final Safety Analysis Report (UFSAR)

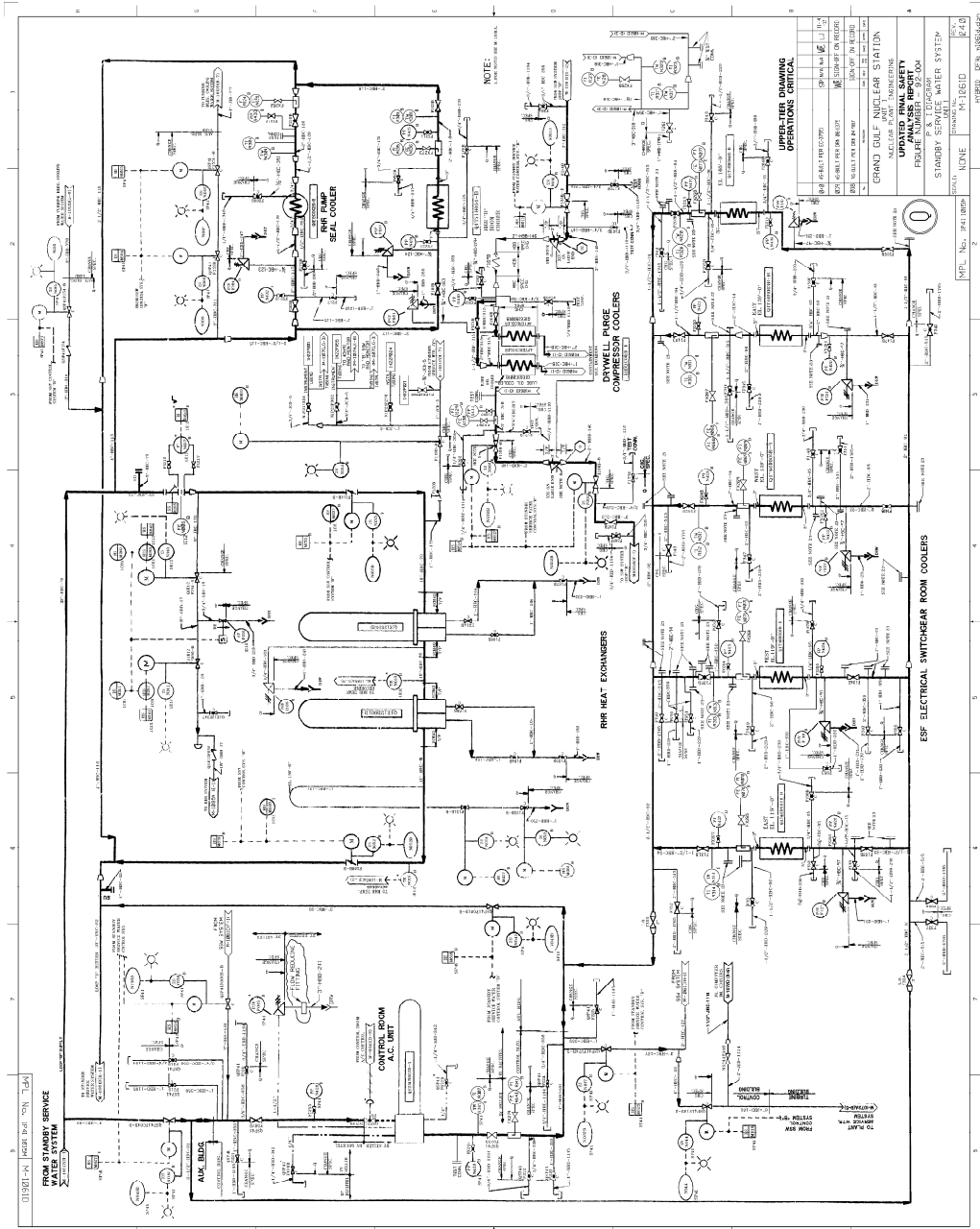
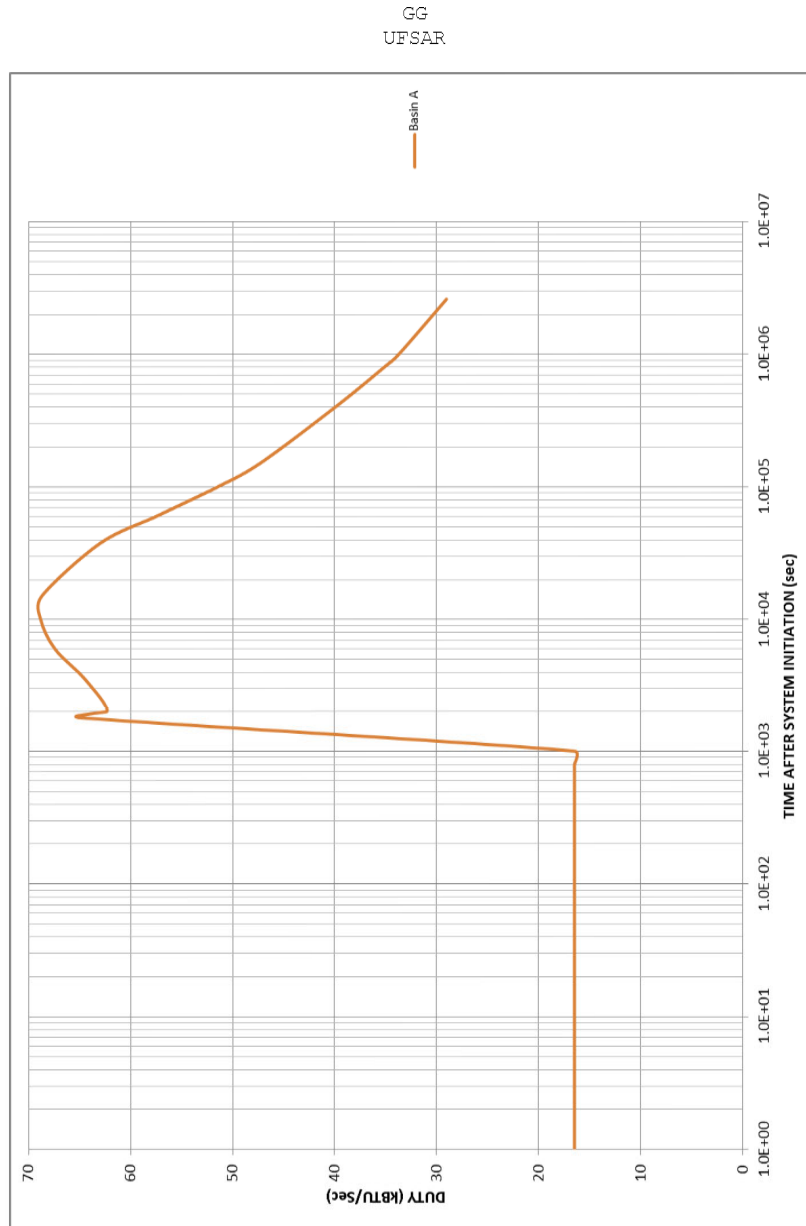

FIGURE 9.2-5: Deleted

FIGURE 9.2-6: Deleted

GRAND GULF NUCLEAR GENERATING STATION
 Updated Final Safety Analysis Report (UFSAR)



GRAND GULF NUCLEAR STATION UNIT 1 UPDATED FINAL SAFETY ANALYSIS REPORT	TOTAL HEAT REJECTION RATE BASIN A (LOOP A AND LOOP C) TIME PERIOD - 0 TO 30 DAYS FIGURE 9.2-6A
---	---

LDC 2017-007

GRAND GULF NUCLEAR GENERATING STATION
Updated Final Safety Analysis Report (UFSAR)

GG
UFSAR

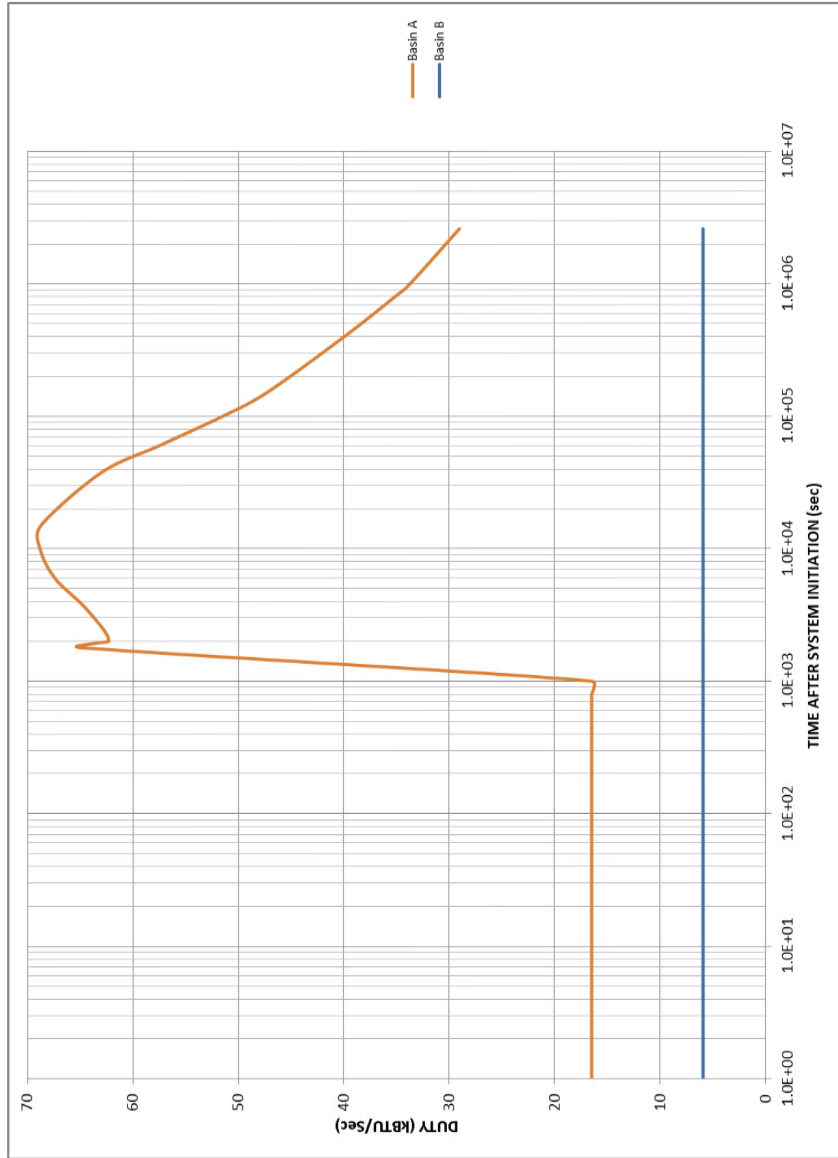

GRAND GULF NUCLEAR STATION UNIT 1 UPDATED FINAL SAFETY ANALYSIS REPORT	TOTAL HEAT REJECTION RATE BASIN A (SSW LOOP A AND HPCS SW LOOP C) BASIN B (SSW LOOP B) TIME PERIOD - 0 TO 30 DAYS FIGURE 9.2-6B
---	---

LDC 2017-007

FIGURE 9.2-7: Deleted

GRAND GULF NUCLEAR GENERATING STATION
Updated Final Safety Analysis Report (UFSAR)

GG
UFSAR

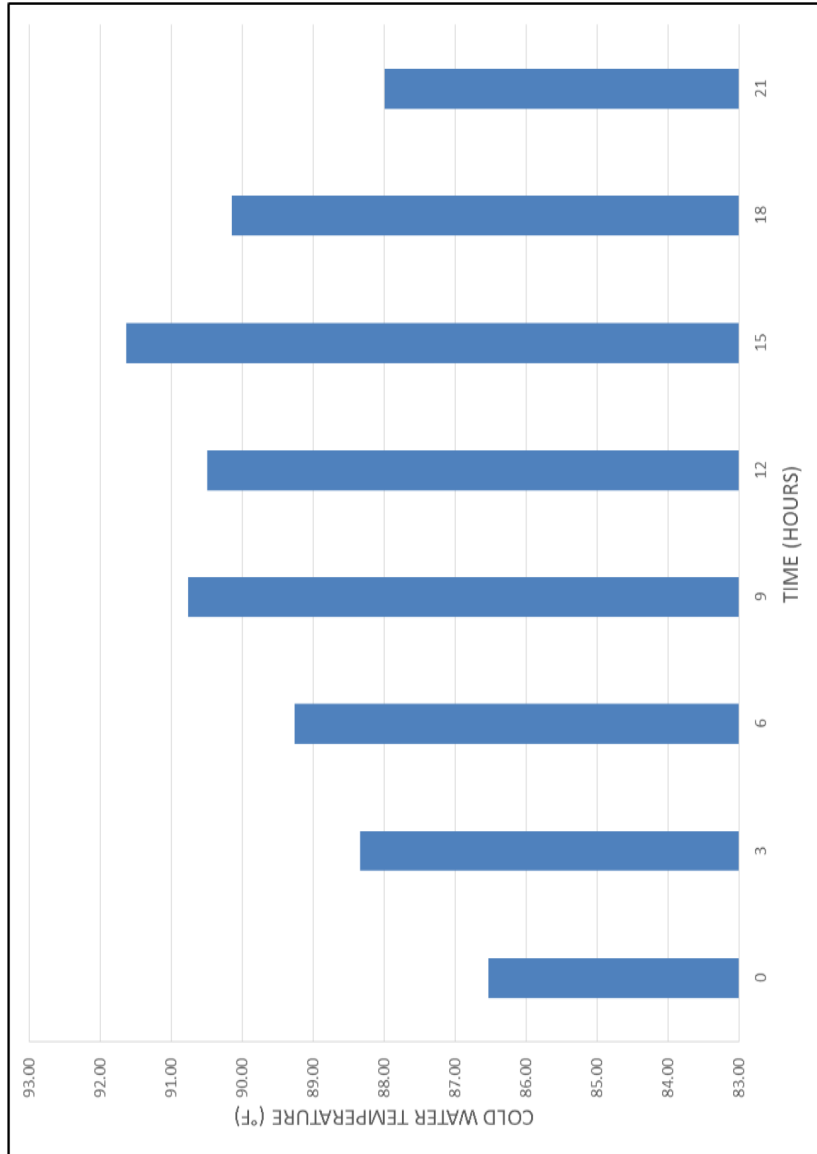

GRAND GULF NUCLEAR STATION UNIT 1 UPDATED FINAL SAFETY ANALYSIS REPORT	STANDBY SERVICE WATER COOLING TOWERS, WORST ONE-DAY PERFORMANCE ALTERNATE SHUTDOWN COOLING FIGURE 9.2-7A
---	---

LDC 2017-007

GRAND GULF NUCLEAR GENERATING STATION
Updated Final Safety Analysis Report (UFSAR)

GG
UFSAR

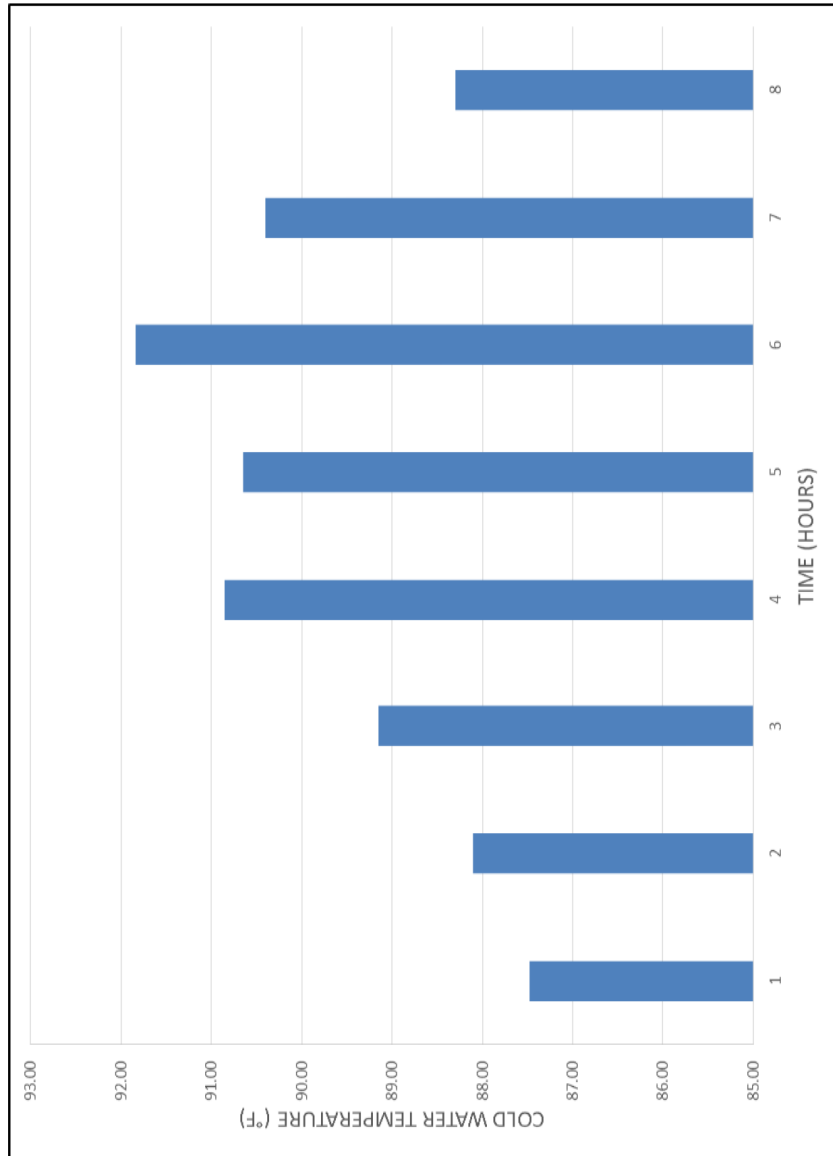

<p align="center">GRAND GULF NUCLEAR STATION UNIT 1 UPDATED FINAL SAFETY ANALYSIS REPORT</p>	<p align="center">STANDBY SERVICE WATER COOLING TOWERS, WORST ONE-DAY PERFORMANCE RECIRCULATION LINE BREAK FIGURE 9.2-7B</p>
--	---

IDC 2017-007

FIGURE 9.2-8: Deleted

GRAND GULF NUCLEAR GENERATING STATION
Updated Final Safety Analysis Report (UFSAR)

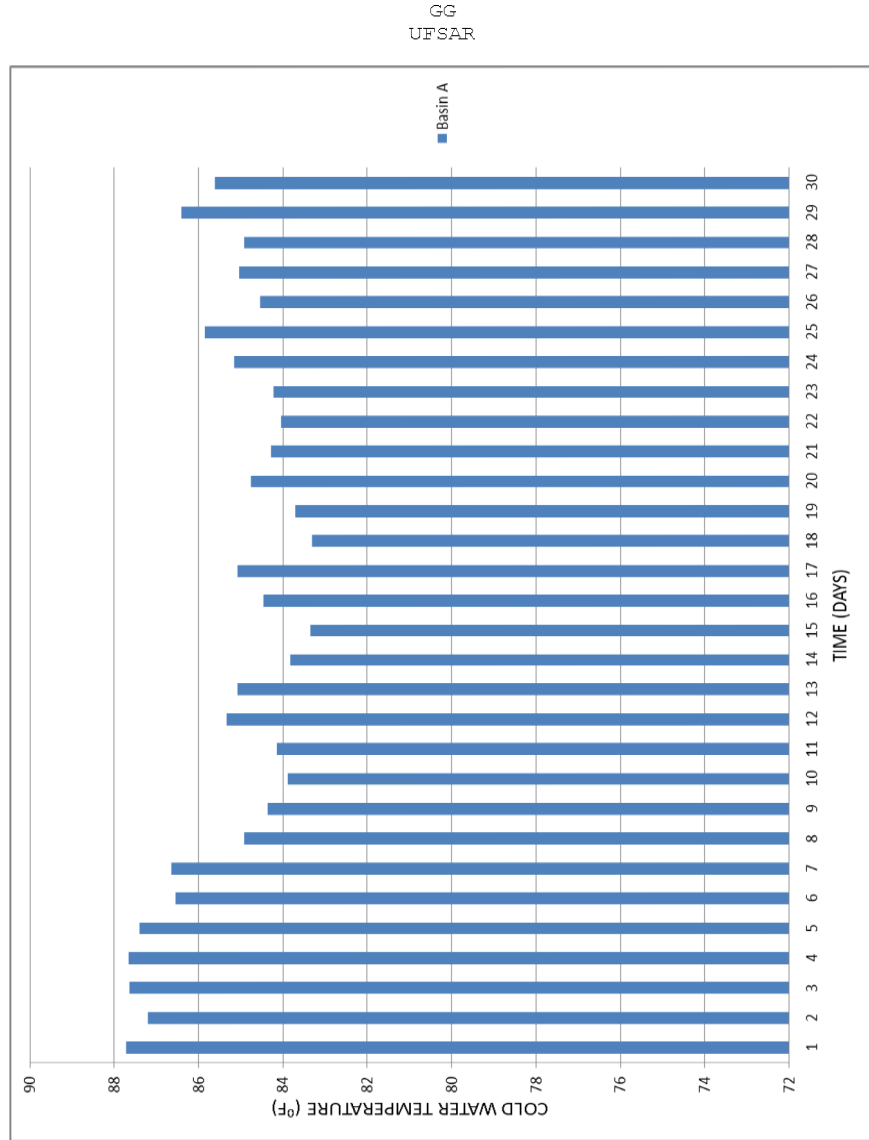

GRAND GULF NUCLEAR STATION UNIT 1 UPDATED FINAL SAFETY ANALYSIS REPORT	STANDBY SERVICE WATER COOLING TOWERS, WORST 30-DAYS PERFORMANCE SSW - LOOP A AND HPCS SW - LOOP C FIGURE 9.2-8A
---	--

LDC 2017-007

GRAND GULF NUCLEAR GENERATING STATION
Updated Final Safety Analysis Report (UFSAR)

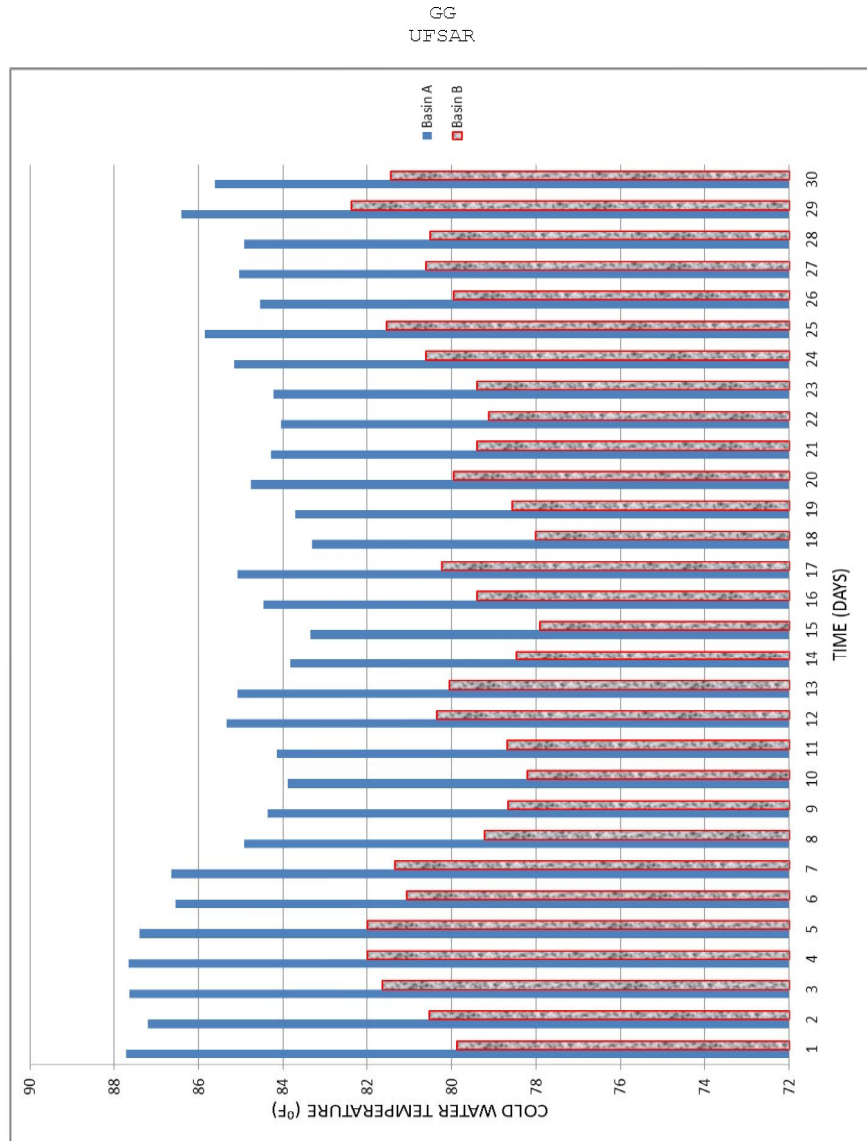

<p align="center">GRAND GULF NUCLEAR STATION UNIT 1 UPDATED FINAL SAFETY ANALYSIS REPORT</p>	<p align="center">STANDBY SERVICE WATER COOLING TOWERS, WORST 30-DAYS PERFORMANCE SSW - LOOPS A & B AND HPCS SW - LOOP C OPERATING</p>
<p align="center">FIGURE 9.2-8B</p>	

LDC 2017-007

GRAND GULF NUCLEAR GENERATING STATION

Updated Final Safety Analysis Report (UFSAR)

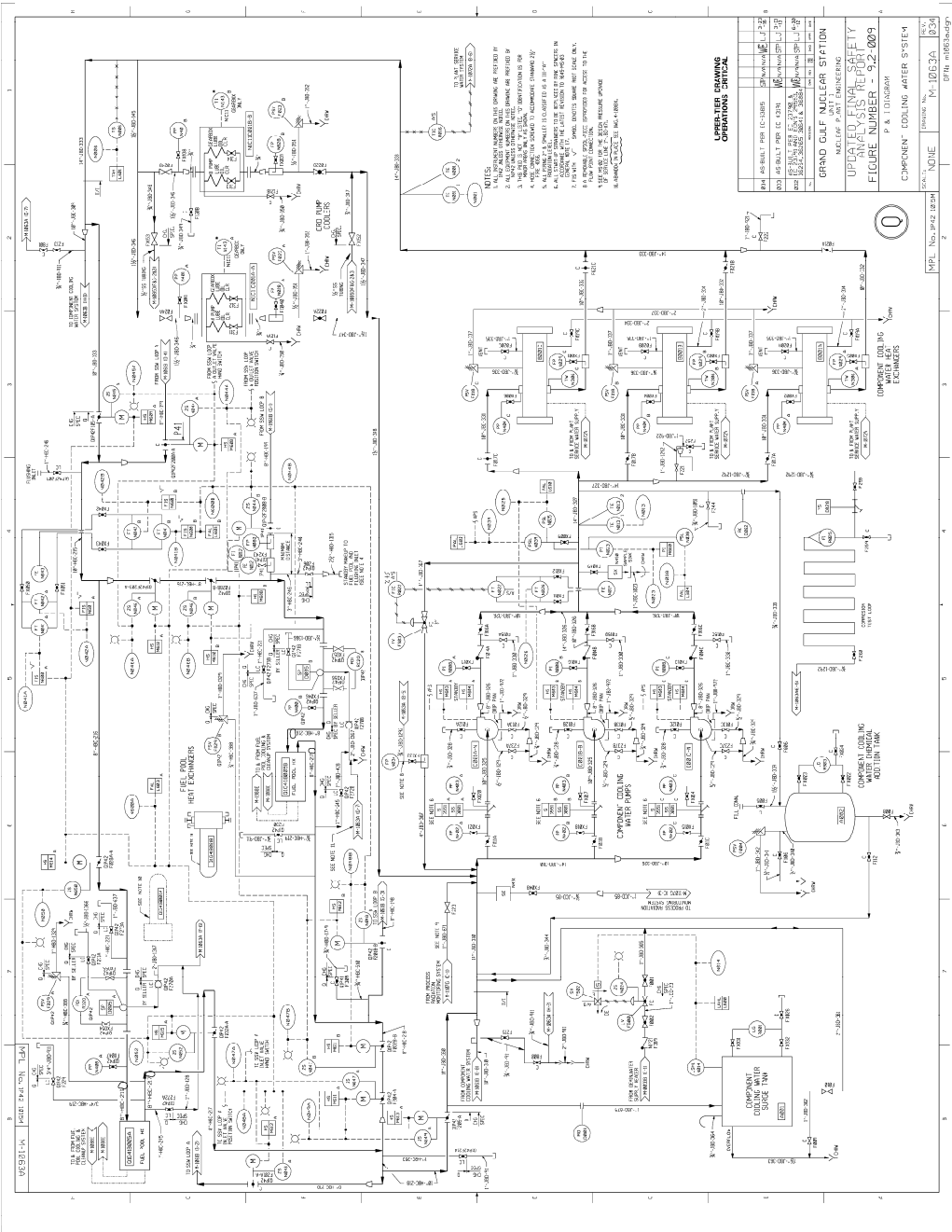

GRAND GULF NUCLEAR GENERATING STATION

Updated Final Safety Analysis Report (UFSAR)

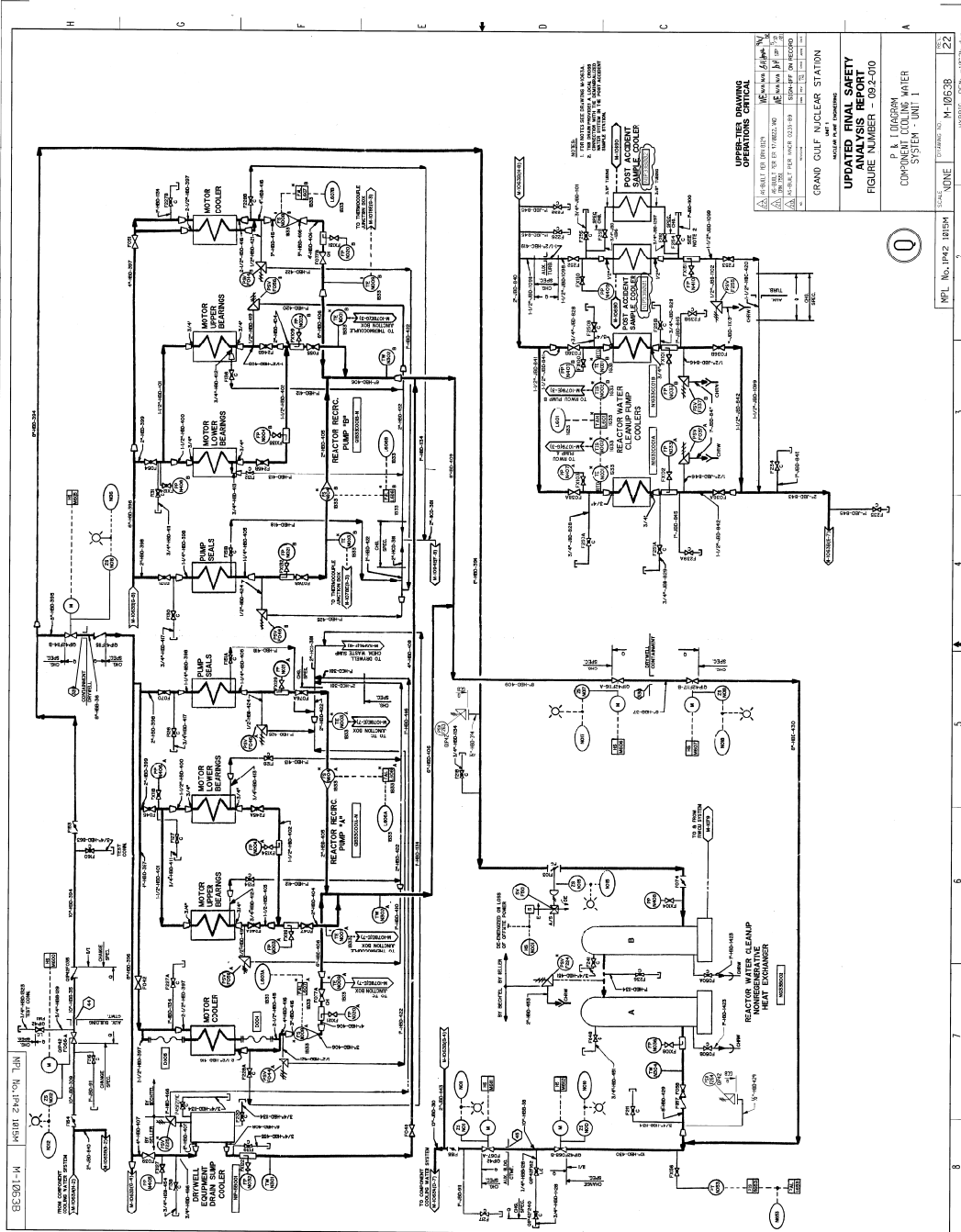

GRAND GULF NUCLEAR GENERATING STATION

Updated Final Safety Analysis Report (UFSAR)

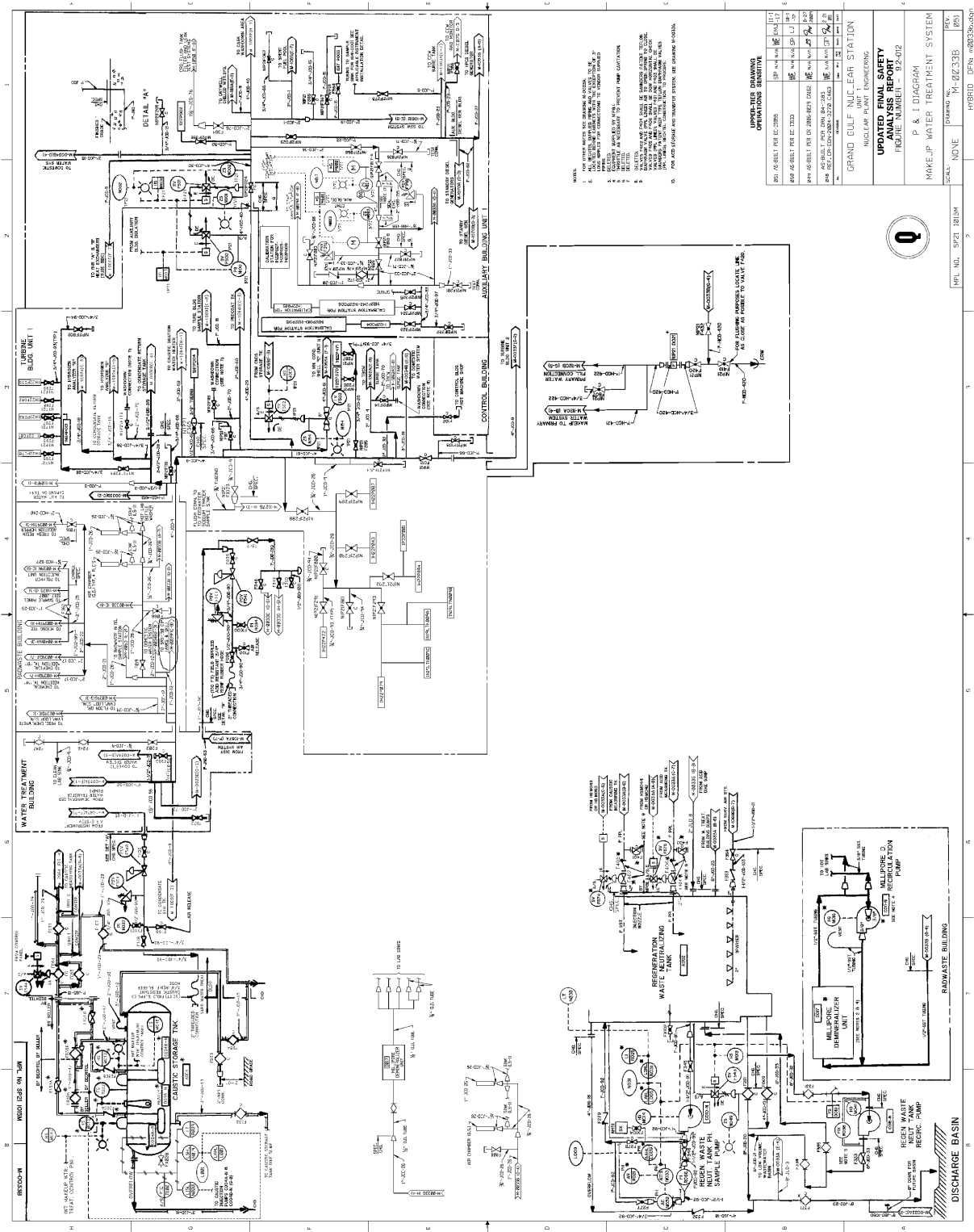

GRAND GULF NUCLEAR GENERATING STATION

Updated Final Safety Analysis Report (UFSAR)

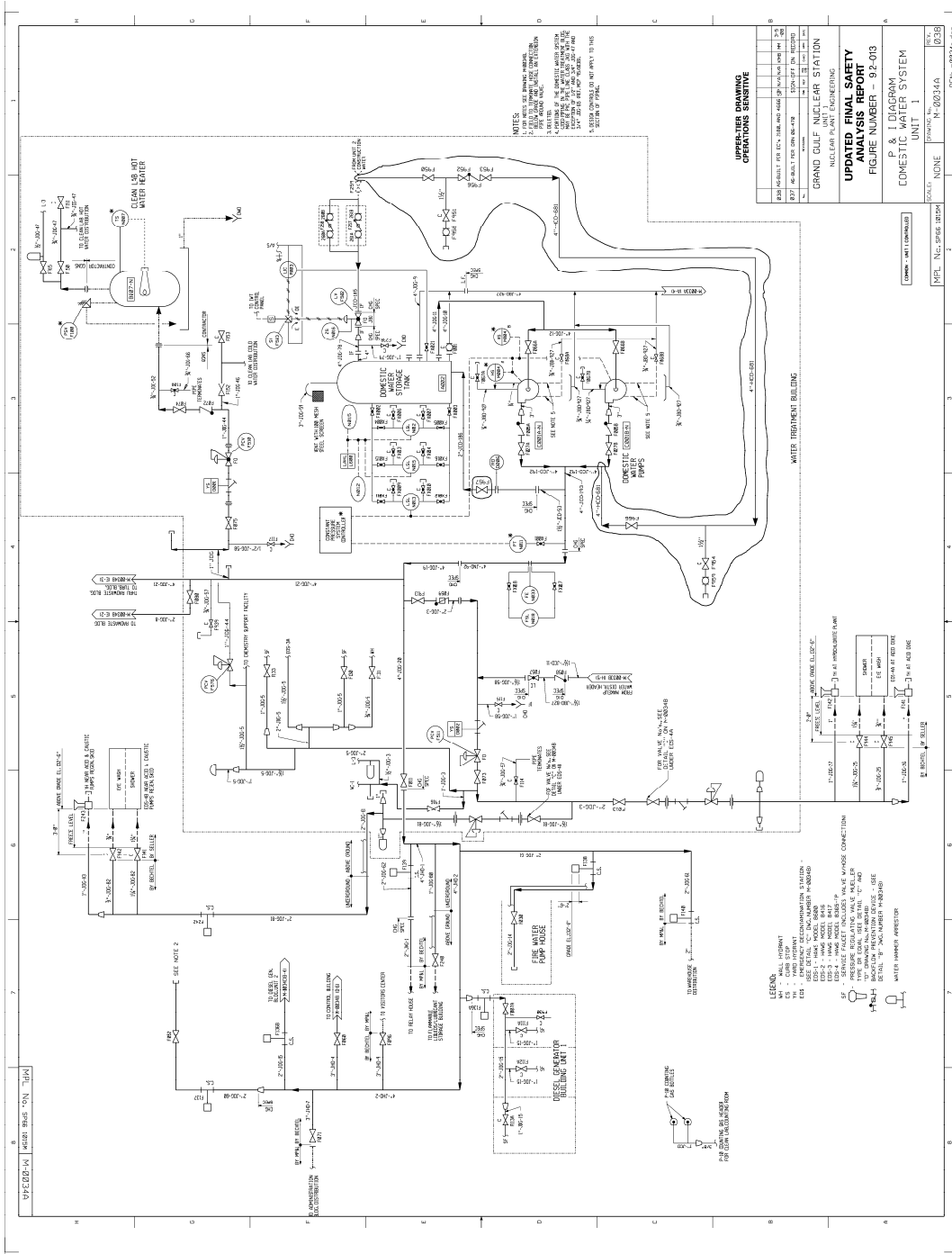

GRAND GULF NUCLEAR GENERATING STATION

Updated Final Safety Analysis Report (UFSAR)

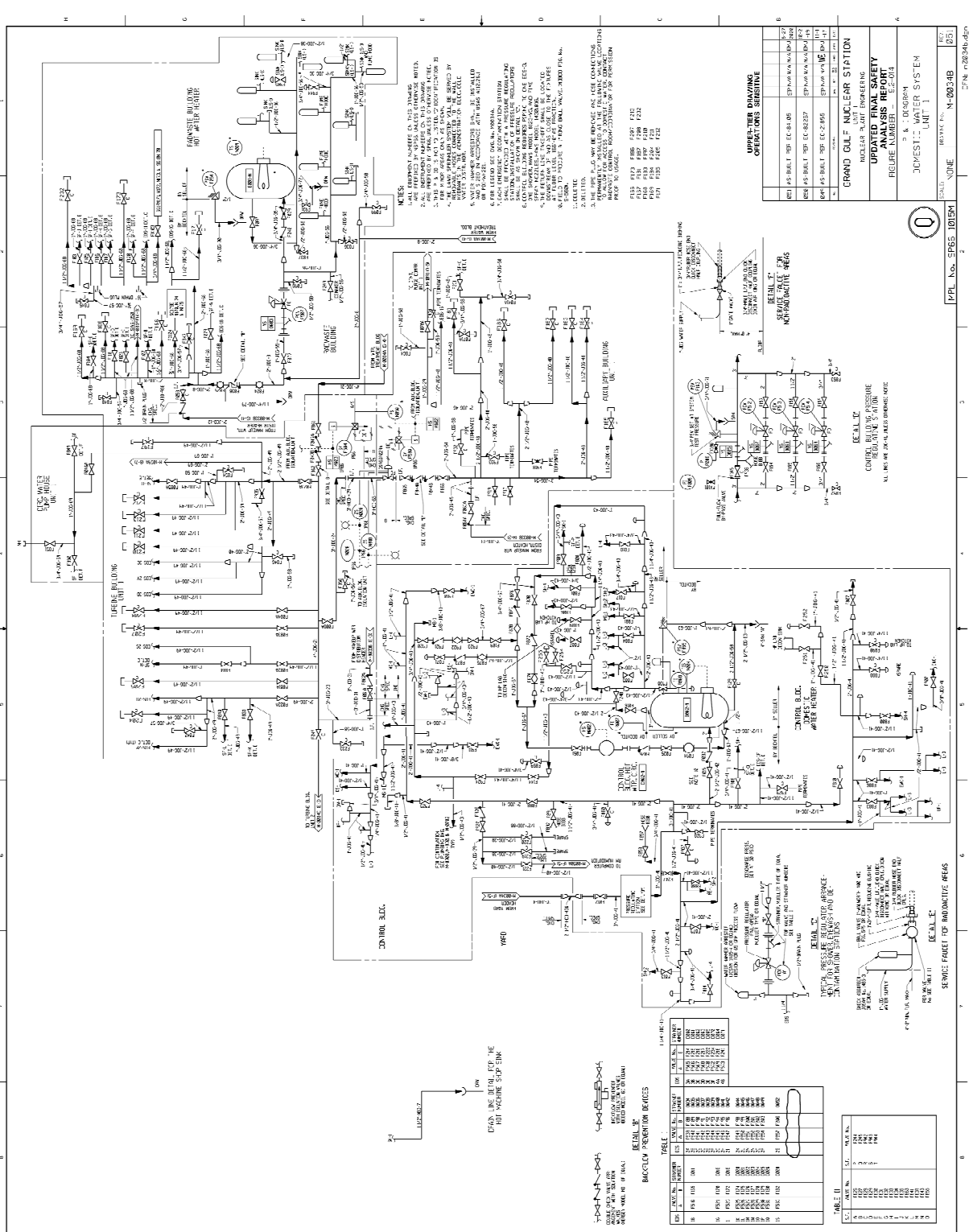

GRAND GULF NUCLEAR GENERATING STATION

Updated Final Safety Analysis Report (UFSAR)

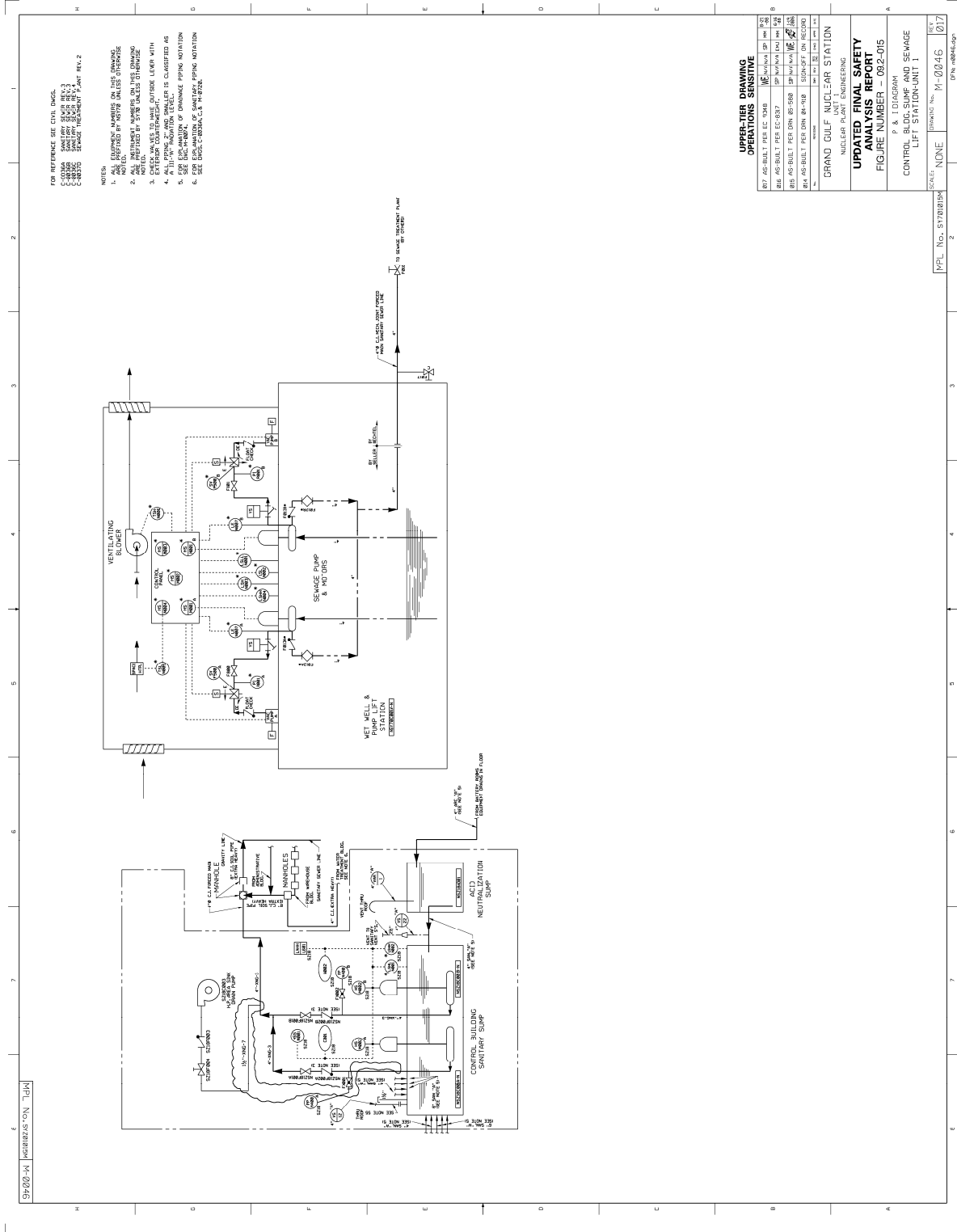

GRAND GULF NUCLEAR GENERATING STATION

Updated Final Safety Analysis Report (UFSAR)

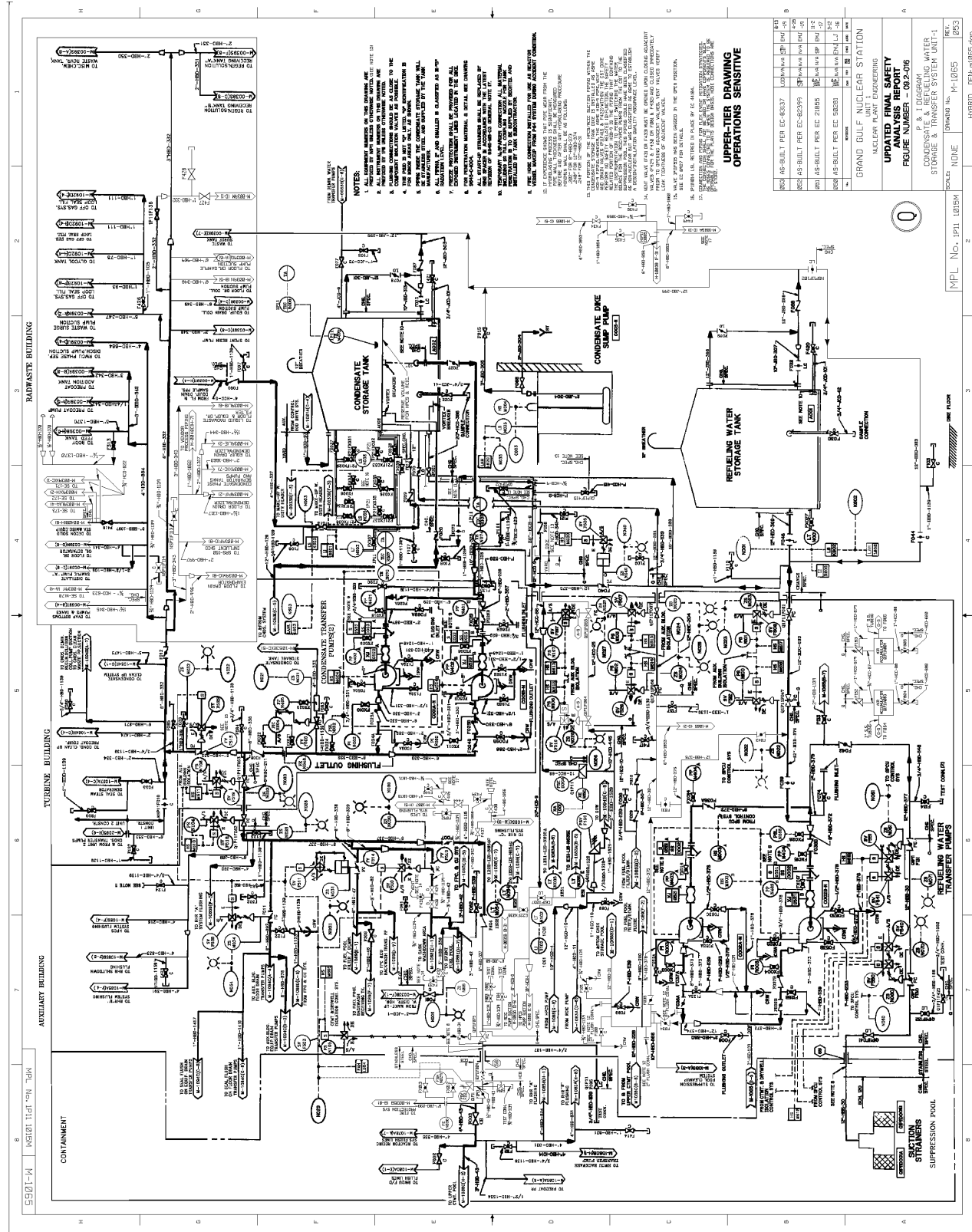

GRAND GULF NUCLEAR GENERATING STATION

Updated Final Safety Analysis Report (UFSAR)

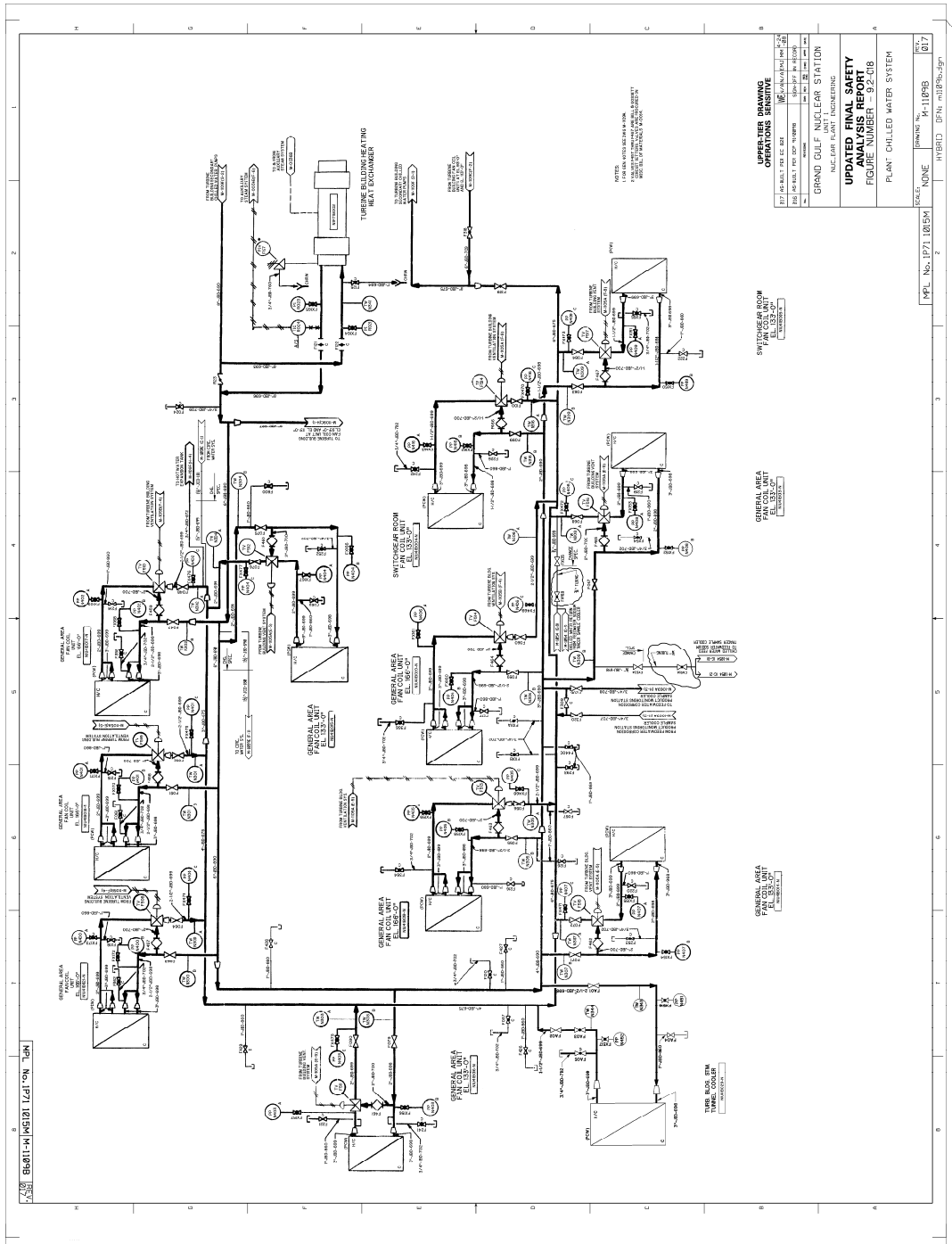

GRAND GULF NUCLEAR GENERATING STATION

Updated Final Safety Analysis Report (UFSAR)

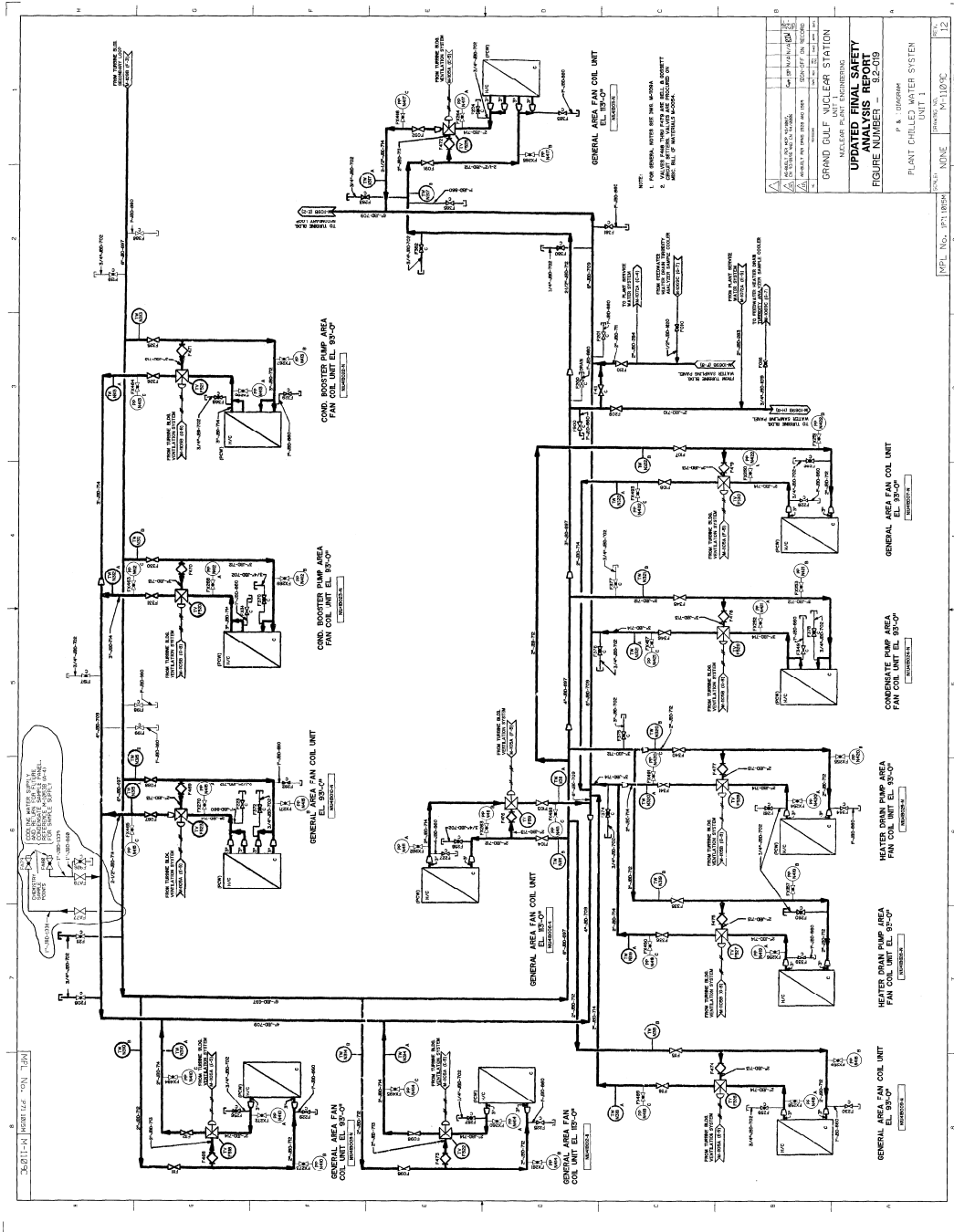

GRAND GULF NUCLEAR GENERATING STATION

Updated Final Safety Analysis Report (UFSAR)

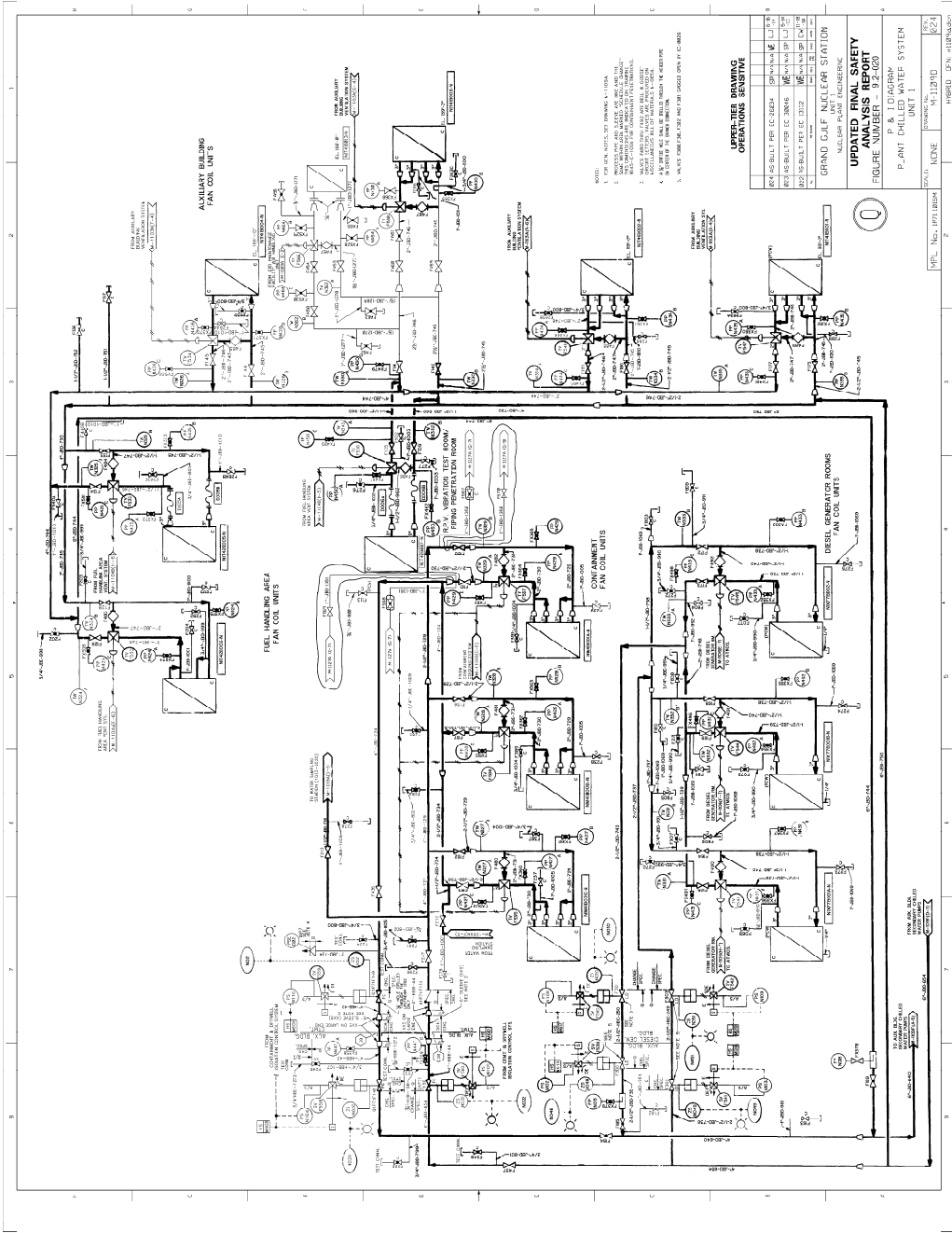

GRAND GULF NUCLEAR GENERATING STATION

Updated Final Safety Analysis Report (UFSAR)

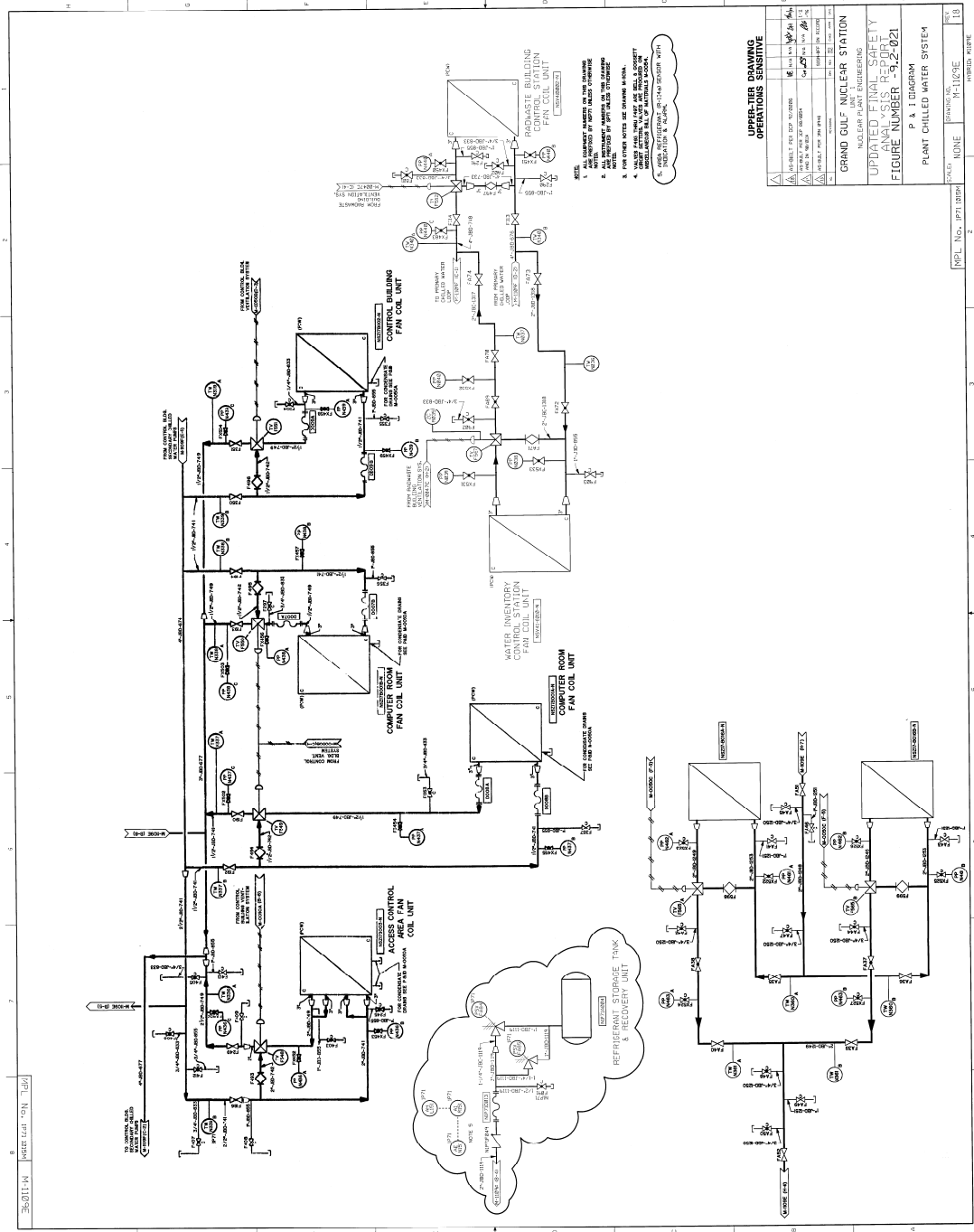

- NOTE:**
1. ALL INSTRUMENTS ARE TO BE INSTALLED IN ACCORDANCE WITH THE INSTRUMENTATION SPECIFICATIONS.
 2. ALL INSTRUMENTS ARE TO BE INSTALLED IN ACCORDANCE WITH THE INSTRUMENTATION SPECIFICATIONS.
 3. ALL INSTRUMENTS ARE TO BE INSTALLED IN ACCORDANCE WITH THE INSTRUMENTATION SPECIFICATIONS.
 4. ALL INSTRUMENTS ARE TO BE INSTALLED IN ACCORDANCE WITH THE INSTRUMENTATION SPECIFICATIONS.
 5. ALL INSTRUMENTS ARE TO BE INSTALLED IN ACCORDANCE WITH THE INSTRUMENTATION SPECIFICATIONS.
 6. ALL INSTRUMENTS ARE TO BE INSTALLED IN ACCORDANCE WITH THE INSTRUMENTATION SPECIFICATIONS.
 7. ALL INSTRUMENTS ARE TO BE INSTALLED IN ACCORDANCE WITH THE INSTRUMENTATION SPECIFICATIONS.
 8. ALL INSTRUMENTS ARE TO BE INSTALLED IN ACCORDANCE WITH THE INSTRUMENTATION SPECIFICATIONS.
 9. ALL INSTRUMENTS ARE TO BE INSTALLED IN ACCORDANCE WITH THE INSTRUMENTATION SPECIFICATIONS.
 10. ALL INSTRUMENTS ARE TO BE INSTALLED IN ACCORDANCE WITH THE INSTRUMENTATION SPECIFICATIONS.

OPERATIONS DRAWING	
NO.	DESCRIPTION
1	REVISION
2	REVISION
3	REVISION
4	REVISION
5	REVISION
6	REVISION
7	REVISION
8	REVISION
9	REVISION
10	REVISION

GRAND GULF NUCLEAR STATION
NUCLEAR PLANT ENGINEERING
UPDATED FINAL SAFETY ANALYSIS REPORT
FIGURE NUMBER - 9.2-122
P & I DIAGRAM
PLANT CHILLED WATER SYSTEM

GRAND GULF NUCLEAR GENERATING STATION

Updated Final Safety Analysis Report (UFSAR)

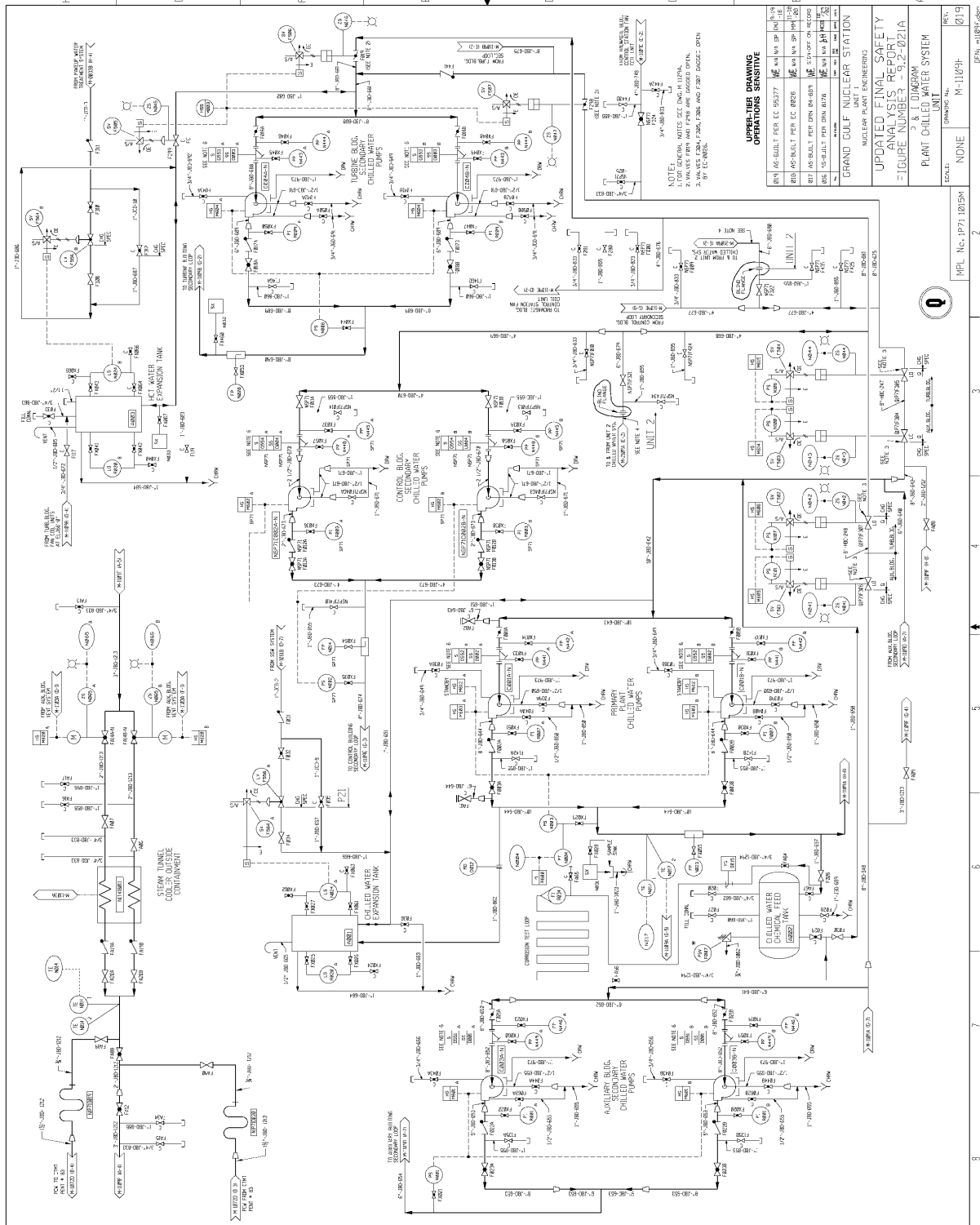

GRAND GULF NUCLEAR GENERATING STATION

Updated Final Safety Analysis Report (UFSAR)

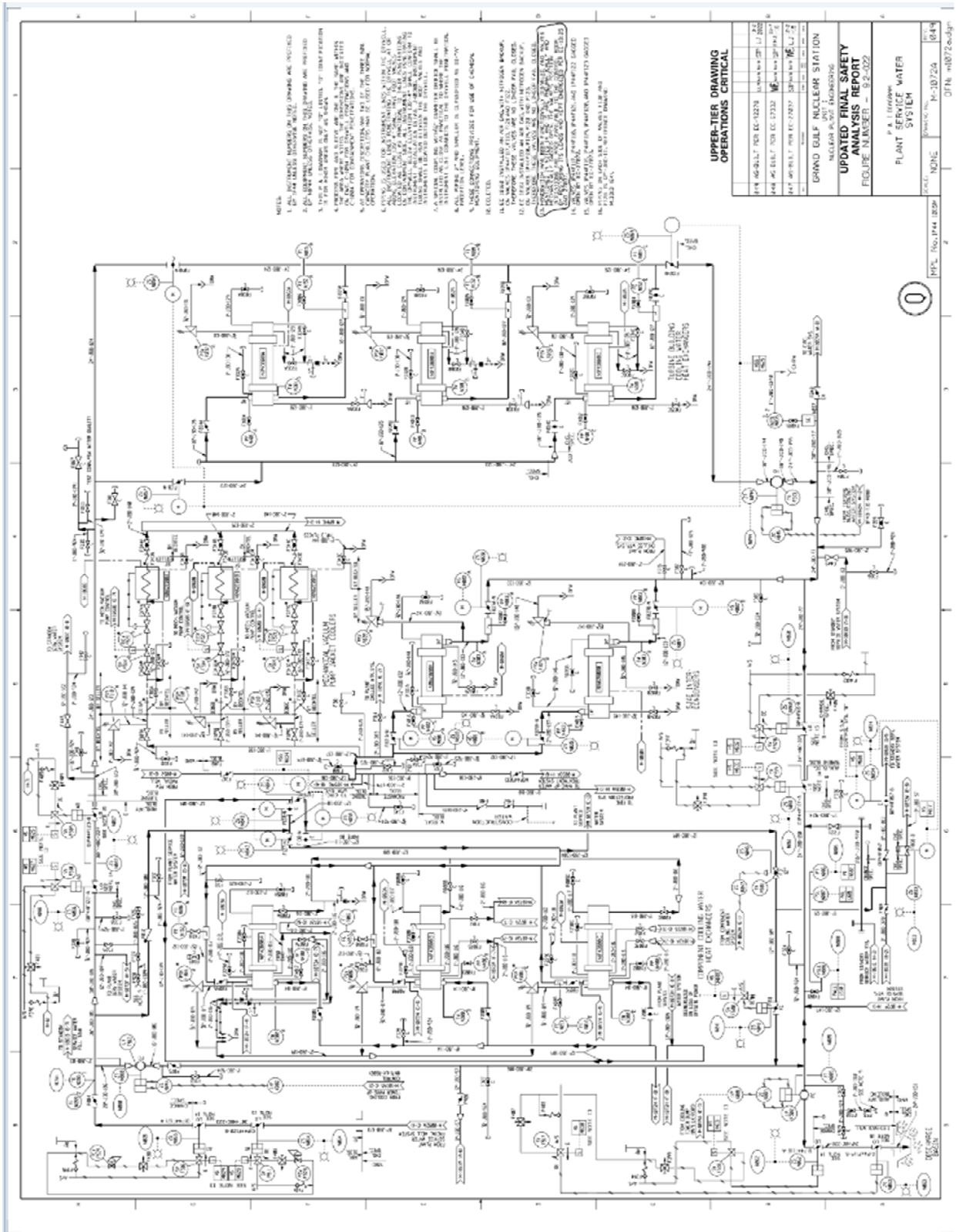

GRAND GULF NUCLEAR GENERATING STATION

Updated Final Safety Analysis Report (UFSAR)

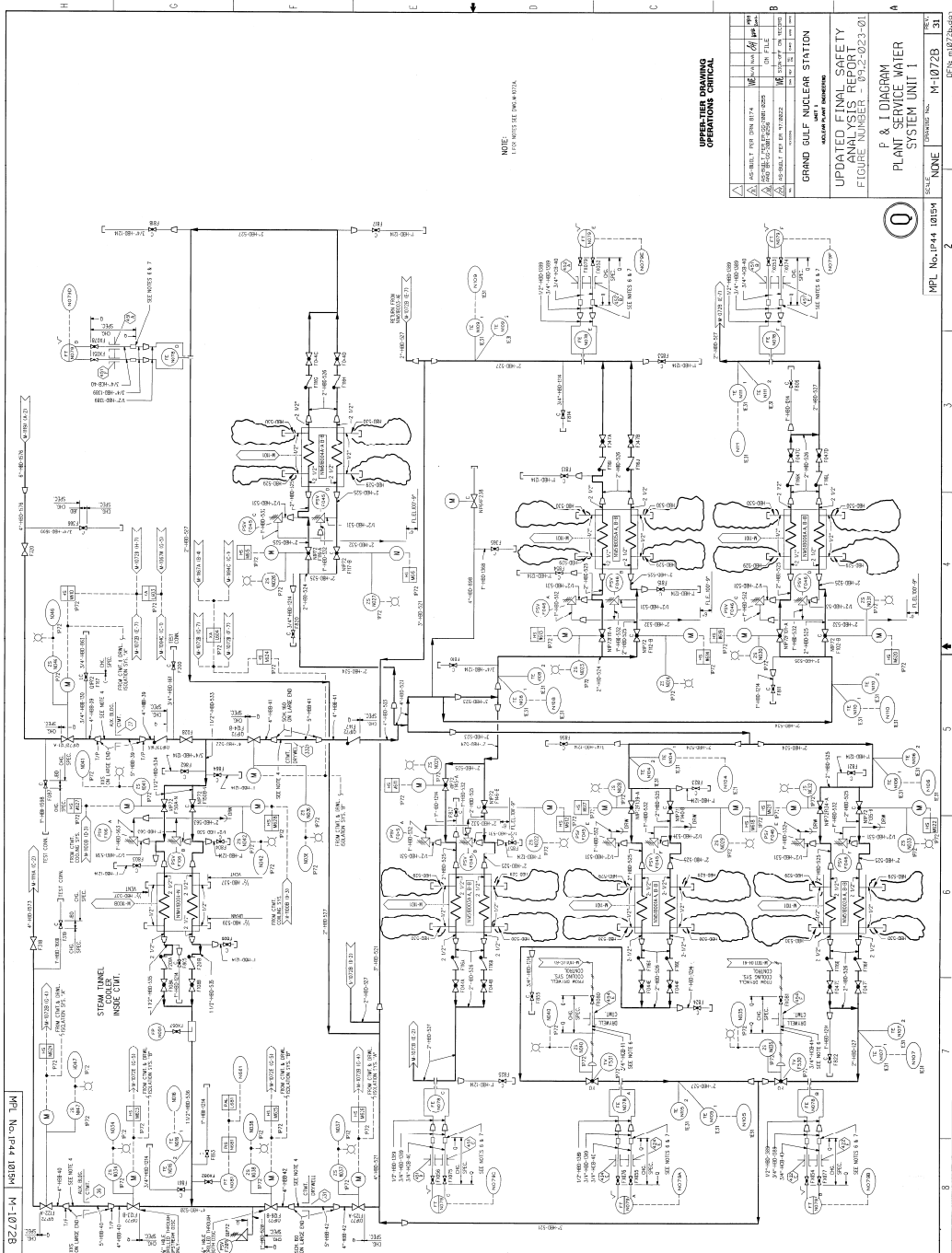

NOTE:
1 FOR NOTES SEE DRAWING

OPERATIONS & MAINTENANCE
OPERATIONS CRITICAL

APPROVED FOR CONSTRUCTION	DATE	BY
APPROVED FOR OPERATION	DATE	BY
APPROVED FOR MAINTENANCE	DATE	BY
APPROVED FOR TESTING	DATE	BY
APPROVED FOR COMMISSIONING	DATE	BY

GRAND GULF NUCLEAR STATION
SCALE: NONE
PROJECT NO.: M-10728
REV. 31

0

MPL No. P44 1035M

GRAND GULF NUCLEAR GENERATING STATION

Updated Final Safety Analysis Report (UFSAR)

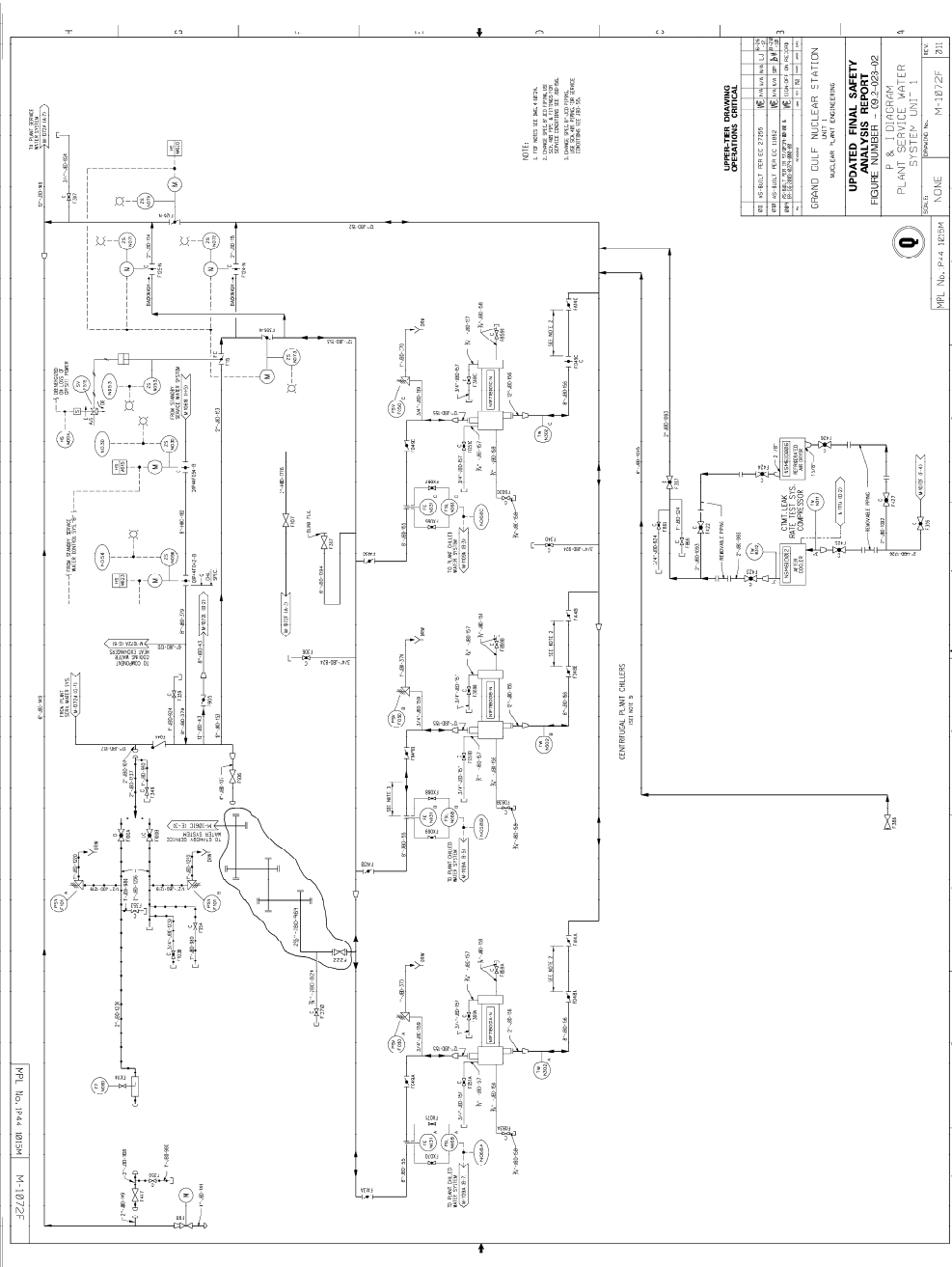

GRAND GULF NUCLEAR GENERATING STATION

Updated Final Safety Analysis Report (UFSAR)

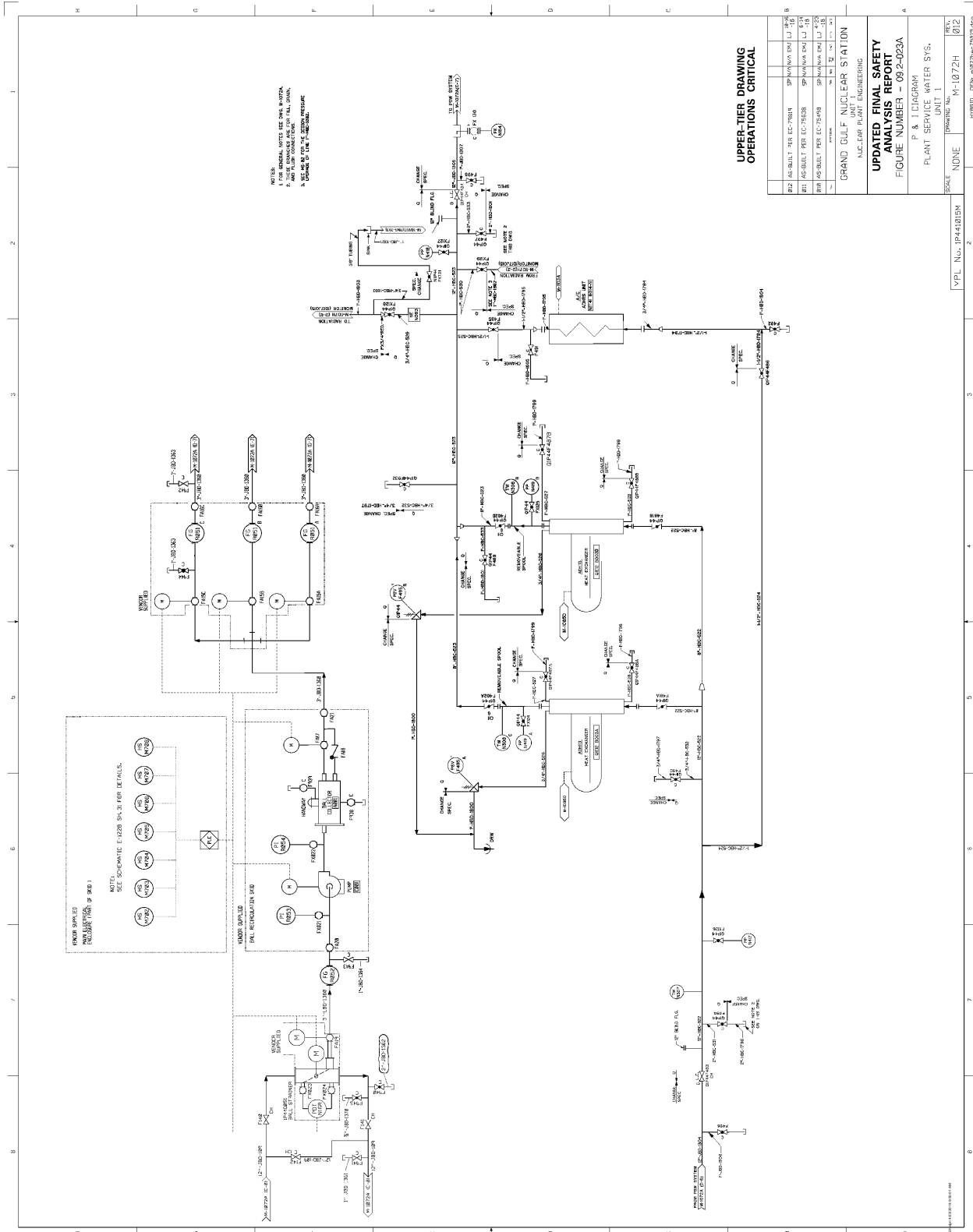

GRAND GULF NUCLEAR GENERATING STATION

Updated Final Safety Analysis Report (UFSAR)

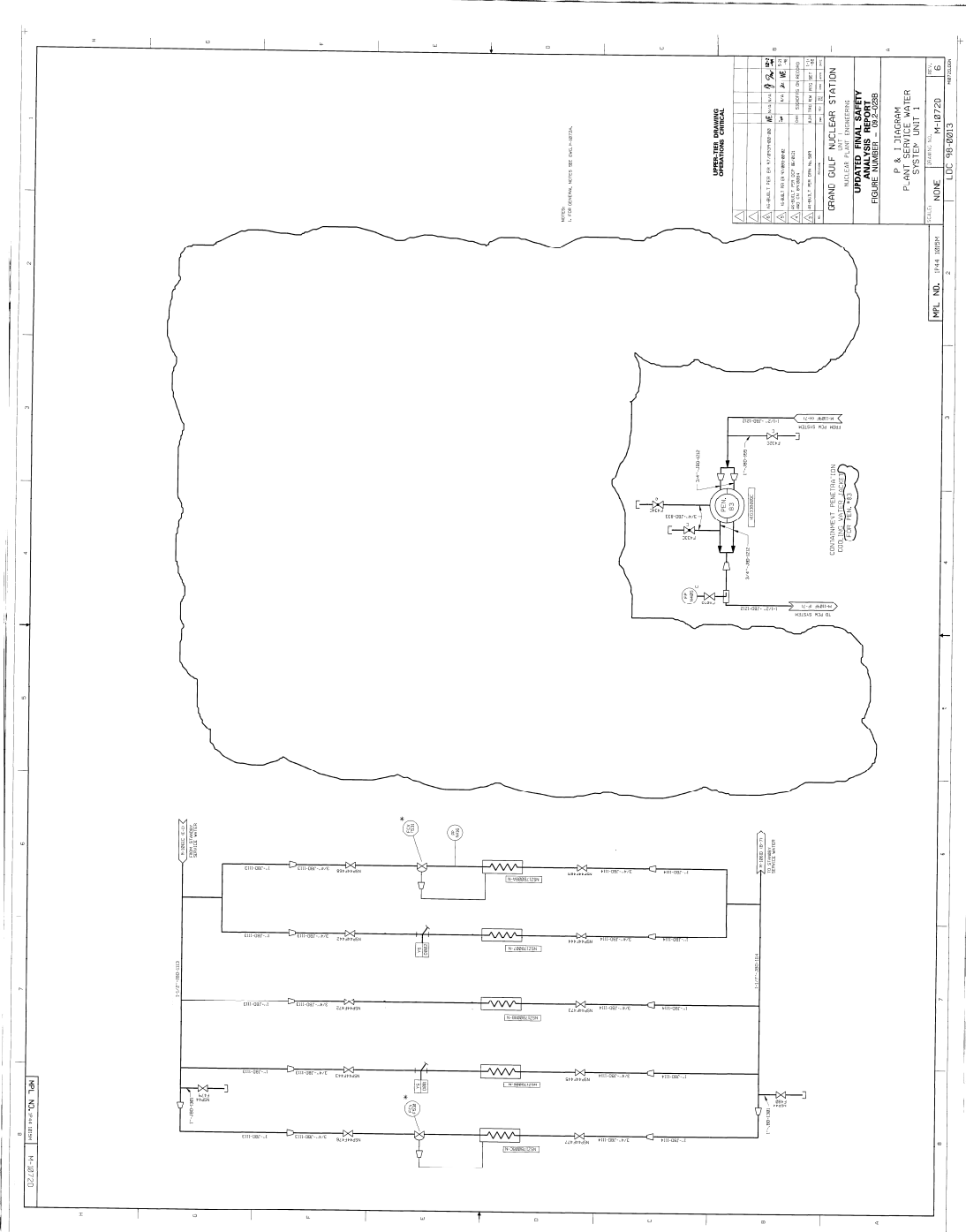

GRAND GULF NUCLEAR GENERATING STATION

Updated Final Safety Analysis Report (UFSAR)

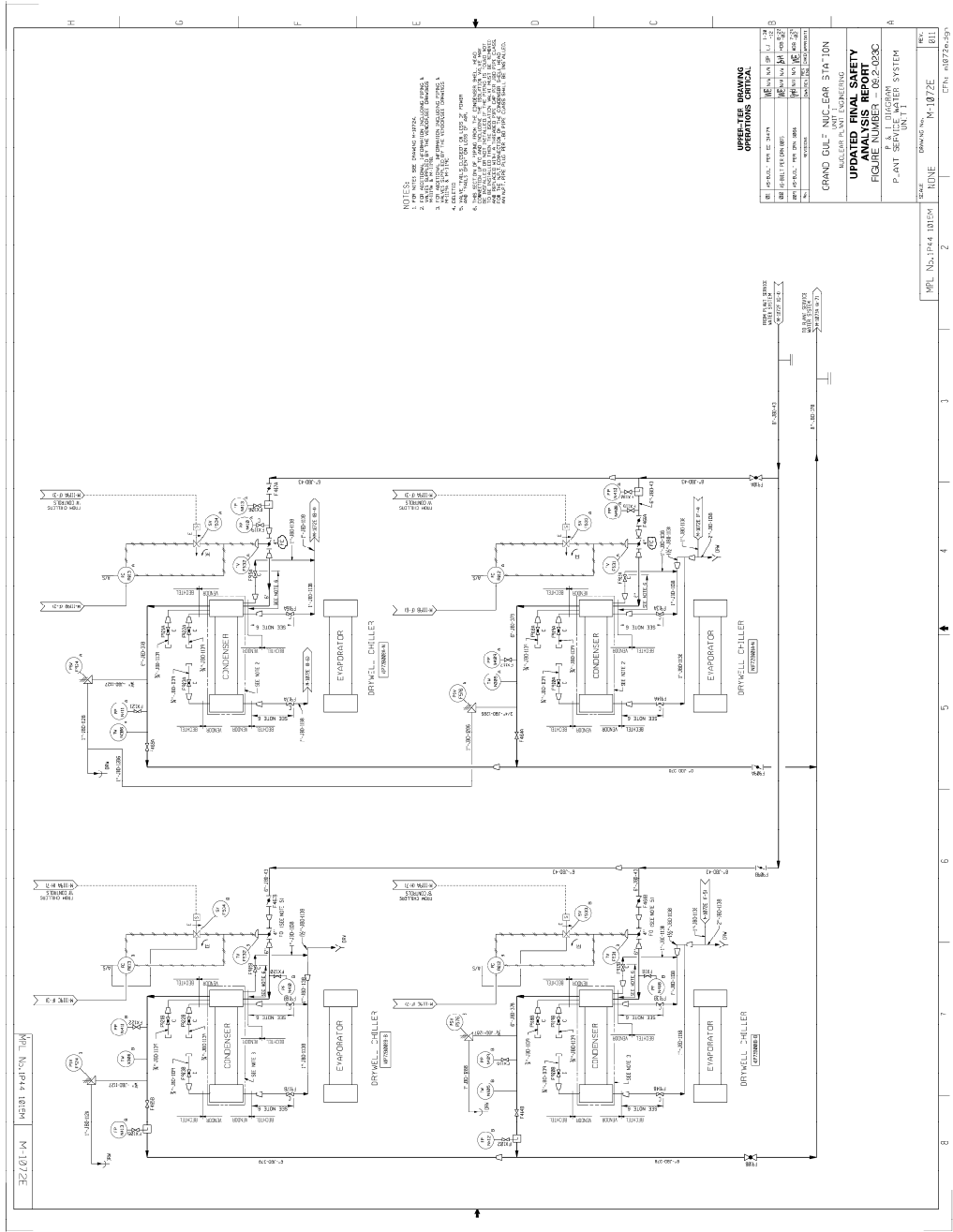

GRAND GULF NUCLEAR GENERATING STATION Updated Final Safety Analysis Report (UFSAR)

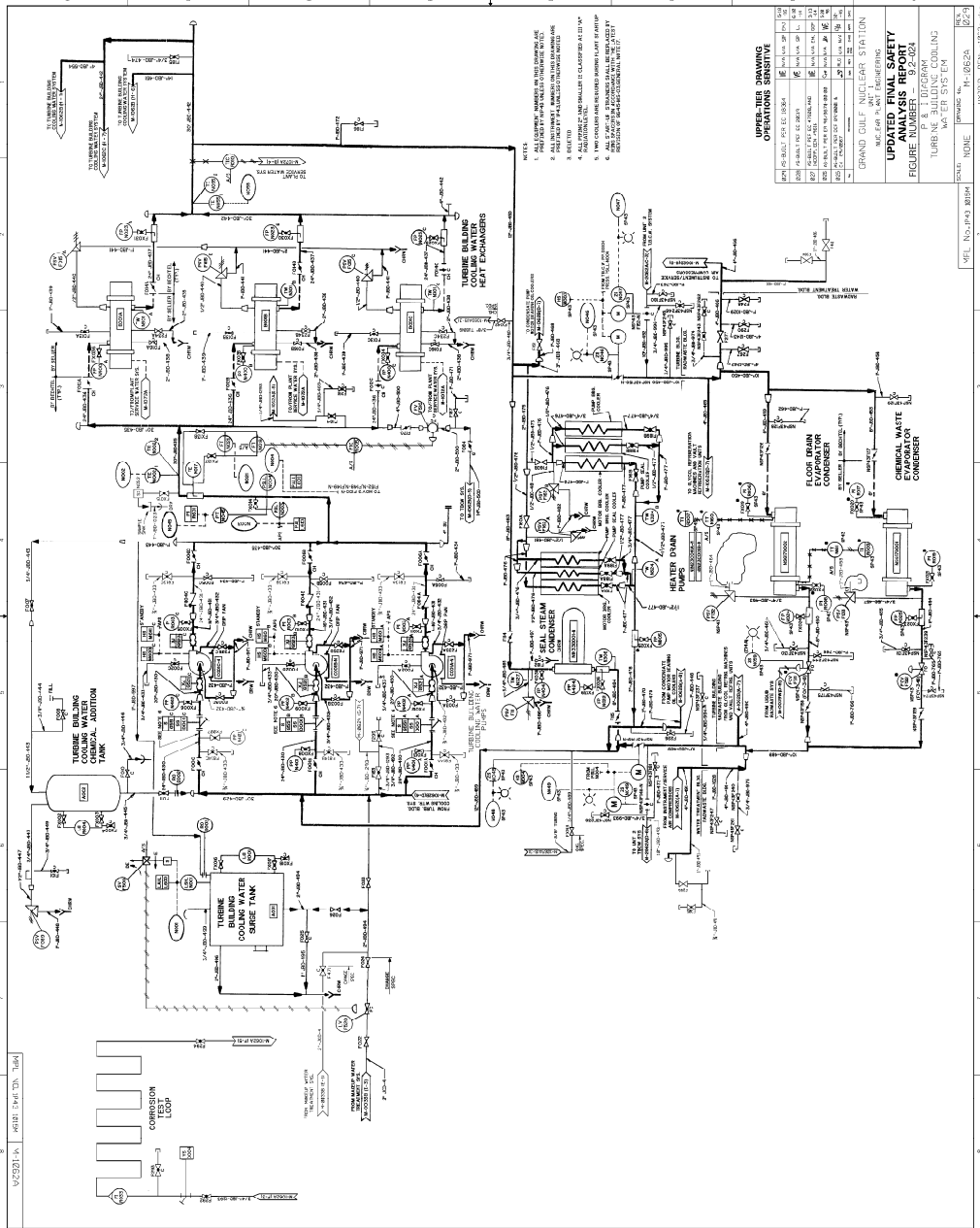

V2321-1A
REVISED: 11/17/78
TURBINE BUILDING

- NOTES:
1. ALL DIMENSIONS ARE IN FEET UNLESS OTHERWISE SPECIFIED.
 2. DIMENSIONS IN PARENTHESIS ARE IN INCHES UNLESS OTHERWISE SPECIFIED.
 3. ALL DIMENSIONS ARE TO CENTER UNLESS OTHERWISE SPECIFIED.
 4. ALL DIMENSIONS ARE TO FACE UNLESS OTHERWISE SPECIFIED.
 5. ALL DIMENSIONS ARE TO CENTER UNLESS OTHERWISE SPECIFIED.
 6. ALL DIMENSIONS ARE TO FACE UNLESS OTHERWISE SPECIFIED.

OPERATING DRAWING
TURBINE BUILDING COOLING

NO.	DESCRIPTION	DATE	BY	CHKD.
1	ISSUED FOR CONSTRUCTION	11/17/78
2
3
4
5
6
7
8
9
10

UPDATED FINAL SAFETY ANALYSIS REPORT
FIGURE NUMBER: 9.2-130
TURBINE BUILDING COOLING

DATE: 11/17/78	BY: ...
REVISED: 11/17/78	BY: ...
DATE: 11/17/78	BY: ...
DATE: 11/17/78	BY: ...
DATE: 11/17/78	BY: ...
DATE: 11/17/78	BY: ...
DATE: 11/17/78	BY: ...
DATE: 11/17/78	BY: ...
DATE: 11/17/78	BY: ...
DATE: 11/17/78	BY: ...

GRAND GULF NUCLEAR GENERATING STATION
Updated Final Safety Analysis Report (UFSAR)

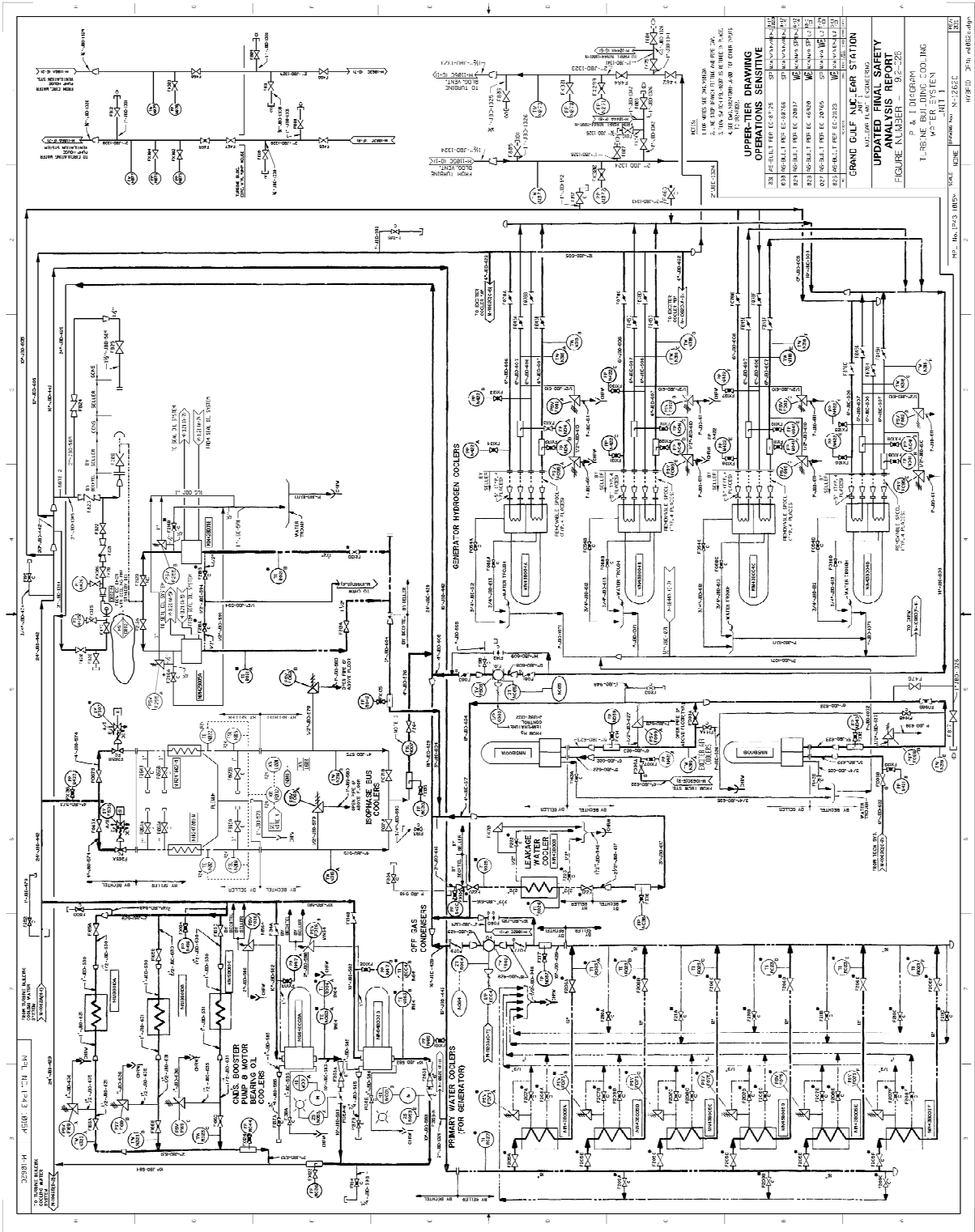

GRAND GULF NUCLEAR GENERATING STATION

Updated Final Safety Analysis Report (UFSAR)

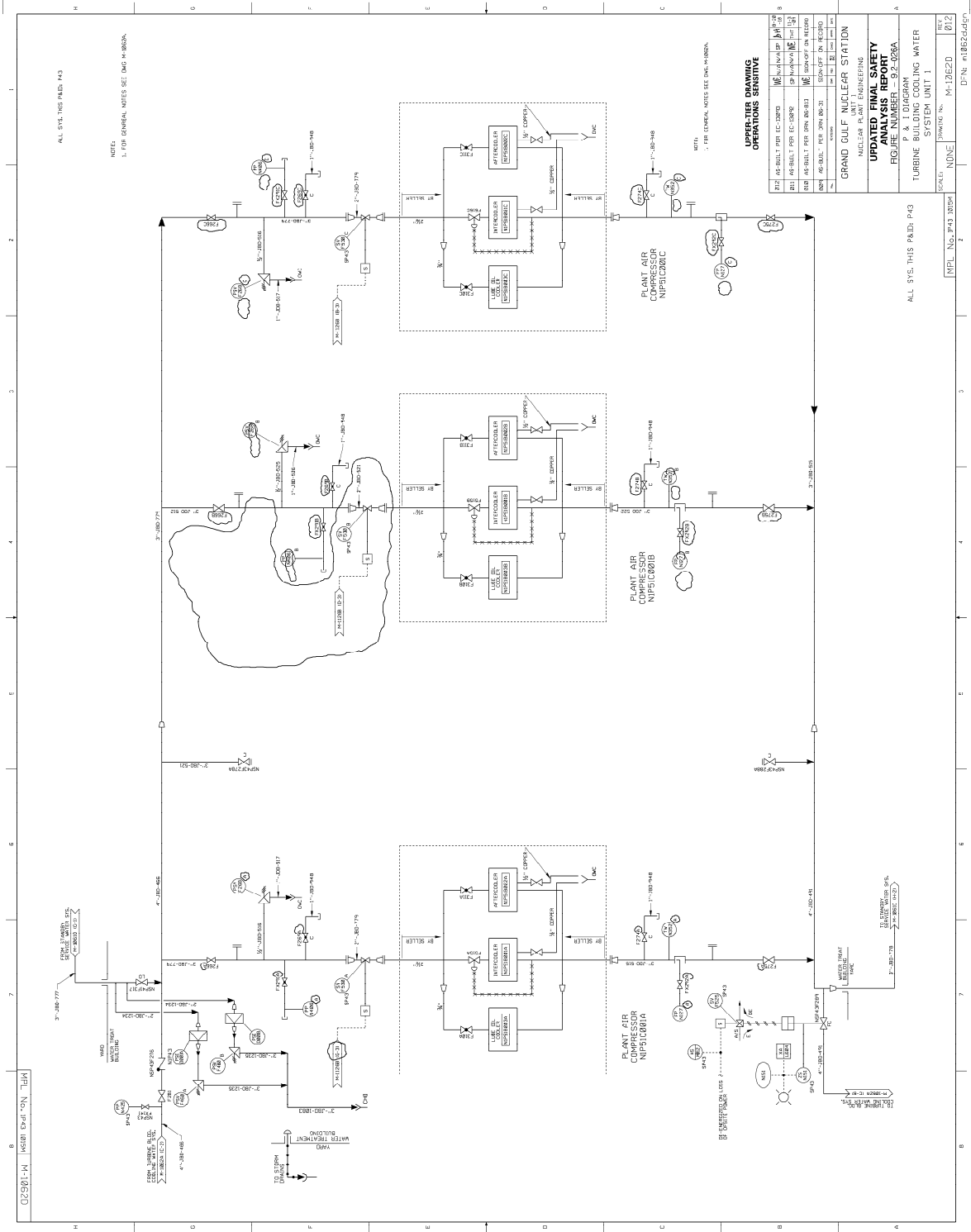

GRAND GULF NUCLEAR GENERATING STATION
Updated Final Safety Analysis Report (UFSAR)

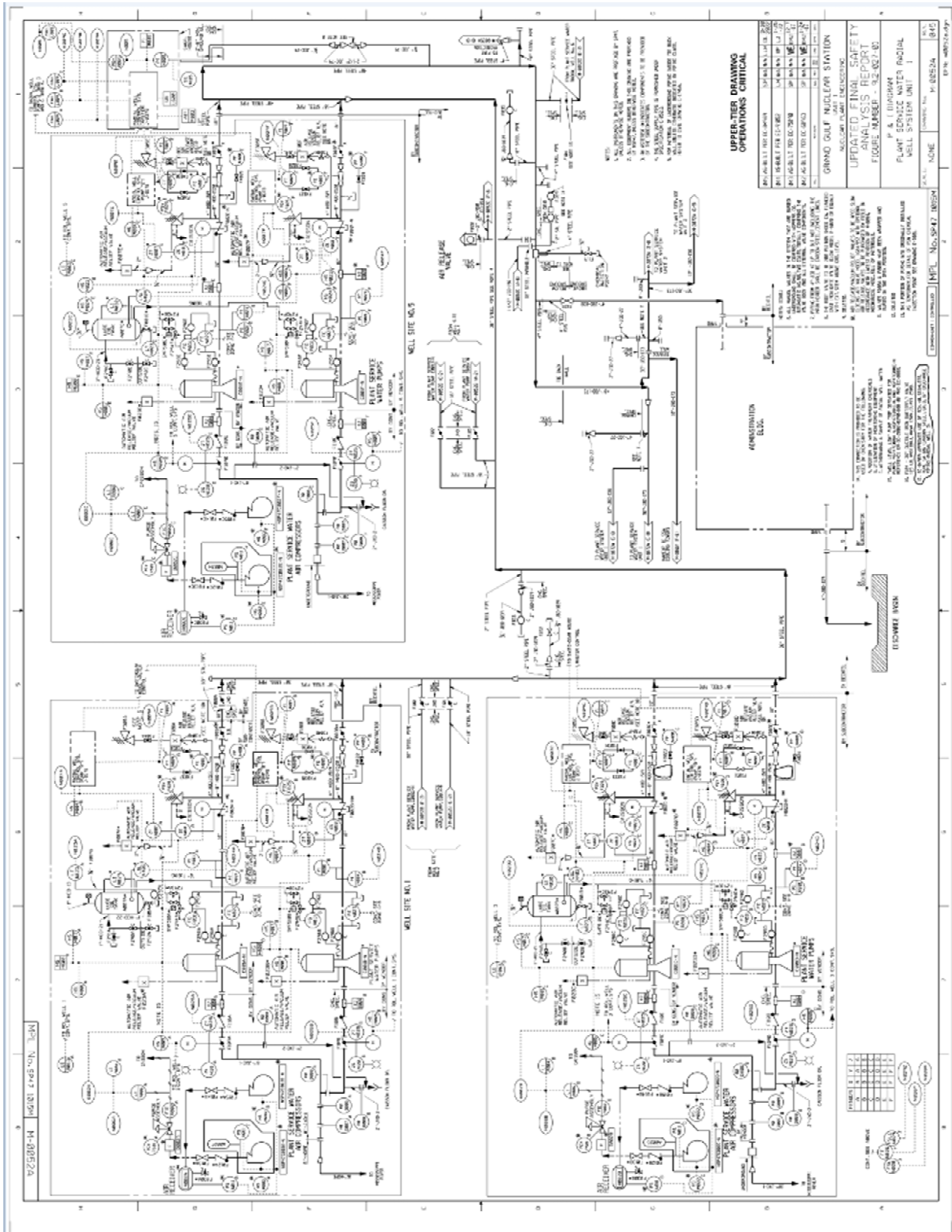

GRAND GULF NUCLEAR GENERATING STATION
 Updated Final Safety Analysis Report (UFSAR)

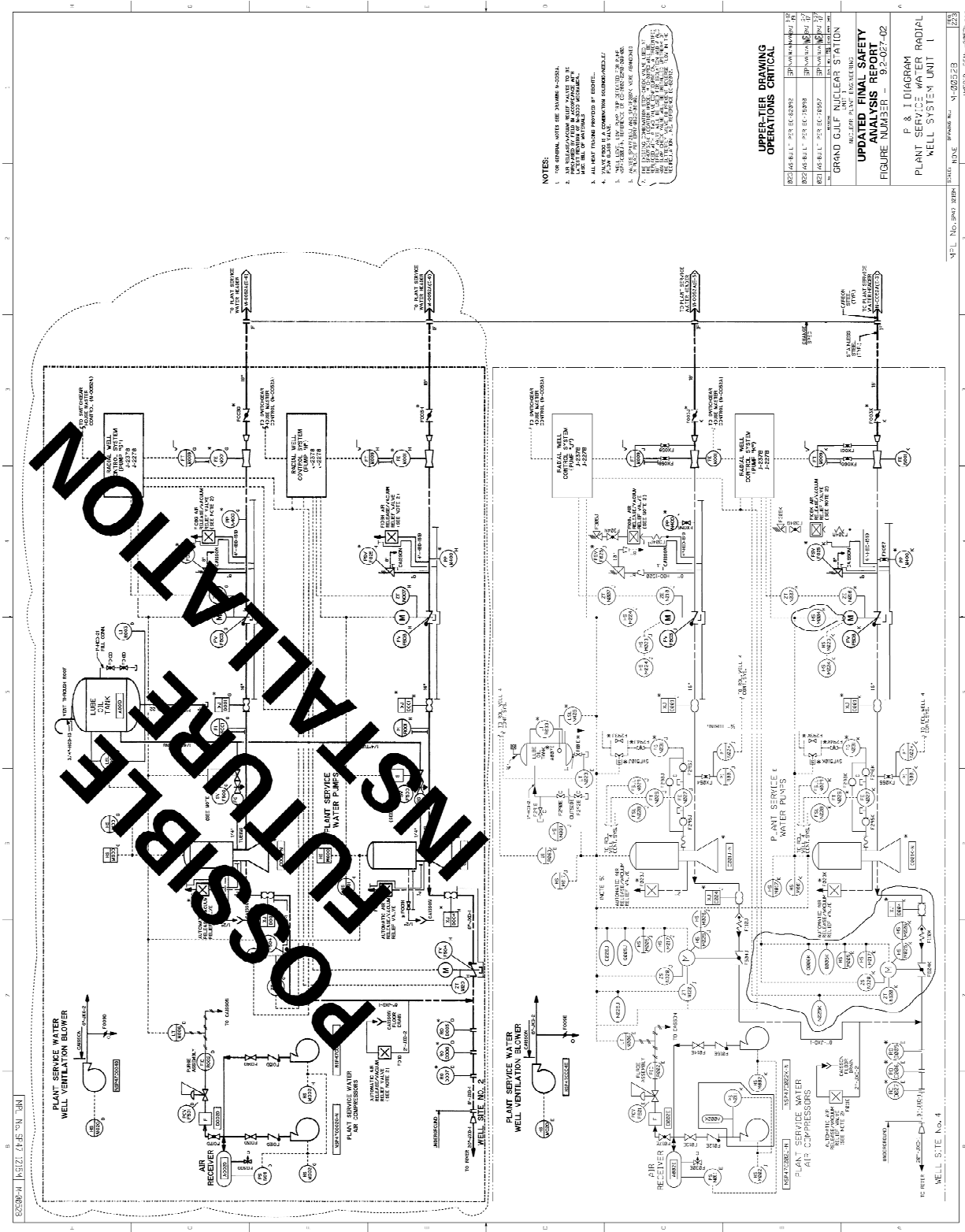

NOTES:

1. OPERATIONAL WITH THE PLANT NORMAL.
2. ALL RELAYS/VALVES MUST HAVE TO BE OPERATIONAL FOR THIS SYSTEM TO FUNCTION.
3. ALL PUMP STARTS PROVIDED BY SCADA.
4. PLANT FOOD IS A CONTINUING MAINTENANCE ITEM.
5. ALL PUMP STARTS ARE TO BE PROVIDED BY SCADA.
6. ALL PUMP STARTS ARE TO BE PROVIDED BY SCADA.
7. ALL PUMP STARTS ARE TO BE PROVIDED BY SCADA.
8. ALL PUMP STARTS ARE TO BE PROVIDED BY SCADA.

OPERATIONS DRAWING
OPERATIONS CRITICAL

DESIGN BUILT PER EC-20893 SHEET NO. 1/1

DESIGN BUILT PER EC-20893 SHEET NO. 2/1

DESIGN BUILT PER EC-20893 SHEET NO. 3/1

DESIGN BUILT PER EC-20893 SHEET NO. 4/1

DESIGN BUILT PER EC-20893 SHEET NO. 5/1

DESIGN BUILT PER EC-20893 SHEET NO. 6/1

DESIGN BUILT PER EC-20893 SHEET NO. 7/1

DESIGN BUILT PER EC-20893 SHEET NO. 8/1

DESIGN BUILT PER EC-20893 SHEET NO. 9/1

DESIGN BUILT PER EC-20893 SHEET NO. 10/1

DESIGN BUILT PER EC-20893 SHEET NO. 11/1

DESIGN BUILT PER EC-20893 SHEET NO. 12/1

DESIGN BUILT PER EC-20893 SHEET NO. 13/1

DESIGN BUILT PER EC-20893 SHEET NO. 14/1

DESIGN BUILT PER EC-20893 SHEET NO. 15/1

DESIGN BUILT PER EC-20893 SHEET NO. 16/1

DESIGN BUILT PER EC-20893 SHEET NO. 17/1

DESIGN BUILT PER EC-20893 SHEET NO. 18/1

DESIGN BUILT PER EC-20893 SHEET NO. 19/1

DESIGN BUILT PER EC-20893 SHEET NO. 20/1

DESIGN BUILT PER EC-20893 SHEET NO. 21/1

DESIGN BUILT PER EC-20893 SHEET NO. 22/1

DESIGN BUILT PER EC-20893 SHEET NO. 23/1

DESIGN BUILT PER EC-20893 SHEET NO. 24/1

DESIGN BUILT PER EC-20893 SHEET NO. 25/1

DESIGN BUILT PER EC-20893 SHEET NO. 26/1

DESIGN BUILT PER EC-20893 SHEET NO. 27/1

DESIGN BUILT PER EC-20893 SHEET NO. 28/1

DESIGN BUILT PER EC-20893 SHEET NO. 29/1

DESIGN BUILT PER EC-20893 SHEET NO. 30/1

DESIGN BUILT PER EC-20893 SHEET NO. 31/1

DESIGN BUILT PER EC-20893 SHEET NO. 32/1

DESIGN BUILT PER EC-20893 SHEET NO. 33/1

DESIGN BUILT PER EC-20893 SHEET NO. 34/1

DESIGN BUILT PER EC-20893 SHEET NO. 35/1

DESIGN BUILT PER EC-20893 SHEET NO. 36/1

DESIGN BUILT PER EC-20893 SHEET NO. 37/1

DESIGN BUILT PER EC-20893 SHEET NO. 38/1

DESIGN BUILT PER EC-20893 SHEET NO. 39/1

DESIGN BUILT PER EC-20893 SHEET NO. 40/1

DESIGN BUILT PER EC-20893 SHEET NO. 41/1

DESIGN BUILT PER EC-20893 SHEET NO. 42/1

DESIGN BUILT PER EC-20893 SHEET NO. 43/1

DESIGN BUILT PER EC-20893 SHEET NO. 44/1

DESIGN BUILT PER EC-20893 SHEET NO. 45/1

DESIGN BUILT PER EC-20893 SHEET NO. 46/1

DESIGN BUILT PER EC-20893 SHEET NO. 47/1

DESIGN BUILT PER EC-20893 SHEET NO. 48/1

DESIGN BUILT PER EC-20893 SHEET NO. 49/1

DESIGN BUILT PER EC-20893 SHEET NO. 50/1

DESIGN BUILT PER EC-20893 SHEET NO. 51/1

DESIGN BUILT PER EC-20893 SHEET NO. 52/1

DESIGN BUILT PER EC-20893 SHEET NO. 53/1

DESIGN BUILT PER EC-20893 SHEET NO. 54/1

DESIGN BUILT PER EC-20893 SHEET NO. 55/1

DESIGN BUILT PER EC-20893 SHEET NO. 56/1

DESIGN BUILT PER EC-20893 SHEET NO. 57/1

DESIGN BUILT PER EC-20893 SHEET NO. 58/1

DESIGN BUILT PER EC-20893 SHEET NO. 59/1

DESIGN BUILT PER EC-20893 SHEET NO. 60/1

DESIGN BUILT PER EC-20893 SHEET NO. 61/1

DESIGN BUILT PER EC-20893 SHEET NO. 62/1

DESIGN BUILT PER EC-20893 SHEET NO. 63/1

DESIGN BUILT PER EC-20893 SHEET NO. 64/1

DESIGN BUILT PER EC-20893 SHEET NO. 65/1

DESIGN BUILT PER EC-20893 SHEET NO. 66/1

DESIGN BUILT PER EC-20893 SHEET NO. 67/1

DESIGN BUILT PER EC-20893 SHEET NO. 68/1

DESIGN BUILT PER EC-20893 SHEET NO. 69/1

DESIGN BUILT PER EC-20893 SHEET NO. 70/1

DESIGN BUILT PER EC-20893 SHEET NO. 71/1

DESIGN BUILT PER EC-20893 SHEET NO. 72/1

DESIGN BUILT PER EC-20893 SHEET NO. 73/1

DESIGN BUILT PER EC-20893 SHEET NO. 74/1

DESIGN BUILT PER EC-20893 SHEET NO. 75/1

DESIGN BUILT PER EC-20893 SHEET NO. 76/1

DESIGN BUILT PER EC-20893 SHEET NO. 77/1

DESIGN BUILT PER EC-20893 SHEET NO. 78/1

DESIGN BUILT PER EC-20893 SHEET NO. 79/1

DESIGN BUILT PER EC-20893 SHEET NO. 80/1

DESIGN BUILT PER EC-20893 SHEET NO. 81/1

DESIGN BUILT PER EC-20893 SHEET NO. 82/1

DESIGN BUILT PER EC-20893 SHEET NO. 83/1

DESIGN BUILT PER EC-20893 SHEET NO. 84/1

DESIGN BUILT PER EC-20893 SHEET NO. 85/1

DESIGN BUILT PER EC-20893 SHEET NO. 86/1

DESIGN BUILT PER EC-20893 SHEET NO. 87/1

DESIGN BUILT PER EC-20893 SHEET NO. 88/1

DESIGN BUILT PER EC-20893 SHEET NO. 89/1

DESIGN BUILT PER EC-20893 SHEET NO. 90/1

DESIGN BUILT PER EC-20893 SHEET NO. 91/1

DESIGN BUILT PER EC-20893 SHEET NO. 92/1

DESIGN BUILT PER EC-20893 SHEET NO. 93/1

DESIGN BUILT PER EC-20893 SHEET NO. 94/1

DESIGN BUILT PER EC-20893 SHEET NO. 95/1

DESIGN BUILT PER EC-20893 SHEET NO. 96/1

DESIGN BUILT PER EC-20893 SHEET NO. 97/1

DESIGN BUILT PER EC-20893 SHEET NO. 98/1

DESIGN BUILT PER EC-20893 SHEET NO. 99/1

DESIGN BUILT PER EC-20893 SHEET NO. 100/1

WELL SITE No. 4
 SHEET NO. 1/1
 SHEET NO. 2/1
 SHEET NO. 3/1
 SHEET NO. 4/1
 SHEET NO. 5/1
 SHEET NO. 6/1
 SHEET NO. 7/1
 SHEET NO. 8/1
 SHEET NO. 9/1
 SHEET NO. 10/1
 SHEET NO. 11/1
 SHEET NO. 12/1
 SHEET NO. 13/1
 SHEET NO. 14/1
 SHEET NO. 15/1
 SHEET NO. 16/1
 SHEET NO. 17/1
 SHEET NO. 18/1
 SHEET NO. 19/1
 SHEET NO. 20/1
 SHEET NO. 21/1
 SHEET NO. 22/1
 SHEET NO. 23/1
 SHEET NO. 24/1
 SHEET NO. 25/1
 SHEET NO. 26/1
 SHEET NO. 27/1
 SHEET NO. 28/1
 SHEET NO. 29/1
 SHEET NO. 30/1
 SHEET NO. 31/1
 SHEET NO. 32/1
 SHEET NO. 33/1
 SHEET NO. 34/1
 SHEET NO. 35/1
 SHEET NO. 36/1
 SHEET NO. 37/1
 SHEET NO. 38/1
 SHEET NO. 39/1
 SHEET NO. 40/1
 SHEET NO. 41/1
 SHEET NO. 42/1
 SHEET NO. 43/1
 SHEET NO. 44/1
 SHEET NO. 45/1
 SHEET NO. 46/1
 SHEET NO. 47/1
 SHEET NO. 48/1
 SHEET NO. 49/1
 SHEET NO. 50/1
 SHEET NO. 51/1
 SHEET NO. 52/1
 SHEET NO. 53/1
 SHEET NO. 54/1
 SHEET NO. 55/1
 SHEET NO. 56/1
 SHEET NO. 57/1
 SHEET NO. 58/1
 SHEET NO. 59/1
 SHEET NO. 60/1
 SHEET NO. 61/1
 SHEET NO. 62/1
 SHEET NO. 63/1
 SHEET NO. 64/1
 SHEET NO. 65/1
 SHEET NO. 66/1
 SHEET NO. 67/1
 SHEET NO. 68/1
 SHEET NO. 69/1
 SHEET NO. 70/1
 SHEET NO. 71/1
 SHEET NO. 72/1
 SHEET NO. 73/1
 SHEET NO. 74/1
 SHEET NO. 75/1
 SHEET NO. 76/1
 SHEET NO. 77/1
 SHEET NO. 78/1
 SHEET NO. 79/1
 SHEET NO. 80/1
 SHEET NO. 81/1
 SHEET NO. 82/1
 SHEET NO. 83/1
 SHEET NO. 84/1
 SHEET NO. 85/1
 SHEET NO. 86/1
 SHEET NO. 87/1
 SHEET NO. 88/1
 SHEET NO. 89/1
 SHEET NO. 90/1
 SHEET NO. 91/1
 SHEET NO. 92/1
 SHEET NO. 93/1
 SHEET NO. 94/1
 SHEET NO. 95/1
 SHEET NO. 96/1
 SHEET NO. 97/1
 SHEET NO. 98/1
 SHEET NO. 99/1
 SHEET NO. 100/1

GRAND GULF NUCLEAR GENERATING STATION

Updated Final Safety Analysis Report (UFSAR)

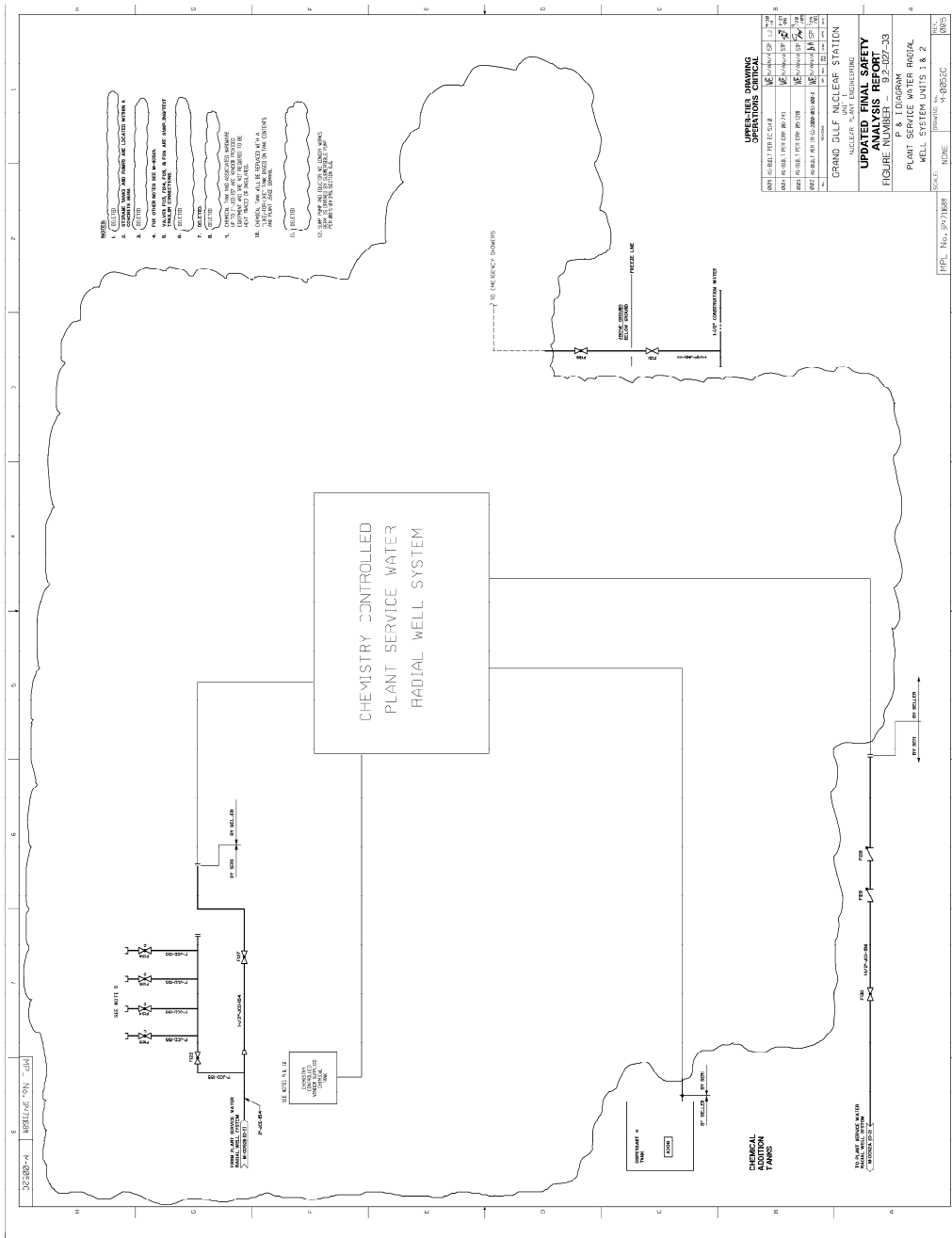

GRAND GULF NUCLEAR GENERATING STATION Updated Final Safety Analysis Report (UFSAR)

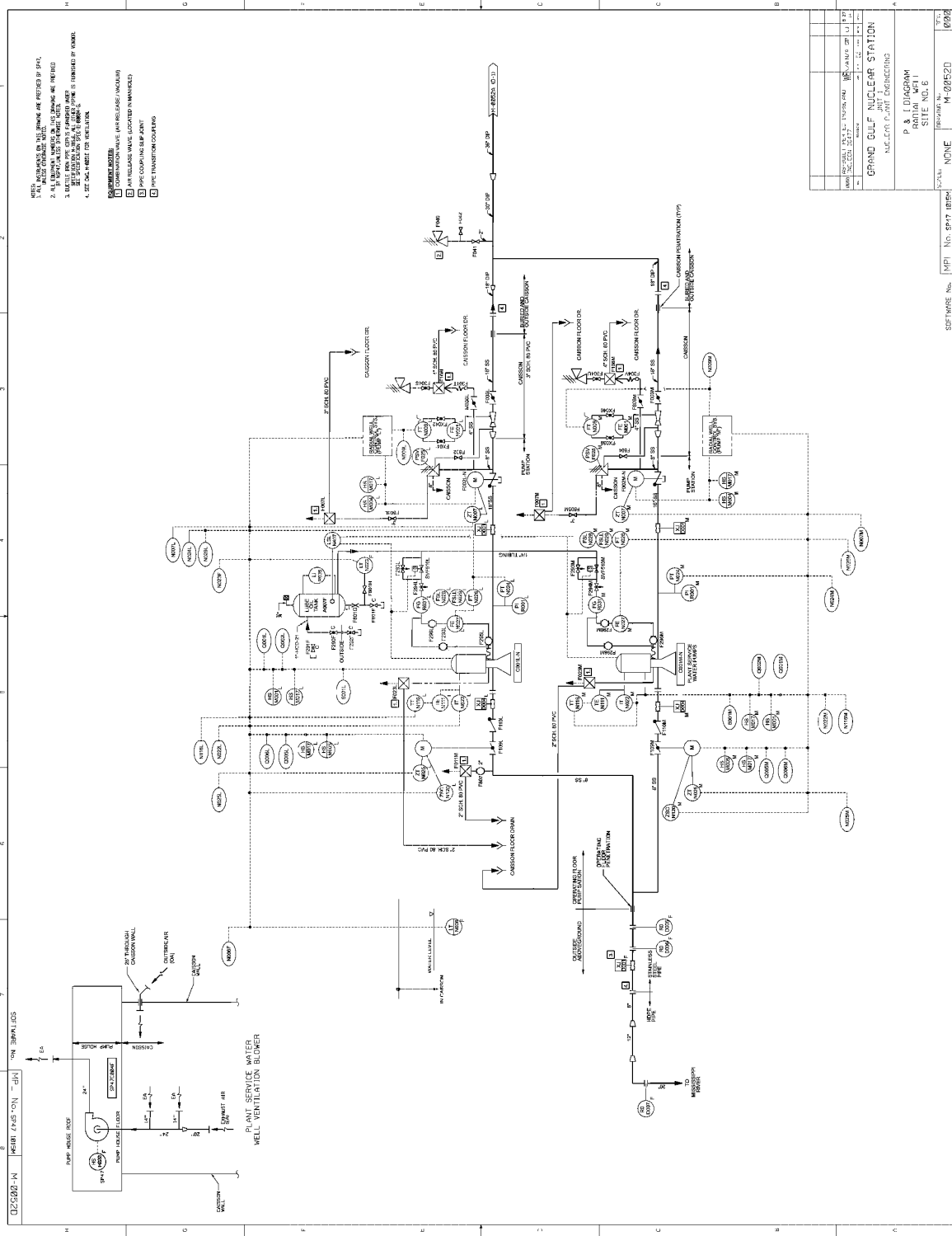

GRAND GULF NUCLEAR GENERATING STATION
Updated Final Safety Analysis Report (UFSAR)

Figures 9.2-28 through 9.2-34 Deleted

GRAND GULF NUCLEAR GENERATING STATION
 Updated Final Safety Analysis Report (UFSAR)

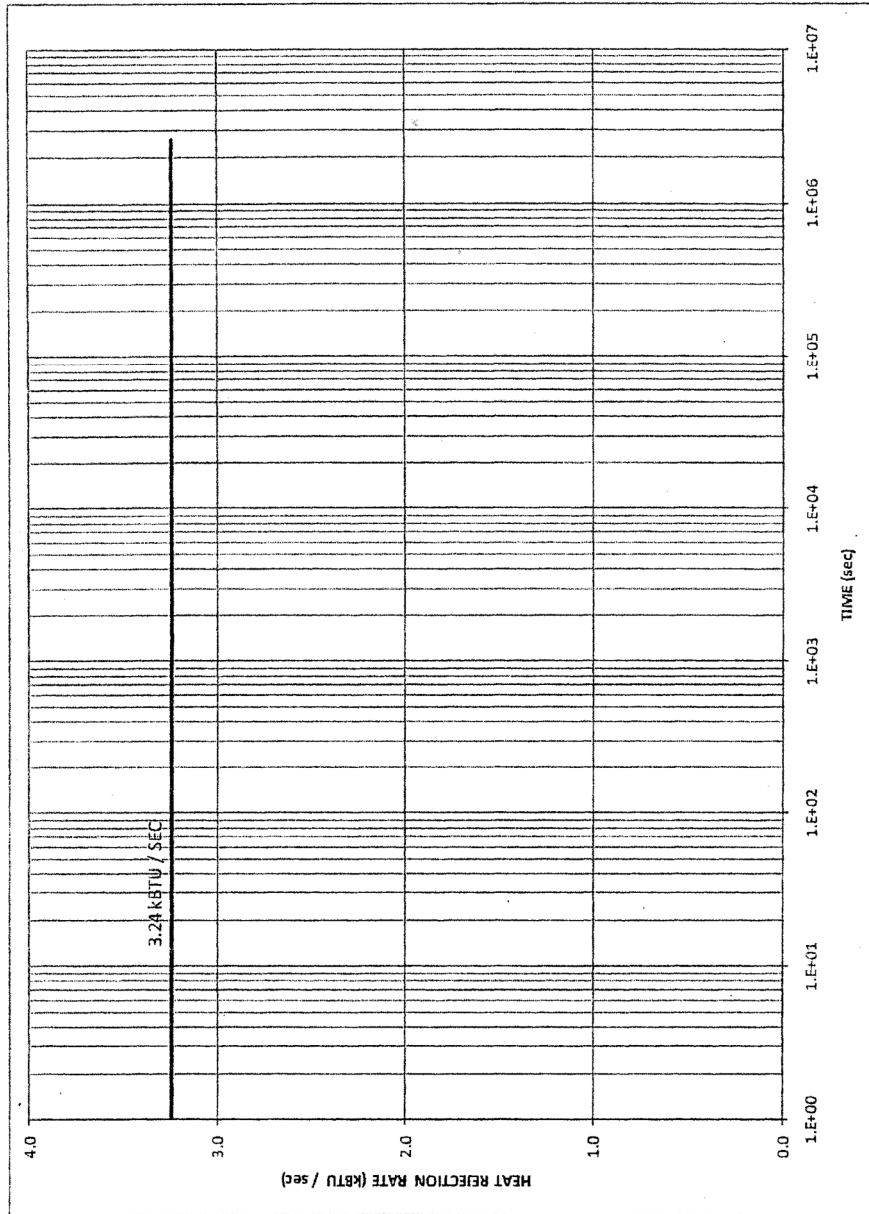

GRAND GULF NUCLEAR STATION
 UNIT 1
 UPDATED FINAL SAFETY ANALYSIS
 REPORT

HEAT REJECTION RATE FOR LOOP C
 TIME PERIOD - 0 TO 30 DAYS

FIGURE 9.2-35

FIGURE 9.2-36: Deleted

FIGURE 9.2-37: Deleted

GRAND GULF NUCLEAR GENERATING STATION
Updated Final Safety Analysis Report (UFSAR)

GG
UFSAR

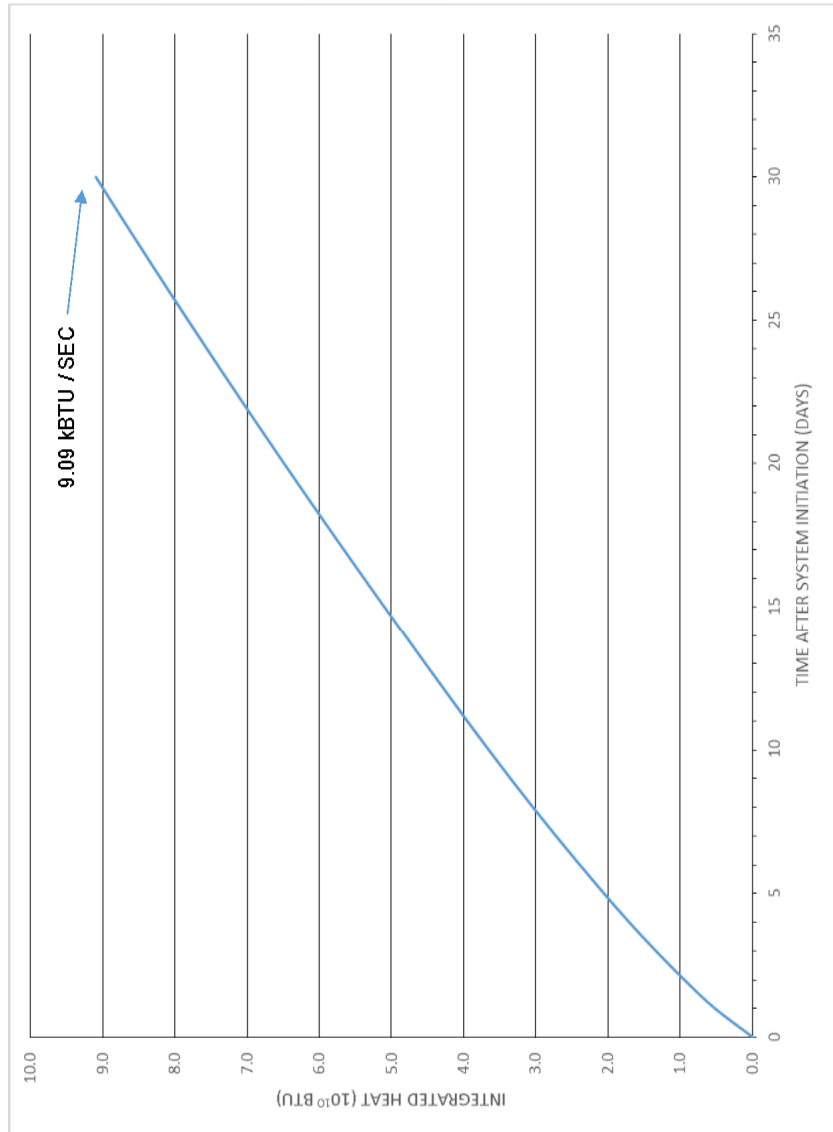

GRAND GULF NUCLEAR STATION UNIT 1 UPDATED FINAL SAFETY ANALYSIS REPORT	TOTAL INTEGRATED HEAT REJECTED BASIN A - LOOP A AND LOOP C TIME PERIOD - 0 TO 30 DAYS FIGURE 9.2-37A
---	---

LDC 2017-007

GRAND GULF NUCLEAR GENERATING STATION
Updated Final Safety Analysis Report (UFSAR)

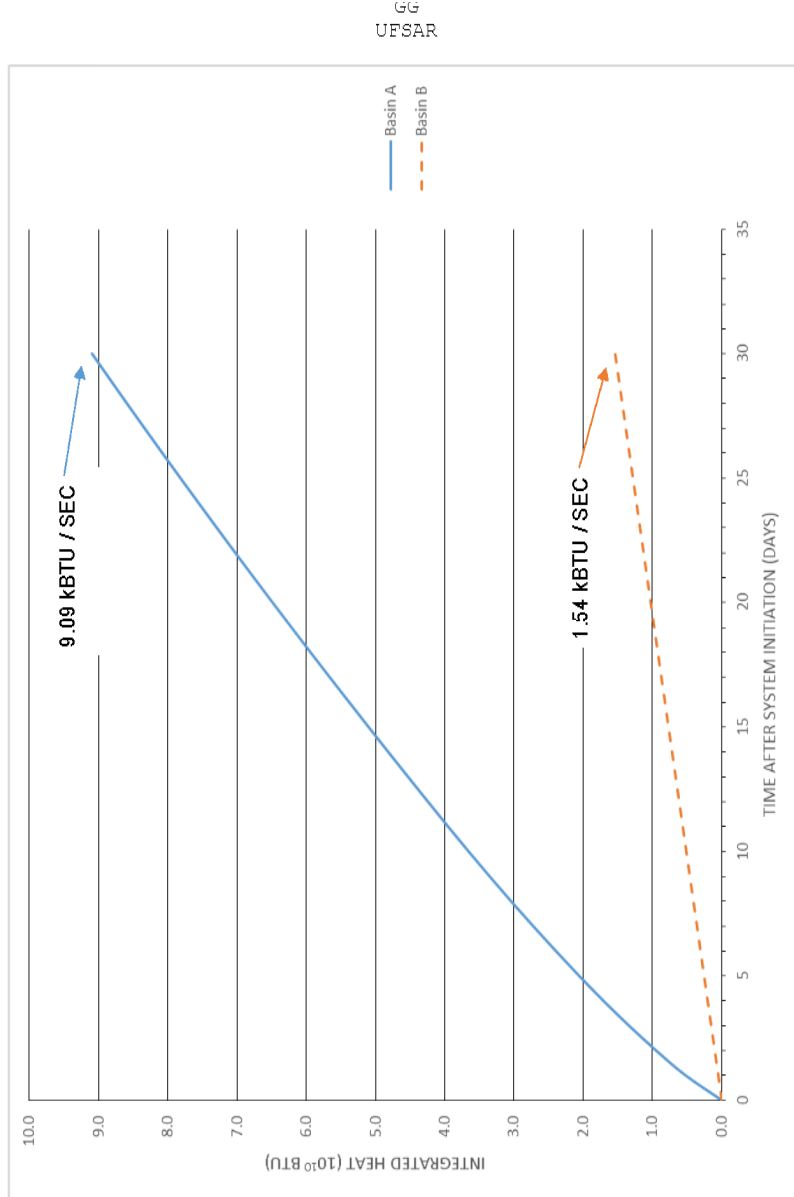

<p align="center">GRAND GULF NUCLEAR STATION UNIT 1 UPDATED FINAL SAFETY ANALYSIS REPORT</p>	<p align="center">TOTAL INTEGRATED HEAT REJECTED BASIN A - LOOP A AND LOOP C BASIN B - LOOP B TIME PERIOD - 0 TO 30 DAYS</p> <p align="center">FIGURE 9.2-37B</p>
---	--

LDC 2017-007

GRAND GULF NUCLEAR GENERATING STATION
Updated Final Safety Analysis Report (UFSAR)

Figures 9.2-38 and 9.2-39 Deleted

GRAND GULF NUCLEAR GENERATING STATION
 Updated Final Safety Analysis Report (UFSAR)

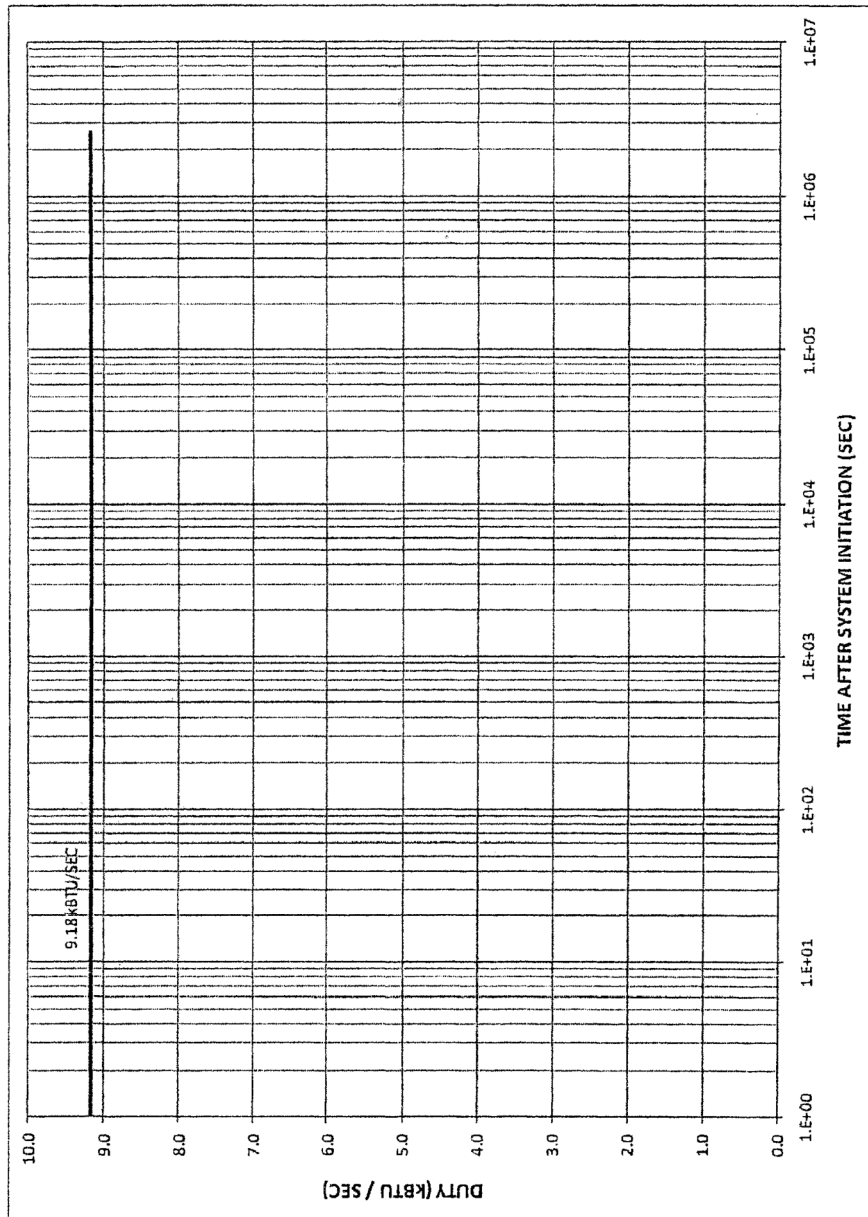

GRAND GULF NUCLEAR STATION UNIT 1 UPDATED FINAL SAFETY ANALYSIS REPORT	HEAT REJECTION RATE LOOP A STATION AUXILIARY LOADS TIME PERIOD - 0 TO 30 DAYS FIGURE 9.2-40
---	--

FIGURE 9.2-41: Deleted

GRAND GULF NUCLEAR GENERATING STATION
 Updated Final Safety Analysis Report (UFSAR)

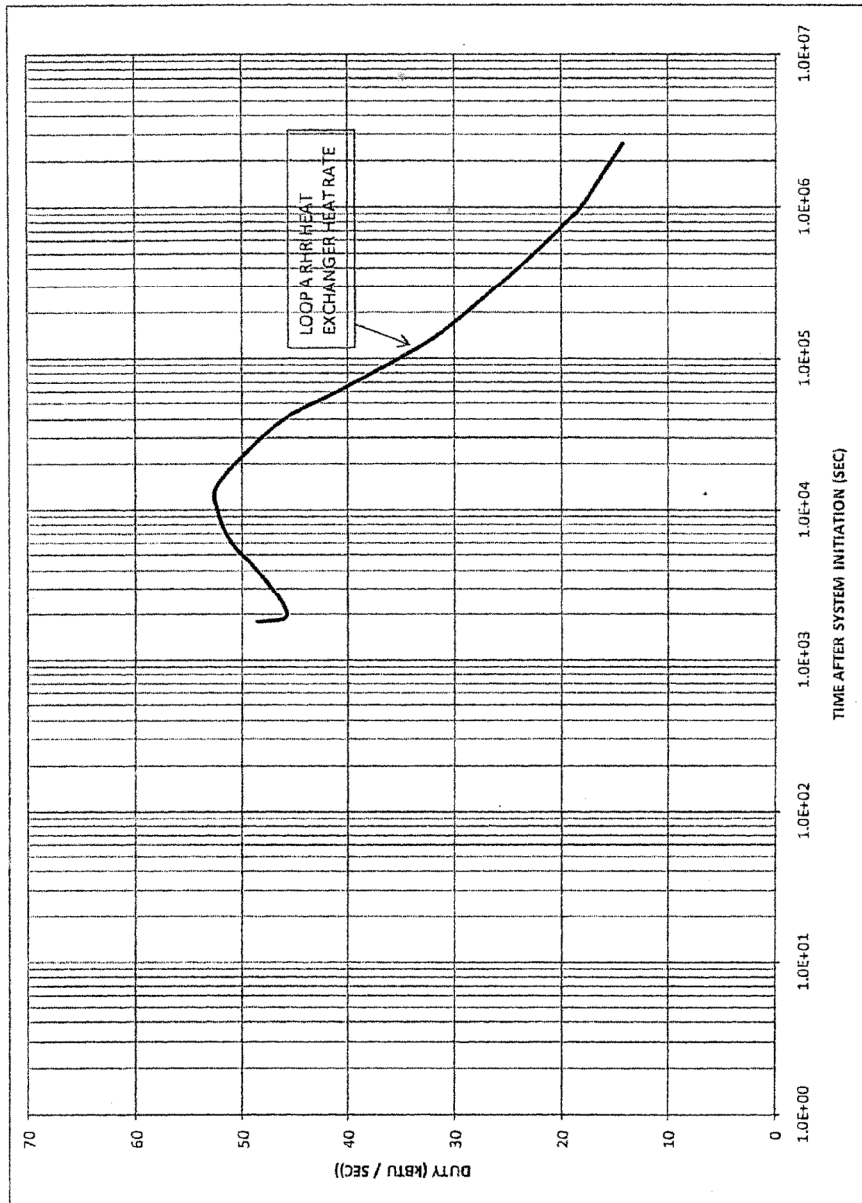

GRAND GULF NUCLEAR STATION UNIT 1 UPDATED FINAL SAFETY ANALYSIS REPORT	HEAT REJECTION RATE LOOP A RHR HEAT EXCHANGER TIME PERIOD - 0 TO 30 DAYS FIGURE 9.2-42
---	---

GRAND GULF NUCLEAR GENERATING STATION
Updated Final Safety Analysis Report (UFSAR)

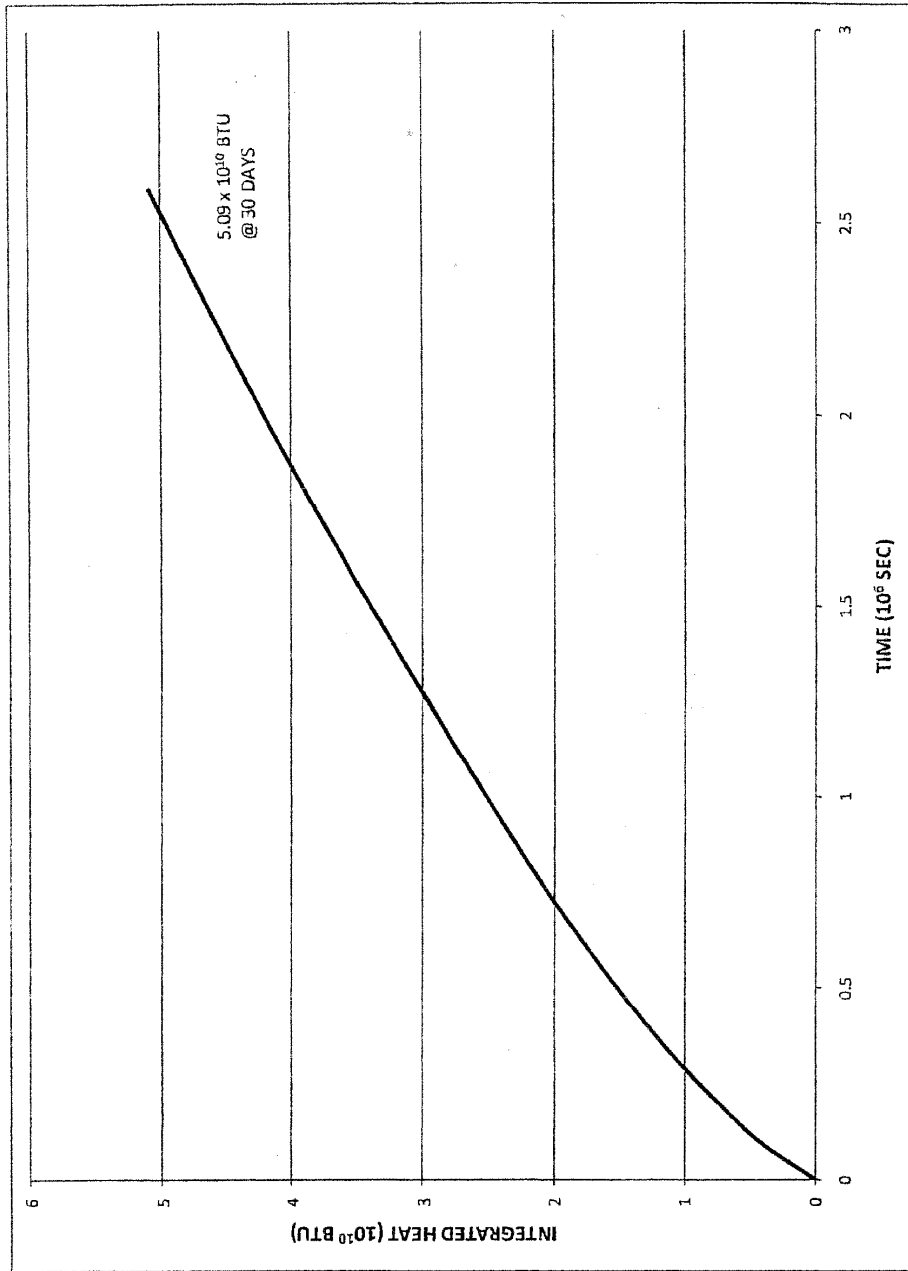

GRAND GULF NUCLEAR STATION UNIT 1 UPDATED FINAL SAFETY ANALYSIS REPORT	TOTAL INTEGRATED HEAT REJECTED BY RHR HEAT EXCHANGER FOR POST-LOCA SHUTDOWN ONLY FIGURE 9.2-43
---	---

Figures 9.2-44 through 9.2-46 Deleted

GRAND GULF NUCLEAR GENERATING STATION
 Updated Final Safety Analysis Report (UFSAR)

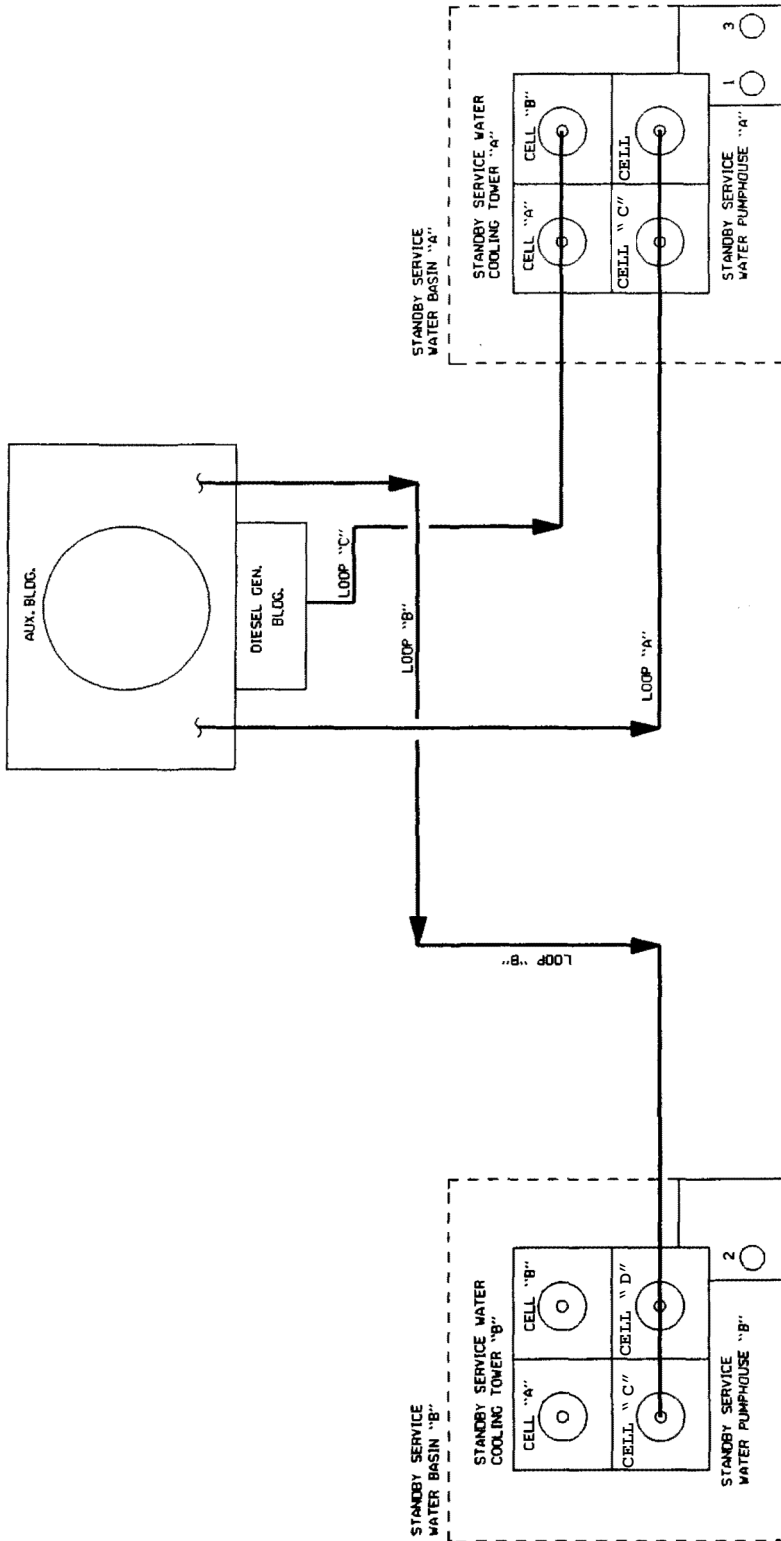

1. "A" SSW PUMP
 2. "B" SSW PUMP
 3. "C" SSW SERVICE WATER PUMP
- NOTE: RETURN PIPING ONLY IS SHOWN AND IT IS A SCHEMATIC REPRESENTATION ONLY.

GRAND GULF NUCLEAR STATION
 UNIT 1
 UPDATED FINAL SAFETY ANALYSIS REPORT
 SIMPLIFIED SSW SYSTEM
 SCHEMATIC
 FIGURE 9.2-47

GRAND GULF NUCLEAR GENERATING STATION

Updated Final Safety Analysis Report (UFSAR)

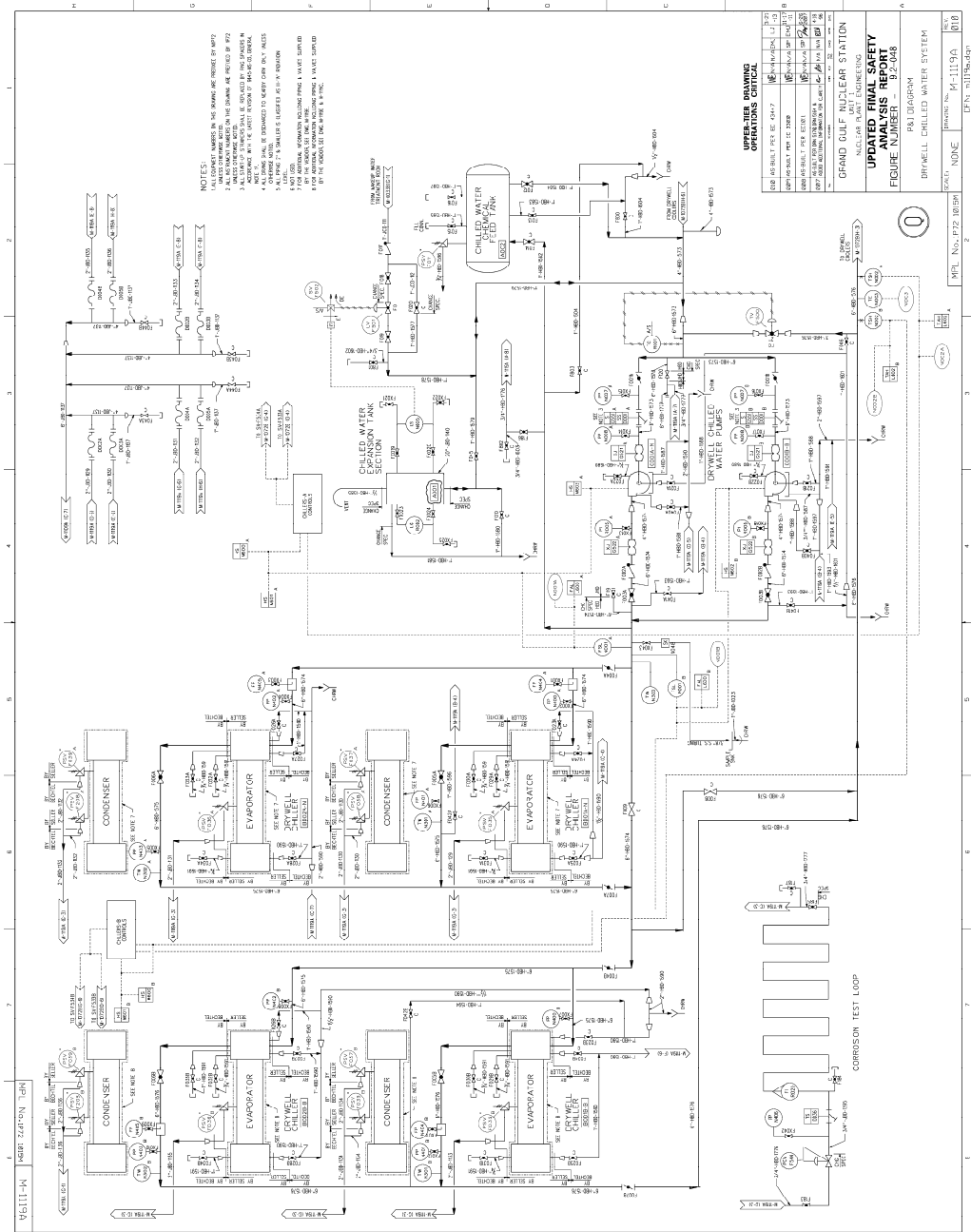

GRAND GULF NUCLEAR GENERATING STATION

Updated Final Safety Analysis Report (UFSAR)

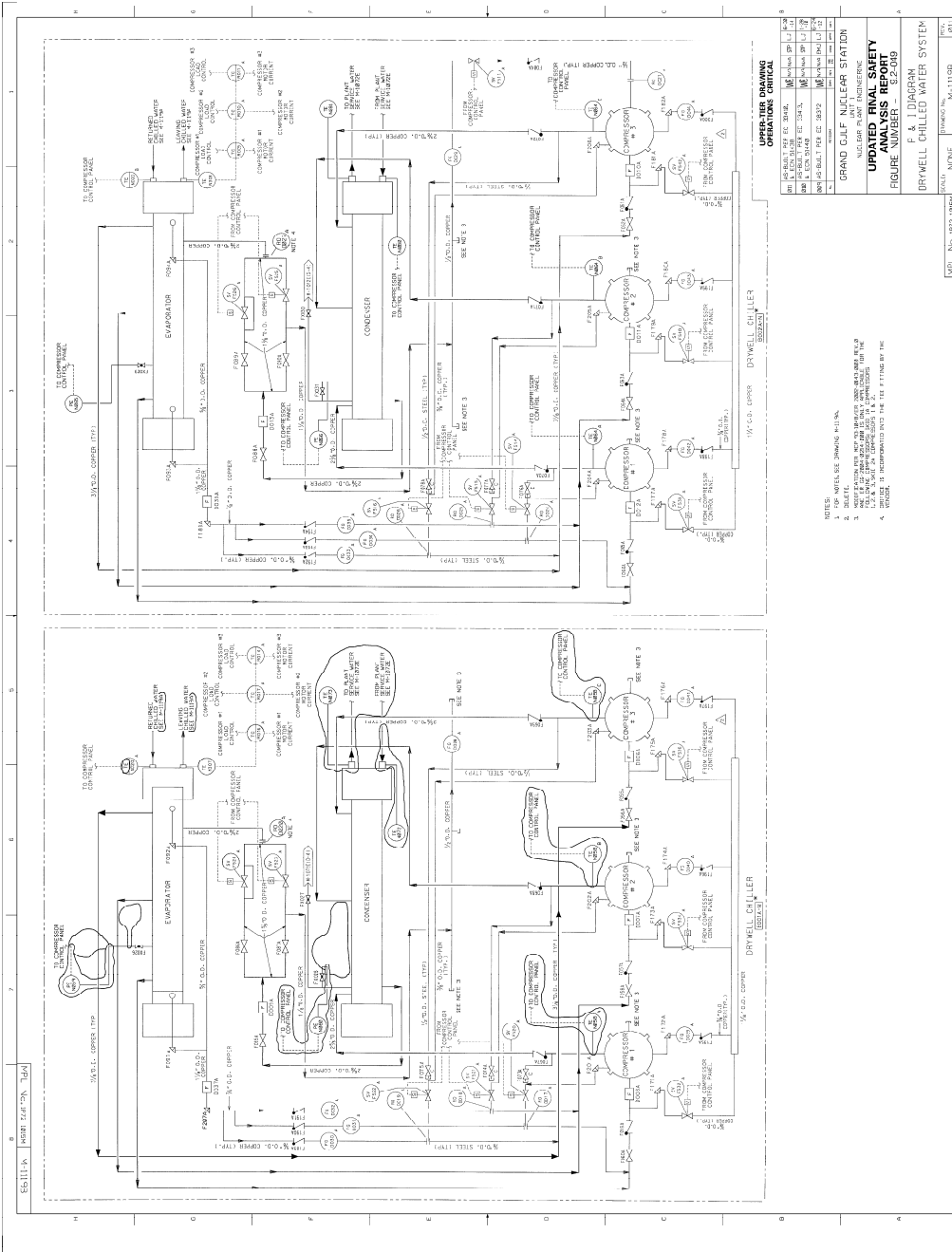

1. THIS DRAWING IS THE PROPERTY OF THE UNITED STATES GOVERNMENT AND IS NOT TO BE REPRODUCED OR TRANSMITTED IN ANY FORM OR BY ANY MEANS, ELECTRONIC OR MECHANICAL, INCLUDING PHOTOCOPYING, RECORDING, OR BY ANY INFORMATION STORAGE AND RETRIEVAL SYSTEM, WITHOUT PERMISSION IN WRITING FROM THE UNITED STATES GOVERNMENT.

**UPPER-TIER DRAWING
OPERATIONS CRITICAL**

REVISION FOR EC 2046, M-11118B (P)
 REVISION FOR EC 2045, M-11118B (P)
 REVISION FOR EC 2032, M-11118B (P)

GRAND GULF NUCLEAR STATION
 NUCLEAR PLANT ENGINEERING
UPDATED FINAL SAFETY ANALYSIS REPORT
FIGURE NUMBER ES-2-09

F & I DIAGRAM
DRYWELL CHILLED WATER SYSTEM

DESIGNED BY: NONE
 DRAWN BY: M-11118B
 CHECKED BY: M-11118B
 APPROVED BY: M-11118B

GRAND GULF NUCLEAR GENERATING STATION

Updated Final Safety Analysis Report (UFSAR)

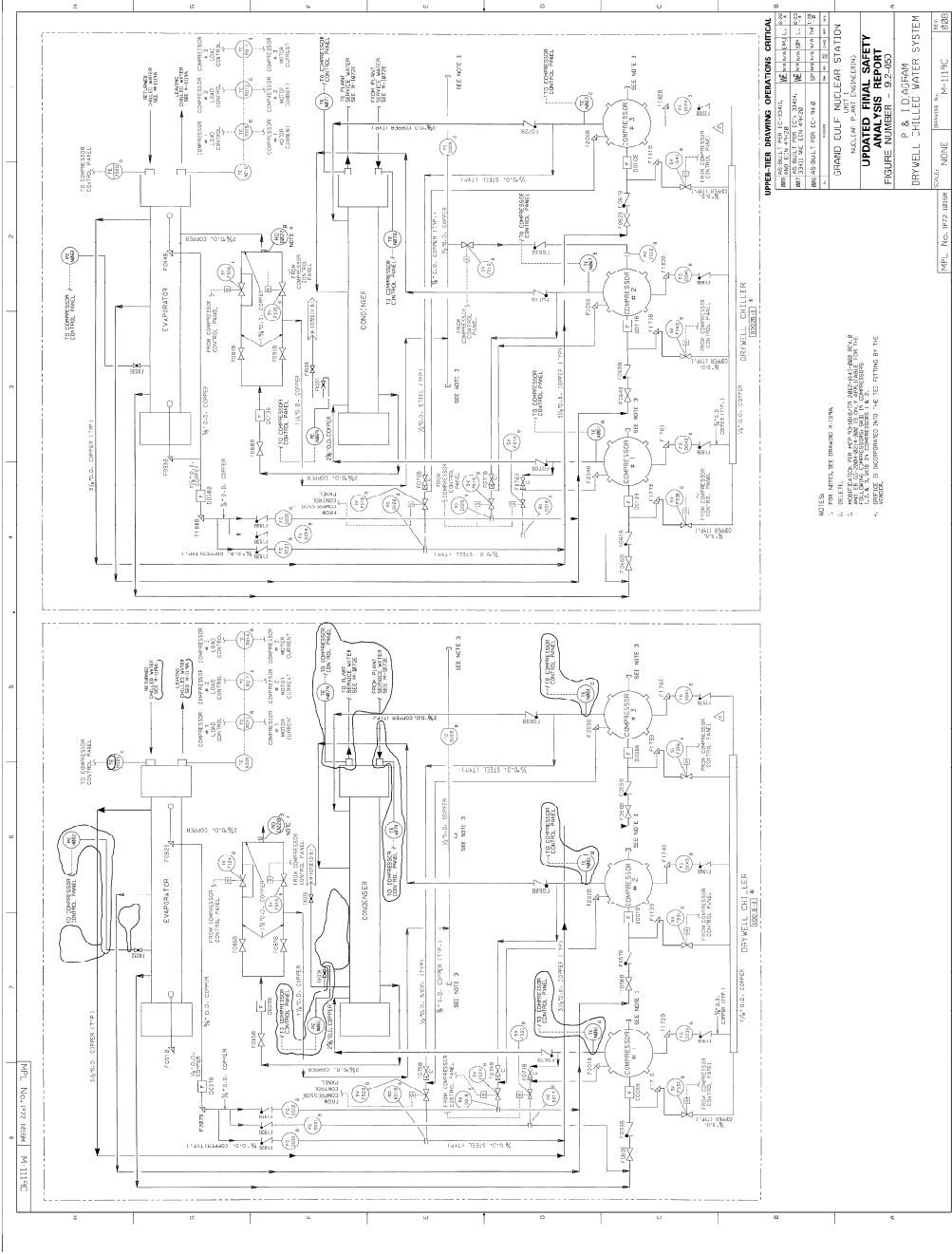

GRAND GULF NUCLEAR GENERATING STATION
Updated Final Safety Analysis Report (UFSAR)

9.3 PROCESS AUXILIARIES

9.3.1 Compressed Air Systems

The compressed air systems include the instrument air system, plant air system, and the service air system.

9.3.1.1 Design Bases

9.3.1.1.1 Safety Design Bases

The auxiliary building penetrations, the containment penetrations, and the drywell penetrations of the compressed air systems are of seismic Category I design and are equipped with sufficient isolation valves to satisfy single-failure criteria.

9.3.1.1.2 Power Generation Design Bases

The function of the compressed air systems is as follows:

- a. To provide a continuous supply of service air of suitable quality and pressure for general plant use
- b. To supply instrument air which meets the quality requirements of ANSI/ISA-7.0.01-1996 Revision, or which meets the quality requirements specifically recommended by the component manufacturers.

Standby onsite power is available to Plant Air Compressor A to replenish compressed air storage following the loss of offsite power.

9.3.1.2 System Description

The instrument, plant and service air systems are shown in Figures 9.3-1 through 9.3-4 and 9.3-31 through 9.3-33. The plant air system consists of three full-capacity, multi-staged, packaged, rotary screw compressors, each complete with inlet filter, capacity control valve, intercooler, and aftercooler. The compressors have a total of 4 air receivers for accumulation.

The plant air system provides the primary function of drying air for use in the instrument air system. The plant air system has two heated type desiccant air dryers. These two plant air dryers are not dedicated to a specific compressor, and are located just upstream of the main instrument air header pressure control station.

GRAND GULF NUCLEAR GENERATING STATION
Updated Final Safety Analysis Report (UFSAR)

The air dryers in the plant air system are designed to reduce the dew point temperature to -40°F at 150 PSIG. The maximum allowable dew point temperature for normal operation is $+22^{\circ}\text{F}$ at line pressure for the ADS air supply downstream of the ADS booster compressors. The maximum allowable dew point temperature for normal operation is -23°F at line pressure for air supply to the balance of the components (non-ADS) served by the instrument air system.

For normal operation, the maximum allowable condensable hydrocarbon (oil) concentration downstream of the air dryers is 1.0 Part Per Million (PPM) when the concentration is expressed as a ratio of weight to weight [PPM, (w/w)] or expressed as a ratio of volume to volume [PPM (v/v)].

The plant air dryer after-filters are designed to remove all particles larger than 3.0 microns (micrometres). The design requirement for process air serving non-safety related components is a maximum entrained particle size of not larger than 50 microns. Each safety related component or group of safety related components using instrument air for process control is equipped with a filter and a filtered bypass line. The filters and filtered bypass lines are designed to remove all entrained particles larger than 3.0 microns. Instrument air serving safety related components must be filtered to remove all particles larger than 40 microns based on the most limiting recommendations made by the manufacturers of all instrument air operated, safety related components installed at GGNS. Although the filters are designed to remove all particles larger than 3.0 microns, safety related component operation is not adversely affected as long as particles larger than 40 microns are removed. Pressure regulators shall be installed on instruments where reduced air pressures are required.

Either the Plant Air Compressor 'A', the Plant Air Compressor 'B' or the Plant Air Compressor 'C' can supply instrument air demands with one of the other compressors as a backup.

Instrument air is also supplied to ADS accumulators by two full-capacity, nonlubricated, reciprocating booster compressors. These compressors will boost the instrument air pressure (110 psig nominal) to the higher operating pressure of the ADS pneumatic supply (160 psig nominal). One booster compressor will operate continuously while the other will be on automatic standby.

GRAND GULF NUCLEAR GENERATING STATION
Updated Final Safety Analysis Report (UFSAR)

The Service Air System is supplied by any of the Plant Air Compressors which each is a full capacity, multi-staged, packaged, rotary screw compressor, complete with inlet filter, capacity control valve, intercooler, and aftercooler. Each compressor has a receiver. During normal operation, Service Air demands are supplied, along with the Instrument Air demands, by any of the three Plant Air Compressors. One of the remaining two compressors may be maintained in standby, capable of starting automatically in response to a low Service Air pressure signal, on low plant air Receiver pressure, or on high Service Air demand.

For a summary of equipment classification of instrument, plant, and service air system components, refer to Table 3.2-1, item XXVI, Equipment Classification.

9.3.1.3 Safety Evaluation

The instrument, plant and service air systems have no safety-related functions as defined in Section 3.2. Failure of these systems will not compromise any safety-related system or component and will not prevent safe reactor shutdown.

These systems contain some features that will assure their operation over the full range of normal plant operations. Instruments, controls, and services such as main steam isolation valves, main steam relief valves, and containment air locks are provided with air accumulators for reliable operation without compressor operation. The location, number, size, and classification of the various accumulators associated with a safety system, or function, are described in the appropriate system subsection. Other pneumatic-operated devices are designed for the fail-safe mode and do not require continuous air supply under emergency or abnormal conditions. Table 9.3-1 gives a list of pneumatically operated valves required for safe shutdown and prevention or mitigation of accidents and shows that these valves assume the safe position in the event of a loss of instrument air pressure.

Plant air compressor A is connected to the engineered safety features bus in order to be available under the offsite power failure condition. It will be shed on a LOCA signal in compliance with Regulatory Guide 1.75. The plant air compressor 'C' is powered from a balance-of-plant bus to provide a redundant source of instrument air.

GRAND GULF NUCLEAR GENERATING STATION
Updated Final Safety Analysis Report (UFSAR)

The auxiliary building, containment, and drywell penetrations of the instrument and service air systems are of seismic Category I design, and have adequate isolation valves to satisfy single-failure criteria. System piping, with the exception of the containment penetrations, is fabricated and installed in accordance with ANSI B31.1, Code for Pressure Piping. The containment penetration piping is fabricated and installed in accordance with Section III of the ASME Boiler and Pressure Vessel Code. The effects of pipe break on safety related systems are discussed in Section 3.6. The effects of internally generated missiles on safety-related systems are discussed in subsection 3.5.1. A single-failure analysis of the safety-related portion of the compressed air systems is presented in Table 9.3-2.

Portions of the instrument air system that penetrate the containment are provided with containment isolation valves which can be remotely actuated by the operator in the control room or will close automatically upon receiving an isolation signal. The instrument air line to drywell coolers can be re-opened after automatic isolation, if required, by the plant operator from the control room. (If the isolation signal returns, valves will reclose.)

9.3.1.4 Tests and Inspections

The instrument, plant and service air systems are proved operable by their use during normal plant operation. Portions of these systems normally closed to air flow can be tested to ensure operability and integrity of each system. Instrument air quality is monitored on a routine basis for compliance with the requirements for dew point temperature, entrained particulate size, and oil content.

9.3.1.5 Instrumentation Application

Instrumentation for the instrument, plant and service air systems is primarily local, consisting of pressure, differential pressure, and temperature indication and/or control. Local control and instrumentation for the plant air dryers is provided by a combination of the plant air dryer vendor and a separate distributed control system (DCS) panel. The DCS control panel and the plant air dryers have redundant control power supplies (one from a BOP inverter backed by a Division 2 powered battery charger and a BOP powered alternate source, and the other from a BOP inverter backed by a Division 1 powered battery charger and alternate source) to

GRAND GULF NUCLEAR GENERATING STATION
Updated Final Safety Analysis Report (UFSAR)

increase their reliability and availability. The power supplies for the plant air dryer heaters are from BOP 480 VAC power sources; the operation of the heaters is not required for the dryers to function properly since the dryers are designed to operate in the conventional purge regeneration mode if the heaters are unavailable. Pressure transmitters and pressure and temperature switches provide control room indication and/or annunciation of the system condition for the compressed air systems. The compressed air systems are intended to be maintained at constant pressure, with local pressure reduction occurring as required.

The Plant Air Compressors are non-safety related. The Plant Air Compressor 'A' has standby onsite power for both the main compressor motor and the local skid mounted instruments and controls. The Plant Air Compressor 'B' and the Plant Air Compressor 'C' have B.O.P power for both the main compressor motor and the local skid mounted instruments and controls. Local control for all three plant air compressors is provided by a combination of the Plant Air Compressor vendor and the same distributed control system that operates with the Plant Air Dryers.

9.3.2 Process Sampling System

9.3.2.1 Design Bases

9.3.2.1.1 Safety Design Bases

- a. The seismic design and quality group classifications of sample lines and their components conform to the classification of the system to which they are connected up to and including the second isolation valve.
- b. Sample points located inside the containment terminate at the containment sampling station and do not penetrate the containment wall, with the exception of the sample points for the post-accident sampling station.
- c. All sampling lines have the process isolation valves located as close as practical to the process taps.
- d. The sampling panels are designed to minimize contamination and radiation at the sample station. Appropriate shielding and area radiation monitors minimize radiation effects.

9.3.2.1.2 Power Generation Design Bases

The process sampling system (PSS) collects representative liquid and gas samples for analysis and provides the analytical information required to monitor plant and equipment performance and changes to operating parameters.

The process sampling system is designed to function during all plant operational modes under individual system requirements. Design guidelines related to PSS capabilities, obtaining representative samples and safety are described in the following paragraphs and Table 9.3-3.

9.3.2.2 System Description

9.3.2.2.1 General Description

The process sampling system provides sampling of all principal fluid process streams associated with plant operation. The process sampling system consists of the following:

- a. Permanently installed sampling nozzles and sample lines.
- b. Sampling panels with analyzers and associated sampling equipment.
- c. Provisions for local grab sampling.

9.3.2.2.2 Sampled Process Streams and Analyzed Parameters

The process streams to be sampled are shown on P&IDs with the sample point symbols. The SE symbol is used for Remote Sample Points which are connected with remote sampling panels or analyzers. The SX symbol designates Local Sample Points provided for local grab sampling (see Figures 1.8-1 and 1.8-2). Figures 9.3-5 through 9.3-8b show the most important sampling panels and condenser leakage detection sampling. The sample points and local analyzers are shown on the P&ID of individual systems. For sampling of radioactive gases see Section 11.5. Table 9.3-3 provides a list of sample points, associated P&ID figures, and analyzed parameters.

GRAND GULF NUCLEAR GENERATING STATION
Updated Final Safety Analysis Report (UFSAR)

9.3.2.2.3 Provisions for Obtaining Representative Samples

The following provisions are incorporated into the PSS:

- a. Where practicable, a sample takeoff connection is located in a turbulent flow zone, where fluid streams are well mixed, after a minimum straight run of 3 pipe diameters of process pipe. (Where physically possible, a straight run of 10 pipe diameters is preferred.)
- b. The connection is made at the side of horizontal process pipe.
- c. Sampling nozzles designed for insertion into the streams are provided for process pipes 2-1/2 inches and larger, unless the process of fluid conditions dictate otherwise.
- d. Sampling lines are sized to maintain turbulent flow and to minimize purge time. Routing is as short and straight as possible. Tubing with large radius bends is used to avoid traps and dead legs.
- e. Sampling nozzles, lines, and associated valves and fittings are fabricated from stainless steel material.
- f. Heat tracing of sampling lines is provided where necessary.
- g. Where necessary sampling equipment is designed for flushing and blowdown in order to remove sediment deposits, air, and gas pockets. In some applications provisions are made to purge sample lines and to reduce plateout or precipitation in sample lines.
- h. Provisions are made to sample the bulk volume of tanks. The standby liquid control system storage tank will be sampled from the top opening so that any low points and potential sediment traps can be avoided.

As shown in Table 9.3-3, the post-accident sample system is also capable of drawing and analyzing samples of the containment atmosphere. The location of this sample line, as shown in Figure 7.5-5, is in a relatively open area of the containment with adequate communication.

GRAND GULF NUCLEAR GENERATING STATION
Updated Final Safety Analysis Report (UFSAR)

The noncondensable hydrogen and fission product noble gases that will be released to the drywell and containment post-accident are assumed to form a homogeneous mixture. The even mixing of noncondensable gases will be promoted by:

- a. Natural convection as a result of temperature gradients in the drywell and the cascading effect of ECCS water exiting from a break
- b. Turbulence resulting from the operation of containment sprays
- c. Depressurization of the reactor coolant system via the sequential opening of safety/relief valves distributed around the suppression pool; this will result in an approximate uniform distribution of noncondensibles in the containment.
- d. Turbulence resulting from the localized burning of hydrogen as initiated by the hydrogen igniter system

Based on the above, the containment atmosphere sample will be representative of actual conditions. The system has the capability to draw a grab sample from the containment for either on-site or off-site analysis.

A representative core sample is directly dependent on the amount of mixing of the reactor coolant from the core region with that of the sample location. Obtaining a sample of reactor coolant that is representative of core conditions is achieved normally by sampling from the recirculation system via the recirculation loop A sample point as listed in Table 9.3-3. Therefore, adequate mixing is accomplished by forced circulation provided by the recirculation pumps. However, core flow circulation in the BWR is inherent without the use of recirculation pumps. Lack of communication between the downcomer and the core could result in disruption of the major natural circulation flow. This situation is not likely to occur in jet pump plants because of the open communication between the regions. In cases where the recirculation pumps are not available, naturally induced coolant flow is established or can be maintained by the density difference between the downcomer region and the core, provided such density difference head is sufficient to balance the losses in the loop.

GRAND GULF NUCLEAR GENERATING STATION
Updated Final Safety Analysis Report (UFSAR)

The primary natural circulation loop is between the downcomer and the core (see Figure 9.3-30). Due to boiling in the core region, a large difference in densities is available to drive natural circulation flow from the downcomer through the jet pumps and into the shroud region. The flow due to natural circulation is given in Figure 4.4-5.

The sample locations for reactor coolant listed in Table 9.3-3, assuming that the recirculation pumps are inoperable, would be either RHR loop A or RHR loop B. In the event of an accident, it is estimated that good mixing is achievable in 10 to 20 minutes. This time is based upon the time required for natural circulated flow to complete one internal circulation loop with the flow rate at about 1 percent of rated flow.

Therefore, obtaining a representative sample is dependent upon maintaining natural circulation flow. First, for an accident such as a DBA LOCA, it is assumed that the majority of the flow of reactor coolant will be the path of least resistance and will be out of the break area and eventually into the suppression pool, with inventory being maintained by ECCS systems. For this worst case, then, sufficient mixing would still take place in that the entire suppression pool and reactor coolant effectively become the same fluid, and a sample from the suppression pool would be representative.

Based on the Grand Gulf analysis, it is concluded that provisions exist for adequate mixing of the core and downcomer fluids and that samples taken at the sample points indicated for reactor coolant in Table 9.3-3 will be representative of core conditions.

9.3.2.2.4 Sampling Panels

Different process conditions, water quality, and analyzing equipment require special treatment of individual sample streams. These specific requirements are incorporated in the design of the process sampling system whose P&IDs are shown in Figures 9.3-5 through 9.3-8b.

Figure 9.3-5 shows the reactor water sample station and feedwater corrosion product monitor supplied by GEH as part of the NSSS. Further discussion related to sampling and analysis of reactor coolant and the coolant chemistry requirements is provided in subsection 5.2.3.2.2.

GRAND GULF NUCLEAR GENERATING STATION
Updated Final Safety Analysis Report (UFSAR)

Figures 9.3-6 through 9.3-8a show the individual sampling trains inside the non-NSSS supplied sampling panels. A typical high pressure and high temperature sample passes through the inlet panel shut-off valve, through the filter, is rough cooled, and pressure reduced to about 25 psig. The second cooler provides the final temperature conditioning to 77 F before the sample enters the conductivity or pH analyzers. Special manual valves are provided to take grab samples for laboratory analysis.

The sample stream can be monitored by temperature and pressure indicators. Flow through each analyzer is adjustable by means of the sample flowmeter. The train is connected to a common header through another flowmeter for continuous blowdown. Samples entering the sampling panel at low temperature (below 140 F) require no rough cooling. Pressure reduction equipment is also provided for initial sample pressure. For convenience, the sampling panels are divided into several sections, each taking care of special functions:

- a. Pressure and temperature conditioning section.
- b. Grab sampling section with a sink which can be flushed with demineralized water, sample hood, and other equipment for protection against radioactive contamination.
- c. Analyzer and monitoring section.

A reclamation header is provided in the turbine building sampling station for all clean water continuous samples to minimize waste processing requirements.

Figure 9.3-7a shows the post-accident sampling station. Samples are admitted into the system by means of valves which are controlled remotely. Instrument air is used to purge the containment atmosphere monitoring lines. Purge control is accomplished remotely. Coolant samples are cooled by Component Cooling Water with a tube-in-shell type stainless steel sample cooler.

The PASS utilizes grab sampling capability and laboratory instrumentation to monitor the following pathways:

- o Reactor Coolant (Undiluted)
- o Containment Atmosphere (Undiluted)

GRAND GULF NUCLEAR GENERATING STATION
Updated Final Safety Analysis Report (UFSAR)

Grab samples utilize either sample cylinders that have double shut-off, quick disconnect, and remotely operated valves or a syringe/septum arrangement.

The post-accident sampling station is provided with return lines for disposal of the samples; liquid samples are returned to the suppression pool through the RHR system, and the gas samples are returned to the drywell. The ventilation exhaust from the sampling station area is filtered with a charcoal adsorber and HEPA filters.

The electrically powered components associated with the post-accident sampling system are supplied from a Class 1E MCC. This MCC is tripped on receipt of an accident signal, but it can be manually reconnected locally.

9.3.2.3 Safety Evaluation

- a. The sample nozzles and lines are designed, fabricated, installed, and tested in accordance with the requirements of the process lines from which the samples are taken.
- b. The reactor water sample line (recirculation system) penetrating the drywell wall has two motor-operated isolation valves (one inside and one outside the drywell), which close automatically on an isolation signal from the Containment and Reactor Vessel Isolation Control System. This line is classified as ASME Code, Section III, Class 2.
- c. Reactor coolant to the reactor sample station is sampled with a GE-designed sample nozzle which has an 1/8-inch diameter port hole facing into the flow stream. This type of sampling nozzle is suitable for obtaining a representative sample and also provides a restriction to limit reactor coolant loss from a rupture of the sample line.
- d. Sample nozzles are stress analyzed for the most severe process conditions to avoid failure.
- e. Pressure reduction valves and other devices (pressure regulators and safety relief valves) are provided for protection of operators and/or equipment (refer to Figures 9.3-5 through 9.3-8b).

GRAND GULF NUCLEAR GENERATING STATION
Updated Final Safety Analysis Report (UFSAR)

- f. Reactor water and main steam sample lines are of sufficient length to permit decay of short-lived radionuclides in order to protect sampling personnel.
- g. All sample lines connected to seismic Category I systems are analyzed as seismic Category I lines up to and including the second isolation valve; main process pipe code classification is applicable. Sample lines from the second isolation valve to the panel/analyzer are in conformance with ANSI B31.1, Power Piping Code.
- h. All samples lines have provisions for purging and draining sample streams to an appropriate waste treatment system or to the systems of their origin.

9.3.2.4 Tests and Inspection

The sample nozzles and associated piping, tubing, fittings, and valves are tested and inspected in accordance with the requirements of the main process pipes from which the samples are taken.

The process sampling system is proved operable by its use during normal plant operation. Grab sampling is provided for laboratory analysis for verification of proper operation and calibration of continuous analyzers.

9.3.2.5 Instrumentation Applications

The most important water samples are analyzed continuously in the centralized sampling panels where all samples are adjusted to required conditions. Temperature, pressure, and flow instruments are used to verify and control individual samples. The analyzers provide alarms when measured values go beyond normal limits. Analog signals are indicated on recorders and/or processed in the computer.

9.3.3 Floor and Equipment Drainage Systems

9.3.3.1 Design Bases

9.3.3.1.1 Safety Design Bases

- a. Drainage from ECCS equipment rooms is configured to prevent flooding of ECCS equipment via discharge piping backflow.

GRAND GULF NUCLEAR GENERATING STATION
Updated Final Safety Analysis Report (UFSAR)

- b. The design allows for detection of abnormal leakage from emergency core cooling systems and from the drywell and containment sumps.
- c. Containment and drywell penetrations are fabricated to the requirements of ASME Code, Section III, Class 2. Auxiliary building penetrations are fabricated to the requirements of ASME Code, Section III, Class 3. Only these portions of the system have been identified as safety-related and are classified accordingly.

9.3.3.1.2 Power Generation Design Basis

- a. The liquid radwaste collection system collects potentially radioactive liquid wastes, at atmospheric pressure, from equipment and floor drainage of the drywell, containment, turbine building, auxiliary building, and radwaste building. All such drainage is conveyed by gravity to sumps within the respective buildings and pumped from there to appropriate collector tanks. Chemical wastes are collected from laboratory drains, equipment decontamination drains, system drains that have chemical additives, and chemical waste sumps located in various areas of the plant, as required. Chemical waste sump pumps transfer this waste to the miscellaneous chemical waste tank located in the radwaste building. Chemically contaminated waste from the regeneration of the condensate demineralizers is collected in a local tank and transferred to a receiving tank in the radwaste building.
- b. Systems that are not potentially radioactive are provided for the collection and disposal of storm drainage, sanitary drainage, oily waste, acid waste, and clear water waste.
- c. The sumps and associated instrumentation are designed to provide the following:
 - 1. A minimum fluid level of 18 inches for sumps in which vertical centrifugal sump pumps are used and 10 inches for sumps in which submersible sump pumps are used
 - 2. A minimum pump run time of 5 minutes (where possible)

GRAND GULF NUCLEAR GENERATING STATION
Updated Final Safety Analysis Report (UFSAR)

3. A signal to initiate the second pump of a duplex model 6 inches above the lowest invert and below the overflow elevation (where applicable)

- d. Open drainage lines from areas that are required to maintain an air pressure differential, but drain to a radioactive sump, are provided with a water seal. All drainage lines into these sumps are turned down and terminated approximately 12 inches below the fluid level at which the sump pump stops in pumping down the sump.

9.3.3.2 System Description

9.3.3.2.1 General Description

The floor and equipment drainage system (FEDS) is designed to assure that waste liquids, valve and pump leakoffs, and tank drains are directed to the proper area for processing or disposal. The process portion of the FEDS consists of sump pumps, sump cooler, tanks, pumps, valves, and instrumentation as shown on Figures 9.3-9 through 9.3-12 and 9.3-28 and 9.3-29. The collection portion of this system consists of collection piping, equipment drains, floor drains, vents, traps (in nonradioactive systems only), cleanouts, acid neutralization tanks, and collection sumps. The expected increase of the FEDS collections of liquid waste is expected to be less than 1%. The FEDS has the capability to perform its existing functions during EPU.

The arrangement of these items is such that the nonradioactive drain systems serve only nonrestricted areas where no radioactivity is present, exclusive of the water closet and urinal wastes in the access control area that are collected by the sanitary system. The nature of the sanitary system makes it unlikely that radioactive wastes would enter the sanitary system through this path. Figures 9.3-13 through 9.3-22 show a schematic diagram indicating the elevation of all plant drains as well as their discharge points.

The Mississippi River and the local probable maximum flood (PMF) have a maximum elevation at El. 103-0 compared with a plant grade elevation at El. 132-6. Therefore, flood water can not inundate the immediate plant site. The floor drains that exist below the PMF level drain into sumps that, in turn, discharge to the liquid radwaste system. With the exception of Control Building sanitary sump which drain into the sanitary sewer line. Should the seismic

GRAND GULF NUCLEAR GENERATING STATION
Updated Final Safety Analysis Report (UFSAR)

Category I structures and volumes as well as nonseismic Category I volumes capable of passing water to them become flooded, the water is not capable of gaining entry to equipment essential in attaining and maintaining a cold, safe shutdown condition for one or more of the following reasons:

- a. Equipment is located inside the drywell or containment which is isolated
- b. Equipment is located inside the ECCS pump rooms which are watertight to an elevation above that of the PMF
- c. Equipment is located above El. 103-0

9.3.3.2.2 Component Description

- a. Collection Piping - In all areas of potential radioactivity, the collection system piping for the liquid system is stainless steel for embedded and chemical drainage and carbon steel for suspended drainage. Offsets in the piping are provided, where necessary, for radiation shielding. In general, the fabrication and installation of the piping provides for a uniform slope that induces waste to flow in the piping at a velocity of not less than 2 feet per second. Equipment drainage piping is terminated not less than 6 inches above the finished floor or drain receiver at each location where the discharge from equipment is to be collected. The final connections are made after the equipment is installed in its proper location.
- b. Collection Sumps (Potentially Radioactive Drains) - These sumps are provided with a well-fitted, but not gas-tight, access cover for convenient maintenance access. In general, each sump is fitted with a vent pipe to exhaust potentially radioactive sump gases into the HVAC exhaust system.
- c. Auxiliary Building Drains - The auxiliary building drains are run so that leakage external to the ECCS rooms does not flow into the rooms.
- d. Equipment Drains - Equipment that may be pressurized during drainage, and that drains via direct or indirect drain connection to the floor drain system, is designed so

GRAND GULF NUCLEAR GENERATING STATION
Updated Final Safety Analysis Report (UFSAR)

that the equipment discharge flow will not exceed the gravity flow capacity of the drainage header at atmospheric pressure.

- e. Floor Drains - All floor drains are installed with rims flush with the low-point elevation of the finished floor. Floor drains in areas of potential radioactivity are welded directly to the collection piping. Floor drains of the embedded drainage piping system are supplied with threaded or other suitable plugs to seal the drains during hydrostatic testing and all required leak rate testing. The suspended drainage piping system is not hydrostatically tested. Also, plugs are installed, as required, to preserve the integrity of the drainage systems. Floor drains in areas not restricted because of potential radioactivity are provided with caulked or threaded connections.

- f. Traps - In general, inlets to all drainage systems, except those in areas of potential radioactivity and those in storm drainage and gravity collection service, are provided with a water seal in the form of a vented P-trap to minimize entry into the building of vermin, foul odors, and toxic, corrosive, or flammable vapors. Air pressure vent lines to the outside atmosphere are provided downstream of the P-traps to prevent excessive back-pressures which could cause blowout or siphonage of the water seal. Traps are not installed at inlets in areas of potential radioactivity in order to preclude either a potential for an accumulation of radioactivity in the trap or difficult maintenance of seal water level.

- g. Cleanouts - In collection system piping from areas of potential radioactivity, cleanouts are normally provided, when practicable, at the base of each vertical riser and at maximum intervals of 50 feet. Equipment hubs and open drains are also used as access points for clean out. Cleanouts are welded directly to the piping and located with their access covers flush with the finished floor or wall.

GRAND GULF NUCLEAR GENERATING STATION
Updated Final Safety Analysis Report (UFSAR)

9.3.3.2.3 System Operation

- a. General - The various subsystems drain directly to the appropriate collection point by gravity. Sump pumps are started automatically when a predetermined high level in the sump is reached.
- b. Potentially Radioactive Equipment Drainage - Drains from equipment carrying radioactive or potentially radioactive fluids are collected in equipment drain (clean radwaste) sumps in each building, and are automatically discharged, directly or indirectly, to the equipment drain collector tank in the radwaste building. The sumps are sized to handle all anticipated normal and transient leakage from the equipment they serve. Transfer to the floor drain processing subsystem is provided in the event flushing or other operations are performed which produce wastes which are not suitable for processing in the equipment drain subsystem.
- c. Potentially Radioactive Floor Drainage - Floor drains from each building are collected in the lowest level of that building, and sump pumps automatically transfer the waste from the sumps, directly or indirectly, to the floor drain collector tank. As with the equipment drainage system, the sumps are sized to handle all anticipated normal and transient floor waste.
- d. ECCS Equipment Room Leakage Detection - Each ECCS pump is located in an individual leaktight room in the auxiliary building with its own sump and duplex sump pump. An excessively high level in any ECCS sump, caused by an inleakage greater than the capacity of a single sump pump or by failure of the sump pump, is monitored by the plant computer and alarmed in the control room. The operating status of the pumps is also monitored by the plant computer, allowing the operator to evaluate if an abnormal leak has occurred or if the pump has failed. The operator can then switch to other ECCS equipment as required.

Backup leak detection is provided in each ECCS equipment room by means of a level switch mounted on one of the walls. Abnormally high leakage in excess of the duplex sump pump removal capabilities is indicated by an alarm in the control room from the wall-mounted level switch.

GRAND GULF NUCLEAR GENERATING STATION
Updated Final Safety Analysis Report (UFSAR)

- e. Storm Drainage - The storm drainage system collects water resulting from precipitation on all building roofs and areaways, paved and unpaved surfaces, and irrigation runoffs outside the buildings, and conveys it to the discharge basin. Additionally, it collects water entering the floor drains in Control Building cable spreading rooms on the 148' and 189' elevations.
- f. Sanitary Drainage - The sanitary drainage system collects nonradioactive liquid wastes and some entrained solids discharged by all plumbing fixtures located in areas not sources of potentially radioactive waste, and conveys them to a sewage treatment facility described in subsection 9.2.4, sanitary waste treatment system.
- g. Acid Waste - The acid waste system collects nonradioactive liquid waste containing chemicals and corrosive substances discharged by laboratory fixtures or equipment, or which enter floor drains located in areas not sources of potentially radioactive waste, and conveys it to a neutralization tank. The effluent from the tank is conveyed to the low volume wastewater basin or the discharge basin.
- h. Oily Waste - Radioactive and nonradioactive oilcontaminated liquid drains are collected in separate oily waste sumps. Nonradioactive oily wastes are passed through an oil-water separator prior to release to the storm drainage system or disposed of via drum processing; potentially radioactive oily waste is passed through another oil-water separator and is then transferred to the floor drain processing subsystem for further treatment.

9.3.3.3 Safety Evaluation

- a. Flooding of ECCS rooms, by backflow through the sump pump discharge piping, is prevented by means of a check valve on the discharge piping near the pump flange. In addition, the pump discharge pipe exits from each ECCS room at an elevation approximately 12 feet above the floor elevation.
- b. Since the floor and equipment drain system is not the only means of leak detection in any safety system, no portion of the system is considered to be safety-related except for the drywell auxiliary, and containment penetrations.

GRAND GULF NUCLEAR GENERATING STATION
Updated Final Safety Analysis Report (UFSAR)

9.3.3.4 Tests and Inspections

The plant equipment and floor drainage systems are proved operable by use during normal plant operation. Portions of the system normally closed to flow can be tested to ensure operability and integrity of the system by pumping water into these sumps and monitoring the operation.

9.3.3.5 Instrumentation Application

Drywell and containment floor and equipment drain sumps are provided with the following instruments and controls:

- a. Two sump pumps are started or stopped on rise and fall of the sump level; one pump is intended as backup to the other.
- b. A leak-detection feature is provided by monitoring the frequency and duration of pump runs. The presence of large leaks is further indicated by a temperature alarm in the control room; changes are sensed by a water temperature element in the sump.
- c. Abnormally high level in the sump is alarmed in the control room by a high level switch. Local pump controls are provided for manual pump activation.

The other sumps, including other equipment drain sumps and turbine and radwaste building floor drain sumps, are provided with instrumentation similar to the above except that they have no temperature elements, temperature alarms, or leak-detection monitoring systems as described above. However, the RHR room (A/B/C) sumps, LPCS room sump, HPCS room sump, RCIC room sump and Auxiliary Building North equipment drain sump have temperature switches and temperature alarms.

9.3.4 Chemical and Volume Control System

(Not applicable to BWRs)

9.3.5 Standby Liquid Control System

9.3.5.1 Design Bases

9.3.5.1.1 Safety Design Bases

The standby liquid control system meets the following safety design bases;

- a. Backup capability for reactivity control is provided, independent of normal reactivity control provisions in the nuclear reactor, to be able to shut down the reactor if the normal control ever becomes inoperative.
- b. The backup system has the capacity for controlling the reactivity difference between the steady-state rated operating condition of the reactor with voids and the cold shutdown condition, including shutdown margin, to assure complete shutdown from the most reactive condition at any time in core life.
- c. The time required for actuation and effectiveness of the backup control is consistent with the nuclear reactivity rate of change predicted between rated operating and cold shutdown conditions. A fast scram of the reactor or operational control of fast reactivity transients is not specified to be accomplished by this system.
- d. Means are provided by which the functional performance capability of the backup control system components can be verified periodically under conditions approaching actual use requirements. Demineralized water, rather than the actual neutron absorber solution, can be injected into the reactor to test the operation of all components of the redundant control system.
- e. The neutron absorber is dispersed within the reactor core in sufficient quantity to provide a reasonable margin for leakage or imperfect mixing.
- f. The system is reliable to a degree consistent with its role as a special safety system; the possibility of unintentional or accidental shutdown of the reactor by this system is minimized.

GRAND GULF NUCLEAR GENERATING STATION
Updated Final Safety Analysis Report (UFSAR)

- g. The system performance is in compliance with the criteria of 10CFR50.62 imposed for the postulated failure of normal scram during anticipated transients. These criteria contain the requirement that the stand-by liquid control system must have a minimum flow capacity and boron content equivalent in control capacity to 86 gallons per minute of 13 weight percent sodium pentaborate solution at the natural Boron-10 isotopic abundance.

9.3.5.2 System Description

The standby liquid control system (See Figures 9.3-24 and 9.3-25) is manually initiated from the main control room, to pump a boron neutron absorber solution into the reactor if the operator believes the reactor cannot be shut down or kept shut down with the control rods. Once the operator decision for initiation of the SLC system is made, the design intent is to simplify the manual process by providing a keylocked switch. This prevents inadvertent injection of neutron absorber by the SLC system. However, insertion of the control rods is expected to assure prompt shutdown of the reactor should it be required.

The keylocked control room switch is provided to assure positive action from the main control room should the need arise. Standard power plant procedural controls are applied to the operation of the keylocked control room switch.

The SLC system is required only to shut down the reactor and keep the reactor from going critical again as it cools.

The SLC system is needed only in the improbable event that not enough control rods can be inserted in the reactor core to accomplish shutdown and cooldown in the normal manner.

The boron solution tank, the test water tank, the two positive displacement pumps, the two explosive valves, the two motor operated pump suction valves, and associated local valves and controls are located in the containment. The liquid is piped into the HPCS discharge piping and injected into the core via the HPCS sparger to ensure adequate mixing. (see Section 5.3, "Reactor Vessel," and subsection 3.9.3, "ASME Code Class 1, 2, and 3 Components, Component Supports and Core Support Structures", and subsection 3.9.5, "Reactor Pressure Vessel Internals").

GRAND GULF NUCLEAR GENERATING STATION
Updated Final Safety Analysis Report (UFSAR)

The boron absorbs thermal neutrons and thereby terminates the nuclear fission chain reaction in the uranium fuel.

The specified neutron absorber solution is sodium pentaborate decahydrate ($\text{Na}_2\text{B}_{10}\text{O}_{16}\cdot 10\text{H}_2\text{O}$) that is enriched with Boron-10. It is prepared by dissolving the sodium pentaborate decahydrate in demineralized water. An air sparger is provided in the tank for mixing. To prevent system plugging, the tank outlet is raised above the bottom of the tank.

At all times when possible to make the reactor critical, the SLC system is able to deliver enough sodium pentaborate solution into the reactor to assure reactor shutdown. This is accomplished by placing sodium pentaborate decahydrate in the SLC tank and filling with demineralized water to at least the low level alarm point. The solution can be diluted with water up to the high level alarm setpoint to allow for evaporation losses. Solution concentration, boron enrichment, and volume conditions that ensure at least the design minimum weight is available are specified in the Technical Specifications.

The saturation temperature of the sodium pentaborate decahydrate solution at the maximum concentration of 9.5% is 40°F (see Figure 9.3-27). The equipment containing the solution is located in an area in which the air temperature is above 40°F during plant operating modes when SLC is required to be operable. In addition, a manually controlled electric resistance heater system provides a backup heat source to the environment. High or low temperature, or high or low liquid level, actuates an alarm in the control room.

Each positive displacement pump is sized to inject the solution into the reactor in 50 to 125 minutes, independent of the amount of solution in the tank. The pump and system design pressure between the explosive valves and the pump discharge is 1700 psig.

The two relief valves are set at the system design pressure. To prevent bypass flow from one pump in case of relief valve failure in the line from the other pump, a check valve is installed downstream of each relief valve line in the pump discharge pipe.

The two explosive-actuated injection valves provide assurance of opening when needed and ensure that boron will not leak into the reactor even when the pumps are being tested.

GRAND GULF NUCLEAR GENERATING STATION
Updated Final Safety Analysis Report (UFSAR)

Each explosive valve is closed by a plug in the inlet chamber. The plug is circumscribed with a deep groove so the end will readily shear off when pushed with the valve plunger. This opens the inlet hole through the plug. The sheared end is pushed out of the way in the chamber; it is shaped so it will not block the ports after release.

The shearing plunger is actuated by an explosive charge with dual ignition primers inserted in the side chamber of the valve. Ignition circuit continuity is monitored by a trickle current, and an alarm occurs in the control room if either circuit opens. Indicator lights show which primary circuit opened.

The SLC system is actuated by either or both of two keylocked, spring return switches on the control room console. The keylocked feature assures that changing the system status is a deliberate act. Changing either switch status to "start" starts an injection pump, actuates an explosive valve, opens a tank outlet valve, and closes reactor cleanup system isolation valves to prevent loss or dilution of boron.

A green light in the control room indicates that power is available to the pump motor contactor and that the contactor is deenergized (pump not running). A red light indicates that the contactor is energized (pump running).

Storage tank liquid level, tank outlet valve position, pump discharge pressure, and loss of continuity on the explosive valves indicate that the system is functioning. If any of those items indicate that the liquid may not be flowing, the operator may immediately change the other switch status to "start" thereby activating the redundant train of the SLC system. The chosen pump will start even though its local switch at the pump is in the "stop" position. This prevents the isolation of the pump from the control room. Pump discharge pressure and valve status are indicated in the control room.

An additional feature of the GGNS SLC System is the ability to mitigate an anticipated transient without scram (ATWS) event as required by 10CFR50.62. In the unlikely event of the reactor failing to scram when necessary, the operator has the capability to use both SLC pumps to inject the sodium pentaborate solution into the reactor core. This action can be accomplished remotely from the control room and allows reactor shutdown independent of the control rods. The MELLLA+ ATWS evaluation, as described in

GRAND GULF NUCLEAR GENERATING STATION
Updated Final Safety Analysis Report (UFSAR)

Section 15.8.1, determined that a 300 second operator delay is acceptable for those analyzed events. This is based on the analysis criteria that SLCS is initiated at the later of either (1) the time of the high pressure ATWS RPT tip plus 5 minutes (300 second operator action) or (2) the time at which suppression pool temperature reaches the BIIT of 110°F plus one minute. Borated water enters the vessel 125 seconds later due to transport delay.

Equipment drains and tank overflow are not piped to the radwaste system but to separate containers (such as 55-gal drums) that can be removed and disposed of independently to prevent any trace of boron from inadvertently reaching the reactor.

Instrumentation consisting of solution temperature indication and control, solution level, and heater system status is provided locally at the storage tank. Table 9.3-4 contains the process data for the various modes of operation of the SLC. Seismic category and quality class are included in Table 3.2-1. Principles of system testing are discussed in subsection 9.3.5.4. The leakage limit for the SLC system is 2.67 gpm.

9.3.5.3 Safety Evaluation

The standby liquid control system is a reactivity control system and is maintained in an operable status during startup and whenever the reactor is critical. The system is never expected to be needed for safety reasons because of the large number of independent control rods available to shut down the reactor. However, to assure the availability of the SLC system, two sets of the components required to actuate the system - pumps and explosive valves - are provided in paralleled redundancy.

The system is designed to bring the reactor from rated power to a cold shutdown at any time in core life. The reactivity compensation provided will reduce reactor power from rated to zero level and allow cooling the nuclear system to room temperature, with the control rods remaining withdrawn in the rated power pattern. It includes the reactivity gains that result from complete decay of the rated power xenon inventory. It also includes the positive reactivity effects from eliminating steam voids, changing water density from hot to cold, reduced Doppler effect in uranium, reducing neutron leakage from boiling to cold, and decreasing control rod worth as the moderator cools.

GRAND GULF NUCLEAR GENERATING STATION
Updated Final Safety Analysis Report (UFSAR)

The minimum average concentration of natural boron in the reactor to provide adequate shutdown margin, after operation of the SLC system, is 780 ppm (parts per million) natural enrichment equivalent. Calculation of the minimum quantity of sodium pentaborate to be injected into the reactor is based on the required 780 ppm natural enrichment equivalent average concentration in the reactor coolant including recirculation loops at 68 F, both Residual Heat Removal (RHR) shutdown cooling subsystems, and reactor high water level and the residual remaining in the SLC supply lines. The result is increased by 25 percent to allow for imperfect mixing and leakage. This concentration will be achieved if the solution is prepared as defined in subsection 9.3.5.2 and maintained above saturation temperature. The saturation temperature of the maximum normal concentration solution (9.5%) is 40 degrees F. A manually controlled tank heater is provided.

Cooldown of the nuclear system will require a minimum of several hours to remove the thermal energy stored in the reactor, cooling water, and associated equipment. The controlled limit for the reactor vessel cooldown is 100 F per hour, and normal operating temperature is approximately 550 F. Use of the main condenser and various shutdown cooling systems requires 10 to 24 hours to lower the reactor vessel to ambient temperature (68 F); this is the condition of maximum reactivity and, therefore, the condition that requires the maximum concentration of boron.

The specified boron injection rate is limited to the range of 6 to 25 ppm per minute. The lower rate assures that the boron is injected into the reactor in approximately two hours. This resulting reactivity insertion is considerably quicker than that covered by the cooldown. The upper limit injection rate assures that there is sufficient mixing so that boron does not recirculate through the core in uneven concentrations that could possibly cause reactor power to rise and fall cyclically.

The SLC system equipment essential for injection of neutron absorber solution into the reactor is designed as seismic Category I for withstanding the specified earthquake loadings (see Chapter 3). The system piping and equipment are designed, installed, and tested in accordance with requirements stated in Section 3.7.

GRAND GULF NUCLEAR GENERATING STATION
Updated Final Safety Analysis Report (UFSAR)

The SLC system is required to be operable in the event of a plant power failure, therefore the pumps, heaters, valves, and controls are powered from the standby ac power supply. The pumps and valves are powered and controlled from separate buses and circuits so that a single failure will not prevent system operation.

The SLC system and pumps have sufficient pressure margin, up to the system relief valve setting of 1700 psig, to assure solution injection into the reactor above the normal pressure in the bottom of the reactor. The nuclear system relief and safety valves begin to relieve pressure above approximately 1100 psig. Therefore, the SLC system positive displacement pumps cannot overpressurize the nuclear system.

Only one of the two standby liquid control pumps is needed for system operation. If a redundant component (e.g., one pump) is found to be inoperable, there is no immediate threat to shutdown capability, and reactor operation can continue during repairs. The time during which one redundant component upstream of the explosive valves may be out of operation should be consistent with the following: the probability of failure of both the control rod shutdown capability and the alternate component in the SLC system; and the fact that nuclear system cooldown takes several hours while liquid control solution injection takes approximately two hours. Since this probability is small, considerable time is available for repairing and restoring the SLC system to an operable condition while reactor operation continues.

GGNS meets the requirement of 10CFR50.62 for an equivalent 86 GPM, 13 weight percent sodium pentaborate SLC system. This requirement is met by operating both SLC pumps simultaneously for injecting the solution into the reactor vessel to mitigate the ATWS event. Although not required by Technical Specifications, the actual SLC concentration and enrichment may demonstrate compliance with 10 CFR 50.62 with a single pump.

9.3.5.3.1 Evaluation Against General Design Criteria

The SLC system is evaluated against the applicable General Design Criteria as follows:

- a. Criterion 2: The SLCS is located in the area outside of the drywell and below the refueling floor. In this location it is protected by the drywell, containment, and

GRAND GULF NUCLEAR GENERATING STATION
Updated Final Safety Analysis Report (UFSAR)

- walls of compartments from external natural phenomena such as earthquakes, tornadoes, hurricanes, and floods and internally from effects of such events and internal postulated events (e.g., DBA-LOCA).
- b. Criterion 4: The SLCS is designed for the expected environment in the containment and specifically for the area in which it is located. In this area, it is not subject to the more violent conditions postulated in this criterion such as missiles, whipping pipes, and discharging fluids. This system is only called upon to perform a pseudo safety function under normal operation conditions.
 - c. Criteria 20, 21, 23, and 25: Criteria 20, 21, 23, and 25 are applicable to protection systems only. The SLC system is a reactivity control system and should be evaluated against Criterion 29.
 - d. Criterion 26: The SLCS is the second reactivity control system required by this criterion. The requirements of this criterion do not apply within the SLCS itself.
 - e. Criterion 27: This criterion applies no specific requirements onto the SLCS and therefore is not applicable. See the General Design Criteria Section for discussion of combined capability.
 - f. Criterion 28: This criterion is not applicable to SLCS because the SLCS is not capable of affecting a reactivity increase.
 - g. Criterion 29 There are no requirements for the SLCS to meet single active failure criteria on an overall system basis, however, the system is designed to be reliable to a degree consistent with its' special role as a backup to the two normal reactivity control systems; the Control Rod Drive system and the Reactor Recirculation system. Two suction valves, two pumps, and two explosive injection valves are provided such that no single active failure will compromise the functional capability of the SLCS to satisfy the original design basis. Additionally, this arrangement provides for the capability to demonstrate the flow capacity required by 10CFR50.62 in the event of a postulated failure of normal scram during anticipated operational occurrences. Although not required by

GRAND GULF NUCLEAR GENERATING STATION
Updated Final Safety Analysis Report (UFSAR)

Technical Specifications, the actual SLC concentration and enrichment may demonstrate compliance with 10 CFR 50.62 with a single pump. The redundant components are fed from independent power sources which in turn are supported by standby power during a loss-of-offsite power. The SLCS also has test capability. A special test tank is supplied for providing test fluid for the injection test. Pumping capability and suction valve operability may be tested at any time. A trickle current continuously monitors continuity of the firing mechanisms of the injection squib valves.

9.3.5.3.2 Evaluation Against Regulatory Guides

The SLC system is evaluated against the applicable regulatory guides as follows:

- a. R. G. 1.26: Because the SLCS is a reactivity control system, all mechanical components are at least Quality Group B. Those portions which are part of the Reactor Coolant Pressure Boundary are Quality Group A. This is shown in Table 3.2-1.
- b. R. G. 1.29: All components of the SLCS which are necessary for injection of neutron absorber into the reactor are seismic Category I. This is shown in Table 3.2-1.

Since the SLC system is located in an area at El. 184'-6" within the containment, it is adequately protected from flooding, tornadoes, and internally and externally generated missiles (see Sections 3.4 and 3.5). SLC system equipment is protected from pipe break by providing adequate distance between the seismic and nonseismic SLC system equipment where such protection is necessary. In addition, appropriate distance is provided between the SLC system and other piping systems. Where adequate protection cannot be assured, barriers have been considered to assure SLC system protection from pipe break (see Section 3.6). It should be noted that the SLC system is not required to provide a safety function during any postulated pipe break events. This system is only required under an extremely low probability event where all of the control rods are assumed to be inoperable while the reactor is at normal full power operation. Therefore, the

GRAND GULF NUCLEAR GENERATING STATION
Updated Final Safety Analysis Report (UFSAR)

protection provided is considered over and above that required to meet the intent of Branch Technical Positions APCS 3-1 and MEB 3-1.

This system is used in a couple of special plant capability demonstration events cited in Appendix A of Chapter 15. Specifically Events 51, 52, and 53 which are extremely low probability nondesign-basis postulated incidents. The analyses given there are to demonstrate additional plant safety consideration far beyond reasonable and conservative assumptions. A system-level, qualitative-type failure mode and effects analysis relative to this system's ability to meet single failure criterion is discussed in Appendix 15A. The standby liquid control system is a diverse reactivity system designed in conformance with IEEE Std. 384 and Regulatory Guide 1.75 for electrical separation criteria.

The standby liquid control system meets the requirement for a "minimum flow capacity and boron content equivalent in control capacity to 86 gallons per minute of 13 weight percent sodium pentaborate solution." Thus, the Grand Gulf SLCS meets the requirements of 10CFR50.62.

9.3.5.4 Testing and Inspection Requirements

Operational testing of the SLC system is performed in at least two parts to avoid inadvertently injecting boron into the reactor.

With the valves to and from the storage tank closed and the valves to and from the test tank opened, demineralized water in the test tank can be recirculated by locally starting either pump.

During a refueling or maintenance outage, the injection portion of the system can be functionally tested by valving the suction line to the test tank and actuating the system from the control room. System operation is indicated in the control room.

After functional tests, the injection valve shear plugs and explosive charges must be replaced and all the valves returned to their normal positions as indicated.

The test tank contains demineralized water for approximately 3 minutes of pump operation when injecting into the reactor. Demineralized water from the makeup water treatment system is available for refilling or flushing the system.

GRAND GULF NUCLEAR GENERATING STATION
Updated Final Safety Analysis Report (UFSAR)

Should the boron solution ever be injected into the reactor, either intentionally or inadvertently, then after making certain that the normal reactivity controls will keep the reactor subcritical, the boron is removed from the reactor coolant system by flushing for gross dilution followed by operating the reactor cleanup system. There is practically no effect on reactor operations when the boron concentration has been reduced below approximately 50 ppm.

The concentration and enrichment of the sodium pentaborate in the solution tank is determined periodically.

The SLC system preoperational test is described in subsection 14.2.12.1.3.

9.3.5.5 Instrumentation Requirements

The instrumentation and control system for the SLC is designed to allow the injection of liquid poison into the reactor and the maintenance of the liquid poison solution well above the saturation temperature. A further discussion of the SLC instrumentation may be found in Section 7.4.

9.3.6 Suppression Pool Cleanup System

9.3.6.1 Design Bases

9.3.6.1.1 Safety Design Bases

- a. The suppression pool cleanup (SPCU) system serves no safety function. Systems analysis has shown that failure of the system will not compromise any safety-related systems or prevent safe shutdown.
- b. Containment penetrations and isolation valves and piping and valves which interface with the residual heat removal system are designed to seismic Category I and ASME Code, Section III, Class 2, requirements. Auxiliary building penetrations and isolation valves are designed to seismic Category I and ASME Code, Section III, Class 3, requirements.

GRAND GULF NUCLEAR GENERATING STATION
Updated Final Safety Analysis Report (UFSAR)

9.3.6.1.2 Power Generation Design Bases

- a. During normal plant operation, the SPCU system is designed to provide continuous cleanup of the suppression pool water at a rate of 1200 gpm using one P11 system pump or up to 2200 gpm using both P11 system pumps.
- b. When required, the system is capable of providing cleanup of the suppression pool water at a rate of 5000 gpm in the Emergency Mode, using RHR "C" pump. However, P60F001/F021 and P60F003/F004/F007-F010 are unable to close against RHR "C" pump shutoff head. Therefore, if both P60F001 and F021 are open, RHR C and the primary containment isolation function of P60F009/F010 and the secondary containment isolation function of P60F003/F004/F007/F008 are inoperable.
- c. The system is designed to maintain the suppression pool water quality at or better than the following conditions:

Conductivity	$\leq 10 \mu\text{mho/cm}$ at 25 C
Chlorides	≤ 0.5 ppm
pH	≥ 5.3 but ≤ 8.6 at 25 C

- d. The system is designed to remove radioactive iodine from the suppression water following a scram shutdown at a rate sufficient to allow normal access for the plant operator to the containment within a reasonable time after the scram has occurred.

9.3.6.2 System Description

The primary purpose of the SPCU system is to remove radioactive iodine and particulates from the containment suppression pool water and to maintain the suppression pool water quality to meet plant operation requirements.

There are two modes of operation for the SPCU system, normal and emergency. The system is operated as required to remove impurities from the suppression pool and minimize operator exposure.

GRAND GULF NUCLEAR GENERATING STATION
Updated Final Safety Analysis Report (UFSAR)

During normal operation, one or both of the refueling water transfer pumps will take suction from the suppression pool, transferring suppression pool water through the SPCU system piping and then to the condensate precoat filters inlet. The condensate precoat filters function to remove impurities from the suppression pool. In addition, the condensate precoat filters maybe utilized with powered resins to function as filter/demineralizers to aid in removing iodine. The processed water is then returned to the suppression pool.

The emergency mode of operation may be used following a scram shutdown of the reactor with SRV lift. During this mode of operation, RHR pump C will take suction from the suppression pool, transferring the water through the SPCU system piping to the condensate precoat filters inlet. The suppression pool water is processed through condensate precoat filters and, if available, through condensate demineralizers, and then returned to the suppression pool. However, P60F001/F021 and P60F003/F004/F007-F010 are unable to close against RHR "C" pump shutoff head. Therefore, if both P60F001 and F021 are open, RHR C and the primary containment isolation function of P60F009/F010 and the secondary containment isolation function of P60F003/F004/F007/F008 are inoperable.

The SPCU system consists of piping, valves, and instrumentation, as shown in Figure 9.3-23. The system does not have any unique major components. The system makes use of the refueling water transfer pumps or RHR pump C, condensate precoat filters, and condensate demineralizers.

The only operational activities which are conducted outside of the control room are:

- a. The isolation of the condensate precoat filters from the condensate system prior to operation of the SPCU system
- b. The return of the condensate precoat filters to the condensate system after the SPCU system is shut down

The condensate full flow filter system (CFFF) replaces the filtering function of the precoat filters during startup.

GRAND GULF NUCLEAR GENERATING STATION
Updated Final Safety Analysis Report (UFSAR)

When the precoat filters are used in conjunction with the condensate demineralizers for condensate system operation, the filters will not be available to the SPCU system.

If the condensate system is shut down, the condensate demineralizers can be operated in series with the precoat filters. This condition is not part of the expected operating paths of the SPCU system; the repositioning of valves would be accomplished locally.

9.3.6.3 Safety Evaluation

The system has no safety-related function as defined in Section 3.2. Failure of the system will not compromise any safety-related system or component and will not prevent safe reactor shutdown.

However, the system incorporates some features that will assure reliable operation over the full range of normal plant operations. These features consist primarily of instrumentation that will monitor and/or control its respective processes and administrative control of P60F001/F021.

Portions of the SPCU system that penetrate the containment and auxiliary building are provided with redundant isolation valves which are automatically closed by an isolation signal. The portion of the SPCU system which interfaces with the RHR system is provided with redundant isolation valves which are administratively controlled closed when the RHR system and the primary containment and secondary containment isolation valves are required to perform their safety function. (Low pressure coolant injection mode.)

9.3.6.4 Tests and Inspections

[HISTORICAL INFORMATION] [System piping and components were hydrostatically tested prior to initial plant startup.]
Nondestructive testing will be performed in accordance with Nuclear Class 2 and 3 requirements, where applicable.

The SPCU system is proven operable by its use during normal plant operation.

9.3.6.5 Instrumentation Requirements

The operation of the SPCU system is controlled by the plant operator who may select either of the operational modes of the system or turn it off using a 3-position, hand selector switch located in the control room.

The containment, auxiliary building, and RHR system isolation valves are supplied with position indication in the control room and remote manual, as well as automatic operation. Refer to subsection 7.4.1.2 for further details.

TABLE 9.3-1: PNEUMATICALLY OPERATED VALVES WHICH HAVE A SAFETY FUNCTION*

<u>System & Figure Number</u>	<u>Valve Number</u>	<u>Design Function</u>	<u>Fail Position</u>	<u>Safe Position</u>
B21, Figure 5.2-6 Nuclear Boiler System	F113	Auxiliary building	Closed	Closed
	F114			
E61, Figure 6.2-81 Combustible Gas Control System	F020	Drywell isolation	Closed	Closed
	F007			
G33, Figure 5.4-21 Reactor Water Cleanup System	F235	Auxiliary building isolation	Closed	Closed
	F234			
G36, Figure 5.4-26 Reactor Water Cleanup Filter/ Demin System	F108	Auxiliary building isolation	Closed	Closed
	F109			
E12, Figure 5.4-17 Residual Heat Removal System	F203	Auxiliary building Isolation	Closed	Closed
Figure 5.4-17	F065A	System Control	Closed	Closed
Figure 5.4-16, SH1	F065B	System Control	Closed	Closed
P45, Figure 9.3-9 Floor & Equipment Drains System	F009	Drywell isolation	Closed	Closed
	F010			
	F003			
	F004			
P45, Figure 9.3-11 Floor & Equipment Drains System	F163	Auxiliary building isolation	Closed	Closed
	F160			
	F161			
	F158			
	F159			
P52, Figure 9.3-3 Compressed Air Systems Service Air System)	F160A	Auxiliary building isolation	Closed	Closed
	F160B			
	F221A			
	F221B			

*A list of pneumatically operated valves required for containment isolation is found in Table 6.2-44.

TABLE 9.3-1: PNEUMATICALLY OPERATED VALVES WHICH HAVE A SAFETY FUNCTION* (CONTINUED)

<u>System & Figure Number</u>	<u>Valve Number</u>	<u>Design Function</u>	<u>Fail Position</u>	<u>Safe Position</u>
P71, Figure 9.2-20	F149	Containment isolation	Closed	Closed
	F148			
	F150			
M41, Figure 9.4-11 Containment Cooling System	F036	Auxiliary building isolation	Closed	Closed
	F037			
	F007			
	F008			
Figure 9.4-13	F013	Drywell isolation	Closed	Closed
	F015			
T41, Figure 9.4-10 Auxiliary Building Ventilation System	F006	Auxiliary building isolation	Closed	Closed
	F007			
T42, Figure 9.4-2 Fuel Handling Area Ventilation System	F020	Auxiliary building isolation	Closed	Closed
	F019			
	F003			
	F004			
	F012			
	F011			
Z51, Figure 9.4-1 Control Room HVAC System	F010	Control room isolation	Closed	Closed
	F011			
	F003	Control room isolation	Closed	Closed
	F004			
	F001			
	F002			

TABLE 9.3-1: PNEUMATICALLY OPERATED VALVES WHICH HAVE A SAFETY FUNCTION* (CONTINUED)

<u>System & Figure Number</u>	<u>Valve Number</u>	<u>Design Function</u>	<u>Fail Position</u>	<u>Safe Position</u>	
P11, Figure 9.2-16 Condensate & Refueling Water Storage & Transfer System	F047	Auxiliary building isolation	Closed	Closed	
	F061				
	F062				
	F063				
		F064	Auxiliary building isolation	Closed	Closed
		F065			
		F066			
		F067			
		F131	Containment isolation	Closed	Closed
		F130			
F075					
P60, Figure 9.3-23 Suppression Pool Cleanup System	F001	System isolation valve	Closed	Closed	
	F021				
		F003	Auxiliary building isolation	Closed	Closed
		F004			
		F007			
		F008			
		F009	Containment isolation	Closed	Closed
		F010			
	P21, Figure 9.2-12 Makeup Water Treatment System	F024	Auxiliary building isolation	Closed	Closed
	P66, Figure 9.2-14 Domestic Water System	F029A	Auxiliary building isolation	Closed	Closed
P41, Figure 9.2-3 Standby Service Water System	F240	System isolation valve	Closed	Closed	
	F239				

TABLE 9.3-1: PNEUMATICALLY OPERATED VALVES WHICH HAVE A SAFETY FUNCTION* (CONTINUED)

<u>System & Figure Number</u>	<u>Valve Number</u>	<u>Design Function</u>	<u>Fail Position</u>	<u>Safe Position</u>
G41, Figure 9.1-26 Fuel Pool Cooling and Cleanup System	F002	System isolation valve	Closed	Closed
	F032			
	F033			
	F019			
	F045			
E51, Figure 5.4-11 Reactor Core Isolation Cooling System	F047			
	F025	System isolation valve	Closed	Closed
	F026			
	F004			
F005				
G46, Figure 9.1-28 Fuel Pool Cooling Filter/Demin System	F253	Auxiliary building isolation	Closed	Closed

**TABLE 9.3-2: SINGLE FAILURE ANALYSIS OF COMPONENTS WHICH PERFORM
A SAFETY FUNCTION AND ARE SERVED BY COMPRESSED AIR SYSTEM**

<u>System & Figure Number</u>	<u>Location</u>	<u>Design Function</u>	<u>Safe Position</u>	<u>Failure Mode on Loss of Air Supply</u>	<u>Comments</u>
B-21 Figures 5.2-6 and 5.2-8 Nuclear Boiler System	E-3, D-3 G-3, G-4 : F041A A-6, C-6 D-6, E-6 H-6, G-6	Main steam safety/relief valves for reactor over-pressure protection.	N/A	Closed (Note6)	See notes 1 and 2
	F041B	Main steam safety/relief valves for reactor over-pressure protection.	N/A	Closed (Note 6)	See notes 1 and 2
	F041C	Main steam safety/relief valves for reactor over-pressure protection.	N/A	Closed (Note 6)	See notes 1 and 2
	F041D (ADS)	Main steam safety/relief valves for reactor over-pressure protection.	N/A	Closed (Note 6)	See notes 1 and 2
	F041E	Main steam safety/relief valves for reactor over-pressure protection.	N/A	Closed (Note 6)	See notes 1 and 2
	F041F (ADS)	Main steam safety/relief valves for reactor over-pressure protection.	N/A	Closed (Note 6)	See notes 1 and 2
	F041G	Main steam safety/relief valves for reactor over-pressure protection.	N/A	Closed (Note 6)	See notes 1 and 2
	F041K (ADS)	Main steam safety/relief valves for reactor over-pressure protection.	N/A	Closed (Note 6)	See notes 1 and 2
	F047A (ADS)	Main steam safety/relief valves for reactor over-pressure protection.	N/A	Closed (Note 6)	See notes 1 and 2

**TABLE 9.3-2: SINGLE FAILURE ANALYSIS OF COMPONENTS WHICH PERFORM
A SAFETY FUNCTION AND ARE SERVED BY COMPRESSED AIR SYSTEM (CONTINUED)**

<u>System & Figure Number</u>	<u>Location</u>	<u>Design Function</u>	<u>Safe Position</u>	<u>Failure Mode on Loss of Air Supply</u>	<u>Comments</u>
F047C		Main steam safety/relief valves for reactor over-pressure protection.	N/A	Closed (Note 6)	See notes 1 and 2
F047D		Main steam safety/relief valves for reactor over-pressure protection.	N/A	Closed (Note 6)	See notes 1 and 2
F047G		Main steam safety/relief valves for reactor over-pressure protection.	N/A	Closed (Note 6)	See notes 1 and 2
F047H		Main steam safety/relief valves for reactor over-pressure protection.	N/A	Closed (Note 6)	See notes 1 and 2
F047L (ADS)		Main steam safety/relief valves for reactor over-pressure protection.	N/A	Closed (Note 6)	See notes 1 and 2
F051A (ADS)		Main steam safety/relief valves for reactor over-pressure protection.	N/A	Closed (Note 6)	See notes 1 and 2
F051B (ADS)		Main steam safety/relief valves for reactor over-pressure protection.	N/A	Closed (Note 6)	See notes 1 and 2
F051C (ADS)		Main steam safety/relief valves for reactor over-pressure protection.	N/A	Closed (Note 6)	See notes 1 and 2
F051D		Main steam safety/relief valves for reactor over-pressure protection.	N/A	Closed (Note 6)	See notes 1 and 2
F051F		Main steam safety/relief valves for reactor over-pressure protection.	N/A	Closed (Note 6)	See notes 1 and 2

**TABLE 9.3-2: SINGLE FAILURE ANALYSIS OF COMPONENTS WHICH PERFORM
A SAFETY FUNCTION AND ARE SERVED BY COMPRESSED AIR SYSTEM (CONTINUED)**

<u>System & Figure Number</u>	<u>Location</u>	<u>Design Function</u>	<u>Safe Position</u>	<u>Failure Mode on Loss of Air Supply</u>	<u>Comments</u>
	F051K	Main steam safety/relief valves for reactor over-pressure protection.	N/A	Closed (Note 6)	See notes 1 and 2
B21, Figure 5.2-6, Nuclear Boiler System	G-3: F028A D-4: F028E C-4: F028C A-4: F028L G-5: F022A D-5: F022E C-5: F022C C-5: F022D	Main steam isolation valves for regulation of steam flow	Closed	Closed	Redundant isolation valves are provided to meet single failure criteria
	D-7: F032A B-7: F032B	Containment isolation	Closed (Note5)	Closed	Redundant isolation valves are provided to meet single failure criteria
	E-1: F113, F114	Auxiliary building isolation	Closed	Closed	Redundant isolation valves are provided to meet single failure criteria
G33, Figure 5.4-21 Reactor Water Cleanup System	E-8: F235 F-8: F234	Auxiliary building isolation	Closed	Closed	Redundant isolation valves are provided to meet single failure criteria
G36, Figure 5.4-26 Reactor Water Cleanup Filter/ Demineralized System	G-2: F106 G-3: F101	Containment isolation	Closed	Closed	Redundant isolation valves are provided to meet single failure criteria
	G-3: F108 G-4: F109	Auxiliary building isolation	Closed	Closed	Redundant isolation valves are provided to meet single failure criteria

**TABLE 9.3-2: SINGLE FAILURE ANALYSIS OF COMPONENTS WHICH PERFORM
A SAFETY FUNCTION AND ARE SERVED BY COMPRESSED AIR SYSTEM (CONTINUED)**

<u>System & Figure Number</u>	<u>Location</u>	<u>Design Function</u>	<u>Safe Position</u>	<u>Failure Mode on Loss of Air Supply</u>	<u>Comments</u>
E12, Figure 5.4-17 Residual Heat Removal system	G-6 : F203	Auxiliary building isolation	Closed	Closed	See Note 3
E61, Figure 6.2-81 Combustible Gas Control System	B-7 : F020 B-6 : F007	Drywall isolation	Closed	Closed	Redundant isolation valves are provided to meet single failure criteria
	B-3 : F009, F010	Containment isolation	Closed	Closed	
P45, Figure 9.3-9 Floor and Equipment Drains System	B-6 : F098, F099	Containment isolation	Closed	Closed	Redundant isolation valves are provided to meet single failure criteria
	E-6 : F009, F010 H-6 : F003, F004	Drywell isolation	Closed	Closed	Redundant isolation valves are provided to meet single failure criteria
P45, Figure 9.3-10 Floor and Equipment Drains System	F-2 : F068	Containment isolation	Closed	Closed	Redundant isolation valves are provided to meet single failure criteria
	F-3 : F067				
	D-2 : F062				
	D-3 : F061				
P45, Figure 9.3-11 Floor and Equipment Drains System	B-2 : F160 C-2 : F161 E-2 : F158, F159	Auxiliary building isolation	Closed	Closed	Redundant isolation valves are provided to meet single failure criteria
	E-5 : F163	Auxiliary building isolation	Closed	Closed	See Note 3
	P52, Figure 9.3-3 Compressed Air System (Service Air System)	C-6 : F105	Containment isolation	Closed	Closed
C-4 : F160A, F160B C-2 : F221A D-2 : F221B		Auxiliary building isolation	Closed	Closed	Redundant isolation valves are provided to meet single failure criteria

9.3-42

LBDCR 2017-069

**GRAND GULF NUCLEAR GENERATING STATION
Updated Final Safety Analysis Report (UFSAR)**

**TABLE 9.3-2: SINGLE FAILURE ANALYSIS OF COMPONENTS WHICH PERFORM
A SAFETY FUNCTION AND ARE SERVED BY COMPRESSED AIR SYSTEM (CONTINUED)**

<u>System & Figure Number</u>	<u>Location</u>	<u>Design Function</u>	<u>Safe Position</u>	<u>Failure Mode on Loss of Air Supply</u>	<u>Comments</u>
P53, Figure 9.3-1B (Instrument Air System)	F-5 : F001	Containment isolation	Closed	Closed	Redundant isolation valves are provided to meet single failure criteria
9.3-2C (Instrument Air System)	F-3, C-7 : Containment Personnel Airlock	See subsection 3.8.3	Closed	Closed	Redundant accumulators are provided to meet single failure criteria
Figure 9.2-20	E-8 : F148 E-7 : F149, F150	Containment isolation	Closed	Closed	Redundant isolation valves are provided to meet single failure criteria
M41, Figure 9.4-11 Containment Cooling System	G-2 : F036, F037 D-1 : F007 C-2 : F008	Auxiliary building isolation	Closed	Closed	Redundant isolation valves are provided to meet single failure criteria
Figure 9.4-13	F013, F015	Drywell isolation	Closed	Closed	Redundant isolation valves are provided to meet single failure criteria
T41, Figure 9.4-10 Auxiliary Building Ventilation System	H-2 : F006 G-2 : F007	Auxiliary building isolation	Closed	Closed	Redundant isolation valves are provided to meet single failure criteria

**TABLE 9.3-2: SINGLE FAILURE ANALYSIS OF COMPONENTS WHICH PERFORM
A SAFETY FUNCTION AND ARE SERVED BY COMPRESSED AIR SYSTEM (CONTINUED)**

<u>System & Figure Number</u>	<u>Location</u>	<u>Design Function</u>	<u>Safe Position</u>	<u>Failure Mode on Loss of Air Supply</u>	<u>Comments</u>
T42, Figure 9.4-2 Fuel Handling Area Ventilation System	G-2 : F020	Auxiliary building isolation	Closed	Closed	Redundant isolation valves are provided to meet single failure criteria
	G-3 : F019				
	D-2 : F011, F012				
	F-8 : F003 E-8 : F004				
Z51, Figure 9.4-1 Control Room HVAC System	F-7 : F001, F002	Control room isolation	Closed	Closed	Redundant isolation valves are provided to meet single failure criteria
	B-7 : F003, F004				
	D-2 : F010				
	C-2 : F011				
Z77, Figure 9.4-8 A/B Safeguard Switchgear and Battery Rooms Ventilation System	G-2 : F001B	Standby exhaust fan isolation dampers	Open	Open	See Note 4
	G-3 : F002B				
	H-8 : F001A	Isolation damper for exhaust fan	Open	Open	See Note 4
	H-7 : F002A				
	B-3 : F003B	Standby air handling unit isolation damper	Open	Open	See Note 4
	B-4 : F035B				
B-6 : F035A	Isolation damper for air handling unit	Open	Open	See Note 4	
B-7 : F003A					
P60, Figure 9.3-23 Suppression Pool Cleanup System	D-4 : F001	System isolation valve	Closed	Closed	Redundant isolation valves are provided to meet single failure criteria See Note 7
	C-5 : F021				
	D-3 : F003	Auxiliary building isolation	Closed	Closed	Redundant isolation valves are provided to meet single failure criteria See Note 7
	F-6 : F007				
	E-3 : F004				
	F-6 : F008				
	F-6 : F009	Containment isolation	Closed	Closed	Redundant isolation valves are provided to meet single failure criteria See Note 7
	F-7 : F010				

9.3-44

Revision 2016-00

**GRAND GULF NUCLEAR GENERATING STATION
Updated Final Safety Analysis Report (UFSAR)**

**TABLE 9.3-2: SINGLE FAILURE ANALYSIS OF COMPONENTS WHICH PERFORM
A SAFETY FUNCTION AND ARE SERVED BY COMPRESSED AIR SYSTEM (CONTINUED)**

<u>System & Figure Number</u>	<u>Location</u>	<u>Design Function</u>	<u>Safe Position</u>	<u>Failure Mode on Loss of Air Supply</u>	<u>Comments</u>
P66, Figure 9.2-14 Domestic Water System	E-3 : F029A	Auxiliary building isolation	Closed	Closed	See Note 3
P11, Figure 9.2-16 Condensate & Refueling Water Storage & Transfer System	B-5 : F047 B-4 : F061 F-6 : F062, F063 D-4 : F065 D-5 : F064 C-4 : F066, F067	Auxiliary building isolation	Closed	Closed	Redundant isolation valves are provided to meet single failure criteria
	D-7 : F075 A-7 : F130, F131	Containment isolation	Closed	Closed	Redundant isolation valves are provided to meet single failure criteria
P41, Figure 9.2-3 Standby Service Water System	H-3 : F240 F-3 : F239	System isolation valve	Closed	Closed	Redundant isolation valves are provided to meet single failure criteria
G-41, Figure 9.1-26 Fuel Pool Cooling & Cleanup System	G-5 : F002 E-1 : F032 E-1 : F033 G-3 : F047 D-3 : F019 D-3 : F045	System isolation valve	Closed	Closed	Redundant isolation valves are provided to meet single failure criteria
E51, Figure 5.4-11 Reactor Core Isolation Cooling System	E-3 : F025 D-3 : F026 B-6 : F004 B-7 : F005	System isolation valve	Closed	Closed	Redundant isolation valves are provided to meet single failure criteria
G46, Figure 9.1-28 Fuel Pool Cooling Filter Demin System	E-5 : F253	Auxiliary Building	Closed isola- tion	Closed	Valve has two air operated solenoid valves to meet single failure criteria

9.3-45

Revision 2016-00

**GRAND GULF NUCLEAR GENERATING STATION
Updated Final Safety Analysis Report (UFSAR)**

Notes

1. The main steam safety/relief valves have dual motive forces; i.e., they are spring actuated and also have air cylinders for operating the valves. Thus, if either the spring fails or air is lost, the valve can be operated.
2. ADS valves have redundant air supplies (i.e., 2 accumulators). Each set of 4 ADS valves has an independent air receiver to charge the smaller accumulators.
3. Redundant isolation valves are not required; failure of this valve will not compromise the SGTS boundary (see subsection 6.2.3).
4. Single failure criteria satisfied by the existence of redundant systems (see subsection 9.4.5).
5. Dependent upon water flow conditions at the time air is lost.
6. Assuming that reactor pressure has not exceeded the spring setting of the SRVs and associated air accumulator does not function as designed.
7. If BOTH P60F001/F021 are OPEN, then RHR C and the primary containment isolation function of P60F009/F010 and the secondary containment isolation function of P60F003/F004/F007/F008 are inoperable. P60F001/F021 are administratively controlled closed for this reason.

GRAND GULF NUCLEAR GENERATING STATION
Updated Final Safety Analysis Report (UFSAR)

TABLE 9.3-3: LIST OF SAMPLING POINTS

<u>Sample</u>	<u>Sample Point</u>	<u>Figure</u>	<u>Parameters</u>
a. <u>Containment Building Sampling Station at El. 184 - 6</u>			
B33-D014	Reactor water recirculation inlet	5.4-2	C, DO ₂ , G
G33-D014	Reactor water cleanup filter demineralizers influent	5.4-21	C, DO ₂ , G, DH ₂
G33-D015A	Reactor water cleanup filter demineralizer A, effluent	5.4-21	C, G
G33-D015B	Reactor water cleanup filter demineralizer B, effluent	5.4-21	C, G
C11-D004	CRD drive water filters discharge	4.6-8	C, DO ₂ , G
b. <u>Turbine Building Sample Conditioning and Analyzing Panel at El. 93 - 0</u>			
N11-N060	Main steam line C	10.3-3	G
N21-N462	Reactor feed pump discharge	10.4-13	C, DO ₂ , G, DH ₂
N19-N420	Condensate pumps discharge	10.4-10	C, Na, G, DO ₂
N22-N450	Cond demin effluent A	10.4-9a	C, Na, G
N22-N451	Cond demin effluent B	10.4-9a	C, Na, G
N22-N452	Cond demin effluent C	10.4-9a	C, Na, G
N22-N453	Cond demin effluent D	10.4-9a	C, Na, G
N22-N454	Cond demin effluent E	10.4-9b	C, Na, G
N22-N455	Cond demin effluent F	10.4-9b	C, Na, G

GRAND GULF NUCLEAR GENERATING STATION
Updated Final Safety Analysis Report (UFSAR)

TABLE 9.3-3: LIST OF SAMPLING POINTS (CONTINUED)

<u>Sample</u>	<u>Sample Point</u>	<u>Figure</u>	<u>Parameters</u>
N22-N456	Cond demin effluent G	10.4-9b	C, Na, G
N22-N457	Cond demin effluent H	10.4-9b	C, Na, G
N22-N466	Cond demin combined effluent	10.4-9b	C, Na, O ₂ , G,
	1* LP condenser shell tube break detector A	9.3-7	C, Na, G
	2* LP condenser shell tube break detector B	9.3-7	C, Na, G
	3* IP condenser shell tube break detector A	9.3-7	C, Na, G
	4* IP condenser shell tube break detector B	9.3-7	C, Na, G
	5* HP condenser shell tube break detector A	9.3-7	C, Na, G
	6* HP condenser shell tube break detector B	9.3-7	C, Na, G
c. <u>Radwaste Building Sampling Panel Adjacent to Water Inventory Control Station at El. 118-0</u>			
SG17-N450	Equipment drain collector tanks pump discharge	11.2-1	G
SG17-N451	Waste surge tanks pump discharge	11.2-1	G

*Selectable sampling points using common sodium and conductivity analyzers.

GRAND GULF NUCLEAR GENERATING STATION
Updated Final Safety Analysis Report (UFSAR)

TABLE 9.3-3: LIST OF SAMPLING POINTS (CONTINUED)

<u>Sample</u>	<u>Sample Point</u>	<u>Figure</u>	<u>Parameters</u>
SG17-N452	Equipment drain filter discharge	11.2-2	G
SG17-N453	Equipment drain demineralizer effluent	11.2-2	G
SG17-N454	Equipment drain sample tank discharge	11.2-3	G
SG17-N455	Floor drain collector tank pump discharge	11.2-4	G
SG17-N456	Floor drain filter discharge	11.2-5	G
SG17-N457	Floor drain demineralizer effluent	11.2-5	G
SG17-N458	Floor drain sample tanks discharge	11.2-6	G
SG17-N460	Misc chemical waste receiver tank pump discharge	11.2-8	G
SG17-N459A	Regeneration sol receiving tank A pump discharge	11.2-8	G
SG17-N459B	Regeneration sol receiving tank B pump discharge	11.2-8	G
SG17-N463	Distillate sample pump discharge	11.2-9	G
SG17-N464A	Evaporator bottoms pump A discharge	11.2-9	G
SG17-N464B	Evaporator bottoms pump B discharge	11.2-9	G

GRAND GULF NUCLEAR GENERATING STATION
Updated Final Safety Analysis Report (UFSAR)

TABLE 9.3-3: LIST OF SAMPLING POINTS (CONTINUED)

<u>Sample</u>	<u>Sample Point</u>	<u>Figure</u>	<u>Parameters</u>
d.	<u>Feedwater Corrosion Product Monitor, Turbine Building, at El. 133-0</u>		
N21-N462	Reactor feed pump discharge	10.4-13	Turb, S
e.	<u>Standby Liquid Control System</u>		
	SLC Storage Tank	9.3-24	G (Borate concentration)
f.	<u>Circulating Water System</u>		
N71-N422A	HP cond out A	10.4-6	G
N71-N422B	HP cond out B	10.4-6	G
N71-N453A	CWP A disch	10.4-5	C, pH, G
N71-N453B	CWP B disch	10.4-5	C, pH, G
N71-N440	CW makeup	10.4-5	C, G
g.	<u>Standby Service Water System</u>		
P41-N033A	SSW pump A disch	9.2-1	G
P41-N033B	SSW pump B disch	9.2-1	G
P41-N034A	SSW cooling twr A rtn	9.2-1	G
P41-N034B	SSW cooling twr B rtn	9.2-1	G
P41-N032A	SSW loop A radn supl	9.2-2	G, R,
P41-N032B	SSW loop B radn supl	9.2-2	G, R,
h.	Deleted		
i.	Deleted		

GRAND GULF NUCLEAR GENERATING STATION
Updated Final Safety Analysis Report (UFSAR)

TABLE 9.3-3: LIST OF SAMPLING POINTS (CONTINUED)

<u>Sample</u>	<u>Sample Point</u>	<u>Figure</u>	<u>Parameters</u>
j. <u>Plant Service Water System</u>			
P44-N037	PSW to CWS	9.2-22	Cl, G
P44-N093	ADHRS disch	9.2-23a	G, R
k. <u>Turbine Building Cooling Water System</u>			
P43-N052	TBCW pumps disch	9.2-24	G
l. <u>Plant Chilled Water System</u>			
P71-N031	Pri pumps disch	9.2-17	G
P71-N032	T.B. sec pumps disch	9.2-17	G
P71-N033	Hot wtr tk disch	9.2-17	G
m. <u>Component Cooling Water System</u>			
P42-N450	CCW pump disch	9.2-9	G
P42-N451	CCW radn supl	9.2-9	R
n. <u>Fuel Pool Cooling and Cleanup System</u>			
G41-D001	Fuel pool H/X disch	9.1-26	G
G41-D002	FPCC filter dem's disch	9.1-26	G
G46-N006A	FP filter dem A disch	9.1-28	C
G46-N006B	FP filter dem disch B	9.1-28	C
G41-N016	Fuel Pool H/X disch	9.1-26	C
o. <u>Suppression Pool Cleanup System</u>			
1P60-N450	Cond precoat filtr inlet	9.3-23	G

GRAND GULF NUCLEAR GENERATING STATION
Updated Final Safety Analysis Report (UFSAR)

TABLE 9.3-3: LIST OF SAMPLING POINTS (CONTINUED)

<u>Sample</u>	<u>Sample Point</u>	<u>Figure</u>	<u>Parameters</u>
p.	<u>Condensate Cleanup System</u>		
1N22-N458	Resin sep & cation regen tank drain	10.4-9c	G
1N22-N459	Anion regen tank outlet drain	10.4-9c	G
1N22-N460	Resin mix & stor tank drain	10.4-9c	G
1N22-N461	Post strainer back flush	10.4-9c	G
1N22-N464	Rinse & bckwsh wtr supply	10.4-9c	G
1N22-N465	Rinse recycle to condenser	10.4-9d	G
1N22-N467	URC feed water	10.4-9e	G
1N22-N468	URC waste outlet	10.4-9e	G
1N22-N469	Slurry from URC eductor	10.4-9e	G
1N22-N470	Precoat filt re-circ pump A DS	10.4-9g	G
1N22-N471	Precoat filt re-circ pump B DS	10.4-9g	G
1N22-N472	Precoat filt re-circ pump C DS	10.4-9f	G
q.	<u>Make Up Water Treatment System</u>		
1	Cation D001A exch sample S1A		G

GRAND GULF NUCLEAR GENERATING STATION
Updated Final Safety Analysis Report (UFSAR)

TABLE 9.3-3: LIST OF SAMPLING POINTS (CONTINUED)

<u>Sample</u>	<u>Sample Point</u>	<u>Figure</u>	<u>Parameters</u>
2	Cation D001A exch sample S2A		G
3	Anion D002A exch sample S3A		G
4	Anion D002A exch sample S4A		G
5	Cation D001B exch sample S1B		G
6	Cation D001B exch sample S2B		G
7	Anion D002B exch sample S3B		G
8	Anion D002B exch sample S4B		G
r. <u>Liquid Radwaste System</u>			
SG17-N465	Distillate smpl pmp radn smpl	11.2-9	G, R
SG17-N461A	Chem wste evap concentrate out	11.2-11	G
SG17-N461B	Flr. drn evap concentrate out	11.2-12	G
SG17-N462A	Chem wste evap distillate out	11.2-11	G
SG17-N462B	Flr drn evap distillate out	11.2-12	G
SG17-N174	Evaporator bottoms tank A sampler	11.2-9	G

GRAND GULF NUCLEAR GENERATING STATION
Updated Final Safety Analysis Report (UFSAR)

TABLE 9.3-3: LIST OF SAMPLING POINTS (CONTINUED)

<u>Sample</u>	<u>Sample Point</u>	<u>Figure</u>	<u>Parameters</u>
SG17-N175	Evaporator bottoms tank B sampler	11.2-9	G
SG17-N173	RWCU phase sep. tank sampler	11.2-10	G
SG17-N171	Condensate phase sep. tank (A) sampler	11.2-12a	G
SG17-N172	Condensate phase sep. tank (B) sampler	(11.2-12a)	G
SG17-N170	Spent resin tank sampler	(11.2-12b)	G
s. <u>Post-Accident Sample Station at El. 93-0 (Turbine Building)</u>			
	Containment Atmosphere	7.5-5	G, H, O ₂
E12-N100A	RHR Loop A	5.4-17	G, C, H, O ₂ , pH
E12-N100B	RHR Loop B	5.4-16	G, C, H, O ₂ , pH
	Suppression Pool	6.2-82	G, C, H, O ₂ , pH
	RECIRC Loop A	5.4-2-1	G, C, H, O ₂ , pH
	Jet Pump Line D	5.4-3	G, C, H, O ₂ , pH
t. <u>Solid Radwaste System</u>			
SG18-N170	Waste holding tank sampler	11.4-1	G

Symbols used under parameters in Table 9.3-3:

- C Conductivity
- Cl₂ Residual chlorine

GRAND GULF NUCLEAR GENERATING STATION
Updated Final Safety Analysis Report (UFSAR)

TABLE 9.3-3: LIST OF SAMPLING POINTS (CONTINUED)

<u>Sample</u>	<u>Sample Point</u>	<u>Figure</u>	<u>Parameters</u>
G	Grab sample for laboratory analysis. Maybe analyzed for chemical parameters, gross radioactivity, identification and quantification of radionuclides, tritium or alpha emitters		
Na	Sodium		
DO ₂	Dissolved oxygen		
pH	pH		
R	Continuous on-line monitoring for gross radioactivity		
Turb	Turbidity		
S	Integrated sample (suspended solids on in-line membrane filters)		
H	Hydrogen concentration		
O ₂	Oxygen concentration		
DH ₂	Dissolved Hydrogen		

TABLE 9.3-4: STANDBY LIQUID CONTROL SYSTEM OPERATING PRESSURE/TEMPERATURE CONDITIONS

	TEST MODES (a)							
	Standby Mode (a)		Circulation Test		Injection Test (b)		Operating Mode (a)	
Piping	Pressure psig (c)	Temp F	Pressure psig (c)	Temp F	Pressure psig (c)	Temp F	Pressure psig (c)	Temp F
Pump suction	Test tank static head (e)	60/100 (d)	Test tank static head (e)	60/100 (d)	Test tank static head (e)	60/100 (d)	Storage tank static head	60/150 (d)
Pump discharge to explosive valve inlet	Test tank static head (e)	60/100	1370	60/100	175 plus reactor static head	60/100	175 plus reactor pressure (f)	60/150
Explosive valve outlet to but not including second isolation check valve	Reactor static head to 1136 (f)	60/100	N/A	N/A	<175 plus reactor static head	60/100	<175 plus reactor pressure (f)	60/150
Second isolation check valve to the reactor	Reactor static head to 1136 (f)	60/560 (g)	N/A	N/A	<80 plus reactor static head (b)	125 (b)	<80 plus reactor pressure (f)	60/560 (g)

NOTES

- a. The pump flow rate will be zero (pump not operating) during the standby mode and at rated flow during the test and operating modes.
- b. Reactor to be at 0 psig and 125°F before changing from the standby mode to the injection test mode.

**TABLE 9.3-4: STANDBY LIQUID CONTROL SYSTEM OPERATING PRESSURE/TEMPERATURE CONDITIONS
(CONTINUED)**

- c. Pressures tabulated represent pressure at the points identified below. To obtain pressure at intermediate points in the system, the pressures tabulated must be adjusted for elevation difference and pressure drop between such intermediate points and the pressure points identified below:

<u>Piping Section</u>	<u>Pressure Point</u>
Pump Suction:	Pump suction flange inlet
Pump discharge to explosive valve inlet:	Pump discharge flange outlet
Explosive valve outlet to but not including first isolation check valve:	Explosive valve outlet
First isolation check valve to the reactor:	Reactor HPCS Nozzle

- d. During chemical mixing, the liquid in the storage tank will not exceed maximum temperature allowed by Technical Specifications.
- e. Pump suction piping will be subject to demineralized water supply pressure during flushing and filling of the piping and during any testing where suction is taken directly from the demineralized water supply line rather than the test tank.
- f. Maximum reactor operating pressure is 1136 psig at HPCS sparger outlet.
- g. 560°F represents maximum sustained operating temperature.

GRAND GULF NUCLEAR GENERATING STATION

Updated Final Safety Analysis Report (UFSAR)

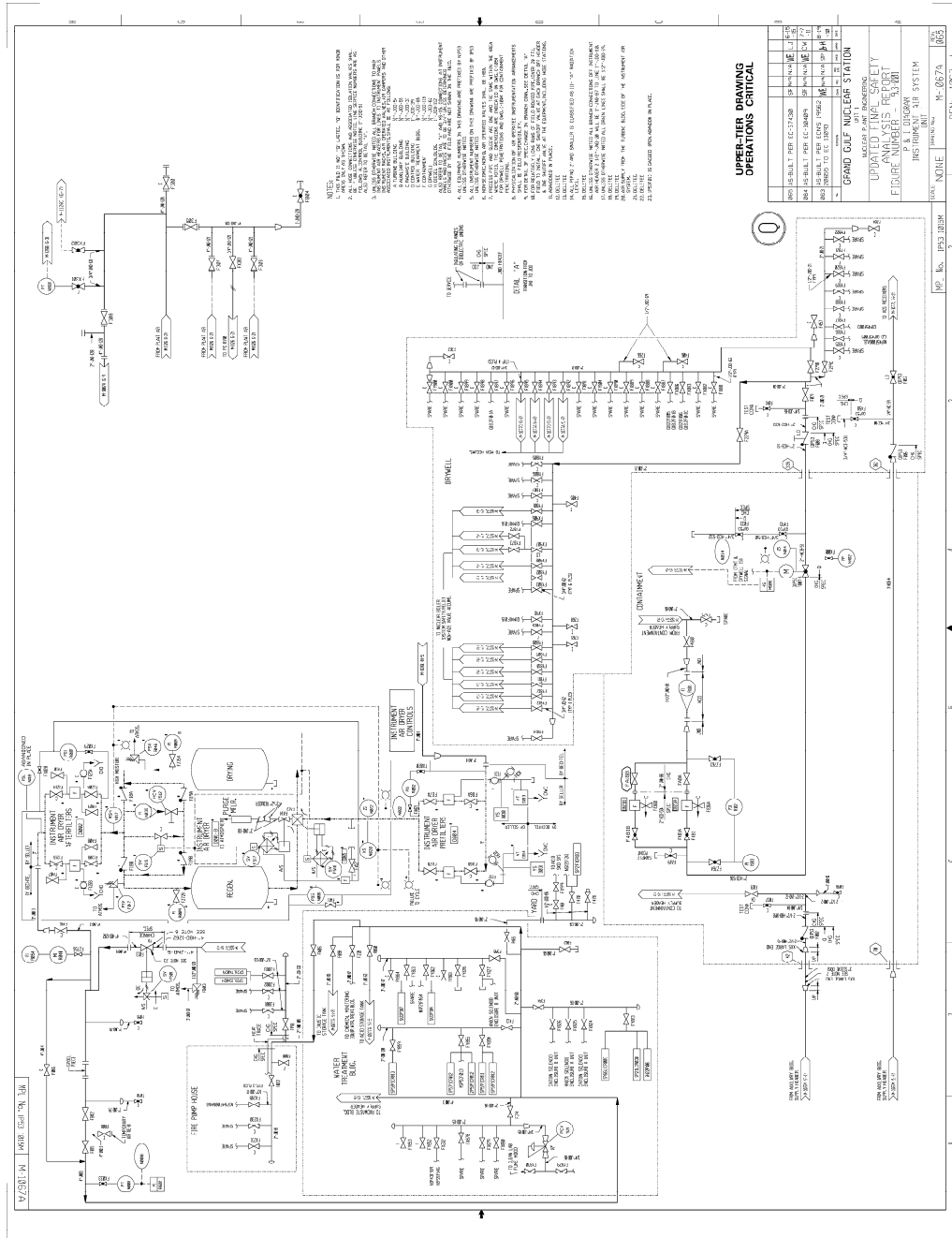

GRAND GULF NUCLEAR GENERATING STATION

Updated Final Safety Analysis Report (UFSAR)

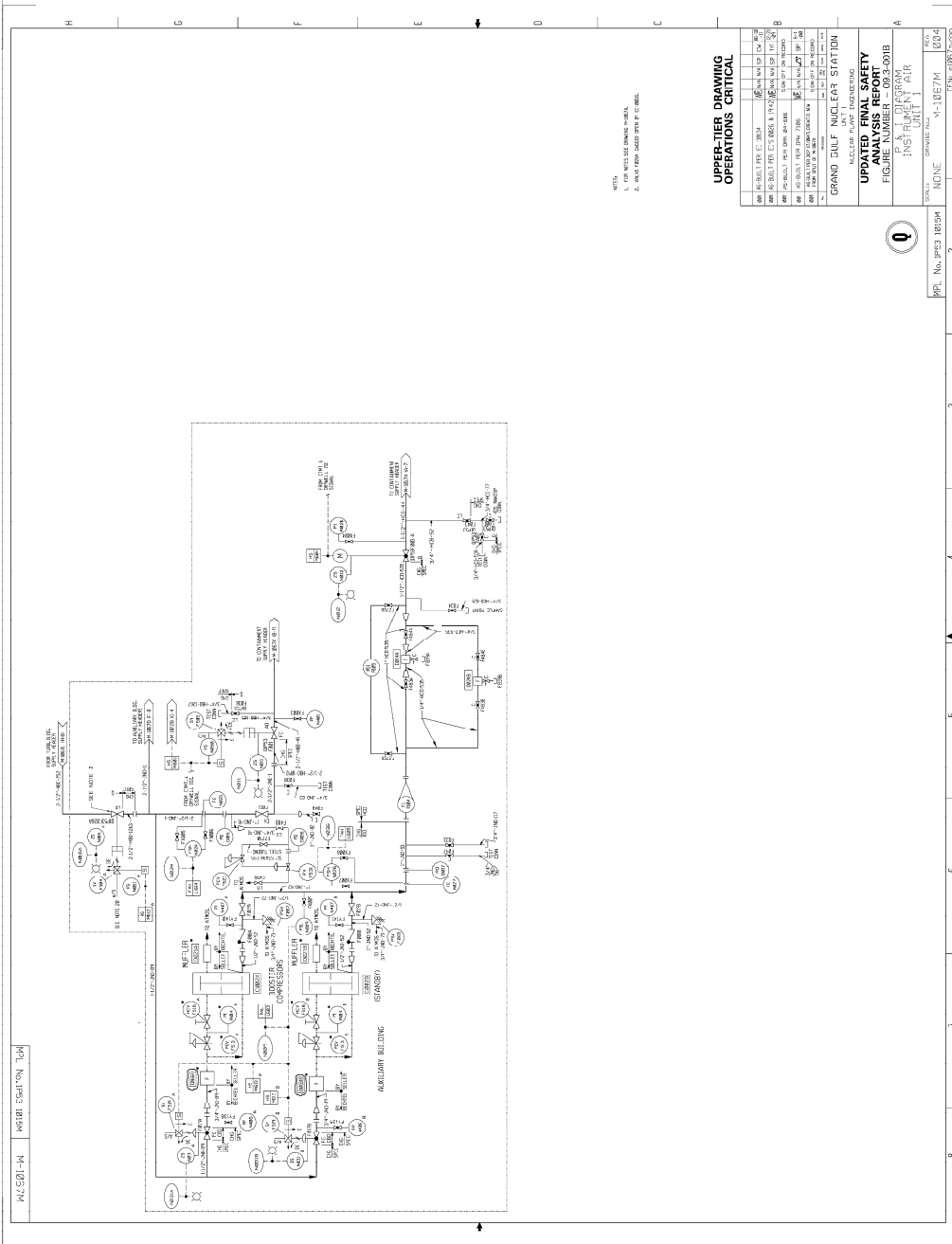

GRAND GULF NUCLEAR GENERATING STATION

Updated Final Safety Analysis Report (UFSAR)

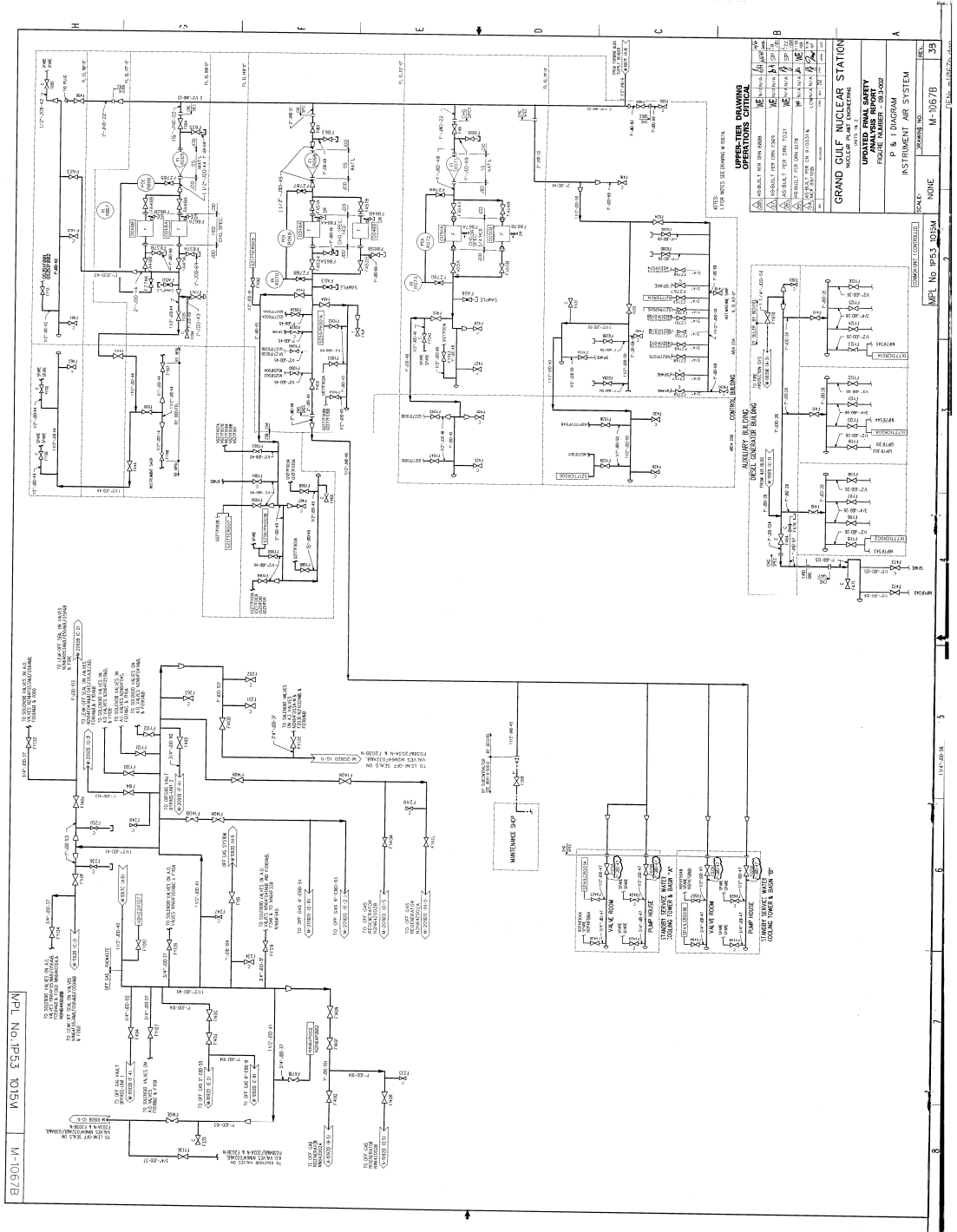
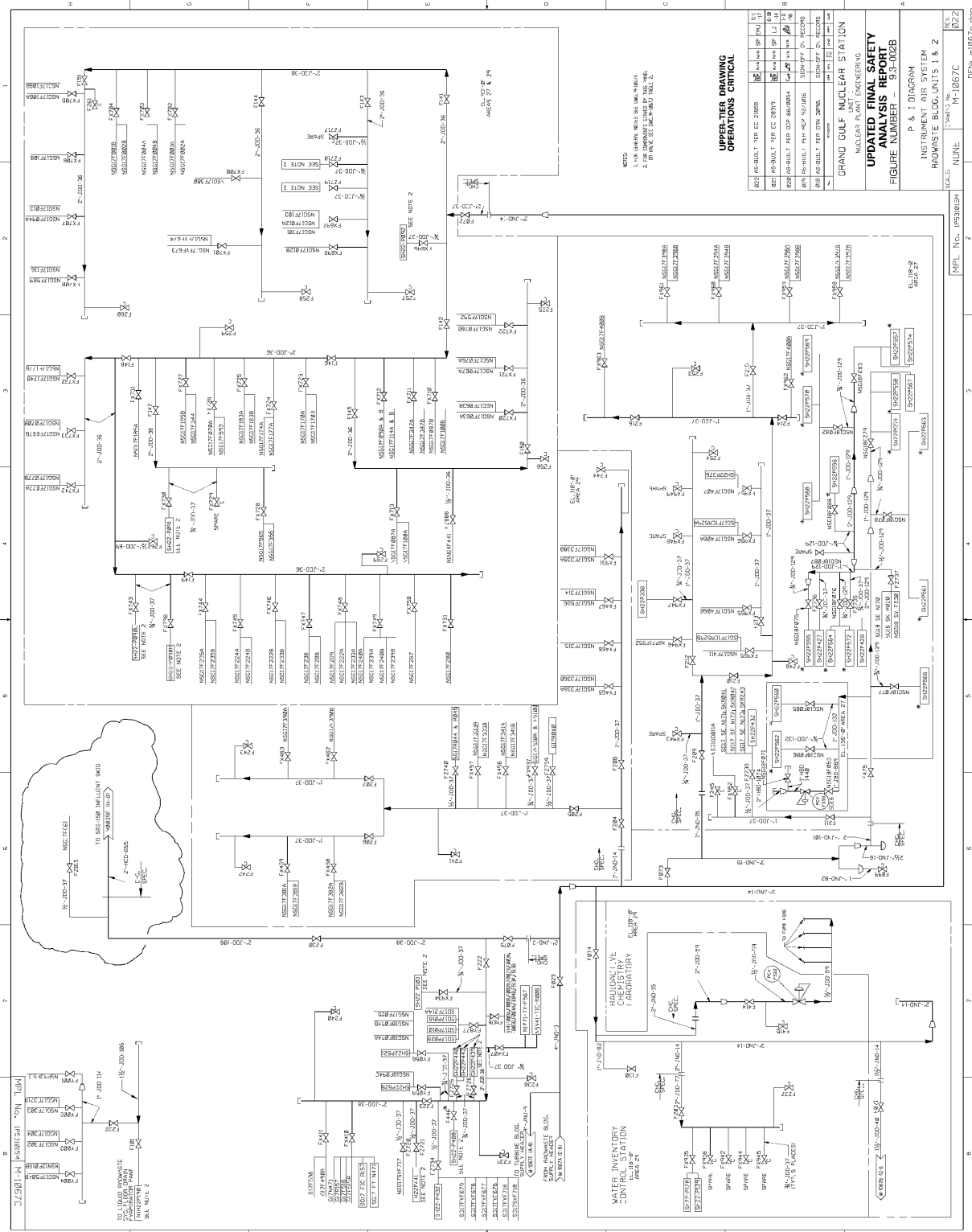

FIGURE 9.3-2a

Deleted

GRAND GULF NUCLEAR GENERATING STATION

Updated Final Safety Analysis Report (UFSAR)



GRAND GULF NUCLEAR GENERATING STATION

Updated Final Safety Analysis Report (UFSAR)

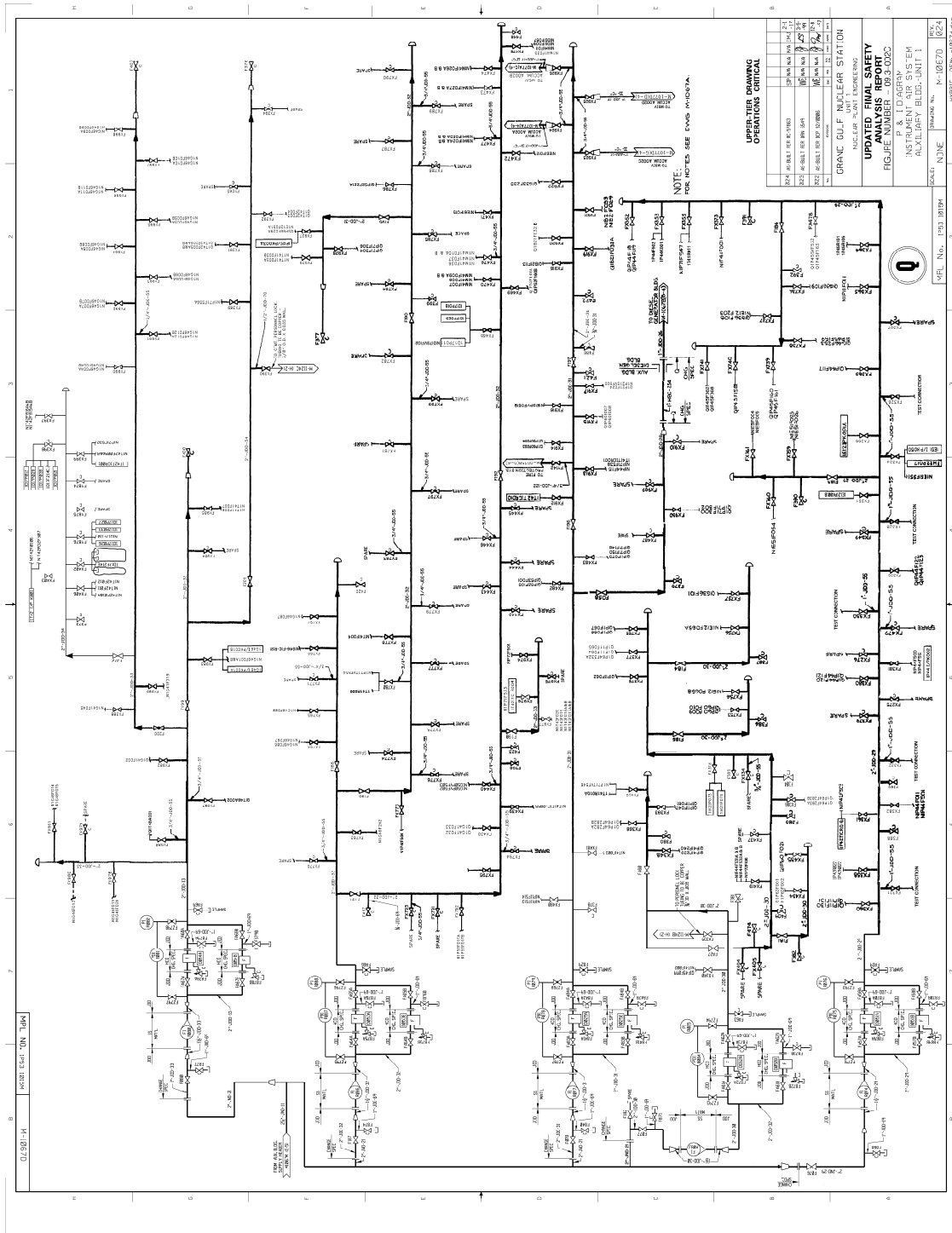

REV	DATE	BY	CHKD	DESCRIPTION
1	08/14/03
2	08/14/03
3	08/14/03
4	08/14/03
5	08/14/03
6	08/14/03
7	08/14/03
8	08/14/03
9	08/14/03
10	08/14/03
11	08/14/03
12	08/14/03
13	08/14/03
14	08/14/03
15	08/14/03
16	08/14/03
17	08/14/03
18	08/14/03
19	08/14/03
20	08/14/03
21	08/14/03
22	08/14/03
23	08/14/03
24	08/14/03
25	08/14/03
26	08/14/03
27	08/14/03
28	08/14/03
29	08/14/03
30	08/14/03
31	08/14/03
32	08/14/03
33	08/14/03
34	08/14/03
35	08/14/03
36	08/14/03
37	08/14/03
38	08/14/03
39	08/14/03
40	08/14/03
41	08/14/03
42	08/14/03
43	08/14/03
44	08/14/03
45	08/14/03
46	08/14/03
47	08/14/03
48	08/14/03
49	08/14/03
50	08/14/03
51	08/14/03
52	08/14/03
53	08/14/03
54	08/14/03
55	08/14/03
56	08/14/03
57	08/14/03
58	08/14/03
59	08/14/03
60	08/14/03
61	08/14/03
62	08/14/03
63	08/14/03
64	08/14/03
65	08/14/03
66	08/14/03
67	08/14/03
68	08/14/03
69	08/14/03
70	08/14/03
71	08/14/03
72	08/14/03
73	08/14/03
74	08/14/03
75	08/14/03
76	08/14/03
77	08/14/03
78	08/14/03
79	08/14/03
80	08/14/03
81	08/14/03
82	08/14/03
83	08/14/03
84	08/14/03
85	08/14/03
86	08/14/03
87	08/14/03
88	08/14/03
89	08/14/03
90	08/14/03
91	08/14/03
92	08/14/03
93	08/14/03
94	08/14/03
95	08/14/03
96	08/14/03
97	08/14/03
98	08/14/03
99	08/14/03
100	08/14/03

GRAND GULF NUCLEAR GENERATING STATION

Updated Final Safety Analysis Report (UFSAR)

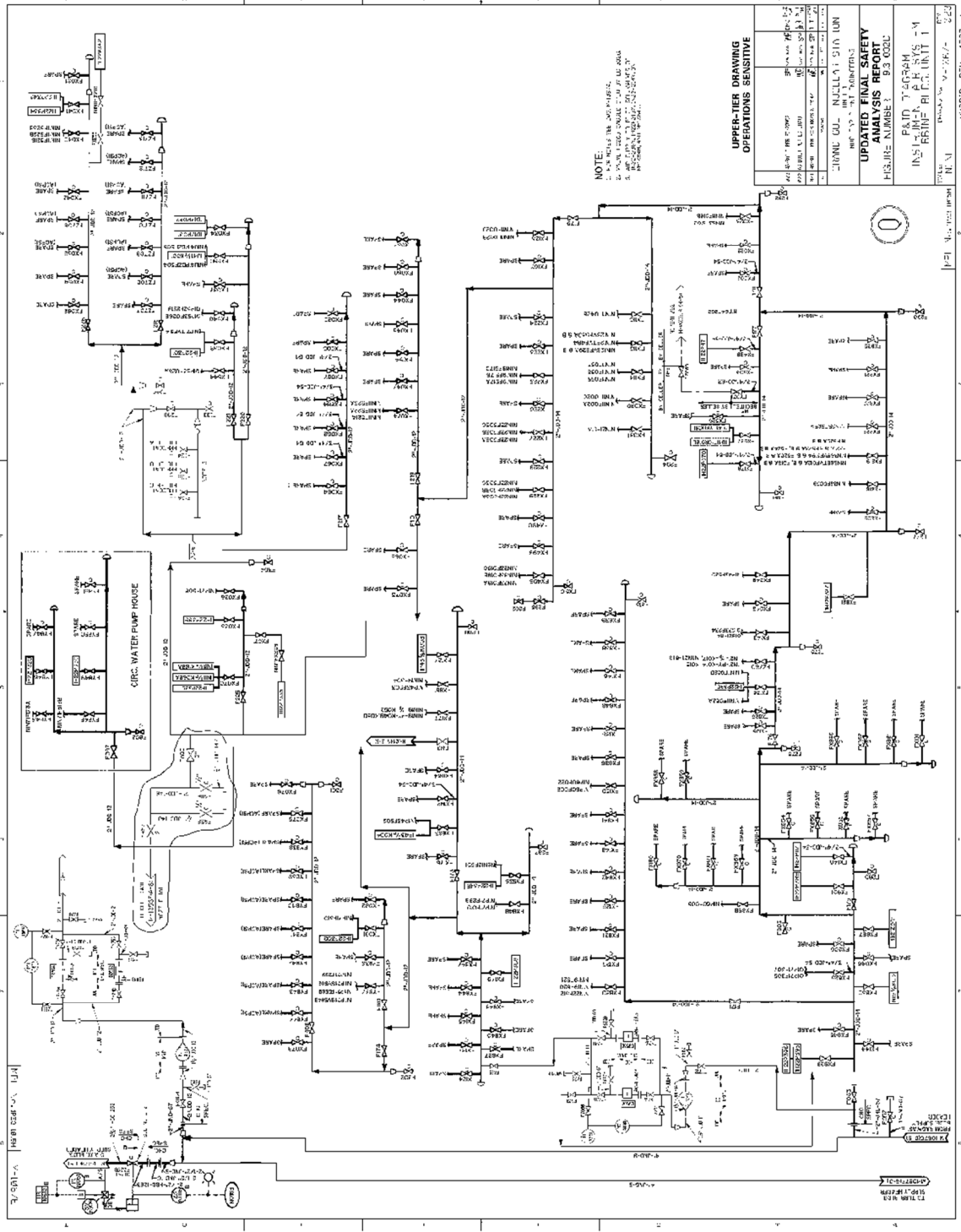

GRAND GULF NUCLEAR GENERATING STATION

Updated Final Safety Analysis Report (UFSAR)

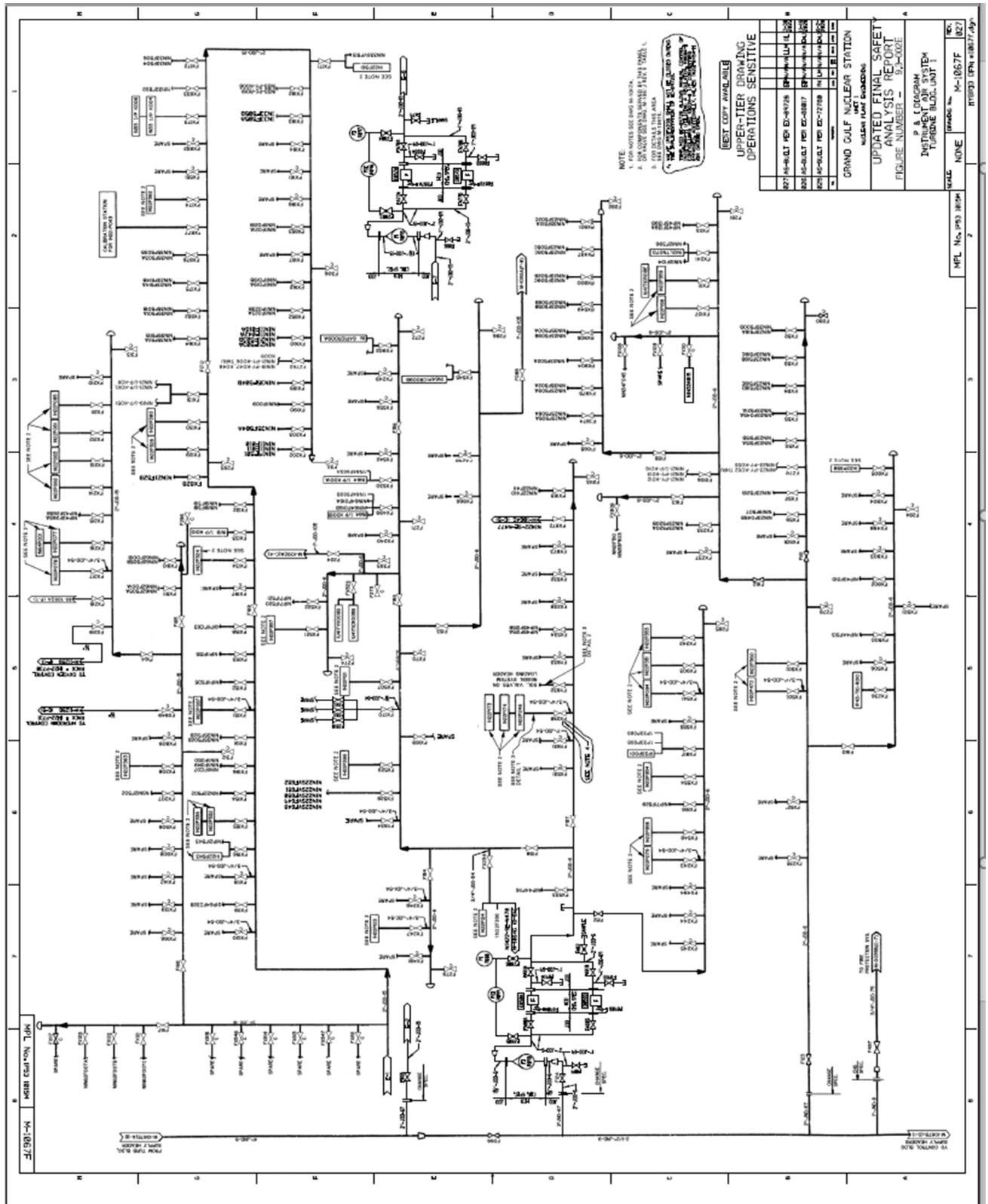

GRAND GULF NUCLEAR GENERATING STATION

Updated Final Safety Analysis Report (UFSAR)

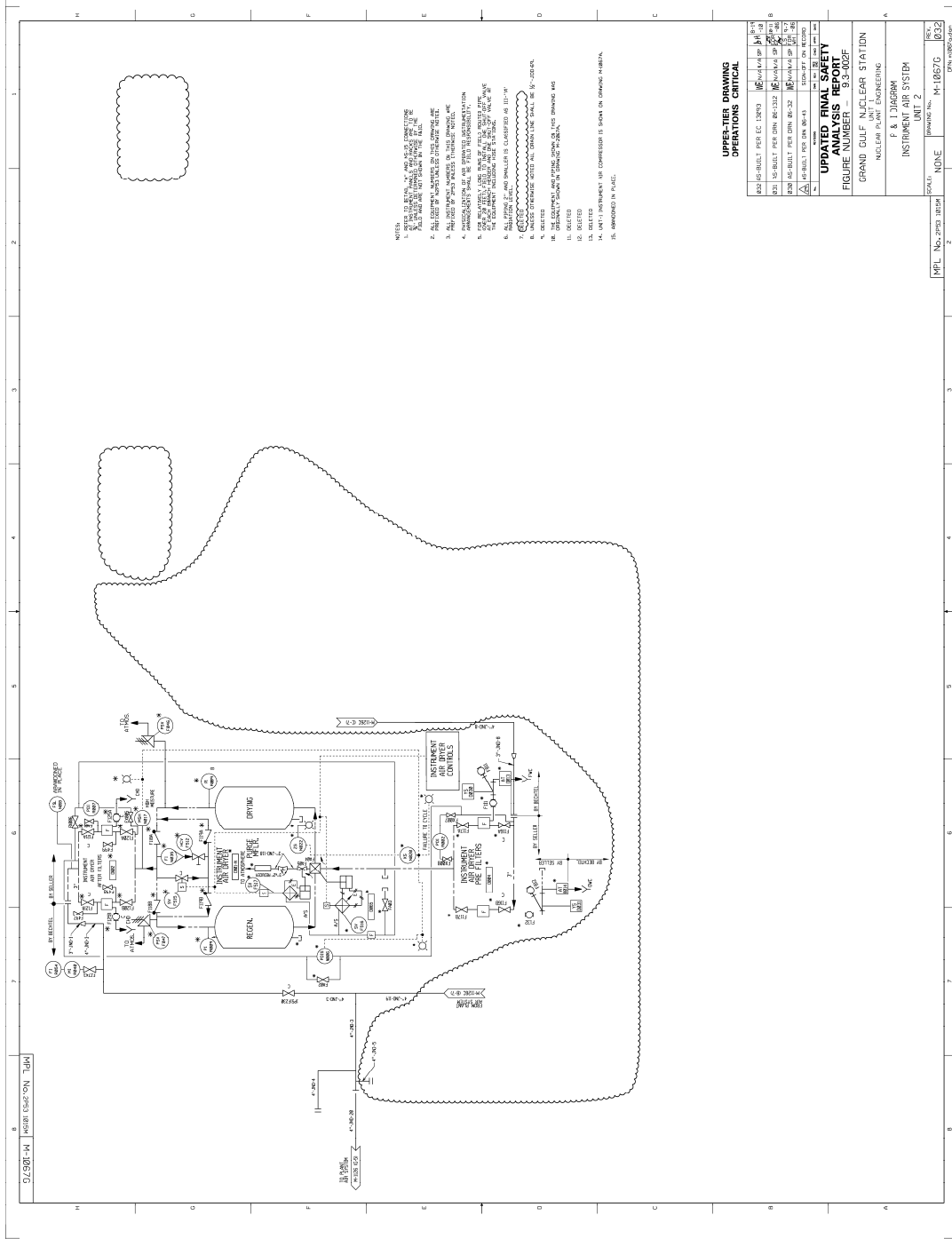

**UPPER-TIER DRAWING
OPERATIONS CRITICAL**

REV	DESCRIPTION	DATE	BY	CHKD
1	ISSUED FOR CONSTRUCTION	10/15/88	J. J. J.	J. J. J.
2	ISSUED FOR CONSTRUCTION	10/15/88	J. J. J.	J. J. J.
3	ISSUED FOR CONSTRUCTION	10/15/88	J. J. J.	J. J. J.
4	ISSUED FOR CONSTRUCTION	10/15/88	J. J. J.	J. J. J.
5	ISSUED FOR CONSTRUCTION	10/15/88	J. J. J.	J. J. J.
6	ISSUED FOR CONSTRUCTION	10/15/88	J. J. J.	J. J. J.
7	ISSUED FOR CONSTRUCTION	10/15/88	J. J. J.	J. J. J.
8	ISSUED FOR CONSTRUCTION	10/15/88	J. J. J.	J. J. J.
9	ISSUED FOR CONSTRUCTION	10/15/88	J. J. J.	J. J. J.
10	ISSUED FOR CONSTRUCTION	10/15/88	J. J. J.	J. J. J.

**UPDATED FINAL SAFETY
ANALYSIS REPORT**

FIGURE NUMBER - S-306F

GRAND GULF NUCLEAR STATION
NUCLEAR PLANT ENGINEERING
F & I DEPARTMENT
INSTRUMENT AIR SYSTEM
UNIT 2

REVISED BY: J. J. J.
DATE: 10/15/88
MPL No. 2013 10677G 032
GPN 400000-001

GRAND GULF NUCLEAR GENERATING STATION
Updated Final Safety Analysis Report (UFSAR)

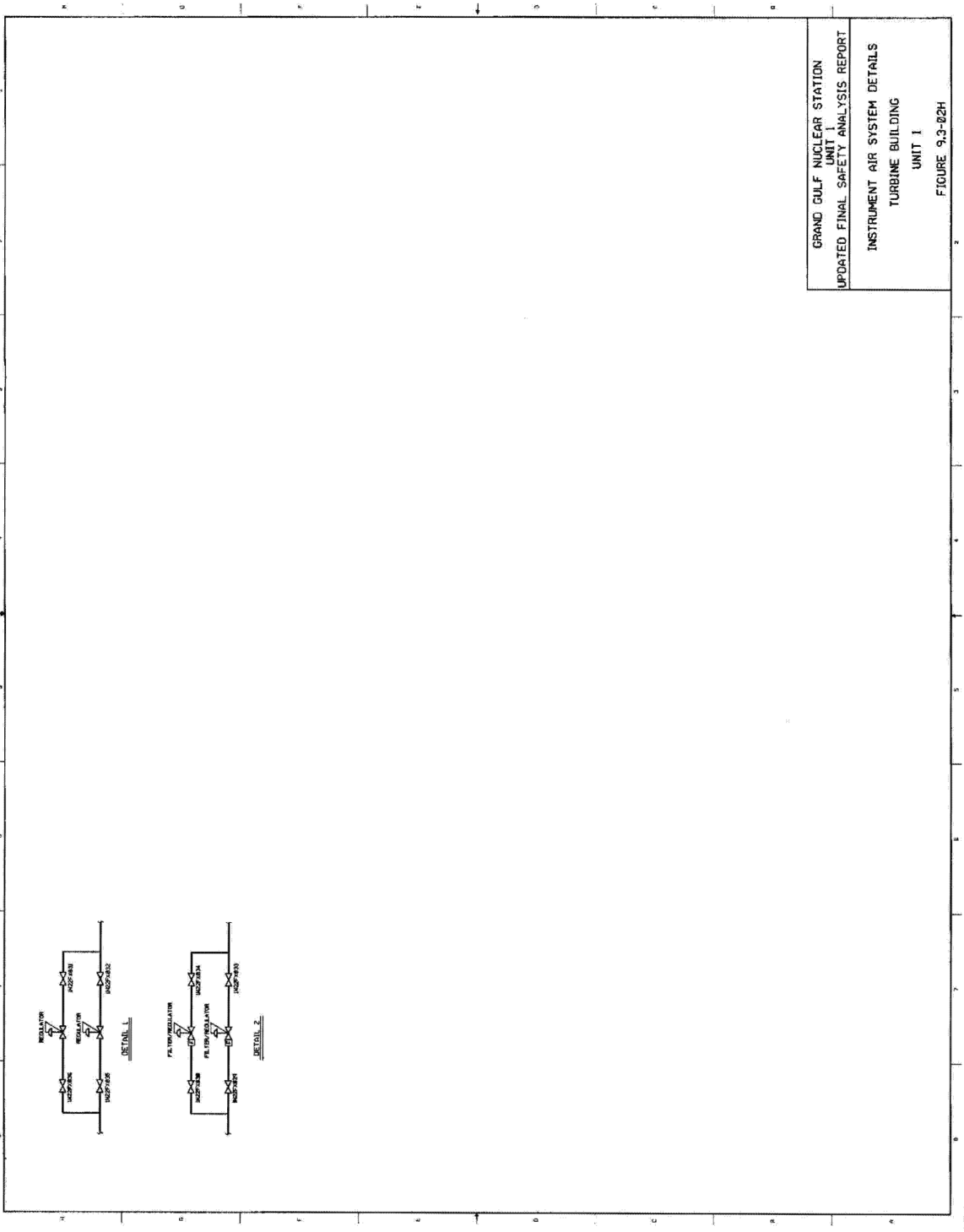

GRAND GULF NUCLEAR STATION
UNIT 1
UPDATED FINAL SAFETY ANALYSIS REPORT
INSTRUMENT AIR SYSTEM DETAILS
TURBINE BUILDING
UNIT 1
FIGURE 9.3-02H

GRAND GULF NUCLEAR GENERATING STATION

Updated Final Safety Analysis Report (UFSAR)

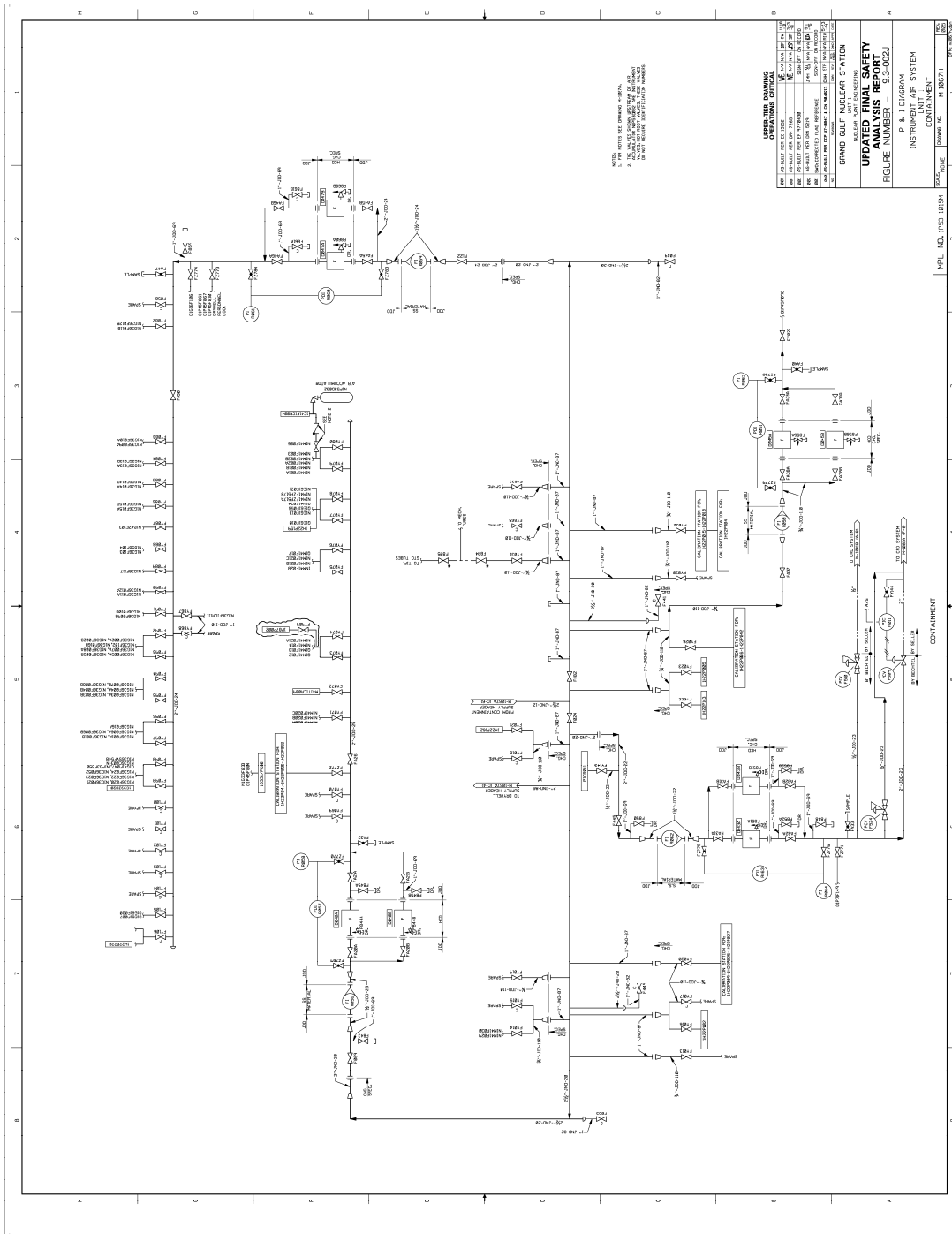

GRAND GULF NUCLEAR GENERATING STATION

Updated Final Safety Analysis Report (UFSAR)

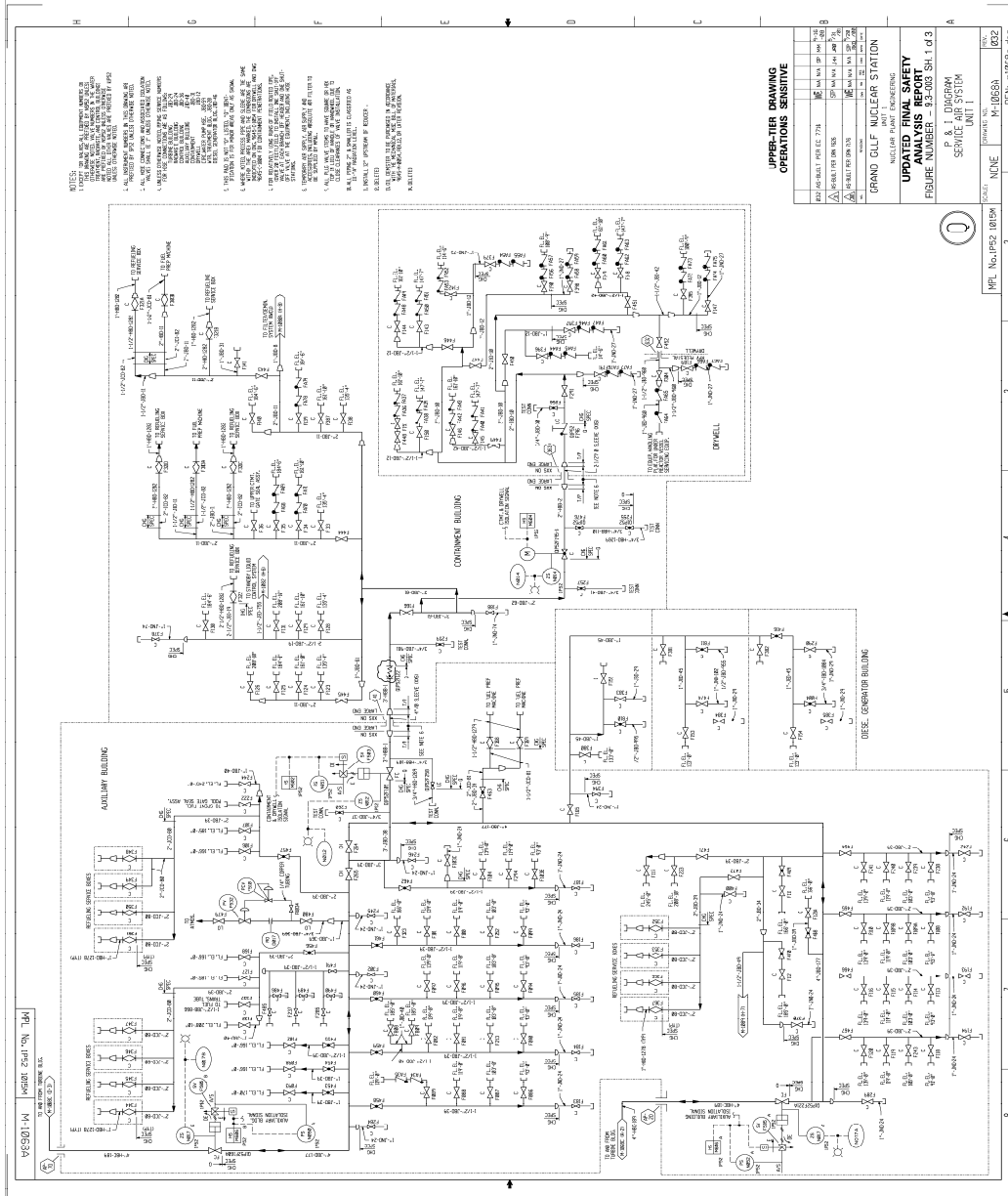

GRAND GULF NUCLEAR GENERATING STATION Updated Final Safety Analysis Report (UFSAR)

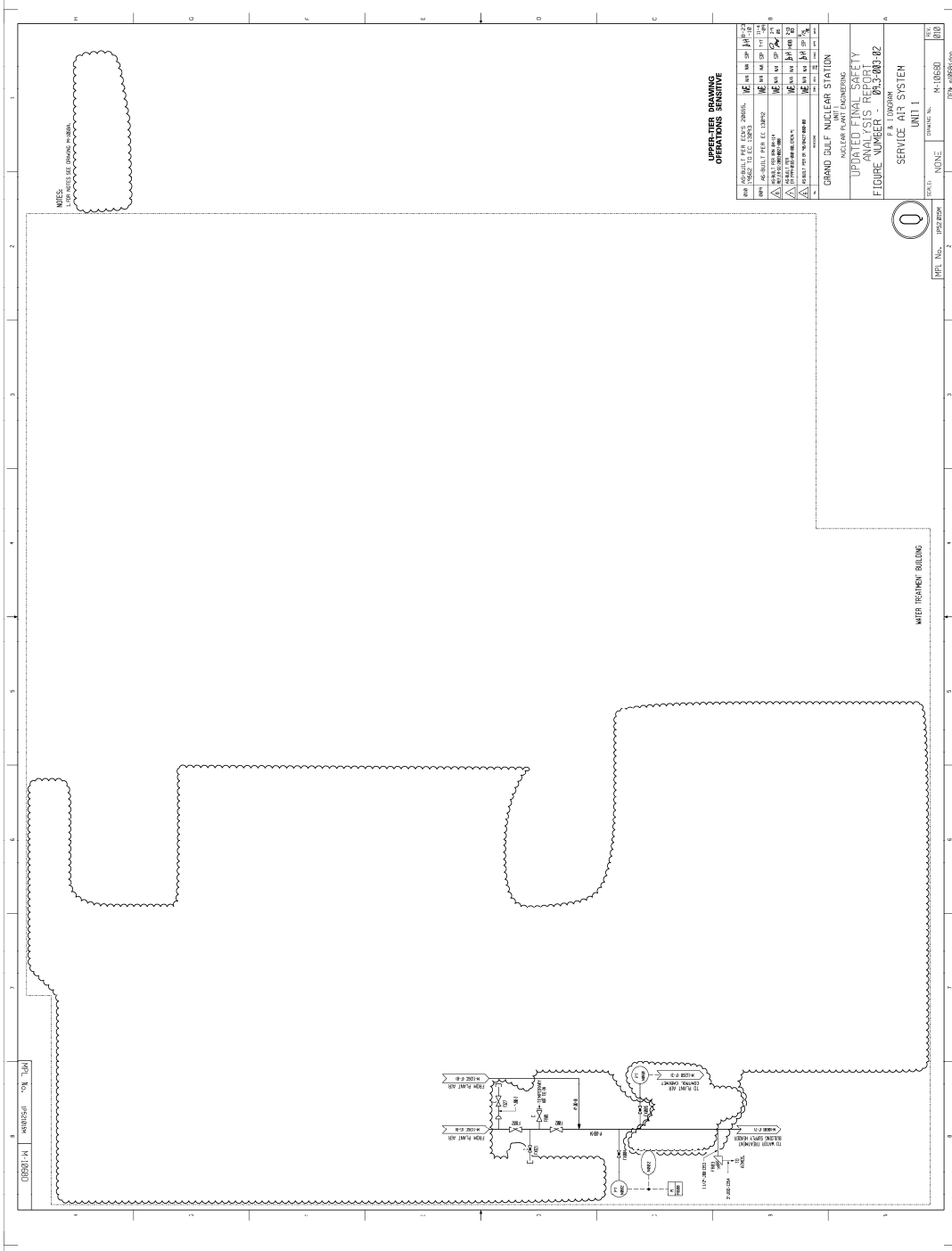

GRAND GULF NUCLEAR GENERATING STATION

Updated Final Safety Analysis Report (UFSAR)

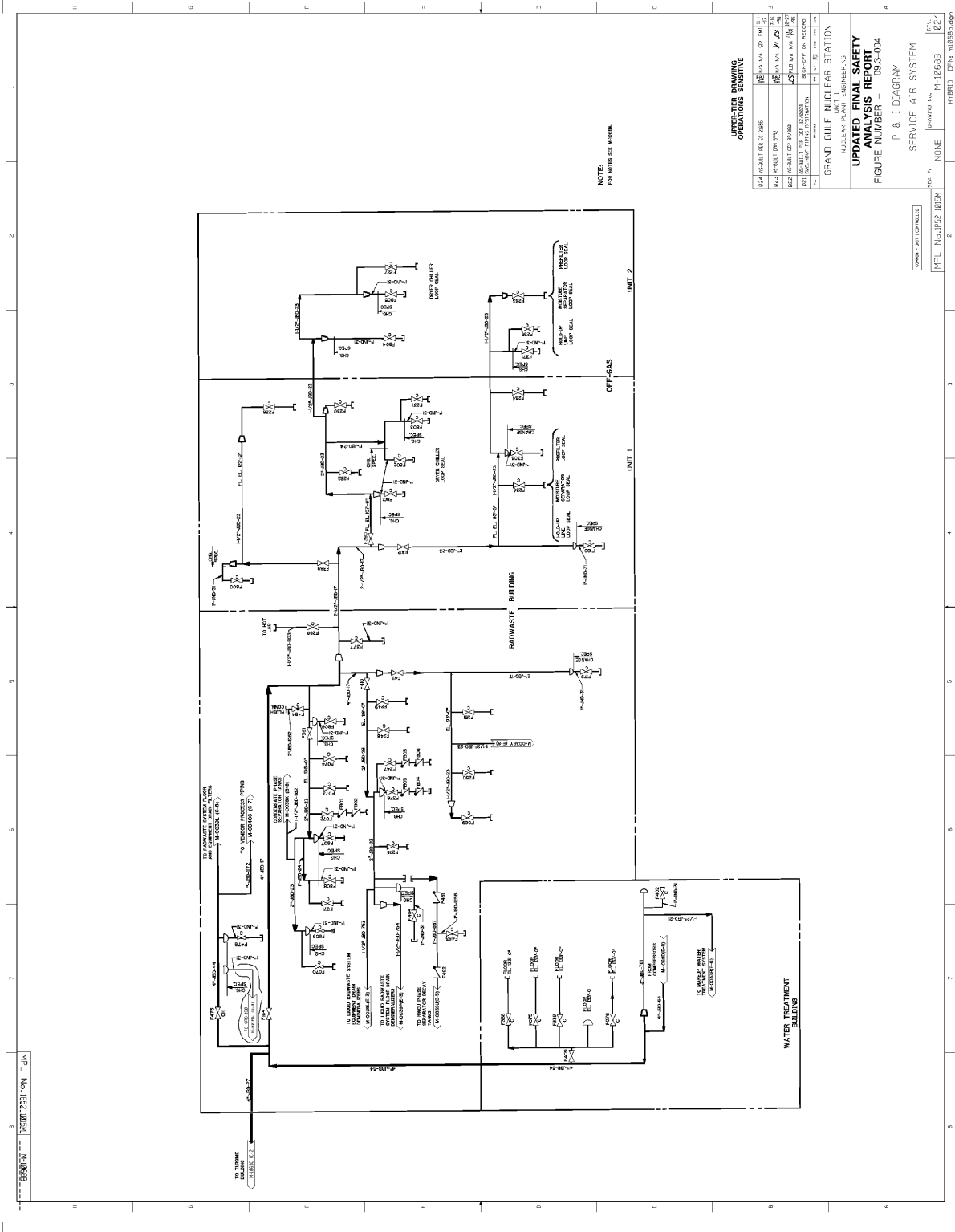

UPPER-TIER DRAWING OPERATORS SCHEMATIC	
DATE (REVISED DATE)	10/25/14 (1)
BY (REVISED BY)	JAS
DESIGNED BY (REVISED BY)	JAS
APPROVED BY (REVISED BY)	JAS
SCALE	AS SHOWN
PROJECT	UPPER-TIER DRAWING OPERATORS SCHEMATIC
UNIT	UNIT 1 & UNIT 2
GRAND GULF NUCLEAR STATION	
UNIT 1 & UNIT 2	
UPDATED FINAL SAFETY ANALYSIS REPORT	
FIGURE NUMBER - 09.3-004	
P & I DIAGRAM	
SERVICE AIR SYSTEM	
REV. #	NONE
DATE	10/25/14
BY	M-110663
APP. NO.	09.3-004
REVISED BY	09.3-004

GRAND GULF NUCLEAR GENERATING STATION Updated Final Safety Analysis Report (UFSAR)

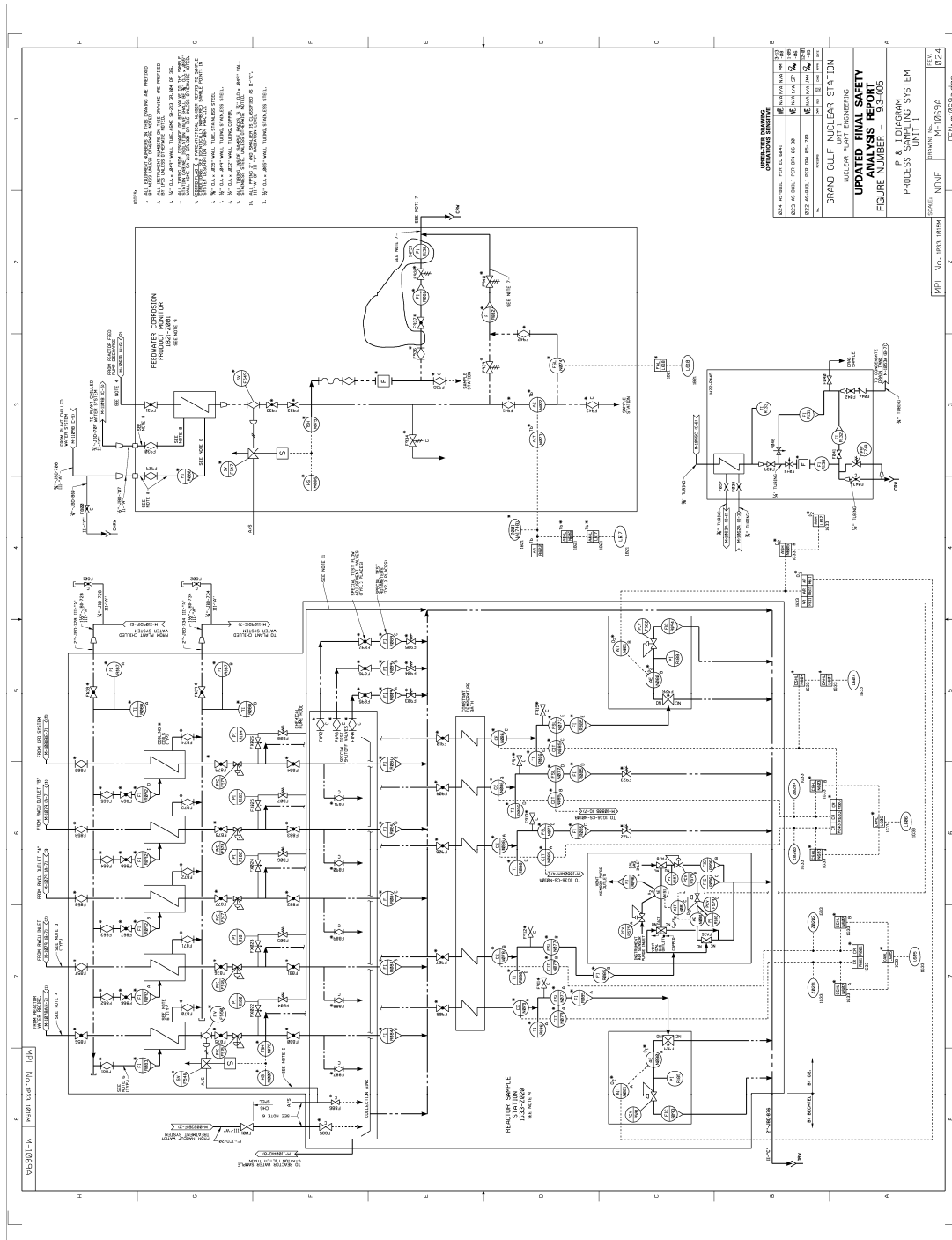

GRAND GULF NUCLEAR GENERATING STATION Updated Final Safety Analysis Report (UFSAR)

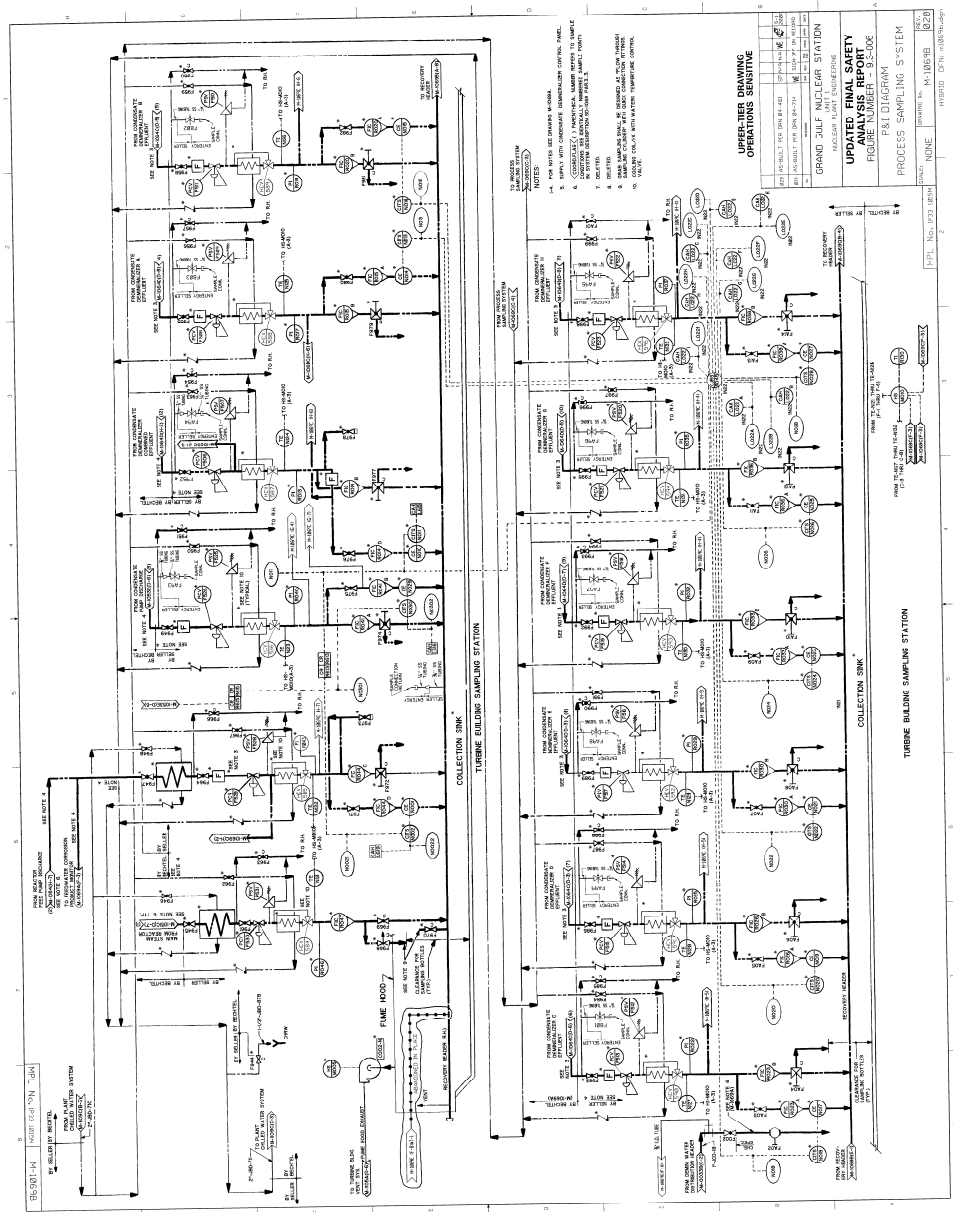

GRAND GULF NUCLEAR GENERATING STATION

Updated Final Safety Analysis Report (UFSAR)

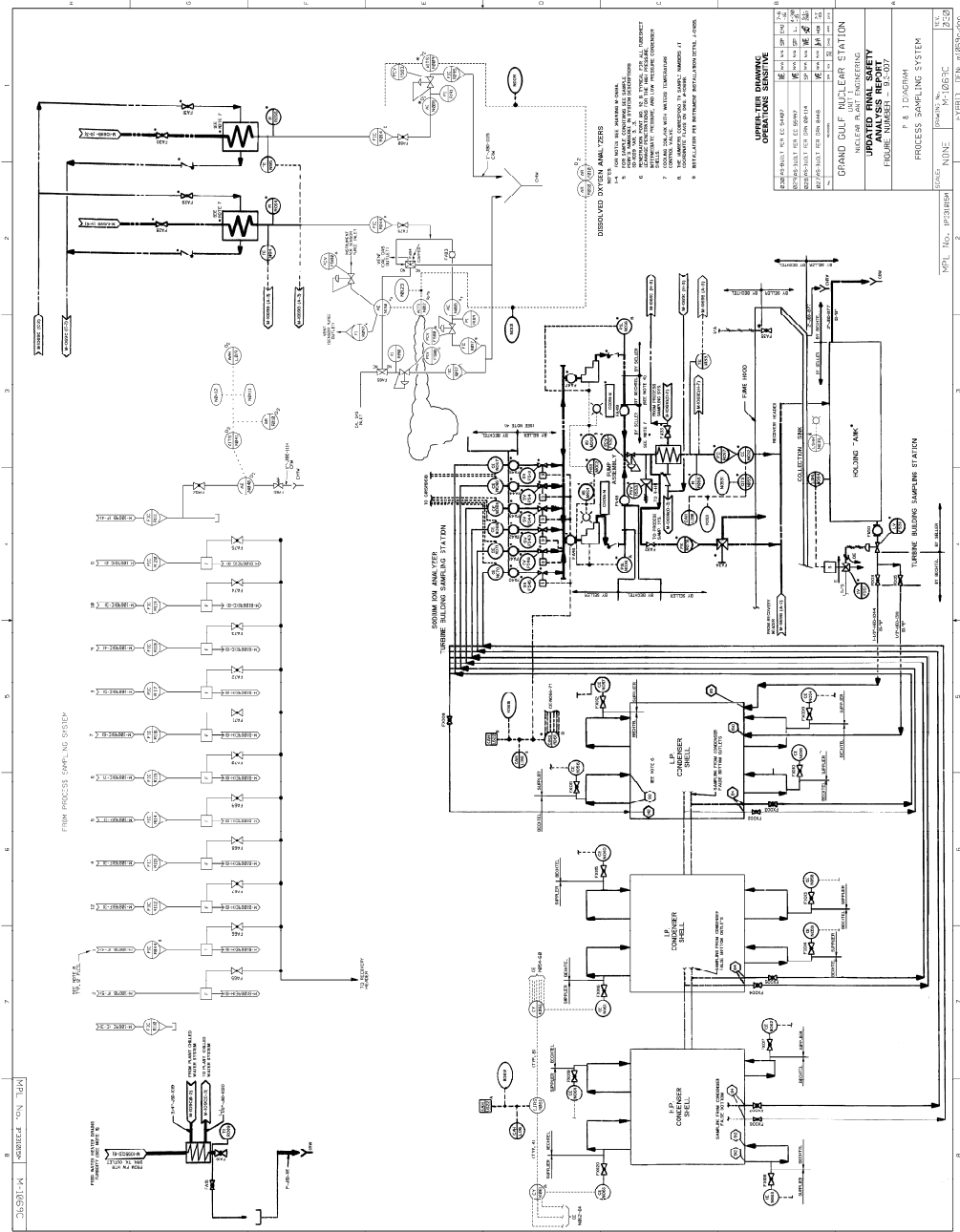
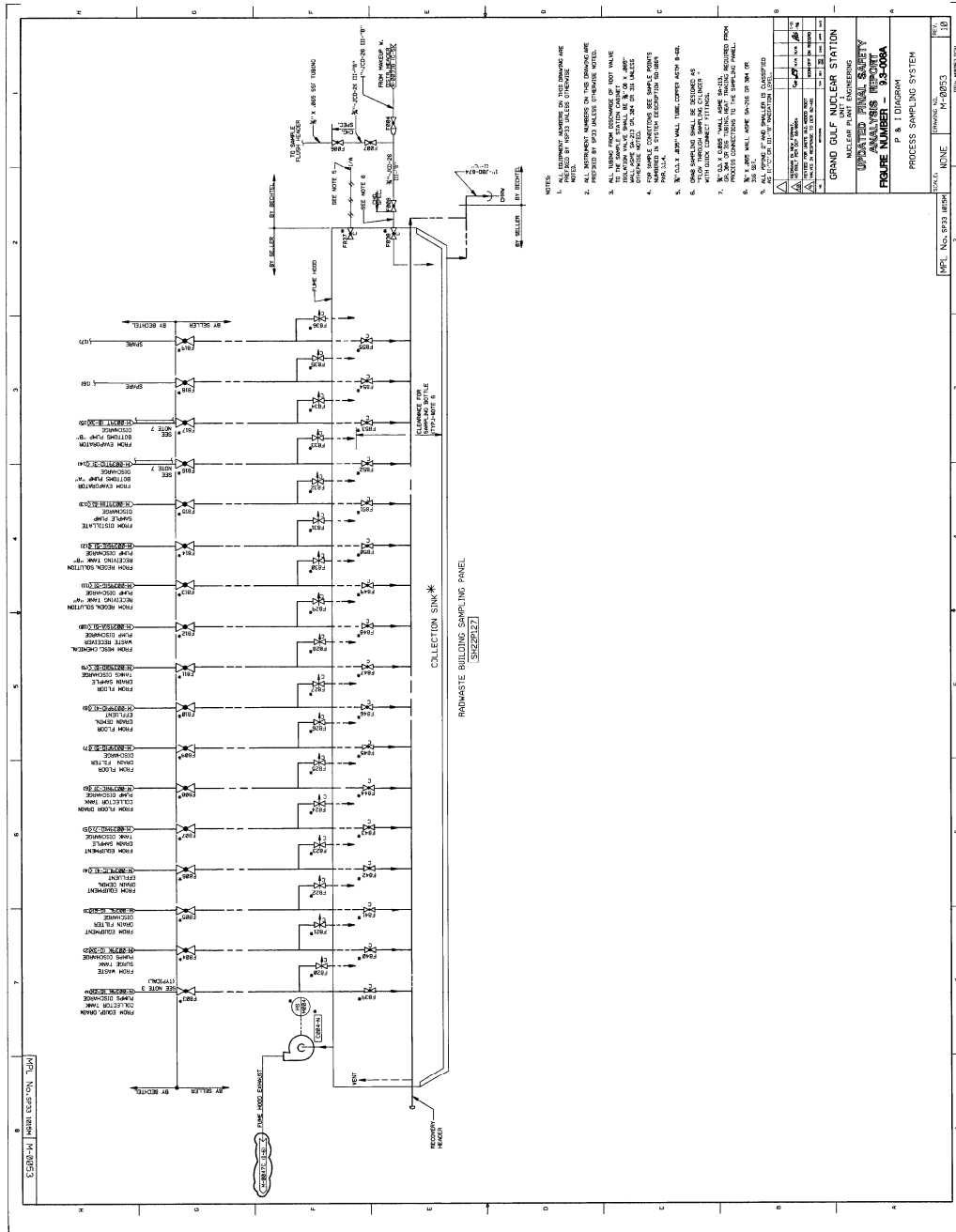

FIGURE 9.3-8: Deleted

GRAND GULF NUCLEAR GENERATING STATION Updated Final Safety Analysis Report (UFSAR)



GRAND GULF NUCLEAR GENERATING STATION

Updated Final Safety Analysis Report (UFSAR)

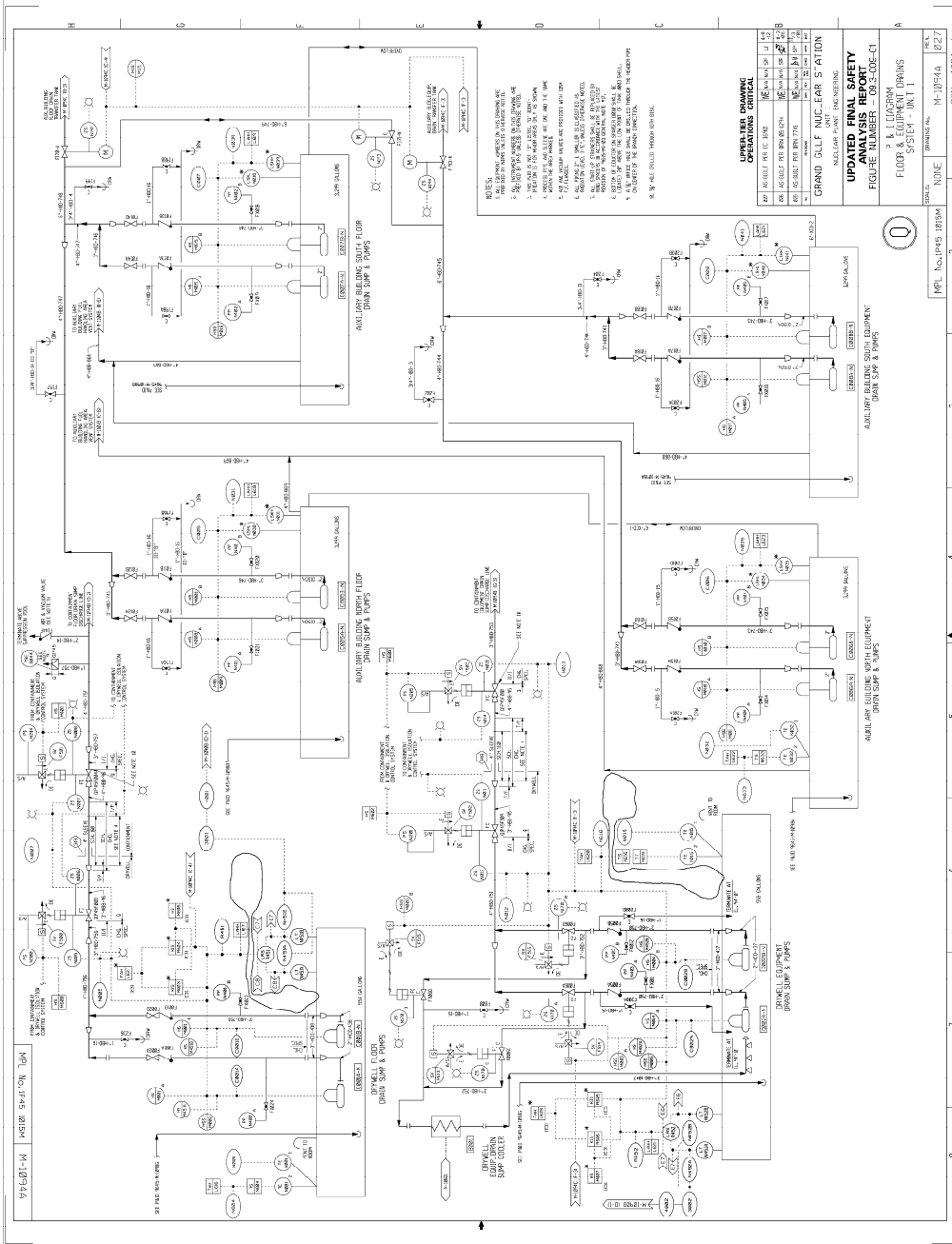

GRAND GULF NUCLEAR GENERATING STATION

Updated Final Safety Analysis Report (UFSAR)

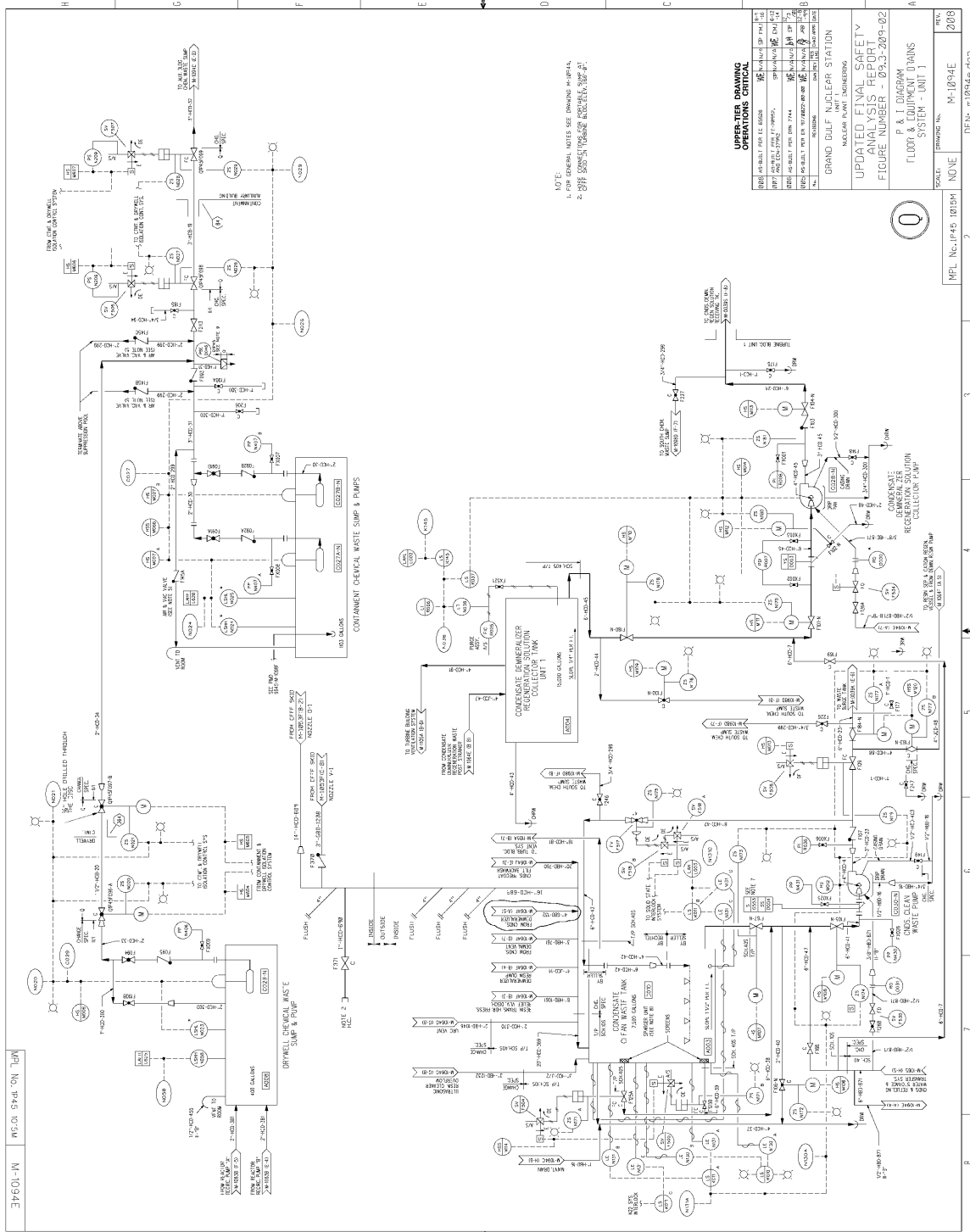

GRAND GULF NUCLEAR GENERATING STATION Updated Final Safety Analysis Report (UFSAR)

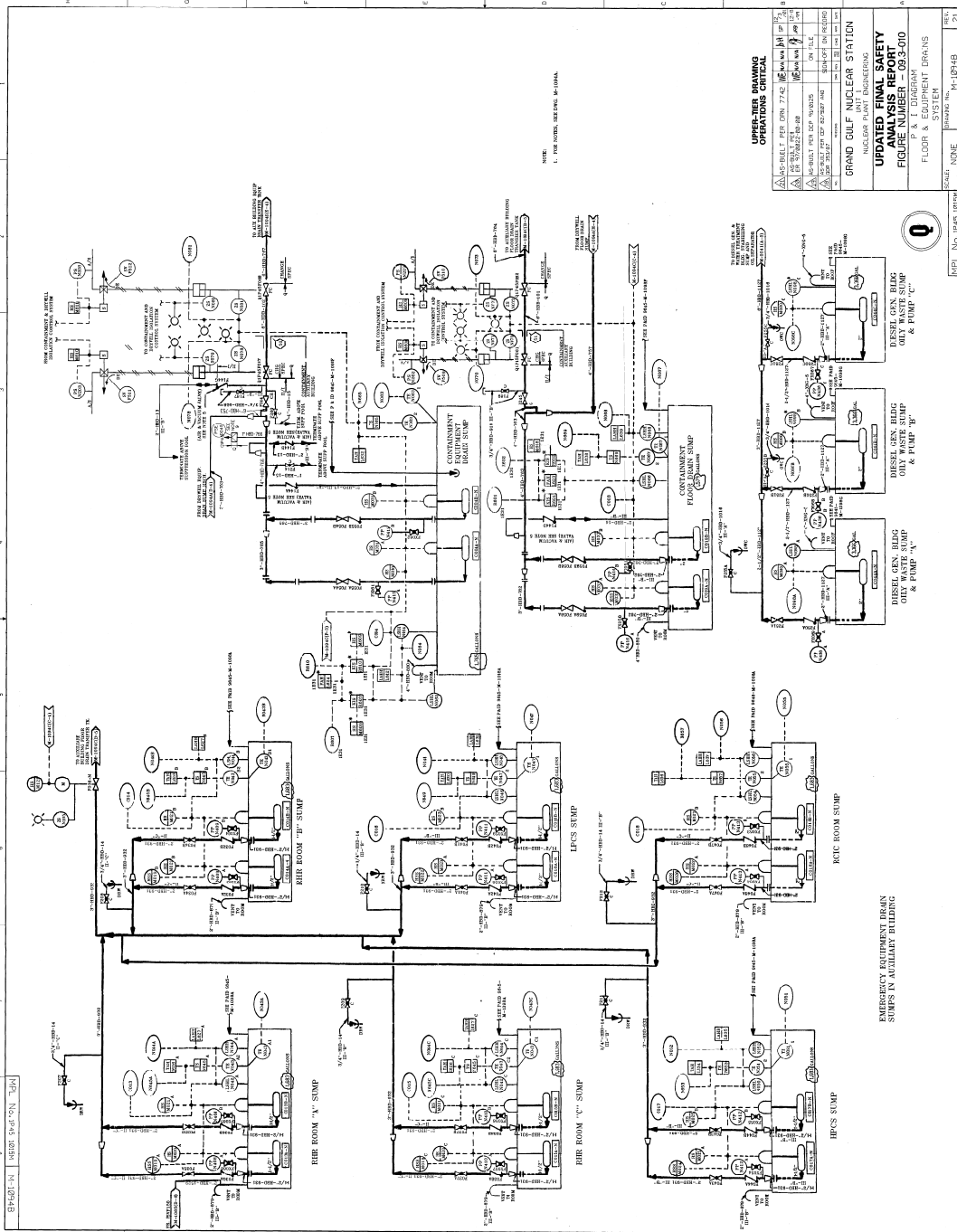

GRAND GULF NUCLEAR GENERATING STATION

Updated Final Safety Analysis Report (UFSAR)

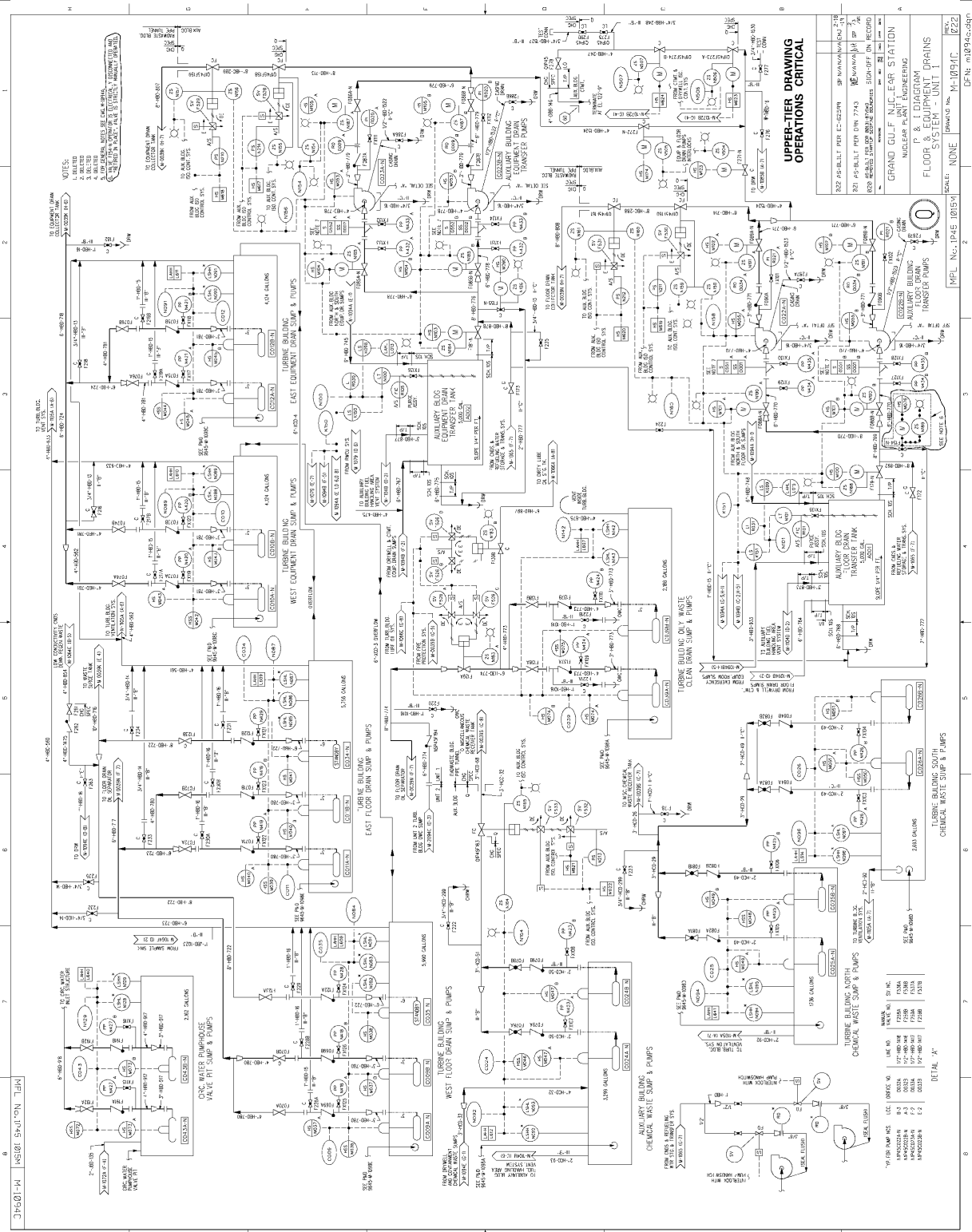

GRAND GULF NUCLEAR GENERATING STATION

Updated Final Safety Analysis Report (UFSAR)

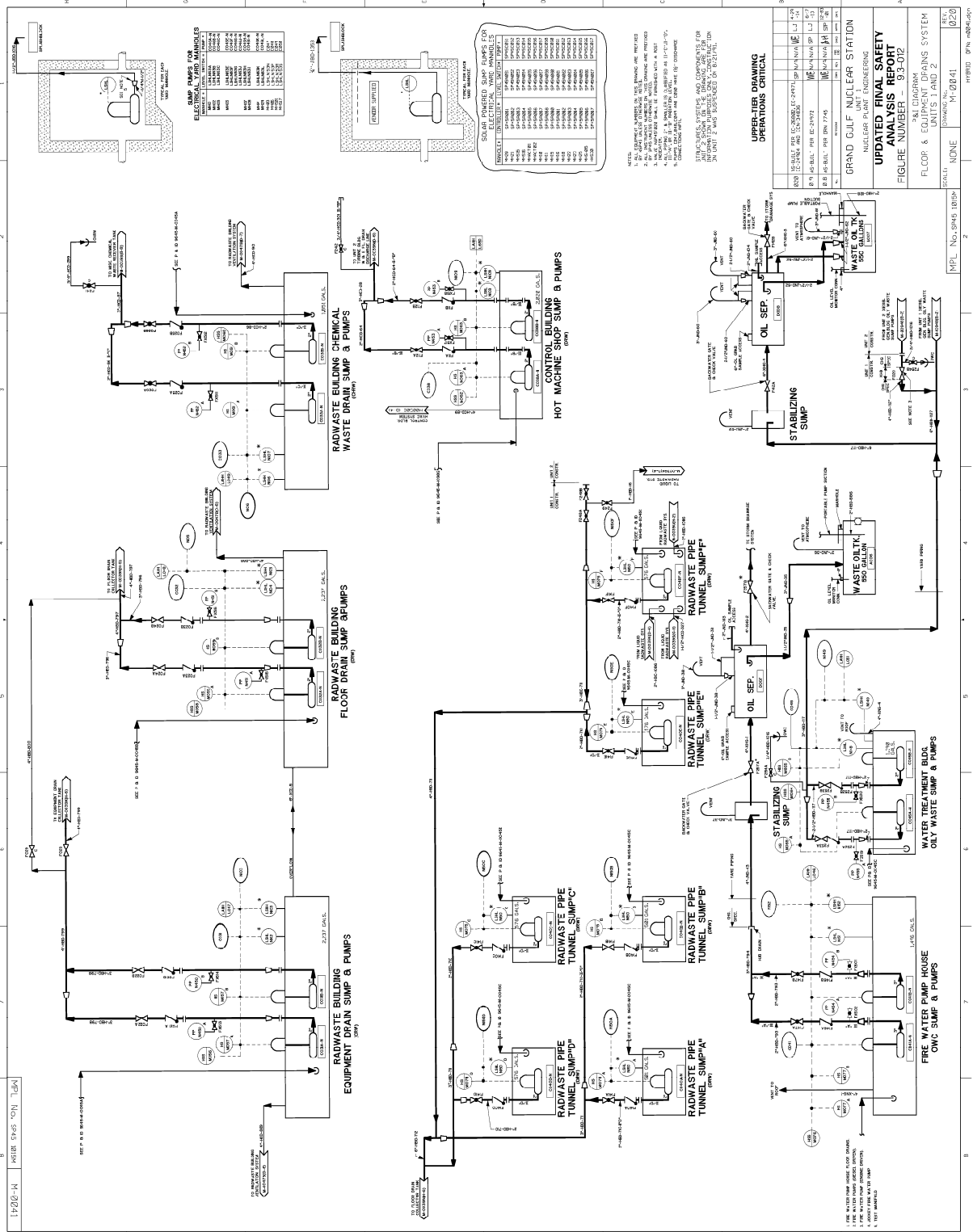

GRAND GULF NUCLEAR GENERATING STATION

Updated Final Safety Analysis Report (UFSAR)

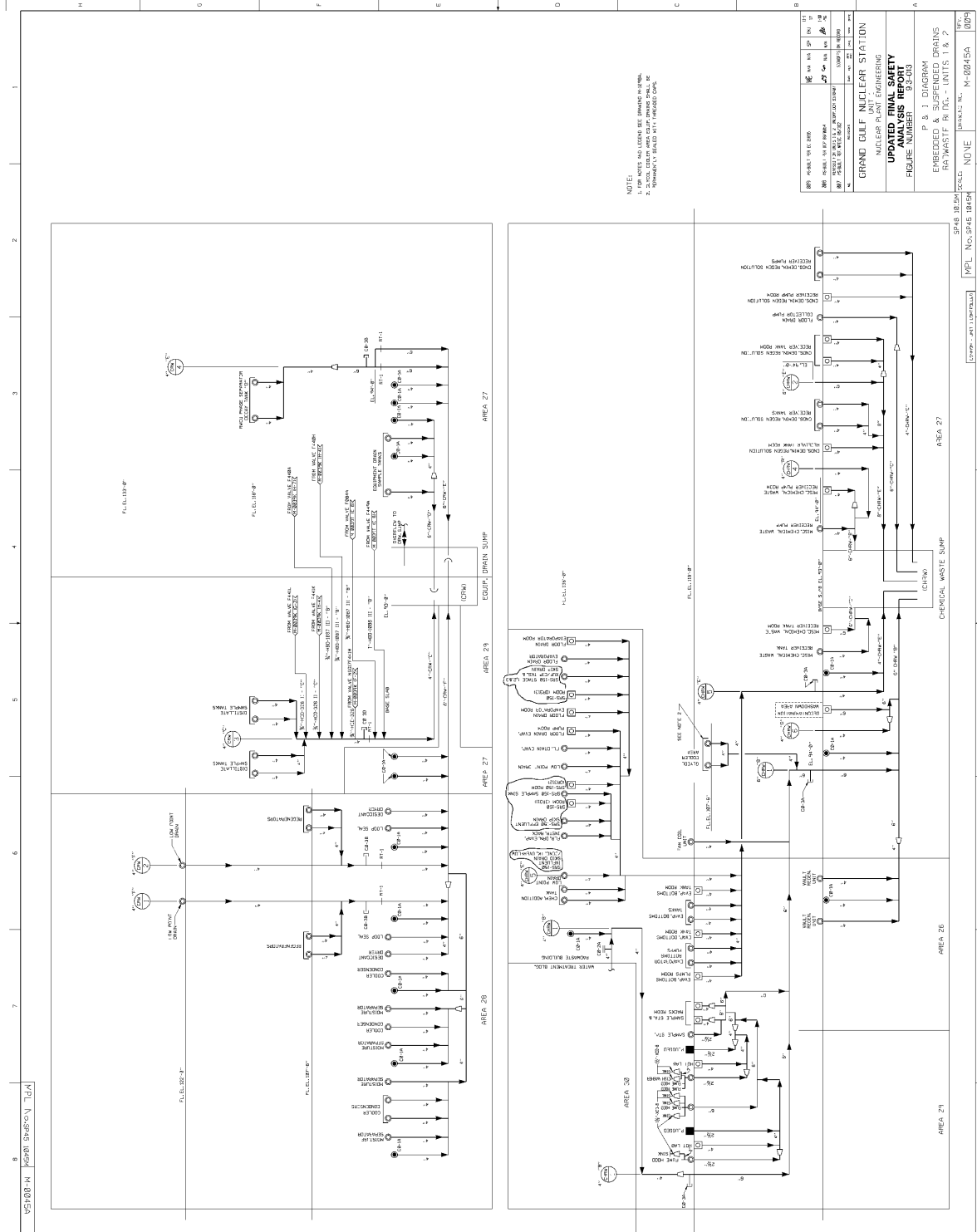

GRAND GULF NUCLEAR GENERATING STATION

Updated Final Safety Analysis Report (UFSAR)

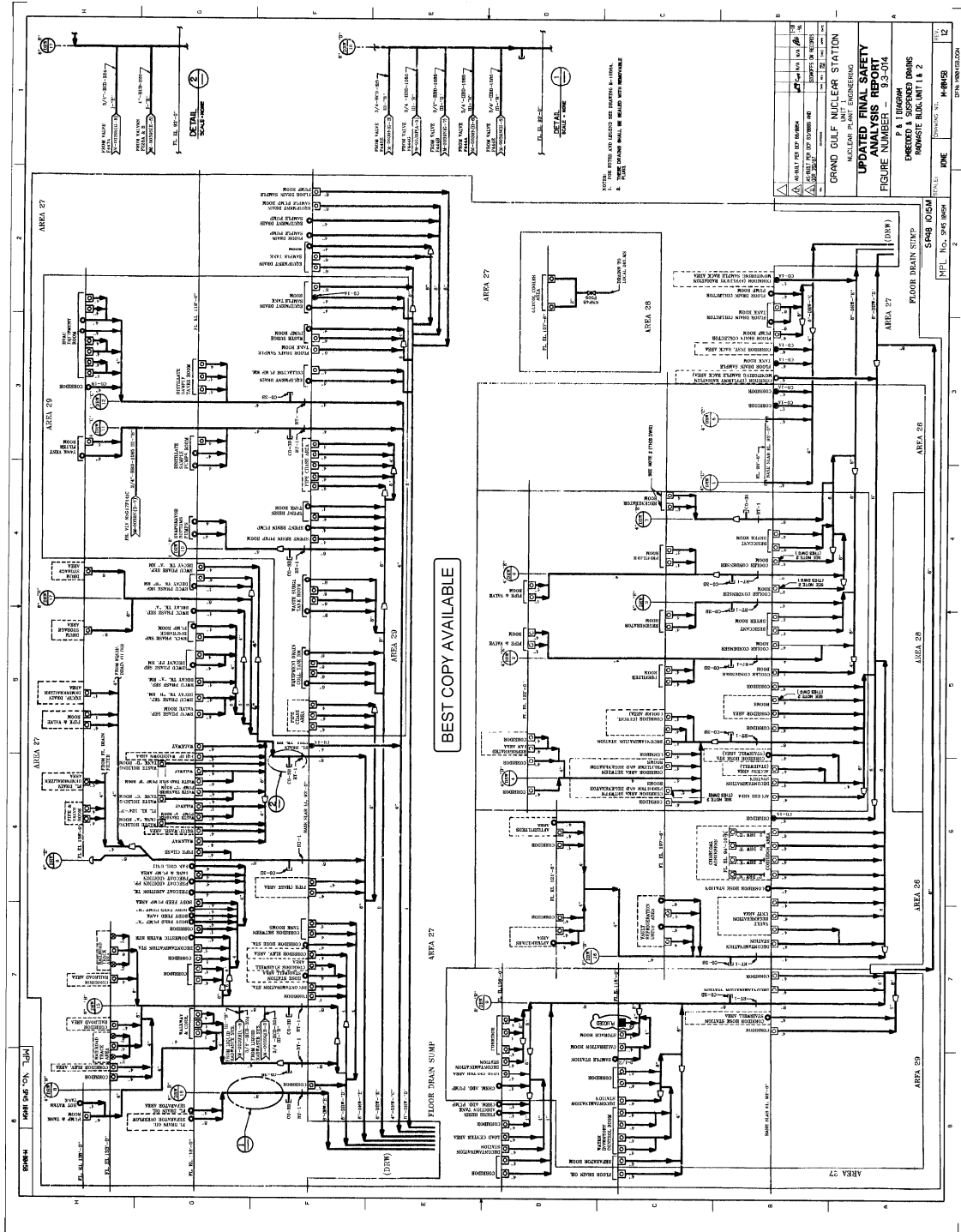

GRAND GULF NUCLEAR GENERATING STATION

Updated Final Safety Analysis Report (UFSAR)

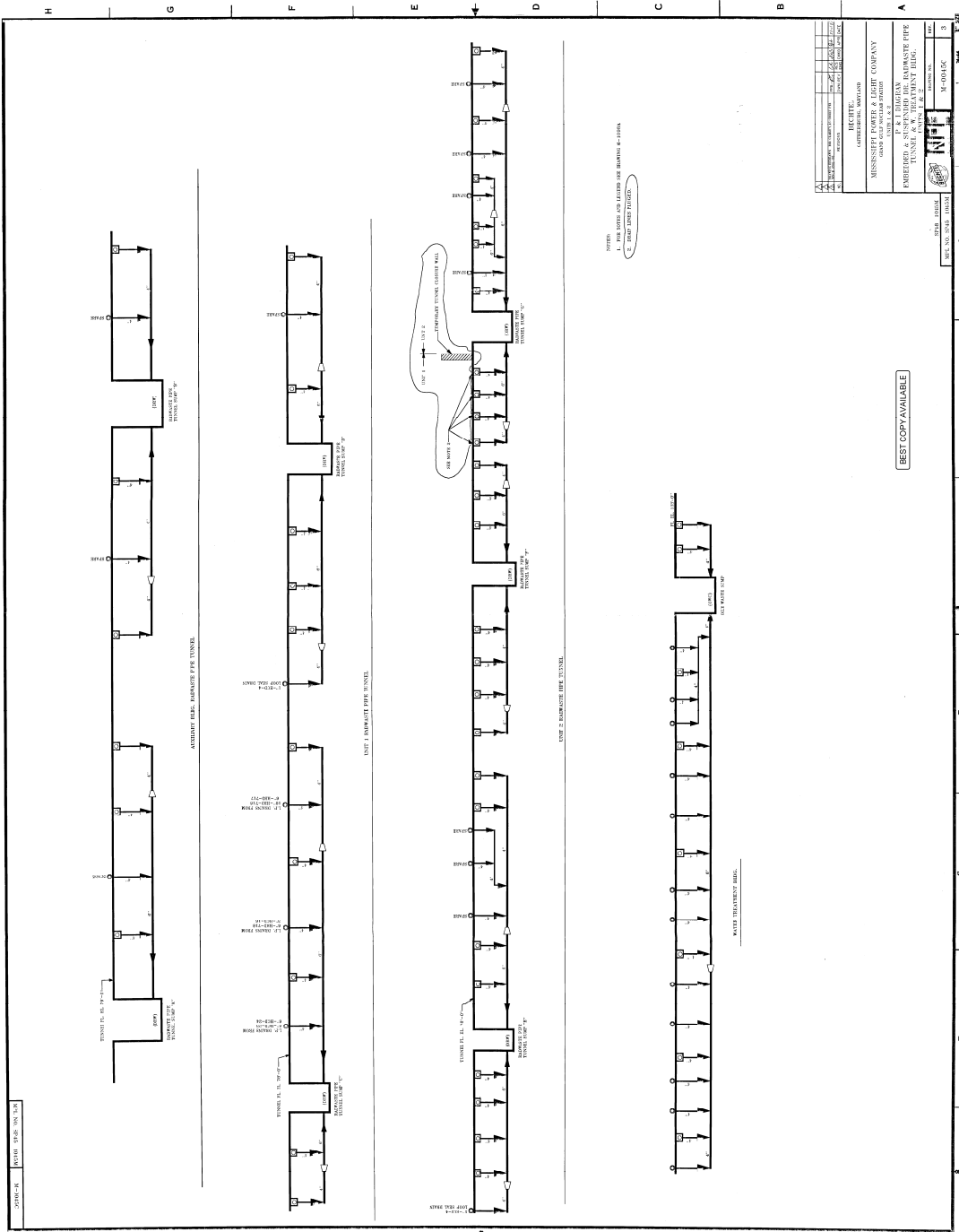

NO.	DESCRIPTION	DATE	BY	CHKD.
1	DESIGNED	10/1/58	W. L. THORNTON	
2	CHECKED	10/1/58	W. L. THORNTON	
3	APPROVED	10/1/58	W. L. THORNTON	
4	REVISION	10/1/58	W. L. THORNTON	
5	REVISION	10/1/58	W. L. THORNTON	
6	REVISION	10/1/58	W. L. THORNTON	
7	REVISION	10/1/58	W. L. THORNTON	
8	REVISION	10/1/58	W. L. THORNTON	
9	REVISION	10/1/58	W. L. THORNTON	
10	REVISION	10/1/58	W. L. THORNTON	
11	REVISION	10/1/58	W. L. THORNTON	
12	REVISION	10/1/58	W. L. THORNTON	
13	REVISION	10/1/58	W. L. THORNTON	
14	REVISION	10/1/58	W. L. THORNTON	
15	REVISION	10/1/58	W. L. THORNTON	
16	REVISION	10/1/58	W. L. THORNTON	
17	REVISION	10/1/58	W. L. THORNTON	
18	REVISION	10/1/58	W. L. THORNTON	
19	REVISION	10/1/58	W. L. THORNTON	
20	REVISION	10/1/58	W. L. THORNTON	
21	REVISION	10/1/58	W. L. THORNTON	
22	REVISION	10/1/58	W. L. THORNTON	
23	REVISION	10/1/58	W. L. THORNTON	
24	REVISION	10/1/58	W. L. THORNTON	
25	REVISION	10/1/58	W. L. THORNTON	
26	REVISION	10/1/58	W. L. THORNTON	
27	REVISION	10/1/58	W. L. THORNTON	
28	REVISION	10/1/58	W. L. THORNTON	
29	REVISION	10/1/58	W. L. THORNTON	
30	REVISION	10/1/58	W. L. THORNTON	
31	REVISION	10/1/58	W. L. THORNTON	
32	REVISION	10/1/58	W. L. THORNTON	
33	REVISION	10/1/58	W. L. THORNTON	
34	REVISION	10/1/58	W. L. THORNTON	
35	REVISION	10/1/58	W. L. THORNTON	
36	REVISION	10/1/58	W. L. THORNTON	
37	REVISION	10/1/58	W. L. THORNTON	
38	REVISION	10/1/58	W. L. THORNTON	
39	REVISION	10/1/58	W. L. THORNTON	
40	REVISION	10/1/58	W. L. THORNTON	
41	REVISION	10/1/58	W. L. THORNTON	
42	REVISION	10/1/58	W. L. THORNTON	
43	REVISION	10/1/58	W. L. THORNTON	
44	REVISION	10/1/58	W. L. THORNTON	
45	REVISION	10/1/58	W. L. THORNTON	
46	REVISION	10/1/58	W. L. THORNTON	
47	REVISION	10/1/58	W. L. THORNTON	
48	REVISION	10/1/58	W. L. THORNTON	
49	REVISION	10/1/58	W. L. THORNTON	
50	REVISION	10/1/58	W. L. THORNTON	
51	REVISION	10/1/58	W. L. THORNTON	
52	REVISION	10/1/58	W. L. THORNTON	
53	REVISION	10/1/58	W. L. THORNTON	
54	REVISION	10/1/58	W. L. THORNTON	
55	REVISION	10/1/58	W. L. THORNTON	
56	REVISION	10/1/58	W. L. THORNTON	
57	REVISION	10/1/58	W. L. THORNTON	
58	REVISION	10/1/58	W. L. THORNTON	
59	REVISION	10/1/58	W. L. THORNTON	
60	REVISION	10/1/58	W. L. THORNTON	

GRAND GULF NUCLEAR GENERATING STATION
Updated Final Safety Analysis Report (UFSAR)

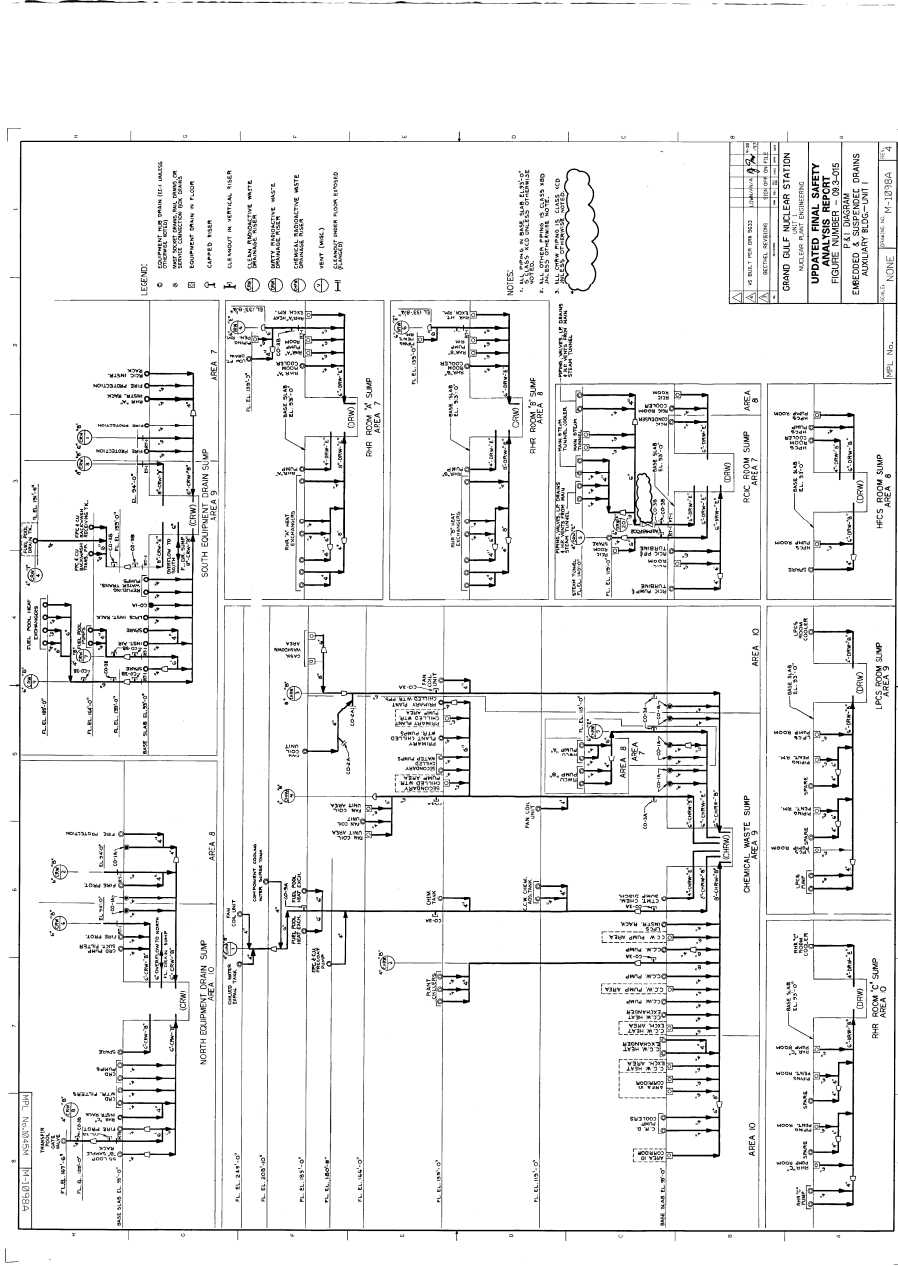

GRAND GULF NUCLEAR GENERATING STATION

Updated Final Safety Analysis Report (UFSAR)

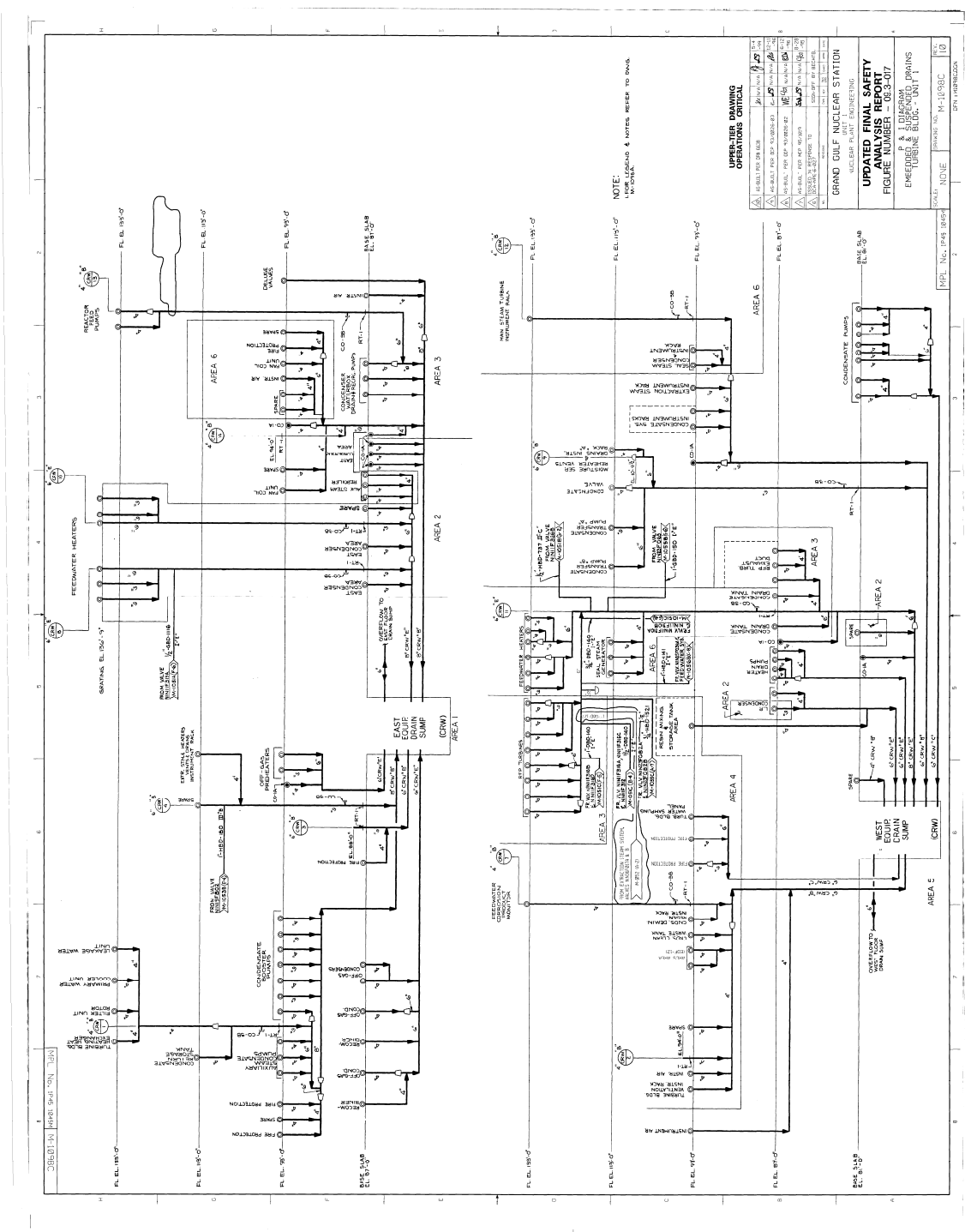

GRAND GULF NUCLEAR GENERATING STATION
Updated Final Safety Analysis Report (UFSAR)

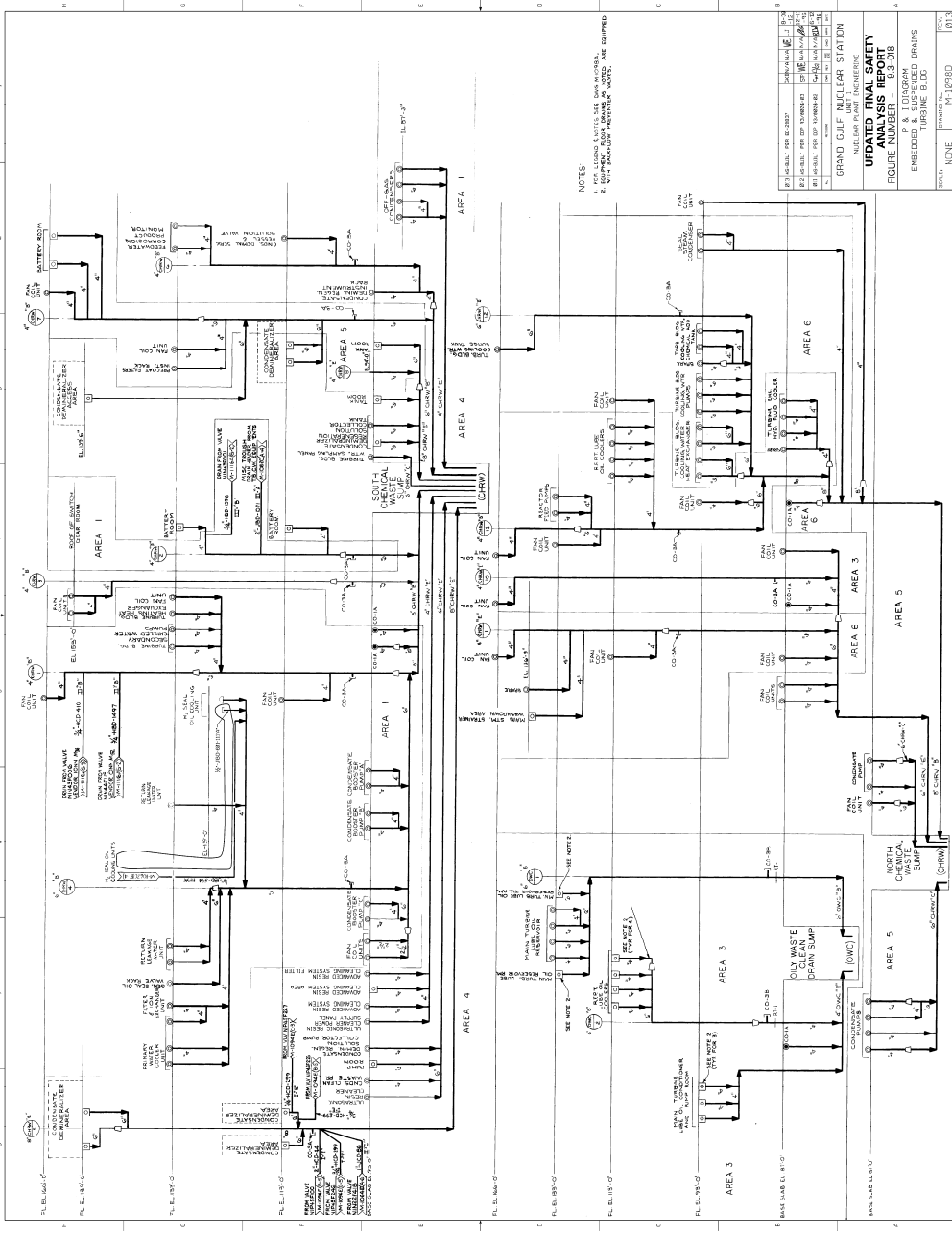

GRAND GULF NUCLEAR GENERATING STATION Updated Final Safety Analysis Report (UFSAR)

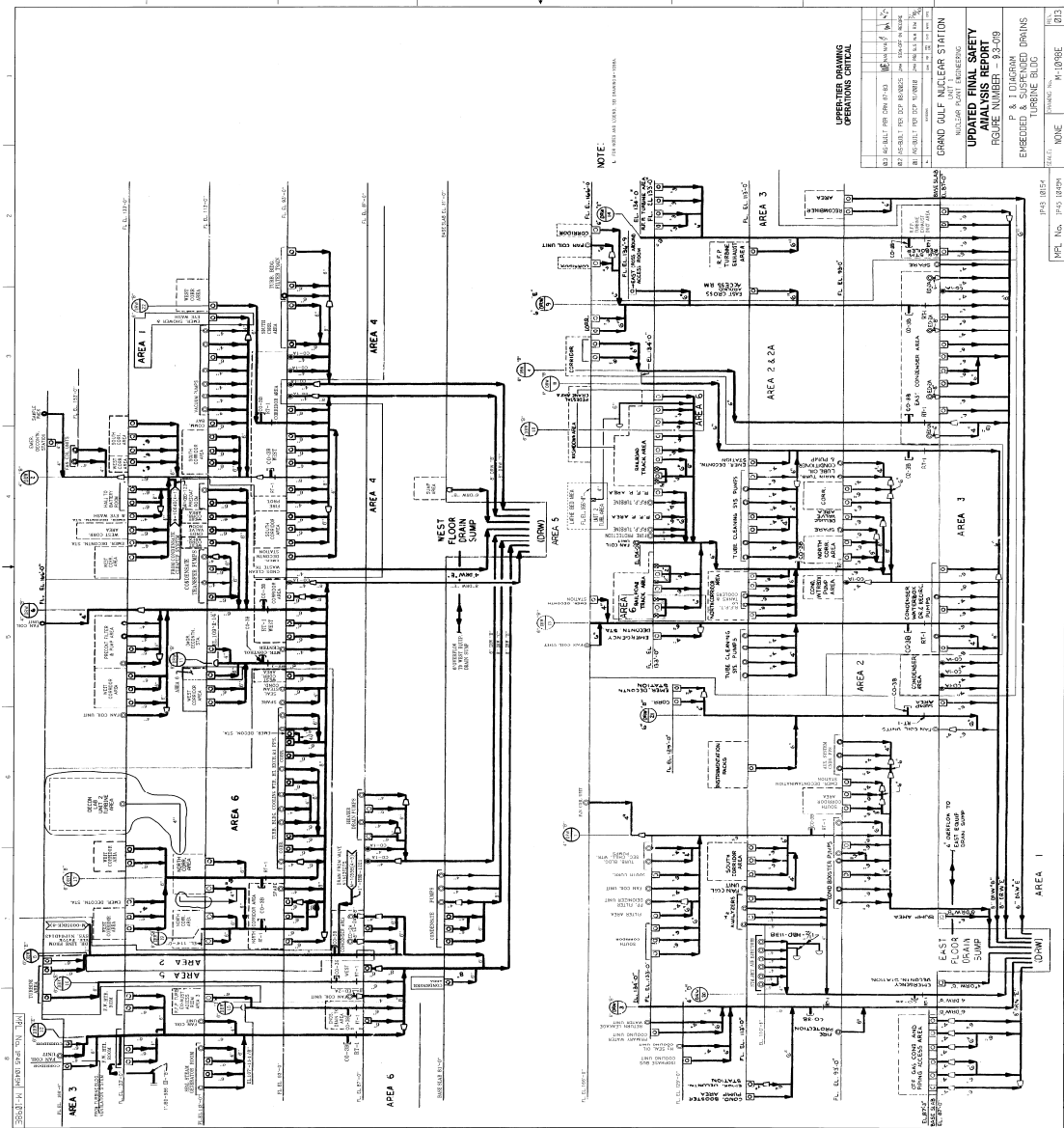

NOTE:
1. THE AREA SHOWN IS FOR EMERGENCY TURBINE DRAIN ONLY.

ALL SCALE FOR DIM. (IN.)	NO. 1/8"
ALL SCALE FOR DIM. (IN.)	NO. 1/4"
ALL SCALE FOR DIM. (IN.)	NO. 3/8"
ALL SCALE FOR DIM. (IN.)	NO. 1/2"
ALL SCALE FOR DIM. (IN.)	NO. 3/4"
ALL SCALE FOR DIM. (IN.)	NO. 1"
ALL SCALE FOR DIM. (IN.)	NO. 1 1/2"
ALL SCALE FOR DIM. (IN.)	NO. 2"
ALL SCALE FOR DIM. (IN.)	NO. 3"
ALL SCALE FOR DIM. (IN.)	NO. 4"
ALL SCALE FOR DIM. (IN.)	NO. 6"
ALL SCALE FOR DIM. (IN.)	NO. 8"
ALL SCALE FOR DIM. (IN.)	NO. 10"
ALL SCALE FOR DIM. (IN.)	NO. 12"
ALL SCALE FOR DIM. (IN.)	NO. 14"
ALL SCALE FOR DIM. (IN.)	NO. 16"
ALL SCALE FOR DIM. (IN.)	NO. 18"
ALL SCALE FOR DIM. (IN.)	NO. 20"
ALL SCALE FOR DIM. (IN.)	NO. 24"
ALL SCALE FOR DIM. (IN.)	NO. 30"
ALL SCALE FOR DIM. (IN.)	NO. 36"
ALL SCALE FOR DIM. (IN.)	NO. 42"
ALL SCALE FOR DIM. (IN.)	NO. 48"
ALL SCALE FOR DIM. (IN.)	NO. 54"
ALL SCALE FOR DIM. (IN.)	NO. 60"

OPERATING MANUAL
OPERATING MANUAL

GRAND GULF NUCLEAR STATION
100-200 0-107 Emergency

**UPDATED FINAL SAFETY
ANALYSIS REPORT**
FIGURE NUMBER - 9.3-93

P & I DIAGRAM
EMERGENCY TURBINE DRAIN
TURBINE BUILDING

SCALE: NONE

DATE: 11-10-86
DRAWN BY: M-LD/RE

IPR No. 100-10168

MPL No. 100-10168

REV. No. 2

FIGURE No. 9.3-93

FIGURE No. 213

GRAND GULF NUCLEAR GENERATING STATION

Updated Final Safety Analysis Report (UFSAR)

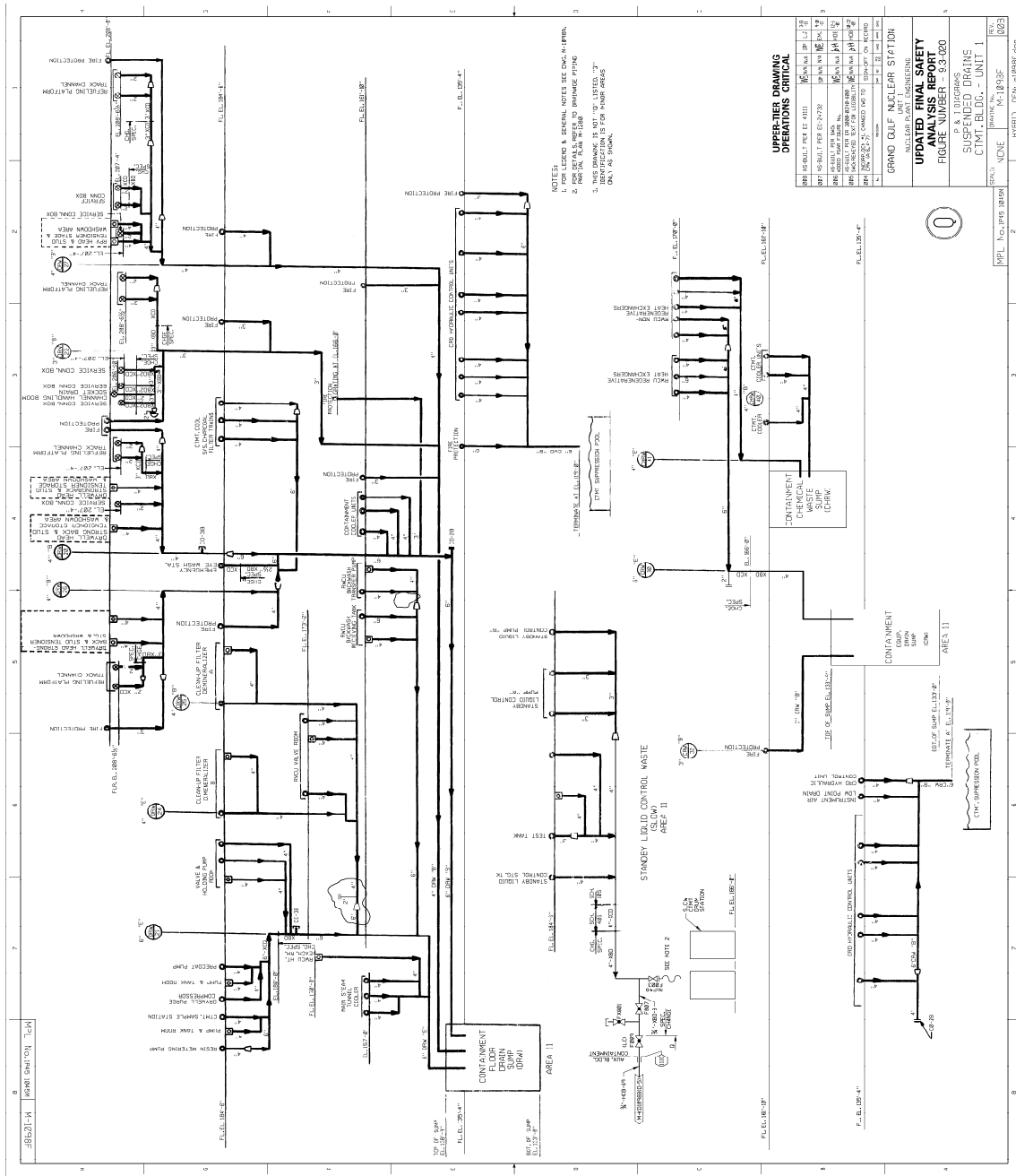

GRAND GULF NUCLEAR GENERATING STATION Updated Final Safety Analysis Report (UFSAR)

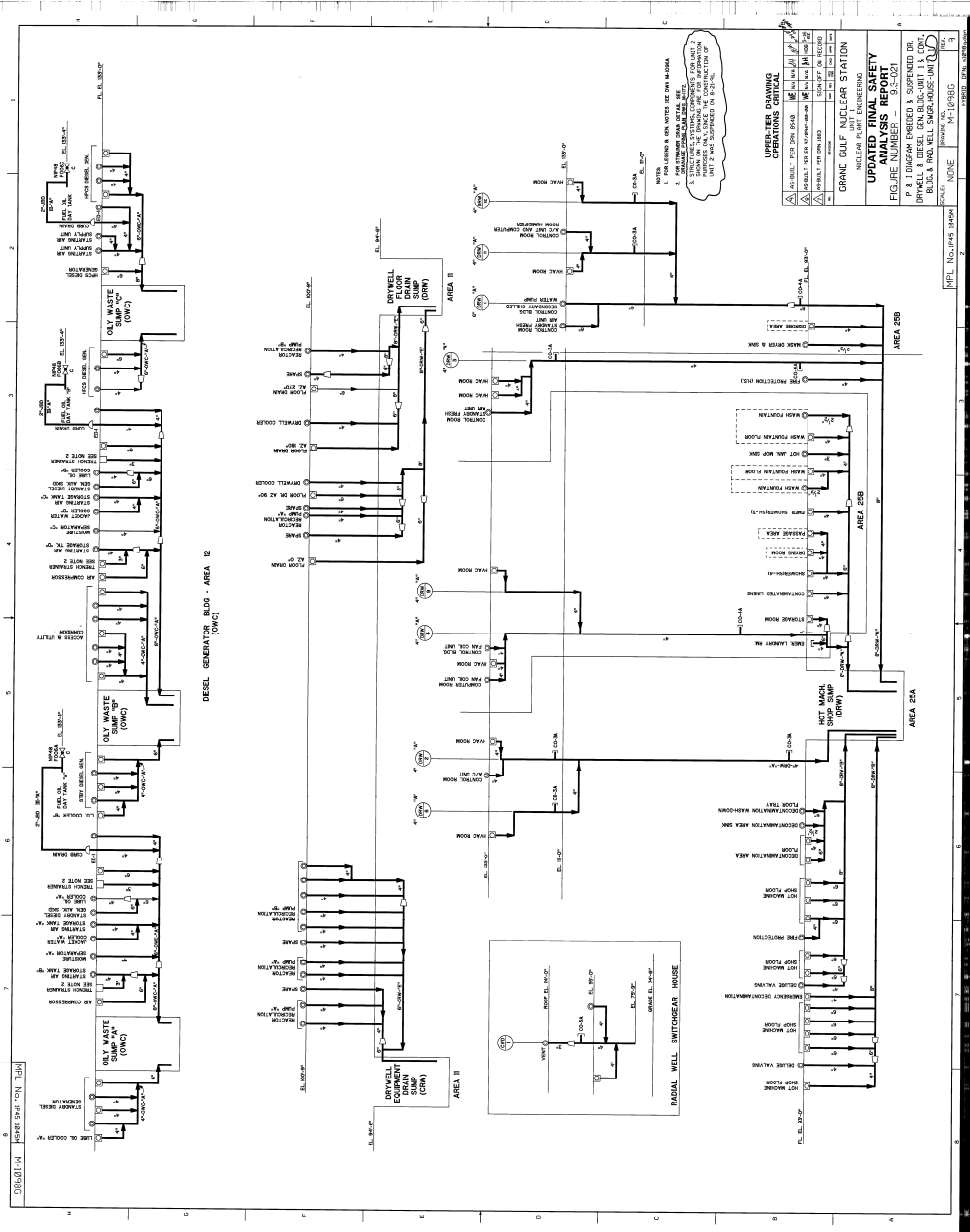

GRAND GULF NUCLEAR GENERATING STATION

Updated Final Safety Analysis Report (UFSAR)

M-1098H

M-1098H

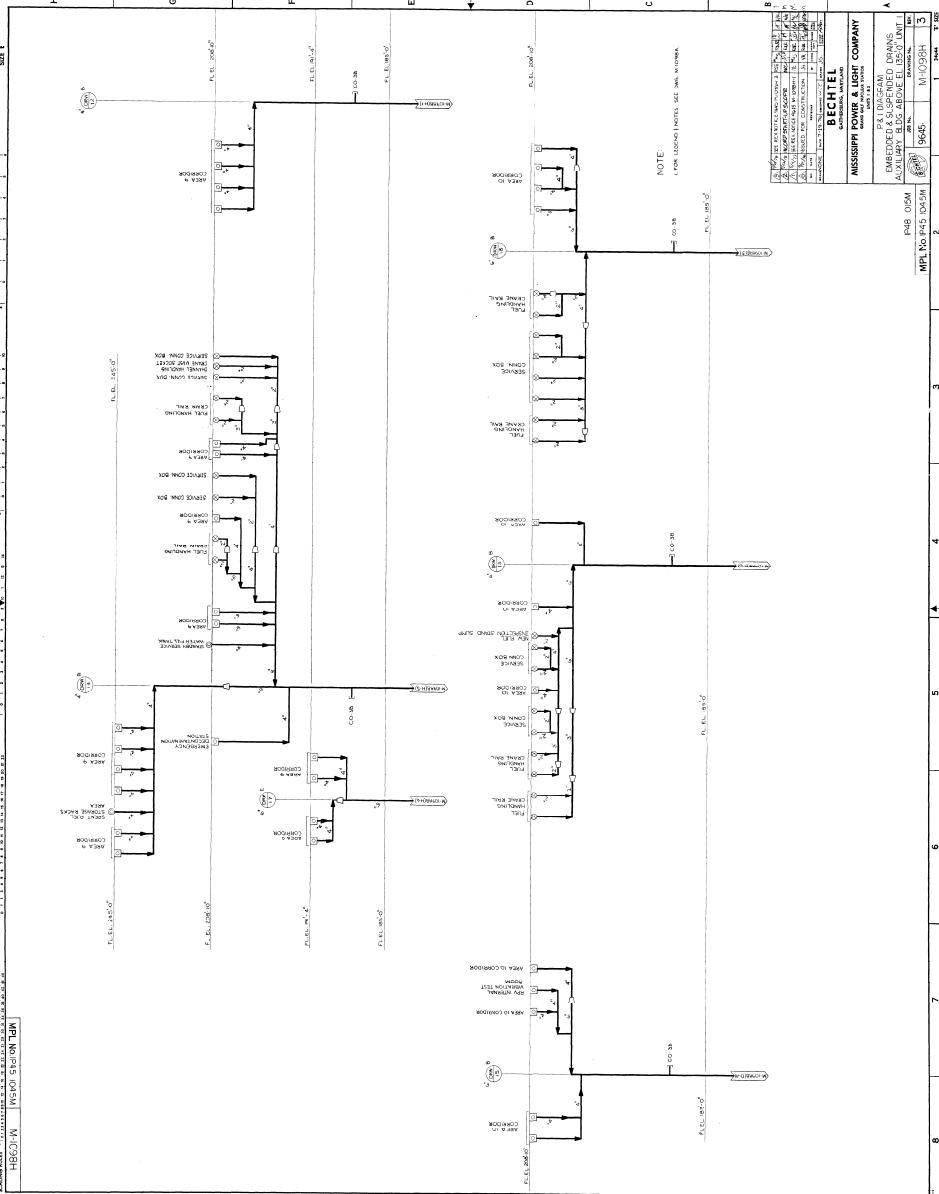

This drawing and design are the property of BECHTEL. They are hereby loaned to the licensee's representative and shall not be reproduced, copied, issued, altered, or used in any way without the express written consent of BECHTEL.

GRAND GULF NUCLEAR GENERATING STATION

Updated Final Safety Analysis Report (UFSAR)

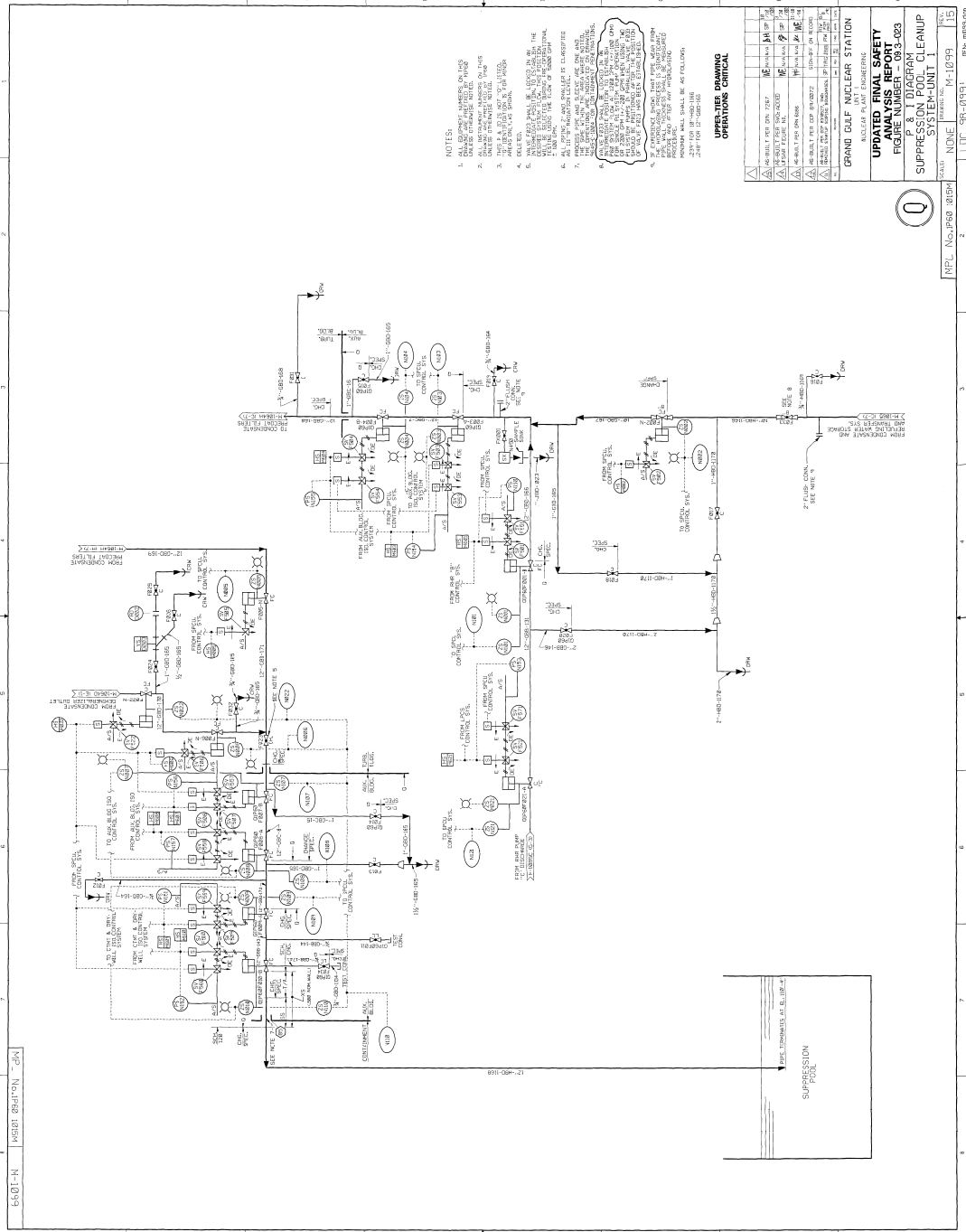

GRAND GULF NUCLEAR GENERATING STATION

Updated Final Safety Analysis Report (UFSAR)

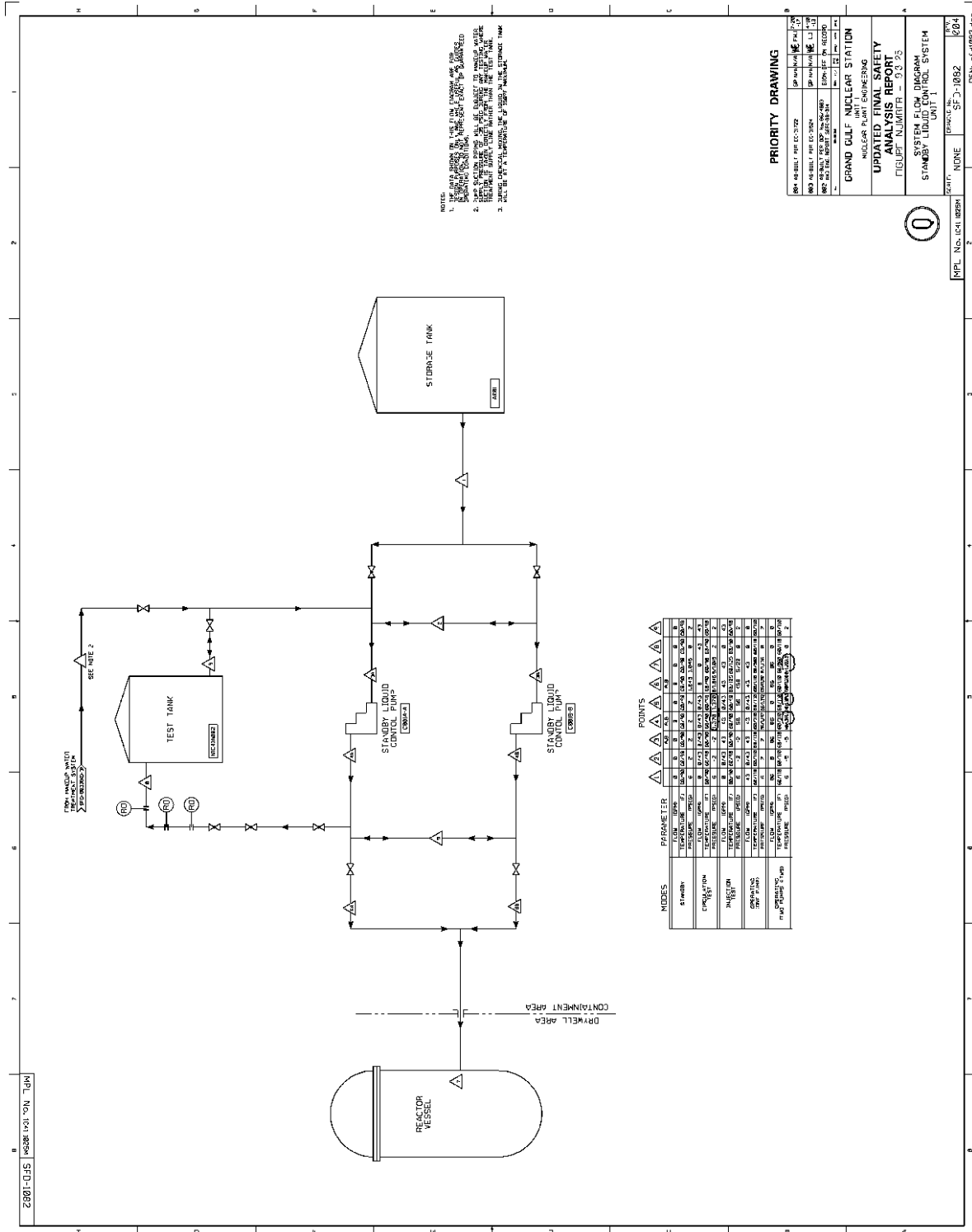

PRIORITY DRAWING

DESIGNED BY: E.C. STOR	DATE: 11/18/77
BY: E.C. STOR	DATE: 11/18/77
BY: E.C. STOR	DATE: 11/18/77
BY: E.C. STOR	DATE: 11/18/77
BY: E.C. STOR	DATE: 11/18/77
BY: E.C. STOR	DATE: 11/18/77

GRAND GULF NUCLEAR STATION
 NUCLEAR PLANT ENGINEERING
UPDATED FINAL SAFETY ANALYSIS REPORT
 GROUP NUMBER - 93.25
 SYSTEM FLOW DIAGRAM
 STANDBY LIQUID CONTROL SYSTEM

MIDDES	PARAMETER	POINTS
STANDBY	TEMPERATURE	1, 2, 3, 4, 5, 6, 7, 8, 9, 10, 11, 12, 13, 14, 15, 16, 17, 18, 19, 20, 21, 22, 23, 24, 25, 26, 27, 28, 29, 30, 31, 32, 33, 34, 35, 36, 37, 38, 39, 40, 41, 42, 43, 44, 45, 46, 47, 48, 49, 50, 51, 52, 53, 54, 55, 56, 57, 58, 59, 60, 61, 62, 63, 64, 65, 66, 67, 68, 69, 70, 71, 72, 73, 74, 75, 76, 77, 78, 79, 80, 81, 82, 83, 84, 85, 86, 87, 88, 89, 90, 91, 92, 93, 94, 95, 96, 97, 98, 99, 100
	PRESSURE	1, 2, 3, 4, 5, 6, 7, 8, 9, 10, 11, 12, 13, 14, 15, 16, 17, 18, 19, 20, 21, 22, 23, 24, 25, 26, 27, 28, 29, 30, 31, 32, 33, 34, 35, 36, 37, 38, 39, 40, 41, 42, 43, 44, 45, 46, 47, 48, 49, 50, 51, 52, 53, 54, 55, 56, 57, 58, 59, 60, 61, 62, 63, 64, 65, 66, 67, 68, 69, 70, 71, 72, 73, 74, 75, 76, 77, 78, 79, 80, 81, 82, 83, 84, 85, 86, 87, 88, 89, 90, 91, 92, 93, 94, 95, 96, 97, 98, 99, 100
	LEVEL	1, 2, 3, 4, 5, 6, 7, 8, 9, 10, 11, 12, 13, 14, 15, 16, 17, 18, 19, 20, 21, 22, 23, 24, 25, 26, 27, 28, 29, 30, 31, 32, 33, 34, 35, 36, 37, 38, 39, 40, 41, 42, 43, 44, 45, 46, 47, 48, 49, 50, 51, 52, 53, 54, 55, 56, 57, 58, 59, 60, 61, 62, 63, 64, 65, 66, 67, 68, 69, 70, 71, 72, 73, 74, 75, 76, 77, 78, 79, 80, 81, 82, 83, 84, 85, 86, 87, 88, 89, 90, 91, 92, 93, 94, 95, 96, 97, 98, 99, 100
	FLOW	1, 2, 3, 4, 5, 6, 7, 8, 9, 10, 11, 12, 13, 14, 15, 16, 17, 18, 19, 20, 21, 22, 23, 24, 25, 26, 27, 28, 29, 30, 31, 32, 33, 34, 35, 36, 37, 38, 39, 40, 41, 42, 43, 44, 45, 46, 47, 48, 49, 50, 51, 52, 53, 54, 55, 56, 57, 58, 59, 60, 61, 62, 63, 64, 65, 66, 67, 68, 69, 70, 71, 72, 73, 74, 75, 76, 77, 78, 79, 80, 81, 82, 83, 84, 85, 86, 87, 88, 89, 90, 91, 92, 93, 94, 95, 96, 97, 98, 99, 100
OPERATING	TEMPERATURE	1, 2, 3, 4, 5, 6, 7, 8, 9, 10, 11, 12, 13, 14, 15, 16, 17, 18, 19, 20, 21, 22, 23, 24, 25, 26, 27, 28, 29, 30, 31, 32, 33, 34, 35, 36, 37, 38, 39, 40, 41, 42, 43, 44, 45, 46, 47, 48, 49, 50, 51, 52, 53, 54, 55, 56, 57, 58, 59, 60, 61, 62, 63, 64, 65, 66, 67, 68, 69, 70, 71, 72, 73, 74, 75, 76, 77, 78, 79, 80, 81, 82, 83, 84, 85, 86, 87, 88, 89, 90, 91, 92, 93, 94, 95, 96, 97, 98, 99, 100
	TEMPERATURE	1, 2, 3, 4, 5, 6, 7, 8, 9, 10, 11, 12, 13, 14, 15, 16, 17, 18, 19, 20, 21, 22, 23, 24, 25, 26, 27, 28, 29, 30, 31, 32, 33, 34, 35, 36, 37, 38, 39, 40, 41, 42, 43, 44, 45, 46, 47, 48, 49, 50, 51, 52, 53, 54, 55, 56, 57, 58, 59, 60, 61, 62, 63, 64, 65, 66, 67, 68, 69, 70, 71, 72, 73, 74, 75, 76, 77, 78, 79, 80, 81, 82, 83, 84, 85, 86, 87, 88, 89, 90, 91, 92, 93, 94, 95, 96, 97, 98, 99, 100
OPERATING	TEMPERATURE	1, 2, 3, 4, 5, 6, 7, 8, 9, 10, 11, 12, 13, 14, 15, 16, 17, 18, 19, 20, 21, 22, 23, 24, 25, 26, 27, 28, 29, 30, 31, 32, 33, 34, 35, 36, 37, 38, 39, 40, 41, 42, 43, 44, 45, 46, 47, 48, 49, 50, 51, 52, 53, 54, 55, 56, 57, 58, 59, 60, 61, 62, 63, 64, 65, 66, 67, 68, 69, 70, 71, 72, 73, 74, 75, 76, 77, 78, 79, 80, 81, 82, 83, 84, 85, 86, 87, 88, 89, 90, 91, 92, 93, 94, 95, 96, 97, 98, 99, 100
	TEMPERATURE	1, 2, 3, 4, 5, 6, 7, 8, 9, 10, 11, 12, 13, 14, 15, 16, 17, 18, 19, 20, 21, 22, 23, 24, 25, 26, 27, 28, 29, 30, 31, 32, 33, 34, 35, 36, 37, 38, 39, 40, 41, 42, 43, 44, 45, 46, 47, 48, 49, 50, 51, 52, 53, 54, 55, 56, 57, 58, 59, 60, 61, 62, 63, 64, 65, 66, 67, 68, 69, 70, 71, 72, 73, 74, 75, 76, 77, 78, 79, 80, 81, 82, 83, 84, 85, 86, 87, 88, 89, 90, 91, 92, 93, 94, 95, 96, 97, 98, 99, 100

MPL No. 1541 0000H
 SHEET NO. SF-D-1052
 DATE: 11/18/77
 DFN: W14052.dgn

FIGURE 9.3-26: DELETED

GRAND GULF NUCLEAR GENERATING STATION
Updated Final Safety Analysis Report (UFSAR)

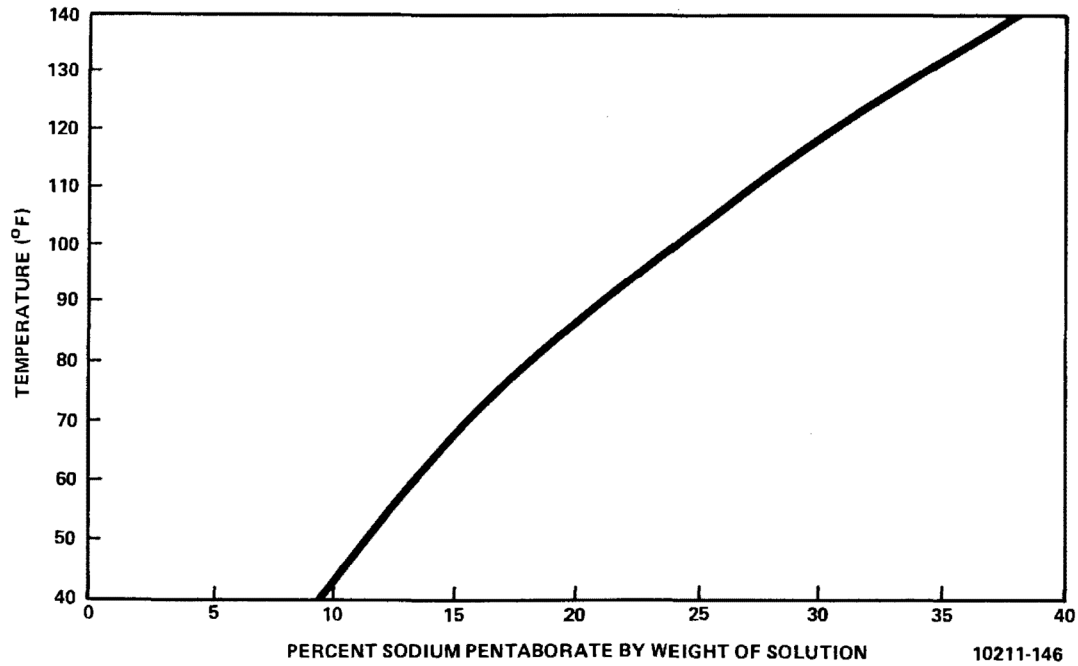

MISSISSIPPI POWER & LIGHT COMPANY
GRAND GULF NUCLEAR STATION
UNITS 1 & 2
UPDATED FINAL SAFETY ANALYSIS REPORT

SATURATION TEMPERATURE OF
SODIUM PENTABORATE SOLUTION
FIGURE 9.3-27

GRAND GULF NUCLEAR GENERATING STATION
Updated Final Safety Analysis Report (UFSAR)

GRAND GULF NUCLEAR GENERATING STATION

Updated Final Safety Analysis Report (UFSAR)

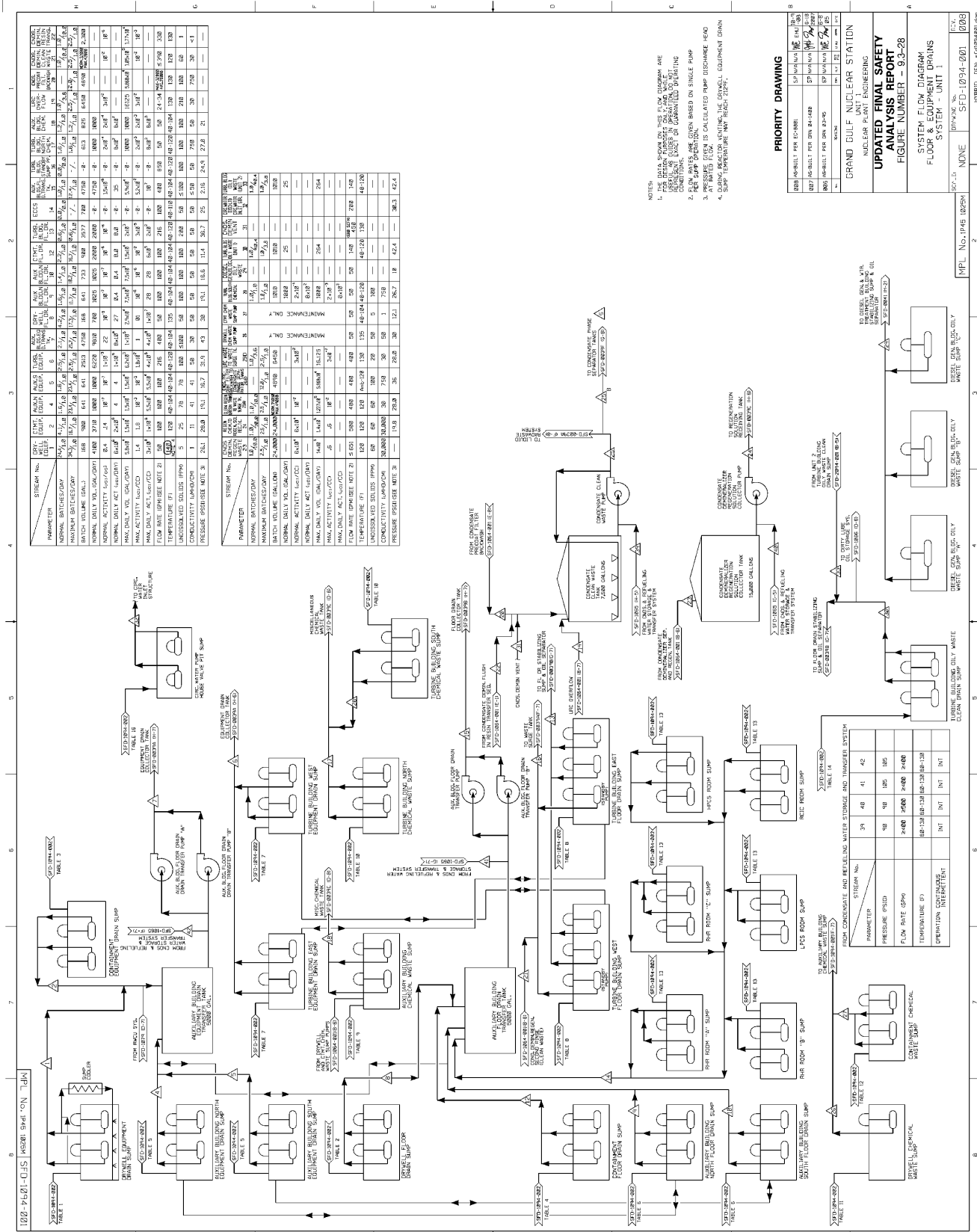

PARAMETER

STREAM No.	COMP. TEMP.	COMP. PRESS.	COMP. DENSITY	COMP. VISC.	COMP. SURF. TENSION	COMP. SOLUBILITY	COMP. PARTICULATE	COMP. PHASE	COMP. COLOR	COMP. ODOUR	COMP. TASTE	COMP. TOXICITY	COMP. CORROSIVENESS	COMP. RADIOACTIVITY	COMP. OTHER
1	100	100	100	100	100	100	100	100	100	100	100	100	100	100	100

NOTES:

- THIS SYSTEM IS DESIGNED TO HANDLE CLEAN WASTE FROM THE REACTOR BUILDING, CONDENSATE TANK, AND OTHER SOURCES. IT IS NOT DESIGNED TO HANDLE HIGHLY RADIOACTIVE WASTE.
- FLOW RATES ARE GIVEN BASED ON SINGLE PUMP OPERATION.
- ALL PUMP FLOWS ARE CALCULATED FROM DESIGN HEAD.
- THIS SYSTEM IS DESIGNED TO HANDLE CLEAN WASTE FROM THE REACTOR BUILDING, CONDENSATE TANK, AND OTHER SOURCES. IT IS NOT DESIGNED TO HANDLE HIGHLY RADIOACTIVE WASTE.

STREAM No. 14

PARAMETER	VALUE
Pressure (PSID)	100
Flow Rate (GPM)	100
Temperature (°F)	100
Operation	Intermittent
Contents	Clean Waste
Interferent	None

STREAM No. 13

PARAMETER	VALUE
Pressure (PSID)	100
Flow Rate (GPM)	100
Temperature (°F)	100
Operation	Intermittent
Contents	Clean Waste
Interferent	None

STREAM No. 12

PARAMETER	VALUE
Pressure (PSID)	100
Flow Rate (GPM)	100
Temperature (°F)	100
Operation	Intermittent
Contents	Clean Waste
Interferent	None

STREAM No. 11

PARAMETER	VALUE
Pressure (PSID)	100
Flow Rate (GPM)	100
Temperature (°F)	100
Operation	Intermittent
Contents	Clean Waste
Interferent	None

STREAM No. 10

PARAMETER	VALUE
Pressure (PSID)	100
Flow Rate (GPM)	100
Temperature (°F)	100
Operation	Intermittent
Contents	Clean Waste
Interferent	None

STREAM No. 9

PARAMETER	VALUE
Pressure (PSID)	100
Flow Rate (GPM)	100
Temperature (°F)	100
Operation	Intermittent
Contents	Clean Waste
Interferent	None

STREAM No. 8

PARAMETER	VALUE
Pressure (PSID)	100
Flow Rate (GPM)	100
Temperature (°F)	100
Operation	Intermittent
Contents	Clean Waste
Interferent	None

GRAND GULF NUCLEAR GENERATING STATION

Updated Final Safety Analysis Report (UFSAR)

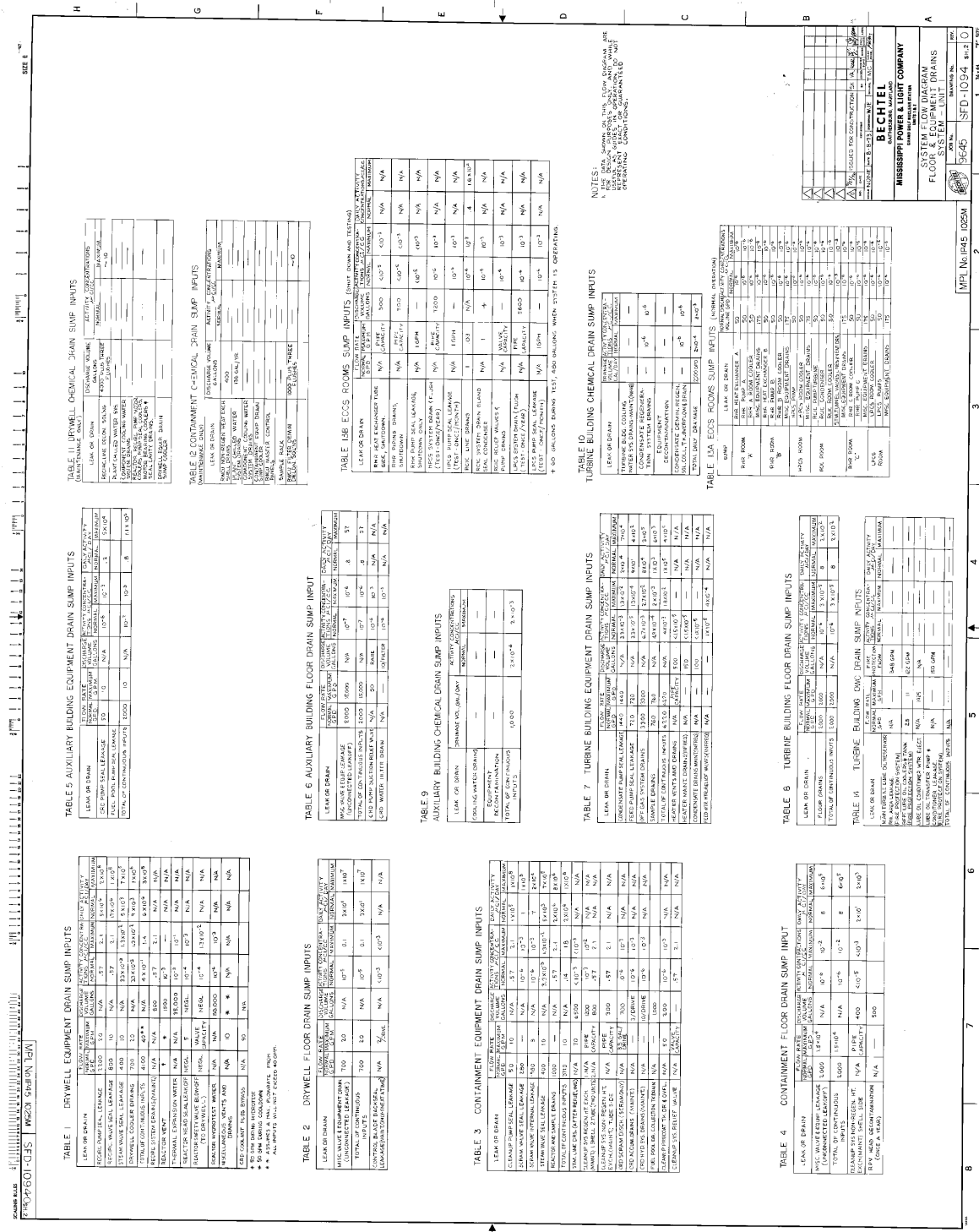

TABLE 1 DRYWELL EQUIPMENT DRAIN SUMP INPUTS

LEAK OR DRAIN	FLOW RATE (GPM)	ACTIVITY	ACTIVITY FREQUENCY (PER HOUR)	ACTIVITY DURATION (MIN)	ACTIVITY DAILY DRAIN VOLUME (GALLONS)	ACTIVITY DAILY DRAIN VOLUME (GALLONS)	ACTIVITY DAILY DRAIN VOLUME (GALLONS)
LEAK OR DRAIN	10
...
TOTAL OF CONTINGUOUS INPUTS

TABLE 2 DRYWELL FLOOR DRAIN SUMP INPUTS

LEAK OR DRAIN	FLOW RATE (GPM)	ACTIVITY	ACTIVITY FREQUENCY (PER HOUR)	ACTIVITY DURATION (MIN)	ACTIVITY DAILY DRAIN VOLUME (GALLONS)	ACTIVITY DAILY DRAIN VOLUME (GALLONS)	ACTIVITY DAILY DRAIN VOLUME (GALLONS)
...
TOTAL OF CONTINGUOUS INPUTS

TABLE 3 CONTAINMENT EQUIPMENT DRAIN SUMP INPUTS

LEAK OR DRAIN	FLOW RATE (GPM)	ACTIVITY	ACTIVITY FREQUENCY (PER HOUR)	ACTIVITY DURATION (MIN)	ACTIVITY DAILY DRAIN VOLUME (GALLONS)	ACTIVITY DAILY DRAIN VOLUME (GALLONS)	ACTIVITY DAILY DRAIN VOLUME (GALLONS)
...
TOTAL OF CONTINGUOUS INPUTS

TABLE 4 CONTAINMENT FLOOR DRAIN SUMP INPUT

LEAK OR DRAIN	FLOW RATE (GPM)	ACTIVITY	ACTIVITY FREQUENCY (PER HOUR)	ACTIVITY DURATION (MIN)	ACTIVITY DAILY DRAIN VOLUME (GALLONS)	ACTIVITY DAILY DRAIN VOLUME (GALLONS)	ACTIVITY DAILY DRAIN VOLUME (GALLONS)
...
TOTAL OF CONTINGUOUS INPUTS

TABLE 5 AUXILIARY BUILDING EQUIPMENT DRAIN SUMP INPUTS

LEAK OR DRAIN	FLOW RATE (GPM)	ACTIVITY	ACTIVITY FREQUENCY (PER HOUR)	ACTIVITY DURATION (MIN)	ACTIVITY DAILY DRAIN VOLUME (GALLONS)	ACTIVITY DAILY DRAIN VOLUME (GALLONS)	ACTIVITY DAILY DRAIN VOLUME (GALLONS)
...
TOTAL OF CONTINGUOUS INPUTS

TABLE 6 AUXILIARY BUILDING FLOOR DRAIN SUMP INPUT

LEAK OR DRAIN	FLOW RATE (GPM)	ACTIVITY	ACTIVITY FREQUENCY (PER HOUR)	ACTIVITY DURATION (MIN)	ACTIVITY DAILY DRAIN VOLUME (GALLONS)	ACTIVITY DAILY DRAIN VOLUME (GALLONS)	ACTIVITY DAILY DRAIN VOLUME (GALLONS)
...
TOTAL OF CONTINGUOUS INPUTS

TABLE 7 TURBINE BUILDING EQUIPMENT DRAIN SUMP INPUTS

LEAK OR DRAIN	FLOW RATE (GPM)	ACTIVITY	ACTIVITY FREQUENCY (PER HOUR)	ACTIVITY DURATION (MIN)	ACTIVITY DAILY DRAIN VOLUME (GALLONS)	ACTIVITY DAILY DRAIN VOLUME (GALLONS)	ACTIVITY DAILY DRAIN VOLUME (GALLONS)
...
TOTAL OF CONTINGUOUS INPUTS

TABLE 8 TURBINE BUILDING FLOOR DRAIN SUMP INPUTS

LEAK OR DRAIN	FLOW RATE (GPM)	ACTIVITY	ACTIVITY FREQUENCY (PER HOUR)	ACTIVITY DURATION (MIN)	ACTIVITY DAILY DRAIN VOLUME (GALLONS)	ACTIVITY DAILY DRAIN VOLUME (GALLONS)	ACTIVITY DAILY DRAIN VOLUME (GALLONS)
...
TOTAL OF CONTINGUOUS INPUTS

TABLE 9 CONTAINMENT CHEMICAL DRAIN SUMP INPUTS

LEAK OR DRAIN	FLOW RATE (GPM)	ACTIVITY	ACTIVITY FREQUENCY (PER HOUR)	ACTIVITY DURATION (MIN)	ACTIVITY DAILY DRAIN VOLUME (GALLONS)	ACTIVITY DAILY DRAIN VOLUME (GALLONS)	ACTIVITY DAILY DRAIN VOLUME (GALLONS)
...
TOTAL OF CONTINGUOUS INPUTS

TABLE 10 TURBINE BUILDING CHEMICAL DRAIN SUMP INPUTS

LEAK OR DRAIN	FLOW RATE (GPM)	ACTIVITY	ACTIVITY FREQUENCY (PER HOUR)	ACTIVITY DURATION (MIN)	ACTIVITY DAILY DRAIN VOLUME (GALLONS)	ACTIVITY DAILY DRAIN VOLUME (GALLONS)	ACTIVITY DAILY DRAIN VOLUME (GALLONS)
...
TOTAL OF CONTINGUOUS INPUTS

TABLE 11 IRRADIATED CHEMICAL DRAIN SUMP INPUTS

LEAK OR DRAIN	FLOW RATE (GPM)	ACTIVITY	ACTIVITY FREQUENCY (PER HOUR)	ACTIVITY DURATION (MIN)	ACTIVITY DAILY DRAIN VOLUME (GALLONS)	ACTIVITY DAILY DRAIN VOLUME (GALLONS)	ACTIVITY DAILY DRAIN VOLUME (GALLONS)
...
TOTAL OF CONTINGUOUS INPUTS

TABLE 12A ECCS ROOMS SUMP INPUTS (NORMAL OPERATION)

LEAK OR DRAIN	FLOW RATE (GPM)	ACTIVITY	ACTIVITY FREQUENCY (PER HOUR)	ACTIVITY DURATION (MIN)	ACTIVITY DAILY DRAIN VOLUME (GALLONS)	ACTIVITY DAILY DRAIN VOLUME (GALLONS)	ACTIVITY DAILY DRAIN VOLUME (GALLONS)
...
TOTAL OF CONTINGUOUS INPUTS

TABLE 12B ECCS ROOMS SUMP INPUTS (EMERGENCY OPERATION)

LEAK OR DRAIN	FLOW RATE (GPM)	ACTIVITY	ACTIVITY FREQUENCY (PER HOUR)	ACTIVITY DURATION (MIN)	ACTIVITY DAILY DRAIN VOLUME (GALLONS)	ACTIVITY DAILY DRAIN VOLUME (GALLONS)	ACTIVITY DAILY DRAIN VOLUME (GALLONS)
...
TOTAL OF CONTINGUOUS INPUTS

NOTES:
1. SEE DRAWING FOR THIS FLOOR AND ROOMS ARE IDENTIFIED BY ROOM NUMBER AND EQUIPMENT IDENTIFIED BY EQUIPMENT ID NUMBER.
2. SEE DRAWING FOR THIS FLOOR AND ROOMS ARE IDENTIFIED BY ROOM NUMBER AND EQUIPMENT IDENTIFIED BY EQUIPMENT ID NUMBER.
3. SEE DRAWING FOR THIS FLOOR AND ROOMS ARE IDENTIFIED BY ROOM NUMBER AND EQUIPMENT IDENTIFIED BY EQUIPMENT ID NUMBER.

BECHTEL
MISSISSIPPI POWER & LIGHT COMPANY
SYSTEMS GROUP
FLOOR & EQUIPMENT DRAINS
SYSTEM - UNIT 1
REV. 10/14/04
3640

GRAND GULF NUCLEAR GENERATING STATION
Updated Final Safety Analysis Report (UFSAR)

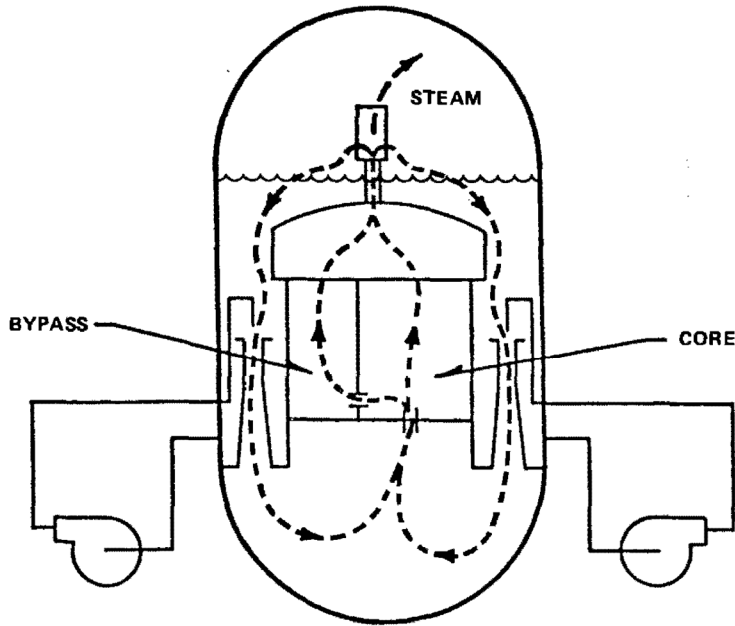

MISSISSIPPI POWER & LIGHT COMPANY
GRAND GULF NUCLEAR STATION
UNITS 1 & 2
UPDATED FINAL SAFETY ANALYSIS REPORT

NORMAL NATURAL CIRCULATION

FIGURE 9.3-30

GRAND GULF NUCLEAR GENERATING STATION

Updated Final Safety Analysis Report (UFSAR)

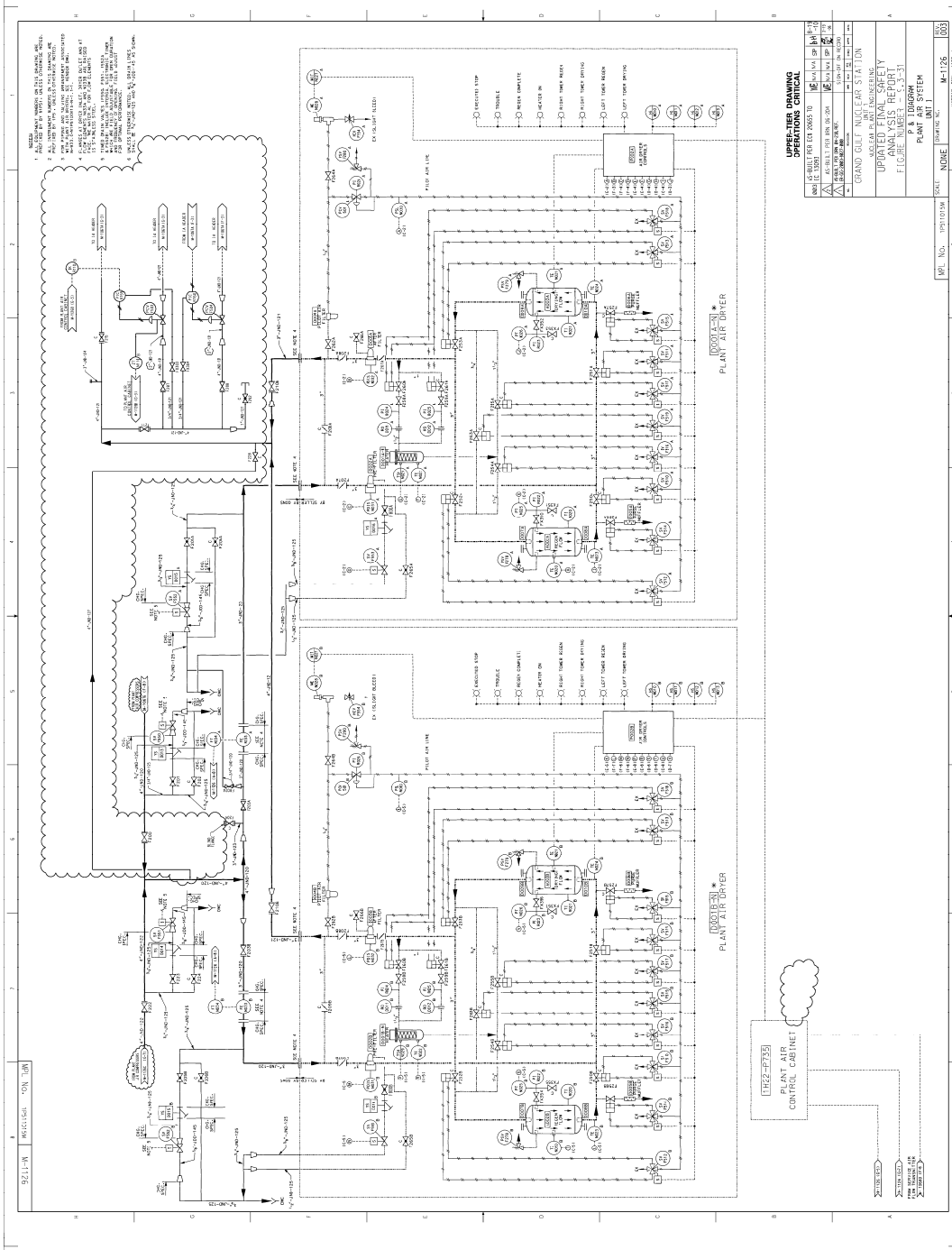

GRAND GULF NUCLEAR GENERATING STATION

Updated Final Safety Analysis Report (UFSAR)

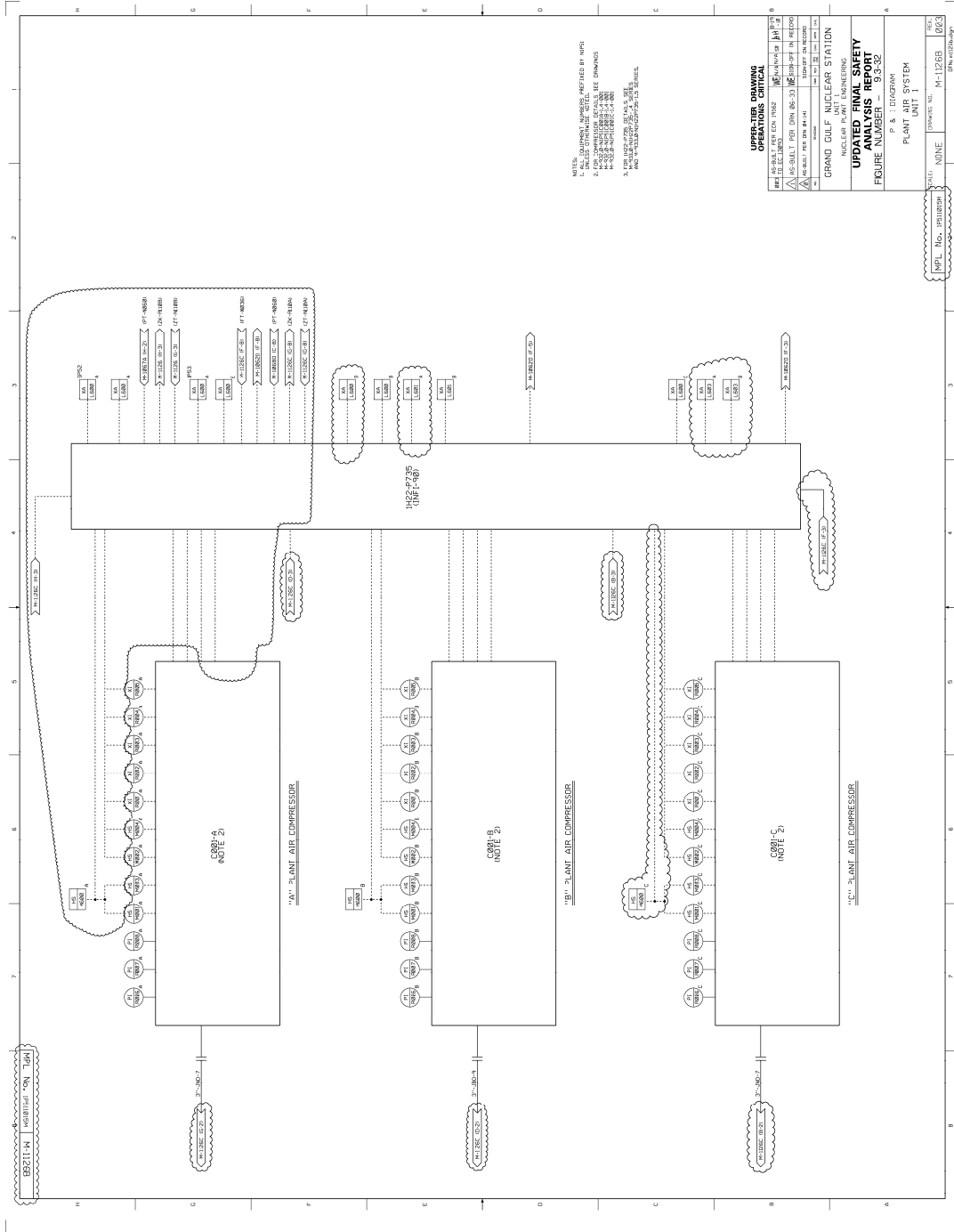

GRAND GULF NUCLEAR GENERATING STATION

Updated Final Safety Analysis Report (UFSAR)

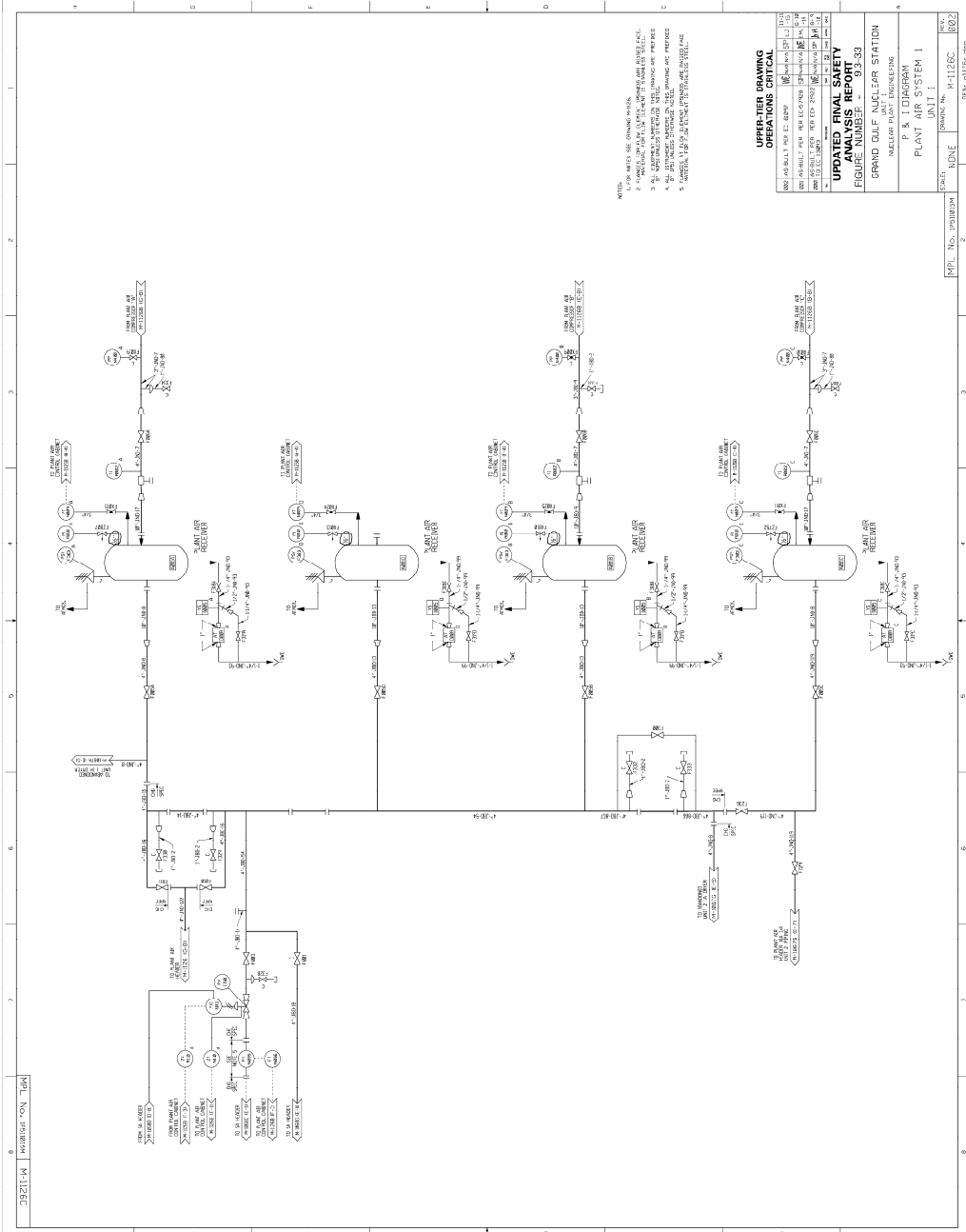

GRAND GULF NUCLEAR GENERATING STATION
Updated Final Safety Analysis Report (UFSAR)

9.4 HEATING, VENTILATION, AND AIR CONDITIONING SYSTEMS

9.4.1 Control Room HVAC System

9.4.1.1 Design Bases

9.4.1.1.1 Safety Design Bases

- a. The control room heating, ventilating, and air conditioning system is designed with sufficient redundancy to ensure operation under emergency conditions assuming the single failure of any one active component.
- b. Provisions are made in the system to detect and limit the introduction of radioactive material into the control room.
- c. Provisions are made in the system for the removal of radioactive and foreign material from the control room environment.
- d. With the exception of the following components which are not required to be safety-related, the control room heating, ventilating, and air conditioning system is designed to seismic Category I requirements:
 1. Control room utility exhaust fan and the associated ductwork extending from the second isolation valve to the exhaust louver
 2. Control room purge exhaust ductwork extending from the second isolation valve to the exhaust louver
 3. Control room freon detectors
 4. Control room humidifiers excluding the support structure and the steam distribution headers

Note: The Control Room Humidifiers have been abandoned in place.

GRAND GULF NUCLEAR GENERATING STATION
Updated Final Safety Analysis Report (UFSAR)

5. Safety-related panel area unit heaters

- e. Provision is made in the system to detect and limit the introduction of smoke into the control room. Provision is made to detect freon gas.
- f. The system is designed to provide a controlled temperature environment to ensure the continued operation of safety-related equipment under accident conditions. The maximum temperature limit in the control room for equipment performance is governed by Technical Requirements Manual (TRM).
- g. The system and components are located in a seismic Category I structure that is tornado-missile, and flood protected.
- h. Nonseismic pipe, ductwork, or components in the control room area are evaluated to ensure that their physical collapse during an SSE will not adversely affect essential components.
- i. The system has been evaluated for the effects of postulated pipe failure and initiation of internally generated missiles. Protection has been provided to the system where necessary to mitigate the consequences of such failures as described in Sections 3.5 and 3.6.
- j. For compliance with codes, standards, and Regulatory Guides refer to Section 3.2 and Appendix 3A.

9.4.1.1.2 Power Generation Design Bases

- a. The system is designed to provide an environment with controlled temperature and humidity to ensure both the comfort and safety of the operators. The design conditions for the control room environment are 72 F with a relative humidity ranging from 20% in the winter to 50% in the summer. These design conditions comply with the human factors guidelines of 73 F to 77 F dry bulb temperature established by NUREG-0700, Guidelines For Control Room Design Reviews. The maximum temperature limit in the control room for equipment performance is identified in Technical Requirements Manual (TRM).

GRAND GULF NUCLEAR GENERATING STATION
Updated Final Safety Analysis Report (UFSAR)

- b. The system is designed to permit periodic inspection of the principal system components.
- c. The outside design conditions for the control room HVAC system are 95 F during the summer and 15 F during the winter.

9.4.1.2 System Description

The control room heating, ventilating, and air-conditioning system and the areas served are shown schematically in Figure 9.4-1. Principal system components are listed and described in Table 9.4-1.

During normal plant operation, control room air is recirculated through one full-capacity air-conditioning unit to maintain control room design conditions. Fresh air makeup is provided from a single intake located at approximate El. 207-0 on the roof of the control building. During normal operation, the intake air quantity will be 2000 cfm.

Cooling water for the control room air-conditioning condenser units is normally supplied by the Unit 1 plant service water system, with automatic switchover to the standby service water system in the event of a loss-of-coolant accident or loss of offsite power. Power to the control room HVAC components is supplied from Unit 1.

The control room is normally maintained at a slightly positive pressure (from fresh air makeup with respect to other plant ventilation zones) to prevent introduction of air into the control room from sources other than the design fresh air makeup system.

The control room standby air unit is designed to process a portion of the control room air conditioning system flow through a filter train during post-accident operation. During the recirculation mode, a portion of the return air from the control room is drawn through the particulate train by the standby air unit fan for cleanup of the control room atmosphere. This air is then mixed with the remaining control room air conditioning system return air and supplied to the control room.

The standby air unit takes air from the air conditioning system return duct upstream of the point where it is discharged. The fan discharge connection is located 10 feet minimum distance

GRAND GULF NUCLEAR GENERATING STATION
Updated Final Safety Analysis Report (UFSAR)

downstream from the filter inlet connection to preclude possible recirculation of the discharge air from the standby air unit fan to the filter train air inlet.

The air conditioning system return duct at the point of connection with the standby air units is sufficiently large, thus reducing air turbulence and further reducing the probability of reverse air flow within the air conditioning system return air duct.

A radiation monitoring system and a control room filter recirculation system have been provided to detect and reduce radioactivity level in the control room. Radiation monitors in the fresh air intake duct detect high radiation in the fresh air supply. A high radiation signal alarms in the control room, automatically closes fresh air intake damper, shuts down and isolates the utility exhaust fan, and starts the emergency filtration unit fans. A radiation monitor is provided in the control room to detect high radiation level in the control room area. After 10 minutes isolation of the control room and when conditions permit, fresh air can be manually brought in through the filter system.

During the filtration recirculation mode, the control room is not pressurized with respect to the surrounding environment. Control room potential inleakage is discussed in Section 6.4.

9.4.1.3 Safety Evaluation

The control room heating, ventilating, and air-conditioning system is designed to maintain a habitable environment and to ensure the operability of components in the control room. With the exception of those items listed in subsection 9.4.1.1.1.d, all control room heating, ventilating, and air conditioning equipment and surrounding structures are of seismic Category I design and operable during loss of the offsite power supply. Redundant components are provided where necessary to ensure that a single failure will not preclude adequate control room ventilation. A control room ventilation system failure analysis is presented in Table 9.4-2.

A radiation monitoring system is provided to detect high radiation in the outside air intake ducts; a radiation monitor is provided in the control room to monitor control room area radiation levels. These monitors alarm in the control room upon detection of high radiation conditions.

GRAND GULF NUCLEAR GENERATING STATION
Updated Final Safety Analysis Report (UFSAR)

Isolation of the control room and initiation of the emergency filtration unit fans are accomplished by the following signals:

- a. High radiation in the outside air intake duct
- b. Manual isolation
- c. Deleted
- d. Loss-of-coolant accident as indicated by:
 1. High drywell pressure, or
 2. Low reactor water level
- e. Deleted

An evaluation of the dose to the operators under various postulated accident conditions is presented in Chapter 15.

For other forms of contamination, such as smoke, provision is made to purge the room with no recirculation. Details on control room habitability are discussed in Section 6.4.

The safety-related isolation valves at the outside air intake are protected from becoming inoperable due to freezing, icing, or other adverse environmental conditions.

9.4.1.4 Inspection and Testing Requirements

Provisions are made for periodic tests of the emergency ventilation fans and filters. These tests include determinations of differential pressure across the filter and of filter efficiency. Connections for testing, such as injection and sampling connections, are located to provide adequate mixing of the injected fluid and representative sampling and monitoring so that test results are indicative of performance.

The high-efficiency particulate air (HEPA) filters are tested periodically with dioctyl phthalate smoke (DOP).

The balance of the system is proven operable by its use during normal plant operation. Portions of the system normally closed to flow can be tested to ensure operability and integrity of the system.

GRAND GULF NUCLEAR GENERATING STATION
Updated Final Safety Analysis Report (UFSAR)

9.4.1.5 Instrumentation Application

The instrumentation and controls for the control room heating, ventilation, and air-conditioning system are designed for automatic operation with manual starting of fans.

Should an operating fan fail, the resultant loss of air flow actuates an alarm, automatically starts the standby fans, and opens the associated dampers. All alarms and manual controls are located in the control room.

Some manual actions outside of the Control Room may be needed to ensure continued AC unit performance under certain conditions. The cooling water flow control valves are air operated and fail open on a loss of air, which would occur during a LOP/LOCA event. Although no immediate actions for AC unit performance would be required, subsequent manual adjustments may be needed to regulate cooling water flow and maintain AC unit cooling performance. Adjustments would depend on factors such as the duration of the event, heat loads and cooling water temperature.

The air-intake duct is monitored for high radiation levels by redundant radiation sensors. A high radiation signal automatically isolates the control room and initiates recirculation of the control room air through filters. (Refer to subsections 7.3.1.1.10 and 7.3.2.10.)

The purge control circuit is initiated by opening the purge air exhaust valves and closing the normal fresh air supply dampers. The mechanical refrigeration units and the control room air conditioning unit fan are shut down.

The control room heating, ventilating, and air-conditioning controls and control dampers are electric and redundant, with the redundant controls put on separate power sources.

Upon sensing the presence of smoke in the return ductwork from the control room or in the fresh air intake duct, the smoke detector causes the following actions simultaneously: the operating air-conditioning unit shuts down, the operating air-conditioning unit's isolation dampers close, and the fire detection system sounds the fire alarm. If the origin of smoke is a fire in the control room, the fire is extinguished, the purge line isolation valves are manually opened, the purge fan is manually started, and the smoke is removed from the area. If the origin of smoke is outside the control room envelope, the control room HVAC system is

GRAND GULF NUCLEAR GENERATING STATION
Updated Final Safety Analysis Report (UFSAR)

placed in a recirculation mode of operation. While in the recirculation mode, fresh air makeup is not necessary for at least 30.8 hours.

For further details on the fire protection devices and alarms provided for the control room HVAC system, refer to subsection 9.5.1.

Upon sensing a high freon concentration, the freon detector initiates an alarm in the control room.

If either a freon or a smoke detection signal is received concurrently with a control room isolation signal (discussed in subsection 9.4.1.3) the air-conditioning unit continues to operate, the purge line isolation valves remain closed, and the purge fan remains idle. This prohibits possible spurious freon or smoke detector signals from compromising system operation under emergency conditions.

9.4.2 Fuel-Handling-Area Ventilation System

9.4.2.1 Design Bases

9.4.2.1.1 Safety Design Bases

- a. The auxiliary building penetrations of the fuel-handling-area ventilation system are of seismic Category I design.
- b. The auxiliary building penetrations of the fuel-handling-area ventilation system are provided with redundant isolation valves.
- c. Radiation detection equipment of the fuel pool sweep exhaust portion of the fuel-handling-area ventilation system is of seismic Category I design and is installed on the seismic Category I portions of ductwork.
- d. The fuel handling area is ventilated and maintained at a slightly negative pressure with respect to surrounding areas during normal operation to ensure that airborne radiation is collected by the system.
- e. The fuel pool cooling and cleanup pump room is provided with a safety grade backup ventilation and cooling system.

GRAND GULF NUCLEAR GENERATING STATION
Updated Final Safety Analysis Report (UFSAR)

9.4.2.1.2 Power Generation Design Bases

- a. The system is designed to provide an environment with controlled temperature and humidity to ensure the comfort and safety of personnel and the integrity of the fuel-handling-area equipment necessary for power generation.
- b. The design conditions in the areas served by the fuel-handling-area ventilation system are as follows:

	Temperature, F	Relative Humidity (%)
Fuel-handling area	80 max./65 min.	50

- c. Design outside air temperatures for the fuel-handling-area ventilation system are as follows:

Summer maximum: 95 F

Winter minimum: 15 F

The minimum design outside air temperature for the sizing of heating coils is 20 F.

- d. The system is designed to permit periodic inspection of the principal system components.

9.4.2.2 System Description

The auxiliary building is divided into six HVAC zones as follows:

- a. Zone 1 - comprising the first floor (El. 93-0)
- b. Zone 2 - comprising the second floor (El. 119-0)
- c. Zone 3 - comprising the third floor (El. 139-0)
- d. Zone 4 - comprising the fourth floor (El. 166-0)
- e. Zone 5 - comprising the fuel-handling area (El. 185-0 and 208-10)
- f. Zone 6 - comprising the steam tunnel, outside containment

Zones 1 through 4 and zone 6 are described in subsection 9.4.6. The zone 5 (fuel-handling-area) ventilation equipment consists of the following:

GRAND GULF NUCLEAR GENERATING STATION
Updated Final Safety Analysis Report (UFSAR)

- a. One 100-percent-capacity fuel-handling-area fan coil unit which consists of a fan, a water coil with cooling water by plant chilled water system, an electrical heater, and a prefilter, recirculates the fuel-handling-area atmosphere at El. 208-10 to maintain the space design conditions.
- b. Two 100-percent-capacity fuel pool sweep supply fans and two 100-percent-capacity fuel pool sweep exhaust fans to provide a controlled circulation of air across the surface of the spent fuel pool, the cask storage pool, and the transfer canal during fuel-handling operations.

Fuel pool sweep preheat and reheat electrical coils maintain the sweep supply air at the required temperature for proper system operation.

- c. One 100-percent-capacity fuel-handling-area fan coil unit which consists of a fan, a water coil with cooling water by plant chilled water system, an electrical heater, and a prefilter, recirculates the atmosphere of the fuel-handling area at El. 185-0 to maintain the space design conditions.
- d. Two 100-percent-capacity fuel-handling-area supply fans provide ventilation air and makeup air to the space during normal operation and during operation of the pool sweep equipment.
- e. One 100-percent-capacity outside air heating coil tempers the supply air during conditions of low outside ambient temperatures.
- f. Two 100-percent-capacity fuel-handling-area exhaust fans exhaust air from the fuel-handling area, the emergency core cooling system (ECCS) pump rooms, and the penetration rooms of the auxiliary building during normal operation.
- g. One 100-percent-capacity fan coil unit provides cooling for the RFV vibration test room at El. 139'-0".

The zone 5 (fuel-handling-area) ventilation system is shown schematically in Figures 9.4-2 and 9.4-3. Principal system components are given and described in Table 9.4-3.

GRAND GULF NUCLEAR GENERATING STATION
Updated Final Safety Analysis Report (UFSAR)

During normal operation, the fuel-handling area is ventilated and maintained at a slightly negative pressure (-0.05 to -0.25 inches water gauge) with respect to surrounding areas. Two 100-percent-capacity supply fans and two 100-percent-capacity exhaust fans are provided. One fuel-handling-area exhaust fan exhausts air from the following regions:

- a. Fuel-handling area, El. 208-10
- b. Fuel-handling area, El. 185-0
- c. Auxiliary building penetration and ECCS pump rooms

Makeup air is supplied to the fuel-handling area by one of the fuel-handling-area supply fans. The fans are started manually and air is drawn through a prefilter and discharged to the fuel-handling area. The supply fans and exhaust fans are electrically interlocked to ensure sequential starting, i.e., exhaust fan prior to supply fan, to maintain a slightly negative pressure. The standby supply or exhaust fan will start automatically to replace the loss of a parallel operating fan. A pressure-control system modulates a damper on the fresh air supply to regulate the airflow and maintain a slightly negative pressure. The general pattern of airflow is from areas of lower contamination to areas of higher potential contamination.

During normal operation, the fuel pool sweep supply and exhaust fans are idle and the associated supply penetration is isolated. During fuel-handling operations, the fuel pool sweep system is manually initiated as needed to control the circulation of air in the area of the spent fuel pool, the cask storage pool, and the transfer canal for radiological controls as discussed in Section 12.5.3.2.4. The system consists of two 100-percent-capacity fuel pool sweep supply fans and two 100-percent-capacity fuel pool sweep exhaust fans that are electrically interlocked to ensure sequential starting, i.e., exhaust fan prior to supply fan. Whenever a pool sweep supply or exhaust fan is in operation, the idle fan will be in a standby mode and will start automatically upon loss of the operating fan, as determined by a low differential pressure switch across the fans.

The fuel pool sweep supply fan delivers a high volume of outside air and directs a portion of this air across the surface of the pools. The remainder of the air not discharged directly across the pool surfaces is supplied to the fuel-handling area above the vicinity of the pools as makeup air for the fuel pool sweep

GRAND GULF NUCLEAR GENERATING STATION
Updated Final Safety Analysis Report (UFSAR)

exhaust fans. During periods of low ambient temperatures, the outside air heating coil is utilized to temper the high volume of incoming air.

With the pool sweep system in operation, slightly more air is exhausted from the area by the pool sweep exhaust fans than is supplied by the pool sweep supply fans. Subsequently, the difference is made up by the operation of the fuel-handling-area supply fans. As in normal operation, a pressure controller positions a damper in the supply air ductwork to maintain the fuel-handling-area at a slight negative pressure with respect to surrounding areas.

During normal operation the fuel handling area ventilation system assures that no ambient air escapes from the fuel-handling area during fuel handling operations without first being monitored for airborne radioactivity. Upon detection of high radioactivity, the standby gas treatment system is initiated, as described below. The standby gas treatment system will maintain a 1/4" water gauge negative pressure in the area and provide filtration of the exhaust air through ESF filters.

Because the fuel-handling area comprises a portion of the boundary region of the standby gas treatment system, certain provisions have been made in the design of the fuel-handling-area ventilation system to ensure the proper operation of the standby gas treatment system and the integrity of the SGTS negative pressure boundary.

A radiation monitoring system is provided on the ductwork of the fuel-handling-area exhaust fans to detect any activity in the exhaust air from the penetration rooms and ECCS rooms of the auxiliary building as well as from the general area of the fuel-handling area. Radiation monitors are also provided on the exhaust ductwork of the fuel pool sweep system to detect the release of any radioactivity associated with the fuel-handling accident. In addition, a radiation monitoring system is provided in the common exhaust ductwork.

The outputs of these radiation monitors are monitored and recorded, and a high-radiation signal from either the fuel-handling-area exhaust or the fuel pool sweep exhaust alarms in the control room. High radiation automatically initiates the standby

GRAND GULF NUCLEAR GENERATING STATION
Updated Final Safety Analysis Report (UFSAR)

gas treatment system, which in turn isolates the auxiliary building penetrations of the ventilation systems within the auxiliary building.

In addition, the closure of the isolation valves in the fuelhandling-area ventilation penetrations trips limit switches and automatically shuts down the following equipment:

- a. Fuel-handling-area supply fan
- b. Fuel-handling-area exhaust fan
- c. Fuel pool sweep supply fan (if operating)
- d. Fuel pool sweep exhaust fan (if operating)
- e. Fuel-handling-area fan coil units

The radiation detectors are appropriately located on the ductwork so that ventilation penetration isolation valves are closed prior to the escape of any significant amount of radioactive material to the environment. Special attention is given to valve closure time, line velocity, monitor location, and detector sensitivity.

9.4.2.3 Safety Evaluation

The fuel-handling area comprises a portion of the boundary region of the standby gas treatment system (SGTS). In response to any standby gas treatment system initiation signal, (refer to FSAR subsection 6.5.3) the following portions of the fuel-handling-area ventilation system perform the indicated functions:

- a. All auxiliary building penetrations of the fuel-handling-area ventilation system are isolated via a safety-related signal.
- b. Following closure of the above isolation valves, the fuel-handling-area fan coil units, supply fans, exhaust fans, and sweep system fans are shut down via a non-safety related trip signal.

All of the auxiliary building penetrations of the fuel-handling-area ventilation system are provided with redundant, air-operated, fail-closed isolation valves to preclude the possibility of airborne radioactivity bypassing the boundary regions of the standby gas treatment system.

GRAND GULF NUCLEAR GENERATING STATION
Updated Final Safety Analysis Report (UFSAR)

Other than the above, the system has no safety-related function as defined in Section 3.2. Failure of the system will not compromise any safety-related system or component and will not prevent safe reactor shutdown.

The standby gas treatment system performs the necessary operations required for the control of radioactivity following a fuel-handling accident or other operational transient, including loss-of-offsite power. Refer to subsections 6.2.3, 6.5.1, and 6.5.3 for the description of this system.

9.4.2.4 Tests and Inspections

The fuel-handling-area ventilation system components are periodically inspected to assure that all normally operating equipment is functioning properly. Standby components are periodically tested to ensure system redundancy and/or reliability.

Radiation instrumentation testing is described in subsection 7.6.2.2.

9.4.2.5 Instrumentation Application

The exhausts from the fuel-handling-area exhaust fan and the fuel pool sweep exhaust fan are continuously monitored for radioactivity. Refer to subsection 7.6.2.2.

A high-high-radiation signal actuates an alarm, automatically initiates isolation of the auxiliary building and the fuel-handling area ventilation systems, and starts the standby gas treatment system. A high signal only alarms and a low-radiation signal indicates failure.

A separate radiation monitoring system is provided to monitor effluent radioactivity releases to the environment. For a further discussion of this system, see subsection 11.5.2.2.7.

The auxiliary building pressure control operates to maintain the fuel pool area in the auxiliary building at the required pressure and provides the operator with sufficient indication to maintain proper operating conditions. (See subsection 7.7.1.9 for a description of auxiliary building pressure control.)

GRAND GULF NUCLEAR GENERATING STATION
Updated Final Safety Analysis Report (UFSAR)

Differential pressure switches are provided across the air supply and exhaust fans to start the standby fan on low differential pressure. Supply and exhaust fans are interlocked to ensure that a supply fan does not start unless an exhaust fan is running.

Temperature controls are provided to maintain the incoming air at the desired temperature.

The supply and exhaust fan discharge and suction dampers automatically open when the fan is started and close when the fan is stopped.

Differential pressure indicators are provided across filters for maintenance purposes.

Fire protection is described in subsection 9.5.1.

9.4.3 Radwaste Building Ventilation System

9.4.3.1 Design Bases

9.4.3.1.1 Power Generation Design Bases

The radwaste building ventilation system is a nonsafety-related system designed to provide an environment with controlled temperature and air-flow patterns to ensure both the comfort and safety of plant personnel and the integrity of equipment and components.

The system design is based on outdoor summer conditions of 95 F dry-bulb and 79 F wet-bulb temperatures. Summer indoor design temperatures include 72 F in the radwaste control station, a maximum temperature of 104 F in areas that may be occupied, and 120 F in the equipment cells. Winter indoor design temperatures include 65 F in occupied areas, 72 F in the radwaste control station, and 50 F in the equipment cells, based on an outdoor design temperature of 15 F.

Once-through ventilation is employed for space cooling and airflow control from areas of low potential radioactivity to higher activity areas. Outside air is filtered, tempered, and delivered to the clean areas such as the radwaste control station and lower-level corridors. A pressure gradient is maintained to create air flow from the corridors (low potential radioactivity) into the equipment cells (higher potential radioactivity) where

GRAND GULF NUCLEAR GENERATING STATION
Updated Final Safety Analysis Report (UFSAR)

it is exhausted after removing airborne contaminants. Provisions have been made to monitor the air for abnormal radiation levels before it is exhausted to the radwaste building vent.

9.4.3.2 System Description

The radwaste building ventilation system is shown schematically in Figures 9.4-4 and 9.4-5. The major system components and associated fabrication and performance data are listed in Table 9.4-4.

Ventilation is provided by two subsystems: one to supply air, the second to exhaust air. The supply air system consists of filter banks, heating coils, two half-capacity supply fans, ductwork, and controls. The filters function to remove dust particulates from the outside air before it is delivered to the system. A heating coil provides freeze protection for the system in addition to maintaining winter indoor design conditions.

The exhaust air system functions to maintain the building under a negative pressure with respect to the outside. The system consists of two full-capacity exhaust air fans, two full-capacity filter trains, each consisting of a HEPA filter, ductwork, and controls. The HEPA filters remove particulate contaminants at an efficiency in excess of 99 percent from the exhaust air before it is released to the radwaste building vent. The supply air fans are interlocked to a flow switch in the exhaust subsystem to prevent them from running while the exhaust fans are not in operation. This prevents the buildup of a positive pressure in the radwaste building that would result in exfiltrating air bypassing the exhaust filters. Dampers are also provided throughout the distribution and exhaust system to ensure the isolation of areas of high potential radioactivity from areas of low potential radioactivity.

Each supply and exhaust fan has the capability of being isolated from the system for maintenance while the other fan is in operation.

Tanks that are potential sources of high radioactivity are vented through a filter assembly consisting of demister, prefilter, HEPA filter, charcoal filter, and fan. Discharge is to the radwaste building vent.

GRAND GULF NUCLEAR GENERATING STATION
Updated Final Safety Analysis Report (UFSAR)

Refer to Table 9.4-14 for an analysis of the radwaste building exhaust filter trains and the storage tank vent filter train with respect to Branch Technical Position ETSB No. 11-2, "Design, Testing, and Maintenance Criteria for Normal Ventilation Exhaust System Air Filtration and Adsorption Units of Light-Water-Cooled Nuclear Power Reactors."

The control station is provided with a chilled-water cooling coil to maintain comfort conditions.

9.4.3.3 Safety Evaluation

The ventilation system has no safety-related function as defined in Section 3.2. Failure of the system will not compromise any safety-related system or component and will not prevent safe reactor shutdown.

However, the ventilation system incorporates some features that will assure reliable operation over the full range of the radwaste system operation. Some of the features include failsafe positions for the control actuators and zone isolation by use of backdraft dampers to prevent reverse flow in the event of fan failures.

A radwaste ventilation system failure analysis is given in Table 9.4-5.

9.4.3.4 Tests and Inspections

The system is designed to permit periodic inspection of important components, such as fans, motors, belts, coils, filters, ductwork, piping, and valves, to assure the integrity and capability of the system. Local display and/or indicating devices are provided for periodic inspection of vital parameters such as room temperature, and test connections are provided in exhaust filter trains and piping for periodic checking of air and water flows for conformance to the design requirements. Portable test and monitoring equipment is available to balance the system when required.

The HEPA filters are tested by using dioctyl phthalate (DOP) aerosol.

9.4.3.5 Instrumentation Application

The supply and exhaust fans are turned on manually from control room handswitches that in turn open the isolation dampers. The exhaust fans are supplied with low flow alarms to annunciate a system malfunction.

A differential pressure indicator is used to monitor the pressure across each outside air filter.

Automatic temperature control, with local indication, is provided for maintaining the incoming air and room temperatures within the desired temperature range.

Each exhaust filter is provided with a differential pressure indicator. Each filter train is provided with a high differential pressure alarm in control room that will automatically alarm when pressure across the filters is too high. When the alarm is actuated, indicating high pressure, the operator can manually operate a control room handswitch that will isolate that particular filter train from the system.

As the filter starts to load, each fan is equipped with flowcontrol devices to actuate fan flow-control inlet vanes to maintain air output of the fan. In case of fan unit failure, the other unit will carry the entire load.

The exhaust air to the radwaste building vent is provided with a radiation monitoring system that alarms in the control room and automatically shuts down the ventilation system upon reaching a high radiation level. For a further description of the radwaste building ventilation radioactivity monitoring system, see subsection 11.5.2.2.6.

9.4.4 Turbine Building Ventilation System

9.4.4.1 Design Bases

9.4.4.1.1 Power Generation Design Bases

The turbine building ventilation system consists of heating, ventilation, and cooling systems designed to provide an environment with controlled temperature and humidity to ensure both the safety of plant personnel and the integrity of equipment and components.

GRAND GULF NUCLEAR GENERATING STATION
Updated Final Safety Analysis Report (UFSAR)

System design is based on outdoor summer conditions of 95 F dry-bulb temperature and 79 F wet-bulb temperature. Indoor design temperatures are 100 F for the area above the operating floor; 96 F for the areas below the operating floor, and 104 F for the elevator machine room.

It is a design objective to limit the relative humidity in the turbine building at 50 percent. An indoor minimum temperature of 65 F is maintained during winter shutdown conditions, based on an outside air design temperature of 15 F. Electric heating coils are sized based on an outside air design temperature of 20 F.

Air-flow control from areas of low potential radioactivity to areas of high potential radioactivity is based on infiltrating outside air above the turbine building operating floor, allowing it to flow down through the lower decks and condenser area into a filter train, and finally, exhausting it through the turbine building vent. Offsite dose calculations of subsection 11.3 indicate filtration is not required; however, the filter train internals (i.e., prefilters, HEPA filters and charcoal) have been installed but no credit is taken for their operation.

9.4.4.2 System Description

The turbine building ventilation system is shown in Figures 9.4-6, 9.4-7, and 9.4-7a. The major system components and associated fabrication and performance data are given in Table 9.4-6. Filter train components (i.e., prefilters, HEPA filters and charcoal) have been installed but no credit is taken for their operation.

The outside air is introduced into the turbine building above the operating floor, and through the turbine building rollup door if open, then drawn down to the areas below the floor by the exhaust system during normal plant operations. During normal operations, the turbine building rollup door may be open when needed for temperature control measures if the turbine building ventilated system is in operation and inflow through the rollup door is periodically confirmed. During shutdown conditions, normal radiological controls practices protect against the occurrence of uncontrolled releases.

Space fan coil terminal units are located throughout the turbine building to provide the cooling capacity required to maintain design temperatures. The units consist of fans, water coils, and cabinets. Ductwork is kept to a minimum.

GRAND GULF NUCLEAR GENERATING STATION
Updated Final Safety Analysis Report (UFSAR)

The turbine building hot water heating system is an integral part of the chilled-water cooling system (see subsection 9.2.7). A steam-to-water heat exchanger is piped in parallel with the turbine building secondary chilled-water system. The piping system delivers water to area fan coil units located throughout the general area of the building. During normal plant operations, cooling alone is required, and the heat exchanger is isolated from the system. During shutdown, the turbine building secondary system is isolated from the rest of the plant chilled-water system, and the steam-to-water heat exchanger along with the hot water expansion tank are brought on the line. The 140 F hot water supply is delivered by the system pumps to fan coil units. However, only the perimeter units function to maintain space temperatures.

The turbine building exhaust air system consists of two full capacity exhaust air fans in parallel, filter housing (including prefilters, HEPA filters and charcoal), isolation dampers, ductwork, and controls. The system exhausts air from the condenser area, turbine building equipment compartments, and the turbine building equipment drain sumps. Air is drawn out through a system of exhaust ductwork to the filter train via one of the exhaust fans. Offsite dose analysis has shown that charcoal and HEPA filters are not necessary for the turbine building exhaust (refer to Section 11.3), however, these components have been installed but no credit is taken for their operation. Because no credit is taken for collection of airborne radioactive material via the turbine building exhaust filter train, no analysis of the filter train is given with respect to Branch Technical Position ETSB No. 11-2, "Design, Testing, and Maintenance Criteria for Normal Ventilation Exhaust System Air Filtration and Adsorption Units of Light-Water-Cooled Nuclear Power Reactors."

A portion of the air is exhausted to atmosphere and a portion is returned to the turbine building, the ratio of which is determined by a pressure control system.

The turbine building occasional release point uses the southeast most roof hatch (smoke vent) to release noble gases from the turbine building. A duct with flow and radiation monitors is connected to the duct and the hatch opened. Releases thru the occasional release point are monitored to ensure site annual, quarterly and immediate releases within regulatory limits.

9.4.4.3 Safety Evaluation

The system has no safety-related function as defined in Section 3.2. Failure of the system will not compromise any safety-related system or component and will not prevent safe reactor shutdown.

However, the system incorporates some features that assure its reliable operation during normal plant operation. The exhaust air system functions to maintain the preferred air-flow patterns and provide ventilation only. The cooling is achieved by area fan coil units operating wholly within the space to limit crossover air flows from areas of high potential radioactivity to areas of low potential radioactivity. Therefore, both systems function independently to control the spread of contamination. Additional features include fail-safe positions for control actuators.

Requirements for monitoring abnormal radiation within the turbine building are given in Section 11.5.

9.4.4.4 Tests and Inspections

The system is designed to permit periodic inspection of important components, such as fans, motors, belts, coils, filters, ductwork, piping, and valves, to assure the integrity and capability of the system. Local display and indicating devices are provided for periodic inspection of vital parameters such as filter pressure drops.

Test connections are provided in the ductwork and piping for periodic checking of air and water flows for conformance to the design requirements. Portable test and monitoring equipment is available to balance the system when required. The fan ratings are in accordance with the AMCA Standard Test Code Bulletin 211A, Certified Rating Program for Air Moving Devices.

9.4.4.5 Instrumentation Application

The exhaust train has control room operated handswitches to control the fans and main line dampers at intake and discharge. The flow-control device for the operating fan maintains a constant air flow through the fan. In case of fan failure, the main line dampers in front of and after that fan close automatically, isolating that fan from the exhaust system, and the standby fan and related damper are initiated automatically.

GRAND GULF NUCLEAR GENERATING STATION
Updated Final Safety Analysis Report (UFSAR)

A radiation monitor located in the exhaust ductwork alarms in the main control room upon reaching a high-radiation level.

The fan coil units of the area and equipment compartments are controlled locally by handswitches, and each is equipped with a temperature switch.

A pressure control system maintains a slight negative pressure in the turbine building with respect to atmosphere by modulating dampers located in the discharge duct of the building and in the duct return to the operating levels. A selector switch was provided for selection of either the Unit 1 or 2 pressure controller (since the Unit 1 and Unit 2 turbine buildings' air space was to have been common) to allow operation of one unit's master pressure controller for both units to prevent cyclic operation of the Unit 1 and 2 HVAC systems. [HISTORICAL INFORMATION] [However, as noted in Section 1.1.1., after Unit 1 had received its Commercial Operating License, Entergy Operations, Inc. formally requested the NRC to return the Construction Permit and officially cancel the second unit at the Grand Gulf Nuclear Station, therefore there is no Unit 2 turbine building HVAC system.] The Unit 1 selector switch is administratively maintained in the Unit 1 position.

9.4.5 Miscellaneous Safety-Related Ventilation And Cooling Systems

The following ventilating and cooling systems are described in this section:

- a. Safeguard switchgear and battery rooms
- b. Diesel generator rooms
- c. Standby service water pumphouses
- d. ECCS pump rooms
- e. Engineered safety features (ESF) electrical switchgear rooms
- f. Fuel pool cooling and cleanup (FPCC) pump room

GRAND GULF NUCLEAR GENERATING STATION
Updated Final Safety Analysis Report (UFSAR)

9.4.5.1 Design Bases

9.4.5.1.1 Safety Design Bases

- a. The ventilation systems for the diesel generator rooms, standby service water pumphouses, ESF electrical switchgear rooms, ECCS pump rooms, and FPCC pump room are designed to seismic Category I specifications.
- b. The ventilation systems for the diesel generator rooms, safeguard switchgear and battery rooms, standby service water pumphouses, ESF electrical switchgear rooms, ECCS pump rooms, and FPCC pump room are designed with sufficient redundancy to meet the single failure criterion for the system it supplies.
- c. The power supplies to the ventilation systems for the diesel generator rooms, safeguard switchgear and battery rooms, standby service water pumphouses, ESF electrical switchgear rooms, ECCS pump rooms, and FP & CU pump room allow uninterrupted operation in the event of loss of normal offsite power.
- d. The Safeguard Switchgear & Battery Room Ventilation System is designed to seismic Category I requirements with the exception of the remote shutdown panel room heat pump and associated ductwork and controls which are not required to be safety related.
- e. Outside air at a rate of 10 air changes per hour for battery rooms is provided to prevent accumulation of hydrogen (H₂) in the area.
- f. The system and components are located in seismic Category I structures that are tornado-missile and flood protected.
- g. Nonseismic pipe, ductwork, or components are analyzed to ensure that their physical collapse during an SSE will not adversely affect the seismic Category I HVAC systems.
- h. The seismic Category I HVAC systems have been analyzed for the postulated effects of pipe failures and initiation of internally generated missiles as described in Sections 3.5 and 3.6.

GRAND GULF NUCLEAR GENERATING STATION
Updated Final Safety Analysis Report (UFSAR)

- i. For compliance with code standards and Regulatory Guides refer to Section 3.2 and Appendix 3A.
- j. Fire protection has been evaluated and is described in subsection 9.5.1.
- k. The effects of smoke from a postulated transformer fire were analyzed and do not affect the operation of the safeguard switchgear and battery rooms. The analysis is discussed in subsection 9.4.5.5.5.

9.4.5.1.2 Power Generation Design Bases

- a. The systems are designed to provide a reliable source of fresh air and an environment with controlled temperature and humidity to ensure the comfort and safety of personnel and the integrity of plant equipment.
- b. The ventilation and cooling systems are designed to permit periodic inspection of the principal components.
- c. A water drip on the head of the intake louver and a slope in the sill of the louver are provided for the air intake louvers in the areas of the HPCS diesel generator room, standby diesel generator rooms, and standby servicewater pumphouses to reduce the possibility of water in the air path.

9.4.5.2 System Description

9.4.5.2.1 Safeguard Switchgear and Battery Rooms

The ventilation system for the safeguard switchgear and battery rooms is shown schematically in Figures 9.4-8a and 9.4-8b. The supply system consists of four 50-percent-capacity fan units complete with outside air filters, electric heating coils, supply air ducts, and controls. The remote shutdown panel room receives additional cooling from a non-safety related heat pump which is controlled by a thermostat located in the remote shutdown panel room. The heat pump arrangement consists of a single packaged type heat pump and its associated ductwork and controls. Two supply fans operate at all times while the other two fans are on standby. Exhaust air is discharged by four 50-percent-capacity exhaust fan units with separate ducts and controls. Two exhaust fans operate at all times while the other two fans are on standby. The system is also capable of providing ventilation cooling in the control

GRAND GULF NUCLEAR GENERATING STATION
Updated Final Safety Analysis Report (UFSAR)

building HVAC equipment room under accident and post-accident conditions, or upon failure of the normal control building HVAC system.

Space design conditions in the safeguard switchgear and battery rooms and in the control building HVAC equipment room are 110°F. The non-safety related heat pump will maintain the remote shutdown panel room at an effective temperature condition of 85°F or less with an ambient outdoor temperature of 95°F to ensure reliable human performance. The major system components and performance data are given in Table 9.4-7.

9.4.5.2.2 Diesel Generator Rooms

The diesel generator building ventilation system is shown schematically in Figure 9.4-9a. The major system components and performance data are listed in Table 9.4-7.

Three independent subsystems, one per diesel generator room, each having 100 percent capacity, are provided for the emergency diesel generator rooms to maintain an indoor design temperature of 120 F dry bulb maximum. Each diesel unit is provided with a fan system connected to the respective diesel engineered safety features bus. The fan is controlled to start on diesel generator startup. Operator action is required to stop the fan after the diesel generator stops. A heating coil has been provided to maintain the minimum required inside air temperature during cold weather.

9.4.5.2.3 Standby Service Water Pumphouses

The standby service water pumphouses ventilation system is shown schematically in Figure 9.4-9a. The major system components and performance data are shown in Table 9.4-7.

The standby service water pumphouse ventilation system consists of three full-capacity fans utilizing separate ducting, dampers, and controls to maintain the space design temperature of the greater of 104°F maximum or during periods of extreme ambient temperature the room temperature may be equal to outdoor air temperature +10°F, not to exceed 111°F. Two of the fans are located in the SSW pumphouse "A" and the other is located in pumphouse "B". In pumphouse "A" one fan is supplied with power from the Division I ESF bus and starts when its associated SSW pump starts, or on high area temperature. The other fan is supplied with power from the Division II ESF bus and starts only

GRAND GULF NUCLEAR GENERATING STATION
Updated Final Safety Analysis Report (UFSAR)

in response to a high area temperature. The fan in pumphouse "B" is supplied with power from the Division II ESF bus and starts when its associated pump starts, or on high area temperature. Electric unit heaters are provided for winter shutdown freeze protection.

GRAND GULF NUCLEAR GENERATING STATION
Updated Final Safety Analysis Report (UFSAR)

9.4.5.2.4 Safety-Related ECCS Pump Rooms

The following pump rooms contain safety-related components:

- RHR A
- RHR B
- RHR C
- HPCS
- LPCS
- RCIC

The cooling and emergency ventilation systems for the safety-related pump rooms are shown schematically in Figure 9.4-9b. Principal system components are listed and described in Table 9.4-7.

Each ECCS pump room is provided with one full capacity fan-coil unit to prevent the room temperature exceeding 157 F during pump operation. The RCIC pump room is provided with one full capacity fan-coil unit to prevent the room temperature exceeding 175 F during pump operation.

The standby service water system provides cooling water for the fan-coil units.

During normal plant operation, the safety-related pump rooms and penetrations rooms are maintained at a slight negative pressure with respect to the corridors by the fuel handling area ventilation system. Supply air is provided from the auxiliary building ventilation system. Air is drawn from the safety-related pump rooms and discharged by the fuel handling area exhaust fans to the fuel handling area vent.

The activity of the exhaust air from the safety-related pump rooms and penetration rooms is continuously monitored. A high activity level actuates an alarm and automatically initiates isolation of the auxiliary building and the fuel handling area ventilation systems and starts the standby gas treatment system as described in subsections 6.5.3 and 9.4.2.

GRAND GULF NUCLEAR GENERATING STATION
Updated Final Safety Analysis Report (UFSAR)

9.4.5.2.5 ESF Electrical Switchgear Rooms

The ESF electrical switchgear rooms are located in the auxiliary building at the 119, 139, and 166 foot levels. Each room is provided with one 100 percent capacity fan coil unit which maintains the space design temperature when the associated electrical equipment is operating. The fan coil units located in switchgear rooms 1A308 and 1A309, El. 139' 0", will maintain the temperature of the rooms at less than 90 F during all modes of normal plant operation and at less than 105 F during all modes of emergency plant operation. The fan coil units located in the remaining switchgear rooms will maintain the room temperature at less than 108 F during all modes of normal and emergency plant operation. The fan coil units are shown schematically in Figure 9.4-9b.

9.4.5.2.6 Fuel Pool Cooling and Cleanup (FPCC) Pump Room

The safety related back-up cooling system for the fuel pool cooling and cleanup pump room is shown schematically in Figure 9.4-9b. The FPCC pump room is provided with two full-capacity fan coil units which will maintain a space temperature of 124 F maximum. The Standby Service Water System provides cooling water for the fan coil units. During normal plant operation, supply air (cooling) is provided to the FPCC pump room from the Auxiliary Building Ventilation System and is exhausted by the fuel handling area exhaust fans via the fuel handling area vent.

9.4.5.3 Safety Evaluation

The diesel generator rooms, ESF electrical switchgear rooms, safeguard switchgear and battery rooms, standby service water pumphouses, and ECCS pump rooms ventilating and cooling systems described in this section are designed to the requirements specified in Table 3.2-1. The remote shutdown panel room heat pump and its associated components serve no safety function. The heat pump is not required to function following an accident to maintain the qualification of the Class 1E equipment located in the remote shutdown panel room. The remote shutdown panel room heat pump is considered to be an associated load, as defined by IEEE-384. The heat pump is fed through one class 1E circuit breaker and one fuse to provide isolation from the 1E power distribution system as described in Table 8.3-10. Redundant components and systems are provided where necessary to ensure that a single failure does not impair or preclude system operation which is supplied by the

GRAND GULF NUCLEAR GENERATING STATION
Updated Final Safety Analysis Report (UFSAR)

ventilation system (see subsection 3.11.4). The systems are connected to the engineered safety features bus and are operable after loss of offsite power supply. The diesel generator rooms, standby service water pumphouses, ESF electrical switchgear rooms, safeguard switchgear and battery rooms, ECCS pump rooms, and fuel pool cooling and cleanup pump room ventilation systems failure analysis is presented in Table 9.4-8.

9.4.5.4 Tests and Inspections

The ventilating and cooling systems are periodically inspected to ensure that all normally operating equipment is functioning properly. Standby components are periodically tested to ensure system operability.

9.4.5.5 Instrumentation Application

9.4.5.5.1 Diesel Generator Rooms

The diesel generator room ventilation supply fans are automatically actuated when the diesel generator is started. A control room handswitch is also provided. This discharge air temperature is monitored and a suction temperature switch is provided to operate the fan at full or half capacity to maintain the summer maximum and winter minimum space temperatures. Also supplied are locally operated fan-coil units equipped with a heating coil controlled by a temperature switch and a cooling coil controlled by a temperature controller to maintain normal indoor design conditions when the diesels are idle.

9.4.5.5.2 Standby Service Water Pumphouses

In the standby service water pumphouse "A", one fan is started automatically when the SSW pump starts or on high area temperature, and the other starts only in response to a high area temperature. In the "B" pumphouse, the fan is started automatically when the SSW pump starts, or on a high area temperature. Each standby service water pumphouse outside air fan has a handswitch located in the control room. Flow-control dampers for return and outside air are controlled by a temperature switch. As the supply air temperature rises, the return air damper closes. Only outside air is circulated. A fall in supply air temperature causes the outside air damper to move toward the closed position and the return air damper to move to the open

GRAND GULF NUCLEAR GENERATING STATION
Updated Final Safety Analysis Report (UFSAR)

position to maintain the supply air temperature above freezing. Locally operated electric unit heaters, controlled by temperature switches, provide winter shutdown freeze protection.

9.4.5.5.3 Safety-Related ECCS Pump Rooms

Recirculating fan coil units for RHR pump rooms A, B, and C and the HPCS, LPCS, and RCIC pump rooms are automatically actuated by their respective pump starters or by manual handswitches located in the control room. The fan-coil units are sized to remove the maximum expected heat gains in order to maintain the space temperature below 155°F (for the ECCS pump rooms) and 175°F (for the RCIC pump room) with the pumps in operation.

During post-accident conditions with the loss of offsite power and loss of non-safety related HVAC systems, due to higher suppression pool temperature, the temperature in the ECCS pump rooms will increase between 2°F and 9°F. Temperature increases in the auxiliary building have been accounted for in the environmental qualification of the safety-related equipment located in these rooms. The evaluation is provided in Section 2.3.1 of the PUSAR.

9.4.5.5.4 ESF Electrical Switchgear Rooms

The fan coil units located in switchgear rooms 1A308 and 1A309, El. 139' 0", will maintain the temperature of the rooms at less than 90°F during all modes of normal plant operation and at less than 105°F during all modes of emergency plant operation. The fan coil units located in the remaining switchgear rooms will maintain the room temperature at less than 108°F during all modes of normal and emergency plant operation. The fan coil units are shown schematically in Figure 9.4-9b. A fan manual handswitch is also located in the control room.

The auxiliary building room temperatures are affected by the increased post-LOCA suppression pool temperatures resulting from EPU (including the effects of loss of offsite power and loss of non-safety related HVAC systems), however, the temperature of the ESF electrical switchgear room only increases by a maximum of 2°F as a result of EPU. Temperature increases in the auxiliary building have been accounted for in the environmental qualification of the safety-related equipment located in these rooms. The evaluation is provided in Section 2.3.1 of the PUSAR.

GRAND GULF NUCLEAR GENERATING STATION
Updated Final Safety Analysis Report (UFSAR)

A crosstie to the standby service water system is provided to ensure an adequate supply of coolant during conditions when plant service water is not available. With either source, the water flow is "on-off" with no modulation.

9.4.5.5.5 Safeguard Switchgear and Battery Rooms

In the safeguard switchgear and battery rooms ventilation system, a duct temperature switch signals the supply and exhaust fans to operate at full or half capacity to maintain the design room temperature. A heating coil is energized by a low supply air temperature signal during the winter. In the event battery room temperature approaches 60°F, battery electrolyte temperature will be monitored to ensure that it remains above 60°F. A flow switch is interlocked with the fan operating circuit to prevent heating coil operation without air flow. Automatic start of the standby fans and operation of the respective isolation dampers is initiated by the detection of low flow or high exhaust or outside air temperature. If started automatically due to low flow, an alarm sounds in the control room simultaneously. In addition, each fan can be actuated by a switch located in the control room. The protection provided against a loss of ventilation flow to any of the Grand Gulf safety-related battery rooms is equivalent to the protection described by Section C.7.g of BTP CMEB 9.5-1.

Dampers in the supply and exhaust air for the control building HVAC equipment room are controlled by a temperature switch in the HVAC equipment room. A high temperature in the HVAC equipment room causes the associated dampers to reposition to allow a portion of the total system air flow to circulate through the HVAC equipment room.

In the event of a loss of ventilation flow in the battery rooms, each room is provided with hydrogen detectors that are set to provide an alarm in the control room at a concentration of 2 percent hydrogen in air. A hydrogen evolution calculation shows that the hydrogen evolution of these batteries is not rapid and a set point of 2 percent will provide ample time for corrective action before the concentration reaches the lower explosive limit of 4 percent. Additionally, the battery rooms are routinely inspected for proper ventilation by plant personnel.

Since the safeguard switchgear and emergency battery rooms' HVAC is a once-through system design and the switchgear and battery space design temperature is limited to a maximum of 110°F, it is

GRAND GULF NUCLEAR GENERATING STATION
Updated Final Safety Analysis Report (UFSAR)

important that ventilation be maintained. Equipment in these rooms have been evaluated for temporary operation at temperatures up to 120°F. With this aspect in mind, the feasibility of HVAC system operation for the safeguard switchgear and emergency battery rooms was analyzed. This analysis was based on the assumptions that: a) both transformers would catch fire simultaneously, b) the transformers' deluge system would fail, c) the fire would be sustained at the surface of a pool of oil, and d) the fire would burn for an extended period of time. Data from this analysis shows that the deposition or smoke contamination on the walls and equipment would be less than 0.061 g/m². This analysis indicates that no detrimental effects are imposed on system operation and that equipment cooling and operation can be maintained. Therefore, the effects of smoke in the transformer fire postulated above do not affect the operation of the safeguard switchgear and battery rooms, and safe shutdown capability is maintained.

The remote shutdown panel room heat pump is operated locally at the thermostat. The desired mode of operation (cooling/heating) must be manually selected at the thermostat. The heat pump provides additional cooling to the remote shutdown panel room in order to maintain and "effective temperature" of 85°F or less.

In the event a fire is detected in either the Division I, II or III switchgear room or Division I or II remote shutdown panel room by the room's associated fire suppression system, the intake and exhaust fans of the safeguard switchgear and battery rooms ventilation system (both Divisions of both Units) will be stopped for up to 90 seconds and will re-start automatically if a start signal is present. The remote shutdown panel room heat pump will remain tripped until the local Division I handswitch station logic is reset.

9.4.5.5.6 Fuel Pool Cooling and Cleanup (FPCC) Pump Room

The FPCC pump room cooler fan is started by a room temperature switch whenever the space temperature exceeds 94 F. The fan can also be started using a manual handswitch which is located in the Control Room. The SSW flow to the cooling coils is "ON-OFF" with no modulation.

The auxiliary building room temperatures are affected by the increased post-LOCA suppression pool temperatures resulting from EPU (including the effects of loss of offsite power and loss of

GRAND GULF NUCLEAR GENERATING STATION
Updated Final Safety Analysis Report (UFSAR)

non-safety related HVAC systems), however, the temperature of the FPCCS pump room is unaffected by EPU. Temperature increases in the auxiliary building have been accounted for in the environmental qualification of the safety-related equipment located in these rooms. The evaluation is provided in Section 2.3.1 of the PUSAR.

9.4.6 Auxiliary Building Ventilation System

9.4.6.1 Design Bases

9.4.6.1.1 Safety Design Bases

- a. The auxiliary building penetration of the auxiliary building ventilation system is of seismic Category I design.
- b. The auxiliary building penetration of the auxiliary building ventilation system is provided with redundant isolation valves.
- c. The auxiliary building ventilation system is designed to maintain a general pattern of airflow from areas of lower radioactivity to areas of higher radioactivity.

9.4.6.1.2 Power Generation Design Bases

- a. The system is designed to provide an environment with controlled temperature and humidity to ensure the comfort and safety of personnel and the integrity of nonsafety-related auxiliary building equipment necessary for power generation.
- b. The design conditions in the areas served by the auxiliary building ventilation system are as follows:

	<u>Temp. (F)</u>	<u>Rel. Hum. (%)</u>
Corridor areas (El. 93-0, El. 1390, and El. 1660)	80 max./65 min.	50
Corridor areas (El. 119-0)	90 max./65 min.	50
Penetration rooms	105 max., normal	-
Steam tunnel, outside containment	125 max., normal	-

GRAND GULF NUCLEAR GENERATING STATION
Updated Final Safety Analysis Report (UFSAR)

- c. Design outside air temperatures for the auxiliary building ventilation system are as follows:

Summer maximum: 95 F

Winter minimum: 15 F

The minimum design outside air temperature for the sizing of heating coils is 20 F.

- d. The system is designed to permit periodic inspection of the principal system components.

9.4.6.2 System Description

The auxiliary building is divided into six HVAC zones as follows:

- a. Zone 1 - comprising the first floor (El. 93-0)
- b. Zone 2 - comprising the second floor (El. 119-0)
- c. Zone 3 - comprising the third floor (El. 139-0)
- d. Zone 4 - comprising the fourth floor (El. 166-0)
- e. Zone 5 - comprising the fuel handling area (El. 185-0 and 208-10)
- f. Zone 6 - comprising the steam tunnel, outside containment

Zones 1 through 4 are each provided with one 100-percent capacity zone fan coil unit, with duct-mounted heating coils, designed for both heating and cooling. The auxiliary building ventilation system is shown schematically in Figure 9.4-10. Principal system components are listed and described in Table 9.4-9.

The Zone 5 (fuel handling area) ventilation equipment is discussed in subsection 9.4.2, and is shown in Figures 9.4-2 and 9.4-3.

Zone 6 is provided with a fan coil unit consisting of two fans in parallel with respect to the airflow, and two cooling coils in series with respect to the airflow. The outside containment steam tunnel cooling subsystem is shown in Figure 9.4-10. Principal system components are listed and described in Table 9.4-9.

GRAND GULF NUCLEAR GENERATING STATION
Updated Final Safety Analysis Report (UFSAR)

During normal plant operation, each auxiliary building zone fan coil unit supplies conditioned air to its respective zone. The units are started manually. Starting of an individual unit will energize the control system and open the outside air damper to its preset normal position. The outside air damper is either open or closed, with no automatic proportioning function. Temperature Controllers in the return air ductwork responds to the return air temperature and gives an output signal to modulate the electric heating coil and the chilled-water three-way valve.

During normal operation, zones 1 through 4 fan coil units provide cooling to rooms occupied by ECCS equipment, which is normally idle. When this ECCS equipment is in operation, cooling is provided by safety-related cooling equipment, as discussed in subsection 9.4.5. A non-safety related air conditioning unit is installed in the RHR C pump room to maintain normal room temperatures during ADHRS operation.

9.4.6.3 Safety Evaluation

Because the auxiliary building comprises a portion of the boundary region of the standby gas treatment system, in response to any standby gas treatment system initiation signal (refer to subsections 6.2.3 and 6.5.3), the auxiliary building penetration of the auxiliary building ventilation system is isolated.

The auxiliary building ventilation penetration is provided with redundant, air-operated, fail-closed isolation valves to preclude the possibility of airborne radioactivity bypassing the boundary regions of the standby gas treatment system. Protection against the postulated failure of high-energy piping is discussed in Section 3.6.

Failure of the nonsafety-related portion of the auxiliary building ventilation system will not jeopardize the functioning of the isolation valves.

Other than the above, the system has no safety-related function as defined in Section 3.2. Failure of the system will not compromise any safety-related system or component and will not prevent safe reactor shutdown.

The standby gas treatment system (SGTS) performs the necessary operations required for the control of radioactivity following an accident. Refer to subsections 6.2.3, 6.5.1, and 6.5.3 for the description of this system.

GRAND GULF NUCLEAR GENERATING STATION
Updated Final Safety Analysis Report (UFSAR)

9.4.6.4 Tests and Inspections

The auxiliary building ventilation system components are periodically inspected to assure that all normally operating equipment is functioning properly. Standby components will be periodically tested to ensure system reliability.

9.4.6.5 Instrumentation Application

Thermocouples are mounted at various locations throughout zones 1 through 4 of the auxiliary building. These provide area temperature monitoring by the plant computer. The fan coil unit for each floor is provided with manual start and manual/ automatic stop. Duct-mounted temperature sensors are provided for cooling water flow control, low temperature fan trip, heating coil control, and fire detection. Particulate filters are provided with differential pressure indication for maintenance purposes. Smoke or heat detectors are mounted in the return air duct from each floor for fire detection.

Thermocouples are mounted at various locations throughout the main steam tunnel outside the containment (zone 5). The average temperature of these thermocouples is monitored by the plant computer, which is used to control cooling water flow and to start the standby fan. The main steam tunnel fans outside the containment are provided with manual/standby start and manual/ automatic stop.

Auxiliary building isolation valves are closed in response to any standby gas treatment system initiation signal. Refer to subsection 7.3.1.1.8 for the description of the standby gas treatment control system.

Radiation monitoring of exhaust air from the auxiliary building is discussed in subsection 9.4.2.

Provisions for maintaining the auxiliary building at a slightly negative pressure with respect to the outside are discussed in subsection 9.4.2.

GRAND GULF NUCLEAR GENERATING STATION
Updated Final Safety Analysis Report (UFSAR)

9.4.7 Containment Cooling System

9.4.7.1 Design Bases

9.4.7.1.1 Safety Design Bases

- a. The containment cooling system is provided with redundant seismic Category I isolation valves at each containment and auxiliary building penetration to preclude the possibility of containment contents escaping to the environment in the event of a postulated loss-of-coolant accident.
- b. The radiation detection equipment in the containment cooling exhaust is of seismic Category I design.

9.4.7.1.2 Power Generation Design Bases

The design bases for the containment cooling system are as follows:

- a. The system is designed to provide an environment suitable for normal operation of equipment necessary for power generation. There is no safety-related equipment dependent on the operation of the containment cooling system.
- b. The system is designed with sufficient redundancy to provide reliable operation during normal plant operation.
- c. The system is designed to permit periodic inspection and testing of the principal system components.
- d. The design conditions in the areas served by the containment cooling system are as follows:

	<u>Temperature</u> (F)	<u>Relative Humidity</u> (%)
Containment	80	60
Subcompartments	105	--
Steam tunnel, inside containment	125	--

The design bases of the containment ventilation and filtration systems are as follows:

GRAND GULF NUCLEAR GENERATING STATION
Updated Final Safety Analysis Report (UFSAR)

- a. The containment filtration system is designed to limit airborne radioisotopes in the containment atmosphere to acceptable levels during normal operation. See Section 12.4 for details.
- b. The ventilation system is designed to provide a reliable source of fresh air for the comfort and protection of personnel to allow containment access during normal operation.
- c. The containment ventilation and filtration systems are designed to permit periodic inspection of the principal system components during normal operation.

The containment temperature and humidity control is achieved by the containment cooling system, which is independent of the containment ventilation and filtration system.

9.4.7.2 System Description

9.4.7.2.1 Containment Cooling System

The containment cooling system is shown schematically in Figures 9.4-11 and 9.4-12. Principal system components are listed and described in Table 9.4-10.

The containment cooling system recirculates the containment atmosphere to maintain the design conditions of 80 F and 60 percent relative humidity during normal plant operation. The temperature in any area other than the steam tunnel does not exceed a maximum of 105 F.

The containment cooling system consists of three 50-percent-capacity recirculation coolers and the associated dampers, ducting, and controls required to maintain the design containment temperature and relative humidity. Each containment cooler consists of a cooling coil and fan and, normally, two fan-coil units operate, with one on common standby. The cooling system supplies conditioned air through ductwork and grilles.

Cooling water for the containment cooling system is provided by the plant chilled-water system.

9.4.7.2.2 Containment Ventilation and Filtration System

The containment ventilation and filtration system is shown in Figure 9.4-11 and 9.4-12. Principal system components are listed and described in Table 9.4-10.

The following lines are incorporated into the containment ventilation and filtration system: one 6-inch-diameter supply line, one 20-inch-diameter purge supply line, one 6-inch-diameter exhaust line, one 20-inch-diameter purge exhaust line.

The normal containment ventilation equipment consists of two 100-percent-capacity containment ventilation supply fans; two 100-percent-capacity containment ventilation exhaust fans; one 100-percent-capacity containment exhaust charcoal filter train; one reactor water sampling station filter train; and the associated ducting, dampers, and controls required to provide a reliable source of fresh air for the comfort and safety of personnel.

The containment exhaust charcoal filter train consists of the following components arranged in series with respect to the air flow:

- a. Demister
- b. Heating coil
- c. Prefilter
- d. High-efficiency particulate air (HEPA) filter bank
- e. Charcoal filter bank
- f. HEPA filter bank

The containment filtration system consists of two 100-percent-capacity containment cooling system charcoal filter trains that continuously recirculate a portion of the containment atmosphere to limit the concentration of airborne radioiodines to an acceptable level during normal operation. Each filtration train consists of the following components arranged in series with respect to the air flow:

- a. Demister
- b. Heating coil

GRAND GULF NUCLEAR GENERATING STATION
Updated Final Safety Analysis Report (UFSAR)

- c. Prefilter
- d. High-efficiency particulate air (HEPA) filter bank
- e. Charcoal filter bank
- f. HEPA filter bank
- g. Centrifugal fan

The heating coil in each filtration train provides humidity control. Operation of the filtration train is manually initiated from the control room.

Refer to Table 9.4-14 for an analysis of the containment exhaust charcoal filter train and the containment cooling system charcoal filter trains with respect to Branch Technical Position ETSB No. 11-2, "Design, Testing, and Maintenance Criteria for Normal Ventilation Exhaust System Air Filtration and Adsorption Units of Light-Water-Cooled Nuclear Power Reactors."

The containment cooling, ventilating, and filtration system has several modes of operation. Manual initiation from the control room is required to shift the system from one mode to another. The modes are as follows:

- a. Normal operating mode
- b. Containment low volume purge mode
- c. Containment high volume purge mode
- d. Containment cleanup mode
- e. Drywell purge mode

The reactor water sampling station filter train consists of one 100-percent-capacity charcoal filter train that is operated to reduce the risk of personnel when a sample of reactor water must be obtained. The reactor water sampling station filter train consists of these components arranged in series as follows:

- a. Prefilter
- b. Heating coil
- c. High-efficiency particulate air (HEPA) filter bank

GRAND GULF NUCLEAR GENERATING STATION
Updated Final Safety Analysis Report (UFSAR)

- d. Charcoal filter bank
- e. HEPA filter bank
- f. Centrifugal fan

Both containment cooling system charcoal filter trains can also be utilized in conjunction with the purge fans to purge the drywell during reactor shutdown. Operation of the drywell purge mode is discussed in subsection 9.4.8.2.2. In addition, the containment exhaust charcoal filter train may be used by the combustible gas control system during post-accident conditions as described in subsection 6.2.5.

During normal plant operation, the containment is maintained at 80 F and 60 percent relative humidity by recirculating the air through coolers equipped with chilled-water cooling coils. Two fan coil units operate, with one unit on common standby.

Containment low volume purge uses the 6" diameter supply and exhaust lines with the 500 SCFM supply fans and exhaust charcoal filter train fans running. The continuous use of the containment low volume purge system is unrestricted in all operating conditions. However, in the event that equipment leakages approach the flows described in Section 12.4, intermittent operation of the 6000 cfm containment purge system will be required to reduce airborne radiation levels to concentrations consistent with ALARA guidelines and containment personnel access requirements. In power operation, startup or hot shutdown operating conditions, the intermittent use of the containment high volume purge system is restricted to containment pressure control; ALARA and air quality considerations for personnel entry due to high explosive gas concentration, low oxygen concentration, high airborne particulate activity, high gaseous radioactivity, smoke or fumes; or surveillance or special testing on the purge system that requires the isolation valve(s) to be open. In cold shutdown or refueling operating conditions, the continuous use of the 20-inch purge system is unrestricted.

The containment high volume purge mode uses the containment cooling system charcoal filter trains and the 20-inch-diameter double-valved purge exhaust penetration and the 20-inch-diameter double-valved purge supply penetration. During power operation, startup, and hot shutdown, the 20-inch purge penetrations will

GRAND GULF NUCLEAR GENERATING STATION
Updated Final Safety Analysis Report (UFSAR)

not be open when the 6-inch ventilation penetrations are open. Operation of the purge system during power operation has been analyzed as described in subsection 6.2.4.3.3.

The closure of the isolation valves will not be affected by debris which might be generated by vent clearing and subsequent suppression pool rise. The isolation valves for the two supply lines (6-inch-diameter and 20-inch-diameter) are located at elevation 173'-3", and the isolation valves for the two exhaust lines (6-inch-diameter and 20-inch-diameter) are located at elevation 177'-9", well above the area of potential turbulence where debris capable of affecting valve closure might be present. In addition, the valve locations are shielded from the turbulent area by intervening concrete floors, or steel grating. As further assurance that the isolation valves will fully close, debris screens are provided. The debris screens are located a minimum of one pipe diameter from the inner side of each inboard isolation valve. The debris screens and piping are seismic Category I and are designed to withstand the LOCA differential pressure.

During the containment high volume purge mode, the entire volume of air routed to one or both of the charcoal filter trains is discharged to the atmosphere with no recirculation to the containment through the 20-inch-diameter purge exhaust line. The containment ventilation supply and exhaust fans are idle during this mode of operation. The drywell/containment purge fans, located in the auxiliary building, supply the makeup air through the 20-inch-diameter purge supply line during this mode of operation. The outside air heating coil tempers the supply air during winter to 65 F. Both charcoal filter trains and purge fans can be utilized to provide additional purge capacity. In power operation, startup or hot shutdown operating conditions, the intermittent use of the containment high volume purge system is restricted to containment pressure control; ALARA and air quality considerations for personnel entry due to high explosive gas concentration, low oxygen concentration, high airborne particulate activity, high gaseous radioactivity, smoke or fumes; or surveillance or special testing on the purge system that requires the isolation valve(s) to be open. In cold shutdown or refueling operating modes, the continuous use of the 20-inch purge system is unrestricted. Continuous operation of this mode is limited to only the cold shutdown and refueling operating modes.

GRAND GULF NUCLEAR GENERATING STATION
Updated Final Safety Analysis Report (UFSAR)

Containment FLEX Vent Valve QLM41F100 and associated control equipment shown on Figure 9.4-11 provide an alternate containment pressure control path if required following a postulated Beyond Design Basis External Event (BDBEE). Following a BDBEE, the 20-inch line and valves Q1M41F034, QJM41F035, Q1M41F036, Q1M41F037, and 1M41F100 can be opened from control panel 1M41P001 located in the Auxiliary Building to provide a vent path to atmosphere.

During the containment cleanup mode, the containment atmosphere is routed through one or both charcoal filtration trains and recirculated to the containment, with no exhaust. To achieve this mode, the outside air dampers are closed. The containment ventilation supply and exhaust fans and the drywell/containment purge fans are idle during this mode of operation.

The main steam tunnel inside containment is provided with a cooler to maintain the temperature at 125 F, maximum. Due to tunnel inaccessibility, the cooler consists of the following:

- a. Two 100-percent-capacity cooling coils arranged in series with respect to the airflow
- b. Two 100-percent-capacity vane axial fans arranged in parallel with respect to the airflow

Drywell chilled water is provided as coolant to the coil. During normal operation, the steam tunnel atmosphere is recirculated and cooled. The system is designed for 100 percent recirculation with no makeup air required.

A containment lower personnel air lock air shower is provided. The air shower takes ambient containment air above El. 208'-10", and creates a wall-of-air at the containment side of the lower personnel air lock door. The air shower is manually activated by personnel in the event of an isolation transient, prior to egress through the containment lower personnel air lock. The air shower is intended to reduce radiation exposure to personnel during egress. The reactor water sampling station filter train is used to limit the risk to personnel who must obtain samples of reactor water.

9.4.7.3 Safety Evaluation

With the exception of containment isolation function (refer to subsection 6.2.4), the system has no safety-related function as defined in Section 3.2 Failure of the system will not compromise any safety-related system or component and will not prevent safe reactor shutdown.

The containment cooling system is not required to function following an accident to maintain the Class IE equipment located inside the containment within the temperature range for which it is qualified to operate.

Should the containment or the drywell cooling systems not be available during normal reactor operation, containment and drywell temperatures would be monitored to assure that the temperature of Class IE equipment does not exceed the temperature for which the equipment is qualified to operate.

However, the system incorporates features that assure reliable operation over the full range of normal plant operations. These features include the installation of redundant principal system components.

The redundant equipment combined with applicable qualification margins should prevent any occurrences of malfunctions of qualified equipment due to exceeding the operating temperature limits. Complete and total failure of these systems will necessitate a plant shutdown because the operating temperature limits will be exceeded.

The system has been designed in accordance with the codes and standards given in Table 3.2-1, Item XXXVII.

The isolation valve closure time for all eight containment isolation valves associated with containment ventilation and filtration is 4 seconds after receiving the signal to close.

The 20-inch containment purge isolation valves are identical to the qualified 20-inch drywell purge isolation valves. The drywell purge valves are qualified to close against LOCA-induced differential pressures. Therefore, the 20-inch containment purge isolation valves are capable of closing under LOCA conditions when the drywell purge isolation valves are opened.

GRAND GULF NUCLEAR GENERATING STATION
Updated Final Safety Analysis Report (UFSAR)

A radiation monitoring system is provided to detect high radiation in the containment ventilation exhaust and drywell purge exhaust. A high-radiation signal actuates an alarm and automatically initiates isolation of the containment and drywell.

A separate radiation monitoring system is also provided to monitor effluent radioactivity releases to the environment. For a further discussion of this system, see subsection 11.5.2.2.4.

9.4.7.4 Tests and Inspections

The cooling and ventilating systems are periodically inspected to assure that all normally operating equipment is functioning properly. Standby components are periodically tested to ensure system reliability.

Tests and inspections performed during initial startup sequence are described in Chapter 14. The containment purge fans are periodically inspected and tested to assure reliable operation when required for containment purge.

Provisions are made for periodic testing of each of the containment charcoal filter trains. These tests include measurement of differential pressure and determination of filter efficiency. The charcoal filters are tested in accordance with RDTM16-1T, Paragraphs 4.5.2, 4.5.4, and 4.5.5 (Report by USAEC Division of Reactor Development and Technology).

The high-efficiency particulate air filters are tested with dioctyl phthalate (DOP) aerosol.

9.4.7.5 Instrumentation Application

Each containment ventilation supply air fan and drywell containment purge fan is controlled by a handswitch located in the control room. The intake filter is equipped with a local differential pressure indicator.

Discharge air temperature from the drywell containment purge fans is monitored, and a temperature switch regulates an electric heating coil to avoid supplying freezing outside air into the containment during the purge mode operation.

GRAND GULF NUCLEAR GENERATING STATION
Updated Final Safety Analysis Report (UFSAR)

Isolation of the containment at both ventilation supply and exhaust penetrations is accomplished by closing valves inside and outside of the containment using handswitches in the control room, or by an automatic isolation control signal (refer to subsection 7.3.1.1.2).

Each containment fan-coil unit is controlled by a local handswitch.

The drywell purge dampers and valves are controlled by handswitches in the control room. Isolation of drywell intake and discharge is accomplished by isolation valves inside and outside of the drywell that are operated by handswitches located in the control room or by an isolation control signal.

The steam tunnel cooler is controlled by a handswitch in the control room. The redundant fan starts in response to a differential pressure switch and/or a temperature switch if the operating unit should fail.

The containment exhaust air system is equipped with radiation monitoring devices that record radioactivity levels.

Separate radiation-monitoring devices actuate an alarm on high radiation and initiate containment isolation.

The containment filter trains of this system are operated by handswitches in the control room.

The containment lower personnel air lock air shower is operated by a local on-off handswitch.

9.4.8 Drywell Cooling System

9.4.8.1 Power Generation Design Bases

The design bases for the drywell cooling system are as follows:

- a. The system is designed to provide an environment with controlled temperature and humidity to ensure the integrity of the drywell equipment.
- b. The system is designed to provide reliable operation during normal plant operation.
- c. The design of the system permits periodic inspection and testing of the principal system components.

GRAND GULF NUCLEAR GENERATING STATION
Updated Final Safety Analysis Report (UFSAR)

- d. The drywell cooling-unit and recirculation fans are considered to be associated loads, as defined by IEEE-384. They are supplied from Class 1E Motor Control Centers that are shed on a LOCA signal and otherwise controlled by the load shedding and sequencing panels, as described in subsection 8.3.1.1.3.

The design bases for the drywell purge system are as follows:

- a. The drywell purge system is designed to purge the drywell at a minimum rate of one air change per hour.
- b. The design of the system permits periodic inspection and testing of the principal system components.

9.4.8.2 System Description

9.4.8.2.1 Drywell Cooling System

The drywell cooling system is shown in Figure 9.4-13. Principal system components are listed and described in Table 9.4-11.

The drywell cooling system is designed to maintain average drywell conditions of 135 F and 50 percent relative humidity during normal plant operation. During reactor shutdown following loss of offsite power, the temperature in any area does not exceed 150 F, except in the CRD area where the temperature does not exceed 185 F.

The drywell cooling system consists of recirculating fan-coil units and the associated dampers, ducting, and controls required to maintain the design drywell temperature and relative humidity. Each fan-coil unit consists of two full-capacity fans in parallel and two full-capacity cooling coils in series. Six fan-coil units are provided to distribute cooling air effectively and with minimum ductwork.

Additionally, the drywell cooling system incorporates two recirculation fans and associated controls and ducting which transfer air from the upper elevation to the lower elevation. These fans alleviate heat stratification in the drywell. Normally, both fans operate simultaneously.

GRAND GULF NUCLEAR GENERATING STATION
Updated Final Safety Analysis Report (UFSAR)

A high ambient temperature signal from the CRD cavity will automatically position ductwork dampers to divert additional air flow from the drywell coolers to the CRD cavity. Cooling water to the drywell coolers is provided by the drywell chilled water system, described in subsection 9.2.11.

9.4.8.2.2 Drywell Purge System

The drywell purge system is shown schematically in Figures 9.4-11 through 9.4-13. Principal system components are listed and described in Table 9.4-10.

During plant power operation, startup, or hot standby operation of the drywell purge mode is limited to operating the system for pressure control, reducing airborne radioactivity levels or air quality for personnel entry, or surveillances or special testing of the purge system. During other plant operational modes the operation of the drywell purge mode is not restricted.

The drywell purge system is designed to purge the drywell at a minimum rate of one air change per hour.

This system consists of the ventilation-filtration portion of the containment cooling system and the associated dampers, ducting, and controls required to purge the drywell.

The drywell filtration-purge system operates by closing the dampers to the containment cooling and distribution system and opening the dampers to the drywell. The ventilation/filtration system can be used for drywell purge, recirculation cleanup, or a ratio of purging and recirculation in the same manner as described in subsection 9.4.7.2.2 for the containment ventilation and filtration systems. The activity of the air is monitored continuously. A high activity level actuates an alarm and initiates containment isolation. Following an incident in the drywell resulting in a release of activity to the area, and when conditions permit, the drywell atmosphere may be cleaned up by utilizing the containment and drywell ventilation system and exhausting through the charcoal filter train to remove airborne contamination prior to discharging to the containment vent.

The drywell purge system is manually initiated. The drywell purge isolation valves fail closed on loss of instrument air or power to the damper actuator solenoid. The drywell purge isolation valves are fast closing valves (i.e., approximately 4 seconds). These valves are qualified to close against LOCA-induced differential

GRAND GULF NUCLEAR GENERATING STATION
Updated Final Safety Analysis Report (UFSAR)

pressures. The 20-inch containment purge isolation valves are identical to the qualified drywell purge isolation valves. Therefore, the 20-inch containment purge isolation valves are capable of closing under LOCA conditions when the drywell purge isolation valves are opened.

The drywell purge isolation valves close in response to any of the following inputs:

- a. Containment and drywell trip logic manual initiation
- b. Containment and drywell ventilation exhaust high radiation
- c. CRVICS trip logic manual initiation
- d. Reactor low water level
- e. Drywell high pressure

With the exception of (a), the valves can be reopened manually only after the isolation signal has been reset.

A separate drywell purge system is provided to purge the hydrogen produced into drywell following a postulated LOCA and is described in subsection 6.2.5.

9.4.8.3 Safety Evaluation

The drywell purge penetrations are of seismic Category I design, and are provided with redundant isolation valves to satisfy single-failure criteria. Other than the above, the drywell cooling and purge systems have no safety-related function as defined in Section 3.2. Failure of cooling and purge systems will not compromise any safety-related system or component and will not prevent safe reactor shutdown.

The drywell cooling system is not required to function following an accident to maintain the Class IE equipment located inside the drywell within the temperature range for which it is qualified to operate.

However, the drywell cooling and purge systems incorporate features that assure reliable operation over the full range of normal plant operations. These features include the installation of redundant principal system components.

GRAND GULF NUCLEAR GENERATING STATION
Updated Final Safety Analysis Report (UFSAR)

The redundant equipment combined with applicable qualification margins should prevent any occurrences of malfunctions of qualified equipment due to exceeding the operating temperature limits. Complete and total failure of these systems will necessitate a plant shutdown because the operating temperature limits will be exceeded.

A radiation-monitoring system is provided in the exhaust of the containment cooling system to detect high radiation when the purge is exhausted. A high-radiation signal actuates an alarm and automatically initiates isolation of the drywell and containment.

9.4.8.4 Inspection and Testing

Return air temperature, discharge air temperature, and fan differential pressure between intake and discharge of the fans are periodically monitored to assure that all normally operating equipment is functioning properly. Standby components of the drywell cooling system are tested periodically to ensure system operability.

Portions of the containment ventilation system that are required for drywell purge are inspected and tested as described in subsection 9.4.7.4.

9.4.8.5 Instrumentation Application

Each typical fan-coil unit is equipped with its own remote handswitch located in the control room. Either fan of the fan-coil units can be selected for operation or standby.

Under normal operation, one fan in each fan-coil unit is operational. A low fan-coil unit differential-pressure will start the standby fan automatically.

The discharge of each fan is equipped with a volume-control damper that is opened when the associated fan starts. The temperature of the discharge air is monitored by the plant computer. A temperature switch actuates a high-temperature alarm located in the control room.

The return air temperature from the recirculating pump area and the drywell head is monitored by the plant computer.

GRAND GULF NUCLEAR GENERATING STATION
Updated Final Safety Analysis Report (UFSAR)

A temperature controller on the discharge of the two drywell coolers, which deliver air to the RPV skirt, modulates the drywell chilled water flow to maintain a minimum discharge air temperature of 70 F.

Area temperature in the CRD cavity is monitored. If this temperature becomes too high, an alarm in the control room is actuated and dampers are repositioned to divert more air from the drywell coolers to the CRD cavity.

9.4.9 Miscellaneous Buildings Nonsafety-Related Ventilation Systems

The following ventilation and cooling systems are described in this section:

- a. Water treatment building ventilation system
- b. Fire water pump house ventilation system
- c. Plant service water radial well weatherproof enclosure ventilation system
- d. Radial well switchgear house ventilation system
- e. Circulating water pumphouse ventilation system
- f. Auxiliary cooling tower power and control building ventilation system

9.4.9.1 Design Bases

9.4.9.1.1 Power Generation Design Bases

- a. The systems are designed to maintain an environment suitable for equipment operation and personnel
- b. The outdoor design conditions are based on temperatures of 95 F in summer and 15 F in winter with the exception of the Auxiliary Cooling Tower Power and Control Building which is based on an outside design temperature of 90.6°F in the summer.
- c. The design conditions for the areas served by the miscellaneous buildings ventilation system are as follows:

GRAND GULF NUCLEAR GENERATING STATION
Updated Final Safety Analysis Report (UFSAR)

<u>Building</u>	<u>Temperature (F)</u> <u>Summer/Winter</u>
Water treatment building:	
Air-conditioned areas - counting room, clean lab, and office	75/70
Non-air-conditioned areas	104/65
Radial well switchgear house	104/65
Fire water pump house	
Compartment 1	115/65
Compartment 2	105/65
Compartment 3	115/65
Plant service water radial well weatherproof enclosure	104/50
Circulating water pumphouse	104/65
Auxiliary cooling tower power and control building	104/40

- d. In case of prolonged failure of the ventilation systems in the non-air-conditioned areas of the water treatment building, plant service water radial well weatherproof enclosure, radial well switchgear house, fire water pump house, circulating water pumphouse, and the auxiliary cooling tower power and control building, the area temperatures would exceed the maximum allowable values for normal operation of mechanical and electrical equipment, at which time temporary ventilation might be required. In case of failure of the cooling system for the air-conditioned areas of the water treatment building, comfort conditions will be exceeded.

9.4.9.2 System Description

The miscellaneous buildings ventilation systems are shown in Figures 9.4-14, 9.4-15, and 9.4-15a. The major system components and associated fabrication and performance data are given in Table 9.4-12.

9.4.9.2.1 Water Treatment Building Ventilation System

The Water Treatment Building ventilation system consists of four subsystems: air conditioned area supply air subsystem; air-conditioned area exhaust subsystem; non air conditioned area ventilation subsystem; and fume hood supply and exhaust.

- a. The air conditioned supply air subsystem provides heating, cooling, and ventilation requirements for all normally occupied areas. These areas include the Chemistry Lab, Counting Room, Insolubles Room, and office area.

The Chemistry Lab and Counting Room are served by a direct expansion air conditioning unit. Heating is provided to each area by a duct mounted heater.

The office area air conditioning system, based on an air-to-air heat pump system, provides heating, cooling, and ventilation requirements for the office area.

The Insolubles Room air conditioning system, based on an air-to-air heat pump system, provides heating and cooling for the Insolubles Room.

- b. The air conditioned area exhaust subsystem consists of the Chemistry Lab and Counting Room exhaust subsystem and the Chemical Storage Room exhaust subsystem.

The Chemistry Lab and Counting Room exhaust subsystem consists of an automatic damper, associated ductwork, and controls. Because of the potential for high activity in the Chemistry Lab and Counting Room, the exhaust air is tied in with the radwaste exhaust system (subsection 9.4.3). An automatic damper located in the exhaust ductwork automatically opens when the indoor unit fan is energized and closes when the fan is deenergized.

GRAND GULF NUCLEAR GENERATING STATION
Updated Final Safety Analysis Report (UFSAR)

The Insolubles Room exhaust subsystem consists of a fan, as discussed above, that runs continuously. The heat pump is interlocked such that it cannot run unless the fan is energized.

The Chemical Storage Room exhaust subsystem consists of a locally controlled exhaust fan. The exhaust air is ducted to the roof.

- c. The non air conditioned area of the Water Treatment Building ventilation subsystem consists of power roof ventilators, motor-operated louvers, and electric unit heaters. Outside air is induced through louvers and exhausted by roof ventilators to maintain the space temperature. The electric unit heaters maintain the thermostat temperature setting during winter when roof ventilator fans are stopped and louvers are closed.
- d. For each fume hood in the clean laboratory, the intake air is ducted from the non air conditioned area with a hood auxiliary air fan and a motor-operated control damper, and the exhaust air is ducted to the roof by a hood exhaust fan.

9.4.9.2.2 Plant Service Water Radial Well Weatherproof Enclosure Ventilation System

The system consists of power wall ventilators, motor-operated louvers, and electric unit heaters. The outside air is induced through louvers and exhausted by wall ventilators to maintain space temperature. The electric unit heaters maintain thermostat temperature setting during winter when wall ventilator fans are stopped and louvers are closed.

9.4.9.2.3 Fire Water Pump House Ventilation System

The fire water pump house is divided into three compartments separated by fire walls. Each compartment has an individual ventilation system that consists of a power roof ventilator and electric unit heater. Each roof ventilator is controlled by a space thermostat located in the compartment. Outside air is induced and exhausted by the roof ventilator to maintain the space temperature. The electric unit heaters maintain thermostat temperature setting when the roof ventilator fan is stopped.

9.4.9.2.4 Radial Well Switchgear House Ventilation System

The system consists of power roof ventilators and electric unit heaters. Outside air is induced through louvers and exhausted by roof ventilators. The ventilators are controlled by thermostats which sense space temperature. The electric unit heaters are controlled by built-in thermostats to maintain thermostat temperature setting when the roof ventilators are stopped.

9.4.9.2.5 Circulating Water Pump House Ventilation System

The circulating water pump house ventilation system consists of five 20-percent- (approximate) capacity (exhaust) ventilation fans, an equal number of intakes, and controls required to maintain the space design temperature. The fans are controlled by thermostats which sense space temperature, and are designed to start at staggered intervals to maintain a maximum space temperature of 104 F. Electric unit heaters are provided for winter shutdown freeze protection and are controlled by built-in thermostats to maintain thermostat temperature setting when the roof ventilators are stopped. The circulating water pump house ventilation system is shown in Figures 9.4-9a & b.

9.4.9.2.6 Auxiliary Cooling Tower Power and Control Building Ventilation System

The system consists of power roof ventilators, motor-operated louvers, and electric unit heaters. The outside air is induced through louvers and exhausted by roof ventilators to maintain space temperature. The ventilators and louvers are controlled by thermostats which sense space temperature. The electric unit heaters maintain thermostat temperature setting during winter when roof ventilator fans are stopped and louvers are closed.

9.4.9.3 Safety Evaluation

The systems have no safety-related function as defined in Section 3.2. Failure of the systems will not compromise any safety-related system or component and will not prevent safe reactor shutdown.

9.4.9.4 Tests and Inspections

The systems are designed to permit periodic inspection of important components, such as fans, motors, belts, coils, filters, ductwork, piping, and valves, to assure the integrity

GRAND GULF NUCLEAR GENERATING STATION
Updated Final Safety Analysis Report (UFSAR)

and capability of the systems. Local display or indicating devices are provided for periodic inspection of vital parameters such as space temperatures.

Portable test and monitoring equipment can be used to balance the system when required. Electric unit heaters are approved by Underwriters Laboratories.

9.4.9.5 Instrumentation Application

For the auxiliary cooling tower power and control building ventilation system, each power roof ventilator and power wall ventilator is equipped with a local temperature switch. The motor-operated outside air-intake louvers are interlocked with their respective ventilator fans. Automatic temperature control is provided for each electric unit heater and ventilator fan to maintain space temperature.

For the balance of the miscellaneous building non-safety related ventilation systems, each power roof ventilator and power wall ventilator is equipped with a local handswitch and a temperature switch with the exception of the circ water pumphouse. The motor-operated outside air-intake louvers are interlocked with their respective ventilator fans. The Circ Water Pumphouse temperature is administratively controlled by operations to maintain the Circ Water Pumphouse temperature within desired limits. Automatic temperature control is provided for each electric unit heater and ventilator fan to maintain space temperature.

Each hood exhaust fan is controlled by a local handswitch and is interlocked with its respective auxiliary air fan and a motor-operated damper.

9.4.10 Control Building Ventilation System

The control building ventilation system consists of the following five subsystems:

- a. Control building air-conditioning subsystem
- b. Control building purge subsystem
- c. Access control area air-conditioning subsystem
- d. Computer rooms air-conditioning subsystem
- a.

GRAND GULF NUCLEAR GENERATING STATION
Updated Final Safety Analysis Report (UFSAR)

- e. Elevator machinery room ventilation subsystem

The system is illustrated in Figures 9.4-16a, 9.4-16b, and 9.4-16c.

9.4.10.1 Power Generation Design Bases

- a. The systems are designed to provide a reliable source of fresh air and an environment with controlled temperature and humidity to ensure the comfort of personnel and the integrity of nonsafety-related plant equipment supplied by the system.
- b. The systems are designed with sufficient redundancy to provide reliable operation during normal conditions.
- c. The ventilation and cooling systems are designed to permit periodic inspection of the principal components.
- d. The design conditions in the areas served by the control building ventilation system are as follows:

	<u>Temp., Max./Min.</u> <u>(F)</u>	<u>Rel. Hum/</u> <u>(%)</u>
Access control area	80/75	-
Upper cable spreading room	104/65	-
Lower cable spreading room	104/65	-
Computer rooms	75	50
HVAC equipment room	104/65	-
Elevator machinery room	104/65	-

- e. Design outside air temperatures for the control building ventilation system are 95 F during the summer and 15 F during the winter.

9.4.10.2 System Description

9.4.10.2.1 Control Building Air-Conditioning Subsystem

The control building air-conditioning subsystem operates continuously to supply an amount of filtered and conditioned air to the HVAC equipment room and the upper and lower cable spreading rooms. All of the air supplied to the cable spreading rooms is returned to the control building fan coil unit. A portion of the air supplied to the HVAC equipment room is exhausted via the computer rooms exhaust fan with the remainder returned to the unit. Makeup outside air is provided to the unit.

9.4.10.2.2 Control Building Purge Subsystem

The control building purge subsystem removes smoke and/or noxious gases from any or all of the following areas:

- a. HVAC equipment room (El. 133-0)
- b. Upper and lower cable spreading rooms
- c. Control room

This system consists of a single fan with branched connections to each of the above areas. The branches into the HVAC equipment room and cable spreading rooms contain normally closed motor-operated dampers. Isolation butterfly valves are provided on the control room purge exhaust line. (See subsection 9.4.1.)

Automatic operation of the purge fan is initiated by a signal from fire or smoke detectors in the HVAC equipment room at El. 133- 0.

9.4.10.2.3 Access Control Area Air-Conditioning Subsystem

This system includes a fan coil unit that draws in an amount of outside air sufficient to maintain a slight negative pressure in the sump, toilets, locker, showers, and other areas. The outside air is mixed with the return air from the HVAC equipment room, first-aid room, and office and corridor areas.

The access control area exhaust fan is operated continuously to maintain a slight negative pressure within the sump, showers, toilets, and storage areas.

GRAND GULF NUCLEAR GENERATING STATION
Updated Final Safety Analysis Report (UFSAR)

This exhaust fan can also be used to purge smoke from the access control area. A connection between the exhaust and return ductwork with a normally closed motor-operated damper is provided to allow purging of the entire access control area.

The HVAC system for the hot machine shop and decontamination facility consists of two fan coil units for cooling, a filter train for filtering the recirculated air and a filter train for filtering the air exhausted from the area. Fresh air for the hot machine shop and decontamination facility is provided via the access control area fan coil unit. The areas are maintained at a slightly negative pressure with respect to the rest of the access control area. Air is exhausted through the hot machine shop exhaust filter train and discharged into the turbine building ventilation system downstream of the turbine building exhaust filter train. The exhausted air is monitored for airborne particulate radiation via the turbine building radiation monitor.

The hot machine shop recirculation and exhaust filter trains each consist of a prefilter, HEPA filter, filter housing, isolation dampers, ductwork and controls. Analysis of the filter trains with respect to Branch Technical Position ETSB No. 11-2, "Design, Testing and Maintenance Criteria for Normal Ventilation Exhaust System Air Filtration and Adsorption Units of Light-Water-Cooled Nuclear Power Reactors" is given in Table 9.4-14.

9.4.10.2.4 Computer Rooms Air-Conditioning Subsystem

This system operates continuously to maintain the computer rooms at 75 F and 50 percent relative humidity. The system consists of two fan coil units and five self-contained air conditioning units. Humidity control for the computer rooms is provided by a humidifier located on the common supply ductwork of the fan coil units.

One fan coil unit supplies filtered and conditioned air to the computer rooms and battery rooms with the redundant unit on standby. Automatic switchover from the operating unit to the standby unit is initiated by the detection of very low flow by a flow element located in the common discharge ducting of fans. The resulting signal causes the following actions simultaneously:

- a. The standby fan starts
- b. The standby fan isolation dampers open

GRAND GULF NUCLEAR GENERATING STATION
Updated Final Safety Analysis Report (UFSAR)

Each fan coil unit fan can also be manually started from a local handswitch. The self-contained air-conditioning units operate continuously to circulate and cool the computer room air. The self-contained units are manually started from a local handswitch.

9.4.10.2.5 Elevator Machinery Room Ventilation Subsystem

The elevator machinery room ventilation subsystem utilizes a wall exhaust fan in conjunction with fixed louvers to maintain the maximum room temperature at 104 F. An electric unit heater is provided to maintain a minimum room temperature of 50 F during the winter.

9.4.10.3 Safety Evaluation

The systems have no safety-related function as defined in Section 3.2. Failure of the systems will not compromise any safety-related system or component and will not prevent safe reactor shutdown. However, these systems incorporate features that assure reliable operation over the full range of normal plant operations. These features include the installation of redundant principal system components.

9.4.10.4 Tests and Inspections

The cooling and ventilation systems are periodically inspected to assure that all normally operating equipment is functioning properly. Standby components are periodically tested to ensure system redundancy.

The control building purge fan is periodically inspected and tested to assure reliable operation when required.

Appropriate test connections have been provided for the hot machine shop recirculation and exhaust filter trains. Local display and indicating devices are provided for periodic inspection of vital parameters such as filter pressure drops.

9.4.10.5 Instrumentation Application

The control building air-conditioning subsystem components are equipped with local handswitches. A local space temperature controller gives an output signal to modulate the chilled-water three-way valve. Freeze protection is provided for the fan-coil

GRAND GULF NUCLEAR GENERATING STATION
Updated Final Safety Analysis Report (UFSAR)

unit in the form of a temperature switch that shuts down the fan and closes the outside-air isolation damper upon sensing a low mixed-air temperature.

The control building purge subsystem exhaust fan is initiated by a signal from

fire or smokedetectors in the HVAC equipment room atEl. 133-0.

This signal also opens the motor-operated damper in the branch duct from the HVAC equipment room to the purge fan.

Manual initiation of the purge fan is required to exhaust smoke from the cable spreading rooms. A manual initiation signal is also required to open any of the motor-operated dampers in the ductwork between these levels and the purge fan. For a description of the control room smoke purge mode, refer to subsection 9.4.1.5.

The access control area fan-coil unit is manually initiated. A temperature controller, located in the access control area corridor, gives an output signal to modulate the chilled-water three-way valve when cooling is required and activates a temperature switch to energize the electric heating coil. The access control area exhaust fan is manually initiated and operates continuously. The hot machine shop recirculation and exhaust filter trains are controlled. Flow from the exhaust filter train is monitored so that under low flow conditions the fresh air supply damper in the room is automatically closed.

The hot machine shop fan coil units are controlled locally by handswitches. One unit operates with the other in standby. Operation of the standby unit is controlled by temperature switches monitoring the area conditions. When conditions exceed the capacity of one unit, the standby unit is automatically started and the two units operate in parallel. A temperature controller located in the area provides an output signal to modulate the chilled water three way valve.

A pressure control system maintains a slight negative pressure in the hot machine shop and decontamination facility with respect to the rest of the access control area by modulating the fresh air supply damper located in the duct supplying fresh air to the hot machine shop.

GRAND GULF NUCLEAR GENERATING STATION
Updated Final Safety Analysis Report (UFSAR)

The computer rooms fan-coil units are controlled by a temperature controller located within the computer room. These units are activated by a local handswitch. Only one fan-coil unit supplies filtered and conditioned air to the computer rooms with the redundant unit on standby. Automatic switchover from the operating unit is initiated by detection of very low flow. The computer room air-conditioning units operate continuously to circulate and cool the computer room air. These self-contained units are activated by a local handswitch. The computer rooms exhaust fan is manually initiated and operates continuously.

GRAND GULF NUCLEAR GENERATING STATION
Updated Final Safety Analysis Report (UFSAR)

**TABLE 9.4-1: CONTROL ROOM HEATING, VENTILATING, AND
AIR-CONDITIONING SYSTEM COMPONENT DESCRIPTION**

Control Room Air Conditioning Unit

Quantity	2
Capacity/unit (cfm)	30,100

Fans (each train)

Type	Centrifugal
Quantity	1
Capacity, cfm	30,100
Static Pressure, in. wg, ext	6.0
Drive	Belt
Motor, hp	40

Cooling Coil (each train)

Type	Direct expansion
Capacity, tons	62.5

Condenser

Type	Horiz., straight tube and shell
Tube Side Fluid	Plant Service Water
Shell Side Fluid	Refrigerant 22
Duty, tons, nominal	80.5

Compressor

Type	Reciprocating
Capacity, tons, nominal	64.5
Motor, hp	100
Drive	Open

Humidifier

The Control Room Humidifiers have been abandoned in place.

GRAND GULF NUCLEAR GENERATING STATION
Updated Final Safety Analysis Report (UFSAR)

**TABLE 9.4-1: CONTROL ROOM HEATING, VENTILATING, AND
AIR-CONDITIONING SYSTEM COMPONENT DESCRIPTION (CONTINUED)**

Control Room Utility Exhaust Fan

Type	Centrifugal
Quantity	1
Capacity, cfm	1950
Static pressure, in. wg, ext	1.0
Drive	Belt
Motor, hp	1.0

Control Room Standby Fresh Air Unit

Type	Multiple filters for removal of radioiodines
Quantity	2
Capacity/unit, cfm	4000

Fans (each train)

Type	Centrifugal
Quantity	1
Capacity, cfm	4000
Static pressure, in. wg	12.6 available at 4000 cfm
Drive	Belt
Motor, hp	20

Demister (each train)

GRAND GULF NUCLEAR GENERATING STATION
Updated Final Safety Analysis Report (UFSAR)

**TABLE 9.4-1: CONTROL ROOM HEATING, VENTILATING, AND
AIR-CONDITIONING SYSTEM COMPONENT DESCRIPTION (CONTINUED)**

Type	Wire mesh screen, w/glass fiber pads
Quantity	One bank
Capacity, cfm	4000
Pressure drop, clean, in. wg	0.23
 <u>Heating Coil (each train)</u>	
Type	Electric
Quantity	1
Capacity, kW	20.7
Pressure drop, in. wg	0.14
 <u>Prefilter (each train)</u>	
Type	Dry
Quantity	One bank
Capacity, cfm	4000
Efficiency, %	90 (ASHRAE 52-68)
Pressure drop, clean, in. wg	0.31
 <u>High Efficiency Particulate Air (HEPA) Filter (each train)</u>	
Type	Dry
Quantity	Two banks
Capacity	4000 each bank
Efficiency, %	99.97 with 0.3 micron DOP smoke
Pressure drop clean, in. wg	1.0

GRAND GULF NUCLEAR GENERATING STATION
Updated Final Safety Analysis Report (UFSAR)

**TABLE 9.4-2: CONTROL ROOM HEATING, VENTILATING, AND AIR-
CONDITIONING
SYSTEM FAILURE ANALYSIS**

<u>Component</u>	<u>Malfunction</u>	<u>Comments</u>
Air-conditioning unit fan	Failure of fan resulting in loss of duct pressure	Should an operating fan fail, resultant loss of air flow actuates alarm, automatically starts standby fan, and opens standby fan isolation dampers.
Condensing unit	Failure of condensing unit resulting in loss of cooling capacity	Following loss of condensing unit, space air temperature increases and high temperature is monitored in the control room. Defective unit would be manually shut down, standby air-conditioning unit started.
Filtration unit fan	Failure of fan resulting in loss of duct fan pressure	Should operating fan fail, resultant loss of air flow actuates alarm, automatically starts standby unit; opens standby isolation dampers.
Control room filtration system	Failure resulting in high pressure differential across filter train	High pressure differential across filter train actuates alarm in control room. Defective filter train would be manually isolated and standby train brought into service.
Radiation monitor in outside air supply duct	Failure resulting in loss of radiation-monitoring capability	Redundant radiation monitors are provided.

GRAND GULF NUCLEAR GENERATING STATION
Updated Final Safety Analysis Report (UFSAR)

**TABLE 9.4-3: FUEL-HANDLING-AREA VENTILATION
SYSTEM COMPONENT DESCRIPTIONS**

Fuel-Handling-Area Supply Fans

Type	Centrifugal
Quantity	2
Fan capacity, cfm	1000
Static pressure, in. wg	1.0
Drive	Belt
Motor, hp	5

Fuel-Handling-Area Exhaust Fans

Type	Centrifugal
Quantity	2
Fan capacity, cfm	13,075
Static pressure, in. wg	3.0
Drive	Belt
Motor, hp	20

Fuel-Handling-Area Outside Air Heating Coil

Retired - In Place

Fuel-Handling-Area Fan Coil Unit, El. 208-10

Type	Centrifugal,
horizontal	drawthrough
Quantity	1
Cooling capacity, tons	102
Heating capacity, kW	176
Fan capacity, cfm	33,700
Static pressure, in. wg, ext.	2.5
Drive	Belt
Motor, hp	40

GRAND GULF NUCLEAR GENERATING STATION
Updated Final Safety Analysis Report (UFSAR)

**TABLE 9.4-3: FUEL-HANDLING-AREA VENTILATION
SYSTEM COMPONENT DESCRIPTIONS (Continued)**

Fuel Pool Sweep Supply Fans

Type	Centrifugal
Quantity	2
Fan capacity, cfm	24,000
Static pressure, in. wg	3.0
Drive	Belt
Motor, hp	20

Fuel Pool Sweep Exhaust Fans

Type	Vaneaxial
Quantity	2
Fan capacity, cfm	14,360
Static pressure, in. wg	3.0
Drive	Direct
Motor, hp	20

Fuel Pool Sweep Preheat Coil

Type	Electric
Capacity, kW	60

Fuel Pool Sweep Reheat Coil

Type	Electric
Capacity, kW	15

Fuel-Handling-Area Fan Coil Unit, El. 185-0

Type	Centrifugal, horizontal drawthrough
Quantity	1
Cooling capacity, tons	20
Heating capacity, kW	90
Fan capacity, cfm	10,500
Static pressure, in. wg, ext.	2.5

GRAND GULF NUCLEAR GENERATING STATION
Updated Final Safety Analysis Report (UFSAR)

**TABLE 9.4-3: FUEL-HANDLING-AREA VENTILATION
SYSTEM COMPONENT DESCRIPTIONS (Continued)**

Drive	Belt
Motor, hp	15
 <u>Supply Air Heating Coil</u>	
Type	Electric
Capacity, kW	15
 <u>RPV Vibration Test Room Fan Coil Unit</u>	
Type	Centrifugal, horizontal drawthrough
Quantity	1
Cooling capacity, tons	4
Fan capacity, cfm	2,380
Static pressure, in. wg, ext.	1.0
Drive	Belt
Motor, hp	2

GRAND GULF NUCLEAR GENERATING STATION
Updated Final Safety Analysis Report (UFSAR)

TABLE 9.4-4: RADWASTE BUILDING VENTILATION/AIR-CONDITIONING SYSTEM

Radwaste Building Outside Air Supply Fans

Type	Centrifugal
Quantity	Two 50% capacity units
Blades	Forward curved
Flow, cfm	24,670
Static pressure, in. wg	2.5
Drive	Belt
Motor horsepower, hp	20
Filter type	Dry, disposable

Radwaste Building Supply Air Heating Coil

Type	Electrical
Quantity	2
Heat transfer, Btu/hr	1,190,000
Air temperature entering, F	15
Air temperature leaving, F	65

Radwaste Building Exhaust Air Fans

Type	Centrifugal
Quantity	Two 100% capacity units
Flow, cfm	51,895
Static pressure, in. wg, ext.	5.0
Drive	Belt
Motor horsepower, hp	60

Radwaste Building Exhaust Air Filter Trains

Type	Unitized construction comprised of prefilter and HEPA filter
Quantity	2

GRAND GULF NUCLEAR GENERATING STATION
Updated Final Safety Analysis Report (UFSAR)

**TABLE 9.4-4: RADWASTE BUILDING VENTILATION/AIR-CONDITIONING
SYSTEM (Continued)**

Media, prefilters	Glass fiber
Efficiency, prefilters, %	90 (ASHRAE 52)
Media, HEPA filters	Glass fiber
Efficiency, HEPA filters, %	99.97 (DOP)
<u>Tank Vent Charcoal Filter Train</u>	
Type	Unitized construction consisting of prefilter, demister, HEPA, and charcoal filter
Quantity	1
Media	Glass mat, fire retardant
Prefilter	mesh pads
Demister	Woven
HEPA	Glass fiber, high efficiency, waterproof
Charcoal filter	Impregnated coconut shell
Efficiency, %	
Prefilter	90, (ASHRAE 52)
HEPA	99.97, with 0.03 micron DOP
Charcoal filter	90 elemental, 30 organic
<u>Radwaste Control Station Fan Coil Unit</u>	
Type	Unitized construction comprised of fan, electrical heating coil, chilled-water cooling coil, air filter, and associated controls

GRAND GULF NUCLEAR GENERATING STATION
Updated Final Safety Analysis Report (UFSAR)

**TABLE 9.4-4: RADWASTE BUILDING VENTILATION/AIR-CONDITIONING
SYSTEM (Continued)**

Quantity	1
Cooling capacity, tons	19
Heating capacity, kW	30 (3 stages)
Fan type	Centrifugal
Fan capacity, cfm	7000
Static pressure, in. wg (external)	3.46
Drive	Belt
Motor, hp	15
Chilled-water flow, gpm	87

Radwaste Building El. 136-0 Zone Heating Coil

Type	Electrical
Quantity	1
Number of stages	8
Capacity, kW	80

Radwaste Building El. 118-0 Zone Heating Coil

Abandoned - In-Place

Radwaste Building El. 93-0 Zone Heating Coil

Type	Electrical
Quantity	1
Number of stages	4
Capacity, kW	40

Radwaste Building Offgas Side Zone Heating Coil

Type	Electrical
Quantity	1
Number of stages	5
Capacity, kW	50

Elevator Machine Room Power Roof Ventilator

GRAND GULF NUCLEAR GENERATING STATION
Updated Final Safety Analysis Report (UFSAR)

**TABLE 9.4-4: RADWASTE BUILDING VENTILATION/AIR-CONDITIONING
SYSTEM (Continued)**

Quantity	1
Type	Axial
Capacity, cfm	2,000
Static pressure, in. wg	0.38
Drive	Direct
Motor, hp	3/4

Elevator Machine Room Unit Heater

Quantity	1
Type	Drawthrough
Electric coil, kW	4
Motor, hp	1/80

Storage Tank Exhaust Fan

Type	Centrifugal
Quantity	1
Capacity, cfm	600
Static pressure, in. wg	5.5
Drive	Belt
Motor, hp	1.5

Tunnel Exhaust Fan

Type	Centrifugal
Quantity	1
Capacity, cfm	2,500
Static pressure, in. wg	1.0
Drive	Belt
Motor, hp	1

Laboratory Hoods Exhaust Fans

Type	Centrifugal
Quantity	4

GRAND GULF NUCLEAR GENERATING STATION
Updated Final Safety Analysis Report (UFSAR)

TABLE 9.4-4: RADWASTE BUILDING VENTILATION/AIR-CONDITIONING SYSTEM (Continued)

Capacity, cfm	1260
Static pressure, in. wg	10.8
Drive	Belt
Motor, hp	5

Refrigerated Charcoal Vault Defrosting Fans

Type	Centrifugal
Quantity	2
Capacity, cfm	1,700
Static pressure, in. wg	0.25
Drive	Belt
Motor, hp	1

Spectrometer Exhaust Fan

Type	Centrifugal
Quantity	1
Capacity, cfm	250
Static pressure, in. wg	10.8
Drive	Belt
Motor, hp	1.5

Water Inventory Control Station Fan Coil Unit

Type	Utilized construction comprised of fan, chilled-water cooling coil, air filter, and associated controls
Quantity	1
Cooling capacity, tons	14
Fan Type	Centrifugal
Fan capacity, cfm	6720
Static pressure, in. wg (external)	2.85
Drive	Belt

GRAND GULF NUCLEAR GENERATING STATION
Updated Final Safety Analysis Report (UFSAR)

**TABLE 9.4-4: RADWASTE BUILDING VENTILATION/AIR-CONDITIONING
SYSTEM (Continued)**

Motor hp	10
Chilled water flow, gpm	55

GRAND GULF NUCLEAR GENERATING STATION
Updated Final Safety Analysis Report (UFSAR)

TABLE 9.4-5: RADWASTE BUILDING VENTILATION SYSTEM FAILURE ANALYSIS

<u>Component</u>	<u>Malfunction</u>	<u>Comments</u>
Ventilation supply air fans	Failure of fan, resulting in loss of air flow	System operates at reduced capacity until corrective action is taken.
Ventilation exhaust filters	Filter failure, resulting in increased filter pressure drop	Increased filter pressure drop has no sudden effect on system capability. Filter pressure drop switch provides alarm for corrective action. Individual filters have local pressure drop indication.
Instrumentation	Instrumentation power failure	Control actuators assume fail-safe positions until corrective action taken.
Ventilation exhaust air fans	Failure of fan, resulting in loss of air flow	Loss of air flow actuates alarm. System automatically switches to standby fan.

GRAND GULF NUCLEAR GENERATING STATION
Updated Final Safety Analysis Report (UFSAR)

TABLE 9.4-6: TURBINE BUILDING VENTILATION SYSTEM

Turbine Building Exhaust Air Fans

Type	Centrifugal, SWSI
Quantity	2
Flow, cfm	10,000 each
Static pressure, in. wg	20
Motor, hp	50

Turbine Building Area Fan Coil Units

Type	Centrifugal
Quantity	2
Drive	Direct
Blades	Forward curved

Post-Accident Sample Room Charcoal Filter Train

Type	Multiple filters for removal of radioiodines
Quantity	1
Capacity, cfm	500

Demister

Type	Woven mesh pads
Quantity	One bank
Capacity, cfm	500

Heating Coil

Type	Electric
Quantity	1
Capacity, kw	5.6

Prefilter

Type	Dry
Quantity	One bank
Capacity, cfm	500

GRAND GULF NUCLEAR GENERATING STATION
Updated Final Safety Analysis Report (UFSAR)

TABLE 9.4-6: TURBINE BUILDING VENTILATION SYSTEM (CONTINUED)

Media	Glass fiber
Efficiency, %	90 ASHRAE 52
Pressure drop, clean, in. wg	0.4

High-Efficiency Particulate Air (HEPA) Filter

Type	Dry
Quantity	Two banks
Capacity, cfm	500 each bank
Media	Glass fiber
Efficiency, %	99.97 with 0.3 micron DOP smoke
Pressure drop, clean, in. wg	1.0

Charcoal Adsorber

Type	Deep bed
Capacity, cfm	500
Media	Impregnated coconut shell
Efficiency credit, %	99, elemental iodine and organic iodide
Depth of bed, in.	8, nominal
Charcoal volume, ft ³	8.5, minimum
Face velocity, fpm	40
Residence time, sec	1.0
Pressure drop, clean, in. wg	4.0 ± 0.5
Charcoal desorption temp. range, F	250 - 300
Charcoal ignition temp., F	640, approx.
Charcoal density, gm/cc	0.3 to 0.55
Impregnant content, % by weight	5, maximum
Charcoal size distribution	8 x 16 Tyler mesh, nominal
Charcoal surface area, m ² /gm	1000, minimum
Charcoal moisture content, %	3, maximum
Charcoal ash content, %	6, maximum

GRAND GULF NUCLEAR GENERATING STATION
Updated Final Safety Analysis Report (UFSAR)

**TABLE 9.4-7: MISCELLANEOUS SAFETY-RELATED VENTILATION AND
COOLING SYSTEM COMPONENT DESCRIPTION**

Safeguard Switchgear And Battery Rooms Air Handling Units

Type	Centrifugal/2-speed
Quantity	4 50% capacity fans
Flow capacity, cfm	21,000/10,500
Static pressure, in. wg	3.2
Drive	Belt
Motor, hp	40
Electric heating coil capacity, kW	125 (one for each unit)

Safeguard Switchgear And Battery Rooms Exhaust Fans

Type	Vane axial/2-speed
Quantity	4 50% capacity fans
Flow capacity, cfm	21,000/10,500
Static pressure, in. wg	4.3
Drive	Direct
Motor, hp	30

Standby Diesel Generator Rooms Outside Air Fans

Quantity	2
Type	Vane axial/2-speed
Flow capacity, cfm (nominal)	100,000/52,000
Static pressure, in. wg	2.5
Drive	Direct
Motor, hp	75

Diesel Generator Room Fan-Coil Units

Quantity	3
Type	Centrifugal, draw-through
Flow capacity, cfm	9,400
Static pressure, in. wg	2
Cooling capacity, Btuh	213,943
Electric heater capacity, kW	56
Fan drive	Belt
Motor, hp	15

GRAND GULF NUCLEAR GENERATING STATION
Updated Final Safety Analysis Report (UFSAR)

**TABLE 9.4-7: MISCELLANEOUS SAFETY-RELATED VENTILATION AND
COOLING SYSTEM COMPONENT DESCRIPTION (CONTINUED)**

Standby Service Water Pumphouse Outside Air Fans

Quantity	2
Type	Vane axial
Flow capacity, cfm	38,750
Static pressure, in. wg	2.5
Drive	Direct
Motor, hp	40

HPCS Diesel Generator Room Outside Air Fans

Quantity	1
Type	Vane axial/2-speed
Fan capacity, cfm (nominal)	64000/33000
Static pressure, in. wg	2.5
Drive	Direct
Motor, hp	40

RHR Pump Room A Cooler

Type	Vane axial
Quantity	1 100% capacity unit/room
Fan capacity, cfm	16,500
Cooling capacity, Btuh (minimum)	382,752
Static pressure, in. wg	Free delivery
Drive	Direct
Motor, hp	5

RHR Pump Room B Cooler

GRAND GULF NUCLEAR GENERATING STATION
Updated Final Safety Analysis Report (UFSAR)

**TABLE 9.4-7: MISCELLANEOUS SAFETY-RELATED VENTILATION AND
COOLING SYSTEM COMPONENT DESCRIPTION (CONTINUED)**

Type	Vane axial
Quantity	1 100% capacity unit/room
Fan capacity, cfm	16,500
Cooling capacity, Btuh (minimum)	337,608
Static pressure, in. wg	Free delivery
Drive	Direct
Motor, hp	5

RHR Pump Room C Cooler

Type	Vane axial
Quantity	1 100% capacity unit
Fan capacity, cfm	9,000
Cooling capacity, Btuh (minimum req'd)	255,888
Static pressure, in. wg	Free delivery
Drive	Direct
Motor, hp	3

LPCS Pump Room Cooler

Type	Vane axial
Quantity	1 100% capacity unit
Fan capacity, cfm	10,000
Cooling capacity, Btuh (minimum req'd)	293,580
Static pressure, in. wg	Free delivery
Drive	Direct
Motor, hp	3

HPCS Pump Room Fan-Coil Unit

Type	Vane axial
Quantity	1 100% capacity unit
Fan capacity, cfm	17,200
Cooling capacity, Btuh (minimum req'd)	533,700
Static pressure, in. wg	Free delivery
Drive	Direct
Motor, hp	5

RCIC Pump Room Cooler

GRAND GULF NUCLEAR GENERATING STATION
Updated Final Safety Analysis Report (UFSAR)

TABLE 9.4-7: MISCELLANEOUS SAFETY-RELATED VENTILATION AND COOLING SYSTEM COMPONENT DESCRIPTION (CONTINUED)

Type	Centrifugal
Quantity	1 100% capacity unit
Fan capacity, cfm	1,200
Cooling capacity, Btuh (minimum req'd)	38,952
Static pressure, in. wg	Free delivery
Drive	Belt
Motor, hp	1

ESF Electrical Switchgear Room Coolers, El. 119 East

	<u>Q1T46B001A</u>	<u>Q1T46B001B</u>
Type	Centrifugal	Centrifugal
Quantity	1 per room	1 per room
Fan capacity, cfm	3,200	4,600
Cooling capacity, Btuh (minimum req'd)	29,520	40,284
Static pressure, in. wg	Free delivery	Free Delivery
Drive	Belt	Belt
Motor, hp	2	2

ESF Electrical Switchgear Room Coolers, El. 119 West

	<u>Q1T46B002A</u>	<u>Q1T46B002B</u>
Type	Vane axial	Vane axial
Quantity	1 100% Capacity Unit	1 100% Capacity Unit
Fan capacity, cfm	11,000	11,000
Cooling capacity, Btuh (minimum req'd)	60,372	55,620
Static pressure, in. wg	Free delivery	Free delivery
Drive	Direct	Direct
Motor, hp	2	2

ESF Electrical Switchgear Room Coolers, El. 139 East

	<u>Q1T46B003A</u>	<u>Q1T46B003B</u>
Type	Vane axial	Vane axial
Quantity	1 100% Capacity Unit	1 100% Capacity Unit

GRAND GULF NUCLEAR GENERATING STATION
Updated Final Safety Analysis Report (UFSAR)

TABLE 9.4-7: MISCELLANEOUS SAFETY-RELATED VENTILATION AND COOLING SYSTEM COMPONENT DESCRIPTION (CONTINUED)

Fan capacity, cfm	12,800	12,800
Cooling capacity, Btuh (minimum req'd)	86,112	85,608
Static pressure, in. wg	Free delivery	Free delivery
Drive	Direct	Direct
Motor, hp	5	5

ESF Electrical Switchgear Room Coolers, El. 139 West

	<u>Q1T46B005A</u>	<u>Q1T46B005B</u>
Type	Centrifugal	Centrifugal
Quantity	1 100% Capacity Unit	1 100% Capacity Unit
Fan capacity, cfm	4,600	4,600
Cooling capacity, Btuh (minimum req'd)	32,076	29,520
Static pressure, in. wg	Free delivery	Free delivery
Drive	Belt	Belt
Motor, hp	2	2

ESF Electrical Switchgear Room Coolers, El. 166

	<u>Q1T46B004A</u>	<u>Q1T46B004B</u>
Type	Centrifugal	Centrifugal
Quantity	1 100% Capacity Unit	1 100% Capacity Unit
Fan capacity, cfm	1,500	1,500
Cooling capacity, Btuh (minimum req'd)	15,624	12,960
Static pressure, in. wg	Free delivery	Free delivery
Drive	Belt	Belt
Motor, hp	1	1

GRAND GULF NUCLEAR GENERATING STATION
Updated Final Safety Analysis Report (UFSAR)

**TABLE 9.4-7: MISCELLANEOUS SAFETY-RELATED VENTILATION AND
COOLING SYSTEM COMPONENT DESCRIPTION (CONTINUED)**

FPCC Room Cooler, El. 166'

Type	Centrifugal
Quantity	2, 100% capacity
Fan capacity, cfm	4,300
Cooling capacity, Btuh (minimum req'd)	76,680
Static pressure, in. wg	3.24
Drive	Belt
Motor, hp	5

Remote Shutdown Panel Room Heat Pump

Type	Packaged
Quantity	1
Fan Capacity, cfm	800
Coil, Transfer Media	Refrigerant 22
Cooling capacity (total), tons	1.5

GRAND GULF NUCLEAR GENERATING STATION
Updated Final Safety Analysis Report (UFSAR)

**TABLE 9.4-8: MISCELLANEOUS SAFETY-RELATED VENTILATION AND
COOLING SYSTEMS FAILURE ANALYSIS**

<u>Component</u>	<u>Malfunction</u>	<u>Comments</u>
<u>Safeguard Switchgear And Battery Rooms</u>		
Supply	Failure of fan	Should an operating fan fail, the redundant supply fans will be automatically initiated if their associated exhaust fans start on high temperature or low flow. Note that Unit 2 fans are slaved to Unit 1 fan signals.
Exhaust fan	Failure of fan	Should an operating fan fail, the redundant exhaust fans will be automatically initiated if there is a high temperature or low flow signal present. Note that Unit 2 fans are slaved to Unit 1 fan signals.
Damper control power	Failure of damper power resulting in loss of damper control	Should damper control power fail, dampers fail open.

GRAND GULF NUCLEAR GENERATING STATION
Updated Final Safety Analysis Report (UFSAR)

TABLE 9.4-8: MISCELLANEOUS SAFETY-RELATED VENTILATION AND COOLING SYSTEMS FAILURE ANALYSIS (CONTINUED)

Diesel Generator Rooms

Fan	Failure of fan resulting in loss of cooling capacity	Should operating fan fail, remaining diesel generators and associated ventilation systems are adequate to achieve safe shutdown.
Damper control power	Failure of damper power resulting in loss of damper control	Should damper control power fail, dampers can be manually opened.

Standby Service Water Pumphouses

Fan	Failure of fan resulting in loss of cooling capacity	Should operating fan fail, its redundant SSW train and associated ventilation system are adequate to achieve safe shutdown.
Damper control power	Failure of damper control power resulting in loss of damper control.	Should damper control power fail, dampers can be manually opened.

ECCS Pump Rooms

GRAND GULF NUCLEAR GENERATING STATION
Updated Final Safety Analysis Report (UFSAR)

TABLE 9.4-8: MISCELLANEOUS SAFETY-RELATED VENTILATION AND COOLING SYSTEMS FAILURE ANALYSIS (CONTINUED)

<p>Low pressure cooling system LPCI (RHR Pump A) LPCI (RHR Pump B) LPCI (RHR Pump C) LPCS</p>	<p>Failure of fan resulting in loss of cooling capacity in any pump room</p>	<p>Loss of one low pressure portion will not prevent adequate cooling under accident conditions. Failure of fan-coil unit resulting in loss of associated pump leaves other three pumps (including at least RHR pump/heat exchanger combination) plus HPCS in operation.</p>
<p>HPCS pump room fan-coil unit</p>	<p>Failure of fan-coil unit resulting in loss of cooling capacity</p>	<p>Constitutes single failure. ADS redundant to HPCS.</p>

ESF Electrical Switchgear Rooms

<p>ESF electrical switchgear room fan-coil unit</p>	<p>Failure of fan-coil unit resulting in loss of cooling capability</p>	<p>Failure of fan-coil unit resulting in loss of operation or electrical switchgear in that room leaves other ESF electrical switchgear in other rooms in operation.</p>
---	---	--

FPCC Pump Room Coolers

<p>FPCC pump room fan-coil unit</p>	<p>Failure of fan-coil unit resulting in loss of cooling capability</p>	<p>Should operating fan-coil unit fail, the redundant fan-coil unit can be manually started</p>
-------------------------------------	---	---

GRAND GULF NUCLEAR GENERATING STATION
Updated Final Safety Analysis Report (UFSAR)

**TABLE 9.4-8: MISCELLANEOUS SAFETY-RELATED VENTILATION AND
COOLING SYSTEMS FAILURE ANALYSIS (CONTINUED)**

Damper control power	Failure of damper control power resulting in loss of damper control	Should damper control power fail, the redundant fan-coil unit dampers will remain operable since they are powered from an independent electrical power source. Also the dampers can be manually opened.
----------------------	---	---

GRAND GULF NUCLEAR GENERATING STATION
Updated Final Safety Analysis Report (UFSAR)

**TABLE 9.4-9: AUXILIARY BUILDING HVAC SYSTEM
COMPONENT DESCRIPTIONS**

Auxiliary Building Fan Coil Units

a. First floor zone - El. 93-0

Type	Centrifugal, vertical drawthrough
Quantity	1
Cooling capacity, T	61.9
Fan capacity, scfm	24,985
Static pressure, in. wg	3.48
Drive	Belt
Motor, hp	30

b. Second floor zone - El. 119-0

Type	Centrifugal, vertical drawthrough
Quantity	1
Cooling capacity, T	51.2
Fan capacity, scfm	21,460
Static pressure, in. wg	3.61
Drive	Belt
Motor, hp	25

c. Third floor zone - El. 139-0

Type	Centrifugal, vertical drawthrough
Quantity	1
Cooling capacity, T	60.4
Fan capacity, scfm	27,420
Static pressure, in. wg	3.64
Drive	Belt
Motor, hp	40

d. Fourth floor zone - El. 166-0

Type	Centrifugal, vertical drawthrough
------	--------------------------------------

GRAND GULF NUCLEAR GENERATING STATION
Updated Final Safety Analysis Report (UFSAR)

**TABLE 9.4-9: AUXILIARY BUILDING HVAC SYSTEM
COMPONENT DESCRIPTIONS (CONTINUED)**

Quantity	1
Cooling capacity, T	28.1
Fan capacity, scfm	12,100
Static pressure, in. wg	3.65
Drive	Belt
Motor, hp	20

Steam Tunnel Cooler, Outside Containment

Type	Vane-Axial, Horizontal
Quantity	1 unit, with 2 fans and 2 coils
Cooling capacity, T	163
Fan type	Vane axial
Fan capacity, scfm	11,000 (each fan)
Static pressure, in. wg., ext.	1.0
Drive	Direct
Motor, hp	7.5
Sensible cooling capacity, T	52

ADHRS Self Contained Air Conditioning Unit

Type	Centrifugal, Vertical Draw Through
Quantity	1
Cooling capacity, T	10
Fan capacity, scfm	4000
Static pressure, in. wg., ext	Free discharge
Drive	Belt
Motor, hp	2.0-evaporator 2-5.0-compressor

Auxiliary Building Heating Coils

a. First floor zone - El. 93-0

Type	Electric
Quantity	2
Capacity, kW	1@ 26 kW & 1@ 22 kW

GRAND GULF NUCLEAR GENERATING STATION
Updated Final Safety Analysis Report (UFSAR)

**TABLE 9.4-9: AUXILIARY BUILDING HVAC SYSTEM
COMPONENT DESCRIPTIONS (CONTINUED)**

No. of stages	2
b. Second floor zone - El. 119-0	
Type	Electric
Quantity	2
Capacity, kW	20
No. of stages	2
c. Third floor zone - El. 139-0	
Type	Electric
Quantity	2
Capacity, kW	35
No. of stages	3
d. Fourth floor zone - El. 166-0	
Type	Electric
Quantity	1
Capacity, kW	50
No. of stages	3

GRAND GULF NUCLEAR GENERATING STATION
Updated Final Safety Analysis Report (UFSAR)

**TABLE 9.4-10: CONTAINMENT VENTILATING, COOLING, AND
PURGE SYSTEM COMPONENT DESCRIPTION**

Containment Coolers

Type	Centrifugal, drawthrough
Quantity	Three 50% capacity units
Cooling capacity, T	63.8 (each)
Fan capacity, cfm	27,500 (each)
Static pressure, in. w.g., ext.	6.6
Drive	Belt
Motor, hp	50

Containment Ventilation Supply Fans

Type	Centrifugal
Quantity	Two 100% capacity units
Capacity, cfm	500 each
Static pressure, in. w.g.	4.0
Drive	Belt
Motor, hp	2

Containment Cooling System Charcoal Filter Trains

Type	Multiple filters for removal of particulates and halogens from air
Quantity	Two 100% capacity trains
Capacity, cfm	3000 each

Fans (Each Train)

Type	Centrifugal
Quantity	One 100% capacity unit
Capacity, cfm	3000
Static pressure, in. w.g.	8.0
Drive	Belt
Motor, hp	15

GRAND GULF NUCLEAR GENERATING STATION
Updated Final Safety Analysis Report (UFSAR)

**TABLE 9.4-10: CONTAINMENT VENTILATING, COOLING, AND
PURGE SYSTEM COMPONENT DESCRIPTION (CONTINUED)**

Demister (Each Train)

Type	Woven mesh pads
Quantity	One bank
Capacity, cfm	3000

Heating Coil (Each Train)

Type	Electric
Quantity	One
Capacity, kw	60

Prefilter (Each Train)

Type	Dry
Quantity	One bank
Capacity, cfm	3,000
Media	Glass fiber
Efficiency, %	90 ASHRAE 52
Pressure drop, clean, in. w.g.	0.5

High-Efficiency Particulate Air (HEPA) Filter (Each Train)

Type	Dry
Quantity	Two banks
Capacity, cfm	3000 each bank
Media	Glass fiber
Efficiency, %	99.97 with 0.3 micron DOP smoke
Pressure drop, clean, in. w.g.	1.0

GRAND GULF NUCLEAR GENERATING STATION
Updated Final Safety Analysis Report (UFSAR)

**TABLE 9.4-10: CONTAINMENT VENTILATING, COOLING, AND
PURGE SYSTEM COMPONENT DESCRIPTION (CONTINUED)**

Charcoal Adsorber (Each Train)

Type	Deep bed
Capacity, cfm	3000
Media	Impregnated coconut shell
Efficiency credit, %	99, elemental iodine and organic iodide
Depth of bed, in.	8, nominal
Charcoal volume, ft ³	78, minimum
Face velocity, fpm	40
Residence time, sec	1.0
Pressure drop, clean, in. w.g.	4.0 ± 0.5
Charcoal desorption temp. range, F	250-300
Charcoal ignition temp., F	640, approx.
Charcoal density, gm/cc	0.3 to 0.55
Impregnant content, % by weight	5, maximum
Charcoal size distribution	8 x 16 Tyler mesh, nominal
Charcoal surface area, m ² /gm	1000, minimum
Charcoal moisture content, %	3, maximum
Charcoal ash content, %	6, maximum

Containment Exhaust Charcoal Filter Train

Type	Multiple filters for removal of radioiodines
Quantity	1
Capacity, cfm	500

Demister (Exhaust Train)

Type	Woven mesh pads
Quantity	One bank
Capacity	500

GRAND GULF NUCLEAR GENERATING STATION
Updated Final Safety Analysis Report (UFSAR)

**TABLE 9.4-10: CONTAINMENT VENTILATING, COOLING, AND
PURGE SYSTEM COMPONENT DESCRIPTION (CONTINUED)**

Heating Coil (Exhaust Train)

Type	Electric
Quantity	1
Capacity, kw	5.6

Prefilter (Exhaust Train)

Type	Dry
Quantity	One bank
Capacity, cfm	500
Media	Glass fiber
Efficiency, %	90 ASHRAE 52
Pressure drop, clean, in. w.g.	0.4

High-Efficiency Particulate Air (HEPA) Filter (Exhaust Train)

Type	Dry
Quantity	Two banks
Capacity, cfm	500 each bank
Media	Glass fiber
Efficiency, %	99.97 with 0.3 micron DOP smoke
Pressure drop, clean, in. w.g.	1.0

GRAND GULF NUCLEAR GENERATING STATION
Updated Final Safety Analysis Report (UFSAR)

**TABLE 9.4-10: CONTAINMENT VENTILATING, COOLING, AND
PURGE SYSTEM COMPONENT DESCRIPTION (CONTINUED)**

Charcoal Adsorber
(Exhaust Train)

Type	Deep Bed
Capacity (cfm)	500
Media	Impregnated coconut shell
Efficiency credit, %	99, elemental iodine and organic iodide
Depth in bed, in.	8, nominal
Charcoal volume, ft ³	8.5, minimum
Face velocity, fpm	40
Residence time, sec	1.0
Pressure drop, clean, in. w.g.	4.0 ± 0.5
Charcoal desorption temp. range, F	250 - 300
Charcoal ignition temp, F	640, approx.
Charcoal density, gm/cc	0.3 to 0.55
Impregnant content, %	5, maximum
Charcoal size distribution	8 x 16 Tyler mesh, nominal
Charcoal surface area, m ² /gm	1000, minimum
Charcoal moisture content, %	3, maximum
Charcoal ash content, %	6, maximum

Containment Ventilation Exhaust Fans (Exhaust Train)

Type	Centrifugal
Quantity	2
Capacity, cfm	500 (each)
Static pressure, in. w.g.	8.0
Drive	Belt
Motor, hp	3

GRAND GULF NUCLEAR GENERATING STATION
Updated Final Safety Analysis Report (UFSAR)

**TABLE 9.4-10: CONTAINMENT VENTILATING, COOLING, AND
PURGE SYSTEM COMPONENT DESCRIPTION (CONTINUED)**

Drywell/Containment
Purge Fans

Type	Centrifugal
Quantity	2
Capacity, cfm	3,000 (each)
Static pressure, in. w.g.	4.0
Drive	Belt
Motor, hp	5

Steam Tunnel Cooler, Inside Containment

Type	Horizontal, drawthrough
Quantity	One 100% capacity unit with 100% capacity redundant fan and coil
Fan type	Vane axial
Fan capacity, cfm	6000, each fan
Cooling capacity, tons	10.2, each coil
Fan drive	Direct
Motor, hp	11.5
Static pressure, in. w.g.	1.0

Containment Outside Air Heating Coil

Type	Electric
Quantity	1
Capacity, kw	85

GRAND GULF NUCLEAR GENERATING STATION
Updated Final Safety Analysis Report (UFSAR)

**TABLE 9.4-10: CONTAINMENT VENTILATING, COOLING, AND
PURGE SYSTEM COMPONENT DESCRIPTION (CONTINUED)**

Containment Lower Personnel
Air Lock Air Shower Fan

Type	Centrifugal
Quantity	1
Capacity, cfm	2000
Static pressure, in. w.g.	3/4
Drive	Electric
Motor, hp	1

Reactor Water Sampling
Station Filter Train

Type	Multiple filters for removal of particulates and halogens from air
Quantity	One
Capacity	1000 cfm

Fan

Type	Centrifugal
Quantity	One
Capacity	1000 cfm
Drive	Belt
Motor	3 hp

Prefilter

Type	Cartridge or bag
Quantity	One
Capacity	2000 cfm
Media	Glass Fiber
Efficiency	60-65%
Pressure Drop (clean)	0.50 in. w.g.

GRAND GULF NUCLEAR GENERATING STATION
Updated Final Safety Analysis Report (UFSAR)

**TABLE 9.4-10: CONTAINMENT VENTILATING, COOLING, AND
PURGE SYSTEM COMPONENT DESCRIPTION (CONTINUED)**

Heating Coil

Type	Electric
Quantity	One
Capacity	5 kw

High Efficiency Particulate Air (HEPA) Filter

Type	Dry
Quantity	2
Media	Glass Fiber

Efficiency (DOP)	99.97%
Pressure Drop	1 in. w.g.

Charcoal Adsorber

Type	Tray
Quantity	3 trays (2 beds/tray)
Capacity	333 cfm
Media	Impregnated Coconut Shell
Efficiency	99% (credit all iodine)
Depth of Bed	2 in.
Residence Time	.25 sec/bed
Pressure Drop	1.1 in. (nominal)

GRAND GULF NUCLEAR GENERATING STATION
Updated Final Safety Analysis Report (UFSAR)

**TABLE 9.4-11: DRYWELL COOLING SYSTEM
COMPONENT DESCRIPTION**

Drywell Fan-Coil Units

Type	Vane axial
Quantity	6 units, each with two fans and coils
Cooling capacity, tons	94 each coil
Fan capacity, cfm	12,000 each fan
Drive	Direct
Motor, hp	20
Static pressure, in. wg., ext.	2.0

Drywell Recirculation Fans

Type	Vane axial
Quantity	2
Fan Capacity, cfm	6,000 each fan
Drive	Direct
Motor, hp	11.5
Static pressure, in. w.g., ext.	1.84

GRAND GULF NUCLEAR GENERATING STATION
Updated Final Safety Analysis Report (UFSAR)

TABLE 9.4-12: MISCELLANEOUS BUILDINGS VENTILATION SYSTEMS
COMPONENT DESCRIPTION

Water Treatment Building Air-Conditioned Area Supply Air Subsystem Heat Pump (Indoor Unit)

Type: Unitized construction comprised of filter section, coil, fan section, and associated controls

Quantity	1
Capacity, cfm	3,520
Static pressure, external, in. wg	0.5
Motor, hp	2
Coil, transfer media	Refrigerant
Filters	H.V. Semipermanent type

Water Treatment Building Air-Conditioned Area Supply Air Subsystem Heat Pump (Outdoor Unit)

Type: Unitized construction comprised of coil, fan section, compressor, and associated controls

Quantity	1
Cooling capacity, tons	9.5
Compressor input, kW	12.1
Heating capacity, Btuh	76,680

Water Treatment Building Air-Conditioned Area Exhaust Air Subsystem Fume Hood Auxiliary Air Fan

Quantity	2
Type	Centrifugal
Capacity, cfm	700
Static pressure, in. wg	0.38
Motor, hp	1

GRAND GULF NUCLEAR GENERATING STATION
Updated Final Safety Analysis Report (UFSAR)

TABLE 9.4-12: MISCELLANEOUS BUILDINGS VENTILATION SYSTEMS
COMPONENT DESCRIPTION (CONTINUED)

Water Treatment Building Air-Conditioned Area Exhaust Air
Subsystem Fume Hood Exhaust Fan

Quantity	2
Type	Centrifugal
Capacity, cfm	1000
Static pressure, in. wg	0.75
Motor, hp	3/4

Water Treatment Building Non-air-Conditioned Area Ventilation
Subsystem Power Roof Ventilator

Quantity	5
Type	Axial
Capacity, cfm	14,000
Static pressure, in. wg	0.38
Drive	Direct
Motor, hp	3.0

Water Treatment Building Non-air-Conditioned Area Ventilation
Subsystem Electric Unit Heater

Quantity	6
Type	Draw-through
Electric coil, kW	35
Motor, hp	1/2

Fire Water Pump House Ventilation System Power Roof Ventilator

Type	Centrifugal
Quantity	3
Capacity, cfm	

GRAND GULF NUCLEAR GENERATING STATION
Updated Final Safety Analysis Report (UFSAR)

TABLE 9.4-12: MISCELLANEOUS BUILDINGS VENTILATION SYSTEMS
COMPONENT DESCRIPTION (CONTINUED)

Compartment I	6,100
Compartment II	3,325
Compartment III	6,100
Drive	Belt
Static pressure, in. wg	0.38
Motor, hp	
Compartment I	1 1/2
Compartment II	1/2
Compartment III	1 1/2

Fire Water Pump House Ventilation System Electric Unit Heater

Type	Draw-through
Quantity	6 (2 for each compartment)
Electric coil, kW	
Compartment I	11
Compartment II	9
Compartment III	12
Motor, hp	
Compartment I	1/12
Compartment II	1/40
Compartment III	1/12

Plant Service Water Radial Well Weatherproof Enclosure Ventilation System Power Wall Ventilator

Quantity	4
Type	Axial
Capacity, cfm	1,475
Static pressure, in. wg	0.25
Drive	Direct

GRAND GULF NUCLEAR GENERATING STATION
Updated Final Safety Analysis Report (UFSAR)

**TABLE 9.4-12: MISCELLANEOUS BUILDINGS VENTILATION SYSTEMS
 COMPONENT DESCRIPTION (CONTINUED)**

Motor, hp 1/4

Plant Service Water Radial Well Weatherproof Enclosure Ventilation System Electric Unit Heater

Quantity 12
 Type Draw-through
 Electric coil, kW 2.0
 Motor, hp 1/4

Radial Well Switchgear House Ventilation System Power Roof Ventilator

Quantity 2
 Type Axial
 Capacity, cfm 4,360
 Static pressure, in. wg 0.25
 Drive Direct
 Motor, hp 3/4

Radial Well Switchgear House Ventilation System Electric Unit Heater

Quantity 2
 Type Draw-through
 Electric coil, kW 34
 Motor, hp 1/2

Circulating Water Pumphouse Ventilation Fan

Quantity 4
 Type Power roof ventilators, axial

GRAND GULF NUCLEAR GENERATING STATION
Updated Final Safety Analysis Report (UFSAR)

TABLE 9.4-12: MISCELLANEOUS BUILDINGS VENTILATION SYSTEMS
COMPONENT DESCRIPTION (CONTINUED)

Flow capacity, cfm	50,000
Static pressure, in. wg	3/8
Drive	Direct
Motor, hp	25

Circulating Water Pumphouse Ventilation Fan (Cont.)

Quantity	1
Type	Power roof ventilators, axial
Flow Capacity, cfm	61,000
Static pressure, in. wg	1/2
Drive	Direct
Motor, hp	20

Circulating Water Pumphouse Unit Heater

Quantity	8
Type	Draw-through
Flow capacity, cfm	1,550
Electric heating capacity, kW	30
Drive	Direct
Motor, hp	½ (or Less)

Circulating Water Pumphouse Tritium Detection Equipment Room 1M104 Air-Conditioning Unit

Type	Vertical, self-contained, water-cooled unit
Quantity	1
Nominal cooling capacity/unit, Btuh	60,000
Nominal fan capacity/unit, cfm	2,000

GRAND GULF NUCLEAR GENERATING STATION
Updated Final Safety Analysis Report (UFSAR)

**TABLE 9.4-13: CONTROL BUILDING HVAC SYSTEMS COMPONENT
DESCRIPTION**

Control Building Air-Conditioning System

Control Building Fan-Coil Unit

Type	Centrifugal, vertical drawthrough
Quantity	1
Cooling capacity, Btuh	215,000
Fan capacity, cfm	4,200
Static pressure, in. wg, ext.	2.6
Drive	Belt
Motor, hp	5

Control Building Purge System

Control Building Purge Fan

Type	Vane axial
Quantity	1
Capacity, cfm	8,000
Static pressure, in. wg, ext.	1.35
Drive	Direct
Motor, hp	3

Access Control Area Air-Conditioning System

Access Control Area Fan-Coil Unit

Type	Centrifugal, horizontal drawthrough
Quantity	1
Cooling capacity, Btuh	882,000
Fan capacity, cfm	14,670
Static pressure, in. wg, ext.	6.59
Drive	Belt

GRAND GULF NUCLEAR GENERATING STATION
Updated Final Safety Analysis Report (UFSAR)

**TABLE 9.4-13: CONTROL BUILDING HVAC SYSTEMS COMPONENT DESCRIPTION
(CONTINUED)**

Motor, hp	15
Electric heater capacity, kW	240

Access Control Area Exhaust Fan

Type	Centrifugal
Quantity	1
Capacity, cfm	1600
Static pressure, in. wg, ext.	3.4
Drive	Belt
Motor, hp	15

Computer Rooms Air-Conditioning System

Computer Rooms Fan-Coil Units

Type	Centrifugal, horizontal drawthrough
Quantity	2
Cooling capacity/unit, Btuh	224,950
Fan capacity, cfm/fan	7,600
Static pressure, in. wg	3.55
Drive	Belt
Motor, hp	7.5

Computer Room Air-Conditioning Units

Type	Vertical, self- contained, water- cooled unit
Quantity	5
Net cooling capacity/unit, Btuh	60,000
Fan capacity/unit, cfm	2,000

GRAND GULF NUCLEAR GENERATING STATION
Updated Final Safety Analysis Report (UFSAR)

**TABLE 9.4-13: CONTROL BUILDING HVAC SYSTEMS COMPONENT DESCRIPTION
(CONTINUED)**

Cooling coil	Direct expansion
--------------	------------------

Computer Rooms Exhaust Fan

Type	Centrifugal
Quantity	1
Capacity, cfm	1,385
Static pressure, in. wg, ext.	1.0
Drive	Belt
Motor, hp	1

Elevator Machinery Room Ventilation System

Control Building Elevator Machinery Room Exhaust Fan

Type	Propeller
Quantity	1
Capacity, cfm	1,500
Static pressure, in. wg	Free delivery
Drive	Direct
Motor, hp	1/4

Control Building Elevator Machinery Room Unit Heater

Type	Drawthrough
Quantity	1
Flow capacity, cfm	300
Electric heat capacity, kW	4
Drive	Direct
Motor, hp	1

Hot Machine Shop Fan Coil Units

GRAND GULF NUCLEAR GENERATING STATION
Updated Final Safety Analysis Report (UFSAR)

**TABLE 9.4-13: CONTROL BUILDING HVAC SYSTEMS COMPONENT DESCRIPTION
(CONTINUED)**

Type	Centrifugal, horizontal, draw- through
Quantity	2
Cooling Capacity, BTUH	217000
Fan Capacity, cfm	9000
Static Pressure, in. wg, ext.	4
Drive	Belt
Motor, hp	15

Hot Machine Shop Recirculation Filter Train

Capacity, cfm	5000
Prefilter:	
Type	Dry
Quantity	One bank
Media	Glass fiber
HEPA Filter:	
Type	Dry
Quantity	One bank
Fan:	
Capacity, cfm	5000
Static Pressure, in. wg, ext	7
Drive	Belt
Motor, hp	15

Hot Machine Shop Exhaust Filter Train

Capacity, cfm	4000
Prefilter:	
Type	Dry
Quantity	One bank
Media	Glass fiber

GRAND GULF NUCLEAR GENERATING STATION
Updated Final Safety Analysis Report (UFSAR)

TABLE 9.4-13: CONTROL BUILDING HVAC SYSTEMS COMPONENT DESCRIPTION
(CONTINUED)

HEPA Filter:

Type	Dry
Quantity	One bank

Fan:

Capacity, cfm	4000
Static Pressure, in. wg, ext.	12
Drive	Belt
Motor, hp	2

GRAND GULF NUCLEAR GENERATING STATION
Updated Final Safety Analysis Report (UFSAR)

**TABLE 9.4-14: COMPARISON OF NORMAL VENTILATION FILTER TRAINS TO
BRANCH TECHNICAL POSITION ETSB NO. 11-2, "DESIGN, TESTING AND
MAINTENANCE CRITERIA FOR NORMAL VENTILATION EXHAUST SYSTEM AIR
FILTRATION AND ADSORPTION UNITS OF LIGHT-WATER-COOLED NUCLEAR
POWER REACTOR PLANTS"**

1. Radwaste Building Exhaust Filter Trains

The radwaste building exhaust filter trains comply with Part B of BTP ETSB 11-2 with the following exceptions:

Position B.2.a - These filter trains consist of prefilters, HEPA filters, and fans only. Charcoal adsorber sections are not provided, since no credit is taken for adsorption. Heaters are not provided since there is no need to reduce the relative humidity of the incoming atmosphere to 70 percent.

Position B.2.b - These filter trains are designed for a capacity of approximately 52,000 cfm. Filter banks are 9 wide(W) x 4 high(H) due to physical space limitations of the installation. There is accessible ductwork of sufficient cross-sectional area located 5-10 diameters upstream of the filter unit inlets to allow for insertion of DOP generators. Turning vanes in the ductwork between the injection point and the filters will serve to promote uniform distribution of the aerosol.

Position B.2.c - Pressure drop across the prefilter bank and across the HEPA filter bank is indicated locally. Total pressure drop across the entire unit is alarmed in the main control room on high level. System flow rate is indicated locally and is alarmed in the main control room on low level.

Position B.3.a - These filter trains consist of prefilters, HEPA filters, and fans only; therefore, heaters are not provided since there is no need to reduce the relative humidity of the incoming atmosphere to 70 percent.

B.3.d - Charcoal adsorber sections are not provided for these filter trains since no credit is taken for adsorption. Filter banks are arranged in a 9W x 4H arrangement, due to physical space limitations of the installation.

GRAND GULF NUCLEAR GENERATING STATION
Updated Final Safety Analysis Report (UFSAR)

**TABLE 9.4-14: COMPARISON OF NORMAL VENTILATION FILTER TRAINS TO
BRANCH TECHNICAL POSITION ETSB NO. 11-2, "DESIGN, TESTING AND
MAINTENANCE CRITERIA FOR NORMAL VENTILATION EXHAUST SYSTEM AIR
FILTRATION AND ADSORPTION UNITS OF LIGHT-WATER-COOLED NUCLEAR
POWER REACTOR PLANTS" (CONTINUED)**

B.3.e - These filter trains are designed for a capacity of approximately 52,000 cfm. Filter banks are 9W x 4H due to physical space limitations of the installation. Doors do not have provisions for locking or opening from inside.

B.3.g - Same comment as B.3.d, first sentence.

B.3.h - Same comment as B.3.d, first sentence.

B.4.c - All components which require servicing or removal are provided with adequate access space consistent with the manufacturer's recommendations.

Four feet of access space is provided upstream of the HEPA filter mounting frame and downstream of the prefilter mounting frame.

B.4.d - Permanent test probes manifolded at a single location are not provided. Adequate individual test points are available. Prefilters and HEPA filters are installed back-to-back on opposite sides of the same mounting frame.

B.4.e - Same comment as B.3.d, first sentence. Comply for other filter components.

B.5.a - Same comment as B.3.d, first sentence. Comply for other filter components.

B.5.b - Same comment as B.3.d, first sentence. Comply for other filter components.

B.5.c - Same comment as B.3.d, first sentence. Comply for other filter components.

GRAND GULF NUCLEAR GENERATING STATION
Updated Final Safety Analysis Report (UFSAR)

**TABLE 9.4-14: COMPARISON OF NORMAL VENTILATION FILTER TRAINS TO
BRANCH TECHNICAL POSITION ETSB NO. 11-2, "DESIGN, TESTING AND
MAINTENANCE CRITERIA FOR NORMAL VENTILATION EXHAUST SYSTEM AIR
FILTRATION AND ADSORPTION UNITS OF LIGHT-WATER-COOLED NUCLEAR
POWER REACTOR PLANTS" (CONTINUED)**

Upstream HEPA filter banks are not tested using DOP following painting in ventilation zones communicating with the system as DOP testing will not detect filters clogged from paint fumes. Differential pressure gauges are used to detect the affect of paint fumes on HEPA filters with total filter train dp alarmed in the main control room on high level.

B.5.d - Same comment as B.3.d, first sentence.

B.6.a - Same comment as B.3.d, first sentence.

B.6.b - Same comment as B.3.d, first sentence.

Table 1 - Same comment as B.3.d, first sentence.

Table 2 - Same comment as B.3.d, first sentence.

2. Radwaste Storage Tank Vent Filter Train

The radwaste storage tank vent filter train complies with Part B of BTP ETSB 11-2 with the following exceptions:

Position B.2.a - Heaters are not provided since no credit is taken for relative humidity control. HEPA filters downstream of the adsorber section are not provided.

Position B.2.c - Pressure drop across the individual filter bank components (demister, prefilter, HEPA filter, and charcoal adsorber) is indicated locally. Total pressure drop across the entire unit is alarmed in the main control room on high level.

Position B.3.a - Same comment as B.2.a, first sentence.

GRAND GULF NUCLEAR GENERATING STATION
Updated Final Safety Analysis Report (UFSAR)

**TABLE 9.4-14: COMPARISON OF NORMAL VENTILATION FILTER TRAINS TO
BRANCH TECHNICAL POSITION ETSB NO. 11-2, "DESIGN, TESTING AND
MAINTENANCE CRITERIA FOR NORMAL VENTILATION EXHAUST SYSTEM AIR
FILTRATION AND ADSORPTION UNITS OF LIGHT-WATER-COOLED NUCLEAR
POWER REACTOR PLANTS" (CONTINUED)**

B.3.e - The upstream side of the demister, which is the first component in the train, is not accessible due to space limitations; however, the item is installed from the downstream side, which is accessible. Access doors are 24 inches x 30 inches due to physical size limitations; however, full man-entry is not required for this unit. Doors do not have inspection windows or provisions for locking or opening from inside.

B.4.c - All components which require servicing or removal are provided with adequate access space consistent with the manufacturer's recommendations. The demister is provided with approximately 36 inches of access space from the mounting frame to the next component. The prefilter and HEPA filter are each provided with approximately 42 inches of access space from the mounting frame to the next component. Internal access to the adsorber section is not required for removal or replacement of charcoal, as this is done externally using automatic equipment. However, a minimum of 30 inches of access space is provided both upstream and downstream of the adsorber section to allow for visual inspection.

B.4.d - Permanent test probes manifolded at a single location are not provided, since adequate individual test points are available. Prefilters and HEPA filters are installed back-to-back on the opposite sides of the same mounting frame.

B.5.c - Upstream HEPA filter banks are not tested using DOP following painting in ventilation zones communicating with the system as DOP testing will not detect filters clogged from paint fumes. Differential pressure gauges are used to detect the affect of paint fumes on HEPA filters with total filter train dp alarmed in the main control room on high level.

3. Containment Exhaust Charcoal Filter Train

GRAND GULF NUCLEAR GENERATING STATION
Updated Final Safety Analysis Report (UFSAR)

**TABLE 9.4-14: COMPARISON OF NORMAL VENTILATION FILTER TRAINS TO
BRANCH TECHNICAL POSITION ETSB NO. 11-2, "DESIGN, TESTING AND
MAINTENANCE CRITERIA FOR NORMAL VENTILATION EXHAUST SYSTEM AIR
FILTRATION AND ADSORPTION UNITS OF LIGHT-WATER-COOLED NUCLEAR
POWER REACTOR PLANTS" (CONTINUED)**

The containment exhaust charcoal filter train complies with Part B of BTP ETSB 11-2 with the following exceptions:

Position B.2.c - Pressure drop across the individual filter bank components (demister, heater, prefilter, HEPA filter, charcoal adsorber, HEPA filter) is indicated locally. Total pressure drop across the entire unit is alarmed in the main control room on high level. System flow rate is indicated in the main control room.

Position B.3.e - The upstream side of the demister which is the first component in the train, is not accessible due to space limitations; however, the item is installed from the downstream side, which is accessible. The final HEPA filter, which is the last component in the train, is not accessible from the downstream side due to space limitations; however, the item is installed from the upstream side, which is accessible. Access doors are 20 inches x 30 inches due to physical size limitations; however, full man-entry is not required for this unit. Doors do not have inspection windows or provisions for locking or opening from inside.

B.4.c - All components which require servicing or removal are provided with adequate access space, consistent with the manufacturer's recommendations. The demister is provided with approximately 34 inches of access space from the mounting frame to the next component. The heater is provided with approximately 24 inches of access space on both the upstream and downstream side. The prefilter is provided with approximately 28 inches of access space from the mounting face to the next component, and the HEPA filter is provided with approximately 36 inches of access space from the mounting face to the next component. Internal access to the adsorber section is not required for removal or replacement of charcoal, as this is done externally using automatic equipment. However, approximately 28 inches of space upstream and 30 inches of space downstream is provided to allow for visual inspection of the adsorber section.

GRAND GULF NUCLEAR GENERATING STATION
Updated Final Safety Analysis Report (UFSAR)

**TABLE 9.4-14: COMPARISON OF NORMAL VENTILATION FILTER TRAINS TO
BRANCH TECHNICAL POSITION ETSB NO. 11-2, "DESIGN, TESTING AND
MAINTENANCE CRITERIA FOR NORMAL VENTILATION EXHAUST SYSTEM AIR
FILTRATION AND ADSORPTION UNITS OF LIGHT-WATER-COOLED NUCLEAR
POWER REACTOR PLANTS" (CONTINUED)**

B.4.d - Permanent test probes manifolded at a single location are not provided since adequate individual test points are available. Prefilters and HEPA filters are installed back-to-back on opposite sides of the same mounting frame.

B.5.c - Upstream HEPA filter banks are not tested using DOP following painting in ventilation zones communicating with the system as DOP testing will not detect filters clogged from paint fumes. Differential pressure gauges are used to detect the affect of paint fumes on HEPA filters with total filter train dp alarmed in the main control room on high level.

4. Containment Cooling System Charcoal Filter Trains

The containment cooling system charcoal filter trains comply with Part B of BTP ETSB 11-2 with the following exceptions:

Position B.2.c - Pressure drop across the individual filter bank components (demister, heater, prefilter, HEPA filter, charcoal adsorber, HEPA filter) is indicated locally. Total pressure drop across the entire unit is alarmed in the main control room on high level. System flow rate is indicated in the main control room.

Position B.3.e - The upstream side of the demister, which is the first component in the train, is not accessible due to space limitations; however, the component is installed from the downstream side, which is accessible. Doors do not have provisions for locking or opening from inside.

GRAND GULF NUCLEAR GENERATING STATION
Updated Final Safety Analysis Report (UFSAR)

**TABLE 9.4-14: COMPARISON OF NORMAL VENTILATION FILTER TRAINS TO
BRANCH TECHNICAL POSITION ETSB NO. 11-2, "DESIGN, TESTING AND
MAINTENANCE CRITERIA FOR NORMAL VENTILATION EXHAUST SYSTEM AIR
FILTRATION AND ADSORPTION UNITS OF LIGHT-WATER-COOLED NUCLEAR
POWER REACTOR PLANTS" (CONTINUED)**

B.4.c - All components which require servicing or removal are provided with adequate access space consistent with the manufacturer's recommendations. Approximately four feet of access space is provided from the face of the mounting frame to the next component for all items which require removal, except the adsorber medium. Internal access to the adsorber section is not required for removal or replacement of charcoal, as this is done externally using automatic equipment. However, access space is provided upstream and downstream of the adsorber section to allow for visual inspection.

B.4.d - Permanent test probes manifolded at a single location are not provided since adequate individual test points are available.

B.5.c - Upstream HEPA filter banks are not tested using DOP following painting in ventilation zones communicating with the system as DOP testing will not detect filters clogged from paint fumes. Differential pressure gauges are used to detect the affect of paint fumes on HEPA filters with total filter train dp alarmed in the main control room on high level.

5. Hot Machine Shop Recirculation and Exhaust Filter Trains

The hot machine shop recirculation and exhaust filter trains comply with Part B of BTP ETSB 11-2 with the following exceptions:

Position B.2.a - These filter trains consist of prefilters, HEPA filters, and fans only. Charcoal adsorber sections are not provided, since no credit is taken for adsorption. Heaters are not provided since there is no need to reduce the relative humidity of the incoming atmosphere to 70 percent.

GRAND GULF NUCLEAR GENERATING STATION
Updated Final Safety Analysis Report (UFSAR)

**TABLE 9.4-14: COMPARISON OF NORMAL VENTILATION FILTER TRAINS TO
BRANCH TECHNICAL POSITION ETSB NO. 11-2, "DESIGN, TESTING AND
MAINTENANCE CRITERIA FOR NORMAL VENTILATION EXHAUST SYSTEM AIR
FILTRATION AND ADSORPTION UNITS OF LIGHT-WATER-COOLED NUCLEAR
POWER REACTOR PLANTS" (CONTINUED)**

Position B.2.c - Pressure drop across the prefilter bank and across the HEPA filter bank is indicated locally.

Position B.3.a - These filter trains consist of prefilters, HEPA filters, and fans only; therefore, heaters are not provided since there is no need to reduce the relative humidity of the incoming atmosphere to 70 percent.

Position B.3.d - Charcoal adsorber sections are not provided for these filter trains since no credit is taken for adsorption.

Position B.3.e - Access doors are 20 inches x 50 inches due to physical size limitations; however, full man-entry is not required for this unit. Doors do not have inspection windows or provisions for locking or opening from inside.

Position B.3.f - Charcoal adsorber sections are not provided for these filter trains since no credit is taken for adsorption.

Position B.3.g - Charcoal adsorber sections are not provided for these filter trains since no credit is taken for adsorption.

Position B.4.e - Charcoal adsorber sections are not provided for these filter trains since no credit is taken for adsorption.

Position B.5.b - Charcoal adsorber sections are not provided for these filter trains since no credit is taken for adsorption.

GRAND GULF NUCLEAR GENERATING STATION
Updated Final Safety Analysis Report (UFSAR)

**TABLE 9.4-14: COMPARISON OF NORMAL VENTILATION FILTER TRAINS TO
BRANCH TECHNICAL POSITION ETSB NO. 11-2, "DESIGN, TESTING AND
MAINTENANCE CRITERIA FOR NORMAL VENTILATION EXHAUST SYSTEM AIR
FILTRATION AND ADSORPTION UNITS OF LIGHT-WATER-COOLED NUCLEAR
POWER REACTOR PLANTS" (CONTINUED)**

Position B.5.c - Charcoal adsorber sections are not provided for these filter trains since no credit is taken for adsorption. Upstream HEPA filter banks are not tested using DOP following painting in ventilation zones communicating with the system as DOP testing will not detect filters clogged from paint fumes. Differential pressure gauges are used to detect the affect of paint fumes on HEPA filters.

Position B.5.d - Charcoal adsorber sections are not provided for these filter trains since no credit is taken for adsorption.

Position B.6.a - Charcoal adsorber sections are not provided for these filter trains since no credit is taken for adsorption.

Position B.6.b - Charcoal adsorber sections are not provided for these filter trains since no credit is taken for adsorption.

Table 1 - Charcoal adsorber sections are not provided for these filter trains since no credit is taken for adsorption.

Table 2 - Charcoal adsorber sections are not provided for these filter trains since no credit is taken for adsorption.

GRAND GULF NUCLEAR GENERATING STATION

Updated Final Safety Analysis Report (UFSAR)

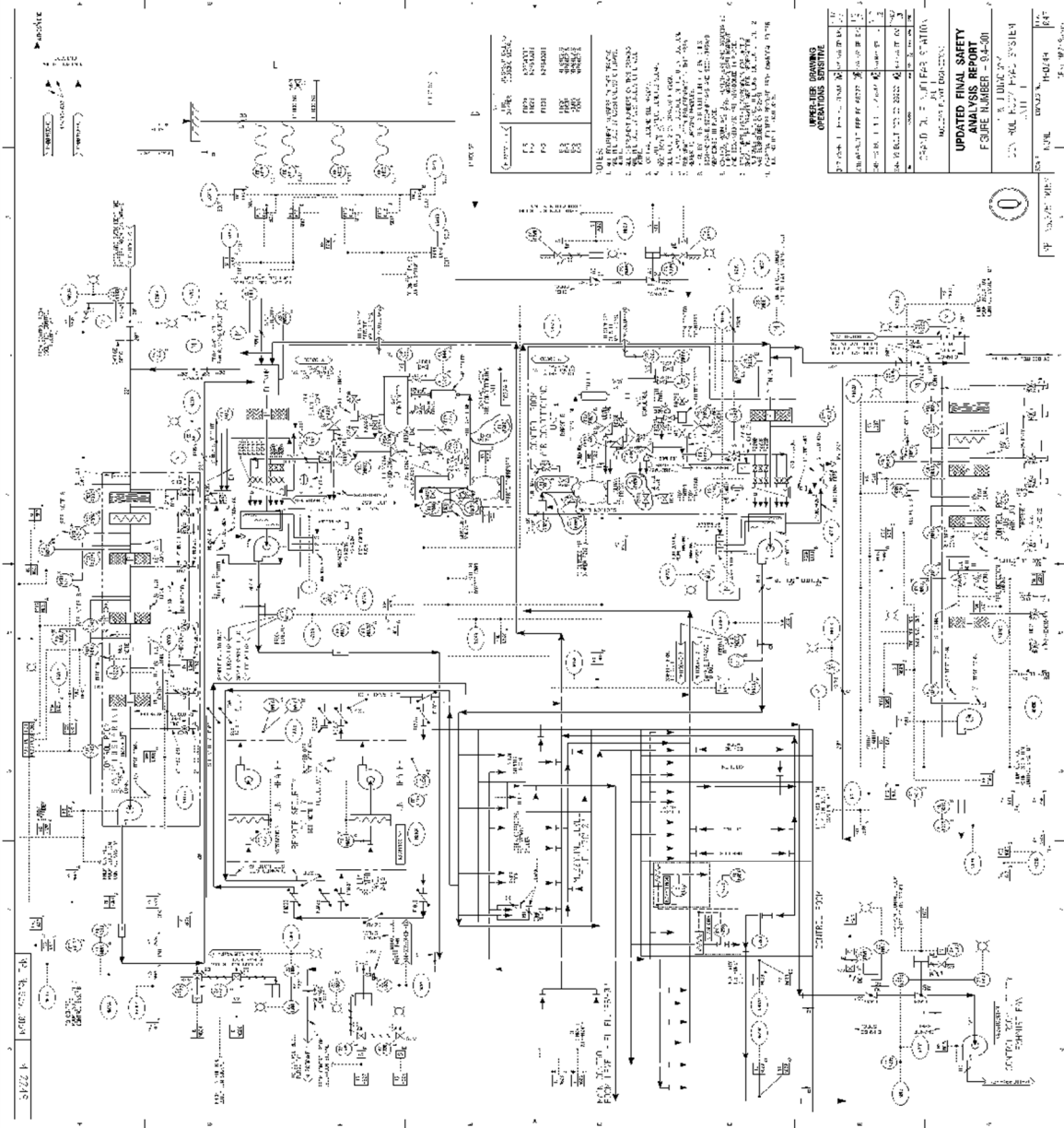

GRAND GULF NUCLEAR GENERATING STATION

Updated Final Safety Analysis Report (UFSAR)

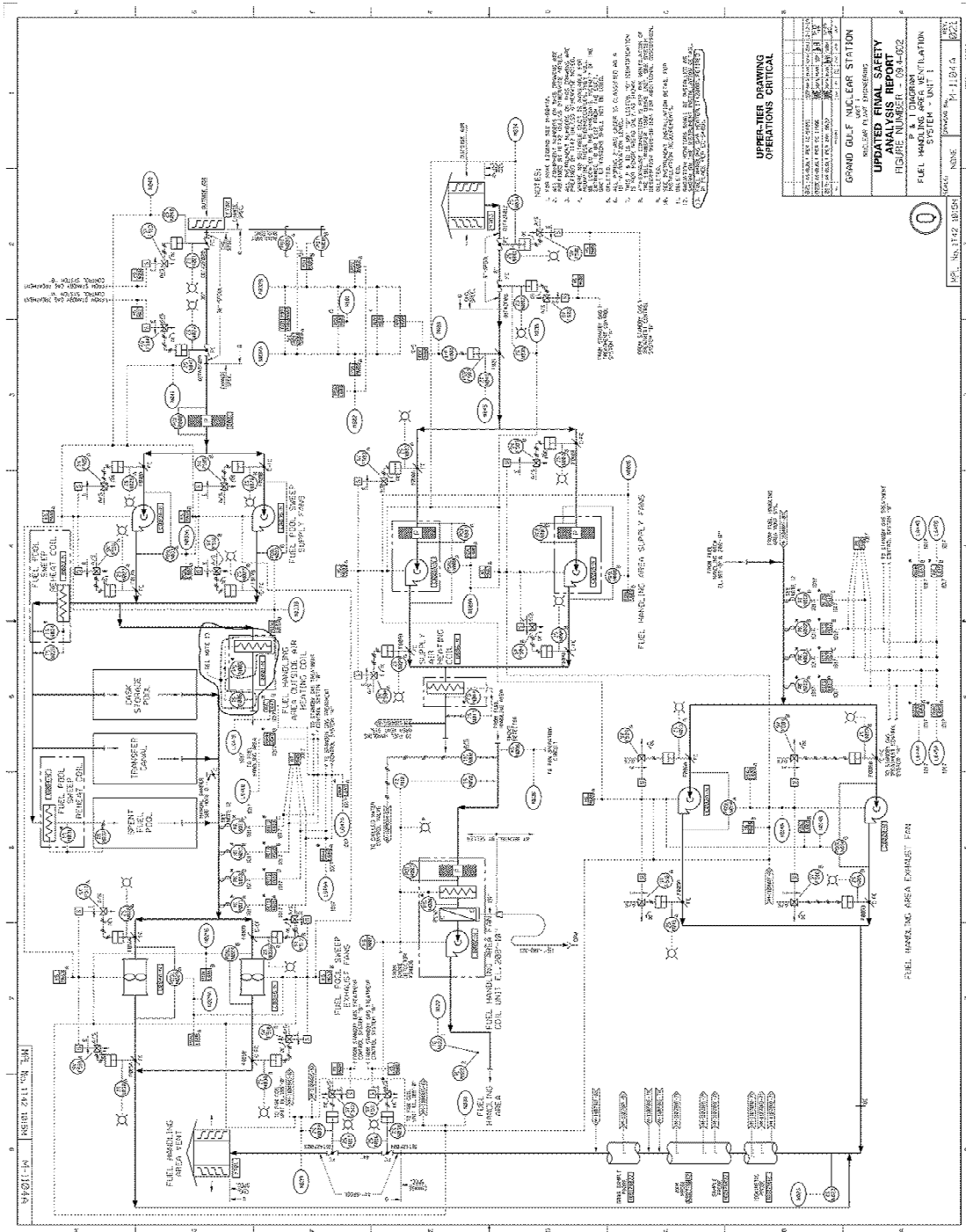

GRAND GULF NUCLEAR GENERATING STATION
Updated Final Safety Analysis Report (UFSAR)

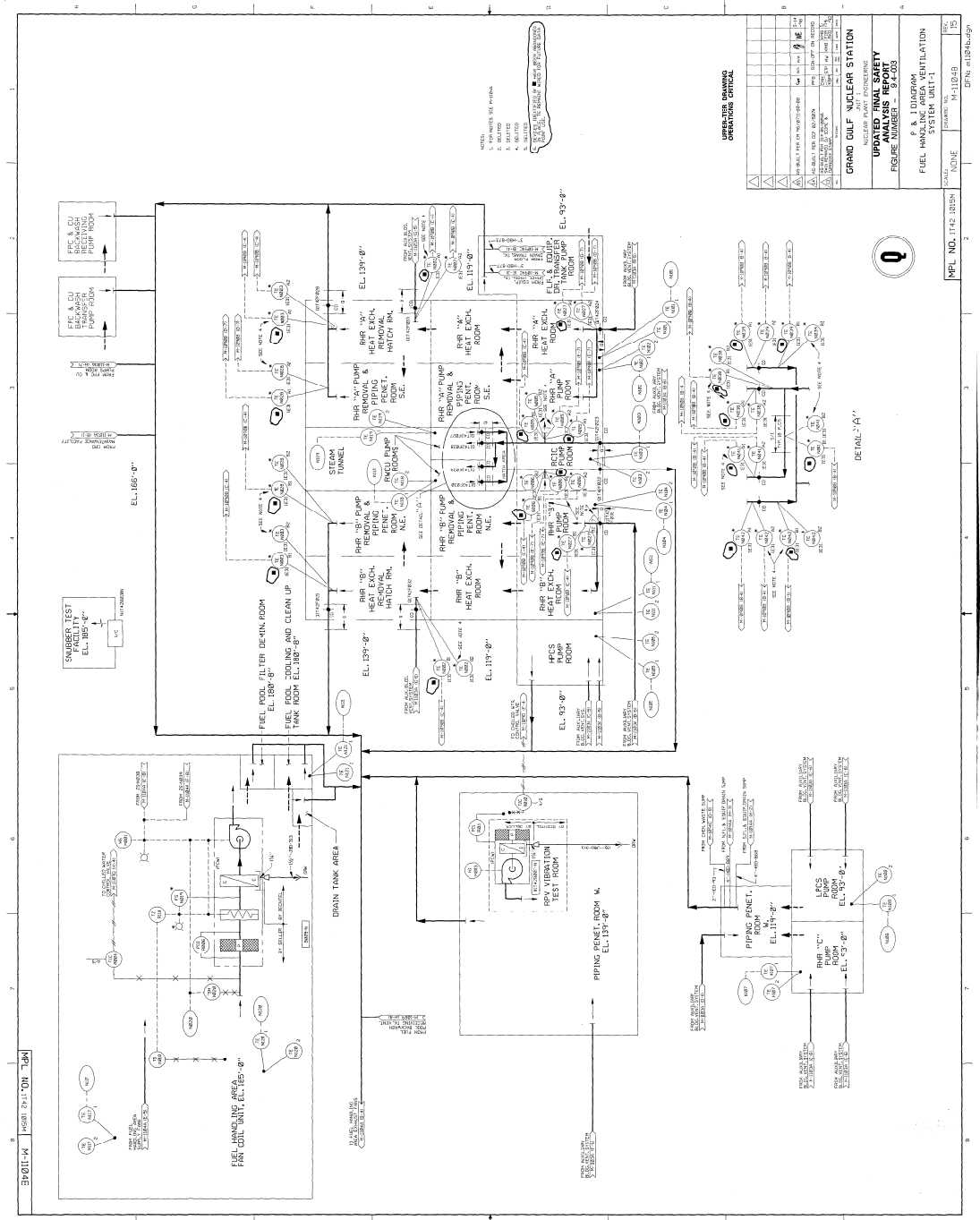

NOTES:
1. ROOMS AS SHOWN.
2. ELEVATIONS AS SHOWN.
3. ROOMS AS SHOWN.
4. ROOMS AS SHOWN.
5. ROOMS AS SHOWN.

OPERATIONAL CONTROL	OPERATIONAL CONTROL
OPERATIONAL CONTROL	OPERATIONAL CONTROL
OPERATIONAL CONTROL	OPERATIONAL CONTROL
OPERATIONAL CONTROL	OPERATIONAL CONTROL
OPERATIONAL CONTROL	OPERATIONAL CONTROL
OPERATIONAL CONTROL	OPERATIONAL CONTROL
OPERATIONAL CONTROL	OPERATIONAL CONTROL

GRAND GULF NUCLEAR STATION
OPERATIONAL SAFETY ANALYSIS REPORT
FIGURE NUMBER - 9.4-03
P & I DIAGRAM
FUEL HANDLING AND VENTILATION SYSTEM (H.V.)

SCALE: NONE
DRAWN BY: M-1104-B
DATE: 10/15/65

GRAND GULF NUCLEAR GENERATING STATION

Updated Final Safety Analysis Report (UFSAR)

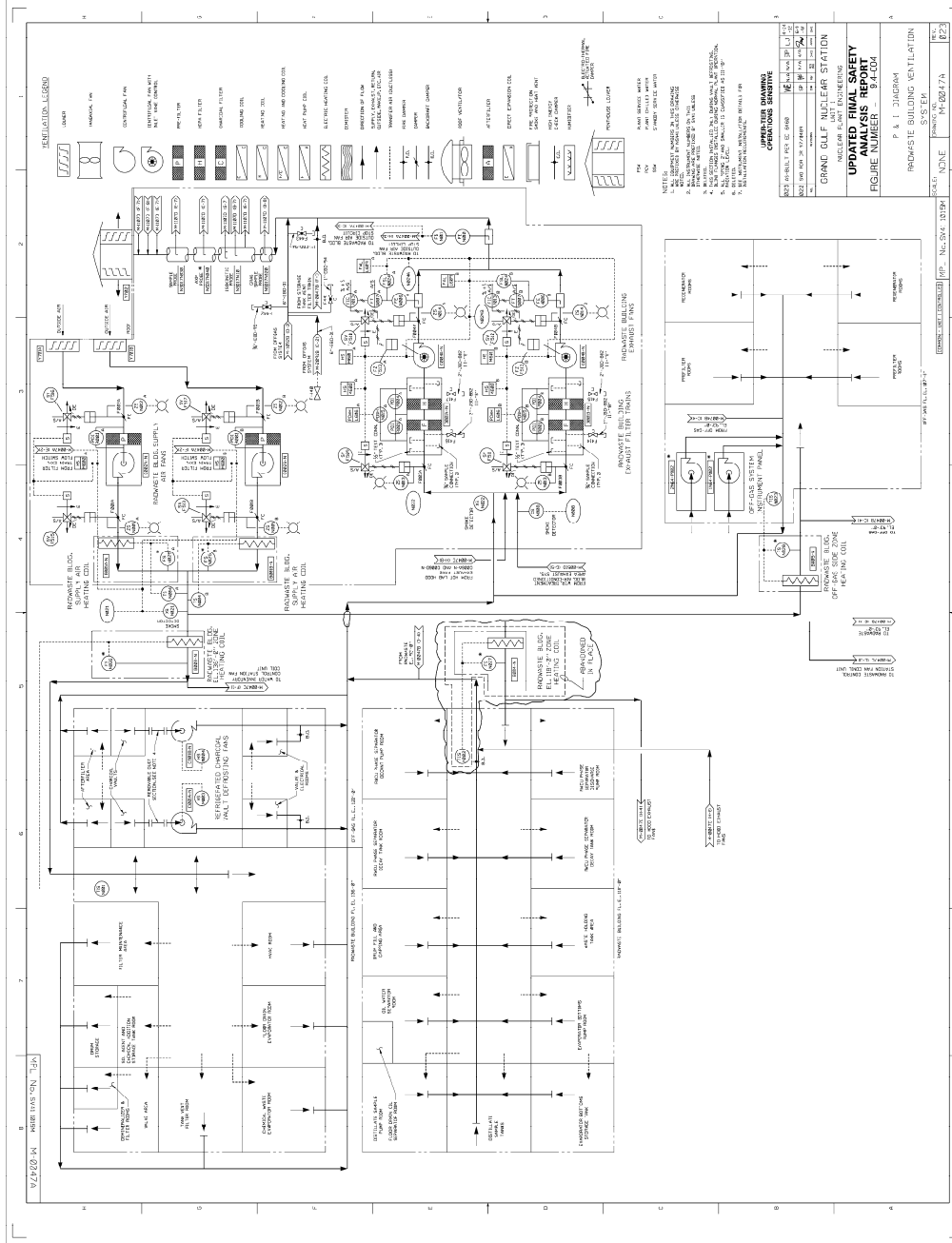

GRAND GULF NUCLEAR GENERATING STATION

Updated Final Safety Analysis Report (UFSAR)

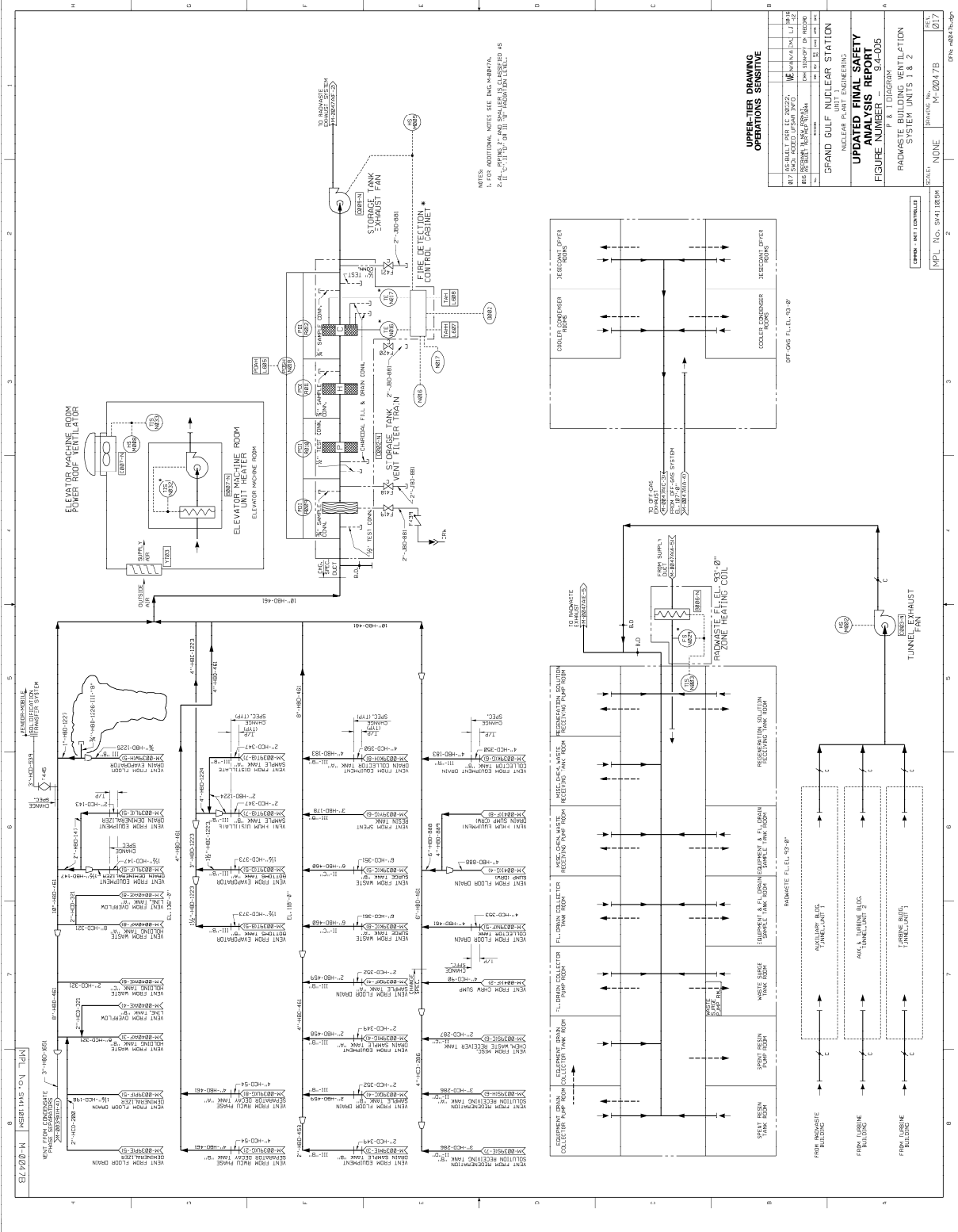

NOTES:
 1. FOR ADDITIONAL NOTES SEE ENG-48878A.
 2. THE DRAWING IS TO BE READ AS SHOWN.

UPPER-TIER DRAWING
 OPERATIONS SENSITIVE

REV.	NO.	DESCRIPTION
017	AS BUILT PRELIMINARY	REVISED FOR UFSAR
018	AS BUILT PRELIMINARY	REVISED FOR UFSAR
019	AS BUILT PRELIMINARY	REVISED FOR UFSAR
020	AS BUILT PRELIMINARY	REVISED FOR UFSAR
021	AS BUILT PRELIMINARY	REVISED FOR UFSAR
022	AS BUILT PRELIMINARY	REVISED FOR UFSAR
023	AS BUILT PRELIMINARY	REVISED FOR UFSAR
024	AS BUILT PRELIMINARY	REVISED FOR UFSAR
025	AS BUILT PRELIMINARY	REVISED FOR UFSAR
026	AS BUILT PRELIMINARY	REVISED FOR UFSAR
027	AS BUILT PRELIMINARY	REVISED FOR UFSAR
028	AS BUILT PRELIMINARY	REVISED FOR UFSAR
029	AS BUILT PRELIMINARY	REVISED FOR UFSAR
030	AS BUILT PRELIMINARY	REVISED FOR UFSAR
031	AS BUILT PRELIMINARY	REVISED FOR UFSAR
032	AS BUILT PRELIMINARY	REVISED FOR UFSAR
033	AS BUILT PRELIMINARY	REVISED FOR UFSAR
034	AS BUILT PRELIMINARY	REVISED FOR UFSAR
035	AS BUILT PRELIMINARY	REVISED FOR UFSAR
036	AS BUILT PRELIMINARY	REVISED FOR UFSAR
037	AS BUILT PRELIMINARY	REVISED FOR UFSAR
038	AS BUILT PRELIMINARY	REVISED FOR UFSAR
039	AS BUILT PRELIMINARY	REVISED FOR UFSAR
040	AS BUILT PRELIMINARY	REVISED FOR UFSAR
041	AS BUILT PRELIMINARY	REVISED FOR UFSAR
042	AS BUILT PRELIMINARY	REVISED FOR UFSAR
043	AS BUILT PRELIMINARY	REVISED FOR UFSAR
044	AS BUILT PRELIMINARY	REVISED FOR UFSAR
045	AS BUILT PRELIMINARY	REVISED FOR UFSAR
046	AS BUILT PRELIMINARY	REVISED FOR UFSAR
047	AS BUILT PRELIMINARY	REVISED FOR UFSAR
048	AS BUILT PRELIMINARY	REVISED FOR UFSAR
049	AS BUILT PRELIMINARY	REVISED FOR UFSAR
050	AS BUILT PRELIMINARY	REVISED FOR UFSAR
051	AS BUILT PRELIMINARY	REVISED FOR UFSAR
052	AS BUILT PRELIMINARY	REVISED FOR UFSAR
053	AS BUILT PRELIMINARY	REVISED FOR UFSAR
054	AS BUILT PRELIMINARY	REVISED FOR UFSAR
055	AS BUILT PRELIMINARY	REVISED FOR UFSAR
056	AS BUILT PRELIMINARY	REVISED FOR UFSAR
057	AS BUILT PRELIMINARY	REVISED FOR UFSAR
058	AS BUILT PRELIMINARY	REVISED FOR UFSAR
059	AS BUILT PRELIMINARY	REVISED FOR UFSAR
060	AS BUILT PRELIMINARY	REVISED FOR UFSAR
061	AS BUILT PRELIMINARY	REVISED FOR UFSAR
062	AS BUILT PRELIMINARY	REVISED FOR UFSAR
063	AS BUILT PRELIMINARY	REVISED FOR UFSAR
064	AS BUILT PRELIMINARY	REVISED FOR UFSAR
065	AS BUILT PRELIMINARY	REVISED FOR UFSAR
066	AS BUILT PRELIMINARY	REVISED FOR UFSAR
067	AS BUILT PRELIMINARY	REVISED FOR UFSAR
068	AS BUILT PRELIMINARY	REVISED FOR UFSAR
069	AS BUILT PRELIMINARY	REVISED FOR UFSAR
070	AS BUILT PRELIMINARY	REVISED FOR UFSAR
071	AS BUILT PRELIMINARY	REVISED FOR UFSAR
072	AS BUILT PRELIMINARY	REVISED FOR UFSAR
073	AS BUILT PRELIMINARY	REVISED FOR UFSAR
074	AS BUILT PRELIMINARY	REVISED FOR UFSAR
075	AS BUILT PRELIMINARY	REVISED FOR UFSAR
076	AS BUILT PRELIMINARY	REVISED FOR UFSAR
077	AS BUILT PRELIMINARY	REVISED FOR UFSAR
078	AS BUILT PRELIMINARY	REVISED FOR UFSAR
079	AS BUILT PRELIMINARY	REVISED FOR UFSAR
080	AS BUILT PRELIMINARY	REVISED FOR UFSAR
081	AS BUILT PRELIMINARY	REVISED FOR UFSAR
082	AS BUILT PRELIMINARY	REVISED FOR UFSAR
083	AS BUILT PRELIMINARY	REVISED FOR UFSAR
084	AS BUILT PRELIMINARY	REVISED FOR UFSAR
085	AS BUILT PRELIMINARY	REVISED FOR UFSAR
086	AS BUILT PRELIMINARY	REVISED FOR UFSAR
087	AS BUILT PRELIMINARY	REVISED FOR UFSAR
088	AS BUILT PRELIMINARY	REVISED FOR UFSAR
089	AS BUILT PRELIMINARY	REVISED FOR UFSAR
090	AS BUILT PRELIMINARY	REVISED FOR UFSAR
091	AS BUILT PRELIMINARY	REVISED FOR UFSAR
092	AS BUILT PRELIMINARY	REVISED FOR UFSAR
093	AS BUILT PRELIMINARY	REVISED FOR UFSAR
094	AS BUILT PRELIMINARY	REVISED FOR UFSAR
095	AS BUILT PRELIMINARY	REVISED FOR UFSAR
096	AS BUILT PRELIMINARY	REVISED FOR UFSAR
097	AS BUILT PRELIMINARY	REVISED FOR UFSAR
098	AS BUILT PRELIMINARY	REVISED FOR UFSAR
099	AS BUILT PRELIMINARY	REVISED FOR UFSAR
100	AS BUILT PRELIMINARY	REVISED FOR UFSAR

GRAND GULF NUCLEAR STATION
 NUCLEAR PLANT ENGINEERING

UPDATED FINAL SAFETY
 ANALYSIS REPORT
 FIGURE NUMBER: 9.4-123

RADIOWASTE BUILDING VENTILATION
 SYSTEM UNITS 1 & 2

SCALE:	NONE
DRAWING NO.:	M-2047B
REV.:	017
DATE:	08/08/89

GRAND GULF NUCLEAR GENERATING STATION

Updated Final Safety Analysis Report (UFSAR)

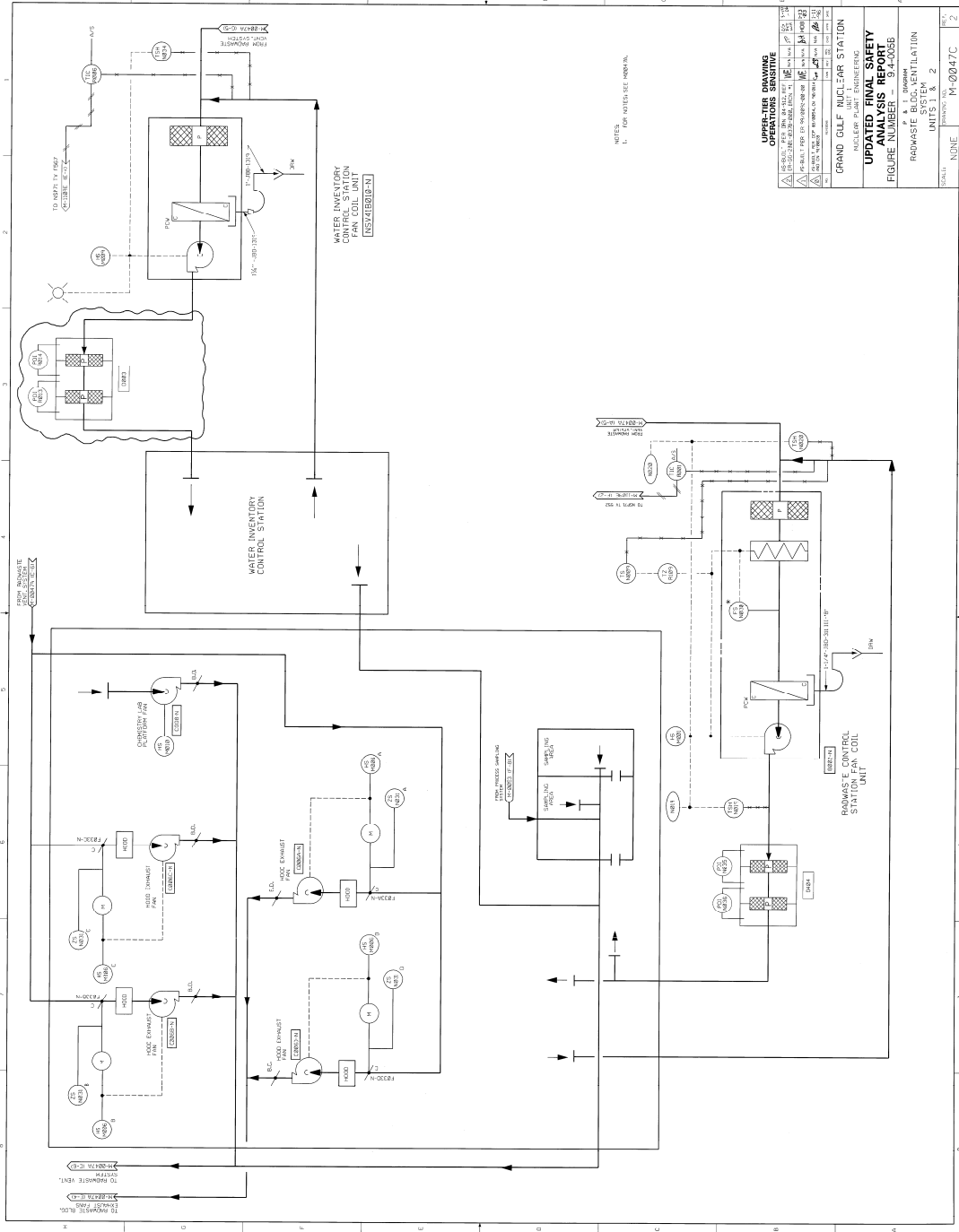

GRAND GULF NUCLEAR GENERATING STATION

Updated Final Safety Analysis Report (UFSAR)

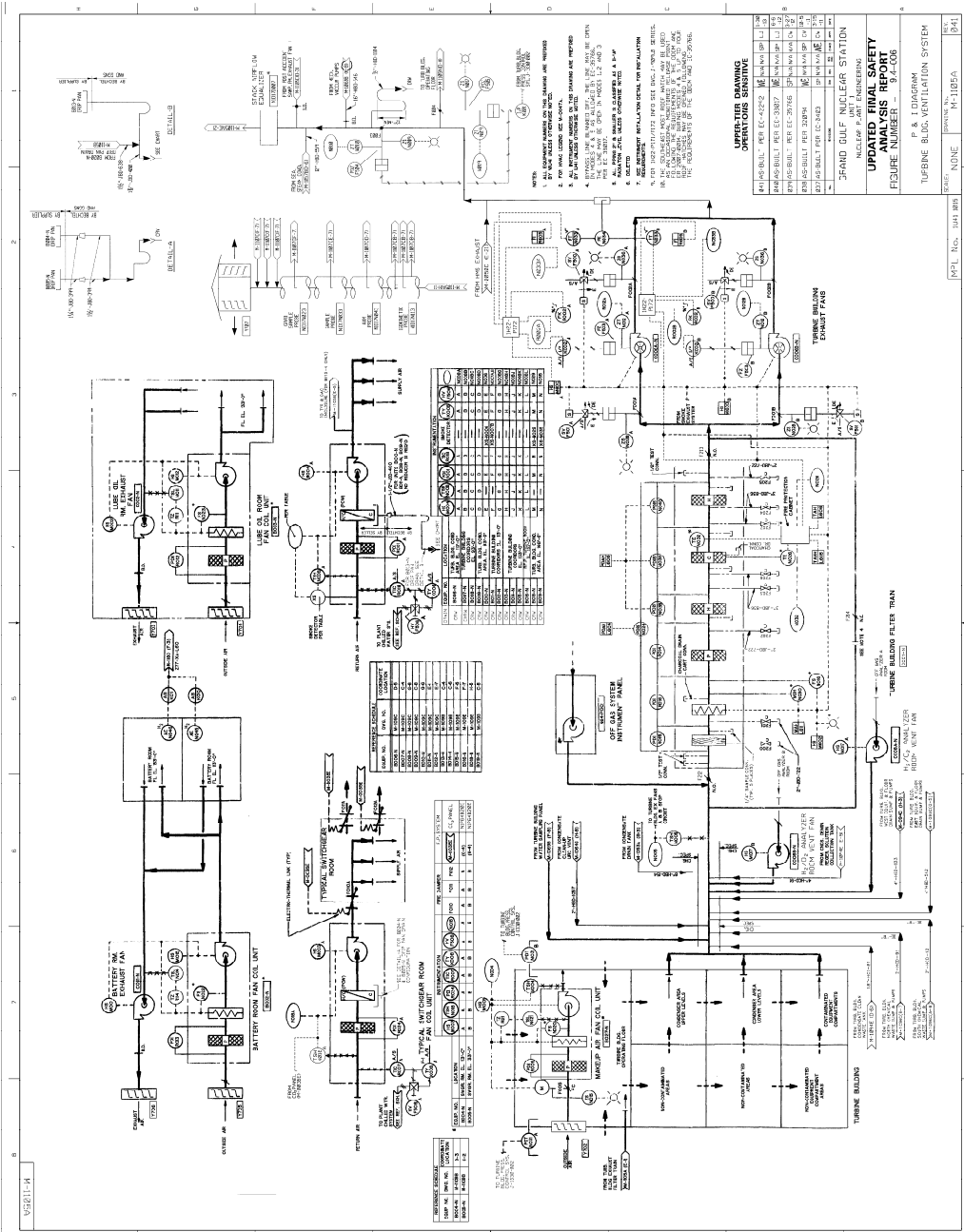

GRAND GULF NUCLEAR GENERATING STATION

Updated Final Safety Analysis Report (UFSAR)

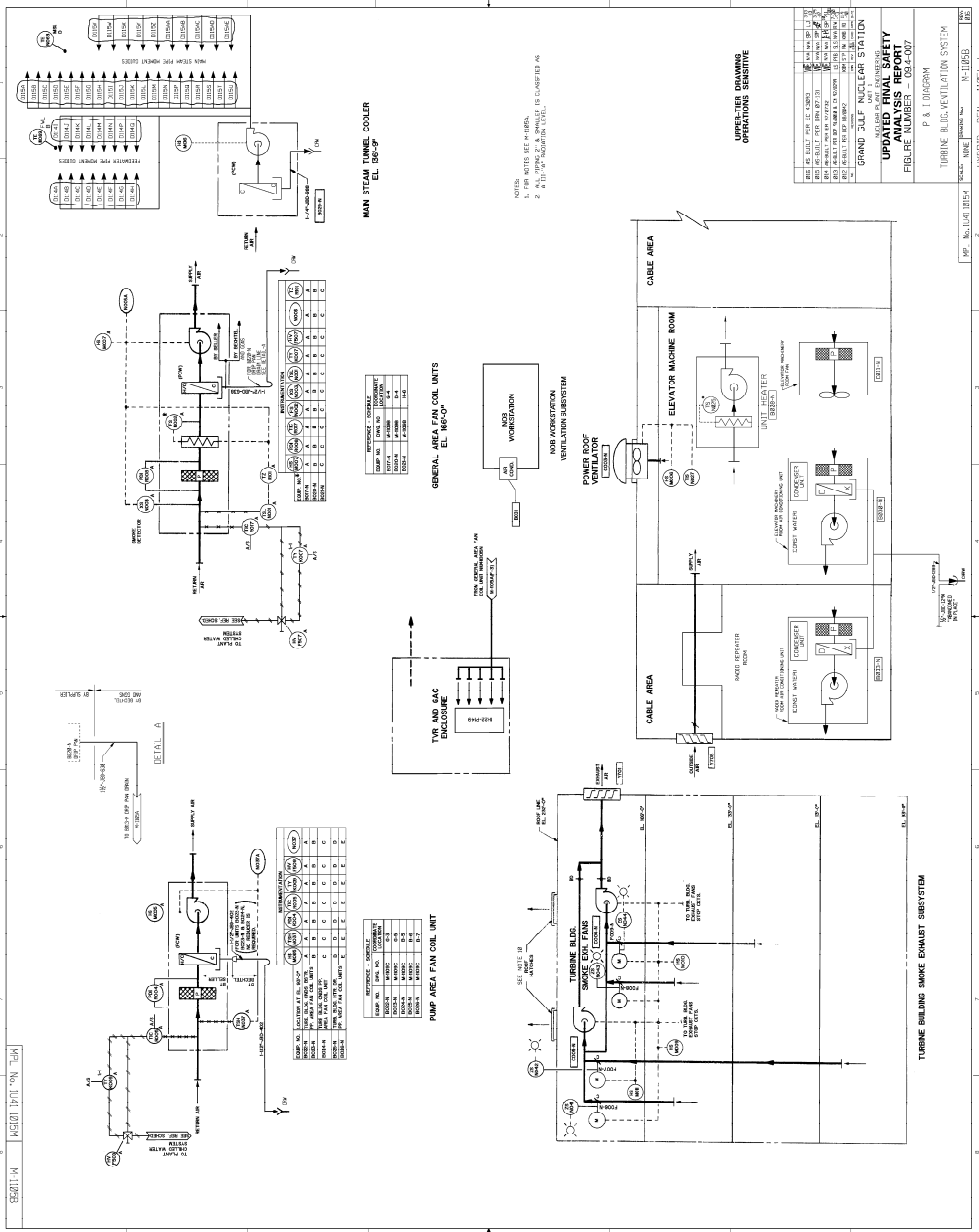

GRAND GULF NUCLEAR GENERATING STATION

Updated Final Safety Analysis Report (UFSAR)

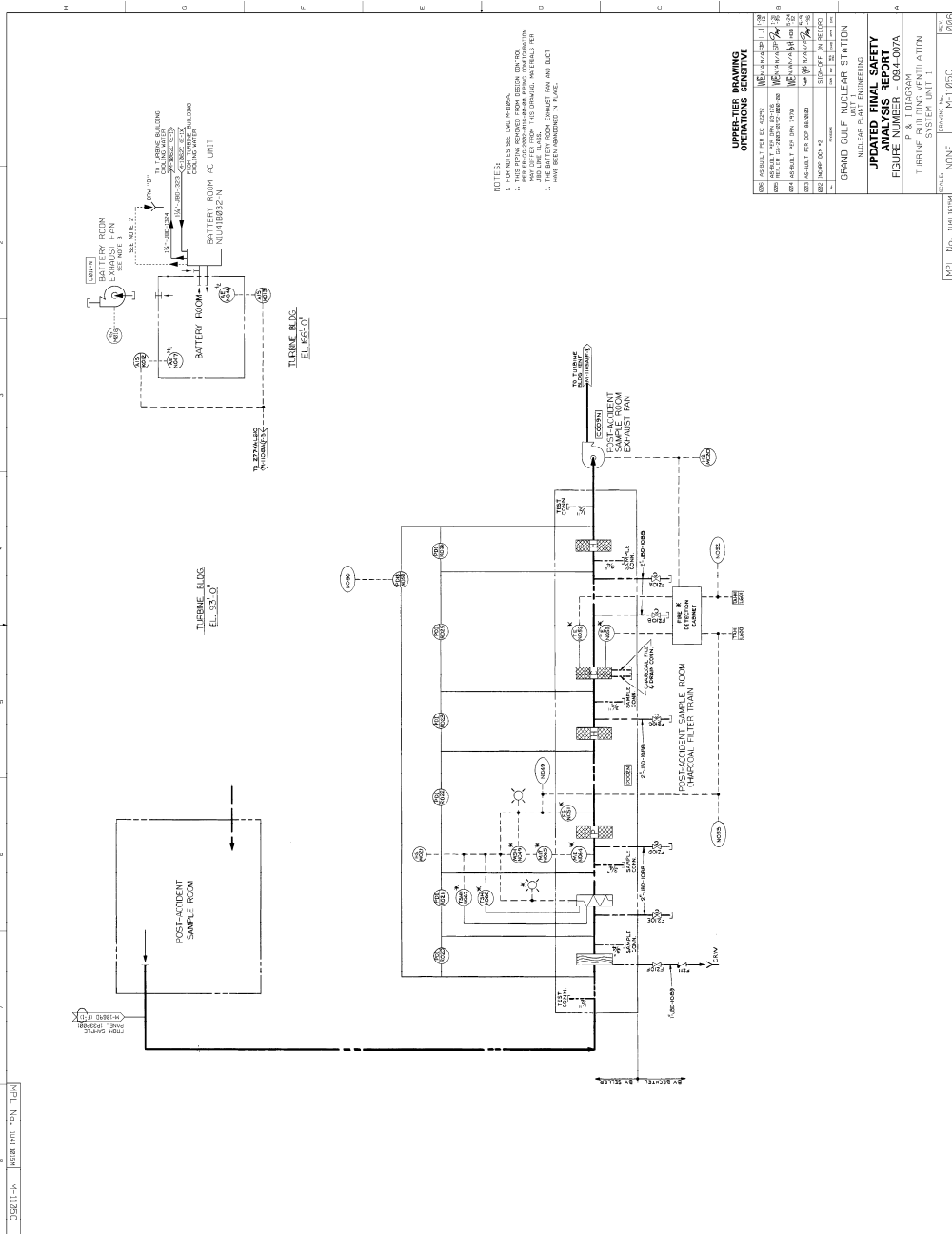
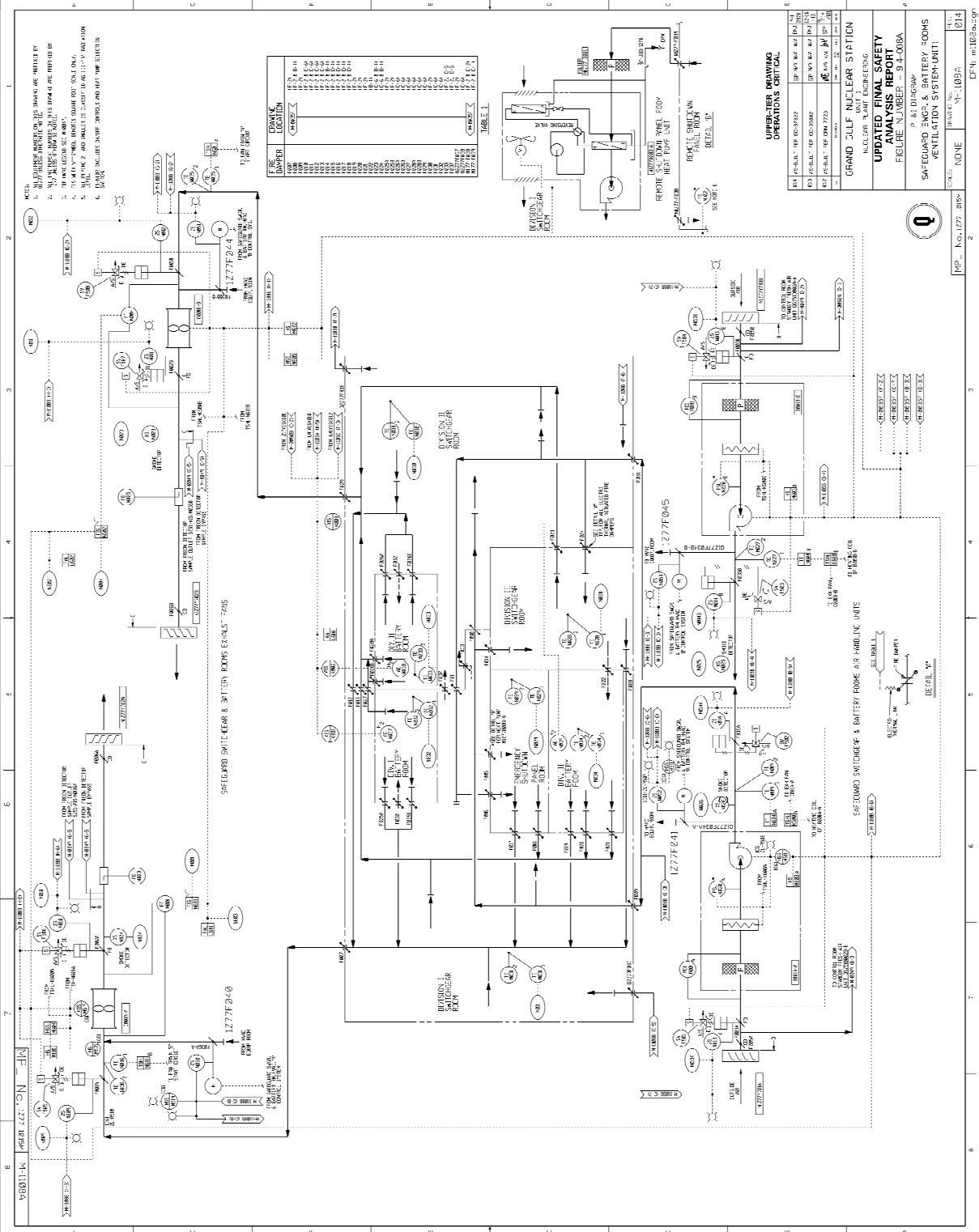

Figure 9.4-8

Deleted

GRAND GULF NUCLEAR GENERATING STATION

Updated Final Safety Analysis Report (UFSAR)



GRAND GULF NUCLEAR GENERATING STATION

Updated Final Safety Analysis Report (UFSAR)

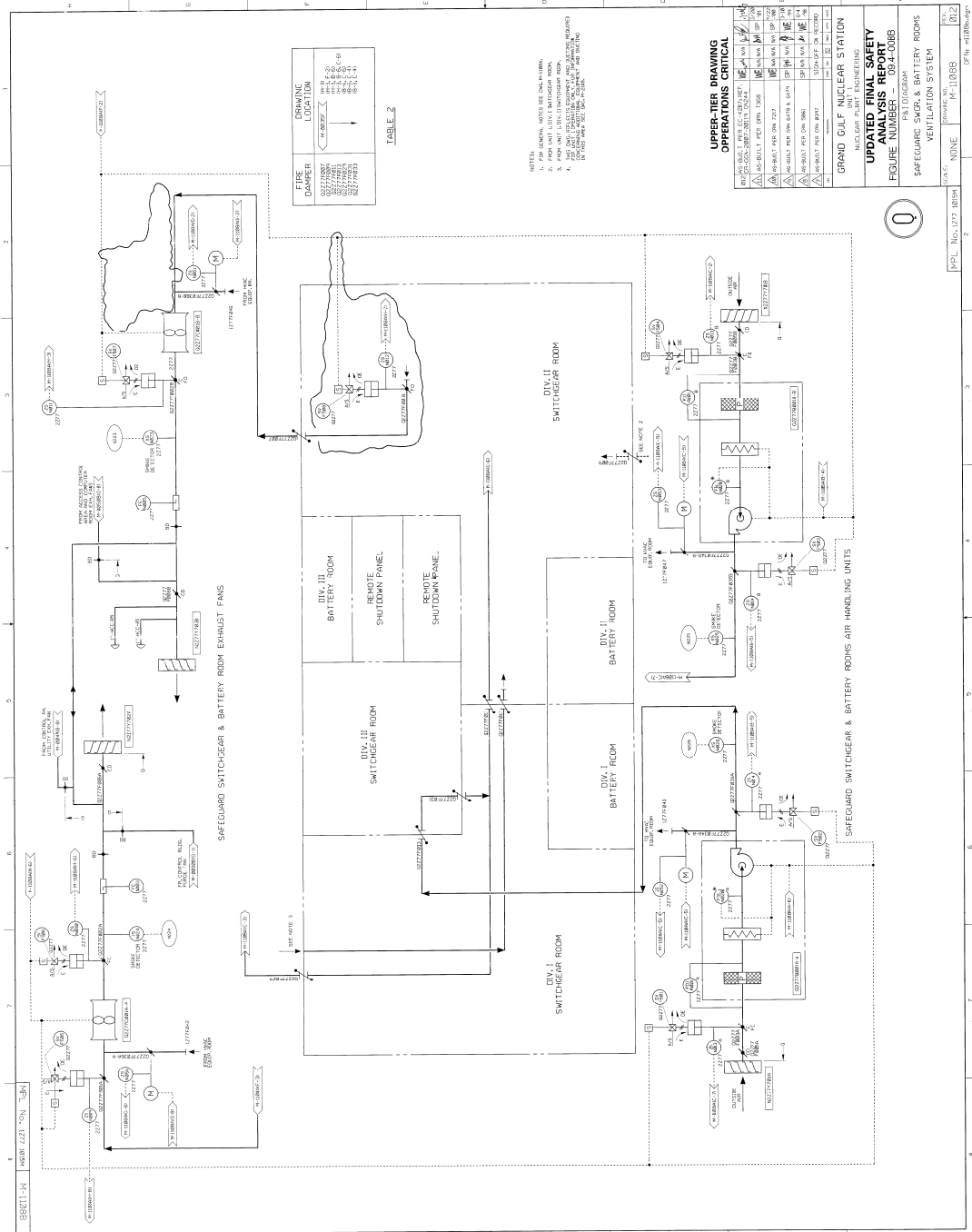

GRAND GULF NUCLEAR GENERATING STATION

Updated Final Safety Analysis Report (UFSAR)

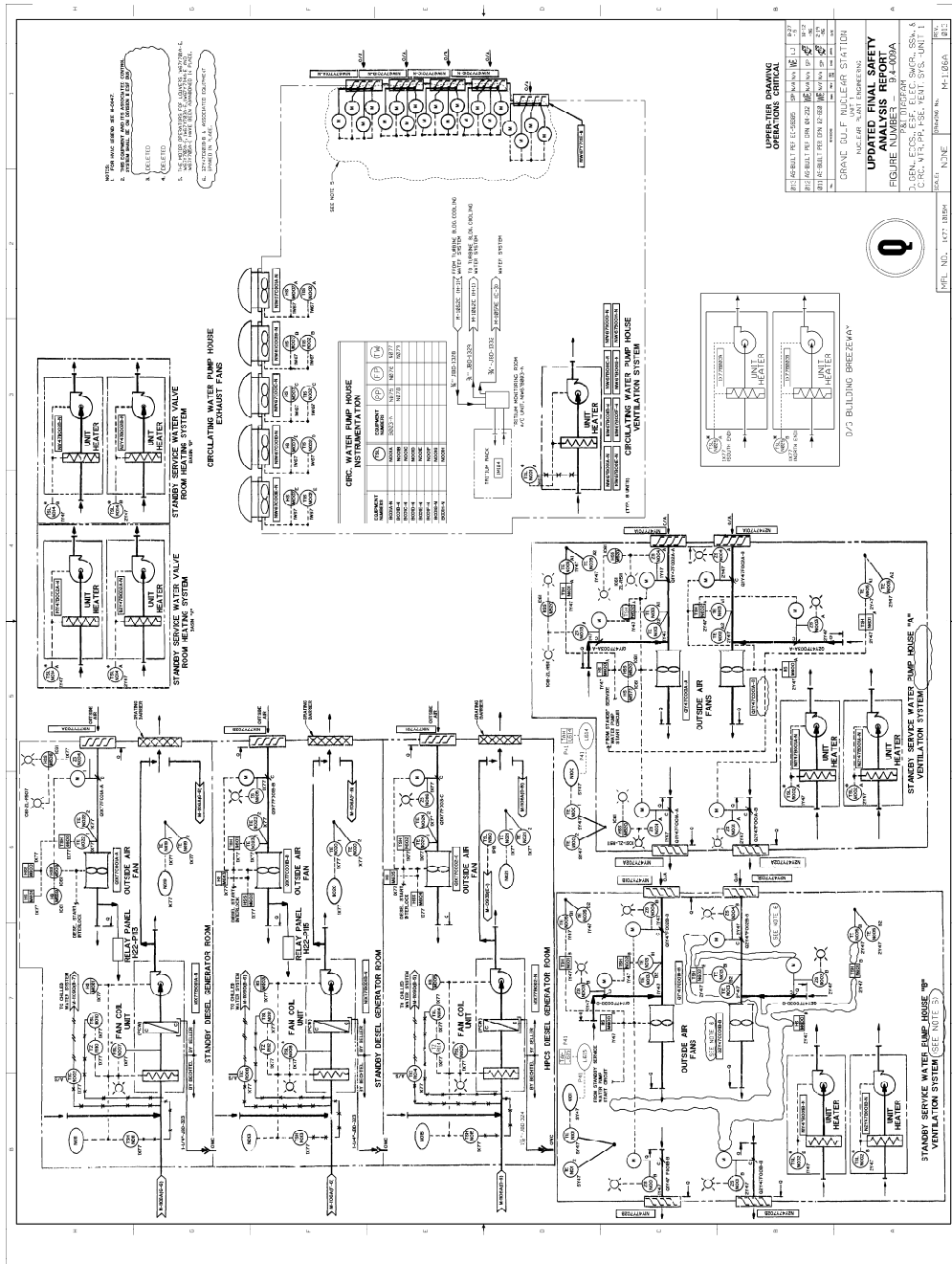

GRAND GULF NUCLEAR GENERATING STATION

Updated Final Safety Analysis Report (UFSAR)

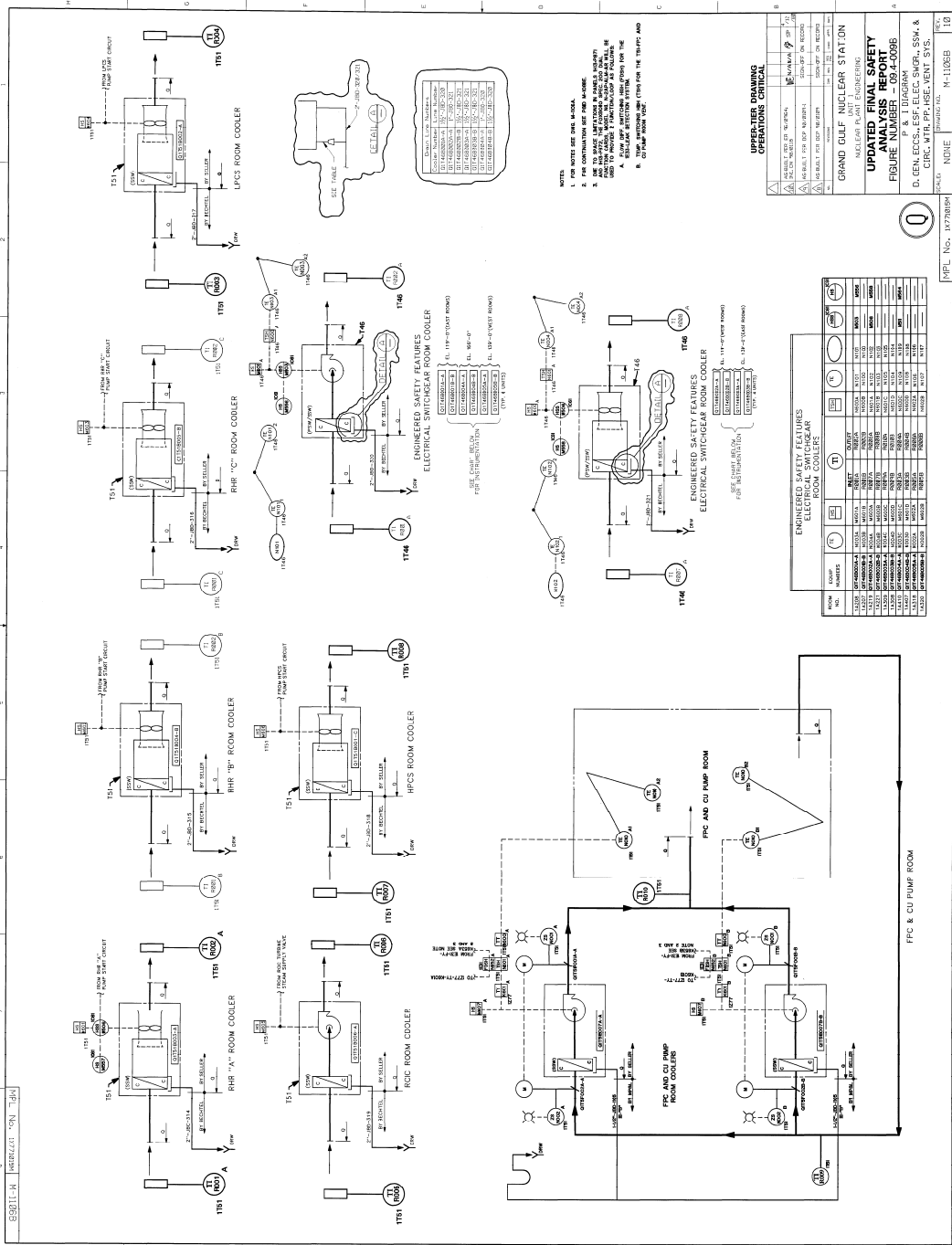

- NOTES:**
- FOR NOTES SEE SHEET 9.4-132A
 - FOR CONTINUATION SEE SHEET 9.4-132B
 - SEE SHEET 9.4-132C FOR ELECTRICAL SYMBOLS AND TERMINALS
 - SEE SHEET 9.4-132D FOR ELECTRICAL SYMBOLS AND TERMINALS
 - SEE SHEET 9.4-132E FOR ELECTRICAL SYMBOLS AND TERMINALS
 - SEE SHEET 9.4-132F FOR ELECTRICAL SYMBOLS AND TERMINALS
 - SEE SHEET 9.4-132G FOR ELECTRICAL SYMBOLS AND TERMINALS
 - SEE SHEET 9.4-132H FOR ELECTRICAL SYMBOLS AND TERMINALS
 - SEE SHEET 9.4-132I FOR ELECTRICAL SYMBOLS AND TERMINALS
 - SEE SHEET 9.4-132J FOR ELECTRICAL SYMBOLS AND TERMINALS
 - SEE SHEET 9.4-132K FOR ELECTRICAL SYMBOLS AND TERMINALS
 - SEE SHEET 9.4-132L FOR ELECTRICAL SYMBOLS AND TERMINALS
 - SEE SHEET 9.4-132M FOR ELECTRICAL SYMBOLS AND TERMINALS
 - SEE SHEET 9.4-132N FOR ELECTRICAL SYMBOLS AND TERMINALS
 - SEE SHEET 9.4-132O FOR ELECTRICAL SYMBOLS AND TERMINALS
 - SEE SHEET 9.4-132P FOR ELECTRICAL SYMBOLS AND TERMINALS
 - SEE SHEET 9.4-132Q FOR ELECTRICAL SYMBOLS AND TERMINALS
 - SEE SHEET 9.4-132R FOR ELECTRICAL SYMBOLS AND TERMINALS
 - SEE SHEET 9.4-132S FOR ELECTRICAL SYMBOLS AND TERMINALS
 - SEE SHEET 9.4-132T FOR ELECTRICAL SYMBOLS AND TERMINALS
 - SEE SHEET 9.4-132U FOR ELECTRICAL SYMBOLS AND TERMINALS
 - SEE SHEET 9.4-132V FOR ELECTRICAL SYMBOLS AND TERMINALS
 - SEE SHEET 9.4-132W FOR ELECTRICAL SYMBOLS AND TERMINALS
 - SEE SHEET 9.4-132X FOR ELECTRICAL SYMBOLS AND TERMINALS
 - SEE SHEET 9.4-132Y FOR ELECTRICAL SYMBOLS AND TERMINALS
 - SEE SHEET 9.4-132Z FOR ELECTRICAL SYMBOLS AND TERMINALS

UPPER TIER DRAWING
OPERATION, CRITICAL

REVISION	DATE	BY	DESCRIPTION
1	10/15/16	J. SMITH	INITIAL DESIGN
2	11/01/16	J. SMITH	REVISED FOR SAFETY REVIEW
3	11/15/16	J. SMITH	REVISED FOR ELECTRICAL REVIEW
4	12/01/16	J. SMITH	REVISED FOR FINAL REVIEW

NO.	ROOM	TYPE	AMT.	QTY.	UNIT	DATE	STATUS
1	115A	ROOM COOLER	1	1	115A	10/15/16	AS BUILT
2	115B	ROOM COOLER	1	1	115B	10/15/16	AS BUILT
3	115C	ROOM COOLER	1	1	115C	10/15/16	AS BUILT
4	115D	ROOM COOLER	1	1	115D	10/15/16	AS BUILT
5	115E	ROOM COOLER	1	1	115E	10/15/16	AS BUILT
6	115F	ROOM COOLER	1	1	115F	10/15/16	AS BUILT
7	115G	ROOM COOLER	1	1	115G	10/15/16	AS BUILT
8	115H	ROOM COOLER	1	1	115H	10/15/16	AS BUILT
9	115I	ROOM COOLER	1	1	115I	10/15/16	AS BUILT
10	115J	ROOM COOLER	1	1	115J	10/15/16	AS BUILT
11	115K	ROOM COOLER	1	1	115K	10/15/16	AS BUILT
12	115L	ROOM COOLER	1	1	115L	10/15/16	AS BUILT
13	115M	ROOM COOLER	1	1	115M	10/15/16	AS BUILT
14	115N	ROOM COOLER	1	1	115N	10/15/16	AS BUILT
15	115O	ROOM COOLER	1	1	115O	10/15/16	AS BUILT
16	115P	ROOM COOLER	1	1	115P	10/15/16	AS BUILT
17	115Q	ROOM COOLER	1	1	115Q	10/15/16	AS BUILT
18	115R	ROOM COOLER	1	1	115R	10/15/16	AS BUILT
19	115S	ROOM COOLER	1	1	115S	10/15/16	AS BUILT
20	115T	ROOM COOLER	1	1	115T	10/15/16	AS BUILT
21	115U	ROOM COOLER	1	1	115U	10/15/16	AS BUILT
22	115V	ROOM COOLER	1	1	115V	10/15/16	AS BUILT
23	115W	ROOM COOLER	1	1	115W	10/15/16	AS BUILT
24	115X	ROOM COOLER	1	1	115X	10/15/16	AS BUILT
25	115Y	ROOM COOLER	1	1	115Y	10/15/16	AS BUILT
26	115Z	ROOM COOLER	1	1	115Z	10/15/16	AS BUILT

0

UFSAR No. 9.4-132

GRAND GULF NUCLEAR GENERATING STATION Updated Final Safety Analysis Report (UFSAR)

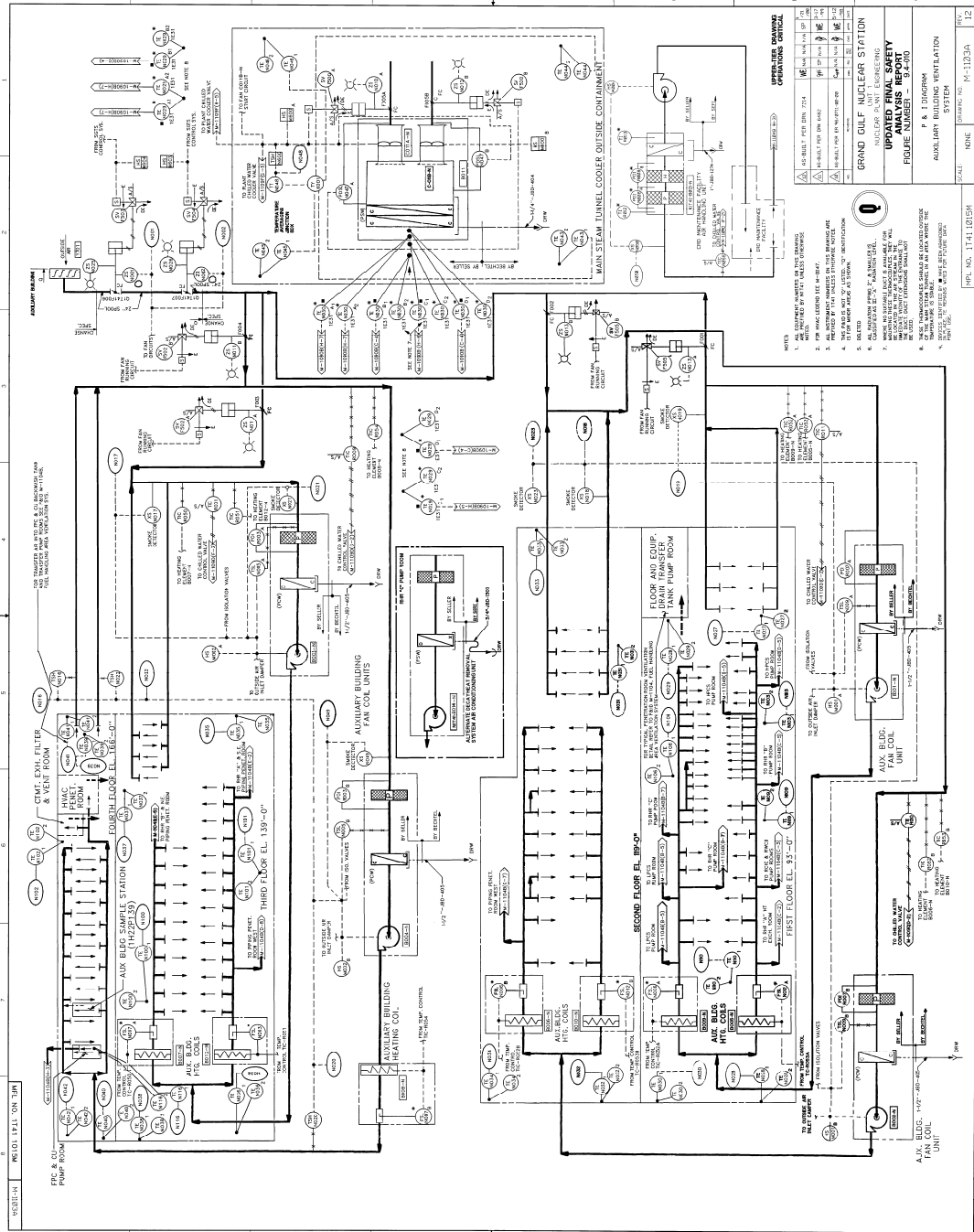

OPERATING MANUAL	
1. ALL WORK SHALL BE IN ACCORDANCE WITH THE UFSAR AND THE REGULATORY COMMISSION'S REQUIREMENTS.	
2. THE WORK SHALL BE COMPLETED BY THE DATE SPECIFIED IN THE WORK ORDER.	
3. THE WORK SHALL BE COMPLETED BY THE DATE SPECIFIED IN THE WORK ORDER.	
4. THE WORK SHALL BE COMPLETED BY THE DATE SPECIFIED IN THE WORK ORDER.	
5. THE WORK SHALL BE COMPLETED BY THE DATE SPECIFIED IN THE WORK ORDER.	
6. THE WORK SHALL BE COMPLETED BY THE DATE SPECIFIED IN THE WORK ORDER.	
7. THE WORK SHALL BE COMPLETED BY THE DATE SPECIFIED IN THE WORK ORDER.	
8. THE WORK SHALL BE COMPLETED BY THE DATE SPECIFIED IN THE WORK ORDER.	
9. THE WORK SHALL BE COMPLETED BY THE DATE SPECIFIED IN THE WORK ORDER.	
10. THE WORK SHALL BE COMPLETED BY THE DATE SPECIFIED IN THE WORK ORDER.	

GRAND GULF NUCLEAR STATION
UPDATED FINAL SAFETY ANALYSIS REPORT
FIGURE NUMBER - 9.4-133

P. R. Thompson
AUXILIARY BUILDING VENTILATION SYSTEM

REV. NO.	17411015H	REV.	12
DATE	10/11/2016	DESCRIPTION	

GRAND GULF NUCLEAR GENERATING STATION

Updated Final Safety Analysis Report (UFSAR)

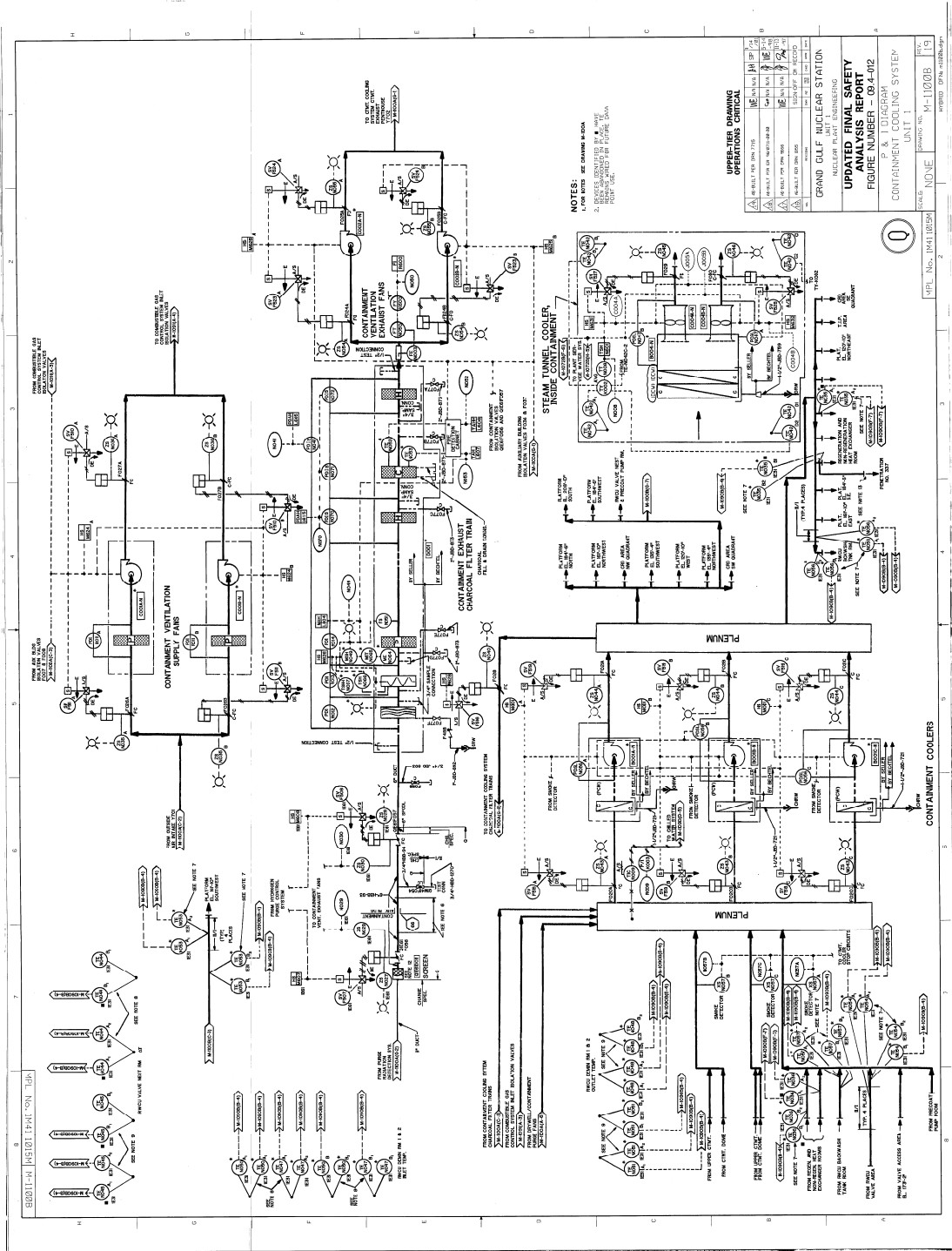

GRAND GULF NUCLEAR GENERATING STATION

Updated Final Safety Analysis Report (UFSAR)

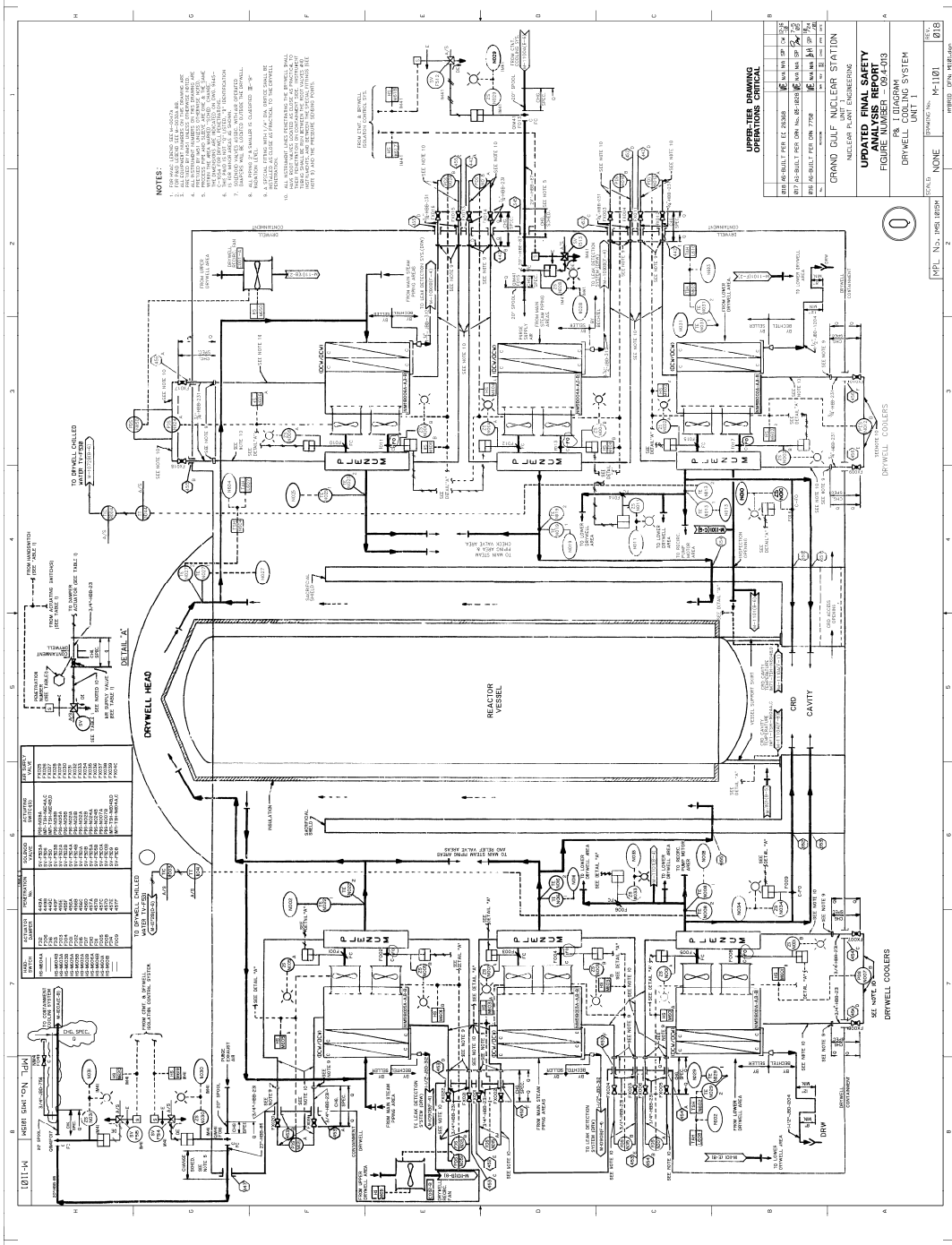

GRAND GULF NUCLEAR GENERATING STATION

Updated Final Safety Analysis Report (UFSAR)

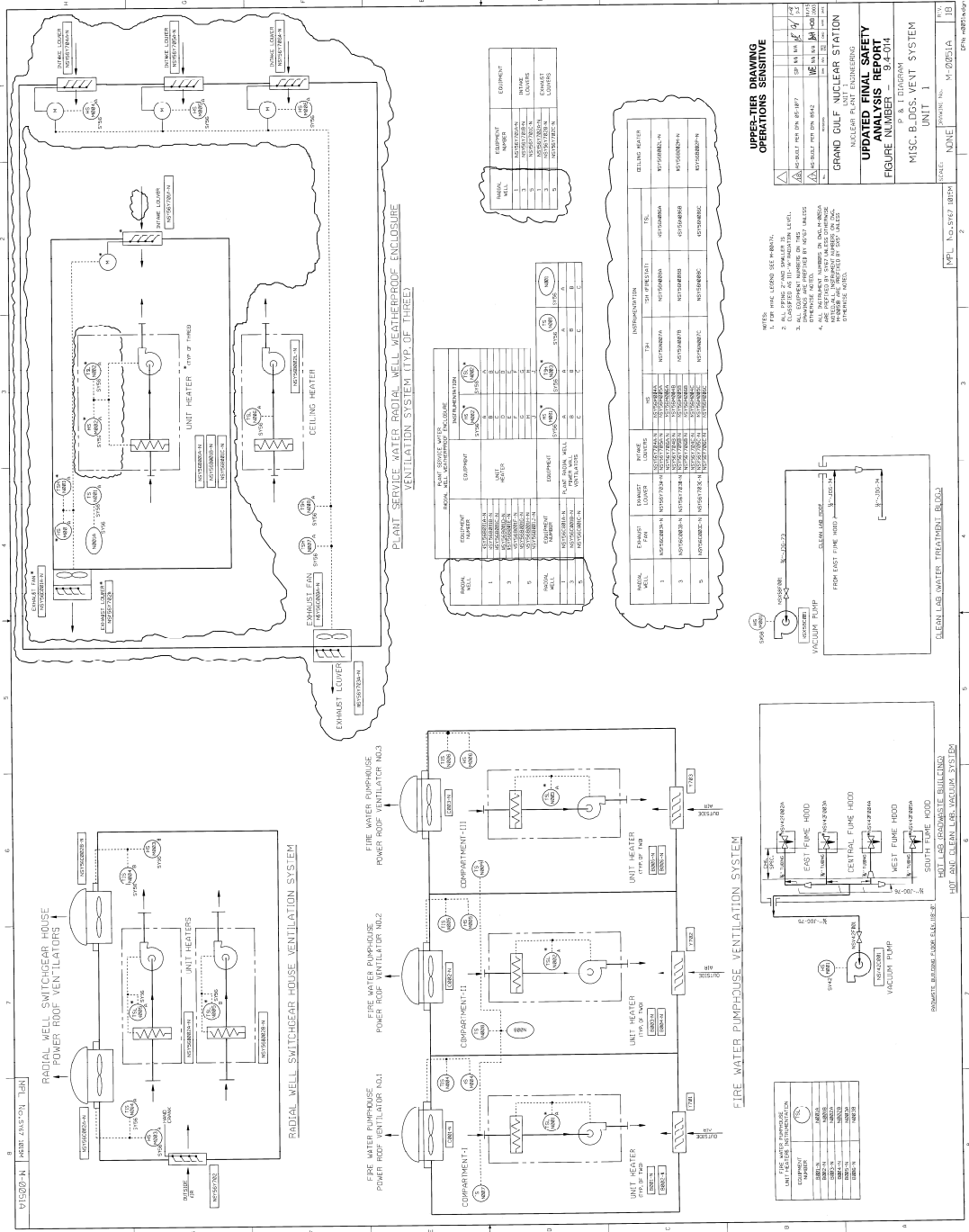

GRAND GULF NUCLEAR GENERATING STATION

Updated Final Safety Analysis Report (UFSAR)

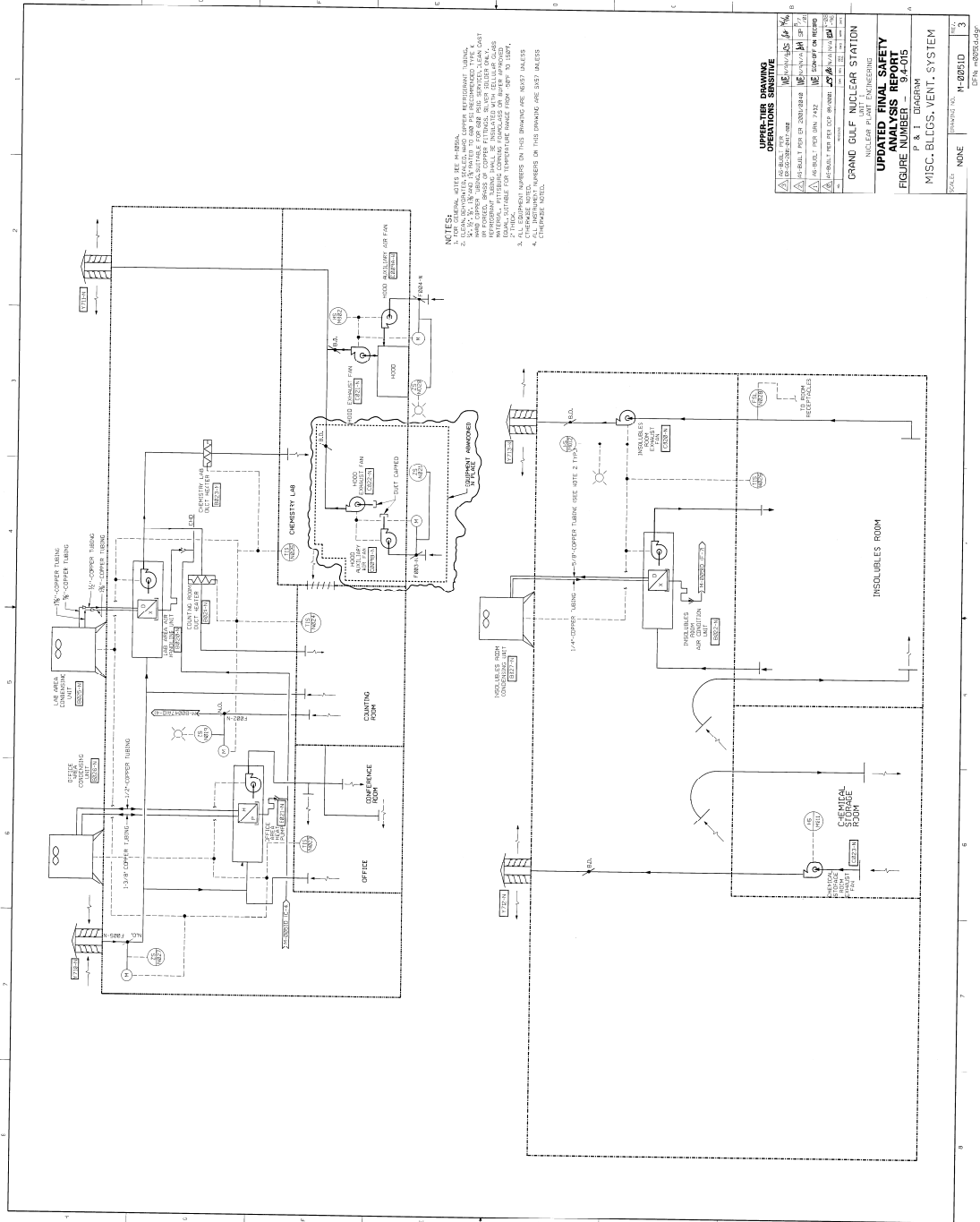

GRAND GULF NUCLEAR GENERATING STATION

Updated Final Safety Analysis Report (UFSAR)

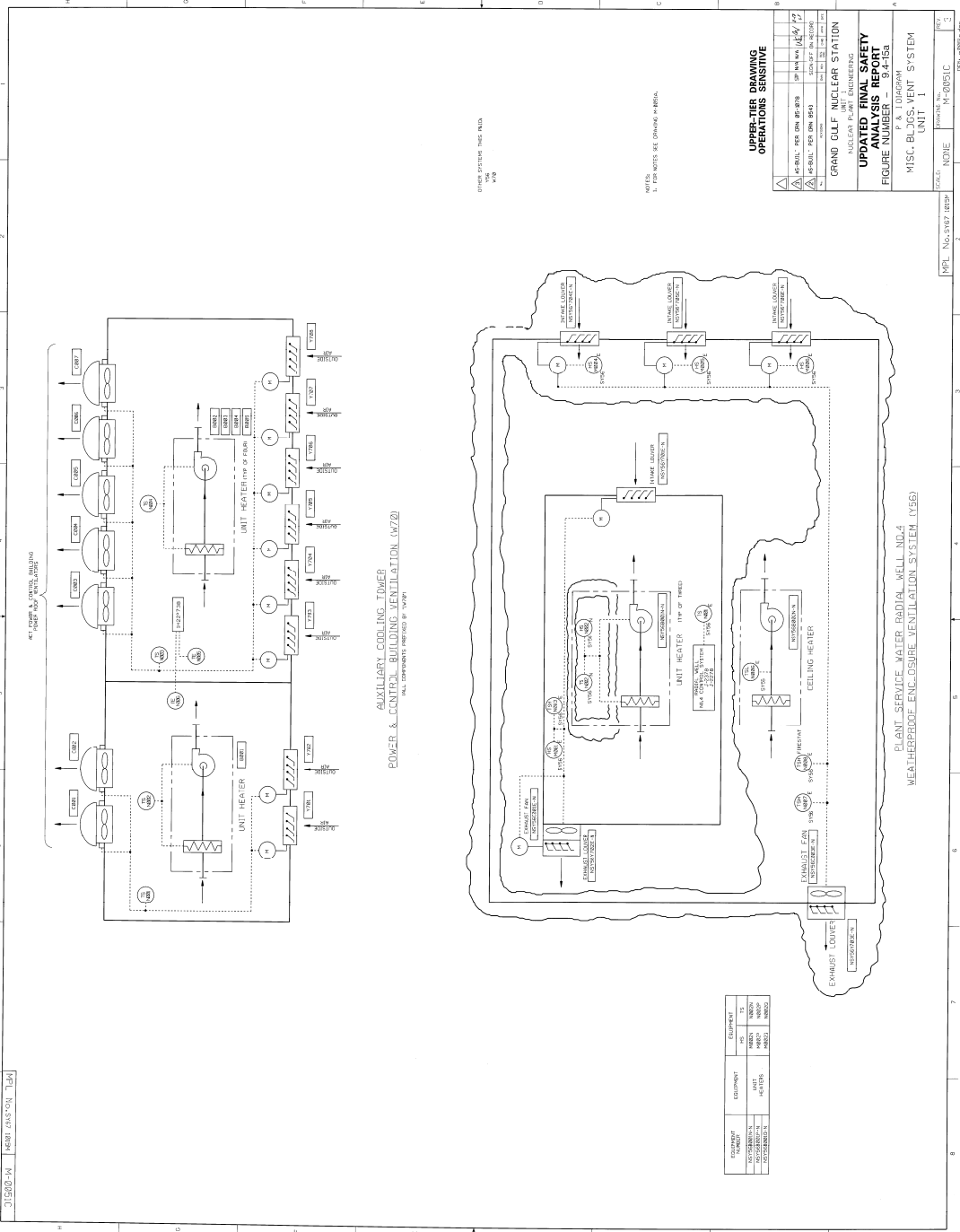

GRAND GULF NUCLEAR GENERATING STATION

Updated Final Safety Analysis Report (UFSAR)

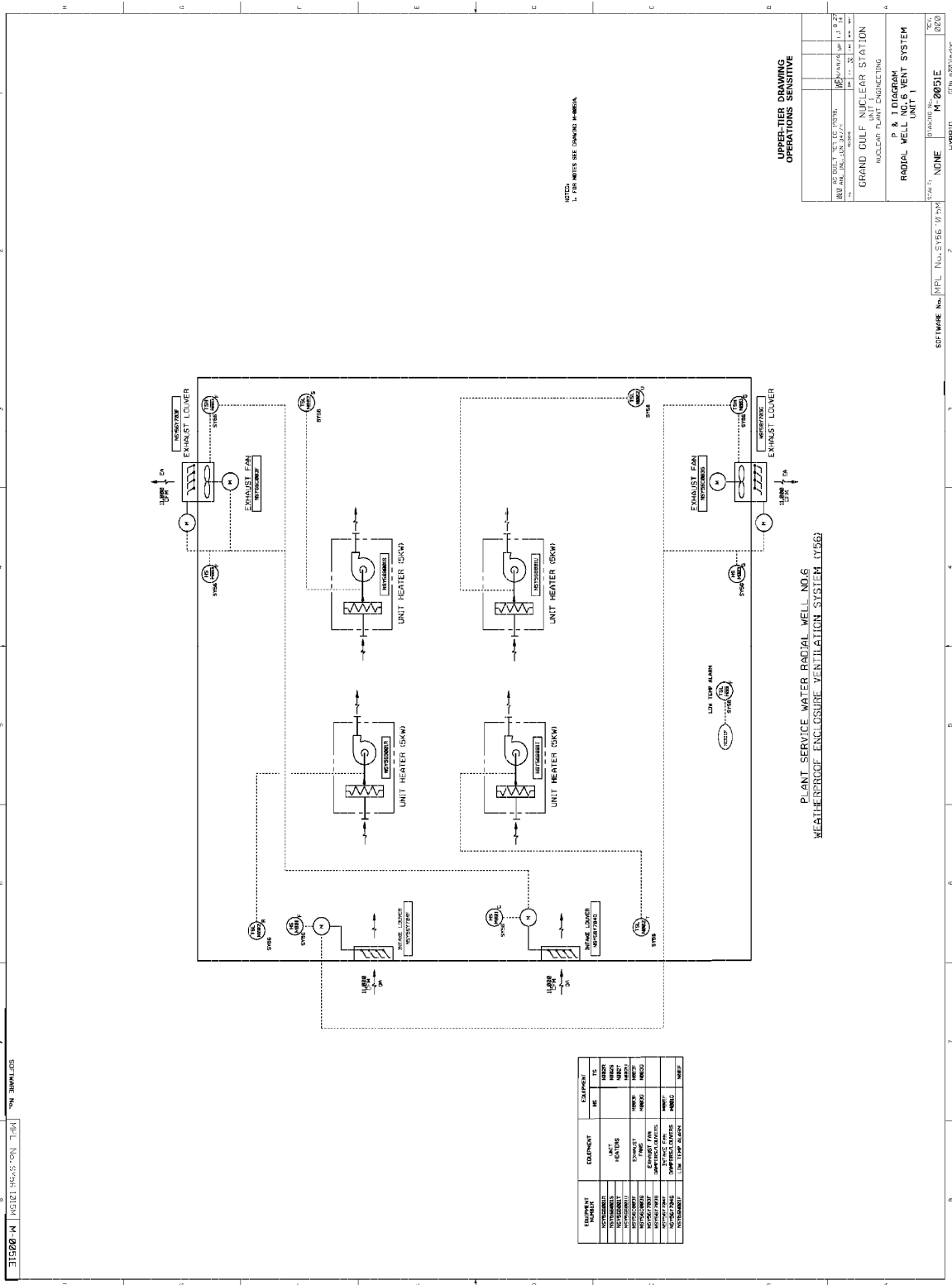

Equipment Number	Equipment Name	Equipment Type
UH-1	UNIT HEATER	HEATER
UH-2	UNIT HEATER	HEATER
UH-3	UNIT HEATER	HEATER
UH-4	UNIT HEATER	HEATER
EF-1	EXHAUST FAN	FAN
EF-2	EXHAUST FAN	FAN
EB-1	EXHAUST BLOWER	BLOWER
EB-2	EXHAUST BLOWER	BLOWER
LTA	LOW TEMP ALARM	ALARM

UPPER-TIER DRAWING
OPERATIONS SENSITIVE

DATE OF BUILDING SET OF PIPING	1978
DATE OF BUILDING SET OF ELECTRICAL	1978
DATE OF BUILDING SET OF MECHANICAL	1978
DATE OF BUILDING SET OF CIVIL	1978
DATE OF BUILDING SET OF CHEMICAL	1978
DATE OF BUILDING SET OF ENVIRONMENTAL	1978
DATE OF BUILDING SET OF SAFETY	1978
DATE OF BUILDING SET OF SECURITY	1978
DATE OF BUILDING SET OF UTILITIES	1978
DATE OF BUILDING SET OF WATER	1978
DATE OF BUILDING SET OF WASTE	1978
DATE OF BUILDING SET OF OTHER	1978

GRAND GULF NUCLEAR STATION
RADIAL WELL VENT SYSTEM
P & I DIAGRAM
UNIT 1
NUCLEAR PLANT ENGINEERING

DRAWING No. M-20051E
SCALE: NONE
HYBRID
SOFTWARE No. NPL No. 5156 (9) 10M
DATE: 01/20/14

Figure 9.4-16

Deleted

GRAND GULF NUCLEAR GENERATING STATION

Updated Final Safety Analysis Report (UFSAR)

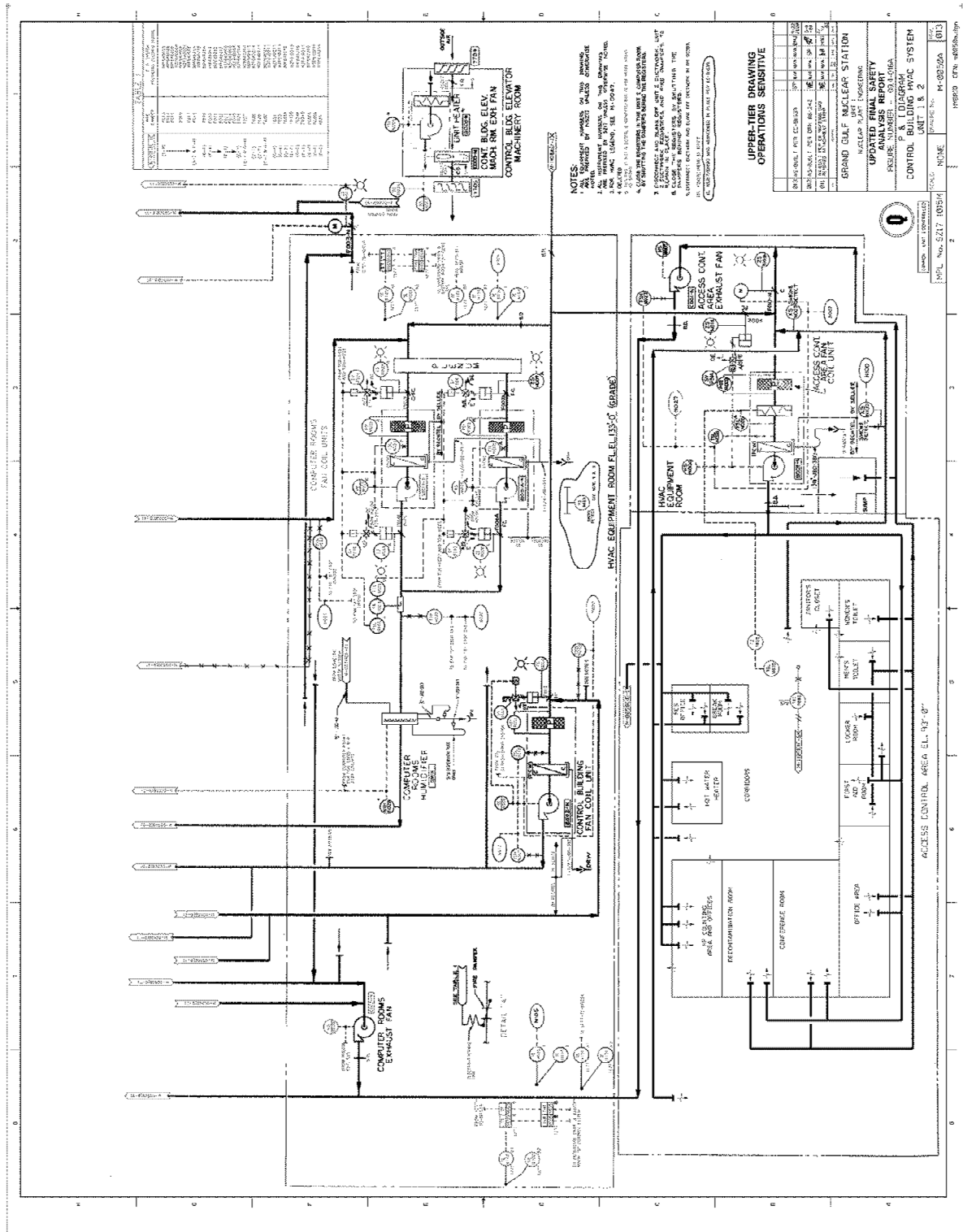

GRAND GULF NUCLEAR GENERATING STATION

Updated Final Safety Analysis Report (UFSAR)

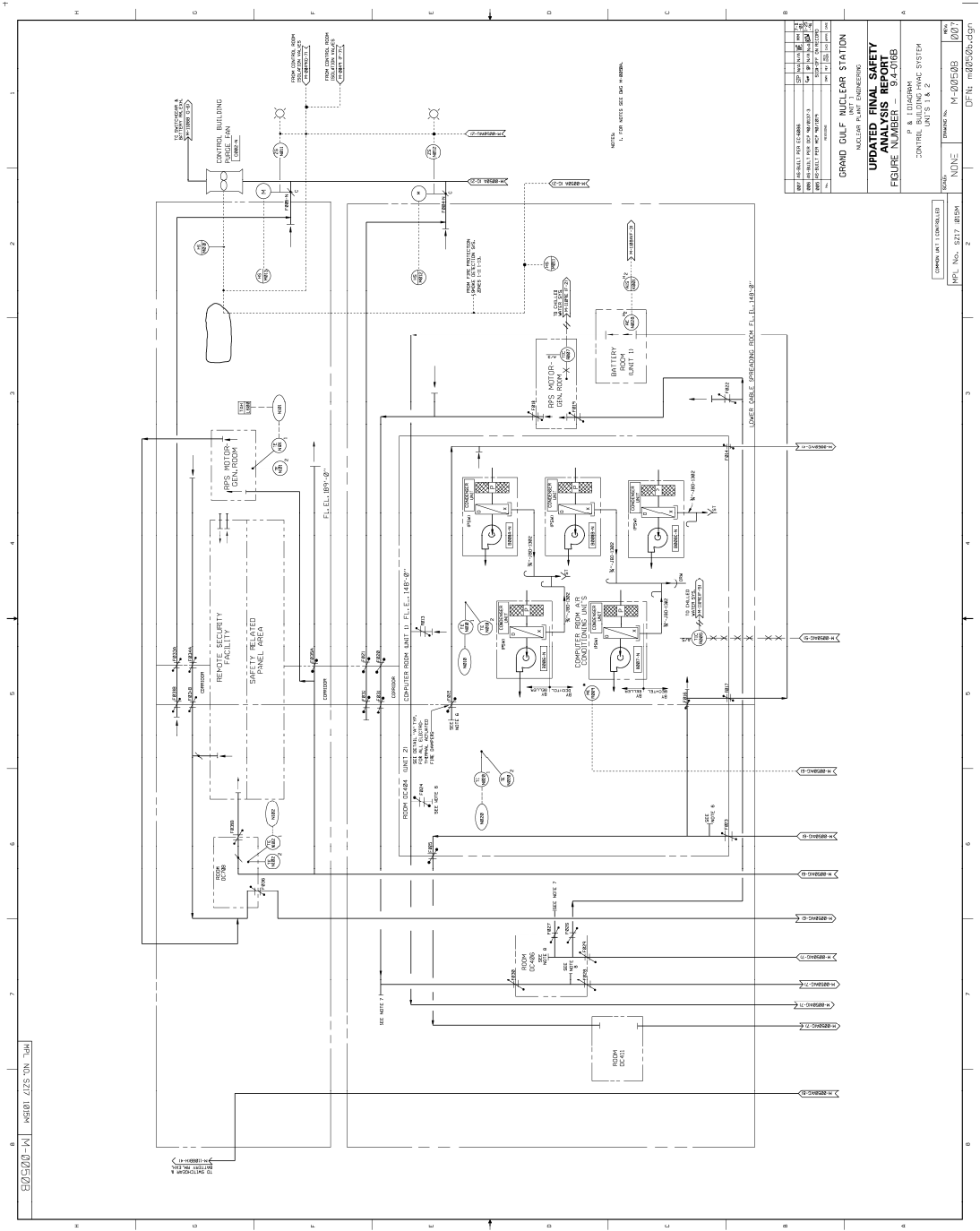

NO.	REVISION	DATE	BY	CHKD.
1	ISSUED FOR CONSTRUCTION	11/15/88
2
3
4

GRAND GULF NUCLEAR STATION
 NUCLEAR PLANT ENGINEERING
UPDATED FINAL SAFETY ANALYSIS REPORT
 FIGURE NUMBER — 9.4-008

CONTROL BUILDING PANEL FAN CONTROL SYSTEM
 UNIT'S 1 & 2

CONTROL NO. 2177
 M-202508
 NONE

DFN: m202508.dgn

GRAND GULF NUCLEAR GENERATING STATION

Updated Final Safety Analysis Report (UFSAR)

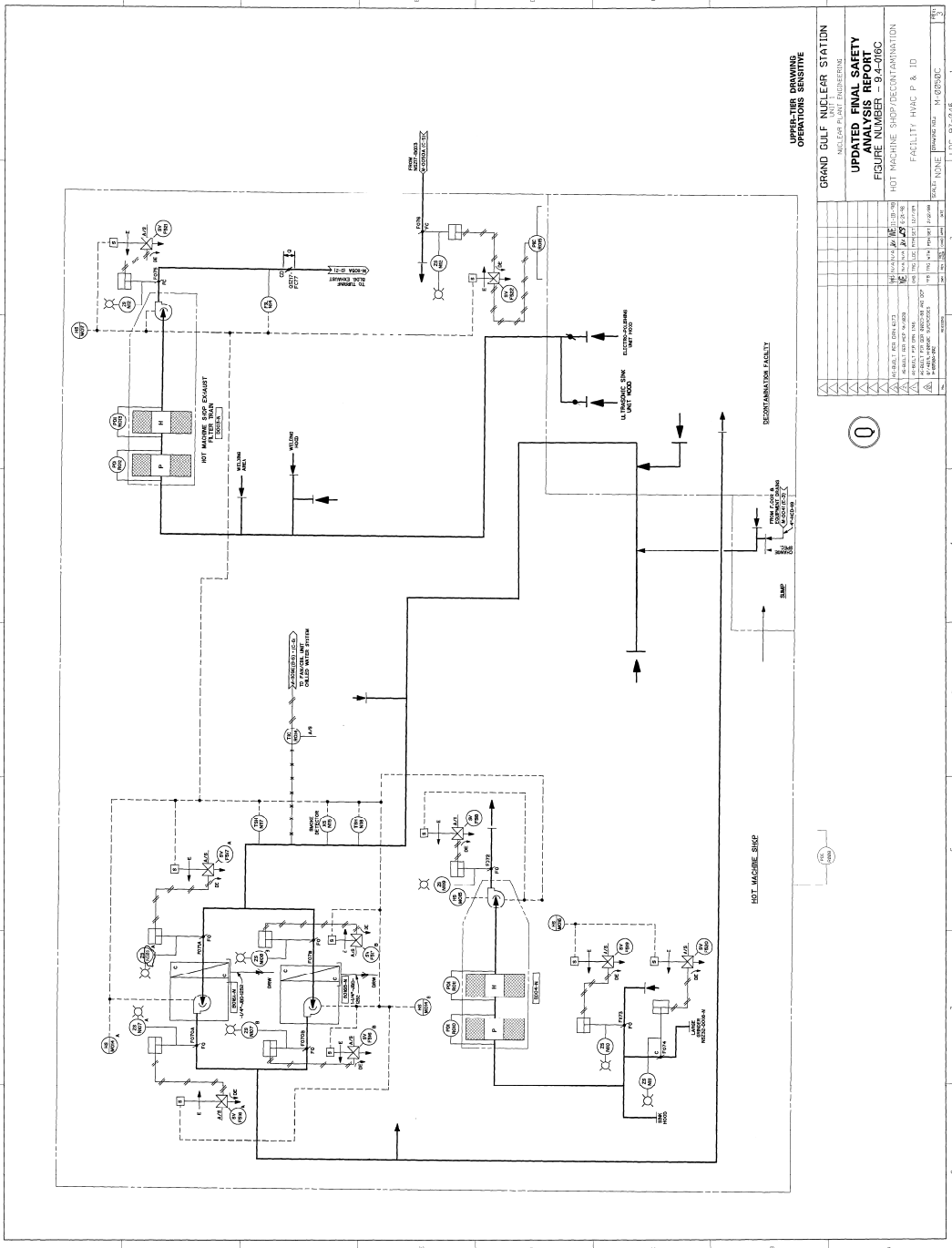

GRAND GULF NUCLEAR STATION NUCLEAR PLANT ENGINEERING OPERATIONS SENSITIVE	
UPDATED FINAL SAFETY ANALYSIS REPORT FIGURE NUMBER - 9.4-144	
HOT MACHINE SHOP/DECONTAMINATION FACILITY HVAC P & ID	
DATE: 10/15/16	DRAWN BY: J. J. ...
CHECKED BY: ...	APPROVED BY: ...
SCALE: NONE	SHEET NO.: 144
PROJECT NO.: 144	DRAWING NO.: 144
FACILITY: NONE	REVISION NO.: 144
DATE: 10/15/16	DRAWN BY: J. J. ...
CHECKED BY: ...	APPROVED BY: ...
SCALE: NONE	SHEET NO.: 144
PROJECT NO.: 144	DRAWING NO.: 144
FACILITY: NONE	REVISION NO.: 144

GRAND GULF NUCLEAR GENERATING STATION
Updated Final Safety Analysis Report (UFSAR)

9.5 OTHER AUXILIARY SYSTEMS

9.5.1 Fire Protection System

9.5.1.1 Design Bases

The bases for the design of the fire protection program are presented herein and in the Fire Hazards Analysis Report, Specification No. M-500.0 (see Appendix 9A). An overview of the Fire Hazards Analysis Report is presented in subsection 9.5.1.3. The intent is to provide a defense-in-depth principle by achieving an adequate balance in:

- a. Preventing a fire from starting.
- b. Quickly detecting and extinguishing fires that occur, thus limiting fire damage.
- c. Designing safety-related systems so that a fire that occurs and burns out of control for considerable length of time, will not prevent safe shutdown.

In addition, fire protection systems are designed so that inadvertent operation or failure of any of these systems will not impair safety-related systems.

Fire protection system water and carbon dioxide pipelines, which penetrate the auxiliary buildings, are provided with redundant isolation valves at each penetration. As discussed in Section 6.2.3.2, these valves are not required to close to ensure the secondary containment design basis is maintained. The isolation valves are gagged open. At each fire water penetration, a 4-inch bypass pipeline around the isolation valves is provided. The 4-inch bypass line includes a 4-inch manual valve which can be operated locally or remotely. The isolation and bypass valves, with respective piping, are designed as seismic Category I.

Fire protection and the provision for use of public fire departments are addressed in subsections A.8 and B.4, respectively, of Table 9.5-11. A comparison of the Grand Gulf fire protection program with Appendix A to NRC Branch Technical Position APCSB 9.5-1 is presented in Table 9.5-11.

GRAND GULF NUCLEAR GENERATING STATION
Updated Final Safety Analysis Report (UFSAR)

Seismic design requirements are imposed on fire protection systems on an individual basis. Every fire protection system component, which may damage safety-related systems or components as a result of its collapse due to an earthquake, is designed with seismic supports to prevent such occurrence.

The following listed documents, codes, standards, and guidelines are referred to in the fire protection system designs:

- a. Documents from the American Nuclear Insurers (ANI):
 - 1. Basic Fire Protection for Nuclear Power Plants, April, 1976
 - 2. Specifications for Fire Protection of New Plant, ANI File No. NS-224

- b. Pamphlets of the National Fire Protection Association (NFPA):
 - 12 Carbon Dioxide Extinguishing Systems (1973 Edition)
 - 12A Halon 1301 Systems (1973 Edition)
 - 13 Sprinkler Systems, Installation (1975 Edition)
 - 14 Standpipe & Hose Systems (1974 Edition)
 - 15 Water Spray Fixed Systems (1973 Edition)
 - 20 Centrifugal Fire Pumps (1974 Edition)
 - 22 Water Tanks (1974 Edition)
 - 24 Outside Protection (1973 Edition)
 - 26 Supervision of Valves (1958 Edition)
 - 30 Flammable and Combustible Liquids Code (1973 Edition)
 - 37 Stationary Combustion Engines and Gas Turbines (1970 Edition)
 - 50 Standard for Bulk Oxygen systems at Consumer Sites (1974 Edition)
 - 50A Gaseous Hydrogen Systems at Consumer Site (1973 Edition)
 - 50B Standard for Liquefied Hydrogen Systems at Consumer Sites (1973 Edition)
 - 70 National Electrical Code (1975 Edition)
 - 72D Proprietary Protection Signaling Systems (1975 Edition)
 - 72E Automatic Fire Detectors (1974 Edition)
 - 75 Electronic Computer/Data Processing Equipment (1972 Edition)
 - 78 Lightning Protection Code (1968 Edition)

GRAND GULF NUCLEAR GENERATING STATION
Updated Final Safety Analysis Report (UFSAR)

80 Fire Doors and Windows (1974 Edition)
90A Air Conditioning and Ventilating Systems (1974 Edition)
92M Waterproofing and Draining of Floors (1972 Edition)
101 Code for Safety to Life from Fire in Buildings and Structures (1973 Edition)
196 Fire Hose (1974 Edition)
204 Guide for Smoke and Heat Venting (1968 Edition)
214 Water Cooling Towers (1971 Edition)
321 Basic Classification of Flammable Liquids (1973 Edition)
803 Nuclear Power Plants (1978 Edition)
NFPA 2001 Standard on Clean Agent Fire Extinguishing Systems

c. Southern Standard Building Code

d. Uniform Building Code

9.5.1.2 System Description

9.5.1.2.1 General Description

The fire protection system consists of an underground yard loop* with two 300,000-gallon nominal capacity (maximum usable capacity - 291,358 gallons) water storage tanks at atmospheric pressure, one electrically driven and two diesel-driven fire pumps (1500 gpm at 125 psig, 145 bhp, single-stage, split case, double suction, centrifugal), one jockey fire pump (30 gpm at 137 psig, 13-stage vertical centrifugal), fire water yard mains, hydrants, standpipes, hose stations, sprinklers, deluge spray systems, automatic clean agent suppression (a term used to encompass Halon 1301, Novec 1230, or similar fire suppression agent) systems, automatic and manual carbon dioxide systems, hydrogen detectors, ionization smoke detectors, photoelectric smoke detectors, heat sensors, ultraviolet flame detectors, manual and automatic alarm systems, fire barriers, fire stops, fire breaks, portable fire extinguishers, portable breathing apparatus, smoke and heat ventilation systems, and associated controls and appurtenances. A station fire truck is also located on-site. While included in various procedures and discussed in NRC correspondence (References 1-3), the fire truck is not used to satisfy any regulatory requirements.

The fire pumps are sized such that the maximum design system demand for any non-safety-related areas can be supplied by any two operating fire pumps. The maximum design demand of any sprinkler

GRAND GULF NUCLEAR GENERATING STATION
Updated Final Safety Analysis Report (UFSAR)

or deluge system is 2717 gpm required for turbine building sprinkler system N1P64D129 or N2P64D129. The 2717 gpm demand with an additional 1000 gpm demand included for manual hose streams (a total of 3717 gpm) can be met if a 110.2 psig pressure is available at the pump discharge. Two fire pumps can deliver 3717 gpm at a discharge pressure of 110.2 psig.

* The Northeast corner of the yard loop is above the ground piping that is routed through the Unit 2 Turbine Building.

GRAND GULF NUCLEAR GENERATING STATION
Updated Final Safety Analysis Report (UFSAR)

The maximum design demand of any sprinkler or deluge system covering safety-related equipment is that of the diesel generator building preaction sprinkler system N1P64D142A, B, C or N2P64D142A, B, C. The 987 gpm demand of this system with an additional demand of 500 gpm included for manual hose streams (a total of 1487 gpm) can be met with a single fire pump running.

The fire fighting water is taken from the two water storage tanks, which are supplied by plant service water. If the water level in either tank drops below a set level, solenoid-operated valves in the 8-inch lines from the plant service water system open, allowing a minimum flow rate of 625 gpm to the storage tanks. At the flow rate of 625 gpm, either storage tank can be refilled from empty in less than 8 hours. The fire pump suction piping is arranged so that any pump can take suction from either water storage tank. An outside hose header test manifold equipped with six hose valves is provided. The fire protection water supply does not provide any water for construction use.

The Condensate and Refueling Water Storage and Transfer (CRWST) system (P11) is utilized as the normally aligned water supply to all fire suppression systems located inside of Containment to minimize suppression pool contamination. These fire suppression systems consist of 2 manually actuated containment cooling system charcoal filter train deluge systems and 13 hose stations. Any fire suppression system inside containment would require action by the plant personnel before it would operate.

The condensate and refueling water storage and transfer system utilizes one continuously running 600 gpm pump. Upon sensing high flow in the containment fire protection supply, a flow switch initiates closure of valves in three of the four branch lines to divert flow to the fire protection supply. The line that is not isolated supplies a maximum of 45 gpm to the seal steam generator and various other insignificant loads. If the fire demand is greater than the capability of the single pump, the standby pump will automatically start on low discharge pressure; an approximately 1200 gpm supply is then available for fire fighting; however the plant fire protection water system (backup fire water source) is the supply which is credited to meet the requirements for a Fire Suppression Water System in containment. The largest postulated fire protection demand would be 135 gpm for one of the charcoal filter train deluge systems and a 500 gpm demand for hose streams for a total of 635 gpm. Therefore, with both pumps operating, sufficient flow is

GRAND GULF NUCLEAR GENERATING STATION
Updated Final Safety Analysis Report (UFSAR)

available. Should the fire last for 2 hours, a total of 76,200 gallons would be required. Since 45 gpm of flow is diverted to the Seal Steam Generator during this period this requires an additional 5,400 gallons of water, resulting in a use of 81,600 gallons of water. The condensate tank has a storage capacity of 300,000 gallons; 130,000 gallons of this storage capacity is available for fire fighting. Therefore, a sufficient quantity of water is also available.

The plant fire protection water system (P64) is available to supply water to the Containment fire suppression systems if the CRWST system is lost or degraded. A normally dosed cross connection from the plant fire protection water system to the condensate and refueling water storage and transfer system has been provided just outside of Containment as the backup fire water source. By re-aligning three manually operated valves, as shown on Figures 9.5-2 and 9.2-16, a continuous water supply to all fire suppression systems inside containment would be maintained. The plant fire protection water system (backup fire water source) is the supply which is credited to meet the requirements for a Fire Suppression Water System in containment.

The fire protection system is designed to operate and/or fail without inducing failure of engineered safety features. No electrically conductive fire extinguishing agent is automatically released on relays, switchgear, motor control center, or other critical safeguard equipment unless safe shutdown capability can be maintained with the loss of the equipment.

Electrical safety-related divisions and electrical cable protection are addressed in the Fire Hazards Analysis Report. Areas and rooms within the station which contain electrical cables or components of the two electrical divisions, which can independently be used to shut down the nuclear reactor safely, are discussed in the Fire Hazards Analysis Report.

Ventilation systems, including smoke and heat removal systems, are discussed in Table 9.5-11, Section D.4, and the individual system descriptions in Sections 6.4 and 9.4.

9.5.1.2.2 System Operation

9.5.1.2.2.1 Water Supply

The function of the jockey fire pump is to replace normal system leakage and maintain system pressure sufficiently high to

GRAND GULF NUCLEAR GENERATING STATION
Updated Final Safety Analysis Report (UFSAR)

preclude continuous or frequent operation of the main fire pumps. Three main fire pumps ensure the full required water flow with one pump out of service. In the event that a demand in excess of the jockey pump discharge capacity is placed on the fire water system, a low pressure switch will automatically start the electric motor-driven fire pump. If the electric motor-driven pump fails to start or cannot maintain system pressure, a low pressure switch will automatically start a diesel engine-driven fire pump. If the first diesel-driven pump fails to start or cannot maintain system pressure, a low pressure switch will automatically start the second diesel-driven fire pump. Both diesels are started by their own self-contained batteries.

Fire pump running, fire pump stopped, loss of power to the electric motor-driven fire pump, loss of battery charge on the diesel-driven fire pumps, as well as several other operational mode equipment failures, are indicated in the control room. The fire pumps are periodically tested in accordance with the requirements of Technical Requirements Manual (TRM) Section 6.2.

The electric motor-driven fire pump is supplied power through a motor control center located in the water treatment building. The power supply circuit to the electric motor-driven fire pump is protected by a load center supply circuit breaker, a load center feeder circuit breaker, and an electric fire pump motor controller circuit breaker. Selection and setting of the protective trip devices for the aforementioned circuit breakers is in accordance with the guidance provided in NFPA 20-1978 and has been approved for Grand Gulf's use by ANI. |

The electric fire pump motor controller circuit breaker provides for instantaneous short circuit protection and time delayed locked rotor current protection. The trip setting (adjusted to the manufacturer's recommendation) does not permit a circuit breaker trip at locked rotor current (LRC) unless LRC is sustained for at least 13 to 19 seconds. Locked rotor current (1050 amps) would be supplied for two to three times the normal starting time (5 to 6 seconds), permitting the normal starting of the motor without tripping the electric fire pump motor controller circuit breaker. This protective trip setting meets the guidance provided in NFPA 20: the electric fire pump motor controller circuit breaker shall have a time delay of not over 20 seconds, and the breaker shall permit normal starting of the motor without tripping.

GRAND GULF NUCLEAR GENERATING STATION
Updated Final Safety Analysis Report (UFSAR)

Additional short circuit and cable protection is achieved by providing protective trips of the load center supply circuit breaker and the load center feeder breaker. The load center supply circuit breaker will not trip unless the sum of the LRC and the total of the other full load currents from loads connected to the load center are maintained for at least 40 to 65 seconds. The load center feeder breaker (which feeds the electric fire pump controller) will not trip unless LRC is maintained for at least 27 to 40 seconds. Therefore, the load center supply and the load center feeder circuit breakers will not open earlier than the electric fire pump motor controller circuit breaker.

With the exception of a portion routed through the northeast corner of the Unit 2 Turbine Building, an outside, 12-inch cement-lined, cast iron, underground yard loop surrounds the entire power block and provides water to hydrants, wet standpipes, hose stations, deluge spray systems, and sprinkler systems. Post-indicator valves are provided for isolating portions of the systems, as required. Fire fighting water system valves have electrical supervision or a locking device and tamper-proof seals, and are periodically inspected in accordance with the requirements of Technical Requirements Manual (TRM) Section 6.2. Two-way hydrants are provided on the yard main at approximately 250-foot intervals. Each fire hydrant is provided with an isolation valve in order to isolate the hydrant in the event of physical damage and/or mechanical malfunction. Provided for each hydrant is a hose house equipped with 250 feet of 2-1/2-inch, lined fire hose, two 2-1/2-inch adjustable spray nozzles, one pry bar, spanner wrenches, adjustable hydrant wrenches, and one fire axe. The fire water pumps are capable of providing water to any point in the station with the shortest leg of the main fire water loop out of service.

The fire water system in the control building functions primarily as a backup fire fighting source. The water supply to the diesel generator building provides both the primary and backup fire fighting source. The water suppression systems and standpipes in the control building are supplied from a single connection from the underground fire water loop. The water suppression systems and standpipes in the diesel generator building are supplied from a single connection from the underground fire water loop. Therefore, a single line break in the loop connection would only negate all permanent water fire suppression systems in the respective buildings. However, a number of alternative backup measures are available in such an event.

GRAND GULF NUCLEAR GENERATING STATION
Updated Final Safety Analysis Report (UFSAR)

Located adjacent to the diesel generator building are outdoor hose houses. Section valves in the underground fire loop allow yard fire hydrants to operate even if the single building connection is lost due to a break in the line. In addition to the outdoor hoses, multiple 1-1/2 inch hose streams are accessible to the diesel generator building from the auxiliary building.

In the event that a break occurred in the control building fire water loop connection, operation of the gaseous fire suppression systems would not be affected. Portable water extinguishers are available throughout the building and provide a backup to the gaseous suppression system. Areas normally served by water suppression systems can be reached by multiple 1-1/2 inch hose streams from the turbine building. A hose connection has been installed in the standby fresh air filter deluge connections to enable connecting the turbine building fire hose and utilizing the turbine building fire loop as a deluge source.

GRAND GULF NUCLEAR GENERATING STATION
Updated Final Safety Analysis Report (UFSAR)

9.5.1.2.2.2 Hose Stations

Wet standpipe hose stations are located throughout the plant in strategic locations to ensure hose stream plant coverage and to serve as backup for fixed suppression systems. Hose stations have 50, 75, 100, or 125 feet of 1-1/2-inch, lined hose, as deemed necessary, and an adjustable nozzle. Hose stations in areas that contain dry nuclear fuel have fixed non-fogging nozzles. The fire brigade training includes the use of fixed or adjustable nozzles on various possible fires. Typical hose stations and their approximate locations are shown in Figure 9.5-4.

9.5.1.2.2.3 Sprinkler Systems

Wet-pipe sprinkler, dry-pipe sprinkler, and pre-action sprinkler systems with fusible heads are provided within the plant as indicated in the Fire Hazards Analysis Report. The wet-pipe sprinkler and dry-pipe sprinkler systems are activated by melting of the fusible element due to sufficiently high ambient temperature. Automatic sprinkler systems protect the cable spreading rooms. Operation of a sprinkler system is signaled in the control room. The pre-action sprinklers include fixed temperature sensors. Upon sensing high ambient temperature, the manual pre-action systems signal the condition locally and in the control room so that an operator will know to investigate and determine whether or not to activate the system; the automatic pre-action systems are activated simultaneously with the signaling actions. The automatic pre-action systems may be manually operated. Localized high ambient temperatures melt the fusible element of sprinkler heads, so that the activated water flow will reach the areas on fire. All wet-pipe, dry-pipe, and pre-action sprinkler systems providing primary protection are designed and installed in accordance with NFPA 13. Also, all automatic sprinkler systems providing primary protection for redundant safe shutdown-related raceways have additional sprinkler heads located below obstructions such as ducts and

GRAND GULF NUCLEAR GENERATING STATION
Updated Final Safety Analysis Report (UFSAR)

cable trays. This configuration is shown in Figure 9.5-27. A piping and instrumentation diagram of the sprinkler systems is given in Figures 9.5-1, 9.5-2, and 9.5-7 through 9.5-8e.

9.5.1.2.2.4 Deluge Spray Systems

Hydraulically designed deluge spray systems with open spray nozzles are provided within the plant. With the exception of HVAC charcoal filter train systems, fixed temperature heat sensors detect high ambient temperature and activate the system automatically. Independent alarms are also given for these systems. The HVAC charcoal filter train systems can be manually activated after a high ambient temperature is detected by fixed temperature sensors and alarmed on the security and fire protection system console. Manual actuation of all deluge spray systems can be accomplished locally. Operation of a deluge spray system will alarm in the control room and locally. Water spray density is in accordance with NFPA 15. Deluge spray systems which protect engineered safety feature transformers include a deluge valve installed outside of the area protected by the respective system. A piping and instrumentation diagram of the deluge spray water systems is presented in Figures 9.5-1, 9.5-2, and 9.5-7 through 9.5-8d.

9.5.1.2.2.5 Gaseous Extinguishing Systems

Manual carbon dioxide, automatic carbon dioxide, or automatic clean agent total flooding gaseous extinguishing systems are provided where water is not a feasible fire fighting agent due to the presence of non-waterproof electrical components. These areas are noted in the Fire Hazards Analysis Report. The manual carbon dioxide systems include rate compensated temperature sensors which, upon sensing a high rate of temperature rise or a high ambient temperature, alarm locally and in the control room so that an operator is alerted to investigate and determine whether or not to activate the system. Rate compensated heat detectors activate the automatic carbon dioxide systems and the automatic clean agent systems. Where required to maintain concentrations, automatic controls close ventilation ductwork and doors, so that an adequate concentration of extinguishing agent is contained within the protected area. Carbon dioxide gas is stored in bulk quantity outdoors, separated from buildings. A carbon dioxide extinguishing system is designed to achieve a concentration of 50 volume percent. A concentration of 30 volume percent will be

GRAND GULF NUCLEAR GENERATING STATION
Updated Final Safety Analysis Report (UFSAR)

maintained for not less than 20 minutes. Carbon dioxide storage capacity is sufficient to provide two actuations of the largest system.

Halon 1301 for the computer room systems is stored in pressurized bottles located outside, but adjacent to the room protected. Clean agent media for the PGCC systems is stored in pressurized bottles located inside the end of the control cabinets in the control room and the control cabinet area (El. 190'). The pressurized bottles are provided with safety pressure relief valves. The computer room Halon 1301 systems are designed to provide a concentration of 5 volume percent in 10 seconds and maintain a concentration of 5 volume percent for a soak time of 10 minutes.

The PGCC clean agent suppression systems will provide an initial concentration for the extinguishment of a detected fire within 10 seconds. Additional clean agent will be provided and maintained to control the potential "deep seat" aspect of the protected hazard for a soak time of 20 minutes.

Prior to the automatic discharge of clean agent media or carbon dioxide into a room, a pre-discharge alarm is sounded and a control room alarm is provided to alert personnel of system activation. The local alarm provides personnel in the room with adequate time to evacuate the area prior to system discharge. Controls of the Halon 1301 systems are provided locally in the computer room to abort the automatic discharge of Halon, if necessary. Lockout switches are provided for the carbon dioxide systems covering the upper and lower cable spreading rooms and the remote shutdown panel rooms to prevent inadvertent actuation while these areas are occupied. The alarms in the control room, which indicate operation of any automatic gaseous fire suppression system, are initiated by control devices located outside of the respective fire area, except for the BOP computer room.

For purposes of detection, alarm, and suppression within the control room, the PGCC fire protection system is divided into fire protection zones. A fire protection zone provides fire detection, alarm, and suppression independently for each PGCC panel module.

A piping and instrumentation diagram of the gaseous extinguishing systems is presented in Figures 9.5-5 and 9.5-6.

GRAND GULF NUCLEAR GENERATING STATION
Updated Final Safety Analysis Report (UFSAR)

9.5.1.2.2.6 Hydrogen Detection

Hydrogen gas concentration detectors are included to sample the atmosphere in each battery room in the control building. The battery room hydrogen gas detector units continuously monitor ambient air, and upon detecting a hydrogen gas concentration of 2 percent or more, the units signal in the control room. The hydrogen water chemistry system includes four hydrogen gas concentration detectors, with two attached to the hydrogen flow control rack and the ceiling mounted above the injection point into condensate. These detector units continuously monitor ambient air, and upon detecting a hydrogen gas concentration in air of 2 percent or more, the units isolate the hydrogen supply line which would result in an HWC system trouble signal in the control room. Hydrogen gas detector units are also provided for the hydrogen offgas system and containment drywell. These units also signal a high hydrogen concentration in the control room.

9.5.1.2.2.7 Smoke and Flame Detection

Smoke detectors, heat detectors, and ultraviolet flame detectors are located as indicated in the Fire Hazards Analysis Report. The smoke, heat, and flame detectors provide early warning capability to permit prompt action by the onsite fire brigade. The smoke, heat, and flame detectors signal in the control room and locally, but do not activate fire protection equipment except for the sliding fire door located between the remote shutdown panel rooms. The smoke detectors in the remote shutdown panel rooms activate an electro-thermal link, thereby shutting the automatic fire door between the two divided panels. Several detectors are connected to each zone module; a signal from a detector identifies the respective zone. Proper functioning of each detector circuit is continuously monitored; malfunction is annunciated.

Area coverage by smoke detectors, heat detectors, or ultraviolet flame detectors is provided in all areas of seismic Category I structures that contain or present an exposure fire hazard to safe shutdown or safety-related systems or components as described in the Fire Hazards Analysis Report. Non-seismic Category I structures do not contain any equipment required for safe shutdown. The minimal amount of safety-related equipment located in non-seismic Category I buildings (the turbine, water treatment, and radwaste buildings) is designed to fail safe or to fail in a manner that does not compromise any required safety functions.

GRAND GULF NUCLEAR GENERATING STATION
Updated Final Safety Analysis Report (UFSAR)

Activation of one or more detectors results in the following:

- a. Visual indication at each signaling detector in the form of an integral light.
- b. Local audible annunciation by means of fire bells.
- c. Visual and audible alarms at the local smoke detection panel.
- d. Visual and audible annunciation in the control room through the security and fire protection system monitoring console. In addition, the area where the signaling detector is located is identified through a CRT display in the control room.

9.5.1.2.2.8 Manual Fire Alarms

Pull-type alarms are manually activated by personnel and signal locally and in the control room. The alarms are divided into the same zones as the detectors; the signal from an alarm identifies the respective zone in the control room.

9.5.1.2.2.9 Fire Barriers

Fire walls and fire barriers are provided as indicated in the Fire Hazards Analysis Report. Fire-rated penetration seals are provided, as necessary, to maintain the integrity of fire walls. Fire barriers are capable of containing the effects of possible fires for the minimum amount of time for which the barrier is rated. Fire breaks are located in vertical electrical cable raceways, not more than 20 feet apart, to prevent the spread of a possible fire by means of electrical cable.

In safety-related or high hazard areas, floor and ceiling structures and supports designated as rated fire barriers are composed of normal weight concrete over galvanized metal decking formwork. Minimum slab thickness is 4-1/2 inches for a 2-hour rated fire barrier and 5-1/4 inches for a 3-hour rated fire barrier; this is in accordance with UL design numbers D902 and D916. Moreover, in the areas noted above, the fire rated walls are constructed in accordance with the Standard Building Code and UL design numbers U904 and U905.

GRAND GULF NUCLEAR GENERATING STATION
Updated Final Safety Analysis Report (UFSAR)

All electrical, piping, tubing, and duct penetrations through fire rated floors and walls are filled to a depth which meets the thicknesses verified by actual fire tests which were witnessed and certified by an independent fire testing agency. Fire barrier closures are designed to withstand a 3-hour fire and are tested in accordance with ANI and Mutual Atomic Energy Reinsurance Pool standards.

During the cable penetration tests, cables were tied to the cable trays with the same ties that are used in Grand Gulf. An assortment of ties were used so that flexibility in procurement would be guaranteed. The cable tray supports utilized for the test were external to the test furnace being mounted on the unexposed side of the test slabs. This mounting simulated actual field installations in that the exposed sections of tray would be held in place during an actual fire by the unexposed sections of the tray system.

Concrete joint sealers and fillers were subjected to 3-hour fire and hose-stream tests in accordance with the ASTM E 119 test setup. The tests were performed by an independent laboratory using materials and construction details representative of those used at Grand Gulf. Figure 9.5-28 shows the concrete slab detail used with four joints completely penetrating the slab. One side of the slab was exposed to a 3-hour fire in accordance with ASTM E 119. Temperature rise on the unexposed surface was within the requirements of ANI. No flame-through occurred, and no water penetrated the joints during the hose-stream tests; therefore, all ANI requirements were satisfied.

Structural steel required for the support of floor/ceiling fire barriers in safety-related buildings is protected as required by the Fire Hazards Analysis Report. Fireproofing of structural steel is provided to meet applicable designs which are tested and listed by a recognized independent testing laboratory.

9.5.1.2.2.10 Portable Extinguishers

Portable fire extinguishers are strategically located throughout the plant, as indicated in the Fire Hazards Analysis Report. Portable fire extinguishers are selected for an area after an evaluation of the type of combustibles present, in order to properly match the type of extinguisher to the service required. Water extinguishers are strategically located for use in spaces which contain safe shutdown-related equipment.

GRAND GULF NUCLEAR GENERATING STATION
Updated Final Safety Analysis Report (UFSAR)

9.5.1.2.2.11 Breathing Apparatus

Portable breathing apparatus and required appurtenances are available to the fire brigade. The breathing apparatus are used by the fire fighters when fighting fires in smoke filled areas or in areas where a fire might cause substances to release dangerous gases and vapors.

9.5.1.2.2.12 Ventilation

Recirculating ventilation systems are designed to prevent spreading smoke and heat throughout the plant. Manual exhaust ventilation systems are available to remove smoke and heat.

Ventilation in each diesel generator bay is provided by an outside air fan which starts automatically when the diesel generator starts. Exhaust air from each diesel generator bay is through a common corridor. Fire detection, which alarms in the control room and locally, is provided in the diesel genera

tor building as described in subsection 9.5.1.2.2.7 and in the Fire Hazards Analysis Report. In the event of a fire in one of the diesel generator bays, administrative procedures require the control room operator to start the outside air fans in the unaffected bays. This minimizes the possibility of smoke from a fire in one diesel generator bay from filtering back into the other diesel generator bays through the exhaust openings in the common corridor.

Portable smoke ejection fans dedicated for use in removing smoke, hot air, and dangerous gases, and providing proper ventilation, have been provided for use by the plant fire brigade. The portable smoke ejectors are rated at 5000 c.f.m. and are powered by either a 115 V ac, 60 cycle, explosion proof motor or by a gasoline engine. A portable emergency generator has been provided to enable the usage of the electric driven portable smoke ejectors when offsite power is not available. These units are strategically located along with similar fire fighting equipment throughout the plant to facilitate quick and easy access by fire brigade members. Portable ducting, compatible for use with the emergency smoke ejectors, is also provided to enable removal of smoke and combustion products through a desired channel to the outside atmosphere.

GRAND GULF NUCLEAR GENERATING STATION
Updated Final Safety Analysis Report (UFSAR)

9.5.1.2.2.13 Power Supply

The fire protection and smoke detection systems are powered from several different types of plant distribution systems. These consist of: non-Class IE ac distribution (Note: the PGCC fire protection system is fed from non-Class IE ac distribution along with a fire control panel backup battery system), non-Class IE uninterruptible ac distribution (UPS), 125 V dc station batteries, and Class IE associated power supplies.

The non-Class IE power distribution system includes the 480 V load centers, MCCs, and 120 V power panels utilized for plant operation. The Class IE associated power supply includes 480 V MCCs.

The non-Class IE 120 V ac uninterruptible power is provided from 30 KVA inverters which are fed from non-Class IE batteries K and L. The chargers for these batteries are powered from Class IE load centers. There is an alternative ac feed directly from Class IE associated power in the event of inverter failure.

The dc control power is provided directly from non-Class IE dc distribution panels fed from batteries D and E. The chargers for these batteries are powered from Class IE load centers.

Non-Class IE chargers will be powered by the diesel generators in case of loss of offsite power. In this case, the above battery feed systems will be available for a time period in excess of the normal 2-hour battery capacity.

Power will be available to all fire protection/detection loads in all postulated fire situations, except for the electric fire pumps. These pumps are backed up by diesel-driven fire pumps, which will ensure adequate response to the hydraulic demands of the fire protection system in case of loss of power to electric fire pumps.

The primary power supply for the fire alarm system is via an inverter feed from the station's non-Class IE battery system. Under normal operating conditions, the battery loads are supplied by two 100 percent capacity battery chargers which are in turn powered from the Class IE ac distribution system. In the unlikely event of a total failure of this battery charger-battery-inverter combination, an automatic transfer switch will connect the power feeder to a Unit 1 Class IE transformer when Unit 2 is under construction and to a Unit 2 inverter after Unit 2 is

GRAND GULF NUCLEAR GENERATING STATION
Updated Final Safety Analysis Report (UFSAR)

operational. Provision has also been made to allow a manual transfer (via a permanently installed transfer switch) to the alternate Class IE ac source for maintenance purposes. Power will thus be available to the alarm system at all times with a possible exception during a LOCA. In case the system is being fed from the Unit 1 Class IE source (an alternate power supply while Unit 2 is under construction) and a LOCA signal occurs, the fire alarm system would be automatically shed from the Class IE supply. For this to occur, however, the situation would be that the normal inverter-battery-battery charger combination fails concurrent with a LOCA (while Unit 2 is under construction). Since fires are not postulated concurrent with a LOCA and since, even then, it would take a second failure to jeopardize the system power, power to the fire alarm system will be available for all postulated fire situations.

9.5.1.3 Safety Evaluation

[HISTORICAL INFORMATION] [The Grand Gulf fire protection program (including the fire protection systems design) is generally based on compliance with the positions of Appendix A to NRC Branch Technical Position (BTP) APCS 9.5-1, dated August 23, 1976 (for plants under construction before July 1, 1976). A point-by-point comparison of the Grand Gulf fire protection program and the positions of Appendix A to BTP APCS 9.5-1 is presented in Table 9.5-11. An earlier preoperational fire hazards analysis (previously presented in Appendix 9A to this FSAR) was performed to substantiate the stated compliance and to demonstrate a level of fire protection sufficient to ensure that no single postulated fire would prevent the plant from being safely shut down.]

On October 27, 1980, the NRC approved a new rule concerning fire protection as applied to nuclear power plants. This rule and its Appendix R, "Fire Protection Program for Nuclear Power Facilities Operating Prior to January 1, 1979," established the minimum acceptable fire protection requirements necessary to resolve certain areas of concern to the NRC staff and licensees of plants operating prior to January 1, 1979. A point-by-point comparison of the Grand Gulf fire protection program and the requirements of 10 CFR 50, Appendix R Sections II and III, is presented in Table 9.5-12.

GRAND GULF NUCLEAR GENERATING STATION
Updated Final Safety Analysis Report (UFSAR)

As noted in the Safety Evaluation Report (NUREG 0831), the NRC Staff's SER concluded, based on evaluation of the fire protection program and related commitments, that the fire protection program: 1) meets the applicable guidelines of the BTP, and 2) meets the intent of Appendix R.

To support the latter conclusion and to provide a fully documented review, GGNS undertook an Appendix R evaluation effort which more specifically addressed compliance with Appendix R requirements. This effort resulted in a new Fire Hazards Analysis Report, which has been submitted to the NRC under separate cover, and is maintained as a separately controlled plant document. This Fire Hazards Analysis Report summarizes an extensive safe shutdown analysis and evaluation of fire areas (as defined by Appendix R) containing safety-related equipment and concludes that no single fire will prevent the plant from being safely shut down and maintained in a safe shutdown condition. It shows that the Grand Gulf fire protection program still meets the guidelines of Appendix A to BTP APCS 9.5-1 and also meets the intent of Appendix R.

In the course of developing the Fire Hazards Analysis Report, with its more specific definition of equipment required for safe shutdown, safe shutdown methodology was closely scrutinized and the required safe shutdown systems list stated in the preoperational fire hazards analysis was refined to accurately reflect the minimum combination of systems (and components) necessary to shut down the plant and to maintain the plant in a safe shutdown condition. The resultant systems (and components) are those required to maintain water level in the reactor pressure vessel (RPV) following an isolation/scram, depressurize the RPV by discharging steam to the suppression pool, cool the suppression pool, and cool the RPV once it is depressurized, and the associated systems to maintain these functions.

These safe shutdown systems provide dual shutdown paths so that the reactor can be depressurized by the main steam/safety relief valves and water level maintained with low pressure ECCS, and also provide dual reactor cooling paths using the alternate shutdown cooling mode of RHR. These minimum required systems are as follows:

- o Nuclear Boiler System (main steam safety relief valves - a minimum of six valves, which can be operated from the remote shutdown panel, must remain functional).

GRAND GULF NUCLEAR GENERATING STATION
Updated Final Safety Analysis Report (UFSAR)

- o Residual Heat Removal Systems A and B: Suppression Pool Cooling, Alternate Shutdown Cooling, and LPCI Modes.
- o Standby Service Water Systems A and B.
- o Standby Diesel Generators A and B.
- o ECCS Rooms HVAC.
- o ESF Switchgear Rooms HVAC.
- o Standby Service Water Pump House HVAC.
- o Diesel Generator Rooms HVAC.
- o Main Control room HVAC, (While important to safe shutdown, a loss of cooling will not result in temperatures that disable components on the success path required for hot shutdown per GGNS-EE-11-00001 (FPP-1))
- o Remote Shutdown Panel System.
- o Portions of electrical distribution systems L11, L21, L51, L62, R28, R20, and R21 required to support the above systems.

Also required for safe shutdown is various instrumentation to monitor the plant response, and portions of the reactor protection system and control rod drive hydraulic system. Furthermore, to ensure that an exposure fire will not increase the probability of a loss of coolant accident, cables related to certain valves which constitute high/low pressure interfaces are also considered safe shutdown-related. Likewise required are certain components considered necessary to mitigate the consequences of concurrent fire-induced circuit failures and postulated multiple spurious operations. A detailed definition of all required systems, components, and devices is provided in the Fire Hazards Analysis Report and its supporting documentation. Attendant bases, criteria, and scope are also defined in the Fire Hazards Analysis Report; followed by a zone-by-zone review of safe shutdown equipment, in-situ and transient combustibles, separation distances and fire barriers, and fire detection and suppression capabilities.

An analysis of safe shutdown in the event of a major fire is discussed in Appendix 9C.

9.5.1.4 Inspection and Testing Requirements

Inspection and testing of fire protection systems and components prior to placement in service is discussed in Table 9.5-11, section C. Inspection and testing after systems and components are in operation, are discussed in Table 9.5-11, section C, in Appendix 9B and Technical Requirements Manual (TRM) Section 6.2.

9.5.1.5 Personnel Qualification and Training

Qualification and training of personnel are discussed in Table 9.5-11, section B, and Sections 9B.3 and 9B.10 of Appendix 9B.

9.5.1.6 Equipment Operability

Technical Requirements Manual (TRM) Section 6.2 contains the operability requirements for the fire protection system, the required actions to be taken when equipment is inoperable, and surveillance requirements. The bases for the requirements contained in Technical Requirements Manual (TRM) Section 6.2 are described in subsections 9.5.1.6.1 through 9.5.1.6.3. The Technical Requirements Manual (TRM) Section 6.2 requirements are implemented by GGNS plant procedures.

9.5.1.6.1 Fire Detection Instrumentation

Operability of the detection instrumentation ensures that both adequate warning capability is available for the prompt detection of fires and that fire suppression systems, that are actuated by fire detectors, will discharge extinguishing agent in a timely manner. Prompt detection and suppression of fires will reduce the potential for damage to safety-related equipment and is an integral element in the overall facility fire protection program.

In the event that a portion of the fire detection instrumentation is inoperable, increasing the frequency of fire watch patrols in the affected area(s), or zone(s), is required to provide detection capability until the inoperable instrumentation is restored to operability.

9.5.1.6.2 Fire Suppression Systems (Water, Spray and/or Sprinklers, Gaseous, and Fire Hose Stations)

The operability of the fire suppression systems ensures that adequate fire suppression capability is available to confine and extinguish fires occurring in any portion of the facility where

GRAND GULF NUCLEAR GENERATING STATION
Updated Final Safety Analysis Report (UFSAR)

safety-related equipment is located. The fire suppression system consists of the water system, spray and/or sprinklers, carbon dioxide systems, clean agent suppression systems and fire hose stations. The collective capability of the fire suppression systems is adequate to minimize potential damage to safety-related equipment and is a major element in the facility fire

In the event that portions of the fire suppression systems are inoperable, alternate backup fire fighting equipment is required to be made available in the affected areas until the inoperable equipment is restored to service. When the inoperable fire fighting equipment is intended for use as a backup means of fire suppression, a longer period of time is allowed to provide an alternate means of fire fighting than if the inoperable equipment is the primary means of fire suppression.

The surveillance requirements provide assurances that the minimum operability requirements of the fire suppression systems are met. An allowance is made for ensuring a sufficient volume of clean agent in the clean agent storage tanks by verifying the weight and pressure of the tanks.

In the event the fire suppression water system becomes inoperable, immediate corrective measures must be taken since this system provides the major fire suppression capability of the plant.

The surveillance requirements for spray and sprinkler systems provide for periodic visual inspections to ensure that temporary structures/objects do not impair the spray patterns which have been established in accordance with the GGNS fire protection design requirements.

9.5.1.6.3 Fire Rated Assemblies

The operability of the fire barriers and barrier penetrations ensure that fire damage will be limited. These design features minimize the possibility of a single fire involving more than one fire area prior to detection and extinguishment. The fire barriers, fire barrier penetrations for conduits, cable trays and piping, fire windows, fire dampers, and fire doors are periodically inspected to verify their operability.

GRAND GULF NUCLEAR GENERATING STATION
Updated Final Safety Analysis Report (UFSAR)

9.5.2 Communications Systems

9.5.2.1 Design Bases

9.5.2.1.1 Power Generation Design Bases

The following communications systems are provided to maintain adequate communication between the control room and various plant locations:

- a. A public address (PA) system is provided for intraplant voice communication. An evacuation alarm system is provided as an integral part of the PA system. This system consists of a multitone generator which may be activated to provide a unique audible alarm signal and visual alarms in high noise plant areas.
- b. A sound-powered telephone system is provided to supplement the public address system and also to provide fixed emergency communication.
- c. A SERI owned telephone system is provided for plant- to-offsite communication. This system interconnects with the local public telephone utility network facilities.
- d. A communications system is provided that consists of mobile and stationary operating stations with intercommunication capability. This system also provides for offsite communications.
- e. A fiber optic link is provided to support data circuits and communications within the power system. The fiber optic link is owned by Entergy Corporation.
- f. Emergency facilities are also equipped with diverse communication systems with reliable back-up power sources to enable dedicated communication among the facilities or off-site as needed.

Power for the communications systems listed in items a, c, and d above is provided from ac uninterruptible power. Item c also has a backup diesel generator. The sound-powered phone (item b) requires no source of ac or dc power, and power for item e is provided by commercial ac power.

GRAND GULF NUCLEAR GENERATING STATION
Updated Final Safety Analysis Report (UFSAR)

9.5.2.1.2 Codes and Standards

The communications systems conform with applicable local codes, standards, ordinances, and Federal Communications Commission regulations.

9.5.2.2 System Description

9.5.2.2.1 General

The plant communications systems are shown in Figures 9.5-9a thru 9.5-9i. Typical locations of the telephone, public address, and sound-powered stations are shown in these figures.

9.5.2.2.2 Intraplant Communications System

Public Address System - The public address (PA) system consists of handset stations and loudspeaker assemblies, with local amplifiers as required. The system provides two independent communications channels: a page channel and a party channel which consists of five separate lines. Party line 1 is reserved for calling the control room. Intraplant communication can be established by using the page channel to call a particular party and then conversing through one of the four (2-5) party lines available, thus leaving the page channel open for use by others. Communication with the control room is established by selecting party line 1 and calling the control room. The conversation is normally shifted to one of the other available party lines. An evacuation alarm system is provided which consists of a multitone generator whose output is broadcast throughout the plant via the PA system. The tone generator also activates visual alarms (rotating warning lights) in high noise level plant areas whenever the evacuation alarm is sounded. The tone generator is manually activated from the main control room.

Table 9.5-14 lists the type of communication systems available or accessible from each working station. This list excludes SERI owned telephones. The table also provides estimates of ambient noise levels, which are mostly in the low noise level category.

Sound-Powered Telephone - To supplement the PA system for intraplant communications and fixed emergency communications, a six-channel sound-powered telephone system is provided which consists of a permanently interconnected series of telephone jacks for sound-powered telephone sets. This system provides communication between the control room and equipment being

GRAND GULF NUCLEAR GENERATING STATION
Updated Final Safety Analysis Report (UFSAR)

maintained, calibrated, or tested. The communication cables shall be run entirely in conduit to provide isolation from other systems and to provide physical protection of the cables.

A dedicated sound powered system allows for exclusive communications between the control room and technical support center, remote shutdown panels and the refueling areas. This separate system is used for extended fuel handling communications without disrupting communications on the PA system.

Radio Communications - The radio communications systems consists of twelve repeater stations operating on twelve duplexed channels that ensure radio communications throughout the plant and its immediate area. These repeaters are accessed by a central control station, control substations, two-way hand-held portables, and vehicle-mounted portables. The two-way hand-held and vehicle-mounted portable units can communicate directly without accessing through the repeater units. Two of the repeaters are controlled by security for their use as described in the Grand Gulf Nuclear Station Emergency Plan.

The two-way radio system design provides for nine repeater serviced channels. Common to each channel is the power supply and the Central Electronics Bank. Each channel is provided with a separate repeater. Each of these channels may be used to communicate with any of the radio serviced areas identified in Table 9.5-14. During a seismic event, any single operable channel would provide an adequate communication means, either to the subject area or, in the case of high noise areas, to a low noise location immediately outside of the high noise area.

It should be emphasized that this system was not designed to remain operable during a seismic event. However, as noted in this discussion, there is redundancy included in some portions of the design, giving added reliability.

Based upon evaluation of I&E Circular 80-09, "Problems with Plant Internal Communications Systems," the use of portable hand-held radios was restricted in certain areas. This decision was based on an evaluation of the plant design and not on actual testing.

9.5.2.2.3 Offsite Communications System

Commercial Telephone - Plant-to-offsite communication during normal operations is accomplished through a SERI owned telephone system, with extensions installed throughout the plant in

GRAND GULF NUCLEAR GENERATING STATION
Updated Final Safety Analysis Report (UFSAR)

addition to the control room. The system provides direct dialing to locations outside the plant, both local and long distance, and also between extensions within the plant.

The SERI owned telephone system has an uninterruptable power supply with a backup diesel generator. Emergency facilities are also equipped with diverse communication systems with reliable back-up power sources to enable dedicated communication among the facilities or off-site as needed.

Power System Communications - Communication with offsite locations within the power system, during the normal plant operation, is accomplished via a fiber optic link. The fiber optic system is owned by Entergy Corporation, and supports data circuits in addition to providing communications throughout the power system.

Radio Communications - The radio communications system is comprised of one repeater located in Claiborne County to support offsite emergency response team functions. The repeater links the offsite emergency response teams with the Control Room, Technical Support Center, and Emergency Operations Facility.

Paging System - Entergy Operations contracts offsite vendors for its paging system. An individual with a pager may be paged from any of the Emergency Response Facilities using this paging system.

9.5.2.2.4 System Operation

Diverse systems are provided to assure means of in-plant and plant-to-offsite communications under all operating conditions. In-plant communications systems have adequate flexibility to keep the plant personnel informed of plant operational status at all times. The intraplant communications systems are provided with a reliable battery power supply source to assure constant communications between all areas of the plant. Each station of the telephone and PA systems has direct access to other stations, so that if one station is inoperable, it will not substantially interfere with continued communications. The PA system is normally fed from a 125-volt station battery through an inverter and static switch. In case of inverter failure, the PA system is automatically transferred to an alternate transformer supply by the static switch. Power to the alternate transformer is fed from the engineered safety features motor control center.

GRAND GULF NUCLEAR GENERATING STATION
Updated Final Safety Analysis Report (UFSAR)

Alternating current power for Unit 1 and common is distributed to each PA system handset and loudspeaker amplifier through a fuse-type panel-board fed from the 120/240 volt ac uninterruptible power distribution panel of Unit 1. Alternating current power for the Unit 2 PA system is fed from the Unit 2 panel-board.

In the event of component failure or loss of power to the public address system, the sound-powered telephone system and the two-way portable radios will be used as alternate methods of communicating with the Control Room.

Only sound-powered telephones can be considered completely functional under emergency conditions. However, portable two-way radios (see subsection 9.5.2.2.2) may be utilized as much as possible, wherever they are needed.

9.5.2.2.5 Safety Evaluation

The system has no safety-related function as discussed in Section 3.2. Failure of the system will not compromise any safety-related system or component and will not prevent safe reactor shutdown.

9.5.2.3 Inspection and Testing

Communications systems of the types described above are conventional and have a history of successful operation at existing plants. Most of these systems are in routine use, and this will assure their availability. Those systems not frequently used, but required during emergency situations, will be tested at periodic intervals to assure operability when required.

9.5.3 Lighting Systems

The plant lighting system provides adequate illumination during both emergency and normal operating conditions. The location and use of plant lighting is listed in Table 9.5-15.

9.5.3.1 Design Bases

9.5.3.1.1 Safety Design Bases

- a. Lighting fixtures and switches containing mercury are not used inside the containment or the fuel handling area except where specifically evaluated and approved.

GRAND GULF NUCLEAR GENERATING STATION
Updated Final Safety Analysis Report (UFSAR)

- b. Adequate emergency and essential lighting are provided in areas used during emergency or shutdown conditions, including those along the appropriate access or exit routes.
- c. Wherever appropriate, lighting conduits, boxes, and fixtures located above components of Class IE systems are provided with supports to prevent failure during an SSE.

9.5.3.1.2 Power Generation Design Bases

- a. Area lighting provides the illumination intensities required for the performance of activities in that area and equal to or greater than those recommended by the Illuminating Engineering Society.
- b. The control room lighting was given special attention with respect to reduction of glare and shadows on the control boards.
- c. Outdoor area lighting provides the illumination levels required for plant operation and for security.

9.5.3.2 System Description

Plant lighting is divided into three subsystems:

- a. Normal lighting (ac and dc)
- b. Essential lighting (ac)
- c. Emergency lighting (dc)

9.5.3.2.1 Normal Lighting System

The normal lighting system provides illumination for the entire plant. The normal lighting load is powered from the balance-of-plant (BOP) ac distribution systems. Approximately 90 percent of plant lighting is provided from BOP lighting panels. Upon loss of BOP power, backup lighting is provided in designated areas from self-contained dc lights with battery packs.

The outdoor area lighting provides illumination required for plant operation, safe movement of plant personnel, and plant security. Lighting of protected outdoor areas is sufficient to permit effective visual inspection of the area, to facilitate surveillance and patrol of the perimeter fence, and for the

GRAND GULF NUCLEAR GENERATING STATION
Updated Final Safety Analysis Report (UFSAR)

operation of any intrusion monitoring device requiring illumination. Refer to Section 13.6 for further details on plant security lighting.

9.5.3.2.2 Essential Lighting System

The essential lighting system is powered from two redundant ESF ac buses (Division 1 and Division 2) and provides illumination in the control room, Class IE switchgear rooms, shutdown panel area, and access routes between these areas where critical tasks are carried out during emergencies.

Each redundant ESF ac bus feeds 50 percent of the essential lighting in the control room, Class IE switchgear rooms, shutdown panel area, and access routes between these areas.

Approximately 10 percent of plant lighting (control room, switchgear and emergency shutdown rooms) is provided from ESF lighting panels.

9.5.3.2.3 Emergency Lighting System

In addition to the essential lighting described in subsection 9.5.3.2.2, the main control room lighting also consists of fluorescent fixtures which are energized at all times from Class IE batteries A and B through inverters. Backup dc lighting with battery packs are provided for areas essential to the operation of equipment required for safe shutdown as tabulated in Table 9.5-15 and along access routes between these areas where critical tasks are carried out during emergencies. The battery packs are designed to provide power for lighting for a minimum continuous period of 8 hours. The battery packs are maintained with power from the BOP lighting panels. Emergency lights in the main control room provide one-fifth of the total room illumination.

9.5.3.3 Safety Evaluation

In the event that BOP power is lost, the normal ac lighting system becomes unavailable. Backup dc lighting with battery packs are available at exit corridors, stairways, and critical areas. The battery packs are designed to provide lighting for a minimum continuous period of 1/2 hour and 8 hours in areas essential for the safe shutdown of the plant.

GRAND GULF NUCLEAR GENERATING STATION
Updated Final Safety Analysis Report (UFSAR)

Upon loss of preferred power to the two Class IE buses, a signal from the potential transformers initiates the starting of the diesel generators. In the control room, since emergency lights are on at all times, there will be no blackout period. Within 10 seconds after the loss of preferred power, the standby diesel generators will energize the Class IE buses and provide power for the essential lighting system.

In all other essential operating areas, upon loss of preferred power to the two Class IE buses, the essential lighting system will be restored within 10 seconds by the standby diesel generators.

The lighting fixtures and structural supports of the essential and emergency lighting systems are designed to ensure that the fixtures do not fail during an SSE event.

Because of restrictions on the use of mercury or its compounds in certain areas to prevent contamination, interior lighting inside the primary containment directly above the refueling pools and lighting directly above the spent fuel storage and handling area will not use fixtures and switches containing mercury except where specifically evaluated and approved.

9.5.3.4 Tests and Inspections

Since the ac lighting circuits are normally energized and maintained continuously, they require no periodic testing. The 8 hour dc lighting system will be inspected and tested quarterly to ensure the operability of the automatic switches and other components in the system.

9.5.4 Diesel Generator Fuel Oil System

9.5.4.1 Design Bases

9.5.4.1.1 Safety Design Bases

- a. The system is designed to meet its operational requirements during emergency conditions despite any single active or passive failure of one of its components.

GRAND GULF NUCLEAR GENERATING STATION
Updated Final Safety Analysis Report (UFSAR)

- b. The minimum onsite fuel storage capacity of the system is sufficient to operate each diesel generator for a duration of seven days while supplying post-LOCA maximum load demands. This time period is sufficient to put the plant in a safe condition.
- c. The design of the diesel generator fuel oil system conforms to the IEEE Criteria for Class IE Electrical Systems for Nuclear Power Generating Stations (Refer to Section 3.10). The miscellaneous equipment conforms to the codes and standards given in Table 3.2-1, Item XLI.
- d. The essential portions of the diesel generator fuel oil system are of seismic Category I design. In addition, the essential portions of the system are protected from damage by flying debris carried by tornadoes and hurricanes.
- e. The system components are protected against corrosion.
- f. The system is protected from potential damage by turbine missiles.

9.5.4.2 Description

The standby and HPCS diesel generator fuel oil systems, shown in Figures 9.5-11 through 9.5-14, consist of the following components and the associated piping, valves, strainers, filters, and controls:

- a. Diesel fuel oil storage tanks
- b. Diesel fuel oil transfer pumps
- c. Diesel fuel oil day tanks
- d. Diesel fuel oil pumps

Each standby and HPCS diesel generator has its own individual fuel oil supply components. Table 9.5-1 gives the applicable data for these components.

The three storage tanks, one for each diesel generator, are of the horizontal type and are buried approximately 11 feet underground, which is well below the frost line to eliminate low temperature

GRAND GULF NUCLEAR GENERATING STATION
Updated Final Safety Analysis Report (UFSAR)

damage of the fuel. Each tank has a storage capacity sufficient to operate its corresponding diesel generator for seven days while supplying post-LOCA maximum load demands.

The volume of fuel oil stored in the standby diesel generator fuel oil storage tanks is maintained at a minimum of 71,768 gallons up to the maximum tank capacity of 76,000 gallons. The usable capacity of the storage tanks ranges from 68,744 gallons at the minimum required storage volume up to 72,976 gallons when the tanks are full (i.e. maximum tank capacity).

The volume of fuel oil stored in the HPCS diesel generator fuel oil storage tank is maintained at a minimum of 47,640 gallons up to the maximum tank capacity of 76,000 gallons. The usable capacity of the storage tank ranges from 44,616 gallons at the minimum required storage volume up to 72,976 gallons when the tank is full (i.e. maximum tank capacity).

The HPCS diesel generator day tank and each standby diesel generator day tank have capabilities equivalent to greater than 1 hour of engine operation while supplying post-LOCA maximum load demands. These tanks are located inside the diesel generator building, which is a seismic Category I structure. The connecting fuel oil piping is physically separated from all hot surfaces or other potential ignition sources within the diesel generator building.

A total of three transfer pumps, one for each diesel generator, are provided. Each pump motor is fed from its associated engineered safety features bus. These pumps are located inside the fuel storage tanks and transfer fuel from the storage tanks to the day tanks. Each transfer pump is automatically controlled by the level sensed in the day tanks. Each day tank is equipped with an overflow line which will return excess fuel oil delivered by the transfer pump back to the fuel oil storage tank.

Each standby diesel generator is provided with a 100-percent capacity engine-driven fuel oil pump. The pumps supply the fuel from the day tanks to the engine manifolds, and start when the diesel start signal is received. The fuel not consumed by the engine is returned to the fuel oil day tank. The fuel oil injector and fuel oil injection pump leakage is returned to the fuel oil drip tank (20 gallons) from which it is pumped back to the day

GRAND GULF NUCLEAR GENERATING STATION
Updated Final Safety Analysis Report (UFSAR)

tank by the fuel oil drip return pump. The minimum day tank level is adequate to ensure sufficient Net Positive Suction Head (NPSH) to the fuel oil pumps.

The fuel oil drip return piping exhibits a significant design margin based on actual service conditions (reference Table 9.5-13). Based upon the overdesign of this piping, a rupture resulting in a potential fire hazard is unlikely.

In the event that the fuel oil drip return pump fails to operate, fuel oil would be directly routed to the standby diesel generator oily waste sump, which has a total volume of 3366 gallons. Assuming that the oily waste sump was initially at a level slightly below the limit set point, approximately 1627 gallons of unused space would be available to hold the 1400 gallons of dripped fuel oil resulting from 7 days of diesel generator operation. The sump is sealed and vented to the roof; consequently, no fire hazard would exist as a result of an increase in sump inventory.

Each standby diesel generator is also equipped with a 100-percent capacity, dc, motor-driven fuel oil pump for use during maintenance or other times when the engine-driven pump may be unavailable. The motor-driven pump is nonessential for proper operation of the diesel generators and the dc motor is non-Class IE.

Each of the two engines of the tandem HPCS diesel generator is provided with two 100-percent capacity fuel oil pumps each of which serves a mutually redundant fuel oil system external to the engine fuel manifolds either of which is capable of supplying fuel oil to the engine. One pump is driven by its respective diesel engine and the redundant pump is dc motor-driven. The DC motor driven pump also ensures the engine is primed to ensure the ten second start requirement is met. Both pumps normally operate and transfer fuel from the day tank to the engine fuel header. The fuel not consumed by the engine is returned to the day tank by a separate return line. The minimum day tank level is adequate to ensure sufficient Net Positive Suction Head (NPSH) to the fuel oil pumps.

Fuel oil used in the standby and HPCS diesel generators meets the requirements set forth in ASTM D975 Table 1, No. 2-D Grade, Diesel Fuel Oil. These requirements are commensurate to or exceed the requirements specified by the manufacturers for those diesel engines used at Grand Gulf.

GRAND GULF NUCLEAR GENERATING STATION
Updated Final Safety Analysis Report (UFSAR)

The stored fuel oil will be tested for possible deterioration and for detection of unacceptable contaminants. The tests consist of measuring for water and sediment and an accelerated oxygen stability analysis.

ASTM-D1796 outlines the test method to determine diesel fuel oil water and sediment, and is referenced in ASTM D975. As an exception to ASTM-D1796, a nominal 6-inch centrifuge cone with equivalent centrifuge may be substituted for the described 8-inch centrifuge cone and centrifuge to fulfill the testing requirement based on their equal volume capacities, accuracy (in the required measurement region of <0.50 ml) and equal repeatability in the required measurement region. The suitability of this substitution is described in ASTM-D96, Paragraph 3.3, and Figures 1, 2, 3, 4 and 5.

9.5.4.3 Safety Evaluation

The diesel generator fuel oil system is designed so that a failure of any one component results in no worse than the loss of fuel supply to only one diesel generator. The loss of one diesel generator and its associated load group will not prevent safe shutdown of the unit (see Section 8.3.1.2.1). Therefore, a failure of any one component of the diesel generator fuel oil system does not preclude safe shutdown of the plant following a loss-of-coolant accident and loss of offsite power. A component failure analysis of the diesel generator fuel oil system is given in Table 9.5-2.

Each fuel oil system is completely independent. There are no common components or cross connections between the systems. Therefore, a failure in one system will not propagate to any of the other systems.

Each diesel generator has a storage tank with a capacity for fuel sufficient to operate that diesel while supplying its rated capacity as prescribed by Plant Technical Specifications (5740KW for Div. 1 and 2, 3300KW for Div. 3); this capacity exceeds the maximum post-LOCA load demands for a duration of seven days. The maximum load demand is calculated using the assumption that a minimum of any two diesel generators is available. This onsite fuel capacity will last longer than the time it would take to replenish the onsite supply from the outside sources.

GRAND GULF NUCLEAR GENERATING STATION
Updated Final Safety Analysis Report (UFSAR)

The diesel fuel oil storage tanks and transfer pumps are located underground inside the protected area, but not in a vital area (per AECM-83/0504, dated August 26, 1983, the NRC was informed of MP&L's intent to take exception to Section 4.3 of ANSI N195-1976 as it applies to the diesel generator fuel oil storage tanks and transfer pumps). The day tanks and diesel generators are protected in accordance with 10 CFR 73.55(c)(1), (h)(1) and Review Guideline No. 17, dated January 22, 1976.

The plant's access to highways and the Mississippi River waterway provide reasonable assurance that additional fuel oil could be obtained within seven days, if needed, even during abnormal weather conditions, such as dust storms, high winds, and heavy rains. Transportation routes in the vicinity of the site are illustrated in Figure 2.1-10. U. S. Highway 61 parallels the Mississippi River from New Orleans, Louisiana to St. Louis, Missouri, and passes within approximately 5 miles of the site. U.S. Highway 61 connects with U.S. Interstate 20 at Vicksburg. Additionally, Mississippi Routes 18 and 547 connect with U.S. Highway 61 at Port Gibson. Several oil companies can provide same day or next day delivery under normal circumstances. Considering plant access routes and the availability of offsite supplies, there is reasonable assurance that additional fuel oil could be obtained within seven days. Emergency fuel may also be obtained from oil storage facilities at the Entergy Baxter Wilson plant in Vicksburg.

Each of the storage tanks is provided with a drain that will be used periodically to remove any water that has accumulated in the tank. In addition, biocides will be added to the stored fuel oil as required. These actions will prevent the growth of algae and fungi and accumulation of sludge in the storage tanks.

Each fuel oil storage tank is provided with a fill connection, sample connection, and a vent line. The fill connections located at grade elevation and the sample connections located six inches above grade are capped and locked to prevent entry of moisture. The tank vents are piped to a height of 5.25 feet above grade. Each vent is a 6-inch-diameter goose necked line and is provided with a fine mesh screen to prevent access. These lines are located within the protected area between the control building, maintenance shop, and the security island. This area is routinely observed by plant personnel during performance of their duties. In the extremely unlikely event of a missile hitting and knocking off the storage tank vent, no adverse effects will occur as the

GRAND GULF NUCLEAR GENERATING STATION
Updated Final Safety Analysis Report (UFSAR)

vent line will remain intact to grade elevation. If the storage tank vent were to collapse or be pinched by a missile hitting it, a vent path, which requires no operator action, would be available through the fuel oil day tank vent (located in the diesel bay) via the fuel oil day tank overflow line (routed below grade). In addition the storage tank can be manually vented by removing the cap on the tank sample connection, by opening the normal fill connection on the tank or by opening the emergency fill connection for the tank. The vent is goose-necked to prevent water from entering even under heavy precipitation. Negligible amounts of moisture will enter during periods of high humidity and this water is drained off from the tank periodically.

A flame arrestor on the underground storage tank vent is not required by NFPA Code (i.e., NFPA Code 30), and therefore no arrestor has been provided.

Each fuel oil storage tank fill line enters the top of the vessel. In order to maintain a seven-day storage capacity for each diesel, the tank level will be above the "seven-day capacity" required level and will be kept as near the top as practical. When filling the tank, oil will enter at a relatively slow velocity and will mix with the very large volume in the tank. Thus, filling the tank will not disturb any sediment which may have accumulated at the bottom. A Y-strainer is located in the fuel oil transfer line from the storage tank to the day tank. Each fuel oil booster pump is equipped with a suction strainer which is monitored by a pressure differential switch and a local panel mounted alarm. Each engine is equipped with a full flow fuel oil filter which filters the fuel immediately prior to entering the fuel oil header. The fuel oil filter is also monitored by a pressure differential switch and a local panel mounted alarm. Maintaining the tank as near full as practical at all times will also preclude accumulation of any appreciable amounts of water.

Filling of each day tank is automatically controlled by a high and low level switch that automatically starts and stops the respective fuel oil transfer pump. Each day tank is provided with a drain line which is routed back to the respective diesel fuel oil storage tank. The fuel oil transfer pumps may also be controlled locally in the diesel generator building. In the unlikely event of a failure in one of the supply trains, the associated day tank low level alarm annunciates when the quantity of fuel oil remaining in the tank provides approximately 30

GRAND GULF NUCLEAR GENERATING STATION
Updated Final Safety Analysis Report (UFSAR)

minutes of full load operation. A break in the fuel oil transfer line, from the transfer pump to the day tank, is detected by either a low level in the day tank or low pressure (via local indicator in the diesel generator building) in the line. The low day tank level is alarmed in the control room.

The diesel generator fuel oil system is designed to withstand adverse environmental conditions such as earthquakes, tornadoes, and hurricanes. Protection against earthquake damage is assured by the seismic Category I design of the system. Protection from hurricanes and tornadoes is provided by locating system components either underground or within the diesel generator building.

Access to the fuel oil transfer pumps and to the fuel oil storage tank level transmitters is provided via a watertight facility with a manhole. The manhole cover is a missile-proof concrete slab.

Material corrosion of the underground tanks is prevented by the application of cathodic protection and protective coating to the tanks. The bottom of the tanks is 1 foot above the highest groundwater level and 7 feet above the probable maximum flood (PMF) level (see Figures 9.5-23 and 24); therefore, lifting of the storage tanks due to hydrodynamic forces is not considered. The only source of water collection in the tanks is from the condensation of moisture in the air. Any water accumulation due to condensation is drained off periodically, as necessary. All underground piping has protective coating and wrapping. Above ground components are located inside seismic Category I structures, which protect these components from detrimental environmental effects.

All storage and day tanks are located a sufficient distance away from the plant control room to preclude any danger to control room personnel or equipment resulting from an oil tank explosion and/or fire.

The system has been evaluated for consequences of moderate energy line breaks in accordance with the guidelines as given in Section 3.6.

GRAND GULF NUCLEAR GENERATING STATION
Updated Final Safety Analysis Report (UFSAR)

9.5.4.4 Tests and Inspections

The diesel generator fuel oil system is designed to permit periodic testing and inspection of all components. The diesel generator fuel oil system operability is demonstrated during the regularly scheduled tests of the diesel generators. The minimum capacity requirement for each of the fuel oil day tanks is 439 gallons for DIV I and II and 290.3 gallons for DIV III. The minimum usable capacity requirements for the fuel oil storage tanks are 68,744 gallons each for the standby diesel generator system and 44,616 gallons each for the HPCS diesel generator system. For a description of the testing, refer to the Technical Specifications. The fuel oil system was hydrostatically tested prior to initial startup. Refer to subsection 9.5.4.2 for a discussion of fuel oil testing for verification of its adequacy to perform its function.

9.5.4.5 Instrument Application

Each diesel generator fuel oil system is provided with adequate instrumentation to verify system performance. The level of the fuel supply in each storage and day tank is indicated in the control room. In addition, the level in each standby diesel generator fuel oil day tank is indicated locally. A general trouble alarm is provided in the control room to annunciate low and high levels in any storage or day tank. In addition the general trouble alarm is also activated for any of the other events listed in 8.3.1.1.4.1f.(5)(c). High and low day tank level alarms are also provided locally in the diesel generator building.

The fuel oil temperature for the standby and HPCS diesel generators is determined by the location and arrangement of the tanks, piping, pumps and associated equipment in the fuel oil subsystem. The storage tanks are each buried approximately 11 feet underground and fuel oil piping to and from the diesel generator building is also buried underground. All of the remaining fuel oil tanks and fuel oil equipment are located within the diesel generator building. Refer to subsection 9.4.5 for a discussion of the ambient temperature control for the diesel generator building. In addition, the fuel oil piping is physically separated from all hot surfaces or other potential ignition sources within the diesel generator building. This arrangement of tanks, piping, and equipment will maintain the temperature of the fuel oil from a minimum of approximately 40 F

GRAND GULF NUCLEAR GENERATING STATION
Updated Final Safety Analysis Report (UFSAR)

to a maximum of approximately 120 F. This range of fuel oil temperature is not expected to impose any adverse effect on the performance of the diesel generators. The fuel oil systems for the standby and HPCS diesel generators have not, therefore, been provided with a means of indicating or monitoring the fuel oil temperature.

9.5.5 Diesel Generator Cooling Water System

9.5.5.1 Safety Design Bases

- a. The diesel generator cooling water system (DGCWS) is capable of removing sufficient heat to allow continuous operation of the diesel engine at maximum load.
- b. The DGCWS has the capability of providing heat to the engine to maintain it in a standby condition.
- c. The cooling water system for each diesel generator is of seismic Category I design and is housed within a separate tornado-missile-proof, flood-protected, seismic Category I structure.
- d. The DGCWS is designed to prevent long-term corrosion that may degrade system performance.
- e. The DGCWS is designed so that a single failure of any active or passive component, assuming a loss of offsite power, cannot result in the loss of more than one diesel generator train.
- f. The DGCWS has sufficient physical separation to protect the system from internally generated missiles and from pipe whip and jet impingement caused by cracks or breaks in high- and moderate-energy piping.

9.5.5.2 System Description

The DGCWS shown in Figures 9.5-11 through 9.5-13b and 9.5-15 consists of the following components and the associated piping, valves, and controls:

- a. Cooling water pumps
- b. Cooling water expansion tank
- c. Cooling water heat exchanger
- d. Cooling water immersion heater

GRAND GULF NUCLEAR GENERATING STATION
Updated Final Safety Analysis Report (UFSAR)

- e. Jacket water heater circulating pump (standby diesel generator only)

An independent cooling water system is provided for each standby diesel generator. Table 9.5-3 gives the applicable data for these components. The codes and standards applicable to the DGCWS are given in Table 3.2-1, Item XLI.

The DGCWS is a closed system with an expansion tank and does not require makeup immediately following the initial fill. Makeup to the tank is manually initiated.

The DGCWS provides cooling water to the diesel engine, lube oil heat exchanger, and turbocharger aftercoolers, and rejects heat to the standby service water system

The individual components heat rejection rates and the total system heat rejection rate are given in Table 9.5-4. The heat rejection margin for the standby diesel generator cooling water heat exchanger is 25 percent and for the HPCS diesel generator cooling water heat exchanger is 1.95 percent.

Each standby diesel engine is provided with two 100-percent-capacity pumps. One pump is motor driven and the other is driven by the diesel engine. In the event of a failure of one pump, the redundant pump will provide full cooling water flow to the diesel engine. Each engine of the tandem HPCS diesel generator is provided with two 50-percent-capacity pumps. Both pumps are driven by the diesel engine. When the diesel engines are in the standby condition, the cooling water is maintained at a constant temperature by circulating through a separate electric immersion heater. This keep warm feature provides the engine with the capability of quick start and load acceptance after a shutdown. The immersion heater is thermostatically controlled and operates in conjunction with a temperature regulating valve. Forced circulation of the cooling water during standby conditions is used for the standby diesel generators, and natural circulation of the cooling water is used for the HPCS diesel generator.

The standby diesel generator DGCWS provides a sufficient heat sink to permit standby diesel engines to start and operate without Standby Service Water (SSW) flow through the DGCWS heat exchangers for the time it takes to bring the SSW system into operation powered by the diesel generator (minimum design time of 2 minutes). The HPCS diesel generator DGCWS also provides a sufficient heat sink to permit the HPCS diesel engines to start

GRAND GULF NUCLEAR GENERATING STATION
Updated Final Safety Analysis Report (UFSAR)

and operate for 2 minutes without SSW flow through the DGCWS heat exchangers. SSW flow through the standby diesel generator DGCWS heat exchangers begins approximately 110 seconds after the generator supplies power to the bus. Power is supplied to the bus 10 seconds after the standby diesel generator start signal. Therefore, the additional time during which the standby diesel engines could operate without SSW flow, the time margin, is 1 minute 40 seconds. SSW flow through the HPCS diesel generator DGCWS heat exchangers begins 10 seconds after the HPCS diesel engine start signal. The time margin for the HPCS diesel engines is therefore 1 minute 50 seconds. The DGCWS can be vented to ensure that the entire system is filled with water.

The diesel generator cooling water is treated as appropriate to preclude corrosion, organic fouling and freezing. The manufacturers of the standby and HPCS diesel generators recommend the use of chromate or nitrite compounds for corrosion inhibition and ethylene glycol as an antifreeze additive. Because of the potential environmental consequences involved with chromates and the chemical and thermal instability of the nitrites a molybdate type inhibitor is used in the diesel coolant systems. Molybdenum is environmentally benign and has considerably less impact than other heavy metals such as chromium. Ethylene glycol will be added as antifreeze only as required in severe weather. Zinc and copper corrosion inhibitors have been formulated into the molybdate inhibitors, thus the additives are compatible with the construction materials of the diesel cooling water systems. The diesel generator cooling water system water chemistry complies with generally accepted water quality standards of the industry.

9.5.5.3 Safety Evaluation

Each DGCWS is designed to meet seismic Category I requirements and is housed inside a seismic Category I structure. The DGCWS is designed so that failure of any one component will result in the loss of cooling water supply to only one diesel generator. There are no interconnections between the DGCWS of any two diesel generators. The loss of one diesel generator and its associated load group will not prevent safe shutdown of the unit (see Section 8.3.1.2.1). Therefore, failure of any one component of the DGCWS will not preclude safe shutdown of the plant following a loss-of-coolant accident and loss of offsite power. A component failure analysis of the DGCWS is given in Table 9.5-8.

GRAND GULF NUCLEAR GENERATING STATION
Updated Final Safety Analysis Report (UFSAR)

During the standby condition of the diesel generators, the engine cooling water is heated and circulated to facilitate a quick engine start. Failure of the system is annunciated by a cooling water low-temperature alarm in the diesel generator room and by a trouble alarm in the control room.

The standby diesel generator sets operate in the following modes:

Emergency Operation - During emergency operation the diesel generator supplies the required power to operate the load assigned to its engineered safety features bus.

Testing - The diesel generators will be tested each month. During testing the diesel generators will be started and synchronized manually for parallel operation with the plant power system. In this mode the diesel generator will be loaded to 50 percent or more of its rated capacity.

Standby - While the diesels are on standby, power is required from the normal site power to operate the jacket water heater and circulation pump and the lube oil heater and circulation pump.

Under the emergency operation condition, the standby diesel generators will start on either a loss of offsite power, or LOCA, or when both occur. The minimum load requirements for the standby diesel generators will occur when a LOCA occurs and offsite power is still available. Under this situation, the standby diesel generators will be running idle, with zero electrical load output.

DeLaval, the standby diesel generator manufacturer, has conducted a special idle endurance test on the same model of diesel generator that is being provided for the Grand Gulf Nuclear Station. The results of this test indicate that the diesel generators are capable of running in an idle (unloaded) condition for 168 continuous hours. At the conclusion of this time period, a 1000 kW resistive load followed by a 4000 kW resistive load a half second later were applied to the diesel generator with no adverse effects experienced. The 168-hour period is equivalent to the 7-day fuel oil storage capacity. This test verified the capability of the standby diesel generators to operate reliably under a minimum load condition.

The HPCS diesel generator can run for a maximum of 4 hours in a no-load condition and must be loaded to at least 50 percent of its continuous rated load for a period of at least 30 minutes before

GRAND GULF NUCLEAR GENERATING STATION
Updated Final Safety Analysis Report (UFSAR)

subsequent no-load operation can be resumed. To assure operability, the diesel generator is started during a LOCA condition and kept in a running standby (no-load) mode until it is assured that offsite power is available. Only in this mode does the HPCS diesel generator remain in an unloaded condition. If the HPCS system is required in conjunction with a loss of offsite power, the diesel generator would start and load the HPCS system. During a LOCA and during accident recovery conditions following a loss of offsite power, the HPCS load is expected to exceed 50 percent of the HPCS diesel continuous rating and thus no degradation of performance is expected.

Approved operating and testing procedures for Grand Gulf have adopted the policy of avoiding light load and/or no load operation. Precautions are provided in the procedures to alert the operators of the hazards of such operations.

Approved operating procedures allow the operator to synchronize the diesel generators to and operate in parallel with off-site power (e.g., LOCA with off-site power availability).

9.5.5.4 Tests and Inspections

The DGCWS is designed to permit periodic testing and inspection of all components.

The DGCWS operability will be demonstrated during the regularly scheduled tests of the diesel generators. The frequency of these tests is given in the Technical Specifications. [HISTORICAL INFORMATION] [The DGCWS was hydrostatically tested prior to initial startup.] The cooling water will be sampled and analyzed periodically to verify that its quality meets the diesel manufacturer's recommendations.

9.5.5.5 Instrumentation Application

Each DGCWS is provided with adequate instrumentation to verify system performance.

Indications of system temperatures and pressures are provided in the diesel generator room. As a minimum, high- and low-temperature, low-pressure, and low-expansion-tank-level alarms are provided locally. Detection of system leakage is accomplished by the increased frequency of low-expansion-tank-level annunciators. A general diesel generator room trouble alarm annunciates in the control room in the event of a system

GRAND GULF NUCLEAR GENERATING STATION
Updated Final Safety Analysis Report (UFSAR)

malfunction. Shutdown of the standby diesel generator and HPCS diesel generator due to a high cooling water temperature is discussed in subsections 8.3.1.1.4.1.f and 8.3.1.1.4.2.10, respectively.

9.5.6 Diesel Generator Starting System

9.5.6.1 Design Bases

9.5.6.1.1 Safety Design Bases

- a. The diesel generator starting system (DGSS) for both the standby and HPCS diesel engines is provided with independent and redundant starting trains, with either train capable of starting its respective engine five times without recharging the associated air receiver.
- b. The DGSS initiates an engine start so that within 10 seconds after receipt of the start signal the diesel generator is operating at rated speed, voltage, and frequency.
- c. The DGSS will perform its intended function in the event of a single active or passive failure.
- d. The portions of the DGSS essential to the starting of a diesel engine are seismic Category I, and the entire DGSS is housed within a seismic Category I structure capable of protecting the system from extreme natural phenomena, missiles, and the effects of pipe whip, jet impingement, and water spray from high- and moderate-energy pipe breaks (Sections 3.5 and 3.6).

9.5.6.2 System Description

9.5.6.2.1 Standby Diesel Generator

The DGSS for the standby diesel generators is shown in Figures 9.5-11, 9.5-11a, 9.5-12, and 9.5-12a and consists of the following components and the associated piping, valves, and controls:

- a. Starting air compressors
- b. Starting air aftercoolers

GRAND GULF NUCLEAR GENERATING STATION
Updated Final Safety Analysis Report (UFSAR)

- c. Starting air dryers
- d. Starting air receivers

A starting system consisting of two redundant trains is provided for each diesel engine. Each train contains one of each of the above-listed components. Each redundant DGSS train is capable of providing the diesel generator with five starts. Table 9.5-5 contains the applicable data for these components. The codes and standards applicable to the DGSS components are listed in Table 3.2-1, Item XLI.

One of the compressors for each diesel generator is driven from a separate diesel engine; the other has an electric motor driver fed from normal BOP power. The motor-driven compressor operates in response to pressure switches on the air receivers and charges both redundant starting air trains. The diesel-driven compressor is provided as a backup to the motor-driven compressor and is started manually.

An air-to-air type aftercooler is provided on the downstream side of both the diesel- and motor-driven starting air compressors to cool the compressed air prior to entering the air dryer. The compressed air passes on the tube side of the cooler, and cooling air is fan-blown over the finned tubes. Each aftercooler operates continuously in conjunction with its respective compressor.

Each starting air dryer assembly consists of a prefilter, two dehydrator towers, an afterfilter, and the interconnecting piping and valves which control the air flow to each tower. Each air dryer assembly processes 76 scfm of compressed air through one of the two available dehydrator towers which contain desiccant to remove moisture. While one tower dries the air, the other tower is purged with a portion of the dried air in order to reactivate the desiccant. An automatic control system provided with the air dryer assembly reverses the modes of the towers on a timed basis, thus ensuring that the air is dried with freshly regenerated desiccant. The air dryer is designed to reduce the starting air dew point temperature to -40°F at 250 psig. The maximum allowable dew point temperature for normal operation may be warmer than -40°F , based on maintaining the compressed air relative humidity low enough to minimize long term corrosion of Carbon Steel Components. The desiccant-type dryer was chosen for reliability, performance, and simplicity of operation. The prefilter removes entrained water and oil from the air entering the air dryer, and

GRAND GULF NUCLEAR GENERATING STATION
Updated Final Safety Analysis Report (UFSAR)

the afterfilter removes any desiccant which may become airborne during drying. Final filtering of the starting air must meet the maximum entrained particulate size limit of 10 microns (micrometres), while the maximum allowable condensable hydrocarbon (oil) concentration downstream of the afterfilter must not exceed a maximum allowable concentration of 1.0 Part Per Million (PPM) when the concentration is expressed as a ratio of weight to weight [PPM (w/w)] or expressed as a ratio of volume to volume [PPM (v/v)].

Following receipt of the start signal, high-pressure air is admitted to the power cylinders, and the cranking cycle duration is approximately one engine revolution.

In addition to supplying dry air for starting of the engines, the standby diesel generator DGSS also provides the control air for the pneumatic logic system.

9.5.6.2.2 HPCS Diesel Generator

The DGSS for the HPCS diesel generator is shown in Figures 9.5-13, 9.5-13a, 9.5-13b, 9.5-16, and 9.5-17 and consists of the following components and associated piping, valves, and controls:

- a. Starting air compressors
- b. Starting air receivers
- c. Starting air dryer package
- d. Starting air motors

A starting system consisting of two redundant trains is provided for each engine of the tandem arrangement. The air supply system contains two air receivers in each of the two trains for a total of four receivers in the DGSS. The air receivers are manifolded as shown in Figure 9.5-17. Each train has one air compressor for charging air into the receivers, one air compressor being electric motor-driven and the other being diesel-engine driven. The electric motor-driven air compressor is powered from non-Class IE power. Each air receiver tanks' pressure instrumentation is designed to automatically start and stop the respective electric motor-driven or diesel engine-driven air compressor for the diesel generator starting air supply system.

GRAND GULF NUCLEAR GENERATING STATION
Updated Final Safety Analysis Report (UFSAR)

The electric motor-driven air compressor can be operated by a local control hand-switch providing manual and auto functions. In the auto position, the air storage tank air pressure instrument's control the air compressor operation. In the manual position, a means is provided for the operator to locally start or stop the air compressor while monitoring air pressure. Manual operation of the electric motor-driven air compressor can be utilized to maintain receiver air pressure if automatic compressor operation is unavailable.

The diesel engine-driven air compressor can be operated by a local control hand-switch with manual and auto functions to back up the electric motor-driven air compressor. In the auto position (normal position), the air storage tank air pressure instrument's control the air compressor operation. In the manual position, a means is provided for the operator to locally start or stop the air compressor while monitoring air pressure. The two compressor discharge lines are cross-tied and enter the air dryer at a common point. The air is then distributed from the air dryer to each of the four air receivers.

Each air receiver is provided with a drain to be opened periodically to remove any accumulated moisture or foreign material.

Each air starting train has two rotary vane motors for each engine for a total of four for the tandem configuration. On receipt of the engine start signal, a normally closed solenoid valve for each engine opens, and air flows to the piston for the pinion gear of the lower motor. The entry of air moves the pinion gear forward to engage with the engine ring gear. Movement of the pinion gear uncovers a port, allowing air pressure to be released to the upper motor pinion gear piston which, in turn, engages its pinion gear with the engine ring gear. Full engagement of the upper pinion gear permits air flow to the air valve which, in turn, opens the air starting valve and releases the main starting air supply. Starting air passes through the air line lubricator, releasing an oil air mist into the starting motors. The motors drive the pinion gears, rotating the ring gear and cranking the engine. Only two of the air motor pinions are needed to be engaged to the flywheel ring gear of each diesel engine to start the engine in the required time. However, all four of the air motor pinions are engaged to the flywheel simultaneously to improve starting reliability. Thus, for the tandem engine all eight starter motors are engaged simultaneously. The tandem engine will normally start

GRAND GULF NUCLEAR GENERATING STATION
Updated Final Safety Analysis Report (UFSAR)

with one bank of dual air starting motors for each engine. However, to ensure positive starting, all four solenoids are energized simultaneously and both banks of dual starting motors crank the engine. The engine starts before the cranking speed reaches 100 rpm. At 150 rpm all solenoids are automatically de-energized causing the air flow to the air motors to stop and pinion gears to disengage. The governor brings the speed up to the rated speed and maintains the speed.

Each redundant train of the DGSS is capable of starting the tandem diesel generator set five times without recharging the air receivers.

The air is delivered to the air receiver by the air compressors where it is stored until it is needed to start the diesel engine. An aftercooler/dryer assembly is provided on the downstream side of the diesel-driven and motor-driven starting air compressors (Figure 9.5-16). The aftercooler cools the compressed air prior to entering the air dryer. The air dryer consists of a prefilter, two dehydrator towers, an afterfilter and the interconnecting piping and valves which control the air flow to each tower. The air dryer has an inlet flow rate of 32 SCFM and is designed to reduce the starting air dew point to temperature -40°F at 250 PSIG. The maximum allowable dew point temperature for normal operation may not be warmer than $+20^{\circ}\text{F}$, based on maintaining the compressed air relative humidity low enough to minimize long term corrosion of Carbon Steel Components. The compressed air flow through the dryer cycles between two desiccant towers by means of valving controlled by a timer. Wet air enters at the bottom of one tower, passes upward through the desiccant bed, where the water vapor is absorbed. The clean dry air is returned to the air system.

A small portion of the dried air is reduced in pressure and passed downward through the desiccant bed in the other tower, removing the moisture collected and reactivating the desiccant. This moisture-laden air is then vented to atmosphere through a muffler.

At preset intervals, the two towers are alternately placed on stream or purge, automatically and without attention. Before going on stream, each tower is slowly repressurized to prevent a sudden inrush of air which can cause excessive desiccant abrasion.

GRAND GULF NUCLEAR GENERATING STATION
Updated Final Safety Analysis Report (UFSAR)

The coalescing prefilter with automatic drain is provided to remove entrained water and oil from the air entering the air dryer ensuring proper desiccant efficiency. The afterfilter removes the desiccant dust carryover. Final filtering of the starting air must meet the maximum entrained particulate size limit of 10 microns (micrometres), while the maximum allowable condensable hydrocarbon (oil) concentration downstream of the afterfilter must not exceed 1.0 Part Per Million (PPM) when the concentration is expressed as a ratio of weight to weight [PPM (w/w)] or expressed as a ratio of volume to volume [PPM (v/v)]. The dual tower heatless desiccant type air dryers were chosen for reliability, performance, and simplicity of operation.

9.5.6.3 Safety Evaluation

The essential portions of the DGSS are designed to seismic Category I requirements and the entire starting system is housed inside a seismic Category I structure. The DGSS is designed so that failure of any component will not result in the loss of starting capability of the engine. There are no cross connections between the starting air systems of any diesel generator. A component failure analysis of the DGSS is given in Table 9.5-9.

During normal plant operation, compressed air for each diesel is stored in an individual starting system. The starting system for each diesel is comprised of redundant starting trains. The system for the standby diesel generator stores sufficient air to start the engine five times under a no-load condition without operation of the compressors. The system for the HPCS diesel generator has adequate air storage capacity to start the engine five consecutive times without recharging by the compressor.

The air start system air receivers (storage tanks) are provided with drains which are opened periodically to remove any moisture or oil carryover which may have accumulated from the starting air compressors. This precludes formation of rust within the system. In addition, the system piping for the standby diesel generator is provided with an air strainer installed before the starting air solenoid valve. The performance of the DGSS filters and strainers is routinely demonstrated as part of surveillance procedures. They are also periodically checked/cleaned during routine inspections (see subsection 9.5.6.4). Pressure switches are located directly upstream of the air strainers, which signals an alarm on the engine control panel when the starting air pressure is low. The system piping immediately upstream of the engine inlet

GRAND GULF NUCLEAR GENERATING STATION
Updated Final Safety Analysis Report (UFSAR)

is installed at an elevation lower than the engine inlet, and is provided with a drip leg to provide for removal of any water which may be present in the lines. The HPCS diesel generator starting air piping system is provided with a strainer before the starting air solenoid valve at the engine inlet which removes particulates and allows for periodic draining of water present in the lines (See Figure 9.5-17). There is no air filter for this system.

GRAND GULF NUCLEAR GENERATING STATION
Updated Final Safety Analysis Report (UFSAR)

Page Deleted

GRAND GULF NUCLEAR GENERATING STATION
Updated Final Safety Analysis Report (UFSAR)

A pressure switch is provided at the entrance of the air motor downstream of the strainer. Low air pressure alarm is provided in the local diesel generator panel. This in turn activates a single alarm, "HPCS Diesel Generator Trouble," in the Control Room. Additionally, the strainers are inspected and cleaned during routine plant maintenance.

9.5.6.4 Tests and Inspections

The DGSS is designed to permit periodic testing and inspection of all components. DGSS air quality is monitored on a routine basis for compliance with the requirements for dew point temperature, entrained particulate size, and oil content.

The DGSS operability will be demonstrated during the regularly scheduled tests of the diesel generators. A further description of the testing and the frequency of the testing is given in the Technical Specifications. [HISTORICAL INFORMATION] [The DGSS was hydrostatically tested prior to initial startup.]

9.5.6.5 Instrumentation Application

Each DGSS is provided with adequate instrumentation to verify system performance. Indications of system pressure are provided in the diesel generator room. Pressure switches automatically start and stop the motor driven and diesel engine driven compressors for the HPCS diesel generator starting air system and the motor driven compressor for the standby diesel generator starting air system. Low air-receiver pressure is annunciated locally. A diesel generator room trouble alarm annunciates in the control room in the event of a system malfunction.

9.5.7 Diesel Engine Lubrication System

9.5.7.1 Safety Design Bases

- a. An independent diesel engine lubrication system (DELS) capable of providing lubricating oil to all moving parts of the diesel engine during diesel generator operation is provided for each standby and HPCS diesel engine.
- b. The DELS is designed such that the oil is heated and circulated to enhance the diesel engine's starting ability (see subsection 9.5.7.2).

GRAND GULF NUCLEAR GENERATING STATION
Updated Final Safety Analysis Report (UFSAR)

- c. Each DELS is of seismic Category I design and is housed within a separate seismic Category I structure capable of protecting the system from extreme natural phenomena, missiles, and the effects of pipe whip or jet impingement from high- and moderate-energy pipe breaks.
- d. The DELS is designed so that a single active or passive failure of any component cannot result in the loss of function of more than one diesel generator.

9.5.7.2 System Description

The DELS shown in Figures 9.5-11 through 9.5-13b and 9.5-18 consists of the following components and the associated piping, valves, filters, strainers, and controls:

- a. Lube oil pumps
- b. Lube oil sump tank (standby diesel generators only)
- c. Lube oil heat exchanger
- d. Lube oil heater (standby diesel generator only)

Table 9.5-6 contains the applicable data for the above components. The codes and standards applicable to the DELS are listed in Table 3.2-1, Item XLI.

The DELS provides lubricating oil to all moving parts of the diesel engine and rejects the heat picked up during circulation to the diesel cooling water system, as described in subsection 9.5.5.2, via the lube oil heat exchanger.

The DELS is provided with various filters and strainers to maintain the required quality of the lube oil during engine operation. The filters are changed and the strainers are cleaned in accordance with the manufacturer's instructions to assure an adequate supply of clean oil to the engine.

9.5.7.2.1 Standby Diesel Generator Lubrication System

Each standby diesel engine is supplied with a lubricating oil system of the dry sump type which has a separate sump tank for holding the lubricating oil supply.

GRAND GULF NUCLEAR GENERATING STATION
Updated Final Safety Analysis Report (UFSAR)

The lube oil sump tank contains a sufficient quantity of oil for 7 days of diesel generator operation at rated load without adding lube oil.

Each standby diesel engine is provided with two 100 percent capacity pumps. One pump is engine driven and a second pump is ac motor driven (Aux. Lube Oil pump). During normal operation, the engine driven pump provides full oil flow. In the event of a failure in the engine driven pump, the redundant ac motor driven pump would provide full oil flow to the diesel engine. During engine operation either of the pumps are capable of providing a pressurized, filtered, and cooled oil supply to the engine lube oil headers. Oil passage branches from the headers provide a flow path to the working parts of the engine. Oil flows by gravity from the engine base drain to the sump tank.

A separate pre-lube pump takes oil warmed by the sump tank immersion heater from the sump and circulates it through a pre-lube filter to the engine headers. This process keeps essential parts of the engine warmed and lubricated while the diesel engine generator is in a standby status and thus ensures the engine's rapid start.

A branch line to the turbochargers provides pre-lube to ensure turbocharger lubrication during engine startup. Oil flow in this line is limited by an orifice to prevent flooding of the turbocharger housing.

9.5.7.2.2 HPCS Diesel Generator Lubrication System

Each engine of the tandem HPCS diesel generator is provided with a complete engine lubricating oil system which is comprised of four separate systems. These are: the main lubricating oil system, the piston cooling oil system, the scavenging oil system, and the soak back oil system. Each system has its own pump. The main lube oil pump and the piston cooling oil pump, although individual pumps, are both contained in a single housing and driven from a common drive shaft. The scavenging oil pump is a separate pump. With the exception of the soak back pump, all the pumps are driven from the accessory gear train at the front of the engine. The soak back pump is driven by an ac motor.

To ensure lubrication of the turbocharger bearings prior to engine start and removal of the residual heat from the turbocharger after engine shutdown, a separate lube oil pressure

GRAND GULF NUCLEAR GENERATING STATION
Updated Final Safety Analysis Report (UFSAR)

source is provided. This pressure source is provided by a continuously running ac motor driven soak back pump as described in Table 9.5-6.

A manual prelubrication of each engine is performed weekly and prior to each manual start to minimize dry engine starts. The lubricant is gravity drained to wearing surfaces by opening the prelube valves. Prelubrication will be performed for a period of not less than 3 and not more than 5 minutes in accordance with the manufacturer's recommendations on manual engine starts, if last start was less than 48 hours ago. If last start was greater than 48 hours ago, prelube until oil flow is observed at the rocker arm with the valve cover removed.

The soak back pump also circulates oil from the lube oil sump through the lube oil filter to the lube oil cooler. The immersion heater heats the engine cooling water which circulates by natural convection through the lube oil cooler tubes (refer to subsection 9.5.5). As the oil is circulated through the lube oil cooler, around the tubes (which act as a heater at this time), the oil is warmed. The oil leaves the lube oil cooler and flows to the engine lube oil strainer housing thus maintaining a full reservoir for the main lube oil and piston cooling pumps. Excess oil spills over a dam in the strainer housing and returns to the lube oil sump.

The engine driven scavenging oil system pump takes oil through the scavenging oil strainer from the lube oil sump. The pump forces oil through the accessory mounted oil filter and oil cooler. The filtered and cooled oil then returns to the strainer housing to supply the main lube oil and piston cooling pumps. Excess oil overflows the strainer housing dam and returns to the sump.

Each HPCS diesel engine sump pan, when supplemented by sufficient dedicated onsite storage, contains a usable inventory capable of supporting a minimum of 7 days of operation.

The main lubricating oil system supplies oil under pressure to most of the moving parts of the engine. The main lube oil pump takes oil from the strainer housing at the right front of the engine. Oil from the pump is supplied to the main lube oil manifold or gallery located above the main crankshaft and extending the length of the engine. Oil tubes provide an oil flow path through the main bearing A-frames to the main bearings and through drilled passages in the crankshaft to the connecting rod

GRAND GULF NUCLEAR GENERATING STATION
Updated Final Safety Analysis Report (UFSAR)

bearings and accessory drive gear at the front of the crankshaft. At the rear of the engine, oil is supplied to the gear train and to the turbocharger.

The piston cooling system supplies oil for piston cooling and lubrication of the piston pin bearing surface.

When an engine is in the normal standby mode, the lubricating oil is warmed and circulated as described, which serves to keep the entire accessory lubricating oil system primed to support a fast emergency start.

9.5.7.3 Safety Evaluation

Each DELS is designed to seismic Category I requirements and is housed inside a seismic Category I structure. The DELS is designed so that failure of any one component will not result in the loss of lubricating oil supply to more than one diesel generator. There are no cross connections or common lines between the diesel lubricating systems. The loss of one diesel generator and its associated load group will not prevent safe shutdown of the unit (see subsection 8.3.1.2.1). Therefore, failure of any one component of the DELS will not preclude safe shutdown of the plant following a loss-of-coolant accident and loss of offsite power. A component failure analysis of the DELS is given in Table 9.5-10.

During the standby condition of the diesel generators, the lubricating oil is heated and circulated, as described in subsection 9.5.7.2, to facilitate a quick engine start. Failure of the system is annunciated by a lube oil low-temperature alarm in the diesel generator room and by a trouble alarm in the control room.

The entry of foreign matter into the DELS is prevented by providing administratively controlled access into the diesel generator building. Care will be taken by the operators when performing maintenance or recharging of the DELS in order to prevent entry of deleterious material into the system.

9.5.7.4 Tests and Inspections

The DELS is designed to permit periodic testing and inspection of all components. The DELS operability will be demonstrated during the regularly scheduled tests of the diesel generators. The frequency of diesel generator testing is outlined in the Technical Specifications. Diesel generator testing is performed

GRAND GULF NUCLEAR GENERATING STATION
Updated Final Safety Analysis Report (UFSAR)

in accordance with the guidelines presented in Regulatory Guide 1.9, Rev. 3. The DELS was in-service hydrostatically or pneumatically leak tested prior to preoperational testing. The lube oil will be sampled and analyzed in accordance with the manufacturer's recommendations once every three months to verify that it can still adequately perform its function.

9.5.7.5 Instrumentation Application

Each DELS is provided with adequate instrumentation to verify system performance. Each DELS is provided with local indications of oil temperature and pressure. The standby DELS is also provided with a local indication of sump tank level. As a minimum, high- and low-temperature, low-system-pressure, high-crankcase- pressure, and low-sump-level alarms are provided locally for each DELS. A general diesel generator room trouble alarm annunciates in the control room in the event of a system malfunction. Lube oil leakage is detected by the system pressure and level instrumentation. Shutdown and alarms of the standby and HPCS diesel generators are discussed in subsections 8.3.1.1.4.1.f. and 8.3.1.1.4.2.10, respectively.

9.5.8 Diesel Generator Combustion Air Intake and Exhaust System

9.5.8.1 Design Bases

9.5.8.1.1 Safety Design Bases

- a. The diesel generator combustion air intake and exhaust system (DGCAIES) is capable of supplying reliable quality air to the diesel engine and exhausting the products of combustion to the atmosphere.
- b. The DGCAIES is of seismic Category I design and is housed within a separate seismic Category I structure capable of protecting the system from rain, snow, ice, sleet, dust storms, missiles, and the effects of pipe whip or jet impingement from high- and moderate-energy pipe breaks.

GRAND GULF NUCLEAR GENERATING STATION
Updated Final Safety Analysis Report (UFSAR)

- c. The DGCAIES is designed so that a single failure of any component will not result in the loss of function of more than one diesel generator.

9.5.8.2 System Description

The DGCAIES, shown in Figures 9.5-11 through 9.5-13b, consists of the following components and the associated piping and expansion joints:

- a. Intake air filter
- b. Intake air silencer
- c. Exhaust silencer

An independent DGCAIES is provided for each diesel generator. The system components are sized and physically arranged so that no degradation of the operation of the engine will occur when the diesel is required to continuously operate at rated output. Table 9.5-7 contains the applicable data for the above components.

The DGCAIES provides filtered ambient air to the diesel engines for combustion and exhausts the products of combustion to the atmosphere. Air for combustion is taken from within the diesel generator room via the room's ventilation system. All of the components of the DGCAIES are located inside the diesel generator building which provides protection from rain, ice, snow, sleet, and dust storms. Figure 1.2-1 shows the location of the diesel generator building with respect to other site components.

9.5.8.3 Safety Evaluation

Each DGCAIES is designed to seismic Category I requirements and is housed inside a seismic Category I structure. The DGCAIES is designed so that failure of any one component will result in the loss of function of only one diesel generator. The loss of one diesel generator and its associated load group will not prevent safe shutdown of the unit (see Section 8.3.1.2.1). Thus, failure of any one component of the DGCAIES will not preclude safe shutdown of the plant following a loss-of-coolant accident and loss of offsite power.

The diesel engine air intake is located within the diesel generator building, thus protecting it from possible clogging due to rain, snow, ice, and sleet. The air intake has an oil bath filter to remove airborne dust or other particles and prevent clogging of the intake line.

GRAND GULF NUCLEAR GENERATING STATION
Updated Final Safety Analysis Report (UFSAR)

The diesel engine exhaust system is located within the diesel generator building, with the exception of the vertical exhaust stack, which penetrates the building roof. The exhaust silencer is provided with an open drain to relieve any condensate which may collect due to rain or melting snow and ice. Ice and/or snow which may enter the diesel exhaust stack will not accumulate, since the exhaust system is located within the heated building. The snow/ice will melt before accumulation clogs the exhaust system, and the liquid would drain through the exhaust silencer drain connection.

The air intake is located so that only negligible dilution or contamination of the intake air by the exhaust products, other gases or dust that may be intentionally or accidentally released on site can occur, and this will not preclude diesel generator operation at rated output. There is nothing in the vicinity of the air intake which could act as a potential restriction to the inlet air flow. The accidental release of onsite stored gases (CO₂ and H₂) in the yard (see Table 2.2-6) will not affect the performance of the diesel generators. The maximum concentration of these gases at the diesel generator air intake is given below (assuming total release of the stored inventory):

<u>Stored Gas</u>	<u>Maximum Concentration</u>			<u>O₂ Available at Air</u>
	<u>g/m³</u>	<u>ppm</u>	<u>% by vol</u>	<u>Intake % by vol</u>
CO ₂ (4 tons)	99.4	55350	5.5	19.8
CO ₂ (10 tons)	156.4	87340	8.7	19.1

The required oxygen content at the diesel air intake for proper operation (no decrease in diesel performance) is 18 percent by volume which is equivalent to a gas concentration of 15 percent by volume. As seen from the table, the accidental release of CO₂ will not result in reducing the O₂ content to below the required minimum of 18 percent by volume at the diesel air intake. Section 9.5.10.1 describes the design basis for the bulk hydrogen storage area and evaluation of impacts on station structures and components. Based on the siting requirements to maintain less than the lower explosive and flammable limit for hydrogen clouds near safety related structures, the hydrogen concentration is

GRAND GULF NUCLEAR GENERATING STATION
Updated Final Safety Analysis Report (UFSAR)

sufficiently low to not impact the required minimum of 18 percent by volume of oxygen at the diesel generator air intake. No effect in performance of the diesel generators is anticipated.

The air intake is located within the diesel generator building, which is designed to withstand tornado missiles. Air is drawn into the diesel generator building through air intake louvers mounted in the building wall. The air intake louvers are protected from tornado missiles by a labyrinth wall which prohibits line-of-sight tornado missiles from impacting the intake louvers (see Figure 9.5-21). The labyrinth wall is also capable of withstanding tornado missiles.

The exhaust piping for the standby diesel generators and HPCS diesel generator, as shown on Figures 9.5-21 and 9.5-22, has been routed inside the diesel generator building to provide protection from tornado missiles. The exhaust silencers are also located within the diesel generator building. The standby and HPCS diesel generator exhaust pipes each extend approximately one foot, three inches above the diesel building roof (El. 172'-0"). The standby diesel generator exhaust pipes are approximately 36 feet apart. The HPCS diesel generator exhaust pipes are approximately 39 feet from the "B" standby diesel generator exhaust pipe. The exhaust pipes for the three diesel generators are centered on a line parallel to and approximately 12 feet to the west of the auxiliary building wall. A 2-foot-high parapet has been provided on the north, west, and south sides of the diesel generator building roof which shields the exposed exhaust pipes from horizontal missiles. The east side of the diesel generator building abuts the auxiliary building, whose roof elevation is 266'-0".

The diesel generator electrical equipment associated with the starting of the diesel engines is enclosed in NEMA Type 12 enclosures. The enclosures are designed to protect the enclosed equipment against fibers, dust and dirt, lint, and light splashing, seepage, dripping, and external condensation of noncorrosive materials, thus ensuring that the equipment will not become inoperable due to foreign material.

The entrance of dust into the diesel generator rooms is minimized by certain features which are incorporated into the design of the ventilation system for each room. During normal operation (i.e., plant in operation, diesel generators not running), the fan which provides ventilation air for the room and combustion air for the engine is shut down, and the outside air intake ductwork is

GRAND GULF NUCLEAR GENERATING STATION
Updated Final Safety Analysis Report (UFSAR)

isolated from the environment by a closed damper. The diesel generator room fan coil unit is ducted to provide a high-velocity airstream across the face of the ventilation air exhaust opening, and provides an "air curtain" effect which aids in reducing the entrance of dust into the room. During plant operation, equipment and personnel access doors are normally kept closed.

During construction, abnormal generation of dust was minimized by using such procedures as watering of roads and reseeded of cleared areas, as discussed in subsection 4.1.2.3.4 of the Final Environmental Report. The accumulation of dust will be minimized by routine general plant maintenance.

9.5.8.4 Tests and Inspections

The DGCAIES is designed to permit periodic testing and inspection of all components. The system operability will be demonstrated during the regularly scheduled tests of the diesel generator. The frequency of these tests is given in TRM Section 3.8.

9.5.8.5 Instrumentation Application

Indication of diesel exhaust gas temperature is provided in the diesel generator room.

9.5.9 Auxiliary Steam System

9.5.9.1 Design Bases

9.5.9.1.1 Safety Design Bases

The auxiliary building penetrations of the auxiliary steam system are of seismic Category I design and are permanently isolated during normal operation by DCP 88-0021.

9.5.9.2 System Description

9.5.9.2.1 Auxiliary Steam System

The auxiliary steam system, shown on Figures 9.5-20 and 20a, consists of a Unit 1 reboiler, three condensate pumps, and one boiler blowdown tank which have been abandoned in place by DCP 88-0021.

9.5.9.3 Safety Evaluation

The auxiliary steam system has no safety-related functions as defined in Section 3.2. Failure of this system will not compromise any safety-related system or component and will not prevent safe reactor shutdown.

The auxiliary steam system penetrations across the auxiliary building are of seismic Category I design and are permanently isolated during normal operation by DCP 88-0021. Other than this, the auxiliary steam system serves no safety function, and system analysis has shown that failure of the system will not compromise any safety-related systems or prevent safe shutdown.

9.5.10 Hydrogen Water Chemistry System

9.5.10.1 Design Basis

9.5.10.1.1 Safety Design Basis

Bulk storage facilities are provided for hydrogen and oxygen in support of the hydrogen water chemistry system on the plant north end of the Unit 2 cooling tower basin. Foundations for permanent liquid by hydrogen and oxygen storage tanks and gaseous hydrogen storage vessels in support of the station HWC system are designed to keep the associated vessel in place during a design basis tornado. Vessel failure with the corresponding loss of all contents is permitted during the tornado. Siting considerations for the storage facilities included evaluation of impact to nearby safety related structures due to fireball or explosion of hydrogen, and oxygen vapor cloud ingestion into safety related air pathways.

There is no consideration for tornado restraint of temporary hydrogen tube trucks that may be on site for an indeterminate time as emergency backup vessels for station hydrogen demand.

9.5.10.1.2 Power Generation Design Basis

The objective of the hydrogen water chemistry system is to further reduce the susceptibility of reactor recirculation piping and reactor vessel lower internal materials to intergranular stress corrosion cracking. This system is designed to perform the following functions when the reactor power is above approximately 10% (1.89 mlb/hr feedwater flow):

GRAND GULF NUCLEAR GENERATING STATION
Updated Final Safety Analysis Report (UFSAR)

- a. Inject sufficient hydrogen into the condensate stream to reduce reactor water electrochemical corrosion potential below normal water chemistry values (below + 150 mV standard hydrogen electrode);
- b. Inject sufficient oxygen into the offgas system to ensure that the excess hydrogen in the offgas stream is recombined.

Intergranular stress corrosion cracking is discussed in Section 5.2.3.5.

9.5.10.2 System Description

9.5.10.2.1 Bulk Storage Facility

Bulk storage facilities are provided for hydrogen and oxygen in support of the hydrogen water chemistry system on the plant north end of the Unit 2 cooling tower basin. The bulk liquid hydrogen facility includes a 20,000 gallons cryogenic tank, cryogenic pumps, atmospheric vaporizers and gas storage tubes to supply high pressure gas to the hydrogen water chemistry, generator cooling and primary water tank blanket systems. Due to the safety significance associated with storage of large hydrogen volumes, the liquid hydrogen tank, including all integral tank attached piping, is design and qualified to Uniform Building Code (UBC) seismic zone 4 requirements and liquid hydrogen filled piping between the tank, hydrogen pumps and vaporizers is qualified to UBC seismic zone 2 requirements. Both of these are conservative with respect to the GGNS design basis earthquake acceleration values. The design of foundations for the hydrogen storage tank and liquid filled piping have been qualified to generic seismic loadings for similar sized tanks. Therefore, a seismic event at the storage facility does not impact siting considerations to station structures.

The bulk liquid oxygen facility includes a 9,000 gallon cryogenic tank and atmospheric vaporizers to supply low pressure gas to the hydrogen water chemistry system. There are no seismic considerations associated with the oxygen storage facility.

9.5.10.2.2 Gas Injection System

The hydrogen water chemistry system consists of the piping valves, controls, instrumentation, and associated equipment and gas supply facilities required to supply gaseous hydrogen and

GRAND GULF NUCLEAR GENERATING STATION
Updated Final Safety Analysis Report (UFSAR)

oxygen to the condensate and offgas systems, respectively. The system described in this subsection is based on the generic Electric Power Research Institute "Guidelines for Permanent BWR Hydrogen Water Chemistry Systems - 1987 Revision."

Hydrogen is supplied from a cryogenic hydrogen storage facility as described in Section 1.2.2.2. A single flow control valve train is used for hydrogen injection into the condensate/feedwater stream through a side stream water path across the condensate booster pump. The single hydrogen injection point contains a check valve to prevent water from entering the hydrogen line. Connections are provided to allow hydrogen piping to be completely purged of air before hydrogen is introduced into the line.

Oxygen is supplied from a cryogenic oxygen storage system as described in Section 1.2.2.2. A single flow control valve train is used for oxygen injection into the offgas system between the offgas preheater and catalytic recombiner for each recombiner train. Each oxygen injection point contains a check valve to prevent offgas from entering the oxygen line.

Table 9.5-17 lists major equipment malfunctions, failure mechanisms, consequences, and design precautions for the major hydrogen water chemistry system components.

9.5.10.2.3 Noble Metal Injection and Monitoring System

The on line noble chemistry injection and monitoring system consists of piping, valves, controls, instrumentation, and associated equipment required to inject noble metal compounds in reactor coolant water via the feedwater system and monitor the noble metal concentrations via samples drawn from the reactor water clean up system.

Injection of noble metals is an intermittent process and is completed while the reactor is in mode 1 and continues for a period of days. The reapplication of noble metals is determined by continuous monitoring of the electrochemical corrosion potential of the reactor coolant water via the monitoring system and via periodic analysis of specimen coupons located within the monitoring system.

GRAND GULF NUCLEAR GENERATING STATION
Updated Final Safety Analysis Report (UFSAR)

Noble metal compounds are introduced into the reactor coolant water as a means to catalyze the hydrogen oxygen reactions and thereby make the hydrogen water chemistry system more effective at reducing intergranular stress corrosion cracking.

9.5.10.3 Safety Evaluation

9.5.10.3.1 Bulk Storage Facility

Foundations for permanent liquid hydrogen and oxygen storage tanks and gaseous hydrogen storage vessels in support of the station HWC system are designed to keep the associated vessel in place during a design basis tornado. Vessel failure with the corresponding loss of all contents is permitted during the tornado. Siting considerations for the storage facilities included evaluation of impact to nearby safety related structures due to fireball or explosion of hydrogen, and oxygen vapor cloud ingestion into safety related air pathways.

Design and siting of these facilities are in compliance with the following listed documents, codes, standards and guidelines:

a. CGA Pamphlets

CGA G-4.4, Industrial Practices for Gaseous Oxygen Transmission and Distribution Piping Systems

CGA G-5.4, Standard for Hydrogen Piping Systems at Consumers Location

CGA P-12, Grounding Requirements for Cryogenic Storage at Consumer Locations

b. NFPA Standards

NFPA 50, Standard for Bulk Oxygen Systems at Consumer sites, 1994

NFPA 50A, Standard for Gaseous Hydrogen Systems at Consumer Sites, 1994

NFPA 50B, Standard for Liquified Hydrogen Systems at Consumer Sites, 1994

NFPA 780, Lightning Protection

GRAND GULF NUCLEAR GENERATING STATION
Updated Final Safety Analysis Report (UFSAR)

c. OSHA Regulations

29CFR1910.103 - "Hydrogen," 7-1-95, OSHA, Labor

29CFR1910.104 - "Oxygen," 7-1-95, OSHA, Labor

d. Supplemental Documents

EPRI NP-5283-SR-A, September 1987, Guidelines for
Permanent BWR Hydrogen Water Chemistry Installations, 1987
Revision

Siting considerations included impact to station safety related structures due to fireball or explosion at the hydrogen storage facility and separation distance to safety related air intakes from hydrogen and oxygen vessels. Leakage from or failure of either facility was evaluated as acceptable with no adverse impact to safe station shutdown. Redundant pressure relief (hydrogen and oxygen) and vent stack design (hydrogen only) vessels provides protection of storage vessels and liquid filled piping from thermal overpressure due to external fire. Due to the explosion potential of hydrogen leaks, there is no fire abatement system. Hydrogen fires are to be allowed to burn until hydrogen source is isolated.

Explosion at the hydrogen storage facility will result in stripping of the enclosure building siding and pressure loads applied to the naked steel framing. These loads are bounded by the existing considerations for a tornado. Therefore, based on siting considerations for the bulk hydrogen storage vessels, no special evaluation of the enclosure building steel or its interface with the containment dome is required.

9.5.10.3.2 Gas Injection System

The hydrogen water chemistry system serves no safety function. Systems analysis has shown that failure of this system will not compromise any safety-related systems or prevent safe shutdown.

The hydrogen water chemistry system is not required to effect or support the safe shutdown of the reactor or perform in the operation of reactor safety features.

GRAND GULF NUCLEAR GENERATING STATION
Updated Final Safety Analysis Report (UFSAR)

There is no equipment redundancy associated with the injection control functions for the hydrogen water chemistry system. Equipment redundancy is provided at the storage facilities to ensure a reliable hydrogen supply to the hydrogen water chemistry and generator hydrogen cooling systems.

All water filled hydrogen water chemistry system piping considered in this section is located within the Turbine Building and the potential consequences of flooding resulting from pipe failure is bounded by failure of other condensate piping in this area.

Use of the side stream condensate injection loop results in a net loss of approximately 100 gpm of water from the condensate booster system downstream of the injection loop suction point. This loss is within the makeup capabilities of the pumped forward heater drain pumps and has no impact on reactor level control.

Excess flow check valve protection is provided for all hydrogen and oxygen piping outside of the storage facilities to ensure that adequate separation is maintained between a large leakage source and any safety related structures or air pathways into safety-related structures.

Connections are provided to allow hydrogen piping to be completely purged of air before hydrogen is introduced into the line. Suitable valves are provided to cross connect the purge outlet to a hydrogen vent line, which contains a flame arrestor.

The hydrogen water chemistry system trips on offgas system isolation and all station trips. Isolation valves fail close on loss of electric or pneumatic power to prevent inadvertent injection of gases during any station transient.

9.5.10.3.3 Noble Metal Injection and Monitoring System

The online noble chemistry injection and monitoring system serves no safety function. Failure of either the injection or the monitoring functions of this system will not compromise any safety-related systems or prevent safe shutdown.

The online noble chemistry injection and monitoring system is not required to affect or support the safe shutdown of the reactor or perform in the operation of reactor safety features.

GRAND GULF NUCLEAR GENERATING STATION
Updated Final Safety Analysis Report (UFSAR)

There is no equipment redundancy associated with the injection or monitoring function of the online noble chemistry system. All water filled injection lines are located within the Turbine building and the potential consequences of flooding are bounded by pipe failures of feedwater piping in this area. All water filled monitoring lines are located within the Containment area and the consequences of flooding are bounded by pipe failures of the reactor water cleanup system in this area.

Loss of power to the injection functions of the system results in activation of fail close valves and inactivation of drive pumps and thus prevents inadvertent noble metal compound injection during any loss of station power. Additionally, there are a series of check valves in the injection lines that prevent backflow of feedwater to the injection system.

9.5.10.4 Tests and Inspections

The functional operability of the hydrogen water chemistry system, including verification of the appropriate time delay for hydrogen and oxygen ramp rates, was initially tested at the time of system installation.

Maintenance requirements for the system are based upon the panel/component vendor recommendations, and considered extended hydrogen water chemistry system shutdown periods and other factors not consistent with normal system operation.

9.5.10.5 Instrument Application

The hydrogen water chemistry system control logic varies hydrogen flow as function of reactor power, to maintain a constant hydrogen concentration in the feedwater. Oxygen flow is based on a percentage of total hydrogen flow and is delayed to account for transit time of the hydrogen through the feedwater, main steam and offgas systems. Instrumentation measures the hydrogen and oxygen flow rates to verify injection rates are in agreement with the determined setpoints.

Pressure switches are provided upstream of the flow control valves to ensure proper valve operation. Additional combustible gas monitoring due to offgas oxygen injection is discussed in Section 7.7.1.10.

GRAND GULF NUCLEAR GENERATING STATION
Updated Final Safety Analysis Report (UFSAR)

9.5.11 References

1. AECM-86/0229, "MP&L Responses to NRC Concerns Regarding Spent Fuel Pool Decay Heat Capability and Associated Operating Procedures," July 25, 1986.
2. GNRO-91/00145, "Solution to Fuel Pool Cooling Issue," November 1, 1991.
3. AECM-81/424, "Transmittal of Proposed FSAR Revision Regarding Ultimate Heat Sink Reliability," October 30, 1981.

GRAND GULF NUCLEAR GENERATING STATION
Updated Final Safety Analysis Report (UFSAR)

**TABLE 9.5-1: DIESEL GENERATOR FUEL OIL SYSTEM
COMPONENT DATA**

Standby and HPCS Diesel Generator Fuel Oil Storage Tanks

Type	Horizontal
Quantity	1 per diesel generator
Capacity, gallons	76,000
Design pressure, internal/ external	Atm/9.2 psi

Standby and HPCS Diesel Generator Fuel Oil Transfer Pumps

Type	Submersible, centrifugal
Quantity	1 per diesel generator
Capacity, gpm	25
TDH, ft	77.5
Driver horsepower	2.5

Standby and HPCS Diesel Generator Fuel Oil Day Tanks

Type	Vertical
Quantity	1 per diesel generator
Capacity, gallons	550
Design pressure	Atm.

Standby Diesel Generator Fuel Oil Pumps

a. Engine-Driven Pump

Type	Gear
Quantity	1 per diesel generator
Capacity, gpm	25
TDH, psi	50

b. Motor-Driven Pump

Type	Screw
Quantity	1 per diesel generator

GRAND GULF NUCLEAR GENERATING STATION
Updated Final Safety Analysis Report (UFSAR)

**TABLE 9.5-1: DIESEL GENERATOR FUEL OIL SYSTEM
COMPONENT DATA (CONTINUED)**

Capacity, gpm	25
TDH, psi	50
Driver horsepower	2

HPCS Diesel Generator Fuel Oil Pumps

a. Engine-Driven Pump

Type	Gear
Quantity	2 per diesel generator
Capacity (each), gpm	4.5
TDH (each), psi	50

b. Motor-Driven Pump

Type	Gear
Quantity	2 per diesel generator
Capacity (each), gpm	5
TDH (each), psi	50
Driver horsepower	1/2

GRAND GULF NUCLEAR GENERATING STATION
Updated Final Safety Analysis Report (UFSAR)

**TABLE 9.5-2: FAILURE ANALYSIS OF DIESEL GENERATOR
FUEL OIL SYSTEM**

Component (Number)	Malfunction	Comments and Consequences
1. Storage tanks, 3	Loss of one tank	There is sufficient capacity in the other two tanks to run the two associated diesels for 7 days at maximum demand load. Only two diesels are required for a safe shutdown following a loss-of-coolant accident and loss of offsite power.
2. Day tanks, 3	Loss of one tank	The fuel supply to one diesel would be lost. However, only two diesels are required for a safe shutdown following a loss-of-coolant accident and loss of offsite power.
3. Transfer pumps, 3	Loss of one pump	Same as item 2.
4. Line between storage tank and day tank, 3	Line fails (rupture of pipe or component)	Same as item 2.
5. Refill line, 3	Pipe rupture	Storage tanks are located underground, below the refill lines; therefore, no fuel will be lost. During prolonged operation, refilling of the tanks will be done through a hose connection located on the recirculation line inside the diesel generator building.
6. SDG Fuel Oil pumps, 4 (2 engine Driven, 2 motor driven)	Loss of one pump	The redundant pump will supply the fuel to its respective diesel engine to operate it for 7 days at maximum load demand.
7. HPCS DG Fuel Oil pumps, 4 (2 engine driven, 2 motor driven)	Loss of motor driven pump	The HPCS diesel will not meet the ten second start requirement. The engine driven pump will supply fuel to operate for 7 days.

GRAND GULF NUCLEAR GENERATING STATION
Updated Final Safety Analysis Report (UFSAR)

**TABLE 9.5-2: FAILURE ANALYSIS OF DIESEL GENERATOR
FUEL OIL SYSTEM (CONTINUED)**

Component (Number)	Malfunction	Comments and Consequences
8. HPCS DG Fuel Oil Pumps 4 (2 engine driven, 2 motor driven)	Loss of engine driven pump	The redundant motor driven pump will supply the fuel to its respective HPCS diesel engine to operate it for 7 days at maximum load demand.

GRAND GULF NUCLEAR GENERATING STATION
Updated Final Safety Analysis Report (UFSAR)

**TABLE 9.5-3: DIESEL GENERATOR COOLING WATER SYSTEM
COMPONENT DATA**

Standby Diesel Generator Cooling Water System

a. Jacket Water Pumps

Type	Centrifugal
Quantity	2 per diesel engine (one motor-driven, one engine-driven)
Capacity, gpm	1800 each
Head, ft	85

b. Jacket Water Cooler

Quantity	1 per diesel engine
Type	TEMA AEW
Duty, Btuh	23.75 x 10 ⁶
Design Conditions	
Tube Side - SSW Cooling Water	
a. Inlet temp, F	90
b. Outlet temp, F	110
c. Flow, gpm	2400
Shell Side - Diesel Generator Jacket Cooling Water	
a. Inlet temp, F	175
b. Outlet temp, F	148.6
c. Flow, gpm	1800
Heat removal design margin, %	175

c. Jacket Water Standpipe

Quantity	1 per diesel engine
Type	Vertical
Capacity, gal	100

GRAND GULF NUCLEAR GENERATING STATION
Updated Final Safety Analysis Report (UFSAR)

**TABLE 9.5-3: DIESEL GENERATOR COOLING WATER SYSTEM
COMPONENT DATA (CONTINUED)**

d. Jacket Water Heater

Type	Immersion
Quantity	1 per diesel engine
Output, kw	75

e. Jacket Water Heater Circulating Pump

Type	Centrifugal
Quantity	1 per diesel engine
Capacity, gpm	10
Head, ft	20

HPCS Diesel Generator Cooling Water System

a. Cooling Water Pumps

Quantity	2 per engine of tandem diesel arrangement (both engine-driven)
Capacity, gpm	330 each
Head, ft	100

b. Cooling Water Heat Exchanger (Jacket Water Cooler)

Quantity	1 per engine of tandem diesel arrangement
Type	TEMA CPK
Duty, Btuh	5.108 x 10 ⁶
Design Conditions	
Tube Side - SSW Cooling Water	
a. Inlet temp, F	90
b. Outlet temp, F	120
c. Flow, gpm	365

GRAND GULF NUCLEAR GENERATING STATION
Updated Final Safety Analysis Report (UFSAR)

**TABLE 9.5-3: DIESEL GENERATOR COOLING WATER SYSTEM
COMPONENT DATA (CONTINUED)**

Shell Side - Diesel Generator Jacket Water	
a. Inlet temp, F	185
b. Outlet temp, F	169
c. Flow, gpm	660
c. <u>Cooling Water Expansion Tank</u>	
Quantity	1 per engine of tandem diesel arrangement
Type	Horizontal
Capacity, gal	150
d. <u>Cooling Water Immersion Heater</u>	
Quantity	1 per engine of tandem diesel arrangement
Output, kw	15

GRAND GULF NUCLEAR GENERATING STATION
Updated Final Safety Analysis Report (UFSAR)

TABLE 9.5-4: COMPONENT AND SYSTEM HEAT REJECTION RATES

Component	Heat Rejection (Btuh) Standby Diesel Generator/ HPCS Diesel Generator*
Turbocharger aftercoolers	$5.737 \times 10^6 / 1.669 \times 10^6$
Lube oil cooler	$2.966 \times 10^6 / 0.863 \times 10^6$
Diesel engine	$9.026 \times 10^6 / 2.488 \times 10^6$
Total	$17.729 \times 10^6 / 5.020 \times 10^6$

*Figures are for one diesel engine of tandem arrangement.

GRAND GULF NUCLEAR GENERATING STATION
Updated Final Safety Analysis Report (UFSAR)

TABLE 9.5-5: DIESEL GENERATORS STARTING AIR SYSTEMS COMPONENTS

Standby Diesel Generator Starting System

a. Air Receivers

Quantity	2 per diesel engine
Type	Vertical
Capacity, ft ³	305 each

b. Air Compressors

Quantity	2 per diesel engine (1 motor-driven, 1 driven by separate diesel engine)
Capacity, scfm	76
Discharge pressure, psi	250

c. Air Dryers

Quantity	2 per diesel engine
Type	Desiccant, Activated Alumina
Capacity, scfm	76
Purge	6 scfm
Effluent	70 scfm
Dew point	-40 F at 250 psig
Dehydrator towers	2 per air dryer

d. Air Aftercoolers

Quantity	2 per diesel engine
Type	Air-to-air

HPCS Diesel Generator Starting System

a. Air Receivers

Quantity	2 for each engine for tandem arrangement
Type	Horizontal

GRAND GULF NUCLEAR GENERATING STATION
Updated Final Safety Analysis Report (UFSAR)

**TABLE 9.5-5: DIESEL GENERATORS STARTING AIR SYSTEMS
COMPONENTS (CONTINUED)**

Capacity, ft ³	35 to 40 each
b. <u>Air Compressors</u>	
Quantity	2 total for tandem arrangement (1 motor-driven, 1 driven by separate diesel engine)
Capacity, scfm	15
Discharge pressure, psi	250
c. <u>Air Motors</u>	
Quantity	2 dual, air-starting motors for each engine of tandem arrangement
Type	Rotary multivane

GRAND GULF NUCLEAR GENERATING STATION
Updated Final Safety Analysis Report (UFSAR)

TABLE 9.5-6: DIESEL GENERATORS LUBRICATION SYSTEM COMPONENTS

Standby Diesel Generator Lubricating Oil System

a. Lube Oil Pumps

Quantity	2 per diesel engine (one motor-driven one engine-driven)
Capacity, gpm	590
Head, psi	80

b. Lube Oil Heat Exchanger

Quantity	1 per diesel
Type	TEMA AEW
Duty, Btuh	3.22 x 10 ⁶
Design Conditions	
Tube Side - Jacket Water	
a) Inlet temp, F	148.6
b) Outlet temp, F	156.7
c) flow, gpm	800
Shell Side - Lube Oil	
a) Inlet temp, F	185.0
b) Outlet temp, F	156.4
c) Flow, gpm	500
Design Margin, %	16

c. Lube Oil Sump Tank

Quantity	1 per diesel
Type	Vertical
Capacity, gal	1200

d. Lube Oil Heater Circulating Pump

Quantity	1 per diesel
Capacity, gpm	125
Head, psi	15

GRAND GULF NUCLEAR GENERATING STATION
Updated Final Safety Analysis Report (UFSAR)

**TABLE 9.5-6: DIESEL GENERATORS LUBRICATION SYSTEM
COMPONENTS (CONTINUED)**

Standby Diesel Generator Lubricating Oil System

e. Lube Oil Heater

Quantity	1 per diesel
Output, kw	30

HPCS Diesel Generator Lubricating Oil System

a. Lube Oil Piston Cooling Pump

Quantity	1 per diesel engine
Capacity, gpm	66
Head, ft	50

b. Main Lube Oil Pressure Pump

Quantity	1 per diesel engine
Capacity, gpm	157
Head, ft	50

c. Lube Oil Scavenging Pump

Quantity	1 per diesel engine
Capacity, gpm	279
Head, psi	35

d. Lube Oil Soak Back Pump

Quantity	1 per diesel engine
Capacity, gpm	5 to 6
Head, psi	25

e. Lube Oil Heat Exchanger (Cooler)

Quantity	1 per diesel
Type	Fin-tube core type
Duty, Btuh	1.744 x 10 ⁶
Design Conditions	

GRAND GULF NUCLEAR GENERATING STATION
Updated Final Safety Analysis Report (UFSAR)

**TABLE 9.5-6: DIESEL GENERATORS LUBRICATION SYSTEM
COMPONENTS (CONTINUED)**

HPCS Diesel Generator Lubricating Oil System

Tube Side - Jacket Water

a) Inlet temp, F	156
b) Outlet temp, F	160
c) Flow, gpm	660

Shell Side - Lube Oil

a) Inlet temp, F	215
b) Outlet temp, F	192
c) Flow, gpm	279

Design Margin - The engine can safely operate with 15 F above the temperatures shown.

f. Lube Oil Sump

Quantity	1 per diesel
Capacity, gal total/usable	215/131

GRAND GULF NUCLEAR GENERATING STATION
Updated Final Safety Analysis Report (UFSAR)

**TABLE 9.5-7: DIESEL GENERATORS COMBUSTION AIR INTAKE
AND EXHAUST SYSTEM COMPONENTS**

Standby Diesel Generator Combustion Air Intake and Exhaust System

a. Intake Air Filter

Quantity	1 per diesel engine
Type	Oil-bath
Capacity, scfm	28,122

b. Intake Air Silencer

Quantity	2 per diesel engine
Type	Residential
Capacity, scfm	14,061 each

c. Exhaust Silencer

Quantity	1 per diesel engine
Type	Residential, chamber
Capacity, scfm	28,122

HPCS Diesel Generator Combustion Air Intake and Exhaust System

a. Intake Air Filter

Quantity	2 per tandem diesel engine
Type	Oil-bath
Capacity, cfm	7,100 each @ 90 F

b. Intake Air Silencer

Quantity	2 per tandem diesel engine
Type	Residential, straight-through
Capacity, cfm	7,100 each @ 90 F

c. Exhaust Silencer

GRAND GULF NUCLEAR GENERATING STATION
Updated Final Safety Analysis Report (UFSAR)

**TABLE 9.5-7: DIESEL GENERATORS COMBUSTION AIR INTAKE
AND EXHAUST SYSTEM COMPONENTS (CONTINUED)**

HPCS Diesel Generator Combustion Air Intake and Exhaust System

Quantity	2 per tandem diesel engine
Type	Residential, chamber
Capacity, cfm	15,800 each @ 790 F

GRAND GULF NUCLEAR GENERATING STATION
Updated Final Safety Analysis Report (UFSAR)

TABLE 9.5-8: FAILURE ANALYSIS FOR DIESEL GENERATOR COOLING WATER SYSTEM

Component (each engine)	Malfunction	Comment/Consequences
Jacket water pump (motor driven)	Loss of pump	Loss has no effect. If the engine driven pump is not available, loss results in loss of diesel generator; use redundant diesel generator.
Jacket water pump (engine driven)	Loss of pump	Loss of diesel generator; use redundant diesel generator. Motor driven Jacket Water Pump may be used as a redundant Jacket Water Supply Source.
Jacket water cooler	Loss of cooler	Loss of diesel generator; use redundant diesel generator
Jacket water heater pump	Loss of pump	Nonessential component
Jacket water heater	Loss of heater	Nonessential component
Jacket water stand- pipe	Rupture; loss of standpipe	Loss of diesel generator; use redundant diesel generator
Jacket water piping	Rupture	Loss of diesel generator; use redundant diesel generator

GRAND GULF NUCLEAR GENERATING STATION
Updated Final Safety Analysis Report (UFSAR)

**TABLE 9.5-9: FAILURE ANALYSIS FOR STANDBY DIESEL GENERATOR
STARTING AIR SYSTEM**

Component (each engine)	Malfunction	Comment/Consequence
Starting air compressor (engine driven)	Loss of compressor	Nonessential component
Starting air compressor (motor driven)	Loss of compressor	Nonessential component
Starting air aftercooler (2)	Loss of aftercooler(s)	Nonessential components
Starting air dryer (2)	Loss of dryer(s)	Nonessential components
Starting air storage tank (2)	Rupture; loss of one tank	Use redundant train
Starting air piping (2 trains)	Rupture	Use redundant train
Starting air solenoid valves (2 trains)	One train fails to open	Use redundant train

GRAND GULF NUCLEAR GENERATING STATION
Updated Final Safety Analysis Report (UFSAR)

**TABLE 9.5-10: FAILURE ANALYSIS FOR
DIESEL GENERATOR LUBRICATION SYSTEM**

<u>Component</u>	<u>Malfunction</u>	<u>Comments/Consequences</u>
Lube oil pump (motor driven)	Loss of pump	Loss has no effect. If the engine driven lube oil pump is not available, loss results in loss of diesel generator; use redundant diesel generator.
Lube oil pump (engine driven)	Loss of pump	Loss of diesel generator; use redundant diesel generator. Motor driven lube oil pump may be used as a redundant lube oil supply source.
Lube oil cooler	Loss of cooler	Loss of diesel generator; use redundant diesel generator
Lube oil filter	Filter clogged	Loss of diesel generator; use redundant diesel generator
Lube oil sump tank	Loss of tank	Loss of diesel generator; use redundant diesel generator
Lube oil strainer	Strainer clogged	Loss of diesel generator; use redundant diesel generator

GRAND GULF NUCLEAR GENERATING STATION
Updated Final Safety Analysis Report (UFSAR)

**TABLE 9.5-10: FAILURE ANALYSIS FOR DIESEL
GENERATOR LUBRICATION SYSTEM (CONTINUED)**

<u>Component</u>	<u>Malfunction</u>	<u>Comments/Consequences</u>
Lube oil piping	Pipe rupture	Loss of diesel generator; use redundant diesel generator
Lube oil heater pump	Loss of pump	Nonessential component
Lube oil prelube filter	Filter clogged	Nonessential component
Lube oil heater	Loss of heater	Nonessential component

GRAND GULF NUCLEAR GENERATING STATION
Updated Final Safety Analysis Report (UFSAR)

TABLE 9.5-11: FIRE PROTECTION PROGRAM COMPARISON WITH NRC REQUIREMENTS

Point-by-point comparison of the fire protection program of the Grand Gulf Nuclear Station, with the positions of the Nuclear Regulatory Commission's Appendix A to Branch Technical Position APCS 9.5-1, dated August 23, 1976, for plants under construction before July 1, 1976.

<u>Appendix A Position</u>	<u>Grand Gulf Station Position</u>
<u>A. Overall Requirements of Nuclear Plant Fire Protection Program</u>	
1. Personnel	Comply. See the Fire Protection Program (Appendix 9B) and the Fire Hazards Analysis Report.
a. Layout Coordination and System Design Requirements	See Appendix 9B.
b. Design and Maintenance	See Appendix 9B.
c. Fire Prevention Activities	See Appendix 9B.
d. Fire Brigade Training	See Appendix 9B.
2. Design Basis	Comply. Fire hazard analysis results were used to improve existing designs, as practicable.
3. Backup	Comply. Hose streams and portable fire extinguishers are provided throughout the plant.
4. Single Failure Criterion	Comply. Redundant fire pumps, piping, and fire suppression means are provided. The diesel generator building has a single supply for sprinkler systems and hose stations. However, fire hydrants are available in the vicinity.
5. Fire Suppression Systems	Comply. Inadvertent operation of the fire suppression systems presents no safe shutdown problem.

GRAND GULF NUCLEAR GENERATING STATION
Updated Final Safety Analysis Report (UFSAR)

TABLE 9.5-11: FIRE PROTECTION PROGRAM COMPARISON WITH NRC REQUIREMENTS (CONTINUED)

6. Fuel Storage Areas	Comply. Fire protection programs will be operative before receiving fuel.
7. Fuel Loading	Comply. Fire protection programs will be operative before fuel load.
8. Multiple-Reactor Sites	Comply. (See Section 1.1.3)
9. Simultaneous Fires	Comply. Possible fires are postulated as presented in the Fire Hazards Analysis Report.
B. <u>Administrative Procedures, Controls, and Fire Brigade</u>	
1. Providing Administrative Procedures	Comply. See Fire Protection Program (Appendix 9B).
2. Bulk Storage of Combustibles	Comply. See Fire Protection Program (Appendix 9B).
3. Special Actions and Procedures	Comply. The Fire Protection Program procedures provide for these items: Fire protection organization Fire protection equipment maintenance Cutting, welding, and hot work following inspection for combustibles Coordination of fire protection during operation/construction period Fire protection test Impairment procedure Fire brigade Control of combustibles
4. Public Fire Department Response	Comply. See Fire Protection Program (Appendix 9B).
5. Fire Brigade	Comply. See Fire Protection Program (Appendix 9B).
a. Equipment Testing and Maintenance	Provisions are described in Appendix 9B.
b. Basic Training	Comply. See Fire Protection Program (Appendix 9B).

GRAND GULF NUCLEAR GENERATING STATION
Updated Final Safety Analysis Report (UFSAR)

TABLE 9.5-11: FIRE PROTECTION PROGRAM COMPARISON WITH NRC REQUIREMENTS (CONTINUED)

c.	Proper Shift Coverage	Comply. See Fire Protection Program (Appendix 9B).
d.	Recommended Standard (NFPA 27)	Provisions have been made for: Organization, training, fire drills, inspection, maintenance, and courses in fire protection in the Fire Protection Program (Appendix 9B). Courses in fire protection - Fire Brigade Procedure
C. <u>Fire Protection Quality Assurance Program</u>		
C.1	Design, Procurement, and Program Construction Phase	<p>The Quality Assurance for fire protection during the design, procurement, and construction phases was controlled by Engineering, Procurement, Construction, Checkout and Turnover, and Quality Assurance department procedures. Some of these procedures were similar to those used for safety-related activities and some were written to address non-safety-related activities and were part of existing project manuals previously reviewed by GGNS Quality Programs. GGNS Quality Programs had the responsibility for auditing the Bechtel Nuclear Quality Assurance Program for Unit II Construction which includes Fire Protection. GGNS QP verifies by audits that the controlling procedures for activities including Fire Protection are implemented.</p> <p>Verification of the effectiveness of the Quality Assurance Program for fire protection is accomplished through design document review, inspections, surveillance and monitoring, tests, and audits.</p> <p>Systems, components, and structures covered by the program are:</p> <ol style="list-style-type: none">1. Automatic pre-action sprinklers

GRAND GULF NUCLEAR GENERATING STATION
Updated Final Safety Analysis Report (UFSAR)

TABLE 9.5-11: FIRE PROTECTION PROGRAM COMPARISON WITH NRC REQUIREMENTS (CONTINUED)

2. Automatic wet-pipe sprinklers
3. Water spray systems
4. Automatic carbon dioxide systems
5. Clean agent suppression systems
6. Standpipes
7. Fire and smoke detection and alarm systems
8. Fire doors and fire dampers
9. Fire walls
10. Penetration seals
11. Fireproofing of structural steel
12. Fire water pump house components

The quality assurance criteria that apply to fire protection during the design, procurement, and construction phases are described as follows:

1. Design Control and Procurement Control

a. Review and Approval

Several levels of design review and approval are applied to the design aspects of the Grand Gulf fire protection system.

Applicable standard procedures of the Project Engineering Procedures Manual are utilized during initial design and during the performance of any design changes. These procedures include:

GRAND GULF NUCLEAR GENERATING STATION
Updated Final Safety Analysis Report (UFSAR)

**TABLE 9.5-11: FIRE PROTECTION PROGRAM COMPARISON WITH NRC
REQUIREMENTS (CONTINUED)**

- (1) Checking and review by design and engineering level personnel within the project engineering team having technical qualifications comparable to those of the engineer or designer who originated the work.
- (2) Review and approval by the originating engineering discipline.
- (3) Review and approval by the Project Engineer or the cognizant Assistant Project Engineer.

In addition to the reviews performed by Project Engineering, a staff fire protection specialist is consulted by the design engineer, as necessary, to ensure design adequacy.

Technical aspects of the procurement documents are also prepared by Project Engineering in accordance with the above procedures. Technical changes in procurement documents are subject to the same degree of design control as was exercised in the preparation of the original document.

- b. Codes and Standards

GRAND GULF NUCLEAR GENERATING STATION
Updated Final Safety Analysis Report (UFSAR)

**TABLE 9.5-11: FIRE PROTECTION PROGRAM COMPARISON WITH NRC
REQUIREMENTS (CONTINUED)**

Codes, standards, and guidelines which control the design, materials, fabrication, installation, and testing of fire protection systems and components are specified in the applicable design documents and in the engineering specifications for procurement of systems and components. Conformance with the applicable codes and standards is ensured by standard document reviews, as described in Part a, and vendor certification provided with the shipment. Deviations from specified codes and standards are documented and reviewed by Project Engineering. Deviations or changes from applicable standards dispositioned "use-as-is" must be justified and approved. The justification and approval shall also be documented and filed.

c. New Designs and Plant Modifications

New designs and plant modifications to the fire protection systems which may affect fire protection capabilities are subjected to the standard review procedures described in Part a. These reviews specifically include the following:

- (1) Wiring isolation and cable separation are reviewed for compliance with Regulatory Guide 1.75, as specified in Appendix 3A.

GRAND GULF NUCLEAR GENERATING STATION
Updated Final Safety Analysis Report (UFSAR)

**TABLE 9.5-11: FIRE PROTECTION PROGRAM COMPARISON WITH NRC
REQUIREMENTS (CONTINUED)**

- (2) Safe shutdown cable routings are reviewed for impact on the safe shutdown analysis described in the Fire Hazards Analysis Report to ensure that adequate protection is provided against the effects of exposure fires on redundant safe shutdown-related components.

- (3) During the design and construction phase, isolation of new or modified rooms by the use of fire-rated barriers (walls, floors, ceilings, penetrations, and doors) is determined by Project Engineering. Any deviations from design that occur during construction are permanently documented in accordance with standard procedures. The level of review provided for deviations or modifications of fire-rated barriers is the same as required for the initial design. Barrier requirements are summarized in the Fire Hazards Analysis Report.

- d. Review and Concurrence in Fire Protection Requirements and Quality Adequacy in Procurement Documents

GRAND GULF NUCLEAR GENERATING STATION
Updated Final Safety Analysis Report (UFSAR)

**TABLE 9.5-11: FIRE PROTECTION PROGRAM COMPARISON WITH NRC
REQUIREMENTS (CONTINUED)**

Procurement documents are reviewed as described in Part a. Additional review of specifications is performed by the Bechtel Quality Engineering organization to verify that quality requirements are correctly stated, inspectable, and controllable, and that there are adequate acceptance and rejection criteria.

Field Engineering procedures provide instructions for control of construction activities including:

- (1) Receipt and control of Project Engineering design documents
- (2) Field Engineering detail design work including field change requests
- (3) Incorporation of design changes including field change requests
- (4) Review of supplier and contractor drawings as delegated by Project Engineering.

2. Instructions, Procedures, and Drawings

The written instructions and procedures used to implement the Bechtel Quality Assurance Program for fire protection and the activities affecting quality during the engineering, procurement, and construction phases of the project are contained in the following manuals and documents:

GRAND GULF NUCLEAR GENERATING STATION
Updated Final Safety Analysis Report (UFSAR)

**TABLE 9.5-11: FIRE PROTECTION PROGRAM COMPARISON WITH NRC
REQUIREMENTS (CONTINUED)**

- a. Quality Assurance Department Procedures Manual (QADPM), which defines responsibilities and outlines quality assurance activities.
- b. Project Engineering Procedures Manual (PEPM), which contains procedures for operation and control of the Engineering Department.
- c. Procurement Supplier Quality Department Manual (PSQDM), which contains source inspection instructions, guidelines, and procedures.
- d. Construction Work Plan Procedures Manual (WP/P), which contains procedures for operation and control of the Construction Department as of October 1, 1975.

Inspections, tests, and administrative controls are accomplished in the following manner:

- (1) Requirements for instructions, procedures, and drawings are defined in the Work Plan/Procedures Program. Contractor and supplier activities are accomplished in accordance with Project Engineering approved drawings and specifications, with monitoring and surveillance by the Bechtel Contracts Administration Department.

GRAND GULF NUCLEAR GENERATING STATION
Updated Final Safety Analysis Report (UFSAR)

**TABLE 9.5-11: FIRE PROTECTION PROGRAM COMPARISON WITH NRC
REQUIREMENTS (CONTINUED)**

(2) The installation or application of penetration seals and fire-retardant coatings is performed in accordance with the Work Plan/Procedures Program for Bechtel and Project Engineering approved drawings and details for contractors.

e. Checkout and Turnover Organization Manual (CTOM), which contains procedures and guidance for preparing test procedures and performing system and component tests.

Written, formal instruction from Project Engineering to suppliers and contractors is in the form of engineering specifications, drawings, and drawing change notices.

These documents contain, reference, or require procedures and instructions, as appropriate, and provide necessary acceptance criteria. These documents, when approved by Project Engineering, provide authorization for construction work.

The sequence of actions for preparation, review, and control of instructions, procedures, and drawings depends upon the type of instructions, procedures, or drawings and is described in the appropriate manuals.

For example, the sequence of actions governing preparation, review, and control of drawings prepared by Project Engineering personnel is described by procedures contained in the Project Engineering Procedures Manual.

GRAND GULF NUCLEAR GENERATING STATION
Updated Final Safety Analysis Report (UFSAR)

**TABLE 9.5-11: FIRE PROTECTION PROGRAM COMPARISON WITH NRC
REQUIREMENTS (CONTINUED)**

Also, review and control of vendor drawings is described in the same manual, although the sequence of actions for preparation, review, and control of these drawings is different. The sequence of actions described in the Bechtel procedures provides for specified drawings, procedures, and instructions to be reviewed and approved by the responsible design discipline. The sequence of actions is subject, when applicable, to review and concurrence by interfacing disciplines at the cognizant design engineering level, and by off-project specialists, as required.

Similarly, the sequence of actions for preparation, review, and control of various instructions and procedures, including those applicable to the fire protection systems, fire retardant coatings, and the installation of penetration seals, are described in the applicable manual. Such procedures are reviewed and concurred with by interfacing departments and disciplines, where required.

Appropriate acceptance criteria, both quantitative and qualitative, are described in the applicable instructions, procedures, or drawings. This requirement is defined in department procedures and applies to instructions, procedures, and drawings prepared by Bechtel Project Engineering or by suppliers.

GRAND GULF NUCLEAR GENERATING STATION
Updated Final Safety Analysis Report (UFSAR)

**TABLE 9.5-11: FIRE PROTECTION PROGRAM COMPARISON WITH NRC
REQUIREMENTS (CONTINUED)**

Bechtel procurement documents require suppliers and contractors to submit specified drawings and procedures to Bechtel for approval prior to start of fabrication or construction. Bechtel review of these documents is performed to determine that interfacing design features are compatible with overall design and installation requirements, and that procedures are acceptable.

Verification that work is accomplished in accordance with approved instructions, procedures, and drawings is obtained through the various levels of surveillance, inspection, and audit.

3. Control of Purchased

The Bechtel Fire Protection Material, Equipment, Quality Assurance Program and services includes a comprehensive system to ensure that purchased material, equipment, and services conform to the procurement documents. This system is described below.

- a. The Bechtel Procurement Department maintains a current list of bidders acceptable to the Corporation. The list is reviewed periodically to verify the adequacy of each vendor for specific services, materials, or equipment. Note: Suppliers for the fire protection system may not have been chosen from this list of bidders, as it is only mandatory for safety-related equipment. Due to the importance of fire protection equipment, nationally recognized suppliers may have been chosen by Project Engineering to supply equipment used.

GRAND GULF NUCLEAR GENERATING STATION
Updated Final Safety Analysis Report (UFSAR)

**TABLE 9.5-11: FIRE PROTECTION PROGRAM COMPARISON WITH NRC
REQUIREMENTS (CONTINUED)**

- b. Source inspection has been provided for major CO2 system components and the fire pumps. The Grand Gulf fire protection design incorporates standard, commercially available equipment and materials which are verified by receipt inspection and, in addition, are subjected to site testing.

- c. The purchase order or subcontract contains the requirements for engineering and quality verification documentation to be submitted by the seller. Drawings and/or documents may be required to be submitted to Project Engineering for review only or for approval prior to proceeding with the work. Drawings and/or documents are specified for "review only" or "prior approval required" commensurate with the complexity of the equipment involved. Drawings and documents are reviewed for interface information and for compliance to requirements of the purchase order or subcontract.

- d. Receiving inspections and related documentation requirements are established by the Project Engineering specifications, and implementation is defined in the Work Plan/Procedures Program.

GRAND GULF NUCLEAR GENERATING STATION
Updated Final Safety Analysis Report (UFSAR)

**TABLE 9.5-11: FIRE PROTECTION PROGRAM COMPARISON WITH NRC
REQUIREMENTS (CONTINUED)**

- | | |
|---------------|--|
| 4. Inspection | <ul style="list-style-type: none">a. Fire protection systems and components are inspected and tested during and after installation to ensure conformance with design requirements. Appropriate records are maintained which document the tests and inspections.
b. Items such as emergency lighting, communication equipment, penetration seals, fire-rated barriers, fire-retardant applications, and electrical cable routing are inspected to ensure proper installation.
c. All cable and wire installations and modifications will be processed in accordance with Regulatory Guide 1.75, as specified in Appendix 3A. During the design and construction phase, compliance with this requirement will be verified by routine inspection of drawings by the electrical engineering discipline, augmented by site inspections as necessary.
d. Previously, inspections and approvals were performed by Bechtel, ANI, and System Services, Inc. Risk Management Services consultants, not by the equipment supplier. Currently, Nuclear Mutual Limited and Entergy Operations perform inspections and approvals. |
|---------------|--|

GRAND GULF NUCLEAR GENERATING STATION
Updated Final Safety Analysis Report (UFSAR)

**TABLE 9.5-11: FIRE PROTECTION PROGRAM COMPARISON WITH NRC
REQUIREMENTS (CONTINUED)**

- e. Bechtel installations, inspections, and verifications are performed by Field Engineering in accordance with the Work Plan/Procedure Program. Contractor installations, inspections, and verifications are performed by the contractor in accordance with the requirements of Project Engineering specifications and Project Engineering approved design drawings and are monitored by Field Contracts Administration Department personnel.
5. Test and Test Control
- Installation testing is accomplished as follows:
- a. Installations completed by Bechtel are tested in accordance with procedures contained and approved in the Construction Work Plan/Procedures Manual and Project Engineering specifications.
 - b. Installations completed by contractors are tested in accordance with procedures approved by Project Engineering and in accordance with the requirements of the Project Engineering specification.
 - c. Completed installations are tested by the Checkout and Turnover Organization (CTO) or the contractor (at the direction of Entergy Operations) to demonstrate the functional reliability of the installation in accordance with CTO procedures or the Project Engineering approved contractor procedures as applicable.

GRAND GULF NUCLEAR GENERATING STATION
Updated Final Safety Analysis Report (UFSAR)

**TABLE 9.5-11: FIRE PROTECTION PROGRAM COMPARISON WITH NRC
REQUIREMENTS (CONTINUED)**

	Qualifications of personnel performing these tests are controlled by the Checkout and Turnover Organization Manual or the contractor manual.
	d. Previously, vendor test results were documented and evaluated by Project Engineering, Middle South Services Risk Control consultants, and ANI. Currently, vendor test results are documented and evaluated by Nuclear Mutual Limited and Entergy Operations. Installation tests performed in the field are evaluated by the Bechtel Checkout and Turnover Organization in accordance with the applicable technical requirements established and documented by Project Engineering. Test results are retained as part of the permanent plant documentation.
6. Inspection, Test, and Operating Status	Inspection, test, and operating status are identified as follows: a. Inspection status is controlled through initiated documentation. b. Test status is provided for as follows: (1) Construction tests are performed in accordance with procedures or instructions, and appropriate tags are placed on the (2) CTO tests are performed in accordance with CTO procedures, and appropriate tags are placed on the hardware as required by the CTO manual.

GRAND GULF NUCLEAR GENERATING STATION
Updated Final Safety Analysis Report (UFSAR)

**TABLE 9.5-11: FIRE PROTECTION PROGRAM COMPARISON WITH NRC
REQUIREMENTS (CONTINUED)**

- | | |
|------------------------|--|
| 7. Nonconforming Items | <ul style="list-style-type: none">a. The Bechtel Quality Assurance Program provides measures which control materials, parts, or components not conforming to prescribed requirements in order to prevent their inadvertent use or installation. Bechtel field procedures and practices incorporate measures for material control, including identification and/or segregation of nonconforming items.
b. The identification, documentation, segregation, review, disposition, and notification to the affected organization of nonconforming materials, parts, components, or services are procedurally controlled by the WP/P and the Project Engineering Procedures Manual.
c. For nonconforming items that may be made usable through rework or repair, or that can be used "as is," reports are prepared for resolution and approval unless repair or rework can be accomplished by use of prior-approved procedures. Nonconformance reviews and dispositions are performed in accordance with the project procedures, and records of documentation and resolution are retained in permanent plant document files. |
|------------------------|--|

GRAND GULF NUCLEAR GENERATING STATION
Updated Final Safety Analysis Report (UFSAR)

**TABLE 9.5-11: FIRE PROTECTION PROGRAM COMPARISON WITH NRC
REQUIREMENTS (CONTINUED)**

8. Corrective Action
- a. The Bechtel Quality Assurance Program applied to fire protection requires implementation of a corrective action program. This includes reporting of significant deficiencies, malfunctions, deviations, defective material, etc. that cannot be resolved at the site and/or require management attention, and that may necessitate changes in program procedures or practices. Routine occurrences or rework generally anticipated for the activity involved are not normally included in the corrective action program.

 - b. Measures are established in the Construction Work Plan/Procedures Program that provide for the identification and disposition of conditions adverse to quality. Condition Reports (CR), Deficiency Reports (DR), and Nonconformance Reports (NCR) are used to identify situations which are not acceptable in accordance with design documents.

They contain the tools for tracking and identifying corrective action to return the condition to conformance. These documents are reviewed by Project Engineering when the disposition is "use-as-is" or "repair."

GRAND GULF NUCLEAR GENERATING STATION
Updated Final Safety Analysis Report (UFSAR)

**TABLE 9.5-11: FIRE PROTECTION PROGRAM COMPARISON WITH NRC
REQUIREMENTS (CONTINUED)**

9. Records	<p style="margin-left: 40px;">a. Records required by instructions, procedures, and drawings are kept to furnish documentary evidence of quality-related activities such as inspection results, audits, nonconforming items, corrective actions, construction, maintenance, modifications, and manufacturers' data. Records are identifiable and retrievable as required by procedures.</p> <p style="margin-left: 40px;">b. These records are available for audit by GGNS and regulatory agencies during the design, procurement, and construction phases of the project. The project will maintain these records in compliance with Bechtel practices regarding retention, location, duration, and responsibility until they are turned over to the project.</p>
10. Audits	<p>Monitoring and audits of fire protection activities are performed to the degree and frequency necessary to assure conformance to governing functional procedures.</p> <p>As a minimum, fire protection activities covered by the program will be audited once per year, or once during the life of the work activity, to assure conformance with governing procedures, specifications, and standards. Periodic monitoring activities shall be conducted on an unscheduled basis.</p> <p>Monitoring and auditing shall be conducted in accordance with Quality Assurance procedures.</p> <p>Audits shall be performed on a scheduled basis to cover all facets of the Quality Assurance Program described herein.</p>

GRAND GULF NUCLEAR GENERATING STATION
Updated Final Safety Analysis Report (UFSAR)

**TABLE 9.5-11: FIRE PROTECTION PROGRAM COMPARISON WITH NRC
REQUIREMENTS (CONTINUED)**

C.2 Startup Testing and Operational Phases	Upon turnover of a fire protection partial from the Bechtel Checkout and Turnover Organization (CTO) to the GGNS Startup Organization, the Fire Protection QA Program came under the management control of the GGNS QP organization. The scope of the Fire Protection QA Program for GGNS was limited to selected aspects of 10CFR50, App. B. Specifically, Sections III-V, VII, X, XI, and XIV-XVIII of Appendix B were invoked, as clarified by Notes 1 through 4.
--	--

NOTES:

1. (a) In some situations where sufficient documentation is not available to allow the preparation of a detailed procedure prior to the activity being performed, the engineer may write the procedure as the work function (valve breakdown, etc.) takes place, and appropriate reviews and evaluations occur after the fact. The equipment/component will not be declared operable until the procedure has received the required reviews and approval, or until a functional test/surveillance has been performed.
- (b) In some situations during work evaluation where sufficient documentation is not available to allow the preparation of a detailed procedure prior to the activity performed (i.e., first time work function is performed), craft Supervisors may prepare the procedure as the work function takes place, providing the procedure is submitted within five working days for appropriate reviews and evaluations. The equipment/component will not be declared operable until the procedure has received the required reviews and approval, or until a functional test/surveillance has been performed.
2. (a) The supplier of equipment and material does not have to have a ANSI N45.2 QA Program or be a qualified supplier under the GGNS QA Program. For such "commercial off-the-shelf" equipment and material, conformance to Procurement Documents will be ensured by one or more of the following: examination of items upon delivery (or prior to installation), inspection and audit at the source, or objective evidence of quality furnished by the supplier.

GRAND GULF NUCLEAR GENERATING STATION
Updated Final Safety Analysis Report (UFSAR)

**TABLE 9.5-11: FIRE PROTECTION PROGRAM COMPARISON WITH NRC
REQUIREMENTS (CONTINUED)**

(b) Material/equipment will be replaced and maintained at equal to or better than original. Should the material/equipment be purchased as nonsafety-related, appropriate engineering procedures will require the engineer to specify material/equipment to be used per the appropriate work document. Should the material/equipment not be an identical replacement, a design change shall be initiated through appropriate procedures to ensure that the replacement material/equipment is reviewed for adequacy and is appropriately documented.

The appropriate engineering procedures which require the engineer to specify material/equipment are independently reviewed to ensure that quality requirements are addressed. The engineer's implementation of the procedure is subject to periodic inspection or monitoring and periodic audit by Quality Assurance.

3. In general, the fire protection systems (as defined in Section C.1 of this table, including emergency lighting and fire-wrapping of cables required by 10 CFR 50, Appendix R) in the following plant areas are included under the Quality Assurance Program.
 1. Control Building Elevations (all elevations)
 2. Auxiliary Building (all elevations)
 3. Containment and Drywell (all elevations)
 4. Diesel Generator Building
 5. Standby Service Water Pump House
 6. Firewater Pump House components, which include the Diesel and Electric driven pumps and drivers, associated controls, and auxiliaries
4. The QA activities which apply to the Fire Protection System are under the management control of the GGNS QA organization. The specific organizations which exercise this control are Quality Assurance, Engineering, Maintenance, and Operations.

This is accomplished by the responsible groups implementing respective Fire Protection QA Program elements in accordance with procedures which address incorporation of suitable requirements (including QA). QA periodically audits to verify that Maintenance and Operations functions are accomplished in accordance with procedures. The above provide confidence to management responsible for fire protection. QA verifies the effectiveness of the QA activities for fire protection through review, inspections, monitoring, and audits.

GRAND GULF NUCLEAR GENERATING STATION
Updated Final Safety Analysis Report (UFSAR)

**TABLE 9.5-11: FIRE PROTECTION PROGRAM COMPARISON WITH NRC
REQUIREMENTS (CONTINUED)**

D. General Guidelines for Plant Protection

1. Building Design

- | | |
|---|---|
| a (1) Isolate Non-Redundant Safety Systems from Hazards | Plant layout is arranged, as much as practical, to isolate safety-related systems from unacceptable fire hazards. |
| a (2) Separate Redundant Safety Systems | Plant layout is arranged, as much as practical, to separate redundant safety-related systems from each other so that both are not subject to damage from a single fire hazard. Redundant systems subject to damage from a single fire hazard are protected by a combination of fire barriers, fire detection, and suppression systems. |
| b. Fire Hazard Analysis | Comply. The Fire Hazards Analysis Report is a separate controlled plant document. |
| c. Cable Spreading Room | Upper and lower cable spreading rooms are provided and are separated by 3-hour fire-rated barriers or barriers that have been evaluated and found acceptable based on the hazards in the area. Cable spreading rooms contain some redundant safe shutdown cables, and are protected as discussed in the Fire Hazards Analysis Report. Smoke detectors, an automatic double-shot total flooding carbon dioxide system, an automatic wet-pipe sprinkler system, and two hose stations with portable fire extinguishers are provided for fire detection and suppression. |

GRAND GULF NUCLEAR GENERATING STATION
Updated Final Safety Analysis Report (UFSAR)

**TABLE 9.5-11: FIRE PROTECTION PROGRAM COMPARISON WITH NRC
REQUIREMENTS (CONTINUED)**

d. Non-Combustibles	<p>Comply. Interior wall and structural components, thermal insulation materials, radiation shielding materials, and soundproofing are noncombustible. Interior finishes in safety-related areas are noncombustible or listed by a nationally-recognized testing laboratory, such as Factory Mutual or Underwriters' Laboratory, Inc., for flame spread of 25 or less in its configuration per ASTM E-84 test. Materials not meeting the above are evaluated prior to use in the plant.</p> <p>(1) Critical Radiant Flux (CRF) and Maximum Specific Optical Density (Dm) parameters, as determined by ASTM E-648 and E-662 respectively, may be used for use in determining the acceptability of floor coverings. Floor coverings having a minimum Critical Radiant Flux (CRF) of 0.45 watts per square centimeter and a Maximum Specific Optical Density (Dm) of 450 are considered acceptable. Ref. ER 2002-0054 and FPE 87-0018</p>
e. Metal Deck Roofing	<p>Comply. Metal deck roofing is noncombustible.</p>
f. Concealed Spaces	<p>Suspended ceilings and supports are noncombustible. Concealed spaces are devoid of combustibles unless otherwise noted in the Fire Hazards Analysis Report. The security-alarmed door providing access to the concealed ceiling space above the control room is locked at all times with access controlled by the Shift Manager.</p> <p>Administrative controls for maintaining fire protection, discussed in Appendix 9B, subsection 9B.6, will provide protection to this area and, specifically, no hot work will be allowed in the concealed space above the control room unless the plant is in cold shutdown.</p>

GRAND GULF NUCLEAR GENERATING STATION
Updated Final Safety Analysis Report (UFSAR)

**TABLE 9.5-11: FIRE PROTECTION PROGRAM COMPARISON WITH NRC
REQUIREMENTS (CONTINUED)**

g. Indoor Dry Transformers	Comply. Indoor transformers are either dry type or cooled with non-combustible liquid.
h. Transformer Oil Spill Hazard	Comply. Buildings containing safety-related systems are protected from exposure or spill fires involving outdoor oil-filled transformers by a combination of 2-hour fire barriers and automatic deluge systems.
i. Floor Drains	Comply. Floor drains are sized to handle water flow from existing water sprinkler systems and hose streams.
j. Three-Hour Fire Barriers	<p>Penetrations and doors meet or exceed the fire rating of the respective fire barrier except as noted in the Fire Hazards Analysis Report. All concrete walls are reinforced and impervious to fire. Penetrations through non-rated fire barriers are not provided with fire rated penetration closures.</p> <p>Duct penetrations in fire-rated walls which are larger than 48 inches in any direction utilize two 1½-hour, UL-rated, curtain-type fire dampers in series, in accordance with NFPA 803-1978, Paragraph 7-3.2.3.</p> <p>Duct penetrations in fire-rated walls of sizes up to 48 in. x 48 in. utilize a single 3-hour UL-rated curtain-type fire damper.</p> <p>Duct penetrations in fire-rated floors utilize trap-door-type fire dampers. The fire doors carry a 3-hour UL label.</p> <p>Fire dampers are arranged to close automatically and to remain tightly closed upon the operation of a fusible link or an electrothermal link.</p> <p>Installation details for fire dampers in ventilation ducts are addressed in the Fire Hazards Analysis Report.</p>

GRAND GULF NUCLEAR GENERATING STATION
Updated Final Safety Analysis Report (UFSAR)

**TABLE 9.5-11: FIRE PROTECTION PROGRAM COMPARISON WITH NRC
REQUIREMENTS (CONTINUED)**

Doors for installation in fire-resistive openings will meet the required rating. The UL label on the doors will indicate the approved fire test rating for the door. For further clarification of door ratings, see the Fire Hazards Analysis Report. For special doors, there is written certification that the doors meet UL label construction for specified fire ratings. Where modifications or repairs are made that deviate from the tested configuration, an evaluation is performed to verify that the assembly continues to meet the required fire rating. Fire doors are controlled by administrative procedures and/or alarms supervised on the SFPS computer.

All concrete joint seals are rated 3 hours as per ASTM E-119.

2. Control of Combustibles

a. Isolation of Safety Systems from Combustibles

Comply. Consistent with the Fire Hazards Analysis Report, safety-related systems are separated or protected from combustibles to the extent practicable.

b. Bulk Gas Storage

Comply. Bulk flammable gases are stored outdoors.

c. Use of Plastic Materials

Comply. The use of plastic materials is minimal.

d. Storage of Flammable Liquids

There are no flammable liquids stored in large quantities in the Seismic Category I structures. Actual quantities are taken into account in the Fire Hazards Analysis Report.

3. Electrical Cable Construction, Cable Trays, and Cable Penetration

a. Non-Combustible Tray Construction

Comply. Cable tray materials are non-combustible.

GRAND GULF NUCLEAR GENERATING STATION
Updated Final Safety Analysis Report (UFSAR)

**TABLE 9.5-11: FIRE PROTECTION PROGRAM COMPARISON WITH NRC
REQUIREMENTS (CONTINUED)**

b. Cable Spreading Room	Refer to Section F.3
c. Cable Water Spray Outside Spreading Room	<p>Fixed suppression is provided where required, as discussed in the Fire Hazards Analysis Report.</p> <p>Cable construction is such as to allow water spraying of cable trays without faulting. The cable termination points do not require weatherproof terminal boxes or cabinets. Only equipment on fire will be wetted with hose streams by the trained fire brigade, and existing water sprinkler systems are located so as to avoid wetting electrical equipment within the buildings, except where installed to protect electrical equipment.</p>
d. Fire-Barrier Penetration	Consistent with the fire hazards analysis, fire barrier penetrations generally equal the fire rating of the respective barrier.
e. Fire Breaks	Fire breaks or stops in cable trays are presently included in vertical runs, spaced every 20 ft or less, and in horizontal runs as deemed necessary by the fire hazards analysis.
f. Cable Flame Test	With the exception of those cables listed in subsection 8.3.3.1, electrical cables in trays and conduits have been tested to demonstrate "as a minimum" compliance with IEEE No. 383 or ICEA S-19-81 flame retardance tests.
g. Non-Toxic New Cable	Comply. To the extent practical, new cable installed will be constructed such that it will not give off corrosive gases while burning.
h. Cable Tray Usage	Comply. No storage will be permitted on cable trays.

GRAND GULF NUCLEAR GENERATING STATION
Updated Final Safety Analysis Report (UFSAR)

**TABLE 9.5-11: FIRE PROTECTION PROGRAM COMPARISON WITH NRC
REQUIREMENTS (CONTINUED)**

i. Venting Cable Tunnels and Chases	Cable chases and tunnels can be manually ventilated, except as discussed in the Fire Hazards Analysis Report. Cable spreading rooms can be manually ventilated using the Control Building purge fan.
j. Cables in Control Room	Cables entering the Control Room terminate there. Cables routed in underfloor trenches (PGCC) are protected in accordance with NEDO-10466-A, except for deviations/changes which have been evaluate. Clean agent suppression protection is not provided in the concealed ceiling space above the Control Room, due to the absence of exposed combustibles.
4. Ventilation	
a. Venting Combustion Products Evaluation	Smoke removal from buildings containing safety-related equipment or potential sources of radioactivity is achieved as follows:
	1. Drywell - Smoke removal from the drywell can be achieved by remote manual positioning of valves and dampers to utilize the containment cooling system charcoal filter trains in an exhaust mode. In this way, smoke can be exhausted at a rate of approximately 6,000 CFM, until such time as the filters become clogged. The radiation level of these exhaust gases is continuously monitored, and upon detection of high radiation level, an alarm signals so that exhausting can be manually terminated if so desired.

GRAND GULF NUCLEAR GENERATING STATION
Updated Final Safety Analysis Report (UFSAR)

**TABLE 9.5-11: FIRE PROTECTION PROGRAM COMPARISON WITH NRC
REQUIREMENTS (CONTINUED)**

2. Containment - Upon detection of smoke in the containment building, the air recirculation fans will automatically shutdown to limit the spread of smoke. Smoke can be exhausted by the containment ventilation exhaust fans at a rate of approximately 500 CFM, until such time as filters become clogged. Similarly, additional ventilation capacity of approximately 6,000 CFM is available by remote manual positioning of valves and dampers to utilize the containment cooling system charcoal filter trains in an exhaust mode. The radiation level of these gases is monitored continually, and upon detection of high radiation levels, an alarm signals so that the exhausting can be manually terminated if desired.

3. Auxiliary building - Upon detection of smoke in the auxiliary building, the air recirculation fans will automatically shut down to limit the spread of smoke. Smoke can be exhausted by the fuel handling area exhaust fans at a rate of approximately 12,000 cfm.

Additional smoke venting is available by remote manual initiation of the fuel pool sweep exhaust fans; however, this would only serve the fuel pool area of the auxiliary building. Any smoke exhausted from the auxiliary building is monitored in the ductwork.

GRAND GULF NUCLEAR GENERATING STATION
Updated Final Safety Analysis Report (UFSAR)

**TABLE 9.5-11: FIRE PROTECTION PROGRAM COMPARISON WITH NRC
REQUIREMENTS (CONTINUED)**

4. Control building - Upon detection of smoke in the control building, the air recirculation fans (except control building fan coil unit NSZ17B002-N) will automatically shut down to limit the spread of smoke. Shutdown of control building fan coil unit NSZ17B002-N is accomplished manually and controlled by administrative procedures. This system and the areas it serves are provided with area wide smoke detection providing early response.

Additionally, for a fire in any of these areas, access is not required for plant safe shutdown. Smoke venting is available, by automatic and manual initiation of the control building purge fan, at a rate of approximately 8,000 cfm. This fan is capable of exhausting the upper and lower cable spreading rooms, the HVAC equipment area, and the main control room. Since no significant sources of radioactivity are present in the control building, these exhaust gases are not monitored for radioactivity levels.

5. Radwaste building - The radwaste building contains a minimal amount of safety-related equipment (all of which is designed to fail safe or in a manner that does not compromise any required safety or safe shutdown function); however, smoke removal is available at a rate of approximately 50,000 cfm, by using the radwaste building exhaust filter trains, until such time as the filters become clogged. Exhaust gases are continuously monitored for radioactivity, and an alarm is given to allow the venting to be manually terminated, if so desired.

GRAND GULF NUCLEAR GENERATING STATION
Updated Final Safety Analysis Report (UFSAR)

**TABLE 9.5-11: FIRE PROTECTION PROGRAM COMPARISON WITH NRC
REQUIREMENTS (CONTINUED)**

6. Turbine building - The turbine building contains a minimal amount of safety-related equipment (all of which is designed to fail safe or in a manner that does not compromise any required safety or safe shutdown function). Upon detection of smoke in the turbine building, fans capable of recirculating smoke to other areas are automatically shut down. Smoke can be exhausted by utilizing the turbine building charcoal filter train and fans, at a rate of approximately 10,000 cfm, until such time as the filters become clogged. Should the filters become clogged, a manually controlled bypass is available to bypass the filters and allow smoke removal to continue.

The exhaust gases are continuously monitored for radioactivity; an alarm is given to allow the venting to be manually terminated, if so desired. Smoke can be exhausted from the turbine building at a rate of approximately 19,000 cfm by manual initiation of the turbine building smoke exhaust fans. During this mode, the turbine building exhaust charcoal filter train and fans are shut down by a control interlock. Additional smoke venting in the turbine building is available through automatic roof hatches located above the operating floor. Heat and smoke vents are provided on a ratio of 1 to 100 sq. ft. of turbine building operating floor area.

GRAND GULF NUCLEAR GENERATING STATION
Updated Final Safety Analysis Report (UFSAR)

**TABLE 9.5-11: FIRE PROTECTION PROGRAM COMPARISON WITH NRC
REQUIREMENTS (CONTINUED)**

b. Failure or Inadvertent Operation of Ventilation Exhaust Systems	All safety-related ventilation exhaust systems include separate redundant components so that a single failure will not prevent safe shutdown of the reactor. Inadvertent operation of any exhaust ventilation system will merely exhaust to atmosphere. Such discharges are monitored for the drywell, containment, auxiliary, and radwaste buildings. Inadvertent operation of the turbine building smoke exhaust fans will result in unmonitored discharge; however, this is considered to be a remote possibility, and levels are expected to be low. There are no significant sources of radioactivity in the control building. Inadvertent operation of a recirculation ventilation system during a fire would possibly spread smoke into all areas served by the system. Spreading smoke will not prevent the operation of safety-related equipment but could cause the fire brigade visibility problems. To preclude this, recirculating ventilation systems are provided with smoke detectors which automatically shut down the fans.
c. Ventilation Systems Power Supply	Power supply and control cable ventilation systems are located in accordance with Regulatory Guide 1.75, as discussed in Appendix 3A. In addition, safety-related systems include redundant components.
d. Charcoal Filter Fire Suppression	Comply. Charcoal filter trains located in the safety-related structures and within the scope of this report are protected in accordance with Regulatory Guide 1.52, as discussed in Appendix 3A. All charcoal filters except offgas adsorbers in the radwaste building are provided with manual deluge systems. The offgas adsorbers are equipped with 1½-inch hose connections.
e. Separation of Supply and Exhaust	Comply. Supply and exhaust points are adequately separated.

GRAND GULF NUCLEAR GENERATING STATION
Updated Final Safety Analysis Report (UFSAR)

**TABLE 9.5-11: FIRE PROTECTION PROGRAM COMPARISON WITH NRC
REQUIREMENTS (CONTINUED)**

f.	Stairwell Smoke Infiltration	Smoke infiltration in stairwells is minimized by normally closed fire doors installed at each level. Stairwells are enclosed by 2-hour fire rated construction.
g.	Smoke and Heat Venting Volume Flow for Cable Spreading Rooms, Diesel Fuel Oil Storage Area, and Switchgear Rooms	Comply. The minimum ventilation requirements are met or exceeded.
h.	Breathing Apparatus	Comply. Breathing apparatus and appurtenances are provided as required.
i.	Automatic Vent Closure for Gas Suppression System	Comply. Vents will close and ventilation will cease prior to firing gas fire suppression systems.

5. Lighting and Communication

a.	Fixed Lighting	The fixed emergency and essential lighting system consists of the following: <ol style="list-style-type: none">1. Essential (normal) AC lighting is installed in the control room, Class 1E switchgear rooms, emergency hot shutdown rooms, and Stair No. 0C02, between Elev. 111'-0" and 116'-0", in the Control Building. These lights are connected to Class IE power supplies and are operated from the diesel generators upon loss of offsite power.2. Emergency AC lighting in the control room is connected via inverters to the station Class IE batteries which have a 4-hour minimum rating.3. Individual DC lighting units are provided for general plant exit lighting. These units as purchased have a minimum rating of one-half hour. Special units with a minimum rating of 8-hour lamp life are used in areas essential to safe shutdown and access/egress routes to these areas.
----	----------------	--

GRAND GULF NUCLEAR GENERATING STATION
Updated Final Safety Analysis Report (UFSAR)

**TABLE 9.5-11: FIRE PROTECTION PROGRAM COMPARISON WITH NRC
REQUIREMENTS (CONTINUED)**

b.	Portable Lights	Comply. Portable lights are provided as required.
c.	Emergency Communication	Comply. Emergency communication is provided as required.
d.	Protection of Fixed Radio	Comply. Fixed radio Repeaters repeaters are protected from exposure fire damage.
E. <u>Fire Detection and Suppression</u>		
1. Fire Detection		
a.	System Compliance with NFPA 72D	Functional requirements of NFPA 72D-1975 are adhered to except that the wiring from the SFPS multiplexers to local control panels is Class B.
b.	Control Room and Local Alarm	Comply. Fire alarms annunciate in the Control Room and locally.
c.	Distinctive Fire Alarms	Comply. Fire alarms are distinctive and unique.
d.	System Connection to Emergency Power	The fire detection and protection system is independent of offsite power. The smoke detection system, computer room Halon system, CO ₂ system and security and fire protection system (SFPS) multiplexers and computers are powered by 120 V ac which is supplied by inverters which in turn are connected to the non-Class IE station battery. The plant deluge systems are connected directly to the non-Class IE station battery which is kept charged by the battery chargers. Thus all of these systems are still powered upon loss of offsite power. The PGCC fire control panels are fed from 120 V ac power panels which are lost on loss of offsite power.

GRAND GULF NUCLEAR GENERATING STATION
Updated Final Safety Analysis Report (UFSAR)

**TABLE 9.5-11: FIRE PROTECTION PROGRAM COMPARISON WITH NRC
REQUIREMENTS (CONTINUED)**

Each fire control panel is equipped with a battery standby power unit that will supply power in the event of primary power failure. The main CO₂ storage tank and supply valves are fed from a 480 V ac source which is connected to the Class IE supply and is shed only on a LOCA. Since fires are not postulated concurrent with a LOCA, this power is available for all postulated fire situations, including loss of offsite power.

2. Fire Protection Water Supply Systems

- | | | |
|----|--------------------------------------|--|
| a. | Underground Yard Fire Main Loop | Comply, except for deviations which are evaluated. ANSI and AWWA standards are used. Lock-open valves with visual indicators are used. Service and sanitary water are separate. |
| b. | Cross Connection of Fire Main Loop | Comply. A common fire protection loop is utilized with sectional control. |
| c. | Water Capacity with Inactive Pump | Comply, except that fire pumps are separated by 2-hour rated fire barriers that are acceptable for the hazards in the area (Ref. ER-2000-093-00-00). Three fire water pumps are provided as described in subsection 9.5.1.2.1. |
| d. | Two Separate Reliable Water Supplies | Two 300,000 gallon tanks (maximum usable capacity - 291,358 gallons) are capable of supplying fire water to the largest demand deluge or sprinkler system (plus 500 gpm for manual hose streams) in a safety-related area of the plant for a 2-hour duration. Tank fill rates are discussed in subsection 9.5.1.2.1. |
| e. | Water Supply Basis | Comply. Two 300,000 gallon tanks (maximum usable capacity - 291,358 gallons) supply water (see subsection 9.5.1.2.1). |
| f. | Lake as Water Supply | Not Applicable. |

GRAND GULF NUCLEAR GENERATING STATION
Updated Final Safety Analysis Report (UFSAR)

**TABLE 9.5-11: FIRE PROTECTION PROGRAM COMPARISON WITH NRC
REQUIREMENTS (CONTINUED)**

g. Outside Manual Hose Installation	Comply. Hydrants are approximately 250 ft apart. Curb valves and hose houses are provided for each hydrant, with appurtenances provided based on needs in each area.
3. Water Sprinklers and Hose Standpipe Systems	
a. Connections to Water Main	<p>Both the primary and secondary fire-fighting water systems share the same header connections to the plant underground water main. However, a second independent connection tied to an interior loop with sectional control has been provided, or provisions have been made for other secondary supplies.</p> <p>Each sprinkler and standpipe system is equipped with an OS&Y gate valve. Each sprinkler system is provided with a water flow alarm. Water shields or baffles are provided to protect safety-related equipment where necessary.</p>
b. Valve Supervision	Comply. An adequate management supervision program is provided, including locking yard section valves with tamper-proof seals and periodic inspection. Valves for all of the sprinkler and deluge systems are provided with electrical supervision. Should the normal valve position change it will alarm, both visually and audibly, in the control room.
c. Automatic Sprinkler System (NFPA 13 and 15)	Comply, except for deviations which are evaluated. Functional requirements of NFPA 13 and 15 are adhered to for primary systems.

GRAND GULF NUCLEAR GENERATING STATION
Updated Final Safety Analysis Report (UFSAR)

**TABLE 9.5-11: FIRE PROTECTION PROGRAM COMPARISON WITH NRC
REQUIREMENTS (CONTINUED)**

d. Interior Hose Installations	All interior locations, with the exception of the drywell, can be reached with at least one effective hose stream with no more than 125 feet of hose. More than 125 feet of hose is required to reach all areas of the drywell. Risers are 4 inch minimum with 2-1/2 inch minimum for a single hose.
e. Hose Nozzles	All hose stations within the buildings, with the exception of the fire hose nozzles on elevation 208' in and out of the containment, include an adjustable nozzle from straight-stream to 90 degrees fog, with shutoff capability. The fire hose nozzles in and out of the containment on elevation 208' are straight-stream nozzles only. Fire brigade personnel are instructed in the proper application of hose streams to the various possible fire hazards.
f. Use of Foam for Fire Protection	Not Applicable. No foam systems are utilized.
4. Halon Suppression Systems	Comply. Functional requirements of NFPA 12A are adhered to.
5. Carbon Dioxide Suppression Systems	Comply. Functional requirements of NFPA 12 are adhered to.
6. Portable Extinguishers	Comply. Portable extinguishers are UL and FM listed and have been selected according to local fire hazards.
F. <u>Guidelines for Specific Plant Areas</u>	
1. Primary and Secondary Containment	
a. Normal Operation	Comply. Fire protection is consistent with the results of the fire hazards analysis. Manual hose stations, smoke detectors, and portable extinguishers are provided to protect areas outside the drywell.

GRAND GULF NUCLEAR GENERATING STATION
Updated Final Safety Analysis Report (UFSAR)

TABLE 9.5-11: FIRE PROTECTION PROGRAM COMPARISON WITH NRC REQUIREMENTS (CONTINUED)

b. Refueling and Maintenance	Comply. Hose stream, portable extinguishers, and breathing apparatus are provided.
2. Control Room	<p>A 3-hour fire barrier or equivalent is provided around the Control Room Complex. Portable extinguishers (water and Halon) are provided in the Control Room and hose stations are located in adjacent areas. The PGCC is protected in accordance with NEDO 10466A, except for deviations / changes which have been evaluated. Smoke detectors are provided in the Control Room and above the suspended ceiling.</p>
	<p>Smoke detectors are also provided in the Control Room cabinets and under the floor with local alarms. Breathing apparatus for Control Room personnel are readily available. Smoke detection is provided in the Control Room ventilation system which automatically alarms and initiates shutdown of the respective system. Manual venting of the Control Room is available. No fixed protection system is provided for the concealed space above the Control Room, due to the absence of exposed combustibles. A noncombustible security and dust barrier will be provided to protect the operating Unit 1 side of the control room from the Unit 2 side.</p>
	<p>The permanent fire detection system will be operational. All work on the Unit 2 side of the barrier will be carried out in accordance with the appropriate procedures that control and restrict welding and burning of combustibles.</p>
3. Cable Spreading Room	<p>Primary protection is provided by an automatic total flooding carbon dioxide suppression system. Backup protection is provided by manual hose streams, portable extinguishers, and automatic sprinklers.</p>

GRAND GULF NUCLEAR GENERATING STATION
Updated Final Safety Analysis Report (UFSAR)

**TABLE 9.5-11: FIRE PROTECTION PROGRAM COMPARISON WITH NRC
REQUIREMENTS (CONTINUED)**

Upper and lower cable spreading rooms are provided and are separated from other areas by 3-hour rated fire barriers, except stairways and corridors having 2-hour barriers and the non-standard fire barrier configuration separating the upper cable spreading room (Fire Zone 0C702) and the corridor (Fire Zone 0C706). This non-standard fire barrier design has been evaluated and found to be adequate for the hazards in the areas (Ref. Fire Protection Evaluation No. 98-0002). An additional exception is the non-standard fire barrier configuration (South wall of 0C712) separating the upper cable spreading room (Fire Zone 0C702) from an HVAC Room (Fire Zone 0C712). This non-standard fire barrier design has been evaluated and found to be adequate for the hazards in the areas (Ref. Fire Protection Evaluation 98-0003 Rev. 1).

Additional 3-hour rated fire barrier exceptions include potentially missing internal conduit fire seals in 1(3"), 1(1"), and 5(3/4") conduits on the 0C702 side of the fire barrier separating the upper cable spreading room (Fire Zone 0C702) from an electrical space (Fire Zone 0C709) and potentially missing internal conduit fire seals in 1(3/4"), 1(1 1/2"), and 1(3") conduit on the 0C702 side of the fire barrier separating the upper cable spreading room (Fire Zone 0C702) from a corridor (Fire Zone 0C706).

The noted conduit configurations have been evaluated and found acceptable based on hazards in the areas (Ref. Fire Protection Evaluation 99-0002). Other 3-hour rated barrier exceptions include 3 penetrations, two installed in the barriers separating 0C702 from 0C703 and one installed in the barrier separating 0C702 from 0C709. These penetrations are installed in configurations not bound by fire endurance qualification testing.

GRAND GULF NUCLEAR GENERATING STATION
Updated Final Safety Analysis Report (UFSAR)

**TABLE 9.5-11: FIRE PROTECTION PROGRAM COMPARISON WITH NRC
REQUIREMENTS (CONTINUED)**

The identified penetrations have been evaluated and found to provide adequate fire separation commensurate with the hazards in the area (Ref. Fire Protection Evaluation 2000-0075). Also, penetration CV-59G which passes through the partial height ceiling of the Instrument Motor Generator Room (Fire Zone 0C707) into the Upper Cable Spreading Room (Fire Zone 0C702). This penetration employs a non-standard penetration seal design which has been evaluated and found acceptable based on the hazards in the areas (Ref. Fire Protection Evaluation 2000/0004). A portion of the barrier which communicates between the upper cable spreading room (Fire Zone 0C702) and the Control Cabinet Area (Fire Zone 0C703) employs a nonstandard barrier design. This arrangement consists of an approximate 2'-0" span of steel girder coated on both sides with 3-hour fireproofing. A non-standard penetration seal design is installed in the barrier separating the upper cable spreading room (Fire Zone 0C702) and the Corridor (Fire Zone 0C706). These arrangements have been evaluated and determined to provide adequate fire separation for the hazards in the areas (Ref. Fire Protection Evaluation 2000/0006).

Two remote entrances are provided for fire brigade access. Aisles are provided which facilitate access to all areas of the rooms. Smoke venting is provided for the rooms by the Control Building purge subsystem.

4. Plant Computer Room

Comply. The plant computers are not safety-related; however, the room is isolated from the rest of the plant by 3-hr fire-rated barriers with the exception of penetration CV-115DA which is located in the North wall of the Computer and Control Panel Room (Fire Zone 0C403).

GRAND GULF NUCLEAR GENERATING STATION
Updated Final Safety Analysis Report (UFSAR)

TABLE 9.5-11: FIRE PROTECTION PROGRAM COMPARISON WITH NRC REQUIREMENTS (CONTINUED)

	<p>This penetration employs a non-standard penetration seal design which has been evaluated and found acceptable based on the hazards in the areas (Ref. Fire Protection Evaluation 2000/0005). Additional exceptions include 7 penetrations, 6 installed in the barriers separating 0C403 from 0C402 and one in the barrier separating 0C403 from 0C408. These penetrations are installed in configurations not bound by fire endurance qualification testing. The identified penetrations have been evaluated and found to provide adequate fire separation commensurate with the hazards in the area (Ref. Fire Protection Evaluation 2000-0075). Manual hose stations, smoke detectors, and automatic Halon 1301 suppression systems are provided. Portable fire extinguishers are available.</p>
5. Switchgear Rooms	<p>Comply. Each room is isolated from the rest of the plant by 3-hr fire-rated barriers. Smoke detectors, automatic CO² suppression systems, portable fire extinguishers, and hose streams are available.</p>
6. Remote Safety-Related Panels	<p>Comply. An automatic sliding fire door, smoke detectors, automatic CO² suppression system, portable fire extinguishers and hose streams are available. Three-hour fire-rated barriers are provided to separate the panels of each division and from the remainder of the plant.</p>
7. Station Battery Rooms	<p>Comply. Three-hour rated enclosures, adequate ventilation, smoke detectors, and hydrogen detectors are provided.</p>
8. Turbine Lubrication and Control Oil Storage Use Areas	<p>Comply. Three-hour fire and rated barriers and sprinkler systems are provided.</p>

GRAND GULF NUCLEAR GENERATING STATION
Updated Final Safety Analysis Report (UFSAR)

**TABLE 9.5-11: FIRE PROTECTION PROGRAM COMPARISON WITH NRC
REQUIREMENTS (CONTINUED)**

9. Diesel Generator Areas	Comply. Three-hour fire rated barriers, ultraviolet flame detectors, pre-action sprinklers, hose streams, and portable fire extinguishers are available.
10. Diesel Fuel Oil Storage Areas	Comply. Diesel fuel oil storage tanks are buried outdoors.
11. Safety-Related Pumps	Safety-related pumps are protected in accordance with the Fire Hazards Analysis Report. Smoke or heat detection is provided.
12. New Fuel Area	A minimal amount of combustibles are postulated in the new fuel and spent fuel pool area. These areas are protected by 3-hr fire-rated walls, smoke detection, hose streams, and portable fire extinguishers are available. Entrance to these areas is controlled by administrative procedures to control introduction of transient combustibles. No additional fire protection is deemed necessary. The spent fuel pool is cooled by the FPC and CU pumps and heat exchangers; in addition, backup cooling capability is provided by RHR "A" and "B" systems.
13. Spent Fuel Pool Area	
14. Radwaste Building	Smoke detectors in the rad-waste building are located strategically, but not throughout the building. Hose streams and portable extinguishers are provided. The radwaste building is separated from the rest of the power block by 3-hr fire rated barriers. Automatic sprinklers are provided for the oil separator.
15. Decontamination Areas	Comply. The hot machine shop in the control building is protected by an automatic sprinkler system, hose streams, and portable fire extinguishers. The ventilation system can be isolated as required.
16. Safety-Related Water Tanks	Not applicable. Cooling tower basins store the necessary water.

GRAND GULF NUCLEAR GENERATING STATION
Updated Final Safety Analysis Report (UFSAR)

**TABLE 9.5-11: FIRE PROTECTION PROGRAM COMPARISON WITH NRC
REQUIREMENTS (CONTINUED)**

17. Cooling Towers	Comply. Non-combustible construction is used.
18. Miscellaneous Areas	Comply. Safety-related equipment is isolated from these areas. See the Fire Hazards Analysis Report.
G. <u>Special Protection Guidelines</u>	
1. Welding and Cutting, Acetyleneoxygen Fuel Gas System	Comply. This equipment is controlled by an administrative procedure to include a permit system.
2. Storage Areas for Dry Ion Exchange Resins	Storage of dry ion exchange resins is controlled by an administrative procedure to include a permit system.
3. Hazardous Chemicals	Hazardous chemicals are not normally stored in safety-related areas. Storage, when necessary, is controlled by administrative procedures to include a permit system.
4. Materials Containing Radioactivity	Materials containing radioactivity are not normally stored in safety-related areas. Storage, when necessary, is controlled by administrative procedures to include a permit system.

GRAND GULF NUCLEAR GENERATING STATION
Updated Final Safety Analysis Report (UFSAR)

**TABLE 9.5-12: FIRE PROTECTION PROGRAM COMPARISON WITH APPENDIX R
TO 10 CFR 50**

On October 27, 1980 the Nuclear Regulatory Commission approved a rule concerning fire protection. The rule and Appendix R were developed to establish the minimum acceptable fire protection requirements necessary to resolve certain areas of concern between the NRC staff and licensees of plants operating prior to January 1, 1979.

This fire protection rule does not apply to Grand Gulf Nuclear Station; however, as a result of a meeting held with the NRC staff on June 30, 1981, and at the staff's request, a comparison of the Grand Gulf Nuclear Station fire protection program to the requirements outlined by 10 CFR 50, Appendix R, Sections II and III is given below:

Appendix R
Requirement

Grand Gulf Nuclear Station
Position /Discussion

II. General Requirements

- | | |
|-----------------------------|--|
| A. Fire Protection Program | Meets the intent. Details of the program are given in Appendix 9B. |
| B. Fire Hazards Analysis | The Grand Gulf Fire Hazards Analysis Report was reviewed and approved by a qualified fire protection engineer and systems engineers, and is a separate controlled plant document. The fire hazards analysis includes the identification of potential in situ and transient fire hazards and the determination of the consequences of a fire in any location on the ability to safely shut down the plant. Where necessary, specific fire protection measures were provided to ensure that safe shutdown capability was maintained in the event that a postulated fire were to occur. |
| C. Fire Prevention Features | 1. Meets the intent. As discussed in the Fire Hazards Analysis Report, all in situ fire hazards have been identified, and suitable fire protection measures have been provided. |

GRAND GULF NUCLEAR GENERATING STATION
Updated Final Safety Analysis Report (UFSAR)

**TABLE 9.5-12: FIRE PROTECTION PROGRAM COMPARISON WITH APPENDIX R
TO 10 CFR 50 (CONTINUED)**

2. Meets the intent. Details are provided in Appendix 9B, Section 9B.6, Administrative Controls.
3. Meets the intent. As described in the Fire Hazards Analysis Report, fire detection systems, portable extinguishers, and standpipe and hose stations are installed in strategic locations throughout the plant.
4. Meets the intent. As described in the Fire Hazards Analysis Report, fire barriers and automatic fire suppression systems have been installed in the plant where required to protect redundant safe shutdown-related systems and components.
5. See the discussions of items III.H and III.I.
6. Meets the intent. Fire detection and suppression systems have been designed by the Architect Engineer and approved for use by ANI. Installation of the systems was performed by trade craftsmen. Maintenance and testing is performed in accordance with approved maintenance and surveillance procedures and the requirements listed in Technical Requirements Manual (TRM) Section 6.2 under the supervision of personnel properly qualified by experience and training for such work.

GRAND GULF NUCLEAR GENERATING STATION
Updated Final Safety Analysis Report (UFSAR)

**TABLE 9.5-12: FIRE PROTECTION PROGRAM COMPARISON WITH APPENDIX R
TO 10 CFR 50 (CONTINUED)**

	7. Meets the intent. Surveillance procedures have been established and are performed in accordance with the requirements listed in Technical Requirements Manual (TRM) Section 6.2 and the Grand Gulf Operations Manual.
D. Alternative or Dedicated Shutdown Capability	As discussed in the Fire Hazards Analysis Report, suitable fire protection measures have been provided to ensure that a fire in any area of the plant will not affect safe shutdown capability. For a discussion of a fire in the control room, see Section III.L of this table.

III. Specific Requirements

A. Water Supplies for Fire Suppression Systems	Meets the intent. As described in subsection 9.5.1.2.1, the Grand Gulf fire protection water supply system consists of two 300,000-gallon nominal capacity water storage tanks at atmospheric pressure and three 1500 gpm fire pumps (one electric, two diesel). Each of the three fire pumps has the capability to take suction from either water storage tank. Each tank has the capability of supplying the maximum fire water demand for a safety-related area for 2 hours. Therefore, an adequate fire water source is constantly available.
B. Sectional Isolation Valves	Meets the intent. As described in subsection 9.5.1.2.2.1 and shown on Figures 9.5-2 and 9.5-3, post indicator valves are provided to permit isolation of portions of the 12-inch underground fire main loop for maintenance or repair without interrupting the entire water supply.

GRAND GULF NUCLEAR GENERATING STATION
Updated Final Safety Analysis Report (UFSAR)

**TABLE 9.5-12: FIRE PROTECTION PROGRAM COMPARISON WITH APPENDIX R
TO 10 CFR 50 (CONTINUED)**

C. Hydrant Isolation Valves Meets the intent. As shown on Figures 9.5-2, 9.5-3, and 9.5-8, valves are installed to permit isolation of outside hydrants from the fire main for maintenance or repair without interrupting the water supply to automatic or manual fire suppression systems in any area containing or presenting a fire hazard to safety-related or safe shutdown equipment.

D. Manual Fire Suppression Meets the intent. As discussed in subsection 9.5.1.2.2 and shown on Figures 9.5-2, 9.5-3, 9.5-7, and 9.5-8, standpipes and hose streams are strategically located throughout the plant. All areas containing safety-related or safe shutdown equipment are designed to permit effective functioning of the plant fire brigade.

All fire suppression systems located inside containment are supplied by the condensate and refueling water storage and transfer system (CRWST) with backup supply available from the fire water loop. The capacity, adequacy, and reliability of the CRWST system is described in subsection 9.5.1.2.1.

Hose stations located inside containment are provided with sufficient lengths of hose to reach any location inside the containment with an effective hose stream. Sufficient lengths of fire hose are available from hose stations outside the drywell to reach areas in the drywell.

GRAND GULF NUCLEAR GENERATING STATION
Updated Final Safety Analysis Report (UFSAR)

**TABLE 9.5-12: FIRE PROTECTION PROGRAM COMPARISON WITH APPENDIX R
TO 10 CFR 50 (CONTINUED)**

E. Hydrostatic Hose Tests	Meets the intent. All fire hose shall be tested at a pressure of 150 psi or 50 psi above maximum fire main operating pressure, whichever is greater. Outside hose shall be tested annually. Interior hose shall be tested every 3 years or replaced every 5 years.
F. Automatic Fire Detection	Meets the intent. As described in subsection 9.5.1.2.2.7, automatic fire and smoke detectors are installed in all areas of seismic Category I structures that contain or present a potential exposure fire hazard detrimental to safe shutdown or to the operation of safety-related systems or equipment as described in the Fire Hazards Analysis Report. Additional information concerning power supplies is described in subsection 9.5.1.2.2.13.
G. Fire Protection of Safe Shutdown Capability	<ol style="list-style-type: none">1. Comply. Active and passive fire protection measures have been provided to ensure hot and cold shutdown capability.2. As described in the Fire Hazards Analysis Report, adequate protection has been provided to ensure that a single exposure fire could not affect redundant safe shutdown-related components.3. As discussed in the Fire Hazards Analysis Report, alternate or dedicated shutdown capability is not required for any area in the plant, except as discussed in Section III.L of this table.

GRAND GULF NUCLEAR GENERATING STATION
Updated Final Safety Analysis Report (UFSAR)

**TABLE 9.5-12: FIRE PROTECTION PROGRAM COMPARISON WITH APPENDIX R
TO 10 CFR 50 (CONTINUED)**

H. Fire Brigade	Meets the intent. The fire brigade is staffed and equipped in accordance with the provisions stated. (See also Appendix 9B.)
I. Fire Brigade Training	Comply. (See also Appendix 9B.)
J. Emergency Lighting	Comply. As discussed in subsection 9.5.3.1.1 and Table 9.5-11, Section D.5.a, eight-hour emergency lighting has been provided for areas essential to the operation of equipment required for safe shutdown as tabulated in Table 9.5-15 and in the access and egress routes thereto.
K. Administrative Controls	Meets the intent. Additional information is provided in Appendix 9B.
L. Alternate or Dedicated Shutdown Capability	Meets the intent. Additional information is provided in Section 7.4.1.5 - Alternate Shutdown System.
M. Fire Barrier Cable Penetration Seal Qualification	<p>Meets the intent. As discussed in subsection 9.5.1.2.2.9 and Table 9.5-11, Section D.3, fire barrier cable penetration seals are qualified and tested in accordance with NFPA, ANI, and IEEE standards. The fire barrier penetration rating generally equals the fire rating of the respective barrier.</p> <p>Additional information on this issue was provided to the NRC at the NRC staff's request by letter dated August 21, 1981 (AECM-81/309).</p>

GRAND GULF NUCLEAR GENERATING STATION
Updated Final Safety Analysis Report (UFSAR)

**TABLE 9.5-12: FIRE PROTECTION PROGRAM COMPARISON WITH APPENDIX R
TO 10 CFR 50 (CONTINUED)**

N. Fire Doors	Meets the intent. Fire doors are provided with self-closing mechanisms. Fire doors, when used as security doors, are kept closed and electrically supervised. All fire ready access to keys for any locked fire doors.
O. Oil Collection System for Reactor Coolant Pump	<p>An exposure fire due to the ignition of the recirculation pump lubricating oil is not a credible event. Each motor utilizes self-lubricated bearings. An upper reservoir containing 52 gallons of lubricating oil surrounds the upper guide bearing and thrust bearing. A lower reservoir containing 7.5 gallons of lubricant surrounds the lower guide bearing. The reservoirs are formed by heavy bearing brackets and, for the lower reservoir, a 1-5/8-inch-thick "oil pan." A supplemental external oiler containing 2 additional gallons of lubricant is attached to the lower reservoir. Details of this design are shown on Figures 9.5-25, 9.5-26, and 9.5-26a Reactor Recirculation Pump Motor Assembly and supplemental oiler assembly. The lubricating oil is cooled by cooling coils installed within the reservoirs.</p> <p>Since the bearings are self-lubricated and the oil is cooled within the reservoir, a pressurized oil system is neither required nor utilized. This design also minimizes piping connections to the oil reservoir. As may be noted from the referenced figures, connections are limited to atmospheric vents, drains, level monitoring connections and supplemental oiler connection.</p>

GRAND GULF NUCLEAR GENERATING STATION
Updated Final Safety Analysis Report (UFSAR)

**TABLE 9.5-12: FIRE PROTECTION PROGRAM COMPARISON WITH APPENDIX R
TO 10 CFR 50 (CONTINUED)**

The heavy construction and non-pressurized design of this lubricating system minimizes the susceptibility of the system to leakage. Also, if a leak were to occur, ignition-enhancing spray would be unlikely. Therefore, an exposure fire due to the ignition of the recirculation pump lubricating oil is not credible and additional fire protection measures for the recirculation pumps, such as an engineered oil containment and collection system, are not required.

TABLE 9.5-13: STANDBY DIESEL GENERATOR FUEL OIL DRIP RETURN PIPING

<u>Pipe Description</u>	<u>Pipe Size (in.)</u>	<u>Design</u>		<u>Normal Operating</u>		<u>Maximum Operating</u>		<u>Calculated Minimum Wall Thickness (ANSI)</u>		<u>Existing Pipe Wall Thickness (in.)</u>	<u>% Excess Pipe Wall Thickness</u>	
		<u>Temp. (°F)</u>	<u>Press. (Psiq)</u>	<u>Temp. (°F)</u>	<u>Press. (Psiq)</u>	<u>Temp. (°F)</u>	<u>Press. (Psiq)</u>	<u>Design*</u>	<u>Oper.**</u>		<u>Design*</u>	<u>Oper.**</u>
1½" Sched 40 TDI Supplied Drip Tank to Drip Pump Suct.	1½	125	5	80	1	100	1	0.091	0.091	0.145	59.0	59.0
2" Sched 40 TDI Supplied Drip Pump Discharge	2	125	125	80	15	100	20	0.103	0.093	0.154	49.5	65.6
1" JBD 425 Sched 80 Drip Pump Discharge	1	125	125	80	15	100	20	0.096	0.092	0.179	86.5	94.6
1" JBD 1045 Sched 80 Drip Tank Overflow	1	125	15	80	0	100	5	0.092	0.092	0.179	94.6	94.6
1" Sched 40 TDI Supplied Vent/Drain	1	125	15	80	0	100	0	0.092	0.092	0.133	44.6	44.6

* Based upon design temperature and pressure.

**Based upon maximum operating temperature and pressure.

TABLE 9.5-14: WORKING STATIONS COMMUNICATION SYSTEMS

Area/Description	Elevation	Installed Communications Available	Ambient Noise Levels (See Notes 1 and 2)
Radwaste Control Room	118'-0"	1 - PA Handset 1 - Sound Power Two-Way Radio	Low
Personnel Access Hatch to Containment	208'-10"	1 - PA Handset Two-Way Radio	Low
	119'-0"	1 - PA Handset 1 - Sound Power Two-Way Radio	High (See Note 3)
Fire Water Pump House	133'-0"	1 - PA Handset (Pump Room A) 1 - Sound Power (Motor Driven Pump Room) Two-Way Radio 3 - Revolving Lights (1 per room)	High (with pumps running) (See Note 12)
Control Bldg/Class IE Swgr Rooms* Div I	111'-0"	4 - Sound Power 1 - PA Handset 1 - PA Receptacle Junction Box Two-Way Radio	Low
		Div II	4 - Sound Power 1 - PA Handset 3 - PA Receptacle Junction Box Two-Way Radio

9.5-138

Revision 2016-00

TABLE 9.5-14: WORKING STATIONS COMMUNICATION SYSTEMS (CONTINUED)

Area/Description	Elevation	Installed Communications Available	Ambient Noise Levels (See Notes 1 and 2)
Div III		2 - Sound Power 2 - PA Receptacle Junction Box Two-Way Radio	Low
Auxiliary Bldg/ESF Swgr Room* Div I	119'-0"	2 - Sound Power 1 - PA Receptacle Junction Box Two-Way Radio	Low
Div II	119'-0"	2 - Sound Power 1 - PA Receptacle Junction Box Two-Way Radio	Low
Div I	139'-0"	2 - Sound Power 1 - PA Receptacle Junction Box Two-Way Radio	Low
Div II	139'-0"	1 - Sound Power 1 - PA Receptacle Junction Box Two-Way Radio	Low
Control Room/Upper Cable Spreading Room	189'-0"	4 - PA Handsets 4 - Sound Power	Low

9.5-139

Revision 2016-00

GRAND GULF NUCLEAR GENERATING STATION
 Updated Final Safety Analysis Report (UFSAR)

TABLE 9.5-14: WORKING STATIONS COMMUNICATION SYSTEMS (CONTINUED)

Area/Description	Elevation	Installed Communications Available	Ambient Noise Levels (See Notes 1 and 2)
Control Room/Operator Controls	166'-0"	6 - PA Handsets 13 - Sound Power 2 - Sound Power Dedicated Telephones Two-Way Radio	Low
Control Room/Lower Cable Spreading Room	148'-0"	4 - PA Handsets 6 - Sound Power	Low
Control Room/Technical Support Center	177'-0"	1 - PA Handset 2 - Sound Power Dedicated Telephones Two-Way Radio	Low
Control Bldg/Remote Shutdown Panels	111'-0"	2 - Sound Power Dedicated Two-Way Radio 4 - PA Handsets 2 - Sound Power	Low
Diesel Generator Building (3 rooms)	133'-0"	PA Handsets 2-Div I 2-Div II 2-Div III Two-Way Radio Revolving Warning Lights (2 per room)	High (with diesels running) (See Notes 4 & 12)

9.5-140

Revision 2016-00

TABLE 9.5-14: WORKING STATIONS COMMUNICATION SYSTEMS (CONTINUED)

Area/Description	Elevation	Installed Communications Available	Ambient Noise Levels (See Notes 1 and 2)
Turbine Bldg/Post-Accident Sampling Station	93'-0"	1 - PA Handset (Located outside of room at door entrance) Two-Way Radio	Low post-accident & with turbine not running) High (turbine running) (See Note 3)
Rad. Chem. Laboratory	118'-0"	1 - PA Handset (Located outside at room door entrance) Two-Way Radio	Low
Ultimate Heat Sink/ S.S.W. Pump House*	133'-0"		
Valve House (Unit 1)*		Two-Way Radio	Low
Valve House (Unit 2)*		Two-Way Radio	Low
Load Center Area (Unit 1)*		Two-Way Radio	Low
Load Center Area (Unit 2)*		Two-Way Radio	Low
SSW Pump Room (Unit 1)*		1 - PA Handset Two-Way Radio	High (See Notes 5 & 12)
SSW Pump Room (Unit 2)*		1 - PA Handset Two-Way Radio	High (See Notes 5 & 12)
Control Building, HVAC Equip. Rm*	133'-0"		

9.5-141

Revision 2016-00

GRAND GULF NUCLEAR GENERATING STATION
 Updated Final Safety Analysis Report (UFSAR)

TABLE 9.5-14: WORKING STATIONS COMMUNICATION SYSTEMS (CONTINUED)

Area/Description	Elevation	Installed Communications Available	Ambient Noise Levels (See Notes 1 and 2)
HVAC Equip. Room (Unit 1)*		1 - PA Handset Two-Way Radio	Low
HVAC Equip. Room (Unit 2)*		1 - PA Handset Two-Way Radio (See Note 3)	High
ECCS Pump Rooms*	93'-0"	1 - PA Handset Two-Way Radio 1 - Revolving Warning Light	High (See Note 12)
RHR "A"*		1 - PA Handset Two-Way Radio 1 - Revolving Warning Light	High (See Note 12)
RHR "B"*		1 - PA Speaker, No Handset Two-Way Radio 1 - Revolving Warning Light	High (See Note 9)
LPCS*		1 - PA Handset Two-Way Radio 1 - Revolving Warning Light	High (See Note 12)
HPCS*		1 - PA Handset Two-Way Radio 1 - Revolving Warning Light	High (See Note 12)

9.5-142

Revision 2016-00

GRAND GULF NUCLEAR GENERATING STATION
Updated Final Safety Analysis Report (UFSAR)

TABLE 9.5-14: WORKING STATIONS COMMUNICATION SYSTEMS (CONTINUED)

- Note 1: These noise levels are based on test results with equipment running. (High greater than 80dB, Low less than 80dB)
- Note 2: Where two-way radio is indicated for high noise areas, it is intended that portable radios be used immediately outside the high noise area.
- Note 3: The PA stations in these designated high noise areas have been tested as satisfactory for normal handset communications.
- Note 4: The nearest PA handset outside of the diesel generator rooms is an estimated distance of 90', in the auxiliary building, El. 139'-0".
- Note 5: The handset is located near the doorway. The operator can stand in the door alcove to reduce noise levels.
- Note 6: Deleted
- Note 7: Deleted
- Note 8: Deleted
- Note 9: The nearest handset is about 46' from the doorway of the RHR C pump room to the CCW pump and heat exchanger area, where the noise level is low.
- Note 10: Deleted
- Note 11: Deleted
- Note 12: PA handsets with receptacles are provided in these high noise areas for use with amplified headsets.
- * Areas so designated are included at the request of NRC Power Systems Branch (PSB) reviewer.

GRAND GULF NUCLEAR GENERATING STATION
Updated Final Safety Analysis Report (UFSAR)

TABLE 9.5-15: LIGHTING SYSTEM TABULATION

	LIGHTING SYSTEMS		
	NORMAL AC + Emer Btry packs	Essential on ESF bus	Emergency on inverter bus
GENERAL PLANT LIGHTING	Yes ²	No	No
SITE LIGHTING (SECURITY)	Yes ¹	No	No
SPECIAL AREAS:			
<u>AUX BLDG ELEC SWGR ROOMS</u>			
1A208 & 1A219 on El. 119'-0"	Yes ²	Yes	No
1A207 & 1A221 on El. 119'-0"	Yes ¹	Yes	No
1A309 & 1A318 on El. 139'-0"	Yes ¹	Yes	No
1A308 on El. 139'-0"	Yes ¹	Yes	No
1A320 on El. 139'-0"	Yes	Yes	No
1A410 on El. 166'-0"	Yes ²	Yes	No
1A407 on El. 166'-0"	Yes ¹	Yes	No
AUX BLDG STAIR 1A10			
El. 119'-0" to El. 166'-0"	Yes ²	No	No
<u>AUX BLDG STAIR 1A12</u>			
El. 119'-0" to El. 139'-0"	Yes ²	No	No
<u>CONTROL BLDG EL 111'-0"</u>			
OC202 Div. I SWGR Area	Yes ²	Yes	No
OC208 Div. II Remote Shutdown RM	Yes ²	Yes	No
OC208A Div. I Remote Shutdown RM	Yes ²	Yes	No
OC215 Div. II SWGR Area	Yes ²	Yes	No
OC216 Corridor	Yes ²	No	No
<u>CONTROL BLDG EL 148'-0"</u>			
OC407 Motor Gen. Room	Yes ²	No	No
OC408 Corridor	Yes ²	No	No
<u>CONTROL BLDG EL 166'-0"</u>			
OC503 Control Room and Inst. Rack Area	Yes ²	Yes	Yes
OC509 Corridor	Yes ²	No	No
OC515 Corridor	Yes ²	No	No
OC501 Corridor	No	Yes	No
<u>CONTROL BLDG EL 189'-0"</u>			

GRAND GULF NUCLEAR GENERATING STATION
Updated Final Safety Analysis Report (UFSAR)

TABLE 9.5-15: LIGHTING SYSTEM TABULATION

	LIGHTING SYSTEMS		
	Yes ²	No	No
OC707 Motor Gen. Room	Yes ²	No	No
OC706 Corridor	Yes ²	No	No
OC703 Upper Control Room	Yes	No	No
<u>CONTROL BLDG STAIR OC02</u>			
El. 111'-0" to El. 166'-0"	No	Yes	Yes
El. 166'-0" to El. 189'-0"	Yes	No	No
El. 93'-0" to El. 111'-0"	Yes	No	No
<u>CONTROL BLDG STAIR OC01</u>			
El. 111'-0" to El. 189'-0"	Yes ²	No	No
El. 93'-0" to El. 111'-0"	Yes	No	No
<u>DIESEL GEN BLDG EL 133'-0"</u>			
1D310 Div. I Relay Control Panel Area	Yes ²	No	No
1D301 Corridor	Yes ²	No	No

NOTE:

¹ No emergency battery packs are provided.

² Eight hour emergency battery packs are provided, where required for operation of, or access/egress to, equipment essential to safe shutdown.

GRAND GULF NUCLEAR GENERATING STATION
Updated Final Safety Analysis Report (UFSAR)

TABLE 9.5-16: Deleted

TABLE 9.5-17: HYDROGEN WATER CHEMISTRY SYSTEM MALFUNCTIONS/EFFECTS

<u>Equipment Item</u>	<u>Malfunction</u>	<u>Consequences</u>	<u>Design Precautions</u>
Hydrogen Storage facility	Vessel pressure boundary failure	Storage vessel rupture with release of hydrogen vapor cloud and potential for fireball or explosion	Site consideration for facility assumed failure and impact on station safe shutdown due to fireball, explosion and vapor cloud drift closer to station prior to ignition or detonation.
	Seismic	Storage vessel rupture with release of hydrogen and potential for fireball or explosion	Seismic design of tank, foundation and all liquid filled piping to minimize the potential vapor cloud source.
	Tornado	Storage vessel relocation closer to station structures prior to rupture with release of hydrogen and potential for fireball	Tornado loading included for foundation design to ensure all permanent vessels fail in place.
	Flood	Storage vessel relocation closer to station structures prior to rupture with release of hydrogen vapor cloud and potential for fireball or explosion	Flood uplift loading included for foundation design to ensure all permanent vessels fail in place.
Oxygen storage facility	Vessel pressure boundary failure	Storage vessel rupture with release of oxygen vapor cloud with increased potential for combustion	Site consideration for facility assumed failure and impact on station safe shutdown due to ingestion of oxygen rich air into safety related air intakes.

TABLE 9.5-17: HYDROGEN WATER CHEMISTRY SYSTEM MALFUNCTIONS/EFFECTS (CONTINUED)

<u>Equipment Item</u>	<u>Malfunction</u>	<u>Consequences</u>	<u>Design Precautions</u>
	Seismic	Storage vessel rupture with release of oxygen	No seismic design requirements for tank or foundation - failure is permitted
	Tornado	Storage vessel relocation closer to station structures prior to rupture with release of oxygen	Tornado loading included for foundation design to ensure vessel fails in place
	Flood	Storage vessel relocation closer to station structures prior to rupture with release of oxygen	Flood uplift loading included for foundation design to ensure vessel fails in place.
Hydrogen Piping	Pressure boundary failure	Large release of hydrogen inside of or near Turbine Building	Excess flow check valve at storage facility to prevent unmitigated flow through downstream pipe break or mispositioned valve.
	Pressure boundary leak	Small release of hydrogen inside of Turbine Building will pocket to form flammable mixture	Hydrogen area detectors provided to identify small leaks at valves and instrumentation. Control logic will close hydrogen isolation valves at panels 1H22-P731 and 1H22-P732 to limit inventory of hydrogen available for leakage, and identify potential problem to operations prior to sufficient hydrogen escapes to cause concern.

TABLE 9.5-17: HYDROGEN WATER CHEMISTRY SYSTEM MALFUNCTIONS/EFFECTS (CONTINUED)

<u>Equipment Item</u>	<u>Malfunction</u>	<u>Consequences</u>	<u>Design Precautions</u>
Oxygen piping	Pressure boundary failure	Large release of oxygen gas inside Turbine Building or near air pathways to safety related structures provides a more flammable environment	Hydrogen piping routed in ventilated area to minimize potential to form a gas pocket if released. Excess flow check valve at storage facility to prevent unmitigated flow through downstream pipe break or mispositioned valve.
Offgas oxygen monitor	Pressure boundary failure	Offgas release through sample line into analyzer room	HVAC system in room to remove air to Turbine Building exhaust duct. Note that new panel designed as rack may reduce effectiveness of this system.
	Oxygen sensor failure	Loss of offgas oxygen concentration monitoring	Oxygen monitor failure or trouble signal will trip HWC system. Offgas hydrogen monitors provide control room indication and alarm if residual hydrogen concentration approaches tower explosive limit.

GRAND GULF NUCLEAR GENERATING STATION

Updated Final Safety Analysis Report (UFSAR)

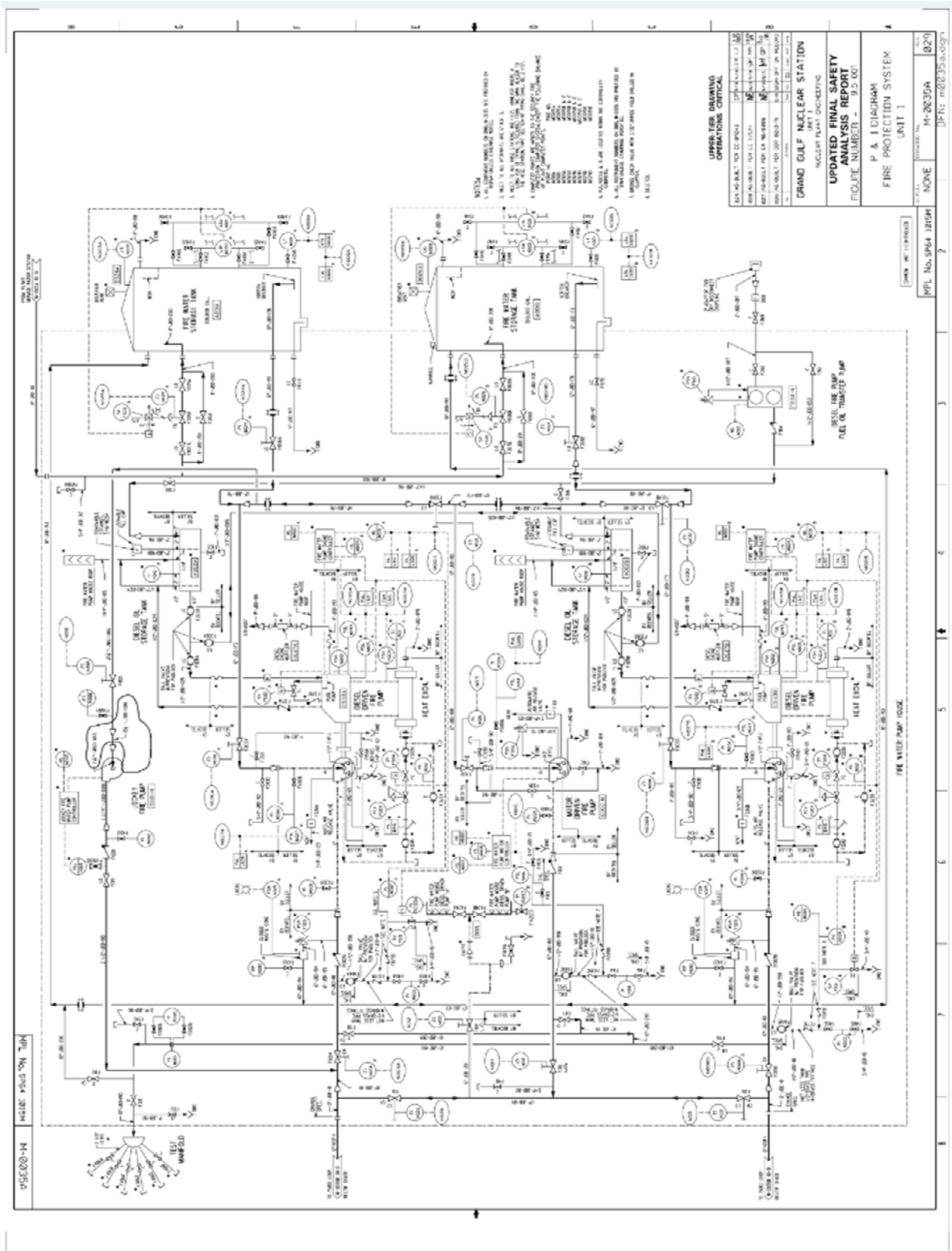

GRAND GULF NUCLEAR GENERATING STATION

Updated Final Safety Analysis Report (UFSAR)

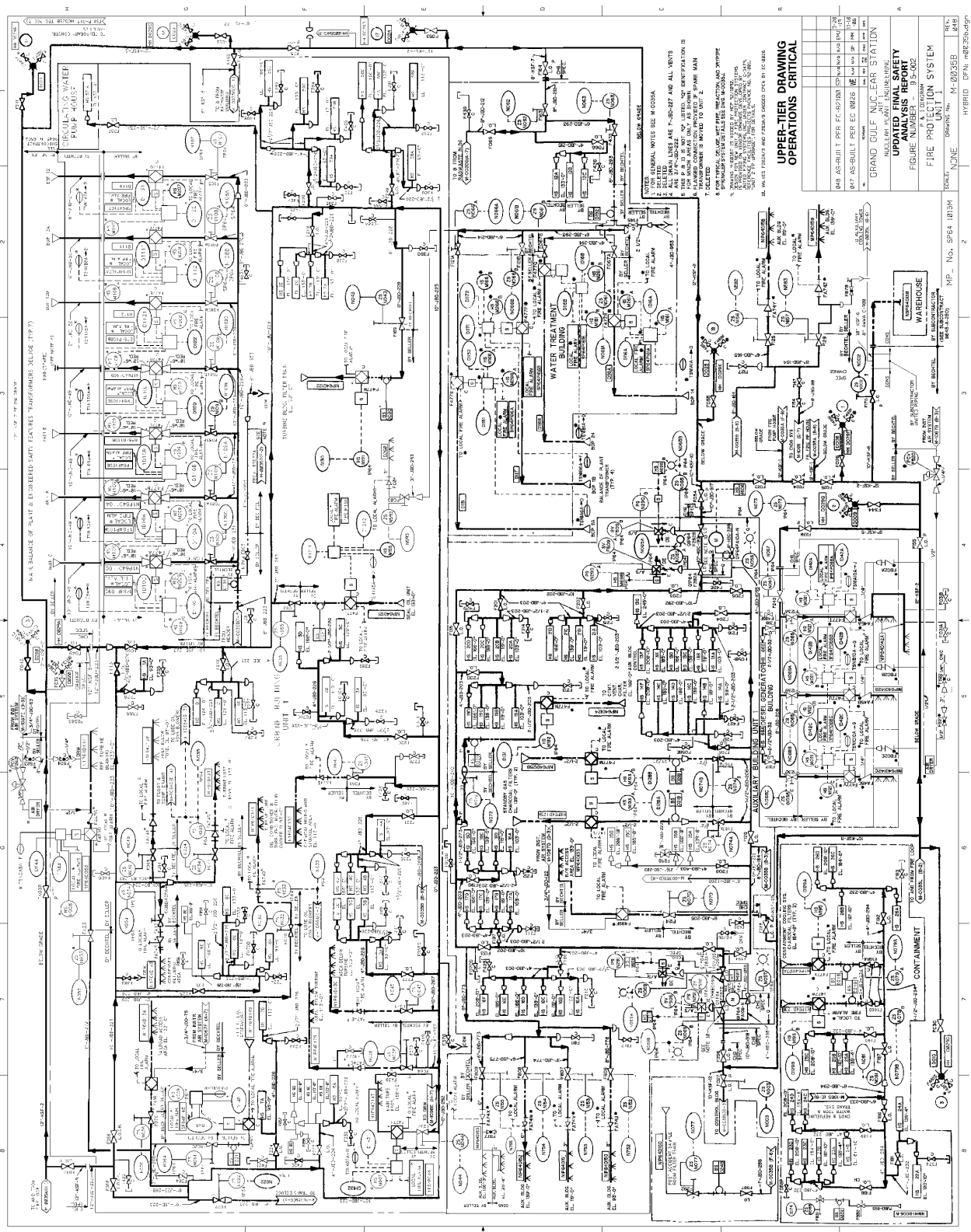
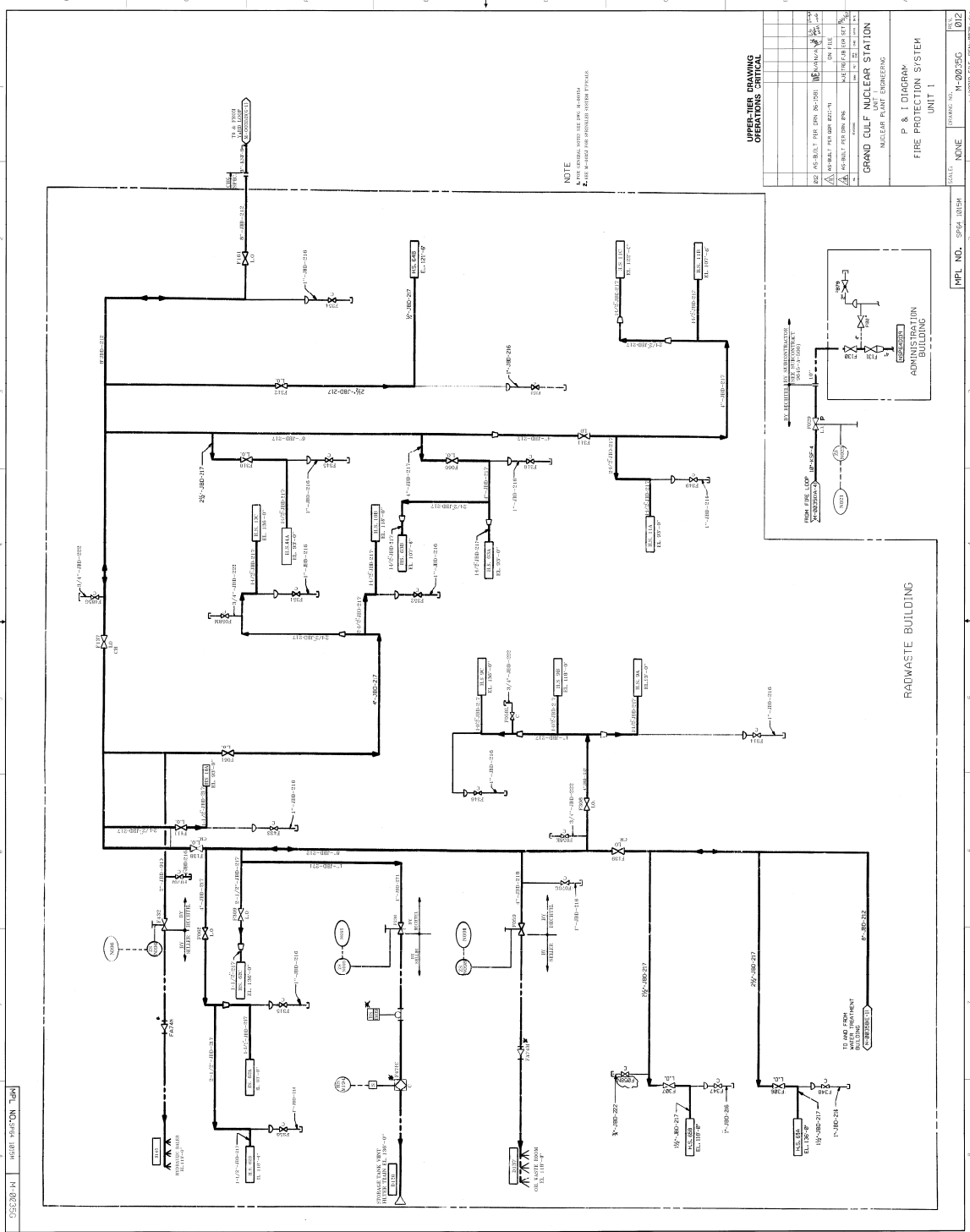

Figure 9.5-3
Deleted

GRAND GULF NUCLEAR GENERATING STATION

Updated Final Safety Analysis Report (UFSAR)



GRAND GULF NUCLEAR GENERATING STATION

Updated Final Safety Analysis Report (UFSAR)

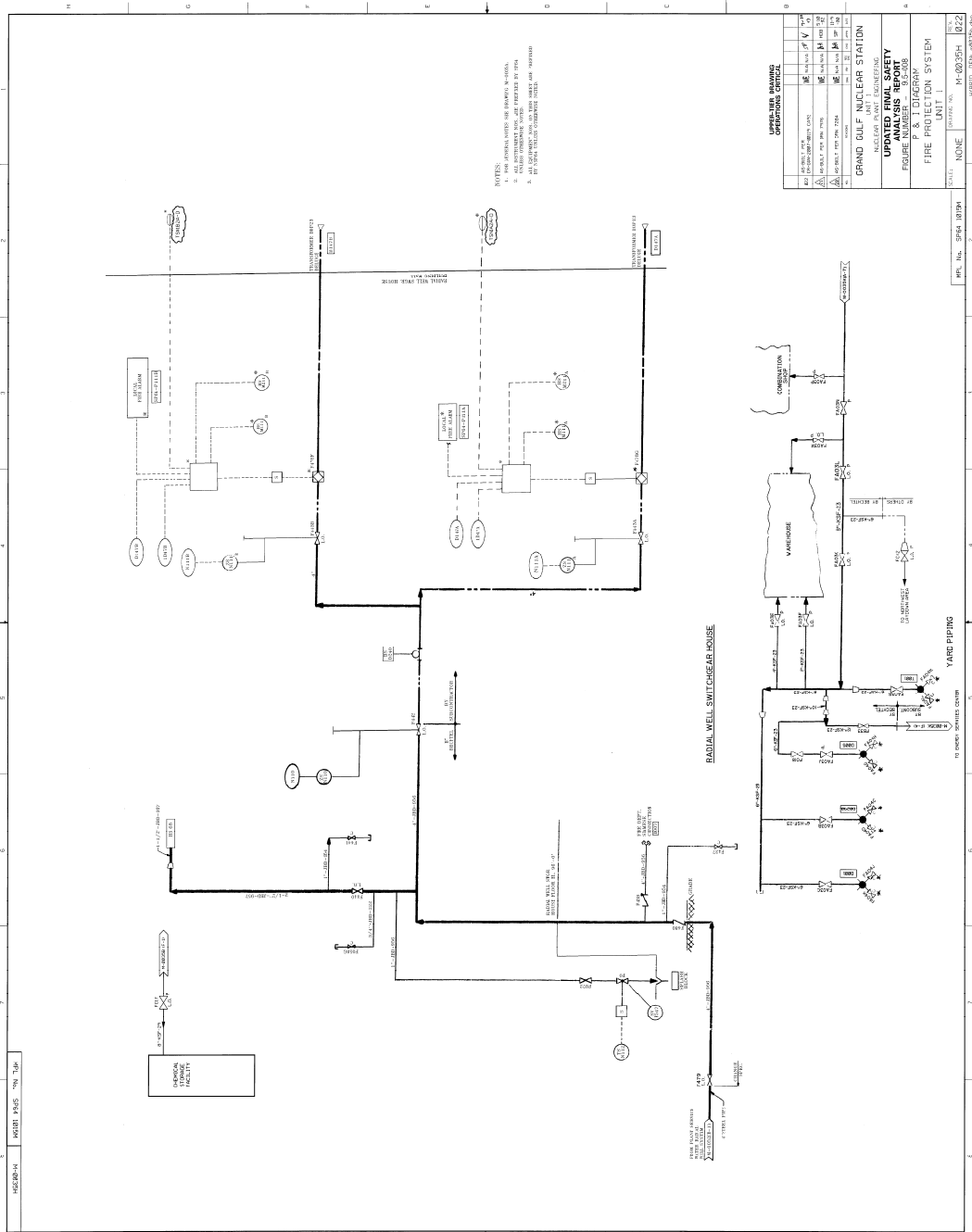

GRAND GULF NUCLEAR GENERATING STATION

Updated Final Safety Analysis Report (UFSAR)

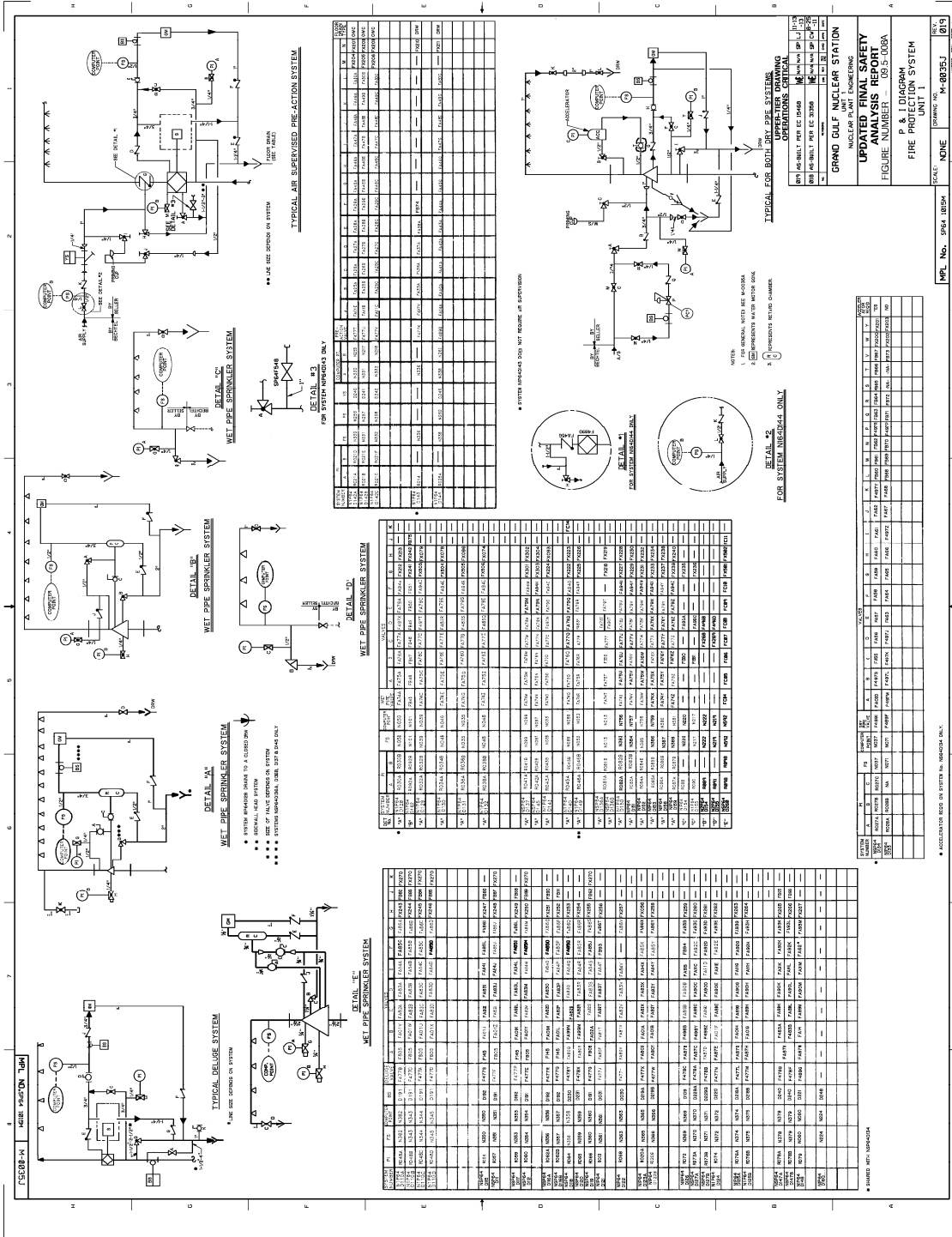

GRAND GULF NUCLEAR GENERATING STATION

Updated Final Safety Analysis Report (UFSAR)

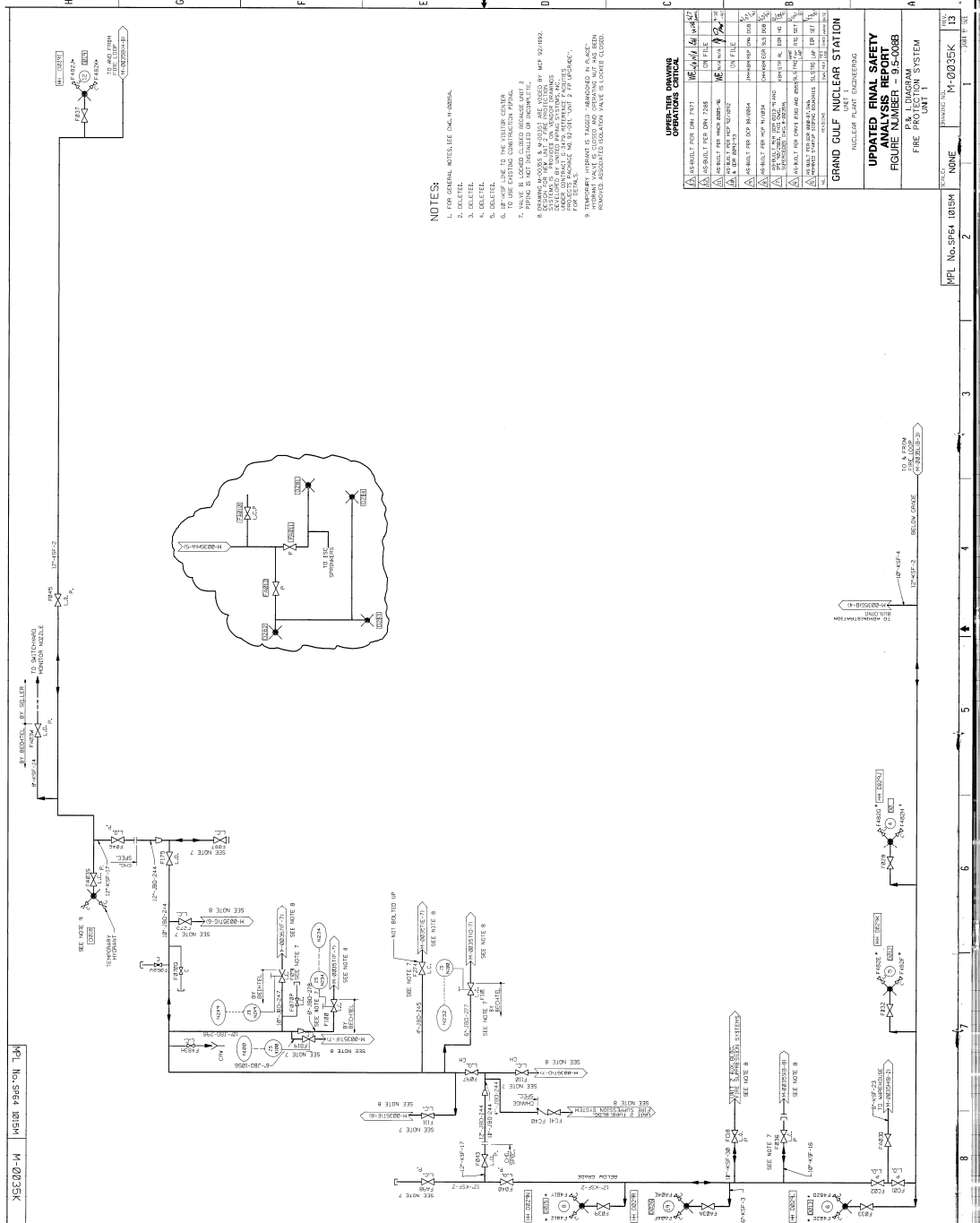

- NOTES:**
1. FOR GENERAL NOTES, SEE DDC-H-0000A.
 2. DELETE.
 3. DELETE.
 4. DELETE.
 5. DELETE.
 6. THE SP-001 AND THE SP-002 PUMPS ARE TO BE REPLACED BY TWO NEW PUMPS.
 7. VALVE B IS LOCKED CLOSED BECAUSE UNIT 2 IS SHUT DOWN.
 8. THE SP-001 AND THE SP-002 PUMPS ARE TO BE REPLACED BY TWO NEW PUMPS.
 9. THE SP-001 AND THE SP-002 PUMPS ARE TO BE REPLACED BY TWO NEW PUMPS.
 10. THE SP-001 AND THE SP-002 PUMPS ARE TO BE REPLACED BY TWO NEW PUMPS.
 11. THE SP-001 AND THE SP-002 PUMPS ARE TO BE REPLACED BY TWO NEW PUMPS.
 12. THE SP-001 AND THE SP-002 PUMPS ARE TO BE REPLACED BY TWO NEW PUMPS.
 13. THE SP-001 AND THE SP-002 PUMPS ARE TO BE REPLACED BY TWO NEW PUMPS.
 14. THE SP-001 AND THE SP-002 PUMPS ARE TO BE REPLACED BY TWO NEW PUMPS.
 15. THE SP-001 AND THE SP-002 PUMPS ARE TO BE REPLACED BY TWO NEW PUMPS.
 16. THE SP-001 AND THE SP-002 PUMPS ARE TO BE REPLACED BY TWO NEW PUMPS.
 17. THE SP-001 AND THE SP-002 PUMPS ARE TO BE REPLACED BY TWO NEW PUMPS.
 18. THE SP-001 AND THE SP-002 PUMPS ARE TO BE REPLACED BY TWO NEW PUMPS.
 19. THE SP-001 AND THE SP-002 PUMPS ARE TO BE REPLACED BY TWO NEW PUMPS.
 20. THE SP-001 AND THE SP-002 PUMPS ARE TO BE REPLACED BY TWO NEW PUMPS.

NO.	DESCRIPTION	DATE	BY	CHKD.
1	AS-BUILT FOR DYN 7001	10/1/71	ME/AMJ	ME/AMJ
2	AS-BUILT FOR DYN 7205	08/1/71	ME/AMJ	ME/AMJ
3	AS-BUILT FOR DYN 7302	08/1/71	ME/AMJ	ME/AMJ
4	AS-BUILT FOR DYN 7303	08/1/71	ME/AMJ	ME/AMJ
5	AS-BUILT FOR DYN 7304	08/1/71	ME/AMJ	ME/AMJ
6	AS-BUILT FOR DYN 7305	08/1/71	ME/AMJ	ME/AMJ
7	AS-BUILT FOR DYN 7306	08/1/71	ME/AMJ	ME/AMJ
8	AS-BUILT FOR DYN 7307	08/1/71	ME/AMJ	ME/AMJ
9	AS-BUILT FOR DYN 7308	08/1/71	ME/AMJ	ME/AMJ
10	AS-BUILT FOR DYN 7309	08/1/71	ME/AMJ	ME/AMJ
11	AS-BUILT FOR DYN 7310	08/1/71	ME/AMJ	ME/AMJ
12	AS-BUILT FOR DYN 7311	08/1/71	ME/AMJ	ME/AMJ
13	AS-BUILT FOR DYN 7312	08/1/71	ME/AMJ	ME/AMJ
14	AS-BUILT FOR DYN 7313	08/1/71	ME/AMJ	ME/AMJ
15	AS-BUILT FOR DYN 7314	08/1/71	ME/AMJ	ME/AMJ
16	AS-BUILT FOR DYN 7315	08/1/71	ME/AMJ	ME/AMJ
17	AS-BUILT FOR DYN 7316	08/1/71	ME/AMJ	ME/AMJ
18	AS-BUILT FOR DYN 7317	08/1/71	ME/AMJ	ME/AMJ
19	AS-BUILT FOR DYN 7318	08/1/71	ME/AMJ	ME/AMJ
20	AS-BUILT FOR DYN 7319	08/1/71	ME/AMJ	ME/AMJ
21	AS-BUILT FOR DYN 7320	08/1/71	ME/AMJ	ME/AMJ
22	AS-BUILT FOR DYN 7321	08/1/71	ME/AMJ	ME/AMJ
23	AS-BUILT FOR DYN 7322	08/1/71	ME/AMJ	ME/AMJ
24	AS-BUILT FOR DYN 7323	08/1/71	ME/AMJ	ME/AMJ
25	AS-BUILT FOR DYN 7324	08/1/71	ME/AMJ	ME/AMJ
26	AS-BUILT FOR DYN 7325	08/1/71	ME/AMJ	ME/AMJ
27	AS-BUILT FOR DYN 7326	08/1/71	ME/AMJ	ME/AMJ
28	AS-BUILT FOR DYN 7327	08/1/71	ME/AMJ	ME/AMJ
29	AS-BUILT FOR DYN 7328	08/1/71	ME/AMJ	ME/AMJ
30	AS-BUILT FOR DYN 7329	08/1/71	ME/AMJ	ME/AMJ
31	AS-BUILT FOR DYN 7330	08/1/71	ME/AMJ	ME/AMJ
32	AS-BUILT FOR DYN 7331	08/1/71	ME/AMJ	ME/AMJ
33	AS-BUILT FOR DYN 7332	08/1/71	ME/AMJ	ME/AMJ
34	AS-BUILT FOR DYN 7333	08/1/71	ME/AMJ	ME/AMJ
35	AS-BUILT FOR DYN 7334	08/1/71	ME/AMJ	ME/AMJ
36	AS-BUILT FOR DYN 7335	08/1/71	ME/AMJ	ME/AMJ
37	AS-BUILT FOR DYN 7336	08/1/71	ME/AMJ	ME/AMJ
38	AS-BUILT FOR DYN 7337	08/1/71	ME/AMJ	ME/AMJ
39	AS-BUILT FOR DYN 7338	08/1/71	ME/AMJ	ME/AMJ
40	AS-BUILT FOR DYN 7339	08/1/71	ME/AMJ	ME/AMJ
41	AS-BUILT FOR DYN 7340	08/1/71	ME/AMJ	ME/AMJ
42	AS-BUILT FOR DYN 7341	08/1/71	ME/AMJ	ME/AMJ
43	AS-BUILT FOR DYN 7342	08/1/71	ME/AMJ	ME/AMJ
44	AS-BUILT FOR DYN 7343	08/1/71	ME/AMJ	ME/AMJ
45	AS-BUILT FOR DYN 7344	08/1/71	ME/AMJ	ME/AMJ
46	AS-BUILT FOR DYN 7345	08/1/71	ME/AMJ	ME/AMJ
47	AS-BUILT FOR DYN 7346	08/1/71	ME/AMJ	ME/AMJ
48	AS-BUILT FOR DYN 7347	08/1/71	ME/AMJ	ME/AMJ
49	AS-BUILT FOR DYN 7348	08/1/71	ME/AMJ	ME/AMJ
50	AS-BUILT FOR DYN 7349	08/1/71	ME/AMJ	ME/AMJ
51	AS-BUILT FOR DYN 7350	08/1/71	ME/AMJ	ME/AMJ
52	AS-BUILT FOR DYN 7351	08/1/71	ME/AMJ	ME/AMJ
53	AS-BUILT FOR DYN 7352	08/1/71	ME/AMJ	ME/AMJ
54	AS-BUILT FOR DYN 7353	08/1/71	ME/AMJ	ME/AMJ
55	AS-BUILT FOR DYN 7354	08/1/71	ME/AMJ	ME/AMJ
56	AS-BUILT FOR DYN 7355	08/1/71	ME/AMJ	ME/AMJ
57	AS-BUILT FOR DYN 7356	08/1/71	ME/AMJ	ME/AMJ
58	AS-BUILT FOR DYN 7357	08/1/71	ME/AMJ	ME/AMJ
59	AS-BUILT FOR DYN 7358	08/1/71	ME/AMJ	ME/AMJ
60	AS-BUILT FOR DYN 7359	08/1/71	ME/AMJ	ME/AMJ
61	AS-BUILT FOR DYN 7360	08/1/71	ME/AMJ	ME/AMJ
62	AS-BUILT FOR DYN 7361	08/1/71	ME/AMJ	ME/AMJ
63	AS-BUILT FOR DYN 7362	08/1/71	ME/AMJ	ME/AMJ
64	AS-BUILT FOR DYN 7363	08/1/71	ME/AMJ	ME/AMJ
65	AS-BUILT FOR DYN 7364	08/1/71	ME/AMJ	ME/AMJ
66	AS-BUILT FOR DYN 7365	08/1/71	ME/AMJ	ME/AMJ
67	AS-BUILT FOR DYN 7366	08/1/71	ME/AMJ	ME/AMJ
68	AS-BUILT FOR DYN 7367	08/1/71	ME/AMJ	ME/AMJ
69	AS-BUILT FOR DYN 7368	08/1/71	ME/AMJ	ME/AMJ
70	AS-BUILT FOR DYN 7369	08/1/71	ME/AMJ	ME/AMJ
71	AS-BUILT FOR DYN 7370	08/1/71	ME/AMJ	ME/AMJ
72	AS-BUILT FOR DYN 7371	08/1/71	ME/AMJ	ME/AMJ
73	AS-BUILT FOR DYN 7372	08/1/71	ME/AMJ	ME/AMJ
74	AS-BUILT FOR DYN 7373	08/1/71	ME/AMJ	ME/AMJ
75	AS-BUILT FOR DYN 7374	08/1/71	ME/AMJ	ME/AMJ
76	AS-BUILT FOR DYN 7375	08/1/71	ME/AMJ	ME/AMJ
77	AS-BUILT FOR DYN 7376	08/1/71	ME/AMJ	ME/AMJ
78	AS-BUILT FOR DYN 7377	08/1/71	ME/AMJ	ME/AMJ
79	AS-BUILT FOR DYN 7378	08/1/71	ME/AMJ	ME/AMJ
80	AS-BUILT FOR DYN 7379	08/1/71	ME/AMJ	ME/AMJ
81	AS-BUILT FOR DYN 7380	08/1/71	ME/AMJ	ME/AMJ
82	AS-BUILT FOR DYN 7381	08/1/71	ME/AMJ	ME/AMJ
83	AS-BUILT FOR DYN 7382	08/1/71	ME/AMJ	ME/AMJ
84	AS-BUILT FOR DYN 7383	08/1/71	ME/AMJ	ME/AMJ
85	AS-BUILT FOR DYN 7384	08/1/71	ME/AMJ	ME/AMJ
86	AS-BUILT FOR DYN 7385	08/1/71	ME/AMJ	ME/AMJ
87	AS-BUILT FOR DYN 7386	08/1/71	ME/AMJ	ME/AMJ
88	AS-BUILT FOR DYN 7387	08/1/71	ME/AMJ	ME/AMJ
89	AS-BUILT FOR DYN 7388	08/1/71	ME/AMJ	ME/AMJ
90	AS-BUILT FOR DYN 7389	08/1/71	ME/AMJ	ME/AMJ
91	AS-BUILT FOR DYN 7390	08/1/71	ME/AMJ	ME/AMJ
92	AS-BUILT FOR DYN 7391	08/1/71	ME/AMJ	ME/AMJ
93	AS-BUILT FOR DYN 7392	08/1/71	ME/AMJ	ME/AMJ
94	AS-BUILT FOR DYN 7393	08/1/71	ME/AMJ	ME/AMJ
95	AS-BUILT FOR DYN 7394	08/1/71	ME/AMJ	ME/AMJ
96	AS-BUILT FOR DYN 7395	08/1/71	ME/AMJ	ME/AMJ
97	AS-BUILT FOR DYN 7396	08/1/71	ME/AMJ	ME/AMJ
98	AS-BUILT FOR DYN 7397	08/1/71	ME/AMJ	ME/AMJ
99	AS-BUILT FOR DYN 7398	08/1/71	ME/AMJ	ME/AMJ
100	AS-BUILT FOR DYN 7399	08/1/71	ME/AMJ	ME/AMJ
101	AS-BUILT FOR DYN 7400	08/1/71	ME/AMJ	ME/AMJ

GRAND GULF NUCLEAR GENERATING STATION

Updated Final Safety Analysis Report (UFSAR)

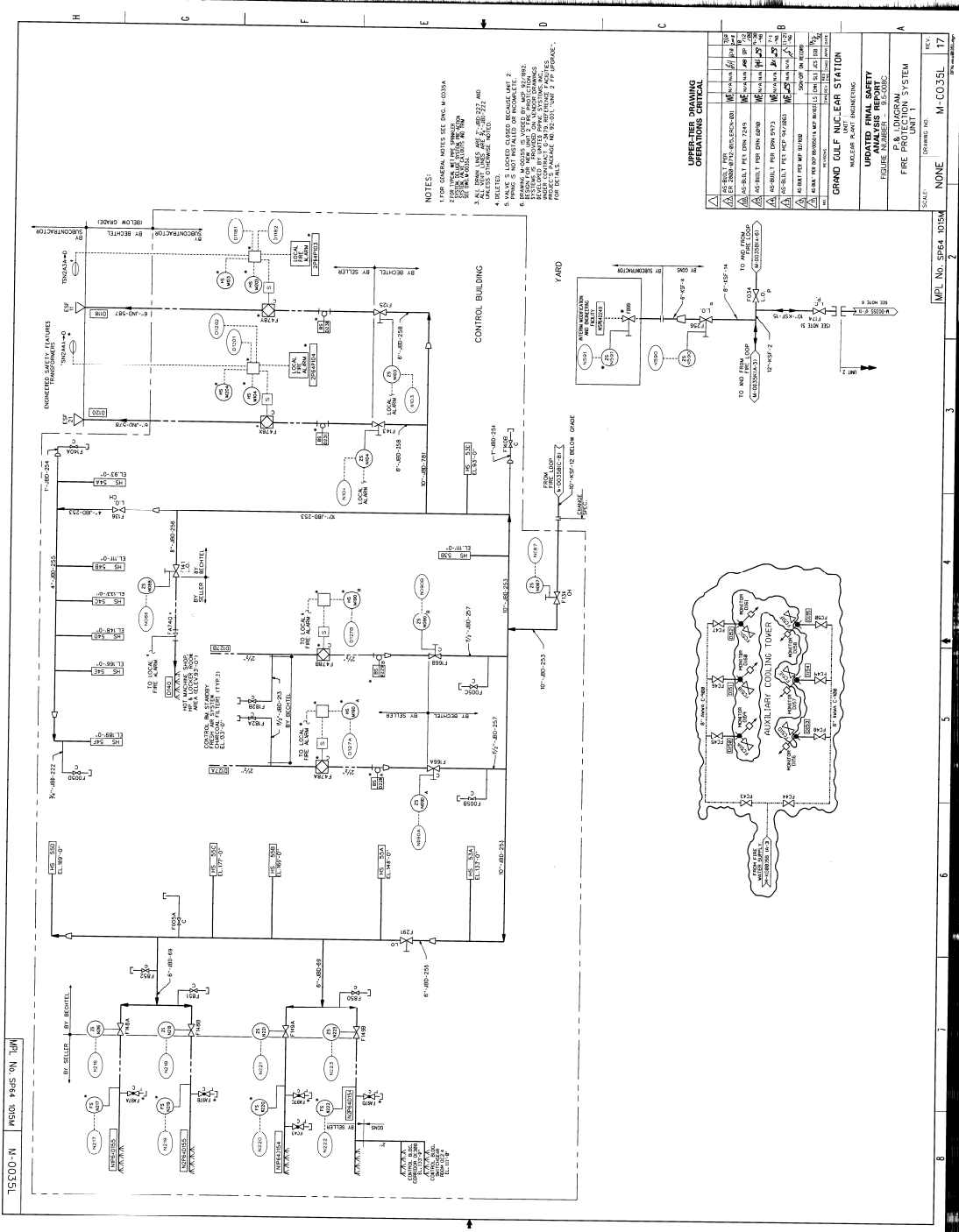
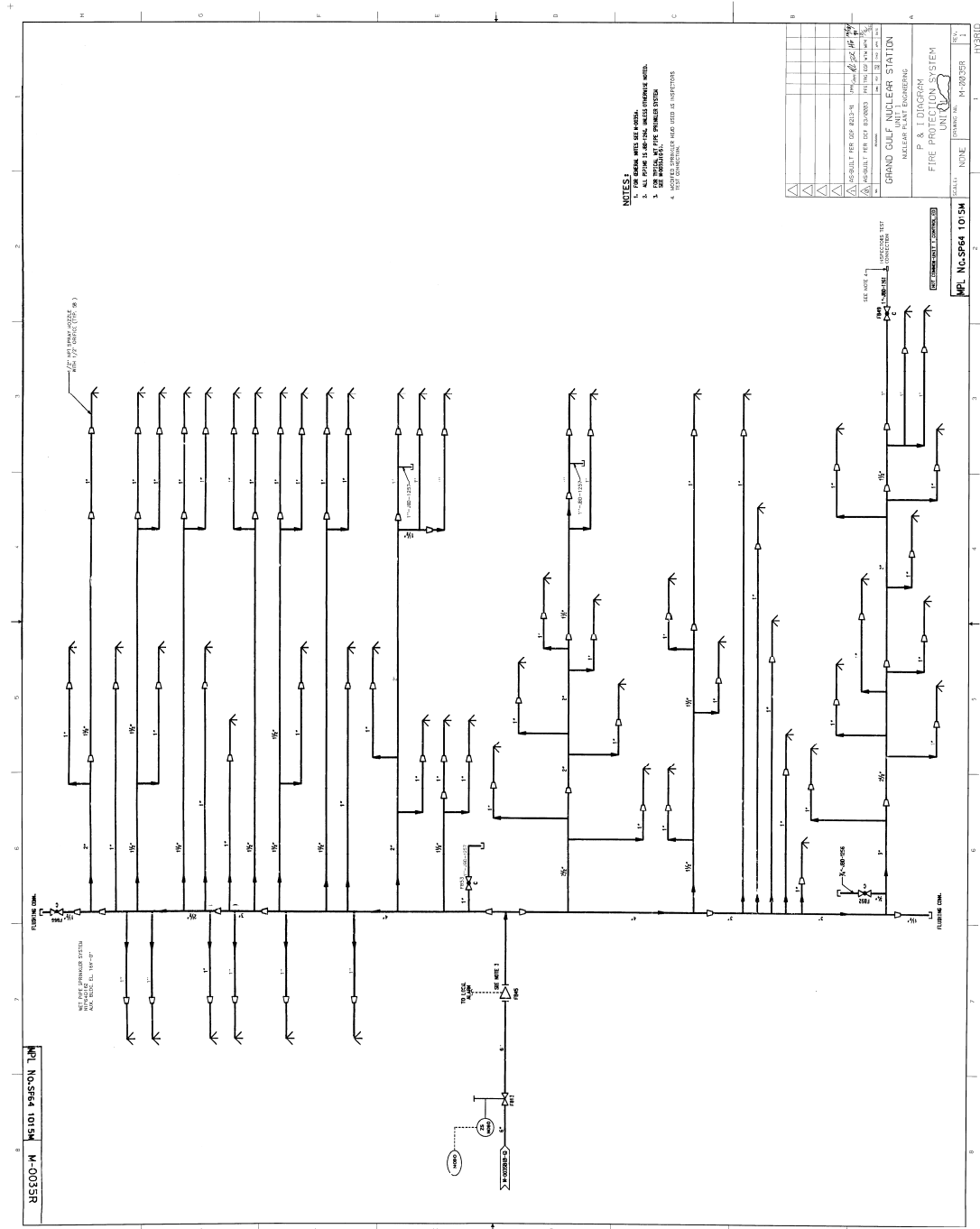

Figure 9.5-8d is deleted

GRAND GULF NUCLEAR GENERATING STATION

Updated Final Safety Analysis Report (UFSAR)



"Figure 9.5-9 is Deleted"

"Figure 9.5-9a is Deleted"

GRAND GULF NUCLEAR GENERATING STATION

Updated Final Safety Analysis Report (UFSAR)

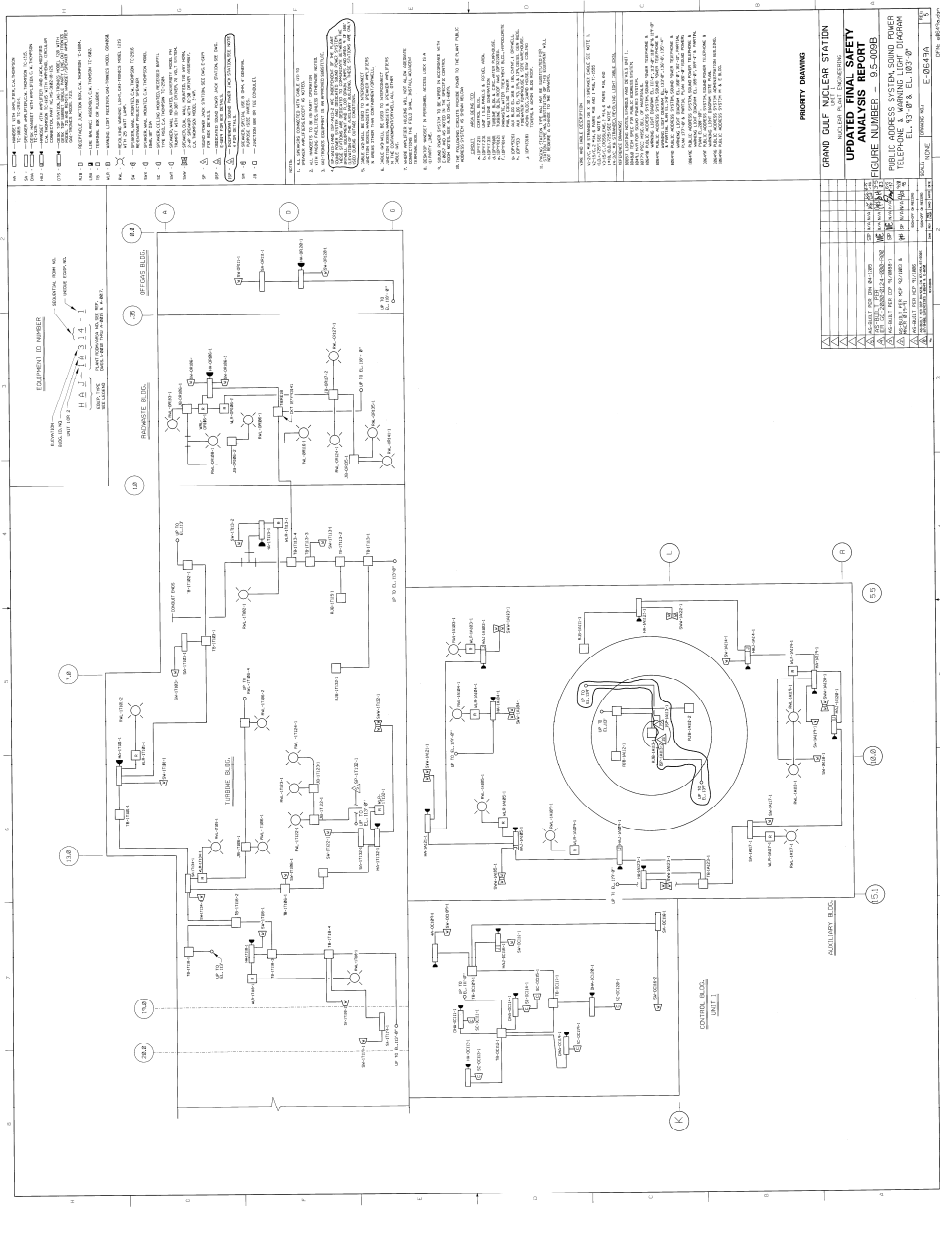

GRAND GULF NUCLEAR GENERATING STATION

Updated Final Safety Analysis Report (UFSAR)

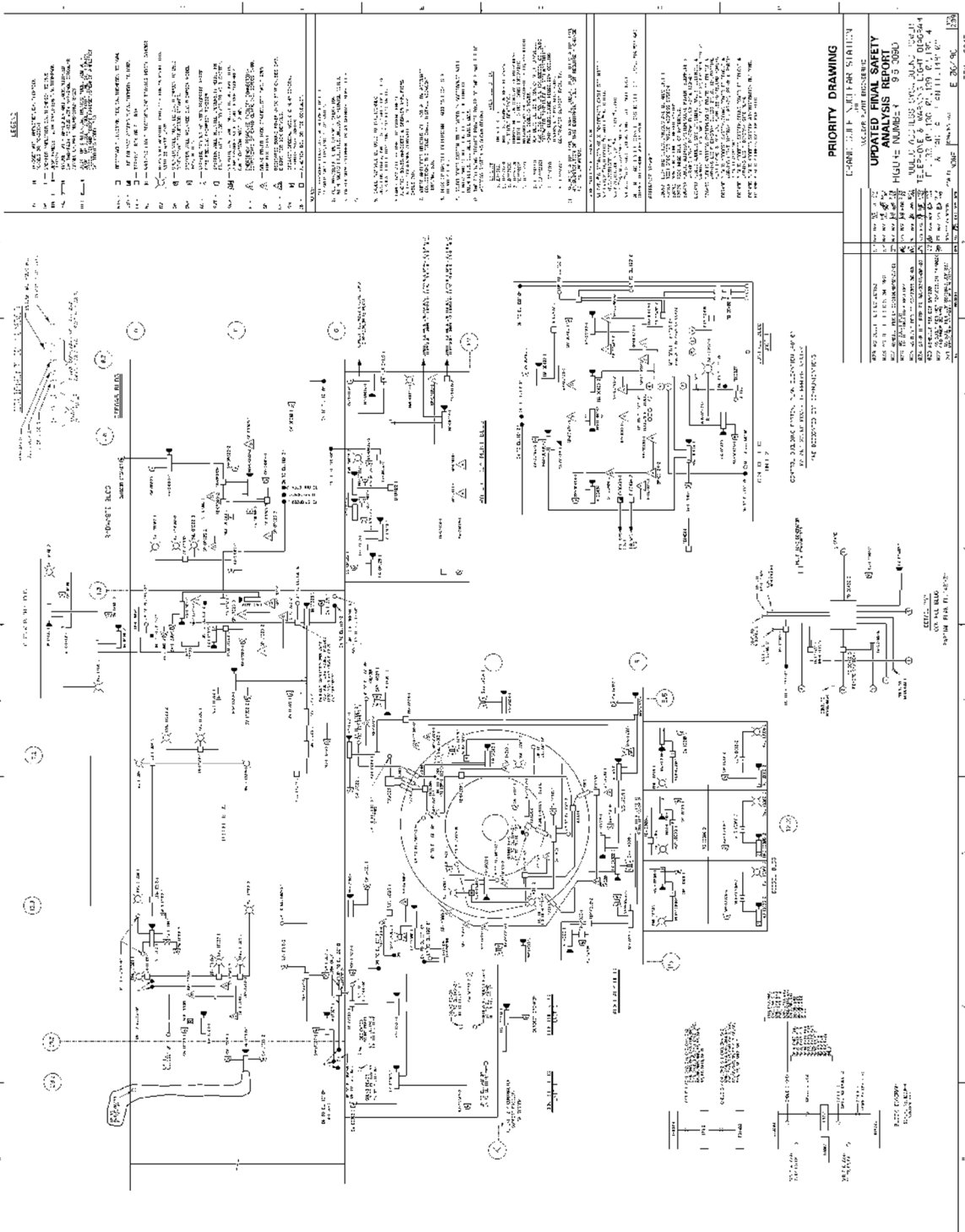

GRAND GULF NUCLEAR GENERATING STATION Updated Final Safety Analysis Report (UFSAR)

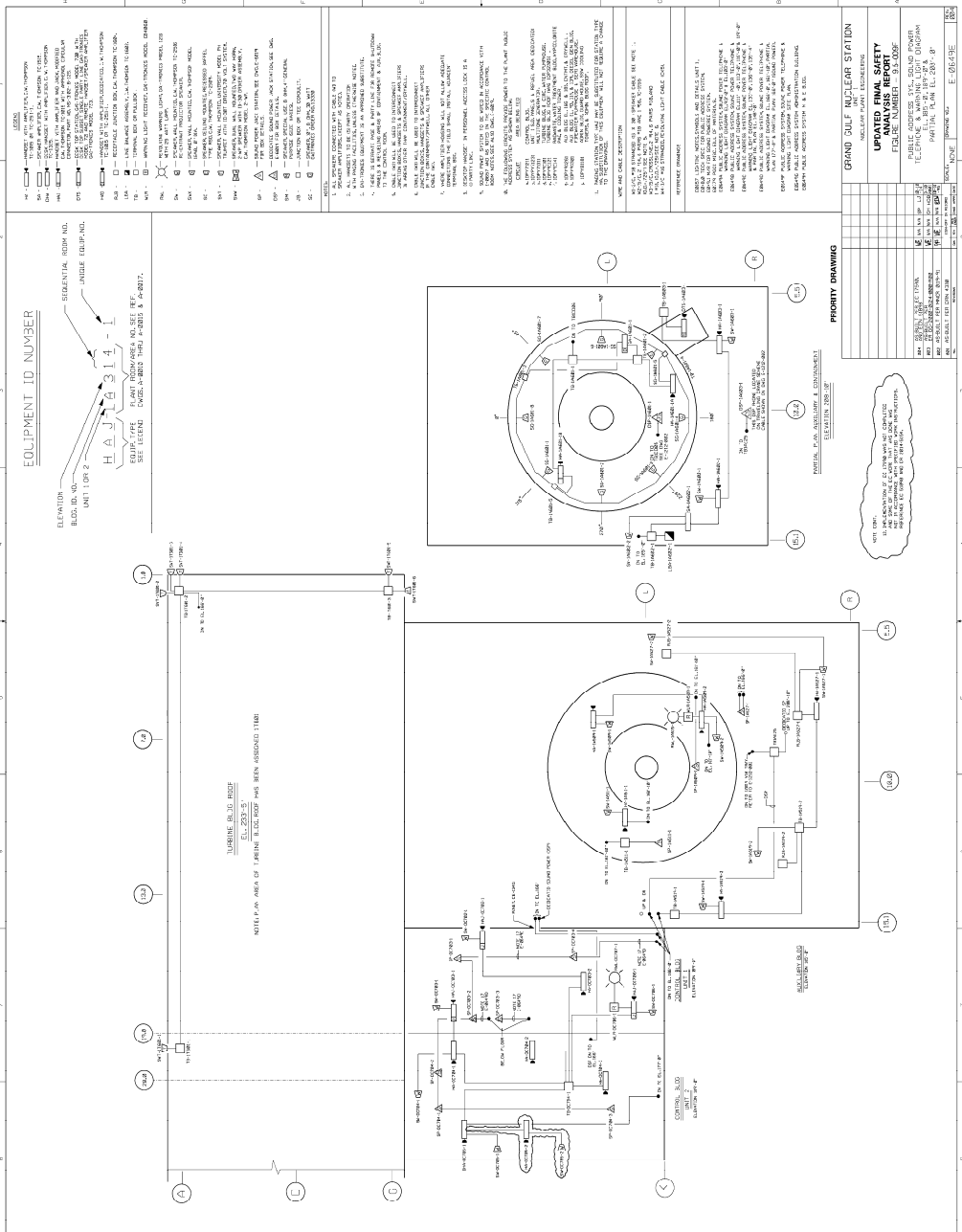

GRAND GULF NUCLEAR GENERATING STATION Updated Final Safety Analysis Report (UFSAR)

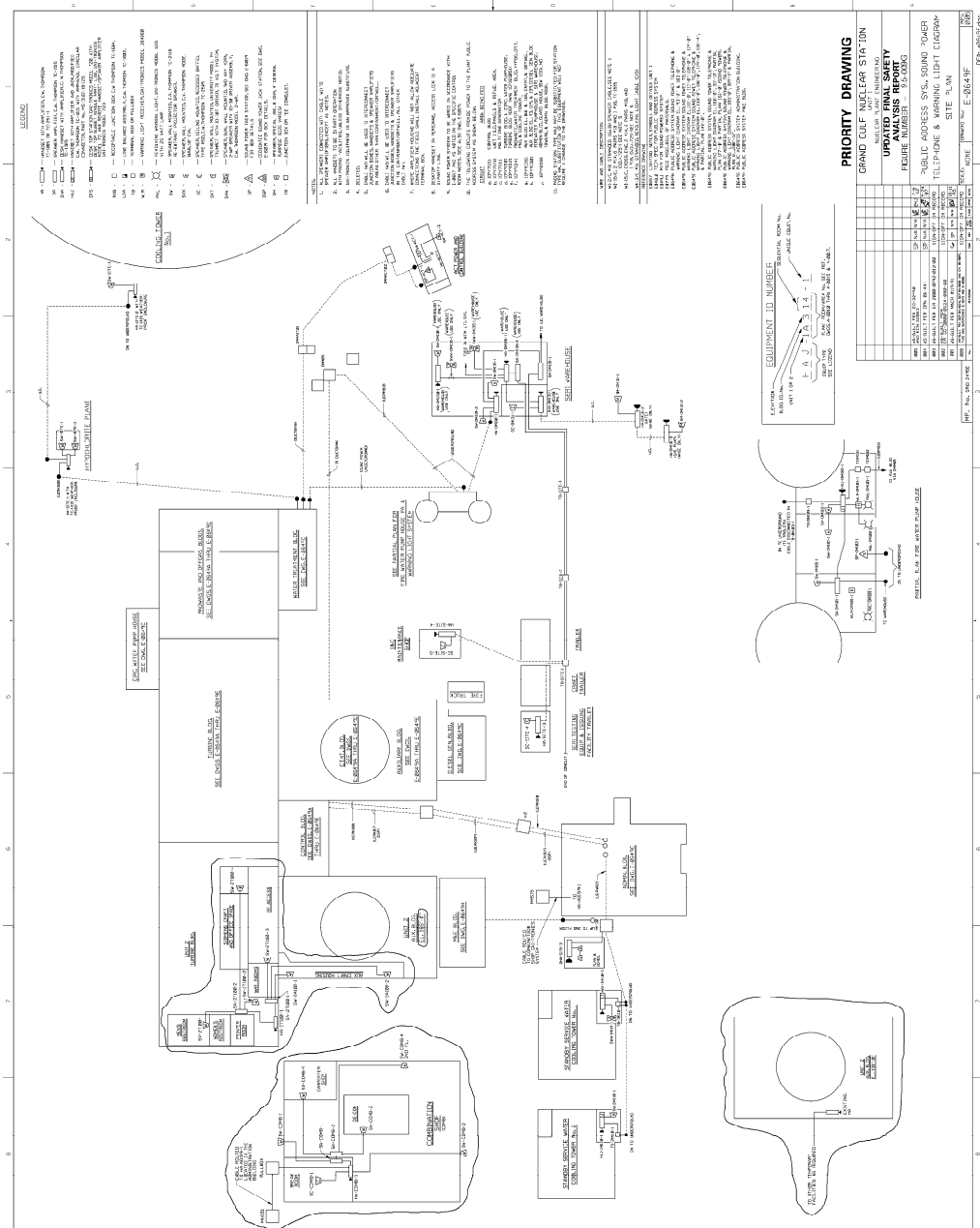

"Figure 9.5-10 is Deleted"

GRAND GULF NUCLEAR GENERATING STATION

Updated Final Safety Analysis Report (UFSAR)

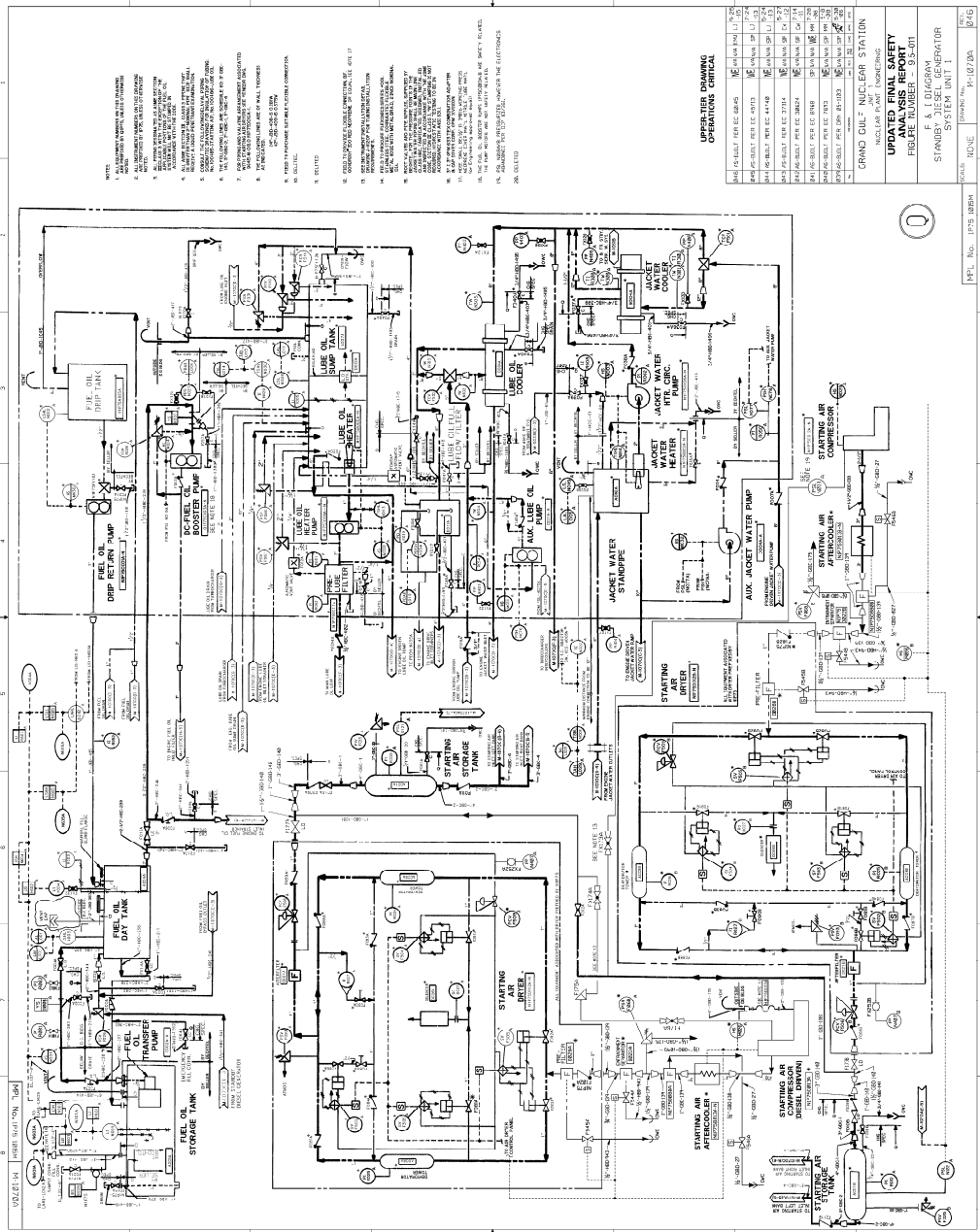

GRAND GULF NUCLEAR GENERATING STATION

Updated Final Safety Analysis Report (UFSAR)

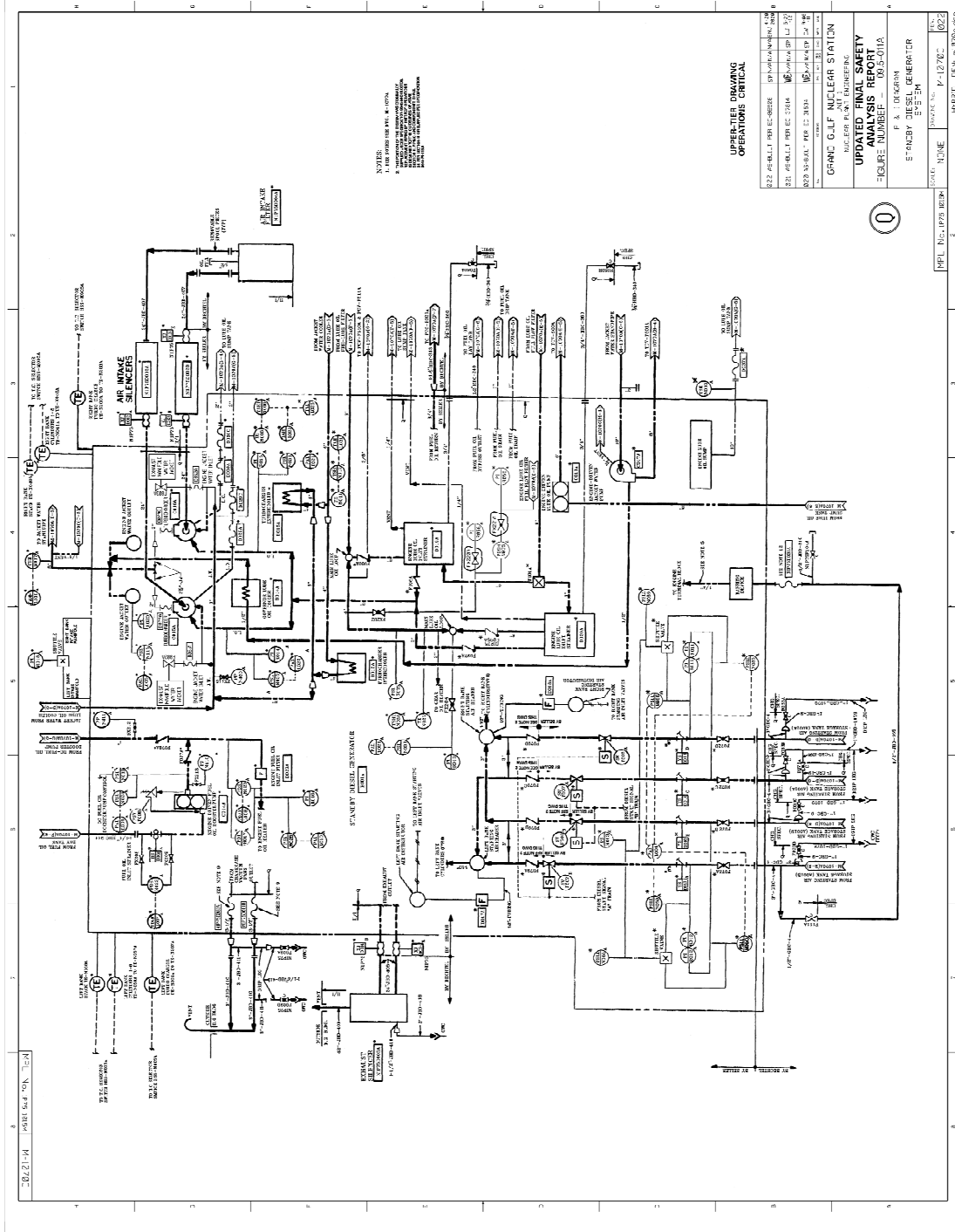

GRAND GULF NUCLEAR GENERATING STATION

Updated Final Safety Analysis Report (UFSAR)

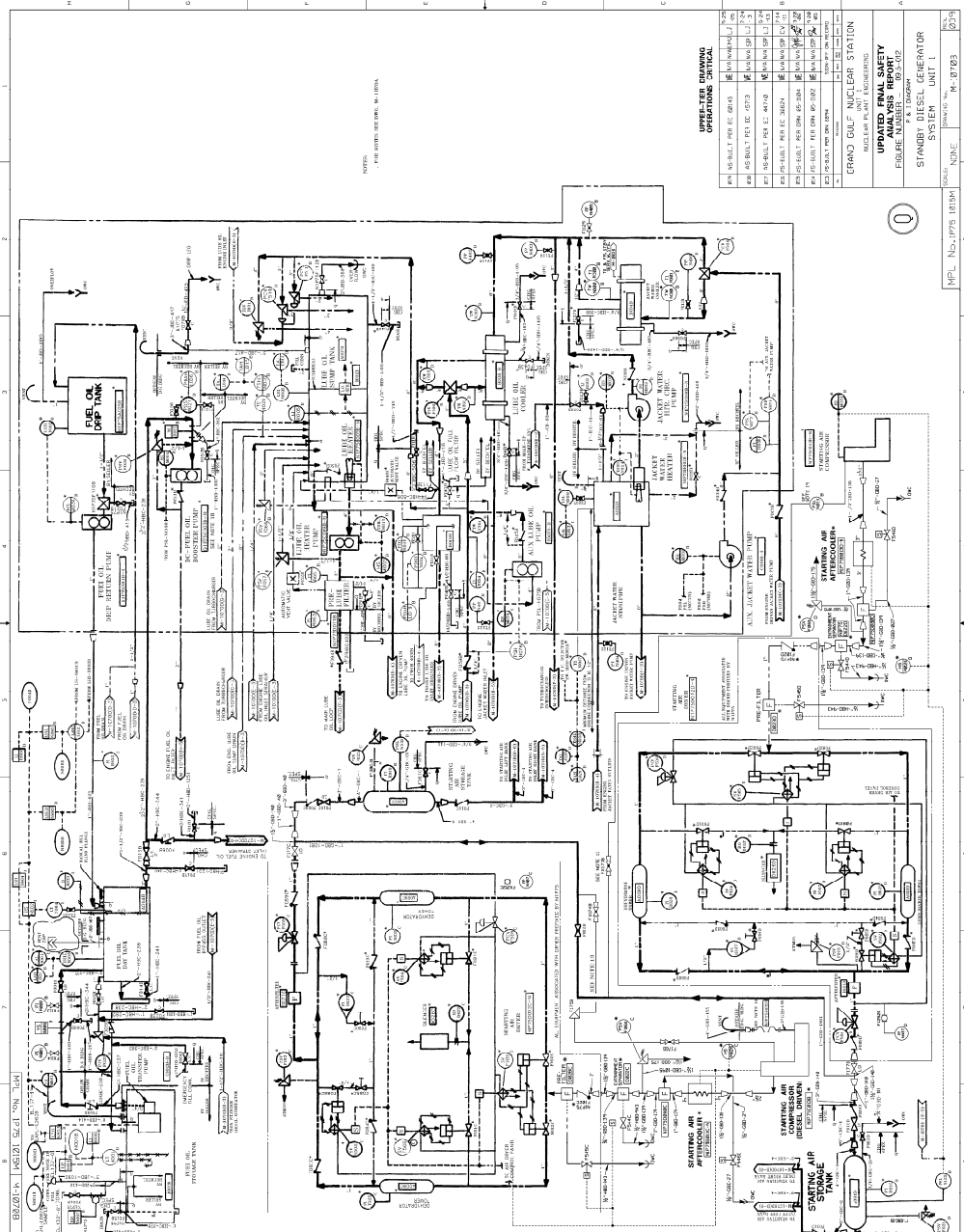

GRAND GULF NUCLEAR GENERATING STATION

Updated Final Safety Analysis Report (UFSAR)

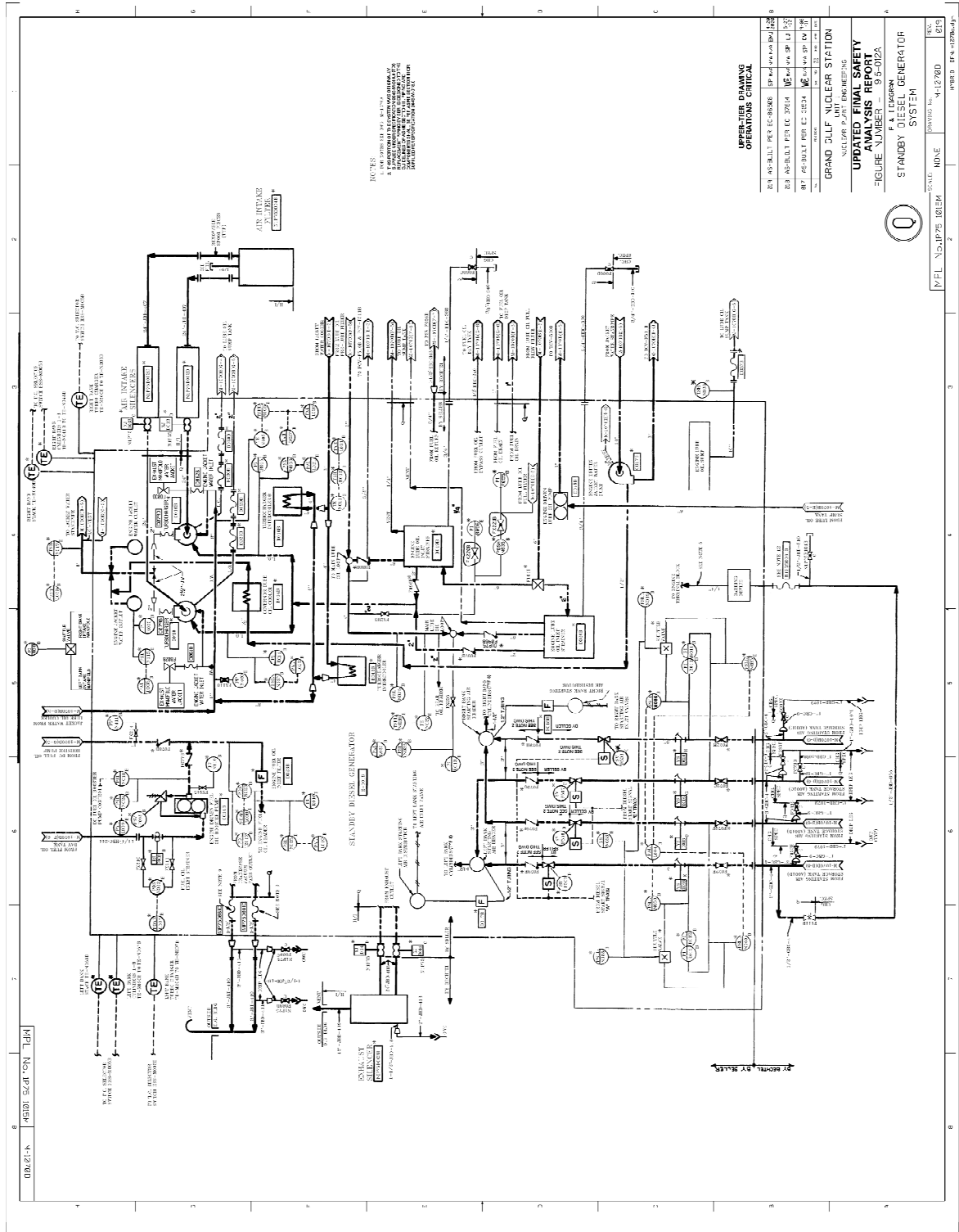

GRAND GULF NUCLEAR GENERATING STATION

Updated Final Safety Analysis Report (UFSAR)

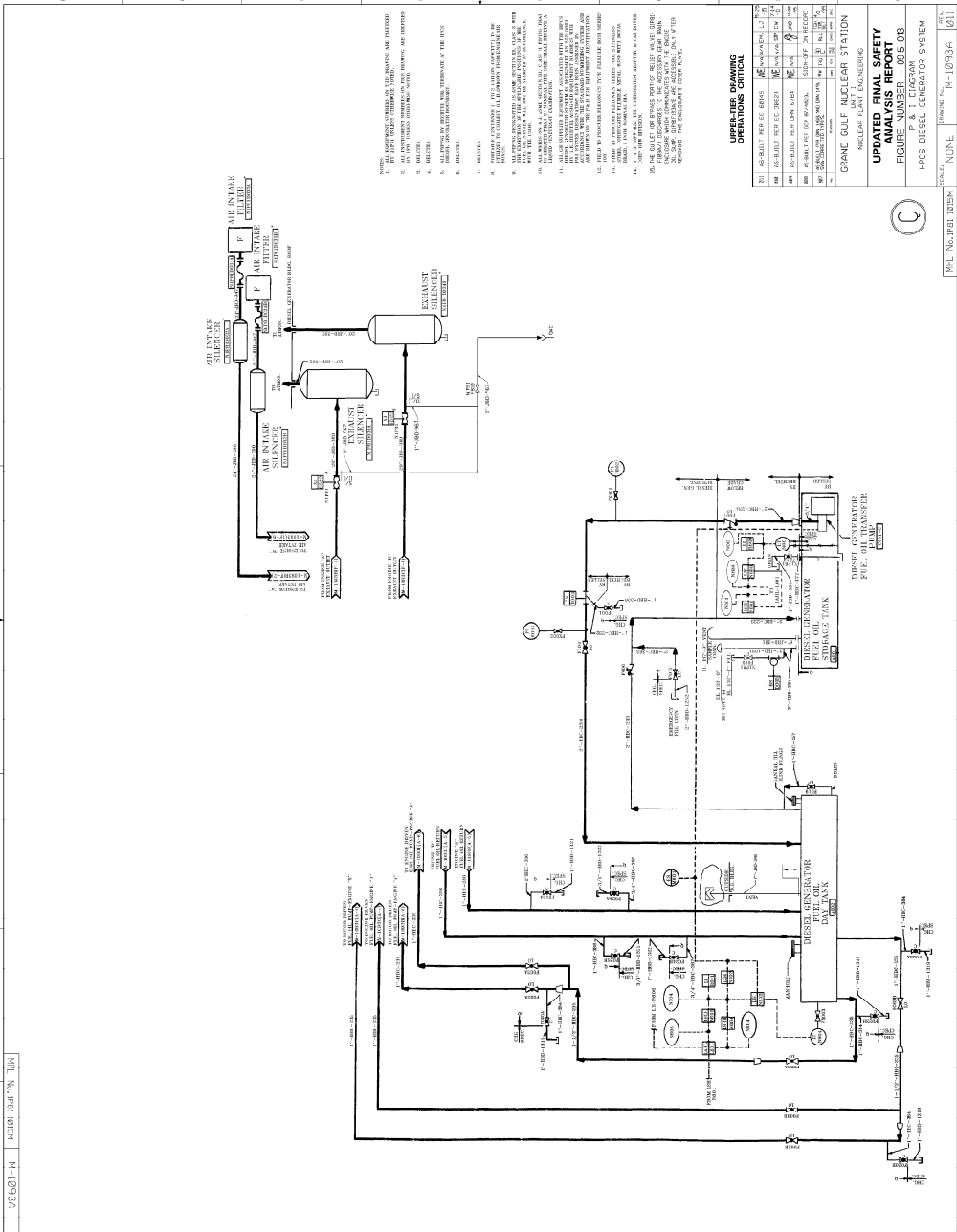

GRAND GULF NUCLEAR GENERATING STATION

Updated Final Safety Analysis Report (UFSAR)

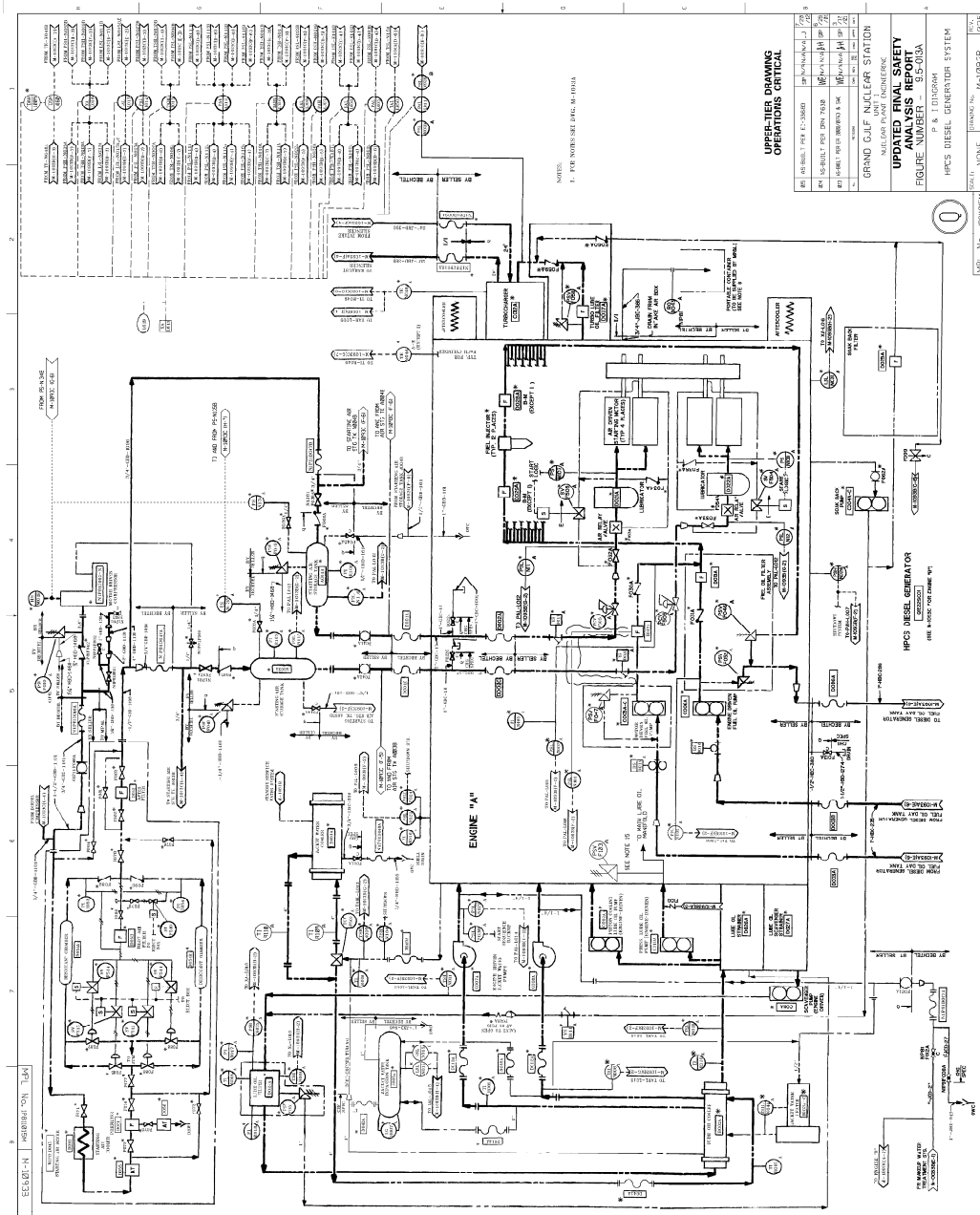

UPPER-TIER DRAWING
OPERATIONS CRITICAL

REV	DATE	BY	CHKD	APP'D	DESCRIPTION
1	10/10/13
2
3
4
5
6
7
8
9
10

GRAND GULF NUCLEAR STATION
SAFETY ANALYSIS REPORT
FIGURE NUMBER: 9.5-03A
P & I DIAGRAM
IPCS DIESEL GENERATOR SYSTEM

REV: NONE
DATE: 10/10/13
APP'D: [Signature]

GRAND GULF NUCLEAR GENERATING STATION

Updated Final Safety Analysis Report (UFSAR)

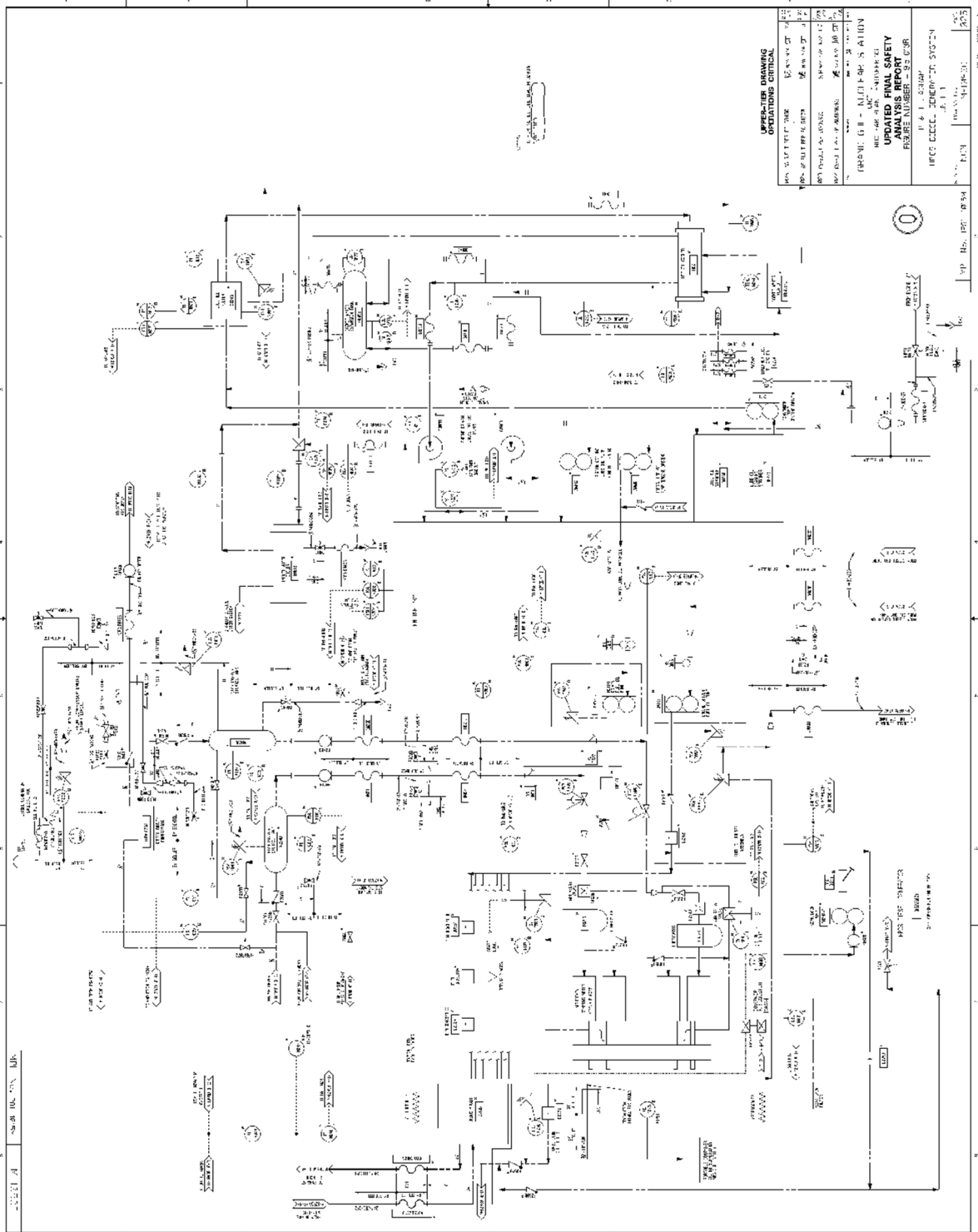

UPPER-PILE DRAWING OPERATIONS CRITICAL	
NO. OF SHEETS	12 OF 12
NO. OF SHEETS USED	12 OF 12
NO. OF SHEETS IN DRAWING	12 OF 12
NO. OF SHEETS IN PROJECT	12 OF 12
GRAND GULF NUCLEAR GENERATING STATION UPPER-PILE DRAWING OPERATIONS CRITICAL DRAWING NUMBER: 12 OF 12	
DATE	12/13/77
BY	W. J. BROWN
CHECKED BY	J. L. BROWN
APPROVED BY	J. L. BROWN
SCALE	AS SHOWN
PROJECT NO.	405

GRAND GULF NUCLEAR GENERATING STATION

Updated Final Safety Analysis Report (UFSAR)

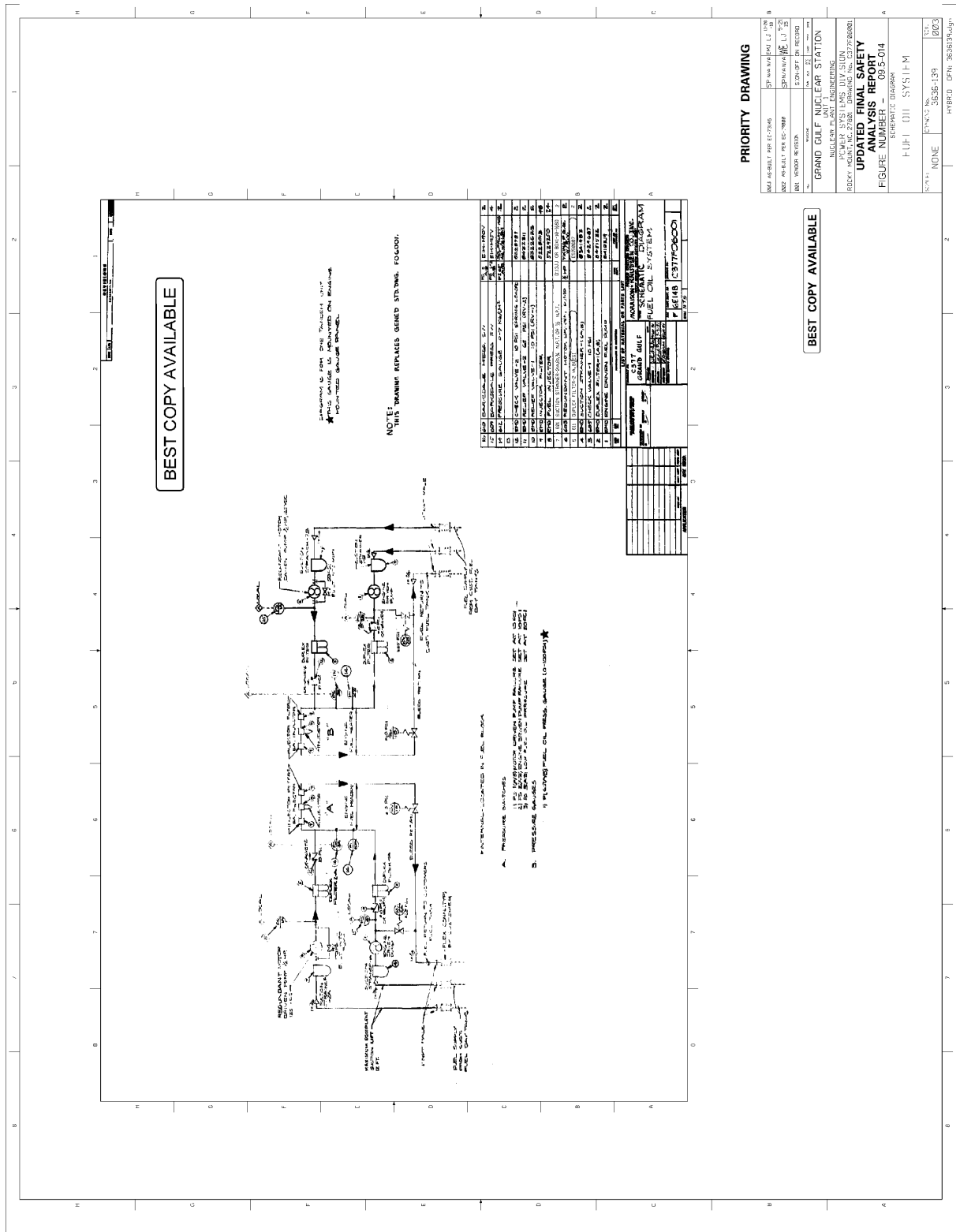

PRIORITY DRAWING

DATE PREPARED FOR: 11-15-79
 DRAWN BY: J. L. WOOD
 CHECKED BY: J. L. WOOD
 APPROVED BY: J. L. WOOD

GRAND GULF NUCLEAR STATION
 ENGINEERING
 NUCLEAR SAFETY DIVISION
 UPDATED FINAL SAFETY ANALYSIS REPORT
 FIGURE NUMBER: 095-014

REV. NO. 1
 DATE 11-15-79

SY. NONE
 ETC. NO. 3635-139
 8023
 HYPERLO DFN: 3635139.dfn

GRAND GULF NUCLEAR GENERATING STATION

Updated Final Safety Analysis Report (UFSAR)

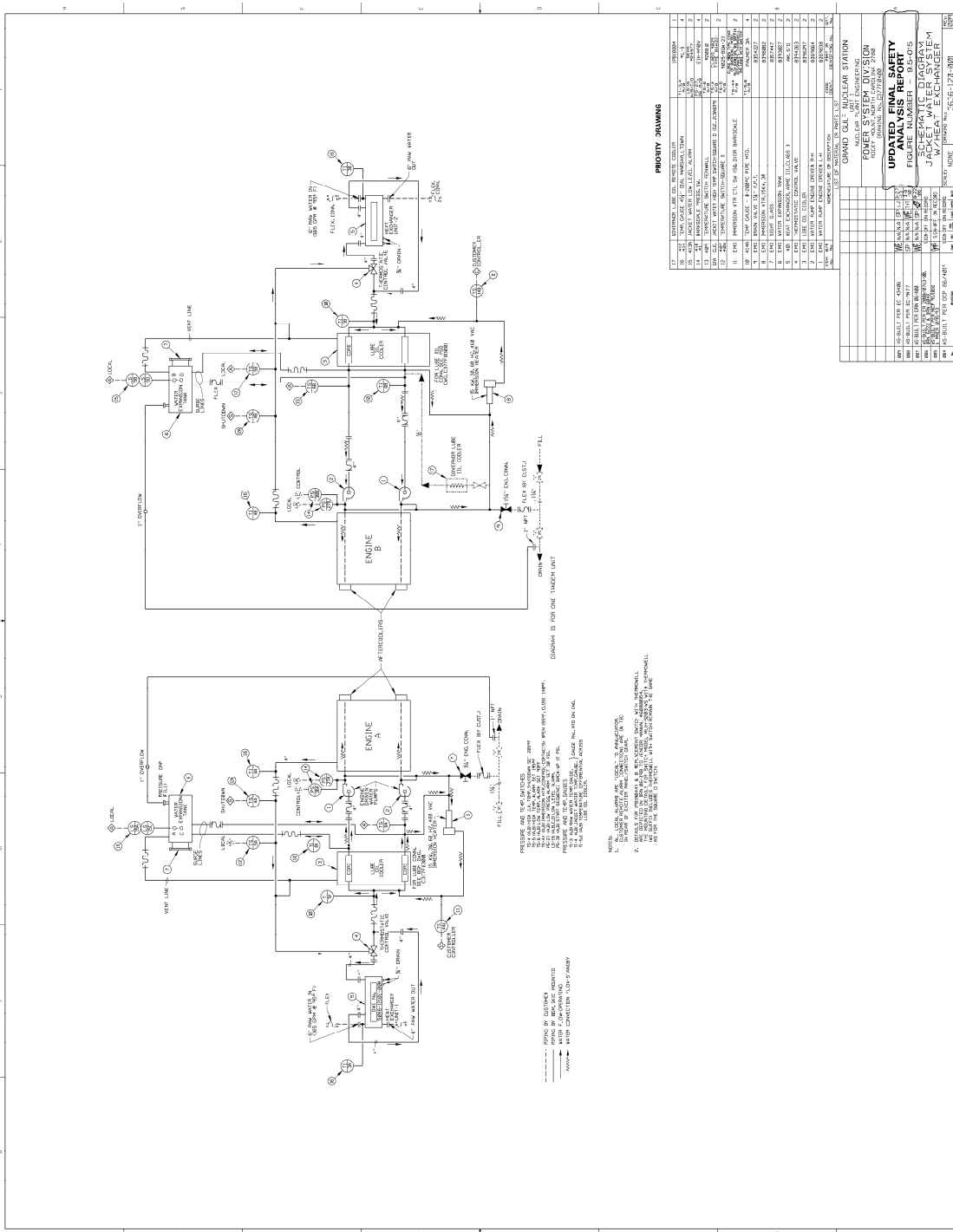

PRIORITY DRAWINGS

NO.	DESCRIPTION	DATE	BY	CHKD.	REV.
1	ENGINE A	10/1/68	J. W. HARRIS	J. W. HARRIS	1
2	ENGINE B	10/1/68	J. W. HARRIS	J. W. HARRIS	1
3	ENGINE C	10/1/68	J. W. HARRIS	J. W. HARRIS	1
4	ENGINE D	10/1/68	J. W. HARRIS	J. W. HARRIS	1
5	ENGINE E	10/1/68	J. W. HARRIS	J. W. HARRIS	1
6	ENGINE F	10/1/68	J. W. HARRIS	J. W. HARRIS	1
7	ENGINE G	10/1/68	J. W. HARRIS	J. W. HARRIS	1
8	ENGINE H	10/1/68	J. W. HARRIS	J. W. HARRIS	1
9	ENGINE I	10/1/68	J. W. HARRIS	J. W. HARRIS	1
10	ENGINE J	10/1/68	J. W. HARRIS	J. W. HARRIS	1
11	ENGINE K	10/1/68	J. W. HARRIS	J. W. HARRIS	1
12	ENGINE L	10/1/68	J. W. HARRIS	J. W. HARRIS	1
13	ENGINE M	10/1/68	J. W. HARRIS	J. W. HARRIS	1
14	ENGINE N	10/1/68	J. W. HARRIS	J. W. HARRIS	1
15	ENGINE O	10/1/68	J. W. HARRIS	J. W. HARRIS	1
16	ENGINE P	10/1/68	J. W. HARRIS	J. W. HARRIS	1
17	ENGINE Q	10/1/68	J. W. HARRIS	J. W. HARRIS	1
18	ENGINE R	10/1/68	J. W. HARRIS	J. W. HARRIS	1
19	ENGINE S	10/1/68	J. W. HARRIS	J. W. HARRIS	1
20	ENGINE T	10/1/68	J. W. HARRIS	J. W. HARRIS	1
21	ENGINE U	10/1/68	J. W. HARRIS	J. W. HARRIS	1
22	ENGINE V	10/1/68	J. W. HARRIS	J. W. HARRIS	1
23	ENGINE W	10/1/68	J. W. HARRIS	J. W. HARRIS	1
24	ENGINE X	10/1/68	J. W. HARRIS	J. W. HARRIS	1
25	ENGINE Y	10/1/68	J. W. HARRIS	J. W. HARRIS	1
26	ENGINE Z	10/1/68	J. W. HARRIS	J. W. HARRIS	1

GRAND GULF NUCLEAR STATION
 POWER SYSTEM DIVISION
 JACKED WATER SYSTEM
 SCHEMATIC DIAGRAM
 JACKED WATER SYSTEM
 ENGINE A
 ENGINE B
 ENGINE C
 ENGINE D
 ENGINE E
 ENGINE F
 ENGINE G
 ENGINE H
 ENGINE I
 ENGINE J
 ENGINE K
 ENGINE L
 ENGINE M
 ENGINE N
 ENGINE O
 ENGINE P
 ENGINE Q
 ENGINE R
 ENGINE S
 ENGINE T
 ENGINE U
 ENGINE V
 ENGINE W
 ENGINE X
 ENGINE Y
 ENGINE Z

GRAND GULF NUCLEAR GENERATING STATION

Updated Final Safety Analysis Report (UFSAR)

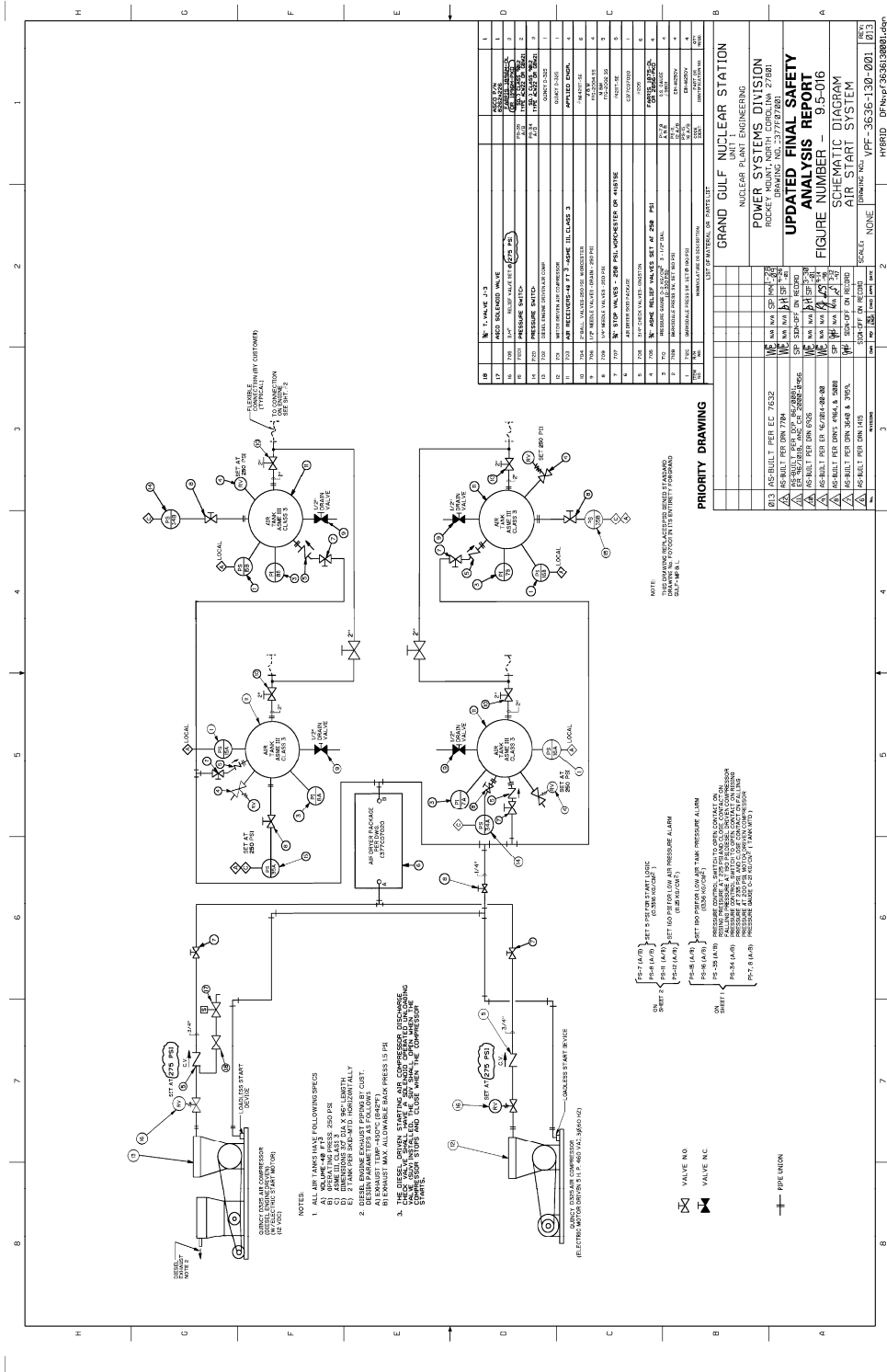

GRAND GULF NUCLEAR GENERATING STATION

Updated Final Safety Analysis Report (UFSAR)

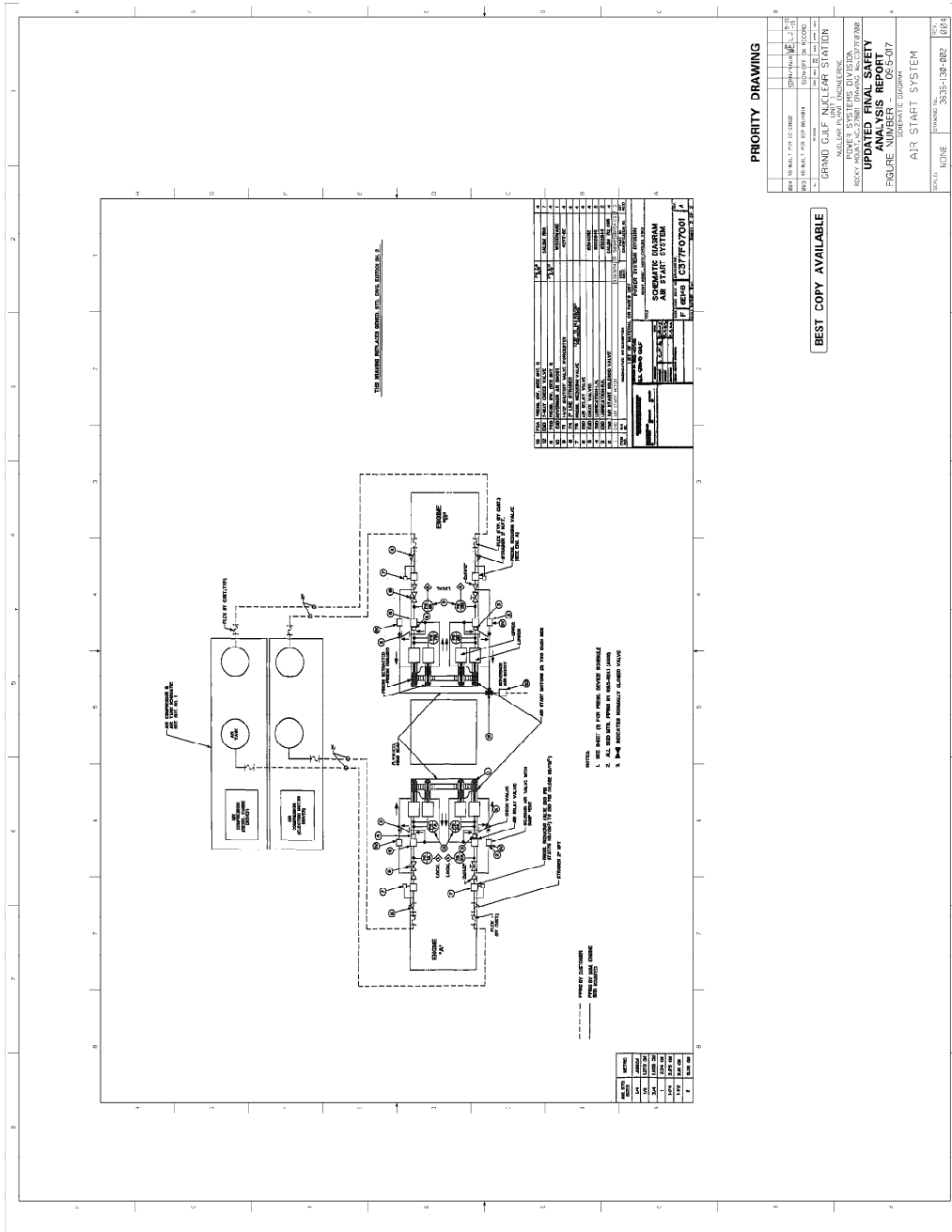

NO.	REV.	DATE	DESCRIPTION
1	1	06/15/07	ISSUED FOR CONSTRUCTION
2	2	06/15/07	REVISED TO REFLECT CHANGES TO THE AIR START SYSTEM
3	3	06/15/07	REVISED TO REFLECT CHANGES TO THE AIR START SYSTEM
4	4	06/15/07	REVISED TO REFLECT CHANGES TO THE AIR START SYSTEM
5	5	06/15/07	REVISED TO REFLECT CHANGES TO THE AIR START SYSTEM
6	6	06/15/07	REVISED TO REFLECT CHANGES TO THE AIR START SYSTEM
7	7	06/15/07	REVISED TO REFLECT CHANGES TO THE AIR START SYSTEM
8	8	06/15/07	REVISED TO REFLECT CHANGES TO THE AIR START SYSTEM
9	9	06/15/07	REVISED TO REFLECT CHANGES TO THE AIR START SYSTEM
10	10	06/15/07	REVISED TO REFLECT CHANGES TO THE AIR START SYSTEM

- NOTES:
1. ALL DIMENSIONS ARE IN INCHES UNLESS OTHERWISE SPECIFIED.
 2. ALL DIMENSIONS ARE TO CENTER UNLESS OTHERWISE SPECIFIED.
 3. ALL DIMENSIONS ARE TO FACE UNLESS OTHERWISE SPECIFIED.
 4. ALL DIMENSIONS ARE TO CENTER UNLESS OTHERWISE SPECIFIED.
 5. ALL DIMENSIONS ARE TO FACE UNLESS OTHERWISE SPECIFIED.

NO.	REV.	DATE	DESCRIPTION
1	1	06/15/07	ISSUED FOR CONSTRUCTION
2	2	06/15/07	REVISED TO REFLECT CHANGES TO THE AIR START SYSTEM
3	3	06/15/07	REVISED TO REFLECT CHANGES TO THE AIR START SYSTEM
4	4	06/15/07	REVISED TO REFLECT CHANGES TO THE AIR START SYSTEM
5	5	06/15/07	REVISED TO REFLECT CHANGES TO THE AIR START SYSTEM
6	6	06/15/07	REVISED TO REFLECT CHANGES TO THE AIR START SYSTEM
7	7	06/15/07	REVISED TO REFLECT CHANGES TO THE AIR START SYSTEM
8	8	06/15/07	REVISED TO REFLECT CHANGES TO THE AIR START SYSTEM
9	9	06/15/07	REVISED TO REFLECT CHANGES TO THE AIR START SYSTEM
10	10	06/15/07	REVISED TO REFLECT CHANGES TO THE AIR START SYSTEM

PRIORITY DRAWING

BEST COPY AVAILABLE
 GRAND GULF NUCLEAR STATION
 FORMIC GASRAM
 AIR START SYSTEM
 FIGURE NUMBER - 06-5-07
 AIR START SYSTEM

GRAND GULF NUCLEAR GENERATING STATION
Updated Final Safety Analysis Report (UFSAR)

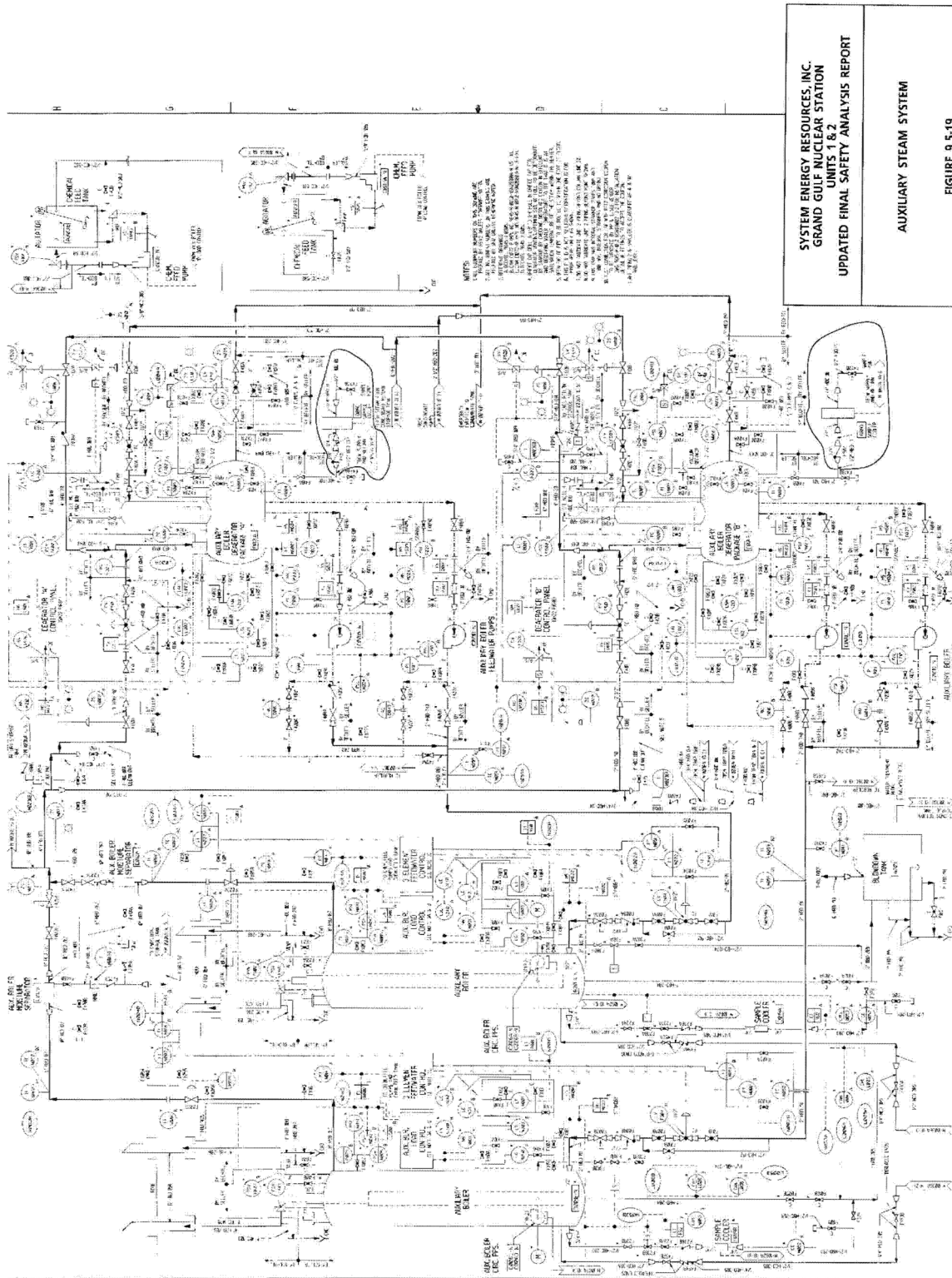

GRAND GULF NUCLEAR GENERATING STATION

Updated Final Safety Analysis Report (UFSAR)

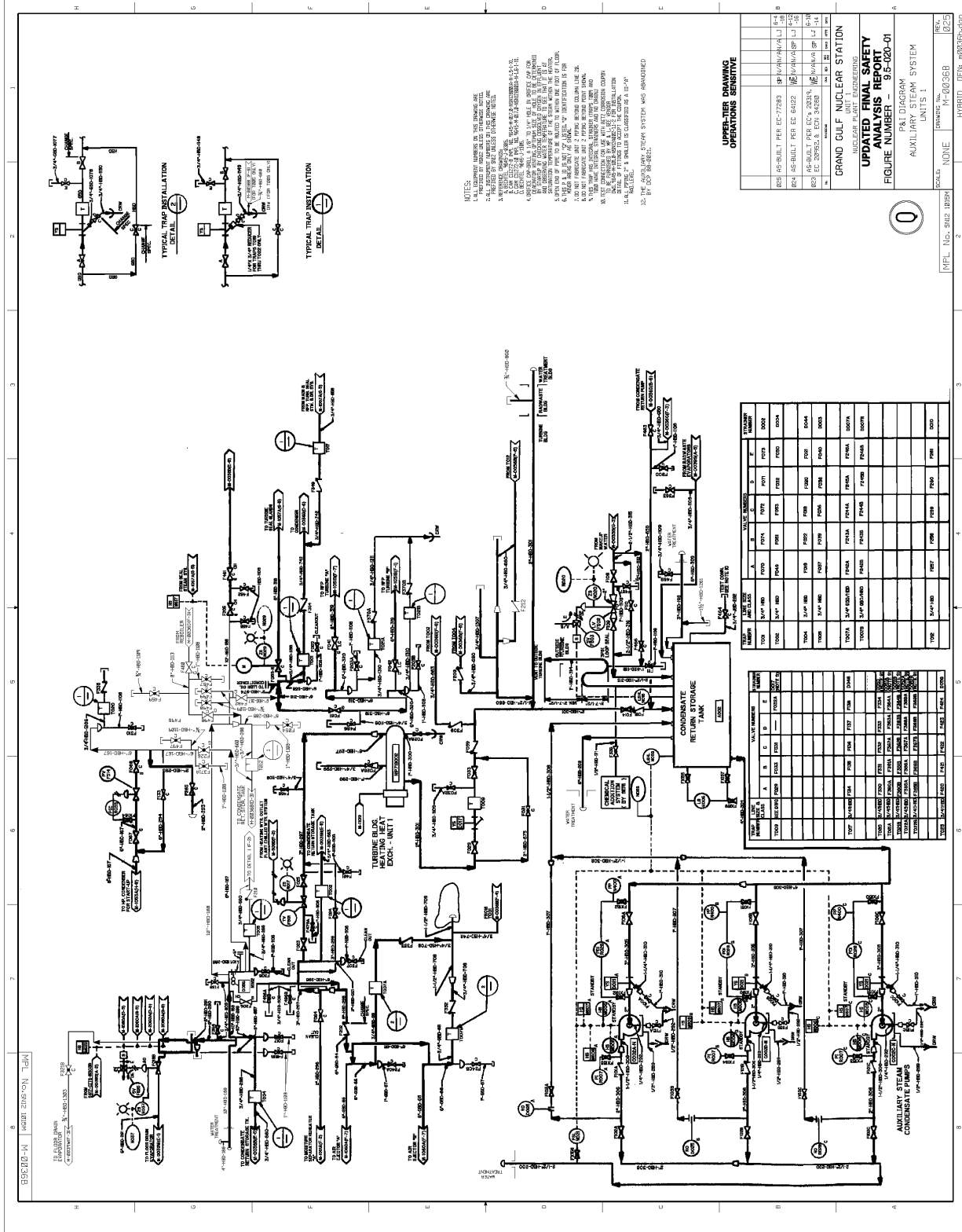

0

UPPER-TIER DRAWING
OPERATIONS SENSITIVE

GRAND GULF NUCLEAR STATION
NUCLEAR PLANT ENGINEERING

UPDATED FINAL SAFETY ANALYSIS REPORT
FIGURE NUMBER — 9.5-020-01

P&ID DIAGRAM
AUXILIARY STEAM SYSTEM
UNITS 1

SCALE: NONE
DRAWING NO. MG-020-01
REV. 002

APP. NO. SWS 103H
DATE: 10/26/2018

PROJECT: GRAND GULF NUCLEAR STATION
UNIT: 1

VALVE NUMBER	A	B	C	D	E	F	G	H	I	J	K	L	M	N	O	P	Q	R	S	T	U	V	W	X	Y	Z	
1001																											
1002																											
1003																											
1004																											
1005																											
1006																											
1007																											
1008																											
1009																											
1010																											
1011																											
1012																											
1013																											
1014																											
1015																											

VALVE NUMBER	A	B	C	D	E	F	G	H	I	J	K	L	M	N	O	P	Q	R	S	T	U	V	W	X	Y	Z	
1016																											
1017																											
1018																											
1019																											
1020																											
1021																											
1022																											
1023																											
1024																											
1025																											
1026																											
1027																											
1028																											
1029																											
1030																											
1031																											

Copyright © 2018 by Westinghouse Electric Company. All rights reserved. No part of this document may be reproduced, stored in a retrieval system, or transmitted in any form or by any means, electronic, mechanical, photocopying, recording, or by any information storage and retrieval system, without the prior written permission of Westinghouse Electric Company.

GRAND GULF NUCLEAR GENERATING STATION

Updated Final Safety Analysis Report (UFSAR)

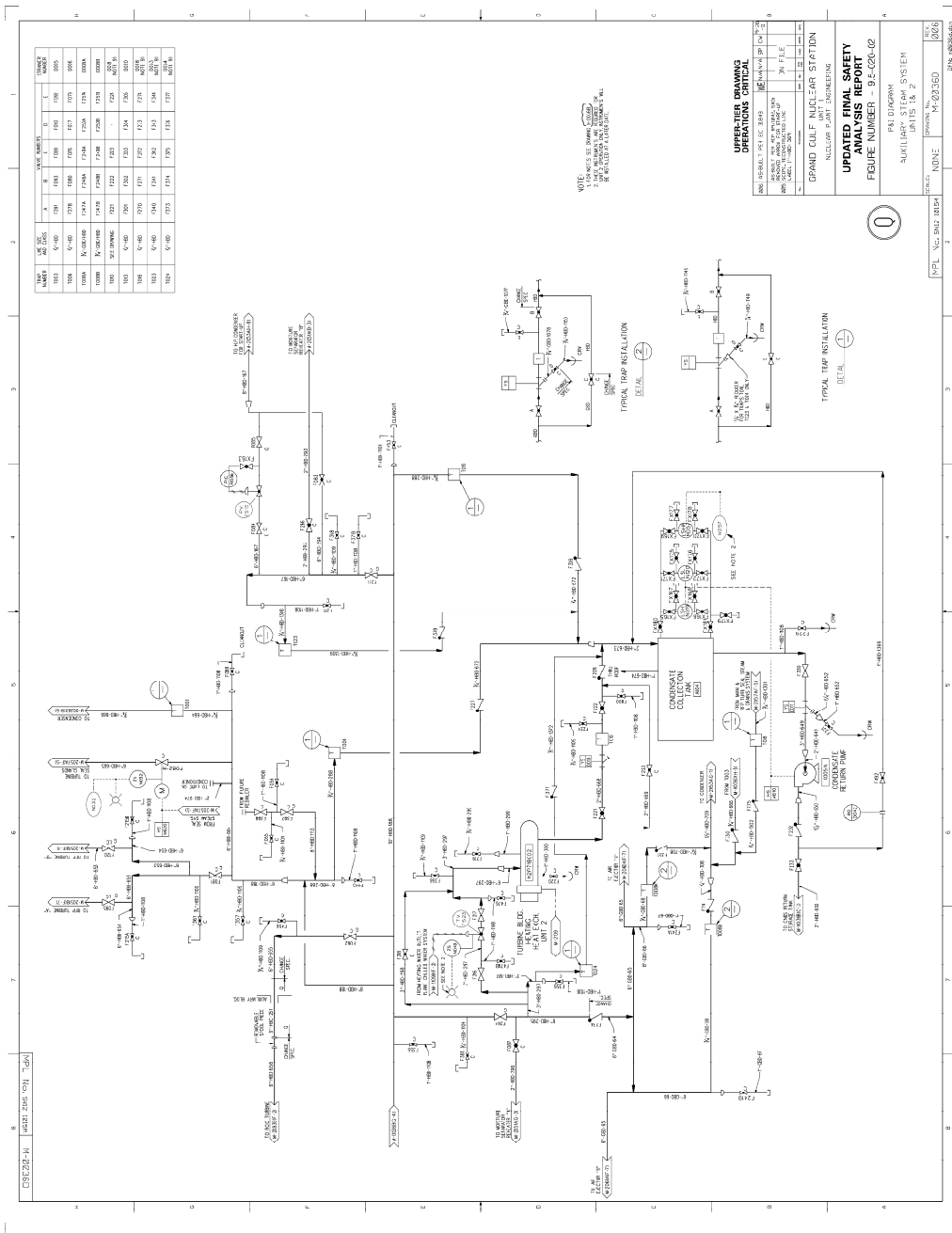

GRAND GULF NUCLEAR GENERATING STATION

Updated Final Safety Analysis Report (UFSAR)

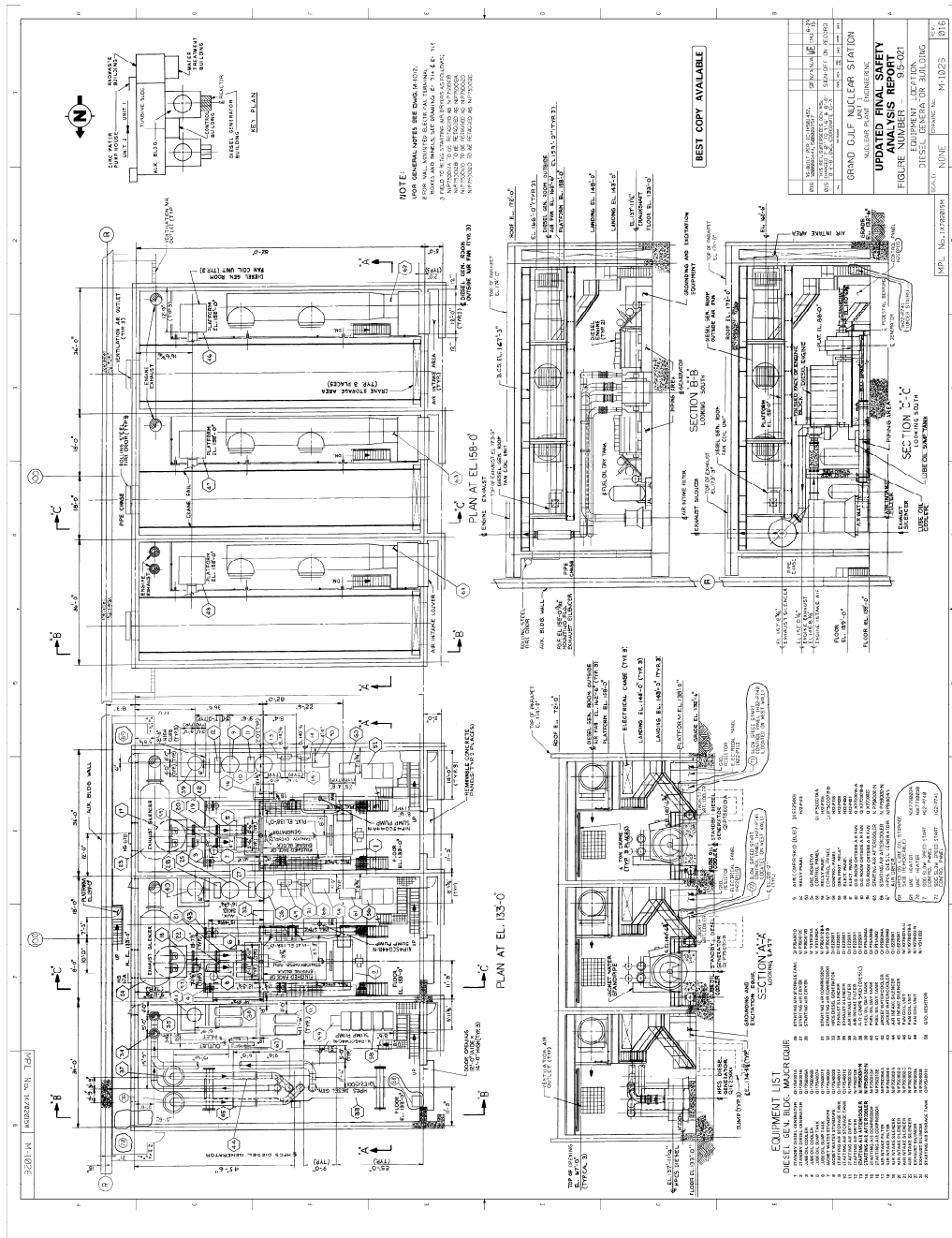

GRAND GULF NUCLEAR GENERATING STATION

Updated Final Safety Analysis Report (UFSAR)

C-15065 UNIT 1 DIESEL GEN. BLDG(AREA 12) REINF. CONG. ROOF PLAN AT EL. 112'-0"

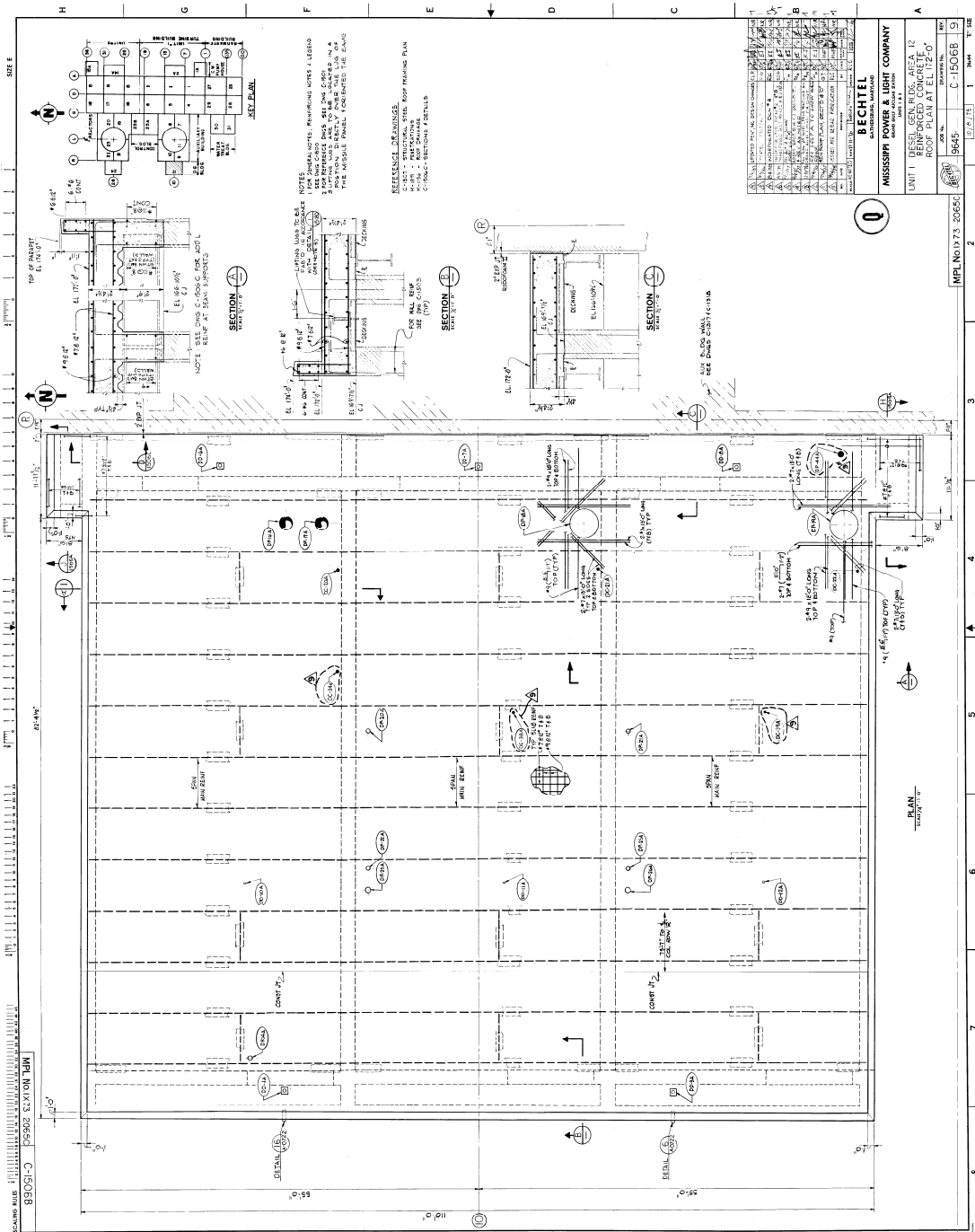

GRAND GULF NUCLEAR GENERATING STATION
Updated Final Safety Analysis Report (UFSAR)

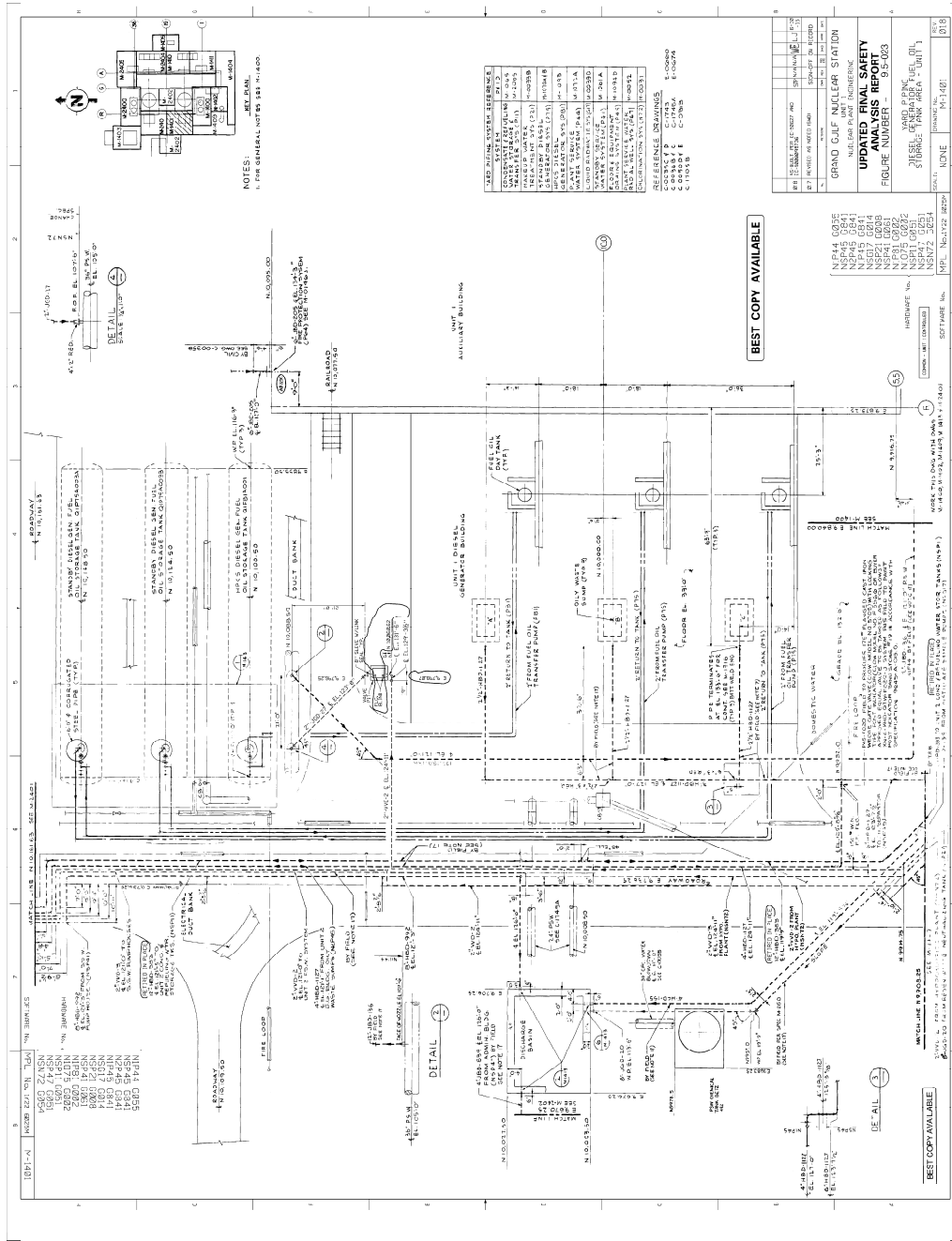

GRAND GULF NUCLEAR GENERATING STATION
 Updated Final Safety Analysis Report (UFSAR)

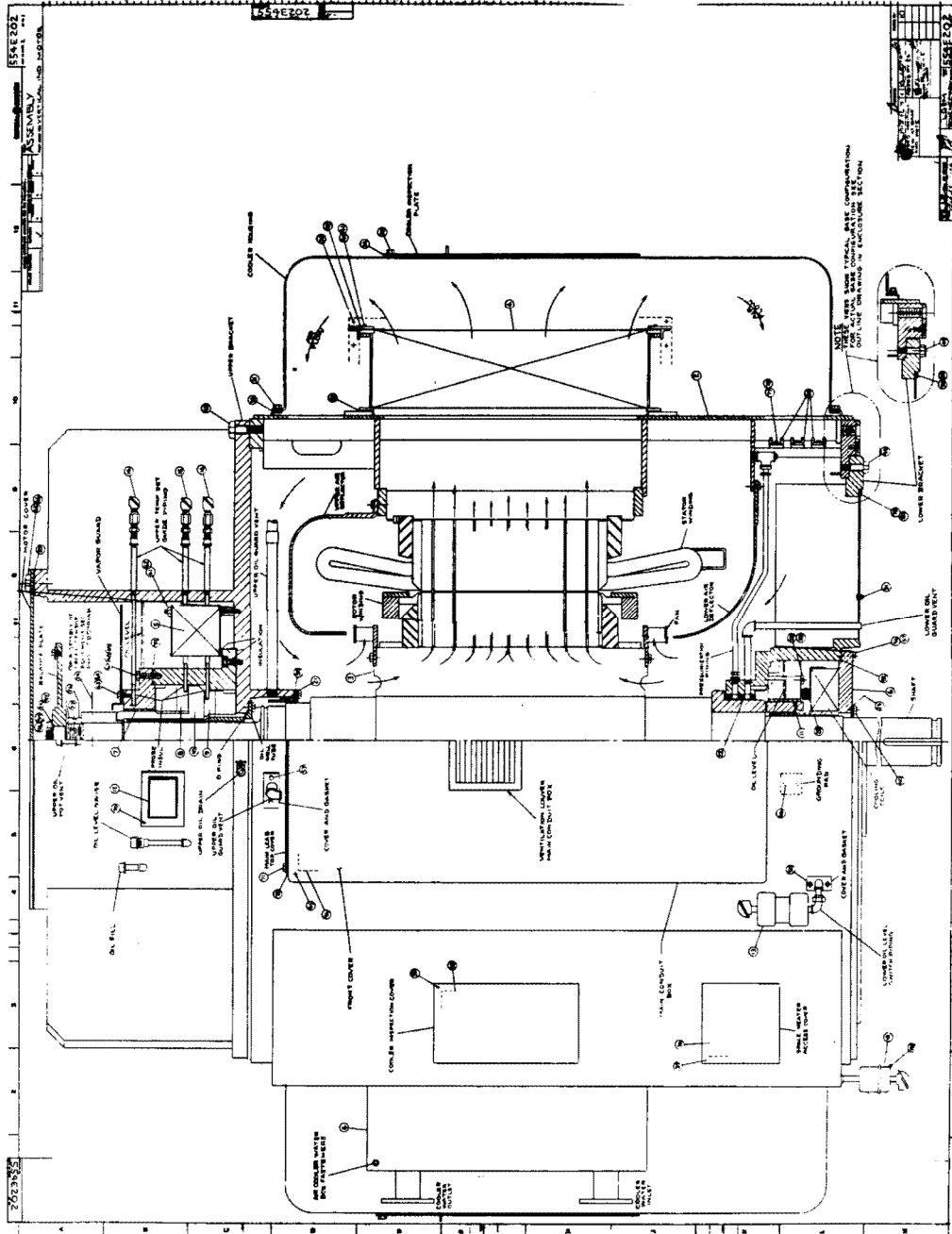

MISSISSIPPI POWER & LIGHT COMPANY
 GRAND GULF NUCLEAR STATION
 UNITS 1 & 2
 UPDATED FINAL SAFETY ANALYSIS REPORT

REACTOR RECIRCULATION
 PUMP MOTOR ASSEMBLY

FIGURE 9.5-25

GRAND GULF NUCLEAR GENERATING STATION
Updated Final Safety Analysis Report (UFSAR)

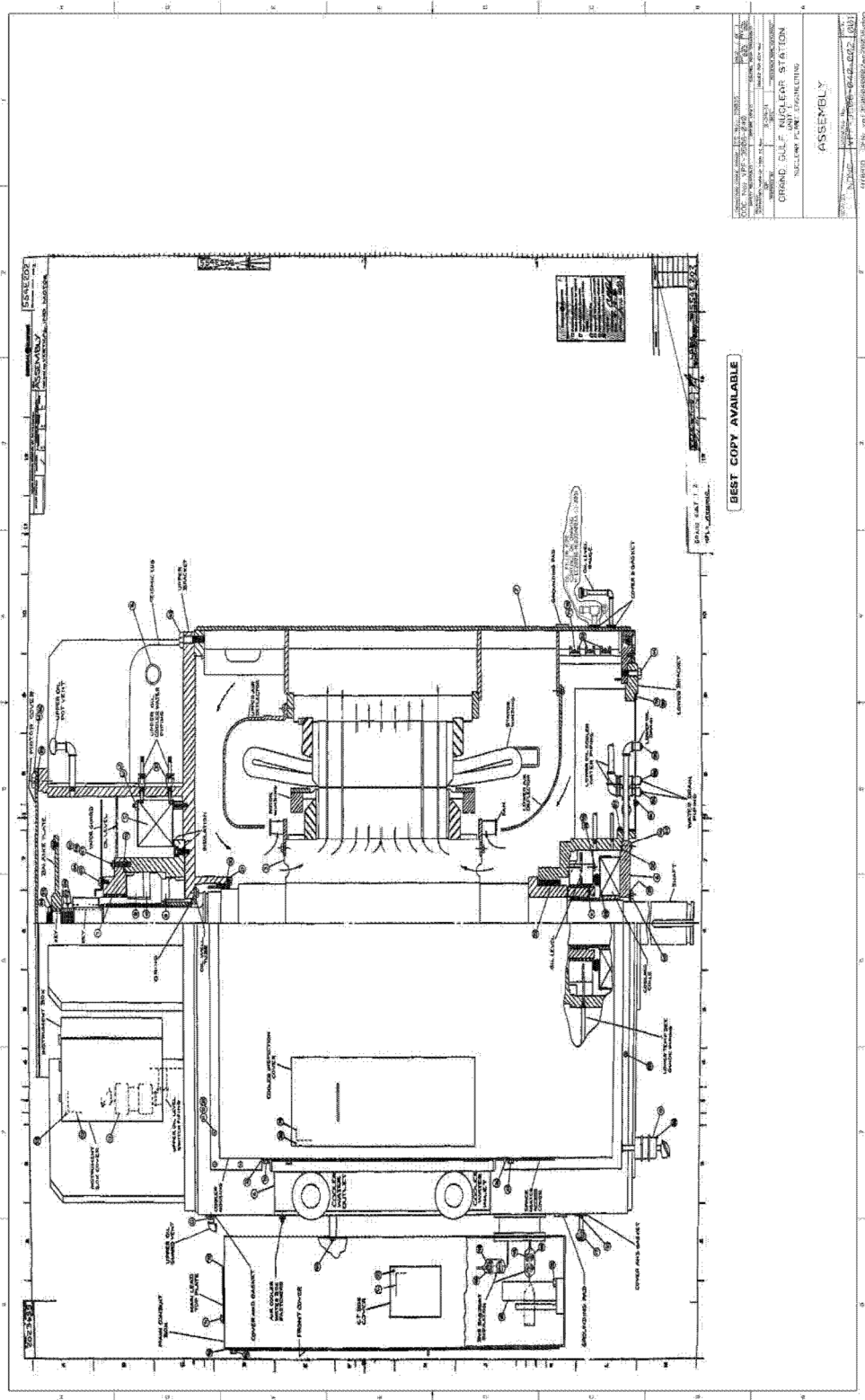

MISSISSIPPI POWER & LIGHT COMPANY
 GRAND GULF NUCLEAR STATION
 UNITS 1 & 2
 UPDATED FINAL SAFETY ANALYSIS REPORT

REACTOR RECIRCULATION
 PUMP MOTOR ASSEMBLY

FIGURE 9.5-26

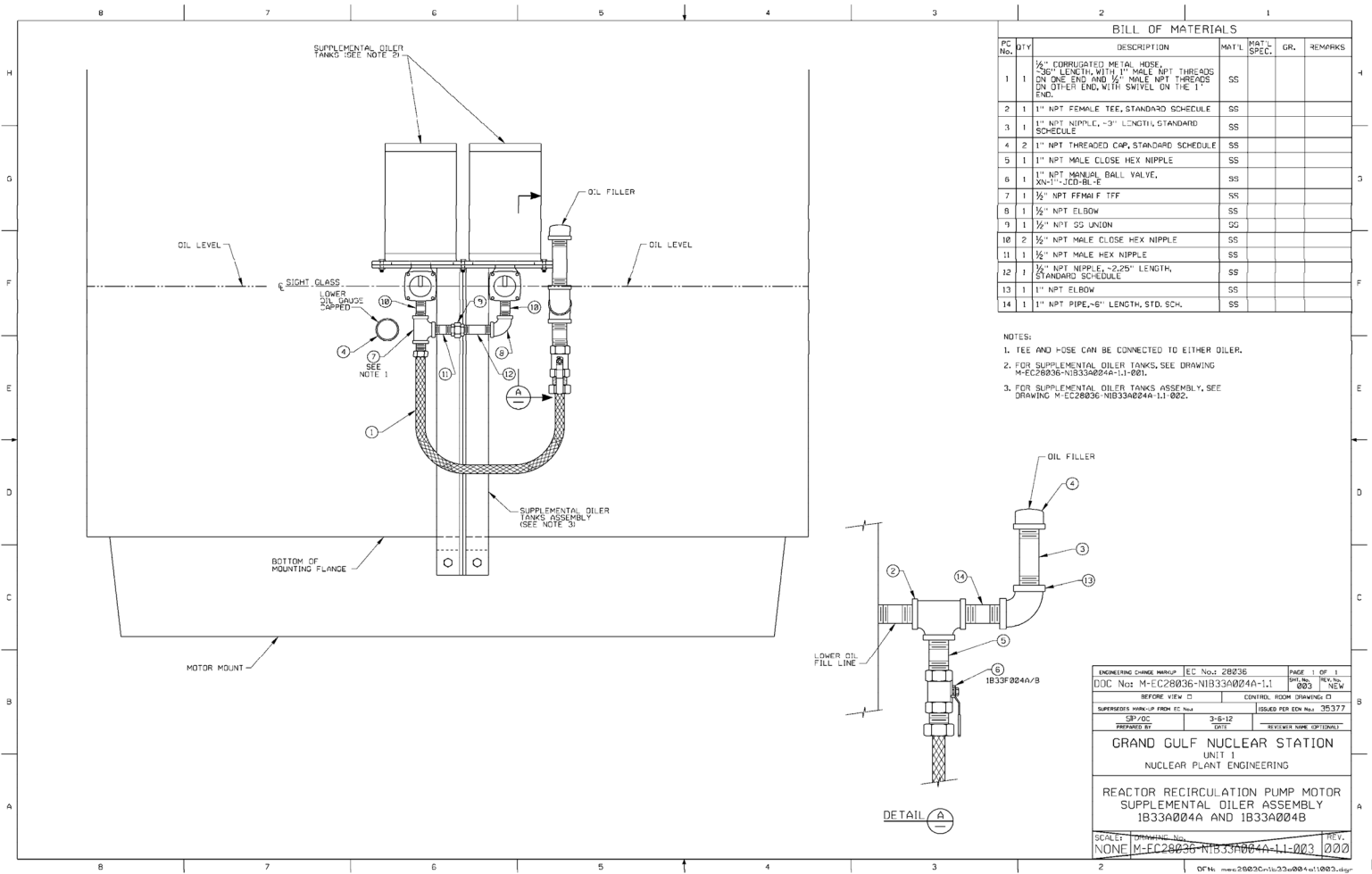

MISSISSIPPI POWER & LIGHT COMPANY	REACTOR RECIRCULATION
GRAND GULF NUCLEAR STATION	PUMP MOTOR ASSEMBLY
UNITS 1 & 2	
UPDATED FINAL SAFETY ANALYSIS REPORT	FIGURE 9.5-26a

9.5-196

Revision 2016-00

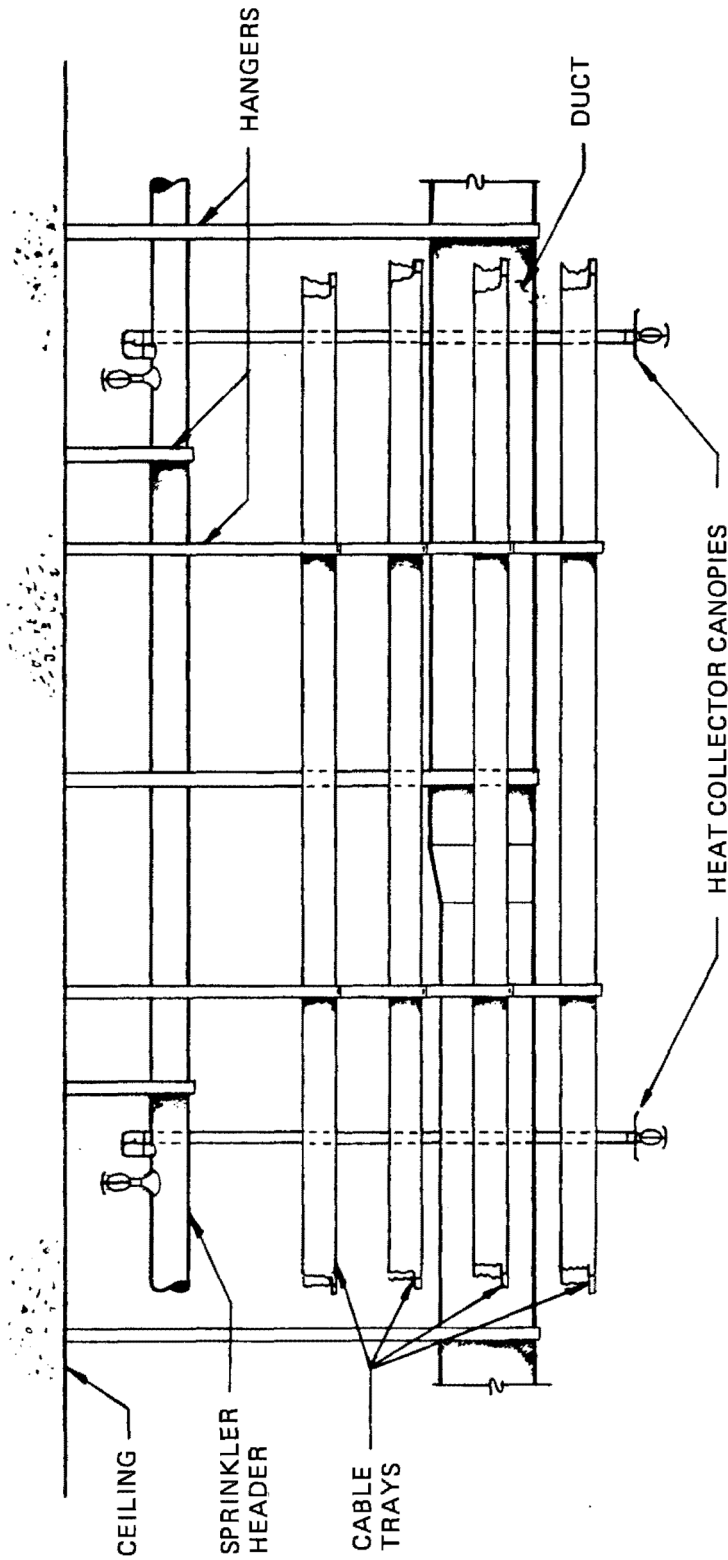

MISSISSIPPI POWER & LIGHT COMPANY GRAND GULF NUCLEAR STATION UNITS 1 & 2 UPDATED FINAL SAFETY ANALYSIS REPORT	TYPICAL SPRINKLER ARRANGEMENT FOR SYSTEMS COVERING REDUNDANT SAFE SHUTDOWN-RELATED RACEWAYS FIGURE 9.5-27
--	--

GRAND GULF NUCLEAR GENERATING STATION
 Updated Final Safety Analysis Report (UFSAR)

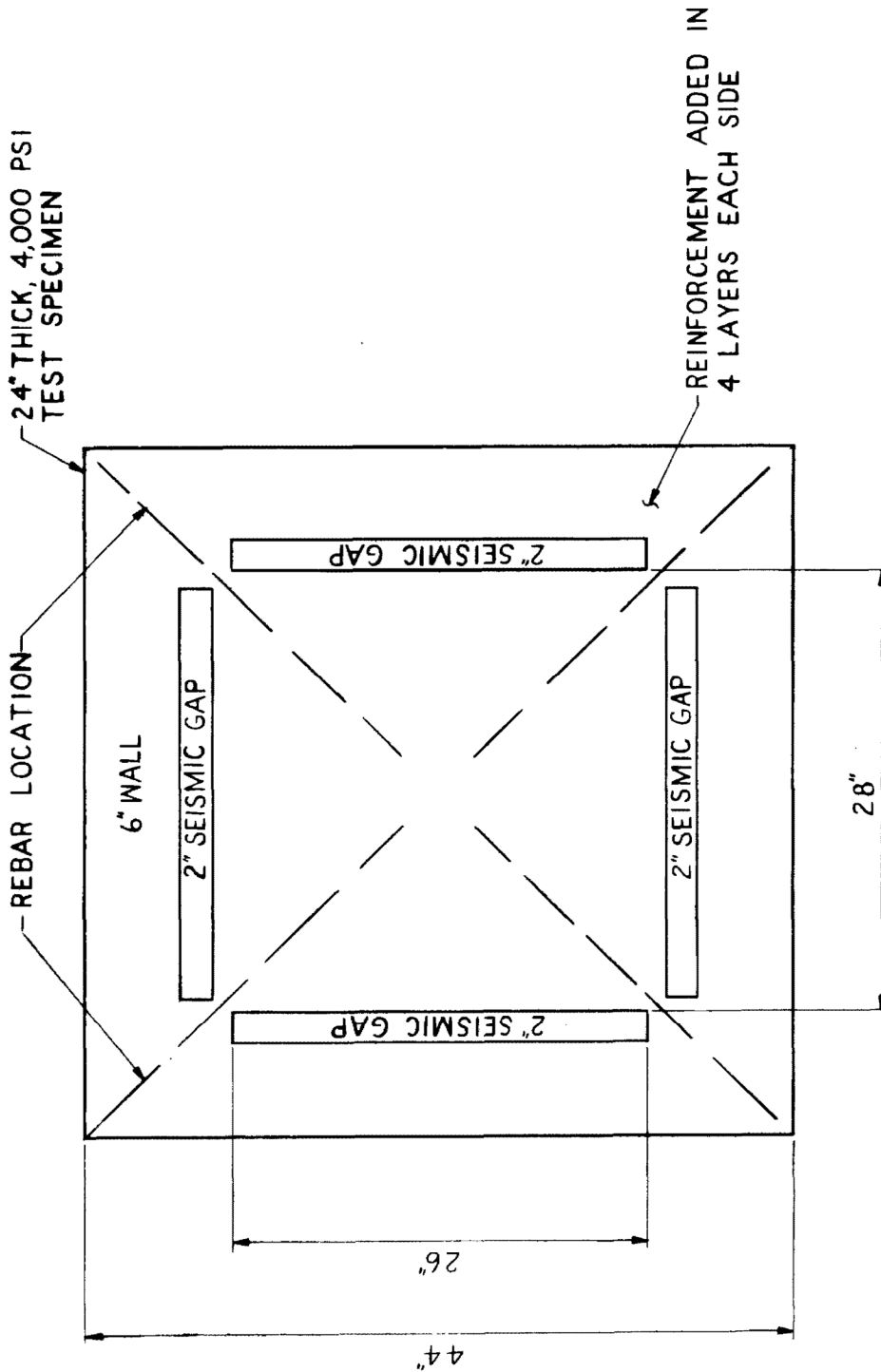

MISSISSIPPI POWER & LIGHT COMPANY GRAND GULF NUCLEAR STATION UNITS 1 & 2 UPDATED FINAL SAFETY ANALYSIS REPORT	SQUARE CONCRETE TEST SPECIMEN WITH SIMULATED SEISMIC GAPS FIGURE 9.5-28
--	---

GRAND GULF NUCLEAR GENERATING STATION
Updated Final Safety Analysis Report (UFSAR)

APPENDIX 9A FIRE HAZARDS ANALYSIS REPORT

The GGNS Fire Hazards Analysis Report is considered part of the Fire Protection Program described in Appendix 9B and as such is subject to the provisions of GGNS Operating License Condition 2.C.(41).

GRAND GULF NUCLEAR GENERATING STATION
Updated Final Safety Analysis Report (UFSAR)

TABLE OF CONTENTS

9A.1.0	INTRODUCTION	9A-3
9A.2.0	DEFINITION	9A-5
9A.3.0	METHODOLOGY	9A-7
9A.4.0	FIRE PROTECTION SYSTEM DESCRIPTION	9A-12
9A.5.0	FIRE HAZARDS ANALYSIS	9A-13
9A.6.0	REFERENCES	9A-355
TABLE 9A.1	FIRE HAZARDS ANALYSIS SUMMARY	After Section 9A.6.0

GRAND GULF NUCLEAR GENERATING STATION
Updated Final Safety Analysis Report (UFSAR)

9A.1.0 INTRODUCTION

The Fire Protection Program at Grand Gulf Nuclear Station is required to be in compliance with the positions of the NRC Appendix A to Branch Technical Position APCS 9.5-1, dated August 23, 1976, for plants under construction before July 1, 1976. This program was reviewed and found acceptable by the NRC as stated in Section 9.5, Fire Protection, of the Safety Evaluation Report. A point-by-point comparison of the Grand Gulf Fire Protection Program and the positions of Appendix A to Branch Technical Position APCS 9.5-1 can be found in UFSAR Table 9.5-11.

On October 27 1980, the NRC approved a new rule concerning fire protection as applied to nuclear power plants. This rule and its Appendix R, Fire Protection Program for Nuclear Power Facilities Operating Prior to January 1, 1979, established the minimum acceptable fire protection requirements necessary to resolve certain areas of concern to the NRC Staff and Licensees of plants operating prior to January 1, 1979. A point-by-point comparison of the Grand Gulf Fire Protection Program and the requirements of 10CFR50, Appendix R, Sections II and III, can be found in UFSAR Table 9.5-12.

This report summarizes the fire hazards analysis performed on the Grand Gulf Nuclear Station Unit 1 to evaluate the fire detection and suppression capabilities and determine compliance to the design requirements of Appendix A to BTP APCS 9.5-1 and 10CFR50, Appendix R, Sections II and III. Controlled plant documents (e.g., P&IDs) are referenced in this report but are not incorporated directly.

The objectives of the fire hazards analysis are:

- a. To consider potential in situ and transient fire hazards.
- b. To document by fire zone, the presence of safety-related equipment.
- c. To document by fire area/fire zone, the presence of safe shutdown systems, components, and devices identified in Appendix R Evaluation Procedure FPP-1.
- d. To determine the consequences of a single fire event on the ability to achieve and maintain the plant in a cold shutdown condition.

GRAND GULF NUCLEAR GENERATING STATION
Updated Final Safety Analysis Report (UFSAR)

- e. Specify available measures for fire detection, fire suppression and fire containment.

The Grand Gulf Nuclear Station is designed to contain all safety-related systems and components in Seismic Category I structures (the Containment, Auxiliary, Control, and Diesel Generator buildings, and the Standby Water -Pump House structures) except for a minimal amount of equipment in the Turbine, Water Treatment, and Radwaste Buildings. All safety-related equipment in these non-Seismic Category I buildings is designed to fail safe or in a manner that does not compromise any required safety functions. All Seismic Category I structures are separated from the non-seismic structures by 3-hour rated fire barriers.

In addition to Seismic Category I structures, the outside yard area, including underground raceway systems, was reviewed for potential fire hazards to Seismic Category I structures.

An evaluation of potential fire hazards, including in situ and transient combustibles, was performed to determine whether any postulated fire could affect safety-related equipment, components, or cables required for safe shutdown of the plant. Appropriate protective features have been provided to ensure that safe shutdown can be achieved given a fire in any plant area. Table 9A.1 provides a description of each Fire Zone of the plant located within a Seismic Category I structure and lists the major safety-related equipment installed in each zone, the combustibles located in each zone, the total fire severity (includes margin for transient combustibles), maximum fire duration for in situ combustible loading and a summary of the fire protection measures available to each zone.

In situ combustibles, such as cable insulation, stored fuel, or equipment lubrication reservoirs, have been identified and evaluated for the safety of the plant. In situ combustibles within the plant are controlled primarily by minimizing the use of combustible materials and isolating the combustible or avoiding the communication of combustibles by separation.

Transient combustibles are necessary for maintenance and other activities. In addition to identifying the in situ combustibles, additional margin for transient combustible loads is provided in each area. The total fire severity (in situ and transient) for each fire zone is identified as Low, Moderate, and High. Combustible loading of 1-hour or less is considered "Low

GRAND GULF NUCLEAR GENERATING STATION
Updated Final Safety Analysis Report (UFSAR)

Severity", greater than 1-hour but less than or equal to 2-hours is considered a "Moderate Severity", and greater than 2-hours but less than or equal to 3-hours is considered a "High Severity".

Calculation MC-QSP64-86058 provides the basis for the combustible loading and severity's identified in this analysis.

The fire hazards analysis was reviewed and found to be acceptable by a qualified fire protection engineer.

9A.2.0 DEFINITIONS

9A.2.1 FIRE AREA

A fire area is a portion of a building comprised of one or more fire zones that is separated from all other fire areas by 3-hour rated fire barriers or their equivalent.

9A.2.2 FIRE ZONE

A fire zone is a subdivision of a fire area that is separated from other fire zones within the fire area by less than 3-hour rated barriers. Fire protection consideration is given to individual fire zones to satisfy specific conditions of each zone. In most cases, individual fire zones are comprised of a single architectural area (room).

9A.2.3 ARCHITECTURAL AREA (ROOM)

An area is a floor space which is not defined by walls. Those floor spaces that are defined by walls are considered rooms. Each area/room has been assigned a unique identification number.

9A.2.4 FIRE BARRIERS

Those components of construction (walls, floors, and their supports) including beams, joists, columns, penetration seals or closures, fire doors, and fire dampers that are rated by approving laboratories in hours of resistance to fire and are used to prevent the spread of fire, are identified as fire barriers. Any fire barrier not meeting these requirements requires an engineering justification for use as a suitable fire barrier.

9A.2.5 ADJACENT FIRE ZONES

Adjacent fire zones are two or more fire zones whose boundaries are within 50 feet horizontally of one another and are not separated by a 3-hour rated fire barrier or the equivalent. No credit is taken for vertical separation when determining the separation distance between fire zones. Adjacent fire zones that share a common boundary are considered to communicate directly. All other adjacent fire zones are considered to communicate indirectly with the subject fire zone.

9A.2.6 IN SITU COMBUSTIBLES

Any flammable or combustible material that is permanently installed or situated in a defined location is an in situ combustible. Cables in a conduit or totally enclosed cable trays are not considered in situ combustibles.

9A.2.7 TRANSIENT COMBUSTIBLE

Any flammable or combustible material that is not permanently installed or situated in a defined location is a transient combustible.

9A.2.8 INTERVENING COMBUSTIBLE

Intervening combustibles are in situ combustible materials which are located between redundant safe shutdown systems or components.

9A.2.9 INSIGNIFICANT COMBUSTIBLES

An insignificant combustible has a combustible loading that is such a small percentage of the overall combustible loading, that its omission will not affect the estimate of the fire duration in the fire zone or area under review.

9A.2.10 NONCOMBUSTIBLE

Non combustibles are materials which, in the form in which they are used and under the conditions anticipated, will not ignite, burn, support combustion, or release flammable vapors when subjected to fire or heat. Non combustibles are also defined as:

GRAND GULF NUCLEAR GENERATING STATION
Updated Final Safety Analysis Report (UFSAR)

- 9A.2.10.1 Materials having a structural base of noncombustible material, as previously defined above, with a surfacing not over 1/16 inch thick, which have a flame-spread rating not higher than 50 as measured by ASTM E 84-81a.
- 9A.2.10.2 Materials, other than described above, having a surface flame-spread rating of 25 or less, as measured by ASTM E 84-81a, and of such composition that surfaces that would be exposed by cutting through the material in any way would result in a flame-spread rating of 25 or less.
- 9A.2.10.3 Elastomeric (anti-sweat) insulation having a flame-spread rating of 25 or less. This material is classified as a Class A material when tested to ASTM E 84-81a requirements.

9A.2.11 SAFETY-RELATED

9A.2.11.1 Systems, structures, and components necessary to ensure:

- (a) The integrity of the reactor coolant pressure boundary,
- (b) The capability to shutdown the reactor and maintain it in a cold shutdown condition, or
- (c) The capability to prevent or mitigate the consequences of accidents that could result in potential off-site exposures comparable to the guideline exposures of 10CFR100.

9A.2.12 SAFE SHUTDOWN SYSTEMS

Safe shutdown systems are those minimum systems, or portions thereof, required to achieve and maintain the plant in a cold shutdown condition.

9A.2.13 SAFE SHUTDOWN COMPONENTS

A safe shutdown component is any component, device, or cabling required to support the operation of a safe shutdown system.

GRAND GULF NUCLEAR GENERATING STATION
Updated Final Safety Analysis Report (UFSAR)

9A.2.14 ALTERNATE SHUTDOWN

Alternate Shutdown is the process of performing and maintaining safe shutdown conditions as a result of a control room fire by utilizing safe shutdown components exclusive from the control room. These components may be designed exclusively for Alternate Shutdown use or for additional functions, however, the components must retain functionality and personnel access considering the postulated effects of a control room fire.

9A.2.15 ASSOCIATED CIRCUITS OF CONCERN

Associated circuits of concern are defined by NRC Generic Letter 81-12 and subsequent clarifications. Any circuits required either directly or indirectly for safe shutdown are considered safe shutdown components.

9A.2.16 ASSOCIATED CIRCUITS

Associated circuits are defined by NRC Regulatory Guide 1.75.

9A.2.17 QUALIFIED FIRE PROTECTION ENGINEER

A qualified fire protection engineer is a person who meets the eligibility requirements for member status in the Society of Fire Protection Engineers.

9A.3.0 METHODOLOGY

9A.3.1 In order to review Grand Gulf Nuclear Station Unit 1 fire prevention, detection, and suppression capabilities and to determine compliance with the requirements of both NRC Branch Technical Position 9.5-1, Appendix A, and Appendix R to 10CFR50, an appendix R evaluation procedure (FPP-1) was written to establish the following review guidelines. The bases of this report included the requirements of Appendix A to NRC Branch Technical Position APCS 9.5-1 and 10CFR50, Appendix R; information/guidance obtained from NRC Appendix R workshops; and information/guidance obtained from the following:

GRAND GULF NUCLEAR GENERATING STATION
Updated Final Safety Analysis Report (UFSAR)

9A.3.1.1 NRC Generic Letter 81-12 and Clarification Letters

9A.3.1.2 NRC Generic Letter 83-33

9A.3.1.3 NRC Generic Letter 86-10

9A.3.1.4 IE Information Notice 84-09

**9A.3.1.5 Inspection and Enforcement Manual, Temporary
Instruction 2515/62, Rev. 1**

9A.3.1.6 NRC Regulatory Guide 1.75

9A.3.2 In addition to the commitments listed in UFSAR Section 9.5.1 the following criteria were used in the preparation of this report:

9A.3.2.1 The postulated fire does not occur coincident with a LOCA or natural phenomena (e.g., tornado, seismic event, etc.). The reactor recirculation pumps are designed to withstand a safe shutdown earthquake without rupture of the oil reservoirs or the supplemental external oilers, the lubricating oil is conservatively included as a combustible in the drywell.

9A.3.2.2 Offsite power is assumed to be lost at any time before, during, or after the occurrence of the postulated fire, except for a fire in Fire Zone 1A322 where offsite power has been demonstrated to be available.

9A.3.2.3 A single failure is not postulated concurrent with the fire. All failures which occur are as a direct result of the postulated fire.

9A.3.2.4 Where a fire hazard is present, the design basis maximum in situ combustible loading and total fire severity considers the total heat energy that can be released through complete combustion of combustible materials determined to be available for ignition within the fire zones of the fire area. No credit is taken for fire detection and suppression when determining the fire severity duration for a fire zone.

GRAND GULF NUCLEAR GENERATING STATION
Updated Final Safety Analysis Report (UFSAR)

9A.3.2.5 Unless specifically noted otherwise, the electrical cabling heat load is based on maximum fill of each cable tray considering conservative combinations of worst-case cable present in that tray. Electrical cables and raceway installed in conduit or totally enclosed cable trays were not considered as contributors to the electrical cabling heat load.

9A.3.2.6 The design basis maximum in situ combustible loading and total fire severity are identified for each fire zone. The fire heat loads are computed in Calculation MC-QSP64-86058 using the following formula:

$$\text{Fire Heat Load} = \text{Combustible Quantity (lb)} \times \text{Heat of Combustion (Btu/lb)} \\ \text{(Btu/Sq Ft)}$$

Fire Zone Floor Area (Sq Ft)

- (a) Each fire area was divided into its respective fire zones, as defined in Subsection 9A.2.2, to obtain a more representative view of the combustibles throughout the plant. The quantity of combustibles within each fire zone is considered to be adequately distributed so that dividing the total combustion heat released by the respective fire zone floor area yields the most conservative fire heat load obtainable.
- (b) The maximum in situ combustibles loading duration is then determined by comparing the calculated fire heat load for that fire zone to Table 5-9B in Fire Protection Handbook, 15th edition, published by NFPA. This table lists the duration of a Class A combustibles fire by its fire heat load in Btu/sq ft (See Calculation MC-QSP64-86058, Appendix 2-Fire Severity Table). The maximum in situ fire duration of each fire zone is conservatively expressed in 15-minute intervals and along with the total fire severity are listed in Table 9A.1 of this report.
- (c) Transient combustibles are necessary for maintenance and other activities. In addition to identifying the in situ combustibles, additional margin for transient combustibles loads is provided in each zone. This is accomplished by

GRAND GULF NUCLEAR GENERATING STATION
Updated Final Safety Analysis Report (UFSAR)

using the Low, Moderate, & High description for the "Total Fire Severity" in each fire zone. Total Fire Severity includes both in situ and transient combustibles. Total combustible loading of 1-hour or less is considered "Low Severity", greater than 1-hour but less than or equal to 2-hours is considered a "Moderate Severity", and greater than 2-hours but less than or equal to 3-hours is considered a "High Severity".

- (d) Unless specifically noted otherwise in the "Fire Zone Analysis" portion of Section 9A.5, the combustible heat loads for all fire zones in the Unit 2 portion of the Control Building are based on the completed design of those areas. The actual combustible heat loads for those fire zones are considerably less than their corresponding design loads.
- (e) Concrete joint sealant (such as rodofoam material used in seismic gaps) has been conservatively included as a combustible material, even though the major portion of this material is embedded between the concrete joints.

9A.3.2.7 All doors, dampers, and electrical and piping penetration seals that are installed in rated fire barriers (walls, floors, and ceilings) are rated by approving laboratories, in hours of resistance to fire, equal to or greater than the barrier in which they are installed. Deviations, modifications, & repairs that deviate from the tested or rated configuration are reviewed and approved by a qualified Fire Protection Engineer. All pressure, airtight, bullet resistant and watertight doors are considered equivalent rated fire barriers (Ref. SER Section 9.5.2.2).

9A.3.2.8 Where a door with a fire rating of 1.5-hours is part of a 2-hour rated fire wall, the wall, as a whole, is considered to be a 2-hour rated fire barrier.

GRAND GULF NUCLEAR GENERATING STATION
Updated Final Safety Analysis Report (UFSAR)

- 9A.3.2.9 Although all reinforced concrete walls are resistant to fire, only those with rated fire penetration seals are fire barriers and are considered capable of containing a fire. Walls that are considered to be fire barriers are shown on Architectural Drawings A-0630 through A-0637. Although the containment wall is shown as a 3-hour rated fire barrier, the containment penetrations through this rated 36-inch concrete wall do not have a 3-hour fire rating. However, these penetrations have been identified as deviations and do not degrade the structure's ability to withstand an exposure fire.
- 9A.3.2.10 The standby service water pump house basins and the transfer tube, which are constantly filled with water, and totally enclosed pipe, HVAC, or electrical chases, which are inaccessible, are not provided within coverage by ionization smoke detector(s), regardless of the presence of safety-related components, because the surveillance requirements of Technical Requirements Manual (TRM) Section 6.2.1, Fire Detection Instrumentation, or NFPA 72 D could not be met. It then follows that these fire zones are not accessible to manual hose streams or portable fire extinguishers. None of these fire zones contain more than one division of safe shutdown components. Therefore, a fire in any one of these chases would not prevent safe shutdown of the reactor.
- 9A.3.2.11 A water suppression effects study has been performed which demonstrates that electrical faulting of Class 1E equipment and cables required for safe shutdown will not occur due to actuation of the automatic water suppression systems.
- 9A.3.2.12 Power and control cables are separated into three independent electrical divisions (I, II, and III), each serving separate safety-related systems. Operation of either Divisions I and III or II and III can be completely lost without affecting safe shutdown capability. Generally, operation of Division I only or operation of Division II only is sufficient to achieve safe shutdown. The operability of either Division I or II is ensured by fire protection measures taken to ensure that a single fire cannot disable both

GRAND GULF NUCLEAR GENERATING STATION
Updated Final Safety Analysis Report (UFSAR)

divisions. Separation criteria utilized during the installation of safety-related cables provide protection against the disabling of redundant safety-related equipment by a self-initiated cable fire. To protect against the effects of an exposure fire from in situ or transient combustibles, each area of the plant where safety-related equipment is installed was analyzed for the postulated exposure fire as described in the Appendix R Evaluation Procedure, FPP-1. Fire protection measures, in addition to separation, were provided where necessary.

9A.3.2.13 The stairwells and elevators (including the elevator machine rooms) are not discussed in the individual fire area analyses for the following reasons:

- (a) The stairs and elevators are separated from the Auxiliary and Control Buildings by 2-hour rated fire barriers, per the Uniform and Southern Building Codes.

Note: The freight elevators are equipped with bi-parting, vertical sliding freight elevator doors. These doors are not labeled or listed because they are larger than the maximum size fire door labeled or listed. However, the manufacturer has certified the doors conform to the requirements of design, materials and construction as established by the individual listing. Additionally, the installation has been evaluated in Fire Protection Evaluation 99-0004 to ensure that the doors will provide protection commensurate with the hazards in the areas.

- (b) The combustible heat loads in each of the stairs and elevators, consists solely of transient combustibles.

GRAND GULF NUCLEAR GENERATING STATION
Updated Final Safety Analysis Report (UFSAR)

- (c) No safe shutdown components are located in any stair or elevator. Stair 1A12 does contain safety-related cables, but they are not required for safe shutdown. Smoke detection is provided for Stair 1A12.
- (d) Stair OC02 also contains safety-related cables that are not required for safe shutdown. These safety-related cables are all located on the landing at Elev. 111' 0" and are not actually located in the stairwell itself. Smoke detection is provided for the landing at Elev. 111' 0".

Therefore, any fire originating in, or communicating to, a stairwell or elevator cannot spread beyond that stair or elevator and will not affect the safe shutdown capability of the reactor.

- 9A.3.2.14 Safe shutdown and/or safety-related piping, ductwork and associated valves/dampers located in zones not provided with coverage by smoke detector(s) were analyzed as discussed under each zone analysis to determine if a fire of the indicated duration would present an exposure hazard to these components.
- 9A.3.3 To perform a fire hazards analysis on the Grand Gulf Nuclear Station Unit 1, a detailed analysis was executed to:
 - 9A.3.3.1 Determine the boundaries of fire areas using the definition of a fire area presented in Subsection 9A.2.1, using Drawings A-0630 through A-0637.
 - 9A.3.3.2 Document and quantify all in situ combustibles and determine fire duration in Calculation MC-QSP64-8658. Using this information, determine the Total fire severity (low, moderate, or high) which includes margin for transient combustibles.
 - 9A.3.3.3 Identify all passive and active fire protection measures present. A complete listing of all drawings that provide this information is found in Section 9A.6.0, References.

GRAND GULF NUCLEAR GENERATING STATION
Updated Final Safety Analysis Report (UFSAR)

- 9A.3.3.4 Determine which fire areas within the scope of this review contain safety-related and safe shutdown equipment. A complete listing of all drawings that provide this information is found in Section 9A.6.0, References.
- 9A.3.4 Circuits that have a physical separation less than what is required by Section III.G.2, Appendix R, are considered by the NRC to be associated circuits of concern. The following protective measures are provided for these circuits.
- Circuits that have a common power supply with safe shutdown circuits are provided with electrical protection by coordinated breakers or fuses.
- Circuits whose spurious actuation could affect safe shutdown capability are considered to be safe shutdown circuits and are protected as required, in accordance with the fire area analysis.
- Circuits that have common enclosures (e.g., raceway, panel, or junction) with safe shutdown circuits are considered safe shutdown circuits when the circuit installation is such that fire initiation or propagation could affect both trains of safe shutdown components. These circuits are protected as required, in accordance with the fire hazards analysis.
- 9A.3.5 Alternate shutdown capability is provided due to the postulated effects of a control room fire. All Division I safe shutdown components and circuits that interface with the control room are provided with a means of isolating these circuits so that Division I components required for safe shutdown may be operated locally. Additional Division I local controls are provided, where necessary, to effect an alternate shutdown in the event of a control room fire. Emergency lighting is provided where required for ingress, egress, and operation of alternate shutdown controls.
- 9A.3.6 A safe shutdown analysis was performed in accordance with Appendix R Evaluation Procedure, FPP-1, to ensure that no single postulated fire would compromise the safe shutdown capability of the plant. The fire areas were then broken down into individual fire zones as

GRAND GULF NUCLEAR GENERATING STATION
Updated Final Safety Analysis Report (UFSAR)

described in Subsection 9A.2.2. The fire detection and suppression capability of each fire area is described in Section 9A.5.0.

9A.3.7 A Fire Protection Program (FPP) review was performed for the installation and implementation of Dry Fuel Storage. This review concluded that there was no impact on the ability to achieve and maintain safe shutdown capability during Dry Fuel Storage operations. The review included an assessment of the transient combustibles into the Auxiliary Building impacted areas and determined that the Fire Severity to these zones with the introduction of these combustibles remained Low. Dry Fuel Storage impacts the following Fire Zones: 1A325, 1A427, 1A523, 1A532, 1A602, and 1A604.

9A.4.0 FIRE PROTECTION SYSTEM DESCRIPTION

9A.4.1 GENERAL DESCRIPTION

9A.4.1.1 The fire protection system consists of an outside yard loop with three fire pumps and one jockey fire pump, fire water yard mains, hydrants, sprinkler systems, automatic deluge systems, automatic Carbon dioxide systems, automatic Halon 1301 systems, standpipes, hose stations, portable fire extinguishers, smoke detectors, hydrogen detectors, ultraviolet flame detectors, heat detectors alarm systems, fire barriers, fire stops, portable breathing apparatus, smoke and heat ventilation systems, two fire water storage tanks, and associated piping, valves, and instrumentation.

9A.4.1.2 Three redundant fire pumps (one electric and two diesel driven) and closed-loop piping ensured delivery of extinguishing water to any Seismic Category I structure with two pumps (with one pump for non-Seismic Category I structures) and one leg of the piping loop out of service.

9A.4.1.3 Fire and smoke detection systems are provided for all areas of Seismic Category I structures that contain or present an exposure fire hazard to safe shutdown or safety-related systems or components, unless otherwise noted in the fire zone analysis. Non-Seismic Category I structures do not contain any equipment required for

GRAND GULF NUCLEAR GENERATING STATION
Updated Final Safety Analysis Report (UFSAR)

safe shutdown. The minimal amount of safety-related equipment located in non-Seismic Category I buildings (the Turbine, Water Treatment, and Radwaste Buildings) is designed to fail safe or to fail in a manner that does not compromise any required safety functions.

- 9A.4.1.4 Fire barriers are provided at every penetration of fire-rated floors and at every fire wall penetration.

9A.4.2 OPERATION

- 9A.4.2.1 The fire protection system automatic wet pipe and dry pipe sprinklers discharge water on high ambient temperature. System actuation initiates both local and control room alarms. The automatic deluge and preaction systems activate on a signal from their rate compensated heat detector and also provide local and control room alarms. The manual deluge and sprinkler systems require operator action following automatic local and control room high temperature alarms. Smoke detectors, heat detectors, and ultraviolet flame detectors provide local and remote alarms but do not actuate fire extinguishing systems, with the exception of the sliding fire door in the remote shutdown panel rooms.

- 9A.4.2.2 A drop in pressure in the underground fire system piping (i.e., activation of any fixed water fire protection system, including hose stations) automatically starts the electric motor driven fire pump and/or standby diesel engine driven fire pump. A demand exceeding the capacity of one fire pump causes additional fire pumps to start.

- 9A.4.2.3 Operation of a clean agent suppression or Carbon dioxide system activates local and control room alarms. The Halon 1301 for the Computer Room OC403 is stored in local bottles in the Unit 1 lower cable spreading room at El. 148' 0"; Carbon dioxide is stored in central bulk storage tanks located outdoors. Clean agent media for the PGCC fire protection system is stored in local bottles in the end cabinet of each PGCC panel module assembly.

For additional details of the fire protection system, see UFSAR Section 9.5.1.

GRAND GULF NUCLEAR GENERATING STATION
Updated Final Safety Analysis Report (UFSAR)

9A.5.0 FIRE HAZARDS ANALYSIS

The following area analyses summarize the safety-related equipment and the fire protection measures provided in each fire zone of the Seismic Category I buildings and the yard area. In addition, Table 9A.1 provides this information in a condensed format.

FIRE ZONE (FZ) / FIRE AREA (FA) CROSS REFERENCE

FZ	FA	FZ	FA	FZ	FA	FZ	FA
1A101	1	1A316	11	1A604	19	0C406A	42
1A102	2	1A318	14	1A605	2	0C407	43
1A103	2	1A319	15	1A606	19	0C408	42
1A104	2	1A320	16			0C409	47
1A105	2	1A321	11	1D301	60	0C409A	47
1A106	2	1A322	11	1D306	63	0C410	44
1A107	1	1A323	11	1D308	62	0C411	42
1A108	1	1A324	11	1D310	61	0C412	42
1A109	5	1A325	17			0C412A	42
1A110A	25	1A326	11	0M101	66	0C501	50
1A110B	25	1A401	19	0M102	66	0C502	50
1A110C1	25	1A402	18	0M103	66	0C503	50
1A110C2	25	1A403	19	1M110	64	0C504	50
1A110C3	25	1A404	18	1M112	64	0C507	50
1A110D1	25	1A405	18	2M110	65	0C507A	50
1A110D2	25	1A406	18	2M110	65	0C507C	42
1A110D3	25	1A407	20			0C509	50
1A110E1	25	1A410	21	SSW	64	0C510	50
				BASIN			
				NO. 1			
1A110E2	25	1A411	25	SSW	65	0C511	50
				BASIN			
				NO. 2			
1A110F1	25	1A414	25			0C512	50
1A110F2	25	1A417	19	0C101	26	0C512A	47
1A110F3	25	1A419	25	0C103	26	0C512B	50
1A110F4	25	1A420	19	0C104	28	0C513	50
1A111	1	1A421	25	0C109	28	0C514	50
1A112	25	1A424	19	0C115	26	0C515	50
1A113	25	1A427	19	0C116	28	0C518	48
1A114	1	1A428	19	0C117	26	0C518A	42
1A115	3	1A429	19	0C125	26	0C601	50
1A116	3	1A430	19	0C126	26	0C602	50
1A117	1	1A431	19	0C128	27	0C603	50
1A118	3	1A432	19	0C202	31	0C603B	42

GRAND GULF NUCLEAR GENERATING STATION
Updated Final Safety Analysis Report (UFSAR)

FIRE ZONE (FZ) / FIRE AREA (FA) CROSS REFERENCE (CONTINUED)

FZ	FA	FZ	FA	FZ	FA	FZ	FA
1A119	3	1A433	19	0C203	30	0C604	51
1A120	1	1A434	19	0C204	30	0C606	50
1A124	2	1A436	19	0C205	30	0C608	50
1A125	2	1A437	19	0C205A	30	0C608B	47
1A127	1	1A438	19	0C206	30	0C609	52
1A130	1	1A439	2	0C207	32	0C610	47
1A131	1	1A440	2	0C208	33	0C611	48
1A132	2	1A441	2	0C208A	34	0C612	42
1A201	6	1A442	2	0C209	35	0C613	50
1A202	2	1A443	25	0C210	36	0C613A	42
1A203	2	1A444	19	0C211	37	0C614	50
1A204	2	1A506	2	0C212	30	0C615	50
1A205	2	1A507	25	0C213	30	0C616	50
1A206	2	1A508	2	0C214	30	0C617	50
1A207	7	1A509	25	0C215	38	0C618	50
1A208	8	1A510	25	0C216	39	0C619	50
1A209	2	1A513	25	0C217	26	0C701	58
1A210	2	1A514	25	0C218	40	0C702	47
1A211	6	1A515	25	0C219	30	0C703	53
1A215	6	1A516	25	0C301	42	0C704	58
1A219	9	1A517	25	0C302	42	0C705	58
1A220	3	1A519	19	0C303	42	0C706	58
1A221	10	1A520	25	0C304	42	0C707	55
1A222	6	1A523	19	0C305	42	0C708	58
1A224	2	1A524	19	0C306	47	0C708A	58
1A225	2	1A525	19	0C307	41	0C709	47
1A226	2	1A527	19	0C308	42	0C711	58
1A301	11	1A528	19	0C309	42	0C712	47
1A302	11	1A529	19	0C401	42	0C713	58
1A303	2	1A530	19	0C402	42	YARD	59
1A304	2	1A531	19	0C402A	50		
1A305	2	1A532	19	0C403	45		
1A306	2	1A533	19	0C404	42		
1A307	2	1A534	19	0C405	42		
1A308	12	1A536	19	0C405A	50		
1A309	13	1A537	19	0C406	42		
1A310	25	1A539	22				
1A311	25	1A601	25				
1A313	25	1A602	19				
1A314	11	1A603	19				

GRAND GULF NUCLEAR GENERATING STATION
Updated Final Safety Analysis Report (UFSAR)

9A.5.1 FIRE AREA 1

9A.5.1.1 FIRE AREA DESCRIPTION

Fire Area 1 consists of Fire Zones 1A107, 1A108, 1A111, 1A120, 1A131 (Elev. 93' 0"), 1A101, 1A114, 1A117 (Elev. 93' 0" and 103' 0"), 1A130 (Elev. 103' 0"), and 1A127 (Elev. 79' 0") in the Auxiliary Building. Fire Zones 1A101, 1A114, 1A117, and 1A120 are completely open to one another and form a passageway around the perimeter of the Auxiliary Building. The ceiling and all walls are 3-hour rated fire barriers, except for those walls and the Auxiliary Building floor slab, which are non-rated exterior barriers. In addition, those interfaces with Stairs 1A10, 1A12 and Elevator No. 3 (Ref. Sect. 9A.3.2.13.a) are 2-hour rated fire barriers (Ref. Methodology Section 9A.3.0). A fire originating in any one fire zone is able to communicate with any other zone in Fire Area 1 (Ref. Architectural Drawing A-0632).

INCLUDED FIRE ZONES	DESCRIPTION
1A101	Passage, Elev. 93' 0" and 103' 0"
1A107	Equipment Drain Transfer Tank Room, Elev. 93' 0"
1A108	Floor Drain Transfer Tank Room, Elev. 93' 0"
1A111	Piping Penetration Room, Elev. 93' 0"
1A114	Fan Coil Area, Elev. 93' 0" and 103' 0"
1A117	Misc. Equip. Area, Elev. 93' 0" and 103' 0"
1A120	CCW Pump and Heat Exchanger Area, Elev. 93' 0"
1A127	Auxiliary Radwaste Pipe Tunnel, Elev. 79' 0"
1A130	Transfer Pump Monorail Room, Elev. 103' 0"
1A131	Floor Drain Transfer Pump Room, Elev. 93' 0"

9A.5.1.2 SAFE SHUTDOWN EQUIPMENT

Divisions I and II

9A.5.1.3 FIRE AREA ANALYSIS

- (a) Fire Zones 1A101, 1A114, and 1A117 are the only fire zones in Fire Area 1 which contain safe shutdown equipment, cable, and raceway, as shown in the microcomputer data base (Ref. FPP-1, Appendix C Data).

GRAND GULF NUCLEAR GENERATING STATION
Updated Final Safety Analysis Report (UFSAR)

- (b) Fire Zone 1A101, which is located east of Column Line G.4, contains both Division I and II safe shutdown components. A qualified rated one-hour fire wrap or wrap which provides an equivalent one hour fire resistance with evaluation (EC 21147), is provided on the Division I safe shutdown horizontal cable trays 1AATMG, 1AATWG, and 1AATWT in accordance with the risk informed, performance based analysis as approved by Amendment 170 to the Facility Operating License. The qualified rated one-hour fire wrap or wrap which provides an equivalent one hour fire resistance with evaluation (EC 21147) is installed on the Division I safe shutdown cable trays 1AATMG, 1AATWG and 1AATWT and specified intervening items where the Division I cable trays would be subject to damage from a floor based transient combustible fire which could also cause a failure of the unprotected safe shutdown Division II RHR B minimum flow transmitter and its associated sensing lines. The qualified rated one-hour fire wrap or wrap which provides an equivalent one hour fire resistance with evaluation (EC 21147) is also installed on the Division I safe shutdown cable trays 1AATMG, 1AATWG, 1AATWT and specified intervening items where the Division I cable trays would be subject to damage from a floor based transient combustible fire located between Division I cable trays 1AATMG, 1AATWG, 1AATWT and Division II conduit 1ABRW310 and Division II cable trays 1ABTOT and 1ABTMG). In summary, the qualified rated one hour fire wrap or wrap which provides an equivalent one hour fire resistance with evaluation (EC 21147) is provided on specified portions of the Division I safe shutdown cable trays 1AATWT, 1AATMG and 1AATWG from the north wall of the Auxiliary Building southward to a point 19.1 feet south of penetration AJ-29 where the Division II RHR-B pump minimum flow transmitter tubing enters the RHR-B pump room. In addition, Amendment 170 provides specific combustible controls for Fire Area 1. Combustible Controls for Amendment 170 to the Facility Operating License include a

GRAND GULF NUCLEAR GENERATING STATION
Updated Final Safety Analysis Report (UFSAR)

designated transient combustible exclusion zone and prohibits Transient Combustible Storage areas for Fire Area 1 (Auxiliary Building evaluation 93/103'). The Specific wrap requirements and combustible controls are detailed in Amendment 170 to the Facility Operating License.

Intervening combustibles located within the transient combustible exclusion zone as defined by Amendment 170 to the Facility Operating License consist of cable trays containing IEEE-383 cable installed in accordance with the requirements of Regulatory Guide 1.75.

Based on the separation between these raceways, the specified raceway wrap and combustible controls in accordance with Amendment 170 to the Facility Operating License, a postulated fire will not affect or propagate to affect more than one train of safe shutdown in this fire zone.

An automatic sprinkler system is installed within the transient combustible exclusion zone described above and extends west to Column Line J.5 and east into Fire Zone 1A101 to Column Line 10.5. A smoke detection system is also provided. Manual fire fighting is provided by installed fire extinguishers and manual hose stream.

- (c) Fire Zone 1A117, which is located west of Column Line G.4, contains both Division I and II safe shutdown components. A qualified rated one hour fire wrap or wrap which provides an equivalent one hour fire resistance with evaluation (EC 21147) is provided on the Division I safe shutdown vertical cable tray 1AATWT and Division I safe shutdown horizontal cable trays 1AATMG, and 1AATWG in accordance with the risk informed, performance based analysis as approved by Amendment 170 to the Facility Operating License. The qualified rated one-hour fire wrap or wrap which provides an equivalent one hour fire resistance with evaluation (EC 21147) is

GRAND GULF NUCLEAR GENERATING STATION
Updated Final Safety Analysis Report (UFSAR)

installed on the Division I safe shutdown cable trays 1AATWT, 1AATMG and 1AATWG and specified intervening items where the Division I cable trays would be subject to damage from a floor based transient combustible fire which could also cause a failure of the unprotected safe shutdown Division II RHR B minimum flow transmitter and its associated sensing lines. The qualified rated one hour fire wrap or wrap which provides an equivalent one hour fire resistance with evaluation (EC 21147) is also installed on the Division I safe shutdown cable trays 1AATMG, 1AATWG, 1AATWT and specified intervening items where the Division I cable trays would be subject to damage from a floor based transient combustible fire located between Division I cable trays 1AATMG, 1AATWG, 1AATWT and Division II conduit 1ABRW310 and Division II cable trays 1ABTOT and 1ABTMG). In summary, the qualified rated one-hour fire wrap or wrap which provides an equivalent one hour fire resistance with evaluation (EC 21147) is provided on specified portions of the Division I safe shutdown cable trays 1AATWT, 1AATMG and 1AATWG from the north wall of the Auxiliary Building southward to a point 19.1 feet south of penetration AJ-29 where the Division II RHR-B pump minimum flow transmitter tubing enters the RHR-B pump room. In addition, Amendment 170 provides specific combustible controls for Fire Area 1. Combustible Controls for Amendment 170 to the Facility Operating License include a designated transient combustible exclusion zone and prohibits Transient Combustible Storage areas for Fire Area 1 (Auxiliary Building evaluation 93/103'). The Specific wrap requirements and combustible controls are detailed in Amendment 170 to the Facility Operating License.

Intervening combustibles located within the transient combustible exclusion zone as defined by Amendment 170 to the Facility Operating

GRAND GULF NUCLEAR GENERATING STATION
Updated Final Safety Analysis Report (UFSAR)

License consist of cable trays containing IEEE-383 cable installed in accordance with the requirements of Regulatory Guide 1.75.

Based on the separation between these raceways, the specified raceway wrap and combustible controls in accordance with Amendment 170 to the Facility Operating License, a postulated fire will not affect or propagate to affect more than one train of safe shutdown in this fire zone.

An automatic sprinkler system is installed within the transient combustible exclusion zone described above and extends west to Column Line J.5 and east into Fire Zone 1A101 to Column Line 10.5. A smoke detection system is also provided. Manual fire fighting is provided by installed fire extinguishers and manual hose stream.

- (d) Fire Zone 1A114 contains only Division I safe shutdown components and is separated from the portion of Fire Zone 1A101 containing Division II safe shutdown components by that part of 1A101 located south of penetration AJ-29 where the Division II RHR-B pump minimum flow transmitter tubing enters the RHR-B pump room. Based on the separation, the specified raceway wrap and combustible controls in accordance with Amendment 170 to the Facility Operating License, a postulated fire occurring in 1A101 or 1A114 will not affect or propagate to affect more than one train of safe shutdown in these fire zones.
- (e) Fire Zone 1A120 does not contain any safe shutdown components and this fire zone separates Fire Zones 1A114 and 1A117 by a distance of more than 90 feet. The intervening combustibles in this separation distance consist of non-safety-related and safety-related ventilated trays containing IEEE-383 cable installed in accordance with the requirements of Regulatory Guide 1.75. Fire propagation via 90 feet of horizontally installed tray containing IEEE-383 cable is not postulated. Therefore, a postulated

GRAND GULF NUCLEAR GENERATING STATION
Updated Final Safety Analysis Report (UFSAR)

fire originating in Fire Zones 1A120, 1A114 or 1A117 will not affect, or propagate to affect, more than one train of safe shutdown in these zones.

- (f) Fire Zones 1A107, 1A108, 1A111, 1A127, 1A130 and 1A131 do not contain any safe shutdown components. These fire zones are only adjacent to, or interface with, each other and Fire Zones 1A101 or 1A114. All of these fire zones are located more than 80 feet south of the Division II safe shutdown components as discussed in Fire Zone 1A101. Based on the separation, the specified raceway wrap and combustible controls in accordance with License Amendment 170 to the Facility Operating License, a postulated fire occurring in these zones will not affect or propagate to affect more than one train of safe shutdown in these fire zones.

- (g) Although the fire protection provided in Fire Area 1 does not strictly comply with the criteria set forth in Section 9A.3.1 of the Appendix R evaluation procedure, in that sprinkler coverage is not provided throughout Fire Area 1 and redundant safe shutdown components are not separated by 3-hour rated fire barriers, the fire protection provided in Fire Area 1 is more than adequate to ensure that at least one train of safe shutdown components will remain free of fire damage.

- (h) The postulated fire with the greatest severity in Fire Area 1 is a fire in Fire Zone 1A114. The total fire severity in Fire Zone 1A114, including transient combustibles, amounts to a low fire load. The maximum in situ combustible loading in Fire Zone 1A114 amounts to less than a 45-minute fire duration (Ref. Calculation MC-QSP64-86058). Since Fire Area 1 is separated from all other fire areas by 3-hour rated fire barriers or their equivalents, a fire occurring in Fire Area 1 will not spread into any other fire area.

GRAND GULF NUCLEAR GENERATING STATION
Updated Final Safety Analysis Report (UFSAR)

9A.5.1.4 Fire Zone Analyses

(a) FIRE ZONE 1A101: PASSAGE, ELEV. 93' 0" AND ELEV. 103' 0"

(1) Safety-Related Equipment

Electrical Cable and Raceway
RHR "A" Instrument Panel
RHR "B" Instrument Panel
RCIC Instrument Panel

(2) Fire Zone Analysis

(a) Fire Zone 1A101 is located in the Auxiliary Building on Elev. 93' 0" and Elev. 103' 0". The ceiling and the North, East, and West walls are 3-hour rated fire barriers, except for the portion of the West boundary that is open to Fire Zones 1A114 and 1A117. The floor and South wall are below grade, non-rated, exterior barriers (Ref. Architectural Drawing A-0632).

(b) The combustible loading in Fire Zone 1A101, including transient combustibles, amounts to a low fire load. The major contributor to this combustible loading is the electrical cable present in the zone. The in situ combustible loading in this fire amounts to less than a 30-minute fire duration (Ref. Calculation MC-QSP64-86058).

(c) Fire Zone 1A101 contains safety-related equipment and the following fire protection measures are provided: coverage by an automatic sprinkler system for that portion of 1A101 north of Column Line 10.5, smoke detection, and accessibility to manual hose streams and portable fire extinguishers.

GRAND GULF NUCLEAR GENERATING STATION
Updated Final Safety Analysis Report (UFSAR)

(d) Fire Zone 1A101, which is located east of Column Line G.4, contains both Division I and II safe shutdown components. A qualified rated one-hour fire wrap or wrap which provides an equivalent one hour fire resistance with evaluation (EC 21147) is provided on the Division I safe shutdown horizontal cable trays 1AATMG, 1AATWG, and 1AATWT in accordance with the risk informed, performance based analysis as approved by License Amendment 170 to the Facility Operating License.

The qualified rated one-hour fire wrap or wrap which provides an equivalent one hour fire resistance with evaluation (EC 21147) is installed on the Division I safe shutdown cable trays 1AATMG, 1AATWG, 1AATWT and specified intervening items where the Division I cable trays would be subject to damage from a floor based transient combustible fire which could also cause a failure of the unprotected safe shutdown Division II RHR B minimum flow transmitter and its associated sensing lines. The qualified rated one-hour fire wrap or wrap which provides an equivalent one hour fire resistance with evaluation (EC 21147) is also installed on the Division I safe shutdown cable trays 1AATMG, 1AATWG, 1AATWT and specified intervening items where the Division I cable trays would be subject to damage from a floor based transient combustible fire located between Division I cable trays 1AATMG, 1AATWG, 1AATWT and Division II conduit 1ABRW310 and Division II cable trays 1ABTOT and 1ABTMG. In summary, the qualified rated one-hour fire wrap or wrap which provides an equivalent one hour fire resistance with evaluation (EC 21147) is provided on specified

GRAND GULF NUCLEAR GENERATING STATION
Updated Final Safety Analysis Report (UFSAR)

portions of the Division I safe shutdown cable trays 1AATWT, 1AATMG and 1AATWG from the north wall of the Auxiliary Building southward to a point 19.1 feet south of penetration AJ-29 where the Division II RHR-B pump minimum flow transmitter tubing enters the RHR-B pump room. In addition, Amendment 170 provides specific combustible controls for Fire Area 1. Combustible Controls for Amendment 170 to the Facility Operating License include a designated transient combustible exclusion zone and prohibits Transient Combustible Storage areas for Fire Area 1 (Auxiliary Building elevation 93/103'). The Specific wrap requirements and combustible controls are detailed in Amendment 170 to the Facility Operating License.

Intervening combustibles located within the transient combustible exclusion zone as defined by Amendment 170 to the Facility Operating License consist of cable trays containing IEEE-383 cable installed in accordance with the requirements of Regulatory Guide 1.75.

- (e) An automatic sprinkler system is installed within the transient combustible exclusion zone described above and extends west to Column Line J.5 and east into Fire Zone 1A101 to Column Line 10.5. A smoke detection system is also provided. Manual fire fighting is provided by installed fire extinguishers and manual hose stream.

Based on the separation between these raceways, the specified raceway wrap and combustible controls in accordance with Amendment 170 to the Facility

GRAND GULF NUCLEAR GENERATING STATION
Updated Final Safety Analysis Report (UFSAR)

Operating License, a postulated fire will not affect or propagate to affect more than one train of safe shutdown in this fire zone.

However, Fire Zone 1A101 has several combinations of adjacency with other fire zones within Fire Area 1. An adjacency discussion is provided in the fire area analysis for Fire Area 1.

- (b) FIRE ZONE 1A107: EQUIPMENT DRAIN TRANSFER TANK RM, ELEV. 93' 0"
- (1) Safety-Related Equipment
None
 - (2) Fire Zone Analysis
 - (a) Fire Zone 1A107 is located in the Auxiliary Building on Elev. 93' 0". The ceiling and North and East walls of Fire Zone 1A107 are 3-hour rated fire barriers. The South and West walls are non-rated barriers, while the floor is a below grade, non-rated, exterior boundary (Ref. Architectural Drawing A-0632).
 - (b) The combustible loading in Fire Zone 1A107 amounts to a low fire load. The only contributors to this combustible loading are the transient combustibles postulated for this fire zone (Ref. Calculation MC-QSP64-86058).
 - (c) Fire Zone 1A107 does not contain any safety-related equipment and the following fire protection measures are provided: accessibility to manual hose streams and portable fire extinguishers.

GRAND GULF NUCLEAR GENERATING STATION
Updated Final Safety Analysis Report (UFSAR)

- (d) Fire Zone 1A107 does not contain any safe shutdown components. Therefore, a fire originating in this fire zone will not affect either train of safe shutdown. However, this fire zone has several combinations of adjacency with other fire zones within this fire area. An adjacency discussion is provided in the fire area analysis for Fire Area 1.

- (c) FIRE ZONE 1A108: FLOOR DRAIN TRANSFER TANK ROOM, ELEV. 93' 0"
 - (1) Safety-Related Equipment

None

 - (2) Fire Zone Analysis
 - (a) Fire Zone 1A108 is located in the Auxiliary Building on Elev. 93' 0". The ceiling and a portion of the East wall of Fire Zone 1A108 are 3-hour rated fire barriers. The floor and the North, South, and West walls are non-rated barriers (Ref. Architectural Drawing A-0632).

 - (b) The combustible loading in Fire Zone 1A108 amounts to a low fire load. The only contributors to this combustible loading are the transient combustibles postulated for this fire zone (Ref. Calculation MC-QSP64-86058).

 - (c) Fire Zone 1A108 does not contain any safety-related equipment and the following fire protection measure is provided: accessibility to manual hose streams and portable fire extinguishers.

 - (d) Fire Zone 1A108 does not contain any safe shutdown components. Therefore, a fire originating in this Fire Zone will not affect either train of safe

GRAND GULF NUCLEAR GENERATING STATION
Updated Final Safety Analysis Report (UFSAR)

shutdown. However, this fire zone has several combinations of adjacency with other fire zones within this fire area. An adjacency discussion is provided in the fire area analysis for Fire Area 1.

(d) FIRE ZONE 1A111: PIPING PENETRATION AREA, ELEV. 93' 0"

(1) Safety-Related Equipment

Electrical Cable and Raceway

(2) Fire Zone Analysis

(a) Fire Zone 1A111 is located in the Auxiliary Building on Elev. 93' 0". The ceiling and North wall of Fire Zone 1A111 are 3-hour rated fire barriers. The floor and South, East and West walls are non-rated barriers (Ref. Architectural Drawing A-0632).

(b) The combustible loading in Fire Zone 1A111, including transient combustibles, amounts to a low fire load. The major contributor to this combustible loading is the concrete joint sealant in the walls. The in situ combustible loading in this fire zone amounts to less than a 15-minute fire duration (Ref. Calculation MC-QSP64-86058).

(c) Fire Zone 1A111 contains safety-related equipment and the following fire protection measures are provided: smoke detection and accessibility to manual hose streams and portable fire extinguishers.

(d) Fire Zone 1A111 does not contain any safe shutdown components. Therefore, a fire originating in this fire zone will not affect either train of safe shutdown. However, this fire zone has

GRAND GULF NUCLEAR GENERATING STATION
Updated Final Safety Analysis Report (UFSAR)

several combinations of adjacency with other fire zones within this fire area. An adjacency discussion is provided in the fire area analysis for Fire Area 1.

(e) FIRE ZONE 1A114: FAN COIL AREA. ELEV. 93' 0" and 103' 0"

(1) Safety-Related Equipment

Electrical Cable and Raceway
LPCS Instrument Panel

(2) Fire Zone Analysis

(a) Fire Zone 1A114 is located in the Auxiliary Building on Elev. 93' 0" and 103' 0". The ceiling and the North wall are 3-hour rated fire barriers, except for the portion of the North wall between Column Lines H and K.2 which is a non-rated barrier. The East and West zone boundaries are open to Fire Zones 1A101 and 1A120, respectively. The floor and South wall are below grade, non-rated, exterior boundaries (Ref. Architectural Drawing A-0632).

(b) The combustible loading in Fire Zone 1A114, including transient combustibles, amounts to a low fire load. The major contributors to this combustible loading are the concrete joint sealant in the walls and the electrical cable present in the zone. The in situ combustible loading in this fire zone amounts to less than a 45-minute fire duration (Ref. Calculation MC-QSP64-86058).

(c) Fire Zone 1A114 contains safety-related equipment and the following fire protection measures are provided: smoke detection and accessibility to manual hose streams and portable fire extinguishers.

GRAND GULF NUCLEAR GENERATING STATION
Updated Final Safety Analysis Report (UFSAR)

(d) Fire Zone 1A114 contains only Division I safe shutdown components. Therefore, a fire originating in this fire zone will not affect more than one train of safe shutdown. However, this fire zone has several combinations of adjacency with other fire zones within this fire area. An adjacency discussion is provided in the fire area analysis for Fire Area 1.

(f) FIRE ZONE 1A117: MISC. EQUIP. AREA, ELEV. 93' 0"
& 103' 0"

(1) Safety-Related Equipment

Electrical Cable and Raceway
RHR "C" Instrument Panel
HPCS Instrument Panel

(2) Fire Zone Analysis

(a) Fire Zone 1A117 is located in the Auxiliary Building on Elev. 93' 0" and 103' 0". The ceiling, South and East boundaries, and that portion of the North wall bordering on the Control Building of Fire Zone 1A117 are 3-hour rated fire barriers, except for those portions of the South and East boundaries that are open to Fire Zones 1A120 and 1A101, respectively. The remaining portion of the North wall, as well as the floor and West wall, are below grade, non-rated, exterior boundaries, except for the 2-hour rated portion of the North wall which interfaces with Elevator No. 3 (Ref. Sect. 9A.3.2.13.a) and Stair 1A10 (Ref. Architectural Drawing A-0632).

(b) The combustible loading in Fire Zone 1A117, including transient combustibles, amounts to a low fire load. The major contributors to this combustible loading are the concrete

GRAND GULF NUCLEAR GENERATING STATION
Updated Final Safety Analysis Report (UFSAR)

joint sealant in the walls and the electrical cable present in this fire zone. The in situ combustible loading in this fire zone amounts to less than a 30-minute fire duration (Ref. Calculation MC-QSP64-86058).

- (c) Fire Zone 1A117 contains safety-related equipment and the following fire protection measures are provided: coverage by an automatic sprinkler system in the portion of Fire Zone 1A117 that is east of Column Line J.5, smoke detection, and accessibility to manual hose streams and portable fire extinguishers.
- (d) Fire Zone 1A117, which is located west of Column Line G.4, contains both Division I and II safe shutdown components. A qualified rated one-hour fire wrap or wrap which provides an equivalent one hour fire resistance with evaluation (EC 21147) is provided on the Division I safe shutdown vertical cable tray 1AATWT and Division I safe shutdown horizontal cable trays 1AATMG, and 1AATWG in accordance with the risk informed, performance based analysis as approved by Amendment 170 to the Facility Operating License. The qualified rated one-hour fire wrap or wrap which provides an equivalent one hour fire resistance with evaluation (EC 21147) is installed on the Division I safe shutdown cable trays 1AATWT, 1AATMG and 1AATWG and specified intervening items where the Division I cable trays would be subject to damage from a floor based transient combustible fire which could also cause a failure of the unprotected safe shutdown Division II RHR B minimum flow transmitter and its associated sensing lines. The qualified rated one-hour

GRAND GULF NUCLEAR GENERATING STATION
Updated Final Safety Analysis Report (UFSAR)

fire wrap or wrap which provides an equivalent one hour fire resistance with evaluation (EC 21147) is also installed on the Division I safe shutdown cable trays 1AATMG, 1AATWG, 1AATWT and specified intervening items where the Division I cable trays would be subject to damage from a floor based transient combustible fire located between Division I cable trays 1AATMG, 1AATWG, 1AATWT and Division II conduit 1ABRW310 and Division II cable trays 1ABTOT and 1ABTMG). In summary, the qualified rated one-hour fire wrap or wrap which provides an equivalent one hour fire resistance with evaluation (EC 21147) is provided on specified portions of the Division I safe shutdown cable trays 1AATWT, 1AATMG and 1AATWG from the north wall of the Auxiliary Building southward to a point 19.1 feet south of penetration AJ-29 where the Division II RHR-B pump minimum flow transmitter tubing enters the RHR-B pump room. In addition, Amendment 170 provides specific combustible controls for Fire Area 1. Combustible Controls for Amendment 170 to the Facility Operating License include a designated transient combustible exclusion zone and prohibits Transient Combustible Storage areas for Fire Area 1 (Auxiliary Building elevation 93/103'). The Specific wrap requirements and combustible controls are detailed in Amendment 170 to the Facility Operating License.

Intervening combustibles located within the transient combustible exclusion zone as defined by Amendment 170 to the Facility Operating License consist of

GRAND GULF NUCLEAR GENERATING STATION
Updated Final Safety Analysis Report (UFSAR)

cable trays containing IEEE-383 cable installed in accordance with the requirements of Regulatory Guide 1.75.

Based on the separation between these raceways, the specified raceway wrap and combustible controls in accordance with Amendment 170 to the Facility Operating License, a postulated fire will not affect or propagate to affect more than one train of safe shutdown in this fire zone.

An automatic sprinkler system is installed within the transient combustible exclusion zone described above and extends west to Column Line J.5 and east into Fire Zone 1A101 to Column Line 10.5. A smoke detection system is also provided. Manual fire fighting is provided by installed fire extinguishers and manual hose stream.

However, Fire Zone 1A117 has several combinations of adjacency with other fire zones within Fire Area 1. An adjacency discussion is provided in the fire area analysis for Fire Area 1.

- (g) FIRE ZONE 1A120: CCW PMP & HEAT EXCHANGER AREA, Elev. 93' 0"
- (1) Safety-Related Equipment
 - Electrical Cable and Raceway
 - (2) Fire Zone Analysis
 - (a) Fire Zone 1A120 is located in the Auxiliary Building on Elev. 93' 0". The ceiling and the East wall are 3-hour rated fire barriers, except for the portion of the East boundary which is open to Fire Zone 1A114. The interface with Stair 1A12 is a 2-hour rated fire barrier.

GRAND GULF NUCLEAR GENERATING STATION
Updated Final Safety Analysis Report (UFSAR)

The floor and West wall are below grade, non-rated, exterior barriers. The North zone boundary is open to Fire Zone 1A117 (Ref. Architectural Drawing A-0632).

- (b) The combustible loading in Fire Zone 1A120, including transient combustibles, amounts to a low fire load. The major contributor to this combustible loading is electrical cable present in the room. The in situ combustible loading in Fire Zone 1A120 amounts to less than a 30-minute fire duration (Ref. Calculation MC-QSP64-86058).
 - (c) Fire Zone 1A120 contains safety-related equipment and the following fire protection measures are provided: smoke detection and accessibility to manual hose streams and portable fire extinguishers.
 - (d) Fire Zone 1A120 does not contain any safe shutdown components. Therefore, a fire originating in this fire zone will not affect either train of safe shutdown. However, this fire zone has several combinations of adjacency with other fire zones within this fire area. An adjacency discussion is provided in the fire area analysis for Fire Area 1.
- (h) FIRE ZONE 1A127: AUXILIARY RADWASTE PIPE TUNNEL, ELEV. 79' 0"
- (1) Safety-Related Equipment
None
 - (2) Fire Zone Analysis

GRAND GULF NUCLEAR GENERATING STATION
Updated Final Safety Analysis Report (UFSAR)

- (a) Fire Zone 1A127 is located in the Auxiliary Building on Elev. 79' 0". Fire Zone 1A127 is a below grade pipe tunnel, bounded by non-rated, exterior barriers, except for the ceiling, which is a non-rated interface with the floor of Fire Zones 1A101, 1A114, 1A108, 1A131, and 1A111 (Ref. Architectural Drawing A-0632). Fire Zone 1A127 also interfaces with the Radwaste Building. However, since there are no safe shutdown components in the Radwaste Building, it is beyond the scope of this report.
 - (b) The combustible loading in Fire Zone 1A127, with no transients postulated, amounts to a low fire load. The only contributor to this combustible loading is the concrete joint sealant in the walls. The in situ combustible loading in Fire Zone 1A127 amounts to less than a 30-minute fire duration (Ref. Calculation MC-QSP64-86058).
 - (c) Fire Zone 1A127 does not contain any safety-related equipment and the fire protection provided is accessibility to manual hose streams and portable fire extinguishers.
 - (d) Fire Zone 1A127 does not contain any safe shutdown components. Therefore, a fire originating in this fire zone will not affect either train of safe shutdown. However, this fire zone has several combinations of adjacency with other fire zones within this fire area. An adjacency discussion is provided in the fire area analysis for Fire Area 1.
- (i) FIRE ZONE 1A130: TRANSFER PUMP MONORAIL ROOM, ELEV. 103' 0"
- (1) Safety-Related Equipment

GRAND GULF NUCLEAR GENERATING STATION
Updated Final Safety Analysis Report (UFSAR)

None

(2) Fire Zone Analysis

- (a) Fire Zone 1A130 is located in the Auxiliary Building on Elev. 103' 0". The ceiling, North wall, and the containment wall where the North and West boundaries connect adjacent to Fire Zone 1A130 are 3-hour rated fire barriers. The floor and South, East, and West walls are non-rated barriers (Ref. Architectural Drawing A-0632).
- (b) The combustible loading in Fire Zone 1A130, including transient combustibles, amounts to a low fire load. The in situ combustible loading in Fire Zone 1A130 amounts to less than a 15-minute fire duration (Ref. Calculation MC-QSP64-86058).
- (c) Fire Zone 1A130 does not contain any safety-related equipment and the fire protection provided is accessibility to manual hose streams and portable fire extinguishers.
- (d) Fire Zone 1A130 does not contain any safe shutdown components. Therefore, a fire originating in this fire zone will not affect either train of safe shutdown. However, this fire zone has several combinations of adjacency with other fire zones within this fire area. An adjacency discussion is provided in the fire area analysis for Fire Area 1.

(j) FIRE ZONE 1A131: FLOOR DRAIN TRANSFER PUMP ROOM, ELEV. 93' 0"

(1) Safety-Related Equipment

None

(2) Fire Zone Analysis

GRAND GULF NUCLEAR GENERATING STATION
Updated Final Safety Analysis Report (UFSAR)

- (a) Fire Zone 1A131 is located in the Auxiliary Building on Elev. 93' 0". Only the North wall and the containment wall where the North and West boundaries connect adjacent to Fire Zone 1A131 are 3-hour rated fire barriers. The floor, ceiling, and South, East, and West walls are non-rated barriers (Ref. Architectural Drawing A-0632).
- (b) The combustible loading in Fire Zone 1A131, including transient combustibles, amounts to a low fire load. The major contributors to this combustible loading are the concrete joint sealant present and the transient combustibles postulated for this fire zone. The in situ combustible loading in this fire amounts to less than a 15-minute fire duration (Ref. Calculation MC-QSP64-86058).
- (c) Fire Zone 1A131 does not contain any safety-related equipment and the accessibility to manual hose streams and portable fire extinguishers is available as a fire protection measure.
- (d) Fire Zone 1A131 does not contain any safe shutdown components. Therefore, a fire originating in this fire zone will not affect either train of safe shutdown. However, this fire zone has several combinations of adjacency with other fire zones within this fire area. An adjacency discussion is provided in the fire area analysis for Fire Area 1.

9A.5.2 FIRE AREA 2

9A.5.2.1 FIRE AREA DESCRIPTION

Fire Area 2 consists of the fire zones shown below in the Included Fire Zones listing. The fire zones in Fire Area 2 are located at each elevation of the Auxiliary Building and in the Enclosure

GRAND GULF NUCLEAR GENERATING STATION
Updated Final Safety Analysis Report (UFSAR)

Building (located on the roof of the Auxiliary Building), which envelops the containment dome. The floor on Elev. 93' 0" is the slab of the Auxiliary Building and is a non-rated exterior

GRAND GULF NUCLEAR GENERATING STATION
Updated Final Safety Analysis Report (UFSAR)

barrier. The walls that form the boundary of Fire Area 2 on Elev. 93' 0", 119' 0", 133' 0", and 166' 0" are 3-hour rated fire barriers. The only 3-hour rated fire barrier on Elev. 185' 0" and 228' 0" is the containment wall. The ceiling of Fire Area 2 is the non-rated roof of the Auxiliary Building. The walls and roof of the Enclosure Building are also non-rated exterior barriers. The floor of the Enclosure Building is a 3-hour rated fire barrier (Ref. Architectural Drawings A-0632 through A-0637).

INCLUDED FIRE ZONES	DESCRIPTION
1A102	RHR A Heat Exchanger Room, Elev. 93' 0"
1A103	RHR A Pump Room, Elev. 93' 0"
1A104	RCIC Room, Elev. 93' 0"
1A105	RHR B Pump Room, Elev. 93' 0"
1A106	RHR B Heat Exchanger Room, Elev. 93' 0"
1A124	Blowout Shaft, Elev. 108' 0"
1A125	Blowout Shaft, Elev. 108' 0"
1A132	Pipe Chase, Elev. 93' 0"
1A202	RHR A Heat Exchanger Room, Elev. 119' 0"
1A203	Piping Penetration Room, Elev. 119' 0"
1A204	Piping Penetration Room, Elev. 119' 0"
1A205	Piping Penetration Room, Elev. 119' 0"
1A206	RHR B Heat Exchanger Room, Elev. 119' 0"
1A209	RWCU Recirculating Pump A Room, Elev. 115' 0"
1A210	RWCU Recirculating Pump B Room, Elev. 115' 0"
1A224	Pipe Chase, Elev. 128' 0"
1A225	Blowout Shaft, Elev. 128' 0"
1A226	Pipe Chase, Elev. 115' 0"
1A303	RHR A Heat Exchanger Room, Elev. 139' 0"
1A304	Piping Penetration Room, Elev. 139' 0"
1A305	Main Steam Tunnel, Elev. 140' 0"
1A306	Piping Penetration Room, Elev. 139' 0"
1A307	RHR B Heat Exchanger Room, Elev. 139' 0"
1A439	Blowout Shaft, Elev. 166' 0"
1A440	Blowout Shaft, Elev. 166' 0"
1A441	RHR Room B blowout Shaft, Elev. 166' 0"
1A442	RHR Room A Blowout Shaft, Elev., 166' 0"
1A506	Unassigned Area. Elev. 185' 0" (Enclosure Building)
1A508	Unassigned Area, Elev. 185' 0" (Enclosure Building)
1A605	Recirculation Fan Area, Elev. 228' 0" (Enclosure Bldg.)

9A.5.2.2 SAFE SHUTDOWN EQUIPMENT

Divisions I and II

GRAND GULF NUCLEAR GENERATING STATION
Updated Final Safety Analysis Report (UFSAR)

9A.5.2.3 FIRE AREA ANALYSIS

- (a) Fire Area 2 can be segregated into four groups of fire zones. Three of these groups are located in the Auxiliary Building proper; the remaining group is in the Enclosure Building.
- (b) The walls along Column Line 9.0 and 11.0 separate the fire zones within the Auxiliary Building into three groups. These walls are 3-hour rated fire barriers from the slab at Elev. 93' 0" to the roof at Elev. 185' 0", except for steel pressure relief panels that open into Fire Zones 1A124 and 1A125 (blowout shafts), allowing the only path of communication between these three groups.
- (c) The group consisting of those fire zones located in the Enclosure Building communicates with each group of fire zones located in the Auxiliary Building through non-rated concrete barriers of the blowout shafts.
- (d) The fire zones in Fire Area 2 are divided into four groups, as follows:
 - (1) Group A - Fire Zones 1A105, 1A106, 1A205, 1A206, 1A306, 1A307, and 1A441 are located north of Column Line 11.0. Fire Zone 1A441 does not contain any safe shutdown components. All of the other fire zones in this group contain only Division II safe shutdown components, as shown in the microcomputer database (Ref. FPP-1, Appendix C Data). Fire Zone 1A307 also contains RHR Heat Exchanger 'B' inlet temperature indication circuits utilized for alternate suppression pool temperature monitoring in the event of a fire in Containment (as discussed in Fire Area 25, Section 9A.5.25). This group of fire zones is separated from other fire zones in Fire Area 2 by the non-rated Auxiliary Building floor slab at Elev. 93' 0" and 3-hour rated fire barriers (walls) between Elev.

GRAND GULF NUCLEAR GENERATING STATION
Updated Final Safety Analysis Report (UFSAR)

93' 0" and Elev. 185' 0", with the exception of the steel pressure relief panels installed in the 3-hour rated fire barrier that separates Group A Fire Zone 1A105 from the blowout shaft, Fire Zone 1A124. The floor at Elev. 185' 0" and West wall of Fire Zone 1A441 (above Elev. 185') are open paths to the exterior.

- (2) Group B - Fire Zones 1A102, 1A103, 1A202, 1A203, 1A303, 1A304, and 1A442 are located south of Column Line 9.0. Fire Zone 1A442 does not contain any safe shutdown components. All of the other fire zones in this group contain only Division I safe shutdown components, as shown in the microcomputer database (Ref. FPP- 1, Appendix C Data). Fire Zone 1A303 also contains RHR Heat Exchanger 'A' inlet temperature indication circuits utilized for alternate suppression pool temperature monitoring in the event of a fire in Containment (as discussed in Fire Area 25, Section 9A.5.25). This group of fire zones is separated from other fire zones in Fire Area 2 by the non-rated Auxiliary Building floor slab at Elev. 93' 0" and 3-hour rated fire barriers (walls) between Elev. 93' 0" and Elev. 185' 0", with the exception of the steel pressure relief panels installed in the 3-hour rated fire barrier that separates Fire Zone 1A103 and the blowout shaft, Fire Zone 1A125. The floor at Elev. 185' 0" and the West wall of Fire Zone 1A442 (above Elev. 185' 0") are open paths to the exterior.
- (3) Group C - Fire Zones 1A104, 1A132, 1A204, 1A209, 1A210, 1A224, 1A225, 1A226, 1A305, 1A439, and 1A440 are located between Column Lines 9.0 and 11.0. Fire Zones 1A104, 1A305 and 1A204 contain only Division I safe shutdown components (Ref. FPP-1 Appendix C Data) and 1A224 contains safe shutdown piping associated with

GRAND GULF NUCLEAR GENERATING STATION
Updated Final Safety Analysis Report (UFSAR)

Division I. 1A210 contains Division II safe shutdown components that are not part of the success path required for hot shutdown following a fire in this area. The other fire zones in this group do not contain safe shutdown components. This group of fire zones is separated from other fire zones in Fire Area 2 by the non-rated Auxiliary Building floor slab at Elev. 93' 0" and 3-hour rated fire barriers (walls) between Elev. 93' 0" and Elev. 185' 0", with the exception of the steel pressure relief panels installed in the 3-hour rated fire barrier that separates Group C Fire Zones 1A104, 1A204, 1A209, 1A210, and 1A225 from the blowout shafts, Fire Zones 1A124 and 1A125. The floor at Elev. 185' 0" and the West wall of Fire Zone 1A441 (above Elev. 185' 0") are open paths to the exterior.

- (4) Group D - Fire Zones 1A506, 1A508, and 1A605 comprise Group D. None of these fire zones contain any safe shutdown components, as shown in the microcomputer data base (Ref. FPP-1, Appendix C Data). Fire Zones 1A506, 1A508, and 1A605 are located in the Enclosure Building above the Auxiliary Building and are not separated from each other by barriers. Fire Zones 1A506 and 1A508 communicate with Fire Zones 1A124, 1A125, 1A439, and 1A440 (blowout shafts) via their non-rated concrete roof and walls above Elev. 185' 0". The blowout shafts, Fire Zones 1A124 and 1A125, also separate Groups A, B, and C at Elev. 108' 0" to Elev. 185' 0". The floor and walls of Fire Zones 1A124 and 1A125 below Elev. 185' 0" are 3-hour rated fire barriers, with the exception of steel pressure relief panels that permit communication with Group A (via Fire Zone 1A105); Group B (via Fire Zone 1A103); and Group C (via Fire Zones 1A104, 1A204, 1A209, 1A210, and 1A225).

GRAND GULF NUCLEAR GENERATING STATION
Updated Final Safety Analysis Report (UFSAR)

- (e) The fire zones within Group A are separated by non-rated barriers. Since the fire zones in Group A only contain Division II safe shutdown components, a postulated fire originating in any fire zone within this group will not affect more than one train of safe shutdown within Group A.
- (f) The fire zones within Group B are also separated by non-rated barriers. Since the fire zones in Group B only contain Division I safe shutdown components, a postulated fire originating in any fire zone within this group will not affect more than one train of safe shutdown within Group B.
- (g) The fire zones within Group C are separated by non-rated barriers. Fire Area 2 is not vulnerable to the multiple spurious operation scenarios that credit mitigation by the Division II equipment located in fire zone 1A210. Therefore, this Division II equipment is not part of the success path required for hot shutdown following a fire in this area. Since the Div II safe shutdown components contained by the fire zones within Group C are only credited for mitigation of scenarios resulting from a fire in a different Fire Area, a postulated fire originating in any fire zones in Group C will not prevent safe shutdown.
- (h) The Fire Zones within Group D are not separated by barriers. Since the fire zones in Group D do not contain any safe shutdown components, a postulated fire originating in any fire zone within this group will not affect either train of safe shutdown within Group D.
- (i) The closest Division I and II safe shutdown components not protected with fire barriers are located in Group C and Group A, respectively. The non-rated steel pressure relief panels located in the North and South walls and floor of Fire Zone 1A124 (blowout shaft) are the only means of communication between Group A and C fire zones.

GRAND GULF NUCLEAR GENERATING STATION
Updated Final Safety Analysis Report (UFSAR)

- (j) The only path of communication from the blowout shaft, Fire Zone 1A124, to Group A fire zones is through non-rated pressure relief panels located in the North wall and floor of Fire Zone 1A124. These panels both interface with Fire Zone 1A105.
- (k) Non-rated pressure relief panels located at three elevations in the South wall of the blowout shaft, Fire Zone 1A124, interface with Fire Zones 1A104, 1A204, and 1A210 in Group C.
- (l) Based on the above communication paths between Group A and Group C fire zones, the closest Division I and II safe shutdown components are located in Fire Zones 1A204 and 1A105. Division I raceway 1AARMH45 in Fire Zone 1A204 and Division II raceway 1ABRMH66 in Fire Zone 1A105 are the closest Division I and II safe shutdown components. These components are separated horizontally by more than 20 feet for any of the communication paths between Fire Zones 1A105 and 1A204. Safe Shutdown cables and components located in Fire Zone 1A104 are credited only for a Control Room Fire.
- (m) There are no intervening combustibles located within the horizontal separation distance between the Division II safe shutdown raceway 1ABRMH66 and the blowout shaft, Fire Zone 1A124. In addition, the portion of the horizontal separation distance in Fire Zones 1A104, 1A204, and 1A210 (which accounts for all of the possible communication paths) do not contain any intervening combustibles.
- (n) The blowout shaft, Fire Zone 1A124, consists of the remaining horizontal separation distance, which contains concrete joint sealant (Rodofoam II). The fire duration for the entire blowout shaft (Elev. 108' 0" to 185' 0") is less than 60-minutes. Most of the joint sealant is embedded between the concrete joints and the characteristics of the Rodofoam II joint sealant are such that it is considered a fire barrier,

GRAND GULF NUCLEAR GENERATING STATION
Updated Final Safety Analysis Report (UFSAR)

as it does not support continuous combustion without a constant fuel source (Ref. Fire Tests Performed at the Portland Cement Association Fire Test Laboratory).

- (o) Fire Zone 1A305 also contains Division I safe shutdown components. The horizontal separation distance between Division I safe shutdown components in Fire Zone 1A305 (1AARM245) and Division II safe shutdown components in Fire Zone 1A105 (1ABRMH66) is more than 30 feet. The paths of communication between these fire zones are typical to those discussed between Fire Zones 1A204 and 1A105, with the addition of Fire Zone 1A226. Fire Zone 1A226 and that portion of the separation distance in 1A305 do not contain intervening combustibles.
- (p) Based on a restricted path of travel, size and location of the pressure relief panels in relation to the unprotected Division I and II safe shutdown components; no intervening combustibles in that portion of the horizontal separation distance in Fire Zones 1A105, 1A104, 1A210, 1A204, 1A226, or 1A305; and the low intervening combustible loading of the Rodofam II in the remaining separation distance in Fire Zone 1A124; a fire originating in any fire zone in Group A, B, C, or D will not affect, or propagate to affect, more than one train of safe shutdown.
- (q) Based on this adjacency discussion, it is concluded that a fire originating in any fire zone in Fire Area 2 will not affect, or propagate to affect, more than one train of safe shutdown.
- (r) Although the fire protection provided in Fire Area 2 does not strictly comply with the criteria set forth in Section 9A.3.1 of the Appendix R evaluation procedure, in that sprinkler coverage is not provided for Fire Area 2 and redundant safe shutdown components are not separated completely by 3-hour rated fire

GRAND GULF NUCLEAR GENERATING STATION
Updated Final Safety Analysis Report (UFSAR)

barriers, the fire protection provided in Fire Area 2 is more than adequate to ensure that at least one train of safe shutdown components will remain free of fire damage.

- (s) The postulated fire with the greatest severity in Fire Area 2 is a fire in Fire Zone 1A124 or Fire Zone 1A125. The total fire severity Fire Zones 1A124 and 1A125, with no transient combustibles postulated, amounts to a low fire load. The maximum in situ combustible loading in each of these fire zones amounts to less than a 60-minute fire duration (Ref. Calculation MC-QSP64-86058). Since Fire Area 2 is separated from all other fire areas by 3-hour rated fire barriers, a fire occurring in Fire Area 2 will not spread into any other fire area.

9A.5.2.4 Fire Zone Analyses

- a. FIRE ZONE 1A102: RHR A HEAT EXCHANGER ROOM, ELEV. 93' 0" and 108' 1-1/16".
 - 1. Safety-Related Equipment
 - RHR A Heat Exchanger
 - Electrical Cable and Raceway
 - 2. Fire Zone Analysis
 - (a) Fire Zone 1A102 is located in the Auxiliary Building on Elev. 93' 0". The South, East, and West walls of Fire Zone 1A102 are 3-hour rated fire barriers. The North wall and floor, which is part of the Auxiliary Building base mat, are non-rated barriers. The ceiling is an open steel grating and is non-rated (Ref. Architectural Drawing A-0632)
 - (b) The combustible loading in Fire Zone 1A102, including transient combustibles, amounts a low fire load. The major contributors to this combustible loading are the electrical cables present in the fire zone. The in situ combustible loading in Fire Zone 1A102 amounts to less than a 15-minute fire duration (Ref. Calculation MC-QSP64-86058).

GRAND GULF NUCLEAR GENERATING STATION
Updated Final Safety Analysis Report (UFSAR)

- (c) Fire Zone 1A102 contains safety-related equipment and the following fire protection measures are provided: heat detection and accessibility to manual hose streams and portable fire extinguishers.
- (d) Fire Zone 1A102 contains only Division I safe shutdown components. Therefore, a fire originating in this fire zone will not affect more than one train of safe shutdown components. However, this fire zone has several combinations of adjacency with other fire zones within this fire area. An adjacency discussion is provided in the fire area analysis for Fire Area 2.
- (e) Ambient temperatures in this Fire Zone can be above 120F during normal operation, which exceeds the operating temperature of the smoke detectors. In lieu of smoke detection, heat detection is provided in this fire zone as evaluated in GGNS-FP-19-00002.

b. FIRE ZONE 1A103: RHR A PUMP ROOM, ELEV. 93' 0"

1. Safety-Related Equipment

RHR A Jockey Pump
RHR A Pump
Electrical Cable and Raceway
Suppression Pool Level Monitors

2. Fire Zone Analysis

- (a) Fire Zone 1A103 is located in the Auxiliary Building on Elev. 93' 0". The East, West, North, and a portion of the South walls of Fire Zone 1A103 are 3-hour rated fire barriers, except for the non-rated pressure relief panels in the North wall. The remainder of the South wall, the ceiling and the floor, which is part of the Auxiliary Building base mat, are non-rated barriers (Ref. Architectural Drawing A-0632).
- (b) The combustible loading in Fire Zone 1A103, including transient combustibles amounts to a low fire load. The major contributors to this combustible loading are the electrical cables,

GRAND GULF NUCLEAR GENERATING STATION
Updated Final Safety Analysis Report (UFSAR)

concrete joint sealant, and PC storage present in the fire zone. The in situ combustible loading in Fire Zone 1A103 amounts to less than a 30-minute fire duration (Ref. Calculation MC-QSP64-86058).

- (c) Fire Zone 1A103 contains safety-related equipment and the following fire protection measures are provided: heat detection and accessibility to manual hose streams and portable fire extinguishers.
- (d) Fire Zone 1A103 contains only Division I safe shutdown components. Therefore, a fire originating in this fire zone will not affect more than one train of safe shutdown components. However, this fire zone has several combinations of adjacency with other fire zones within this fire area. An adjacency discussion is provided in the fire area analysis for Fire Area 2.
- (e) Ambient temperatures in this Fire Zone can be above 120F during normal operation, which exceeds the operating temperature of the smoke detectors. In lieu of smoke detection, heat detection is provided in this fire zone as evaluated in GGNS-FP-19-00002.

c. FIRE ZONE 1A104: RCIC ROOM, ELEV. 93' 0"

1. Safety-Related Equipment

RCIC Room Cooler
RCIC Pump
RCIC Turbine
RCIC Turbine Gland Seal Unit
Electrical Cable and Raceway

2. Fire Zone Analysis

- (a) Fire Zone 1A104 is located in the Auxiliary Building on Elev. 93' 0". The North, East, West, and South walls of Fire Zone 1A104 are 3-hour rated fire barriers, except for two non-rated steel pressure relief panels in the North and South walls and the interface with Fire Zone 1A132. The ceiling, which is part grating, and

GRAND GULF NUCLEAR GENERATING STATION
Updated Final Safety Analysis Report (UFSAR)

the floor, which is a part of the Auxiliary Building base mat, are non-rated barriers (Ref. Architectural Drawing A-0632).

- (b) The combustible loading in Fire Zone 1A104, including transient combustibles, amounts to a low fire load. The major contributors to this combustible loading are the electrical cables, concrete joint sealant and PC storage present in the room. The in situ combustible loading in Fire Zone 1A104 amounts to less than a 30-minute fire duration (Ref. Calculation MC-QSP64-86058).
- (c) Fire Zone 1A104 contains safety-related equipment and the following fire protection measures are provided: heat detection and accessibility to manual hose streams and portable fire extinguishers.
- (d) Fire Zone 1A104 contains only Division 1 safe shutdown components. Therefore, a fire originating in this fire zone will only affect Division 1 safe shutdown components. These Division 1 safe shutdown components are credited only for a Control Room fire. This fire zone has several combinations of adjacency with other fire zones within this fire area. An adjacency discussion is provided in the fire area analysis for Fire Area 2.
- (e) Ambient temperatures in this Fire Zone can be above 120F during normal operation, which exceeds the operating temperature of the smoke detectors. In lieu of smoke detection, heat detection is provided in this fire zone as evaluated in GGNS-FP-19-00002.

d. FIRE ZONE 1A105: RHR B PUMP ROOM, ELEV. 93' 0"

1. Safety-Related Equipment

RHR B Pump
RHR B Jockey Pump
Electrical Cable and Raceway
Suppression Pool Level Monitors

GRAND GULF NUCLEAR GENERATING STATION
Updated Final Safety Analysis Report (UFSAR)

2. Fire Zone Analysis

- (a) Fire Zone 1A105 is located in the Auxiliary Building on Elev. 93' 0". The East, West, South, and a portion of the North walls of Fire Zone 1A105 are 3-hour rated fire barriers, except for the non-rated pressure relief panels in the South wall. The remainder of the North wall, the floor, which is part of the Auxiliary Building base mat, and the ceiling are non-rated barriers (Ref. Architectural Drawing A-0632).
- (b) The combustible loading in Fire Zone 1A105, including transient combustibles, amounts to a low fire load. The major contributors to this combustible loading are the electrical cables, concrete joint sealant and PC storage present in the fire zone. The in situ combustible loading in Fire Zone 1A105 amounts to less than a 30-minute fire duration (Ref. Calculation MC-QSP64-86058).
- (c) Fire Zone 1A105 contains safety-related equipment and the following fire protection measures are provided: heat detection and accessibility to manual hose streams and portable fire extinguishers.
- (d) Fire Zone 1A105 contains only Division II safe shutdown components. Therefore, a fire originating in this fire zone will not affect more than one train of safe shutdown components. However, this fire zone has several combinations of adjacency with other fire zones within this fire area. An adjacency discussion is provided in the fire area analysis for Fire Area 2.
- (e) Ambient temperatures in this Fire Zone can be above 120F during normal operation, which exceeds the operating temperature of the smoke detectors. In lieu of smoke detection, heat detection is provided in this fire zone as evaluated in GGNS-FP-19-00002.

GRAND GULF NUCLEAR GENERATING STATION
Updated Final Safety Analysis Report (UFSAR)

- e. FIRE ZONE 1A106: RHR B HEAT EXCHANGER AREA, ELEV. 93' 0" and 108' 1-1/16".
1. Safety-Related Equipment

RHR B Heat Exchanger
Electrical Cable and Raceway
 2. Fire Zone Analysis
 - (a) Fire Zone 1A106 is located in the Auxiliary Building on Elev. 93' 0". The North, East, and West walls of Fire Zone 1A106 are 3-hour rated fire barriers. The South wall and floor, which is part of the Auxiliary Building base mat, are non-rated barriers. The ceiling is an open steel grating and is not rated (Ref. Architectural Drawing A-0632).
 - (b) The combustible loading in Fire Zone 1A106, including transient combustibles, amounts to a low fire load. The major contributors to this combustible loading are the electrical cables present in the fire zone. The in situ combustible loading in Fire Zone 1A106 amounts to less than a 15-minute fire duration (Ref. Calculation MC-QSP64-86058).
 - (c) Fire Zone 1A106 contains safety-related equipment and the following fire protection measures are provided: heat detection and accessibility to manual hose streams and portable fire extinguishers.
 - (d) Fire Zone 1A106 contains only Division II safe shutdown components. Therefore, a fire originating in this fire zone will not affect more than one train of safe shutdown components. However, this fire zone has several combinations of adjacency with other fire zones within this fire area. An adjacency discussion is provided in the fire area analysis for Fire Area 2.
 - (e) Ambient temperatures in this Fire Zone can be above 120F during normal operation, which exceeds the operating temperature of the smoke detectors. In lieu of smoke detection, heat detection is provided in this fire zone as evaluated in GGNS-FP-19-00002.

GRAND GULF NUCLEAR GENERATING STATION
Updated Final Safety Analysis Report (UFSAR)

- f. FIRE ZONE 1A124: BLOWOUT SHAFT, ELEV. 108' 0" thru 185' 0"
1. Safety-Related Equipment

None
 2. Fire Zone Analysis
 - (a) Fire Zone 1A124 is located in the Auxiliary Building on Elev. 108' 0" to Elev. 185' 0". The East and West walls of Fire Zone 1A124 below Elev. 185' 0" are 3-hour rated fire barriers. The North and South walls and floor are also 3-hour rated fire barriers, except for non-rated steel pressure relief panels. The ceiling and walls above Elev. 185' 0" are non-rated exterior barriers (Ref. Architectural Drawings A-0632 thru A-0636).
 - (b) The combustible loading in Fire Zone 1A124, with no transient combustibles postulated amounts to a low fire load. The only contributor to this combustible loading is the concrete joint sealant in the walls. The in situ combustible loading in this fire zone amounts to less than a 60-minute fire duration (Ref. Calculation MC-QSP64-86058). (c) Fire Zone 1A124 does not contain any safety-related equipment, and being a sealed chase, no fire protection measures are provided.
 - (c) Fire Zone 1A124 does not contain any safe shutdown components. Therefore, a fire originating in this fire zone will not affect either train of safe shutdown components. However, this fire zone has several combinations of adjacency with other fire zones within this fire area. An adjacency discussion is provided in the fire area analysis for Fire Area 2.

GRAND GULF NUCLEAR GENERATING STATION
Updated Final Safety Analysis Report (UFSAR)

- g. FIRE ZONE 1A125: BLOWOUT SHAFT, ELEV. 108' 0" thru 185' 0"
1. Safety-Related Equipment
None
 2. Fire Zone Analysis
 - (a) Fire Zone 1A125 is located in the Auxiliary Building on Elev. 108' 0" to Elev. 185' 0". The East and West walls of Fire Zone 1A125 below Elev. 185' 0" are 3-hour rated fire barriers. The North and South walls and floor are also 3-hour rated fire barriers, except for non-rated steel pressure relief panels. The ceiling and all walls above Elev. 185' 0" are non-rated exterior barriers (Ref. Architectural Drawings A-0632 through A-0636).
 - (b) The combustible loading in Fire Zone 1A125, with no transient combustibles postulated, amounts to a low fire load. The only contributor to this combustible loading is the concrete joint sealant. The in situ combustible loading in this fire zone amounts to less than a 60-minute fire duration (Ref. Calculation MC-QSP64-86058).
 - (c) Fire Zone 1A125 does not contain safety-related components and, being a sealed chase, no fire protection measures are provided.
 - (d) Fire Zone 1A125 does not contain any safe shutdown components. Therefore, a fire originating in this fire zone will not affect either train of safe shutdown components. However, this fire zone has several combinations of adjacency with other fire zones within this fire area. An adjacency discussion is provided in the fire area analysis for Fire Area 2.
- h. FIRE ZONE 1A132: PIPE CHASE, ELEV. 93' 0"
1. Safety-Related Equipment
Piping
 2. Fire Zone Analysis

GRAND GULF NUCLEAR GENERATING STATION
Updated Final Safety Analysis Report (UFSAR)

- (a) Fire Zone 1A132 is located in the Auxiliary Building on Elev. 93' 0" to Elev. 128' 0". There are no 3-hour rated fire barriers enclosing Fire Zone 1A132, except for the South wall (Ref. Architectural Drawing A-0632).
 - (b) There is no combustible loading postulated for Fire Zone 1A132 (Ref. Calculation MC-QSP64-86058).
 - (c) Fire Zone 1A132 only contains safety-related piping and no fire protection measures are provided (Ref. Fire Protection Evaluation 87/0005).
 - (d) Fire Zone 1A132 does not contain any safe shutdown components. Therefore, a fire originating in this fire zone will not affect either train of safe shutdown components. However, this fire zone has several combinations of adjacency with other fire zones within this fire area. An adjacency discussion is provided in the fire area analysis for Fire Area 2.
- i. FIRE ZONE 1A202: RHR A HEAT EXCHANGER RM, ELEV. 119' 0"
- 1. Safety-Related Equipment
 - RHR A Heat Exchanger
 - Electrical Cable and Raceway
 - 2. Fire Zone Analysis
 - (a) Fire Zone 1A202 is located in the Auxiliary Building on Elev. 119' 0". The East, West, and South walls of Fire Zone 1A202 are 3-hour-rated fire barriers. The North wall is a non-rated barrier. The floor and ceiling are open steel grating and are not rated (Ref. Architectural Drawing A-0633).
 - (b) The combustible loading in Fire Zone 1A202, including transient combustibles, amounts to a low fire load. The major contributors to this combustible loading are the electrical cables present in this fire zone. The in situ

GRAND GULF NUCLEAR GENERATING STATION
Updated Final Safety Analysis Report (UFSAR)

combustible loading in Fire Zone 1A202 amounts to less than a 15-minute fire duration (Ref. Calculation MC-QSP64-86058).

- (c) Fire Zone 1A202 contains safety-related equipment and the following fire protection measures are available: heat detection and accessibility to manual hose streams and portable fire extinguishers.
- (d) Fire Zone 1A202 contains only Division I safe shutdown components. Therefore, a fire originating in this fire zone will not affect more than one train of safe shutdown components. However, this fire zone has several combinations of adjacency with other fire zones within this fire area. An adjacency discussion is provided in the fire area analysis for Fire Area 2.
- (e) Ambient temperatures in this Fire Zone can be above 120F during normal operation, which exceeds the operating temperature of the smoke detectors. In lieu of smoke detection, heat detection is provided in this fire zone as evaluated in GGNS-FP-19-00002

j. FIRE ZONE 1A203: PIPING PENETRATION ROOM, ELEV. 119' 0"

1. Safety-Related Equipment

RHR A Room Cooler
Electrical Cable and Raceway

2. Fire Zone Analysis

- (a) Fire Zone 1A203 is located in the Auxiliary Building on Elev. 119' 0". The ceiling and the North, East, West, and a portion of the South walls of Fire Zone 1A203 are 3-hour rated fire barriers. The remainder of the South wall and floor are non-rated barriers (Ref. Architectural Drawing A-0633).
- (b) The combustible loading in Fire Zone 1A203, including transient combustibles, amounts to a low fire load. The major contributors to this combustible loading are the electrical cables

GRAND GULF NUCLEAR GENERATING STATION
Updated Final Safety Analysis Report (UFSAR)

and PC storage present in the fire zone. The in situ combustible loading in Fire Zone 1A203 amounts to less than a 15-minute fire duration (Ref. Calculation MC-QSP64-86058).

- (c) Fire Zone 1A203 contains safety-related equipment and the following fire protection measures are available: heat detection and accessibility to manual hose stream and portable fire extinguishers.
- (d) Fire Zone 1A203 contains only Division I safe shutdown components. Therefore, a fire originating in this fire zone will not affect more than one train of safe shutdown components. However, this fire zone has several combinations of adjacency with other fire zones within this fire area. An adjacency discussion is provided in the fire area analysis for Fire Area 2.
- (e) Ambient temperatures in this Fire Zone can be above 120F during normal operation, which exceeds the operating temperature of the smoke detectors. In lieu of smoke detection, heat detection is provided in this fire zone as evaluated in GGNS-FP-19-00002

k. FIRE ZONE 1A204: PIPING PENETRATION ROOM, ELEV. 119' 0"

1. Safety-Related Equipment

Electrical Cable and Raceway

2. Fire Zone Analysis

- (a) Fire Zone 1A204 is located in the Auxiliary Building on Elev. 119' 0". The ceiling and North, South, East, and West (except for a small segment on Elev. 128' 0") walls of Fire Zone 1A204 are 3-hour rated fire barriers, except for the non-rated pressure relief panel in the North wall. The floor is a non-rated barrier Ref. Architectural Drawing A-0633).

GRAND GULF NUCLEAR GENERATING STATION
Updated Final Safety Analysis Report (UFSAR)

- (b) The combustible loading in Fire Zone 1A204, including transient combustibles, amounts to a low fire load. The major contributors to this combustible loading are the electrical cables and PC storage present in the fire zone. The in situ combustible loading in Fire Zone 1A204 amounts to less than a 45-minute fire duration (Ref. Calculation MC-QSP64-86058).
- (c) Fire Zone 1A204 contains safety-related equipment and the following fire protection measures are available: smoke detection and accessibility to manual hose streams and portable fire extinguishers.
- (d) Fire Zone 1A204 contains only Division I safe shutdown components. Therefore, a fire originating in this fire zone will not affect more than one train of safe shutdown components. However, this fire zone has several combinations of adjacency with other fire zones within this fire area. An adjacency discussion is provided in the fire area analysis for Fire Area 2.

1. FIRE ZONE 1A205: PIPING PENETRATION ROOM ELEV. 119' 0"

1. Safety-Related Equipment

RHR B Room Cooler
Electrical Cable and Raceway

2. Fire Zone Analysis

- (a) Fire Zone 1A205 is located in the Auxiliary Building on Elev. 119' 0". The ceiling and the South, East, West, and a portion of the North walls of Fire Zone 1A205 are 3-hour rated fire barriers. The remainder of the North wall and floor are non-rated barriers (Ref. Architectural Drawing A-0633).
- (b) The combustible loading in Fire Zone 1A205, including transient combustibles, amounts to a low fire load. The major contributors to the combustible loading are the electrical cables present in the fire zone. The in situ combustible loading in Fire Zone 1A205 amounts to less than a 15-minute fire duration (Ref. Calculation MC-QSP64-86058).

GRAND GULF NUCLEAR GENERATING STATION
Updated Final Safety Analysis Report (UFSAR)

- (c) Fire Zone 1A205 contains safety-related equipment and the following fire protection measures are provided: heat detection and accessibility to manual hose streams and portable fire extinguishers.
 - (d) Fire Zone 1A205 contains only Division II safe shutdown components. Therefore, a fire originating in this fire zone will not affect more than one train of safe shutdown components. However, this fire zone has several combinations of adjacency with other fire zones within this fire area. An adjacency discussion is provided in the fire area analysis for Fire Area 2.
 - (e) Ambient temperatures in this Fire Zone can be above 120F during normal operation, which exceeds the operating temperature of the smoke detectors. In lieu of smoke detection, heat detection is provided in this fire zone as evaluated in GGNS-FP-19-00002.
- m. FIRE ZONE 1A206: RHR B HEAT EXCHANGER RM, ELEV. 119' 0"
- 1. Safety-Related Equipment

RHR B Heat Exchanger
Electrical Cable and Raceway
 - 2. Fire Zone Analysis
 - (a) Fire Zone 1A206 is located in the Auxiliary Building on Elev. 119' 0". The North, East, and West walls of Fire Zone 1A206 are 3-hour rated fire barriers. The South wall is a non-rated barrier. The floor and ceiling are open steel grating and are not rated (Ref. Architectural Drawing A-0633).
 - (b) The combustible loading in Fire Zone 1A206, with only transient combustibles postulated, amounts to a low fire load (Ref. Calculation MC-Q5P64-86058).
 - (c) Fire Zone 1A206 contains safety-related equipment and the following fire protection measures are provided: heat detection and accessibility to manual hose streams and portable fire extinguishers.

GRAND GULF NUCLEAR GENERATING STATION
Updated Final Safety Analysis Report (UFSAR)

- (d) Fire Zone 1A206 contains only Division II safe shutdown components. Therefore, a fire originating in this fire zone will not affect more than one train of safe shutdown components. However, this fire zone has several combinations of adjacency with other fire zones within this fire area. An adjacency discussion is provided in the fire area analysis for Fire Area 2.
 - (e) Ambient temperatures in this Fire Zone can be above 120F during normal operation, which exceeds the operating temperature of the smoke detectors. In lieu of smoke detection, heat detection is provided in this fire zone as evaluated in GGNS-FP-19-00002.
- n. FIRE ZONE 1A209: RWCU RECIRCULATION PUMP A ROOM, ELEV. 115' 0"
- 1. Safety-Related Equipment
 - Electrical Cable and Raceway
 - 2. Fire Zone Analysis
 - (a) Fire Zone 1A209 is located in the Auxiliary Building on Elev. 115' 0". The West wall and South wall (except for the non-rated pressure relief panel and the interface with Fire Zone 1A132) are 3-hour rated fire barriers. The floor, ceiling, and the North and East walls are non-rated barriers (Ref. Architectural Drawing A-0633).
 - (b) The combustible loading in Fire Zone 1A209, including transient combustibles, amounts to a low fire load. The major contributor to this combustible loading is the concrete joint sealant present in the fire zone. The in situ combustible loading in Fire Zone 1A209 amounts to less than a 15-minute fire duration (Ref. Calculation MC-QSP64-86058).
 - (c) Fire Zone 1A209 contains safety-related equipment and the following fire protection measures are provided: smoke detection and accessibility to manual hose streams and portable fire extinguishers.

GRAND GULF NUCLEAR GENERATING STATION
Updated Final Safety Analysis Report (UFSAR)

- (d) Fire Zone 1A209 does not contain any safe shutdown components. Therefore, a fire originating in this fire zone will not affect either train of safe shutdown components. However, this fire zone has several combinations of adjacency with other fire zones within this fire area. An adjacency discussion is provided in the fire area analysis for Fire Area 2.
- o. FIRE ZONE 1A210: RWCU RECIRCULATION PUMP B ROOM, ELEV 115' 0"
 - 1. Safety-Related Equipment
 - Electrical Cable and Raceway
 - 2. Fire Zone Analysis
 - (a) Fire Zone 1A210 is located in the Auxiliary Building on Elev. 115' 0". The West and North walls (except for the non-rated pressure relief panels) are 3-hour rated fire barriers enclosing Fire Zone 1A210. The floor, ceiling, and the East and South walls are non-rated barriers (Ref. Architectural Drawing A-0633).
 - (b) The combustible loading in Fire Zone 1A210, including transient combustibles, amounts to a low fire load. The major contributor to this combustible loading is the concrete joint sealant in the walls. The in situ combustible loading in Fire Zone 1A210 amounts to less than a 15-minute fire duration (Ref. Calculation MC-QSP64-86058).
 - (c) Fire Zone 1A210 contains safety-related equipment and the following fire protection measures are provided: smoke detection and accessibility to manual hose streams and portable fire extinguishers.
 - (d) Fire Zone 1A210 contains Division II safe shutdown components. Fire Area 2 is not vulnerable to the multiple spurious operation scenarios that credit mitigation by the Division II equipment located in fire zone 1A210. Therefore, this Division II equipment is not part of the success path required for hot

GRAND GULF NUCLEAR GENERATING STATION
Updated Final Safety Analysis Report (UFSAR)

shutdown following a fire in this area. Since the Div II safe shutdown components contained by the fire zones within Group C are only credited for mitigation of scenarios resulting from a fire in a different Fire Area, a postulated fire originating in any fire zones in Group C will not prevent safe shutdown. However, this fire zone has several combinations of adjacency with other fire zones within this fire area. An adjacency discussion is provided in the fire area analysis for Fire Area 2.

- p. FIRE ZONE 1A224: PIPE CHASE, ELEV. 128' 0"
1. Safety-Related Equipment
Piping
 2. Fire Zone Analysis
 - (a) Fire Zone 1A224 is located in the Auxiliary Building on Elev. 128' 0". The West wall of Fire Zone 1A224 is a 3-hour rated fire barrier. All other walls, the floor, and ceiling are non-rated barriers (Ref. Architectural Drawing A-0633).
 - (b) The combustible loading in Fire Zone 1A224, with no transient combustibles postulated, amounts to a low fire load. The only contributor to this combustible loading is the concrete joint sealant present in the walls. The in situ combustible loading in Fire Zone 1A224 amounts to less than a 15-minute fire duration (Ref. Calculation MC-QSP64-86058).
 - (c) Fire Zone 1A224 contains safety-related piping and accessibility to manual hose streams and portable fire extinguishers is available as a fire protection measure (Ref. Fire Protection Evaluation 87/0005).
 - (d) Fire Zone 1A224 contains only safe shutdown piping. This fire zone has several combinations of adjacency with other fire zones within this fire area. An adjacency discussion is provided in the fire area analysis for Fire Area 2.

GRAND GULF NUCLEAR GENERATING STATION
Updated Final Safety Analysis Report (UFSAR)

- q. FIRE ZONE 1A225: BLOWOUT SHAFT, ELEV. 128' 0"
1. Safety-Related Equipment
Electrical Cable & Raceway
Piping & Ductwork
 2. Fire Zone Analysis
 - (a) Fire Zone 1A225 is located in the Auxiliary Building on Elev. 128 0'. The West and South walls (except for the non-rated pressure relief panel) and the Ceiling of Fire Zone 1A225 are 3-hour rated fire barriers. All other walls and the floor are non-rated barriers (Ref. Architectural Drawing A-0633).
 - (b) The combustible loading in Fire Zone 1A225, with no transient combustibles postulated, amounts to a low fire load. The only contributor to this combustible loading is the concrete joint sealant present in the fire zone. The in situ combustible loading in Fire Zone 1A225 amounts to less than a 15-minute fire duration (Ref. Calculation MC-QSP64-86058).
 - (c) Fire Zone 1A225 contains safety-related equipment and the accessibility to manual hose streams and portable fire extinguishers is available as a fire protection measure. Smoke detection located in Fire Zone 1A204 provides acceptable detection coverage for Fire Zone 1A225 (Ref. Fire Protection Evaluation 87/0004).
 - (d) Fire Zone 1A225 does not contain any safe shutdown components. Therefore, a fire originating in this fire zone will not affect either train of safe shutdown components. However, this fire zone has several combinations of adjacency with other fire zones within this fire area. An adjacency discussion is provided in the fire area analysis for Fire Area 2.
- r. FIRE ZONE 1A226: PIPE CHASE, ELEV. 115' 0"
1. Safety-Related Equipment
Piping

GRAND GULF NUCLEAR GENERATING STATION
Updated Final Safety Analysis Report (UFSAR)

2. Fire Zone Analysis

- (a) Fire Zone 1A226 is located in the Auxiliary Building on Elev. 115' 0", between Fire Zones 1A209 and 1A210. The West wall of Fire Zone 1A226 is a 3-hour rated fire barrier. All other walls, the floor, and ceiling are non-rated barriers (Ref. Architectural Drawing A-0633).
- (b) The combustible loading in Fire Zone 1A226, with no transient combustibles postulated, amounts to a low fire load. The only contributor to this combustible loading is the concrete joint sealant present in the fire zone. The in situ combustible loading in Fire Zone 1A226 amounts to less than a 15-minute fire duration (Ref. Calculation MC-QSP64-86058).
- (c) Fire Zone 1A226 contains safety-related piping and accessibility to manual hose streams and portable fire extinguishers is available as a fire protection measure (Ref. Fire Protection Evaluation 87/0005).

Fire Zone 1A226 does not contain any safe shutdown components. Therefore, a fire originating in this fire zone will not affect either train of safe shutdown components. However, this fire zone has several combinations of adjacency with other fire zones within this fire area. An adjacency discussion is provided in the fire area analysis for Fire Area 2.

s. FIRE ZONE 1A303: RHR A HEAT EXCHANGER RM, ELEV. 139' 0"

1. Safety-Related Equipment

Electrical Cable and Raceway

2. Fire Zone Analysis

- (a) Fire Zone 1A303 is located in the Auxiliary Building on Elev. 139' 0". A portion of the ceiling and East, West, and South walls of Fire Zone 1A303 are 3-hour rated fire barriers. The North wall, the remainder of the ceiling (open to blowout shaft 1A442), and the grating floor are non-rated barriers (Ref. Architectural Drawing A-0634).

GRAND GULF NUCLEAR GENERATING STATION
Updated Final Safety Analysis Report (UFSAR)

- (b) The combustible loading in Fire Zone 1A303, including transient combustibles, amounts to a low fire load. The major contributor to this combustible loading is the concrete joint sealant present in the fire zone. The in situ combustible loading in Fire Zone 1A303 amounts to less than a 15-minute fire duration (Ref. Calculation MC-QSP64-86058).
 - (c) Fire Zone 1A303 contains safety-related equipment and the following fire protection measures are provided: heat detection and accessibility to manual hose streams and portable fire extinguishers.
 - (d) Fire Zone 1A303 contains only Division I safe shutdown components. Therefore, a fire originating in this fire zone will not affect more than one train of safe shutdown components. However, this fire zone has several combinations of adjacency with other fire zones within this fire area. An adjacency discussion is provided in the fire area analysis for Fire Area 2. Fire Zone 1A303 also contains RHR Heat Exchanger 'A' inlet temperature indication circuits utilized for alternate suppression pool temperature monitoring in the event of a fire in Containment (as discussed in Fire Area 25, Section 9A.5.25).
 - (e) Ambient temperatures in this Fire Zone can be above 120F during normal operation, which exceeds the operating temperature of the smoke detectors. In lieu of smoke detection, heat detection is provided in this fire zone as evaluated in GGNS-FP-19-00002.
- t. FIRE ZONE 1A304: PIPING PENETRATION ROOM ELEV. 139' 0"
- 1. Safety-Related Equipment
 - Electrical Cable and Raceway
 - 2. Fire Zone Analysis
 - (a) Fire Zone 1A304 is located in the Auxiliary Building on Elev. 139' 0". The ceiling, floor, and North, East, West, and a portion of the

GRAND GULF NUCLEAR GENERATING STATION
Updated Final Safety Analysis Report (UFSAR)

South walls of Fire Zone 1A304 are 3-hour-rated fire barriers. The remainder of the South wall is a non-rated barrier (Ref. Architectural Drawing A-0634).

- (b) The combustible loading in Fire Zone 1A304, including transient combustibles, amounts to a low fire load. The major contributor to this combustible loading is the concrete joint sealant located in the fire zone. The in situ combustible loading in Fire Zone 1A304 amounts to less than a 15-minute fire duration (Ref. Calculation MC-QSP64-86058).
- (c) Fire Zone 1A304 contains safety-related equipment and the following fire protection measures are provided: heat detection and accessibility to manual hose streams and portable fire extinguishers.
- (d) Fire Zone 1A304 contains only Division I safe shutdown components. Therefore, a fire originating in this fire zone will not affect more than one train of safe shutdown components. However, this fire zone has several combinations of adjacency with other fire zones within this fire area. An adjacency discussion is provided in the fire area analysis for Fire Area 2.
- (e) Ambient temperatures in this Fire Zone can be above 120F during normal operation, which exceeds the operating temperature of the smoke detectors. In lieu of smoke detection, heat detection is provided in this fire zone as evaluated in GGNS-FP-19-00002.

u. FIRE ZONE 1A305: MAIN STEAM TUNNEL, ELEV. 140' 0"

1. Safety-Related Equipment

MSIV Accumulators
Electrical Cable and Raceway

2. Fire Zone Analysis

- (a) Fire Zone 1A305 is located in the Auxiliary Building on Elev. 140' 0". All four walls, the

GRAND GULF NUCLEAR GENERATING STATION
Updated Final Safety Analysis Report (UFSAR)

ceiling (except the portion open to blowout shafts 1A439 and 1A440), and the floor (except the portion open to pipe chase 1A226) are 3-hour rated fire barriers (Ref. Architectural Drawing A-0634).

- (b) The combustible loading in Fire Zone 1A305, with no transient combustibles postulated, amounts to a low fire load. The major contributor to this combustible loading is the concrete joint sealant present in the fire zone. The in situ combustible loading in Fire Zone 1A305 amounts to less than a 15-minute fire duration (Ref. Calculation MC-QSP64-86058).
- (c) Fire Zone 1A305 contains safety-related equipment and the following fire protection measures are provided: heat detection and accessibility to manual hose streams and portable fire extinguishers.
- (d) Fire Zone 1A305 contains only Division I safe shutdown components. Therefore, a fire originating in this fire zone will not affect more than one train of safe shutdown components. However, this fire zone has several combinations of adjacency with other fire zones within this fire area. An adjacency discussion is provided in the fire area analysis for Fire Area 2.
- (e) Ambient temperatures in this Fire Zone can be above 120F during normal operation, which exceeds the operating temperature of the smoke detectors. In lieu of smoke detection, heat detection is provided in this fire zone as evaluated in GGNS-FP-19-00002.

v. FIRE ZONE 1A306: PIPING PENETRATION ROOM, ELEV. 139' 0"

- 1. Safety-Related Equipment
 - Electrical Cable and Raceway
- 2. Fire Zone Analysis

GRAND GULF NUCLEAR GENERATING STATION
Updated Final Safety Analysis Report (UFSAR)

- (a) Fire Zone 1A306 is located in the Auxiliary Building on Elev. 139' 0". The ceiling, floor, and East, West, South, and a portion of the North walls of Fire Zone 1A306 are 3-hour-rated fire barriers. The remainder of the North wall is a non-rated barrier (Ref. Architectural Drawing A-0634).
- (b) The combustibile loading in Fire Zone 1A306, including transient combustibles, amounts to a low fire load. The major contributor to this combustibile loading is the concrete joint sealant present in the fire zone. The in situ combustibile loading in Fire Zone 1A306 amounts to less than a 15-minute fire duration (Ref. Calculation MC-QSP64-86058).
- (c) Fire Zone 1A306 contains safety-related equipment and the following fire protection measures are provided: heat detection and accessibility to manual hose streams and portable fire extinguishers.
- (d) Fire Zone 1A306 contains only Division II safe shutdown components. Therefore, a fire originating in this fire zone will not affect more than one train of safe shutdown components. However, this fire zone has several combinations of adjacency with other fire zones within this fire area. An adjacency discussion is provided in the fire area analysis for Fire Area 2.
- (e) Ambient temperatures in this Fire Zone can be above 120F during normal operation, which exceeds the operating temperature of the smoke detectors. In lieu of smoke detection, heat detection is provided in this fire zone as evaluated in GGNS-FP-19-00002.

w. FIRE ZONE 1A307: RHR B HEAT EXCHANGER RM, ELEV. 139' 0"

- 1. Safety-Related Equipment
 - Electrical Cable and Raceway
- 2. Fire Zone Analysis

GRAND GULF NUCLEAR GENERATING STATION
Updated Final Safety Analysis Report (UFSAR)

- (a) Fire Zone 1A307 is located in the Auxiliary Building on Elev. 139' 0". A portion of the ceiling and the North, East, and West walls of Fire Zone 1A307 are 3-hour rated fire barriers. The South wall, grating floor, and remainder of the ceiling (open to blowout shaft 1A441) are non-rated barriers (Ref. Architectural Drawing A-0634).
- (b) The combustible loading in Fire Zone 1A307, including transient combustibles, amounts to a low fire load. The major contributor to this combustible loading is the concrete joint sealant present in the fire zone. The in situ combustible loading in Fire Zone 1A307 amounts to less than a 15-minute fire duration (Ref. Calculation MC-QSP64-86058).
- (c) Fire Zone 1A307 contains safety-related equipment and the following fire protection measures are provided: heat detection and accessibility to manual hose streams and portable fire extinguishers.
- (d) Fire Zone 1A307 contains only Division II safe shutdown components. Therefore, a fire originating in this fire zone will not affect more than one train of safe shutdown components. However, this fire zone has several combinations of adjacency with other fire zones within this fire area. An adjacency discussion is provided in the fire area analysis for Fire Area 2. Fire Zone 1A307 also contains RHR Heat Exchanger 'B' inlet temperature indication circuits utilized for alternate suppression pool temperature monitoring in the event of a fire in Containment (as discussed in Fire Area 25, Section 9A.5.25).
- (e) Ambient temperatures in this Fire Zone can be above 120F during normal operation, which exceeds the operating temperature of the smoke detectors. In lieu of smoke detection, heat detection is provided in this fire zone as evaluated in GGNS-FP-19-00002.

GRAND GULF NUCLEAR GENERATING STATION
Updated Final Safety Analysis Report (UFSAR)

- x. FIRE ZONE 1A439: BLOWOUT SHAFT, ELEV. 166' 0"
 - 1. Safety-Related Equipment

None
 - 2. Fire Zone Analysis
 - (a) Fire Zone 1A439 is located in the Auxiliary Building on Elev. 166' 0. The North, East, and West walls of Fire Zone 1A439 are 3-hour rated fire barriers on Elev. 166' 0". The South wall is only a partial wall between 1A439 and 1A440 and is a non-rated barrier. The floor is open to Fire Zone 1A305 and the ceiling and all four walls on Elev. 185' 0" are non-rated barriers (Ref. Architectural Drawings A-0635 and A-0636).
 - (b) The combustible loading in Fire Zone 1A439, with no transient combustibles postulated, amounts to a low fire load. The only contributor to this combustible loading is the concrete joint sealant in the fire zone. The in situ combustible loading in Fire Zone 1A439 amounts to less than a 15-minute fire duration (Ref. Calculation MC-QSP64-86058).
 - (c) Fire Zone 1A439 does not contain any safety-related components and no fire protection measures are provided.
 - (d) Fire Zone 1A439 does not contain any safe shutdown components. Therefore, a fire originating in this fire zone will not affect either train of safe shutdown components. However, this fire zone has several combinations of adjacency with other fire zones within this fire area. An adjacency discussion is provided in the fire area analysis for Fire Area 2.
- y. FIRE ZONE 1A440: BLOWOUT SHAFT, ELEV. 166' 0"
 - 1. Safety-Related Equipment

None
 - 2. Fire Zone Analysis

GRAND GULF NUCLEAR GENERATING STATION
Updated Final Safety Analysis Report (UFSAR)

- (a) Fire Zone 1A440 is located in the Auxiliary Building on Elev. 166' 0". The South, East, and West walls of Fire Zone 1A440 are 3-hour rated fire barriers on Elev. 166' 0". The North wall is only a partial wall between 1A439 and 1A440 and is a non-rated barrier. The floor is open to Fire Zone 1A305 and the ceiling and all four walls on Elev. 185' 0" are non-rated barriers (Ref. Architectural Drawings A-0635 and A-0636).
 - (b) The combustible loading in Fire Zone 1A440, with no transient combustibles postulated, amounts to a low fire load. The only contributor to this combustible loading is the concrete joint sealant in the fire zone. The in situ combustible loading in Fire Zone 1A440 amounts to less than a 15-minute fire duration (Ref. Calculation MC-QSP64-86058).
 - (c) Fire Zone 1A440 does not contain any safety-related components and no fire protection measures are provided.
 - (d) Fire Zone 1A440 does not contain any safe shutdown components. Therefore, a fire originating in this fire zone will not affect either train of safe shutdown components. However, this fire zone has several combinations of adjacency with other fire zones within this fire area. An adjacency discussion is provided in the fire area analysis for Fire Area 2.
- z. FIRE ZONE 1A441: RHR ROOM B BLOWOUT SHAFT, ELEV. 166' 0"
- 1. Safety-Related Equipment
None
 - 2. Fire Zone Analysis
 - (a) Fire Zone 1A441 is located in the Auxiliary Building on Elev. 166' 0". All four walls of Fire Zone 1A441 on Elev. 166' 0" are 3-hour rated fire barriers. The floor is open to 1A307 and the ceiling and all four walls at Elev. 185' 0", which are external boundaries, are non-rated barriers (Ref. Architectural Drawings A-0635 and A-0636).

GRAND GULF NUCLEAR GENERATING STATION
Updated Final Safety Analysis Report (UFSAR)

- (b) The combustible loading in Fire Zone 1A441, with no transient combustibles postulated, amounts to a low fire load. The only contributor to this combustible loading is the concrete joint sealant present in the fire zone. The in situ combustible loading in Fire Zone 1A441 amounts to less than a 15-minute fire duration (Ref. Calculation MC-QSP64-86058).
 - (c) Fire Zone 1A441 does not contain any safety-related components and no fire protection measures are provided.
 - (d) Fire Zone 1A441 does not contain any safe shutdown components. Therefore, a fire originating in this fire zone will not affect either train of safe shutdown components. However, this fire zone has several combinations of adjacency with other fire zones within this fire area. An adjacency discussion is provided in the fire area analysis for Fire Area 2.
- aa. FIRE ZONE 1A442: RHR ROOM A BLOWOUT SHAFT, ELEV. 166' 0"
- 1. Safety-Related Equipment
None
 - 2. Fire Zone Analysis
 - (a) Fire Zone 1A442 is located in the Auxiliary Building on Elev. 166' 0". All four walls of Fire Zone 1A442 on Elev. 166' 0" are 3-hour rated fire barriers. The floor is open to 1A303 and the ceiling and all four walls at Elev. 185' 0", which are external boundaries, are non-rated barriers (Ref. Architectural Drawings A-0635 and A-0636).
 - (b) The combustible loading in Fire Zone 1A442, with no transient combustibles postulated, amounts to a low fire load. The only contributor to this combustible loading is the concrete joint sealant present in the fire zone. The in situ combustible loading in Fire Zone 1A442 amounts to less than a 15-minute fire duration (Ref. Calculation MC-QSP64-86058).

GRAND GULF NUCLEAR GENERATING STATION
Updated Final Safety Analysis Report (UFSAR)

- (c) Fire Zone 1A442 does not contain any safety-related components and no fire protection measures are provided.
- (d) Fire Zone 1A442 does not contain any safe shutdown components. Therefore, a fire originating in this fire zone will not affect either train of safe shutdown components. However, this fire zone has several combinations of adjacency with other fire zones within this fire area. An adjacency discussion is provided in the fire area analysis for Fire Area 2.

bb. FIRE ZONE 1A506: UNASSIGNED AREA, ELEV. 185' 0"

1. Safety-Related Equipment

None

2. Fire Zone Analysis

- (a) Fire Zone 1A506 is located above the Auxiliary Building roof on Elev. 185' 0". The floor, the South wall, and the West wall of Fire Zone 1A506 are 3-hour rated fire barriers. All other walls and the ceiling are non-rated exterior barriers (Ref. Architectural Drawings A-0636 and A-0637).
- (b) The combustible loading in Fire Zone 1A506, with no transient combustibles postulated, amounts to a low fire load. The only contributor to this combustible loading is the concrete joint sealant present in the fire zone. The in situ combustible loading in Fire Zone 1A506 amounts to less than a 15-minute fire duration (Ref. Calculation MC-QSP64-86058).
- (c) Fire Zone 1A506 does not contain any safety-related components and no fire protection measures are provided.
- (d) Fire Zone 1A506 does not contain any safe shutdown components. Therefore, a fire originating in this fire zone will not affect either train of safe shutdown components. However, this fire zone has several combinations of adjacency with other fire zones within this

GRAND GULF NUCLEAR GENERATING STATION
Updated Final Safety Analysis Report (UFSAR)

fire area. An adjacency discussion is provided
in the fire area analysis for Fire Area 2.

cc. FIRE ZONE 1A508: UNASSIGNED AREA, ELEV. 185' 0"

1. Safety-Related Equipment

None

2. Fire Zone Analysis

- (a) Fire Zone 1A508 is located above the Auxiliary Building roof on Elev. 185' 0". The floor, the North wall, and the West wall of Fire Zone 1A508 are 3-hour rated fire barriers. All other walls and the ceiling are non-rated exterior barriers (Ref. Architectural Drawings A-0636 and A-0637).
- (b) The combustible loading in Fire zone 1A508, with no transient combustibles postulated, amounts to a low fire load. The only contributor to this combustible loading is the concrete joint sealant in the room. The in situ combustible loading in Fire Zone 1A508 amounts to less than a 15-minute fire duration (Ref. Calculation MC-QSP64-86058).
- (c) Fire Zone 1A508 does not contain any safety-related components and no fire protection measures are provided.
- (d) Fire Zone 1A508 does not contain any safe shutdown components. Therefore, a fire originating in this fire zone will not affect either train of safe shutdown components. However, this fire zone has several combinations of adjacency with other fire zones within this fire area. An adjacency discussion is provided in the fire area analysis for Fire Area 2.

dd. FIRE ZONE 1A605: RECIRCULATION FAN AREA, ELEV. 228' 0"

1. Safety-Related Equipment

Radiation Monitors (4)
Electrical Cable and Raceway

GRAND GULF NUCLEAR GENERATING STATION
Updated Final Safety Analysis Report (UFSAR)

2. Fire Zone Analysis

- (a) Fire Zone 1A605 is located above the Auxiliary Building roof on Elev. 228' 0". The floor and the West and East (containment dome only) walls of Fire Zone 1A605 are 3-hour rated fire barriers, while the North and South walls and the ceiling are non-rated exterior barriers (Ref. Architectural Drawing A-0637).
- (b) The combustible loading in Fire Zone 1A605, including transient combustibles, amounts to a low fire load. The major contributor to this combustible loading is the concrete joint sealant in the walls. The in situ combustible loading in Fire Zone 1A605 amounts to less than a 15-minute fire duration (Ref. Calculation MC-QSP64-86058).
- (c) Fire Zone 1A605 contains safety-related equipment and the following fire protection measure is provided: accessibility to manual hose streams and portable fire extinguishers. Smoke detection is not provided for Fire Zone 1A605 for the following reasons: 1) the safety-related equipment is all located in HVAC ductwork and conduit, therefore, it does not present a fuel source; 2) there are no other combustibles or sources of ignition in the HVAC ductwork to present a potential exposure fire threat to the safety-related equipment; 3) access to this fire zone is through a security alarmed door, so that transient combustible entrance and exit are monitored; and 4) there is a very low transient combustible loading postulated for this zone.
- (d) Fire Zone 1A605 does not contain any safe shutdown components. Therefore, a fire originating in this fire zone will not affect either train of safe shutdown components. However, this fire zone has several combinations of adjacency with other fire zones within this fire area. An adjacency discussion is provided in the fire area analysis for Fire Area 2.

GRAND GULF NUCLEAR GENERATING STATION
Updated Final Safety Analysis Report (UFSAR)

9A.5.3 FIRE AREA 3

9A.5.3.1 FIRE AREA DESCRIPTION

Fire Area 3 consists of Fire Zones 1A115, 1A116, 1A118, 1A119 (Elev. 93' 0"), and 1A220 (Elev. 120' 6") in the Auxiliary Building. A 3-hour rated fire barrier separates Fire Zones 1A115 and 1A119 from Fire Zones 1A116 and 1A118. However, this barrier extends only up to Elev. 120' 6". Fire Zone 1A220 has a steel grating floor which straddles this barrier, thereby allowing 1A220 to communicate directly with Fire Zones 1A115 and 1A116 (Ref. Architectural Drawings A-0632 and A-0633). Therefore, a fire originating in any one fire zone of Fire Area 3 is able to communicate with any other zone in Fire Area 3.

INCLUDED FIRE ZONES	DESCRIPTION
1A115	Piping Penetration Room, Elev. 93' 0"
1A116	Piping Penetration Room, Elev. 93' 0"
1A118	RHR C Room, Elev. 93' 0"
1A119	LPCS Room, Elev. 93' 0"
1A220	Piping Penetration Room, Elev. 120' 6"

9A.5.3.2 SAFE SHUTDOWN EQUIPMENT

Division I & II

9A.5.3.3 FIRE AREA ANALYSIS

Fire Zones 1A115 and 1A119 contain only Division I safe shutdown cables, and raceway as shown in the microcomputer database (Ref. FPP-1, Appendix C Data). Fire Zones 1A116 and 1A118 contain only Division II safe shutdown components, cables, and raceway; safe shutdown equipment associated with both Divisions are located in Fire Zone 1A220. However, Fire Area 3 is not vulnerable to the multiple spurious operation scenarios that credit mitigation by the Division II equipment located in these fire zones. The Div II safe shutdown components within this Fire Area are only credited for mitigation of scenarios resulting from a fire in a different Fire Area. Since this fire area is separated from all other fire areas by 3-hour rated fire barriers, Fire Area 3 fully complies with Appendix R requirements. Therefore, in the event of a fire in this fire area, safe shutdown capability would be maintained by separate Division II safe shutdown equipment. The postulated fire with the greatest severity duration in Fire Area 3 is a fire in Fire Zone 1A118. The total fire severity in Fire Zone 1A118,

GRAND GULF NUCLEAR GENERATING STATION
Updated Final Safety Analysis Report (UFSAR)

including transient combustibles, amounts to a low fire load. The maximum in situ combustible loading in this fire zone amounts to less than a 30-minute fire duration (Ref. Calculation MC-Q5P64-86058). Therefore, a fire occurring in Fire Area 3 will not spread into any other fire area.

9A.5.3.4 FIRE ZONE ANALYSES

a. FIRE ZONE 1A115: PIPING PENETRATION ROOM, ELEV. 93' 0"

1. Safety-Related Equipment

Suppression Pool Level Monitor
Electrical Cable and Raceway

2. Fire Zone Analysis

- (a) Fire Zone 1A115 is located in the Auxiliary Building on Elev. 93' 0". Fire Zone 1A115 communicates directly with Fire Zones 1A119 and 1A220 and can communicate indirectly with Fire Zones 1A116 and 1A118 (via the grating floor in Fire Zone 1A220) by traveling up into Fire Zone 1A220 and back down into Fire Zones 1A116 and 1A118, respectively. The North, South, and East walls of Fire Zone 1A115 are 3-hour rated fire barriers (Ref. Architectural Drawing A-0632). A portion of the ceiling of Fire Zone 1A115 (i.e., floor of Fire Zone 1A219) is 3-hour rated (Architectural Drawing A-0633).
- (b) The combustible loading in Fire Zone 1A115, including transient combustibles, amounts a low fire load. The major contributor to this combustible loading is the concrete joint sealant in the walls. The in situ combustible loading in this fire zone amounts to less than a 15-minute fire duration (Ref. Calculation MC-Q5P64-86058).
- (c) Fire Zone 1A115 contains safety-related equipment and the following fire protection measures are provided: heat detection and accessibility to manual hose streams and portable fire extinguishers.

GRAND GULF NUCLEAR GENERATING STATION
Updated Final Safety Analysis Report (UFSAR)

(d) Fire Zones 1A115 contains only Division I safe shutdown components, cables, and raceway. Fire Zone 1A115 is adjacent to Fire Zone 1A119, which also contains Division I cables or components. Fire Zone 1A115 is also adjacent to Fire Zone 1A220, which contains both Division I and II equipment. Fire Zones 1A116 and 1A118, which are adjacent to Fire Zone 1A115 as well, contain Division II cables and/or components; however, the Division II cables/components located in these fire zones are not part of the success path required for hot shutdown following a fire in this area. The Div II safe shutdown components within this Fire Area are only credited for mitigation of scenarios resulting from a fire in a different Fire Area. Therefore, a fire in Fire Zone 1A115 will not prevent safe shutdown.

(e) Ambient temperatures in this Fire Zone can be above 120F during normal operation, which exceeds the operating temperature of the smoke detectors. In lieu of smoke detection, heat detection is provided in this fire zone as evaluated in GGNS-FP-19-00002.

b. FIRE ZONE 1A116: PIPING PENETRATION ROOM, ELEV. 93' 0"

1. Safety-Related Equipment

Suppression Pool Level Monitor
ADHRS Pumps, Heat Exchanger
Electrical Cable and Raceway

2. Fire Zone Analysis

(a) Fire Zone 1A116 is located in the Auxiliary Building on Elev. 93' 0". Fire Zone 1A116 communicates directly with Fire Zones 1A118 and 1A220 and can communicate indirectly (via the grating floor in Fire Zone 1A220) with Fire Zones 1A115 and 1A119 by traveling up into Fire Zone 1A220 and back down into Fire Zones 1A115 and 1A119, respectively. The North, South, and East walls of Fire Zone 1A116 are 3-hour rated

GRAND GULF NUCLEAR GENERATING STATION
Updated Final Safety Analysis Report (UFSAR)

fire barriers (Ref. Architectural Drawing A-0632). A portion of the ceiling of Fire Zone 1A116 (i.e., floor of Fire Zone 1A221) is 3-hour rated (Architectural Drawing A-0633).

- (b) The combustible loading in Fire Zone 1A116, including transient combustibles, amounts to a low fire load. The major contributor to this combustible loading is the concrete joint sealant in the walls. The in situ combustible loading in Fire Zone 1A116 amounts to less than a 15-minute fire duration (Ref. Calculation MC-QSP64-86058).

- (c) Fire Zone 1A116 contains safety-related equipment and the following fire protection measures are provided: heat detection and accessibility to manual hose streams and portable fire extinguishers.

- (d) Fire Zones 1A116 contains only Division II safe shutdown components, cables, and raceway. Fire Zone 1A116 is adjacent to Fire Zones 1A115 and 1A119, which contain Division I cables or components. Fire Zone 1A116 is also adjacent to Fire Zone 1A118, which contains Division II cables and/or components and Fire Zone 1A220, which contains both Division I and II equipment; however, the Division II cables/components located in these fire zones are not part of the success path required for hot shutdown following a fire in this area. The Div II safe shutdown components within this Fire Area are only credited for mitigation of scenarios resulting from a fire in a different Fire Area. Therefore, a fire in Fire Zone 1A116 will not prevent safe shutdown.

- (e) Ambient temperatures in this Fire Zone can be above 120F during normal operation, which exceeds the operating temperature of the smoke detectors. In lieu of smoke detection, heat detection is provided in this fire zone as evaluated in GGNS-FP-19-00002.

GRAND GULF NUCLEAR GENERATING STATION
Updated Final Safety Analysis Report (UFSAR)

c. FIRE ZONE 1A118: RHR C ROOM, ELEV. 93' 0"

1. Safety-Related Equipment

RHR C Pump
RHR C Jockey Pump
RHR C Room Cooler
Electrical Cable and Raceway

2. Fire Zone Analysis

- (a) Fire Zone 1A118 is located in the Auxiliary Building on Elev. 93' 0". Fire Zone 1A118 communicates directly with Fire Zone 1A116 and can communicate indirectly with Fire Zones 1A115, 1A119, and 1A220 (via the grating floor in Fire Zone 1A220) by traveling up into Fire Zone 1A220 via Fire Zone 1A116 and back down into Fire Zones 1A115 and 1A119, respectively. The ceiling and North, South, and West walls of Fire Zone 1A118 are 3-hour rated fire barriers (Ref. Architectural Drawing A-0632).
- (b) The combustible loading in Fire Zone 1A118, including transient combustibles, amounts to a low fire load. The major contributors to this combustible loading are the electrical cable present in the room and the concrete joint sealant in the walls. The in situ combustible loading in this fire zone amounts to less than a 30-minute fire duration (Ref. Calculation MC-Q5P64-86058).
- (c) Fire Zone 1A118 contains safety-related equipment and the following fire protection measures are provided: heat detection and accessibility to manual hose streams and portable fire extinguishers.
- (d) Fire Zones 1A118 contains only Division II safe shutdown components, cables, and raceway. Fire Zone 1A118 is adjacent to Fire Zones 1A115 and 1A119, which contain Division I cables or components. Fire Zone 1A118 is also adjacent to Fire Zone 1A116, which contains Division II cables and/or components and Fire Zone 1A220, which contains both Division I and II equipment; however, the Division II cables/components located in these fire zones are not part of the

GRAND GULF NUCLEAR GENERATING STATION
Updated Final Safety Analysis Report (UFSAR)

success path required for hot shutdown following a fire in this area. The Div II safe shutdown components within this Fire Area are only credited for mitigation of scenarios resulting from a fire in a different Fire Area. Therefore, a fire in Fire Zone 1A118 will not prevent safe shutdown.

- (e) Ambient temperatures in this Fire Zone can be above 120F during normal operation, which exceeds the operating temperature of the smoke detectors. In lieu of smoke detection, heat detection is provided in this fire zone as evaluated in GGNS-FP-19-00002.

d. FIRE ZONE 1A119: LPCS ROOM, ELEV. 93' 0"

1. Safety-Related Equipment

LPCS Pump
LPCS Jockey Pump
LPCS Room Cooler
Electrical Cable and Raceway

2. Fire Zone Analysis

- (a) Fire Zone 1A119 is located in the Auxiliary Building on Elev. 93' 0". Fire Zone 1A119 communicates directly with Fire Zone 1A115, and can communicate indirectly with Fire Zones 1A220, 1A116, and 1A118 (via the grating floor in Fire Zone 1A220) by traveling up into Fire Zone 1A220 from Fire Zone 1A115 and back down into Fire Zones 1A116 and 1A118, respectively. The ceiling and North, South, and West walls of Fire Zone 1A119 are 3-hour rated fire barriers (Ref. Architectural Drawing A-0632).
- (b) The combustible loading in Fire Zone 1A119, including transient combustibles, amounts to a low fire load. The major contributors to this combustible loading are the electrical cable and lube oil present in the zone and the concrete joint sealant in the walls. The in situ combustible loading in Fire Zone 1A119 amounts to less than a 30-minute fire duration (Ref. Calculation MC-QSP64-86058).

GRAND GULF NUCLEAR GENERATING STATION
Updated Final Safety Analysis Report (UFSAR)

- (c) Fire Zone 1A119 contains safety-related equipment and the following fire protection measures are provided: heat detection and accessibility to manual hose streams and portable fire extinguishers.

- (d) Fire Zones 1A119 contains only division I safe shutdown components, cables, and raceway. Fire Zone 1A119 is adjacent to Fire Zone 1A115, which also contains Division I cables and/or components, Fire Zone 1A119 is also adjacent to Fire Zone 1A220, which contains both Division I and II equipment. Fire Zones 1A116 and 1A118, which are adjacent to Fire Zone 1A119 as well, contain Division II cables and/or components; however, the Division II cables/components located in these fire zones are not part of the success path required for hot shutdown following a fire in this area. The Div II safe shutdown components within this Fire Area only credited for mitigation of scenarios resulting from a fire in a different Fire Area. Therefore, a fire in Fire Zone 1A119 will not prevent safe shutdown.

- (e) Ambient temperatures in this Fire Zone can be above 120F during normal operation, which exceeds the operating temperature of the smoke detectors. In lieu of smoke detection, heat detection is provided in this fire zone as evaluated in GGNS-FP-19-00002.

e. FIRE ZONE 1A220: PIPING PENETRATION ROOM, ELEV. 120' 6"

1. Safety-Related Equipment

Electrical Cable and Raceway

2. Fire Zone Analysis

- (a) Fire Zone 1A220 is located in the Auxiliary Building on Elev. 120' 6". Fire Zone 1A220 communicates directly with Fire Zones 1A115 and 1A116 through its grating floor. Fire Zone 1A220 also communicates indirectly with Fire Zones 1A119 and 1A118 through Fire Zones 1A115 and

GRAND GULF NUCLEAR GENERATING STATION
Updated Final Safety Analysis Report (UFSAR)

1A116, respectively. The ceiling and fourwalls of Fire Zone 1A220 are 3-hour rated fire barriers (Ref. Architectural Drawing A-0633).

- (b) The combustible loading in Fire Zone 1A220, including transient combustibles, amounts to a low fire load. The in situ combustible loading in Fire Zone 1A220 amounts to less than a 15-minute fire duration (Ref. Calculation MC-QSP64-86058).
- (c) Fire Zone 1A220 contains safety-related cable and raceway and the following fire protection measures are provided: heat detection and accessibility to manual hose streams and portable fire extinguishers.
- (d) Fire Zone 1A220 contains Division I and II safe shutdown components, cables, or raceways and is adjacent to Fire Zones 1A115, and 1A119, which contain Division I cables and/or components. Fire Zone 1A220 is also adjacent to Fire Zones 1A116 and 1A118, which contain Division II cables and/or components; however, the Division II cables/components located in these fire zones are not part of the success path required for hot shutdown following a fire in this area. The Div II safe shutdown components within this Fire Area only credited for mitigation of scenarios resulting from a fire in a different Fire/Area. Therefore a fire in Fire Zone 1A220 will not prevent safe shutdown.
- (e) Ambient temperatures in this Fire Zone can be above 120F during normal operation, which exceeds the operating temperature of the smoke detectors. In lieu of smoke detection, heat detection is provided in this fire zone as evaluated in GGNS-FP-19-00002.

GRAND GULF NUCLEAR GENERATING STATION
Updated Final Safety Analysis Report (UFSAR)

9A.5.4

NO FIRE AREA HAS BEEN ASSIGNED FOR SECTION 9A.5.4.

9A.5.5 FIRE AREA 5

9A.5.5.1 FIRE AREA DESCRIPTION

Fire Area 5 consists solely of Fire Zone 1A109 on Elev. 93' 0", in the Auxiliary Building. The ceiling and four walls are 3-hour rated fire barriers (Ref. Architectural Drawing A-0632).

INCLUDED FIRE ZONE	DESCRIPTION
1A109	HPCS Pump Room, Elev. 93' 0"

9A.5.5.2 SAFE SHUTDOWN EQUIPMENT

None

9A.5.5.3 FIRE AREA ANALYSIS

Fire Zone 1A109 does not contain any safe shutdown components, as shown in the microcomputer database (Ref. FPP-1, Appendix C Data). This area does not contain any safe shutdown equipment and is separated from all other areas by 3-hour rated fire barriers. The total fire severity in Fire Zone 1A109, including transient combustibles amounts to a low fire load. The maximum in situ combustible loading in this fire zone amounts to less than a 30-minute fire duration (Ref. Calculation MC-QSP64-86058). Therefore, a fire occurring in Fire Area 5 will not spread into any other fire area.

9A.5.5.4 FIRE ZONE ANALYSES

FIRE ZONE 1A109: HPCS PUMP ROOM, ELEV. 93' 0"

1. Safety-Related Equipment

HPCS Pump
HPCS Jockey Pump
HPCS Room Cooler

GRAND GULF NUCLEAR GENERATING STATION
Updated Final Safety Analysis Report (UFSAR)

Electrical Cable and Raceway

2. Fire Zone Analysis

- (a) Fire Zone 1A109 is located in the Auxiliary Building on Elev. 93' 0". The ceiling and four walls of Fire Zone 1A109 are 3-hour rated fire barriers (Ref. Architectural Drawing A-0632).
- (b) The combustible loading in Fire Zone 1A109, including transient combustibles amounts to a low fire load. The major contributors to this combustible loading are the electrical cable and lube oil present in the room and the concrete joint sealant in the walls. The in situ combustible loading in this fire zone amounts to a 30-minute fire duration (Ref. Calculation MC-QSP64-86058).
- (c) Fire Zone 1A109 contains safety-related equipment and the following fire protection measures are provided: heat detection and accessibility to manual hose streams and portable fire extinguishers.
- (d) Fire Zone 1A109 does not contain any safe shutdown components and is totally enclosed in 3-hour rated fire barriers. Therefore, a fire in Fire Zone 1A109 will not affect either train of safe shutdown components.
- (e) Ambient temperatures in this Fire Zone can be above 120F during normal operation, which exceeds the operating temperature of the smoke detectors. In lieu of smoke detection, heat detection is provided in this fire zone as evaluated in GGNS-FP-19-00002.

9A.5.6 FIRE AREA 6

9A.5.6.1 FIRE AREA DESCRIPTION

Fire Area 6 consists of Fire Zones 1A201, 1A211, 1A215, and 1A222 (Elev. 119' 0") in the Auxiliary Building. The floor, ceiling, and walls of Fire Area 6 are 3-hour rated fire barriers, except for those walls or portions of walls that are below grade non-rated

GRAND GULF NUCLEAR GENERATING STATION
Updated Final Safety Analysis Report (UFSAR)

exterior barriers. In addition, those interfaces with Stairs 1A10, 1A12, and Elevator No. 3 (Ref. Sect. 9A.3.2.13.a) are 2-hour rated fire barriers (Ref. Methodology Section 9A.3.0). Fire Zones 1A201, 1A211, 1A215, and 1A222 are portions of the same corridor along the perimeter of the Auxiliary Building. These zones are not separated from their respective adjacent fire zones by a rated fire barrier (Ref. Architectural Drawing A-0633). Therefore, a fire originating in any one-fire zone of Fire Area 6 is able to communicate with any other fire zone in Fire Area 6.

INCLUDED FIRE ZONES	DESCRIPTION
1A201	Passage, Elev. 119' 0"
1A211	Miscellaneous Equipment Area, Elev. 119' 0"
1A215	Fan Coil Area, Elev. 119' 0"
1A222	Motor Control Center Area, Elev. 119' 0"

9A.5.6.2 SAFE SHUTDOWN EQUIPMENT

Divisions I and II

9A.5.6.3 FIRE AREA ANALYSIS

- a. Fire Zones 1A201 and 1A215 contain only Division I and II safe shutdown cables, raceway, and components, however, the Division II cables/raceway, and components located in these fire zones are not part of the success path required for hot shutdown following a fire in this area. The Div II safe shutdown components within these fire zones are only credited for mitigation of scenarios resulting from a fire in a different Fire Area. Fire Zones 1A211 and 1A222 contain both Divisions I and II safe shutdown components, as shown in the microcomputer database (Ref. FPP-1 Appendix C Data).

- b. Fire Zone 1A211, which is located west of Column Line G.4, contains both Division I and II safe shutdown components. All Division I safe shutdown components located in this zone are located east of a line approximately 17 feet -5 inches east of Column H at Division I safe shutdown vertical cable tray 1AATWT. All Division II safe shutdown components in this zone are located west of this line at Division II safe shutdown vertical cable tray 1ABTOT. A qualified rated one-hour fire wrap or wrap which provides an equivalent one hour fire resistance with evaluation (EC 21147) is provided on the Div II safe shutdown vertical cable tray 1ABTOT in accordance with the risk informed, performance based analysis as approved by Amendment 170 to

GRAND GULF NUCLEAR GENERATING STATION
Updated Final Safety Analysis Report (UFSAR)

the Facility Operating License. The qualified rated one-hour fire wrap or wrap which provides an equivalent one hour fire resistance with evaluation (EC 21147) is installed on the Division II safe shutdown cable tray 1ABTOT and specified intervening items where the cable tray would be subject to damage from a floor based transient combustible fire located between Division I vertical cable tray 1AATWT and Division II vertical cable tray 1ABTOT. In addition, Amendment 170, specifies locations where non-rated Kaowool wrap will be maintained "As Is" as a flame propagation retardant to prevent these raceways from contributing to the fire loading and provides specific combustible controls for Fire Area 6. Combustible Controls for Amendment 170 to the Facility Operating License include a designated transient combustible exclusion zone and limits on the size and locations of Transient Combustible Storage areas for Fire Area 6 (Auxiliary Building elevation 119'). The Specific wrap requirements and combustible controls are detailed in Amendment 170 to the Facility Operating License.

Intervening combustibles located within the transient combustible exclusion zone as defined by Amendment 170 to the Facility Operating License consist of cable trays containing IEEE-383 cable installed in accordance with the requirements of Regulatory Guide 1.75.

Based on the separation between these raceways, the specified raceway wrap and combustible controls in accordance with Amendment 170 to the Facility Operating License, a postulated fire will not affect or propagate to affect more than one train of safe shutdown in this fire zone.

An automatic sprinkler system is installed within the transient combustible exclusion zone described above and extends west to Column Line J.5 and east into Fire Zone 1A201 to Column Line 13.0. A smoke detection system is also provided. Manual fire fighting is provided by installed fire extinguishers and manual hose stream.

- c. Fire Zone 1A201, east of G.4 contains only Division I safe shutdown components. Therefore, a fire originating in this fire zone will not affect more than one train of safe shutdown. A portion of Fire Zone 1A201 is a designated transient combustible exclusion zone in accordance with Amendment 170 to the Facility Operating License. Amendment 170 to the Facility Operating License provides specific combustible controls for Fire Area 6. Based on the

GRAND GULF NUCLEAR GENERATING STATION
Updated Final Safety Analysis Report (UFSAR)

separation between these raceways, the specified raceway wrap and combustible controls in accordance with Amendment 170 to the Facility Operating License, a postulated fire in Fire Zones 1A201 or 1A211 will not affect or propagate to affect more than one train of safe shutdown in these fire zones.

- d. Fire Zone 1A215 contains only Division I safe shutdown components. Fire Zone 1A215 is located more than 90 feet from Fire Zone 1A211 and is separated from 1A211 by Fire Zone 1A201. Therefore, a postulated fire originating in Fire Zone 1A201, 1A215, or 1A211 will not affect, or propagate to affect, more than one train of safe shutdown in these zones.
- e. Fire Zone 1A222 contains both Division I and II safe shutdown components. All Division I safe shutdown components are located south of Column Line 9.5. In addition, all Division II safe shutdown components are located north of Column Line 11.4. Therefore, Division I and II safe shutdown components in Fire Zone 1A222 are separated horizontally by more than 28 feet. This separation distance does not contain any intervening combustibles and an automatic sprinkler system is installed not only within this separation distance but extending north to Column Line 12.2 and south to Column Line 8.4. Therefore, a fire originating in Fire Zone 1A222 will not affect, or propagate to affect, more than one train of safe shutdown in this fire zone.
- f. Since Fire Zone 1A222 separates the Division I safe shutdown components located in Fire Zone 1A215 from the Division II safe shutdown components located in Fire Zone 1A211, a postulated fire originating in Fire Zones 1A211, 1A215, or 1A222 will not affect, or propagate to affect, more than one train of safe shutdown components.
- g. Based on this adjacency discussion, it is concluded that the fire protection measures provided in Fire Zones 1A222 and 1A211 ensure that a postulated fire originating in Fire Zone 1A201, 1A215, 1A222, or 1A211 will not affect, or propagate to affect, more than one train of safe shutdown.

GRAND GULF NUCLEAR GENERATING STATION
Updated Final Safety Analysis Report (UFSAR)

- h. Although the fire protection provided in Fire Area 6 does not strictly comply with the criteria set forth in Section 9A.3.1 of the Appendix R evaluation procedure, in that sprinkler coverage is not provided throughout Fire Area 6 and redundant safe shutdown components are not separated by 3-hour rated fire barriers, the fire protection provided in Fire Area 6 is more than adequate to ensure that at least one train of safe shutdown components will remain free of fire damage.
- i. The postulated fire with the greatest severity duration in Fire Area 6 is a fire in Fire Zone 1A201. The total fire severity loading in Fire Zone 1A201, including transient combustibles amounts to a moderate fire load. The maximum in situ combustible loading in this fire zone amounts to less than a 90-minute fire duration. (Ref. Calculation MC-QSP64-86058).
- j. Since Fire Area 6 is separated from all other fire areas by 3-hour rated fire barriers or their equivalents, a fire occurring in Fire Area 6 will not spread into any other fire area.

9A.5.6.4 FIRE ZONE ANALYSES

- a. FIRE ZONE 1A201: PASSAGE, ELEV. 119' 0"
 - 1. Safety-Related Equipment
 - MSIV Leakage Control Panels
 - Exhaust Blowers
 - Electrical Cable and Raceway
 - 2. Fire Zone Analysis
 - (a) Fire Zone 1A201 is located in the Auxiliary Building on Elev. 119' 0". The ceiling, floor, and the North, West (column lines 6.5 - 13.6), and East walls of Fire Zone 1A201 are 3-hour rated fire barriers. The South wall is a below grade, non-rated exterior barrier (Ref. Architectural Drawing A-0633).
 - (b) The combustible loading in Fire Zone 1A201, including transient combustibles amounts to a moderate fire load. The major contributor to

GRAND GULF NUCLEAR GENERATING STATION
Updated Final Safety Analysis Report (UFSAR)

this combustible loading is the electrical cable present in the zone. The in situ combustible loading in this fire zone amounts to less than a 90-minute fire duration. (Ref. Calculation MC-QSP64-86058).

- (c) Fire Zone 1A201 contains safety-related equipment and the following fire protection measures are provided: partial fire zone coverage by an automatic sprinkler system, smoke detection, and accessibility to manual hose streams and portable fire extinguishers.
- (d) Fire Zone 1A201 contains Division I and II safe shutdown cable, raceway, and components, however, the Division II cables/raceway, and components located in these fire zones are not part of the success path required for hot shutdown following a fire in this area. The Div II safe shutdown components within these fire zones are only credited for mitigation of scenarios resulting from a fire in a different fire Area. Failure of these components will not prevent safe shutdown. However, Fire Zone 1A201 has several combinations of adjacency with other fire zones within Fire Area 6. An adjacency discussion is provided in the fire area analysis for Fire Area 6. A portion of Fire Zone 1A201 is a designated transient combustible exclusion zone in accordance with Amendment 170 to the Facility Operating License. Amendment 170 to the Facility Operating License provides specific combustible controls for Fire Area 6.

b. FIRE ZONE 1A211: MISCELLANEOUS EQUIPMENT AREA, ELEV. 119' 0"

1. Safety-Related Equipment

Electrical Cable and Raceway

2. Fire Zone Analysis

- (a) Fire Zone 1A211 is located in the Auxiliary Building on Elev. 119' 0". The ceiling, floor, South wall, and that portion of the North wall

GRAND GULF NUCLEAR GENERATING STATION
Updated Final Safety Analysis Report (UFSAR)

that is physically adjacent to the Control Building of Fire Zone 1A211 are 3-hour rated fire barriers. In addition, those interfaces with Stair 1A10 and Elevator No. 3 (Ref. Sect. 9A.3.2.13.a) are 2-hour rated fire barriers (Ref. Methodology Section 9A.3.0). The remainder of the North wall is a below grade, non-rated exterior barrier. The East and West boundaries of 1A211 are open to Fire Zones 1A201 and 1A222, respectively (Ref. Architectural Drawing A-0633).

- (b) The combustible loading in Fire Zone 1A211, including transient combustibles amounts to a low fire load. The major contributor to this combustible loading is the electrical cable present in the fire zone. The in situ combustible loading in Fire Zone 1A211 amounts to less than a 30-minute fire duration. (Ref. Calculation MC-QSP64-86058).
- (c) Fire Zone 1A211 contains safety-related equipment and the following fire protection measures are provided: partial fire zone coverage by an automatic sprinkler system, smoke detection, and accessibility to manual hose streams and portable fire extinguishers.
- (d) Fire Zone 1A211, contains both Division I and II safe shutdown components. All Division I safe shutdown components located in this zone are located east of a line approximately 17 feet-5 inches east of Column H at Division I safe shutdown vertical cable tray 1AATWT. All Division II safe shutdown components in this zone are located west of this line at Division II safe shutdown vertical cable tray 1ABTOT. A qualified rated one-hour fire wrap or wrap which provides an equivalent one hour fire resistance with evaluation (EC 21147) is provided on the Div II safe shutdown vertical cable tray 1ABTOT in accordance with the risk informed, performance based analysis as approved by Amendment 170 to the Facility Operating License. The qualified rated one-hour wrap or wrap which

GRAND GULF NUCLEAR GENERATING STATION
Updated Final Safety Analysis Report (UFSAR)

provides an equivalent one hour fire resistance with evaluation (EC 21147) is installed on the Division II safe shutdown cable tray 1ABTOT and specified intervening items where the cable tray would be subject to damage from a floor based transient combustible fire located between Division I vertical cable tray 1AATWT and Division II vertical cable tray 1ABTOT. In addition, Amendment 170, specifies locations where non-rated Kaowool wrap will be maintained "As Is" as a flame propagation retardant to prevent these raceways from contributing to the fire loading and provides specific combustible controls for Fire Area 6. Combustible controls for Amendment 170 to the Facility Operating License include a designated transient combustible exclusion zone and limits on the size and locations of Transient Combustible Storage areas for Fire Area 6 (Auxiliary Building elevation 119'). The Specific wrap requirements and combustible controls are detailed in Amendment 170 to the Facility Operating License.

Intervening combustibles located within the transient combustible exclusion zone as defined by Amendment 170 to the Facility Operating License consist of cable trays containing IEEE-383 cable installed in accordance with the requirements of Regulatory Guide 1.75.

Based on the separation between these raceways, the specified raceway wrap and combustible controls in accordance with Amendment 170 to the Facility Operating License, a postulated fire will not affect or propagate to affect more than one train of safe shutdown in this fire zone.

An automatic sprinkler system is installed within the transient combustible exclusion zone described above and extends west to Column Line J.5 and east into Fire Zone 1A201 to Column Line 13.0. A smoke detection system is also

GRAND GULF NUCLEAR GENERATING STATION
Updated Final Safety Analysis Report (UFSAR)

provided. Manual fire fighting is provided by installed fire extinguishers and manual hose stream.

However, Fire Zone 1A211 has several combinations of adjacency with other fire zones within Fire Area 6. An adjacency discussion is provided in the fire area analysis for Fire Area 6.

c. FIRE ZONE 1A215: FAN COIL AREA, ELEV. 119' 0"

1. Safety-Related Equipment

Electrical Cable and Raceway

2. Fire Zone Analysis

- (a) Fire Zone 1A215 is located in the Auxiliary Building on Elev. 119' 0". The ceiling, floor, and North wall of Fire Zone 1A215 are 3-hour rated fire barriers. The South wall is a non-rated, below grade, exterior barrier. The East and West boundaries of 1A215 are open to Fire Zones 1A201 and 1A222, respectively (Ref. Architectural Drawing A-0633).
- (b) The combustible loading in Fire Zone 1A215, including transient combustibles amounts to a low fire load. The major contributor to this combustible loading is the electrical cable present in the fire zone. The in situ combustible loading in Fire Zone 1A215 amounts to less than a 60-minute fire duration. (Ref. Calculation MC-QSP64-86058).
- (c) Fire Zone 1A215 contains safety-related equipment and the following fire protection measures are provided: smoke detection and accessibility to manual hose streams and portable fire extinguishers.
- (d) Fire Zone 1A215 contains Division I and II safe shutdown cables, raceway, and components, however, the Division II cables/raceway, and component located in these fire zones are not

GRAND GULF NUCLEAR GENERATING STATION
Updated Final Safety Analysis Report (UFSAR)

part of the success path required for hot shutdown following a fire in this area. The Div II safe shutdown components within these fire zones are only credited for mitigation of sceneries resulting from a fire in a different Fire Area. Failure of these cables, raceway, and components will not prevent safe shutdown. However, Fire Zone 1A215 has several combinations of adjacency with other fire zones within Fire Area 6. An adjacency discussion is provided in the fire area analysis for Fire Area 6.

- d. FIRE ZONE 1A222: MOTOR CONTROL CENTER AREA, ELEV. 119' 0"
 - 1. Safety-Related Equipment
 - Electrical Cable and Raceway
 - 2. Fire Zone Analysis
 - (a) Fire Zone 1A222 is located in the Auxiliary Building on Elev. 119' 0". The ceiling and floor of Fire Zone 1A222 are 3-hour rated fire barriers. The North, South, and West walls of Fire Zone 1A222 are non-rated, below grade, exterior barriers; except for the portion of the South wall, which interfaces with Stair 1A12, and is a 2-hour rated fire barrier (Ref. Methodology Section 9A.3.0). The East boundary of 1A222 is open to Fire Zones 1A211 and 1A215 and is a 3-hour rated barrier between Column Lines 7.5 and 12.5 (Ref. Architectural Drawing A-0633).
 - (b) The combustible loading in Fire Zone 1A222, including transient combustibles amounts to a low fire load. The major contributor to this combustible loading is the electrical cable present in the zone. The in situ combustible loading in Fire Zone 1A222 amounts to less than a 45-minute fire duration (Ref. Calculation MC-QSP64-86058).

GRAND GULF NUCLEAR GENERATING STATION
Updated Final Safety Analysis Report (UFSAR)

- (c) Fire Zone 1A222 contains safety-related equipment and the following fire protection measures are provided: partial fire zone coverage by an automatic sprinkler system, smoke detection, and accessibility to manual hose streams and portable fire extinguishers.

- (d) In Fire Zone 1A222, the minimum separation distance between Division I and II safe shutdown components (1ABTMH01 and 1AATMG74) is 28 feet (Ref. Physical Raceway Drawings E-1678 and E-1679). The 28 feet separating raceways 1AATMG74 and 1ABTMH01 does not contain any intervening combustibles. Therefore, a postulated fire originating in Fire Zone 1A222 will not affect, or propagate to affect, more than one train of safe shutdown. However, Fire Zone 1A222 has several combinations of adjacency with other fire zones within Fire Area 6. An adjacency discussion is provided in the fire area analysis for Fire Area 6.

9A.5.7 FIRE AREA 7

9A.5.7.1 FIRE AREA DESCRIPTION

Fire Area 7 consists solely of Fire Zone 1A207 (Elev. 119 0") in the Auxiliary Building. The floor, ceiling, and all walls are 3-hour rated fire barriers (Ref. Architectural Drawing A-0633)

INCLUDED FIRE ZONE	Description
1A207	Electrical Switchgear Room, Elev. 119' 0"

9A.5.7.2 SAFE SHUTDOWN EQUIPMENT

Division II

9A.5.7.3 FIRE AREA ANALYSIS

Fire Zone 1A207 contains only Division II safe shutdown equipment and cable and raceway, as shown in the microcomputer database (Ref. FPP-1, Appendix C Data). Since this fire area contains only Division II safe shutdown components and is separated from all other fire areas by 3 hour rated fire barriers, Fire Area 7 fully complies with Appendix R requirements. Therefore, in the event of

GRAND GULF NUCLEAR GENERATING STATION
Updated Final Safety Analysis Report (UFSAR)

a fire in this fire area, safe shutdown capability would be maintained by separate Division I safe shutdown equipment. The total fire severity in Fire Zone 1A207, including transient combustibles amounts to a low fire load. The maximum in situ combustible loading in this fire zone amounts to less than a 45-minute fire duration (Ref. Calculation MC-QSP64-86058). Therefore, a fire occurring in Fire Area 7 will not spread into any other fire area.

9A.5.7.4 FIRE ZONE ANALYSIS

FIRE ZONE 1A207: ELECTRICAL SWITCHGEAR ROOM, ELEV. 119' 0"

1. Safety-Related Equipment

Electrical Cable and Raceway
ESF Electrical Switchgear Room East Cooler
Motor Control Center
6.9 kV Switchgear

2. Fire Zone Analysis

- (a) Fire Zone 1A207 is located in the Auxiliary Building on Elev. 119' 0". Fire Zone 1A207 is bounded on all sides by 3-hour rated fire barriers (Ref. Architectural Drawing A-0633).
- (b) The combustible loading in Fire Zone 1A207, including transient combustible amounts to a low fire load. The major combustibles to this combustible loading are electrical cable present in the room, pipe/component insulation, and the concrete joint sealant in the walls. The in situ combustible loading in Fire Zone 1A207 amounts to less than a 45-minute fire duration (Ref. Calculation MC-QSP64-86058).
- (c) Fire Zone 1A207 contains safety-related equipment and the following fire protection measures are provided: smoke detection, automatic Carbon dioxide suppression system, and accessibility to manual hose streams and portable fire extinguishers.

GRAND GULF NUCLEAR GENERATING STATION
Updated Final Safety Analysis Report (UFSAR)

- (d) Since Fire Zone 1A207 contains only Division II safe shutdown equipment and is completely enclosed by 3 hour rated fire barriers, a fire originating in this fire zone will not affect more than one train of safe shutdown components.

9A.5.8 FIRE AREA 8

9A.5.8.1 FIRE AREA DESCRIPTION

Fire Area 8 consists solely of Fire Zone 1A208 (Elev. 119' 0" and Elev. 121' 6") in the Auxiliary Building. The floor, ceiling, and all walls are 3-hour rated fire barriers (Ref. Architectural Drawing A-0633).

INCLUDED FIRE ZONE	DESCRIPTION
1A208	Electrical Switchgear Room, Elev. 119' 0" & 121' 6"

9A.5.8.2 SAFE SHUTDOWN EQUIPMENT

Division I

9A.5.8.3 ALTERNATE SHUTDOWN CONTROLS

1H22-P295

9A.5.8.4 FIRE AREA ANALYSIS

Fire Zone 1A208 contains only Division I safe shutdown equipment and cable and raceway, as shown in the microcomputer database (Ref. FPP-1, Appendix C Data). Since this fire area contains only Division I safe shutdown components and is separated from all other fire areas by 3-hour rated fire barriers, Fire Area 8 fully complies with Appendix R requirements. Therefore, in the event of a fire in this fire area, safe shutdown capability would be maintained by separate Division II safe shutdown equipment. The total fire severity in Fire Zone 1A208, including transient combustibles amounts to a low fire load. The maximum in situ combustible loading in this fire zone amounts to less than a 60-minute fire duration (Ref. Calculation MC-QSP64-86058). Therefore, a fire occurring in Fire Area 8 will not spread into any other fire area.

GRAND GULF NUCLEAR GENERATING STATION
Updated Final Safety Analysis Report (UFSAR)

9A.5.8.5 FIRE ZONE ANALYSIS

FIRE ZONE 1A208: ELECTRICAL SWITCHGEAR ROOM, ELEV. 119' 0"
AND 121' 6"

1. Safety-Related Equipment

Electrical Cable and Raceway
ESF Electrical Switchgear Room East Cooler
Motor Control Center
6.9 kV Switchgear
GE Panel
DC Starters
Alternate Shutdown Panel

2. Fire Zone Analysis

- (a) Fire Zone 1A208 is located in the Auxiliary Building on Elev. 119' 0" and 121' 6". Fire Zone 1A208 is bounded on all sides by 3-hour rated fire barriers (Ref. Architectural Drawing A-0633).
- (b) The combustible loading in Fire Zone 1A208, including transient combustibles amounts to a low fire load. The major contributor to this combustible loading is electrical cable. The in situ combustible loading in this fire amounts to less than a 60-minute fire duration (Ref. Calculation MC-QSP64-86058).
- (c) Fire Zone 1A208 contains safety-related equipment and the following fire protection measures are provided: automatic Carbon dioxide suppression system, smoke detection, and accessibility to manual hose streams and portable fire extinguishers.
- (d) Since Fire Zone 1A208 contains only Division I safe shutdown equipment and is completely enclosed by 3-hour rated fire barriers, a fire originating in this fire zone will not affect more than one train of safe shutdown components.

GRAND GULF NUCLEAR GENERATING STATION
Updated Final Safety Analysis Report (UFSAR)

9A.5.9 FIRE AREA 9

9A.5.9.1 FIRE AREA DESCRIPTION

Fire Area 9 consists solely of Fire Zone 1A219 (Elev. 119' 0") in the Auxiliary Building. The floor, ceiling, and all walls are 3-hour rated fire barriers (Ref. Architectural Drawing A-0633).

INCLUDED FIRE ZONE	DESCRIPTION
1A219	Electrical Switchgear Room, Elev. 119' 0"

9A.5.9.2 SAFE SHUTDOWN EQUIPMENT

Division I

9A.5.9.3 ALTERNATE SHUTDOWN CONTROLS

1H22-P296

9A.5.9.4 FIRE AREA ANALYSIS

Fire Zone 1A219 contains only Division I safe shutdown equipment and cable and raceway, as shown in the microcomputer database (Ref. FPP-1, Appendix C Data). Since this fire area contains only Division I safe shutdown components and is separated from all other fire areas by 3-hour rated fire barriers, Fire Area 9 fully complies with Appendix R requirements. Therefore, in the event of a fire in this fire area, safe shutdown capability would be maintained by separate Division II safe shutdown equipment. The total fire severity in Fire Zone 1A219, including transient combustibles amounts to a low fire load. The maximum in situ combustible loading in this fire zone amounts to less than a 45-minute fire duration (Ref. Calculation MC-QSP64-86058). Therefore, a fire occurring in Fire Area 9 will not spread into any other fire area.

9A.5.9.5 FIRE ZONE ANALYSIS

FIRE ZONE 1A219: ELECTRICAL SWITCHGEAR ROOM, ELEV. 119' 0"

1. Safety-Related Equipment

Electrical Cable and Raceway
ESF Electrical Switchgear Room West Cooler
Motor Control Center
Load Centers

GRAND GULF NUCLEAR GENERATING STATION
Updated Final Safety Analysis Report (UFSAR)

Alternate Shutdown Panel

2. Fire Zone Analysis

- (a) Fire Zone 1A219 is located in the Auxiliary Building on Elev. 119' 0". Fire Zone 1A219 is bounded on all sides by 3-hour rated fire barriers (Ref. Architectural Drawing A-0633).
- (b) The combustible loading in Fire Zone 1A219, including transient combustibles amounts to a low fire load. The major contributor to this combustible loading is electrical cable. The in situ combustible loading in this fire zone amounts to less than a 45-minute fire duration (Ref. Calculation MC-QSP64-86058).
- (c) Fire Zone 1A219 contains safety-related equipment and the following fire protection measures are provided: automatic Carbon dioxide suppression system, smoke detection, and accessibility to manual hose streams and portable fire extinguishers.
- (d) Since Fire Zone 1A219 contains only Division I safe shutdown equipment and is completely enclosed by 3-hour rated fire barriers, a fire originating in this fire zone will not affect more than one train of safe shutdown components.

9A.5.10 FIRE AREA 10

9A.5.10.1 FIRE AREA DESCRIPTION

Fire Area 10 consists solely of Fire Zone 1A221 (Elev. 119' 0") in the Auxiliary Building. The floor, ceiling, and all walls are 3-hour rated fire barriers (Ref. Architectural Drawing A-0633).

INCLUDED FIRE ZONE	DESCRIPTION
1A221	Electrical Switchgear Room, Elev. 119' 0"

9A.5.10.2 SAFE SHUTDOWN EQUIPMENT

Division II

GRAND GULF NUCLEAR GENERATING STATION
Updated Final Safety Analysis Report (UFSAR)

9A.5.10.3 FIRE AREA ANALYSIS

Fire Zone 1A221 contains Division II safe shutdown equipment and cable and raceway, as shown on the microcomputer database (Ref. FPP-1, Appendix C Data). Since this fire area contains only Division II safe shutdown components and is separated from all other fire areas by 3-hour rated fire barriers, Fire Area 10 fully complies with Appendix R requirements. Therefore, in the event of a fire in Fire Area 10, safe shutdown capability would be maintained by separate Division I safe shutdown equipment. The total fire severity in Fire Zone 1A221, including transient combustibles amounts to a low fire load. The maximum in situ combustible loading in this fire zone amounts to less than a 45-minute fire duration (Ref. Calculation MC-QSP64-86058). Therefore, a fire occurring in Fire Area 10 will not spread into any other fire area.

9A.5.10.4 FIRE ZONE ANALYSIS

FIRE ZONE 1A221: ELECTRICAL SWITCHGEAR ROOM, ELEV. 119' 0"

1. Safety-Related Equipment

ESF Electrical Switchgear Room West Cooler
Electrical Cable and Raceway
Motor Control Center
Load Centers

2. Fire Zone Analysis

- (a) Fire Zone 1A221 is located in the Auxiliary Building on Elev. 119' 0". Fire Zone 1A221 is bounded on all sides by 3-hour rated fire barriers (Ref. Architectural Drawing A-0633).
- (b) The combustible loading in Fire Zone 1A221, including transient combustibles amounts to a low fire load. The major contributor to this combustible loading is the electrical cable present in the room. The in situ combustible loading in Fire Zone 1A221 amounts to less than a 45-minute fire duration (Ref. Calculation MC-QSP64-86058).

GRAND GULF NUCLEAR GENERATING STATION
Updated Final Safety Analysis Report (UFSAR)

- (c) Fire Zone 1A221 contains safety-related equipment and the following fire protection measures are provided: automatic Carbon dioxide suppression system, smoke detection, and accessibility to manual hose streams and portable fire extinguishers.
- (d) Since Fire Zone 1A221 contains only Division II safe shutdown equipment, and is completely enclosed by 3-hour rated fire barriers, a fire originating in this fire zone will not affect more than one train of safe shutdown components

9A.5.11 FIRE AREA 11

9A.5.11.1 FIRE AREA DESCRIPTION

- (a) Fire Area 11 consists of Fire Zones 1A301, 1A302, 1A314, 1A316, 1A321, 1A322, 1A323, 1A326 (Elev. 139' 0"), and 1A324 (Elev. 154' 6") in the Auxiliary Building. Fire Zones 1A301, 1A302, 1A314, 1A316, 1A321, and 1A322 comprise an open, U-shaped passage around the perimeter of the Auxiliary Building on Elev. 139' 0". Fire Zone 1A301 is separated from Fire Zone 1A302 by the main steam tunnel. Fire Zones 1A323, 1A324, and 1A326 communicate with each other and all other fire zones in this fire area through open areas and non-rated barriers.
- (b) The floor, ceiling, and walls of Fire Area 11 are 3-hour rated fire barriers, except for portions of the South and West walls, which are non-rated exterior barriers, and a portion of the North wall between Column Lines K through L.7, which is a 2-hour rated fire barrier (Ref. Architectural Drawing A-0634). In addition, the interfaces with Stairs 1A10, 1A12, and Elevator No. 3 (Ref. Sect. 9A.3.2.13.a) are 2-hour rated fire barriers (Ref. Methodology Section 9A.3.0).

GRAND GULF NUCLEAR GENERATING STATION
Updated Final Safety Analysis Report (UFSAR)

Therefore, a fire originating in any fire zone of Fire Area 11 could communicate with any other fire zone in Fire Area 11.

INCLUDED FIRE ZONE	DESCRIPTION
1A301	Corridor, Elev. 139' 0"
1A302	Corridor, Elev. 139' 0"
1A314	Passage, Elev. 139' 0"
1A316	Motor Control Center, Elev. 139' 0"
1A321	Motor Control Center, Elev. 139' 0"
1A322	Centrifugal Chiller Area, Elev. 139' 0"
1A323	Standby Gas Treatment Area, Elev. 139' 0"
1A324	1A323 and 1A326, Elev. 154' 6"
1A326	Standby Gas Treatment Area, Elev. 139' 0"

9A.5.11.2 SAFE SHUTDOWN EQUIPMENT

Divisions I and II

9A.5.11.3 FIRE AREA ANALYSIS

- (a) Fire Zones 1A316 and 1A322 contain both Division I and II safe shutdown components. Fire Zones 1A301, 1A302, and 1A314 contain only Division I safe shutdown components. Fire Zone 1A321 contains only Division II safe shutdown components. In addition, Fire Zones 1A323, 1A324, and 1A326 do not contain any safe shutdown components, as shown in the microcomputer database (Ref FPP-1, Appendix C Data).
- (b) Fire Zone 1A316, which is located west of Column Line G.4, contains both Division I and II safe shutdown components. All Division I safe shutdown components located in the zone are located east of a line approximately 18 feet east of column H at Division I safe shutdown vertical cable tray 1AATWT. All Division II safe shutdown components in this zone are located west of this line at Division II safe shutdown vertical cable tray 1ABTOT. A qualified rated one-hour fire wrap or wrap which provides an equivalent one hour fire resistance with evaluation (EC 21147) is provided on the Div II safe shutdown vertical cable tray 1ABTOT in

GRAND GULF NUCLEAR GENERATING STATION
Updated Final Safety Analysis Report (UFSAR)

accordance with the risk informed, performance based analysis as approved by Amendment 170 to the Facility Operating License. The qualified rated one-hour fire wrap or wrap which provides an equivalent one hour fire resistance with evaluation (EC 21147) is installed on the Division II safe shutdown cable tray 1ABTOT and specified intervening items where the cable tray would be subject to damage from a floor based transient combustible fire located between Division I vertical cable tray 1AATWT and Division II vertical cable tray 1ABTOT. In addition, Amendment 170, specifies locations where non-rated Kaowool wrap will be maintained "As Is" as a flame propagation retardant to prevent these raceways from contributing to the fire loading and provides specific combustible controls for Fire Area 11. Combustible Controls for Amendment 170 to the Facility Operating License include a designated transient combustible exclusion zone and limits on the size and locations of Transient Combustible Storage areas for Fire Area 11 (Auxiliary Building elevation 139'). The Specific wrap requirements and combustible controls are detailed in Amendment 170 to the Facility Operating License.

- (c) The transient combustible exclusion zone as defined by Amendment 170 contains intervening combustibles which consist of two non-safety related open trays and three tray risers containing IEEE cable to non safety-related MCC 12B51, which is located along the South wall of Fire Zone 1A316, between column lines G.4 and H. These trays are located 9 feet from Division I safe shutdown components and are totally enclosed in the vicinity of the Division II safe shutdown components to satisfy the requirements of Regulatory Guide 1.75. Based on the separation between these raceways, the specified raceway wrap and combustible controls in accordance with Amendment 170 to the Facility

GRAND GULF NUCLEAR GENERATING STATION
Updated Final Safety Analysis Report (UFSAR)

Operating License, a postulated fire will not affect or propagate to affect more than one train of safe shutdown in this fire zone.

An automatic sprinkler system is installed within the transient combustible exclusion zone described above and extends west to Column Line J.5 and east into Fire Zone 1A301 to Column Line 13.0. A smoke detection system is also provided. Manual fire fighting is provided by installed fire extinguishers and manual hose stream.

- (d) Fire Zone 1A301, east of G.4 contains only Division I safe shutdown components. A portion of Fire Zone 1A301 is a designated transient combustible exclusion zone in accordance with Amendment 170 to the Facility Operating License. Amendment 170 to the Facility Operating License provides specific combustibles controls for Fire Area 11. Based on the separation between these raceways, the specified raceway wrap and combustibles controls in accordance with Amendment 170 to the Facility Operating License, a postulated fire occurring in 1A301 or 1A316 will not affect or propagate to affect more than one train of safe shutdown in these fire zones.

Fire Zone 1A301 also contains RHR Heat Exchanger 'A' & 'B' inlet temperature indication circuits utilized for alternate suppression pool temperature monitoring in the event of a fire in Containment (as discussed in Fire Area 25, Section 9A.5.25).

- (e) Fire Zone 1A321 contains only Division II safe shutdown components and is separated from the portion of Fire Zone 1A316 containing Division I safe shutdown components by that part of 1A316 located west of a line approximately 18 feet east of column H at Division I safe shutdown vertical cable tray 1AATWT. Based on the separation between these raceways, the specified raceway wrap and combustibles controls in accordance with Amendment 170 to the Facility

GRAND GULF NUCLEAR GENERATING STATION
Updated Final Safety Analysis Report (UFSAR)

Operating License, a postulated fire occurring in 1A301, 1A316 or 1A321 will not affect or propagate to affect more than one train of safe shutdown in these fire zones.

- (f) Fire Zone 1A322 also contains Division I and II safe shutdown components. All Division I safe shutdown components in Fire Zone 1A322 are located 17 feet south of Column Line 9.0. All Division II safe shutdown components are located 6 feet north of Column Line 9.0. Therefore, Division I and II safe shutdown components located in 1A322 are separated by 23 feet. There are no intervening electrical combustibles located within this 23-foot separation distance, since the two cable trays located within this separation distance are totally enclosed. There are, however, two 1200-ton centrifugal chillers, each containing 20.0 gallons of lube oil, physically located within this 23-foot separation distance. The first chiller is located 8 feet north of Column Line 7.5, directly below the closest Division I safe shutdown component discussed above. The second chiller is located 5 feet south of Column Line 9.0, 12 feet from Division I safe shutdown components and 11 feet from Division II safe shutdown components. The oil in each of these chillers is pressurized to 80 psig, which could be released into Fire Zone 1A322, should the oil sight glass or oil collection container (approximately 1-quart - not pressurized) on the chiller motors fail during a fire. Because Fire Zone 1A322 is completely covered by an automatic sprinkler system, an exposure fire heating the oil enough to cause failure of the sight glass or oil collector container is not postulated. The chiller motor is located in the center of the chiller with the sight glass facing south. Also contained within the 23 foot separation distance is insulation on chiller piping. This insulation is located between the redundant divisions; however, due to the difference in elevation between the insulated piping and safe shutdown components and because the chiller

GRAND GULF NUCLEAR GENERATING STATION
Updated Final Safety Analysis Report (UFSAR)

pipings does not completely traverse the separation distance, it is unlikely that a fire could propagate along this insulation to damage more than one train. A postulated fire originating in this fire zone will not affect, or propagate to affect, more than one train of safe shutdown components in this fire zone. In addition, an automatic sprinkler system is installed throughout Fire Zone 1A322. However, even if a fire did damage the redundant components being protected by the separation distance, these components are primarily associated with the diesel generators, which are used only during a loss of offsite power. An analysis has been performed demonstrating that even if the redundant diesel generator cables are damaged, the preferred offsite power source is available and safe shutdown is assured. (Reference 6.19)

- (g) Fire Zones 1A314 and 1A302 are located east of Fire Zone 1A322 and only contain Division I safe shutdown components. The portion of Fire Zone 1A322 that contains Division I safe shutdown components separates the Division II safe shutdown components in Fire Zone 1A322 from Fire Zone 1A314 and 1A302. Based on the fire protection provided in 1A322, 1A314, or 1A302 will not affect, or propagate to affect, more than one train of safe shutdown in these fire zones.

Fire Zone 1A302 also contains RHR Heat Exchanger 'A' inlet temperature indication circuits utilized for alternate suppression pool temperature monitoring in the event of a fire in Containment (as discussed in Fire Area 25, Section 9A.5.25).

- (h) Fire Zone 1A321 is located north of Fire Zone 1A322 and contains only Division II safe shutdown components. The portion of Fire Zone 1A322 that contains Division II safe shutdown components separates the Division I safe shutdown components in Fire Zone 1A322 from Fire

GRAND GULF NUCLEAR GENERATING STATION
Updated Final Safety Analysis Report (UFSAR)

Zone 1A321. Based on the fire protection provided in 1A322, a postulated fire originating in Fire Zone 1A321 or 1A322 will not affect, or propagate to affect, more than one train of safe shutdown components in these fire zones.

- (i) Fire Zones 1A323, 1A324, and 1A326 do not contain any safe shutdown components. These fire zones are separated from Division I safe shutdown components without barriers located in Fire Zones 1A316 and 1A322 by that portion of 1A316 and 1A322 containing only Division II safe shutdown components, as well as the separation distance discussed previously. Based on the fire protection provided in Fire Zones 1A316 and 1A322, a postulated fire originating in Fire Zone 1A323, 1A324, or 1A326 will not affect, or propagate to affect, more than one train of safe shutdown components in these fire zones.
- (j) Based on the above area analysis, the fire protection measures provided in Fire Zones 1A316 and 1A322 ensure that a postulated fire originating in any fire zone within Fire Area 11 will not affect, or propagate to affect, more than one train of safe shutdown components.
- (k) Although the fire protection provided in Fire Area 11 does not strictly comply with the criteria set forth in Section 9A.3.1 of the Appendix R evaluation procedure, in that sprinkler coverage is not provided throughout Fire Area 11 and redundant safe shutdown components are not separated by 3-hour rated fire barriers, the fire protection provided in Fire Area 11 is more than adequate to ensure that at least one train of safe shutdown components will remain free of fire damage.
- (l) The postulated fire with the greatest severity in Fire Area 11 can occur in Fire Zone 1A301. The combustible loading in Fire Zone 1A301, including transient combustibles amounts to a high fire load. The in situ combustible loading in this fire zone amounts to less than a 150-

GRAND GULF NUCLEAR GENERATING STATION
Updated Final Safety Analysis Report (UFSAR)

minute fire duration (Ref. Calculation MC-QSP64-86058). Fire Area 11 is separated from all other fire areas by 3-hour rated fire barriers and a fire occurring in Fire Area 11 will not spread into any other fire area.

9A.5.11.4 FIRE ZONE ANALYSES

a. FIRE ZONE 1A301: CORRIDOR, ELEV. 139' 0"

1. Safety-Related Equipment

Electrical Cable and Raceway

2. Fire Zone Analysis

- (a) Fire Zone 1A301 is located in the Auxiliary Building on Elev. 139' 0". The ceiling, floor and walls are 3-hour rated fire barriers, except for that portion of the West boundary that is open to Fire Zone 1A316 (Ref. Architectural Drawing A-0634).
- (b) The combustible loading in Fire Zone 1A301, including transient combustibles amounts to a high fire load. The major contributor to this combustible loading is the electrical cable present in this room. The in situ combustible loading in this fire zone amounts to less than a 165-minute fire duration (Ref. Calculation MC-QSP64-86058).
- (c) Fire Zone 1A301 contains safety-related equipment and the following fire protection measures are provided: smoke detection, partial coverage by automatic sprinkler system, and accessibility to hose stations and portable fire extinguishers.
- (d) Fire Zone 1A301 contains only Division I safe shutdown components. Therefore, a fire originating in Fire Zone 1A301 will not affect more than one train of safe shutdown. However, this fire zone is adjacent to Fire Zone 1A316. An adjacency discussion is provided in the fire area analysis for Fire Area 11. A portion of

GRAND GULF NUCLEAR GENERATING STATION
Updated Final Safety Analysis Report (UFSAR)

Fire Zone 1A301 is a designated transient combustible exclusion zone in accordance with Amendment 170 to the Facility Operating License. Amendment 170 to the Facility Operating License provided specific combustibles controls for Fire Area 11.

Fire Zone 1A301 also contains RHR Heat Exchangers 'A' & 'B' inlet temperature indication circuits utilized for alternate suppression pool temperature monitoring in the event of a fire in Containment (as discussed in Fire Area 25, Section 9A.5.25).

- b. FIRE ZONE 1A302: CORRIDOR, ELEV. 139' 0"
 - 1. Safety-Related Equipment
 - Electrical Cable and Raceway
 - 2. Fire Zone Analysis
 - (a) Fire Zone 1A302 is located in the Auxiliary Building on Elev. 139' 0". The ceiling, floor, and walls are 3-hour rated fire barriers, except for that portion of the West boundary that is open to Fire Zone 1A314 (Ref. Architectural Drawing A-0634).
 - (b) The combustibles loading in Fire Zone 1A302, including transient combustibles amounts to a high fire load. The major contributor to this combustibles loading is the electrical cable present in the room. The in situ combustibles loading in this fire zone amounts to less than a 135-minute fire duration (Ref. Calculation MC-QSP64-86058).
 - (c) Fire Zone 1A302 contains safety-related equipment and the following fire protection measures are provided: smoke detection and accessibility to hose stations and portable fire extinguishers.

GRAND GULF NUCLEAR GENERATING STATION
Updated Final Safety Analysis Report (UFSAR)

- (d) Fire Zone 1A302 contains only Division I safe shutdown components. Therefore, a fire originating in this fire zone will not affect more than one train of safe shutdown. Fire Zone 1A302 is adjacent to Fire Zone 1A314. An adjacency discussion is provided in the fire area analysis for Fire Area 11.

Fire Zone 1A302 also contains RHR Heat Exchanger 'A' inlet temperature indication circuits utilized for alternate suppression pool temperature monitoring in the event of a fire in Containment (as discussed in Fire Area 25, Section 9A.5.25).

c. FIRE ZONE 1A314: PASSAGE, ELEV. 139' 0"

1. Safety-related Equipment

Electrical Cable and Raceway
Signal Isolating Cabinet

2. Fire Zone Analysis

- (a) Fire Zone 1A314 is located in the Auxiliary Building on Elev. 139' 0". The ceiling, floor, and walls are 3-hour rated fire barriers, except for those portions of the East and West boundaries that are open to Fire Zones 1A302 and 1A322, respectively. In addition, a portion of the South wall is a non-rated exterior barrier (Ref. Architectural Drawing A-0634).
- (b) The combustible loading in Fire Zone 1A314, including transient combustibles amounts to a moderate fire load. The major contributor to this combustible loading is the electrical cable present in the room. The in situ combustible loading in this fire zone amounts to less than a 105-minute fire duration (Ref. Calculation MC-QSP64-86058).

GRAND GULF NUCLEAR GENERATING STATION
Updated Final Safety Analysis Report (UFSAR)

- (c) Fire Zone 1A314 contains safety-related equipment and the following fire protection measures are provided: smoke detection and accessibility to hose stations and portable fire extinguishers.
 - (d) Fire Zone 1A314 contains only Division I safe shutdown components. Therefore, a fire originating in this fire zone will not affect more than one train of safe shutdown. However, this fire zone communicates with Fire Zones 1A302 and 1A322 within this fire area. An adjacency discussion is provided in the fire area analysis for Fire Area 11.
- d. FIRE ZONE 1A316: MOTOR CONTROL CENTER, ELEV. 139' 0"
- 1. Safety-Related Equipment
 - Electrical Cable and Raceway
 - Signal Isolating Cabinet
 - 2. Fire Zone Analysis
 - (a) Fire Zone 1A316 is located in the Auxiliary Building on Elev. 139' 0". The floor, ceiling, and walls are 3-hour rated fire barriers, except for those portions of the East and West boundaries that are open to Fire Zones 1A301 and 1A321, respectively. A portion of the North wall is a 2-hour rated exterior fire barrier (Ref. Architectural Drawing A-0634). In addition, the interface with Stair 1A10 and Elevator No. 3 (Ref. Sect. 9A.3.2.13.a) is a 2-hour rated fire barrier (Ref. Methodology Section 9A.3.0).
 - (b) The combustible loading in Fire Zone 1A316, including transient combustibles amounts to a low fire load. The major contributor to this combustible loading is the electrical cable present in the room. Thermo-Lag fire barrier material is utilized in this fire zone and is less than 5 percent of the total combustible loading. The in situ combustible loading in this fire zone amounts to less than a 60-minute fire duration (Ref. Calculation MC-QSP64-86058).

GRAND GULF NUCLEAR GENERATING STATION
Updated Final Safety Analysis Report (UFSAR)

- (c) Fire Zone 1A316 contains safety-related equipment and the following fire protection measures are provided: smoke detection, partial coverage by automatic sprinkler system, and accessibility to hose stations and portable fire extinguishers.
- (d) Fire Zone 1A316, which is located west of Column Line G.4, contains both Division I and II safe shutdown components. All Division I safe shutdown components located in this zone are located east of a line approximately 18 feet east of column H at Division I safe shutdown vertical cable tray 1ABTOT. A qualified rated one-hour fire wrap or wrap which provides an equivalent one hour fire resistance with evaluation (EC 21147) is provided on the Div II safe shutdown vertical cable tray 1ABTOT in accordance with the risk informed, performance based analysis as approved by Amendment 170 to the Facility Operating License. The qualified rated one-hour fire wrap or wrap which provides an equivalent one hour fire resistance with evaluation (EC 21147) is installed on the Division I I safe shutdown cable tray 1ABTOT and specified intervening items where the cable tray would be subject to damage from a floor based transient combustible fire located between Division I vertical cable tray 1AATWT and Division II vertical cable tray 1ABTOT. In addition, Amendment 170, specifies locations where non-rated Kawool wrap will be maintained "As Is" as a flame propagation retardant to prevent these raceways from contributing to the fire loading and provides specific combustible controls for Fire Area 11. Combustible Controls for Amendment 170 to the Facility Operating License include a designated transient combustible exclusion zone and limits on the size and locations of Transient Combustible Storage areas for fire Area 11 (Auxiliary Building evaluation 166'). The Specific wrap requirements and combustible controls are detailed in Amendment 170 to the Facility Operating License.

GRAND GULF NUCLEAR GENERATING STATION
Updated Final Safety Analysis Report (UFSAR)

The transient combustible exclusion zone as defined by Amendment 170 contains intervening combustibles which consist of two non-safety related open trays and three tray risers containing IEEE cable to non safety-related MCC 12B51, which is located along the South wall of Fire Zone 1A316, between column lines G.4 and H. These trays are located 9 feet from Division I safe shutdown components and are totally enclosed in the vicinity of the Division II safe shutdown components to satisfy the requirements of Regulatory Guide 1.75. Based on the separation between these raceways, the specified raceway wrap and combustible controls in accordance with Amendment 170 to the Facility Operating License, a postulated fire will not affect or propagate to affect more than one train of safe shutdown in this fire zone.

An automatic sprinkler system is installed within the transient combustible exclusion zone described above and extends west to Column Line J.5 and east into Fire Zone 1A301 to Column Line 13.0. A smoke detection system is also provided. Manual fire fighting is provided by installed fire extinguishers and manual hose stream.

However, Fire Zone 1A316 has several combinations of adjacency with other fire zones within Fire Area 11. An adjacency discussion is provided in the fire area analysis for Fire Area 11.

e. FIRE ZONE 1A321: MOTOR CONTROL CENTER. ELEV. 139' 0"

1. Safety-Related Equipment

Electrical Cable and Raceway

2. Fire Zone Analysis

- (a) Fire Zone 1A321 is located in the Auxiliary Building on Elev. 139' 0". The floor, ceiling, north wall, and portions of the east and west walls are 3-hour rated fire barriers, except for those portions of the East, South, and west walls

GRAND GULF NUCLEAR GENERATING STATION
Updated Final Safety Analysis Report (UFSAR)

boundaries, which are completely, open to Fire Zones 1A316, 1A322, and 1A324, respectively. In addition, the interfaces with Fire Zones 1A323 and 1A326 are non-rated barriers (Ref. Architectural Drawing A-0634).

- (b) The combustible loading in Fire Zone 1A321, including transient combustibles amounts to a low fire load. The major contributor to this combustible loading is the electrical cable present in the room. The in situ combustible loading in this fire zone amounts to less than a 60-minute fire duration (Ref. Calculation MC-QSP64-86058).
- (c) Fire Zone 1A321 contains safety-related equipment and the following fire protection measures are provided: smoke detection, partial coverage by automatic sprinkler system, and accessibility to hose stations and portable fire extinguishers.
- (d) Fire Zone 1A321 contains only Division II safe shutdown components. Therefore, a fire originating in this fire zone will not affect more than one train of safe shutdown. However, this fire zone has several combinations of adjacency with other fire zones within this fire area. An adjacency discussion is provided in the fire area analysis for Fire Area 11.

f. FIRE ZONE 1A322: CENTRIFUGAL CHILLER AREA, ELEV. 139' 0"

1. Safety-Related Equipment

Electrical Cable and Raceway

2. Fire Zone Analysis

- (a) Fire Zone 1A322 is located in the Auxiliary Building on Elev. 139' 0". The ceiling, floor, and portions of the east and west walls are 3-hour rated fire barriers, except for the North and East boundaries that are open to Fire Zones 1A321, 1A314, and 1A324. In addition, portions of the South and West walls are non-rated exterior barriers and interfaces

GRAND GULF NUCLEAR GENERATING STATION
Updated Final Safety Analysis Report (UFSAR)

with Fire Zones 1A323 and 1A326 are non-rated barriers (Ref. Architectural Drawing A-0634). The interface with Stair 1A12 is a 2-hour rated fire barrier (Ref. Methodology Section 9A.3.0).

- (b) The combustible loading in Fire Zone 1A322, including transient combustibles amounts to a low fire load. The major contributor to this combustible loading is the electrical cable present in the room. The in situ combustible loading in this fire zone amounts to less than a 30-minute fire duration. (Ref. Calculation MC-QSP64-86058).
- (c) Fire Zone 1A322 contains safety-related equipment and the following fire protection measures are provided: smoke detection, complete coverage by automatic sprinklers, and accessibility to hose stations and portable fire extinguishers.
- (d) Fire Zone 1A322 contains both Division I and II safe shutdown cable and raceway. All of the Division I safe shutdown components are located 17 feet south of Column Line 9.0. All Division II safe shutdown is located 6 feet north of Column Line 9.0. Therefore, Division I and II safe shutdown components are separated by 23 feet. There are no intervening electrical combustibles located within this separation distance, since the trays within this separation distance are totally enclosed. There are, however, two 1200-ton centrifugal chillers, each containing 20.0 gallons of lube oil, physically located within this 23-foot separation distance. The first chiller is located 8 feet north of Column Line 7.5, directly below the closest Division I safe shutdown component discussed above. The second chiller is located 5 feet south of Column Line 9.0, 12 feet from Division I safe shutdown components and 11 feet from Division II safe shutdown components. The oil in each of these chillers is pressurized to 80 psig, which could be released into Fire Zone 1A322, should the oil sight glass or oil

GRAND GULF NUCLEAR GENERATING STATION
Updated Final Safety Analysis Report (UFSAR)

collection container (approximately 1-quart - not pressurized) on the chiller motors fail during a fire. Because Fire Zone 1A322 is completely covered by an automatic sprinkler system, an exposure fire heating the oil enough to cause failure of the sight glass or oil collector container is not postulated. The chiller motor is located in the center of the chiller with the sight glass facing south. Also contained within the 23 foot separation distance is insulation on chiller piping. This insulation is located between the redundant divisions; however, due to the difference in elevation between the insulated piping and safe shutdown components and because the chiller piping does not completely traverse the separation distance, it is unlikely that a fire could propagate along this insulation to damage more than one train. A postulated fire originating in this Fire Zone will not affect, or propagate to affect, more than one train of safe shutdown components in this zone. However, even if a fire did damage the redundant components being protected by the separation distance, these components are primarily associated with the diesel generators, which are used only during a loss of offsite power. An analysis has been performed demonstrating that even if the redundant diesel generator cables are damaged, the preferred offsite power source is available and safe shutdown is assured (Reference 6.19). Fire Zone 1A322 is adjacent to other fire zones in this area. An adjacency discussion is provided in the fire area analysis for Fire Area 11.

g. FIRE ZONE 1A323: STANDBY GAS TREATMENT AREA, ELEV. 139' 0"

1. Safety-Related Equipment

Standby Gas Treatment System Filter Train
Damper Drive Operator
Electrical Cable and Raceway

2. Fire Zone Analysis

GRAND GULF NUCLEAR GENERATING STATION
Updated Final Safety Analysis Report (UFSAR)

- (a) Fire Zone 1A323 is located in the Auxiliary Building on Elev. 139' 0". The floor of Fire Zone 1A323 is a 3-hour rated fire barrier, while the ceiling and all four walls are not rated (Ref. Architectural Drawing A-0634).
 - (b) The combustible loading in Fire Zone 1A323, including transient combustibles amounts to a moderate fire load. The major contributors to this combustible loading are the electrical cables present in the room and the charcoal in the standby gas treatment system filter train. The in situ combustible loading in this fire zone amounts to less than a 90-minute fire duration (Ref. Calculation MC-QSP64-86058).
 - (c) Fire Zone 1A323 contains safety-related equipment and the following fire protection measures are provided: smoke detection, deluge fire suppression system within the standby gas treatment system filter train, and accessibility to hose stations and portable fire extinguishers.
 - (d) Fire Zone 1A323 does not contain any safe shutdown components. Therefore, a fire originating in this fire zone will not affect either train of safe shutdown. However, this fire zone has several combinations of adjacency with other fire zones within this fire area. An adjacency discussion is provided in the fire area analysis for Fire Area 11.
- h. FIRE ZONE 1A324: ROOF OF STANDBY GAS TREATMENT AREA 1A323 AND 1A326, ELEV. 154'-6"
- 1. Safety Equipment
 - Electrical Cable and Raceway
 - 2. Fire Zone Analysis
 - (a) Fire Zone 1A324 is located in the Auxiliary Building on Elev. 154' 6". The ceiling and West wall of Fire Zone 1A324 are 3-hour rated fire barriers. The East and North boundaries are open

GRAND GULF NUCLEAR GENERATING STATION
Updated Final Safety Analysis Report (UFSAR)

to 1A321 and the South boundary is open to 1A322. The floor of Fire Zone 1A324 is a non-rated barrier (Ref. Architectural Drawing A-0634).

- (b) The combustible loading in Fire Zone 1A324, including transient combustibles amounts to a low fire load. The major contributor to this combustible loading is the electrical cable present in the room. The in situ combustible loading in this fire zone amounts to less than a 15-minute fire duration. (Ref. Calculation MC-QSP64-86058).
 - (c) Fire Zone 1A324 contains safety-related cable and raceway and the following fire protection measures are provided: smoke detection (located in 1A321 and 1A322) and accessibility to hose stations and portable fire extinguishers.
 - (d) Fire Zone 1A324 does not contain any safe shutdown components. Therefore, a fire originating in this fire zone will not affect either train of safe shutdown. However, this fire zone has several combinations of adjacency with other fire zones within this fire area. An adjacency discussion is provided in the fire area analysis for Fire Area 11.
- i. FIRE ZONE 1A326: STANDBY GAS TREATMENT AREA, ELEV. 139' 0"
- 1. Safety-Related Equipment
 - Standby Gas Treatment System Filter Train
 - Damper Drive Operator
 - Electrical Cable and Raceway
 - 2. Fire Zone Analysis
 - (a) Fire Zone 1A326 is located in the Auxiliary Building on Elev. 139' 0". The floor and West wall of Fire Zone 1A326 are 3-hour rated fire barriers. The ceiling and remaining walls are non-rated barriers (Ref. Architectural Drawing A-0634).

GRAND GULF NUCLEAR GENERATING STATION
Updated Final Safety Analysis Report (UFSAR)

- (b) The combustible loading in Fire Zone 1A326, including transient combustibles amounts to a moderate fire load. The major contributors to this combustible loading are the electrical cables present in the room and the charcoal in the standby gas treatment system filter train. The in situ combustible loading in this fire zone amounts to less than a 90-minute fire duration (Ref. Calculation MC-QSP64-86058).
- (c) Fire Zone 1A326 contains safety-related equipment and the following fire protection measures are provided: smoke detection, deluge fire suppression system for the standby gas treatment charcoal filter train, and accessibility to hose stations and portable fire extinguishers.
- (d) Fire Zone 1A326 does not contain any safe shutdown components. Therefore, a fire originating in this fire zone will not affect either train of safe shutdown. However, this fire zone has several combinations of adjacency with other fire zones within this fire area. An adjacency discussion is provided in the fire area analysis for Fire Area 11.

9A.5.12 FIRE AREA 12

9A.5.12.1 FIRE AREA DESCRIPTION

Fire Area 12 consists solely of Fire Zone 1A308 (Elev. 139' 0") in the Auxiliary Building. The floor, ceiling, and all walls are 3-hour rated fire barriers (Ref. Architectural Drawing A-0634).

INCLUDED FIRE ZONE	DESCRIPTION
1A308	Electrical Penetration Room, Elev. 139' 0"

9A.5.12.2 SAFE SHUTDOWN EQUIPMENT

Division II

GRAND GULF NUCLEAR GENERATING STATION
Updated Final Safety Analysis Report (UFSAR)

9A.5.12.3 FIRE AREA ANALYSIS

Fire Zone 1A308 contains only Division II safe shutdown equipment and cable and raceway, as shown in the microcomputer database (Ref. FPP-1, Appendix C Data). Since this fire area contains only Division II safe shutdown components and is separated from all other fire areas by 3-hour rated fire barriers, Fire Area 12 fully complies with Appendix R requirements. Therefore, in the event of a fire in this fire area, safe shutdown capability would be maintained by separate Division I safe shutdown equipment. The total fire severity in Fire Zone 1A308, including transient combustibles amounts to a moderate fire load. The maximum in situ combustible loading in this fire zone amounts to less than a 90-minute fire duration (Ref. Calculation MC-QSP64-86058). Therefore, a fire occurring in Fire Area 12 will not spread into any other fire area.

9A.5.12.4 FIRE ZONE ANALYSIS

FIRE ZONE 1A308: ELECTRICAL PENETRATION ROOM, ELEV. 139' 0"

1. Safety-Related Equipment

- GE Panel
- Power Panels
- Fuse Panels
- 6.9 kV Switchgear
- Load Centers
- ESF Electrical Switchgear Room Cooler
- Electrical Cable and Raceway

2. Fire Zone Analysis

- (a) Fire Zone 1A308 is located in the Auxiliary Building on Elev. 139' 0". Fire Zone 1A308 is bounded on all sides by 3-hour rated fire barriers (Ref. Architectural Drawing A-0634).
- (b) The combustible loading in Fire Zone 1A308, including transient combustibles amounts to a moderate fire load. The major contributor to this combustible loading is the electrical cable present in the room. The in situ combustible

GRAND GULF NUCLEAR GENERATING STATION
Updated Final Safety Analysis Report (UFSAR)

loading in this fire zone amounts to less than a 90-minute fire duration (Ref. Calculation MC-QSP64-86058).

- (c) Fire Zone 1A308 contains safety-related equipment and the following fire protection measures are provided: an automatic Carbon dioxide suppression system, smoke detection, and accessibility to manual hose streams and portable fire extinguishers.
- (d) Since Fire Zone 1A308 contains only Division II safe shutdown equipment and is completely enclosed by 3-hour rated fire barriers, a fire originating in this fire zone will not affect more than one train of safe shutdown components.

9A.5.13 FIRE AREA 13

9A.5.13.1 FIRE AREA DESCRIPTION

Fire Area 13 consists only of Fire Zone 1A309 (Elev. 139' 0") in the Auxiliary Building. The floor, ceiling, and all walls are 3-hour rated fire barriers (Ref. Architectural Drawing A-0634).

INCLUDED FIRE ZONE	DESCRIPTION
1A309	Electrical Penetration Room, Elev. 139' 0"

9A.5.13.2 SAFE SHUTDOWN EQUIPMENT

Division I

9A.5.13.3 FIRE AREA ANALYSIS

Fire Zone 1A309 contains only Division I safe shutdown equipment and cable and raceway, as shown in the microcomputer database (Ref. FPP-1, Appendix C Data). Since this fire area contains only Division I safe shutdown components and is separated from all other fire areas by 3-hour rated fire barriers, Fire Area 13 fully complies with Appendix R requirements. Therefore, in the event of a fire in this fire area, safe shutdown capability would be maintained by separate Division II safe shutdown equipment. The total fire severity in Fire Zone 1A309, including transient combustibles amounts to a moderate fire load. The maximum in situ combustible loading in this fire zone amounts to less than a 75-

GRAND GULF NUCLEAR GENERATING STATION
Updated Final Safety Analysis Report (UFSAR)

minute fire duration (Ref. Calculation MC-QSP64-86058). Therefore, a fire occurring in Fire Area 13 will not spread into any other fire area.

9A.5.13.4 FIRE ZONE ANALYSIS

FIRE ZONE 1A309: ELECTRICAL PENETRATION ROOM, ELEV. 139' 0"

1. Safety-Related Equipment

Power Panel
Load Centers
Fuse Panels
ESF Electrical Switchgear Room Cooler
Electrical Cable and Raceway

2. Fire Zone Analysis

- (a) Fire Zone 1A309 is located in the Auxiliary Building on Elev. 139' 0". Fire Zone 1A309 is bounded on all sides by 3-hour rated fire barriers. (Ref. Architectural Drawing A-0634).
- (b) The combustible loading in Fire Zone 1A309, including transient combustibles amounts to a moderate fire load. The major contributor to this combustible loading is the electrical cable present in the room. The in situ combustible loading in Fire Zone amounts to less than a 75-minute fire duration (Ref. Calculation MC-QSP64-86058).
- (c) Fire Zone 1A309 contains safety-related equipment and the following fire protection measures are provided: automatic Carbon dioxide suppression system, smoke detection, and the accessibility to manual hose streams and portable fire extinguishers.
- (d) Since Fire Zone 1A309 contains only Division I safe shutdown equipment and is completely enclosed by 3-hour fire barriers, a fire originating in this fire zone will not affect more than one train of safe shutdown components.

GRAND GULF NUCLEAR GENERATING STATION
Updated Final Safety Analysis Report (UFSAR)

9A.5.14 FIRE AREA 14

9A.5.14.1 FIRE AREA DESCRIPTION

Fire Area 14 consists solely of Fire Zone 1A318 (Elev. 139' 0") in the Auxiliary Building. The floor, ceiling, and all walls are 3-hour rated fire barriers (Ref. Architectural Drawing A-0634).

INCLUDED FIRE ZONE	DESCRIPTION
1A318	Electrical Penetration Room, Elev. 139' 0"

9A.5.14.2 SAFE SHUTDOWN EQUIPMENT

Division I

9A.5.14.3 FIRE AREA ANALYSIS

Fire Zone 1A318 contains only Division I safe shutdown equipment and cable and raceway, as shown in the microcomputer database (Ref. FPP-1, Appendix C Data). Since this fire area contains only Division I safe shutdown components and is separated from all other fire areas by 3-hour rated fire barriers, Fire Area 14 fully complies with Appendix R requirements. Therefore, in the event of a fire in this fire area, safe shutdown capability would be maintained by separate Division II safe shutdown equipment. The total fire severity in Fire Zone 1A318, including transient combustibles amounts to a moderate fire load. The maximum in situ combustible loading in this fire zone amounts to less than a 60-minute fire duration (Ref. Calculation MC-QSP64-86058). Therefore, a fire occurring in Fire Area 14 will not spread into any other fire area.

9A.5.14.4 FIRE ZONE ANALYSIS

FIRE ZONE 1A318: ELECTRICAL PENETRATION ROOM, ELEV. 139' 0"

1. Safety-Related Equipment

- Electrical Cable and Raceway
- 6.9 kV Switchgear
- Motor Control Center
- Fuse Panels
- Electrical Switchgear Room Cooler

2. Fire Zone Analysis

GRAND GULF NUCLEAR GENERATING STATION
Updated Final Safety Analysis Report (UFSAR)

- (a) Fire Zone 1A318 is located in the Auxiliary Building on Elev. 139' 0". Fire Zone 1A318 is bounded on all sides by 3-hour rated fire barriers (Ref. Architectural Drawing A-0634).
- (b) The combustible loading in Fire Zone 1A318, including transient combustibles amounts to a moderate fire load. The major contributor to this combustible loading is the electrical cable present in the room. The in situ combustible loading in Fire Zone 1A318 amounts to less than a 90-minute fire duration (Ref. Calculation MC-QSP64-86058).
- (c) Fire Zone 1A318 contains safety-related equipment and the following fire protection measures are provided: automatic Carbon dioxide suppression, smoke detection, and accessibility to manual hose streams and portable fire extinguishers.
- (d) Since Fire Zone 1A318 contains only Division I safe shutdown components and is completely enclosed by 3-hour rated fire barriers, a fire originating in this fire zone will not affect more than one train of safe shutdown components.

9A.5.15 FIRE AREA 15

9A.5.15.1 FIRE AREA DESCRIPTION

Fire Area 15 consists only of Fire Zone 1A319 (Elev. 139' 0") in the Auxiliary Building. The floor, ceiling, and all walls are 3-hour rated fire barriers (Ref. Architectural Drawing A-0634).

INCLUDED FIRE ZONE	DESCRIPTION
1A319	RPV Instrumentation Test Room, Elev. 139' 0"

9A.5.15.2 SAFE SHUTDOWN EQUIPMENT

Division III

GRAND GULF NUCLEAR GENERATING STATION
Updated Final Safety Analysis Report (UFSAR)

9A.5.15.3 FIRE AREA ANALYSIS

Fire Zone 1A319 contains only Division III safe shutdown cables and raceway, as shown in the microcomputer database (Ref. FPP-1, Appendix C Data). Spurious actuation of equipment associated with the Division III cables located within Fire Zone 1A319 will not prevent safe shutdown per GGNS-EE-11-00001 (FPP-1). Fire Area 15 is totally enclosed by 3-hour rated fire barriers. The total fire severity in Fire Zone 1A319, including transient combustibles amounts to a low fire load. The maximum in situ combustible loading in this fire zone amounts to less than a 15-minute fire duration (Ref. Calculation MC-QSP64-86058). Therefore, a fire occurring in Fire Area 15 will not spread into any other fire area.

9A.5.15.4 FIRE ZONE ANALYSIS

FIRE ZONE 1A319: RPV INSTRUMENTATION TEST RM, ELEV. 139' 0"

1. Safety-Related Equipment

Electrical Cable and Raceway

2. Fire Zone Analysis

- (a) Fire Zone 1A319 is located in the Auxiliary Building on Elev. 139' 0". Fire Zone 1A319 is bounded on all sides by 3-hour rated fire barriers (Ref. Architectural Drawing A-0634).
- (b) The combustible loading in Fire Zone 1A319, including transient combustibles, amounts to a low fire load. The major contributor to this combustible loading is the concrete joint sealant in the walls. The in situ combustible loading in this fire zone amounts to less than a 15-minute fire duration (Ref. Calculation MC-QSP64-86058).
- (c) Fire Zone 1A319 contains safety-related equipment and the following fire protection measures are provided: smoke detection and accessibility to manual hose streams and portable fire extinguishers.

GRAND GULF NUCLEAR GENERATING STATION
Updated Final Safety Analysis Report (UFSAR)

- (d) Fire Zone 1A319 contains Division III safe shutdown cables. However, spurious actuation of the equipment associated with these cables will not prevent hot shutdown per GGNS-EE-11-00001 (FPP-1). Since Fire Zone 1A319 is totally enclosed by 3-hour rated fire barriers, a fire originating in this fire zone will not spread to other fire zones.

9A.5.16 FIRE AREA 16

9A.5.16.1 FIRE AREA DESCRIPTION

Fire Area 16 consists solely of Fire Zone 1A320 (Elev. 139' 0") in the Auxiliary Building. The floor, ceiling, and all walls are 3-hour rated fire barriers (Ref. Architectural Drawing A-0634).

INCLUDED FIRE ZONE	DESCRIPTION
1A320	Electrical Penetration Room, Elev. 139' 0".

9A.5.16.2 SAFE SHUTDOWN EQUIPMENT

Division II

9A.5.16.3 FIRE AREA ANALYSIS

Fire Zone 1A320 contains only Division II safe shutdown equipment and cable and raceway, as shown in the microcomputer database (Ref. FPP-1, Appendix C Data). Since this fire area contains only Division II safe shutdown components and is separated from all other fire areas by 3-hour rated fire barriers, Fire Area 16 fully complies with Appendix R requirements. Therefore, in the event of a fire in this fire area, safe shutdown capability would be maintained by separate Division I safe shutdown equipment. The total fire severity in Fire Zone 1A320, including transient combustibles amounts to a low fire load. The maximum in situ combustible loading in this fire zone amounts to less than a 60-minute fire duration (Ref. Calculation MC-QSP64-86058). Therefore, a fire occurring in Fire Area 16 will not spread into any other fire area.

9A.5.16.4 FIRE ZONE ANALYSIS

FIRE ZONE 1A320: ELECTRICAL PENETRATION ROOM, ELEV. 139' 0"

1. Safety-Related Equipment

GRAND GULF NUCLEAR GENERATING STATION
Updated Final Safety Analysis Report (UFSAR)

Electrical Cable and Raceway
Motor Control Center
Fuse Panels
Electrical Switchgear Room Cooler

2. Fire Zone Analysis

- (a) Fire Zone 1A320 is located in the Auxiliary Building on Elev. 139' 0". Fire Zone 1A320 is bounded on all sides by 3-hour rated fire barriers (Ref. Architectural Drawing A-0634).
- (b) The combustible loading in Fire Zone 1A320, including transient combustibles amounts to a low fire load. The major contributor to this combustible loading is the electrical cable present in the fire zone. The in situ combustible loading in Fire Zone 1A320 amounts to less than a 60-minute fire duration (Ref. Calculation MC-QSP64-86058).
- (c) Fire Zone 1A320 contains safety-related equipment and the following fire protection measures are provided: automatic Carbon dioxide suppression, smoke detection, and accessibility to manual hose streams and portable fire extinguishers.
- (d) Since Fire Zone 1A320 contains only Division II safe shutdown components and is totally enclosed by 3-hour rated fire barriers, a fire originating in this fire zone would not affect more than one train of safe shutdown components.

9A.5.17 FIRE AREA 17

9A.5.17.1 FIRE AREA DESCRIPTION

Fire Area 17 consists of Fire Zone 1A325 (Elev. 133' 0") in the Auxiliary Building. The floor, ceiling, and east and south walls are 3-hour rated fire barriers. The portion of the North wall adjacent to Stair 1A10 is a 2-hour rated fire barrier (Ref.

GRAND GULF NUCLEAR GENERATING STATION
Updated Final Safety Analysis Report (UFSAR)

Methodology Section 9A.3.0). The remainder of the North wall and the West wall are non-rated exterior barriers. The West wall contains a rolling door (Ref. Architectural Drawing A-0634).

INCLUDED FIRE ZONE	DESCRIPTION
1A325	Railroad Area, Elev. 133' 0"

9A.5.17.2 SAFE SHUTDOWN EQUIPMENT

None

9A.5.17.3 FIRE AREA ANALYSIS

Fire Zone 1A325 does not contain any safe shutdown components, as shown in the microcomputer database (Ref. FPP-1, Appendix C Data). The total fire severity in Fire Zone 1A325, including transient combustibles, amounts to a low fire load. The maximum in situ combustible loading in this fire zone amounts to less than a 15-minute fire duration (Ref. Calculation MC-QSP64-86058). Since this fire area is separated from other fire areas in the balance of the Auxiliary Building by the 3-hour rated fire barriers, a fire occurring in Fire Area 17 will not spread into any other fire area.

9A.5.17.4 FIRE ZONE ANALYSIS

FIRE ZONE 1A325: RAILROAD AREA, ELEV. 133' 0"

1. Safety-Related Equipment

None

2. Fire Zone Analysis

- (a) Fire Zone 1A325 is located in the Auxiliary Building on Elev. 133' 0". The ceiling, floor, and east and South walls of Fire Zone 1A325 are 3-hour rated fire barriers. A portion of the North wall adjacent to the Stair 1A10 is a 2-hour rated fire barrier. The remainder of the North wall and West wall are non-rated exterior walls (Ref. Architectural Drawing A-0634). The ceiling hatch that connects to Fire Zone 1A427 is a 3-hour rated barrier. The hatch is designed such that joints do not require any fire

GRAND GULF NUCLEAR GENERATING STATION
Updated Final Safety Analysis Report (UFSAR)

retardant sealant to maintain this rating. No combustible gases or flames can penetrate the joint configuration.

- (b) Fire Zone 1A325 does not contain any safety-related equipment. The combustible loading in Fire Zone 1A325, including transient combustibles, amounts to a low fire load. The contributors to this combustible loading are the concrete joint sealant in the walls and wood. The in situ combustible loading in this fire zone amounts to less than a 15-minute fire duration (Ref. Calculation MC-QSP64-86058).
- (c) Since Fire Zone 1A325 is a railroad bay, varying quantities and compositions of transient combustibles are expected. Even with a formidable transient combustible load present, the fire protection measures provided (3-hour rated fire barriers separating 1A325 from other fire areas of the Auxiliary Building, an automatic sprinkler system, and accessibility to manual hose streams and portable fire extinguishers) ensure that a fire in 1A325 will not affect either train of safe shutdown.
- (d) Since Fire Zone 1A325 does not contain any safe shutdown components, and is separated from other fire areas in the Auxiliary Building by 3-hour rated fire barriers, a fire originating in Fire Zone 1A325 will not affect either train of safe shutdown components.
- (e) Fire Zone 1A325 is utilized as a pathway for implementation of Dry Fuel Storage equipment. This equipment does not introduce significant combustibles into this zone that would alter the current assessment of the plant to achieve and maintain safe shutdown. The transient combustibles introduced for this plant operational activity has been evaluated and it has been determined that the Fire Severity for this event is Low.

GRAND GULF NUCLEAR GENERATING STATION
Updated Final Safety Analysis Report (UFSAR)

9A.5.18 FIRE AREA 18

9A.5.18.1 FIRE AREA DESCRIPTION

Fire Area 18 consists of Fire Zones 1A404, 1A405, 1A406, (Elev. 166' 0"), and 1A402 (Elev. 174' 0") in the Auxiliary Building. All of the fire zones in Fire Area 18 are separated by non-rated barriers (Ref. Architectural Drawing A-0635). Therefore, a fire originating in any one-fire zone of Fire Area 18 is able to communicate with any other zone in Fire Area 18. Fire Area 18 is separated from other fire areas by 3-hour rated firewalls and floors and the ceiling, which is a non-rated exterior barrier.

INCLUDED FIRE ZONES	DESCRIPTION
1A402	Main Steam Tunnel Roof, Elev. 174' 0"
1A404	Unassigned, Elev. 166' 0"
1A405	Containment Ventilation Equipment Rm., Elev. 166' 0"
1A406	Containment Exhaust Filter and Ventilation Room, Elev. 166' 0"

9A.5.18.2 SAFE SHUTDOWN EQUIPMENT

None

9A.5.18.3 FIRE AREA ANALYSIS

Fire Zones 1A402, 1A404, 1A405, and 1A406 do not contain any safe shutdown components, as shown in the microcomputer database (Ref. FPP-1, Appendix C Data). This fire area does not contain any safe shutdown components and is separated from all other fire areas by 3-hour rated fire barriers. Therefore, a fire in this fire area would not affect either train of safe shutdown components. The postulated fire with the greatest severity duration in Fire Area 18 is a fire in Fire Zone 1A406. The total fire severity Fire Zone 1A406, including transient combustibles, amounts to a low fire load. The maximum in situ combustible loading in this fire zone amounts to less than a 60-minute fire duration (Ref. Calculation MC-QSP64-86058). Therefore, a fire occurring in Fire Area 18 will not spread into any other fire area.

9A.5.18.4 FIRE ZONE ANALYSES

- a. FIRE ZONE 1A402: MAIN STEAM TUNNEL ROOF, ELEV. 174' 0"
 - 1. Safety-Related Equipment

GRAND GULF NUCLEAR GENERATING STATION
Updated Final Safety Analysis Report (UFSAR)

Electrical Cable and Raceway

2. Fire Zone Analysis

- (a) Fire Zone 1A402 is located in the Auxiliary Building on Elev. 174' 0". Fire Zone 1A402 communicates directly with Fire Zones 1A404 and 1A405 and can communicate indirectly with Fire Zone 1A406. The floor and the East and West walls of Fire Zone 1A402 are 3-hour rated fire barriers. The North and South walls of Fire Zone 1A402 are non-rated barriers. The ceiling is a non-rated exterior barrier (Ref. Architectural Drawing A-0635).
- (b) The combustible loading in Fire Zone 1A402, including transient combustibles, amounts to a low fire load. The major contributor to this combustible loading is contaminated equipment storage. The in situ combustible loading in this fire zone amounts to less than a 30-minute fire duration (Ref. Calculation MC-QSP64-86058).
- (c) Fire Zone 1A402 contains safety-related equipment and the following fire protection measures are provided: smoke detection and accessibility to manual hose streams and portable fire extinguishers.
- (d) Although Fire Zone 1A402 is assumed to communicate with all other zones within Fire Area 18, none of these fire zones contain any safe shutdown components and therefore, a fire in Fire Zone 1A402 will not affect either train of safe shutdown components.

b. FIRE ZONE 1A404: UNASSIGNED, ELEV. 166' 0"

1. Safety-Related Equipment

Electrical Cable and Raceway

2. Fire Zone Analysis

GRAND GULF NUCLEAR GENERATING STATION
Updated Final Safety Analysis Report (UFSAR)

- (a) Fire Zone 1A404 is located in the Auxiliary Building on Elev. 166' 0". Fire Zone 1A404 communicates directly with Fire Zone 1A402 and can communicate indirectly with Fire Zones 1A405 and 1A406. The floor, and the East, West, and South walls of Fire Zone 1A404 are 3-hour-rated fire barriers. The North wall is a 3-hour-rated fire barrier, except for the non-rated portion that is physically adjacent to Fire Zone 1A402. The ceiling is a non-rated exterior barrier (Ref. Architectural Drawing A-0635).
 - (b) The combustible loading in Fire Zone 1A404, including transient combustibles, amounts to a low fire load. The major contributor to this combustible loading is stored maintenance materials. The in situ combustible loading in this fire zone amounts to less than a 15-minute fire duration (Ref. Calculation MC-QSP64-86058).
 - (c) Fire Zone 1A404 contains safety-related equipment and the following fire protection measures are provided: smoke detection and accessibility to manual hose streams and portable fire extinguishers.
 - (d) Although Fire Zone 1A404 is assumed to communicate with all other zones within Fire Area 18, none of these fire zones contain safe shutdown components and therefore, a fire in Fire Zone 1A404 will not affect either train of safe shutdown components.
- c. FIRE ZONE 1A405: CONTAINMENT VENT. EQUIP. RM, Elev. 166' 0"
- 1. Safety-Related Equipment
 - Electrical Cable and Raceway
 - 2. Fire Zone Analysis
 - (a) Fire Zone 1A405 is located in the Auxiliary Building on Elev. 166' 0". Fire Zone 1A405 communicates directly with Fire Zones 1A402 and

GRAND GULF NUCLEAR GENERATING STATION
Updated Final Safety Analysis Report (UFSAR)

1A406 and can communicate indirectly with Fire Zone 1A404. The floor and the West, East, and a portion of the South walls are 3-hour rated fire barriers, except for the portion of the East wall that is physically adjacent to Fire Zone 1A406. The ceiling, the remainder of the South wall, and the North wall physically adjacent to Fire Zone 1A406 are non-rated barriers. The remainder of the North wall is a 3-hour rated fire barrier (Ref. Architectural Drawing A-0635).

- (b) The combustible loading in Fire Zone 1A405, including transient combustibles, amounts to a low fire load. The major contributor to the combustible loading is the electrical cable present in the room. The in situ combustible loading in this fire zone amounts to less than a 15-minute fire duration (Ref. Calculation MC-QSP64-86058).
 - (c) Fire Zone 1A405 contains safety-related equipment and the following fire protection measures are provided: smoke detection and accessibility to manual hose streams and portable fire extinguishers.
 - (d) Although Fire Zone 1A405 is assumed to communicate with all other zones within Fire Area 18, none of these fire zones contain safe shutdown components and therefore, a fire in Fire Zone 1A405 will not affect either train of safe shutdown components.
- d. FIRE ZONE 1A406: CONTAINMENT EXHAUST FILTER AND VENTILATION ROOM, ELEV. 166' 0"
- 1. Safety-Related Equipment
 - Electrical Cable and Raceway
 - 2. Fire Zone Analysis
 - (a) Fire Zone 1A406 is located in the Auxiliary Building on Elev. 166' 0". Fire Zone 1A406 communicates directly with Fire Zone 1A405 and

GRAND GULF NUCLEAR GENERATING STATION
Updated Final Safety Analysis Report (UFSAR)

can communicate indirectly with Fire Zones 1A402 and 1A404. The floor, and the North and East walls of Fire Zone 1A406 are 3-hour rated fire barriers. The South and West walls of Fire Zone 1A406 are non-rated barriers. The ceiling is a non-rated exterior barrier (Ref. Architectural Drawing A-0635).

- (b) The combustible loading in Fire Zone 1A406, including transient combustibles, amounts to a low fire load. The major contributors to this combustible loading are the charcoal filter media and the electrical cable present in the room. The in situ combustible loading in this fire zone amounts to less than a 60-minute fire duration (Ref. Calculation MC-QSP64-86058).
- (c) Fire Zone 1A406 contains safety-related equipment and the following fire protection measures are provided: deluge system for the charcoal filter train, smoke detection, and accessibility to manual hose streams and portable fire extinguishers.
- (d) Although Fire Zone 1A406 is assumed to communicate with all other zones within Fire Area 18, none of these fire zones contain any safe shutdown components and therefore, a fire in Fire Zone 1A406 will not affect either train of safe shutdown components.

9A.5.19 FIRE AREA 19

9A.5.19.1 FIRE AREA DESCRIPTION

- a. Fire Area 19 consists of those fire zones shown below in the Included Fire Zones listing. The floor and walls of Fire Area 19 are 3-hour rated fire barriers, except for those walls, or portions of walls, that are non-rated exterior barriers. Portions of the ceiling of Fire Area 19 forms the base of the non-rated roof slab. In addition, those interfaces with Stairs 1A10, 1A12, and Elevator No. 3 (Ref. Sect. 9A.3.2.13.a) are 2-hour rated fire barriers (Ref. Methodology Section 9A.3.0).

GRAND GULF NUCLEAR GENERATING STATION
Updated Final Safety Analysis Report (UFSAR)

- b. The fire zones listed below, which are all located in the Auxiliary Building, can be classified into three distinct groups: Group A includes those fire zones that form a passageway around the perimeter of the Auxiliary Building on Elev. 166' 0"; Group B consists of the remaining fire zones of Fire Area 19 that are located on this elevation; and Group C includes those fire zones of Fire Area 19 that are either located on Elev. 185' 0" and above, or are segregated from the fire zones of Groups A and B by 3-hour rated fire barriers. Group A communicates with Group B through non-rated barriers and with Group C through non-rated hatchways between floors (Ref. Architectural Drawing A-0635, A-0636, and A-0637). Therefore, a fire originating in any one fire zone of Fire Area 19 is able to communicate with any other zone in Fire Area 19.

INCLUDED FIRE ZONES	DESCRIPTION
1A401	Passage, Elev. 166' 0"
1A403	Passage, Elev. 166' 0"
1A417	Miscellaneous Equipment Area, Elev. 166' 0"
1A420	Miscellaneous Equipment Area, Elev. 166' 0"
1A424	Set down Area, Elev. 166' 0"
1A427	Spent Fuel Cask Handling Area, Elev. 166' 0"
1A428	Passage, Elev. 166' 0"
1A429	Water Sampling Station, Elev. 166' 0"
1A430	CRD Repair Area, Elev. 166' 0"
1A431	Spent Fuel Pool, Elev. 167' 6"
1A432	FPC and CU Pump Room, Elev. 166' 0"
1A433	FPC and CU Backwash Transfer Pump Rm., Elev. 166' 0"
1A434	Passage, Elev. 166' 0"
1A436	FPC & CU Backwash Receiving Tank Rm., Elev. 166' 0"
1A437	Transfer Canal, Elev. 176' 6"
1A438	Shipping Cask Storage Pool, Elev. 159' 6"
1A444	Inspection Area, Elev. 166' 9"
1A519	Storage Area, Elev. 185' 0"
1A523	Spent Fuel Hatch Area, Elev. 185' 0"
1A524	Concrete Platform, Elev. 195' 3"
1A525	Transfer Tube, Elev. 182' 0"
1A527	Load Center Area, Elev. 185' 0"
1A528	New Fuel Storage Vault, Elev. 185' 0"
1A529	FPC and CU Tank Room, Elev. 180' 8"
1A530	Fuel Pool Filter Demineralizer Room, Elev. 180' 8"
1A531	Piping Area, Elev. 185' 0"
1A532	Cask Washdown Area, Elev. 185' 0"

GRAND GULF NUCLEAR GENERATING STATION
Updated Final Safety Analysis Report (UFSAR)

1A533	Fuel Pool Filter Demineralizer Room, Elev. 191' 4"
1A534	Fuel Pool Filter Demineralizer Room, Elev. 191' 4"
1A536	Pipe Chase, Elev. 185' 0"
1A537	Drain Tank Area, Elev. 191' 4"
1A602	Storage Area, Elev. 208' 10"
1A603	Passage, Elev. 208' 10"
1A604	Fuel Handling Area, Elev. 208' 10"
1A606	HVAC Units Area, Elev. 245' 0"

9A.5.19.2 SAFE SHUTDOWN EQUIPMENT

Divisions I and II

9A.5.19.3 FIRE AREA ANALYSIS

- (a) Group A consists of Fire Zones 1A401, 1A403, and 1A420, which contain only Division I safe shutdown components; 1A424, which contains only Division II safe shutdown components; and 1A417 and 1A428, which contain both Division I and Division II safe shutdown components. Fire Zone 1A401 also contains RHR Heat Exchanger 'A' inlet temperature indication circuits utilized for alternate suppression pool temperature monitoring in the event of a fire in Containment (as discussed in Fire Area 25, Section 9A.5.25).

Fire Zone 1A403 also contains RHR Heat Exchanger 'A' inlet temperature indication circuits utilized for alternate suppression pool temperature monitoring in the event of a fire in Containment (as discussed in Fire Area 25, Section 9A.5.25). Group B consists of Fire Zones 1A427, 1A429, 1A430, 1A432, 1A433, 1A434, and 1A436, none of which contain any safe shutdown components. Group C consists of Fire Zones 1A431, 1A437, 1A438, 1A444, 1A519, 1A523, 1A524, 1A525, 1A527, 1A528, 1A529, 1A530, 1A531, 1A532, 1A533, 1A534, 1A536, 1A537, 1A602, 1A603, 1A604, and 1A606. None of these fire zones contain any safe shutdown components as shown in the microcomputer database (Ref. FPP-1, Appendix C Data).

GRAND GULF NUCLEAR GENERATING STATION
Updated Final Safety Analysis Report (UFSAR)

- (b) Fire Zone 1A417, which is located west of Column Line G.4, contains both Division I and II safe shutdown components. All Division I safe shutdown components located in this zone with exception of conduit 1AARMI07 are located east of a line approximately 18 feet east of Column H at Division I safe shutdown vertical cabletray 1AATWT. All Division II safe shutdown components in this zone are located west of this line at Division II safe shutdown vertical cable tray 1ABTOT.

Intervening combustibles located within the transient combustible exclusion zone as defined by Amendment 170 to the Facility Operating License consist of cable trays containing IEEE-383 cable installed in accordance with the requirements of Regulatory Guide 1.75.

An automatic sprinkler system is installed within the transient combustible exclusion zone described above and extends west into Fire Zone 1A428 to Column Line 10.0 and east into Fire Zone 1A401 to Column Line 11.0. A smoke detection system is also provided. Manual fire fighting is provided by installed fire extinguishers and manual hose stream.

- (c) A qualified rated one-hour fire wrap or wrap which provides an equivalent one hour fire resistance with evaluation (EC 21147) is provided on the Div II safe shutdown vertical cable tray 1ABTOT in accordance with the risk informed, performance based analysis as approved by Amendment 170 to the Facility Operating License. The qualified rated one-hour fire wrap or wrap which provides an equivalent one hour fire resistance with evaluation (EC 21147) is installed on the Division II safe shutdown cable tray 1ABTOT and specified intervening items where the cable tray would be subject to damage from a floor based transient combustible fire located between Division I vertical cable tray 1AATWT and Division II vertical cable tray 1ABTOT. In addition, Amendment 170, specifies

GRAND GULF NUCLEAR GENERATING STATION
Updated Final Safety Analysis Report (UFSAR)

locations where non-rated Kaowool wrap will be maintained "As Is" as a flame propagation retardant to prevent these raceways from contributing to the fire loading and provides specific combustibles controls for Fire Area 19. Division I conduit 1AARMI07 is the only Division I safe shutdown component which extends west of a line approximately 18 feet east of Column H at Division I safe shutdown vertical cable tray 1AATWT in Fire Zone 1A417. This Division I conduit is not subject to damage from a floor based transient combustibles fire due its height and does not require wrap. Combustibles Controls for Amendment 170 to the Facility Operating License include a designated transient combustibles exclusion zone and limits on the size and locations of Transient Combustibles Storage areas for Fire Area 19 (Auxiliary Building elevation 166'). The Specific wrap requirements and combustibles controls are detailed in Amendment 170 to the Facility Operating License.

- (d) Fire Zone 1A401, east of G.4 contains only Division I safe shutdown components. Therefore, a fire originating in this fire zone will not affect more than one train of safe shutdown. A portion of Fire Zone 1A401 is a designated transient combustibles exclusion zone in accordance with Amendment 170 to the Facility Operating License. Amendment 170 to the Facility Operating License provides specific combustibles controls for Fire Area 19. Based on the separation between these raceways, the specified raceway wrap and combustibles controls in accordance with Amendment 170 to the Facility Operating License, a postulated fire in Fire Zones 1A401 or 1A417 will not affect or propagate to affect more than one train of safe shutdown in these fire zones.

- (e) Fire Zones 1A403 and 1A420 contain only Division I safe shutdown components. Fire Zones 1A403 and 1A420 are located more than 45 feet from Fire Zone 1A417 and are separated from the Division

GRAND GULF NUCLEAR GENERATING STATION
Updated Final Safety Analysis Report (UFSAR)

II safe shut components in Fire Zone 1A417 by Fire Zone 1A401. Therefore a postulated fire originating in these fire zones will not affect or propagate to affect more than one train of safe shutdown in these fire zones.

- (f) Fire Zone 1A424 contains only Division II safe shutdown components. Fire Zone 1A424 is located west of Fire Zone 1A417 and is separated from Division I safe shutdown components in Fire Zone 1A401 by the portion of Fire Zone 1A417 that contains only Division II safe shutdown. Based on the separation between these raceways, the specified raceway wrap and combustible controls in accordance with Amendment 170 to the Facility Operating License, a postulated fire occurring in 1A424, 1A417 or 1A401 will not affect or propagate to affect more than one train of safe shutdown in these fire zones.
- (g) Fire Zone 1A428 contains both Division I and II safe shutdown components. All Division I safe shutdown components are located south of Column Line 6.2 and east of Column Line N. All Division II safe shutdown components are located more than 21 feet north of Column Line 11.0. Therefore, Division I and II safe shutdown components in Fire Zone 1A428 are separated by more than 110 feet. The intervening combustibles within this separation distance consist of IEEE cable in ventilated trays, installed in accordance with the requirements of Regulatory Guide 1.75. Additionally, automatic sprinkler protection is provided north of Column Line 10.0 protecting more than 39 feet of the total 110-foot separation distance. Fire propagation via more than 110 feet of horizontally installed cable tray containing IEEE-383 cable is not postulated. Therefore, a fire originating in Fire Zone 1A428 will not affect, or propagate to affect, more than one train of safe shutdown in this zone.

GRAND GULF NUCLEAR GENERATING STATION
Updated Final Safety Analysis Report (UFSAR)

- (h) Fire Zone 1A420 contains only Division I safe shutdown components and Fire Zone 1A424 contains only Division II safe shutdown components. Division I safe shutdown components in Fire Zone 1A420 are separated from the Division II safe shutdown components located in Fire Zone 1A428 and 1A424 by the separation distance discussed in Fire Zone 1A425 above, as well as the remaining portion of Fire Zone 1A428 containing only Division I safe shutdown components. Therefore, the fire protection provided in Fire Zone 1A425 ensures that a postulated fire originating in Fire Zone 1A420, 1A424, or 1A428 will not affect, or propagate to affect, more than one train of safe shutdown in those fire zones.
- (i) Fire Zones 1A427, 1A429, 1A430, 1A432, 1A433, 1A434, and 1A436 (Group B) do not contain any safe shutdown components. These fire zones are located so that the only path of communication between Division I and II safe shutdown components is via Fire Zone 1A428. The fire zone that is located the closest to both Division I and II safe shutdown components is Fire Zone 1A432. The Division I safe shutdown components are located east of Column Line N and south of Column Line 6.2 in Fire Zone 1A428, more than 50 feet from Fire Zone 1A432. The Division II safe shutdown components are also located in Fire Zone 1A428 more than 21 feet north of Column Line 11.0. Division II safe shutdown components are located more than 75 feet from Fire Zone 1A432. Therefore, a postulated fire originating in any of these zones will not affect, or propagate to affect, more than one train of safe shutdown (refer to the discussion on Fire Zone 1A428, above).
- (j) The remaining fire zones in Fire Area 19 (Group C) do not contain any safe shutdown components except for Fire Zone 1A527. Fire Zone 1A527 contains Division I & II safe shutdown components. However, as demonstrated by analysis, spurious operation or failure of these

GRAND GULF NUCLEAR GENERATING STATION
Updated Final Safety Analysis Report (UFSAR)

components will not prevent hot shutdown per GGNS-EE-11-00001 (FPP-1). These fire zones are all separated from the fire zones located on Elev. 166' 0" by 3-hour rated fire barriers, except for two non-rated hatches in the floor at Elev. 185' 0". These hatches interface with Fire Zones 1A427 and 1A428. The hatch that interfaces with Fire Zone 1A428 is the closest to both Division I and Division II safe shutdown components, which are located in Fire Zone 1A428. This hatch is located in the vicinity of Fire Zone 1A432; therefore, the separation distance between this hatch and Division I and II safe shut-down components is similar to the separation distances previously discussed in Fire Zone 1A432. In addition, these hatches are separated by a horizontal distance of more than 115 feet. The intervening combustibles between these hatches on Elev. 185' 0" (Fire Zones 1A524, 1A527, 1A519, and 1A523) consist primarily of IEEE-383 cable, in addition to the wood located in Fire Zones 1A523 and 1A527 (these two fire zones are separated by a horizontal distance of 60 feet). A postulated fire originating in any fire zone on Elev. 185' 0" is not postulated to propagate via the IEEE-383 cable over this 115-foot separation distance to both hatches. Therefore, a postulated fire originating in any of these fire zones will not affect, or propagate to affect, more than one train of safe shutdown.

- (k) The fire zones of Group A communicate with the fire zones of Group B through non-rated barriers and open boundaries and with the fire zones of Group C through non-rated hatchways between floors. The fire zones within Groups B and C do not contain any safe shutdown components or provide fire propagation paths between Division I and II safe shutdown components located in Group A fire zones. Therefore, Division I and/or Division II safe shutdown components located in Group A fire zones are adequately protected. A fire originating in any fire zone of any group

GRAND GULF NUCLEAR GENERATING STATION
Updated Final Safety Analysis Report (UFSAR)

in Fire Area 19 will not affect, or propagate to affect, more than one train of safe shutdown components.

- (l) Although the fire zones of Fire Area 19 communicate directly or indirectly with each other through numerous combinations of adjacency, no further adjacency discussions are required.
- (m) Although the fire protection provided in Fire Area 19 does not strictly comply with the criteria set forth in Section 9A.3.1 of the Appendix R evaluation procedure (FPP-1), in that sprinkler coverage is not provided throughout Fire Area 19 and redundant safe shutdown components are not separated by 3-hour rated fire barriers, the fire protection provided in Fire Area 19 is more than adequate to ensure that at least one train of safe shutdown components will remain free of fire damage.
- (n) The postulated fire with the greatest severity in Fire Area 19 occurs in Fire Zone 1A403. The total fire severity in Fire Zone 1A403, including transient combustibles, amounts to a moderate fire load. The maximum in situ combustible loading in this fire zone amounts to less than a 75-minute fire duration (Ref. Calculation MC-QSP64-86058). Fire Area 19 is separated from all other fire areas by 3-hour rated fire barriers and a fire occurring in Fire Area 19 will not spread into any other fire area.

9A.5.19.4 FIRE ZONE ANALYSES

- a. FIRE ZONE 1A401: PASSAGE, ELEV. 166' 0"
 - 1. Safety-Related Equipment
 - Electrical Cable and Raceway
 - 2. Fire Zone Analysis

GRAND GULF NUCLEAR GENERATING STATION
Updated Final Safety Analysis Report (UFSAR)

- (a) Fire Zone 1A401 is located in the Auxiliary Building on Elev. 166' 0". The floor, and North and East walls of Fire Zone 1A401 are 3-hour rated fire barriers while the ceiling is the base of the roof slab. Portions of the South (EL 166' to 174') and West (column lines 10 to 12.5) boundaries are 3-hour rated fire barriers. The South and West zone boundaries are open to Fire Zones 1A403 and 1A417, respectively (Ref. Architectural Drawing A-0635).
- (b) The combustible loading in Fire Zone 1A401, including transient combustibles, amounts to a low fire load. The major contributor to this combustible loading is the electrical cable present in this zone. The in situ combustible loading in this fire zone amounts to less than a 45-minute fire duration (Ref. Calculation MC-QSP64-86058).
- (c) Fire Zone 1A401 contains safety-related equipment and the following fire protection measures are provided: smoke detection, partial coverage by an automatic sprinkler system, and accessibility to manual hose streams and portable fire extinguishers.
- (d) Fire Zone 1A401 contains only Division I safe shutdown components. Therefore, a fire originating in Fire Zone 1A401 will not affect more than one train of safe shutdown components. However, Fire Zone 1A401 has several combinations of adjacency with other fire zones within Fire Area 19. An adjacency discussion is provided in the fire area analysis for Fire Area 19. A portion of Fire Zone 1A401 is a designated transient combustible exclusion zone in accordance with Amendment 170 to the Facility Operating License. Amendment 170 to the Facility Operating License provides specific combustible controls for Fire Area 19.

Fire Zone 1A401 also contains RHR Heat Exchanger 'A' inlet temperature indication circuits utilized for alternate suppression pool

GRAND GULF NUCLEAR GENERATING STATION
Updated Final Safety Analysis Report (UFSAR)

temperature monitoring in the event of a fire in Containment (as discussed in Fire Area 25, Section 9A.5.25).

- b. FIRE ZONE 1A403: PASSAGE, ELEV. 166' 0"
 - 1. Safety-Related Equipment
 - Electrical Cable and Raceway
 - 2. Fire Zone Analysis
 - (a) Fire Zone 1A403 is located in the Auxiliary Building on Elev. 166' 0". The floor and South and East walls, as well as part of the West wall (Column Lines 7.5 to 10), of Fire Zone 1A403 are 3-hour rated fire barriers, while the ceiling is the base of the roof slab. A portion of the North (EL 166' to 174') boundary is a 3-hour rated fire barrier. The remaining portion of the West zone boundary and the North zone boundary are open to Fire Zones 1A420 and 1A401, respectively (Ref. Architectural Drawing A- 0635).
 - (b) The combustible loading in Fire Zone 1A403, including transient combustibles, amounts to moderate fire load. The major contributor to this combustible loading is the electrical cable present in the zone. The in situ combustible loading in this fire zone amounts to less than a 75-minute fire duration (Ref. Calculation MC-QSP64-86058).
 - (c) Fire Zone 1A403 contains safety-related equipment and the following fire protection measures are provided: smoke detection and accessibility to manual hose streams and portable fire extinguishers.
 - (d) Fire Zone 1A403 contains only Division I safe shutdown components. Therefore, a fire originating in this fire zone will not affect more than one train of safe shutdown. However, this fire zone has several combinations of adjacency with other fire zones within this fire area. An adjacency discussion is provided in the fire area analysis for Fire Area 19.

GRAND GULF NUCLEAR GENERATING STATION
Updated Final Safety Analysis Report (UFSAR)

Fire Zone 1A403 also contains RHR Heat Exchanger 'A' inlet temperature indication circuits utilized for alternate suppression pool temperature monitoring in the event of a fire in Containment (as discussed in Fire Area 25, Section 9A.5.25).

- c. FIRE ZONE 1A417: MISCELLANEOUS EQUIPMENT AREA, ELEV. 166' 0"
1. Safety-Related Equipment

Electrical Cable and Raceway
Containment H2 Analyzer Sample Rack B
Drywell H2 Analyzer Sample Rack B
 2. Fire Zone Analysis
 - (a) Fire Zone 1A417 is located in the Auxiliary Building on Elev. 166' 0". The floor, part of the North wall (Column Lines G.4 to K), and all of the South wall in Fire Zone 1A417 are 3-hour rated fire barriers, while the ceiling is the base of the roof slab. The remaining portion of the North wall is an exterior 2-hour rated fire barrier, while the East and West zone boundaries are open to Fire Zones 1A401 and 1A424, respectively (Ref. Architectural Drawing A-0635).
 - (b) The combustible loading in Fire Zone 1A417, including transient combustibles, amounts to a low fire load. The major contributor to this combustible loading is the electrical cable present in the zone. The in situ combustible loading in Fire Zone 1A417 amounts to less than a 15-minute fire duration (Ref. Calculation MC-QSP64-86058).
 - (c) Fire Zone 1A417 contains safety-related equipment and the following fire protection measures are provided: smoke detection, nearly complete coverage by an automatic sprinkler system, and accessibility to manual hose streams and portable fire extinguishers.

GRAND GULF NUCLEAR GENERATING STATION
Updated Final Safety Analysis Report (UFSAR)

- (d) Fire Zone 1A417, which is located west of Column Line G.4, contains both Division I and II safe shutdown components. All Division I safe shutdown components located in this zone with exception of conduit 1AARMI07 are located east of a line approximately 18 feet east of Column H at Division I safe shutdown vertical cable tray 1AATWT. All Division II safe shutdown components in this zone are located west of this line at Division II safe shutdown vertical cable tray 1ABTOT.

A qualified rated one-hour fire wrap or wrap which provides an equivalent one hour fire resistance with evaluation (EC 21147) is provided on the Div II safe shutdown vertical cable tray 1ABTOT in accordance with the risk informed, performance based analysis as approved by Amendment 170 to the Facility Operating License. The qualified rated one-hour firewrap or wrap which provides an equivalent one hour fire resistance with evaluation (EC 21147) is installed on the Division II safe shutdown cable tray 1ABTOT and specified intervening items where the cable tray would be subject to damage from a floor based transient combustible fire located between Division I vertical tray 1AATWT and Division II vertical cable tray 1ABTOT. In addition, Amendment 170, specifies locations where non-rated Kaowool wrap will be maintained "As Is" as a flame propagation retardant to prevent these raceways from contribution to the fire loading and provides specific combustible controls for Fire Area 19. Division I conduit 1AARMI07 is the only Division I safe shutdown component which extends west of a line approximately 18 feet east of Column H at Division I safe shutdown vertical cable tray 1AATWT in Fire Zone 1A417. This Division I conduit is not subject to damage from a floor based transient combustible fire due its height and does not require wrap. Combustible Controls for Amendment 170 to the Facility Operating License include a designated transient combustible exclusion zone and limits on the

GRAND GULF NUCLEAR GENERATING STATION
Updated Final Safety Analysis Report (UFSAR)

size and locations of Transient Combustible Storage areas for Fire Area 19 (Auxiliary Building elevation 166'). The Specific wrap requirements and combustible controls are detailed in License Amendment 170 to the Facility Operating License.

Intervening Combustibles located within the transient combustible exclusion zone as defined by Amendment 170 to the Facility Operating License consist of cable trays containing IEEE-383 cable installed in accordance with the requirements of Regulatory Guide 1.75.

An automatic sprinkler system is installed within the transient combustible exclusion zone described above and extends west into Fire Zone 1A428 to Column Line 10.0 and east into Fire Zone 1A401 to Column Line 11.0. A smoke detection system is also provided. Manual fire fighting is provided by installed fire extinguishers and manual hose stream.

However, Fire Zone 1A417 has several combinations of adjacency with other fire zones within Fire Area 19. An adjacency discussion is provided in the fire area analysis for Fire Area 19.

- (e) All other safe shutdown circuits in Fire Zone 1A417 that are located within 20 feet of 1AARMI07 and 1AXRW203 are wrapped with a nominal one-hour fire barrier with the exception of conduits 1ABRHI19 and 1ABRHI20, which contain R20 system circuits that feed MCC 16B41. A design basis fire in Fire Zone 1A417 could affect the R20 system circuits resulting in the loss of MCC 16B41, which could lead to, as a worst case condition, the loss of all Division II AC powered safe shutdown equipment. However, Division I AC powered safe shutdown equipment would still be available. In addition, there are no intervening combustibles within this 23-foot separation distance. Fire Zone 1A417 also has nearly complete sprinkler coverage, which

GRAND GULF NUCLEAR GENERATING STATION
Updated Final Safety Analysis Report (UFSAR)

extends west, into Fire Zone 1A428 to Column Line 10.0 and east into Fire Zone 1A401 to Column Line 11.0. Therefore, a fire originating in this fire zone will not affect more than one train of safe shutdown.

(f) This fire zone has several combinations of adjacency with other fire zones within this fire area. An adjacency discussion is provided in the fire area analysis for Fire Area 19.

d. FIRE ZONE 1A420: MISCELLANEOUS EQUIPMENT AREA, ELEV. 166' 0"

1. Safety-Related Equipment

Electrical Cable and Raceway
Drywell H2 Analyzer Sample Rack A
Containment H2 Analyzer Sample Rack A

2. Fire Zone Analysis

(a) Fire Zone 1A420 is located in the Auxiliary Building on Elev. 166' 0". The floor, North wall, and part of the South wall (Column Lines G.4 to K) of Fire Zone 1A420 are 3-hour rated fire barriers. The remaining portion of the South wall is a non-rated exterior wall and the ceiling is the base of the roof slab. The East and West zone boundaries are completely open to Fire Zones 1A403 and 1A428, respectively (Ref. Architectural Drawing A-0635).

(b) The combustible loading in Fire Zone 1A420, including transient combustibles amounts to a low fire load. The major contributor to this combustible loading is the electrical cable present in the zone. The in situ combustible loading in Fire Zone 1A420 amounts to less than a 60-minute fire duration (Ref. Calculation MC-QSP64-86058).

GRAND GULF NUCLEAR GENERATING STATION
Updated Final Safety Analysis Report (UFSAR)

- (c) Fire Zone 1A420 contains safety-related equipment and the following fire protection measures are provided: smoke detection and accessibility to manual hose streams and portable fire extinguishers.
 - (d) Fire Zone 1A420 contains only Division I safe shutdown components. Therefore, a fire originating in this fire zone will not affect more than one train of safe shutdown. However, this fire zone has several combinations of adjacency with other fire zones within this fire area. An adjacency discussion is provided in the fire area analysis for Fire Area 19.
- e. FIRE ZONE 1A424: SETDOWN AREA, ELEV. 166' 0"
- 1. Safety-Related Equipment
 - Electrical Cable and Raceway
 - 2. Fire Zone Analysis
 - (a) Fire Zone 1A424 is located in the Auxiliary Building on Elev. 166' 0". The ceiling, containment wall, and floor of Fire Zone 1A424 are 3-hour rated fire barriers. The North wall (east of Column Line N.5, Ref. Sect. 3.2.13.a) is a 2-hour rated fire barrier and between Column Lines N.5 and P is a non-rated exterior wall. The East, West, and South zone boundaries are completely open to Fire Zones 1A417, 1A427, and 1A428, respectively (Ref. Architectural Drawing A-0635).
 - (b) The combustible loading in Fire Zone 1A424, including transient combustibles, amounts to a low fire load. The major contributor to this combustible loading is the electrical cable present in the fire zone. The in situ combustible loading in Fire Zone 1A424 amounts to less than a 45-minute fire duration (Reference Calculation MC-QSP64-86058).

GRAND GULF NUCLEAR GENERATING STATION
Updated Final Safety Analysis Report (UFSAR)

- (c) Fire Zone 1A424 contains safety-related equipment and the following fire protection measures are provided: smoke detection, nearly complete coverage by an automatic sprinkler system and accessibility to manual hose streams and portable fire extinguishers.
 - (d) Fire Zone 1A424 contains only Division II safe shutdown components. Therefore, a fire originating in this fire zone will not affect more than one train of safe shutdown. However, this fire zone has several combinations of adjacency with other fire zones within this fire area. An adjacency discussion is provided in the fire area analysis for Fire Area 19.
- f. FIRE ZONE 1A427: SPENT FUEL CASK HANDLING AREA, Elev. 166' 0"
- 1. Safety-Related Equipment

None
 - 2. Fire Zone Analysis
 - (a) Fire Zone 1A427 is located in the Auxiliary Building on Elev. 166' 0". The floor and Ceiling (except for Equipment Hatch) in Fire Zone 1A427 are 3-hour rated fire barriers. The East zone boundary is completely open to Fire Zone 1A424 and the South wall is a non-rated barrier. The North and West walls are non-rated exterior walls (Ref. Architectural Drawing A-0635). The floor hatch that connects to Fire Zone 1A325 is a 3-hour rated barrier. The hatch is designed such that joints do not require any fire retardant sealant to maintain this rating. No combustible gases or flames can penetrate the joint configuration.
 - (b) The combustible loading in Fire Zone 1A427, including transient combustibles, amounts to a low fire load. The major contributors to this combustible loading are the concrete joint sealant in the walls and transient postulated for the zone. The in situ combustible loading in

GRAND GULF NUCLEAR GENERATING STATION
Updated Final Safety Analysis Report (UFSAR)

Fire Zone 1A427 amounts to less than a 15-minute fire duration (Reference Calculation MC-QSP64-86058).

- (c) Fire Zone 1A427 does not contain any safety-related equipment and the accessibility to manual hose streams and portable fire extinguishers is available as a fire protection measure.
- (d) Fire Zone 1A427 does not contain any safe shutdown components. Therefore, a fire originating in this fire zone will not affect either train of safe shutdown. However, this fire zone has several combinations of adjacency with other fire zones within this fire area. An adjacency discussion is provided in the fire area analysis for Fire Area 19.
- (e) Fire Zone 1A427 is utilized as a pathway for implementation of Dry Fuel Storage equipment. This equipment does not introduce significant combustibles into this zone that would alter the current assessment of the plant to achieve and maintain safe shutdown. The transient combustibles introduced for this plant operational activity has been evaluated and it has been determined that the Fire Severity for this event is Low.

g. FIRE ZONE 1A428: PASSAGE, ELEV. 166' 0"

1. Safety-Related Equipment

FPC and CU Pump Room Cooler
Fuel Pool Pump Panel
Electrical Cable and Raceway

2. Fire Zone Analysis

- (a) Fire Zone 1A428 is located in the Auxiliary Building on Elev. 166' 0". The ceiling (except for the non-rated hatch), floor, Containment wall, and the portion of the West wall that borders on Fire Zones 1A431 and 1A444 of Fire Zone 1A428 are 3-hour rated fire barriers. All

GRAND GULF NUCLEAR GENERATING STATION
Updated Final Safety Analysis Report (UFSAR)

remaining boundaries of this fire zone are non-rated barriers. The North, East, and a portion of the West zone boundaries are completely open to Fire Zones 1A424, 1A420, and 1A434, respectively (Ref. Architectural Drawing A-0635).

- (b) The combustible loading in Fire Zone 1A428, including transient combustibles amounts to a low fire load. The major contributor to this combustible loading is the electrical cable present in the fire zone. The in situ combustible loading in Fire Zone 1A428 amounts to less than a 60-minute fire duration (Ref. Calculation MC-QSP64-86058).
- (c) Fire Zone 1A428 contains safety-related equipment and the following fire protection measures are provided: smoke detection, partial coverage by an automatic sprinkler system and accessibility to manual hose streams and portable fire extinguishers.
- (d) Fire Zone 1A428 contains both Division I and II safe shutdown components. All Division I safe shutdown components are located south of Column Line 6.2 and east of Column Line N. All Division II safe shutdown components are located more than 21 feet north of Column Line 11.0. Therefore, Division I and II safe shutdown components in Fire Zone 1A428 are separated by more than 110 feet. The intervening combustibles within this separation distance consist of IEEE cable in ventilated trays, installed in accordance with the requirements of Regulatory Guide 1.75.
- (e) Additionally, automatic sprinkler protection is provided north of Column Line 10.0 protecting more than 39 feet of the total 110-foot separation distance. Fire propagation via more than 110 feet of horizontally installed cable tray containing IEEE-383 cable is not postulated. Therefore, a fire originating in this fire zone will not affect more than one

GRAND GULF NUCLEAR GENERATING STATION
Updated Final Safety Analysis Report (UFSAR)

train of safe shutdown. However, this fire zone has several combinations of adjacency with other fire zones within this fire area. An adjacency discussion is provided in the fire area analysis for Fire Area 19.

- h. FIRE ZONE 1A429: WATER SAMPLING STATION ELEV. 166' 0"
1. Safety-related
None
 2. Fire Zone Analysis
 - (1) Fire Zone 1A429 is located in the Auxiliary Building on Elev. 166' 0". The ceiling and floor of Fire Zone 1A429 are 3-hour rated fire barriers. All four walls of this fire zone are non-rated barriers (Ref. Architectural Drawing A-0635).
 - (b) The combustible loading in Fire Zone 1A429, based solely on transient combustibles, amounts to a low fire load (Ref. Calculation MC-QSP64-86058).
 - (c) There is no safety-related equipment in Fire Zone 1A429 and the accessibility to manual hose streams and portable fire extinguishers is available as a fire protection measure.
 - (d) Fire Zone 1A429 does not contain any safe shutdown components. Therefore, a fire originating in this fire zone will not affect either train of safe shutdown. However, this fire zone has several combinations of adjacency with other fire zones within this fire area. An adjacency discussion is provided in the fire area analysis for Fire Area 19.
- i. FIRE ZONE 1A430: CRD REPAIR AREA, ELEV. 166' 0"
1. Safety-Related Equipment
Piping & Valves

GRAND GULF NUCLEAR GENERATING STATION
Updated Final Safety Analysis Report (UFSAR)

2. Fire Zone Analysis

- (a) Fire Zone 1A430 is located in the Auxiliary Building on Elev. 166' 0". The ceiling, floor, and South and West walls of Fire Zone 1A430 are 3-hour rated fire barriers. The North and East walls are non-rated barriers (Ref. Architectural Drawing A-0635).
- (b) The total combustible loading in Fire Zone 1A430, including transient combustibles, amounts to a low fire load. The major contributors to this combustible loading are rubber hose and nylon material in this fire zone. The in situ combustible loading in Fire Zone 1A430 amounts to less than a 15-minute fire duration (Reference Calculation MC-QSP64-86058).
- (c) Fire Zone 1A430 contains safety-related piping & valves associated with fuel pool cooling and the following fire protection measures are provided: smoke detection and accessibility to manual hose streams and portable fire extinguishers.
- (d) Although safety-related equipment is located in Fire Zone 1A430, smoke detection is not required since means are available to restore fuel pool cooling, the spent fuel will remain submerged, and means are available to reestablish normal fuel pool water level (Ref. MNCR 14-87).
- (e) Fire Zone 1A430 does not contain any safe shutdown components. Therefore, a fire originating in this fire zone will not affect either train of safe shutdown. However, this fire zone has several combinations of adjacency with other fire zones within this fire area. An adjacency discussion is provided in the fire area analysis for Fire Area 19.

j. FIRE ZONE 1A431: SPENT FUEL POOL, ELEV. 167' 6"

1. Safety-Related Equipment

Piping

GRAND GULF NUCLEAR GENERATING STATION
Updated Final Safety Analysis Report (UFSAR)

2. Fire Zone Analysis

- (a) Fire zone 1A431 is located in the Auxiliary Building on Elev. 167' 6". The floor and South, East, and West walls of Fire Zone 1A431 are 3-hour rated fire barriers. The North wall is a non-rated barrier. Fire Zone 1A431 is open to Fire Zone 1A604 on Elev. 208' 10" (Ref. Architectural Drawings A-0635, A-0636, and A-0637).
- (b) Since the spent fuel pool is designed to be constantly filled with water, there is no combustible loading postulated for Fire Zone 1A431 (Ref. Calculation MC-QSP64-86058).
- (c) Fire Zone 1A431 contains only safety-related piping and the accessibility to manual hose streams and portable fire extinguishers (located on Elev. 208' 10") are available as a fire protection measure (Ref. Fire Protection Evaluation 87/0005).
- (d) Although no combustible loading is postulated for Fire Zone 1A431, if a fire were to occur in this fire zone, neither train of safe shutdown components would be affected. In addition, this fire zone has several combinations of adjacency with other fire zones within this fire area. An adjacency discussion is provided in the fire area analysis for Fire Area 19.

k. FIRE ZONE 1A432: FPC and CU PUMP ROOM, ELEV. 166' 0"

1. Safety-Related Equipment

Electrical Cable and Raceway
FPC and CU Pumps

2. Fire Zone Analysis

- (a) Fire Zone 1A432 is located in the Auxiliary Building on Elev. 166' 0". The ceiling, floor, and North wall of Fire Zone 1A432 are 3-hour

GRAND GULF NUCLEAR GENERATING STATION
Updated Final Safety Analysis Report (UFSAR)

rated fire barriers. The South, East, and West walls are non-rated barriers (Ref. Architectural Drawing A-0635).

- (b) The combustible loading in Fire Zone 1A432, including transient combustibles, amounts to a low fire load. The major contributor to this combustible loading is the transient combustible postulated for this fire zone. The in situ combustible loading amounts to less than a 15-minute fire duration (Ref. Calculation MC-QSP64-86058).
 - (c) Fire Zone 1A432 contains safety-related equipment and the following fire protection measures are provided: smoke detection and accessibility to manual hose streams and portable fire extinguishers.
 - (d) Fire Zone 1A432 does not contain any safe shutdown components. Therefore, a fire originating in this fire zone will not affect either train of safe shutdown. However; this fire zone has several combinations of adjacency with other fire zones within this fire area. An adjacency discussion is provided in the fire area analysis for Fire Area 19.
1. FIRE ZONE 1A433: FPC and CU BACKWASH TRANSFER PUMP ROOM, ELEV. 166' 0"
- 1. Safety-Related Equipment
 - Piping
 - 2. Fire Zone Analysis
 - (a) Fire Zone 1A433 is located in the Auxiliary Building on Elev. 166' 0". The ceiling and floor of Fire Zone 1A433 are 3-hour rated fire barriers. The four walls of this fire zone are non-rated barriers (Ref. Architectural Drawing A-0635).

GRAND GULF NUCLEAR GENERATING STATION
Updated Final Safety Analysis Report (UFSAR)

- (b) The combustible loading in Fire Zone 1A433, including transient combustibles, amounts to a low fire load. The major contributor to this combustible loading is the transient combustible loading postulated for this fire zone. The in situ combustible loading amounts to less than a 15-minute fire duration (Ref. Calculation MC-QSP64-86058).
 - (c) Fire Zone 1A433 contains only safety-related piping and the accessibility to manual hose streams and portable fire extinguishers is available as a fire protection measure (Ref. Fire Protection Evaluation 87/0005).
 - (d) Fire Zone 1A433 does not contain any safe shutdown components. Therefore, a fire originating in this fire zone will not affect either train of safe shutdown. However, this fire zone has several combinations of adjacency with other fire zones within this fire area. An adjacency discussion is provided in the fire area analysis for Fire Area 19.
- m. FIRE ZONE 1A434: PASSAGE, ELEV. 166' 0"
- 1. Safety-Related Equipment
 - Electrical Cable and Raceway
 - 2. Fire Zone Analysis
 - (a) Fire Zone 1A434 is located in the Auxiliary Building on Elev. 166' 0". The ceiling and floor of Fire Zone 1A434 are 3-hour rated fire barriers. Except where they border on Stair 1A12, the South and West walls are non-rated barriers. The North wall is a non-rated barrier. The East zone boundary is completely open to Fire Zone 1A428 (Ref. Architectural Drawing A-0635).
 - (b) The combustible loading in Fire Zone 1A434, including transient combustibles, amounts to a low fire load. The major contributor to this combustible loading is the electrical cable

GRAND GULF NUCLEAR GENERATING STATION
Updated Final Safety Analysis Report (UFSAR)

present in the fire zone. The transient combustible loading in Fire Zone 1A434 amounts to less than a 45-minute fire duration (Ref. Calculation MC-QSP64-86058).

- (c) Fire Zone 1A434 contains safety-related equipment and the following fire protection measures are provided: smoke detection and accessibility to manual hose streams and portable fire extinguishers.
- (d) Fire Zone 1A434 does not contain any safe shutdown components. Therefore, a fire originating in this fire zone will not affect either train of safe shutdown. However, this fire zone has several combinations of adjacency with other fire zones within this fire area. An adjacency discussion is provided in the fire area analysis for Fire Area 19.

n. FIRE ZONE 1A436: FPC AND CU BACKWASH RECEIVING TANK ROOM, ELEV. 166' 0"

1. Safety-Related Equipment

None

2. Fire Zone Analysis

- (a) Fire Zone 1A436 is located in the Auxiliary Building on Elev. 166' 0". The ceiling, floor, and North and West walls of Fire Zone 1A436 are 3-hour rated fire barriers. The South and East walls are non-rated barriers (Ref. Architectural Drawing A-0635).
- (b) The combustible loading in Fire Zone 1A436, based solely on transient combustibles, amounts to a low fire load (Ref. Calculation MC-QSP64-86058).
- (c) Fire Zone 1A436 does not contain safety-related equipment and accessibility to manual hose streams and portable fire extinguishers is provided as a fire protection measure.

GRAND GULF NUCLEAR GENERATING STATION
Updated Final Safety Analysis Report (UFSAR)

- (d) Fire Zone 1A436 does not contain any safe shutdown components. Therefore, a fire originating in this fire zone will not affect either train of safe shutdown. However, this fire zone has several combinations of adjacency with other fire zones within this fire area. An adjacency discussion is provided in the fire area analysis for Fire Area 19.
- o. FIRE ZONE 1A437: TRANSFER CANAL, ELEV. 176' 6"
 - 1. Safety-Related Equipment
 - Piping
 - 2. Fire Zone Analysis
 - (a) Fire Zone 1A437 is located in the Auxiliary Building on Elev. 176' 6". The West wall and eastern half of the North wall of Fire Zone 1A437 are 3-hour rated fire barriers. All remaining zone boundaries are non-rated. Fire Zone 1A437 is open to Fire Zone 1A604 on Elev. 208' 10" (Ref. Architectural Drawings A-0635, A-0636, and A-0637).
 - (b) Since the transfer canal is designed to be constantly filled with water, there is no combustible loading postulated for this fire zone (Ref. Calculation MC-QSP64-86058).
 - (c) Fire Zone 1A437 contains only safety-related piping and accessibility to manual hose streams and portable fire extinguishers (located on Elev. 208' 10") is available as a fire protection measure (Ref. Fire Protection Evaluation 87/0005).
 - (d) Fire Zone 1A437 does not contain any safe shutdown components. Although no combustible loading is postulated for Fire Zone 1A437, if a fire were to occur in this fire zone, neither train of safe shutdown components would be affected. In addition, this fire zone has several combinations of adjacency with other

GRAND GULF NUCLEAR GENERATING STATION
Updated Final Safety Analysis Report (UFSAR)

fire zones within this fire area. An adjacency discussion is provided in the fire area analysis for Fire Area 19.

p. FIRE ZONE 1A438: SHIPPING CASK STORAGE POOL, ELEV. 159' 6"

1. Safety-Related Equipment

Piping

2. Fire Zone Analysis

- (a) Fire Zone 1A438 is located in the Auxiliary Building on Elev. 159' 6". The floor and North, East, and West walls are 3-hour rated fire barriers. The South wall is a non-rated barrier. Fire Zone 1A438 is open to Fire Zone 1A604 on Elev. 208' 10" (Ref. Architectural Drawings A-0635, A-0636, and A-0637).
- (b) Since the shipping cask storage area is designed to be constantly filled with water, there is no combustible loading postulated for Fire Zone 1A438 (Ref. Calculation MC-QSP64-86058).
- (c) There is safety-related piping located in Fire Zone 1A438, and the accessibility to manual hose streams and portable fire extinguishers (located on Elev. 208' 10") is available as a fire protection measure (Ref. Fire Protection Evaluation 87/0005).
- (d) Fire Zone 1A438 does not contain any safe shutdown components. Although no combustible loading is postulated for Fire Zone 1A438, if a fire were to occur in this fire zone, neither train of safe shutdown components would be affected. In addition, this fire zone has several combinations of adjacency with other fire zones within this fire area. An adjacency discussion is provided in the fire area analysis for Fire Area 19.

q. FIRE ZONE 1A444: INSPECTION AREA, ELEV. 166' 9"

1. Safety-Related Equipment

GRAND GULF NUCLEAR GENERATING STATION
Updated Final Safety Analysis Report (UFSAR)

None

2. Fire Zone Analysis

- (a) Fire Zone 1A444 is located in the Auxiliary Building on Elev. 166' 9". The floor and East, West, and eastern half of the North walls of Fire Zone 1A444 are 3-hour rated firebarriers. All remaining zone boundaries are non-rated (Ref. Architectural Drawing A-0635).
- (b) The combustible loading in Fire Zone 1A444, based solely on transient combustibles, amounts to a low fire load (Ref. Calculation MC-QSP64-86058).
- (c) Fire Zone 1A444 does not contain any safety-related equipment and the accessibility to manual hose streams and portable fire extinguishers is available as a fire protection measure.
- (d) Fire Zone 1A444 does not contain any safe shutdown components. Therefore, a fire originating in this fire zone will not affect either train of safe shutdown. In addition, this fire zone has several combinations of adjacency with other fire zones within this fire area. An adjacency discussion is provided in the fire area analysis for Fire Area 19.

r. FIRE ZONE 1A519: STORAGE AREA, ELEV. 185' 0"

1. Safety-Related Equipment

Electrical Cable and Raceway

2. Fire Zone Analysis

- (a) Fire Zone 1A519 is located in the Auxiliary Building on 185' 0". The ceiling, floor, portions of the east, south, and west boundaries, and containment wall of Fire Zone 1A519 are 3-hour rated fire barriers. The interfaces with Stair 1A10 and Elevator No. 3 (Ref. Sect. 3.2.13.a) are 2-hour rated fire barriers. Fire Zone 1A519 communicates directly with Fire Zones 1A523,

GRAND GULF NUCLEAR GENERATING STATION
Updated Final Safety Analysis Report (UFSAR)

1A531, and 1A524 through open spaces. The remaining zone boundaries are non-rated (Ref. Architectural Drawing A-0636).

- (b) The combustible loading in Fire Zone 1A519, including transient combustibles, amounts to a low fire load. The major contributor to this combustible loading is the electrical cable present in the zone. The in situ combustible loading in Fire Zone 1A519 amounts to less than a 30-minute fire duration (Ref. Calculation MC-QSP64-86058).
- (c) Fire Zone 1A519 contains safety-related equipment and the following fire protection measures are provided: smoke detection and accessibility to manual hose streams and portable fire extinguishers.
- (d) Fire Zone 1A519 does not contain any safe shutdown components. Therefore, a fire originating in this fire zone will not affect either train of safe shutdown. However, this fire zone has several combinations of adjacency with other fire zones within, this fire area. An adjacency discussion is provided in the fire area analysis for Fire Area 19.

s. FIRE ZONE 1A523: SPENT FUEL HATCH AREA, ELEV. 185' 0"

1. Safety-Related Equipment

Electrical Cable and Raceway

2. Fire Zone Analysis

- (a) Fire Zone 1A523 is located in the Auxiliary Building on Elev. 185' 0". The ceiling and floor (except for the non-rated hatchways) are 3-hour rated fire barriers. The North and West walls are non-rated, exterior walls; the South wall is a non-rated barrier; and the East zone boundary is completely open to Fire Zone 1A519 (Ref. Architectural Drawing A-0636).

GRAND GULF NUCLEAR GENERATING STATION
Updated Final Safety Analysis Report (UFSAR)

- (b) The combustible loading in Fire Zone 1A523, including transient combustibles, amounts to a low fire load. The major contributor to this combustible loading is the wood located in Fire Zone 1A523. The in situ combustible loading in Fire Zone 1A523 amounts to less than a 15-minute fire duration (Ref. Calculation MC-QSP64-86058).
 - (c) Fire Zone 1A523 contains safety-related equipment and the following fire protection measures are provided: smoke detection (located on Elev. 208' 10") and accessibility to manual hose streams and portable fire extinguishers.
 - (d) Fire Zone 1A523 does not contain any safe shutdown components. Therefore, a fire originating in this fire zone will not affect either train of safe shutdown. However, this fire zone has several combinations of adjacency with other fire zones within this fire area. An adjacency discussion is provided in the fire area analysis for Fire Area 19.
 - (e) Fire Zone 1A523 is utilized as a pathway for implementation of Dry Fuel Storage equipment. This equipment does not introduce significant combustibles into this zone that would alter the current assessment of the plant to achieve and maintain safe shutdown. The transient combustibles introduced for this plant operational activity has been evaluated and it has been determined that the Fire Severity for this event is Low.
- t. FIRE ZONE 1A524: CONCRETE PLATFORM, ELEV. 195' 3"
- 1. Safety-Related Equipment
 - Electrical Cable and Raceway
 - 2. Fire Zone Analysis
 - (a) Fire Zone 1A524 is located in the Auxiliary Building on Elev. 195' 3". The floor, ceiling, and East wall are 3-hour rated fire barriers.

GRAND GULF NUCLEAR GENERATING STATION
Updated Final Safety Analysis Report (UFSAR)

The North and South zone boundaries are completely open to Fire Zones 1A519 and 1A527, respectively. The West wall is a non-rated barrier (Ref. Architectural Drawing A-0636).

- (b) The combustible loading in Fire Zone 1A524, including transient combustibles, amounts to a low fire load. The major contributor to this combustible loading is the electrical cable present in the fire zone. The in situ combustible loading in Fire Zone 1A524 amounts to less than a 30-minute fire duration (Ref. Calculation MC-QSP64-86058).
- (c) Fire Zone 1A524 contains safety-related equipment and the following fire protection measures are provided: smoke detection (located in 1A527) and accessibility to manual hose streams and portable fire extinguishers.
- (d) Fire Zone 1A524 does not contain any safe shutdown components. Therefore, a fire originating in this fire zone will not affect either train of safe shutdown. However, this fire zone has several combinations of adjacency with other fire zones within this fire area. An adjacency discussion is provided in the fire area analysis for Fire Area 19.

u. FIRE ZONE 1A525: TRANSFER TUBE, ELEV. 182' 0"

1. Safety-Related Equipment

Fuel Transfer Tube
Fuel Transfer Tube Bellows

2. Fire Zone Analysis

- (a) Fire Zone 1A525 is located in the Auxiliary Building on Elev. 182' 0". The ceiling, floor, and North, South, and East walls of Fire Zone 1A525 are 3-hour rated fire barriers. The West wall is a non-rated barrier (Ref. Architectural Drawing A-0636)

GRAND GULF NUCLEAR GENERATING STATION
Updated Final Safety Analysis Report (UFSAR)

- (b) The combustible loading in Fire Zone 1A525, with no transient combustible postulated for this fire zone, amounts to a low fire load. The only contributor to this combustible loading is the concrete joint sealant in the walls. The in situ combustible loading in Fire Zone 1A525 amounts to less than a 15-minute fire duration (Ref. Calculation MC-QSP64-86058). However, no fire is anticipated because the transfer tube is designed to be constantly filled with water.
- (c) Since the transfer tube is designed to be constantly filled with water and, therefore, inaccessible for fire fighting purposes, active fire protection measures are not provided for Fire Zone 1A525.
- (d) Fireproofing of structural steel in this room is not required due to insignificant fire exposure potential. Fire loading within the room is extremely low, adequate boundary construction prevents exposure from outside the room, the room has limited access, and transient combustible are strictly controlled.
- (e) Fire Zone 1A525 does not contain any safe shutdown components. Although no fire is expected in Fire Zone 1A525, if one were to occur in this fire zone, neither train of safe shutdown components would be affected. In addition, this fire zone has several combinations of adjacency with other fire zones within this fire area. An adjacency discussion is provided in the fire area analysis for Fire Area 19.

v. FIRE ZONE 1A527: LOAD CENTER AREA, ELEV. 185' 0"

1. Safety-Related Equipment

Air Receivers
FPC and CU Heat Exchangers
Electrical Cable and Raceway

2. Fire Zone Analysis

GRAND GULF NUCLEAR GENERATING STATION
Updated Final Safety Analysis Report (UFSAR)

- (a) Fire Zone 1A527 is located in the Auxiliary Building on Elev. 185' 0". The floor, ceiling (except for the non-rated hatchways), portions of the North (EL 185' to 195') and East boundaries, and containment wall are 3-hour rated fire barriers. The West wall is a non-rated barrier, while the South wall is a non-rated exterior wall. The North zone boundary is open to Fire Zone 1A524, while the interface with Stair 1A12 is a 2-hour rated fire barrier (Ref. Architectural Drawing A-0636).
- (b) The combustible loading in Fire Zone 1A527, including transient combustibles, amounts to a low fire load. The major contributor to this combustible loading is the electrical cable present in the fire zone. The in-situ combustible loading in Fire Zone 1A527 amounts to less than a 45 minute fire duration (Ref. Calculation MC-QSP64-86058).
- (c) Zone 1A527 contains safety-related equipment and the following fire protection measures are provided: smoke detection and accessibility to manual hose streams and portable fire extinguishers.
- (d) Fire Zone 1A527 does not contain Division I & II safe shutdown components. However, as demonstrated by analysis, spurious operation or failure of these components will not prevent hot shutdown per GGNS-EE-11-00001 (FPP-1). However, this fire zone has several combinations of adjacency with other fire zones within this fire area. An adjacency discussion is provided in the fire area analysis for Fire Area 19.

w. FIRE ZONE 1A528: NEW FUEL STORAGE VAULT, ELEV. 185' 0"

1. Safety-Related Equipment

None

2. Fire Zone Analysis

GRAND GULF NUCLEAR GENERATING STATION
Updated Final Safety Analysis Report (UFSAR)

- (a) Fire Zone 1A528 is located in the Auxiliary Building on Elev. 185' 0". The floor and all four walls of Fire Zone 1A528 are 3-hour rated fire barriers. Fire Zone 1A528 is open to Fire Zone 1A604 or Elev. 208' 10" (Ref. Architectural Drawings A-0636 and A-0637).
- (b) There is no combustible loading postulated for Fire Zone 1A528 (Ref. Calculation MC-QSP64-86058).
- (c) Fire Zone 1A528 does not contain any safety-related equipment and accessibility to manual hose streams and portable fire extinguishers (located on Elev. 208' 10") is available as a fire protection measure.
- (d) Fire Zone 1A528 does not contain any safe shutdown components. Although no combustible loading is postulated for Fire Zone 1A528, if a fire were to occur in this fire zone, neither train of safe shutdown components would be affected. In addition, this fire zone has several combinations of adjacency with other fire zones within this fire area. An adjacency discussion is provided in the fire area analysis for Fire Area 19.

x. FIRE ZONE 1A529: FPC and CU TANK ROOM, ELEV. 180' 8"

1. Safety-Related Equipment

Electrical Cable and Raceway

2. Fire Zone Analysis

- (a) Fire Zone 1A529 is located in the Auxiliary Building on Elev. 180' 8". The floor and North wall of Fire Zone 1A529 are 3-hour rated fire barriers. The ceiling and remaining threewalls are non-rated barriers (Ref. Architectural Drawing A-0636).
- (b) The combustible loading in Fire Zone 1A529, including transient combustibles, amounts to a low fire load. The major contributor to this

GRAND GULF NUCLEAR GENERATING STATION
Updated Final Safety Analysis Report (UFSAR)

combustible loading is the lube oil present in the fire zone. The transient combustible loading in Fire Zone 1A529 amounts to less than a 15-minute fire duration (Ref. Calculation MC-QSP64-86058).

- (c) Fire Zone 1A529 contains safety-related equipment and the following fire protection measures are provided: smoke detection and accessibility to manual hose streams and portable fire extinguishers.
- (d) Fire Zone 1A529 does not contain any safe shutdown components. Therefore, a fire originating in this fire zone will not affect either train of safe shutdown. However, this fire zone has several combinations of adjacency with other fire zones within this fire area. An adjacency discussion is provided in the fire area analysis for Fire Area 19.

y. FIRE ZONE 1A530: FUEL POOL FILTER DEMINERALIZER ROOM,
ELEV. 180' 8"

1. Safety-Related Equipment

None

2. Fire Zone Analysis

- (a) Fire Zone 1A530 is located in the Auxiliary Building on Elev. 180' 8". The floor and a portion of the North wall of Fire Zone 1A530 are 3-hour rated fire barriers. The ceiling, South, and East walls are non-rated barriers, while the West wall is a non-rated, exterior wall (Ref. Architectural Drawing A-0636).
- (b) The combustible loading in Fire Zone 1A530, including transient combustibles, amounts to a low fire load. The major contributors to this combustible loading are the in situ combustibles postulated for this fire zone, which amounts to less than a 15-minute fire duration (Ref. Calculation MC-QSP64-86058).

GRAND GULF NUCLEAR GENERATING STATION
Updated Final Safety Analysis Report (UFSAR)

- (c) Fire Zone 1A530 does not contain any safety-related equipment and accessibility to manual hose streams and portable fire extinguishers is available as a fire protection measure.
- (d) Fire Zone 1A530 does not contain any safe shutdown components. Therefore, a fire originating in this fire zone will not affect either train of safe shutdown. However, this fire zone has several combinations of adjacency with other fire zones within this fire area. An adjacency discussion is provided in the fire area analysis for Fire Area 19.

z. FIRE ZONE 1A531: PIPING AREA, ELEV. 185' 0"

1. Safety-Related Equipment

Piping

2. Fire Zone Analysis

- (a) Fire Zone 1A531 is located in the Auxiliary Building on Elev. 185' 0". The ceiling, floor, and a portion of the South wall of Fire Zone 1A531 are 3-hour rated fire barriers. The North wall is a non-rated fire barrier; the West wall is a non-rated, exterior wall; and the East zone boundary is completely open to Fire Zone 1A519 (Ref. Architectural Drawing A-0636).
- (b) The combustible loading in Fire Zone 1A531, based solely on transient combustibles, amounts to a low fire load (Ref. Calculation MC-QSP64-86058).
- (c) Fire Zone 1A531 contains only safety-related piping and accessibility to manual hose streams and portable fire extinguishers is available as a fire protection measure (Ref. Fire Protection Evaluation 87/0005).
- (d) Fire Zone 1A531 does not contain any safe shutdown components. Therefore, a fire originating in this fire zone will not affect either train of safe shutdown. In addition, this

GRAND GULF NUCLEAR GENERATING STATION
Updated Final Safety Analysis Report (UFSAR)

fire zone has several combinations of adjacency with other fire zones within this fire area. An adjacency discussion is provided in the fire area analysis for Fire Area 19.

aa. FIRE ZONE 1A532: CASK WASHDOWN AREA, ELEV. 185' 0"

1. Safety-Related Equipment

None

2. Fire Zone Analysis

- (a) Fire Zone 1A532 is located in the Auxiliary Building on Elev. 185' 0". The floor and all four walls of Fire Zone 1A532 are 3-hour rated fire barriers. Fire Zone 1A532 is open to Fire Zone 1A604 on Elev. 208' 10" (Ref. Architectural Drawings A-0636 and A-0637).
- (b) There is no insitu combustible loading postulated for Fire Zone 1A532 (Ref. Calculation MC-QSP64-86058). Transient combustibles exist in support of Dry Fuel Storage operations.
- (c) Fire Zone 1A532 does not contain any safety-related equipment and accessibility to manual hose streams, and portable fire extinguishers (located on Elev. 208' 10") is available as a fire protection measure.
- (d) Fire Zone 1A532 does not contain any safe shutdown components. Although no combustible loading is postulated for Fire Zone 1A532, if a fire were to occur in this fire zone, neither train of safe shutdown components would be affected. In addition, this fire zone has several combinations of adjacency with other fire zones within this fire area. An adjacency discussion is provided in the fire area analysis for Fire Area 19.
- (e) Fire Zone 1A532 is utilized as a pathway for implementation of Dry Fuel Storage equipment. This equipment does not introduce significant combustibles into this zone that would alter the

GRAND GULF NUCLEAR GENERATING STATION
Updated Final Safety Analysis Report (UFSAR)

current assessment of the plant to achieve and maintain safe shutdown. The transient combustibles introduced for this plant operational activity has been evaluated and it has been determined that the Fire Severity for this event is Low.

bb. FIRE ZONE 1A533: FUEL POOL FILTER DEMINERALIZER ROOM,
ELEV. 191' 4"

1. Safety-Related Equipment

Piping

2. Fire Zone Analysis

- (a) Fire Zone 1A533 is located in the Auxiliary Building on Elev. 191' 4". The ceiling and North wall of Fire Zone 1A533 are 3-hour rated fire barriers. The floor and South and East walls are non-rated barriers, while the West wall is a non-rated, exterior wall (Ref. Architectural Drawing A-0636).
- (b) There is no combustible loading postulated for Fire Zone 1A533 (Ref. Calculation MC-QSP64-86058).
- (c) Fire Zone 1A533 contains only safety-related piping and is accessible only by lifting a concrete floor hatch. Therefore, accessibility to manual hose streams and portable fire extinguishers is available as a fire protection measure only when the concrete floor hatch has been lifted (Ref. Fire Protection Evaluation 87/0005).
- (d) Fire Zone 1A533 does not contain any safe shutdown components. Although no combustible loading is postulated for Fire Zone 1A533, if a fire were to occur in this fire zone, neither train of safe shutdown components would be affected. In addition, this fire zone has several combinations of adjacency with other

GRAND GULF NUCLEAR GENERATING STATION
Updated Final Safety Analysis Report (UFSAR)

fire zones within this fire area. An adjacency discussion is provided in the fire area analysis for Fire Area 19.

cc. FIRE ZONE 1A534: FUEL POOL FILTER DEMINERALIZER ROOM, ELEV. 191' 4"

1. Safety-Related Equipment

None

2. Fire Zone Analysis

- (a) Fire Zone 1A534 is located in the Auxiliary Building on Elev. 191' 4". The ceiling in Fire Zone 1A534 is a 3-hour rated fire barrier. The West wall is a non-rated, exterior wall, while the floor and remaining three walls are non-rated barriers (Ref. Architectural Drawing A-0636).
- (b) There is no combustible loading postulated for Fire Zone 1A534 (Ref. Calculation MC-QSP64-86058).
- (c) Fire Zone 1A534 is accessible only by lifting a concrete floor hatch. Therefore, fire protection measures in the form of accessibility to manual hose streams and portable fire extinguishers are available only when the concrete floor hatch has been lifted.
- (d) Fire Zone 1A534 does not contain any safe shutdown components. Although no combustible loading is postulated for Fire Zone 1A534, if a fire were to occur in this fire zone, neither train of safe shutdown components would be affected. In addition, this fire zone has several combinations of adjacency with other fire zones within this fire area. An adjacency discussion is provided in the fire area analysis for Fire Area 19.

dd. FIRE ZONE 1A536: PIPE CHASE, ELEV. 185' 0"

1. Safety-Related Equipment

GRAND GULF NUCLEAR GENERATING STATION
Updated Final Safety Analysis Report (UFSAR)

None

2. Fire Zone Analysis

- (a) Fire Zone 1A536 is located in the Auxiliary Building on Elev. 185' 0". The floor, ceiling, and East wall of Fire Zone 1A536 are 3-hour rated fire barriers. The North and South walls are non-rated barriers, while the West wall is a non-rated exterior wall (Ref. Architectural Drawing A-0636).
- (b) There is no combustible loading postulated for Fire Zone 1A536 (Ref. Calculation MC-QSP64-86058).
- (c) There is no safety-related equipment located in Fire Zone 1A536 and accessibility to manual hose streams and portable fire extinguishers is provided as a fire protection measure.
- (d) Fire Zone 1A536 does not contain any safe shutdown components. Although no combustible loading is postulated for Fire Zone 1A536, if a fire were to occur in this fire zone, neither train of safe shutdown components would be affected. In addition, this fire zone has several combinations of adjacency with other fire zones within this fire area. An adjacency discussion is provided in the fire area analysis for Fire Area 19.

ee. FIRE ZONE 1A537: DRAIN TANK AREA, ELEV. 191' 4"

1. Safety-Related Equipment

Drain Tank

2. Fire Zone Analysis

- (a) Fire Zone 1A537 is located in the Auxiliary Building on Elev. 191' 4". The ceiling and North wall of Fire Zone 1A537 are 3-hour rated fire barriers. The floor and three remaining walls are non-rated barriers (Ref. Architectural Drawing A-0636).

GRAND GULF NUCLEAR GENERATING STATION
Updated Final Safety Analysis Report (UFSAR)

- (b) The combustible loading in Fire Zone 1A537, with only transient combustibles postulated for this fire zone, amounts to a low fire load (Ref. Calculation MC-QSP64-86058).
- (c) There is safety-related equipment located in Fire Zone 1A537 and accessibility to portable fire extinguishers is provided as a fire protection measure. No smoke detection is provided because the safety-related equipment in this zone consists only of the drain tank.
- (d) Fire Zone 1A537 does not contain any safe shutdown components. Therefore, a fire originating in this fire zone will not affect either train of safe shutdown. However, this fire zone has several combinations of adjacency with other fire zones within this fire area. An adjacency discussion is provided in the fire area analysis for Fire Area 19.

ff. FIRE ZONE 1A602: STORAGE AREA, ELEV. 208' 10"

1. Safety-Related Equipment

Electrical Cable and Raceway

2. Fire Zone Analysis

- (a) Fire Zone 1A602 is located in the Auxiliary Building on Elev. 208' 10". The floor (except for the non-rated hatch), portions of the ceiling and East wall, and containment wall of Fire Zone 1A602 are 3-hour rated firebarriers. The South and West zone boundaries are completely open to Fire Zones 1A603 and 1A604, respectively. The North wall and remaining portion of the East wall are non-rated, exterior walls, while the ceiling is the base of the roof slab. The interfaces with Stair 1A10 and Elevator No. 3 (Ref. Sect. 3.2.13.a) are 2-hour rated fire barriers (Ref. Architectural Drawing A-0637).
- (b) The combustible loading in Fire Zone 1A602, including transient combustibles, amounts to a low fire load. The major contributor to the combustible loading is the electrical cable

GRAND GULF NUCLEAR GENERATING STATION
Updated Final Safety Analysis Report (UFSAR)

present in the fire zone. The in situ combustible loading in Fire Zone 1A602 amounts to less than a 15-minute fire duration (Ref. Calculation MC-QSP64-86058).

- (c) Fire Zone 1A602 contains safety-related equipment and the following fire protection measures are provided: smoke detection and accessibility to manual hose streams and portable fire extinguishers.
- (d) Fire Zone 1A602 does not contain any safe shutdown components. Therefore, a fire originating in this fire zone will not affect either train of safe shutdown. However, this fire zone has several combinations of adjacency with other fire zones within this fire area. An adjacency discussion is provided in the fire area analysis for Fire Area 19.
- (e) Fire Zone 1A602 is utilized as a pathway and temporary setup location for implementation of Dry Fuel Storage equipment. This equipment does not introduce significant combustibles into this zone that would alter the current assessment of the plant to achieve and maintain safe shutdown. The transient combustibles introduced for this plant operational activity has been evaluated and it has been determined that the Fire Severity for this event is Low.

gg. FIRE ZONE 1A603: PASSAGE, ELEV. 208' 10"

1. Safety-Related Equipment

Electrical Cable and Raceway
Enclosure Building Recirculation Fans

2. Fire Zone Analysis

- (a) Fire Zone 1A603 is located in the Auxiliary Building on Elev. 208' 10". The floor (except for the hatchway located at the south end of the zone), portions of the ceiling and East wall, and the containment wall of Fire Zone 1A603 are 3-hour rated fire barriers. The North and West zone boundaries are completely open to

GRAND GULF NUCLEAR GENERATING STATION
Updated Final Safety Analysis Report (UFSAR)

Fire Zones 1A602 and 1A604, respectively. The South wall and remaining portion of the East wall are non-rated exterior walls, while the ceiling is the base of the roof slab (Ref. Architectural Drawing A-0637).

- (b) The combustible loading in Fire Zone 1A603, including transient combustibles, amounts to a low fire load. The major contributors to this combustible loading are the electrical cables and PC storage present in the firezone. The in situ combustible loading amounts to less than a 30-minute fire duration (Ref. Calculation MC-QSP64-86058).
- (c) Fire Zone 1A603 contains safety-related equipment and the following fire protection measures are available: smoke detection and accessibility to manual hose streams and portable fire extinguishers.
- (d) Fire Zone 1A603 contains Division I & II safe shut-down components. However, as demonstrated by analysis, spurious operation or failure of these components will not prevent hot shutdown per GGNS-EE-11-00001 (FPP-1). However, this fire zone has several combinations of adjacency with other fire zones within this fire area. An adjacency discussion is provided in the fire area analysis for Fire Area 19.

hh. FIRE ZONE 1A604: FUEL HANDLING AREA, ELEV. 208' 10"

1. Safety-Related Equipment

150-Ton Spent Fuel Cask Crane
Electrical Cable and Raceway
Fuel Preparation Machine
Fuel Handling Platform
5-Ton New Fuel Bridge Crane

2. Fire Zone Analysis

- (a) Fire Zone 1A604 is located in the Auxiliary Building on Elev. 208' 10". The floor of Fire Zone 1A604, except for the hatchway located at the north end of the zone, is a 3-hour rated

GRAND GULF NUCLEAR GENERATING STATION
Updated Final Safety Analysis Report (UFSAR)

fire barrier. The interface with Stair 1A12 is a 2-hour rated fire barrier. The East zone boundary is completely open to Fire Zones 1A602 and 1A603. The North, South, and West walls are non-rated, exterior walls, while the ceiling forms the base of the roof slab and non-rated floor of 1A606 (Ref. Architectural Drawing A-0637).

- (b) The combustible loading in Fire Zone 1A604, including transient combustibles, amounts to a low fire load. The major contributors to the combustible loading are the PC storage and electrical cable present in the fire zone. The in situ combustible loading amounts to less than a 15-minute fire duration (Ref. Calculation MC-QSP64-86058).
- (c) Fire Zone 1A604 contains safety-related equipment and the following fire protection measures are provided: smoke detection and accessibility to manual hose streams and portable fire extinguishers.
- (d) Fire Zone 1A604 does not contain any safe shutdown components. Therefore, a fire originating in this fire zone will not affect either train of safe shutdown. However, this fire zone has several combinations of adjacency with other fire zones within this fire area. An adjacency discussion is provided in the fire area analysis for Fire Area 19.
- (e) Fire Zone 1A602 is utilized as a pathway and temporary setup location for implementation of Dry Fuel Storage equipment. This equipment does not introduce significant combustibles into this zone that would alter the current assessment of the plant to achieve and maintain safe shutdown. The transient combustibles introduced for this plant operational activity has been evaluated and it has been determined that the Fire Severity for this event is Low.

ii. FIRE ZONE 1A606: HVAC UNIT AREA, ELEV. 245' 0"

1. Safety-Related Equipment

GRAND GULF NUCLEAR GENERATING STATION
Updated Final Safety Analysis Report (UFSAR)

Electrical Cable and Raceway

2. Fire Zone Analysis

- (a) Fire Zone 1A606 is located in the Auxiliary Building on Elev. 245' 0". The South and West walls of Fire Zone 1A606 are non-rated, exterior walls and the East wall is a 3-hour rated fire barrier. The North wall is completely open to Fire Zone 1A604; the floor is a non-rated barrier; and the ceiling is the base of the roof slab. The interfaces with Stair 1A12 are 2-hour rated fire barriers (Ref. Architectural Drawing A-0637).
- (b) The combustible loading in Fire Zone 1A606, including transient combustibles, amounts to a low fire load. The major contributor to the combustible loading is the electrical cable present in the fire zone. The in situ combustible loading in Fire Zone 1A606 amounts to less than a 15-minute fire duration (Ref. Calculation MC-QSP64-86058).
- (c) Since Fire Zone 1A606 contains safety-related equipment, the following fire protection measures are provided: smoke detection and accessibility to manual hose streams and portable fire extinguishers.
- (d) Fire Zone 1A606 does not contain any safe shutdown components. Therefore, a fire originating in this fire zone will not affect either train of safe shutdown. However, this fire zone has several combinations of adjacency with other fire zones within this fire area. An adjacency discussion is provided in the fire area analysis for Fire Area 19.

GRAND GULF NUCLEAR GENERATING STATION
Updated Final Safety Analysis Report (UFSAR)

9A.5.20 FIRE AREA 20

9A.5.20.1 FIRE AREA DESCRIPTION

Fire Area 20 consists only of Fire Zone 1A407 (Elev. 166' 0") in the Auxiliary Building. The floor and walls are 3-hour rated fire barriers. The roof forms the ceiling and is a non-rated exterior barrier (Ref. Architectural Drawing A-0635).

INCLUDED FIRE ZONE	DESCRIPTION
1A407	Motor Control Center, Elev. 166' 0"

9A.5.20.2 SAFE SHUTDOWN EQUIPMENT

Division II

9A.5.20.3 FIRE AREA ANALYSIS

Fire Zone 1A407 contains only Division II safe shutdown equipment and cable and raceway, as shown in the microcomputer data base (Ref. FPP-1, Appendix C Data). Since this Fire Area contains only Division II safe shutdown components and is separated from all other Fire Areas by 3-hour rated fire barriers, Fire Area 20 fully complies with Appendix R requirements. Therefore, in the event of a fire in this fire area, safe shutdown capability would be maintained by separate Division I safe shutdown equipment. The total fire severity in Fire Zone 1A407, including transient combustibles amounts to a moderate fire load. The maximum in situ combustible loading in this fire zone amounts to less than a 90-minute fire duration (Ref. Calculation MC-QSP64-86058). Therefore, a fire occurring in Fire Area 20 will not spread into any other fire area.

9A.5.20.4 FIRE ZONE ANALYSIS

FIRE ZONE 1A407: MOTOR CONTROL CENTER, ELEV. 166' 0"

1. Safety-Related Equipment

Electrical Cable and Raceway
Motor Control Center
ESF Electrical Switchgear Room Cooler

2. Fire Zone Analysis

GRAND GULF NUCLEAR GENERATING STATION
Updated Final Safety Analysis Report (UFSAR)

- (a) Fire Zone 1A407 is located in the Auxiliary Building on Elev. 166' 0" and is bounded by 3-hour rated fire barriers, except for the ceiling, which is the roof and is a non-rated exterior barrier (Ref. Architectural Drawing A-0635).
- (b) The combustible loading in Fire Zone 1A407, including transient combustibles, amounts to a moderate fire load. The major contributor to this combustible loading is the electrical cable present in the zone. The in situ combustible loading in Fire Zone 1A407 amounts to less than a 90-minute fire duration (Ref. Calculation MC-QSP64-86058).
- (c) Fire Zone 1A407 contains safety-related equipment and the following fire protection measures are provided: smoke detection, automatic Carbon dioxide suppression system, and accessibility to manual hose streams and portable fire extinguishers.
- (d) Since Fire Zone 1A407 contains only Division II safe shutdown equipment and is separated from other fire zones by 3-hour rated fire barriers, a fire occurring in this fire zone will not affect more than one train of safe shutdown components.

9A.5.21 FIRE AREA 21

9A.5.21.1 FIRE AREA DESCRIPTION

Fire Area 21 consists only of Fire Zone 1A410 (Elev. 166' 0") in the Auxiliary Building. The floor and walls are 3-hour rated fire barriers. The roof forms the ceiling and is a non-rated exterior barrier (Ref. Architectural Drawing A-0635).

INCLUDED FIRE ZONE	DESCRIPTION
1A410	Motor Control Center, Elev. 166' 0"

9A.5.21.2 SAFE SHUTDOWN EQUIPMENT

Division I

GRAND GULF NUCLEAR GENERATING STATION
Updated Final Safety Analysis Report (UFSAR)

9A.5.21.3 ALTERNATE SHUTDOWN CONTROLS

1H22-P298

9A.5.21.4 FIRE AREA ANALYSIS

Fire Zone 1A410 contains only Division I safe shutdown equipment and cable and raceway, as shown in the microcomputer data base (Ref. FPP-1, Appendix C Data). Since this fire area contains only Division I safe shutdown components and is separated from all other fire areas by 3-hour rated fire barriers, Fire Area 21 fully complies with Appendix R requirements. Therefore, in the event of a fire in this fire area, safe shutdown capability would be maintained by separate Division II safe shutdown equipment. The total fire severity in Fire Zone 1A410, including transient combustibles amounts to a moderate fire load. The maximum in situ combustible loading in this fire zone amounts to less than a 90-minute fire duration (Ref. Calculation MC-QSP64-86058). Therefore, a fire occurring in Fire Area 21 will not spread into any other fire area.

9A.5.21.5 FIRE ZONE ANALYSIS

FIRE ZONE 1A410: MOTOR CONTROL CENTER, ELEV. 166' 0"

1. Safety-Related Equipment

Electrical Cable and Raceway
Motor Control Center
ESF Electrical Switchgear Room Cooler
Alternate Shutdown Panel

2. Fire Zone Analysis

- (a) Fire Zone 1A410 is located in the Auxiliary Building on Elev. 166' 0". Fire Zone 1A410 is completely enclosed by 3-hour rated fire barriers except for the ceiling, which is the roof and is a non-rated exterior barrier (Ref. Architectural Drawing A-0635).
- (b) The combustible loading in Fire Zone 1A410, including transient combustibles, amounts to a moderate fire load. The major contributor to this combustible loading is the electrical cable present in the zone. The in situ combustible

GRAND GULF NUCLEAR GENERATING STATION
Updated Final Safety Analysis Report (UFSAR)

loading in Fire Zone 1A410 amounts to less than a 90-minute fire duration (Ref. Calculation MC-QSP64-86058).

- (c) Fire Zone 1A410 contains safety-related equipment and the following fire protection measures are provided: smoke detection, an automatic Carbon dioxide suppression system, and accessibility to manual hose streams and portable fire extinguishers.
- (d) Since Fire Zone 1A410 contains only Division I safe shutdown components and is separated from other fire zones by 3-hour rated firebarriers, a fire occurring in this fire zone will not affect more than one train of safe shutdown components.

9A.5.22 FIRE AREA 22

9A.5.22.1 FIRE AREA DESCRIPTION

Fire Area 22 consist only of Fire Zone 1A539 (Elev. 185' 0") in the Auxiliary Building. For Fire Zone 1A539, the North wall and the floor are 3-hour rated fire barriers, while the ceiling, and the East, South, and West Walls are non-rated exterior barriers above the roof at Elev. Elev. 185' 0" (Ref. Architectural Drawing A-0636).

INCLUDED FIRE ZONE	DESCRIPTION
1A539	Cable Space, Elev. 185' 0"

9A.5.22.2 SAFE SHUTDOWN EQUIPMENT

Divisions I and II

9A.5.22.3 FIRE AREA ANALYSIS

Fire Zone 1A539 contains Division I and Division II safe shutdown cable and raceway, as shown in the microcomputer data base (Ref. FPP-1, Appendix C Data). All Division II safe shutdown cable and raceway are provided with 1-hour rated fire barriers and an automatic (wet pipe) sprinkler system and fire detection is provided throughout Fire Area 22. Since all Division II safe shutdown cabling is provided with a 1-hour rated fire barrier, the

GRAND GULF NUCLEAR GENERATING STATION
Updated Final Safety Analysis Report (UFSAR)

area has area wide suppression and detection, and the fire area is separated from other fire areas by 3-hour rated fire barriers, Fire Area 22 fully complies with Appendix R requirements. Therefore, in the event of a fire in this fire area, safe shutdown capability would be maintained by separate Division I safe shutdown equipment. The total fire severity in Fire Zone 1A539, including transient combustibles, amounts to a high fire load. The maximum in situ combustible loading in this fire zone amounts to less than a 150-minute fire duration (Ref. Calculation MC-QSP64-86058). Therefore, a fire occurring in Fire Area 22 will not spread into any other fire area.

9A.5.22.4 FIRE ZONE ANALYSES

FIRE ZONE 1A539: CABLE SPACE, ELEV. 185' 0"

1. Safety-Related Equipment

Electrical Cable and Raceway

2. Fire Zone Analysis

- (a) Fire Zone 1A539 is located in the Auxiliary Building on Elev. 185' 0". The North wall and the floor of Fire Zone 1A539 are 3-hour rated fire barriers, while the ceiling and the East, West, and South walls are non-rated exterior barriers above the roof at Elev. 185' 0" (Ref. Architectural Drawing A-0636).
- (b) The combustible loading in Fire Zone 1A539, including transient combustibles, amounts to a high fire load. The major contributor to this combustible loading is the electrical cable and thermo-lag material present in the zone. Thermo-Lag fire barrier material is approximately 70 percent of the total combustible loading. The in situ combustible loading in Fire Zone 1A539 amounts to less than a 150-minute fire duration (Ref. Calculation MC-QSP64-86058).
- (c) Fire Zone 1A539 contains safety-related equipment and the following fire protection measures are provided: automatic sprinkler protection, smoke detection and accessibility to portable fire extinguishers.

GRAND GULF NUCLEAR GENERATING STATION
Updated Final Safety Analysis Report (UFSAR)

(d) Although Fire Zone 1A539 contains both Division I & II safe shutdown components, this fire zone is separated from all other fire areas by 3-hour rated fire barriers, all Division II safe shutdown is provided with 1-hour fire barriers, and the area is protected by automatic suppression and detection. Therefore, a fire originating in this fire zone will not affect, or propagate to affect, more than one train of safe shutdown.

9A.5.23 NO FIRE AREA HAS BEEN ASSIGNED FOR SECTION 9A.5.23.

9A.5.24 NO FIRE AREA HAS BEEN ASSIGNED FOR SECTION 9A.5.24

9A.5.25 FIRE AREA 25

9A.5.25.1 FIRE AREA DESCRIPTION

Fire Area 25 consists of Fire Zones 1A110A (Elev. 93' 0"); 1A110B (Elev. 119' 0"); 1A110C1, 1A110C2, 1A110C3, 1A311, 1A313 (Elev. 135' 4"); 1A310 (Elev. 140' 0"); 1A110D1, 1A110D2, 1A110D3, 1A419, 1A421 (Elev. 161' 10"); 1A411, 1A414 (Elev. 170' 0"); 1A443 (Elev. 173' 2"); 1A110E1, 1A110E2, 1A509, 1A510, 1A514, 1A515, 1A516, 1A517, 1A520 (Elev. 184' 6"); 1A513, (Elev. 184' 3"); 1A507 (Elev. 185 0"); 1A601, 1A110F1, 1A110F2, 1A110F3, and 1A110F4 (Elev. 208' 10") in the containment and Fire Zones 1A113 (Elev. 94' 6"), and 1A112 (Elev. 100' 9") in the drywell (Ref. Architectural Drawings A-0632 through A-0637 inclusive). The floors between elevations in the containment are made of steel grating with concrete pads to support specific pieces of equipment. There are no rated fire walls inside the containment. Therefore, a fire originating in any fire zone in the containment can communicate with any other fire zone in the containment. The same is true for the two fire zones in the drywell; however, a fire originating in either the drywell or containment cannot spread to the other, as discussed below.

INCLUDED FIRE ZONE	DESCRIPTION
1A110A	Suppression Pool, Elev. 93' 0"
1A110B	Suppression Pool, Elev. 119' 0"
1A110C1	Electrical Containment Penetration Area, Elev 135' 4"

GRAND GULF NUCLEAR GENERATING STATION
Updated Final Safety Analysis Report (UFSAR)

1A110C2	Electrical Containment Penetration Area, Elev 135' 4"
1A110C3	Electrical Containment Penetration Area, Elev 135' 4"
1A110D1	Unassigned, Elev. 161' 10"
1A110D2	Unassigned, Elev. 161' 10"
1A110D3	Containment Cooler Area, Elev. 161' 10"
1A110E1	Miscellaneous Equipment Area, Elev. 184' 6"
1A110E2	Drywell Purge Compartment and Standby Liquid Control System Area, Elev. 184' 6"
1A110F1	Reactor Containment Area, Elev. 208' 10"
1A110F2	Reactor Containment Area, Elev. 208' 10"
1A110F3	Reactor Containment Area, Elev. 208' 10"
1A110F4	Reactor Containment Area, Elev. 208' 10"
*1A112	Drywell Area, Elev. 100' 9"
*1A113	Reactor Vessel Area, Elev. 94' 6"
1A310	Main Steam Pipe Tunnel, Elev. 140' 0"
1A311	CRD Hydraulic Control Area, Elev. 135' 4"
1A313	CRD Hydraulic Control Area, Elev. 135' 4"
1A411	Unassigned, Elev. 170' 0"
1A414	RWCU Heat Exchanger Room, Elev. 170' 0"
1A419	RWCU Pump Room, Elev. 161' 10"
1A421	RWCU Backwash Tank Room, Elev. 161' 10"
1A443	Valve Access Area, Elev. 173' 2"
1A507	Heat Exchanger Area, Elev. 185' 0"
1A509	Miscellaneous Equipment Area, Elev. 184' 6"
1A510	Steam Separator Storage Area, Elev. 184' 6"
1A513	Drywell Head Area, Elev. 184' 3"
1A514	Sample Area, Elev. 184' 6"
1A515	Pump Area, Elev. 184' 6"
1A516	Filter Demineralizer Area, Elev. 184' 6"
1A517	Filter Demineralizer Area, Elev. 184' 6"
1A520	Containment Fuel Pool, Elev. 167' 6" and Steam Dryer Storage Area, Elev. 184' 6"
1A601	Reactor Containment Area, Elev. 208' 10"
*Note: Fire zones are located in the drywell.	

9A.5.25.2 SAFE SHUTDOWN EQUIPMENT

Division I and II

9A.5.25.3 FIRE AREA ANALYSIS

- a. Fire Zones 1A110E2, 1A110F1, 1A110F2, 1A110F3, 1A110F4, 1A113, 1A419, 1A421, 1A443, 1A507, 1A510, 1A513, 1A515, 1A516, 1A517, 1A520, and 1A601 do not contain any safe shutdown components.

GRAND GULF NUCLEAR GENERATING STATION
Updated Final Safety Analysis Report (UFSAR)

- b. Fire Zones 1A110A, 1A110B, 1A110E1, 1A110C1, 1A110C2, 1A110C3, 1A110D3, 1A112, 1A310, 1A311, and 1A313 contain both Division I and II safe shutdown components and cable and raceway, as shown in the microcomputer data base (Ref. FPP-1, Appendix C Data) and Table 9A.1. Fire Zones 1A110D1, 1A110D2, 1A411, 1A414, 1A509, and 1A514 contain only Division I safe shutdown cable and raceway, as also shown in the microcomputer data base and Table 9A.1. All of the above fire zones with the exception of 1A112 and 1A113, the drywell and reactor vessel area, respectively, are located in the containment. The drywell is totally segregated from containment by a 5-foot-thick concrete wall with vault type doors.

9A.5.25.4 CONTAINMENT

- a. As discussed in the fire area description for Fire Area 25, the floors between elevations in the containment are mainly of steel grating with concrete equipment pads, and none of the walls which physically separate the individual fire zones are rated fire barriers. In addition, a number of fire zones are completely open to one another. Given this configuration, the fire area analysis discusses the fire protection measures and separation distances provided in the containment as a whole rather than first discussing the redundant safe shutdown component found in each fire zone and/or its adjacent fire zones. This same approach is used to discuss the fire protection provided for the drywell.
- b. In the containment, redundant M71 (suppression pool temperature monitoring) temperature elements and the associated cables are located within 3 inches of one another. These instruments are positioned all around the drywell wall at Elev. 143' ±12" and extend down to the suppression pool, Fire Zone 1A110B (Ref. Drawings J-0155T and J-4507). The cables leading to and from these instruments are installed in conduit in accordance with the requirements of Reg. Guide 1.75, and the leads to the elements are encased in a ceramic material (Ref. Drawing J-561.0-Q1C61N403A-1.1-1-6). Given the above protection, coupled with the fact that these thermocouple cables are very low energy instrumentation circuits, these cables cannot act either as an ignition or as a fuel source.

GRAND GULF NUCLEAR GENERATING STATION
Updated Final Safety Analysis Report (UFSAR)

Furthermore, where the redundant M71 instruments are located within 3 inches of one another they are separated by a 1/2-inch-thick steel plate (Ref. Drawing J-0155T).

The M71 system instruments themselves are not provided with radiant energy shields since the only in situ combustibles in close proximity to the M71 instruments consist of short lengths of exposed IEEE-383 cable installed from the drywell penetration sleeves to totally enclosed tray systems, which are located within 3 feet of M71 instruments M71-TE-N012A and M71-TE-N012B. All other in situ combustibles (IEEE-383 cable) are located more than 9 feet above or 17 feet from (horizontally) the M71 instruments, except for M71 instruments M71-TE-N026B and M71-TE-N026A, which are located 6 feet horizontally from cable trays 1CETOM01 and 1CETOM04, which also contain IEEE-383 cable. Other combustibles in the containment presenting a potential fire exposure are the small amounts of lubrication oil in Fire Zones 1A310 (Elev. 140' 0"), 1A419 (Elev. 161' 10"); lubrication oil in 1A110E1 and 1A110E2 (Elev. 184' 6"); and hydraulic fluid in Fire Zone 1A110F4 (El. 208' 10"), which are separated from the M71 instruments by radiant energy shields, i.e., concrete walls and floors. Concrete joint sealant is also shown as a combustible material in containment. However, as discussed in Section 9A.3.0.f of this report, concrete joint sealant does not support combustion without an additional fuel source. The only combustible material located below the M71 instruments is concrete joint sealant. Finally, the limited transient combustibles postulated for Fire Area 25 do not present an exposure fire hazard to the M71 instruments. Division I M71 is redundant only to Division II M71 and not to other safe shutdown systems.

- c. In the event of a fire inside Containment, instruments for an alternate means of monitoring suppression pool temperature exist in Auxiliary Building Fire Zones 1A303 and 1A307. These instruments, N1E12TEN004A/B, monitor RHR Heat Exchanger inlet temperatures and are separated from Containment by 3-hour rated fire barrier and fire occurring in Fire Area 25 can not spread to these fire areas. These instruments provide control room indication and their cables are routed completely outside of the Containment.

GRAND GULF NUCLEAR GENERATING STATION
Updated Final Safety Analysis Report (UFSAR)

- d. For safe shutdown components other than the M71 systems discussed above, all redundant safe shutdown components are separated by 35 feet without intervening combustibles except for Division I pressure switches 1B21PSN150L, S, U, and V and related raceways located in Fire Zone 1A110D3. All Division I safe shutdown components in Fire Zone 1A110D3 are protected with radiant energy shields. In addition, conduit 1CARNP14 from Fire Zone 1A110D3 to azimuth 19 degrees in Fire Zone 1A411 is also protected with a radiant energy shield to achieve more than a 20-foot horizontal separation between redundant safe shutdown components in Fire Zone 1A110D3. In addition, all of the electrical cables in the containment are IEEE-383 qualified and are installed in accordance with the separation requirements of Reg. Guide 1.75. All cable insulation used in the containment is of the non-flame propagating type. Therefore, a fire initiating in Fire Area 25 will not affect more than one train of safe shutdown components.
- e. The following paragraphs outline the current fire protection measures that are provided for the redundant safe shutdown cable and raceway in the containment.
1. An exposure fire due to transient combustibles during operation is not postulated in the drywell since it is inaccessible during operation. The containment is a limited access area and combustible materials are normally prohibited by strict administrative control.
 2. The fire load in the containment, based on insitu combustibles, is a moderate fire load. However, of the 32 fire zones, this fire loading is only in Fire Zones 1A110C2 and 1A110C3. The total fire severity for the balance of containment is a low fire load, as shown in Table 9A.1 (Ref. Calculation MC-QSP64-86058). The chief contributors to this combustible loading are the electrical cables. The calculation method used to determine this loading is very conservative and assumes that all cable trays are filled to design maximum capacity.
 3. Provision is made for smoke detection by the two ionization smoke detectors mounted in the containment cooling system (M41) ductwork on Elev. 174' 8" and

GRAND GULF NUCLEAR GENERATING STATION
Updated Final Safety Analysis Report (UFSAR)

179' 0". The two ducts in which these smoke detectors are mounted take suction from the top of the containment dome. Additional smoke detection capability is provided in the M41 system ductwork at Elev. 190' 0", which takes suction from several different fire zones on Elev. 161' 0" (Ref. Drawings M-1474 and M-1475). Therefore, smoke detectors are located in the M41 ductwork so as to detect a fire anywhere in the containment and provide early warning of a fire in the containment. Fire detection is also provided by the redundant ambient air temperature monitors in the containment cooling system which monitors the containment environment (Ref. Drawings M-1100A and M-1100B).

4. Additional fire protection equipment in the form of manual hose streams and portable fire extinguishers has been provided in the containment for the use of the fire brigade, if necessary. See Table 9A.1 for a more detailed listing of the fire protection measures that are provided for each fire zone in the containment.
5. In the event of a fire inside Containment, M71 Suppression Pool Temperature Monitoring instruments may be lost. An alternate means of monitoring suppression pool temperature exists outside Containment with RHR Heat Exchanger inlet temperature elements.

9A.5.25.5 DRYWELL

- a. The drywell (Fire Zones 1A112 and 1A113) is separated from the balance of the containment by a 5-foot-thick concrete wall with vault type doors. Therefore, based on the construction of the wall, a fire breaching the drywell wall is not postulated.
- b. As stated earlier, the drywell is inaccessible during plant operation; therefore, no transient combustibles are postulated (except at the drywell interlock).
- c. The combustible loading in Fire Zones 1A112 and 1A113 amounts to a low fire load (Ref. Calculation MC-QSP64-86058). There are only three types of in situ combustibles found in the drywell: 1) the lubricating oil contained

GRAND GULF NUCLEAR GENERATING STATION
Updated Final Safety Analysis Report (UFSAR)

for the two reactor recirculation pump motors, 2) the electrical cable in the drywell, and 3) radiation shielding blankets are enclosed in steel drums with lids and locking rings except for the permanent leadshielding blankets around the recirculation suction and discharger risers (A and B). The NRC concluded in the SER, Section 9.5.4.3, that "...an engineered oil leak collection system or additional fire protection for the (recirculation) pumps is not required." Since 59.5 of the total 61.5 gallons of the recirculation pump lube oil is confined within the metal motor housing an exposure fire due to the ignition of the recirculation pump lubricating oil is not postulated to occur. All the lube oil is however, conservatively included as a combustible in Fire Zone 1A112. There are a total of 32 drums of radiation shielding blankets. Each drum contains a maximum of 18 blankets and the blankets consist of lead enclosed in a polyester reinforced vinyl material with an overall blanket size of approximately 1.5 ft x 3 ft x 0.75 in. The blanket materials are totally enclosed in steel drums with lids and locking rings, the drums are stored in maximum group sizes of three and four drums and scattered throughout the fire zone (thus not concentrating the materials), and the overall combustible loading in this zone is low. For these reasons, an exposure fire due to the ignition of the vinyl material is not postulated to occur. This combustible material is however, conservatively included as a combustible in Fire Zone 1A112. Permanent Lead shielding blankets will be utilized to encase the Recirculation suction and discharge risers A and B. The permanent lead blankets are approximately 1 ft x 4 ft x .5 in and 2 ft x 4 ft x .5 in. The blankets encasing the Recirculation risers consist of an Alpha Maritex type material which is noncombustible, so therefore is not considered as a combustible in Fire Zone 1A112.

- d. All electrical cables in Fire Zone 1A112 are IEEE-383 qualified and are installed in accordance with the separation requirements of Reg. Guide 1.75. All cable insulation used in the drywell is of the non-flame propagating type. Except for the two Division I and Division II ventilated tray systems, which are separated by a minimum of 45 feet horizontally and located above Elev. 112' 2", all other safety-related cables in Fire

GRAND GULF NUCLEAR GENERATING STATION
Updated Final Safety Analysis Report (UFSAR)

Zone 1A112 are installed in totally enclosed raceway systems. All electrical cables in Fire Zone 1A113, which is inside the reactor vessel pedestal, are IEEE-383 qualified. Fire Zone 1A113 does not contain any safe shutdown components.

- e. If a fire were to occur in the drywell, it would be detected by the dual thermocouples that are provided to monitor the drywell ambient air temperature (SystemM51). These thermocouples alarm when the temperature in the drywell reaches 145 degrees F, which is 10 degrees F above the normal ambient air temperature of 135 degrees F. Two of these thermocouples are mounted on Elev. 182' 8" and the third is mounted at approximately Elev. 110' 0" (Ref. Drawings M-1101, M-1471, and M-1474).
- f. In Fire Zone 1A112, four of the six safe shutdown ADS/safety relief valves are located between azimuth 270 degrees and azimuth 330 degrees at Elev. 154'. All of the cables to these valves, and within 14 feet horizontally of the valves, are installed in totally enclosed raceway systems in accordance with the separation requirements of Reg. Guide 1.75. The nearest insitu combustible loading to this group of valves consists of the 61.5 gallons of lubrication oil in the B reactor recirculation pump located at azimuth 325 degrees at Elev. 120' which is 34 feet below two (Q1B21F051D and F047D on Elev. 154') of the four ADS and relief valves discussed above.

The only other in situ combustible loading close to these four valves is the Division II IEEE-383 cable in cable trays 1CBTMN04, 05, and 06 located between azimuth 258 degrees and azimuth 325 degrees at Elev. 168' 6". These cable trays are located more than 9 feet horizontally from the nearest valve Q1B21F051B and its associated Division I raceway.

- g. The remaining two safe shutdown ADS/safety relief valves (Q1B21F051A and Q1B21F047G) are located between azimuth 50 degrees and azimuth 85 degrees at approximate Elev. 154'. All cables related to these valves, within 4 feet horizontally and 14 feet vertically of the valves, are installed in a totally enclosed raceway system in accordance with the separation requirements of Reg. Guide 1.75. The nearest in situ combustible loading to this

GRAND GULF NUCLEAR GENERATING STATION
Updated Final Safety Analysis Report (UFSAR)

group of valves and related raceway consists of Division I IEEE-383 cable in cable trays ATMN03 and ATMN04, located between azimuth 50 degrees and azimuth 90 degrees at Elev. 168' 6". These cable trays are located more than 14 feet above the valves and more than 9 feet above the closest Division II conduit containing circuits routed to these valves. The only other in situ combustible loading close to these two valves is the 61.5 gallons of lubrication oil in the "A" reactor recirculation pump located at azimuth 1450 and Elev. 120', which is more than 32 feet horizontally and 34 feet vertically below the two valves.

- h. Since transient combustibles are not postulated for Fire Zones 1A112 and 1A113, (except at personnel airlock) and based on the limited amount and locations of the in situ combustible loadings in these fire zones, a postulated fire originating in either Fire Zone 1A112 or 1A113 will not affect or propagate to affect more than one train of safe shutdown components.

9A.5.25.6 CONCLUSION

- a. Although the fire protection provided for Fire Area 25 does not meet the criteria of Section 3.2 of the Appendix R Evaluation Procedure FPP-1, in that neither automatic suppression nor radiant energy shield have been provided for redundant safe shutdown components within 20 feet horizontally of each other, the fire protection provided in Fire Area 25 is more than adequate to ensure that at least one train of safe shutdown components will remain free of fire damage, or an alternate means will be available to perform the respective safe shutdown function.
- b. The postulated fire with the greatest severity in Fire Area 25 occurs in Fire Zones 1A110C2, 1A110C3. The total fire severity in Fire Zones 1A110C2 and 1A110C3, including transient combustibles amounts to a moderate fire load. The maximum in situ combustible loading in these fire zones amounts to less than a 90-minute fire duration (Ref. Calculation MC-QSP64-86058). Fire Area 25 is separated from all other fire areas by 3-hour rated fire barriers, or their equivalents, and a fire occurring in Fire Area 25 will not spread to any other fire area.

GRAND GULF NUCLEAR GENERATING STATION
Updated Final Safety Analysis Report (UFSAR)

9A.5.25.7 FIRE ZONE ANALYSES

- a. FIRE ZONE 1A110A: SUPPRESSION POOL, ELEV. 93' 0"
 - 1. Safety-Related Equipment
 - Electrical Cable and Raceway
 - 2. Fire Zone Analysis
 - (a) Fire Zone 1A110A is located in the Containment Building on Elev. 93' 0". The floor of Fire Zone 1A110A is part of the non-rated containment building base mat. The outer walls, adjacent to the Auxiliary Building, are 3-hour rated fire barriers. The inner walls, adjacent to the drywell, are non-rated barriers. The ceiling of Fire Zone 1A110A is open to Fire Zone 1A110B on Elev. 119' 0" (Ref. Architectural Drawings A-0632 and A-0633).
 - (b) There is no combustibile loading postulated for Fire Zone 1A110A (Ref. Calculation MC-QSP64-86058).
 - (c) Fire Zone 1A110A contains safety-related equipment and the following fire protection measures are provided: smoke and heat detection (as discussed in the fire area analysis for Fire Area 25) and accessibility to manual hose streams and portable fire extinguishers.
 - (d) Fire Zone 1A110A contains both Division I and Division II suppression pool temperature monitoring thermocouple leads. As discussed in the fire area analysis for Fire Area 25, a fire occurring in Fire Area 25 will not affect, or propagate to affect, more than one train of safe shutdown components, or an alternate means will be available to perform the respective safe shutdown function.
- b. FIRE ZONE 1A110B: SUPPRESSION POOL, ELEV. 119' 0"
 - 1. Safety-Related Equipment

GRAND GULF NUCLEAR GENERATING STATION
Updated Final Safety Analysis Report (UFSAR)

Suppression Pool Temperature Monitoring
Thermocoupling Leads, Electrical Cable, and Raceway

2. Fire Zone Analysis

- (a) Fire Zone 1A110B is located in the Containment Building on Elev. 119' 0". The floor of Fire Zone 1A110B is open to Fire Zone 1A110A on Elev. 93' 0". The outer walls, adjacent to the Auxiliary Building, are 3-hour rated fire barriers. The inner walls, adjacent to the drywell, are non-rated barriers. The ceiling of Fire Zone 1A110B is open to Fire Zones 1A110C1, 1A110C2, and 1A110C3 on Elev. 135' 4" (Ref. Architectural Drawings A-0633 and A-0634).
- (b) The combustible loading in Fire Zone 1A110B, including transient combustibles, amounts to a low fire load. The major contributor to this combustible loading is the concrete joint sealant in the walls which, as discussed in Section 9A.3.0.f of this report, does not support combustion without an additional fuel source. The in situ combustible loading in Fire Zone 1A110B amounts to less than a 15-minute fire duration (Ref. Calculation MC-QSP64-86058).
- (c) Fire Zone 1A110B contains safety-related equipment and the following fire protection measures are provided: smoke and heat detection (as discussed in the fire area analysis for Fire Area 25) and accessibility to manual hose streams and portable fire extinguishers.
- (d) Fire Zone 1A110B contains both Division I and Division II suppression pool temperature monitoring thermocouple leads. As discussed in the fire area analysis for Fire Area 25, a fire occurring in Fire Area 25 will not affect, or propagate to affect, more than one train of safe shutdown components, or an alternate means will be available to perform the respective safe shutdown function.

GRAND GULF NUCLEAR GENERATING STATION
Updated Final Safety Analysis Report (UFSAR)

c. FIRE ZONE 1A110C1: ELECTRICAL CONTAINMENT PENETRATION AREA, ELEV. 135' 4"

1. Safety-Related Equipment

Reactor Vessel Level and Pressure Instrument Panel A
Main Steam Flow Instrument Panel A
Jet Pump A Instrument Rack
RPIS Multiplexer
Suppression Pool Temperature Monitors
Electrical Cable and Raceway

2. Fire Zone Analysis

- (a) Fire Zone 1A110C1 is located in the Containment Building on Elev. 135' 4". The floor of Fire Zone 1A110C1 is open to Fire Zone 1A110B on Elev. 119' 0". The walls of Fire Zone 1A110C1 are non-rated barriers except for the Auxiliary Building interface, which is a 3-hour rated fire barrier. Fire Zone 1A110C1 is open to Fire Zone 1A313 on Elev. 135' 4". The ceiling of Fire Zone 1A110C1 is open to Fire Zone 1A110D1 on Elev. 161' 10". A non-rated floor separates Fire Zones 1A110C1 and 1A419, on Elev. 161' 10" (Ref. Architectural Drawings A-0634 and A-0635).
- (b) The combustible loading in Fire Zone 1A110C1, with no transient combustibles postulated for this fire zone, amounts to a moderate fire load. The chief contributor to this combustible loading is the electrical cable in the fire zone. The in situ combustible loading in the fire zone amounts to less than a 75-minute fire duration (Ref. Calculation MC-QSP64-86058).
- (c) Fire Zone 1A110C1 contains safety-related equipment and the following fire protection measures are provided: smoke and heat detection (as discussed in the fire area analysis for Fire Area 25) and accessibility to manual hose streams and portable fire extinguishers.
- (d) Fire Zone 1A110C1 contains both Division I and Division II suppression pool temperature monitors in addition to other Division I safe

GRAND GULF NUCLEAR GENERATING STATION
Updated Final Safety Analysis Report (UFSAR)

shutdown cable and raceway, which are not redundant to suppression pool temperature monitoring. As discussed in the fire area analysis for Fire Area 25, a fire occurring in Fire Area 25 will not affect, or propagate to affect, more than one train of safe shutdown components, or an alternate means will be available to perform the respective safe shutdown function.

d. FIRE ZONE 1A110C2: ELECTRICAL CONTAINMENT PENETRATION AREA, ELEV. 135' 4"

1. Safety-Related Equipment

Reactor Vessel Level and Pressure Instrument Pnls B & C
Jet Pump B Instrument Rack
Main Steam Flow Instrument Panel B
Recirculation Pump A Instrument Rack
Main Steam Flow and Recirculation Instrument Panel C
Suppression Pool Temperature Monitors
Electrical Cable and Raceway

2. Fire Zone Analysis

(a) Fire Zone 1A110C2 is located in the Containment Building on Elev. 135' 4". The floor of Fire Zone 1A110C2 is open to Fire Zone 1A110B on Elev. 119' 0". The walls of Fire Zone 1A110C2 are non-rated barriers except for the Auxiliary Building interface, which is a 3-hour rated fire barrier. Fire Zone 1A110C2 is open to Fire Zones 1A311 and 1A313, both located on Elev. 135' 4". The ceiling of Fire Zone 1A110C2 is open to Fire Zones 1A110D2 and 1A110D3 on Elev. 161' 10", and a non-rated floor separates Fire Zones 1A110C2 and 1A520 on Elev. 167' 10" (Ref. A-0634 and A-0635).

(b) The combustible loading in Fire Zone 1A110C2, with no transient combustibles postulated for this fire zone, amounts to a moderate fire load. The chief contributor to this combustible loading is the electrical cable in the fire

GRAND GULF NUCLEAR GENERATING STATION
Updated Final Safety Analysis Report (UFSAR)

zone. The in situ combustibile loading in the fire zone amounts to less than a 90-minute fire duration (Ref. Calculation MC-QSP64-86058).

- (c) Fire Zone 1A110C2 contains safety-related equipment and the following fire protection measures are provided: smoke and heat detection (as discussed in the fire area analysis for Fire Area 25) and accessibility to manual hose streams and portable fire extinguishers.
 - (d) Fire Zone 1A110C2 contains both Division I and Division II suppression pool monitors in addition to other Division II safe shutdown cable and raceway, which are not redundant to suppression pool temperature monitoring. As discussed in the fire area analysis for Fire Area 25, a fire occurring in Fire Area 25 will not affect, or propagate to affect, more than one train of safe shutdown components, or an alternate means will be available to perform the respective safe shutdown function.
- e. FIRE ZONE 1A110C3: ELECTRICAL CONTAINMENT PENETRATION AREA, ELEV. 135' 4"
- 1. Safety-Related Equipment
 - Recirculation Pump B Instrument Rack
 - Reactor Vessel Level and Pressure Instrument Panel D
 - Main Steam Flow and Recirculation Instrument Panel D
 - RPIS Multiplexer Unit
 - RWCU System Instrument Panel
 - Suppression Pool Temperature Monitors
 - Electrical Cable and Raceway
 - 2. Fire Zone Analysis
 - (a) Fire Zone 1A110C3 is located in the Containment Building on Elev. 135' 4". The floor of Fire Zone 1A110C3 is open to Fire Zone 1A110B on Elev. 119' 0". The walls of Fire Zone 1A110C3 are non-rated barriers except for the Auxiliary Building interface, which is a 3-hour rated fire barrier. Fire Zone 1A110C3 is open to Fire Zone 1A311 on Elev. 135' 4". The ceiling of Fire Zone

GRAND GULF NUCLEAR GENERATING STATION
Updated Final Safety Analysis Report (UFSAR)

1A110C3 is open to Fire Zone 1A110D3 on Elev. 135' 4" (Ref. Architectural Drawings A-0634 and A-0635).

- (b) The combustible loading in Fire Zone 1A110C3, with no transient combustibles postulated for this fire zone, amounts to a moderate fire load. The chief contributor to this combustible loading is the electrical cable in the fire zone. The in situ combustible loading in the fire zone amounts to less than a 90-minute fire duration (Ref. Calculation MC-QSP64-86058).
- (c) Fire Zone 1A110C3 contains safety-related equipment and the following fire protection measures are provided: smoke and heat detection (as discussed in the fire area analysis for Fire Area 25) and accessibility to manual hose streams and portable fire extinguishers.
- (d) Fire Zone 1A110C3 contains both Division I and Division II suppression pool monitors in addition to other Division II safe shutdown cable and raceway, which are not redundant to suppression pool temperature monitoring. As discussed in the fire area analysis for Fire Area 25, a fire occurring in Fire Area 25 will not affect, or propagate to affect, more than one train of safe shutdown components, or an alternate means will be available to perform the respective safe shutdown function.

f. FIRE ZONE 1A110D1: UNASSIGNED, ELEV. 161' 10"

1. Safety-Related Equipment

Electrical Cable and Raceway

2. Fire Zone Analysis

- (a) Fire Zone 1A110D1 is located in the Containment Building on Elev. 161'10". The floor of Fire Zone 1A110D1 is open to Fire Zone 1A110C1 on Elev. 135' 4". Fire Zone 1A110D1 is open to Fire Zone 1A443 on Elev. 173' 2". The walls of Fire Zone 1A110D1 are non-rated barriers except for

GRAND GULF NUCLEAR GENERATING STATION
Updated Final Safety Analysis Report (UFSAR)

the Auxiliary Building interface, which is a 3-hour rated fire barrier. The ceiling of Fire Zone 1A110D1 is open to Fire Zone 1A509 on Elev. 184' 6" (Ref. Architectural Drawings A-0635 and A-0636).

- (b) The combustible loading in Fire Zone 1A110D1, with no transient combustibles postulated for this fire zone, amounts to a low fire load. The chief contributor to this combustible loading is the electrical cable in the fire zone. The in situ combustible loading in the fire zone amounts to less than a 45-minute fire duration (Ref. Calculation MC-QSP64-86058).
- (c) Fire Zone 1A110D1 contains safety-related equipment and the following fire protection measures are provided: smoke and heat detection (as discussed in the fire area analysis for Fire Area 25) and accessibility to manual hose streams and portable fire extinguishers.
- (d) Fire Zone 1A110D1 contains strictly Division I safe shutdown cable and raceway. As discussed in the fire area analysis for Fire Area 25, a fire occurring in Fire Area 25 will not affect, or propagate to affect, more than one train of safe shutdown components, or an alternate means will be available to perform the respective safe shutdown function.

g. FIRE ZONE 1A110D2: UNASSIGNED, ELEV. 161' 10"

1. Safety-Related Equipment

Electrical Cable and Raceway

2. Fire Zone Analysis

- (a) Fire Zone 1A110D2 is located in the Containment Building on Elev. 161' 10". The floor of Fire Zone 1A110D2 is open to Fire Zones 1A313 and 1A110C2 on Elev. 135' 4". The walls of Fire Zone 1A110D2 are non-rated barriers except for the Auxiliary Building interface, which is a 3-hour rated fire barrier. The ceiling of Fire Zone

GRAND GULF NUCLEAR GENERATING STATION
Updated Final Safety Analysis Report (UFSAR)

1A110D2 is open to Fire Zone 1A110E1 on Elev. 184' 6" (Ref. Architectural Drawings A-0635 and A-0636).

- (b) The combustible loading in Fire Zone 1A110D2, with no transient combustibles postulated for this fire zone, amounts to a low fire load. The chief contributor to this combustible loading is the electrical cable in the fire zone. The in situ combustible loading in the fire zone amounts to less than a 30-minute fire duration (Ref. Calculation MC-QSP64-86058).
 - (c) Fire Zone 1A110D2 contains safety-related equipment and the following fire protection measures are provided: smoke and heat detection (as discussed in the fire area analysis for Fire Area 25) and accessibility to manual hose streams and portable fire extinguishers.
 - (d) Fire Zone 1A110D2 contains strictly Division I safe shutdown cable and raceway. As discussed in the fire area analysis for Fire Area 25, a fire occurring in Fire Area 25 will not affect, or propagate to affect, more than one train of safe shutdown components, or an alternate means will be available to perform the respective safe shutdown function.
- h. FIRE ZONE 1A110D3: CONTAINMENT COOLER AREA, ELEV. 161' 10"
- 1. Safety-Related Equipment
 - Electrical Cable and Raceway
 - 2. Fire Zone Analysis
 - (a) Fire Zone 1A110D3 is located in the Containment Building on Elev. 161' 10". The floor of Fire Zone 1A110D3 is open to Fire Zones 1A311, 1A110C2, and 1A110C3 on Elev. 135' 4". The walls of Fire Zone 1A110D3 are non-rated barriers except for the Auxiliary Building interface, which is a 3-hour rated fire barrier. The

GRAND GULF NUCLEAR GENERATING STATION
Updated Final Safety Analysis Report (UFSAR)

ceiling of Fire Zone 1A110D3 is open to Fire Zone 1A110E2 on Elev. 184' 6" (Ref. Architectural Drawings A-0635 and A-0636).

- (b) The combustible loading in Fire Zone 1A110D3, with no transient combustibles postulated for this fire zone, amounts to a low fire load. The chief contributor to this combustible loading is the electrical cable in the fire zone. The in situ combustible loading in the fire zone amounts to less than a 30-minute fire duration (Ref. Calculation MC-QSP64-86058).
 - (c) Fire Zone 1A110D3 contains safety-related equipment and the following fire protection measures are provided: smoke and heat detection (as discussed in the fire area analysis for Fire Area 25) and accessibility to manual hose streams and portable fire extinguishers.
 - (d) Fire Zone 1A110D3 contains redundant Division I and Division II safe shutdown components. All Division I safe shutdown components are protected with radiant energy shields in Fire Zone 1A110D3. In addition, conduit 1CARNP14, which is also in adjacent Fire Zone 1A411, is protected with a radiant energy shield from azimuth 19 degrees back to Fire Zone 1A110D3. As discussed in the fire area analysis for Fire Area 25, a fire occurring in Fire Area 25 will not affect, or propagate to affect, more than one train of safe shutdown components, or an alternate means will be available to perform the respective safe shutdown function.
- i. FIRE ZONE 1A110E1: MISCELLANEOUS EQUIPMENT AREA, ELEV. 184' 6"
 - 1. Safety-Related Equipment
 - Drywell Purge Compressor Unit
 - Electrical Cable and Raceway
 - 2. Fire Zone Analysis

GRAND GULF NUCLEAR GENERATING STATION
Updated Final Safety Analysis Report (UFSAR)

- (a) Fire Zone 1A110E1 is located in the Containment Building on Elev. 184' 6". The floor of Fire Zone 1A110E1 is open to Fire Zone 1A110D2 on Elev. 161' 10". The walls of Fire Zone 1A110E1 are non-rated barriers except for the Auxiliary Building interface, which is a 3-hour rated fire barrier. The ceiling of Fire Zone 1A110E1 is open to Fire Zone 1A110F2 on Elev. 208' 10" (Ref. Architectural Drawings A-0636 and A-0637).
- (b) The combustible loading in Fire Zone 1A110E1, with no transient combustibles postulated for this fire zone, amounts to a low fire load. The chief contributors to this combustible loading is the compressor lube oil, PC storage, and the electrical cable in the fire zone. The in situ combustible loading in the fire zone amounts to less than a 30-minute fire duration (Ref. Calculation MC-QSP64-86058).
- (c) Fire Zone 1A110E1 contains safety-related equipment and the following fire protection measures are provided: smoke and heat detection (as discussed in the fire area analysis for Fire Area 25) and accessibility to manual hose streams and portable fire extinguishers.
- (d) Fire Zone 1A110E1 contains non Divisional safe shutdown cables, raceway, and components. The lube oil in this fire zone is contained in the drywell purge compressor, which in turn is located on a concrete pad surrounded by a 4-inch-high dike. This diked-off area is of sufficient volume to contain the oil, thus preventing an oil-fed, three-dimensional fire in the containment. The non Divisional safe shutdown components located in fire zone 1A110E1 are not part of the success path required for hot shutdown following a fire in this area. Failure of the cables and components located in Fire Zone 1A110E1 will not prevent safe shutdown. As discussed in the fire area analysis for Fire Area 25, a fire occurring in Fire Area 25 will not affect, or propagate to affect, more

GRAND GULF NUCLEAR GENERATING STATION
Updated Final Safety Analysis Report (UFSAR)

than one train of safe shutdown components, or an alternate means will be available to perform the respective safe shutdown function.

- j. FIRE ZONE 1A110E2: DRYWELL PURGE COMPARTMENT AND STANDBY LIQUID CONTROL SYSTEM AREA, ELEV. 184' 6"
1. Safety-Related Equipment

Drywell Purge Compressor Unit
Standby Liquid Control Storage Tanks
Standby Liquid Control Pumps
Electrical Cable and Raceway
 2. Fire Zone Analysis
 - (a) Fire Zone 1A110E2 is located in the Containment Building on Elev. 184' 6". The floor of Fire Zone 1A110E2 is open to Fire Zone 1A110D3 on Elev. 161' 10". The walls of Fire Zone 1A110E2 are non-rated barriers except for the Auxiliary Building interface, which is a 3-hour rated fire barrier. The ceiling of Fire Zone 1A110E2 is open to Fire Zones 1A110F3 and 1A110F4 on Elev. 208' 10" (Ref. Architectural Drawings A-0636 and A-0637).
 - (b) The combustible loading in Fire Zone 1A110E1, with no transient combustibles postulated for this fire zone, amounts to a low fire load. The chief contributors to this combustible loading is the lube oil, charcoal filter media, and the electrical cable in the fire zone. The in situ combustible loading in the fire zone amounts to less than a 45-minute fire duration (Ref. Calculation MC-QSP64-86058).
 - (c) Fire Zone 1A110E2 contains safety-related equipment and the following fire protection measures are provided: smoke and heat detection (as discussed in the fire area analysis for Fire Area 25), manual deluge fire suppression systems within the containment cooling system filter trains, and accessibility to manual hose streams and portable fire extinguishers.

GRAND GULF NUCLEAR GENERATING STATION
Updated Final Safety Analysis Report (UFSAR)

- (d) Fire Zone 1A110E2 does not contain any safe shutdown components. The lube oil in this fire zone is contained in the drywell purge compressor, which in turn is located on a concrete pad surrounded by a 4-inch-high dike. This diked-off area is of sufficient volume to contain the oil, thus preventing an oil-fed, three-dimensional fire in the containment. A small amount of lube oil is provided for the standby liquid control pumps. The oil from these pumps is also contained by this 4-inch dike. As discussed in the fire area analysis for Fire Area 25, a fire occurring in Fire Area 25 will not affect, or propagate to affect, more than one train of safe shutdown components, or an alternate means will be available to perform the respective safe shutdown function.
- k. FIRE ZONE 1A110F1: REACTOR CONTAINMENT AREA, ELEV. 208' 10"
1. Safety-Related Equipment
Electrical Cable and Raceway
 2. Fire Zone Analysis
 - (a) Fire Zone 1A110F1 is located in the Containment Building on Elev. 208' 10". The floor of Fire Zone 1A110F1 is open to Fire Zone 1A509 on Elev. 184' 6". The walls of Fire Zone 1A110F1 are non-rated barriers except for the Auxiliary Building interface, which is a 3-hour rated fire barrier. Fire Zone 1A110F1 is open to Fire Zone 1A110F2 on Elev. 208' 10". The ceiling of Fire Zone 1A110F1 is the 3-hour rated Containment Building roof (Ref. Architectural Drawing A-0637).
 - (b) The combustible loading in Fire Zone 1A110F1, with no transient combustibles postulated for this fire zone, amounts to a low fire load. The sole contributor to this combustible loading is the concrete joint sealant in the walls. The in situ combustible loading in the fire zone amounts to less than a 15-minute fire duration (Ref. Calculation MC-QSP64-86058).

GRAND GULF NUCLEAR GENERATING STATION
Updated Final Safety Analysis Report (UFSAR)

- (c) Fire Zone 1A110F1 contains safety-related components and the following fire protection measures are provided: smoke and heat detection (as discussed in the fire area analysis for Fire Area 25) and accessibility to manual hose streams and portable fire extinguishers.
 - (d) Fire Zone 1A110F1 does not contain any safe shutdown components. As discussed in the fire area analysis for Fire Area 25, a fire occurring in Fire Area 25 would not affect, or propagate to affect, more than one train of safe shutdown components, or an alternate means will be available to perform the respective safe shutdown function.
1. FIRE ZONE 1A110F2: REACTOR CONTAINMENT AREA, ELEV. 208' 10"
- 1. Safety-Related Equipment
 - Hydrogen Recombiner
 - Electrical Cable and Raceway
 - 2. Fire Zone Analysis
 - (a) Fire Zone 1A110F2 is located in the Containment Building on Elev. 208' 10". The floor of Fire Zone 1A110F2 is open to Fire Zone 1A110E1 on Elev. 184' 6". The walls of Fire Zone 1A110F2 are non-rated barriers except for the Auxiliary Building interface, which is a 3-hour rated fire barrier. Fire Zone 1A110F2 is open to Fire Zone 1A110F1 on Elev. 208' 10". The ceiling of Fire Zone 1A110F2 is the 3-hour rated Containment Building roof (Ref. Architectural Drawing A-0637).
 - (b) The combustible loading in Fire Zone 1A110F2, including transient combustibles amounts to a low fire load. The major contributor to this combustible loading is the transient combustibles. The transient combustible loading is more than 95 percent of the total combustible

GRAND GULF NUCLEAR GENERATING STATION
Updated Final Safety Analysis Report (UFSAR)

loading. The in situ combustible loading in the fire zone amounts to less than a 15-minute fire duration (Ref. Calculation MC-QSP64-860580).

- (c) Fire Zone 1A110F2 contains safety-related components and the following fire protection measures are provided: smoke and heat detection (as discussed in the fire area analysis for Fire Area 25) and accessibility to manual hose streams and portable fire extinguishers.
 - (d) Fire Zone 1A110F2 does not contain any safe shutdown components. As discussed in the fire area analysis for Fire Area 25, a fire occurring in Fire Area 25 would not affect, or propagate to affect, more than one train of safe shutdown components, or an alternate means will be available to perform the respective safe shutdown function.
- m. FIRE ZONE 1A110F3: REACTOR CONTAINMENT AREA, ELEV. 208' 10"
- 1. Safety-Related Equipment
 - Electrical Cable and Raceway
 - 2. Fire Zone Analysis
 - (a) Fire Zone 1A110F3 is located in the Containment Building on Elev. 208' 10". The floor of Fire Zone 1A110F3 is open to Fire Zone 1A110E2 on Elev. 184' 6". The walls of Fire Zone 1A110F3 are non-rated barriers except for the Auxiliary Building interface, which is a 3-hour rated fire barrier. Fire Zone 1A110F3 is open to Fire Zone 1A110F4 on Elev. 208' 10". The ceiling of Fire Zone 1A110F3 is the 3-hour rated Containment Building roof (Ref. Architectural Drawing A-0637).
 - (b) The combustible loading in Fire Zone 1A110F3, with no transient combustibles postulated for this fire zone, amounts to a low fire load. The sole contributor to this combustible loading is the concrete joint sealant in the walls. The in

GRAND GULF NUCLEAR GENERATING STATION
Updated Final Safety Analysis Report (UFSAR)

situ combustible loading in the fire zone amounts to less than a 15-minute fire duration (Ref. Calculation MC-QSP64-86058).

- (c) Fire Zone 1A110F3 contains safety-related components and the following fire protection measures are provided: smoke and heat detection (as discussed in the fire area analysis for Fire Area 25) and accessibility to manual hose streams and portable fire extinguishers.
- (d) Fire Zone 1A110F3 does not contain any safe shutdown components. As discussed in the fire area analysis for Fire Area 25, a fire occurring in Fire Area 25 would not affect, or propagate to affect, more than one train of safe shutdown components, or an alternate means will be available to perform the respective safe shutdown function.

n. FIRE ZONE 1A110F4: REACTOR CONTAINMENT AREA, ELEV. 208' 10"

1. Safety-Related Equipment

Hydrogen Recombiner
Electrical Cable and Raceway

2. Fire Zone Analysis

- (a) Fire Zone 1A110F4 is located in the Containment Building on Elev. 208' 10". The floor of Fire Zone 1A110F4 is open to Fire Zone 1A110E2 on Elev. 184' 6". The walls of Fire Zone 1A110F4 are non-rated barriers except for the Auxiliary Building interface, which is a 3-hour rated fire barrier. Fire Zone 1A110F4 is open to Fire Zone 1A110F3 on Elev. 208' 10". The ceiling of Fire Zone 1A110F4 is the 3-hour rated Containment Building roof (Ref. Architectural Drawing A-0637).
- (b) The combustible loading in Fire Zone 1A110F4, with no transient combustibles postulated for this fire zone, amounts to a low fire load. The contributors to this combustible loading include

GRAND GULF NUCLEAR GENERATING STATION
Updated Final Safety Analysis Report (UFSAR)

the hydraulic fluid and the dryer/separator strong back covers in the fire zone. The in situ combustible loading in the fire zone amounts to less than a 15-minute fire duration (Ref. Calculation MC-QSP64-86058).

- (c) Fire Zone 1A110F4 contains safety-related components and the following fire protection measures are provided: smoke and heat detection (as discussed in the fire area analysis for Fire Area 25) and accessibility to manual hose streams and portable fire extinguishers.
- (d) Fire Zone 1A110F4 does not contain any safe shutdown components. As discussed in the fire area analysis for Fire Area 25, a fire occurring in Fire Area 25 would not affect, or propagate to affect, more than one train of safe shutdown components, or an alternate means will be available to perform the respective safe shutdown function.

o. FIRE ZONE 1A112: DRYWELL AREA, ELEV. 100' 9"

1. Safety-Related Equipment

Reactor Recirculation Pumps
Hydrogen Igniters
Drywell Valve Handling Crane
Main Steam Isolation Valves
Electrical Cable and Raceway

2. Fire Zone Analysis

- (a) Fire Zone 1A112 is located in the Containment Building on Elev. 100' 9". The floor of Fire Zone 1A112 is part of the non-rated Containment Building base mat. The walls and the ceiling of Fire Zone 1A112 are non-rated barriers (Ref. Architectural Drawings A-0633 through A-0635).
- (b) The combustible loading in Fire Zone 1A112, including transient combustibles (at the personnel airlock), amounts to a low fire load. The chief contributors to this combustible loading are the lube oil and electrical cable in

GRAND GULF NUCLEAR GENERATING STATION
Updated Final Safety Analysis Report (UFSAR)

the fire zone. The in situ combustible loading in the fire zone amounts to less than a 30-minute fire duration (Ref. Calculation MC-QSP64-86058).

- (c) Fire Zone 1A112 contains safety-related equipment and the following fire protection measures are provided: heat detection (as discussed in the fire area analysis for Fire Area 25) and accessibility to manual hose streams and portable fire extinguishers.
- (d) Fire Zone 1A112 contains redundant Division I and Division II safe shutdown cable and raceway. As discussed in the fire area analysis for Fire Area 25, a fire occurring in Fire Area 25 will not affect, or propagate to affect, more than one train of safe shutdown components, or an alternate means will be available to perform the respective safe shutdown function.

p. FIRE ZONE 1A113: REACTOR VESSEL AREA, ELEV. 94' 6"

1. Safety-Related Equipment

Reactor Vessel
Control Rod Drive Assemblies
Electrical Cable and Raceway

2. Fire Zone Analysis

- (a) Fire Zone 1A113 is located in the Containment Building on Elev. 94' 6". The floor of Fire Zone 1A113 is part of the non-rated Containment Building base mat. The walls and the ceiling of Fire Zone 1A113 are non-rated barriers (Ref. Architectural Drawings A-0632 through A-0635).
- (b) The combustible loading in Fire Zone 1A113, with no transient combustibles postulated for this fire zone, amounts to a low fire load. The sole contributor to this combustible loading is the electrical cable in the fire zone. The in situ combustible loading in the fire zone amounts to less than a 45-minute fire duration (Ref. Calculation MC-QSP64-86058).

GRAND GULF NUCLEAR GENERATING STATION
Updated Final Safety Analysis Report (UFSAR)

- (c) Fire Zone 1A113 contains safety-related equipment and the following fire protection measures are provided: heat detection (as discussed in the fire area analysis for Fire Area 25) and accessibility to manual hose streams and portable fire extinguishers.
 - (d) Fire Zone 1A113 does not contain any safe shutdown components. As discussed in the fire area analysis for Fire Area 25, a fire occurring in Fire Area 25 will not affect, or propagate to affect, more than one train of safe shutdown components, or an alternate means will be available to perform the respective safe shutdown function.
- q. FIRE ZONE 1A310: MAIN STEAM PIPE TUNNEL, ELEV. 140' 0"
- 1. Safety-Related Equipment
 - Electrical Cable and Raceway
 - 2. Fire Zone Analysis
 - (a) Fire Zone 1A310 is located in the Containment Building on Elev. 140' 0". The floor and ceiling of Fire Zone 1A310 are non-rated barriers. The walls of Fire Zone 1A310 are non-rated barriers except for the Auxiliary Building interface, which is a 3-hour rated fire barrier. The ceiling of Fire Zone 1A310 is open to Fire Zone 1A414 (Elev. 170' 0") via a small open manway (Ref. Civil Drawing C-1045A and Architectural Drawing A-0634).
 - (b) The combustible loading in Fire Zone 1A310, with no transient combustibles postulated for this fire zone, amounts to a low fire load. The chief contributor to this combustible loading is the concrete joint sealant in the walls. The in situ combustible loading in the fire zone amounts to less than a 15-minute fire duration (Ref. Calculation MC-QSP64-86058).

GRAND GULF NUCLEAR GENERATING STATION
Updated Final Safety Analysis Report (UFSAR)

- (c) Fire Zone 1A310 contains safety-related equipment and the following fire protection measures are provided: smoke and heat detection (as discussed in the fire area analysis for Fire Area 25) and accessibility to manual hose streams and portable fire extinguishers.
 - (d) Fire Zone 1A310 contains both Division I (M71) and other Division II safe shutdown cable and raceway, which are not redundant to one another. In addition, the walls of the steam tunnel are 2-foot-thick concrete walls and, therefore, act as radiant energy shields for the two safe shutdown conduits in this fire zone, isolating the conduits in Fire Zone 1A310 from the other fire zones in containment. As discussed in the fire area analysis for Fire Area 25, a fire occurring in Fire Area 25 will not affect, or propagate to affect, more than one train of safe shutdown components, or an alternate means will be available to perform the respective safe shutdown function.
- r. FIRE ZONE 1A311: CRD HYDRAULIC CONTROL AREA, Elev. 135' 4"
- 1. Safety-Related Equipment
 - CRD Hydraulic Control Units
 - Suppression Pool Temperature Monitors
 - Electrical Cable and Raceway
 - 2. Fire Zone Analysis
 - (a) Fire Zone 1A311 is located in the Containment Building on Elev. 135' 4". The floor of Fire Zone 1A311 is a non-rated barrier. The walls of Fire Zone 1A311 are non-rated barriers except for the Auxiliary Building interface, which is a 3-hour rated fire barrier. Fire Zone 1A311 is open to Fire Zones 1A110C2 and 1A110C3 on Elev. 135' 4". The ceiling of Fire Zone 1A311 is open to Fire Zone 1A110D3 on Elev. 161' 10" (Ref. Architectural Drawings A-0634 and A-0635).

GRAND GULF NUCLEAR GENERATING STATION
Updated Final Safety Analysis Report (UFSAR)

- (b) The combustible loading in Fire Zone 1A311, with no transient combustibles postulated for this fire zone, amounts to a moderate fire load. The chief contributor to this combustible loading is the electrical cable in the fire zone. The in situ combustible loading in the fire zone amounts to less than a 75-minute fire duration (Ref. Calculation MC-QSP64-86058).
 - (c) Fire Zone 1A311 contains safety-related equipment and the following fire protection measures are provided: smoke and heat detection (as discussed in the fire area analysis for Fire Area 25) and accessibility to manual hose streams and portable fire extinguishers.
 - (d) Fire Zone 1A311 contains redundant Division I and Division II suppression pool temperature monitors. As discussed in the fire area analysis for Fire Area 25, a fire occurring in Fire Area 25 will not affect, or propagate to affect, more than one train of safe shutdown components, or an alternate means will be available to perform the respective safe shutdown function.
- s. FIRE ZONE 1A313: CRD HYDRAULIC CONTROL AREA, Elev. 135' 4"
- 1. Safety-Related Equipment
 - CRD Hydraulic Control Units
 - Suppression Pool Temperature Monitors
 - Electrical Cable and Raceway
 - 2. Fire Zone Analysis
 - (a) Fire Zone 1A313 is located in the Containment Building on Elev. 135' 4". The floor of Fire Zone 1A313 is a non-rated barrier. The walls of Fire Zone 1A313 are non-rated barriers except for the Auxiliary Building interface, which is a 3-hour rated fire barrier. Fire Zone 1A313 is open to Fire Zones 1A110C1 and 1A110C2 on Elev. 135' 4". The ceiling of Fire Zone 1A313 is open to Fire Zone 1A110D2 on Elev. 161' 10". The remainder of the ceiling is a non-rated barrier (Ref. Architectural Drawings A-0634 and A-0635).

GRAND GULF NUCLEAR GENERATING STATION
Updated Final Safety Analysis Report (UFSAR)

- (b) The combustible loading in Fire Zone 1A313, with no transient combustibles postulated for this fire zone, amounts to low fire load. The chief contributor to this combustible loading is the electrical cable in the fire zone. The in situ combustible loading in the fire zone amounts to less than a 60-minute fire duration (Ref. Calculation MC-QSP64-86058).
 - (c) Fire Zone 1A313 contains safety-related equipment and the following fire protection measures are provided: smoke and heat detection (as discussed in the fire area analysis for Fire Area 25) and accessibility to manual hose streams and portable fire extinguishers.
 - (d) Fire Zone 1A313 contains redundant Division I and Division II suppression pool temperature monitors. As discussed in the fire area analysis for Fire Area 25, a fire occurring in Fire Area 25 will not affect, or propagate to affect, more than one train of safe shutdown components, or an alternate means will be available to perform the respective safe shutdown function.
- t. FIRE ZONE 1A411: UNASSIGNED, ELEV. 170' 0"
- 1. Safety-Related Equipment
 - Electrical Cable and Raceway
 - 2. Fire Zone Analysis
 - (a) Fire Zone 1A411 is located in the Containment Building on Elev. 170' 0". The floor and ceiling of Fire Zone 1A411 are non-rated barriers. The walls of Fire Zone 1A411 are non-rated barriers except for the Auxiliary Building interface, which is a 3-hour rated fire barrier. The North and South boundaries of Fire Zone 1A411 are open to Fire Zones 1A110D1 and 1A110D3, respectively, on Elev. 161' 10" and Fire Zones 1A110E2 and 1A509, respectively, on Elev. 184' 6" (Ref. Architectural Drawings A-0635 and A-0636).

GRAND GULF NUCLEAR GENERATING STATION
Updated Final Safety Analysis Report (UFSAR)

- (b) The combustible loading in Fire Zone 1A411, with no transient combustibles postulated for this fire zone, amounts to a low fire load. The sole contributor to this combustible loading is the concrete joint sealant in the walls. The in situ combustible loading in the fire zone amounts to less than a 15-minute fire duration (Ref. Calculation MC-QSP64-86058).
 - (c) Fire Zone 1A411 contains safety-related equipment and the following fire protection measures are provided: smoke and heat detection (as discussed in the fire area analysis for Fire Area 25) and accessibility to manual hose streams and portable fire extinguishers.
 - (d) Fire Zone 1A411 contains Division I safe shutdown cable and raceway. All Division I safe shutdown cable and raceway are provided with radiant energy shields in 1A411. As discussed in the fire area analysis for Fire Area 25, a fire occurring in Fire Area 25 will not affect, or propagate to affect, more than one train of safe shutdown components, or an alternate means will be available to perform the respective safe shutdown function.
- u. FIRE ZONE 1A414: RWCU HEAT EXCHANGER RM, ELEV. 170' 0"
- 1. Safety-Related Equipment
 - Electrical Cable and Raceway
 - 2. Fire Zone Analysis
 - (a) Fire Zone 1A414 is located in the Containment Building on Elev. 170' 0". The floor, ceiling, and walls are non-rated barriers. A portion of the ceiling is open to Fire Zone 1A507 on Elev. 185' 0". The floor of Fire Zone 1A414 is open to Fire Zone 1A310 (Elev. 140' 0") via a small open manway (Ref. Civil Drawing C-1045A and Architectural Drawing A-0635).

GRAND GULF NUCLEAR GENERATING STATION
Updated Final Safety Analysis Report (UFSAR)

- (b) The combustible loading in Fire Zone 1A414, with no transient combustibles postulated for this zone, amounts to a low fire load. The sole contributor to this combustible loading is the electrical cable in the fire zone. The in situ combustible loading in the fire zone amounts to less than a 15-minute fire duration (Ref. Calculation MC-QSP64-86058).
 - (c) Fire Zone 1A414 contains safety-related equipment and the following fire protection measures are provided: smoke and heat detection (as discussed in the fire area analysis for Fire Area 25) and accessibility to manual hose streams and portable fire extinguishers.
 - (d) Fire Zone 1A414 contains Division I safe shutdown cable and raceway. As discussed in the fire area analysis for Fire Area 25, a fire occurring in Fire Area 25 will not affect, or propagate to affect, more than one train of safe shutdown components, or an alternate means will be available to perform the respective safe shutdown function.
- v. FIRE ZONE 1A419: RWCU PUMP ROOM, ELEV. 161' 10"
- 1. Safety-Related Equipment
 - Electrical Cable and Raceway
 - 2. Fire Zone Analysis
 - (a) Fire Zone 1A419 is located in the Containment Building on Elev. 161' 10". The floor, ceiling, and walls are non-rated barriers (Ref. Architectural Drawing A-0635).
 - (b) The combustible loading in Fire Zone 1A419, with no transient combustibles postulated for this zone, amounts to a low fire load. The sole contributor to this combustible loading is the RWCU pump lubrication oil. The in situ combustible loading in the fire zone amounts to less than a 15-minute fire duration (Ref. Calculation MC-QSP64-86058).

GRAND GULF NUCLEAR GENERATING STATION
Updated Final Safety Analysis Report (UFSAR)

- (c) Fire Zone 1A419 contains safety-related equipment and the following fire protection measures are provided: smoke and heat detection (as discussed in the fire area analysis for Fire Area 25) and accessibility to manual hose streams and portable fire extinguishers.
 - (d) Fire Zone 1A419 does not contain any safe shutdown components. As discussed in the fire area analysis for Fire Area 25, a fire occurring in Fire Area 25 will not affect, or propagate to affect, more than one train of safe shutdown components, or an alternate means will be available to perform the respective safe shutdown function.
- w. FIRE ZONE 1A421: RWCU BACKWASH TANK RM, ELEV. 161' 10"
- 1. Safety-Related Equipment
 - Electrical Cable and Raceway
 - 2. Fire Zone Analysis
 - (a) Fire Zone 1A421 is located in the Containment Building on Elev. 161' 10". The floor, ceiling, and walls are non-rated barriers (Ref. Architectural Drawing A-0635).
 - (b) There is no combustible loading postulated for Fire Zone 1A421 (Ref. Calculation MC-QSP64-86058).
 - (c) Fire Zone 1A421 contains safety-related equipment and the following fire protection measures are provided: smoke and heat detection (as discussed in the fire area analysis for Fire Area 25) and accessibility to manual hose streams and portable fire extinguishers.
 - (d) Fire Zone 1A421 does not contain any safe shutdown components. As discussed in the fire area analysis for Fire Area 25, a fire occurring in Fire Area 25 will not affect, or propagate to affect, more than one train of safe shutdown

GRAND GULF NUCLEAR GENERATING STATION
Updated Final Safety Analysis Report (UFSAR)

components, or an alternate means will be available to perform the respective safe shutdown function.

- x. FIRE ZONE 1A443: VALVE ACCESS AREA, ELEV. 173' 2"
 - 1. Safety-Related Equipment
 - Electrical Cable and Raceway
 - 2. Fire Zone Analysis
 - (a) Fire Zone 1A443 is located in the Containment Building on Elev. 173' 2". The floor, ceiling, and wall are non-rated barriers. Fire Zone 1A443 is open to Fire Zone 1A110D1 on Elev. 161' 10" (Ref. Architectural Drawing A-0635).
 - (b) There is no combustible loading postulated for Fire Zone 1A443 (Ref. Calculation MC-QSP64-86058).
 - (c) Fire Zone 1A443 contains safety-related equipment and the following fire protection measures are provided: smoke and heat detection (as discussed in the fire area analysis for Fire Area 25) and accessibility to manual hose streams and portable fire extinguishers.
 - (d) Fire Zone 1A443 does not contain any safe shutdown components. As discussed in the fire area analysis for Fire Area 25, a fire occurring in Fire Area 25 will not affect, or propagate to affect, more than one train of safe shutdown components, or an alternate means will be available to perform the respective safe shutdown function.

- y. FIRE ZONE 1A507: HEAT EXCHANGER AREA, ELEV. 185' 0"
 - 1. Safety-Related Equipment
 - Electrical Cable and Raceway
 - 2. Fire Zone Analysis

GRAND GULF NUCLEAR GENERATING STATION
Updated Final Safety Analysis Report (UFSAR)

- (a) Fire Zone 1A507 is located in the Containment Building on Elev. 185' 0". The floor is open to Fire Zone 1A414 on Elev. 170' 0". The ceiling and walls are non-rated barriers (Ref. Architectural Drawing A-0636).
 - (b) There is no combustible loading postulated for Fire Zone 1A507 (Ref. Calculation MC-QSP64-86058).
 - (c) Fire Zone 1A507 contains safety-related equipment and the following fire protection measures are provided: smoke and heat detection (as discussed in the fire area analysis for Fire Area 25) and accessibility to manual hose streams and portable fire extinguishers.
 - (d) Fire Zone 1A507 does not contain any safe shutdown components. As discussed in the fire area analysis for Fire Area 25, a fire occurring in Fire Area 25 will not affect, or propagate to affect, more than one train of safe shutdown components, or an alternate means will be available to perform the respective safe shutdown function.
- z. FIRE ZONE 1A509: MISCELLANEOUS EQUIPMENT AREA, ELEV. 184' 6"
- 1. Safety-Related Equipment
 - Electrical Cable and Raceway
 - 2. Fire Zone Analysis
 - (a) Fire Zone 1A509 is located in the Containment Building on Elev. 184' 6". The floor of Fire Zone 1A509 is a non-rated barrier. The walls of Fire Zone 1A509 are non-rated barriers except for the Auxiliary Building interface, which is a 3-hour rated fire barrier. The ceiling is open to Fire Zone 1A110F1 on Elev. 208' 10" (Ref. Architectural Drawings A-0636 and A-0637).

GRAND GULF NUCLEAR GENERATING STATION
Updated Final Safety Analysis Report (UFSAR)

- (b) The combustible loading in Fire Zone 1A509, with no transient combustibles postulated for this zone, amounts to a low fire load. The major contributor to this combustible loading is the electrical cable in the fire zone. The in situ combustible loading in the fire zone amounts to less than a 60-minute fire duration (Ref. Calculation MC-QSP64-86058).
 - (c) Fire Zone 1A509 contains safety-related equipment and the following fire protection measures are provided: smoke and heat detection (as discussed in the fire area analysis for Fire Area 25) and accessibility to manual hose streams and portable fire extinguishers.
 - (d) Fire Zone 1A509 contains Division I safe shutdown cable and raceway. As discussed in the fire area analysis for Fire Area 25, a fire occurring in Fire Area 25 will not affect, or propagate to affect, more than one train of safe shutdown components, or an alternate means will be available to perform the respective safe shutdown function.
- aa. FIRE ZONE 1A510: STEAM SEPARATOR STORAGE AREA, ELEV. 184' 6"
- 1. Safety-Related Equipment
None
 - 2. Fire Zone Analysis
 - (a) Fire Zone 1A510 is located in the Containment Building on Elev. 184' 6". The ceiling is open to Fire Zone 1A601 on Elev. 208' 10". The floor and walls are non-rated barriers (Ref. Architectural Drawing A-0636).
 - (b) There is no combustible loading postulated for Fire Zone 1A510 (Ref. Calculation MC-QSP64-86058).

GRAND GULF NUCLEAR GENERATING STATION
Updated Final Safety Analysis Report (UFSAR)

(c) Fire Zone 1A510 does not contain any safety-related equipment and the following fire protection measures are provided: smoke and heat detection (as discussed in the fire area analysis for Fire Area 25) and accessibility to manual hose streams and portable fire extinguishers.

(d) Fire Zone 1A510 does not contain any safe shutdown components. As discussed in the fire area analysis for Fire Area 25, a fire occurring in Fire Area 25 will not affect, or propagate to affect, more than one train of safe shutdown components, or an alternate means will be available to perform the respective safe shutdown function.

bb. FIRE ZONE 1A513: DRYWELL HEAD AREA, ELEV. 184' 3"

1. Safety-Related Equipment

Electrical Cable and Raceway

2. Fire Zone Analysis

(a) Fire Zone 1A513 is located in the Containment Building on Elev. 184' 3". The ceiling is open to Fire Zone 1A601 on Elev. 208' 10". The floor and walls are non-rated barriers (Ref. Architectural Drawing A-0636).

(b) The combustible loading in Fire Zone 1A513, with no transient combustibles postulated for this zone, amounts to a low fire load. The sole contributor to this combustible loading is the concrete joint sealant in the walls. The in situ combustible loading in the fire zone amounts to less than a 15-minute fire duration (Ref. Calculation MC-QSP64-86058).

(c) Fire Zone 1A513 contains safety-related equipment and the following fire protection measures are provided: smoke and heat detection (as discussed in the fire area analysis for Fire Area 25) and accessibility to manual hose streams and portable fire extinguishers.

GRAND GULF NUCLEAR GENERATING STATION
Updated Final Safety Analysis Report (UFSAR)

(d) Fire Zone 1A513 does not contain any safe shutdown components. As discussed in the fire area analysis for Fire Area 25, a fire occurring in Fire Area 25 will not affect, or propagate to affect, more than one train of safe shutdown components, or an alternate means will be available to perform the respective safe shutdown function.

cc. FIRE ZONE 1A514: SAMPLE AREA, ELEV. 184' 6"

1. Safety-Related Equipment

Electrical Cable and Raceway

2. Fire Zone Analysis

- (a) Fire Zone 1A514 is located in the Containment Building on Elev. 184' 6". The floor, ceiling, and walls are non-rated barriers (Ref. Architectural Drawing A-0636).
- (b) The combustible loading in Fire Zone 1A514, including transient combustibles, amounts to a low fire load. The major contributor to this combustible loading is the electrical cable in the fire zone. The in situ combustible loading in the fire zone amounts to less than a 15-minute fire duration (Ref. Calculation MC-QSP64-86058).
- (c) Fire Zone 1A514 contains safety-related equipment and the following fire protection measures are provided: smoke and heat detection (as discussed in the fire area analysis for Fire Area 25) and accessibility to manual hose streams and portable fire extinguishers.
- (d) Fire Zone 1A514 contains Division I safe shutdown cables. As discussed in the fire area analysis for Fire Area 25, a fire occurring in Fire Area 25 will not affect, or propagate to affect, more than one train of safe shutdown components, or an alternate means will be available to perform the respective safe shutdown function.

GRAND GULF NUCLEAR GENERATING STATION
Updated Final Safety Analysis Report (UFSAR)

dd. FIRE ZONE 1A515: PUMP AREA, ELEV. 184' 6"

1. Safety-Related Equipment

Electrical Cable and Raceway

2. Fire Zone Analysis

- (a) Fire Zone 1A515 is located in the Containment Building on Elev. 184' 6". The floor, ceiling, and walls are non-rated barriers (Ref. Architectural Drawing A-0636).
- (b) The combustible loading in Fire Zone 1A515, with no transient combustibles postulated for this zone, amounts to a low fire load. The sole contributor to this combustible loading is the electrical cable in the fire zone. The in situ combustible loading in the fire zone amounts to less than a 15-minute fire duration (Ref. Calculation MC-QSP64-86058).
- (c) Fire Zone 1A515 contains safety-related equipment and the following fire protection measures are provided: smoke and heat detection (as discussed in the fire area analysis for Fire Area 25) and accessibility to manual hose streams and portable fire extinguishers.
- (d) Fire Zone 1A515 does not contain any safe shutdown components. As discussed in the fire area analysis for Fire Area 25, a fire occurring in Fire Area 25 will not affect, or propagate to affect, more than one train of safe shutdown components, or an alternate means will be available to perform the respective safe shutdown function.

ee. FIRE ZONE 1A516: FILTER DEMINERALIZER AREA, ELEV. 184' 6"

1. Safety-Related Equipment

Electrical Cable and Raceway

2. Fire Zone Analysis

GRAND GULF NUCLEAR GENERATING STATION
Updated Final Safety Analysis Report (UFSAR)

- (a) Fire Zone 1A516 is located in the Containment Building on Elev. 184' 6". The floor, ceiling, and walls are non-rated barriers (Ref. Architectural Drawing A-0636).
- (b) There is no combustible loading postulated for Fire Zone 1A516 (Ref. Calculation MC-QSP64-86058).
- (c) Fire Zone 1A516 contains safety-related equipment and the following fire protection measures are provided: smoke and heat detection (as discussed in the fire area analysis for Fire Area 25). Fire Zone 1A516 is accessible only by lifting a concrete hatch. Therefore, accessibility to manual hose streams and portable fire extinguishers is available only when the concrete hatch has been lifted.
- (d) Fire Zone 1A516 does not contain any safe shutdown components. As discussed in the fire area analysis for Fire Area 25, a fire occurring in Fire Area 25 will not affect, or propagate to affect, more than one train of safe shutdown components, or an alternate means will be available to perform the respective safe shutdown function.

ff. FIRE ZONE 1A517: FILTER DEMINERALIZER AREA, ELEV. 184' 6"

1. Safety-Related Equipment

Electrical Cable and Raceway

2. Fire Zone Analysis

- (a) Fire Zone 1A517 is located in the Containment Building on Elevation 184'-6". The floor, ceiling, and walls are non-rated barriers (Ref. Architectural Drawing A-0636).
- (b) There is no combustible loading postulated for Fire Zone 1A517 (Ref. Calculation MC-QSP64-86058).

GRAND GULF NUCLEAR GENERATING STATION
Updated Final Safety Analysis Report (UFSAR)

- (c) Fire Zone 1A517 contains safety-related equipment and the following fire protection measures are provided: smoke and heat detection (as discussed in the fire area analysis for Fire Area 25). Fire Zone 1A517 is accessible only by lifting a concrete hatch. Therefore, accessibility to manual hose streams and portable fire extinguishers is available only when the concrete hatch has been lifted.
- (d) Fire Zone 1A517 does not contain any safe shutdown components. As discussed in the fire area analysis for Fire Area 25, a fire occurring in Fire Area 25 will not affect, or propagate to affect, more than one train of safe shutdown components, or an alternate means will be available to perform the respective safe shutdown function.

gg. FIRE ZONE 1A520: STEAM DRYER STORAGE AREA AND CONTAINMENT FUEL POOL, ELEV. 167' 6" AND 184' 6"

1. Safety-related Equipment

None

2. Fire Zone Analysis

- (a) Fire Zone 1A520 is located in the Containment Building on Elevation 167' 6" and 184' 6". The ceiling is open to Fire Zone 1A601 on Elev. 208' 10". The floor and walls are non-rated barriers except that portion of the west wall, which is an Auxiliary Building interface and is a 3-hour rated fire barrier. (Ref. Architectural Drawing A-0636).
- (b) The combustible loading in Fire Zone 1A520, with no transient combustibles postulated for this zone, amounts to a low fire load. The sole contributor to this combustible loading is the concrete joint sealant in the walls. The in situ combustible loading in the fire zone amounts to less than a 15-minute fire duration (Ref. Calculation MC-QSP64-86058).

GRAND GULF NUCLEAR GENERATING STATION
Updated Final Safety Analysis Report (UFSAR)

- (c) Fire Zone 1A520 does not contain safety-related equipment and the following fire protection measures are provided: smoke and heat detection (as discussed in the fire area analysis for Fire Area 25) and accessibility to manual hose streams and portable fire extinguishers.
- (d) Fire Zone 1A520 does not contain any safe shutdown components. As discussed in the fire area analysis for Fire Area 25, a fire occurring in Fire Area 25 will not affect, or propagate to affect, more than one train of safe shutdown components, or an alternate means will be available to perform the respective safe shutdown function.

hh. FIRE ZONE 1A601: REACTOR CONTAINMENT AREA, ELEV. 208' 10"

1. Safety-Related Equipment

Containment Polar Crane
Refueling Platform
Fuel Preparation Machine
Hydrogen Igniters
Electrical Cable and Raceway

2. Fire Zone Analysis

- (a) Fire Zone 1A601 is located in the Containment Building on Elev. 208' 10". The floor of Fire Zone 1A601 is open to Fire Zones 1A510 on Elev. 184' 4", 1A513 on Elev. 184' 3", and 1A520 on Elev. 167' 6" and 184' 6". The walls of Fire Zone 1A601 are non-rated barriers. The ceiling of Fire Zone 1A601 is part of the 3-hour fire rated Containment Building roof (Ref. Architectural Drawing A-0637).
- (b) The combustible loading in Fire Zone 1A601, with no transient combustibles postulated for this zone, amounts to a low fire load. The major contributor to this combustible loading is the electrical cable insulation in the fire zone. The in situ combustible loading in the fire zone amounts to less than a 15-minute fire duration (Ref. Calculation MC-QSP64-86058).

GRAND GULF NUCLEAR GENERATING STATION
Updated Final Safety Analysis Report (UFSAR)

- (c) Fire Zone 1A601 contains safety-related equipment and the following fire protection measures are provided: smoke and heat detection (as discussed in the fire area analysis for Fire Area 25) and accessibility to manual hose streams and portable fire extinguishers.
- (d) Fire Zone 1A601 does not contain any safe shutdown components. As discussed in the fire area analysis for Fire Area 25, a fire occurring in Fire Area 25 will not affect, or propagate to affect, more than one train of safe shutdown components, or an alternate means will be available to perform the respective safe shutdown function.

9A.5.26 FIRE AREA 26

9A.5.26.1 FIRE AREA DESCRIPTION

Fire Area 26 consists of those fire zones shown below in the Included Fire Zones listing. These fire zones are located on Elev. 93' 0", except for Fire Zone 0C217, which is located on Elev. 111' 0" in the Control Building. The ceiling and the North and East walls of Fire Area 26 at Elev. 93' 0" are 3-hour rated fire barriers. The South wall of Fire Area 26 is a 3-hour rated fire barrier, except for a small portion west of Column Line K, which is a non-rated exterior wall. The West wall is a non-rated exterior wall, except for a small segment between Column Lines 20.0 and 18.7, which is an interface with Stair 0C01 and Elevator No. 1 (Ref. Methodology Section 9A.3.0) The floor (slab) is a non-rated exterior barrier. Elevations 93' 0" and 111' 0" communicate through the non-rated floor in Fire Zone 0C217. Fire Zone 0C217 is separated from the balance of the Control Building by 3-hour rated walls and ceiling, except for protected openings in the ceiling and east wall and the potential for not having internal conduit fire seals in conduits in Penetrations CE-356BA and CE-357BA that are located in the North and South walls. These openings are protected by a steel plate, structural steel fire proofing, and Thermo-Lag design, which provide adequate protection for in situ and transient fire hazards. Adequacy of these deviations are established in Fire Protection Evaluation No. 1996-001, Rev. 0 and 2000-010, Rev. 0. The West wall of 0C217 is a non-rated exterior barrier (Ref. Architectural Drawing A-0630). Therefore,

GRAND GULF NUCLEAR GENERATING STATION
Updated Final Safety Analysis Report (UFSAR)

Fire Area 26 is separated from other fire areas by 3-hour rated fire barriers or barriers which provide a level of protection commensurate with the fire hazards in the area.

INCLUDED FIRE ZONE	DESCRIPTION
0C101	Health Physics Office Area and Control Point
0C103	Health Physics Checkout, Elev. 93' 0"
0C115	Corridor, Elev. 93' 0"
0C117	Corridor, Elev. 93' 0"
0C125	HVAC Room, Elev. 93' 0"
0C126	Sump Room, Elev. 93' 0"
0C217	HVAC Chase, Elev. 111' 0"

9A.5.26.2 SAFE SHUTDOWN EQUIPMENT

Division I

9A.5.26.3 FIRE AREA ANALYSIS

- (a) Only a single division of safe shutdown components (Division I) is located within Fire Area 26. The Division I safe shutdown components are located in Fire Zone 0C115. In addition, Fire Zone 0C115 is the only zone within Fire Area 26 that contains safety-related components.
- (b) Fire Zones 0C125 and 0C126 are separated from all other fire zones in Fire Area 26 by 2-hour rated fire barriers maintained for good fire protection practice. All other fire zones within Fire Area 26 may communicate with one another through non-rated barriers.
- (c) Since this fire area contains only Division I safe shutdown components and is separated from all other fire areas by 3-hour rated fire barriers or barriers, which are adequate for the hazards involved, Fire Area 26 fully complies with Appendix R requirements. Therefore, in the event of a fire in this fire area, safe shutdown capability would be maintained by separate Division II safe shutdown equipment. The postulated fire with the greatest severity in Fire Area 26 occurs in Fire Zone 0C101. The total fire severity in Fire Zone 0C101, including transient combustibles amounts to a

GRAND GULF NUCLEAR GENERATING STATION
Updated Final Safety Analysis Report (UFSAR)

moderate fire load. The maximum in situ combustible loading in this fire zone amounts to less than a 90-minute fire duration (Ref. Calculation MC-QSP64-86058). Therefore, a fire occurring in Fire Area 26 will not spread into any other fire area.

9A.5.26.4 FIRE ZONE ANALYSES

a. FIRE ZONE 0C101: HEALTH PHYSICS OFFICE AREA AND CONTROL POINT, ELEV. 93' 0"

1. Safety-Related Equipment

None

2. Fire Zone Analysis

- (a) Fire Zone 0C101 is located in the Control Building on Elev. 93' 0". The north and east walls and ceiling of Fire Zone 0C101 are 3-hour rated fire barriers. That portion of the south and west walls which interface with Fire Zones 0C125 and 0C126 are 2-hour rated fire barriers. The floor and the remaining portions of the South, and West walls are non-rated barriers (Ref. Architectural Drawing A-0630).
- (b) The combustible loading in Fire Zone 0C101, including transient combustibles, amounts to a moderate fire load. The major contributors to this combustible loading are the electrical cables present in Fire Zone 0C101, the ordinary Class A combustibles associated with the offices and floor tiling present in the zone. The in situ combustible loading in this fire zone amounts to less than a 90-minute fire duration (Ref. Calculation MC-QSP64-86058).
- (c) Fire Zone 0C101 does not contain any safety-related equipment; however, the following fire protection measures are provided: partial coverage by an automatic sprinkler system, smoke detection and accessibility to manual hose streams and portable fire extinguishers.

GRAND GULF NUCLEAR GENERATING STATION
Updated Final Safety Analysis Report (UFSAR)

- (d) Fire Zone 0C101 does not contain any safe shutdown components; however, Fire Zone 0C101 may communicate through non-rated barriers with Fire Zone 0C115, which contains only Division I safe shutdown cable and raceway. Therefore, a fire originating in this fire zone will not affect, or propagate to affect, more than one train of safe shutdown components.
- b. FIRE ZONE 0C103: HEALTH PHYSICS CHECKOUT, ELEV. 93' 0"
- 1. Safety-Related Equipment

None
 - 2. Fire Zone Analysis
 - (a) Fire Zone 0C103 is located in the Control Building on Elev. 93' 0". The East wall and ceiling of Fire Zone 0C103 are 3-hour rated fire barriers. The floor and the North wall of Fire Zone 0C103 are non-rated barriers. The south boundary is open to Fire Zone 0C115 and the west boundary is open to Fire Zone 0C101. (Ref. Architectural Drawing A-0630).
 - (b) The combustible loading in Fire Zone 0C103, including transient combustibles, amounts to a low fire load. The major contributors to this combustible loading are the electrical cables and floor tiling present in the room. The in situ combustible loading in Fire Zone 0C103 amounts to less than a 60-minute fire duration (Ref. Calculation MC-QSP64-86058).
 - (c) Fire Zone 0C103 does not contain any safety-related equipment; however, the following fire protection measures are provided: area coverage by an automatic sprinkler system, smoke detection, and accessibility to manual hose streams and portable fire extinguishers.
 - (d) Fire Zone 0C103 does not contain any safe shutdown components; however, Fire Zone 0C103 may communicate through open space with Fire Zone 0C115, which contains only Division I safe

GRAND GULF NUCLEAR GENERATING STATION
Updated Final Safety Analysis Report (UFSAR)

shutdown cable and raceway. Therefore, a fire originating in this fire zone will not affect, or propagate to affect, more than one train of safe shutdown components.

c. FIRE ZONE 0C115: CORRIDOR, ELEV. 93'0"

1. Safety-Related Equipment

Electrical Cable and Raceway

2. Fire Zone Analysis

- (a) Fire Zone 0C115 is located in the Control Building on Elev. 93' 0". The ceiling and the East and South walls of Fire Zone 0C115 are 3-hour rated fire barriers, except for a portion of the South wall, which is a non-rated, below grade, exterior barrier. The west and a portion of the north wall, located adjacent to Fire Zone 0C125, are 2-hour rated fire barriers. The floor and remaining portion of the north wall of Fire Zone 0C115 are non-rated barriers (Ref. Architectural Drawing A-0630).
- (b) The combustible loading in Fire Zone 0C115, including transient combustibles, amounts to a low fire load. The major contributors to this combustible loading are the electrical cables and floor tiling present in the room. The in situ combustible loading in Fire Zone 0C115 amounts to less than a 45-minute fire duration (Ref. Calculation MC-QSP64-86058).
- (c) Since Fire Zone 0C115 contains safety-related equipment, the following fire protection measures are provided: smoke detection and accessibility to manual hose streams and portable fire extinguishers.
- (d) Fire Zone 0C115 contains only Division I safe shutdown components and is the only fire zone in Fire Area 26 which contains safe shutdown components. Therefore, a fire originating in this fire zone will not affect more than one train of safe shutdown.

GRAND GULF NUCLEAR GENERATING STATION
Updated Final Safety Analysis Report (UFSAR)

d. FIRE ZONE 0C117: CORRIDOR, ELEV. 93' 0"

1. Safety-Related Equipment

None

2. Fire Zone Analysis

- (a) Fire Zone 0C117 is located in the Control Building on Elev. 93' 0". The ceiling of the Fire Zone 0C117 is a 3-hour rated firebarrier. The floor and the North, West, and a portion of the East walls of Fire Zone 0C117 are non-rated barriers. The South and remaining portion of the East boundary is open to Fire Zones 0C115 and 0C101, respectively. (Ref. Architectural Drawing A-0630).
- (b) The combustible loading in Fire Zone 0C117, including transient combustibles, amounts to a low fire load. The major contributors to this combustible loading are the electrical cables and floor tiling present in the room. The in situ combustible loading in Fire Zone 0C117 amounts to less than a 60-minute fire duration (Ref. Calculation MC-QSP64-86058).
- (c) Fire Zone 0C117 does not contain any safety-related equipment; however, the following fire protection measures are provided: complete coverage by automatic sprinklers, smoke detection and accessibility to manual hose streams and portable fire extinguishers.
- (d) Fire Zone 0C117 does not contain any safe shutdown components; however, Fire Zone 0C117 communicates with Fire Zone 0C115, which contains only Division I safe shutdown cable and raceway. Therefore, a fire originating in this fire zone will not affect, or propagate to affect, more than one train of safe shutdown components.

e. FIRE ZONE 0C125: HVAC ROOM, ELEV. 93' 0"

1. Safety-Related Equipment

GRAND GULF NUCLEAR GENERATING STATION
Updated Final Safety Analysis Report (UFSAR)

None

2. Fire Zone Analysis

- (a) Fire Zone 0C125 is located in the Control Building on Elev. 93' 0". The ceiling of Fire Zone 0C125 is a 3-hour rated fire barrier. The East, South, and that portion of the northwall physically adjacent to Fire Zone 0C101 and that portion of the West wall physically adjacent to Stair No. 0C01 are 2-hour rated fire barriers. That portion of the West wall adjacent to Stair 0C01 is a 2-hour rated fire barrier. That portion of the North and West walls adjacent to Fire Zone 0C126 are non-rated barriers. The floor of Fire Zone 0C125 is a non-rated barrier (Ref. Architectural Drawing A-0630).
- (b) The combustible loading in Fire Zone 0C125, including transient combustibles, amounts to a low fire load. The major contributors to this combustible loading are the electrical cables and rubber air hose present in the fire zone. The in situ combustible loading in Fire Zone 0C125 amounts to less than a 15-minute fire duration (Ref. Calculation MC-QSP64-86058).
- (c) Fire Zone 0C125 does not contain any safety-related equipment; however, the following fire protection measures are provided: smoke detection and accessibility to manual hose streams and portable fire extinguishers.
- (d) Fire Zone 0C125 does not contain any safe shutdown components but may communicate through non-rated barriers with Fire Zone 0C126 which also contains no safe shutdown components. Fire Zone 0C125 is separated from Fire Zone 0C115, which contains only Division I safe shutdown components, by 2-hour fire rated barriers maintained for good fire protection practice. Therefore, a fire originating in this fire zone will not affect either train of safe shutdown.

f. FIRE ZONE 0C126: SUMP ROOM, ELEV. 93' 0"

GRAND GULF NUCLEAR GENERATING STATION
Updated Final Safety Analysis Report (UFSAR)

1. Safety-Related Equipment

None

2. Fire Zone Analysis

(a) Fire Zone 0C126 is located in the Control Building on Elev. 93' 0". The ceiling of Fire Zone 0C126 is a 3-hour rated fire barrier. The North wall of Fire Zone 0C126 is a 2-hour rated fire barrier maintained for good fire protection practice. The floor and East, West, and South walls are non-rated barriers (Ref. Architectural Drawing A-0630).

(b) The combustible loading in Fire Zone 0C126, with only transient combustibles postulated, amounts to a low fire load (Ref. Calculation MC-QSP64-86058).

(c) Fire Zone 0C126 does not contain safety-related equipment; however, the following fire protection measures are provided: smoke detection and accessibility to manual hose streams and portable fire extinguishers.

(d) Fire Zone 0C126 does not contain any safe shutdown components but may communicate through non-rated barriers with Fire Zone 0C125, which contains no safe shutdown components. Fire Zone 0C126 is separated from Fire Zone 0C115, which contains only Division I safe shutdown components, by 2-hour fire rated barriers maintained for good fire protection practice. Therefore, a fire originating in this fire zone will not affect either train of safe shutdown.

g. FIRE ZONE 0C217: HVAC CHASE, ELEV. 111' 0"

1. Safety-Related Equipment

None

2. Fire Zone Analysis

GRAND GULF NUCLEAR GENERATING STATION
Updated Final Safety Analysis Report (UFSAR)

- (a) Fire Zone 0C217 is located in the Control Building on Elev. 111' 0". The floor and west wall of 0C217 are non-rated barriers. All other walls and ceiling are 3-hour rated except for protected openings in the ceiling and east wall and the potential for not having internal conduit fire seals in conduits in Penetrations CE-356BA and CE-357BA that are located in the North and South walls. These openings are protected by a steel plate, structural steel fire proofing and Thermo-Lag design, which provide adequate protection for in situ and transient fire hazards. Adequacy of this configuration is established in Fire Protection Evaluation No. 96-1, Rev. 0. Penetrations CE-356BA, CE-357BA are located in the fire barrier separating 0C217 from 0C214. These penetrations contain conduits in which the internal conduit seal could not be verified on the 0C217 side of the wall. Fire Protection Evaluation 2000/010 documents the adequacy of the existing configuration based on the following: 1) Internal conduit seals installed on the 0C214 side. 2) Low combustible loading Fire Zone 0C214 and no combustible loading in 0C217. 3) Partial suppression system (sprinklers) in 0C214. 4) Areas wide smoke detection in 0C214. 5) Accessibility to manual hose steams and portable extinguishers in 0C214.
- (b) There is no combustible loading postulated for Fire Zone 0C217 (Ref. Calculation MC-QSP64-86058).
- (c) There are no fire protection measures provided for Fire Zone 0C217.
- (d) Fire Zone 0C217 does not contain any safe shutdown components; however, Fire Zone 0C217 may communicate through non-rated barriers with Fire Zone 0C115, which contains only Division I safe shutdown cable and raceway. Therefore, a fire originating in this fire zone will not affect, or propagate to affect more than one train of safe shutdown.

GRAND GULF NUCLEAR GENERATING STATION
Updated Final Safety Analysis Report (UFSAR)

9A.5.27 FIRE AREA 27

9A.5.27.1 FIRE AREA DESCRIPTION

Fire Area 27 consists solely of Fire Zone 0C128 (Elev. 93' 0") in the Control Building. The ceiling and all four walls are 3-hour rated fire barriers. The floor is the non-rated floor (slab) of the Control Building (Ref. Architectural Drawing A-0630).

INCLUDED FIRE ZONE	DESCRIPTION
0C128	Hot Water Heater Room, Elev. 93' 0"

9A.5.27.2 SAFE SHUTDOWN EQUIPMENT

None

9A.5.27.3 FIRE AREA ANALYSIS

Fire Zone 0C128 does not contain any safe shutdown components, as shown in the microcomputer data base (Ref. FPP-1, Appendix C Data). Fire Area 27 is separated from other fire areas by 3-hour rated fire barriers. The postulated fire in Fire Zone 0C128 is based solely on transient combustibles. Considering transients only, the combustible loading for 0C128 amounts to a low fire load. Therefore, a fire occurring in Fire Zone 0C128 will not spread to any other fire area.

9A.5.27.4 FIRE ZONE ANALYSIS

FIRE ZONE 0C128: HOT WATER HEATER ROOM, ELEV. 93' 0"

1. Safety-Related Equipment

None

2. Fire Zone Analysis

- (a) Fire Zone 0C128 is located in the Control Building on Elev. 93' 0". The ceiling and all four walls of Fire Zone 0C128 are 3-hour rated fire barriers. The floor is the non-rated floor (slab) of the Control Building (Ref. Architectural Drawing A-0630).

GRAND GULF NUCLEAR GENERATING STATION
Updated Final Safety Analysis Report (UFSAR)

- (b) The combustible loading in Fire Zone 0C128, based solely on transient combustibles, amounts to a low fire load (Ref. Calculation MC-QSP64-86058).
- (c) Fire Zone 0C128 does not contain any safety-related equipment and the following fire protection measures are provided: smoke detection and accessibility to manual hose streams and portable fire extinguishers are available as fire protection measures.
- (d) Fire Zone 0C128 is totally enclosed with 3-hour rated fire barriers and does not contain any safe shutdown or safety-related components.

9A.5.28 FIRE AREA 28

9A.5.28.1 FIRE AREA DESCRIPTION

Fire Area 28 consists of Fire Zones 0C104, 0C109, and 0C116 (Elev. 93' 0") in the Control Building. The North, South, and East walls and ceiling of Fire Area 28 are 3-hour rated fire barriers. The exterior (below grade) West wall and floor (slab) of this fire area are non-rated barriers. A fire originating in any one of the fire zones within Fire Area 28 could communicate with the other fire zones in Fire Area 28, since they are not separated by rated fire barriers (Ref. Architectural Drawing A-0630). Therefore, a fire originating in any one fire zone in Fire Area 28 could communicate with any other zone in Fire Area 28.

INCLUDED FIRE ZONE	DESCRIPTION
0C104	Sump Room, Elev. 93' 0"
0C109	Decontaminated Area, Elev. 93' 0"
0C116	Hot Machine Shop, Elev. 93' 0"

9A.5.28.2 SAFE SHUTDOWN EQUIPMENT

Division I

9A.5.28.3 FIRE AREA ANALYSIS

Fire Zone 0C104 does not contain any safe shutdown components. Fire Zones 0C109 and 0C116 each contain only Division I safe shutdown cable and raceway, as shown in the microcomputer data base (Ref. FPP-1, Appendix C Data). Since this fire area contains

GRAND GULF NUCLEAR GENERATING STATION
Updated Final Safety Analysis Report (UFSAR)

only Division I safe shutdown components and is separated from all other fire areas by 3-hour rated fire barriers, Fire Area 28 fully complies with Appendix R requirements. Therefore, in the event of a fire in this fire area, safe shutdown capability would be maintained by separate Division II safe shutdown equipment. The postulated fire with the greatest severity duration in Fire Area 28 is a fire in Fire Zone 0C109. The total fire severity in Fire Zone 0C109, including transient combustibles, amounts to a low fire load. The maximum in situ combustible loading in Fire Zone 0C109 amounts to less than a 15-minute fire duration (Ref. Calculation MC-QSP64-86058). Therefore, a fire occurring in Fire Area 28 will not spread into any other fire area.

9A.5.28.4 FIRE ZONE ANALYSES

a. FIRE ZONE 0C104: SUMP ROOM, ELEV. 93' 0"

1. Safety-Related Equipment

None

2. Fire Zone Analysis

- (a) Fire Zone 0C104 is located in the Control Building on Elev. 93' 0". The floor is the non-rated base slab of the Control Building. The North and East walls of Fire Zone 0C104 are 3-hour rated fire barriers. The ceiling and the South and West walls are non-rated barriers that separate 0C104 from Fire Zone 0C116 (Ref. Architectural Drawing A-0630).
- (b) The combustible loading in Fire Zone 0C104, which consists solely of transient combustibles, amounts to a low fire load. (Ref. Calculation MC-QSP64-86058).
- (c) Fire Zone 0C104 does not contain any safety-related equipment and accessibility to manual hose streams and portable fire extinguishers is provided as a fire protection measure.
- (d) Fire Zone 0C104 is adjacent to Fire Zones 0C109 and 0C116, both of which contain only Division I safe shutdown cable and raceway. Therefore, a

GRAND GULF NUCLEAR GENERATING STATION
Updated Final Safety Analysis Report (UFSAR)

fire in Fire Zone 0C104 will not affect, or propagate to affect, more than one train of safe shutdown components.

- b. FIRE ZONE 0C109: DECONTAMINATED AREA, ELEV. 93' 0"
1. Safety-Related Equipment
Electrical Cable and Raceway
 2. Fire Zone Analysis
 - (a) Fire Zone 0C109 is located in the Control Building on Elev. 93' 0". The floor is the non-rated base slab of the Control Building. The ceiling and the North, East, and a portion of the West walls of Fire Zone 0C109 are 3-hour rated fire barriers. The South and remaining portion of the West wall are non-rated barriers (Ref. Architectural Drawing A-0630).
 - (b) The combustible loading in Fire Zone 0C109, including transient combustibles, amounts to a low fire load. The major contributor to this combustible loading is the electrical cable present in the fire zone. The in situ combustible loading in Fire Zone 0C109 amounts to less than a 15-minute fire duration (Ref. Calculation MC-QSP64-86058).
 - (c) Fire Zone 0C109 contains safety-related equipment and the following fire protection measures are provided: automatic sprinkler system, smoke detection, and accessibility to manual hose streams and portable fire extinguishers.
 - (d) Fire Zone 0C109 contains Division I safe shutdown cable and raceway and is adjacent to Fire Zone 0C104, which does not contain any safe shutdown components. Fire Zone 0C109 is also adjacent to Fire Zone 0C116, which also contains only Division I safe shutdown cable and raceway. Therefore, a fire in Fire Zone 0C109 will not affect, or propagate to affect, more than one train of safe shutdown components.

GRAND GULF NUCLEAR GENERATING STATION
Updated Final Safety Analysis Report (UFSAR)

- c. FIRE ZONE 0C116: HOT MACHINE SHOP, ELEV. 93' 0"
1. Safety-Related Equipment
Electrical Cable and Raceway
 2. Fire Zone Analysis
 - (a) Fire Zone 0C116 is located in the Control Building on Elev. 93' 0". The floor is the non-rated base slab of the Control Building. The ceiling and the South wall, along with portions of the North and East walls, of Fire Zone 0C116 are 3-hour rated fire barriers. The West (exterior) and the remaining portions of the North and East walls are non-rated walls (Ref. Architectural Drawing A-0630).
 - (b) The combustible loading in Fire Zone 0C116, including transient combustibles, amounts to a low fire load. The major contributors to this combustible loading are the lube oils and the electrical cable present in the fire zone. The in situ combustible loading in Fire Zone 0C116 amounts to less than a 15-minute fire duration (Ref. Calculation MC-QSP64-86058).
 - (c) Fire Zone 0C116 contains safety-related equipment and the following fire protection measures are provided: automatic sprinkler system, smoke detection, and accessibility to manual hose streams and portable fire extinguishers.
 - (d) Fire Zone 0C116 contains Division I safe shutdown cable and raceway and is adjacent to Fire Zone 0C104, which does not contain any safe shutdown components. Fire Zone 0C116 is also adjacent to Fire Zone 0C109, which contains only Division I safe shutdown components. Therefore, a fire in Fire Zone 0C116 will not affect, or propagate to affect, more than one train of safe shutdown components.

GRAND GULF NUCLEAR GENERATING STATION
Updated Final Safety Analysis Report (UFSAR)

9A.5.29 No fire area has been assigned for Section 9A.5.29

9A.5.30 FIRE AREA 30

9A.5.30.1 FIRE AREA DESCRIPTION

Fire Area 30 consists of fire zones 0C203, 0C204, 0C205, 0C205A, 0C206, 0C212, 0C213, 0C214 and 0C219 (all on Elev. 111' 0") in the Control Building. The floor, ceiling and walls of Fire Area 30 are 3-hour rated fire barriers except as follows: that portion of the west wall which is a below grade, non-rated exterior barrier; interfaces with Stair 0C01 are 2-hour rated fire barriers (Ref. Methodology Section 9A.3.0); protected opening in the west wall of 0C214 and the potential for not having internal conduit fire seals in conduits in Penetrations CE-356BA and CE-357BA that are located in the north and south walls that interface with Fire Zone 0C217 and penetrations CE-192BA and CE-193BA located in the South wall which separates 0C214 and 0C216. The opening in the west wall of 0C214, where it interfaces with 0C217, is protected by a steel plate, structural steel fire proofing, and Thermo-Lag design which provides adequate protection for in situ and transient fire hazards (Ref. Fire Protection Evaluation No. 96-1, Rev. 0). Adequacy of the potential for not having internal conduit fire seals in conduits in Penetrations CE-356BA and CE-357BA is established in Fire Protection Evaluation No. 2000-010, Rev. 0. Penetrations CE-192BA and CE-193BA while not 3-hour rated, they have been evaluated and found acceptable to provide adequate fire separation commensurate with the hazards in the area (Ref. Fire Protection Evaluation 200-0075, ER 2000-0113). All of the zones listed above are separated from each other by non-rated fire barriers (Ref. Architectural Drawing A-0630). Therefore, a fire originating in any one fire zone of Fire Area 30 is able to communicate with any other zone in this fire area.

INCLUDED FIRE ZONES	DESCRIPTION
0C203	Division II Switchgear Area (Unit 2), Elev. 111' 0"
0C204	Division III Battery Room (Unit 2), Elev. 111' 0"
0C205	Emergency Hot Shutdown Room (Unit 2), Elev. 111' 0"
0C205A	Emergency Hot Shutdown Room (Unit 2), Elev. 111' 0"
0C206	Division II Battery Room (Unit 2), Elev. 111' 0"

GRAND GULF NUCLEAR GENERATING STATION
Updated Final Safety Analysis Report (UFSAR)

0C212	Division I Battery Room (Unit 2), Elev. 111' 0"
0C213	Division III Switchgear Room (Unit 2), Elev. 111' 0"
0C214	Division I Switchgear Area (Unit 2), Elev. 111' 0"
0C219	Pipe Chase (Unit 2), Elev. 111' 0'

9A.5.30.2 SAFE SHUTDOWN EQUIPMENT

Divisions I and II

9A.5.30.3 FIRE AREA ANALYSIS

- a. Fire Zones 0C204, 0C205, 0C205A, 0C206, 0C212, 0C213, and 0C219 do not contain any safe shutdown components. Fire Zone 0C203 contains only Division II safe shutdown cable and raceway. Fire Zone 0C214 contains both Division I and Division II safe shutdown cable and raceway, as shown in the microcomputer data base (Ref. FPP-1, Appendix C Data).
- b. Fire Zone 0C214 contains Division I safe shutdown components, which are related only to the Y47 system which supports Division I P41 system. All Division II safe shutdown components related to these two systems and located in Fire Zone 0C214 are protected with 1-hour rated fire barriers and partial area automatic sprinkler protection. This partial area suppression system provides a level of protection which is commensurate with the hazards in the fire zone (Ref. Fire Protection Engineering Evaluation No. 96-2). The remaining Division II safe shutdown components located in this zone are related to the Z77 system and are unprotected and not required for a fire in Fire Zone 0C214 because Division I Z77 remains available.
- c. The nearest unprotected Division II safe shutdown components in Fire Area 30 are located in Fire Zone 0C203. However, these Division II components are related only to the Z77 system and are not required.
- d. All other fire zones within Fire Area 30 do not contain any safe shutdown components.

GRAND GULF NUCLEAR GENERATING STATION
Updated Final Safety Analysis Report (UFSAR)

- e. Although each zone may communicate with all other zones in Fire Area 30, the combination of separation, protection of Division II safe shutdown components with 1-hour rated fire barriers, partial area coverage by automatic sprinkler and detection, and low combustible loading, ensure that at least one train of safe shutdown components remains free from fire damage.
- f. Based on the above analysis, the fire protection measures provided in Fire Zone 0C214 ensures that a postulated fire originating in any fire zone within Fire Area 30 will not affect, or propagate to affect, more than one train of safe shutdown components.
- g. Although the fire protection provided in Fire Area 30 does not strictly comply with Appendix R, in that fire detection and sprinkler coverage is not provided throughout Fire Area 30, the fire protection features provided in Fire Area 30 is more than adequate to ensure that at least one train of safe shutdown components will remain free of fire damage. See "Fire Zone Analysis" for description of specific fire protection features provided in each zone.
- h. The postulated fire with the greatest severity in Fire Area 30 occurs in Fire Zones 0C204, 0C205, 0C205A, 0C213 and 0C214. The total fire severity in these fire zones, including transient combustibles, amounts to a low fire load (Ref. Calculation MC-QSP64-86058). Fire Area 30 is separated from all other fire areas by 3-hour rated fire barriers or barriers which are adequate for the hazards involved; therefore, a fire occurring in Fire Area 30 will not spread into any other fire area.

9A.5.30.4 FIRE ZONE ANALYSIS

- a. FIRE ZONE 0C203: DIVISION II SWITCHGEAR AREA (UNIT 2),
ELEV. 111' 0''
 - 1. Safety-Related Equipment
 - Electrical Cable and Raceway
 - 2. Fire Zone Analysis

GRAND GULF NUCLEAR GENERATING STATION
Updated Final Safety Analysis Report (UFSAR)

- (a) Fire Zone 0C203 is located in the Control Building on Elev. 111' 0". The floor, ceiling, and North, East, and South walls of Fire Zone 0C203 that are Fire Area 30 boundaries are 3-hour rated fire barriers. All ceilings, walls and doors between adjacent fire zones within this fire area are non-rated barriers. The non-rated barriers and doors enable a fire originating in Fire Zone 0C203 to communicate with all other fire zones in Fire Area 30 (Ref. Architectural Drawing A-0630).
 - (b) The combustible loading in Fire Zone 0C203, including transient combustibles, amounts to a low fire load. The major contributor to this combustible loading is the electrical cable postulated for Unit 2 in the fire zone. The in situ combustible loading in Fire Zone 0C203 amounts to less than a 15-minute fire duration (Ref. Calculation MC-QSP64-86058).
 - (c) Fire Zone 0C203 contains safety-related equipment and the following fire protection measures are provided: smoke detection and accessibility to manual hose stations and portable fire extinguishers.
 - (d) Fire Zone 0C203 contains only Division II safe shutdown components. These components are related to the Z77 system only. A fire originating in 0C203 will not affect more than one train of safe shutdown in 0C203. However, Fire Zone 0C203 communicates with all other fire zones within Fire Area 30 via the non-rated barriers. An adjacency discussion is provided in the fire area analysis for Fire Area 30.
- b. FIRE ZONE 0C204: DIVISION III BATTERY ROOM (UNIT 2), ELEV. 111' 0"
- 1. Safety-Related Equipment

None
 - 2. Fire Zone Analysis

GRAND GULF NUCLEAR GENERATING STATION
Updated Final Safety Analysis Report (UFSAR)

- (a) Fire Zone 0C204 is located in the Control Building on Elev. 111' 0". The floor and North wall of Fire Zone 0C204 are 3-hour rated fire barriers. The ceiling, East, South and West walls are non-rated barriers. The non-rated barriers enable a fire originating in Fire Zone 0C204 to communicate with all other fire zones in Fire Area 30 (Ref. Architectural Drawing A-0630).
 - (b) The combustible loading in Fire Zone 0C204, including transient combustibles, amounts to a low fire load. The major contributor to this combustible loading is the wood table top present in the room. The in situ combustible loading in Fire Zone 0C204 amounts to less than a 30-minute fire duration (Ref. Calculation MC-QSP64-86058).
 - (c) Fire Zone 0C204 does not contain any safety-related equipment and the following fire protection measures are provided: smoke detection and accessibility to manual hose stations and portable fire extinguishers.
 - (d) Although Fire Zone 0C204 does not contain any safe shutdown components, a fire originating in Fire Zone 0C204 could communicate with other fire zones in Fire Area 30 via the non-rated barriers. An adjacency discussion is provided in the fire area analysis for Fire Area 30.
- c. FIRE ZONE 0C205: EMERGENCY HOT SHUTDOWN ROOM (UNIT 2),
ELEV. 111' 0"
- 1. Safety-Related Equipment
None
 - 2. Fire Zone Analysis
 - (a) Fire Zone 0C205 is located in the Control Building on Elev. 111' 0". The floor of Fire Zone 0C205 is a 3-hour rated fire barrier. The ceiling and all four walls between adjacent fire zones are non-rated barriers. The non-rated

GRAND GULF NUCLEAR GENERATING STATION
Updated Final Safety Analysis Report (UFSAR)

barriers enable a fire in Fire Zone 0C203 to communicate with all other fire zones in Fire Area 30 (Ref. Architectural Drawing A-0630).

- (b) The combustible loading in Fire Zone 0C205, including transient combustibles, amounts to a low fire load. The in situ combustible loading in Fire Zone 0C203 amounts to less than a 30-minute fire duration (Ref. Calculation MC-QSP64-86058).
 - (c) Fire Zone 0C205 does not contain any safety-related equipment and the following fire protection measures are provided: smoke detection and accessibility to manual hose stations and portable fire extinguishers.
 - (d) Although Fire Zone 0C205 does not contain any safe shutdown components, a fire originating in 0C205 could communicate with other fire zones in Fire Area 30 via the non-rated barriers. An adjacency discussion is provided in the fire area analysis for Fire Area 30.
- d. FIRE ZONE 0C205A: EMERGENCY HOT SHUTDOWN ROOM (UNIT 2),
ELEV. 111' 0"
- 1. Safety-Related Equipment
None
 - 2. Fire Zone Analysis
 - (a) Fire Zone 0C205A is located in the Control Building on Elev. 111' 0". The floor of Fire Zone 0C205A is a 3-hour rated fire barrier. The ceiling and all four walls between adjacent fire zones are non-rated barriers. The non-rated barriers enable a fire originating in Fire Zone 0C205A to communicate with all other fire zones in Fire Area 30 (Ref. Architectural Drawing A-0630).
 - (b) The combustible loading in Fire Zone 0C205A, including transient combustibles, amounts to a low fire load. The in situ combustible loading

GRAND GULF NUCLEAR GENERATING STATION
Updated Final Safety Analysis Report (UFSAR)

in Fire Zone 0C205A amounts to less than a 30-minute fire duration (Ref. Calculation MC-QSP64-86058).

- (c) Fire Zone 0C205A does not contain any safety-related equipment and the following fire protection measures are provided: smoke detection and accessibility to manual hose stations and portable fire extinguishers.
 - (d) Although Fire Zone 0C205A does not contain any safe shutdown components, a fire originating in 0C205A could communicate with other fire zones in Fire Area 30 via the non-rated barriers. An adjacency discussion is provided in the fire area analysis for Fire Area 30.
- e. FIRE ZONE 0C206: DIVISION II BATTERY ROOM (UNIT 2), ELEV. 111' 0"
- 1. Safety-Related Equipment
 - Electrical Cable and Raceway
 - 2. Fire Zone Analysis
 - (a) Fire Zone 0C206 is located in the Control Building on Elev. 111' 0". The floor and South wall of Fire Zone 0C206 are 3-hour rated fire barriers. The ceiling, North, East and West walls between adjacent fire zones are non-rated barriers. The non-rated barriers enable a fire originating in Fire Zone 0C206 to communicate with all other fire zones in Fire Area 30 (Ref. Architectural Drawing A-0630).
 - (b) The combustible loading in Fire Zone 0C206, including transient combustibles, amounts to a low fire load. The major contributors to this combustible loading are the battery rack covers present in this room. The in situ combustible loading in Fire Zone 0C206 amounts to less than a 15-minute fire duration (Ref. Calculation MC-QSP64-86058).

GRAND GULF NUCLEAR GENERATING STATION
Updated Final Safety Analysis Report (UFSAR)

- (c) Fire Zone 0C206 contains safety-related equipment, and the following fire protection measures are provided: smoke detection, accessibility to manual hose stations and portable fire extinguishers.
 - (d) Although Fire Zone 0C206 does not contain any safe shutdown components, a fire originating in 0C206 could communicate with other fire zones in Fire Area 30 via the non-rated barriers. An adjacency discussion is provided in the fire area analysis for Fire Area 30.
- f. FIRE ZONE 0C212: DIVISION I BATTERY ROOM (UNIT 2), ELEV. 111' 0"
- 1. Safety-Related Equipment
 - Electrical Cable and Raceway
 - 2. Fire Zone Analysis
 - (a) Fire Zone 0C212 is located in the Control Building on Elev. 111' 0". The Ceiling, Floor, and South wall of Fire Zone 0C212 are 3-hour rated fire barriers. The North, East and West walls between adjacent fire zones are non-rated barriers. The non-rated barrier enable a fire originating in Fire Zone 0C212 to communicate with all other fire zones in Fire Area 30 (Ref. Architectural Drawing A-0630).
 - (b) The combustible loading in Fire Zone 0C212, including transient combustibles, amounts to a low fire load. The major contributor to this combustible loading are the battery rack covers present in this room. The in situ combustible loading in Fire Zone 0C212 amounts to less than a 15-minute fire duration (Ref. Calculation MC-QSP64-86058).
 - (c) Fire Zone 0C212 contains safety-related equipment and the following fire protection measures are provided: smoke detection, accessibility to manual hose stations and portable fire extinguishers.

GRAND GULF NUCLEAR GENERATING STATION
Updated Final Safety Analysis Report (UFSAR)

- (d) Although Fire Zone 0C212 does not contain any safe shutdown components, a fire originating in 0C212 could communicate with other fire zones in Fire Area 30 via the non-rated barriers. An adjacency discussion is provided in the fire area analysis for Fire Area 30.
- g. FIRE ZONE 0C213: DIVISION III SWITCHGEAR ROOM (UNIT 2),
ELEV. 111' 0"
- 1. Safety-Related Equipment

None
 - 2. Fire Zone Analysis
 - (a) Fire Zone 0C213 is located in the Control Building on Elev. 111' 0". The floor, ceiling, and North wall of Fire Zone 0C213 are 3-hour rated fire barriers. The East, South and West walls between adjacent fire zones are non-rated barriers. The non-rated barriers enable a fire originating in Fire Zone 0C213 to communicate with all other fire zones in Fire Area 30 (Ref. Architectural Drawing A-0630).
 - (b) The combustible loading in Fire Zone 0C213, including transient combustibles, amounts to a low fire load. The in situ combustible loading in Fire Zone 0C213 amounts to less than a 30-minute fire duration (Ref. Calculation MC-QSP64-86058).
 - (c) Fire Zone 0C213 does not contain any safety-related equipment and the following fire protection measure is provided: smoke detection and accessibility to manual hose stations and portable fire extinguishers.
 - (d) Although Fire Zone 0C213 does not contain any safe shutdown components, a fire originating in 0C213 could communicate with other fire zones in Fire Area 30 via the non-rated barriers. An adjacency discussion is provided in the fire area analysis for Fire Area 30.

GRAND GULF NUCLEAR GENERATING STATION
Updated Final Safety Analysis Report (UFSAR)

- h. FIRE ZONE 0C214: DIVISION I SWITCHGEAR AREA (UNIT 2),
ELEV. 111' 0"
1. Safety-Related Equipment

Electrical Cable and Raceway
 2. Fire Zone Analysis
 - (a) Fire Zone 0C214 is located in the Control Building on Elev. 111' 0". The floor, ceiling and North and South walls of Fire Zone 0C214 are 3-hour rated fire barriers. The East wall between adjacent fire zones is a non-rated barrier. The non-rated barrier enables a fire originating in Fire Zone 0C214 to communicate with all other fire zones in Fire Area 30 (Ref. Architectural Drawing A-0630). The West wall is a below grade, non-rated exterior barrier; except for the interface with Room 0C217 and Stair 0C01. The interface with Stair 0C01 is 2-hour rated fire barriers (Ref. Methodology Section 9A.3.0). The interface between 0C217 and 0C214 utilizes 3-hour fire rated construction except for a protected opening in the east wall of 0C217. The opening in the east wall of 0C217 is protected by a steel plate, structural steel fire proofing, and Thermo-Lag design which provides adequate protection for in situ and transient fire hazards (Ref. Fire Protection Evaluation No. 96-1, Rev. 0). The South wall is 3-hour rated with exception of penetrations CE-192BA and CE-193BA. These penetrations are installed in configurations not bound by supporting fire endurance testing. However, they have been evaluated and found to provide adequate fire separation commensurate with the hazards in the area (Ref. Fire Protection Evaluation 2000-0075, ER 2000-0113).
 - (b) The combustible loading in Fire Zone 0C214, including transient combustibles, amounts to a low fire load. The major contributor to this combustible loading is the Thermo-Lag material in this room. Thermo-Lag is approximately 20

GRAND GULF NUCLEAR GENERATING STATION
Updated Final Safety Analysis Report (UFSAR)

percent of the total combustible loading. The in situ combustible loading in this fire zone amounts to less than a 30-minute fire duration (Ref. Calculation MC-QSP64-86058).

- (c) Fire Zone 0C214 contains safety-related cable and raceway and the following fire protection measures are provided: smoke detection, partial area sprinkler protection, and accessibility to manual hose stations and portable fire extinguishers.
- (d) Fire Zone 0C214 contains both Division I and II safe shutdown components. The Division I components are related to the P41 and Y47 systems. All functionally redundant Division II safe shutdown is protected with 1-hour rated fire barriers and is located within the coverage area of the partial area sprinkler system. This partial area sprinkler system is located in the southwest corner of Fire Zone 0C214 and provides sprinkler protection for an area approximately 15 feet wide and 34 feet long. This partial area suppression system provides a level of protection which is commensurate with the hazards in the fire zone (Ref. Fire Protection Engineering Evaluation No. 96-2).
- (e) A fire originating in 0C214 could only affect one train of safe shutdown in 0C214, since the other train of safe shutdown is protected with 1-hour rated fire barriers and a partial area suppression system which provides a level of protection commensurate with the hazards in the fire zone. However, a fire originating in 0C214 could communicate with other fire zones in Fire Area 30 via the non-rated barriers. An adjacency discussion is provided in the fire area analysis for Fire Area 30.

i. FIRE ZONE 0C219: PIPE CHASE (UNIT 2), ELEV. 111' 0"

1. Safety-Related Equipment

None

GRAND GULF NUCLEAR GENERATING STATION
Updated Final Safety Analysis Report (UFSAR)

2. Fire Zone Analysis

- (a) Fire Zone 0C219 is located in the Control Building on Elev. 111' 0". The floor of Fire Zone 0C219 is a 3-hour rated fire barrier, while the ceiling and North, South, and East walls are non-rated interior walls. The West wall is a non-rated exterior wall. Fire Zone 0C219 communicates with all other fire zones in this fire area through non-rated barriers (Ref. Architectural Drawing A-0630).
- (b) The combustible loading in Fire zone 0C219 amounts to a low fire load. The sole contributor to this combustible loading is the concrete joint sealant in the walls. The in situ combustible loading in Fire Zone 0C219, with no transients postulated, amounts to less than a 15-minute fire duration (Ref. Calculation MC-QSP64-86058).
- (c) Fire Zone 0C219 is a totally inaccessible pipe chase that contains no safety-related components. Therefore, no fire protection measures are provided or required.
- (d) Although Fire Zone 0C219 does not contain any safe shutdown components, a fire originating in 0C219 communicates with other fire zones in Fire Area 30 via non-rated barriers. An adjacency discussion is provided in the fire area analysis for Fire Area 30.

9A.5.31 FIRE AREA 31

9A.5.31.1 FIRE AREA DESCRIPTION

Fire Area 31 consists only of Fire Zone 0C202 (Elev. 111' 0") in the Control Building. The floor, ceiling, and walls are 3-hour rated fire barriers (Ref. Architectural Drawing A-0630 and Fire Protection Evaluation No. 2000/011).

INCLUDED FIRE ZONE	DESCRIPTION
0C202	Division I Switchgear Area, Elev. 111' 0"

GRAND GULF NUCLEAR GENERATING STATION
Updated Final Safety Analysis Report (UFSAR)

9A.5.31.2 SAFE SHUTDOWN EQUIPMENT

Divisions I and II

9A.5.31.3 ALTERNATE SHUTDOWN CONTROLS

1H22-P152

1H22-P299

9A.5.31.4 FIRE AREA ANALYSIS

Fire Zone 0C202 contains both Division I and Division II safe shutdown equipment and cable and raceway, as shown in the microcomputer data base (Ref. FPP-1, Appendix C Data). All the Division II safe shutdown cable and raceway in Fire Zone 0C202 are provided with 1-hour fire barriers, and an automatic Carbon dioxide suppression system is provided throughout 0C202. Since adequate protection is provided to ensure that at least one train (Division II) of safe shutdown components will remain free of fire damage and Fire Area 31 is separated from all other fire areas by 3-hour rated fire barriers, Fire Area 31 fully complies with Appendix R requirements. The total fire severity in Fire Zone 0C202, including transient combustibles, amounts to a low fire load. The maximum in situ combustible loading in this fire zone amounts to less than a 60-minute fire duration (Ref. Calculation MC-QSP64-86058). Therefore, a fire occurring in Fire Area 31 will not spread into any other fire area.

9A.5.31.5 FIRE ZONE ANALYSIS

FIRE ZONE 0C202: DIVISION I SWITCHGEAR AREA. ELEV. 111' 0"

1. Safety-Related Equipment

- Motor Control Center
- Switchgear
- Electrical Cable and Raceway
- Battery Chargers
- Load Shedding Panel
- DC Distribution Panel
- Transfer Switch Panel
- Alternate Shutdown Panel

2. Fire Zone Analysis

GRAND GULF NUCLEAR GENERATING STATION
Updated Final Safety Analysis Report (UFSAR)

- (a) Fire Zone 0C202 is located in the Control Building on Elev. 111' 0". The walls, ceiling, and floor of Fire Zone 0C202 are 3-hour rated fire barriers (Ref. Architectural Drawing A-0630 and Fire Protection Evaluation No. 2000/011).
- (b) The combustible loading in Fire Zone 0C202, including transient combustibles, amounts to a low fire load. The major contributor to this combustible loading is the electrical cable present in this zone. Thermo-Lag fire barrier material is utilized in this fire zone and is less than 5 percent of the total combustible loading. The in situ combustible loading in this fire zone amounts to less than a 60-minute fire duration (Ref. Calculation MC-QSP64-86058).
- (c) Fire Zone 0C202 contains safety-related equipment and the following fire protection measures are provided: smoke detection, automatic Carbon dioxide suppression system, and accessibility to manual hose streams and portable fire extinguishers.
- (d) Fire Zone 0C202 contains both Division I and II safe shutdown components, this fire zone is completely enclosed by 3-hour barriers and all Division II safe shutdown is provided with 1-hour fire barriers and automatic suppression. Therefore, a fire originating in this fire zone will not affect, or propagate to affect, more than on train of safe shutdown.

9A.5.32 FIRE AREA 32

9A.5.32.1 FIRE AREA DESCRIPTION

Fire Area 32 consists solely of Fire Zone 0C207 (Elev. 111' 0") in the Control Building. The ceiling, floor, and all walls are 3-hour rated fire barriers (Ref. Architectural Drawing A-0630).

INCLUDED FIRE ZONE	DESCRIPTION
0C207	Division I Battery Room, Elev. 111' 0"

GRAND GULF NUCLEAR GENERATING STATION
Updated Final Safety Analysis Report (UFSAR)

9A.5.32.2 SAFE SHUTDOWN EQUIPMENT

Division I

9A.5.32.3 FIRE AREA ANALYSIS

Fire Zone 0C207 contains Division I safe shutdown equipment and cable and raceway, as shown on the microcomputer data base (Ref. FPP-1, Appendix C Data). Since this fire area contains only Division I safe shutdown components and is separated from all other fire areas by 3-hour rated fire barriers, Fire Area 32 fully complies with Appendix R requirements. Therefore, in the event of a fire in this fire area, safe shutdown capability would be maintained by separate Division II safe shutdown equipment. The total fire severity in Fire Zone 0C207, including transient combustibles, amounts to a low fire load. The maximum in situ combustible loading in this fire zone amounts to less than a 45-minute fire duration (Ref. Calculation MC-QSP64-86058). Therefore, a fire occurring in Fire Area 32 will not spread into any other fire area.

9A.5.32.4 FIRE ZONE ANALYSIS

FIRE ZONE 0C207: DIVISION I BATTERY ROOM, ELEV. 111' 0"

1. Safety-related Equipment

Electrical Cable and Raceway
Electrical Batteries

2. Fire Zone Analysis

- (a) Fire Zone 0C207 is located in the Control Building on Elev. 111' 0". Fire Zone 0C207 is bounded on all sides by 3-hour rated fire barriers (Ref. Architectural Drawing A-0630).
- (b) The combustible loading in Fire Zone 0C207, including transient combustibles, amounts to a low fire load. The battery cases are the major contributor to this combustible loading. The in situ combustible loading in this fire zone amounts to less than a 45-minute fire duration (Ref. Calculation MC-QSP64-86058).

GRAND GULF NUCLEAR GENERATING STATION
Updated Final Safety Analysis Report (UFSAR)

- (c) Fire Zone 0C207 contains safety-related equipment and the following fire protection measures are provided: smoke detection and accessibility to manual hose streams and portable fire extinguishers. In addition, a hazard due to excessive hydrogen accumulation is prevented by continuous operation of redundant ventilation systems and hydrogen detection.
- (d) Since Fire Zone 0C207 contains only Division I safe shutdown components and is completely enclosed by 3-hour rated barriers, a fire originating in this fire zone will not affect more than one train of safe shutdown components.

9A.5.33 FIRE AREA 33

9A.5.33.1 FIRE AREA DESCRIPTION

Fire Area 33 consists solely of Fire Zone 0C208 (Elev. 111' 0") in the Control Building. The floor, ceiling, and all walls are 3-hour rated fire barriers (Ref. Architectural Drawing A-0630). The 3-hour rated door separating Fire Zone 0C208 from Fire Zone 0C208A (Fire Area 34) is a sliding door designed to automatically slide shut upon smoke detection on either side of the door.

INCLUDED FIRE ZONE	DESCRIPTION
0C208	Emergency Hot Shutdown Room, Elev. 111'0

9A.5.33.2 SAFE SHUTDOWN EQUIPMENT

Division II

9A.5.33.3 FIRE AREA ANALYSIS

Fire Zone 0C208 contains Division II safe shutdown equipment and cables and raceway, as shown on the microcomputer data base (Ref. FPP-1, Appendix C Data). Since this fire area contains only Division II safe shutdown components and is separated from all other fire areas by 3-hour rated fire barriers, Fire Area 33 fully complies with Appendix R requirements. Therefore, in the event of a fire in Fire Area 33, safe shutdown capability would be maintained by separate Division I safe shutdown equipment. The

GRAND GULF NUCLEAR GENERATING STATION
Updated Final Safety Analysis Report (UFSAR)

total fire severity in Fire Zone 0C208, including transient combustibles, amounts to a low fire load. The maximum in situ combustible loading in Fire Zone 0C208 amounts to less than a 45-minute fire duration (Ref. Calculation MC-QSP64-86058). Therefore, a fire occurring in Fire Area 33 will not spread into any other fire area.

9A.5.33.4 FIRE ZONE ANALYSIS

FIRE ZONE 0C208: EMERGENCY HOT SHUTDOWN ROOM, ELEV. 111' 0"

1. Safety-Related Equipment

Remote Shutdown Panel
Electrical Cable and Raceway

2. Fire Zone Analysis

- (a) Fire Zone 0C208 is located in the Control Building on Elev. 111' 0". The ceiling, floor, and all four walls are 3-hour rated fire barriers (Ref. Architectural Drawing A-0630).
- (b) The combustible loading in Fire Zone 0C208, including transient combustibles, amounts to a low fire load. The major contributor to this combustible loading is the electrical cable present in the room. The in situ combustible loading in Fire Zone 0C208 amounts to less than a 45-minute fire duration (Ref. Calculation MC-QSP64-86058).
- (c) Fire Zone 0C208 contains safety-related equipment and the following fire protection measures are provided: an automatic Carbon dioxide suppression system, smoke detection, and accessibility to manual hose streams and portable fire extinguishers. In addition, detection of smoke in either Fire Zone 0C208 or 0C208A will cause the sliding 3-hour rated door to slide shut automatically. Automatic Carbon dioxide suppression systems are provided to flood Fire Zones 0C208 and 0C208A upon heat detection in either fire zone.

GRAND GULF NUCLEAR GENERATING STATION
Updated Final Safety Analysis Report (UFSAR)

- (d) Since Fire Zone 0C208 contains only Division II safe shutdown components and is completely enclosed by 3-hour rated fire barriers, a fire in this fire zone will not affect more than one train of safe shutdown components.

9A.5.34 FIRE AREA 34

9A.5.34.1 FIRE AREA DESCRIPTION

Fire Area 34 consists solely of Fire Zone 0C208A (Elev. 111' 0") in the Control Building. The floor, ceiling, and all walls are 3-hour rated fire barriers (Ref. Architectural Drawing A-0630). The 3-hour rated door separating Fire Zone 0C208A from Fire Zone 0C208 (Fire Area 33) is a sliding door designed to automatically slide shut upon smoke detection on either side of the door.

INCLUDED FIRE ZONE	DESCRIPTION
0C208A	Emergency Hot Shutdown Room, Elev. 111'0

9A.5.34.2 SAFE SHUTDOWN EQUIPMENT

Division I

9A.5.34.3 ALTERNATE SHUTDOWN CONTROLS

1H22-P150

9A.5.34.4 FIRE AREA ANALYSIS

Fire Zone 0C208A contains Division I safe shutdown equipment and cables and raceway, as shown on the microcomputer data base (Ref. FPP-1, Appendix C Data). Since this fire area contains only Division I safe shutdown components and is separated from all other fire areas by 3-hour rated fire barriers, Fire Area 34 fully complies with Appendix R requirements. Therefore, in the event of a fire in Fire Area 34, safe shutdown capability would be maintained by separate Division II safe shutdown equipment. The total fire severity in Fire Zone 0C208A, including transient combustibles, amounts to a moderate fire loading. The maximum in situ combustible loading in Fire Zone 0C208A amounts to less than a 90-minute fire duration (Ref. Calculation MC-QSP64-86058). Therefore, a fire occurring in Fire Area 34 will not spread into any other fire area.

GRAND GULF NUCLEAR GENERATING STATION
Updated Final Safety Analysis Report (UFSAR)

9A.5.34.5 FIRE ZONE ANALYSIS

FIRE ZONE 0C208A: EMERGENCY HOT SHUTDOWN RM, ELEV. 111' 0"

1. Safety-Related Equipment

Remote Shutdown Panels
Electrical Cable and Raceway

2. Fire Zone Analysis

- (a) Fire Zone 0C208A is located in the Control Building on Elev. 111' 0". The ceiling, floor, and all four walls are 3-hour rated fire barriers (Ref. Architectural Drawing A-0630).
- (b) The combustible loading in Fire Zone 0C208A, including transient combustibles, amounts to a moderate fire loading. The major contributor to this combustible loading is the electrical cable present in the room. The in situ combustible loading in Fire Zone 0C208A amounts to less than a 90-minute fire duration (Ref. Calculation MC-QSP64-86058).
- (c) Fire Zone 0C208A contains safety-related equipment and the following fire protection measures are provided: an automatic Carbon dioxide suppression system, smoke detection, and accessibility to manual hose streams and portable fire extinguishers. In addition, detection of smoke in either Fire Zone 0C208A or 0C208 will cause the sliding 3-hour rated door to slide shut automatically. Automatic Carbon dioxide suppression systems are provided to flood Fire Zones 0C208A and 0C208 upon heat detection in either fire zone.
- (d) Since Fire Zone 0C208A contains only Division I safe shutdown components and is completely enclosed by 3-hour rated fire barriers, a fire in this fire zone will not affect more than one train of safe shutdown components.

GRAND GULF NUCLEAR GENERATING STATION
Updated Final Safety Analysis Report (UFSAR)

9A.5.35 FIRE AREA 35

9A.5.35.1 FIRE AREA DESCRIPTION

Fire Area 35 consists solely of Fire Zone 0C209 (Elev. 111' 0") in the Control Building. The ceiling, floor, and all walls are 3-hour rated fire barriers (Ref. Architectural Drawing A-0630 and Fire Protection Evaluation No. 2000/011).

INCLUDED FIRE ZONE	DESCRIPTION
0C209	Division III Battery Room, Elev. 111' 0"

9A.5.35.2 SAFE SHUTDOWN EQUIPMENT

None

9A.5.35.3 FIRE AREA ANALYSIS

Fire Zone 0C209 does not contain any safe shutdown components, as shown in the microcomputer data base (Ref. FPP-1, Appendix C Data). This fire area contains no safe shutdown components and is separated from all other fire areas by 3-hour rated fire barriers. The total fire severity in Fire Zone 0C209, including transient combustibles, amounts to a low fire load. The maximum in situ combustible loading in this fire zone amounts to less than a 15-minute fire duration (Ref. Calculation MC-QSP64-86058). Therefore, a fire occurring in Fire Area 35 will not spread into any other fire area.

9A.5.35.4 FIRE ZONE ANALYSIS

FIRE ZONE 0C209: DIVISION III BATTERY ROOM, ELEV. 111' 0"

1. Safety-Related Equipment

Electrical Cable and Raceway
Electric Batteries

2. Fire Zone Analysis

- (a) Fire Zone 0C209 is located in the Control Building on Elev. 111' 0" and is bounded on all sides by 3-hour rated fire barriers (Ref. Architectural Drawing A-0630 and Fire Protection Evaluation No. 2000/011).

GRAND GULF NUCLEAR GENERATING STATION
Updated Final Safety Analysis Report (UFSAR)

- (b) The combustible loading in Fire Zone 0C209, including transient combustibles, amounts to a low fire load. The battery cases are the major contributor to this combustible loading. The in situ combustible loading in this fire zone amounts to less than a 15-minute fire duration (Ref. Calculation MC-QSP64-86058).
- (c) Fire Zone 0C209 contains safety-related equipment and the following fire protection measures are provided: smoke detection and accessibility to manual hose streams and portable fire extinguishers. In addition, a hazard due to excessive hydrogen accumulation is prevented by continuous operation of redundant ventilation systems and hydrogen detection.
- (d) Since Fire Zone 0C209 does not contain any safe shutdown components and is completely enclosed by 3-hour rated barriers, a fire originating in this fire zone will not affect either train of safe shutdown components.

9A.5.36 FIRE AREA 36

9A.5.36.1 FIRE AREA DESCRIPTION

Fire Area 36 consists solely of Fire Zone 0C210 (Elev. 111' 0") in the Control Building. The floor, ceiling, South, and East walls are 3-hour rated fire barriers (Ref. Architectural Drawing A-0630 and Fire Protection Evaluation No. 2000/011). The North wall is a 3-hour fire barrier except that portion which separates Fire Area 38 from Fire Area 36. The West wall utilized 3-hour construction except that exposed flanges of embedded steel columns are unprotected. (Ref. Fire Protection Engineering Evaluation FPE 94-0002). Additionally, the West wall contains penetration CE-129BA which is not a 3-hour rated configuration (Ref. Fire Protection Evaluation 2000-0075).

INCLUDED FIRE ZONE	DESCRIPTION
0C210	Division III Switchgear Area, Elev. 111' 0"

9A.5.36.2 SAFE SHUTDOWN EQUIPMENT

Division II

GRAND GULF NUCLEAR GENERATING STATION
Updated Final Safety Analysis Report (UFSAR)

9A.5.36.3 FIRE AREA ANALYSIS

Fire Zone 0C210 contains only Division II safe shutdown components, as shown in the microcomputer data base (Ref. FFP-1, Appendix C Data). Since this fire area contains only Division II safe shutdown components and is separated from all other fire areas by 3-hour rated fire barriers or fire barriers which are adequate for the hazards involved (See discussion in "Fire Zone Analysis"), Fire Area 36 fully complies with Appendix R requirements. Therefore, in the event of a fire in this fire area, safe shutdown capability would be maintained by separate Division I safe shutdown equipment. The total fire severity in Fire Zone 0C210, including transient combustibles, amounts to a low fire load. The maximum in situ combustible loading in Fire Zone 0C210 amounts to less than a 45-minute fire duration (Ref. Calculation MC-QSP64-86058). Therefore, a fire occurring in Fire Area 36 will not spread into any other fire area.

9A.5.36.4 FIRE ZONE ANALYSIS

FIRE ZONE 0C210: DIVISION III SWITHEGEAR AREA, ELEV. 111' 0"

1. Safety-Related Equipment

HPCS Transformer
Motor Control Center
Switchgear
Electrical Cable and Raceway
Battery Chargers

2. Fire Zone Analysis

- (a) Fire Zone 0C210 is located in the Control Building on Elev. 111' 0". The ceiling, floor, South, and East walls of Fire Zone 0C210 are 3-hour rated fire barriers (Ref. Architectural Drawing A-0630 and Fire Protection Evaluation No. 2000/011). The North wall is a 3-hour fire barrier except that portion which separates Fire Zone 0C215 from Fire Zone 0C210 (Fire Area 36). The West wall and that portion of the North wall separating Fire Zone 0C210 from Fire Zone 0C215 (Fire Area 38) utilize 3-hour construction except that exposed flanges of embedded steel columns are unprotected. Although not 3-hour

GRAND GULF NUCLEAR GENERATING STATION
Updated Final Safety Analysis Report (UFSAR)

rated, the configuration of these walls provides a substantial barrier to the propagation of fire and is adequate for the hazards associated with the areas on either side (Ref. FPE 94-0002). Combustible loading is low, automatic detection and suppression is provided in both areas, along with fire extinguishers and hose stations. In addition, these walls do not separate redundant safe shutdown components. Additionally, the West wall contains penetration CE-129BA which is not a 3-hour rated configuration. Penetration CE-129BA is installed in a configuration not bound by supporting fire endurance testing. However, CE-129BA has been evaluated and found acceptable to provide adequate fire separation commensurate with the hazards in the area (Ref. Fire Protection Evaluation 2000-0075, ER 2000-0113).

- (b) The combustible loading in Fire Zone 0C210, including transient combustibles, amounts to a low fire load. The major contributor to this combustible loading is the electrical cable present in the room. The in situ combustible loading in Fire Zone 0C210 amounts to less than a 45-minute fire duration (Ref. Calculation MC-QSP64-86058).
- (c) Fire Zone 0C210 contains safety-related equipment and the following fire protection measures are provided: an automatic carbon dioxide suppression system, smoke detection, and accessibility to manual hose streams and portable fire extinguishers.
- (d) Since Fire Zone 0C210 is the only fire zone in Fire Area 36 and contains only Division II safe shutdown equipment, a fire in Fire Zone 0C210 will not affect more than one train of safe shutdown components.

GRAND GULF NUCLEAR GENERATING STATION
Updated Final Safety Analysis Report (UFSAR)

9A.5.37 FIRE AREA 37

9A.5.37.1 FIRE AREA DESCRIPTION

Fire Area 37 consists solely of Fire Zone 0C211 (Elev. 111' 0") in the Control Building. The ceiling, floor, and walls of Fire Zone 0C211 are 3-hour rated fire barriers (Ref. Architectural Drawing A-0630 and Fire Protection Evaluation No. 2000/011).

INCLUDED FIRE ZONE	DESCRIPTION
0C211	Division II Battery Room, Elev. 111' 0"

9A.5.37.2 SAFE SHUTDOWN EQUIPMENT

Division II

9A.5.37.3 FIRE AREA ANALYSIS

Fire Zone 0C211 contains only Division II safe shutdown equipment and cable and raceway, as shown in the microcomputer data base (Ref. FPP-1, Appendix C Data). Since this fire area contains only Division II safe shutdown components and is separated from all other fire areas by 3-hour rated fire barriers, Fire Area 37 fully complies with Appendix R requirements. Therefore, in the event of a fire in this fire area, safe shutdown capability would be maintained by separate Division I safe shutdown equipment. The total fire severity in Fire Zone 0C211, including transient combustibles, amounts to a low fire loading. The maximum in situ combustible loading in this fire zone amounts to less than a 45-minute fire duration (Ref. Calculation MC-QSP64-86058). Therefore, a fire occurring in Fire Area 37 will not spread into any other fire area.

9A.5.37.4 FIRE ZONE ANALYSIS

FIRE ZONE 0C211: DIVISION II BATTERY ROOM, ELEV. 111' 0"

1. Safety-Related Equipment
 - Electric Batteries
 - Electrical Cable and Raceway
2. Fire Zone Analysis

GRAND GULF NUCLEAR GENERATING STATION
Updated Final Safety Analysis Report (UFSAR)

- (a) Fire Zone 0C211 is located in the Control Building on Elev. 111' 0". Fire Zone 0C211 is bounded on all sides by 3-hour rated fire barriers (Ref. Architectural Drawing A-0630 and Fire Protection Evaluation No. 2000/011).
- (b) The combustible loading in Fire Zone 0C211, including transient combustibles, amounts to a low fire loading. The battery cases are the major contributor to this combustible loading. The in situ combustible loading in this fire zone amounts to less than a 45-minute fire duration (Ref. Calculation MC-QSP64-86058).
- (c) Fire Zone 0C211 contains safety-related equipment and the following fire protection measures are provided: smoke detection and accessibility to manual hose streams and portable fire extinguishers. In addition, a hazard due to excessive hydrogen accumulation is prevented by continuous operation of redundant ventilation systems and hydrogen detection.
- (d) Since Fire Zone 0C211 contains only Division II safe shutdown components and is completely enclosed by 3-hour rated barriers, a fire originating in this fire zone will not affect more than one train of safe shutdown components.

9A.5.38 FIRE AREA 38

9A.5.38.1 FIRE AREA DESCRIPTION

Fire Area 38 consists of Fire Zone 0C215 (Elev. 111' 0") in the Control Building. The floor, ceiling and North, and South Walls are 3-hour rated fire barriers. The East wall utilizes 3-hour construction except that exposed flanges of embedded steel columns are unprotected (Ref. Fire Protection Engineering Evaluation "FPE" 94-0002). Additionally, the East wall contains penetration CE-129BA which is not a 3-hour rated configuration (Ref. Fire Protection Evaluation 200-0075). In addition, the West wall is a non-rated exterior barrier (Ref. Architectural Drawing A-0630).

INCLUDED FIRE ZONE	DESCRIPTION
-----------------------	-------------

GRAND GULF NUCLEAR GENERATING STATION
Updated Final Safety Analysis Report (UFSAR)

0C215	Division II Switchgear Area, Elev. 111' 0"
-------	--

9A.5.38.2 SAFE SHUTDOWN EQUIPMENT

Divisions I and II

9A.5.38.3 FIRE AREA ANALYSIS

Fire Zone 0C215 contains both Division I and Division II safe shutdown equipment, and cable and raceway, as shown in the microcomputer data base (Ref. FPP-1, Appendix C Data). All the Division I cable and raceway in Fire Zone 0C215 are provided with a 1-hour fire barrier, and an automatic (carbon dioxide) suppression system is provided throughout 0C215. Since one division of redundant safe shutdown in this fire area is provided with 1-hour fire barriers, the area has automatic suppression throughout, and the area is separated from other fire areas by 3-hour rated barriers or fire barriers which are adequate for the hazards involved (See discussion in "Fire Zone Analysis"), Fire Area 38 fully complies with Appendix R requirements. The total fire severity in Fire Zone 0C215, including transient combustibles, amounts to a low fire loading. The maximum in situ combustible loading in this Fire Zone amounts to less than a 45-minute fire duration (Ref. Calculation MC-QSP64-86058). Therefore, a fire occurring in Fire Area 38 will not spread into any other fire area.

9A.5.38.4 FIRE ZONE ANALYSIS

- a. FIRE ZONE 0C215: DIVISION II SWITCHGEAR AREA, ELEV. 111' 0"
 - 1. Safety-Related Equipment
 - Load Shedding Panel
 - Switchgear
 - Electrical Cable and Raceway
 - Motor Control Center
 - Battery Chargers
 - DC Distribution Panel
 - 2. Fire Zone Analysis
 - (a) Fire Zone 0C215 is located in the Control Building on Elev. 111' 0". The ceiling, floor, north and south walls, and the portion of the West boundary that separated Fire Zone 0C215 from Fire Zone 0C218 are 3-hour fire rated

GRAND GULF NUCLEAR GENERATING STATION
Updated Final Safety Analysis Report (UFSAR)

barriers (Ref. Architectural Drawing A-0630). The East wall is a 3-hour fire barrier except that portion which separates Fire Zone 0C215 from Fire Zone 0C210 (Fire Area 36), and penetration CE-129BA. The portion of the wall separating these areas utilizes 3-hour construction except that exposed flanges of embedded steel columns are unprotected. Although not 3-hour rated, this wall configuration provides a substantial barrier to the propagation of fire and is adequate for the hazards associated with the areas on either side (Ref. FPE 94-0002). Combustible loading is low, automatic detection and suppression is provided in both areas, along with fire extinguishers and hose stations. In addition, this portion of wall does not separate redundant safe shutdown components. Additionally, the East wall contains penetration CE-129BA which is not a 3-hour rated configuration. Penetration CE-129BA is installed in a configuration not bound by supporting fire endurance testing. However, CE-129BA has been evaluated and found acceptable to provide adequate fire separation commensurate with the hazards in the area (Ref. Fire Protection Evaluation 2000-0075, ER 2000-0113).

- (b) The combustible loading in Fire Zone 0C215, including transient combustibles, amounts to a low fire loading. The major contributor to this combustible loading is the electrical cable present in the zone. The in situ combustible loading in this Fire Zone amounts to less than a 45-minute fire duration (Ref. Calculation MC-QSP64-86058).
- (c) Fire Zone 0C215 contains safety-related equipment and the following fire protection measures are provided: smoke detection, an automatic carbon dioxide suppression system, and accessibility to manual hose streams and portable fire extinguishers.

GRAND GULF NUCLEAR GENERATING STATION
Updated Final Safety Analysis Report (UFSAR)

- (d) Fire Zone 0C215 is the only fire zone in Fire Area 38 and contains both Division I and Division II safe shutdown components. All the Division I safe shutdown cable and raceway are provided with 1-hour fire barriers. This protection of one division, combined with the other fire protection measures, is adequate to protect the Division I train of safe shutdown components from the effects of a postulated fire in the Fire Zone 0C215. Therefore, a fire in Fire Zone 0C215 will not affect more than one train of safe shutdown.

9A.5.39 FIRE AREA 39

9A.5.39.1 FIRE AREA DESCRIPTION

Fire Area 39 consists only of Fire Zone 0C216 (Elev. 111' 0") in the Control Building. The floor, ceiling, and walls are 3-hour rated fire barriers, except for the portion of the South wall that is an exterior non-rated wall and penetrations CE-192BA and CE-193BA located in the North wall (Ref. Fire Protection Evaluation 2000-0075, ER 2000-0113, Architectural Drawing A-0630). In addition, the interfaces with Stair 0C01 and Elevator No. 1 are 2-hour rated fire barriers (Ref. Methodology Section 9A.3.0).

INCLUDED FIRE ZONE	DESCRIPTION
0C216	Corridor, Elev. 111' 0"

9A.5.39.2 SAFE SHUTDOWN EQUIPMENT

Division II

9A.5.39.3 FIRE AREA ANALYSIS

Fire Zone 0C216 contains only Division II safe shutdown cable and raceway, as shown in the microcomputer data base (Ref. FPP-1, Appendix C Data). This fire area contains only Division II safe shutdown components and is separated from all other fire areas by 3-hour rated fire barriers, except for penetrations CE-192BA and CE-193BA located in the North wall. Penetrations CE-192BA and CE-193BA are installed in configurations not bound by supporting fire endurance testing and are therefore not considered 3-hour

GRAND GULF NUCLEAR GENERATING STATION
Updated Final Safety Analysis Report (UFSAR)

rated. However, they have been evaluated and found acceptable to provide adequate fire separation commensurate with the hazards in the area (Ref. Fire Protection Evaluation 2000-0075, ER 2000-0113). In the event of a fire in this fire area, safe shutdown capability would be maintained by separate Division I safe shutdown equipment. The total fire severity in Fire Zone 0C216, including transient combustibles, amounts to a low fire load. The maximum in situ combustible loading in this fire zone amounts to less than a 15-minute fire duration (Ref. Calculation MC-QSP64-86058). Therefore, a fire occurring in Fire Area 39 will not spread into any other fire area.

9A.5.39.4 FIRE ZONE ANALYSIS

FIRE ZONE 0C216: CORRIDOR, ELEV. 111' 0"

1. Safety-Related Equipment

Electrical Cable and Raceway

2. Fire Zone Analysis

(a) Fire Zone 0C216 is located in the Control Building on Elev. 111' 0". The floor, ceiling, and walls are 3-hour rated fire barriers, except for the portion of the South wall that is an exterior non-rated wall and penetrations CE-192BA and CE-193BA located in the North wall (Ref. Fire Protection Evaluation 2000-0075, ER 2000-0113, Architectural Drawing A-0630). In addition, the interfaces with Stair 0C01 and Elevator No. 1 are 2-hour rated fire barriers (Ref. Methodology Section 9A.3.0). Penetrations CE-192BA and CE-193BA are installed in configurations not bound by supporting fire endurance testing and are therefore not considered 3-hour rated. However, they have been evaluated and found acceptable to provide adequate fire separation commensurate with the hazards in the area (Ref. Fire Protection Evaluation 2000-0075, ER 2000-0113).

(b) The combustible loading in Fire Zone 0C216, including transient combustibles, amounts to a low fire load. The in situ combustible loading

GRAND GULF NUCLEAR GENERATING STATION
Updated Final Safety Analysis Report (UFSAR)

in this fire zone amounts to less than a 15-minute fire duration (Ref. Calculation MC-QSP64-86058).

- (c) Fire Zone 0C216 contains safety-related equipment and the following fire protection measures are provided: smoke detection and accessibility to manual hose stations and portable fire extinguishers.
- (d) Fire Zone 0C216 contains only Division II safe shutdown cable and raceway and a fire originating in Fire Zone 0C216 will not affect more than one train of safe shutdown components.

9A.5.40 FIRE AREA 40

9A.5.40.1 FIRE AREA DESCRIPTION

Fire Area 40 consists only of Fire Zone 0C218 (Elev. 111' 0") in the Control Building. The floor, ceiling, and North, South, and East walls of Fire Zone 0C218 are 3-hour rated fire barriers. The West wall is a non-rated exterior barrier (Ref. Architectural Drawing A-0630).

INCLUDED FIRE ZONE	DESCRIPTION
0C218	Pipe Chase, Elev. 111' 0"

9A.5.40.2 SAFE SHUTDOWN EQUIPMENT

Piping

9A.5.40.3 FIRE AREA ANALYSIS

Fire Zone 0C218 does not contain any safe shutdown components with the exception of piping as shown in the microcomputer data base (Ref. FPP-1, Appendix C Data). This fire area is separated from all other fire areas by 3-hour rated fire barriers. The total fire severity in Fire Zone 0C218, with no transient combustibles postulated, amounts to a low fire load. The maximum in situ combustible loading in this fire zone amounts to less than a 15-minute fire duration (Ref. Calculation MC-QSP64-86058). Therefore, a fire occurring in Fire Area 40 will not spread into any other fire area.

GRAND GULF NUCLEAR GENERATING STATION
Updated Final Safety Analysis Report (UFSAR)

9A.5.40.4 FIRE ZONE ANALYSIS

FIRE ZONE 0C218: PIPE CHASE, ELEV. 111' 0"

1. Safety-Related Equipment

Piping

2. Fire Zone Analysis

- (a) Fire Zone 0C218 is located in the Control Building on Elev. 111' 0". The floor, ceiling, and North, South, and East walls of Fire Zone 0C218 are 3-hour rated fire barriers. The West wall is a non-rated exterior barrier (Ref. Architectural Drawing A-0630).
- (b) The combustible loading in Fire Zone 0C218, with no transient combustibles postulated, amounts to a low fire load. The sole contributor to this combustible loading is the concrete joint sealant in the walls of the fire zone. The in situ combustible loading in this fire zone amounts to less than a 15-minute fire duration (Ref. Calculation MC-QSP64-86058).
- (c) Fire Zone 0C218 is totally sealed with only limited access through a removable 24" x 21.25" hatch (Ref. MCP 89/1015, Rev. 0). The pipe chase contains only safe shutdown/safety-related piping; therefore, active fire protection measures are neither provided or required.
- (d) Fire Zone 0C218 contains only safe shutdown piping and is separated from all other fire areas by 3-hour fire barrier. The operation of the safe shutdown system associated with the piping in the fire zone would not be adversely affected by the postulated fire duration (Ref. Fire Protection Evaluation 87/0005).

GRAND GULF NUCLEAR GENERATING STATION
Updated Final Safety Analysis Report (UFSAR)

9A.5.41 FIRE AREA 41

9A.5.41.1 FIRE AREA DESCRIPTION

Fire Area 41 consists solely of Fire Zone 0C307 (Elev. 133' 0") in the Control Building. For Fire Zone 0C307, the West wall is a 2-hour rated fire barrier which is an exterior wall of the Control Building. The North, South, and East walls, and the floor and ceiling are 3-hour rated fire barriers (Ref. Architectural Drawing A-0630).

INCLUDED FIRE ZONE	DESCRIPTION
0C307	Electrical Space, Elev. 133' 0"

9A.5.41.2 SAFE SHUTDOWN EQUIPMENT

Division II

9A.5.41.3 FIRE AREA ANALYSIS

Fire Zone 0C307 contains only Division II safe shutdown cable and raceway, as shown on the microcomputer data base (Ref. FPP-1, Appendix C Data). Since this fire area contains only Division II safe shutdown components and is separated from the remainder of the Control Building by 3-hour rated fire barriers, Fire Area 41 fully complies with Appendix R requirements. Therefore, in the event of a fire in Fire Area 41, safe shutdown capability would be maintained by separate Division I safe shutdown equipment. The total fire severity in Fire Zone 0C307, including transient combustibles, amounts to a high fire load. The maximum in situ combustible loading in this fire zone amounts to less than a 180-minute fire duration (Ref. Calculation MC-QSP64-86058). Therefore, a fire occurring in Fire Area 41 will not spread into any other fire area.

9A.5.41.4 FIRE ZONE ANALYSIS

FIRE ZONE 0C307: ELECTRICAL SPACE, ELEV. 133' 0"

1. Safety-Related Equipment
Electrical Cable and Raceway
2. Fire Zone Analysis

GRAND GULF NUCLEAR GENERATING STATION
Updated Final Safety Analysis Report (UFSAR)

- (a) Fire Zone 0C307 is located in the Control Building on Elev. 133' 0". The ceiling, floor, and the North, South, and East walls are 3-hour rated fire barriers. The West wall, which is an exterior wall, is a 2-hour rated fire barrier (Ref. Architectural Drawing A-0630).
- (b) The combustible loading in Fire Zone 0C307, including transient combustibles, amounts to a high fire load. The major contributor to this combustible loading is the electrical cable present in the room. The in situ combustible loading in Fire Zone 0C307 amounts to less than a 180-minute fire duration (Ref. Calculation MC-QSP64-86058).
- (c) Fire Zone 0C307 contains safety-related equipment and the following fire protection measures are provided: smoke detection and accessibility to manual hose streams and portable fire extinguishers.
- (d) Since Fire Zone 0C307 contains only Division II safe shutdown cable and raceway, a fire in Fire Zone 0C307 will not affect more than one train of safe shutdown components.

9A.5.42 FIRE AREA 42

9A.5.42.1 FIRE AREA DESCRIPTION

- (a) Fire Area 42 consists of the Fire Zones tabulated below, in the listing of Included Fire Zones on elevations 133' 0", 148' 0", 166' 0", and 177' 0" in the Control Building. The floor, ceiling and walls of Fire Area 42 are 3-hour rated fire barriers except as follows: those walls, or portions of walls, that are 2-hour rated exterior barriers; penetration CV-115DA in the South wall of 0C404 and a protected opening in the floor of 0C303 and penetrations CE-200DA, CE-201DA, CE-202DA, CE-205DA, CE-208DA, CE-230DA, CE-259DA, CE-270DA and CE-277DA. Penetration CV-115DA, located in the barrier that separates Fire Area 42 from Fire Area 45, has been evaluated and found to provide adequate

GRAND GULF NUCLEAR GENERATING STATION
Updated Final Safety Analysis Report (UFSAR)

fire separation for the hazards in the area (Ref. Fire Protection Evaluation 2000-0005). The opening in the floor of 0C303 is protected by a steel plate, structural steel fire proofing, and Thermo-Lag design which provides adequate protection for the in situ and transient fire hazards (Ref. Fire Protection Evaluation No. 96-1, Rev. 0). The identified penetrations, while not 3-hour rated, have been evaluated and found acceptable to provide adequate fire separation commensurate with the hazards in the area (Ref. Fire Protection Evaluation 2000-0075, ER 2000-0113). The ceiling of Fire Zone 0C402 has the potential for not having internal conduit fire seal in conduits in penetration CE-80E (Ref. FPE 2003-001, Rev. 0). In addition, those interfaces with Stairs 0C01, 0C02, and Elevator No. 1 are 2-hour rated fire barriers (Ref. Methodology Section 9A.3.0).

- (b) Fire Zones 0C301, 0C302, 0C303, 0C304, 0C305, 0C308, and 0C309 are all located on Elev. 133' 0" in the Control Building. Fire zone 0C302 is separated from the other fire zones by minimum 2-hour rated fire barriers. Fire Zone 0C303 is separated from Fire Zone 0C304 by 3-hour rated barriers, separated from Fire Zone 0C305 by non-rated barriers, and separated from the other fire zones by 2-hour rated barriers.

Fire Zone 0C308 is separated from Fire Zone 0C309 by non-rated barriers and separated from the other fire zones by minimum 2-hour rated barriers. The remaining fire zones on this elevation in Fire Area 42 are separated from each other by minimum 2-hour rated barriers.

- (c) Fire Zones 0C401, 0C402, 0C404, 0C405, 0C406, 0C408, 0C411, and 0C412 are all located on Elev. 148' 0" in the Control Building. Fire Zone 0C402 is separated from the other fire zones on this elevation in Fire Area 42 by minimum 2-hour rated barriers with the following penetration exceptions: CE-200DA, CE-201DA, CE-202DA, CE-205DA, CE-208DA, CE-230DA, CE-270DA and CE-

GRAND GULF NUCLEAR GENERATING STATION
Updated Final Safety Analysis Report (UFSAR)

277DA. The identified penetrations, while not 3-hour rated, have been evaluated and found acceptable to provide adequate fire separation commensurate with the hazards in the area (Ref. Fire Protection Evaluation 2000-0075, ER 2000-0113). The remaining fire zones on this elevation in Fire Area 42 are separated from each other by non-rated barriers, 2-hour rated barriers, or 3-hour rated barriers. The fire zones on Elev. 148' 0" can communicate with the fire zones on Elev. 133' 0" only through the non-rated ceiling in 0C304 (the floor of 0C412).

- (d) Fire Zones 0C406A, 0C412A, 0C507C, 0C518A, 0C603B, and 0C613A form two HVAC chases that extend from Elev. 148' 0" to 177' 0". These fire zones are separated from all other fire zones in Fire Area 42 by non-rated barriers. Fire Zone 0C612 is an extension of the vertical electrical space formed by 0C304 and 0C412. Except the ceiling of Fire Zone 0C612 which is a 3-hour rated fire barrier and has the potential for not having internal conduit fire seal in conduits penetration CE-37G (Ref. FPE 2003-001, Rev. 0).

INCLUDED FIRE ZONES	DESCRIPTION
0C301	Passage, Elev. 133' 0"
0C302	HVAC Equipment Room, Elev. 133' 0"
0C303	HVAC Equipment Room (Unit 2) Elev. 133' 0"
0C304	Electrical Space (Unit 2), Elev. 133' 0"
0C305	Electrical Space (Unit 2), Elev. 133' 0"
0C308	Corridor, Elev. 133' 0"
0C309	Lobby, Elev. 133' 0"
0C401	Corridor, Elev. 148' 0"
0C402	Lower Cable Spreading Room, Elev. 148' 0"
0C404	Unit 1 Support Area, Elev. 148' 0"
0C405	Unit 1 Support Area, Elev. 148' 0"
0C406	Unit 1 Support Area, Elev. 148' 0"
0C406A	HVAC Chase (Unit 2), Elev. 148' 0"
0C408	Corridor, Elev. 148' 0"
0C411	Unit 1 Support Area, Elev. 148' 0"
0C412	Electrical Space (Unit 2), Elev. 148' 0"
0C412A	HVAC Chase (Unit 2), Elev. 148' 0"
0C507C	HVAC Chase (Unit 2), Elev. 166' 0"
0C518A	HVAC Chase (Unit 2), Elev. 166' 0"

GRAND GULF NUCLEAR GENERATING STATION
Updated Final Safety Analysis Report (UFSAR)

0C603B	HVAC Chase (Unit 2), Elev. 177' 0"
0C612	Electrical Space (Unit 2), Elev. 166' 0" to 177' 0"
0C613A	HVAC Chase (Unit 2), Elev. 166' 0" and 177' 0"

9A.5.42.2 SAFE SHUTDOWN EQUIPMENT

Division I and II

9A.5.42.3 FIRE AREA ANALYSIS

- (a) Fire Zones 0C301, 0C305, 0C309, 0C404, 0C405, 0C406, 0C408, 0C411, 0C412A, 0C507C, and 0C603B do not contain any safe shutdown equipment. Fire Zones 0C302, 0C303, 0C401 and 0C402 contain both Division I and Division II safe shutdown equipment, cable, and raceway; Fire Zones 0C304, 0C412 and 0C612 contain Division II safe shutdown cable and raceway as shown in the microcomputer database (Ref FPP-1, Appendix C Data). Fire Zones 0C406A, 0C518A, and 0C613A contain safe shutdown ductwork.
- (b) Fire Zones 0C302, 0C303, and 0C308 are situated in the Control Building (Elev. 133' 0") as a group, each containing both Division I and II safe shutdown equipment, cable, and raceway. All three fire zones are separated from each other by 2-hour rated fire barriers.
- (c) Fire Zone 0C302 contains both Division I Standby Service Water System (P41) and Division II Residual Heat Removal (E12) safe shutdown cable and raceway. All Division I P41 cable and raceway are provided with 1-hour rated fire barriers (fire wrapping) and a manually actuated deluge sprinkler system protects the control room standby fresh air unit located in this zone. The manually actuated deluge sprinkler system which protects the control room standby fresh air units in 0C302 provides a level of protection which is commensurate with the hazards in the fire zone (Ref. Fire Protection Engineering Evaluation No. 96-3). It is not credible that a fire could develop outside the control room standby fresh air unit and spread

GRAND GULF NUCLEAR GENERATING STATION
Updated Final Safety Analysis Report (UFSAR)

beyond the point of origin due to the low combustible loading and the type and arrangement of the combustibles in the fire zone. Therefore, the partial sprinkler system described above will provide a level of protection commensurate with the fire hazards present the zone.

- (d) Fire Zones 0C302 and 0C303 both contain Division I and Division II safeguard switchgear and battery room ventilation (Z77) safe shutdown components. A portion of both Division I and II safe shutdown (Z77) cable and raceway in 0C302 are provided with 1-hour rated fire barriers. The Z77 system, which consist of both Unit 1 and Unit 2 (dedicated for Unit 1 operation) equipment, is designed to operate with two supply air handling units (AHU), two exhaust fans (EF), and the corresponding ductwork, dampers, etc. A total of four AHU/EF trains exist. A minimum of two trains are required for proper ventilation. There are two complete sets of equipment in 0C302 and two complete sets in 0C303. The Z77 ductwork does not cross the 0C302/0C303 room boundary.
- (e) If a fire were to occur in either 0C302 or 0C303, the Z77 equipment in that fire zone could be disabled, but the power supplies would not be affected. The Z77 equipment in the other fire zone (0C302 or 0C303) would still be operational. As previously indicated, a minimum of two trains of AHU/EF are required to provide proper ventilation for the safeguard switchgear and battery rooms. The logic associated with the Z77 system permits manually initiated operation using the undamaged equipment and cable and raceway located in the other fire zone.
- (f) Therefore, two complete sets of Z77 equipment will be available to provide proper ventilation to the safeguard switchgear and battery rooms should a fire occur in either 0C302 or 0C303. The low combustible loading in 0C302 and 0C303 in conjunction with the manual deluge system protecting the control room standby fresh air

GRAND GULF NUCLEAR GENERATING STATION
Updated Final Safety Analysis Report (UFSAR)

unit in 0C302, and the 2-hour fire barrier between the rooms precludes the spread of a fire from one zone to the other. Therefore, for the purpose of evaluating the Z77 system redundancies, it is only necessary to consider Z77 equipment in one fire zone that could affect the Z77 equipment located in the other zones. This equipment consists only of Z77 cable and raceway in 0C302 that affects Z77 equipment in 0C303. This cable and raceway has been provided with 1-hour rated fire barriers and partial suppression, as described above, in 0C302. If a fire were to occur in either Fire Zone 0C302 or 0C303, both Division I and Division II Z77 safe shutdown equipment would be affected. However, fire protection measures as described above and the appropriate system logic will permit at least two trains of Z77 equipment (both Division I and Division II components) to function.

- (g) Fire Zone 0C308 contains both Division I and Division II safe shutdown cable and raceway. All of the Division I safe shutdown cable and raceway (except Division I and Division II Control Room HVAC Z51) are provided with 1-hour rated fire barriers and automatic suppression is provided throughout the zone. Fire Zone 0C308 is separated from 0C302 and 0C303 by 2-hour fire barriers, and all three zones have a low total combustible loading. Therefore, a fire originating in any one of these three zones will not affect, or propagate to affect, more than one train of safe shutdown.

- (h) Fire Zone 0C402 contains both Division I and Division II redundant safe shutdown equipment. However, adequate fire protection measures, such as the protection of Division I safe shutdown components (except Division I and Division II Control Room HVAC Z51) with 1-hour rated fire barriers, total coverage with an automatic carbon dioxide suppression system, total coverage by an automatic sprinkler system, and low combustible loading, ensure that a least one train of safe shutdown components remains free

GRAND GULF NUCLEAR GENERATING STATION
Updated Final Safety Analysis Report (UFSAR)

from fire damage. Also, unprotected safe shutdown components in 0C302, 0C303, or 0C308 are separated by more than 50 feet of horizontal distance and 2-hour rated fire barriers. Therefore, a fire originating in 0C302, 0C303, 0C308, or 0C402 will not propagate into the other zones. Also, due to the 2-hour rated fire barriers, low combustible loading (less than a 75-minute fire duration), and automatic carbon dioxide suppression system, a fire originating in Fire Zone 0C402 will not spread to both 0C302 and 0C303 to affect more than one train of safe shutdown.

- (i) Fire Zones 0C302, 0C303, 0C308, 0C401, and 0C402 contain safe shutdown equipment, cables and raceway for both Division I and Division II trains of Control Room HVAC (Z51); cables and raceway for the Division II train are also located in Fire Zones 0C304, 0C412 and 0C612. While important to safe shutdown, a loss of cooling will not result in temperatures that disable components on the success path required for hot shutdown following a fire in this area per GGNS-EE-11-00001 (FPP-1)
- (j) The remaining fire zones (0C301, 0C305, 0C309, 0C404, 0C405, 0C406, 0C408, 0C411, 0C412A, 0C507C, and 0C603B) do not contain any safe shutdown components and components on the success path required for hot shutdown following a fire in this area located in Fire Zones 0C302, 0C303, 0C308, and 0C402 are adequately protected. Therefore, a fire originating in any of these zones will not affect more than one train of safe shutdown.
- (k) Fire Zones 0C406A, 0C518 and 0C613A only contain safe shutdown ductwork and based on the postulated fire duration of the zones, operation of the safe shutdown systems would not be adversely affected.

GRAND GULF NUCLEAR GENERATING STATION
Updated Final Safety Analysis Report (UFSAR)

- (l) Although the fire protection provided in Fire Area 42 does not strictly comply with the requirements of Appendix R, the fire protection measures provided, in the form of 1-hour fire barriers (fire wrapping), 2-hour rated fire barriers (walls), manual and automatic fire suppression systems, and manual fire protection measures, are more than adequate to ensure that at least one train of safe shutdown components remains free of fire damage.

- (m) The postulated fire with the greatest severity in Fire Area 42 occurs in Fire Zone 0C304. The total fire severity in Fire Zone 0C304, including transient combustibles, amounts to a moderate fire load. The maximum in situ combustible loading in Fire Zone 0C304 amounts to less than a 90-minute fire duration (Ref. Calculation MC-QSP64-86058). Fire Area 42 is separated from all other fire areas by 3-hour rated fire barriers except the ceiling of Fire Zone 0C402 that conduits in penetration may not be sealed internally for fire/smoke on the 0C609 side of the barrier of Fire Area 52 (Ref. FPE 2003-001, Rev. 0), and a fire occurring in this fire area will not spread into any other fire area.

9A.5.42.4 FIRE ZONE ANALYSES

- a. FIRE ZONE 0C301: PASSAGE, ELEV. 133' 0"
 - 1. Safety-Related Equipment
None
 - 2. Fire Zone Analysis
 - (a) Fire Zone 0C301 is located in the Control Building on Elev. 133' 0". For Fire Zone 0C301, the East wall, floor, and ceiling are 3-hour rated fire barriers. The North, South, and West walls are 2-hour rated fire barriers (Ref. Architectural Drawing A-0630).

GRAND GULF NUCLEAR GENERATING STATION
Updated Final Safety Analysis Report (UFSAR)

- (b) The combustible loading in Fire Zone 0C301, including transient combustibles, amounts to a low fire load. The in situ combustible loading in Fire Zone 0C301 amounts to less than a 15-minute fire duration (Ref. Calculation MC-QSP64-86058).
- (c) The following fire protection measures are provided for Fire Zone 0C301: accessibility to manual hose streams and portable fire extinguishers.
- (d) Fire Zone 0C301 does not contain any safe shutdown components. Therefore, a fire originating in this fire zone will not affect either train of safe shutdown. However, this fire zone has several combinations of adjacency with other fire zones within this fire area. An adjacency discussion is provided in the fire area analysis for Fire Area 42.

b. FIRE ZONE 0C302: HVAC EQUIPMENT ROOM, ELEV. 133' 0"

1. Safety-Related Equipment

Electrical Cable and Raceway
Control Room Standby Fresh Air Unit
Control Room A/C Unit
Safeguard Switchgear and Battery Room Air Handling Units
Safeguard Switchgear and Battery Room Exhaust Fans

2. Fire Zone Analysis

- (a) Fire Zone 0C302 is located in the Control Building on Elev. 133' 0". For Fire Zone 0C302, the South, portions of the East and West walls, and the floor and ceiling are 3-hour rated fire barriers. All remaining zone boundaries are 2-hour rated fire barriers (Ref. Architectural Drawing A-0630).
- (b) The combustible loading in Fire Zone 0C302, including transient combustibles, amounts to a low fire load. The major contributors to this combustible loading are the electrical cables

GRAND GULF NUCLEAR GENERATING STATION
Updated Final Safety Analysis Report (UFSAR)

and thermo-lag materials present in the zone. Approximately 95 percent of the combustible loading in this fire zone is from Thermo-Lag. The in situ combustible loading in Fire Zone 0C302 amounts to less than a 60-minute fire duration (Ref. Calculation MC-QSP64-86058).

- (c) Fire Zone 0C302 contains safety-related equipment and the following fire protection measures are provided: manually initiated deluge system to protect the filters (charcoal filter media is removed per Ref. ER-GG-2001-0315-000, Rev. 0) of the control room standby fresh air unit, fire detection system in the control room standby fresh air unit, area smoke detection, and accessibility to manual hose streams and portable fire extinguishers.
- (d) Fire Zone 0C302 contains both Division I Standby Service Water System (P41) and Division II Residual Heat Removal (E12) system safe shutdown cable and raceway. However, the Division I P41 system cable and raceway have been provided with 1-hour rated fire barriers.
- (e) Fire Zone 0C302 also contains redundant Z77 system safe shutdown components, which are not functionally redundant to any of the systems discussed above. Those Z77 system components that are functionally redundant to Z77 components in 0C303 are provided with 1-hour rated fire barriers.
- (f) The Z77 system is designed to operate with two supply air handling units (AHU), two exhaust fans (EF), and the corresponding ductwork, dampers, etc. This equipment is located in Fire Zones 0C302 and 0C303. Both Unit 1 and Unit 2 designated equipment is required to provide ventilation to the safeguard switchgear and battery rooms which are required for safe shutdown of Unit 1. Four air handling unit/exhaust fan trains exist (a minimum of two trains are required for proper ventilation). There are two complete trains in 0C302 and two

GRAND GULF NUCLEAR GENERATING STATION
Updated Final Safety Analysis Report (UFSAR)

complete trains in 0C303. In addition, Z77 ductwork does not cross the 0C302/0C303 boundary.

- (g) If a fire were to occur in either 0C302 or 0C303, the Z77 trains in that fire zone would be disabled; but the Z77 trains in the other fire zone (0C302 or 0C303) would still be operational and, as indicated above, a minimum of two trains of AHU/EF are required to provide proper ventilation for the safeguard switchgear and battery rooms. Also, the logic associated with the Z77 system permits operation using only the equipment located in one room. Therefore, enough Z77 equipment would be available to provide proper ventilation to the safeguard switchgear and battery room should a fire occur in either 0C302 or 0C303.
- (h) All redundant cable and raceway, with regard to the system requirements of Z77 and any other functional redundancies, (except Division I and Division II Control Room HVAC Z51) are provided with 1-hour rated fire barriers (fire wrapping). In addition, the manually actuated deluge sprinkler system which protects the control room standby fresh air units in 0C302 provides a level of protection which is commensurate with the hazards in the fire zone (Ref. Fire Protection Engineering Evaluation No. 96-3). It is not credible that a fire could develop outside the control room standby fresh air unit and spread beyond the point of origin due to the low combustible loading and the type and arrangement of the combustibles in the fire zone. Therefore, the partial sprinkler system described above will provide a level of protection commensurate with the fire hazards present the zone. Additionally, the charcoal filter media is removed from Control Room Standby Fresh Air Unit per ER-GG-2001-0315-000, Rev. 0 which further reduces the combustible loading in Fire Zone 0C302.

GRAND GULF NUCLEAR GENERATING STATION
Updated Final Safety Analysis Report (UFSAR)

- (i) Fire Zone 0C302 also contains safe shutdown equipment, cables and raceway for Division I and Division II trains of Control Room HVAC (Z51). While important to safe shutdown, a loss of cooling will not result in temperatures that disable components on the success path required for hot shutdown following a fire in this area.
- (j) Therefore, a fire originating in this fire zone will not affect more than one train of safe shutdown. However, this fire zone has several combinations of adjacency with other fire zones within this fire area. An adjacency discussion is provided in the fire area analysis for Fire Area 42.

c. FIRE ZONE 0C303: HVAC EQUIPMENT RM (UNIT 2), ELEV. 133' 0"

1. Safety-Related Equipment

Electrical Cable and Raceway
Control Room Standby Fresh Air Unit
Control Room A/C Unit
Safeguard Switchgear and Battery Room Air Handling Units
Safeguard Switchgear and Battery Room Exhaust Fans

2. Fire Zone Analysis

- (a) Fire Zone 0C303 is located in the Control Building on Elev. 133' 0". For Fire Zone 0C303, the North, a portion of the West, and East wall, and the ceiling from top side or the floor above are 3-hour rated fire barriers. The ceiling from bottom side or ceiling of Fire Zone 0C303 is evaluated to withstand the hazard (Ref. Fire Protection Evaluation No. 2005-001, Rev. 0). Approximately $\frac{1}{4}$ of the structural steel supporting ceiling on the East side of Room 0C303 above Control Room Standby Fresh Air Unit is fireproofed and $\frac{3}{4}$ on the West side has no fireproofing material. However, the charcoal filter media which accounted for more than 82 percent of the original in situ combustible loading in Fire Zone 0C303 is removed from Control Room Standby Fresh Air Unit per ER-GG-

GRAND GULF NUCLEAR GENERATING STATION
Updated Final Safety Analysis Report (UFSAR)

2001-0315-000, Rev. 0. The floor is a 3-hour rated barrier except for a protected opening between 0C303 and 0C217. This opening is protected by a steel plate, structural steel fire proofing, and Thermo-Lag design which provides adequate protection for in situ and transient fire hazards (Ref. Fire Protection Evaluation No. 96-1, Rev. 0). The walls separating Fire Zone 0C303 from Fire Zone 0C305 are non-rated. The South and remaining portions of the West walls are 2-hour rated fire barriers (Ref. Architectural Drawing A-0630).

- (b) The combustible loading in Fire Zone 0C303, including transient combustibles, amounts to a low fire load. The major contributors to this combustible loading are Thermo-Lag and the electrical cable insulation. Thermo-Lag fire barrier material is utilized in this fire zone and is more than 52 percent of the total combustible loading. The in situ combustible loading in Fire Zone 0C303 amounts to less than a 15-minute fire duration (Ref. Calculation MC-QSP64-86058).
- (c) Fire Zone 0C303 contains safety-related equipment and the following fire protection measures are provided: deluge system to protect the filters (charcoal filter media is removed per Ref. ER-GG-2001-0315-000, Rev. 0) of the control room standby fresh air unit, fire detection system in the control room standby fresh air unit, area smoke detection, and accessibility to manual hose streams and portable fire extinguishers.
- (d) Fire Zone 0C303 contains both Division I and II Z77 system safe shutdown cable and raceway. For a description of the Z77 system redundancy evaluation, refer to the fire zone analysis for Fire Zone 0C302. Fire Zone 0C303 also contains safe shutdown equipment, cables and raceway for Division I and Division II trains of Control Room HVAC (Z51). While important to safe shutdown, a loss of cooling will not result in

GRAND GULF NUCLEAR GENERATING STATION
Updated Final Safety Analysis Report (UFSAR)

temperatures that disable components on the success path required for hot shutdown following a fire in this area per GGNS-EE-11-00001 (FPP-1). Therefore, should a fire occur in 0C303, the safe shutdown capability would not be affected. However, this fire zone has several combinations of adjacency with other fire zones within this fire area. An adjacency discussion is provided in the fire area analysis for Fire Area 42.

d. FIRE ZONE 0C304: ELECTRICAL SPACE (UNIT 2), ELEV. 133' 0"

1. Safety-Related Equipment

Electrical Cable and Raceway

2. Fire Zone Analysis

- (a) Fire Zone 0C304 is located in the Control Building on Elev. 133' 0". In Fire Zone 0C304, the North, East and South walls and the floor are 3-hour rated fire barriers, while the West wall is a 2-hour rated exterior wall. The ceiling of this zone is a non-rated barrier (Ref. Architectural Drawing A-0630).
- (b) The combustible loading in Fire Zone 0C304, including transient combustibles, amounts to a moderate fire load. The major contributor to this combustible loading is the electrical cable postulated for Unit 2 in the zone. The in situ combustible loading in Fire Zone 0C304 amounts to less than a 90-minute fire duration (Ref. Calculation MC-QSP64-86058).
- (c) Fire Zone 0C304 contains safety-related equipment and the following fire protection measures are provided: smoke detection and accessibility to manual hose streams and portable fire extinguishers.
- (d) Fire Zone 0C304 contains safe shutdown cables and raceway for Division II Control Room HVAC (Z51). While important to safe shutdown, a loss of cooling will not result in temperatures that disable components on the success path required

GRAND GULF NUCLEAR GENERATING STATION
Updated Final Safety Analysis Report (UFSAR)

for hot shutdown following a fire in this area per GGNS-EE-11-00001 (FPP-1). However, this fire zone has several combinations of adjacency with other fire zones within this fire area. An adjacency discussion is provided in the fire area analysis for Fire Area 42.

- e. FIRE ZONE 0C305: ELECTRICAL SPACE (UNIT 2), ELEV. 133' 0"
 - 1. Safety-Related Equipment
 - None
 - 2. Fire Zone Analysis
 - (a) Fire Zone 0C305 is located in the Control Building on Elev. 133' 0". For Fire Zone 0C305, the North, South, and East walls are non-rated barriers. The floor and ceiling are 3-hour rated fire barriers, while the West wall is a 2-hour rated exterior barrier. (Ref. Architectural Drawing A-0630).
 - (b) The combustible loading in Fire Zone 0C305, which consists solely of transient combustibles, amounts to a low fire load (Ref. Calculation MC-QSP64-86058).
 - (c) Fire Zone 0C305 does not contain any safety-related components and the following fire protection measures are provided: smoke detection and accessibility to manual hose streams and portable fire extinguishers.
 - (d) Fire Zone 0C305 does not contain any safe shutdown components. Therefore, a fire originating in this fire zone will not affect, or propagate to affect, more than one train of safe shutdown as discussed in the fire area analysis. However, this fire zone has several combinations of adjacency with other fire zones within this fire area. An adjacency discussion is provided in the fire area analysis for Fire Area 42.

- f. FIRE ZONE 0C308: CORRIDOR, ELEV. 133' 0"

GRAND GULF NUCLEAR GENERATING STATION
Updated Final Safety Analysis Report (UFSAR)

1. Safety-Related Equipment
Electrical Cable and Raceway
 2. Fire Zone Analysis
 - (a) Fire Zone 0C308 is located in the Control Building on elev. 133' 0". For Fire Zone 0C308, the ceiling, floor, and a portion of the south wall separating Fire Zone 0C308 from Fire Zone 0C306 are 3-hour rated fire barriers. The remaining zone boundaries are 2-hour rated fire barriers, with the exception of Door 0C312 which is non-rated (Ref. Architectural Drawing A-0630).
 - (b) The combustible loading in Fire Zone 0C308, including transient combustibles, amounts to a low fire load. Thermo-Lag fire barrier material is utilized in this fire zone and is approximately 35 percent of the total combustible loading. The in situ combustible loading in Fire Zone amounts to less than a 30-minute fire duration (Ref. Calculation MC-QSP64-86058).
 - (c) Fire Zone 0C308 contains safety-related components and the following fire protection measures are provided: automatic sprinklers, smoke detection and accessibility to manual hose streams and portable fire extinguishers.
 - (d) Fire Zone 0C308 also contains safe shutdown equipment, cables and raceway for Division I and Division II trains of Control Room HVAC (Z51). While important to safe shutdown, a loss of cooling will not result in temperatures that disable components on the success path required for hot shutdown following a fire in this area per GGNS-EE-11-0001 (FPP-1).
 - (e) Fire Zone 0C308 contains both Division I and II safe shutdown cable and raceway. All of the functionally redundant Division I safe shutdown cable and raceway (except Division I and Division II Control Room HVAC Z51) is provided with 1-hour rated fire barriers (fire wrapping). This protection, along with the automatic
-

GRAND GULF NUCLEAR GENERATING STATION
Updated Final Safety Analysis Report (UFSAR)

sprinklers and smoke detection provided throughout the zone, is more than adequate to ensure that a least one train of safe shutdown components remains free of fire damage in Fire Zone 0C308. In addition, this fire zone has several combinations of adjacency with other fire zones within this fire area. An adjacency discussion is provided in the fire area analysis for Fire Area 42.

g. FIRE ZONE 0C309: LOBBY, ELEV. 133' 0"

1. Safety-Related Equipment

None

2. Fire Zone Analysis

- (a) Fire Zone 0C309 is located in the Control Building on Elev. 133' 0". The floor, ceiling, and Door 0C312 of Fire Zone 0C309 are non-rated fire barriers, while the remaining zone boundaries are 2-hour fire rated barriers. It should be noted that the floor, ceiling, and South and West walls are also exterior surfaces (Ref. Architectural Drawing A-0630).
- (b) The combustible loading in Fire Zone 0C309, including transient combustibles, amounts to a low fire load. The in situ combustible loading in Fire Zone 0C309 amounts to less than a 30-minute fire duration (Ref. Calculation MC-QSP64-86058).
- (c) Fire Zone 0C309 does not contain any safety-related components and the following fire protection measure is provided: accessibility to manual hose streams and portable fire extinguishers.
- (d) Fire Zone 0C309 does not contain any safe shutdown components. Therefore, a fire originating in this fire zone will not affect either train of safe shutdown. However, this fire zone has several combinations of adjacency

GRAND GULF NUCLEAR GENERATING STATION
Updated Final Safety Analysis Report (UFSAR)

with other fire zones within this fire area. An adjacency discussion is provided in the fire area analysis for Fire Area 42.

- h. FIRE ZONE 0C401: CORRIDOR, ELEV. 148' 0"
 - 1. Safety-Related Equipment
 - Electrical Cable and Raceway
 - 2. Fire Zone Analysis
 - (a) Fire Zone 0C401 is located in the Control Building on Elev. 148' 0". For Fire Zone 0C401, the East and the section of the West wall adjacent to Fire Zone 0C403 (Fire Area 45), floor, and ceiling are 3-hour rated fire barriers. The South wall is a 2-hour rated fire barrier except penetration CE-200DA located in the South wall. Penetration CE-200DA is installed in a configuration not bound by supporting fire endurance testing and is therefore not considered 3-hour rated. However, CE-200DA had been evaluated and found acceptable to provide adequate fire separation commensurate with the hazards in the area (Ref. Fire Protection Evaluation 2000-0075, ER2000-0113). The North wall and that section of the West wall adjacent to Fire Zone 0C404 are non-rated barriers (Ref. Architectural Drawing A-0630).
 - (b) The combustible loading in Fire Zone 0C401, including transient combustibles, amounts to a low fire load. The major contributor to this combustible loading is the electrical cable present in the zone. The in situ combustible loading amounts to less than a 30-minute fire duration (Ref. Calculation MC-QSP64-86058).
 - (c) Fire Zone 0C401 contains safety-related components and the following fire protection measures are provided: smoke detection and accessibility to manual hose streams and portable fire extinguishers.

GRAND GULF NUCLEAR GENERATING STATION
Updated Final Safety Analysis Report (UFSAR)

- (d) Fire Zone 0C401 contains safe shutdown equipment, cables and raceway for Division I and Division II trains of Control Room HVAC (Z51). While important to safe shutdown, a loss of cooling will not result in temperatures that disable components on the success path required for hot shutdown following a fire in this area per GGNS-EE-11-00001 (FPP-1). However, this fire zone has several combinations of adjacency with other fire zones within this fire area. An adjacency discussion is provided in the fire area analysis for Fire Area 42.

- i. FIRE ZONE 0C402: LOWER CABLE SPREADING RM, ELEV. 148' 0"
 - 1. Safety-Related Equipment
 - Electrical Cable and Raceway

 - 2. Fire Zone Analysis
 - (a) Fire Zone 0C402 is located in the Control Building on Elev. 148' 0". The walls between this zone and Fire Zones 0C401, 0C408, and Stair 0C02, as well as the portion of the West boundary which is an exterior wall, are 2-hour rated fire barriers with the exception of penetration CE-200DA located in the North wall separating this zone from 0C401. The floor, ceiling, and all remaining walls are 3-hour rated fire barriers with the exception of penetrations CE-201DA, CE-202DA, CE-205DA, CE-208DA, CE-230DA, CE-270DA and CE-277DA. The identified penetration exceptions are installed in configurations not bound by supporting fire endurance testing and are therefore not considered 3-hour rated. However, they have been evaluated and found acceptable to provide adequate fire separation commensurate with the hazards in the area (Ref. Fire Protection Evaluation 2000-0075, ER 2000-0113, Architectural Drawing A-0630). In addition, the ceiling of Fire Zone 0C402 has the potential for not having internal conduit fire seal in conduits in penetration CE-80E (Ref. FPE 2003-001, Rev. 0).

GRAND GULF NUCLEAR GENERATING STATION
Updated Final Safety Analysis Report (UFSAR)

- (b) The combustible loading in Fire Zone 0C402, including transient combustibles, amounts to a moderate fire load. The major contributor to this combustible loading is the electrical cable present in the zone. Thermo-Lag fire barrier material is utilized in this fire zone and is less than 10 percent of the total combustible loading. The in situ combustible loading in Fire Zone 0C402 amounts to less than a 75-minute fire duration (Ref. Calculation MC-QSP64-86058).
- (c) Fire Zone 0C402 contains safety-related equipment and the following fire protection measures are provided: automatic carbon dioxide suppression system, automatic sprinkler system, smoke detection, accessibility to manual hose streams and portable fire extinguishers.
- (d) Fire Zone 0C402 also contains safe shutdown equipment, cables and raceway for Division I and Division II trains of Control Room HVAC (Z51). While important to safe shutdown, a loss of cooling will not result in temperatures that disable components on the success path required for hot shutdown following a fire in this area per GGNS-EE-11-00001 (FPP-1).
- (e) Fire Zone 0C402 contains both Division I and II safe shutdown components. All of the Division I cable and raceway (except Division I and Division II Control Room HVAC Z51) are provided with 1-hour rated fire barriers. Therefore, a fire originating in this fire zone will not affect more than one train of safe shutdown. However, this fire zone has several combinations of adjacency with other fire zones within this fire area. An adjacency discussion is provided in the fire area analysis for Fire Area 42.

Fire Zone 0C402 also contains RHR Heat Exchanger 'A' & 'B' inlet temperature indication circuits utilized for alternate suppression pool temperature monitoring in the event of a fire in Containment (as discussed in Fire Area 25, Section 9A.5.25).

GRAND GULF NUCLEAR GENERATING STATION
Updated Final Safety Analysis Report (UFSAR)

- j. FIRE ZONE 0C404: UNIT 1 SUPPORT AREA, ELEV. 148' 0"
1. Safety-Related Equipment
None
 2. Fire Zone Analysis
 - (a) Fire Zone 0C404 is located in the Control Building on Elev. 148' 0". For Fire Zone 0C404, the floor, ceiling and a portion of the West wall are 3-hour rated fire barriers. The South wall is a 3-hour rated fire barrier with exception of penetration CV-115DA (Ref. Architectural Drawing A-0630). Penetration CV-115AD, which communicates between Fire Zone 0C403 and Fire Zone 0C404, has a nonstandard penetration seal design installed. The penetration seal design employs Kaowool material covered with metal flashing covered with metal flashing on the 0C404 side of the penetration opening. The metal flashing assembly, on the 0C404 side, is covered with structural steel fireproofing material. This arrangement has been evaluated in Fire Protection Evaluation 2000/0005 and determined to provide adequate fire separation for the hazards in the areas based on the following: 1) substantial construction of the non-standard seal installed, 2) Low combustible loading in Fire Zone 0C403 and Moderate combustible loading in 0C404, 3) automatic suppression systems (total flooding Halon 1301) in 0C403, 4) area wide smoke detection in 0C403 and 5) accessibility to manual hose streams and portable extinguishers in 0C403 and 0C404. The South wall, West wall where it interfaces with Fire Zone 0C405A (Fire Area 50), floor and ceiling are 3-hour rated fire barriers. The North, East and the remainder of the West wall are non-rated barriers (Ref. Architectural Drawing A-0630).
 - (b) The combustible loading in Fire Zone 0C404, including transient combustibles, amounts to a low fire load. The in situ combustible loading

GRAND GULF NUCLEAR GENERATING STATION
Updated Final Safety Analysis Report (UFSAR)

in Fire Zone amounts to less than a 60-minute fire duration (Ref. Calculation MC-QSP64-86058).

- (c) The following fire protection measure is provided for Fire Zone 0C404: smoke detection and accessibility to manual hose streams and portable fire extinguishers.
- (d) Fire Zone 0C404 does not contain any safe shutdown components. Therefore, a fire originating in this fire zone will not affect either train of safe shutdown. However, this fire zone has several combinations of adjacency with other fire zones within this fire area. An adjacency discussion is provided in the fire analysis for Fire Area 42.

k. FIRE ZONE 0C405: UNIT 1 SUPPORT AREA, ELEV. 148'-0"

1. Safety-related Equipment

Electrical Cable and Raceway

2. Fire Zone Analysis

- (a) Fire Zone 0C405 is located in the Control Building on Elev. 148' 0". The exterior portion of the West wall is a 2-hour rated fire barrier. The boundaries Fire Zone 0C405 shares with Fire Zones 0C404, 0C406, 0C406A, 0C408, 0C411, 0C412 and 0C412A are non-rated barriers. The floor, ceiling, North wall, East wall and the walls adjoining Fire Zone 0C405A (Fire Area 50) are 3-hour rated fire barriers. (Ref. Architectural Drawing A-0630).
- (b) The combustible loading in Fire Zone 0C405, including transient combustibles, amounts to a low fire load. The in situ combustible loading in Fire Zone 0C405 amounts to less than a 30-minute fire duration (Ref. Calculation MC-QSP64-86058).

GRAND GULF NUCLEAR GENERATING STATION
Updated Final Safety Analysis Report (UFSAR)

- (c) Fire Zone 0C405 contains safety-related equipment and the following fire protection measures are provided: automatic sprinkler system, smoke detection and accessibility to manual hose streams and portable fire extinguishers.
- (d) Fire Zone 0C405 does not contain any safe shutdown components, Therefore, a fire originating in this fire zone will not affect either train of safe shutdown. However, this fire zone has several combinations of adjacency with other fire zones within this fire area. An adjacency discussion is provided in the fire area analysis for Fire Area 42.

1. FIRE ZONE 0C406: UNIT 1 SUPPORT AREA, ELEV. 148' 0"

1. Safety Equipment

None

2. Fire Zone Analysis

- (a) Fire Zone 0C406 is located in the Control Building on Elev. 148'-0". The floor and ceiling are 3-hour rated fire barriers. The four walls are non-rated barriers (Ref. Architectural Drawing A-0630).
- (b) The combustible loading in Fire Zone 0C406, including transient combustibles, amounts to a low fire load. The major contributor to this combustible loading is paper in the form of files and books. The in situ combustible loading amounts to less than a 60-minute fire duration (Ref. Calculation MC-QSP64-86058).
- (c) The following fire protection measures are provided for Fire Zone 0C406: smoke detection and accessibility to manual hose streams and portable fire extinguishers.
- (d) Since Fire Zone 0C406 does not contain any safe shutdown components, a fire occurring in Fire Zone 0C406 will not affect either train of safe

GRAND GULF NUCLEAR GENERATING STATION
Updated Final Safety Analysis Report (UFSAR)

shutdown components. However, this fire zone has several combinations of adjacency with other fire zones within this fire area. An adjacency discussion is provided in the fire area analysis for Fire Area 42.

- m. FIRE ZONE 0C406A: HVAC CHASE (UNIT 2), ELEV. 148'-0"
1. Safety-related Equipment
 - Duckwork
 2. Fire Zone Analysis
 - (a) Fire Zone 0C406A is located in the Control Building on Elev. 148' 0". The West wall is a 2-hour rated fire barrier. The floor is a 3-hour rated fire barrier. The ceiling, North, South and East walls are non-rated barriers (Ref. Architectural Drawing A-0630).
 - (b) The combustible loading in Fire Zone 0C406A which consists solely of transient combustibles, amounts to a low fire load (Ref. Calculation MC-QSP64-86058).
 - (c) The following fire protection measure is provided for Fire Zone 0C406A: accessibility to manual hose streams and portable fire extinguishers.
 - (d) Fire Zone 0C406A contains only safe shutdown ductwork. The operation of safe shutdown and safety-related systems associated with the ductwork in this chase would not be adversely affected by the postulated fire duration (Ref. Fire Protection Evaluation 87/0005). However, this fire zone has several combinations of adjacency with other fire zones within this fire area. An adjacency discussion is provided in the fire area analysis for Fire Area 42.
- n. FIRE ZONE 0C408: CORRIDOR, 148' 0"
1. Safety-Related Equipment

GRAND GULF NUCLEAR GENERATING STATION
Updated Final Safety Analysis Report (UFSAR)

Electrical Cable and Raceway

2. Fire Zone Analysis

- (a) Fire Zone 0C408 is located in the Control Building on Elev. 148' 0". The walls between Fire Zone 0C408 and Fire Zone 0C402, as well as the exterior portion of the South wall of 0C408, and the interfaces with Stair 0C01 and elevator No. 1 are 2-hour rated fire barriers. The floor, ceiling, and portions of the South wall separating 0C408 from 0C407 and 0C409 are 3-hour rated fire barriers. The remainder of the walls separating Fire Zone 0C408 from Fire Zones 0C404, 0C406 and 0C406A are non-rated barriers. The East wall separating 0C408 from 0C403 is 3-hour rated with the exception of penetration CE-259DA. Penetration CE-259DA is installed in a configuration not bound by supporting fire endurance testing and therefore not considered 3-hour rated. However, CE-259DA has been evaluated and found acceptable to provide adequate fire separation commensurate with the hazards in the area (Ref. Fire Protection Evaluation 2000-0075, ER 2000-0113, Architectural Drawing A-0630).
- (b) The combustible loading in Fire Zone 0C408, including transient combustibles, amounts to a low fire load. The major contributor to this combustible loading is the electrical cable present in the zone. The in situ combustible loading in Fire Zone 0C408 amounts to less than a 15-minute fire duration (Ref. Calculation MC-QSP64-86058).
- (c) Fire Zone 0C408 contains safety-related equipment and the following fire protection measures are provided: smoke detection and accessibility to manual hose streams and portable fire extinguishers.
- (d) Fire Zone 0C408 does not contain any safe shutdown components. Therefore, a fire originating in this fire zone will not affect either train of safe shutdown. However, this

GRAND GULF NUCLEAR GENERATING STATION
Updated Final Safety Analysis Report (UFSAR)

fire zone has several combinations of adjacency with other fire zones within this fire area. An adjacency discussion is provided in the fire area analysis for Fire Area 42.

- o. FIRE ZONE 0C411: UNIT 1 SUPPORT AREA, ELEV. 148' 0"
 - 1. Safety-Related Equipment

None
 - 2. Fire Zone Analysis
 - (a) Fire Zone 0C411 is located in the Control Building on Elevation 148' 0". The floor and ceiling are 3-hour rated fire barriers. The four walls are non-rated barriers (Ref. Architectural Drawing A-0630).
 - (b) The combustible loading in Fire Zone 0C411, including transient combustibles amounts to a low fire load. The in situ combustible loading in this fire zone amounts to less than a 15-minute fire duration (Ref. Calculation MC-QSP64-86058).
 - (c) Fire Zone 0C411 does not contain any safety-related equipment and the following fire protection measure is provided: accessibility to manual hose streams and portable fire extinguishers.
 - (d) Fire Zone 0C411 does not contain any safe shutdown components. Therefore, a fire originating in this fire zone will not affect either train of safe shutdown. However, this fire zone has several combinations of adjacency with other fire zones within this fire area. An adjacency discussion is provided in the fire area analysis for Fire Area 42.
- p. FIRE ZONE 0C412: ELECTRICAL SPACE (UNIT 2), ELEV. 148' 0"
 - 1. Safety-Related Components

Electrical Cable and Raceway

GRAND GULF NUCLEAR GENERATING STATION
Updated Final Safety Analysis Report (UFSAR)

2. Fire Zone Analysis

- (a) Fire Zone 0C412 is located in the Control Building on Elev. 148' 0". The North wall is a 3-hour rated fire barrier. The West wall is an exterior wall with a 2-hour fire rating. The floor, ceiling and East and south walls are non-rated barriers (Ref. Architectural Drawing A-0630).
- (b) The combustible loading in Fire Zone 0C412, including transient combustibles, amounts to a low fire load. The in situ combustible loading in Fire Zone amounts to less than a 60-minute fire duration (Ref. Calculation MC-QSP64-86058).
- (c) Fire Zone 0C412 contains safety-related components and the following fire protection measures are provided: smoke detection (in 0C304) and accessibility to manual hose streams and portable fire extinguishers.
- (d) Fire Zone 0C412 contains safe shutdown equipment, cables and raceway for Division II Control Room HVAC (Z51). While important to safe shutdown, a loss of cooling will not result in temperatures that disable components on the success path required for hot shutdown following a fire in this area per GGNS-EE-11-00001 (FPP-1). However, this fire zone has several combinations of adjacency with other fire zones within this fire area. An adjacency discussion is provided in the fire area analysis for Fire Area 42.

q. FIRE ZONE 0C412A: HVAC CHASE (UNIT 2), ELEV. 148' 0"

1. Safety-Related Equipment

None

2. Fire Zone Analysis

GRAND GULF NUCLEAR GENERATING STATION
Updated Final Safety Analysis Report (UFSAR)

- (a) Fire Zone 0C412A is located in the Control Building on Elev. 148' 0". The exterior West wall is a 2-hour rated fire barrier. The floor is a 3-hour rated fire barrier. The ceiling, North, South and East walls are non rated barriers (Ref. Architectural Drawing A-0630).
 - (b) The combustible loading in Fire Zone 0C412A, with no transients postulated, amounts a low fire load. The sole contributor to this combustible loading is the concrete joint sealant in the walls. The in situ combustible loading in this fire zone amounts to less than a 15-minute fire duration (Ref. Calculation MC-QSP64-86058).
 - (c) Fire Zone 0C412A is a sealed chase and does not contain any safety-related equipment. Therefore, no active fire protection measures are provided for this fire zone.
 - (d) Fire Zone 0C412A does not contain any safe shutdown components. Therefore, a fire originating in this fire zone will not affect either train of safe shutdown. However, this fire zone has several combinations of adjacency with other fire zones within this fire area. An adjacency discussion is provided in the fire area analysis for Fire Area 42.
- r. FIRE ZONE 0C507C: HVAC CHASE (UNIT 2), ELEV. 166' 0"
- 1. Safety-Related Equipment
 - Ductwork
 - 2. Fire Zone Analysis
 - (a) Fire Zone 0C507C is located in the Control Building on Elev. 166' 0". In Fire Zone 0C507C, the North, South and East walls are 3-hour rated fire barriers. The exterior West wall is a 2-hour rated fire barrier, while the floor and ceiling are non-rated barriers (Ref. Architectural Drawing A-0631).

GRAND GULF NUCLEAR GENERATING STATION
Updated Final Safety Analysis Report (UFSAR)

- (b) There is no transient or in situ combustibile loading postulated for Fire Zone 0C507C (Ref. Calculation MC-QSP64-86058).
 - (c) Fire Zone 0C507C contains only safety-related ductwork and is a totally enclosed HVAC chase. Therefore, no active fire protection measures are provided for this fire zone (Ref. Fire Protection Evaluation 87/0005).
 - (d) Fire Zone 0C507C does not contain any safe shutdown components. Although no combustibile loading is postulated for Fire Zone 0C507C, if a fire were to occur in this fire zone, neither train of safe shutdown components would be affected. In addition, this fire zone has several combinations of adjacency with other fire zones within this fire area. An adjacency discussion is provided in the fire area analysis for Fire Area 42.
- s. FIRE ZONE 0C518A: HVAC CHASE (UNIT 2), ELEV. 166' 0"
- 1. Safety-Related Equipment
 - Ductwork
 - 2. Fire Zone Analysis
 - (a) Fire Zone 0C518A is located in the Control Building on Elev. 166' 0". In Fire Zone 0C518A, the North, South, and East walls are 3-hour rated fire barriers. The West wall is a 2-hour rated fire barrier, while the floor and ceiling are non-rated barriers (Ref. Architectural Drawing A-0631).
 - (b) There is no transient or in situ combustibile loading postulated for Fire Zone 0C518A (Ref. Calculation MC-QSP64-86058).
 - (c) Since Fire Zone 0C518A is essentially inaccessible, has no combustibile loading, and contains only safety-related ductwork, no active fire protection measures are provided for this zone (Ref. Fire Protection Evaluation 87/0005).

GRAND GULF NUCLEAR GENERATING STATION
Updated Final Safety Analysis Report (UFSAR)

- (d) Fire Zone 0C518A contains only safe shutdown ductwork. The operation of the safe shutdown and safety-related systems associated with the ductwork in this chase would not be adversely affected by the postulated fire duration. In addition, this fire zone has several combinations of adjacency with other fire zones within this fire area. An adjacency discussion is provided in the fire area analysis for Fire Area 42.
- t. FIRE ZONE 0C603B: HVAC CHASE (UNIT 2), ELEV. 177' 0"
- 1. Safety-Related Equipment
 - Ductwork
 - 2. Fire Zone Analysis
 - (a) Fire Zone 0C603B is located in the Control Building on Elev. 177' 0". In Fire Zone 0C603B, the ceiling and North, South, and East walls are 3-hour rated fire barriers. The exterior West wall is a 2-hour rated fire barrier, while the floor is a non-rated barrier (Ref. Architectural Drawing A-0631).
 - (b) There is no transient or in situ combustible loading postulated for Fire Zone 0C603B (Ref. Calculation MC-QSP64-86058).
 - (c) Fire Zone 0C603B is a sealed chase and contains only safety-related ductwork. Therefore, no active fire protection measures are provided for this fire zone (Ref. Fire Protection Evaluation 87/0005).
 - (d) Fire Zone 0C603B does not contain any safe shutdown components. Although no combustible loading is postulated for Fire Zone 0C603B, if a fire were to occur in this fire zone, neither train of safe shutdown components would be affected. In addition, this fire zone has several combinations of adjacency with other

GRAND GULF NUCLEAR GENERATING STATION
Updated Final Safety Analysis Report (UFSAR)

fire zones within this fire area. An adjacency discussion is provided in the fire area analysis for Fire Area 42.

u. FIRE ZONE 0C612: ELECTRICAL SPACE (UNIT 2), ELEV. 166' 0" TO 177' 0"

1. Safety-Related Equipment

Electrical Cable and Raceway

2. Fire Zone Analysis

- (a) Fire Zone 0C612 is located in the Control Building on Elev. 166' 0" to 177' 0". In Fire Zone 0C612, the ceiling and the North, South, and East walls are 3-hour rated fire

barriers, except the ceiling may lack internal conduit fire seal in conduits in penetration CE-37G (Ref. FPE 2003- 001, Rev. 0). The exterior West wall is a 2-hour rated fire barrier, while the floor is a non-rated barrier (Ref. Architectural Drawing A- 0631).

- (b) There is no transient or in situ combustibile loading postulated for Fire Zone 0C612 (Ref. Calculation MC-QSP64-86058).

- (c) Fire Zone 0C612 contains safety-related components and the following fire protection measure is provided for this zone: smoke detection (in 0C304) and accessibility to manual hose streams and portable fire extinguishers (from 0C412).

- (d) Fire Zone 0C612 contains safe shutdown cables and raceway for Division II Control Room HVAC (Z51). While important to safe shutdown, a loss of cooling will not result in temperatures that disable components on the success path required for hot shutdown following a fire in this area per GGNS-EE-11-00001 (FPP-1). Although no combustibile loading is postulated for Fire Zone 0C612, if a fire were to occur in this fire

GRAND GULF NUCLEAR GENERATING STATION
Updated Final Safety Analysis Report (UFSAR)

zone, neither train of safe shutdown components would be affected. In addition, this fire zone has several combinations of adjacency with other fire zones within this fire area. An adjacency discussion is provided in the fire area analysis for Fire Area 42.

v. FIRE ZONE 0C613A: HVAC CHASE (UNIT 2), ELEV. 177' 0"

1. Safety-Related Equipment

Ductwork

2. Fire Zone Analysis

- (a) Fire Zone 0C613A is located in the Control Building on Elev. 177' 0". In Fire Zone 0C613A, the North, South and East walls, as well as the ceiling are 3-hour rated fire barriers. The West wall is a 2-hour rated fire barrier. The floor of this zone is a non-rated barrier (Ref. Architectural Drawing A-0631).
- (b) There is no transient or in situ combustibile loading postulated for Fire Zone 0C613A (Ref. Calculation MC-QSP64-86058).
- (c) Since Fire Zone 0C613A is essentially inaccessible, has no combustibile loading, and contains only safety-related ductwork, no active fire protection measures are provided in this zone (Ref. Fire Protection Evaluation 87/0005).
- (d) Fire Zone 0C613A contains only safe shutdown ductwork. The operation of the safe shutdown and safety-related systems associated with the ductwork in this chase would not be adversely affected by the postulated fire duration. In addition, this fire zone has several combinations of adjacency with other fire zones within this fire area. An adjacency discussion is provided in the fire area analysis for Fire Area 42.

GRAND GULF NUCLEAR GENERATING STATION
Updated Final Safety Analysis Report (UFSAR)

9A.5.43 FIRE AREA 43

9A.5.43.1 FIRE AREA DESCRIPTION

Fire Area 43 consists solely of Fire Zone 0C407 (Elev. 148' 0") in the Control Building. The floor, ceiling, and all walls are 3-hour rated fire barriers (Ref. Architectural Drawing A-0630).

INCLUDED FIRE ZONE	DESCRIPTION
0C407	Instrument Motor Generator, Elev. 148' 0"

9A.5.43.2 SAFE SHUTDOWN EQUIPMENT

Division II

9A.5.43.3 FIRE AREA ANALYSIS

Fire Zone 0C407 contains Division II safe shutdown components, as shown in the microcomputer data base (Ref. FPP-1, Appendix C Data). This fire area is separated from all other fire areas by 3-hour rated fire barriers. The total fire severity in Fire Zone 0C407, including transient combustibles, amounts to a low fire load. The maximum in situ combustible loading amounts to less than a 15-minute fire duration (Ref. Calculation MC-QSP64-86058). Therefore, a fire occurring in Fire Area 43 will not spread into any other fire area.

9A.5.43.4 FIRE ZONE ANALYSIS

FIRE ZONE 0C407: INSTRUMENT MOTOR GENERATOR, ELEV. 148' 0"

1. Safety-Related Equipment
 - Electrical Cable and Raceway
 - RPS Motor Generator Set
 - Transformers

2. Fire Zone Analysis
 - (a) Fire Zone 0C407 is located in the Control Building on Elev. 148' 0". The ceiling, floor, and walls are all 3-hour rated fire barriers (Ref. Architectural Drawing A-0630).

GRAND GULF NUCLEAR GENERATING STATION
Updated Final Safety Analysis Report (UFSAR)

- (b) The combustible loading in Fire Zone 0C407, including transient combustibles, amounts to a low fire load. The in situ combustible loading amounts to less than a 15-minute fire duration (Ref. Calculation MC-QSP64-86058).
- (c) Fire Zone 0C407 contains safety-related equipment and the following fire protection measures are provided: automatic carbon dioxide suppression system, smoke detection, and accessibility to manual hose streams and portable fire extinguishers.
- (d) Fire Zone 0C407 contains only Division II safe shutdown cables, raceway and components and is completely enclosed by 3-hour rated fire barriers. Therefore, a fire originating in this fire zone will not propagate to another fire zone and will only affect one train of safe shutdown components.

9A.5.44 FIRE AREA 44

9A.5.44.1 FIRE AREA DESCRIPTION

Fire Area 44 consists only of Fire Zone 0C410 (Elev. 148' 0") in the Control Building. The floor, ceiling, and all walls are 3-hour rated fire barriers (Ref. Architectural Drawing A-0630).

INCLUDED FIRE ZONE	DESCRIPTION
0C410	Battery Room, Elev. 148' 0"

9A.5.44.2 SAFE SHUTDOWN EQUIPMENT

Division II

9A.5.44.3 FIRE AREA ANALYSIS

Fire Area 44 contains Division II shutdown equipment, as shown in the microcomputer data base (Ref. FPP-1, Appendix C Data). Failure of this equipment does not prevent safe shutdown per GGNS-EE-11-00001 (FPP-1). This fire area is separated from all other fire areas by 3-hour rated fire barriers. The total fire severity in Fire Zone 0C410, including transient combustibles, amounts to a low fire load. The maximum in situ combustible loading in this

GRAND GULF NUCLEAR GENERATING STATION
Updated Final Safety Analysis Report (UFSAR)

fire zone amounts to less than a 45-minute fire duration (Ref. Calculation MC-QSP64-86058). Therefore, a fire occurring in Fire Area 44 will not spread into any other fire area.

9A.5.44.4 FIRE ZONE ANALYSIS

FIRE ZONE 0C410: BATTERY ROOM, ELEV. 148' 0"

1. Safety-Related Equipment

Electrical Cable and Raceway

2. Fire Zone Analysis

- (a) Fire Zone 0C410 is located in the Control Building on Elev. 148' 0" and is bounded on all sides by 3-hour rated fire barriers (Ref. Architectural Drawing A-0630).
- (b) The combustible loading in Fire Zone 0C410, including transient combustibles, amounts to a low fire load. The electrical cables and battery cases are the major contributors to this combustible loading. The in situ combustible loading in this fire zone amounts to less than a 45-minute fire duration (Ref. Calculation MC-QSP64-86058).
- (c) Fire Zone 0C410 contains safety-related equipment and the following fire protection measures are provided: smoke detection and accessibility to hose stations and portable fire extinguishers. In addition, a hazard due to excessive hydrogen accumulation is prevented by continuous operation of redundant ventilation systems and hydrogen detection.
- (d) Fire Zone 0C410 contains Division II safe shutdown equipment. However, failure of this equipment does not prevent safe shutdown per GGNS-EE-11-00001 (FPP- 1). Since Fire Zone 0C410 is totally enclosed by 3- hour rated fire barriers, a fire originating in this zone will not propagate to any other fire zones.

GRAND GULF NUCLEAR GENERATING STATION
Updated Final Safety Analysis Report (UFSAR)

9A.5.45 FIRE AREA 45

9A.5.45.1 FIRE AREA DESCRIPTION

Fire Area 45 consists solely of Fire Zone 0C403 (Elev. 148' 0") in the Control Building. The floor, ceiling, and all four walls are 3-hour rated fire barriers with the exception of penetrations CV-115DA, CE-201DA, CE-202DA, CE-205DA, CE-230DA, CE-259DA, CE-270DA and CE-277DA which are located in the East, West and South walls. (Ref. Architectural Drawing A-0630).

INCLUDED FIRE ZONE	DESCRIPTION
0C403	Computer and Control Panel Room Elev. 148' 0'

9A.5.45.2 SAFE SHUTDOWN EQUIPMENT

Non Divisional

9A.5.45.3 FIRE AREA ANALYSIS

Fire Zone 0C403 contains Non Divisional safe shutdown components, as shown in the microcomputer data base (Ref. FPP-1, Appendix C, Data). Failure of the safe shutdown equipment located in this fire area will not prevent safe shutdown per GGNS-EE-11-00001 (FPP-1). However, Fire Zone 0C403 does contain RHR Heat Exchanger 'A' & 'B' inlet temperature indication circuits utilized for alternate suppression pool temperature monitoring in the event of a fire in Containment (as discussed in Fire Area 25, Section 9A.5.25). The total fire severity in Fire Zone 0C403, including transient combustibles, amounts to a low fire load. The maximum in situ combustible loading in Fire Zone 0C403 amounts to less than a 60-minute fire (Ref. Calculation MC-QSP64-86058). Therefore, a fire occurring in Fire Area 45 will not spread into any other fire area.

9A.5.45.4 FIRE ZONE ANALYSIS

FIRE ZONE 0C403: COMPUTER & CONTROL PANEL RM, ELEV. 148' 0"

1. Safety-Related Equipment
Control Cabinets
Electrical Cable and Raceway
2. Fire Zone Analysis

GRAND GULF NUCLEAR GENERATING STATION
Updated Final Safety Analysis Report (UFSAR)

- (a) Fire Zone 0C403 is located in the Control Building on Elev. 148' 0". The floor, ceiling, and four walls of Fire Zone 0C403 are 3-hour rated fire barriers with the exception of penetrations CE-201DA, CE-202DA, CE-205DA, CE-230DA, CE-259DA, CE-270DA and CE-277DA which are located in the East, West and South walls. These penetrations are installed in configurations not bound by supporting fire endurance testing. However, they have been evaluated and found acceptable to provide adequate fire separation commensurate with the hazards in the area (Ref. Fire Protection Evaluation 2000-0075 and ER 2000-0113). Another exception is penetration CV-115DA which is located in the North wall (Ref. Architectural Drawing A-0630). Penetration CV-115DA which communicates between Fire Zone 0C403 and Fire Zone 0C404, has a nonstandard penetration seal design installed. The penetration seal design employs Kaowool material covered by metal flashing around the 0C404 side of the penetration opening. The metal flashing assembly, on the 0C404 side, is covered with structural steel fireproofing material. This arrangement has been evaluated in Fire Protection Evaluation 2000/0005 and determined to provide adequate fire separation for the hazards in the areas based on the following: 1) substantial construction of the non-standard seal installed, 2) Low combustible loading in Fire Zone 0C403 and Moderate loading in 0C404 3) automatic suppression systems (total flooding Halon 1301) in 0C403, 4) area wide smoke detection in 0C403, and 5) accessibility to manual hose streams and portable extinguishers in 0C403 and 0C404.
- (b) The combustible loading in Fire Zone 0C403, including transient combustibles, amounts to a low fire load. The major contributor to this combustible loading is the electrical cable present in the room. The in situ combustible loading in Fire Zone 0C403 amounts to less than a 60-minute fire duration (Ref. Calculation MC-QSP64-86058).

GRAND GULF NUCLEAR GENERATING STATION
Updated Final Safety Analysis Report (UFSAR)

- (c) Fire Zone 0C403 contains safety-related components and the following fire protection measures are provided: smoke detection, Halon 1301 suppression system, and accessibility to manual hose streams and portable fire extinguishers.

- (d) Fire Zone 0C403 contains Non divisional safe shutdown components, cables, and raceway. However, failure of this equipment will not prevent safe shutdown following a postulated fire in this area per GGNS-EE-11-00001 (FPP-1). Since Fire Zone 0C403 is completely enclosed by 3-hour rated fire barriers, a fire originating in this area will not propagate to any other Fire Zones. However, Fire Zone 0C403 does contain RHR Heat Exchanger 'A' & 'B' inlet temperature indication circuits utilized for alternate suppression pool temperature monitoring in the event of a fire in Containment (as discussed in Fire Area 25, Section 9A.5.25).

9A.5.46 No fire area has been assigned for Section 9A.5.46.

9A.5.47 FIRE AREA 47 FIRE

9A.5.47.1 FIRE AREA DESCRIPTION

Fire Area 47 consists of those fire zones shown below in the Included Fire Zones listing. The floor and walls of Fire Area 47 are 3-hour rated fire barriers, except for those walls that are either 2-hour rated, non-rated exterior barriers, or non-standard fire barriers/penetrations which have been evaluated for acceptability based on hazards in the area. In addition, the floor of Fire Zone 0C702 has the potential for not having internal conduit fire seal in conduits in penetration CE-36G (Ref. FPE 2003-001, Rev. 0). The ceiling of Fire Area 47 is the non-rated roof of the Control Building. The structural steel supporting this portion of the roof is coated with 3-hour fireproofing (Ref. Architectural Drawings A-0604, A-0630, and A-0631).

INCLUDED FIRE ZONES	DESCRIPTION
0C306	Electrical Space, Elev. 133' 0"
0C409	Electrical Space, Elev. 148' 0"
0C409A	HVAC Chase, Elev. 148' 0"

GRAND GULF NUCLEAR GENERATING STATION
Updated Final Safety Analysis Report (UFSAR)

0C512A	HVAC Chase, Elev. 166' 0"
0C608B	HVAC Chase, Elev. 177' 0"
0C610	Electrical Space, Elev. 166' 0" and 177' 0"
0C702	Upper Cable Spreading Room, Elev. 189' 0"
0C709	Electrical Space, Elev. 190' 0"
0C712	HVAC Room, Elev. 189' 0"

9A.5.47.2 SAFE SHUTDOWN EQUIPMENT

Division I and Division II

9A.5.47.3 FIRE AREA ANALYSIS

- (a) The fire zones listed above, which are all located in the Control Building can be segregated into three distinct groups: Group A includes those fire zones comprising the electrical space from Elev. 133' 0" to 190' 0"; Group B consists of the fire zones making up the HVAC chase from Elev. 148' 0" to 177' 0"; and Group C is the HVAC room and the upper cable spreading room.
- (b) All Group B and Group C Fire Zones identified above contain safe shutdown equipment, cables and raceway for both Division I and Division II trans of Control Room HVAC (Z51), as shown in the microcomputer data base (Ref. FPP-1 Appendix C Data). While important to safe shutdown, a loss of cooling will not result in temperatures that disable components on the success path required for hot shutdown following a fire in this area per GGNS-EE-11-00001 (FPP-1).
- (c) Group A consists of Fire Zones 0C306 and 0C409, which contain only Division II safe shutdown components; and 0C610 and 0C709, neither of which contains any safe shutdown components, as shown in the microcomputer data base (Ref. FPP-1 Appendix C Data). This group of fire zones is separated from the other fire zones in Fire Area 47 by the 2 and 3-hour rated South wall of the electrical chase. The postulated fire with the greatest severity in any of these four zones, including transient combustibles, amounts to a low fire load. The maximum in situ combustible

GRAND GULF NUCLEAR GENERATING STATION
Updated Final Safety Analysis Report (UFSAR)

loading in any of these four fire zones amounts to less than 15-minute fire duration (Ref. Calculation MC-QSP64-86058). Therefore, a fire originating in Group A will not affect, or propagate to affect, more than one train of safe shutdown components.

- (d) Group B consists of Fire Zone 0C409A which contains only Division II cable and raceway; and 0C512A, and 0C608B, neither of which contain any safe shutdown components, on the success path required for hot shutdown following a fire in this area as shown in the microcomputer data base (Ref. FPP-1 Appendix C Data). Group B is separated from the other fire zones in Fire Area 47 by its 3-hour rated ceiling and its 2- and 3-hour rated North wall. The postulated fire with the greatest severity in any of these three fire zones, including transient combustibles, amounts to a low fire load. The maximum in situ combustible loading in any of these three fire zones amounts to less than 15-minute fire duration (Ref. Calculation MC-QSP64-86058). There is no combustible loading postulated for Fire Zone 0C512A. Therefore, a fire originating in Group B will not affect, or propagate to affect, more than one train of safe shutdown components.
- (e) Group C consists of Fire Zones 0C712, which does not contain any safe shutdown components on the success path required for hot shutdown following a fire in this area and 0C702, which contains both Division I and II safe shutdown components. The postulated fire with the greatest severity in either of these two fire zones occurs in Fire Zone 0C702. The total fire severity in Fire Zone 0C702, including transient combustibles, amounts to a low fire load. The maximum in situ combustible loading in Fire Zone 0C702 amounts to less than 60-minute fire duration (Ref. Calculation MC-QSP64-86058).

GRAND GULF NUCLEAR GENERATING STATION
Updated Final Safety Analysis Report (UFSAR)

- (f) All Division II safe shutdown components on the success path required for hot shutdown following a fire in this area in Fire Zone 0C702 are protected with 1-hour rated fire barriers (fire wrapping) and automatic suppression. Group C is separated from the other fire zones in Fire Area 47 by its 3-hour rated floor and the 2-hour rated wall separating Fire Zones 0C712 and 0C709. Therefore a fire in Group C will not affect, or propagate to affect, more than one train of safe shutdown components.
- (g) The only path of communication between Division II safe shutdown components, located in 0C306 and 0C409, and the nearest redundant Division I safe shutdown components, located in 0C702, is via 0C610 and 0C709. Fire Zone 0C709 interfaces with 0C702 via the 3-hour rated east wall, with the exception of penetration CE-156GA, of 0C709 and through 0C712. Penetration CE-156GA is installed in a configuration not bound by supporting fire endurance testing and therefore not considered 3-hour rated. However, the penetration has been evaluated and found acceptable to provide adequate fire separation commensurate with the hazards in the area (Ref. Fire Protection Evaluation 2000-0075, ER 2000-0113). Fire Zone 0C 712 is separated from 0C709 by a 2-hour rated fire barrier (south wall of 0C709) and from 0C702 by a 2-hour rated fire barrier (east wall of 0C712) and a non-standard fire barrier configuration (south wall of 0C712). This non-standard fire barrier configuration has been evaluated (Fire Protection Evaluation No. 98-0003, Rev. 1) based on the hazards in the area and determined to be acceptable. In addition, the floor of Fire Zone 0C702 is a 3-hour rated fire barrier, except where it interfaces with Fire Zone 0C609 of Fire Area 52 that conduits in penetration may not be sealed internally for fire/smoke on the 0C609 side of the barrier (Ref. FPE 2003-001, Rev. 0). The postulated fire with the greatest severity in Fire Zones 0C306, 0C409, 0C610, 0C709 or 0C712, including transient combustibles,

GRAND GULF NUCLEAR GENERATING STATION
Updated Final Safety Analysis Report (UFSAR)

amounts to a low fire load. The maximum insitu combustible loading in any of these fire zones amounts to less than a 15-minute fire duration (Ref. Calculation MC-QSP64-86058). Therefore, Fire Zones 0C306 and 0C409 are minimally separated from Fire Zone 0C702 by a combination of a 2-hour rated fire barrier (0C709/0C712), Fire Zone 0C712 (low combustible loading) and

- (h) Other combinations of adjacency exist within Fire Area 47; however, no further discussion is required, since they do not involve more than a single division of safe shutdown.

- (i) The fire protection provided in Fire Area 47 does not strictly comply with the criteria set forth in Section 9A.3.1 of the Appendix R evaluation procedure, in that redundant safe shutdown components are not separated completely by 3-hour rated fire barriers. However, the fire protection provided in Fire Area 47 is more than adequate to ensure that at least one train of safe shutdown components will remain free of fire damage. The postulated fire with the greatest severity duration in Fire Area 47 is a fire in Fire Zone 0C702. The total fire severity in Fire Zone 0C702, including transient combustibles, amounts to a low fire load. The maximum in situ combustible loading in Fire Zone 0C702 amounts to less than a 60-minute fire duration (Ref. Calculation MC-QSP64-86058). Therefore, a fire originating in any fire zone of Fire Area 47 will not affect, or propagate to affect, more than one train of redundant safe shutdown components.

9A.5.47.4 FIRE ZONE ANALYSES

- a. FIRE ZONE 0C306: ELECTRICAL SPACE, ELEV. 133' 0"
 - 1. Safety-Related Equipment
 - Electrical Cable and Raceway
 - 2. Fire Zone Analysis

GRAND GULF NUCLEAR GENERATING STATION
Updated Final Safety Analysis Report (UFSAR)

- (a) Fire Zone 0C306 is located in the Control Building on Elev. 133' 0". The floor and all four walls of Fire Zone 0C306 are 3-hour rated fire barriers. The ceiling is open to Fire Zone 0C409 on Elev. 148' 0" (Ref. Architectural Drawing A-0630).
 - (b) The combustible loading in Fire Zone 0C306, with only transient combustibles postulated, amounts to a low fire load (Ref. Calculation MC-QSP64-86058).
 - (c) Fire Zone 0C306 contains safety-related equipment and the following fire protection measures are provided: smoke detection and accessibility to manual hose streams and portable fire extinguishers.
 - (d) Fire Zone 0C306 contains only Division II safe shutdown components. Therefore, a fire originating in this fire zone will not affect more than one train of safe shutdown components. However, this fire zone has several combinations of adjacency with other fire zones within this fire area. An adjacency discussion is provided in the fire area analysis for Fire Area 47.
- b. FIRE ZONE 0C409: ELECTRICAL SPACE, ELEV. 148' 0"
- 1. Safety-Related Equipment
 - Electrical Cable and Raceway
 - 2. Fire Zone Analysis
 - (a) Fire Zone 0C409 is located in the Control Building on Elev. 148' 0". The North and East walls of Fire Zone 0C409 are 3-hour rated fire barriers with exception of penetration CE-208DA. Penetration CE-208DA is installed in a configuration not bound by supporting fire endurance testing and therefore not considered 3-hour rated. However, the penetration has been evaluated and found acceptable to provide adequate fire separation commensurate with the hazards in the area (Ref. Fire Protection

GRAND GULF NUCLEAR GENERATING STATION
Updated Final Safety Analysis Report (UFSAR)

Evaluation 2000-0075, ER 2000-0113). Both the South and West (external) walls are 2-hour rated fire barriers. The floor and ceiling are open to Fire Zone 0C306 on Elev. 133' 0" and Fire Zone 0C610 on Elev. 166' 0", respectively (Ref. Architectural Drawing A-0630).

- (b) The combustible loading in Fire Zone 0C409, with only transient combustibles postulated, amounts to a low fire load (Ref. Calculation MC-QSP64-86058).
- (c) Fire Zone 0C409 contains safety-related equipment and the following fire protection measures are provided: smoke detection and accessibility to manual hose streams and portable fire extinguishers.
- (d) Fire Zone 0C409 contains only Division II safe shutdown components. Therefore, a fire originating in this fire zone will not affect more than one train of safe shutdown components. However, this fire zone has several combinations of adjacency with other fire zones within this fire area. An adjacency discussion is provided in the fire area analysis for Fire Area 47.

c. FIRE ZONE 0C409A: HVAC CHASE, ELEV. 148' 0"

1. Safety-Related Equipment

Electrical Cable and Raceway

2. Fire Zone Analysis

- (a) Fire Zone 0C409A is located in the Control Building on Elev. 148' 0". The floor, South and East walls of Fire Zone 0C409A are 3-hour rated fire barriers. Both the North wall and West (exterior) wall are 2-hour rated fire barriers. The ceiling is open to Fire Zone 0C512A on Elev. 166' 0" (Ref. Architectural Drawing A-0630).
- (b) The combustible loading in Fire Zone 0C409A, with no transient combustibles postulated, amounts to a low fire load. The sole contributor

GRAND GULF NUCLEAR GENERATING STATION
Updated Final Safety Analysis Report (UFSAR)

to this combustible loading is the concrete joint sealant present in the fire zone. The in situ combustible loading in Fire Zone 0C409A amounts to less than a 15-minute fire duration (Ref. Calculation MC-QSP64-86058).

- (c) Fire Zone 0C409A contains safety-related equipment; however, the fire zone is within a sealed chase and no active fire protection measures are provided.
- (d) Fire Zone 0C409A contains safe shutdown equipment, cables and raceway for Division II train of Control Room HVAC (Z51). While important to safe shutdown, a loss of cooling will not result in temperatures that disable components on the success path required for hot shutdown following a fire in this area per GGNS-EE-11-00001 (FPP-1).
- (e) Fire Zone 0C409A contains only Division II safe shutdown components on the success path required for hot shutdown. Therefore, a fire originating in this fire zone will not affect more than one train of safe shutdown components. However, this fire zone has several combinations of adjacency with other fire zones within this fire area. An adjacency discussion is provided in the fire area analysis for Fire Area 47.

d. FIRE ZONE 0C512A: HVAC CHASE, ELEV. 166' 0"

1. Safety-Related Equipment

Electrical Cable and Raceway

2. Fire Zone Analysis

- (a) Fire Zone 0C512A is located in the Control Building on Elev. 166' 0". The North, South, and East walls of Fire Zone 0C512A are 3-hour rated fire barriers. The West wall is a 2-hour rated exterior barrier. The floor and ceiling are open to Fire Zones 0C409A (Elev. 148' 0") and 0C608B (Elev. 177' 0"), respectively (Ref. Architectural Drawing A-0631).

GRAND GULF NUCLEAR GENERATING STATION
Updated Final Safety Analysis Report (UFSAR)

- (b) There is no combustible loading postulated for Fire Zone 0C512A (Ref. Calculation MC-QSP64-86058).
 - (c) Fire Zone 0C512A contains safety-related equipment; however, the fire zone is within a sealed chase and no active fire protection measures are provided.
 - (d) Fire Zone 0C512A contains safe shutdown equipment, cables and raceway for Division I and Division II trains of Control Room HVAC (Z51). While important to safe shutdown, a loss of cooling will not result in temperatures that disable components on the success path required for hot shutdown following a fire in this area per GGNS-EE-11-00001 (FPP-1). However, this fire zone has several combinations of adjacency with other fire zones within this fire area. An adjacency discussion is provided in the fire area analysis for Fire Area 47.
- e. FIRE ZONE 0C608B: HVAC CHASE, ELEV. 177' 0"
- 1. Safety-Related Equipment
 - Electrical Cable and Raceway
 - 2. Fire Zone Analysis
 - (a) Fire Zone 0C608B is located in the Control Building on Elev. 177' 0". The ceiling and the North, South, and East walls of Fire Zone 0C608B are 3-hour rated fire barriers. The West wall is a 2-hour rated exterior barrier. The floor is open to Fire Zone 0C512A on Elev. 166' 0" (Ref. Architectural Drawing A-0631).
 - (b) The combustible loading in Fire Zone 0C608B, with only transient combustibles postulated, amounts to a low fire load (Ref. Calculation MC-QSP64-86058).

GRAND GULF NUCLEAR GENERATING STATION
Updated Final Safety Analysis Report (UFSAR)

- (c) Fire Zone 0C608B contains safety-related equipment and the following fire protection measures are provided: smoke detection and accessibility to manual hose streams and portable fire extinguishers.
 - (d) Fire Zone 0C608B contains safe shutdown equipment, cables and raceway for Division I and Division II trains of Control Room HVAC (Z51). While important to safe shutdown, a loss of cooling will not result in temperatures that disable components on the success path required for hot shutdown following a fire in this area per GGNS-EE-11-00001 (FPP-1). However, this fire zone has several combinations of adjacency with other fire zones within this fire area. An adjacency discussion is provided in the fire area analysis for Fire Area 47.
- f. FIRE ZONE 0C610: ELECTRICAL SPACE, ELEV. 166' 0" AND 177' 0"
- 1. Safety-Related Equipment
 - Electrical Cable and Raceway
 - 2. Fire Zone Analysis
 - (a) Fire Zone 0C610 is an electrical chase located in the Control Building on Elev. 166' 0" and 177' 0". The North, South, and East walls of Fire Zone 0C610 are 3-hour rated fire barriers. The West wall is a 2-hour rated exterior barrier on both elevations. The floor and ceiling are open to Fire Zone 0C409 on Elev. 148' 0" and Fire Zone 0C709 on Elev. 190' 0", respectively (Ref. Architectural Drawing A-0631).
 - (b) The combustible loading in Fire Zone 0C610, with only transient combustibles postulated, amounts to a low fire load (Ref. Calculation MC-QSP64-86058).
 - (c) Fire Zone 0C610 contains safety-related equipment and the following fire protection measures are provided: smoke detection (from

GRAND GULF NUCLEAR GENERATING STATION
Updated Final Safety Analysis Report (UFSAR)

smoke detector(s) located above in Fire Zone 0C709). Fire Zone 0C610 is within a sealed chase and therefore no other active fire protection measures are provided.

- (d) Fire Zone 0C610 does not contain any safe shutdown components. Therefore, a fire originating in this fire zone will not affect either train of safe shutdown components. However, this fire zone has several combinations of adjacency with other fire zones within this fire area. An adjacency discussion is provided in the fire area analysis for Fire Area 47.

g. FIRE ZONE 0C702: UPPER CABLE SPREADING ROOM, ELEV. 189' 0"

1. Safety-Related Equipment

Electrical Cable and Raceway

2. Fire Zone Analysis

- (a) Fire Zone 0C702 is located in the Control Building on Elev. 189' 0". The floor, the East wall, and portions of the North, South, and West walls of Fire Zone 0C702 are 3-hour rated fire barriers, with the exceptions as noted below. Except the floor of Fire Zone 0C702 that conduits in penetration CE-36G may not be sealed internally for fire/smoke on the 0C609 side of the barrier of Fire Area 52 (Ref. FPE 2003-001, Rev. 0). The remaining portions of the North and West walls are 2-hour rated fire barriers, except for that portion of the West wall which is a non-rated exterior barrier and the wall separating Fire Zones 0C702 (Fire Area 47) and 0C706 (Fire Area 58) which is a non-standard fire barrier configuration with potentially missing internal conduit fire seals in 1 (3/4"), 1 (1.5"), and 1 (3") conduit on the 0C702 side of the fire barrier. The non-standard fire barrier configuration separating 0C702 and 0C706 utilizes reinforced concrete construction to approximately the 197'-4" elevation, a double steel plate partition from the 197'-4" elevation to approximately the 201'-4" elevation, and a

GRAND GULF NUCLEAR GENERATING STATION
Updated Final Safety Analysis Report (UFSAR)

W27 x 94 I-beam from top of the double steel plate partition to the underside of the Control Building roof reinforced concrete slab. The double steel plate partition and the I-beam have 3-hour structural steel fireproofing material applied to each side of the configuration. For specific details of the above described fire barrier partition configuration refer to the following Drawings: C-0625A; C-626C (Elevation AA, Detail 5, and Sections E & DD). While not a standard fire barrier design, this configuration has been evaluated in Fire Protection Evaluation 98-0002 and 99-0002 and determined to provide adequate fire separation for the hazards in the areas based on the following: 1) substantial construction of the double steel plate and I-Beam assembly; 2) 3-hour rated structural steel fireproofing material applied on each side of the double steel plate and I-Beam partition assembly; 3) low combustible loading in 0C702 and 0C706; 4) automatic suppression systems (total flood carbon dioxide & sprinklers) in 0C702; 5) area wide smoke detection in 0C702 & 0C706; and 6) accessibility to manual hose streams and portable fire extinguishers in 0C702 & 0C706. Additional exceptions include potentially missing internal conduit fire seals in 1 (3"), 1 (1"), and 5 (3/4") conduits on the 0C702 side of the fire barrier separating the upper cable spreading room (Fire Zone 0C702) from an electrical space (Fire Zone 0C709). The noted conduit configurations have been evaluated and found acceptable based on hazards in the areas (Ref. Fire Protection Evaluation 99-0002). In addition, the South wall of 0C712, which separates Fire Zone 0C712 from 0C702 is a non-standard fire barrier configuration. The non-standard fire barrier configuration separating 0C702 and 0C712 utilizes reinforced concrete construction to approximately the 200'-7" elevation, a bolted steel angle assembly from the 200'-7" elevation to approximately the 201'-11" elevation and a W27 x 94 I-beam from the top of the steel angle assembly to the underside of the Control Building roof reinforced concrete

GRAND GULF NUCLEAR GENERATING STATION
Updated Final Safety Analysis Report (UFSAR)

slab. The bolted steel angle assembly and the I-beam have 3-hour structural steel fireproofing material applied to each side of the configuration. For specific details of the above described fire barrier configuration refer to the following Drawings: C-0626C-Elev. P and C-0626D Details 7 & 8. While not a standard fire barrier design, this configuration has been evaluated in Fire Protection Evaluation 98-0003 Rev.1 and determined to provide adequate fire separation for the hazards in the areas based on the following: 1) substantial construction of the steel angle and I-Beam assembly; 2) 3-hour rated structural steel fireproofing material applied on each side of the bolted steel angle and I-Beam assembly 3) low combustible loading in 0C702 and 0C712; 4) automatic suppression systems (total flood carbon dioxide & sprinklers) in 0C702; 5) area wide smoke detection in 0C702 & 0C712; 6) accessibility to manual hose streams and portable fire extinguishers in 0C702 & 0C712, and 7) low combustible loading in fire zones that are adjacent to 0C702 through 0C712 (0C306, 0C409, 0C610, 0C709). Other exceptions include penetrations CE-352G(West wall), CE-365G(East wall) and CE-156GA(West Wall). These penetrations are installed in configurations not bound by supporting fire endurance testing and therefore not consider 3-hour rated. However, they have been evaluated and found acceptable to provide adequate fire separation commensurate with the hazards in the area (Ref. Fire Protection Evaluation 2000-0075, ER 2000-0113). A portion of the East wall of 0C702, which separates Fire Zone 0C702 and Fire Zone 0C703 (area South of door 0C709) employs a nonstandard barrier design. This arrangement consists of an approximate 2'-0" span of steel girder coated on both sides with 3-hour fireproofing. In the North wall of Fire Zone 0C702, a non-standard penetration seal design (CE-456G) is installed in the barrier separating Fire Zone 0C702 and Fire Zone 0C706. These arrangements have been evaluated in Fire Protection Evaluation 2000/

GRAND GULF NUCLEAR GENERATING STATION
Updated Final Safety Analysis Report (UFSAR)

0006 and determined to provide adequate fire separation for the hazards in the areas based on the following: 1) Substantial construction of the penetration seal/barrier design installed, 2) low combustible loading in Fire Zones 0C702, 0C703 and 0C706, 3) automatic suppression systems (total flooding CO₂ and sprinklers) in 0C702 and 0C703, 4) area wide smoke detection 0C702, 0C703 and 0C706, and 5) accessibility to manual hose streams and portable extinguishers in 0C702, 0C703 and 0C706. Penetration CV-59G is located in the partial height ceiling of 0C707 and provides separation of Fire Zones 0C702 and 0C707. Penetration CV-59G has a non-standard penetration seal design and is not equipped with a fire damper. The penetration seal design employs Kaowool material covered with metal flashing around the 0C707 side of the penetration opening. The metal flashing assembly, on the 0C707 side is covered with structural steel fireproofing material. The non-standard design has been evaluation by Fire Protection Evaluation 2000-0004 and determined to provide adequate fire separation for the hazards in the area based on the following 1) substantial construction of the non-standard seal installed; 2) Low combustible loading in Fire Zones 0C702 and 0C707; 3) automatic suppression systems (total flood CO₂ and sprinklers in 0C702); 4) area wide smoke detection in 0C702 and 0C707 and 5) accessibility to manual hose streams and portable fire extinguishers in 0C702 and 0C707. The ceiling and remaining portion of the South wall are also non-rated exterior barriers (Ref. Architectural Drawing A-0631).

- (b) The combustible loading in Fire Zone 0C702, including transient combustibles, amounts to a low fire load. The major contributor to this combustible loading is the electrical cable present in the fire zone. Thermo-Lag fire barrier material is utilized in this fire zone and is less than 10 percent of the total

GRAND GULF NUCLEAR GENERATING STATION
Updated Final Safety Analysis Report (UFSAR)

combustible loading. The in situ combustible loading in Fire Zone 0C702 amounts to less than a 60-minute fire duration (Ref. Calculation MC-QSP64-86058).

- (c) Fire Zone 0C702 contains safety-related equipment and the following fire protection measures are provided: an automatic carbon dioxide suppression system, an automatic sprinkler system, smoke detection, and accessibility to manual hose streams and portable fire extinguishers.
- (d) Fire Zone 0C702 contains safe shutdown equipment, cables and raceway for Division I and Division II trains of Control Room HVAC (Z51). While important to safe shutdown, a loss of cooling will not result in temperatures that disable components on the success path required for hot shutdown following a fire in this area per GGNS-EE-11-00001 (FPP-1).
- (e) Fire Zone 0C702 contains Division I safe shutdown cables and raceways, and redundant Division II safe shutdown raceway. All Division II safe shutdown components on the success path required for hot shutdown are protected with 1-hour rated fire barriers. Therefore, a fire originating in this fire zone will not affect both trains of safe shutdown components. However, this fire zone has several combinations of adjacency with other fire zones within this fire area. An adjacency discussion is provided in the fire area analysis for Fire Area 47.

h. FIRE ZONE 0C709: ELECTRICAL SPACE, ELEV. 190' 0"

1. Safety-Related Equipment

Electrical Cable and Raceway

2. Fire Zone Analysis

- (a) Fire Zone 0C709 is located in the Control Building on Elev. 190' 0". The West wall and ceiling of Fire Zone 0C709 are non-rated

GRAND GULF NUCLEAR GENERATING STATION
Updated Final Safety Analysis Report (UFSAR)

exterior barriers. The North and East walls of Fire Zone 0C709 are 3-hour rated fire barriers with the exception of CE-156GA in the East wall. Penetration CE-156GA is installed in a configuration not bound by supporting fire endurance testing and therefore not considered 3-hour rated. However, the penetration has been evaluated and found acceptable to provide adequate fire separation commensurate with the hazards in the area (Ref. Fire Protection Evaluation 2000-0075, ER 2000-0113). The South wall of Fire Zone 0C709 is a 2-hour rated fire barrier. The floor is open to Fire Zone 0C610 on Elev. 177' 0" (Ref. Architectural Drawing A-0631).

- (b) The combustible loading in Fire Zone 0C709, with only transient combustibles postulated, amounts to a low fire load (Ref. Calculation MC-QSP64-86058).
 - (c) Fire Zone 0C709 contains safety-related equipment and the following fire protection measures are provided: smoke detection and accessibility to manual hose streams and portable fire extinguishers.
 - (d) Fire Zone 0C709 does not contain any safe shutdown components. Therefore, a fire originating in this fire zone will not affect either train of safe shutdown components. However, this fire zone has several combinations of adjacency with other fire zones within this fire area. An adjacency discussion is provided in the fire area analysis for Fire Area 47.
- i. FIRE ZONE 0C712: HVAC ROOM, ELEV. 189' 0"
 - 1. Safety-Related Equipment
 - Electrical Cable and Raceway
 - 2. Fire Zone Analysis

GRAND GULF NUCLEAR GENERATING STATION
Updated Final Safety Analysis Report (UFSAR)

- (a) Fire Zone 0C712 is located in the Control Building on Elev. 189' 0". The floor of 0C712 and those portions of the north and east wall that separate 0C712 and 0C707 are 3-hour rated fire barriers. The remaining portion of the north and east walls separate 0C712 from 0C709/0C702 and are 2-hour rated barriers. The south wall is a non-standard fire barrier configuration. This non-standard fire barrier configuration is described in the "Fire Zone Analysis" for Fire Zone 0C702 and has been evaluated and determined to provide adequate fire separation (Refer to Fire Protection Evaluation No. 98-0003, Rev. 1). The West wall and ceiling of Fire Zone 0C712 are non-rated exterior barriers (Ref. Architectural Drawing A-0631).
- (b) The combustible loading in Fire Zone 0C712, including transient combustibles, amounts to a low fire load. The in situ combustible loading in Fire Zone 0C712 amounts to less than a 15-minute fire duration (Ref. Calculation MC-QSP64-86058).
- (c) Fire Zone 0C712 contains safety-related equipment and the following fire protection measures are provided: smoke detection and accessibility to manual hose streams and portable fire extinguishers.
- (d) Fire Zone 0C712 contains safe shutdown equipment, cables and raceway for Division I and Division II trains of Control Room HVAC (Z51). While important to safe shutdown, a loss of cooling will not result in temperatures that disable components on the success path required for hot shutdown following a fire in this area per GGNS-EE-11-00001 (FPP-1). However, this fire zone has several combinations of adjacency with other fire zones within this fire area. An adjacency discussion is provided in the fire area analysis for Fire Area 47.

GRAND GULF NUCLEAR GENERATING STATION
Updated Final Safety Analysis Report (UFSAR)

9A.5.48 FIRE AREA 48

9A.5.48.1 FIRE AREA DESCRIPTION

Fire Area 48 consists of Fire Zones 0C518 (Elev. 166' 0") and 0C611 (Elev. 177' 0") in the Control Building. These two zones communicate directly with each other via an open penetration. The floor, ceiling, and North, South, and East walls of the area are 3-hour rated fire barriers. The West wall is an exterior wall, which is a 2-hour rated fire barrier (Ref. Architectural Drawing A-0631).

INCLUDED FIRE ZONES	DESCRIPTION
0C518	Electrical Space, Elev. 166' 0"
0C611	Electrical Space, Elev. 177' 0"

9A.5.48.2 SAFE SHUTDOWN EQUIPMENT

None

9A.5.48.3 FIRE AREA ANALYSIS

Fire Zones 0C518 and 0C611 do not contain any safe shutdown components, as shown in the microcomputer data base (Ref. FPP-1, Appendix C Data). This fire area is separated from all other fire areas by 3-hour rated fire barriers. In the event of a fire in this fire area, safe shutdown capability would not be affected. The postulated fire with the greatest severity in either Fire Zones 0C518 or 0C611, including transient combustibles, amounts to a low fire load. The maximum in situ combustible loading in either of these two fire zones amounts to less than a 15-minute fire duration. Therefore, a fire occurring in Fire Area 48 will not spread into any other fire area.

9A.5.48.4 FIRE ZONE ANALYSES

- a. FIRE ZONE 0C518: ELECTRICAL SPACE, ELEV. 166' 0"
 - 1. Safety-Related Equipment
 - None
 - 2. Fire Zone Analysis

GRAND GULF NUCLEAR GENERATING STATION
Updated Final Safety Analysis Report (UFSAR)

- (a) Fire Zone 0C518 is located in the Control Building on Elev. 166' 0". The floor and the North, South, and East walls of Fire Zone 0C518 are 3-hour rated fire barriers. The West wall, which is an exterior wall, is a 2-hour rated fire barrier. The ceiling is a non-rated barrier with open electrical penetrations (Ref. Architectural Drawing A-0631).
- (b) The combustible loading in Fire Zone 0C518, which consists solely of transient combustibles, amounts to a low fire load (Ref. Calculation MC-QSP64-86058).
- (c) Fire Zone 0C518 does not contain any safety-related equipment and the following fire protection measure is provided: accessibility to manual hose stations and portable fire extinguishers. Prior to Unit 2 operation, smoke detection will be provided.
- (d) Fire Zone 0C518 is adjacent only to Fire Zone 0C611, neither of which contains safe shutdown components. Therefore, a fire originating in Fire Zone 0C518 will not affect, or propagate to affect, either train of safe shutdown components.

b. FIRE ZONE 0C611: ELECTRICAL SPACE, ELEV. 177' 0"

1. Safety-Related Equipment

None

2. Fire Zone Analysis

- (a) Fire Zone 0C611 is located in the Control Building on Elev. 177' 0". The ceiling and the North, South, and East walls of Fire Zone 0C611 are 3-hour rated fire barriers. The West wall, which is an exterior wall, is a 2-hour rated fire barrier. The floor is a non-rated barrier with open electrical penetrations (Ref. Architectural Drawing A-0631).

GRAND GULF NUCLEAR GENERATING STATION
Updated Final Safety Analysis Report (UFSAR)

- (b) The combustible loading in Fire Zone 0C611, including transient combustibles, amounts to a low fire load. The in situ combustible loading in Fire Zone 0C611 amounts to less than a 15-minute fire duration (Ref. Calculation MC-QSP64-86058).
- (c) Fire Zone 0C611 does not contain any safety-related equipment and the following fire protection measure is provided: accessibility to manual hose stations and portable fire extinguishers. Prior to Unit 2 operation, smoke detection will be provided.
- (d) Fire Zone 0C611 is adjacent only to Fire Zone 0C518, neither of which contains safe shutdown components. Therefore, a fire originating in Fire Zone 0C611 will not affect, or propagate to affect, either train of safe shutdown components.

9A.5.49 NO FIRE AREA HAS BEEN ASSIGNED FOR SECTION 9A.5.49

9A.5.50 FIRE AREA 50

9A.5.50.1 FIRE AREA DESCRIPTION

Fire Area 50 consists of those fire zones shown below in the Included Fire Zones listing. These fire zones are located at Elev. 148' 0", 166' 0", 174' 0", and 177' 0" in the Control Building (Ref. Architectural Drawings A-0630 and A-0631). Fire Area 50 is separated from other fire areas by 3-hour rated barriers, except for an interface with Stairs 0C01 and 0C02 and Elevator No. 1 (Ref. Methodology Section 9A.3.0) and the potential for not having internal conduit fire seals in conduits in penetration CE-146E(A) and CE-148E(A) that are located in the West wall of Fire Zone 0C514. Adequacy of these deviations is established in Fire Protection Evaluation 2003-001, Rev. 0.

INCLUDED FIRE ZONES	DESCRIPTION
0C402A	HVAC Chase, Elev. 148' 0"
0C405A	HVAC Chase, Elev. 148' 0"
0C501	Passage, Elev. 166' 0"
0C502	Unit 1 Support Area, Elev. 174' 6"
0C503	Units 1 and 2 Control Room, Elev. 166' 0"

GRAND GULF NUCLEAR GENERATING STATION
Updated Final Safety Analysis Report (UFSAR)

0C504	Suspended Ceiling Above Instrument Rack Area, Elev. 174' 6"
0C507	Operations' Work Area, Elev. 166' 0"
0C507A	HVAC Chase, Elev. 166' 0"
0C509	Corridor, Elev. 166' 0"
0C510	Office, Elev. 166' 0"
0C511	Dining Area, Elev. 166' 0"
0C512	Kitchen, Elev. 166' 0"
0C512B	HVAC Chase, Elev. 166' 0"
0C513	Toilet, Elev. 166' 0"
0C514	Locker Room, Elev. 166' 0"
0C515	Corridor, Elev. 166' 0"
0C601	Viewing Gallery, Elev. 177' 0"
0C602	Corridor No. 1, Elev. 177' 0"
0C603	Emergency Dormitory, Elev. 177' 0"
0C606	Toilet, Elev. 177' 0"
0C608	Technical Support Room, Elev. 177' 0"
0C613	Corridor, Elev. 177' 0"
0C614	Corridor No. 2, Elev. 177' 0"
0C615	Storage Closet, Elev. 177' 0"
0C616	Storage Closet, Elev. 177' 0"
0C617	Electrical Chase, Elev. 177' 0"
0C618	Electrical Chase, Elev. 177' 0"
0C619	Electrical Chase, Elev. 177' 0"

9A.5.50.2 SAFE SHUTDOWN EQUIPMENT

Divisions I and II

9A.5.50.3 FIRE AREA ANALYSIS

- (a) Fire Zone 0C503 consists of the Unit 1 and 2 control room. The Unit 1 portion of Fire Zone 0C503 was reviewed separately, in accordance with the Control Room Fire Hazards Analysis (Ref. Procedure FPP-2). This review documents all safe shutdown cables and devices located in the control room. Alternate shutdown capability has been provided for the Unit 1 control room, to meet the intent of Sections III.G.3 and III.L of 10CFR50, Appendix R. The Unit 2 portion of 0C503 is strictly a Unit 2 plant area. Fire Zone 0C503 was reviewed in accordance with the Fire Hazards Analysis Procedure, FPP-1, the combustible loading, zone configuration, and fire protection measures and their relationship to other zones within Fire Area 50.

GRAND GULF NUCLEAR GENERATING STATION
Updated Final Safety Analysis Report (UFSAR)

- (b) Fire Zones 0C502 and 0C504 are the Unit 1 and 2 spaces located above the control room suspended ceiling at Elev. 174' 6". Fire Zone 0C601 is the control room viewing gallery at Elev. 177' 0". Fire Zone 0C618 is an electrical chase on Elev. 177' 0", which is open to Fire Zone 0C503 through its non-rated floor. These fire zones are separated from other fire areas and fire zones within Fire Area 50, as follows: the floor (0C503, Elev. 166' 0"); ceiling (0C502, 0C504, 0C601, 0C617, 0C618 and 0C619, Elev. 189' 0"); and the North and South walls are 3-hour rated fire barriers. Electrical chase 0C617 and 0C619 are separated from 0C502, 0C504 and 0C601 by non-rated barriers. The East wall is also a 3-hour rated fire barrier, except for those portions interfacing with Stair 0C02 and Fire Zone 0C501, which are 2-hour rated fire barriers. The West boundary is formed by 2-hour rated fire barriers or barriers that have been evaluated and found acceptable for the hazards in the area. This boundary is located west of Column Line H.8/J.1 at Elev. 166' 0" and 177' 0" and separates the remaining fire zones in Fire Area 50 from the Control Room, ceiling spaces above the Control Room, and the Control Room Viewing Gallery.
- (c) All of the fire zones in Fire Area 50 that are located west of the 2-hour rated fire barrier near Column Line H.8 are separated from other fire areas as follows: the floor (Elev. 166' 0"); ceiling (Elev. 189' 0"), and the North, South, and West walls are 3-hour rated fire barriers, except for those interfaces with Stairs 0C01 and 0C03, Elevator No. 1, a portion of the boundaries of 0C515 and 0C613 which are 2-hour rated fire barriers, and West wall of Fire Zone 0C514 that conduits in penetrations may not be sealed internally for fire/smoke on the 0C609 side of the barrier of Fire Area 52 (Ref. FPE 2003-001, Rev. 0). In addition, Fire Zones 0C507A and 0C512B (HVAC chases) interface with Fire Zones 0C402A and 0C405A (located at Elev. 148' 0"), via an opening at the boundary

GRAND GULF NUCLEAR GENERATING STATION
Updated Final Safety Analysis Report (UFSAR)

between these zones at Elev. 166' 0". The HVAC chases 0C402A and 0C405A on Elev. 148' 0" are separated from other fire areas by 3-hour rated fire barriers. All of the fire zones (west of the 2-hour rated fire barrier, near Column Line H.8) that are located on Elev. 166' 0" are separated from fire zones located on Elev. 177' 0" by a 3-hour rated fire barrier, except for those interfaces with Stairs 0C01 and 0C03 and Elevator No. 1.

- (d) Fire Zones 0C502, 0C503, 0C504, 0C603, and 0C617 are the only fire zones in Fire Area 50 that contain safe shutdown components, as shown in the microcomputer data base (Ref. FPP-1 Appendix C Data). The control room, Fire Zone 0C503, contains both Division I and II safe shutdown components. As previously stated, alternate shutdown capability has been provided for the Unit 1 control room. Fire Zone 0C502 contains cables associated with both trains of CR HVAC. The loss of CR HVAC will not prevent safe shutdown per GGNS-EE-11- 00001.

- (e) Fire Zone 0C504 contains Division I and II safe shutdown components. With a non-rated barrier separating Fire Zones 0C503 and 0C504 (i.e. the suspended ceiling over the control room area) Fire Zone 0C504 is considered as a part of the Control Room. During a postulated Control Room fire (Fire Zone 0C503), safe shutdown capabilities are provided by the Alternate Shutdown System. Fire Zones 0C502, 0C504, 0C601, 0C617, 0C618 and 0C619 are the only fire zones in Fire Area 50 that have a common boundary with the control room (Fire Zone 0C503) that is less than a 2-hour rated fire barrier. Fire Zone 0C603 contains only Division II safe shutdown cables associated with CR HVAC. The loss of CR HVAC will not prevent safe shutdown per GGNS-EE-11-00001. A fire originating in this fire zone will not affect Division I components.

GRAND GULF NUCLEAR GENERATING STATION
Updated Final Safety Analysis Report (UFSAR)

- (f) Fire Zone 0C617 contains only Division I safe shutdown cable and raceway, and is separated from fire zones 0C608 by a 2-hour rated West wall. The ceiling is a 3-hour rated fire barrier. The North and East walls which interface with 0C601 are non-rated barriers. The South wall which interfaces with 0C504 is a non-rated barrier as well. Fire Zone 0C504 contains both Division I and II safe shutdown components. Although the postulated fire duration in this cable chase is zero, if a fire were to originate within 0C617 it could potentially propagate to affect both trains of safe shutdown equipment. This is considered acceptable based on the alternate shutdown capability which has been provided for the Unit 1 control room as previously described. Due to the absence of in situ and transient combustibles in the chase a fire originating in or propagating from the chase is not considered a credible event.
- (g) There are no transient or in situ combustibles postulated for Fire Zones 0C502, 0C504 and 0C617. The postulated fire in the Viewing Gallery (Fire Zone 0C601), including transient combustibles amounts to a low fire load. The maximum in situ combustible loading in Fire Zone 0C601 amounts to less than a 30-minute fire duration. The Viewing Gallery is separated from the control room by a non-rated floor and non-rated viewing partition walls at Elev. 177' 0" and is separated from 0C618 by non-rated barriers. The postulated fire in the Cable Chase (Fire Zone 0C618) amounts to a moderate fire load. The maximum in situ combustible loading in Fire Zone 0C618 amounts to less than a 75-minute fire duration. The postulated fire with the greatest severity in Fire Area 50 occurs in Fire Zones 0C615. The total fire severity including transient combustibles, amounts to a moderate fire load. The maximum in situ combustible loading in this fire zone amounts to less than a 120-minute fire duration (Ref. Calculation MC-QSP64-86058). Fire Zones 0C601, 0C618 and 0C619 are separated by non-rated barriers and all

GRAND GULF NUCLEAR GENERATING STATION
Updated Final Safety Analysis Report (UFSAR)

three zones are in turn separated from 0C502, 0C503 and 0C504 by non-rated barriers. Therefore, a fire originating in 0C601, 0C618 or 0C619 could potentially propagate to affect both trains of safe shutdown equipment in 0C503 or 0C504. However, this is acceptable based on the alternate shutdown capability which has been provided for the Unit 1 control room as previously described.

- (h) Although Fire Area 50 does not strictly comply with the requirements of Appendix R, the installed fire protection features and alternate shutdown capability assure that a fire originating in fire zones 0C601, 0C617, 0C618 or 0C619 will not affect the ability to achieve and maintain safe shutdown. The available fire protection features in all other fire zones within fire area 50 ensure that a fire originating within any of the remaining fire zones will not affect or propagate to affect either train of safe shutdown equipment in Fire Area 50. In addition, installed fire protection features will prevent, a fire occurring in Fire Area 50, from spreading into another fire area.

- (i) Fire zones located west of the 2-hour rated fire barrier near Column Line H.8 communicate directly and indirectly with each other and have numerous adjacency combinations. Since these fire zones and 0C501 do not contain safe shutdown components and these zones are separated from Fire Zones 0C502, 0C503, 0C504, 0C601, 0C617, 0C618 and 0C619 by 2-hour rated fire barriers or barriers evaluated and found adequate for the hazards in the area with the exception of the West wall of Fire Zone 0C618 where conduits in penetrations may not be sealed internally for fire/smoke on the 0C618 side of the barrier (Ref. FPE 2003-001, Rev. 0). Therefore, no further adjacency reviews are required.

GRAND GULF NUCLEAR GENERATING STATION
Updated Final Safety Analysis Report (UFSAR)

9A.5.50.4 FIRE ZONE ANALYSES

- a. FIRE ZONE 0C402A: HVAC CHASE, ELEV. 148' 0"
1. Safety-Related Equipment
None
 2. Fire Zone Analysis
 - (a) Fire Zone 0C402A is located in the Control Building on Elev. 148' 0". The floor and four walls of Fire Zone 0C402A are 3-hour rated fire barriers. The ceiling is a non-rated barrier that opens into the HVAC chase (0C512B) at Elev. 166' 0" (Ref. Architectural Drawings A-0630 and A-0631).
 - (b) There is no transient or in situ combustible loading postulated for Fire Zone 0C402A (Ref. Calculation MC-QSP64-86058).
 - (c) Fire Zone 0C402A does not contain any safety-related equipment and the following fire protection measures are provided: smoke detection and accessibility to manual hose streams and portable fire extinguishers.
 - (d) Fire Zone 0C402A does not contain any safe shutdown components. A fire originating in this fire zone will not affect, or propagate to affect, either train of safe shutdown components (refer to the fire area analysis for Fire Area 50).
- b. FIRE ZONE 0C405A: HVAC CHASE, ELEV. 148' 0"
1. Safety-Related Equipment
None
 2. Fire Zone Analysis
 - (a) Fire Zone 0C405A is located in the Control Building on Elev. 148' 0". The floor and the four walls of Fire Zone 0C405A are 3-hour rated fire barriers. The ceiling is a non-rated

GRAND GULF NUCLEAR GENERATING STATION
Updated Final Safety Analysis Report (UFSAR)

barrier that opens into the HVAC chase (0C507A) at Elev. 166' 0" (Ref. Architectural Drawings A-0630 and A-0631).

- (b) There is no transient or in situ combustible loading postulated for Fire Zone 0C405A (Ref. Calculation MC-QSP64-86058).
- (c) Fire Zone 0C405A does not contain any safety-related equipment and the following fire protection measures are provided: smoke detection and accessibility to manual hose streams and portable fire extinguishers.
- (d) Fire Zone 0C405A does not contain any safe shutdown components. A fire originating in this fire zone will not affect, or propagate to affect, either train of safe shutdown components (refer to the fire area analysis for Fire Area 50).

c. FIRE ZONE 0C501: PASSAGE, ELEV. 166' 0"

1. Safety-Related Equipment

None

2. Fire Zone Analysis

- (a) Fire Zone 0C501 is located in the Control Building on Elev. 166' 0". The floor, ceiling, and East wall of Fire Zone 0C501 are 3-hour rated fire barriers. The North, South, and West walls are 2-hour rated fire barriers (Ref. Architectural Drawing A-0631).
- (b) The combustible loading in Fire Zone 0C501, which consists solely of transient combustibles, amounts to a low fire load (Ref. Calculation MC-QSP64-86058).
- (c) Fire Zone 0C501 does not contain any safety-related equipment and the following fire protection measure is provided: accessibility to manual hose streams and portable fire extinguishers.

GRAND GULF NUCLEAR GENERATING STATION
Updated Final Safety Analysis Report (UFSAR)

- (d) Fire Zone 0C501 does not contain any safe shutdown components. A fire originating in this fire zone will not affect, or propagate to affect, either train of safe shutdown components (refer to the fire area analysis for Fire Area 50).
- d. FIRE ZONE 0C502: UNIT 1 SUPPORT AREA, ELEV. 174' 6"
- 1. Safety-Related Equipment
 - Electrical Cable and Raceway
 - 2. Fire Zone Analysis
 - (a) Fire Zone 0C502 is located in the Control Building on Elev. 174' 6". The ceiling and the North, and East walls of Fire Zone 0C502 are 3-hour rated fire barriers, except for the portion of the North wall which is physically adjacent to Fire Zone 0C616 and is a 2-hour rated fire barrier. The West wall is a 2-hour rated fire barrier, while the floor (i.e., the suspended ceiling over the control room area, Fire Zone 0C503) and South wall, including the interfaces with 0C601 and 0C619 are non-rated barriers (Ref. Architectural Drawing A-0631).
 - (b) There is no transient or in situ combustible loading postulated for Fire Zone 0C502 (Ref. Calculation MC-QSP64-86058).
 - (c) Fire Zone 0C502 contains safety-related equipment and the following fire protection measures are provided: smoke detection and accessibility to manual hose streams and portable fire extinguishers.
 - (d) Fire Zone 0C502 is a Unit 1 support area and contains Division I & II safe shutdown cables associated with both trains of CR HVAC. The loss of CR HVAC will not prevent safe shutdown per GGNS-EE-11-00001. Fire Zone 0C502 openly communicates with Fire Zone 0C504 (i.e., the suspended ceiling areas above the control room are divided by an imaginary zone boundary). A

GRAND GULF NUCLEAR GENERATING STATION
Updated Final Safety Analysis Report (UFSAR)

fire originating in this fire zone, could propagate to affect, both trains of safe shutdown components in 0C504. However, due to installed fire protection features and the alternate shutdown capability as previously discussed, a fire in 0C502 will not diminish the ability to achieve and maintain safe shutdown. Due to the absence of in situ or transient combustibles, a fire originating in or propagating from this zone is not considered a credible event.

e. FIRE ZONE 0C503: CONTROL ROOM AREA, ELEV. 166' 0"

1. Safety-Related Equipment

Electrical Cable and Raceway
Control Cabinets

2. Fire Zone Analysis

(a) Fire Zone 0C503 is located in the Control Building on Elev. 166' 0". The floor and the North, and South walls of Fire Zone 0C503 are 3-hour rated fire barriers. The East wall is a 3-hour rated fire barrier, except for the interface with Fire Zone 0C501 and Stair 0C02, between Column Lines 17.2 and 18.9, which is a 2-hour rated fire barrier. The West wall is a 2-hour rated fire barrier. The ceiling of Fire Zone 0C503 is actually a drop ceiling on Elev. 174' 6" and is a non-rated barrier (Ref. Architectural Drawing A-0631). The Unit 1 and Unit 2 control rooms are separated from one another by a non-rated barrier, which extends between Column Lines G.1 and J. The Unit 1 control room area meets the intent of Sections III.G.3 and III.L of Appendix R, as discussed in the fire area analysis.

(b) The combustible loading in Fire Zone 0C503, including transient combustibles, amounts to a low fire load. The major contributor to this combustible loading is the electrical cable, carpet, paper, and PC work stations present in

GRAND GULF NUCLEAR GENERATING STATION
Updated Final Safety Analysis Report (UFSAR)

the fire zone. The in situ combustible loading in Fire Zone 0C503 amounts to less than a 15-minute fire duration (Ref. Calculation MC-QSP64-86058). The in situ and transient combustible loads postulated for Fire Zone 0C503 are such that a fire in Fire Zone 0C503 could potentially affect both trains of safe shutdown components. However, as discussed above, the Unit 1 control room area meets the intent of Section III.G.3 and III.L of App. R, as discussed in the fire area analysis.

(c) Fire Zone 0C503 contains safety-related equipment and the following fire protection measures are provided: clean agent suppression system installed in the PGCC floor sections, smoke detection, and the accessibility to manual hose streams and portable fire extinguishers. These features are available in both the Unit 1 and Unit 2 control room areas, with the exception of suppression in the Unit 2 control room area.

(d) Fire Zone 0C503 contains both Division I and II Safe Shutdown components. As discussed in the Fire Area Analysis, Alternate Shutdown capability has been provided for Fire Zone 0C503. Therefore, a fire originating in this fire zone, while potentially affecting more than one train of safe shutdown, will not diminish the ability to achieve and maintain a safe shutdown condition. This fire zone has several combinations of adjacency with other fire zones within this fire area. An adjacency discussion is provided in the fire area analysis for Fire Area 50.

f. FIRE ZONE 0C504: SUSPENDED CEILING ABOVE INSTRUMENT RACK AREA, ELEV. 174' 6"

1. Safety-Related Equipment
Electrical Cable and Raceway
2. Fire Zone Analysis

GRAND GULF NUCLEAR GENERATING STATION
Updated Final Safety Analysis Report (UFSAR)

- (a) Fire Zone 0C504 is located in the Control Building on Elev. 174' 6". The ceiling and the South, and East walls of Fire Zone 0C504 are 3-hour rated fire barriers, except for the 2-hour rated portion of the East wall which interfaces with Stair 0C01. The West wall is a 2-hour rated fire barrier with the exception of penetration CV-145E. The floor (i.e., the suspended ceiling over the control room area, Fire Zone 0C503) and North wall, including the interfaces with 0C601 and 0C617 are non-rated barriers (Ref. Architectural Drawing A-0631). Penetration CV-145E, while not 2-hour fire rated, has been evaluated and found acceptable for the hazards in the area. (Ref. ER 2000-1065, FPE 2002-0002)
- (b) There is no transient or in situ combustible loading postulated for Fire Zone 0C504 (Ref. Calculation MC-QSP64-86058).
- (c) Fire Zone 0C504 contains safety-related equipment and the following fire protection measures are provided: smoke detection and accessibility to manual hose streams and portable fire extinguishers.
- (d) Fire Zone 0C504 contains Division I and II safe shutdown components. With a non-rated barrier separating Fire Zones 0C503 and 0C504 (i.e. the suspended ceiling over the control room area) Fire Zone 0C504 is considered as a part of the Control Room. During a postulated Control Room fire (Fire Zone 0C503), safe shutdown capabilities are provided by the Alternate Shutdown System.
- (e) In summary, a postulated fire in 0C504, or any of the adjacent fire zones will not prevent safe shutdown.

g. FIRE ZONE 0C507: OPERATIONS' WORK AREA, ELEV. 166' 0"

1. Safety-Related Equipment

None

GRAND GULF NUCLEAR GENERATING STATION
Updated Final Safety Analysis Report (UFSAR)

2. Fire Zone Analysis

- (a) Fire Zone 0C507 is located in the Control Building on Elev. 166' 0". The floor, ceiling, and the North and West walls of Fire Zone 0C507 are 3-hour rated fire barriers. The South wall of Fire Zone 0C507 is a 2-hour rated fire barrier. The East wall is a 2-hour rated fire barrier except that conduits in penetrations CE-107E(A) and CE-189E(A) may not be sealed internally for fire/smoke on the 0C507A side of the barrier (Ref. FPE 2003-001, Rev. 0 and Architectural Drawing A-0631).
- (b) The combustible loading in Fire Zone 0C507, including transient combustibles, amounts to a moderate fire load. The major contributor to this combustible loading is floor tile, paper, and office furnishings present in the fire zone. The in situ combustible loading in Fire Zone 0C507 amounts to less than a 75-minute fire duration (Ref. Calculation MC-QSP64-86058).
- (c) Fire Zone 0C507 does not contain any safety-related equipment and the following fire protection measures are provided: smoke detection and accessibility to manual hose streams and portable fire extinguishers.
- (d) Fire Zone 0C507 does not contain any safe shutdown components. A fire originating in this fire zone will not affect, or propagate to affect, either train of safe shutdown components (refer to the fire area analysis for Fire Area 50).

h. FIRE ZONE 0C507A: HVAC CHASE, ELEV. 166' 0"

1. Safety-Related Equipment

None

2. Fire Zone Analysis

GRAND GULF NUCLEAR GENERATING STATION
Updated Final Safety Analysis Report (UFSAR)

- (a) Fire Zone 0C507A is located in the Control Building on Elev. 166' 0". The ceiling of Fire Zone 0C507A is a 3-hour rated fire barrier. The four walls of Fire Zone 0C507A are 2-hour rated fire barriers and the floor is open to Fire Zone 0C405A on Elev. 148' 0" with the exception of the West and North walls of Fire Zone 0C507A where conduits in penetrations CE-107E(A) and CE-189E(A) may not be sealed internally for fire/smoke on the 0C507A side of the barrier (Ref. FPE 2003-001, Rev. 0 and Architectural Drawings A-0630 and A-631).
 - (b) There is no transient or in situ combustibile loading postulated for Fire Zone 0C507A (Ref. Calculation MC-QSP64-86058).
 - (c) Fire Zone 0C507A does not contain any safety-related equipment and smoke detection and accessibility to manual hose streams and portable fire extinguishers are provided from Fire Zone 0C405A.
 - (d) Fire Zone 0C507A does not contain any safe shutdown components. A fire originating in this fire zone will not affect, or propagate to affect, either train of safe shutdown components (refer to the fire area analysis for Fire Area 50).
- i. FIRE ZONE 0C509: CORRIDOR, ELEV. 166' 0"
- 1. Safety-Related Equipment
None
 - 2. Fire Zone Analysis
 - (a) Fire Zone 0C509 is located in the Control Building on Elev. 166' 0". The floor and ceiling of Fire Zone 0C509 are 3-hour rated fire barrier. The East wall is a 2-hour rated fire barrier except that conduits in penetrations CE-168E(A) and CE-195E(A) may not be sealed internally for fire/smoke on the 0C618 side of the barrier (Ref. FPE 2003-001, Rev. 0). The

GRAND GULF NUCLEAR GENERATING STATION
Updated Final Safety Analysis Report (UFSAR)

North wall of Fire Zone 0C509 is a 2-hour rated fire barrier and the South wall and a portion of the West wall are non-rated barriers (Ref. Architectural Drawing A-0631). In addition, the interface with Stair 0C03 is a 2-hour rated fire barrier (Ref. Methodology Section 9A.3.0).

- (b) The combustible loading in Fire Zone 0C509, including transient combustibles, amounts to a low fire load. The major contributor to this combustible loading is paper present in the fire zone. The in situ combustible loading in Fire Zone 0C509 amounts to less than a 30-minute fire duration (Ref. Calculation MC-QSP64-86058).
- (c) Fire Zone 0C509 does not contain any safety-related equipment and the following fire protection measures are provided: smoke detection and accessibility to manual hose streams and portable fire extinguishers.
- (d) Fire Zone 0C509 does not contain any safe shutdown components. A fire originating in this fire zone will not affect, or propagate to affect, either train of safe shutdown components (refer to the fire area analysis for Fire Area 50).

j. FIRE ZONE 0C510: OFFICE, ELEV. 166' 0"

1. Safety-Related Equipment

None

2. Fire Zone Analysis

- (a) Fire Zone 0C510 is located in the Control Building on Elev. 166' 0". The ceiling, floor, and West wall of Fire Zone 0C510 are 3-hour rated fire barriers. The North, South, and East walls of Fire Zone 0C510 are non-rated barriers (Ref. Architectural Drawing A-0631).
- (b) The combustible loading in Fire Zone 0C510, including transient combustibles, amounts to a low fire load. The major contributor to this

GRAND GULF NUCLEAR GENERATING STATION
Updated Final Safety Analysis Report (UFSAR)

combustible loading is the paper and carpet present in the fire zone. The in situ combustible loading in Fire Zone 0C510 amounts to less than a 30-minute fire duration (Ref. Calculation MC-QSP64-86058).

- (c) Fire Zone 0C510 does not contain any safety-related equipment and the following fire protection measures are provided: smoke detection and accessibility to manual hose streams and portable fire extinguishers.
- (d) Fire Zone 0C510 does not contain any safe shutdown components. A fire originating in this fire zone will not affect, or propagate to affect, either train of safe shutdown components (refer to the fire area analysis for Fire Area 50).

k. FIRE ZONE 0C511: DINING AREA, ELEV. 166' 0"

1. Safety-Related Equipment

None

2. Fire Zone Analysis

- (a) Fire Zone 0C511 is located in the Control Building on Elev. 166' 0". The ceiling, floor, and a portion of the West wall of Fire Zone 0C511 are 3-hour rated fire barriers. The East wall of Fire Zone 0C511 is a 2-hour rated fire barrier except that conduits in penetrations CE-143E(A), CE-144E(A), and CE-193E(A) may not be sealed internally for fire/smoke on the 0C512B side of the barrier (Ref. FPE 2003-001, Rev. 0) and the North, South, and the remainder of the West walls are non-rated barriers (Ref. Architectural Drawing A-0631).
- (b) The combustible loading in Fire Zone 0C511, including transient combustibles, amounts to a low fire load. The major contributor to this combustible loading is the paper and vinyl floor tile present in the fire zone. The in situ

GRAND GULF NUCLEAR GENERATING STATION
Updated Final Safety Analysis Report (UFSAR)

combustible loading in Fire Zone 0C511 amounts to less than a 45-minute fire duration (Ref. Calculation MC-QSP64-86058).

- (c) Fire Zone 0C511 does not contain any safety-related equipment and the following fire protection measures are provided: smoke detection in Fire Zone 0C512 and accessibility to manual hose streams and portable fire extinguishers.
- (d) Fire Zone 0C511 does not contain any safe shutdown components. A fire originating in this fire zone will not affect, or propagate to affect, either train of safe shutdown components (refer to the fire area analysis for Fire Area 50).

1. FIRE ZONE 0C512: KITCHEN, ELEV. 166' 0"

1. Safety-Related Equipment

None

2. Fire Zone Analysis

- (a) Fire Zone 0C512 is located in the Control Building on Elev. 166' 0". The ceiling, floor, and West wall of Fire Zone 0C512 are 3-hour rated fire barriers. The North, South, and East walls of Fire Zone 0C512 are non-rated barriers (Ref. Architectural Drawing A-0631).
- (b) The combustible loading in Fire Zone 0C512, including transient combustibles, amounts to a moderate fire load. The major contributor to this combustible loading are the countertops. The in situ combustible loading in Fire Zone 0C512 amounts to less than a 90-minute fire duration (Ref. Calculation MC-QSP64-86058).
- (c) Fire Zone 0C512 does not contain any safety-related equipment and the following fire protection measures are provided: smoke

GRAND GULF NUCLEAR GENERATING STATION
Updated Final Safety Analysis Report (UFSAR)

detection, dry chemical extinguishing system for the cooking surface, and accessibility to manual hose streams and portable fire extinguishers.

- (d) Fire Zone 0C512 does not contain any safe shutdown components. A fire originating in this fire zone will not affect, or propagate to affect, either train of safe shutdown components (refer to the fire area analysis for Fire Area 50).

m. FIRE ZONE 0C512B: HVAC CHASE, ELEV. 166' 0"

1. Safety-Related Equipment

Ductwork

2. Fire Zone Analysis

- (a) Fire Zone 0C512B is located in the Control Building on Elev. 166' 0". The ceiling of Fire Zone 0C512B is a 3-hour rated fire barrier. The four walls of Fire Zone 0C512B are 2-hour rated fire barriers and the floor is open to Fire Zone 0C402A on Elev. 143' 0" with the exception of the West and North walls of Fire Zone 0C512B where conduits in penetrations CE-143E(A), CE-144E(A), and CE-193E(A) may not be sealed internally for fire/smoke on the 0C512B side of the barrier (Ref. FPE 2003-001, Rev. 0 and Architectural Drawings A-0630 and A-0631).
- (b) There is no transient or in situ combustible loading postulated for Fire Zone 0C512B (Ref. Calculation MC-QSP64-86058).
- (c) Fire Zone 0C512B contains only safety-related ductwork and smoke detection and accessibility to manual hose streams and portable extinguishers are provided from Fire Zone 0C402A (Ref. Fire Protection Evaluation 87/0005).
- (d) Fire Zone 0C512B does not contain any safe shutdown components. A fire originating in this fire zone will not affect, or propagate to

GRAND GULF NUCLEAR GENERATING STATION
Updated Final Safety Analysis Report (UFSAR)

affect, either train of safe shutdown components
(refer to the fire area analysis for Fire Area
50).

n. FIRE ZONE 0C513: TOILET, ELEV. 166' 0"

1. Safety-Related Equipment

Ductwork

2. Fire Zone Analysis

(a) Fire Zone 0C513 is located in the Control Building on Elev. 166' 0". The ceiling, floor, and West wall of Fire Zone 0C513 are 3-hour rated fire barriers. The North, South, and East walls of Fire Zone 0C513 are non-rated barriers (Ref. Architectural Drawing A-0631).

(b) The combustible loading in Fire Zone 0C513 including transient combustibles, amounts to a low fire load. The major contributor to this combustible loading is the plastic accessories present in the fire zone. The in situ combustible loading in Fire Zone 0C513 amounts to less than a 15-minute fire duration (Ref. Calculation MC-QSP64-86058).

(c) Fire Zone 0C513 contains only safety-related ductwork and the following fire protection measure is provided: accessibility to manual hose streams and portable fire extinguishers (Ref. Fire Protection Evaluation 87/0005).

(d) Fire Zone 0C513 does not contain any safe shutdown components. A fire originating in this fire zone will not affect, or propagate to affect, either train of safe shutdown components (refer to the fire area analysis for Fire Area 50).

o. FIRE ZONE 0C514: LOCKER ROOM, ELEV. 166' 0"

1. Safety-Related Equipment

Electrical Cable and Raceway

GRAND GULF NUCLEAR GENERATING STATION
Updated Final Safety Analysis Report (UFSAR)

2. Fire Zone Analysis

- (a) Fire Zone 0C514 is located in the Control Building on Elev. 166' 0". The ceiling, floor, and the South wall of Fire Zone 0C514 are 3-hour rated fire barriers. The West wall is a 3-hour rated fire barrier except that conduits in penetrations CE-146E(A) and CE-148E(A) may not be sealed internally for fire/smoke on the 0C609 side of the barrier (Ref. FPE 2003-001, Rev. 0). That portion of the North wall physically adjacent to Fire Zone 0C512B is a 2-hour rated fire barrier. The remainder of the North wall is a non-rated barrier. The East wall is a 2-hour rated fire barrier with the exception of penetration CV-145E. Penetration CV-145E, while not 2-hour fire rated, has been evaluated and found acceptable for the hazards in the area. (Ref. ER 2000-0165, FPE 2002-0002) (Ref. Architectural Drawing A-0631).
- (b) The combustible loading in Fire Zone 0C514 amounts to a low fire load. The major contributor to this combustible loading is personnel apparel located in lockers present in the fire zone. The in situ combustible loading in Fire Zone 0C514 amounts to less than a 15-minute fire duration (Ref. Calculation MC-QSP64-86058).
- (c) Fire Zone 0C514 contains safety-related equipment and the following fire protection measures are provided: smoke detection and accessibility to manual hose streams and portable fire extinguishers.
- (d) Fire Zone 0C514 does not contain any safe shutdown components. A fire originating in this fire zone will not affect, or propagate to affect, either train of safe shutdown components (refer to the fire area analysis for Fire Area 50).

p. FIRE ZONE 0C515: CORRIDOR, ELEV. 166' 0"

1. Safety-Related Equipment

GRAND GULF NUCLEAR GENERATING STATION
Updated Final Safety Analysis Report (UFSAR)

None

2. Fire Zone Analysis

- (a) Fire Zone 0C515 is located in the Control Building on Elev. 166' 0". The ceiling and floor of Fire Zone 0C515 are 3-hour rated fire barriers. The North wall is both a 2- and 3-hour rated fire barrier. The West wall of Fire Zone 0C515 is a 2-hour rated fire barrier. The East wall and the portion of the South wall physically adjacent to Fire Zone 0C510 are non-rated barriers. The remaining portion of the South wall, facing the outside and physically adjacent to Fire Zone 0C610, is a 2-hour and 3-hour rated fire barrier, respectively (Ref. Architectural Drawing A-0631).
- (b) The combustible loading of Fire Zone 0C515, including transient combustibles, amounts to a low fire load. The major contributor to this combustible loading is the vinyl floor tile present in the fire zone. The in situ combustible loading in Fire Zone 0C515 amounts to less than a 15-minute fire duration (Ref. Calculation MC-QSP64-86058).
- (c) Fire Zone 0C515 does not contain any safety-related equipment and the following fire protection measures are provided: smoke detection and accessibility to manual hose streams and portable fire extinguishers.
- (d) Fire Zone 0C515 does not contain any safe shutdown components. A fire originating in this fire zone will not affect, or propagate to affect, either train of safe shutdown components (refer to the fire area analysis for Fire Area 50).

q. FIRE ZONE 0C601: VIEWING GALLERY, ELEV. 177' 0"

1. Safety-Related Equipment

None

GRAND GULF NUCLEAR GENERATING STATION
Updated Final Safety Analysis Report (UFSAR)

2. Fire Zone Analysis

- (a) Fire Zone 0C601 is located in the Control Building on Elev. 177' 0". The ceiling of Fire Zone 0C601 is a 3-hour rated fire barrier. The West wall is a 2-hour rated fire barrier with the exception of the interfaces with 0C617, 0C618 and 0C619 which are non-rated. The remaining walls and floor are non-rated barriers (Ref. Architectural Drawing A-0631).
- (b) The combustible loading in Fire Zone 0C601, including transient combustibles, amounts to a low fire load. The major contributors to this combustible loading are paper and carpet present in the fire zone. The in situ combustible loading in Fire Zone 0C601 amounts to less than a 30-minute fire duration (Ref. Calculation MC-QSP64-86058).
- (c) Fire Zone 0C601 does not contain any safety-related equipment and the following fire protection measures are provided: smoke detection and accessibility to manual hose streams and portable fire extinguishers.
- (d) Fire Zone 0C601 does not contain any safe shutdown components. With non-rated barriers separating 0C601 from 0C503 and 0C617 a fire originating in fire zone 0C601 could propagate to affect one division (0C617) or potentially both divisions (0C503). However, during a postulated control room fire (fire zone 0C503), safe shutdown capabilities will be maintained by the alternate shutdown system (refer to the fire area analysis for Fire Area 50). Therefore, a postulated fire in 0C601 will not prevent safe shutdown.

r. FIRE ZONE 0C602: CORRIDOR NO. 1, ELEV. 177' 0"

1. Safety-Related Equipment

None

2. Fire Zone Analysis

GRAND GULF NUCLEAR GENERATING STATION
Updated Final Safety Analysis Report (UFSAR)

- (a) Fire Zone 0C602 is located in the Control Building on Elev. 177' 0". The floor and ceiling of Fire Zone 0C602 are 3-hour rated fire barriers. All walls of Fire Zone 0C602 are 2-hour rated fire barriers, with the exception of the walls that are physically adjacent to Fire Zones 0C606, 0C608, 0C613 and 0C614, which are not rated (Ref. Architectural Drawing A-0631) and Fire Protection Evaluation 87/0017).
 - (b) The combustible loading in Fire Zone 0C602, including transient combustibles, amounts to a low fire load. The major contributor to this combustible loading is the ceiling light diffusers and carpet present in the fire zone. The in situ combustible loading in Fire Zone 0C602 amounts to less than a 15-minute fire duration (Ref. Calculation MC-QSP64-86058).
 - (c) Fire Zone 0C602 does not contain any safety-related equipment and the following fire protection measures are provided: smoke detection and accessibility to manual hose streams and portable fire extinguishers.
 - (d) Fire Zone 0C602 does not contain any safe shutdown components. A fire originating in this fire zone will not affect, or propagate to affect, either train of safe shutdown components (refer to the fire area analysis for Fire Area 50).
- s. FIRE ZONE 0C603: EMERGENCY DORMITORY, ELEV 177' 0"
- 1. Safety-Related Equipment
 - Electrical Cable and Raceway
 - 2. Fire Zone Analysis
 - (a) Fire Zone 0C603 is located in the Control Building on Elev. 177' 0". The floor, ceiling, the North wall, and portions of the South and West walls of Fire Zone 0C603 are 3-hour rated fire barriers. A portion of the East wall and the remainder of the South wall are 2-hour rated

GRAND GULF NUCLEAR GENERATING STATION
Updated Final Safety Analysis Report (UFSAR)

fire barriers. The remaining portions of the East and West walls are non-rated barriers (Ref. Architectural Drawing A-0631).

- (b) The combustible loading in Fire Zone 0C603, including transient combustibles, amounts to a moderate fire load. The major contributor to this combustible loading is the paper, PC workstations floor covering, and miscellaneous office supplies/equipment present in the fire zone. The in situ combustible loading in Fire Zone 0C603 amounts to less than a 90-minute fire duration (Ref. Calculation MC-QSP64-86058).
- (c) Fire Zone 0C603 contains safety-related equipment and the following fire protection measures are provided: smoke detection and accessibility to manual hose streams and portable fire extinguishers.
- (d) Fire Zone 0C603 contains Division II safe shutdown cables associated with CR HVAC. The loss of CR HVAC will not prevent safe shutdown per GGNS-EE-11-00001. A fire originating in this fire zone will not affect, or propagate to affect, Division I safe shutdown components (refer to fire area analysis for Fire Area 50).

t. FIRE ZONE 0C606: TOILET, ELEV. 177' 0"

1. Safety-Related Equipment

None

2. Fire Zone Analysis

- (a) Fire Zone 0C606 is located in the Control Building on Elev. 177' 0". The floor, ceiling and West wall of Fire Zone 0C606 are 3-hour rated fire barriers. The North, East and South walls are non-rated barriers (Ref. Architectural Drawing A-0631 and Fire Protection Evaluation 87/0017)

GRAND GULF NUCLEAR GENERATING STATION
Updated Final Safety Analysis Report (UFSAR)

- (b) The combustible loading in Fire Zone 0C606, including transient combustibles, amounts to a low fire load. The major contributor to this combustible loading is the ceiling light diffusers and vinyl floor tile present in the fire zone. The in situ combustible loading in Fire Zone 0C511 amounts to less than a 15-minute fire duration (Ref. Calculation MC-QSP64-86058).
 - (c) Fire Zone 0C606 does not contain any safety-related equipment and the following fire protection measure is provided: smoke detection and accessibility to manual hose streams and portable fire extinguishers.
 - (d) Fire Zone 0C606 does not contain any safe shutdown components. A fire originating in this fire zone will not affect, or propagate to affect, either train of safe shutdown components (refer to the fire area analysis for Fire Area 50).
- u. FIRE ZONE 0C608: TECHNICAL SUPPORT RM, ELEV. 177' 0"
- 1. Safety-related Equipment
 - Ductwork, Electrical Cable and Raceway
 - 2. Fire Zone Analysis
 - (a) Fire Zone 0C608 is located in the Control Building on Elev. 177' 0". The floor, ceiling, and the South wall and a portion of the West wall of Fire Zone 0C608 are 3-hour rated fire barriers. The North wall is a non-rated barrier. The East wall is a 2-hour rated fire barrier (Ref. Architectural Drawing A-0631 and Fire Protection Evaluation 87/0017).
 - (b) A support structure constructed of 2x4 inch lumber is located above the suspended ceiling near the southeast corner. The contribution to the combustible loading from this support structure is insignificant (i.e. equivalent to a fire duration of less than one-minute).

GRAND GULF NUCLEAR GENERATING STATION
Updated Final Safety Analysis Report (UFSAR)

- (c) The combustible loading in Fire Zone 0C608, including transient combustibles, amounts to a low fire load. The major contributor to this combustible loading is the paper and furniture present in the fire zone. The in situ combustible loading in Fire Zone 0C608 amounts to less than a 45-minute fire duration (Ref. Calculation MC-QSP64-86058).
- (d) Fire Zone 0C608 does not contain any safe shutdown components. A fire originating in this fire zone will not affect, or propagate to affect, either train of safe shutdown components (refer to the fire area analysis for Fire Area 50).

v. FIRE ZONE 0C613: CORRIDOR, ELEV. 177' 0"

1. Safety-Related Equipment

None

2. Fire Zone Analysis

- (a) Fire Zone 0C613 is located in the Control Building on Elev. 177' 0". The floor, ceiling, and portion of the North and South walls adjacent to Fire Zones 0C613A and 0C610, respectively, are 3-hour rated fire barriers. The remaining portions of the North and West walls are 2-hour rated fire barriers. The East wall and a portion of the South wall are non-rated barriers (Ref. Architectural Drawing A-0631 and Fire Protection Evaluation 87/0017).
- (b) The combustible loading in Fire Zone 0C613, including transient combustibles, amounts to a low fire load. The major contributor to this combustible loading is the carpet present in the fire zone. The in situ combustible loading in Fire Zone 0C613 amounts to less than a 15-minute fire duration (Ref. Calculation MC-QSP64-86058).

GRAND GULF NUCLEAR GENERATING STATION
Updated Final Safety Analysis Report (UFSAR)

- (c) Fire Zone 0C613 does not contain any safety-related components and the following fire protection measures are provided: smoke detection and accessibility to manual hose streams and portable fire extinguishers.
- w. FIRE ZONE 0C614: CORRIDOR NO. 2, ELEV. 177' 0"
- 1. Safety-related Equipment
None
 - 2. Fire Zone Analysis
 - (a) Fire Zone 0C614 is located in the Control Building on Elev. 177' 0". The floor, ceiling, and the major portion of the West wall of Fire Zone 0C614 are 3-hour rated fire barriers. The East wall (that separates fire Zone 0C614 from Fire Zone 0C502) and a small portion of the West wall are 2-hour rated fire barriers. The South walls are non-rated barriers (Ref. Architectural Drawing A-0631).
 - (b) The combustible loading in Fire Zone 0C614, including transient combustibles, amounts to a low fire load. The major contributor to this combustible loading is the vinyl floor tile present in the fire zone. The in situ combustible loading in Fire Zone 0C614 amounts to less than a 15-minute fire duration (Ref. Calculation MC-QSP64-86058).
 - (c) Fire Zone 0C614 does not contain any safety-related components and the following fire protection measures are provided: smoke detection and accessibility to manual hose streams and portable fire extinguishers.
 - (d) Fire Zone 0C614 does not contain any safe shutdown components. A fire originating in this fire zone will not affect, or propagate to affect, either train of safe shutdown components (refer to the fire area analysis for Fire Area 50).
- x. FIRE ZONE 0C615: STORAGE CLOSET, ELEV. 177' 0"

GRAND GULF NUCLEAR GENERATING STATION
Updated Final Safety Analysis Report (UFSAR)

1. Safety-Related Equipment

None

2. Fire Zone Analysis

- (a) Fire Zone 0C615 is located in the Control Building on Elev. 177' 0". The floor, ceiling, and the North, South, and West walls of Fire Zone 0C615 are 3-hour rated fire barriers. The East wall is a non-rated barrier (Ref. Architectural Drawing A-0631).
- (b) The combustible loading in Fire Zone 0C615, including transient combustibles, amounts to a moderate fire load. The major contributor to this combustible loading is the paper storage in this fire zone. The in situ combustible loading in Fire Zone 0C615 amounts to less than a 120-minute fire duration (Ref. Calculation MC-QSP64-86058).
- (c) Fire Zone 0C615 does not contain any safety-related components and the following fire protection measures are provided: accessibility to manual hose streams and portable fire extinguishers.
- (d) Fire Zone 0C615 does not contain any safe shutdown components. A fire originating in this fire zone will not affect, or propagate to affect, either train of safe shutdown components (refer to the fire area analysis for Fire Area 50).

y. FIRE ZONE 0C616: STORAGE CLOSET, ELEV. 177' 0"

1. Safety-Related Equipment

Electrical Cable and Raceway

2. Fire Zone Analysis

- (a) Fire Zone 0C616 is located in the Control Building on Elev. 177' 0". The floor, ceiling, and North wall of Fire Zone 0C616 are 3-hour

GRAND GULF NUCLEAR GENERATING STATION
Updated Final Safety Analysis Report (UFSAR)

rated fire barriers. The South and East walls are 2-hour rated fire barriers. The West wall is a non-rated fire barrier (Ref. Architectural Drawing A-0631).

- (b) The combustible loading in Fire Zone 0C616, including transient combustibles, amounts to a low fire load. The major contributor to this combustible loading is the paper and vinyl floor tile present in the fire zone. The in situ combustible loading in Fire Zone 0C616 amounts to less than a 45-minute fire duration (Ref. Calculation MC-QSP64-86058).
- (c) Fire Zone 0C616 contains safety-related cable and raceway and the following fire protection measures are provided: smoke detection (located in 0C603) and accessibility to manual hose streams and portable fire extinguishers.
- (d) Fire Zone 0C616 does not contain any safe shutdown components. A fire originating in this fire zone will not affect, or propagate to affect, either train of safe shutdown components (refer to the fire area analysis for Fire Area 50).

z. FIRE ZONE 0C617: ELECTRICAL CHASE, ELEV. 177' 0"

1. Safety-Related Equipment

Electrical Cable and Raceway

2. Fire Zone Analysis

- (a) Fire Zone 0C617 is located in the Control Building on Elev. 177' 0". The ceiling is a 3-hour rated fire barrier. The West wall is a 2-hour rated fire barrier. The floor, North, South and East walls are non-rated barriers. (Ref. Architectural Drawing A-0631).
- (b) There is no transient or in situ combustible loading postulated for Fire Zone 0C617 (Ref. Calculation MC-QSP64-86058).

GRAND GULF NUCLEAR GENERATING STATION
Updated Final Safety Analysis Report (UFSAR)

- (c) Fire Zone 0C617 contains safety-related components and the following fire protection measure is provided: smoke detection. Fire Zone 0C617 is a sealed electrical chase and therefore, no other active fire protection measures are provided.
- (d) Fire Zone 0C617 contains only Division I safe shutdown cable and raceway. 0C617 can communicate with 0C503 through the floor of 0C617 or via 0C601 and communicate with 0C504, through non-rated barriers. A fire originating in this fire zone could affect one division of safe shutdown and could potentially propagate to affect both divisions of safe shutdown. However, during a postulated control room fire (fire zone 0C503), safe shutdown capabilities will be maintained by the alternate shutdown system (refer to fire area analysis for Fire Area 50). Due to the absence of in situ or transient combustibles in the chase, a fire originating in or propagating from this zone is not considered a credible event.

aa. FIRE ZONE 0C618: ELECTRICAL CHASE, ELEV. 177' 0"

1. Safety-Related Equipment

None

2. Fire Zone Analysis

- (a) Fire Zone 0C618 is located in the Control Building on Elev. 177' 0". The ceiling of Fire Zone 0C618 is a 3-hour rated fire barrier. Portions of the chase that interface with 0C602 are 2-hour rated fire barriers with the exception of the West wall of Fire Zone 0C618 where conduits in penetrations CE-168E(A) and CE-195E(A) may not be sealed internally for fire/smoke on the 0C618 side of the barrier (Ref. FPE 2003-001, Rev. 0). The remaining walls, which interface with 0C601, and the floor are non-rated barriers (Ref. Architectural Drawing A-0631).

GRAND GULF NUCLEAR GENERATING STATION
Updated Final Safety Analysis Report (UFSAR)

- (b) The combustible loading in Fire Zone 0C618, with no transient combustibles postulated, amounts to a moderate fire load. The only contributors to this combustible loading are the electrical cables present in the fire zone. The in situ combustible loading in Fire Zone 0C618 amounts to less than a 75-minute fire duration (Ref. Calculation MC-QSP64-86058).
- (c) Fire Zone 0C618 does not contain any safety-related equipment and the following fire protection measure is provided: smoke detection. Fire Zone 0C618 is a sealed electrical chase and therefore, no other active fire protection measures are provided.
- (d) Fire Zone 0C618 does not contain any safe shutdown components. 0C618 can communicate with 0C503 through the floor or via 0C601 and can communicate with 0C617, through non-rated barriers. A fire originating in this fire zone could propagate to affect either or both trains of safe shutdown. However, during a postulated control room fire (fire zone 0C503), safe shutdown capabilities will be maintained by the alternate shutdown system (refer to the fire area analysis for Fire Area 50). Therefore, a postulated fire in 0C618 will not prevent safe shutdown.

bb. FIRE ZONE 0C619: ELECTRICAL CHASE, ELEV. 177' 0"

1. Safety-Related Equipment

None

2. Fire Zone Analysis

- (a) Fire Zone 0C619 is located in the Control Building on Elev. 177' 0". The ceiling and floor of Fire Zone 0C619 are 3-hour rated fire barriers. The West wall of Fire Zone 0C619 is a 2-hour rated

GRAND GULF NUCLEAR GENERATING STATION
Updated Final Safety Analysis Report (UFSAR)

fire barrier. The North, South and East walls are non-rated barriers. (Ref. Architectural Drawing A-0631).

- (b) The combustible loading in Fire Zone 0C619, with no transient combustibles postulated, amounts to a moderate fire load. The only contributors to this combustible loading are the electrical cables present in the fire zone. The in situ combustible loading in Fire Zone 0C619 amounts to less than a 120-minute fire duration (Ref. Calculation MC-QSP64-86058).
- (c) Fire Zone 0C619 does not contain any safety-related equipment and the following fire protection measure is provided: smoke detection. Fire Zone 0C619 is a sealed electrical chase and therefore, no other active fire protection measures are provided.
- (d) Fire Zone 0C619 does not contain any safe shutdown components. 0C619 can communicate with 0C503 through the floor of 0C619 or via 0C601 and communicate with 0C502, through non-rated barriers. A fire originating in this fire zone could potentially propagate to affect one or both divisions of safe shutdown. However, during a postulated control room fire (fire zone 0C503), safe shutdown capabilities will be maintained by the alternate shutdown system (refer to the fire area analysis Fire Area 50). Therefore, a postulated fire in 0C619 will not prevent safe shutdown.

9A.5.51 FIRE AREA 51

9A.5.51.1 FIRE AREA DESCRIPTION

Fire Area 51 consists solely of Fire Zone 0C604 (Elev. 177' 0") in the Control Building. The floor, ceiling, and walls are 3-hour rated fire barriers (Ref. Architectural Drawing A-0631)

INCLUDED FIRE ZONE	DESCRIPTION
0C604	CAS, Elev. 177' 0"

GRAND GULF NUCLEAR GENERATING STATION
Updated Final Safety Analysis Report (UFSAR)

9A.5.51.2 SAFE SHUTDOWN EQUIPMENT

None

9A.5.51.3 FIRE AREA ANALYSIS

Fire Zone 0C604 does not contain any safe shutdown components, as shown on the microcomputer data base (Ref. FPP-1, Appendix C Data). The postulated fire with the greatest severity in Fire Zones 0C604, including transient combustibles, amounts to a moderate fire load. The maximum in situ combustible loading in either of these two fire zones amounts to less than a 90-minute fire duration (Ref. Calculation MC-QSP64-86058). Fire Area 51 is separated from all other fire areas by 3-hour rated fire barriers. Therefore, a fire originating in Fire Area 51 will not spread into any other fire area.

9A.5.51.4 FIRE ZONE ANALYSIS

FIRE ZONE 0C604: CAS, ELEV. 177' 0"

1. Safety-Related Equipment

None

2. Fire Zone Analysis

- (a) Fire Zone 0C604 is located in the Control Building on Elev. 177' 0". The ceiling, floor, and walls are all 3-hour rated fire barriers (Ref. Architectural Drawing A-0631)
- (b) The combustible loading in Fire Zone 0C604, including transient combustibles, amounts to a moderate fire load. The major contributor to this combustible loading is the office furniture, computer equipment and vinyl floor tile present in the fire zone. The in situ combustible loading in Fire Zone 0C604 amounts to less than a 105-minute fire duration (Ref. Calculation MC-QSP64-86058).

GRAND GULF NUCLEAR GENERATING STATION
Updated Final Safety Analysis Report (UFSAR)

- (c) Fire Zone 0C604 does not contain any safety-related components and the following fire protection measures are provided: smoke detection and accessibility to manual hose streams and portable fire extinguishers.
- (d) Since Fire Zone 0C604 does not contain any safe shutdown components, a fire in Fire Zone 0C604 will not affect either train of safe shutdown components.

9A.5.52 FIRE AREA 52

9A.5.52.1 FIRE AREA DESCRIPTION

Fire Area 52 consists solely of Fire Zone 0C609 (Elev. 166' 0" and 177' 0") in the Control Building. Fire Zone 0C609 is a totally sealed and inaccessible cable chase. The floor, ceiling, and North, South, and East walls are 3-hour rated fire barriers. Except for sealed penetrations in the floor, ceiling, and East wall of Fire Zone 0C609 which has the potential for not having internal conduit fire seals in conduits in penetrations CE-146E(A), CE-148E(A), CE-80E, and CE-36G (Ref. FPE 2003-001, Rev. 0). The West wall is a 2-hour rated fire barrier, which is an exterior wall of the Control Building (Ref. Architectural Drawing A-0631).

INCLUDED FIRE ZONE	DESCRIPTION
0C609	Electrical Space, Elev. 166' 0" and 177' 0"

9A.5.52.2 SAFE SHUTDOWN EQUIPMENT

None

9A.5.52.3 FIRE AREA ANALYSIS

Fire Zone 0C609 contains no safe shutdown components, as shown on the microcomputer data base (Ref. FPP-1, Appendix C Data). This fire area is separated from other fire areas by 3-hour rated fire barriers and the 2-hour rated exterior wall. Except the floor and ceiling of Fire Zone 0C609 and the East wall of Fire Zone 0C609 where it interface with Fire zone 0C514 of Fire Area 50, the conduits in penetrations may not be sealed internally for fire/smoke on the 0C609 side of the barrier (Ref. FPE 2003-001, Rev.

GRAND GULF NUCLEAR GENERATING STATION
Updated Final Safety Analysis Report (UFSAR)

0). Although no combustible loading is postulated for Fire Area 52, if a fire were to occur in this area, it would not spread into any other fire area.

9A.5.52.4 FIRE ZONE ANALYSIS

FIRE ZONE 0C609: ELECTRICAL SPACE, ELEV. 166' 0" AND 177' 0"

1. Safety-Related Equipment

Electrical Cable and Raceway

2. Fire Zone Analysis

- (a) Fire Zone 0C609 is located in the Control Building on Elev. 166' 0" and 177' 0". The ceiling, floor, and the North, South, and East walls are 3-hour rated fire barriers. Except for sealed penetrations in the floor, ceiling, and East wall of Fire Zone 0C609 which has the potential for not having internal conduit fire seals in conduits in penetrations CE-146E(A), CE-148E(A), CE-80E, and CE-36G (Ref. FPE 2003-001, Rev. 0). The West wall is an exterior wall, which is a 2-hour rated fire barrier (Ref. Architectural Drawing A-0631).
- (b) There is no in situ or transient combustible loading postulated for Fire Zone 0C609 (Ref. Calculation MC-QSP64-86058).
- (c) Fire Zone 0C609 contains safety-related cables; however they are routed in metallic conduit. Because of this, and the fact that 0C609 is a totally sealed cable chase bounded by 2- and 3-hour rated fire barriers with no combustible loading, no active fire protection measures are provided or required.
- (d) Although no combustible loading is postulated for Fire Zone 0C609, if a fire were to occur in this fire zone, neither train of safe shutdown components would be affected.

GRAND GULF NUCLEAR GENERATING STATION
Updated Final Safety Analysis Report (UFSAR)

9A.5.53 FIRE AREA 53

9A.5.53.1 FIRE AREA DESCRIPTION

Fire Area 53 consists only of Fire Zone 0C703 (Elev. 190' 0") in the Control Building (Ref. Architectural Drawing A-0631). The floor and all four walls are 3-hour rated fire barriers with the exception of penetrations CE-352G and CE-365G which are located in the East and West walls respectively and the structural steel portion of the West wall that separates 0C703 from 0C702 and 0C706. The identified penetrations, while not 3-hour rated, have been evaluated and found acceptable to provide adequate fire separation commensurate with the hazards in the area (Ref. Fire Protection Evaluation 2000-0075, ER 2000-0113). The ceiling is the non-rated roof of the Control Building, which is supported by structural steel coated with 3-hour rated fireproofing (Ref. Architectural Drawing A-0604).

INCLUDED FIRE ZONE	DESCRIPTION
0C703	Control Cabinet Area, Elev. 190' 0"

9A.5.53.2 SAFE SHUTDOWN EQUIPMENT

Division I

9A.5.53.3 FIRE AREA ANALYSIS

Fire Zone 0C703 contains only Division I safe shutdown equipment and cable and raceway, as shown in the microcomputer data base (Ref. FPP-1, Appendix C Data). Since this fire area contains only Division I safe shutdown components and is separated from all other fire areas by 3-hour rated fire barriers, Fire Area 53 fully complies with Appendix R requirements. Therefore, in the event of a fire in this fire area, safe shutdown capability would be maintained by separate Division II safe shutdown equipment. The postulated fire with the greatest severity in Fire Zone 0C703, including transient combustibles, amounts to a low fire load. The maximum in situ combustible loading in the fire zone amounts to less than a 30-minute fire duration (Ref. Calculation MC-QSP64-86058). Therefore, a fire occurring in Fire Area 53 will not spread into any other fire area.

9A.5.53.4 FIRE ZONE ANALYSIS

FIRE ZONE 0C703: CONTROL CABINET AREA, ELEV. 190' 0"

GRAND GULF NUCLEAR GENERATING STATION
Updated Final Safety Analysis Report (UFSAR)

1. Safety-Related Equipment

Electrical Cable and Raceway
PGCC Control Panels, Termination Cabinets, and Floor
Sections

2. Fire Zone Analysis

- (a) Fire Zone 0C703 is located in the Control Building on Elev. 190' 0". The floor and all four walls of Fire Zone 0C703 are 3-hour rated fire barriers with the exception of penetrations CE-352G and CE-365G which are located in the East and West wall respectively and the structural steel portion of the West wall that separates 0C703 from 0C702 and 0C706 as indicated below. These penetrations are installed in configurations not bound by supporting fire endurance testing and therefore not considered 3-hour rated. However, they have been evaluated and found acceptable to provide adequate fire separation commensurate with the hazards in the area (Ref. Fire Protection Evaluation 2000-0075, ER 2000-0113). The ceiling of this zone forms a part of the non-rated roof of the Control Building (Ref. Architectural Drawing A-0631). The structural steel supporting this roof is coated with a 3-hour rated fireproofing barrier (Ref. Architectural Drawing A-0604). A portion of the West wall (areas North and South of door 0C709) which separates Fire Zone 0C703 from Fire Zones 0C702 and 0C706 employs a non-standard barrier design. The arrangement South of door 0C709 (separating 0C703 and 0C702) consists of an approximate 2'-0" span of steel girder coated on both sides with 3-hour fireproofing. The arrangement North of door 0C709 (separating Fire Zone 0C703 and Fire Zone 0C706) consists of an approximate 11'-8" span of steel girder coated on both sides with 3-hour fireproofing. These arrangements have been evaluated in Fire Protection Evaluation 2000/0006 and determined to provide adequate fire separation for the hazards in the areas based on the following: 1) substantial

GRAND GULF NUCLEAR GENERATING STATION
Updated Final Safety Analysis Report (UFSAR)

construction of the non-standard barriers installed, 2) low combustible loading in Fire Zones 0C702, 0C703 and 0C706, 3) automatic suppression systems (total flooding CO2 and sprinklers) in 0C702 and 0C703, 4) area wide smoke detection in 0C702, 0C703 and 0C706, and 5) accessibility to manual hose streams and portable extinguishers in 0C702, 0C703 and 0C706.

- (b) The combustible loading in Fire Zone 0C703, including transient combustibles, amounts to a low fire load. The major contributor to this combustible loading is the electrical cable, floor tile and carpet present in the zone. The in situ combustible loading in Fire Zone 0C703 amounts to less than a 45-minute fire duration (Ref. Calculation MC-QSP64-86058).
- (c) Fire Zone 0C703 contains safety-related equipment and the following fire protection measures are provided: manual total flooding carbon dioxide system, clean agent suppression system (for the PGCC floor section), smoke detection, and accessibility to manual hose stations and portable fire extinguishers.
- (d) Since Fire Zone 0C703 contains only Division I safe shutdown equipment, a fire originating in Fire Zone 0C703 will not affect more than one train of safe shutdown components.

9A.5.54 No fire area has been assigned to Section 5.54

GRAND GULF NUCLEAR GENERATING STATION
Updated Final Safety Analysis Report (UFSAR)

THIS PAGE INTENTIONALLY LEFT BLANK

GRAND GULF NUCLEAR GENERATING STATION
Updated Final Safety Analysis Report (UFSAR)

THIS PAGE INTENTIONALLY LEFT BLANK

GRAND GULF NUCLEAR GENERATING STATION
Updated Final Safety Analysis Report (UFSAR)

9A.5.55 FIRE AREA 55

9A.5.55.1 FIRE AREA DESCRIPTION

Fire Area 55 consists solely of Fire Zone 0C707 (Elev. 190' 0") in the Control Building. The floor, ceiling, and walls are 3-hour rated fire barriers with exception of a ceiling penetration which has been evaluated for acceptability based on the hazards in the area (Ref. Architectural Drawing A-0631).

INCLUDED FIRE ZONE	DESCRIPTION
0C707	Instrument Motor Generator Room, Elev 190' 0"

9A.5.55.2 SAFE SHUTDOWN EQUIPMENT

None

9A.5.55.3 FIRE AREA ANALYSIS

Fire Zone 0C707 does not contain any safe shutdown components, as shown in the microcomputer data base (Ref. FPP-1, Appendix C Data). This fire area is separated from all other fire areas by 3-hour rated fire barriers. The postulated fire with the greatest severity, including transient combustibles, amounts to a low fire load. The maximum in situ combustible loading in Fire Zone 0C707 amounts to less than a 15-minute fire duration (Ref. Calculation MC-QSP64-86058). Therefore, a fire occurring in Fire Area 55 will not spread into any other fire area.

9A.5.55.4 FIRE ZONE ANALYSIS

FIRE ZONE 0C707: INSTRUMENT MOTOR GENERATOR RM, ELEV. 190' 0"

1. Safety-Related Equipment

Electrical Cable and Raceway
Inverter

2. Fire Zone Analysis

- (a) Fire Zone 0C707 is located in the Control Building on Elev. 190' 0". The ceiling, floor, and walls are all 3-hour rated fire barriers (Ref. Architectural Drawing A-0631). The partial

GRAND GULF NUCLEAR GENERATING STATION
Updated Final Safety Analysis Report (UFSAR)

height ceiling is a 3-hour rated fire barrier with the exception of penetration CV-59G. Penetration CV-59G is located in the partial height ceiling of 0C707 and provides separation of Fire Zones 0C702 and 0C707. Penetration CV-59G employs a nonstandard penetration seal design and is not equipped with a fire damper. The penetration seal design employs Kaowool material covered with metal flashing around the 0C707 side of the penetration opening. The metal flashing assembly, on the 0C707 side, is covered with structural steel fireproofing material. This arrangement has been evaluated in Fire Protection Evaluation 2000/0004 and determined to provide adequate fire separation for the hazards in the areas based on the following: 1) Substantial construction of the non-standard seal installed 2) Low combustible loading in Fire Zone 0C702 and 0C707 3) automatic suppression systems (total flooding CO2 and sprinklers) in 0C702 4) area wide smoke detection in 0C702 and 0C707 and 5) accessibility to manual hose streams and portable extinguishers in 0C702 and 0C707.

- (b) The combustible loading in Fire Zone 0C707, including transient combustibles, amounts to a low fire load. The major contributor to this combustible loading is the electrical cable present in the room. The in situ combustible loading in Fire Zone 0C707 amounts to less than a 15-minute fire duration (Ref. Calculation MC-QSP64-86058).
- (c) Fire Zone 0C707 contains safety-related components and the following fire protection measures are provided: smoke detection and accessibility to manual hose streams and portable fire extinguishers.
- (d) Since Fire Zone 0C707 does not contain any safe shutdown components and is completely enclosed by 3-hour fire barriers, a fire originating in this fire zone will not affect either train of safe shutdown components.

GRAND GULF NUCLEAR GENERATING STATION
Updated Final Safety Analysis Report (UFSAR)

9A.5.56 FIRE AREA 56

No fire area has been assigned to Section 5.56

9A.5.57 NO FIRE AREA HAS BEEN ASSIGNED FOR SECTION 9A.5.57

9A.5.58 FIRE AREA 58

9A.5.58.1 FIRE AREA DESCRIPTION

Fire Area 58 consists of Fire Zones 0C701, 0C704, 0C706, 0C708, 0C708A and 0C711 on Elev. 190' 0" and Fire Zones 0C705 and 0C713 on Elev. 189' 0". These fire zones are located in the Control Building. The floor and walls are 3-hour rated fire barriers, except those portions of the North, South, and West walls which are non-rated exterior barriers, or non-standard fire barriers which have been evaluated for acceptability based on hazards in the area. In addition, those interfaces with Stair 0C01 and 0C02 and Elevator No. 1 are 2-hour rated fire barriers (Ref. Methodology Section 9A.3.0). The floor of Fire Zone 0C705 has the potential for not having internal conduit fire seal in conduits in penetration CE-37G (Ref. FPE 2003-001, Rev. 0). The ceiling is the non-rated roof of the Control Building, which is supported by structural steel coated with 3-hour rated fireproofing (Ref. Architectural Drawing A-0631). All Fire Zones within Fire Area 58 are separated by non-rated barriers. Therefore, a fire originating in any fire zone of Fire Area 58 is able to communicate with any other fire zone within this area.

INCLUDED FIRE ZONES	DESCRIPTION
0C701	Corridor, Elev. 190'-0"
0C704	Control Cabinet Area (Unit 2), Elev. 190'0"
0C705	Unit 1 Support Area, Elev. 189'0"
0C706	Corridor, Elev. 190'0"
0C708	Unit 1 Support Area, Elev. 190'-0"
0C708A	HVAC Chase (Unit 2), Elev. 190'0"
0C711	Unit 1 Support Area, Elev. 190'-0"
0C713	HVAC Room (Unit 2), Elev. 189'0"

9A.5.58.2 SAFE SHUTDOWN EQUIPMENT

Ductwork

GRAND GULF NUCLEAR GENERATING STATION
Updated Final Safety Analysis Report (UFSAR)

9A.5.58.3 FIRE AREA ANALYSIS

Fire Zone 0C701, 0C704, 0C705, 0C706, 0C708, 0C708A and 0C711 do not contain any safe shutdown components, as shown in the microcomputer data base (Ref. FPP-1 Appendix C Data). Fire Zone 0C713 contains only safe shutdown ductwork and based on the postulated fire duration of the zone, operation of the safe shutdown systems would not be adversely affected. Therefore, a postulated fire in this fire area would not affect more than one train of safe shutdown. The postulated fire with the greatest severity in Fire Area 58 occurs in Fire Zone 0C704. The total fire severity in Fire Zone 0C704, including transient combustibles, amounts a moderate fire load. The maximum in situ combustible loading in Fire Zone 0C704 amounts to less than a 105-minute fire duration (Ref. Calculation MC-QSP64-86058). Therefore, a fire originating in Fire Area 58 will not spread into any other fire area. Although all fire zones in Fire Area 58 communicate directly or indirectly with each other and have numerous adjacency combinations, further adjacency evaluations are not required since only safe shutdown ductwork is located in Fire Area 58. In addition, the floor of Fire Zone 0C705 is a 3-hour rated fire barrier, except where it interfaces with Fire Zone 0C612 of Fire Area 42 that conduits in penetration may not be sealed internally for fire/smoke on the 0C612 side of the barrier (Ref. FPE 2003-001, Rev. 0).

9A.5.58.4 FIRE ZONE ANALYSIS

- a. FIRE ZONE 0C701: CORRIDOR, ELEV. 190'0"
 1. Safety-Related Equipment
 - Ductwork
 2. Fire Zone Analysis
 - (a) Fire Zone 0C701 is located in the Control Building on Elev. 190'0". Fire Zone 0C701 communicates directly with Fire Zone 0C711. In Fire Zone 0C701, the floor, South wall and that portion of the West wall that interfaces with Fire Zone 0C703 (Fire Area 53) are 3-hour rated fire barriers. The ceiling and remainder of the walls in this fire zone are non-rated barriers (Ref. Architectural Drawing A-0631).

GRAND GULF NUCLEAR GENERATING STATION
Updated Final Safety Analysis Report (UFSAR)

- (b) The combustible loading in Fire Zone 0C701, which consists solely of transient combustibles, amounts a low fire load (Ref. Calculation MC-QSP64-86058).
 - (c) Fire Zone 0C701 contains only safety-related ductwork and the following fire protection measures are provided: accessibility to manual hose streams and portable fire extinguishers (Ref. Fire Protection Evaluation 87/0005).
 - (d) Fire Zone 0C701 does not contain any safe shutdown components and fire originating in Fire Zone 0C701 could communicate with all other fire zones in Fire Area 58 via the non-rated barriers. However, as previously stated, only safe shutdown ductwork is located in Fire Area 58.
- b. FIRE ZONE 0C704: CONTROL CABINET AREA (U-2), ELEV. 190' 0"
- 1. Safety-Related Equipment
None
 - 2. Fire Zone Analysis
 - (a) Fire Zone 0C704 is located in the Control Building on Elev. 190' 0". The floor and the South wall are 3-hour rated fire barriers. All of the remaining walls in this fire zone are non-rated barriers. The ceiling is the non-rated roof of the Control Building at Elev. 206' 0". Fire Zone 0C704 communicates with all other zones in Fire Area 58 via non-rated barriers (Ref. Architectural Drawing A-0631).
 - (b) The combustible loading in Fire Zone 0C704, including transient combustibles, amounts to a moderate fire load. The major contributor to this combustible loading is the raised fiberglass floor, electrical cables, security system cabinets, computer equipment, and office furniture located in this zone. The in situ

GRAND GULF NUCLEAR GENERATING STATION
Updated Final Safety Analysis Report (UFSAR)

combustible loading in this fire zone amounts to less than a 120-minute fire duration (Ref. Calculation MC-QSP64-86058).

- (c) Fire Zone 0C704 does not contain any safety-related equipment and the following fire protection measures are provided: smoke detection, accessibility to manual hose streams and portable fire extinguishers.
- (d) Fire Zone 0C704 does not contain any safe shutdown components and a fire originating in Fire Zone 0C704 could communicate with other fire zones in Fire Area 58 via the non-rated barriers. However, as previously stated, only safe shutdown ductwork is located in Fire Area 58.

c. FIRE ZONE 0C705: UNIT 1 SUPPORT AREA, ELEV. 189' 0"

1. Safety-Related Equipment

Electrical Cable and Raceway

2. Fire Zone Analysis

- (a) Fire Zone 0C705 is located in the Control Building on Elev. 189' 0". The floor and East wall are 3-hour rated fire barriers, except the floor of Fire Zone 0C705 that conduits in penetration CE-37G may not be sealed internally for fire/smoke on the 0C612 side of the barrier of fire Area 42 (Ref. FPE 2003-001, Rev. 0). All of the remaining walls are non-rated barriers. The ceiling is the non-rated roof of the Control Building at Elev. 206' 0". Fire Zone 0C705 communicates with all other fire zones in Fire Area 58 due to the non-rated barriers (Ref. Architectural Drawing A-0631).
- (b) The combustible loading in Fire Zone 0C705, including transient combustibles, amounts a low fire load. The major contributor to this combustible loading is the electrical cables, SMC wall/roof insulation, computer equipment, and office furniture in this zone. The in situ

GRAND GULF NUCLEAR GENERATING STATION
Updated Final Safety Analysis Report (UFSAR)

combustible loading in this fire zone amounts to less than a 30-minute fire duration (Ref. Calculation MC-QSP64-86058).

- (c) Fire Zone 0C705 contains safety-related equipment and the following fire protection measures are provided: smoke detection, a manual sprinkler system and accessibility to manual hose streams and portable fire extinguishers.
 - (d) Fire Zone 0C705 does not contain any safe shutdown components and a fire originating in Fire Zone 0C705 could communicate with all other fire zones in Fire Area 58, via non-rated barriers. However, as previously stated, only safe shutdown ductwork is located in Fire Area 58.
- d. FIRE ZONE 0C706: CORRIDOR, ELEV. 190' 0"
- 1. Safety-Related Equipment
 - Electrical Cable and Raceway
 - 2. Fire Zone Analysis
 - (a) Fire Zone 0C706 is located in the Control Building on Elev. 190' 0". The floor is a 3-hour rated fire barrier. The East wall is a 3-hour rated fire barrier except the portion separating 0C706 from 0C703 which is a non-standard barrier and the portion separating 0C706 from 0C704 which is a non-rated barrier. The South wall is a 3-hour rated fire barrier with the following exceptions; non-rated exterior portions, non-standard penetration CE-456G (in the wall separating Fire Zones 0C702 (Fire Area 47) and 0C706) and the non-standard barrier itself separating 0C706 from 0C702. The non-standard fire barrier configuration separating 0C702 and 0C706 utilizes reinforced concrete construction to approximately the 197'-4" elevation, a double steel plate partition from the 197'4" elevation to approximately the 201'-4" elevation, and a W27 x 94 I-beam from top of the double steel plate partition to the underside of the Control

GRAND GULF NUCLEAR GENERATING STATION
Updated Final Safety Analysis Report (UFSAR)

Building roof reinforced concrete slab. The double steel plate partition and the I-beam have 3-hour structural steel fireproofing material applied to each side of the configuration. For specific details of the above described fire barrier partition configuration refers to the following Drawings: C-0625A; C-626C (Elevation AA, Detail 5, and Sections E & DD). While not a standard fire barrier design, this configuration has been evaluated in Fire Protection Evaluation 98-0002 and determined to provide adequate fire separation for the hazards in the areas based on the following: 1) substantial construction of the double steel plate and I-Beam assembly; 2) 3-hour rated structural steel fire proofing material applied on each side of the double steel plate and I-Beam partition assembly; 3) low combustible loading in 0C702 and 0C706; 4) automatic suppression systems (total flood carbon dioxide & sprinklers) in 0C702; 5) area wide smoke detection in 0C702 & 0C706; and 6) accessibility to manual hose streams and portable fire extinguishers in 0C702 & 0C706. A portion of the East wall of 0C706, which separates Fire Zone 0C706 and Fire Zone 0C703 employs a nonstandard barrier design. This arrangement consists of an approximate 11'-8" span of steel girder coated on both sides with 3-hour fireproofing. In the south wall of Fire Zone 0C706, a nonstandard penetration seal design (CE-456G) is installed in the barrier separating Fire Zone 0C706 and Fire Zone 0C702. These arrangements have been evaluated in Fire Protection Evaluation 2000/0006 and determined to provide adequate fire separation for the hazards in the areas based on the following: 1) substantial construction of the non-standard seal and barrier installed, 2) low combustible loading in Fire Zones 0C702, 0C703, and 0C706, 3) automatic suppression systems (total flooding CO₂ and sprinklers) in 0C702 and 0C703, 4) area wide smoke detection in 0C702, 0C703 and 0C706, and 5) accessibility to manual hose streams and portable extinguishers in 0C702, 0C703 and

GRAND GULF NUCLEAR GENERATING STATION
Updated Final Safety Analysis Report (UFSAR)

0C706. In addition, those interfaces with Stair 0C01 and Elevator No. 1 are 2-hour rated fire barriers (Ref. Methodology Section 9A.3.0). The ceiling is the non-rated roof of the Control Building at Elev. 206' 0". Fire Zone 0C706 communicates with all other fire zones in Fire Area 58 via non-rated barriers. (Ref. Architectural Drawing A-0631).

- (b) The combustible loading in Fire Zone 0C706, including transient combustibles, amounts to a low fire load. The major contributor to this fire loading is the electrical cable present in this zone. The in situ combustible loading in Fire Zone 0C706 amounts to less than a 15-minute fire duration (Ref. Calculation MC-QDP64-86058).
- (c) Fire Zone 0C706 contains safety-related cables and raceway and the following fire protection measures are provided: smoke detection and accessibility to manual hose streams and portable fire extinguishers.
- (d) Fire Zone 0C706 does not contain any safe shutdown components and a fire originating in Fire Zone 0C706 could communicate with all other Fire Zones in Fire Area 58, via non-rated barriers. However, as previously stated, only safe shutdown ductwork is located in Fire Area 58.

e. FIRE ZONE 0C708: UNIT 1 SUPPORT AREA, ELEV. 190'0"

1. Safety Related Equipment

Electrical Cable and Raceway
Inverter

2. Fire Zone Analysis

- (a) Fire Zone 0C708 is located in the Control Building on Elev. 190'0". The floor of Fire Zone 0C708 is a 3-hour rated fire barrier. The Ceiling and all walls are non-rated barriers (Ref. Architectural Drawing A-0631).

GRAND GULF NUCLEAR GENERATING STATION
Updated Final Safety Analysis Report (UFSAR)

- (b) The combustible loading in Fire Zone 0C708, including transient combustibles, amounts to a low fire load. The major contributor to this combustible loading is rodofoam on equipment present in the room. The in situ combustible loading in Fire Zone 0C708 amounts to less than a 15-minute fire duration (Ref. Calculation MC-QSP64-86058).
 - (c) Fire Zone 0C708 contains safety-related equipment and the following fire protection measures are provided: smoke detection and accessibility to manual hose streams and portable fire extinguishers.
 - (d) Since Fire Zone 0C708 does not contain any safe shutdown components, a fire originating in this fire zone may communicate with all other fire zones in Fire Area 58, via the non-rated barriers.
- f. FIRE ZONE 0C708A: HVAC CHASE (Unit 2), ELEV. 190' 0"
- 1. Safety-Related Equipment
 - Electrical Cable and Raceway
 - 2. Fire Zone Analysis
 - (a) Fire Zone 0C708A is located in the Control Building on Elev. 190' 0". The floor is a 3-hour rated fire barrier. The interface with Stair 0C01 is a 2-hour rated fire barrier (Ref. Methodology Section 9A.3.0). The ceiling is the non-rated roof of the Control Building at Elev. 206' 0". The North, East and South walls are non-rated barriers. A fire originating in Fire Zone 0C708A may communicate with all other fire zones in Fire Area 58, via the non-rated barriers (Ref. Architectural Drawing A-0631).
 - (b) The combustible loading in Fire Zone 0C708A, including transient combustibles, amounts to a low fire load. The in situ combustible loading

GRAND GULF NUCLEAR GENERATING STATION
Updated Final Safety Analysis Report (UFSAR)

in Fire Zone 0C708A amounts to less than a 15-minute fire duration (Ref. Calculation MC-QSP64-86058).

- (c) Fire Zone 0C708A contains safety-related cables and raceway and the following fire protection measures are provided: smoke detection, accessibility to manual hose streams and portable fire extinguishers.
- (d) Fire Zone 0C708A does not contain any safe shutdown components. A fire originating in Fire Zone 0C708A may communicate with all other fire zones in Fire Area 58, via the non-rated barriers. As previously stated, only safe shutdown ductwork is located in Fire Area 58.

g. FIRE ZONE 0C711: UNIT 1 SUPPORT AREA, ELEV. 190'0"

1. Safety-Related Equipment

None

2. Fire Zone Analysis

- (a) Fire Zone 0C711 is located in the Control Building on Elev. 190'0". For Fire Zone 0C711, the floor, East wall and that portion of the West wall adjacent to Fire Zone 0C702 (Fire Area 47) are 3-hour rated fire barriers. The South wall is an interface with Stair 0C02, which is a 2-hour rated fire barrier (Ref. Methodology Section 3.0). The North wall and that portion of the West wall adjacent to Fire Zone 0C701 are non-rated barriers. The ceiling is the non-rated roof of the Control Building (Ref. Architectural Drawing A-0631).
- (b) The combustible loading in Fire Zone 0C711, which consists solely of transient combustibles, amount to a low fire load (Ref. Calculation MC-QSP64-86058).

GRAND GULF NUCLEAR GENERATING STATION
Updated Final Safety Analysis Report (UFSAR)

- (c) Fire Zone 0C711 does not contain any safety-related components and the following fire protection measures are provided: smoke detection and accessibility to manual hose streams and portable extinguishers.
 - (d) Fire Zone 0C711 does not contain any safe shutdown components. A fire originating in Fire Zone 0C711 may communicate with all other fire zones in Fire Area 58, via the non-rated barriers. As previously stated, only safety shutdown ductwork is located in Fire Area 58.
- h. FIRE ZONE 0C713: HVAC ROOM (UNIT 2), ELEV. 189' 0"
- 1. Safety-Related Equipment
 - Ductwork
 - 2. Fire Zone Analysis
 - (a) Fire Zone 0C713 is located in the Control Building on Elev. 189' 0". The floor is a 3-hour rated fire barrier. The North, South, and East walls are non-rated barriers. The West wall is a non-rated exterior barrier. The ceiling is the non-rated roof of the Control Building at Elev. 206' 0". Fire Zone 0C713 communicates with all other fire zones in Fire Area 58 through non-rated barriers (Ref. Architectural Drawing A-0631).
 - (b) The combustible loading in Fire Zone 0C713 consists of transient combustibles only and amounts to a low fire load (Ref. Calculation MC-QSP64-86058).
 - (c) Fire Zone 0C713 contains only safety-related ductwork and the following fire protection measure is provided: accessibility to manual hose streams and portable fire extinguishers. (Ref. Fire Protection Evaluation 87/0005).
 - (d) Fire Zone 0C713 contains only safe shutdown ductwork. A fire originating in Fire Zone 0C713 could communicate with all other fire zones in

GRAND GULF NUCLEAR GENERATING STATION
Updated Final Safety Analysis Report (UFSAR)

Fire Area 58 via the non-rated barriers. An adjacency discussion is provided in the fire area analysis for Fire Area 58.

9A.5.59 FIRE AREA 59

9A.5.59.1 FIRE AREA DESCRIPTION

Fire Area 59 is the yard which includes all components outside of the power block, including those located underground. Fire Area 59 is not divided into fire zones (Ref. to Civil Drawing C-0012).

9A.5.59.2 SAFE SHUTDOWN EQUIPMENT

Division I and II

9A.5.59.3 FIRE AREA ANALYSIS

- a. Fire Area 59 contains redundant Division I and Division II safe shutdown cable and raceway, as shown in the microcomputer data base (Ref. FPP-1, Appendix C Data). All safe shutdown cable and raceway in Fire Area 59 are located underground. The underground raceway consists of reinforced concrete duct banks and manholes to facilitate cable pulling. The cables are installed within 6-inch PVC conduits which terminate at the manhole. These three manholes are labeled MH01, MH20, and MH21.
- b. Manhole MH01 is a four-compartment manhole and is located approximately 275 feet west of the Control Building, as shown on raceway plan drawing E-0660. As shown on Electrical Drawings E-0674 and E-0665, two compartments contain the Division I cables and two compartments contain the Division II cables. Each compartment is separated by a 12-inch concrete wall with a 4-inch-diameter drainage hole, which allows the compartments to communicate (Ref. Civil Drawing C-0038C). Manhole MH01 compartments are sealed with pressure type-water-, gas-, and steam tight bolted lids, with rubber gaskets to prevent the entry of any potential flammable liquid.
- c. Both the PVC conduit and cable insulation represent in situ combustibles. The cable is qualified to IEEE 383 and installed in accordance with the separation requirements of Regulatory Guide 1.75.

GRAND GULF NUCLEAR GENERATING STATION
Updated Final Safety Analysis Report (UFSAR)

Bulk air flow into the manhole that could drive combustion is prevented by minimizing leakage paths to small gaps, seals and through the sump pump discharge pipe. Also the relative position of the drainage holes compared to the combustibles and the expected presence of ground water within the manhole make the spread of a fire through the drainage holes unlikely. Therefore, a fire originating in any compartment of Manhole MH01 will not affect or propagate to more than one train of safe shutdown.

- d. The closest in situ combustibles to Manhole MH01 are the Unit 2 diesel fuel tanks, located approximately 25 feet from Manhole MH01, and the Unit 1 diesel fuel tank, located approximately 35 feet away. All tanks are buried approximately 10 feet below grade and are provided with an oil collection sump to collect and contain any potentially spilled oil. In addition, the flash point of the fuel (fuel oil No. 2) is a minimum of 100 F with an auto ignition point of 494 F and is classified as a Class II combustible liquid with a low ignition susceptibility. Refueling activities are supervised by operations personnel, and further protection is afforded by a yard hydrant, which is located approximately 50 feet north of MH01 (Ref. Civil Drawing C-0035E).
- e. Based on the location and installation configuration of the manhole, separation from the nearest yard fire hazard, and precautions taken during refueling activity, a fire at the oil collection sump or tank will not affect or propagate to either train of safe shutdown.
- f. Manhole MH20 contains only Division I safe shutdown cable (Ref. Electrical Drawing E-0665). As shown on site raceway plan drawing E-0660, MH20 is located south of the southeast corner of Standby Service Water Cooling Tower No. 1.
- g. Manhole MH21 contains only Division II safe shutdown cable (Ref. Electrical Drawing E-0665). As shown on site raceway plan drawing E-0660, MH21 is located south of the southeast corner of Standby Service Water Cooling Tower No. 2.

GRAND GULF NUCLEAR GENERATING STATION
Updated Final Safety Analysis Report (UFSAR)

- h. These manholes are similar in design to Manhole MH01; however, only a single division of safe shutdown is located in each manhole. The PVC conduit and IEEE 383 cables represent the only in situ combustibles. Therefore, a fire originating within either manhole will not affect or propagate to more than one train of safe shutdown.
- i. Manholes MH20 and MH21 are located approximately 275 feet and 450 feet, respectively, from Manhole MH01 and are separated from each other by approximately 175 feet.
- j. There are no yard in situ combustibles (fire hazards) located within the 175 foot distance separating Manholes MH20 and MH21. The transient combustibles postulated for the Standby Service Water Pump House (Fire Areas 64 and 65) are also considered as the postulated transient combustibles for the vicinity of these manholes.
- k. Manholes MH20 and MH21 each contain only a single division of safe shutdown and are separated by a horizontal distance greater than 150 feet with no intervening combustibles. In addition, further protection is provided by fire hydrants in the vicinity of each Standby Service Water Basin (Ref. Civil Drawing C-0035D). Therefore, a postulated fire would not propagate to affect both trains of safe shutdown.
- l. Other safe shutdown and safety-related components housed within seismic Category I structures are protected from potential yard fire hazards, as described in the following paragraphs.
- m. All diesel fuel oil storage tanks are buried so that the tops of the tanks are approximately 10 feet below grade, and therefore, the fuel oil in the tanks will not contribute to a fire in the yard area. The closest fill connection is located approximately 20 feet from the Diesel Generator Building North wall, which is the closest Category I structure. Fuel Oil Tank No. 2 has a low ignition susceptibility and the oil collection sump design will contain a potential spill for the reasons previously presented in the discussion for Manhole MH01. These factors, in combination with the precautions exercised during the filling activity and access to fire hydrants, minimize potential fire propagation. Furthermore,

GRAND GULF NUCLEAR GENERATING STATION
Updated Final Safety Analysis Report (UFSAR)

protection of the safety-related components contained in the Category I structure is enhanced by the 2-foot thick concrete exterior wall.

- n. Electrical transformers are located at least 10 feet from structures containing safety-related equipment and any seismic Category I structure walls that are within 50 feet of a transformer are at least 2-hour rated fire barriers. All transformers are surrounded by a gravel filled pit and each is protected by an automatic deluge system, which initiates an alarm in the control room and locally when the system actuates. In addition, fire hydrants are located around the power block such that all transformers can be reached by hydrant hose streams. Due to the relative position of ESF Transformers 11 and 21 to the HVAC air intakes, smoke detection on the intake ductwork has been provided. Upon detection of the presence of smoke in the supply ductwork, a signal sounds the alarm associated with the fire detection system and operator action is required.
- o. As shown on Civil Drawing C-0012, the flammable liquids storage area is located approximately 300 feet south of the Water Treatment Building. This location is at least 500 feet from the nearest Category I structure or component.
- p. As shown on Civil Drawing C-0012, the oil separator area is located approximately 100 feet south of the Diesel Generator Building, which is the nearest Category I structure. This location is adequately separated from safety-related structures and components.
- q. Two fuel tanks have been installed underground in the vicinity of the warehouse. No safety-related structure or component important to safety is located within 200 feet of this location.
- r. Deleted
- s. Other miscellaneous areas such as warehouses, shops, Interim Modification and Engineering Facility, the Administration Building, and the Auxiliary Cooling Tower do not pose a fire hazard to safety-related components, due to their physical separation and accessibility to fire hydrants. In addition to fire hydrants, the Auxiliary

GRAND GULF NUCLEAR GENERATING STATION
Updated Final Safety Analysis Report (UFSAR)

Cooling Tower is partially protected by monitor nozzles. The natural draft cooling tower contains combustible fill materials, however, it is located over 500 feet from the nearest Category I structure or component.

- t. Therefore, it is concluded that a fire in Fire Area 59 will not prevent safe shutdown of the reactor.

9A.5.60 FIRE AREA 60

9A.5.60.1 FIRE AREA DESCRIPTION

Fire Area 60 consists solely of Fire Zone 1D301 (Elev. 133 0") in the Diesel Generator Building. The walls of Fire Area 60 are all 3-hour rated fire barriers, except for those portions of the North, South, and West walls that are non-rated exterior barriers (Ref. Architectural Drawings A-0634 and A-0635). The floor is also a non-rated exterior barrier. The ceiling is the non-rated roof of the Diesel Generator Building, which is supported by structural steel that is coated with 3-hour fire proofing (Ref. Architectural Drawings A-0629).

INCLUDED FIRE ZONE	DESCRIPTION
1D301	Corridor, Elev. 133' 0"

9A.5.60.2 SAFE SHUTDOWN EQUIPMENT

Division I and II

9A.5.60.3 FIRE AREA ANALYSIS

Fire Zone 1D301 contains redundant Division I and II safe shutdown cable and raceway, as shown in the microcomputer data base (Ref. FPP-1, Appendix C Data). Division I raceways 1DATDL58, 1DATHL58, 1DATML58, 1DATWL58, and 1DARML09 are separated from the closest Division II safe shutdown raceways 1DBTDL57, 1DBTHL57, 1DBTML57, 1DBTWL57, and 1DBRML10 by a horizontal distance of 20.5' feet. In addition, this distance is free of intervening combustibles with exception of fire hose station HS-66B which is required per TRM 6.2.6. This information has been verified by a field walkdown. Raceway Drawing E-1714 shows this separation distance to be free of electrical combustibles as well. In addition, since Fire Zone 1D301 has also been provided with a preaction sprinkler system and is separated from all other fire areas by 3-hour fire rated barriers, Fire Area 60 fully complies with Appendix R

GRAND GULF NUCLEAR GENERATING STATION
Updated Final Safety Analysis Report (UFSAR)

requirements. Therefore, in the event of a fire in this fire area, at least one train of safe shutdown components will remain free of fire damage. The total fire severity in Fire Zone 1D301, including transient combustibles, amounts to a low fire load. The maximum in situ combustible loading in Fire Zone 1D301 amounts to less than a 30-minute fire duration (Ref. Calculation MC-QSP64-86058). Therefore, a fire occurring in Fire Area 60 will not spread into any other fire area.

9A.5.60.4 FIRE ZONE ANALYSES

FIRE ZONE 1D301: CORRIDOR, ELEV. 133' 0"

1. Safety-Related Equipment

Electrical Cable and Raceway

2. Fire Zone Analysis

- (a) Fire Zone 1D301 is located in the Diesel Generator Building on Elev. 133'. Since Fire Zone 1D301 is the only zone in the fire area, it does not communicate directly or indirectly with any other zone. The walls are 3-hour rated fire barriers, except for those portions that are non-rated exterior barriers. The floor and ceiling are also non-rated exterior barriers (Ref. Architectural Drawings A-0634 and A-0635).
- (b) The combustible loading in Fire Zone 1D301, including transient combustibles, amounts to a low fire load. The major contributors to this combustible loading are the electrical cable present in the room and the concrete joint sealant in the walls. The in situ combustible loading in this fire zone amounts to less than a 30-minute fire duration (Ref. Calculation MC-QSP64-86058).
- (c) Fire Zone 1D301 contains safety-related equipment and the following fire protection measures are provided: ultraviolet flame detection, automatic preaction sprinkler system, and accessibility to manual hose streams and portable fire extinguishers.

GRAND GULF NUCLEAR GENERATING STATION
Updated Final Safety Analysis Report (UFSAR)

- (d) Fire Zone 1D301 contains redundant Division I and II safe shutdown components. However, as described in the fire area analysis for Fire Area 60, adequate protection has been provided in Fire Area 60 to ensure that at least one train of safe shutdown components will remain free of fire damage should a fire occur in Fire Zone 1D301.

9A.5.61 FIRE AREA 61

9A.5.61.1 FIRE AREA DESCRIPTION

Fire Area 61 consists only of Fire Zone 1D310 (Elev. 133'-0") in the Diesel Generator Building. The North, East, and a portion of the South wall adjacent to 1D301 are 3-hour rated fire barriers. The remaining portion of the South wall as well as the West wall and floor (slab) are non-rated exterior barriers (Ref. Architectural Drawings A-0634 and A-0635). In addition, the ceiling is a non-rated roof, which is supported by structural steel coated with a 3-hour rated fireproofing barrier (Ref. Architectural Drawing A-0629).

INCLUDED FIRE ZONE	DESCRIPTION
1D310	Diesel Generator Bay, Elev. 133' 0"

9A.5.61.2 SAFE SHUTDOWN EQUIPMENT

Division I

9A.5.61.3 ALTERNATE SHUTDOWN CONTROLS

1H22-P113
1H22-9400

9A.5.61.4 FIRE AREA ANALYSIS

Fire Zone 1D310 contains only Division I safe shutdown equipment and cable and raceway as shown in the microcomputer data base (Ref. FPP-1, Appendix C Data). Since this fire area contains only Division I safe shutdown components and is separated from all other fire areas by 3-hour rated fire barriers, Fire Area 61 fully complies with Appendix R requirements. Therefore, in the event of a fire in this fire area, safe shutdown capability would be maintained by separate Division II safe shutdown equipment. The

GRAND GULF NUCLEAR GENERATING STATION
Updated Final Safety Analysis Report (UFSAR)

total fire severity in Fire Zone 1D310, including transient combustibles, amounts to a low fire load. The maximum in situ combustible loading in Fire Zone 1D301 amounts to less than a 30-minute fire duration (Ref. Calculation MC-QSP64-86058). Therefore, a fire occurring in Fire Area 61 will not spread into any other fire area.

9A.5.61.5 FIRE ZONE ANALYSIS

FIRE ZONE 1D310: DIESEL GENERATOR BAY, ELEV. 133'-0"

1. Safety-Related Equipment

Standby Diesel Generator
Starting Air Storage Tanks
Lube Oil Sump Tank
Lube Oil Cooler
Jacket Water Standpipe
Jacket Water Cooler
Fuel Oil Day Tank
Electrical Panel
Control Panel
Relay Panel
Diesel Generator Outside Air Fan
Electrical Cable and Raceway

2. Fire Zone Analysis

- (a) Fire Zone 1D310 is located in the Diesel Generator Building on Elev. 133' 0". The North and East walls and a portion of the South wall (adjacent to 1D301) of Fire Zone 1D310 are 3-hour rated fire barriers. The floor, ceiling, West wall and the remaining portion of the South wall are non-rated exterior barriers (Ref. Architectural Drawings A-0634 and A-0635).
- (b) The combustible loading in Fire Zone 1D310, including transient combustibles, amounts to a moderate fire load. The major contributors to this combustible loading are the miscellaneous in situ combustibles (e.g., lubricating oil and fuel oil) present in the room. The in situ combustible loading in Fire Zone 1D310 amounts to less than a 90-minute fire duration (Ref. Calculation MC-QSP64-86058).

GRAND GULF NUCLEAR GENERATING STATION
Updated Final Safety Analysis Report (UFSAR)

- (c) Fire Zone 1D310 contains safety-related equipment and the following fire protection measures are provided: automatic preaction sprinkler system which is activated by heat detection, ultraviolet flame detection, and accessibility to hose streams and portable fire extinguishers.
- (d) Since Fire Zone 1D310 contains only Division I safe shutdown equipment, a fire originating in this zone will not affect more than one train of safe shutdown components.

9A.5.62 FIRE AREA 62

9A.5.62.1 FIRE AREA DESCRIPTION

Fire Area 62 consists only of Fire Zone 1D308 (Elev. 133' 0") in the Diesel Generator Building. The North, East, and South walls are 3-hour rated fire barriers. The West wall and floor (slab) are non-rated exterior barriers (Ref. Architectural Drawings A-0634 and A-0635). In addition, the ceiling is a non-rated roof, which is supported by structural steel coated with a 3-hour rated fireproofing barrier (Ref. Architectural Drawing A-0629).

INCLUDED FIRE ZONE	DESCRIPTION
1D308	Diesel Generator Bay, Elev. 133' 0"

9A.5.62.2 SAFE SHUTDOWN EQUIPMENT

Division II

9A.5.62.3 FIRE AREA ANALYSIS

Fire Zone 1D308 contains only Division II safe shutdown equipment and cable and raceway, as shown in the microcomputer data base (Ref. FPP-1, Appendix C Data). Since this fire area contains only Division II safe shutdown components and is separated from all other fire areas by 3-hour rated fire barriers, Fire Area 62 fully complies with Appendix R requirements. Therefore, in the event of a fire in this fire area, safe shutdown capability would be maintained by separate Division I safe shutdown equipment. The total fire severity in Fire Zone 1D308, including transient combustibles, amounts to a moderate fire load. The maximum in situ combustible loading in Fire Zone 1D308 amounts to less than a 75-

GRAND GULF NUCLEAR GENERATING STATION
Updated Final Safety Analysis Report (UFSAR)

minute fire duration (Ref. Calculation MC-QSP64-86058). Therefore, a fire occurring in Fire Area 62 will not spread into any other fire area.

9A.5.62.4 FIRE ZONE ANALYSIS

FIRE ZONE 1D308: DIESEL GENERATOR BAY, ELEV. 133' 0"

1. Safety-Related Equipment

Standby Diesel Generator
Starting Air Storage Tanks
Lube Oil Sump Tank
Lube Oil Cooler
Jacket Water Standpipe
Jacket Water Cooler
Fuel Oil Day Tank
Electrical Panel
Control Panel
Relay Panel
Diesel Generator Outside Air Fan
Electrical Cable and Raceway

2. Fire Zone Analysis

- (a) Fire Zone 1D308 is located in the Diesel Generator Building on Elev. 133' 0". The North, South, and East walls of Fire Zone 1D308 are 3-hour rated fire barriers. The floor, ceiling, and West wall are non-rated exterior barriers (Ref. Architectural Drawings A-0634 and A-0635).
- (b) The combustible loading in Fire Zone 1D308, including transient combustibles, amounts to a moderate fire load. The major contributors to this combustible loading are the miscellaneous insitu combustibles (e.g., lubricating oil, fuel oil, etc.) present in the room. The in situ combustible loading in Fire Zone 1D308 amounts to less than a 75-minute fire duration (Ref. Calculation MC-QSP64-86058).
- (c) Fire Zone 1D308 contains safety-related equipment and the following fire protection measures are provided: automatic preaction sprinkler system which is activated by heat

GRAND GULF NUCLEAR GENERATING STATION
Updated Final Safety Analysis Report (UFSAR)

detection, ultraviolet flame detection, and accessibility to hose streams and portable fire extinguishers.

- (d) Since Fire Zone 1D308 contains only Division II safe shutdown equipment, a fire originating in this zone will not affect more than one train of safe shutdown components.

9A.5.63 FIRE AREA 63

9A.5.63.1 FIRE AREA DESCRIPTION

Fire Area 63 consists solely of Fire Zone 1D306 (Elev. 133' 0") in the Diesel Generator Building. The East and South walls and portions of the North wall adjacent to Fire Zone 1D301 are 3-hour rated fire barriers. The remaining portion of the North wall, West wall, and floor (slab) are non-rated exterior barriers (Ref. Architectural Drawings A-0634 and A-0635). In addition, the ceiling is a non-rated roof, which is supported by structural steel coated with a 3-hour rated fireproofing barrier (Ref. Architectural Drawing A-0629).

INCLUDED FIRE ZONE	DESCRIPTION
1D306	Diesel Generator Bay, Elev. 133' 0"

9A.5.63.2 SAFE SHUTDOWN EQUIPMENT

None

9A.5.63.3 FIRE AREA ANALYSIS

Fire Zone 1D306 does not contain any safe shutdown components, as shown in the microcomputer data base (Ref. FPP-1, Appendix C Data). This fire area is separated from all other fire areas by 3-hour rated fire barriers. Therefore, in the event of a fire in this fire area, safe shutdown capability would be maintained by either division of safe shutdown equipment. The total fire severity in Fire Zone 1D306, including transient combustibles, amounts to a low fire load. The maximum in situ combustible loading in Fire Zone 1D306 amounts to less than a 60-minute fire duration (Ref. Calculation MC-QSP64-86058). Therefore, a fire occurring in Fire Area 63 will not spread into any other fire area.

GRAND GULF NUCLEAR GENERATING STATION
Updated Final Safety Analysis Report (UFSAR)

9A.5.63.4 FIRE ZONE ANALYSIS

FIRE ZONE 1D306: DIESEL GENERATOR BAY, ELEV. 133' 0"

1. Safety-Related Equipment

Relay and Control Panels
Fuel Oil Day Tank
HPCS Diesel Generator
Exhaust Silencers
Air Intake Filters
Air Intake Silencers
Air Compressor Skid
Diesel Generator Room Outside Air Fan
Electrical Cable and Raceway

2. Fire Zone Analysis

- (a) Fire Zone 1D306 is located in the Diesel Generator Building on Elev.133' 0". The East, South, and portions of the North wall adjacent to Fire Zone 1D301 are 3-hour rated fire barriers. The floor, ceiling, West wall, and a portion of the North wall are non-rated exterior barriers (Ref. Architectural Drawings A-0634 and A-0635).
- (b) The combustible loading in Fire Zone 1D306, including transient combustibles, amounts to a low fire load. The major contributors to this combustible loading are the miscellaneous in situ combustibles (e.g., lubricating oil, fuel oil, etc.) present in the room. The in situ combustible loading in this fire zone amounts to less than a 60-minute fire duration (Ref. Calculation MC-QSP64-86058).
- (c) Fire Zone 1D306 contains safety-related equipment and the following fire protection measures are provided: an automatic preaction sprinkler system which is activated by heat detection, an ultraviolet flame detection system, and accessibility to manual hose streams and portable fire extinguishers.

GRAND GULF NUCLEAR GENERATING STATION
Updated Final Safety Analysis Report (UFSAR)

- (d) Since Fire Zone 1D306 does not contain any safe shutdown components, a fire in Fire Zone 1D306 will not affect either train of safe shutdown components.

9A.5.64 FIRE AREA 64

9A.5.64.1 FIRE AREA DESCRIPTION

Fire Area 64 consists of Fire Zones 1M110, 1M112 (Elev. 133' 0"), and Basin No. 1, which includes the cooling tower (Elev. 82' 6") in the Standby Service Water Cooling Tower and Basin Complex A. The exterior boundary of Fire Area 64 is a non-rated concrete structural barrier. Fire Zones 1M110, 1M112, and Basin No. 1 are separated by non-rated barriers and, therefore, a fire originating in any one fire zone of Fire Area 64 could communicate with any other zone in Fire Area 64 (Ref. Architectural Drawing A-0634 and Civil Drawing C-0012).

INCLUDED FIRE ZONE	DESCRIPTION
1M110	Standby Service Water Pump House, Elev. 133' 0"
1M112	Standby Service Water Valve Room, Elev. 133' 0"
Basin No.1	Standby Service Water Basin (Including Cooling Tower), Elev. 82' 6"

9A.5.64.2 SAFE SHUTDOWN EQUIPMENT

Division I

9A.5.64.3 FIRE AREA ANALYSIS

- (a) Fire Zones 1M110, 1M112, and Basin No. 1 contain only Division I safe shutdown equipment, cable, and raceway, as shown in the microcomputer data base (Ref. FPP-1, Appendix C Data). The closest Division II safe shutdown components are located in Fire Area 65 (Basin Complex B) and Manhole No. 21 (Fire Area 59) in the yard. These Division I and II safe shutdown components are separated by a horizontal distance of more than 65 feet and non-rated exterior barriers. There are no intervening combustibles (yard fire hazards) located within this separation distance. Fire Zone 1M110 also contains Unit 2 Division II ventilation circuits which are considered safe shutdown for a fire in Fire

GRAND GULF NUCLEAR GENERATING STATION
Updated Final Safety Analysis Report (UFSAR)

Zone OC214 only (See Fire Area 30 Analysis / OC214).

- (b) The postulated fire with the greatest severity in Fire Area 64 occurs in Fire Zone 1M110. The total fire severity in Fire Zone 1M110, including transient combustibles, amounts to a low fire load. The in situ combustible loading in Fire Zone 1M110 amounts to less than a 30-minute fire duration (Ref. Calculation MC-QSP64-86058). Therefore, a fire occurring in Fire Area 64 will not affect, or propagate to affect, more than one train of safe shutdown.

- (c) The Division I and II safe shutdown components discussed above are not separated by 3 hr. fire rated barriers. The 65 ft. open air separation with no intervening combustibles plus the non-rated concrete barriers is sufficient to prevent the propagation of fire to affect more than one train of safe shutdown. Fire detection is not provided within this separation distance since it is exterior open space.

9A.5.64.4 FIRE ZONE ANALYSES

- a. FIRE ZONE 1M110: STANDBY SERVICE WATER PUMP HOUSE, ELEV. 133' 0"
 - 1. Safety-Related Equipment
 - Standby Service Water Pump
 - Standby Service Water Room Cooler
 - Electrical Cable and Raceway
 - HPCS Pump
 - Motor Control Center
 - Load Center

 - 2. Fire Zone Analysis
 - (a) Fire Zone 1M110 is located in the Standby Service Water Cooling Tower and Basin Complex A on Elev. 133' 0". The floor, ceiling, and all four walls of Fire Zone 1M110 are non-rated exterior barriers (Ref. Architectural Drawing A-0634).

GRAND GULF NUCLEAR GENERATING STATION
Updated Final Safety Analysis Report (UFSAR)

- (b) The combustible loading in Fire Zone 1M110, including transient combustibles, amounts to a low fire load. The major contributors to this combustible loading are the electrical cables and lube oil present in the room. The in situ combustible loading in Fire Zone 1M110 amounts to less than a 30-minute fire duration (Ref. Calculation MC-QSP64-86058).
 - (c) Fire Zone 1M110 contains safety-related equipment and the following fire protection measures are provided: smoke detection and accessibility to yard hose stations and portable fire extinguishers (Ref. Civil Drawing C-0035D).
 - (d) Fire Zone 1M110 is adjacent to Fire Zones 1M112 and Basin No. 1, both of which contain only Division I safe shutdown components. Therefore, a fire in Fire Zone 1M110 will not affect, or propagate to affect, more than one train of safe shutdown components. Fire Zone 1M110 also contains Unit 2 Division II ventilation circuits which are considered safe shutdown for a fire in Fire Zone OC214 only. (See Fire Area 30 Analysis/OC214)
- b. FIRE ZONE 1M112: STANDBY SERVICE WATER VALVE ROOM, ELEV. 133' 0"
- 1. Safety-Related Equipment
 - Electrical Cable and Raceway
 - 2. Fire Zone Analysis
 - (a) Fire Zone 1M112 is located in the Standby Service Water Cooling Tower and Basin Complex A on Elev. 133' 0". The floor, ceiling, and all four walls of Fire Zone 1M112 are non-rated exterior barriers (Ref. Architectural Drawing A-0634).
 - (b) There is no combustible loading postulated for Fire Zone 1M112 (Ref. Calculation MC-QSP64-86058).

GRAND GULF NUCLEAR GENERATING STATION
Updated Final Safety Analysis Report (UFSAR)

- (c) Fire Zone 1M112 contains safety-related equipment and the following fire protection measures are provided: smoke detection and accessibility to yard hose stations and portable fire extinguishers (Ref. Civil Drawing C-0035D).
 - (d) Fire Zone 1M112 is adjacent to Fire Zones 1M110 and Basin No. 1, both of which contain only Division I safe shutdown components. Although no combustible loading is postulated for Fire Zone 1M112, if a fire were to occur in this zone, at least one train of safe shutdown components would remain free from fire damage.
- c. FIRE ZONE BASIN NO. 1: STANDBY SERVICE WATER BASIN, ELEV. 82' 6"
- 1. Safety-Related Equipment
 - Standby Service Water Cooling Tower Fans
 - Electrical Cable and Raceway
 - Standby Service Water Pump
 - HPCS Pump
 - 2. Fire Zone Analysis
 - (a) This fire zone includes the basin and the standby service water cooling tower. Basin No. 1 is located beneath the Standby Service Water Cooling Water Towers on Elev. 82' 6". The floor, ceiling, and all four walls of Basin No. 1 are non-rated exterior barriers and all but the ceiling are underground. All of the walls of the cooling tower are non-rated exterior barriers (Ref. Architectural Drawing A-0634).
 - (b) The combustible loading in Basin No. 1 amounts to a low fire load. The only contributor to this combustible loading is the cathodic protection PVC conduit and cable and the concrete joint sealant in the walls. The in situ combustible loading in Fire Zone Basin No. 1 amounts to less than a 15-minute fire duration (Ref. Calculation MC-QSP64-86058). No transient combustible loading is postulated in this fire zone.

GRAND GULF NUCLEAR GENERATING STATION
Updated Final Safety Analysis Report (UFSAR)

- (c) Basin No. 1 contains safety-related equipment and the following fire protection measure is provided: accessibility to yard hose stations and portable fire extinguishers (Ref. Civil Drawing C-0035D). Since Basin No. 1 is designed to be filled with water, smoke detection is not provided.

- (d) Basin No. 1 is adjacent to Fire Zones 1M110 and 1M112, both of which contain only Division I safe shutdown components. Therefore, a fire in Basin No. 1 will not affect, or propagate to affect, more than one train of safe shutdown components.

9A.5.65 FIRE AREA 65

9A.5.65.1 FIRE AREA DESCRIPTION

Fire Area 65 consists of Fire Zones 2M110, 2M112 (Elev. 133' 0"), and Basin No. 2, which includes the cooling tower (Elev. 82' 6") in the Standby Service Water Cooling Tower and Basin Complex B. The exterior boundary of Fire Area 65 is a non-rated concrete structural barrier. Fire Zones 2M110, 2M112, and Basin No. 2 are separated by non-rated barriers, and, therefore, a fire originating in any one fire zone of Fire Area 65 could communicate with any other zone in Fire Area 65 (Ref. Architectural Drawing A-0634 and Civil Drawing C-0012).

INCLUDED FIRE ZONE	DESCRIPTION
2M110	Standby Service Water Pump House, Elev. 133' 0"
2M112	Standby Service Water Valve Room, Elev. 133' 0"
Basin No.2	Standby Service Water Basin (Including Cooling Tower), Elev. 82' 6"

9A.5.65.2 SAFE SHUTDOWN EQUIPMENT

Division II

9A.5.65.3 FIRE AREA ANALYSIS

- a. Fire Zones 2M110, 2M112, and Basin No. 2 contain only Division II safe shutdown equipment, cable, and raceway, as shown in the microcomputer data base (Ref. FPP-1, Appendix C Data). The closest Division I safe shutdown components are located in Fire Area 64 (Basin Complex A).

GRAND GULF NUCLEAR GENERATING STATION
Updated Final Safety Analysis Report (UFSAR)

These Division I and II safe shutdown components are separated by a horizontal distance of more than 65 feet and non-rated exterior barriers. There are no intervening combustibles (yard fire hazards) located within this separation distance.

- b. The postulated fire with the greatest severity in Fire Area 65 occurs in Fire Zone 2M110. The total fire severity in Fire Zone 2M110, including transient combustibles, amounts to a low fire load. The in situ combustible loading in Fire Zone 2M110 amounts to less than a 30-minute fire duration (Ref. Calculation MC-QSP64-86058). Therefore, a fire occurring in Fire Area 65 will not affect, or propagate to affect, more than one train of safe shutdown.

- c. The Division I and II safe shutdown components discussed above are not separated by 3 hr. fire rated barriers. The 65 ft. open air separation with no intervening combustibles plus the non-rated concrete barriers is sufficient to prevent the propagation of fire to affect more than one train of safe shutdown. Fire detection is not provided within this separation distance since it is exterior open space.

9A.5.65.4 FIRE ZONE ANALYSES

- a. FIRE ZONE 2M110: STANDBY SERVICE WATER PUMP HOUSE, ELEV. 133' 0"
 - 1. Safety-Related Equipment
 - Standby Service Water Pump
 - Standby Service Water Room Cooler
 - Electrical Cable and Raceway
 - HPCS Pump
 - Motor Control Center
 - Load Center

 - 2. Fire Zone Analysis
 - (a) Fire Zone 2M110 is located in the Standby Service Water Cooling Tower and Basin Complex B on Elev. 133' 0". The floor, ceiling, and all

GRAND GULF NUCLEAR GENERATING STATION
Updated Final Safety Analysis Report (UFSAR)

four walls of Fire Zone 2M110 are non-rated exterior barriers (Ref. Architectural Drawing A-0634).

- (b) The combustible loading in Fire Zone 2M110, including transient combustibles, amounts to a low fire load. The major contributors to this combustible loading are the electrical cables and lube oil present in the room. The in situ combustible loading in Fire Zone 2M110 amounts to less than a 30-minute fire duration (Ref. Calculation MC-QSP64-86058).
 - (c) Fire Zone 2M110 contains safety-related equipment and the following fire protection measures are provided: smoke detection and accessibility to yard hose stations and portable fire extinguishers (Ref. Civil Drawing C-0035D).
 - (d) Fire Zone 2M110 is considered to be adjacent to Fire Zones 2M112 and Basin No. 2, both of which contain only Division II safe shutdown components. Therefore, a fire in Fire Zone 2M110 will not affect, or propagate to affect, more than one train of safe shutdown components.
- b. FIRE ZONE 2M112: STANDBY SERVICE WATER VALVE ROOM, ELEV. 133' 0"
- 1. Safety-Related Equipment
 - Electrical Cable and Raceway
 - 2. Fire Zone Analysis
 - (a) Fire Zone 2M112 is located in the Standby Service Water Cooling Tower and Basin Complex B on Elev. 133' 0". The floor, ceiling, and all four walls of Fire Zone 2M112 are non-rated exterior barriers (Ref. Architectural Drawing A-0634).
 - (b) There is no combustible loading postulated for Fire Zone 2M112 (Ref. Calculation MC-QSP64-86058).

GRAND GULF NUCLEAR GENERATING STATION
Updated Final Safety Analysis Report (UFSAR)

- (c) Fire Zone 2M112 contains safety-related equipment and the following fire protection measures are provided: smoke detection and accessibility to yard hose stations and portable fire extinguishers (Ref. Civil Drawing C-0035D).
 - (d) Fire Zone 2M112 is adjacent to Fire Zones 2M110 and Basin No. 2, both of which contain only Division II safe shutdown components. Although no combustible loading is postulated for Fire Zone 2M112, if a fire were to occur in this zone, at least one train of safe shutdown components would remain free from fire damage.
- c. FIRE ZONE BASIN NO. 2: STANDBY SERVICE WATER BASIN, ELEV. 82' 6"
- 1. Safety-Related Equipment
 - Standby Service Water Cooling Tower Fans
 - Electrical Cable and Raceway
 - Standby Service Water Pump
 - HPCS Pump
 - 2. Fire Zone Analysis
 - (a) This fire zone includes the basin and the standby service water cooling tower. Basin No. 2 is located beneath the standby service water cooling water towers on Elev. 82' 6". The floor, ceiling, and all four walls of Basin No. 2 are non-rated exterior barriers and all but the ceiling are underground. All of the walls of the cooling tower are non-rated exterior barriers (Ref. Architectural Drawing A-0634).
 - (b) The combustible loading in Basin No. 2 amounts to a low fire load. The only contributor to this combustible loading is the cathodic protection PVC conduit and cable and the concrete joint sealant in the walls. The in situ combustible loading in Fire Zone Basin No. 2 amounts to less than a 15-minute fire duration (Ref. Calculation MC-QSP64-86058).

GRAND GULF NUCLEAR GENERATING STATION
Updated Final Safety Analysis Report (UFSAR)

- (c) Basin No. 2 contains safety-related equipment and the following fire protection measure is provided: accessibility to yard hose stations and portable fire extinguishers (Ref. Civil Drawing C-0035D). Since Basin No. 2 is designed to be filled with water, smoke detection is not provided.
- (d) Basin No. 2 is considered to be adjacent to Fire Zones 2M110 and 2M112, both of which contain only Division II safe shutdown components. Therefore, a fire in Basin No. 2 will not affect, or propagate to affect, more than one train of safe shutdown components.

9A.5.66 FIRE AREA 66

9A.5.66.1 FIRE AREA DESCRIPTION

Fire Area 66 consists of Fire Zones 0M101, 0M102 and 0M103 (Elev. 133'0") in the Fire Water Pump House. The exterior boundary of Fire Area 66 is a non-rated barrier. Fire Zones 0M101, 0M102, and 0M103 are separated by 2-hour rated barriers which are adequate to withstand the hazards in the area, and, therefore, a fire originating in any one fire zone of Fire Area 66 could not communicate with any other zone in Fire Area 66 (Ref. Architectural Drawing A-0350 and FPE-2000/0071).

INCLUDED FIRE ZONE	DESCRIPTION
0M101	Diesel Driven Fire Pump Room 0M101, Elev. 133' 0"
0M102	Motor Driven Fire Pump Room 0M102, Elev. 133' 0"
0M103	Diesel Driven Fire Pump Room 0M103, Elev. 133' 0"

9A.5.66.2 SAFE SHUTDOWN EQUIPMENT

None

9A.5.66.3 FIRE AREA ANALYSIS

- a. Fire Zones 0M101, 0M102, and 0M103 contain no safe shutdown equipment, cable, or raceway, as shown in the microcomputer data base (Ref. FPP-1, Appendix C Data). The closest safe shutdown components are located in the Auxiliary Building. These safe shutdown components are

GRAND GULF NUCLEAR GENERATING STATION
Updated Final Safety Analysis Report (UFSAR)

separated from the Fire Water Pump House by a horizontal distance of more than 200 feet and non-rated exterior barriers.

- b. There are no Division I or II safe shutdown components in Fire Area 66. The 200 feet open air separation plus the non-rated concrete barriers is sufficient to prevent the propagation of fire from the Fire Water Pump House to affect either train of safe shutdown. Fire detection is provided throughout the Fire Water Pump House and automatic sprinkler protection is provided in 0M101 and 0M103.
- c. The postulated fire with the greatest severity in Fire Area 66 occurs in Fire Zone 0M101 and has a duration of less than 120 minutes. Therefore, a fire occurring in Fire Area 66 will not affect, or propagate to affect either train of safe shutdown. Additionally, a fire originating in any of the pump rooms will not affect or propagate to affect a fire pump in another Fire Zone.

9A.5.66.4 FIRE ZONE ANALYSIS

- a. FIRE ZONE 0M101: DIESEL DRIVEN FIRE PUMP ROOM, ELEV. 133'0"
 - 1. Safety-Related Equipment
None
 - 2. Fire Zone Analysis
 - (a) Fire Zone 0M101 is located in the Fire Water Pump House on Elev. 133'0". The floor, ceiling, and exterior walls of Fire Zone 0M101 are non-rated exterior barriers. The wall separating Fire Zone 0M101 from 0M102 (Motor Driven Fire Pump Room) is a 2-hour rated fire barrier (Ref. Architectural Drawing A-0350).
 - (b) The combustible loading in Fire Zone 0M101, including transient combustibles amounts to a moderate fire duration. The major contributor to this combustible loading is the diesel fuel present in the room. The in situ combustible

GRAND GULF NUCLEAR GENERATING STATION
Updated Final Safety Analysis Report (UFSAR)

loading in Fire Zone 0M101 amounts to less than a 120-minute fire duration (Ref. Calculation MC-QSP64-86058).

- (c) Fire Zone 0M101 contains no safety-related-equipment and the following fire protection measures are provided: automatic fire suppression, smoke detection and accessibility to yard hose stations and portable fire extinguishers.
- (d) Fire Zone 0M101 is adjacent to Fire Zone 0M102 which contains no safe shutdown components. Therefore, a fire in Fire Zone 0M101 will not affect, or propagate to affect, either train of safe shutdown components.

b. FIRE ZONE 0M102: MOTOR DRIVEN FIRE PUMP ROOM, ELEV. 133'0"

1. Safety-Related Equipment

None

2. Fire Zone Analysis

- (a) Fire Zone 0M102 is located in the Fire Water Pump House on Elev. 133'0". The floor, ceiling, and exterior walls of Fire Zone 0M102 are non-rated exterior barriers. The walls separating Fire Zone 0M102 from 0M101 and 0M103 (Diesel Driven Fire Pump Rooms) are 2-hour rated fire barriers (Ref. Architectural Drawing A-0350).
- (b) The combustible loading in Fire Zone 0M102, including transient combustibles amounts to a low fire load. The major contributor to this combustible loading is the ordinary combustibles present in the room. The in situ combustible loading in Fire Zone 0M102 amounts to less than a 15-minute fire duration (Ref. Calculation MC-QSP64-86058).

GRAND GULF NUCLEAR GENERATING STATION
Updated Final Safety Analysis Report (UFSAR)

- (c) Fire Zone 0M102 contains no safety-related-equipment and the following fire protection measures are provided: automatic smoke detection and accessibility to yard hose stations and portable fire extinguishers.
 - (d) Fire Zone 0M102 is adjacent to Fire Zone 0M101 and Fire Zone 0M103 which contain no safe shutdown components. Therefore, a fire in Fire Zone 0M102 will not affect, or propagate to affect, either train of safe shutdown components.
- c. FIRE ZONE 0M103: DIESEL DRIVEN FIRE PUMP ROOM, ELEV. 133'0"
- 1. Safety-Related Equipment
None
 - 2. Fire Zone Analysis
 - (a) Fire Zone 0M103 is located in the Fire Water Pump House on Elev. 133'0". The floor, ceiling, and exterior walls of Fire Zone 0M101 are non-rated exterior barriers. The wall separating Fire Zone 0M103 from 0M102 (Motor Driven Fire Pump Room) is a 2-hour rated fire barrier (Ref. Architectural Drawing A-0350).
 - (b) The combustible loading in Fire Zone 0M103, including transient combustibles amounts to a moderate fire load. The major contributor to this combustible loading is the diesel fuel present in the room. The in situ combustible loading in Fire Zone 0M103 amounts to less than a 105-minute fire duration (Ref. Calculation MC-QSP64-86058).
 - (c) Fire Zone 0M103 contains no safety-related-equipment and the following fire protection measures are provided: automatic fire suppression, smoke detection and accessibility to yard hose stations and portable fire extinguishers.

GRAND GULF NUCLEAR GENERATING STATION
Updated Final Safety Analysis Report (UFSAR)

- (d) Fire Zone 0M103 is adjacent to Fire Zone 0M102 which contains no safe shutdown components. Therefore, a fire in Fire Zone 0M103 will not affect, or propagate to affect, either train of safe shutdown components.

9A.6.0 REFERENCES

The plant documents that were utilized in performing the fire hazards analysis are listed in the following sections.

GRAND GULF NUCLEAR GENERATING STATION
Updated Final Safety Analysis Report (UFSAR)

9A.6.1 EVALUATIONS, STUDIES & PROCEDURES

9A.6.1.1	GGNS-EE-11-00001-GGNS APPENDIX R SAFE SHUTDOWN ANALYSIS (FPP-1)
9A.6.1.2	15026-FPP-1 - WSES - Water Suppression Effects Study
9A.6.1.3	15026-FPP-2 - Control Room Fire Hazards Analysis Procedure

9A.6.1.4 GGNS-95-0046-ENGINEERING REPORT FOR AN EVALUATION OF A FIRE IN FIRE ZONE 1A322

9A.6.2 SAFE SHUTDOWN SYSTEM PIPING AND INSTRUMENTATION DIAGRAMS

9A.6.2.1	9643-FP-1061B - Safe Shutdown Diagram Standby Service Water System Unit 1
9A.6.2.2	9645-FP-1061C - Safe Shutdown Diagram Standby Service Water System Unit 1
9A.6.2.3	9645-FP-1061D - Safe Shutdown Diagram Standby Service Water System Unit 1
9A.6.2.4	9645-FP-1070A -Safe Shutdown Diagram Standby Diesel Generator System Unit 1
9A.6.2.5	9645-FP-1070B -Safe Shutdown Diagram Standby Diesel Generator System Unit 1
9A.6.2.6	9645-FP-1070C -Safe Shutdown Diagram Standby Diesel Generator System Unit 1
9A.6.2.7	9645-FP-1070D -Safe Shutdown Diagram Standby Diesel Generator System Unit 1
9A.6.2.8	9645-FP-1077B - Safe Shutdown Diagram Nuclear Boiler System Unit 1
9A.6.2.9	9645-FP-1077C - Safe Shutdown Diagram Nuclear Boiler System Unit 1
9A.6.2.10	9645-FP-1085A - Safe Shutdown Diagram Residual Heat Removal System Unit 1
9A.6.2.11	9645-FP-1085B - Safe Shutdown Diagram Residual Heat Removal System Unit 1
9A.6.2.12	9645-FP-1106A - Safe Shutdown Diagram D. Gen., ECCS., ESF, Elec. Swgr., SSW., and Circ Wtr. P.P HSE. Vent. Sys. - Unit 1
9A.6.2.13	9645-FP-1106B - Safe Shutdown Diagram D. Gen., ECCS., ESF., Elec. Swgr., SSW., and Circ Wtr. P.P HSE. Vent. Sys. - Unit 1
9A.6.2.14	9645-FP-1108A - Safe Shutdown Diagram Safeguard Swgr. and Battery Rooms Ventilation System - Unit 1
9A.6.2.15	9645-FP-1108B - Safe Shutdown Diagram Safeguard Swgr. and Battery Rooms Ventilation System - Unit 1

GRAND GULF NUCLEAR GENERATING STATION
Updated Final Safety Analysis Report (UFSAR)

9A.6.2.16	9645-FP-1110B - Safe Shutdown Diagram Containment and Drywell Instr. & Control Sys. Unit 1
-----------	--

9A.6.3 THIS SECTION NOT USED

GRAND GULF NUCLEAR GENERATING STATION
Updated Final Safety Analysis Report (UFSAR)

9A.6.4 PHYSICAL RACEWAY LOCATION DRAWINGS

9A.6.4.1	9645-E-0660 - Site Raceway Plan Units 1 & 2
9A.6.4.2	9645-E-0665 - Electrical Manhole Details Units 1 & 2
9A.6.4.3	9645-E-0672 - Enlarged Site Raceway Plans Units 1 & 2
9A.6.4.4	9645-E-0674 - Enlarged Site Raceway Plans Units 1 & 2
9A.6.4.5	9645-E-0687 - Raceway Plan Embedded Conduit Control Bldg. El. 93'-0" Unit 1
9A.6.4.6	9645-E-0688 - Raceway Plan Control Bldg. El. 111' 0" Area 25A Unit 1
9A.6.4.7	9645-E-0689 - Raceway Plan Control Bldg. El. 133' 0" Area 25A Units 1 & 2
9A.6.4.8	9645-E-0690 - Raceway Plan Control Bldg. El. 148' 0" Area 25A Unit 1
9A.6.4.9	9645-E-0690A - Partial Raceway Plan Control Bldg. El. 148' 0" Area 25A Unit 1
9A.6.4.10	9645-E-0691 - Raceway Plan Control Bldg. Elev. 166' 0" Area 25A Unit 1
9A.6.4.11	9645-E-0692 - Raceway Plan Control Bldg. Elev. 189' 0" Area 25A Unit 1
9A.6.4.12	9645-E-0693 - Raceway Plan Control Bldg. Elev. 177' 0" Area 25A Unit 1
9A.6.4.13	9645-E-0694 - Raceway Plan at Ceiling Control Bldg. El. 93' 0" Area 25A Unit 1
9A.6.4.14	9645-E-0695 - Raceway Sections & Details Control Bldg. Area 25A Units 1 & 2
9A.6.4.15	9645-E-0700 - Raceway Plan at Ceiling Control Bldg. El. 93'0" Area 25B Unit 2
9A.6.4.16	9645-E-0701 - Raceway Plan Control Building El. 111' 0" Area 25B Unit 2
9A.6.4.17	9645-E-0701A - Partial Raceway Plan Control Bldg. El. 111'-0" Area 25B Unit 2
9A.6.4.18	9645-E-0702 - Raceway Plan Control Building El. 133'-0" Area 25B Units 1 & 2
9A.6.4.19	9645-E-0703 - Raceway Plan Control Building El. 148'-0" Area 25B Unit 2
9A.6.4.20	9645-E-0703A - Partial Raceway Plan Control Bldg. El. 148'-0" Area 25B Unit 2
9A.6.4.21	9645-E-0704 - Raceway Plan Control Building El. 166' 0" Area 25B Unit 2
9A.6.4.22	9645-E-0705 - Raceway Plan Control Building El. 189' 0" Area 25B Unit 2
9A.6.4.23	9645-E-0705A - Partial Raceway Plan Control Bldg El. 189'-0" Area 25B Unit 2
9A.6.4.24	9645-E-0706 - Raceway Plan at Ceiling Control Bldg. El. 177'-0" Area 25B Unit 2

GRAND GULF NUCLEAR GENERATING STATION
Updated Final Safety Analysis Report (UFSAR)

9A.6.4.25	9645-E-0708 - Raceway Plan Control Building El. 93' 0" Area 25B Units 1 & 2
9A.6.4.26	9645-E-0716 - Raceway Sections & Details Control Bldg Area 23A & 25B Units 1 & 2
9A.6.4.26	9645-E-0724 - Raceway Sections and Details Control Building Area 25A and 25B Units 1 and 2
9A.6.4.27	9645-E-1630 - Embedded Raceway Plan Diesel Generator Bldg. El. 133' 0" Area 12 Unit 1
9A.6.4.28	9645-E-1672 - Raceway Plan Aux. Bldg. El. 93' 0" Area 7 Unit 1
9A.6.4.29	9645-E-1693 - Auxiliary Building Vertical Cable Tray Chase Unit 1
9A.6.4.30	9645-E-1700 - Raceway Plan Containment El. 93'-0" and 100'-9" Area 11 Unit 1
9A.6.4.31	9645-E-1701 - Raceway Plan Containment El. 114'-6" & 120'-10" Area 11 Unit 1
9A.6.4.32	9645-E-1702A - Raceway Plan AZ 0° to 90° Containment Bldg. El. 135' 4" Area 11 Unit 1
9A.6.4.33	9645-E-1702B - Raceway Plan AZ 90° to 180° Containment Bldg. El. 135'-4" Area 11 Unit 1
9A.6.4.34	9645-E-1702C - Raceway Plan AZ 180° to AZ 270° Containment Bldg. El. 135'-4" Area 11 Unit 1
9A.6.4.35	9645-E-1702D - Raceway Plan AZ 270° to 0 Containment Bldg. El. 135'-4" Area 11 Unit 1
9A.6.4.36	9645-E-1702E - RPS Conduit Plan Between CTMT & Drywell Wall El. 135'-4" Area 11 Unit 1
9A.6.4.37	9645-E-1702F - Raceway Plan Hydrogen Igniter System Containment Bldg. Unit 1
9A.6.4.38	9645-E-1703 - Raceway Plan Containment Bldg. El. 161'-10" Area 11 Unit 1
9A.6.4.39	9645-E-1704 - Raceway Plan Containment Bldg. El. 184'-6" Area 11 Unit 1
9A.6.4.40	9645-E-1705 - Raceway Plan Containment Bldg. El. 208'-10" Area 11 Unit I
9A.6.4.41	9645-E-1714 - Exposed Raceway Plan Diesel Generator Building El. 133'0" Area 12 Unit 1
9A.6.4.42	9645-E-1715 - Exposed Raceway Plan Diesel Generator Building El. 158'-0" Area 12 Unit 1
9A.6.4.43	9645-E-1716 - Raceway Plan Standby Service Water Cooling Towers No.1 & No.2

GRAND GULF NUCLEAR GENERATING STATION
Updated Final Safety Analysis Report (UFSAR)

9A.6.5 EQUIPMENT LOCATION DRAWINGS

9A.6.5.1	9645-M-0013 - Equipment Location Control Building Plan at El. 93'-0", 111' 0", 133' 0", & El. 148' 0" Units 1 & 2
9A.6.5.2	9645-M-0014 - Equipment Location Control Building Plan at El. 166'-0", 177' 0", & 189' 0"
9A.6.5.3	9645-M-0015 - Equipment Location Control Building Sections Unit 1 & 2
9A.6.5.4	9645-M-1012 - Equipment Location Auxiliary Building & Containment Plan at El. 93'-0" & 100'-9" Unit 1
9A.6.5.5	9645-M-1013 - Equipment Location Auxiliary Building & Containment Plan at El. 119' 0", 120' 10", & 114' 6" Unit 1
9A.6.5.6	9645-M-1014 - Equipment Location Auxiliary Building & Containment Plan at El. 139' 0", 135' 4" & 147' 7" Unit 1
9A.6.5.7	9645-M-1015A - Equipment Location Auxiliary Building & Containment Plan at El. 161' 10" & 166' 0" Unit 1
9A.6.5.8	9645-M-1015B - Equipment Location & Containment Plan at El. 161' 0" Unit 1
9A.6.5.9	9645-M-1016 - Equipment Location Auxiliary Building & Containment Plan at El. 184'-6" and 185'-0" Unit 1
9A.6.5.10	9645-M-1017 - Equipment Location Auxiliary Building & Containment Plan at El. 208'-10" Unit 1
9A.6.5.11	9645-M-1019 - Equipment Location Auxiliary Building & Containment Section "A-A" Unit 1
9A.6.5.12	9645-M-1020 - Equipment Location Auxiliary Building & Containment Section "B-B" Unit 1
9A.6.5.13	9645-M-1021 - Equipment Location Auxiliary Building & Containment Section "C-C" Unit 1
9A.6.5.14	9645-M-1022 - Equipment Location Auxiliary Building & Containment Section "D-D" Unit 1
9A.6.5.15	9645-M-1023 - Equipment Location Auxiliary Building & Containment Section "E-E" Unit 1
9A.6.5.16	9645-M-1024 - Equipment Location Auxiliary Building & Containment Section "F-F" Unit 1
9A.6.5.17	9645-M-1026 - Equipment Location Diesel Generator Building Unit 1
9A.6.5.18	9643-M-1027 - Equipment Location Standby Service Water Pump House Basin "A"
9A.6.5.19	9645-M-2027 - Equipment Location Standby Service Water Pump House Basin "B"

GRAND GULF NUCLEAR GENERATING STATION
Updated Final Safety Analysis Report (UFSAR)

9A.6.6 FIRE PROTECTION PIPING AND INSTRUMENTATION DIAGRAM

9A.6.6.1	9645-M-0035A - P&I Diagram Fire Protection System Units 1&2
9A.6.6.2	9645-M-0035B - P&I Diagram Fire Protection System Units 1&2
9A.6.6.3	9645-M-0035D - P&I Diagram Fire Protection System Units 1&2
9A.6.6.4	9645-M-0035E - P&I Diagram Fire Protection System Units 1&2
9A.6.6.5	9645-M-0035F - P&I Diagram Fire Protection System Units 1&2
9A.6.6.6	9645-M-0035G - P&I Diagram Fire Protection System Units 1&2
9A.6.6.7	9645-M-0035H - P&I Diagram Fire Protection System Units 1&2
9A.6.6.8	9645-M-0035J - P&I Diagram Fire Protection System Units 1&2
9A.6.6.9	9645-M-0035K - P&I Diagram Fire Protection System Units 1&2
9A.6.6.10	9645-M-0035L - P&I Diagram Fire Protection System Units 1&2
9A.6.6.11	9645-M-0035M - P&I Diagram Fire Protection System Units 1&2
9A.6.6.12	9645-M-0035P - P&I Diagram Fire Protection System Units 1&2

9A.6.7 HOSE STATION AND FIRE EXTINGUISHER LOCATION DRAWINGS

9A.6.7.1	NPE-M-7100 - Hose Station & Fire Ext. Location Auxiliary Building & Containment Plan at El. 93' 0" & 100' 9" Unit 1
9A.6.7.2	NPE-M-7101 - Hose Station & Fire Ext. Locations Auxiliary Building & Containment Plan at El. 119' 0", 120' 10", & 114' 6" Unit 1
9A.6.7.3	NPE-M-7102 - Hose Station & Fire Ext. Locations Auxiliary Building & Containment Plan at El. 139' 0", 135' 4" & 147' 7" Unit 1
9A.6.7.4	NPE-M-7103 - Hose Station and Fire Ext. Locations Auxiliary Building & Containment Plan at El. 161' 10" & 166' 0" Unit 1
9A.6.7.5	NPE-M-7104 - Hose Station and Fire Ext. Locations Auxiliary Building & Containment Plan at El. 184'-6" & 185' 0" Unit 1
9A.6.7.6	NPE-M-7105 - Hose Station and Fire Ext. Locations Auxiliary Building & Containment Plan at El. 208'-10" Unit 1

GRAND GULF NUCLEAR GENERATING STATION
Updated Final Safety Analysis Report (UFSAR)

9A.6.7.7	NPE-M-7115 - Hose Station and Fire Ext. Location Control Building Plan at El. 93' 0", 111' 0", 133' 0", El. 148' 0" Unit 1
9A.6.7.8	NPE-M-7117 - Hose Station and Fire Ext. Location Control Building Plan at El. 166' 0", 177' 0", & 189' 0" Units 1 & 2
9A.6.7.9	NPE-M-7121 - Hose Station and Fire Ext. Location Diesel Generator Building Unit 1

GRAND GULF NUCLEAR GENERATING STATION
Updated Final Safety Analysis Report (UFSAR)

9A.6.8 FIRE AND SMOKE DETECTOR LOCATION DRAWINGS

9A.6.8.1	9645-E-0950 - Raceway Plan Control Building El. 93'-0", 111'-0", 133'-0", & 148'-0" Fire and Smoke Detection System Units 1 & 2
9A.6.8.2	9645-E-0951 - Raceway Plan Control Building El. 166'-0", 177'-0" & 189'-0" Fire and Smoke Detection System Units 1 & 2
9A.6.8.3	9645-E-0964 - Raceway Plan Miscellaneous Buildings Fire and Smoke Detection System Units 1 & 2
9A.6.8.4	9645-E-0965 - Raceway Plan Water Treatment Building El. 133'-0" and Standby Water Pump House Basin "A" & "B" Fire and Smoke Detection System Units 1
9A.6.8.5	9645-E-1800 - Raceway Plan Auxiliary Building and Containment El. 119'-0", 120'-10", 114'-6" Fire and Smoke Detection System Unit 1
9A.6.8.6	9645-E-1801 - Raceway Plan Auxiliary Building and Containment El. 139'-0", 135'-4", 147'-7" Fire and Smoke Detection System Unit 1
9A.6.8.7	9645-E-1802 - Raceway Plan Auxiliary Building and Containment El. 161'-10", 166'-0" Fire and Smoke Detection Unit 1
9A.6.8.8	9645-E-1803 - Raceway Plan Auxiliary Building and Containment El. 184'-6", 185'-0" Fire and Smoke Detection Unit 1
9A.6.8.9	9645-E-1804 - Raceway Plan Auxiliary Building and Containment El. 208'-10", Fire and Smoke Detection Unit 1
9A.6.8.10	9645-E-1809 - Raceway Plan Auxiliary Building and Containment El. 93'-0", 100'-9" Fire and Smoke Detection Unit 1

9A.6.9 FIRE PROTECTION PLAN DRAWINGS

9A.6.9.1	9645-A-0630 - Units 1 & 2 Control Building Fire Protection Plans
9A.6.9.2	9645-A-0631 - Units 1 & 2 Control Building Fire Protection Plans
9A.6.9.3	9645-A-0632 - - Unit 1 Auxiliary Bldg. Fire Protection Fl. Plan at El. 93'-0" & 103' -0"
9A.6.9.4	9645-A-0633 - Unit 1 Auxiliary Bldg. Fire Protection Plan at El. 119'-0"
9A.6.9.5	9645-A-0634 - Unit 1 Aux. & Diesel Gen. Bldg. and SSW Pumphouse Fire Protection Floor Plans at El. 133'-0" & 139'-0"
9A.6.9.6	9645-A-0635 - Unit 1 Aux. & Diesel Gen. Bldg. Fire Protection Plan at El. 166'-0"

GRAND GULF NUCLEAR GENERATING STATION
Updated Final Safety Analysis Report (UFSAR)

9A.6.9.7	9643-A-0636 - Unit 1 Auxiliary Bldg. Fire Protection Plan at El. 185'-0"
9A.6.9.8	9645-A-0637 - Unit 1 Auxiliary Bldg. Fire Protection Plan at El. 208'-10"
9A.6.9.9	A-0350-Units 1 & 2 Fire Water Pump House Floor Plan & Roof Plan at El. 133'-0"

GRAND GULF NUCLEAR GENERATING STATION
Updated Final Safety Analysis Report (UFSAR)

9A.6.10 LISTING OF FIRE ZONES BY FIRE AREA

9A.6.10.1	9645-A-0640- Fire Protection Fire Area/Zone Schedule Unit 1
9A.6.10.2	9645-A-0641- Fire Protection Fire Area/Zone Schedule Unit 1

9A.6.11 FIRE PROTECTION COATING DRAWINGS

9A.6.11.1	9645-A-0611 -Unit 1 Aux. Bldg. - Area 7 Fire-proofing Structural Steel - Floor Elev. 119'-0"
9A.6.11.2	9645-A-0612 - Unit 1 Aux. Bldg. Area 8 Fireproofing Structural Steel - Floor Elev. 119'-0"
9A.6.11.3	9645-A-0613 - Unit 1 Aux. Bldg. Area 9 Fireproofing Structural Steel - Floor Elev. 119'-0"
9A.6.11.4	9645-A-0614 - Unit 1 Aux. Bldg. Area 10 Fire-proofing Structural Steel - Floor Elev. 119'-0"
9A.6.11.5	9645-A-0615 - Unit 1 Aux. Bldg. Area 7 Fireproofing Structural Steel - Floor Elev. 139'-0"
9A.6.11.6	9645-A-0616 - Unit 1 Aux. Bldg. Area 8 Fireproofing Structural Steel - Floor Elev. 139'-0"
9A.6.11.7	9645-A-0617 - Unit 1 Aux. Bldg. Area 9 Fireproofing Structural Steel - Floor Elev. 139'-0"
9A.6.11.8	9645-A-0618 - Unit 1 Aux. Bldg. Area 10 Fire-proofing Structural Steel - Floor Elev. 139'-0"
9A.6.11.9	9645-A-0619 - Unit 1 Aux. Bldg. Area 7 Fireproofing Structural Steel - Floor Elev. 166' 0"
9A.6.11.10	9645-A-0620 - Unit 1 Aux. Bldg. Area 8 Fireproofing Structural Steel - Floor Elev. 166' 0"
9A.6.11.11	9645-A-0621 - Unit 1 Aux. Bldg. Area 9 Fireproofing Structural Steel - Floor Elev. 166' 0"
9A.6.11.12	9645-A-0622 - Unit 1 Aux. Bldg. Area 10 Fire-proofing Structural Steel - Floor Elev. 166' 0"
9A.6.11.13	9645-A-0623 - Unit 1 Aux. Bldg. Area 9 Fireproofing Structural Steel - Floor Elev. 185' 0"
9A.6.11.14	9645-A-0624 - Unit 1 Aux. Bldg. Area 10 Fire-proofing Structural Steel - Floor Elev. 185' 0"
9A.6.11.15	9645-A-0625 - Unit 1 Aux. Bldg. Area 9 Fireproofing Structural Steel - Floor Elev. 208'-10"
9A.6.11.16	9645-A-0626 - Unit 1 Aux. Bldg. Area 10 Fire-proofing Structural Steel - Floor Elev. 208'-10"
9A.6.11.17	9645-A-0629 - Unit 1 and Common Bldg. Fire Protection Misc. Notes and Details

9A.6.12 BLOCKOUT PENETRATION DRAWINGS

Due to the large number of drawings associated with this item, only the drawing series for each Q building is listed. The penetration detail sheets which describe each installation are

GRAND GULF NUCLEAR GENERATING STATION
Updated Final Safety Analysis Report (UFSAR)

also provided.

Detail Sheets

9645-M-0800A
9645-M-0800B
9645-M-0800C
9645-M-0800D
9645-M-0800E
9645-M-0800F

CONTROL BUILDING
9645-M-0650, Sheets 1 through 41
9645-M-0851 through M-0865
DIESEL GENERATOR BUILDING
9645-M-1890, Sheets 1, 2, and 3
9645-M-1891
CONTAINMENT BUILDING
9645-M-1880, Sheets 1 through 8
9645-M-1881 through M-1885
AUXILIARY BUILDING
9645-M-1850 Sheets 1 through 62
9645-M-1851 through M-1874
SSW BASINS
9645-M-1840, Sheets 1 and 2
9645-M-1841
9645-M-2840, Sheets 1 and 2
9645-M-1841

GRAND GULF NUCLEAR GENERATING STATION
Updated Final Safety Analysis Report (UFSAR)

9A.6.13 DOOR SCHEDULES AND INTERIOR DETAILS

9A.6.13.1	9645-A-0740	Units 1 & 2 Interior Details
9A.6.13.2	9645-A-0741	Units 1 & 2 Interior Details
9A.6.13.3	9645-A-0742	Units 1 & 2 Interior Details
9A.6.13.4	9645-A-0743	Units 1 & 2 Door Schedule
9A.6.13.5	9645-A-0745	Units 1 & 2 Door Schedule
9A.6.13.6	9645-A-0746	Units 1 & 2 Door Schedule
9A.6.13.7	9645-A-0747	Units 1 & 2 Door Schedule
9A.6.13.8	9645-A-0749	Unit 2 Door Schedule
9A.6.13.9	9645-A-0750A	Units 1 & 2 Door Schedule
9A.6.13.10	9645-A-0750C	Units 1 & 2 Pressure Door Elevations
9A.6.13.11	9645-A-0750D	Units 1 & 2 Pressure and Watertight Door Elevations
9A.6.13.12	9645-A-0750E	Airtight Door Elevations

9A.6.14 FIRE DAMPER INSTALLATION DETAIL DRAWINGS

9A.6.14.1	9645-M-0210A - HVAC Fire Damper Installation Details Units 1 & 2
9A.6.14.2	9645-M-0210B - HVAC Fire Damper Installation Details Units 1 & 2

9A.6.15 CALCULATIONS

9A.6.15.1	Calculation MC-QSP64-86058, Combustible Heat Load Calculation
-----------	---

9A.6.16 LIGHTING DRAWINGS

9A.6.16.1	9645-E-0627 - Lighting & Communication Plan Control Bldg. Elev. 148'-0" Units 1 & 2
9A.6.16.2	9645-E-0628 - Lighting & Communication Plan Control Bldg. Elev. 166'-0" Units 1 & 2
9A.6.16.3	9645-E-0630 - Lighting & Communication Plan Control Bldg. Elev. 177'-0" Units 1 & 2
9A.6.16.4	9645-E-0636 - Lighting & Communication Plan Control Bldg. Elev. 93'-0" Units 1 & 2
9A.6.16.5	9645-E-0637 - Lighting & Communication Plan Control Bldg. Elev. 111'-0" Units 1 & 2
9A.6.16.6	9645-E-0638 - Lighting & Communication Plan Control Bldg. Elev. 133'-0" Units 1 & 2

9A.6.17 EXPOSURE FIRE PROTECTION OF SAFE SHUTDOWN RELATED CABLES

9A.6.17.1	E-7070 - Control Bldg. Elev.93'-0"Area 25A Unit 1
9A.6.17.2	E-7071 - Control Bldg. Elev. 111'-0"Area 25A Unit1
9A.6.17.3	E-7071A - Control Bldg.Elev.111'-0"Area 25B Unit 2

GRAND GULF NUCLEAR GENERATING STATION
Updated Final Safety Analysis Report (UFSAR)

9A.6.17.4	E-7072 - Control Bldg. Elev. 133'-0"Area 25A Unit 1
9A.6.17.5	E-7073 - Control Bldg. Elev. 133'-0"Area 25B Unit 2
9A.6.17.6	E-7074 - Control Bldg. Elev. 1482-0"Area 25A Unit 1
9A.6.17.7	E-7075 - Control Bldg. Elev.177'-0"Area 25A Unit 1
9A.6.17.8	E-7076 - Control Bldg. Elev.189'-0" Area 25Aunit 1
9A.6.17.9	E-7077 - Auxiliary Bldg. Elev.93 -0"Area 7 Unit 1
9A.6.17.10	E-7078 - Auxiliary Bldg. Elev.93'-0"Area 8 Unit 1
9A.6.17.11	E-7079 - Auxiliary Bldg. Elev. 93'-0" Area 9 Unit 1
9A.6.17.12	E-7080 - Auxiliary Bldg. Elev. 93'-0" Area 10 Unit 1
9A.6.17.13	E-7081 - Auxiliary Bldg. Elev. 119'-0" Area 7 Unit 1
9A.6.17.14	E-7082 - Auxiliary Bldg. Elev. 119'-0" Area 8 Unit 1
9A.6.17.15	E-7083 - Auxiliary Bldg. Elev. 119'-0" Area 9 Unit 1
9A.6.17.16	E-7084 - Auxiliary Bldg. Elev. 119'-0" Area 10 Unit 1
9A.6.17.17	E-7085 - Auxiliary Bldg. Elev. 139'-0" Area 7 Unit 1
9A.6.17.18	E-7086 - Auxiliary Bldg. Elev. 139'-0" Area B Unit 1
9A.6.17.19	E-7087 - Auxiliary Bldg. Elev. 139'-0" Area 9 Unit 1
9A.6.17.20	E-7088 - Auxiliary Bldg. Elev. 139'-0" Area 10 Unit 1
9A.6.17.21	E-7089 - Auxiliary Bldg. Elev. 166'-0" Area 7 Unit 1
9A.6.17.22	E-7090 - Auxiliary Bldg. Elev. 166'-0" Area 8 Unit 1
9A.6.17.23	E-7091 - Auxiliary Bldg. Elev. 166'-0" Area 9 Unit 1
9A.6.17.24	E-7092 Auxiliary Bldg. Elev. 166'-0" Area 11 Unit 1
9A.6.17.25	E-7093 Containment Bldg. Elev. 114'-6" 120'-10" Area 11 Unit 1
9A.6.17.26	E-7094 Containment Bldg. Elev.135'-4" Area 11 Unit 1
9A.6.17.27	E-7095 Containment Bldg. Elev. 161'-10" Area 11 Unit 1
9A.6.17.28	E-7096 Containment Bldg. Elev. 184'-6" Area 11 Unit 1

GRAND GULF NUCLEAR GENERATING STATION
Updated Final Safety Analysis Report (UFSAR)

9A.6.17.29	E-7097 Diesel Generator Bldg. Elev. 133'-0" Area 12 Unit 1
9A.6.17.30	E-7098 Diesel Generator Bldg. Elev. 158'-0"Area 12 Unit 1
9A.6.17.31	E-7099 Diesel Generator Bldg. Elev. 133'-0" Area 12 Unit 1
9A.6.17.32	E-7100 Standby Service Water Cooling Towers No.1 & No. 2
9A.6.17.33	E-7101 Misc. Sections & Details Control Bldg. Area 25A Unit 1
9A.6.17.34	E-7102 Raceway Sections & Details Control Bldg. Area 25A Unit 1
9A.6.17.35	E-7103 Auxiliary Building Vertical Cable Tray Chase Unit 1
9A.6.17.36	E-7104 Raceway Sections & Details Auxiliary Building Unit 1
9A.6.17.37	E-7105 Raceway Sections & Details Containment Bldg. Area 11 Unit 1

GRAND GULF NUCLEAR GENERATING STATION
Updated Final Safety Analysis Report (UFSAR)

9A.6.18 THERMO-LAG WRAP DETAILS OF PROTECTED SAFE SHUTDOWN RACEWAYS

9A.6.18.1	Due to the large number of drawings associated with this item, only the drawing series is listed. E-7106 Series Drawings
-----------	---

9A.6.19 MISCELLANEOUS REFERENCES

9A.6.19.1	9645-C-0012	Site and Yard Work Plot Plan
9A.6.19.2	9645-C-0035D	Site and Yard Work Fire Water Loop
9A.6.19.3	9645-C-0035E	Site and Yard Work Fire Water Loop
9A.6.19.4	9645-C-0038C	Electrical Manholes Reinforced Concrete Plans, Sections & Details
9A.6.19.5	9645-C-1045A	Unit 1 Containment Concrete and Misc. Steel Plan at Elev. 161'-10" & 170'-0"
9A.6.19.6	9645-J-0155T	Instrument Installation Detail Suppression Pool Temperature Element
9A.6.19.7	9645-J-561.0	Q1C61N403A-1.1-1-6 - Vendor Drawing of Thermocouple
9A.6.19.8	NPE-J-1507	Instrument Location Auxiliary Building & Containment Plan at Elev. 139'-0", 135'-4" & 147'-7" Unit 1
9A.6.19.9	9645-M-1100A	P&I Diagram Containment Cooling System Unit 1
9A.6.19.10	9645-M-1100B	P&I Diagram Containment Cooling System Unit 1
9A.6.19.11	NPE-M-1101	P&I Diagram Drywell Cooling System Unit 1
9A.6.19.12	9645-M-1471	HVAC Containment El.93' Unit 1
9A.6.19.13	9645-M-1474	HVAC Containment El.161'-10" Unit 1
9A.6.19.14	9645-M-1475	HVAC Containment El. 184'-6" Unit 1

9A.6.20 FIRE PROTECTION EVALUATIONS

9A.6.20.1 Fire Protection Evaluations are filed and maintained by GGNS Document Control.

TABLE 9A.1:

FIRE HAZARDS ANALYSIS SUMMARY TABLE

The following table briefly summarizes the individual fire zone analyses found in Section 5.0 of this report. This summary provides the following information:

- Fire Area Number: As shown on Architectural Drawings A-0640 and A-0641.
- Physical Location: Defined by the elevation and building column line coordinates of the fire zone, as shown on Architectural Drawings A-0630 through A-0637, inclusive.
- Safe Shutdown Equipment: Division(s) present in the fire zone, as listed in the microcomputer data base (FPP-1 Appendix C Data); the individual safe shutdown components are listed under major safety-related equipment.
- Major Safety-Related Equipment: Equipment and safe shutdown components that are shown on the safe shutdown piping and instrumentation drawings and the equipment location drawings.
- Fire Protection: Measures provided to protect safety-related and safe shutdown components in a fire zone are discussed in the fire zone analysis. The table lists only the active measures provided, as well as the rated fire zone boundaries. All other passive fire protection measures provided are discussed in the subject fire zone analysis.
- Combustible Materials: Major in situ combustible materials located in that fire zone as shown in Calculation MC-QSP64-86058 and some transient combustibles postulated for that fire zone. Transient combustibles listed, if any, are not intended to represent all possible transient combustibles for a particular area.
- Maximum In situ Combustible Loading: Duration of a fire if all the in situ combustible materials in the fire zone were to ignite and burn completely, as determined in Calculation MC-QSP64-86058.

- Total Fire Severity: Duration of a fire if all the combustible materials, in situ (as determined in Calculation MC-QSP64-86058) and a maximum amount of transients, in the fire zone were to ignite and burn completely. The total fire severity descriptions are defined as follows:

Low	<	60 minutes	<	Moderate	<	120 minutes	<	High	<	180 minutes
------------	---	------------	---	-----------------	---	-------------	---	-------------	---	-------------

FIRE HAZARD ANALYSIS SUMMARY

Fire Area	Fire Zone	Fire Zone Elevation, Ft, Column Location	Safe Shutdown Equipment	Major Safety-Related Equipment (Quantity)	Fire Protection	Combustible Materials	Max. Insitu Combustible Loading (Minutes)	Total Fire Severity
1	1A101	Passage, Elev. 93' 0" and 103' 0", Area Bounded by Column Lines 5.5-15.1 and G-G.4	Divisions I and II	Electrical Cable and Raceway RHR "A" Instrument Panel RHR "B" Instrument Panel RCIC Instrument Panel	Partial Coverage by Automatic Sprinkler Smoke Detection Hose Streams Portable Extinguishers 3-Hr Rated Ceiling and North, East, and West Walls	Electrical Cable Transient	<30	Low
1	1A107	Equipment Drain Transfer Tank Room, Elev. 93' 0", Area Bounded by Column Lines 7-7.8 and H-H.7	None	None	Hose Streams Portable Extinguishers 3-Hr Rated Ceiling and North and East Walls	Transient	<15	Low
1	1A108	Floor Drain Transfer Tank Room, Elev. 93' 0", Area Bounded by Column Lines 6.2.-7 and H-H.7	None	None	Hose Streams Portable Extinguishers 3-Hr Rated Ceiling and Part of East Wall	Transient	<15	Low
1	1A111	Piping Penetration Room, Elev. 93' 0", Area Bounded by Column Lines 6.2 - Containment Wall and J.3-K.2	None	Electrical Cable and Raceway	Smoke Detection Hose Streams Portable Extinguishers 3-Hr Rated Ceiling and North Wall	Concrete Joint Sealant Transient	<15	Low
1	1A114	Fan Coil Area, Elev. 93' 0" and 103' 0", Area Bounded by Column Lines 5.5-7.5 and G.4-0	Division I Only	Electrical Cable and Raceway LPCS Instrument Panel	Smoke Detection Hose Streams Portable Extinguishers 3-Hr Rated Ceiling and Portions of the North Wall	Electrical Cable Concrete Joint Sealant Transient	<45	Low

FIRE HAZARD ANALYSIS SUMMARY

Fire Area	Fire Zone	Fire Zone Elevation, Ft, Column Location	Safe Shutdown Equipment	Major Safety-Related Equipment (Quantity)	Fire Protection	Combustible Materials	Max. Insitu Combustible Loading (Minutes)	Total Fire Severity
1	1A117	Miscellaneous Equip. Area, Elev. 93' 0" And 103' 0", Area Bounded by Column Lines 12.5-15.1 and G.4-R	Divisions I and II	Electrical Cable and Raceway RHR "C" Instrument Panel HPCS Instrument Panel	Smoke Detection Hose Streams Portable Extinguishers Partial Coverage by Automatic Sprinkler 3-Hr Rated Ceiling South Wall, East, Wall bordering Fire Zone 1A109, and Portion of North Wall Bordering on the Control Building	Electrical Cable Concrete Joint Sealant Lube Oil Plastic Stretcher Transient	<30	Low
1	1A120	CCW Pump and Heat Exchanger Area, Elev. 93' 0", Area Bounded by Column Lines 5.5-12.5 and Q-R	None	Electrical Cable and Raceway	Smoke Detection Hose Streams Portable Extinguishers 3-Hr Rated Ceiling and East Wall (Column Lines 7.5-12.5) 2-Hr Rated interface with Stair 1A12.	Electrical Cable Transient	<30	Low
1	1A127	Auxiliary Radwaste Pipe Tunnel, Elev. 79' 0", Area Bounded by Column Lines G-J.4 and 0.9-6.5	None	None	Hose Streams Portable Extinguishers	Concrete Joint Sealant	<30	Low
1	1A130	Transfer Pump Monorail Room, Elev. 103' 0", Area Bounded by Column Lines 6.2-7.8 and H.7-J.3	None	None	Hose Streams Portable Extinguishers 3-Hr Rated Ceiling and North Wall	Concrete Joint Sealant Plastic bucket Transient	<15	Low

9A-422

LBDCR

2020-079

GRAND GULF NUCLEAR GENERATING STATION
Updated Final Safety Analysis Report (UFSAR)

FIRE HAZARD ANALYSIS SUMMARY

Fire Area	Fire Zone	Fire Zone Elevation, Ft, Column Location	Safe Shutdown Equipment	Major Safety-Related Equipment (Quantity)	Fire Protection	Combustible Materials	Max. Insitu Combustible Loading (Minutes)	Total Fire Severity
1	1A131	Floor Drain Transfer Pump Room, Elev. 93' 0", Area Bounded by Column Lines 6.2-7.8 and H.7-J.3	None	None	Hose Streams Portable Extinguishers 3-Hr Rated North Wall	Concrete Joint Sealant Transient Lube Oil	<15	Low
2	1A102	RHR A Heat Exchanger Room, Elev. 93' 0", and 108' 1-1/16" Area Bounded by Column Lines G.4-H and 6.4-7.5	Division I	RHR A Heat Exchanger Electrical Cable and Raceway	Heat Detection Hose Streams Portable Extinguishers 3-Hr Rated South, East, and West Walls	Electrical Cable Transient	<15	Low
2	1A103	RHR A Pump Room, Elev. 93' 0", Area Bounded by Column Lines G.4- Containment Wall and 7.5-9.0	Division I	RHR A Jockey Pump RHR A Pump Electrical Cable and Raceway Suppression Pool Level Monitors	Heat Detection Hose Streams Portable Extinguishers 3-Hr Rated East, West, North (Except Blowout Panel), and a portion of South Walls	Electrical Cable Lubricating Oil Compressible Cork Concrete Joint Sealant PC Storage Transient	<30	Low
2	1A104	RCIC Room, Elev. 93' 0", Area Bounded by Column Lines G.4- Containment Wall and 9.0-11.0	Division I	RCIC Room Cooler RCIC Pump RCIC Turbine RCIC Turbine Gland Seal Unit Electrical Cable and Raceway	Heat Detection Hose Streams Portable Extinguishers 3-Hr Rated East, West, North (Except Blowout Panel), and South (Except Blowout Panel and Interface with 1A132) Walls	Electrical Cable Lubricating Oil Concrete Joint Sealant PC Storage Transient	<30	Low

9A-423

LBDCR

2020-079

GRAND GULF NUCLEAR GENERATING STATION
Updated Final Safety Analysis Report (UFSAR)

FIRE HAZARD ANALYSIS SUMMARY

Fire Area	Fire Zone	Fire Zone Elevation, Ft, Column Location	Safe Shutdown Equipment	Major Safety-Related Equipment (Quantity)	Fire Protection	Combustible Materials	Max. Insitu Combustible Loading (Minutes)	Total Fire Severity
2	1A105	RHR B Pump Room, Elev. 93' 0", Area Bounded by Column Lines 11.0-12.5 and G.4-Containment Walls	Division II	RHR B Pump RHR B Jockey Pump Electrical Cable and Raceway Suppression Pool Level Monitors	Heat Detection Hose Streams Portable Extinguishers 3-Hr Rated South (Except Blowout Panel), East, West, and a portion of the North Walls	Electrical Cable Lubricating Oil Compressible Cork Concrete Joint Sealant PC Storage Transient	<30	Low
2	1A106	RHR B Heat Exchanger Area, Elev. 93' 0", and 108' 1-1/16" Area Bounded by Column Lines 12.5-13.6 and G.4-H	Division II	RHR B Heat Exchanger Electrical Cable and Raceway	Heat Detection Hose Streams Portable Extinguishers 3-Hr Rated East, West, and North Walls	Electrical Cable Transient	<15	Low
2	1A124	Blowout Shaft, Elev. 108' 0", Area Bounded by Column Lines 11.0-11.5 and G.9-Containment Wall	None	None	3-Hr Rated East, West, North, and South Walls and Floor, Elev. 108' 0" to 185' 0" (Except Blowout Panels in the North and South Walls)	Concrete Joint Sealant	<60	Low
2	1A125	Blowout Shaft, Elev. 108' 0", Area Bounded by Column Lines 8.5-9.0 and G.9-Containment Wall	None	None	3-Hr Rated East, West, North, and South Walls and Floor, Elev. 108' 0" to 185' 0" (Except Blowout Panels in the North and South Walls)	Concrete Joint Sealant	<60	Low
2	1A132	Pipe Chase, Elev. 93' 0", Area Bounded by Column Lines 9.0-9.5 and G.7G.9	None	Piping	3-Hr Rated South Wall	None	0	0

9A-424

LBDCR

2021-001

GRAND GULF NUCLEAR GENERATING STATION
Updated Final Safety Analysis Report (UFSAR)

FIRE HAZARD ANALYSIS SUMMARY

Fire Area	Fire Zone	Fire Zone Elevation, Ft, Column Location	Safe Shutdown Equipment	Major Safety-Related Equipment (Quantity)	Fire Protection	Combustible Materials	Max. Insitu Combustible Loading (Minutes)	Total Fire Severity
2	1A202	RHR A Heat Exchanger Room, Elev. 119' 0", Area Bounded by Column Lines 6.5-7.5 and G.4-Containment Wall	Division I	RHR A Heat Exchangers Electrical Cable and Raceway	Heat Detection Hose Streams Portable Extinguisher 3-Hr Rated East, West, and South Walls	Electrical Cable Transient	<15	Low
2	1A203	Piping Penetration Room, Elev. 119' 0", Area Bounded by Column Lines 7.5-9.0 and G.4-Containment Wall	Division I	RHR A Room Cooler Electrical Cable and Raceway	Heat Detection Hose Streams Portable Extinguishers 3-Hr Rated Ceiling and North, East, West Walls, and a Portion of the South Wall	Electrical Cable Transient Concrete Joint Sealant PC Storage	<15	Low
2	1A204	Piping Penetration Room, Elev. 119' 0", Area Bounded by Column Lines 9.0-11.0 and G.4-G.7 and the Passage Abutting Containment on Elev. 128' 0"	Division I	Electrical Cable and Raceway	Smoke Detection Hose Streams Portable Extinguishers 3-Hr Rated Ceiling, North (Except Blowout Panel), South, East, and West Walls (except for portion on EL 128')	Electrical Cable Transient Concrete Joint Sealant PC Storage	<45	Low
2	1A205	Piping Penetration Room, Elev. 119' 0", Area Bounded by Column Lines 11.0-12.5 and G.4-Containment Wall	Division II	RHR B Room Cooler Electrical Cable and Raceway	Heat Detection Hose Streams Portable Extinguishers 3-Hr Rated Ceiling, and South, East, West Walls, and Portion of the North Wall	Electrical Cable Transient Concrete Joint Sealant	<15	Low

GRAND GULF NUCLEAR GENERATING STATION
Updated Final Safety Analysis Report (UFSAR)

9A-425

LBDCR

2021-001

FIRE HAZARD ANALYSIS SUMMARY

Fire Area	Fire Zone	Fire Zone Elevation, Ft, Column Location	Safe Shutdown Equipment	Major Safety-Related Equipment (Quantity)	Fire Protection	Combustible Materials	Max. Insitu Combustible Loading (Minutes)	Total Fire Severity
2	1A206	RHR B Heat Exchanger Room, Elev. 119' 0", Area Bounded by Column Lines 12.5-13.5 and G.4-H	Division II	RHR B Heat Exchanger Electrical Cable and Raceway	Heat Detection Hose Streams Portable Extinguishers 3-Hr Rated North, East, and West Walls	Transient	<15	Low
2	1A209	RWCU Recirculation Pump A Room, Elev. 115' 0", Area Bounded by Column Lines 9.0-10.0 and G.7-Containment Wall	None	Electrical Cable and Raceway	Smoke Detection Hose Streams Portable Extinguishers 3-Hr Rated West and South Wall (Except for Blowout Panel)	Concrete Joint Sealant Transient Lube Oil	<15	Low
2	1A210	RWCU Recirculation Pump B Room, Elev. 115' 0", Area Bounded by Column Lines 10.2-11.0 and G.7-Containment Wall	Division II	Electrical Cable and Raceway	Smoke Detection Hose Streams Portable Extinguishers 3-Hr Rated West and North Wall (Except for Blowout Panel)	Concrete Joint Sealant Transient Lube Oil	<15	Low
2	1A224	Pipe Chase, Elev. 128' 0", Area Bounded By Column Lines 9.8-10.2 and G.8-Containment Wall	Piping	Piping	Hose Streams Portable Extinguishers 3-Hr Rated West Wall	Concrete Joint Sealant	<15	Low
2	1A225	Blowout shaft, Elev. 128' 0", Area Bounded by Column Lines 9.0-9.8 and G.8-Containment Wall	None	Electrical Cable and Raceway, Piping and Ductwork	Hose Streams Portable Extinguishers 3-Hr Rated Ceiling, West and South Walls (Except for Blowout Panel in South Wall) Smoke Detection from adjacent zone, 1A204	Concrete Joint Sealant	<15	Low

FIRE HAZARD ANALYSIS SUMMARY

Fire Area	Fire Zone	Fire Zone Elevation, Ft, Column Location	Safe Shutdown Equipment	Major Safety-Related Equipment (Quantity)	Fire Protection	Combustible Materials	Max. Insitu Combustible Loading (Minutes)	Total Fire Severity
2	1A226	Pipe Chase, Elev. 115' 0", Area Bounded by Column Lines 10.0-10.2 and G.8-Containment Wall	None	Piping	Hose Streams Portable Extinguishers 3-Hr Rated West Wall	Concrete Joint Sealant	<15	Low
2	1A303	RHR A Heat Exchanger Room, Elev. 139' 0", Area Bounded by Column Lines 6.5-7.5 and G.4-H	Division I	Electrical Cable and Raceway	Heat Detection Hose Streams Portable Extinguishers 3-Hr Rated East, West, and South Walls and Ceiling (Except Portion Open to Blowout Shaft)	Concrete Joint Sealant Transient	<15	Low
2	1A304	Piping Penetration Room, Elev. 139' 0", Area Bounded by Column Lines 7.5-9.0 and G.4-Containment Wall	Division I	Electrical Cable and Raceway	Heat Detection Hose Streams Portable Extinguishers 3-Hr Rated Ceiling, Floor, North, East and West Walls, and a Portion of the South Wall	Concrete Joint Sealant Transients	<15	Low
2	1A305	Main Steam Tunnel, Elev. 140' 0", Area Bounded by Column Lines 9.0-11.0 and G-Containment Wall	Division I	MSIV Accumulators Electrical Cable and Raceway	Heat Detection Hose Streams Portable Extinguishers 3-Hr Rated Walls, Floor (Except Opening to Pipe-Chase), and Ceiling (Except Opening to Blowout Shaft)	Concrete Joint Sealant Lube Oil	<15	Low

9A-427

LBDCR

2021-001

GRAND GULF NUCLEAR GENERATING STATION
Updated Final Safety Analysis Report (UFSAR)

FIRE HAZARD ANALYSIS SUMMARY

Fire Area	Fire Zone	Fire Zone Elevation, Ft, Column Location	Safe Shutdown Equipment	Major Safety-Related Equipment (Quantity)	Fire Protection	Combustible Materials	Max. Insitu Combustible Loading (Minutes)	Total Fire Severity
2	1A306	Piping Penetration Room, Elev. 139' 0", Area Bounded by Column Lines 11.0-12.5 and G.4-Containment Wall	Division II	Electrical Cable and Raceway	Heat Detection Hose Streams Portable Extinguishers 3-Hr Rated Floor, Ceiling, East, West, South, and a Portion of North Walls	Concrete Joint Sealant Transient	<15	Low
2	1A307	RHR B Heat Exchanger Room, Elev. 139'0", Area Bounded by Column Lines 12.5-13.5 and G.4-H	Division II	Electrical Cable and Raceway	Heat Detection Hose Streams Portable Extinguishers 3-Hr Rated North, East, and West Walls and Ceiling (Except Portion Open to Blowout Shaft)	Concrete Joint Sealant Transient	<15	Low
2	1A439	Blowout Shaft, Elev. 166' 0", Area Bounded by Column Lines 10.0-11.0 and G.8-Containment Wall	None	None	3-Hr Rated North, East, and West Walls on Elev. 166' 0"	Concrete Joint Sealant	<15	Low
2	1A440	Blowout Shaft, Elev. 166' 0", Area Bounded by Column Lines 9.0-10.0 and G.8-Containment Wall	None	None	3-Hr Rated South, East, and West Walls on Elev. 166' 0"	Concrete Joint Sealant	<15	Low
2	1A441	RHR Room B Blowout Shaft, Elev. 166' 0", Area Bounded by Column Lines 12.5-13.5 and G.7-H	None	None	3-Hr Rated Walls (All Sides) on Elev. 166' 0"	Concrete Joint Sealant	<15	Low

9A-428

LBDCR

2021-001

GRAND GULF NUCLEAR GENERATING STATION
Updated Final Safety Analysis Report (UFSAR)

FIRE HAZARD ANALYSIS SUMMARY

Fire Area	Fire Zone	Fire Zone Elevation, Ft, Column Location	Safe Shutdown Equipment	Major Safety-Related Equipment (Quantity)	Fire Protection	Combustible Materials	Max. Insitu Combustible Loading (Minutes)	Total Fire Severity
2	1A442	RHR Room A Blowout Shaft, Elev. 166' 0", Area Bounded by Column Lines 6.4-7.5 and G.7H	None	None	3-Hr Rated Walls (All Sides) on Elev. 166' 0"	Concrete Joint Sealant	<15	Low
2	1A506	Unassigned Area, Elev. 185' 0", Area Bounded by Column Lines 11.5-13.8 and H-L	None	None	3-Hr Rated West Wall, South wall, and Floor	Concrete Joint Sealant	<15	Low
2	1A508	Unassigned Area, Elev. 185' 0", Area Bounded by Column Lines 6.2-8.5 and H-M	None	None	3-Hr Rated West Wall, North wall, and Floor	Concrete Joint Sealant	<15	Low
2	1A605	Recirculation Fan Area, Elev. 228' 0", Area Bounded by Column Lines 6.2-10.0 and M-P, 10.0-13.8 and L-P	None	Radiation Monitors (4) Electrical Cable And Raceway	Hose Streams Portable Extinguishers 3-Hr Rated Floor, East (Containment Dome) and West Walls	Concrete Joint Sealant Transient	<15	Low
3	1A115	Piping Penetration Room, Elev. 93' 0", Area Bounded by Column Lines 7.5-10.0 and Containment Wall-P.4	Division I	Suppression Pool Level Monitor Electrical Cable and Raceway	Heat Detection Hose Streams Portable Extinguishers 3-Hr Rated North, South, and East Walls, and portion of Ceiling	Concrete Joint Sealant Transient	<15	Low
3	1A116	Piping Penetration Room, Elev. 93' 0", Area Bounded by Column Lines 10.0-12.5 and Containment Wall-P-4	Division II	Suppression Pool Level Monitor Electrical Cable and Raceway ADHRS Pumps & Heat Exchanger	Heat Detection Hose Streams Portable Extinguishers 3-Hr Rated for North, South, and East Walls, and portion of Ceiling	Concrete Joint Sealant Lubricating Oil Transient	<15	Low

9A-429

LBDCR

2021-001

GRAND GULF NUCLEAR GENERATING STATION
Updated Final Safety Analysis Report (UFSAR)

FIRE HAZARD ANALYSIS SUMMARY

Fire Area	Fire Zone	Fire Zone Elevation, Ft, Column Location	Safe Shutdown Equipment	Major Safety-Related Equipment (Quantity)	Fire Protection	Combustible Materials	Max. Insitu Combustible Loading (Minutes)	Total Fire Severity
3	1A118	RHR C Room, Elev. 93'0", Area Bounded by Column Lines 10.0-12.5 and P.4-Q	Division II	RHR Pump C RHR C Room Cooler RHR C Jockey Pump Electrical Cable and Raceway	Heat Detection Hose Streams Portable Extinguishers 3-Hr Rated Ceiling, North, South and West Walls	Concrete Joint Sealant Electrical Cable Lubricating Oil Transient	<30	Low
3	1A119	LPCS Room, Elev. 93' 0", Area Bounded by Column Lines 7.5-10.0 and P.4-Q	Division I	LPCS Pump LPCS Room Cooler LPCS Jockey Pump Electrical Cable and Raceway	Heat Detection Hose Streams Portable Extinguishers 3-Hr Rated Ceiling, North, South, and West Walls	Concrete Joint Sealant Electrical Cable Lubricating Oil Transient	<30	Low
3	1A220	Piping Penetration Room, Elev. 120' 6", Area Bounded by Column Lines 9-11 and Containment Wall-P.4	Division I and II	Electrical Cable and Raceway	Heat Detection Hose Streams Portable Extinguishers 3-Hr Rated Walls and Ceiling	Concrete Joint Sealant Transient	<15	Low
5	1A109	HPCS Pump Room, Elev. 93' 0", Area Bounded by Column Lines 12.3-13.8 and H-K	None	HPCS Pump HPCS Room Cooler HPCS Jockey Pump Electrical Cable and Raceway	Heat Detection Hose Streams Portable Extinguishers 3-Hr Rated Walls and Ceiling	Concrete Joint Sealant Electrical Cable Lubricating Oil Transient	<30	Low
6	1A201	Passage, Elev. 119' 0", Area Bounded by Column Lines G - G.4 and 5.5 - 15.1	Division I and II	MSIV Leakage Control Panels (2) Exhaust Blowers (3) Electrical Cable and Raceway	Partial Coverage by Automatic Sprinkler Smoke Detection Hose Streams Portable Extinguishers 3-Hr Rated Ceiling Floor, and East, West (Column Lines 6.5 - 13.6), and North Walls	Electrical Cable Transient PC Storage	<90	Moderate

9A-430

IBDCR

2021-001

GRAND GULF NUCLEAR GENERATING STATION
Updated Final Safety Analysis Report (UFSAR)

FIRE HAZARD ANALYSIS SUMMARY

Fire Area	Fire Zone	Fire Zone Elevation, Ft, Column Location	Safe Shutdown Equipment	Major Safety-Related Equipment (Quantity)	Fire Protection	Combustible Materials	Max. Insitu Combustible Loading (Minutes)	Total Fire Severity
6	1A211	Miscellaneous Equipment Area, Elev. 119' 0", Area Bounded by Column Lines G.4 - P.4 and 15.1 - 12.5, Containment Wall, 13.8 and 13.5	Divisions I and II	Electrical Cable and Raceway	Partial Coverage by Automatic Sprinkler Smoke Detection Hose Streams Portable Extinguishers 3-Hour Rated Ceiling Floor, South Wall, and portion of North Wall	Electrical Cable Lube Oil Concrete Joint Sealant Transient Plastic Stretcher Pipe/Component Insulation	<30	Low
6	1A215	Fan Coil Area, Elev. 119' 0". Area Bounded by Column Lines G.4 - P.4 and 5.5 - 7.5, Containment Wall, 6.2 and 6.5	Division I and II	Electrical Cable and Raceway	Smoke Detection Hose Streams Portable Extinguishers 3-Hour Rated Ceiling, Floor, and North Wall	Electrical Cable Concrete Joint Sealant Transient Miscellaneous Class A Combustibles Plastics	<60	Low
6	1A222	Motor Control Center Area, Elev. 119' 0", Area Bounded by Column Lines P.4-R and 15.1-5.5	Divisions I and II	Electrical Cable and Raceway	Partial Coverage By Automatic Sprinkler Smoke Detection Hose Streams Portable Extinguishers 3-Hr Rated Ceiling and Floor and East Wall (Between Column Lines 7.5 and 12.5) Portion of South wall separating Stair 1A12 is 2-hr rated	Electrical Cable Transient Lube Oil Concrete Joint Sealant Miscellaneous Class A Combustibles Plastics	<45	Low
7	1A207	Electrical Switchgear Room, Elev. 119' 0", Area Bounded by Column Lines 12.3 - 13.8 and H - K	Division II	ESF Electrical Switchgear Room East Cooler Motor Control Center (2) 6.9 kV Switchgear Electrical Cable and Raceway	Automatic CO ₂ Suppression System Smoke Detection Hose Streams Portable Extinguishers 3-Hour Rated Walls, Floor, and Ceiling	Concrete Joint Sealant Transient Electrical Cable Pipe/Component Insulation	<45	Low

9A-431

LBDCR 2020-079

GRAND GULF NUCLEAR GENERATING STATION
Updated Final Safety Analysis Report (UFSAR)

FIRE HAZARD ANALYSIS SUMMARY

Fire Area	Fire Zone	Fire Zone Elevation, Ft, Column Location	Safe Shutdown Equipment	Major Safety-Related Equipment (Quantity)	Fire Protection	Combustible Materials	Max. Insitu Combustible Loading (Minutes)	Total Fire Severity
8	1A208	ESF Electrical Switchgear Room, Elev. 119' 0" and 121' 6", Area Bounded by Column Lines 6.2 - 7.8 and H - K	Division I Alternate Shutdown Controls 1H22-P295	ESF Electrical Switchgear Room East Cooler Motor Control Center (2) 6.9 kV Switchgear Electrical Cable and Raceway GE Panel DC Starters Alternate Shutdown Panel	Automatic CO ₂ Suppression System Smoke Detection Hose Streams Portable Extinguishers 3-Hour Rated Floor, Ceiling, and Walls	Concrete Joint Sealant Electrical Cable Transient Pipe/Component Insulation	<60	Low
9	1A219	Electrical Switchgear Room, Elev. 119' 0", Area Bounded by Column Lines 7.5 - 9 and Containment Wall - P.4	Division I Alternate Shutdown Controls 1H22P296	Motor Control Center ESF Switchgear Room West Cooler Load Centers (2) Electrical Cable and Raceway Alternate Shutdown Panel	Automatic CO ₂ Suppression System Smoke Detection Hose Streams Portable Extinguishers 3-Hour Rated Floor, Ceiling, and Walls	Concrete Joint Sealant Electrical Cable Transient Pipe/Component Insulation	<45	Low
10	1A221	Electrical Switchgear Room, Elev. 119' 0", Area Bounded by Column Lines P.4 - Containment Wall and 11 - 12.5	Division II	ESF Electrical Switchgear Room West Cooler Electrical Cable and Raceway Motor Control Center Load Centers	Smoke Detection Hose Streams Automatic CO ₂ Suppression System Portable Extinguishers 3-Hour Rated Walls, Floor and Ceiling	Electrical Cable Concrete Joint Sealant Transient Pipe/Component Insulation	<45	Low

9A-432

Revision 2016-00

GRAND GULF NUCLEAR GENERATING STATION
 Updated Final Safety Analysis Report (UFSAR)

FIRE HAZARD ANALYSIS SUMMARY

Fire Area	Fire Zone	Fire Zone Elevation, Ft, Column Location	Safe Shutdown Equipment	Major Safety-Related Equipment (Quantity)	Fire Protection	Combustible Materials	Max. Insitu Combustible Loading (Minutes)	Total Fire Severity
11	1A301	Corridor, Elevation 139' 0", Area Bounded by Column Lines 11-15.1 and G-G.4	Division I	Electrical Cable and Raceway	Smoke Detection Partial Coverage by Automatic Sprinklers Hose Streams Portable Extinguishers 3-Hr Rated Floor, Ceiling, and Walls (except at opening along 1A316)	Electrical Cable Transient	<150	High
11	1A302	Corridor, Elevation 139' 0", Area Bounded by Column Lines 5.5-9 and G-G.4	Division I	Electrical Cable and Raceway	Smoke Detection Hose Streams Portable Extinguishers 3-Hr Rated Floor, Ceiling, and Walls (except at opening along 1A314)	Electrical Cable Transient	<135	High
11	1A314	Passage, Elevation 139' 0", Area Bounded by Column Lines 5.5-7.5 and G.4-P.4	Division I	Electrical Cable and Raceway Signal Isolating Cabinet	Smoke Detection Hose Streams Portable Extinguishers 3-Hr Rated Floor, Ceiling, North Wall and Portion of South Wall	Electrical Cable Lubricating Oil Concrete Joint Sealant Transient Emergency Decon Station	<105	Moderate

9A-433

Revision 2016-00

GRAND GULF NUCLEAR GENERATING STATION
Updated Final Safety Analysis Report (UFSAR)

FIRE HAZARD ANALYSIS SUMMARY

Fire Area	Fire Zone	Fire Zone Elevation, Ft, Column Location	Safe Shutdown Equipment	Major Safety-Related Equipment (Quantity)	Fire Protection	Combustible Materials	Max. Insitu Combustible Loading (Minutes)	Total Fire Severity
11	1A316	Motor Control Center, Elev. 139' 0", Area Bounded by Column Lines 12.5 - 15.1 and G.4-N, 12.5 and 13.6 and N - P.4	Division I and II	Electrical Cable and Raceway Signal Isolating Cabinet	Smoke Detection Partial Coverage by Automatic Sprinkler Hose Streams Portable Extinguishers 3-Hour Rated Floor Ceiling, South, East (Except along opening at 1A301) and West Walls (Except along opening at 1A321) 3-Hr Rated North Wall (Column Lines G.4 - K) 2-Hr Rated North Wall (Column Lines K - N)	Electrical Cable Concrete Joint Sealant Transient Plastics Thermo-Lag	<60	Low
11	1A321	Motor Control Center Elev. 139' 0", Area Bounded by Column Lines 10 - 13.6 and P.4 - Q 12.5 - 13.6 and Q - R	Division II	Electrical Cable and Raceway	Smoke Detection Partial Coverage by Automatic Sprinkler Hose Streams Portable Extinguishers 3-Hour Rated Floor Ceiling, North, South and Portions of the East and West Walls	Electrical Cable Concrete Joint Sealant Transient Plastics Pipe/Component Insulation	<60	Low

9A-434

LBDCR 2020-079

GRAND GULF NUCLEAR GENERATING STATION
Updated Final Safety Analysis Report (UFSAR)

FIRE HAZARD ANALYSIS SUMMARY

Fire Area	Fire Zone	Fire Zone Elevation, Ft, Column Location	Safe Shutdown Equipment	Major Safety-Related Equipment (Quantity)	Fire Protection	Combustible Materials	Max. Insitu Combustible Loading (Minutes)	Total Fire Severity
11	1A322	Centrifugal Chiller Area, Elev. 139' 0", Area Bounded by Column Lines 5.5 - 10 and P.4 - R	Divisions I and II (See Ref. 6.19 for evaluation of loss of Offsite Power)	Electrical Cable and Raceway	Smoke Detection Automatic Sprinklers Hose Streams Portable Extinguishers 3-Hr Rated Floor, Ceiling, and Portion of West and East Walls 2-Hr Rated Wall that Interfaces with Stair 1A12	Electrical Cable Lubricating Oil Concrete Joint Sealant Transient Pipe/Component Insulation	<30	Low
11	1A323	Standby Gas Treatment Area, Elev. 139' 0", Area Bounded by Column Lines 10.3-12.6 and Q-Q.5	None	Standby Gas Treatment System Filter Train Damper Drive Operator Electrical Cable and Raceway	Smoke Detection Deluge System for Charcoal Filters Hose Streams Portable Extinguishers 3-Hr Rated Floor	Electrical Cable Charcoal Filter Transient	<90	Moderate
11	1A324	Roof of Standby Gas Treatment Areas 1A323 and 1A326, Elev. 154' 6", Area Bounded by Column Lines 10-12.6 and Q-R	None	Electrical Cable and Raceway	Hose Streams Portable Extinguishers 3-Hr Rated Ceiling and West Wall Smoke Detection (Via 1A321 and 1A322)	Electrical Cable Transient	<15	Low
11	1A326	Standby Gas Treatment Area, Elev. 139' 0", Area Bounded by Column Lines 10.3-12.6 and Q.5-R	None	Standby Gas Treatment System Filter Train Damper Drive Operator Electrical Cable and Raceway	Smoke Detection Deluge System for Charcoal Filters Hose Streams Portable Extinguishers 3-Hr Rated Floor and West Wall	Electrical Cable Charcoal Filter Transient	<90	Moderate

9A-435

Revision 2016-00

GRAND GULF NUCLEAR GENERATING STATION
Updated Final Safety Analysis Report (UFSAR)

FIRE HAZARD ANALYSIS SUMMARY

Fire Area	Fire Zone	Fire Zone Elevation, Ft, Column Location	Safe Shutdown Equipment	Major Safety-Related Equipment (Quantity)	Fire Protection	Combustible Materials	Max. Insitu Combustible Loading (Minutes)	Total Fire Severity
12	1A308	Electrical Penetration Room, Elev. 139' 0", Area Bounded by Column Line H - K, Containment Wall and 12.3 - 13.8	Division II	Fuse Panels (2) 6.9 kV Switchgear (2) Load Centers (2) ESF Electrical Switchgear Room Cooler Electrical Cable and Raceway Power Panel GE Panel	Automatic CO ₂ Suppression System Smoke Detection Hose Streams Portable Extinguishers 3-Hour Rated Floor, Ceiling, and Walls	Electrical Cable Transient Concrete Joint Sealant Pipe/Component Insulation	<90	Moderate
13	1A309	Electrical Penetration Room, Elev. 139' 0", Area Bounded by Column Lines 6.2 - 7.8, and H - K	Division I	Load Centers (2) Fuse Panels (2) ESF Electrical Switchgear Room Cooler Power Panel Electrical Cable and Raceway	Automatic CO ₂ Suppression System Smoke Detection Hose Streams Portable Extinguishers 3-Hr Rated Floor, Ceiling, and Walls	Electrical Cable Concrete Joint Sealant Transient Pipe/Component Insulation	<75	Moderate
14	1A318	Electrical Penetration Room, Elev. 139' 0", Area Bounded by Column Lines 7.5 - 9 and Containment Wall - P.4	Division I	6.9 kV Switchgear (2) Motor Control Center Fuse Panels (2) Electrical Switchgear Room Cooler Electrical Cable and Raceway	Automatic CO ₂ Suppression System Smoke Detection Hose Streams Portable Extinguishers 3-Hr Rated Floor, Ceiling, and Walls	Electrical Cable Concrete Joint Sealant Transient Pipe/Component Insulation	<90	Moderate
15	1A319	RPV Instrumentation Test Room, Elev. 139' 0", Area Bounded by Column Lines 9.0-11.0 and Containment Wall-P.4	Division III	Electrical Cable and Raceway	Smoke Detection Hose Streams Portable Extinguishers 3-Hr Rated Floor, Ceiling, and Walls	Concrete Joint Sealant Transient Wood	<15	Low

9A-436

Revision 2016-00

GRAND GULF NUCLEAR GENERATING STATION
Updated Final Safety Analysis Report (UFSAR)

FIRE HAZARD ANALYSIS SUMMARY

Fire Area	Fire Zone	Fire Zone Elevation, Ft, Column Location	Safe Shutdown Equipment	Major Safety-Related Equipment (Quantity)	Fire Protection	Combustible Materials	Max. Insitu Combustible Loading (Minutes)	Total Fire Severity
16	1A320	Electrical Penetration Room, Elev. 139' 0", Area Bounded by Column Lines 11.0 - 12.5 and Containment Wall - P.4	Division II	Motor Control Center Fuse Panels (2) Electrical Cable and Raceway Electrical Switchgear Room Cooler	Automatic CO ₂ Suppression System Smoke Detection Hose Streams Portable Extinguishers 3-Hr Rated Floor, Ceiling, and Walls	Electrical Cable Concrete Joint Sealant Transient Pipe/Component Insulation	<60	Low
17	1A325	Railroad Area, Elev. 133' 0", Area Bounded by Column Lines 13.6-15.1 and N-R	None	None	Auto Sprinkler System Hose Streams Portable Extinguishers 3-Hr Rated Floor, Ceiling, North, South, and East Walls Portion of North wall separating Stair 1A10 is 2-hr rated	Concrete Joint Sealant Transient Wood DFS Transient	<15	Low
18	1A402	Main Steam Tunnel Roof, Elev. 174' 0", Area Bounded by Column Lines 11.0-9.0 and G.4-G.8	None	Electrical Cable and Raceway	Smoke Detection Hose Streams Portable Extinguishers 3-Hr Rated Floor, and East and West Walls	Rubber Hose Plastics Transient	<30	Low
18	1A404	Unassigned, Elev. 166' 0", Area Bounded by Column Lines 7.5-9.0 and G.4-Containment Wall	None	Electrical Cable and Raceway	Smoke Detection Hose Streams Portable Extinguishers 3-Hr Rated Floor and East, West, South, and a portion of the North Walls	Concrete Joint Sealant Transient	<15	Low

FIRE HAZARD ANALYSIS SUMMARY

Fire Area	Fire Zone	Fire Zone Elevation, Ft, Column Location	Safe Shutdown Equipment	Major Safety-Related Equipment (Quantity)	Fire Protection	Combustible Materials	Max. Insitu Combustible Loading (Minutes)	Total Fire Severity
18	1A405	Containment Ventilation Equipment Room, Elev. 166' 0", Area Bounded by Column Lines 11.0-12.0 and G.4 - Containment Wall	None	Electrical Cable and Raceway	Smoke Detection Hose Streams Portable Extinguishers 3-Hr Rated Floor, and East and West Walls and portions of the North and South Walls	Electrical Cable Concrete Joint Sealant Transient	<15	Low
18	1A406	Containment Exhaust Filter and Ventilation Room, Elev. 166' 0", Area Bounded By Column Lines 12.0-12.5 and G.4-H.4	None	Electrical Cable and Raceway	Smoke Detection Hose Stream Portable Extinguishers Deluge System (For Filter) 3-Hr Rated Floor, and North and East Walls	Electrical Cable Charcoal Filter Media Transient	<60	Low
19	1A401	Passage, Elev. 166' 0" Area Bounded by Column Lines 10.0-15.1 and G-G.4	Division I	Electrical Cable and Raceway	Smoke Detection Hose Streams Portable Extinguishers Partial Coverage By Auto Sprinkler 3-Hr Rated Floor, North, and East Walls, and portions of the South (EL 166' to 174') and West (column lines 10 to 12.5) boundaries	Electrical Cable Transient Concrete Joint Sealant	<45	Low
19	1A403	Passage, Elev. 166' 0" Area Bounded by Column Lines 5.5-10.0 and G-G.4	Division I	Electrical Cable and Raceway	Smoke Detection Hose Streams Portable Extinguishers 3-Hr Rated Floor, and South, East, and Partial West Walls, and a portion of the North (EL 166' to 174') boundary	Electrical Cable Transient	<75	Moderate

9A-438

Revision 2020-079

GRAND GULF NUCLEAR GENERATING STATION
Updated Final Safety Analysis Report (UFSAR)

FIRE HAZARD ANALYSIS SUMMARY

Fire Area	Fire Zone	Fire Zone Elevation, Ft, Column Location	Safe Shutdown Equipment	Major Safety-Related Equipment (Quantity)	Fire Protection	Combustible Materials	Max. Insitu Combustible Loading (Minutes)	Total Fire Severity
19	1A417	Miscellaneous Equipment Area, Elev. 166' 0", Area Bounded by Column Lines Containment Wall -15.1 and G.4 - L	Divisions I and II	Containment H ₂ Analyzer Sample Rack B Drywell H ₂ Analyzer Sample Rack B Electrical Cable and Raceway	Smoke Detection Hose Streams Portable Extinguishers Nearly Complete Coverage by Auto Sprinkler 3-Hr Rated Floor and South and Partial North Walls	Electrical Cable Transient Concrete Joint Sealant	<15	Low
19	1A420	Miscellaneous Equipment Area, Elev. 166' 0", Area Bounded by Column Lines 5.5 - Containment Wall and G.4-M	Division I	Drywell H ₂ Analyzer Sample Rack A Containment H ₂ Analyzer Sample Rack A Electrical Cable and Raceway	Smoke Detection Hose Streams Portable Extinguishers 3-Hr Rated Floor, North and Partial South (Column Lines G.4 - K) Walls	Transient Electrical Cable Concrete Joint Sealant	<60	Low
19	1A424	Setdown Area, Elev. 166' 0", Area Bounded by Column Lines 12.5 - 15.1 and L-P.4; 13.4-13.6 and P.4-R	Division II	Electrical Cable and Raceway	Smoke Detection Hose Streams Portable Extinguishers Nearly Complete Coverage by Auto Sprinkler 3-Hr Rated Ceiling, Floor, and Containment Wall 2-Hr Rated North Wall (except N.5 to R)	Electrical Cable Transient Concrete Joint Sealant Plastic Fiberglass Insulation	<45	Low
19	1A427	Spent Fuel Cask Handling Area, Elev. 166' 0", Area Bounded by Column Lines 13.6 - 15.1 and P-R	None	None	Hose Streams Portable Extinguishers 3-Hr Rated Floor and Ceiling	Transient Neoprene Fiberglass Insulation DFS Transient	<15	Low

9A-439

LBDCR

2020-079

GRAND GULF NUCLEAR GENERATING STATION
Updated Final Safety Analysis Report (UFSAR)

FIRE HAZARD ANALYSIS SUMMARY

Fire Area	Fire Zone	Fire Zone Elevation, Ft, Column Location	Safe Shutdown Equipment	Major Safety-Related Equipment (Quantity)	Fire Protection	Combustible Materials	Max. Insitu Combustible Loading (Minutes)	Total Fire Severity
19	1A428	Passage, Elev. 166' 0", Area Bounded by Column Lines 5.5-12.5 and Containment Wall, M-P.4	Divisions I and II	FPC and CU Pump Room Coolers (2) Fuel Pool Pump Panel Electrical Cable and Raceway	Smoke Detection Hose Streams Portable Extinguishers Partial Coverage by Auto Sprinkler 3-Hr Rated Ceiling (except hatch), Floor, Containment Wall, and Portion of the West Wall	Electrical Cable Transient Concrete Joint Sealant	<60	Low
19	1A429	Water Sampling Station, Elev. 166' 0", Area Bounded by Column Lines 6.4-7 and P.4-P.6	None	None	Hose Streams Portable Extinguishers 3-Hr Rated Ceiling and Floor	Transient	<15	Low
19	1A430	CRD Repair Area, Elev. 166' 0", Area Bounded by Column Lines 11.0-13.4 and P.4-R	None	Piping & Valves	Smoke Detection Hose Streams Portable Extinguishers 3-Hr Rated Ceiling, Floor and South and West Walls	Nylon Plastic Fiberglass Insulation Rubber Hose Electrical Cable Transient	<15	Low
19	1A431	Spent Fuel Pool Area, Elev. 167' 6", Area Bounded by Column Lines 810.5 and P.4-R	None	Piping	Hose Streams Portable Extinguishers 3-Hr Rated Floor and South, East and West Walls	None	0	0
19	1A432	FPC and CU Pump Room, Elev. 166' 0", Area Bounded by Lines 7-8 and P.4-Q	None	FPC and CU Pumps (2) Electrical Cable and Raceway	Smoke Detection Hose Streams Portable Extinguishers 3-Hr Rated Floor, Ceiling, and North Wall	Transient Lube Oil Cloth Bag	<15	Low

9A-440

Revision 2016-00

GRAND GULF NUCLEAR GENERATING STATION
Updated Final Safety Analysis Report (UFSAR)

FIRE HAZARD ANALYSIS SUMMARY

Fire Area	Fire Zone	Fire Zone Elevation, Ft, Column Location	Safe Shutdown Equipment	Major Safety-Related Equipment (Quantity)	Fire Protection	Combustible Materials	Max. Insitu Combustible Loading (Minutes)	Total Fire Severity
19	1A433	FPC and CU Backwash Transfer Pump Room, Elev. 166' 0", Area Bounded by Column Lines 6.2-7 and P.7Q	None	Piping	Hose Streams Portable Extinguishers 3-Hr Rated Ceiling and Floor	Transient Turbine Oil	<15	Low
19	1A434	Passage, Elev. 166' 0", Area Bounded by Column Lines 5.5-6.2 and P.4-R	None	Electrical Cable and Raceway	Smoke Detection Hose Streams Portable Extinguishers 3-Hr Rated Ceiling and Floor	Electrical Cable Transient	<45	Low
19	1A436	FPC and CU Backwash Receiving Tank Room, Elev. 166' 0", Area Bounded by Column Lines 6.4-8 and QR	None	None	Hose Streams Portable Extinguishers 3-Hr Rated Ceiling, Floor and North and West Walls	Transient	<15	Low
19	1A437	Transfer Canal, Elev. 176' 0", Area Bounded by Column Lines 10.5 - 11.0 and P.4-R	None	Piping	Hose Streams Portable Extinguishers 3-Hr Rated West Wall and Partial North Wall	None	0	0
19	1A438	Shipping Cask Storage Pool, Elev. 159' 6", Area Bounded by Column Lines 11.0-12.2 and Q-R Column Lines	None	Piping	Hose Streams Portable Extinguishers 3-Hr Rated Floor and North, East and West Walls	None	0	0
19	1A444	Inspection Area, Elev. 166' 9", Area Bounded By Column Lines 10.5-11.0 and P.4-R	None	None	Hose Streams Portable Extinguishers 3-Hr Rated Floor and a Portion of the North Wall and East and West Walls	Transient	<15	Low

9A-441

Revision 2016-00

GRAND GULF NUCLEAR GENERATING STATION
Updated Final Safety Analysis Report (UFSAR)

FIRE HAZARD ANALYSIS SUMMARY

Fire Area	Fire Zone	Fire Zone Elevation, Ft, Column Location	Safe Shutdown Equipment	Major Safety-Related Equipment (Quantity)	Fire Protection	Combustible Materials	Max. Insitu Combustible Loading (Minutes)	Total Fire Severity
19	1A519	Storage Area, Elev. 185' 0", Area Bounded by Column Line 11.0-15.1 and L-P.4	None	Electrical Cable and Raceway	Smoke Detection Hose Streams Portable Extinguishers 3-Hr Rated Ceiling, Floor, Containment Wall, and portions of the east, south, and west boundaries	Electrical Cable Concrete Joint Sealant Snubber Test Facility Furnishings Transient	<30	Low
19	1A523	Spent Fuel Hatch Area, Elev. 185' 0", Area Bounded by Column Lines 13.6-15.1 and P-R	None	Electrical Cable and Raceway	Smoke Detection Hose Streams Portable Extinguishers 3-Hr Rated Floor and Ceiling (Except Non-Rated Hatchways)	Wood Transient DFS Transient	<15	Low
19	1A524	Concrete Platform, Elev. 195' 3", Area Bounded by Column Lines 10.2-11.0 and Containment Wall - P.4	None	Electrical Cable and Raceway	Smoke Detection (Located in 1A527) Hose Streams Portable Extinguishers 3-Hr Rated Floor, Ceiling and East Wall	Electrical Cable Transient	<30	Low
19	1A525	Transfer Tube, Elev. 182' 0", Area Bounded By Column Lines 10.2 - 11.0 and Containment Wall - P.4	None	Fuel Transfer Tube Fuel Transfer Tube Bellows	3-Hr Rated Ceiling, Floor, and North, South, and East Walls	Concrete Joint Sealant	<15	Low
19	1A527	Load Center Area, Elev. 185' 0", Area Bounded by Column Lines 5.5-10.2 and M-R	Division I and II	FPC and CU Heat Exchangers (2) Electrical Cable and Raceway Air Receivers	Smoke Detection Hose Streams Portable Extinguishers 3-Hr Rated Floor, Ceiling, (Except for Equipment Hatches), Containment Wall, and portions of the North (EL 185' to 195') and East boundaries	Electrical Cable Transient Concrete Joint Sealant Wood Ecodex Decontamination Station	<45	Low

GRAND GULF NUCLEAR GENERATING STATION
Updated Final Safety Analysis Report (UFSAR)

9A-442

LBDCR

2019-091
2020-079

FIRE HAZARD ANALYSIS SUMMARY

Fire Area	Fire Zone	Fire Zone Elevation, Ft, Column Location	Safe Shutdown Equipment	Major Safety-Related Equipment (Quantity)	Fire Protection	Combustible Materials	Max. Insitu Combustible Loading (Minutes)	Total Fire Severity
19	1A528	New Fuel Storage Vault, Elev. 185' 0", Area Bounded by Column Lines 11.0-13.4 and P.4-P.7	None	None	Hose Streams Portable Extinguishers 3-Hr Rated Floor and Walls	None	0	0
19	1A529	FPU and CU Tank Room, Elev. 180' 8", Area Bounded by Column Lines 6.5-8.2 and P.4-P.7	None	Electrical Cable and Raceway	Smoke Detection Hose Streams Portable Extinguishers Streams 3-Hr Rated Floor and North Wall	Transient Lube Oil	<15	Low
19	1A530	Fuel Pool Filter Demineralizer Room, Elev. 180' 8", Area Bounded by Column Lines 6.5-8.2 and P.7-R	None	None	Hose Streams Portable Extinguishers 3-Hr Rated Floor and a portion of the North Wall	Transient Turbine Oil	<15	Low
19	1A531	Piping Area, Elev. 185' 0", Area Bounded by Column Lines 11.0-13.6 and P.4-R	None	Piping & Valves	Hose Streams Portable Extinguishers 3-Hr Rated Ceiling, Floor, and a portion of the South Wall	Transient	<15	Low
19	1A532	Cask Washdown Area Elev. 185' 0", Area Bounded by Column Lines 12.3-13.3 and Q-Q.8	None	None	Hose Streams Portable Extinguishers 3-Hr Rated Floor and Walls	DFS Transient	0	0
19	1A533	Fuel Pool Filter Demineralizer Room, Elev. 191' 4", Area Bounded by Column Lines 7.5-8.2 and Q-R	None	Piping	3-Hr Rated Ceiling and North Wall Accessibility to Hose Streams and Portable Extinguishers Only When Concrete Hatch is Removed	None	0	0

GRAND GULF NUCLEAR GENERATING STATION
Updated Final Safety Analysis Report (UFSAR)

9A-443

LBDCR 2019-091
2020-079

FIRE HAZARD ANALYSIS SUMMARY

Fire Area	Fire Zone	Fire Zone Elevation, Ft, Column Location	Safe Shutdown Equipment	Major Safety-Related Equipment (Quantity)	Fire Protection	Combustible Materials	Max. Insitu Combustible Loading (Minutes)	Total Fire Severity
19	1A534	Fuel Pool Filter Demineralizer Room, Elev. 191' 4", Area Bounded by Column Lines 6.5-7.5 and Q-R	None	None	3-Hr Rated Ceiling Accessibility to Hose Streams and Portable Extinguishers Only When Concrete Hatch is Removed	None	0	0
19	1A536	Pipe Chase, Elev. 185' 0", Area Bounded by Column Lines 8.2-13.2 and Q.8-R	None	None	3-Hr Rated Floor, Ceiling, and East Wall Hose Streams Portable Extinguishers	None	0	0
19	1A537	Drain Tank Area, Elev. 191' 4", Area Bounded by Column Lines 7.3-8.2 and P.4-Q	None	Drain Tank	3-Hr Rated Ceiling and North Wall Portable Extinguishers	Transient	<15	Low
19	1A602	Storage Area, Elev. 208' 10" Area Bounded by Column Lines 10.0-15.1 and L-P.4	None	Electrical Cable and Raceway	Smoke Detection Hose Streams Portable Extinguishers 3-Hr Rated Floor, portions of the ceiling and East wall, and Containment Wall (Except Hatch) 2-Hr interface with stair 1A10 and Elevator No. 3	Transient Electrical Cable Wood Plastic Bags Concrete Joint Sealant DFS Transient	<15	Low
19	1A603	Passage, Elev. 208' 10", Area Bounded by Column Lines 5.5-10.0 and M-P.4	None	Enclosure Building Recirculation Fans (2) Electrical Cable and Raceway	Smoke Detection Hose Streams Portable Extinguishers 3-Hr Rated Floor (Except Hatchway), portions of the ceiling and East wall, and Containment Wall	Electrical Cable Transient Concrete Joint Sealant PC Storage	<30	Low

FIRE HAZARD ANALYSIS SUMMARY

Fire Area	Fire Zone	Fire Zone Elevation, Ft, Column Location	Safe Shutdown Equipment	Major Safety-Related Equipment (Quantity)	Fire Protection	Combustible Materials	Max. Insitu Combustible Loading (Minutes)	Total Fire Severity
19	1A604	Fuel Handling Area Elev. 208' 10", Area Bounded by Column Lines 5.5-15-1 and P.4-R	None	Electrical Cable and Raceway 150-Ton Spent Fuel Cask Crane Fuel Preparation Machine Fuel Handling Platform 5-Ton New Fuel Bridge Crane	Smoke Detection Hose Streams Portable Extinguishers 3-Hr Rated Floor (Except Hatch) 2-hr rated interface with Stair 1A12	Electrical Cable Concrete Joint Sealant Plastic Stretcher PC Storage Transient DFS Transient	<15	Low
19	1A606	HVAC Unit Area, Elev. 245' 0", Area Bounded by Column Lines 5.5-10.0 and P-R	None	Electrical Cable and Raceway	Smoke Detection Hose Streams Portable Extinguishers 3-Hr Rated East Wall 2-Hr Rated Walls around Stair 1A12	Electrical Cable Transient	<15	Low
20	1A407	Motor Control Center, Elev. 166' 0", Area Bounded by Column Lines 12.5-13.8 and H - H.7	Division II	Motor Control Center ESF Electrical Switchgear Room Cooler Electrical Cable and Raceway	Smoke Detection Automatic CO ₂ Suppression System Hose Streams Portable Extinguishers 3-Hr Rated Walls and Floor	Electrical Cable Transient Pipe/Component Insulation	<90	Moderate
21	1A410	Motor Control Center, Elev. 166' 0", Area Bounded by Column Lines 6.2 - 7.8 and H - H.7	Division I Alternate Shutdown Controls 1H22-P298	Motor Control Center ESF Electrical Switchgear Room Cooler Electrical Cable and Raceway Alternate Shutdown Panel	Smoke Detection Automatic CO ₂ Suppression System Hose Streams Portable Extinguishers 3-Hr Rated Walls and Floor	Electrical Cable Transient Pipe/Component Insulation	<90	Moderate
22	1A539	Cable Space, Elev. 185' 0", Area Bounded by Column Lines 14.5 - 15.1 and G-H	Divisions I AND II	Electrical Cable and Raceway	Smoke Detection Automatic Sprinkler System Portable Extinguishers 3-Hr Rated North Wall and Floor	Electrical Cable Thermo-Lag Transient	<150	High

9A-445

LBDCR

2019-091
2020-079

GRAND GULF NUCLEAR GENERATING STATION
Updated Final Safety Analysis Report (UFSAR)

FIRE HAZARD ANALYSIS SUMMARY

Fire Area	Fire Zone	Fire Zone Elevation, Ft, Column Location	Safe Shutdown Equipment	Major Safety-Related Equipment (Quantity)	Fire Protection	Combustible Materials	Max. Insitu Combustible Loading (Minutes)	Total Fire Severity
25	1A110A	Suppression Pool, Elev. 93' 0", Area Bounded by Column Lines 6.5-13 and H.5-N.6, Minus Reactor and Drywell Areas	Division I and II	Electrical Cable and Raceway	Hose Streams Portable Extinguishers Smoke Detection in HVAC Ductwork Redundant Ambient Temperature Sensors 3-Hr Rated Outer Wall	None	0	0
25	1A110B	Suppression Pool, Elev. 119' 0", Area Bounded by Column Lines 6.5-13 and H.5-N.6, Minus Reactor and Drywell Areas	Division I and II	Suppression Pool Temperature Monitor Thermocouple Leads Electrical Cable and Raceway	Hose Streams Portable Extinguishers Smoke Detection in HVAC Ductwork Redundant Ambient Temperature Sensors 3-Hr Rated Outer Wall	Concrete Joint Sealant Transient	<15	Low
25	1A110C1	Electrical Containment Penetration Area, Elev. 135' 4", Area Bounded by Column Lines 6.8-9.0 and H.7-K	Divisions I and II (Note: Division II Raceway Contains Only M71 Cables)	Reactor Vessel Level and Pressure Instrument Panel A Main Steam Flow Instrument Panel A Jet Pump A Instrument Rack RPIS Multiplexer Suppression Pool Temperature Monitors Electrical Cable and Raceway	Hose Streams Portable Extinguishers Smoke Detection in HVAC Ductwork Redundant Ambient Temperature Sensors 3-Hr Rated Wall of Auxiliary Building	Electrical Cable Concrete Joint Sealant	<75	Moderate

9A-446

Revision 2016-00

GRAND GULF NUCLEAR GENERATING STATION
Updated Final Safety Analysis Report (UFSAR)

FIRE HAZARD ANALYSIS SUMMARY

Fire Area	Fire Zone	Fire Zone Elevation, Ft, Column Location	Safe Shutdown Equipment	Major Safety-Related Equipment (Quantity)	Fire Protection	Combustible Materials	Max. Insitu Combustible Loading (Minutes)	Total Fire Severity
25	1A110C2	Electrical Containment Penetration Area, Elev. 135' 4", Area Bounded by Column Lines 6.7-12.8 and L.9-N.6	Divisions I and II (Note: Division I Raceway Contains only M71 Cables)	Jet Pump B Instrument Rack Reactor Vessel Level and Pressure Instrument Panels B and C Main Steam Flow Instrument Panel B Recirc Pump A Instrument Rack Suppression Pool Temperature Monitors Main Steam Flow and Recirc. Instrument Panel C Electrical Cable and Raceway	Hose Streams Portable Extinguishers Smoke Detection in HVAC Ductwork Redundant Ambient Temperature Sensors 3-Hr Rated Wall of Auxiliary Building	Electrical Cable Concrete Joint Sealant	<90	Moderate
25	1A110C3	Electrical Containment Penetration Area, Elev. 135' 4", Area Bounded by Column Lines 11.0-12.8 and H.7-K.1	Divisions I and II (Note: Division I Raceway Contains Only M71 Cables)	Recirc Pump B Instrument Rack Reactor Vessel Level and Pressure Instrument Panel D Main Steam Flow and Recirc Instrument Panel D RPIS Multiplexing Unit Suppression Pool Temperature Monitors RWCU System Instrument Panel Electrical Cable and Raceway	Hose Streams Portable Extinguishers Smoke Detection in HVAC Ductwork Redundant Ambient Temperature Sensors 3-Hr Rated Wall of Auxiliary Building	Electrical Cable Concrete Joint Sealant	<90	Moderate

FIRE HAZARD ANALYSIS SUMMARY

Fire Area	Fire Zone	Fire Zone Elevation, Ft, Column Location	Safe Shutdown Equipment	Major Safety-Related Equipment (Quantity)	Fire Protection	Combustible Materials	Max. Insitu Combustible Loading (Minutes)	Total Fire Severity
25	1A110D1	Unassigned, Elev. 161' 10" Area Bounded by Column Lines 7.0-9.0 and H.7-J.7	Division I	Electrical Cable and Raceway	Hose Streams Portable Extinguishers Smoke Detection in HVAC Ductwork Redundant Ambient Temperature Sensors 3-Hr Rated Wall of Auxiliary Building	Electrical Cable	<45	Low
25	1A110D2	Unassigned, Elev. 161' 10", Area Bounded by Column Lines 6.5-6.7 and J.7-L.8; 6.8-8.8 and L.8-N.3; 8.8-10.3 and L.8-N.6	Division I	Electrical Cable and Raceway	Hose Streams Portable Extinguishers Smoke Detection in HVAC Ductwork Redundant Ambient Temperature Sensors 3-Hr Rated Auxiliary Building Interface	Electrical Cable	<30	Low
25	1A110D3	Containment Cooler Area, Elev. 161' 10", Area Bounded by Column Lines 11.6-13.6 and H.5-N.6	Divisions I and II	Electrical Cable and Raceway	Hose Streams Portable Extinguishers Smoke Detection in HVAC Ductwork Redundant Ambient Temperature Sensors 3-Hr Rated Wall of Auxiliary Building	Electrical Cable Concrete Joint Sealant Vinyl lead shielding blankets Lube oil	<30	Low
25	1A110E1	Miscellaneous Equipment Area, Elev. 184' 6", Area Bounded by Column Lines 6.5-6.7 and K.2-L.5; 6.7-9.0 and L.5-N.2; 9.0-10.4 and N.2-N.6	Non Divisional	Drywell Purge Compressor Unit Electrical Cable and Raceway	Hose Streams Portable Extinguishers Smoke Detection in HVAC Ductwork Redundant Ambient Temperature Sensors 3-Hr Rated Auxiliary Building and Enclosure Building Interfaces	Electrical Cable Lube Oil Ecodex PC Storage	<30	Low

9A-448

Revision 2016-00

GRAND GULF NUCLEAR GENERATING STATION
Updated Final Safety Analysis Report (UFSAR)

FIRE HAZARD ANALYSIS SUMMARY

Fire Area	Fire Zone	Fire Zone Elevation, Ft, Column Location	Safe Shutdown Equipment	Major Safety-Related Equipment (Quantity)	Fire Protection	Combustible Materials	Max. Insitu Combustible Loading (Minutes)	Total Fire Severity
25	1A110E2	Drywell Purge Compartment and Standby Liquid Control System Area, Elev. 184' 6" Area Bounded by Column Lines 11.0-13.6 and H.7-N.5	None	Standby Liquid Control Storage Tank Standby Liquid Control Pumps (2) Drywell Compressor Unit Electrical Cable and Raceway	Hose Streams Portable Extinguishers Smoke Detection in HVAC Ductwork Redundant Ambient Temperature Sensors 3-Hr Rated Auxiliary Building and Enclosure Building Interfaces Manual Deluge for CCS Filters	Electrical Cable Lube Oil Charcoal Filter Media	<45	Low
25	1A110F1	Reactor Containment Area, Elev. 208' 10", Area Bounded by Column Lines 6.5-9.0 and H.7-L	None	Electrical Cable and Raceway	Hose Streams Portable Extinguishers Smoke Detection in HVAC Ductwork Redundant Ambient Temperature Sensors 3-Hr Rated Enclosure Building Interface 3-HR Rated Ceiling and Enclosure Building Interface	Concrete Joint Sealant	<15	Low
25	1A110F2	Reactor Containment Area, Elev. 208' 10", Area Bounded by Column Lines 6.5-9.0 and L-N.5	None	Hydrogen Recombiner Electrical Cable and Raceway	Hose Streams Portable Extinguishers Smoke Detection in HVAC Ductwork Redundant Ambient Temperature Sensors 3-Hr Rated Ceiling and Auxiliary Building and Enclosure Building Interfaces	Concrete Joint Sealant Neoprene Transient	<15	Low

FIRE HAZARD ANALYSIS SUMMARY

Fire Area	Fire Zone	Fire Zone Elevation, Ft, Column Location	Safe Shutdown Equipment	Major Safety-Related Equipment (Quantity)	Fire Protection	Combustible Materials	Max. Insitu Combustible Loading (Minutes)	Total Fire Severity
25	1A110F3	Reactor Containment Area, Elev. 208' 10", Area Bounded by Column Lines 11.0-13.6 LN.5	None	Electrical Cable and Raceway	Hose Streams Portable Extinguishers Smoke Detection in HVAC Ductwork Redundant Ambient Temperature Sensors 3-Hr Rated Ceiling and Auxiliary Building and Enclosure Building Interfaces	Concrete Joint Sealant	<15	Low
25	1A110F4	Reactor Containment Area, Elev. 208' 10", Area Bounded by Column Lines 11.0-13.6 and H.7-L	None	Hydrogen Recombiner Electrical Cable and Raceway	Hose Streams Portable Extinguishers Smoke Detection in HVAC Ductwork Redundant Ambient Temperature Sensors 3-Hr Rated Ceiling and Enclosure Building Interface	Hydraulic Fluid	<15	Low
25	1A112	Drywell Area, Elev. 100' 9", Area Bounded by Column Lines 8.5-12.2 and J.5-M.5, Minus the Reactor Vessel Area	Divisions I and II	Reactor Recirc Pumps (2) Hydrogen Igniters Drywell Valve Handling Crane Main Steam Isolation Valves Electrical Cable and Raceway	Hose Streams for Most Portions of Drywell Portable Extinguishers Ambient Temperature Sensors	Electrical Cable Lube Oil Transient Polyester reinforced vinyl (enclosed in metal drums) Acrylic (supplemental Oiler) Buna-N (Supplemental Oiler)	<30	Low

9A-450

LBDCR

2019-091

GRAND GULF NUCLEAR GENERATING STATION
Updated Final Safety Analysis Report (UFSAR)

FIRE HAZARD ANALYSIS SUMMARY

Fire Area	Fire Zone	Fire Zone Elevation, Ft, Column Location	Safe Shutdown Equipment	Major Safety-Related Equipment (Quantity)	Fire Protection	Combustible Materials	Max. Insitu Combustible Loading (Minutes)	Total Fire Severity
25	1A113	Reactor Vessel Area, Elev. 94' 6", Area Bounded by Column Lines 9.5-10.5 and K.5-L.5	None	Reactor Vessel Control Rod Drive Assemblies Electrical Cable and Raceway	Hose Streams Portable Extinguishers Ambient Temperature Sensors	Electrical Cable	<45	Low
25	1A310	Main Steam Pipe Tunnel, Elev. 140' 0", Area Bounded by Column Lines 9-11 and H.5-J.5	Divisions I and II (Note: The Single Division I Raceway Contains M71 Cable)	Electrical Cable and Raceway	Hose Streams Portable Extinguishers Redundant Ambient Temperature Sensors 3-Hr Rated Auxiliary Building Interface Smoke Detection in HVAC Ductwork	Lube Oil Concrete Joint Sealant	<15	Low
25	1A311	CRD Hydraulic Control Area, Elev. 135' 4", Area Bounded by Column Lines 12.0-13.6 and J.9-M.2	Divisions I and II, M71 Cable Only	CRD Hydraulic Control Units (14) Suppression Pool Temperature Monitors Electrical Cable and Raceway	Hose Streams Portable Extinguishers Smoke Detection in HVAC Ductwork Redundant Ambient Temperature Sensors 3-Hr Rated Auxiliary Building Interface	Electrical Cable Concrete Joint Sealant	<75	Moderate
25	1A313	CRD Hydraulic Control Area, Elev. 135' 4", Area Bounded by Column Lines 6.5-8.0 and J.8-M.2	Divisions I and II, M71 Cable Only	CRD Hydraulic Control Units (14) Suppression Pool Temperature Monitors Electrical Cable and Raceway	Hose Streams Portable Extinguishers Smoke Detection in HVAC Ductwork Redundant Ambient Temperature Sensors 3-Hr Rated Auxiliary Building Interface	Electrical Cable Concrete Joint Sealant	<60	Low

9A-451

Revision 2016-00

GRAND GULF NUCLEAR GENERATING STATION
Updated Final Safety Analysis Report (UFSAR)

FIRE HAZARD ANALYSIS SUMMARY

Fire Area	Fire Zone	Fire Zone Elevation, Ft, Column Location	Safe Shutdown Equipment	Major Safety-Related Equipment (Quantity)	Fire Protection	Combustible Materials	Max. Insitu Combustible Loading (Minutes)	Total Fire Severity
25	1A411	Unassigned, Elev. 170' 0", Area Bounded by Column Lines 9-11 and H.5-H.8	Division I	Electrical Cable and Raceway	Hose Streams Portable Extinguishers Smoke Detection in HVAC Ductwork Redundant Ambient Temperature Sensors 3-Hr Rated Auxiliary Building Interface	Concrete Joint Sealant	<15	Low
25	1A414	RWCU Heat Exchanger Room, Elev. 170' 0", Area Bounded by Column Lines 9-11 and H.8-J.5	Division I	Electrical Cable and Raceway	Hose Streams Portable Extinguishers Smoke Detection in HVAC Ductwork Redundant Ambient Temperature Sensors	Electrical Cable	<15	Low
25	1A419	RWCU Pump Room, Elev. 161' 10", Area Bounded by Column Lines 7.2-8.2 and J.8-K.2	None	Electrical Cable and Raceway	Hose Streams Portable Extinguishers Smoke Detection in HVAC Ductwork Redundant Ambient Temperature Sensors	Lube Oil	<15	Low
25	1A421	RWCU Backwash Tank Room, Elev. 161' 10", Area Bounded by Column Lines 7.2-Drywell Wall and K.2-L.8	None	Electrical Cable and Raceway	Hose Streams Portable Extinguishers Smoke Detection in HVAC Ductwork Redundant Ambient Temperature Sensors	None	0	0
25	1A443	Valve Access Area, Elev. 173' 2", Area Bounded by Column Lines 7.2-Drywell Wall and K.2-L.8	None	Electrical Cable and Raceway	Hose Streams Portable Extinguishers Smoke Detection in HVAC Ductwork Redundant Ambient Temperature Sensors	None	0	0

9A-452

Revision 2016-00

GRAND GULF NUCLEAR GENERATING STATION
Updated Final Safety Analysis Report (UFSAR)

FIRE HAZARD ANALYSIS SUMMARY

Fire Area	Fire Zone	Fire Zone Elevation, Ft, Column Location	Safe Shutdown Equipment	Major Safety-Related Equipment (Quantity)	Fire Protection	Combustible Materials	Max. Insitu Combustible Loading (Minutes)	Total Fire Severity
25	1A507	Heat Exchanger Area, Elev. 185' 0", Area Bounded by Column Lines 9.0-11.0 and H.8-J.3	None	Electrical Cable and Raceway	Hose Streams Portable Extinguishers Smoke Detection in HVAC Ductwork Redundant Ambient Temperature Sensors	None	0	0
25	1A509	Miscellaneous Equipment Area, Elev. 184' 6", Area Bounded by Column Lines 6.5-9.0 and H.8-K.2	Division I	Electrical Cable and Raceway	Hose Streams Portable Extinguishers Smoke Detection in HVAC Ductwork Redundant Ambient Temperature Sensors 3-Hr Rated Enclosure Building Interface	Electrical Cable Charcoal Filter Media	<60	Low
25	1A510	Steam Separator Storage Area, Elev. 184' 6", Area Bounded by Column Lines 9.0-11.0 and J.3-K.2	None	None	Hose Streams Portable Extinguishers Smoke Detection in HVAC Ductwork Redundant Ambient Temperature Sensors	None	0	0
25	1A513	Drywell Head Area, Elev. 184' 3", Area Bounded by Column Lines 9.0-11.0 and K.2-L.5	None	Electrical Cable and Raceway	Hose Streams Portable Extinguishers Smoke Detection in HVAC Ductwork Redundant Ambient Temperature Sensors	Concrete Joint Sealant	<15	Low

9A-453

Revision 2016-00

GRAND GULF NUCLEAR GENERATING STATION
Updated Final Safety Analysis Report (UFSAR)

FIRE HAZARD ANALYSIS SUMMARY

Fire Area	Fire Zone	Fire Zone Elevation, Ft, Column Location	Safe Shutdown Equipment	Major Safety-Related Equipment (Quantity)	Fire Protection	Combustible Materials	Max. Insitu Combustible Loading (Minutes)	Total Fire Severity
25	1A514	Sample Area, Elev. 184' 6", Area Bounded by Column Lines 8.3-9.0 and K.2-L.7	Division I	Electrical Cable and Raceway	Hose Streams Portable Extinguishers Smoke Detection in HVAC Ductwork Redundant Ambient Temperature Sensors	Electrical Cable Transient	<15	Low
25	1A515	Pump Area, Elev. 184' 6", Area Bounded by Column Lines 7.5-8.3 and K.2-L.7	None	Electrical Cable and Raceway	Hose Streams Portable Extinguishers Smoke Detection in HVAC Ductwork Redundant Ambient Temperature Sensors	Electrical Cable	<15	Low
25	1A516	Filter Demineralizer Area, Elev. 184' 6", Area Bounded by Column Lines 7.0-7.5 and K.2-L.0	None	Electrical Cable and Raceway	Smoke Detection in HVAC Ductwork Redundant Ambient Temperature Sensors Accessibility to Hose Streams and Portable Extinguishers Only When Concrete Hatch is Removed	None	0	0
25	1A517	Filter Demineralizer Area, Elev. 184' 6", Area Bounded by Column Lines 7.0-7.5 and K.2-L.0	None	Electrical Cable and Raceway	Smoke Detection in HVAC Ductwork Redundant Ambient Temperature Sensor Accessibility to Hose Streams and Portable Extinguishers Only When Concrete Hatch is Removed	None	0	0

9A-454

Revision 2016-00

GRAND GULF NUCLEAR GENERATING STATION
Updated Final Safety Analysis Report (UFSAR)

FIRE HAZARD ANALYSIS SUMMARY

Fire Area	Fire Zone	Fire Zone Elevation, Ft, Column Location	Safe Shutdown Equipment	Major Safety-Related Equipment (Quantity)	Fire Protection	Combustible Materials	Max. Insitu Combustible Loading (Minutes)	Total Fire Severity
25	1A520	Steam Dryer Storage Area and Containment Fuel Pool, Elev. 184' 6" and 167' 6", Respectively, Area Bounded by Column Lines 9.0-11.1 and L.5-N.2	None	None	Hose Streams Portable Extinguishers Smoke Detection in HVAC Ductwork Redundant Ambient Temperature Sensors 3-Hour Rated Auxiliary Building Interface	Concrete Joint Sealant	<15	Low
25	1A601	Reactor Containment Area, Elev. 208' 10", Area Bounded by Column Lines 9.0-11.0 and H.2-N.6	None	Containment Polar Crane Refueling Platform Fuel Preparation Machine Hydrogen Igniters Electrical Cable and Raceway	Hose Streams Portable Extinguishers Smoke Detection in HVAC Ductwork Redundant Ambient Temperature Sensors 3-Hr Rated Ceiling and Auxiliary Building and Enclosure Building Interfaces	Concrete Joint Sealant	<15	Low
26	OC101	Health Physics Office Area and Control Point, Elev. 93' 0", Area Bounded by Column Lines 18.9-22.8 and G-K	None	None	Partial Automatic Sprinkler System Smoke Detection Hose Streams Portable Extinguishers 3-Hr Rated Ceiling, North and East Walls 2-Hr Rating on Portion of the South and West Walls	Electrical Cable Floor Tile Plastic Paper Particle Board Laminate PVC Misc. Class A Combustibles	<90	Moderate

FIRE HAZARD ANALYSIS SUMMARY

Fire Area	Fire Zone	Fire Zone Elevation, Ft, Column Location	Safe Shutdown Equipment	Major Safety-Related Equipment (Quantity)	Fire Protection	Combustible Materials	Max. Insitu Combustible Loading (Minutes)	Total Fire Severity
26	OC103	Health Physics Checkout, Elev. 93'0", Area Bounded by Column Lines 18.8-19.4 and G-G.6	None	None	Automatic Sprinkler System Smoke Detection Hose Streams Portable Extinguishers 3-Hr Rated Ceiling and East Wall	Electrical Cable Transient Misc. Class "A" Combustibles Floor Tile	<60	Low
26	OC115	Corridor, Elev. 93' 0", Area Bounded by Column Lines 18.7-18.9 and G-K	Division I	Electrical Cable and Raceway	Smoke Detection Hose Streams Portable Extinguishers 3-Hr Rated Ceiling, East Wall, and a Portion of the South Wall 2-Hr Rated West Wall and Portion of the North Wall	Electrical Cable Transient Misc. Class A Combustibles Plastic Floor Tile	<45	Low
26	OC117	Corridor, Elev. 93' 0", Area Bounded by Column Lines 18.9-21.0 and H-H.3	None	None	Automatic Sprinkler System Smoke Detection Hose Streams Portable Extinguishers 3-Hr Rated Ceiling	Electrical Cable Transient Plastic Wood Floor Tile	<60	Low
26	OC125	HVAC Room, Elev. 93' 0", Area Bounded by Column Lines 18.9-20.7 and J.1-K	None	None	Smoke Detection Hose Streams Portable Extinguishers 3-Hr Rated Ceiling 2-Hr Rated South and East Walls and Portions of North and West Walls	Electrical Cable Transient Rubber hose	<15	Low

9A-456

Revision 2016-00

GRAND GULF NUCLEAR GENERATING STATION
Updated Final Safety Analysis Report (UFSAR)

FIRE HAZARD ANALYSIS SUMMARY

Fire Area	Fire Zone	Fire Zone Elevation, Ft, Column Location	Safe Shutdown Equipment	Major Safety-Related Equipment (Quantity)	Fire Protection	Combustible Materials	Max. Insitu Combustible Loading (Minutes)	Total Fire Severity
26	OC126	Sump Room, Elev. 93' 0", Area Bounded by Column Lines 20-20.7 and J.6-K	None	None	Smoke Detection Hose Streams Portable Extinguishers 3-Hr Rated Ceiling 2-Hr Rated North Wall	Transient	<15	Low
26	OC217	HVAC Chase, Elev. 111' 0", Area Bounded by Column Lines 21.3-22 and J.6-K	None	None	3-Hr Rated Ceiling and East, North, and South Walls	None	0	0
27	OC128	Hot Water Heater Room, Elev. 93' 0", Area Bounded by Column Lines 17.6-18.4 and H-H.3	None	None	Smoke Detection Hose Streams Portable Extinguishers 3-Hr Rated Ceiling and Walls	Transient	<15	Low
28	OC104	Sump Room, Elev. 93' 0", Area Bounded by Column Lines 16.6-17.2 and G-G.2	None	None	Hose Streams Portable Extinguishers 3-Hr Rated North, and East Walls	Transient	<15	Low
28	OC109	Decontaminated Area, Elev. 93' 0", Area Bounded by Column Lines 17.1-18.4 and G.3-H	Division I	Electrical Cable and Raceway	Automatic Sprinkler System Smoke Detection Hose Streams Portable Extinguishers 3-Hr Rated North, East, and a portion of the West Walls, and Ceiling	Concrete Joint Sealant Electrical Cable Misc. Cable A Combustibles Rubber Transient	<15	Low

9A-457

Revision 2016-00

GRAND GULF NUCLEAR GENERATING STATION
Updated Final Safety Analysis Report (UFSAR)

FIRE HAZARD ANALYSIS SUMMARY

Fire Area	Fire Zone	Fire Zone Elevation, Ft, Column Location	Safe Shutdown Equipment	Major Safety-Related Equipment (Quantity)	Fire Protection	Combustible Materials	Max. Insitu Combustible Loading (Minutes)	Total Fire Severity
28	OC116	Hot Machine Shop, Elev. 93' 0", Area Bounded by Column Lines 15-17 and G-H, 15-18.4 and H-K	Division I	Electrical Cable and Raceway	Automatic Sprinkler System Smoke Detection Hose Streams Portable Extinguishers 3-Hr Rated South, North (partial), and East Walls (See Drawing A-0630) and Ceiling	Concrete Joint Sealant Electrical Cable Lube Oil Transient Wood	<15	Low
30	OC203	Division II Switchgear Area (Unit 2), Elev. 111' 0", Area Bounded by Column Lines 18.9-22.8 and G.1-G.7	Division II	Electrical Cable and Raceway	Smoke Detection Hose Streams Portable Extinguishers 3-Hr Rated Floor, Ceiling, and North, East and South walls	Electrical Cable Concrete Joint Sealant Misc. Class A Combustibles Plastic Foam Transient	<15	Low
30	OC204	Division III Battery Room (Unit 2), Elev. 111' 0", Area Bounded by Column Lines 21.2-22.8 and G.7-H	None	None	Hose Streams Portable Extinguishers Smoke Detection 3-Hr Rated Floor and North wall	Concrete Joint Sealant Wood Transient	<30	Low
30	OC205	Emergency Hot Shutdown Room (Unit 2), Elev. 111' 0", Area Bounded by Column Lines 20.9-21.2 and G.7-H	None	None	Hose Streams Portable Extinguishers Smoke Detection 3-Hr Rated Floor	Electrical Cable Concrete Joint Sealant Foam Transient	<30	Low
30	OC205A	Emergency Hot Shutdown Room (Unit 2), Elev. 111' 0", Area Bounded by Column Lines 20.4-20.9 and G.7-H	None	None	Hose Streams Portable Extinguishers Smoke Detection 3-Hr Rated Floor	Electrical Cable Concrete Joint Sealant Foam Plastic Transient	<30	Low

9A-458

LBDCR

2019-091

GRAND GULF NUCLEAR GENERATING STATION
Updated Final Safety Analysis Report (UFSAR)

FIRE HAZARD ANALYSIS SUMMARY

Fire Area	Fire Zone	Fire Zone Elevation, Ft, Column Location	Safe Shutdown Equipment	Major Safety-Related Equipment (Quantity)	Fire Protection	Combustible Materials	Max. Insitu Combustible Loading (Minutes)	Total Fire Severity
30	OC206	Division II Battery Room (Unit 2), Elev. 111' 0", Area Bounded by Column Lines 18.9 - 19.6 and G.6-H.1	None	Electrical Cable and Raceway	Smoke Detection Hose Streams Portable Extinguishers 3-Hr Rated Floor and South wall	Concrete Joint Sealant Battery Cases Plastic Transient	<15	Low
30	OC212	Division I Battery Room (Unit 2), Elev. 111' 0", Area Bounded by Column Lines 18.9-19.6 and H.1-H-9	None	Electrical Cable and Raceway	Smoke Detection Hose Streams Portable Extinguishers 3-Hr Rated Floor and South wall	Concrete Joint Sealant Battery Cases Plastic Transient	<15	Low
30	OC213	Division III Switchgear Room (Unit 2), Elev. 111' 0", Area Bounded by Column Lines 20.4-22.8 and G.9-H.8	None	None	Hose Streams Portable Extinguishers Smoke Detection 3-Hr Rated Floor, Ceiling and North Wall	Electrical Cable Concrete Joint Sealant Transient Wood Foam	<30	Low

9A-459

LBDCR

2019-091
2020-079

FIRE HAZARD ANALYSIS SUMMARY

Fire Area	Fire Zone	Fire Zone Elevation, Ft, Column Location	Safe Shutdown Equipment	Major Safety-Related Equipment (Quantity)	Fire Protection	Combustible Materials	Max. Insitu Combustible Loading (Minutes)	Total Fire Severity
30	OC214	Division I Switchgear Area (Unit 2), Elev. 111' 0", Area Bounded by Column Lines 18.9-22.8 and H.8-K	Division I and II	Electrical Cable and Raceway	Smoke Detection Partial Area Sprinkler System Hose Streams Portable Extinguishers 3-Hr Rated Floor, Ceiling, and Walls that interface with Fire Zones OC215, OC216 & OC217. 2-Hr Rated interface with Stair OC01. See fire zone analysis for complete barrier discussion (Ref. Fire Protection Evaluation 2000-0075).	Electrical Cable Concrete Joint Sealant Thermo-Lag Plastic Transient	<30	Low
30	OC219	Pipe Chase (Unit 2), Elev. 111' 0", Area Bounded by Column Lines 20.5 - 21 and J.9-K	None	None	3-Hr Rated Floor	Concrete Joint Sealant	<15	Low
31	OC202	Division I Switchgear Area, Elev. 111' 0", Area Bounded by Column Lines 15 -18.9 and G.1-G.8 and 17.6 - 18.1 and G.8 - H.1	Division I and II Alternate Shutdown Controls 1H22-P152 1H22-P299	Switchgear Electrical Cable and Raceway Motor Control Center Battery Chargers (2) DC Distribution Panel Load Shedding Panel Transfer Switch Panel Alternate Shutdown Panel	Smoke Detection Automatic CO ₂ Suppression System Hose Streams Portable Extinguishers 3-Hr Rated Walls, Ceiling, and Floor	Electrical Cable Concrete Joint Sealant Transient Thermo-Lag	<60	Low

FIRE HAZARD ANALYSIS SUMMARY

Fire Area	Fire Zone	Fire Zone Elevation, Ft, Column Location	Safe Shutdown Equipment	Major Safety-Related Equipment (Quantity)	Fire Protection	Combustible Materials	Max. Insitu Combustible Loading (Minutes)	Total Fire Severity
32	OC207	Division I Battery Room, Elev. 111' 0", Area Bounded by Column Lines 18.1-18.9 and G.6-H.1	Division I	Electrical Cable and Raceway Electrical Batteries	Smoke Detection Hose Streams Portable Extinguishers 3-Hr Rated Ceiling, Floor, and Walls Hydrogen Detection	Concrete Joint Sealant Battery Cases Plastic Transient	<45	Low
33	OC208	Emergency Hot Shutdown Room, Elev. 111' 0", Area Bounded by Column Lines 16.6-17.1 and G.7-H	Division II	Remote Shutdown Panel Electrical Cable and Raceway	Automatic CO ₂ Suppression System Smoke Detection Hose Streams Portable Extinguishers 3-Hr Rated Ceiling, Floor, and Walls	Electrical Cable Concrete Joint Sealant Transient	<45	Low
34	OC208A	Emergency Hot Shutdown Room, Elev. 111' 0", Area Bounded by Column Lines 17.1-17.6 and G.7-H	Division I Alternate Shutdown Controls 1H22-P150	Electrical Cable and Raceway Remote Shutdown Panel	Automatic CO ₂ Suppression System Smoke Detection Hose Streams Portable Extinguishers 3-Hr Rated Ceiling, Floor, and Walls	Electrical Cable Concrete Joint Sealant Transient	<90	Moderate
35	OC209	Division III Battery Room, Elev. 111' 0", Area Bounded by Column Lines 15.1-16.6 and G.7-H	None	Electric Batteries Electrical Cable and Raceway	Smoke Detection Hose Streams Portable Extinguishers 3-Hour Rated Ceiling, Floor, and Walls Hydrogen Detection	Concrete Joint Sealant Battery Cases Transient	<15	Low

FIRE HAZARD ANALYSIS SUMMARY

Fire Area	Fire Zone	Fire Zone Elevation, Ft, Column Location	Safe Shutdown Equipment	Major Safety-Related Equipment (Quantity)	Fire Protection	Combustible Materials	Max. Insitu Combustible Loading (Minutes)	Total Fire Severity
36	OC210	Division III Switchgear Area, Elev. 111' 0" Area Bounded by Column Lines 15-17.6 and H-H.8	Division II II	HPCS Transformer Motor Control Centers (2) Switchgear (2) Electrical Cable and Raceway Battery Chargers (2)	Automatic CO ₂ Suppression System Smoke Detection Hose Streams Portable Extinguishers 3-Hr Rated Walls, Ceiling, and Floor except that portion of North Wall separating Fire Areas 36 & 38 See fire zone analysis for complete barrier discussion (Ref. Fire Protection Evaluation 2000-0075).	Electrical Cable Concrete Joint Sealant Transient	<45	Low
37	OC211	Division II Battery Room, Elev. 111' 0", Area Bounded by Column Lines 18.1-18.9 and H.1-H.9	Division II	Electric Batteries Electrical Cable and Raceway	Smoke Detection Hose Streams Portable Extinguishers 3-Hr Rated Ceiling, Floor and All Four Walls H ₂ Detection	Concrete Joint Sealant Battery Cases Transient	<45	Low

FIRE HAZARD ANALYSIS SUMMARY

Fire Area	Fire Zone	Fire Zone Elevation, Ft, Column Location	Safe Shutdown Equipment	Major Safety-Related Equipment (Quantity)	Fire Protection	Combustible Materials	Max. Insitu Combustible Loading (Minutes)	Total Fire Severity
38	OC215	Division II Switchgear Area, Elev. 111' 0" Area Bounded by Column Lines 15-18.9 and H.9-K.1, and 17.6-18.1 and G.8-H.9	Divisions I AND II	Switchgear (2) Electrical Cable and Raceway Motor Control Center Battery Chargers (2) DC Distribution Panel Load Shedding Panel	Smoke Detection Automatic CO ₂ Suppression System Hose Streams Portable Extinguishers 3-Hr Rated North, East and South Walls, the portion of the West wall that separates Fire Zone OC215 from Fire Zone OC218, Ceiling, and Floor except that portion of East Wall separating Fire Areas 36 & 38 See fire zone analysis for complete barrier discussion (Ref. Fire Protection Evaluation 2000-0075).	Electrical Cable Concrete Joint Sealant Wood Plastic Transient	<45	Low

9A-463

LBDCR

2020-079

GRAND GULF NUCLEAR GENERATING STATION
Updated Final Safety Analysis Report (UFSAR)

FIRE HAZARD ANALYSIS SUMMARY

Fire Area	Fire Zone	Fire Zone Elevation, Ft, Column Location	Safe Shutdown Equipment	Major Safety-Related Equipment (Quantity)	Fire Protection	Combustible Materials	Max. Insitu Combustible Loading (Minutes)	Total Fire Severity
39	OC216	Corridor, Elev. 111' 0", Area Bounded by Column Lines 18.5-18.9 and J.4-K.5	Division II	Electrical Cable and Raceway	Smoke Detection Hose Streams Portable Extinguishers 3-Hr Rated Ceiling, Floor, East Wall, and Portions of the North and South Walls 2-Hr Rated West Wall and the Remainder of the North Wall See fire zone analysis for complete barrier discussion (Ref. Fire Protection Evaluation 2000-0075).	Concrete Joint Sealant Transient	<15	Low
40	OC218	Pipe Chase, Elev. 111' 0", Area Bounded by Column Lines J.9-K and 16.7-17.4	Piping	Piping	3-Hour Rated Floor, Ceiling, and Walls Except West Wall	Concrete Joint Sealant	<15	Low
41	OC307	Electrical Space, Elev. 133' 0", Area Bounded by Column Lines J.8-K and 15.1-15.3	Division II	Electrical Cable and Raceway	Smoke Detection Hose Streams Portable Extinguishers 3-Hr Rated North, South and East Walls, Ceiling, and Floor 2-Hr Rated West Wall (Exterior)	Electrical Cable Transient	<180	High

9A-464

Revision 2016-00

GRAND GULF NUCLEAR GENERATING STATION
Updated Final Safety Analysis Report (UFSAR)

FIRE HAZARD ANALYSIS SUMMARY

Fire Area	Fire Zone	Fire Zone Elevation, Ft, Column Location	Safe Shutdown Equipment	Major Safety-Related Equipment (Quantity)	Fire Protection	Combustible Materials	Max. Insitu Combustible Loading (Minutes)	Total Fire Severity
42	OC301	Passage, Elev. 133' 0", Area Bounded by Column Lines 18.2-19.2 and G.1 - G.2	None	None	Hose Streams Portable Extinguishers 3-Hour Rated East Wall, Floor and Ceiling 2-Hr Rated North, South, and West Walls	Transient Concrete Joint Sealant Pipe/Component Insulation	<15	Low
42	OC302	HVAC Equipment Room, Elev. 133' 0", Area Bounded by Column Lines 15.1 - 18.9 and G.1 - J.9	Divisions I AND II	Control Room Standby Fresh Air Unit Control Room A/C Unit Electrical Cable and Raceway Safeguard Switchgear and Battery Room Air Handling Units (2) Safeguard Switchgear and Battery Room Exhaust Fans (2)	Smoke Detection Deluge System for Air Handling Unit Filters Hose Streams Portable Extinguishers 3-Hr Rated South, West, and East Walls, Floor, and Ceiling 2-Hr Rated North and portions of the East and West walls	Electrical Cable Concrete Joint Sealant Wood Foam Transient Thermo-Lag	<60	Low

FIRE HAZARD ANALYSIS SUMMARY

Fire Area	Fire Zone	Fire Zone Elevation, Ft, Column Location	Safe Shutdown Equipment	Major Safety-Related Equipment (Quantity)	Fire Protection	Combustible Materials	Max. Insitu Combustible Loading (Minutes)	Total Fire Severity
42	OC303	HVAC Equipment Room, Unit 2, Elev. 133' 0", Area Bounded by Column Lines 18.9-22.8 and G.1-J.9	Division I and II	Control Room Standby Fresh Air Unit Electrical Cable and Raceway Control Room A/C Unit Safeguard Switchgear and Battery Room Air Handling Units (2) Safeguard Switchgear and Battery Room Exhaust Fans (2)	Smoke Detection Deluge System for Air Handling Unit Filters Hose Streams Portable Extinguishers 3-Hr Rated North, West, and East Walls, Floor and Ceiling See Fire Protection Evaluation No. 2005-0001, Rev. 0 for ceiling evaluation to withstand the hazard in Fire Zone OC303. 2-Hr Rated South and West Walls	Electrical Cable Transient Lube Oil Concrete Joint Sealant	<15	Low
42	OC304	Electrical Space (Unit 2), Elev. 133' 0" Area Bounded by Column Lines 22.7-22.8 and J.8-J.9	Division II	Electrical Cable and Raceway	Smoke Detection Hose Streams Portable Extinguishers 3-Hr Rated North, East, and South Walls and Floor 2-Hr Rated West Wall	Electrical Cable Transient	<90	Moderate
42	OC305	Electrical Space (Unit 2), Elev. 133' 0", Area Bounded by Column Lines 20.2 - 20.7 and J.8 - J.9	None	None	Smoke Detection Hose Streams Portable Extinguishers 3-Hour Rated Floor, and Ceiling 2-Hr Rated West Wall	Transient	<15	Low

9A-466

LBDCR 2017-073

GRAND GULF NUCLEAR GENERATING STATION
Updated Final Safety Analysis Report (UFSAR)

FIRE HAZARD ANALYSIS SUMMARY

Fire Area	Fire Zone	Fire Zone Elevation, Ft, Column Location	Safe Shutdown Equipment	Major Safety-Related Equipment (Quantity)	Fire Protection	Combustible Materials	Max. Insitu Combustible Loading (Minutes)	Total Fire Severity
42	OC308	Corridor, Elev. 133' 0", Area Bounded by Column Lines 18.6 - 18.9 and J.8 - K.5, 18.6 - 19.2 and J.4 - J.8	Divisions I and II	Electrical Cable and Raceway	Smoke Detection Automatic Sprinkler System Hose Streams Portable Extinguishers 3-Hr Rated Floor, ceiling, and a portion of the South wall 2-Hr Rated Walls (Except Door OC312)	Transient Concrete Joint Sealant Plastic Stretcher Floor Tile Thermo-Lag	<30	Low
42	OC309	Lobby, Elev. 133' 0", Area Bounded by Column Lines 17.6 - 18.6 and K - K.5	None	None	Hose Streams Portable Extinguishers 2-Hr Rated Walls (Except for Non-rated Doors)	Transient Concrete Joint Sealant Floor Tile Paper Wood	<30	Low
42	OC401	Corridor, Elev. 148' 0", Area Bounded by Column Lines 18.7 - 19.1 and G.1 - G.5, 18.5 - 18.7 and G.1 - G.3	Divisions I and II	Electrical Cable and Raceway	Smoke Detection Hose Streams Portable Extinguishers 3-Hour Rated Floor, Ceiling, East, and portion of West Wall adjacent to OC403 2-Hr Rated South Wall See fire zone analysis for complete barrier discussion (Ref. Fire Protection Evaluation 2000-0075).	Electrical Cable Transient	<30	Low

FIRE HAZARD ANALYSIS SUMMARY

Fire Area	Fire Zone	Fire Zone Elevation, Ft, Column Location	Safe Shutdown Equipment	Major Safety-Related Equipment (Quantity)	Fire Protection	Combustible Materials	Max. Insitu Combustible Loading (Minutes)	Total Fire Severity
42	OC402	Lower Cable Spreading Room, Elev. 148' 0", Area Bounded by Column Lines 15.2 - 16 and G.1 - J.9, 16.0 - 18.6 and G.1 - G.5, 16 - 18.3 and H.8 - J.3	Divisions I AND II	Electrical Cable and Raceway	Automatic CO ₂ Suppression System Automatic Sprinkler Smoke Detection Hose Streams Portable Extinguishers 3-Hr Rated South, East (Column Lines 15.1 - 17.2) and West Walls (Except for Column Lines 15.1 - 15.3), Floor, and Ceiling (Except internal conduit fire seal may not exist, Ref. FPE 2003-001, Rev. 0) All Remaining Walls or Wall Sections are 2-Hr Rated See fire zone analysis for complete barrier discussion (Ref. Fire Protection Evaluation 2000-0075).	Electrical Cable Concrete Joint Sealant Transient Thermo-Lag	<75	Moderate
42	OC404	Unit 1 Support Area Elev. 148' 0", Area Bounded by Column Lines 18.9 -22.0 and G.5 - H.8	None	None	Smoke Detection Hose Streams Portable Extinguishers 3-Hour Rated Floor, Ceiling, South wall, and a portion of the West wall	Electrical Cable Concrete Joint Sealant Wood Transient Paper Elastic	<60	Low

9A-468

LBDCR

2020-079

GRAND GULF NUCLEAR GENERATING STATION
Updated Final Safety Analysis Report (UFSAR)

FIRE HAZARD ANALYSIS SUMMARY

Fire Area	Fire Zone	Fire Zone Elevation, Ft, Column Location	Safe Shutdown Equipment	Major Safety-Related Equipment (Quantity)	Fire Protection	Combustible Materials	Max. Insitu Combustible Loading (Minutes)	Total Fire Severity
42	OC405	Unit 1 Support Area Elev. 148' 0", Area Bounded by Column Lines 19.1 - 22.8 and G.1 - G.5, 22 - 22.8 and G.5 - J.7, 19.4 - 22.8 and H.8 - J.9	None	Electrical Cable and Raceway	Automatic Sprinkler Smoke Detection Hose Streams Portable Extinguishers 3-Hr Rated North and East Walls, the walls that separate Fire Zone OC405 from Fire Zone OC405A, Floor and Ceiling 2-Hr Rated Exterior West Wall	Electrical Cable Concrete Joint Sealant Wood Transient Plastic Hydraulic Fluid Caulking Compound	<30	Low
42	OC406	Unit 1 Support Area Elev. 148' 0", Area Bounded by Column Lines 18.9 - 20.3 and J.3 - J.7	None	None	Smoke Detection Hose Streams Portable Extinguishers 3-Hr Rated Floor and ceiling	Transient Concrete Joint Sealant Wood Paper Plastic Rubber	<60	Low
42	OC406A	HVAC Chase (Unit 2), Elev. 148' 0", Area Bounded by Column Lines 18.9 - 20.0 and J.7 - J.9	Ductwork	Ductwork	Hose Streams Portable Extinguishers 3-Hr Rated Floor, 2-Hr Rated West Wall where it interfaces with Stair OC01	Transient	<15	Low

FIRE HAZARD ANALYSIS SUMMARY

Fire Area	Fire Zone	Fire Zone Elevation, Ft, Column Location	Safe Shutdown Equipment	Major Safety-Related Equipment (Quantity)	Fire Protection	Combustible Materials	Max. Insitu Combustible Loading (Minutes)	Total Fire Severity
42	OC408	Corridor, Elev. 148' 0", Area Bounded by Column Lines 18.6 - 18.9 and H.8 - K.5, 18.9 - 19.3 and H.8 - J.3	None	Electrical Cable and Raceway	Smoke Detection Hose Streams Portable Extinguishers 3-Hr Rated Floor, Ceiling and that portion of the East and South walls adjacent to OC403, OC407 and OC409 2-Hr Rated (Portions of the North, West and South Walls that are adjacent to OC402, Stair OC01, elevator No. 1, and outside area) See fire zone analysis for complete barrier discussion (Ref. Fire Protection Evaluation 2000-0075).	Electrical Cable Transient	<15	Low
42	OC411	Unit 1 Support Area, Elev. 148' 0", Area Bounded by Column Lines 20.9 - 22.5 and J.5 - J.7	None	None	Hose Streams Portable Extinguishers 3-Hr Rated Floor and ceiling.	Electrical Cable Concrete Joint Sealant Plastic Transient Paper Combustible/ Flammable Liquids	<15	Low

9A-470

LBDCR

2020-079

GRAND GULF NUCLEAR GENERATING STATION
Updated Final Safety Analysis Report (UFSAR)

FIRE HAZARD ANALYSIS SUMMARY

Fire Area	Fire Zone	Fire Zone Elevation, Ft, Column Location	Safe Shutdown Equipment	Major Safety-Related Equipment (Quantity)	Fire Protection	Combustible Materials	Max. Insitu Combustible Loading (Minutes)	Total Fire Severity
42	OC412	Electrical Space (Unit 2), Elev. 148' 0", Area Bounded by Column Lines 22.6 - 22.8 and J.5 - J.7	Division II	Electrical Cable and Raceway	Smoke Detection (in OC304) Hose Streams Portable Extinguishers 3-Hr Rated North Wall 2-Hr Rated West Wall	Electrical Cable Transient	<60	Low
42	OC412A	HVAC Chase (Unit 2) Elev. 148' 0", Area Bounded by Column Lines 20.9 - 22.5 and J.7 - J.9	None	None	3-Hr Rated Floor 2-Hr Rated West Wall	Concrete Joint Sealant	<15	Low
42	OC507C	HVAC Chase (Unit 2), Elev. 166' 0", Area Bounded by Column Lines 20.7 - 22.5 and J.7 - J.9	None	Ductwork	3-Hr Rated North, South and East Walls 2-Hr Rated West Wall	None	0	0
42	OC518A	HVAC Chase (Unit 2), Elev. 166' 0", Area Bounded by Column Lines 18.9 - 20 and J.7 - J.9	Ductwork	Ductwork	3-Hr Rated North, South, and East Walls 2-Hr Rated West Wall	None	0	0
42	OC603B	HVAC Chase (Unit 2), Elev. 177' 0", Area Bounded by Column Lines 20.7 - 22.0 and J.7 - J.9	None	Ductwork	3-Hr Rated North, South and East Walls and Ceiling 2-Hr Rated West Wall	None	0	0

9A-471

Revision 2016-00

GRAND GULF NUCLEAR GENERATING STATION
Updated Final Safety Analysis Report (UFSAR)

FIRE HAZARD ANALYSIS SUMMARY

Fire Area	Fire Zone	Fire Zone Elevation, Ft, Column Location	Safe Shutdown Equipment	Major Safety-Related Equipment (Quantity)	Fire Protection	Combustible Materials	Max. Insitu Combustible Loading (Minutes)	Total Fire Severity
42	OC612	Electrical Space (Unit 2), Elev. 166' 0" to 177' 0", Area Bounded by Column Lines 22.6 - 22.8 and J.7 - J.9	Division II	Electrical Cable and Raceway	Smoke Detection (in OC304) 3-Hr Rated North, South, and East Walls and Ceiling (Except internal conduit fire seal may not exist, Ref. FPE 2003-001, Rev. 0) Hose Streams Portable Extinguishers 2-Hr Rated West Wall	None	0	0
42	OC613A	HVAC Chase (Unit 2), Elev. 177' 0", Area Bounded by Column Lines 18.9 - 20 and J.7 - J.9	Ductwork	Ductwork	3-Hr Rated Ceiling and North, East and South Walls 2-Hr Rated West Wall	None	0	0
43	OC407	Instrument Motor Generator, Elev. 148' 0", Area Bounded by Column Lines 17-18.3 and J.3-J.7	Division II	RPS Motor Generator Set Transformers (3) Electrical Cable and Raceway	Automatic CO ₂ Suppression System Smoke Detection Hose Streams Portable Extinguishers 3-Hr Rated Fire Barriers	Transient Concrete Joint Sealant	<15	Low
44	OC410	Battery Room, Elev. 148' 0", Area Bounded by Column Lines 15.7 - 16.8 and J.5-J.7	Division II	Electrical Cable and Raceway	Smoke Detection H ₂ Detection Hose Stream Portable Extinguishers 3-Hr Rated Floor, Ceiling, and Walls	Electrical Cable Battery Cases Transient	<45	Low

9A-472

LBDCR

2019-091

GRAND GULF NUCLEAR GENERATING STATION
Updated Final Safety Analysis Report (UFSAR)

FIRE HAZARD ANALYSIS SUMMARY

Fire Area	Fire Zone	Fire Zone Elevation, Ft, Column Location	Safe Shutdown Equipment	Major Safety-Related Equipment (Quantity)	Fire Protection	Combustible Materials	Max. Insitu Combustible Loading (Minutes)	Total Fire Severity
45	OC403	Computer and Control Room, Elev. 148' 0", Area Bounded by Column Lines 16-18.9 and G.5-H.8	Non Divisional	Control Cabinets Electrical Cable and Raceway	Smoke Detection Automatic Halon Suppression System Hose Streams Portable Extinguishers 3-Hr Fire Rated Ceiling, Floor and Walls See fire zone analysis for complete barrier discussion (Ref. Fire Protection Evaluation 2000-0075).	Concrete Joint Sealant Transient Electric Cable Wood Paper Plastic Floor Tile	<60	Low
47	OC306	Electrical Space, Elev. 133' 0", Area Bounded by Column Lines 17.7-18.2 and J.8-K	Division II	Electrical Cable Raceway	Smoke Detection Hose Streams Portable Extinguishers 3-Hr Rated Floor Walls	Transient	<15	Low
47	OC409	Electrical Space, Elev. 148' 0", Area Bounded by Column Lines 17.7-18.2 and J.8-K	Division II	Electrical Cable Raceway	Smoke Detection Hose Streams Portable Extinguishers 3-Hr Rated North and East Walls 2-Hr Rated South and West Walls See fire zone analysis for complete barrier discussion (Ref. Fire Protection Evaluation 2000-0075).	Transient	<15	Low

9A-473

Revision 2016-00

GRAND GULF NUCLEAR GENERATING STATION
Updated Final Safety Analysis Report (UFSAR)

FIRE HAZARD ANALYSIS SUMMARY

Fire Area	Fire Zone	Fire Zone Elevation, Ft, Column Location	Safe Shutdown Equipment	Major Safety-Related Equipment (Quantity)	Fire Protection	Combustible Materials	Max. Insitu Combustible Loading (Minutes)	Total Fire Severity
47	OC409A	HVAC Chase, Elev. 148' 0", Area Bounded by Column Lines 15.5-17.7 and J.8-K	Division II	Electrical Cable and Raceway	3-Hr Rated Floor, and South and East Walls 2-Hr Rated North and West Walls	Concrete Joint Sealant	<15	Low
47	OC512A	HVAC Chase, Elev. 166' 0", Area Bounded by Column Lines 15.5-17.7 and J.8-K	Divisions I and II	Electrical Cable and Raceway	3-Hr Rated North, South, and East Walls 2-Hr Rated West Wall	None	0	0
47	OC608B	HVAC Chase, Elev. 177' 0", Area Bounded by Column Lines 15.5-17.7 and J.8-K	Divisions I and II	Electrical Cable and Raceway	Smoke Detection Hose Streams Portable Extinguishers 3-Hr Rated Ceiling and North, South, and East Walls 2-Hr Rated West Wall	Transient	<15	Low
47	OC610	Electrical Space, Elev. 166' 0" to 177' 0", Area Bounded by Column Lines 17.7-18.4 and J.8-K	None	Electrical Cable and Raceway	Smoke Detection (Located in OC709) 3-Hr Rated North, South, and East Walls 2-Hr Rated West Wall	Transient	<15	Low

FIRE HAZARD ANALYSIS SUMMARY

Fire Area	Fire Zone	Fire Zone Elevation, Ft, Column Location	Safe Shutdown Equipment	Major Safety-Related Equipment (Quantity)	Fire Protection	Combustible Materials	Max. Insitu Combustible Loading (Minutes)	Total Fire Severity
47	OC702	Upper Cable Spreading Room, Elev. 189' 0", Area Bounded by Column Lines 15.1 - 18.6 and G.1 - J.5, Minus Control Cabinet Area	Division I and II	Electrical Cable and Raceway	Automatic CO ₂ Suppression System Automatic Sprinkler System Smoke Detection Hose Streams Portable Extinguishers 3-Hour Rated Floor (Except internal conduit fire seal may not exist, Ref. FPE 2003-001, Rev. 0), East Wall, and Portions of North, South, and West Walls 2-Hr Rated Portions of North and West Walls Acceptable for hazards in the area - Portions of the North and West Walls. See fire zone analysis for complete barrier discussion (Ref. Fire Protection Evaluation 2000-0075).	Electrical Cable Transient Concrete Joint Sealant Thermo-Lag	<60	Low

FIRE HAZARD ANALYSIS SUMMARY

Fire Area	Fire Zone	Fire Zone Elevation, Ft, Column Location	Safe Shutdown Equipment	Major Safety-Related Equipment (Quantity)	Fire Protection	Combustible Materials	Max. Insitu Combustible Loading (Minutes)	Total Fire Severity
47	OC709	Electrical Space, Elev. 190' 0", Area Bounded by Column Lines 17.7 -18.2 and J.8-K	None	Electrical Cable and Raceway	Smoke Detection Hose Streams Portable Extinguishers 3-Hr Rated North and East Walls 2-Hr Rated South Wall See fire zone analysis for complete barrier discussion (Ref. Fire Protection Evaluation 2000-0075).	Transient	<15	Low
47	OC712	HVAC Room, Elev. 189' 0", Area Bounded by Column Lines J.5-K and 15.5-18.0	Divisions I and II	Electrical Cable and Raceway	Smoke Detection Hose Streams Portable Extinguishers 3-Hr Rated Floor and Portions of North and East Walls 2-Hr Rated Portions of North and East Walls. Acceptable for hazards in the area - South Wall	Concrete Joint Sealant Transient	<15	Low
48	OC518	Electrical Space, Elev. 166' 0", Area Bounded by Column Lines 20 to 20.7 and J.8 to K	None	None	Hose Streams Portable Extinguishers 3-Hr Rated Floor and North, South, and East Walls 2-Hr Rated West Wall (Exterior)	Transient	<15	Low

9A-476

LBDCR

2019-091

GRAND GULF NUCLEAR GENERATING STATION
Updated Final Safety Analysis Report (UFSAR)

FIRE HAZARD ANALYSIS SUMMARY

Fire Area	Fire Zone	Fire Zone Elevation, Ft, Column Location	Safe Shutdown Equipment	Major Safety-Related Equipment (Quantity)	Fire Protection	Combustible Materials	Max. Insitu Combustible Loading (Minutes)	Total Fire Severity
48	OC611	Electrical Space, Elev. 177' 0", Area Bounded by Column Lines 20 to 20.7 and J.8 to K	None	None	Hose Streams Portable Extinguishers 3-Hr Rated Ceiling and North, South, and East Walls 2-Hr Rated West Wall (Exterior)	Transient Plastic Chairs	<15	Low
50	OC402A	HVAC Chase, Elev. 148' 0", Area Bounded by Column Lines 16-16.6 and H.8-J.2	None	None	Smoke Detection Hose Streams Portable Extinguishers 3-Hr Rated Walls and Floor	None	0	0
50	OC405A	HVAC Chase, Elev. 148' 0", Area Bounded by Column Lines 21.4-22 and H.8-J.2	None	None	Smoke Detection Hose Streams Portable Extinguishers 3-Hr Rated Walls and Floor	None	0	0
50	OC501	Passage, Elev. 166' 0", Area Bounded by Column Lines 18.5-18.9 and G.1-G.2	None	None	Hose Streams Portable Extinguishers 3-Hr Rated Floor, Ceiling, and East Wall 2-Hr Rated North, South and West Walls	Transient	<15	Low

9A-477

Revision 2016-00

GRAND GULF NUCLEAR GENERATING STATION
Updated Final Safety Analysis Report (UFSAR)

FIRE HAZARD ANALYSIS SUMMARY

Fire Area	Fire Zone	Fire Zone Elevation, Ft, Column Location	Safe Shutdown Equipment	Major Safety-Related Equipment (Quantity)	Fire Protection	Combustible Materials	Max. Insitu Combustible Loading (Minutes)	Total Fire Severity
50	OC502	Unit 1 Support Area, Elev. 174' 6", Area Bounded by Column Lines 18.9-22.8 and G.1-J	Divisions I and II	Electrical Cable and Raceway	Smoke Detection Hose Streams Portable Extinguishers 3-Hr Rated Ceiling, and North and East Walls 2-Hr Rated West Wall and a Portion of the North Wall. The South wall that interfaces with 0C601 and 0C619 is a non-rated barrier.	None	0	0
50	OC503	Control Room, Elev. 166' 0", Area Bounded by Column Lines 15.1-22.8 and G.1-J	Division I and II	Electrical Cable and Raceway PGCC Control Cabinets Termination Cabinets PGCC Floor Sections	Clean Agent Suppression System (for PGCC Floor Sections) Smoke Detection Hose Streams Portable Extinguishers 3-Hr Rated Floor, North and South Walls, and Portion of East Wall 2-Hr Rated West Wall and Portion of East Wall	Carpet Misc. Class A Combustibles Plastic Cable Insulation Concrete Joint Sealant Foam Transient	<15	Low

FIRE HAZARD ANALYSIS SUMMARY

Fire Area	Fire Zone	Fire Zone Elevation, Ft, Column Location	Safe Shutdown Equipment	Major Safety-Related Equipment (Quantity)	Fire Protection	Combustible Materials	Max. Insitu Combustible Loading (Minutes)	Total Fire Severity
50	OC504	Suspended Ceiling Above Instrument Rack Area, Elev. 174' 6", Area Bounded by Column Lines 15.1-G.1-J	Division I and II	Electrical Cable and Raceway	Smoke Detection Hose Streams Portable Extinguishers 3-Hr Rated Ceiling, and South and East Walls and Portion of East Wall 2-Hr Rated West Wall and Portion of East Wall. The North wall that interfaces with OC601 and OC617 is a non-rated barrier. See zone analysis for East Wall exceptions	None	0	0
50	OC507	Operations' Work Area, Elev. 166' 0", Area Bounded by Column Lines 19.7-22.8 and J-J.8	None	None	Smoke Detection Hose Streams Portable Extinguishers 3-Hr Rated Floor, Ceiling and North and West Walls 2-Hr Rated South and East (Except internal conduit fire seal may not exist, Ref. FPE 2003-001, Rev. 0) Walls	Transient Paper Wood Floor Tile Polyester Particle Board, Laminate Cork, Cotton, PVC Foam Padded Chair	<75	Moderate

9A-479

Revision 2016-00

GRAND GULF NUCLEAR GENERATING STATION
Updated Final Safety Analysis Report (UFSAR)

FIRE HAZARD ANALYSIS SUMMARY

Fire Area	Fire Zone	Fire Zone Elevation, Ft, Column Location	Safe Shutdown Equipment	Major Safety-Related Equipment (Quantity)	Fire Protection	Combustible Materials	Max. Insitu Combustible Loading (Minutes)	Total Fire Severity
50	OC507A	HVAC Chase, Elev. 166' 0", Area Bounded by Column Lines 21.4-22 and H.8-J.2	None	None	Smoke Detection (in OC405A) Hose Streams Portable Extinguishers 3-Hr Rated Ceiling 2-Hr Rated Walls (Except for the North and West walls internal conduit fire seal may not exist, Ref. FPE 2003-001, Rev. 0)	None	0	0
50	OC509	Corridor, Elev. 166' 0", Area Bounded by Column Lines 18-20 and J-J.5	None	None	Smoke Detection Hose Streams Portable Extinguishers 3-Hr Rated Floor and Ceiling 2-Hr Rated East (Except internal conduit fire seal may not exist, Ref. FPE 2003-001, Ref. 0), West (Column Lines 18.9-20 and North Walls)	Transient Misc. Class A Combustibles Plastic Floor Tile	<30	Low
50	OC510	Office, Elev. 166' 0", Area Bounded by Column Lines 17.5-18.5 and J.3-J.8	None	None	Smoke Detection Hose Streams Portable Extinguishers 3-Hr Rated Floor Ceiling and West Wall	Concrete Joint Sealant Transient Paper Plastic Carpet Foam	<30	Low

9A-480

Revision 2016-00

GRAND GULF NUCLEAR GENERATING STATION
Updated Final Safety Analysis Report (UFSAR)

FIRE HAZARD ANALYSIS SUMMARY

Fire Area	Fire Zone	Fire Zone Elevation, Ft, Column Location	Safe Shutdown Equipment	Major Safety-Related Equipment (Quantity)	Fire Protection	Combustible Materials	Max. Insitu Combustible Loading (Minutes)	Total Fire Severity
50	OC511	Dining Area, Elev. 166' 0", Area Bounded by Column Lines 17-17.5 and J-J.8, 17-17-16.3, and J.2-J.4	None	None	Smoke Detection (in OC512) Hose Streams Portable Extinguishers 3-Hr Rated Floor, Ceiling and a Portion of the West Wall 2-Hr Rated East Wall (Except internal conduit fire seal may not exist, Ref. FPE 2003-001, Rev. 0)	Cork Foam Paper Plastic Floor Tile Wood Transient	<45	Low
50	OC512	Kitchen, Elev. 166' 0", Area Bounded by Column Lines 16.3-17 and J.4-J.8	None	None	Smoke Detection Cook Surface Dry Chemical System Hose Stream Portable Extinguishers 3-Hr Rated Floor, Ceiling, and West Wall	Cork Plastic Floor Tile Wood Transient Paper	<90	Moderate
50	OC512B	HVAC Chase, Elev. 166' 0", Area Bounded by Column Lines 16-16.6 and H.8-J.2	None	Ductwork	Smoke Detection (in OC402A) Hose Streams Portable Extinguishers 3-Hr Rated Ceiling 2-Hr Rated Walls (Except for the North and West walls internal conduit fire seal may not exist, Ref. FPE 2003-001, Rev. 0)	None	0	0

9A-481

Revision 2016-00

GRAND GULF NUCLEAR GENERATING STATION
Updated Final Safety Analysis Report (UFSAR)

FIRE HAZARD ANALYSIS SUMMARY

Fire Area	Fire Zone	Fire Zone Elevation, Ft, Column Location	Safe Shutdown Equipment	Major Safety-Related Equipment (Quantity)	Fire Protection	Combustible Materials	Max. Insitu Combustible Loading (Minutes)	Total Fire Severity
50	OC513	Toilet, Elev. 166' 0", Area Bounded by Column Lines 15.9-16.3 and J.3-J.8	None	Ductwork	Hose Streams Portable Extinguishers 3-Hr Rated Floor, Ceiling, and West Wall	Paper Transient Plastic	<15	Low
50	OC514	Locker Room, Elev. 166' 0", Area Bounded by Column Lines 15.1-15.9 and J-J.8 and 15.9-16.3 and J.2-J.3	None	Electrical Cable and Raceway	Smoke Detectors Hose Streams Portable Extinguishers 3-Hr Rated Floor, Ceiling, South and West (Except internal conduit fire seal may not exist, Ref. FPE 2003-001, Rev. 0) Walls 2-Hr Rated Portion of North and East Walls see zone analysis for exceptions	Clothing Plastic Hard Hats Transient	<15	Low
50	OC515	Corridor, Elev. 166' 0", Area Bounded by Column Lines 18.5-18.9 and J.5-K.5	None	None	Smoke Detection Hose Streams Portable Extinguishers 3-Hr Rated Floor/Ceiling 2 and 3 Hr Rated Walls (Except East Wall and Portion of South Wall; See Drawing A-0631)	Transient Cork Plastic Floor Tile	<15	Low

FIRE HAZARD ANALYSIS SUMMARY

Fire Area	Fire Zone	Fire Zone Elevation, Ft, Column Location	Safe Shutdown Equipment	Major Safety-Related Equipment (Quantity)	Fire Protection	Combustible Materials	Max. Insitu Combustible Loading (Minutes)	Total Fire Severity
50	OC601	Viewing Gallery, Elev. 177' 0", Area Bounded by Column Lines 17.1-20.7 and H.1-H.8	None	None	Smoke Detection Hose Streams Portable Extinguishers 3-Hr Rated Ceiling 2-Hr Rated West Wall except the interfaces with OC617 and OC618 and OC619.	Paper Carpet Foam Wood Transient	<30	Low
50	OC602	Corridor No. 1, Elev. 177' 0", Area Bounded by Column Lines 18.5-19.5 and J.1-J.5	None	None	Smoke Detection Hose Streams Portable Extinguishers 3-Hr Rated Floor/Ceiling 2-Hr Rated Walls (except those physically adjacent to OC606, OC608, OC613 and OC614)	Carpet Plastic Transient	<15	Low
50	OC603	Emergency Dormitory, Elev. 177' 0", Area Bounded by Column Lines 20.9-22.8 and J.1-J.8	Division I and II	Electrical Cable and Raceway	Smoke Detection Hose Streams Portable Extinguishers 3-Hr Rated Floor, Ceiling, North and portions of the South and West Walls 2-Hr Rated portion of the East and South Walls	Paper Plastic Foam Floor Covering Wood Transient	<90	Moderate

9A-483

Revision 2016-00

GRAND GULF NUCLEAR GENERATING STATION
Updated Final Safety Analysis Report (UFSAR)

FIRE HAZARD ANALYSIS SUMMARY

Fire Area	Fire Zone	Fire Zone Elevation, Ft, Column Location	Safe Shutdown Equipment	Major Safety-Related Equipment (Quantity)	Fire Protection	Combustible Materials	Max. Insitu Combustible Loading (Minutes)	Total Fire Severity
50	OC606	Toilet, Elev. 177' 0", Area Bounded by Column Lines 18.3-15.1 and H.8-J.8	None	None	Smoke Detection Hose Streams Portable Extinguishers 3-Hr Rated Floor, Ceiling, and West Wall	Paper Towels Transient Floor Tile Plastic	<15	Low
50	OC608	Technical Support Room, Elev. 177' 0", Area Bounded by Column Lines 15.1-18.8 and H.8-J.8	None	Ductwork, Electrical Cable and Raceway	Smoke Detection Hose Streams Portable Extinguishers 3-Hr Rated Floor, Ceiling, South wall and a portion of the West wall 2-Hr Rated East Wall	Paper Plastic Foam Wood Transient Carpet Cloth	<45	Low
50	OC613	Corridor, Elev. 177' 0", Area Bounded by Column Lines 18.5-18.9 and J.5-K.5	None	None	Smoke Detection Hose Streams Portable Extinguishers 3-Hr Rated Floor, Ceiling, and Portions of the North and South Walls 2-Hr Rated West Wall and Portions of the North and South Walls	Transient Carpet Plastic	<15	Low
50	OC614	Corridor No. 2, Elev. 177' 0", Area Bounded by Column Lines 19.5-20.9 and J.1-J.3	None	None	Smoke Detection Hose Streams Portable Extinguishers 3-Hr Rated Floor, Ceiling and a large portion of the West wall 2-Hr Rated East and North Walls and a small portion of the West wall	Transient Floor Tile	<15	Low

FIRE HAZARD ANALYSIS SUMMARY

Fire Area	Fire Zone	Fire Zone Elevation, Ft, Column Location	Safe Shutdown Equipment	Major Safety-Related Equipment (Quantity)	Fire Protection	Combustible Materials	Max. Insitu Combustible Loading (Minutes)	Total Fire Severity
50	OC615	Storage Closet, Elev. 177' 0", Area Bounded by Column Lines 22.4-22.6 and J.8-K	None	None	Hose Streams Portable Extinguishers 3-Hr Rated Floor, Ceiling, and North, South and West Walls	Paper Floor Tile Transient	<120	Moderate
50	OC616	Storage Closet, Elev. 177' 0", Area Bounded by Column Lines 22.4-22.8 and H.8-J.2	None	Electrical Cable and Raceway	Smoke Detection (in OC603) Hose Streams Portable Extinguishers 3-Hr Rated Floor, Ceiling and North Wall 2-Hr Rated South and East Walls	Wood Paper Floor Tile Transient	<45	Low
50	OC617	Electrical Chase, Elev. 177' 0", Area Bounded by Column Lines 17.8-18.5 and H.8-J.1	Division I	Electrical Cable and Raceway	Smoke Detection 3-Hr Rated Ceiling 2-Hr rated West wall North, South, East wall floor are non-rated.	None	0	0
50	OC618	Electrical Chase, Elev. 177' 0", Area Bounded by Column Lines 18.8-19 and H.8-J.1	None	None	Smoke Detection 3-Hr Rated Ceiling 2-Hr Rated Walls that interface with OC602. Walls (Except for the West wall internal conduit fire seal may not exist, Ref. FPE 2003-001, Rev. 0) that interface with OC601 are non-rated.	Electrical Cable	<75	Moderate

9A-485

Revision 2016-00

GRAND GULF NUCLEAR GENERATING STATION
Updated Final Safety Analysis Report (UFSAR)

FIRE HAZARD ANALYSIS SUMMARY

Fire Area	Fire Zone	Fire Zone Elevation, Ft, Column Location	Safe Shutdown Equipment	Major Safety-Related Equipment (Quantity)	Fire Protection	Combustible Materials	Max. Insitu Combustible Loading (Minutes)	Total Fire Severity
50	OC619	Electrical Chase, Elev. 177' 0", Area Bounded by Column Lines 19.4-20 and H.8-J.1	None	None	Smoke Detection 3-Hr Rated Ceiling and Floor 2-Hr rated West wall North, South, East wall are non-rated	Electrical Cable	<120	Moderate
51	OC604	CAS, Elev. 177' 0", Area Bounded by Column Lines 19.8 - 20.9 and J.3-J.8	None	None	Smoke Detection Hose Streams Portable Extinguishers 3-Hour Rated Floor, Ceiling and Walls	Paper Plastic Foam Floor Tile Transient Particle Board Laminate PVC	<105	Moderate
52	OC609	Electrical Space, Elev. 166' 0" and 177' 0", Area Bounded by Column Lines 15-15.3 and J.8-K	None	Electrical Cable and Raceway	3-Hr Rated North, South, and East Walls, Floor and Ceiling (Except for the Floor, Ceiling, and East wall internal conduit fire seal may not exist, Ref. FPE 2003-001, Rev. 0) 2-Hr Rated West Wall (Exterior)	None	0	0

FIRE HAZARD ANALYSIS SUMMARY

Fire Area	Fire Zone	Fire Zone Elevation, Ft, Column Location	Safe Shutdown Equipment	Major Safety-Related Equipment (Quantity)	Fire Protection	Combustible Materials	Max. Insitu Combustible Loading (Minutes)	Total Fire Severity
53	OC703	Control Cabinet Area, Elev. 190' 0", Area Bounded by Column Lines 17 to 18.9 and G.4 to H.9	Division I	Electrical Cable and Raceway PGCC Control Cabinets Termination Cabinets PGCC Floor Sections	Manual CO ₂ System Clean Agent Suppression Systems (for PGCC floor sections) Smoke Detection Hose Streams Portable Extinguishers 3-Hr Rated Walls and Floor See fire zone analysis for complete barrier discussion (Ref. Fire Protection Evaluation 2000-0075).	Concrete Joint Sealant Electrical Cable Transient Foam Floor Tile Wood Carpet	<45	Low
55	OC707	Instrument Motor Generator Room, Elev. 190' 0", Area Bounded by Column Lines 16.9-18.6 and J.5-J.8	None	Inverter Electrical Cable and Raceway	Smoke Detection Hose Streams Portable Extinguishers 3-Hr Rated Floor, Ceiling, and Walls	Electrical Cable Transient Concrete Joint Sealant	<15	Low
58	OC701	Corridor, Elev. 190' 0", Area Bounded by Column Lines 18.6-19.2 and G.2-G.5	None	Ductwork	Hose Streams Portable Extinguishers 3-Hr Rated Floor, South Wall and West Wall adjacent to OC703	Transient	<15	Low

FIRE HAZARD ANALYSIS SUMMARY

Fire Area	Fire Zone	Fire Zone Elevation, Ft, Column Location	Safe Shutdown Equipment	Major Safety-Related Equipment (Quantity)	Fire Protection	Combustible Materials	Max. Insitu Combustible Loading (Minutes)	Total Fire Severity
58	OC704	Control Cabinet Area (Unit 2), Elev. 190' 0", Area Bounded by Column Lines 18.9-20.7 and G.4-H.9	None	None	Smoke Detection Hose Streams Portable Extinguishers 3-Hr Rated South Wall and Floors	Electrical Cable Concrete Joint Sealant Transient Wood, Carpet, Plastic Particle Board, Laminate PVC, Fiberglass Foam Padded Chair	<120	Moderate
58	OC705	Unit 1 Support Area, Elev. 189' 0" Area Bounded by Column Lines 19.2-22.8 and G.1-J.9 Excluding Control Cabinet Area, Instrument Motor Generator Room, HVAC Chase, and HVAC Room	None	Electrical Cable and Raceway	Manual Sprinkler Smoke Detection Hose Streams Portable Extinguishers 3-Hr Rated Floor, (Except internal conduit fire seal may not exist, Ref. FPE 2003-001, Rev. 0) and East Wall	Electrical Cable Concrete Joint Sealant Plastic Wood Transient Paper PVC	<30	Low
58	OC706	Corridor, Elev. 190' 0", Area Bounded by Columns 18.6-18.9 and J.1-K.5; 18.9-19.5 and J.1-J.4	None	Electrical Cable and Raceway	Smoke Detection Hose Streams Portable Extinguishers 3-Hr Rated Floor, and Portions of the South Wall adjacent to OC702, OC707 & OC709 and Portions of East Wall adjacent to OC703 2-Hr Rated West Wall and Portion of the North Wall adjacent to Stair OC701	Electrical Cable Transient	<15	Low

9A-488

LBDCR 2019-091

GRAND GULF NUCLEAR GENERATING STATION
Updated Final Safety Analysis Report (UFSAR)

FIRE HAZARD ANALYSIS SUMMARY

Fire Area	Fire Zone	Fire Zone Elevation, Ft, Column Location	Safe Shutdown Equipment	Major Safety-Related Equipment (Quantity)	Fire Protection	Combustible Materials	Max. Insitu Combustible Loading (Minutes)	Total Fire Severity
58	OC708	Unit 1 Support Area, Elev. 190'0", Area Bounded by Column Lines 18.9-20.3 and J.5-J.8	None	Electrical Cable and Raceway Inverter	Smoke Section Hose Streams Portable Extinguishers 3-Hr Rated Floor	Transient Foam	<15	Low
58	OC708A	HVAC Chase (Unit 2), Elev. 190' 0", Area Bounded by Columns 18.9-20.0 and J.8K	None	Electrical Cable and Raceway	Smoke Detection Hose Streams Portable Extinguishers 3-Hr Rated Floor, 2-Hr Rated West Wall	Plastic Transient	<15	Low
58	OC711	Unit 1 Support Area, Elev. 190'0", Area Bounded by Column Lines 18.4-19.2 and G.1-G.2	None	None	Smoke Detection Hose Streams Portable Extinguishers 3-Hr Rated Floor and East Wall and Portion of West Wall adjacent to OC702 2-Hr Rated South Wall	Transient	None	None
58	OC713	HVAC Room (Unit 2), Elev. 189' 0", Area Bounded by Columns 20.7-22.4 and J.5K	Ductwork	Ductwork	Hose Streams Portable Extinguishers 3-Hr Rated Floor	Transient	<15	Low
60	1D301	Corridor, Elev. 133' 0", Area Bounded by Column Lines 6.5-13.5 and R to West Wall of Corridor	Divisions I and II	Electrical Cable and Raceway	Ultraviolet Flame Detection Hose Stream Portable Extinguishers 3-Hr Rated East and West Walls Automatic Pre-action Sprinkler System	Concrete Joint Sealant Electrical Cable Transient	<30	Low

9A-489

Revision 2016-00

**GRAND GULF NUCLEAR GENERATING STATION
Updated Final Safety Analysis Report (UFSAR)**

FIRE HAZARD ANALYSIS SUMMARY

Fire Area	Fire Zone	Fire Zone Elevation, Ft, Column Location	Safe Shutdown Equipment	Major Safety-Related Equipment (Quantity)	Fire Protection	Combustible Materials	Max. Insitu Combustible Loading (Minutes)	Total Fire Severity
61	1D310	Diesel Generator Bay, Elev. 133' 0", Area Bounded by Column Lines 7 to 9 and R to the West Wall	Division I	Standby Diesel Generator Starting Air Storage Tanks (2) Lube Oil Sump Tank Lube Oil Cooler Jacket Water Standpipe Jacket Water Cooler Fuel Oil Day Tank Relay Panel Control Panel Diesel Generator Outside Air Fan Electrical Cable and Raceway Electrical Panel	Automatic Pre-Action Sprinkler System Ultraviolet Flame Detection Hose Streams Portable Extinguishers 3-Hour Rated North, East, and Partial South Walls	Concrete Joint Sealant Electrical Cable Lubricating Oil Fuel Oil Plastic Wood Transient Rubberized Water Jacket Hose Assemblies	<90	Moderate
62	1D308	Diesel Generator Bay, Elev. 133' 0", Area Bounded by Column Lines 9 to 11 and R to the West Wall	Division II	Standby Diesel Generator Starting Air Storage Tanks (2) Lube Oil Sump Tank Lube Oil Cooler Jacket Water Standpipe Jacket Water Cooler Fuel Oil Day Tank Relay Panel Diesel Generator Outside Air Fan Electrical Cable and Raceway Control Panel Electrical Panel	Automatic Pre-Action Sprinkler System Ultraviolet Flame Detection Hose Streams Portable Extinguishers 3-Hour Rated North, South and East Walls	Concrete Joint Sealant Electrical Cable Lubricating Oil Fuel Oil Transient	<75	Moderate

9A-490

Revision 2016-00

GRAND GULF NUCLEAR GENERATING STATION
Updated Final Safety Analysis Report (UFSAR)

FIRE HAZARD ANALYSIS SUMMARY

Fire Area	Fire Zone	Fire Zone Elevation, Ft, Column Location	Safe Shutdown Equipment	Major Safety-Related Equipment (Quantity)	Fire Protection	Combustible Materials	Max. Insitu Combustible Loading (Minutes)	Total Fire Severity
63	1D306	Diesel Generator Bay, Elev. 133' 0", Area Bounded by Column Lines 11-13 and R-West Wall	None	Fuel Oil Day Tank HPCS Diesel Generator Exhaust Silencers (2) Air Intake Filters (2) Air Compressor Skids D.G. Room Outside Air Fan Air Intake Silencers (2) Electrical Cable and Raceway Relay and Control Panels	Auto Pre-action Water Sprinkler Ultraviolet Flame Detection Hose Streams Portable Extinguishers 3-Hr Rated East, South and Portion of North Walls	Fuel Oil Electrical Cable Concrete Joint Sealant Lube Oil Transient Rubber Hose	<60	Low
64	1M110	Standby Service Water Pump House, Elev. 133' 0", Southwest Corner of the Standby Service Water Cooling Tower and Basin Complex A	Division I	SSW Pump SSW Room Cooler Motor Control Center Load Center HPCS Pump Electrical Cable and Raceway	Smoke Detection Hose Streams Portable Extinguishers	Electrical Cable Concrete Joint Sealant Lubricating Oil Transient Wood	<30	Low
64	1M112	Standby Service Water Valve Room, Elev. 133' 0", Southeast Corner of the Standby Service Water Cooling Tower and Basin Complex A	Division I	Electrical Cable and Raceway	Smoke Detection Hose Streams Portable Extinguishers	None	0	0

9A-491

Revision 2016-00

GRAND GULF NUCLEAR GENERATING STATION
Updated Final Safety Analysis Report (UFSAR)

FIRE HAZARD ANALYSIS SUMMARY

Fire Area	Fire Zone	Fire Zone Elevation, Ft, Column Location	Safe Shutdown Equipment	Major Safety-Related Equipment (Quantity)	Fire Protection	Combustible Materials	Max. Insitu Combustible Loading (Minutes)	Total Fire Severity
64	Basin No. 1	Standby Service Water Basin, Elev. 82' 6", Located Underneath the Standby Service Water Cooling Tower Complex A	Division I	SSW Cooling Tower Fans (2) SSW Pump HPCS Pump Electrical Cable and Raceway	Hose Streams Portable Extinguishers	Concrete Joint Sealant Cathodic protection PVC conduit and cable	<15	Low
65	2M110	Standby Service Water Pump Hose, Elev. 133' 0", Southwest Corner of the Standby Service Water Cooling Tower and Basin Complex B	Division II	SSW Pump SSW Room Cooler Motor Control Center Load Center HPCS Pump Electrical Cable and Raceway	Smoke Detection Hose Stream Portable Extinguishers	Concrete Joint Sealant Transient Electrical Cable Lubricating Oil Wood	<30	Low
65	2M112	Standby Service Water Valve Room Elev. 133' 0", Southeast Corner of the Standby Service Water Cooling Tower and Basin Complex B	Division II	Electrical Cable and Raceway	Smoke Detection Hose Stream Portable Extinguishers	None	0	0
65	Basin No. 2	Standby Service Water Basin No. 2, Elev. 82' 6", Located Underneath the Standby Service Water Cooling Tower Complex B	Division II	SSW Cooling Tower Fans (2) SSW Pump HPCS Pump Electrical Cable and Raceway	Hose Stream Portable Extinguishers	Concrete Joint Sealant Cathodic protection PVC conduit and cable PVC conduit and cable	<15	Low
66	0M101	Diesel Driven Fire Pump Room, Elev. 133'0"	None	None	Automatic Sprinkler System Smoke Detection Hose Stream Portable Extinguishers	Diesel Fuel Batteries Plastic	<120	Moderate

9A-492

Revision 2016-00

GRAND GULF NUCLEAR GENERATING STATION
Updated Final Safety Analysis Report (UFSAR)

FIRE HAZARD ANALYSIS SUMMARY

Fire Area	Fire Zone	Fire Zone Elevation, Ft, Column Location	Safe Shutdown Equipment	Major Safety-Related Equipment (Quantity)	Fire Protection	Combustible Materials	Max. Insitu Combustible Loading (Minutes)	Total Fire Severity
66	0M102	Electric Driven Fire Pump Room, Elev. 133'-0"	None	None	Smoke Detection Hose Stream Portable Extinguishers	Electric Motor	<15	Low
66	0M103	Diesel Driven Fire Pump Room, Elec. 133'-0"	None	None	Automatic Sprinkler System Smoke Detection Hose Stream Portable Extinguishers	Diesel Fuel Batteries Plastic	<105	Moderate

GRAND GULF NUCLEAR GENERATING STATION
Updated Final Safety Analysis Report (UFSAR)

APPENDIX 9B FIRE PROTECTION PROGRAM

9B.1 SCOPE AND APPLICABILITY

GGNS has incorporated the Fire Protection Program into the UFSAR. The GGNS Fire Protection Program is described in the following sections of the UFSAR or Technical Requirements Manual (TRM):

<u>UFSAR</u>	<u>Fire Protection Program Elements</u>
7.4.1.5	Alternate Shutdown System
9.5.1	Fire Protection System
Appendix 9A	Fire Hazards Analysis Report
Appendix 9B	Fire Protection Program
Appendix 9C	Analysis of Safe Shutdown
Table 9.5-11	Comparison with NRC Branch Technical Position APCS9.5-1, Appendix A
Table 9.5-12	Comparison with Appendix R to 10CFR Part 50
Figures 9.5-1 to 9.5-8e, inclusive	Fire Protection Systems
TRM Section 6.2	Fire Protection System Relocated Technical Specifications

The purpose of the Fire Protection Program is to extend the concept of defense-in-depth to fire protection in fire areas important to safety with the following objectives:

- To prevent fires from starting
- To detect rapidly, control, and extinguish promptly those fires that do occur
- To provide protection for structures, systems, and components important to safety so that a fire that is not promptly extinguished by fire suppression activities will not compromise the ability to achieve the safe shutdown of the plant

The Fire Protection Program also delineates the responsibilities and the methods to be used to accomplish the objectives stated above. This Fire Protection Program will interface with other GGNS manuals, plans, and procedures to provide an effective and coordinated Fire Protection Program that encompasses all phases of operation, administration, maintenance, and emergency

GRAND GULF NUCLEAR GENERATING STATION
Updated Final Safety Analysis Report (UFSAR)

activities. These interfaces will, as a minimum, include the Emergency Plan and implementing document, the Security Plan and security instructions, plant administrative procedures, operating and emergency operating instructions, the surveillance programs, and the quality assurance program and training program.

9B.2 ORGANIZATIONS AND RESPONSIBILITIES

The personnel and/or organizations responsible for the formulation, implementation, and assessment of the effectiveness of the GGNS Fire Protection Program are detailed in the following sections and shown on Figure 9B-1.

9B.2.1 Organizations and Responsibilities

9B.2.1.1 Corporate Management

The Site Vice President GGNS, has the overall responsibility for the formulation, implementation, and assessment of the effectiveness of the GGNS Fire Protection Program.

9B.2.1.2 Deleted

9B.2.1.3 Director, Regulatory & Performance Improvement

The Director, Regulatory & Performance Improvement, is responsible for assisting with the regulatory interface for the Fire Protection Program and maintaining the Operating License.

9B.2.1.4 Director, Engineering

The Director, Engineering - GGNS, is responsible for the formulation and administration of the Fire Protection Program. He has on his staff, or as consultants, a qualified Fire Protection Engineer, and personnel trained and experienced in Nuclear Plant Safety. His responsibilities include:

- a. Coordination of building layout and systems design with fire area requirements, including consideration of potential hazards associated with postulated designbasis fires.
- b. Design of fire detection, suppression, and extinguishing systems.
- c. Maintenance of the Fire Hazards Analysis Report.

GRAND GULF NUCLEAR GENERATING STATION
Updated Final Safety Analysis Report (UFSAR)

- d. Periodically conducting inspections to:
 - 1. Ensure the proper storage/use and control of combustible materials.
 - 2. Ensure effectiveness of housekeeping to eliminate fire hazards.
 - 3. Determine the availability of fire protection equipment and systems. This includes periodically evaluating the results of tests of the systems and equipment.
- e. Deleted
- f. Maintaining familiarity with building layouts and changes with respect to fire protection.
- g. Investigating fire reports.
- h. Deleted
- i. Preparing and implementing the fire inspection program and fire fighting procedures.

9B.2.1.5 Deleted

9B.2.1.6 Manager, Quality Assurance Programs

The manager responsible for the quality assurance program is responsible for ensuring compliance with the Fire Protection Program through the Entergy Quality Assurance Program Manual and as described in the GGNS UFSAR Table 9.5-11, Position C.2. This position also verifies continued compliance with NRC requirements.

9B.2.1.7 Fire Departments

The Claiborne County Fire Department will provide backup support for the onsite Fire Brigade when requested and will be invited to participate in annual drills (see agreement in Appendix D of the Grand Gulf Nuclear Station Emergency Plan).

9B.2.1.8 General Manager, Plant Operations

GRAND GULF NUCLEAR GENERATING STATION
Updated Final Safety Analysis Report (UFSAR)

The General Manager, Plant Operations is responsible for implementation of the Fire Protection Program, including staffing the fire brigade and operating and maintaining the fire protection systems.

9B.2.1.9 Shift Fire Chief (Shift Manager)

The Shift Fire Chief has the responsibility for:

- a. Ensuring a full fire brigade is maintained during the shift.
- b. Evaluating fire-fighting equipment.
- c. Ensuring that prompt and effective corrective actions are taken to correct conditions adverse to the Fire Protection Program.
- d. Reviewing and evaluating proposed work activities for potential fire possibilities and transient fire loads.
- e. Determining control room habitability. The determination of control room habitability is that of the Shift Manager (Licensed SRO) or the Control Room Supervisor (Licensed SRO). It is intended that the control room be evacuated, only if there is eminent danger to personnel or if visibility is reduced such that normal operation is degraded.

9B.2.1.10 Fire Brigade

The Shift Fire Brigade is composed of five personnel on the shift. If a fire were to start in the control room, the response would be initially by one of the control room operators (normally three licensed operators at all times) and subsequently by the fire brigade. The fire brigade is described in more detail in Section 9B.7.

9B.2.1.11 Manager, Training

The Manager, Training is responsible for implementing a program that indoctrinates plant personnel with unescorted access to the plant in evacuation procedures and procedures for reporting fires. He is also responsible for the training and qualification

GRAND GULF NUCLEAR GENERATING STATION
Updated Final Safety Analysis Report (UFSAR)

of the Plant Fire Brigade personnel and for developing, conducting and assessing fire drills to determine training effectiveness.

9B.2.1.12 Manager, Maintenance

The Manager, Maintenance is responsible for the corrective and preventive maintenance activities and the installation of plant modifications.

9B.2.1.13 Maintenance Discipline Superintendents

The Maintenance Discipline Superintendents are responsible for the implementation of preventive and corrective maintenance programs for equipment, structures, and components associated with the fire protection system. The Maintenance Discipline Superintendents, in conjunction with the Assistant Operations Manager, Shift and Assistant Operations Manager, Support, are jointly responsible for testing of fire protection equipment.

9B.2.1.14 Administrative Services Supervisor

The Administrative Services Supervisor is responsible for maintaining the Fire Brigade training and drill records for a minimum of 3 years.

9B.2.2 Deleted

9B.3 QUALIFICATIONS OF PERSONNEL

The fire brigade members' qualifications shall include satisfactory completion of an annual physical examination for performing strenuous activity. The personnel responsible for the maintenance and testing of the fire protection systems shall be qualified by training and experience for such work.

The personnel responsible for the training of the fire brigade shall be qualified by training and experience for such work. He will be knowledgeable on the topics and experienced in fighting the types of fires that could occur in the plant.

The Fire Protection Engineer shall meet the eligibility requirements for membership in the Society of Fire Protection Engineers.

GRAND GULF NUCLEAR GENERATING STATION
Updated Final Safety Analysis Report (UFSAR)

9B.4 FIRE PROTECTION EVALUATION

In accordance with the Nuclear Regulatory Commission's request by letter dated September 30, 1976 (MAEC-76/49), a re-evaluation of the Grand Gulf Nuclear Station Fire Protection Program was performed. The evaluation entailed a point-by-point comparison of the GGNS Fire Protection Program and systems design to the positions as outlined in Appendix A to Branch Technical Position APCSB 9.5-1, "Guidelines for Fire Protection for Nuclear Power Plants Docketed Prior to July 1, 1976." The methods for and results of the evaluation are presented in the Fire Hazards Analysis Report and Table 9.5-11, respectively. A detailed tabulation of the potential fire hazards is presented in the Fire Hazards Analysis Report, which is maintained as a separate document at the GGNS site and includes a detailed analysis of the consequences of a fire in each area.

On October 27, 1980, the Nuclear Regulatory Commission approved a rule concerning fire protection. The rule and its Appendix R were developed to establish the minimum acceptable fire protection requirements necessary to resolve certain areas of concern in contrast between the NRC staff and licensees of plants operating prior to January 1, 1979.

This fire protection rule does not apply to the Grand Gulf Nuclear Station; however, as a result of a meeting held with the NRC staff on June 30, 1981 and at the NRC staff's request, a comparison of the Grand Gulf Nuclear Station Fire Protection Program to the requirements outlined by 10 CFR 50, Appendix R, Sections II and III, was performed. The results of this comparison are presented in Table 9.5-12.

9B.5 PROGRAM IMPLEMENTATION

The fire protection program for GGNS is fully operational.

Plant administrative procedures describe the details and provide for additional instructions to implement the requirements of the Fire Protection Program stated herein.

Responsibilities of those persons or organizations needed to implement the Fire Protection Program are provided in Section 9B.2.

GRAND GULF NUCLEAR GENERATING STATION
Updated Final Safety Analysis Report (UFSAR)

9B.6 ADMINISTRATIVE CONTROLS

Administrative controls have been established to minimize fire hazards in areas containing structures, systems, and components important to safety and to maintain the performance of the fire protection systems and personnel. These administrative controls address the guidance of "Nuclear Power Plant Fire Protection Functional Responsibilities, Administrative Controls, and Quality Assurance," (see letter MAEC 77/0035) Attachments 3, 4, and 5, and include procedures which:

- a. Govern the handling and limit the use of ordinary combustible materials, combustible and flammable gases and liquids, and other combustible supplies in safety-related areas.
- b. Prohibit the storage of combustibles in safety-related areas and establish designated storage areas with appropriate fire protection.
- c. Govern the handling of and limit transient fire loads in buildings containing safety-related systems or equipment during all phases of operation and especially during maintenance, modification, or refueling operations.
- d. Provide for the in-plant fire protection review of proposed work activities to identify potential transient fire hazards and specify additional fire protection requirements, if any, in the work activity procedure.
- e. Govern the use of ignition sources by use of a fire control permit system to control welding, grinding, flame cutting, brazing, or soldering operations. A separate permit shall be used for each area where work is to be done. If work is to continue for more than one shift, the permit shall be valid for not more than 24 hours when the plant is operating or for the duration of the particular job when the plant is shut down. Also, no hot work will be allowed in the concealed space above the control room unless the plant is in cold shutdown.
- f. Control the removal of all waste, debris, scrap, oil spills, or other combustibles resulting from a work activity immediately following the completion of work or at the end of each shift, whichever comes first.

GRAND GULF NUCLEAR GENERATING STATION
Updated Final Safety Analysis Report (UFSAR)

- g. Provide for periodic housekeeping inspections to ensure continued compliance with administrative controls.
- h. Control the use of specific combustibles in safety-related areas. Wood used in the plant is treated with a fire retardant, pressure treated fire retardant lumber, or evaluated by Fire Protection Staff. Equipment or supplies (such as new fuel) shipped in untreated combustible packing or containers may be unpacked in safety-related areas if required for valid operating reasons. However, all combustible materials shall be removed from the area immediately following the unpacking.
- i. Delineate the actions to be taken by the individual discovering a fire.
- j. Delineate the actions to be taken by the control room operator to determine the need for brigade assistance upon the report of a fire or receipt of a fire alarm in the control room.
- k. Describe the actions to be taken by the fire brigade after notification by the control room operator of a fire.
- l. Describe the fire fighting strategies for fighting fires in all safety-related areas and areas presenting a hazard to safety-related equipment.
- m. Govern leak testing such that open flames or combustion-generated smoke shall not be permitted.
- n. Provide for the disarming of fire detection or fire suppression systems and delineate the requirements for fire protection during periods when the fire protection system is impaired.
- o. Provide for the testing and maintenance of the fire protection systems and equipment.
- p. Govern the operability requirements, required actions, and surveillance requirements specified in Technical Requirements Manual (TRM) Section 6.2.

GRAND GULF NUCLEAR GENERATING STATION
Updated Final Safety Analysis Report (UFSAR)

9B.7 FIRE BRIGADE

9B.7.1 Fire Brigade Personnel

A site fire brigade trained and equipped for fire fighting shall be established to ensure adequate manual fire fighting capability for all areas of the plant containing structures, systems, or components important to safety. The fire brigade shall be composed of at least five members on each shift. The number of Fire Brigade personnel may be less than the minimum requirements for a period of time not to exceed 2 hours in order to accommodate unexpected absence, provided immediate action is taken to fill the required positions. The Fire Brigade shall not include the Shift Manager, the STA, the two other members of the minimum shift crew necessary for safe shutdown of the unit, and any personnel required for other essential functions during a fire emergency. At least one AO shall be available to respond to non-fire-fighting commands from the control room. The fire brigade leader and at least two fire brigade members shall have sufficient training in or knowledge of plant safety-related systems to understand the effects of fire and fire suppressants on the safe shutdown capability. These two fire brigade members will be qualified Nuclear Operator-B.

The fire brigade leader shall be competent to assess and advise control room personnel of the potential safety consequences of the fire. He shall advise the shift fire chief of the possible need to notify the offsite fire department for assistance.

The fire brigade leader reports to the Shift Fire Chief and is responsible for taking charge of the fire fighting operation. This includes the safety of the fire brigade members at the scene of the fire; organizing the fire brigade for fire fighting; evaluating the conditions at the fire scene; identifying the tactics to use in confinement and extinguishment; directing the attack and extinguishment; directing the overhaul by searching and extinguishing hidden fires; preserving evidence that would yield to the fire origin; and assisting the shift fire chief in completion of any fire reports.

The fire brigade members are plant personnel who have been properly trained in the methods of fire fighting in accordance with this appendix and meet the physical requirements for the

GRAND GULF NUCLEAR GENERATING STATION
Updated Final Safety Analysis Report (UFSAR)

strenuous activities associated with fire fighting. The fire brigade members at the fire scene carry out the directives of the fire brigade leader.

RP personnel shall respond to fires involving radiologically posted areas with appropriate instrumentation. RP may not respond to fire outside radiologically posted areas.

The fire brigade organization is provided on Figure 9B-1.

9B.7.2 Fire Brigade Equipment

The minimum equipment provided for the fire brigade shall consist of personal protective equipment such as turnout coats, boots, gloves, hard hats, portable lights, two-way radios, portable ventilation equipment, and portable extinguishers. Self-contained breathing apparatus shall be provided. At least 10 masks shall be available for firebrigade use. At least a 1-hour supply of air in extra bottles shall be available at the plant site for each self-contained breathing apparatus designated to the fire brigade's use. In addition, an onsite 6-hour supply of reserve air shall be provided and arranged to permit quick and complete replenishment of exhausted air supply bottles as they are returned.

The fire fighting equipment is periodically tested and checked in accordance with plant procedures to ensure the operability of the equipment for fire fighting emergencies.

9B.8 TRAINING

The fire brigade training program ensures that the capability to fight potential fires is established and maintained. The fire training program consists of classroom instruction, actual fire fighting practice, and fire drills. Training and drills meet all the requirements of 10 CFR 50, Appendix R, Section III.I, Fire Brigade Training.

9B.8.1 Instruction for Members of the Fire Brigade

Prior to assignment to a fire brigade, personnel shall receive instruction in the following topics:

- a. Identification of fire hazards (and their location) and associated types of fires that occur in the plant.

GRAND GULF NUCLEAR GENERATING STATION
Updated Final Safety Analysis Report (UFSAR)

- b. Identification and location of installed and portable fire fighting equipment in the plant.
- c. Familiarization with plant layout including access and egress routes for each area.
- d. Proper use of installed and portable fire fighting equipment.
- e. Correct methods of fighting various types of fires.
- f. Indoctrination in the Fire Protection Plan. This shall include individual and fire brigade responsibilities.
- g. Proper use of breathing, communication, lighting, and portable ventilation equipment.
- h. Detailed review of the fire fighting strategies.
- i. Review of modifications, changes, etc., to the physical plant, procedures, fire fighting equipment, or Fire Protection Plan.
- j. Methods of fighting fires inside buildings and confined spaces.
- k. The toxic and corrosive characteristics of expected products of combustion.

In addition to the above topics, fire brigade leaders shall receive training in directing and coordinating fire fighting activities.

Periodic refresher training sessions are held to repeat the classroom instruction aspects of the above topics for all brigade members over a two-year period. Regular planned meetings are held at least every 3 months for all brigade members to review changes in the fire protection program and other subjects as necessary. Aspects of the refresher training sessions may be included in the regular planned meetings that are held every 3 months.

9B.8.2 Practice for Fire Brigades

Practice sessions are held for each shift fire brigade on the proper methods of fighting the various types of fires that could occur in a nuclear power plant. The practice sessions provide brigade members with experience in actual fire extinguishment and

GRAND GULF NUCLEAR GENERATING STATION
Updated Final Safety Analysis Report (UFSAR)

the use of emergency breathing apparatus under strenuous conditions encountered in fire fighting. Practice sessions are provided at least once per year for each fire brigade member.

9B.8.3 Instruction for All Station Employees

All personnel with unescorted access to the GGNS Protected Area shall receive an indoctrination on evacuation procedures and procedures for reporting fires as part of Plant Access Training.

In addition, security personnel shall receive instruction that addresses entry procedures for offsite fire departments and vehicle control for persons exiting the station.

9B.8.4 Special Fire Protection Training

Training for offsite fire departments will be in accordance with the Emergency Plan.

9B.8.5 Program Administration

Training/instruction of fire brigade personnel in the topics specified in Section 9B.8.1 above will be scheduled and coordinated by the Training Department. The instructor assigned will be knowledgeable on the topics and experienced in fighting the types of fires that could occur in the plant. The instructor shall also be knowledgeable of type and operation of the fire protection equipment installed at GGNS.

Training/instruction for plant personnel with unescorted access to the plant as specified in Section 9B.8.3 above shall be coordinated by the Training Department.

Training/instruction for security personnel on procedures for entry of offsite fire departments and vehicle control for persons exiting the station as specified in Section 9B.8.3 above shall be coordinated by the Superintendent, Security.

9B.9 FIRE BRIGADE DRILLS AND PRACTICES

9B.9.1 Types of Fire Brigade Drills and Practices

Fire brigade drills are performed to promote effective teamwork on the fire brigade. Various types of drills include, but are not limited to, the following:

GRAND GULF NUCLEAR GENERATING STATION
Updated Final Safety Analysis Report (UFSAR)

- a. Simulated use of equipment for various situations and types of fires which could reasonably occur in various areas of the plant. The simulations shall stress conformance to proper procedures and established fire fighting plans.
- b. Actual operation of the fire protection equipment where practical. This includes breathing, communication, portable lighting, and ventilation equipment.

9B.9.2 Guidelines for Fire Brigade Drills and Practices

Fire brigade drills are conducted using the following guidelines:

- a. Each fire brigade shall be drilled at least once per ninety-two days with:
 - 1. A maximum allowable extension not to exceed 25 percent of the ninety-two day time interval, but
 - 2. The combined time interval for any three consecutive drill intervals shall not exceed 3.25 times the specified ninety-two day time interval.
- b. Each fire brigade member should participate in each drill. Each fire brigade member shall participate in two drills per year, as a minimum.
- c. At least one drill per year for each fire brigade shall be unannounced. Each unannounced drill shall be separated by a minimum of 4 weeks.
- d. At least one drill per year will be conducted on a backshift for each fire brigade.
- e. All drills will be pre-planned to meet established training objectives and shall be critiqued to determine the effectiveness in meeting these objectives.
- f. Unannounced drills shall be pre-planned and critiqued by members of the management staff responsible for plant safety and fire protection.
- g. Performance deficiencies of fire brigades or individual fire brigade members will be corrected by providing additional training for noted weak areas.

GRAND GULF NUCLEAR GENERATING STATION
Updated Final Safety Analysis Report (UFSAR)

- h. An unsatisfactory drill performance by a fire brigade will be corrected by providing additional training for noted weak areas. A repeat drill will be held within 30 days of the critique.
- i. At least once every 3 years, a randomly selected unannounced drill shall be monitored and critiqued by a group of qualified individuals who are independent of the GGNS staff.
- j. Each fire brigade drill shall be evaluated on the following, as a minimum:
 - 1. Assessment of fire alarm effectiveness.
 - 2. The time required to notify and assemble the fire brigade.
 - 3. The selection, placement, and use of equipment and fire fighting strategies.
 - 4. An assessment of each fire brigade member's knowledge in the fire fighting strategy and techniques for the fire area.
 - 5. An assessment of the brigade's conformance to established plant fire fighting procedures and use of the fire fighting equipment, including self-contained breathing equipment, communication equipment, and ventilation equipment when applicable.
 - 6. Assessment of the fire brigade leader's effectiveness in directing the brigade's activities.

9B.10 QUALITY ASSURANCE

The GGNS fire protection system goes through two major phases from design to operational status. These phases are: (1) design, procurement, and construction; and (2) startup testing and operation. Appropriate quality assurance programs and requirements are applied to the fire protection system during each phase.

The QA program applied to each phase addresses the 10-point QA criteria presented in Section C of Appendix A to Branch Technical Position APCS 9.5-1. Furthermore, in each phase, the QA

GRAND GULF NUCLEAR GENERATING STATION
Updated Final Safety Analysis Report (UFSAR)

activities are under the management control of the appropriate QA organization. Management control, as used here, is defined as the authority and responsibility for establishing, controlling, and verifying the implementation and adequacy of the fire protection QA program.

During the design, procurement, and construction phases of the fire protection system, the fire protection QA program was under the management control of the Bechtel Grand Gulf QA organization. This program had been developed to ensure that the GGNS design was of sufficient quality to meet its design function. Table 9.5-11, Section C, describes the QA program scope. During this phase, the Director, Quality had the responsibility for verifying the implementation and adequacy of the Bechtel fire protection QA program chiefly through a documented audit program.

During the operational phase (startup, preoperational testing, and operations), the fire protection QA program is under the management control of the GGNS organization. The specific organizations which exercise this control are: Quality Assurance, Engineering, Maintenance, and Operations. Section C of Table 9.5-11 describes the fire protection QA program applicable during the startup and operational phases.

9B.11 SYSTEMS

Section 9.5.1 of the UFSAR describes the Fire Protection System.

Section 7.4.1.5 of the UFSAR describes the Alternate Shutdown System which may be utilized in case of a Control Room exposure fire.

9B.12 FIRE HAZARDS ANALYSIS

Appendix 9A of the UFSAR describes the Fire Hazards Analysis Report.

9B.13 ANALYSIS OF SAFE SHUTDOWN IN THE EVENT OF A MAJOR FIRE

An analysis of safe shutdown in the event of a major fire is discussed in Appendix 9C.

GRAND GULF NUCLEAR GENERATING STATION
Updated Final Safety Analysis Report (UFSAR)

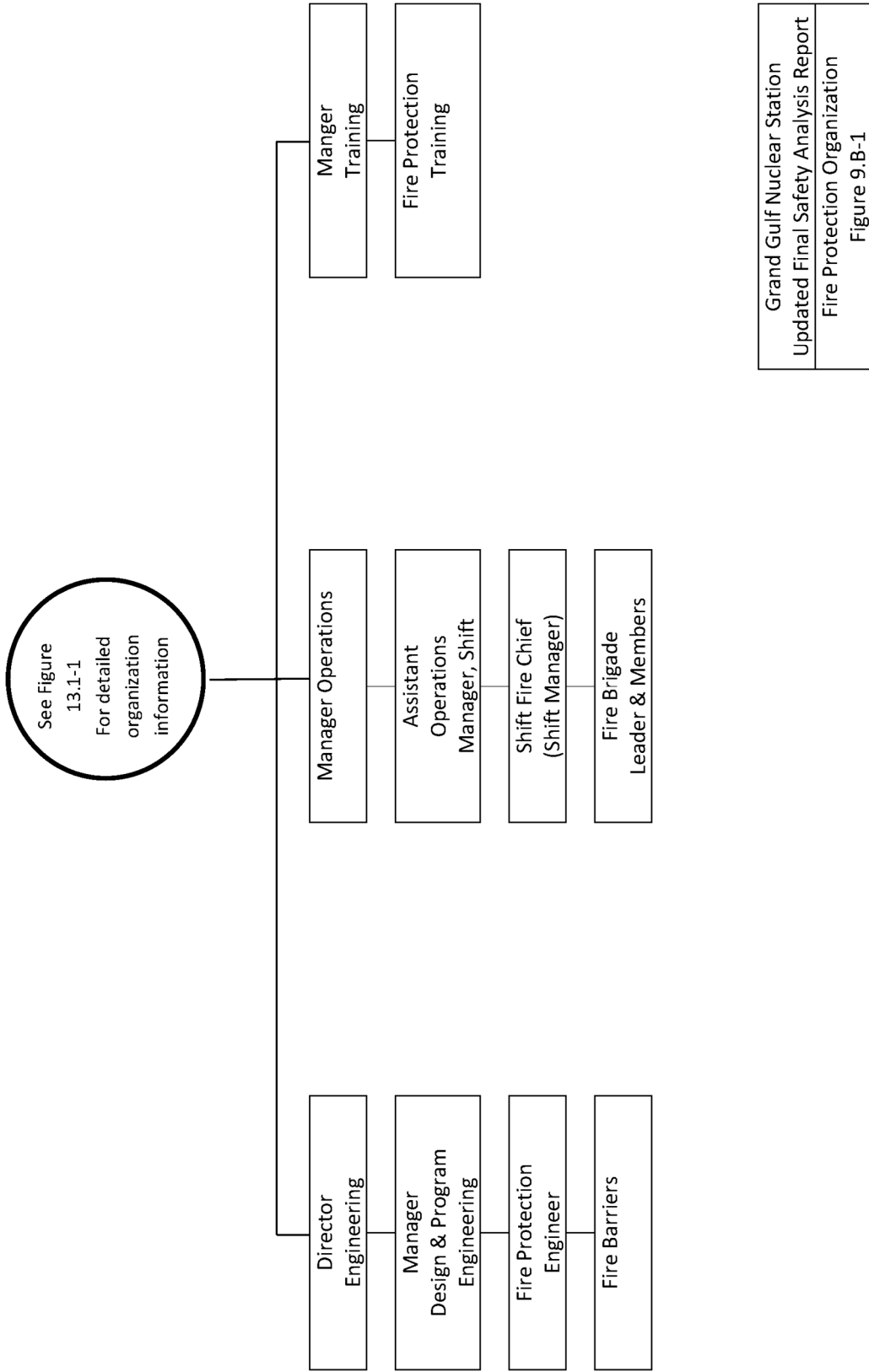

Grand Gulf Nuclear Station
 Updated Final Safety Analysis Report
 Fire Protection Organization
 Figure 9.B-1

GRAND GULF NUCLEAR GENERATING STATION
Updated Final Safety Analysis Report (UFSAR)

**APPENDIX 9C ANALYSIS OF SAFE SHUTDOWN IN THE
EVENT OF A MAJOR FIRE**

The discussion in this appendix is applicable to the current cycle. The baseline analysis was performed for the GGNS-1 initial core based on an 8x8 GE fueled core. New analyses have been performed based on a 10x10 GNF3 fueled core and are applicable to the current cycle.

9C.1 IDENTIFICATION OF CAUSES AND FREQUENCY CLASSIFICATION

9C.1.1 Identification of Causes

A major fire in the plant can cause loss of power and control to unprotected plant components. 10CFR50 Appendix R requires consideration of such a fire, and that a loss of off-site power be postulated coincident with the fire. A single exposure fire cannot affect redundant safe shutdown-related components. Alternate or Dedicated Shutdown Capability is addressed in Table 9.5-12.

9C.1.2 Frequency Classification

This transient disturbance is categorized as an infrequent incident.

9C.2 SEQUENCE OF EVENTS AND SYSTEMS OPERATION

Table 9C-1 lists the sequence of events for Figures 9C.

9C.2.1 Identification of Operator Actions

During the postulated event of a fire in the control room which results in a loss of system control or an evacuation from the control room, the operator will take actions to achieve safe shutdown at the Remote Shutdown Panel (RSP) in accordance with site specific procedures. The operator will scram the reactor and verify that all control rods are inserted prior to evacuation, if possible. At the RSP, the operator will continue with actions as directed by site specific procedures.

If the postulated fire event is not in the control room, any actions could be performed from the control room instead of the RSP.

GRAND GULF NUCLEAR GENERATING STATION
Updated Final Safety Analysis Report (UFSAR)

9C.2.2 Systems Operation

This event assumes that all equipment not protected is non-functional due to the fire. Systems protected include main steam SRVs, Residual Heat Removal System (suppression pool cooling, shutdown cooling, and LPCI modes), Standby Service Water System, Standby Diesel Generators, supporting HVAC systems, Remote Shutdown Panel System, portions of electrical distributions to support the above, and various instrumentation.

Immediately after scram and isolation at event initiation, the reactor pressure increases to the relief setpoints of the SRVs. After the initial opening, the SRVs switch to the low-low-set mode, where they continue to cycle automatically, maintaining the reactor at high pressure (approx. 1000 psig).

The NRC has accepted a less restrictive requirement of no fuel damage using automatic depressurization system (ADS) and low pressure systems to achieve safe shutdown allowing some core uncover but requiring the PCT to remain below 1500°F. Two Appendix R cases were analyzed.

Case 1 involves operator action to manually open 6 SRVs and start 1 RHR pump and align in the LPCI mode. Case 2 involves spurious opening of 1 SRV at event initiation and operator action to manually open an additional 6 SRVs and start 1 RHR pump and align in the LPCI mode.

For Case 1 and Case 2, the upper portion of the core is allowed to be uncovered to middle of active fuel (MAF) prior to the opening of the SRVs and prior to initiation of LPCI. The core is allowed to be uncovered to just below MAF after LPCI is injected.

Long-term decay heat removal will follow after the reactor inventory is restored and the reactor is depressurized. When reactor pressure is low enough, the shutdown cooling (SDC) mode of RHR can be initiated. If SDC is not operable as a result of the fire, decay heat can be removed by an alternate method, where suppression pool water is injected into the reactor vessel by the LPCI mode of RHR and the heated water is discharged back to the pool through the SRVs. In this Alternate Shutdown Cooling mode, heat from the suppression pool is removed by the RHR heat exchanger prior to returning to the RPV.

GRAND GULF NUCLEAR GENERATING STATION
Updated Final Safety Analysis Report (UFSAR)

9C.2.3 The Effect of Single Failures and Operator Errors

Appendix R to 10CFR50 does not require that a single failure or operator errors be considered in addition to the fire and loss of off-site power. All consequences of the fire, including hot shorts, open circuits, shorts to ground and general equipment failures, were considered in addition to a coincident loss of off-site power.

9C.3 CORE AND SYSTEM PERFORMANCE

9C.3.1 Mathematical Model

The current cycle core analysis (Reference 11,) was performed using the General Electric Model TRACG-LOCA (Reference 12) to predict reactor pressure, water level, and steam flow response and the core heat transfer, fuel heat transfer coefficients, and resulting PCT. The General Electric evaluation model PRIME-LOCA (Reference 12, 16 and 17) provides the parameters to initialize the fuel stored energy and fuel rod fission gas inventory at the onset of the transient for input to TRACG-LOCA.

The current cycle containment analysis (Reference 11) was performed using the General Electrical computer code SHEX. The SHEX code uses a coupled pressure vessel and containment model to predict the suppression pool bulk temperature and the pressures and temperatures in the drywell and wetwell airspaces.

The initial core analysis (Reference 13) was performed using the General Electric model (SAFE) to predict reactor pressure, water level and steam flow response. This information was then used to determine the steam cooling heat transfer coefficient for the fuel rods during the event, as described in Reference 1. The General Electric evaluation model (CHASTE) was then used to calculate the fuel rod heat-up and the resulting PCT. Evaluations that accounted for the differences between the GE and AREVA fuel types were performed for subsequent cycles (References 7, 8, 9, and 10).

GRAND GULF NUCLEAR GENERATING STATION
Updated Final Safety Analysis Report (UFSAR)

9C.3.2 Input Parameters and Initial Conditions

The initial conditions for the postulated fire event are described as follows. At the start of the postulated fire event, the reactor is assumed to be operating at full power (4408 MWt), low water (level 4), and steady state conditions. The design basis fire occurs to initiate the event, simultaneous with the loss of all unprotected safe shutdown systems. It is conservatively assumed that a loss of off-site power occurs at the same time which leads to events such as a reactor scram, turbine trip, loss of feedwater, and MSIV closure.

9C.3.3 Results

The Appendix R sequence of events for safe shutdown is summarized in Table 9C-1. The Appendix R analysis results are performed for the water level, reactor pressure, peak cladding temperature and LPCI flow for Case 1 (6 SRVs) and for Case 2 (1 SRV and 6 SRVs).

The Case 1 and Case 2 water levels in the average and hot channels and core bypass region drop below TAF for a short [brief] period of time during the Appendix R fire protection event. The Case 1 water level drops below TAF to MAF for about 24 minutes after opening the SRVs and after LPCI is injected. The Case 2 water level drops below TAF to MAF for about 18 minutes before opening the SRVs and before initiating LPCI.

The Case 1 and Case 2 calculated PCT is below the Appendix R limit of 1500°F. Therefore, the fuel integrity is maintained for GNF3 and the requirement of the Reactor Pressure Vessel (RPV) depressurization using the SRVs remains valid.

9C.3.4 Assumptions

The analysis of the minimum safe shutdown systems performed by the fuel vendor is based on the following assumptions:

- a. No credit is assumed for offsite power. For analysis purposes, this assumption is simulated by the loss of offsite power and reactor isolation at time zero to maximize the primary system stored energy.
- b. All of the safe shutdown systems not affected by the fire event are considered to be available and to function normally.

GRAND GULF NUCLEAR GENERATING STATION
Updated Final Safety Analysis Report (UFSAR)

- c. The fire event does not occur simultaneously or coincident with any other abnormal conditions except the loss of offsite power. No other challenges to the safe shutdown systems are considered as part of this analysis.
- d. Plant operating and system actuation parameters are consistent with the plant safety analysis and technical specifications for the initiating event.
- e. High pressure makeup systems are not considered to be available.
- f. Operator actions are consistent with the plant Technical Specifications and the actual plant procedures.
- g. The reactor decay heat is modeled with the nominal value of the 1979 ANS decay heat. This is judged to be the most appropriate decay heat assumption for this study.
- h. The initial core power is set at 100% of current licensed thermal power. Initial steam flow, core flow, and vessel pressure are consistent with the heat balance for 100% of rated core power.
- i. The LPCI flow rate curve in Reference 14 is used with the rated flow of 908 lbm/sec at vessel to drywell pressure differential of 20 psid. The LPCI shutoff head is 210.8 psid.
- j. The core remains in nucleate boiling until core uncovering.
- k. Essentially no credit is taken for feedwater flow. With the loss of offsite power, the flow is linearly ramped to zero flow in 5 seconds. The feedwater enthalpy is constant during the coastdown.

GRAND GULF NUCLEAR GENERATING STATION
Updated Final Safety Analysis Report (UFSAR)

9C.4 BARRIER PERFORMANCE

The analysis for the current cycle core shows that for Case 1 the core is uncovered for about 24 minutes and the peak cladding temperature is 1375°F, and Case 2 the core is uncovered for about 18 minutes and the peak cladding temperature is 1360°F, which are well below the acceptance criterion of 1500°F for Appendix R.

Safety/relief valves open in the pressure relief mode of operation as the vessel pressure increases beyond their setpoints. The pressure in the vessel is limited as shown in Figure 9C-1, well below the vessel pressure limit of 1325 psig (steam dome pressure).

9C.5 CONFORMANCE WITH 10CFR50 APPENDIX R PERFORMANCE CRITERIA

10CFR50 Appendix R, Section III.L, requires that the following performance criteria be met, relative to the shutdown:

- a. The capability to reach cold shutdown in 72 hours - This criterion is easily met by the use of 6 SRVs for Case 1, and 1 SRV and 6 SRVs for Case 2 to depressurize, initiating LPCI flow within 27 minutes for Case 1, 23 minutes for Case 2 establishing alternate shutdown cooling alignment at 31 minutes after the reactor trip, and reaching cold shutdown conditions within a few hours after the reactor trip.
- b. Able to achieve and maintain subcritical reactivity - This is met by the ability to scram the reactor using control rods; the first immediate operator action in the event of a major fire in the control room is to scram the reactor. To assure the reactor is scrammed for all fire conditions, local manual action is taken to de-power the scram solenoids. This action is considered to be feasible and reliable for all fire conditions (Reference BWROG TP-11-011 and NEDO-33638).

GRAND GULF NUCLEAR GENERATING STATION
Updated Final Safety Analysis Report (UFSAR)

- c. Maintain reactor coolant level above the top of the core - Reactor coolant makeup is provided by use of LPCI to reflood the core, and to replenish inventory lost by blowdown through the SRVs. Level, however, is not maintained above the core. As noted in Section 9C.3.3 the level drops below the top of the active fuel for Case 1 and Case 2; however, the fuel is uncovered for no more than 24 minutes in Case 1 and 18 minutes in Case 2 and the basic safety objective of no fuel cladding is met. The PCT is maintained well below the level where cladding expansion or perforation could be expected (References 2, 3, 4, and 5). This deviation from Section III.L of Appendix R has been approved by the NRC (Reference 6).
- d. Fission product boundary integrity shall not be affected - conformance with this criterion is addressed in Section 9C.4.
- e. Capable of achieving and maintaining decay heat removal - This criterion is met in the initial phase by use of SRVs to transfer residual and decay heat to the suppression pool, and use of RHR to transfer heat to service water and the atmosphere. Normally, long term decay heat removal is provided by use of the shutdown cooling (SDC) mode of RHR. An alternative, if SDC is not available, is LPCI injection to the vessel taking suction from the suppression pool, and outflow through the SRVs to the suppression pool, and suppression pool cooling with RHR. Use of these systems for this event is within the design bases for the systems.

GRAND GULF NUCLEAR GENERATING STATION
Updated Final Safety Analysis Report (UFSAR)

- f. Process monitoring for direct readings of process variables - I&E Notice 84-09 (NRC) states that for BWR's, these should include reactor vessel level and pressure, suppression pool level and temperature, diagnostic instrumentation for shutdown systems, and level indication for all tanks used.

Reactor vessel level and pressure are protected to assure their availability in a major fire. An exception request was approved by the NRC for not protecting suppression pool level instrumentation (Reference 6). Analyses demonstrate that suppression pool bulk temperature can be maintained below 185°F (Reference 11) for this event if suppression pool cooling or alternate shutdown cooling is initiated manually by the operator at approximately 30 minutes from reactor trip. In the event of a fire inside Containment, instruments for an alternate means of monitoring suppression pool temperature exist in Auxiliary Building Fire Zones 1A303 and 1A307. These instruments, N1E12TEN004A/B, monitor RHR Heat Exchange inlet temperatures and are separated from Containment by 3-hour rated fire barrier and a fire occurring in Fire Area 25 can not spread to these fire areas. These instruments provide control room indication and their cables are routed completely outside of the Containment.

LPCI suction for flooding, and makeup until transfer the shutdown cooling mode of RHR, is from the suppression pool. With SRV blowdown to the suppression pool, this forms a closed cycle. Additionally, alternate shutdown cooling, suppression pool cooling and SDC mode of RHR are closed loop functions. Accordingly, since tanks are not used for this event, tank level instrumentation is not required.

GRAND GULF NUCLEAR GENERATING STATION
Updated Final Safety Analysis Report (UFSAR)

9C.6 REFERENCES

1. "Additional Information Required for NRC Staff Generic Report on Boiling Water Reactors," NEDO-24708A, Revision 1, December, 1980.
2. Letter, R.H. Buchholz (GE) to D.G. Eisenhut (NRC), "GE Cladding Hoop Stress at Perforation," MFN 278-79, November 16, 1979.
3. "Cladding Swelling and Rupture Models for LOCA Analysis," NUREG-0630, April, 1980.
4. Letter, Harold Bernard (NRC) to G.G. Sherwood (GE), "Supplementary Acceptance of Licensing Topical Report NEDE 20566A (P)," May 11, 1982.
5. "General Electric Company Analytical Model for Loss-of-Coolant Analysis in Accordance with 10CFR50 Appendix K-Vol. I.," NEDO-20566, January, 1976.
6. Letter, Lester L. Kintner (NRC) to William T. Cottle, "Issuance of Amendment No. 82 to Facility Operating License No. NPF-29 - Grand Gulf Nuclear Station, Unit 1, Regarding the Fire Protection Program (TAC No. 77505)," GNRI-91/00177 dated August 23, 1991.
7. "Grand Gulf Unit 1 Conformance to Appendix R Requirements with ENC Fuel", XN-NF-994, October 1986.
8. Letter, N. L. Garner (ANF) to J. B. Lee (SERI) "Fire Scenario Evaluation for 9x9-5 Reload Fuel", MPEX-90/037, May 14, 1990.
9. GEXI-96/00541, "Appendix R Evaluation for Grand Gulf Unit 1," D.J. Liffengren, dated August 15, 1996.
10. Letter, K.V. Walters (FRA-ANP) to J.B. Lee (Entergy), "Evaluation of Atrium-10 Fuel for Conformance to 10CFR50 Appendix R Requirements for Grand Gulf Nuclear Station," GEXI-2001/00020, March 16, 2001.
11. GGNS-NE-10-00003, Rev. 5, GGNS Appendix R - Fire Protection = Thermal Hydraulic Analysis
12. NEDE-33005P-A, Revision 2, May 2018, Licensing Topical Report TRACG Application for Emergency Core Cooling System/

GRAND GULF NUCLEAR GENERATING STATION
Updated Final Safety Analysis Report (UFSAR)

Loss-of-Coolant-Accident Analyses for BWR/2-6. |

13. Letter, A. R. Smith (GE) to F. W. Titus (MSES), "Transmittal of Fire Protection Analysis for Grand Gulf Unit 1," MPGE-85/128, June 17, 1985.
14. CEXO2019-00052, "GGNS Cycle 23 GNF3 Fuel Introduction - Design Input Request Response Transmittal for Task F0611 Appendix R Fire Protection", April 15, 2019.
15. Deleted.
16. Licensing Topical Report, Global Nuclear Fuel, "The PRIME Model for Analysis of Fuel Rod Thermal-Mechanical Performance", Part 1 - Technical Bases - NEDC-33256P-A, Revision 1, Part 2 - Qualification - NEDC-33257P-A, Revision 1, and Part 3 Application Methodology - NEDC-33258P-A, Revision 1, September 2010.
17. Licensing Topical Report, GE Hitachi Nuclear Energy, "Implementation of PRIME Models and Data in Downstream Methods", NEDO-33173 Supplement 4-A, Revision 1, November 2012.

GRAND GULF NUCLEAR GENERATING STATION
Updated Final Safety Analysis Report (UFSAR)

TABLE 9C.1: SEQUENCE OF EVENTS FOR SAFE SHUTDOWN IN THE EVENT OF A MAJOR FIRE
(CURRENT CYCLE ANALYSIS)
(FIGURES 9C)

<u>APPROXIMATE ELAPSED TIME</u>	<u>EVENT</u>
0	Reactor trips automatically, or is tripped by the operator, due to effects of fire.
0	Offsite power is lost.
0	All unprotected shutdown systems are lost due to the fire.
0 - 5 sec.	Turbine trip, loss of feedwater, and MSIV closure occur.
30 sec.	Safety relief valves open due to high pressure, and subsequently close as pressure drops. Valves cycle several times maintaining the reactor at high pressure until the operator can initiate corrective action.
23 sec.	At time of depressurization the operator opens 6 SRVs, starts one RHR pump, and aligns the RHR in the LPCI mode.
26.3 mins.	Vessel pressure drops below the LPCI pump shutoff head, flow begins and eventually refloods the core.
30.8 mins.	Vessel water level restored above TAF in the downcomer region and consequently the reactor core is fully recovered.
31 mins.	Alternate shutdown cooling mode initiated to remove long term decay heat.
3.0 hrs.	Peak suppression pool temperature is reached.

GRAND GULF NUCLEAR GENERATING STATION
Updated Final Safety Analysis Report (UFSAR)

APPENDIX 9D GGNS COMPLIANCE WITH NUREG-0612, "CONTROL OF HEAVY LOADS AT NUCLEAR POWER PLANTS"

9D.1 Scope of NUREG-0612

NUREG-0612 provides a defense-in-depth approach for controlling the handling of heavy loads so that load handling accidents have a very low probability of occurrence. For GGNS, a heavy load is defined as any load exceeding 1140 lbs. which is the weight of a fuel bundle and its associated handling tool. The following summarizes this defense-in-depth approach.

1. Assure that there is a well designed handling system.
2. Provide sufficient operator training, load handling instructions, and equipment inspection to assure reliable operation of the handling system.
3. Define safe load travel paths and procedures and operator training to assure to the extent practical that heavy loads are not carried over or near irradiated fuel or safe shutdown equipment.

Loads that must be carried over irradiated fuel or safe shutdown equipment are assigned to one or more load safety classes, in accordance with Table 9.1-7. Section 9.1.4.2.2.5 outlines the actions appropriate for handling loads in the different classes.

4. Provide mechanical stops or electrical interlocks to prevent movement of heavy loads over irradiated fuel or in proximity to equipment associated with redundant shutdown paths.
5. Where mechanical stops or electrical interlocks cannot be provided, provide a single-failure-proof crane or perform load drop analyses to demonstrate that unacceptable consequences will not result.

Heavy loads that can be handled in accordance with these five guidelines are not evaluated for load drop consequences.

GRAND GULF NUCLEAR GENERATING STATION
Updated Final Safety Analysis Report (UFSAR)

9D.2 Initial Compliance

By NRC Generic Letters dated December 22, 1980 (unnumbered), and February 3, 1981 (Generic Letter 81-07), all licenses were requested to evaluate their plants against the guidance of NUREG-0612 and to provide their submittals in two parts; Phase I (six month response) and Phase II (nine month response).

9D.2.1 GGNS Submittals for Phase I & II

The Phase I response addressed Section 5.1.1 of NUREG-0612 which provides guidelines to ensure that all load handling systems at nuclear power plants are designed and operated such that their probability of failure is uniformly small and appropriate for the critical tasks in which they are employed. Section 5.1.1 covers the following areas:

1. Definition of safe load paths
2. Development of load handling procedures
3. Periodic inspection and testing of cranes
4. Qualifications, training, and specified conduct of operators
5. Special lifting devices should satisfy the guidelines of ANSI N14.6-1978
6. Lifting devices that are not specially designed should be installed and used in accordance with the guidelines of ANSI B30.9
7. Design of cranes to ANSI B30.2 or CMAA-70

The Phase II response addressed Sections 5.1.2 through 5.1.6 of NUREG-0612 which provides guidelines to ensure the safe operation of load handling systems located in areas where their failure could have significant consequences. The guidelines require that (a) additional features beyond those normally required for all load handling systems be provided to ensure that the potential for a load drop is extremely small (e.g., a single-failure-proof crane), or (b) provide conservative evaluations of load-handling accidents that indicate the potential consequences of any load drop to be acceptably small. Sections 5.1.2 through 5.1.6 cover the need for electrical interlocks/mechanical stops, single-failure-proof cranes or load drop analyses in areas where

GRAND GULF NUCLEAR GENERATING STATION
Updated Final Safety Analysis Report (UFSAR)

irradiated fuel or safety related equipment could be exposed to impact from a dropped load. Also provided are the specific guidelines for single-failure-proof handling systems.

On November 23, 1981 in AECM-81/427, MP&L provided the initial response to the Phase I request followed by a revision submitted in AECM-82/0017 dated February 25, 1982. Additional information was provided in AECM-82/338 dated August 6, 1982 and AECM-82/415 dated November 19, 1982. Supplement 5 to the GGNS SER documents acceptable GGNS compliance with the Phase I program scope.

9D.2.2 NRC Response to GGNS Submittals

The NRC issued Generic Letter 85-11 on June 27, 1985 documenting completion of the NUREG-0612 program. The letter eliminated the need for further effort regarding compliance with the criteria of Phase II on the basis of Phase I compliance and a selected sampling of Phase II reviews. It was determined from this sampling that the majority of risk associated with heavy loads handling had been resolved by implementation of Phase I and in addition, no further heavy loads handling concerns were identified from the selected Phase II reviews. The objective of NUREG-0612 is to provide for a maximum practical defense-in-depth approach to the safe handling of heavy loads and it was concluded in the letter that this objective had been met without the need for further action by GGNS regarding Phase II.

In 2008, due to renewed concerns regarding heavy load handling, the NRC required additional actions under NEI 08-05 as endorsed in RIS 08-28. These actions required a load drop analysis of the RPV Head onto the RPV flange. The GGNS response is contained in Engineering Report GGNS-CS-07-00002. As part of this response GGNS identified Bechtel calculation C-G171.0 and GE calculation NEDC-23566 as performing the required analysis, and satisfactory results were demonstrated in these calculations. The calculations were initially identified in the GGNS Phase II response and are now maintained as part of the design and license basis.

9D.2.3 Summary of GGNS Phase I Actions

The complete GGNS Phase I response is contained in References 6 through 9. The following summarizes this initial response to the various items of concern as stated in Ref. 3. See Section 9D.3 for subsequent evaluation of the Containment Hatchway Crane for Phase I concerns.

GRAND GULF NUCLEAR GENERATING STATION
Updated Final Safety Analysis Report (UFSAR)

9D.2.3.1 Phase I Action Items and Responses

ITEM 1: Report the results of your review of plant arrangements to identify all overhead handling systems from which a load drop may result in damage to any system required for plant shutdown or decay heat removal (taking no credit for any interlocks, technical specifications, operating procedures, or detailed structural analysis).

GRAND GULF NUCLEAR GENERATING STATION
Updated Final Safety Analysis Report (UFSAR)

ITEM 2: Justify the exclusion of any overhead handling system from the above category by verifying that there is sufficient physical separation from any load-impact point and any safety-related component to permit a determination by inspection that no heavy load drop can result in damage to any system or component required for plant shutdown or core decay heat removal.

ITEM 1 & 2 RESPONSE: The fixed overhead handling systems for which a load drop could result in damage to safe shutdown equipment or could impact irradiated fuel at Grand Gulf are listed below. Other handling systems not listed were excluded based on a review of plant handling systems, plant arrangement, and the location of safe shutdown equipment.

<u>HANDLING SYSTEM</u>	<u>CAPACITY (Tons)</u>	<u>LOCATION</u>
Containment Polar Crane/ Aux Hoist	125/35	Containment
Spent Fuel Cask Crane	150	Aux. Bldg.
New Fuel Bridge Crane	5	Aux. Bldg.
Monorail for LPCS & RHR "C" Hatches	10	Aux. Bldg. (El. 139')

ITEM 3: With respect to the design and operation of heavy load-handling systems in the containment and spent-fuel-pool area and those load-handling systems identified in Item 1, provide your evaluation concerning compliance with the guidelines of NUREG 0612, Section 5.1.1. The following specific information should be included in your reply: (Items 3a-3g below).

ITEM 3a: Drawings and sketches sufficient to clearly identify the location of safe load paths, spent fuel, and safety-related equipment.

ITEM 3b: A discussion of measures taken to ensure that load-handling operations remain within safe load paths, including procedures, if any, for deviation from these paths.

ITEMS 3a & 3b RESPONSE: With regard to the four handling systems identified in the response to Item 1. above, there are many different load handling situations encountered. Defining safe load paths in the manner described in NUREG 0612, Section 5.1.1(1), is neither required nor prudent for every situation. To do so would unnecessarily restrict plant operation and maintenance activities. To address this problem, the

GRAND GULF NUCLEAR GENERATING STATION
Updated Final Safety Analysis Report (UFSAR)

possible load handling situations that could be encountered have been identified. Each load handling situation has been assigned a safety class designation, roughly in order of safety significance. Safe load path and load handling procedural requirements have been defined for each safety class.

For each of the heavy loads listed in the response to Item 3.c, the safe load path/procedural requirements corresponding to the assigned safety class have been added to the appropriate plant procedures. Each such heavy lift is supervised by a designated individual who is responsible for enforcing the procedural requirements.

ITEM 3c: A tabulation of heavy loads to be handled by each crane which includes the load identification, load weights, its designated lifting device, and verification that the handling of such loads is governed by a written procedure containing, as a minimum, the information identified in NUREG 0612, Section 5.1.1(2).

ITEM 3c RESPONSE: The requested information was provided in tabular form in AECM's 81/427 and 82/017.

ITEM 3d: Verification that lifting devices identified in 3.c, above, comply with the requirements of ANSI N14.6-1978 or ANSI B30.9-1971 as appropriate. For lifting devices where these standards, as supplemented by NUREG 0612, Sections 5.1.1(4) or 5.1.1(5), are not met, describe any proposed alternatives and demonstrate their equivalency in terms of load-handling reliability.

ITEM 3d RESPONSE: With regard to special lifting devices, there are three identified in Item 3.c., above, that are used to handle heavy loads in the containment. These special lifting devices are:

1. Head Strongback Carousel
2. Dryer/Separator Strongback
3. Drywell Head Lifting Frame (Strongback)

These three devices were evaluated against Sections 3.2 and 5 of ANSI N14.6 which establishes stress design factors for load bearing members, material toughness requirements, and inspection, testing, and maintenance criteria. Some exceptions were taken

GRAND GULF NUCLEAR GENERATING STATION
Updated Final Safety Analysis Report (UFSAR)

with regard to frequency of testing and inspection activities and with respect to the magnitude of load tests as detailed in AECMs 81/427 and 82/415 ER-GG-2007-0010 and ER-GG-2007-0011,

ITEM 3e: Verification that ANSI B30.2-1976, Chapter 2.2, has been invoked with respect to crane inspection, testing, and maintenance. Where any exception is taken to this standard, sufficient information should be provided to demonstrate the equivalency of proposed alternatives.

ITEM 3e RESPONSE: Procedures were reviewed and modified as required to verify that the provisions of the standard were satisfied. No exceptions to the standard were taken. The standard does not apply in the case of the LPCS/RHR "C" Hatch Monorail/Hoist System but inspection, testing, and maintenance requirements for this system are covered by procedures prepared following the guidelines of ANSI B30.16-1973, Section 16-2.2.

ITEM 3f: Verification that crane design complies with the guidelines of CMAA Specification 70 and Chapter 2-1 of ANSI B30.2-1976, including the demonstration of equivalency of actual design requirements for instances where specific compliance with these standards is not provided.

ITEM 3f RESPONSE: Based on comparisons with the crane purchase specifications, it was found that the Containment Polar Crane and the New Fuel Bridge Crane comply with the guidelines of CMAA-70-1975 and ANSI B30.2-1976, with one minor exception in regard to storage of welding rods. It was determined that the LPCS/RHR "C" monorail system meets the intent of NUREG-0612, Section 5.1.1(7) based on comparison of the hoist design methods with ANSI B30.16 and HMI 100-74.

ITEM 3g: Exceptions, if any, taken to ANSI B30.2-1976 with respect to operator training, qualification, and conduct.

ITEM 3g RESPONSE: Procedural controls ensure operator training, qualification, and conduct. No exceptions to guidance in ANSI B30.2-1976, Chapter 2-3 were taken. ANSI B30.2-1976 does not apply to the LPCS/RHR "C" Hatch Monorail/Hoist system but appropriate requirements are imposed procedurally to assure hoist operators are properly trained and certified.

GRAND GULF NUCLEAR GENERATING STATION
Updated Final Safety Analysis Report (UFSAR)

9D.3 Continuing Compliance

Continuing compliance with NUREG-0612 is assured by compliance with procedures established during Phase I to control the operation, maintenance, testing, and inspection of cranes and by compliance with established design criteria regarding crane design and evaluation of heavy load drops.

For special lifting devices, the guidelines of ANSI N14.6-78 are specified with some staff clarification. ANSI N14.6-78 is implemented as specified except that the acceptance criteria of Para. 5.5.2 is applied to fabrication and repair welds only. The acceptance criteria for inservice inspection shall be limited to "No Cracks". Additionally, the use of later editions of ASME Section V may be used to permit the use of advanced NDE technology.

For the Dryer/Separator Strongback the requirement to routinely examine the load bearing welds every 5th refueling outage by nondestructive examination (NDE) (Magnetic Particle or Liquid Penetrant) has been deleted. The lifting device shall be examined visually and dimensionally. The visual and dimensional examination shall be performed prior to the initial lift each outage. Any cracks in the coating or dimensions out of tolerance shall require, magnetic particle or liquid penetrant examination of the suspect welds and/or additional welds as required by Design Engineering.

Based on NRC Generic Letter 85-11, dated 6/27/85, the GGNS position regarding handling of heavy loads is as follows. Heavy loads that can be handled in accordance with NUREG 0612, section 5.1.1 guidelines are not evaluated for load drop consequences except for the RPV Head which was evaluated for drop onto the RPV flange. Any heavy load not handled in accordance with section 5.1.1 guidelines is evaluated to ensure the load cannot drop (redundant rigging, single failure proof, etc.) or that consequences of a load drop are acceptable per NUREG 0612 section 5.1 criteria (i.e., doses less than 25% 10CFR100 limits, Keff less than 0.95, etc.). Heavy loads which cannot be handled in accordance with Section 5.1.1 guidelines and whose drop consequences are unacceptable receive NRC approval prior to movement.

GRAND GULF NUCLEAR GENERATING STATION
Updated Final Safety Analysis Report (UFSAR)

9D.3.1 Containment Hatchway Crane Evaluation

Subsequent to closure of the NUREG-0612 program, the Containment Hatchway Crane was installed on the Containment refueling floor to assist the Polar Crane. As described in Section 9.1.4.2.2.2,

GRAND GULF NUCLEAR GENERATING STATION
Updated Final Safety Analysis Report (UFSAR)

the crane handles miscellaneous loads that can pass over the Spent Fuel Pool and the RPV. A complete evaluation of the crane and its use was conducted and documented in Safety Evaluation CFR85/4503R11. It was concluded that the requirements of NUREG-0612, as applicable to GGNS, were met. The following summarizes the safety evaluation in the same format as the initial Phase I evaluation of other cranes in 9D.2.3 above.

ITEMS 1 & 2 - The Containment Hatchway Crane is located in Containment and has a maximum capacity of 4.2 tons.

ITEM 3a & b - Loads handled over the RPV and Spent Fuel Pool are restricted to 1140 lbs. Load handling such that RHR Div. II or FPCCU systems could be affected when operating, is not permitted. Plant operations procedures in conjunction with posted zonal and load/height restrictions ensure these requirements are met.

ITEM 3c - The crane can handle any miscellaneous load, including a heavy load, within procedurally imposed limits. Typical heavy loads handled in the Containment equipment hatch area are Safety Relief Valves, Low Power Range Monitor Casks, and Control Rod Drives. The crane does not handle any heavy load not capable of being handled by the Polar Crane.

ITEM 3d - No change from initial Phase I response summarized in Section 9D.2.3. However, consideration of lifting devices is not required since this crane has been assumed to drop all loads handled within its operating range. The postulated load drops have been shown not to jeopardize required plant safety systems.

ITEM 3e - Plant operations procedures in conjunction with vendor supplied maintenance instructions ensure that inspection, testing, and maintenance is accomplished as required in ANSI B30.2-1976.

ITEM 3f - ANSI B30.2-1976 and CMAA-70 do not specifically apply to the Containment Hatchway Crane since it is a hydraulic telescoping boom type crane. However, the crane load bearing parts were analyzed by GGNS for all applicable loads in accordance with the requirements of the AISC Steel Construction Manual, 7th Edition. Structural modifications and crane derating were performed as a result of this evaluation. This ensures the structural integrity of the crane structure but load drops are still considered possible since the crane hoisting winch and brakes were not evaluated. The postulated drops were shown to be acceptable as described under Item 3d.

ITEM 3g - same as for LPCS/RHR Monorail in 9D.2.3.1, Item 3g.

GRAND GULF NUCLEAR GENERATING STATION
Updated Final Safety Analysis Report (UFSAR)

9D.4 References

1. NUREG-0612, "Control of Heavy Loads at Nuclear Power Plants, July 1980
2. NUREG-0554, "Single-Failure-Proof Crane for Nuclear Power Plants, May 1979
3. NRC Generic Letter (unnumbered) dated December 22, 1980
4. NRC Generic Letter 81-07 dated February 3, 1981
5. NRC Generic Letter 85-11 dated June 27, 1985 (MAEC-85/0213)
6. AECM-81/427, dated November 23, 1981
7. AECM-82/0017, dated February 25, 1982
8. AECM-82/338 dated August 6, 1982
9. AECM-82/415 dated November 19, 1982
10. ANSI B30.1-1976, "Overhead and Gantry Cranes," The American Society of Mechanical Engineers, New York, NY
11. ANSI B30.9-1971, "Slings," The American Society of Mechanical Engineers, New York, NY.
12. ANSI B30.16-1973, "Overhead Hoist (Underhung)", The American Society of Mechanical Engineers, New York, NY
13. ANSI N14.6-1978, "Standard for Special Lifting Devices for Shipping Containers Weighing 10,000 Pounds (4500 kg) or More for Nuclear Materials", American National Standards Institute, New York, NY
14. "Specifications for Electric Overhead Travelling Cranes," CMAA-70-1975, (supersedes EOCI - Specification 61). Available from Crane Manufacturers Association of America, Pittsburgh, PA, copyrighted.
15. GGNS SSER 5, Section 9.0 and Appendix L
16. HMI 100-74, "Standard Specification for Electric Wire Rope Hoists", Hoist Manufacturers Institute
17. Safety Evaluation CFR 85/4503R11

GRAND GULF NUCLEAR GENERATING STATION
Updated Final Safety Analysis Report (UFSAR)

18. AISC Manual of Steel Construction, 7th Edition
19. Bechtel Calculation C-G171.0
20. GE Calculation NEDC-23566
21. GGNS-CS-07-00002

GRAND GULF NUCLEAR GENERATING STATION
Updated Final Safety Analysis Report (UFSAR)

**APPENDIX 9D GGNS COMPLIANCE WITH NUREG-0612, "CONTROL
OF HEAVY LOADS AT NUCLEAR POWER PLANTS"**

- 9D.1 Scope of NUREG-0612
- 9D.2 Initial Compliance
 - 9D.2.1 GGNS Submittals for Phase I & II
 - 9D.2.2 NRC Response to GGNS Submittals
- 9D.3 Continuing Compliance
 - 9D.3.1 Containment Hatchway Crane Evaluation
- 9D.4 References