

## 1.8 SYMBOLS AND TERMS USED IN ENGINEERING AND TEXT

### 1.8.1 TEXT DEFINITIONS AND ABBREVIATIONS

Definitions used throughout the FSAR are listed in the Glossary of Terms, Table 1.8-1. Acronyms and technical abbreviations are listed in Tables 1.8-2 and 1.8-3, respectively.

### 1.8.2 DRAWING INDEX AND SYMBOLS

Abbreviations used on drawings are listed in Table 1.8-5.

Symbols used on GE supplied Piping and Instrument Diagrams (P&ID's) are shown on Figure 1.8-1. Symbols for other P&ID's are shown on Dwgs. M-100, Sh. 1, M-100, Sh. 2, M-100, Sh. 3, and M-100, Sh. 4. Logic Symbols and Instrument Symbols are shown on Figures 1.8-3 and 1.8-4, respectively.

### 1.8.3 PIPING IDENTIFICATION

Piping is identified on the Piping and Instrument Diagrams (P&ID's) by a three-group identifier. The first group is the nominal pipe size in inches; the second is a three-letter group for the pipe class; and the third is a three-digit group sequentially assigned within a pipe class.

Example: 6"-HBD-117

Size	Class	Sequence
------	-------	----------

The three-letter group for the pipe class is described in detail in Table 1.8-6.

The three-digit sequence number is assigned consecutively to identify specific lines in a pipe class as follows:

Piping common to both units	0-99 and 3001-3999
Piping for Unit 1	100-199 and 1000-1999
Piping for Unit 2	200-299 and 2000-2999

### 1.8.4 VALVE IDENTIFICATION

All manual and remotely operated valves will have unique identification numbers for tracking purposes and will be shown on the P&ID's.

Listed below are the numbering systems used for each group of valves.

All manual valves, except those which have a GE Master Parts List (MPL) number, and those valves supplied by vendors as part of the equipment package and not installed by Bechtel/PPL will be identified by the following method:

SSES-FSAR

Text Rev. 55

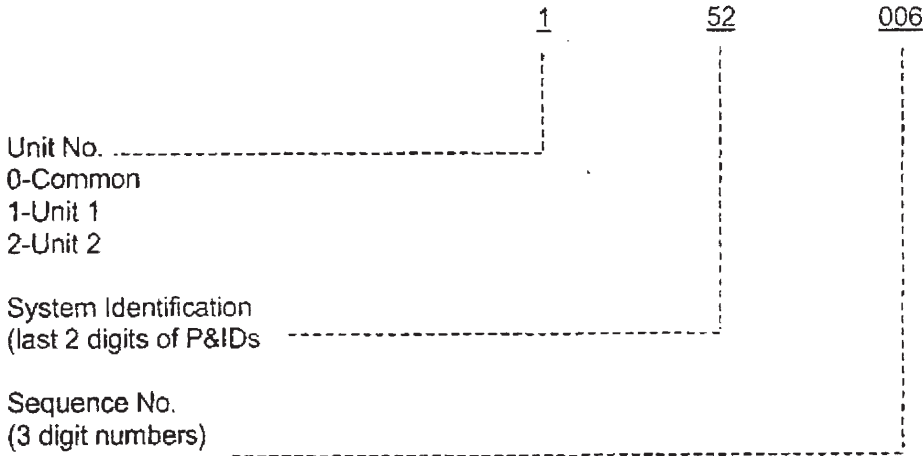

Remote operated valves which do not have a GE MPL number, are identified by the operator number, e.g.:

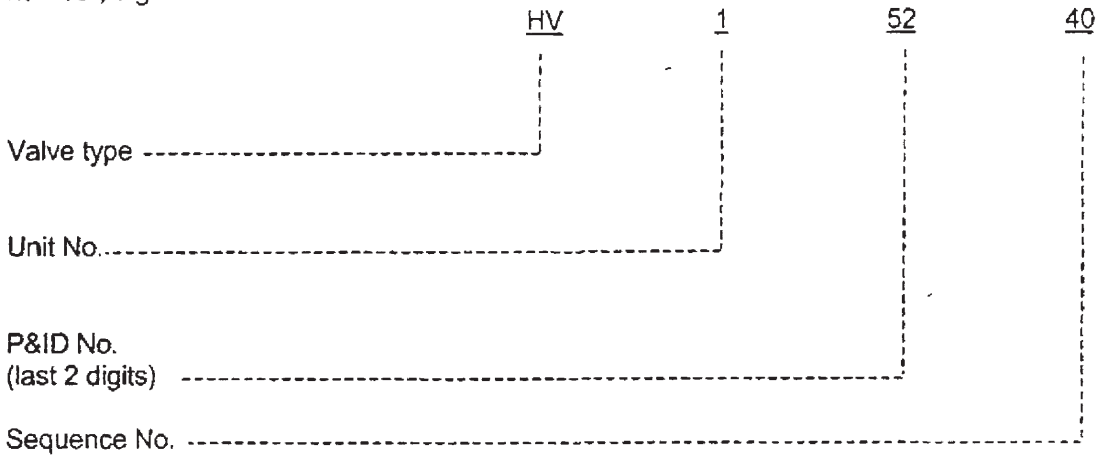

Those valves in GE's MPL are identified by the GE numbering system, e.g.:

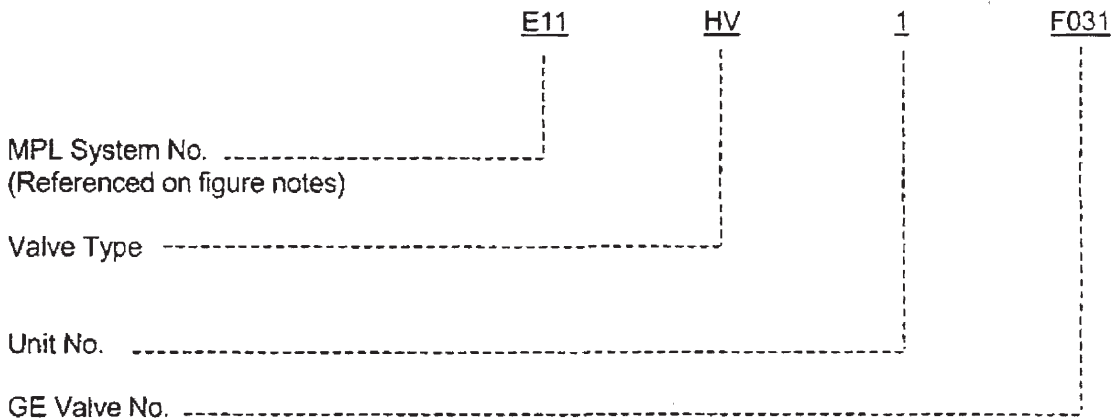

Valves that are not numbered but are supplied as part of vendor mounted equipment will be identified in the vendor's operation and maintenance manuals. This is to avoid duplication of numbering these valves.

1.8.5 INSTRUMENT IDENTIFICATION

1.8.5.1 Instrument Components

Identification of instruments and control devices is made by the use of one of the following numbering systems:

1. Instruments and devices within GE scope of design are numbered in accordance with the GE MPL system. Associated devices shown on P&ID's but without any numerical identity are numbered as in 2 below.
2. Except as in 1 above, instrument identifications are based on Instrument Society of America (ISA) Standard S5.1-1973, as modified by Dwgs. M-100, Sh. 1, M-100, Sh. 2, M-100, Sh. 3, and M-100, Sh. 4.

In general, each instrument or device in a measurement loop is assigned the same number, however, loops containing instruments and devices identified in the GE MPL system are an exception to this rule.

When a loop contains more than one instrument component of the same functional type, a suffix letter will be added and used to establish a unique identity for those components.

Redundant measurement loops will be identified by the addition of a suffix letter to each instrument component or device in the loop. In the case of redundant loops containing more than one instrument of the same functional type, the suffix letter will be followed by a number.

Instrument and device numbers are constructed as follows:

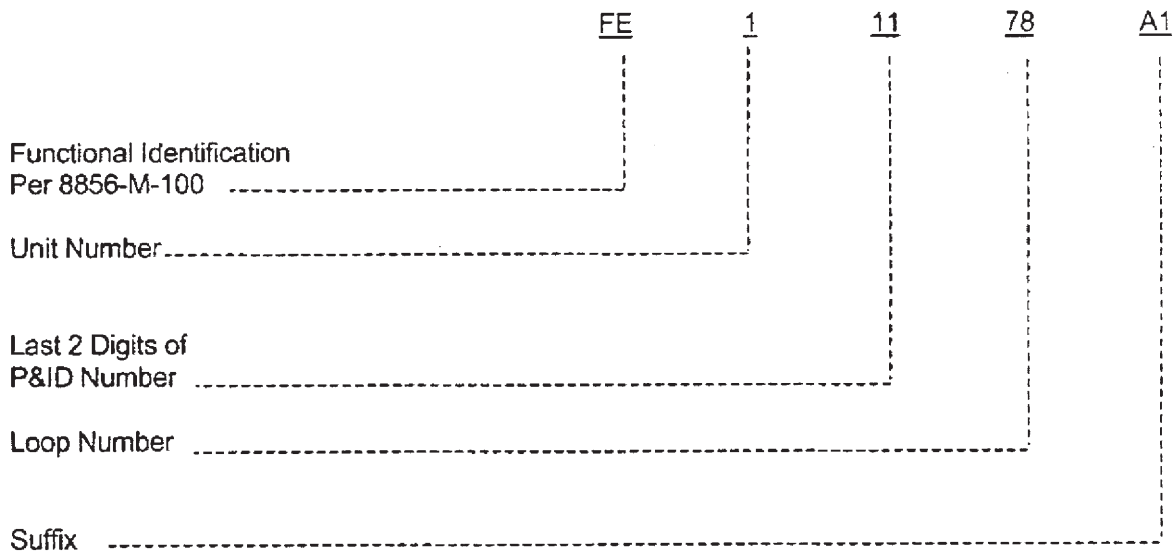

# SSES-FSAR

Text Rev. 55

A zero in the unit number position indicates that the instrument or device is common to both units.

## 1.8.5.2 Instrument Location

Instrument components and devices are mounted on racks and panels which are identified by a 5 character, alpha-numeric code. This code is marked adjacent to the instrument component identifier, as shown on Dwg. M-100, Sh. 1.

The code numbers identify the unit number and the general location of the rack or panel by the following block-number assignment:

C001 - C099	NSSS Local Panels and Racks
C101 - C199	Turbine Building
C201 - C299	Reactor Building
C301 - C399	Radwaste Building
C401 - C499	Primary Containment
C501 - C599	Miscellaneous Locations
C601 - C699	Control Structure
C701 - C799	Administration Building

A prefix digit is used to identify the unit or common plant assignment.

With each block-number assignment above, the series from 076 through 099 are reserved for local racks and panels in heating and ventilation service. The following examples illustrate typical rack or panel assignments:

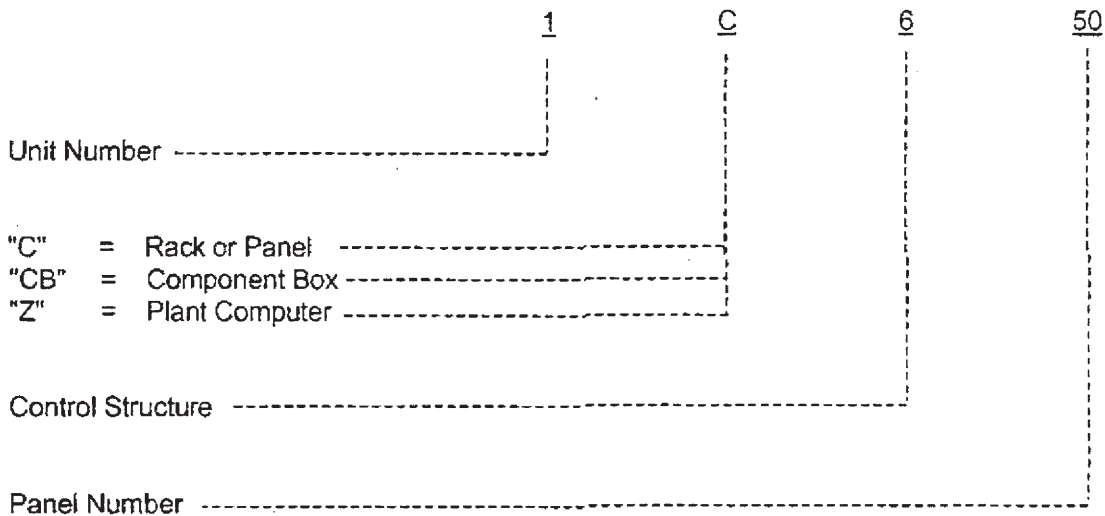

1.8.6 ELECTRICAL COMPONENT IDENTIFICATION

This section describes the methods used to identify electrical equipment locations and to number electrical schemes, cables, and raceways. Additional information is contained in Section 8.3.

1.8.6.1 Equipment Location Numbers

Each piece of electrical equipment is identified by an equipment number. To facilitate cable routing from one equipment location to another, a location number is also assigned to each piece of electrical equipment. Generally, the equipment number and equipment location number for a specific piece of electrical equipment are identical. For large pieces of electrical equipment, such as switchgear, load centers, and motor control centers, which are compartmentalized, the equipment location number consists of the basic equipment number plus additional suffixed information to identify a location within the equipment itself. The following two examples illustrate equipment location numbers:

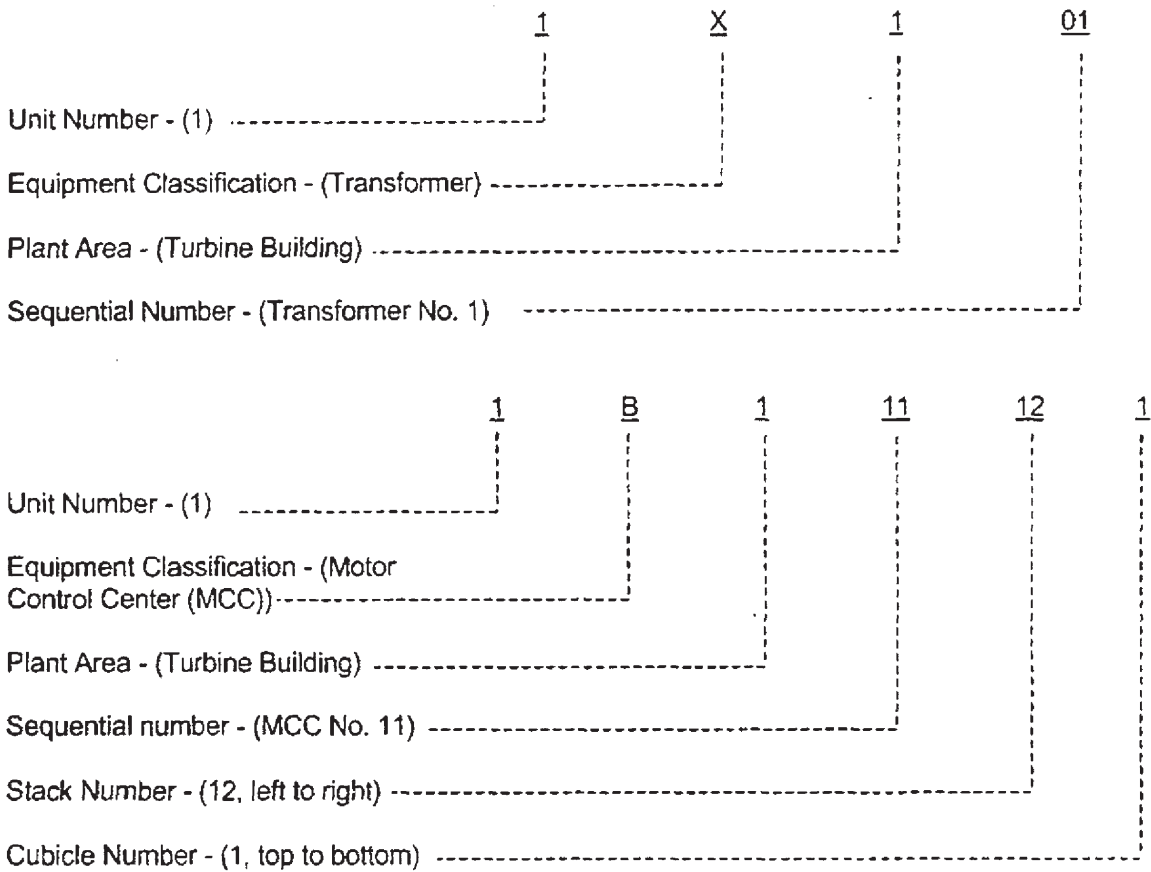

In the first example, the equipment number and equipment location number for transformers 1X101 are identical. In the second example, the basic MCC equipment number 1B111 is suffixed to establish an equipment location number, 1B11121, which identifies a specific compartment within the MCC.

To distinguish one piece of electrical equipment from other duplicate equipment used in the same service, a suffix letter is added to the basic equipment number to establish individual equipment location numbers. For example, if main transformer 1X101 is composed of a bank of three single phase transformers, the transformers for phases A, B and C are identified with equipment location numbers 1X101A, 1X101B and 1X101C, respectively.

Equipment location numbers are generally assigned to items listed in the circuit and raceway schedules. Accordingly, most electrical equipment related to systems such as lighting, communications, and cathodic protection is not included.

Electrical equipment which is an integral part of mechanical equipment is assigned the same number as the mechanical equipment.

All major pieces of electrical equipment are listed in an equipment index. The equipment index provides a description of the equipment and identifies pertinent drawings such as applicable electrical layout drawings and P&ID's.

1.8.6.2 Scheme Numbers

Each electrical scheme is identified by a six character number. The first character is numeric and refers to the plant unit number for which the scheme is applicable. The second character is alphabetic and classifies the scheme by major plant system. The last four characters are numeric, with the exception of GE supplied cables, and provide a sequential, but arbitrary, identity for each scheme. Given below is an example of a typical scheme number.

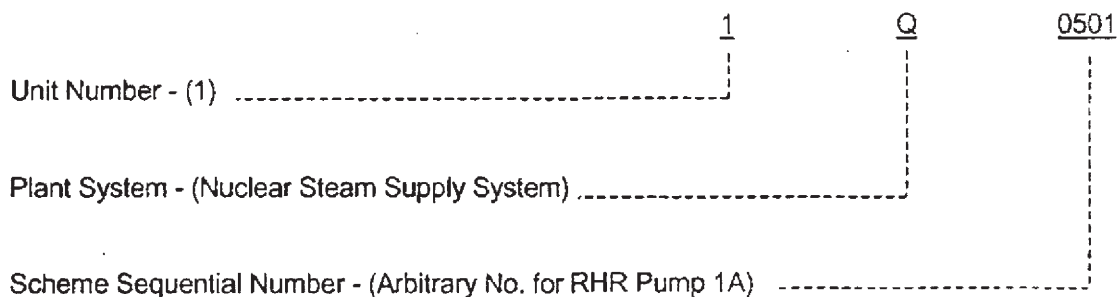

A log of all schemes is maintained in the scheme number index which contains pertinent information such as scheme description, scheme drawing number and source drawing number.

1.8.6.3 Scheme Cable Numbers

Except for cabling associated with the plant lighting, communications, and cathodic protection systems, each cable in the plant is identified by a scheme cable number composed of nine characters. The first character is alphabetic and indicates the separation group to which the cable belongs. The second character is also alphabetic and denotes the system voltage level. Characters three through eight identify the six character scheme number to which the cable is assigned. The ninth and final character is alphabetic, except for GE supplied cables, and provides a distinctive identity to each cable in the block diagram shown on the scheme drawings. The following two examples illustrate typical scheme cable numbers:

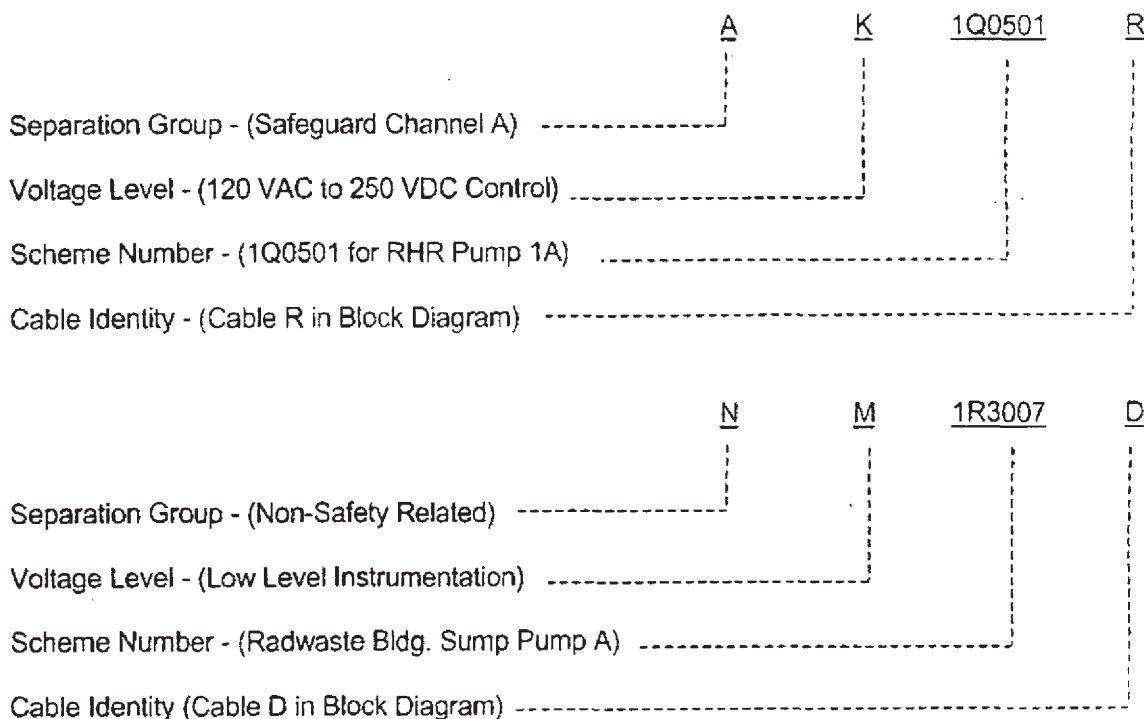

An alpha-numeric listing of all scheme cable numbers is maintained in the electrical circuit schedule. The circuit schedule also identifies the cable type, quantity of conductors, from and to equipment location numbers, and the cable routing. The circuit schedule uses the first two characters of the scheme cable number as a facility code, ensures that separation and voltage criteria are not violated.

A cable marker is affixed to each end of the cable for permanent identification. Cable markers for Class IE cables have distinguishing colors for each separation group. Additionally, all Class 1E cables are marked at regular intervals along their length with colors corresponding to the cable marker colors.

#### 1.8.6.4 Raceway Numbers

All scheduled electrical cable trays, conduits, conduit sleeves and junction boxes are identified by six character raceway numbers; PGCC ducts by seven character numbers and manholes by five character numbers. The two examples given below illustrate typical raceway numbers for engineered safety feature and non-safety feature cable trays, respectively.

SSES-FSAR

Text Rev. 55

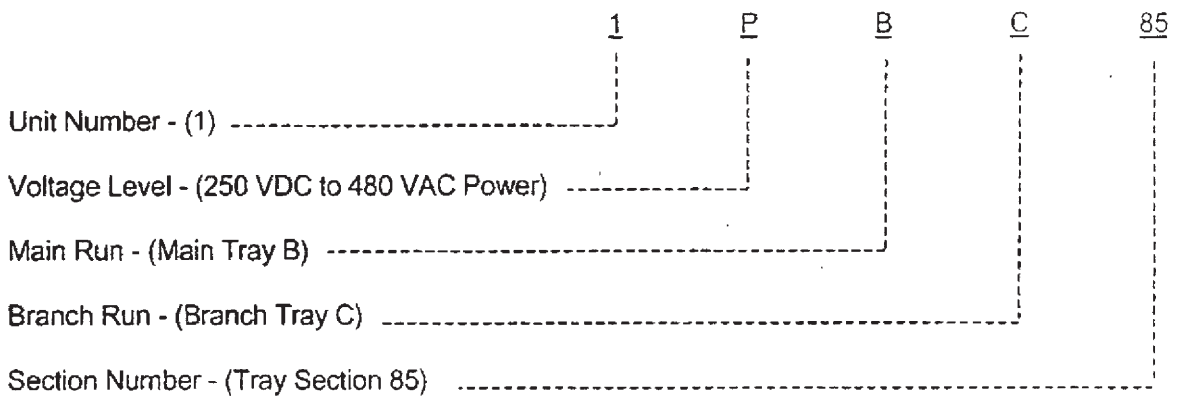
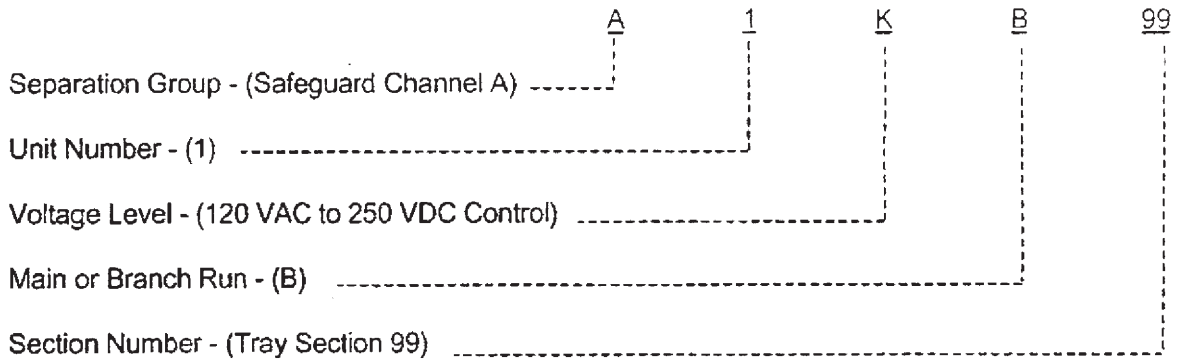

The first character of each engineered safety feature cable tray is an alphabetic letter that relates to the first character of each engineered safety feature scheme cable eligible for routing, therein. Non-safety feature cable tray, whose first character is numeric representing the unit number, may only contain scheme cable numbers prefixed by the letter N. This same practice was followed for conduit numbers as shown below.

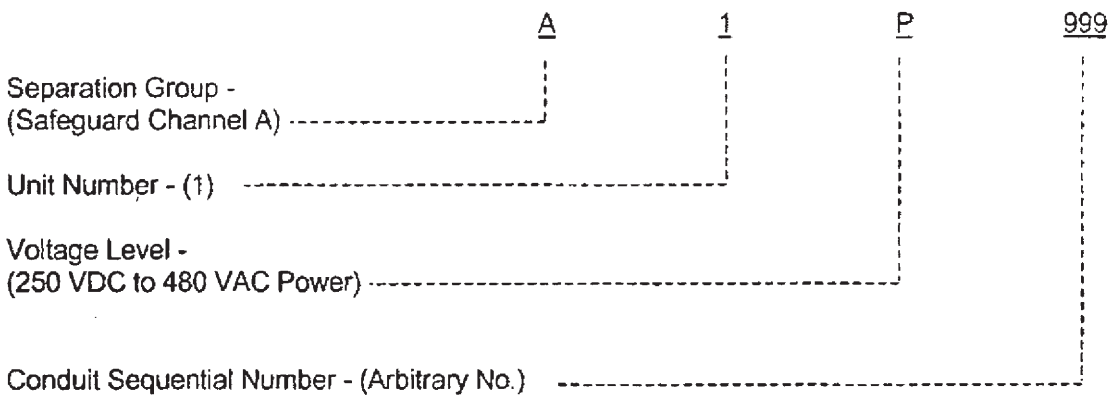



SSES-FSAR

Text Rev. 55

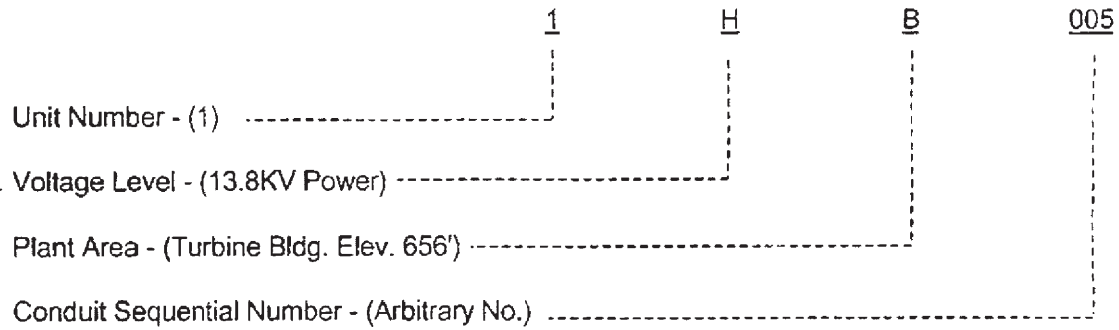

An alphanumeric listing of all raceway numbers is maintained in the electrical Raceway Schedule, which also contains the raceway type, length from end point locations, percent fill, and list of included cables.

Raceway markers are affixed to each raceway for permanent identification. Identification markers for Class IE raceways are marked at regular intervals along the length of the raceway with unique and distinguishing colors for each separation group corresponding to the cable marker colors.

**Table 1.8-1**

**SSES PROJECT GLOSSARY TERMS**

TERM	DEFINITION	REFERENCE
Abnormal occurrence	Any reportable occurrence that is determined by the Commission to be significant from the standpoint of public health or safety	
Abnormal Operational Transients	Infrequent design events that may be reasonably expected during the course of planned operations, including events that are a result of (or follow)a single equipment malfunction or operator error. Power failures, pump trips, and rod withdrawal errors are typical of the single malfunctions or errors which may initiate the events in this category.	
Acceptable	Demonstrated to be adequate by the safety analysis of the Plant.	
Accident	A single event, not reasonably expected to occur during the course of plant operations, that has been hypothesized for analyses purposes or postulated from unlikely but conceivable situations and that causes or threatens to cause a violation of one or more fission product barriers.	
Achieving Criticality	All actions which are normally accomplished in bringing the Plant from a condition in which all control rods are fully inserted to a condition in which nuclear criticality is achieved and maintained.	
Achieving Shutdown	Achieving shutdown begins where power operation ends and includes all actions normally accomplished in achieving nuclear shutdown (more than one rod subcritical) following power operation.	
Activated Device	A mechanical module in a system used to accomplish an action. An activated device is controlled by an actuation device.	
Active components	<ul style="list-style-type: none"> <li>a. Those components whose operability is relied upon to perform a safety function such as safe shutdown of the reactor or mitigation of the consequences of a postulated pipe break in the reactor coolant pressure boundary.</li> <li>b. Active component is one in which mechanical motion must occur to complete the component's intended function.</li> </ul>	
Active failure	The failure of an active component such as a piece of mechanical equipment, component of the electrical supply system or instrumentation and control equipment to act on command to perform its design function. Examples include the failure of a motor-operated valve to move to its correct position, the failure of an electrical breaker or relay to respond, the failure of a pump, fan, or diesel generator to start, etc.	
Actuation Device	An electrical or electromechanical module controlled by an electrical decision output used to produce mechanical operation of one or more activated devices, thus achieving necessary action.	
Additional Plant Capability Event	An event which neither qualifies as neither an abnormal operational transient nor an accident but which is postulated to demonstrate some special capability of the Plant.	

**Table 1.8-1**

**SSSES PROJECT GLOSSARY TERMS**

TERM	DEFINITION	REFERENCE
Administrative Controls	Measures to prevent the existence or development of an unsafe condition in connection with the operation of the reactor. They also define the administrative action to be taken in the event a safety limit or allowed condition for operation is exceeded. Requirements concerning the facility's organization and management, procedures, record keeping, review and audit, and reporting are specified.	
Alteration of the Reactor Core	The act of moving any component in the region above the core support plate, below the upper grid and within the shroud. Normal control rod movement with the control rod drive hydraulic system is not defined as a core alteration. Normal movement of in-core instrumentation and the traversing in-core probe is not defined as a core alteration.	
Alternate Rod Injection	An alternate means of inserting control rods. One of the features provided in order to mitigate a postulated anticipated transient without scram (ATWS) event.	
Analog channel calibration	Adjustment of channel output such that it responds, with acceptable range and accuracy, to known values of the parameter which the channel measures. Calibration shall encompass the entire channel, including alarm or trip, and shall be deemed to include the channel functional test.	
Analog channel check	A qualitative determination of acceptable operability by observation of channel behavior during operation. This determination may include comparison of the channel with other independent channels measuring the same variable.	
Analog channel functional test	Injection of a simulated signal into the channel to verify that it is operable, including alarm and/or trip initiating action.	
Anticipated operational occurrences	Anticipated operational occurrences mean those conditions of normal operation which are expected to occur one or more times during the life of the nuclear power unit and include but are not limited to loss of power to all recirculation pumps, tripping of the turbine-generator set, isolation of the main condensers, and loss of all off-site power (10 CFR 50 Appendix A).	
Anticipated transients (with Scram)	This group of anticipated abnormal transients include events which present a demand for protection action by the Reactor Protection System and which have a probability of occurrence greater than $10^{-3}$ per year. The events which fall in this category of anticipated transients are listed below: a. Loss of load b. Excessive load increase c. Loss of one feedwater pump d. Loss of flow (one pump) e. Rod withdrawal f. Startup accident g. Accidental depressurization of Reactor Coolant System h. Plant blackout	

**Table 1.8-1**

**SSES PROJECT GLOSSARY TERMS**

TERM	DEFINITION	REFERENCE
Anticipated Transients Without Scram (ATWS)	Anticipated operational occurrences which require reactor shutdown followed by the failure to insert all control rods; i.e. a failure to SCRAM.	
Associated Areas	The off-Site equipment, facilities and structures which are necessary for the operation of the Project. These include the makeup water pump facility, the makeup water pipeline, the discharge structure, the transmission line, the railroad spur, and the rights-of-way and access roads associated with the above.	
Average linear power density	Total thermal power produced in the fuel rods divided by the total active fuel length of all rods in the core.	
Average rod power	Total thermal power produced in the fuel rods divided by the number of fuel rods (assuming all rods have equal length).	
Channel	An arrangement of components and sensors as required to generate a single protective action signal when required by a generating station condition. A Channel loses its identity where single action signals are combined.	
Class 1E Electric Systems	The safety classification of the electric equipments and systems that are essential to emergency reactor shutdown containment isolation, reactor core cooling and reactor heat removal or otherwise are essential in preventing significant release of radiation to the environment.	
Closed System	Piping system containing fluid, not freely accessible to the environment, penetrating containment but not communicating with either primary coolant pressure boundary or containment atmosphere.	
Cold Shutdown	When the reactor is in the shutdown mode; the reactor coolant is maintained at equal to or less than 200°F, and the reactor vessel is vented to containment atmosphere.	
Common mode failure	The failure of two or more components of the same or similar design by the same failure mechanism. Such failure mechanisms for components may result from the adverse conditions from a design basis event for which the components were expected by design to remain functional. Such failures may result from a design deficiency or manufacturing deficiency. Redundant equipment can be made inoperable by this mechanism.	
Components	Items from which a system is assembled.	
Containment (primary and secondary)	The structures that enclose components of the reactor coolant pressure boundary and which provides an essentially leaktight barrier against the uncontrolled release of fission products to the environment.	
Containment Atmosphere	Free volume enclosed by the primary containment.	

**Table 1.8-1**

**SSS PROJECT GLOSSARY TERMS**

TERM	DEFINITION	REFERENCE
Containment integrity	<p>Exists when all the following conditions exist:</p> <ul style="list-style-type: none"> <li>a. All nonautomatic containment isolation valves not required for normal operation are closed or under administrative control.</li> <li>b. Blind flanges are properly installed where required.</li> <li>c. The equipment door is properly closed and sealed.</li> <li>d. At least one door in each personnel air lock is properly closed and sealed.</li> <li>e. All automatic containment isolation trip valves are operable or closed.</li> <li>f. The containment leakage satisfies Technical Specification.</li> </ul>	
Containment isolation	<p>Establishment of mechanical barrier(s) in appropriate fluid systems penetrating the Containment which would otherwise represent open paths for the fission products in the event of a loss-of-coolant accident inside the Containment.</p>	
Controlled Access Area	<p>The area immediately surrounding the principal Project Structures, enclosed with a fence or other suitable physical barrier, such that entry into this area is controlled. This area will encompass the Reactor Buildings, the Turbine Buildings, the Auxiliary Buildings, Control Building, Diesel-Generator Buildings, Radwaste Building, and the Cooling Towers.</p>	
Controls	<p>Methods and devices by which actuation is used to affect the value of a variable.</p>	
Cooldown	<p>When used with respect to nuclear reactors, means apparatus and mechanisms, the actuation of which directly affects the reactivity or power level of the reactor.</p>	
Critical items	<p>Cooldown begins where achieving shutdown ends and includes all actions normally accomplished in the continued removal of decay heat and the reduction of nuclear system temperature and pressure.</p> <p>Those structures, units (or components) and systems which require a degree of design review, verification, inspection and documentation over and above that applied in the course of normal engineering, procurement and construction. As a minimum, critical items include all structures and systems required to maintain the integrity of the reactor primary system pressure boundary, to provide Containment Engineered Safety Features, assure safe shutdown under all conditions and continued residual heat removal.</p>	
Degree of redundancy	<p>The difference between the number of sensors of a variable and the number of sensors which when tripped will cause an automatic system trip.</p>	
Design Basis	<p>“Design basis” means that information which identifies the specific functions to be performed by a structure, system, or component of a facility, and the specific values or ranges of values chosen for controlling parameters as reference bounds for design. These values may be (1) restraints derived from generally accepted “state of art” practices for achieving functional goals, or (2) requirements derived from analysis (based on calculation and/or experiments) or the effects of a postulated accident for which a structure, system, or component must meet its functional goals.</p>	

**Table 1.8-1**

**SSES PROJECT GLOSSARY TERMS**

TERM	DEFINITION	REFERENCE
Design Basis Accidents (DBA)	The hypothesized accident whose characteristics and consequences are utilized in the design of those systems and components pertinent to the preservation of radioactive material barriers and the restriction of radioactive material release from the barriers upon occurrence of a loss-of-coolant accident. The potential radiation exposures resulting from a DBA are not exceeded by any similar accident postulated from the same general accident assumptions.	
Design Basis Events (DBE)	Postulated events used in a design to establish the performance requirements of structures, systems, and components.	
Design features	Those features of the facility such as materials of construction and geometric arrangements which, if altered or modified, would have a significant effect on safety.	
Design Power	The power level equal to 102% of the licensed or rated core thermal power level. The design power level is equivalent to 4031 MWt.	
Diffuser	The submerged section of the discharge pipeline which has multiple ports.	
Dilution Zone	The boundary of the dilution zone is defined as that point where the Plant discharge is mixed with the Susquehanna River.	
Discharge structure	The diffuser section, connecting discharge pipeline, and anchors, both the shoreline anchors and river bed anchors.	
Drywell	A pressure-containing envelope surrounding the reactor and its recirculation loops which will channel steam resulting from the LOCA through the suppression pool for condensation. Part of primary containment.	
Emergencies	Unplanned events characterized by risks sufficient to require immediate action to avoid or mitigate an abrupt or rapidly deteriorating situation.	
Emergency Conditions (Infrequent Incidents)	Those deviations from Normal Conditions which require shutdown for correction of the conditions or repair of damage in the system. The conditions have a low probability of occurrence but are included to provide assurance that no gross loss of structural integrity will result as a concomitant effect of any damage developed in the system.	
Engineered Safeguards	(Same as Engineered Safety Features).	

**Table 1.8-1**

**SSES PROJECT GLOSSARY TERMS**

TERM	DEFINITION	REFERENCE
Engineered Safety Features (ESF)	<p>a. Features of a unit or system other than reactor trip or those used only for normal operation, that are provided to prevent, limit or mitigate the release of radioactive material in excess of 10 CFR 50.67 limits.</p> <p>b. Engineered Safety Feature System (ESFS) consists of those systems, including essential support systems or components thereof the primary purpose of which during a design basis accident (DBA) will be to:</p> <ol style="list-style-type: none"> <li>(1) Retain fuel temperatures within design limits by maintaining fuel coolant inventory and temperatures within design limits.</li> <li>(2) Maintain fuel temperatures within design limits by inserting auxiliary negative reactivity.</li> <li>(3) Prevent the escape of radioactive materials to the environment in excess of 10 CFR 50.67 limits by isolation of the systems or structures.</li> <li>(4) Reduce the quantity of radioactivity available for leakage and its potential for leakage by purification, cleanup, containment heat removal and containment pressure reduction.</li> <li>(5) Control the concentration of combustible gases in the containment systems within established limits.</li> </ol>	
Exclusion area	A circle within a radius of 1800 ft from the centerline of the reactors, as defined by 10CFR 100.3.	
Extended Load Line Limit Analysis	Safety analyses performed to demonstrate adequate safety margins in support of a license amendment permitting operation with an elevated load line on the power-flow map; i.e. with increased thermal power at a given recirculation flow.	
Failure	The termination of the ability of an item to perform its required function. Failures may be unannounced and not detected until the next test (unannounced failure), or they may be announced and detected by any number of methods at the instant of occurrence (announced failure).	
Faulted Condition (Limiting Faults)	Those combinations of conditions associated with extremely-low-probability, postulated events whose consequences are such that the integrity and operability of the nuclear energy system may be impaired to the extent that considerations of public health and safety are involved. Such considerations require compliance with safety criteria as may be specified by jurisdictional authorities.	
Functional Test	The manual operation or initiation of a system, subsystem, or component to verify that it functions within design tolerances (eg, the manual start of a core spray pump to verify that it runs and that it pumps the required volume of water).	
General Design Criteria (GDC)	A set of design criteria for structures, systems, and components important to safety, which are given in Appendix A to 10 CFR 50, and provide reasonable assurance that the Plant can be operated without undue risk to the health and safety of the public.	
Globe Stop Check Valve (GCK)	These valves shall be designed to normally function as check valves, but in addition they shall be provided with means for positive shutoff using manual or mechanical actuators.	

**Table 1.8-1**

**SSS PROJECT GLOSSARY TERMS**

TERM	DEFINITION	REFERENCE
Heatup	Heatup begins where achieving criticality ends and includes all actions which are normally accomplished in approaching nuclear system rated temperature and pressure by using nuclear power (reactor critical). Heatup extends through warmup and synchronization of the turbine generator.	
High radiation area	Any area, accessible to personnel, in which there exists radiation originating in whole or in part within licensed material at such levels that a major portion of body could receive in any one hour a dose in excess of 100 mrem.	
Hot shutdown	See Technical Specification Section 1.1.	
Startup/Hot standby	See Technical Specification Section 1.1.	
Immediate	Immediate means that the required action will be initiated as soon as practicable considering the safe operation of the unit and the importance of the required action.	
Inactive components	Those components whose operability (eg, valve opening or closing, pump operation or trip) are not relied upon to perform the system function during the transients or events considered in the respective operating condition categories.	
Incident	Any natural or accidental event of infrequent occurrence and its related consequences which affect the Plant operation and require the use of Engineered Safety Feature systems. Such events, which are analyzed independently and are not assumed to occur simultaneously, include the loss-of-coolant accident, steam line ruptures, steam generator tube ruptures, etc. A system blackout may be an isolated occurrence or may be concurrent with any event requiring Engineered Safety Feature systems use.	
Incident Detection Circuitry	Includes those trip systems which are used to sense the occurrence of an incident.	
Increased Core Flow	Operation with core flow greater than 100% of original design. Used to provide additional reactivity at end of core life to permit a longer fuel cycle and more economic operation.	
Instrument Calibration	An instrument calibration means the adjustment of an instrument signal output so that it corresponds, within acceptable range and accuracy, to a known value(s) of the parameter which the instrument monitors. Calibration shall encompass the entire instrument including actuation, alarm, or trip.	
Channel check	See Technical Specification Section 1.1.	
Channel Functional Test	See Technical Specification Section 1.1.	
Irradiated Fuel	Fuel that has been in the reactor during reactor operation.	
Isolated Condition	Condition in which the reactor is isolated from the main condenser.	
Limiting conditions for operation	The lowest functional capability or performance levels of equipment required for safe operation of the facility.	



**Table 1.8-1**

**SSES PROJECT GLOSSARY TERMS**

TERM	DEFINITION	REFERENCE
Limiting safety system settings	Settings for automatic protective devices are related to those variables having significant safety functions. (Where a limiting safety system setting is specified for a variable on which a safety limit has been placed, the setting has been chosen so that automatic protective action will correct the most severe abnormal situation anticipated before a safety limit is exceeded).	
Linear power density	The thermal power produced per unit length of fuel rod (kW/ft). Since fuel assembly geometry is standardized, this is the unit of power density most commonly used. For all practical purposes it differs from kW/liter by a constant factor which includes geometry and the fraction of the total thermal power which is generated in the fuel rod.	
Load Group	An arrangement of buses, transfers, switching equipment, and loads fed from a common power supply.	
Local heat flux	The heat flux at the outer surface of the cladding (Btu/ft <sup>2</sup> hr). For nominal rod parameters this differs from linear power density by a constant factor.	
Logic	That array of components which combines individual bistable output signals to produce decision outputs.	
Logic channel	A logic channel is a group of logic matrices which operate in response to the digital single action signals from the analog channels to generate a protective action signal.	
Logic System functional test	See Technical Specification Section 1.1.	
Long Term	The remainder of the recovery period following the short term. In comparison with the short term where the main concern is to remain within NRC specified site criteria, the long-term period of operation involves bringing the Plant to cold shutdown conditions where access to the Containment can be gained and repair effected.	
Loss-of-Coolant Accident (LOCA)	Those postulated accidents that result from the loss of reactor coolant, at a rate in excess of the capability of the Reactor Coolant Makeup System, from breaks of pipes containing reactor coolant, up to and including a break equivalent in size to the double-ended rupture of the largest pipe of the Reactor Coolant System.	
Low Population Zone (LPZ)	The area included in a three mile radius from the midpoint of the centerline between the two reactor buildings on on Plant Site, and in 10 CFR 100.3 as defined.	
Low power physics tests	Tests below a nominal five percent of rated power which measure fundamental characteristics of the reactor core and related instrumentation.	
Manual Component	A component, the operability of which is relied upon to perform a manual nuclear safety function such as providing manual action or operator information required for initiation of action for safe shutdown of the reactor or mitigation of the consequences of an accident.	
Material surveillance program	The provisions for the placement of reactor vessel material specimens in the reactor vessel, and the program of periodic withdrawal and testing of such specimens to monitor, over the service life of the vessel, changes in the fracture toughness properties of the vessel as a result of neutron irradiation.	

**Table 1.8-1**

**SSS PROJECT GLOSSARY TERMS**

TERM	DEFINITION	REFERENCE
Minimum Critical Heat Flux Ratio (MCHFR)	The lowest value of the ratio of critical heat flux (that heat flux which results in transition boiling) to the actual heat flux at the same location.	
Minimum degree of redundancy	The degree of redundancy below which operation is prohibited or otherwise restricted by the Technical Specifications.	
Missile Barrier	A physical barrier which protects essential components, systems or structures from potential missiles arising from consequences of a loss-of coolant accident.	
Mode	See Technical Specification Section 1.1.	
Module	Any assembly of interconnected components which constitutes an identifiable device, instrument, or piece of equipment. A module can be disconnected, removed as a unit, and replaced with a spare. It has definable performance characteristics which permit it to be tested as a unit. A module could be a card or other subassembly of a larger device, provided it meets the requirements of this definition.	
Normal conditions	Normal conditions are any condition in the course of system startup, operation in the design power range, hot standby and system shutdown, other than Upset, Emergency, Faulted or Testing Conditions.	
Normal operation	Operation of the plant under planned, anticipated conditions including, but not limited to, the following: a. Reactor critical (any temperature) b. Power operation c. Reactor startup d. Reactor shutdown e. Refueling f. Periodic testing g. Nuclear system cooldown h. Nuclear system heatup i. Standby (reactor shutdown, nuclear system maintained at constant temperature)	
Nuclear-fueled electrical generating facility (the Plant)	The reactor, turbine-generator, cooling tower, associated buildings (reactor building, turbine building, and administration building), and the switchyard.	
Nuclear Power Unit	A nuclear power unit means a nuclear power reactor and associated equipment necessary for electric power generation and includes those structures, systems, and components required to provide reasonable assurance the facility can be operated without undue risk to the health and safety of the public.	
Nuclear Safety Operational Analysis	A systematic identification of the requirements for the limitations on plant operation necessary to satisfy nuclear safety operational criteria.	
Nuclear Safety Operational Criteria	A set of standards used to select nuclear safety operational requirements.	

**Table 1.8-1**

**SSS PROJECT GLOSSARY TERMS**

TERM	DEFINITION	REFERENCE
Nuclear System	<p>Generally includes those systems most closely associated with the reactor vessel which are designed to contain or be in communication with the water and steam coming from or going to the reactor core. The nuclear system includes the following:</p> <ul style="list-style-type: none"> <li>a. Reactor vessel</li> <li>b. Reactor assembly and internals</li> <li>c. Reactor core</li> <li>d. Main steam lines from reactor vessel out to and including the isolation valve outside the Containment</li> <li>e. Neutron monitoring system</li> <li>f. Reactor recirculation system</li> <li>g. Control rod drive system</li> <li>h. Residual heat removal system</li> <li>i. Reactor core isolation cooling system</li> <li>j. Emergency core cooling systems</li> <li>k. Reactor water cleanup system</li> <li>l. Feedwater system piping between the reactor vessel and the first valve outside the Containment</li> <li>m. Pressure relief system</li> </ul> <p>See Reactor Coolant Pressure Boundary</p>	
Nuclear System Process Barrier		
Occupational dose	<p>Include exposure of an individual to radiation (i) in a restricted area; or (ii) in the course of employment in which the individual's duties involve exposure to radiation, provided that "occupational dose" shall not be deemed to include any exposures of an individual to radiation for the purpose of medical diagnosis or medical therapy of such individual.</p> <p>See Technical Specification Section 1.1.</p>	
Operable	A system or component is operating when it is performing its intended functions in the required manner.	
Operating	Interval between the end of one refueling outage and the end of the next subsequent refueling outage.	
Operating Cycle	The adjective "operational", along with its noun and verb forms, is used in reference to the working or functioning of the Plant, in contrast to the design of the Plant.	
Operational	These reports include the Startup Report, First Year Operation Report, and Semiannual Operating Records. Operating reports are submitted in writing to the Director, Division of Reactor Licensing, USNRC, Washington, D.C. 20545.	
Operating reports		

**Table 1.8-1**

**SSES PROJECT GLOSSARY TERMS**

TERM	DEFINITION	REFERENCE
Operating Basis Earthquake (OBE)	That earthquake which produces vibratory ground motion for which those structures, systems, and components necessary for power generation are designed to remain operable.	
Operator	Any individual who manipulates a control of a facility. An individual is deemed to manipulate a control if he directs another to manipulate a control	
Operator error	An active deviation from written operating procedures or nuclear plant standard operating practices. A single operator error is the set of actions that is a direct consequence of a single reasonably expected erroneous decision. The set of actions is limited as follows: a. Those actions that could be performed by only one person. b. Those actions that would have constituted a correct procedure had the initial decision been correct. c. Those actions that are subsequent to the initial operator error and that affect the designed operation of the plant but are not necessarily directly related to operator error.	
Passive Component	A component in which mechanical movement does not occur in order for the component to perform its intended function.	
Passive failure	The structural failure of a static component which limits the component's effectiveness in carrying out its design function. When applied to a fluid system, this could mean a break in the pressure boundary.	
Peaking Factor	The ratio of the maximum fuel rod surface heat flux in an assembly to the average surface heat flux of the core.	
Penetration Assembly, Elec.	Provides the means to allow passage of electrical circuits through a single aperture (nozzle or other opening) in the containment pressure barrier, while maintaining the integrity of the pressure barrier.	
Pennsylvania Power & Light Company (PP&L)	The owner-operator of the Project, having total controlling ownership.	
Period of recovery	The time necessary to bring the Plant to a cold shutdown and regain access to faulted equipment. The recovery period is the sum of the short-term and long-term periods.	
Place in Cold Shutdown Condition	Conduct an uninterrupted normal Plant shutdown operation until the cold shutdown condition is attained.	
Place in Isolated Condition	Conduct an uninterrupted normal isolation of the reactor from the main (turbine) condenser including the closure of the main steam line isolation valves.	
Place in Shutdown Condition	Conduct an uninterrupted normal plant shutdown operation until shutdown is attained.	

**Table 1.8-1**

**SSES PROJECT GLOSSARY TERMS**

TERM	DEFINITION	REFERENCE
Planned Operation	<p>Normal plant operation under planned conditions in the absence of significant abnormalities. Operations subsequent to an incident (transient, accident, or special event) are not considered planned operations until the procedures being followed or equipment being used are identical to those used during any one of the defined planned operations. The established planned operations can be considered as a chronological sequence: refueling outage; achieving criticality; heatup; power operation; achieving shutdown; cooldown; refueling outage.</p> <p>The following planned operations are identified:</p> <ol style="list-style-type: none"> <li>Refueling Outage</li> <li>Achieving Criticality</li> <li>Heatup</li> <li>Reactor Power Operation</li> <li>Achieving Shutdown</li> <li>Cooldown</li> </ol>	
Plant	Those structures, systems and components that make up the Susquehanna Steam Electric Station.	
Power density	The thermal power produced per unit volume of the core (kW/liter).	
Power Generation	When used to modify such words as design basis, action and system, this term indicates that the objective, design basis, action, or system is related to the mission of the Plant, to generate electrical power, as opposed to concerns considered to be of primary safety importance. Thus, the words "power generation" identify aspects of the Plant which are not considered to be of primary importance with respect to safety.	
Power Generation Design Basis	The power generation design basis for a power generation system states in functional terms the unique design requirements which establish the limits within which the power generation objective shall be met. A safety system may have a power generation design basis which states in functional terms the unique design requirements which establish the limits within which the power generation objective for the system shall be met.	
Power Generation Evaluation	Shows how the system satisfies some or all of the power generation design bases. Because power generation evaluations are not directly pertinent to public safety, generally they are not included. However, where a system or component has both safety and power generation objectives, a power generation evaluation can clarify the safety versus power generation capabilities.	

**Table 1.8-1**

**SSSES PROJECT GLOSSARY TERMS**

TERM	DEFINITION	REFERENCE
Power Generation System	<p>Any system, the actions of which are not essential to a safety action, but which are essential to a power generation action. Power generation systems are provided for any of the following purposes:</p> <ul style="list-style-type: none"> <li>a. To carry out the mission of the Plant-generate electrical power through planned operation.</li> <li>b. To avoid conditions which would limit the ability of the Plant to generate electrical power.</li> <li>c. To facilitate and expedite the return to conditions permitting the use of the Plant to generate electrical power following an abnormal operational transient, accident, or special event.</li> </ul>	
Power operation condition	<p>When the reactor is critical and the neutron flux power range instrumentation indicates greater than two percent of rated power.</p>	
Power uprate	<p>Evaluations, tests, modifications, setpoint changes, and license amendments which permitted an increase in rated thermal power from the original 3293 Mwt to 3441 Mwt; allowing an increase in the nominal generator rating from approximately 1100 to approximately 1150 MWe, and in the net plant rating from approximately 1050 MWe to approximately 1100 MWe. Extended Power Uprate (EPU): The operating license for both units was further modified to permit operation at 3952 MWt with a nominal generator output of 1300 MWe.</p>	
Preferred power source	<p>That power supply which is preferred to furnish electrical energy under accident or post accident. It is obtained from start-up transformers. The switchgear is arranged to auto transfer from one preferred source to another preferred source in the event the preferred source fails.</p>	
Preferred power system	<p>The off-site external commercial power system.</p>	
Preoperational Test Program	<p>The preoperational test program applicable to the nuclear steam supply system is the test program conducted prior to fuel loading. The test program applicable to other Plant systems is the test program conducted prior to that system's required operation.</p>	
Principal design criteria	<p>The criteria which establish the necessary design, fabrication, construction, testing and performance requirements for structures, systems and components important to safety, that is, structures, systems, and components that provide reasonable assurance that the facility can be operated without undue risk to the health and safety of the public.</p>	
Principal Project structures	<p>The Reactor Buildings, Control Buildings, Diesel Generator Building, Radwaste Building, Turbine Buildings, and Cooling Towers.</p>	

**Table 1.8-1**

**SSES PROJECT GLOSSARY TERMS**

TERM	DEFINITION	REFERENCE
Probable maximum flood (PMF)	The hypothetical flood characteristics (peak discharge, volume and hydrograph shape) that are considered to be the most severe "reasonably possible": at a particular location, based on relative comprehensive hydrometeorological analyses of critical runoff producing precipitation (and snowmelt, if pertinent) and hydrological factors favorable for maximum flood runoff.  Refer to Chapter 2 of the SSES FSAR for specific values which apply to the Susquehanna Steam Electric Station.	
Probable maximum precipitation (PMP)	The theoretically greatest precipitation over the applicable drainage area that would produce flood flows that have virtually no risk of being exceeded.  Refer to Chapter 2 of the SSES FSAR for specific values which apply to the Susquehanna Steam Electric Station.	
Probable maximum winds	The hypothetical tornado or other cyclonictype windstorm that might result from the most severe combinations of meteorological parameters that are considered reasonably possible in the region involved, if the tornado or other type windstorm should approach the point under study along a critical path and at optimum rate of movement.	
Protection System	The aggregate of the protective signal system and the protective actuator system	
Protective action	<ul style="list-style-type: none"> <li>a. Protective action at the channel level is the generation of a signal by a single channel when the variable(s) sensed exceeds a limit.</li> <li>b. Protective action at the system level is the operation of sufficient actuated equipment to accomplish a protective function (for example: rapid insertion of control rod, closing of containment isolation valves, safety injection, core spray).</li> </ul>	
Protective Actuator System	An arrangement of components that performs a protective action when it receives a signal from the protective signal system (for example: control rods, their drive mechanisms and their trip mechanisms; isolation valves, their operators and their contractors; core spray pumps, their motors and circuit breakers).	
Protective function	Any one of the functions necessary to limit the safety consequences of a design basis event (for example: rapid reduction of reactor power following a control rod ejection, isolation of the Containment following a steam line break, removal of heat from the core following a loss-of-coolant-accident).	
Quality Assurance (QA)	All those planned and systematic actions necessary to provide adequate confidence that a structure, system or component will perform satisfactorily in service. Quality assurance includes quality control, which comprises those quality assurance actions related to physical characteristics of a material, structure, component, or system which provide a means to control the quality of the material, structure, component, or system of predetermined requirements.	

**Table 1.8-1**

**SSS PROJECT GLOSSARY TERMS**

TERM	DEFINITION	REFERENCE
Quality Control (QC)	Those quality assurance actions related to physical characteristics of a material, structure, component, or system which provide a means to control the quality of the material, structure, component or system to predetermined requirements.	
Q-Listed system	Q-Listed systems, structures and components are those which prevent or mitigate the consequences of postulated accidents that could cause undue risk to the health and safety of the public. They include materials, structures, and equipment whose failure could cause significant release of radioactivity to the environment comparable to 10 CFR 50.67 limits at the Site exclusion distance, or which are vital to the safe shutdown of the Plant, or which are necessary for the removal of decay and sensible heat from the reactor.	
Quality Group	A classification which identifies the importance of structures, systems, and components with respect to Plant safety functions in accordance with definitions given in NRC Regulatory Guide 1.26.	
Radiation area	Any area, accessible to personnel, in which there exists radiation originating in whole or in part within licensed material, at such levels that a major portion of the body could receive in any one hour a dose in excess of 5 mrem, or in any five consecutive days a dose in excess of 100 mrem.	
Radioactive Material Barrier	Includes the systems, structures, or equipment that together physically prevent the uncontrolled release of radioactive materials. The barriers are the fuel cladding, the reactor coolant system and the Containment.	
Radioactive waste	Radioactive wastes are solids, liquids, and gaseous effluents from the radioactive waste systems that have concentration or radioactivity in excess of background.	
Rated power	The power level at which the reactor is producing 100 percent of reactor vessel rated steam flow. This is the maximum power that could be authorized by the operating license. Rated coolant flow, rated neutron flux and rated nuclear system pressure refer to values of these parameters when the reactor is at rated power.	
Reactivity	A state variable of neutron chain reactions which is indicative of a deviation in the chain reaction from criticality. It is measured in terms of where $\rho = k_{eff} - 1/k_{eff}$ . Positive values correspond to a supercritical state and negative values to a subcritical state.  Usage has established "units" of delta k/k for reactivity change. This term (delta k/k) is used to represent a departure from criticality, and is referred to as reactivity worth. Reactivity worth is the reactivity attributable to the specified component material, portion of material, or void in the nuclear reactor.	
Reactor Building	Structural complex enclosing the primary containment, and forming secondary containment.	
Reactor Coolant System	The vessels, pipes, pumps, tubes, valves and similar process equipment that contain the steam, water, gases, and radioactive materials coming from, going to, or in communication with the reactor vessel.	



**Table 1.8-1**

**SSS PROJECT GLOSSARY TERMS**

TERM	DEFINITION	REFERENCE
Reactor coolant pressure boundary (RCPB)	<p>All those pressure-containing components such as pressure vessels, piping, pumps and valves, which are (1) part of the Reactor Coolant System, or (2) connected to the Reactor Coolant System, up to and including any and all of the following:</p> <ol style="list-style-type: none"> <li>The outermost containment isolation valve in system piping which penetrates primary reactor Containment.</li> <li>The second of two valves normally closed during normal reactor operation in system piping which does not penetrate primary reactor Containment. The Reactor Coolant System safety and relief valves.</li> </ol>	
Reactor critical	When the neutron chain reaction is self-sustaining and $k_{eff} = 1.0$ .	
Reactor Power Operations	Reactor power operation begins after heatup is complete and includes any operation with the mode switch in the "Startup" or "Run" position with the reactor critical and above 1 percent rated power.	
Reactor Vessel Pressure	Unless otherwise indicated, reactor vessel pressures are those measured by the reactor vessel steam space detectors.	
Redundant equipment or system	An equipment or system that duplicates the essential function of another equipment or system to the extent that either may perform the required function regardless of the state of operation or failure of the other.	
Refueling Mode	See Technical Specification Section 1.1.	
Refueling operation condition	Any operation within the Containment involving movement of core components when the vessel head is completely unbolted or removed and there is fuel in the reactor.	
Refueling Outage	The period of time between the shutdown of the unit prior to a refueling and the startup of the unit after that refueling. For the purpose of designating frequency of testing and surveillance, a refueling outage shall mean a regularly scheduled outage. However, where such outages occur within 8 months of the completion of the previous refueling outage, the required surveillance testing need not be performed until the next regularly scheduled outage.	
Refueling shutdown condition	When the reactor is subcritical by at least 10,000 pcm, $T_{avg}$ is $\leq 140^{\circ}F$ , and fuel or fuel inserts are scheduled to be moved to or from the reactor core.	
Reliability	The probability that a component will perform its specified function without failure for a specified time in a specified environment.	

**Table 1.8-1**

**SSSES PROJECT GLOSSARY TERMS**

TERM	DEFINITION	REFERENCE
Reportable Occurrence	<p>They are as follows:</p> <ol style="list-style-type: none"> <li>1) Failure of the reactor protection system or other systems settings to initiate the required protective function by the time a monitored parameter reaches the setpoint specified as the limiting safety-system setting in the technical Specifications or failure to complete the required protective function.</li> <li>2) Operation of the unit or affected systems when any parameter or operation subject to a limiting condition for operation is less conservative than the least conservative aspect of the limiting condition for operation established in the technical specifications.</li> <li>3) Abnormal degradation discovered in fuel cladding, reactor coolant pressure boundary, or primary containment.</li> </ol>	
	<ol style="list-style-type: none"> <li>4) Reactivity anomalies involving disagreement with the predicted value of reactivity balance under steady-state conditions during power operation greater than or equal to 1% <math>\Delta k/k</math>; a calculated reactivity balance indicating 5 shutdown margin less conservative than specified in the technical specifications; short-term reactivity increases that correspond to a reactor period of less than 5 seconds or, if subcritical, an unplanned reactivity insertion of more than 0.5% <math>\Delta k/k</math>; or occurrence of any unplanned criticality.</li> <li>5) Failure or malfunction or one or more components which prevents or could prevent, by itself, the fulfillment of the functional requirements of system(s) used to cope with accidents analyzed in the SAR.</li> <li>6) Personnel error or procedural inadequacy which prevents or could prevent, by itself, the fulfillment of the functional requirements of systems(s) used to cope with accidents analyzed in the SAR.</li> <li>7) Conditions arising from natural or manmade events that as a direct result of the event, require plant shutdown, operation of safety systems, or other protective measures required by the technical specifications.</li> </ol>	
	<ol style="list-style-type: none"> <li>8) Errors discovered in the transient or accident analyses or in the method used for such analysis as described in the safety analysis report or in the bases for the technical specifications but have or could have permitted reactor operation in a manner less conservative than assumed in the analyses</li> <li>9) Performance of structures, systems, or components that requires remedial action or corrective measures to prevent operation in a manner less conservative than that assumed in the accident analyses in the SAR or technical Specifications bases; or discovery during plant life of conditions not specifically considered in the SAR or technical Specifications that require remedial action or corrective measures to prevent the existence or development of an unsafe condition.</li> </ol>	

**Table 1.8-1**

**SSes PROJECT GLOSSARY TERMS**

TERM	DEFINITION	REFERENCE
Response spectrum	<p>A plot of the maximum response of single degree of freedom bodies, at a damping value expressed as a percent of critical damping, of different natural frequencies, mounted on the surface of interest (that is, on the ground for the ground response spectrum or on the floor of a building for that floor's floor response spectrum) when the surface is subjected to a given earthquake's motion.</p> <p>NOTE: The response spectrum is not the floor motion or the ground motion.</p> <p>Any area access which is controlled by the licensee for purposes of protection of individuals from exposure to radiation and radioactive materials. "Restricted Area" shall not include any areas used as residential quarters, although a separate room or rooms in a residential building may be set apart as a restricted area.</p>	
Restricted area	<p>NOTE: The response spectrum is not the floor motion or the ground motion.</p> <p>Any area access which is controlled by the licensee for purposes of protection of individuals from exposure to radiation and radioactive materials. "Restricted Area" shall not include any areas used as residential quarters, although a separate room or rooms in a residential building may be set apart as a restricted area.</p>	
Rod power or rod integral power	<p>The length integrated linear power in one rod (kW).</p>	
Run Mode	<p>See Technical Specification Section 1.1.</p>	
Safe Shutdown Earthquake (SSE)	<p>The "Safe Shutdown Earthquake" is that maximum probable earthquake which produces the vibratory ground motion for which structures, systems and components designed to Seismic Category I requirements remain functional.</p>	
Safety	<p>When used to modify such words as objective, design basis, action, and system, the word indicates that, that objective, design basis, action, or system is related to concerns considered to be of safety significance, as opposed to the Plant mission - to generate electrical power. Thus, the word "safety" identifies aspects of the plant which are considered to be of importance with respect to safety. A safety objective or safety design basis does not necessarily indicate that the system is an engineered safety feature.</p>	
Safety Action	<p>An ultimate action in the Plant which is essential to the avoidance of specified conditions considered to be of safety significance. The specified conditions are those that are most directly related to the ultimate limits on the integrity of the radioactive material barriers and the release of radioactive material. There are safety actions associated with planned operation, abnormal operational transients, accidents, and special events. Safety actions include such actions as reactor scram, emergency core cooling, reactor shutdown from outside the control room and the indication to the operator of the values of certain process variables.</p>	
Safety Class	<p>A classification which identifies the importance of structures systems, and components with respect to Plant functions in accordance with definitions given in ANSI N212 for BWR's</p>	
Safety Design Basis	<p>The safety design basis for a safety system states in functional terms the unique design requirements that establish the limits within which the safety objective shall be met. A power generation system may have a safety design basis which states in functional terms the unique design requirements that ensure that neither planned operation nor operational failure by the system results in conditions for which Plant safety actions would be inadequate.</p>	

**Table 1.8-1**

**SSSES PROJECT GLOSSARY TERMS**

TERM	DEFINITION	REFERENCE
Safety Evaluation	Shows how the system satisfies the safety design bases. A safety evaluation is performed only for those systems that have safety design bases. Safety evaluations form the basis for the Technical Specifications and establish why specific safety limitations are imposed.	
Safety limits	Limits upon important process variables which are found to be necessary to reasonably protect the integrity of certain of the physical barriers which guard against the uncontrolled release of radioactivity.	
Safety Related Safety System	See Section 17.2.2 for this definition Any system, group of systems, components, or groups of components the actions of which are essential to accomplishing a safety action.	
Scram	Refers to the automatic rapid insertion of control rods into the reactor core in response to the detection of undesirable conditions.	
Seiche	An oscillation of the surface of a lake or landlocked sea that varies in period from a few minutes to several hours and is thought to be initiated chiefly by local variations in atmospheric pressure aided in some instances by winds and tidal currents and that continues for a time after the inequalities of atmospheric pressure have disappeared.	
Seismic Category I	Plant features required to assure 1) the integrity of the reactor coolant pressure boundary, 2) the capability to shut down the reactor and maintain it in a safe shutdown condition, or 3) the capability to prevent or mitigate the consequences of accidents which could result in potential off-site exposures comparable to the guideline exposure of 10 CFR 50.67.	
	Plant features required to meet NRC GDC-1 of Appendix A to 10 CFR 50 and Appendix B of 10 CFR 50.	
	Plant features required to meet NRC GDC-2 of Appendix A to 10 CFR 50 and Proposed Appendix A to 10 CFR 100. Plant features designed to withstand effects of the Safe Shutdown Earthquake.	

**Table 1.8-1**

**SSES PROJECT GLOSSARY TERMS**

TERM	DEFINITION	REFERENCE
Seismic Category II (Non-Seismic Category I)	<p>Plant features not required to assure 1) the integrity of the reactor coolant pressure boundary, 2) the capability to shut down the reactor and maintain it in a safe shutdown condition, or 3) the capability to prevent or mitigate the consequences of accidents which could result in exposures comparable to the guidelines of exposures of 10 CFR 50.67.</p> <p>Plant features not required to meet NRC GDC-1 of Appendix A to 10 CFR 50 and Appendix B to 10 CFR 50.</p> <p>Plant features not required to meet NRC GDC-2 of Appendix A to 10 CFR 50 and proposed Appendix A to 10 CFR 100. Plant features not designed to withstand the effects of the Safe Shutdown Earthquake.</p>	
Senior Operator	Any individual designated by a facility licensee under 10 CFR 50 to direct the licensed activities of licensed operators.	
Sensor	That part of a channel used to detect variations in a measured variable.	
Service conditions	Environmental, power, and signal conditions expected as a result of normal operating requirements, expected extremes in operating requirements, and postulated conditions appropriate for the design basis events of the station.	
Short term	The time immediately following the incident during which automatic actions are performed, system responses are checked, type of incident is identified and preparations for long-term recovery operations are made. The short term is the first 24 hours following initiation of system operations after the incident.	
Shut Down	See Technical Specification Section 1.1.	
Shutdown Mode	See Technical Specification Section 1.1.	
Simulated Automatic Actuation	Simulated automatic actuation means applying a simulated signal to sensor to actuate the circuit in question.	

**Table 1.8-1**

**SSS PROJECT GLOSSARY TERMS**

TERM	DEFINITION	REFERENCE
Single failure	<p>a. An occurrence which results in the loss of capability of a component to perform its intended safety functions. Multiple failures resulting from a single occurrence are considered to be a single failure. Fluid and electrical systems are considered to be designed against and assumed single failure if neither (1) a single failure of any active component (assuming passive components function properly) nor (2) a single failure of any passive component (assuming active components function properly) results in a loss of the capability of the system to perform its safety functions.</p> <p>b. Single failures are spontaneous occurrences imposed upon safety systems that are required to respond to a design basis event. They are postulated in spite of the fact that they were designed to remain functional under the adverse condition imposed by the accident. No mechanism for the cause of the single failure need be postulated. Single failures of passive components in electrical systems should be assumed in designing against a single failure.</p>	
<p>Site Features</p> <p>Spring Loaded Piston Actuated Check Valve (SLPACK)</p>	<p>Those features that are important to safety by virtue of the physical setting of the Plant.</p> <p>Spring loaded piston actuated check valves operate as follows for the following modes:</p> <p><u>During Normal Flow:</u></p> <p>a. A spring loaded piston operator is held open by air pressure. Meanwhile, the valve is fully open by action of force due to flow alone.</p> <p><u>During Accidental Loss of Operator Air:</u></p> <p>b. The valve shall remain in the fully open position when the flow rate is equal to or greater than the normal flow rate indicated in the Valve Data Sheets. With a flow rate less than normal, the valve may be partially open due to the force of spring against force due to flow.</p> <p><u>Upon Reversal of Flow:</u></p> <p>c. Valve shall tightly shut as a normal check valve. In addition, the Control room operator will assist in starting valve closure by sending a remote signal to open a fail-open solenoid valve, releasing air pressure from the operator cylinder. All signal wiring will be furnished by others.</p>	
Standby power source	The power supply that is selected to furnish electrical energy when the preferred power supply is not available. It consists of an electrical generating unit and all necessary auxiliaries, usually a diesel generator set.	
Standby power system	Those on Site power sources and their distribution equipment provided to energize devices essential to safety and capable of operation independently of the preferred power system.	
Startup Mode	See Technical Specification Section 1.1.	
Startup testing	After fuel has been loaded into the reactor, testing is conducted under conditions similar to those for Hot Functional Testing with the reactor subcritical to complete those tests which could not be completed during the initial hot functional testing and those which must be done with the core in position.	

**Table 1.8-1**

**SSS PROJECT GLOSSARY TERMS**

TERM	DEFINITION	REFERENCE
Suppression Pool	A pool of water, located in the lower section of the Containment. During relief-valve discharge and postulated LOCA's, it serves as a heat sink and a pressure-suppression water pool comparable to the pool in the torus or suppression chamber of earlier BWR plants.	
Surveillance Frequency	See Technical Specification Section 1.4.	
Surveillance requirements	Requirements relating to test, calibration or inspection to assure that the necessary quality of systems and components is maintained, that facility operation will be within the safety limits and that the limiting conditions of operation will be met.	
Swing bus	A bus that is automatically transferred to one or the other of two redundant standby power sources.	
System Redundancy	System that duplicates an essential function of another system to the extent that either may perform a required function regardless of the state of operation or failure of the other.	
Technical Specifications (as used in the FSAR)	Encompass the nuclear safety operational requirements and limits to be used by plant operations and management personnel. They are prepared in accordance with the requirements of 10 CFR 50.36 and are incorporated by reference into the operating license issued by the U.S. Nuclear Regulatory Commission.	
Testing Conditions	Testing conditions are those tests in addition to the ten (10) hydrostatic or pneumatic tests permitted by ASME Section III, paragraphs NB-6222 and NB-6322 including leak tests or subsequent hydrostatic tests.	
Testable Check Valve	These valves are designed to normally function as a check valve, but in addition, they shall be provided with a manual test lever to prove operability during shutdown.	
Test Duration	The elapsed time between test initiation and test termination.	
Test Interval	The elapsed time between the initiation of identical tests.	
Thermal power	The total core heat transfer rate from the fuel and the coolant.	
Tornado criteria	The design parameters applicable to the design tornado, such as rotational and translational velocities, design pressure differential and associated time interval and the tornado-generated missile impact load with a statement of whether the imposed loads will be established simultaneously in establishing the tornado design.	
Transition Boiling	Transition boiling means the boiling regime between nucleate and film boiling. Transition boiling is the regime in which both nucleate and film boiling occur intermittently with neither type being completely stable.	
Trip	The change of state of a bistable device that represents the change from a normal condition. A trip signal, which results from a trip, is generated in the channels of a trip system and produces subsequent trips and trip signals throughout the system as directed by the logic.	
Trip System	That portion of a system encompassing one or more channels, logic and bistable devices used to produce signals to the actuation logic. A trip system terminates and loses its identity where outputs are combined in logic.	

**Table 1.8-1**

**SSS PROJECT GLOSSARY TERMS**

TERM	DEFINITION	REFERENCE
Type tests	Tests made on one or more units to verify adequacy of design.	
Ultimate Heat Sink	The spray pond and associated structures and components.	
Unrestricted area	Any area access to which is not controlled by the licensee for purposes of protection of individuals from exposure to radiation and radioactive materials and any area used for residential quarters.	
Upset Conditions (Incidents of Moderate Frequency)	Any deviations from Normal Conditions anticipated to occur often enough that design should include a capability to withstand the conditions without operational impairment. The Upset Conditions include those transients which result from any single operator error or control malfunction, transients caused by a fault in a system component requiring its isolation from the system and transients due to loss of load or power. Upset Conditions include any abnormal incidents not resulting in a forced outage and also forced outages for which the corrective action does not include any repair of mechanical damage. The estimated duration of an Upset Condition shall be included in the Design Specifications.	



SSES-FSAR

Table Rev. 55

<b>Table 1.8-2</b>	
ACRONYMS	
NAME	ABBREVIATION
Alternate Rod Injection	ARI
American Concrete Institute	ACI
American Institute of Steel Construction, Inc.	AISC
American National Standards Institute	ANSI
American Society of Civil Engineers	ASCE
American Society of Mechanical Engineers	ASME
American Society of Mechanic Engineers Boiler and Pressure Vessel Code	ASME B&PV Code
American Society for Testing and Materials	ASTM
Anticipated Transient Without Scram	ATWS
Anticipated Transient Without Scram Recirculation Pump Trip	ATWS RPT
American Welding Society	AWS
American Petroleum Institute	API
American Water Works Association	AWWA
Area Radiation Monitor	ARM
Areva NP, Inc.	AREVA
As Low As Reasonably Achievable (radiation dose)	ALARA
Automatic Depressurization	ADS
Average Power Range Monitor	APRM
Balance of Plant	BOP
Bechtel Power Corporation (San Francisco)	Bechtel
Beginning of Core Life	BOL
Boiling Water Reactor	BWR
Boron Injection Initiation Temperature	BIIT
Closed Cooling Water	CCW
Control Rod Drive	CRD
Control Rod Position Indicator	CRPI
Core Spray	CS
Critical Power Ratio	CPR
Departure from Nucleate Boiling	DNB
Design Assessment Report	DAR
Design Basis Accident	DBA
Diesel Engine Generator	DG
Drawing	Dwg.
Dye Penetrant Test/Liquid Penetrant Test	PT
East	E
Electrohydraulic Control	EHC
Emergency Core Cooling System	ECCS
End of Core Life	EOL
End of Cycle	EOC
Engineered Safety Features	ESF
Engineering Change Authorization	ECA
Engineering Change Notice	ECN

SSES-FSAR

Table Rev. 55

<b>Table 1.8-2</b>	
ACRONYMS	
NAME	ABBREVIATION
Environmental Protection Plan	EPP
Environmental Report – Operating License Stage	ER-OL
Equivalent Full Power Years	EFPY
Excess Flow Check Valve	EFCV
Extended Load Line Limit Analysis	ELLA
Feedwater Controller Failure	FWCF
Field Deviation Disposition Request	FDDR
Final Environmental Statement	FES
Final Safety Analysis Report	FSAR
Framatome ANP, Inc.	FANP or FRA-ANP
Fuel Pool Cooling and Cleanup	FPCC
Fuel Handling Accident	FHA
Full Arc (Mode of TCV Operation)	FA
Full-Length Emergency Cooling Heat Transfer	FLECHT
Functional Control Diagram	FCD
General Electric Company	GE
Heat Exchanger	HX
Heating and Ventilating	H&V
Heating Ventilating and Air-Conditioning	HVAC
High Efficiency Particulate Air-Filter	HEPA
High Energy Line Break	HELB
High Pressure Coolant Injection	HPCI
Hydraulic Control Unit	HCU
Increased Core Flow	ICF
Instrument Data Sheet	IDS
Institute of Electrical and Electronics Engineers	IEEE
Instrument Society of America	ISA
Insulated Power Cable Engineers Association	IPCEA
Interim Acceptance Criteria (NRC)	IAC
Intermediate Range Monitor	IRM
Leakage Control System	LCS
Leak Detection System	LDS
Limiting Condition of Operation	LCO
Limiting Safety System Setting	LSSS
Liner Heat Generation Rate	LHGR
Local Power Range Monitor	LPRM
Loss-Of-Coolant Accident	LOCA
Loss of Offsite Power	LOOP
Low Pressure Coolant Injection	LPCI
Low Population Zone	LPZ
Magnetic Particle Test	MT
Main Steam Isolation Valve	MSIV

SSES-FSAR

Table Rev. 55

<b>Table 1.8-2</b>	
ACRONYMS	
NAME	ABBREVIATION
Main Steam Isolation Valve Leakage Control System	MSIV-LCS
Main Steam Line	MSL
Main Steam Line Break (Accident)	MSLB or MSLBA
Manufacturers Standardization Society	MSS
Maximum Average Planar Linear Heat Generation Rate	MAPLHGR
Mean Low Water Datum	MLD
Mean Sea Level	MSL
Minimum Critical Heat Flux Ratio	MCHFR
Minimum Critical Power Ratio	MCPR
Moderate Energy Line Break	MELB
Motor Control Center	MCC
Motor-Generator Set	MG
National Electrical Manufacturers Association	NEMA
Neutron-Monitoring System	NMS
Nil Ductility Transition Temperature	NDTT
Nondestructive Examination	NDE
Nondestructive Testing	NDT
North	N
Nuclear Boiler	NB
Nuclear Boiler Rated (power)	NBR
Nuclear Energy Division (GE)	GED
Nuclear Measurement Analysis and Control	NUMAC
Nuclear Regulatory Commission	NRC
Nuclear Safety Operational Analysis	NSOA
Nuclear Steam Supply Shutoff System	NSSSS
Nuclear Steam Supply System	NSSS
Operating Basis Earthquake	OBE
Operating Limit Minimum Critical Power Ratio	OLMCPR
Operator Display Assembly	ODA
Oscillation Power Range Monitor	OPRM
Peak Cladding Temperature	PCT
Pennsylvania Power and Light co.	PP&L
Piping and Instrumentation Diagram	P&ID
Plant Vent Stack	PVS
Power Range Neutron Monitor	PRNM
Preconditioning Cladding Interim Operating Management Recommendation	PCIOMR
Preliminary Safety Analysis Report	PSAR
Primary Containment and Reactor Vessel Isolation Control System	PCRVICES
Probable Maximum Flood	PMF
Process Computer System	PCS
Public Address System	PA
Quality Assurance	QA

SSES-FSAR

Table Rev. 55

<b>Table 1.8-2</b>	
ACRONYMS	
NAME	ABBREVIATION
Quality Control	QC
Radiographic Test	RT
Reactor Coolant Pressure Boundary	RCPB
Reactor Core Isolation Cooling	RCIC
Reactor Manual Control	RMC
Reactor Pressure Vessel	RPV
Reactor Protection System	RPS
Reactor System Outline	RSO
Reactor Water Cleanup	RWCU
Recirculation Flow Controller Failure	RFCF
Regulatory Guide (NRC) (formerly Safety Guide)	RG
Residual Heat Removal	RHR
Rod Block Monitor	RBM
Rod Sequence Control System	RSCS
Rod Position Information System	RPIS
Rod Withdrawal Error	RWE
Rod Worth Minimizer	RWM
Safe Shutdown	SS
Safe Shutdown Earthquake	SSE
Safety Analysis Report	SAR
Siemens Westinghouse Power Corporation	SWPC
Single-Loop Operation	SLO
Safety/Relief Valve	SRV
Safety Limit Minimum Critical Power Ratio	SLMCPR
Seismic Category I or II	SC I or II
Service Water	SW
Source Range Monitor	SRM
South	S
Standby Gas Treatment System	SGTS
Standby Liquid Control	SLC
Station Black Out	SBO
Traversing Incore Probe	TIP
Turbine Control Valve	TCV
Turbine-Generator	TG
Turbine Trip Without Bypass	TTWOB
Ultimate Heat Sink (Spray Pond)	UHS
Ultrasonic Testing	UT
Valves Wide Open	VWO
West	W

## TECHNICAL ABBREVIATIONS

Word	Abbreviation
absolute	abs
absolute ampere	abamp
actual cubic feet per minute	acfm
alternating current	ac
altitude	alt
ampere(s)	A
ampere-hour(s)	A-hr
ampere per square centimeter	A/cm <sup>2</sup>
angstroms	Å
antilogarithm	log <sup>-1</sup> , antilog
approximately	≈ or approx
asymmetrical	asym
atmosphere	atm
atomic mass unit	amu
atomic number	at. no.
atomic percent	at. %
atomic weight	at. wt.
atomic weight unit	awu
audio-frequency	af
average	avg
bar(s)	bar
barns	b
barrel(s)	bbl
Baume	Be
billion electron volts	BeV
biot(s)	Bi
body centered cubic	bcc
boiling point	bp
brake horsepower	bhp
Brinell hardness number	Bhn
British thermal unit	Btu
calculated	calc
calorie(s)	cal
candela(s)	cd
candlepower	cp
Celsius (centigrade)	°C
cent(s)	c
centigran	cq
centimeter(s)	cm
centimeter-gram-second	cgs

## TECHNICAL ABBREVIATIONS

Word	Abbreviation
centimeters per second	cm/sec
centipoise	cp
chemically pure	cp
coefficient	coef
cologarithm	colog
concentrated	conc
constant	const
cosecant	csc
cosine	cos
contangent	cot
coulomb(s)	C
counts per minute	cpm
cubic	cu
cubic centimeter(s)	cc or cm <sup>3</sup>
cubic feet per minute	cfm
cubic feet per second	cfs
cubic foot (feet)	cu ft or ft <sup>3</sup>
cubic inches	cu in. or in. <sup>3</sup>
cubic meter	m <sup>3</sup>
cubic micron(3)	cu, or u <sup>3</sup>
cubic millimeter(s)	cu mm, or mm <sup>3</sup>
cubic yard	cu yd or yd <sup>3</sup>
Curies	Ci
curies per minute	Ci/min
curies per second	Ci/sec
cycles per second	c/s
(hertz electronics)	(hz)
cylinder	cyl
day	day
debye(s)	D
decibel(s)	dB
degree(s)	deg or °
degree Baume	°B
degree Celsius (centigrade)	°C
degree Fahrenheit	°F
degree Kelvin (absolute)	°K
decimeter(s)	dm
departure from nucleate boiling	DNB
diameter	diam
diamond pyramid hardness	DPH

## TECHNICAL ABBREVIATIONS

Word	Abbreviation
direct current	dc
disintegration(s)	dis
disintegrations per minute	dpm
disintegrations per second	dps
dollar(s)	\$(eq, \$15)
dyne(s)	dyn
electromagnetic force	emf
electromagnetic unit	emu
electron volt(s)	eV
electrostatic units	esu
entropy units	eu
equation(s)	Eq, Eqs
equivalent	equiv
erg(s)	erg
exponential	exp
exponential integral	Ei
Fahrenheit	°F
farad(s)	F
feet (foot)	ft
feet per minute	fpm
feet per second	fps
fermi (=10 <sup>-13</sup> cm)	F
figure	Fig.
foot-candle	ft-c
foot-lambert	ft-L
foot-pound	ft-lb
franklin(s)	Fr
frequency modulation	FM
gallon(s)	gal
gallons per minute	gpm
gallons per second	gps
gallons per hour	gph
gauss	G
gilbert (s)	Gi
gram (s)	g
gram-calorie	g-cal
gram-molecular volume	gmV
grams per liter	g/liter
henry (-ies)	H
hertz (cycle per second)	Hz

## TECHNICAL ABBREVIATIONS

Word	Abbreviation
high frequency	hf
high voltage	hv
horsepower	hp
hours(s)	hr
hydrogen ion concentration, negative logarithm of	pH
hyperbolic cosecant	csch
hyperbolic cosine	cosh
hyperbolic cotangent	coth
hyperbolic sine	sinh
inch(es)	in.
inches of mercury	in. Hg
inches of water	in. H <sub>2</sub> O
inch-pound	in.-lb
inside diameter	ID
integrated neutron flux	nvt
intermediate frequency	i.f.
international angstrom	IA
joule(s)	J
kelvin	°K
kilocalorie (s)	kcal
kilocurie	kCi
kilocycle	kc
kilocycles per second	kc/sec
kiloelectron volt(s)	keV
kilogauss	kG
kilogram (s)	kg
kilogram meter	kg-m
kilogram-weight	kg-wt
kilohm (s)	K
kilojoule (s)	kJ
kiloliter (s)	kl
kilometer (s)	km
kilo-oersted	kDe
kilovolt (s)	kV
kilovolt-ampere (s)	kVa
kilowatt (s)	kW
kilowatt-hour (s)	kWh
kinetic energy	KE or T
Knopp Hardness Number (microhardness)	KHN



## TECHNICAL ABBREVIATIONS

Word	Abbreviation
laboratory	lab
lambert	L
limit	lim
liter(s)	liters or l
logarithm (common)	log
logarithm (natural)	ln or loq
lumen	lm
lumens per watt	lm/W
lux	lx
magnetomotive force	mef
magnified 50 times	50X
maximum	max
maxwell (s)	Mx
megacycle(s)	Mc
megacycles per second	Mcps
megacycles per second (electronics)	MHz
megacycles per second (mechanics)	Mcps
megavolts	MV
megawatts	MW
megawatt-day (s)	MWd
megawatt-electric	MW(e)
megawatt-hour(s)	MWh
megawatt-second (s)	MWs
megawatt-year(s)	MWy
megawatt-thermal	MW(t)
megohm(s)	M
melting point	mp
meter(s)	m
meter-kilogram second	mks
rho	rho.
microampere (s)	μA
microangstrom	μA
microbar	μbar
microbarn(s)	μb
microcoulomb(s)	μC
microcuries	μCi
microgram	μg
microfarad	μF
microhenry	μH
microinch	μin.

## TECHNICAL ABBREVIATIONS

Word	Abbreviation
micromicrons	$\mu\mu$
micromole	$\mu\text{M}$
micron(s)	
microsecond	$\mu\text{sec}$
microvolt(s)	$\mu\text{V}$
microwatt(s)	$\mu\text{W}$
mile	mi
miles per hour	mph
millicurie (s)	mCi
milligauss	mG
milligram	mg
milligrams per decimeter per day	add
millihenry	mH
milliliter(s)	ml
milli-mass-unit	msu
millimeter	mm
millimicron(s)	m
millimole(s)	mM
million electron volts	MeV
million volts	MV
milliroentgen per hour	mR/hr
millisecond(s)	msec
millivolt(s)	mV
minimum	min
minute(s)	min
molal	molal
molar	M
mole	mole
mole percent	mole %
molecular weight	mol. wt
month	mo
nanocuries	nCi
nanosecond(s)	nsec
neper(s)	Np
net positive suction head	NPSH
neutron flux	nv
neutrons per volume time	nvt
neutrons per square centimeter per second	$\text{n/cm}^2\text{-sec}$
newton (s)	N

TECHNICAL ABBREVIATIONS

Word	Abbreviation
normal	N
nuclear magnetron	nm
number	No.
oersted	Oe
ohm(s)	ohm or
ounce(s)	oz
outside diameter	OD
page	P
pages	pp
parts per billion	ppb
parts per million	ppm
percent	%
percent milli-k	pcM
picofarad(s)	pF
poise	P
potential difference	PD
potential energy	PE or V
pound	lb
pounds per square inch	psi
pounds per square inch absolute	psia
pounds per square inch differential	psid
pounds per square inch gauge	psig
pressure (millimeter of mercury)	mm Hg
probable error	pe
radian	rad
rad	rad
Radiation Protection Guide	RPG
Radioactivity Concentration Guide	RCG
Rankins (degree)	°R
revolutions per minute	rpm
revolutions per second	rps
roentgen(s)	R
roentgen equivalent man	Rem
root mean square	rms
secant	sec
second(s)	sec
Section	Sec.
sine	sin
specific gravity	sp gr
square	sq

## TECHNICAL ABBREVIATIONS

Word	Abbreviation
square centimeters	cm <sup>2</sup>
square foot	ft <sup>2</sup>
square inch(es)	in. <sup>2</sup>
square kilometer(s)	km <sup>2</sup>
square meter(s)	m <sup>2</sup>
square micron(s)	μ <sup>2</sup>
square millimeter(s)	mm <sup>2</sup>
stainless steel	SS
standard	std
standard temperature and pressure	STP
steradian	sr
tangent	tan
temperature	temp
tensile yield strength	tys
tesla (Wb/m <sup>2</sup> )	T
thousand circular mills	kcmil
thousand electron volts	keV
trace	Tr
transpose	tr
ultimate tensile strength	uts
ultraviolet	uv
velocity	v
versus	vs
volt(s)	V
volume	vol
volume parts per million	vpm
water gage	wg
watt(s)	W
weber	Wb
weight	wt
weight percent	wt%
x units	xu
yard(s)	yd
year(s)	yr

## DRAWING ABBREVIATIONS

Abbreviation	Description
A	AMBER, AMMETER, AMPERE
AC	ALTERNATING CURRENT
ACB	AIR CIRCUIT BREAKER
AIR COND	AIR CONDITIONING UNIT
AL	ALARM OF ALUMINUM
AMP	AMPLIFIER OF AMPERE
ANALY	ANALYZER
ANNUN	ANNUNCIATOR
AD	AIR OPERATED
APPROX	APPROXIMATE
AR	ALARM RELAY
ARM	ARMATURE
ARP	ARRESTER OR ARRANGE
ASSY	ASSEMBLY
A/T	AMPERE TRANSDUCER
AUTO	AUTOMATIC
AUTO TRANS	AUTO TRANSFORMER
AUX	AUXILIARY
AVG	AVERAGING OR AVERAGE
AWG	AMERICAN WIRE GAUGE
BAR	BARRIER
BAT	BATTERY
BCT	BUSHING CURRENT TRANSFORMER
BD	BOARD
BDD	BACK DRAFT DAMPER
BIL	BASIC IMPULSE INSULATION LEVEL
BKR	BREAKER
BLDG	BUILDING
BLO	BLOWER
BLP	BOILER
B/M	BILL OF MATERIAL
BOD	BOTTOM OF DUCT
BOP	BOTTOM OF PIPE
BRG	BEARING
BSTR	BOOSTER
BYP	BYPASS
CAB	CABINET
CAP	CAPACITOR OR CAPACITY

---

 DRAWING ABBREVIATIONS

Abbreviation	Description
CAS	CASING
CAUS	CAUSTIC
CAV	CAVITY
CB	CONTROL BOARD
CC	CONTROL CABINET OR COOLING COIL
CE	CONDUCTIVITY CELL
CH	CONTROL HOUSE (SWITCHYARD)
CHEM	CHEMICAL
CHG	CHANGE OR CHARGER, CHARGING
CHLOP	CHLORINATOR OR CHLORINE
CHW	CHILLED WATER
CIRC	CIRCULATING
CKT	CIRCUIT
CL	CENTER LINE
CLR	COOLER
CND	CONDUIT
CNDS	CONDENSATE
COL	COLUMN
COMM	COMMUNICATION OR COMMON
COMP	COMPUTER, COMPONENT
CON	CONSOLE
COND	CONDENSER OR CONDUCTOR
CONT	CONTROL
CONTC	CONTRACTOR
CONTD	CONTINUED
COOL	COOLING
CR	CONTROL ROOM
CS	CONTROL SWITCH OR CONTROL STATION
CTR	CENTER
CUB	CUBICLE
CW	COOLING WATER, CIRCULATING WATER, OR CLOCKWISE
CENTRIF	CENTRIFUGAL
CONTAIN	CONTAINMENT
COMPR	COMPRESSOR
CCW	COMPONENT COOLING WATER
CNCT	CONCENTRATE
DB	DRY BULB
DC	DIRECT CURRENT
DEMIN	DEMINERALIZER

---

 DRAWING ABBREVIATIONS

Abbreviation	Description
DET	DETECTOR
DIAG	DIAGRAM
DIA	DIAMETER
DIFF	DIFFERENTIAL
DISC	DISCONNECT
DISCH	DISCHARGE
DIST	DISTRIBUTION
DP	DIFFERENTIAL PRESSURE OR DEW POINT
DR	DRIVE
DRN	DRAIN
DWG	DRAWING
E/P	ELECTRO TO PNEUMATIC TRANSDUCER
EL	ELEVATION
ELEC	ELECTRIC OR ELECTRICAL
EMER	EMERGENCY
EMT	ELECTRICAL METALLIC TUBING
ENG	ENGINE
ENT	ENTERING
EQUIP	EQUIPMENT
EXC	EXCITER OR EXCITATION
EXH	EXHAUST
EXHTR	EXHAUSTER
EXT	EXTRACTOR
EXTN	EXTRACTION
ENCL	ENCLOSURE
ESP	ENGINEERED SAFETY FEATURES
P	FLOW
FC	FAIL CLOSED
FD	FIRE DAMPER
FDR	FEEDER
FIG	FIGURE
FIL	FILTER
FL	FLAME
FLEX	FLEXIBLE
FLD	FIELD
FO	FAIL OPEN
F/T	FREQUENCY TRANSDUCER
FW	FEEDWATER

---

 DRAWING ABBREVIATIONS

Abbreviation	Description
PS	FLOW SWITCH
G	GREEN
GEN	GENERATOR
GOV	GOVERNOR
GR	GEAR
GRD	GROUND
GS	GLAND SEAL
GSS	GLAND SEAL STEAM
GNI	GUIDE
H	HYDROGEN
HEV	HEATING AND VENTILATION UNIT
HI	HIGH
HP	HIGH PRESSURE OR HORSEPOWER OR HIGH POINT
HSE	HOUSE
HT	HEAT TRACING
HTR	HEATER
HV	HIGH VOLTAGE
HWC	HOT WATER CIRCULATION
HYD	HYDRAULIC
HYDZ	HYDRAZINE
HTG	HEATING
HVAC	HEATING, VENTILATING & AIR CONDITIONING
IN	INLET, INPUT, OR INTAKE
INC	INCOMING
IND	INDICATOR
INST	INSTRUMENT
INV	INVERTER
IP	INTERMEDIATE PRESSURE
ISO	ISOLATION OR ISOLATED
ITL	INTERLOCK
JB	JUNCTION BOX
KCHIL	THOUSAND CIRCULAR MILLS
KVA	KILOVOLT-AMPERE
KV	KILOVOLT
KW	KILOWATT



## DRAWING ABBREVIATIONS

Abbreviation	Description
L	LEFT OR LEVEL
LA	LIGHTNING ARRESTER
LAB	LABORATORY
LAL	LEVEL ALARM, LOW
LC	LOAD CENTER
LCS	LOCAL CONTROL STATION
LIM	LIMIT
LIQ	LIQUID
LO	LUBRICATION OIL, LOW, OR LOCKOUT
LP	LOW PRESSURE
LS	LEVEL SWITCH OR LIMIT SWITCH
LTG	LIGHTING
LVG	LEAVING
M	MAIN
MACH	MACHINE
MAN	MANUAL
MISC	MISCELLANEOUS
MCC	MOTOR CONTROL CENTER
MECH	MECHANIC OR MECHANICAL
MFR	MANUFACTURE OR MANUFACTURER
MG OR M-G	MOTOR-GENERATOR
MH	MAN HOLE
MISC	MISCELLANEOUS
MO	MOTOR OPERATED
MOV	MOTOR OPERATED VANE OR VALVE
MS	MAIN STEAM
MT	MAIN TRANSFORMER
MTR	MOTOR OR METER
NC	NORMALLY CLOSED
NEC	NATIONAL ELECTRICAL CODE
NESF	NON-ENGINEERED SAFETY FEATURES
NEUT	NEUTRAL
NO	NUMBER OR NORMALLY OPEN
NORM	NORMAL
NP	NAMP PLATE
NEG	NEGATIVE
NPS	NEGATIVE PHASE SEQUENCE

---

**DRAWING ABBREVIATIONS**

Abbreviation	Description
O	OXYGEN
OC	OVERCURRENT
OCB	OIL CIRCUIT BREAKER
OL	OVERLOAD
OUT	OUTLET OR OUTPUT
P	PRESSURE
PAL	PRESSURE ALARM LOW
PB	PULL BOX OR PUSHBUTTON
PH	PHASE
PMG	PERMANENT MAGNET GENERATOR
PNL	PANEL
PO	POSITION OR POSITIONER
POS	POSITION SWITCH OR POSITIVE
PP	PUMP
PRESS	PRESSURE
PS	PRESSURE SWITCH
PT	POTENTIAL TRANSFORMER OR PRESSURE TRANSMITTER
PWF	POWER
POT	POTENTIAL
PW	PILOT WIRE
R	RIGHT OR RED
RAD	RADIATION
RE	ROOF EXHAUSTER OR RADIATION ELEMENT
REACT	REACTOR
REC	RECEIVER
RECIRC	RECIRCULATION OR RECIRCULATING
RECP	RECEPTACLE
RECT	RECTIFIER
REG	REGULATOR
REF	REFERENCE
RH	REHEAT OR RELATIVE HUMIDITY
RHEO	RHEOSTAT
RHTR	REHEATER
RIY	RELAY
RM	ROOM
RR	RAILROAD
RS	REVERSING STARTER

---

**DRAWING ABBREVIATIONS**

Abbreviation	Description
RTD	RESISTANCE TEMPERATURE DETECTOR
RECIP	RECIPROCATOR OR RECIPROCATING
RHR	RESIDUAL HEAT REMOVAL
SAMP	SAMPLING
SCAV	SCAVENGING
SCHFM	SCHEMATIC
SCRN	SCREEN
SD	STEAM LOAD DRAIN OR DUMP VALVE
SEC	SECONDARY
SECT	SECTION
SEL	SELECTOR
SEP	SEPARATOR
SERV	SERVICE
SEW	SEWAGE
SPT	SHAFT
SH	SUPERHEATER
SHLD	SHIELD
SI	SEAL IN RELAY OR CONTACT
SIG	SIGNAL
SL	SEAL
SO	SEAL OIL
SP	SPEED OR SPARE
STM	STEAM
STA	STATION
STRY	STANDBY
STD	STANDARD
STG	STORAGE
STR	STARTER
STUP	STARTUP
SUBSTA	SUBSTATION
SUCT	SUCTION
SUPHTR	SUPERHEATER
SUPT	SUPPORT
SV	SOLENOID VALVE
SW	SWITCH OR SERVICE WATER
SWBD	SWITCHBOARD
SWGFP	SWITCHGEAR
SYN	SYNCHRONOUS, SYNCHRONIZING OR SYNCHRONISM
SWYD	SWITCHYARD (ie, SWITCHING STATION)

## DRAWING ABBREVIATIONS

Abbreviation	Description
SYS	SYSTEM
SS	STARTUP SOURCES
SHED	SHEDDING
T	TEMPERATURE, TRANSUCER OR TRANSMITTER
TAL	TEMPERATURE ALARM
TACH	TACHOMETER
TB	TERMINAL BOX
TC	THERMOCOUPLE OR TRIP COIL
TD	TIME DELAY
TDC	TIME DELAY (TIME DELAY TO CLOSE)
TDD	TIME DELAY (ON DEENERGIZING)
TDE	TIME DELAY (ON ENERGIZING)
TDO	TIME DELAY (TIME DELAY TO OPEN)
TE	THERMAL ELEMENT
TEL	TELEPHONE
TEMP	TEMPERATURE OR TEMPORARY
TERM	TERMINAL
THERMO	THERMOSTAT
THROT	THROTTLE
TG OP T-G	TURNING GEAR OR TURBINE-GENERATOR
TK	TANK
TOS	TORQUE SWITCH
TRAV	TRAVELING
TRANS	TRANSFER OR TRANSFORMER
TS	TEMPERATURE SWITCH OR TEST SWITCH
TURB	TURBINE
TYP	TYPICAL
TV	TELEVISION (RECEIVER)
TVC	TELEVISION CAMERA (TRANSMITTER)
UP	UPSTREAM OR UPPER
UV	UNDERVOLTAGE
UF	UNDERFREQUENCY
V	VOLT, VOLTAGE, VOLTMETER OR VALVE
VAC	VACUUM
VAP	VAPOR
VB	VIBROMETER
VENT	VENTILATION

SSES-PSAR

TABLE 1.8-5

Sheet 9 of 9

---

DRAWING ABBREVIATIONS

Abbreviation	Description
VERT	VERTICAL
V/T	VOLT TRANSDUCER
W	WEST, WHITE, OR WATTMETER
WB	WET BULB
WHSE	WAREHOUSE
WP	WEATHERPROOF
W/T	WATT TRANSDUCER
WTR	WATER

---

## TABLE 1.8-6

Sheet 1 of 2

## PIPING AND VALVE CLASS IDENTIFICATION

Pipe and valve classes are designated by a three-letter code. The first letter indicates the primary valve and flange pressure rating; the second letter, the type of material; and the third letter, the code to which the piping is designed.

## FIRST LETTER - PRIMARY PRESSURE RATING

Unless otherwise noted, all ratings are in accordance with ANSI B16.5 (NOTE 7)

- A - Specific pressure @ specific temperature
- B - 2500#
- C - 1500#
- D - 900#
- E - 600#
- F - 400#
- G - 300#
- H - 150#
- J - 125# ANSI B16.1
- K - 175# WOG Underwriters' Laboratories, Inc.
- L - 250# ANSI B16.1
- X - Gravity rating
- Y - General use as designated on piping class sheets.

Additional pressure ratings for valves:

- M - 200# (manufacturer's rating)
- N - 150# WOG
- P - 100# (manufacturer's rating)
- R - 75# (manufacturer's rating)
- S - 50# WOG
- T - 25# AWWA (or manufacturer's rating)
- Z - General use as designated on piping class sheets.

## SECOND LETTER - MATERIAL

- A - Alloy Steel
- B - Carbon Steel
- C - Austenitic Stainless Steel
- D - Copper, Brass or Bronze
- E - Copper-Nickel
- F - Carbon Steel - Copper Bearing
- G - Carbon Steel - Lined
- H - Cast Iron

SSES-PSAR

TABLE 1.8-6

Sheet 2 of 2

- J - Concrete
- K - Vitrified Clay
- L - Carbon Steel - Impact Tested
- M - Cast Iron - High Silicon
- N - Carbon Steel - Galvanized
- P - Cast Iron - Cement Lined
- Q - Asbestos-Cement
- R - Carbon Steel-(RHR, Service Water & ES Water Systems)

THIRD LETTER - APPLICABLE CODES

- A - Nuclear Power Plant Components, ASME B&PV Code, Sect. III, Class 1
- B - Nuclear Power Plant Components, ASME B&PV Code, Sect. III, Class 2
- C - Nuclear Power Plant Components, ASME B&PV Code, Sect. III, Class 3
- D - Power Piping Code, ANSI B31.1.0
- F - National Fire Protection Association Code
- G - Uniform Plumbing Code
- H - Power Boilers, ASME B&PV Code, Sect. I
- J - American Water Works Standards

MEASURED VARIABLE (FIRST LETTER)	CONTROLLING (SECOND AND THIRD LETTER)										MEASURING (SECOND AND THIRD LETTER)										SEE NOTE 3
	RECORDING	INDICATING	NON-INDICATING	CONTROL VALVE	SUMMER	FUNCTION GENERATOR	REORDERER	INDICATOR	OBSERVATION GLASS	PRIMARY ELEMENT	TEST POINT	TRANSMITTER OR PREAMP	INTEGRATOR	AMPLIFIER	SAMPLER	INDICATING SWITCH	NON-INDICATING SWITCH	ALARMS	TRANSDUCER NON-INDICATING	TRANSDUCER INDICATING	
AIR	A	-	-	-	-	-	R	-	-	-	-	-	-	-	-	-	-	-	-	-	
CONDUCTIVITY	C	CR	CC	CCV	-	-	CR	C1	CE	CA	CT	-	-	-	-	-	-	-	-	-	
DENSITY	D	DR	DC	DCV	-	-	DR	D1	-	-	DX	DT	-	-	-	-	-	-	-	-	
DIFF. PRESS.	DP	SPRC	SPIC	SPCV	-	-	SPR	SP1	-	-	SPX	SPD	-	-	-	-	-	-	-	-	
FLOW	F	FRC	FIC	FCV	-	-	FR	F1	FE	FA	FT	-	-	-	-	-	-	-	-	-	
HYDROGEN	H	-	-	-	-	-	H2	H1	H2E	-	-	-	-	-	-	-	-	-	-	-	
HYDROGEN ION CONC.	pH	pHRC	pHIC	pHCV	-	-	pHR	pH1	pHE	pHX	-	-	-	-	-	-	-	-	-	-	
LEVEL	L	LRC	LIC	LCV	-	-	LR	L1	LE	LT	-	-	-	-	-	-	-	-	-	-	
MOISTURE	M	MRC	MIC	-	-	-	MR	M1	ME	MT	-	-	-	-	-	-	-	-	-	-	
NEUTRON FLUX	N	NRC	NIC	-	-	-	NR	N1	NE	NX	NT	-	-	-	-	-	-	-	-	-	
OXYGEN	O	-	-	-	-	-	O2	O1	O2E	-	-	-	-	-	-	-	-	-	-	-	
PRESSURE	P	PRC	PIC	PCV	-	-	PR	P1	PE	PX	PT	-	-	-	-	-	-	-	-	-	
POSITION	PO	-	-	-	-	-	PR	P1	PE	PX	PT	-	-	-	-	-	-	-	-	-	
RADIATION	R	-	-	-	-	-	RR	R1	RE	RX	-	-	-	-	-	-	-	-	-	-	
SPEED	S	SRC	SIC	SCV	-	-	SR	S1	SE	-	-	-	-	-	-	-	-	-	-	-	
TEMPERATURE	T	TRC	TIC	TCV	-	-	TR	T1	TE	TX	TT	-	-	-	-	-	-	-	-	-	
TIME	I	-	-	-	-	-	II	-	-	-	-	-	-	-	-	-	-	-	-	-	
TURBIDITY	TB	-	-	-	-	-	TBR	-	-	-	-	-	-	-	-	-	-	-	-	-	
VIBRATION	Vs	-	-	-	-	-	VBR	-	-	-	-	-	-	-	-	-	-	-	-	-	
WEIGHT FACTOR	WF	WRC	WIC	-	-	-	-	-	-	-	-	-	-	-	-	-	-	-	-	-	

MISCELLANEOUS ABBREVIATIONS:

- ADS AUTOMATIC DEPRESSURIZATION
- AS AIR SUPPLY
- AW ACID WASTE (CORROSIVE/CAUSTIC)
- CIT CONDUCTIVITY INDICATOR OR TRANSMITTER
- CRD CONTROL ROD DRIVE
- CRDHS CONTROL ROD DRIVE HYDRAULIC SYSTEM
- CRS CONDUCTIVITY RECORDING SWITCH
- CRW CLEAN RADWASTE
- CT CYCLE TIMER
- DRW DIRTY RADWASTE
- DT DIFFERENTIAL TEMPERATURE SWITCH
- ASm CONVERTER (VOLTAGE / PNEUMATIC)
- CIS SPECIAL ELECTRIC POWER SUPPLY REQUIRED
- EVD FILTER DEMINERALIZER
- FC INDICATES CLOSURE ON AIR OR ELECTRICAL FAILURE
- FI FLOW INDICATOR TRANSMITTER
- FO INDICATES OPENS ON AIR OR ELECTRICAL FAILURE
- FRCS FLOW RECORDING CONTROLLER SWITCH
- HCU HYDRAULIC CONTROL UNIT
- HE HEAT EXCHANGER
- IP CONVERTER (CURRENT/PNEUMATIC)
- LC LOCK CLOSED
- LD/RS LEVEL & DENSITY RECORDER SYSTEM
- LIM SW LIMIT SWITCH
- LIRS LEVEL INDICATOR RECORDING SYSTEM
- LO LOCK OPEN
- LRS LEVEL RECORDING SWITCH
- MSV MAIN STEAM ISOLATION VALVE
- MV (I) MILLIVOLT TO CURRENT SYSTEM
- NC NORMALLY CLOSED
- ND NORMALLY DE-ENERGIZED
- NE NORMALLY ENERGIZED
- NO NORMALLY OPEN
- NSSS NUCLEAR STEAM SUPPLY SYSTEM
- NW NORMAL WASTE (CONVENTIONAL)

MISCELLANEOUS ABBREVIATIONS:

- RBCW REACTOR BUILDING CLOSED COOLING WATER
- RBEDT REACTOR BUILDING EQUIPMENT DRAIN TANK
- RM REMOTE MANUAL
- RMC REMOTE MANUAL CONTROL
- RMS REMOTE MANUAL SYSTEM
- RPS REACTOR PROTECTION SYSTEM
- RPV REACTOR PRESSURE VESSEL
- SS SELECTOR SWITCH
- SSa SELECTIVE SWITCH AUTOMATIC
- SQR SQUARE ROOT CONVERTOR
- SR TURBINE BUILDING CLOSED COOLING WATER
- TBCW TURBIDITY RECORDER SWITCH
- TBR TURBIDITY RECORDER SWITCH
- TD TIME DELAY SWITCH
- TOS TORQUE OVERLOAD SWITCH
- TORS TORQUE RECORDER SWITCH
- TOT TORQUE TRANSMITTER
- TRS TEMPERATURE RECORDER SWITCH

NOTES:

- ALL SOLENOID VALVES SHOWN IN DE-ENERGIZED POSITION
- "NE" - DENOTES SOLENOID IS NORMALLY ENERGIZED DURING PLANT OPERATION
- FOR THE TYPE OF TRANSDUCER (SWITCH OR TRANSMITTER) REFER TO THE PARTICULAR SYSTEM MASTER PARTS LIST

FAI FAIL AS IS  
MS HAND SWITCH } SEE NOTE 2

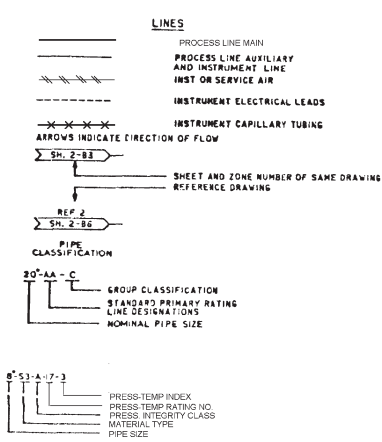
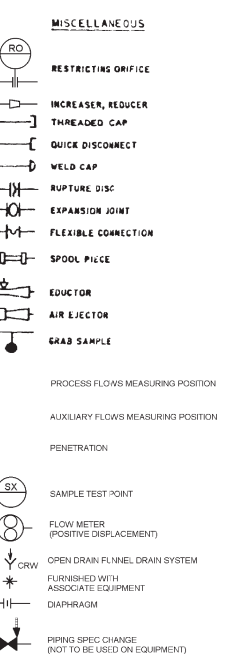
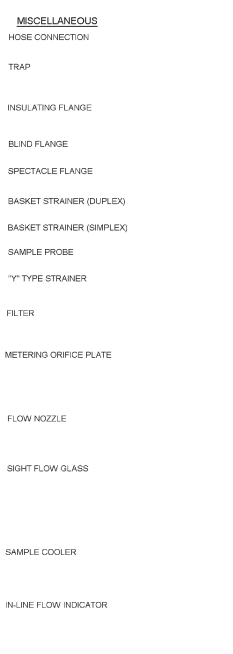
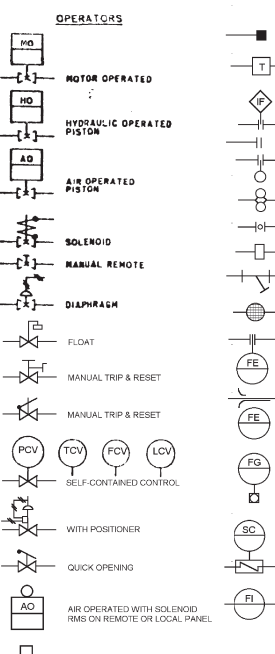
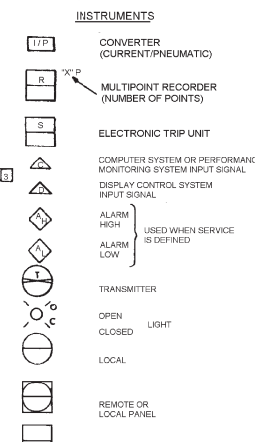
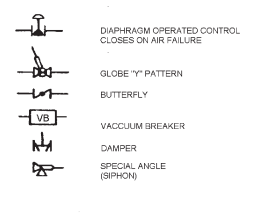
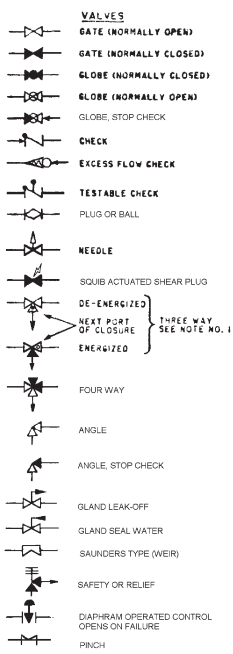

FSAR REV. 65

SUSQUEHANNA STEAM ELECTRIC STATION  
UNITS 1 & 2  
FINAL SAFETY ANALYSIS REPORT

PIPING AND INSTRUMENT  
SYMBOLS

FIGURE 1.8-1, Rev 54

AutoCAD: Figure Fsar 1\_8\_1.dwg



THIS FIGURE HAS BEEN  
REPLACED BY DWG.  
M-100, Sh. 1

FSAR REV. 65

SUSQUEHANNA STEAM ELECTRIC STATION  
UNITS 1 & 2  
FINAL SAFETY ANALYSIS REPORT

Figure 1.8-2A replaced by dwg.  
M-100, Sh. 1

FIGURE 1.8-2A, Rev. 55

AutoCAD Figure 1\_8\_2A.doc

THIS FIGURE HAS BEEN  
REPLACED BY DWG.  
M-100, Sh. 2

FSAR REV. 65

SUSQUEHANNA STEAM ELECTRIC STATION  
UNITS 1 & 2  
FINAL SAFETY ANALYSIS REPORT

Figure 1.8-2B replaced by dwg.  
M-100, Sh. 2

FIGURE 1.8-2B, Rev. 56

AutoCAD Figure 1\_8\_2B.doc

THIS FIGURE HAS BEEN  
REPLACED BY DWG.  
M-100, Sh. 3

FSAR REV. 65

SUSQUEHANNA STEAM ELECTRIC STATION  
UNITS 1 & 2  
FINAL SAFETY ANALYSIS REPORT

Figure 1.8-2C replaced by dwg.  
M-100, Sh. 3

FIGURE 1.8-2C, Rev. 48

AutoCAD Figure 1\_8\_2C.doc

THIS FIGURE HAS BEEN  
REPLACED BY DWG.  
M-100, Sh. 4

FSAR REV. 65

SUSQUEHANNA STEAM ELECTRIC STATION UNITS 1 & 2 FINAL SAFETY ANALYSIS REPORT
Figure 1.8-2D replaced by dwg. M-100, Sh. 4
FIGURE 1.8-2D, Rev. 55

AutoCAD Figure 1\_8\_2D.doc

ELECTRICAL POWER IS AVAILABLE BUT THE INPUT IS NORMALLY NOT SHOWN EXCEPT IN CASES SUCH AS AUXILIARY POWER, BATTERY POWER, STANDBY POWER OR POWER FROM COMMAND SWITCHES "UPSTREAM" OF THIS BLOCK.

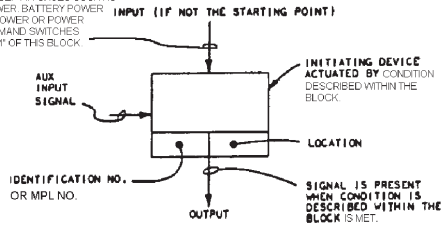

**COMMAND BLOCK**  
THIS BLOCK CAN REPRESENT A SWITCH, VALVE, PROBE, TIMER, OR TRIP CIRCUIT. IT IS NORMALLY THE STARTING POINT OF A FUNCTIONAL SEQUENCE WITH AN OUTPUT ONLY, BUT CAN HAVE INPUT AND AUX. INPUT DEPENDING ON THE TYPE OF DEVICE. THE SAME DEVICE MAY HAVE A NUMBER OF OUTPUTS, BUT EACH FUNCTIONAL SEQUENCE INITIATED SHALL BE SHOWN BY AN INDIVIDUAL BLOCK SHOWING THE SAME IDENTIFICATION NUMBER & CROSS REF.

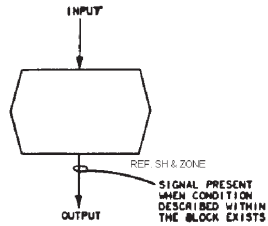

**PERMISSIVE CONDITION BLOCK**  
WHERE THE PERMISSIVE IS A GENERAL CONDITION AND NOT IDENTIFIED WITH A SINGLE DEVICE THE OUTPUTS ENCLOSURE ONLY IS SHOWN

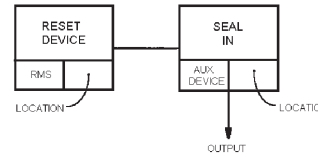

**SEAL-IN BLOCK**  
A SEAL-IN OR LATCHING BLOCK'S FUNCTION IS TO MAINTAIN AN INPUT SIGNAL TO A DEVICE ONCE THE DEVICE HAS BEEN ACTUATED. RESETTING OR INHIBITING A SEAL-IN MAY BE EITHER EXPRESSED OR IMPLIED. IF IMPLIED, THE SEAL-IN WILL BE RESET OR INHIBITED BY INTERRUPTING THE SIGNAL TO THE DEVICE DOWNSTREAM FROM THE POINT WHERE SEAL-IN IS INDICATED. A SEAL-IN SHOWN WITHOUT A RESET DEVICE IMPLIES THAT THE RESET DEVICE IS PART OF, AND LOCATED ON THE NEAREST VALVE OR CONTACTOR. IN ALL OTHER CASES THE RESET DEVICE SHALL BE SHOWN IN CONJUNCTION WITH THE SEAL-IN.

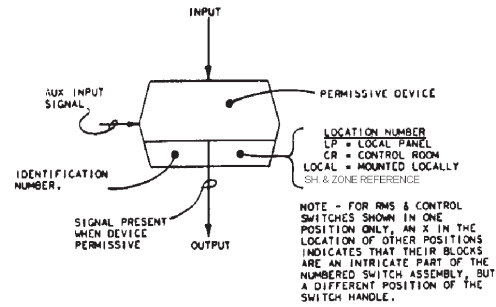

**PERMISSIVE DEVICE BLOCK**  
THIS BLOCK DEFINES A PERMISSIVE FUNCTION WHICH MUST BE SATISFIED TO PERMIT THE SIGNAL FLOW TO PASS TO THE NEXT BLOCK. THIS BLOCK HAS INCOMING, OUTGOING AND MAY HAVE AUXILIARY SIGNALS. THE OUTPUT FROM THIS PERMISSIVE MAY BE SEALED IN.

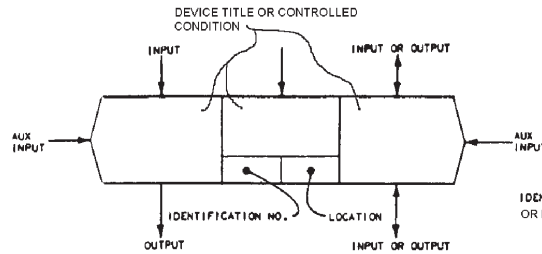

**PERMISSIVE OPERATED BY OTHER DEVICES BLOCK**  
THIS BLOCK IS A PERMISSIVE OPERATED BY DEVICES SUCH AS VALVE OR PUMP SWITCHGEAR DESIGNATED IN THE INNER BLOCK. THIS COND. OR DEVICE EFFECTS THE OPERATION OF THE FINAL DEVICE. IT HAS ELECT. INPUTS, MECH INPUTS, AUX INPUTS (MECH OR ELEC) AND MECH OR ELECT OUTPUTS. THIS DEVICE IS NORMALLY A VALVE. THIS IS ALSO USED FOR OTHER INPUT/OUTPUT POWER SOURCES SUCH AS AIR OR HYDRAULIC. A SOLENOID PILOT VALVE FOR AN AIR OPERATED VALVE IS AN EXAMPLE OF THIS TYPE DEVICE.

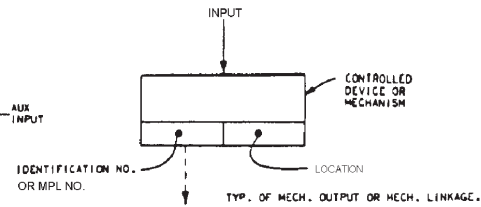

**FINAL DEVICE BLOCK**  
THIS BLOCK CAN BE A RELAY, VALVE, ELECTRO-MECH SW, ETC. NORMALLY IT HAS ONLY INPUTS, BUT CAN HAVE MECH OUTPUTS OR POSITION SWITCH OUTPUTS.

**LINES ASSOCIATED WITH LOGIC SYMBOLS**

ELECT. FLOW SIGNAL

AUXILIARY SIGNAL SOURCE SUCH AS AIR OR HYDRAULIC

MECHANICAL LINKAGE

**LEGEND**



START OF PRIMARY INITIATING SIGNAL



SH. NO. LETTER DESIGNATION ON DWG MUST MATCH LETTER DESIGNATION ON THE INTERFACING DWG

FSAR REV.65

SUSQUEHANNA STEAM ELECTRIC STATION  
UNITS 1 & 2  
FINAL SAFETY ANALYSIS REPORT

LOGIC SYMBOLS

FIGURE 1.8-3, Rev 54

AutoCAD: Figure Fsar\_1.8-3.dwg



**BASIC CONTROLLER**

CONTAINS 2 OR 3-MODE CONTROL, SET POINT, MANUAL-AUTOMATIC SELECTION, REVERSE OR DIRECT ACTING, CASCADE SWITCH, AND VALVE POSITION INDICATOR

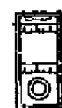

**BASIC M/A CONTROLLER**

CONTAINS 2 OR 3-MODE CONTROL, MANUAL AUTOMATIC SELECTION, REVERSE OR DIRECT ACTING, AND INDICATORS FOR PROCESS VALUE AND VALVE POSITION. THE CONTROLLER SET POINT MUST COME FROM SOME EXTERNAL DEVICE, SYMBOL WILL ALSO BE USED TO INDICATE ONLY A MANUAL TO AUTOMATIC TRANSFER STATION.



**RATIO SET STATION**

CONTAINS A RATIO ADJUSTMENT KNOB 1.3 TO 3.01, INPUT AND OUTPUT INDICATORS, AND THE RATIO AMPLIFIER.



**BIAS-MANUAL AUTOMATIC STATION**

CONTAINS A BIAS ADJUSTMENT KNOB -20 TO +20%, INPUT AND OUTPUT INDICATORS, BIAS AMPLIFIER, AND MANUAL AUTOMATIC SELECTION.

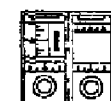

**BASIC CASCADE COMBINATION**

UTILIZES THE STANDARD CONTROLLER AS THE PRIMARY AND A CONTROLLER WITHOUT INTEGRAL SET POINT ON THE SECONDARY. MUST BE OPERATED IN CASCADE OR IN MANUAL

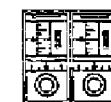

**CASCADE (2 STANDARD CONTROLLERS)**

ANY TWO STANDARD CONTROLLERS MAY BE OPERATED IN CASCADE. THIS COMBINATION MAY BE OPERATED OUT OF CASCADE WITH THE "SECONDARY" CONTROLLER ON AUTOMATIC.



**MANUAL LOADING STATION**

CONTAINS A MANUAL KNOB, POWER SUPPLY, AND VALVE POSITION INDICATOR. SIMPLY PROVIDES 10-50mA INTO A 600 OHM LOAD FOR REMOTE POSITIONING OF VALVES AND DAMPERS. MAY BE USED FOR A SET POINT STATION WHEN POSITION IS NOT CRITICAL.



**SET POINT STATION**

CONTAINS THE PRECISE SET POINT UNIT ONLY. TO BE USED WHEN SET POINT MUST BE REMOTE FROM THE CONTROLLER.



**HIGH - LOW LIMIT STATION**

CONTAINS ELECTRONIC CIRCUITRY TO LIMIT CONTROL SIGNALS TO A PRESET VALUE



**INTEGRATOR**

PANEL MOUNTED INTEGRATOR FOR TOTALIZING FLOW SIGNALS. 6 DIGIT COUNTER

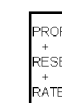

**RACK MOUNTED 3-MODE CONTROLLER**

PROPORTIONAL RESET PLUS RATE



**RACK-MOUNTED 2-MODE CONTROLLER**

PROPORTIONAL PLUS RESET



**RACK-MOUNTED RATE ACTION DEVICE**

CONTAINS ADJUSTABLE RATE ACTION UNIT



**MANUALLY OPERATED ROTARY SWITCH**

WITH ROUND KNOB OPERATOR

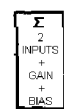

**2-INPUT PROPORTIONAL AMPLIFIER (RACK-MOUNTED)**

CONTAINS TWO INPUT CIRCUITS, INPUT BIAS ADJUSTMENT, OUTPUT BIAS ADJUSTMENT AND GAIN ADJUSTMENT

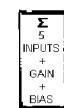

**5-INPUT SUMMATION AMPLIFIER (RACK-MOUNTED)**

SAME AS 2 INPUT SUMMATION AMPLIFIER BUT CONTAINS 5 INPUT CIRCUITS

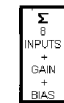

**8-INPUT SUMMATION AMPLIFIER (RACK-MOUNTED)**

SAME AS 2 INPUT SUMMATION AMPLIFIER BUT CONTAINS 8 INPUT CIRCUITS

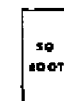

**SQUARE ROOT EXTRACTOR (PANEL OR RACK MOUNTED)**

CONTAINS CIRCUITRY TO EXTRACT THE SQUARE ROOT OF THE INPUT SIGNAL AND TRANSMIT A LINEAR SIGNAL.

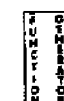

**FUNCTION GENERATOR (RACK MOUNTED)**

CONTAINS CIRCUITRY TO PROVIDE AN OUTPUT AS A VARIABLE FUNCTION OF THE INPUT SIGNAL.



**SIGNAL SELECTOR (RACK MOUNTED)**

CONTAINS CIRCUITRY TO SELECT THE HIGHER OR LOWER OF A GROUP OF INPUT SIGNALS

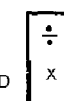

**MULTIPLIER-DIVIDER (RACK MOUNTED)**

GENERALLY USED FOR COMPENSATION OF FLOW SIGNALS

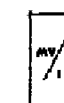

**MILLVOLT CONVERTER**

CONVERTS MILLIVOLT INPUT SIGNALS TO ELECTRONIC OUTPUT SIGNALS 10-50 mA.

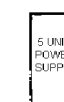

**5-UNIT POWER SUPPLY**

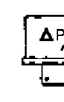

**DIFFERENTIAL PRESSURE TRANSMITTER**

CONVERTS DIFFERENTIAL PRESSURE TO AN ELECTRONIC SIGNAL. 10-50 mA.

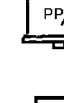

**PROCESS PRESSURE TRANSMITTER**

CONVERTS PROCESS PRESSURE TO AN ELECTRONIC SIGNAL. 10-50 mA.



**SINGLE UNIT POWER SUPPLY**

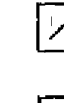

**ADJUSTABLE HIGH OR LOW ALARM UNIT**



**ELECTR-PNEUMATIC CONVERTER**

RACK-MOUNTED SET POINT  
THIS IS A PRECISE SET POINT UNIT FOR RACK MOUNTING ONLY.



**LARGE CASE ROUND CHART RECORDER**

DIRECTLY OPERATED.

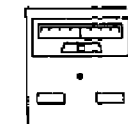

**INDICATING/CONTROLLING PYROMETER**

MILLIVOLTMETER TYPE CURRENT OUTPUT, POSITION MODULATION OR TIME DURATION CONTROL FORMS.

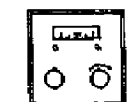

**ELECTRO-MECHANICAL CONTROLLER**

CONTAINS A 3-MODE CONTROLLER, EITHER TIME, POSITION, OR CURRENT MODULATION. SET POINT COMES FROM A CONTROL SLIDE-WIRE MOUNTED IN A SERVO-RECORDER.



**RECORDER CONTROLLER IN COMMON CASE**

TWO OR THREE MODE CONTROLLER, SINGLE PEN RECORDER.



**MINIATURE STRIP-CHART RECORDER**

SINGLE PEN POTENTIOMETRIC TYPE, 4" CHART 1/2% ACCURACY.



**MINIATURE STRIP-CHART RECORDER**

TWO-PEN POTENTIOMETRIC TYPE, 4" CHART 1/2% ACCURACY.



**EDGEWISE INDICATORS, GANG MOUNTED**



**LARGE-CASE, STRIP-CHART RECORDER**

POTENTIOMETRIC, 12" CHART, 1/4% OF FULL SCALE ACCURACY.



**LARGE-CASE, ROUND-CHART RECORDER**

POTENTIOMETRIC 12" CHART, 1/4% ACCURACY



**INDICATING GAGE, DIRECTLY OPERATED**

PANEL MOUNTING



**PNEUMATIC OPERATOR**

WITH COVER AND CURRENT-TO-PNEUMATIC TRANSDUCER



**PNEUMATIC COVER**

WITHOUT COVER BUT WITH CURRENT-TO-PNEUMATIC TRANSDUCER



**HEAVY-DUTY PNEUMATIC OPERATOR**



**PNEUMATIC POSITIONER AND VALVE**

PIPE MOUNTED



**PNEUMATICALLY OPERATED CONTROL VALVE**

MAY OR MAY NOT HAVE INTEGRAL I/P TRANSDUCER WITH ACTUATOR



**PNEUMATICALLY ACTUATED CONTROL VALVE**

MAY OR MAY NOT HAVE INTEGRAL I/P TRANSDUCER-WITHOUT ACTUATOR



**3-WAY SOLENOID OPERATED VALVE**

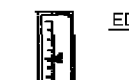

**EDGEWISE INDICATOR**



**TEMPERATURE SENSOR**

THERMOCOUPLE OR RESISTANCE TEMPERATURE DETECTOR



**LIQUID-LEVEL TRANSMITTER**

POSITIVE DISPLACEMENT TYPE



**ORIFICE PLATE INSTALLATION**

PLATE AND FLANGES



**INDUSTRIAL MASS FLOWMETER**

WITH SELF-CONTAINED INTEGRATOR, DIGITAL READOUT.



**INDICATOR ELECTRICALLY OPERATED**

250' SCALE, PANEL MOUNTING



**MANUALLY OPERATED ROTARY SWITCH**

WITH PISTOL GRIP HANDLE.

- P = PROPORTIONAL CONTROLLER
- P + R = PROPORTIONAL PLUS RESET CONTROLLER
- P + R + R = PROPORTIONAL PLUS RESET PLUS RATE CONTROLLER
- M/A = MANUAL-AUTOMATIC SELECTION
- S. P. = SET POINT

FSAR REV.65

SUSQUEHANNA STEAM ELECTRIC STATION  
UNITS 1 & 2  
FINAL SAFETY ANALYSIS REPORT

INSTRUMENT SYMBOLS

FIGURE 1.8-4, Rev 54