

Enclosure 1 to E-55607

**French Approval Certificate of a Package Design, Number
F/348/AF-96 (Revision Fq), English.**

TRANSPORT AND RESOURCES DEPARTMENT

F/348/AF-96 (Fq)
page 1/3

APPROVAL CERTIFICATE FOR PACKAGE DESIGN

The French Competent Authority,

Pursuant Article L. 595-1 of the Environment Code;

Pursuant to the request presented by the company **TN International** by letter COR-19-016933-015 dated 22 February 2019;

Pursuant to the safety analysis report DOS-18-016472-000 version 1.0, dated 20 February 2019;

Pursuant to the previously issued certificate, under reference F/348/IF-96 (Fp);

Certifies that the package design comprising the **FCC4** packaging, as described below in Appendix **0** at version q and loaded with one of the following contents:

- a maximum of 2 new PWR 17x17 XL, PWR 17x17 XLR, PWR 17x17 GAIA fuel assemblies, in Version 1 of the packaging, as described in Appendix 1 at version q;
- or, a maximum of 2 new PWR 16x16 fuel assemblies in Version 2 of the packaging, as described in Appendix 2 at version q;
- or, a maximum of 2 new PWR 18x18 fuel assemblies in Version 2 of the packaging, as described in Appendix 3 at version q;
- or, a maximum of 2 boxes containing new PWR 17x17 XL or PWR 17x17 XLR non-assembled fuel rods, in Version 1 of the packaging, as described in Appendix 4 at version q;
- or, a maximum of 2 boxes containing new PWR 17x17 non-assembled fuel rods in Version 1 of the packaging, as described in Appendix 5 at version q;
- or, a maximum of 2 boxes containing new PWR 15x15 non-assembled fuel rods in Version 1 of the packaging, as described in Appendix 6 at version q;
- or, a maximum of 2 boxes containing new PWR 14x14 8-foot non-assembled fuel rods in Version 1 of the packaging, as described in Appendix 7 at version q;
- or, a maximum of 2 boxes containing new PWR 14x14 10-foot non-assembled fuel rods in Version 1 of the packaging, as described in Appendix 8 at version q;
- or, a maximum of 2 boxes containing new PWR 16x16 non-assembled fuel rods in Version 1 of the packaging, as described in Appendix 10 at version q;
- or, a maximum of 2 boxes containing new PWR 18x18 non-assembled fuel rods in Version 1 of the packaging, as described in Appendix 11 at version q;
- or, a maximum of 2 new 17x17 EPR fuel assemblies or a single new 17x17 EPR fuel assembly fitted with a RCCA and a smooth walled dummy or a mock-up of the EPR assembly, in Version 1 of the packaging, as described in Appendix 12 at version q;
- or, a maximum of 2 boxes containing new 17x17 EPR fuel rods in version 1 of the packaging, as described in Appendix 13 at version q;

conforms to the requirements and regulations, agreements and recommendations for **type A packages, loaded with fissile materials** listed below:

- regulations for the safe transport of radioactive material, IAEA Safety Standards series, No. SSR-6, 2012 edition;
- European Agreement on the International Carriage of Dangerous Goods by Road (ADR);
- regulations governing International Rail Transportation of Dangerous Goods (RID);
- European Agreement on the International Carriage of Dangerous Goods by inland waterways (ADN);
- International maritime code for dangerous goods (IMDG code of the IMO);

- Decree dated 29 May 2009 (modified) concerning the carriage of dangerous goods by terrestrial routes (TMD Order);
- Decree dated 23 November 1987 (modified) concerning the safety of ships, division 411 (RSN Order).

This certificate does not relieve the consignor from compliance with any requirements drawn up by the government of any country through or towards which the package will be transported. This Approval Certificate may be appealed, before the competent jurisdiction, within a period of two months from the date of its signature.

The validity of this certificate expires on **31 December 2022**.

Registration number: **CODEP-DTS-2017-027110**

Signed in Montrouge, 14 August 2019

**For the President of the ASN and by delegation,
the Director for Transportation and Sources**

Fabien FÉRON

SUMMARY OF CERTIFICATE VERSIONS

Issue	Expiry	Type of issue and modifications made	Authority	Type of certificate	Revision index														
					Body	t	0	1	2	3	4	5	6	7	8	9	10	11	12
31/01/00	31/01/05	Initial approval	DGSNR	F/348/IF-85	Aa	-	a	a	a	a								-	-
12/02/04	31/01/05	Extension	DGSNR	F/348/IF-85	Ab	-	b	b	b	b	-	-			-	-	-	-	-
30/12/04	31/01/10	Renewal	DGSNR	F/348/IF-96	Bc	-	c	c	-	-	c	c	c	c	c	-	-	-	-
20/07/05	31/01/10	Extension	DGSNR	F/348/IF-96	Bd	-	d	d	-	-	d	d	d	d	d	d	-	-	-
11/07/08	31/01/10	Extension	ASN	F/348/IF-96	Be	-	e	-	e	e	-	-	-	-	-	-	e	e	-
15/07/09	31/12/10	Renewal	ASN	F/348/IF-96	Cf	-	f	f	f	f	f	f	f	f	f	-	f	f	f
13/01/10	31/12/10	Extension	ASN	F/348/IF-96	Cg	-	g	g	g	g	g	g	g	g	g	-	g	g	g
04/10/10	30/09/13	Renewal	ASN	F/348/IF-96	Dh	-	h	h	h	h	h	h	h	h	h	-	h	h	h
20/04/12	30/09/13	Extension	ASN	F/348/IF-96	Di	-	h											-	i
02/05/13	30/04/18	Renewal	ASN	F/348/IF-96	Ej	-	j	j	j	j	j	j	j	j	j	-	j	j	j
10/04/14	30/04/18	Extension	ASN	F/348/IF-96	Ek	-	j	k	-	-	-	-	-	-	-	-	-	-	k
18/04/15	30/04/18	Extension	ASN	F/348/IF-96	El	-	l	-											l
18/12/15	30/04/18	Extension	ASN	F/348/IF-96	Em	-	m												l
18/01/17	31/12/17	Extension	ASN	F/348/IF-96	En	-	n												l
11/12/17	31/12/22	Renewal	ASN	F/348/IF-96	Fo	-	o	o	o	o	o	o	o	o	o	-	o	o	o
29/12/17	31/12/22	Modifications	ASN	F/348/IF-96	Fp	-	p	o	o	o	o	o	o	o	o	-	o	p	o
14/08/19	31/12/22	Extension	ASN	F/348/AF-96	Fq	-	q	q	q	q	q	q	q	q	q	-	q	q	q

APPENDIX 0

FCC4 PACKAGING

1. PACKAGING DEFINITION

The packaging was designed, manufactured, inspected, tested, maintained and used in compliance with the TN International Safety Analysis Report DOS-18-016472 version 1.0.

The packaging, of a generally cylindrical form, is presented in Figure 0.1.

The packaging design drawing is 229K0400 or 229K0600 for Version 1 and 229K0500 for Version 2.

The overall external dimensions of the packaging are:

- length: 5,748 mm;
- width: 1,134 mm;
- height: 1,297 mm

The maximum permissible mass of the packaging, loaded for transport, is 5,550 kg.

The packaging comprises the following principal sub-assemblies:

1.1 Body

The FCC4 packaging comprises a horizontal cylindrical casing, which, in turn, comprises two connected half-shells, holding:

- a metallic cradle consisting of two stringers and suspended by means of shock mounts from the lower shell;
- Internal equipment fitted to the cradle and designed to accommodate one of the types of content.

This internal equipment comprises:

- A support frame, whose rigid structure, in the form of an inverted "T", is designed to hold the contents horizontally. The fabricated part of the frame contains neutron-absorbing resin. A tilting mechanism attached to the bottom plate is used to rotate the support frame to a vertical position for assembly loading and unloading;
- Two L-shaped doors, filled with neutron-absorbing resin, which are attached to the support frame and used to enclose the contents;
- A bottom plate, to support the fuel assemblies when loading or unloading when the support frame is in a vertical position;
- A two-part top plate used to close off the cavities and to wedge the contents at the other end.

1.2 Closing system

The two cylindrical half-shells are connected using 50 bolts.

The doors and top plates are connected to the frame using hinge pins and ball locking pins. The bottom plate is screwed to the frame.

1.3 Shock absorbing systems

Two axial shock absorbers are fitted to the end of the upper shell. They are made up of two metallic boxes containing a block of balsa wood.

Two additional axial shock absorbers are fixed to the top plates for the transport of EPR assemblies with RCCA, or if transporting a mock-up of the EPR assembly or a smooth walled dummy of an EPR assembly with RCCA. The smooth-walled dummy is described in Chapter 1.4 of DOS-12-00057682-040 Rev. 2 of the Safety Analysis Report.

1.4 Handling and tie-down components

Handling can be performed using standard lifting machinery, with the aid of an appropriate lifting beam or slings fitted with shackles or hooks.

There are three possible lifting modes:

- using the 4 lifting boxes welded to the upper shell: these lifting boxes are composed of folded sheet metal with a hole for passing a shackle or a hook;

- by 4 lifting boxes, welded on the lower shell;
- using the passages for the forks located under the lower shell.

In addition, the packaging is designed to be lashed down during transport, as per the requirements laid out in Chapter 1.7 of DOS-12-00057682-070 Rev. 1 - the Safety Analysis Report.

1.5 Safety functions

Criticality protection is provided by the elements identified in the appendices describing the contents, such as the insulation system, and in terms of the packaging, the elements below:

- The internal equipment: comprising the frame, doors and end plates, as well as radial and axial supports for the fuel rod boxes and the fuel rod boxes themselves, with the assembly as a whole forming two neutron cavities;
- The neutron-absorbing resin placed in the doors and frame;
- The top and bottom shells protecting the internal system during normal and accidental transport conditions (NCT and ACT).

The fuel is protected from shocks, principally, by the two half-shells and the internal equipment system.

Fire protection is provided, principally, by the two half-shells, the internal fittings and the resin contained within the doors and frame.

2. ACTION TO BE TAKEN BY THE SHIPPER PRIOR TO SHIPPING THE PACKAGE

The packaging must be used in line with applicable procedures, in compliance with the instructions for use in chapter 1.7 of DOS-12-00057682-070 Rev. 1 of the Safety Analysis Report.

The sender must check that, for all screws providing a security function of Class 10.9 or higher, the surface treatment has been carried out, in accordance with the following precautions:

- The surface is not prepared by etching prior to treatment, unless the pickled surface has been neutralized;
- Degassing, starting 3 hours or less after the completion of the surface treatment work.

3. MAINTENANCE PROGRAM

Packaging maintenance is described in Chapter 1.8 of DOS-12-00057682-080 Rev. 2 of the Safety Analysis Report.

As a dispensation from Chapter 1.8, when the intermediate maintenance of FCC4 version 1 series 600 packaging (§ 2.3.1 of Chapter 1.8) takes place before the end of the 5-year period following on from the last basic maintenance or after the initial commissioning of the packaging, the tests on the shaft stops and connections may not be carried out prior to the start of the next rotation.

Any packaging that does not satisfy the criteria given in the Maintenance Program must be taken out of service until the appropriate corrective action has been carried out.

4. NOTIFICATION AND RECORDING OF SERIAL NUMBERS

If any packaging is retired from service or changes owner, this must be reported to the competent authorities. Accordingly, an owner giving up a packaging must communicate the name of the new owner.

5. QUALITY ASSURANCE

The quality assurance principles to be applied during the design, manufacture, inspection, testing, maintenance and use of the package must comply with those described in chapter 1.9 of DOS-12-00057682-090 Rev. 0 of the Safety Analysis Report.

**Security-Related Information
Figure Withheld Pursuant 10 CFR 2.390.**

APPENDIX 1

CONTENT NO. 1

FRESH 17x17 PWR FUEL ASSEMBLIES

The contents should be loaded into an FCC 4 Version 1 packaging.

1. DEFINITION OF AUTHORIZED RADIOACTIVE CONTENTS

1.1 Characteristics of the fuel assemblies

The authorized radioactive contents, as described in Chapter 1.3 - Ref. DOS-18-016472-005 version 1.0 of the Safety Analysis Report, comprise a maximum of two fresh fuel assemblies, designed for use in pressurized water reactors (PWR), as detailed below:

Characteristics of the assemblies before irradiation:	17x17 XL, XLR and GAIA⁽¹⁾
Type of array	17x17
Length (foot)	14
Nominal grid pitch (mm)	12.6
Maximum total weight of assembly with or without RCCA (kg)	877
Maximum UO ₂ weight per assembly (kg)	690
Nominal active length (mm)	4,267
Maximum number of fuel rods	288 ⁽²⁾
Characteristics of the fuel rods before irradiation:	
Cladding:	
- Material	Zirconium alloy, possibly pre-oxidized
- Minimum metal thickness (mm)	0.52
- Minimum outer diameter (mm)	9.40
Pellets:	ENU ⁽³⁾
- Maximum diameter (mm)	8.30
- Maximum oxide density (100% of theoretical density)	10.96
- Maximum initial enrichment (²³⁵ U/U _{total}) (%)	5
- Maximum mass ratio ²³² U/U _{total} (%)	5.10 ⁻⁸
- Maximum mass ratio ²³⁴ U/U _{total} (%)	0.055
- Maximum mass ratio ²³⁶ U/U _{total} (%)	0.05
Maximum absolute internal fuel rod pressure at 20°C (bar)	32.7
<p>(1) 17x17 XL, XLR and GAIA designations are for 17x17, 14-foot grids, currently used in 1,000, 1,300 and 1,450 MW_e reactors. The authorized contents can be made up of different types of assembly as long as they all have the characteristics given in the above table.</p> <p>(2) This number of rods corresponds to the maximum number of rods to be inserted into the structure (carcass or assembly framework), including the guide tubes.</p> <p>(3) ENU: enriched natural uranium</p>	

Residues of glycerin may be present on the fuel assemblies or on the mock-up of the assembly (a maximum of 5 grams of residue on each).

The mechanical resistance properties of the materials used in the rod cladding must respect the following table:

R_{p0.2} (MPa)	≥ 250
R_m (MPa)	≥ 400
A_t (% over 50 mm)	≥ 25

1.2 Loading conditions

All assemblies making up a load must adhere to the conditions defined in the table below.

Type of assembly	Maximum number of assemblies authorized for a load	Maximum initial enrichment level per rod for each assembly making up a load (²³⁵ U/U _{total})	Minimum number of rods in each loaded assembly ⁽¹⁾
17x17 XL/XLR/ GAIA	2	5	264

(1) Incomplete UO₂ fuel rod assemblies can be completed by gadolinium rods; or rods containing depleted uranium or other metallic materials, or even by solid metallic rods (graphite & beryllium not included) which may contain neutron absorbers. These additional rods or bars will have dimensions equivalent to the UO₂ rods. By "number of rods per assembly", we mean the total number of fuel rods and replacement rods or bars.

All assemblies included in a load, bar one, can be replaced by dummy assemblies.

The presence of a desiccant is allowed.

The presence of materials with a greater hydrogen content than water as part of the packaging is not permitted.

Maximum activity level per packaging: The maximum activity of the content is less than 1 A₂.

Physical state: Fuel rod assemblies containing sintered pellets in a Zirconium alloy cladding, possibly pre-oxidized, meeting the criteria given in Paragraph 1.1 of the appendix.

Chemical composition: Uranium oxide pellets (UO₂) and/or fuel pellets made up a mixture of UO₂ at a ²³⁵U enrichment level not exceeding 5% and a body acting as a neutron poison, with a mixture density of not more than 10.96 g/cm³. The pellets may contain chrome oxides (but no other form of doping product).

Special form: The materials being shipped are not in special form.

2. MAINTAINING SUB-CRITICALITY

The demonstration of maintaining sub-criticality is the subject of Chapter 2.5-1 DOS-12-00057682-501 Rev. 0.

Criticality-Safety Index (CSI): 0.625 (Number N=80)

APPENDIX 2

CONTENTS N°2

FRESH 16x16 PWR FUEL ASSEMBLIES

The contents should be loaded into an FCC 4 Version 2 packaging.

1. DEFINITION OF AUTHORIZED RADIOACTIVE CONTENTS

1.1 Characteristics of the fuel assemblies

The authorized radioactive contents, as described in Chapter 1.3 - Ref. DOS-18-016472-005 version 1.0 of the Safety Analysis Report, comprise a maximum of two fresh fuel assemblies, designed for use in pressurized water reactors (PWR), as detailed below:

Characteristics of the assemblies before irradiation:	16x16
Type or array	16x16
Nominal grid pitch (mm)	14.3
Maximum total weight of assembly with or without RCCA (kg)	877
Maximum UO ₂ weight per assembly (kg)	639
Nominal active length (mm)	3,900
Maximum number of fuel rods	236 ⁽¹⁾
Characteristics of the fuel rods before irradiation:	
Cladding: Material	Zirconium alloy, possibly pre-oxidized
- Minimum metal thickness (mm)	0.68
- Minimum outer diameter (mm)	10.70
Pellets:	ENU *
- Maximum diameter (mm)	9.14
- Maximum oxide density (100% of theoretical density)	10.96
- Maximum initial enrichment (²³⁵ U/U _{total}) (%)	4.5
- Maximum mass ratio ²³² U/U _{total} (%)	5.10 ⁻⁸
- Maximum mass ratio ²³⁴ U/U _{total} (%)	0.055
- Maximum mass ratio ²³⁶ U/U _{total} (%)	0.05
Maximum absolute internal fuel rod pressure at 20°C (bar)	32.7
(1) This number of rods corresponds to the maximum number of rods to be inserted into the structure (carcass or assembly framework), including the guide tubes.	
* ENU: enriched natural uranium	

Residues of glycerin may be present on the fuel assemblies or on the mock-up of the assembly (a maximum of 5 grams of residue on each).

The mechanical resistance properties of the materials used in the rod cladding must respect the following table:

R_{p0.2} (MPa)	≥ 250
R_m (MPa)	≥ 400
A_t (% over 50 mm)	≥ 25

1.2 Loading conditions

All assemblies making up a load must adhere to the conditions defined in the table below.

Type of assembly	Maximum number of assemblies authorized for a load	Maximum initial enrichment level per rod for each assembly making up a load (²³⁵ U/U _{total})	Minimum number of rods in each loaded assembly ⁽¹⁾
16x16	2	4,5	236
(1) Incomplete UO ₂ fuel rod assemblies can be completed by gadolinium rods; or rods containing depleted uranium or other metallic materials, or even by solid metallic rods (graphite & beryllium not included) which may contain neutron absorbers. These additional rods or bars will have dimensions equivalent to the UO ₂ rods. By "number of rods per assembly", we mean the total number of fuel rods and replacement rods or bars.			

All assemblies included in a load, bar one, can be replaced by dummy assemblies.

The presence of a desiccant is allowed.

The presence of materials with a greater hydrogen content than water as part of the packaging is not permitted.

Maximum activity level per packaging: The maximum activity of the content is less than 1 A₂.

Material classification: Activity less than 1 A₂.

Physical State: Fuel rod assemblies containing sintered pellets in a Zirconium alloy cladding, possibly pre-oxidized, meeting the criteria given in Paragraph 1.1 of the appendix.

Chemical composition: Uranium oxide pellets (UO₂) and/or fuel pellets made up a mixture of UO₂ at a ²³⁵U enrichment level not exceeding 4.5% and a body acting as a neutron poison, with a mixture density of not more than 10.96 g/cm³. The pellets may contain chrome oxides (but no other form of doping product).

Special form: The materials being shipped are not in special form.

2. MAINTAINING SUB-CRITICALITY

The demonstration of maintaining sub-criticality is the subject of Chapter 2.5-1 DOS-12-00057682-501 Rev. 0.

Criticality-Safety Index (CSI): 8.33 (Number N=6)

APPENDIX 3

CONTENT No. 3

FRESH 18x18 PWR FUEL ASSEMBLIES

The contents should be loaded into an FCC 4 Version 2 packaging.

1. DEFINITION OF AUTHORIZED RADIOACTIVE CONTENTS

1.1 Characteristics of the fuel assemblies

The authorized radioactive contents, as described in Chapter 1.3 - Ref. DOS-18-016472-005 version 1.0 of the Safety Analysis Report, comprise a maximum of two fresh fuel assemblies, designed for use in pressurized water reactors (PWR), as detailed below:

Characteristics of the assemblies before irradiation:	18x18
Type of array	18x18
Nominal grid pitch (mm)	12.7
Maximum total weight of assembly with or without RCCA (kg)	877
Maximum UO ₂ weight per assembly (kg)	630
Nominal active length (mm)	3,900
Maximum number of fuel rods	300 ⁽¹⁾
Characteristics of the fuel rods before irradiation:	
Cladding:	
- Material	Zirconium alloy, possibly pre-oxidized
- Minimum metal thickness (mm)	0.60
- Minimum outer diameter (mm)	9.46
Pellets:	ENU*
- Maximum diameter (mm)	8.08
- Maximum oxide density (100% of theoretical density)	10.96
- Maximum initial enrichment (²³⁵ U/U _{total}) (%)	4.5
- Maximum mass ratio ²³² U/U _{total} (%)	5.10 ⁻⁸
- Maximum mass ratio ²³⁴ U/U _{total} (%)	0.055
- Maximum mass ratio ²³⁶ U/U _{total} (%)	0.05
Maximum absolute internal fuel rod pressure at 20°C (bar)	32.7
(1) This number of rods corresponds to the maximum number of rods to be inserted into the structure (carcass or assembly framework), including the guide tubes.	
* ENU: enriched natural uranium	

Residues of glycerin may be present on the fuel assemblies or on the mock-up of the assembly (a maximum of 5 grams of residue on each).

The mechanical resistance properties of the materials used in the rod cladding must respect the following table:

R_{p0.2} (MPa)	≥ 250
R_m (MPa)	≥ 400
A_t (% over 50 mm)	≥ 25

1.2 Loading conditions

All assemblies making up a load must adhere to the conditions defined in the table below.

Type of assembly	Maximum number of assemblies authorized for a load	Maximum initial enrichment level per rod for each assembly making up a load (²³⁵ U/U _{total})	Minimum number of rods in each loaded assembly ⁽¹⁾
18x18	2	4.5	300

(1) Incomplete UO₂ fuel rod assemblies can be completed by gadolinium rods; or rods containing depleted uranium or other metallic materials, or even by solid metallic rods (graphite & beryllium not included) which may contain neutron absorbers. These additional rods or bars will have dimensions equivalent to the UO₂ rods. By "number of rods per assembly", we mean the total number of fuel rods and replacement rods or bars

All assemblies included in a load, bar one, can be replaced by dummy assemblies.

The presence of a desiccant is allowed.

The presence of materials with a greater hydrogen content than water as part of the packaging is not permitted.

Maximum activity level per packaging: The maximum activity of the content is less than 1 A₂.

Material classification: Activity less than 1 A₂.

Physical state: Fuel rod assemblies containing sintered pellets in a Zirconium alloy cladding, possibly pre-oxidized, meeting the criteria given in Paragraph 1.1 of the appendix.

Chemical composition: Uranium oxide pellets (UO₂) and/or fuel pellets made up a mixture of UO₂ at a ²³⁵U enrichment level not exceeding 4.5% and a body acting as a neutron poison, with a mixture density of not more than 10.96 g/cm³. The pellets may contain chrome oxides (but no other form of doping product).

Special form: The materials being shipped are not in special form.

2. MAINTAINING SUB-CRITICALITY

The demonstration of maintaining sub-criticality is the subject of Chapter 2.5-1 DOS-12-00057682-501 Rev. 0.

Criticality-Safety Index (CSI): 8.33 (Number N=6)

APPENDIX 4

CONTENT No. 4 17x17

PWR FUEL RODS

The contents should be loaded into an FCC 4 Version 1 packaging.

1. DEFINITION OF AUTHORIZED RADIOACTIVE CONTENTS

1.1 Characteristics of the fuel rods

The authorized radioactive contents, as described in Chapter 1.3 DOS-18-016472-005 version 1.0 of the Safety Analysis Report, comprise fresh fuel rods designed for use in pressurized water reactors (PWR), as detailed below:

Characteristics of the fuel rods before irradiation:	17x17 XL, XLR
Maximum total mass per cavity (kg)	856
Maximum total mass of rods per box (kg)	537
Max mass of UO ₂ (kg)	443/box ⁽¹⁾ or 20/package ⁽²⁾
Nominal active length (mm)	4,267
Maximum number of fuel rods	185
Cladding:	
- Material	Zirconium alloy, possibly pre-oxidized
- Minimum metal thickness (mm)	0.52
- Minimum outer diameter (mm)	9.40
Pellets:	ENU *
- Maximum diameter (mm)	8.30
- Maximum oxide density (100% of theoretical density)	10.96
- Maximum initial enrichment (²³⁵ U/U _{total}) (%)	5
- Maximum mass ratio ²³² U/U _{total} (%)	5.10 ⁻⁸
- Maximum mass ratio ²³⁴ U/U _{total} (%)	0.055
- Maximum mass ratio ²³⁶ U/U _{total} (%)	0.05
Minimum Gd ₂ O ₃ content (by mass) of gadolinium rods (%) ⁽³⁾	2
Maximum absolute internal fuel rod pressure at 20°C (bar)	32.7
<p>(1) This maximum mass is only applicable to gadolinium contents and those using spacers. (2) This maximum mass is only applicable to non-gadolinium rods and those using neither axial nor radial spacers. (3) Rods with a Gd₂O₃ content of less than 2% are assumed equal to UO₂ rods (without gadolinium).</p>	
<p>* ENU: enriched natural uranium</p>	

The mechanical resistance properties of the materials used in the rod cladding must respect the following table:

R_{p0.2} (MPa)	≥ 250
R_m (MPa)	≥ 400
A_t (% over 50 mm)	≥ 25

1.2 Loading conditions

All rods making up a load must adhere to the conditions defined in the table below.

Type of array	Maximum number of rods authorized per load, per box	Maximum initial enrichment level of each rod making up a load (²³⁵ U/ U _{total})	Minimum number of rods in each loaded assembly ⁽¹⁾
17x17 XL, XLR	185 ⁽²⁾	5	Full row of fuel rods or inert rods
(1)	Incomplete rows of fuel rods may be topped up using solid stainless steel (or Zirconium alloy) bars with a nominal diameter of between 9.5 mm and 10 mm, possibly containing a neutron poison. The term "number of rods per box" means the total number of fuel rods and steel (or zirconium alloy) bars.		
(2)	When transporting small quantities of UO ₂ fuel rods without radial or axial supports, the maximum permissible mass of UO ₂ per package is 20 kg.		

The presence of a desiccant is allowed.

The presence of materials with a greater hydrogen content than water as part of the packaging is not permitted.

Maximum activity level per packaging: The maximum activity of the content is less than 1 A₂.

Material classification: Activity less than 1 A₂.

Physical state: Fuel rod assemblies containing sintered pellets in a Zirconium alloy cladding, possibly pre-oxidized, meeting the criteria given in Paragraph 1.1 of the appendix.

Chemical composition: Uranium oxide pellets (UO₂) and/or fuel pellets made up a mixture of UO₂ at a ²³⁵U enrichment level not exceeding 5% and a body acting as a neutron poison, with a mixture density of not more than 10.96 g/cm³. The pellets may contain chrome oxides (but no other form of doping product).

Special form: The materials being shipped are not in special form.

2. INTERNAL FITTINGS

The internal fittings comprise a fuel rod box, as described in Chapters 1.3-1 & 1.3-2 DOS-12-00057682-031 Rev. 1 & DOS-12-00057682-032 Rev. 1 of the Safety Analysis Report.

2.1 Fuel rod box

The non-assembled rods are grouped in FCC4 version rod boxes which are inserted in place of the assemblies inside the FCC4 version 1 packagings.

The channel is made of a U-shaped plate closed at the ends and reinforced with two stringers welded on the upper part of the plate.

A radial support system is used to hold the rods in place. A general arrangement drawing is given in Figure 4.1.

The minimum height of the radial support is 85 mm.

2.2 Spacers

A set of 2 spacers is used to provide longitudinal support to the box within the cavity (one spacer at the top, another at the bottom). The spacers are described in detail in Chapter 1.3-1 of DOS-12-00057682-031 Rev. 1 of the Safety Analysis Report.

3. MAINTAINING SUB-CRITICALITY

The demonstration of maintaining sub-criticality is the subject of Chapter 2.5-2 DOS-12-00057682-502 Rev. 0.

When transporting small quantities of UO_2 fuel rods without radial or axial supports, the maximum permissible mass of UO_2 per package is 20 kg.

Criticality-Safety Index (CSI):

- When transporting UO_2 rods with radial and axial support, criticality-safety index is equal to 0 (number N infinite)
- When transporting UO_2 - Gd_2O_3 rods with or without radial and axial support, criticality-safety index is equal to 0 (number N infinite)
- When transporting small quantities of UO_2 rods without radial or axial support, criticality-safety index is equal to 50 (number $N=1$)

**FIGURE 4.1
ROD BOX DIAGRAM**

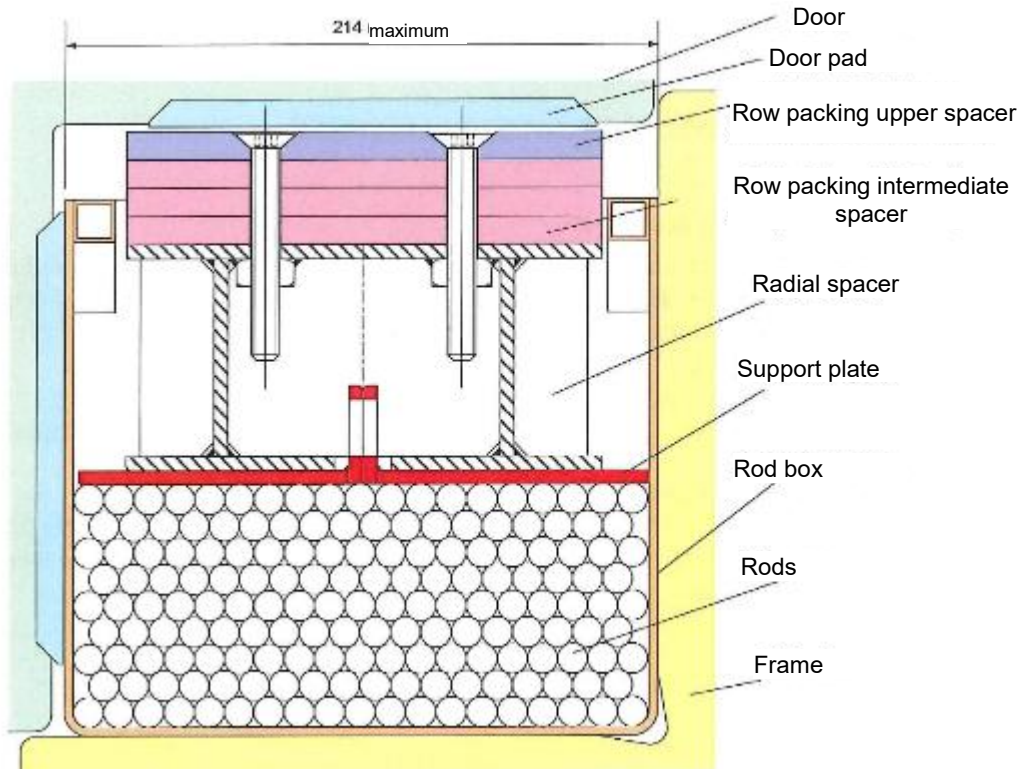

APPENDIX 5

CONTENT No.5 17x17 TWELVE-FOOT

PWR FUEL RODS

The contents should be loaded into an FCC 4 Version 1 packaging.

1. DEFINITION OF AUTHORIZED RADIOACTIVE CONTENTS

1.1 Characteristics of the fuel rods

The authorized radioactive contents, as described in Chapter 1.3 DOS-18-016472-005 version 1.0 of the Safety Analysis Report, comprise fresh fuel rods designed for use in pressurized water reactors (PWR), as detailed below:

Characteristics of the fuel rods before irradiation:	17x17 - 12-foot
Maximum total mass per cavity (kg)	856
Maximum total mass of rods per box (kg)	461
Max mass of UO ₂ (kg)	380/box ⁽¹⁾ or 20/package ⁽²⁾
Nominal active length (mm)	3,658
Maximum number of fuel rods per box	185
Cladding:	
- Material	Zirconium alloy, possibly pre-oxidized
- Minimum metal thickness (mm)	0.52
- Minimum outer diameter (mm)	9.40
Pellets:	ENU *
- Maximum diameter (mm)	8.30
- Maximum oxide density (100% of theoretical density)	10.96
- Maximum initial enrichment (²³⁵ U/U _{total}) (%)	5
- Maximum mass ratio ²³² U/U _{total} (%)	5.10 ⁻⁸
- Maximum mass ratio ²³⁴ U/U _{total} (%)	0.055
- Maximum mass ratio ²³⁶ U/U _{total} (%)	0.05
Minimum Gd ₂ O ₃ content (by mass) of gadolinium rods (%) ⁽³⁾	2
Maximum absolute internal fuel rod pressure at 20°C (bar)	32.7
<p>(1) This maximum mass is only applicable to gadolinium contents and those using spacers. (2) This maximum mass is only applicable to non-gadolinium rods and those using neither axial nor radial spacers. (3) Rods with a Gd₂O₃ content of less than 2% are assumed equal to UO₂ rods (without gadolinium).</p>	
<p>* ENU: enriched natural uranium</p>	

The mechanical resistance properties of the materials used in the rod cladding must respect the following table:

R_{p0.2} (MPa)	≥ 250
R_m (MPa)	≥ 400
A_t (% over 50 mm)	≥ 25

1.2 Loading conditions

All rods making up a load must adhere to the conditions defined in the table below.

Type of array	Maximum number of rods authorized per load, per box	Maximum initial enrichment level of each rod making up a load (²³⁵ U/ U _{total})	Minimum number of rods in each loaded assembly ⁽¹⁾
17x17	185 ⁽²⁾	5	Full row of fuel rods or inert rods

(1) Incomplete rows of fuel rods may be topped up using solid stainless steel (or Zirconium alloy) bars with a nominal diameter of between 9.5 mm and 10 mm, possibly containing a neutron poison. The term "number of rods per box" means the total number of fuel rods and steel (or zirconium alloy) bars.
(2) When transporting small quantities of UO₂ fuel rods without radial or axial supports, the maximum permissible mass of UO₂ per package is 20 kg.

The presence of a desiccant is allowed.

The presence of materials with a greater hydrogen content than water as part of the packaging is not permitted.

Maximum activity level per packaging: The maximum activity of the content is less than 1 A₂.

Material classification: Activity less than 1 A₂.

Physical State: Fuel rod assemblies containing sintered pellets in a Zirconium alloy cladding, possibly pre-oxidized, meeting the criteria given in Paragraph 1.1 of the appendix.

Chemical composition: Uranium oxide pellets (UO₂) and/or fuel pellets made up a mixture of UO₂ at a ²³⁵U enrichment level not exceeding 5% and a body acting as a neutron poison, with a mixture density of not more than 10.96 g/cm³. The pellets may contain chrome oxides (but no other form of doping product).

Special form: The materials being shipped are not in special form.

2. INTERNAL FITTINGS

The internal fittings comprise a fuel rod box, as described in Chapters 1.3-1 & 1.3-2 DOS-12-00057682-031 Rev. 1 & DOS-12-00057682-032 Rev. 1 of the Safety Analysis Report.

2.1 Fuel rod box

The non-assembled rods are grouped in FCC4 version rod boxes which are inserted in place of the assemblies inside the FCC4 version 1 packagings.

The channel is made of a U-shaped plate closed at the ends and reinforced with two stringers welded on the upper part of the plate.

A radial support system is used to hold the rods in place. A general arrangement drawing is given in Figure 5.1.

The minimum height of the radial support is 85 mm.

2.2 Spacers

A set of 2 spacers is used to provide longitudinal support to the box within the cavity (one spacer at the top, another at the bottom). The spacers are described in detail in Chapter 1.3-1 of DOS-12-00057682-031 Rev. 1 of the Safety Analysis Report.

3. MAINTAINING SUB-CRITICALITY

The demonstration of maintaining sub-criticality is the subject of Chapter 2.5-2 DOS-12-00057682-502 Rev. 0 of the Safety Analysis Report.

When transporting small quantities of UO_2 fuel rods without radial or axial supports, the maximum permissible mass of UO_2 per package is 20 kg.

Criticality-Safety Index (CSI):

- When transporting UO_2 rods with radial and axial support, criticality-safety index is equal to 0 (number N infinite)
- When transporting $\text{UO}_2\text{-Gd}_2\text{O}_3$ rods with or without radial and axial support, criticality-safety index is equal to 0 (number N infinite)
- When transporting small quantities of UO_2 rods without radial or axial support, criticality-safety index is equal to 50 (number $N=1$)

**FIGURE 5.1
ROD BOX DIAGRAM**

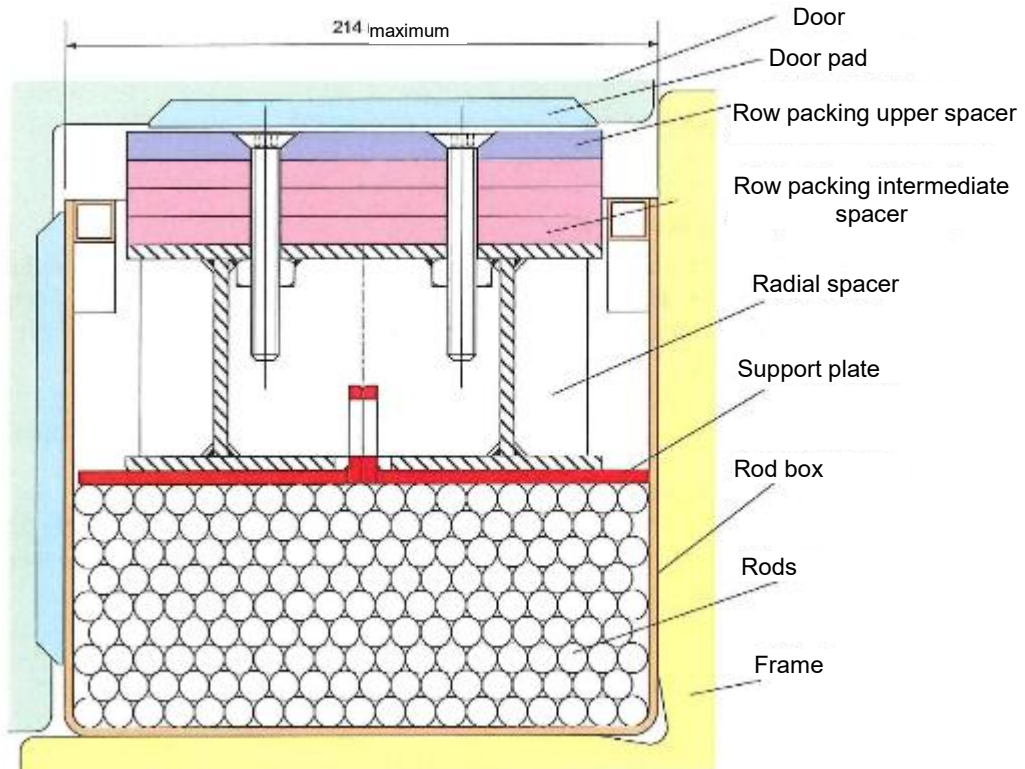

APPENDIX 6

CONTENTS No.6 15x15 TWELVE-FOOT

PWR FUEL RODS

The contents should be loaded into an FCC 4 Version 1 packaging.

1. DEFINITION OF AUTHORIZED RADIOACTIVE CONTENTS

1.1 Characteristics of the fuel rods

The authorized radioactive contents, as described in Chapter 1.3 DOS-18-016472-005 version 1.0 of the Safety Analysis Report, comprise fresh fuel rods designed for use in pressurized water reactors (PWR), as detailed below:

Characteristics of the fuel rods before irradiation:	15x15 - 12-foot
Maximum total mass per cavity (kg)	856
Maximum total mass of rods per box (kg)	470
Maximum mass of UO ₂ (kg)	389/box ⁽¹⁾ or 21.1/package ⁽²⁾
Nominal active length (mm)	3,658
Maximum number of fuel rods per box	148
Cladding:	
- Material	Zirconium alloy, possibly pre-oxidized
- Minimum metal thickness (mm)	0.57
- Minimum outer diameter (mm)	10.68
Pellets:	ENU *
- Maximum diameter (mm)	9.4
- Maximum oxide density (100% of theoretical density)	10.96
- Maximum initial enrichment (²³⁵ U/U _{total}) (%)	5
- Maximum mass ratio ²³² U/U _{total} (%)	5.10 ⁻⁸
- Maximum mass ratio ²³⁴ U/U _{total} (%)	0.055
- Maximum mass ratio ²³⁶ U/U _{total} (%)	0.05
Minimum Gd ₂ O ₃ content (by mass) of gadolinium rods (%) ⁽³⁾	2
Maximum absolute internal fuel rod pressure at 20°C (bar)	32.7

- (1) This maximum mass is only applicable to gadolinium contents and those using spacers.
 (2) This maximum mass is only applicable to non-gadolinium rods and those using neither axial nor radial spacers.
 (3) Rods with a Gd₂O₃ content of less than 2% are assumed equal to UO₂ rods (without gadolinium).

* ENU: enriched natural uranium

The mechanical resistance properties of the materials used in the rod cladding must respect the following table:

R_{p0.2} (MPa)	≥ 250
R_m (MPa)	≥ 400
A_t (% over 50 mm)	≥ 25

1.2 Loading conditions

All rods making up a load must adhere to the conditions defined in the table below.

Type of array	Maximum number of rods authorized per load, per box	Maximum initial enrichment level of each rod making up a load (²³⁵ U/ U _{total})	Minimum number of rods in each loaded assembly ⁽¹⁾
15x15	148 ⁽²⁾	5	Full row of fuel rods or inert rods

(1) Incomplete rows of fuel rods may be topped up using solid stainless steel (or Zirconium alloy) bars with a nominal diameter of between 10.7 mm and 11 mm, possibly containing a neutron poison. The term "number of rods per box" means the total number of fuel rods and steel (or zirconium alloy) bars.

(2) When transporting small quantities of UO₂ fuel rods without radial or axial supports, the maximum permissible mass of UO₂ per package is 21.1 kg.

The presence of a desiccant is allowed.

The presence of materials with a greater hydrogen content than water as part of the packaging is not permitted.

Maximum activity level per packaging: The maximum activity of the content is less than 1 A₂.

Material classification: Activity is less than 1 A₂.

Physical State: Fuel rod assemblies containing sintered pellets in a Zirconium alloy cladding, possibly pre-oxidized, meeting the criteria given in Paragraph 1.1 of the appendix.

Chemical composition: Uranium oxide pellets (UO₂) and/or fuel pellets made up a mixture of UO₂ at a ²³⁵U enrichment level not exceeding 5% and a body acting as a neutron poison, with a mixture density of not more than 10.96 g/cm³. The pellets may contain chrome oxides (but no other form of doping product).

Special form: The materials being shipped are not in special form.

2. INTERNAL FITTINGS

The internal fittings comprise a fuel rod box, as described in Chapters 1.3-1 & 1.3-2 DOS-12-00057682-031 Rev. 1 & DOS-12-00057682-032 Rev. 1 of the Safety Analysis Report.

2.1 Fuel rod box

The non-assembled rods are grouped in FCC4 version rod boxes which are inserted in place of the assemblies inside the FCC4 version 1 packagings.

The channel is made of a U-shaped plate closed at the ends and reinforced with two stringers welded on the upper part of the plate.

A radial and axial wedging system adapts to the length of the rods and ensures their positioning. A general arrangement drawing is given in Figure 6.1.

The minimum height of the radial support is 85 mm.

2.2 Spacers

A set of 2 spacers is used to provide longitudinal support to the box within the cavity (one spacer at the top, another at the bottom). The spacers are described in detail in Chapter 1.3-1 of DOS-12-00057682-031 Rev. 1 of the Safety Analysis Report.

3. MAINTAINING SUB-CRITICALITY

The demonstration of maintaining sub-criticality is the subject of Chapter 2.5-2 DOS-12-00057682-502 Rev. 0 of the Safety Analysis Report.

When transporting small quantities of UO_2 fuel rods without radial or axial supports, the maximum permissible mass of UO_2 per package is 21.1 kg.

Criticality-Safety Index (CSI):

- When transporting UO_2 rods with radial and axial support, criticality-safety index is equal to 0 (number N infinite);
- When transporting $\text{UO}_2\text{-Gd}_2\text{O}_3$ rods with or without radial and axial support, criticality-safety index is equal to 0 (number N infinite);
- When transporting small quantities of UO_2 rods without radial or axial support, criticality-safety index is equal to 50 (Number $N=1$).

FIGURE 6.1
ROD BOX DIAGRAM

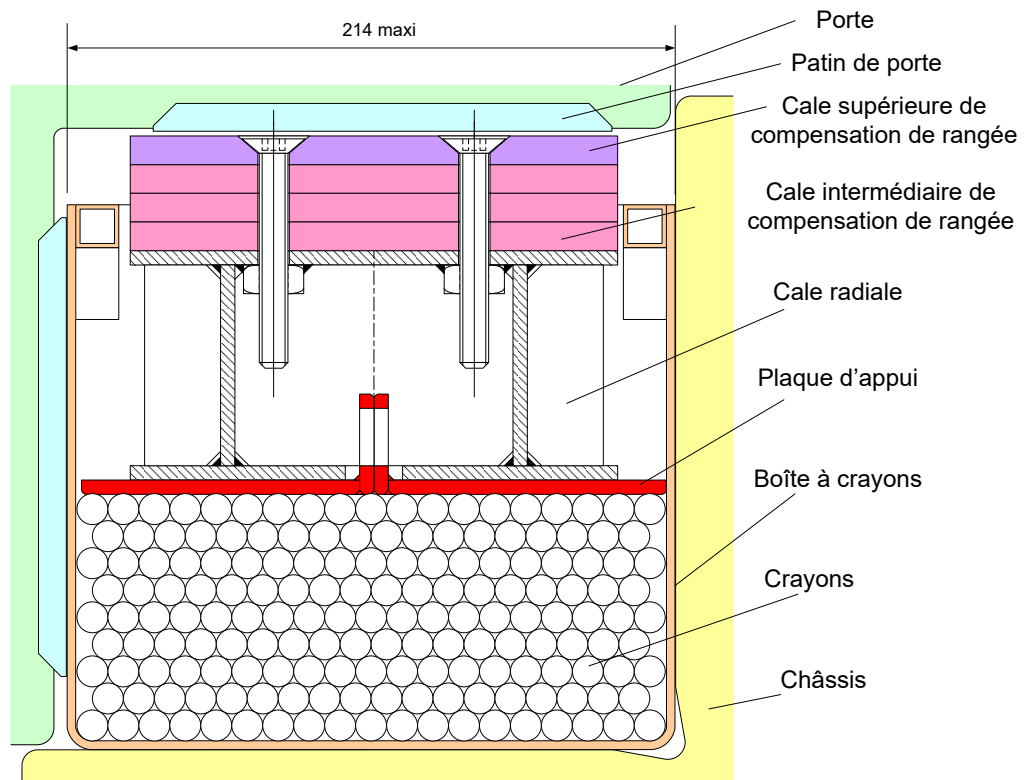

APPENDIX 7

CONTENT No. 7 14x14 EIGHT-FOOT

PWR FUEL RODS

The contents should be loaded into an FCC 4 Version 1 packaging.

1. DEFINITION OF AUTHORIZED RADIOACTIVE CONTENTS

1.1 Characteristics of the fuel rods

The authorized radioactive contents, as described in Chapter 1.3 DOS-18-016472-005 version 1.0 of the Safety Analysis Report, comprise fresh fuel rods designed for use in pressurized water reactors (PWR), as detailed below:

Characteristics of the fuel rods before irradiation:	14x14 - 8-foot
Maximum total mass per cavity (kg)	856
Maximum total mass of rods per box (kg)	471
Maximum mass of UO ₂ (kg)	394/box ⁽¹⁾ or 21.1/package ⁽²⁾
Nominal active length (mm)	2,413
Maximum number of fuel rods per box	222
Cladding:	
- Material	Zirconium alloy, possibly pre-oxidized
- Minimum metal thickness (mm)	0.57
- Minimum outer diameter (mm)	10.68
Pellets:	ENU *
- Maximum diameter (mm)	9.40
- Maximum oxide density (100% of theoretical density)	10.96
- Maximum initial enrichment (²³⁵ U/U _{total}) (%)	5
- Maximum mass ratio ²³² U/U _{total} (%)	5.10 ⁻⁸
- Maximum mass ratio ²³⁴ U/U _{total} (%)	0.055
- Maximum mass ratio ²³⁶ U/U _{total} (%)	0.05
Minimum Gd ₂ O ₃ content (by mass) of gadolinium rods (%) ⁽³⁾	2
Maximum absolute internal fuel rod pressure at 20°C (bar)	32.7
<p>(1) This maximum mass is only applicable to gadolinium contents and those using spacers. (2) This maximum mass is only applicable to non-gadolinium rods and those using neither axial nor radial spacers. (3) Rods with a Gd₂O₃ content of less than 2% are assumed equal to UO₂ rods (without gadolinium).</p>	
* ENU: enriched natural uranium	

The mechanical resistance properties of the materials used in the rod cladding must respect the following table:

R_{p0.2} (MPa)	≥ 250
R_m (MPa)	≥ 400
A_t (% over 50 mm)	≥ 25

1.2 Loading conditions

All rods making up a load must adhere to the conditions defined in the table below.

Type of array	Maximum number of rods authorized per load, per box	Maximum initial enrichment level of each rod making up a load (235U/ U _{total})	Minimum number of rods in each loaded assembly ⁽¹⁾
14x14	222 ⁽²⁾	5	Full row of fuel rods or inert rods

(1) Incomplete rows of fuel rods may be topped up using solid stainless steel (or Zirconium alloy) bars with a nominal diameter of between 10.7 mm and 11 mm, possibly containing a neutron poison. The term "number of rods per box" means the total number of fuel rods and steel (or zirconium alloy) bars.

(2) When transporting small quantities of UO₂ fuel rods without radial or axial supports, the maximum permissible mass of UO₂ per package is 21.1 kg.

The presence of a desiccant is allowed.

The presence of materials with a greater hydrogen content than water as part of the packaging is not permitted.

Maximum activity level per packaging: The maximum activity of the content is less than 1 A₂.

Material classification: Activity is less than 1 A₂.

Physical State: Fuel rod assemblies containing sintered pellets in a Zirconium alloy cladding, possibly pre-oxidized, meeting the criteria given in Paragraph 1.1 of the appendix.

Chemical composition: Uranium oxide pellets (UO₂) and/or fuel pellets made up a mixture of UO₂ at a ²³⁵U enrichment level not exceeding 5% and a body acting as a neutron poison, with a mixture density of not more than 10.96 g/cm³. The pellets may contain chrome oxides (but no other form of doping product).

Special form: The materials being shipped are not in special form.

2. INTERNAL FITTINGS

The internal fittings comprise a fuel rod box, as described in Chapters 1.3-1 & 1.3-2 DOS-12-00057682-031 Rev. 1 & DOS-12-00057682-032 Rev. 1 of the Safety Analysis Report.

2.1 Fuel rod box

The non-assembled rods are grouped in FCC4 version rod boxes which are inserted in place of the assemblies inside the FCC4 version 1 packagings.

The channel is made of a U-shaped plate closed at the ends and reinforced with two stringers welded on the upper part of the plate.

A radial and axial wedging system adapts to the length of the rods and ensures their positioning. A general arrangement drawing is given in Figure 7.1.

The minimum height of the radial support is 85 mm.

2.2 Spacers

A set of 2 spacers is used to provide longitudinal support to the box within the cavity (one spacer at the top, another at the bottom). The spacers are described in detail in Chapter 1.3-1 of DOS-12-00057682-031 Rev. 1 of the Safety Analysis Report.

3. MAINTAINING SUB-CRITICALITY

The demonstration of maintaining sub-criticality is the subject of Chapter 2.5-2 DOS-12-00057382-502 Rev. 0.

When transporting small quantities of UO_2 fuel rods without radial or axial supports, the maximum permissible mass of UO_2 per package is 21.1 kg.

Criticality-Safety Index (CSI):

- When transporting UO_2 rods with radial and axial support, criticality-safety index is equal to 0 (number N infinite)
- When transporting $\text{UO}_2\text{-Gd}_2\text{O}_3$ rods with or without radial and axial support, criticality-safety index is equal to 0 (number N infinite)
- When transporting small quantities of UO_2 rods without radial or axial support, criticality-safety index is equal to 50 (number $N=1$),

**FIGURE 7.1
ROD BOX DIAGRAM**

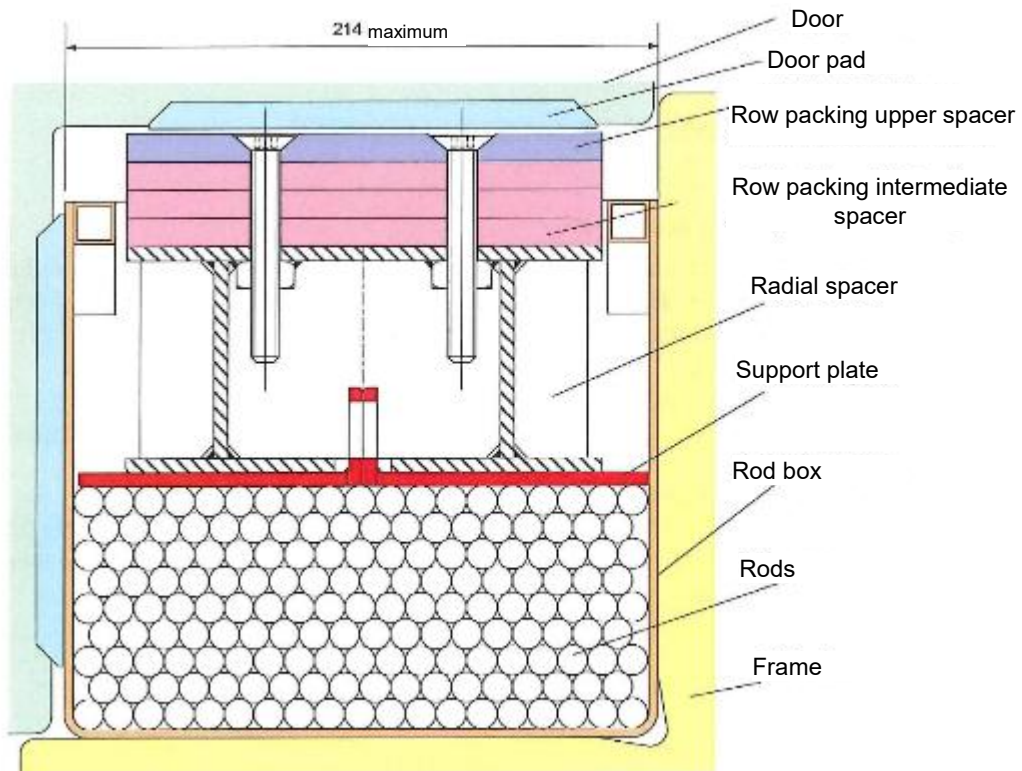

APPENDIX 8
CONTENT NO. 8 14x14 TEN-FOOT
PWR FUEL RODS

The contents should be loaded into an FCC 4 Version 1 packaging.

1. DEFINITION OF AUTHORIZED RADIOACTIVE CONTENTS

1.1 Characteristics of the fuel rods

The authorized radioactive contents, as described in Chapter 1.3 DOS-18-016472-005 version 1.0 of the Safety Analysis Report, comprise fresh fuel rods designed for use in pressurized water reactors (PWR), as detailed below:

Characteristics of the fuel rods before irradiation:	14x14 - 10-foot
Maximum total mass per cavity (kg)	856
Maximum total mass of rods per box (kg)	443
Max mass of UO ₂ (kg)	374/box ⁽¹⁾ or 21.1/package ⁽²⁾
Nominal active length (mm)	3048
Maximum number of fuel rods per box	167
Cladding:	
- Material	Zirconium alloy, possibly pre-oxidized
- Minimum metal thickness (mm)	0,57
- Minimum outer diameter (mm)	10,68
Pellets:	ENU *
- Maximum diameter (mm)	9,40
- Maximum oxide density (100% of theoretical density)	10,96
- Maximum initial enrichment (²³⁵ U/U _{total}) (%)	5
- Maximum mass ratio ²³² U/U _{total} (%)	5.10 ⁻⁸
- Maximum mass ratio ²³⁴ U/U _{total} (%)	0,055
- Maximum mass ratio ²³⁶ U/U _{total} (%)	0,05
Minimum Gd ₂ O ₃ content (by mass) of gadolinium rods (%) ⁽³⁾	2
Maximum absolute internal fuel rod pressure at 20°C (bar)	32,7
(1) This maximum mass is only applicable to gadolinium contents and those using spacers.	
(2) This maximum mass is only applicable to non-gadolinium rods and those using neither axial nor radial spacers.	
(3) Rods with a Gd ₂ O ₃ content of less than 2% are assumed equal to UO ₂ rods (without gadolinium).	
* ENU: enriched natural uranium	

The mechanical resistance properties of the materials used in the rod cladding must respect the following table:

R_{p0.2} (MPa)	≥ 250
R_m (MPa)	≥ 400
A_t (% over 50 mm)	≥ 25

1.2 Loading conditions

All rods making up a load must adhere to the conditions defined in the table below.

Type of array	Maximum number of rods authorized per load, per box	Maximum initial enrichment level of each rod making up a load (²³⁵ U/ U _{total})	Minimum number of rods in each loaded assembly ⁽¹⁾
14x14	167 ⁽²⁾	5	Full row of fuel rods or inert rods
<p>(1) Incomplete rows of fuel rods may be topped up using solid stainless steel (or Zirconium alloy) bars with a nominal diameter of between 10.7 mm and 11 mm, possibly containing a neutron poison. The term "number of rods per box" means the total number of fuel rods and steel (or zirconium alloy) bars.</p> <p>(2) When transporting small quantities of UO₂ fuel rods without radial or axial supports, the maximum permissible mass of UO₂ per package is 21.1 kg.</p>			

The presence of a desiccant is allowed.

The presence of materials with a greater hydrogen content than water as part of the packaging is not permitted.

Maximum activity level per packaging: The maximum activity of the content is less than 1 A₂.

Material classification: Activity is less than 1 A₂.

Physical State: Fuel rod assemblies containing sintered pellets in a Zirconium alloy cladding, possibly pre-oxidized, meeting the criteria given in Paragraph 1.1 of the appendix.

Chemical composition: Uranium oxide pellets (UO₂) and/or fuel pellets made up a mixture of UO₂ at a ²³⁵U enrichment level not exceeding 5% and a body acting as a neutron poison, with a mixture density of not more than 10.96 g/cm³. The pellets may contain chrome oxides (but no other form of doping product).

Special form: The materials being shipped are not in special form.

2. INTERNAL FITTINGS

The internal fittings comprise a fuel rod box, as described in Chapters 1.3-1 & 1.3-2 DOS-12-00057682-031 Rev. 1 & DOS-12-00057682-032 Rev. 1 of the Safety Analysis Report.

2.1 Fuel rod box

The non-assembled rods are grouped in FCC4 version rod boxes which are inserted in place of the assemblies inside the FCC4 version 1 packagings.

The channel is made of a U-shaped plate closed at the ends and reinforced with two stringers welded on the upper part of the plate.

A radial and axial wedging system adapts to the length of the rods and ensures their positioning. A general arrangement drawing is given in Figure 8.1.

The minimum height of the radial support is 85 mm.

2.2 Spacers

A set of 2 spacers is used to provide longitudinal support to the box within the cavity (one spacer at the top, another at the bottom). The spacers are described in detail in Chapter 1.3-1 of DOS-12-00057682-031 Rev. 1 of the Safety Analysis Report.

3. MAINTAINING SUB-CRITICALITY

The demonstration of maintaining sub-criticality is the subject of Chapter 2.5-2 DOS-12-00057682-502 Rev. 0 of the Safety Analysis Report.

When transporting small quantities of UO_2 fuel rods without radial or axial supports, the maximum permissible mass of UO_2 per package is 21.1 kg.

Criticality-Safety Index (CSI):

- When transporting UO_2 rods with radial and axial support, criticality-safety index is equal to 0 (number N infinite),
- When transporting $\text{UO}_2\text{-Gd}_2\text{O}_3$ rods with or without radial and axial support, criticality-safety index is equal to 0 (number N infinite)
- When transporting small quantities of UO_2 rods without radial or axial support, criticality-safety index is equal to 50 (number N=1)

**FIGURE 8.1
ROD BOX DIAGRAM**

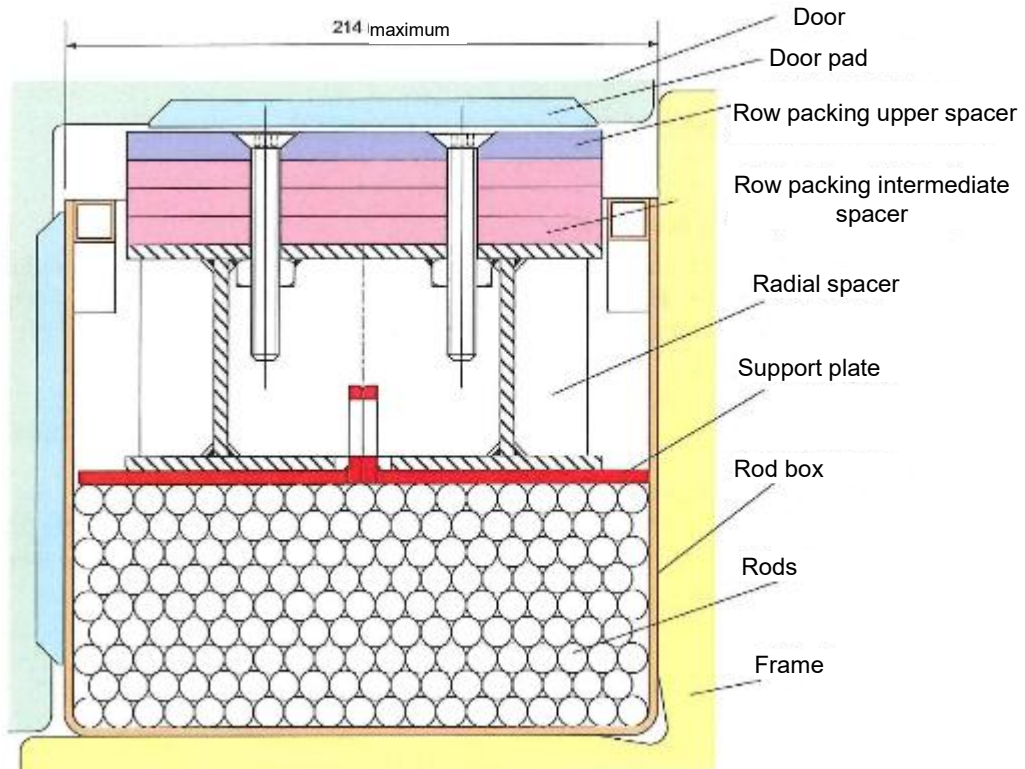

APPENDIX 10

CONTENTS No. 10 16x16

PWR FUEL RODS

The contents should be loaded into an FCC 4 Version 1 packaging.

1. DEFINITION OF AUTHORIZED RADIOACTIVE CONTENTS

1.1 Characteristics of the fuel rods

The authorized radioactive contents, as described in Chapter 1.3 DOS-18-016472-005 version 1.0 of the Safety Analysis Report, comprise fresh fuel rods designed for use in pressurized water reactors (PWR), as detailed below:

Characteristics of the fuel rods before irradiation:	16x16
Maximum total mass per cavity (kg)	856
Maximum total mass of rods per box (kg)	504
Maximum mass of UO ₂ (kg)	401/box ⁽¹⁾ or 21.1/package ⁽²⁾
Nominal active length (mm)	3,900
Maximum number of fuel rods per box	148
Cladding: Material	Zirconium alloy, possibly pre-oxidized
- Minimum metal thickness (mm)	0.68
- Minimum outer diameter (mm)	10.70
Pellets:	ENU *
- Maximum diameter (mm)	9.14
- Maximum oxide density (100% of theoretical density)	10.96
- Maximum initial enrichment (²³⁵ U/U _{total}) (%)	5
- Maximum mass ratio ²³² U/U _{total} (%)	5.10 ⁻⁸
- Maximum mass ratio ²³⁴ U/U _{total} (%)	0.055
- Maximum mass ratio ²³⁶ U/U _{total} (%)	0.05
Minimum Gd ₂ O ₃ content (by mass) of gadolinium rods (%) ⁽³⁾	2
Maximum absolute internal fuel rod pressure at 20°C (bar)	32.7
<p>(1) This maximum mass is only applicable to gadolinium contents and those using spacers. (2) This maximum mass is only applicable to non-gadolinium rods and those using neither axial nor radial spacers. (3) Rods with a Gd₂O₃ content of less than 2% are assumed equal to UO₂ rods (without gadolinium).</p> <p>* ENU: enriched natural uranium</p>	

The mechanical resistance properties of the materials used in the rod cladding must respect the following table:

R_{p0.2} (MPa)	≥ 250
R_m (MPa)	≥ 400
A_t (% over 50 mm)	≥ 25

1.2 Loading conditions

All rods making up a load must adhere to the conditions defined in the table below.

Type of array	Maximum number of rods authorized per load, per box	Maximum initial enrichment level of each rod making up a load (²³⁵ U/ U _{total})	Minimum number of rods in each loaded assembly ⁽¹⁾
16x16	148 ⁽²⁾	5	Full row of fuel rods or inert rods

(1) Incomplete rows of fuel rods may be topped up using solid stainless steel (or Zirconium alloy) bars with a nominal diameter of between 10.7 mm and 11 mm, possibly containing a neutron poison. The term "number of rods per box" means the total number of fuel rods and steel (or zirconium alloy) bars.

(2) When transporting small quantities of UO₂ fuel rods without radial or axial supports, the maximum permissible mass of UO₂ per package is 21.1 kg.

The presence of a desiccant is allowed.

The presence of materials with a greater hydrogen content than water as part of the packaging is not permitted.

Maximum activity level per packaging: The maximum activity of the content is less than 1 A₂.

Material classification: Activity is less than 1 A₂

Physical State: Fuel rod assemblies containing sintered pellets in a Zirconium alloy cladding, possibly pre-oxidized, meeting the criteria given in Paragraph 1.1 of the appendix.

Chemical form: Uranium oxide pellets (UO₂) and/or fuel pellets made up a mixture of UO₂ at a ²³⁵U enrichment level not exceeding 5% and a body acting as a neutron poison, with a mixture density of not more than 10.96 g/cm³. The pellets may contain chrome oxide (but no other doping material).

Special form: The materials being shipped are not in special form.

2. INTERNAL FITTINGS

The internal fittings comprise a fuel rod box, as described in Chapters 1.3-1 & 1.3-2 DOS-12-00057682-031 Rev. 1 & DOS-12-00057682-032 Rev. 1 of the Safety Analysis Report.

2.1 Rod boxes

The non-assembled rods are grouped in FCC4 version rod boxes which are inserted in place of the assemblies inside the FCC4 version 1 packagings.

The channel is made of a U-shaped plate closed at the ends and reinforced with two stringers welded on the upper part of the plate.

A radial and axial wedging system adapts to the length of the rods and ensures their positioning. A general arrangement drawing is given in Figure 10.1.

The minimum height of the radial support is 85 mm.

2.2 Spacers

A set of 2 spacers is used to provide longitudinal support to the box within the cavity (one spacer at the top, another at the bottom). The spacers are described in detail in Chapter 1.3-1 of DOS-12-00057682-031 Rev. 1 of the Safety Analysis Report.

3. MAINTAINING SUB-CRITICALITY

The demonstration of maintaining sub-criticality is the subject of Chapter 2.5-2 DOS-12-00057682-502 Rev. 0 of the Safety Analysis Report.

When transporting small quantities of UO_2 fuel rods without radial or axial supports, the maximum permissible mass of UO_2 per package is 21.1 kg.

Criticality-Safety Index (CSI):

- When transporting UO_2 rods with radial and axial support, criticality-safety index is equal to 0 (number N infinite),
- When transporting $\text{UO}_2\text{-Gd}_2\text{O}_3$ rods with or without radial and axial support, criticality-safety index is equal to 0 (number N infinite)
- When transporting small quantities of UO_2 rods without radial or axial support, criticality-safety index is equal to 50 (number $N=1$)

FIGURE 10.1
ROD BOX DIAGRAM

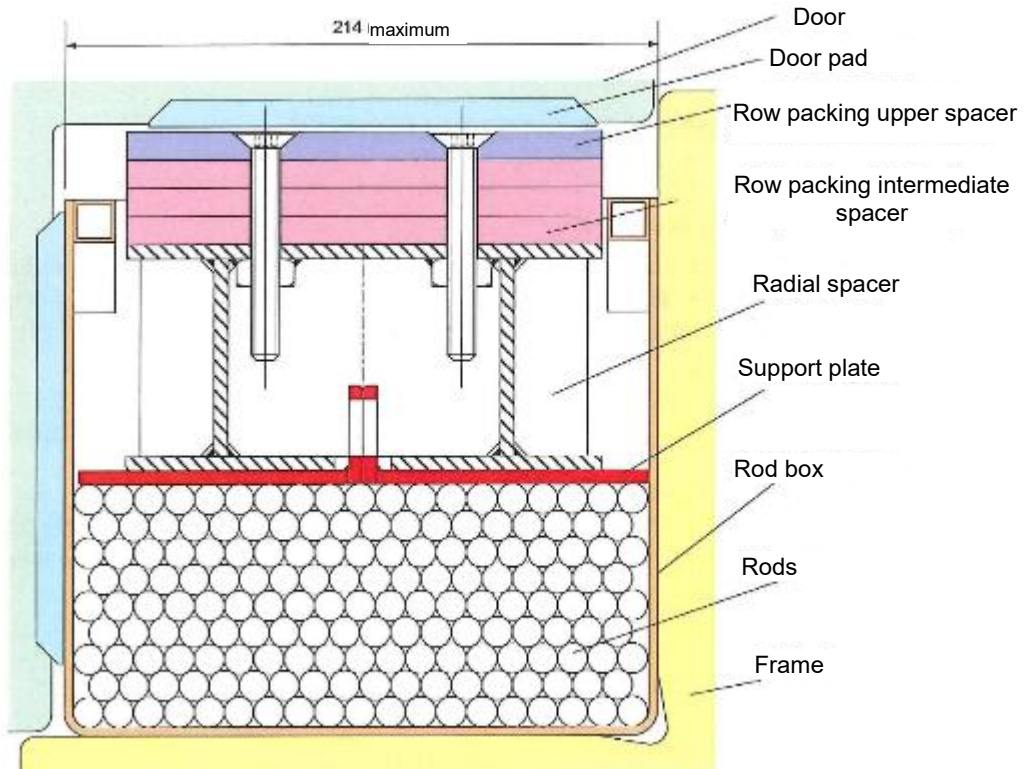

APPENDIX 11

Contents N° 11 18x18

PWR FUEL RODS

The contents should be loaded into an FCC 4 Version 1 packaging.

1. DEFINITION OF AUTHORIZED RADIOACTIVE CONTENTS

1.1 Characteristics of the fuel rods

The authorized radioactive contents, as described in Chapter 1.3 DOS-18-016472-005 version 1.0 of the Safety Analysis Report, comprise fresh fuel rods designed for use in pressurized water reactors (PWR), as detailed below:

Characteristics of the fuel rods before irradiation:	18x18
Maximum total mass per cavity (kg)	856
Maximum total mass of rods per box (kg)	544
Max mass of UO ₂ (kg)	430/box ⁽¹⁾ or 20/package ⁽²⁾
Nominal active length (mm)	3,900
Maximum number of fuel rods per box	205
Cladding:	
- Material	Zirconium alloy, possibly pre-oxidized
- Minimum metal thickness (mm)	0.60
- Minimum outer diameter (mm)	9.46
Pellets:	ENU *
- Maximum diameter (mm)	8.08
- Maximum oxide density (97.5 % of theoretical density)	10.96
- Maximum initial enrichment (²³⁵ U/U _{total}) (%)	5
- Maximum mass ratio ²³² U/U _{total} (%)	5.10 ⁻⁸
- Maximum mass ratio ²³⁴ U/U _{total} (%)	0.055
- Maximum mass ratio ²³⁶ U/U _{total} (%)	0.05
Minimum Gd ₂ O ₃ content (by mass) of gadolinium rods (%) ⁽³⁾	2
Maximum absolute internal fuel rod pressure at 20°C (bar)	32.7
<p>(1) This maximum mass is only applicable to gadolinium contents and those using spacers. (2) This maximum mass is only applicable to non-gadolinium rods and those using neither axial nor radial spacers. (3) Rods with a Gd₂O₃ content of less than 2% are assumed equal to UO₂ rods (without gadolinium).</p>	
<p>* ENU: enriched natural uranium</p>	

The mechanical resistance properties of the materials used in the rod cladding must respect the following table:

R_{p0.2} (MPa)	≥ 250
R_m (MPa)	≥ 400
A_t (% over 50 mm)	≥ 25

1.2 Loading conditions

All rods making up a load must adhere to the conditions defined in the table below.

Type of array	Maximum number of rods authorized per load, per box	Maximum initial enrichment level of each rod making up a load (²³⁵ U/ U _{total})	Minimum number of rods in each loaded assembly ⁽¹⁾
18x18	205 ⁽²⁾	5	Full row of fuel rods or inert rods

(1) Incomplete rows of fuel rods may be topped up using solid stainless steel (or Zirconium alloy) bars with a nominal diameter of between 9.5 mm and 10 mm, possibly containing a neutron poison. The term "number of rods per box" means the total number of fuel rods and steel (or zirconium alloy) bars.
(2) When transporting small quantities of UO₂ fuel rods without radial or axial supports, the maximum permissible mass of UO₂ per package is 20 kg.

The presence of a desiccant is allowed.

The presence of materials with a greater hydrogen content than water as part of the packaging is not permitted.

Maximum activity level per packaging: The maximum activity of the content is less than 1 A₂.

Material classification: Activity is less than 1 A₂.

Physical State: Fuel rod assemblies containing sintered pellets in a Zirconium alloy cladding, possibly pre-oxidized, meeting the criteria given in Paragraph 1.1 of the appendix.

Chemical form: Uranium oxide pellets (UO₂) and/or fuel pellets made up a mixture of UO₂ at a ²³⁵U enrichment level not exceeding 5% and a body acting as a neutron poison, with a mixture density of not more than 10.96 g/cm³. The pellets may contain chrome oxides (but no other form of doping product).

Special form: The materials being shipped are not in special form.

2. INTERNAL FITTINGS

The internal fittings comprise a fuel rod box, as described in Chapters 1.3-1 & 1.3-2 DOS-12-00057682-031 Rev. 1 & DOS-12-00057682-032 Rev. 1 of the Safety Analysis Report.

2.1 Rod boxes

The non-assembled rods are grouped in FCC4 version rod boxes which are inserted in place of the assemblies inside the FCC4 version 1 packagings.

The channel is made of a U-shaped plate closed at the ends and reinforced with two stringers welded on the upper part of the plate.

A radial and axial wedging system adapts to the length of the rods and ensures their positioning. A general arrangement drawing is given in Figure 11.1.

The minimum height of the radial support is 85 mm.

2.2 Spacers

A set of 2 spacers is used to provide longitudinal support to the box within the cavity (one spacer at the top, another at the bottom). The spacers are described in detail in Chapter 1.3-1 of DOS-12-00057682-031 Rev. 1 of the Safety Analysis Report.

3. MAINTAINING SUB-CRITICALITY

This is covered in chapter 2.5-2 DOS-12-00057682-502 Rev. 0 of the Safety Analysis Report.

When transporting small quantities of UO_2 fuel rods without radial or axial supports, the maximum permissible mass of UO_2 per package is 20 kg.

Criticality-Safety Index (CSI):

- When transporting UO_2 rods with radial and axial support, criticality-safety index is equal to 0 (number N infinite),
- When transporting $\text{UO}_2\text{-Gd}_2\text{O}_3$ rods with or without radial and axial support, criticality-safety index is equal to 0 (number N infinite)
- When transporting small quantities of UO_2 rods without radial or axial support, criticality-safety index is equal to 50 (number $N=1$)

**FIGURE 11.1
ROD BOX DIAGRAM**

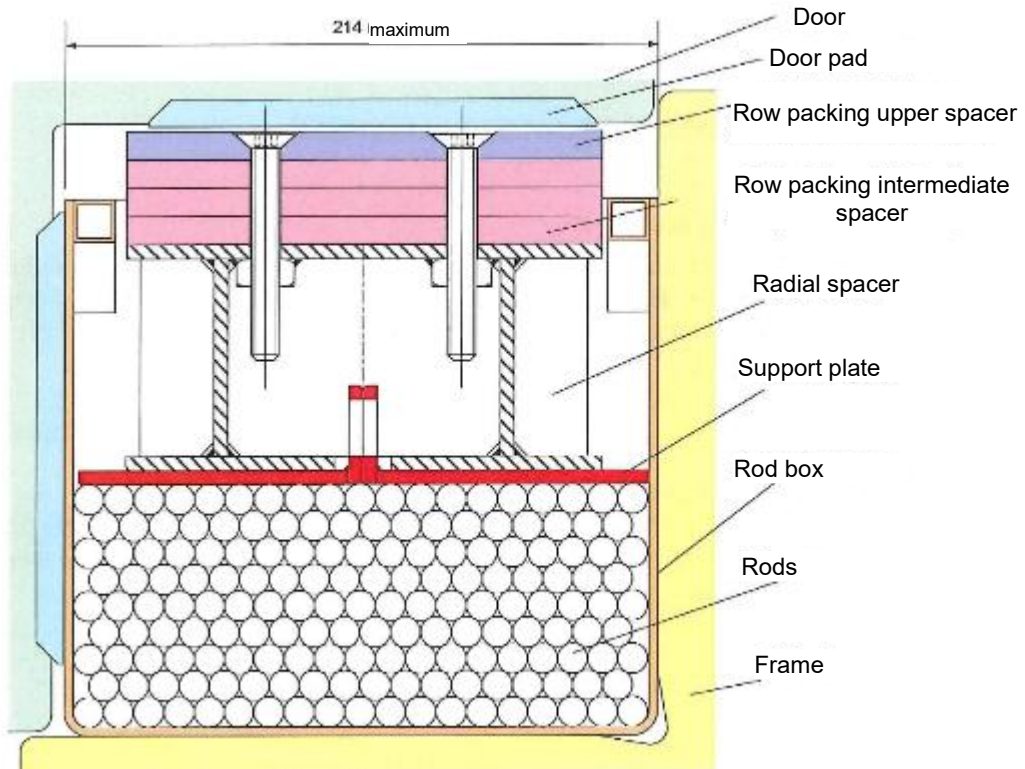

APPENDIX 12
CONTENT No. 12 17x17 TYPE EPR
EPR FUEL ASSEMBLIES

The contents should be loaded into an FCC 4 Version 1 packaging.

1. DEFINITION OF AUTHORIZED RADIOACTIVE CONTENTS

1.1 Characteristics of the fuel assemblies

The authorized radioactive content, described in chapter 1.3 reference DOS-18-016472-005 version 1.0 of the Safety Analysis Report, comprises:

- a maximum of two new fuel assemblies designed for use in pressurized water reactors (PWR), as detailed below;
- a maximum of a new fuel assembly, fitted with an RCCA, designed for use in pressurized water reactors (PWR), and a smooth walled dummy, with radial spacers, or a mock-up of the assembly, as described below:

Characteristics of the assemblies before irradiation:	17x17 EPR ⁽¹⁾
Type of array	17x17
Nominal array pitch (mm)	12.6
Maximum total weight of assembly with or without RCCA (kg)	877
Maximum UO ₂ weight per assembly (kg)	681
Nominal active length (mm)	4,200
Maximum number of fuel rods	289 ⁽²⁾
Characteristics of the fuel rods before irradiation:	
Cladding:	
- Material	Zirconium alloy, possibly pre-oxidized
- Minimum metal thickness (mm)	0.52
- Minimum outer diameter (mm)	9.40
Pellets:	ENU *
- Maximum diameter (mm)	8.30
- Maximum oxide density (100% of theoretical density)	10.96
- Maximum initial enrichment (²³⁵ U/U _{total}) (%)	5
- Maximum mass ratio ²³² U/U _{total} (%)	5.10 ⁻⁸
- Maximum mass ratio ²³⁴ U/U _{total} (%)	0.055
- Maximum mass ratio ²³⁶ U/U _{total} (%)	0.05
Maximum absolute internal fuel rod pressure at 20°C (bar)	32.7
<p>(1) 17x17 EPR designations are for 17x17, 14-foot networks currently used in EPR type reactors. The authorized contents can be made up of different types of assembly as long as they all have the characteristics given in the above table.</p> <p>(2) This number of rods corresponds to the maximum number of rods to be inserted into the structure (carcass or assembly framework), including the guide tubes.</p> <p>* ENU: enriched natural uranium</p>	

Residues of glycerin may be present on the fuel assemblies or on the mock-up of the assembly (a maximum of 5 grams of residue on each).

A mock-up of the assembly comprises the same structural elements as an EPR™ fuel assembly, as detailed previously, unless it has tungsten carbide pellets in place of the fuel rod pellets. The maximum weight is 877 kg.

The smooth walled dummy assembly and its radial spacers, described in Figure 12.1, are in stainless steel. The mechanical resistance properties of the materials used in the rod cladding must respect the following table:

R_{p0.2} (MPa)	≥ 250
R_m (MPa)	≥ 400
A_t (% over 50 mm)	≥ 25

1.2 Loading conditions

All assemblies making up a load must adhere to the conditions defined in the table below.

Type of assembly	Maximum number of assemblies authorized for a load	Maximum initial enrichment level per rod for each assembly making up a load (²³⁵ U/U _{total})	Minimum number of rods in each loaded assembly ⁽¹⁾
17x17 EPR	2	5	265

(1) Incomplete UO₂ fuel rod assemblies can be completed by gadolinium rods; or rods containing depleted uranium or other metallic materials, or even by solid metallic rods (graphite & beryllium not included) which may contain neutron absorbers. These additional rods or bars will have dimensions equivalent to the UO₂ rods. The "number of rods per assembly" is understood to mean the total number of fuel rods and additional rods or bars.

The presence of a desiccant is allowed.

The presence of materials with a greater hydrogen content than water as part of the packaging is not permitted.

Maximum activity level per packaging: The maximum activity of the content is less than 1 A₂.

Material classification: Activity is less than 1 A₂.

Physical State: Fuel rod assemblies containing sintered pellets in a Zirconium alloy cladding, possibly pre-oxidized, meeting the criteria given in Paragraph 1.1 of the appendix.
For the mock-up of the fuel rod assemblies containing pellets of tungsten carbide.
For the smooth walled dummy assembly with a steel structure.

Chemical composition: For fuel rod assemblies containing uranium oxide pellets (UO₂) and/or fuel pellets made up a mixture of UO₂ at a ²³⁵U enrichment level not exceeding 5% and a body acting as a neutron poison, with a mixture density of not more than 10.96 g/cm³. The pellets may contain chrome oxides (but no other form of doping product).

Special form: The materials being shipped are not in special form.

2. MAINTAINING SUB-CRITICALITY

The demonstration of maintaining sub-criticality is the subject of Chapter 2.5-1 DOS-12-00057682-501 Rev. 0 of the Safety Analysis Report.

Criticality-Safety Index (CSI): 0.625 (Number N=80),

FIGURE 12.1
DRAWING OF THE SMOOTH WALLED DUMMY ASSEMBLY

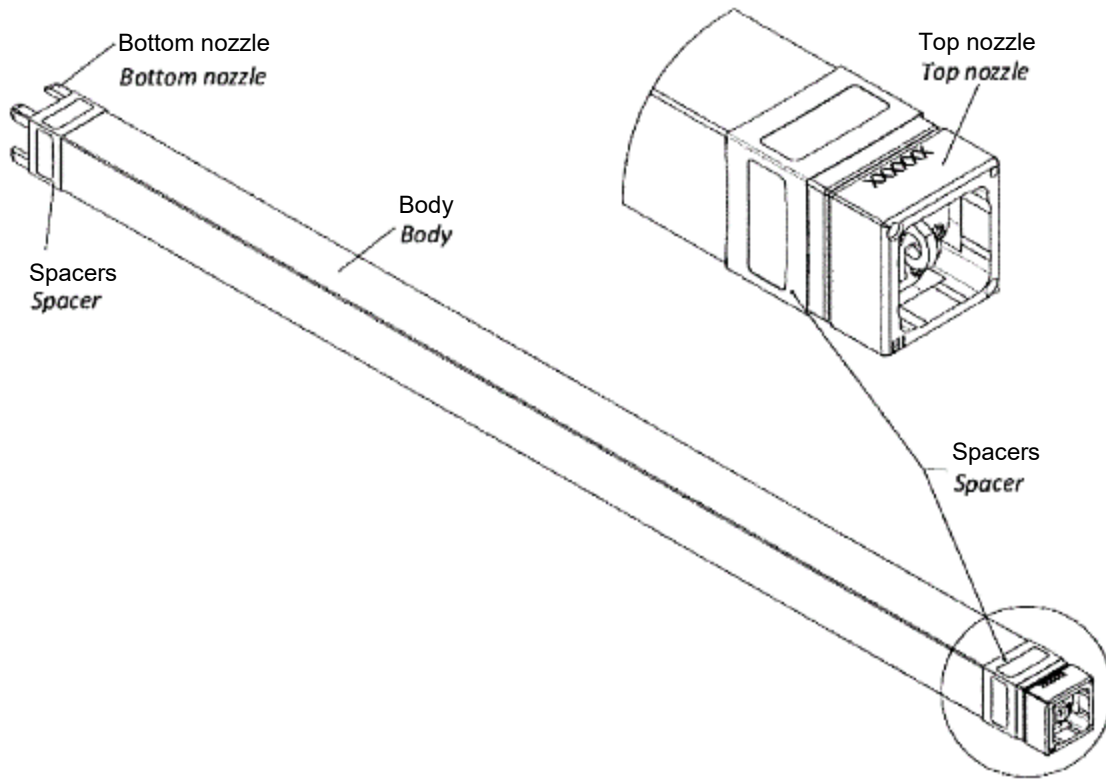

APPENDIX 13

CONTENTS No.13 17x17 TYPE EPR

EPR TYPE FUEL RODS

The contents should be loaded into an FCC 4 Version 1 packaging.

1. DEFINITION OF AUTHORIZED RADIOACTIVE CONTENTS

1.1 Characteristics of the fuel rods

The authorized radioactive contents, as described in Chapter 1.3 DOS-18-016472-005 version 1.0 of the Safety Analysis Report, comprise fresh fuel rods designed for use in pressurized water reactors, as detailed below:

Characteristics of the fuel rods before irradiation:	17x17 EPR type
Maximum total mass per cavity (kg)	856
Maximum total mass of rods per box (kg)	537
Max mass of UO ₂ (kg)	436/box ⁽¹⁾ or 20/package ⁽²⁾
Nominal active length (mm)	4,200
Maximum number of fuel rods	185
Cladding:	
- Material	Zirconium alloy, possibly pre-oxidized
- Minimum metal thickness (mm)	0.52
- Minimum outer diameter (mm)	9.40
Pellets:	ENU *
- Maximum diameter (mm)	8.30
- Maximum oxide density (100% of theoretical density)	10.96
- Maximum initial enrichment (²³⁵ U/U _{total}) (%)	5
- Maximum mass ratio ²³² U/U _{total} (%)	5.10 ⁻⁸
- Maximum mass ratio ²³⁴ U/U _{total} (%)	0.055
- Maximum mass ratio ²³⁶ U/U _{total} (%)	0.05
Minimum Gd ₂ O ₃ content (by mass) of gadolinium rods (%) ⁽³⁾	2
Maximum absolute internal fuel rod pressure at 20°C (bar)	32.7
<p>(1) This maximum mass is only applicable to gadolinium contents and those using spacers. (2) This maximum mass is only applicable to non-gadolinium rods and those using neither axial nor radial spacers. (3) Rods with a Gd₂O₃ content of less than 2% are assumed equal to UO₂ rods (without gadolinium).</p>	
<p>* ENU: enriched natural uranium</p>	

The mechanical resistance properties of the materials used in the rod cladding must respect the following table:

R_{p0.2} (MPa)	≥ 250
R_m (MPa)	≥ 400
A_t (% over 50 mm)	≥ 25

1.2 Loading conditions

All rods making up a load must adhere to the conditions defined in the table below.

Type of array	Maximum number of rods authorized per load, per box	Maximum initial enrichment level of each rod making up the load (²³⁵ U/U _{total})	Minimum number of rods in each loaded assembly ⁽¹⁾
17x17 EPR	185 ⁽²⁾	5	Full row of fuel rods or inert rods

(1) Incomplete rows of fuel rods may be topped up using solid stainless steel (or Zirconium alloy) bars with a nominal diameter of between 9.5 mm and 10 mm, possibly containing a neutron poison. The term "number of rods per box" means the total number of fuel rods and steel (or zirconium alloy) bars.
(2) When transporting small quantities of UO₂ fuel rods without radial or axial supports, the maximum permissible mass of UO₂ per package is 20 kg.

The presence of a desiccant is allowed.

The presence of materials with a greater hydrogen content than water as part of the packaging is not permitted.

Maximum activity level per packaging: The maximum activity of the content is less than 1 A₂.

Material classification: Activity is less than 1 A₂.

Physical State: Fuel rod assemblies containing sintered pellets in a Zirconium alloy cladding, possibly pre-oxidized, meeting the criteria given in Paragraph 1.1 of the appendix.

Chemical form: Uranium oxide pellets (UO₂) and/or fuel pellets made up a mixture of UO₂ at a ²³⁵U enrichment level not exceeding 5% and a body acting as a neutron poison with a mixture density of not more than 10.96 g/cm³. The pellets may contain chrome oxides (but no other doping materials).

Special form: The materials being shipped are not in special form.

2. INTERNAL FITTINGS

The internal fittings comprise a fuel rod box, as described in Chapters 1.3-1 & 1.3-2 DOS-12-00057682-031 Rev. 1 & DOS-12-00057682-032 Rev. 1 of the Safety Analysis Report.

Rod boxes

The non-assembled rods are grouped in EPR rod boxes which are inserted in place of the assemblies inside the FCC4 version 1.

The channel is made of a U-shaped plate closed at the ends and reinforced with two stringers welded on the upper part of the plate.

A radial support system is used to hold the rods in place. A general arrangement drawing is given in Figure 13.1.

The minimum height of the radial support is 85 mm.

3. MAINTAINING SUB-CRITICALITY

The demonstration of maintaining sub-criticality is the subject of Chapter 2.5-2 DOS-12-00057682-502 Rev. 0 of the Safety Analysis Report.

When transporting small quantities of UO_2 fuel rods without radial or axial supports, the maximum permissible mass of UO_2 per package is 20 kg.

Criticality-Safety Index (CSI):

- When transporting UO_2 rods with radial and axial support, criticality-safety index is equal to 0 (number N infinite),
- When transporting $\text{UO}_2\text{-Gd}_2\text{O}_3$ rods with or without radial and axial support, criticality-safety index is equal to 0 (number N infinite)
- When transporting small quantities of UO_2 rods without radial or axial support, criticality-safety index is equal to 50 (number $N=1$)

FIGURE 13.1
ROD BOX DIAGRAM

