

DET DA

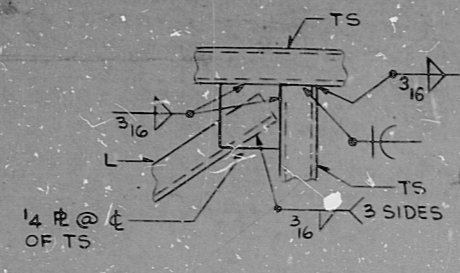

DET DB

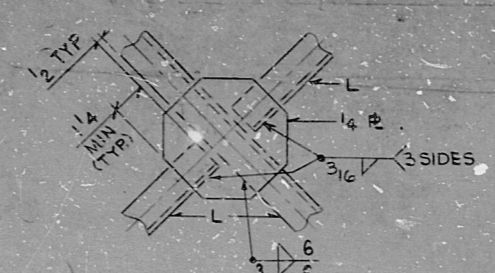

DET DC

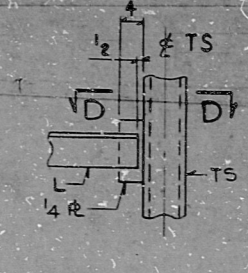

DET DD

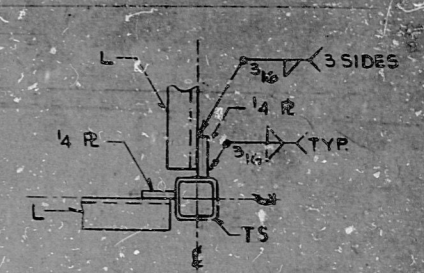

SECT DD

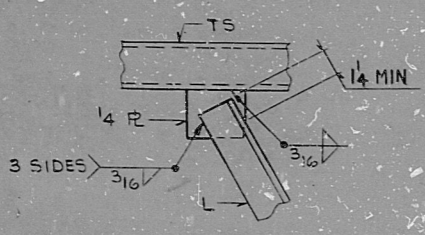

DET DE

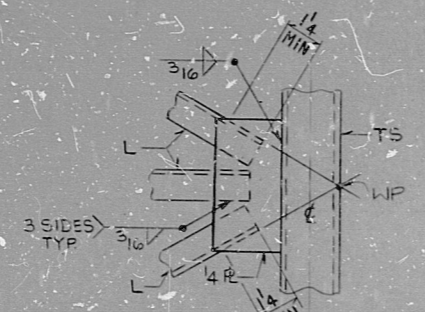

DET DF

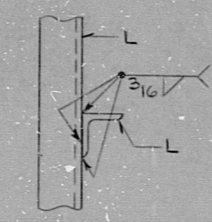

DET DG

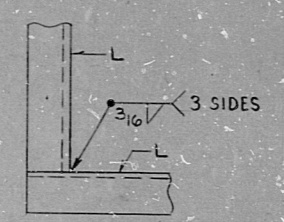

DET DH

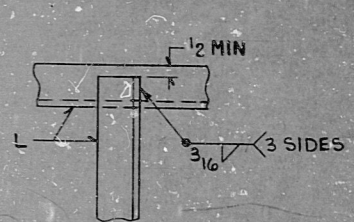

DET DJ

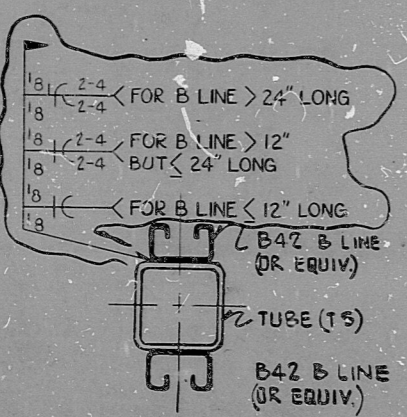

DETAIL FA2

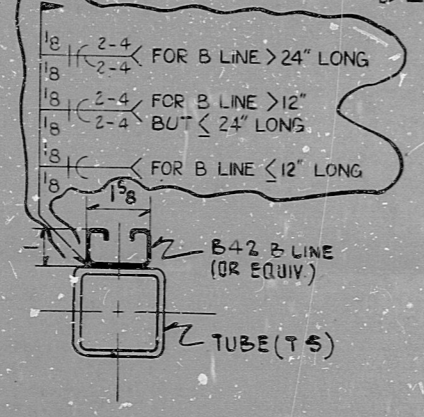

DETAIL FA1

(ALL TUBE SIZES ARE AS SHOWN ON THE SUPPORT DETAILS)
ADDITIONAL STRUTS MAY BE WELDED ON OTHER FACES AS REQ'D

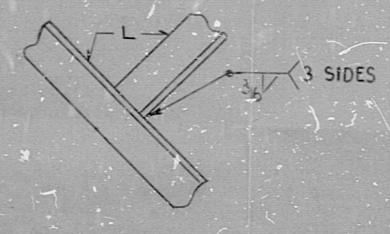

DET DK

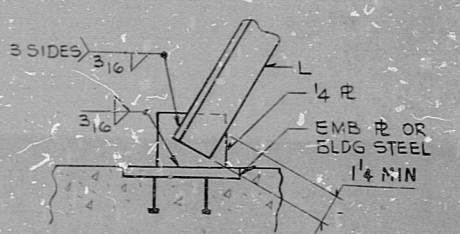

DET DL

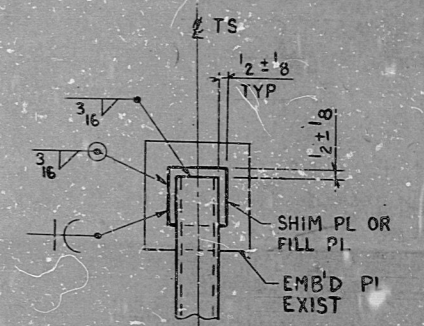

SECT DM

PRC
APERTURE
CARD

EBASCO
CONSTRUCTION SITE

NOTE FOR REV. 3: INCORPORATED PCP-35Q-2161, 6901.

5				EBASCO SERVICES INCORPORATED		NUCLEAR SAFETY RELATED		WPPSS QUALITY CLASS 1, 166	
4				DIV. ELEC. DR. WD		WASHINGTON PUBLIC POWER SUPPLY SYSTEM		WPPS-324	
3				CH. K. ENG		NUCLEAR PROJECTS NO. 3 & 5		0-5033	
2				DATE DEC 1, 1980		BOX DETAILS		SEISMIC MTD. CONN. DETAILS	
1				APPROVED		SHIM PL OR FILL PL		EMB'D PL EXIST	
REV				DATE		BY		APPROVED	

11

11

9.8

8.5"

11"

17"

11

11

9.8

8.5"

11"

17"

15
RIDS

8303290736

