

<b>MONTICELLO NUCLEAR GENERATING PLANT</b>		E-PLAN
<b>TITLE:</b>	<b>EMERGENCY PLAN</b>	Revision 54
		Page 1 of 120

Approval: 602000015499

<b><u>INFORMATION USE</u></b>
<ul style="list-style-type: none"><li>• Procedure should be available, but <u>NOT</u> necessarily at the work location.</li><li>• Procedure may be performed from memory.</li><li>• User remains responsible for procedure adherence.</li></ul>

<b>MONTICELLO NUCLEAR GENERATING PLANT</b>		E-PLAN
<b>TITLE:</b>	<b>EMERGENCY PLAN</b>	Revision 54
		Page 2 of 120

TABLE OF CONTENTS

<u>SECTION</u>	<u>PAGE</u>
1.0 DEFINITIONS AND ABBREVIATIONS .....	3
2.0 SCOPE AND APPLICABILITY .....	5
3.0 SUMMARY OF EMERGENCY PLAN .....	6
4.0 EMERGENCY CLASSIFICATION SYSTEM.....	7
5.0 ORGANIZATIONAL CONTROL OF EMERGENCIES .....	9
6.0 EMERGENCY MEASURES.....	34
7.0 EMERGENCY FACILITIES AND EQUIPMENT .....	55
8.0 MAINTAINING EMERGENCY PREPAREDNESS .....	86
9.0 RECOVERY.....	90
10.0 APPENDIX A .....	92
11.0 APPENDIX B .....	96
12.0 ANNEX A.....	104
13.0 FIGURES.....	109
Figure 13.1 MONTICELLO PLANT EMERGENCY ORGANIZATION .....	109
Figure 13.2 INTERFACE BETWEEN FUNCTIONAL AREAS OF EMERGENCY ACTIVITY .....	112
Figure 13.3 INTERFACE BETWEEN FUNCTIONAL AREAS OF EMERGENCY ACTIVITY DURING HOSTILE ACTION BASED EVENTS .....	113
Figure 13.4 PLAN VIEW OF TECHNICAL SUPPORT CENTER, BACK-UP OPERATIONAL SUPPORT CENTER.....	114
Figure 13.5 PLAN VIEW OF THE EMERGENCY OPERATIONS FACILITY.....	115
Figure 13.6 DIRECT DEDICATED TELEPHONES (HOT LINES) .....	116
Figure 13.7 PLAN VIEW OF OPERATIONAL SUPPORT CENTER.....	118
Figure 13.8 SUMMARY OF SIGNIFICANT CHANGES .....	120

<b>MONTICELLO NUCLEAR GENERATING PLANT</b>		E-PLAN
<b>TITLE:</b>	<b>EMERGENCY PLAN</b>	Revision 54
		Page 3 of 120

## 1.0 DEFINITIONS AND ABBREVIATIONS

- 1.1 Assessment Action - Actions taken during or after an accident to obtain and process information necessary to make decisions regarding emergency measures.
- 1.2 Committed Dose Equivalent (CDE) refers to the dose received over the 50 year period following an intake of radioactive materials.
- 1.3 Committed Effective Dose Equivalent (CEDE) is the sum of the products of the weighted factors applicable to each of the body organs or tissues that are irradiated and the committed dose equivalent to these organs or tissue.
- 1.4 Corrective Actions – Emergency measures taken to terminate an emergency situation at or near the source in order to prevent or minimize a radioactive release, e.g., shutting down equipment, firefighting, repair and damage control, etc.
- 1.5 Effective dose equivalent (EDE) is the sum of the product of the absorbed dose in tissue, quality factors, and all other necessary modifying factors at the location of interest.
- 1.6 Emergency Action Level (EAL) – A pre-determined, site-specific, observable threshold for an Initiating Condition that, when met or exceeded, places the plant in a given emergency classification level.
- 1.7 Emergency Director (ED) – The Plant Manager or his designee. This individual has overall responsibility and authority for managing the emergency effort within the plant. The ED will also manage efforts external to the plant until relieved of those responsibilities by the Emergency Manager.
- 1.8 Emergency Manager (EM) – This person is responsible to direct the overall MNGP emergency response effort. The EM will assume control of the Emergency Operations Facility and direct NSPM Emergency response efforts.
- 1.9 EOF – Emergency Operations Facility
- 1.10 Emergency Planning Zones – A defined area around the plant to facilitate emergency planning by state and local authorities, to assure that prompt and effective actions are taken to protect the public in the event of a release of radioactive material. It is defined for:
  - Plume Exposure Pathway – A 10 mile radius around the plant where the principal exposure source is: (1) whole body exposure to gamma radiation from the plume and from deposited material; and (2) inhalation exposure from the passing radioactive plume (Short Term Exposure).
  - Ingestion Exposure Pathway – A 50 mile radius around the plant where the principal exposure would be from the ingestion of contaminated water or foods such as milk or fresh vegetables (Long Term Exposure).
- 1.11 ERDS – Emergency Response Data System
- 1.12 ERF Communicator - Individual qualified to perform duties as Plant Status Communicator in the TSC, OSC, or EOF.

<b>MONTICELLO NUCLEAR GENERATING PLANT</b>		E-PLAN
<b>TITLE:</b>	<b>EMERGENCY PLAN</b>	Revision 54
		Page 4 of 120

- 1.13 Emergency Worker – An individual who has an essential mission to protect the health and safety of the public, and who could be exposed to ionizing radiation from the plume or from its deposition. Emergency workers may or may not be individuals normally exposed to ionizing radiation as a part of their occupations. Ultimately, state and local authorities designate what categories of workers are classified as emergency workers.
- 1.14 Facility Activation – An Emergency Response Facility is activated when the minimum staff per Figure 13.1 is available and the facility is ready to assume its assigned Emergency Plan functions and relieve the on-shift staff of those functions. Although the facility may be ready, the on-shift staff relief may be postponed in the interests of completing critical tasks prior to turnover.
- 1.15 FTS – Federal Telephone System
- 1.16 Initiating Condition (IC) – An event or condition that aligns with the definition of one of the four emergency classification levels by virtue of the potential or actual effects or consequences.
- 1.17 Northern States Power Company – Minnesota (NSPM) - is the operator of the Monticello Nuclear Generating Plant.
- 1.18 OSC – Operational Support Center
- 1.19 PASS – Post–Accident Sampling System
- 1.20 Protective Actions – Emergency measures taken before or after a release of radioactive materials in order to prevent or minimize radiological exposures to the population.
- 1.21 Protective Action Guides (PAG) – Projected dose to individuals that warrants protective action prior to and/or following a radioactive release.
- 1.22 REC – Radiological Emergency Coordinator
- 1.23 Recovery Actions – Actions taken after an emergency to restore the plant to normal.
- 1.24 SEC – Shift Emergency Communicator
- 1.25 TSC – Technical Support Center
- 1.26 Total Effective Dose Equivalent (TEDE) is the sum of EDE and CEDE.
- 1.27 Xcel Energy is the owner of the Monticello Nuclear Generating Plant.

<b>MONTICELLO NUCLEAR GENERATING PLANT</b>		E-PLAN
<b>TITLE:</b>	<b>EMERGENCY PLAN</b>	Revision 54
		Page 5 of 120

## 2.0 SCOPE AND APPLICABILITY

In accordance with license conditions, 10CFR Part 50, and NRC Regulatory guidance, the Northern States Power Company – Minnesota (NSPM) has developed and implemented an emergency response plan for the Monticello Nuclear Generating Plant (MNGP) and a joint off-site plan for the MNGP and the Prairie Island Nuclear Generating Plant. Xcel Energy's wholly owned subsidiary NSPM operates the Monticello Nuclear Generating Plant. As asset owner, Xcel Energy retains all owner obligations.

In any emergency situation at Monticello, the initial response would be made by the site staff and, if needed, by local support agencies. It is expected that the initial response would have to extend for a period of hours, by which time the site staff would be augmented by other segments of the overall NSPM emergency response organization. Once all centers are activated and the emergency organization is at full strength, the scope of the plant staff response will be reduced to the immediate plant site activities. This plan covers the actions and responsibilities of the Monticello plant staff and the local off-site support agencies.

The plan is directed toward the following areas:

- 2.1 Organization and actions within the plant to control and limit the consequences of an accident.
- 2.2 Organization and actions controlling site and initial off-site activities in the event of an uncontrolled release of radioactive material. This includes notification of and coordination with required off-site support agencies.
- 2.3 Identifying and evaluating the consequences of accidents that may occur and affect the safety of public and plant personnel.
- 2.4 Describing the protective action levels and actions that are required to protect the public and plant personnel in the event of an accident.
- 2.5 Considerations necessary for the purposes of re-entry and recovery.
- 2.6 Arrangements required for medical support in the event of injury.
- 2.7 The training necessary to assure adequate response to emergencies.
- 2.8 Notification systems used to notify the public in the event of an incident involving or potential of involving an off-site release.

The Emergency Plan is dependent upon the Emergency Plan Implementing Procedures for implementation. The procedures are the activating mechanism for the State Plan, which in turn activates the local government and service support agencies. Finally, the procedures reference standing plant operating, radiological control and security procedures in defining the plant's response to the spectrum of emergency situations.

<b>MONTICELLO NUCLEAR GENERATING PLANT</b>		E-PLAN
<b>TITLE:</b>	<b>EMERGENCY PLAN</b>	Revision 54
		Page 6 of 120

### 3.0 SUMMARY OF EMERGENCY PLAN

Abnormal events, both realized and potential, requiring emergency preparedness response are classified into four classes of Emergency Action Levels. The four levels of emergency classes, in increasing order of severity are:

- (1) Notification of Unusual Event
- (2) Alert
- (3) Site Area Emergency
- (4) General Emergency

Each class requires specific immediate actions on the part of the plant staff in order to protect the public, plant personnel and property. As the severity level of the emergency increases, so does the response of the off-site agencies, in order to protect the public.

The lowest class (least severe) is the Notification of Unusual Event. This classification will be handled by plant personnel, with advisory notification to local and state authorities. The Alert Classification requires prompt notification of local and state authorities, which will place their various organizations in the standby mode. In both the Notification of Unusual Event and the Alert Classification, the plant staff is expected to restore the situation to normal without further or minimum involvement of off-site authorities. The two higher severity classes, the Site Area and the General Emergency, (the General Emergency being the most severe), require prompt notification of off-site authorities with immediate involvement of those organizations to assess the emergency situation and to implement the required protective actions for the general public.

<b>MONTICELLO NUCLEAR GENERATING PLANT</b>		E-PLAN
<b>TITLE:</b>	<b>EMERGENCY PLAN</b>	Revision 54
		Page 7 of 120

#### 4.0 EMERGENCY CLASSIFICATION SYSTEM

Emergency situations are classified according to severity, taking into consideration potential as well as actual events in process. Monticello Nuclear Generating Plant has and maintains the capability to assess, classify, and declare an emergency condition within 15 minutes after the availability of indications to plant operators that an emergency action level has been exceeded. Upon identification of the appropriate emergency classification level the emergency condition will be promptly declared. The four standardized classifications are as follows:

1. Notification of Unusual Event (NUE)
2. Alert
3. Site Area Emergency (SAE)
4. General Emergency (GE)

The rationale connecting the four action levels is to provide a mechanism for timely notification of events which could lead to significant consequences given subsequent operator error or equipment failure or which might be indicative of more serious conditions which are not yet fully realized. It should be noted that various events could require a graded scale of response. A minor incident could increase in severity and advance to the next class of emergency.

The process of assessing and classifying an event as a specific type of emergency requires a broad knowledge of integrated plant instrumentation and response to various transients. The various Initiating Conditions (IC) for each emergency class are specified in Annex A of this plan. Annex A also includes the detailed set of Emergency Action Levels (EAL) applicable to the Monticello Nuclear Generating Plant. The EALs are the plant-specific indications, conditions, or instrument readings that are utilized to classify emergency conditions at the plant and were developed using the EAL development methodology found in NEI 99-01, Revision 6.

The ICs and EALs are grouped into the following symptom-based, event based, and barrier-based recognition categories.

- R – Abnormal Rad Levels/Radiological Effluent
- C – Cold Shutdown/Refueling System Malfunction
- E – Independent Spent Fuel Storage Installations
- F – Fission Product Barrier
- H – Hazards And Other Conditions Affecting Plant Safety
- S – System Malfunction

<b>MONTICELLO NUCLEAR GENERATING PLANT</b>		E-PLAN
<b>TITLE:</b>	<b>EMERGENCY PLAN</b>	Revision 54
		Page 8 of 120

Following is a brief description of each emergency classification and its associated response level.

#### 4.1 Notification of Unusual Event

Events are in process or have occurred which indicate a potential degradation of the level of safety of the plant or indicate a security threat to facility protection has been initiated. No releases of radioactive material requiring off-site response or monitoring are expected unless further degradation of safety systems occurs.

The purpose of this classification is to assure that the first step in future response has been carried out, to bring the operations staff to a state of readiness, and to provide systematic handling of unusual event information and decision-making.

#### 4.2 Alert

Events are in process or have occurred which involve an actual or potential substantial degradation of the level of safety of the plant or a security event that involves probable life threatening risk to site personnel or damage to site equipment because of HOSTILE ACTION. Any releases are expected to be limited to small fractions of the EPA Protective Action Guideline exposure levels.

The purpose of this classification is to assure that emergency personnel are readily available to respond if the situation becomes more serious or to perform confirmatory radiation monitoring if required, and provide offsite authorities current information on plant status and parameters.

#### 4.3 Site Area Emergency

Events are in process or have occurred which involve actual or likely major failures of plant functions needed for protection of the public or HOSTILE ACTION that results in intentional damage or malicious acts; (1) toward site personnel or equipment that could lead to the likely failure of or; (2) that prevent effective access to equipment needed for the protection of the public. Any releases are not expected to result in exposure levels which exceed EPA Protective Action Guideline exposure levels beyond the site boundary.

The purpose of the Site Area Emergency declaration is to assure that emergency response centers are staffed, to assure that monitoring teams are dispatched, to assure that personnel required for evacuation of near-site areas are at duty stations if the situation becomes more serious, to provide consultation with offsite authorities, and to provide updates to the public through government authorities.

<b>MONTICELLO NUCLEAR GENERATING PLANT</b>		E-PLAN
<b>TITLE:</b>	<b>EMERGENCY PLAN</b>	Revision 54
		Page 9 of 120

#### 4.4 General Emergency

Events are in process or have occurred which involve actual or IMMEDIATE substantial core degradation or melting with potential for loss of containment integrity or HOSTILE ACTION that results in an actual loss of physical control of the facility. Releases can be reasonably expected to exceed EPA Protective Action Guideline exposure levels off-site for more than the immediate site area.

The purpose of the General Emergency declaration is to initiate predetermined protective actions for the public, to provide continuous assessment of information from the licensee and offsite organizational measurements, to initiate additional measures as indicated by actual or potential releases, to provide consultation with offsite authorities, and to provide updates for the public through government authorities.

### 5.0 ORGANIZATIONAL CONTROL OF EMERGENCIES

#### 5.1 Normal Site Organization

##### 5.1.1 Site Management Organization

The normal site organization is comprised of the plant organization and several other fleet support organizations. Each organizational area has a report directly to the Site Vice President or provides on-site functional support to the Site Vice President with an indirect reporting responsibility to the Site Vice President.

Responsibilities and authority of the various functional groups and individual positions are delineated in site procedures which also provide detailed organizational descriptions.

<b>MONTICELLO NUCLEAR GENERATING PLANT</b>		E-PLAN
<b>TITLE:</b>	<b>EMERGENCY PLAN</b>	Revision 54
		Page 10 of 120

## 5.1.2 Shift Organization

### 5.1.2.1 Operations

The Shift Manager holds a Senior Reactor Operator license and is the senior member of the Operations shift organization. The Shift Manager has the responsibility and authority to direct operating activities of the plant IAW applicable regulations and procedures. The Shift Manager maintains the broadest perspective of operational conditions affecting plant safety and serves as or provides oversight of the technical advisor to the Control Room Supervisor and Control Room operations crew.

The Control Room Supervisor holds a Senior Reactor Operator license and reports to the Shift Manager. The Control Room Supervisor has the responsibility to supervise operating activities of the plant in accordance with applicable regulations and procedures under the direction of the Shift Manager.

A third SRO is qualified to support the shift manager in evaluation of off normal conditions.

Licensed Operators assigned to the Control Room perform plant manipulations and take direction from the Control Room Supervisor.

Auxiliary Operators outside the Control Room manipulate plant equipment and generally take direction from the Lead Plant Equipment and Control Room Operator or the Control Room Supervisor.

### 5.1.2.2 Fire Brigade

The plant Fire Brigade is staffed by qualified Operators, Chemistry and Radiation Protection Technicians. The Fire Brigade is maintained in accordance with 4 AWI-08.01.01 (FIRE PREVENTION PRACTICES).

### 5.1.2.3 Radiation Protection

Two Radiation Protection Technicians are assigned to each operating shift. The normal responsibilities of a shift Radiation Protection Technician are conducting routine and special radiological surveys, operation of plant Count Room equipment, access control and Radiation Work Permit preparation.

<b>MONTICELLO NUCLEAR GENERATING PLANT</b>		E-PLAN
<b>TITLE:</b>	<b>EMERGENCY PLAN</b>	Revision 54
		Page 11 of 120

5.1.2.4 Chemistry

One Chemistry Technician is assigned to each operating shift. The normal responsibilities of the shift Chemistry Technician are conducting routine and special chemistry sampling and analysis and operation of the plant Chemistry Lab.

5.1.2.5 Security (Shift Emergency Communicator)

Security personnel perform duties in accordance with the Security Plan. In addition, Security personnel on each shift are normally assigned the responsibility of primary Shift Emergency Communicator (SEC). As SEC, Security personnel perform emergency and non-emergency communications as directed by the Shift Manager. If dedicated Security personnel are not available to perform this function, other SEC qualified personnel may also be assigned responsibility of primary SEC.

5.1.3 Minimum Shift Staffing

Minimum shift staffing **SHALL** be as indicated in Table 1, Minimum Shift Staffing And Capability For Additions For Nuclear Power Plant Emergencies.

5.1.4 Onshift Staffing Analysis

The Onshift Staffing Analysis provides the supporting documentation for developing the onshift staffing levels as indicated in Table 1, Minimum Shift Staffing and Capability for Additions for Nuclear Power.

<b>MONTICELLO NUCLEAR GENERATING PLANT</b>		E-PLAN
<b>TITLE:</b>	<b>EMERGENCY PLAN</b>	Revision 54
		Page 12 of 120

## 5.2 Emergency Organization and Responsibilities

Under emergency conditions the organization of the site staff is altered to simplify communications channels and make more efficient use of personnel resources (refer to Figure 13.1, Monticello Plant Emergency Organization). The Monticello Emergency Response Organization (ERO) consists of various groups which staff the site Emergency Response Facilities including the Technical Support Center, Operational Support Center and Emergency Operations Facility (or backup EOF if necessary). Functional responsibilities of the various groups are described in this section. A detailed description of individual position responsibilities and leadership designations for the various groups is contained in Emergency Plan Implementing Procedure A.2-001 (EMERGENCY ORGANIZATION). A detailed description of personnel assignments is found in Form 5790-001-01 (EMERGENCY RESPONSE ORGANIZATION).

### 5.2.1 Technical Support Center Emergency Organization

The Technical Support Center ERO consists of a Coordination and Direction Group and six subordinate groups. Each group is represented at the command table in the Technical Support Center. The TSC will be activated within 60 minutes of an Alert or higher declaration.

When a transition from Emergency Operating Procedures (EOPs) to Severe Accident Management Guidelines (SAMGs) occurs, an Accident Management Team (AMT) is formed to utilize the SAMGs. The AMT is comprised of the following ERO positions; Operations Group Leader, Assistant Operations Group Leader, Engineering Coordinator, Nuclear Engineer, SPDS Operator, Trending Individual. AMT members are the Decision Maker and Evaluators. Evaluators are responsible for assessing control parameters, plant status, system status and EOP/SAMG actions and develop potential strategies that may be utilized to mitigate an event.

#### 5.2.1.1 Direction and Control

The Direction and Control Group consists of the Plant Manager and other senior plant management personnel designated by the Plant Manager. Designated members of this group staff the Emergency Director position in the TSC. Qualified Shift Managers are also included in this group and function as the Emergency Director during the initial stages of an emergency until relieved by a designated TSC Emergency Director.

The Emergency Director is responsible for overall emergency direction and control. The Emergency Director has the authority and responsibility to unilaterally initiate emergency response actions including making off-site protective action recommendations to authorities responsible for implementing off-site emergency measures.

<b>MONTICELLO NUCLEAR GENERATING PLANT</b>		E-PLAN
<b>TITLE:</b>	<b>EMERGENCY PLAN</b>	Revision 54
		Page 13 of 120

Functional responsibilities of the Emergency Director include:

- Recommend off-site protective measures. This responsibility may not be delegated and is relinquished to the Emergency Manager when the EOF is activated.
- Overall direction and control of the Technical Support Center personnel and activities.
- Ensure 24 hour coverage of key Emergency Response Organization positions in the TSC and OSC and continuity of personnel and material resources.
- Make decisions regarding plant emergency response facility habitability including on-site protective actions (including KI use), personnel monitoring and evacuations.
- Approval of emergency radiation exposures in excess of normal limits.
- Communications with utility and off-site Emergency Response Organizations. EOF assumes responsibility for communications with off-site agencies when activated.

When the EOF is activated, the overall direction and control responsibility is transferred from the TSC Emergency Director to the Emergency Manager in the EOF. The TSC Emergency Director retains authority and responsibility for decisions immediately affecting the plant including event classification, direction of plant emergency response and on-site protective measures including emergency exposure authorization. Responsibility for offsite functions of notification and protective action recommendations transfer from the TSC to the EOF Emergency Manager. The transition of command and control functions is depicted below.

<b>CONTROL ROOM</b>	<b>TSC</b>	<b>EOF</b>
<b><u>On-Shift/Emergency Director</u></b>	<b><u>TSC Emergency Director</u></b>	<b><u>EOF Emergency Manager</u></b>
Classification	Classification	
Notifications	Notifications	Notifications
PARs	PARs	PARs
Emergency Exposure Controls	Emergency Exposure Controls	

**Transition of Command and Control Functions**

<b>MONTICELLO NUCLEAR GENERATING PLANT</b>		E-PLAN
<b>TITLE:</b>	<b>EMERGENCY PLAN</b>	Revision 54
		Page 14 of 120

### 5.2.1.2 Radiation Protection and Chemistry Groups

The Radiation Protection and Chemistry Groups consists of the Radiological Emergency Coordinator (REC) and members of the Radiation Protection and Chemistry Groups. The REC reports to the Emergency Director and is staffed by Radiation Protection and Chemistry Manager designees. The group is divided into three sections:

- Monitoring Section
- Chemistry Section
- Off-site Dose Projection

The Radiological Emergency Coordinator is the group leader and responsible for coordination of all on-site Radiation Protection and Chemistry emergency response activities.

The Monitoring Section consists of the Monitoring Section Leader, and members of the plant Radiation Protection/Chemistry staff and other NSPM personnel with demonstrated experience in radiation protection.

Responsibilities of the Monitoring Section include on-site radiological surveys, in-plant surveys, personnel exposure control, access control, and initial off-site radiological monitoring.

The Chemistry Section consists of the Chemistry Section Leader and members of the plant Chemistry staff.

Responsibilities of the Chemistry Section include chemistry sampling and analysis, plant and EOF Count Room operation, PASS sampling and core damage assessment, if necessary. Chemistry personnel also function as off-site Dose Projection Specialists.

Off-site dose projection is performed by a Dose Projection Specialist. The Dose Projection Specialist positions are staffed by qualified personnel trained in off-site dose projection. The Dose Projection Specialist responsibilities include off-site dose projections, monitoring current and forecast meteorological information and providing off-site dose projection results to the REC or RPSS.

<b>MONTICELLO NUCLEAR GENERATING PLANT</b>		E-PLAN
<b>TITLE:</b>	<b>EMERGENCY PLAN</b>	Revision 54
		Page 15 of 120

#### 5.2.1.3 Support Group

The Support Group is staffed by members of the Performance Improvement, Supply Chain groups and others designated by site management. The Support Group Leader reports to the Emergency Director and is responsible for on-site logistics support, emergency document control, print and drawing retrieval, administrative services, emergency procurement and warehouse support. The Support Group Leader is also responsible to coordinate the establishment of 24-hour ERO shift schedules as requested by the Emergency Director.

#### 5.2.1.4 Operations Group

The Operations Group consists of the Operations Group Leader and all members of the Operations staff including the duty operating crew, off-duty Shift Managers, Control Room Supervisors and all Operators. The Operations Group Leader is staffed by Shift Operation Manager designees and includes off-duty Shift Managers and Control Room Supervisors that report to the Emergency Director. The Operations Group Leader serves as the primary link between the TSC and Control Room for the purpose of providing technical and operational advice and support to the duty Control Room operating staff.

When the TSC is staffed and a transition point from the EOPs to the SAMGs is reached, the duty Shift Manager and Operations Group Leader will make a joint decision to transition from the EOPs to the Severe Accident Management Guidelines (SAMGs). At this point, the Operations Group Leader would inform the TSC that they have relieved the duty Shift Manager as the Decision Maker. The Decision Maker is designated to assess and select the strategies to be implemented. When using the SAMGs, the Operations Group Leader will act as the Decision Maker and directs actions as specified in the SAMGs. The Assistant Operations Group Leader is a member of the Accident Management Team (AMT). The Assistant Operations Group Leaders primary responsibility is to recommend actions to the Operations Group Leader based on the SAMGs.

The Assistant Operations Group Leader is an off-duty Shift Manager or Control Room Supervisor.

In addition, the Operations Group provides off-duty personnel to staff and support the Operational Support Center (OSC).

<b>MONTICELLO NUCLEAR GENERATING PLANT</b>		E-PLAN
<b>TITLE:</b>	<b>EMERGENCY PLAN</b>	Revision 54
		Page 16 of 120

#### 5.2.1.5 Engineering Group

The Engineering Group consists of the Engineering Group Leader and members of the Engineering and Maintain the Plant Groups. The Engineering Group Leader position is staffed by Engineering Manager Designees and reports to the Emergency Director. The Engineering Group Leader is responsible for overall direction of Engineering Group activities and assessment. The Engineering Coordinator reports to the Engineering Group Leader until the SAMGs are entered. When using the SAMGs the Engineering Coordinator becomes a member of the Accident Management Team (AMT) and reports to the Operations Group Leader. Responsibilities of the Engineering Coordinator include engineering evaluation of the event, assessment of inoperable systems or system components, development of accident mitigation strategies and parameter trending and analysis.

#### 5.2.1.6 Maintenance Group

The Maintenance Group consists of the Maintenance Group Leader and members of the Mechanical and Electrical Maintenance Groups including Instrument and Control and designated personnel capable of performing emergency tasks. The Maintenance Group Leader position is staffed by Maintenance Manager designees and reports to the Emergency Director. The Maintenance Group Leader is responsible for the overall direction of corrective actions including damage control and emergency repairs to systems, components or equipment. The OSC Coordinator reports to the Maintenance Group Leader and is responsible for the coordination of emergency repair activities initiated out of the OSC.

#### 5.2.1.7 Security Group

The Security Group consists of the Security Group Leader, Security Lieutenant/SEC and members of the plant Security force. The Security Group Leader position is staffed by the Security Manager or designee and reports to the Emergency Director. The Security Group Leader is responsible for the direction and coordination of security emergency activities including personnel accountability, evacuation of on-site areas and site traffic control and access. The duty Shift Emergency Communicator reports to the Emergency Director (Shift Manager) and is responsible for making or assisting with initial off-site notification. The duty Shift Emergency Communicator may be a qualified SEC from other departments.

<b>MONTICELLO NUCLEAR GENERATING PLANT</b>		E-PLAN
<b>TITLE:</b>	<b>EMERGENCY PLAN</b>	Revision 54
		Page 17 of 120

#### 5.2.1.8 Emergency Communications Group

The Communications Group consists of the Offsite Communicators and qualified Emergency Communicators from various site and fleet support groups. Designated personnel are qualified to staff emergency communicator positions in the TSC, OSC, EOF and Control Room. Responsibilities of the Emergency Communicators include emergency notifications to off-site authorities, transmission of Emergency Follow-up Messages and other required information to off-site authorities, intra-utility communications and communications links between site emergency response facilities.

#### 5.2.2 Operational Support Center Emergency Organization

The OSC Emergency Response Organization includes personnel from Maintenance, Operations, Radiation Protection and Chemistry. The OSC is activated within 60 minutes of an Alert or higher declaration.

##### 5.2.2.1 Coordination and Direction

The OSC Coordinator is responsible for coordination of all OSC activities including dispatching repair teams, personnel accountability in the OSC and OSC habitability. The OSC Coordinator position is staffed by individuals with Maintenance or Operations experience and reports to the Maintenance Group Leader.

##### 5.2.2.2 Mechanical Maintenance

The Mechanical Maintenance Group consists of Machinists, Steamfitter – Welders, Riggers and Repairmen from the plant Maintenance Department, as well as designated personnel capable of performing emergency tasks. They are responsible for emergency repair activities under the direction of the OSC Coordinator.

##### 5.2.2.3 Electrical Maintenance

The Electrical Maintenance Group consists of the Electrical Maintenance Coordinator and Station Electricians from the plant Maintenance Department, as well as designated personnel capable of performing emergency tasks. They are responsible for emergency repair activities under the direction of the OSC Coordinator.

<b>MONTICELLO NUCLEAR GENERATING PLANT</b>		E-PLAN
<b>TITLE:</b>	<b>EMERGENCY PLAN</b>	Revision 54
		Page 18 of 120

#### 5.2.2.4 Instrument & Control

The I&C Group consists of the I&C Maintenance Coordinator and I&C Specialists from the plant Maintenance Department, as well as designated personnel capable of performing emergency tasks. They are responsible for emergency repairs under the direction of the OSC Coordinator.

#### 5.2.2.5 Radiation Protection

The Radiation Protection Group consists of the Radiation Protection Coordinator, Radiation Protection Technicians, Chemistry Technicians, and other NSPM personnel with radiation protection/chemistry experience and personnel designated and trained to perform on-site, out of plant and off-site radiological monitoring surveys. Radiation protection responsibilities include: OSC RP support, staffing Main Access Control, in-plant emergency team support, in-plant and out-plant radiological surveys, Emergency Response Center habitability, off-site environmental monitoring, Assembly Point staffing and Fire Brigade support (as necessary).

#### 5.2.2.6 Operations

The Operations Group consists of available non-duty Shift Managers, Control Room Supervisors, Operators and other personnel reporting to the Operations Manager. Their responsibilities include OSC operations support, in-plant emergency teams, augment the duty Control Room staff (as necessary) and Fire Brigade support (as necessary).

### 5.2.3 EOF Emergency Organization

The EOF Emergency Organization consists of a Direction and Control Group and four subordinate groups. The EOF Emergency Organization is staffed by personnel from the NSPM organization and is activated within 90 minutes of an Alert or higher declaration.

#### 5.2.3.1 Direction and Control

The Direction and Control Group consists of Site and Fleet Senior Management personnel. Designated members of this group staff the Emergency Manager position in the EOF. The Emergency Manager is responsible for overall direction and control of the utilities emergency response effort. The Emergency Manager relieves the Emergency Director of the following responsibilities:

- Off-site dose projections and coordination and direction of off-site radiological monitoring teams.

<b>MONTICELLO NUCLEAR GENERATING PLANT</b>		E-PLAN
<b>TITLE:</b>	<b>EMERGENCY PLAN</b>	Revision 54
		Page 19 of 120

- Communications with off-site authorities including Federal, State, and local authorities and Xcel Energy/NSPM executive management.

In addition, the Emergency Manager assumes the authority and responsibility to provide protective action recommendations to authorities responsible for implementing off-site emergency measures. Other responsibilities of the Emergency Manager include:

- Coordinate the emergency response efforts of other utility personnel assisting the site organization.
- Obtain and coordinate the services of outside consultants and vendors.
- Advise Xcel Energy/NSPM executive management on matters related to emergency response efforts and needed resources to support the effort.

#### 5.2.3.2 Technical Support Group

The EOF Technical Support Group consists of select personnel from various site and fleet groups. The Technical Support Supervisor is staffed by site and fleet personnel and reports to the Emergency Manager. The Technical Support Group is responsible for trending critical parameters, engineering evaluation in support of the TSC Engineering Group, technical assessment and advising the Emergency Manager on technical matters related to the event.

#### 5.2.3.3 Radiation Protection Support Group

The Radiation Protection Support Group is staffed by Radiation Protection Technicians, Chemistry Technicians, and other NSPM personnel with radiation protection (chemistry) experience and personnel designated and trained to perform on-site, out of plant and off-site radiological monitoring surveys. The Radiation Protection Support Supervisor position is staffed by NSPM personnel with demonstrated experience in radiation protection and reports to the Emergency Manager. The Radiation Protection Support Group includes plant Chemistry personnel for off-site dose projection and EOF Count Room operation and designated personnel who function as sample couriers and drivers for off-site radiological monitoring teams. Radiation Protection Support Group responsibilities include:

- Direction and coordination of the utility off-site radiological monitoring teams.
- Off-site dose projection.

<b>MONTICELLO NUCLEAR GENERATING PLANT</b>		E-PLAN
<b>TITLE:</b>	<b>EMERGENCY PLAN</b>	Revision 54
		Page 20 of 120

- EOF Count Room activation and operation.
- EOF habitability, personnel monitoring and decontamination (as necessary).
- Communications with State Emergency Operation Center personnel on matters related to dose projections and off-site protective action recommendations.
- Staffing the Health Physics Network (HPN) and communications with the NRC (as necessary).

The Radiation Protection Support Supervisor advises the Emergency Manager on matters related to actual or potential radiological impact on the environment, off-site protective action recommendations, and EOF habitability.

#### 5.2.3.4 EOF General Staff, Logistics, and Support Group

The EOF general staff consists of the EOF Coordinator, off-site communicators, administrative and logistics support personnel.

The EOF Coordinator position is staffed by designated NSPM personnel and reports to the Emergency Manager. The EOF Coordinator is responsible for operation of the EOF and assists the Emergency Manager with administrative duties.

The off-site communicators, EOF Security Coordinator, Agency Liaison and Administrative Staff report to the EOF Coordinator.

The off-site communicators are responsible for communications with Federal, State and Local authorities as directed by the Emergency Manager.

The Administrative Staff is responsible for emergency document control, recording and document distribution in the EOF.

The off-site Agency Liaison is responsible to serve as the initial interface with off-site (Non-MNGP/NSPM) Emergency Organizations (e.g. NRC Incident Response Team) responding to the EOF.

The EOF Security Group is staffed by personnel from the Site Security Group. The EOF Security Coordinator reports to the EOF Coordinator. Responsibilities of EOF Security include EOF access, dosimetry issuance to EOF personnel and Fitness-for-duty assessment (if required during off-hours activations).

<b>MONTICELLO NUCLEAR GENERATING PLANT</b>		E-PLAN
<b>TITLE:</b>	<b>EMERGENCY PLAN</b>	Revision 54
		Page 21 of 120

### 5.3 Emergency Response Organization Augmentation

The Emergency Response Organization augmentation goals are outlined in Table 1. The augmentation of each functional area and the methods used to accomplish ERO augmentation are described in this section.

#### 5.3.1 ERO Augmentation Description and Goals

##### 5.3.1.1 Plant Operations and Operational Assessment

The duty Operations crew retains the responsibility for plant operation throughout an emergency situation. When in Severe Accident Management Guidelines (SAMGs) the duty operations staff implements the actions as directed by the SAMGs. Non-duty Operations personnel in the TSC and OSC will augment the duty Operations staff.

The responsibilities of the non-duty Operations personnel include operational assessment, under the direction of the Emergency Director in the TSC, and support of emergency repair and corrective action efforts in the OSC including Fire Brigade support.

When the TSC is staffed and a transition point from the EOPs to the SAMGs is reached, the duty Shift Manager and Operations Group Leader will make a joint decision to transition from the EOPs to the SAMGs. At this point, the Operations Group Leader would inform the TSC that they have relieved the duty Shift Manager as the Decision Maker. The Decision Maker is designated to assess and select the strategies to be implemented. When using the SAMGs, the Operations Group Leader will act as the Decision Maker and direct control room response as specified in the SAMGs. The Assistant Operations Group Leader is a member of the Accident Management Team (AMT).

<b>MONTICELLO NUCLEAR GENERATING PLANT</b>		E-PLAN
<b>TITLE:</b>	<b>EMERGENCY PLAN</b>	Revision 54
		Page 22 of 120

#### 5.3.1.2 Emergency Direction and Control

The duty Shift Manager initially assumes the duties and responsibilities of the Emergency Director until relieved by a designated TSC Emergency Director. Once relieved, the duty Shift Manager's primary focus returns to overall coordination of emergency response activities of the duty Operations crew. The TSC Emergency Director assumes overall responsibility for the utility emergency response activities until relieved of notification and protective action recommendation functions by the Emergency Manager in the EOF. Once relieved of offsite functions, the TSC Emergency Director's primary focus is on site operation and overall direction of plant emergency response activities in plant emergency response facilities including the on-site Assembly Point. The Emergency Manager assumes overall authority and responsibility for the utility's emergency response activities from the Emergency Director and retains this authority until the event is terminated or the transition to recovery is complete.

#### 5.3.1.3 Notification and Communications

The Shift Emergency Communicator (SEC) is responsible for the performance of initial emergency notifications to the State, counties, and other off-site and utility support organizations. A licensed operator or designee is responsible for performance of Federal notifications. The duty SEC and licensed operator or designee will be augmented within 60 minutes with two additional Emergency Communicators in the TSC and within 90 minutes with two more Emergency Communicators at the EOF.

#### 5.3.1.4 Radiological Assessment and Protective Actions

The Shift Radiation Protection Technicians are responsible for initial radiological assessment including in-plant radiological surveys. The shift Chemistry Technician is responsible for initial chemistry sampling, sample analysis, and off-site dose projection operation if required.

The Shift Radiation Protection Technicians will be augmented by three additional Radiation Protection personnel within 60 minutes and three more Radiation Protection personnel within 90 minutes. The responsibilities of these additional Radiation Protection personnel include in-plant surveys, access control, and off-site radiological monitoring.

<b>MONTICELLO NUCLEAR GENERATING PLANT</b>		E-PLAN
<b>TITLE:</b>	<b>EMERGENCY PLAN</b>	Revision 54
		Page 23 of 120

In addition, a qualified Radiological Emergency Coordinator (REC) will augment the shift RP staff within 60 minutes. The REC is responsible for overall coordination of the Radiation Protection and Chemistry Group's emergency response activities. A qualified Radiation Protection Support Supervisor will be augmented within 90 minutes. The RPSS is responsible for dose assessment in the EOF.

The Shift Chemistry Technician will be augmented with one additional Chemist within 60 minutes.

#### 5.3.1.5 Engineering and Technical Support

Technical support for the shift Operations staff is initially provided by the duty Shift Manager or Shift Technical Advisor (when staffed separately on-shift). The plant Engineering and Operations staff will provide additional technical support personnel, knowledgeable in the areas of nuclear core/thermal hydraulics, electrical, and mechanical engineering. Augmentation in this area includes the addition of the core/thermal hydraulics position and two more members of the TSC Engineering Staff within 60 minutes. The TSC Engineering Staff is responsible to provide technical support to the Control Room staff under the direction of the Emergency Director.

Specific individuals from the TSC Engineering Staff are also members of an Accident Management Team (AMT). They will evaluate parameters used within the SAMGs.

#### 5.3.1.6 Repair and Corrective Actions

The duty Operations crew is initially responsible for any emergency repair and corrective actions that may be immediately required prior to ERO augmentation. After augmentation, repair and corrective actions are the responsibility of the Maintenance Group under the direction of the Emergency Director. The Maintenance Group consists of mechanical and electrical maintenance personnel including instrument and control technicians, as well as designated personnel capable of performing emergency tasks. Personnel from these groups report to the OSC where they are assigned corrective action tasks by the OSC Coordinator.

Augmentation in the maintenance area includes the addition of one mechanical maintenance and one electrical maintenance person within 60 minutes and one I&C Group member within 90 minutes.

<b>MONTICELLO NUCLEAR GENERATING PLANT</b>		E-PLAN
<b>TITLE:</b>	<b>EMERGENCY PLAN</b>	Revision 54
		Page 24 of 120

5.3.1.7 Firefighting

A shift fire brigade trained and equipped for fire fighting ensures adequate manual fire fighting capability for all areas of the plant containing structures, systems or components important to safety.

Firefighting is the responsibility of the shift Fire Brigade. The shift Fire Brigade may be augmented by non-duty, Fire Brigade qualified, personnel available from the OSC. Additional support for the Fire Brigade is also available from the local Fire Departments upon request.

5.3.1.8 Rescue Operations and First Aid

The shift Fire Brigade is initially responsible for any immediate search and rescue operations or medical emergency response that may be required. After ERO augmentation, additional support for search and rescue and medical emergency response is available from the OSC staff under the direction of the OSC Coordinator.

5.3.1.9 Site Access Control, Accountability and Security

Site access, personnel accountability, coordination of evacuees and on-site traffic control are the responsibilities of the site Security Group. Augmentation of the on-duty, shift Security Force will be as directed by the Emergency Director and Security Group Leader.

5.3.1.10 Administrative and Logistics Support

The Support Group is responsible for administrative support, document control and logistics in the on-site emergency response facilities.

5.3.1.11 Environmental Monitoring Support

The site Radiation Protection/Chemistry Group is responsible to coordinate post-accident environs monitoring with the REMP contractor.

<b>MONTICELLO NUCLEAR GENERATING PLANT</b>		E-PLAN
<b>TITLE:</b>	<b>EMERGENCY PLAN</b>	Revision 54
		Page 25 of 120

### 5.3.2 Augmentation Methods

In order to ensure the goals of Table 1 (Minimum Shift Staffing and Capability for Additions for Nuclear Power Plant Emergencies ) can be achieved, two methods have been developed for the notification of site emergency response personnel. The methods include an Emergency Response Organization (ERO) Pager Network and automatic callout system for select site groups such as Business Support, Operations, Maintenance, Radiation Protection, and Chemistry.

The ERO Pager Network consists of a commercial pager system which provides coverage to an area of approximately 75 mile radius of Minneapolis. This area includes both the Monticello and Prairie Island nuclear sites. The system may be accessed via commercial telephone and has primary and backup telephone numbers. Designated ERO personnel carry ERO pagers. This group includes:

- ◆ Emergency Directors
- ◆ TSC Group Leaders
- ◆ TSC Engineering Staff
- ◆ Emergency Communicators
- ◆ Radiation Protection/Chemistry personnel
- ◆ Operations Shift Managers
- ◆ Maintenance Supervision and Engineers
- ◆ Support Group personnel
- ◆ Emergency Managers
- ◆ EOF Technical Engineering personnel
- ◆ EOF Radiation Protection Support personnel

Each pager in the network may be activated individually and all pagers in the network may be activated by one telephone (group) call.

To supplement the Pager Network, an automated callout system is utilized for site groups, including Operations, Maintenance, Support Group, Radiation Protection/Chemistry. The ERO roster utilized by the automated callout system is reviewed and updated quarterly.

Whether contacted by pager or other means, ERO personnel are instructed to respond immediately to the event.

<b>MONTICELLO NUCLEAR GENERATING PLANT</b>		E-PLAN
<b>TITLE:</b>	<b>EMERGENCY PLAN</b>	Revision 54
		Page 26 of 120

If an emergency has been declared based on a security event or security threat, onsite MNGP ERO personnel may be instructed to “duck and cover” until the threat has passed or, if safe, report to an alternate near site location to standby for activation of their respective facility. ERO members who are off-site will be instructed to report to the EOF. They will not be instructed to staff the affected facilities until it is safe to do so.

#### 5.4 Augmentation of On-Site Emergency Organization

##### 5.4.1 Licensee Headquarters Support

This augmentation capability is completely described in the Off-site Nuclear Emergency Plan. The purpose of this capability is to support the plant and EOF in as many areas as is practical. Such areas include: Government Agency Interface, Logistics Support, Technical Analysis, News Media Interface, Xcel Energy and NSPM Executive Management Interface.

##### 5.4.2 Local Support Services

###### 5.4.2.1 Monticello Fire Department

The Monticello Fire Department will provide fire and rescue assistance upon request in the event of a fire at the plant and Hostile Action Based (HAB) event. The Monticello Fire Department will be the lead fire agency for all emergencies in the City of Monticello. For a HAB event, the fire department will deploy a representative to the Incident Command Post dependent upon type, location, and scope of the incident, once scene safety is established. The MNGP Fire Brigade Leader will work with the Fire Department Leader to provide local coordination of fire fighting and non-fire fighting activities. Non-fire fighting tasks may include actions such as spraying water to contain radiological releases or directing water to plant locations for refilling/cooling purposes. In all cases, such operations may begin only when the radiological and security threats are mitigated to insure the safety of both plant personnel and fire fighters.

The City of Monticello has agreements in place to call upon resources of other agencies to assist in the response to a HAB event. The Monticello Fire Department will coordinate with other local fire departments to the extent necessary and consistent with the plans. If the fire department requires assistance to respond to an event at MNGP, including an HAB event, the Monticello Fire Department will be supplemented by resources available pursuant to the North Suburban Mutual Aid Agreement and the Minnesota Fire and Rescue Mutual Aid Plan.

<b>MONTICELLO NUCLEAR GENERATING PLANT</b>		E-PLAN
<b>TITLE:</b>	<b>EMERGENCY PLAN</b>	Revision 54
		Page 27 of 120

#### 5.4.2.2 CentraCare Health Monticello

CentraCare Health Monticello, also referred to as “local hospital”, serves as the principal off-site medical facility for initial treatment of radiation complicated injury or illness. In addition, St. Cloud Hospital (CentraCare) and North Memorial Hospital (in Robbinsdale) have been designated as the definitive care center for injuries or illness that require services/facilities that the local hospital is unable to provide. Emergency procedures have been established at both hospitals and training of hospital personnel is accomplished periodically.

A complete description of local medical support services may be found in the Off-site Nuclear Emergency Plan.

#### 5.4.2.3 Burlington Northern and Santa Fe Railway

The Burlington Northern and Santa Fe Railway Dispatcher will stop and re-route trains away from the plant site, if necessary.

#### 5.4.2.4 Ambulance Service

There are two ambulance services that are available to provide service to the Monticello Nuclear Generating Plant. CentraCare Health ambulance service will provide ambulatory services and be the lead Emergency Medical Service (EMS) agency for all emergencies at MNGP. For a Hostile Action Based (HAB) event, CentraCare Health ambulance service will deploy a representative to the Incident Command Post dependent upon type, location, and scope of the incident, once scene safety is established. The CentraCare Health representative will work under the direction and control of the Incident Commander, which shall be either the Wright County Sheriff’s Office or Monticello Fire Department, dependent on the type of incident.

CentraCare Health ambulance service may utilize mutual aid to supplement their response. This mutual aid includes the relationships with St. Cloud Hospital (CentraCare) and North Memorial Medical Center. If the response to an emergency, including a HAB event, requires additional resources, CentraCare Health will engage the resources of its affiliate, St. Cloud Hospital (CentraCare) as needed and as available.

A complete description of response capabilities, organizational resources, activation plans, designations of emergency operations centers and letters of agreement for the organizations mentioned above are available in the Minnesota Emergency Operations Plan.

<b>MONTICELLO NUCLEAR GENERATING PLANT</b>		E-PLAN
<b>TITLE:</b>	<b>EMERGENCY PLAN</b>	Revision 54
		Page 28 of 120

#### 5.4.2.5 Local Law Enforcement

For a HAB event, Wright County Sheriff's Office will set up an Incident Command Post (ICP) near the site. The pre-designated ICP location(s) have been identified; however, selection will depend on the incident. The Wright County Sheriff's Office maintains the list of potential ICP sites and will be responsible for designating the site during a response and notifying the other agencies responding to the location. The Incident Command Post should be responsible for tracking resources and personnel at or near the site.

Unified Command will be established and includes the Wright and Sherburne Counties, state, federal and utility personnel. For a HAB event, communication will be established between the Incident Commander and plant security and operations as soon as possible. The Wright County Sheriff's Office Tactical Response Team will be the lead tactical response operations group coordinator and coordinate the tactical law enforcement response with Command. If the response to an emergency, including a HAB event, requires additional resources, Wright County and the Sheriff have agreements in place to call upon the resources of neighboring law enforcement and emergency response service providers to assist. Wright County Sheriff's Office may request tactical team resources as needed from: Minnesota State Patrol Special Response Team, Sherburne County ERT, and FBI SWAT.

The initial hostile action response goals are:

- Maintain vital plant systems to prevent a release of radioactive materials, protection of on-site workforce, neutralizing the adversaries and restoring plant operating conditions.

Law enforcement tactical operational priorities include:

- Securing a perimeter around the site, immediate containment of vital areas, sweep and securing of vital areas, safe movement of critical workers on the site, neutralizing adversaries, protection/evacuation of the on-site workforce, sweep of protected area and owner controlled area.

<b>MONTICELLO NUCLEAR GENERATING PLANT</b>		E-PLAN
<b>TITLE:</b>	<b>EMERGENCY PLAN</b>	Revision 54
		Page 29 of 120

Sherburne County will support the ICP with a Sherburne County Sheriff's Representative. If the response to an emergency, including a HAB event, requires additional resources, Sherburne County Sheriff's Department and Sherburne County Emergency Services have agreements in place to call upon the resources of neighboring law enforcement and emergency response service providers to assist.

## 5.5 Coordination with Participating Government Agencies

Appropriate State and Local government emergency plans have been developed in support of the Monticello emergency preparedness effort. Figure 13.2, Interface Between Functional Areas of Emergency Activity, shows the interface relationships between functional areas of emergency activity. Figure 13.3, Interface Between Functional Areas of Emergency Activity During Hostile Action Based Events, illustrates the interface relationships between on-site and off-site functional areas of emergency response during events requiring use of an off-site Incident Command Post.

### 5.5.1 Minnesota Department of Public Safety

The Minnesota Department of Public Safety has the responsibility for notification and coordination of state agencies in the event of a major emergency at Monticello. In the event of an emergency situation at the plant, the State Emergency Operations Center is activated and the Minnesota Duty Officer will immediately call the Department of Health, Governor's Office, and other state agencies with emergency assignments to coordinate the implementation of any emergency procedures. The state agencies responsible for emergency procedures have established a system of 24-hour communications.

The state agencies and local government agencies are responsible for protecting the general public and providing logistical support such as food, temporary quarters, water, and sanitary facilities in the event that evacuation and isolation is required.

### 5.5.2 Minnesota Health Department

The Minnesota Department of Health (MDH) is responsible for providing radiological expertise in the State Emergency Operations Center in conjunction with the Department of Public Safety.

The Minnesota Department of Health will interpret data and participate in recommending protective actions to the Governor's Authorized Representative.

<b>MONTICELLO NUCLEAR GENERATING PLANT</b>		E-PLAN
<b>TITLE:</b>	<b>EMERGENCY PLAN</b>	Revision 54
		Page 30 of 120

5.5.3 Wright County Sheriff

In the event of an accident the Sheriff of Wright County will notify all necessary civil support groups in Wright County. The sheriff or designee is also responsible for protection of the general public and can provide personnel and equipment for evacuation, relocation and isolation of affected areas.

5.5.4 Monticello Radiological Emergency Preparedness

The Monticello Radiological Emergency Preparedness has the responsibility for coordination of city populace in the event of a major emergency that affects the city of Monticello.

5.5.5 U.S. Department of Energy

Protection for the general public is provided through the Nuclear/Radiological Incident Annex of the National Response Framework. Under this plan, individual DOE officers are assigned geographic responsibilities for incidents occurring in their region. Their immediate objective is to rapidly dispatch a team of specialists to the incident site and assist the state in evaluating the hazard. The DOE will then provide the materials and equipment to counteract and control any acute hazard, and establish communications with local authorities.

5.5.6 Sherburne County Sheriff

In the event of an accident, the Sheriff of Sherburne County will notify all necessary civil support groups in Sherburne County. The sheriff or designee is also responsible for protection of the general public and can provide personnel and equipment for evacuation, relocation and isolation of affected areas.

5.5.7 Minnesota State Patrol

The State Patrol may assist with the protection of the general public by providing personnel and equipment to re-route traffic in the event of a general emergency. Plans have been made for re-routing federal and state highways. Signs and equipment required for re-routing will be stored in the areas where they would be needed to facilitate highway closings.

5.5.8 Minnesota Department of Transportation

Assist the State Patrol in blocking and re-routing traffic around the plant site. The Minnesota Department of Transportation has the necessary personnel, vehicles, signals, and barriers for establishing and maintaining detour routes.

5.5.9 City of Minneapolis Water Department

The Water Department can shut off water intakes, if necessary.

<b>MONTICELLO NUCLEAR GENERATING PLANT</b>		E-PLAN
<b>TITLE:</b>	<b>EMERGENCY PLAN</b>	Revision 54
		Page 31 of 120

5.5.10 City of St. Paul Water Department

The Water Department can shut off water intakes, if necessary.

A complete description of response capabilities, organizational resources, activation plans, designations of emergency operations centers and letters of agreement for the organizations mentioned above are available in the Minnesota Emergency Operations Plan.

5.6 Coordination with Other Participating Agencies

5.6.1 Institute Of Nuclear Power Operations (INPO)

INPO will coordinate requests from other utility INPO members and participants. They will notify NEI and EPRI of events, maintain an emergency resource capability and information on industry assistance capabilities, coordinate the delivery of persons and materials under its Nuclear Power Plant and Transportation Agreements, and provide member communications to facilitate the flow of technical information about the emergency.

5.6.2 Pooled Equipment Inventory Company (PEICo)

Southern Nuclear Services, LLC ("SNS"), as agent for Pooled Equipment Inventory Company (PEICo) will support the Monticello emergency preparedness effort for withdrawal of PIM Pass Cask D24AEIOIAOOI & A002. The emergency contact list of the PIM Program Manager's Organization is provided in the LOA in the event there is a need to withdraw the subject equipment.

<b>MONTICELLO NUCLEAR GENERATING PLANT</b>		E-PLAN
<b>TITLE:</b>	<b>EMERGENCY PLAN</b>	Revision 54
		Page 32 of 120

Table 1  
MINIMUM SHIFT STAFFING AND CAPABILITY FOR ADDITIONS FOR NUCLEAR POWER PLANT EMERGENCIES

<b>Major Functional Area</b>	<b>Major Tasks</b>	<b>Position Title or Expertise</b>	<b>On Shift</b>	<b>Capability for Additions</b>		
				<b>60 min</b>	<b>90 min</b>	
Plant Operations and Assessment of Operational Aspects		Shift Manager	1	---	---	
		Control Room Supv	1	---	---	
		SRO	1	---	---	
		Nuclear Lead	1	---	---	
		PE&RO (RO)				
		Nuclear PE&RO	2	---	---	
		Nuclear Asst. PEO	3	---	---	
Emergency Direction and Control		Emergency Director (Shift Manager until relieved)	1*	---	---	
Notification/ Communication	Notify licensee, Local, State, and Federal personnel & agencies	Shift Emergency Communicator	1	---	---	
	Maintain Communications	Emergency Communicators	---	2	2	
Radiological Accident Assessment and Support of Operational Accident Assessment	Emergency Operations Facility & TSC Leads	Emergency Manager (EOF)	---	---	1	
	Off-Site Dose Assessment	ED (TSC)	---	1	---	
		Radiological Emergency Coord	---	1	---	
		RPSS	---	---	1	
	Off-Site Surveys	Radiation Protection /Support	---	1	1	
				---	1	1
	On-Site (out-of-plant)/ In-Plant Surveys			2	1	1
	Chemistry/Radio-Chemistry	Chemistry	1	1	---	

<b>MONTICELLO NUCLEAR GENERATING PLANT</b>		E-PLAN
<b>TITLE:</b>	<b>EMERGENCY PLAN</b>	Revision 54
		Page 33 of 120

Table 1  
MINIMUM SHIFT STAFFING AND CAPABILITY FOR ADDITIONS FOR NUCLEAR POWER PLANT EMERGENCIES (CONT'D)

<b>Major Functional Area</b>	<b>Major Tasks</b>	<b>Position Title or Expertise</b>	<b>On Shift</b>	<b>Capability for Additions</b>		
				<b>60 min</b>	<b>90 min</b>	
Plant System Engineering, Repair and Corrective actions	Technical Support	Technical Advisors	1*	---	---	
		Core/Thermal Hyd.	---	1	---	
		Electrical	---	1	---	
		Mechanical	---	1	---	
		Repair & Corrective Actions	Mech Maint	---	1	---
		Elec Maint	---	1	---	
		I&C	---	---	1	
Protective Actions (In-Plant)	Radiation Protection	Radiation Protection	2*	1	1	
	a. Access Control					
	b. HP Coverage for response actions					
	c. Personnel monitoring					
	d. Dosimetry					
Fire Fighting		Fire Brigade per 4 AWI-08.01.01			Local Support	
Rescue Operations and First Aid			2*		Local Support	
Site Access Control and Personnel Accountability	Security, Communications, Personnel Accountability	Security Force			All per Security Plan	
<b>Total</b>			13	14	9	

\* May be provided by shift personnel assigned other functions.

<b>MONTICELLO NUCLEAR GENERATING PLANT</b>		E-PLAN
<b>TITLE:</b>	<b>EMERGENCY PLAN</b>	Revision 54
		Page 34 of 120

## 6.0 EMERGENCY MEASURES

### 6.1 Summary of Responses

For each of the four emergency classifications discussed in Section 4.0 certain generic emergency response actions are required to be taken by the site Emergency Response Organization. These generic emergency response actions are in addition to those actions specific to the type of emergency. This section summarizes the generic emergency response actions.

#### 6.1.1 Notification of Unusual Event

- 6.1.1.1 Promptly inform State and Local off-site authorities of the nature of the emergency condition.
- 6.1.1.2 Inform the NRC of the Unusual Event.
- 6.1.1.3 Augment on-shift resources as necessary.
- 6.1.1.4 Assess and respond to the off-normal condition.
- 6.1.1.5 Terminate the Unusual Event with notification to the State and Local off-site authorities and the NRC.

OR

- 6.1.1.6 Escalate to a more severe emergency class.

#### 6.1.2 Alert

- 6.1.2.1 Promptly inform the State and Local off-site authorities of the Alert and the nature of the emergency condition.
- 6.1.2.2 Augment on-shift resources by activating the Technical Support Center (TSC), Operational Support Center (OSC), and Emergency Operations Facility (EOF) or Back-up EOF
- 6.1.2.3 Notify the NRC of the Alert.
- 6.1.2.4 Establish the Emergency Response Data System (ERDS) communication link with the NRC.
- 6.1.2.5 Assess and respond to the emergency condition.
- 6.1.2.6 Dispatch on-site and off-site radiological survey teams and associated communications.
- 6.1.2.7 Provide periodic plant status updates to off-site authorities (Follow-up Messages).
- 6.1.2.8 Provide periodic meteorological assessments to off-site authorities and, if releases are occurring, estimates for actual releases.

<b>MONTICELLO NUCLEAR GENERATING PLANT</b>		E-PLAN
<b>TITLE:</b>	<b>EMERGENCY PLAN</b>	Revision 54
		Page 35 of 120

6.1.2.9 Terminate the Alert with notification to the State and Local off-site authorities and the NRC.

OR

6.1.2.10 Escalate to a more severe emergency class.

6.1.3 Site Area Emergency

6.1.3.1 Promptly inform the State and Local off-site authorities of the Site Area Emergency and the nature of the emergency condition.

6.1.3.2 Augment on-shift resources by activating the Technical Support Center (TSC), Operational Support Center (OSC) and Emergency Operations Facility (EOF) or Back-up EOF.

6.1.3.3 Notify the NRC of the Site Area Emergency.

6.1.3.4 Establish the ERDS communication link with the NRC.

6.1.3.5 Assess and respond to the emergency condition.

6.1.3.6 If radiological and environmental conditions permit evacuate on-site, non-essential personnel.

6.1.3.7 Dispatch on-site and off-site radiological survey teams and associated communications as necessary.

6.1.3.8 Provide a dedicated individual for plant status updates to off-site authorities.

6.1.3.9 Make utility senior technical and management staff available for consultation with the NRC and State on a periodic basis.

6.1.3.10 Provide meteorological data and dose estimates to off-site authorities for actual releases via a dedicated individual or automated transmission.

6.1.3.11 Provide release data and dose projections based on available plant condition information and foreseeable contingencies.

6.1.3.12 Terminate the Site Area Emergency with notification to the State and Local off-site authorities and the NRC.

OR

6.1.3.13 Enter Recovery with notification to the State and Local off-site authorities and the NRC.

OR

6.1.3.14 Escalate to a General Emergency.

<b>MONTICELLO NUCLEAR GENERATING PLANT</b>		E-PLAN
<b>TITLE:</b>	<b>EMERGENCY PLAN</b>	Revision 54
		Page 36 of 120

#### 6.1.4 General Emergency

- 6.1.4.1 Promptly inform the State and Local off-site authorities of the General Emergency and the nature of the emergency condition.
- 6.1.4.2 Make off-site protective action recommendations to State and Local authorities based on actual or potential plant conditions and radiological releases.
- 6.1.4.3 Augment on-shift resources by activating the Technical Support Center (TSC), Operational Support Center (OSC) and Emergency Operations Facility (EOF) or Back-up EOF.
- 6.1.4.4 Notify the NRC of the General Emergency.
- 6.1.4.5 Establish the ERDS communication link with the NRC.
- 6.1.4.6 Assess and respond to the emergency condition.
- 6.1.4.7 If radiological and environmental conditions permit evacuate on-site, non-essential personnel.
- 6.1.4.8 Dispatch on-site and off-site radiological survey teams and associated communications.
- 6.1.4.9 Provide a dedicated individual for plant status updates to off-site authorities.
- 6.1.4.10 Make utility senior technical and management staff available for consultation with the NRC and State on a periodic basis.
- 6.1.4.11 Provide meteorological data and dose estimates to off-site authorities for actual releases via a dedicated individual or automated transmission.
- 6.1.4.12 Provide release data and dose projections based on available plant condition information and foreseeable contingencies.
- 6.1.4.13 Enter Recovery with notification to the State and Local off-site authorities and the NRC.

### 6.2 Emergency Response Activation

#### 6.2.1 Notification Scheme

In the event an emergency classification is declared procedures and systems are in place to facilitate timely activation of the site Emergency Response Organization and notification of State and Local authorities, Federal agencies and the general public within the 10 mile EPZ. This section describes the notification methods and processes used to activate on-site and off-site emergency response.

<b>MONTICELLO NUCLEAR GENERATING PLANT</b>		E-PLAN
<b>TITLE:</b>	<b>EMERGENCY PLAN</b>	Revision 54
		Page 37 of 120

#### 6.2.1.1 Activation of the On-Site ERO

When an abnormal condition is identified by the shift operating staff the duty Control Room Supervisor and Shift Manager are notified. An assessment of the safety significance of the event is performed and a determination of the emergency classification made using the Emergency Action Levels (EALs) contained in the Emergency Plan Implementing Procedures.

Upon declaring an emergency condition, the duty Shift Manager is responsible for implementation of the Emergency Plan and assumes the role of Emergency Director. The Shift Manager directs the completion of the necessary emergency notifications including the on-site Emergency Response Organization.

When directed, the Shift Emergency Communicator notifies the site Emergency Response Organization. During normal working hours, ERO notification is made using the plant public address system. During non-working hours, ERO notification is made using the ERO Pager Network and automated callout system. The detailed instructions for ERO notification are contained in the implementing procedures and associated forms and call-lists.

#### 6.2.1.2 State and Local Authorities and NRC

Under the direction of the Shift Manager (Emergency Director) the Shift Emergency Communicator will notify State and Local authorities and a licensed operator or designee will notify the NRC using commercial telephone and the FTS Emergency Notification System (ENS) respectively. Notification procedures are contained in the Emergency Plan Implementing Procedures and associated forms.

A security threat to MNGP requires an accelerated notification to the NRC immediately after notification to state and local authorities. The goal is to initiate the accelerated call within about 15 minutes of discovery of an imminent threat or attack against the station. This implements the requirements of SA-05-02, "Safeguards Advisory for Operating Power Reactors", January 26, 2005.

<b>MONTICELLO NUCLEAR GENERATING PLANT</b>		E-PLAN
<b>TITLE:</b>	<b>EMERGENCY PLAN</b>	Revision 54
		Page 38 of 120

In addition to the initial notifications, provisions are included in the Emergency Plan Implementing Procedures for follow-up notifications to State authorities which contain the following information (if it is known and appropriate):

- 6.2.1.2.1 Location of the incident, name and telephone number of the caller;
- 6.2.1.2.2 Date and time of the incident;
- 6.2.1.2.3 Emergency classification;
- 6.2.1.2.4 Type of actual or potential release and estimated release duration/impact times;
- 6.2.1.2.5 Estimate of quantity of radioactive material released or being released and the release point;
- 6.2.1.2.6 Estimates of relative quantities and concentration of noble gases, iodines and particulates;
- 6.2.1.2.7 Meteorological conditions;
- 6.2.1.2.8 Actual or projected dose rates at the site boundary and integrated dose at the site boundary;
- 6.2.1.2.9 Projected dose rates and integrated dose at projected peak and at about 2, 5 and 10 miles, including affected sectors;
- 6.2.1.2.10 Estimates of any surface radioactive contamination on-site or off-site;
- 6.2.1.2.11 Licensee emergency response actions underway;
- 6.2.1.2.12 Recommended emergency actions including protective measures;
- 6.2.1.2.13 Request for any needed on-site support by off-site organizations.
- 6.2.1.2.14 Prognosis for worsening or termination of the event based on plant information.

<b>MONTICELLO NUCLEAR GENERATING PLANT</b>		E-PLAN
<b>TITLE:</b>	<b>EMERGENCY PLAN</b>	Revision 54
		Page 39 of 120

#### 6.2.1.3 Off-site Emergency Response Organization

Notification and activation of the Off-site Emergency Response Organization is accomplished by the Shift Emergency Communicator per the site ERO notification procedures. The ERO notification procedures support the notification of select Xcel Energy/NSPM management and technical personnel who staff the Joint Information Center (JIC).

#### 6.2.1.4 General Public

The decision to notify the general public will be made by State or Local authorities based on information and recommendations provided by the MNGP. The Emergency Director is initially responsible for recommendations involving notification of the general public and is relieved of this responsibility by the Emergency Manager.

Notification of the general public is accomplished through Local Authorities use of the Public Alert and Notification System (ANS), and Emergency Alert System (EAS), and auto dialing telephone systems. The State or Local authorities are responsible for activation of these systems and the information provided to the public. See Section 7.7 and 7.8 for additional information.

#### 6.2.2 Emergency Action Levels (EALs)

The Emergency Action Levels (EALs) for each of the four emergency classifications are outlined in the Initiating Conditions in Annex A. These Emergency Action Levels are also identified for each Initiating Condition in the Emergency Plan Implementing Procedures. State and Local authorities are notified for all four emergency classifications and will activate the appropriate elements of their respective emergency plans based on information provided in the notification from the utility.

#### 6.2.3 Authentication

Communications made for the purpose of notifying off-site authorities of an emergency will be authenticated before the initiation of their emergency response actions. The methods used for authentication are developed and mutually agreed to by the utility and off-site authorities and are located in the off-site plans.

<b>MONTICELLO NUCLEAR GENERATING PLANT</b>		E-PLAN
<b>TITLE:</b>	<b>EMERGENCY PLAN</b>	Revision 54
		Page 40 of 120

### 6.3 Assessment Actions

#### 6.3.1 Determining Magnitude of Release

The magnitude of releases and release rates from normal pathways (e.g., Stack and Reactor Building vent) are determined using installed plant instrumentation. Installed side-stream isokinetic samplers and wide-range radiation monitors normally monitor plant effluent releases, and would be the primary method used in an emergency. Portable hand held radiation instruments are used in the event the installed monitors become inoperable.

Releases from other than normal pathways (e.g., hard pipe containment vent) will be estimated either from installed plant instrumentation or from a determination of the amount of activity available for release plus the particulars of the release path. Field measurements will be used to assist in the assessment effort by making physical measurements of dose rates and airborne, liquid and surface contamination. Field measurements are primarily the responsibility of the Radiation Protection Support Group, headquartered at the EOF, and under the direction of the Emergency Manager.

#### 6.3.2 Off-Site Dose Projection

The primary means of performing dose projections is RASCAL (Radiological Assessment System for Consequence Analysis) using the Unified RASCAL Interface(URI).

URI provides a site specific overlay on RASCAL meteorological, dispersion, and dose assessment models for all required input for emergency dose assessment as well as reports and plume graphics. Using URI, the user does not interact with any part of the original RASCAL input or output screens. Meteorological and effluent data from process monitors and meteorological instruments located at the plant site is entered into RASCAL using URI. This data is available from one central location to be used by the Dose Projection Specialist for entry into the dose projection software.

The URI code supports three modes of operation: Rapid Assessment, Detailed Assessment, and Sum Assessment.

##### 6.3.2.1 Rapid Assessment

This mode is intended for use as an aid to supporting decision-makers during the initial phases of a rapidly evolving incident. It is useful for quickly providing estimates of offsite dose projections relative to established Protective Action Guideline (PAG) exposure levels in support of initial protective action decision-making but limits options in order to simplify the assessment.

<b>MONTICELLO NUCLEAR GENERATING PLANT</b>		E-PLAN
<b>TITLE:</b>	<b>EMERGENCY PLAN</b>	Revision 54
		Page 41 of 120

#### 6.3.2.2 Detailed Assessment

This mode provides a user-interface to produce more deliberate and comprehensive offsite dose projections than those produced by the Rapid Assessment option. It supports development of refined off-site dose projections based on changing plant status and/or meteorological conditions or field monitoring and sampling results.

#### 6.3.2.3 Sum Assessment

This mode permits the user to add archived data from previously completed dose assessments into a single report characterizing multiple concurrent releases. It is an additive process, producing a composite report and is solely for concurrent releases rather than integration of an entire event.

The URI supports expected emergency effluent dose assessment changes such as summing of multiple release/multiple source events and assessment to 50 miles.

The URI program can be run from computer stations located in the Control Room, TSC, EOF, and the Back-up EOF. Independent battery powered laptop computers are available in the TSC, EOF and Back-up EOF.

The Radiological Emergency Coordinator has the capability to estimate the total off-site population dose (manrem) received during a release. The off-site dose assessment computer will supply the projected dose rates or doses (whole body and thyroid) at various distances. Field Team radiation survey results may also be used to determine the off-site dose rates. Population distribution charts comprised of the sectors and distances from the plant are available. The Radiological Emergency Coordinator will determine the applicable doses or dose rates in the sectors and calculate the estimated total population dose by referring to the population totals in the sectors of interest.

#### 6.3.3 Field Radiation Surveys

The task of field radiation surveillance will be accomplished by two (2) teams under the supervision of Emergency Operations Facility (EOF) personnel. The EOF will be the central point for receipt and analysis of all off-site field monitoring data.

<b>MONTICELLO NUCLEAR GENERATING PLANT</b>		E-PLAN
<b>TITLE:</b>	<b>EMERGENCY PLAN</b>	Revision 54
		Page 42 of 120

Survey teams will normally be composed of 2 individuals each, at least one of whom **SHALL** be trained in radiological field monitoring. Each team **SHALL** be equipped with appropriate monitoring equipment, including dose rate instruments, air sampling equipment and sample collection media and containers. This equipment has the capability to detect and measure radioiodine concentrations in the air as low as  $1 \times 10^{-7}$   $\mu\text{Ci/cc}$  under field conditions. The estimated deployment time for the initial and second monitoring team is 60 minutes and 90 minutes respectively from an Alert or higher classification.

#### 6.4 Corrective Actions

##### 6.4.1 Fire Control

The Fire Brigade, which is composed entirely of plant personnel, is fully equipped, trained and capable of dealing with fire emergencies. At the direction of the Emergency Director and the Brigade Leader, the Fire Brigade will be deployed as necessary.

##### 6.4.2 Repair and Damage Control

The repair and damage control functions are assigned to the Maintenance Group. Personnel are assigned according to the skills they possess so that the team is capable of coping with the emergency situation. Repair and damage control team members are selected from available personnel.

#### 6.5 Protective Actions

##### 6.5.1 Protective Cover, Evacuation, Personnel Accountability

In the course of an emergency situation where there is an actual or potential release of radioactive material to the environs in excess of normal operating levels, an assessment of projected exposure to persons on-site and off-site will be made. The result of this assessment will be a determining factor for implementing protective actions.

##### 6.5.1.1 Plant Site

During the course of an emergency, the REC is responsible for on-site monitoring operations. The on-site monitoring procedures contain criteria for initiating evacuations of various degrees. In all cases of elevated radiation levels or in potentially hazardous situations, non-essential personnel will be evacuated from affected areas of the plant. A plant evacuation is required at the Site Area Emergency level, radiological and environmental conditions permitting. The plant evacuation includes the owner-controlled area outside of the Protected Area.

<b>MONTICELLO NUCLEAR GENERATING PLANT</b>		E-PLAN
<b>TITLE:</b>	<b>EMERGENCY PLAN</b>	Revision 54
		Page 43 of 120

A personnel accounting process is part of a plant or site evacuation. A system using the plant security computer and individual Security I.D. badges enables the Emergency Director to account for all personnel within the Protected Area in 30 minutes or less. Card readers are located at the TSC, Security Access Facility and Access Control to expedite the process. Backup methods are also available in case of a computer malfunction.

Personnel within the plant are notified of an evacuation by the plant Public Address (PA) system. A warning tone and voice instructions are part of the procedure. Time required for this process is less than 5 minutes from decision to evacuate.

Personnel outside of the plant buildings are notified by the plant evacuation siren, which is located atop the Reactor Building. The siren initiation is simultaneous with the PA system alarm.

After the accounting process is completed, Security personnel are dispatched to ensure that all personnel in the Owner-Controlled Area outside the Protected Area have been notified. This process should be completed within 60 minutes of the start of the evacuation.

In the event of a Site Area or General Emergency, the following actions will be taken:

- 6.5.1.1.1 All plant employees not having emergency assignments at the site and having been cleared of radioactive contamination, will be directed to proceed to the Emergency Operations Facility, a designated off-site assembly point or sent home;
- 6.5.1.1.2 All working and non-working visitors and contractor and construction personnel, having been cleared of radioactive contamination, will be directed to leave the site, unless requested otherwise by the Emergency Director;
- 6.5.1.1.3 Persons who may be within the restricted area but outside the security fence, will be directed to proceed to the designated assembly point for accountability and radioactive contamination check before being directed to leave the site.

<b>MONTICELLO NUCLEAR GENERATING PLANT</b>		E-PLAN
<b>TITLE:</b>	<b>EMERGENCY PLAN</b>	Revision 54
		Page 44 of 120

6.5.1.1.4 Persons who are not cleared of radioactive contamination following a plant evacuation will be decontaminated at a location on the plant site, at an off-site assembly point, or at a County Emergency Worker Monitoring and Decontamination Facility.

6.5.1.2 Onsite Protective Actions for Hostile Action Events

6.5.1.2.1 Onsite Protective Actions designed for protection of personnel as described in Section 6.5.1.1 may be inappropriate for a Hostile Action Event. Alternate actions as described in NSIR/DRP-ISG-01 Section IV.F have been developed and proceduralized.

6.5.1.3 Off-Site Public

Actions planned to protect the off-site public and criteria for their implementation are described in the MINNESOTA EMERGENCY OPERATIONS PLAN.

Initiation of protective actions for off-site areas is the responsibility of the State of Minnesota. Prior to the EOF being activated, the Emergency Director will make recommendations for protective actions if it is determined that they are necessary. Recommendations will be directed to the State EOC and will come directly from the Emergency Director. If the State EOC is not activated and it is determined by MNGP that immediate protective actions should be initiated at the MN Duty Officer and Local level, the recommendation will be made directly to the MN Duty Officer and Local authorities. When the EOF is activated, the protective action recommendation function will normally be transferred to the Emergency Manager.

The current issue of the “Manual of Protective Action Guides and Protective Actions for Nuclear Incidents” (EPA 400-R-92) **SHALL** be used as a basis for recommendations for protective actions for the off-site public; however, more conservative protective actions based on discussions with the State may be recommended in the course of an emergency. Protective action recommendations **SHALL** also be consistent with the guidance of the U.S. Food and Drug Administration’s, Department of Health and Human Services’ document titled “Accidental Radioactive Contamination of Human Food and Animal Feeds: Recommendations for State and Local Agencies”, August, 1998.

<b>MONTICELLO NUCLEAR GENERATING PLANT</b>		E-PLAN
<b>TITLE:</b>	<b>EMERGENCY PLAN</b>	Revision 54
		Page 45 of 120

Tables 2, 3, 4 and 5 provide guidelines and action levels to be used in the formulation of protective action recommendations.

#### 6.5.2 Routes for Site Evacuation

Evacuation of personnel from the site **SHALL** be accomplished in personal private vehicles and augmented by MNGP vehicles when necessary and available. Personnel are to proceed to the designated assembly area as directed by traffic control personnel.

6.5.2.1 Monticello Service Center Assembly Area –  
118 Dundas Road, Monticello, Minnesota

6.5.2.2 Xcel Energy Sherburne County Generating Plant (Sherco) –  
13999 Industrial Blvd, Becker, Minnesota

#### 6.5.3 Evacuation Time Estimates (ETE) – Plume Exposure EPZ

Time estimates for evacuation of the plume exposure EPZ are referenced in an appendix to the Off-site Nuclear Emergency Plan and in the Plant Emergency Plan Implementing Procedure for making off-site protective action recommendations. MNGP and the State of Minnesota use the ETE to develop pre-determined protective action recommendations.

#### 6.5.4 Use of On-Site Protective Equipment and Supplies

##### 6.5.4.1 Respiratory Protection and Protective Clothing

In an emergency situation, the protection afforded by individual respiratory equipment must be weighed against the negative aspects of its use. In the case where a respirator may lead to additional external exposure because of the inherent difficulties of working while wearing a respirator, it may be prudent to forego the respirator in favor of a lower total dose to the individual.

In general the use of protective clothing and respiratory protection equipment will be governed by existing Radiation Protection Procedures. The Radiological Emergency Coordinator will make decisions on the use of this equipment during emergency situations.

A supply of protective clothing is stored in the TSC.

A very limited supply of this equipment is stored at each assembly point. Large supplies of respiratory equipment are stored at the plant access control area and protective clothing will normally be available in the warehouse located outside the security fence.

<b>MONTICELLO NUCLEAR GENERATING PLANT</b>		E-PLAN
<b>TITLE:</b>	<b>EMERGENCY PLAN</b>	Revision 54
		Page 46 of 120

#### 6.5.4.2 Thyroid Prophylaxis

A supply of potassium iodide (KI) will be maintained at the Technical Support Center and the Emergency Operations Facility. Each of these locations will have a minimum of 200 boxes, each of which contain a 10-day supply of KI at recommended dosages for one person. In the event that an individual is expected to receive a dose to the thyroid in excess of 25 Rem (due to radioiodine uptake), the use of KI as a blocking agent may be recommended. KI will not be made available to off-site personnel under this plan.

#### 6.5.5 Emergency Exposure Control

##### 6.5.5.1 Exposure Limits

Although an emergency situation transcends the normal requirements of limiting exposure, there are suggested levels for exposure to be accepted in emergencies. Immediate re-entry may be necessary to account for missing personnel or to secure vital equipment. Additional exposure for this purpose must be approved by the Emergency Director based on the following criteria and the guidelines in Table 5:

6.5.5.1.1 In order to avoid restricting actions that may be necessary to save lives or protect the health and safety of the public, it **SHALL** be the discretion of the Emergency Director that determines the amount of exposure that will be permitted in order to perform the emergency mission. However, the dose resulting from emergency exposure should be limited to 25 REM for life-saving activities and the protection of large populations. Individuals undertaking any emergency operation in which the dose will exceed 25 REM to the whole body should do so only on a voluntary basis and with full awareness of the risk involved (EPA-400).

6.5.5.1.2 In situations where protecting valuable property is involved, the dose resulting from emergency exposure should be limited to 10 REM (EPA-400).

<b>MONTICELLO NUCLEAR GENERATING PLANT</b>		E-PLAN
<b>TITLE:</b>	<b>EMERGENCY PLAN</b>	Revision 54
		Page 47 of 120

#### 6.5.5.2 Exposure Control

Under emergency conditions, exposure control would be implemented in accordance with the Emergency Plan Implementing Procedure A.2-401 (EMERGENCY EXPOSURE CONTROL).

Each person entering the controlled area would be required to wear a permanent record device (DLR) and a self reading dosimeter (SRD).

The responsibility for maintaining exposure control for site activities rests with the Radiological Emergency Coordinator and the Radiation Protection Group. With this responsibility would be the option of establishing Access Control at alternate locations on site if the primary access control facility becomes uninhabitable. In this event, the access control function would be relocated to an alternate location within the Administration Building, Security Access Facility or the EOF. In any case, strict exposure control of all individuals passing through the access point would be maintained on a 24 hour basis.

In order to enhance the exposure control process and to provide dosimetry for an expanded number of people, a dosimetry vendor would be called upon to expedite the shipment of extra dosimetry devices and to supply personnel and instrumentation for on-site appraisal of exposures.

It must be noted, however, that every effort will be made to keep the exposures of plant staff personnel and off-site emergency personnel below the limits for normal operations.

#### 6.5.6 Contamination Control Measures

##### 6.5.6.1 Plant Site

The Radiation Protection Group is responsible for preventing or minimizing direct or subsequent ingestion exposure to radioactive materials deposited on the ground or other surfaces. Personnel, material and equipment will be checked at the main access control point. Decontamination will be effected when needed and when practical. Equipment which cannot be decontaminated will remain within the Radiological Controlled Area or be controlled through a conditional release process.

<b>MONTICELLO NUCLEAR GENERATING PLANT</b>		E-PLAN
<b>TITLE:</b>	<b>EMERGENCY PLAN</b>	Revision 54
		Page 48 of 120

The site guidelines for release of equipment to a clean area are no detectable licensed radioactive material above background, using the following criteria:

- 6.5.6.1.1 A. Use of a counting system that meets a minimum detection sensitivity of 1000 dpm/100cm<sup>2</sup> beta/gamma provided that this equates to an MDA no higher than 20 dpm/100cm<sup>2</sup> alpha based on 10CFR61 plant beta to alpha ratios.
- 6.5.6.1.2 B. Using a frisker type instrument to conduct a direct frisk survey with no reproducible counts above background provided background is < 200 cpm.

Should any normally clean areas become contaminated in excess of 20 dpm/100 cm<sup>2</sup> alpha or 1000 dpm/100 cm<sup>2</sup> beta-gamma (as determined by smear tests), they **SHALL** be barricaded or roped and posted as a Contaminated Area, per normal plant procedures. Such areas **SHALL** be decontaminated as soon as practical. Access to such areas which lie outside the protected area will be controlled by plant security until properly decontaminated and cleared.

Under emergency conditions, the Radiological Emergency Coordinator has the option of implementing emergency guidelines for contamination control which are in excess of normal limits.

The Radiation Protection Group is responsible for controlling all food and water supplies at the plant during an emergency. Whenever an evacuation due to radiological condition occurs, all food and water supplies within the evacuated area will be considered contaminated and measures will be taken to prevent their use.

Before any water or food may be consumed, the Radiation Protection Group must verify that the water/food is not contaminated and the area in which it is consumed is less than detectable using normal contamination survey methods. Random samples of water/food **SHALL** be analyzed for contamination on a periodic basis.

#### 6.5.6.2 Off-Site Areas

Protective actions planned for persons in off-site areas and criteria for their implementation are described in the MINNESOTA EMERGENCY OPERATIONS PLAN.

<b>MONTICELLO NUCLEAR GENERATING PLANT</b>		E-PLAN
<b>TITLE:</b>	<b>EMERGENCY PLAN</b>	Revision 54
		Page 49 of 120

## 6.6 Aid to Affected Personnel

In case of an accident or emergency, protection of personnel from radioactive contamination and exposure is the responsibility of the Radiation Protection Group. The highest priority for medical treatment of radiation injuries are personnel suspected of receiving 25 rem or more of penetrating radiation to the whole body.

The order of medical treatment will be:

- A. Immediate care of serious injuries
- B. Decontamination of personnel
- C. Care of other injuries
- D. Determining any internal contaminations through bioassays and whole body counts.
- E. Follow-up treatment

### 6.6.1 Decontamination and First Aid

#### 6.6.1.1 Decontamination

As soon as practical, attempts **SHALL** be made to decontaminate individuals found to be contaminated. First aid or removal from a hazardous environment, however, **SHALL** take precedence over decontamination actions. Precautions will be taken to prevent the spread of contamination to other parts of the body. Particular attention will be paid to open wounds in order to prevent internal contamination.

Contamination monitoring will be accomplished using thin-window GM pancake-type probes for maximum sensitivity. Each assembly area where decontamination may be conducted is equipped with one or more of these instruments.

The primary decontamination facility is located in the plant Access Control Area. Two showers and a large sink, plus various other supplies are provided for this express purpose. If the primary facility is not accessible, decontamination kits are also provided in the emergency supplies for the EOF and off-site Assembly Points. Decontamination operations at an Assembly Point would be on a small scale due to limited resources. If necessary, contaminated personnel at an Assembly Point will be placed in protective clothing and transported to an adequate facility.

The decontamination kits contain the equipment and materials necessary for small scale personnel decontamination operations. Decontamination materials are made available for use at Access Control, EOF, and Off-Site Assembly Points to deal with various skin contamination.

<b>MONTICELLO NUCLEAR GENERATING PLANT</b>		E-PLAN
<b>TITLE:</b>	<b>EMERGENCY PLAN</b>	Revision 54
		Page 50 of 120

The waste generated in decontamination operations will be retained for proper disposal.

6.6.1.2 First Aid

Fire Brigade personnel receive first aid training (Red Cross Multi-Media or equivalent) on a periodic basis. The level of skills is sufficient for the time it takes for off-site medical personnel to arrive.

6.6.2 Medical Transportation

Arrangements for transportation of radiologically contaminated casualties have been made with local hospital's Ambulance Service. The personnel at the service receive radiological training from MNGP Training Staff members on a regular basis. The procedure for handling contaminated personnel includes protective measures for equipment as well as the ambulance service personnel.

6.6.3 Medical Treatment

The Monticello Nuclear Generating Plant has made arrangements for medical services with a local hospital located approximately five miles from the plant in Monticello. In addition, if the response requires additional resources, CentraCare Health - Monticello will utilize existing mutual aid and transfer agreements with hospitals appropriate to patient needs and acuity.

Injured personnel who must be moved to the local hospital while in a contaminated condition **SHALL** be accompanied by personnel who are qualified in radiological monitoring who will stay in attendance and maintain radiological control until decontamination is satisfactorily completed.

The person escorting the patient will take along survey instruments. In addition, DLR badges, self reading dosimeters, survey instruments and other supplies and protective equipment for hospital employees are available at the local hospital. For definitive care hospitals, equipment is maintained in the definitive care emergency kit.

The patient will be put in a separate room and this will be considered a Contaminated Area. Upon release of the patient from the room, it **SHALL** be sealed until decontaminated and cleared by Radiation Protection. All hospital equipment in the room will be surveyed and decontaminated to site guidelines for release of equipment to a clean area before being released.

If deemed necessary patients may be sent to another hospital for radiological studies, or other reasons. This arrangement is formalized in a LOA with CentraCare Health - Monticello and St. Cloud Hospital (CentraCare).

<b>MONTICELLO NUCLEAR GENERATING PLANT</b>		E-PLAN
<b>TITLE:</b>	<b>EMERGENCY PLAN</b>	Revision 54
		Page 51 of 120

Table 2

EPA GUIDELINES FOR RECOMMENDED PROTECTIVE ACTIONS (WHOLE BODY AND THYROID DOSE FROM EXPOSURE TO A GASEOUS PLUME)

<b>Projected Does (REM) to the Population</b>	<b>Recommended Actions</b>	<b>Comments</b>
Whole Body <1 (TEDE) Thyroid <5 (CDE) Skin <50 (CDE)	No planned protective actions. Monitor environmental radiation levels.	
Whole Body >1 (TEDE) Thyroid >5 (CDE) Skin >50 (CDE)	Evacuate unless constraints make it impractical. Monitor environmental radiation levels. Control access.	Shelter if evacuation were not immediately possible.

<b>MONTICELLO NUCLEAR GENERATING PLANT</b>		E-PLAN
<b>TITLE:</b>	<b>EMERGENCY PLAN</b>	Revision 54
		Page 52 of 120

Table 3  
RECOMMENDED DERIVED INTERVENTION LEVEL (DIL) OR CRITERION FOR EACH  
RADIONUCLIDE  
GROUP (A), (B)

<u>All Components of the Diet</u>		
<u>Radionuclide Group</u>	<u>(Bq/kg)</u>	<u>(pci/kg)</u>
Sr-90	160	4300
I-131	170	4600
Cs-134 & Cs-137	1200	32,000
Pu-238 + Pu-239 + Am-241	2	54
Ru-103 + Ru-106 <sup>(c)</sup>	$\frac{C_3}{6800} + \frac{C_6}{450} < 1$	$\frac{C_3}{180,000} + \frac{C_6}{12,000} < 1$

Notes:

- (a) The DIL for each radionuclide group (except for Ru-103 + Ru-106) is applied independently. Each DIL applies to the sum of the concentrations of the radionuclides in the group at the time of measurement.
- (b) Applicable to foods as prepared for consumption. For dried or concentrated products such as powdered milk or concentrated juices, adjust by a factor appropriate to reconstitution, and assume the reconstitution water is not contaminated. For spices, which are consumed in very small quantities, use a dilution factor of 10.
- (c) Due to the large difference in DILs for Ru-103 and Ru-106, the individual concentrations of Ru-103 and Ru-106 are divided by their respective DILs and then summed. The sum must be less than one. C<sub>3</sub> and C<sub>6</sub> are the concentrations, at the time of measurement, for Ru-103 and Ru-106, respectively.
- (d) Reference U.S. Food and Drug Administration's, Department of Health and Human Services' document titled "Accidental Radioactive Contamination of Human Food and Animal Feeds: Recommendations for State and Local Agencies", August 1998, for further discussion of this table.

<b>MONTICELLO NUCLEAR GENERATING PLANT</b>		E-PLAN
<b>TITLE:</b>	<b>EMERGENCY PLAN</b>	Revision 54
		Page 53 of 120

Table 4  
RECOMMENDED PROTECTIVE ACTIONS

<b>Accident Phase</b>	<b>Exposure Pathway</b>	<b>Example of Actions to be Recommended</b>
EARLY (EMERGENCY) PHASE (NOTE 1) (0 to 4 days)*	Inhalation of gases, radioiodine or particulate	Evacuation, shelter, Access Control, respiratory protection, prophylaxis (thyroid protection)
	Direct whole body exposure	Evacuation, shelter, Access Control
INTERMEDIATE PHASE (NOTE 2)  (24 hours to 30 days)*	Ingestion of Milk	Take cows off pasture, prevent cows from drinking surface water, discard contaminated milk, or divert to stored products such as cheese
	Ingestion of fruits and vegetables	Wash all produce, or impound produce, delay harvest until approved, substitute uncontaminated produce
	Ingestion of water	Cut off contaminated supplies, substitute from other sources, filter, demineralize
	Whole body exposure an inhalation	Relocation, decontamination, Access Control
LATE PHASE (NOTE 3)  (over 30 days)	Ingestion of food and water contaminated from the soil either by resuspension or uptake through roots	Decontamination, condemnation, or destruction of food, deep plowing, condemnation or alternate use of land
	Whole body exposure from deposition material or inhalation of resuspended material	Relocation, Access Control, decontamination, fixing of contamination, deep plowing
NOTE 1	Early Phase -	Time period from the onset of major release and subsequent plume exposure periods up to 4 days.
NOTE 2	Intermediate Phase -	Time period of moderate continuous release with plume exposure and contamination of environment.
NOTE 3	Late Phase	Recovery period
* "Typical Pst - Accident Time Periods"		

<b>MONTICELLO NUCLEAR GENERATING PLANT</b>		E-PLAN
<b>TITLE:</b>	<b>EMERGENCY PLAN</b>	Revision 54
		Page 54 of 120

Table 5  
EMERGENCY EXPOSURE GUIDELINES

<b>EXPOSURE LIMIT<sup>1</sup></b>	<b>EMERGENCY</b>	<b>COMMENTS</b>
5 REM (TEDE) <sup>(2)(3)</sup>	All emergency activities	This dose limit applies when a lower dose is not practicable through application of ALARA practices.
10 REM (TEDE) <sup>(2)(3)</sup>	Protection of valuable property	This dose limit applies when a lower dose is not practicable through application of ALARA practices.
25 REM (TEDE) <sup>(2)(3)</sup>	Life saving or protection of large populations	This dose limit applies when a lower dose is not practicable through application of ALARA practices.
> 25 REM (TEDE) <sup>(2)(3)</sup>	Life saving or protection of large populations	Doses in excess of 25 REM should be on a voluntary basis to persons fully aware of the risks involved.
NOTE 1:	Dose limits for emergency workers and activities are based on EPA 400-R-92-001, May 1992.	
NOTE 2:	Sum of external effective dose equivalent and committed effective dose equivalent to non-pregnant adults from external exposure and intake during the duration of an emergency.	
NOTE 3:	Exposure to the lens of the eye should be limited to <u>3</u> times the value listed and doses to the skin and extremities should be limited to <u>10</u> times the value listed.	

<b>MONTICELLO NUCLEAR GENERATING PLANT</b>		E-PLAN
<b>TITLE:</b>	<b>EMERGENCY PLAN</b>	Revision 54
		Page 55 of 120

## 7.0 EMERGENCY FACILITIES AND EQUIPMENT

### 7.1 Emergency Response Centers

Plan views of the Technical Support Center, Back-up Operations Support Center, Emergency Operations Facility (EOF) and Operations Support Center (OSC) as described below, are shown in Figures 13.4, 13.5, and 13.7.

#### 7.1.1 Technical Support Center

The Technical Support Center (TSC) serves as a center outside of the Control Room that acts in support of the command and control function. Plant status and diagnostic information will be available at this location for use by technical and management personnel in support of reactor command and control functions. The Emergency Director resides in the TSC when activated.

The TSC is located on the first level of the Plant Engineering Building (PEB). The TSC has approximately 5700 sq ft of floor space and is within the controlled ventilation boundary of the Emergency Ventilation System (EVS). This system is independent of the Emergency Filtration Train System (EFT) which serves the Control Room.

An emergency equipment locker located in the TSC contains protective, anti-contamination clothing for TSC personnel.

#### 7.1.2 Operations Support Center

The Operational Support Center (OSC) serves as the facility to which Mechanical, Electrical and I&C maintenance personnel report in an emergency. In addition to maintenance personnel, off-duty Operations personnel also report to the OSC. The OSC functions as the staging area from which emergency teams are dispatched, by the TSC or Control Room, to undertake emergency corrective actions.

The primary OSC is located on the first and second levels of the Plant Administration Building within the Outage Control Center, PAB2 conference room, I&C offices, Operations Department Break Room and Plant Lunch Room. The primary OSC is a dedicated facility which serves as a maintenance support area and conference room during normal operation. The primary OSC is outside a filtered ventilation boundary.

The Back-up OSC is located within the TSC shell structure in the east end of the TSC. The Back-up OSC is located within the EVS controlled ventilation boundary. The Back-up OSC is activated if the primary OSC becomes uninhabitable or as other circumstances dictate.

Emergency equipment lockers, located in the primary OSC, contain protective anti-contamination clothing for OSC emergency team personnel.

<b>MONTICELLO NUCLEAR GENERATING PLANT</b>		E-PLAN
<b>TITLE:</b>	<b>EMERGENCY PLAN</b>	Revision 54
		Page 56 of 120

### 7.1.3 Emergency Operations Facility

In the event of an Alert, Site Area Emergency, or a General Emergency, the Emergency Operations Facility (EOF) will be activated. The EOF serves as a center for evaluation and coordination of off-site activities related to the emergency. Additionally, the facility will be the base of operations for environmental surveillance and communications with supporting operations. The Emergency Manager is in charge of the EOF.

The EOF is located within the site Training Center, 1 mile south by southeast of the plant (approximately 5 minutes driving time). It was designed primarily as a training facility and also in accordance with NUREG 0696. In the event the EOF is needed, it is capable of prompt conversion from a training facility to an Emergency Response Facility.

The EOF will be activated and staffed by Site ERO personnel. The Emergency Plan Implementing Procedures describe the functions, equipment and personnel responsibilities more fully.

The EOF will also provide office space, trailer space and communications hook-ups for NRC Incident Response Teams, vendors, and technical support contractors. Media personnel may be assembled in the Training Center Multi-Purpose Room or other designated waiting area. The JIC will be the main point of contact for the media to obtain information regarding the emergency.

The EOF has facilities and capabilities for:

- ◆ Management of overall licensee emergency response,
- ◆ Coordination of radiological and environmental assessment,
- ◆ Determination of recommended public protective actions,
- ◆ Notification of offsite agencies,
- ◆ Coordination of event, plant, and response information provided to public information staff for dissemination to the media and public,
- ◆ Staffing and activation of the facility within time frames and at emergency classification levels defined in the emergency plan,
- ◆ Coordination of emergency response activities with Federal, State, and local agencies,
- ◆ Obtaining and displaying key plant data and radiological information, and
- ◆ Analyzing plant technical information and providing technical briefings on event conditions and prognosis to licensee staff and offsite agency responders.

<b>MONTICELLO NUCLEAR GENERATING PLANT</b>		E-PLAN
<b>TITLE:</b>	<b>EMERGENCY PLAN</b>	Revision 54
		Page 57 of 120

#### 7.1.4 Alternative Facilities

In the case of Hostile Action Events activation of onsite Emergency Response Facilities may be unsafe. Alternative Response Facilities have been developed to allow onsite ERO personnel to muster in a location near the site but away from any onsite hostile activity. The alternative facility selected for Monticello is the EOF/Training Building described in Section 7.1.3. This facility is accessible in the event of an onsite Hostile Action and provides the ability to perform the following functions:

- ◆ Communication with the Control Room and onsite Security Forces
- ◆ Notification of offsite Emergency Response Organizations
- ◆ Engineering Assessment Activities including damage control team preparation and planning.

#### 7.1.5 Back-up EOF

In the event the primary EOF becomes uninhabitable during a real emergency, the functions of the EOF would be transferred to the Back-up EOF.

The Back-up EOF is located at the Xcel Energy corporate office in downtown Minneapolis, 45 miles southeast of plant.

The Back-up EOF has facilities and capabilities for:

- ◆ Management of overall licensee emergency response,
- ◆ Coordination of radiological and environmental assessment
- ◆ Determination of recommended public protective actions
- ◆ Notification of offsite agencies
- ◆ Coordination of event, plant, and response information provided to public information staff for dissemination to the media and public,
- ◆ Coordination of emergency response activities with Federal, State, and local agencies,
- ◆ Obtaining and displaying key plant data and radiological information, and
- ◆ Analyzing plant technical information and providing technical briefings on event conditions and prognosis to licensee staff and offsite agency responders.

<b>MONTICELLO NUCLEAR GENERATING PLANT</b>		E-PLAN
<b>TITLE:</b>	<b>EMERGENCY PLAN</b>	Revision 54
		Page 58 of 120

#### 7.1.6 Assembly Points

In the event of a plant evacuation, the On-Site Assembly Point (or an Off-Site Assembly Point, as appropriate) will be activated. The function of the assembly point is to provide a center for personnel accountability and radiological contamination screening along with any other immediately necessary actions.

The On-Site Assembly Point is located approximately 1000 feet south of the plant, within the Site Administration Building . The location of the Off-Site Assembly Point is dependent upon the nature of the emergency conditions. Its location will be announced over the public address system when announcement of evacuation is made.

#### 7.1.7 Access Control

The Primary Access Control Point is located in the lower level of the Plant Administration Building. This is the primary entry/exit point from the Radiologically Controlled Area.

An alternate Access Control Point will be located in the Administration Building, Security Access Facility, or at a point designated by the ED, if the Primary Access Control Point becomes uninhabitable due to high radiation or high airborne levels.

#### 7.1.8 Sign-in Boards for ERO Assignments

The boards are used to make speedy personnel duty assignments during the initial stage of an emergency, to insure that qualified personnel fill the positions in the ERO, and insure that the more important positions in the ERO are filled first.

The board consists of a layout of the Emergency Response Organization. Under the board is a list of the individuals who are qualified to fill that position.

The boards are located in each facility. Personnel who have key positions within those facilities have the responsibility of checking the boards when it is announced that ERO personnel are to report to their duty stations. The boards are reviewed and updated quarterly.

<b>MONTICELLO NUCLEAR GENERATING PLANT</b>		E-PLAN
<b>TITLE:</b>	<b>EMERGENCY PLAN</b>	Revision 54
		Page 59 of 120

## 7.2 Communications Systems

### 7.2.1 Normal On-Site Communications

Normal on-site communications is provided by the plant telephone system which has a maximum capacity of 36,000 lines and 12,000 trunks. The telephone system processing equipment located in the Plant Administration Building telephone room and the Plant Engineering Building communication room is powered by UPS/battery backed non-1E instrument buses. Portions of the system are also provided with an alternative power source from lighting panels backed by the non-1E Diesel Generator. Telephone system components at remote locations are powered from lighting panels backed by stand-alone UPSs.

The plant PA System may also be used for in-plant communications. The PA System is powered by normal plant power, backed up by uninterruptible power.

Portable radios are used for communications between individuals and base stations located in the Control Room, TSC, EOF, and Security Building.

### 7.2.2 Normal Off-Site Communications

Normal off-site communications is provided by the following telephone circuits:

7.2.2.1 46 two way ISDN trunks (TDS Telecom)

7.2.2.2 46 two way ISDN trunks to Minneapolis (Dial 8 access)

7.2.2.3 23 ISDN trunks to the Monticello Training Center

### 7.2.3 Alternate Off-Site Communications

#### 7.2.3.1 Radio Receiver/Transmitter

An alternate method for communications is provided by an AC powered radio transceiver with control consoles located in the TSC, Control Room and EOF.

From either console, communications may be established with the EOF, Sherburne and Wright County Sheriffs, Plant Security, Operations and Radiation Protection portable radios, and the Xcel Energy System Control Center.

<b>MONTICELLO NUCLEAR GENERATING PLANT</b>		E-PLAN
<b>TITLE:</b>	<b>EMERGENCY PLAN</b>	Revision 54
		Page 60 of 120

### 7.2.3.2 Emergency Response Organization Pager Network

An ERO Pager Network is utilized for notification of site Emergency Response Organization members. The system consists of a commercial pager network with independent, transmitters. Transmitters are located in various areas from St. Cloud to Red Wing. Each pager group has a primary and back-up telephone number which are from separate trunk lines, which further increases accessibility. Each transmitter is installed with a back-up power supply (battery or diesel).

### 7.2.3.3 Direct Dedicated Telephones

Direct dedicated telephones as described below are diagrammed in Figure 13.6.

7.2.3.3.1 Three dedicated lines exist between the TSC and the EOF.

7.2.3.3.2 Site FTS System – this dedicated telephone network connects the plant site with the NRC Operations Center. Site extensions are located in the Control Room, TSC, Duty Shift Manager Office and Site NRC Office. Site extensions include ENS, HPN, and various other extensions connecting to the NRC Operations Center.

7.2.3.3.3 EOF FTS System – this dedicated telephone network connects the EOF with the NRC Operations Center. EOF extensions are located in the EOF and adjoining classrooms. EOF extensions include ENS, HPN and various other extensions connecting to the NRC Operations Center.

7.2.3.3.4 An automatic-ringing line exists between the TSC and the State EOC.

7.2.3.3.5 Two dedicated lines exists between the EOF and the Back-up EOF.

7.2.3.3.6 An auto ring line exists between the EOF and the State EOC.

7.2.3.3.7 Four dedicated Federal Telephone System (FTS) lines exists in both the EOF and TSC to connect the NRC incident response team with the NRC Operations Center.

<b>MONTICELLO NUCLEAR GENERATING PLANT</b>		E-PLAN
<b>TITLE:</b>	<b>EMERGENCY PLAN</b>	Revision 54
		Page 61 of 120

7.2.3.3.8 Two dedicated cellular phones providing back-up communications for Field Teams.

7.2.3.4 Radio Links

Radio links exist for communications between the Minnesota Division of Homeland Security and Emergency Management and the Control Room, TSC , EOF, and Back-up EOF at the plant site.

7.2.3.5 Emergency Response Data System

ERDS is a direct near real-time electronic data link between the plant's on-site computer system and the NRC Operations Center that provides for the automated transmission of a limited data set of selected parameters. The ERDS supplements the existing voice transmission over the FTS-ENS.

7.2.4 Emergency Communications Matrix

Tables 6 and 7 depict the different communications media by which emergency centers pass information, and give primary and alternate contacts for centers where appropriate.

7.2.5 Testing

Testing of the various communications links is accomplished in two ways.

7.2.5.1 Each month a communications test is conducted in accordance with a surveillance procedure (1225).

7.2.5.2 Drills involving communications equipment are conducted on a regular basis to assure operability.

<b>MONTICELLO NUCLEAR GENERATING PLANT</b>		E-PLAN
<b>TITLE:</b>	<b>EMERGENCY PLAN</b>	Revision 54
		Page 62 of 120

### 7.3 Assessment Facilities

The plant instrumentation and monitors perform indicating, recording and protective functions. The regulating systems provide the ability to regulate the plant safely from shutdown to full power and to monitor and maintain key variables such as reactor power, flow, temperature and radioactivity levels within predetermined safe limits during both steady state and plant transients. Plant instrumentation and control systems also provide means to cope with abnormal operating conditions. The control and display of information of these various systems are centralized in the main Control Room. This instrumentation would provide the basis for initiation of protective systems.

#### 7.3.1 On-Site Systems and Equipment

##### 7.3.1.1 Safety Parameter Display System (SPDS)

The Safety Parameter Display System (SPDS) is an integrated function of the Plant Process Computer System (PPCS); and is designed to provide plant operators with a concise display of critical plant parameters as an aid in implementation of the plant Emergency Operating Procedures (EOPs). The Monticello SPDS is based on plant Emergency Operating Procedures (EOPs) and General Electric (GE) generic Emergency Response Information System (ERIS). PPCS displays are available in the Work Execution Center Office, Duty Shift Manager Office, Technical Support Center (TSC), Emergency Operations Facility (EOF) and throughout the Control Room. The PPCS terminals in the TSC include one for Radiation Protection Group use and one for Technical Engineering use.

SPDS information is presented to the operator via color graphic computer system monitors. Operator interface to the computer system is via keyboards, mice, monitors, and printers. Input data from plant sensors is gathered via the Data Acquisition System (DAS) and interfaced to the PPCS, which supports the various SPDS displays. Signals are processed through various algorithms such as signal range checking, limit checking, averaging, logical manipulations and validation. The results are then made available on the SPDS displays.

<b>MONTICELLO NUCLEAR GENERATING PLANT</b>		E-PLAN
<b>TITLE:</b>	<b>EMERGENCY PLAN</b>	Revision 54
		Page 63 of 120

The SPDS displays can be classified into two categories, Top-Level and Lower-Level displays. In general, Top-Level displays provide information on several control parameters, both current and historical. The Lower-Level displays are designed to augment the Top-Level displays by providing more detail or background on specific items contained in the Top-Level displays. The overall SPDS display structure is as follows:

#### 7.3.1.1.1 Top Level SPDS Displays

##### 1. Critical Plant Variables (000)

The CPV display provides the status of all critical plant parameters including RPV level, pressure, reactor power, drywell pressure and temperature, torus pressure, temperature and level, and radioactive release rate information.

##### 2. Reactor Pressure Vessel Control (011)

The RPV display provides detailed status and control parameter information including RPV water level, RPV pressure, reactor power and RPV temperature.

##### 3. Containment Control (021)

This display provides specific information regarding containment control including drywell pressure and temperature and torus water level, temperature and pressure.

##### 4. H<sub>2</sub>/O<sub>2</sub> Control (022)

This display provides the hydrogen and oxygen concentrations in containment.

##### 5. Radiation Control (111-113)

The Radiation Monitor displays provide detailed information on Reactor/Turbine and Radwaste Building area radiation monitors and plant process monitors.

<b>MONTICELLO NUCLEAR GENERATING PLANT</b>		E-PLAN
<b>TITLE:</b>	<b>EMERGENCY PLAN</b>	Revision 54
		Page 64 of 120

#### 7.3.1.1.2 Lower-Level SPDS Displays

##### 1. Trend Plot Displays

Trend plot displays support the RPV and Containment Control displays by providing detailed parameter trend plots of those displays.

##### 2. Validation Displays

The Validation displays are used to display how a parameter is determined.

##### 3. Two Dimensional Plot Displays

The 2-D plot displays provide plant specific two dimensional limits in an x-y format and are identical to the curves used in the EOPs.

In addition, Menu Displays are provided to assist the user in selection of individual displays from applicable display types. The following Menus are available: SPDS, Trend Plot, Validation, and 2D Plot.

The SPDS displays are designed with common display characteristics for ease of understanding. Data is displayed according to defined conventions for use of color, shape, format, alarm and validation processing.

A display color coding scheme is used to aid the operator in prioritizing information and recognizing off-normal conditions. In addition, displays provide indication of both validated parameter and process limit status. Status windows are also provided to alert the operator when approaching or exceeding a critical parameter limit (EOP entry condition).

<b>MONTICELLO NUCLEAR GENERATING PLANT</b>		E-PLAN
<b>TITLE:</b>	<b>EMERGENCY PLAN</b>	Revision 54
		Page 65 of 120

### 7.3.1.2 Geophysical Phenomena Monitors

#### 7.3.1.2.1 Seismic Monitoring System

The Seismic Monitoring System is made up of three independent sensing systems: the peak-recording accelerometers, the seismic-switch-activated annunciator system and the accelerograph recording system. The peak-recording accelerometers and the sensors for the accelerograph system (force-balance accelerometers) are located in the drywell, on the refueling floor and in the seismic shed (located to the north of the number 2 warehouse). Seismic switches for the annunciator system are also located in the seismic shed. The seismic trigger which initiates the accelerograph is located in the number 12 125 VDC Battery Room.

Each of the peak-recording accelerometers is a self-contained unit. The sensing mechanism is a permanent magnet stylus attached to the end of a torsional accelerometer. Low frequency accelerations cause the magnet to erase pre-recorded lines on a small (approximately 1/4 inch square) piece of magnetic tape. Each peak recording accelerometer unit contains three torsional accelerometers and magnetic tapes - one each for longitudinal, transverse, and vertical accelerations.

The magnetic tapes can be removed from the accelerometers, developed and evaluated by plant personnel for a rapid determination of the severity of a seismic disturbance.

<b>MONTICELLO NUCLEAR GENERATING PLANT</b>		E-PLAN
<b>TITLE:</b>	<b>EMERGENCY PLAN</b>	Revision 54
		Page 66 of 120

The Control Room annunciator 6-C-08 (EARTHQUAKE) is initiated by either seismic switch of the Seismic Annunciator System or the seismic trigger of the accelerograph recording system. In addition to this, each of the seismic switches has its own alarm. The first of these is the alarm 6-C-13 (OPERATIONAL BASIS EARTHQUAKE (OBE)) which annunciates when its switch senses an acceleration  $> .03$  g. The second alarm is the 6-C-18 (DESIGN BASIS EARTHQUAKE (DBE)), which annunciates when its switch senses an acceleration  $> .06$ g. These two switches do not activate the accelerograph recording system.

The accelerograph recording system gives a more detailed record of a disturbance than the peak recording accelerometers – it records accelerations in three directions (longitudinal, transverse, and vertical, as above) from each of the three sensor locations on magnetic tape cartridges located in the Control Room. This system has five major components: a trigger, three sensors, and the recording and control units. When the trigger (located in the No. 12 125 VDC Battery Room) senses the beginning of a seismic disturbance, (an acceleration  $> .01$  g), it will start the accelerograph recorders and also triggers the earthquake event alarm 6-C-08 in the Control Room.

A summary of the Seismic Monitoring Equipment is provided in Table 8.

#### 7.3.1.2.2

#### Meteorological Monitoring System

The purpose of the meteorological monitoring system is to monitor and determine atmospheric dilution and dispersion parameters for the Monticello Plant site.

The meteorological monitoring system consists of two instrumented towers, associated signal transmission and data processing equipment, and associated power supplies.

<b>MONTICELLO NUCLEAR GENERATING PLANT</b>		<b>E-PLAN</b>
<b>TITLE:</b>	<b>EMERGENCY PLAN</b>	Revision 54
		Page 67 of 120

The primary meteorological tower facility is located on the plant site southeast of the Reactor Building. It consists of a guyed 100m tower with six instrumentation booms located in pairs at 10m, 43m, and 100m.

At each height one boom is reserved for A-train instrumentation and the other boom is reserved for B-train instrumentation. Two elevator systems are installed on the tower allowing each train of equipment to operate independently so maintenance may be performed without taking both trains out of service.

Instrumentation consists of wind speed and direction sensors along with aspirated temperature sensors. One sensor of each type is mounted at each location for each train for a total of six instruments of each type. Two precipitation monitors, one for each train, are located at the base of the tower. The majority of instrumentation is powered from a local UPS. Data is collected, processed, and then communicated from the tower to a receiver inside the Plant Administration Building. Meteorological data is available on the Process Computer System in the Plant Control Room, TSC, and the EOF. A meteorological data recorder is also provided in the control room.

A backup meteorological tower is located approximately 3/4 mile from the Reactor Building and is adjacent to the EOF. This tower is a 30 meter self-supported tower with an instrument elevator which lifts single train wind speed and wind direction sensor to the 22 meter elevation. Signals from the tower are fed to an instrument processor rack and provide a backup source of wind speed and wind direction data.

<b>MONTICELLO NUCLEAR GENERATING PLANT</b>		<b>E-PLAN</b>
<b>TITLE:</b>	<b>EMERGENCY PLAN</b>	Revision 54
		Page 68 of 120

Meteorological data from the 100 meter tower is collected and a 15 minute running average is calculated every minute. The data is available on the Process Computer System in the Plant Control Room, TSC, and the EOF.

Meteorological data from the backup tower is collected and a 15 minute running average is calculated every minute. The data is available on the Process Computer System in the Plant Control Room, TSC, and the EOF.

Displays of 15 minute running average meteorological data from both sensor trains on the 100 meter tower and backup tower are simultaneously available on computer terminals in both the TSC and EOF.

The Meteorological Data Collection software includes data quality control tests which flag questionable or bad data to the user. Plant Chemistry personnel access hourly averaged data on a daily basis and review the data for reasonableness in accordance with plant Chemistry Department procedures. Plant I&C personnel perform a periodic surveillance test on the 100 meter tower and annual instrument maintenance on both towers in accordance with the plant surveillance program. System problems are corrected through the plant Work Order process.

In addition to the site meteorological monitoring system, regional meteorological data is available through the National Weather Service by commercial telephone. National Oceanic and Atmospheric Administration (NOAA) Weather Alert radios are also installed in the Control Room, TSC and EOF to provide warning of adverse weather.

<b>MONTICELLO NUCLEAR GENERATING PLANT</b>		E-PLAN
<b>TITLE:</b>	<b>EMERGENCY PLAN</b>	Revision 54
		Page 69 of 120

### 7.3.1.3 Radiological Monitors

#### 7.3.1.3.1 Process Radiation Monitoring System

The function of the process radiation monitoring system is to provide a continuous monitoring and readout of the radioactivity of all process lines and vents that can release radioactivity directly to the environs. In addition, this system also continuously measures, indicates and records the radioactivity concentration levels of in-plant process streams and vents. A list of the plant process monitors is provided in Table 10.

#### 7.3.1.3.2 Area Radiation Monitoring System

A list of the Area Radiation Monitors is provided in Table 11.

The functions of the Area Radiation Monitoring System are:

1. Warn of excessive gamma radiation levels in areas where nuclear fuel is stored or handled.
2. Provide operating personnel with a continuous indication in the main Control Room of gamma radiation levels at selected locations within the various plant buildings.
3. Contribute supervisory information to the Control Room so that correct decisions may be made with respect to deployment of personnel in the event of a radiation incident.
4. Assist in the detection of unauthorized or inadvertent movement of radioactive material in the plant including the radwaste area.
5. Supplement other systems including Process Radiation Monitoring, Leak Detection, etc., in detecting abnormal migrations of radioactive material in or from the process streams.

<b>MONTICELLO NUCLEAR GENERATING PLANT</b>		E-PLAN
<b>TITLE:</b>	<b>EMERGENCY PLAN</b>	Revision 54
		Page 70 of 120

6. Provide local alarms at key points where a substantial change in radiation level might be of immediate importance to personnel frequenting the area.
7. Maintain a permanent record of the radiation levels in the areas being monitored.

#### 7.3.1.4 Process Monitors

7.3.1.4.1 There are many instruments in the plant which may be used to assess the many potential conditions that the plant may experience. These instruments may be used individually or in groups of indicators to assess a certain situation. There is no specific indication that in itself can correctly identify an emergency condition 100% of the time. Therefore, the operators must utilize their general knowledge along with the guidelines provided in Emergency Plan Implementing Procedure A.2-101 (CLASSIFICATION OF EMERGENCIES) to analyze process indications. Specific process monitors of reactor systems which are used during various plant emergencies are discussed in A.2-101. In addition, a summary of the types of measured parameters in the Control Room is provided in Table 12, Instruments Available for Monitoring Major Systems.

#### 7.3.1.4.2 Reactor Protection System

The Reactor Protection System is designed to prevent, in conjunction with the Primary Containment and Containment Isolation Systems, the release of radioactive materials in excess of the guidelines of 10CFR50.67, and to prevent fuel damage as a consequence of single operator error or single equipment failure. When specified limits have been exceeded, the Reactor Protection System initiates a reactor scram.

<b>MONTICELLO NUCLEAR GENERATING PLANT</b>		E-PLAN
<b>TITLE:</b>	<b>EMERGENCY PLAN</b>	Revision 54
		Page 71 of 120

#### 7.3.1.4.3 Primary Containment Isolation System

The purpose of the Primary Containment Isolation System is to prevent the release of radioactive materials in excess of the guidelines of 10CFR50.67 by isolating the reactor vessel and closing containment where required following an accident.

#### 7.3.1.5 Containment Radiation Monitor

There are two containment radiation monitors which have ion chamber detectors and a response range of  $10^0$  to  $10^8$  R/hr. The detectors are located at approximately the midline of the drywell and separated to enhance the redundant feature of the system. As safety monitors, they satisfy 1E requirements and are qualified under LOCA conditions to IEEE 323-1974. The detectors are encased in steel to protect them from containment sprays and high temperatures.

In the event of a large release of radioactivity to the containment atmosphere, the containment monitors can be used to estimate the amount of activity available for release from containment.

#### 7.3.1.6 Fire Detection Devices

##### 7.3.1.6.1 Early Warning Fire Detectors

Fire detectors (smoke, heat, and flame) are located in most areas of the plant. The detectors in each area initiate an alarm locally and in the Control Room upon detecting either combustion or a failure in the detector system. Detectors in certain areas of the plant will activate their respective sprinkler systems.

##### 7.3.1.6.2 HAD (Heat Activated Device)

The HAD System utilizes the heat from a fire to operate a pneumatic system to either sound alarms or automatically initiate a deluge or sprinkler system. The HAD System is used in conjunction with the building siding deluge, the cooling tower deluges, the recirculation MG set deluges, and the lube oil reservoir deluge. These systems can also be operated locally.

<b>MONTICELLO NUCLEAR GENERATING PLANT</b>		E-PLAN
<b>TITLE:</b>	<b>EMERGENCY PLAN</b>	Revision 54
		Page 72 of 120

7.3.1.6.3 LHD (Linear Heat Detection)

The LHD utilizes a Protectowire linear heat fire detection system and is capable of initiating an alarm once its rated activation temperature is reached.

7.3.1.7 Post-Accident Sample System

The Post-Accident Sample System (PASS) was designed to provide a means of assessing core damage during and after a loss-of-coolant accident. The facility is located outside of secondary containment to enhance accessibility. Local shielding and area radiation monitoring are also provided to protect the operator.

The capabilities of the system include:

7.3.1.7.1 Large and small volume liquid coolant samples from jet pumps A and B and RHR pumps A and B;

7.3.1.7.2 Gas samples from drywell and torus.

7.3.2 Facilities and Equipment for Off-Site Monitoring

7.3.2.1 Geophysical Phenomena Monitors

In the event that a seismic disturbance is indicated by on-site detection equipment, plant procedures require the operator to confirm the validity and intensity of the disturbance by contacting an off-site source. The list of off-site sources includes:

7.3.2.1.1 Prairie Island Nuclear Plant  
(Located near Red Wing, Minnesota);

7.3.2.1.2 National Earthquake Information Service  
(Golden, Colorado)

7.3.2.2 Radiological Monitors

The Monticello off-site radiation monitoring program includes TLD stations which are located in the general areas of the site boundary, in an outer ring, in special interest areas, and in control stations, many miles from the plant. Also included in the program is a group of air monitoring stations positioned on the site boundary and in the city of Monticello. The program, known as the Radiological Environmental Monitoring Program, is administered at the Site.

<b>MONTICELLO NUCLEAR GENERATING PLANT</b>		E-PLAN
<b>TITLE:</b>	<b>EMERGENCY PLAN</b>	Revision 54
		Page 73 of 120

### 7.3.2.3 Laboratory Facilities

In the event that the lab facilities on-site become unusable or overloaded, back-up facilities are available. The chemistry labs at Prairie Island are available for chemical analysis work. For radiochemical analysis, the back-up countroom at the EOF is equipped with a computer-based multi-channel analyzer and gross beta counting equipment. The counting facilities at Prairie Island are also available, if needed.

## 7.4 Protective Facilities and Equipment

### 7.4.1 Assembly Points

In the event of a Site Area or General Emergency, the Site Administration Building (SAB) is designated as the assembly point for evacuated personnel. The SAB is located approximately 1000 feet south of the plant.

This structure offers cover from fallout, but does not have special ventilation or shielding properties. It has the capacity to handle the number of people expected to report there. An emergency equipment locker at the assembly point contains a supply of emergency equipment and protective clothing.

The Receiving Warehouse has been identified as an alternate assembly point for specific events. This facility may be used to relocate and assemble and account for non-essential personnel during security threats.

### 7.4.2 Emergency Operations Facility (EOF)

The EOF is located approximately 1 mile southeast of the plant and is activated at the Alert, Site Area or General Emergency classification. The EOF is contained within the site Training Center which houses the Training Staff, administrative offices and Control Room Simulator.

The EOF was designed and constructed IAW NUREG 0696 and is a concrete structure which contains sufficient shielding (for the EOF section of the building) to provide a protection factor of 5. The EOF portion of the building is served by two independent off-site power sources for reliability. The building ventilation system includes an "emergency" mode which provides filtered air to pressurize the EOF through a high efficiency particulate absolute (HEPA) filtration system. The layout of the building entrances and exits were also designed to facilitate emergency operations.

Radiological monitoring of the EOF is provided by air sampling and Dosimeter Area Radiation Monitor (DARM) which may be supplemented with radiological surveys by the EOF Radiation Protection Staff.

Extensive communications equipment is installed to provide primary and back-up methods of communicating with plant Emergency Response Facilities, utility headquarters, off-site agencies and utility Field Monitoring teams. Critical plant parameter data is available in the EOF through the plant Safety Parameter Display System (SPDS).

<b>MONTICELLO NUCLEAR GENERATING PLANT</b>		E-PLAN
<b>TITLE:</b>	<b>EMERGENCY PLAN</b>	Revision 54
		Page 74 of 120

Meteorological data is provided by the ERIS system. Off site dose projection is provided by RASCAL.

#### 7.4.3 Back-up EOF

The Back-up EOF is located at the Xcel Energy corporate office in downtown Minneapolis, 45 miles southeast of the plant.

In the event the primary EOF became uninhabitable during a real emergency, the functions of the EOF would be transferred to the Back-up EOF.

Extensive communications equipment is installed to provide primary and back-up methods of communicating with plant emergency Response Facilities, off-site agencies and utility Field Monitoring teams. Critical plant parameter data is available in the Back-up EOF through the plant Safety Parameter Display System (SPDS). Meteorological data is provided and displayed by the ERIS system. Off site dose projection is provided by RASCAL.

#### 7.4.4 Emergency Kits

Table 13 lists the location and general contents of emergency kits to be used in response to an emergency at the Monticello Plant.

### 7.5 First Aid and Medical Supplies

#### 7.5.1 First Aid Center

A decon shower and first aid supplies are located in the Main Access Control area in the lower level of the Plant Administration Building. Immediate and temporary care may be given to a victim in this area. If the injury involves contamination that cannot be removed without causing further injury, steps will be taken to minimize the spread of contamination until medical assistance arrives or until the victim has been transported to the hospital.

#### 7.5.2 First Aid Kits

First Aid kits are located in the Fire Brigade Room at Main Access Control, Work Execution Center and various other areas on the plant site. Stretchers and shock blankets are located on each level of the Containment Building, Turbine Building and Main Access Control.

### 7.6 Damage Control Equipment and Supplies

#### 7.6.1 Firefighting Equipment

A full line of fire fighting equipment and supplies is available for damage control operations. The equipment is stored in the Fire Brigade Room adjacent to the Main Access Control area in addition to various areas within the plant for easy access and quick response to fires.

<b>MONTICELLO NUCLEAR GENERATING PLANT</b>		E-PLAN
<b>TITLE:</b>	<b>EMERGENCY PLAN</b>	Revision 54
		Page 75 of 120

### 7.6.2 Spill and Leak Control Equipment

Spill and leak control equipment includes electric and gas driven pumps, various patching supplies and welding equipment. This equipment is available in the warehouse along with machine shop facilities for response to a wide variety of problems.

### 7.7 Public Alert and Notification System (ANS)

Within the Plume Exposure Emergency Planning Zone (EPZ) there exists provisions for alerting and providing notification to the public. The state and local authorities are responsible for activation of this system.

The ANS system consists of a primary and backup activation and monitoring of outdoor warning sirens, primary and backup initiation of the Emergency Alert System (EAS), primary and backup initiation of the Integrated Public Alert and Warning System (IPAWS), and county auto-dial notification systems for special populations.

Emergency Planning Visitor Guides are available for distribution in all recreational areas to advise transient populations of the action they should take in the event of an accident at the MNGP. Annual Emergency Planning Guides are distributed to all residential and business addresses within the 10-mile EPZ and contain information for the public to use in the event they hear sirens or EAS Messages over the local radio system.

Activation of the ANS begins with a protective action recommendation (PAR) of evacuation or sheltering by the MNGP Emergency Director/Manager. The Minnesota Division of Homeland Security and Emergency Management (HSEM) is responsible for coordinating the recommendation and making it a decision with appropriate approvals and assigning siren activation times and EAS activation times. The Sherburne and Wright County Sheriff's Offices are responsible for activation of the outdoor warning sirens.

The system consists of 106 sirens. The 106 sirens provide 100% coverage of the populated area within the 10-mile EPZ. In the event that a siren is not working, affected areas will still be alerted through the use of IPAWS.

Additional, detailed information about the ANS system, including system design, siren coverage analysis, testing schedules, and an evaluation of the current system is found in the Alert and Notification System Design Report.

### 7.8 Auto Dialing Telephone Systems

To further ensure prompt notification, auto-dialing systems are used to notify various commercial, institutional, and education facilities in the 10 mile zone. These locations may harbor large groups of people during all or part of a day. Auto dialing systems will be activated by the local counties.

### 7.9 Mapping

10 mile EPZ maps are periodically updated to reflect population and geo-physical changes.



<b>MONTICELLO NUCLEAR GENERATING PLANT</b>		E-PLAN
<b>TITLE:</b>	<b>EMERGENCY PLAN</b>	Revision 54
		Page 77 of 120

Table 7  
COMMUNICATIONS CONTACTS

LOCATION	CONTACT	
	PRIMARY	ALTERNATE
Control Room	Shift Manager	Control Room Supervisor
EOF and Back-up EOF	Emergency Manager	EOF Coordinator
Minnesota Division of Emergency Management	Duty Officer	Duty Officer
Minnesota Planning and Assessment Center	Planning Chief	State Duty Officer
Wright Country Sheriff	Sheriff	Dispatcher
Sherburne Country Sheriff	Sheriff	Dispatcher
Monticello Civil Defense	Monticello CD Driver	Sheriff Dispatcher
Minnesota State Patrol (St. Cloud)	Captain	Dispatcher
Monticello City Hall	Mayor	City Administrator
Monticello F. D.	Sheriff	Dispatcher
NRC HPN	NRC - Operations Center	Region III Lisle
NRC ENS	NRC - Operations Center	Region III Lisle

Table 8  
SEISMIC MONITORING INSTRUMENTATION

LOCATION	DESCRIPTION	ACTUATING DEVICE	SETPOINT
6-C-08	Earthquake	Accelerograph Trigger	.01 g
		<u>OR</u>	
		OBE Alarm Module	.03 g
6-C-13	Operational Basis Earthquake	<u>OR</u>	
		DBE Alarm Module	.06 g
6-C-18	Design Basis Earthquake	OBE Alarm Module	.03 g
		DBE Alarm Module	.06 g

<b>MONTICELLO NUCLEAR GENERATING PLANT</b>		E-PLAN
<b>TITLE:</b>	<b>EMERGENCY PLAN</b>	Revision 54
		Page 78 of 120

Table 9  
ON-SITE METEOROLOGICAL MONITORING INSTRUMENTATION

SYSTEM	PARAMETER	SENSOR LOCATION (METERS)	INDICATOR LOCATIONS
100 meter Tower	WIND SPEED	10	Met Data Recorder in the control Room. Process Computer System displays in the Control Room, TSC, and EOF.
		43	
		100	
	WIND DIRECTION	10	Met Data Recorder in the control Room. Process Computer System displays in the Control Room, TSC, and EOF.
		43	
		100	
	TEMPERATURE	10	Met Data Recorder in the control Room. Process Computer System displays in the Control Room, TSC, and EOF.
		43	
		100	
	$\Delta$ TEMPERATURE	43 100	
Backup Tower	WIND SPEED	22	Process Computer System displays in the Control Room, TSC, and EOF.
	WIND DIRECTION	22	

Back-up Sources of Meteorological Data		
Data Source	Location	Method
National Weather Service	MSP Airport and Chanhassen, MN	Commercial Telephone and website
NOAA Weather Alert Radio	Regional	Alert Radio in TSC and EOF

<b>MONTICELLO NUCLEAR GENERATING PLANT</b>		E-PLAN
<b>TITLE:</b>	<b>EMERGENCY PLAN</b>	Revision 54
		Page 79 of 120

Table 10  
PROCESS RADIATION MONITORS

MONITOR	NUMBER OF DETECTORS	INDICATOR LOCATIONS	INDICATOR RANGE
Main Steam Line Radiation Monitor	4	Panel C-02, C-10	1 – 10 <sup>6</sup> mrem/hr
Off-gas Pretreatment Rad Monitor	2	Panel C-02, C-10	1 – 10 <sup>6</sup> mrem/hr
Flux Tilt Monitor	1	Panel C-02, C-10	0 – 125 units
Stack WRGM	2	Panel C-257 Panel C-258	10 <sup>0</sup> – 10 <sup>12</sup> µCi/Sec
Reactor Building Vent WRGM	2	Panel C-257 Panel C-258	10 <sup>0</sup> – 10 <sup>12</sup> µCi/Sec
Fuel Pool Monitor	2	Panel C-10	0.1 – 1000 mrem/hr
Reactor Building Exhaust Plenum Monitor	2	Panel C-02, C-10	.01 – 100 mrem/hr
Process Liquid:			
Radwaste Liquid Effluent Monitor	1	Panel C-10	10 <sup>-1</sup> – 10 <sup>6</sup> CPS
Service Water Effluent Monitor	1	Panel C-02, C-10	10 <sup>-1</sup> – 10 <sup>6</sup> CPS
RBCCW Radiation Monitor	1	Panel C-02, C-10	10 <sup>-1</sup> – 10 <sup>6</sup> CPS
Discharge Canal Rad Monitor	2	Panel C-02, C-10	10 <sup>-1</sup> – 10 <sup>6</sup> CPS
Turbine Building Normal Waste Sump Radiation Monitor	2	Panel C-02, C-10	10 – 10 <sup>6</sup> CPM
Drywell CAM Monitor	1	Panel C-02	10 – 10 <sup>6</sup> CPM
Control Room Radiation	2	Panel C-257 Panel C-258	10 <sup>-1</sup> – 10 <sup>4</sup> mrem/hr
Sewer Lift Station	1	Panel C-249	10 – 10 <sup>7</sup> CPM
Hard Pipe Vent	1	Panel C-289B	10 – 10 <sup>7</sup> mrem/hr

Continuous Air Monitors
<ol style="list-style-type: none"> <li>1. Primary OSC</li> <li>2. TSC</li> <li>3. SJAE Room (Condensate Pump Area)</li> <li>4. 951' Turbine Floor East</li> <li>5. 1027' Reactor Building</li> <li>6. Recombiner Building (TB RR Access)</li> <li>7. Off-gas Storage Building</li> <li>8. 962' Reactor Building (CUPR Vent)</li> <li>9. 962' RX Building East (Samples Stm Chase)</li> </ol>

<b>MONTICELLO NUCLEAR GENERATING PLANT</b>		E-PLAN
<b>TITLE:</b>	<b>EMERGENCY PLAN</b>	Revision 54
		Page 80 of 120

Table 11  
AREA RADIATION MONITORS

STA.	PANEL C-11 SENSOR LOCATION BUILDING	AREA	<u>SENSOR RANGE</u> (MR/HR)
A-1	Reactor	Refuel Floor	0.1 – 1000
A-2	Reactor	Refuel Floor (High Range)	1.0 – 10,000
A-3	Reactor	Refuel Floor West Stairway	0.1 – 1000
A-4	Reactor	1001' Source Storage	0.1 – 1000
A-5	Reactor	1001' Fuel Pool Room	0.1 – 1000
A-6	Reactor	1001' Decon Equipment Area	0.1 – 1000
A-7	Reactor	985' Chem Sample Area	0.1 – 1000
A-8	Reactor	962' Cleanup System Access	0.1 – 1000
A-9	Reactor	962' Reactor Building East	0.1 – 1000
A-10	Reactor	935' East CRD Module Area	0.1 – 1000
A-11	Reactor	935' West CRD Module Area	0.1 – 1000
A-12	Reactor	935' TIP Drive	0.1 – 1000
A-13	Reactor	TIP Cubicle	1.0 – 10,000
A-14	Reactor	HPCI Turbine Area	0.1 – 1000
A-15	Reactor	896' Radwaste Drain Tank Room	0.1 – 1000
A-16	Reactor	RCIC Pump Area	0.1 – 1000
A-17	Reactor	A RHR Room	0.1 – 1000
A-18	Reactor	B RHR Room	0.1 – 1000
A-19	Office	Chemistry Lab	0.1 – 1000
A-20	Office	Control Room (Low Range)	0.01 – 100
A-21	Office	Control Room (High Range)	1.0 – 10,000
B-1	Turbine	Operating Floor (North Wall)	1.0 – 10,000
B-2	Turbine	Shield Wall	0.1 – 1000
B-3	Turbine	Condensate Demin Operating Area	0.1 – 1000
B-4	Turbine	MVP Room	0.1 – 1000
B-5	Turbine	Feedwater Pump Area	0.1 – 1000
C-1	Radwaste	Radwaste Control Room	0.1 – 1000
C-3	Radwaste	Conveyor Operating Aisle	0.1 – 1000
D-1	13.8kV Switchgear Room	13.8kV Switchgear Room	0.1 – 1000

<b>MONTICELLO NUCLEAR GENERATING PLANT</b>		E-PLAN
<b>TITLE:</b>	<b>EMERGENCY PLAN</b>	Revision 54
		Page 81 of 120

Table 11  
AREA RADIATION MONITORS (CONT'D)

STA.	PANEL C-252 & C-11 SENSOR LOCATION BUILDING	AREA	<u>SENSOR RANGE</u> (MR/HR)
E-1	Recombiner	Instrument Room	0.1 – 1000
E-2	Recombiner	Pump Room	0.1 – 1000
F-1	Gas Storage	Foyer (Low Range)	0.1 – 1000
F-2	Gas Storage	Foyer (High Range)	100 – 1,000,000
STA.	PANEL C-257 & C-258 SENSOR LOCATION BUILDING	AREA	<u>SENSOR RANGE</u> (MR/HR)
	Reactor	Containment	10 <sup>0</sup> – 10 <sup>8</sup> R/HR

<b>MONTICELLO NUCLEAR GENERATING PLANT</b>		E-PLAN
<b>TITLE:</b>	<b>EMERGENCY PLAN</b>	Revision 54
		Page 82 of 120

Table 12  
INSTRUMENTS AVAILABLE FOR MONITORING MAJOR SYSTEMS

<u>Measured Parameter</u>	<u>Type of Readout</u>	<u>Range</u>	<u>Indicator Location</u>
1. <u>Source Range</u>			
a. Neutron Level	Log Scale Indicator, Recorder, Annunciator	$10^{-1}$ to $10^6$ CPS	System Cabinets Main Control Panels
b. Reactor Period	Linear Scale Indicator, Annunciator	-100 to 10 Sec	System Cabinets Main Control Panels
2. <u>Intermediate Range</u>			
a. Neutron Level	Digital Bargraph Display, Recorder, Annunciator	0 to 125 (units)	System Cabinets Main Control Panels
3. <u>Power Range</u>			
a. Neutron Level	Linear Scale Indicator, Recorder, Annunciator	0 to 125%	System Cabinets Main Control Panels
4. <u>Reactor Coolant Range</u>			
a. Recirc Loop Temperature	Linear Scale Indicator, Computer Printout	0 to 600°F	Main Control Panels
b. Reactor Pressure	Linear Indicator, Recorder, Computer Printout, Annunciator	0 to 1500 PSIG	Main Control Panels
c. Core Flow	Linear Scale	0 to $80 \times 10^6$ LB/HR	Main Control Panels
d. Circ Flow	Linear Indicator, Recorder, Computer Printout	0 to $35 \times 10^3$ GPM	Main Control Panels
e. Jet Pump Flow	Linear Scale Indicator, Computer Printout	0 to $44 \times 10^6$ LB/HR	Main Control Panels
5. <u>Main Steam</u>			
a. Steam Line Flow	Linear Indicator	0 to $2.5 \times 10^6$ LB/HR	Main Control Panels
b. Total Steam Flow	Linear Scale Recorder	0 to $10 \times 10^6$ LBS/HR	Main Control Panels
c. Main Steam Line Pressure	Linear Scale Indicator, Computer Printout	900 to 1000 psig (on C-07) 0 to 1200 psig (on C-03)	Main Control Panels

<b>MONTICELLO NUCLEAR GENERATING PLANT</b>		E-PLAN
<b>TITLE:</b>	<b>EMERGENCY PLAN</b>	Revision 54
		Page 83 of 120

Table 12  
INSTRUMENTS AVAILABLE FOR MONITORING MAJOR SYSTEMS (CONT'D)

<u>Measured Parameter</u>	<u>Type of Readout</u>	<u>Range</u>	<u>Indicator Location</u>
6. <u>Containment</u>			
a. Pressure	Linear Scale Recorder, Computer Printout, Annunciator	-2 to +3 psig recorder 0-80 psig recorder 0 to +250 psig recorder	Main Control Panels
b. Torus Pressure	Linear Scale Recorder	-2 to +3 psig	Main Control Panels
c. Torus Level	Linear Scale Indicator	-15" to 15" -8' to 14' recorder (in Linear Feet)	Main Control Panels
d. Torus Water Temperature	Digital Indicator, Annunciator	30° - 240°F	Main Control Panels
e. N <sub>2</sub> Makeup Flow	Linear Scale Recorder, Annunciator	0 - 2 SCFM	Main Control Panels
f. N <sub>2</sub> Purge Flow	Linear Scale Indicator	0 - 5000 SCFM	Main Control Panels
g. Drywell Sumps	Level Recorder	0" - 14"	Main Control Panels
h. Drywell Cooling Fans	Indicator Lights	Stby/Off/On	System Cabinet Control Panels
7. <u>Station Electric</u>			
a. Busses 15 and 16 4.16 KV Bus Voltage	Linear Scale Indicator, Annunciators	0-5250 AC Volts	Main Control Panels
b. Breaker Positions	Indicator Lights	Open/Closed	Main Control Panels
c. Amperage	Linear Scale Indicators	Various	Main Control Panels
d. Generator Output	Linear Scale Recorder, Indicator, Computer Printout	0 to 800 MW 0 to 700 MW	Main Control Panels

<b>MONTICELLO NUCLEAR GENERATING PLANT</b>		E-PLAN
<b>TITLE:</b>	<b>EMERGENCY PLAN</b>	Revision 54
		Page 84 of 120

Table 12  
INSTRUMENTS AVAILABLE FOR MONITORING MAJOR SYSTEMS (CONT'D)

<u>Measured Parameter</u>	<u>Type of Readout</u>	<u>Range</u>	<u>Indicator Location</u>
8. <u>Feedwater Condensate</u>			
a. Feedwater Temperature	Linear Scale Recorder	32 to 430°F	Main Control Panels
b. Condensate Header Pressure	Linear Scale Indicator	0 to 500 psig	Main Control Panels
c. Feedwater Discharge Pres	Linear Scale Indicator and Recorder	0 to 2000 psig	Main Control Panels
d. Feedwater Flow	Linear Scale Indicator	0 to 5 x 10 <sup>6</sup> LB/HR	Main Control Panels
e. Total Feedwater Flow	Linear Scale Recorder	0 to 10 x 10 <sup>6</sup> LB/HR	Main Control Panels
9. <u>Condenser Systems</u>			
a. Condenser Vacuum	Linear Scale Recorder, Annunciator	0 to 30" HG Vac	Main Control Panels
b. Hotwell Level	Linear Scale Recorder, Annunciator	-15 to +15"	Main Control Panels
c. CST Level	Linear Scale Indicator	5' to 30'	Main Control Panels
10. <u>ECCS Systems</u>			
a. LPCI, Core Spray Pump Status	Indicator Light	----	
b. LPCI Flow	Square Root Scale Recorder, Indicator	0 to 10,000 GPM	Main Control Panels
c. Core Spray Flow	Square Root Scale Indicator	0 to 5000 GPM	Main Control Panels
d. LPCI Core Spray Valve Positions	Indicator Lights Computer Printout	----	Main Control Panels
e. ADS Valve Positions	Indicator Lights Annunciator	----	Main Control Panels
f. ADS Discharge Temperature	Linear Scale Recorder, Annunciator	0 to 600°F	System Temperature Recorder
g. HPCI Flow	Linear Scale Indicator	0 to 3500 GPM	Main Control Panel
11. <u>Decay Heat Removal System</u>			
a. RCIC Flow	Linear Scale Indicator/ Controller	0 to 500 GPM	Main Control Panel
b. LPCI Mode of RHR (see above)			

<b>MONTICELLO NUCLEAR GENERATING PLANT</b>		E-PLAN
<b>TITLE:</b>	<b>EMERGENCY PLAN</b>	Revision 54
		Page 85 of 120

Table 13  
EMERGENCY KITS

LOCATION	GENERAL CONTENTS
Site Administration Building Assembly Point	Protective Clothing & Equipment Radiological Monitoring Equipment Emergency Supplies Personnel Decontamination Supplies First Aid Kit
Control Room & Work Execution Center	Protective Clothing & Equipment Radiological Monitoring Equipment Communications Equipment Toxic Chemical Monitoring Equipment Emergency Supplies First Aid Kits
Access Control	Protective Clothing & Equipment Radiological Monitoring Equipment Personnel Decontamination Equipment First Aid Kits
Technical Support Center	Radiological Monitoring Equipment Communications Equipment Emergency Supplies
Emergency Operations Facility	Protective Clothing & Equipment Radiological Monitoring Equipment Communications Equipment Personnel Decontamination Equipment Emergency Supplies First Aid Kit Definitive Care Emergency Kit
Emergency Vehicle & Equipment Storage Facility	Vehicles for Emergency Use (2) Radiological Monitoring Equipment Protective Clothing & Equipment Communications Equipment Emergency Supplies
Monticello Plant Security Access Facility (Ambulance/Fire E Kit)	Protective Clothing & Equipment Dosimetry
CentraCare Health Monticello	Protective Clothing & Equipment Radiological Monitoring Equipment Personnel Decontamination Equipment Emergency Supplies

<b>MONTICELLO NUCLEAR GENERATING PLANT</b>		E-PLAN
<b>TITLE:</b>	<b>EMERGENCY PLAN</b>	Revision 54
		Page 86 of 120

## 8.0 MAINTAINING EMERGENCY PREPAREDNESS

### 8.1 Organizational Preparedness

#### 8.1.1 Emergency Response Organization Training

Training of ERO personnel is controlled by the EP Training Program Description (TPD). The requirements for training in the TPD are based on a graded approach to the systematic approach to training.

Off-site Emergency Preparedness Coordinators will make provisions for the training of those off-site organizations who may be called upon to provide assistance in the event of an emergency.

#### 8.1.2 Drills, Exercises and Tests

The Off-site Nuclear Emergency Plan contains the specific requirements for the conduct of required drills and exercises.

The conduct of periodic drills and exercises are the responsibility of the Nuclear Emergency Preparedness Group in accordance with the Emergency Preparedness Drill & Exercise Manual, which includes:

- 8.1.2.1 An exercise which tests the integrated capability and basic elements of the Emergency Plan **SHALL** be conducted every 2 years. This exercise may be included in the full participation biennial exercise which tests the off-site state and local emergency plans.
- 8.1.2.2 In order to ensure that adequate emergency response capabilities are maintained during the interval between biennial exercises, drills **SHALL** be conducted including at least one drill involving a combination of some of the principal functional areas of the on-site emergency response capabilities. The principal functional areas of emergency response include activities such as management and coordination of emergency response, accident assessment, protective action decision making, and plant system repair and corrective actions. During these drills, activation of all of the Emergency Plan's response facilities (TSC, OSC, and EOF) is not necessary, opportunities to consider accident management strategies may be provided, supervised instruction is permitted, operating staff may have the opportunity to resolve problems (success paths) rather than have controllers intervene, and the drills may focus on on-site training objectives.
- 8.1.2.3 A medical emergency drill, involving response to and transport of a simulated contaminated, injured individual, which provides for off-site support agency participation, **SHALL** be conducted annually.

<b>MONTICELLO NUCLEAR GENERATING PLANT</b>		E-PLAN
<b>TITLE:</b>	<b>EMERGENCY PLAN</b>	Revision 54
		Page 87 of 120

- 8.1.2.4 Health Physics Drills which involve response to and analysis of simulated elevated airborne or liquid samples and direct radiation measurements in the environment **SHALL** be conducted semi-annually. These drills may be performed as stand alone Health Physics Drills or included as part of other drills or exercises.
- 8.1.2.4.1 The analysis of in-plant liquid samples (with actual elevated radiation levels) including the use of the Post Accident Sampling System (PASS) will be included in biennial chemistry training/walkthroughs and may be performed in conjunction with full scale exercises/drills or Health Physics drills.
- 8.1.2.4.2 Radiological monitoring drills which include the collection and analysis of environmental samples for the purpose of ground deposition assessment **SHALL** be conducted annually and may be performed as stand alone Health Physics Drills or included as part of other drills or exercises.
- 8.1.2.5 Fire Drills **SHALL** be conducted in accordance with applicable Plant Administrative Control Directives.
- 8.1.2.6 In addition to drills and exercises, periodic tests are conducted to ensure an adequate state of emergency preparedness is maintained. These tests include:
- 8.1.2.6.1 Communications tests with State and Local government agencies, local law enforcement, and off-site facilities within the plume EPZ are conducted monthly in accordance with plant Surveillance 1225.
- 8.1.2.6.2 Communications tests with the NRC via the Emergency Notification System (ENS ) and Health Physics Network (HPN) are conducted monthly in accordance with Surveillance 1225.
- 8.1.2.6.3 Emergency Response Organization Augmentation tests are conducted quarterly in accordance with plant Surveillance 1317.
- 8.1.2.6.4 The Public Alert Notification System (ANS) is tested weekly in accordance with plant Surveillance Test 1359.

<b>MONTICELLO NUCLEAR GENERATING PLANT</b>		E-PLAN
<b>TITLE:</b>	<b>EMERGENCY PLAN</b>	Revision 54
		Page 88 of 120

- 8.1.2.6.5 The Annual Performance Review for the ANS is conducted in accordance with plant Surveillance 1408.
- 8.1.2.6.6 The Auto Dialing Telephone Systems are tested by Sherburne County and Wright County staff. Completion of the testing and system maintenance is verified on a semi-annual basis in accordance with plant Surveillance 1410.
- 8.1.2.6.7 The ERDS communication link is tested on a quarterly basis in accordance with plant Surveillance 1416.

## 8.2 Planning

### 8.2.1 Responsibility

The overall responsibility for radiological emergency response planning rests with NSPM management.

At the site level the Site Vice President, Monticello Site has overall authority and responsibility for the Monticello Emergency Plan and Emergency Plan Implementing Procedures. The Site Emergency Planners are responsible for the development and updating of the Emergency Plan and coordination of the plan with off-site emergency response plans.

### 8.2.2 Review and Updating of the Emergency Plan

The Monticello Emergency Plan **SHALL** be reviewed and certified to be current on an annual basis in accordance with the Off-site Nuclear Emergency Plan. Other reviews of the Emergency Plan and Implementing Procedures will be performed as required by Technical Specifications. Annual revisions to the Emergency Plan are conducted in accordance with Surveillance Procedure 1406 and may be based on the following:

- 8.2.2.1 Lessons learned during drills and exercises and industry lessons learned.
- 8.2.2.2 Changes in the normal plant or Emergency Response Organization structures.
- 8.2.2.3 Modifications to plant systems, components or instrumentation.
- 8.2.2.4 Changes in the functions or responsibilities of supporting agencies and organizations.
- 8.2.2.5 Lessons learned from real emergency plan activations.
- 8.2.2.6 Changes in State or Federal regulations.

<b>MONTICELLO NUCLEAR GENERATING PLANT</b>		E-PLAN
<b>TITLE:</b>	<b>EMERGENCY PLAN</b>	Revision 54
		Page 89 of 120

Changes to the Emergency Plan **SHALL** be reviewed and approved in accordance with plant Technical Specifications and applicable Administrative Control Directives. Distribution of controlled copies of the Emergency Plan **SHALL** be performed in accordance with applicable MNGP document control procedures.

In addition to the annual review, all Emergency Plan Implementing Procedures containing telephone numbers are reviewed at least quarterly to verify the correct numbers in accordance with Surveillance Procedure 1240.

### 8.3 Maintenance and Inventory of Emergency Equipment and Supplies

#### 8.3.1 Equipment and Supplies Inventory

Emergency Equipment and supplies **SHALL** be inventoried at least quarterly in accordance with plant Surveillance Procedure 1102-01 and 1102-02.

#### 8.3.2 Instrument and Facilities Functional Check

Key emergency response equipment and instrumentation located in the Technical Support Center and Emergency Operation Facility is tested monthly in accordance with plant Surveillance Test 1230.

<b>MONTICELLO NUCLEAR GENERATING PLANT</b>		E-PLAN
<b>TITLE:</b>	<b>EMERGENCY PLAN</b>	Revision 54
		Page 90 of 120

## 9.0 RECOVERY

### 9.1 General Approach

In general, the site organization will be responsible for the short term recovery, that is recovery from an emergency condition in which no core damage or serious release of radioactivity to the environment has occurred.

If it is clear that a high potential exists for core damage or a serious release of radioactivity to the environment has occurred, a Recovery Phase will be activated to provide for the long-term recovery actions and for establishing support arrangements.

Before reoccupying buildings after an emergency, certain recovery criteria must be satisfied:

- There must be assurance that the problem encountered is solved and that the same incident cannot immediately recur;
- The normally occupied areas must be free of significant contamination;
- Radiation areas and High Radiation areas must be properly defined;
- Airborne radioactivity must be eliminated or controlled.

### 9.2 Investigation of Incidents

All incidents **SHALL** be investigated by qualified plant staff personnel and reported to the Plant Operations Review Committee, Management and Safety Review Committee (MSRC) and the NRC in accordance with guidelines for reportable events which are set forth in the Administrative Control Directives and the Technical Specifications.

### 9.3 Recovery Procedures

All recovery operations **SHALL** be performed in accordance with written procedures. These procedures **SHALL** include the following activities:

- Investigation of the course of the incident.
- Investigation of plant conditions following an accident.
- Repair and restoration of facilities.
- Testing and startup of restored facilities.

Methods for determining the extent of radioactive contamination and general protective measures to be taken for personnel performing recovery operations are established in site Radiation Protection Procedures.

Written procedures for recovery of the facility from the specific post accident conditions will be prepared by qualified plant staff members and submitted to the Plant Operations Review Committee. The Plant Operations Review Committee approval of all such procedures is required prior to their initiation.

<b>MONTICELLO NUCLEAR GENERATING PLANT</b>		E-PLAN
<b>TITLE:</b>	<b>EMERGENCY PLAN</b>	Revision 54
		Page 91 of 120

#### 9.4 Criteria for Resumption of Operation

If the plant is shutdown as the result of an emergency, it will be restarted only when:

- The conditions which caused the emergency are corrected.
- The cause of the emergency is understood.
- Restoration, repair and testing is completed as required.
- No unreviewed safety questions exist.
- All conditions of the license and technical specifications are satisfied.

#### 9.5 Long Term Recovery

If extensive plant damage exists and contamination of plant or site environs has occurred, then a Recovery Phase will be required.

Entry into the Recovery Phase will take place in an incremental manner as the functions change from operational to engineering/construction. The decision to enter the Recovery Phase will be made by Site Management. The Recovery Manager will be selected from several qualified designees who are members of the site organization. The Emergency Manager and the Emergency Director will share responsibility at least during the early part of the Recovery Phase.

If a transition to the Recovery Phase becomes necessary, the site engineering/construction oriented staff would provide the nucleus of the organization responsible to carry out the Recovery Phase.

The plant staff would be augmented as required by specialists from the site organization and the NSPM/Xcel Energy corporate office. These specialty areas include Engineering Services, Licensing Administration, Maintenance, Quality Assurance, Communications and Security personnel. In addition, appropriate assistance would be secured from the Architect-Engineer and the Technical Support Services vendor organizations. This support could be broadened as required by consultant help from the several organizations familiar with the MNGP and organization. The overall organizations envisioned for a substantial Recovery Phase would be a blend of site staff and appropriate vendor and consultant personnel. On a prior basis it is counter productive to define in detail the extensive organization that might be involved in a sizable Recovery Phase because of the unlimited variation of conditions that could result from plant emergencies. However, the nucleus organization has been identified together with guidelines on how the organization might be expanded to meet the requirements demanded at the time.

When the Emergency Manager and Emergency Director agree that the emergency condition has been terminated, a complete transfer of the responsibilities for off-site support may be made to the Recovery Organization. The EOF will then become the Recovery Center and will function as Command Center for the Recovery Organization activation and implementation in accordance with applicable Emergency Plan Implementing Procedures.

<b>MONTICELLO NUCLEAR GENERATING PLANT</b>		E-PLAN
<b>TITLE:</b>	<b>EMERGENCY PLAN</b>	Revision 54
		Page 92 of 120

10.0 APPENDIX A

<u>Procedure No.</u>	<u>Procedure Title</u>	<u>Plan Section Reference</u>
<u>000 Series</u>	<u>Organization</u>	
A.2-001	Emergency Organization	5.1, 5.2, 5.3
<u>100 Series</u>	<u>Activation</u>	
A.2-101	Classification of Emergencies	4.0, 6.2.2, Annex A
A.2-102	Notification of an Unusual Event (NUE)	4.1, 6.1.1, Annex A
A.2-103	Alert	4.2, 6.1.2, Annex A
A.2-104	Site Area Emergency	4.3, 6.1.3, Annex A
A.2-105	General Emergency	4.4, 6.1.4, Annex A
A.2-106	Activation And Operation of the TSC	5.2.1, 7.1.1
A.2-107	Activation And Operation of the OSC	5.2.2, 7.1.2
A.2-108	Access Control During Emergencies	7.1.6
A.2-109	Activation and Operation of the Back-Up OSC	7.1.2
A.2-110	Response to a Security Threat	5.3.2
A.2-111	Activation of Alternative Facilities During a Security Event	7.1.4
<u>200 Series</u>	<u>Assessment</u>	
A.2-201	On-Site Protective Action	6.3.2, 6.5
A.2-202	Off-Site Monitoring During an Emergency	6.3
A.2-203	Radioactive Liquid Releases	6.3
A.2-204	Off-Site Protective Action Recommendations	6.5.1.3
A.2-205	Personnel Accountability	6.5.1, 7.1.5
A.2-206	Work Control During Emergencies	5.3.1.6, 6.4.2
A.2-208	Core Damage Assessment	7.3.1.5
A.2-209	Responsibilities of the Radiological Emergency Coordinator	5.2.1.2
A.2-210	Engineering Support in the TSC	5.2.1.5
A.2-213	Responsibilities of the Emergency Director	5.2.1.1

<b>MONTICELLO NUCLEAR GENERATING PLANT</b>		E-PLAN
<b>TITLE:</b>	<b>EMERGENCY PLAN</b>	Revision 54
		Page 93 of 120

10.0 APPENDIX A (CONT'D)

<u>Procedure No.</u>	<u>Procedure Title</u>	<u>Plan Section Reference</u>
<u>300 Series</u>	<u>Protective Actions</u>	
A.2-301	Emergency Evacuation	6.5.1, 6.5.2
A.2-302	Activation of the Assembly Points	6.5.1, 7.1.5
A.2-303	Search and Rescue	5.3.1.8
A.2-304	Thyroid Prophylaxis (Potassium Iodide Use)	6.5.4.2
<u>400 Series</u>	<u>Radiological Surveillance and Control</u>	
A.2-401	Emergency Exposure Control	6.5.5
A.2-402	On-Site Radiological Monitoring	6.5.6, 6.3
A.2-404	Emergency Air Sampling and Analysis	6.3
A.2-405	Release Rate Determinations	6.3.1
A.2-406	Off-Site Dose Projection	6.3.2
A.2-407	Personnel & Vehicle Monitoring And Decontamination	6.5.1
A.2-408	Sample Coordination During Emergencies	6.3
A.2-409	Self-Contained Breathing Apparatus (SCBA) Use During an Emergency	6.5.4.1
A.2-410	Out-of-Plant Surveys	6.3.3
A.2-411	Establishment of a Secondary Access Control Point	7.1.6
A.2-412	Reactor Coolant Sample Obtained from Reactor Sample Station	7.3.1.7
A.2-413	Small Volume Liquid Sample Obtained at the Post Accident Sampling System	7.3.1.7
A.2-414	Large Volume Liquid Sample Obtained at Post Accident Sampling System	7.3.1.7
A.2-415	Containment Gas Sample Obtained at Post Accident Sampling System	7.3.1.7
A.2-417	Draining the Trap, Sump and Collector of Post Accident Sampling System	7.3.1.7

<b>MONTICELLO NUCLEAR GENERATING PLANT</b>		E-PLAN
<b>TITLE:</b>	<b>EMERGENCY PLAN</b>	Revision 54
		Page 94 of 120

10.0 APPENDIX A (CONT'D)

<u>Procedure No.</u>	<u>Procedure Title</u>	<u>Plan Section Reference</u>
A.2-418	Post Accident Sampling Station Demin Water Tank Fill Procedure	7.3.1.7
A.2-419	Containment Atmosphere Sample Obtained from Reactor Sample Station	7.3.1.7
A.2-420	Containment Atmosphere Radiochemical Analysis	7.3.1.7
A.2-422	Stack Iodine/Particulate Sampling and Analysis	6.3.1
A.2-423	Reactor Building Vents Iodine/Particulate Sampling & Analysis	6.3.1
A.2-424	EOF Count Room Procedures	7.3.2.3
<u>500 Series</u>	<u>Communications and Documentation</u>	
A.2-501	Communications During an Emergency	7.2
A.2-502	Record Keeping During an Emergency	---
A.2-504	Emergency Communicator Duties in the TSC And OSC	5.2.1.8
<u>600 Series</u>	<u>Re-Entry and Recovery</u>	
A.2-601	Re-Entry	9.1
A.2-602	Event Termination or Recovery	9.5
<u>700 Series</u>	<u>Emergency Preparedness</u>	
A.2-701	PANS System False Activation or Failure	---
A.2-703	Response to Off-Site Situations Involving Radioactive Material	---
<u>800 Series</u>	<u>EOF Procedures</u>	
A.2-801	Responsibilities of the Emergency Manager	5.2.3.1, 7.1.3
A.2-802	Activation and Operation of the EOF	5.2.3.4, 7.1.3
A.2-803	Emergency Communications at the EOF	5.2.3, 7.1.3
A.2-804	EOF Support and Logistics	5.2.3.4, 7.1.3
A.2-805	Technical Support in the EOF	5.2.3.2, 7.1.3

<b>MONTICELLO NUCLEAR GENERATING PLANT</b>		E-PLAN
<b>TITLE:</b>	<b>EMERGENCY PLAN</b>	Revision 54
		Page 95 of 120

10.0 APPENDIX A (CONT'D)

<u>Procedure No.</u>	<u>Procedure Title</u>	<u>Plan Section Reference</u>
A.2-806	Radiation Protection Support in the EOF	5.2.3.3, 7.1.3
A.2-807	Off-Site Dose Assessment and Protective Action Recommendations	5.2.3.3, 7.1.3
A.2-808	Radiological Monitoring and Control at the EOF	5.2.3.4, 7.1.3
A.2-809	EOF Security	5.2.3.4, 7.1.3
A.2-810	Transfer to the Backup EOF	7.4.3
A.2-811	Event Termination or Recovery in the EOF	9.0
A.2-812	Off-site Agency Liaison at the EOF	5.2.3.4, 7.1.3

<b>MONTICELLO NUCLEAR GENERATING PLANT</b>		E-PLAN
<b>TITLE:</b>	<b>EMERGENCY PLAN</b>	Revision 54
		Page 96 of 120

11.0 APPENDIX B

**NUREG-0654 Section**

**Emergency Plan Section**

A. Assignment of Responsibility

1.a.	5.4 & 5.5
1.b.	5.4 & 5.5
1.c.	Figure 13.2, Figure 13.3
1.d.	5.2
1.e.	5.1 & 5.2
2.a.	State/Local Plans
2.b.	State/Local Plans
3	Off-Site Plan
4	5.2, 5.2.1.3

B. On-Site Emergency Organization

1	5.1.2
2	5.2.1.1, 5.3.1.2
3	5.3.1.2
4	5.2, 5.2.1.1, 5.3.1.2
5	5.2, 5.3.1 & 5.3.2, Table 1
6	Figure 13.2, Figure 13.3
7	5.2.3, Off-site Plan
7.a.	5.2.3, Off-site Plan
7.b.	5.2.3, Off-site Plan
7.c.	5.2.3, Off-site Plan
7.d.	5.2.3, Off-site Plan
8	Off-site Plan & 5.4
9	5.4.2

<b>MONTICELLO NUCLEAR GENERATING PLANT</b>		E-PLAN
<b>TITLE:</b>	<b>EMERGENCY PLAN</b>	Revision 54
		Page 97 of 120

11.0 APPENDIX B (CONT'D)

<u>NUREG-0654 Section</u>	<u>Emergency Plan Section</u>
C. Emergency Response Support and Resources	
1.a.	5.2.3.1
1.b.	Off-site Plan
1.c.	Off-site Plan
2.a.	State/Local Plans
2.b.	Off-site Plan
3	7.3.2.3 Off-site Plan
4	Off-site Plan
D. Emergency Classification System	
1	Section 4.0, Annex A
2	Section 4.0, Annex A
3	State/Local Plans
4	State/Local Plans
E. Emergency Classification System	
1	6.2.1.2, 6.2.3
2	6.2.1.1
3	6.2.1.2
4.a.	6.2.1.2.1
4.b.	6.2.1.2.2
4.c.	6.2.1.2.3
4.d.	6.2.1.2.4
4.e.	6.2.1.2.5
4.f.	6.2.1.2.6
4.g.	6.2.1.2.7
4.h.	6.2.1.2.8
4.i.	6.2.1.2.9
4.j.	6.2.1.2.10
4.k.	6.2.1.2.11

<b>MONTICELLO NUCLEAR GENERATING PLANT</b>		E-PLAN
<b>TITLE:</b>	<b>EMERGENCY PLAN</b>	Revision 54
		Page 98 of 120

11.0 APPENDIX B (CONT'D)

<u>NUREG-0654 Section</u>	<u>Emergency Plan Section</u>
4.l.	6.2.1.2.12
4.m.	6.2.1.2.13
4.n.	6.2.1.2.14
5	State/Local Plans
6	6.2.1.4
7	6.5.1.3, State/Local Plans
F. Emergency Communications	
1.a.	7.2
1.b.	7.2
1.c.	7.2
1.d.	7.2, 7.2.3.3
1.e.	6.2, 7.2.3.2
1.f.	7.2, 7.2.3.3
2	7.2.2
3	7.2.5
G. Public Education and Information	
1	Off-site Plan
2	Off-site Plan
3.a.	Off-site Plan
3.b.	7.1.3 Off-site Plan
4.a.	Off-site Plan
4.b.	Off-site Plan
4.c.	Off-site Plan
5	Off-site Plan

<b>MONTICELLO NUCLEAR GENERATING PLANT</b>		E-PLAN
<b>TITLE:</b>	<b>EMERGENCY PLAN</b>	Revision 54
		Page 99 of 120

11.0 APPENDIX B (CONT'D)

<u>NUREG-0654 Section</u>	<u>Emergency Plan Section</u>
H. Emergency Facilities and Equipment	
1	7.1.1, 7.1.2
2	7.1.3
3	State/Local Plans
4	6.2.1.1
5	Table 8 through Table 12
5.a.	7.3.1.2, Table 8 and Table 9
5.b.	7.3.1.3, Table 10 and Table 11
5.c.	7.3.1.4, Table 12
5.d.	7.3.1.6
6.a.	7.3.2.1
6.b.	7.3.2.2
6.c.	7.3.2.3
7	7.4.4, Table 13
8	7.3.1.2.2
9	7.1.2
10	8.3.1
11	Table 13
12	7.3.2.3
I. Accident Assessment	
1	4.0, Table 8 through Table 12
2	6.3, 7.3
3.a.	6.3.1
3.b.	6.3.1
4	6.3.2
5	7.3.1.2.2, Table 9
6	6.3.1, 6.3.2

<b>MONTICELLO NUCLEAR GENERATING PLANT</b>		E-PLAN
<b>TITLE:</b>	<b>EMERGENCY PLAN</b>	Revision 54
		Page 100 of 120

11.0 APPENDIX B (CONT'D)

<u>NUREG-0654 Section</u>	<u>Emergency Plan Section</u>
7	6.3.3
8	6.3.2, 6.3.3
9	6.3.3
10	6.3.2
11	State Plan
J. Protective Response	
1.a.	6.5.1
1.b.	6.5.1
1.c.	6.5.1
1.d.	6.5.1.1
2	6.5.2
3	6.5.1.1
4	6.5.1.1
5	6.5.1.1
6.a.	6.5.4
6.b.	6.5.4
6.c.	6.5.4.2
7	6.5.1.3
8	6.5.3
9	State/Local Plan
10.a.	Off-site Plan
10.b.	Off-site Plan
10.c.	7.7 and 7.8
10.d.	State/Local Plan
10.e.	State/Local Plan
10.f.	State/Local Plan
10.g.	State/Local Plan
10.h.	State/Local Plan

<b>MONTICELLO NUCLEAR GENERATING PLANT</b>		E-PLAN
<b>TITLE:</b>	<b>EMERGENCY PLAN</b>	Revision 54
		Page 101 of 120

11.0 APPENDIX B (CONT'D)

<u>NUREG-0654 Section</u>	<u>Emergency Plan Section</u>
10.i.	State/Local Plan
10.j.	State/Local Plan
10.k.	State/Local Plan
10.l.	State/Local Plan
10.m.	6.5.1.3, Table 2 thru Table 5, State/Local
11	State/Local
12	State/Local
K. Radiological Exposure Control	
1.a.	6.6 & Table 5
1.b.	6.6 & Table 5
1.c.	6.6 & Table 5
1.d.	6.6 & Table 5
1.e.	6.6 & Table 5
1.f.	6.6 & Table 5
1.g.	6.6 & Table 5
2	6.5.5
3.a.	6.5.5.2
3.b.	6.5.5
4	State/Local Plans
5.a.	6.6.1
5.b.	6.6.1
6.a.	6.5.6.1
6.b.	6.5.6
6.c.	6.5.6.1
7	6.1.1.1

<b>MONTICELLO NUCLEAR GENERATING PLANT</b>		E-PLAN
<b>TITLE:</b>	<b>EMERGENCY PLAN</b>	Revision 54
		Page 102 of 120

11.0 APPENDIX B (CONT'D)

<u>NUREG-0654 Section</u>	<u>Emergency Plan Section</u>
L. Medical and Public Health Support	
1	6.6.2, 6.6.3
2	6.6.1.2
3	State Plan
4	5.4.2, 6.6.2
M. Recovery and Re-entry Planning and Post Accident Operations	
1	9.0
2	9.0
3	9.0, Off-site Plan
4	6.3.2
N. Exercises and Drills	
1.a.	8.1.2.1
1.b.	8.1.2
2.a.	8.1.2.6
2.b.	8.1.2.5
2.c.	8.1.2.3
2.d.	8.1.2.2
2.e.	8.1.2.4
3.a.	8.1.2
3.b.	8.1.2
3.c.	8.1.2
3.d.	8.1.2
3.e.	8.1.2
3.f.	8.1.2
4	8.1.2
5	8.1.2

<b>MONTICELLO NUCLEAR GENERATING PLANT</b>		E-PLAN
<b>TITLE:</b>	<b>EMERGENCY PLAN</b>	Revision 54
		Page 103 of 120

11.0 APPENDIX B (CONT'D)

<u>NUREG-0654 Section</u>	<u>Emergency Plan Section</u>
O. Radiological Emergency Response Training	
1	8.1.1 & Off-site Plan
1.a.	8.1.1 & Off-site Plan
1.b.	8.1.1 & State/Local Plans
2	8.1.2
3	6.6.1.2 & Off-site Plan
4.a.	8.1.1 & Off-site Plan
4.b.	8.1.1 & Off-site Plan
4.c.	8.1.1 & Off-site Plan
4.d.	8.1.1 & Off-site Plan
4.e.	8.1.1 & Off-site Plan
4.f.	8.1.1 & Off-site Plan
4.g.	8.1.1 & Off-site Plan
4.h.	8.1.1 & Off-site Plan
4.i.	8.1.1 & Off-site Plan
4.j.	8.1.1 & Off-site Plan
5	8.1.1 & Off-site Plan
P. Responsibility for the Planning Effort: Development, Periodic Review and Distribution of Emergency Plans	
1	Off-site Plan
2	8.2.1
3	8.2.1
4	8.2.2
5	8.2.2
6	8.2.2
7	Appendix A
8	Appendix B, Table of Contents
9	Off-site Plan
10	8.2.2

<b>MONTICELLO NUCLEAR GENERATING PLANT</b>		E-PLAN
<b>TITLE:</b>	<b>EMERGENCY PLAN</b>	Revision 54
		Page 104 of 120

12.0 ANNEX A

**MNGP EMERGENCY ACTION LEVELS AND APPLICABLE DEFINITIONS**

Emergency Action Levels

The site specific Emergency Action Levels are contained in 5790-101-02 (MONTICELLO NUCLEAR GENERATING PLANT EMERGENCY ACTION LEVEL MATRIX), Revision 13. These EALs are based on NEI 99-01, Revision 6.

Emergency Plan Implementing Procedure A.2-101 (CLASSIFICATION OF EMERGENCIES) requires use of 5790-101-02.



12.0 FIGURE Annex A-1 Monticello Nuclear Generating Plant Emergency Action Level Matrix (Cont'd)  
 Right half of Page 1 of 5790-101-02, Revision 13.

		GENERAL EMERGENCY	SITE AREA EMERGENCY	ALERT	UNUSUAL EVENT
		FCI 1 2 3 4 Loss of any two barriers and Loss of Potential Loss of the First Barrier	FCI 1 2 3 4 Loss of Potential Loss of any two barriers FCI 1 2 3 4 5 6 7 8 9 10 LOSS OF POTENTIAL LOSS OF ANY TWO BARRIERS	FCI 1 2 3 4 Any Loss of any Potential Loss of either the Fuel Clad or RCS Barrier	
		<b>Fuel Cladding Barrier</b> LOSS POTENTIAL LOSS	<b>RCS Barrier</b> LOSS POTENTIAL LOSS	<b>Containment Barrier</b> LOSS POTENTIAL LOSS	
FPO Degradation	<b>1. RCS Activity</b> A. Coolant activity is greater than 300 µCi/gm dose equivalent >131.	<b>1. Primary Containment Pressure</b> A. Primary containment pressure greater than 1.94 psig due to RCS leakage.	<b>1. Primary Containment Conditions</b> A. UNPLANNED rapid drop in primary containment pressure following primary containment pressure rise OR B. Primary containment pressure response not consistent with LOCA conditions.	<b>1. Primary Containment Conditions</b> A. Primary containment pressure greater than 50 psig OR B. Greater than or equal to 8% hydrogen and greater than or equal to 5% oxygen in Drywell or Torus OR C. Heat Capacity Limit (HCL) exceeded	
	<b>2. RPV Water Level</b> A. SAMG entry is required.	<b>2. RPV Water Level</b> A. RPV water level cannot be restored and maintained above -120 in. or cannot be determined.	<b>2. RPV Water Level</b> A. RPV water level cannot be restored and maintained above -120 in. or cannot be determined.	<b>2. RPV Water Level</b> A. SAMG entry is required.	
	<b>3. SVA</b>	<b>3. RCS Leak Rate</b> A. UNSOLUBLE leak in ANY of the following: MSX, HPCI, RWCU, ROIC as indicated by high flow/temperature isolation setpoints OR B. Emergency RPV Depressurization	<b>3. RCS Leak Rate</b> A. UNSOLUBLE primary system leakage that results in exceeding Control Room indication of EITHER of the following: 1. Max Normal Operating Temperature OR 2. Max Normal Operating Area Radiation Level	<b>3. Primary Containment Isolation Failure</b> A. UNSOLUBLE direct downstream pathway to the environment exists after primary containment isolation signal OR B. Intentional primary containment venting per EOPs OR C. UNSOLUBLE primary system leakage that results in exceeding Control Room indication of EITHER of the following: 1. Max Safe Operating Temperature OR 2. Max Safe Operating Area Radiation Level	
	<b>4. Primary Containment Radiation</b> A. Containment High Range Rad (Drywell Radiation) monitor reading greater than 1.5 E+04 R/hr.	<b>4. Primary Containment Radiation</b> A. Containment High Range Rad (Drywell Radiation) monitor reading greater than 6.2 E+04 R/hr.	<b>4. Primary Containment Radiation</b> A. Containment High Range Rad (Drywell Radiation) monitor reading greater than 6.2 E+04 R/hr.	<b>4. Primary Containment Radiation</b> A. Containment High Range Rad (Drywell Radiation) monitor reading greater than 3.5 E+04 R/hr.	
	<b>5. Emergency Director Judgement</b> A. ANY condition in the opinion of the Emergency Director that indicates Loss of the Fuel Clad Barrier.	<b>5. Emergency Director Judgement</b> A. ANY condition in the opinion of the Emergency Director that indicates Potential Loss of the Fuel Clad Barrier.	<b>5. Emergency Director Judgement</b> A. ANY condition in the opinion of the Emergency Director that indicates Potential Loss of the RCS Barrier.	<b>5. Emergency Director Judgement</b> A. ANY condition in the opinion of the Emergency Director that indicates Potential Loss of the Containment Barrier.	
	<b>6. Emergency Director Judgement</b> A. ANY condition in the opinion of the Emergency Director that indicates Loss of the Fuel Clad Barrier.	<b>6. Emergency Director Judgement</b> A. ANY condition in the opinion of the Emergency Director that indicates Potential Loss of the Fuel Clad Barrier.	<b>6. Emergency Director Judgement</b> A. ANY condition in the opinion of the Emergency Director that indicates Potential Loss of the RCS Barrier.	<b>6. Emergency Director Judgement</b> A. ANY condition in the opinion of the Emergency Director that indicates Potential Loss of the Containment Barrier.	
		GENERAL EMERGENCY	SITE AREA EMERGENCY	ALERT	UNUSUAL EVENT
Loss of Power	<b>SQ1</b> Prolonged loss of all offsite and all onsite AC power to essential buses. Note: The Emergency Director should declare the General Emergency promptly upon determining that 4 hours has been exceeded, or will likely be exceeded. SSI1 1 2 3 4 a. Loss of ALL offsite and ALL onsite AC power to essential buses 15 and 16 AND b. EITHER of the following: - Restoration of at least one AC essential bus in less than 4 hours is not likely - Reactor vessel water level cannot be restored and maintained above -14F (Minimum Steam Cooling RPV Water Level)	<b>SS1</b> Loss of all offsite and all onsite AC power to essential buses for 15 minutes or longer. Note: The Emergency Director should declare the Site Area Emergency promptly upon determining that 15 minutes has been exceeded, or will likely be exceeded. SSI1 1 2 3 4 Loss of ALL offsite and ALL onsite AC power to essential buses 15 and 16 for 15 minutes or longer	<b>SA1</b> Loss of all but one AC power source to essential buses for 15 minutes or longer. Note: The Emergency Director should declare the Alert promptly upon determining that 15 minutes has been exceeded, or will likely be exceeded. SSI1 1 2 3 4 a. AC power capacity to essential buses 15 and 16 is reduced to a single power source (Table S1) for 15 minutes or longer AND b. Any additional single power source failure will result in a loss of AC power to SAFETY SYSTEMS. Table S1 SS Reactor Transformer SS Reactor Transformer SS Reactor Transformer SS Reactor Transformer SS Reactor Transformer SS Emergency Diesel Generator	<b>SU1</b> Loss of all offsite AC power capability to essential buses for 15 minutes or longer. Note: The Emergency Director should declare the Unusual Event promptly upon determining that 15 minutes has been exceeded, or will likely be exceeded. SSI1 1 2 3 4 Loss of ALL offsite AC power capability (Table S2) to essential buses 15 and 16 for 15 minutes or longer. Table S2 SS Reactor Transformer SS Reactor Transformer SS Reactor Transformer	
	<b>SQ2</b> Loss of all AC and Vital DC power sources for 15 minutes or longer. Note: The Emergency Director should declare the General Emergency promptly upon determining that 15 minutes has been exceeded, or will likely be exceeded. SSI1 1 2 3 4 a. Loss of ALL offsite and ALL onsite AC power to essential buses 15 and 16 for 15 minutes or longer AND b. Indicated voltage is less than 110 VDC or ALL 120 VDC Vital DC base for 15 minutes or longer	<b>SS2</b> Loss of all Vital DC power for 15 minutes or longer. Note: The Emergency Director should declare the Site Area Emergency promptly upon determining that 15 minutes has been exceeded, or will likely be exceeded. SSI1 1 2 3 4 Indicated voltage is less than 110 VDC or ALL 120 VDC Vital DC base for 15 minutes or longer.	<b>SA2</b> UNPLANNED loss of Control Room indications for 15 minutes or longer with a significant transient in progress. Note: The Emergency Director should declare the Alert promptly upon determining that 15 minutes has been exceeded, or will likely be exceeded. SSI1 1 2 3 4 a. An UNPLANNED event results in the inability to monitor one or more of the following parameters from within the Control Room for 15 minutes or longer: Reactor Power RPV Water Level RPV Pressure Primary Containment Pressure Suppression Pool Level Suppression Pool Temperature AND b. ANY of the following transient events in progress: - Automatic or manual reactor power less than 25% thermal reactor power - Electrical load reactor greater than 25% full electrical load - Reactor scram - ECCS activation - Thermal power coefficient greater than 10%	<b>SU2</b> UNPLANNED loss of Control Room indications for 15 minutes or longer. Note: The Emergency Director should declare the Unusual Event promptly upon determining that 15 minutes has been exceeded, or will likely be exceeded. SSI1 1 2 3 4 An UNPLANNED event results in the inability to monitor one or more of the following parameters from within the Control Room for 15 minutes or longer: Reactor Power RPV Water Level RPV Pressure Primary Containment Pressure Suppression Pool Level Suppression Pool Temperature	
	<b>SQ3</b> Reactor coolant activity greater than Technical Specification allowable limits. SSI1 1 2 3 4 Offsite Protection Radiation Monitor (OPR) 15-150A or RM-15-150B high radiation alarm (H-A-12) tripped. SSI2 1 2 3 4 Coolant sample activity greater than 0.2 µCi/gm dose equivalent >131.	<b>SS3</b> Reactor coolant activity greater than Technical Specification allowable limits. SSI1 1 2 3 4 Offsite Protection Radiation Monitor (OPR) 15-150A or RM-15-150B high radiation alarm (H-A-12) tripped. SSI2 1 2 3 4 Coolant sample activity greater than 0.2 µCi/gm dose equivalent >131.	<b>SA3</b> Automatic or manual screen fails to shutdown the reactor, and subsequent manual actions taken at the main control boards are not successful in shutting down the reactor. Note: A manual action in any operator action, or set of actions, which causes the control rods to be rapidly inserted into the core, and does not include manually driving in control rods or implementation of boron injection strategy. SSI1 1 2 3 4 a. An automatic or manual screen did not reduce reactor power to less than 4% AND b. Manual action taken at the main control boards are not successful in reducing reactor power to less than 4%.	<b>SU3</b> Reactor coolant activity greater than Technical Specification allowable limits. SSI1 1 2 3 4 Offsite Protection Radiation Monitor (OPR) 15-150A or RM-15-150B high radiation alarm (H-A-12) tripped. SSI2 1 2 3 4 Coolant sample activity greater than 0.2 µCi/gm dose equivalent >131. <b>SU4</b> RCS leakage for 15 minutes or longer. Note: The Emergency Director should declare the Unusual Event promptly upon determining that 15 minutes has been exceeded, or will likely be exceeded. SSI1 1 2 3 4 RCS unisolated pressure boundary leakage greater than 10 gpm for 15 minutes or longer. SSI2 1 2 3 4 RCS vented leakage greater than 25 gpm for 15 minutes or longer. SSI3 1 2 3 4 Leakage from the RCS to a location outside primary containment greater than 25 gpm for 15 minutes or longer.	
	<b>SQ4</b> Inability to shutdown the reactor causing a challenge to RPV water level or RCS heat removal. SSI1 1 2 3 4 a. An automatic or manual screen did not reduce reactor power to less than 4% AND b. All manual actions to shutdown the reactor are not successful in reducing reactor power to less than 4%. AND c. EITHER of the following conditions exist: - Reactor vessel water level cannot be restored and maintained above -14F (Minimum Steam Cooling RPV Water Level) - Heat Capacity Limit (HCL) exceeded	<b>SS4</b> Inability to shutdown the reactor causing a challenge to RPV water level or RCS heat removal. SSI1 1 2 3 4 a. An automatic or manual screen did not reduce reactor power to less than 4% AND b. Manual action taken at the main control boards are not successful in reducing reactor power to less than 4%.	<b>SA4</b> Automatic or manual screen fails to shutdown the reactor, and subsequent manual actions taken at the main control boards are not successful in shutting down the reactor. Note: A manual action in any operator action, or set of actions, which causes the control rods to be rapidly inserted into the core, and does not include manually driving in control rods or implementation of boron injection strategy. SSI1 1 2 3 4 a. An automatic or manual screen did not reduce reactor power to less than 4% AND b. Manual action taken at the main control boards are not successful in reducing reactor power to less than 4%.	<b>SU5</b> Automatic or manual screen fails to shutdown the reactor. Note: A manual action in any operator action, or set of actions, which causes the control rods to be rapidly inserted into the core, and does not include manually driving in control rods or implementation of boron injection strategy. SSI1 1 2 3 4 a. An automatic or manual screen did not reduce reactor power to less than 4% AND b. ANY of the following is successful in reducing reactor power to less than 4%: - Manual screen partition - Mode select to shutdown - Alternate Rod Injection (ARI) - Subsequent automatic action	
<b>SQ5</b> Hazardous event affecting a SAFETY SYSTEM needed for the current operating mode. Note: - If the affected SAFETY SYSTEM has already been rendered inoperative or out of service before the hazardous event occurred, then this emergency declaration is not warranted. - If the hazardous event only results in ISBLE DAMAGE, with no indication of degraded performance to at least one train of a SAFETY SYSTEM, then the emergency declaration is not warranted. SSI1 1 2 3 4 a. The occurrence of ANY of the following hazardous events: - Seismic event (Earthquake) - Internal or external flooding event - High voltage or transient strike - FIRE - EXPLOSION - River level greater than 65 ft A - River level less than 80.0 ft A - Other events with similar hazard characteristics as determined by the Shift Manager AND b. 1. Downtime has caused indication of degraded performance on one train of a SAFETY SYSTEM needed for the current operating mode AND 2. EITHER of the following: - Downtime has caused indication of degraded performance to a second train of the SAFETY SYSTEM needed for the current operating mode - Downtime has resulted in ISBLE DAMAGE to the second train of the SAFETY SYSTEM needed for the current operating mode	<b>SS5</b> Hazardous event affecting a SAFETY SYSTEM needed for the current operating mode. Note: - If the affected SAFETY SYSTEM has already been rendered inoperative or out of service before the hazardous event occurred, then this emergency declaration is not warranted. - If the hazardous event only results in ISBLE DAMAGE, with no indication of degraded performance to at least one train of a SAFETY SYSTEM, then the emergency declaration is not warranted. SSI1 1 2 3 4 a. The occurrence of ANY of the following hazardous events: - Seismic event (Earthquake) - Internal or external flooding event - High voltage or transient strike - FIRE - EXPLOSION - River level greater than 65 ft A - River level less than 80.0 ft A - Other events with similar hazard characteristics as determined by the Shift Manager AND b. 1. Downtime has caused indication of degraded performance on one train of a SAFETY SYSTEM needed for the current operating mode AND 2. EITHER of the following: - Downtime has caused indication of degraded performance to a second train of the SAFETY SYSTEM needed for the current operating mode - Downtime has resulted in ISBLE DAMAGE to the second train of the SAFETY SYSTEM needed for the current operating mode	<b>SA5</b> Hazardous event affecting a SAFETY SYSTEM needed for the current operating mode. Note: - If the affected SAFETY SYSTEM has already been rendered inoperative or out of service before the hazardous event occurred, then this emergency declaration is not warranted. - If the hazardous event only results in ISBLE DAMAGE, with no indication of degraded performance to at least one train of a SAFETY SYSTEM, then the emergency declaration is not warranted. SSI1 1 2 3 4 a. The occurrence of ANY of the following hazardous events: - Seismic event (Earthquake) - Internal or external flooding event - High voltage or transient strike - FIRE - EXPLOSION - River level greater than 65 ft A - River level less than 80.0 ft A - Other events with similar hazard characteristics as determined by the Shift Manager AND b. 1. Downtime has caused indication of degraded performance on one train of a SAFETY SYSTEM needed for the current operating mode AND 2. EITHER of the following: - Downtime has caused indication of degraded performance to a second train of the SAFETY SYSTEM needed for the current operating mode - Downtime has resulted in ISBLE DAMAGE to the second train of the SAFETY SYSTEM needed for the current operating mode	<b>SU6</b> Loss of all onsite or offsite communications capabilities. SSI1 1 2 3 4 Loss of ALL of the following onsite communication methods: - Commercial Telephone - Plant Telephone - Portable radio - Plant PA System SSI2 1 2 3 4 Loss of ALL of the following Offsite Response Organization (SRO) communication methods: - Commercial Telephone - Direct Dial-In Telephone - Radio Receiver Transmitter SSI3 1 2 3 4 Loss of ALL of the following NRC communication methods: - Federal Telecommunications System (FTS) - Commercial Telephone		

HOT CONDITIONS

Modes 1, 2, 3

12.0 FIGURE Annex A-1 Monticello Nuclear Generating Plant Emergency Action Level Matrix (Cont'd)  
 Left half of Page 2 of 5790-101-02, Revision 13.

		GENERAL EMERGENCY	SITE AREA EMERGENCY	ALERT	UNUSUAL EVENT																																
Abnormal Rad Release	Effluents (Release Status)	<p>GE1 Release of gaseous radioactivity resulting in off-site dose greater than 1,000 mrem TEDE or 5,000 mrem byrad CDC.</p> <p>Note: The pre-calculated effluent monitor values presented in GAL RG1.1 should be used for emergency classification assessments and the results from a dose assessment using actual meteorology are available.</p> <p>RG1.1 <input type="checkbox"/> 1 <input type="checkbox"/> 2 <input type="checkbox"/> 3 <input type="checkbox"/> 4 <input type="checkbox"/> 5 <input type="checkbox"/> DEF</p> <p>Reading on the following radionuclide monitor greater than the reading shown for 10 minutes or longer:</p> <table border="1"> <tr> <td>Gas: I-131 Monitor (C/A or S)</td> <td>10-100 uCi/m<sup>3</sup></td> </tr> </table> <p>RG1.2 <input type="checkbox"/> 1 <input type="checkbox"/> 2 <input type="checkbox"/> 3 <input type="checkbox"/> 4 <input type="checkbox"/> 5 <input type="checkbox"/> DEF</p> <p>Dose assessment using actual meteorology indicates dose greater than 100 mrem TEDE or 500 mrem byrad CDC at or beyond the SITE BOUNDARY.</p> <p>RG1.3 <input type="checkbox"/> 1 <input type="checkbox"/> 2 <input type="checkbox"/> 3 <input type="checkbox"/> 4 <input type="checkbox"/> 5 <input type="checkbox"/> DEF</p> <p>Rad survey results indicate EITHER of the following at or beyond the SITE BOUNDARY:</p> <ul style="list-style-type: none"> <li>Classified area dose rate greater than 1,000 mR/hr expected to continue for 10 minutes or longer.</li> <li>Analysis of rad survey sample indicate thyroid CDC greater than 5,000 mrem for one hour of inhalation.</li> </ul>	Gas: I-131 Monitor (C/A or S)	10-100 uCi/m <sup>3</sup>	<p>SE1 Release of gaseous radioactivity resulting in off-site dose greater than 100 mrem TEDE or 500 mrem byrad CDC.</p> <p>Note: The pre-calculated effluent monitor values presented in GAL RG1.1 should be used for emergency classification assessments and the results from a dose assessment using actual meteorology are available.</p> <p>RG1.1 <input type="checkbox"/> 1 <input type="checkbox"/> 2 <input type="checkbox"/> 3 <input type="checkbox"/> 4 <input type="checkbox"/> 5 <input type="checkbox"/> DEF</p> <p>Reading on the following radionuclide monitor greater than the reading shown for 10 minutes or longer:</p> <table border="1"> <tr> <td>Gas: I-131 Monitor (C/A or S)</td> <td>10-100 uCi/m<sup>3</sup></td> </tr> </table> <p>RG1.2 <input type="checkbox"/> 1 <input type="checkbox"/> 2 <input type="checkbox"/> 3 <input type="checkbox"/> 4 <input type="checkbox"/> 5 <input type="checkbox"/> DEF</p> <p>Dose assessment using actual meteorology indicates dose greater than 100 mrem TEDE or 500 mrem byrad CDC at or beyond the SITE BOUNDARY.</p> <p>RG1.3 <input type="checkbox"/> 1 <input type="checkbox"/> 2 <input type="checkbox"/> 3 <input type="checkbox"/> 4 <input type="checkbox"/> 5 <input type="checkbox"/> DEF</p> <p>Rad survey results indicate EITHER of the following at or beyond the SITE BOUNDARY:</p> <ul style="list-style-type: none"> <li>Classified area dose rate greater than 100 mR/hr expected to continue for 10 minutes or longer.</li> <li>Analysis of rad survey sample indicate thyroid CDC greater than 500 mrem for one hour of inhalation.</li> </ul>	Gas: I-131 Monitor (C/A or S)	10-100 uCi/m <sup>3</sup>	<p>AL1 Release of gaseous or liquid radioactivity resulting in off-site dose greater than 10 mrem TEDE or 50 mrem byrad CDC.</p> <p>Note: The pre-calculated effluent monitor values presented in GAL RA1.1 should be used for emergency classification assessments and the results from a dose assessment using actual meteorology are available.</p> <p>RA1.1 <input type="checkbox"/> 1 <input type="checkbox"/> 2 <input type="checkbox"/> 3 <input type="checkbox"/> 4 <input type="checkbox"/> 5 <input type="checkbox"/> DEF</p> <p>Reading on ANY of the following radionuclide monitors greater than the reading shown for 10 minutes or longer:</p> <table border="1"> <tr> <th colspan="2">Gaseous Effluent Monitors</th> </tr> <tr> <td>Gas: I-131 Monitor (C/A or S)</td> <td>10-100 uCi/m<sup>3</sup></td> </tr> <tr> <td>Gas: Xe-135 Monitor (C/A or S)</td> <td>10-100 uCi/m<sup>3</sup></td> </tr> <tr> <th colspan="2">Liquid Effluent Monitors</th> </tr> <tr> <td>Discharge Canal</td> <td>2000 cps</td> </tr> <tr> <td>Service Water</td> <td>200 cps</td> </tr> <tr> <td>Turbine</td> <td>10-100 cps</td> </tr> </table> <p>RA1.2 <input type="checkbox"/> 1 <input type="checkbox"/> 2 <input type="checkbox"/> 3 <input type="checkbox"/> 4 <input type="checkbox"/> 5 <input type="checkbox"/> DEF</p> <p>Dose assessment using actual meteorology indicates dose greater than 10 mrem TEDE or 50 mrem byrad CDC at or beyond the SITE BOUNDARY.</p> <p>RA1.3 <input type="checkbox"/> 1 <input type="checkbox"/> 2 <input type="checkbox"/> 3 <input type="checkbox"/> 4 <input type="checkbox"/> 5 <input type="checkbox"/> DEF</p> <p>Analysis of liquid effluent sample indicates a concentration or release rate that would result in dose greater than 10 mrem TEDE or 50 mrem byrad CDC at or beyond the SITE BOUNDARY for one hour of exposure.</p> <p>RA1.4 <input type="checkbox"/> 1 <input type="checkbox"/> 2 <input type="checkbox"/> 3 <input type="checkbox"/> 4 <input type="checkbox"/> 5 <input type="checkbox"/> DEF</p> <p>Rad survey results indicate EITHER of the following at or beyond the SITE BOUNDARY:</p> <ul style="list-style-type: none"> <li>Classified area dose rate greater than 10 mR/hr expected to continue for 10 minutes or longer.</li> <li>Analysis of rad survey sample indicate thyroid CDC greater than 500 mrem for one hour of inhalation.</li> </ul>	Gaseous Effluent Monitors		Gas: I-131 Monitor (C/A or S)	10-100 uCi/m <sup>3</sup>	Gas: Xe-135 Monitor (C/A or S)	10-100 uCi/m <sup>3</sup>	Liquid Effluent Monitors		Discharge Canal	2000 cps	Service Water	200 cps	Turbine	10-100 cps	<p>UE1 Release of gaseous or liquid radioactivity greater than 10 mrem byrad CDC limits for 10 minutes or longer.</p> <p>NOTE: The Emergency Director should declare the Emergency Action Level promptly upon determining that the applicable time has been exceeded, or will likely be exceeded.</p> <ul style="list-style-type: none"> <li>If an ongoing release is detected and the release start time is unknown, assume that the release duration has exceeded 10 minutes.</li> <li>If the effluent flow past an effluent monitor is known to have stopped due to actions to isolate the release path, then the effluent monitor reading is no longer valid for classification purposes.</li> </ul> <p>RG1.1 <input type="checkbox"/> 1 <input type="checkbox"/> 2 <input type="checkbox"/> 3 <input type="checkbox"/> 4 <input type="checkbox"/> 5 <input type="checkbox"/> DEF</p> <p>Reading on ANY of the following effluent radionuclide monitors greater than the listed values for 10 minutes or longer:</p> <table border="1"> <tr> <th colspan="2">Gaseous Effluent Monitors</th> </tr> <tr> <td>Gas: I-131 Monitor (C/A or S)</td> <td>10-100 uCi/m<sup>3</sup></td> </tr> <tr> <td>Gas: Xe-135 Monitor (C/A or S)</td> <td>10-100 uCi/m<sup>3</sup></td> </tr> <tr> <th colspan="2">Liquid Effluent Monitors</th> </tr> <tr> <td>Discharge Canal</td> <td>2000 cps</td> </tr> <tr> <td>Service Water</td> <td>200 cps</td> </tr> <tr> <td>Turbine</td> <td>10-100 cps</td> </tr> </table> <p>RG1.2 <input type="checkbox"/> 1 <input type="checkbox"/> 2 <input type="checkbox"/> 3 <input type="checkbox"/> 4 <input type="checkbox"/> 5 <input type="checkbox"/> DEF</p> <p>Reading on ANY effluent radionuclide monitor greater than 2 times the alarm output established by a current radionuclide discharge permit for 10 minutes or longer.</p> <p>RG1.3 <input type="checkbox"/> 1 <input type="checkbox"/> 2 <input type="checkbox"/> 3 <input type="checkbox"/> 4 <input type="checkbox"/> 5 <input type="checkbox"/> DEF</p> <p>Sample analysis for gaseous or liquid release indicates a concentration or release rate greater than 2 times the CDCM limit for 10 minutes or longer.</p>	Gaseous Effluent Monitors		Gas: I-131 Monitor (C/A or S)	10-100 uCi/m <sup>3</sup>	Gas: Xe-135 Monitor (C/A or S)	10-100 uCi/m <sup>3</sup>	Liquid Effluent Monitors		Discharge Canal	2000 cps	Service Water	200 cps	Turbine	10-100 cps
	Gas: I-131 Monitor (C/A or S)	10-100 uCi/m <sup>3</sup>																																			
Gas: I-131 Monitor (C/A or S)	10-100 uCi/m <sup>3</sup>																																				
Gaseous Effluent Monitors																																					
Gas: I-131 Monitor (C/A or S)	10-100 uCi/m <sup>3</sup>																																				
Gas: Xe-135 Monitor (C/A or S)	10-100 uCi/m <sup>3</sup>																																				
Liquid Effluent Monitors																																					
Discharge Canal	2000 cps																																				
Service Water	200 cps																																				
Turbine	10-100 cps																																				
Gaseous Effluent Monitors																																					
Gas: I-131 Monitor (C/A or S)	10-100 uCi/m <sup>3</sup>																																				
Gas: Xe-135 Monitor (C/A or S)	10-100 uCi/m <sup>3</sup>																																				
Liquid Effluent Monitors																																					
Discharge Canal	2000 cps																																				
Service Water	200 cps																																				
Turbine	10-100 cps																																				
Spent Fuel Pool Level (In Plant Pool)	<p>RG2 Spent fuel pool level cannot be restored to at least 75% for 10 minutes or longer.</p> <p>Note: The Emergency Director should declare the General Emergency promptly upon determining that 10 minutes has been exceeded, or will likely be exceeded.</p> <p>RG2.1 <input type="checkbox"/> 1 <input type="checkbox"/> 2 <input type="checkbox"/> 3 <input type="checkbox"/> 4 <input type="checkbox"/> 5 <input type="checkbox"/> DEF</p> <p>Spent fuel pool level cannot be restored to at least 75% for 10 minutes or longer.</p>	<p>RG2 Spent fuel pool level at 75%.</p> <p>RG2.1 <input type="checkbox"/> 1 <input type="checkbox"/> 2 <input type="checkbox"/> 3 <input type="checkbox"/> 4 <input type="checkbox"/> 5 <input type="checkbox"/> DEF</p> <p>Lowering of spent fuel pool level to 75%.</p>	<p>RA2 Significant lowering of water level above, or damage to, irradiated fuel.</p> <p>RA2.1 <input type="checkbox"/> 1 <input type="checkbox"/> 2 <input type="checkbox"/> 3 <input type="checkbox"/> 4 <input type="checkbox"/> 5 <input type="checkbox"/> DEF</p> <p>Uncovery of irradiated fuel in the REFUELING PATHWAY.</p> <p>RA2.2 <input type="checkbox"/> 1 <input type="checkbox"/> 2 <input type="checkbox"/> 3 <input type="checkbox"/> 4 <input type="checkbox"/> 5 <input type="checkbox"/> DEF</p> <p>Damage to irradiated fuel resulting in a release of radioactivity from the fuel as indicated by ANY of the following radionuclide monitors:</p> <table border="1"> <tr> <td>Monitor</td> <td>Alerting</td> </tr> <tr> <td>A-1 WPP 20 mCi/sec</td> <td>20 mCi/sec</td> </tr> <tr> <td>A-2 WPP 20 mCi/sec</td> <td>20 mCi/sec</td> </tr> <tr> <td>A-3 WPP 20 mCi/sec</td> <td>20 mCi/sec</td> </tr> <tr> <td>RA-17-450R 20 mCi/sec</td> <td>20 mCi/sec</td> </tr> <tr> <td>RA-17-450R 20 mCi/sec</td> <td>20 mCi/sec</td> </tr> <tr> <td>RA-17-450R 20 mCi/sec</td> <td>20 mCi/sec</td> </tr> <tr> <td>RA-17-450R 20 mCi/sec</td> <td>20 mCi/sec</td> </tr> <tr> <td>RA-17-450R 20 mCi/sec</td> <td>20 mCi/sec</td> </tr> </table> <p>RA2.3 <input type="checkbox"/> 1 <input type="checkbox"/> 2 <input type="checkbox"/> 3 <input type="checkbox"/> 4 <input type="checkbox"/> 5 <input type="checkbox"/> DEF</p> <p>Lowering of spent fuel pool level to 75%.</p>	Monitor	Alerting	A-1 WPP 20 mCi/sec	20 mCi/sec	A-2 WPP 20 mCi/sec	20 mCi/sec	A-3 WPP 20 mCi/sec	20 mCi/sec	RA-17-450R 20 mCi/sec	20 mCi/sec	RA-17-450R 20 mCi/sec	20 mCi/sec	RA-17-450R 20 mCi/sec	20 mCi/sec	RA-17-450R 20 mCi/sec	20 mCi/sec	RA-17-450R 20 mCi/sec	20 mCi/sec	<p>UE2 UNPLANNED loss of water level above irradiated fuel.</p> <p>UE2.1 <input type="checkbox"/> 1 <input type="checkbox"/> 2 <input type="checkbox"/> 3 <input type="checkbox"/> 4 <input type="checkbox"/> 5 <input type="checkbox"/> DEF</p> <p>a. UNPLANNED water level drop in the REFUELING PATHWAY as indicated by ANY of the following:</p> <ul style="list-style-type: none"> <li>Event that results in water level alarm.</li> <li>Visual observation of an uncontrolled water level drop below a full load bottom stop level.</li> <li>Observation of water leakage into the drywell or the reactor building from piping penetrations surrounding the drywell.</li> </ul> <p>AND</p> <p>b. UNPLANNED rise in area radiation levels as indicated by ANY of the following radionuclide monitors:</p> <table border="1"> <tr> <td>A-1 WPP 20 mCi/sec</td> <td>20 mCi/sec</td> </tr> <tr> <td>A-2 WPP 20 mCi/sec</td> <td>20 mCi/sec</td> </tr> <tr> <td>A-3 WPP 20 mCi/sec</td> <td>20 mCi/sec</td> </tr> <tr> <td>RA-17-450R 20 mCi/sec</td> <td>20 mCi/sec</td> </tr> </table>	A-1 WPP 20 mCi/sec	20 mCi/sec	A-2 WPP 20 mCi/sec	20 mCi/sec	A-3 WPP 20 mCi/sec	20 mCi/sec	RA-17-450R 20 mCi/sec	20 mCi/sec							
Monitor	Alerting																																				
A-1 WPP 20 mCi/sec	20 mCi/sec																																				
A-2 WPP 20 mCi/sec	20 mCi/sec																																				
A-3 WPP 20 mCi/sec	20 mCi/sec																																				
RA-17-450R 20 mCi/sec	20 mCi/sec																																				
RA-17-450R 20 mCi/sec	20 mCi/sec																																				
RA-17-450R 20 mCi/sec	20 mCi/sec																																				
RA-17-450R 20 mCi/sec	20 mCi/sec																																				
RA-17-450R 20 mCi/sec	20 mCi/sec																																				
A-1 WPP 20 mCi/sec	20 mCi/sec																																				
A-2 WPP 20 mCi/sec	20 mCi/sec																																				
A-3 WPP 20 mCi/sec	20 mCi/sec																																				
RA-17-450R 20 mCi/sec	20 mCi/sec																																				
Security	<p>HC1 HOSTILE ACTION resulting in loss of physical control of the facility.</p> <p>HC1.1 <input type="checkbox"/> 1 <input type="checkbox"/> 2 <input type="checkbox"/> 3 <input type="checkbox"/> 4 <input type="checkbox"/> 5 <input type="checkbox"/> DEF</p> <p>a. A HOSTILE ACTION is occurring or has occurred within the Plant PROTECTED AREA as reported by the Security Staff Supervisor.</p> <p>AND</p> <p>b. EITHER of the following has occurred:</p> <ol style="list-style-type: none"> <li>ANY of the following safety functions cannot be controlled or maintained:                     <ul style="list-style-type: none"> <li>Readiness Control</li> <li>SPV water level</li> <li>RCS level control</li> </ul> </li> <li>Damage to spent fuel pool occurred or is imminent.</li> </ol>	<p>HS1 HOSTILE ACTION within the Plant PROTECTED AREA.</p> <p>HS1.1 <input type="checkbox"/> 1 <input type="checkbox"/> 2 <input type="checkbox"/> 3 <input type="checkbox"/> 4 <input type="checkbox"/> 5 <input type="checkbox"/> DEF</p> <p>A HOSTILE ACTION is occurring or has occurred within the Plant PROTECTED AREA as reported by the Security Staff Supervisor.</p>	<p>HA1 HOSTILE ACTION within the OWNER CONTROLLED AREA or within the adjacent times within 30 minutes.</p> <p>HA1.1 <input type="checkbox"/> 1 <input type="checkbox"/> 2 <input type="checkbox"/> 3 <input type="checkbox"/> 4 <input type="checkbox"/> 5 <input type="checkbox"/> DEF</p> <p>A HOSTILE ACTION is occurring or has occurred within the OWNER CONTROLLED AREA as reported by the Security Staff Supervisor.</p> <p>HA1.2 <input type="checkbox"/> 1 <input type="checkbox"/> 2 <input type="checkbox"/> 3 <input type="checkbox"/> 4 <input type="checkbox"/> 5 <input type="checkbox"/> DEF</p> <p>A vehicle authorized for NRC class access that is not within 30 minutes of the site.</p>	<p>UE3 Confirmed SECURITY CONDITION or threat.</p> <p>UE3.1 <input type="checkbox"/> 1 <input type="checkbox"/> 2 <input type="checkbox"/> 3 <input type="checkbox"/> 4 <input type="checkbox"/> 5 <input type="checkbox"/> DEF</p> <p>A SECURITY CONDITION has been notified as a HOSTILE ACTION as reported by the Security Staff Supervisor.</p> <p>UE3.2 <input type="checkbox"/> 1 <input type="checkbox"/> 2 <input type="checkbox"/> 3 <input type="checkbox"/> 4 <input type="checkbox"/> 5 <input type="checkbox"/> DEF</p> <p>Notification of a credible security threat issued at WPP.</p> <p>UE3.3 <input type="checkbox"/> 1 <input type="checkbox"/> 2 <input type="checkbox"/> 3 <input type="checkbox"/> 4 <input type="checkbox"/> 5 <input type="checkbox"/> DEF</p> <p>A credible indication from the NRC providing information of an actual threat.</p>																																	
	Natural & Disturbance Phenomena	<p>Table H1</p> <table border="1"> <thead> <tr> <th>Rooms</th> <th>Applicable Mode(s)</th> </tr> </thead> <tbody> <tr> <td>BOTH RHR Rooms (Reactor Building 896' SW and SE)</td> <td>3 / 4</td> </tr> <tr> <td>MCC-133 Room</td> <td>3 / 4</td> </tr> <tr> <td>(Turbine Building S11' East)</td> <td>2 / 3</td> </tr> <tr> <td>MVP Room</td> <td>2 / 3</td> </tr> <tr> <td>(Turbine Building S08' West)</td> <td>2 / 3</td> </tr> </tbody> </table>	Rooms	Applicable Mode(s)	BOTH RHR Rooms (Reactor Building 896' SW and SE)	3 / 4	MCC-133 Room	3 / 4	(Turbine Building S11' East)	2 / 3	MVP Room	2 / 3	(Turbine Building S08' West)	2 / 3			<p>UE4 Seismic event greater than OBE levels.</p> <p>UE4.1 <input type="checkbox"/> 1 <input type="checkbox"/> 2 <input type="checkbox"/> 3 <input type="checkbox"/> 4 <input type="checkbox"/> 5 <input type="checkbox"/> DEF</p> <p>Seismic event greater than Operating Data Outgoing (ODO) as indicated by Annunciator OPERATIONAL BASIS DATA QUALITY (O-B-D-Q) 13) reached.</p> <p>UE4.2 <input type="checkbox"/> 1 <input type="checkbox"/> 2 <input type="checkbox"/> 3 <input type="checkbox"/> 4 <input type="checkbox"/> 5 <input type="checkbox"/> DEF</p> <p>Overloads on fans.</p> <p>Note: GAL H4.4 does not apply to motive traffic impediments such as fog, snow, ice, or vehicle breakdowns or accidents.</p> <p>UE4.3 <input type="checkbox"/> 1 <input type="checkbox"/> 2 <input type="checkbox"/> 3 <input type="checkbox"/> 4 <input type="checkbox"/> 5 <input type="checkbox"/> DEF</p> <p>A breakdown within the Plant PROTECTED AREA.</p> <p>UE4.4 <input type="checkbox"/> 1 <input type="checkbox"/> 2 <input type="checkbox"/> 3 <input type="checkbox"/> 4 <input type="checkbox"/> 5 <input type="checkbox"/> DEF</p> <p>Internal room or area flooding of a magnitude sufficient to require manual or automatic electrical isolation of a SAFETY SYSTEM component needed for the current operating mode.</p> <p>UE4.5 <input type="checkbox"/> 1 <input type="checkbox"/> 2 <input type="checkbox"/> 3 <input type="checkbox"/> 4 <input type="checkbox"/> 5 <input type="checkbox"/> DEF</p> <p>Movement of personnel within the Plant PROTECTED AREA is impeded due to an offsite event including hazardous materials (e.g., an offsite chemical spill or toxic gas release).</p> <p>UE4.6 <input type="checkbox"/> 1 <input type="checkbox"/> 2 <input type="checkbox"/> 3 <input type="checkbox"/> 4 <input type="checkbox"/> 5 <input type="checkbox"/> DEF</p> <p>A hazardous event that results in on-site conditions sufficient to prohibit plant staff from accessing the site via personnel vehicles.</p> <p>UE4.7 <input type="checkbox"/> 1 <input type="checkbox"/> 2 <input type="checkbox"/> 3 <input type="checkbox"/> 4 <input type="checkbox"/> 5 <input type="checkbox"/> DEF</p> <p>Power loss greater than 20%.</p> <p>UE4.8 <input type="checkbox"/> 1 <input type="checkbox"/> 2 <input type="checkbox"/> 3 <input type="checkbox"/> 4 <input type="checkbox"/> 5 <input type="checkbox"/> DEF</p> <p>Power loss less than 20%.</p>																				
Rooms	Applicable Mode(s)																																				
BOTH RHR Rooms (Reactor Building 896' SW and SE)	3 / 4																																				
MCC-133 Room	3 / 4																																				
(Turbine Building S11' East)	2 / 3																																				
MVP Room	2 / 3																																				
(Turbine Building S08' West)	2 / 3																																				
Fire or Explosion	<p>Table H2</p> <table border="1"> <thead> <tr> <th>Building Name</th> <th>Room(s)/Area(s) with Safety Equipment</th> </tr> </thead> <tbody> <tr> <td>Reactor Building</td> <td>All</td> </tr> <tr> <td>HPCI Building</td> <td>All</td> </tr> <tr> <td>Turbine Building</td> <td>All</td> </tr> <tr> <td>Control and Administration Building</td> <td>Control Room, Cable Spreading Room, and Battery Rooms</td> </tr> <tr> <td>Diesel Generator Building</td> <td>All</td> </tr> <tr> <td>Diesel Fuel Oil Transfer House</td> <td>All</td> </tr> <tr> <td>EFT Building</td> <td>All</td> </tr> <tr> <td>Intake Structure</td> <td>All</td> </tr> </tbody> </table>	Building Name	Room(s)/Area(s) with Safety Equipment	Reactor Building	All	HPCI Building	All	Turbine Building	All	Control and Administration Building	Control Room, Cable Spreading Room, and Battery Rooms	Diesel Generator Building	All	Diesel Fuel Oil Transfer House	All	EFT Building	All	Intake Structure	All			<p>UE5 100% generator tripping decreasing the level of safety of the plant.</p> <p>Note: The Emergency Director should declare the Unusual Event promptly upon determining that the applicable time has been exceeded, or will likely be exceeded.</p> <p>UE5.1 <input type="checkbox"/> 1 <input type="checkbox"/> 2 <input type="checkbox"/> 3 <input type="checkbox"/> 4 <input type="checkbox"/> 5 <input type="checkbox"/> DEF</p> <p>a. A FIRE or NOT-ADVERTISED event (NAD) within the following FIRE detector indications:</p> <ul style="list-style-type: none"> <li>Report from the fire (i.e., visual observation)</li> <li>Receipt of multiple (more than 1) fire alarms or indications</li> <li>Fire verification of a single fire alarm</li> </ul> <p>AND</p> <p>b. The FIRE is located within ANY of the Table H2 plant rooms or areas.</p> <p>UE5.2 <input type="checkbox"/> 1 <input type="checkbox"/> 2 <input type="checkbox"/> 3 <input type="checkbox"/> 4 <input type="checkbox"/> 5 <input type="checkbox"/> DEF</p> <p>a. Receipt of a single fire alarm (i.e., no other indications of a FIRE).</p> <p>AND</p> <p>b. The FIRE is located within ANY of the Table H2 plant rooms or areas.</p> <p>AND</p> <p>c. The existence of a FIRE is not verified within 30 minutes of alarm receipt.</p> <p>UE5.3 <input type="checkbox"/> 1 <input type="checkbox"/> 2 <input type="checkbox"/> 3 <input type="checkbox"/> 4 <input type="checkbox"/> 5 <input type="checkbox"/> DEF</p> <p>A FIRE within the Plant PROTECTED AREA or SITE PROTECTED AREA not extinguished within 10 minutes of the initial report, alarm or indication.</p> <p>UE5.4 <input type="checkbox"/> 1 <input type="checkbox"/> 2 <input type="checkbox"/> 3 <input type="checkbox"/> 4 <input type="checkbox"/> 5 <input type="checkbox"/> DEF</p> <p>A FIRE within the Plant PROTECTED AREA or SITE PROTECTED AREA that requires firefighting capability on-site for the response agency to extinguish.</p>															
	Building Name	Room(s)/Area(s) with Safety Equipment																																			
Reactor Building	All																																				
HPCI Building	All																																				
Turbine Building	All																																				
Control and Administration Building	Control Room, Cable Spreading Room, and Battery Rooms																																				
Diesel Generator Building	All																																				
Diesel Fuel Oil Transfer House	All																																				
EFT Building	All																																				
Intake Structure	All																																				
Tanks, Corrosive, Liquefied or Flammable Gases		<p>HA3 Gaseous release impeding access to equipment necessary for normal plant operations, shutdown, or start-up.</p> <p>Note: The equipment in the laboratory or area was already inoperative or out of service before the event occurred, then no emergency classification is warranted.</p> <p>HA3.1 <input type="checkbox"/> 1 <input type="checkbox"/> 2 <input type="checkbox"/> 3 <input type="checkbox"/> 4 <input type="checkbox"/> 5 <input type="checkbox"/> DEF</p> <p>a. Release of toxic, corrosive, liquefied or flammable gas into any of the Table H1 plant rooms or areas.</p> <p>AND</p> <p>b. Entry into the room or area is prohibited or impeded.</p>																																			
Control Room Evacuation	<p>HC2 Inability to control a key safety function from outside the Control Room.</p> <p>Note: The Emergency Director should declare the Site Area Emergency promptly upon determining that 10 minutes has been exceeded, or will likely be exceeded.</p> <p>HC2.1 <input type="checkbox"/> 1 <input type="checkbox"/> 2 <input type="checkbox"/> 3 <input type="checkbox"/> 4 <input type="checkbox"/> 5 <input type="checkbox"/> DEF</p> <p>a. An event has resulted in plant control being transferred from the Control Room to the alternate shutdown panel.</p> <p>AND</p> <p>b. Control of ANY of the following key safety functions is not reestablished within 10 minutes:</p> <ul style="list-style-type: none"> <li>Readiness control (Mode 1 and 2 only)</li> <li>SPV water level</li> <li>RCS level control</li> </ul>	<p>HA4 Control Room evacuation resulting in transfer of plant control to alternate locations.</p> <p>HA4.1 <input type="checkbox"/> 1 <input type="checkbox"/> 2 <input type="checkbox"/> 3 <input type="checkbox"/> 4 <input type="checkbox"/> 5 <input type="checkbox"/> DEF</p> <p>An event has resulted in plant control being transferred from the Control Room to the alternate shutdown panel.</p>																																			
Staff Manager / Emergency Director Judgment	<p>HC3 Other conditions exist which in the judgment of the Emergency Director warrant declaration of a General Emergency.</p> <p>HC3.1 <input type="checkbox"/> 1 <input type="checkbox"/> 2 <input type="checkbox"/> 3 <input type="checkbox"/> 4 <input type="checkbox"/> 5 <input type="checkbox"/> DEF</p> <p>Other conditions exist which in the judgment of the Emergency Director indicate that events are in progress or have occurred which involve actual or imminent substantial degradation or melting with potential for loss of containment integrity or HOSTILE ACTION that results in an actual loss of physical control of the facility. Release can be reasonably expected to exceed EPA Protective Action Guidelines exposure levels. Able to cross the Site Inhabitable Area.</p>	<p>HS2 Other conditions exist which in the judgment of the Emergency Director warrant declaration of a Site Area Emergency.</p> <p>HS2.1 <input type="checkbox"/> 1 <input type="checkbox"/> 2 <input type="checkbox"/> 3 <input type="checkbox"/> 4 <input type="checkbox"/> 5 <input type="checkbox"/> DEF</p> <p>Other conditions exist which in the judgment of the Emergency Director indicate that events are in progress or have occurred which involve actual or likely major release of plant effluents needed for protection of the public or HOSTILE ACTION that results in intentional damage to radioactive acts. (1) Downed the personnel or equipment that could reach the Site Inhabitable Area; (2) that prevent effective access to equipment needed for the protection of the public. Any release are not expected to result in exposures levels which exceed EPA Protective Action Guidelines exposure levels beyond the site boundary.</p>	<p>HA2 Other conditions exist which in the judgment of the Emergency Director warrant declaration of an Alert.</p> <p>HA2.1 <input type="checkbox"/> 1 <input type="checkbox"/> 2 <input type="checkbox"/> 3 <input type="checkbox"/> 4 <input type="checkbox"/> 5 <input type="checkbox"/> DEF</p> <p>Other conditions exist which in the judgment of the Emergency Director indicate that events are in progress or have occurred which involve actual or potential substantial degradation of the level of safety of the plant or a security threat to public protection that is not expected to be resolved by the personnel or damage to site equipment because of HOSTILE ACTION. Any release are expected to be limited to local factors of the EPA Protective Action Guidelines exposure levels.</p>	<p>UE6 Other conditions exist which in the judgment of the Emergency Director warrant declaration of a UE.</p> <p>UE6.1 <input type="checkbox"/> 1 <input type="checkbox"/> 2 <input type="checkbox"/> 3 <input type="checkbox"/> 4 <input type="checkbox"/> 5 <input type="checkbox"/> DEF</p> <p>Other conditions exist which in the judgment of the Emergency Director indicate that events are in progress or have occurred which indicate potential degradation of the level of safety of the plant or indicate a security threat to public protection that is not expected to be resolved by the personnel or damage to site equipment because of HOSTILE ACTION. Any release are expected to be limited to local factors of the EPA Protective Action Guidelines exposure levels.</p>																																	
ES&S Events	<p>Table ET (Applicable to HSMs 1A/B-5A/B)</p> <table border="1"> <thead> <tr> <th>Location of Dose Rate</th> <th>Total Dose Rate (Neutron + Gamma mR/hr)</th> </tr> </thead> <tbody> <tr> <td>3 feet from the HSM Surface</td> <td>200</td> </tr> <tr> <td>On-Contact Outside HSM Door Centerline</td> <td>200</td> </tr> <tr> <td>On-Contact End shield wall exterior</td> <td>40</td> </tr> </tbody> </table>	Location of Dose Rate	Total Dose Rate (Neutron + Gamma mR/hr)	3 feet from the HSM Surface	200	On-Contact Outside HSM Door Centerline	200	On-Contact End shield wall exterior	40	<p>Table ES (Applicable to HSMs 5A/B-10A/B)</p> <table border="1"> <thead> <tr> <th>Location of Dose Rate</th> <th>Total Dose Rate (Neutron + Gamma mR/hr)</th> </tr> </thead> <tbody> <tr> <td>On-Contact HSM or HSM-41 Front Surface</td> <td>1000</td> </tr> <tr> <td>On-Contact side or HSM-41 Door Centerline</td> <td>200</td> </tr> <tr> <td>On-Contact End shield wall exterior</td> <td>40</td> </tr> </tbody> </table>	Location of Dose Rate	Total Dose Rate (Neutron + Gamma mR/hr)	On-Contact HSM or HSM-41 Front Surface	1000	On-Contact side or HSM-41 Door Centerline	200	On-Contact End shield wall exterior	40	<p>Table E2 (Applicable to HSMs 11A/B-15A/B)</p> <table border="1"> <thead> <tr> <th>Location of Dose Rate</th> <th>Total Dose Rate (Neutron + Gamma mR/hr)</th> </tr> </thead> <tbody> <tr> <td>On-Contact HSM-41 Front End Screen</td> <td>2000</td> </tr> <tr> <td>On-Contact HSM-41 Door Centerline</td> <td>4</td> </tr> <tr> <td>On-Contact End shield wall exterior</td> <td>8</td> </tr> </tbody> </table>	Location of Dose Rate	Total Dose Rate (Neutron + Gamma mR/hr)	On-Contact HSM-41 Front End Screen	2000	On-Contact HSM-41 Door Centerline	4	On-Contact End shield wall exterior	8	<p>UE7 Damage to a closed and CONFINEMENT BOUNDARY.</p> <p>UE7.1 <input type="checkbox"/> 1 <input type="checkbox"/> 2 <input type="checkbox"/> 3 <input type="checkbox"/> 4 <input type="checkbox"/> 5 <input type="checkbox"/> DEF</p> <p>Damage to a closed and CONFINEMENT BOUNDARY as indicated by a radiation reading greater than any of the values listed in Table E1, E2, or E3 as applicable to the HSM.</p>									
Location of Dose Rate	Total Dose Rate (Neutron + Gamma mR/hr)																																				
3 feet from the HSM Surface	200																																				
On-Contact Outside HSM Door Centerline	200																																				
On-Contact End shield wall exterior	40																																				
Location of Dose Rate	Total Dose Rate (Neutron + Gamma mR/hr)																																				
On-Contact HSM or HSM-41 Front Surface	1000																																				
On-Contact side or HSM-41 Door Centerline	200																																				
On-Contact End shield wall exterior	40																																				
Location of Dose Rate	Total Dose Rate (Neutron + Gamma mR/hr)																																				
On-Contact HSM-41 Front End Screen	2000																																				
On-Contact HSM-41 Door Centerline	4																																				
On-Contact End shield wall exterior	8																																				

Modes:  1 Power Operation  2 Startup  3 Hot Shutdown  4 Cold Shutdown  5 Refueling  DEF Default

12.0 FIGURE Annex A-1 Monticello Nuclear Generating Plant Emergency Action Level Matrix (Cont'd)  
Right half of Page 2 of 5790-101-02, Revision 13.

	GENERAL EMERGENCY	SITE AREA EMERGENCY	ALERT	UNUSUAL EVENT																																				
Inventory Control	<p>CS1 Loss of NPV inventory affecting containment challenge.</p> <p>Note: The Emergency Director should declare the General Emergency promptly upon determining that 30 minutes has been exceeded, or will likely be exceeded.</p> <p>CS1.1 <table border="1"><tr><td>4</td><td>3</td><td>2</td><td>1</td></tr></table>            a. RPV level less than 125 ft. (TAF) for 30 minutes or longer            AND            b. ANY indication from the Containment Challenge Table C1</p> <p>CS1.2 <table border="1"><tr><td>4</td><td>3</td><td>2</td><td>1</td></tr></table>            a. RPV level cannot be monitored for 30 minutes or longer            AND            b. Core uncover is indicated by EITHER of the following:            - Refueling Floor radiation monitor reading greater than 3 R/hr;            - UNPLANNED rise in drywell floor or equipment drain sump levels of sufficient magnitude to indicate core uncover.            AND            c. ANY indication from the Containment Challenge Table C1</p>	4	3	2	1	4	3	2	1	<p>CS1 Loss of NPV inventory affecting containment challenge.</p> <p>Note: The Emergency Director should declare the Site Area Emergency promptly upon determining that 30 minutes has been exceeded, or will likely be exceeded.</p> <p>CS1.1 <table border="1"><tr><td>4</td><td>3</td><td>2</td><td>1</td></tr></table>            a. SECONDARY CONTAINMENT established            AND            b. RPV level less than 47 ft.</p> <p>CS1.2 <table border="1"><tr><td>4</td><td>3</td><td>2</td><td>1</td></tr></table>            a. SECONDARY CONTAINMENT established            AND            b. RPV level less than 108 in. (TAF)</p> <p>CS1.3 <table border="1"><tr><td>4</td><td>3</td><td>2</td><td>1</td></tr></table>            a. RPV level cannot be monitored for 30 minutes or longer            AND            b. Core uncover is indicated by EITHER of the following:            - Refueling Floor radiation monitor reading greater than 3 R/hr;            - UNPLANNED rise in drywell floor or equipment drain sump levels of sufficient magnitude to indicate core uncover.</p>	4	3	2	1	4	3	2	1	4	3	2	1	<p>CA1 Loss of NPV inventory.</p> <p>Note: The Emergency Director should declare the Alert promptly upon determining that 15 minutes has been exceeded, or will likely be exceeded.</p> <p>CA1.1 <table border="1"><tr><td>4</td><td>3</td><td>2</td><td>1</td></tr></table>            Loss of RPV inventory as indicated by level less than 47 ft.</p> <p>CA1.2 <table border="1"><tr><td>4</td><td>3</td><td>2</td><td>1</td></tr></table>            a. RPV level cannot be monitored for 15 minutes or longer            AND            b. UNPLANNED rise in drywell floor or equipment drain sump levels due to a loss of RPV inventory</p>	4	3	2	1	4	3	2	1	<p>CU1 UNPLANNED loss of NPV inventory for 15 minutes or longer.</p> <p>Note: The Emergency Director should declare the Unusual Event promptly upon determining that 15 minutes has been exceeded, or will likely be exceeded.</p> <p>CU1.1 <table border="1"><tr><td>4</td><td>3</td><td>2</td><td>1</td></tr></table>            UNPLANNED loss of reactor coolant heads in RPV level less than a previously required lower limit for 15 minutes or longer</p> <p>CU1.2 <table border="1"><tr><td>4</td><td>3</td><td>2</td><td>1</td></tr></table>            a. RPV level cannot be monitored            AND            b. UNPLANNED rise in drywell floor or equipment drain sump levels</p>	4	3	2	1	4	3	2	1
4	3	2	1																																					
4	3	2	1																																					
4	3	2	1																																					
4	3	2	1																																					
4	3	2	1																																					
4	3	2	1																																					
4	3	2	1																																					
4	3	2	1																																					
4	3	2	1																																					
Loss of Power	<p><b>Containment Challenge Table C1</b></p> <p>- SECONDARY CONTAINMENT not established*</p> <p>- Greater than or equal to 5% hydrogen and greater than or equal to 5% oxygen in primary containment</p> <p>- UNPLANNED rise in containment pressure resulting in Drywell Pressure greater than 1.94 psig</p> <p>- Two or more Reactor Building areas exceed Max. Safe Radiation Levels (C.S-1300, Table X)</p> <p>* If SECONDARY CONTAINMENT is re-established prior to exceeding the 30-minute time limit, then declaration of a General Emergency is not required.</p>		<p>CA2 Loss of all off-site and all on-site AC power to essential buses for 15 minutes or longer.</p> <p>Note: The Emergency Director should declare the Alert promptly upon determining that 15 minutes has been exceeded, or will likely be exceeded.</p> <p>CA2.1 <table border="1"><tr><td>4</td><td>3</td><td>2</td><td>1</td></tr></table>            Loss of ALL off-site and ALL on-site AC Power to essential buses 15 and 16 for 15 minutes or longer.</p>	4	3	2	1	<p>CU2 Loss of all off-site AC power sources to essential buses for 15 minutes or longer.</p> <p>Note: The Emergency Director should declare the Unusual Event promptly upon determining that 15 minutes has been exceeded, or will likely be exceeded.</p> <p>CU2.1 <table border="1"><tr><td>4</td><td>3</td><td>2</td><td>1</td></tr></table>            a. AC power capability to Essential buses 15 and 16 is reduced to a single power source (Table S1) for 15 minutes or longer.            AND            b. Any additional single power source that will result in loss of all AC power to SAFETY SYSTEMS.</p> <p><b>Table S1</b></p> <table border="1"> <tr><td>15 Reserve Transformer</td></tr> <tr><td>15B Auxiliary Transformer</td></tr> <tr><td>15B Auxiliary Transformer</td></tr> <tr><td>15B Emergency Diesel Generator</td></tr> <tr><td>15B Emergency Diesel Generator</td></tr> </table>	4	3	2	1	15 Reserve Transformer	15B Auxiliary Transformer	15B Auxiliary Transformer	15B Emergency Diesel Generator	15B Emergency Diesel Generator																							
4	3	2	1																																					
4	3	2	1																																					
15 Reserve Transformer																																								
15B Auxiliary Transformer																																								
15B Auxiliary Transformer																																								
15B Emergency Diesel Generator																																								
15B Emergency Diesel Generator																																								
Cold SSB Inlet System Malfunction	<p><b>Table C2: RCS Heat-Up Duration Thresholds</b></p> <table border="1"> <thead> <tr> <th>RCS</th> <th>SECONDARY CONTAINMENT</th> <th>Heat-up Duration</th> </tr> </thead> <tbody> <tr> <td>Not Intact</td> <td>Not Established</td> <td>0 minutes</td> </tr> <tr> <td>Not Intact</td> <td>Established</td> <td>20 minutes*</td> </tr> <tr> <td>Intact</td> <td>N/A</td> <td>60 minutes*</td> </tr> </tbody> </table> <p>* If an RCS heat removal system is in operation within this time frame and RCS temperature is being reduced, the EAL is not applicable.</p>		RCS	SECONDARY CONTAINMENT	Heat-up Duration	Not Intact	Not Established	0 minutes	Not Intact	Established	20 minutes*	Intact	N/A	60 minutes*	<p>CA3 Inability to maintain the plant in cold shutdown.</p> <p>Note: The Emergency Director should declare the Alert promptly upon determining that the applicable time has been exceeded, or will likely be exceeded.</p> <p>CA3.1 <table border="1"><tr><td>4</td><td>3</td><td>2</td><td>1</td></tr></table>            UNPLANNED rise in RCS temperature to greater than 212°F for greater than the duration specified in Table C2</p> <p>CA3.2 <table border="1"><tr><td>4</td><td>3</td><td>2</td><td>1</td></tr></table>            UNPLANNED RCS pressure rise greater than 10 psig</p>	4	3	2	1	4	3	2	1	<p>CU3 UNPLANNED rise in RCS temperature.</p> <p>Note: The Emergency Director should declare the Unusual Event promptly upon determining that 15 minutes has been exceeded, or will likely be exceeded.</p> <p>CU3.1 <table border="1"><tr><td>4</td><td>3</td><td>2</td><td>1</td></tr></table>            UNPLANNED rise in RCS temperature to greater than 212°F</p> <p>CU3.2 <table border="1"><tr><td>4</td><td>3</td><td>2</td><td>1</td></tr></table>            Loss of ALL RCS temperature and RPV level indicators for 15 minutes or longer</p>	4	3	2	1	4	3	2	1								
RCS	SECONDARY CONTAINMENT	Heat-up Duration																																						
Not Intact	Not Established	0 minutes																																						
Not Intact	Established	20 minutes*																																						
Intact	N/A	60 minutes*																																						
4	3	2	1																																					
4	3	2	1																																					
4	3	2	1																																					
4	3	2	1																																					
Communications			<p>CU4 Loss of all on-site or off-site communications capabilities.</p> <p>CU4.1 <table border="1"><tr><td>4</td><td>3</td><td>2</td><td>1</td></tr></table>            Loss of ALL of the following on-site communication methods:            - Commercial Telephones            - Plant Telephones            - Portable radios            - Plant PA System</p> <p>CU4.2 <table border="1"><tr><td>4</td><td>3</td><td>2</td><td>1</td></tr></table>            Loss of ALL of the following Off-Site Response Organization (ORO) communication methods:            - Commercial Telephones            - Direct Dedicated Telephones            - Radio/Receiver Transmitter</p> <p>CU4.3 <table border="1"><tr><td>4</td><td>3</td><td>2</td><td>1</td></tr></table>            Loss of ALL of the following NRC communication methods:            - Federal Telecommunications System (FTS)            - Commercial Telephones</p>	4	3	2	1	4	3	2	1	4	3	2	1																									
4	3	2	1																																					
4	3	2	1																																					
4	3	2	1																																					
Random Events			<p>CA4 Hazardous event affecting a SAFETY SYSTEM needed for the current operating mode.</p> <p>Note:            - If the affected SAFETY SYSTEM train was already inoperative or out of service before the hazardous event occurred, then the emergency declaration is not warranted.            - If the hazardous event only resulted in VISIBLE DAMAGE, with no indications of degraded performance to a second train of a SAFETY SYSTEM, then the emergency declaration is not warranted.</p> <p>CA4.1 <table border="1"><tr><td>4</td><td>3</td><td>2</td><td>1</td></tr></table>            The occurrence of ANY of the following hazardous events:            - Seismic event (Earthquake)            - Internal or external flooding event            - High winds or tornado strike            - DSE            - EXPLOSION            - Reactor level greater than 10 ft. gage            - Reactor level less than 100 ft. gage            - Other events with similar hazard characteristics as determined by the S&amp;EH manager</p> <p>AND            b. 1. Direct damage has caused indications of degraded performance on one train of a SAFETY SYSTEM needed for the current operating mode.            AND            2. EITHER of the following:            - Direct damage has caused indications of degraded performance to a second train of the SAFETY SYSTEM needed for the current operating mode.            - Direct damage has resulted in VISIBLE DAMAGE to the second train of the SAFETY SYSTEM needed for the current operating mode.</p>	4	3	2	1																																	
4	3	2	1																																					

**COLD CONDITIONS**

DEFINITIONS		
<b>CONFINEMENT BOUNDARY:</b> The barrier(s) between areas containing spent fuel and the environment once the spent fuel is processed for dry storage.	<b>IMMINENT:</b> The trajectory of events or conditions is such that an EAL will be met within a relatively short period of time regardless of mitigation or corrective actions.	<b>SECURITY CONDITION:</b> Any Security Event as listed in the approved security contingency plan that constitutes a threat to compromise to site security, threat to site personnel, or a potential degradation to the level of safety of the plant. A SECURITY CONDITION does not involve a HOSTILE ACTION.
<b>EXPLOSION:</b> A rapid, violent and catastrophic failure of a piece of equipment due to combustion, chemical reaction or overpressurization. A release of steam (from high energy lines or components) or an electrical component failure (caused by short circuits, grounding, wiring, etc.) should not automatically be considered an explosion. Such events may require a post-event inspection to determine if the attributes of an explosion are present.	<b>INDEPENDENT SPENT FUEL STORAGE INSTALLATION (ISFSI):</b> A complex that is designed and constructed for the interim storage of spent nuclear fuel and other radioactive materials associated with spent fuel storage.	<b>SECONDARY CONTAINMENT:</b> SECONDARY CONTAINMENT includes the Reactor Building (including the HPCI Building), the Standby Gas Treatment System, the Off-gas Diffusion Fans, and connecting pipes and ducts. SECONDARY CONTAINMENT is isolated along with an automatic isolation of the Standby Gas Treatment System to minimize radiological releases to the environment.
<b>FIRE:</b> Combustion characterized by heat and light. Sources of smoke such as slipping drive belts or overheated electrical equipment do not constitute FIRES. Observation of flame is preferred but is NOT required if large quantities of smoke and heat are observed.	<b>ISFSI PROTECTED AREA:</b> The area surrounding the Independent Spent Fuel Storage Installation encompassed by the double chain link fence surrounding the ISFSI as defined in the Security Plan; the ISFSI Protected Area is excluded from the Plant Protected Area.	<b>SITE BOUNDARY:</b> If or Dose Assessment and Protective Action Recommendation purposes the SITE BOUNDARY is the closest distance at which members of the public would be exposed to a radioactive release. The SITE BOUNDARY for liquid releases of radioactive material is defined in OCOM-02.01 (LIQUID EFFLUENTS). The SITE BOUNDARY for gaseous releases of radioactive material is defined in OCOM-03.01 (GASEOUS EFFLUENTS).
<b>HOSTILE ACTION:</b> An act toward a NPP or its personnel that includes the use of violent force to destroy equipment, take HOSTAGES, and/or intimidate the licensee to achieve an end. This includes attack by air, land, or water using guns, explosives, PROJECTILES, vehicles, or other devices used to deliver destructive force. Other acts that satisfy the overall intent may be included. HOSTILE ACTION should not be construed to include acts of civil disobedience or felonious acts that are not part of a concerted attack on the NPP. Non-licensure-based EALs should be used to address such activities (i.e., this may include violent acts between individuals in the owner controlled area).	<b>OWNER CONTROLLED AREA:</b> The OCA boundaries consist of the plant property enclosed by a three strand barbed wire fence and a posted boundary on the Wright County side of the river.	<b>UNPLANNABLE:</b> An open or breached system line that cannot be isolated, remotely or locally.
<b>PROTECTED AREA:</b> The area surrounding the plant encompassed by the chain link fence and certain structures as defined in the Security Plan; excludes the ISFSI Protected Area. In areas where two fences are present, the inner fence is designated as the Protected Area barrier.	<b>REFUELING PATHWAY:</b> The reactor refueling cavity, spent fuel pool, or fuel transfer canal.	<b>UNPLANNED:</b> A parameter change or an event that is not (1) the result of an intended condition or (2) an expected plant response to a transient. The cause of the parameter change or event may be known or unknown.
<b>SAFETY SYSTEM:</b> A system required for safe plant operation, cooling down the plant and/or placing it in the cold shutdown condition, including the ECCS. These are typically systems classified as safety-related.		<b>VISIBLE DAMAGE:</b> Damage to a SAFETY SYSTEM that is readily observable without measurements, testing, or analysis. The visual impact of the damage is sufficient to cause concern regarding the operability or reliability of the affected SAFETY SYSTEM train.

Modes 4, 5, DEF

<b>MONTICELLO NUCLEAR GENERATING PLANT</b>		<b>E-PLAN</b>
<b>TITLE:</b>	<b>EMERGENCY PLAN</b>	Revision 54
		Page 109 of 120

13.0 FIGURES

Figure 13.1  
MONTICELLO PLANT EMERGENCY ORGANIZATION

Technical Support Center  
Positions Report Within 60 Minutes

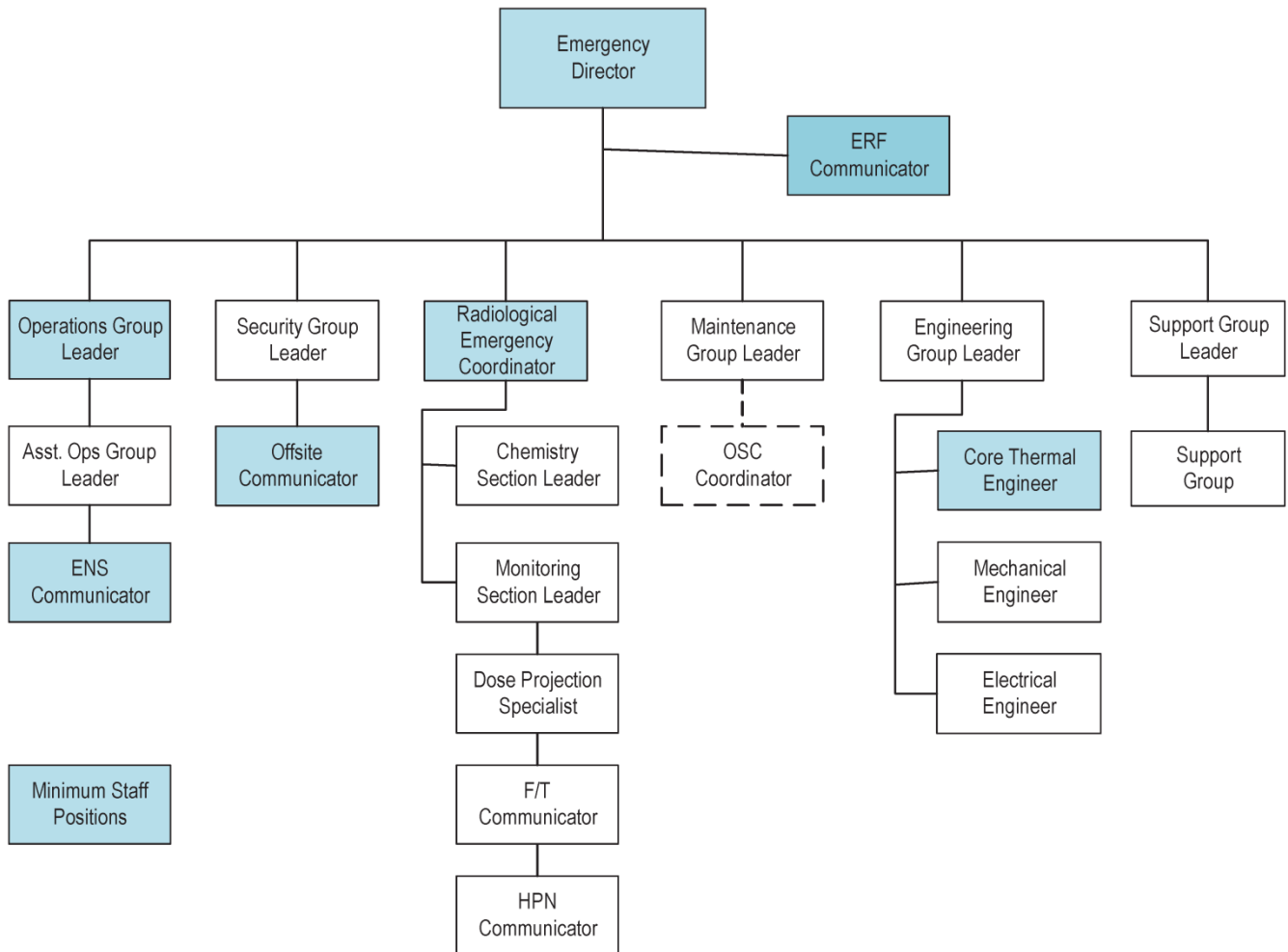

<b>MONTICELLO NUCLEAR GENERATING PLANT</b>		<b>E-PLAN</b>
<b>TITLE:</b>	<b>EMERGENCY PLAN</b>	Revision 54
		Page 110 of 120

Figure 13.1  
MONTICELLO PLANT EMERGENCY ORGANIZATION (CONT'D)

**Operational Support Center**  
 Positions Report Within 60 Minutes Unless Otherwise Indicated on Table 1

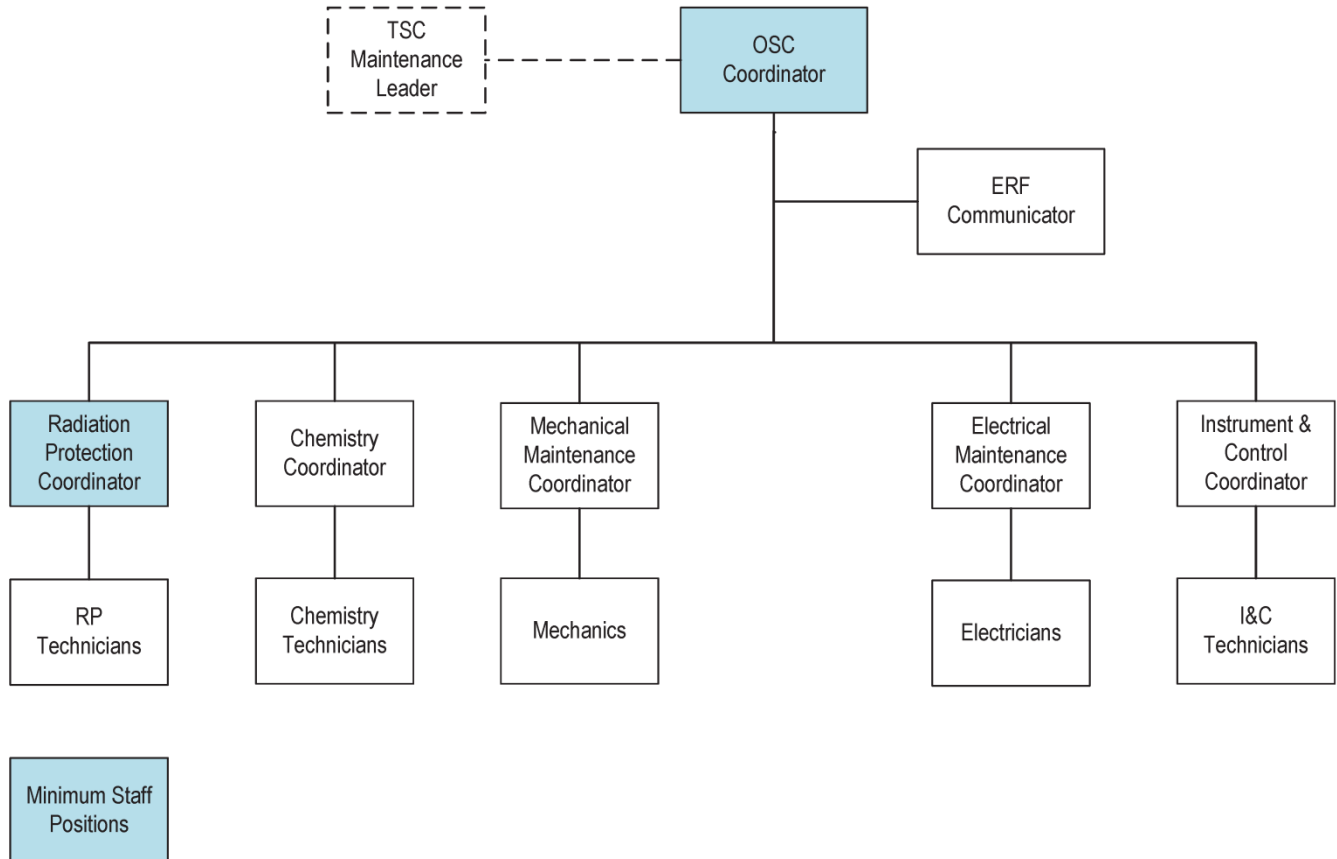

<b>MONTICELLO NUCLEAR GENERATING PLANT</b>		<b>E-PLAN</b>
<b>TITLE:</b>	<b>EMERGENCY PLAN</b>	Revision 54
		Page 111 of 120

Figure 13.1  
MONTICELLO PLANT EMERGENCY ORGANIZATION (CONT'D)

Emergency Operations Facility  
 Positions Report Within 90 Minutes

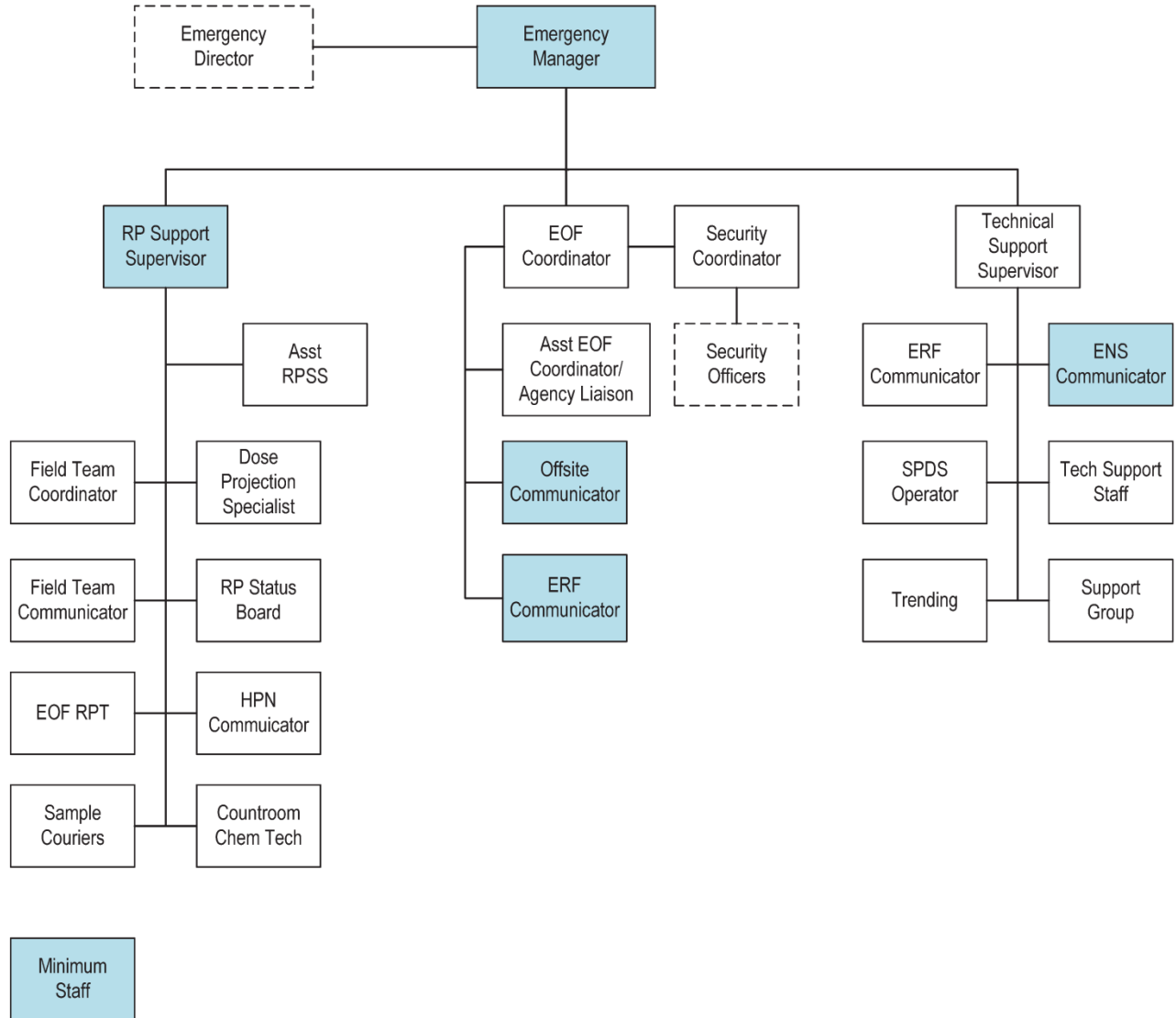

<b>MONTICELLO NUCLEAR GENERATING PLANT</b>		E-PLAN
<b>TITLE:</b>	<b>EMERGENCY PLAN</b>	Revision 54
		Page 112 of 120

Figure 13.2  
INTERFACE BETWEEN FUNCTIONAL AREAS OF EMERGENCY ACTIVITY

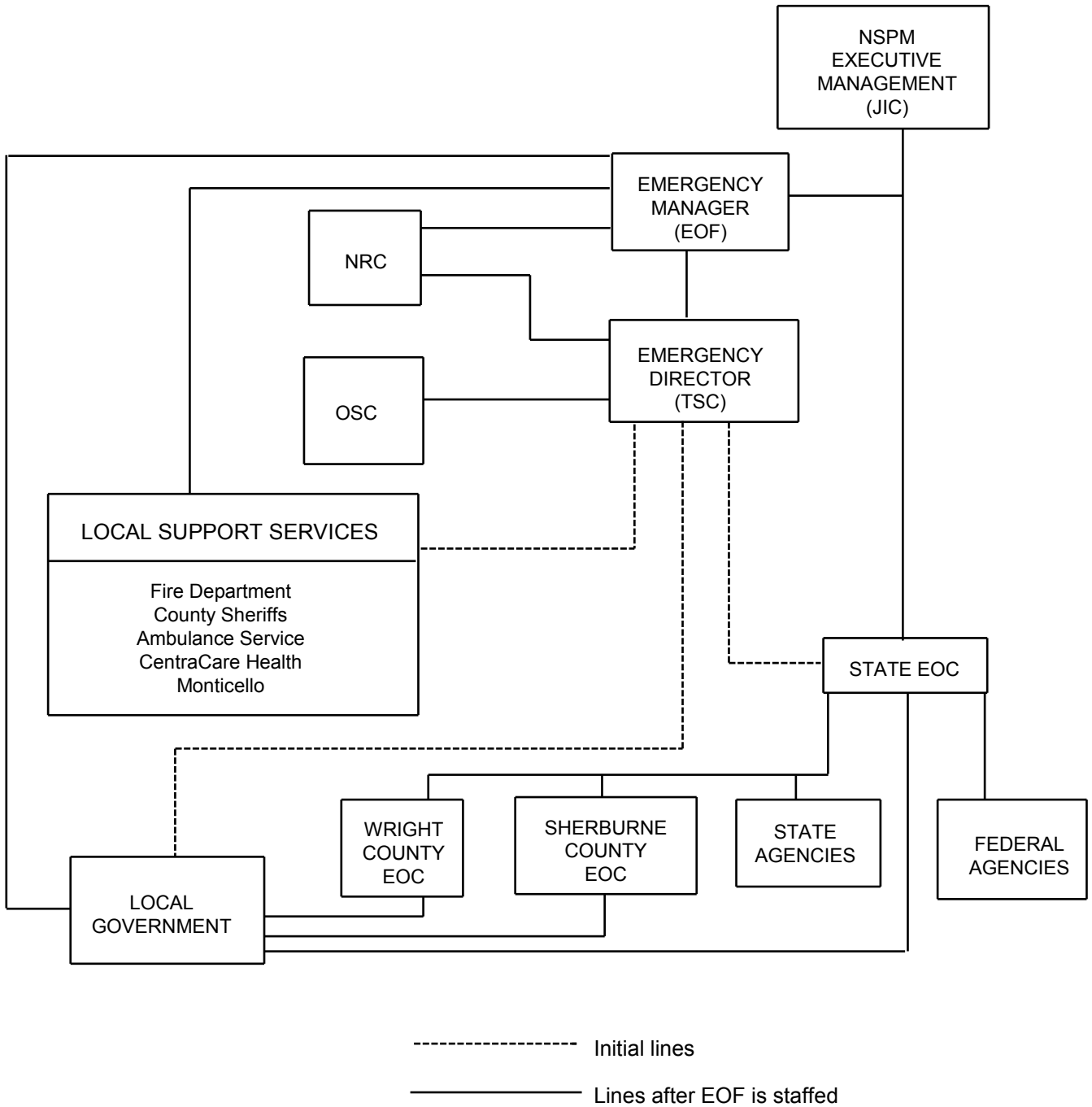

<b>MONTICELLO NUCLEAR GENERATING PLANT</b>		<b>E-PLAN</b>
<b>TITLE:</b>	<b>EMERGENCY PLAN</b>	Revision 54
		Page 113 of 120

Figure 13.3  
INTERFACE BETWEEN FUNCTIONAL AREAS OF EMERGENCY ACTIVITY DURING  
HOSTILE ACTION BASED EVENTS

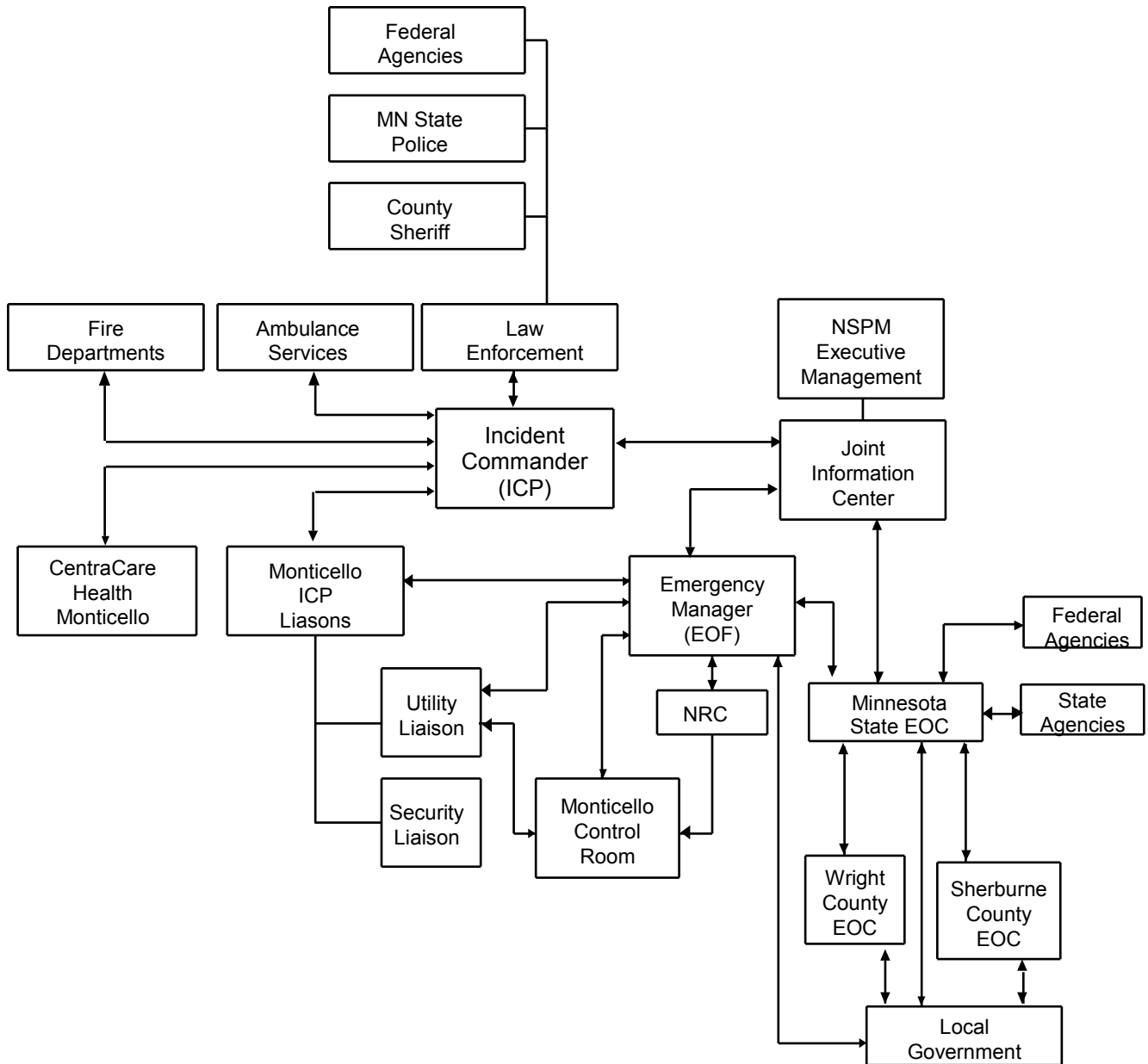

↔ Direct Interface

<b>MONTICELLO NUCLEAR GENERATING PLANT</b>		<b>E-PLAN</b>
<b>TITLE:</b>	<b>EMERGENCY PLAN</b>	Revision 54
		Page 114 of 120

Figure 13.4  
PLAN VIEW OF TECHNICAL SUPPORT CENTER, BACK-UP OPERATIONAL SUPPORT CENTER

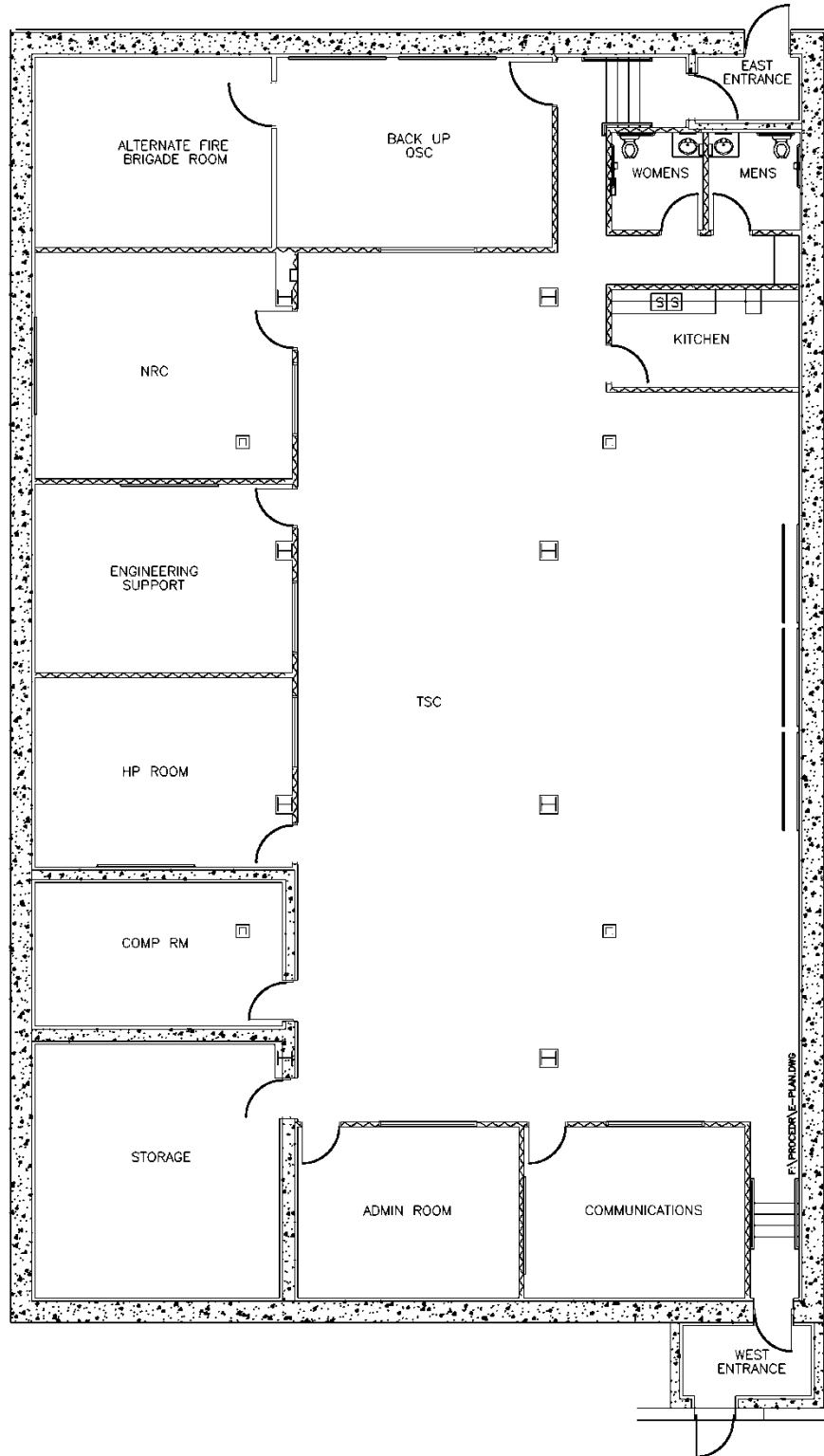

<b>MONTICELLO NUCLEAR GENERATING PLANT</b>		<b>E-PLAN</b>
<b>TITLE:</b>	<b>EMERGENCY PLAN</b>	Revision 54
		Page 115 of 120

**Figure 13.5  
PLAN VIEW OF THE EMERGENCY OPERATIONS FACILITY**



<b>MONTICELLO NUCLEAR GENERATING PLANT</b>		E-PLAN
<b>TITLE:</b>	<b>EMERGENCY PLAN</b>	Revision 54
		Page 116 of 120

Figure 13.6  
DIRECT DEDICATED TELEPHONES (HOT LINES)

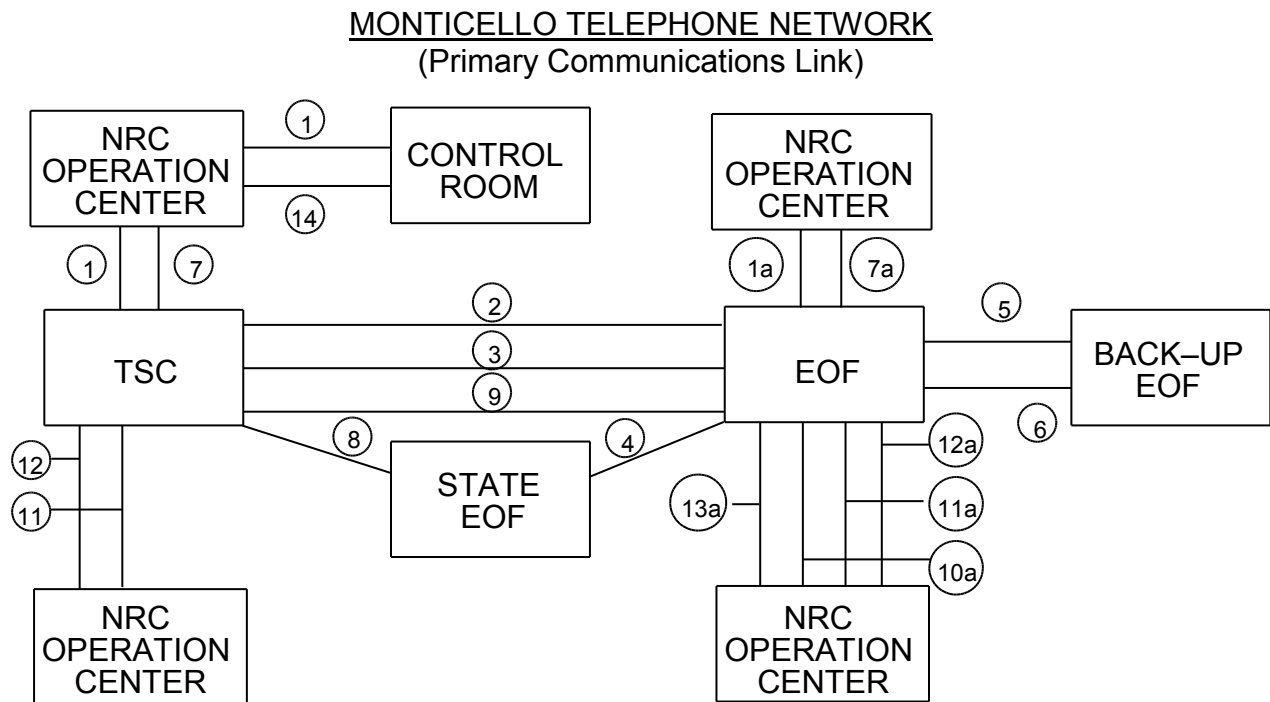

<u>Number</u>	<u>Name</u>	<u>Stations</u>
1	Emergency Notification System (ENS)	5 station FTS line between the Control Room, TSC, NRC Conference Room in TSC, NRC Office, and NRC Operations Center.
1a	ENS (EOF)	3 station FTS line between the EOF, EOF NRC work area, and NRC Operations Center.
2	EOF – TSC 1 (EM–ED)	2 station line between the EOF (EM) and TSC (ED).
3	EOF TSC 2 (RPSS–REC)	2 station line between the EOF (RPSS) and TSC (REC).
4	EOF – MN. State EOC (1)	3 station auto ring hotline between the EOF and the Minnesota State EOC. Either station can activate the circuit.
5	EOF – Back–Up EOF 1	2 station line between the EOF and the Back-Up EOF.

<b>MONTICELLO NUCLEAR GENERATING PLANT</b>		E-PLAN
<b>TITLE:</b>	<b>EMERGENCY PLAN</b>	Revision 54
		Page 117 of 120

Figure 13.6  
DIRECT DEDICATED TELEPHONES (HOT LINES) (CONT'D)

6	EOF – Back-Up EOF 2 (Tech Support)	2 station line between technical support groups at the EOF and the Back-Up EOF.
7	Health Physics Network (HPN)	4 station FTS line between the TSC, TSC Health Physics Room, NRC Conference Room in TSC, and NRC Operations Center.
7a	HPN	3 station FTS line between the EOF, EOF NRC work area and NRC Operation Center.
8	TSC – MN State EOC (1)	2 station auto ring hotline between the TSC and the Minnesota State EOC. Either station can activate the circuit.
9	EOF – TSC 3 (Tech Support)	2 station line between the Technical Support groups at the EOF and the TSC.
10a	Management Counterpart Link (DSO/STL)	2 Station FTS line between EOF and NRC Operations Center
11	Protective Measures Counterpart	2 station FTS line between NRC protective measures personnel at the site and NRC Operations Center.
11a	Protective Measures Counterpart Link (PMCL)	2 station FTS line at the EOF between NRC protective measures personnel at the EOF and NRC Operations Center.
12	Reactor Safety Counterpart Link (RSCL)	2 station FTS line between NRC reactor safety personnel at the site and NRC Operations Center.
12a	Reactor Safety Counterpart Link (RSCL)	2 station FTS line at the EOF between NRC reactor safety personnel at the EOF and NRC Operations Center.
13a	Local Area Network (LAN)	2 Station FTS line between EOF and NRC Operations Center
14	Emergency Response Data System (ERDS)	ERDS VPN channel link over which raw reactor process data is transmitted from the site.

(1) Auto-Ring Hotlines (Dedicated Private Lines). The interconnection of two or more telephones, which automatically ring the circuit when the telephone is removed from its cradle. This service can be provided intra-facility, intra-city, or inter-city. This is a full-period circuit which is available 24 hours a day with no limit to its use.

<b>MONTICELLO NUCLEAR GENERATING PLANT</b>		<b>E-PLAN</b>
<b>TITLE:</b>	<b>EMERGENCY PLAN</b>	Revision 54
		Page 118 of 120

Figure 13.7  
PLAN VIEW OF OPERATIONAL SUPPORT CENTER

PAB 1st Floor OSC Assembly Areas

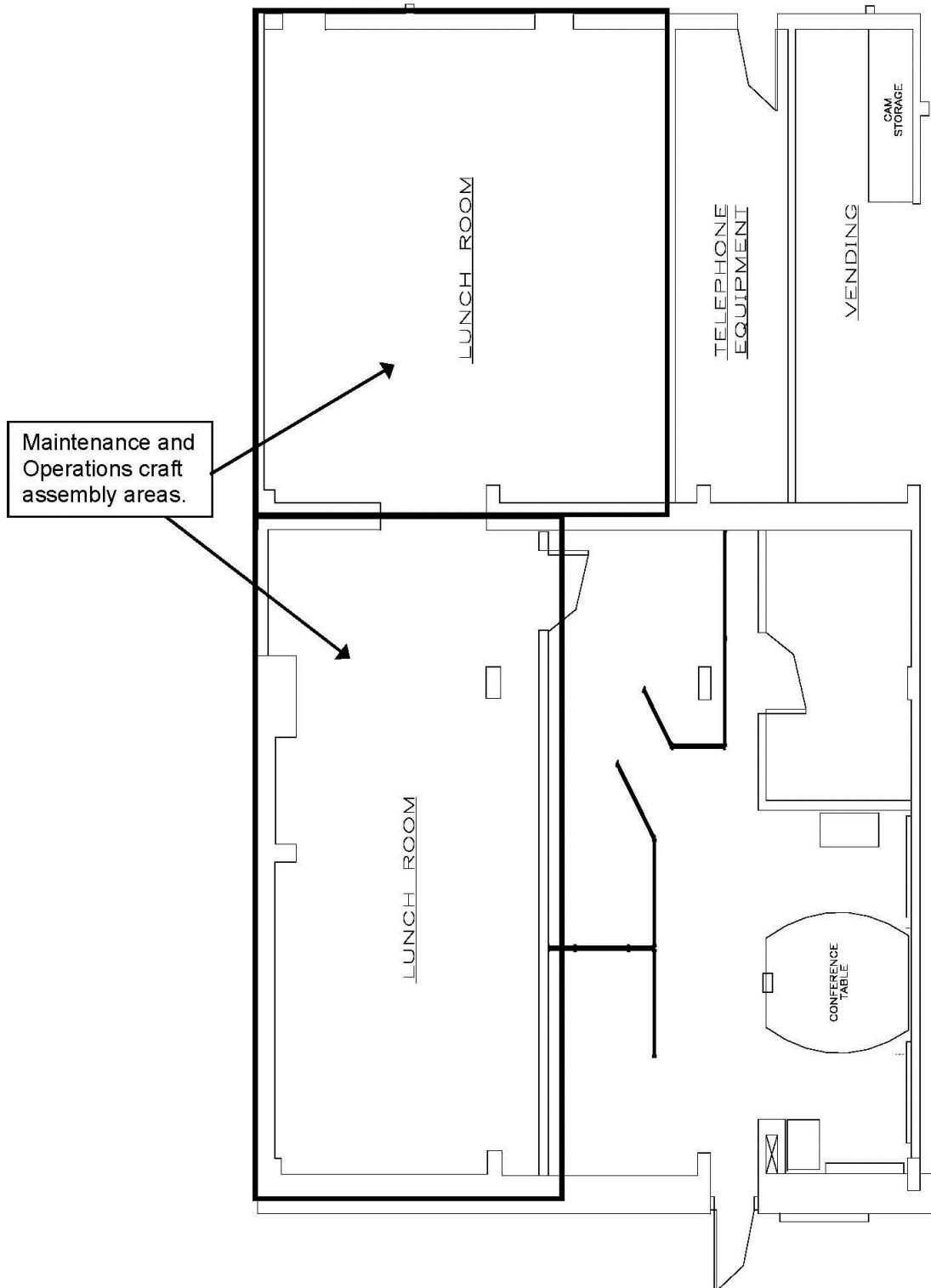

<b>MONTICELLO NUCLEAR GENERATING PLANT</b>		<b>E-PLAN</b>
<b>TITLE:</b>	<b>EMERGENCY PLAN</b>	Revision 54
		Page 119 of 120

Figure 13.7  
PLAN VIEW OF OPERATIONAL SUPPORT CENTER (CONT'D)  
PAB 2nd Floor OSC Command Center

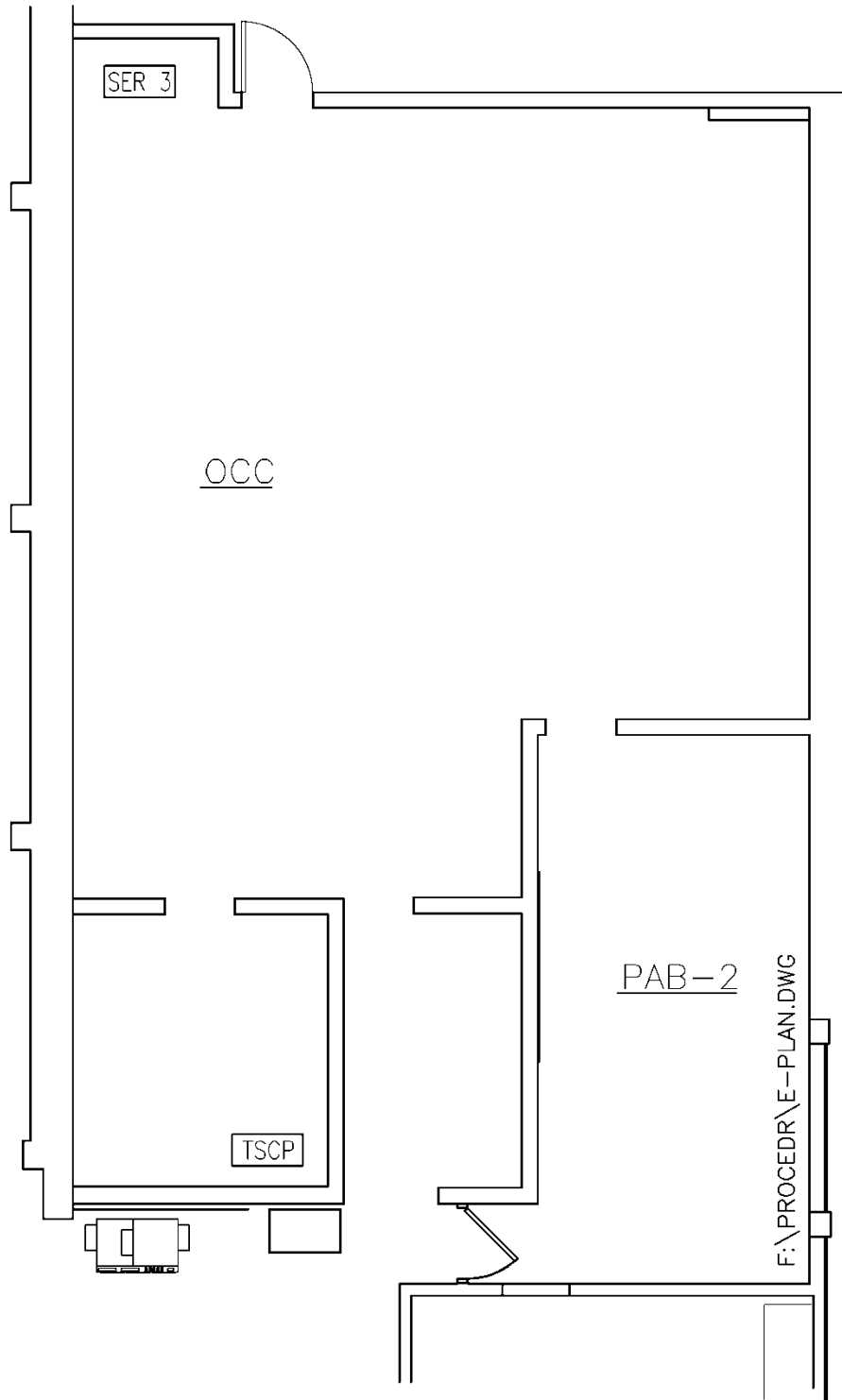

<b>MONTICELLO NUCLEAR GENERATING PLANT</b>		E-PLAN
<b>TITLE:</b>	<b>EMERGENCY PLAN</b>	Revision 54
		Page 120 of 120

Figure 13.8  
SUMMARY OF SIGNIFICANT CHANGES

<u>Section</u>	<u>Change and Reason for Change</u>
1.13	Update Emergency Worker definition to align with the definition given in current revision of FEMA P-1028 / December 2019.
6.5.5.2 & 6.6.3	Update terminology for individual dosimetry to align with current term used at MNGP (DLR and SRD).
7.3.1.1	Editorial clarifications and update to align with changes completed for EC19932 (PPCS Replacement).