

LaSalle UNITS 1 AND 2

UFSAR, REVISION 24

AND

FIRE PROTECTION REPORT (FPR), REVISION 9

**THE SECURITY SENSITIVE INFORMATION HAS BEEN REDACTED
FROM THE ORIGINAL DOCUMENT.**

THIS DOCUMENT PROVIDES THE REDACTED VERSION.

**THE REDACTED INFORMATION WITHIN THIS DOCUMENT
IS INDICATED BY SOLID BLACKEDOUT REGIONS.**

LSCS-UFSAR

CHAPTER 2.0 - SITE CHARACTERISTICS

TABLE OF CONTENTS

	<u>PAGE</u>
2.1 <u>GEOGRAPHY AND DEMOGRAPHY</u>	2.1-1
2.1.1 Site Location and Description	2.1-1
2.1.1.1 Specification of Location	2.1-1
2.1.1.2 Site Area Map	2.1-1
2.1.1.3 Boundaries for Establishing Effluent Release Limits	2.1-1
2.1.2 Exclusion Area Authority and Control	2.1-2
2.1.2.1 Authority	2.1-2
2.1.2.2 Control of Activities Unrelated to Plant Operation	2.1-2
2.1.2.3 Arrangements for Traffic Control	2.1-2
2.1.2.4 Abandonment or Relocation of Roads	2.1-3
2.1.3 Population Distribution	2.1-3
2.1.3.1 Population Within 10 Miles	2.1-4
2.1.3.2 Population Between 10 and 50 Miles	2.1-5
2.1.3.3 Transient Population	2.1-5
2.1.3.4 Low Population Zone	2.1-6
2.1.3.5 Population Centers	2.1-7
2.1.3.6 Population Density	2.1-7
2.1.4 References	2.1-7
2.2 <u>NEARBY INDUSTRIAL, TRANSPORTATION AND MILITARY FACILITIES</u>	2.2-1
2.2.1 Locations and Routes	2.2-1
2.2.2 Descriptions	2.2-1
2.2.2.1 Description of Facilities	2.2-1
2.2.2.2 Descriptions of Products and Materials	2.2-1
2.2.2.3 Pipelines	2.2-2
2.2.2.4 Waterways	2.2-2
2.2.2.5 Airports	2.2-3
2.2.2.6 Projections of Industrial Growth	2.2-3
2.2.3 Evaluation of Potential Accidents	2.2-4
2.2.3.1 Determination of Design-Basis Events	2.2-4
2.2.3.2 Effects of Design-Basis Events	2.2-5
2.2.4 References	2.2-7

LSCS-UFSAR
TABLE OF CONTENTS (Cont'd)

	<u>PAGE</u>
2.3 <u>METEOROLOGY</u>	2.3-1
2.3.1 Regional Climatology	2.3-1
2.3.1.1 General Climate	2.3-1
2.3.1.2 Regional Meteorological Conditions for Design and Operating Bases	2.3-2
2.3.1.2.1 Thunderstorms, Hail, and Lightning	2.3-3
2.3.1.2.2 Tornadoes	2.3-4
2.3.1.2.3 Sleet, Freezing Rain, and Glaze	2.3-5
2.3.1.2.4 Snow and Ice Loading	2.3-6
2.3.1.2.5 Ultimate Heat Sink Design Data	2.3-6
2.3.1.2.5.1 Original Ultimate Heat Sink Data	2.3-6
2.3.1.2.5.2 Power Uprate Ultimate Heat Sink Data	2.3-7
2.3.2 Local Meteorology	2.3-7
2.3.2.1 Data Sources	2.3-7
2.3.2.2 Normal and Extreme Values of Meteorological Parameters	2.3-7
2.3.2.2.1 Wind Summaries	2.3-7
2.3.2.2.2 Temperatures	2.3-10
2.3.2.2.3 Atmospheric Moisture	2.3-11
2.3.2.2.3.1 Relative Humidity	2.3-11
2.3.2.2.3.2 Wet Bulb Temperature	2.3-11
2.3.2.2.3.3 Dew-Point Temperature	2.3-12
2.3.2.2.4 Precipitation	2.3-12
2.3.2.2.4.1 Precipitation Measured as Water Equivalent	2.3-12
2.3.2.2.4.2 Precipitation Measured as Snow or Ice Pellets	2.3-12
2.3.2.2.5 Fog	2.3-13
2.3.2.2.6 Atmospheric Stability	2.3-14
2.3.2.3 Potential Influence of the Plant and Its Facilities on Local Meteorology	2.3-15
2.3.3 Meteorological Measurement Program and Radiological Environmental Monitoring Program	2.3-15
2.3.3.1 Meteorological Measurement Program	2.3-15
2.3.3.1.1 Instrumentation	2.3-16
2.3.3.1.2 Equipment Maintenance and Calibration Procedures	2.3-16
2.3.3.1.3 Meteorological Measurement Program During a Disaster	2.3-16
2.3.3.1.4 Data Analysis Procedure	2.3-16
2.3.3.2 Radiological Environmental Monitoring Program	2.3-16
2.3.4 Short-Term (Accident) Diffusion Estimates	2.3-17
2.3.4.1 Objective	2.3-17
2.3.4.2 Calculations	2.3-17
2.3.4.3 Atmospheric Diffusion Model	2.3-18
2.3.4.4 Regulatory Guide 1.145 Methodology	2.3-21

LSCS-UFSAR
TABLE OF CONTENTS (Cont'd)

	<u>PAGE</u>
2.3.4a Short-term (Accident) Diffusion Estimates (Alternate Source Term χ/Q Analysis)	2.3-24
2.3.4a.1 Objective	2.3-24
2.3.4a.2 Calculation of χ/Q at the EAB and LPZ	2.3-24
2.3.4a.2.1 PAVAN Meteorological Database	2.3-27
2.3.4a.2.2 PAVAN Input Parameters	2.3-28
2.3.4a.2.3 PAVAN EAB and LPZ χ/Q	2.3-29
2.3.4a.3 Calculation of χ/Q at the Control Room Intakes	2.3-30
2.3.4a.3.1 ARCON96 Model Analysis	2.3-30
2.3.4a.3.1.1 ARCON96 Meteorological Database	2.3-33
2.3.4a.3.1.2 ARCON96 Input Parameters	2.3-34
2.3.4a.3.1.3 ARCON96 Control Room Intake χ/Q	2.3-35
2.3.4a.3.2 PAVAN Model Analysis	2.3-36
2.3.4a.3.2.1 PAVAN Meteorological Database	2.3-36
2.3.4a.3.2.2 PAVAN Input Parameters	2.3-36
2.3.4a.3.2.3 PAVAN Control Room Intake χ/Q	2.3-37
2.3.4a.3.3 Control Room Intake χ/Q (In accordance with RG 1.194)	2.3-38
2.3.5 Long-Term (Routine) Diffusion Estimates	2.3-39
2.3.5.1 Objective	2.3-39
2.3.5.2 Calculations	2.3-39
2.3.6 References	2.3-40

LSCS-UFSAR
TABLE OF CONTENTS (Cont'd)

	<u>PAGE</u>
2.4 <u>HYDROLOGIC ENGINEERING</u>	2.4-1
2.4.1 Hydrologic Description	2.4-1
2.4.1.1 Site and Facilities	2.4-1
2.4.1.2 Hydrosphere	2.4-2
2.4.2 Floods	2.4-4
2.4.2.1 Flood History	2.4-4
2.4.2.2 Flood Design Considerations	2.4-4
2.4.2.3 Effects of Local Intense Precipitation	2.4-5
2.4.2.4 Site Drainage System	2.4-8
2.4.2.4.1 Storm Sewer System	2.4-8
2.4.2.4.2 Culverts	2.4-8
2.4.2.4.3 Ditches	2.4-9
2.4.3 Probable Maximum Flood (PMF) on Streams and Rivers	2.4-9
2.4.4 Potential Dam Failures, Seismically Induced	2.4-10
2.4.5 Probable Maximum Surge and Seiche Flooding	2.4-10
2.4.6 Probable Maximum Tsunami Flooding	2.4-10
2.4.7 Ice Flooding	2.4-10
2.4.8 Cooling Water Canals and Reservoirs	2.4-11
2.4.8.1 Capacity and Operating Plan for Cooling Lake	2.4-11
2.4.8.2 Probable Maximum Flood Design	2.4-11
2.4.8.2.1 Design Precipitation	2.4-11
2.4.8.2.2 Infiltration Losses and Rainfall Excess	2.4-12
2.4.8.2.3 Unit Hydrograph	2.4-12
2.4.8.2.4 Development of SPF and PMF Hydrographs	2.4-13
2.4.8.2.5 Reservoir Routing	2.4-14
2.4.8.2.6 Stillwater Levels in Lake	2.4-14
2.4.8.2.7 Auxiliary Spillway Design	2.4-14
2.4.8.2.8 Coincident Wind Wave Activity	2.4-17
2.4.8.3 Water Level at Plant Site	2.4-18
2.4.8.4 Blowdown Waterline	2.4-18
2.4.8.5 Service Spillway	2.4-19
2.4.8.6 Makeup Water Discharge Structure	2.4-19
2.4.9 Channel Diversions	2.4-19
2.4.10 Flooding Protection Requirements	2.4-20
2.4.11 Low Water Considerations	2.4-20
2.4.11.1 Low Flows in Streams	2.4-20
2.4.11.2 Low Water Resulting from Surges, Seiches, or Tsunami	2.4-21
2.4.11.3 Historical Low Water	2.4-21
2.4.11.4 Future Controls	2.4-21
2.4.11.5 Plant Requirements	2.4-21
2.4.11.6 Heat Sink Dependability Requirements	2.4-21

LSCS-UFSAR
TABLE OF CONTENTS (Cont'd)

	<u>PAGE</u>
2.4.12 Dispersion, Dilution, and Travel Times of Accidental Releases of Liquid Effluents in Surface Water	2.4-23
2.4.13 Groundwater	2.4-23
2.4.13.1 Description and Onsite Use	2.4-23
2.4.13.1.1 Regional Hydrogeologic Systems	2.4-23
2.4.13.1.1.1 Alluvial Aquifer	2.4-24
2.4.13.1.1.2 Glacial Drift Aquitard	2.4-25
2.4.13.1.1.3 Buried Bedrock Valley Aquifers	2.4-26
2.4.13.1.1.4 Pennsylvanian Aquitard	2.4-27
2.4.13.1.1.5 Cambrian-Ordovician Aquifer	2.4-28
2.4.13.1.1.6 Eau Claire Aquitard	2.4-31
2.4.13.1.1.7 Mt. Simon Aquifer	2.4-31
2.4.13.1.2 Site Hydrogeologic Systems	2.4-31
2.4.13.1.2.1 Alluvial Aquifer	2.4-32
2.4.13.1.2.2 Glacial Drift Aquitard	2.4-33
2.4.13.1.2.3 Buried Bedrock Valley Aquifers	2.4-34
2.4.13.1.2.4 Pennsylvanian Aquitard	2.4-35
2.4.13.1.2.5 Cambrian-Ordovician Aquifer	2.4-36
2.4.13.1.3 Onsite Use of Groundwater	2.4-37
2.4.13.2 Sources	2.4-37
2.4.13.2.1 Regional Groundwater	2.4-37
2.4.13.2.1.1 Present Use	2.4-37
2.4.13.2.1.2 Projected Future Use	2.4-38
2.4.13.2.1.3 Regional Flow and Gradients	2.4-38
2.4.13.2.1.3.1 Alluvial Aquifer	2.4-38
2.4.13.2.1.3.2 Buried Bedrock Valley Aquifers	2.4-39
2.4.13.2.1.3.3 Cambrian-Ordovician Aquifer	2.4-39
2.4.13.2.1.3.4 Mt. Simon Aquifer	2.4-41
2.4.13.2.2 Site Groundwater	2.4-42
2.4.13.2.2.1 Present Use	2.4-42
2.4.13.2.2.2 Projected Future Use	2.4-42
2.4.13.2.2.3 Site Flow and Gradients	2.4-43
2.4.13.2.2.3.1 Alluvial Aquifer	2.4-43
2.4.13.2.2.3.2 Glacial Drift Aquitard	2.4-43
2.4.13.2.2.3.3 Buried Bedrock Valley Aquifers	2.4-45
2.4.13.2.2.3.4 Pennsylvanian Aquitard	2.4-45
2.4.13.2.2.3.5 Cambrian-Ordovician Aquifer	2.4-46
2.4.13.3 Accident Effects	2.4-48
2.4.13.4 Monitoring or Safeguard Requirements	2.4-48
2.4.13.5 Design Bases for Hydrostatic Loading	2.4-48
2.4.14 Technical Specification and Emergency Operation Requirements	2.4-49
2.4.15 References	2.4-49

LSCS-UFSAR
TABLE OF CONTENTS (Cont'd)

	<u>PAGE</u>
2.5 <u>GEOLOGY, SEISMOLOGY, AND GEOTECHNICAL ENGINEERING</u>	2.5-1
2.5.1 Basic Geologic and Seismic Information	2.5-1
2.5.1.1 Regional Geology	2.5-2
2.5.1.1.1 Regional Physiography	2.5-2
2.5.1.1.1.1 Interior Plains Physiographic Division	2.5-3
2.5.1.1.1.1.1 Central Lowland Province	2.5-3
2.5.1.1.1.1.1.1 Till Plains Section	2.5-3
2.5.1.1.1.1.1.2 Great Lakes Section	2.5-5
2.5.1.1.1.1.1.3 Wisconsin Driftless Section	2.5-7
2.5.1.1.1.1.1.4 Dissected Till Plains Section	2.5-7
2.5.1.1.1.1.1.5 Western Young Drift Section	2.5-7
2.5.1.1.1.1.2 Interior Low Plateaus Province	2.5-8
2.5.1.1.1.2 Interior Highlands Physiographic Division	2.5-8
2.5.1.1.1.2.1 Ozark Plateaus Province	2.5-8
2.5.1.1.1.2.1.1 Lincoln Hills Section	2.5-8
2.5.1.1.1.2.1.2 Salem Plateau Section	2.5-9
2.5.1.1.2 Regional Geologic Setting	2.5-9
2.5.1.1.3 Regional Stratigraphy	2.5-9
2.5.1.1.3.1 Cenozoic Erathem	2.5-10
2.5.1.1.3.1.1 Quaternary System	2.5-10
2.5.1.1.3.1.2 Tertiary System	2.5-10
2.5.1.1.3.2 Mesozoic Erathem	2.5-10
2.5.1.1.3.2.1 Cretaceous System	2.5-10
2.5.1.1.3.2.2 Jurassic System	2.5-11
2.5.1.1.3.2.3 Triassic System	2.5-11
2.5.1.1.3.3 Paleozoic Erathem	2.5-11
2.5.1.1.3.3.1 Permian System	2.5-11
2.5.1.1.3.3.2 Pennsylvanian System	2.5-11
2.5.1.1.3.3.3 Mississippian System	2.5-11
2.5.1.1.3.3.4 Devonian System	2.5-11
2.5.1.1.3.3.5 Silurian System	2.5-12
2.5.1.1.3.3.6 Ordovician System	2.5-12
2.5.1.1.3.3.7 Cambrian System	2.5-12
2.5.1.1.3.4 Precambrian Basement Complex	2.5-13
2.5.1.1.4 Historical Geology	2.5-13
2.5.1.1.4.1 Precambrian Era	2.5-13
2.5.1.1.4.2 Paleozoic Era	2.5-14
2.5.1.1.4.2.1 Cambrian Period	2.5-14
2.5.1.1.4.2.2 Ordovician Period	2.5-14
2.5.1.1.4.2.3 Silurian Period	2.5-15
2.5.1.1.4.2.4 Devonian Period	2.5-15

LSCS-UFSAR
TABLE OF CONTENTS (Cont'd)

		<u>PAGE</u>
2.5.1.1.4.2.5	Mississippian Period	2.5-16
2.5.1.1.4.2.6	Pennsylvanian Period	2.5-16
2.5.1.1.4.2.7	Permian Period	2.5-16
2.5.1.1.4.3	Mesozoic Era	2.5-17
2.5.1.1.4.3.1	Triassic Period	2.5-17
2.5.1.1.4.3.2	Jurassic Period	2.5-17
2.5.1.1.4.3.3	Cretaceous Period	2.5-17
2.5.1.1.4.4	Cenozoic Era	2.5-17
2.5.1.1.4.4.1	Tertiary Period	2.5-17
2.5.1.1.4.4.2	Quaternary Period	2.5-17
2.5.1.1.5	Regional Structural Geology	2.5-18
2.5.1.1.5.1	Regional Tectonic Features	2.5-19
2.5.1.1.5.1.1	Basins, Arches, and Domes	2.5-20
2.5.1.1.5.1.1.1	Wisconsin Dome	2.5-20
2.5.1.1.5.1.1.2	Wisconsin Arch	2.5-20
2.5.1.1.5.1.1.3	Ashton Arch	2.5-21
2.5.1.1.5.1.1.4	Illinois Basin	2.5-21
2.5.1.1.5.1.1.5	LaSalle Anticlinal Belt	2.5-22
2.5.1.1.5.1.1.6	Sangamon Arch	2.5-22
2.5.1.1.5.1.1.7	DuQuoin Monocline	2.5-22
2.5.1.1.5.1.1.8	Mississippi River Arch	2.5-22
2.5.1.1.5.1.1.9	Lincoln Fold	2.5-23
2.5.1.1.5.1.1.10	Cap au Gres Faulted Flexure	2.5-23
2.5.1.1.5.1.1.11	Kankakee Arch	2.5-23
2.5.1.1.5.1.1.12	Michigan Basin	2.5-24
2.5.1.1.5.1.2	Faults	2.5-24
2.5.1.1.5.1.2.1	Faults in the Mississippi Valley of Wisconsin	2.5-24
2.5.1.1.5.1.2.2	Other Postulated Faults in Wisconsin	2.5-25
2.5.1.1.5.1.2.3	Sandwich Fault Zone	2.5-25
2.5.1.1.5.1.2.4	Plum River Fault Zone	2.5-26
2.5.1.1.5.1.2.5	Faults in the Chicago Metropolitan Area	2.5-26
2.5.1.1.5.1.2.6	Centralia Fault	2.5-26
2.5.1.1.5.1.2.7	St. Louis Fault	2.5-27
2.5.1.1.5.1.2.8	Cap au Gres Faulted Flexure	2.5-27
2.5.1.1.5.1.2.9	Fortville Fault	2.5-27
2.5.1.1.5.1.2.10	Royal Center Fault	2.5-28
2.5.1.1.5.1.2.11	Mt. Carmel Fault	2.5-28
2.5.1.1.5.1.2.12	Minor Faulting in the Site Area	2.5-28
2.5.1.1.5.1.2.13	Cryptovolcanic or Astrobleme Structures	2.5-29
2.5.1.1.5.1.2.14	Other Postulated Faults	2.5-30
2.5.1.1.5.1.3	Folds	2.5-30
2.5.1.1.5.1.3.1	Northwest-Southeast Folds	2.5-30
2.5.1.1.5.1.3.1.1	LaSalle Anticlinal Belt	2.5-31
2.5.1.1.5.1.3.1.2	Leesville Anticline	2.5-31

LSCS-UFSAR
TABLE OF CONTENTS (Cont'd)

		<u>PAGE</u>
2.5.1.1.5.1.3.1.3	Dupo Anticline	2.5-31
2.5.1.1.5.1.3.1.4	Pittsfield-Hadley Anticline	2.5-32
2.5.1.1.5.1.3.1.5	Folds in Southeastern Iowa	2.5-32
2.5.1.1.5.1.3.2	North-South Folds	2.5-32
2.5.1.1.5.1.3.2.1	DuQuoin Monocline	2.5-32
2.5.1.1.5.1.3.2.2	Salem and Loudon Anticlines	2.5-33
2.5.1.1.5.1.3.2.3	Clay City Anticline	2.5-33
2.5.1.1.5.1.3.3	Northeast-Southwest Folds	2.5-33
2.5.1.1.5.1.3.3.1	Baraboo Syncline	2.5-34
2.5.1.1.5.1.3.4	East-West Folds	2.5-34
2.5.1.1.5.1.3.4.1	Upper Mississippi Valley Folds	2.5-34
2.5.1.1.6	Regional Structure	2.5-35
2.5.1.1.6.1	Regional Tectonic Structures	2.5-35
2.5.1.1.6.2	Regional Karst	2.5-35
2.5.1.1.6.3	Landslides	2.5-35
2.5.1.1.6.4	Man's Activities	2.5-36
2.5.1.1.6.5	Regional Warping	2.5-37
2.5.1.1.6.6	Regional Groundwater Conditions	2.5-37
2.5.1.2	Site Geology	2.5-37
2.5.1.2.1	Site Physiography	2.5-39
2.5.1.2.1.1	Uplands	2.5-39
2.5.1.2.1.2	Valley Bottom	2.5-40
2.5.1.2.1.3	Site Karst	2.5-41
2.5.1.2.2	Site Stratigraphy	2.5-41
2.5.1.2.2.1	Soil	2.5-41
2.5.1.2.2.1.1	Uplands	2.5-41
2.5.1.2.2.1.1.1	Cenozoic Erathem	2.5-42
2.5.1.2.2.1.1.1.1	Quaternary System	2.5-42
2.5.1.2.2.1.1.1.1.1	Pleistocene Series	2.5-42
2.5.1.2.2.1.1.1.1.1.1	Cahokia Alluvium	2.5-42
2.5.1.2.2.1.1.1.1.1.2	Peyton Colluvium	2.5-42
2.5.1.2.2.1.1.1.1.1.3	Richland Loess	2.5-42
2.5.1.2.2.1.1.1.1.1.4	Wedron Formation	2.5-42
2.5.1.2.2.1.1.1.1.1.4.1	Yorkville Till Member	2.5-43
2.5.1.2.2.1.1.1.1.1.4.2	Malden Till Member	2.5-43
2.5.1.2.2.1.1.1.1.1.4.3	Tiskilwa Till Member	2.5-44
2.5.1.2.2.1.1.1.1.1.5	Buried Bedrock Valley Fill	2.5-44
2.5.1.2.2.1.2	Valley Bottoms	2.5-44
2.5.1.2.2.1.2.1	Cenozoic Erathem	2.5-45
2.5.1.2.2.1.2.1.1	Quaternary System	2.5-45
2.5.1.2.2.1.2.1.1.1	Pleistocene Series	2.5-45
2.5.1.2.2.1.2.1.1.1.1	Grayslake Peat	2.5-45
2.5.1.2.2.1.2.1.1.1.2	Peyton Colluvium	2.5-45

LSCS-UFSAR
TABLE OF CONTENTS (Cont'd)

		<u>PAGE</u>
2.5.1.2.2.1.2.1.1.1.3	Cahokia Alluvium	2.5-45
2.5.1.2.2.1.2.1.1.1.4	Henry Formation	2.5-46
2.5.1.2.2.1.3	Soil Conservation Service Soil Series	2.5-46
2.5.1.2.2.2	Rock	2.5-46
2.5.1.2.2.2.1	Paleozoic Erathem	2.5-47
2.5.1.2.2.2.1.1	Pennsylvanian System	2.5-47
2.5.1.2.2.2.1.1.1	Des Moinesian Series	2.5-47
2.5.1.2.2.2.1.1.1.1	Kewanee Group	2.5-47
2.5.1.2.2.2.1.1.1.1.1	Carbondale Formation	2.5-48
2.5.1.2.2.2.1.1.1.1.2	Spoon Formation	2.5-48
2.5.1.2.2.2.1.2	Ordovician System	2.5-49
2.5.1.2.2.2.1.2.1	Champlainian Series	2.5-49
2.5.1.2.2.2.1.2.1.1	Blackriveran Stage	2.5-49
2.5.1.2.2.2.1.2.1.1.1	Platteville Group	2.5-49
2.5.1.2.2.2.1.2.1.1.1.1	Nachusa Formation	2.5-49
2.5.1.2.2.2.1.2.1.1.1.2	Grand Detour Formation	2.5-49
2.5.1.2.2.2.1.2.1.1.1.3	Mifflin Formation	2.5-50
2.5.1.2.2.2.1.2.1.1.1.4	Pecatonica Formation	2.5-50
2.5.1.2.2.2.1.2.1.1.2	Ancell Group	2.5-50
2.5.1.2.2.2.1.2.1.1.2.1	Glenwood Formation	2.5-50
2.5.1.2.2.2.1.2.1.1.2.2	St. Peter Sandstone	2.5-50
2.5.1.2.2.2.1.2.2	Canadian Series	2.5-50
2.5.1.2.2.2.1.2.2.1	Prairie du Chien Group	2.5-50
2.5.1.2.2.2.1.2.2.1.1	Shakopee Dolomite	2.5-50
2.5.1.2.2.2.1.2.2.1.2	New Richmond Sandstone	2.5-51
2.5.1.2.2.2.1.2.2.1.3	Oneota Dolomite	2.5-51
2.5.1.2.2.2.1.2.2.1.4	Gunter Sandstone	2.5-51
2.5.1.2.2.2.1.3	Cambrian System	2.5-51
2.5.1.2.2.2.1.3.1	Croixan Series	2.5-51
2.5.1.2.2.2.1.3.1.1	Trempealeauan Stage	2.5-51
2.5.1.2.2.2.1.3.1.1.1	Eminence Formation	2.5-51
2.5.1.2.2.2.1.3.1.1.2	Potosi Dolomite	2.5-51
2.5.1.2.2.2.1.3.1.2	Franconian Stage	2.5-52
2.5.1.2.2.2.1.3.1.2.1	Franconia Formation	2.5-52
2.5.1.2.2.2.1.3.1.2.2	Ironton Sandstone	2.5-52
2.5.1.2.2.2.1.3.1.3	Dresbachian Stage	2.5-52
2.5.1.2.2.2.1.3.1.3.1	Galesville Sandstone	2.5-52
2.5.1.2.2.2.1.3.1.3.2	Eau Claire Formation	2.5-52
2.5.1.2.2.2.1.3.1.3.3	Mt. Simon Sandstone	2.5-53
2.5.1.2.2.2.1.4	Precambrian Basement Complex	2.5-53
2.5.1.2.3	Bedrock Topography	2.5-53
2.5.1.2.4	Site Structural Geology	2.5-53

LSCS-UFSAR
TABLE OF CONTENTS (Cont'd)

		<u>PAGE</u>
2.5.1.2.4.1	Site Folding	2.5-54
2.5.1.2.4.2	Site Jointing	2.5-54
2.5.1.2.4.3	Site Faulting	2.5-55
2.5.1.2.5	Geologic Map	2.5-55
2.5.1.2.6	Site Historical Geology	2.5-55
2.5.1.2.6.1	Paleozoic Era	2.5-56
2.5.1.2.6.1.1	Cambrian Period	2.5-56
2.5.1.2.6.1.2	Ordovician Period	2.5-56
2.5.1.2.6.1.3	Silurian Period through Mississippian Period	2.5-57
2.5.1.2.6.1.4	Pennsylvanian Period	2.5-57
2.5.1.2.6.1.5	Permian Period	2.5-57
2.5.1.2.6.2	Mesozoic Era	2.5-57
2.5.1.2.6.3	Cenozoic Era	2.5-58
2.5.1.2.6.3.1	Tertiary Period	2.5-58
2.5.1.2.6.3.2	Quaternary Period	2.5-58
2.5.1.2.7	Plot Plan	2.5-60
2.5.1.2.8	Geologic Profiles	2.5-60
2.5.1.2.9	Excavation and Backfill	2.5-60
2.5.1.2.10	Engineering Geology	2.5-60
2.5.1.2.10.1	Soil and Rock Behavior During Prior Earthquakes	2.5-61
2.5.1.2.10.2	Evaluation of Joints Relative to Structural Foundations	2.5-61
2.5.1.2.10.3	Evaluation of Weathering Profiles and Zones of Alteration or Structural Weakness	2.5-61
2.5.1.2.10.4	Unrelieved Residual Stresses in Bedrock	2.5-61
2.5.1.2.10.5	Stability of Soil and Rock	2.5-61
2.5.1.2.10.6	Effects of Man's Activities	2.5-61
2.5.1.2.11	Site Groundwater Conditions	2.5-61
2.5.1.2.12	Geophysical Investigations	2.5-62
2.5.1.2.13	Soil and Rock Properties	2.5-62
2.5.2	Vibratory Ground Motion	2.5-62
2.5.2.1	Seismicity	2.5-62
2.5.2.2	Geologic Structures and Tectonic Activity	2.5-63
2.5.2.3	Correlation of Earthquake Activity with Geologic Structures or Tectonic Provinces	2.5-63
2.5.2.3.1	The New Madrid Area	2.5-64
2.5.2.3.2	The Wabash Valley Area	2.5-64
2.5.2.3.3	The St. Louis Area	2.5-64
2.5.2.3.4	The Keweenaw Peninsula	2.5-64
2.5.2.3.5	Anna, Ohio, Seismogenic Region	2.5-65
2.5.2.4	Maximum Earthquake Potential	2.5-66
2.5.2.5	Seismic Wave Transmission Characteristics of the Site	2.5-69
2.5.2.6	Safe Shutdown Earthquake	2.5-70
2.5.2.7	Operating-Basis Earthquake	2.5-70

LSCS-UFSAR
TABLE OF CONTENTS (Cont'd)

		<u>PAGE</u>
2.5.3	Surface Faulting	2.5-70
2.5.3.1	Geologic Conditions of the Site	2.5-71
2.5.3.2	Evidence of Fault Offset	2.5-71
2.5.3.3	Earthquakes Associated with Capable Faults	2.5-71
2.5.3.4	Investigation of Capable Faults	2.5-71
2.5.3.5	Correlation of Epicenters with Capable Faults	2.5-71
2.5.3.6	Description of Capable Faults	2.5-71
2.5.3.7	Zone Requiring Detailed Faulting Investigation	2.5-71
2.5.3.8	Results of Faulting Investigation	2.5-71
2.5.4	Stability of Subsurface Materials and Foundations	2.5-72
2.5.4.1	Geologic Features	2.5-72
2.5.4.2	Properties of Subsurface Materials	2.5-72
2.5.4.2.1	Field Investigations	2.5-72
2.5.4.2.2	Laboratory Tests	2.5-73
2.5.4.2.2.1	Static Tests	2.5-73
2.5.4.2.2.1.1	Direct Shear Tests	2.5-73
2.5.4.2.2.1.2	Unconfined Compression Tests	2.5-74
2.5.4.2.2.1.3	Triaxial Compression Tests	2.5-74
2.5.4.2.2.1.4	Compaction Tests	2.5-75
2.5.4.2.2.1.5	Consolidation Tests	2.5-75
2.5.4.2.2.1.6	Permeability Tests	2.5-75
2.5.4.2.2.1.7	Particle Size Analyses	2.5-76
2.5.4.2.2.1.8	Atterberg Limits	2.5-76
2.5.4.2.2.1.9	Moisture Determinations	2.5-76
2.5.4.2.2.1.10	Density Determinations	2.5-76
2.5.4.2.2.2	Dynamic Tests	2.5-76
2.5.4.2.2.2.1	Cyclic Triaxial Compression Tests	2.5-76
2.5.4.2.2.2.2	Resonant Column Tests	2.5-77
2.5.4.2.2.2.3	Shockscope Tests	2.5-77
2.5.4.3	Exploration	2.5-77
2.5.4.3.1	Geologic Reconnaissance	2.5-78
2.5.4.3.2	Soil and Rock Borings	2.5-78
2.5.4.3.3	Test Pits	2.5-78
2.5.4.3.4	Groundwater Measurements	2.5-79
2.5.4.3.5	Geophysical Measurements	2.5-79
2.5.4.4	Geophysical Surveys	2.5-79
2.5.4.4.1	Refraction Surveys	2.5-80
2.5.4.4.2	Shear Wave Velocity Survey	2.5-80
2.5.4.4.3	Surface Wave Survey	2.5-80
2.5.4.4.4	Micromotion Studies	2.5-81
2.5.4.5	Excavations and Backfill	2.5-81
2.5.4.5.1	Excavations	2.5-81
2.5.4.5.1.1	Main Plant Site	2.5-82
2.5.4.5.1.2	Seismic Category I Pipelines	2.5-83

LSCS-UFSAR
TABLE OF CONTENTS (Cont'd)

		<u>PAGE</u>
2.5.4.5.1.3	Seismic Category I Intake Flume and Pond	2.5-83
2.5.4.5.1.3.1	Outwash Deposit	2.5-84
2.5.4.5.1.3.2	Lacustrine Deposit	2.5-84
2.5.4.5.2	Backfill	2.5-84
2.5.4.5.2.1	Main Plant Site	2.5-85
2.5.4.5.2.2	Seismic Category I Pipelines	2.5-85
2.5.4.5.2.3	Seismic Category I Intake Flume and Pond	2.5-86
2.5.4.6	Groundwater Conditions	2.5-86
2.5.4.7	Response of Soil and Rock to Dynamic Loading	2.5-86
2.5.4.8	Liquefaction Potential	2.5-86
2.5.4.8.1	Sand Deposit Under Main Plant Foundation	2.5-87
2.5.4.8.1.1	Subsurface Conditions	2.5-87
2.5.4.8.1.2	Soil Characteristics Influencing Liquefaction	2.5-87
2.5.4.8.1.3	Liquefaction Potential of Sand Deposit	2.5-88
2.5.4.8.1.4	Conclusions	2.5-89
2.5.4.8.2	Sand Deposits in Intake Flume Slopes	2.5-90
2.5.4.8.3	Liquefaction Potential of Isolated Sand Deposits	2.5-90
2.5.4.9	Earthquake Design Basis	2.5-90
2.5.4.10	Static Stability	2.5-90
2.5.4.10.1	Main Plant Structures	2.5-91
2.5.4.10.1.1	Bearing Capacity	2.5-91
2.5.4.10.1.2	Settlement Analyses	2.5-92
2.5.4.10.1.3	Lateral Pressures	2.5-94
2.5.4.10.1.3.1	Static Lateral Pressures	2.5-94
2.5.4.10.1.3.1.1	Static Earth Pressures	2.5-94
2.5.4.10.1.3.1.2	Static Water Pressure	2.5-95
2.5.4.10.1.3.2	Incremental Dynamic Lateral Pressures	2.5-95
2.5.4.10.1.3.2.1	Dynamic Earth Pressure	2.5-95
2.5.4.10.1.3.2.2	Incremental Dynamic Water Pressure	2.5-96
2.5.4.10.2	Seismic Category I Pipelines	2.5-97
2.5.4.10.2.1	Bearing Capacity	2.5-98
2.5.4.10.2.2	Settlement	2.5-98
2.5.4.10.2.3	Lateral and Vertical Pressures	2.5-98
2.5.4.10.3	Seismic Category I Intake Flume and Pond	2.5-98
2.5.4.10.3.1	Bearing Capacity	2.5-99
2.5.4.10.3.2	Settlement Analyses	2.5-99
2.5.4.10.3.3	Lateral Pressures	2.5-100
2.5.4.11	Design Criteria	2.5-101
2.5.4.12	Techniques to Improve Subsurface Conditions	2.5-101
2.5.4.13	Subsurface Instrumentation	2.5-101
2.5.4.14	Construction Notes	2.5-102
2.5.5	Stability of Slopes	2.5-102
2.5.5.1	Slope Characteristics	2.5-103
2.5.5.2	Design Criteria and Analyses	2.5-103

LSCS-UFSAR
TABLE OF CONTENTS (Cont'd)

		<u>PAGE</u>
2.5.5.2.1	Excavated Slopes	2.5-104
2.5.5.2.2	Excavated Slopes with Retaining Wall	2.5-105
2.5.5.2.3	Rebuilt Slopes	2.5-105
2.5.5.2.4	Slope Protection	2.5-105
2.5.5.2.5	CSCS Pond Flume Failure Analysis	2.5-106
2.5.5.2.6	CSCS Pond Surveillance Program	2.5-108
2.5.5.2.7	CSCS Pond Turbidity	2.5-109
2.5.5.2.8	Seepage	2.5-110
2.5.5.3	Logs of Borings	2.5-110
2.5.5.4	Compacted Fill	2.5-110
2.5.6	Embankments and Dams	2.5-111
2.5.6.1	General	2.5-111
2.5.6.2	Exploration	2.5-111
2.5.6.2.1	Field Investigations	2.5-111
2.5.6.2.2	Laboratory Tests	2.5-112
2.5.6.3	Foundation and Abutment Treatment	2.5-112
2.5.6.4	Embankment	2.5-112
2.5.6.4.1	Construction	2.5-112
2.5.6.4.2	Settlement	2.5-113
2.5.6.4.3	Slope Protection	2.5-114
2.5.6.4.4	Dike Failure Analysis	2.5-115
2.5.6.4.5	Makeup and Blowdown Pipeline Peripheral Dike Penetrations	2.5-115
2.5.6.4.6	Auxiliary Spillway	2.5-116
2.5.6.5	Slope Stability	2.5-117
2.5.6.6	Seepage Control	2.5-117
2.5.6.7	Diversion and Closure	2.5-119
2.5.6.8	Instrumentation	2.5-119
2.5.6.9	Construction Notes	2.5-120
2.5.7	References	2.5-120
2.5.7.1	Key to References Cited in Text	2.5-120
2.5.7.2	References Consulted in Preparation of Text (Listed Alphabetically)	2.5-140
Appendix 2.5A Selected Structures Outside the 200-mile Radius		2.5A-i

LSCS-UFSAR

CHAPTER 2.0 - SITE CHARACTERISTICS

LIST OF TABLES

<u>NUMBER</u>	<u>TITLE</u>
2.1-1	Distance From Gaseous Effluent Release Point to Nearest Site Boundary in the Cardinal Compass Directions
2.1-2	1970 and Projected 2020 Populations for Cities Within 10 Miles of the Site
2.1-3	1970 and Projected 2020 Population for Cities Within 50 Miles of the Site
2.1-4	Population Distribution Within the LPZ
2.1-5	Industries Within 10 Miles of the Site
2.1-6	Present and Projected Population Centers Within 50 Miles of the Site
2.1-7	1970 and Projected 2020 Population Densities Within 10 Miles of the Site
2.1-8	Cumulative Population Within 50 Miles
2.2-1	Commercial Airports Within 20 Miles of the Site
2.2-2	Dock and Anchorage Facilities on the Illinois River Near the Site
2.2-3	Industries With Hazardous Materials Within 10 Miles of the Site
2.2-4	Commodities Transported on the Illinois River Near the Site During 1974 in Thousands of Tons
2.2-4a	Hazardous Chemicals Transported on the Illinois River Near the Site During 2008
2.2-5	Private Airstrips Within 20 Miles of the Site
2.3-1	Tornado Summary for Illinois
2.3-2	Measures of Glazing in Various Severe Winter Storms
2.3-3	Summary of Maximum 5-Minute Wind Speeds Occurring After 18 Glaze Storms Throughout the United States
2.3-4	Wind-Glaze Thickness Relations for Five Periods of Greatest Speed and Greatest Thickness
2.3-5	Argonne National Laboratory: Percentage Frequency and Mean of 19- and 150-Foot Wind Speed (mph) for Indicated Wind Direction, January 1950-December 1964
2.3-6	Argonne National Laboratory: Frequency Distribution of the Number of Consecutive Hours of 19- and 150-Foot Wind Direction Persistence from Indicated Directions, January 1950-December 1964
2.3-7	Three-Way Joint Frequency Distribution of Wind Speed, Wind Direction and Pasquill Stability Class for 300-foot Level at Dresden Station for 5-year Period (December 1, 1973 - November 30, 1978)

LSCS-UFSAR
LIST OF TABLES (Cont'd)

<u>NUMBER</u>	<u>TITLE</u>
2.3-8	Three-Way Joint Frequency Distribution of Wind Speed, Wind Direction and Pasquill Stability Class for 300-foot Level at Dresden Station for 2-year Period (October 1, 1976 - September 30, 1978)
2.3-9	Comparison of LaSalle County Station 33-foot Level Temperatures (°F) (October 1976 - September 1978) with Average and Extreme Temperature Data from Peoria (October 1976 - September 1978) and Argonne (1950-1964)
2.3-10	Mean Relative Humidity (%) at Designated Hour, Peoria (1960-1974)
2.3-11	Argonne National Laboratory: Average Hourly 5-foot Relative Humidity (%) January 1950 - December 1964
2.3-12	Monthly Maximum, Minimum, and Average Relative Humidities (%) For LaSalle County Station
2.3-13	Monthly Maximum, Minimum, and Average Wet Bulb and Dew-Point Temperatures (°F) for LaSalle County Station
2.3-14	Argonne National Laboratory: Average Hourly 5-foot Wet Bulb Temperature (°F) January 1950 - December 1964
2.3-15	Argonne National Laboratory: Average Hourly 5-foot Dew-Point Temperature (°F) January 1950 - December 1974
2.3-16	Argonne National Laboratory: Maximum Amounts of Precipitation (in.) with Day of Occurrence, January 1950 - December 1964
2.3-17	Argonne National Laboratory: Maximum Precipitation (in.) for Specified Time Intervals, January 1950 - December 1964
2.3-18	Precipitation (Water Equivalent) for Peoria (in.)
2.3-19	Snow and Ice Pellets: Peoria (1941-1974)
2.3-20	Monthly Three-Way Joint Frequency Distribution of Wind Speed, Wind Direction and Pasquill Stability Class for the 375-foot Level at LaSalle County Station (January)
2.3-21	Monthly Three-Way Joint Frequency Distribution of Wind Speed, Wind Direction and Pasquill Stability Class for the 375-foot Level at LaSalle County Station (February)
2.3-22	Monthly Three-Way Joint Frequency Distribution of Wind Speed, Wind Direction and Pasquill Stability Class for the 375-foot Level at LaSalle County Station (March)
2.3-23	Monthly Three-Way Joint Frequency Distribution of Wind Speed, Wind Direction and Pasquill Stability Class for the 375-foot Level at LaSalle County Station (April)
2.3-24	Monthly Three-Way Joint Frequency Distribution of Wind Speed, Wind Direction and Pasquill Stability Class for the 375-foot Level at LaSalle County Station (May)
2.3-25	Monthly Three-Way Joint Frequency Distribution of Wind Speed, Wind Direction and Pasquill Stability Class for the 375-foot Level at LaSalle County Station (June)

LSCS-UFSAR
LIST OF TABLES (Cont'd)

<u>NUMBER</u>	<u>TITLE</u>
2.3-26	Monthly Three-Way Joint Frequency Distribution of Wind Speed, Wind Direction and Pasquill Stability Class for the 375-foot Level at LaSalle County Station (July)
2.3-27	Monthly Three-Way Joint Frequency Distribution of Wind Speed, Wind Direction and Pasquill Stability Class for the 375-foot Level at LaSalle County Station (August)
2.3-28	Monthly Three-Way Joint Frequency Distribution of Wind Speed, Wind Direction and Pasquill Stability Class for the 375-foot Level at LaSalle County Station (September)
2.3-29	Monthly Three-Way Joint Frequency Distribution of Wind Speed, Wind Direction and Pasquill Stability Class for the 375-foot Level at LaSalle County Station (October)
2.3-30	Monthly Three-Way Joint Frequency Distribution of Wind Speed, Wind Direction and Pasquill Stability Class for the 375-foot Level at LaSalle County Station (November)
2.3-31	Monthly Three-Way Joint Frequency Distribution of Wind Speed, Wind Direction and Pasquill Stability Class for the 375-foot Level at LaSalle County Station (December)
2.3-32	Three-Way Joint Frequency Distribution of Wind Speed, Wind Direction, and Pasquill Stability Class for the 375-foot Level at LaSalle County Station (October 1, 1976 - September 30, 1978)
2.3-33	χ/Q Values (sec/meter ³) at Exclusion Area Boundary for Effluents Released from Plant Common Stack
2.3-34	χ/Q Values (sec/meter ³) at Actual Site Boundary for Effluents Released from Plant Common Stack
2.3-35	χ/Q Values (sec/meter ³) at Low Population Zone Boundary for Effluents Released from Plant Common Stack
2.3-36	Fifth Percentile χ/Q Values (sec/meter ³) for the Period of 0-1 Hour for Effluents Released from Plant Common Stack
2.3-37	Fifth Percentile χ/Q Values (sec/meter ³) for the Time Period of 0-2 Hours for Effluents Released from Plant Common Stack
2.3-38	Fifth Percentile χ/Q Values (sec/meter ³) for the Period of 0-8 Hours for Effluents Released from Plant Common Stack
2.3-39	Fifth Percentile χ/Q Values (sec/meter ³) for the Time Period of 8-24 Hours for Effluents Released from Plant Common Stack
2.3-40	Fifth Percentile χ/Q Values (sec/meter ³) for the Time Period of 1-4 Days for Effluents Released from Plant Common Stack
2.3-41	Fifth Percentile χ/Q Values (sec/meter ³) for the Period of 4-30 Days for Effluents Released from Plant Common Stack
2.3-42	Fiftieth Percentile χ/Q Values (sec/meter ³) for the Time Period of 0-1 Hour for Effluents Released from Plant Common Stack
2.3-43	Fiftieth Percentile χ/Q Values (sec/meter ³) for the Time Period of 0-2 Hours for Effluents Released from Plant Common Stack

LSCS-UFSAR
LIST OF TABLES (Cont'd)

<u>NUMBER</u>	<u>TITLE</u>
2.3-44	Fiftieth Percentile χ/Q Values (sec/meter ³) for the Time Period of 0-8 Hours for Effluents Released from Plant Common Stack
2.3-45	Fiftieth Percentile χ/Q Values (sec/meter ³) for the Time Period of 8-24 Hours for Effluents Released from Plant Common Stack
2.3-46	Fiftieth Percentile χ/Q Values (sec/meter ³) for the Time Period of 1-4 Days for Effluents Released from Plant Common Stack
2.3-47	Fiftieth Percentile χ/Q Values (sec/meter ³) for the Time Period of 4-30 Days for Effluents Released from Plant Common Stack
2.3-48	χ/Q Values (sec/meter ³) at Exclusion Area Boundary for Effluents Released Through SGTS Vent
2.3-49	χ/Q Values (sec/meter ³) at Actual Site Boundary for Effluents Released Through SGTS Vent
2.3-50	χ/Q Values (sec/meter ³) at Low Population Zone Boundary for Effluents Released Through SGTS Vent
2.3-51	Fifth Percentile χ/Q Values (sec/meter ³) for the Time Period of 0-1 Hour for Effluents Released Through SGTS Vent
2.3-52	Fifth Percentile χ/Q Values (sec/meter ³) for the Time Period of 0-2 Hours for Effluents Released Through SGTS Vent
2.3-53	Fifth Percentile χ/Q Values (sec/meter ³) for the Time Period of 0-8 Hours for Effluents Released Through SGTS Vent
2.3-54	Fifth Percentile χ/Q Values (sec/meter ³) for the Time Period of 8-24 Hours for Effluents Released Through SGTS Vent
2.3-55	Fifth Percentile χ/Q Values (sec/meter ³) for the Time Period of 1-4 Days for Effluents Released Through SGTS Vent
2.3-56	Fifth Percentile χ/Q Values (sec/meter ³) for the Time Period of 4-30 Days for Effluents Released Through SGTS Vent
2.3-57	Fiftieth Percentile χ/Q Values (sec/meter ³) for the Time Period of 0-1 Hour for Effluents Released Through SGTS Vent
2.3-58	Fiftieth Percentile χ/Q Values (sec/meter ³) for the Time Period of 0-2 Hours for Effluents Released Through SGTS Vent
2.3-59	Fiftieth Percentile X/Q Values (sec/meter ³) for the Time Period of 0-8 Hours for Effluents Released Through SGTS Vent
2.3-60	Fiftieth Percentile X/Q Values (sec/meter ³) for the Time Period of 8-24 Hours for Effluents Released Through SGTS Vent
2.3-61	Fiftieth Percentile X/Q Values (sec/meter ³) for the Time Period of 1-4 Days for Effluents Released Through SGTS Vent
2.3-62	Fiftieth Percentile X/Q Values (sec/meter ³) for the Time Period of 4-30 Days for Effluents Released Through SGTS Vent
2.3-63	Annual Average X/Q Values (sec/meter ³) for Effluents Released from Plant Common Stack and SGTS Vent
2.3-64	Meteorological Instrument Locations and Analog Data Recording Systems (Deleted)

LSCS-UFSAR
LIST OF TABLES (Cont'd)

<u>NUMBER</u>	<u>TITLE</u>
2.3-65	Environmental Radiological Monitoring Program (Deleted)
2.3-66	Maximum Values for the Lower Limits of Detection (LLD) (Deleted)
2.3-67	LaSalle Power Station Joint Wind Stability Class Occurrence Distribution (1999-2003) – 33 ft Wind Speed and Direction, 200-33 ft Delta Temperature
2.3-68	LaSalle Power Station Joint Wind Stability Class Occurrence Distribution (1999-2003) – 375 ft Wind Speed and Direction, 375-33 ft Delta Temperature
2.4-1	Characteristics of Illinois River Tributaries
2.4-2	Intakes on the Illinois River Within 50 River Miles Downstream of the Site
2.4-3	Maximum Readings on Illinois River Gauges Period 1940-73
2.4-4	Local Probable Maximum Precipitation at the LSCS Site
2.4-5	Standard Project Flood and Probable Maximum Flood Estimates for Illinois River Stations
2.4-6	Design Precipitation for Cooling Lake
2.4-7	Standard Project Inflow Flood Hydrograph for Cooling Lake
2.4-8	Probable Maximum Inflow Flood Hydrograph for Cooling Lake
2.4-8a	Listing of Input Data to Spillway Rating and Flood Routing Program
2.4-8b	Wind Wave Characteristics on Cooling Lake
2.4-8c	Wind Wave Characteristics at Lake Screen House with Probable Maximum Flood
2.4-9	100-Year Recurrence Interval Low Flows of Illinois River at Marseilles, Illinois: 1921-1971, 12-Month Period Ending March 31
2.4-10	Groundwater Quality in the Cambrian-Ordovician Aquifer
2.4-11	Surface Elevations and Measurement Dates for Observation Wells
2.4-12	Physical Characteristics of LSCS Water Wells
2.4-13	Water Quality Analyses for LSCS Water Wells
2.4-14	Major Municipal and Industrial Pumping Centers Within 25 Miles
2.4-15	Public Groundwater Supplies Within 10 Miles
2.4-16	Domestic Well Inventory
2.4-17	Piezometer Installation Records and Measurement Dates
2.4-18	Additional Unplotted Piezometer Data
2.5-1	Scope of Work
2.5-2	Physiographic Classification and Correlation Chart
2.5-3	Tabulation of Faults in Illinois
2.5-4	Tabulation of Faults in Wisconsin
2.5-5	Tabulation of Faults in Missouri
2.5-6	Tabulation of Faults in Iowa
2.5-7	Tabulation of Faults in Indiana
2.5-8	Tabulation of Folds in Illinois
2.5-9	Tabulation of Folds in Wisconsin
2.5-10	Tabulation of Folds in Missouri

LSCS-UFSAR
LIST OF TABLES (Cont'd)

<u>NUMBER</u>	<u>TITLE</u>
2.5-11	Tabulation of Folds in Iowa
2.5-12	Tabulation of Folds in Indiana
2.5-13	Estimated Physical and Chemical Properties and Interpretations of Agricultural Soils as Construction Materials
2.5-14	Modified Mercalli Intensity (Damage) Scale of 1931
2.5-15	Tabulation of Earthquake Epicenters
2.5-16	Reference List for Tables 2.5-15 through 2.5-21
2.5-17	Tabulation of Earthquake Epicenters of Intensity V (MM) and Greater
2.5-18	Tabulation of Earthquake Epicenters
2.5-19	Areas of Many Earthquake Epicenters
2.5-20	Significant Earthquakes
2.5-21	Recorded Earthquake Epicenters Within 50 Miles of the Site
2.5-22	Rock Unconfined Compression Test Results
2.5-23	Laboratory Permeability Data
2.5-24	Dynamic Triaxial Compression Test Data
2.5-25	Resonant Column Test Results
2.5-26	Shockscope Test Results
2.5-27	In Situ Field Permeability Tests
2.5-28	Parameters for Analysis of Rock-Soil-Structure Interaction
2.5-29	Summary of Boring Information for Sand Deposit Near Elevation 595 Feet MSL in Vicinity of Main Plant
2.5-30	Ultimate Bearing Capacities
2.5-31	Effective Soil Parameters
2.5-32	Summary of Results of Stability Analysis of CSCS Cooling Pond and Flume and Maximum Cut Height and Side Slopes of 4:1
2.5-33	Riprap and Bedding Gradations
2.5-34	Variation of Peripheral Dike Height
2.5-35	Summary of Peripheral Dike Camber
2.5-36	Summary of Results of Stability Analysis of Peripheral Dike for Maximum Height and Side Slope of 3:1
2.5-37	Reference List for Tables 2.5-3 through 2.5-12
2.5-38	Installation Dates for Main Plant Settlement Monuments
2.5-39	Index Properties for Materials Used in Triaxial Tests
2.5-40	Consolidation Parameters for Settlement Analysis
2.5-41	Comparison of Theoretical and Measured Settlement
2.5-42	Summary of Gas Storage Fields Within 30 Miles

LSCS-UFSAR

CHAPTER - 2.0 SITE CHARACTERISTICS

LIST OF FIGURES

<u>NUMBER</u>	<u>TITLE</u>
2.1-1	Location of the Site within the State of Illinois
2.1-2	Location of the Site with Respect to LaSalle County and Brookfield Township
2.1-3	Major Structures and Site Layout
2.1-4	Exclusion Area
2.1-5	Transportation Routes in the Site Vicinity
2.1-6	1979 and Projected Populations within 50 Miles of the Site
2.1-7	Present (1975) and Projected Populations
2.1-8	Cities within 10 Miles of the Site
2.1-9	Present and Projected Population Centers Within 50 Miles of the Site
2.1-10	Topographic Features and Transportation Routes within the LPZ
2.1-11	1980 Population Density within 50 Miles of the Site
2.1-12	2020 Population Density within 50 miles of the Site
2.2-1	Airports and Flight Patterns within 20 Miles of the Site
2.2-2	Gas Pipelines within 10 Miles of the Site
2.3-1	Number of Tornadoes Per County
2.3-2	Annual Wind Rose, 375-Foot Level
2.3-3	October 1976 and October 1977 Wind Rose, 375-Foot Level
2.3-4	November 1976 and November 1977 Wind Rose, 375-Foot Level
2.3-5	December 1976 and December 1977 Wind Rose, 375-Foot Level
2.3-6	January 1977 and January 1978 Wind Rose, 375-Foot Level
2.3-7	February 1977 and February 1978 Wind Rose, 375-Foot Level
2.3-8	March 1977 and March 1978 Wind Rose, 375-Foot Level
2.3-9	April 1977 and April 1978 Wind Rose, 375-Foot Level
2.3-10	May 1977 and May 1978 Wind Rose, 375-Foot Level
2.3-11	June 1977 and June 1978 Wind Rose, 375-Foot Level
2.3-12	July 1977 and July 1978 Wind Rose, 375-Foot Level
2.3-13	August 1977 and August 1978 Wind Rose, 375-Foot Level
2.3-14	September 1977 and September 1978 Wind Rose, 375-Foot Level
2.3-15	Topographic Profiles of the Area 0 to 5 Miles from the LaSalle County Station
2.3-16	Topographic Profiles of the Area 5 to 10 Miles from the LaSalle County Station
2.3-17	Topographic Features Within a 10-Mile Radius of the LaSalle County Station
2.4-1	Site Location Plan
2.4-2	Hydrosphere

LSCS-UFSAR
LIST OF FIGURES (Cont'd)

<u>NUMBER</u>	<u>TITLE</u>
2.4-2a	Surface Water Bodies Within a 5-Mile Radius of the Plant Site
2.4-3	General Site Plan
2.4-4	Drainage Area
2.4-5	Illinois Waterway Profile
2.4-6	Site Grading and Drainage Plan - Zones for Local Intense Precipitation Analysis
2.4-6a	Site Grading Plan - Ditches and Culverts (Deleted)
2.4-6b	Zones for Plant Flooding Analysis (Deleted)
2.4-7	15-Minute Unit Hydrographs
2.4-8	Hydrograph of PMF with Antecedent SPF and Variation of Lake Level with Time
2.4-9	Area and Capacity of Lake
2.4-10	Outflow Rating
2.4-11	Plan of Auxiliary Spillway
2.4-12	Centerline Section of Auxiliary Spillway
2.4-12a	Centerline Section of Auxiliary Spillway (Modified)
2.4-13	Longitudinal Section of Auxiliary Spillway
2.4-13a	Service Spillway Plan
2.4-13b	Service Spillway Sections
2.4-14	Freeboard Requirements
2.4-15	Top-of-Dike and Top-of-Road Elevations
2.4-16	Municipal and Industrial Groundwater Use Within 25 Miles
2.4-17	Site Stratigraphic Units and their Hydrogeologic Characteristics
2.4-18	Potentiometric Surface of the Cambrian-Ordovician Aquifer, Fall 1963
2.4-19	Potentiometric Surface of the Cambrian-Ordovician Aquifer, October 1971
2.4-20	Domestic Water Well Inventory, Including Onsite Water Wells
2.4-21	Locations of Piezometers and Observation Wells
2.4-22	Daily Precipitation and Fluctuations of Water Levels in Piezometers
2.4-23	Daily Precipitation and Fluctuations of Water Levels in Observation Wells
2.5-1	General Site Location
2.5-2	Plot Plan Sheet 1: Overall Site Sheet 2: Main Plant Area Blowup Sheet 3: CSCS Flume Area Blowup
2.5-3	Site Area Surficial Geologic Map
2.5-4	Site Area Bedrock Geology
2.5-5	Regional Physiography Map
2.5-6	Regional Bedrock Geology
2.5-7	Generalized Regional Systemic Distribution Map

LSCS-UFSAR
LIST OF FIGURES (Cont'd)

<u>NUMBER</u>	<u>TITLE</u>
2.5-8	Regional Geologic Cross Sections
2.5-9	Regional Tectonic Map, Basins and Arches, Paleozoic Rocks
2.5-10	Regional Precambrian Surface
2.5-11	Relative Movement of Regional Tectonic Features
2.5-12	Regional Tectonic Map - Folds
2.5-13	Regional Tectonic Map - Faults
2.5-14	Site Structural Geology
2.5-15	Cross Section - South Bluff of Illinois River
2.5-16	Economic Geology in Site Vicinity
2.5-17	Explanation of Boring Logs
2.5-18	Soil Classification System
2.5-19	Logs of Borings
	Boring 1 Sheets 1 and 2
	Boring 2 Sheets 3, 4, and 5
	Boring 3 Sheets 6 and 7
	Boring 4 Sheets 8 and 9
	Boring 5 Sheet 9
	Boring 6 Sheets 10 and 11
	Boring 7 Sheets 12 and 13
	Boring 8 Sheet 14
	Boring 9 Sheets 15 and 16
	Boring 10 Sheet 17
	Boring 11 Sheets 18 and 19
	Boring 12 Sheet 20
	Boring 13 Sheet 21
	Boring 14 Sheet 22
	Boring 15 Sheet 23
	Boring 16 Sheet 24
	Boring 17 Sheet 25
	Boring 18 Sheet 26
	Boring 19 Sheet 27
	Boring 20 Sheet 28
	Boring 21 Sheet 29
	Boring 22 Sheet 30
	Boring 23 Sheet 31
	Boring 24 Sheet 32
	Boring 25 Sheet 33
	Boring 26 Sheet 34
	Boring 27 Sheet 35
	Boring 28 Sheet 36
	Boring 29 Sheet 37
	Boring 30 Sheets 38 and 39
	Boring 31 Sheets 40 and 41

LSCS-UFSAR
LIST OF FIGURES (Cont'd)

<u>NUMBER</u>	<u>TITLE</u>
Boring 32	Sheets 42 and 43
Boring 33	Sheet 44
Boring 34	Sheet 45
Boring 35	Sheet 46
Boring 36	Sheet 47
Boring 37	Sheets 48 and 49
Boring 38	Sheets 50 and 51
Boring 39	Sheet 52
Boring 40	Sheet 53
Boring 41	Sheet 54
Boring 42	Sheet 55
Boring 43	Sheet 56
Boring 44	Sheet 57
Boring 45	Sheet 58
Boring 46	Sheet 59
Boring 47	Sheet 60
Boring 48	Sheet 61
Boring 49	Sheet 62
Boring 50	Sheet 63
Boring 51	Sheet 64
Boring 52	Sheet 65
Boring 53	Sheet 66
Boring 54	Sheet 67
Boring 55	Sheets 68 and 69
Boring 56	Sheets 70 and 71
Boring 57	Sheets 72 and 73
Boring 58	Sheet 74
Boring 59	Sheet 75
Boring 60	Sheet 76
Boring 61	Sheets 77 and 78
Boring 62	Sheets 79, 80, and 81
Boring 63	Sheets 82 and 83
Boring 64	Sheets 84 and 85
Boring 65	Sheets 86 and 87
Boring 66	Sheet 88
Boring 67	Sheet 89
Boring 68	Sheets 90 and 91
Boring 69	Sheets 92 and 93
Boring 70	Sheets 94 and 95
Boring 71	Sheets 96 and 97
Boring 72	Sheet 98
Boring 73	Sheet 99
Boring 74	Sheet 100

LSCS-UFSAR
LIST OF FIGURES (Cont'd)

NUMBER

TITLE

Boring 75	Sheet 100
Boring 76	Sheet 101
Boring 77	Sheet 101
Boring 78	Sheet 102
Boring 79	Sheet 102
Boring 80	Sheet 103
Boring 81	Sheet 103
Boring 82	Sheet 104
Boring 83	Sheet 104
Boring 84	Sheet 105
Boring 85	Sheet 105
Boring 86	Sheet 106
Boring 87	Sheet 106
Boring 88	Sheet 107
Boring 89	Sheet 107
Boring 90	Sheet 108
Boring 91	Sheet 108
Boring 92	Sheet 109
Boring 93	Sheet 109
Boring 94	Sheet 110
Boring 95	Sheet 110
Boring 96	Sheet 111
Boring 97	Sheet 111
Boring 98	Sheet 112
Boring 99	Sheet 112
Boring 100	Sheet 113
Boring 101	Sheet 113
Boring 102	Sheet 114
Boring 103	Sheet 114
Boring 104	Sheet 115
Boring 105	Sheet 115
Boring 105A	Sheet 116
Boring 105B	Sheet 116
Boring 106	Sheet 117
Boring 107	Sheet 117
Boring 108	Sheet 118
Boring 109	Sheet 118
Boring 109A	Sheet 119
Boring 110	Sheet 119
Boring 111	Sheet 120
Boring 112	Sheet 120
Boring 113	Sheet 121
Boring 114	Sheet 121

LSCS-UFSAR
LIST OF FIGURES (Cont'd)

NUMBER

TITLE

Boring 115	Sheet 122
Boring 116	Sheet 122
Boring 117	Sheet 123
Boring 118	Sheet 123
Boring 119	Sheet 124
Boring 120	Sheet 124
Boring 121	Sheet 125
Boring 122	Sheet 125
Boring 123	Sheet 126
Boring 124	Sheet 126
Boring 125	Sheet 127
Boring 126	Sheet 127
Boring 127	Sheet 128
Boring 128	Sheet 128
Boring 129	Sheet 129
Boring 130	Sheet 129
Boring 130A	Sheet 130
Boring 130B	Sheet 130
Boring 131	Sheet 131
Boring 132	Sheet 131
Boring 133	Sheet 132
Boring 134	Sheet 132
Boring 135	Sheet 133
Boring 136	Sheet 133
Boring 137	Sheet 134
Boring 138	Sheet 134
Boring 139	Sheet 135
Boring 140	Sheet 135
Boring 141	Sheet 136
Boring 142	Sheet 136
Boring 143	Sheet 137
Boring 144	Sheet 137
Boring 145	Sheet 138
Boring 146	Sheet 138
Boring 147	Sheet 139
Boring 148	Sheet 139
Boring 149	Sheet 140
Boring 150	Sheet 140
Boring 151	Sheet 141
Boring 152	Sheet 141
Boring 153	Sheet 142
Boring 154	Sheet 142
Boring 155	Sheet 143

LSCS-UFSAR
LIST OF FIGURES (Cont'd)

<u>NUMBER</u>	<u>TITLE</u>
Boring 156	Sheet 143
Boring 157	Sheet 144
Boring 158	Sheet 144
Boring 159	Sheet 145
Boring 160	Sheet 146
Boring 161	Sheet 146
Boring 162	Sheet 147
Boring 163	Sheet 147
Boring 164	Sheet 148
Boring 165	Sheet 148
Boring 166	Sheet 149
Boring 167	Sheet 149
Boring 168	Sheet 150
Boring 169	Sheet 150
Boring 170	Sheet 151
Boring 4A01	Sheets 152 and 153
Boring 4C01	Sheet 154
Boring 5B01	Sheet 155
Boring 5B02	Sheet 156
Boring 5B03	Sheet 157
Boring 8B01	Sheet 158
Boring 8B02	Sheet 159
Boring 9A01	Sheet 160
Boring 10D01	Sheet 161
Boring 10D02	Sheet 162
Boring 16B01	Sheet 163
Boring 16B02	Sheet 164
Boring 21D01	Sheet 165
Boring 21D02	Sheet 166
Boring 21D03	Sheet 167
Boring 27C01	Sheet 168
Boring 27C02	Sheet 169
Boring 27D01	Sheet 170
Boring 28C01	Sheet 171
Boring 29C01	Sheet 172
Boring 32A01	Sheet 173
Boring 32B01	Sheet 174
Boring 32B02	Sheet 175
Boring 32B03	Sheet 176
Boring 33C01	Sheet 177
Boring 33C02	Sheets 178 and 179
Boring 34B01	Sheet 180
Boring 34D01	Sheet 181

LSCS-UFSAR
LIST OF FIGURES (Cont'd)

<u>NUMBER</u>	<u>TITLE</u>
Boring 34D02	Sheet 182
Boring D-1	Sheet 183
Boring D-2	Sheets 184 and 185
Boring D-3	Sheet 186
Boring D-4	Sheet 187
Boring D-5	Sheet 188
Boring D-6	Sheet 189
Boring D-7	Sheet 190
Boring D-8	Sheet 191
Boring D-9	Sheet 192
Boring D-10	Sheets 193 and 194
Boring D-11	Sheet 195
Boring D-12	Sheets 196 and 197
Boring D-13	Sheet 198
Boring D-14	Sheets 199 and 200
Boring R-1	Sheet 201
Boring R-2	Sheet 201
Boring R-3	Sheet 202
Boring R-4	Sheet 202
Boring R-5	Sheet 203
Boring R-6	Sheet 203
Boring R-7	Sheet 204
Boring R-8	Sheet 205
Boring R-9	Sheet 206
Boring R-10	Sheet 207
Boring R-11	Sheet 208
Boring R-12	Sheet 209
Boring R-13	Sheet 210
Boring R-14	Sheet 211
Boring R-15	Sheet 212
Boring R-16	Sheet 212
Boring R-17	Sheet 213
Boring R-18	Sheet 213
Boring R-19	Sheet 214
Boring R-20	Sheet 214
Boring R-21	Sheet 215
Boring R-22	Sheet 215
Boring R-23	Sheet 216
Boring R-24	Sheet 217
Boring F-101	Sheet 218
Boring F-102	Sheet 219
Boring F-103	Sheet 220
Borings F-104 and F-105	Sheet 221

LSCS-UFSAR
LIST OF FIGURES (Cont'd)

<u>NUMBER</u>	<u>TITLE</u>
	Borings F-106 and F-107 Sheet 222
	Borings F-108 and F-109 Sheet 223
	Borings F-110 and F-111 Sheet 224
	Borings F-112 and F-113 Sheet 225
	Borings F-114 and F-115 Sheet 226
	Borings F-116 and F-117 Sheet 227
	Borings F-118 and F-119 Sheet 228
	Borings F-119A and F-120 Sheet 229
	Borings F-121 and F-122 Sheet 230
	Borings F-123 and F-124 Sheet 231
	Boring F-125 Sheet 232
	Borings F-201 and F-202 Sheet 233
	Borings F-204 and F-205 Sheet 234
	Boring F-206 Sheet 235
	Boring F-301 Sheet 236
	Boring F-303 Sheet 237
	Boring F-305 Sheet 238
	Boring F-307 Sheet 239
	Boring F-351 Sheet 240
	Borings F-401 and F-402 Sheet 241
	Borings F-402A and F-403 Sheet 242
	Boring F-404 Sheet 243
	Boring F-405 Sheet 244
	Borings F-407 and F-409 Sheet 245
	Borings F-411 and F-413 Sheet 246
	Borings F-415 and F-417 Sheet 247
	Borings F-501 and F-502 Sheet 248
	Borings F-503 and F-504 Sheet 249
	Boring F-505 Sheet 250
	Boring F-1 Sheet 251
	Boring F-2 Sheet 252
	Boring F-3 Sheet 253
	Boring F-4 Sheet 254
	Boring F-5 Sheet 255
	Boring F-6 Sheet 256
	Boring F-7 Sheet 257
	Boring F-8 Sheet 258
	Boring F-9 Sheet 259
	Boring F-10 Sheet 260
	Boring F-11 Sheet 261
2.5-20	Explanation of Test Pit Logs
2.5-21	Logs of Test Pits
	Test Pit 1 Sheet 1

LSCS-UFSAR
LIST OF FIGURES (Cont'd)

NUMBER

TITLE

Test Pit 2	Sheet 1
Test Pit 3	Sheet 1
Test Pit 4	Sheet 1
Test Pit 5	Sheet 2
Test Pit 6	Sheet 2
Test Pit 7	Sheet 2
Test Pit 8	Sheet 2
Test Pit 9	Sheet 3
Test Pit 10	Sheet 3
Test Pit 11	Sheet 3
Test Pit 12	Sheet 3
Test Pit 13	Sheet 4
Test Pit 14	Sheet 4
Test Pit 15	Sheet 4
Test Pit 16	Sheet 4
Test Pit 17	Sheet 5
Test Pit 18	Sheet 5
Test Pit 19	Sheet 5
Test Pit 20	Sheet 5
Test Pit 21	Sheet 6
Test Pit 22	Sheet 6
Test Pit A1	Sheet 7
Test Pit A2	Sheet 7
Test Pit A3	Sheet 7
Test Pit A4	Sheet 7
Test Pit A5	Sheet 8
Test Pit A6	Sheet 8
Test Pit A7	Sheet 8
Test Pit A8	Sheet 8
Test Pit A9	Sheet 9
Test Pit A10	Sheet 9
Test Pit A11	Sheet 9
Test Pit A12	Sheet 10
Test Pit A13	Sheet 10
Test Pit A14	Sheet 10
Test Pit A15	Sheet 11
Test Pit A16	Sheet 11
Test Pit A17	Sheet 11
Test Pit R1	Sheet 12
Test Pit R2	Sheet 12
Test Pit R3	Sheet 12
Test Pit R4	Sheet 12

2.5-22 Glacial Map of Illinois

LSCS-UFSAR
LIST OF FIGURES (Cont'd)

<u>NUMBER</u>	<u>TITLE</u>
2.5-23	Woodfordian Lakes and Sublakes of Illinois
2.5-24	Site Vicinity Soil Stratigraphic Column - Uplands
2.5-25	Site Vicinity Soil Stratigraphic Column - Valley Bottoms
2.5-26	Upland Agricultural Soils
2.5-27	Site Area Rock Stratigraphic Column
2.5-28	Bedrock Topography Map
2.5-29	Plot Plan of Geologic Sections
2.5-30	Site Geologic Section A-A'
2.5-31	Site Geologic Section B-B'
2.5-32	Limits of Pleistocene Glaciation
2.5-33	Sequence of Glaciations and Interglacial Drainage in Illinois
2.5-34	Earthquake Epicenter Map
2.5-35	Earthquake Epicenter Map - 35.5° to 38.5° North Latitude, 87.0° to 90.0° West Longitude
2.5-36	Earthquake Epicenter and Regional Tectonic Map
2.5-37	Basins and Arches, 35.5° to 38.5° North Latitude, 87.0° to 90.0° West Longitude
2.5-38	Generalized Iseismal Maps of 1909 and 1912 - Northern Illinois Earthquakes
2.5-39	Response Spectra - Safe Shutdown Earthquake
2.5-40	Response Spectra - Operating-Basis Earthquake
2.5-41	General Site Plan
2.5-42	Unconfined Compression Test Plot Plan and Data Sheet 1: Main Plant Area Sheet 2: Intake Flume Area
2.5-43	Envelope of Triaxial Compression Tests Sheet 1: Undisturbed Wedron Silty Clay Sheet 2: Remolded Wedron Silty Clay Compacted to 95% of Modified Proctor Density Sheet 3: Remolded Wedron Silty Clay Compacted to 90% of Modified Proctor Density
2.5-44	Envelope of Compaction Tests Sheet 1: Modified Proctor Data on Wedron Silty Clay Sheet 2: Relative Density Data on Ticona Valley Fill Sheet 3: Modified Proctor Data on Dike Sand Drainage Blanket
2.5-45	Consolidation Test Data Boring 1 Sheets 1 and 2 Boring 14 Sheet 3 Boring 26 Sheet 4 Boring 30 Sheet 5 Boring 31 Sheet 5 Boring 35 Sheet 6 Boring 38 Sheets 6 and 7

LSCS-UFSAR
LIST OF FIGURES (Cont'd)

<u>NUMBER</u>	<u>TITLE</u>
	Boring 40 Sheet 8
	Boring 54 Sheets 8 and 9
	Boring 55 Sheet 10
	Boring 57 Sheets 10 and 11
	Boring 59 Sheet 11
	Boring 62 Sheet 12
	Boring 63 Sheet 12
	Boring 85 Sheet 13
	Boring 99 Sheet 14
	Boring 105 Sheet 15
	Boring 108 Sheet 16
	Boring 111 Sheet 17
	Boring 130B Sheet 18
	Boring 157 Sheet 19
	Boring 8B02 Sheet 20
	Boring 10D01 Sheet 20
	Boring 27C02 Sheet 21
	Boring D5 Sheet 22
	Boring D2 Sheet 22
	Boring D8 Sheet 23
	Test Pit 15 Sheet 24
	Test Pit 19 Sheet 24
2.5-46	Envelope of Grain Sizes Sheet 1: Wedron Silty Clay Fill Sheet 2: Ticona Valley Fill Sheet 3: Dike Sand Drainage Blanket
2.5-47	Plot Plan of Geophysical Explorations
2.5-48	Seismic Refraction Survey Data Sheet 1: Seismic Line 1 Sheet 2: Seismic Line 2 Sheet 3: Seismic Line 2A Sheet 4: Seismic Line 2B Sheet 5: Seismic Line 3 Sheet 6: Seismic Line 3A
2.5-49	Stratigraphic Column with Geophysical Data Summary
2.5-50	Excavation Plan Sheet 1: Main Plant Area Sheet 2: CSCS Pond and Flume Area Sheet 3: Lake Screen House Area
2.5-51	Geologic Profiles of Major Foundations
2.5-52	Profile of Sand Deposit Exposed in Bottom of CSCS Intake Flume
2.5-53	Profile of Lacustrine Deposit Exposed on Banks of CSCS Intake Flume

LSCS-UFSAR
LIST OF FIGURES (Cont'd)

<u>NUMBER</u>	<u>TITLE</u>
2.5-54	Section Through Concrete Retaining Wall
2.5-55	Soil-Structure Interaction Parameters Sheet 1: Variation of Shear Modules with Shear Strain Sheet 2: Variation of Damping Ratio with Shear Strain
2.5-56	Borings Penetrating Sand Deposit Near Elevation 595 feet MSL in Vicinity of Main Plant
2.5-57	Gross Applied Static Foundation Loading
2.5-58	Consolidation Settlement Assuming the Structural Foundation Completely Flexible
2.5-58a	Theoretical Settlement Time History at Settlement Measurement Point TR2 (Turbine Building)
2.5-58b	Theoretical Settlement Time History at Settlement Measurement Point R1 (Reactor Building)
2.5-59	CSCS Cooling Pond and Pipelines
2.5-60	Plan of CSCS Outlet Chute Structure
2.5-61	Plan of Intake Flume at Lake Screen house
2.5-62	Profile of Intake Flume at Lake Screen House
2.5-63	Section Through Sheet Piling Retaining Wall
2.5-64	Profile of Concrete Retaining Wall
2.5-65	Cross Section Through CSCS Pond Berm
2.5-66	Locations of Plant Settlement Monuments
2.5-67	Plant Settlement Readings
2.5-68	Critical Failure Surfaces, Intake Flume Sheet 1: In Situ Material Sheet 2: Lacustrine Deposit Sheet 3: Retaining Wall on Flume Slope Sheet 4: Outwash Deposit
2.5-69	Postulated CSCS Pond Intake Flume Failure Condition
2.5-70	Typical Peripheral Dike Cross Section
2.5-71	Plan of Makeup Pipeline Dike Penetration
2.5-72	Makeup Pipeline Cross Section
2.5-73	Plan of Blowdown Pipeline Dike Penetration
2.5-74	Blowdown Pipeline Cross Section
2.5-75	Critical Peripheral Dike Failure Surface - Steady Seepage Condition
2.5-76	Peripheral Dike Drainage Ditches
2.5-77	Locations of Observation Wells and Settlement Monuments
2.5-78	Profile Through Sand and Gravel Deposit at Peripheral Dike Station 291+00
2.5-79	Undrained Shear Strength Versus Depth
2.5-80	Other Proposed Faults
2.5-81	Geologic Map of North Flume Wall
2.5-82	Geologic Map of South Flume Wall

LSCS-UFSAR
LIST OF FIGURES (Cont'd)

<u>NUMBER</u>	<u>TITLE</u>
2.5-83	Critical Lateral Pressure Distribution Diagrams
2.5-84	Typical Stress-Strain Curves from Triaxial Tests
2.5-85	Typical Cyclic Triaxial Test Data
2.5-86	South Flume Wall Excavation from 6330E to 6790E
2.5-87	North Flume Wall Excavation from 6230E to 6680E
2.5-88	North Flume Wall Excavation from 7280E to 7950E
2.5-89	Main Plant Excavation - West Wall
2.5-90	Main Plant Excavation - North Wall
2.5-91	Flowchart for the Settlement Calculation for Rigid Foundation
2.5-92	Gas Storage Fields Within 30 Miles

CHAPTER 2.0 - SITE CHARACTERISTICS

2.1 GEOGRAPHY AND DEMOGRAPHY

2.1.1 Site Location and Description

2.1.1.1 Specification of Location

The LaSalle County Station, Units 1 and 2 (LSCS) is located in Brookfield Township of LaSalle County in northeastern Illinois. The Illinois River is 5 miles north of the site. Figure 2.1-1 shows the site within the state of Illinois, and Figure 2.1-2 shows the site with respect to LaSalle County and Brookfield Township. The midpoint of the approximate centerline between the two reactors in the Universal Transverse Mercator Coordinate System is 4,567,200 meters north and 360,200 meters east, which corresponds to 41°14'44" north latitude and 88° 40'06" west longitude.

2.1.1.2 Site Area Map

The LSCS site occupies approximately 3060 acres, of which 2058 acres comprise the cooling lake. Figure 2.1-3 shows the layout of the major structures and the site boundary on a topographic background. The pipeline corridor occupies an additional 716 acres of company property near the LSCS site.

There are no industries or residences on the site.

The major transportation routes near the site include the Illinois River, approximately 3 miles north of the northern boundary; Illinois State Highway 170, 0.5 mile east of the eastern boundary of the site; and Interstate Highway 80, 8 miles north of the northern site boundary. The Chicago, Rock Island, & Pacific Railroad, approximately 3 1/4 miles north of the northern site boundary, is the closest operable railroad line. Figure 2.1-5 illustrates the transportation routes in the vicinity of the site.

2.1.1.3 Boundaries for Establishing Effluent Release Limits

10 CFR 20.106 requires that "a licensee shall not possess, use, or transfer licensed material so as to release to an unrestricted area radioactive material in concentrations which exceed the limits specified in Appendix 'B', Table II of this part...". 10 CFR 50.34a also requires that "in the case of an application filed on or after January 2, 1971, the application shall also identify the design objectives, and the means to be employed, for keeping levels of radioactive material in effluents to unrestricted areas as low as reasonably achievable."

The LSCS site comprises the area of applicability for the establishment of effluent release limits. Expected

concentrations of radionuclides in effluents are shown in Sections 11.2 and 11.3.

Distances from the release point of gaseous effluents, the station vent stack, to the site boundary in the cardinal compass directions are given in Table 2.1-1. The site boundary closest to the release point of gaseous effluents is in the western direction at a distance of 1670 feet (509 meters).

Liquid effluents are discharged into the cooling lake blowdown line which subsequently discharges into the Illinois River; thus radionuclides in liquid effluents enter the environment at that point.

Solid radioactive materials are shipped from the LSCS site via truck or rail car in special radioactive containers or casks.

2.1.2 Exclusion Area Authority and Control

2.1.2.1 Authority

The plant exclusion area consists of approximately 640 acres. The exclusion area is shown in Figure 2.1-4. No public roads cross it.

The LSCS exclusion area is totally owned and controlled by EGC. All mineral rights and easements for this area are owned and maintained by EGC. As sole owner, EGC has authority to determine and control all activities in this exclusion area, including removal and exclusion of personnel or property from the area.

The exclusion area boundary is posted conspicuously with "Private Property - No Trespassing" signs. In addition, administrative procedures including routine surveillance are imposed to control access to the exclusion area.

The exclusion area boundary was defined in conformance with the guidelines of 10 CFR 100, with the elevated release of gaseous effluents being the dominant release path.

2.1.2.2 Control of Activities Unrelated to Plant Operation

No activities are permitted within the exclusion area except those related to plant operations.

2.1.2.3 Arrangements for Traffic Control

Since the exclusion area is not traversed by any highway, railway, or waterway, traffic control arrangements have not been considered.

2.1.2.4 Abandonment or Relocation of Roads

No major transportation arteries are involved in the siting of LaSalle County Station. No state or county highway traverses the LSCS site. Two 16-foot gravel roadways (former township roadways abandoned for the creation of the cooling lake) traverse the present exclusion area. These abandoned roadways have no public access or usage and are under complete control of EGC. They now terminate in the cooling lake or peripheral dikes.

All abandonment proceedings are completed. The Highway Commissioner of Brookfield Township has the authority possessed under state law to effect this abandonment. The following procedures were followed to achieve abandonment:

- a. a preliminary hearing was held with Brookfield Township officials,
- b. a preliminary order was issued,
- c. an inducement agreement was filed by Commonwealth Edison,
- d. public notice of a hearing on this matter was given,
- e. a public hearing was held, and
- f. a final order was issued.

Carl Stasell (Supervisor and Chairman of the Board), Edward Caputo (Highway Commissioner - Brookfield Township), Emmett Moran (Auditor), Everett Caldwell (Auditor), George Laatz (Auditor), Lawrence Gage, Jr. (Auditor), and Robert Widman (Town Clerk), were the public authorities who made the final determination. A legislative public hearing was held prior to abandonment. No roads will be relocated.

2.1.3 Population Distribution

The U.S. Bureau of the Census MEDLIST (Master Enumeration District List) was used to determine the 1970 population distribution for the area within 50 miles of the site. The MEDLIST contains the 1970 populations of states, counties, townships, and enumeration districts. Enumeration districts are low-population statistical units. Within each enumeration district the Census Bureau has designated a point as the centroid in order to give each enumeration district a geographic location. The enumeration district centroid coordinates are also on the MEDLIST. These centroids are not necessarily the geographic center of the enumeration district. They are chosen as the point that "best" represents the population distribution within the enumeration district.

Since the populations of the enumeration districts are associated with the centroids, the centroid for sparsely populated areas may cause zero populations in annular sectors in which the actual population is not, in fact, zero. A smoothing technique was developed to modify the MEDLIST data so as to distribute the population of the enumeration district over a finite area surrounding the centroid of the district.

The population projections for 1980, 1990, 2000, 2010, and 2020 were made using a modified ratio technique. The modified ratio technique is used by professional demographers and is based on the knowledge that the population of large areas is more accurately predicted than that of a smaller area and assumes that the ratio of the population of the smaller area (such as the township) to the population of the larger area (such as the state) changes at a constant rate. To determine the rate of change of the ratio, a historic base period is required. The base period for the projections made in this report is 1960-1970.

The ratio technique was modified in such a way that the change in the ratio established during the base period is maintained for the first 20 years, but then gradually changes towards a zero growth rate. This modification considers the fact that the growth rate of the smaller area may differ significantly from that of the larger area during the base period and allows it to differ for the few years following, but realizes that at some point in time, the growth rates of the two areas will become the same.

The modified ratio technique was applied to the ratio of the township population to the state population. The state population was projected geometrically using the growth rate of the state during the base period.

2.1.3.1 Population Within 10 Miles

The population within 10 miles (see Figure 2.1-6) is low. The 1970 population of 15,624 is projected to grow to 24,284 by 2020. The population density in 1970 was 49.73 people per square mile and is projected to grow to 77.29 people per square mile by 2020. The present and projected population densities still reflect a rural character for the general area within 10 miles of the site.

The 1975 and projected (2020) population within 5 miles of the site is illustrated in Figure 2.1-7. For greater accuracy in the 0-5 mile region, an onsite house count was conducted in August 1975. To determine the population of the area, the number of houses counted was multiplied by 3.1 (the average number of people per household based on Census Bureau MEDLIST statistics for the area). The future populations were projected on the basis of the 1975 house count and the modified ratio technique. The total 1975 population within 5 miles of the site is 1106, with a low population density of 14.08 people per square mile. The population is projected to grow to 1273 by 2020, which will

maintain a low population density of 16.20 people per square mile. The low population density reflects the rural character of the area surrounding the site.

There are no cities or towns within 5 miles of the site. Within 10 miles of the site there are a few cities but no major population centers (cities with populations greater than 25,000). Table 2.1-2 lists all cities within 10 miles of the site with their respective 1970 and projected 2020 populations, and Figure 2.1-8 locates them.

2.1.3.2 Population Between 10 and 50 Miles

The 1970 population and the estimated projected populations through 2020 at 10-year intervals for the area within 50 miles of the site are summarized in Figure 2.1-6. The total population within 50 miles was 933,907 in 1970 and is projected to approach 1,660,000 by 2020. Approximately 90% of the 1970 population within 50 miles lives more than 20 miles away from the site.

The most heavily populated sectors within 50 miles of the site lie in the north-northeast, northeast, and east-northeast directions. The 1970 populations are 177,101, 207,829, and 114,318 respectively. The high populations in these sectors are due primarily to the inclusion of the cities of Joliet (1970 population 80,378) and Aurora (1970 population 69,207). Table 2.1-3 provides the 1970 and projected 2020 populations for all cities within 50 miles of the site. Also included in this area are some outlying suburbs of Chicago such as Romeoville (1970 population 12,674), Woodridge (1970 population 11,028), St. Charles (1970 population 11,895), and Naperville (1970 population 23,885). The greater population growth within 50 miles of the site will most probably occur between 35 and 50 miles north-northeast, northeast, and east-northeast due to the expansion of cities such as Joliet and Aurora and the further development of the Chicago suburbs. Figure 2.1-9 locates all population centers within 50 miles of the site.

The average 1970 population density for the 50-mile radius area was 118.9 people per square mile, with the 2020 density projected to be 211.1 people per square mile. The most densely populated area, between 40 and 50 miles from the site, has an average density of 153.3 people per square mile. This is expected to increase by 2020 to 292.7 people per square mile. The least densely populated area, within 10 miles of the plant site, had a 1970 average density of 49.7 people per square mile. This is projected to reach 77.2 people per square mile by 2020.

2.1.3.3 Transient Population

There are no schools, hospitals, or industries within 5 miles of the site. According to the LaSalle County agricultural agent, no migrant workers are employed anywhere in the area (Reference 1).

The only public facilities within 10 miles of the plant site are located in the towns of Marseilles and Seneca. Both have a municipal swimming pool and park. Illini State Park is located just outside Marseilles on the south side of the Illinois River. This park has facilities for boating, camping, picnicking, and fishing and had a visitor rate of 524,319 for the 1974 season (Reference 2). Illini State Park is outside the 5-mile radius from the plant site.

The nearest industries are also located in Marseilles and Seneca. Table 2.1-5 lists all industry within 10 miles of the site.

2.1.3.4 Low Population Zone

The low population zone (LPZ) as defined in 10 CFR 100 is "the area immediately surrounding the exclusion area which contains residents, the total number and density of which are such that there is a reasonable probability that appropriate protection measures could be taken in their behalf in the event of a serious accident". 10 CFR 100.11 also lists two numerical criteria to be met by the LPZ, namely, (1) that the LPZ is "of such size that an individual located at any point on its outer boundary who is exposed to the radioactive cloud resulting from the postulated fission product release (during the entire period of passage) would not receive a total radiation dose to the whole body in excess of 25 rem or a total radiation dose in excess of 300 rem to the thyroid from iodine exposure", and (2) "a population center distance of at least one and one-third times the distance from the reactor to the outer boundary of the low population zone".

The LPZ for LSCS is the area, including the exclusion area, within a radius of 6400 meters (3.98 miles) centered at the vent stack. This designation of the LPZ radius satisfies the radiation dose criteria of 10 CFR 100.11(a) (2) (see Chapter 15.0). The maximum permissible LPZ radius based on the population center distance criterion would be 8.5 miles. The nearest population center within the meaning of 10 CFR 100 is approximately 11.3 miles from the site. This LPZ radius of 6400 meters was selected for the PSAR; it satisfies the population center criteria of 10 CFR 100.11(a)(3).

A map of the LPZ showing topographic features, highways, railways, waterways, and other important features is shown in Figure 2.1-10.

There are no facilities or institutions such as schools, hospitals, prisons, beaches, or parks within a 5-mile radius of the site.

The total current and projected populations of the LPZ by sectors are given in Table 2.1-4. This includes both residential and transient populations. Figure 2.1-7 illustrates the population distribution within 5 miles of the site.

2.1.3.5 Population Centers

A population center is defined in 10 CFR 100.3(c) as a densely populated center of 25,000 or more inhabitants. Ottawa, Illinois, located approximately 11.3 miles northwest of the plant site, is the nearest population center within the meaning of 10 CFR 100. Ottawa is projected to have a population of 25,904 by 2020. Table 2.1-6 provides the present and projected population centers and their distances and directions from the site. Figure 2.1-9 locates these population centers.

There are six communities within 10 miles of the site: Seneca, Ransom, Kinsman, Marseilles, Grand Ridge, and Verona. Table 2.1-2 details their locations and present and projected populations. The 1970 and projected 2020 population densities for the 10-mile area are listed in Table 2.1-7. The 1970 average density of the 10-mile area is 49.75, and the projected 2020 density is 77.30. The city of Marseilles is the largest population grouping in the 10-mile area, with a 1970 population of 4320. The northwest, north-northwest, and north sector densities are the greatest due to the city of Marseilles. The urban densities for Marseilles are 46.19 people per square mile in the northwest sector, 131.96 people per square mile in the north-northwest sector, and 88.01 people per square mile in the north sector. The average urban density for these three sectors is 88.72 people per square mile.

2.1.3.6 Population Density

The population density in 1980 within 50 miles of LSCS is projected to be approximately 141 people/mi². By 2020, the density is projected to reach 211 people/mi². Figure 2.1-11 shows the 1980 population with relation to the uniform density of 500 people/mi² in each of the 16 compass directions within 50 miles of the plant site. Figure 2.1-12 shows the 2020 population with relation to the uniform density of 1000 people/mi² in each of the 16 compass directions within 50 miles of the plant site. Table 2.1-8 details the cumulative populations shown in Figures 2.1-11 and 2.1-12.

2.1.4 References

1. J. Daugherty, LaSalle COOP Extension Service, Telephone Conversation with J. Montgomery, Sargent & Lundy Cultural Resources Analyst, August 27, 1975.
2. B. Rogers, Department of Conservation, State of Illinois, Personal Communication to J. Prey, Sargent & Lundy, 1975.

LSCS-UFSAR

TABLE 2.1-1

DISTANCE FROM GASEOUS EFFLUENT RELEASE POINT TO
NEAREST SITE BOUNDARY IN THE CARDINAL COMPASS DIRECTIONS

<u>DIRECTION</u>	<u>DISTANCE</u>
N	1,002 m (3,363 ft)
NNE	1,330 m (4,375 ft)
NE	2,408 m (7,900 ft)
ENE	4,450 m (14,600 ft)
E	1,996 m (6,550 ft)
ESE	838m (2,750 ft)
SE	884 m (2,900 ft)
SSE	838 m (2,750 ft)
S	829 m (2,720 ft)
SSW	829 m (2,720 ft)
SW	610 m (2,000 ft)
WSW	509m (1,670 ft)
W	509 m (1,670 ft)
WNW	625 m (2,050 ft)
NW	732 m (2,400 ft)
NNW	848 m (2,788 ft)

LSCS-UFSAR

TABLE 2.1-2

1970 AND PROJECTED 2020 POPULATIONS
FOR TOWNS WITHIN 10 MILES OF THE SITE

<u>TOWN</u>	<u>1970 POPULATION</u>	<u>2020 POPULATION</u>	<u>DISTANCE AND DIRECTION FROM SITE</u>
Seneca	1781	2695	5.6 miles NE
Ransom	440	796	6.2 miles S
Kinsman	153	215	6.4 miles SE
Marseilles	4320	6579	6.8 miles NNW
Grand Ridge	698	970	8.2 miles W
Verona	220	320	9.0 miles ESE

LSCS-UFSAR

TABLE 2.1-3 (SHEET 1 OF 3)

1970 AND PROJECTED POPULATION FOR CITIES WITHIN 50.0 MILES OF THE SITE
(All Cities Are In Illinois)

<u>CITY</u>	<u>1970 POPULATION</u>	<u>2020 POPULATION</u>	<u>DISTANCE & DIRECTION FROM SITE</u>
Seneca	1781	2695	5.6 Miles NE
Ransom	440	796	6.2 Miles S
Kinsman	153	215	6.4 Miles SE
Marseilles	4320	6579	6.8 Miles NNW
Grand Ridge	698	970	8.2 Miles W
Verona	220	320	9.0 Miles ESE
Streator East*	1660	3128	10.6 Miles SW
Ottawa	18716	25904	11.3 Miles NW
Streator West*	2077	2812	11.4 Miles SW
Streator	15600	21433	11.8 Miles SW
Naplate	686	901	12.2 Miles WNW
Kangley	290	417	12.4 Miles WSW
Mazon	727	1107	12.7 Miles E
South Streator*	1869	2836	13.4 Miles SW
Morris	8194	12328	15.1 Miles ENE
Dwight	3841	6182	16.3 Miles SE
Leonore	196	282	16.6 Miles WSW
Cornell	532	751	17.9 Miles S
Odell	1076	1665	18.5 Miles SSE
North Utica	974	1460	18.7 Miles WNW
Lisbon	261	386	18.7 Miles NNE
Gardner	1212	1961	19.1 Miles ESE
Sheridan	724	1015	19.2 Miles N
Carbon Hill	317	572	19.5 Miles E
Oglesby	4175	5511	19.9 Miles W
Coal City	3040	5299	20.0 Miles E
Central City	56	95	20.0 Miles E
Long Point	310	371	20.3 Miles SW
Newark	590	934	20.6 Miles NNE
Tonica	821	1269	20.6 Miles W
Eileen	371	669	20.9 Miles E
South Wilmington	725	1076	21.0 Miles ESE
Braceville	668	1143	21.1 Miles E
Lostant	465	592	21.5 Miles WSW
East Brooklyn	72	106	21.5 Miles ESE
Diamond	452	800	21.7 Miles E
Millington	338	505	21.8 Miles N
Godley	242	425	22.1 Miles E
La Salle	10736	14172	22.9 Miles WNW
Braidwood	2323	4111	23.0 Miles E
Wenona	1080	1548	23.4 Miles WSW
Cedar Point	304	470	23.6 Miles W
Reddick	247	376	24.0 Miles ESE
Campus	217	263	24.2 Miles SE
Peru	11772	19537	24.3 Miles WNW
Dana	173	176	24.6 Miles SW
Essex	364	537	24.7 Miles E
Emington	101	97	25.0 Miles SE
Pontiac	9031	14648	25.5 Miles S
Minooka	768	1932	25.6 Miles NE
Rutland	437	446	26.1 Miles SW
Troy Grove	281	509	26.1 Miles NW
Leland	743	1184	26.1 Miles NNW
Channahon	1505	2784	26.2 Miles ENE
Standard	282	455	26.6 Miles W
Somonauk	1112	1830	26.7 Miles N
Earlville	1410	2272	27.2 Miles NNW
Flanagan	878	1224	27.3 Miles SSW
Dalzell	579	887	27.4 Miles WNW
Wilmington	4335	6577	27.4 Miles E
Sandwich	5056	9132	27.8 Miles N
Toluca	1319	1780	27.8 Miles WSW
Spring Valley	5605	8587	28.0 Miles WNW
Saunemin	415	552	28.0 Miles SSE
McNabb	246	421	28.5 Miles W
Union Hill	156	240	28.7 Miles ESE
Magnolia	328	562	28.8 Miles WSW
Granville	1232	1990	29.1 Miles W
Buckingham	198	307	29.2 Miles ESE
Yorkville	2049	3959	29.6 Miles NNE
Plano	4664	9126	29.6 Miles NNE
Ladd	1328	2034	29.8 Miles WNW
Cabery	287	376	29.8 Miles SE
Mark	379	612	30.1 Miles W

* Indicates an unincorporated area

LSCS-UFSAR

TABLE 2.1-3 (SHEET 2 OF 3)

<u>CITY</u>	<u>1970 POPULATION</u>	<u>2020 POPULATION</u>	<u>DISTANCE & DIRECTION FROM SITE</u>
Minok	2267	3582	30.3 Miles SW
Cherry	551	804	30.8 Miles WNW
Shorewood	1749	4969	30.8 Miles NE
Elwood	794	1399	30.9 Miles ENE
Kempton	263	353	31.1 Miles SE
Mendota	6902	11201	31.3 Miles NW
Varna	417	610	31.5 Miles WSW
Seatonville	318	489	32.3 Miles WNW
Symerton	155	243	32.4 Miles E
Herscher	988	1622	32.4 Miles ESE
Bonfield	241	399	32.5 Miles ESE
Cullom	572	658	32.9 Miles SE
La Rose	165	190	32.9 Miles WSW
Depue	1919	3103	33.1 Miles W
Hollowayville	94	152	33.5 Miles WNW
Arlington	250	365	33.8 Miles WNW
Rockdale	2085	3121	33.8 Miles ENE
Oswego	1862	4419	34.4 Miles NNE
Chenoa	1860	3248	34.6 Miles S
Paw Paw	846	1305	34.6 Miles NNW
Hennepin	535	788	34.7 Miles W
Plainfield	2928	6364	35.0 Miles NE
Fairbury	3359	5441	35.5 Miles SSE
Joliet	80378	127627	35.7 Miles ENE
Benson	490	725	36.0 Miles SW
Hinckley	1053	1741	36.1 Miles N
Crest Hill	7460	13533	36.2 Miles NE
Gridley	1007	1538	36.4 Miles SSW
Bureau Junction	466	773	36.4 Miles W
Waterman	990	1539	36.5 Miles N
Panola	30	36	36.8 Miles SSW
Forrest	1219	1743	36.8 Miles SSE
Sugar Grove	1230	2798	37.1 Miles NNE
La Moille	669	975	37.3 Miles NNW
Henry	2610	4447	37.3 Miles WSW
Shabbona	730	1075	37.4 Miles NNW
Manhattan	1530	2873	37.6 Miles ENE
Compton	399	713	37.7 Miles NW
Montgomery	3278	5654	37.7 Miles NNE
Irwin	87	153	38.1 Miles ESE
Malden	262	376	38.3 Miles WNW
Washburn	1173	1729	39.0 Miles SW
El Paso	2291	3859	39.2 Miles SSW
Chatsworth	1255	1490	39.3 Miles SSE
West Brooklyn	225	402	39.5 Miles NW
Lockport	9985	18073	39.8 Miles NE
Dover	176	257	39.9 Miles WNW
Sublette	361	523	39.9 Miles NW
Aurora	69207	119100	39.9 Miles NNE
Strawn	144	185	39.9 Miles SSE
Lacon	2147	3187	40.4 Miles WSW
Lee	252	362	40.5 Miles NNW
New Lenox	2855	6120	40.6 Miles ENE
Romeoville	12674	33120	40.9 Miles NE
Roanoke	2040	3143	41.4 Miles SW
Bourbonnais	5909	10815	41.5 Miles E
Sparland	585	891	42.0 Miles WSW
Piper City	817	986	42.0 Miles SE
Lexington	1615	2779	42.1 Miles S
Princeton	6959	11670	42.1 Miles WNW
Secor	508	770	42.3 Miles SW
Bradley	9881	18086	42.3 Miles E
North Aurora	4833	8498	42.6 Miles NNE
Chebanse	1185	2089	42.6 Miles ESE
Manteno	2864	2343	42.8 Miles E
Kankakee	30944	42365	42.8 Miles ESE
Kappa	131	220	43.1 Miles SSW
Maple Park	660	1007	43.3 Miles N
Elburn	1122	2084	43.3 Miles NNE
Clifton	1339	2356	43.5 Miles ESE
Tiskilwa	973	1470	43.6 Miles W
Bolingbrook**	6483	18370	44.6 Miles NE
Ashkum	590	811	44.6 Miles SE
Naperville	23885	56185	45.0 Miles NE
Mokena	1643	3580	45.1 Miles ENE

** Indicates only the part of the city population which falls within 50 miles of LSCS.

LSCS-UFSAR

TABLE 2.1-3 (SHEET 3 OF 3)

<u>CITY</u>	<u>1970 POPULATION</u>	<u>2020 POPULATION</u>	<u>DISTANCE & DIRECTION FROM SITE</u>
Lemont	5080	9160	45.3 Miles NE
Steward	308	447	45.4 Miles NNW
Aroma Park Northwest	2010	3807	45.4 Miles ESE
Frankfort	2325	5066	45.6 Miles ENE
Batavia	8994	16346	45.7 Miles NNE
Danforth	404	503	45.8 Miles SE
Peotone	2345	4178	46.0 Miles E
Ohio	506	673	46.4 Miles WNW
Aroma Park	896	1741	46.5 Miles ESE
Cortland	541	993	46.5 Miles N
Warrenville	3854	7674	47.0 Miles NNE
Colfax	935	1298	47.0 Miles S
Hudson	802	1594	47.1 Miles SSW
Amboy	2184	3371	47.2 Miles NW
Anchor	200	213	47.2 Miles S
Woodridge	11028	27451	47.4 Miles NE
Arbary Hills	1291	2813	47.4 Miles ENE
Metamora	2176	3612	47.7 Miles SW
Gilman	1786	2551	47.8 Miles SE
De Kalb	32949	73346	47.8 Miles N
Sibley	381	451	47.8 Miles SSE
Wyanet	1005	1678	48.0 Miles W
Eureka	3028	5322	48.0 Miles SW
Geneva	9115	15161	48.1 Miles NNE
Malta	961	1572	48.3 Miles NNW
Chillicothe	6052	10072	48.4 Miles WSW
Thawville	271	371	48.4 Miles SE
Towanda	578	816	48.4 Miles SSW
Cooksville	241	347	48.6 Miles S
Westhaven	470	1112	48.9 Miles ENE
Downers Grove**	5407	11802	48.9 Miles NE
Lisle**	4331	10780	49.0 Miles NE
Darien**	484	952	49.2 Miles NE
St. Charles**	11895	22601	49.3 Miles NNE
Monee	940	1865	49.5 Miles ENE
West Chicago**	6106	12053	49.5 Miles NNE
Orland Park**	4114	9740	49.6 Miles ENE
Winfield**	20	39	49.6 Miles NNE
Onarga	1436	2021	49.7 Miles SE
Creston	595	975	49.7 Miles NNW
Sycamore**	454	833	49.7 Miles N
Rochelle**	6	9	49.8 Miles NNW

** Indicates only the part of the city population which falls within 50 miles of LSCS.

LSCS-UFSAR

TABLE 2.1-4
(SHEET 1 OF 4)

POPULATION DISTRIBUTION WITHIN THE LPZ

YEAR: 1990

	<u>0 - 1 mi.</u>	<u>1 - 2 mi.</u>	<u>2 - 3 mi.</u>	<u>3 - 4 mi.</u>	<u>TOTAL</u>
N	0	3	0	0	3
NNE	0	0	0	18	18
NE	0	0	10	24	34
ENE	0	0	0	10	20
E	0	3	3	10	16
ESE	0	0	10	14	24
SE	0	3	7	14	24
SSE	0	0	10	11	21
S	0	3	7	20	30
SSW	3	10	7	13	33
SW	0	3	9	12	24
WSW	3	20	7	7	37
W	0	16	10	19	45
WNW	0	14	3	19	36
NW	0	0	10	45	55
NNW	0	7	3	14	24
TOTAL	6	82	96	250	434

LSCS-UFSAR

TABLE 2.1-4
(SHEET 2 OF 4)

YEAR: 2000

	<u>0 - 1 mi.</u>	<u>1 - 2 mi.</u>	<u>2 - 3 mi.</u>	<u>3 - 4 mi.</u>	<u>TOTAL</u>
N	0	3	0	0	3
NNE	0	0	0	18	18
NE	0	0	10	25	35
ENE	0	0	0	10	10
E	0	3	3	10	16
ESE	0	0	10	15	25
SE	0	3	7	15	25
SSE	0	0	10	11	21
S	0	3	7	19	29
SSW	3	10	7	13	33
SW	0	3	10	14	27
WSW	3	21	8	8	40
W	0	18	12	22	52
WNW	0	15	3	22	40
NW	0	0	10	53	63
NNW	0	7	3	15	25
TOTAL	6	86	100	270	462

LSCS-UFSAR

TABLE 2.1-4
(SHEET 3 OF 4)

YEAR: 2010

	<u>0 - 1 mi.</u>	<u>1 - 2 mi.</u>	<u>2 - 3 mi.</u>	<u>3 - 4 mi.</u>	<u>TOTAL</u>
N	0	3	0	0	3
NNE	0	0	0	19	19
NE	0	0	10	26	36
ENE	0	0	0	10	10
E	0	3	3	10	16
ESE	0	0	10	15	25
SE	0	3	7	15	25
SSE	0	0	10	11	21
S	0	3	7	20	30
SSW	3	10	7	14	34
SW	0	3	10	15	28
WSW	3	22	9	9	43
W	0	18	12	24	54
WNW	0	15	3	24	42
NW	0	0	10	57	67
NNW	0	7	3	15	25
TOTAL	0	87	101	284	478

LSCS-UFSAR

TABLE 2.1-4
(SHEET 4 OF 4)

YEAR: 2020

	<u>0 - 1 mi.</u>	<u>1 - 2 mi.</u>	<u>2 - 3 mi.</u>	<u>3 - 4 mi.</u>	<u>TOTAL</u>
N	0	4	0	0	4
NNE	0	0	0	19	19
NE	0	0	11	26	37
ENE	0	0	0	11	11
E	0	4	4	11	19
ESE	0	0	11	15	26
SE	0	4	7	15	26
SSE	0	0	11	11	22
S	0	4	7	20	31
SSW	4	11	7	14	36
SW	0	4	10	16	30
WSW	4	22	9	9	44
W	0	18	13	25	56
WNW	0	15	4	25	44
NW	0	0	11	60	71
NNW	0	7	4	15	26
TOTAL	8	93	109	292	502

LSCS-UFSAR

TABLE 2.1-5 (Historical)

INDUSTRIES WITHIN 10 MILES OF THE SITE

<u>COMMUNITY</u>	<u>NAME OF INDUSTRY</u>	<u>NO. OF EMPLOYEES</u>	<u>PRODUCT/SERVICE</u>
Grand Ridge	Pfiester Associated Growers	35-1,000 (seasonal)	hybrid seed, chemical herbicides
Marseilles	Asphalt Paving Co.	5-50 (seasonal)	commercial and private paving
	Bates & Rogers Construction Co.	14	general contracting
	Beker Industries Corp.	135	sulfuric acid, wet process phosphoric acid
	Boren Blasting Inc.	10	custom drilling and blasting
	Borg-Warner Chemical, Borg-Warner Corp.	350	acrylonitrile, butadiene, nitrogen
	Carroll Electric Service	7	electrical contractor
	Central Heating & Engineering	1	heating contractor
	Consumer Oil Products	2	oil distributor: retail and wholesale
	Nick Cosmutto, Jr., General Contractor	1	cabinet maker
	Decker Electric	4	electrical contractor
	Hicks Gas Sales & Services	3	
	Illinois Nitrogen Corp.	90	
	Iverson Machine Shop	1	machine shop
	Keisman Mfg. Co., Dan-Jae Division	150	jackets: leather and cloth
	M&M Grain & Farm Supply Co., Inc	4	grain supplier
	Marseilles Plumbing & Heating	8	heating & plumbing contracting & maintenance
	Marseilles Salvage Co.	5	salvage
	Marseilles Sheet Metal, Inc.	5	sheet metal
	Material Service Corp.	100	lightweight concrete aggregate
	National Biscuit Co., Carton Factory Division	350	boxes
	Northern Illinois Gas Co.	2	service office
	P&H Pattern Shop	4	patterns and models
	Pittsburgh - Des Moines Steel Co	80	steel fabrication: bridges, structures
	Plastic Capacitors Corp.	27	capacitor units for dispensing and storing electricity
	Roe Aluminum Exteriors	4	aluminum exteriors
	Spicer Concrete Products	4	concrete products
	Spicer Gravel Co. Inc.	22	sand, gravel, readimix concrete
	Standard Foundary Products	12	aluminum and brass castings
	Standard Oil Division of Amoco Oil Co.	2	oil distributor
	Valley Metal Products	4	ornamental iron work, fire escapes, stairways, castings
Seneca	E. I. DuPont de Nemours & Co., Polymer Intermediates Dept.	230	
	Muffler's Fritz Excavating & Septic Service	2	ammonia excavating and septic service
	Tri-State Motor Transit	61	trucking

LSCS-UFSAR

TABLE 2.1-6

PRESENT AND PROJECTED POPULATION CENTERS
WITHIN 50 MILES OF THE SITE

<u>CITY*</u>	<u>1970 POPULATION</u>	<u>2020 POPULATION</u>	<u>DISTANCE AND DIRECTION FROM SITE</u>
Ottawa, Illinois	18,716	25,904	11.3 miles NW
Joliet, Illinois	80,378	127,627	35.7 miles ENE
Aurora, Illinois	69,207	119,100	39.9 miles NNW
Romeoville, Illinois	12,674	33,120	40.9 miles NE
Kankakee, Illinois	30,944	42,365	42.8 miles ESE
Naperville, Illinois	23,885	56,185	45.0 miles NE
Woodridge, Illinois	11,028	27,451	47.4 miles NE
DeKalb, Illinois	32,949	73,346	47.8 miles N

* For city locations see Figure 2.1-9.

LSCS-UFSAR

TABLE 2.1-7

1970 AND PROJECTED 2020 POPULATION
DENSITIES WITHIN 10 MILES OF THE SITE

<u>DIRECTION</u>	<u>1970 DENSITY</u>	<u>2020 DENSITY</u>
N	98.96	150.29
NNE	55.62	84.08
NE	71.76	110.98
ENE	14.57	20.98
E	30.56	44.72
ESE	19.76	28.88
SE	16.30	22.92
SSE	24.34	44.05
S	23.48	42.48
SSW	21.95	41.35
SW	56.12	101.76
WSW	18.23	22.92
W	44.77	58.06
WNW	48.03	75.53
NW	86.07	135.57
NNW	165.22	252.20

LSCS-UFSAR

TABLE 2.1-8

(Sheet 1 of 2)

CUMULATIVE POPULATION WITHIN 50 MILES

1980

<u>DIRECTION</u>	<u>0-5*</u>	<u>0-10</u>	<u>0-20</u>	<u>0-30</u>	<u>0-40</u>	<u>0-50</u>
N	9	1,937	4,000	23,193	29,140	86,742
NNE	55	953	2,184	12,017	94,063	214,748
NE	370	1,389	7,204	12,789	111,707	286,048
ENE	25	202	8,152	16,444	92,490	133,737
E	47	510	4,534	20,341	26,722	69,094
ESE	41	288	1,697	4,538	10,098	48,926
SE	39	353	5,368	6,315	8,063	14,903
SSE	49	624	2,256	3,466	11,254	13,343
S	42	596	1,784	15,300	19,574	25,041
SSW	61	597	2,159	4,376	8,944	14,698
SW	28	1,355	22,639	25,139	29,159	42,305
WSW	52	314	2,585	6,907	13,883	25,444
W	54	722	3,403	11,955	16,357	22,572
WNW	45	1,055	10,295	40,947	46,495	56,318
NW	110	1,923	15,564	18,155	28,144	33,021
NNW	54	3,351	6,317	10,300	13,786	18,443

* Based on 500 people mi², population would be as follows:

0-5 mi:	2,454 people/sector
0-10 mi:	9,817 people/sector
0-20 mi:	39,270 people/sector
0-30 mi:	88,357 people/sector
0-40 mi:	157,080 people/sector
0-50 mi:	245,436 people/sector

LSCS-UFSAR

TABLE 2.1-8
(SHEET 2 OF 2)

<u>DIRECTION</u>	<u>2020</u>					
	<u>0-5</u>	<u>0-10</u>	<u>0-20</u>	<u>0-30</u>	<u>0-40</u>	<u>0-50</u>
N	11	2,822	5,801	34,756	43,576	132,100
NNE	64	1,373	3,145	17,982	142,183	323,800
NE	425	1,919	10,600	19,307	169,062	441,252
ENE	30	285	12,117	24,823	136,197	200,163
E	55	723	6,666	30,238	39,873	101,639
ESE	48	405	2,455	6,591	15,006	71,548
SE	46	496	7,883	9,174	11,637	21,379
SSE	54	919	3,297	4,984	16,255	19,160
S	47	881	2,568	22,525	28,728	36,663
SSW	68	880	3,153	6,300	12,971	21,590
SW	36	2,034	32,657	36,185	42,017	61,506
WSW	66	437	3,702	9,920	20,151	37,096
W	69	1,090	4,863	17,366	23,848	32,955
WNW	57	1,540	14,840	59,409	67,489	81,923
NW	135	2,797	22,248	26,025	40,745	47,816
NNW	62	4,874	9,296	15,137	20,175	26,978

2.2 NEARBY INDUSTRIAL, TRANSPORTATION, AND MILITARY FACILITIES

2.2.1 Locations and Routes

There are no storage facilities, mining and quarry operations, transportation facilities, or gas pipelines within 5 miles of the plant. There are no refineries, or underground gas storage facilities within 10 miles. There are 2 crude oil pipelines within 5 miles of the plant. Both are owned and operated by Enbridge Energy.

The only military facility within 10 miles is the Illinois Army Reserve National Guard (ILARNG) Training Facility (Figure 2.2-2). It is located approximately 1 mile northwest of LaSalle County Station and encompasses approximately 2560 acres. There are no missile sites or bombing ranges at the facility, but there are 5 firing ranges, all firing in the direction of north to northwest (Reference 10).

A historical list of industries within 10 miles is shown in Table 2.1-5. The commercial airports within 20 miles are listed in Table 2.2-1, and all airports and aircraft flight patterns are illustrated in Figure 2.2-1. Dock and anchorage facilities on the Illinois River near the site are listed in Table 2.2-2, and [REDACTED] within 10 miles are shown in Figure 2.2-2.

2.2.2 Descriptions

2.2.2.1 Description of Facilities

A historical list of industries within 10 miles of the site is shown in Table 2.1-5 along with their respective products and number of employees. Table 2.2-3 lists the manufacturers and users of hazardous materials within 5 miles of the site.

The nearest industries are located in Seneca, Illinois, approximately 5.6 miles northeast of the site. There are also local farms that are as close as 1100 feet from the site. [REDACTED]

2.2.2.2 Descriptions of Products and Materials

There are several hazardous products or materials regularly manufactured, stored, used, or transported within 5 miles of the site. The industries within 5 miles of the site that deal with hazardous materials are listed in Table 2.2-3 with all the hazardous materials manufactured, stored, or used, as well as their maximum quantities and modes of transportation.

2.2.2.3 Pipelines

[REDACTED]

They are not used for storage and are not likely to be used to transport or store any other product (Reference 2).

[REDACTED]

2.2.2.4 Waterways

The Illinois River is the only waterway near the site used for commercial navigation. The river traffic passing by the site area consists mainly of cargo barges with a few small pleasure boats. The plant site is located approximately 5 miles south of the Illinois River at approximately river mile 250. [REDACTED]

[REDACTED]

The cargo transported by barge on the Illinois River passing by the site area consists largely of petroleum, coal, chemicals, and sludge (Reference 3). Table 2.2-4 lists the commodities passed downriver from the Dresden Island Lock and upstream from the Marseilles Lock. [REDACTED]

[REDACTED] These commodities are transported on either tank-type barges (for petroleum, sludge, etc.) or hopper-type barges (for coal, grain, etc.). The standard size hopper barge is approximately 35 feet by 195 feet, while the tank type is approximately 50 feet by 290 feet. A number of barges may be put together and transported as a tow. The maximum tow width at the Marseilles and Dresden Island Locks is 108 feet. The tow length is dependent upon such limitations as maneuverability in the shipping channel, type of cargo transported, and size of the tug.

LSCS-UFSAR

The shipping channel of the Illinois River is approximately 150 feet on either side of the sailing line of the river (Reference 4). The normal water depth of the channel at river mile 249 is approximately 9 feet to 11 feet. The intake structure for the plant is approximately 250 feet south of the shipping channel. All nearby docks and anchorages are listed in Table 2.2-2.

2.2.2.5 Airports

There are no commercial airports within 10 miles of the site, and there is only one private airstrip within 5 miles. Figure 2.2-1 locates all airports within 20 miles of the site. As shown, there are 5 commercial and 14 private airports. All commercial airports are listed in Table 2.2-1. As indicated in the table, these airports can handle both twin-engine and single-engine aircraft. With the exception of the Ottawa Airport, single-engine aircraft predominate. Specific or well-established landing and holding patterns associated with the smaller airports are practically nonexistent. Furthermore, the distance from the site negates any effect from potential and existing landing and holding patterns.

Table 2.2-5 lists the private airfields within 20 miles of the site with their respective distance and direction from the site. Most of these airfields are very small, consisting of a single turf runway suitable only for small single-engine aircraft. Very few have any facilities such as fuel, telephone, ground transportation, and rest stops.

There are also three airway corridors within 10 miles of the site (see Figure 2.2-1). These airway corridors are approximately 8 miles wide, with most aircraft flying within a mile or two of the centerline. All the traffic on these airways must conform to minimum low-altitude regulations established by the Federal Aviation Administration (FAA). They must fly at least 1,000 feet above the tallest object in the airway corridor. According to one representative of the FAA, most aircraft fly at around 5,000 feet or above with a few between 3,000 feet and 5,000 feet and almost none between 2,000 feet and 3,000 feet. Most of the aircraft that fly at the lower altitudes (3,000 feet to 5,000 feet) are small single-engine aircraft (Reference 5).

There are no airports within 10 miles of the site with projected operations greater than $500d^2$ (d = distance in miles) movements per year, nor are there any airports with projected operations greater than $1000d^2$ per year outside 10 miles.

2.2.2.6 Projections of Industrial Growth

There are existing industries located inside a 5-mile radius of the site. Those industries are listed in table 2.2-3. The historic list of industries within 10 miles of the plant is shown in Table 2.1-5. There are no immediate plans for expansion of any of these industries.

[REDACTED]

[REDACTED]

[REDACTED]

[REDACTED]

[REDACTED]

[REDACTED]

[REDACTED]

[REDACTED]

[REDACTED]

[REDACTED]

[REDACTED]

[REDACTED]

[REDACTED]

[REDACTED]

[REDACTED]

[REDACTED]

[REDACTED]

[REDACTED]

[REDACTED]

2.2.3.2 Effects of Design-Basis Events

[REDACTED]

[REDACTED]

[REDACTED]

[REDACTED]

[REDACTED]

[REDACTED]

[REDACTED]

[REDACTED]



2.2.4. References

1. Bob Wheeler, Tri-State Motor Transit, Personal Communication to Jane Prey, Sargent & Lundy, 1975.
2. Philip Cali, Northern Illinois Gas Co., Personal Communication to Jane Prey, Sargent & Lundy, 1975.
3. Department of the Army, Chicago District Corps of Engineers, Lock Statistics, 1974.
4. Russell Carlock, Army Corps of Engineers, Personal Communication to Jane Prey, Sargent & Lundy, 1975.
5. Allen Slingo, Federal Aviation Administration, Personal Communication to Jane Prey, Sargent & Lundy, 1975.
6. Robert Tolson, Continental Grain Co., Personal Communication to Jane Prey, Sargent & Lundy, 1975.
7. U.S. Department of the Army, "Waterborne Commerce of the United States," Part 3, 1972-1974.
8. CRC, "Handbook of Chemistry and Physics," 49th Edition, 1969.
9. Chlorine Institute, Letter to S. Wu, Sargent & Lundy, September 2, 1975.

LSCS-UFSAR

10. Illinois Army Reserve National Guard, Personal Communication to Thomas J. Borzym, February 26, 1986.
11. Survey of Chlorine Shipment in the Vicinity of LaSalle County Station, performed by Sargent & Lundy, 1986.
12. LaSalle Design Analysis L-003414, Toxic Chemical Analyses of 2008 Offsite Chemical Survey Results

TABLE 2.2-1

COMMERCIAL AIRPORTS WITHIN 20 MILES OF THE SITE

<u>AIRPORT</u>	<u>RUNWAYS:</u> <u>ORIENTATION/</u> <u>LENGTH</u> <u>(°/ft)</u>	<u>TYPE</u>	<u>TYPE OF</u> <u>AIRCRAFT</u>	<u>NUMBER OF</u> <u>OPERATIONS PER</u> <u>YEAR BY TYPE</u>	<u>DISTANCE & DIRECTION</u> <u>FROM SITE</u>
[REDACTED]	[REDACTED]	[REDACTED]	[REDACTED]	[REDACTED]	[REDACTED]
[REDACTED]	[REDACTED]	[REDACTED]	[REDACTED]	[REDACTED]	[REDACTED]
[REDACTED]	[REDACTED]	[REDACTED]	[REDACTED]	[REDACTED]	[REDACTED]
[REDACTED]	[REDACTED]	[REDACTED]	[REDACTED]	[REDACTED]	[REDACTED]
[REDACTED]	[REDACTED]	[REDACTED]	[REDACTED]	[REDACTED]	[REDACTED]
[REDACTED]	[REDACTED]	[REDACTED]	[REDACTED]	[REDACTED]	[REDACTED]

HAZARDOUS CHEMICALS TRANSPORTED ON
THE ILLINOIS RIVER NEAR THE SITE DURING 2008

CHEMICALS

NUMBER OF PASSES THROUGH
MARSEILLES LOCK

[REDACTED]

[REDACTED]

[REDACTED]

LSCS-UFSAR

TABLE 2.2-5

PRIVATE AIRSTRIPS WITHIN 20 MILES OF THE SITE

<u>AIRSTRIP</u>	<u>DISTANCE & DIRECTION FROM SITE</u>
[REDACTED]	[REDACTED]
[REDACTED]	[REDACTED]
[REDACTED]	[REDACTED]
[REDACTED]	[REDACTED]
[REDACTED]	[REDACTED]
[REDACTED]	[REDACTED]
[REDACTED]	[REDACTED]
[REDACTED]	[REDACTED]
[REDACTED]	[REDACTED]
[REDACTED]	[REDACTED]
[REDACTED]	[REDACTED]
[REDACTED]	[REDACTED]
[REDACTED]	[REDACTED]
[REDACTED]	[REDACTED]
[REDACTED]	[REDACTED]

2.3 METEOROLOGY

This section provides a meteorological description of the site and its surrounding areas. This includes a description of general climate, a description of meteorological conditions used for design and operating-basis considerations, summaries of normal and extreme values of meteorological parameters, a discussion of the potential influence of the plant and its facilities on local meteorology, a description of the onsite meteorological measurements program, and short-term and long-term diffusion estimates. Summaries of meteorological parameters were made using data from Argonne National Laboratory (1950-1964), the first-order National Weather Service station at Peoria, Illinois (1971-1978), Dresden Station (1973-1978), and LSCS (1976-1978). Because of problems encountered with the ΔT sensors at LSCS, onsite stability data were not available for the initial submittal of the UFSAR. At that time, onsite wind roses for the 8-month period May 1, 1975, through December 31, 1975, and joint frequency data from the Dresden site for 2-year period of record (January 1, 1974, through December 31, 1975) were provided.

The problems with the ΔT sensors have been resolved. Stability data defined by the temperature gradient between 33-foot and 375-foot levels have been recorded since October 1, 1976, and 2 full years (October 1, 1976, through September 30, 1978) of joint frequency data of wind speed, wind direction, and stability, defined by the 33-375-foot ΔT are now included here.

Also presented in this section are comparisons of onsite temperature and humidity conditions with representative data from Peoria and Argonne. The onsite historical data used in this comparison is 2 years of temperature and humidity data available from the 33-foot level of the LSCS onsite meteorological tower (October 1, 1976, through September 30, 1978).

Other data sources on particular topics have been used and are specifically referenced in the text.

2.3.1 Regional Climatology

2.3.1.1 General Climate

The LSCS site is located in north central Illinois. Climate in the area is basically continental, being influenced by the full impact of weather systems that traverse the midcontinent. As a result, the site experiences a wide range of climatic conditions characterized by a high variability and a wide range of temperature extremes. For example, extreme temperatures recorded at Ottawa, Illinois, range from 112°F to -26°F (Reference 1). Monthly average temperatures in the area range from the mid-twenties in January to the mid-seventies in July.

LSCS-UFSAR

A typical summer is warm and humid, with only an occasional cool front with its associated stormy weather interrupting a long succession of hot days. Summer temperatures reach 90° F or more nearly 20 times per year (Reference 2). The fall season is moderate, with little precipitation and comfortable temperatures in the mid-fifties. Winters are generally cold, with average daily maximum and minimum temperatures ranging between the low thirties and the mid-teens to lower twenties. Minimum temperatures extend below 0° F several times each winter.

Synoptic scale low-pressure systems move through the state quite frequently during the winter months, resulting in a maximum of cloudiness. In the spring the continued frequent passage of these storm systems results in that season's relatively high frequency of tornadoes and severe thunderstorms. Such storms are generated as a result of the contrasting air masses associated with the synoptic scale lows.

Precipitation in the LSCS site area averages about 34 inches annually, with monthly averages ranging from about 1.8 inch in January to 4.98 inches in July. The area receives an average of 27 inches of snow annually. Sleet occurs about 6 or 7 times annually (Reference 3). September 1961 is the wettest month on record, with a total of 13.09 inches of rain recorded at Peoria. The most rain in 24 hours recorded at Peoria is 5.06 inches, in April 1950.

Without the protection of natural barriers, mid-Illinois experiences a wide spectrum of winds. The prevailing winds at Peoria are generally southerly except for February, when they are from the northwest. This differs slightly from the usual pattern for the LSCS area, where winds are from the south or southwest during summer and from the west for five winter months. The site is far enough away from the Great Lakes not to be influenced by special diffusion problems associated with land-sea interfaces. The diffusion is fairly good from a dispersion standpoint, and the gently rolling, almost featureless land around the site approximates the kind of areas for which the diffusion equations were developed.

Humidity varies with wind direction, being driest with the west or northwest winds, and more humid with east or south winds. The relative humidity is lowest in afternoons and highest at night and during periods of precipitation. Heavy fog is rare, the peak being two days per month in winter.

The area is subject to a good number of sunshine days, but December averages only 37% as much bright sunshine as July.

2.3.1.2 Regional Meteorological Conditions for Design and Operating Bases

2.3.1.2.1 Thunderstorms, Hail, and Lightning

At Peoria, the data show thunderstorms occurring an average of 49 days per year for the period 1944-1976 (Reference 11). The month of June averages the most. There is an average of five or more thunderstorm days per month throughout the season from April through September. December has the fewest thunderstorms. A thunderstorm day is recorded only if thunder is heard; the observation is independent of whether or not rain and/or lightning were observed concurrent with the thunder. These figures do not therefore serve as an indication of the severity of the storms experienced in these areas.

A severe thunderstorm is defined by the National Severe Storms Forecast Center of the National Weather Service (Reference 4) as a thunderstorm which possesses one or more of the following characteristics:

- a. winds of 50 knots or greater,
- b. hail 3/4 inch or greater in diameter, and
- c. a cumulonimbus cloud favorable to tornado formation.

Although the National Weather Service does not publish records of severe thunderstorms, it has published a report called Severe Local Storm Occurrences, 1955-1967 (Reference 4), which gives values for the total number of hail reports 3/4 inch or greater, winds of 50 knots (57.5 mph) or greater, and the number of tornadoes for the period 1955-1967 by one-degree squares (latitude x longitude).

During the 1955-1967 period, the report shows that the one-degree square containing the LSCS site had nine hailstorms producing 3/4-inch hail or greater, 34 occurrences of 50-knot winds or greater, and 43 tornadoes. Hail data for Illinois, compiled at Urbana (Reference 19) and in central Illinois, recorded about 14% of the hailstorms had maximum stones of 1 inch or more in diameter. There have been infrequent occurrences of hailstones larger than 3 inches and up to grapefruit size (Reference 20).

Hail occurs most frequently in the month of May, followed by April and March, even though June is the peak month for thunderstorms.

J. L. Marshall in Lightning Protection (Reference 5) presents a formula for estimating the frequency of lightning flashes per thunderstorm day, taking into account the distance of the location from the equator:

$$N = (0.1 + 0.35 \sin \alpha) (0.40 \pm 0.20) \tag{2.3-1}$$

where:

N = number of flashes to earth per thunderstorm day per km², and

α = geographical latitude.

LSCS-UFSAR

For the LSCS site, which is located approximately 41° north latitude, the frequency of lightning flashes, N, ranges from 0.065 to 0.198 flashes per thunderstorm day per km². The value 0.2 will be used as the most conservative estimate of lightning frequency in the following calculations.

Since the representative average number of thunderstorm days in the site region is 49, the frequency of lightning flashes per km² per year is 9.8 as calculated below:

$$\begin{aligned} (0.198 \text{ flashes/ thunderstorm day km}^2) \quad \times \quad (49 \text{ thunderstorm days/ year}) \\ = 9.8 \text{ flashes/ km}^2 \text{ year} \end{aligned}$$

2.3.1.2.2 Tornadoes

Illinois ranks eighth in the United States in average annual number of tornadoes (Reference 6). Tornadoes occur with the greatest frequency in Illinois during the months of March through June. The number of tornadoes by year for the entire state of Illinois for the period 1916-1969 is shown in Table 2.3-1. Figure 2.3-1 illustrates the total number of tornadoes for Illinois counties during the same period of record. It can be seen that the number of tornadoes is nine for LaSalle County and three for adjoining Grundy County.

Illinois tornadoes can occur at all hours of the day but are more common during the afternoon and evening hours. About 50% of Illinois tornadoes travel from the southwest to northeast, and slightly over 80% exhibit directions of movement toward the northeast through east. Fewer than 2% move toward a direction with some westerly component.

Using data from the period of record 1953-1962, Thom (Reference 7) computed an annual average occurrence of 1.7 tornadoes for the 1-degree square (latitude x longitude) containing the site. Using a method developed by Thom, the likelihood of a given point being struck by a tornado in any given year can be calculated. Thus, applying the 1.7 annual occurrence value, the probability of a tornado occurring within the 1-degree square containing the LSCS site in any given year is calculated to be 0.0016. This converts to a recurrence interval of 625 years, as compared to recurrence intervals of 250 to 300 years calculated for one-degree squares in the tornado belt of Oklahoma and Kansas.

For the period 1916-1969, Illinois Tornadoes (Reference 6) lists 43 tornadoes which occurred in the 10-county area (LaSalle, Bureau, Putnam, Marshall, Woodford, Livingston, Grundy, Kendall, DeKalb, and Lee) surrounding and including the LSCS site. Figure 2.3-1 shows the county distribution of tornadoes for the entire state for this period.

LSCS-UFSAR

The following are the design-basis tornado parameters which were used for LSCS:

- a. maximum translational wind speed - 60 mph,
- b. maximum rotational wind speed - 300 mph, and
- c. external pressure drop - 3 psi in 3 seconds.

The design wind velocity for the site is 90 mph based on a 100-year mean occurrence interval.

2.3.1.2.3 Sleet, Freezing Rain, and Glaze

Sleet or freezing rain can occur during the colder months of the year when rain falls through a very shallow layer of cold air from an overlying warm layer. The rain then freezes on contact with the ground or other objects, forming glaze.

Occurrences of glaze storms applicable to the site are as follows (Reference 8):

- a. thickness of 0.25 inch: once every year,
- b. thickness of 0.50 inch: once every two years, and
- c. thickness of 0.75 inch or greater: once every three years.

Ice measurements recorded in some of the most severe Illinois glaze storms are shown in Table 2.3-2 (Reference 8).

The listings reveal the occurrence of large radial thicknesses at various locations throughout Illinois and indicate that quite severe glazing has occurred and can occur in any part of the state.

The Association of American Railroads (Reference 9) made a 9-year study of glaze accumulations in 1955. This data was summarized by Bennet (Reference 10) according to the greatest point thickness measured in 60-mile by 60-mile squares. For the square containing the LSCS site, the maximum recorded thickness for this period of record was between 0.75 and 0.99 inch.

Strong winds during and after a glaze storm greatly increase the amount of damage to trees and power lines. In studying wind effects on glaze-loaded wires, the Association of American Railroads (Reference 9) concluded that maximum wind gusts were not as significant (harmful) a measure of wind damage potential as were the speeds sustained over 5-minute periods. Table 2.3-3 lists the maximum 5-minute wind speeds occurring after 148 glaze storms scattered throughout the United States. Twenty-seven of the 32 cases with 0.25 inch or more of glaze were with a 5-minute wind of 15 mph or greater.

LSCS-UFSAR

Table 2.3-4 shows the specific glaze thickness data for the five fastest 5-minute speeds and the speeds with the five greatest measured glaze thicknesses. Although these extremes were collected from various locations throughout the United States in an 11-year study, they are considered applicable design values for locations in Illinois. From the available data it is seen that moderate speeds are most prevalent.

Speeds of 25 mph or higher are not unusual, and there have been 5-minute winds in excess of 40 mph with glaze thicknesses of 0.5 inch or more.

In an analysis of 92 glaze storms occurring in Illinois between 1900 and 1960, Changnon (Reference 8) determined that in 66 storms (72%), the heaviest glaze layers disappeared within 2 days; in 11 storms, in 3 to 5 days; in 8 storms, in 6 to 8 days; in 4 storms, in 8 to 11 days; and in 3 storms, from 12 to 15 days. Fifteen days was the absolute maximum persistence of glaze.

2.3.1.2.4 Snow and Ice Loading

The following statistics apply for loads on Seismic Category I structures due to local probable maximum precipitation (PMP) at the LSCS site vicinity:

- a. 100-year recurrence interval ground snow load = 24.0 psf, and
- b. 48-hour probable maximum winter precipitation = 15.9 in.

The corresponding water load of snow and ice loads due to a winter PMP with a 100-year recurrence interval antecedent snowpack is less than 83.2 lb/ft², which is the design load for the roofs of safety-related structures (see Subsection 2.4.2).

2.3.1.2.5 Ultimate Heat Sink Design Data

2.3.1.2.5.1 Original Ultimate Heat Sink Data (Historical)

Meteorological data (January 1948 to August 1974) from the Peoria, Illinois airport were used in evaluating the performance of an 83-acre cooling pond as an ultimate heat sink. Since Peoria weather data were not available for January 1952 through December 1956, Springfield, Illinois data were substituted for that period. The data consist of 3-hour interval readings for the wind speed, dry bulb, and the dew point temperatures, and cloud cover information.

Worst evaporation weather situations were obtained by selecting the weather conditions of the 30 consecutive days for which the evaporation loss was maximum. June 22, 1954 to July 21, 1954, constituted a 30-day worst-case evaporation episode. The mean dry bulb, mean dew point and mean wind speed recorded during these 30 days were 81.6° F, 63.0° F, and 9.9 mph, respectively.

LSCS-UFSAR

A synthetic worst temperature period was made up by using the worst 24-hour period weather data for the first day and the worst consecutive 30 days for the second to thirty-first days. For the worst 24 hours (July 3, 1949) mean dry bulb, mean dew point and mean wind speed were determined to be 86.0° F, 70.8° F, and 6.3 mph, respectively. For the worst 30 days (July 4, 1955 to August 2, 1955) the above mean conditions (dry bulb, dew point and wind speed) were determined to be 80.7° F, 70.7° F, and 8.1 mph, respectively. For details of ultimate heat sink design, see Subsection 9.2.6.

2.3.1.2.5.2 Power Uprate Ultimate Heat Sink Data

During the review of the UHS for Power Uprate in 1999, it was determined that the historical weather data of section 2.3.1.2.5.1 should be updated to include recent weather data which was more severe than the original data. Refer to subsection 9.2.6.

The UHS temperature limit varies with the diurnal cycle such that the most restrictive temperature occurring in the morning hours ensures that the maximum temperature of the cooling water supplied to the plant remains below the 107° F design limit regardless of when the postulated event occurs. This analysis has been updated to include weather data through September 2010, which includes the period where the maximum indicated cooling water supplied to the plant from the cooling lake was observed.

2.3.2 Local Meteorology

Note: In addition to the information provided below and in the following subsections of section 2.3, newer LSCS meteorological tower data was utilized for determination of χ/Q values for use with Alternative Source Term (AST) analyses described in Chapter 15. The development of these AST χ/Q values is detailed in Section 2.3.4a.

2.3.2.1 Data Sources

Regional meteorological data from Peoria, Argonne National Laboratory (ANL), and the Dresden Station have been compared to the LSCS site meteorological data. Peoria data have been extracted from the local climatological monthly and annual summaries which are available from the U.S. Department of Commerce, NOAA, EDS, National Climatic Center (NCC), Asheville, North Carolina (Reference 11). A 15-year (1950-1964) climatological summary compiled by ANL has also provided a comparative base for onsite meteorological measurements (Reference 18).

EGC's Dresden Station is located approximately 22 miles east of LSCS. Joint frequency distributions of wind speed, wind direction and stability for the 300-foot level of the Dresden tower for the 5-year period (December 1, 1973-November 30, 1978) have been included to represent the expected long-term conditions at the LSCS site. Joint frequency data for the Dresden 300-foot level for the period of LSCS onsite observations are also provided for a comparative analysis for the same period (October 1, 1976-September 30, 1978).

2.3.2.2 Normal and Extreme Values of Meteorological Parameters

2.3.2.2.1 Wind Summaries

At LSCS, Delta-T instrumentation for sensing the temperature difference between the 33-foot and 375-foot levels was installed in October 1976. The period of record of wind data recorded at the 375-foot level is provided (October 1, 1976, through September 30, 1978) to correspond with these available temperature gradient data for the same period.

Figures 2.3-2 through 2.3-14 consist of an annual and 12 monthly wind roses for the 375-foot level of the LSCS 400-foot onsite meteorological tower. These wind records indicate two centers of directional bias, one from the south, south-southwest, and southwest sectors, and one from the west and west-northwest sectors. The 375-foot level recorded the prevailing winds from the west-northwest 9.6% of the time, winds

LSCS-UFSAR

from the west 9.3% of the time, winds from the southwest 7.6% of the time, and winds from the south-southwest 8.8% of the time.

A wind speed of 3 m/sec or greater was recorded at the 375-foot level for 92% of the period of record (see Figure 2.3-2).

The monthly data indicate seasonal variations. Winds from the sector extending west-northwest counterclockwise to south are dominant for most of the period sampled.

The longest persistence of calm conditions observed at the LSCS 375-foot level was 5 hours on one occasion. The longest persistence of wind direction observed at the 375-foot level was one occurrence of 42 hours from the south. On two other occasions wind persistence lasted 35 hours, and on one other occasion wind persistence lasted 34 hours.

Long-term (15-year) wind roses for the 19-foot and 150-foot level wind speed and wind direction at ANL (1950-1964) are given in Table 2.2-5. Wind direction persistence at ANL for the same period and levels are presented in Table 2.3-6. A 5-year (1973-1978) period-of-record joint frequency table for the 300-foot level at Dresden is given in Table 2.3-7. In addition, a 2-year (1976-1978) period-of-record joint frequency table for the 300-foot level at Dresden is given in Table 2.3-8.

At ANL, the longest persistence of calm conditions observed at the 150-foot level was 9 hours on one occurrence. The longest persistence of wind direction at the 150-foot level was 101 hours with wind direction from the west-northwest.

The direction distributions of winds for the LSCS 2-year period, the two periods of record at Dresden, and the long-term period at ANL are all very similar. Although the prevailing wind directions vary slightly by local site and period of record, the sector extending west-northwest counterclockwise to south is dominant for all of these data sets. The prevailing wind for the LSCS 2-year period at the 375-foot level is west-northwest, while the prevailing wind for the Dresden 300-foot level for the same period of record is west. The prevailing wind for the 5-year period of record at the Dresden 300-foot level is west, and the 15-year period of record for the lower ANL level indicates a prevailing wind from the southwest.

Other than winds occurring in the sector extending west-northwest counterclockwise through south, which is dominant in the wind records at all three locations, there is a fairly uniform distribution of wind direction frequencies at the three measurement sites for all periods of record presented.

LSCS-UFSAR

Representativeness of the LSCS Data

The reasonable (minimum) amount of meteorological data required by NRC Regulatory Guide 1.23 for use in site dispersion and accident release analyses is that gathered continuously over a representative, consecutive 12-month period. To be representative, an annual data summary must reflect the "typical" atmospheric conditions of the site area, which must be determined objectively. Objective assessment is provided for the 2-year period of the LSCS onsite record. To show the representativeness of the LSCS data, a comparative tabulation is presented of the LSCS data and meteorological data from the Dresden station. A comparison is made of the 2 years of wind and atmospheric stability data collected at the LSCS site with wind and stability data for two separate periods of record at the Dresden station. The two periods of record at Dresden presented are: A 2-year period corresponding to the LSCS 2-year period, and a 5-year period which includes the 2-year period presented for LSCS.

Detailed 375-foot wind records are available from the LSCS site for the period October 1, 1976, through September 30, 1978. Data for the same period of record are also available from the Dresden Station. In addition, wind records for a 5-year period of record (December 1, 1973, through November 30, 1978) recorded at the Dresden station 300-foot level are available for use as an approximation of long-term conditions in the site region for comparison purposes. Frequencies of occurrence (in percent) for the periods specified above are presented below for the specified wind speed intervals:

<u>WIND SPEED (MPH)</u>	<u>MEASUREMENT LEVEL</u>		
	<u>LSCS 375-Foot</u>	<u>DRESDEN 300-Foot (2 YEARS)</u>	<u>DRESDEN 300-Foot (5 YEARS)</u>
CALM	0.51%	0.00%	0.00%
1-3	1.19%	2.12%	7.43%
4-7	8.62%	14.92%	13.91%
8-12	18.63%	31.01%	27.25%
13-18	26.59%	34.62%	30.39%
19-24	22.51%	12.58%	13.03%
>24	21.94%	4.23%	7.28%

The 13-18-mph wind speed class is dominant both at Dresden and LSCS, although the over-19-mph speed classes are more dominant at LaSalle. Obviously, the frequency distribution is shifted towards greater speeds at LSCS, where the wind speed exceeds 13 mph for 77.0% of the time and 19 mph for about 44% of the time. Clearly, the LaSalle station is on the open prairie, whereas Dresden is nearer a river plain.

LSCS-UFSAR

Figure 2.3-2 presents the 375-foot level period-of-record wind rose at LSCS. Table 2.3-8 presents the 300-foot level wind rose at Dresden corresponding to the same period of record, and Table 2.3-7 presents a 300-foot level wind rose at Dresden for the long-term period. Comparison of these wind roses shows a slight difference in the dominant wind direction. The most dominant wind directions at LSCS are WNW, W, S, and SSW, in decreasing order of frequency. At Dresden the dominant directions are W, WNW, SSW, and SW, for the same 2-year period, and W, SSW, SW, and S for the long-term period. In general, the dominant south through west-northwest sector is a common feature.

Wind direction distribution comparisons indicate the presence, during the 2-year period of record at LaSalle, of an annual average wind regime similar to the long-term regime corresponding to the height of the sensor levels. The differences in wind speed frequency distributions at the two stations may in part be attributed to the 75-foot height difference between sensor levels.

A comparison of long-term and short-term atmospheric stability data at Dresden with the 2 years of onsite stability data at LaSalle is presented in Subsection 2.3.2.2.6.

In summary, comparison of LSCS onsite wind rose data with wind data representing both short- and long-term periods at the Dresden station suggests that the LSCS data are representative of long-term conditions at the site. Comparison of LSCS stability data with short-term and long-term stability data for Dresden indicates that differences exist but that the short-term frequency distribution at LSCS would be similar to that for long-term conditions.

2.3.2.2.2 Temperatures

The Peoria and ANL average and extreme temperature data are presented in Table 2.3-9 in comparison with the same temperature statistics measured at the 33-foot (10-meter) level at the LSCS meteorological tower.

Temperatures from the 5.5-foot level at ANL were used. Temperature measurements at Peoria were made at the National Weather Service standard height of 4.5 feet above the surface. The 33-foot (10-meter) level at the LSCS site is reported as the standard for the NRC.

Peoria and ANL monthly temperatures, when compared with LSCS, average about the same.

The highest temperature reported at the Peoria airport during the period October 1976 through September 1978 was 100° F, and the lowest was -25° F. Extremes for the LSCS tower for the same period were 95.0° F and -20.5° F.

2.3.2.2.3 Atmospheric Moisture

2.3.2.2.3.1 Relative Humidity

The relative humidity for a given moisture content of the air is inversely proportional to the temperature cycle. A maximum relative humidity usually occurs during the early morning hours, and a minimum is typically observed in midafternoon. For the annual cycle, the lowest humidities occur in midspring, while late summer experiences the highest values. The average hourly relative humidities by month for Peoria and ANL are presented in Tables 2.3-10 and 2.3-11, respectively. Table 2.3-11 shows that for ANL, the highest average relative humidities are recorded during August between midnight and sunrise, with an average 30% change during the day. In winter the mean daily humidity ranges from about 65% to 85%. The Peoria station also observes the highest humidities (Table 2.3-10) during the later summer; however, the daylight variation averages nearly 20% during this period. The mean daily humidity range is similar to that at Argonne for the winter period.

Annual averages for the diurnal trend demonstrate nearly identical patterns at both Peoria and ANL. The seasonal trend also indicates a similar character.

Table 2.3-12 lists the monthly maximum, minimum, and average relative humidity for LSCS for the 2 years of monitoring activity (October 1, 1976-September 30, 1978). These relative humidities are calculated from the dry bulb and dew-point temperatures measured at the 33-foot tower level.

2.3.2.2.3.2 Wet Bulb Temperature

The wet bulb temperature is not as strong a function of the ambient temperature as relative humidity and will be used as one measure of the amount of water vapor in the atmosphere as it is frequently used in cooling tower studies. The wet bulb temperature is defined to be the temperature to which an air parcel may be cooled by evaporating water into it at constant pressure until it is saturated. All latent heat utilized in the process is supplied by the air parcel.

The monthly maximum, minimum, and average wet bulb temperatures for the LSCS site are shown in Table 2.3-13 for the 2 years of recorded onsite data (October 1, 1976-September 30, 1978). The wet bulb temperatures are computed as a function of the measured dew-point temperature. One dew-point sensor is located at the 33-foot level of the LSCS tower. Average hourly wet bulb temperatures for ANL are shown by month in Table 2.3-14.

2.3.2.2.3.3 Dew-Point Temperature

The dew-point temperature is another measure of the amount of water vapor in the atmosphere. It is included here so that measured onsite dew-point temperatures can be compared to establish their representativeness. Dew-point temperature is defined as the temperature to which air must be cooled to produce saturation with respect to water vapor, with pressure and water vapor content remaining constant.

The dew-point temperature is lower than the wet bulb temperature except at saturation, when they are the same. The monthly maximum, minimum, and average dew-point temperatures for the 33-foot level at the LSCS site are given in Table 2.3-13. Average hourly dew points for ANL are shown by month in Table 2.3-15.

2.3.2.2.4 Precipitation

Precipitation is not monitored at the LSCS site. Long-term data from the Peoria airport and ANL were therefore used for indication of precipitation averages and extremes applicable to the region surrounding the LSCS site.

2.3.2.2.4.1 Precipitation Measured as Water Equivalent

Maximum daily amounts of precipitation (water equivalent) in inches for ANL are shown by month in Table 2.3-16. A maximum daily amount of 4.45 inches was recorded on October 10, 1954.

Maximum precipitation (water equivalent) in inches recorded for specified time intervals at ANL are shown in Table 2.3-17. The maximum 1-hour duration precipitation recorded was 2.2 inches on June 10, 1953. The maximum 48-hour duration precipitation recorded was 8.62 inches on October 9, 1954. Maximum, minimum, and normal monthly and yearly values of precipitation (water equivalent) in inches for the Peoria station (1941-1974) are shown in Table 2.3-18. The maximum monthly precipitation for the entire period of record is 13.09 inches, recorded in September 1961. The minimum monthly precipitation for the entire period of record is 0.03 inch, recorded in October 1964. The average yearly precipitation for the period of record 1941 to 1970 is 35.0 inches.

2.3.2.2.4.2 Precipitation Measured as Snow or Ice Pellets

Maximum monthly and daily recorded values of snow and/or ice pellets (in inches) for the Peoria station (1941-1974) are shown in Table 2.3-19. The maximum monthly value for the entire period is 18.9 inches, recorded in December 1973. The maximum daily value for the entire period is 10.2 inches, recorded in 1973.

2.3.2.2.5 Fog

Fog is an aggregate of minute water droplets suspended in the atmosphere near the surface of the earth. According to international definition, fog reduces visibility to less than 0.62 mile (Reference 12). Fog types are generally coded as fog, ground fog, and ice fog in observation records. Observing procedures by the National Weather Service define ground fog as that which hides less than 0.6 of the sky and does not extend to the base of any clouds that may lie above it (Reference 11). Ice fog is composed of suspended particles of ice. It usually occurs in high latitudes in calm clear weather at temperatures below -20° F and increases in frequency as temperature decreases (Reference 12).

Fog forms when the ambient dry bulb temperature and the dew-point temperature are nearly identical or equal. The processes by which these temperatures become the same and fog occurs are either by cooling the air to its dew point or by adding moisture to the air until the dew point reaches the ambient dry bulb temperature. This latter process is of particular interest with respect to cooling facility operation at power generating stations.

Cooling facility fog generally occurs when atmospheric conditions are conducive to natural fog formation. Natural processes such as radiational cooling at night or the advection of moist air are generally contributing factors. Thus the previous summary of natural fog occurrence is important to the understanding of the potential fogging problems for a proposed plant site.

Data on fog intensity and frequency are presented below for Peoria (1941-1970) (Reference 11). Fog is a local atmospheric phenomenon; these data should thus be considered only as regional estimates. The average numbers of days during which heavy fog (visibility less than or equal to 1/4 mile) occurred at Peoria are as follows:

<u>Month</u>	<u>Peoria</u>
January	3
February	3
March	2
April	1
May	1
June	1

LSCS-UFSAR

July	1
August	1
September	1
October	2
November	2
<u>December</u>	<u>3</u>
Yearly Average	21

2.3.2.2.6 Atmospheric Stability

Data from the LSCS meteorological tower were used to estimate stability as indicated from the temperature lapse rate. Use of a lapse rate scheme provides a direct estimate of the stability parameter. Two years of LSCS data (October 1, 1976-September 30, 1978) was utilized to provide a direct and realistic estimate of the stability parameters. Monthly and annual summaries of wind speed-wind direction-stability joint frequencies for the period are presented in Tables 2.3-20 through 2.3-32. For comparison of short-term and long-term dispersion conditions over extended periods, the joint frequency distribution data of wind speed-wind direction and Pasquill stability class (Reference 13) for the Dresden 300-foot level data defined by the 35- to 300-foot delta T are presented in Tables 2.3-7 and 2.3-8.

The percent frequencies for each stability class recorded at the LSCS site and the Dresden site, based on two complete annual cycles, are extracted below for comparison.

	<u>A</u>	<u>B</u>	<u>C</u>	<u>D</u>	<u>E</u>	<u>F</u>	<u>G</u>
LSCS							
(2 years)	3.47	3.56	4.65	45.76	24.30	14.09	4.17
Dresden							
(2 years)	6.62	5.69	7.32	37.90	30.12	9.82	1.98
Dresden							
(5 years)	5.58	4.41	5.48	34.07	31.15	9.43	9.17

At the LSCS 375-foot level, for two complete annual cycles, the joint frequency of occurrence of calm wind by stability class showed only 0.03% occurrence of calm winds associated with unstable classes (A, B, C); 0.14% occurrence of calm winds with neutral stability (D); but 0.21%, 0.07%, and 0.02% occurrence of calm winds

with slightly stable, moderately stable, or extremely stable atmospheric conditions respectively. These are very small time windows.

2.3.2.3 Potential Influence of the Plant and Its Facilities on Local Meteorology

An investigation of potential fogging for the original 4480-acre lake indicated that light fog would extend to a distance of 200 meters from the lake shore on a few rare occasions (Reference 14). In the course of adapting the results of this investigation to the smaller 2190-acre lake, it was concluded that instances of fog with a visibility of 1/4 mile would be limited to a few hours per month at a distance over 200 meters from the lake shore (Reference 14). This conclusion also holds for the 2058-acre lake. Under these circumstances, the public road most likely to be affected would be subject to a maximum of a few hours per month of light fog, which would occur primarily in the hours between midnight and 6 a.m. (Reference 14).

To aid the assessment of topographic effects on the surrounding airflow regimes, reference is made to the topographic cross sections for each of the 16 compass point directions radiating 5 miles and 10 miles from the plant as provided in Figures 2.3-15 and 2.3-16 respectively. The plant, located at an elevation of approximately 710 feet, is at one of the highest points within a 5-mile radius. In the southwest quadrant, a gentle increase in elevation ranging from 725 to 750 feet is evidenced. The remaining area surrounding the plant site is characterized by a gentle slope decreasing away from the site to an elevation of 484 feet at the Illinois River, located 4.5 miles north. No large-scale topographic obstructions to favorable dispersion conditions are evident.

Figure 2.3-17 provides a general topographic description within a 10-mile radius of the plant.

2.3.3 Meteorological Measurement Program & Environmental Monitoring Program

2.3.3.1 Onsite Meteorological Measurements Program

The meteorological measurements program at the LaSalle site consists of monitoring wind direction, wind speed, temperature, and precipitation. Two methods of determining atmospheric stability are used: delta T (vertical temperature difference) is the principal method; sigma theta (standard deviation of the horizontal WD) is available for use when delta T is not available. These data, referenced in ANSI/ANS 2.5 (1984), are used to determine the meteorological conditions prevailing at the plant site. Site specific information on instrumentation, calibration procedures, as well as the meteorological measurements program during a disaster can be found in the Generating Station Emergency Plan (GSEP) annex.

The meteorological tower is equipped with instrumentation that conforms with the system accuracy recommendations of Regulatory Guide 1.23 and ANSI/ANS 2.5 (1984). The equipment is placed on booms oriented into the generally prevailing wind at the site. Equipment signals are brought to an instrument shack with controlled environmental conditions. The shack at the base of the tower houses the recording equipment, signal conditioners, etc., used to process and retransmit the data to the end-point users.

Recorded meteorological data are used to generate wind roses and to provide estimates of airborne concentrations of gaseous effluents and projected offsite radiation dose. Instrument calibrations and data consistency evaluations are performed routinely to ensure maximum data integrity. Data recovery objective is to attain better than 90% from each measuring and recording system. Data storage and records retention are also maintained in compliance with ANSI/ANS 2.5 (1984).

2.3.3.1.1 Deleted

2.3.3.1.2 Deleted

2.3.3.1.3 Deleted

2.3.3.1.4 Deleted

2.3.3.2 Radiological Environmental Monitoring Program

The Radiological Environmental Monitoring Program (REMP) being conducted in the vicinity of the station has as its objectives:

- (1) Provide data on measurable levels of radiation and radioactivity in the environment and relate these data to radioactive emissions;
- (2) Identify changes in the use of nearby offsite areas to assure adequate surveillance and evaluation of doses to individuals from principal pathways of exposure;
- (3) Provide environment surveillance in case of an unplanned release; and
- (4) Provide year round monitoring of principal pathways of exposure.

The REMP provides representative measurements of radiation and of radioactive materials in those exposure pathways and for those radionuclides that lead to the highest potential radiation exposures of members of the public resulting from the station operation. This monitoring program implements section IV.b.2 of Appendix I to 10CFR50 and thereby supplements the radiological effluent monitoring program by verifying that the measurable concentrations of radioactive materials and levels of radiation are not higher than expected on the basis of effluent measurements and the modeling of the environmental exposure pathways.

The site specific annex of the Offsite Dose Calculation Manual (ODCM) describes the current REMP and presents the required detection capabilities for environmental sample analysis tabulated in terms of the a priori minimum detectable concentration (MDC). The a priori MDC is a before-the-fact limit representing the capabilities of a measurement system and is not an after the fact limit for a particular measurement.

2.3.4 Short-Term (Accident) Diffusion Estimates

2.3.4.1 Objective

The accident analyses of Chapter 15.0 utilize the arbitrary meteorological parameters of Regulatory Guide 1.3 (Rev. 2) with an elevated stack in contrast to analyses based on realistic local meteorology.

For the control rod drop accident discussed in Section 15.4.9, the accident analysis also utilized Regulatory Guide 1.145 methodology for determining the atmospheric dispersion factors based on historical site meteorology. Atmospheric dispersion factors were calculated for an elevated release out the station vent stack and for a ground level release via the turbine building.

The short-term (accident) diffusion calculations of the atmospheric dilution factor (χ/Q) based on the LSCS meteorological tower data referenced above are provided in this section. These calculations were performed using appropriate atmospheric dispersion models assuming an elevated release with plume rise. The results indicate the conservative nature of the meteorological parameters of Regulatory Guide 1.3 (Rev. 2).

2.3.4.2 Calculations

Short-term (accident) diffusion estimates are used to evaluate the potential severity of an accident during a year of "typical" weather conditions. In order to evaluate the impact of an accident at LSCS, conservative and realistic estimates of atmospheric dilution factors (χ/Q) are calculated. These dilution factors are then used in calculating the radiological dose rates listed in Chapter 15.0.

Since the station vent stack height is greater than twice the reactor building height, the atmospheric dilution factors at ground level for LSCS were calculated by use of Gaussian plume diffusion models for an elevated, continuously emitting point source. The centerline diffusion model is used for time periods up to 8 hours and the sector average diffusion model for time periods greater than 8 hours. Plume rise is accounted for by use of Briggs' (Reference 17) formulas for momentum-dominated plumes. Cumulative frequency distribution of time-period averaged χ/Q values was prepared, and values that were exceeded 5% and 50% of the time were

derived. Details of the models and the cumulative frequency distribution analysis are presented in Subsection 2.3.4.3.

In the short-term diffusion estimates, hourly χ/Q values were computed from the concurrent hourly mean values of wind speed, wind direction, and Pasquill stability class of the LSCS meteorological tower data for the period of October 1, 1976, through September 30, 1978. The wind speed and wind direction at the 375-foot level were used in the diffusion estimates for the elevated release. The Pasquill stability class was determined from the measured vertical temperature difference (ΔT) between the 33-foot and 375-foot levels of the meteorological tower. When a recorded hourly wind speed was less than the threshold speed of the wind sensor, a minimum wind speed of 0.15 m/sec (one-half of the threshold speed) and a wind direction that occurred in the previous hour were used for the hour.

Short-term diffusion calculations were made to determine the 5% and 50% χ/Q values for accident time periods of 0-1 hour, 0-2 hours, 0-8 hours, 8-24 hours, 1-4 days, and 4-26 days at the exclusion area boundary (EAB), the actual site boundary (ASB), and the low population zone (LPZ) boundary, as well as at distances of 0.5, 1.5, 2.5, 3.5, 4.5, 7.5, 15.0, 25.0, 35.0, and 45.0 miles from the plant center for effluents released from the station vent stack and the standby gas treatment system (SGTS) vent (located within the stack). The 5% and 50% χ/Q values for each of the 16 sectors, as well as the direction-independent sector, were determined.

For effluents released from the station vent stack, the calculated 5% and 50% χ/Q values at EAB, ASB, and LPZ are presented in Tables 2.3-33 through 2.3-35. The calculated 50% χ/Q values for various radial distances up to 45 miles are presented in Tables 2.3-36 through 2.3-41 for accident time periods of 0-1 hour, 0-2 hours, 0-8 hours, 8-24 hours, 1-4 days, and 4-30 days, respectively. The corresponding 5% χ/Q values are given in Tables 2.3-42 through 2.3-47.

For effluents released from the SGTS vent, the calculated 5% and 50% χ/Q values at EAB, ASB, and LPZ are presented in Tables 2.3-48 through 2.3-50. The calculated 5% χ/Q values for various radial distances up to 45 miles are presented in Tables 2.3-51 through 2.3-56 for accident time periods of 0-1 hour, 0-2 hours, 0-8 hours, 8-24 hours, 1-4 days, and 4-30 days, respectively. The corresponding 50% χ/Q values are given in Tables 2.3-57 through 2.3-62.

2.3.4.3 Atmospheric Diffusion Model

The atmospheric dilution factors at ground level for LSCS were calculated by use of Gaussian plume diffusion models for an elevated, continuously emitting point source. The Gaussian plume diffusion models for ground-level concentrations are used to describe the downwind spread of effluent for LSCS. A continuous elevated release of effluents at a constant emission rate is assumed in the diffusion estimates. Total reflection of the plume is assumed in the diffusion estimates.

LSCS-UFSAR

Total reflection of the plume is assumed to take place at the ground surface, i.e., there is no deposition or reaction at the surface.

For short-term releases up to 8 hours, hourly ground-level plume centerline values of χ/Q are calculated from the following centerline diffusion equation:

$$\chi/Q = \frac{1}{u\pi\sigma_y\sigma_z} \exp\left[-\frac{1}{2}\left(\frac{h_e}{\sigma_z}\right)^2\right] \quad (2.3-2)$$

where:

χ/Q = ground-level relative concentration (sec/m³),

u = mean wind speed (m/sec),

σ_y = horizontal diffusion parameter (meters),

σ_z = vertical diffusion parameter (meters), and

h_e = effective plume height (meters).

Both σ_y and σ_z are functions of downwind distance from the point of release to a receptor and the Pasquill stability class. The numerical values of σ_y and σ_z for Pasquill stability Classes A through F are digitized from Gifford's graphs (References 15 and 16). The values of σ_z for Pasquill Stability Classes A and B have been cut off at 1000 meters.

The following equations are used to determine the values of σ_y and σ_z for Pasquill stability class G in terms of σ_y and σ_z for Pasquill stability class F:

$$\sigma_y (G) = 2/3 \sigma_y (F) \quad (2.3-3)$$

$$\sigma_z (G) = 3/5 \sigma_z (F)$$

The effective plume height is defined as the sum of the physical station vent stack height and the rise of the plume above the stack. In the case of elevated releases, the effective plume height is determined from

$$h_e = h_s + h_{pr} - h_c \quad (2.3-4)$$

where:

h_s = physical station vent stack height (meters),

h_{pr} = plume rise (meters), and

LSCS-UFSAR

h_c = height corrections to account for stack downwash (meters).

The correction for stack downwash is accounted for only if the flue gas exit velocity from the stack (vent) is less than 1.5 times the mean wind speed at the stack top. The following formula is used to determine the effect of stack downwash on plume height:

$$h_c = 3(1.5 - W_0/u)D \quad (2.3-5)$$

where:

W_0 = flue gas exit velocity (m/sec), and

D = inside diameter of the stack (vent) (meters).

Plume rise is calculated using Briggs' (Reference 17) formulas for momentum-dominated plumes. For neutral and unstable atmospheric conditions (Pasquill stability Classes A through D), the momentum plume rise is calculated from the following formula:

$$h_{pr} = 1.44D(W_0/u)^{2/3} (X/D)^{1/3} \quad (2.3-6)$$

The result from Equation 2.3-5, corrected by Equation 2.3-6 if necessary, is compared with

$$h_{pr} = 3(W_0/u)D \quad (2.3-7)$$

and the smaller value of the two is used.

For stable atmospheric conditions (Pasquill stability classes E through G), compare the smaller value of Equation 2.3-6 or 2.3-7 to:

$$h_{pr} = 4(F_m/S)^{1/4} \quad (2.3-8)$$

and also to:

$$h_{pr} = 1.5(F_m/u)^{1/3} (S)^{-1/6} \quad (2.3-9)$$

Use the smallest value. The momentum flux parameter, F_m , is defined as:

$$F_m = W_0^2 D^2 / 4 \quad (2.3-10)$$

LSCS-UFSAR

The stability parameter, S, is defined by:

<u>Stability Class</u>	<u>Stability Parameter</u>
E	8.7 x 10 ⁻⁴
F	1.75 x 10 ⁻³
G	2.45 x 10 ⁻³

For time periods greater than 8 hours, hourly χ/Q values are calculated from the following sector-average diffusion model:

$$\chi/Q = \frac{2.032}{\sigma_z U_x} \exp \left[-\frac{1}{2} \left(\frac{h_e}{\sigma_z} \right)^2 \right] \quad (2.3-11)$$

where x is the distance from the release point to the receptor and the other terms are as previously defined.

Hourly χ/Q values are computed by use of these models. From these hourly χ/Q values, cumulative frequency distributions were prepared from the mean values by sliding time period "windows" of 1, 2, 8, 16, 72, and 624 hours. These intervals correspond to time periods of 0-1 hour, 0-2 hours, 0-8 hours, 8-24 hours, 1-4 days, and 4-30 days. For each time interval used, the mean χ/Q value in each sector is computed. The cumulative frequency distribution for each of the individual time periods is then examined to determine the fifth and fiftieth percentile χ/Q values in each of the 16 cardinal sectors.

2.3.4.4 Regulatory Guide 1.145 Methodology

Directionally dependent accident atmospheric dilution (i.e., χ/Q) factors were determined for 16 downwind sectors at the Exclusion Area Boundary (EAB) and the Low Population Zone (LPZ) boundary using Regulatory Guide (RG) 1.145 (Revision 1) methodology. Atmospheric dilution factors were determined for an elevated release out the station vent stack and for a ground level release via the turbine building.

Since the EAB is nonuniform, the distance from the release point to the EAB varies with direction. The LPZ boundary was modeled as a uniform circular boundary located 6400 meters from the release point.

Elevated Release

Directionally dependent χ/Q values for an elevated release out the station vent stack were determined based on 1978 through 1987 historical site meteorology at a

LSCS-UFSAR

height of 375 feet above grade. For each of the 16 downwind sectors, the distance between the station vent stack and the EAB was taken to be the minimum distance from the stack to the EAB within a 45 degree sector centered on the sector's compass direction. The distance between the vent stack and the LPZ boundary was taken to be 6400 meters which is sector independent. When determining χ/Q values due to an elevated release out the station vent stack, the release height was set at 100 meters.

χ/Q values, determined via RG 1.145 methodology, at the EAB for an elevated release were determined as follows:

The 0.5 percentile χ/Q value was determined at the EAB for each of the 16 compass sectors. The 0.5 percentile χ/Q is the value which is exceeded 0.5 percent of the total number of hours in the data set. LaSalle Station is located more than 3.2 kilometers from a large body of water. Per Section 2.1.1 of RG 1.145, fumigation conditions were considered to occur at the time of the accident and continue for 1/2 hour. Fumigation χ/Q values were determined for each of the 16 compass direction sectors over the time period of 0 to 1/2 hour post accident. The maximum χ/Q value at each of the 16 EAB sector distances (i.e., either the fumigation or nonfumigation value) was used as the χ/Q value for the time period which extends to 1/2 hour after the accident. Nonfumigation EAB χ/Q values are used for times between 1/2 to 2 hours post accident. Since the release is a stack release, the maximum χ/Q value could occur at a distance greater than the EAB distance. To determine whether the maximum 0.5 percentile χ/Q value, in a given sector, occurs at the EAB or at a distance greater than the EAB, χ/Q values were determined for each of the 16 sectors at the minimum EAB distance and for distances of 100 meter intervals out to 100,000 meters. The maximum sector EAB nonfumigation χ/Q value is defined as the largest of the nonfumigation 0.5% χ/Q values at the EAB, or at distances greater than the EAB, over all 16 sectors. The 5% overall site χ/Q value is then determined at the EAB. The 5% overall site χ/Q value is the 2 hr. χ/Q value which is exceeded 5% of the time. The maximum sector EAB nonfumigation χ/Q value is compared against the 5% overall site χ/Q value and the larger value represents the EAB χ/Q value to be used in accident consequence assessments. If the maximum sector χ/Q value is larger than the 5% overall site χ/Q value and if a 0 to 1/2 hour post accident fumigation χ/Q value is warranted (i.e., the sector fumigation value is greater than the 0 to 2 hr. nonfumigation EAB value for that sector) then the fumigation χ/Q value is the value for the sector which provides the maximum sector χ/Q value.

χ/Q values, determined via RG 1.145 methodology, at the LPZ boundary for an elevated release were determined as follows:

Sector χ/Q values at the LPZ boundary are to be determined for post accident time periods of 0 to 2 hr., 2 to 8 hr., 8 to 24 hr., 1-4 days, and 4 to 30 days. The 0.5 percentile, 0 to 2 hr., χ/Q value is determined at the LPZ boundary for each of the

16 sectors. The annual average χ/Q value is also determined at the LPZ boundary for each of the 16 sectors. For a given sector, χ/Q values for post accident time periods, other than 2 hours, are determined by logarithmic interpolation between the 2 hr. sector χ/Q value and the annual average χ/Q value for the same sector. The largest of the 16 sector χ/Q values is chosen for each time period to represent the LPZ boundary χ/Q value. The largest sector χ/Q values occur in the same sector for all post accident time periods. Sector χ/Q fumigation values, for 0 to 1/2 hr. post accident, are determined at the LPZ boundary. For each sector, if the fumigation χ/Q value exceeds the nonfumigation χ/Q value, then the fumigation χ/Q value is used for the 0 to 1/2 hr. time period. Nonfumigation χ/Q values are then used over the 1/2 to 2 hr. time period. The 5% overall site χ/Q value is then determined at the LPZ boundary for each time period. The maximum sector χ/Q value for each time period is compared against the 5% overall site χ/Q value and the maximum value is designated as the LPZ boundary χ/Q value.

Ground Level Release

Directionally dependent χ/Q values for a ground level release via the turbine building were determined based on 1982 through 1987 historical site meteorology at a height of 33 feet above grade. For each of the 16 downwind sectors, the distance between the turbine building and the EAB was taken to be the minimum distance from the nearest point on the turbine building to the EAB within a 45 degree sector centered on the compass direction of interest. The distance to the LPZ boundary was taken to be 6400 meters which is sector independent.

χ/Q values, determined via RG 1.145 methodology, at the EAB for a ground level release via the turbine building were determined as follows:

The 0.5 percentile χ/Q value was determined for each of the 16 compass sectors. The 5% overall site χ/Q value was also determined. The maximum sector 0.5 percentile χ/Q value is compared against the 5% overall site χ/Q value and the larger value is designated as the EAB χ/Q value.

χ/Q values, determined via RG 1.145 methodology, at the LPZ boundary for a ground level release via the turbine building were determined as follows:

Sector χ/Q values are to be determined at the LPZ boundary for post accident time periods of 0 to 2 hr., 2 to 8 hr., 8 to 24 hr., 1 to 4 days, and 4 to 30 days. The 0.5 percentile, 0 to 2 hr., χ/Q value is determined at the LPZ boundary for each of the 16 sectors. The annual average χ/Q value is also determined at the LPZ boundary for each of the 16 sectors. For a given sector, χ/Q values for post accident time periods, other than 2 hours, are determined by logarithmic interpolation between the 2 hr. sector χ/Q value and the annual average χ/Q value for the same sector. The largest of the 16 sector χ/Q values is chosen for each time period to represent the LPZ boundary χ/Q value. The largest sector χ/Q values occur in the same

sector for all post accident time periods. The 5% overall site χ/Q value is also determined at the LPZ boundary for each time period. The maximum sector χ/Q value for each time period is compared against the 5% overall site χ/Q value and the maximum value is designated as the LPZ boundary χ/Q value.

Control rod drop accident χ/Q values determined via RG 1.145 methodology are given in Section 15.0.5. The χ/Q values are for the EAB and LPZ boundary due to an elevated release out the station vent stack and a ground level release out the turbine building.

2.3.4a. Short-term (Accident) Diffusion Estimates (Alternative Source Term χ/Q Analysis)

2.3.4a.1 Objective

Estimates of atmospheric diffusion (χ/Q) at the Exclusion Area Boundary (EAB), the outer boundary of the Low Population Zone (LPZ) and the Control Room Intakes are calculated using Alternative Source Term methodologies and current LSCS meteorological tower data for the regulated short-term (accident) time averaging periods of 0-2 hrs, 2-8 hrs, 8-24 hrs, 1-4 days and 4-30 days.

2.3.4a.2 Calculation of χ/Q at the EAB and LPZ

χ/Q was calculated at the EAB and LPZ for the Stack, which encompasses the Standby Gas Treatment Stack (SGTS), and a turbine building release using the NRC-recommended model PAVAN (Reference 21), in accordance with Regulatory Guide 1.145 (Reference 22). The Turbine Building release scenario χ/Q results were also used as the χ/Q for the stack as a ground-level release.

The Stack was modeled as an elevated release consistent with the original LaSalle Station licensing as documented in the LaSalle SER, even though its height of 112.8 m above grade is less than 2.5 times the height of its highest adjacent building, the Reactor Building.

For elevated releases during non-fumigation conditions, the equation for ground-level relative concentration at the plume centerline is:

$$\chi/Q = \frac{1}{\pi \bar{U}_h \sigma_y \sigma_z} \exp\left[\frac{-h_e^2}{2\sigma_z^2}\right] \quad (2.3.4a-1)$$

where:

χ/Q is relative concentration, in sec/m³.

\bar{U}_h is windspeed representing conditions at the release height, in m/sec.

LSCS-UFSAR

- σ_y is lateral plume spread, in meters, a function of atmospheric stability and distance.
- σ_z is vertical plume spread, in meters, a function of atmospheric stability and distance.
- π is 3.14159.
- h_e is effective stack height, in meters: $h_e = h_s - h_t$
- h_s is the initial height of the plume (usually the stack height) above plant grade, in meters.
- h_t is the maximum terrain height above plant grade between the release point and the point for which the calculation is made, in meters. If h_t is greater than h_s then $h_e = 0$.

For elevated release during fumigation conditions, the equation for ground-level relative concentration at the plume centerline is:

$$\chi/Q = \frac{1}{(2\pi)^{1/2} \bar{U}_{h_e} \sigma_y h_e}, h_e > 0 \quad (2.3.4a-2)$$

where:

- \bar{U}_{h_e} is windspeed representative of the fumigation layer of depth h_e , in m/sec; in lieu of information to the contrary, the NRC staff considers a value of 2 m/sec as a reasonably conservative assumption for h_e of about 100 m.
- σ_y is the lateral plume spread, in m, that is representative of the layer at a given distance; a moderately stable (F) atmospheric stability condition is usually assumed.

For the fumigation case that assumes F stability and a windspeed of 2 m/s, Equation 2.3.4a-1 should be used instead of 2.3.4a-2 at distances greater than the distance at which the χ/Q values determined using Equation 2.3.4a-1 with $h_e = 0$ and Equation 2.3.4a-2 are equal.

For ground-level releases, calculation of the χ/Q for the 2 hours following the accident is based on the following equations:

$$\chi/Q = \frac{1}{\bar{U}_{10} (\pi \sigma_y \sigma_z + A/2)} \quad (2.3.4a-3)$$

$$\chi/Q = \frac{1}{\bar{U}_{10}(3\pi\sigma_y\sigma_z)} \quad (2.3.4a-4)$$

$$\chi/Q = \frac{1}{\bar{U}_{10}\pi\Sigma_y\sigma_z} \quad (2.3.4a-5)$$

where:

χ/Q is relative concentration, in sec/m³.

π is 3.14159.

\bar{U}_{10} is wind speed at 10 meters above plant grade, in m/sec.

σ_y is lateral plume spread, in meters, a function of atmospheric stability and distance.

σ_z is vertical plume spread, in meters, a function of atmospheric stability and distance.

Σ_y is lateral plume spread, in meters, with meander and building wake effects (in meters), a function of atmospheric stability, wind speed, and distance [for distances of 800 m or less, $\Sigma_y = M\sigma_y$, where M is determined from Reg. Guide 1.145 Fig. 3; for distances greater than 800 m, $\Sigma_y = (M-1)\sigma_{y,800\text{ m}} + \sigma_y$].

A is the smallest vertical-plane cross-sectional area of the reactor building, in meter². (Other structures or a directional consideration may be justified when appropriate.)

Plume meander is only considered during neutral (D) or stable (E, F, or G) atmospheric stability conditions. For such, the higher of the values resulting from Equations 2.3.4a-3 and 2.3.4a-4 is compared to the value of Equation 2.3.4a-5 for meander, and the lower value is selected. For all other conditions (stability classes A, B, or C), meander is not considered and the higher χ/Q value of equations 2.3.4a-3 and 2.3.4a-4 is selected.

The χ/Q values calculated at the EAB based on meteorological data representing a 1-hour average are assumed to apply for the entire 2-hour period.

To determine the maximum sector χ/Q value at the EAB, a cumulative frequency probability distribution (probabilities of a given χ/Q value being exceeded in that sector during the total time) is constructed for each of the 16 sectors using the χ/Q values calculated for each hour of data. This probability is then plotted versus the

χ/Q values and a smooth curve is drawn to form an upper bound of the computed points. For each of the 16 curves, the χ/Q value that is exceeded 0.5 percent of the total hours is selected and designated as the sector χ/Q value. The highest of the 16 sector χ/Q values is the maximum sector χ/Q .

Per RG 1.145, LaSalle is classified as an inland site (i.e., more than 3.2 km from large bodies of water such as oceans or Great Lakes); therefore, the maximum sector χ/Q value at the EAB is determined by comparison of the sector fumigation and non-fumigation (as determined in the above paragraph) χ/Q values. If the fumigation value is greater, then it is used for the 0 - 1/2 hour time period and the non-fumigation value is used for the 1/2 – 2 hour time period. Otherwise, the non-fumigation sector value is used for the entire 0-2 hour time period. The maximum sector χ/Q at the LPZ for stack releases during fumigation conditions at inland sites are determined in the same manner as the EAB.

Determination of the LPZ maximum sector χ/Q is based on a logarithmic interpolation between the 2-hour sector χ/Q and the annual average χ/Q for the same sector. For each time period, the highest of these 16 sector χ/Q values is identified as the maximum sector χ/Q value. The maximum sector χ/Q values will, in most cases, occur in the same sector. If they do not occur in the same sector, all 16 sets of values are used in dose assessment requiring time-integrated concentration considerations. The set that results in the highest time-integrated dose within a sector is considered the maximum sector χ/Q .

The 5% overall site χ/Q value for the EAB and LPZ is determined by constructing an overall cumulative probability distribution for all directions. The value of χ/Q is plotted versus the probability of it being exceeded, and an upper bound curve is drawn. From this curve, the 2-hour χ/Q value that is exceeded 5% of the time is found. The 5% overall site χ/Q at the LPZ for intermediate time periods is determined by logarithmic interpolation of the maximum of the 16 annual average χ/Q values and the 5% 2-hour χ/Q values.

2.3.4a.2.1 PAVAN Meteorological Database

The meteorological database for the EAB and LPZ χ/Q calculations was prepared for use in PAVAN by transforming the five years (i.e. 1999-2003) of hourly meteorological tower data observations at the 375 and 33 ft levels, as supplied by Murray and Trettel, Inc. (Reference 23) into a joint wind speed-wind direction-stability class occurrence frequency distribution as shown in Tables 2.3-67 and 2.3-68. In accordance with Regulatory Guide 1.145, wind direction was distributed into 16- 22.5° sectors and atmospheric stability class was determined by the 375 – 33 ft vertical temperature difference.

Fourteen (14) wind speed categories were defined according to Regulatory Issue Summary (RIS) 2006-04 (Reference 24) with the first category identified as "calm" as shown in the table below. In the equations shown in Section 2.3.4a.2, it should

LSCS-UFSAR

be noted that wind speed appears as a factor in the denominator. This presents an obvious difficulty in making calculations for hours of calm. The minimum wind speed (i.e. wind threshold) was set to 0.7 mph and calm wind speeds were assigned a value of 0.3 mph. The procedures used by PAVAN assign a direction to each calm hour according to the directional distribution for the lowest non-calm wind-speed class. This procedure is performed separately for the calms in each stability class.

The fourteen wind speed categories based on the guidance in Section 4 of RIS 2006-04 are as follows:

PAVAN WIND SPEED CATEGORIES

Category No.	Regulatory Issue summary 2006-04 Speed Interval (mph)
1 (Calm)	0 to <0.7
2	>=0.7 to <1.12
3	>=1.12 to <1.68
4	>=1.68 to <2.24
5	>=2.24 to <2.80
6	>=2.80 to <3.36
7	>=3.36 to <4.47
8	>=4.47 to <6.71
9	>=6.71 to <8.95
10	>=8.95 to <11.18
11	>=11.18 to <13.42
12	>=13.42 to <17.90
13	>=17.90 to <22.4
14	>=22.4

2.3.4a.2.2 PAVAN Input Parameters

The PAVAN model was also executed to determine the χ/Q for a stack and turbine building release to the EAB and LPZ. The Turbine Building release scenario χ/Q results were also used as the χ/Q for the stack as a ground-level release.

The Stack was modeled as an elevated release with a height of 112.8 m and the turbine building/stack ground-level release as a ground-level release with a height of 10.0 m (as required by PAVAN for ground-level releases). An EAB distance of 509 m, the shortest distance between the stack and EAB, was used for the elevated release scenarios. For all ground-level release scenarios the worst-case EAB distance of 423 m, the shortest distance between the turbine building and EAB was conservatively utilized. An LPZ distance of 6400 m was used for both the elevated and ground-level release scenarios.

LSCS-UFSAR

The EAB distance is directionally dependent; therefore, in order to determine the distance at which the maximum EAB χ/Q value would occur for the assumed elevated stack release, additional distances of 440, 460, 480, 500 m, and 1200 through 3300 m in increments of 100 m were executed by PAVAN.

For the elevated release, terrain elevations of 17 m above plant grade were used for the SSW through NW sectors for distances of 1600 m and greater. Otherwise, plant grade receptor elevation was assumed.

No terrain elevations were used for the ground-level release. The maximum ground-level release EAB and LPZ χ/Q values always are predicted by PAVAN to occur at the minimum EAB and LPZ distances.

2.3.4a.2.3 PAVAN EAB and LPZ χ/Q

Atmospheric χ/Q diffusion factors predicted by PAVAN at the EAB and LPZ are summarized below:

Maximum PAVAN EAB and LPZ χ/Q to be Used for Accident Analyses

SCENARIO	Release Type	Meteorological Database	χ/Q (sec/m ³)					
			0-0.5 hour (max fumigation)	0-2 hrs	0-8 hrs	8-24 hrs	1-4 days	4-30 days
Stack to EAB (1) (Max)	Elevated	Upper: 375 ft wind; 375-33 ft Delta T	8.80E-05 (509 m)	2.74E-06 (2500 m)	1.29E-06 (2500 m)	8.83E-07 (2500 m)	3.89E-07 (2500 m)	1.20E-07 (2500 m)
Turbine Building to EAB ⁽²⁾⁽³⁾ (423 m)	Ground	Lower: 33 ft wind; 200-33 ft Delta T	N/A	6.63E-04	3.05E-04	2.09E-04	9.36E-05	3.02E-05
Stack to LPZ (6400 m)	Elevated	Upper: 375 ft wind; 375-33 ft Delta T	1.05E-05	1.77E-06	8.34E-07	5.72E-07	2.53E-07	7.81E-08
Turbine Building to LPZ ⁽²⁾⁽³⁾ (6400 m)	Ground	Lower: 33 ft wind; 200-33 ft Delta T	N/A	2.65E-05	1.08E-05	6.87E-06	2.63E-06	6.74E-07

- 1) The nearest distance at which the maximum elevated χ/Q value was found is shown below the χ/Q value.
- 2) The Turbine Building release scenario χ/Q results were also used as the χ/Q for the Stack as a ground-level release.
- 3) Ground-level Stack χ/Q values used during Reactor Building Drawdown.

2.3.4a.3 Calculation of χ/Q at the CR/AEER Intakes

Estimates of atmospheric diffusion (χ/Q) are made for each of the two CR/AEER Intakes (i.e. North and South) for releases from the Stack, encompassing the Standby Gas Treatment Stack (SGTS), and the Unit 1 and Unit 2 Main Steam Isolation Valves (MSIV) pathway through the turbine seals. The NRC-sponsored computer codes ARCON96 (Reference 25) and PAVAN are utilized consistent with the procedures in Regulatory Guide 1.194 (Reference 26).

2.3.4a.3.1 ARCON96 Model Analysis

ARCON96 is utilized in both elevated release mode and ground-level release mode for calculation of Control Room χ/Q at the LaSalle Station. Its technical bases is described as follows, per Reference 25.

For elevated releases, the relative concentration is given by:

$$\frac{\chi}{Q} = \frac{1}{\pi\sigma_y\sigma_zU} \exp\left[-0.5\left(\frac{y}{\sigma_y}\right)^2\right] \exp\left[-0.5\left(\frac{h_e - h_i}{\sigma_z}\right)^2\right] \quad (2.3.4a-6)$$

where h_e is the effective stack height and h_i is the height of the intake. Wake corrections are not made to diffusion coefficients used in calculating concentrations in elevated plumes. Effective stack height is determined from the actual stack height (h_s), the difference in terrain elevation between the stack and intake locations ($t_s - t_i$), and stack downwash (Δh_d) by

$$h_e = h_s + (t_s - t_i) + \Delta h_d \quad (2.3.4a-7)$$

where the stack downwash is computed as

$$\Delta h_d = 4r_s \left[\frac{w_o}{U(h_s)} - 1.5 \right] \quad (2.3.4a-8)$$

and r_s is the radius of the stack, w_o is the vertical velocity of the effluent, and $U(h_s)$ is the wind speed at stack height. A release is considered elevated if the actual stack height is more than 2.5 times the height of structures in the immediate vicinity of the stack. Plume rise is not considered in calculating effective stack height in ARCON96. If consideration of plume rise is desired, the plume rise must be calculated manually and added to the release height before the release height is entered.

The sector-average model is used in calculating relative concentrations for elevated releases for averaging period longer than 8 hours. The sector-average plume model for elevated releases may be derived in the same manner as the sector-average plume model for ground-level releases. It is

$$\frac{\chi}{Q} = \frac{2}{(2\pi)^{1/2} W_s \sigma_z U} \exp \left[-0.5 \left(\frac{h_e - h_i}{\sigma_z} \right)^2 \right] \quad (2.3.4a-9)$$

Note that the use of the elevated plume models may lead to unrealistically low concentrations at control room intakes. Near the base of stacks the highest concentrations are likely to occur during low wind speed conditions when there may be reversals in the wind direction. In accordance with Regulatory Guide 1.194, Regulatory Guide 1.145 methodology is used to estimate potential control room intake concentrations during low wind speed conditions (See PAVAN modeling analysis in Section 2.3.4a.3.2).

The basic model for a ground-level release is as follows:

$$\frac{\chi}{Q} = \frac{1}{\pi \sigma_y \sigma_z U} \exp \left[-0.5 \left(\frac{y}{\sigma_y} \right)^2 \right] \quad (2.3.4a-10)$$

where:

- χ/Q = relative concentration (concentration divided by release rate)
[ci/m³]/(ci/s)
- σ_y, σ_z = diffusion coefficients (m)
- U = wind speed (m/s)
- y = distance from the center of the plume (m)

This equation assumes that the release is continuous, constant, and of sufficient duration to establish a representative mean concentration. It also assumes that the material being released is reflected by the ground. Diffusion coefficients are typically determined from atmospheric stability and distance from the release point using empirical relationships. A diffusion coefficient parameterization from the NRC PAVAN and XOQDOQ (Reference 27) codes is used for σ_y and σ_z .

The diffusion coefficients have the general form

$$\sigma = a x^b + c$$

where x is the distance from the release point, in meters, and a , b , and c are parameters that are functions of stability. The parameters are defined for 3 distance ranges – 0 to 100 m, 100 to 1000 m, and greater than 1000 m. The

parameter values may be found in the listing of Subroutine NSIGMA1 in Appendix A of NUREG/CR-6331 Rev. 1.

Diffusion coefficient adjustments for wakes and low wind speeds are incorporated as follows:

To estimate diffusion in building wakes, composite wake diffusion coefficients, Σ_y and Σ_z , replace σ_y and σ_z . The composite wake diffusion coefficients are defined by

$$\Sigma_y = \left(\sigma_y^2 + \Delta\sigma_{y1}^2 + \Delta\sigma_{y2}^2 \right)^{1/2} \quad (2.3.4a-11)$$

$$\Sigma_z = \left(\sigma_z^2 + \Delta\sigma_{z1}^2 + \Delta\sigma_{z2}^2 \right)^{1/2} \quad (2.3.4a-12)$$

The variables σ_y and σ_z are the normal diffusion coefficients, $\Delta\sigma_{y1}$ and $\Delta\sigma_{z1}$ are the low wind speed corrections, and $\Delta\sigma_{y2}$ and $\Delta\sigma_{z2}$ are the building wake corrections. These corrections are described and evaluated in Ramsdell and Fosmire (Reference 28). The low wind speed corrections are:

$$\Delta\sigma_{y1}^2 = 9.13 \times 10^5 \left[1 - \left(1 + \frac{x}{1000U} \right) \exp\left(\frac{-x}{1000U} \right) \right] \quad (2.3.4a-13)$$

$$\Delta\sigma_{z1}^2 = 6.67 \times 10^2 \left[1 - \left(1 + \frac{x}{100U} \right) \exp\left(\frac{-x}{100U} \right) \right] \quad (2.3.4a-14)$$

The variable x is the distance from the release point to the receptor, in meters, and U is the wind speed in meters per second. It is appropriate to use the slant range distance for x because these corrections are made only when the release is assumed to be at the ground level and the receptor is assumed to be on the axis of the plume. The diffusion coefficients corrections that account for enhanced diffusion in the wake have a similar form. These corrections are:

$$\Delta\sigma_{y2}^2 = 5.24 \times 10^{-2} U^2 A \left[1 - \left(1 + \frac{x}{10\sqrt{A}} \right) \exp\left(\frac{-x}{10\sqrt{A}} \right) \right] \quad (2.3.4a-15)$$

$$\Delta\sigma_{z2}^2 = 1.17 \times 10^{-2} U^2 A \left[1 - \left(1 + \frac{x}{10\sqrt{A}} \right) \exp\left(\frac{-x}{10\sqrt{A}} \right) \right] \quad (2.3.4a-16)$$

The constant A is the cross-sectional area of the building.

An upper limit is placed on Σ_y as a conservative measure. This limit is the standard deviation associated with a concentration uniformly distributed across a sector with width equal to the circumference of a circle with radius to the distance between the source and receptor. This value is

$$\Sigma_{y_{max}} = \frac{2\pi x}{\sqrt{12}} \approx 1.81x \quad (2.3.4a-17)$$

2.3.4a.3.1.1 ARCON96 Meteorological Database

The LaSalle meteorological tower data for the five-year period, 1999-2003, were applied in the ARCON96 modeling analyses. Wind measurements were taken at tower elevations 33 ft, 200 ft and 375 ft, and the vertical temperature difference (i.e., delta T) was measured between 200 ft and 33 ft and between 375 ft and 33 ft on the tower. Wind speeds reported as "calm" were assigned a value of 0.3 mph (i.e. 0.13 m/s). ARCON96, however, re-assigns a default value of 0.5 m/s to each wind speed lower than 0.5 m/s.

Executing ARCON96 requires the meteorological input file to contain two (2) wind levels (lower and upper) and one (1) delta T stability class. Since the LaSalle χ/Q analysis necessitates the modeling of both ground-level and elevated sources, two ARCON96 meteorological databases were obtained from Murray & Trettel as follows:

Meteorological Database	Lower Level Wind	Upper Level Wind	Delta T Stability Class Levels
Lower	33 ft	200 ft	200-33 ft
Upper	33 ft	375 ft	375-33 ft

The most representative or conservative (for stack as a ground-level release) database was then selected to be utilized in ARCON96 for each of the release points as shown below:

Release	Meteorological Database
Unit 1 and 2 MSIV	Lower
Stack as an elevated release	Upper
Stack as a ground-level release	Upper and Lower, with the more conservative results utilized

Tables 2.3-67 and 2.3-68 provide joint wind-speed direction-stability class occurrence frequency distributions for the 33 ft wind/200-33 ft delta temperature and the 375 ft wind/375-33 ft delta temperature data sets, respectively.

2.3.4a.3.1.2 ARCON96 Input Parameters

The release points identified for the ARCON96 modeling analyses are the Stack, encompassing the Standby Gas Treatment Stack (SGTS), and the Unit 1 and Unit 2 Main Steam Isolation Valves (MSIV) pathway through the turbine seals.

The Stack was modeled in ARCON96 as both an elevated release and a ground-level release. Modeling the Stack as an elevated release is consistent with the original LaSalle Station licensing as documented in the LaSalle SER, even though its height of 112.8 m above grade is less than 2.5 times the height of its highest adjacent building, the Reactor Building. For elevated releases, aerodynamic building plume downwash effects are not present. The stack was modeled in ground-level release mode from its actual release height (per RG 1.194 Table A-2, "ARCON96 Input Parameters for Design Basis Assessments") to obtain χ/Q values to be utilized for the Reactor Building Drawdown period for the Fuel Handling Accident (FHA) and Loss of Coolant Accident (LOCA). Aerodynamic building plume downwash effects are present for ground-level releases, therefore, in accordance with RG 1.194, the building area perpendicular to the wind direction is utilized.

The Unit 1 and Unit 2 MSIV, both with a release height of 20.4 m (66.9 ft) above grade, are conservatively assumed located at the closest point to both the North CR/AEER and South CR/AEER intakes along the high and low pressure turbines, and is executed by ARCON96 as a ground-level release. In accordance with RG 1.194, the building area perpendicular to the wind direction is utilized.

ARCON96 is executed for separate releases from the Stack and MSIV to each of the two Control Room Intakes (i.e. North and South).

The releases for the Control Room Intake modeling scenarios are each treated as a point source, and are conservatively assumed to have a zero (0) vertical velocity, exhaust flow and stack radius. The ARCON96 input parameter values were set in accordance with RG 1.194, Table A-2 (e.g. surface roughness length = 0.2 m; wind direction window = 90 degrees, 45 degree on either side of line of sight from source to receptor; minimum wind speed = 0.5 m/s; and averaging sector width constant = 4.3).

2.3.4a.3.1.3 ARCON96 Control Room Intake χ/Q

The χ/Q values resulting from the ARCON96 modeling analysis of each Source/Control Room Intake scenario are presented below.

MAXIMUM ARCON96 χ/Q Results: CR/AEER Intakes							
SCENARIO			χ/Q (sec/m ³)				
Source	Receptor	Type of Release	0-2 hrs	2-8 hrs	8-24 hrs	1-4 days	4-30 days
Stack	North CR/AEER Intake	Elevated ⁽¹⁾	1.00E-36 ⁽²⁾	1.00E-36	1.00E-36	1.00E-36	2.75E-36
	South CR/AEER Intake ⁽³⁾		Note (3)				
Stack	North CR/AEER Intake	Ground-Level (33 and 375 ft wind; 375-33 ft Delta T)	6.64E-04	4.35E-04	1.66E-04	1.12E-04	9.34E-05
	South CR/AEER Intake		6.81E-04	5.04E-04	2.13E-04	1.34E-04	9.70E-05
Stack	North CR/AEER Intake	Ground-Level (33 and 200 ft wind; 200-33 ft Delta T)	5.51E-04	3.29E-04	1.39E-04	9.40E-05	7.47E-05
	South CR/AEER Intake		6.83E-04	4.87E-04	2.11E-04	1.29E-04	9.61E-05
Unit 1 MSIV	North CR/AEER Intake	Ground-Level	1.01E-03	7.52E-04	3.13E-04	2.29E-04	1.81E-04
	South CR/AEER Intake		8.13E-03	6.09E-03	2.42E-03	1.76E-03	1.46E-03
Unit 2 MSIV	North CR/AEER Intake	Ground-Level	8.13E-03	6.09E-03	2.42E-03	1.76E-03	1.46E-03
	South CR/AEER Intake		8.84E-04	6.70E-04	2.61E-04	1.67E-04	1.32E-04

- (1) These χ/Q values are used in conjunction with PAVAN 0-2 hr, 1-4 day and 4-30 day values to calculate final χ/Q stack values in accordance with RG 1.194 methodology.
- (2) The values of 1.00E-36 in this table are a result of inherent computational limitation; thus elevated stack release χ/Q values can be considered essentially zero.
- (3) The Stack to South CR/AEER Intake scenario model run failed to complete due to computational underflow (calculated χ/Q values below the computer maximum limit of negative exponents). All elevated stack release χ/Q values can be considered essentially zero.

2.3.4a.3.2 PAVAN Model Analysis

As mentioned in Section 2.3.4a.3, a PAVAN modeling analysis was also performed to determine χ/Q values at the Control Room Intakes for releases from the Stack. For this PAVAN analysis, which supplements the ARCON96 modeling analysis results for the 0-2 hour, 1-4 day, and 4-30 day χ/Q time intervals, maximum PAVAN χ/Q results are utilized irrespective of Stack to Control Room Intake direction.

PAVAN was executed in stack release mode utilizing the equations outlined above in Section 2.3.4a.2.

2.3.4a.3.2.1 PAVAN Meteorological Database

The meteorological database utilized for the Control Room Intake χ/Q calculations was prepared for use in PAVAN by transforming the five years (i.e. 1999-2003) of hourly meteorological tower data wind observations at the 375 level and delta temperature observations at 375-33 ft into a joint wind speed-wind direction-stability class occurrence frequency distribution in the same manner explained in Section 2.3.4a.2.1.

2.3.4a.3.2.2 PAVAN Input Parameters

PAVAN was executed in stack-level release mode with a stack-to-intake horizontal distance of 54 m. The release height of the Stack is 112.8 m, however, for this PAVAN assessment, RG 1.194, Section 3.2.2 requires the release height to be measured from the height of the intake (40.7 m above grade elevation); therefore, the actual stack release height of 112.8 m above grade was reduced by 40.7 m, to 72.1 m for modeling purposes.

An additional set of PAVAN runs was also executed for the Stack to Control Room Intake scenario in accordance with RG 1.194 guidance to determine the distance at which the actual maximum χ/Q would occur in each given downwind sector. The additional distances modeled are as follows: 50, 100, 200, 300, 400, 600, 800, 1000, 1500, 1600, 1700, 1800, 1900, 2000, 2100, 2200, 2300, 2400, 2500, 3000, 3500, 4000, 4500, and 5000 meters.

In order to conservatively account for isolated areas of terrain higher than the plant grade, terrain elevations of 17 m (55.8 ft) above plant grade were used for the SSW through NW sectors for all distances 1600 m and greater. Elsewhere, plant grade receptor elevation was assumed.

LSCS-UFSAR

2.3.4a.3.2.3 PAVAN Control Room Intake χ/Q

The χ/Q values resulting from the PAVAN modeling analysis for the Control Room Intake scenario are presented below.

PAVAN Stack χ/Q Results: Control Room Intakes						
Scenario	Horizontal Distance (m)	χ/Q (sec/m ³) ¹				
		0-2 hours	0-8 hours	8-24 hours	1-4 days	4-30 days
Stack to CR/AEER Intake ²	50	6.10E-06	1.08E-09	1.44E-11	1.22E-15	1.75E-21
	54 (Actual Distance)	6.10E-06	2.96E-09	6.51E-11	1.65E-14	1.13E-19
	100	6.10E-06	2.32E-07	4.53E-08	1.30E-09	8.02E-12
	200	6.10E-06	9.77E-07	3.91E-07	5.37E-08	3.10E-09
	300	6.10E-06	1.47E-06	7.19E-07	1.53E-07	1.66E-08
	400	6.10E-06	1.75E-06	9.37E-07	2.42E-07	3.46E-08
	600	6.10E-06	2.06E-06	1.20E-06	3.71E-07	6.86E-08
	800	6.10E-06	2.39E-06	1.50E-06	5.42E-07	1.26E-07
	1000	6.10E-06	2.65E-06	1.75E-06	7.08E-07	1.94E-07
	1500	9.54E-06	4.18E-06	2.77E-06	1.13E-06	3.13E-07
	1600	1.17E-05	5.58E-06	3.85E-06	1.72E-06	5.39E-07
	1700	1.14E-05	5.41E-06	3.73E-06	1.67E-06	5.24E-07
	1800	1.05E-05	5.05E-06	3.50E-06	1.58E-06	5.03E-07
	1900	1.02E-05	4.91E-06	3.40E-06	1.53E-06	4.88E-07
	2000	9.54E-06	4.60E-06	3.20E-06	1.45E-06	4.67E-07
	2100	9.43E-06	4.54E-06	3.15E-06	1.42E-06	4.55E-07
	2200	9.04E-06	4.36E-06	3.02E-06	1.37E-06	4.39E-07
	2300	9.40E-06	4.47E-06	3.09E-06	1.38E-06	4.34E-07
	2400	9.54E-06	4.51E-06	3.10E-06	1.37E-06	4.26E-07
	2500	9.11E-06	4.31E-06	2.96E-06	1.32E-06	4.10E-07
3000	7.97E-06	3.75E-06	2.57E-06	1.13E-06	3.51E-07	
3500	6.56E-06	3.11E-06	2.14E-06	9.49E-07	2.96E-07	
4000	6.16E-06	2.88E-06	1.97E-06	8.60E-07	2.63E-07	
4500	5.81E-06	2.68E-06	1.82E-06	7.86E-07	2.35E-07	
5000	5.38E-06	2.46E-06	1.66E-06	7.13E-07	2.11E-07	

¹ Shading and bolding identifies maximum for each given time period.

² χ/Q values equally applicable to the North and South CR/AEER Intakes, since the distance from both Intakes to the Stack are equal; thus, utilizing applicable RG 1.145 methodology as specified by RG 1.194 for elevated release, the resulting controlling χ/Q values are directionally independent.

2.3.4a.3.3 Control Room χ/Q Results (In accordance with RG 1.194)

Below are the maximum Control Room Intake χ/Q results to be used for accident analyses in accordance with RG 1.194, as derived based on the ARCON96 and PAVAN analysis χ/Q values.

Maximum Control Room Intake χ/Q Results to be Used for Accident Analyses (in accordance with RG 1.194)								
Scenario				χ/Q (sec/m ³)				
Source	Receptor	Type of Release	Meteorological Database	0-2 hrs	2-8 hrs	8-24 hrs	1-4 days	4-30 days
Stack	CR/AEER	Elevated ⁽¹⁾	Upper: 33 and 375 ft wind; 375-33 ft Delta T	1.17E-05	1.00E-36	1.00E-36	7.17E-08	2.25E-08
Stack	CR/AEER	Ground-Level ⁽²⁾	Worst Case of Either Upper: 33 and 375 ft wind; 375-33 ft Delta T, or Lower: 33 and 200 ft wind; 200-33 ft Delta T	6.83E-04	5.04E-04	2.13E-04	1.34E-04	9.70E-05
MSIV	CR/AEER	Ground-Level	Lower: 33 and 200 ft wind; 200-33 ft Delta T	8.13E-03	6.09E-03	2.42E-03	1.76E-03	1.46E-03

- 1) Elevated release χ/Q values are calculated in accordance with RG 1.194, Section 3.2.2.
- 2) Ground-level Stack χ/Q values used during Reactor Building Drawdown.

2.3.5 Long-Term (Routine) Diffusion Estimates

2.3.5.1 Objective

For routine effluent releases, the annual average atmospheric dilution factors for an elevated release were made by use of LSCS meteorological tower data from October 1, 1976, through September 30, 1978, for effluents released from both the station vent stack and the SGTS vent.

2.3.5.2 Calculations

Annual average χ/Q values were computed for actual site boundary distances as well as the following radial distances: 0.5, 1.5, 2.5, 3.5, 4.5, 7.5, 15.0, 25.0, 35.0, and 45.0 miles. The joint frequency distribution data of wind direction and wind speed by atmospheric stability class from the LSCS meteorological tower at the 375-foot level, given in Table 2.3-32, are used as meteorological data input for annual average diffusion estimates. Calms are assigned a wind speed of one-half the threshold speed of the vane or anemometer (whichever is higher) and a wind direction in proportion to the directional distribution, within a stability class, of the lowest non-calm wind speed category.

Ground-level sector average values of χ/Q based on the joint frequency statistics of wind and stability are computed from the following equation:

$$(\chi/Q)_i = 2.032 \sum_k \sum_j \frac{F_{ijk}}{x U_j \sigma_{zk}} \exp \left[\frac{1}{2} \left(\frac{h_e}{\sigma_{zk}} \right)^2 \right] \quad (2.3-12)$$

where:

$(\chi/Q)_i$ = annual average relative ground-level concentrations (sec/m³) in the *i*th downwind sector,

F_{ijk} = joint frequency distribution at *i*th wind direction, *j*th wind speed category, and *k*th stability class,

x = downwind distance (meters),

U_j = mean wind speed in the *j*th wind speed category (m/sec),

σ_{zk} = vertical diffusion parameter at distance *x* for the *k*th stability class (meters), and

h_e = effective plume height (meters).

LSCS-UFSAR

Annual χ/Q calculations for LSCS were made using the methods of NRC Regulatory Guide 1.111. Use of these methods limits modeled release levels to a maximum height of 100 meters. Although the actual stack height of LSCS is 113 meters, the use of a 100-meter release height for both the common plant stack and SGTS vent for annual average χ/Q calculations is conservative.

Table 2.3-63 presents the calculated annual average χ/Q values at actual site boundary distances as well as various radial distances up to 45 miles for effluents released from the station vent stack and the SGTS vent, respectively.

2.3.6 References

1. "Climate Summary of the United States - Illinois," Climatography of the United States, No. 60-15, U.S. Department of Commerce, Weather Bureau, 1964.
2. "Climate of the States - Illinois," Climatography of the United States, No. 60-11, U.S. Department of Commerce, Weather Bureau, June 1969.
3. S. A. Changnon, Jr., "Climatology of Hourly Occurrences of Selected Atmospheric Phenomena in Illinois," Circular 93, Illinois State Water Survey, Urbana, Illinois, 1968.
4. Severe Local Storm Occurrences, 1955-1967, Technical Memorandum WBTM FCST 12, U.S. Department of Commerce NOAA, Weather Bureau, Office of Meteorological Operations, Weather Analysis and Prediction Division, Silver Spring, Maryland, September 1969.
5. J. L. Marshall, Lightning Protection, John Wiley & Sons, New York, 1973.
6. Illinois Tornadoes, Illinois State Water Survey, Urbana, Illinois, 1971.
7. H. C. Thom, "Tornado Probabilities," Monthly Weather Review, Vol. 91, pp. 730-736, 1963.
8. S. A. Changnon, Jr., "Climatology of Severe Winter Storms in Illinois," Bulletin 53, Illinois State Water Survey, Urbana, Illinois, 1969.
9. Association of American Railroads, "Glaze Storm Loading, Summary 1927-28 to 1936-37," 1955.
10. I. Bennet, "Glaze, Its Meteorology and Climatology, Geographical Distribution, and Economic Effects," U.S. Army Quartermasters Research and Engineering Center, Technical Report EP-105, 1959.

LSCS-UFSAR

11. "Local Climatological Data, Annual Summary with Comparative Data", U.S. Department of Commerce, NOAA, EDS, Peoria, Illinois, 1941-1977.
12. Glossary of Meteorology, (Ed. by R. E. Huschke), American Meteorological Society, Boston, Massachusetts, 1959, Second Printing with Corrections, 1970.
13. F. Pasquill, "The Estimation of the Dispersion of Windblown Material", *Meteorology Magazine*, Vol. 90, No. 1063, pp. 33-49, 1961.
14. R. Hippler, Amendment to report entitled "Summary of Statistical Analysis of Fogging by the Proposed LaSalle County Station Cooling Pond", April 17, 1972 (the amendment was prepared on July 17, 1973 and presented as Exhibits 9 and 9a before the ASLB July 18-20, 1973).
15. F. A. Gifford, Jr., "Use of Routine Meteorological Observations for Estimating Atmospheric Dispersion," *Nuclear Safety*, Vol. 2, No. 4, pp. 47-57, June 1961.
16. F. A. Gifford, Jr., "Atmospheric Dispersion Calculations Using the Generalized Gaussian Plume Model," *Nuclear Safety*, Vol. 2, No. 2, pp. 56-69, December 1960.
17. G. A. Briggs, "Plume Rise," TID-25075, AEC, Critical Review Series, U.S. Atomic Energy Commission, 1969.
18. H. Mosses and M. A. Bogner, "Fifteen-Year Climatological Summary (January 1, 1950 - December 31, 1964)," Argonne National Laboratory, AN-7084, September 1967.
19. S. A. Changnon, Jr., "Areal-Temporal Variations of Hail Intensity in Illinois," *Journal of Applied Meteorology*, Vol. 6, pp. 536-541, June 1967.
20. N. Towery, Atmospheric Sciences Section, Illinois State Water Survey, Telephone Conversation with R. H. LaPlaca, Sargent & Lundy Meteorologist, February 3, 1977.
21. Atmospheric Dispersion Code System for Evaluating Accidental Radioactivity Releases from Nuclear Power Stations; PAVAN, Version 2; Oak Ridge National Laboratory; U.S. Nuclear Regulatory Commission; December 1997.
22. Regulatory Guide 1.145; Atmospheric Dispersion Models for Potential Accident Consequence Assessments at Nuclear Power Plants (Revision 1); U.S. Nuclear Regulatory Commission; November 1982.

LSCS-UFSAR

23. LaSalle 1999-2003 Meteorological Tower Data; provided by Murray & Trettel, Inc. via e-mail from Dan Davidson on 8/3/2004.
24. NRC Regulatory Issue Summary 2006-04, Experience with Implementation of Alternative Source Terms, March 7, 2006.
25. Atmospheric Relative Concentrations in Building Wakes; NUREG/CR-6331, PNNL-10521, Rev. 1; prepared by J. V. Ramsdell, Jr., C. A. Simmons, Pacific Northwest National Laboratory; prepared for U.S. Nuclear Regulatory Commission; May 1997 (Errata, July 1997).
26. Regulatory Guide 1.194; Atmospheric Relative Concentrations for Control Room Radiological Habitability Assessments at Nuclear Power Plants; U.S. Nuclear Regulatory Commission; June 2003.
27. XOQDOQ: Computer Program for the Meteorological Evaluation of Routine Releases at Nuclear Power Stations; NUREG/CR-2919; J. F. Sagendorf, J. T. Goll, and W. F. Sandusky, U.S. Nuclear Regulatory Commission; Washington, D.C; 1982.
28. Atmospheric Dispersion Estimates in the Vicinity of Buildings; J. V. Ramsdell and C. J. Fosmire, Pacific Northwest Laboratory; 1995.

LSCS-UFSAR

TABLE 2.3-1

TORNADO SUMMARY FOR ILLINOIS

<u>YEAR</u>	<u>NUMBER</u>	<u>YEAR</u>	<u>NUMBER</u>	<u>YEAR</u>	<u>NUMBER</u>
1916	2*	1934	3	1952	4
1917	4*	1935	2*	1953	3*
1918	5*	1936	1	1954	7*
1919	0	1937	1	1955	25
1920	7*	1938	18*	1956	28*
1921	3	1939	4	1957	42*
1922	2*	1940	1	1958	27*
1923	1	1941	4	1959	37*
1924	3	1942	8*	1960	40
1925	4*	1943	2	1961	34*
1926	1	1944	1*	1962	13
1927	18*	1945	3*	1963	11*
1928	7*	1946	4	1964	7
1929	4*	1947	6	1965	28*
1930	7	1948	13*	1966	11*
1931	1	1949	6*	1967	40*
1932	4	1950	3	1968	8*
1933	4*	1951	5*	1969	10

* Indicates death occurred

LSCS-UFSAR

TABLE 2.3-2

MEASURES OF GLAZING IN VARIOUS SEVERE WINTER STORMS

STORM DATA	RADIAL THICKNESS OF ICE ON WIRE (in.)	RATIO OF ICE WEIGHT TO WEIGHT OF 0.25- in. TWIG	WEIGHT OF ICE (oz) ON 1 FOOT OF STANDARD (#12) WIRE	CITY	STATE SECTION
2-4 Feb. 1813			11	Springfield	WSW
20 Mar. 1912	0.5			Decatur	C
21 Feb. 1913	2.0			La Salle	NE
11-12 Mar. 1923	1.6		12	Marengo	NE
17-19 Dec 1924	1.2	15:1	8	Springfield	WSW
22-23 Jan. 1927	1.1		2	Cairo	SE
31 Mar 1929	0.5			Moline	NW
7-8 Jan. 1930	1.2			Carlinville	WSW
1-2 Mar. 1932	0.5			Galena	NW
7-8 Jan. 1937	1.5			Quincy	W
31 Dec. 1947-1 Jan. 1948	1.0		72	Chicago	NE
10 Jan. 1949	0.8			Macomb	W
8 Dec. 1956	0.5			Alton	WSW
20-22 Jan. 1959	0.7	12:1		Urbana	E
26-27 Jan. 1967	1.7	17:1	40	Urbana	E

LSCS-UFSAR

TABLE 2.3-3

SUMMARY OF MAXIMUM 5-MINUTE WIND SPEEDS
OCCURRING AFTER 18 GLAZE STORMS THROUGHOUT
THE UNITED STATES

WIND SPEED INTERVALS (mph)	<u>NUMBER OF CASES</u>	NUMBER OF CASES WHEN RADIAL THICKNESS OF ICE <u>WAS 0.25 INCH OR MORE</u>
0-4	1	0
5-9	17	2
10-14	35	3
15-19	46	15
20-24	27	6
25-29	10	3
30-34	6	1
35-39	2	1
40-44	1	0
45-49	2	1
50-54	1	0
Total	148	32

LSCS-UFSAR

TABLE 2.3-4
WIND-GLAZE THICKNESS RELATIONS FOR FIVE PERIODS OF GREATEST SPEED AND GREATEST THICKNESS*

RANK	FIVE PERIODS WHEN FIVE FASTEST 5-MINUTE SPEEDS WERE REGISTERED		FIVE PERIODS WHEN FIVE GREATEST ICE THICKNESSES WERE MEASURED	
	SPEED (mph)	ICE THICKNESS (in.)	ICE THICKNESS (in.)	SPEED (mph)
1	50	0.19	2.87	30
2	46	0.79	1.71	18
3	45	0.26	1.50	21
4	40	0.30	1.10	28
5	35	0.78	1.00	18

* From data collected throughout the United States in an 11-year study

LSCS- UFSAR

TABLE 2.3-5
(Sheet 1 of 2)

ARGONNE NATIONAL LABORATORY: PERCENTAGE FREQUENCY

AND MEAN OF 19- AND 150-FOOT WIND SPEED (mph)

FOR INDICATED WIND DIRECTION,

JANUARY 1950 – DECEMBER 1964

(NUMBER OF HOURLY OBSERVATIONS: 131,496)

	DIRECTION DEGREES	CALM	1-5	4-7	8-12	13-18	19-24	25-31	32-38	39-46	>46	MISSING	TOTAL	MEAN SPEED
19-FOOT LEVEL	CALM	2.005	0.015	0.000	0.000	0.000	0.000	0.000	0.000	0.000	0.000	0.001	2.021	0.01
	10	0.027	0.321	0.880	0.700	0.227	0.021	0.002	0.000	0.000	0.000	0.001	2.180	7.43
	20	0.018	0.300	0.900	0.778	0.268	0.040	0.002	0.000	0.000	0.000	0.002	2.307	7.75
	30	0.019	0.452	1.325	1.336	0.472	0.077	0.004	0.000	0.000	0.000	0.005	3.689	8.11
	40	0.022	0.318	0.849	0.786	0.297	0.034	0.001	0.000	0.000	0.000	0.002	2.308	7.81
	50	0.021	0.313	0.745	0.684	0.284	0.041	0.001	0.000	0.000	0.000	0.003	2.091	7.89
	60	0.022	0.390	0.926	0.951	0.307	0.049	0.001	0.000	0.000	0.000	0.008	2.653	7.80
	70	0.027	0.318	0.860	0.695	0.215	0.021	0.002	0.000	0.000	0.000	0.004	2.142	7.32
	80	0.029	0.358	0.840	0.526	0.165	0.017	0.000	0.000	0.000	0.000	0.001	1.935	6.75
	90	0.039	0.529	0.948	0.422	0.113	0.008	0.000	0.000	0.000	0.000	0.001	2.059	5.82
	100	0.034	0.452	0.645	0.319	0.072	0.002	0.000	0.000	0.000	0.000	0.000	1.525	5.52
	110	0.037	0.501	0.570	0.263	0.037	0.000	0.000	0.000	0.000	0.000	0.002	1.408	4.98
	120	0.047	0.621	0.712	0.331	0.055	0.001	0.000	0.000	0.000	0.000	0.004	1.770	5.03
	130	0.046	0.469	0.631	0.342	0.064	0.000	0.000	0.000	0.000	0.000	0.002	1.554	5.50
	140	0.038	0.477	0.745	0.351	0.059	0.003	0.000	0.000	0.000	0.000	0.005	1.678	5.51
	150	0.027	0.598	0.964	0.537	0.123	0.006	0.002	0.000	0.000	0.000	0.006	2.264	5.99
	160	0.024	0.395	0.687	0.494	0.145	0.014	0.000	0.000	0.000	0.000	0.002	1.762	6.65
	170	0.027	0.316	0.838	0.696	0.208	0.023	0.003	0.000	0.000	0.000	0.001	2.111	7.37
	180	0.026	0.265	0.811	1.062	0.454	0.086	0.011	0.001	0.000	0.000	0.002	2.716	8.93
	190	0.036	0.342	1.050	1.331	0.516	0.047	0.005	0.000	0.000	0.000	0.001	3.327	8.47
	200	0.029	0.335	1.325	1.485	0.619	0.078	0.008	0.000	0.000	0.000	0.003	3.881	8.65
	210	0.037	0.527	1.881	1.894	1.037	0.113	0.009	0.001	0.000	0.000	0.004	5.501	8.73
	220	0.032	0.490	1.429	1.488	0.612	0.069	0.012	0.001	0.000	0.000	0.005	4.138	8.28
	230	0.033	0.586	1.229	1.214	0.409	0.047	0.010	0.000	0.000	0.000	0.002	3.529	7.62
	240	0.025	0.532	1.380	1.236	0.479	0.105	0.033	0.001	0.000	0.000	0.005	3.796	8.14
	250	0.028	0.375	1.126	0.988	0.424	0.133	0.027	0.000	0.000	0.000	0.002	3.103	8.49
	260	0.033	0.388	1.351	1.023	0.494	0.150	0.032	0.000	0.000	0.000	0.001	3.472	8.52
	270	0.027	0.452	1.608	1.165	0.662	0.201	0.033	0.000	0.000	0.000	0.003	4.151	8.72
	280	0.025	0.305	1.105	0.903	0.488	0.107	0.010	0.000	0.000	0.000	0.004	2.948	8.56
	290	0.023	0.256	0.979	0.985	0.500	0.059	0.005	0.000	0.000	0.000	0.002	2.807	8.69
	300	0.033	0.348	1.196	1.169	0.522	0.100	0.008	0.000	0.000	0.000	0.005	3.382	8.50
	310	0.020	0.300	0.894	0.893	0.343	0.046	0.002	0.000	0.000	0.000	0.002	2.499	8.16
	320	0.042	0.300	0.782	0.754	0.302	0.043	0.002	0.000	0.000	0.000	0.002	2.226	8.00
	330	0.037	0.413	1.089	1.051	0.483	0.059	0.003	0.000	0.000	0.000	0.002	3.137	8.17
	340	0.033	0.307	0.738	0.705	0.344	0.055	0.011	0.000	0.000	0.000	0.000	2.192	8.28
	350	0.025	0.303	0.831	0.730	0.302	0.030	0.003	0.000	0.000	0.000	0.001	2.226	7.80
	360	0.019	0.299	0.894	0.680	0.270	0.030	0.001	0.000	0.000	0.000	0.002	2.194	7.64
	MISSING	0.016	0.451	0.373	0.181	0.052	0.005	0.000	0.000	0.000	0.000	0.239	1.317	5.02
	TOTAL	3.086	14.71	36.13	31.15	12.42	1.918	0.240	0.003	0.000	0.000	0.332	100.000	
	CUMULATIVE		6	1	0	3	1.918	0.240	0.003	0.000	0.000	0.332	100.000	
	TOTAL	3.086	17.80	53.93	89.08	97.50	99.42	99.66	99.66	99.66	99.66	15 YEAR MEAN=		7.63

LSCS- UFSAR

TABLE 2.3-5
(Sheet 2 of 2)

ARGONNE NATIONAL LABORATORY: PERCENTAGE FREQUENCY

AND MEAN OF 19- AND 150-FOOT WIND SPEED (mph)

FOR INDICATED WIND DIRECTION,

JANUARY 1950 – DECEMBER 1964

(NUMBER OF HOURLY OBSERVATIONS: 131,496)

	DIRECTION DEGREES	CALM	1-5	4-7	8-12	13-18	19-24	25-31	32-38	39-46	>46	MISSING	TOTAL	MEAN SPEED
150- FOOT LEVEL	CALM	0.572	0.005	0.001	0.001	0.001	0.000	0.000	0.000	0.000	0.000	0.002	0.581	0.05
	10	0.004	0.062	0.317	0.851	0.579	0.110	0.019	0.000	0.000	0.000	0.005	1.948	11.29
	20	0.002	0.080	0.346	0.913	0.577	0.189	0.043	0.002	0.001	0.000	0.003	2.156	11.73
	30	0.005	0.103	0.419	1.214	1.018	0.281	0.063	0.005	0.000	0.000	0.003	3.110	12.23
	40	0.003	0.068	0.313	0.944	0.749	0.207	0.032	0.002	0.001	0.000	0.002	2.320	12.10
	50	0.005	0.064	0.306	0.844	0.602	0.179	0.037	0.004	0.000	0.000	0.002	2.042	11.93
	60	0.003	0.085	0.371	1.079	0.759	0.197	0.044	0.006	0.000	0.000	0.005	2.549	11.87
	70	0.005	0.073	0.288	1.018	0.534	0.154	0.048	0.004	0.000	0.000	0.008	2.131	11.70
	80	0.005	0.077	0.325	1.032	0.497	0.131	0.025	0.000	0.000	0.000	0.007	2.092	11.18
	90	0.009	0.095	0.438	1.307	0.407	0.092	0.011	0.002	0.000	0.000	0.004	2.365	10.16
	100	0.018	0.007	0.392	0.873	0.266	0.039	0.010	0.000	0.000	0.000	0.005	1.671	9.59
	110	0.006	0.074	0.374	0.741	0.243	0.033	0.005	0.000	0.000	0.000	0.003	1.478	9.46
	120	0.007	0.108	0.459	0.927	0.328	0.049	0.005	0.000	0.000	0.000	0.002	1.884	9.62
	130	0.006	0.095	0.383	0.796	0.257	0.039	0.005	0.000	0.000	0.000	0.002	1.583	9.48
	140	0.009	0.100	0.422	0.866	0.307	0.060	0.007	0.001	0.000	0.000	0.002	1.774	9.67
	150	0.007	0.127	0.563	1.188	0.422	0.098	0.016	0.002	0.000	0.000	0.006	2.429	9.85
	160	0.004	0.115	0.440	0.918	0.392	0.122	0.019	0.006	0.000	0.000	0.004	2.019	10.35
	170	0.005	0.081	0.451	1.018	0.542	0.162	0.049	0.007	0.000	0.000	0.004	2.320	11.23
	180	0.008	0.083	0.482	1.386	1.036	0.360	0.112	0.021	0.005	0.000	0.008	3.500	12.65
	190	0.005	0.087	0.484	1.651	1.332	0.387	0.084	0.011	0.002	0.000	0.011	4.056	12.51
	200	0.004	0.090	0.476	1.532	1.492	0.538	0.110	0.010	0.001	0.000	0.008	4.260	13.17
	210	0.008	0.110	0.532	1.703	2.001	0.905	0.163	0.023	0.003	0.000	0.001	5.457	13.88
	220	0.006	0.084	0.408	1.235	1.516	0.630	0.125	0.015	0.004	0.000	0.007	4.031	13.81
	230	0.006	0.081	0.402	1.241	1.313	0.411	0.104	0.019	0.003	0.000	0.024	3.604	13.22
	240	0.005	0.102	0.487	1.438	1.307	0.456	0.150	0.049	0.006	0.000	0.027	4.025	13.28
	250	0.008	0.075	0.376	1.095	0.943	0.332	0.141	0.049	0.011	0.000	0.017	3.047	13.42
	260	0.005	0.078	0.359	1.045	1.028	0.372	0.186	0.067	0.011	0.001	0.018	3.170	14.02
	270	0.002	0.090	0.399	1.168	1.329	0.550	0.251	0.058	0.008	0.001	0.033	3.889	14.40
	280	0.005	0.068	0.328	0.839	0.979	0.351	0.119	0.020	0.000	0.000	0.012	2.720	13.57
	290	0.004	0.068	0.322	0.884	1.048	0.350	0.096	0.014	0.003	0.000	0.011	2.800	13.43
	300	0.004	0.081	0.396	1.064	1.228	0.411	0.119	0.017	0.002	0.000	0.007	3.329	13.36
	310	0.005	0.076	0.302	0.861	0.942	0.257	0.059	0.004	0.002	0.000	0.011	2.519	12.78
	320	0.005	0.088	0.314	0.847	0.801	0.231	0.059	0.005	0.001	0.000	0.007	2.359	12.46
	330	0.004	0.106	0.404	0.991	0.982	0.325	0.075	0.014	0.001	0.000	0.019	2.920	12.75
	340	0.003	0.075	0.301	0.735	0.695	0.175	0.023	0.004	0.001	0.000	0.014	2.026	12.06
	350	0.003	0.084	0.315	0.876	0.771	0.217	0.042	0.001	0.000	0.000	0.007	2.316	12.21
	360	0.005	0.069	0.299	0.876	0.738	0.195	0.029	0.004	0.000	0.000	0.008	2.224	12.11
	MISSING	0.009	0.208	0.194	0.328	0.185	0.043	0.001	0.000	0.000	0.000	0.328	1.295	9.12
	TOTAL	0.769	3.285	14.19	38.32	30.14	9.639	2.483	0.444	0.062	0.002	0.656	100.000	
	CUMLATIVE TOTAL	0.769	4.054	5	8	4	4	6	1	2	4	15 YEAR MEAN=		12.27

LSCS- UFSAR

TABLE 2.3-6

ARGONNE NATIONAL LABORATORY: FREQUENCY DISTRIBUTION OF THE

NUMBER OF CONSECUTIVE HOURS OF 19- AND 150-FOOT WIND

DIRECTION PERSISTENCE FROM INDICATED DIRECTIONS.

JANUARY 1950 – DECEMBER 1964

DIRECTION (36 POINTS)

		CALM	1	2	3	4	5	6	7	8	9	10	11	12	13	14	15	16	17	18	19	20	21	22	23	24	25	26	27	28	29	30	31	32	33	34	35	36	MISSING
19-FT Level	HOURS OF PERSISTENCE	924	1961	1868	1772	1829	1913	1955	1868	1789	1900	1929	1965	1989	1970	1929	1989	2160	2319	2308	2413	2402	2359	2519	2666	2810	2577	2626	2448	2440	2441	2331	2240	2180	2069	1941	2078	2140	438
	1	310	814	720	676	756	781	762	731	713	762	822	790	782	767	802	872	904	916	958	901	920	1075	1094	1166	1182	1097	1058	1028	1019	973	906	913	889	864	851	828	833	93
	2	130	419	388	397	425	467	409	389	401	408	431	438	438	430	435	461	496	506	499	522	483	543	565	651	688	630	628	613	599	538	494	487	481	501	489	411	409	43
	3	51	261	248	238	252	303	248	251	279	260	240	251	258	246	278	308	314	309	313	316	338	405	440	463	460	435	388	391	346	353	317	343	333	324	281	244	276	20
	4	24	216	192	178	190	213	200	182	178	202	187	178	160	203	163	101	200	227	227	252	290	281	311	337	337	310	296	250	251	256	219	255	215	188	194	185	166	7
	5	26	162	139	133	154	157	138	134	146	152	148	119	107	117	146	146	161	181	184	201	191	229	244	250	241	238	206	204	186	182	175	158	167	169	130	133	141	5
	6	13	111	100	116	135	118	109	105	100	95	86	92	71	86	90	94	108	115	131	149	155	144	169	196	202	173	159	158	158	132	130	125	131	110	103	92	94	0
	7	9	100	99	85	98	89	96	95	94	81	69	56	44	59	75	69	92	85	123	128	125	143	147	165	123	114	139	123	114	124	106	118	117	101	87	85	92	0
	8	4	89	75	87	79	87	68	65	68	58	52	29	37	47	59	59	53	72	72	95	92	128	138	119	122	114	107	73	89	75	76	76	66	75	70	67	69	2
	9	1	70	73	73	58	65	64	44	47	36	29	29	31	43	32	46	47	66	68	86	81	100	112	88	98	103	81	75	96	70	69	83	67	62	65	70	51	0
	10	1	49	58	59	49	54	48	45	38	20	34	23	24	26	41	36	43	60	42	78	85	83	91	91	67	61	64	63	65	67	62	52	47	48	39	51	45	1
	11	2	43	56	45	48	38	33	39	39	25	15	16	15	24	21	25	24	36	50	68	75	71	68	54	66	62	47	66	63	46	42	40	46	31	38	49	0	
	12	0	33	46	48	34	34	28	27	26	17	14	14	10	17	14	21	24	20	35	44	73	52	66	43	37	44	45	51	48	38	46	35	36	34	25	25	25	2
	13	0	20	29	26	36	38	34	21	22	7	8	16	8	14	17	13	24	23	39	51	46	63	38	46	42	32	40	34	36	39	34	40	32	24	19	20	21	2
	14	0	17	25	29	25	24	20	25	15	10	7	7	8	6	8	9	18	19	17	35	40	51	53	38	32	41	31	28	37	32	31	29	29	25	24	31	18	1
	15	0	22	20	21	21	22	12	12	10	3	13	12	9	6	8	5	15	21	25	39	46	46	35	22	25	31	26	29	27	29	22	25	23	16	27	20	18	0
	16	0	16	22	30	21	24	13	12	9	8	4	3	10	8	7	5	10	14	17	29	33	28	37	39	24	26	21	16	23	23	18	22	17	18	18	16	13	0
	17	0	22	29	16	14	19	12	10	3	3	6	9	3	2	5	4	7	12	24	24	32	29	33	27	20	21	24	24	20	30	19	15	14	10	18	18	9	0
	18	0	16	16	18	21	12	12	5	11	5	4	4	2	4	1	6	4	8	10	16	34	23	30	20	23	20	15	17	17	19	12	8	6	9	7	16	11	0
	19	0	11	14	13	9	7	10	11	7	3	3	3	1	1	3	5	3	8	10	21	26	21	21	27	6	13	13	11	17	19	8	13	11	6	12	10	13	1
20	0	36	40	45	40	29	18	28	18	15	10	9	12	17	11	6	12	29	41	62	72	79	71	62	41	41	54	57	56	53	35	28	34	20	23	34	20	1	
21-25	0	16	20	13	20	13	13	11	11	7	4	3	1	2	6	3	3	8	14	36	27	42	30	32	23	23	28	23	28	26	18	20	17	28	24	9	1		
16-30	0	7	6	11	15	11	4	5	5	2	2	1	1	2	1	1	4	4	20	39	27	16	17	11	18	12	13	7	9	10	7	6	8	5	5	5	1		
31-35	0	6	5	4	5	4	1	5	6	1	0	0	1	0	0	0	1	4	7	13	10	20	7	2	9	13	5	11	4	2	6	5	1	5	3	4	0	0	
36-40	0	2	3	4	5	6	4	3	2	1	0	0	0	1	1	0	0	0	4	9	13	11	10	5	3	4	5	8	3	4	4	5	3	1	2	3	3		
41-48	0	3	1	3	6	4	2	5	1	1	0	0	0	0	0	0	0	0	2	9	11	9	8	7	4	4	3	6	7	2	3	4	1	1	2	1	3		
>48	0	3	1	3	6	4	2	5	1	1	0	0	0	0	0	0	0	0	2	9	11	9	8	7	4	4	3	6	7	2	3	4	3	1	1	2	1	3	
MAXIMUM PERSISTENCE	12	89	50	63	64	62	55	61	64	59	35	31	36	45	45	33	31	40	52	65	77	75	92	95	67	60	69	77	68	58	53	75	92	91	56	79	53	370	

		CALM	1	2	3	4	5	6	7	8	9	10	11	12	13	14	15	16	17	18	19	20	21	22	23	24	25	26	27	28	29	30	31	32	33	34	35	36	MISSING
150-FT LEVEL	HOURS OF PERSISTENCE	413	1650	1577	1496	1512	1596	1600	1528	1441	1414	1522	1523	1545	1466	1485	1577	1668	1857	1851	1859	1858	1955	1981	2116	2254	2159	2150	2114	2125	2094	2039	1953	1833	1780	1713	1708	1756	338
	1	81	722	654	609	638	699	679	639	590	647	641	641	676	702	680	734	764	808	820	810	828	909	959	954	1044	1038	1034	949	925	969	854	819	789	742	753	717	751	48
	2	37	376	370	348	362	419	427	401	374	368	376	411	433	408	386	437	458	484	458	480	467	483	550	634	660	616	501	590	558	510	490	466	447	399	391	391	20	20
	3	10	252	267	250	236	261	248	243	259	286	281	267	262	282	277	293	296	340	338	337	360	419	390	418	428	399	401	358	324	324	338	302	302	268	266	248	12	
	4	1	183	191	174	156	170	196	191	166	189	202	199	168	179	192	199	214	208	235	253	274	266	312	324	315	326	258	246	239	231	233	238	214	211	210	175	152	8
	5	4	151	132	127	135	144	142	136	149	132	135	135	134	145	164	152	165	187	204	195	183	222	251	229	263	228	218	224	208	191	185	149	184	166	142	114	97	12
	6	0	113	104	97	112	102	103	108	119	111	109	97	94	87	93	103	150	137	150	152	161	150	190	173	174	175	194	143	139	134	120	124	116	123	98	88	91	2
	7	0	91	98	90	66	87	99	104	103	85	85	76	70	68	70	79	109	119	114	139	119	151	152	170	132	131	141	122	127	107	103	99	102	100	85	76	82	1
	8	1	67	81	74	68	73	80	79	68	73	52	68	43	62	67	67	75	76	97	105	103	133	116	104	136	119	114	91	90	95	81	70	83	81	71	82	71	3
	9	0	55	62	73	67	54	55	56	65	55	62	42	20	55	44	71	68	73	78	91	96	90	103	112	80	112	74	72	76	75	58	72	55	64	65	56	54	1
	10	0	42	51	59	44	45	42	56	48	35	52	38	21	32	53	37	50	69	61	81	71	87	115	95	69	79	77	57	61	59	69	67	67					

LSCS- UFSAR

TABLE 2.3-7
(Sheet 1 of 2)

THREE-WAY JOINT FREQUENCY DISTRIBUTION OF WIND SPEED, WIND DIRECTION
AND PASQUILL STABILITY CLASS FOR 300-FT LEVEL AT DRESDEN STATION FOR
5-YEAR PERIOD (DECEMBER 1, 1973 – NOVEMBER 30, 1978)

		DIRECTION CLASS																	STABILITY CLASS								
	Speed Class	N	NNE	NE	ENE	E	ESE	SE	SSE	S	SSW	SW	WSW	W	WNW	NW	NNW	TOTAL	EU	MU	SU	N	SS	MS	ES	TOTAL	
9	EU	0.01	0.00	0.00	0.00	0.00	0.00	0.00	0.00	0.00	0.00	0.02	0.00	0.00	0.00	0.00	0.00	0.03	0.03								
	MU	0.01	0.01	0.00	0.00	0.00	0.01	0.00	0.00	0.00	0.00	0.01	0.01	0.00	0.02	0.00	0.01	0.08		0.08							
	SU	0.01	0.01	0.01	0.01	0.001	0.00	0.01	0.01	0.01	0.00	0.01	0.01	0.01	0.00	0.00	0.00	0.09			0.09						
	N	0.03	0.02	0.03	0.05	0.05	0.03	0.06	0.06	0.04	0.05	0.08	0.07	0.03	0.04	0.05	0.04	0.73				0.73					
	SS	0.59	0.26	0.18	0.35	0.29	0.15	0.09	0.11	0.07	0.06	0.06	0.09	0.07	0.10	0.05	0.05	2.57					2.57				
	MS	0.06	0.05	0.03	0.03	0.02	0.00	0.02	0.02	0.02	0.04	0.01	0.04	0.01	0.03	0.02	0.02	0.01	0.41						0.41		
3	ES	1.38	0.55	0.04	0.12	0.19	0.17	0.16	0.16	0.20	0.09	0.10	0.09	0.08	0.03	0.08	0.08	3.52							3.52	7.43	
	EU	0.10	0.09	0.07	0.03	0.07	0.05	0.08	0.06	0.05	0.05	0.05	0.09	0.09	0.09	0.07	0.10	1.14	1.14								
	MU	0.05	0.05	0.04	0.06	0.07	0.05	0.10	0.07	0.05	0.04	0.05	0.06	0.07	0.05	0.04	0.05	0.90		0.90							
	SU	0.06	0.05	0.03	0.05	0.08	0.06	0.06	0.06	0.08	0.08	0.07	0.05	0.09	0.06	0.09	0.07	1.04			1.04						
	N	0.24	0.20	0.24	0.38	0.26	0.37	0.33	0.37	0.33	0.26	0.34	0.41	0.33	0.25	0.24	0.26	4.76				4.76					
	SS	0.19	0.15	0.18	0.29	0.15	0.20	0.29	0.25	0.21	0.22	0.27	0.23	0.29	0.22	0.16	0.17	3.47					3.47				
4	MS	0.09	0.12	0.10	0.10	0.06	0.08	0.10	0.13	0.09	0.09	0.11	0.17	0.12	0.15	0.12	0.08	1.71						1.71			
	ES	0.11	0.11	0.03	0.04	0.04	0.02	0.04	0.05	0.05	0.05	0.06	0.08	0.04	0.09	0.05	0.03	0.89						0.89	13.91		
	EU	0.18	0.25	0.14	0.12	0.08	0.03	0.06	0.08	0.10	0.06	0.07	0.07	0.17	0.15	0.21	0.17	1.94	1.94								
	MU	0.07	0.11	0.08	0.07	0.07	0.06	0.09	0.12	0.10	0.10	0.08	0.11	0.12	0.06	0.08	0.09	1.41		1.41							
	SU	0.07	0.09	0.11	0.13	0.11	0.10	0.14	0.11	0.11	0.10	0.07	0.13	0.12	0.12	0.06	0.12	1.69			1.69						
	N	0.61	0.59	0.75	0.73	0.70	0.41	0.50	0.53	0.68	0.54	0.58	0.64	0.61	0.52	0.63	0.63	9.60				9.60					
2	SS	0.56	0.41	0.51	0.38	0.50	0.46	0.65	0.52	0.49	0.67	0.63	0.53	0.66	0.46	0.45	0.35	8.23					8.23				
	MS	0.10	0.09	0.11	0.05	0.08	0.10	0.18	0.24	0.18	0.23	0.31	0.33	0.33	0.22	0.19	0.13	2.87						2.87			
	ES	0.12	0.16	0.06	0.05	0.05	0.03	0.06	0.06	0.08	0.09	0.15	0.18	0.17	0.08	0.10	0.07	1.51						1.51	27.25		
	EU	0.10	0.09	0.15	0.04	0.05	0.03	0.03	0.04	0.08	0.13	0.09	0.07	0.10	0.18	0.21	0.16	1.55	1.55								
	MU	0.08	0.10	0.05	0.06	0.03	0.03	0.06	0.04	0.11	0.13	0.09	0.09	0.12	0.11	0.09	0.12	1.31		1.31							
	SU	0.07	0.09	0.08	0.11	0.05	0.05	0.09	0.08	0.09	0.08	0.11	0.10	0.15	0.15	0.14	0.12	1.56			1.56						
1	N	0.56	0.57	0.68	0.51	0.52	0.30	0.41	0.56	0.81	0.84	0.74	0.57	0.98	1.11	0.84	0.71	10.71				10.71					
	SS	0.53	0.43	0.24	0.18	0.37	0.49	0.50	0.60	0.97	1.19	1.10	0.54	0.94	0.88	0.75	0.52	10.23					10.23				
	MS	0.17	0.15	0.06	0.01	0.05	0.10	0.23	0.17	0.30	0.45	0.59	0.45	0.30	0.18	0.21	0.16	3.58						3.58			
	ES	0.19	0.13	0.05	0.07	0.05	0.05	0.08	0.03	0.07	0.12	0.14	0.14	0.14	0.05	0.05	0.09	1.45						1.45	30.39		
	EU	0.01	0.05	0.03	0.03	0.03	0.04	0.00	0.00	0.05	0.05	0.06	0.03	0.06	0.12	0.04	0.02	0.62	0.62								
	MU	0.02	0.03	0.03	0.02	0.02	0.00	0.00	0.01	0.06	0.05	0.04	0.03	0.07	0.08	0.02	0.05	0.53		0.53							
9	SU	0.03	0.03	0.03	0.01	0.01	0.01	0.01	0.02	0.06	0.08	0.08	0.02	0.07	0.08	0.10	0.09	0.73			0.73						
	N	0.24	0.21	0.24	0.13	0.16	0.17	0.15	0.20	0.51	0.57	0.41	0.33	0.72	0.58	0.40	0.31	5.33				5.33					
	SS	0.13	0.21	0.03	0.05	0.10	0.11	0.16	0.31	0.62	0.65	0.41	0.26	0.45	0.39	0.22	0.12	4.22					4.22				
	MS	0.06	0.04	0.00	0.00	0.00	0.00	0.02	0.03	0.16	0.19	0.09	0.08	0.02	0.07	0.01	0.03	0.80						0.80			
	ES	0.12	0.12	0.02	0.03	0.06	0.05	0.04	0.03	0.05	0.10	0.07	0.02	0.02	0.01	0.03	0.03	0.80						0.80	13.03		
	EU	0.00	0.01	0.00	0.00	0.00	0.01	0.00	0.00	0.02	0.02	0.01	0.01	0.02	0.02	0.00	0.00	0.12	0.12								
5	MU	0.00	0.01	0.00	0.00	0.00	0.01	0.00	0.00	0.01	0.01	0.02	0.01	0.03	0.03	0.00	0.00	0.13		0.13							
	SU	0.01	0.00	0.01	0.00	0.00	0.00	0.00	0.00	0.02	0.03	0.03	0.03	0.04	0.07	0.00	0.01	0.25			0.25						
	N	0.07	0.04	0.07	0.02	0.03	0.08	0.08	0.09	0.25	0.29	0.22	0.19	0.29	0.16	0.05	0.10	2.03				2.03					
	SS	0.06	0.15	0.00	0.00	0.01	0.01	0.05	0.12	0.22	0.36	0.14	0.07	0.14	0.08	0.01	0.00	1.42					1.42				
	MS	0.00	0.01	0.00	0.00	0.00	0.00	0.00	0.00	0.00	0.00	0.00	0.00	0.00	0.00	0.00	0.00	0.01						0.01			
	ES	0.12	0.07	0.07	0.09	0.08	0.06	0.05	0.03	0.02	0.02	0.02	0.00	0.02	0.02	0.02	0.01	0.70						0.70	4.66		

TABLE 2.3-7

LSCS- UFSAR

TABLE 2.3-7
(Sheet 2 of 2)

THREE -WAY JOINT FREQUENCY DISTRIBUTION OF WIND SPEED, WIND DIRECTION

AND PASQUILL STABILITY CLASS FOR 300-FT LEVEL AT DRESDEN STATION FOR

5-YEAR PERIOD (DECEMBER 1, 1973 - NOVEMBER 30, 1978)

		DIRECTION CLASS																	STABILITY CLASS							
Speed Class		N	NNE	NE	ENE	E	ESE	SE	SSE	S	SSW	SW	WSW	W	WNW	NW	NNW	TOTAL	EU	MU	SU	N	SS	MS	ES	TOTAL
3	EU	0.00	0.00	0.00	0.00	0.00	0.00	0.00	0.00	0.01	0.00	0.01	0.00	0.00	0.00	0.00	0.00	0.02	0.02							
	MU	0.00	0.00	0.00	0.00	0.00	0.00	0.00	0.00	0.00	0.00	0.01	0.00	0.01	0.00	0.00	0.00	0.02		0.02						
	SU	0.00	0.00	0.00	0.00	0.00	0.00	0.00	0.00	0.00	0.00	0.01	0.00	0.00	0.01	0.04	0.00	0.00	0.06			0.06				
-	N	0.02	0.03	0.01	0.00	0.01	0.01	0.01	0.01	0.02	0.05	0.04	0.07	0.07	0.05	0.00	0.00	0.47				0.47				
3	SS	0.15	0.07	0.01	0.00	0.00	0.00	0.00	0.00	0.01	0.04	0.05	0.03	0.02	0.03	0.00	0.00	0.41					0.41			
8	MS	0.01	0.02	0.00	0.00	0.00	0.00	0.00	0.00	0.00	0.00	0.00	0.00	0.00	0.00	0.00	0.00	0.03						0.03		
	ES	0.03	0.02	0.02	0.03	0.03	0.01	0.00	0.02	0.02	0.00	0.01	0.02	0.00	0.02	0.02	0.00	0.25							0.25	1.26
3	EU	0.01	0.01	0.00	0.00	0.00	0.00	0.00	0.00	0.00	0.00	0.00	0.00	0.00	0.00	0.00	0.00	0.02	0.02							
	MU	0.00	0.01	0.00	0.00	0.00	0.00	0.00	0.00	0.00	0.00	0.00	0.00	0.00	0.00	0.00	0.00	0.01		0.01						
	SU	0.01	0.00	0.00	0.00	0.00	0.00	0.00	0.00	0.00	0.00	0.00	0.00	0.00	0.02	0.00	0.00	0.03			0.03					
-	N	0.05	0.06	0.00	0.00	0.00	0.00	0.00	0.00	0.00	0.00	0.02	0.01	0.02	0.00	0.00	0.00	0.16				0.16				
4	SS	0.13	0.04	0.00	0.00	0.00	0.00	0.00	0.00	0.00	0.01	0.00	0.00	0.01	0.00	0.00	0.00	0.19					0.19			
6	MS	0.00	0.00	0.00	0.00	0.00	0.00	0.00	0.00	0.00	0.00	0.00	0.00	0.00	0.00	0.00	0.00	0.00						0.00		
	FS	0.00	0.00	0.00	0.00	0.00	0.00	0.00	0.00	0.00	0.00	0.00	0.00	0.00	0.00	0.00	0.00	0.00							0.00	0.41
G T	EU	0.06	0.07	0.01	0.00	0.00	0.00	0.00	0.00	0.00	0.00	0.00	0.00	0.00	0.00	0.00	0.00	0.14	0.14							
	MU	0.02	0.00	0.00	0.00	0.00	0.00	0.00	0.00	0.00	0.00	0.00	0.00	0.00	0.00	0.00	0.00	0.02		0.02						
	SU	0.02	0.01	0.00	0.00	0.00	0.00	0.00	0.00	0.00	0.00	0.00	0.00	0.00	0.00	0.00	0.00	0.03			0.03					
-	N	0.19	0.09	0.00	0.00	0.00	0.00	0.00	0.00	0.00	0.00	0.00	0.00	0.00	0.00	0.00	0.00	0.28				0.28				
4	SS	0.22	0.18	0.01	0.00	0.00	0.00	0.00	0.00	0.00	0.00	0.00	0.00	0.00	0.00	0.00	0.00	0.41					0.41			
6	MS	0.01	0.01	0.00	0.00	0.00	0.00	0.00	0.00	0.00	0.00	0.00	0.00	0.00	0.00	0.00	0.00	0.02						0.02		
	ES	0.02	0.01	0.00	0.01	0.00	0.01	0.00	0.00	0.00	0.00	0.00	0.00	0.00	0.00	0.00	0.00	0.05							0.05	0.95
C A L M	EU	0.00	0.00	0.00	0.00	0.00	0.00	0.00	0.00	0.00	0.00	0.00	0.00	0.00	0.00	0.00	0.00	0.00	0.00							
	MU	0.00	0.00	0.00	0.00	0.00	0.00	0.00	0.00	0.00	0.00	0.00	0.00	0.00	0.00	0.00	0.00	0.00		0.00						
	SU	0.00	0.00	0.00	0.00	0.00	0.00	0.00	0.00	0.00	0.00	0.00	0.00	0.00	0.00	0.00	0.00	0.00			0.00					
-	N	0.00	0.00	0.00	0.00	0.00	0.00	0.00	0.00	0.00	0.00	0.00	0.00	0.00	0.00	0.00	0.00	0.00				0.00				
4	SS	0.00	0.00	0.00	0.00	0.00	0.00	0.00	0.00	0.00	0.00	0.00	0.00	0.00	0.00	0.00	0.00	0.00					0.00			
6	MS	0.00	0.00	0.00	0.00	0.00	0.00	0.00	0.00	0.00	0.00	0.00	0.00	0.00	0.00	0.00	0.00	0.00						0.00		
	ES	0.00	0.00	0.00	0.00	0.00	0.00	0.00	0.00	0.00	0.00	0.00	0.00	0.00	0.00	0.00	0.00	0.00							0.00	0.00
	Total	8.16	6.54	4.64	4.44	4.54	3.96	4.99	5.41	7.55	8.27	7.76	6.46	8.30	7.32	5.79	5.16	99.29	5.58	4.41	5.48	34.07	31.15	9.43	9.17	99.29
S U B - T O T	U	0.47	0.57	0.40	0.22	0.23	0.16	0.17	0.18	0.31	0.31	0.31	0.27	0.44	0.56	0.53	0.45	5.58								
	MU	0.25	0.32	0.20	0.21	0.19	0.16	0.25	0.24	0.33	0.33	0.30	0.31	0.42	0.35	0.23	0.32	4.41								
	SU	0.28	0.28	0.27	0.31	0.26	0.22	0.31	0.27	0.36	0.39	0.36	0.34	0.49	0.54	0.39	0.41	5.48								
-	N	2.01	1.81	2.02	1.82	1.73	1.32	1.54	1.83	2.67	2.59	2.46	2.23	3.09	2.80	2.10	2.05	34.07								
4	SS	2.56	1.90	1.16	1.25	1.42	1.42	1.74	1.92	2.62	3.21	2.64	1.74	2.59	2.13	1.64	1.21	31.15								
6	MS	0.50	0.49	0.30	0.19	0.21	0.28	0.55	0.59	0.77	0.97	1.14	1.04	0.80	0.64	0.55	0.41	9.43								
	ES	2.09	1.17	0.29	0.44	0.50	0.40	0.43	0.38	0.49	0.47	0.55	0.53	0.47	0.30	0.35	0.31	9.17								

LSCS-UFSAR

TABLE 2.3-8
(Sheet 1 of 2)

THREE-WAY JOINT FREQUENCY DISTRIBUTION OF WIND SPEED, WIND DIRECTION
AND PASQUILL STABILITY CLASS FOR 300-FT LEVEL AT DRESDEN STATION FOR
2-YEAR PERIOD (OCTOBER 1, 1976-SEPTEMBER 30, 1978)

Speed Class	DIRECTION CLASS																	STABILITY CLASS							
	N	NNE	NE	ENE	E	ESE	SE	SSE	S	SSW	SW	WSW	W	WNW	NW	NNW	TOTAL	EU	MU	SU	N	SS	MS	ES	TOTAL
9	EU	0.02	0.00	0.00	0.00	0.00	0.00	0.00	0.00	0.00	0.00	0.01	0.00	0.00	0.00	0.00	0.03	0.03							
	MU	0.00	0.01	0.00	0.00	0.00	0.00	0.00	0.00	0.00	0.00	0.00	0.01	0.02	0.00	0.02	0.06	0.06							
	SU	0.00	0.00	0.00	0.00	0.02	0.00	0.00	0.00	0.00	0.02	0.00	0.02	0.00	0.00	0.00	0.06		0.06						
-	N	0.03	0.04	0.04	0.05	0.05	0.03	0.07	0.07	0.03	0.02	0.12	0.14	0.04	0.07	0.05	0.03	0.88			0.88				
3	SS	0.05	0.01	0.05	0.05	0.05	0.07	0.00	0.06	0.05	0.05	0.06	0.11	0.05	0.09	0.02	0.02	0.79				0.79			
	MS	0.00	0.00	0.02	0.01	0.03	0.00	0.02	0.00	0.02	0.00	0.03	0.00	0.00	0.03	0.03	0.00	0.19					0.19		
	ES	0.06	0.01	0.00	0.00	0.00	0.00	0.01	0.01	0.00	0.01	0.00	0.00	0.00	0.00	0.01	0.00	0.11						0.11	2.12
	SU	0.11	0.11	0.08	0.04	0.07	0.06	0.07	0.07	0.05	0.05	0.05	0.09	0.11	0.12	0.08	0.12	1.28	1.28						
4	MU	0.06	0.06	0.05	0.04	0.07	0.07	0.06	0.09	0.03	0.03	0.08	0.07	0.09	0.07	0.01	0.07	0.95	0.95						
	SU	0.08	0.03	0.03	0.08	0.09	0.09	0.05	0.09	0.05	0.08	0.11	0.07	0.12	0.05	0.09	0.07	1.18		1.18					
-	N	0.21	0.16	0.27	0.37	0.24	0.43	0.42	0.39	0.34	0.34	0.48	0.67	0.43	0.22	0.25	0.19	5.41			5.41				
7	SS	0.20	0.16	0.20	0.37	0.18	0.25	0.26	0.21	0.24	0.34	0.41	0.36	0.35	0.18	0.17	0.16	4.04				4.04			
	MS	0.05	0.12	0.14	0.09	0.07	0.05	0.09	0.08	0.09	0.09	0.10	0.19	0.11	0.12	0.15	0.11	1.65					1.65		
	ES	0.03	0.03	0.00	0.00	0.00	0.00	0.03	0.02	0.03	0.03	0.03	0.05	0.03	0.06	0.04	0.03	0.41						0.41	14.92
	EU	0.23	0.16	0.16	0.16	0.09	0.02	0.10	0.14	0.14	0.08	0.08	0.05	0.22	0.22	0.27	0.29	2.41	2.41						
8	MU	0.09	0.14	0.07	0.07	0.12	0.06	0.13	0.22	0.14	0.12	0.08	0.09	0.19	0.09	0.13	0.12	1.86		1.86					
	SU	0.09	0.12	0.14	0.18	0.18	0.12	0.24	0.20	0.17	0.11	0.05	0.16	0.16	0.14	0.07	0.18	2.31			2.31				
-	N	0.60	0.53	0.80	0.84	0.68	0.51	0.61	0.69	0.72	0.72	0.89	0.79	0.85	0.74	0.60	0.68	11.25			11.25				
1	SS	0.32	0.35	0.57	0.36	0.55	0.49	0.68	0.63	0.53	0.83	0.75	0.74	0.89	0.48	0.51	0.30	8.98				8.98			
2	MS	0.11	0.09	0.12	0.07	0.05	0.07	0.23	0.24	0.19	0.26	0.50	0.40	0.41	0.21	0.30	0.22	3.47					3.47		
	ES	0.05	0.07	0.02	0.02	0.00	0.00	0.03	0.01	0.05	0.05	0.10	0.12	0.08	0.03	0.02	0.08	0.73						0.73	31.01
	EU	0.05	0.08	0.11	0.05	0.03	0.03	0.05	0.06	0.13	0.12	0.08	0.03	0.11	0.27	0.32	0.22	1.74	1.74						
1	MU	0.07	0.10	0.08	0.13	0.05	0.04	0.07	0.08	0.16	0.17	0.10	0.11	0.20	0.16	0.08	0.17	1.77		1.77					
3	SU	0.10	0.12	0.11	0.16	0.07	0.06	0.16	0.12	0.12	0.10	0.14	0.18	0.19	0.19	0.18	0.12	2.12			2.12				
-	N	0.61	0.56	0.71	0.44	0.49	0.31	0.52	0.82	1.05	0.94	0.94	0.70	1.33	1.35	1.16	0.91	12.84			12.84				
1	SS	0.35	0.36	0.16	0.10	0.25	0.49	0.65	0.93	1.29	1.27	1.16	0.51	1.20	1.27	1.04	0.64	11.67				11.67			
8	MS	0.20	0.09	0.06	0.01	0.02	0.08	0.35	0.18	0.24	0.48	0.71	0.36	0.35	0.24	0.28	0.21	3.86					3.86		
	ES	0.07	0.05	0.01	0.01	0.00	0.03	0.02	0.00	0.01	0.11	0.05	0.08	0.03	0.07	0.04	0.04	0.62						0.62	34.62
	EU	0.01	0.04	0.04	0.07	0.01	0.05	0.00	0.00	0.10	0.06	0.03	0.03	0.16	0.28	0.07	0.03	0.98	0.98						
1	MU	0.03	0.04	0.06	0.05	0.01	0.00	0.01	0.00	0.08	0.05	0.05	0.07	0.12	0.15	0.04	0.10	0.86		0.86					
9	SU	0.01	0.05	0.07	0.03	0.00	0.01	0.01	0.04	0.07	0.05	0.05	0.04	0.16	0.16	0.14	0.12	1.01			1.01				
-	N	0.14	0.21	0.26	0.12	0.07	0.22	0.22	0.25	0.48	0.56	0.38	0.37	0.81	0.68	0.39	0.27	5.43			5.43				
2	SS	0.09	0.11	0.01	0.00	0.01	0.04	0.09	0.35	0.51	0.58	0.30	0.30	0.53	0.31	0.20	0.11	3.54				3.54			
4	MS	0.05	0.05	0.01	0.00	0.00	0.00	0.01	0.00	0.09	0.14	0.07	0.06	0.03	0.12	0.02	0.02	0.67					0.67		
	ES	0.00	0.00	0.00	0.00	0.00	0.01	0.00	0.00	0.01	0.04	0.03	0.00	0.00	0.00	0.00	0.00	0.09						0.09	12.58
	EU	0.00	0.02	0.00	0.00	0.00	0.00	0.00	0.00	0.02	0.00	0.03	0.01	0.03	0.05	0.00	0.00	0.16	0.16						
2	MU	0.00	0.00	0.00	0.01	0.00	0.00	0.00	0.00	0.00	0.02	0.00	0.03	0.05	0.06	0.00	0.00	0.17		0.17					
5	SU	0.03	0.00	0.03	0.00	0.00	0.00	0.01	0.00	0.00	0.04	0.05	0.05	0.09	0.14	0.00	0.02	0.46			0.46				
-	N	0.04	0.00	0.04	0.00	0.01	0.09	0.15	0.04	0.22	0.24	0.19	0.15	0.34	0.19	0.05	0.07	1.82			1.82				
3	SS	0.02	0.03	0.00	0.00	0.00	0.01	0.07	0.10	0.05	0.33	0.11	0.09	0.16	0.00	0.00	0.00	0.97				0.97			
1	MS	0.00	0.00	0.00	0.00	0.00	0.00	0.00	0.00	0.00	0.00	0.00	0.01	0.00	0.00	0.00	0.00	0.01					0.01		
	ES	0.00	0.00	0.01	0.00	0.00	0.00	0.00	0.00	0.00	0.00	0.00	0.00	0.00	0.00	0.00	0.00	0.01						0.01	3.60

TABLE 2.3-8

LSCS-UFSAR

TABLE 2.3-8
(Sheet 2 of 2)

THREE-WAY JOINT FREQUENCY DISTRIBUTION OF WIND SPEED, WIND DIRECTION
AND PASQUILL STABILITY CLASS FOR 300-FT LEVEL AT DRESDEN STATION FOR
2-YEAR PERIOD (OCTOBER 1, 1976-SEPTEMBER 30, 1978)

	Speed Class	N	NNE	NE	ENE	E	ESE	SE	SSE	S	SSW	SW	WSW	W	WNW	NW	NNW	TOTAL	EU	MU	SU	N	SS	MS	ES	TOTAL	CLASS	DIRECTION
3	EU	0.00	0.00	0.00	0.00	0.00	0.00	0.00	0.00	0.01	0.00	0.00	0.00	0.01	0.00	0.00	0.00	0.02	0.02									
2	MU	0.00	0.00	0.00	0.00	0.00	0.00	0.00	0.00	0.00	0.00	0.00	0.00	0.02	0.00	0.00	0.00	0.02	0.02	0.02								
-	SU	0.00	0.00	0.00	0.00	0.00	0.00	0.00	0.00	0.00	0.00	0.00	0.00	0.03	0.09	0.00	0.00	0.12			0.12							
3	N	0.00	0.00	0.00	0.00	0.00	0.03	0.02	0.00	0.04	0.02	0.03	0.03	0.03	0.07	0.00	0.00	0.27				0.27						
8	SS	0.00	0.00	0.00	0.00	0.00	0.00	0.00	0.01	0.03	0.05	0.00	0.01	0.01	0.00	0.00	0.00	0.11					0.11					
	MS	0.00	0.00	0.00	0.00	0.00	0.00	0.00	0.00	0.00	0.00	0.00	0.00	0.00	0.00	0.00	0.00	0.00					0.00					
	ES	0.00	0.00	0.00	0.01	0.00	0.00	0.00	0.00	0.00	0.00	0.00	0.00	0.00	0.00	0.00	0.00	0.01							0.01			
																										0.55		
3	SU	0.00	0.00	0.00	0.00	0.00	0.00	0.00	0.00	0.00	0.00	0.00	0.00	0.00	0.00	0.00	0.00	0.00	0.00	0.00								
9	MU	0.00	0.00	0.00	0.00	0.00	0.00	0.00	0.00	0.00	0.00	0.00	0.00	0.00	0.00	0.00	0.00	0.00	0.00	0.00	0.00							
-	SU	0.00	0.00	0.00	0.00	0.00	0.00	0.00	0.00	0.00	0.00	0.00	0.00	0.00	0.06	0.00	0.00	0.06			0.06							
4	N	0.00	0.00	0.00	0.00	0.00	0.00	0.00	0.00	0.00	0.00	0.00	0.00	0.00	0.00	0.00	0.00	0.00				0.00						
6	SS	0.00	0.00	0.00	0.00	0.00	0.00	0.00	0.00	0.00	0.02	0.00	0.00	0.00	0.00	0.00	0.00	0.02					0.02					
	MS	0.00	0.00	0.00	0.00	0.00	0.00	0.00	0.00	0.00	0.00	0.00	0.00	0.00	0.00	0.00	0.00	0.00					0.00					
	FS	0.00	0.00	0.00	0.00	0.00	0.00	0.00	0.00	0.00	0.00	0.00	0.00	0.00	0.00	0.00	0.00	0.00							0.00		0.00	
G	EU	0.00	0.00	0.00	0.00	0.00	0.00	0.00	0.00	0.00	0.00	0.00	0.00	0.00	0.00	0.00	0.00	0.00	0.00	0.00								
T	MU	0.00	0.00	0.00	0.00	0.00	0.00	0.00	0.00	0.00	0.00	0.00	0.00	0.00	0.00	0.00	0.00	0.00	0.00	0.00	0.00							
-	SU	0.00	0.00	0.00	0.00	0.00	0.00	0.00	0.00	0.00	0.00	0.00	0.00	0.00	0.00	0.00	0.00	0.00	0.00	0.00								
4	N	0.00	0.00	0.00	0.00	0.00	0.00	0.00	0.00	0.00	0.00	0.00	0.00	0.00	0.00	0.00	0.00	0.00				0.00						
5	SS	0.00	0.00	0.00	0.00	0.00	0.00	0.00	0.00	0.00	0.00	0.00	0.00	0.00	0.00	0.00	0.00	0.00					0.00					
	MS	0.00	0.00	0.00	0.00	0.00	0.00	0.00	0.00	0.00	0.00	0.00	0.00	0.00	0.00	0.00	0.00	0.00					0.00					
	ES	0.00	0.00	0.00	0.00	0.00	0.00	0.00	0.00	0.00	0.00	0.00	0.00	0.00	0.00	0.00	0.00	0.00							0.00		0.00	
C	EU	0.00	0.00	0.00	0.00	0.00	0.00	0.00	0.00	0.00	0.00	0.00	0.00	0.00	0.00	0.00	0.00	0.00	0.00	0.00								
A	MU	0.00	0.00	0.00	0.00	0.00	0.00	0.00	0.00	0.00	0.00	0.00	0.00	0.00	0.00	0.00	0.00	0.00	0.00	0.00	0.00							
L	SU	0.00	0.00	0.00	0.00	0.00	0.00	0.00	0.00	0.00	0.00	0.00	0.00	0.00	0.00	0.00	0.00	0.00	0.00	0.00								
M	N	0.00	0.00	0.00	0.00	0.00	0.00	0.00	0.00	0.00	0.00	0.00	0.00	0.00	0.00	0.00	0.00	0.00	0.00	0.00								
	SS	0.00	0.00	0.00	0.00	0.00	0.00	0.00	0.00	0.00	0.00	0.00	0.00	0.00	0.00	0.00	0.00	0.00				0.00						
	MS	0.00	0.00	0.00	0.00	0.00	0.00	0.00	0.00	0.00	0.00	0.00	0.00	0.00	0.00	0.00	0.00	0.00					0.00					
	ES	0.00	0.00	0.00	0.00	0.00	0.00	0.00	0.00	0.00	0.00	0.00	0.00	0.00	0.00	0.00	0.00	0.00							0.00		0.00	
	Total	4.26	4.11	4.53	3.99	3.56	3.82	5.51	6.20	7.58	8.62	8.42	7.33	10.15	8.85	6.81	5.74	99.48	6.62	5.69	7.32	37.90	30.12	9.85	1.98	99.48		
S	EU	0.42	0.41	0.39	0.32	0.20	0.16	0.22	0.27	0.45	0.31	0.27	0.22	0.64	0.94	0.74	0.66	6.62										
U	MU	0.25	0.35	0.26	0.30	0.25	0.17	0.27	0.39	0.41	0.39	0.31	0.37	0.68	0.55	0.26	0.48	5.69										
B	SU	0.31	0.32	0.38	0.45	0.36	0.28	0.47	0.45	0.41	0.40	0.40	0.50	0.77	0.83	0.48	0.51	7.32										
-	N	1.63	1.50	2.12	1.82	1.54	1.62	2.01	2.26	2.88	2.84	3.03	2.85	3.83	3.32	2.50	2.15	37.90										
T	SS	1.03	1.02	0.99	0.88	1.04	1.35	1.75	2.29	2.70	3.47	2.79	2.12	3.19	2.33	1.94	1.23	30.12										
O	MS	0.41	0.35	0.35	0.18	0.17	0.20	0.70	0.50	0.63	0.97	1.41	1.02	0.90	0.72	0.78	0.56	9.85										
T	ES	0.21	0.16	0.04	0.04	0.00	0.04	0.09	0.04	0.10	0.24	0.21	0.25	0.14	0.16	0.11	0.15	1.98										

Stability is based on 35-300 foot Delta-T.

LSCS-UFSAR

TABLE 2.3-9

COMPARISON OF LA SALLE COUTNY STATION 33-FOOT LEVEL TEMPERATURES (°F)
(OCTOBER 1976 - SEPTEMBER 1978) WITH AVERAGE AND EXTREME TEMPERATURE DATA FROM PEORIA
(OCTOBER 1976 - SEPTEMBER 1978) AND ARGONNE (1950-1964)

MONTH*	AVERAGE			MAXIMUM			MINIMUM		
	LA SALLE	PEORIA	ARGONNE**	LA SALLE	PEORIA	ARGONNE	LA SALLE	PEORIA	ARGONNE
January	10.9	11.0	21.0	35.5	39.0	65.0 (1950)	-20.5	-25.0	-20.0(1963)
February	20.7	21.2	26.0	59.2	65.0	67.0 (1954)	-9.9	-13.0	-16.0(1951)
March	37.7	38.5	33.0	75.6	74.0	79.0 (1963)	- 2.8	-6.0	-9.0(1960)
April	52.8	54.2	47.0	84.9	86.0	84.0 (1962)	27.6	27.0	14.0 (1947)
May	64.3	64.5	58.0	92.4	91.0	91.0 (1952) (1964)	31.4	32.0	27.0 (1963)
June	69.3	70.8	68.0	93.1	98.0	96.0 (1953)	44.5	44.0	34.0 (1963)
July	73.8	76.6	71.0	95.0	100.0	101.0 (1956)	52.5	50.0	45.0 (1963)
August	70.5	72.3	70.0	88.1	92.0	96.0 (1956)	52.7	50.0	41.0 (1963)
September	67.1	68.5	63.0	93.3	95.0	96.0 (1953)	43.2	41.0	32.0 (1956)
October	50.3	49.3	53.0	87.4	87.0	89.0 (1963)	25.8	20.0	16.0 (1952) (1962)
November	35.7	36.2	37.0	69.7	71.0	77.0 (1950)	-2.4	-2.0	-2.0 (1950) (1958)
December	20.7	21.9	25.0	51.1	54.0	62.0 (1951)	-14.3	-11.0	-18.0 (1958) (1960)
Entire Record***	47.5	48.8	47.7	95.0	100.0	101.0(1956)	-20.5	-25.0	-20.0(1963)

* Each month consists of data from a combination of 2 months during the period October 1, 1976 through September 30, 1978

** Average data for Argonne are based upon the period 1950-1964 as indicated in table title.

*** Entire record consists of the period October 1, 1976 through September 30, 1978

LSCS-UFSAR

TABLE 2.3-10

MEAN RELATIVE HUMIDITY (%) AT DESIGNATED HOUR*PEORIA (1960-1974)

<u>MONTH</u>	<u>HOUR (00)</u>	<u>HOUR (06)</u>	<u>HOUR (12)</u>	<u>HOUR (18)</u>
January	77	78	68	72
February	77	79	68	72
March	77	81	64	66
April	72	78	56	56
May	76	81	57	57
June	76	81	56	57
July	81	86	59	60
August	82	87	59	63
September	82	88	60	65
October	77	85	58	62
November	79	83	66	70
December	81	83	73	77
Year	78	83	62	64

* Local time

LSCS-UFSAR

TABLE 2.3-11

ARGONNE NATIONAL LABORATORY:

AVERAGE HOURLY 5-FOOT RELATIVE HUMIDITY (%).

JANUARY 1950 - DECEMBER 1964

-----MONTH-----

HOUR	JAN	FEB	MAR	APR	MAY	JUN	JUL	AUG	SEP	OCT	NOV	DEC
1	86	85	84	80	80	85	89	91	86	81	82	86
2	86	86	84	81	81	86	90	92	87	82	83	86
3	86	86	85	82	83	87	91	93	88	84	84	87
4	86	87	86	83	84	88	91	93	89	85	85	87
5	87	87	86	84	85	89	92	94	90	86	85	88
6	87	88	87	83	82	85	88	92	90	87	86	88
7	88	88	85	78	75	77	81	86	85	85	86	88
8	87	85	80	72	69	72	73	78	76	78	84	88
9	84	81	73	67	64	67	67	71	68	68	77	84
10	80	76	69	63	61	63	63	66	62	62	71	80
11	76	72	66	60	58	59	60	62	57	58	66	76
12	74	71	64	57	56	57	58	59	54	55	63	73
13	72	69	63	56	55	56	56	57	52	53	62	72
14	72	69	62	55	54	55	56	57	51	52	61	71
15	72	69	63	55	54	56	55	57	52	53	61	72
16	74	70	64	56	55	56	57	58	53	54	64	75
17	78	73	66	57	56	58	59	61	57	60	68	78
18	81	77	70	61	59	61	62	68	65	66	72	81
19	83	80	74	66	64	67	69	76	73	71	75	82
20	84	82	78	70	69	72	76	82	78	74	76	83
21	84	83	80	73	72	76	81	86	81	76	77	84
22	85	84	81	75	75	80	84	88	82	77	79	85
23	85	84	82	77	78	82	86	89	83	79	80	85
24	86	85	83	78	79	83	87	90	85	80	81	86

LSCS-UFSAR

TABLE 2.3-12

MONTHLY MAXIMUM, MINIMUM, AND AVERAGE RELATIVE HUMIDITIES (%)
FOR THE LA SALLE COUNTY STATION*

<u>MONTH **</u>	<u>MAXIMUM</u>	<u>MINIMUM</u>	<u>AVERAGE</u>
January	100.0	54.6	86.3
February	100.0	40.8	82.0
March	100.0	18.0	73.4
April	100.0	17.5	62.6
May	100.0	16.9	63.0
June	100.0	20.9	65.0
July	100.0	33.4	79.5
August	100.0	33.7	78.0
September	100.0	21.7	75.5
October	100.0	18.6	70.3
November	100.0	22.7	66.8
December	100.0	31.2	78.5

* Measurements taken at the 33-foot level.

** Data for each month consists of a combination of data for 2 months during the period October 1, 1976 through September 30, 1978.

LSCS-UFSAR

TABLE 2.3-13

MONTHLY MAXIMUM, MINIMUM, AND AVERAGE WET BULB AND DEW-POINT TEMPERATURES (°F)

FOR THE LA SALLE COUNTY STATION*

MONTH**	MAXIMUM		MINIMUM		AVERAGE	
	WET BULB	DEW-POINT	WET BULB	DEW-POINT	WET BULB	DEW-POINT
January	34.2	34.0	-20.5	-20.8	10.1	7.5
February	53.4	51.2	-9.9	-10.0	19.2	15.8
March	62.5	58.2	-2.8	-2.8	34.3	29.2
April	66.7	62.6	27.6	25.3	45.9	38.3
May	73.9	69.8	31.4	28.2	56.0	49.6
June	87.1	86.8	44.5	41.4	61.1	55.4
July	92.9	92.9	52.5	50.9	68.9	66.4
August	79.2	77.6	52.7	51.4	65.4	62.7
September	76.7	75.2	43.2	42.2	32.0	57.9
October	65.5	62.4	25.8	24.0	45.3	39.8
November	63.8	60.6	-2.4	-2.5	31.9	25.1
December	46.4	46.2	-14.3	-14.5	18.9	14.7

* Measurements taken at the 33-foot level.

** Monthly data are combinations of data for 2 months during period October 1, 1976 through September 30, 1978.

LUCS-UFSAR

TABLE 2.3-14

ARGONNE NATIONAL LABORATORY:

AVERAGE HOURLY 5-FOOT* WET BULB TEMPERATURE (°F)

JANUARY 1950 – DECEMBER 1964

----- HOUR -----	-----MONTH-----											
	JAN	FEB	MAR	APR	MAY	JUN	JUL	AUG	SEP	OCT	NOV	DEC
1	20	23	29	40	49	58	63	62	55	45	33	23
2	20	23	28	39	49	58	63	62	55	45	33	23
3	20	22	28	39	48	58	62	62	54	45	33	23
4	19	22	27	39	48	57	62	61	54	44	32	22
5	19	22	27	38	48	58	62	61	54	44	32	22
6	18	22	27	39	50	59	64	62	54	44	32	22
7	18	22	28	40	51	61	65	64	56	45	32	21
8	19	23	29	42	53	62	66	65	57	47	33	22
9	20	25	31	43	54	63	67	66	59	49	35	24
10	22	26	32	45	55	64	67	67	60	50	36	25
11	23	27	33	46	56	64	67	67	60	51	37	26
12	24	28	34	46	56	65	68	67	61	52	38	27
13	25	28	35	47	56	65	68	68	61	52	39	27
14	25	28	35	47	57	65	68	68	61	52	39	28
15	25	28	35	47	57	65	68	67	61	52	38	27
16	24	28	34	46	56	65	68	67	60	51	37	26
17	23	27	33	46	55	64	67	67	59	50	36	26
18	23	26	32	44	54	63	67	66	58	48	35	25
19	22	25	31	43	53	62	65	65	57	48	35	25
20	22	25	31	42	51	60	65	64	57	47	35	25
21	22	25	30	42	51	60	64	64	57	47	34	24
22	21	25	30	41	50	59	64	64	56	46	34	24
23	21	24	30	41	50	59	64	63	56	46	33	23
24	21	23	29	40	49	59	63	63	55	46	33	23

* Calculated from 5-foot relative humidity and 5.5-foot temperature

LUCS-UFSAR

TABLE 2.3-15

ARGONNE NATIONAL LABORATORY:

AVERAGE HOURLY 5-FOOT* DEWPOINT TEMPERATURE (°F)

JANUARY 1950 – DECEMBER 1974

----- HOURLY -----	-----MONTH-----											
	JAN	FEB	MAR	APR	MAY	JUN	JUL	AUG	SEP	OCT	NOV	DEC
1	16	19	25	35	45	55	61	60	52	41	29	19
2	15	19	25	35	45	55	60	60	52	41	29	19
3	15	18	24	35	45	55	60	60	52	41	29	19
4	15	18	24	35	44	55	60	60	52	41	29	18
5	15	18	24	35	45	55	60	59	51	41	29	18
6	15	18	24	35	46	57	61	60	52	41	28	18
7	15	18	24	36	46	57	61	61	53	42	29	18
8	15	19	25	36	47	57	62	62	53	43	30	18
9	16	20	25	36	47	57	61	61	53	43	30	19
10	17	20	25	37	48	57	61	61	53	43	30	20
11	17	21	26	37	48	57	61	61	53	43	30	20
12	18	21	26	37	48	57	61	61	52	43	30	21
13	18	21	26	37	48	57	61	60	52	42	30	21
14	18	21	26	37	47	57	61	60	52	42	30	21
15	18	21	26	37	47	57	60	60	52	42	30	21
16	18	21	26	37	47	57	61	60	52	41	29	21
17	17	21	26	36	46	57	60	60	52	41	29	20
18	17	21	26	36	46	56	60	61	52	41	29	20
19	17	21	26	36	45	56	60	61	53	42	29	20
20	17	20	26	36	45	55	61	61	53	42	29	20
21	17	20	26	36	45	56	61	61	53	42	29	20
22	17	20	26	36	45	56	61	61	53	42	29	19
23	16	20	26	36	45	56	61	61	52	42	29	19
24	16	19	25	36	45	56	61	61	52	41	29	19

* Calculated from 5-foot relative humidity and 5.5-foot temperature

LUCS-UFSAR

TABLE 2.3-16

ARGONNE NATIONAL LABORATORY: MAXIMUM AMOUNTS

OF PRECIPITATION (in.) WITH DAY OF OCCURRENCE.

JANUARY 1950 – DECEMBER 1964

YEAR	MONTH												ANNUAL
	JAN	FEB	MAR	APR	MAY	JUN	JUL	AUG	SEP	OCT	NOV	DEC	
1950 DAY	1.41 13	0.46 14	0.34 26	1.45 24	0.08 9	2.32 2	1.92 16	0.83 27	1.04 21	1.01 7	0.38 8	0.50 6	2.32
1951 DAY	1.17 2	0.78 18	0.63 29	1.07 11	2.95 10	1.21 21	3.39 8	1.49 20	2.39 26	0.93 6	0.99 6	0.37 6	3.39
1952 DAY	0.82 19	0.06 4	1.28 18	1.37 12	0.46 22	2.28 13	1.04 7	1.53 9	0.96 1	0.58 14	0.89 25	0.59 20	2.28
1953 DAY	0.31 23	0.69 20	1.20 12	1.10 30	1.04 22	4.23 10	1.68 17	2.04 2	0.68 4	0.58 4	0.52 22	0.78 2	4.23
1954 DAY	0.59 26	0.84 15	1.34 25	1.01 6	0.96 31	0.65 3	2.12 6	1.61 18	0.31 17	4.45 10	0.38 23	0.48 27	4.45
1955 DAY	0.81 5	0.40 26	0.44 3	0.75 20	1.58 24	1.42 9	0.70 23	2.79 5	0.49 27	1.49 5	0.47 15	0.30 2	2.79
1956 DAY	0.11 2	0.52 16	0.17 28	0.88 29	0.97 5	0.43 15	0.82 8	1.26 12	0.26 5	0.23 26	0.35 6	0.23 23	1.26
1957 DAY	0.71 22	0.75 8	0.70 11	0.94 24	0.66 18	1.11 13	3.20 12	2.37 14	0.51 20	1.05 23	0.89 14	0.57 18	3.20
1958 DAY	0.30 21	0.26 27	0.11 5	0.68 5	1.60 31	2.18 8	1.54 2	1.84 15	0.77 17	0.79 22	0.30 25	0.20 8	2.18
1959 DAY	0.23 21	0.71 9	1.37 26	2.95 27	0.81 11	0.83 25	1.54 2	1.36 3	1.06 26	1.06 6	1.79 4	0.98 27	2.95
1960 DAY	2.36 12	0.57 10	0.29 30	1.61 16	1.02 17	0.91 11	0.82 26	0.43 3	1.01 18	0.82 13	0.56 15	0.22 5	2.36
1961 DAY	0.01 2	0.40 3	0.90 13	1.19 24	0.54 25	0.90 19	1.00 28	2.01 1	2.68 13	1.03 19	0.51 3	0.67 23	2.68
1962 DAY	0.60 6	0.32 26	0.42 11	1.25 30	0.79 7	1.04 4	1.25 2	1.44 6	0.66 10	0.29 7	0.43 16	0.20 26	1.44
1963 DAY	0.40 19	0.20 20	0.33 25	1.40 29	1.25 17	0.94 7	2.09 19	0.50 2	0.94 2	0.42 19	1.08 22	0.30 11	2.09
1964 DAY	0.24 19	0.20 12	0.75 25	1.51 5	0.70 8	0.99 19	1.42 18	0.80 21	1.07 20	0.20 8	0.77 27	0.26 2	1.51

LUCS-UFSAR

TABLE 2.3-17

ARGONNE NATIONAL LABORATORY:

MAXIMUM PRECIPITATION (in.) FOR SPECIFIED TIME INTERVALS,

JANUARY 1950 – DECEMBER 1964

MONTH	1	2	3	6	12	36	48
JAN	0.44	0.63	0.88	1.16	2.04	2.69	2.69
DAY	25	13	12	11	11	11	10
YEAR	1950	1950	1960	1960	1960	1960	1960
FEB	0.32	0.58	0.76	0.95	1.00	1.07	1.07
DAY	15	8	15	15	15	15	14
YEAR	1954	1957	1954	1954	1954	1954	1954
MAR	0.52	0.68	0.86	1.15	1.43	2.40	2.40
DAY	19	12	12	12	24	24	23
YEAR	1954	1953	1953	1953	1954	1954	1954
APR	1.18	1.34	1.70	2.50	3.00	3.35	3.35
DAY	30	27	27	27	27	27	26
YEAR	1962	1959	1959	1959	1959	1959	1959
MAY	1.12	1.26	1.36	1.56	2.29	3.40	3.43
DAY	24	24	24	24	10	9	9
YEAR	1955	1955	1955	1955	1951	1951	1951
JUN	2.20	3.28	4.00	4.22	4.23	4.23	4.25
DAY	10	10	10	10	9	8	9
YEAR	1953	1953	1953	1953	1953	1953	1953
JUL	1.40	2.00	2.12	2.76	2.90	3.49	3.49
DAY	6	6	6	6	6	12	11
YEAR	1954	1954	1954	1954	1954	1957	1957
AUG	1.92	2.32	2.34	2.40	2.78	2.79	2.79
DAY	14	14	14	5	5	4	4
YEAR	1957	1957	1957	1955	1955	1955	1955
SEP	1.04	1.44	1.82	2.39	2.56	4.66	4.92
DAY	3	13	26	13	13	12	12
YEAR	1961	1961	1961	1961	1961	1961	1961
OCT	1.40	2.44	2.79	3.63	4.98	8.10	8.62
DAY	9	9	9	9	9	9	9
YEAR	1954	1954	1954	1954	1954	1954	1954
NOV	0.42	0.62	0.75	0.97	1.67	1.90	1.95
DAY	10	10	4	10	4	3	3
YEAR	1952	1952	1959	1952	1959	1959	1959
DEC	0.36	0.48	0.56	0.65	0.90	1.29	1.33
DAY	27	27	27	27	22	2	2
YEAR	1959	1959	1959	1959	1961	1953	1953

LSCS-UFSAR

TABLE 2.3-18

PRECIPITATION (WATER EQUIVALENT)
FOR PEORIA (in.)

MONTH	NORMAL	MAXIMUM MONTHLY	YEAR	MINIMUM MONTHLY	YEAR	24 - HOUR MAXIMUM	YEAR
(a)*		35		35		31	
January	1.82	8.11	1965	0.25	1956	4.45	1965
February	1.50	5.18	1942	0.33	1947	1.92	1954
March	2.80	6.95	1973	0.39	1958	3.39	1944
April	4.36	8.66	1947	0.71	1971	5.06	1950
May	3.87	7.96	1957	1.04	1964	3.62	1956
June	3.91	11.69	1974	0.98	1971	4.44	1974
July	3.76	8.42	1958	0.57	1945	3.56	1953
August	3.07	8.61	1965	0.81	1974	4.32	1955
September	3.55	13.09	1961	0.41	1956	4.15	1961
October	2.51	10.80	1941	0.03	1964	3.70	1969
November	2.02	5.29	1946	0.43	1953	2.45	1946
December	1.89	6.34	1949	0.33	1962	3.38	1949
Year	35.06	13.09	Sept. 1961	0.03	Oct. 1964	5.06	April 1950

Length of record, in years, through 1974.

Normals are always based on record for the 1941-1970 period.

LSCS-UFSAR

TABLE 2.3-19

SNOW AND ICE PELLETS: PEORIA (1941-1974) (in.)

MONTH	MAXIMUM MONTHLY	YEAR	24 -HOUR MAXIMUM	YEAR
(a)*	31		31	
January	12.0	1955	9.0	1967
February	12.0	1960	7.6	1944
March	16.9	1960	9.0	1946
April	4.6	1970	3.6	1970
May	0.1	1966	0.0	1966
June	0.0		0.0	
July	0.0		0.0	
August	0.0		0.0	
September	0.0		0.0	
October	1.8	1967	1.8	1967
November	9.1	1974	7.2	1951
December	18.9	1973	10.2	1973
Year	18.9	Dec. 1973	10.2	Dec. 1973

* Length of record, in years, through 1974.

LSCS-UFSAR

TABLE 2.3-20
(SHEET 1 OF 2)

MONTHLY THREE-WAY JOINT FREQUENCY DISTRIBUTION OF WIND SPEED.

WIND DIRECTION AND PASQUILL STABILITY CLASS FOR THE 375-FOOT

LEVEL AT LA SALLE COUNTY STATION (JANUARY)

(Values in Percent of Total Observations)

STABILITY CATEGORY	SPEED (mph)	N	NNE	NE	ENE	E	ESE	SE	SSE	S	SSW	SW	WSW	W	WNW	NW	NNW	TOTAL
A	CALM																	00.00
	1-3	0.00	0.00	0.00	0.00	0.00	0.00	0.00	0.00	0.00	0.00	0.00	0.00	0.00	0.00	0.00	0.00	00.00
	4-7	0.00	0.00	0.00	0.00	0.00	0.00	0.00	0.00	0.00	0.00	0.00	0.00	0.00	0.00	0.00	0.00	00.00
	8-12	0.00	0.00	0.00	0.00	0.00	0.00	0.00	0.00	0.00	0.00	0.00	0.00	0.00	0.00	0.00	0.00	00.00
	13-18	0.00	0.00	0.00	0.00	0.00	0.00	0.00	0.00	0.00	0.00	0.00	0.00	0.00	0.00	0.00	0.00	00.00
	19-24	0.00	0.00	0.00	0.00	0.00	0.00	0.00	0.00	0.00	0.00	0.00	0.00	0.00	0.00	0.00	0.00	00.00
	>24	0.00	0.00	0.00	0.00	0.00	0.00	0.00	0.00	0.00	0.00	0.00	0.00	0.00	0.00	0.17	0.00	00.17
	TOTALS		0.00	0.00	0.00	0.00	0.00	0.00	0.00	0.00	0.00	0.00	0.00	0.00	0.00	0.17	0.00	00.17
B	CALM																	00.00
	1-3	0.00	0.00	0.00	0.00	0.00	0.00	0.00	0.00	0.00	0.00	0.00	0.00	0.00	0.00	0.00	0.00	00.00
	4-7	0.00	0.00	0.00	0.00	0.00	0.00	0.00	0.00	0.00	0.00	0.00	0.00	0.00	0.00	0.00	0.00	00.00
	8-12	0.00	0.00	0.00	0.00	0.00	0.00	0.00	0.00	0.00	0.00	0.00	0.00	0.00	0.00	0.00	0.00	00.00
	13-18	0.00	0.00	0.00	0.00	0.00	0.00	0.00	0.00	0.00	0.00	0.00	0.00	0.00	0.00	0.00	0.00	00.00
	19-24	0.00	0.00	0.00	0.00	0.00	0.00	0.00	0.00	0.00	0.00	0.00	0.00	0.00	0.00	0.00	0.00	00.00
	>24	0.00	0.00	0.00	0.00	0.00	0.00	0.00	0.00	0.00	0.00	0.00	0.00	0.00	0.25	0.08	0.00	00.33
	TOTALS		0.00	0.00	0.00	0.00	0.00	0.00	0.00	0.00	0.00	0.00	0.00	0.00	0.25	0.08	0.00	00.33
C	CALM																	00.00
	1-3	0.00	0.00	0.00	0.00	0.00	0.00	0.00	0.00	0.00	0.00	0.00	0.00	0.00	0.00	0.00	0.00	00.00
	4-7	0.00	0.00	0.08	0.08	0.00	0.00	0.00	0.00	0.00	0.00	0.00	0.00	0.00	0.00	0.00	0.00	00.17
	8-12	0.00	0.00	0.00	0.00	0.00	0.00	0.00	0.00	0.08	0.00	0.00	0.00	0.00	0.00	0.00	0.00	00.08
	13-18	0.00	0.00	0.00	0.00	0.00	0.00	0.00	0.00	0.00	0.00	0.08	0.00	0.00	0.00	0.00	0.00	00.08
	19-24	0.00	0.00	0.00	0.00	0.00	0.00	0.00	0.00	0.00	0.00	0.00	0.08	0.08	0.00	0.00	0.00	00.17
	>24	0.00	0.00	0.00	0.00	0.00	0.00	0.00	0.00	0.00	0.00	0.00	0.17	0.33	0.08	0.17	0.00	00.75
	TOTALS		0.00	0.00	0.08	0.08	0.00	0.00	0.00	0.00	0.08	0.00	0.08	0.25	0.42	0.08	0.17	0.00
D	CALM																	00.00
	1-3	0.00	0.08	0.00	0.00	0.00	0.00	0.00	0.00	0.00	0.00	0.00	0.00	0.00	0.08	0.00	0.08	00.25
	4-7	0.08	0.00	0.17	0.25	0.17	0.08	0.08	0.00	0.00	0.17	0.33	0.25	0.08	0.58	0.17	0.00	02.42
	8-12	1.84	1.00	0.67	0.67	0.08	0.00	0.00	0.42	0.83	1.09	0.58	0.50	1.09	1.00	0.50	0.75	11.02
	13-18	2.09	1.75	1.00	0.25	0.33	0.00	0.00	0.25	1.34	1.50	1.50	0.92	1.17	1.17	0.25	0.92	14.44
	19-24	2.09	0.42	0.50	0.33	0.00	0.00	0.25	0.42	1.50	0.67	0.33	1.00	2.09	1.67	1.09	2.09	14.44
	>24	0.08	0.00	0.17	0.00	0.00	0.00	0.08	0.17	0.58	0.25	0.50	1.92	3.76	3.92	0.58	0.17	12.19
	TOTALS		6.18	3.26	2.50	1.50	0.58	0.08	0.42	1.25	4.26	3.67	3.26	4.59	8.18	8.43	2.59	4.01
E	CALM																	00.08
	1-3	0.08	0.00	0.00	0.00	0.00	0.00	0.00	0.00	0.00	0.00	0.00	0.00	0.08	0.00	0.00	0.08	00.33
	4-7	0.08	0.25	0.17	0.00	0.08	0.08	0.00	0.17	0.17	0.25	0.00	0.08	0.08	0.17	0.33	0.33	02.25
	8-12	0.17	0.25	0.33	0.00	0.25	0.00	0.00	0.33	0.25	0.17	1.25	0.42	0.50	0.58	0.08	0.17	04.76
	13-18	0.00	0.50	0.42	0.00	0.25	0.00	0.00	0.08	0.42	0.75	0.17	1.09	0.50	1.00	0.42	0.33	05.93
	19-24	0.17	0.25	0.17	0.00	0.00	0.08	0.08	0.08	0.50	0.25	0.00	0.67	1.09	1.75	0.58	0.08	05.68
	>24	0.00	0.00	0.00	0.00	0.00	0.00	0.00	0.00	0.67	0.50	0.25	1.75	2.75	3.67	0.25	0.00	09.85
	TOTALS		0.50	1.25	1.09	0.00	0.58	0.08	0.08	0.67	2.00	1.92	1.67	4.01	5.01	7.26	1.67	1.00

LSCS-UFSAR

TABLE 2.3-20
(SHEET 2 OF 2)

MONTHLY THREE-WAY JOINT FREQUENCY DISTRIBUTION OF WIND SPEED.

WIND DIRECTION AND PASQUILL STABILITY CLASS FOR THE 375-FOOT

LEVEL AT LA SALLE COUNTY STATION (JANUARY)

(Values in Percent of Total Observations)

STABILITY CATEGORY	SPEED (mph)	N	NNE	NE	ENE	E	ESE	SE	SSE	S	SSW	SW	WSW	W	WNW	NW	NNW	TOTAL	
F	CALM																	00.08	
	1-3	0.00	0.00	0.00	0.00	0.00	0.00	0.00	0.00	0.00	0.00	0.00	0.00	0.00	0.00	0.00	0.00	00.00	
	4-7	0.00	0.00	0.00	0.08	0.17	0.00	0.00	0.00	0.00	0.00	0.08	0.17	0.08	0.00	0.17	0.00	0.00	00.75
	8-12	0.00	0.08	0.00	0.00	0.08	0.00	0.00	0.00	0.08	0.25	0.08	0.08	0.00	0.17	0.17	0.00	0.00	01.00
	13-18	0.00	0.08	0.25	0.00	0.00	0.00	0.00	0.00	0.25	0.42	0.00	0.00	0.33	0.58	0.42	0.42	0.00	02.75
	19-24	0.00	0.00	0.25	0.00	0.00	0.00	0.00	0.00	0.17	0.42	0.08	0.00	0.17	0.58	0.58	1.59	0.17	04.01
	>24	0.17	0.00	0.08	0.00	0.00	0.00	0.00	0.00	0.17	0.50	0.25	0.00	0.00	0.42	0.58	0.08	0.08	02.34
	TOTALS		0.17	0.17	0.58	0.08	0.25	0.00	0.00	0.67	1.59	0.50	0.25	0.58	1.75	1.92	2.09	0.25	10.93
G	CALM																	00.17	
	1-3	0.00	0.00	0.00	0.00	0.00	0.00	0.00	0.00	0.00	0.00	0.00	0.00	0.00	0.00	0.00	0.00	0.00	00.00
	4-7	0.00	0.08	0.00	0.00	0.00	0.00	0.00	0.00	0.00	0.00	0.00	0.00	0.00	0.00	0.00	0.00	0.00	00.08
	8-12	0.00	0.33	0.33	0.00	0.00	0.00	0.00	0.00	0.00	0.00	0.08	0.17	0.00	0.00	0.00	0.00	0.00	00.92
	13-18	0.00	0.17	0.00	0.08	0.00	0.00	0.00	0.00	0.08	0.08	0.00	0.00	0.00	0.25	0.08	0.17	0.00	00.92
	19-24	0.00	0.00	0.00	0.00	0.00	0.00	0.00	0.00	0.17	0.00	0.17	0.00	0.00	0.00	0.25	0.25	0.00	00.83
	>24	0.00	0.00	0.00	0.00	0.00	0.00	0.00	0.00	0.00	0.00	0.33	0.25	0.00	0.00	0.00	0.17	0.00	00.75
	TOTALS		0.00	0.58	0.33	0.08	0.00	0.00	0.00	0.25	0.08	0.50	0.33	0.17	0.25	0.33	0.58	0.00	03.67

Note: Stability is based on 33- and 375-foot ΔT for the period of record (October 1, 1976-September 30, 1978).

LSCS-UFSAR

TABLE 2.3-21
(SHEET 1 OF 2)

MONTHLY THREE-WAY JOINT FREQUENCY DISTRIBUTION OF WIND SPEED.

WIND DIRECTION AND PASQUILL STABILITY CLASS FOR THE 375-FOOT

LEVEL AT LA SALLE COUNTY STATION (FEBRUARY)

(Values in Percent of Total Observations)

STABILITY CATEGORY	SPEED (mph)	N	NNE	NE	ENE	E	ESE	SE	SSE	S	SSW	SW	WSW	W	WNW	NW	NNW	TOTAL
A	CALM																	00.00
	1-3	0.00	0.00	0.00	0.00	0.00	0.00	0.00	0.00	0.00	0.00	0.00	0.00	0.00	0.00	0.00	0.00	00.00
	4-7	0.00	0.00	0.00	0.00	0.00	0.00	0.00	0.00	0.00	0.00	0.00	0.00	0.00	0.00	0.00	0.00	00.00
	8-12	0.00	0.00	0.00	0.00	0.00	0.00	0.00	0.00	0.00	0.00	0.00	0.00	0.00	0.00	0.00	0.00	00.00
	13-18	0.00	0.00	0.00	0.00	0.00	0.00	0.00	0.00	0.00	0.00	0.00	0.00	0.00	0.00	0.00	0.00	00.00
	19-24	0.00	0.00	0.00	0.00	0.00	0.00	0.00	0.00	0.00	0.00	0.00	0.00	0.00	0.00	0.00	0.00	00.00
	>24	0.00	0.00	0.00	0.00	0.00	0.00	0.00	0.00	0.00	0.00	0.00	0.00	0.00	0.00	0.00	0.00	00.00
	TOTALS	0.00	0.00	0.00	0.00	0.00	0.00	0.00	0.00	0.00	0.00	0.00	0.00	0.00	0.00	0.00	0.00	0.00
B	CALM																	00.00
	1-3	0.00	0.00	0.00	0.00	0.00	0.00	0.00	0.00	0.00	0.00	0.00	0.00	0.00	0.00	0.00	0.00	00.00
	4-7	0.00	0.00	0.00	0.00	0.00	0.00	0.00	0.00	0.00	0.00	0.00	0.00	0.00	0.00	0.00	0.00	00.00
	8-12	0.00	0.00	0.00	0.00	0.00	0.00	0.00	0.00	0.00	0.00	0.00	0.00	0.00	0.00	0.00	0.00	00.00
	13-18	0.00	0.00	0.00	0.00	0.00	0.00	0.00	0.00	0.00	0.00	0.00	0.00	0.00	0.00	0.00	0.00	00.00
	19-24	0.00	0.00	0.00	0.00	0.00	0.00	0.00	0.00	0.00	0.00	0.00	0.00	0.00	0.00	0.00	0.00	00.00
	>24	0.00	0.00	0.00	0.00	0.00	0.00	0.00	0.00	0.00	0.00	0.00	0.00	0.09	0.00	0.00	0.00	00.09
	TOTALS	0.00	0.00	0.00	0.00	0.00	0.00	0.00	0.00	0.00	0.00	0.00	0.00	0.00	0.09	0.00	0.00	0.00
C	CALM																	00.00
	1-3	0.00	0.00	0.00	0.00	0.00	0.00	0.00	0.00	0.00	0.00	0.00	0.00	0.00	0.00	0.00	0.00	00.00
	4-7	0.00	0.00	0.00	0.00	0.00	0.00	0.00	0.00	0.00	0.00	0.00	0.00	0.00	0.00	0.00	0.00	00.00
	8-12	0.00	0.00	0.00	0.00	0.00	0.00	0.00	0.00	0.00	0.00	0.00	0.00	0.00	0.00	0.00	0.00	00.00
	13-18	0.09	0.09	0.00	0.00	0.00	0.00	0.00	0.00	0.19	0.09	0.00	0.00	0.00	0.00	0.00	0.00	00.46
	19-24	0.00	0.00	0.00	0.00	0.00	0.00	0.00	0.00	0.19	0.09	0.00	0.19	0.19	0.00	0.09	0.00	00.74
	>24	0.00	0.00	0.00	0.00	0.00	0.00	0.00	0.00	0.00	0.00	0.00	0.00	0.00	0.00	0.09	0.00	00.09
	TOTALS	0.09	0.09	0.00	0.00	0.00	0.00	0.00	0.00	0.37	0.19	0.00	0.19	0.19	0.00	0.19	0.00	01.30
D	CALM																	00.37
	1-3	0.00	0.09	0.00	0.19	0.19	0.00	0.00	0.00	0.00	0.00	0.00	0.00	0.00	0.00	0.00	0.00	00.46
	4-7	0.46	0.65	0.74	0.56	0.46	0.09	0.00	0.19	0.19	0.19	0.37	0.65	0.46	0.19	0.19	0.00	05.39
	8-12	0.65	0.74	0.09	0.84	0.19	0.00	0.28	0.46	0.65	0.28	0.65	0.65	0.74	1.77	0.56	1.02	09.57
	13-18	1.21	0.56	0.09	0.00	0.00	0.00	0.00	0.65	1.49	0.09	0.37	1.02	1.02	0.74	1.77	2.97	11.99
	19-24	0.00	0.19	0.19	0.00	0.09	0.00	0.09	1.49	0.93	0.00	0.56	0.46	0.84	0.65	1.12	1.02	07.62
	>24	0.00	0.00	0.46	0.46	0.00	0.00	0.56	1.12	0.46	0.46	0.65	1.67	3.44	2.42	0.09	0.28	12.08
	TOTALS	2.32	2.23	1.58	2.04	0.93	0.09	0.93	3.90	3.72	1.02	2.60	4.46	6.51	5.76	3.72	5.30	47.49
E	CALM																	00.56
	1-3	0.00	0.00	0.00	0.00	0.00	0.00	0.00	0.00	0.00	0.00	0.00	0.09	0.00	0.00	0.00	0.00	00.09
	4-7	0.09	0.56	0.00	0.00	0.00	0.19	0.00	0.00	0.09	0.28	0.37	0.65	0.93	0.37	0.37	0.28	04.18
	8-12	0.19	0.19	0.09	0.00	0.00	0.00	0.19	0.00	0.19	0.28	0.84	0.37	0.93	0.65	0.84	0.56	05.30
	13-18	0.00	0.09	0.37	0.00	0.00	0.00	0.37	0.46	0.28	0.37	0.65	1.39	1.12	0.84	0.74	0.19	06.88
	19-24	0.00	0.00	0.00	0.09	0.19	0.00	0.09	0.09	0.46	0.46	1.21	1.21	0.56	0.84	0.65	0.09	05.95
	>24	0.00	0.00	0.00	0.00	0.00	0.00	0.09	0.93	0.65	0.74	0.56	1.02	0.37	0.37	0.37	0.00	05.11
	TOTALS	0.28	0.84	0.46	0.09	0.19	0.19	0.74	1.49	1.67	2.14	3.62	4.74	3.90	3.07	2.97	1.12	28.07

LSCS-UFSAR

TABLE 2.3-21
(SHEET 2 OF 2)

MONTHLY THREE-WAY JOINT FREQUENCY DISTRIBUTION OF WIND SPEED,

WIND DIRECTION AND PASQUILL STABILITY CLASS FOR THE 375-FOOT

LEVEL AT LA SALLE COUNTY STATION (FEBRUARY)

(Values in Percent of Total Observations)

STABILITY CATEGORY	SPEED (mph)	N	NNE	NE	ENE	E	ESE	SE	SSE	S	SSW	SW	WSW	W	WNW	NW	NNW	TOTAL
F	CALM																	00.00
	1-3	0.00	0.00	0.00	0.00	0.00	0.00	0.00	0.00	0.00	0.00	0.00	0.00	0.00	0.00	0.00	0.00	00.00
	4-7	0.09	0.00	0.00	0.00	0.00	0.00	0.00	0.00	0.00	0.00	0.00	0.00	0.00	0.00	0.28	0.00	00.37
	8-12	0.28	0.09	0.00	0.00	0.00	0.00	0.00	0.00	0.00	0.37	0.46	0.09	0.09	0.37	0.37	0.46	02.60
	13-18	0.19	0.09	0.00	0.00	0.00	0.00	0.00	0.00	0.37	0.28	0.19	0.00	0.93	0.84	0.93	0.74	04.55
	19-24	0.09	0.00	0.00	0.00	0.00	0.00	0.00	0.28	0.09	0.46	0.65	0.37	0.09	0.37	1.30	0.46	04.28
	>24	0.00	0.00	0.00	0.00	0.00	0.00	0.00	0.00	0.00	0.28	1.02	1.77	0.56	0.28	0.00	0.00	03.90
	TOTALS		0.65	0.19	0.00	0.00	0.00	0.00	0.28	0.09	1.12	2.32	2.79	0.74	1.67	2.51	2.04	1.30
G	CALM																	00.00
	1-3	0.00	0.00	0.00	0.00	0.00	0.00	0.00	0.00	0.00	0.00	0.00	0.00	0.00	0.00	0.00	0.00	00.00
	4-7	0.09	0.00	0.00	0.00	0.00	0.00	0.00	0.00	0.00	0.19	0.19	0.19	0.09	0.00	0.19	0.09	01.02
	8-12	0.19	0.09	0.00	0.00	0.00	0.00	0.00	0.00	0.00	0.19	0.19	0.09	0.00	0.09	0.28	0.00	01.12
	13-18	0.37	0.00	0.00	0.00	0.00	0.00	0.00	0.00	0.09	0.19	0.00	0.00	0.00	0.74	0.65	0.74	02.79
	19-24	0.28	0.09	0.00	0.00	0.00	0.00	0.00	0.09	0.28	0.19	0.00	0.00	0.00	0.19	0.00	0.00	01.12
	>24	0.00	0.00	0.00	0.00	0.00	0.00	0.00	0.00	0.00	0.37	0.93	0.00	0.00	0.00	0.00	0.00	01.30
	TOTALS		0.93	0.19	0.00	0.00	0.00	0.00	0.00	0.09	0.37	1.12	1.30	0.28	0.09	1.02	1.12	0.84

Note: Stability is based on 33-and 375-foot ΔT for the period of record (October 1, 1976-September 30, 1978).

LSCS-UFSAR

TABLE 2.3-22
(SHEET 1 OF 2)

MONTHLY THREE-WAY JOINT FREQUENCY DISTRIBUTION OF WIND SPEED.

WIND DIRECTION AND PASQUILL STABILITY CLASS FOR THE 375-FOOT

LEVEL AT LA SALLE COUNTY STATION (MARCH)

(Values in Percent of Total Observations)

STABILITY CATEGORY	SPEED (mph)	N	NNE	NE	ENE	E	ESE	SE	SSE	S	SSW	SW	WSW	W	WNW	NW	NNW	TOTAL
A	CALM																	00.00
	1-3	0.00	0.00	0.00	0.00	0.00	0.00	0.00	0.00	0.00	0.00	0.00	0.00	0.00	0.00	0.00	0.00	00.00
	4-7	0.00	0.00	0.00	0.00	0.00	0.00	0.00	0.00	0.00	0.00	0.00	0.00	0.00	0.09	0.00	0.00	00.09
	8-12	0.00	0.00	0.00	0.00	0.00	0.00	0.00	0.09	0.00	0.00	0.00	0.00	0.00	0.00	0.00	0.00	00.09
	13-18	0.00	0.36	0.09	0.09	0.00	0.18	0.00	0.09	0.00	0.00	0.00	0.00	0.00	0.54	0.09	0.18	01.62
	19-24	0.00	0.00	0.00	0.00	0.09	0.00	0.09	0.00	0.00	0.00	0.00	0.00	0.00	0.09	0.09	0.00	00.36
	>24	0.00	0.00	0.00	0.00	0.09	0.00	0.09	0.09	0.09	0.09	0.09	0.18	0.09	0.09	0.00	0.00	00.81
	TOTALS		0.00	0.36	0.09	0.09	0.18	0.18	0.18	0.27	0.09	0.09	0.18	0.09	0.09	0.72	0.18	0.18
B	CALM																	00.00
	1-3	0.00	0.00	0.00	0.00	0.00	0.00	0.00	0.00	0.00	0.00	0.00	0.00	0.00	0.00	0.00	0.00	00.00
	4-7	0.00	0.00	0.00	0.00	0.00	0.00	0.00	0.00	0.00	0.00	0.00	0.00	0.00	0.00	0.00	0.00	00.00
	8-12	0.00	0.00	0.00	0.00	0.00	0.09	0.18	0.00	0.00	0.00	0.00	0.00	0.00	0.00	0.00	0.00	00.27
	13-18	0.00	0.00	0.00	0.00	0.00	0.09	0.18	0.27	0.18	0.00	0.00	0.00	0.00	0.00	0.00	0.09	00.81
	19-24	0.00	0.00	0.00	0.00	0.00	0.00	0.00	0.00	0.09	0.00	0.00	0.00	0.00	0.00	0.00	0.09	00.18
	>24	0.00	0.00	0.00	0.00	0.00	0.09	0.00	0.18	0.54	0.27	0.18	0.09	0.09	0.09	0.09	0.00	01.62
	TOTALS		0.00	0.00	0.00	0.00	0.00	0.27	0.36	0.45	0.81	0.27	0.18	0.09	0.09	0.09	0.09	0.18
C	CALM																	00.00
	1-3	0.00	0.00	0.00	0.00	0.00	0.00	0.00	0.00	0.00	0.00	0.00	0.00	0.00	0.00	0.00	0.00	00.00
	4-7	0.00	0.09	0.18	0.00	0.09	0.00	0.00	0.00	0.00	0.00	0.00	0.00	0.00	0.00	0.00	0.00	00.36
	8-12	0.00	0.63	0.36	0.00	0.00	0.00	0.00	0.00	0.00	0.00	0.00	0.00	0.00	0.09	0.00	0.00	01.08
	13-18	0.00	0.00	0.00	0.09	0.00	0.00	0.27	0.18	0.00	0.00	0.00	0.00	0.00	0.00	0.09	0.00	00.63
	19-24	0.00	0.00	0.00	0.00	0.00	0.27	0.18	0.09	0.09	0.18	0.18	0.00	0.09	0.00	0.18	0.09	01.35
	>24	0.00	0.00	0.27	0.00	0.00	0.18	0.19	0.54	0.09	0.45	0.63	0.09	0.36	0.09	0.18	0.00	02.98
	TOTALS		0.00	0.72	0.81	0.09	0.09	0.45	0.54	0.81	0.18	0.63	0.81	0.09	0.45	0.18	0.45	0.09
D	CALM																	00.18
	1-3	0.00	0.27	0.09	0.00	0.00	0.00	0.09	0.00	0.09	0.00	0.00	0.00	0.00	0.00	0.09	0.00	00.63
	4-7	0.27	0.27	0.36	0.18	0.27	0.09	0.09	0.00	0.00	0.27	0.18	0.36	0.45	0.27	0.45	0.45	03.97
	8-12	1.80	0.36	0.99	0.27	0.45	0.54	0.27	0.00	0.09	0.18	0.00	0.27	0.18	0.18	0.18	0.90	06.67
	13-18	0.45	0.72	1.26	0.81	0.72	1.44	1.35	0.99	0.36	0.27	0.00	0.36	1.17	1.89	1.17	0.90	13.89
	19-24	0.27	0.18	0.90	0.09	0.36	1.17	0.81	0.54	0.72	0.81	0.27	0.18	0.81	1.44	0.99	0.54	10.10
	>24	0.27	0.18	1.44	0.63	0.54	1.44	0.81	0.63	0.36	1.89	0.45	1.35	0.72	1.08	0.81	0.72	13.35
	TOTALS		3.07	1.98	5.05	1.98	2.34	4.69	3.43	2.16	1.62	3.43	0.90	2.52	3.34	4.87	3.70	3.52
E	CALM																	00.27
	1-3	0.00	0.00	0.09	0.00	0.00	0.00	0.00	0.09	0.00	0.09	0.00	0.00	0.00	0.00	0.00	0.00	00.27
	4-7	0.00	0.00	0.09	0.00	0.00	0.18	0.09	0.18	0.00	0.00	0.18	0.09	0.00	0.00	0.00	0.00	00.81
	8-12	0.36	0.45	0.45	0.81	0.36	0.27	0.09	0.36	0.27	0.27	0.09	0.18	0.18	0.18	0.18	0.18	04.69
	13-18	0.09	0.36	0.45	0.81	0.36	0.27	0.18	0.09	0.09	0.18	0.09	0.72	0.63	0.72	0.18	0.27	05.50
	19-24	0.36	0.09	0.09	0.09	0.18	0.27	0.36	0.27	0.00	0.18	0.00	0.36	0.45	0.36	0.27	0.27	03.61
	>24	0.09	0.00	0.00	0.00	0.27	0.90	0.72	0.63	1.26	2.07	0.45	0.18	0.09	1.44	0.09	0.18	08.39
	TOTALS		0.90	0.90	1.17	1.71	1.17	1.89	1.44	1.62	1.62	2.80	0.81	1.53	1.35	2.71	0.72	0.90

LSCS-UFSAR

TABLE 2.3-22
(SHEET 2 OF 2)

MONTHLY THREE-WAY JOINT FREQUENCY DISTRIBUTION OF WIND SPEED.

WIND DIRECTION AND PASQUILL STABILITY CLASS FOR THE 375-FOOT

LEVEL AT LA SALLE COUNTY STATION (MARCH)

(Values in Percent of Total Observations)

STABILITY CATEGORY	SPEED (mph)	N	NNE	NE	ENE	E	ESE	SE	SSE	S	SSW	SW	WSW	W	WNW	NW	NNW	TOTAL	
F	CALM																	00.00	
	1-3	0.00	0.00	0.00	0.00	0.00	0.00	0.00	0.00	0.00	0.00	0.00	0.00	0.00	0.00	0.00	0.09	00.09	
	4-7	0.00	0.09	0.00	0.00	0.00	0.00	0.18	0.09	0.00	0.09	0.00	0.00	0.09	0.00	0.00	0.00	00.54	
	8-12	0.00	0.09	0.09	0.00	0.09	0.18	0.09	0.00	0.00	0.00	0.00	0.09	0.00	0.00	0.00	0.09	00.72	
	13-18	0.09	0.09	0.09	0.00	0.27	0.36	0.18	0.00	0.00	0.00	0.00	0.00	0.09	0.09	0.09	0.09	01.35	
	19-24	0.00	0.00	0.00	0.00	0.00	0.27	0.27	0.00	0.09	0.09	0.00	0.27	0.18	0.36	0.45	0.27	0.00	02.16
	>24	0.00	0.00	0.00	0.00	0.00	0.09	2.25	0.54	1.44	2.43	0.81	0.45	0.09	0.27	0.09	0.00	08.48	
	TOTALS		0.09	0.27	0.18	0.00	0.36	0.90	2.98	0.63	1.53	2.52	1.08	0.72	0.54	0.81	0.45	0.27	13.35
G	CALM																	00.00	
	1-3	0.00	0.00	0.00	0.00	0.00	0.00	0.00	0.00	0.00	0.00	0.00	0.00	0.00	0.00	0.00	0.00	00.00	
	4-7	0.00	0.00	0.00	0.00	0.00	0.00	0.00	0.00	0.00	0.00	0.00	0.00	0.00	0.00	0.00	0.00	00.00	
	8-12	0.00	0.00	0.00	0.00	0.00	0.00	0.09	0.00	0.00	0.00	0.00	0.00	0.00	0.00	0.00	0.00	00.09	
	13-18	0.00	0.00	0.00	0.00	0.00	0.00	0.00	0.00	0.00	0.00	0.00	0.00	0.00	0.00	0.00	0.00	00.00	
	19-24	0.00	0.00	0.00	0.00	0.00	0.00	0.00	0.00	0.00	0.00	0.00	0.00	0.00	0.00	0.00	0.00	00.00	
	>24	0.00	0.00	0.00	0.00	0.00	0.00	0.45	0.27	0.18	0.18	0.63	0.27	0.00	0.00	0.00	0.00	01.98	
	TOTALS		0.00	0.00	0.00	0.00	0.00	0.00	0.54	0.27	0.18	0.18	0.63	0.27	0.00	0.00	0.00	0.00	02.07

Note: Stability is based on 33- and 375-foot ΔT for the period of record (October 1, 1976-September 30, 1978).

LSCS-UFSAR

TABLE 2.3-23
(SHEET 1 OF 2)

MONTHLY THREE-WAY JOINT FREQUENCY DISTRIBUTION OF WIND SPEED.

WIND DIRECTION AND PASQUILL STABILITY CLASS FOR THE 375-FOOT

LEVEL AT LA SALLE COUNTY STATION (APRIL)

(Values in Percent of Total Observations)

STABILITY CATEGORY	SPEED (mph)	N	NNE	NE	ENE	E	ESE	SE	SSE	S	SSW	SW	WSW	W	WNW	NW	NNW	TOTAL
A	CALM																	00.00
	1-3	0.00	0.00	0.00	0.00	0.00	0.00	0.00	0.00	0.00	0.00	0.00	0.00	0.00	0.00	0.00	0.00	00.00
	4-7	0.00	0.00	0.00	0.00	0.00	0.07	0.00	0.00	0.00	0.00	0.00	0.00	0.00	0.00	0.00	0.00	00.07
	8-12	0.00	0.00	0.00	0.00	0.00	0.00	0.07	0.00	0.07	0.07	0.00	0.00	0.00	0.00	0.00	0.00	00.22
	13-18	0.00	0.00	0.00	0.00	0.00	0.00	0.00	0.00	0.07	0.14	0.00	0.07	0.00	0.00	0.00	0.00	00.29
	19-24	0.00	0.00	0.00	0.00	0.00	0.00	0.07	0.07	0.00	0.07	0.00	0.00	0.00	0.00	0.00	0.00	00.22
	>24	0.00	0.00	0.00	0.00	0.29	0.00	0.00	0.00	0.00	0.00	0.00	0.50	0.14	0.07	0.00	0.00	01.01
	TOTALS		0.00	0.00	0.00	0.00	0.29	0.07	0.14	0.07	0.14	0.29	0.50	0.22	0.07	0.00	0.00	0.00
B	CALM																	00.00
	1-3	0.00	0.00	0.00	0.00	0.00	0.00	0.00	0.00	0.00	0.00	0.00	0.00	0.00	0.00	0.00	0.00	00.00
	4-7	0.00	0.00	0.00	0.00	0.00	0.00	0.00	0.00	0.00	0.00	0.00	0.07	0.00	0.00	0.00	0.00	00.07
	8-12	0.07	0.07	0.07	0.00	0.00	0.00	0.00	0.00	0.00	0.00	0.00	0.00	0.00	0.00	0.00	0.00	00.22
	13-18	0.00	0.00	0.00	0.00	0.00	0.00	0.00	0.00	0.00	0.00	0.00	0.00	0.00	0.00	0.00	0.00	00.00
	19-24	0.00	0.00	0.00	0.00	0.00	0.00	0.00	0.00	0.00	0.00	0.07	0.00	0.00	0.14	0.00	0.00	00.22
	>24	0.00	0.00	0.00	0.00	0.07	0.00	0.00	0.00	0.00	0.14	0.36	0.43	0.43	0.14	0.07	0.07	01.72
	TOTALS		0.07	0.07	0.07	0.00	0.07	0.00	0.00	0.00	0.00	0.14	0.43	0.50	0.43	0.29	0.07	0.07
C	CALM																	00.00
	1-3	0.00	0.00	0.00	0.00	0.00	0.00	0.00	0.00	0.00	0.00	0.00	0.00	0.00	0.00	0.00	0.00	00.00
	4-7	0.00	0.00	0.07	0.00	0.00	0.00	0.00	0.00	0.00	0.00	0.07	0.00	0.00	0.00	0.00	0.00	00.14
	8-12	0.00	0.07	0.07	0.00	0.00	0.00	0.00	0.00	0.07	0.00	0.14	0.07	0.00	0.00	0.00	0.00	00.43
	13-18	0.00	0.50	0.22	0.14	0.07	0.00	0.00	0.00	0.07	0.07	0.07	0.00	0.00	0.14	0.00	0.00	01.22
	19-24	0.00	0.29	0.00	0.07	0.07	0.00	0.22	0.22	0.07	0.00	0.22	0.14	0.07	0.14	0.00	0.00	01.51
	>24	0.00	0.07	0.00	0.00	0.22	0.00	0.00	0.07	0.00	0.07	0.29	0.50	0.43	0.36	0.07	0.36	02.44
	TOTALS		0.00	0.93	0.36	0.22	0.36	0.00	0.22	0.29	0.14	0.14	0.79	0.72	0.50	0.65	0.07	0.36
D	CALM																	00.00
	1-3	0.00	0.00	0.00	0.07	0.00	0.00	0.07	0.00	0.00	0.00	0.00	0.00	0.00	0.07	0.00	0.00	00.22
	4-7	0.22	0.22	0.29	0.36	0.29	0.22	0.43	0.29	0.07	0.14	0.36	0.00	0.00	0.00	0.00	0.00	02.87
	8-12	0.57	1.01	1.36	0.86	0.36	0.93	1.01	0.22	0.22	0.29	0.57	0.79	0.72	0.50	0.29	0.57	10.27
	13-18	0.79	3.66	1.87	0.65	0.79	0.72	0.79	0.29	1.01	0.50	0.50	0.72	0.50	0.79	0.36	1.01	14.93
	19-24	0.57	1.08	0.79	1.15	0.57	0.43	0.79	0.57	0.57	0.29	0.14	0.43	0.29	1.29	0.93	1.08	10.98
	>24	0.29	0.00	0.14	0.50	1.08	0.72	0.07	0.14	0.86	0.36	0.65	0.79	1.08	1.65	0.57	0.36	09.26
	TOTALS		2.44	5.96	4.45	3.59	3.09	3.02	3.16	1.51	2.73	1.58	2.23	2.73	2.58	4.31	2.15	3.02
E	CALM																	00.14
	1-3	0.00	0.00	0.00	0.00	0.00	0.00	0.00	0.00	0.00	0.07	0.00	0.00	0.00	0.00	0.00	0.00	00.07
	4-7	0.07	0.07	0.07	0.07	0.07	0.00	0.22	0.07	0.07	0.14	0.07	0.07	0.00	0.00	0.00	0.07	01.08
	8-12	0.14	0.43	0.14	0.14	0.14	0.43	0.43	0.22	0.07	0.22	0.22	0.07	0.00	0.07	0.07	0.07	02.87
	13-18	0.36	0.72	0.57	0.86	0.65	0.72	0.22	0.29	0.36	0.14	0.29	0.36	0.36	0.22	0.14	0.22	06.46
	19-24	0.14	0.07	0.29	0.65	0.22	0.57	0.65	0.29	0.65	0.22	0.14	0.50	0.22	0.14	0.07	0.14	04.95
	>24	0.14	0.07	0.07	0.50	1.08	0.65	0.36	0.22	0.79	0.65	0.43	0.36	1.22	0.22	0.00	0.00	06.75
	TOTALS		0.86	1.36	1.15	2.23	2.15	2.37	1.87	1.08	1.94	1.44	1.15	1.36	1.79	0.65	0.29	0.50

LSCS-UFSAR

TABLE 2.3-23
(SHEET 2 OF 2)

MONTHLY THREE-WAY JOINT FREQUENCY DISTRIBUTION OF WIND SPEED,

WIND DIRECTION AND PASQUILL STABILITY CLASS FOR THE 375-FOOT

LEVEL AT LA SALLE COUNTY STATION (APRIL)

(Values in Percent of Total Observations)

STABILITY CATEGORY	SPEED (mph)	N	NNE	NE	ENE	E	ESE	SE	SSE	S	SSW	SW	WSW	W	WNW	NW	NNW	TOTAL	
F	CALM																	00.07	
	1-3	0.00	0.00	0.00	0.00	0.00	0.00	0.07	0.00	0.00	0.14	0.00	0.00	0.00	0.00	0.00	0.00	00.22	
	4-7	0.00	0.07	0.14	0.00	0.07	0.07	0.14	0.14	0.00	0.14	0.00	0.14	0.00	0.00	0.00	0.00	00.93	
	8-12	0.14	0.07	0.00	0.00	0.22	0.14	0.07	0.07	0.22	0.14	0.07	0.00	0.00	0.00	0.00	0.00	01.15	
	13-18	0.07	0.00	0.00	0.14	0.36	0.36	0.22	0.43	0.36	0.29	0.22	0.00	0.00	0.07	0.22	0.14	02.87	
	19-24	0.00	0.00	0.00	0.00	0.29	0.22	0.65	0.22	0.22	0.22	0.29	0.29	0.07	0.22	0.57	0.29	0.00	03.30
	>24	0.00	0.00	0.00	0.00	0.00	0.22	0.29	0.50	0.50	2.01	0.72	0.22	0.00	0.07	0.07	0.00	04.59	
	TOTALS		0.22	0.14	0.14	0.14	0.93	1.01	1.44	1.36	1.29	3.02	1.29	0.43	0.22	0.72	0.57	0.14	13.14
G	CALM																	00.00	
	1-3	0.00	0.00	0.00	0.00	0.00	0.00	0.00	0.00	0.00	0.00	0.00	0.00	0.00	0.00	0.00	0.00	00.00	
	4-7	0.00	0.00	0.00	0.00	0.00	0.00	0.00	0.00	0.00	0.14	0.14	0.00	0.00	0.00	0.00	0.00	00.29	
	8-12	0.00	0.00	0.00	0.00	0.00	0.00	0.00	0.00	0.00	0.00	0.00	0.00	0.00	0.00	0.00	0.00	00.00	
	13-18	0.00	0.00	0.00	0.00	0.00	0.00	0.00	0.00	0.07	0.00	0.07	0.07	0.00	0.00	0.00	0.00	00.22	
	19-24	0.00	0.00	0.00	0.00	0.00	0.00	0.00	0.36	0.43	0.50	0.07	0.14	0.07	0.36	0.07	0.07	0.00	02.08
	>24	0.00	0.00	0.00	0.00	0.00	0.00	0.00	0.00	0.22	0.36	0.93	1.29	0.50	0.07	0.14	0.14	0.00	03.66
	TOTALS		0.00	0.00	0.00	0.00	0.00	0.00	0.36	0.65	0.93	1.15	1.65	0.65	0.43	0.22	0.22	0.00	06.25

Note: Stability based on 33- and 375-foot ΔT for the period of record (October 1, 1976 – September 30, 1978).

LSCS-UFSAR

TABLE 2.3-24
(SHEET 1 OF 2)

MONTHLY THREE-WAY JOINT FREQUENCY DISTRIBUTION OF WIND SPEED.

WIND DIRECTION AND PASQUILL STABILITY CLASS FOR THE 375-FOOT

LEVEL AT LA SALLE COUNTY STATION (MAY)

(Values in Percent of Total Observations)

STABILITY CATEGORY	SPEED (mph)	N	NNE	NE	ENE	E	ESE	SE	SSE	S	SSW	SW	WSW	W	WNW	NW	NNW	TOTAL
A	CALM																	00.00
	1-3	0.00	0.00	0.00	0.00	0.00	0.00	0.00	0.00	0.00	0.00	0.00	0.00	0.00	0.00	0.00	0.00	00.15
	4-7	0.00	0.00	0.08	0.08	0.46	0.23	0.30	0.08	0.08	0.15	0.00	0.00	0.00	0.00	0.00	0.00	01.44
	8-12	0.00	0.00	0.00	0.30	0.53	0.38	0.08	1.29	0.46	0.38	0.00	0.00	0.00	0.00	0.00	0.00	03.42
	13-18	0.00	0.00	0.00	0.08	0.00	0.38	0.08	0.38	0.46	0.30	0.08	0.00	0.15	0.00	0.00	0.00	01.90
	19-24	0.00	0.00	0.00	0.00	0.00	0.08	0.00	0.00	0.08	0.08	0.08	0.46	0.38	0.00	0.00	0.00	01.14
	>24	0.00	0.00	0.00	0.00	0.00	0.00	0.00	0.00	0.08	0.46	0.00	0.00	0.38	0.30	0.08	0.00	01.37
	TOTALS		0.00	0.00	0.08	0.46	1.06	1.14	0.46	1.82	1.14	1.37	0.15	0.46	0.91	0.30	0.08	0.00
B	CALM																	00.00
	1-3	0.00	0.00	0.00	0.00	0.00	0.00	0.00	0.00	0.00	0.00	0.00	0.00	0.00	0.00	0.00	0.00	00.00
	4-7	0.00	0.00	0.00	0.00	0.00	0.00	0.00	0.00	0.00	0.00	0.00	0.00	0.00	0.08	0.00	0.00	00.08
	8-12	0.00	0.08	0.23	0.38	0.00	0.15	0.15	0.08	0.00	0.15	0.08	0.00	0.00	0.00	0.00	0.00	01.29
	13-18	0.00	0.00	0.30	0.30	0.00	0.00	0.00	0.15	0.00	0.15	0.15	0.15	0.08	0.00	0.00	0.00	01.29
	19-24	0.00	0.08	0.08	0.00	0.00	0.00	0.00	0.23	0.00	0.00	0.15	0.08	0.00	0.00	0.00	0.00	00.61
	>24	0.00	0.00	0.08	0.00	0.61	0.15	0.15	0.15	0.08	0.00	0.15	0.00	0.08	0.00	0.08	0.00	01.52
	TOTALS		0.00	0.15	0.68	0.68	0.51	0.30	0.30	0.61	0.08	0.30	0.53	0.23	0.15	0.08	0.08	0.00
C	CALM																	00.00
	1-3	0.00	0.00	0.00	0.00	0.00	0.00	0.00	0.00	0.00	0.00	0.00	0.00	0.00	0.00	0.00	0.00	00.00
	4-7	0.08	0.00	0.08	0.08	0.08	0.15	0.08	0.00	0.00	0.08	0.08	0.15	0.00	0.00	0.00	0.00	00.84
	8-12	0.00	0.00	0.61	0.61	0.53	0.00	0.00	0.08	0.08	0.23	0.08	0.00	0.08	0.08	0.00	0.00	02.35
	13-18	0.00	0.00	0.38	0.38	0.08	0.08	0.00	0.00	0.15	0.15	0.15	0.46	0.08	0.00	0.00	0.00	01.90
	19-24	0.00	0.00	0.15	0.08	0.00	0.00	0.08	0.08	0.08	0.38	0.08	0.08	0.00	0.00	0.00	0.08	01.06
	>24	0.00	0.00	0.15	0.00	0.38	0.00	0.00	0.00	0.08	0.15	0.00	0.00	0.15	0.00	0.00	0.00	00.91
	TOTALS		0.08	0.00	1.37	1.14	1.06	0.23	0.15	0.15	0.38	0.99	0.38	0.68	0.30	0.08	0.00	0.00
D	CALM																	00.30
	1-3	0.00	0.00	0.00	0.08	0.08	0.00	0.08	0.00	0.00	0.00	0.00	0.00	0.15	0.08	0.00	0.00	00.46
	4-7	0.30	0.15	0.61	0.23	0.30	0.08	0.23	0.15	0.30	0.61	0.46	0.30	0.15	0.30	0.15	0.23	04.56
	8-12	0.76	1.44	0.99	0.76	0.38	0.84	0.30	0.30	0.46	0.53	0.38	0.68	0.68	0.68	0.23	0.15	09.57
	13-18	0.30	1.59	3.04	1.67	0.84	0.53	0.76	0.08	0.38	1.06	0.68	0.91	1.75	0.32	0.15	0.08	14.05
	19-24	0.00	0.15	1.14	0.84	0.38	0.38	0.30	0.08	0.76	1.06	0.30	0.38	0.23	0.00	0.08	0.00	06.07
	>24	0.00	0.00	0.76	0.53	0.15	0.23	0.15	0.15	0.91	0.46	0.76	0.30	0.84	0.30	0.08	0.00	05.62
	TOTALS		1.37	3.34	6.53	4.10	2.13	2.05	1.82	0.76	2.81	3.72	2.58	2.58	3.80	1.59	0.68	0.46
E	CALM																	00.08
	1-3	0.00	0.00	0.00	0.00	0.00	0.00	0.00	0.00	0.00	0.00	0.00	0.00	0.00	0.08	0.00	0.00	00.08
	4-7	0.00	0.23	0.15	0.00	0.00	0.15	0.08	0.23	0.08	0.15	0.08	0.15	0.08	0.08	0.00	0.00	01.44
	8-12	0.15	0.23	0.53	0.14	0.23	0.00	0.30	0.00	0.23	0.23	0.38	0.30	0.08	0.00	0.08	0.00	02.89
	13-18	0.15	0.23	0.46	0.84	0.76	0.61	0.61	0.15	0.30	0.46	0.53	0.30	0.30	0.08	0.00	0.00	05.77
	19-24	0.08	0.08	0.00	0.91	0.61	0.23	0.23	0.15	0.99	0.30	0.46	0.38	0.15	0.08	0.30	0.00	04.94
	>24	0.23	0.00	0.00	0.38	0.08	0.00	0.23	0.84	1.37	0.38	0.38	0.46	0.23	0.00	0.00	0.00	04.56
	TOTALS		0.61	0.76	1.14	2.28	1.67	0.99	1.44	1.37	2.96	1.52	1.82	1.59	0.84	0.30	0.38	0.00

LSCS-UFSAR

TABLE 2.3-24
(SHEET 2 OF 2)

MONTHLY THREE-WAY JOINT FREQUENCY DISTRIBUTION OF WIND SPEED,

WIND DIRECTION AND PASQUILL STABILITY CLASS FOR THE 375-FOOT

LEVEL AT LA SALLE COUNTY STATION (MAY)

(Values in Percent of Total Observations)

STABILITY CATEGORY	SPEED (mph)	N	NNE	NE	ENE	E	ESE	SE	SSE	S	SSW	SW	WSW	W	WNW	NW	NNW	TOTAL
F	CALM																	00.00
	1-3	0.00	0.00	0.00	0.00	0.00	0.00	0.00	0.00	0.00	0.00	0.00	0.00	0.00	0.00	0.00	0.00	00.00
	4-7	0.00	0.00	0.00	0.00	0.08	0.15	0.00	0.00	0.00	0.08	0.00	0.15	0.00	0.00	0.00	0.00	00.46
	8-12	0.00	0.00	0.00	0.23	0.38	0.23	0.15	0.08	0.38	0.30	0.30	0.00	0.23	0.23	0.00	0.00	02.51
	13-18	0.23	0.00	0.08	0.15	0.30	0.23	0.08	0.08	0.15	0.15	0.46	0.61	0.53	0.23	0.08	0.00	03.34
	19-24	0.08	0.00	0.00	0.30	0.08	0.23	0.38	0.08	0.38	0.68	0.99	0.91	0.76	0.30	0.00	0.00	05.16
	>24	0.00	0.00	0.00	0.00	0.00	0.00	0.08	0.84	1.14	0.38	0.68	0.30	0.15	0.00	0.00	0.00	03.57
	TOTALS		0.30	0.00	0.08	0.68	0.84	0.84	0.68	1.06	2.13	1.52	2.58	1.82	1.67	0.76	0.08	0.00
G	CALM																	00.00
	1-3	0.00	0.00	0.00	0.00	0.00	0.00	0.00	0.00	0.00	0.00	0.00	0.00	0.00	0.00	0.00	0.00	00.00
	4-7	0.00	0.00	0.00	0.00	0.08	0.08	0.00	0.00	0.00	0.00	0.00	0.08	0.08	0.00	0.00	0.00	00.30
	8-12	0.00	0.00	0.00	0.00	0.00	0.08	0.00	0.00	0.08	0.00	0.38	0.00	0.08	0.00	0.00	0.00	00.61
	13-18	0.00	0.00	0.00	0.00	0.00	0.00	0.00	0.08	0.38	0.08	0.00	0.00	0.08	0.00	0.00	0.00	00.61
	19-24	0.00	0.00	0.08	0.08	0.00	0.00	0.00	0.00	0.23	0.23	0.00	0.00	0.23	0.00	0.00	0.00	00.76
	>24	0.00	0.00	0.00	0.00	0.00	0.00	0.00	0.00	0.30	0.08	0.00	0.08	0.61	0.00	0.00	0.00	01.06
	TOTALS		0.00	0.00	0.08	0.08	0.08	0.15	0.00	0.08	0.99	0.38	0.38	0.15	1.06	0.00	0.00	0.00

Note: Stability is based on 33- and 375-foot ΔT for the period of record (October 1, 1976 – September 30, 1978).

LSCS-UFSAR

TABLE 2.3-25
(SHEET 1 OF 2)

MONTHLY THREE-WAY JOINT FREQUENCY DISTRIBUTION OF WIND SPEED.

WIND DIRECTION AND PASQUILL STABILITY CLASS FOR THE 375-FOOT

LEVEL AT LA SALLE COUNTY STATION (JUNE)

(Values in Percent of Total Observations)

STABILITY CATEGORY	SPEED (mph)	N	NNE	NE	ENE	E	ESE	SE	SSE	S	SSW	SW	WSW	W	WNW	NW	NNW	TOTAL
A	CALM																	00.00
	1-3	0.00	0.00	0.00	0.00	0.00	0.00	0.00	0.00	0.00	0.00	0.00	0.00	0.00	0.00	0.00	0.00	00.00
	4-7	0.00	0.00	0.00	0.00	0.00	0.00	0.00	0.00	0.00	0.00	0.00	0.00	0.00	0.00	0.00	0.00	00.00
	8-12	0.00	0.11	0.00	0.00	0.00	0.00	0.00	0.00	0.00	0.00	0.00	0.00	0.00	0.00	0.00	0.00	00.11
	13-18	0.00	0.00	0.00	0.23	0.00	0.00	0.00	0.00	0.00	0.00	0.00	0.00	0.00	0.11	0.00	0.00	00.34
	19-24	0.23	0.11	0.00	0.00	0.00	0.00	0.00	0.00	0.00	0.00	0.00	0.00	0.00	0.34	0.11	0.00	00.80
	>24	0.00	0.11	0.00	0.00	0.00	0.00	0.00	0.00	0.00	0.34	1.49	0.00	0.00	0.23	0.11	0.11	02.40
	TOTALS		0.23	0.34	0.00	0.23	0.00	0.00	0.00	0.00	0.34	1.49	0.00	0.00	0.69	0.23	0.11	0.00
B	CALM																	00.00
	1-3	0.00	0.00	0.00	0.00	0.00	0.00	0.00	0.00	0.00	0.00	0.00	0.00	0.00	0.00	0.00	0.00	00.00
	4-7	0.00	0.00	0.11	0.00	0.00	0.00	0.00	0.00	0.00	0.00	0.00	0.00	0.00	0.00	0.00	0.00	00.11
	8-12	0.00	0.46	0.80	0.11	0.00	0.00	0.00	0.00	0.00	0.00	0.00	0.00	0.11	0.00	0.00	0.00	01.49
	13-18	0.00	0.00	0.00	0.00	0.00	0.00	0.00	0.00	0.11	0.11	0.11	0.11	0.11	0.11	0.11	0.00	00.80
	19-24	0.46	0.00	0.00	0.00	0.00	0.00	0.00	0.00	0.11	1.03	0.34	0.00	0.23	0.00	0.00	0.00	02.17
	>24	0.34	0.00	0.00	0.00	0.00	0.00	0.00	0.11	0.34	0.34	0.00	0.00	0.23	0.46	0.11	0.00	01.94
	TOTALS		0.80	0.46	0.91	0.11	0.00	0.00	0.00	0.11	0.57	1.49	0.46	0.11	0.69	0.57	0.23	0.00
C	CALM																	00.00
	1-3	0.00	0.00	0.00	0.00	0.00	0.00	0.00	0.00	0.00	0.00	0.00	0.00	0.00	0.00	0.00	0.00	00.00
	4-7	0.00	0.11	0.11	0.00	0.00	0.00	0.00	0.00	0.00	0.00	0.00	0.00	0.00	0.00	0.00	0.00	00.23
	8-12	0.11	0.23	0.46	0.00	0.23	0.00	0.23	0.23	0.00	0.00	0.00	0.00	0.11	0.23	0.00	0.00	01.83
	13-18	0.00	0.11	0.00	0.11	0.00	0.00	0.11	0.00	0.23	0.11	0.80	0.11	0.11	0.11	0.23	0.11	02.17
	19-24	0.00	0.00	0.00	0.00	0.00	0.00	0.00	0.23	0.46	0.11	0.34	0.11	0.34	0.11	0.23	0.00	01.94
	>24	0.11	0.00	0.00	0.00	0.00	0.00	0.00	0.00	0.00	0.11	0.00	0.00	0.00	0.11	0.23	0.00	00.57
	TOTALS		0.23	0.46	0.57	0.11	0.23	0.00	0.34	0.46	0.69	0.34	1.14	0.23	0.57	0.57	0.69	0.11
D	CALM																	00.11
	1-3	0.00	0.00	0.00	0.00	0.00	0.00	0.00	0.00	0.00	0.00	0.23	0.00	0.00	0.00	0.00	0.00	00.23
	4-7	0.34	0.69	0.57	1.14	0.00	0.34	0.23	0.00	0.23	0.11	0.46	0.23	0.11	0.11	0.23	0.34	05.14
	8-12	0.69	1.49	0.46	0.69	0.23	0.46	0.91	0.69	1.37	0.34	0.57	0.69	0.46	0.34	0.57	0.57	10.51
	13-18	0.00	0.34	0.57	0.57	0.23	0.34	1.03	1.03	1.37	0.57	0.91	1.03	1.37	1.60	2.06	0.69	13.71
	19-24	0.11	0.00	0.00	0.00	0.57	0.11	0.34	0.46	0.34	0.80	0.57	0.11	0.34	0.46	1.03	0.34	05.60
	>24	0.23	0.00	0.00	0.00	0.00	0.00	0.00	0.46	1.37	1.60	0.34	0.34	0.34	0.46	1.60	0.69	07.43
	TOTALS		1.37	02.51	1.60	2.40	1.03	1.26	2.51	2.63	4.69	3.43	3.09	2.40	2.63	2.97	5.49	2.63
E	CALM																	00.11
	1-3	0.00	0.00	0.00	0.00	0.00	0.00	0.00	0.00	0.00	0.00	0.00	0.00	0.00	0.00	0.00	0.00	00.00
	4-7	0.11	0.00	0.11	0.00	0.00	0.00	0.00	0.00	0.00	0.11	0.11	0.00	0.23	0.11	0.00	0.00	00.80
	8-12	0.23	0.69	0.34	0.57	0.23	0.23	0.23	0.23	0.00	0.11	0.00	0.34	0.23	0.00	0.34	0.00	03.77
	13-18	0.23	0.00	0.11	0.91	0.34	1.49	0.23	0.11	0.57	0.91	0.46	0.11	0.23	0.23	0.34	0.34	06.63
	19-24	0.00	0.11	0.00	0.34	0.69	0.34	0.46	0.91	0.57	0.57	0.69	0.23	0.11	0.57	0.23	0.46	06.29
	>24	0.11	0.00	0.00	0.00	0.00	0.11	0.23	0.57	2.06	1.37	1.03	0.69	0.34	0.11	0.57	0.23	07.43
	TOTALS		0.69	0.80	0.57	1.83	1.26	2.17	1.14	1.83	3.20	3.09	2.29	1.37	1.14	1.03	1.49	1.03

LSCS-UFSAR

TABLE 2.3-25
(SHEET 2 OF 2)

MONTHLY THREE-WAY JOINT FREQUENCY DISTRIBUTION OF WIND SPEED.

WIND DIRECTION AND PASQUILL STABILITY CLASS FOR THE 375-FOOT

LEVEL AT LA SALLE COUNTY STATION (JUNE)

(Values in Percent of Total Observations)

STABILITY CATEGORY	SPEED (mph)	N	NNE	NE	ENE	E	ESE	SE	SSE	S	SSW	SW	WSW	W	WNW	NW	NNW	TOTAL
F	CALM																	00.23
	1-3	0.00	0.00	0.23	0.00	0.00	0.00	0.00	0.00	0.00	0.00	0.00	0.00	0.00	0.00	0.00	0.00	00.23
	4-7	0.00	0.11	0.00	0.11	0.00	0.00	0.00	0.00	0.00	0.00	0.00	0.11	0.00	0.00	0.00	0.00	00.34
	8-12	0.23	0.00	0.00	0.00	0.00	0.00	0.11	0.11	0.23	0.11	0.00	0.11	0.00	0.11	0.46	0.34	01.83
	13-18	0.11	0.00	0.00	0.00	0.11	0.00	0.11	0.11	0.57	0.11	0.00	0.00	0.00	0.23	0.00	0.11	01.49
	19-24	0.00	0.00	0.00	0.11	0.23	0.34	0.80	0.46	0.34	0.11	0.80	0.00	0.46	0.23	0.00	0.00	03.89
	>24	0.00	0.00	0.00	0.00	0.00	0.23	0.57	0.80	0.57	0.91	1.03	0.11	0.34	0.46	0.23	0.00	05.26
	TOTALS		0.34	0.11	0.23	0.23	0.34	0.57	1.60	1.49	1.71	1.26	1.83	0.34	0.80	1.03	0.69	0.46
G	CALM																	00.00
	1-3	0.00	0.00	0.00	0.00	0.00	0.00	0.00	0.00	0.00	0.00	0.00	0.00	0.00	0.00	0.11	0.00	00.11
	4-7	0.00	0.00	0.00	0.00	0.00	0.00	0.00	0.00	0.00	0.00	0.00	0.00	0.00	0.00	0.00	0.11	00.11
	8-12	0.00	0.00	0.00	0.00	0.00	0.00	0.00	0.00	0.11	0.00	0.00	0.00	0.00	0.00	0.00	0.00	00.11
	13-18	0.00	0.00	0.00	0.00	0.00	0.00	0.00	0.00	0.23	0.00	0.00	0.00	0.00	0.11	0.11	0.11	00.57
	19-24	0.00	0.00	0.00	0.00	0.00	0.00	0.00	0.00	0.11	0.11	0.11	0.00	0.00	0.11	0.23	0.00	00.69
	>24	0.00	0.00	0.00	0.00	0.00	0.00	0.00	0.00	0.23	0.00	0.11	0.00	0.00	0.00	0.11	0.00	00.46
	TOTALS		0.00	0.00	0.00	0.00	0.00	0.00	0.00	0.69	0.11	0.23	0.00	0.00	0.23	0.57	0.23	02.06

Note: Stability is based on 33- and 375-foot ΔT for the period of record (October 1, 1976 – September 30, 1978).

LSCS-UFSAR

TABLE 2.3-26
(SHEET 1 OF 2)

MONTHLY THREE-WAY JOINT FREQUENCY DISTRIBUTION OF WIND SPEED.

WIND DIRECTION AND PASQUILL STABILITY CLASS FOR THE 375-FOOT

LEVEL AT LA SALLE COUNTY STATION (JULY)

(Values in Percent of Total Observations)

STABILITY CATEGORY	SPEED (mph)	N	NNE	NE	ENE	E	ESE	SE	SSE	S	SSW	SW	WSW	W	WNW	NW	NNW	TOTAL
A	CALM																	00.00
	1-3	0.00	0.00	0.00	0.00	0.00	0.00	0.00	0.00	0.00	0.00	0.00	0.11	0.11	0.00	0.00	0.00	00.22
	4-7	0.00	0.00	0.11	0.00	0.00	0.00	0.00	0.00	0.22	0.43	0.00	0.11	0.00	0.00	0.00	0.00	00.86
	8-12	0.00	0.00	0.11	0.86	0.11	0.00	0.00	0.00	0.11	0.32	0.11	0.22	0.22	0.00	0.00	0.00	01.40
	13-18	0.32	0.11	0.43	0.00	0.00	0.00	0.00	0.00	0.11	0.00	0.11	0.32	0.00	0.00	0.00	0.00	01.40
	19-24	0.00	0.00	0.00	0.00	0.00	0.00	0.00	0.00	0.00	0.00	0.00	0.00	0.00	0.00	0.00	0.00	00.00
	>24	0.00	0.00	0.00	0.00	0.00	0.00	0.00	0.00	0.00	0.11	0.00	0.00	0.00	0.00	0.00	0.00	00.11
	TOTALS		0.32	0.11	0.65	0.86	0.11	0.00	0.00	0.43	0.86	0.22	0.65	0.32	0.11	0.00	0.00	0.11
B	CALM																	00.00
	1-3	0.00	0.00	0.00	0.00	0.00	0.00	0.00	0.00	0.00	0.00	0.00	0.00	0.00	0.00	0.00	0.00	00.00
	4-7	0.00	0.00	0.00	0.00	0.00	0.00	0.00	0.00	0.00	0.11	0.11	0.00	0.00	0.11	0.00	0.00	00.32
	8-12	0.00	0.00	0.11	0.00	0.00	0.00	0.00	0.00	0.00	0.00	0.22	0.11	0.11	0.00	0.00	0.00	00.54
	13-18	0.00	0.00	0.11	0.00	0.00	0.00	0.00	0.00	0.00	0.00	0.00	0.00	0.00	0.00	0.00	0.00	00.11
	19-24	0.00	0.00	0.00	0.00	0.00	0.00	0.00	0.00	0.00	0.00	0.00	0.00	0.00	0.00	0.00	0.00	00.00
	>24	0.00	0.00	0.00	0.00	0.00	0.00	0.00	0.00	0.00	0.00	0.00	0.00	0.00	0.00	0.00	0.00	00.00
	TOTALS		0.00	0.00	0.22	0.00	0.00	0.00	0.00	0.00	0.00	0.32	0.22	0.11	0.00	0.11	0.00	0.00
C	CALM																	00.00
	1-3	0.00	0.00	0.00	0.00	0.00	0.00	0.00	0.00	0.00	0.00	0.00	0.00	0.00	0.00	0.00	0.00	00.00
	4-7	0.00	0.00	0.00	0.00	0.00	0.00	0.00	0.00	0.11	0.00	0.00	0.00	0.00	0.00	0.00	0.00	00.11
	8-12	0.00	0.00	0.00	0.00	0.00	0.00	0.00	0.00	0.00	0.22	0.00	0.00	0.00	0.00	0.00	0.00	00.22
	13-18	0.00	0.00	0.11	0.00	0.00	0.00	0.00	0.00	0.00	0.00	0.00	0.11	0.00	0.00	0.00	0.00	00.22
	19-24	0.00	0.00	0.00	0.00	0.00	0.00	0.00	0.00	0.22	0.32	0.00	0.00	0.00	0.00	0.00	0.00	00.54
	>24	0.00	0.00	0.00	0.00	0.00	0.00	0.00	0.00	0.00	0.32	0.32	0.00	0.00	0.00	0.00	0.00	00.32
	TOTALS		0.00	0.00	0.11	0.00	0.00	0.00	0.00	0.00	0.32	0.86	0.11	0.00	0.00	0.00	0.00	0.00
D	CALM																	00.11
	1-3	0.00	0.22	0.00	0.00	0.11	0.00	0.22	0.22	0.00	0.11	0.11	0.22	0.00	0.00	0.00	0.00	01.19
	4-7	1.40	1.08	0.32	0.32	0.22	0.22	0.11	0.54	0.76	0.32	0.76	0.65	0.32	0.11	0.22	0.43	07.78
	8-12	1.62	1.19	0.43	1.19	0.43	0.32	0.32	0.65	1.30	1.30	0.22	1.73	1.19	0.22	0.76	0.65	13.50
	13-18	0.11	1.30	0.86	0.43	0.32	0.11	0.32	1.19	1.62	1.51	0.86	1.51	1.19	1.19	0.97	0.54	14.04
	19-24	0.22	0.00	0.00	0.00	0.00	0.00	0.22	0.11	1.19	0.65	0.00	0.86	0.65	0.00	0.22	0.22	04.32
	>24	0.00	0.00	0.00	0.00	0.00	0.00	0.00	0.22	0.11	0.54	0.11	0.00	0.32	0.65	0.00	0.00	01.94
	TOTALS		3.35	3.78	1.62	1.94	1.08	0.65	1.19	2.92	4.97	4.43	2.05	4.97	3.67	2.16	2.16	1.84
E	CALM																	00.22
	1-3	0.00	0.11	0.00	0.00	0.00	0.00	0.00	0.00	0.00	0.11	0.00	0.00	0.00	0.00	0.00	0.22	00.43
	4-7	0.00	0.32	0.11	0.32	0.22	0.11	0.32	0.32	0.43	0.43	0.11	0.00	0.22	0.11	0.22	0.00	03.24
	8-12	0.22	0.32	0.22	0.86	0.32	0.11	0.11	0.32	0.00	0.65	0.11	0.97	0.43	0.11	0.11	0.00	04.86
	13-18	0.00	0.00	0.43	1.19	0.65	0.32	0.22	0.76	0.97	0.97	0.86	0.76	0.43	0.22	0.32	0.43	08.53
	19-24	0.00	0.00	0.00	0.32	0.54	0.11	0.65	0.97	1.40	1.08	1.08	0.86	0.22	0.22	0.22	0.11	07.78
	>24	0.00	0.00	0.00	0.00	0.11	0.00	0.00	0.54	1.19	1.30	0.76	0.54	0.00	0.11	0.00	0.00	04.54
	TOTALS		0.22	0.76	0.76	2.70	1.84	0.65	1.30	2.92	4.00	4.54	2.92	3.13	1.30	0.76	0.86	0.76

LSCS-UFSAR

TABLE 2.3-26
(SHEET 2 OF 2)

MONTHLY THREE-WAY JOINT FREQUENCY DISTRIBUTION OF WIND SPEED.

WIND DIRECTION AND PASQUILL STABILITY CLASS FOR THE 375-FOOT

LEVEL AT LA SALLE COUNTY STATION (JULY)

(Values in Percent of Total Observation)

STABILITY CATEGORY	SPEED (mph)	N	NNE	NE	ENE	E	ESE	SE	SSE	S	SSW	SW	WSW	W	WNW	NW	NNW	TOTAL
F	CALM																	00.22
	1-3	0.00	0.00	0.00	0.00	0.00	0.11	0.00	0.00	0.00	0.00	0.00	0.00	0.11	0.00	0.00	0.00	00.22
	4-7	0.00	0.00	0.11	0.00	0.22	0.00	0.11	0.22	0.00	0.00	0.00	0.11	0.11	0.00	0.00	0.11	00.97
	8-12	0.00	0.00	0.22	0.22	0.11	0.32	0.11	0.00	0.11	0.43	0.65	0.32	0.00	0.00	0.00	0.00	02.48
	13-18	0.00	0.00	0.00	0.00	0.32	0.11	0.32	0.00	0.97	0.65	0.43	0.11	0.22	0.43	0.00	0.43	04.10
	19-24	0.00	0.00	0.00	0.32	0.32	0.54	0.54	0.11	0.54	1.08	0.22	0.32	0.76	0.00	0.43	0.22	05.40
	>24	0.00	0.00	0.00	0.00	0.11	0.22	0.00	0.00	0.76	0.65	1.08	1.19	0.22	0.00	0.00	0.00	04.21
	TOTALS		0.00	0.00	0.32	0.54	1.08	1.30	1.08	0.43	2.38	2.81	2.38	2.05	1.40	0.43	0.43	0.76
G	CALM																	00.00
	1-3	0.00	0.00	0.00	0.00	0.00	0.00	0.00	0.00	0.00	0.00	0.00	0.00	0.00	0.00	0.00	0.00	00.00
	4-7	0.11	0.00	0.00	0.00	0.00	0.00	0.00	0.00	0.00	0.00	0.00	0.00	0.22	0.00	0.00	0.00	00.32
	8-12	0.00	0.00	0.00	0.00	0.00	0.00	0.00	0.00	0.00	0.00	0.00	0.11	0.00	0.00	0.11	0.22	00.43
	13-18	0.00	0.00	0.00	0.00	0.00	0.00	0.00	0.00	0.11	0.00	0.00	0.00	0.00	0.00	0.00	0.22	00.32
	19-24	0.00	0.00	0.00	0.00	0.00	0.11	0.32	0.11	0.00	0.11	0.11	0.00	0.00	0.00	0.11	0.22	00.97
	>24	0.00	0.00	0.00	0.00	0.11	0.00	0.32	0.00	0.11	0.11	0.00	0.11	0.00	0.00	0.00	0.00	00.76
	TOTALS		0.11	0.00	0.00	0.00	0.11	0.11	0.65	0.11	0.22	0.22	0.00	0.22	0.22	0.00	0.22	0.65

Note: Stability is based on 33- and 375-foot ΔT for the period of record (October 1, 1976 – September 30, 1978).

LSCS-UFSAR

TABLE 2.3-27
(SHEET 1 OF 2)

MONTHLY THREE-WAY JOINT FREQUENCY DISTRIBUTION OF WIND SPEED.

WIND DIRECTION AND PASQUILL STABILITY CLASS FOR THE 375-FOOT

LEVEL AT LA SALLE COUNTY STATION (AUGUST)

(Values in Percent of Total Observation)

STABILITY CATEGORY	SPEED (mph)	N	NNE	NE	ENE	E	ESE	SE	SSE	S	SSW	SW	WSW	W	WNW	NW	NNW	TOTAL
A	CALM																	00.00
	1-3	0.00	0.00	0.09	0.00	0.00	0.00	0.00	0.09	0.09	0.00	0.00	0.00	0.00	0.09	0.00	0.00	00.37
	4-7	0.00	0.00	0.09	0.00	0.00	0.00	0.00	0.00	0.00	0.00	0.00	0.00	0.00	0.00	0.00	0.00	00.09
	8-12	0.00	0.00	0.00	0.00	0.09	0.00	0.00	0.00	0.00	0.00	0.00	0.00	0.00	0.00	0.09	0.00	00.18
	13-18	0.00	0.00	0.00	0.00	0.00	0.00	0.00	0.00	0.00	0.00	0.18	0.09	0.00	0.00	0.00	0.00	00.27
	19-24	0.00	0.00	0.00	0.00	0.00	0.00	0.00	0.00	0.00	0.09	0.09	0.00	0.00	0.00	0.00	0.00	00.18
	>24	0.00	0.00	0.00	0.00	0.00	0.00	0.00	0.00	0.00	0.00	0.00	0.00	0.00	0.00	0.00	0.00	00.00
	TOTALS		0.00	0.00	0.18	0.00	0.09	0.00	0.00	0.09	0.18	0.27	0.09	0.00	0.00	0.09	0.09	0.00
B	CALM																	00.00
	1-3	0.09	0.00	0.00	0.00	0.00	0.00	0.00	0.00	0.00	0.00	0.00	0.00	0.00	0.09	0.00	0.00	00.18
	4-7	0.00	0.00	0.00	0.09	0.00	0.00	0.00	0.00	0.00	0.00	0.00	0.00	0.00	0.00	0.00	0.00	00.09
	8-12	0.00	0.00	0.00	0.00	0.00	0.00	0.00	0.00	0.00	0.00	0.00	0.00	0.09	0.00	0.00	0.00	00.09
	13-18	0.00	0.00	0.00	0.00	0.00	0.00	0.00	0.00	0.00	0.00	0.18	0.27	0.00	0.00	0.00	0.00	00.46
	19-24	0.00	0.00	0.00	0.00	0.00	0.00	0.00	0.00	0.00	0.00	0.00	0.00	0.00	0.00	0.00	0.00	00.00
	>24	0.00	0.00	0.00	0.00	0.00	0.00	0.00	0.00	0.00	0.00	0.00	0.00	0.00	0.00	0.00	0.00	00.00
	TOTALS		0.09	0.00	0.00	0.09	0.00	0.00	0.00	0.00	0.00	0.18	0.27	0.00	0.09	0.09	0.00	0.00
C	CALM																	00.00
	1-3	0.00	0.00	0.00	0.00	0.00	0.00	0.00	0.00	0.00	0.00	0.00	0.00	0.00	0.00	0.00	0.00	00.00
	4-7	0.00	0.00	0.00	0.00	0.00	0.00	0.00	0.00	0.00	0.00	0.00	0.00	0.00	0.00	0.00	0.00	00.00
	8-12	0.00	0.00	0.00	0.00	0.00	0.00	0.00	0.00	0.09	0.00	0.00	0.00	0.00	0.00	0.00	0.00	00.09
	13-18	0.00	0.00	0.00	0.00	0.00	0.00	0.00	0.00	0.00	0.00	0.18	0.09	0.00	0.00	0.00	0.00	00.27
	19-24	0.00	0.00	0.00	0.00	0.00	0.00	0.00	0.00	0.00	0.27	0.09	0.00	0.00	0.00	0.00	0.00	00.37
	>24	0.00	0.00	0.00	0.00	0.00	0.00	0.00	0.00	0.00	0.00	0.00	0.09	0.00	0.00	0.00	0.00	00.09
	TOTALS		0.00	0.00	0.00	0.00	0.00	0.00	0.00	0.00	0.09	0.27	0.27	0.18	0.00	0.00	0.00	0.00
D	CALM																	00.46
	1-3	0.18	0.27	0.09	0.18	0.00	0.27	0.27	0.00	0.18	0.00	0.09	0.00	0.09	0.09	0.09	0.27	02.10
	4-7	1.19	0.55	0.55	0.09	0.37	0.91	1.46	1.01	0.64	0.55	0.18	0.37	0.55	0.73	1.01	1.28	11.43
	8-12	0.18	0.73	0.55	0.18	0.27	0.73	2.38	1.37	1.19	1.37	0.64	0.91	1.01	1.65	1.10	0.82	15.08
	13-18	0.18	0.37	0.18	0.09	0.09	0.37	1.10	1.28	1.19	1.83	0.37	0.18	0.27	1.28	1.10	0.82	10.69
	19-24	0.00	0.00	0.00	0.00	0.00	0.00	0.00	0.55	0.91	1.01	0.46	0.64	0.18	0.46	0.82	0.18	05.21
	>24	0.00	0.00	0.00	0.00	0.00	0.00	0.00	0.09	0.46	0.46	0.09	0.64	0.00	0.00	0.00	0.09	01.83
	TOTALS		1.74	1.92	1.37	0.55	0.73	2.29	5.21	4.30	4.57	5.21	1.83	2.74	2.10	4.20	4.11	3.47

LSCS-UFSAR

TABLE 2.3-27
(SHEET 2 OF 2)

MONTHLY THREE-WAY JOINT FREQUENCY DISTRIBUTION OF WIND SPEED.

WIND DIRECTION AND PASQUILL STABILITY CLASS FOR THE 375-FOOT

LEVEL AT LA SALLE COUNTY STATION (AUGUST)

(Values in Percent of Total Observation)

STABILITY CATEGORY	SPEED (mph)	N	NNE	NE	ENE	E	ESE	SE	SSE	S	SSW	SW	WSW	W	WNW	NW	NNW	TOTAL
E	CALM																	00.91
	1-3	0.00	0.37	0.27	0.00	0.00	0.00	0.00	0.00	0.09	0.00	0.00	0.18	0.09	0.09	0.09	0.09	01.28
	4-7	0.27	0.18	0.18	0.27	0.18	0.27	0.37	0.55	0.27	0.46	0.00	0.09	0.27	0.09	0.09	0.00	03.56
	8-12	0.37	0.27	0.37	0.27	0.55	0.64	0.27	0.27	0.09	0.09	0.09	0.27	0.18	0.37	0.37	0.37	04.84
	13-18	0.18	0.09	0.18	0.18	0.82	0.82	0.82	1.01	0.27	0.27	1.01	0.27	0.18	0.09	0.55	0.64	07.40
	19-24	0.27	0.00	0.00	0.09	0.09	0.18	0.37	1.10	1.10	0.73	0.73	0.18	0.09	0.09	0.09	0.55	05.67
	>24	0.00	0.00	0.00	0.00	0.00	0.00	0.18	0.46	1.37	0.46	0.27	0.09	0.00	0.00	0.00	0.00	02.83
	TOTALS	1.10	0.91	1.01	0.82	1.65	1.92	2.01	3.38	3.20	2.01	2.10	1.10	0.82	0.73	1.19	1.65	26.51
F	CALM																	00.18
	1-3	0.00	0.00	0.00	0.00	0.00	0.00	0.00	0.09	0.00	0.09	0.00	0.00	0.00	0.00	0.00	0.00	00.18
	4-7	0.18	0.37	0.27	0.09	0.18	0.46	0.18	0.18	0.18	0.09	0.18	0.00	0.09	0.09	0.18	0.00	02.74
	8-12	0.46	0.18	0.09	0.18	0.00	0.27	0.27	0.64	0.00	0.09	0.27	0.18	0.27	0.27	0.27	0.64	04.11
	13-18	0.27	0.09	0.00	0.00	0.27	0.46	0.64	1.10	0.27	0.00	1.10	0.37	0.09	0.55	0.27	0.18	05.67
	19-24	0.09	0.00	0.00	0.00	0.00	0.18	0.55	0.73	0.46	0.37	0.46	0.27	0.00	0.00	0.00	0.27	03.29
	>24	0.00	0.00	0.00	0.00	0.00	0.00	0.37	0.37	0.46	0.00	0.27	0.18	0.00	0.00	0.00	0.00	01.65
	TOTALS	1.01	0.64	0.37	0.27	0.46	1.37	2.01	3.11	1.37	0.55	2.29	1.01	0.46	0.91	0.73	1.10	17.82
G	CALM																	00.00
	1-3	0.00	0.00	0.00	0.00	0.00	0.00	0.00	0.27	0.00	0.00	0.00	0.00	0.00	0.00	0.00	0.00	00.27
	4-7	0.00	0.00	0.00	0.00	0.00	0.00	0.00	0.18	0.00	0.00	0.00	0.00	0.00	0.00	0.00	0.00	00.18
	8-12	0.00	0.00	0.00	0.00	0.09	0.00	0.27	0.09	0.37	0.00	0.00	0.00	0.00	0.00	0.09	0.00	00.91
	13-18	0.00	0.00	0.00	0.00	0.09	0.00	0.00	0.46	0.09	0.00	0.09	0.00	0.09	0.09	0.09	0.00	01.01
	19-24	0.00	0.00	0.00	0.00	0.00	0.18	0.27	0.46	0.55	0.00	0.18	0.27	0.00	0.00	0.00	0.00	01.92
	>24	0.00	0.00	0.00	0.00	0.00	0.00	0.09	0.18	0.27	0.55	0.46	0.27	0.00	0.00	0.00	0.00	01.83
	TOTALS	0.00	0.00	0.00	0.00	0.18	0.18	0.64	1.65	1.28	0.55	0.73	0.55	0.09	0.09	0.18	0.00	06.12

Note: Stability is based on 33- and 375-foot ΔT for the period of record (October 1, 1976 – September 30, 1978).

LSCS-UFSAR

TABLE 2.3-28
(SHEET 1 OF 2)

MONTHLY THREE-WAY JOINT FREQUENCY DISTRIBUTION OF WIND SPEED.

WIND DIRECTION AND PASQUILL STABILITY CLASS FOR THE 375-FOOT

LEVEL AT LA SALLE COUNTY STATION (SEPTEMBER)

(Values in Percent of Total Observation)

STABILITY CATEGORY	SPEED (mph)	N	NNE	NE	ENE	E	ESE	SE	SSE	S	SSW	SW	WSW	W	WNW	NW	NNW	TOTAL
A	CALM																	00.00
	1-3	0.00	0.00	0.00	0.00	0.00	0.00	0.00	0.00	0.00	0.00	0.00	0.00	0.00	0.00	0.00	0.00	00.00
	4-7	0.13	0.00	0.00	0.00	0.00	0.25	0.00	0.00	0.25	0.00	0.13	0.00	0.00	0.00	0.13	0.13	01.00
	8-12	0.00	0.00	0.00	0.11	0.13	0.13	0.25	0.00	0.63	0.13	0.13	0.00	0.00	0.00	0.00	0.13	01.63
	13-18	0.00	0.00	0.00	0.75	0.25	0.00	0.00	0.00	0.00	0.25	0.38	0.00	0.13	0.00	0.13	0.00	01.88
	19-24	0.00	0.00	0.00	0.00	0.00	0.00	0.00	0.00	0.75	0.13	0.25	0.00	0.00	0.13	0.00	0.00	01.25
	>24	0.00	0.00	0.00	0.00	0.00	0.00	0.00	0.00	0.00	0.00	0.25	0.50	0.25	0.38	0.00	0.00	01.38
	TOTALS		0.13	0.00	0.00	0.88	0.38	0.38	0.25	0.75	1.00	0.88	1.13	0.25	0.63	0.00	0.25	0.25
B	CALM																	00.00
	1-3	0.00	0.00	0.00	0.00	0.00	0.00	0.00	0.00	0.00	0.00	0.00	0.00	0.00	0.00	0.00	0.00	00.00
	4-7	0.00	0.00	0.00	0.00	0.13	0.00	0.00	0.00	0.00	0.00	0.13	0.00	0.00	0.00	0.00	0.13	00.38
	8-12	0.00	0.00	0.00	0.00	0.13	0.13	0.63	0.13	0.13	0.38	0.13	0.13	0.00	0.00	0.00	0.38	02.13
	13-18	0.00	0.00	0.00	0.13	0.13	0.13	0.00	0.25	0.25	0.00	0.50	0.00	0.00	0.00	0.50	0.25	02.13
	19-24	0.00	0.00	0.00	0.13	0.00	0.00	0.00	0.00	0.13	0.00	0.13	0.00	0.13	0.13	0.25	0.00	00.88
	>24	0.00	0.00	0.00	0.13	0.00	0.00	0.00	0.00	0.00	0.00	0.00	0.00	0.00	0.00	0.00	0.00	00.13
	TOTALS		0.00	0.00	0.00	0.38	0.38	0.25	0.63	0.38	0.50	0.38	0.88	0.13	0.13	0.13	0.75	0.75
C	CALM																	00.00
	1-3	0.00	0.00	0.00	0.00	0.00	0.00	0.00	0.00	0.00	0.00	0.13	0.00	0.00	0.00	0.00	0.00	00.13
	4-7	0.13	0.00	0.13	0.00	0.00	0.13	0.00	0.00	0.13	0.00	0.00	0.00	0.00	0.00	0.00	0.00	00.50
	8-12	0.00	0.00	0.00	0.00	0.00	0.13	0.25	0.00	0.00	0.00	0.00	0.00	0.00	0.00	0.13	0.13	00.63
	13-18	0.00	0.00	0.00	0.25	0.13	0.00	0.13	0.00	0.13	0.00	0.38	0.13	0.13	0.00	0.38	0.00	01.63
	19-24	0.00	0.00	0.00	0.25	0.25	0.00	0.00	0.00	0.13	0.00	0.00	0.00	0.00	0.00	0.00	0.00	00.63
	>24	0.00	0.00	0.00	0.13	0.00	0.00	0.00	0.00	0.00	0.00	0.00	0.00	0.00	0.00	0.00	0.00	00.13
	TOTALS		0.13	0.00	0.13	0.63	0.38	0.25	0.38	0.00	0.38	0.00	0.50	0.13	0.13	0.00	0.50	0.13
D	CALM																	00.13
	1-3	0.00	0.00	0.00	0.00	0.00	0.00	0.00	0.00	0.00	0.00	0.25	0.13	0.00	0.00	0.00	0.00	00.38
	4-7	0.00	0.38	0.75	0.25	0.50	0.13	0.63	0.25	0.00	0.63	0.50	0.25	0.75	0.25	0.00	0.00	05.26
	8-12	0.00	0.25	1.50	0.50	0.25	0.13	0.00	0.38	0.63	2.00	0.88	0.25	0.75	0.13	0.13	0.00	07.76
	13-18	0.13	0.13	0.88	0.75	0.13	0.13	0.38	1.00	2.63	2.25	0.75	0.63	1.25	0.50	0.75	0.50	12.77
	19-24	0.00	0.00	0.00	0.75	0.75	1.13	0.38	0.50	1.38	1.00	0.50	0.25	1.38	0.50	0.00	0.13	08.64
	>24	0.13	0.00	0.00	0.13	0.00	0.00	0.00	0.13	0.13	0.50	0.25	0.00	0.38	0.00	0.00	0.00	01.63
	TOTALS		0.25	0.75	3.13	2.38	1.63	1.50	1.38	2.25	4.76	6.38	3.13	1.50	4.51	1.38	0.88	0.63

LSCS-UFSAR

TABLE 2.3-28
(SHEET 2 OF 2)

MONTHLY THREE-WAY JOINT FREQUENCY DISTRIBUTION OF WIND SPEED.

WIND DIRECTION AND PASQUILL STABILITY CLASS FOR THE 375-FOOT

LEVEL AT LA SALLE COUNTY STATION (SEPTEMBER)

(Values in Percent of Total Observation)

STABILITY CATEGORY	SPEED (mph)	N	NNE	NE	ENE	E	ESE	SE	SSE	S	SSW	SW	WSW	W	WNW	NW	NNW	TOTAL
E	CALM																	00.00
	1-3	0.00	0.25	0.00	0.00	0.00	0.00	0.00	0.00	0.13	0.00	0.00	0.00	0.00	0.00	0.00	0.00	00.38
	4-7	0.38	0.25	0.00	0.13	0.38	0.50	0.63	0.25	0.13	0.13	0.13	0.00	0.13	0.00	0.00	0.00	03.00
	8-12	0.00	0.13	0.00	0.38	0.38	0.13	0.00	0.38	0.50	0.00	0.13	0.13	0.00	0.25	0.13	0.13	02.63
	13-18	0.00	0.75	0.25	0.38	0.00	0.13	0.13	0.75	0.88	1.13	0.00	0.25	0.13	0.00	0.25	0.00	05.01
	19-24	0.13	0.00	0.00	0.63	0.00	0.25	0.13	1.25	1.38	1.00	0.75	0.00	0.38	0.50	0.75	0.38	07.51
	>24	0.00	0.00	0.00	0.00	0.00	0.00	0.00	0.00	0.50	0.38	0.00	0.00	0.13	0.38	0.00	0.00	01.38
	TOTALS	0.50	1.38	0.25	1.50	0.75	1.00	0.88	2.63	3.50	2.63	1.00	0.38	0.75	1.13	1.13	0.50	19.90
F	CALM																	00.13
	1-3	0.00	0.00	0.00	0.00	0.00	0.00	0.00	0.00	0.13	0.00	0.00	0.00	0.00	0.00	0.00	0.00	00.13
	4-7	0.00	0.00	0.00	0.00	0.13	0.13	0.25	0.00	0.13	0.00	0.00	0.00	0.13	0.00	0.00	0.00	00.75
	8-12	0.00	0.38	0.00	0.00	0.25	0.88	0.38	0.50	0.75	0.38	0.13	0.13	0.13	0.00	0.00	0.00	03.88
	13-18	0.13	0.25	0.00	0.13	0.50	0.13	0.00	0.25	0.00	0.38	0.00	0.13	0.13	0.00	0.00	0.13	02.13
	19-24	0.00	0.00	0.00	0.25	0.75	0.25	0.13	0.75	0.50	1.38	1.38	0.38	0.50	0.13	0.75	0.38	07.51
	>24	0.38	0.00	0.00	0.00	0.00	0.00	0.00	0.38	0.13	1.13	0.50	0.25	0.38	0.13	0.00	0.00	03.25
	TOTALS	0.50	0.63	0.00	0.38	1.63	1.38	0.75	1.88	1.63	3.25	2.00	0.88	1.25	0.25	0.75	0.50	17.77
G	CALM																	00.00
	1-3	0.00	0.00	0.00	0.00	0.00	0.00	0.00	0.00	0.00	0.00	0.00	0.00	0.00	0.00	0.00	0.00	00.00
	4-7	0.00	0.00	0.00	0.00	0.00	0.00	0.00	0.00	0.00	0.00	0.00	0.00	0.00	0.00	0.00	0.00	00.00
	8-12	0.00	0.00	0.00	0.00	0.00	0.00	0.00	0.25	0.00	0.00	0.25	0.50	0.13	0.00	0.00	0.00	01.13
	13-18	0.00	0.00	0.00	0.00	0.00	0.00	0.00	0.00	0.00	0.13	0.00	0.50	1.13	0.38	0.13	0.00	02.25
	19-24	0.13	0.00	0.00	0.00	0.25	0.25	0.25	0.25	0.13	0.63	1.00	0.38	0.75	0.13	0.00	0.00	04.13
	>24	0.00	0.00	0.00	0.00	0.00	0.00	0.25	0.38	0.00	0.25	0.75	0.13	0.13	0.00	0.00	0.00	01.88
	TOTALS	0.13	0.00	0.00	0.00	0.25	0.25	0.50	0.88	0.25	0.88	2.50	2.13	1.38	0.25	0.00	0.00	09.39

Note: Stability is based on 33- and 375-foot ΔT for the period of record (October 1, 1976 – September 30, 1978).

LSCS-UFSAR

TABLE 2.3-29
(SHEET 1 OF 2)

MONTHLY THREE-WAY JOINT FREQUENCY DISTRIBUTION OF WIND SPEED.

WIND DIRECTION AND PASQUILL STABILITY CLASS FOR THE 375-FOOT

LEVEL AT LA SALLE COUNTY STATION (OCTOBER)

(Values in Percent of Total Observation)

STABILITY CATEGORY	SPEED (mph)	N	NNE	NE	ENE	E	ESE	SE	SSE	S	SSW	SW	WSW	W	WNW	NW	NNW	TOTAL
A	CALM																	00.00
	1-3	0.09	0.00	0.00	0.00	0.00	0.00	0.00	0.00	0.00	0.00	0.00	0.00	0.00	0.00	0.00	0.00	00.09
	4-7	0.00	0.00	0.00	0.00	0.00	0.00	0.00	0.00	0.00	0.00	0.00	0.00	0.00	0.00	0.00	0.00	00.00
	8-12	0.09	0.00	0.00	0.18	0.00	0.00	0.00	0.00	0.18	0.00	0.00	0.00	0.00	0.00	0.00	0.00	00.44
	13-18	0.00	0.00	0.00	0.35	0.26	0.00	0.00	0.00	0.79	0.88	0.00	0.00	0.00	0.09	0.09	0.00	02.47
	19-24	0.00	0.00	0.00	0.09	0.00	0.00	0.00	0.00	0.18	0.00	0.00	0.00	0.00	0.09	0.00	0.09	00.44
	>24	0.00	0.00	0.00	0.00	0.00	0.00	0.00	0.26	0.18	0.09	0.00	0.26	0.00	0.00	0.00	0.00	00.79
	TOTALS	0.18	0.00	0.00	0.62	0.26	0.00	0.00	0.26	1.32	0.97	0.00	0.26	0.00	0.18	0.09	0.09	04.23
B	CALM																	00.00
	1-3	0.00	0.00	0.00	0.00	0.00	0.00	0.00	0.00	0.00	0.00	0.00	0.00	0.00	0.00	0.00	0.00	00.00
	4-7	0.09	0.00	0.00	0.18	0.00	0.00	0.00	0.00	0.09	0.35	0.09	0.00	0.09	0.35	0.09	0.18	01.50
	8-12	0.09	0.00	0.00	0.00	0.18	0.00	0.00	0.00	0.53	0.00	0.00	0.00	0.09	0.35	0.35	0.18	01.76
	13-18	0.09	0.26	0.00	0.35	0.09	0.00	0.00	0.00	0.18	0.00	0.00	0.18	0.18	0.62	0.26	0.18	02.38
	19-24	0.09	0.62	0.09	0.18	0.00	0.00	0.00	0.09	0.18	0.00	0.00	0.09	0.35	0.53	0.09	0.44	02.73
	>24	0.00	0.18	0.00	0.09	0.00	0.00	0.00	0.00	0.26	0.00	0.18	0.79	0.26	0.00	0.00	0.00	01.76
	TOTALS	0.35	1.06	0.09	0.79	0.26	0.00	0.00	0.09	1.23	0.35	0.26	1.06	0.97	1.85	0.79	0.97	10.13
C	CALM																	00.00
	1-3	0.00	0.00	0.00	0.00	0.00	0.00	0.00	0.00	0.09	0.00	0.00	0.00	0.00	0.00	0.00	0.00	00.09
	4-7	0.00	0.00	0.09	0.00	0.00	0.00	0.00	0.00	0.00	0.09	0.09	0.09	0.09	0.00	0.00	0.09	00.53
	8-12	0.00	0.18	0.00	0.00	0.09	0.09	0.00	0.00	0.00	0.00	0.00	0.09	0.18	0.09	0.26	0.18	01.15
	13-18	0.09	0.35	0.35	0.18	0.18	0.09	0.00	0.00	0.00	0.00	0.00	0.09	0.00	0.18	0.53	0.35	02.38
	19-24	0.09	0.53	0.26	0.44	0.09	0.00	0.00	0.44	0.09	0.00	0.09	0.18	0.09	0.09	0.00	0.09	02.47
	>24	0.00	0.00	0.00	0.00	0.00	0.09	0.35	0.00	0.09	0.00	0.00	0.26	0.09	0.44	0.00	0.00	01.32
	TOTALS	0.18	1.06	0.70	0.62	0.35	0.26	0.35	0.44	0.26	0.09	0.18	0.70	0.44	0.79	0.79	0.70	07.93
D	CALM																	00.00
	1-3	0.00	0.00	0.00	0.00	0.00	0.00	0.00	0.00	0.00	0.00	0.09	0.00	0.00	0.09	0.00	0.00	00.18
	4-7	0.75	0.35	0.09	0.00	0.00	0.00	0.00	0.09	0.09	0.35	0.26	0.09	0.09	0.09	0.26	0.44	03.00
	8-12	0.79	0.70	0.44	0.35	0.44	0.44	0.09	0.18	0.09	0.35	0.44	0.44	0.09	0.53	0.35	0.26	05.99
	13-18	1.94	0.26	0.44	0.53	0.44	0.62	0.88	0.53	0.44	0.35	0.26	0.18	0.09	0.44	0.44	3.17	11.01
	19-24	1.06	0.35	0.35	0.88	0.00	0.26	0.00	1.85	0.88	1.23	0.62	0.62	1.50	0.35	0.26	2.64	12.86
	>24	0.26	0.00	0.00	0.18	0.00	0.18	0.00	0.53	0.53	0.09	0.09	0.44	0.97	0.53	0.00	0.09	03.88
	TOTALS	4.85	1.67	1.32	1.94	0.88	1.50	0.97	3.17	2.03	2.38	1.76	1.76	2.73	2.03	1.32	6.61	36.92

LSCS-UFSAR

TABLE 2.3-29
(SHEET 2 OF 2)

MONTHLY THREE-WAY JOINT FREQUENCY DISTRIBUTION OF WIND SPEED.

WIND DIRECTION AND PASQUILL STABILITY CLASS FOR THE 375-FOOT

LEVEL AT LA SALLE COUNTY STATION (OCTOBER)

STABILITY CATEGORY	SPEED (mph)	N	NNE	NE	ENE	E	ESE	SE	SSE	S	SSW	SW	WSW	W	WNW	NW	NNW	TOTAL
E	CALM																	00.00
	1-3	0.00	0.09	0.00	0.00	0.09	0.00	0.00	0.00	0.00	0.00	0.00	0.00	0.00	0.00	0.00	0.09	00.26
	4-7	0.35	0.18	0.09	0.00	0.00	0.00	0.00	0.00	0.44	0.00	0.26	0.00	0.18	0.00	0.26	0.18	01.94
	8-12	0.18	0.00	0.09	0.00	0.18	0.18	0.00	0.00	0.18	0.53	0.09	0.00	0.09	0.00	0.44	0.35	02.29
	13-18	0.35	0.44	0.18	0.09	0.70	0.26	0.00	0.09	0.44	0.00	0.35	0.09	0.00	0.18	0.09	0.53	03.79
	19-24	0.88	0.18	0.09	0.62	1.67	0.26	0.00	0.53	0.26	0.88	0.44	0.00	0.26	0.35	1.15	0.44	08.02
	>24	0.00	0.00	0.00	0.09	0.18	0.09	0.70	0.44	0.44	0.79	0.26	0.44	0.26	0.70	0.09	0.00	04.49
	TOTALS	1.76	0.88	0.44	0.79	2.82	0.79	0.70	1.06	1.76	2.20	1.41	0.53	0.79	1.23	2.03	1.59	20.79
F	CALM																	00.00
	1-3	0.00	0.00	0.00	0.00	0.00	0.00	0.00	0.09	0.00	0.00	0.00	0.00	0.00	0.00	0.00	0.00	00.09
	4-7	0.00	0.00	0.26	0.00	0.00	0.09	0.18	0.09	0.09	0.00	0.09	0.09	0.26	0.09	0.18	0.09	01.50
	8-12	0.18	0.09	0.00	0.00	0.18	0.26	0.00	0.09	0.35	0.26	0.35	0.09	0.09	0.18	0.18	0.18	02.47
	13-18	0.18	0.00	0.00	0.00	0.44	0.18	0.09	0.00	0.26	0.35	0.70	0.26	0.00	0.00	0.26	0.44	03.17
	19-24	0.00	0.00	0.00	0.00	0.26	0.09	0.09	0.00	0.44	0.26	0.62	0.18	0.00	0.09	0.79	0.35	03.17
	>24	0.00	0.00	0.00	0.00	0.18	0.35	0.18	0.18	0.88	0.44	0.97	0.09	0.35	0.09	0.09	0.09	03.88
	TOTALS	0.35	0.09	0.26	0.00	1.06	0.97	0.53	0.44	2.03	1.32	2.73	0.70	0.70	0.44	1.50	1.15	14.27
G	CALM																	00.09
	1-3	0.00	0.00	0.00	0.00	0.00	0.00	0.09	0.00	0.00	0.00	0.00	0.09	0.09	0.00	0.00	0.09	00.35
	4-7	0.09	0.00	0.00	0.00	0.00	0.00	0.00	0.00	0.09	0.00	0.00	0.35	0.18	0.18	0.09	0.09	01.06
	8-12	0.00	0.00	0.00	0.00	0.00	0.00	0.00	0.00	0.18	0.00	0.18	0.26	0.18	0.00	0.00	0.00	00.79
	13-18	0.00	0.00	0.00	0.00	0.00	0.00	0.00	0.00	0.26	0.26	0.35	0.18	0.00	0.00	0.00	0.00	01.06
	19-24	0.26	0.00	0.00	0.00	0.00	0.00	0.00	0.00	0.09	0.53	0.18	0.09	0.00	0.09	0.00	0.00	01.23
	>24	0.00	0.00	0.00	0.00	0.00	0.00	0.00	0.00	0.79	0.26	0.09	0.00	0.00	0.00	0.00	0.00	01.15
	TOTALS	0.35	0.00	0.00	0.00	0.00	0.00	0.00	0.09	0.00	1.41	1.06	0.79	0.97	0.44	0.26	0.09	05.73

Note: Stability is based on 33- and 375-foot ΔT for the period of record (October 1, 1976 – September 30, 1978).

LSCS-UFSAR

TABLE 2.3-30
(SHEET 1 OF 2)

MONTHLY THREE-WAY JOINT FREQUENCY DISTRIBUTION OF WIND SPEED.

WIND DIRECTION AND PASQUILL STABILITY CLASS FOR THE 375-FOOT

LEVEL AT LA SALLE COUNTY STATION (NOVEMBER)

(Values in Percent of Total Observation)

STABILITY CATEGORY	SPEED (mph)	N	NNE	NE	ENE	E	ESE	SE	SSE	S	SSW	SW	WSW	W	WNW	NW	NNW	TOTAL	
A	CALM																	00.00	
	1-3	0.00	0.00	0.00	0.00	0.00	0.00	0.00	0.00	0.00	0.00	0.00	0.00	0.00	0.00	0.00	0.00	00.00	
	4-7	0.00	0.00	0.00	0.00	0.00	0.00	0.00	0.00	0.00	0.00	0.00	0.00	0.00	0.00	0.00	0.00	00.00	
	8-12	0.00	0.00	0.00	0.00	0.00	0.00	0.00	0.00	0.07	0.00	0.07	0.00	0.00	0.00	0.00	0.00	00.15	
	13-18	0.00	0.07	0.37	0.00	0.00	0.00	0.00	0.00	0.07	0.15	0.07	0.00	0.07	0.07	0.00	0.07	00.97	
	19-24	0.00	0.00	0.07	0.00	0.00	0.00	0.00	0.00	0.00	0.22	0.07	0.07	0.37	0.15	0.15	0.07	00.00	01.20
	>24	0.00	0.00	0.00	0.00	0.00	0.00	0.00	0.00	0.00	0.00	0.07	0.07	0.45	0.00	0.07	0.00	00.00	00.67
	TOTALS		0.00	0.07	0.45	0.00	0.00	0.00	0.00	0.07	0.45	0.22	0.22	0.90	0.22	0.22	0.15	0.00	03.00
B	CALM																	00.00	
	1-3	0.07	0.07	0.00	0.00	0.00	0.00	0.00	0.00	0.00	0.00	0.00	0.00	0.00	0.00	0.00	0.00	00.15	
	4-7	0.30	0.22	0.00	0.00	0.00	0.00	0.00	0.00	0.00	0.00	0.00	0.00	0.00	0.00	0.00	0.00	00.52	
	8-12	0.37	0.22	0.37	0.00	0.07	0.00	0.00	0.07	0.22	0.00	0.07	0.00	0.30	0.15	0.00	0.00	01.87	
	13-18	0.07	0.15	0.60	0.00	0.07	0.00	0.00	0.30	0.00	0.07	0.00	0.00	0.07	0.07	0.00	0.00	01.42	
	19-24	0.07	0.07	0.07	0.00	0.00	0.00	0.00	0.07	0.00	0.00	0.00	0.07	0.22	0.52	0.07	0.00	01.20	
	>24	0.00	0.00	0.00	0.00	0.07	0.00	0.00	0.00	0.07	0.00	0.30	0.52	0.15	0.15	0.00	0.00	01.27	
	TOTALS		0.90	0.75	1.05	0.00	0.22	0.00	0.00	0.45	0.30	0.07	0.37	0.60	0.75	0.90	0.07	0.00	06.44
C	CALM																	00.07	
	1-3	0.07	0.00	0.00	0.00	0.00	0.00	0.00	0.00	0.00	0.00	0.00	0.00	0.15	0.00	0.07	0.00	00.30	
	4-7	0.00	0.00	0.00	0.00	0.00	0.07	0.00	0.07	0.00	0.07	0.07	0.15	0.07	0.00	0.07	0.00	00.60	
	8-12	0.22	0.52	0.00	0.00	0.00	0.00	0.00	0.22	0.00	0.07	0.00	0.15	0.07	0.00	0.00	0.00	01.27	
	13-18	0.22	0.22	0.22	0.00	0.22	0.00	0.22	0.00	0.07	0.00	0.07	0.00	0.15	0.37	0.15	0.00	01.95	
	19-24	0.07	0.07	0.00	0.00	0.00	0.00	0.07	0.00	0.07	0.00	0.00	0.07	0.30	0.07	0.00	0.00	00.75	
	>24	0.00	0.00	0.00	0.00	0.07	0.07	0.00	0.00	0.07	0.00	0.75	0.22	0.45	0.00	0.07	0.00	01.72	
	TOTALS		0.60	0.82	0.22	0.00	0.30	0.15	0.30	0.30	0.22	0.15	0.90	0.60	1.20	0.45	0.37	0.00	06.67
D	CALM																	00.07	
	1-3	0.07	0.00	0.07	0.00	0.00	0.00	0.00	0.00	0.00	0.00	0.00	0.00	0.15	0.00	0.00	0.00	00.30	
	4-7	0.07	0.07	0.00	0.00	0.00	0.00	0.00	0.22	0.00	0.22	0.22	0.22	0.22	0.00	0.00	0.00	01.27	
	8-12	0.30	0.22	0.37	0.52	0.00	0.00	0.15	0.22	0.67	0.15	0.45	0.60	1.12	0.60	0.22	0.07	05.69	
	13-18	0.22	0.30	1.65	0.15	0.15	0.15	0.15	0.45	0.45	0.60	0.52	0.52	2.55	2.40	1.95	0.45	12.66	
	19-24	0.07	0.22	0.15	0.15	0.30	0.60	0.67	1.35	0.22	0.37	0.60	0.97	1.57	5.17	2.32	0.45	15.21	
	>24	0.07	0.00	0.00	0.00	0.07	0.22	0.37	0.37	1.27	0.52	0.60	0.90	2.40	2.85	0.60	0.22	10.49	
	TOTALS		0.82	0.82	2.25	0.82	0.52	0.97	1.35	2.62	2.62	1.87	2.40	3.22	8.01	11.01	5.09	1.20	45.69

LSCS-UFSAR

TABLE 2.3-30
(SHEET 2 OF 2)

MONTHLY THREE-WAY JOINT FREQUENCY DISTRIBUTION OF WIND SPEED.

WIND DIRECTION AND PASQUILL STABILITY CLASS FOR THE 375-FOOT

LEVEL AT LA SALLE COUNTY STATION (NOVEMBER)

(Values in Percent of Total Observation)

STABILITY CATEGORY	SPEED (mph)	N	NNE	NE	ENE	E	ESE	SE	SSE	S	SSW	SW	WSW	W	WNW	NW	NNW	TOTAL
E	CALM																	00.07
	1-3	0.00	0.00	0.07	0.07	0.07	0.00	0.22	0.07	0.00	0.00	0.00	0.07	0.00	0.00	0.00	0.00	00.60
	4-7	0.00	0.00	0.07	0.37	0.00	0.00	0.15	0.00	0.15	0.00	0.00	0.15	0.15	0.15	0.15	0.07	01.42
	8-12	0.07	0.07	0.07	0.00	0.07	0.07	0.30	0.07	0.15	0.07	0.52	0.52	0.15	0.07	0.22	0.00	02.47
	13-18	0.00	0.00	0.30	0.15	0.22	0.37	0.67	0.37	0.00	0.45	0.07	0.60	0.75	1.42	1.12	0.15	06.67
	19-24	0.00	0.00	0.22	0.00	0.22	0.07	0.37	0.00	0.15	0.07	0.30	0.15	0.75	1.27	1.20	0.07	04.87
	>24	0.00	0.00	0.00	0.00	0.15	0.00	0.07	0.22	1.35	1.20	0.52	0.15	0.37	1.65	0.30	0.00	05.99
	TOTALS	0.07	0.07	0.75	0.60	0.75	0.52	1.80	0.75	1.80	1.80	1.42	1.65	2.17	4.57	3.00	0.30	22.10
F	CALM																	00.00
	1-3	0.00	0.00	0.00	0.00	0.07	0.00	0.07	0.00	0.00	0.00	0.00	0.00	0.00	0.00	0.00	0.00	00.15
	4-7	0.00	0.00	0.07	0.00	0.00	0.07	0.15	0.00	0.15	0.00	0.00	0.00	0.07	0.07	0.00	0.00	00.60
	8-12	0.00	0.00	0.07	0.30	0.00	0.07	0.07	0.00	0.00	0.00	0.00	0.15	0.30	0.60	0.15	0.07	01.80
	13-18	0.07	0.00	0.00	0.00	0.37	0.15	0.15	0.22	0.22	0.15	0.45	0.07	0.22	0.90	1.42	0.67	05.09
	19-24	0.00	0.00	0.00	0.00	0.30	0.30	0.00	0.15	0.22	0.22	0.22	0.15	0.82	0.22	0.37	0.00	03.00
	>24	0.00	0.00	0.00	0.00	0.00	0.00	0.00	0.07	0.45	0.52	0.75	0.45	1.05	0.90	0.00	0.00	04.19
	TOTALS	0.07	0.00	0.15	0.30	0.75	0.60	0.45	0.45	1.05	0.90	1.42	0.82	2.47	2.70	1.95	0.75	14.83
G	CALM																	00.00
	1-3	0.00	0.00	0.00	0.00	0.00	0.00	0.00	0.00	0.00	0.00	0.00	0.00	0.00	0.00	0.00	0.00	00.00
	4-7	0.00	0.00	0.00	0.00	0.00	0.00	0.00	0.00	0.00	0.00	0.00	0.00	0.00	0.07	0.00	0.00	00.07
	8-12	0.00	0.00	0.00	0.00	0.00	0.00	0.00	0.00	0.07	0.07	0.00	0.00	0.00	0.00	0.00	0.00	00.15
	13-18	0.00	0.00	0.00	0.00	0.00	0.00	0.00	0.00	0.00	0.07	0.22	0.30	0.00	0.07	0.00	0.00	00.67
	19-24	0.00	0.00	0.00	0.00	0.00	0.00	0.00	0.00	0.00	0.00	0.15	0.00	0.00	0.00	0.00	0.00	00.15
	>24	0.00	0.00	0.00	0.00	0.00	0.00	0.00	0.00	0.00	0.15	0.00	0.00	0.07	0.00	0.00	0.00	00.22
	TOTALS	0.00	0.00	0.00	0.00	0.00	0.00	0.00	0.00	0.07	0.30	0.37	0.30	0.07	0.15	0.00	0.00	01.27

Note: Stability is based on 33- and 375-foot ΔT for the period of record (October 1, 1976 – September 30, 1978).

LSCS-UFSAR

TABLE 2.3-31
(SHEET 1 OF 2)

MONTHLY THREE-WAY JOINT FREQUENCY DISTRIBUTION OF WIND SPEED.

WIND DIRECTION AND PASQUILL STABILITY CLASS FOR THE 375-FOOT

LEVEL AT LA SALLE COUNTY STATION (DECEMBER)

(Values in Percent of Total Observation)

STABILITY CATEGORY	SPEED (mph)	N	NNE	NE	ENE	E	ESE	SE	SSE	S	SSW	SW	WSW	W	WNW	NW	NNW	TOTAL
A	CALM																	00.15
	1-3	0.00	0.00	0.00	0.00	0.00	0.00	0.00	0.00	0.00	0.00	0.00	0.08	0.00	0.00	0.00	0.00	00.08
	4-7	0.00	0.00	0.00	0.00	0.08	0.15	0.08	0.00	0.00	0.00	0.00	0.00	0.00	0.00	0.00	0.00	00.30
	8-12	0.00	0.00	0.08	0.08	0.00	0.08	0.00	0.00	0.00	0.00	0.08	0.00	0.15	0.00	0.00	0.00	00.45
	13-18	0.00	0.00	0.00	0.00	0.00	0.00	0.15	0.00	0.00	0.00	0.00	0.53	0.76	0.00	0.00	0.00	01.44
	19-24	0.08	0.00	0.00	0.00	0.00	0.00	0.00	0.00	0.00	0.00	0.08	0.08	0.60	0.00	0.00	0.00	00.83
	>24	0.00	0.00	0.00	0.00	0.00	0.08	0.00	0.23	0.00	0.00	0.00	0.23	0.15	0.00	0.15	0.00	00.83
	TOTALS		0.08	0.00	0.08	0.08	0.08	0.30	0.23	0.23	0.00	0.00	0.15	0.91	1.66	0.00	0.15	0.00
B	CALM																	00.08
	1-3	0.00	0.00	0.00	0.00	0.00	0.00	0.00	0.00	0.00	0.00	0.00	0.00	0.00	0.00	0.08	0.00	00.08
	4-7	0.00	0.00	0.00	0.00	0.00	0.00	0.00	0.00	0.00	0.00	0.00	0.00	0.08	0.00	0.00	0.00	00.08
	8-12	0.00	0.00	0.23	0.00	0.00	0.00	0.00	0.00	0.00	0.00	0.00	0.00	0.00	0.00	0.00	0.00	00.23
	13-18	0.30	0.08	0.08	0.08	0.08	0.08	0.00	0.00	0.00	0.00	0.08	0.15	0.08	0.00	0.00	0.00	00.98
	19-24	0.00	0.00	0.00	0.00	0.00	0.15	0.15	0.00	0.00	0.00	0.00	0.00	0.00	0.00	0.00	0.08	00.38
	>24	0.00	0.00	0.00	0.00	0.00	0.00	0.00	0.00	0.00	0.00	0.15	0.08	0.00	0.38	0.00	0.00	00.60
	TOTALS		0.30	0.08	0.30	0.08	0.08	0.23	0.15	0.00	0.00	0.00	0.23	0.23	0.15	0.38	0.08	0.08
C	CALM																	00.00
	1-3	0.00	0.00	0.00	0.00	0.00	0.00	0.00	0.00	0.00	0.00	0.00	0.00	0.00	0.00	0.00	0.00	00.00
	4-7	0.00	0.00	0.00	0.00	0.00	0.00	0.00	0.00	0.08	0.00	0.00	0.00	0.00	0.00	0.00	0.00	00.08
	8-12	0.08	0.00	0.00	0.00	0.00	0.00	0.00	0.00	0.00	0.08	0.00	0.08	0.00	0.00	0.00	0.08	00.30
	13-18	0.00	0.00	0.00	0.00	0.15	0.08	0.15	0.00	0.00	0.00	0.08	0.76	0.23	0.23	0.00	0.00	01.66
	19-24	0.53	0.00	0.00	0.00	0.00	0.00	0.08	0.00	0.00	0.15	0.30	0.15	0.23	0.00	0.00	0.00	01.44
	>24	0.00	0.00	0.00	0.00	0.00	0.0	0.15	0.00	0.00	0.00	0.08	0.15	0.23	1.21	0.00	0.00	01.81
	TOTALS		0.60	0.00	0.00	0.00	0.15	0.08	0.38	0.00	0.08	0.23	0.45	1.13	0.68	1.44	0.00	0.08
D	CALM																	00.00
	1-3	0.00	0.00	0.00	0.00	0.08	0.00	0.00	0.00	0.00	0.08	0.00	0.00	0.00	0.00	0.00	0.00	00.15
	4-7	0.00	0.08	0.00	0.08	0.00	0.00	0.08	0.15	0.08	0.00	0.08	0.45	0.23	0.00	0.23	0.08	01.51
	8-12	0.68	0.08	0.30	0.23	0.53	0.38	0.60	0.53	0.15	0.08	0.68	1.13	1.13	0.53	0.76	0.60	08.38
	13-18	0.53	0.08	0.08	0.33	0.68	0.68	1.44	0.08	0.38	0.30	0.45	1.28	2.04	1.59	0.83	1.51	12.31
	19-24	0.53	0.00	0.45	0.38	0.08	0.15	0.08	0.53	0.68	0.45	0.83	1.21	1.96	2.57	2.27	1.21	13.37
	>24	0.00	0.00	0.15	0.00	0.0	0.00	1.13	0.68	3.70	0.76	0.76	1.36	3.10	2.64	2.04	0.23	16.54
	TOTALS		1.74	0.23	0.98	1.06	1.36	1.21	3.32	1.96	4.98	1.66	2.79	5.44	8.46	7.33	6.12	3.63

LSCS-UFSAR

TABLE 2.3-31
(SHEET 2 OF 2)

MONTHLY THREE-WAY JOINT FREQUENCY DISTRIBUTION OF WIND SPEED.

WIND DIRECTION AND PASQUILL STABILITY CLASS FOR THE 375-FOOT

LEVEL AT LA SALLE COUNTY STATION (DECEMBER)

(Values in Percent of Total Observation)

STABILITY CATEGORY	SPEED (mph)	N	NNW	NW	ENE	E	SES	SE	SSE	S	SSW	SW	WSW	W	WNW	NW	NNW	TOTAL
E	CALM																	00.15
	1-3	0.08	0.00	0.00	0.00	0.00	0.00	0.08	0.00	0.00	0.00	0.08	0.00	0.00	0.15	0.00	0.00	00.38
	4-7	0.08	0.08	0.00	0.00	0.00	0.00	0.15	0.00	0.08	0.15	0.08	0.08	0.38	0.00	0.23	0.00	01.28
	8-12	0.15	0.38	0.23	0.08	0.00	0.00	0.00	0.38	0.15	0.15	0.53	0.60	0.53	0.08	0.45	0.38	04.08
	13-18	0.68	0.08	0.15	0.15	0.15	0.00	0.08	0.00	0.15	0.45	0.76	1.28	0.83	0.38	0.15	0.76	06.04
	19-24	0.45	0.00	0.00	0.08	0.23	0.00	0.15	0.15	0.53	0.38	0.53	0.60	0.53	0.83	0.53	0.23	05.21
	>24	0.00	0.00	0.00	0.00	0.08	0.15	0.38	0.45	2.04	2.72	0.53	0.60	0.68	1.36	0.08	0.00	09.06
	TOTALS	1.44	0.53	0.38	0.30	0.45	0.15	0.83	0.98	2.95	3.85	2.49	3.17	2.95	2.79	1.44	1.36	26.21
F	CALM																	0.00
	1-3	0.00	0.00	0.00	0.00	0.00	0.00	0.00	0.00	0.00	0.00	0.00	0.00	0.00	0.00	0.00	0.00	0.00
	4-7	0.08	0.00	0.00	0.00	0.00	0.00	0.00	0.00	0.08	0.00	0.00	0.23	0.15	0.00	0.00	0.00	00.53
	8-12	0.00	0.00	0.00	0.00	0.00	0.00	0.00	0.00	0.00	0.15	0.30	0.23	0.00	0.00	0.08	0.08	00.83
	13-18	0.15	0.15	0.00	0.00	0.00	0.00	0.00	0.00	0.23	0.38	0.30	0.15	0.23	0.30	0.23	0.00	02.11
	19-24	0.08	0.00	0.00	0.00	0.00	0.00	0.38	0.00	0.23	0.15	0.15	0.23	0.60	0.38	0.15	0.00	02.34
	>24	0.00	0.00	0.00	0.00	0.00	0.00	0.00	0.08	0.53	0.53	0.53	0.30	0.08	0.30	0.00	0.00	02.34
	TOTALS	0.30	0.15	0.00	0.00	0.00	0.00	0.38	0.08	1.06	1.21	1.28	1.13	1.06	0.98	0.45	0.08	08.16
G	CALM																	00.00
	1-3	0.00	0.00	0.00	0.00	0.00	0.00	0.00	0.00	0.00	0.00	0.00	0.00	0.00	0.00	0.00	0.00	00.00
	4-7	0.00	0.00	0.00	0.00	0.00	0.00	0.00	0.00	0.00	0.00	0.00	0.00	0.00	0.08	0.00	0.00	00.08
	8-12	0.00	0.00	0.00	0.00	0.00	0.00	0.00	0.00	0.00	0.00	0.00	0.00	0.00	0.00	0.00	0.08	00.08
	13-18	0.00	0.00	0.00	0.00	0.00	0.00	0.00	0.00	0.00	0.00	0.00	0.00	0.08	0.00	0.00	0.00	00.08
	19-24	0.00	0.00	0.00	0.00	0.00	0.00	0.00	0.00	0.00	0.00	0.00	0.00	0.00	0.00	0.00	0.00	00.00
	>24	0.00	0.00	0.00	0.00	0.00	0.00	0.08	0.15	0.15	0.30	0.60	0.00	0.08	0.00	0.00	0.00	01.36
	TOTALS	0.00	0.00	0.00	0.00	0.00	0.00	0.08	0.15	0.15	0.30	0.60	0.00	0.15	0.08	0.00	0.08	01.59

Note: Stability is based on 33- and 375-foot ΔT for the period of record (October 1, 1976 – September 30, 1978).

LSCS-UFSAR

TABLE 2.3-32
(SHEET 1 OF 2)

THREE-WAY JOINT FREQUENCY DISTRIBUTION OF WIND SPEED, WIND DIRECTION,

AND PASQUILL STABILITY CLASS FOR THE 375-FOOT LEVEL AT

LA SALLE COUNTY STATION (OCTOBER 1, 1976 – SEPTEMBER 30, 1978)

(Values in Percent of Total Observation)

STABILITY CATEGORY	SPEED (mph)	N	NNE	NE	ENE	E	ESE	SE	SSE	S	SSW	SW	WSW	W	WNW	NW	NNW	TOTAL
A	CALM																	00.01
	1-3	0.01	0.00	0.01	0.00	0.01	0.01	0.00	0.01	0.01	0.00	0.00	0.01	0.01	0.01	0.00	0.00	00.07
	4-7	0.01	0.00	0.02	0.01	0.05	0.06	0.04	0.02	0.05	0.01	0.01	0.00	0.00	0.01	0.01	0.01	00.31
	8-12	0.01	0.01	0.01	0.12	0.07	0.05	0.03	0.14	0.13	0.06	0.04	0.01	0.01	0.00	0.01	0.01	00.72
	13-18	0.02	0.04	0.07	0.10	0.04	0.05	0.02	0.06	0.13	0.16	0.06	0.07	0.11	0.05	0.03	0.01	01.04
	19-24	0.02	0.01	0.01	0.01	0.01	0.01	0.01	0.05	0.06	0.04	0.02	0.09	0.14	0.04	0.01	0.01	00.54
	>24	0.00	0.01	0.00	0.00	0.04	0.01	0.01	0.06	0.06	0.18	0.10	0.13	0.10	0.04	0.04	0.00	00.77
	TOTALS	0.07	0.07	0.13	0.24	0.21	0.18	0.11	0.34	0.44	0.46	0.24	0.31	0.38	0.15	0.10	0.04	03.47
B	CALM																	00.01
	1-3	0.01	0.01	0.00	0.00	0.00	0.00	0.00	0.00	0.00	0.00	0.00	0.00	0.00	0.01	0.01	0.00	00.04
	4-7	0.04	0.02	0.01	0.02	0.01	0.00	0.00	0.00	0.01	0.04	0.02	0.01	0.01	0.04	0.01	0.02	00.26
	8-12	0.05	0.07	0.15	0.04	0.03	0.03	0.07	0.02	0.07	0.05	0.03	0.01	0.05	0.04	0.03	0.04	00.79
	13-18	0.04	0.04	0.10	0.07	0.03	0.02	0.01	0.08	0.05	0.04	0.08	0.05	0.04	0.07	0.06	0.04	00.85
	19-24	0.04	0.07	0.02	0.02	0.00	0.01	0.01	0.04	0.04	0.07	0.05	0.02	0.07	0.12	0.03	0.05	00.67
	>24	0.02	0.01	0.01	0.01	0.07	0.02	0.01	0.04	0.10	0.06	0.13	0.18	0.12	0.13	0.04	0.01	00.96
	TOTALS	0.21	0.22	0.29	0.18	0.14	0.09	0.11	0.18	0.27	0.26	0.31	0.27	0.30	0.40	0.17	0.15	03.56
C	CALM																	00.01
	1-3	0.01	0.00	0.00	0.00	0.00	0.00	0.00	0.00	0.01	0.00	0.01	0.00	0.01	0.00	0.01	0.00	00.04
	4-7	0.01	0.01	0.06	0.01	0.01	0.03	0.01	0.01	0.02	0.02	0.03	0.04	0.01	0.00	0.01	0.01	00.30
	8-12	0.04	0.14	0.13	0.06	0.07	0.01	0.03	0.04	0.03	0.05	0.02	0.04	0.04	0.04	0.03	0.03	00.80
	13-18	0.04	0.12	0.12	0.10	0.07	0.02	0.07	0.01	0.06	0.04	0.14	0.15	0.06	0.10	0.10	0.04	01.23
	19-24	0.07	0.08	0.04	0.07	0.03	0.02	0.06	0.09	0.10	0.13	0.11	0.09	0.12	0.04	0.04	0.02	01.09
	>24	0.01	0.01	0.04	0.01	0.07	0.03	0.05	0.05	0.03	0.09	0.16	0.14	0.19	0.21	0.07	0.04	01.19
	TOTALS	0.17	0.36	0.38	0.24	0.26	0.12	0.22	0.21	0.25	0.32	0.47	0.45	0.43	0.38	0.25	0.13	04.65
D	CALM																	00.14
	1-3	0.02	0.07	0.02	0.04	0.04	0.02	0.06	0.01	0.02	0.01	0.05	0.02	0.04	0.04	0.01	0.03	00.32
	4-7	0.40	0.34	0.35	0.27	0.21	0.17	0.27	0.24	0.18	0.29	0.33	0.31	0.27	0.21	0.24	0.26	04.31
	8-12	0.82	0.76	0.68	0.58	0.30	0.41	0.53	0.43	0.60	0.60	0.50	0.72	0.77	0.69	0.46	0.53	09.40
	13-18	0.69	0.99	1.05	0.53	0.42	0.44	0.69	0.60	0.97	0.85	0.59	0.77	1.22	1.16	0.95	1.13	13.07
	19-24	0.43	0.24	0.41	0.40	0.25	0.35	0.34	0.71	0.82	0.68	0.43	0.62	1.00	1.33	0.99	0.86	09.87
	>24	0.11	0.01	0.27	0.21	0.18	0.25	0.29	0.39	0.96	0.63	0.46	0.85	1.54	1.48	0.55	0.24	08.44
	TOTALS	2.49	2.42	2.78	2.04	1.39	1.64	2.17	2.39	3.56	3.07	2.37	3.29	4.84	4.92	3.20	3.05	45.76

LSCS-UFSAR

TABLE 2.3-32
(SHEET 2 OF 2)

THREE-WAY JOINT FREQUENCY DISTRIBUTION OF WIND SPEED, WIND DIRECTION,

AND PASQUILL STABILITY CLASS FOR THE 375-FOOT LEVEL AT

LA SALLE COUNTY STATION (OCTOBER 1, 1976 – SEPTEMBER 30, 1978)

(Values in Percent of Total Observation)

STABILITY CATEGORY	SPEED (mph)	N	NNE	NE	ENE	E	ESE	SE	SSE	S	SSW	SW	WSW	W	WNW	NW	NNW	TOTAL
E	CALM																	00.21
	1-3	0.01	0.06	0.04	0.01	0.01	0.00	0.03	0.01	0.01	0.02	0.01	0.03	0.01	0.04	0.01	0.04	00.35
	4-7	0.11	0.17	0.09	0.10	0.07	0.11	0.15	0.14	0.15	0.17	0.11	0.12	0.21	0.09	0.14	0.08	02.01
	8-12	0.18	0.28	0.24	0.24	0.21	0.17	0.17	0.21	0.17	0.23	0.38	0.35	0.27	0.19	0.27	0.18	03.75
	13-18	0.18	0.27	0.33	0.45	0.42	0.40	0.30	0.32	0.36	0.47	0.43	0.62	0.47	0.47	0.36	0.32	06.20
	19-24	0.21	0.07	0.08	0.32	0.38	0.19	0.29	0.43	0.63	0.47	0.49	0.43	0.41	0.60	0.51	0.22	05.74
	>24	0.05	0.01	0.01	0.10	0.18	0.17	0.26	0.44	1.15	1.06	0.45	0.53	0.58	0.88	0.14	0.03	06.04
	TOTALS	0.76	0.85	0.79	1.21	1.28	1.05	1.21	1.55	2.48	2.42	1.87	2.08	1.97	2.27	1.43	0.88	24.30
F	CALM																	00.07
	1-3	0.00	0.00	0.01	0.00	0.01	0.01	0.01	0.01	0.01	0.02	0.00	0.00	0.01	0.00	0.00	0.01	00.10
	4-7	0.03	0.05	0.07	0.02	0.07	0.08	0.10	0.06	0.06	0.04	0.05	0.07	0.07	0.04	0.05	0.01	00.87
	8-12	0.10	0.07	0.04	0.08	0.11	0.18	0.10	0.12	0.18	0.18	0.21	0.11	0.11	0.17	0.12	0.15	02.02
	13-18	0.13	0.06	0.04	0.04	0.24	0.17	0.15	0.21	0.31	0.22	0.33	0.18	0.25	0.35	0.35	0.24	03.26
	19-24	0.03	0.00	0.02	0.07	0.17	0.19	0.33	0.21	0.35	0.40	0.45	0.25	0.46	0.37	0.42	0.11	03.82
	>24	0.04	0.00	0.01	0.00	0.02	0.09	0.30	0.32	0.65	0.85	0.74	0.33	0.28	0.24	0.04	0.01	03.94
	TOTALS	0.32	0.18	0.19	0.21	0.62	0.71	0.99	0.94	1.55	1.72	1.79	0.94	1.18	1.16	0.99	0.54	14.09
G	CALM																	00.03
	1-3	0.00	0.00	0.00	0.00	0.00	0.00	0.01	0.02	0.00	0.00	0.00	0.01	0.01	0.00	0.01	0.01	00.06
	4-7	0.02	0.01	0.00	0.00	0.01	0.01	0.00	0.01	0.01	0.03	0.03	0.05	0.04	0.03	0.02	0.02	00.29
	8-12	0.01	0.04	0.03	0.00	0.01	0.01	0.03	0.02	0.07	0.02	0.09	0.08	0.03	0.01	0.04	0.02	00.50
	13-18	0.03	0.01	0.00	0.01	0.01	0.00	0.00	0.05	0.12	0.05	0.10	0.12	0.07	0.10	0.08	0.08	00.82
	19-24	0.05	0.01	0.00	0.01	0.01	0.04	0.10	0.13	0.16	0.15	0.13	0.06	0.10	0.07	0.05	0.01	01.08
	>24	0.00	0.00	0.00	0.00	0.01	0.00	0.09	0.10	0.21	0.31	0.43	0.12	0.09	0.01	0.04	0.00	01.40
	TOTALS	0.12	0.07	0.03	0.01	0.04	0.05	0.22	0.33	0.56	0.57	0.77	0.43	0.34	0.21	0.24	0.15	04.17
Sector Totals(%)		4.14	4.17	4.58	4.13	3.95	3.84	5.03	5.93	9.11	8.81	7.82	7.77	9.43	9.50	6.38	4.94	99.53
Calm		0.47																

Note: Stability is based on 33- and 375-foot ΔT for the period of record (October 1, 1976 – September 30, 1978).

LSCS-UFSAR

TABLE 2.3-33

X/Q VALUES (sec / meter³) AT EXCLUSION AREA BOUNDARY FOR EFFLUENTS

RELEASED FROM PLANT COMMON STACK

<u>SECTOR</u>	<u>ACTUAL SITE BOUNDARY (km)</u>	<u>0-1 HOUR</u>		<u>0-2 HOURS</u>		<u>0-8 HOURS</u>		<u>8-24 HOURS</u>		<u>1-4 DAYS</u>		<u>4-30 DAYS</u>	
		<u>5 PERCENT</u>	<u>50 PERCENT</u>	<u>5 PERCENT</u>	<u>50 PERCENT</u>	<u>5 PERCENT</u>	<u>50 PERCENT</u>	<u>5 PERCENT</u>	<u>50 PERCENT</u>	<u>5 PERCENT</u>	<u>50 PERCENT</u>	<u>5 PERCENT</u>	<u>50 PERCENT</u>
		N	.51	5.271-07	3.654-25	6.588-07	5.645-25	4.436-07	1.227-21	1.927-07	1.704-20	8.926-08	7.582-19
NNE	.51	6.313-07	3.398-25	4.517-07	3.427-25	2.905-07	7.600-25	1.634-07	5.430-23	8.236-08	5.807-20	4.148-08	4.621-11
NE	.51	2.891-07	2.940-25	2.557-07	3.032-25	1.346-07	7.314-29	9.696-08	3.069-26	5.092-08	3.310-22	3.037-08	5.507-10
ENE	.51	4.089-07	3.610-25	3.140-07	3.699-25	1.202-07	2.509-24	8.118-08	5.827-23	6.227-08	9.346-21	2.929-08	1.534-10
E	.51	3.750-07	4.116-21	2.768-07	3.689-21	1.205-07	2.839-21	9.994-08	3.445-21	6.377-08	1.118-19	2.914-08	2.957-10
ESE	.51	9.550-08	6.785-21	6.435-08	5.258-21	4.137-08	3.500-21	2.769-08	8.478-21	2.433-08	8.498-20	1.099-08	1.394-11
SE	.51	1.099-08	1.352-22	7.247-09	2.994-23	1.358-08	1.114-22	1.583-08	2.405-22	1.482-08	5.255-20	8.549-09	2.749-17
SSE	.51	3.076-09	3.234-21	1.992-09	2.162-21	1.678-09	4.476-22	3.290-09	2.892-22	8.766-09	7.038-21	6.347-09	9.777-19
S	.51	5.512-08	6.720-24	2.692-08	1.091-24	1.957-08	1.674-24	1.506-08	1.684-24	6.281-09	2.205-23	7.059-09	2.657-19
SSW	.51	8.424-08	1.680-22	6.186-08	1.832-23	3.039-08	2.743-24	2.682-08	1.183-24	3.057-08	3.203-23	1.041-08	4.735-13
SW	.51	2.031-07	7.908-21	1.008-07	5.488-21	1.221-07	1.997-21	3.293-08	3.687-22	2.552-08	3.337-22	1.500-08	1.528-14
WSW	.51	8.202-07	4.096-24	7.902-07	1.471-24	3.620-07	8.927-24	1.415-07	1.831-24	8.620-08	1.513-24	2.948-08	1.396-12
W	.51	7.155-07	3.246-25	5.756-07	3.367-25	3.595-07	1.016-27	1.485-07	4.169-27	6.847-08	8.058-25	1.201-08	3.604-12
WNW	.51	4.907-07	3.360-25	2.726-07	3.355-25	1.046-07	6.159-29	7.537-09	7.549-29	1.133-08	1.155-26	9.933-09	2.870-12
NW	.51	1.643-08	3.232-25	1.922-08	3.292-25	3.416-08	7.429-29	3.064-08	7.680-26	3.613-08	1.215-21	1.174-08	1.331-18
NNW	.51	8.412-07	3.498-25	5.315-07	3.596-25	1.563-07	4.946-24	1.621-07	1.017-22	7.978-08	1.084-20	3.209-08	4.905-17
ALL		2.798-07	3.750-25	1.826-07	6.127-25	1.161-07	5.673-24	8.311-08	7.880-23	5.401-08	3.244-21	2.360-08	2.413-12

LSCS-UFSAR

TABLE 2.3-34

X/Q VALUES (sec / meter³) AT ACTUAL SITE BOUNDARY FOR EFFLUENTS

RELEASED FROM PLANT COMMON STACK

<u>SECTOR</u>	<u>ACTUAL SITE BOUNDARY (km)</u>	<u>0-1 HOUR</u>		<u>0-2 HOURS</u>		<u>0-8 HOURS</u>		<u>8-24 HOURS</u>		<u>1-4 DAYS</u>		<u>4-30 DAYS</u>	
		<u>5 PERCENT</u>	<u>50 PERCENT</u>	<u>5 PERCENT</u>	<u>50 PERCENT</u>	<u>5 PERCENT</u>	<u>50 PERCENT</u>	<u>5 PERCENT</u>	<u>50 PERCENT</u>	<u>5 PERCENT</u>	<u>50 PERCENT</u>	<u>5 PERCENT</u>	<u>50 PERCENT</u>
		N	1.02	1.117-06	1.335-12	7.046-07	3.787-12	1.722-07	1.885-11	1.271-07	1.961-11	5.926-08	2.191-11
NNE	1.33	7.413-07	1.163-10	8.607-07	7.423-11	1.600-07	1.096-10	1.150-07	8.727-11	4.268-08	1.224-10	2.670-08	2.306-09
NE	2.41	8.180-07	2.205-08	7.843-07	2.257-08	1.699-07	8.065-09	1.151-07	2.395-09	4.378-08	1.556-09	1.172-08	3.053-09
ENE	4.45	1.895-06	2.102-07	1.503-06	1.448-07	5.169-07	7.533-09	1.301-07	1.349-08	5.220-08	6.304-09	1.484-08	7.907-09
E	1.97	6.801-07	5.388-08	6.135-07	2.727-08	1.639-07	1.058-08	1.222-07	2.532-09	5.088-08	1.846-09	1.197-08	4.140-09
ESE	.84	8.653-07	1.341-12	5.866-07	9.743-13	1.437-07	5.642-13	1.071-07	3.180-13	4.609-08	4.079-13	2.919-08	3.604-10
SE	.88	5.450-07	9.734-13	2.406-07	5.039-13	1.189-07	1.816-13	7.872-08	2.067-13	4.166-08	7.163-13	2.296-08	1.074-11
SSE	.84	2.012-07	1.032-12	1.904-07	5.705-13	7.906-08	1.054-13	5.125-08	5.607-14	1.346-08	1.240-13	1.902-08	6.688-13
S	.83	6.787-07	7.258-14	7.179-07	1.875-14	1.589-07	1.614-14	9.614-08	6.720-15	2.857-08	7.633-15	1.484-08	2.354-13
SSW	.83	6.897-07	1.548-13	7.459-07	7.004-14	1.485-07	2.196-14	1.144-07	6.660-15	3.755-08	6.510-15	2.848-08	1.646-10
SW	.61	8.829-07	6.343-17	2.595-07	4.636-17	1.658-07	6.406-18	1.222-07	1.905-18	3.819-08	1.442-18	1.449-08	5.467-13
WSW	.51	4.927-07	1.567-24	5.049-07	2.789-24	3.926-07	1.705-23	1.193-07	2.218-24	5.597-08	1.641-24	2.878-08	1.349-12
W	.51	7.026-07	4.419-29	7.045-07	2.166-28	3.873-07	1.288-27	1.431-07	4.033-27	5.349-08	1.023-24	1.190-08	3.481-12
WNW	.63	8.869-07	7.884-22	2.661-07	5.417-22	1.533-07	1.051-22	1.249-07	1.175-22	2.165-08	7.638-22	2.525-08	3.078-11
NW	.73	2.373-07	1.202-18	2.514-07	1.017-18	1.168-07	4.973-19	8.524-08	1.019-17	3.685-08	1.984-15	1.432-08	6.505-14
NNW	.85	1.109-08	2.864-15	1.023-06	4.737-15	3.556-07	3.643-14	2.935-07	8.223-14	5.731-08	1.751-13	3.292-08	8.023-12
ALL		1.136-06	4.030-12	7.603-07	3.215-12	1.671-07	3.160-12	1.192-07	1.789-12	4.763-08	1.907-12	2.331-08	5.410-10

TABLE 2.3-35

X/Q VALUES (sec / meter³) AT LOW POPULATION ZONE BOUNDARY FOR EFFLUENTS
RELEASED FROM PLANT COMMON STACK

<u>SECTOR</u>	<u>LPZ BOUNDARY (km)</u>	<u>0-1 HOUR</u>		<u>0-2 HOURS</u>		<u>0-8 HOURS</u>		<u>8-24 HOURS</u>		<u>1-4 DAYS</u>		<u>4-30 DAYS</u>	
		<u>5 PERCENT</u>	<u>50 PERCENT</u>	<u>5 PERCENT</u>	<u>50 PERCENT</u>	<u>5 PERCENT</u>	<u>50 PERCENT</u>	<u>5 PERCENT</u>	<u>50 PERCENT</u>	<u>5 PERCENT</u>	<u>50 PERCENT</u>	<u>5 PERCENT</u>	<u>50 PERCENT</u>
		N	6.40	4.060-07	2.175-07	3.761-07	1.482-07	2.257-07	5.935-08	5.734-08	1.503-08	2.461-08	7.910-09
NNE	6.40	4.061-07	2.155-07	3.747-07	1.377-07	2.032-07	5.131-08	5.166-08	1.189-08	2.214-08	5.365-09	1.143-08	6.063-09
NE	6.40	4.039-07	2.081-07	3.517-07	1.205-07	1.812-07	4.568-08	4.548-08	9.682-09	1.922-08	4.320-09	9.494-09	5.261-09
ENE	6.40	4.075-07	2.515-07	3.718-07	1.695-07	2.124-07	5.428-08	5.378-08	1.222-08	2.210-08	5.911-09	1.208-08	6.018-09
E	6.40	4.089-07	2.631-07	3.889-07	1.749-07	2.388-07	6.123-08	6.534-08	1.585-08	3.136-08	7.576-09	1.827-08	7.661-09
ESE	6.40	4.046-07	2.608-07	3.755-07	1.848-07	2.623-07	6.997-08	7.148-08	1.613-08	3.704-08	7.561-09	2.464-08	5.976-09
SE	6.40	4.084-07	2.834-07	3.811-07	1.807-07	2.440-07	6.068-08	6.600-08	1.400-08	2.655-08	5.936-09	1.404-08	6.064-09
SSE	6.40	4.105-07	3.238-07	3.954-07	1.933-07	2.604-07	7.510-08	7.166-08	1.632-08	3.097-08	6.986-09	1.019-08	4.882-09
S	6.40	4.124-07	3.359-07	3.992-07	1.871-07	2.716-07	5.859-08	6.937-08	1.186-08	2.454-08	3.949-09	7.178-09	3.619-09
SSW	6.40	4.149-07	3.540-07	4.051-07	2.007-07	2.976-07	7.231-08	8.571-08	1.532-08	3.541-08	5.565-09	1.438-08	3.327-09
SW	6.40	4.134-07	3.359-07	4.019-07	2.030-07	2.824-07	7.681-08	8.404-08	1.783-08	4.109-08	5.702-09	1.447-08	3.990-09
WSW	6.40	4.109-07	2.913-07	3.938-07	1.847-07	2.383-07	6.599-08	6.586-08	1.529-08	2.654-08	4.800-09	9.820-09	4.002-09
W	6.40	4.075-07	2.379-07	3.656-07	1.604-07	1.916-07	5.068-08	5.160-08	1.130-08	1.994-08	4.316-09	8.114-09	3.210-09
WNW	6.40	4.111-07	2.665-07	3.857-07	1.637-07	2.196-07	5.113-08	5.816-08	1.055-08	2.168-08	3.357-09	8.569-09	3.792-09
NW	6.40	4.114-07	2.406-07	3.321-07	1.610-07	2.352-07	5.735-08	5.906-08	1.396-08	2.201-08	5.083-09	9.981-09	3.735-09
NNW	6.40	4.064-07	2.287-07	3.732-07	1.553-07	2.198-07	5.284-08	5.684-08	1.206-08	2.574-08	4.821-09	1.198-08	3.990-09
ALL		4.092-07	2.630-07	3.866-07	1.708-07	2.358-07	5.752-08	6.252-08	1.332-08	2.601-08	5.621-09	1.337-08	4.956-09

TABLE 2.3-36

FIFTIETH PERCENTILE X/Q VALUES (sec / meter³) FOR THE PERIOD OF 0-1 HOUR FOR EFFLUENTSRELEASED FROM PLANT COMMON STACKDISTANCE FROM THE SITE (mi)

<u>SECTOR</u>	<u>0.5</u>	<u>1.5</u>	<u>2.5</u>	<u>3.5</u>	<u>4.5</u>	<u>7.5</u>	<u>15.0</u>	<u>25.0</u>	<u>35.0</u>	<u>45.0</u>
N	2.225-15	3.782-08	1.432-07	2.085-07	2.310-07	1.821-07	1.025-07	6.973-08	5.564-08	4.295-08
NNE	2.549-16	3.003-08	1.355-07	2.054-07	2.286-07	1.804-07	1.018-07	6.966-08	5.795-08	4.598-08
NE	7.193-13	1.701-08	1.210-07	1.901-07	2.145-07	1.736-07	9.369-08	7.142-08	6.096-08	5.202-08
ENE	8.439-16	3.813-08	1.570-07	2.475-07	2.514-07	1.985-07	1.134-07	7.437-08	5.879-08	4.540-08
E	3.906-13	9.317-08	2.479-07	2.654-07	2.513-07	1.915-07	1.042-07	6.946-08	5.147-08	3.696-08
ESE	4.521-13	9.757-08	2.528-07	2.696-07	2.530-07	1.959-07	1.053-07	6.795-08	4.960-08	3.656-08
SE	6.257-14	8.055-08	2.061-07	2.930-07	2.773-07	2.105-07	1.109-07	7.526-08	5.667-08	4.297-08
SSE	3.366-43	9.571-08	2.807-07	3.260-07	3.148-07	2.381-07	1.249-07	7.748-08	5.400-08	3.942-08
S	3.052-14	7.094-08	2.532-07	3.256-07	3.284-07	2.655-07	1.456-07	9.056-08	6.430-08	4.860-08
SSW	1.017-13	8.292-08	2.681-07	3.477-07	3.425-07	2.795-07	1.557-07	9.143-08	6.161-08	4.629-08
SW	5.430-13	1.078-07	2.823-07	3.325-07	3.270-07	2.644-07	1.380-07	7.978-08	5.420-08	3.359-08
WSW	2.058-14	6.534-08	1.886-07	2.845-07	2.944-07	2.414-07	1.435-07	9.224-08	6.689-08	5.081-08
W	4.264-17	1.957-08	1.398-07	2.257-07	2.479-07	2.117-07	1.278-07	8.388-08	7.170-08	5.834-08
WNW	1.061-16	2.695-08	1.526-07	2.526-07	2.644-07	2.204-07	1.245-07	8.675-08	6.903-08	5.566-08
NW	6.756-17	2.105-08	1.470-07	2.438-07	2.489-07	2.076-07	1.230-07	8.131-08	6.327-08	5.351-08
NNW	3.176-16	3.353-08	1.409-07	2.156-07	2.425-07	1.993-07	1.095-07	7.193-08	5.855-08	4.549-08
ALL	3.466-15	4.992-08	1.669-07	2.572-07	2.601-07	2.061-07	1.149-07	7.536-08	5.824-08	4.507-08

TABLE 2.3-37

FIFTIETH PERCENTILE X/Q VALUES (sec / meter³) FOR THE TIME PERIOD OF 0-2 HOURS FOR EFFLUENTSRELEASED FROM PLANT COMMON STACKDISTANCE FROM THE SITE (mi)

<u>SECTOR</u>	<u>0.5</u>	<u>1.5</u>	<u>2.5</u>	<u>3.5</u>	<u>4.5</u>	<u>7.5</u>	<u>15.0</u>	<u>25.0</u>	<u>35.0</u>	<u>45.0</u>
N	3.444-15	3.195-08	1.101-07	1.471-07	1.450-07	1.188-07	7.236-08	5.029-08	3.699-08	2.973-08
NNE	2.969-16	1.981-08	8.744-08	1.317-07	1.360-07	1.127-07	6.970-08	5.078-08	3.745-08	3.087-08
NE	8.458-18	1.181-08	7.587-08	1.165-07	1.241-07	1.013-07	6.798-08	4.956-08	3.729-08	3.076-08
ENE	2.428-16	2.886-08	1.224-07	1.636-07	1.673-07	1.341-07	7.679-08	4.947-08	3.560-08	2.851-08
E	3.111-13	5.572-08	1.434-07	1.731-07	1.728-07	1.392-07	7.668-08	4.821-08	3.447-08	2.712-08
ESE	4.089-13	5.743-08	1.445-07	1.808-07	1.798-07	1.406-07	8.028-08	5.045-08	3.553-08	2.775-08
SE	2.830-14	4.222-08	1.370-07	1.780-07	1.800-07	1.507-07	8.490-08	5.403-08	3.913-08	3.045-08
SSE	2.098-13	5.355-08	1.617-07	1.871-07	1.915-07	1.734-07	9.622-08	5.966-08	4.195-08	3.124-08
S	7.721-15	3.895-08	1.406-07	1.805-07	1.869-07	1.715-07	1.027-07	6.373-08	4.544-08	3.421-08
SSW	2.192-14	4.420-08	1.552-07	1.924-07	1.984-07	1.777-07	1.129-07	7.026-08	4.744-08	3.523-08
SW	4.271-13	6.416-08	1.666-07	1.934-07	1.987-07	1.731-07	9.991-08	6.212-08	4.323-08	3.148-08
WSW	9.876-15	4.210-08	1.366-07	1.780-07	1.833-07	1.625-07	9.753-08	6.240-08	4.463-08	3.416-08
W	7.086-17	1.793-08	1.072-07	1.580-07	1.606-07	1.403-07	8.764-08	6.313-08	4.712-08	3.817-08
WNW	8.926-17	1.787-08	1.055-07	1.566-07	1.636-07	1.416-07	8.607-08	5.894-08	4.449-08	3.584-08
NW	4.820-17	1.635-08	1.010-07	1.546-07	1.627-07	1.339-07	8.344-08	6.039-08	4.430-08	3.553-08
NNW	9.605-16	2.371-08	1.078-07	1.527-07	1.531-07	1.249-07	7.597-08	5.320-08	3.841-08	3.053-08
ALL	4.527-15	3.390-08	1.271-07	1.666-07	1.703-07	1.404-07	8.215-08	5.454-08	3.955-08	3.084-08

TABLE 2.3-38

FIFTIETH PERCENTILE X/Q VALUES (sec / meter³) FOR THE PERIOD OF 0-8 HOURS FOR EFFLUENTSRELEASED FROM PLANT COMMON STACK

SECTOR	DISTANCE FROM THE SITE (mi)									
	0.5	1.5	2.5	3.5	4.5	7.5	15.0	25.0	35.0	45.0
N	7.020-14	1.774-08	4.531-08	5.441-08	5.929-08	5.075-08	3.472-08	2.489-08	1.830-08	1.475-08
NNE	1.573-15	1.080-08	3.782-08	4.718-08	5.076-08	4.513-08	3.176-08	2.349-08	1.683-08	1.381-08
NE	3.247-17	5.849-09	3.173-08	4.391-08	4.516-08	4.264-08	2.976-08	2.057-08	1.503-08	1.225-08
ENE	6.665-15	1.192-08	4.029-08	4.889-08	5.210-08	4.683-08	3.029-08	2.126-08	1.591-08	1.286-08
E	1.524-18	1.950-08	4.804-08	5.583-08	6.211-08	5.343-08	3.521-08	2.440-08	1.749-08	1.355-08
ESE	1.400-13	1.941-08	5.244-08	6.969-08	7.086-08	5.899-08	3.653-08	2.495-08	1.748-08	1.401-08
SE	2.467-17	1.319-08	4.195-08	5.274-08	6.254-08	5.571-08	3.558-08	2.605-08	1.812-08	1.471-08
SSE	4.381-14	1.654-08	4.890-08	7.002-08	7.705-08	6.513-08	4.139-08	2.791-08	1.985-08	1.563-08
S	6.841-15	1.215-08	4.136-08	4.961-08	6.035-08	5.818-08	3.896-08	2.767-08	1.946-08	1.583-08
SSW	8.259-15	1.232-08	4.733-08	6.425-08	7.801-08	6.903-08	4.141-08	2.982-08	2.076-08	1.639-08
SW	6.825-14	2.022-08	5.550-08	7.429-08	7.727-08	6.634-08	3.933-07	2.820-08	1.868-08	1.510-08
WSW	1.903-14	1.442-08	4.634-08	6.219-08	6.931-08	6.128-08	3.798-08	2.638-08	1.836-08	1.440-08
W	1.025-16	7.697-09	3.641-08	4.814-08	5.089-08	4.733-08	3.402-08	2.581-08	1.806-08	1.487-08
WNW	3.071-17	5.837-09	3.435-08	4.709-08	5.031-08	4.755-08	3.388-08	2.600-08	1.845-08	1.561-08
NW	3.943-17	7.035-09	3.869-08	4.987-08	5.808-08	5.412-08	3.594-08	2.749-08	2.047-08	1.710-08
NNW	1.188-14	1.291-08	3.951-08	4.838-08	5.095-08	4.607-08	3.121-08	2.266-08	1.646-08	1.348-08
ALL	1.250-14	1.323-08	4.168-08	4.995-08	5.764-08	5.016-08	3.462-08	2.501-08	1.783-08	1.436-08

TABLE 2.3-39

FIFTIETH PERCENTILE X/Q VALUES (sec / meter³) FOR THE TIME PERIOD OF
8-24 HOURS FOR EFFLUENTS RELEASED FROM PLANT COMMON STACK

SECTOR	DISTANCE FROM THE SITE (mi)									
	0.5	1.5	2.5	3.5	4.5	7.5	15.0	25.0	35.0	45.0
N	1.475-13	6.309-09	1.404-09	1.516-08	1.461-08	1.120-08	6.418-09	3.960-09	2.800-09	2.137-09
NNE	5.810-15	3.854-09	9.542-09	1.172-08	1.169-08	9.299-09	5.413-09	3.581-09	2.428-09	1.876-09
NE	1.804-16	2.032-09	7.946-09	9.670-09	9.556-09	8.168-09	4.965-09	3.224-09	2.248-09	1.701-09
ENE	5.888-15	3.411-09	9.021-09	1.155-08	1.210-08	8.971-09	5.310-09	3.383-09	2.332-09	1.783-09
E	7.190-14	5.918-09	1.321-08	1.555-08	1.551-08	1.204-08	6.475-09	4.006-09	2.747-09	2.082-09
ESE	1.079-13	5.680-08	1.358-08	1.636-08	1.602-08	1.263-08	6.869-09	4.025-09	2.768-09	2.059-09
SE	1.426-14	3.688-09	9.396-09	1.381-08	1.388-08	1.126-08	6.204-09	3.832-09	2.661-09	1.990-09
SSE	1.718-14	4.501-09	1.083-08	1.621-08	1.637-08	1.375-08	7.660-09	4.404-09	3.003-09	2.278-09
S	2.757-15	3.101-09	8.823-09	1.095-08	1.238-08	1.013-08	6.196-09	3.997-09	2.737-09	2.046-09
SSW	1.866-15	2.792-09	9.049-09	1.383-08	1.580-08	1.446-08	8.077-09	4.691-09	3.199-09	2.402-09
SW	1.892-14	4.888-09	1.453-08	1.713-08	1.794-08	1.344-08	7.552-09	4.484-09	3.127-09	2.354-09
WSW	2.707-15	3.532-09	1.017-08	1.427-03	1.562-08	1.287-08	7.272-09	4.253-09	2.923-09	2.220-09
W	1.635-16	1.751-09	8.322-09	1.068-08	1.106-08	9.148-09	5.862-09	3.721-09	2.602-09	1.982-09
WNW	1.522-17	1.437-09	7.639-09	1.823-08	1.034-08	9.186-09	5.940-09	3.749-09	2.737-09	2.032-09
NW	3.143-16	2.554-09	8.835-09	1.293-08	1.416-08	1.152-08	6.442-09	3.988-09	2.921-09	2.259-09
NNW	1.502-14	3.816-09	9.062-09	1.162-08	1.211-08	8.585-09	5.322-09	3.487-09	2.425-09	1.880-09
ALL	8.388-15	3.762-09	9.737-09	1.279-08	1.326-08	1.058-08	6.126-09	3.828-09	2.646-09	2.005-09

TABLE 2.3-40

FIFTIETH PERCENTILE X/Q VALUES (sec / meter³) FOR THE TIME PERIOD OF
1-4 DAYS FOR EFFLUENTS RELEASED FROM PLANT COMMON STACK

SECTOR	DISTANCE FROM THE SITE (mi)									
	0.5	1.5	2.5	3.5	4.5	7.5	15.0	25.0	35.0	45.0
N	5.233-13	4.013-09	7.532-09	7.792-09	7.655-09	5.531-09	3.086-09	1.973-09	1.291-09	9.748-10
NNE	1.330-13	2.233-09	4.303-09	5.258-09	5.354-09	4.337-09	2.677-09	1.701-09	1.220-09	9.337-10
NE	1.060-14	1.307-09	3.473-09	4.158-09	4.227-09	3.918-09	2.054-09	1.311-09	9.319-10	7.125-10
ENE	5.264-14	1.579-09	4.465-09	5.798-09	5.891-09	4.622-09	2.528-09	1.554-09	1.059-09	7.990-10
E	1.849-13	3.148-09	6.783-09	7.616-09	7.331-09	5.543-09	3.017-09	1.914-09	1.247-09	9.538-10
ESE	1.728-13	3.031-09	6.813-09	7.488-09	7.245-09	5.611-09	2.976-09	1.904-09	1.248-09	9.527-10
SE	1.051-13	1.899-09	4.889-09	5.861-09	5.859-09	4.675-09	2.791-09	1.759-09	1.201-09	8.937-10
SSE	4.524-14	1.841-09	5.764-09	6.893-09	6.675-09	5.072-09	2.606-09	1.551-09	1.047-09	8.158-10
S	3.399-15	1.110-09	3.684-09	3.909-09	4.257-09	3.926-09	2.236-09	1.335-09	9.036-10	6.758-10
SSW	2.984-15	9.044-10	3.588-09	5.210-09	5.819-09	4.827-09	2.667-09	1.560-09	1.055-09	7.910-10
SW	1.207-14	1.724-09	4.985-09	5.031-09	5.787-09	5.139-09	2.694-09	1.737-09	1.054-09	8.120-10
WSW	1.105-15	8.733-10	3.404-09	4.892-09	4.898-09	4.296-09	2.520-09	1.507-09	1.004-09	7.720-10
W	8.649-16	7.072-10	2.926-09	4.008-09	4.250-09	4.136-09	2.237-09	1.432-09	1.023-09	7.734-10
WNW	8.927-17	5.577-10	2.158-09	2.942-09	3.381-09	3.804-09	1.989-09	1.269-09	8.541-10	6.834-10
NW	2.377-14	1.453-09	4.229-09	5.058-09	4.791-09	4.281-09	2.398-09	1.564-09	1.097-09	8.250-10
NNW	4.092-14	1.598-09	4.202-09	5.022-09	4.640-09	4.065-09	2.207-09	1.398-09	9.976-10	7.569-10
ALL	3.306-14	1.699-09	4.466-09	5.538-09	5.581-09	4.538-09	2.557-09	1.606-09	1.088-09	8.326-10

TABLE 2.3-41

FIFTIETH PERCENTILE X/Q VALUES (sec / meter³) FOR THE PERIOD OF 4-30 DAYS FOR EFFLUENTSRELEASED FROM PLANT COMMON STACKDISTANCE FROM THE SITE (mi)

<u>SECTOR</u>	<u>0.5</u>	<u>1.5</u>	<u>2.5</u>	<u>3.5</u>	<u>4.5</u>	<u>7.5</u>	<u>15.0</u>	<u>25.0</u>	<u>35.0</u>	<u>45.0</u>
N	8.002-10	3.812-09	6.544-09	6.939-09	6.317-09	4.842-09	2.605-09	1.651-09	1.119-09	8.613-10
NNE	1.155-09	3.323-09	5.268-09	5.977-09	5.904-09	4.450-09	2.647-09	1.822-09	1.184-09	9.223-10
NE	2.575-09	3.025-09	4.900-09	5.174-09	5.081-09	3.938-09	2.389-09	1.686-09	1.107-09	8.335-10
ENE	9.480-10	3.765-09	5.700-09	5.842-09	5.888-09	4.450-09	2.458-09	1.510-09	1.031-09	7.886-10
E	2.027-09	4.911-09	7.924-09	7.703-09	7.211-09	5.211-09	2.985-09	1.775-09	1.182-09	9.390-10
ESE	2.938-10	5.423-09	6.214-09	5.852-09	5.658-09	3.827-09	2.077-09	1.272-09	8.282-10	6.246-10
SE	2.198-12	3.289-09	5.772-09	5.760-09	5.800-09	4.187-09	2.287-09	1.385-09	9.822-10	7.198-10
SSE	3.181-13	2.275-09	4.855-09	5.167-09	4.829-09	3.774-09	1.995-09	1.185-09	7.985-10	5.995-10
S	1.508-13	1.378-09	3.029-09	3.442-09	3.424-09	2.634-09	1.426-09	8.480-10	5.336-10	4.081-10
SSW	8.050-11	1.483-09	3.511-09	3.550-09	3.207-09	2.509-09	1.381-09	8.853-10	5.329-10	4.275-10
SW	3.284-11	1.488-09	3.251-09	3.772-09	3.899-09	3.066-09	1.709-09	9.962-10	7.051-10	4.909-10
WSW	1.144-10	9.892-10	3.178-09	3.802-09	3.908-09	3.564-09	2.112-09	1.065-09	7.863-10	5.954-10
W	2.486-10	1.735-09	2.699-09	3.278-09	3.173-09	2.617-09	1.550-09	9.533-10	6.282-10	4.839-10
WNW	1.652-10	1.366-09	2.969-09	3.768-09	3.704-09	2.966-09	1.767-09	9.930-10	7.240-10	5.735-10
NW	3.522-13	1.398-09	3.241-09	3.722-09	3.710-09	2.886-09	1.715-09	1.071-09	7.743-10	5.760-10
NNW	3.699-12	1.811-09	3.596-09	4.006-09	3.903-09	3.036-09	1.736-09	1.065-09	6.877-10	5.212-10
ALL	2.212-10	2.610-09	4.571-09	4.962-09	4.865-09	3.734-09	2.072-09	1.245-09	8.538-10	6.570-10

TABLE 2.3-42

FIFTH PERCENTILE X/Q VALUES (sec / meter³) FOR THE TIME PERIOD OF 0-1 HOUR FOR EFFLUENTSRELEASED FROM PLANT COMMON STACKDISTANCE FROM THE SITE (mi)

<u>SECTOR</u>	<u>0.5</u>	<u>1.5</u>	<u>2.5</u>	<u>3.5</u>	<u>4.5</u>	<u>7.5</u>	<u>15.0</u>	<u>25.0</u>	<u>35.0</u>	<u>45.0</u>
N	6.761-07	3.104-07	3.800-07	4.004-07	4.386-07	3.548-07	2.524-07	1.710-07	1.359-07	1.197-07
NNE	6.455-07	3.170-07	3.785-07	4.004-07	4.468-07	3.801-07	2.753-07	1.881-07	1.511-07	1.298-07
NE	5.676-07	4.458-07	3.787-07	3.976-07	4.416-07	3.837-07	2.842-07	1.984-07	1.555-07	1.353-07
ENE	5.076-07	4.430-07	3.829-07	4.026-07	4.571-07	3.899-07	2.936-07	2.041-07	1.633-07	1.398-07
E	5.624-07	3.364-07	3.819-07	4.035-07	4.570-07	3.849-07	2.786-07	1.947-07	1.577-07	1.381-07
ESE	4.604-07	3.296-07	3.828-07	4.008-07	4.405-07	3.618-07	2.547-07	1.678-07	1.304-07	1.146-07
SE	2.291-07	3.183-07	3.879-07	4.032-07	4.565-07	3.937-07	3.053-07	2.100-07	1.681-07	1.417-07
SSE	1.748-07	3.128-07	3.873-07	4.057-07	4.648-07	3.916-07	3.112-07	2.089-07	1.620-07	1.434-07
S	4.693-07	4.466-07	3.882-07	4.068-07	4.804-07	4.216-07	3.364-07	2.236-07	1.765-07	1.530-07
SSW	4.994-07	7.552-07	3.963-07	4.107-07	4.838-07	5.367-07	4.206-07	2.932-07	2.246-07	1.929-07
SW	1.193-06	7.271-07	4.402-07	4.098-07	4.737-07	3.916-07	3.187-07	2.122-07	1.801-07	1.520-07
WSW	1.431-06	5.666-07	3.881-07	4.054-07	4.725-07	3.956-07	3.260-07	2.144-07	1.766-07	1.523-07
W	9.876-07	5.590-07	3.878-07	4.040-07	4.577-07	3.938-07	3.257-07	2.146-07	1.800-07	1.580-07
WNW	7.719-07	3.126-07	3.814-07	4.045-07	4.667-07	3.911-07	3.146-07	2.116-07	1.729-07	1.523-07
NW	2.829-07	3.814-07	3.825-07	4.051-07	4.695-07	4.446-07	3.457-07	2.343-07	2.005-07	1.781-07
NNW	1.060-06	3.129-07	3.812-07	4.000-07	4.535-07	3.881-07	3.126-07	2.084-07	1.713-07	1.488-07
ALL	6.062-07	3.996-07	3.848-07	4.040-07	4.608-07	3.886-07	3.033-07	2.050-07	1.633-07	1.436-07

TABLE 2.3-43

FIFTH PERCENTILE X/Q VALUES (sec / meter³) FOR THE TIME PERIOD OF 0-2 HOURS FOR EFFLUENTSRELEASED FROM PLANT COMMON STACKDISTANCE FROM THE SITE (mi)

<u>SECTOR</u>	<u>0.5</u>	<u>1.5</u>	<u>2.5</u>	<u>3.5</u>	<u>4.5</u>	<u>7.5</u>	<u>15.0</u>	<u>25.0</u>	<u>35.0</u>	<u>45.0</u>
N	5.598-07	2.917-07	3.590-07	3.760-07	3.695-07	2967-07	1.873-07	1.235-07	9.677-08	8.536-08
NNE	4.714-07	2.836-07	3.524-07	3.709-07	3.716-07	3.105-07	2.009-07	1.320-07	1.043-07	9.170-08
NE	4.698-07	3.192-07	3.360-07	3.437-07	3.543-07	3.115-07	2.096-07	1.423-07	1.133-07	9.728-08
ENE	4.682-07	3.406-07	3.523-07	3.641-07	3.748-07	3.255-07	2.162-07	1.453-07	1.083-07	9.405-08
E	4.761-07	3.023-07	3.643-07	3.814-07	3.812-07	3.160-07	2.062-07	1.409-07	1.077-07	9.354-08
ESE	3.584-07	3.097-07	3.693-07	3.766-07	3.747-07	3.121-07	1.959-07	1.273-07	9.892-08	8.513-08
SE	2.149-07	3.139-07	3.745-07	3.822-07	3.777-07	3.139-07	2.072-07	1.410-07	1.117-07	9.723-08
SSE	1.329-07	3.007-07	3.782-07	3.917-07	3.903-07	3.492-07	2.331-07	1.546-07	1.218-07	1.055-07
S	4.152-07	3.165-07	3.750-07	3.937-07	4.365-07	3.545-07	2.397-07	1.560-07	1.249-07	1.050-07
SSW	4.303-07	5.325-07	3.848-07	4.011-07	4.346-07	3.922-07	3.088-07	2.130-07	1.738-07	1.407-07
SW	6.547-07	5.332-07	3.892-07	3.992-07	4.047-07	3.558-07	2.410-07	1.641-07	1.352-07	1.127-07
WSW	6.710-07	4.335-07	3.675-07	3.885-07	4.127-07	3.619-07	2.479-07	1.691-07	1.290-07	1.054-07
W	6.044-07	3.882-07	3.556-07	3.656-07	3.636-07	3.201-07	2.219-07	1.520-07	1.228-07	1.070-07
WNW	5.161-07	2.837-07	3.600-07	3.813-07	3.814-07	3.303-07	2.300-07	1.580-07	1.307-07	1.132-07
NW	2.486-07	3.056-07	3.627-07	3.668-07	4.037-07	3.518-07	2.535-07	1.779-07	1.409-07	1.190-07
NNW	6.134-07	2.941-07	3.617-07	3.713-07	3.768-07	3.238-07	2.158-07	1.443-07	1.157-07	9.717-08
ALL	4.720-07	3.150-07	3.676-07	3.830-07	3.844-07	3.330-07	2.174-07	1.481-07	1.187-07	1.002-07

TABLE 2.3-44

FIFTH PERCENTILE X/Q VALUES (sec / meter³) FOR THE TIME PERIOD OF 0-8 HOURS FOR EFFLUENTSRELEASED FROM PLANT COMMON STACKDISTANCE FROM THE SITE (mi)

<u>SECTOR</u>	<u>0.5</u>	<u>1.5</u>	<u>2.5</u>	<u>3.5</u>	<u>4.5</u>	<u>7.5</u>	<u>15.0</u>	<u>25.0</u>	<u>35.0</u>	<u>45.0</u>
N	2.534-07	1.608-07	2.126-07	2.260-07	2.223-07	1.719-07	1.075-07	8.487-08	5.681-08	4.929-08
NNE	1.595-07	1.418-07	1.849-07	1.976-07	1.991-07	1.603-07	1.042-07	6.859-08	5.499-08	4.794-08
NE	1.824-07	1.616-07	1.591-07	1.775-07	1.775-07	1.533-07	1.065-07	8.943-08	6.116-08	5.343-08
ENE	1.691-07	1.759-07	1.951-07	2.082-07	2.122-07	1.728-07	1.116-07	8.439-08	5.663-08	4.733-08
E	1.834-07	1.781-07	2.365-07	2.416-07	2.331-07	1.814-07	1.085-07	7.356-08	5.668-08	4.870-08
ESE	1.187-07	1.875-07	2.480-07	2.641-07	2.526-07	1.907-07	1.106-07	8.999-08	5.899-08	5.072-08
SE	8.993-08	1.751-07	2.363-07	2.475-07	2.416-07	1.865-07	1.156-07	9.757-08	6.317-08	5.439-08
SSE	3.586-08	1.735-07	2.493-07	2.613-07	2.455-07	2.015-07	1.240-07	1.010-07	6.166-08	5.421-08
S	1.304-07	1.646-07	2.330-07	2.697-07	2.694-07	2.243-07	1.350-07	1.088-07	6.385-08	5.296-08
SSW	1.225-07	3.160-07	2.838-07	2.974-07	2.990-07	2.448-07	1.630-07	1.277-07	8.807-08	7.400-08
SW	2.381-07	2.525-07	2.727-07	2.844-07	2.774-07	2.195-07	1.347-07	1.083-07	6.622-08	5.392-08
WSW	2.821-07	1.910-07	2.237-07	2.306-07	2.403-07	2.135-07	1.371-07	1.153-07	6.886-08	5.525-08
W	2.832-07	1.842-07	1.843-07	1.901-07	1.913-07	1.633-07	1.135-07	1.011-07	6.721-08	5.587-08
WNW	1.086-07	1.391-07	1.973-07	2.165-07	2.148-07	1.815-07	1.174-07	9.713-08	6.393-08	5.286-08
NW	9.785-08	1.618-07	2.015-07	2.294-07	2.316-07	2.084-07	1.389-07	1.129-07	7.337-08	6.240-08
NNW	2.430-07	1.535-07	1.966-07	2.097-07	2.178-07	1.763-07	1.102-07	8.681-08	5.838-08	5.082-08
ALL	1.630-07	1.764-07	2.232-07	2.345-07	2.330-07	1.896-07	1.192-07	9.711-08	6.077-08	5.249-08

TABLE 2.3-45

FIFTH PERCENTILE X/Q VALUES (sec / meter³) FOR THE TIME PERIOD OF 8-24 HOURS FOR EFFLUENTSRELEASED FROM PLANT COMMON STACKDISTANCE FROM THE SITE (mi)

<u>SECTOR</u>	<u>0.5</u>	<u>1.5</u>	<u>2.5</u>	<u>3.5</u>	<u>4.5</u>	<u>7.5</u>	<u>15.0</u>	<u>25.0</u>	<u>35.0</u>	<u>45.0</u>
N	1.638-07	5.631-08	6.011-08	6.131-08	5.509-08	4.019-08	2.111-08	1450-08	8.969-09	7.127-09
NNE	1.328-07	5.398-08	5.320-08	5.482-08	4.816-08	3.536-08	1.919-08	1392-08	7.851-09	6.014-09
NE	1.194-07	6.246-08	4.911-08	4.710-08	4.320-08	3.188-08	1.904-08	1.402-08	8.358-09	6.950-09
ENE	1.206-07	5.751-08	5.760-08	5.630-08	5.116-08	3.816-08	2.136-08	1.454-08	8.613-09	6.906-09
E	1.282-07	6.016-08	7.281-08	6.670-08	6.051-08	4.254-08	2.275-08	1.502-08	8.871-09	6.991-09
ESE	9.259-08	7.716-08	7.818-08	7.848-08	6.837-08	4.800-08	2.426-08	1.502-08	9.346-09	7.301-09
SE	8.173-08	5.756-08	6.966-08	6.877-08	6.279-08	4.403-08	2.328-08	1.504-08	9.323-09	7.325-09
SSE	3.821-08	5.567-08	7.814-08	7.693-08	6.699-08	4.796-08	2.461-08	1.526-08	9.463-09	7.399-09
S	9.718-08	5.308-08	6.385-08	6.625-08	6.711-08	5.265-08	2.887-08	1.630-08	1.060-08	8.007-09
SSW	1.129-07	1.075-07	9.198-08	8.854-08	8.267-08	6.001-08	3.495-08	2.386-08	1.350-08	1.083-08
SW	1.415-07	1.006-07	8.871-08	8.822-08	7.850-08	5.516-08	2.850-08	1.624-08	1.065-08	8.177-09
WSW	1.385-07	8.841-08	7.097-08	6.815-08	6.334-08	4.755-08	2.850-08	1.674-08	1.158-08	8.162-09
W	1.249-07	7.278-08	5.838-08	5.468-08	4.810-08	3.485-08	1.905-08	1.429-0	8.673-09	7.269-09
WNW	1.870-07	5.443-08	6.041-08	8.138-08	5.627-08	4.089-08	2.275-08	1.501-08	9.137-09	7.371-09
NW	7.958-08	6.401-08	5.857-08	6.352-08	5.748-08	4.619-08	2.901-08	1.756-08	1.192-08	9.531-09
NNW	2.864-07	5.715-08	5.747-08	5.855-08	5.295-08	3.990-08	2.172-08	1.478-08	8.846-09	7.012-09
ALL	1.214-07	6.243-08	6.553-08	6.429-08	5.876-08	4.295-08	2.369-08	1.528-08	9.451-09	7.471-09

TABLE 2.3-46

FIFTH PERCENTILE X/Q VALUES (sec / meter³) FOR THE TIME PERIOD OF 1-4 DAYS FOR EFFLUENTSRELEASED FROM PLANT COMMON STACKDISTANCE FROM THE SITE (mi)

<u>SECTOR</u>	<u>0.5</u>	<u>1.5</u>	<u>2.5</u>	<u>3.5</u>	<u>4.5</u>	<u>7.5</u>	<u>15.0</u>	<u>25.0</u>	<u>35.0</u>	<u>45.0</u>
N	5.853-08	2.306-08	2.383-08	2.535-08	2.379-08	1.789-08	9.593-09	6.005-09	4.095-09	3.095-09
NNE	5.088-08	2.238-08	2.176-08	2.352-08	2.102-08	1.601-08	9.000-09	5.478-09	3.836-09	2.977-09
NE	4.799-08	2.503-08	1.940-08	2.057-08	1.827-08	1.431-08	9.041-09	5.826-09	4.099-09	3.455-09
ENE	3.630-08	2.317-08	2.320-08	2.342-08	2.104-08	1.614-08	9.643-09	5.965-09	4.130-09	3.021-09
E	4.971-08	2.754-08	3.242-08	3.290-08	2.967-08	2.072-08	1.189-08	8.032-09	5.094-09	3.959-09
ESE	4.293-08	2.827-08	3.599-08	3.787-08	3.544-08	2.585-08	1.312-08	8.328-09	5.214-09	3.914-09
SE	1.805-08	2.600-08	2.919-08	2.981-08	2.541-08	1.861-08	9.627-09	5.572-09	3.960-09	2.993-09
SSE	1.834-08	2.439-08	3.233-08	3.246-08	2.939-08	2.067-08	1.115-08	7.328-09	4.298-09	3.262-09
S	3.197-08	1.467-08	2.455-08	2.610-08	2.387-08	1.852-08	1.100-08	8.383-09	4.833-09	3.854-09
SSW	2.929-08	4.652-08	3.645-08	3.616-08	3.346-08	2.598-08	1.523-08	9.912-09	6.635-09	5.327-09
SW	3.979-08	4.552-08	4.317-08	4.343-08	3.865-08	2.583-08	1.353-08	8.736-09	5.034-09	3.835-09
WSW	6.769-08	3.625-08	2.985-08	2.998-08	2.558-08	1.765-08	1.051-08	7.566-09	4.710-09	3.756-09
W	5.259-08	2.526-08	2.252-08	2.087-08	1.901-08	1.318-08	7.512-09	5.124-09	3.122-09	2.549-09
WNW	1.768-08	1.454-08	2.131-08	2.259-08	2.143-08	1.712-08	9.045-09	5.506-09	3.717-09	2.843-09
NW	1.949-08	1.994-08	2.026-08	2.266-08	2.268-08	1.886-08	1.157-08	8.503-09	5.315-09	4.119-09
NNW	6.035-08	2.506-08	2.571-08	2.797-08	2.436-08	1.788-08	1.006-08	6.161-09	4.155-09	3.116-09
ALL	4.526-08	2.591-08	2.616-08	2.762-08	2.502-08	1.865-08	1.064-08	7.131-09	4.461-09	3.505-09

TABLE 2.3-47

FIFTH PERCENTILE X/Q VALUES (sec / meter³) FOR THE TIME PERIOD OF 4-30 DAYS FOR EFFLUENTS
RELEASED FROM PLANT COMMON STACK

SECTOR	DISTANCE FROM THE SITE (mi)									
	0.5	1.5	2.5	3.5	4.5	7.5	15.0	25.0	35.0	45.0
N	5.266-08	1.263-08	1.063-08	1.105-08	1.035-08	8.596-09	4.380-09	2.804-09	2.094-09	1.563-09
NNE	4.546-08	1.096-08	1.100-08	1.101-08	1.050-08	8.275-09	4.664-09	3.231-09	2.165-09	1.904-09
NE	1.774-08	1.226-08	9.059-09	8.791-09	9.182-09	6.992-09	4.210-09	2.753-09	1.962-09	1.536-09
ENE	3.013-08	1.152-08	1.113-08	1.258-08	1.170-08	9.191-09	5.280-09	4.421-09	2.334-09	2.072-09
E	1.973-08	1.316-08	1.722-08	1.793-08	1.756-08	1.218-08	6.470-09	4.910-09	2.502-09	2.359-09
ESE	3.670-08	1.412-08	2.365-08	2.223-08	2.334-08	1.570-08	8.384-09	5.014-09	3.535-09	2.588-09
SE	1.968-08	1.324-08	1.376-08	1.440-08	1.352-08	9.924-09	5.361-09	2.904-09	1.997-09	1.554-09
SSE	2.190-08	1.733-08	1.100-08	1.092-08	9.593-09	6.897-09	4.075-09	2.618-09	1.467-09	1.311-09
S	1.657-08	7.134-08	7.218-09	7.518-09	7.532-09	6.079-09	3.887-09	2.544-09	1.593-09	1.354-09
SSW	1.502-08	1.478-08	1.618-08	1.595-08	1.386-08	1.042-08	5.917-09	4.391-09	2.399-09	2.125-09
SW	2.098-08	1.469-08	1.664-08	1.542-08	1.384-08	1.029-08	5.686-09	2.745-09	1.939-09	1.489-09
WSW	3.856-08	1.360-08	1.114-08	1.048-08	9.410-09	6.802-09	4.060-09	2.630-09	1.636-09	1.399-09
W	1.806-08	8.961-09	8.314-09	7.940-09	7.655-09	5.485-09	3.00-09	2.512-09	1.303-09	1.186-09
WNW	1.314-08	6.710-09	9.517-09	9.033-09	8.269-09	6.753-09	3.931-09	2.533-09	1.696-09	1.366-09
NW	1.457-08	7.004-09	8.574-09	9.560-09	9.677-09	8.014-09	5.264-09	2.800-09	2.083-09	1.565-09
NNW	1.898-08	1.129-08	1.104-08	1.138-08	1.156-08	8.177-09	4.440-09	2.722-09	1.800-09	1.496-09
ALL	2.285-08	1.284-08	1.305-08	1.350-08	1.280-08	9.450-09	5.287-09	3.366-09	2.159-09	1.764-09

TABLE 2.3-48

X/Q VALUES (sec / meter³) AT EXCLUSION AREA BOUNDARY FOREFFLUENTS RELEASED THROUGH SGTS VENT

<u>SECTOR</u>	<u>EXCLUSION AREA BOUNDARY (km)</u>	<u>0-1 HOUR</u>		<u>0-2 HOURS</u>		<u>0-8 HOURS</u>		<u>8-24 HOURS</u>		<u>1-4 DAYS</u>		<u>4-30 DAYS</u>	
		<u>5 PERCENT</u>	<u>50 PERCENT</u>	<u>5 PERCENT</u>	<u>50 PERCENT</u>	<u>5 PERCENT</u>	<u>50 PERCENT</u>	<u>5 PERCENT</u>	<u>50 PERCENT</u>	<u>5 PERCENT</u>	<u>50 PERCENT</u>	<u>5 PERCENT</u>	<u>50 PERCENT</u>
		N	.51	3.742-06	1.090-12	3.437-06	3.872-13	1.467-08	1.749-13	1.080-06	8.583-14	6.338-07	7.702-14
NNE	.51	3.861-06	7.831-13	3.525-06	3.135-13	1.714-06	1.315-13	1.043-06	4.555-14	1.125-06	3.254-14	4.187-07	2.772-08
NE	.51	1.448-06	4.399-20	9.135-07	4.899-20	4.630-07	9.781-14	4.644-07	3.581-14	2.076-07	1.938-14	3.039-07	9.296-09
ENE	.51	2.283-06	1.373-12	9.592-07	4.485-13	3.942-07	1.451-13	3.243-07	4.510-14	1.844-07	2.753-14	2.832-07	7.088-09
E	.51	3.174-06	1.784-12	2.402-06	6.190-13	9.502-07	2.067-13	7.170-07	8.632-14	1.902-07	5.253-14	1.531-07	1.694-08
ESE	.51	2.457-06	1.708-12	1.739-06	6.118-13	9.221-07	1.842-13	5.153-07	6.768-14	1.885-07	4.654-14	1.347-07	6.219-09
SE	.51	2.587-07	1.476-12	3.042-07	4.932-13	1.640-07	1.469-13	1.441-07	4.495-14	5.282-07	3.020-14	4.025-08	6.389-14
SSE	.51	1.961-07	1.853-12	1.942-07	6.515-13	6.346-08	1.957-13	6.056-08	6.332-14	3.195-08	3.117-14	3.818-08	4.341-14
S	.51	1.126-06	1.925-12	8.626-07	6.662-13	3.585-07	1.888-13	2.435-07	5.143-14	7.359-08	2.396-14	4.494-08	2.387-14
SSW	.51	9.038-07	2.088-12	6.637-07	7.448-13	3.091-07	1.941-13	2.217-07	4.999-14	6.854-08	2.421-14	2.931-08	2.593-10
SW	.51	2.329-06	2.308-12	1.407-06	8.448-13	5.296-07	2.863-11	3.029-07	8.849-14	1.106-07	2.927-14	3.087-08	2.357-10
WSW	.51	2.501-06	1.832-12	1.824-06	6.264-13	3.960-07	1.827-13	3.279-07	4.962-14	1.780-07	1.995-14	5.807-08	1.441-10
W	.51	3.476-06	5.727-13	2.462-06	3.524-13	8.569-07	1.169-13	4.724-07	3.456-14	1.938-07	1.682-14	1.411-07	1.770-10
WNW	.51	3.534-06	1.137-12	2.025-06	3.642-13	8.928-07	1.036-13	6.292-07	2.965-14	1.667-07	9.749-15	8.197-08	2.536-10
NW	.51	1.311-06	1.040-12	7.939-07	3.672-13	8.168-07	1.268-13	7205-07.	4.229-14	2.944-07	2.535-14	1.247-07	7.655-14
NNW	.51	2.370-06	1.131-12	1.574-06	3.872-13	7.331-07	1.441-13	6.352-07	4.538-14	1.970-07	2.558-14	1.337-07	1.556-09
ALL		2.422-06	1.480-12	1.446-06	5.029-13	6.825-07	1.598-13	5.284-07	4.890-14	1.950-07	2.849-14	1.637-07	5.328-10

LSCS-UFSAR

TABLE 2.3-49

X/Q VALUES (sec / meter³) AT ACTUAL SITE BOUNDARY FOR EFFLUENTS
RELEASED THROUGH SGTS VENT

SECTOR	ACTUAL SITE BOUNDARY (km)	0-1 HOUR		0-2 HOURS		0-8 HOURS		8-24 HOURS		1-4 DAYS		4-30 DAYS	
		5 PERCENT	50 PERCENT	5 PERCENT	50 PERCENT	5 PERCENT	50 PERCENT	5 PERCENT	50 PERCENT	5 PERCENT	50 PERCENT	5 PERCENT	50 PERCENT
N	1.02	1.997-06	2.914-08	1.526-06	1.826-08	8.078-07	9.021-09	3.669-07	3.622-09	2.197-07	2.443-09	8.132-08	1.466-08
NNE	1.33	2.486-06	5.498-08	1.550-06	5.714-08	6.815-07	2.492-08	3.143-07	8.577-09	1.719-07	5.165-09	8.277-08	1.610-08
NE	2.41	1.625-06	2.088-07	1.281-06	1.754-07	5.645-07	8.562-08	1.692-07	2.781-08	7.367-08	1.232-08	3.812-08	1.388-08
ENE	4.45	1.653-06	5.424-07	1.352-06	3.720-07	5.861-07	1.429-07	1.660-07	3.599-08	7.389-08	1.730-08	3.129-08	1.645-08
E	1.97	1.654-06	3.266-07	1.105-06	2.446-07	5.458-07	1.126-07	1.734-07	3.591-08	8.098-08	1.692-08	4.003-08	1.791-08
ESE	.84	1.723-06	6.407-09	1.528-06	4.374-09	7.895-07	1.526-09	3.576-07	4.865-10	1.545-07	2.691-10	7.262-08	9.553-09
SE	.88	1.150-06	3.960-09	7.555-07	7.450-09	2.814-07	2.270-09	1.551-07	7.103-10	6.849-06	3.352-10	5.318-08	5.770-10
SSE	.84	1.001-06	9.496-09	6.791-07	5.269-09	2.336-07	1.772-09	1.129-07	5.244-10	6.577-08	2.044-10	6.225-08	1.986-10
S	.83	1.605-06	8.364-09	1.317-06	4.933-09	4.996-07	1.654-09	2.667-07	4.202-10	7.427-08	1.516-10	2.936-08	1.403-10
SSW	.83	1.719-06	9.242-09	1.430-06	5.544-09	5.528-07	1.879-09	2.410-07	4.146-10	1.048-07	1.628-10	4.235-08	1.689-09
SW	.61	2.082-06	7.661-11	1.495-06	4.735-11	5.743-07	2.093-11	3.873-07	4.657-12	1.097-07	1.880-12	5.765-08	7.541-10
WSW	.51	2.164-06	1.061-12	1.328-06	5.118-13	4.693-07	2.546-13	3.057-07	4.351-14	1.227-07	1.523-14	6.418-08	1.511-10
W	.51	3.250-06	7.499-13	2.304-06	4.583-13	6.463-07	1.762-13	4.416-07	3.389-14	1.718-07	1.222-14	1.572-07	1.769-10
WNW	.63	2.336-06	8.104-11	1.537-06	5.560-11	6.036-07	1.178-11	3.703-07	3.939-12	1.005-07	1.217-12	8.936-08	6.586-10
NW	.73	1.501-06	9.585-10	1.131-06	5.879-10	5.841-07	2.084-10	5.318-07	7.549-11	1.918-07	3.153-11	1.027-07	9.515-11
NNW	.85	1.348-06	6.861-09	9.957-07	3.899-09	4.917-07	1.488-09	2.988-07	4.443-10	1.262-07	1.760-11	5.410-08	3.959-09
ALL		1.651-06	8.321-09	1.293-06	5.682-09	5.616-07	2.870-09	2.437-07	1.082-09	9.500-08	5.929-10	6.376-08	5.433-09

TABLE 2.3-50

X/Q VALUES (sec / meter³) AT LOW POPULATION ZONE BOUNDARY FOR EFFLUENTS
RELEASED THROUGH SGTS VENT

<u>SECTOR</u>	<u>ACTUAL SITE BOUNDARY (km)</u>	<u>0-1 HOUR</u>		<u>0-2 HOURS</u>		<u>0-8 HOURS</u>		<u>8-24 HOURS</u>		<u>1-4 DAYS</u>		<u>4-30 DAYS</u>	
		<u>5 PERCENT</u>	<u>50 PERCENT</u>	<u>5 PERCENT</u>	<u>50 PERCENT</u>	<u>5 PERCENT</u>	<u>50 PERCENT</u>	<u>5 PERCENT</u>	<u>50 PERCENT</u>	<u>5 PERCENT</u>	<u>50 PERCENT</u>	<u>5 PERCENT</u>	<u>50 PERCENT</u>
N	6.40	1.286-06	3.906-07	9.401-07	2.793-07	4.995-07	1.357-07	1.182-07	3.358-08	5.405-08	1.635-08	2.604-08	1.338-08
NNE	6.40	1.470-06	3.970-07	1.010-06	2.656-07	4.989-07	1.199-07	1.119-07	2.815-08	5.006-08	1.286-08	2.598-08	1.470-08
NE	6.40	1.440-06	3.607-07	9.835-07	2.335-07	5.042-07	1.064-07	1.088-07	2.547-08	4.730-08	1.135-08	2.003-08	1.318-08
ENE	6.40	1.382-06	4.317-07	9.559-07	3.193-07	4.773-07	1.271-07	1.135-07	2.674-08	5.010-08	1.376-08	2.705-08	1.321-08
E	6.40	1.369-06	4.223-07	9.367-07	3.257-07	4.996-07	1.482-07	1.270-07	3.466-08	6.899-08	1.612-08	3.422-08	1.723-08
ESE	6.40	1.206-06	4.161-07	9.517-07	3.301-07	4.837-07	1.538-07	1.357-07	3.657-08	7.170-08	1.628-08	3.881-08	1.457-08
SE	6.40	1.448-06	4.699-07	9.841-07	3.583-07	4.852-07	1.532-07	1.277-07	3.402-08	5.332-08	1.346-08	2.363-08	1.243-08
SSE	6.40	1.532-06	5.474-07	1.162-07	4.285-07	5.763-07	1.817-07	1.417-07	4.187-08	6.348-08	1.402-08	2.149-08	1.120-08
S	6.40	1.951-06	6.389-07	1.266-06	4.587-07	7.176-07	1.752-07	1.918-07	3.335-08	8.420-08	1.169-08	2.874-08	7.690-09
SSW	6.40	2.301-06	7.155-07	1.524-06	5.316-07	7.984-07	2.170-07	2.347-07	4.754-08	1.192-07	1.638-08	4.388-08	7.426-08
SW	6.40	1.690-06	6.457-07	1.218-06	4.608-07	6.120-07	2.026-07	1.707-07	4.830-08	8.473-08	1.696-08	2.893-08	9.201-09
WSW	6.40	1.573-06	5.750-07	1.321-06	3.964-07	6.887-07	1.672-07	1.674-07	3.840-08	6.181-08	1.252-08	2.181-08	1.061-08
W	6.40	1.624-06	4.921-07	1.089-06	3.338-07	5.016-07	1.385-07	1.090-07	3.055-08	4.356-08	1.246-08	1.608-08	7.776-09
WNW	6.40	1.532-06	5.040-07	1.060-06	3.338-07	5.516-07	1.325-07	1.337-07	2.756-08	5.536-08	9.427-09	2.172-08	9.233-09
NW	6.40	1.859-06	4.849-07	1.383-06	3.274-07	7.435-07	1.514-07	1.850-07	3.397-08	6.810-08	1.99-08	2.971-08	9.340-09
NNW	6.40	1.461-06	4.306-07	1.011-06	2.902-07	4.978-07	1.236-07	1.158-07	2.738-08	5.250-08	1.192-08	2.363-08	8.464-09
ALL		1.505-06	4.633-07	1.090-66	3.373-07	5.630-07	1.469-07	1.361-07	3.291-08	6.229-08	1.372-08	2.826-08	1.138-08

LSCS-UFSAR

TABLE 2.3-51

FIFTIETH PERCENTILE X/Q VALUES (sec / meter³) FOR THE PERIOD OF
0-1 HOUR FOR EFFLUENTS RELEASED THROUGH SGTS VENT

SECTOR	DISTANCE FROM THE SITE (mi)									
	0.5	1.5	2.5	3.5	4.5	7.5	15.0	25.0	35.0	45.0
N	2.362-06	1.909-06	1.535-06	1.437-06	1.233-06	7.933-07	4.801-07	3.084-07	2.143-07	1.857-07
NNE	3.055-06	2.170-06	1.706-06	1.673-06	1.390-06	9.543-07	5.489-07	3.227-07	2.173-07	1.878-07
NE	1.505-06	1.903-06	1.659-06	1.618-06	1.299-06	8.743-07	5.385-07	3.224-07	2.427-07	2.042-07
ENE	1.557-06	1.849-06	1.631-06	1.599-06	1.273-06	8.560-07	5.266-07	3.168-07	2.418-07	1.966-07
E	1.733-06	1.812-06	1.556-06	1.576-06	1.333-06	9.129-07	5.156-07	3.216-07	2.511-07	2.041-07
ESE	1.727-06	1.720-06	1.460-06	1.351-06	1.111-06	7.153-07	4.023-07	2.773-07	1.976-07	1.734-07
SE	1.170-06	1.671-06	1.640-06	1.620-06	1.337-06	9.290-07	5.552-07	3.337-07	2.622-07	2.175-07
SSE	9.300-07	1.918-06	1.948-06	1.897-06	1.438-06	9.842-07	5.841-07	3.378-07	2.644-07	2.223-07
S	1.641-06	2.238-06	2.552-06	2.211-06	1.773-06	1.163-06	6.473-07	3.951-07	2.958-07	2.335-07
SSW	1.736-06	2.196-06	2.660-06	2.439-06	2.218-06	1.653-06	9.340-07	5.403-07	3.985-07	3.270-07
SW	2.873-06	2.173-06	2.196-06	2.063-06	1.692-06	1.080-06	6.636-07	4.133-07	3.107-07	2.585-07
WSW	1.581-06	2.027-06	1.989-06	1.984-06	1.576-06	1.037-06	6.432-07	3.701-07	2.784-07	2.379-07
W	2.188-06	2.016-06	2.085-06	1.953-06	1.640-06	1.005-06	6.313-07	3.878-07	2.871-07	2.347-07
WNW	1.969-06	2.044-06	1.747-06	1.799-06	1.448-06	9.879-07	6.271-07	4.123-07	3.112-07	2.707-07
NW	1.542-06	2.105-06	2.275-06	2.114-06	1.746-06	1.173-06	7.235-07	4.471-07	3.235-07	2.842-07
NNW	1.407-06	1.691-06	1.639-06	1.654-06	1.372-06	9.328-07	5.677-07	3.342-07	2.679-07	2.198-07
ALL	1.662-06	1.979-06	1.747-06	1.748-06	1.422-06	9.718-07	5.839-07	3.408-07	2.640-07	2.177-07

TABLE 2.3-51

LSCS-UFSAR

TABLE 2.3-52

FIFTIETH PERCENTILE X/Q VALUES (sec / meter³) FOR THE PERIOD OF 0-2 HOUR FOR EFFLUENTS0-2 HOURS FOR EFFLUENTS RELEASED THROUGH SGTS VENT

DISTANCE FROM THE SITE (mi)

<u>SECTOR</u>	<u>0.5</u>	<u>1.5</u>	<u>2.5</u>	<u>3.5</u>	<u>4.5</u>	<u>7.5</u>	<u>15.0</u>	<u>25.0</u>	<u>35.0</u>	<u>45.0</u>
N	1.663-06	1.395-06	1.220-06	1.054-06	9.072-07	5.889-07	3.462-07	2.159-07	1.699-07	1.410-07
NNE	2.341-06	1.566-06	1.380-06	1.173-06	9.595-07	6.327-07	3.658-07	2.294-07	1.690-07	1.416-07
NE	1.175-06	1.145-06	1.224-06	1.088-06	9.441-07	6.387-07	3.755-07	2.369-07	1.834-07	1.501-07
ENE	1.174-06	1.127-06	1.188-06	1.050-06	9.193-07	6.137-07	3.591-07	2.191-07	1.689-07	1.386-07
E	1.528-06	1.133-06	1.119-06	1.029-06	9.225-07	6.148-07	3.631-07	2.243-07	1.742-07	1.458-07
ESE	1.568-06	1.125-06	1.352-06	1.063-06	9.033-07	5.658-07	3.365-07	2.112-07	1.570-07	1.322-07
SE	6.673-07	1.094-06	1.181-06	1.072-06	9.281-07	6.307-07	3.805-07	2.416-07	1.871-07	1.580-07
SSE	6.780-07	1.138-06	1.352-06	1.264-06	1.125-06	7.041-07	3.975-07	2.620-07	1.993-07	1.658-07
S	1.397-06	1.760-06	1.663-06	1.371-06	1.268-06	7.760-07	4.013-07	2.490-07	1.871-07	1.607-07
SSW	1.406-06	1.828-06	1.811-06	1.622-06	1.662-06	1.048-06	5.749-07	3.590-07	2.959-07	2.360-07
SW	1.629-06	1.763-06	1.547-06	1.305-06	1.239-06	7.787-07	4.082-07	2.753-07	1.956-07	1.673-07
WSW	1.366-06	1.618-06	1.632-06	1.412-06	1.263-06	8.177-07	3.992-07	2.493-07	1.822-07	1.497-07
W	1.528-06	1.284-06	1.360-06	1.217-06	1.068-06	7.454-07	4.089-07	2.674-07	1.997-07	1.747-07
WNW	1.415-06	1.279-06	1.314-06	1.149-06	9.868-07	6.685-07	4.042-07	2.804-07	2.039-07	1.806-07
NW	1.163-06	1.563-06	1.709-06	1.511-06	1.348-06	9.390-07	4.819-07	3.196-07	2.544-07	2.082-07
NNW	1.097-06	1.090-06	1.214-06	1.121-06	9.475-07	6.443-07	3.890-07	2.584-07	1.907-07	1.683-07
ALL	1.378-06	1.327-06	1.350-06	1.198-06	1.055-06	6.704-07	3.868-07	2.407-07	1.873-07	1.568-07

TABLE 2.3-52

LSCS-UFSAR

TABLE 2.3-53

FIFTH PERCENTILE X/Q VALUES (sec / meter³) FOR THE PERIOD OF 0-8 HOUR FOR EFFLUENTSRELEASED THROUGH SGTS VENTDISTANCE FROM THE SITE (mi)

<u>SECTOR</u>	<u>0.5</u>	<u>1.5</u>	<u>2.5</u>	<u>3.5</u>	<u>4.5</u>	<u>7.5</u>	<u>15.0</u>	<u>25.0</u>	<u>35.0</u>	<u>45.0</u>
N	1.032-06	6.576-07	6.414-07	5.376-07	4.754-07	3.147-07	2.085-07	1.234-07	9.294-08	6.919-08
NNE	1.198-06	7.287-07	6.626-07	5.431-07	4.758-07	3.093-07	2.044-07	1.200-07	9.269-08	6.870-08
NE	5.910-07	5.536-07	5.664-07	5.387-07	4.764-07	3.133-07	2.192-07	1.354-07	1.070-07	8.188-08
ENE	5.700-07	5.392-07	5.510-07	5.077-07	4.565-07	3.055-07	1.863-07	1.100-07	7.827-08	6.358-08
E	6.470-07	5.678-07	6.334-07	5.349-07	4.805-07	3.049-07	2.018-07	1.224-07	8.867-08	6.755-08
ESE	8.605-07	5.582-07	6.089-07	5.173-07	4.812-07	3.053-07	2.108-07	1.269-07	9.758-08	7.024-08
SE	2.789-07	5.435-07	5.615-07	4.984-07	4.617-07	3.095-07	2.155-07	1.335-07	1.030-07	8.070-08
SSE	2.332-07	5.719-07	6.826-07	5.946-07	5.317-07	3.439-07	2.361-07	1.496-07	1.193-07	9.354-08
S	5.670-07	8.926-07	9.462-07	7.895-07	6.847-07	4.103-07	2.484-07	1.417-07	1.052-07	7.842-08
SSW	6.146-07	9.614-07	9.536-07	8.279-07	7.622-07	5.066-07	2.797-07	2.013-07	1.471-07	1.151-07
SW	6.886-07	7.989-07	7.582-07	6.546-07	5.792-07	4.092-07	2.517-07	1.413-07	1.040-07	7.308-08
WSW	5.741-07	8.006-07	8.330-07	7.432-07	6.606-07	4.090-07	2.476-07	1.401-07	9.948-08	6.959-08
W	6.249-07	5.482-07	5.927-07	5.248-07	4.720-07	3.248-07	2.243-07	1.399-07	1.097-07	8.595-08
WNW	5.296-07	5.890-07	6.730-07	5.794-07	5.274-07	3.478-07	2.310-07	1.372-07	1.100-07	7.991-08
NW	6.825-07	8.308-07	8.989-07	7.772-07	7.071-07	4.635-07	2.654-07	1.594-07	1.217-07	9.739-08
NNW	5.678-07	5.188-07	5.770-07	5.297-07	4.932-07	3.207-07	2.088-07	1.284-07	9.740-08	7.452-08
ALL	6.317-07	6.229-07	6.781-07	5.891-07	5.219-07	3.406-07	2.272-07	1.346-07	1.030-07	7.714-08

TABLE 2.3-53

LSCS-UFSAR

TABLE 2.3-54

FIFTH PERCENTILE X/Q VALUES (sec / meter³) FOR THE TIME PERIOD OF 8-24 HOUR FOR EFFLUENTS
RELEASED THROUGH SGTS VENT

SECTOR	DISTANCE FROM THE SITE (mi)									
	0.5	1.5	2.5	3.5	4.5	7.5	15.0	25.0	35.0	45.0
N	5.249-07	2.154-07	1.678-07	1.379-07	1.118-07	6.487-08	3.379-08	1.847-08	1.283-08	8.764-09
NNE	5.446-07	2.157-07	1.653-07	1.315-07	1.033-07	6.111-08	3.826-08	1.746-08	1.107-08	8.055-09
NE	3.391-07	1.812-07	1.393-07	1.205-07	1.018-07	6.188-08	3.214-08	1.833-08	1.295-08	9.274-09
ENE	2.794-07	1.742-07	1.478-07	1.282-07	1.087-07	6.390-08	3.302-08	1.752-08	1.105-08	7.855-09
E	3.905-07	2.039-07	1.735-07	1.443-07	1.159-07	6.839-08	3.360-08	1.874-08	1.284-08	8.431-09
ESE	4.355-07	2.132-07	1.880-07	1.505-07	1.226-07	7.204-08	3.469-08	1.922-08	1.33-08	9.154-09
SE	1.478-07	1.868-07	1.697-07	1.436-07	1.175-07	6.859-08	3.383-08	1.873-08	1.273-08	9.329-09
SSE	1.104-07	2.133-07	1.976-07	1.603-07	1.279-07	7.862-08	3.504-08	1.979-08	1.427-08	9.889-09
S	3.059-07	2.319-07	2.613-07	2.219-07	1.757-07	9.767-08	4.828-08	2.139-08	1.523-08	1.044-08
SSW	2.462-07	2.810-07	2.985-07	2.696-07	2.176-07	1.196-07	6.530-08	3.246-08	2.279-08	1.539-08
SW	3.972-07	2.451-07	2.289-07	1.959-07	1.599-07	9.069-08	5.143-08	2.199-08	1.527-08	1.024-08
WSW	3.700-07	2.352-07	2.163-07	1.970-07	1.642-07	9.522-08	4.471-08	2.217-08	1.490-08	1.009-08
W	3.514-07	1.876-07	1.466-07	1.206-07	9.943-08	6.353-08	3.333-08	1.846-08	1.297-08	9.370-09
WNW	3.327-07	2.094-07	1.869-07	1.557-07	1.241-07	7.040-08	3.479-08	1.950-08	1.407-08	9.467-09
NW	4.206-07	2.257-07	2.366-07	2.022-07	1.656-07	9.959-08	5.620-08	2.979-08	1.906-08	1.319-08
NNW	3.380-07	1.683-07	1.493-07	1.299-07	1.096-07	6.496-08	3.285-08	1.819-08	1.272-08	8.830-09
ALL	3.725-07	2.136-07	1.874-07	1.543-07	1.240-07	7.442-08	3.510-08	1.964-08	1.377-08	9.470-09

TABLE 2.3-54

LSCS-UFSAR

TABLE 2.3-55

FIFTH PERCENTILE X/Q VALUES (sec / meter³) FOR THE TIME PERIOD OF 1-4 DAYS FOR EFFLUENTS
RELEASED THROUGH SGTS VENT

SECTOR	DISTANCE FROM THE SITE (mi)									
	0.5	1.5	2.5	3.5	4.5	7.5	15.0	25.0	35.0	45.0
N	3.102-07	9.516-08	7.307-08	6.318-03	4.932-08	2.988-08	1.702-08	9.173-09	6.321-09	4.322-09
NNE	3.630-07	1.011-07	6.702-08	5.770-08	4.418-08	2.769-08	1.616-08	7.645-09	5.631-09	3.884-09
NE	1.336-07	6.191-08	6.287-08	5.360-08	4.458-08	2.822-08	1.640-08	8.940-09	6.406-09	4.441-09
ENE	1.153-07	6.221-08	6.772-08	5.782-08	4.800-08	2.845-08	1.563-08	7.444-09	5.004-09	3.733-09
E	1.284-07	9.054-08	8.426-08	7.535-08	6.276-08	3.831-08	1.970-08	1.048-08	7.087-09	5.329-09
ESE	1.707-07	9.813-08	8.515-08	7.756-08	6.542-08	4.219-08	2.048-08	1.116-08	7.652-09	5.614-09
SE	6.332-08	8.131-08	7.055-08	6.336-08	4.887-08	2.912-08	1.721-08	7.476-09	5.584-09	4.089-09
SSE	5.338-08	9.495-08	8.219-08	7.145-08	6.023-08	3.675-08	1.886-08	9.387-09	6.426-09	4.443-09
S	9.258-08	9.737-08	1.002-07	8.031-08	8.277-08	5.295-08	2.622-08	1.489-08	9.943-09	6.710-09
SSW	9.160-08	1.233-07	1.410-07	1.290-07	1.085-07	6.347-08	3.425-08	1.717-08	1.177-08	8.055-09
SW	1.335-07	1.190-07	1.094-07	9.381-08	8.138-08	4.923-08	2.236-08	1.431-08	9.854-09	6.789-09
WSW	1.513-07	9.471-08	7.865-08	7.186-08	5.838-08	3.409-08	1.913-08	9.664-09	6.176-09	4.110-09
W	1.401-07	6.640-08	5.814-08	4.979-08	4.059-08	2.370-08	1.351-08	6.660-09	4.614-09	3.582-09
WNW	8.066-08	7.181-08	6.950-08	5.922-08	5.089-08	2.921-08	1.688-08	8.116-09	4.823-09	3.734-09
NW	1.717-07	8.369-08	7.544-08	7.362-08	6.308-08	3.941-08	2.133-08	1.182-08	9.051-09	6.137-09
NNW	1.168-07	6.130-08	6.671-08	6.020-08	4.975-08	2.938-08	1.576-08	7.860-09	5.110-09	3.772-09
ALL	1.350-07	9.054-08	7.845-08	7.033-08	5.869-08	3.454-08	1.885-08	9.882-09	6.766-09	4.578-09

TABLE 2.3-55

LSCS-UFSAR

TABLE 2.3-56

FIFTH PERCENTILE X/Q VALUES (sec / meter³) FOR THE TIME PERIOD OF 4-30 DAYS FOR EFFLUENTSRELEASED THROUGH SGTS VENTDISTANCE FROM THE SITE (mi)

<u>SECTOR</u>	<u>0.5</u>	<u>1.5</u>	<u>2.5</u>	<u>3.5</u>	<u>4.5</u>	<u>7.5</u>	<u>15.0</u>	<u>25.0</u>	<u>35.0</u>	<u>45.0</u>
N	1.311-07	3.097-08	3.368-08	3.066-08	2.533-08	1.621-08	8.458-09	4.169-09	3.339-09	2.369-09
NNE	2.728-07	5.353-08	3.303-08	2.724-08	2.413-08	1.722-08	1.245-08	5.178-09	3.606-09	3.194-09
NE	1.331-07	4.440-08	2.747-08	2.447-08	2.030-08	1.298-08	7.184-09	3.786-09	3.090-09	2.141-09
ENE	8.938-08	3.015-08	3.246-08	3.126-08	2.753-08	1.719-08	1.010-08	4.683-09	3.335-09	2.697-09
E	5.284-08	5.387-08	4.204-08	3.658-08	3.068-08	1.986-08	1.614-08	5.233-09	3.673-09	3.225-09
ESE	1.029-07	5.117-08	4.989-08	4.616-08	3.825-08	2.371-08	1.606-08	6.098-09	4.773-09	3.254-09
SE	4.722-08	3.168-08	3.210-08	2.707-08	2.231-08	1.389-08	7.220-09	3.528-09	2.319-09	2.101-09
SSE	6.956-08	2.988-08	2.723-08	2.452-08	2.036-08	1.264-08	7.009-09	3.246-09	2.239-09	1.765-09
S	5.140-08	2.835-08	3.290-08	3.061-08	2.980-08	1.886-08	1.378-08	5.407-09	3.255-09	2.844-09
SSW	5.262-08	5.513-08	5.062-08	4.711-08	4.004-08	2.559-08	1.462-08	7.214-09	4.389-09	2.875-09
SW	5.564-08	5.473-08	3.816-08	3.613-08	2.887-08	1.651-08	1.057-08	4.522-09	3.440-09	3.030-09
WSW	8.488-08	3.091-08	2.642-08	2.490-08	2.103-08	1.315-08	9.097-09	4.686-09	2.948-09	2.440-09
W	1.032-07	2.739-08	2.132-08	1.788-08	1.479-08	9.357-09	6.727-09	2.551-09	2.038-09	1.583-09
WNW	5.720-08	2.813-08	2.635-08	2.439-08	2.012-08	1.294-08	6.946-09	3.415-09	2.312-09	1.904-09
NW	7.914-08	4.736-08	4.098-08	3.517-08	2.986-08	1.971-08	1.401-08	5.131-09	3.541-09	3.010-09
NNW	7.902-08	3.020-08	3.195-08	2.568-08	2.140-08	1.355-08	7.151-09	3.660-09	2.695-09	2.070-09
ALL	1.034-07	4.207-08	3.493-08	3.189-08	2.750-08	1.739-08	1.117-08	4.812-09	3.394-09	2.730-09

TABLE 2.3-56

LSCS-UFSAR

TABLE 2.3-57
FIFTIETH PERCENTILE X/Q VALUES (sec / meter³) FOR THE TIME PERIOD OF
0-1 HOUR FOR EFFLUENTS RELEASED THROUGH SGTS VENT

<u>SECTOR</u>	<u>DISTANCE FROM THE SITE (mi)</u>									
	<u>0.5</u>	<u>1.5</u>	<u>2.5</u>	<u>3.5</u>	<u>4.5</u>	<u>7.5</u>	<u>15.0</u>	<u>25.0</u>	<u>35.0</u>	<u>45.0</u>
N	3.098-09	2.763-07	4.317-07	4.125-07	3.675-07	2.522-07	1.410-07	9.069-08	6.394-08	5.102-08
NNE	2.874-09	2.669-07	4.325-07	4.063-07	3.748-07	2.584-07	1.486-07	9.567-08	6.759-08	5.487-08
NE	1.585-12	2.331-07	4.008-07	3.742-07	3.453-07	2.409-07	1.570-07	1.031-07	8.169-08	6.627-08
ENE	3.599-09	3.494-07	5.049-07	4.732-07	4.020-07	2.791-07	1.577-07	9.622-08	7.027-08	5.446-08
E	4.196-09	4.128-07	5.148-07	4.579-07	3.862-07	2.553-07	1.415-07	8.418-08	5.720-08	4.352-08
ESE	4.048-09	3.957-07	5.052-07	4.621-07	3.916-07	2.629-07	1.427-07	8.176-08	5.678-08	4.236-08
SE	3.696-09	4.148-07	5.514-07	5.130-07	4.340-07	2.885-07	1.618-07	9.533-08	6.562-08	5.166-08
SSE	4.401-09	5.693-07	6.688-07	6.034-07	5.019-07	3.227-07	1.659-07	9.347-08	5.988-08	4.556-08
S	4.955-09	7.001-07	7.468-07	6.775-07	5.704-07	3.842-07	1.923-07	1.110-07	7.382-08	5.617-08
SSW	5.210-09	7.913-07	8.629-07	7.430-07	6.496-07	4.198-07	2.088-07	1.118-07	6.972-08	5.077-08
SW	5.404-09	6.951-07	7.637-07	6.672-07	5.785-07	3.759-07	1.776-07	9.183-08	5.815-08	4.282-08
WSW	4.662-09	4.936-07	6.419-07	6.039-07	5.353-07	3.663-07	1.898-07	1.115-07	7.611-08	5.586-08
W	2.992-09	2.942-07	5.252-07	5.080-07	4.570-07	3.239-07	1.924-07	1.227-07	8.748-08	6.822-08
WNW	3.286-09	3.572-07	5.732-07	5.379-07	4.599-07	3.337-07	1.951-07	1.213-07	8.589-08	6.596-08
NW	3.209-09	3.947-07	5.492-07	5.144-07	4.462-07	3.136-07	1.810-07	1.114-07	8.075-08	6.375-08
NNW	3.213-09	2.963-07	4.793-07	4.566-07	4.053-07	2.716-07	1.482-07	9.420-08	6.854-08	5.562-08
ALL	3.820-09	4.011-07	5.423-07	5.015-07	4.273-07	2.909-07	1.618-07	9.716-08	6.754-08	5.289-08

LSCS-UFSAR

TABLE 2.3-58

FIFTIETH PERCENTILE X/Q VALUES (sec / meter³) FOR THE PERIOD OF
0-2 HOURS FOR EFFLUENTS RELEASED THROUGH SGTS VENT

SECTOR	DISTANCE FROM THE SITE (mi)									
	0.5	1.5	2.5	3.5	4.5	7.5	15.0	25.0	35.0	45.0
N	1.734-09	2.093-07	3.127-07	3.048-07	2.642-07	1.829-07	1.077-07	6.656-08	4.671-08	3.710-08
NNE	1.424-09	1.939-07	2.980-07	2.844-07	2.577-07	1.779-07	1.073-07	6.850-08	4.886-08	4.018-08
NE	1.388-12	1.791-07	2.664-07	2.495-07	2.217-07	1.676-07	1.084-07	6.937-08	4.960-08	4.274-08
ENE	2.140-09	2.630-07	3.781-07	3.407-07	2.941-07	1.941-07	1.065-07	6.438-08	4.513-08	3.576-08
E	2.901-09	3.051-07	3.875-07	3.485-07	2.944-07	1.948-07	1.047-07	6.051-08	4.198-08	3.054-08
ESE	2.627-09	3.065-07	3.915-07	3.553-07	3.049-07	2.014-07	1.101-07	6.155-08	4.257-08	3.110-08
SE	2.262-09	3.074-07	4.168-07	3.980-07	3.355-07	2.208-07	1.230-07	7.133-08	4.714-08	3.671-08
SSE	3.271-09	4.167-07	5.119-07	4.621-07	3.983-07	2.531-07	1.288-07	7.397-08	4.769-08	3.603-08
S	3.795-09	4.609-07	5.262-07	4.920-07	4.258-07	2.757-07	1.378-07	8.058-08	5.394-08	4.060-08
SSW	4.448-09	5.364-07	6.376-07	5.604-07	4.846-07	3.111-07	1.524-07	8.357-08	5.420-08	3.934-08
SW	4.525-09	4.907-07	5.585-07	5.036-07	4.315-07	2.766-07	1.325-07	7.293-08	4.688-08	3.436-08
WSW	3.363-09	3.438-07	4.537-07	4.383-07	3.801-07	2.523-07	1.304-07	7.601-08	4.960-08	3.846-08
W	1.738-09	2.430-07	3.783-07	3.658-07	3.155-07	2.296-07	1.347-07	8.362-08	5.772-08	4.491-08
WNW	1.903-09	2.482-07	3.856-07	3.615-07	3.135-07	2.243-07	1.298-07	7.916-08	5.694-08	4.378-08
NW	1.817-09	2.714-07	3.906-07	3.607-07	3.092-07	2.178-07	1.306-07	8.072-08	5.773-08	4.516-08
NNW	1.748-09	2.264-07	3.330-07	3.040-07	2.728-07	1.914-07	1.122-07	6.951-08	4.825-08	3.748-08
ALL	2.484-09	2.871-07	3.937-07	3.653-07	3.134-07	2.115-07	1.179-07	7.064-08	4.797-08	3.762-08

TABLE 2.3-58

LSCS-UFSAR

TABLE 2.3-59

FIFTIETH PERCENTILE X/Q VALUES (sec / meter³) FOR THE PERIOD OF
0-8 HOURS FOR EFFLUENTSRELEASED THROUGH SGTS VENTDISTANCE FROM THE SITE (mi)

<u>SECTOR</u>	<u>0.5</u>	<u>1.5</u>	<u>2.5</u>	<u>3.5</u>	<u>4.5</u>	<u>7.5</u>	<u>15.0</u>	<u>25.0</u>	<u>35.0</u>	<u>45.0</u>
N	9.779-10	1.117-07	1.519-07	1.424-07	1.294-07	9.177-08	5.441-08	3.375-08	2.425-08	1.893-08
NNE	7.482-10	9.428-08	1.308-07	1.237-07	1.117-07	8.258-08	5.125-08	3.101-08	2.314-08	1.823-08
NE	6.374-10	8.560-08	1.185-07	1.134-07	1.022-07	7.548-08	4.626-08	2.820-08	2.089-08	1.624-08
ENE	8.580-10	1.142-07	1.455-07	1.336-07	1.179-07	8.042-08	4.836-08	2.901-08	2.081-08	1.618-08
E	1.119-09	1.371-07	1.703-07	1.548-07	1.351-07	9.190-08	5.280-08	3.091-08	2.177-08	1.598-08
ESE	1.011-09	1.328-07	1.770-07	1.630-07	1.425-07	9.638-08	5.379-08	3.109-08	2.217-08	1.658-08
SE	8.849-10	1.246-07	1.742-07	1.610-07	1.440-07	9.859-08	5.719-08	3.294-08	2.377-08	1.762-08
SSE	1.111-09	1.779-07	2.202-07	1.966-07	1.673-07	1.109-07	6.149-08	3.556-08	2.413-08	1.821-08
S	1.089-09	1.783-07	1.954-07	1.805-07	1.614-07	1.114-07	6.131-08	3.593-08	2.465-08	1.906-08
SSW	1.186-09	2.143-07	2.654-07	2.330-07	2.017-07	1.302-07	6.836-08	3.924-08	2.671-08	1.992-08
SW	1.451-09	2.274-07	2.515-07	2.209-07	1.865-07	1.238-07	6.420-08	3.381-08	2.301-08	1.705-08
WSW	1.052-09	1.484-07	1.936-07	1.780-07	1.580-07	1.036-07	5.716-08	3.249-08	2.269-08	1.657-08
W	7.639-10	1.067-07	1.464-07	1.414-07	1.273-07	9.498-08	5.581-08	3.248-08	2.428-08	1.745-08
WNW	6.798-10	9.290-08	1.421-07	1.385-07	1.231-07	9.327-08	5.836-08	3.548-08	2.540-08	1.952-08
NW	8.016-10	1.207-07	1.704-07	1.543-07	1.430-07	9.935-08	6.166-08	3.874-08	2.871-08	2.211-08
NNW	8.204-10	1.045-07	1.400-07	1.284-07	1.168-07	8.259-08	5.092-08	3.058-08	2.258-08	1.736-08
ALL	9.321-10	1.253-07	1.651-07	1.529-07	1.356-07	9.446-08	5.512-08	3.228-08	2.332-08	1.763-08

TABLE 2.3-59

LSCS-UFSAR

TABLE 2.3-60

FIFTIETH PERCENTILE X/Q VALUES (sec / meter³) FOR THE PERIOD OF
8-24 HOURS FOR EFFLUENTS

RELEASED THROUGH SGTS VENT

DISTANCE FROM THE SITE (mi)

<u>SECTOR</u>	<u>0.5</u>	<u>1.5</u>	<u>2.5</u>	<u>3.5</u>	<u>4.5</u>	<u>7.5</u>	<u>15.0</u>	<u>25.0</u>	<u>35.0</u>	<u>45.0</u>
N	3.455-10	3.853-08	4.122-08	3.664-08	3.067-08	1.959-08	9.783-09	5.306-09	3.508-09	2.675-09
NNE	2.490-10	2.931-08	3.350-08	3.035-08	2.540-08	1.647-08	8.258-09	4.575-09	3.271-09	2.429-09
NE	2.218-10	2.842-08	3.096-08	2.757-08	2.359-08	1.506-08	7.501-09	4.128-09	2.850-09	2.137-09
ENE	2.654-10	3.221-08	3.520-08	3.037-08	2.534-08	1.571-08	7.734-09	4.380-09	3.089-09	2.272-09
E	3.527-10	4.375-08	4.393-08	3.816-08	3.108-08	1.976-08	9.366-09	5.121-09	3.473-09	2.537-09
ESE	3.229-10	4.094-08	4.382-08	3.913-08	3.304-08	2.069-08	9.572-09	5.150-09	3.377-09	2.421-09
SE	2.698-10	3.506-08	4.145-08	3.694-08	3.100-08	1.914-08	9.032-09	5.096-09	3.304-09	2.471-09
SSE	3.203-10	4.734-08	5.155-08	4.572-08	3.848-08	2.257-08	1.080-09	5.841-09	3.824-09	2.825-09
S	3.101-10	4.677-08	4.375-08	3.688-08	3.099-08	1.941-08	9.528-09	5.080-09	3.360-09	2.526-09
SSW	3.402-10	5.675-08	6.384-08	5.352-08	4.440-08	2.609-08	1.219-08	6.403-09	4.314-09	3.030-09
SW	4.033-10	6.466-08	6.673-08	5.459-08	4.530-03	2.698-08	1.235-08	6.051-09	3.921-09	2.782-09
WSW	3.076-10	4.409-08	4.676-08	4.115-08	3.493-08	2.150-08	1.005-08	5.283-09	3.544-09	2.562-09
W	2.314-10	2.943-08	3.554-08	3.336-08	2.833-08	1.793-08	9.070-09	4.790-09	3.434-09	2.596-09
WNW	1.982-10	2.468-08	3.136-08	3.026-08	2.593-08	1.678-08	8.928-09	5.315-09	3.686-09	2.697-09
NW	2.631-10	3.651-08	4.203-08	3.663-08	3.093-08	2.008-08	1.015-08	5.745-09	4.049-09	2.986-09
NNW	2.634-10	3.119-08	3.476-08	3.030-08	2.515-08	1.632-08	8.287-09	4.718-09	3.258-09	2.453-09
ALL	2.890-10	3.785-08	4.069-08	3.607-08	2.989-08	1.888-08	9.042-09	5.022-09	3.410-09	2.528-09

TABLE 2.3-60

LSCS-UFSAR

TABLE 2.3-61

FIFTIETH PERCENTILE X/Q VALUES (sec / meter³) FOR THE TIME PERIOD OF
1-4 DAYS FOR EFFLUENTS

RELEASED THROUGH SGTS VENT

DISTANCE FROM THE SITE (mi)

<u>SECTOR</u>	<u>0.5</u>	<u>1.5</u>	<u>2.5</u>	<u>3.5</u>	<u>4.5</u>	<u>7.5</u>	<u>15.0</u>	<u>25.0</u>	<u>35.0</u>	<u>45.0</u>
N	2.145-10	2.065-08	2.058-08	1.748-08	1.485-08	9.230-09	4.576-09	2.558-09	1.759-09	1.283-09
NNE	1.575-10	1.492-08	1.008-08	1.397-08	1.199-08	7.720-09	3.997-09	2.261-09	1.546-09	1.180-09
NE	8.610-10	1.300-08	1.409-08	1.226-08	1.022-08	6.211-09	3.226-09	1.890-09	1.271-09	9.141-10
ENE	1.236-10	1.685-08	1.840-08	1.489-08	1.232-08	7.775-09	3.650-09	1.989-09	1.339-09	1.004-09
E	1.848-10	2.066-08	2.114-08	1.743-08	1.452-08	8.907-09	4.630-09	2.373-09	1.636-09	1.170-09
ESE	1.619-10	1.989-08	2.105-08	1.751-08	1.437-08	8.805-09	4.398-09	2.360-09	1.620-09	1.175-09
SE	1.207-10	1.456-08	1.651-08	1.506-08	1.194-08	7.947-09	4.041-09	2.273-09	1.532-09	1.128-09
SSE	1.305-10	1.642-08	1.753-08	1.590-08	1.282-08	7.815-09	3.758-09	1.988-09	1.363-09	9.483-10
S	1.117-10	1.486-08	1.555-08	1.302-08	1.040-08	6.719-09	3.125-09	1.722-09	1.132-09	8.520-10
SSW	1.277-10	1.836-08	2.107-08	1.814-08	1.506-08	8.825-09	4.193-09	2.190-09	1.447-09	1.026-09
SW	1.548-10	2.228-08	2.231-08	1.916-08	1.587-08	9.084-09	4.124-09	2.224-09	1.483-09	9.773-10
WSW	8.952-11	1.387-08	1.584-08	1.365-08	1.130-08	7.280-09	3.725-09	1.962-09	1.210-09	8.873-10
W	8.178-11	1.160-08	1.461-08	1.352-08	1.163-08	7.165-09	3.609-09	2.081-09	1.403-09	1.009-09
WNW	6.601-11	7.965-09	1.103-08	1.081-08	9.296-09	5.849-09	2.806-09	1.782-08	1.224-09	8.965-10
NW	1.152-10	1.458-08	1.502-08	1.306-08	1.100-08	7.354-09	3.622-09	2.043-09	1.405-09	1.059-09
NNW	1.028-10	1.354-08	1.512-08	1.260-08	1.080-08	6.562-09	3.333-09	1.88 9-09	1.304-09	9.193-10
ALL	1.308-10	1.566-08	1.748-08	1.307-08	1.246-08	7.808-09	3.856-09	2.215-09	1.434-09	1.043-09

TABLE 2.3-61

LSCS-UFSAR

TABLE 2.3-62

FIFTIETH PERCENTILE X/Q VALUES (sec / meter³) FOR THE PERIOD OF
4-30 DAYS FOR EFFLUENTS RELEASED THROUGH SGTS VENT

SECTOR	DISTANCE FROM THE SITE (mi)									
	0.5	1.5	2.5	3.5	4.5	7.5	15.0	25.0	35.0	45.0
N	1.854-08	1.877-08	1.721-08	1.487-08	1.235-08	7.657-09	4.132-09	2.092-09	1.405-09	1.093-09
NNE	2.206-08	2.103-08	1.867-08	1.550-08	1.275-08	8.129-09	4.626-09	2.260-09	1.618-09	1.146-09
NE	1.188-08	1.435-08	1.596-08	1.433-08	1.212-08	7.848-09	4.224-09	2.165-09	1.559-09	1.127-09
ENE	1.133-08	1.598-08	1.697-08	1.459-08	1.196-08	7.310-09	3.610-09	1.892-09	1.330-09	9.513-10
E	1.141-08	2.281-08	2.156-08	1.864-09	1.545-08	9.537-09	4.888-09	2.547-09	1.661-09	1.327-09
ESE	1.171-08	1.819-08	1.811-08	1.556-08	1.318-06	8.482-09	4.234-09	2.147-09	1.433-09	9.560-10
SE	2.163-08	1.740-08	1.647-08	1.349-08	1.124-08	6.932-09	3.330-09	1.856-09	1.282-09	8.952-10
SSE	1.848-10	1.296-08	1.501-08	1.252-09	1.014-08	6.216-09	2.774-09	1.542-09	1.005-09	7.603-10
S	1.104-10	1.032-08	1.081-08	9.222-09	7.581-09	4.535-09	2.239-09	9.363-10	6.490-10	4.615-10
SSW	2.394-09	1.253-08	1.035-08	8.485-09	7.033-09	4.216-09	2.052-09	9.425-10	7.343-10	5.235-10
SW	1.967-09	1.141-08	1.261-08	1.095-08	8.937-09	5.439-09	2.461-09	1.282-09	8.261-10	6.479-10
WSW	6.935-10	9.999-09	1.387-08	1.113-08	9.155-09	5.847-09	2.428-09	1.478-09	9.106-10	6.456-10
W	1.029-09	9.616-09	1.032-08	8.763-09	7.267-08	4.600-09	2.198-09	1.155-09	7.924-10	5.883-10
WNW	1.608-09	9.867-09	1.220-08	1.007-08	8.475-09	5.105-09	2.487-09	1.448-09	9.823-10	7.042-10
NW	5.268-10	1.135-08	1.159-08	1.031-08	8.666-09	5.395-09	2.750-09	1.430-09	1.025-09	7.279-10
NNW	4.716-09	1.066-08	1.081-08	9.437-09	7.802-09	4.910-09	2.342-09	1.329-09	8.697-10	6.932-10
ALL	2.643-09	1.394-08	1.484-08	1.250-08	1.036-08	6.417-09	2.978-09	1.652-09	1.130-09	8.311-10

TABLE 2.3-62

LSCS-UFSAR

TABLE 2.3-63

ANNUAL AVERAGE X/Q VALUES (sec/meter³)FOR EFFLUENTS RELEASED FROM PLANT COMMON STACK AND SGTS VENT*

SECTOR	SITE BOUNDARY	DISTANCE FROM THE SITE (mi)										
		0.5	1.5	2.5	3.5	4.5	7.5	15.0	25.0	35.0	45.0	
N	16.4	18.4	25.0	23.8	19.9	16.5	10.4	5.01	2.82	1.91	1.43	
NNE	16.4	16.1	23.7	23.2	19.7	16.5	10.7	5.29	3.02	2.07	1.55	
NE	24.0	15.6	24.0	22.0	18.1	15.0	9.4	4.52	2.56	1.76	1.32	
ENE	23.7	15.0	26.1	24.8	20.6	17.0	10.5	4.88	2.69	1.80	1.33	
E	30.7	17.6	32.8	30.2	24.5	19.9	12.1	5.54	3.02	2.02	1.49	
ESE	18.0	18.1	31.3	29.1	24.5	20.1	12.3	5.62	3.04	2.01	1.47	
SE	11.5	11.3	21.8	20.2	16.5	13.5	8.3	3.84	2.11	1.42	1.05	
SSE	7.1	7.0	21.6	20.9	17.2	14.1	8.6	3.92	2.12	1.41	1.03	
S	16.0	16.1	22.4	20.0	15.1	12.8	7.5	3.27	1.72	1.12	0.81	
SSW	14.1	14.0	27.2	25.6	19.9	17.1	10.2	4.53	2.38	1.55	1.12	
SW	17.3	16.9	24.7	22.3	17.1	14.6	8.8	3.95	2.11	1.39	1.01	
WSW	15.9	12.1	19.6	18.1	13.8	11.8	7.0	3.06	1.60	1.03	0.75	
W	17.5	11.5	15.3	14.6	11.6	10.1	6.4	3.06	1.69	1.14	0.84	
WNW	12.4	8.9	13.7	13.0	10.3	9.0	5.6	2.72	1.53	1.03	0.77	
NW	8.2	8.0	20.8	20.3	16.2	14.1	8.8	4.23	2.36	1.59	1.18	
NNW	11.6	12.3	18.0	17.5	14.1	12.3	7.8	3.83	2.19	1.50	1.13	

TABLE 2.3-63

REV. 0 – APRIL 1984

LSCS – UFSAR

TABLE 2.3-67
(Sheet 1 of 3)

LASALLE POWER STATION JOINT WIND-STABILITY CLASS OCCURRENCE
FREQUENCY DISTRIBUTION (1999-2003)
33 FT WIND SPEED AND DIRECTION
200 – 33 FT DELTA TEMPERATURE

Wind Direction Category																		
	Wind Speed Category ⁽¹⁾	N	NNE	NE	ENE	E	ESE	SE	SSE	S	SSW	SW	WSW	W	WNW	NW	NNW	Total
1 (A)	2	0	0	0	0	0	0	0	0	0	0	0	0	0	0	0	0	0
	3	0	0	0	0	0	0	0	0	0	0	0	0	0	0	0	0	0
	4	0	0	0	0	0	0	0	0	0	0	0	0	0	0	0	0	0
	5	0	0	0	0	0	0	0	0	0	0	0	0	0	0	0	0	0
	6	0	0	0	0	0	0	0	0	0	0	0	0	0	0	0	0	0
	7	0	0	0	0	0	0	0	0	0	0	0	0	0	0	0	0	0
	8	0	0	0	0	0	0	0	0	0	0	1	0	1	0	0	0	0
	9	2	2	1	0	1	0	2	3	0	7	6	5	1	0	1	1	1
	10	4	12	9	2	0	2	1	1	4	15	17	13	5	4	1	1	1
	11	6	3	8	8	2	4	1	0	7	23	13	16	14	4	0	1	1
	12	2	8	21	11	1	4	3	3	20	60	51	26	15	21	6	2	2
	13	2	0	4	1	4	0	0	1	12	41	51	14	4	11	3	0	0
	14	0	0	0	1	0	1	0	3	8	28	27	3	6	2	0	0	0
	2 (B)	2	0	0	0	0	0	0	0	0	0	0	0	0	0	0	0	0
3		0	0	0	0	0	0	0	0	0	0	0	0	0	0	0	0	0
4		0	0	0	0	0	0	0	0	0	0	0	0	0	0	0	0	0
5		0	0	0	0	0	0	0	0	0	0	0	0	0	0	0	0	0
6		0	0	0	0	0	0	0	0	0	0	0	0	0	0	0	0	0
7		0	0	0	0	0	0	0	0	0	0	0	0	0	0	0	0	0
8		2	6	4	2	1	3	5	5	8	8	9	3	0	2	4	1	1
9		16	16	15	18	4	6	4	12	8	20	21	20	14	5	2	2	2
10		24	17	30	26	5	12	6	9	15	33	34	22	18	27	4	6	6
11		7	5	12	21	7	6	6	12	19	36	26	29	25	17	14	9	9
12		14	5	11	10	7	6	5	14	17	43	63	44	33	44	14	13	13
13	4	0	7	3	7	0	1	3	18	35	32	42	12	14	18	6	6	
14	1	0	1	0	0	4	3	3	7	7	16	5	8	11	2	0	0	
3 (C)	2	0	0	0	0	0	0	0	0	0	0	0	0	0	0	0	0	0
	3	0	0	0	0	0	0	0	0	0	0	0	0	0	0	0	0	0
	4	0	0	0	0	0	0	0	0	0	0	0	0	0	0	0	0	0
	5	0	0	0	0	0	0	0	0	0	0	0	0	0	0	0	0	0
	6	0	0	0	0	0	0	0	1	0	0	0	0	0	1	0	0	0
	7	0	0	3	1	1	1	0	0	7	1	1	1	1	1	2	5	5
	8	13	30	45	23	13	15	15	23	24	26	28	30	31	21	7	16	16
	9	53	70	44	28	18	20	34	16	33	28	33	38	30	49	30	25	25
	10	33	37	25	25	18	13	22	23	24	32	40	48	36	40	30	35	35
	11	14	13	14	20	17	17	14	17	21	26	56	49	42	56	35	21	21
12	20	9	11	11	19	14	14	28	40	45	60	51	57	77	42	32	32	

LSCS – UFSAR

TABLE 2.3-67
(Sheet 2 of 3)

LASALLE POWER STATION JOINT WIND-STABILITY CLASS OCCURRENCE
FREQUENCY DISTRIBUTION (1999-2003)
33 FT WIND SPEED AND DIRECTION
200 – 33 FT DELTA TEMPERATURE

Wind Direction Category																		
	Wind Speed Category ⁽¹⁾	N	NNE	NE	ENE	E	ESE	SE	SSE	S	SSW	SW	WSW	W	WNW	NW	NNW	Total
	13	3	0	6	0	7	4	3	5	18	31	36	35	15	33	16	10	222
	14	0	0	0	0	0	2	1	2	11	22	6	5	9	25	6	1	90
4 (D)	2	0	0	0	0	0	0	0	0	0	0	0	1	0	0	0	0	1
	3	1	0	0	1	0	1	0	0	0	0	2	0	1	0	1	0	7
	4	0	1	0	1	2	1	0	1	3	1	4	4	2	1	0	2	23
	5	5	9	1	9	3	5	6	1	1	5	4	3	3	5	4	5	69
	6	14	13	13	6	7	12	7	10	7	7	22	10	4	4	9	7	152
	7	51	58	61	38	28	30	41	28	36	42	40	37	39	26	33	33	621
	8	248	250	157	118	94	102	91	83	92	81	104	90	115	147	72	109	1953
	9	303	319	131	113	139	98	91	79	107	103	110	137	152	167	150	205	2404
	10	242	202	194	127	124	76	70	56	105	98	121	153	179	205	197	266	2415
	11	156	109	209	175	104	64	45	76	98	104	164	153	190	221	189	270	2327
	12	156	63	287	316	135	87	86	108	169	186	222	185	326	432	297	462	3517
	13	39	8	135	101	83	49	17	39	92	116	107	93	180	282	154	216	1711
14	5	0	29	64	27	28	11	14	51	69	50	52	152	139	42	58	791	
5 (E)	2	0	0	2	0	0	0	0	1	0	0	0	0	0	0	1	1	5
	3	2	1	0	0	0	0	0	1	3	1	1	1	1	0	1	0	12
	4	3	0	3	1	1	1	3	9	4	5	2	6	5	3	5	5	56
	5	9	10	9	4	3	5	5	6	8	4	8	6	4	4	8	3	96
	6	10	12	3	5	11	9	11	5	14	9	10	12	12	6	13	7	149
	7	45	51	13	9	22	22	33	22	26	33	27	32	36	26	34	28	459
	8	242	234	67	43	133	127	89	90	85	69	104	91	98	132	111	107	1822
	9	163	146	114	79	244	107	82	95	91	105	130	140	135	165	177	137	2110
	10	98	58	131	160	223	68	86	86	122	156	188	135	126	141	138	106	2022
	11	32	17	116	148	148	82	68	73	155	188	180	115	107	107	76	59	1671
	12	6	12	43	131	111	56	63	104	245	303	245	133	138	138	44	24	1796
	13	0	1	19	21	13	16	32	32	124	183	86	58	121	152	21	7	886
14	0	0	10	4	1	7	7	13	61	75	19	22	116	179	6	2	522	
6 (F)	2	0	0	0	0	0	0	0	0	0	0	0	0	0	0	0	0	0
	3	0	1	1	1	0	1	2	0	1	1	0	1	0	0	0	0	9
	4	2	0	4	3	4	1	2	5	0	1	2	3	4	1	2	2	36
	5	5	3	5	1	4	2	2	3	5	7	1	9	11	2	7	3	70
	6	5	1	7	2	4	4	9	5	9	9	4	8	15	12	11	8	113
	7	24	38	5	7	19	26	22	23	21	22	26	18	40	47	18	16	372
	8	118	57	10	11	113	164	132	129	133	108	130	114	119	167	76	79	1660
	9	23	1	2	11	247	110	96	91	135	156	141	158	141	113	112	52	1589
10	4	4	1	11	90	24	46	77	85	95	151	138	75	58	47	7	913	

TABLE 2.3-67
(Sheet 3 of 3)

LASALLE POWER STATION JOINT WIND-STABILITY CLASS OCCURRENCE
FREQUENCY DISTRIBUTION (1999-2003)
33 FT WIND SPEED AND DIRECTION
200 – 33 FT DELTA TEMPERATURE

		Wind Direction Category																
	Wind Speed Category ⁽¹⁾	N	NNE	NE	ENE	E	ESE	SE	SSE	S	SSW	SW	WSW	W	WNW	NW	NNW	Total
	11	0	3	0	2	23	16	21	35	66	106	149	83	51	35	13	2	605
	12	0	0	0	1	2	8	17	19	47	99	135	32	32	12	1	0	405
	13	0	0	0	2	0	3	0	2	11	26	33	9	10	16	0	0	112
	14	0	0	0	0	0	3	1	1	3	2	0	0	1	5	0	0	16
7 (G)	2	0	0	0	0	0	0	0	0	0	0	0	0	0	0	0	0	0
	3	0	0	0	0	0	0	0	0	0	0	0	0	0	0	0	0	1
	4	1	1	0	1	2	2	4	1	3	0	0	0	0	3	1	0	19
	5	0	0	1	3	1	1	4	0	3	3	3	1	1	0	4	1	26
	6	2	1	1	0	2	5	4	5	3	4	6	4	7	4	5	5	58
	7	1	2	0	0	11	16	17	20	18	18	15	27	61	38	12	7	263
	8	35	2	0	7	46	131	198	245	172	146	163	122	216	178	32	22	1715
	9	7	0	0	3	56	113	130	186	252	253	265	205	171	83	47	3	1774
	10	0	0	1	0	16	28	33	64	97	150	222	178	82	15	6	1	893
	11	0	0	0	0	1	0	9	11	28	62	126	52	17	1	2	0	309
	12	0	0	0	0	0	0	1	3	2	8	22	32	48	7	0	0	0
	13	0	0	0	0	0	0	0	1	1	4	1	0	2	0	0	0	9
	14	0	0	0	0	0	0	0	0	1	0	2	0	0	0	0	0	3

Notes:

(1) Wind Speed Categories defined as follows:

Category	Wind Speed (mph)
1 (Calm)	<0.70
2	>=0.7 to <1.12
3	>=1.12 to <1.68
4	>=1.68 to <2.24
5	>=2.24 to <2.80
6	>=2.80 to <3.36
7	>=3.36 to <4.47
8	>=4.47 to <6.71
9	>=6.71 to <8.95
10	>=8.95 to <11.18
11	>=11.18 to <13.42
12	>=13.42 to <17.90
13	>=17.90 to <22.40
14	>=22.40

LSCS – UFSAR

TABLE 2.3-68
(Sheet 1 of 3)

LASALLE POWER STATION JOINT WIND-STABILITY CLASS OCCURRENCE
FREQUENCY DISTRIBUTION (1999-2003)
375 FT WIND SPEED AND DIRECTION
375 – 33 FT DELTA TEMPERATURE

Wind Direction Category																		
Wind Speed Category ⁽¹⁾	N	NNE	NE	ENE	E	ESE	SE	SSE	S	SSW	SW	WSW	W	WNW	NW	NNW	Total	
1 (A)	2	0	0	0	0	0	0	0	0	0	0	0	0	0	0	0	0	
	3	0	0	0	0	0	0	0	0	0	0	0	0	0	0	0	0	
	4	0	0	0	0	0	0	0	0	0	0	0	0	0	0	0	0	
	5	0	0	0	0	0	0	0	0	0	0	0	0	0	0	0	0	
	6	0	0	0	0	0	0	0	0	0	0	0	0	0	0	0	0	
	7	0	0	0	0	0	0	0	0	0	0	0	0	0	0	0	0	
	8	0	0	0	0	0	0	0	0	0	0	0	0	0	0	0	0	
	9	0	0	0	0	0	0	0	0	0	0	0	0	0	0	0	0	
	10	0	0	0	0	0	0	0	0	0	0	0	0	0	0	0	0	
	11	0	0	0	0	0	0	0	0	0	0	0	0	0	0	0	0	
	12	0	0	0	0	0	0	0	0	0	0	1	0	0	0	0	0	
	13	0	0	0	0	0	0	0	0	1	0	0	0	0	0	0	0	
14	0	0	0	0	0	0	0	0	0	0	0	0	0	0	0	0		
2 (B)	2	0	0	0	0	0	0	0	0	0	0	0	0	0	0	0		
	3	0	0	0	0	0	0	0	0	0	0	0	0	0	0	0		
	4	0	0	0	0	0	0	0	0	0	0	0	0	0	0	0		
	5	0	0	0	0	0	0	0	0	0	0	0	0	0	0	0		
	6	0	0	0	0	0	0	0	0	0	0	0	0	0	0	0		
	7	0	0	0	0	0	0	0	0	0	0	0	0	0	0	0		
	8	0	0	0	0	0	0	0	0	0	0	0	0	0	0	0		
	9	0	0	0	0	0	0	0	0	0	0	0	0	0	0	0		
	10	0	0	0	0	0	0	0	0	0	0	0	1	0	0	0		
	11	0	0	0	0	0	0	0	0	0	0	0	0	0	0	0		
12	0	1	1	1	0	0	0	0	0	5	6	4	2	4	0	0		
13	0	0	2	0	0	0	0	0	1	10	3	5	2	1	1	0		
14	0	0	0	0	0	0	0	1	3	17	12	2	2	0	0	0		
3 (C)	2	0	0	0	0	0	0	0	0	0	0	0	0	0	0	0		
	3	0	0	0	0	0	0	0	0	0	0	0	0	0	0	0		
	4	0	0	0	0	0	0	0	0	0	0	0	0	0	0	0		
	5	0	0	0	0	0	0	0	0	0	0	0	0	0	0	0		
	6	0	0	0	0	0	0	0	0	0	0	0	0	0	0	0		
	7	0	0	0	0	0	0	0	0	0	0	0	0	0	0	0		
	8	0	0	0	0	0	0	0	0	0	0	0	0	0	0	0		
	9	0	0	0	0	0	0	0	0	1	1	0	1	0	1	0		
	10	1	1	0	2	2	0	1	2	0	4	2	6	3	1	0	2	
	11	4	8	5	6	0	3	0	0	1	4	9	6	10	3	1	0	

LSCS – UFSAR

TABLE 2.3-68
(Sheet 2 of 3)

LASALLE POWER STATION JOINT WIND-STABILITY CLASS OCCURRENCE
FREQUENCY DISTRIBUTION (1999-2003)
375 FT WIND SPEED AND DIRECTION
375 – 33 FT DELTA TEMPERATURE

Wind Direction Category																		
	Wind Speed Category ⁽¹⁾	N	NNE	NE	ENE	E	ESE	SE	SSE	S	SSW	SW	WSW	W	WNW	NW	NNW	Total
	12	5	7	14	6	0	7	0	2	10	15	10	16	8	6	5	0	111
	13	5	5	15	3	6	3	0	2	14	30	32	6	5	6	7	3	142
	14	4	1	2	0	1	0	2	4	15	57	58	15	7	4	6	2	178
4 (D)	2	0	0	0	0	0	0	0	0	0	0	0	0	0	0	0	0	0
	3	0	0	0	1	1	0	0	0	0	1	0	0	0	0	0	0	3
	4	1	2	2	2	0	1	0	1	2	1	1	0	2	3	0	0	18
	5	3	1	0	5	3	1	7	4	3	0	6	3	4	2	4	4	50
	6	5	3	6	8	6	1	4	6	5	4	4	9	7	7	6	6	87
	7	28	23	22	27	15	19	21	22	19	21	14	16	18	14	13	15	307
	8	108	105	158	102	73	71	77	81	69	68	78	70	98	65	84	86	1393
	9	160	197	145	108	77	101	79	92	103	89	92	99	115	131	133	119	1840
	10	189	221	129	133	111	88	92	89	112	99	120	130	129	140	142	160	2084
	11	205	230	149	144	93	86	81	86	118	98	134	141	149	177	203	165	2259
	12	321	281	438	397	183	122	110	154	196	222	326	286	334	363	366	271	4370
	13	248	131	362	344	142	86	77	118	178	249	302	247	298	400	439	305	3926
	14	171	60	313	258	153	142	73	104	321	472	419	304	460	594	670	312	4826
5 (E)	2	0	0	0	0	0	0	0	0	0	0	0	0	0	0	0	0	0
	3	0	0	1	0	0	1	0	0	1	0	0	0	1	0	1	0	5
	4	1	4	3	2	5	2	1	2	1	4	1	2	1	2	0	1	32
	5	5	3	2	6	2	1	2	3	4	6	3	2	2	2	1	5	49
	6	2	4	4	4	5	3	2	2	2	1	2	6	4	2	5	5	53
	7	11	11	5	10	5	10	8	10	11	10	8	14	8	4	10	12	147
	8	37	34	32	42	38	35	31	18	27	28	35	23	27	30	35	36	508
	9	43	72	58	46	59	51	44	48	25	27	45	47	52	42	46	27	732
	10	54	68	79	70	72	71	46	45	40	41	49	65	56	57	71	43	927
	11	53	99	82	118	90	51	51	45	49	48	59	68	68	53	68	65	1067
	12	154	195	170	227	189	133	82	86	112	108	136	129	145	178	165	108	2317
	13	145	59	133	136	166	105	93	96	156	154	199	156	176	217	197	128	2316
	14	62	15	67	66	135	153	150	178	524	989	663	272	476	571	235	73	4629
6 (F)	2	0	0	0	0	0	0	0	0	0	0	0	0	0	0	0	0	0
	3	1	0	1	0	0	0	0	1	1	0	0	0	0	0	0	0	4
	4	1	1	0	2	1	0	0	0	1	0	2	0	3	1	1	0	13
	5	1	5	2	2	1	1	1	1	1	0	0	0	2	1	1	1	20
	6	1	4	1	1	1	1	2	5	4	0	2	0	2	3	0	2	29
	7	3	4	5	4	6	6	5	2	6	4	8	11	2	5	3	4	78
	8	10	13	15	13	19	15	17	14	13	19	14	24	17	21	15	10	249

TABLE 2.3-68
(Sheet 3 of 3)

LASALLE POWER STATION JOINT WIND-STABILITY CLASS OCCURRENCE
FREQUENCY DISTRIBUTION (1999-2003)
375 FT WIND SPEED AND DIRECTION
375 – 33 FT DELTA TEMPERATURE

	Wind Speed Category ⁽¹⁾	Wind Direction Category																Total	
		N	NNE	NE	ENE	E	ESE	SE	SSE	S	SSW	SW	WSW	W	WNW	NW	NNW		
	10	16	25	8	8	16	28	36	40	33	30	28	31	34	38	32	20	423	
	11	29	18	21	10	22	38	46	40	40	40	45	41	50	39	36	20	535	
	12	55	41	32	19	53	75	106	84	74	77	102	77	93	129	117	60	1194	
	13	29	7	15	6	38	73	57	77	90	112	130	103	123	158	136	68	1222	
	14	19	0	3	10	34	89	109	132	284	458	511	302	231	149	77	21	2429	
7 (G)	2	0	0	0	0	0	0	0	0	0	0	0	0	0	0	0	0	0	
	3	0	0	1	0	1	0	0	0	0	0	0	1	0	0	1	0	4	
	4	0	0	0	0	0	0	0	0	0	0	0	0	1	0	1	0	2	
	5	0	0	0	0	0	0	0	0	0	0	0	1	0	0	0	1	2	
	6	0	1	0	0	0	0	0	0	0	0	0	2	0	2	0	1	7	
	7	0	3	1	0	0	0	0	0	3	2	1	0	2	2	0	3	0	17
	8	0	1	1	0	4	1	2	6	6	6	1	8	6	6	6	3	4	55
	9	1	2	1	0	1	1	1	4	5	8	11	12	17	6	4	2	76	
	10	3	1	0	0	5	2	2	6	24	15	11	14	14	8	9	4	118	
	11	4	4	1	2	0	2	5	19	23	15	20	21	14	14	10	3	157	
	12	5	4	3	1	4	9	32	67	65	55	62	38	32	38	21	12	448	
	13	13	4	3	0	0	7	34	68	71	70	68	41	39	35	23	8	484	
14	3	0	0	0	0	27	44	97	192	204	245	187	54	49	15	6	1123		

Notes:

(1) Wind Speed Categories defined as follows:

Category	Wind Speed (mph)
1 (Calm)	<0.70
2	>=0.7 to <1.12
3	>=1.12 to <1.68
4	>=1.68 to <2.24
5	>=2.24 to <2.80
6	>=2.80 to <3.36
7	>=3.36 to <4.47
8	>=4.47 to <6.71
9	>=6.71 to <8.95
10	>=8.95 to <11.18
11	>=11.18 to <13.42
12	>=13.42 to <17.90
13	>=17.90 to <22.40
14	>=22.40

2.4 HYDROLOGIC ENGINEERING

2.4.1 Hydrologic Description

2.4.1.1 Site and Facilities

The LaSalle County Station site is located in the southeastern part of LaSalle County, 6 miles southeast of Marseilles, Illinois, 3 miles west of State Highway 170, and 1/2 mile north of the Grand Ridge-Mazon Road (LaSalle County Highway 6) as shown in Figure 2.4-1.

Condenser water is cooled by means of a cooling lake forming a part of the closed cooling system. The surface area of the cooling lake at its normal pool elevation of 700 feet MSL is 2,058 acres. The lake is created by constructing dikes totaling 37,942 feet in length on three sides.

Makeup water for the cooling lake is pumped from the Illinois River. A small part of the lake water is blown down to the Illinois River to prevent the dissolved solids in the lake from building up to excessive levels. Three baffle dikes are constructed within the lake to channel the flow of water and to increase the flow path for efficient heat dissipation.

In the unlikely event of a breach in the peripheral dike, emergency shutdown water supply would be obtained from the ultimate heat sink (UHS), which is an excavated pond as shown in Figure 2.5-59. The UHS is also characterized as the core standby cooling systems (CSCS) pond.

The LSCS site and the cooling lake cover an area of approximately 3,060 acres. The station is located approximately 5.0 miles south of the Illinois River. The cooling lake is approximately 2 miles south of the Illinois River at its closest point.

The river screen house is located at 249.5 river miles upstream from the mouth of the Illinois River at Grafton, Illinois.

The normal pool elevation of the Marseilles pool is 482.8 feet MSL.

The terrain around the plant site is gently rolling, with ground surface elevations varying from 700 feet to 724 feet MSL, which is 217 feet above the normal pool elevation in the Illinois River. The plant grade and floor elevations are 710 feet and 710.5 feet MSL respectively. The plant floor is 188 feet above a postulated probable maximum flood (PMF) with coincident wind waves in the Illinois River. The station site may therefore be characterized as "floodproof" or "dry" regarding floods in the Illinois River. Safety-related structures at the plant site are similarly unaffected by wave runup due to winds coincident with a postulated probable maximum water

level in the cooling lake. The elevation of the perimeter road around the plant buildings (including all the safety-related structures) is 709 feet MSL or above.

The river screen house and the outfall structure, both non-safety-related structures, are the only plant facilities that are potentially affected by floods in the Illinois River. The river screen house is capable of withstanding a 100-year flood in the Illinois River.

The Illinois River is a perennial stream with a drainage area of 7,640 mi² near the station site. Makeup requirements are less than 14% of the all-time recorded low flow in the Illinois River. It is therefore unlikely that the river flow would ever be so low as to affect makeup pumping to the cooling lake.

Access to transportation facilities around the station site is readily available under all hydrologic conditions. The Illinois River is navigable and forms a part of the Illinois Waterway, as shown in Figure 2.4-5.

None of the highways or railroads in the site vicinity would be affected by floods in the Illinois River or by a probable maximum precipitation condition on the cooling lake.

Figures 2.4-4 and 2.4-2 show the natural drainage features in the station site vicinity. Details of site drainage are discussed in Subsection 2.4.2.3.

2.4.1.2 Hydrosphere

The LSCS site is located in the Illinois River basin, which is drained by the main stem of the Illinois River and its tributaries, including the canal system in the Chicago area. The upper part of the basin includes the north and south branches of the Chicago River, the canal from Wilmette to the Chicago River, the Chicago Sanitary and Ship Canal, the Calumet-Sag Channel, and the Des Plaines and Du Page Rivers. The lower part includes the Kankakee, Mazon, Fox, Vermilion, Mackinaw, Spoon, Sangamon, and La Moine Rivers and their tributaries. The Illinois River is the largest tributary of the Mississippi River above the mouth of the Missouri River. It flows in a westerly, southwesterly, and southerly direction a distance of 273 miles to its confluence with the Mississippi River.

The natural drainage area of the Illinois River is 28,200 mi², including 1,000 mi² in Wisconsin and 3,200 mi² in Indiana. Diversions from the Lake Michigan watershed by reversal of the flow of the Chicago and Calumet Rivers increase the natural drainage area of the Illinois River from 28,200 mi² to 29,010 mi². The drainage area of the Illinois River near the LSCS site is 7640 mi².

Details on the principal tributaries of the Illinois River are presented in Table 2.4-1. Locally, South Kickapoo Creek discharges into the Illinois River from the south 0.5

LSCS-UFSAR

mile downstream of the river screen house. Other streams in the site vicinity are Spring Brook, Deadly Run, Armstrong Run, and Hog Run. These streams discharge into the Illinois River from the south at 2.4 miles, 3.7 miles, 4.5 miles, and 4.8 miles upstream of the screen house, respectively. North Kickapoo Creek and Rat Run discharge into the Illinois River from the north at 0.5 mile and 2 miles upstream of the screen house, respectively (Reference 1). Figure 2.4-2a shows the surface water bodies within a 5-mile radius of the plant site.

In the site vicinity, the Illinois River has a U-shaped cross section, with a width and depth at normal pool of 800 feet and 12 feet respectively, and a floodplain 1.5 mile wide.

The nearest U.S. Geological Survey (USGS) stream-gauging station downstream of the site is at Marseilles, Illinois, 3 miles from the river screen house. This gauge became operational on October 1, 1939. Flow records for the years 1919 to 1939 are available for Morris, Illinois, 14 miles upstream of the river screen house. Corresponding to a drainage area of 7,640 mi² at Marseilles, Illinois, the average discharge of the Illinois River is 10,750 cfs for the 55-year period of record. The maximum and minimum flows recorded at Marseilles are 93,900 cfs on July 14, 1957, and 1,460 cfs on October 15, 1943, respectively (Reference 2).

The nearest USGS stream-gauging stations upstream of the site are on the Mazon River near Coal City, Illinois, on the Kankakee River near Wilmington, Illinois, on the Du Page River at Shorewood, Illinois, on Hickory Creek at Joliet, Illinois, and on the Chicago Sanitary and Ship Canal at Lockport, Illinois.

Of all the locks on the Illinois River and on its tributaries upstream of the site, that at Lockport, Illinois is the highest, with a lift of 39.5 feet (References 3 and 4) and a dam height above the foundation of 51 feet (Reference 5).

Water resources development by the U.S. Corps of Engineers upstream of the site consists of the improvement of navigational facilities in the Illinois River, shore protection works, channel improvements, and construction of ditches and levees for drainage and flood control (References 3 and 6).

Although many potential reservoir sites in the headwater areas have been investigated by different agencies (References 7, 8, and 9), there are no projects under construction or planned in the Illinois River basin upstream of the LSCS site, as indicated in Reference 5.

Major hydrologic features of the region are shown in Figure 2.4-2. A list of Illinois River water users within 50 river miles downstream of the river screen house is presented in Table 2.4-2. The extent and the pattern of groundwater use are discussed in Subsection 2.4.13.2.

2.4.2 Floods

2.4.2.1 Flood History

The most significant historical flood events for the Illinois River near the site are those of May 1943, July 1957, and December 1982.

The May 1943 flood was a record for the Illinois River Basin (Reference 9). At Marseilles, Illinois, the flood was characterized by two peaks, one on May 12 and one on May 21, the latter being more severe, with a discharge of 73,800 cfs and the crest stage at elevation 476.7 feet MSL. The water surface profile corresponding to the 1943 flood is shown in Figure 2.4-5.

The July 1957 flood was not basin-wide. It exceeded the May 1943 flood at Marseilles, Illinois, and had a discharge of 93,900 cfs and a flood stage of 478.1 feet MSL (Reference 2). Flood stages at stations along the Illinois Waterway are shown in Table 2.4-3.

The December 1982 flood exceeded all previous floods. It had a discharge of 94,100 cfs. The crest stage elevation peaked on December 4 at 479.69 feet MSL (Reference 83).

A flood stage of 504.7 feet MSL occurred in the Illinois River at Morris, Illinois, in 1831.

On January 21, 1916, a stage of 488.3 feet MSL occurred in the Illinois River at Marseilles, Illinois, as a result of an ice jam. However, the likelihood of the repetition of such an extreme event is remote because of the reduction in winter ice caused by heated discharges from upstream power plants and industrial operations (Reference 11). Furthermore, all-season navigation is available on the Illinois Waterway.

Since there are no large bodies of water in the immediate vicinity of the site, surges, seiches, and tsunami floods are not relevant. A review of the literature has revealed no major dam failures affecting the surrounding region.

2.4.2.2 Flood Design Considerations

Of the following flood events considered, Item 3 is the controlling event: (1) a postulated probable maximum flood (PMF) in the Illinois River, (2) a probable maximum precipitation (PMP) with antecedent standard project storm (SPS) on the cooling lake and its drainage area, and (3) a local PMP at the plant site.

LSCS-UFSAR

Effect of PMP on the adjacent drainage areas of South Kickapoo Creek and Armstrong Run is included in Item 2 above and is addressed in Subsection 2.4.8. PMP in the drainage basin of any other creek does not affect the site.

Failure of upstream dams on the Illinois River or its tributaries is also not relevant, since these are low dams for navigation and hydropower generation, and their failure would not exceed the severity of Item 1. Failure of the cooling lake dikes would not cause flooding of the LSCS site.

2.4.2.3 Effects of Local Intense Precipitation

Natural grade elevation at the site varies from 700 feet to 724 feet MSL. The plant grade and floor elevations are 710 feet and 710.5 feet MSL respectively.

Natural drainage at the station site is generally toward the cooling lake, as shown in Figures 2.4-3 and 2.4-4. Elevations of the ground surface, of the plant grade, of the roads, and of the railroads in the site vicinity are shown in Figure 2.4-6.

The lowest elevation of the road around the laydown area north of railroad track number 5 is 708 feet MSL. The top elevation of the road on the west of the laydown areas varies from 708.0 feet to 709.0 feet MSL. The top elevation of railroad track number 3, which enters the plant building, varies between 709.5 and 710.5 feet MSL. The site drainage system is designed for a precipitation intensity of 4 in./hr. The areas to the northwest and south of Zones I and II of the plant area are drained away by existing creeks and gullies (Figure 2.4.6). Therefore, the runoff from the areas to the north, west, and south of the plant area cannot contribute to plant flooding in the event PMP occurs at the site.

On the east side of the switchyard, the finished grade is at elevation 713.0 feet, beyond which there are lower elevations towards the lake on the east. Therefore, storm runoff from the switchyard area flows east towards the lake and does not reach the plant buildings. A portion of the switchyard, however, is included in Zone II as shown in Figure 2.4-6. The total drainage area contributing runoff, which could potentially cause flooding near the plant buildings, is shown in Figure 2.4-6. The probable maximum precipitation falling on different zones in this area has been considered in the analysis of local intense precipitation on the plant site.

The offsite drainage ditches are designed to discharge a 50-year storm runoff. The offsite drainage culverts crossing access roads or railroad tracks are designed to discharge a 10-year storm runoff without any static head at the entrance of culverts and to discharge a 50-year storm runoff utilizing available head at the entrance of culverts.

Analysis

The 24-hour PMP at the site is 32.1 inches (Reference 13). To route the runoff from the rainfall over the plant area, the 24-hour PMP is divided into smaller time intervals (References 14, 15, and 19). Distribution of the PMP into smaller time periods is given in Table 2.4-4. The corresponding distribution for the winter PMP is also shown in Table 2.4-4. Since the winter PMP is much less severe than the summer PMP, the potential of plant flooding is analyzed for the latter.

It was conservatively assumed in the analysis that the infiltration losses are negligible, the site drainage system is not functioning, and the precipitation falling on different portions of the site area is assumed to reach the peripheral roads simultaneously.

The rational formula was used in estimating the peak runoff from the area and a coefficient of runoff equal to 1 was used. The time of concentration was computed from Kirpich's formula (Reference 14) and channel flow travel time. For the peak flow over the peripheral roads and railroad tracks a broad crested weir formula

$Q = CLH^{3/2}$ was used where:

Q = Discharge over the road or railroad track (cfs)

L = Length over which flow takes place (feet)

H = Head over the weir (feet)

C = Coefficient of discharge.

In this analysis, a coefficient of discharge of 2.64 was used (Reference 84).

The plant area was divided into two zones, Zone I and Zone II (Figure 2.4-6). The maximum runoff from each of the zones was assumed to flow over the peripheral roads and railroads acting as weirs, to obtain the maximum water level upstream of the peripheral roads and railroads.

The storm runoff from Zone I flows west between the plant building and the parking lot and flows over the 367-foot long north-south access road, that has a crest elevation of 709.0 feet, west of the plant building, and reaches the cooling lake. The water level upstream of the north-south access road was calculated with the peak runoff flowing over the access road. The obstruction to flow due to the gatehouse upstream of the access road was considered. A step-backwater calculation was performed using the HEC-RAS computer program (Reference 85) from the north-south access road upstream to the location downstream of Track No. 3, where a 175-foot segment of the track has a low elevation of 709.5 feet, for overflow. The runoff from Area D of Zone I (Figure 2.4-6) flows over this 175 foot

long track. The maximum water level upstream of Track No. 3 and near the plant building was estimated considering the submergence effect of the calculated maximum water level downstream of the 175 foot overflow section of Track No. 3.

The total area of Zone I is 66.4 acres. A runoff coefficient of 1 was conservatively used. The estimated time of concentration was 14 minutes and the corresponding maximum intensity of rainfall due to PMP would be 34.5 inches per hour and the corresponding peak runoff was calculated to be 628 cubic feet per second. This peak runoff would produce a water level of less than 707.5 feet upstream of the north-south access road and a maximum water level of 710.1 feet near the east side of the plant building.

The storm water runoff due to PMP from Zone II flows south and over railroad Track No. 1, then turns west and flows over the North-South Access Road, then into the wide PMP Channel west of the Access Road, then north into the Cooling Lake. This flow path has undergone several alterations. Buildings No. 34, 35, 36, and 37 have been removed and the adjoining grades have been lowered. Track No. 1 has been lowered to elevations ranging from 708.95 feet to 709.52 feet over a length of 820 feet. The access road has a crest elevation of 707.0 feet over a length of 2297 feet, so Track No. 1 acts as a weir controlling the water surface elevations upstream.

For Zone II, step-backwater analysis was performed using the HEC-RAS computer program (Reference 85) and up-to-date cross sections. The critical drainage area between the Reactor Building and Track No. 1 is 19.79 acres. The Time of Concentration for this area is 11.8 minutes and the PMP intensity is 36.7 inches per hour for this duration. Using the Rational Formula with a runoff coefficient of 1, the peak discharge at Track No. 1 is 726 cfs. The backwater model results in a water level of less than 710 feet MSL at Track No. 1 and less than 710.3 feet MSL adjacent to the east side of the Plant.

Therefore, a conservative estimate of the water surface elevation near the plant buildings due to local intense precipitation at the plant area would be 710.1 feet in Zone I and 710.3 feet in Zone II. These elevations are below the plant floor elevation and would not cause flooding to the plant buildings.

The roof drains are designed for a precipitation intensity of 4 in./hr based on Reference 12. The roofs of safety-related structures are designed to withstand the snow and ice loads due to a winter PMP with a 100-year recurrence interval antecedent snowpack. Conservatively assuming that the roof drains are clogged at the time of the PMP, the maximum accumulation of water on the roofs of safety-related structures is limited by the height of parapet walls, viz 16 inches. The corresponding water load is therefore 83.2 lb/ft². The roofs of safety-related structures can withstand this load. The load due to accumulated snowpack and winter PMP would be less than 83.2 lb/ft².

The effect of PMP on the lake and its drainage area is discussed in Subsection 2.4.8.2.

2.4.2.4 Site Drainage System

2.4.2.4.1 Storm Sewer System

Discharge Calculations

The design discharge is calculated using the rational method. The storm sewer system is designed to discharge the runoff from a 4-in./hr storm and is checked to verify that water levels in the manholes will not rise above grade elevations.

Storm Sewers, Inlets and Manholes

The storm sewer system consists of either corrugated metal pipe or reinforced concrete pipe with manholes located at all changes in direction, grade, or pipe size or at 350-foot maximum intervals. Manholes are precast concrete or cast in place concrete with grated covers at inlet locations. Inlets are located in depressed areas with adequate provision for silting. A separate storm sewer system is provided for draining runoff from the transformers and oil tank areas.

Design Minimums

- A. Minimum size of pipes: 12-inch diameter
- B. Minimum velocity: 2.0 fps

2.4.2.4.2 Culverts

Discharge Calculations

The design discharge is calculated using the rational method. Culverts are designed to discharge the runoff from a 4-in./hr storm without any static head at the entrance of culverts.

Design Limitations

- A. Type - Corrugated metal pipe or reinforced concrete pipe
- B. Minimum Size - 12-inch diameter
- C. Maximum Velocity - 8.0 fps

2.4.2.4.3 Ditches

Discharge Calculations

The discharge capacity of ditches conforms to culvert discharges.

Design Limitations

- A. Minimum Bottom Width - 1.0 foot
- B. Minimum Side Slopes - 3:1
- C. Minimum Longitudinal Slopes - 0.20%
- D. Maximum Velocity - 3.0 fps

2.4.3 Probable Maximum Flood (PMF) on Streams and Rivers

The station site is "floodproof" or "dry" with regard to a postulated PMF in the Illinois River, since the plant floor at elevation 710.5 feet MSL is 188 feet higher than the probable maximum flood plus wave runup elevation of 522.5 feet MSL obtained by superimposing the maximum (1%) wave characteristics of sustained 40-mph overland winds on the probable maximum water level.

A separate discussion of PMF on South Kickapoo Creek and Armstrong Run is not required, since the lake drainage area of 1200 acres does include the drainage areas of these streams.

Approximate estimates of standard project flood (SPF) and PMF made by the U.S. Army Corps of Engineers (Reference 16) for some Illinois River stations are presented in Table 2.4-5. Based on these estimates, the extrapolated PMF discharge corresponding to a drainage area of 7,640 mi² near the LSCS site is 316,000 cfs. Allowing for the effect of urbanization, a conservative maximum value of 350,000 cfs is obtained for the PMF flow in the Illinois River near the plant site.

Using cross-section data obtained from References 10 and 17, the PMF stillwater level in the Illinois River is estimated as 521.8 feet MSL in the site vicinity following the slope-area method (Reference 14).

Corresponding to an effective fetch of 2.4 miles for the most critical point on the Illinois River shoreline, wind wave characteristics corresponding to 40 mph overland winds were investigated using Reference 18. The wave heights estimated are 3.3 feet for the significant wave and 5.5 feet for the maximum (1%) wave. The height of runup of the maximum wave is 0.7 feet. Adding this value to the PMF stillwater level of 521.8 feet MSL yields a probable maximum wave runup elevation

LSCS-UFSAR

of 522.5 feet MSL, which is 188 feet below the plant floor elevation of 710.5 feet MSL. A postulated PMF on the Illinois River, therefore, does not affect any safety-related facility.

2.4.4 Potential Dam Failures, Seismically Induced

The LSCS site is "floodproof" or "dry".

Figure 2.4-5 shows the locations and heights of dams on the Illinois Waterway. Of all the dams on the Illinois River and on its tributaries upstream of the site, that at Lockport, Illinois is the highest, with a lift of 39.5 feet (References 3 and 4) and a dam height above the foundation of 51 feet (Reference 5).

In the event of a seismically induced dam failure, it is unlikely that the resulting flood stage would exceed the Illinois River PMF stage at the site.

Breaching of the peripheral dikes of the cooling lake at the time of a postulated seismic event would cause the impounded water to discharge directly into local creeks that meet the Illinois River. Since the plant grade is set at elevation 710 feet MSL, and the plant floor is at elevation 710.5 feet MSL, there is no likelihood of flooding of the plant facilities due to this phenomenon.

Since cooling of the power plant condensers is accomplished by pumping from the cooling lake and not from the Illinois River directly, plant safety is not affected by postulated blockage of the Illinois River or by any other concurrent flooding condition. Failure of cooling lake dikes would not affect the UHS, as described in Subsection 2.4.11.6.

2.4.5 Probable Maximum Surge and Seiche Flooding

Flooding due to surges or seiches is not relevant for LSCS.

2.4.6 Probable Maximum Tsunami Flooding

Flooding due to tsunami is not relevant to LSCS.

2.4.7 Ice Flooding

Although ice formation takes place on all rivers in the Illinois River basin, flooding caused by ice jams is a rare event, as described in Subsection 2.4.2.1. Essential for ice jam formation is a constriction to passage of flowing ice. Such a constriction does not exist in the Illinois River near the site, since the river is approximately 800 feet wide and is kept navigable by dredging when required.

The lake screen house is protected against icing in the lake by provision of warming lines near the screen house.

2.4.8 Cooling Water Canals and Reservoirs

2.4.8.1 Capacity and Operating Plan for Cooling Lake

At normal pool, the lake has a water surface elevation of 700 feet MSL, a surface area of 2,058 acres, and a capacity of 31,706 acre-feet. Drainage area of the lake is 1,200 acres.

Makeup water is pumped from the Illinois River using three pumps with a total capacity of 90,000 gpm. The rate of pumping varies depending upon the plant operating load level and the weather conditions. It is designed to maintain a constant lake level and a total dissolved solids (TDS) level of less than the applicable State of Illinois water quality standard for receiving waters and effluents discharged to the waters of Illinois in the blowdown. The minimum operating lake level is 697.75 feet MSL. Lake level is continuously monitored in the main control room of the power plant.

2.4.8.2 Probable Maximum Flood Design

In the hydrologic design of the 2058-acre cooling lake, a standard project storm (SPS) is postulated to occur prior to the probable maximum precipitation (PMP), with three rainless days between them. The freeboard and riprap requirements for the peripheral dike are determined by superimposing significant wave characteristics of sustained 40-mph overland winds on the probable maximum water level in the lake. Wave runup elevation at the plant site is obtained by superimposing the maximum (1%) wave characteristics of sustained 40-mph overland winds on the probable maximum water level in the lake.

Safety-related facilities at the plant site are unaffected by the probable maximum water level in the lake with coincident wind wave activity.

Details of the design are presented in the following subsections. These include a discussion of design precipitation, unit hydrograph of 15-minute duration, standard project flood (SPF) and probable maximum flood (PMF) hydrographs, area and capacity of lake, outflow rating, auxiliary spillway design, wave runup, and height of peripheral dikes.

2.4.8.2.1 Design Precipitation

The design precipitation consists of SPS of 48-hour duration followed by three rainless days and then PMP of 48-hour duration. Values of PMP are obtained from Reference 13. Precipitation data for SPS are obtained from Reference 19. This publication is also used in the distribution of SPS and PMP into 6-hour intervals as shown in Table 2.4-6.

In order to maximize the peak discharge rate, the maximum 6-hour rainfalls shown in Table 2.4-6, 10.28 inches for SPS and 25.3 inches for PMP, are redistributed into 15-minute periods and higher intensities assumed for the shorter intervals based on Curve C, Figure 18 of Reference 20. For all other 6-hour periods, the SPS and PMP rainfalls are also redistributed into 15-minute periods, but a uniform distribution of rainfall is assumed for the shorter intervals.

2.4.8.2.2 Infiltration Losses and Rainfall Excess

The drainage basin of the cooling lake consists of Swygert and Rutland silt loams for 80% of the area and Bryce Silty clay for the rest of the area (Reference 70). The classification for the drainage basin would therefore be hydrologic soil group C (Reference 20, Appendix A). The infiltration rate for soil group C varies between 0.08 inch per hour to 0.15 inch per hour, and an average rate of 0.12 inch per hour is recommended by the Bureau of Reclamation (Reference 20, Chapter III, B-51). Discussion with the U.S. Army Corps of Engineers indicated that the flood studies made for the tributaries in the Illinois River basin in the past used an initial loss of 1.5 inches and an average infiltration loss of 0.1 inch per hour.

Conservatively, an initial loss of 0.5 inch and a subsequent average infiltration loss of 0.1 inch per hour are applied to the rainfall due to SPS. No initial loss is considered for the PMP, since the soil is assumed fully saturated by the antecedent SPS. Only an average infiltration loss of 0.1 inch per hour is applied to the PMP. Rainfall excess is obtained by subtracting the losses from the SPS and PMP values for all the 15-minute increments.

2.4.8.2.3 Unit Hydrograph

A unit hydrograph of 15-minute duration applicable to the 1200-acre drainage area of the cooling lake is shown in Figure 2.4-7. It is synthetically derived following Snyder's method described in Reference 14. No record of unit hydrographs developed from observed flood hydrographs is available for small drainage areas in the general vicinity of the cooling lake.

As a certain amount of judgment was involved in developing the unit hydrograph, a comparison was made with a unit hydrograph developed for the 1200-acre basin by the procedure outlined in Reference 71. This unit hydrograph is shown in Figure 2.4-7 for comparison with the unit hydrograph used for the development of flood hydrographs. The peak discharge and time to peak obtained from Reference 71 are 720 cfs and 1 hour as compared to 768 cfs and 0.875 hour used in the flood hydrograph development. Hence the unit hydrograph used for the development of flood hydrographs for the drainage basin of the cooling lake is conservative.

2.4.8.2.4 Development of SPF and PMF Hydrographs

The hydrograph of surface runoff resulting from incremental precipitation during each 15-minute period is obtained by multiplying the unit hydrograph ordinates by the rainfall excess during that period. Tables 2.4-7 and 2.4-8 and Figure 2.4-8 show the SPF and PMF hydrographs obtained by adding the surface runoff, assumed base flow of 2 cfs from the 1200-acre drainage area, and direct precipitation on the lake.

2.4.8.2.5 Reservoir Routing

Routing of PMF with antecedent SPF through the lake is performed using the U.S. Army Hydrologic Engineering Center's computer program 22-J2-L210, "Spillway Rating and Flood Routing", 1966. Input to the program consists of the elevation-capacity data shown in Figure 2.4-9 and derived from topographic maps of the area with a scale of 1 inch to 200 feet and a contour interval of 2 feet. The initial water level used for routing is the normal lake level. A listing of the input data to the program is provided in Table 2.4-8a.

The energy head over the spillway is equal to the water surface elevation minus the spillway crest elevation minus the spillway approach loss. The spillway approach loss at the design head was specified as 0.102 foot in the program. It was found that the maximum still water elevation is essentially the same for different approach losses of 0.01, 0.05, and 0.10 and 0.30 foot.

The program calculates the outflow from the lake shown in Figure 2.4-10 for the 300-foot (crest length) auxiliary spillway having side slopes of 10:1 (horizontal:vertical) and crest elevation of 702.5 feet MSL and for the service spillway described in Subsection 2.4.8.5. Auxiliary spillway rating is based on critical flow conditions at the crest.

2.4.8.2.6 Stillwater Levels in Lake

The maximum lake level corresponding to the SPF is 701.6 feet MSL, which is lower than the auxiliary spillway crest elevation.

When the SPF is followed by the PMF, with three rainless days between the SPS and the PMP, the lake level varies from a maximum of 701.6 feet MSL during SPF to 701 feet MSL before the rise due to PMF, and to a maximum of 704.3 feet MSL during PMF as shown in Figure 2.4-8. Subsequent to the PMF, the lake level continues to fall and reaches 702.5 feet MSL in 10 days from the start of SPS.

The effect of distributing the rainfall for all 6-hour periods into 15-minute values in the same manner as was done for the maximum 6-hour rainfall as discussed in Subsection 2.4.8.2.1 was also examined. The peak discharge for SPF and PMF increased only by 3% by this new distribution, and the maximum still water level obtained by routing this PMF with antecedent SPF through the lake was the same as 704.3 feet.

2.4.8.2.7 Auxiliary Spillway Design

The 300-foot auxiliary spillway is an integral part of the peripheral dikes as shown in Figures 2.4-3 and 2.4-11. The maximum outflow through the spillway having a crest elevation of 702.5 feet MSL is 2380 cfs when the probable maximum water

LSCS-UFSAR

level in the lake is 704.3 feet MSL. This flow is naturally directed toward South Kickapoo Creek, which joins the Illinois River.

The velocity at the crest is a maximum of 6.2 fps. To prevent potential erosion at the spillway crest, a 9-inch bituminous concrete pavement and an upstream concrete cutoff wall are provided along the crest as shown in Figures 2.4-12 and 2.4-13. To prevent frost action on the pavement, a drainage blanket is provided under the crest in accordance with recommendations of the U.S. Army Corps of Engineers (Reference 21).

The spillway channel downstream of the spillway has a longitudinal slope of 10:1 (horizontal:vertical). Banks of 2 feet 6 inches on both sides of the spillway channel keep the flow confined to the channel. During peak PMF flow, the depth and velocity of flow in the channel are 0.8 foot and 10.1 fps respectively, assuming a value of 0.04 for Manning's roughness coefficient. To prevent potential erosion, the spillway channel was designed with 24-inch thick stone riprap placed on 12 inch thick crushed stone bedding. The bedding is placed on a subgrade of compacted cohesive material. The gradation for the bedding is given in Table 2.5-33. The individual stones of the auxiliary spillway riprap were designed to fall between the following gradation limits:

<u>Approximate Weight (lb)</u>	<u>Percent Passing by Weight</u>
690	100
340	40-100
165	20-53
45	0-15
15	0-2

This gradation satisfies the guidelines for gradation limits stated in References 22, 23, and 24.

The gradation of the riprap as originally measured in the field was as follows:

<u>Approximate Weight (lb)</u>	<u>Percent Passing by Weight</u>
1400	100
900	87
700	64
340	36
165	21
45	8
15	1.5

Thickness at the riprap was measured during placement of 24 inches. The as-placed riprap contained larger size stones than specified; therefore, remedial actions were taken so that the stone size was appropriate for the 24-inch layer thickness. These remedial actions included breaking the largest individual stones, addition of peripheral dike riprap to provide more stone-to-stone contact and a more uniform riprap thickness, and reworking of the riprap surface to provide a more even downstream surface to the auxiliary spillway.

After completion of the above remedial measures, a gradation test of the in-place riprap indicated that the gradation does not satisfy the required average stone size of 16 inches. The in-place riprap had an average size of 8 inches.

At this stage of construction, the decision was made to alter the design of the downstream slope of the spillway as described below:

- a. The downstream slope of the spillway was flattened to 30:1 to reduce the velocity of flow to 7.5 fps and to use the easily available riprap whose average size was about 8 inches.
- b. A rock trench was provided at the demonstration end of the modified spillway. The purpose of this rock trench was for protection against potential scour at the end of the spillway.
- c. A wedge shaped concrete pavement was provided at the upstream end of the slope of the spillway. This pavement was installed because the existing riprap at that location could not resist the higher velocities and the coarser riprap could not be placed there without restricting the flow over the spillway. Downstream of this pavement, a minimum thickness of 30 inches of new riprap was provided.

The main purpose of the above modification was to make the riprap design consistent with the 8 fps limiting flow for the available riprap.

The slope of the spillway was flattened to 30:1 to reduce the velocity of flow from 10.1 fps to 7.5 fps. These modifications are shown in Figure 2.5-12a. The space between new layer of riprap and the existing riprap was filled with bedding material. The gradations of this bedding material and the new riprap are tabulated below:

LSCS-UFSAR

New Riprap

<u>Size in Inches</u>	<u>Percent Passing by Weight</u>
24	90-100
14	30-70
6	0-35
4	0-10

Bedding Layer

<u>Sieve Size</u>	<u>Percent Finer by Weight</u>
2-1/2 inch	100
2 inch	90-100
1 inch	60-90
1/2 inch	35-65
#4	20-40
#16	5-35
#200	4-12

The modification to the spillway was completed in the field during the winter of 1980-81.

A bedding layer may have two functions: as a filter material, and as a load-transferring gravel blanket. The bedding layer is not required to act as a filter material because the auxiliary spillway subgrade is composed of a compacted cohesive material (LL > 30) resistant to surface erosion (Reference 83). The bedding layer, therefore, was provided to satisfy the requirements of a well-graded, load transferring gravel blanket with gradation limits as outlined in Reference 84.

The approach section of the spillway has 18-inch thick stone riprap protection on 9-inch thick crushed stone bedding. Gradation of riprap for the approach section is the same as the peripheral dike riprap gradation number described in Subsection 2.5.6.4.3.

The material and soundness tests for the riprap and bedding used in the auxiliary spillway are the same as for the peripheral dike described in Subsection 2.5.6.4.3.

2.4.8.2.8 Coincident Wind Wave Activity

To determine the freeboard allowance for various points along the peripheral dike, significant wave characteristics associated with 40-mph overland winds coincident with the PMF and the wave runup on the riprapped interior slopes (3:1, horizontal:vertical) of the peripheral dikes are computed at several locations shown

in Figure 2.4-14. The calculations of the effective fetch, average depth, over water wind speed, significant wave height and period are made using the procedures developed by the U.S. Army Corps of Engineers (References 18 and 18a). The results of the analysis are given in Table 2.4-8b.

Figure 2.4-14 shows the wave runup including setup at critical locations, the largest value being 2.9 feet. Adding this to the probable maximum water level of 704.3 feet MSL yields a wave runup elevation of 707.2 feet MSL at the most critical point on the peripheral dike.

To prevent wave overtopping during PMF, the elevation of the top-of-road on the peripheral dike is provided to be higher than the wave runup elevation all around the lake. Accordingly, the top-of-road and the top-of-dike elevations vary from 705.7 to 707.3 feet MSL, and from 705 to 706.6 feet MSL respectively, as shown in Figure 2.4-15.

2.4.8.3 Water Level at Plant Site

Wave runup including setup at the plant site is computed to be 1.3 feet, corresponding to maximum (1%) wave characteristics associated with 40-mph overland winds coincident with the PMF using the methodology of Reference 18. The wave runup elevation obtained by adding the wave runup to the probable maximum water level is 705.6 feet MSL. Since the plant grade and floor elevations are 710 feet and 710.5 feet MSL respectively, there is no flooding at the plant due to 40-mph overland winds coincident with the probable maximum water level in the lake.

2.4.8.4 Blowdown Waterline

The lake blowdown line has a discharge capacity of 200 cfs. It originates in the cooler portion of the lake. The blowdown pipe is laid under the interior dike, under the lake, and under the exterior dike, as shown in Figure 2.4-3. It is a 66-inch diameter welded steel pipe encased in concrete and provided with antiseep concrete collars. The centerline elevations of the pipe are 694.75 feet MSL at the inlet and 682 feet MSL near the toe of the exterior dike. Beyond the exterior dike, a prestressed concrete pipeline carries the discharge to the Illinois River, with the diameter reducing to 54 inches before reaching the river outfall structure. The blowdown pipe is designed to have a gravity flow. A motor-operated shutoff valve at both the river and lake ends permits maintenance on the pipeline as required, as well as flexibility in the lake operation. Since the intake of the pipe is under water and the remainder of the line up to the outfall structure is buried below frost depth, ice blockage during the winter months is not a problem.

The lake blowdown line is required to perform several functions during normal plant operation. The most significant of these is to blow down a small portion of the

total water volume of the cooling lake to control the dissolved solids level of the water. A second use for the lake blowdown line during normal operation of the plant is to dilute and discharge low-level radioactive wastes to the river. The liquid radwaste system for LSCS Units 1 and 2 operates as a maximum recycle system, but a minimum periodic discharge is necessary to maintain the plant water inventory in balance.

In addition, this discharge blowdown line is used for the following purposes during normal plant operation: dilution and discharge of treated sanitary wastes, control of water level in the cooling lake, and dilution and discharge of nonradioactive wastes from the makeup demineralizer system (abandoned-in-place). In all cases these discharges satisfy the requirements established by federal and state laws governing liquid discharges to public waterways.

2.4.8.5 Service Spillway

A gated, reinforced concrete service spillway is provided at the southwestern end of the Number 1 interior dike to pick up and direct the lake water into the blowdown line to the Illinois River.

The design discharge of this control structure is 200 cfs; the crest is at elevation 697.75 feet MSL. Three 11-foot by 2-foot, 3-inch steel roller gates are provided. The plan and sections of the service spillway are shown in Figures 2.4-13a and 2.4-13b.

2.4.8.6 Makeup Water Discharge Structure

A reinforced concrete discharge structure is provided at the northern portion of the peripheral dike to discharge the makeup water from the Illinois River into the lake. The makeup water pipe embedded in the dike is a 60-inch diameter welded steel pipe encased in concrete and provided with antiseep concrete collars. The pipe has a centerline elevation of 702.5 feet MSL at the outlet and of 682 feet MSL near the toe of the dike. The makeup water is discharged through a concrete chute designed to pass a flow of 200 cfs without erosion of the upstream slope of the dike.

2.4.9 Channel Diversions

The Illinois River flows in the same general location as its predecessor of nearly a million years ago, the Ticona River (Reference 4). Presence of navigation locks and dams over the entire length of the river has further stabilized the river course. Based on the available evidence, no change in the regime of the river is expected.

Illinois River flow near the site has increased since January 17, 1900, because of the reversal in the flow of the Chicago and Calumet Rivers (resulting in the addition of an area of 810 mi² to the natural drainage area of the Illinois River basin) and because of diversion from Lake Michigan.

Due to the considerable width of the Illinois River and the well-developed flood plain, there is little likelihood that rock falls, ice jams, or subsidence would completely divert the flow from the river screen house location.

Cooling of the power plant condensers is accomplished by pumping from the cooling lake and not directly from the Illinois River. Emergency supply of cooling water is always available for use from the submerged UHS.

2.4.10 Flooding Protection Requirements

The plant floor is 4.9 feet higher than the probable maximum wave runup elevation of 705.6 feet MSL in the cooling lake and is therefore not subjected to flooding from the lake.

The lake screen house is affected by static and dynamic consequences of wave activity. As described in Subsection 3.4.2, the walls of the lake screen house are designed for the hydrodynamic forces superimposed on the hydrostatic forces. The maximum cooling lake level at the lake screen house due to a 40-mph overland wind superimposed over the PMF pool elevation of 704.3 feet MSL is estimated as 706.11 feet MSL. This elevation is obtained considering the maximum (1%) wave activity, using the corps methods (References 18 and 18a). The pertinent wind wave characteristics are tabulated in Table 2.4-8c.

Details of flood-protection measures are discussed in Subsection 3.4.1.

2.4.11 Low Water Considerations

2.4.11.1 Low Flows in Streams

Flow rates in the Illinois River at Marseilles, Illinois, corresponding to a 100-year recurrence interval drought, are presented in Table 2.4-9 based on Reference 25. The 1-day, 100-year low flow of 1592 cfs is 8 times the total capacity of 200 cfs for the makeup pumps at the river screen house. Therefore, postulated droughts in the Illinois River do not affect the makeup pumping to the cooling lake.

Performance of the ultimate heat sink is similarly unaffected by low flows in the Illinois River.

LSCS-UFSAR

The 7-day, 10-year low flow in the Illinois River near the site is 3228 cfs (Reference 26).

2.4.11.2 Low Water Resulting From Surges, Seiches, or Tsunami

This topic is not pertinent to the LSCS station.

2.4.11.3 Historical Low Water

The minimum recorded flow of the Illinois River at Marseilles, Illinois, is 1,460 cfs on October 16, 1943. Based on Reference 25, this flow can be expected for 1 day once in approximately 150 years.

According to Reference 27, the minimum low water elevation recorded by a U.S. Corps of Engineers' gauge is 480.5 feet MSL on January 2, 1943, at river mile 247.1, and 482.5 feet MSL on February 14, 1954, at river mile 271.4. The normal pool elevation is 482.8 feet MSL.

2.4.11.4 Future Controls

No future water uses are expected to affect the ability of safety-related facilities to function adequately.

2.4.11.5 Plant Requirements

The safety-related cooling water flow rates are discussed in Subsection 9.2.6. Details of the lake intake structure are shown in Figure 2.5-59. The minimum design operating level in the lake is 697.75 feet MSL.

The makeup pumps on the Illinois River have a total capacity of 200 cfs. Adequate water supply to the cooling lake would be available during a 100-year drought.

2.4.11.6 Heat Sink Dependability Requirements

The source of normal water supply is the cooling lake. In the unlikely event of a breach in the peripheral dike, emergency shutdown water supply would be obtained from the ultimate heat sink (UHS), which is an excavated pond with a capacity and surface area of 460 acre-feet and 83 acres, respectively, at the design level of 690 feet MSL as shown in Figure 2.5-59. The UHS is also characterized as the core standby cooling system (CSCS) pond. There are no retaining structures for the UHS. The intake flume is a part of the excavated UHS. Loss of the cooling lake has no effect on the UHS.

LSCS-UFSAR

The analysis presented in Subsection 9.2.6 supporting the availability of a 30-day supply of water during which design temperatures are not exceeded is based on worst period of record weather conditions.

The emergency shutdown capability of the plant is not dependent on water input from the main cooling lake or from the Illinois River. Furthermore, it is not affected by postulated low water conditions in the Illinois River.

The use of UHS water supply for fire protection and service water purposes is described in Subsection 9.2.6.

Design bases that establish the structural integrity of the UHS are described in Subsection 2.5.5.

Probable loss of the UHS capacity due to suspended sediment carried by makeup water pumped from the Illinois River was estimated. Based on an average turbidity of 67 Jackson Turbidity Units from the Illinois River water obtained from Reference 28, a conservative estimate of the volume of sediment deposited in the lake during a plant life of 40 years is 59 acre-feet. Almost all of this sediment will be deposited in the deeper parts of the lake, where the average velocity is as low as 0.04 fps. However, assuming that 5% of the total sediment carried by the makeup water is deposited in the UHS, a loss of approximately 3 acre-feet to the UHS capacity is possible during plant life.

Probable loss of UHS capacity due to runoff from the 315-acre drainage area of the UHS was estimated. Based on an average annual sediment yield of 100 tons/ mi² obtained from Reference 9, a conservative estimate of the volume of sediment deposited in the UHS is approximately 2.3 acre-feet during the plant life.

The probable loss to the UHS pond capacity due to sediment deposition therefore totals 5.3 acre-feet, which is a negligible amount compared to the UHS volume. A surveillance program to monitor changes in the UHS capacity is described in Subsection 2.5.5.

In the event of a postulated loss of the cooling lake, the high groundwater conditions prevailing in the surrounding region might result in some inflow to the UHS due to seepage. This inflow has been ignored in the capacity analysis presented in Subsection 9.2.6.

The effect of a postulated 200-foot breach of the peripheral dike on flow conditions at the eastern edge of the UHS was analyzed. The maximum velocity of flow is estimated to be approximately 4.6 fps. To protect against potential erosion, a 9-inch thick gravel layer with stones of 1.5-inch average size is provided along the eastern edge of the UHS.

2.4.12 Dispersion, Dilution, and Travel Times of Accidental Releases of Liquid Effluents in Surface Water

Normal release rates and dilution factors for radioactive effluents to the Illinois River are discussed in Subsection 11.2.3.3. A list of surface water users on the Illinois River within 50 river miles downstream of the site is presented in Table 2.4-2.

There are no outside radwaste tanks; all are housed in the main plant structures. The radwaste tanks are housed in concrete cells below grade level except for two small concentrated waste tanks in the drumming station where solid waste is processed.

Those radwaste tanks which are below grade level are housed in the basement of the turbine building at elevation 663 feet 0 inch. The design groundwater elevation is 700 feet 0 inch and the plant grade elevation is 710 feet 0 inch. Therefore, the effluents due to a postulated spill cannot move out of the basement of the turbine building.

The two small concentrated waste tanks in the drumming station have a capacity of 5000 gallons each and are housed in separate rooms. The floor and the bottom portion of the walls of these two rooms have a metallic liner which would prevent any leakage of liquid radwaste due to a postulated radwaste tank spillage.

2.4.13 Groundwater

The discussion of regional groundwater hydrology includes the hydrogeologic systems within a 25-mile radius circle centered at the LaSalle County Station, Units 1 and 2. The discussion of site groundwater hydrology includes the hydrogeologic systems within the LSCS property lines.

The physical and hydrogeologic characteristics, yields, recharge and discharge, and groundwater quality are described for each hydrogeologic system in Subsection 2.4.13.1. The regional and site hydraulic gradients and directions of groundwater flow are discussed in Subsection 2.4.13.2. In addition, onsite use of groundwater is described in Subsection 2.4.13.1.3; the effects of groundwater use at LSCS on groundwater users in the vicinity of the plant are described in Subsection 2.4.13.2.2.3.5.

2.4.13.1 Description and Onsite Use

2.4.13.1.1 Regional Hydrogeologic Systems

The regional area is defined as the area within a 25-mile radius circle centered at LSCS (Figure 2.4-16). This radius was selected to include the major groundwater

pumping centers which have reversed the hydraulic gradient in the Cambrian-Ordovician Aquifer in the vicinity of the site (Subsections 2.4.13.2.1.3.3 and 2.4.13.2.2.3.5). The site is situated on the east limb of the LaSalle Anticline; however, the discussion of regional hydrogeologic systems also includes the changes in hydrogeologic characteristics on the west limb of the anticline.

The hydrogeologic systems in the regional area include the alluvial aquifer along the Illinois River, the glacial drift aquitard, the glaciofluvial aquifers in buried bedrock valleys, the Pennsylvanian aquitard, the Cambrian-Ordovician Aquifer, the Eau Claire aquitard, and the Mt. Simon Aquifer. The hydrogeologic characteristics of each system are summarized in Figure 2.4-17.

2.4.13.1.1.1 Alluvial Aquifer

The alluvial aquifer along the Illinois River is developed within alluvium and outwash deposits that have infilled an erosional bedrock valley developed in Ordovician strata on the crest of the LaSalle Anticline and Pennsylvanian strata on the limbs of the anticline. These alluvial deposits include silty clay, silt, sand, and gravel. To the east of Utica, the Illinois River flows on a bedrock floor, and the thickness of the alluvium, as shown on well logs on file with the Illinois State Geological Survey, is generally less than 25 feet. In this area, the well logs indicate that sand and gravel deposits in this area occur only locally within the predominantly silty or clayey alluvium. To the west of Utica, the thickness of alluvium and outwash in the channel may be greater than 50 feet. The combined thickness of the alluvium and outwash in the city of LaSalle well field was as much as 56 feet, with nearly 30 feet of outwash gravels reported beneath the alluvium in well No. 6 (Reference 29, Illinois Environmental Protection Agency).

Recharge to the alluvial aquifer occurs by inflow from the Illinois River during periods of high river levels, by direct infiltration of precipitation through the silty or clayey alluvium, and by seepage of groundwater through the bedrock valley walls. Discharge from the aquifer is primarily by evapotranspiration losses and by seepage to the Illinois River when the water table in the aquifer is above the level of the river. Discharge may also occur by seepage to the underlying bedrock and by withdrawals of pumping wells. Drawdowns resulting from groundwater withdrawals may induce local recharge to the aquifer from the river.

To the east of Utica, yields in the alluvial aquifer are limited by the restricted areal extent and thickness of the permeable sand and gravel deposits within the alluvium. Small dependable yields suitable for domestic purposes are only locally available. To the west of Utica, large groundwater withdrawals can be sustained in those areas where the aquifer is thicker and more continuous. The combined average pumping rate of the city of LaSalle well field, which consists of five production wells in the alluvial aquifer, is more than 5680 gpm (Reference 29, Illinois Environmental Protection Agency).

Groundwater quality analyses for the alluvial aquifer at the city of LaSalle indicate that the hardness ranges from 325 to 561 ppm, total dissolved solids range from 404 to 751 ppm, and iron content ranges from 0.1 to 3.4 ppm. Additional data for one composite water sample from wells number 2 and 3, collected in 1947, indicate an alkalinity of 308 ppm, a chloride concentration of 24 ppm, a sulfate concentration of 263 ppm, and a nitrate content of 11 ppm (Reference 30, Hanson, 1950).

2.4.13.1.1.2 Glacial Drift Aquitard

Glacial drift is present throughout most of the regional area. Drift thicknesses range from nearly 200 feet over the buried Ticona Bedrock Valley to locally absent in the Illinois River valley. The glacial drift aquitard, as described in this subsection, does not include the valley fill deposits of the buried bedrock valley aquifers. The physical characteristics, distribution, stratigraphy, and depositional history of the glacial drift are presented in Subsections 2.5.1.2.2.1 and 2.5.1.2.6.3.2.

With the exception of the alluvium and outwash in the Illinois River valley and the glaciofluvial fill in the buried bedrock valleys, the drift consists primarily of silty clay tills with a thin loess cover. The tills are generally impermeable except in the uppermost 20 feet, where some permeability has resulted from development of the soil profile and jointing in the till. Studies of sanitary landfill leachate migration in similar tills in northeastern Illinois have indicated typical permeabilities of 1.0×10^{-7} cm/sec (0.1 feet per year) (Reference 31, Kempton, 1975). Within the tills, there are thin, discontinuous pockets of sand and gravel; between the lower tills, there may be a thin, discontinuous layer of sand and gravel (Subsection 2.5.1.2.2.1.1.1.1.4.2).

Groundwater in the glacial drift aquitard occurs predominantly in the thin, discontinuous sands and gravels within and between the tills. These sands and gravels are recharged slowly by the infiltration of precipitation through the overlying, relatively impermeable silty clay. Groundwater is discharged from the sand and gravel pockets to the underlying glacial drift or bedrock, to the surface streams where they intersect these deposits, and to pumping wells. The tills serve to confine groundwater in the underlying bedrock aquifers.

Well yields from the glacial drift aquitard are quite variable and typically low due to the limited vertical and lateral extent of the sand and gravel pockets within the till and the slow rate of recharge. Reported yields are suitable only for domestic or low-demand farm purposes, ranging between 2.5 and 15 gpm (Reference 32, Randall, 1955).

Chemical analyses were performed from 1937 to 1947 on ground-water samples collected from municipal wells in the glacial drift at Lostant, located approximately 21 miles southwest of the site. Total dissolved solids for these wells varied from 431 to 455 ppm, alkalinity ranged from 310 to 324 ppm, and hardness ranged from 107

to 166 ppm. The following ranges for selected constituents were also reported: chlorides, 24.0 to 117.0 ppm; sulfates, 33.9 to 40.7 ppm; nitrates, 3.3 to 5.8 ppm; sodium, 97.2 to 138.9 ppm; and iron, 0.4 to 3.7 ppm (Reference 30, Hanson, 1950; Reference 33, Randall, 1955). These wells are no longer in use. In 1970, a chemical analysis was performed on a water sample from a dug well used for public water supply at Leonore, located about 17 miles west of the site. The results of the analysis are as follows: total dissolved solids, 565 ppm; hardness, 426 ppm; total alkalinity, 258 ppm; chlorides, 19 ppm; sulfates, 130 ppm; nitrates, 24.0 ppm; and iron, none (Reference 29, Illinois Environmental Protection Agency).

2.4.13.1.1.3 Buried Bedrock Valley Aquifers

The buried bedrock valley aquifers in the regional area consist of sand and gravel fill in valleys cut into the Pennsylvanian bedrock. The major buried bedrock valley systems with respect to the LaSalle County Station are the east-west trending Ticona Bedrock Valley and the northwest-southeast trending Kempton Bedrock Valley (Figure 2.5-28). The discussion of buried bedrock valley aquifers is limited to the Ticona Valley, since data are generally not available for the upper portion of the Kempton Valley in the vicinity of the site. The physical characteristics, distribution, stratigraphy, and depositional history of the glaciofluvial deposits in the buried Ticona Valley are discussed in Subsections 2.5.1.2.2.1.1.1.1.1.5 and 2.5.1.2.6.3.2.

The glaciofluvial deposits in the buried Ticona Valley are quite variable and consist of clean to clayey sand, gravelly sand, and sandy gravel with some interbedded silt layers (Reference 34, Randall, 1955). The width of the buried Ticona Valley ranges from 1.5 to 3 miles and is greatest near Grand Ridge (Reference 35, Randall, 1955). The elevation of the top of the valley fill decreases to the west from approximately 540 to 560 feet MSL north of the LaSalle County Station to approximately 540 to 550 feet MSL at Grand Ridge (Reference 36, Randall, 1955).

Although the glaciofluvial deposits are overlain by essentially impermeable tills, groundwater in the buried bedrock valley aquifers is reported to occur under water table conditions (Reference 37, Randall, 1955). Randall explained the occurrence of water table conditions as the result of limited recharge due to the presence of the overlying, relatively impermeable till and the proximity of discharge areas at both ends of the buried bedrock valley. Groundwater levels, direction of groundwater movement, and hydraulic gradients within this aquifer are discussed in Subsection 2.4.13.2.1.3.2.

The buried bedrock valley aquifers are recharged primarily by seepage through the overlying clayey tills. In addition, groundwater apparently enters the aquifers from the adjacent Pennsylvanian bedrock (Reference 38, Randall, 1955). Recharge may also occur from the Vermilion River where it intersects the upper portion of the

buried Ticona Valley during periods of high surface water levels. The aquifer discharges groundwater at both ends where the buried bedrock valley intersects the Illinois River valley at Seneca and Hennepin. Groundwater is also discharged to pumping wells finished in the aquifer.

Yields from the buried bedrock valley aquifers are dependent upon the physical characteristics of the glaciofluvial deposits and type of well construction. Where the glaciofluvial deposits are clean and relatively well sorted, well yields of 100 gpm or more can be expected (Reference 37, Randall, 1955). The production well at Grand Ridge (Well Number 3) yielded 285 gpm for 11 hours in 1975, with a drawdown of only 6 feet; the water level returned to the normal static level one-half hour after pumping ceased (Reference 39, Knecht, 1975).

Groundwater in the glaciofluvial deposits of the buried Ticona Valley is moderately soft to hard (hardness ranges from 77 to 175 ppm). Alkalinity ranges from 276 to 356 ppm and total dissolved solids range from 285 to 376 ppm (Reference 40, Randall, 1955). The following concentration ranges were given for chemical analyses on wells in the vicinity of Grand Ridge between 1925 to 1954: chloride, 0.3 to 8 ppm; iron, trace to 7.2 ppm; and nitrate, 0.1 to 6 ppm (Reference 40, Randall, 1955). In 1975, a chemical analysis was performed by the Illinois Environmental Protection Agency on a sample from Well Number 3 at Grand Ridge. The reported values of hardness, alkalinity, total dissolved solids, chloride, iron, and nitrate fall within the ranges given above.

2.4.13.1.1.4 Pennsylvanian Aquitard

The Pennsylvanian aquitard consists predominantly of impermeable shale with some interbedded underclay, sandstone, limestone, and coal. The physical characteristics, stratigraphy, and depositional history of the Pennsylvanian strata are discussed in Subsections 2.5.1.2.2.1.1 and 2.5.1.2.6.1.4.

Groundwater occurs primarily in the sandstone beds and occasionally in joints in the limestone beds. Groundwater occurs locally under leaky artesian conditions where the sandstone and limestone beds are recharged by vertical seepage through the overlying glacial deposits or Pennsylvanian shales (Reference 41, Randall, 1955; Reference 42, Csallany, 1966). In those areas where these sandstones or limestones are exposed at the surface, they are recharged by the direct infiltration of precipitation, and groundwater occurs under water table conditions. Groundwater is discharged in springs along the river valleys cut into these formations or to the underlying strata. In addition, groundwater is discharged locally to the overlying glacial drift in those areas where the potentiometric surface in the Pennsylvanian aquitard is higher than the potentiometric surface in the drift (Subsection 2.4.13.2.2.3.4).

The Pennsylvanian formations are generally unfavorable as aquifers and are used where the overlying glacial deposits are thin or absent (Reference 42, Csallany, 1966). Well yields are low, averaging 6.4 gpm, and are suitable only for domestic or farm supplies (Reference 43, Randall, 1955). Groundwater quality in the upper 100 to 200 feet of the Pennsylvanian strata is acceptable for most domestic and farm purposes (Reference 44, Randall, 1955). These formations are generally cased off in wells drilled to deeper formations because the groundwater quality is better in the underlying Cambrian-Ordovician Aquifer. Gas, usually methane, has been reported in some Pennsylvanian wells in the regional area (Reference 44, Randall, 1955).

2.4.13.1.1.5 Cambrian-Ordovician Aquifer

The Cambrian-Ordovician Aquifer is composed of the following strata, in descending order: the Ordovician-age Galena, Platteville, Ancell, and Prairie du Chien Groups and the Cambrian-age Eminence Formation, Potosi Dolomite, Franconia Formation, Ironton Sandstone, and Galesville Sandstone. The lithology, physical characteristics, and depositional history of these strata are described in Subsections 2.5.1.2.2.2.1.2, 2.5.1.2.2.2.1.3, 2.5.1.2.6.1.1, and 2.5.1.2.6.1.2.

These sandstone and dolomite strata are grouped into hydrogeologic units based upon similar lithologic and hydrogeologic characteristics between adjacent units. The hydrogeologic units include, in descending order: the Galena-Platteville dolomite; the Glenwood-St. Peter sandstone; the Prairie du Chien, Eminence, Potosi, and Franconia dolomites; and the Ironton-Galesville sandstone (Figure 2.4-17). Available data in northeastern Illinois indicate that, on a regional basis, these hydrogeologic units behave hydraulically as one aquifer (Reference 45, Suter et al.; Reference 46, Papadopulos, Larsen, and Neil, 1969). Hoover and Schicht (Reference 47, 1967) indicate that these hydrogeologic units also function as one aquifer in LaSalle County.

The strata that comprise the Cambrian-Ordovician Aquifer have been folded during the development of the LaSalle Anticlinal Belt (Subsection 2.5.1.1.5.1.1.5). East of the anticline, the Glenwood-St. Peter sandstone is exposed at the surface at Starved Rock State Park, whereas west of the anticline, the top of the Glenwood-St. Peter sandstone is encountered in wells at Peru at depths of 1367 to 1455 feet. Typical well depths east of the anticline range between 400 to 1200 feet; in contrast, typical well depths west of the anticline range between 1000 to 2800 feet (Reference 48, Hoover and Schicht, 1967).

The Galena-Platteville dolomite and portions of the Glenwood-St. Peter sandstone may be locally absent resulting from erosion east of the crest of the LaSalle Anticline. Where the Galena-Platteville dolomite is present and immediately underlies permeable glacial deposits, joints in the dolomite may be solution-enlarged. The dolomite in these areas is fairly permeable and yields small to moderate quantities of groundwater to wells. Where the Galena-Platteville

dolomite is overlain by the Maquoketa Shale, such as west of the LaSalle Anticline, or by the Pennsylvanian shales, the joints are tight, and the dolomite is less favorable as a source of groundwater.

Groundwater in the Glenwood-St. Peter sandstone occurs in the intergranular pore spaces. The productivity of this hydrogeologic unit is determined by the primary permeability of the sandstone, which is quite variable and is controlled by the texture and the cementation of the sand. The upper part of the Glenwood-St. Peter sandstone is often shaly or dolomitic; the lower part is commonly composed of shale and conglomerate (Reference 49, Walton and Csallany, 1962). The middle portion is the most permeable and, consequently, the most productive. When the Glenwood-St. Peter sandstone and overlying Galena-Platteville dolomite are not cased off, these hydrogeologic units supply approximately 15% of the total yield of wells penetrating the entire thickness of the Cambrian-Ordovician Aquifer (Reference 50, Hoover and Schicht, 1967).

Groundwater in the Prairie du Chien, Eminence, Potosi, and Franconia dolomites occurs predominantly in joints. The Potosi dolomite is locally highly jointed and partially accounts for the high yields of several deep wells in the Cambrian-Ordovician Aquifer (Reference 51, Walton and Csallany, 1962). However, if the joints are tight and if interbedded shales are common, as in the Prairie du Chien and Franconia dolomites, the dolomites are less favorable as sources of groundwater. The Prairie du Chien, Eminence, Potosi, and Franconia dolomites may supply as much as 35% of the total yield of wells penetrating the entire thickness of the Cambrian-Ordovician Aquifer (Reference 50, Hoover and Schicht, 1967).

The Ironton-Galesville sandstone is regionally the most consistently permeable and productive hydrogeologic unit of the Cambrian-Ordovician Aquifer (Reference 52, Hoover and Schicht, 1967). The average permeability of this sandstone is about 3 times greater than the average permeability of the Glenwood-St. Peter sandstone (Reference 53, Walton and Csallany, 1962). The basal zone of the Ironton-Galesville sandstone is the least cemented and is the most favorable source of groundwater in the Cambrian-Ordovician Aquifer (Reference 52, Hoover and Schicht, 1967). Yields from the Ironton-Galesville sandstone constitute approximately 50% of the total yield of wells penetrating the entire thickness of the Cambrian-Ordovician Aquifer (Reference 50, Hoover and Schicht, 1967).

Groundwater in the Cambrian-Ordovician Aquifer generally occurs under artesian conditions. In the regional area, the aquifer is recharged primarily by through-flow and by vertical leakage through the overlying glacial drift or bedrock confining beds. The primary area of recharge is located in Boone, DeKalb, Kane, Kendall, and McHenry Counties, Illinois, and in southeastern Wisconsin (Reference 54, Sasman et al., 1973). Recharge also occurs by the direct infiltration of precipitation in those

areas where the Galena-Platteville dolomite and Glenwood-St. Peter sandstone are exposed at the surface (Figure 2.5-4).

The Illinois River may recharge the aquifer in the vicinity of major pumping centers where the groundwater withdrawals have drawn the water level in the aquifer below the level of the river (Reference 55, Hoover and Schicht, 1967).

Potentiometric surface maps for the Cambrian-Ordovician Aquifer in 1963 and 1971 are presented in Figures 2.4-18 and 2.4-19 and discussed in Subsection 2.4.13.2.1.3.3. Comparison of these maps shows the change in groundwater levels in the Cambrian-Ordovician Aquifer in response to pumping during this interval.

The potentiometric surface map for 1963 indicates that the Cambrian-Ordovician Aquifer normally discharged groundwater to the Illinois River, with the exception of those areas within the cones of depression where the potentiometric surface has been lowered below the river level. By 1971, however, much of the groundwater flowing toward the river was being diverted to the cones of depression, and the major groundwater discharge is to pumping wells. Groundwater is probably not discharged to the underlying bedrock formations because the potentiometric levels in the underlying Mt. Simon Aquifer are more than 50 feet higher than the potentiometric levels in the Cambrian-Ordovician Aquifer (Reference 56, Walton and Csallany, 1962).

Hoover and Schicht (Reference 57, 1967) list the results of 13 aquifer pump tests performed on wells penetrating the Cambrian-Ordovician Aquifer in LaSalle County. Values for the coefficient of transmissivity ranged between 13,400 and 22,000 gpd/ft. The value for the coefficient of storage was assumed to be 0.0006 for periods of pumping of several years or longer. Observed specific capacities of wells uncased in the Cambrian-Ordovician Aquifer in LaSalle County ranged from 5.3 to 19.8 gpm per foot of drawdown, with an average of 10.5 gpm/ft (Reference 58, Hoover and Schicht, 1967). In general, specific capacities are greater for those wells penetrating the deeper hydrogeologic units of the aquifer.

The quality of groundwater in the Cambrian-Ordovician Aquifer is not uniform. Water quality varies with the well location either east or west of the LaSalle Anticline. In addition, for those wells east of the anticline, the water quality varies between areas where the aquifer is exposed or overlain by glacial deposits and those areas where the aquifer is overlain by the Pennsylvanian aquitard. Most wells in the aquifer produce water from more than one hydrogeologic unit within the aquifer; therefore, the water quality can be determined only for the aquifer as a whole. Maximum, minimum, and mean concentrations of selected chemical constituents are given in Table 2.4-10.

In general, groundwater quality in the Cambrian-Ordovician Aquifer in LaSalle County is better east of the LaSalle Anticline where the Pennsylvanian aquitard is absent and there is direct recharge to the aquifer by the infiltration of precipitation.

Typically, the concentrations of chlorides, sulfates, hardness, and total dissolved solids are significantly higher where the Pennsylvanian aquitard is present. In fact, Hoover and Schicht (Reference 59, 1967) indicate that the southern limit of potable water in the Cambrian-Ordovician Aquifer (1,500 ppm total dissolved mineral concentration) lies only several miles south of the Illinois River. This area generally corresponds with the occurrence of a continuous, confining layer of Pennsylvanian shales overlying the aquifer.

The groundwater quality west of the LaSalle Anticline does not differ significantly from that east of the LaSalle Anticline where the Pennsylvanian aquitard is absent. However, due to the increased depths of wells west of the anticline, the temperature of groundwater east of the anticline averages 54.6° F, whereas the temperature west of the anticline averages 73° F (Reference 60, Hoover and Schicht, 1967).

2.4.13.1.1.6 Eau Claire Aquitard

The Eau Claire aquitard is composed of the upper and middle beds of the Eau Claire Formation. These beds consist of shales, dolomites, and shaly dolomitic sandstones which grade laterally from one to another. The Eau Claire aquitard forms an essentially impermeable confining bed between the overlying Cambrian-Ordovician Aquifer and the underlying Mt. Simon Aquifer.

2.4.13.1.1.7 Mt. Simon Aquifer

The Mt. Simon Aquifer consists of the lower sandstone beds of the Eau Claire Formation and the Mt. Simon Sandstone. There are no wells in the regional area that extend to the Mt. Simon Aquifer because the groundwater is too highly mineralized for most purposes, and adequate supplies are more easily obtained from shallower aquifers. Walton and Csallany (Reference 56, 1962) report that the potentiometric levels in the Mt. Simon Aquifer are more than 50 feet higher than in the Cambrian-Ordovician Aquifer.

2.4.13.1.2 Site Hydrogeologic Systems

The hydrogeologic systems at the site consist of the alluvial aquifer, the glacial drift aquitard, the buried bedrock valley aquifers, the Pennsylvanian aquitard, the Cambrian-Ordovician Aquifer, the Eau Claire aquitard, and the Mt. Simon Aquifer. The hydrogeologic characteristics of these systems are summarized in Figure 2.4-17. The physical and hydrogeologic characteristics, yields, recharge and discharge, and groundwater quality of each aquifer are discussed in the following subsections. Since the Mt. Simon Aquifer is not used for groundwater supplies within 25 miles of the site, the Mt. Simon Aquifer and the overlying Eau Claire aquitard will not be discussed relative to the site.

2.4.13.1.2.1 Alluvial Aquifer

The alluvial aquifer at the site is located along the Illinois River about 4 miles north of the main plant buildings. Although alluvial deposits occur along both sides of the Illinois River valley, the river functions as a hydrogeologic discharge boundary, thereby separating the alluvial aquifers on opposite sides of the river. The alluvial aquifer at the site extends along the river and is bounded on the north by the Illinois River and on the south by the valley walls. The width of the aquifer ranges from a minimum of 600 feet to a maximum of 7000 feet; in the vicinity of the river screen house, the width of the aquifer ranges from 3500 to 4800 feet.

Based upon information from 24 borings performed and logged by Dames & Moore from November 1970 to July 1972 (Figure 2.5-2, Sheet 1), the alluvial aquifer at the site can generally be divided into two layers. The upper layer is alluvium and consists of silty clay or clayey silt and may contain organic material near the top of the layer. The lower layer, present in 17 borings, is outwash and consists of silty sand, gravelly sand, and sand and gravel mixtures. The total thickness of the alluvium and outwash in the 24 borings varied from 0.9 feet (Boring R-18) to 37 feet (Boring 34-B-01), with an average of 16.7 feet. The outwash is locally absent in the vicinity of the river screen house and becomes thicker to the east. In borings in which both layers are present, the alluvium averages 6.6 feet thick, and the outwash averages 15.1 feet thick.

Groundwater in the alluvial aquifer occurs under water table conditions predominantly in the intergranular pore spaces of the permeable sand and gravel layer. The aquifer receives recharge primarily by the direct infiltration of precipitation and by inflow from the Illinois River during periods of high river levels. Infiltration rates have been determined for the upper 5 feet of weathered soil by the USDA Soil Conservation Service for the agricultural soil series in LaSalle County. For the soil series mapped in the vicinity of the river screen house (Reference 61, Alexander and Paschke, 1972), reported infiltration rates range from less than 43 ft/yr to more than 14,500 ft/yr; the infiltration rates occurring most frequently are 434 to 1,448 ft/yr. High infiltration rates are common in those areas where the parent material for the soil series consists predominantly of sand and gravel, that is, where the lower, permeable layer of alluvium is close to the surface. Groundwater from the alluvial aquifer is discharged directly to the Illinois River when the water table is above the river level and to the underlying Pennsylvanian bedrock by slow seepage.

Yields from the alluvial aquifer at the site are not known. The yields are probably adequate for domestic use only, owing to the limited recharge, the small saturated thickness, and the lateral discontinuity of the sand and gravel deposits. Higher yields may be sustained if drawdowns resulting from the groundwater withdrawals are large enough to induce recharge from the river. The chemical quality of groundwater in the alluvial aquifer at the site is not known.

2.4.13.1.2.2 Glacial Drift Aquitard

The glacial drift aquitard is present throughout the upland portion of the site and consists of relatively impermeable silty clay or clay tills with occasional discontinuous pockets of well-graded sand and gravel. The thickness of the drift in those site borings which completely penetrated the till on the upland ranged from 77.0 to 180.0 feet. A more complete description of the lithologic and stratigraphic characteristics of the glacial drift is presented in Subsection 2.5.1.2.2.1.1.1.1.

The results of field permeability tests conducted in five borings indicate low permeabilities for the upper 5 to 15 feet of glacial drift, ranging from 1.61×10^{-8} to 2.75×10^{-7} cm/sec (1.66×10^{-2} to 2.84×10^{-1} ft/yr) (Table 2.5-27). The tested intervals consisted of silty clay with some sand and fine gravel. In laboratory tests of selected undisturbed samples, the permeabilities ranged from 5.26×10^{-9} to 7.33×10^{-7} cm/sec (5.44×10^{-3} to 7.58×10^{-1} ft/yr) (Table 2.5-23, Sheet 1).

Groundwater in the glacial drift aquitard occurs primarily in discontinuous sand and gravel pockets within the tills and in a well-graded sand and gravel unit present between the Malden and Tiskilwa tills (Subsection 2.5.1.2.2.1.1.1.1.4.2). Because of the limited recharge resulting from the impermeable nature of the tills, groundwater in the drift occurs predominantly under water table conditions; however, groundwater levels in five of the piezometers installed at deeper levels in the drift indicate apparent artesian conditions.

Groundwater was observed seeping from some of the sand and gravel pockets exposed during excavation of the intake flume. Many of the pockets were drained within a few days, which suggests a limited areal extent for those deposits. Others, however, continue to seep long after being exposed; these pockets may be of greater areal extent or may be receiving small amounts of recharge, or both. The amount of groundwater seeping from the sand and gravel pockets exposed in the flume is sufficient only to wet the slopes of the flume beneath the seep.

During winter 1975-76, the excavations for the CSCS intake flume and pond partially filled with water from precipitation to a depth of approximately 12 feet in the flume and 3 feet in the pond. Water level and rainfall measurements were made for a 2-week period during March 1976 in order to determine the rate at which the water level declined due to seepage into the sand deposits and/or evaporation. The rate of seepage may be used to estimate indirectly the relative degree of interconnection and lateral continuity of the sand deposits in the glacial drift. The water levels showed virtually no change over the 2-week period. Even though the water levels indicate that there would be essentially no seepage out of the CSCS intake flume and pond over a 30-day period, the sand deposits exposed in the excavations were removed.

The permeable zones within the glacial drift aquitard are recharged by the slow infiltration of precipitation through the tills to the water table. The USDA Soil Conservation Service has published soil interpretation data sheets for each soil series at the site which list the infiltration rates for the upper 5 feet of agricultural soil (Figure 2.5-26). For all of the soil series present in the upland portion of the site, the infiltration rates range from 43 to 4,343 ft/yr; the infiltration rates occurring most frequently on the data sheets are 434 to 1,448 ft/yr (Table 2.5-13). The permeability of the tills below the weathered zone is probably on the order of 10 ft/yr (Reference 31, Kempton, 1975). Faint vertical jointing may occur locally in the upper 20 feet of the till; this phenomenon is somewhat typical in silty and clayey tills and may result in higher rates of infiltration in this zone (Reference 31, Kempton, 1975).

Upon reaching the water table, groundwater moves under gravity flow to discharge areas in nearby stream valleys. Groundwater in the glacial drift aquitard is also discharged to the underlying bedrock, to the glaciofluvial deposits of the buried bedrock valley aquifers, or to pumping wells.

The thin, discontinuous nature of the sand and gravel pockets and the low recharge rate through the tills limit the quantity of water available from the glacial drift aquitard to amounts suitable only for domestic or low-demand farm purposes. The quality of groundwater in the glacial drift aquitard at the site is not known.

2.4.13.1.2.3 Buried Bedrock Valley Aquifers

The buried bedrock valley aquifers at the site include glaciofluvial deposits in the east-west trending Ticona Bedrock Valley and in a northwest-southeast trending tributary of the Kempton Bedrock Valley. The site is located over a saddle in the bedrock topography that functions as a drainage divide between these two buried drainage systems (Figure 2.5-28). Based upon bedrock elevations reported in site borings, the bedrock surface beneath the main plant buildings slopes to the northeast toward the center of the buried Kempton Valley tributary. The buried drainage divide appears to be located less than 1 mile north of the main plant buildings. Both valley systems are cut into the Pennsylvanian strata that form the bedrock surface beneath the site. The glaciofluvial deposits of the buried Ticona Valley are exposed along the Illinois River near Hennepin and Seneca.

The glaciofluvial deposits generally consist of silty, fine to coarse sand with some gravel and occasional pockets of silt, clayey silt, or silty clay. Thick layers of clean, well-sorted, fine to medium sand are more common in the buried Ticona Valley than in the tributary of the buried Kempton Valley or over the divide; gravels are also more prevalent in the buried Ticona Valley. Based upon the results of grain size analyses performed on two samples from Boring 3, the permeability of the glaciofluvial deposits is estimated to range from 1.4×10^{-3} to 7.8×10^{-3} cm/sec (1400 to 8300 ft/yr).

The thickness of the glaciofluvial deposits in the buried Ticona Valley in site borings that reached bedrock varied from 65 to 115 feet. Bedrock in the buried Ticona Valley was generally encountered near elevation 460 feet MSL in these borings. Glaciofluvial deposits over the drainage divide and in the tributary of the buried Kempton Valley were much thinner, ranging from 7 to 50 feet thick. The bedrock elevations ranged from about 510 feet MSL over the saddle to 551 feet MSL near the east edge of the tributary valley.

Groundwater in the glaciofluvial deposits of the buried Ticona Valley apparently occurs under water table conditions. "Dry" sand or gravel is reported at the top of the glaciofluvial deposits in four wells north of the site (Reference 62, Illinois State Geological Survey). Groundwater levels in the piezometer installed in Boring 3, which is located over the divide, also indicate apparent water table conditions (Table 2.4-17). The conditions under which groundwater occurs in the glaciofluvial deposits of the buried Kempton Valley tributary are not known, since piezometers were not installed in these deposits.

The buried bedrock valley aquifers are recharged slowly by infiltration of precipitation through the thick overlying glacial tills (Subsection 2.4.13.1.2.2). The Pennsylvanian strata may also provide some recharge (Subsection 2.4.13.2.2.3.4). Randall (Reference 38, 1955) suggests the presence of a groundwater divide at elevation 535 feet MSL in the buried Ticona Valley between Grand Ridge and the Vermilion River. In the vicinity of the site, groundwater in the glaciofluvial deposits of the buried Ticona Valley apparently moves eastward to discharge where the Illinois River intersects the buried Ticona Valley at Seneca. Groundwater flow in the glaciofluvial deposits of the buried Kempton Valley tributary is probably to the southeast, following the bedrock topography. Groundwater in these deposits discharges at some point downgradient to a surface stream, to the underlying bedrock, or to the buried Mahomet Bedrock Valley, of which the Kempton Valley is a tributary.

The potential for groundwater development from the buried Ticona Valley aquifer in the vicinity of the site is limited by the low recharge rate to the aquifer. The potential for groundwater development from the aquifer in the tributary of the buried Kempton Valley which extends beneath part of the site is even more limited because of the reduced thickness, areal extent, and permeability of the aquifer. Wells in the buried bedrock valley aquifers near the site are used only for domestic or farm purposes. Groundwater quality in these aquifers at the site is not known.

2.4.13.1.2.4 Pennsylvanian Aquitard

The Pennsylvanian aquitard consists of alternating beds of shale, siltstone, underclay, sandstone, limestone, coal, and many gradational units. Relatively impermeable shale and siltstone comprise more than 90% of the strata of the Pennsylvanian System (Subsection 2.5.1.2.2.1.1). The thickness of the

Pennsylvanian aquitard was 189 feet in the only site boring that reached the underlying Platteville Group (Boring 2) and 180 to 187 feet in the two water wells drilled at the site (Subsection 2.4.13.1.2.5). However, the thickness of the aquitard is probably quite variable over the site, as both the top and base of the Pennsylvanian System are marked by erosional contacts.

Groundwater in the Pennsylvanian aquitard occurs under artesian conditions. Wells finished in Pennsylvanian rocks obtain water predominantly from the thin sandstone and limestone beds which are recharged by seepage through the overlying shales and glacial drift. In general, the Pennsylvanian rocks supply less than 10 gpm; these yields are suitable only for domestic or farm uses. The quality of groundwater in the Pennsylvanian aquitard at the site is not known. The Pennsylvanian strata are usually cased off in wells finished in the underlying Cambrian-Ordovician Aquifer, as in the two water wells at the site.

2.4.13.1.2.5 Cambrian-Ordovician Aquifer

The Cambrian-Ordovician Aquifer at the site consists of the following stratigraphic units: the Ordovician-age Platteville, Ancell, and Prairie du Chien Groups, and the Cambrian-age Eminence Formation, Potosi Dolomite, Franconia Formation, Ironton Sandstone, and Galesville Sandstone. The lithologic characteristics and approximate thicknesses of these units are given in Subsection 2.5.1.2.2.2.1.2 and 2.5.1.2.2.2.1.3; the hydrogeologic characteristics of the units are summarized in Subsection 2.4.13.1.1.5.

Two groundwater wells were drilled into the Cambrian-Ordovician Aquifer at the site during 1972 and 1974. The characteristics of each well and its subsequent development are summarized in Table 2.4-12. Well No. 1 is 1629 feet deep and Well No. 2 is 1620 feet deep. Both wells are finished in the Ironton-Galesville sandstone, the most productive hydrogeologic unit of the aquifer (Subsection 2.4.13.1.1.5). The wells are cased into the Oneota Dolomite (Prairie du Chien Group), Well No. 1 to a depth of 921 feet and Well No. 2 to a depth of 989 feet. The contact between the Platteville Group and the overlying Pennsylvanian aquitard is at elevation 367 feet MSL in Boring 2. The elevation of the static water level in the wells after completion ranged between 450 and 460 feet MSL, indicating that groundwater in the aquifer occurs under artesian conditions. The specific capacities for Well No. 1 and Well No. 2, as determined from pumping tests following the development of each well, are 1.88 and 9.24 gpm/ft, respectively.

Chemical analyses were performed on groundwater samples from each of the onsite wells. The results of the analyses for major chemical constituents are summarized in Table 2.4-13. These analyses apply to the entire Cambrian-Ordovician Aquifer. The concentrations of the various constituents cannot be determined for the

LSCS-UFSAR

individual hydrogeologic units of the aquifer, since the wells are open to all of the units below the Oneota Dolomite (Figure 2.4-17).

2.4.13.1.3 Onsite Use Of Groundwater

Groundwater will be used at LSCS to supply the water requirements for the following plant systems: makeup demineralizer; potable supply. Groundwater will be obtained from two deep wells in the Cambrian-Ordovician Aquifer (Subsection 2.4.13.1.2.5); each well is equipped with a deep well submersible pump with a rated capacity of 300 gpm. The water will be stored in a 350,000-gallon, ground level tank prior to distribution to the demineralizer and domestic systems.

Maximum groundwater use is presently estimated to be approximately 521,600 gpd. The maximum water requirements for each system and the percentage of the total used are as follows: makeup demineralizer, 479,600 gpd (92%); potable supply, 15,000 gpd (3%); sand filter backwash, 11,500 gpd (2%); and recreational supply, 15,500 gpd (3%). The average pumping rate will be 300 gpm for one well and 500 gpm (combined) for both wells operating simultaneously. (Note: Makeup-demineralizer is abandoned-in-place and replaced by a vendor trailer).

2.4.13.2 Sources

2.4.13.2.1 Regional Groundwater

The regional area for the evaluation of groundwater conditions is shown in Figure 2.4-16.

2.4.13.2.1.1 Present Use

Major municipal and industrial pumping centers within 25 miles of LSCS are shown in Figure 2.4-16 and are listed in Table 2.4-14. All public groundwater supplies within 10 miles are listed in Table 2.4-15 and are also shown in Figure 2.4-16. Domestic groundwater supplies are discussed in Subsection 2.4.13.2.2.

Groundwater for public use within 10 miles of the site is obtained predominantly from wells in the Cambrian-Ordovician Aquifer. Water supplies for Seneca, Kinsman, Marseilles, and Illini State Park are taken entirely from this aquifer. Ransom withdraws groundwater from both the Cambrian-Ordovician Aquifer and from the more permeable zones in the Pennsylvanian aquitard. Grand Ridge is the only municipality within 10 miles to obtain water from the glaciofluvial deposits of the buried Ticona Bedrock Valley. Table 2.4-14 gives the available data on wells in each public system and the average daily consumption from each system. The remainder of the small communities shown on Figure 2.4-16 are not served by public water supply systems. Residents of these communities and the surrounding

rural areas obtain groundwater from individual wells in the glacial drift, the Pennsylvanian strata, or the upper portion of the Cambrian-Ordovician Aquifer.

Total pumpage from deep wells of the major municipal and industrial pumping centers listed in Table 2.4-14 was approximately 15 mgd in 1974. The largest withdrawals occurred at Ottawa, where 3.80 mgd were pumped from municipal and industrial wells, and at Marseilles, where 3.37 mgd were pumped. Pumpage for the public water supply systems within 10 miles of the site (Table 2.4-15) totaled less than 1 mgd.

A large cone of depression has developed in the potentiometric surface of the Cambrian-Ordovician Aquifer (Subsection 2.4.13.2.1.3.3) in response to continuous and increasing withdrawals of groundwater at the major municipal and industrial pumping centers along the Illinois River (Figure 2.4-16). Of the pumping centers listed in Table 2.4-14, only the city of LaSalle does not use groundwater from the Cambrian-Ordovician Aquifer, but rather obtains groundwater from wells in the coarse alluvial deposits along the Illinois River. Groundwater used by industries in the regional area is either purchased from the nearest municipal supply system or pumped from private industrial wells. Except for the five large industrial users listed in Table 2.4-14, most industrial wells provide groundwater only for potable purposes and pump less than 25,000 gpd.

2.4.13.2.1.2 Projected Future Use

The city of Peru has drilled an additional well that will be tied into the existing municipal system upon completion of pumphouse construction. A new well installed at Utica should be in service by May 1976. There are no other known plans for additional municipal or industrial wells in the regional area.

2.4.13.2.1.3 Regional Flow and Gradients

2.4.13.2.1.3.1 Alluvial Aquifer

Alluvial aquifers in the regional area are confined to the valleys of the Illinois River and its tributaries. The aquifers are hydraulically connected to the adjacent river or stream, and groundwater levels fluctuate with changes in the river or stream level. Groundwater levels will also vary with the amount and seasonal distribution of precipitation.

Groundwater normally moves toward the river or stream, with a smaller component of flow in the downstream direction. Groundwater flow toward the river or stream may be reversed when the river or stream level exceeds the groundwater level in the alluvial aquifer; during these periods, the alluvial aquifers are recharged by seepage through the banks of the river or stream. The direction of groundwater movement may also be reversed in the vicinity of pumping wells in response to

groundwater withdrawals. Pumping from the alluvial aquifers will neither affect nor be affected by groundwater use at LSCS.

2.4.13.2.1.3.2 Buried Bedrock Valley Aquifers

The buried bedrock valley aquifers in the regional area consist of the Ticona Bedrock Valley and a tributary of the Kempton Bedrock Valley. In most places, the bedrock valleys have been cut into Pennsylvanian strata. However, over the crest of the LaSalle Anticline, the floor of the buried Ticona Valley is formed by the underlying Galena and Platteville dolomites or, in some areas, the St. Peter Sandstone (Reference 35, Randall, 1955).

The Illinois River intersects the buried Ticona Valley near Seneca and Hennepin. Static water levels reported by Randall (Reference 41, 1955) indicate the presence of a groundwater divide at elevation 535 feet MSL, about halfway between Grand Ridge and the Vermilion River (about 11 miles west of LSCS). East of the divide, groundwater moves toward Seneca under a hydraulic gradient of about 3.2 ft/mi, whereas west of the divide, groundwater moves toward Hennepin under a hydraulic gradient of about 3.8 ft/mi. The direction of groundwater flow may be locally reversed in response to large groundwater withdrawals. Grand Ridge is the only community within 10 miles of LSCS to withdraw groundwater for public supply from the buried Ticona Valley (Table 2.4-15). The magnitude and the direction of the hydraulic gradient were not determined in the glaciofluvial deposits of the buried Kempton Valley tributary; however, the direction of groundwater flow probably follows the south-southeast trend of the bedrock valley (Figure 2.5-28).

Groundwater levels in the Cambrian-Ordovician Aquifer at the site will not be affected by the offsite use of groundwater from the buried bedrock valley aquifers. The cooling lake will not affect groundwater levels in the buried bedrock valley aquifers because, where present, these aquifers are overlain by 100 to 150 feet of relatively impermeable glacial drift. Groundwater use at the site will not affect the water levels in the buried bedrock valley aquifers, since these aquifers are separated from the Cambrian-Ordovician Aquifer by the Pennsylvanian aquitard.

2.4.13.2.1.3.3 Cambrian-Ordovician Aquifer

The Cambrian-Ordovician Aquifer is widely used in the regional area to supply groundwater for municipal, industrial, and some domestic uses. The largest withdrawals are concentrated at pumping centers along the Illinois River (Table 2.4-14 and Figure 2.4-16). The following history of changes in the potentiometric surface of the Cambrian-Ordovician Aquifer in the regional area is summarized from Hoover and Schicht (Reference 63, 1967) and Sasman et al. (Reference 64, 1973). Static water levels in municipal and industrial wells in 1963 and 1971 are included in Tables 2.4-14 and 2.4-15.

Prior to extensive groundwater development of the Cambrian-Ordovician Aquifer, the potentiometric surface in the regional area sloped to the south and southeast. A groundwater ridge existed just north of the Illinois River valley, and potentiometric surface contours near the Illinois River were bent in the upstream direction around the river in LaSalle and Grundy Counties, indicating leakage from the aquifer into the river. Many communities along the Illinois River using this aquifer for water supply had flowing wells. In 1895, the estimated potentiometric surface along the Illinois River in the regional area ranged from an elevation slightly greater than 500 feet MSL to 550 feet MSL; the static water level was 506 feet MSL (flowing) at Ottawa and 560 feet MSL (flowing) at Peru. By 1915, groundwater withdrawals had modified the potentiometric surface and, although the wells were still flowing, the water levels had declined 21 feet at Ottawa and 75 feet at Peru. The elevation of the potentiometric surface at Marseilles in 1915 was 505 feet MSL (flowing).

Groundwater withdrawals from the Cambrian-Ordovician Aquifer for municipal and industrial purposes increased significantly (more than 5 times) from 1915 to 1963 at pumping centers along the Illinois River. The increased level of use is reflected in the potentiometric surface in 1963 (Figure 2.4-18); the map indicates a groundwater trough along the Illinois River and a large cone of depression centered at Ottawa. From 1915 to 1963, the potentiometric surface declined 30 feet at Ottawa, from elevation 485 feet MSL to 455 feet MSL, and 18 feet at Marseilles, from elevation 505 feet MSL to 487 feet MSL. Over this same period, static water levels at Oglesby dropped 56 feet, from elevation 539 feet MSL to 483 feet MSL. Hoover and Schicht (Reference 65, 1967) defined an area of diversion of groundwater flow based on the potentiometric surface in 1963 (Figure 2.4-18). Based upon flow lines (not shown) drawn at right angles to the potentiometric surface contours, groundwater flows from potentiometric highs north and south of the Illinois River toward the river and the cones of depression developed at the major pumping centers. The hydraulic gradient in the Cambrian-Ordovician Aquifer north of the Illinois River was 7.5 ft/mi north of the 650-foot potentiometric surface contour and 12.5 ft/mi south of the 650-foot contour; south of the river the hydraulic gradient was about 4 ft/mi (Reference 60, Hoover and Schicht, 1967). Hoover and Schicht (Reference 65, 1967) calculated recharge to the Cambrian-Ordovician Aquifer through the overlying glacial drift and bedrock formations in the vicinity of the Illinois River to be about 10,800 gpd/mi²; recharge from the Illinois River was considered to be minimal.

Groundwater levels have continued to decline since 1963 in response to increasing groundwater withdrawals from the Cambrian-Ordovician Aquifer along the Illinois River, as shown in Figure 2.4-19. At Ottawa, the potentiometric surface declined 24 feet between 1963 and 1971, from elevation 455 to 431 feet MSL. Over this same period, static water levels dropped 17 feet at Marseilles, from elevation 487 to 470 feet MSL, and 18 feet at Seneca, from elevation 443 to 425 feet MSL. The largest decline was recorded at Oglesby, where the potentiometric surface fell 38 feet from elevation 483 to 445 feet MSL. The most recent water level elevations in municipal

and industrial wells are given in Tables 2.4-14 and 2.4-15. Comparison of these levels with those in 1963 (Figure 2.4-18) and 1971 (Figure 2.4-19) indicates that the area of diversion has expanded to the west and east and now includes the LaSalle County Station site. Hydraulic gradients near the river have increased in response to greater use of groundwater in this region. In 1971, the hydraulic gradient north of the Illinois River was 5.9 ft/mi north of the 650-foot potentiometric surface contour and 14.3 ft/mi south of the 650-foot contour; south of the river, the hydraulic gradient ranged from 6.25 to 10.0 ft/mi.

Flowing artesian conditions, once prevalent in the Cambrian-Ordovician Aquifer along the Illinois River, now occur only locally where the ground surface is below the present static water level, most notably at Utica. Elsewhere, groundwater withdrawals may have lowered static water levels to within the St. Peter Sandstone; in these areas, groundwater no longer occurs under artesian conditions. Pumping at continually increasing rates will eventually dewater the upper portions of the aquifer, which will reduce the saturated thickness and, therefore, the transmissivity of the aquifer.

Using a model aquifer and a mathematical model, Hoover and Schicht (Reference 60, 1967) estimated that water levels in the Cambrian-Ordovician Aquifer will decline an additional 195 feet (from the 1963 level) at the Ottawa pumping center and 98 feet in the LaSalle-Peru-Oglesby area by the year 2000, assuming the rate of increase in pumpage shown in 1963 continues. Currently, the potentiometric surface of the Cambrian-Ordovician Aquifer at Ottawa is approximately 110 feet above the base of the St. Peter sandstone. Continued pumpage will eventually completely dewater the St. Peter Sandstone and a portion of the underlying formations, with a resultant decrease in the coefficient of transmissivity of approximately 20% (Reference 60, Hoover and Schicht, 1967). Thus, the cone of depression centered on the Ottawa pumping center will continue to deepen and expand through the year 2000 due to both increased pumping rates and decreased transmissivity. Similarly, the cone of depression associated with the LaSalle-Peru-Oglesby pumping center will continue to deepen and expand until equilibrium is reached. Recharge from the Illinois River may increase as the potentiometric levels in the Cambrian-Ordovician Aquifer decrease, especially where the St. Peter Sandstone crops out near Ottawa.

2.4.13.2.1.3.4 Mt. Simon Aquifer

The Mt. Simon Aquifer is not used for groundwater supply in the regional area. Data are not available on water levels or hydraulic gradients in this aquifer.

2.4.13.2.2 Site Groundwater

Groundwater conditions for the site, which is defined as the area within the property lines of the LaSalle County Station, are evaluated in the following subsections. The site is shown in Figure 2.4-4.

2.4.13.2.2.1 Present Use

Groundwater for construction purposes at LaSalle County Station was supplied from the two LSCS wells in the Cambrian-Ordovician Aquifer (Subsection 2.4.13.1.2.5 and Table 2.4-12). The average daily use is 40,000 gpd.

An inventory of domestic wells was conducted by Dames & Moore in 1970 in the following sections of Township 32N, Range 5E: 7, 8, 9, 16, 17, 18, 19, 20, and 21 (Figure 2.4-20). Domestic well data for the remainder of the area shown in Figure 2.4-20 was obtained from an inventory made in 1934 by the Illinois State Water Survey (Reference 66). The results of both inventories are summarized in Table 2.4-16.

Domestic water supplies are most commonly obtained from either the sand and gravel zones within the glacial drift or the sandstone and limestone beds of the underlying Pennsylvanian strata. Wells in these strata generally yield enough water for domestic or low-demand farm purposes. After prolonged pumping, some drift wells may require long recovery periods, and some wells reportedly pump air. About 75% of the drift wells in Table 2.4-16 are actually cisterns and range from 11 to 55 feet in depth.

Only 11 domestic wells in the inventoried area reach the Cambrian-Ordovician Aquifer. The distance to these wells from the main plant buildings varies from less than 1 mile to approximately 3.8 miles. The effects of plant groundwater use on these wells are discussed in Subsection 2.4.13.2.2.3.5.

2.4.13.2.2.2 Projected Future Use

Maximum groundwater use at LaSalle County Station is estimated to be 521,600 gpd from the two wells in the Cambrian-Ordovician Aquifer (Subsection 2.4.13.1.3). The effects of plant groundwater use on domestic wells in the inventoried area are discussed in Subsection 2.4.13.2.2.3. Domestic wells within the cooling lake (Figure 2.4-20 and Table 2.4-16) were sealed with concrete grout during the construction of the cooling lake dikes.

2.4.13.2.2.3 Site Flow and Gradients

2.4.13.2.2.3.1 Alluvial Aquifer

The thickness of the alluvial aquifer in the vicinity of the river screen house ranges from 0.9 to 19.3 feet and averages 7.6 feet. Groundwater was encountered in eight of the 14 R-series borings taken on the floodplain at depths of 3.2 to 6 feet. Groundwater was not encountered in the other borings, where the upper fine-grained alluvium directly overlies the Pennsylvanian bedrock.

Groundwater elevations in the alluvial aquifer decrease from the bluff toward the river, indicating that groundwater flows toward the river, with localized flow toward South Kickapoo Creek. The hydraulic gradient in the alluvial aquifer was not determined, since groundwater levels in the various borings were not measured on the same dates. Groundwater use at LaSalle County Station will have no effect on groundwater levels in the alluvial aquifer.

2.4.13.2.2.3.2 Glacial Drift Aquitard

The glacial drift aquitard is present throughout the upland portion of the site as glacial till. The till ranged in thickness from 77.0 feet (Boring D-4) to 180.0 feet (Boring 6) in borings that completely penetrated the till. Piezometers were installed in the glacial drift aquitard in 29 borings from 1970 to 1973. Dates of installation, tested intervals, and records of measurement are given in Table 2.4-17. The piezometer locations are shown in Figure 2.4-21. The records of daily precipitation and potentiometric levels for 13 piezometers installed near the surface of the aquitard are presented in Figure 2.4-22. Water levels in the remaining piezometers, which were installed at different levels in the glacial drift, were measured infrequently or only over short periods of time; these data are therefore not suitable for graphical presentation and are summarized in Table 2.4-18.

Twenty additional piezometers were installed during December 1974 to measure normal ground water fluctuations around the cooling lake (Figure 2.4-21, Table 2.4-11). These piezometers are hereinafter called ground water observation wells to distinguish them from the piezometers installed earlier. A typical observation well is 25 feet deep, and the tested interval consists of the lower 8 feet. Water levels were measured on a monthly basis and the results are presented with daily precipitation data in Figure 2.4-23 (Table 2.4-18). NUREG-0486 "Final Environmental Statement" dated November 1978, Section 6.3.3 specifies these observation wells will be monitored during filling of the lake and for at least two years thereafter. After completion of the ground water monitoring program as specified in NUREG-0486 "Final Environmental Statement", the number of observation wells monitored, frequency of monitoring and documentation requirements will be as described in the plant surveillance program.

Water levels measured in the near-surface piezometers and observation wells indicate that the water table generally lies within 10 feet of the surface and suggest that the water table conforms to the surface topography. Groundwater levels do not appear to respond uniformly to precipitation events (Figures 2.4-22 and 2.4-23). The absence of rapid fluctuations or a direct relationship to precipitation events probably reflects both the time lag for the infiltration of precipitation through the till to the water table and/or the infrequent water level measurements. The permeability of the upper 15 feet of till, excluding the agricultural soil, ranges from 5.26×10^{-9} to 7.33×10^{-7} cm/sec (5.44×10^{-3} to 7.58×10^{-1} ft/yr) (Subsection 2.4.13.1.2.2).

Occasional sand and gravel pockets were noted within the glacial till in boreholes and in the excavations. These pockets act as storage zones for infiltrating groundwater. Wells or cisterns that intercept one or more of these zones may exhibit high short-term yields. Most of the sand and gravel pockets exposed in the excavations appear to be discontinuous; groundwater seepage from these pockets generally ceased in a matter of hours or days after the pockets were exposed. However, groundwater flowed continuously from one sand and gravel pocket exposed in the key trench excavation for the main peripheral dike at Station 291 + 00 until it was excavated and backfilled with clay fill (Figure 2.5-78). The pocket was approximately 200 feet long, 60 feet wide, and 25 to 35 feet thick. Groundwater flow decreased with time as the deposit was dewatered.

Seams of sand were also noted in the tested intervals of piezometers installed in Borings 36, 37, and 41 beneath the main plant buildings. The following water level elevations were recorded on May 25, 1971 (Table 2.4-18): 594 feet MSL in Boring 37, 634.6 feet MSL in Boring 41, and 646.5 feet MSL in Boring 36. The variation in water levels indicates that the sand seams present within the till are apparently hydraulically separated. Measured water levels in Borings 36 and 41 suggest that groundwater in these sand seams apparently occurs under artesian conditions, whereas water levels in Boring 37 indicate apparent water table conditions.

The tested interval of the piezometer installed in Boring 37 intersects the sand layer between the Malden and Tiskilwa tills noted in 26 borings near the main plant buildings at an approximate elevation of 595 feet MSL (Subsection 2.5.1.2.2.1.1.1.1.4.2). The only other piezometer at the level of this sand layer is the shallow piezometer installed in Boring 6 (6-S in Table 2.4-18). Groundwater conditions cannot be determined on the basis of these two piezometers, since the piezometer in Boring 37 was not installed until November 30, 1970, and water level data are not available for the piezometer installed in Boring 6 after July 15, 1970.

Groundwater levels in the till will not be affected by groundwater withdrawals from the LSCS wells. Groundwater levels around the cooling lake were monitored in observation wells on a monthly basis to determine water table fluctuations prior to filling the lake. The records obtained from the monitoring program were compared

with groundwater levels after the lake was filled to determine changes in water levels due to seepage from the lake. Seepage through the dike surrounding the cooling lake is estimated to be 1 gpd per lineal foot of dike, or approximately 38,000 gpd (Subsection 2.5.6.6). Seepage through the upper till to the underlying tills and bedrock strata is expected to be minimal owing to the low permeability and thickness of the till (Subsection 2.4.13.1.2.2).

2.4.13.2.2.3.3 Buried Bedrock Valley Aquifers

The major portion of the buried Ticona Bedrock Valley lies about 2 miles north of the main plant buildings (Figure 2.5-28). The site is located over a buried preglacial drainage divide which separates the east-west trending buried Ticona Valley from a northwest-southeast trending tributary of the buried Kempton Valley. A piezometer was installed over the divide in permeable sand and gravel in Boring 3. The top of the sand and gravel occurs at elevation 549.5 feet MSL; the piezometer is slotted from elevation 527.5 to 547.5 feet MSL. One month after installation of the piezometer, the groundwater level was 12.3 feet below the top of the sand and gravel, at elevation 536.8 feet MSL, indicating that groundwater is under water table conditions.

Groundwater in the buried bedrock valley aquifers is probably under water table conditions, as suggested by the water levels measured in Boring 3 and the "dry" sand reported at the top of the valley fill in the buried Ticona Valley (Subsection 2.4.13.1.2.3). Since piezometers were not installed in either the major portion of the buried Ticona Valley or in the tributary of the buried Kempton Valley, the magnitude and direction of the hydraulic gradients in these aquifers were not determined. Based upon the bedrock topography, however, groundwater in the valley fill deposits south of the divide probably moves toward the southeast, and groundwater in the valley fill deposits north of the divide probably moves to the northwest to the buried Ticona Valley and then to the east toward the Illinois River.

Groundwater use at LSCS will not affect groundwater levels in the buried bedrock valley aquifers.

2.4.13.2.2.3.4 Pennsylvanian Aquitard

Pennsylvanian strata form the bedrock surface throughout the site. One piezometer was installed in the Pennsylvanian aquitard beneath the site in Boring 6 (6-D in Table 2.4-17). The water level elevation on July 15, 1970, was 589.9 feet MSL (Table 2.4-18), more than 60 feet above the top of the Pennsylvanian strata. This water level suggests that the groundwater in the aquitard is under artesian conditions. Water levels in wells finished in Pennsylvanian strata also indicate artesian conditions (Reference 62, Illinois State Geological Survey).

A downward hydraulic gradient exists between the glacial drift aquitard and the underlying Pennsylvanian aquitard, as evidenced by higher groundwater levels in the drift than in the Pennsylvanian strata (Table 2.4-17). Groundwater seepage through the drift in response to this hydraulic gradient accounts for the limited recharge to the Pennsylvanian aquitard at the site. Similarly, a downward hydraulic gradient exists between the Pennsylvanian aquitard and the Cambrian-Ordovician Aquifer at the site (Subsection 2.4.13.2.2.3.5). The Cambrian-Ordovician Aquifer is confined under leaky artesian conditions, and the rate of recharge to the aquifer by leakage is approximately 10,800 gpd/mi² (Subsection 2.4.13.2.1.3.3).

Groundwater use at LSCS should have an insignificant effect on groundwater levels in the Pennsylvanian aquitard. Plant groundwater withdrawals from the Cambrian-Ordovician Aquifer will lower the potentiometric surface in the vicinity of the pumping wells, thereby locally increasing the downward hydraulic gradient from the Pennsylvanian aquitard. Groundwater levels in the Pennsylvanian aquitard may decline locally with time in response to increased leakage. The magnitude of the water level decline cannot be determined from the available data; however, the decline is expected to be small and localized, since the vertical permeability of the Pennsylvanian aquitard is low.

2.4.13.2.2.3.5 Cambrian-Ordovician Aquifer

Groundwater in the Cambrian-Ordovician Aquifer beneath the site occurs under leaky artesian conditions. Static water level measurements in the onsite wells by the Illinois State Water Survey on November 21, 1975, indicate that the potentiometric surface is approximately 426 feet MSL, while the elevation of the top of the aquifer is about 367 feet MSL (Subsection 2.4.13.1.2.5). Hoover and Schicht (Reference 65, 1967) estimate the amount of recharge by leakage reaching the Cambrian-Ordovician Aquifer in the vicinity of the site to be 10,800 gpd/mi² (Subsection 2.4.13.2.1.3.3). The vertical permeabilities of the individual stratigraphic formations that comprise and overlie the Cambrian-Ordovician Aquifer are not known.

The direction of groundwater movement in the Cambrian-Ordovician Aquifer beneath the site in 1963 was apparently to the east-southeast (Figure 2.4-18). Groundwater withdrawals from this aquifer at the pumping centers along the Illinois River between 1963 and 1971 have reversed the direction of the hydraulic gradient at the site, with resultant groundwater movement to the north-northwest (Figure 2.4-19). The magnitude of the hydraulic gradient at the site in 1971 was approximately 6.25 feet/mi. The increasing withdrawals of groundwater projected through the year 2000 by Hoover and Schicht (Subsection 2.4.13.2.1.3.3) will cause the area of diversion shown in Figure 2.4-18 to continue to expand until recharge to the aquifer within the area equals the volume of groundwater withdrawn. The

LSCS-UFSAR

hydraulic gradients will continue to increase toward the municipal and industrial pumping centers in response to the greater withdrawals of groundwater.

The maximum groundwater withdrawal at LSCS will be approximately 521,600 gpd. Assuming a recharge rate of 10,800 gpd/mi², this withdrawal is equivalent to the natural recharge to the Cambrian-Ordovician Aquifer by leakage through the overlying glacial drift and Pennsylvanian shales over the area within a circle of radius 4 miles (Reference 65, Hoover and Schicht, 1967). This radius does not consider additional recharge to the aquifer due to throughflow in the aquifer or due to induced recharge resulting from the increased hydraulic gradient over the areal extent of the cone of depression. Assuming an anticipated cone of depression with a radius somewhat less than 4 miles at steady state, where steady state is defined as no change in groundwater flow conditions with respect to time (Reference 67, Todd, 1955), the plant groundwater withdrawals would not affect water levels in either the nearest municipal wells (Seneca, distance 5 miles) or industrial wells (Beker Industries, distance 5 miles).

The shape of the anticipated cone of depression has been calculated using the leaky artesian well formula developed by Hantush and Jacob (Reference 68, 1955). For these calculations, groundwater withdrawals at the plant wells were assumed to be from a single well pumping continuously at a constant rate of 350 gpm (504,000 gpd). Hydrogeologic characteristics of the Cambrian-Ordovician Aquifer and overlying confining beds were taken from Hoover and Schicht (Reference 69, 1967) as follows:

<u>Cambrian-Ordovician Aquifer</u>	
transmissivity	12,000 gpd/ft
storage coefficient	0.0004
<u>Confining beds</u>	
vertical permeability	0.00078 gpd/ft ²
thickness	350 ft

Based on these assumed values, the radius of the cone of depression associated with the plant wells would reach 4 miles after approximately 45 days, with anticipated drawdowns at the plant wells of approximately 36 feet, at wells 1 mile from the plant of approximately 9 feet, at wells 2 miles from the plant of approximately 4.5 feet, and at wells 3 miles from the plant of approximately 1.5 feet. These data indicate the anticipated effects on domestic wells in the Cambrian-Ordovician Aquifer within the radius of influence are water level changes of only a few feet. These calculations represent a conservative analysis (i.e., greater drawdown than actually anticipated) of the effects of the plant groundwater withdrawals on water levels in the Cambrian-Ordovician Aquifer.

However, the drawdowns and radius of influence anticipated here do not consider the continued expansion of the cones of depression associated with the municipal

and industrial pumping centers along the Illinois River. The continued expansion, the result of an increased volume of groundwater withdrawal, indicates that steady-state conditions do not exist within the aquifer and that the natural recharge by leakage and throughflow in the vicinity of LaSalle County Station are already diverted to these existing pumping centers. Increased throughflow and induced recharge within the cone of depression resulting from the plant groundwater withdrawals may minimize the effect of these withdrawals on potentiometric levels beyond the 4-mile radius; however, the present expansion and deepening of the regional cone of depression in the Cambrian-Ordovician Aquifer along the Illinois River is expected to continue.

2.4.13.3 Accident Effects

An accidental spill of radioactive materials would have no effect on the public groundwater supplies. The principal aquifer in the area is overlain by approximately 350 feet of impervious till and underlying shales. The permeability of the till ranges from 5.26×10^{-9} to 7.33×10^{-7} cm/sec; therefore, fluids infiltrating the till alone would require more than 600 years to move vertically through the till to bedrock (underlying shales).

Effects of an accidental release of liquid radwaste are discussed in Subsection 2.4.12.

2.4.13.4 Monitoring or Safeguard Requirements

Monitoring or safeguard requirements will not be necessary for the protection of existing or future groundwater users due to the effective, essentially impermeable horizontal and vertical seal formed by the glacial till and underlying Pennsylvanian strata. Changes in groundwater levels in the till resulting from seepage from the cooling lake will be monitored using the 20 existing groundwater observation wells shown in Figure 2.4-21 (Subsection 2.4.13.2.2.3.2).

2.4.13.5 Design Bases for Hydrostatic Loading

The groundwater level assumed for calculation of hydrostatic loading on the power plant foundations is elevation 700 feet MSL. This design groundwater level is equivalent to the design cooling lake level. The design groundwater level is based upon the assumptions that: 1) the granular fill around the plant foundations will be hydraulically connected with the cooling lake due to the granular fill around the intake pipelines; and, 2) that the groundwater level in the granular fill around the plant foundations would therefore reflect the cooling lake level.

Since the granular fill around the plant foundations will be covered with 20 feet of essentially impermeable, compacted clay and the surrounding clayey till is also essentially impermeable at depths below the soil profile, the infiltration of

precipitation through the compacted clay cover or the seepage of groundwater from the clayey till should be minimal.

2.4.14 Technical Specification and Emergency Operation Requirements

In the event that the cooling lake level drops to an elevation of 690 feet MSL or lower, the nuclear reactors are shut down as described in Subsection 9.2.6.

A surveillance program to monitor potential sedimentation of the UHS is described in Subsection 2.5.5.2.6.

2.4.15 References

1. U.S. Army Corps of Engineers, "Charts of the Illinois Waterway," U.S. Army Engineer District, Chicago, Illinois, 1974.
2. U.S. Geological Survey, "Water Resources Data for Illinois," Champaign, Illinois, 1974.
3. U.S. Army Corps of Engineers, "Water Resources Development in Illinois," U.S. Army Engineer District, Chicago, Illinois, 1973.
4. State of Illinois, "Kankakee River Basin Study - A Comprehensive Plan for Water Resources Development," Department of Public Works and Buildings, Springfield, Illinois, 1967.
5. U.S. Committee of the International Commission on Large Dams, World Register of Dams, Paris, 1973.
6. U.S. Army Corps of Engineers, "Chicago District Project Maps: Flood Control, Shore Protection, River and Harbor Works - Lake Area," Revised to June 30, 1974.
7. H. H. Dawes and M. L. Terstriep, "Potential Surface Water Reservoirs of Northern Illinois," Report of Investigation 58, Illinois State Water Survey, Urbana, Illinois, 1967.
8. H. H. Dawes and M. L. Terstriep, "Potential Surface Water Reservoirs of North-Central Illinois," Report of Investigation 56, Illinois State Water Survey, Urbana, Illinois, 1966.
9. U.S. Army Corps of Engineers, "Upper Mississippi River Comprehensive Basin Study," Appendix D: Surface Water Hydrology, U.S. Army Engineer District, St. Louis, Missouri, 1970.

LSCS-UFSAR

10. State of Illinois, "Map Atlas of Upper Illinois River," Department of Public Works and Buildings, Springfield, Illinois, 1971.
11. T. A. Butts, R. E. Evans, and S. Lin, "Water Quality Features of the Upper Illinois Waterway," Report of Investigation 79, Illinois State Water Survey, Urbana, Illinois, 1975.
12. State of Illinois, "Revised Plumbing Code," Article 13.6.2, Department of Public Health, Division of Sanitary Engineering, 1969.
13. National Oceanic and Atmospheric Administration, "Seasonal Variation of the Probable Maximum Precipitation East of the 105th Meridian for Areas from 10-1000 Square Miles and Durations of 6, 12, 24 and 48 Hours," Hydrometeorological Report Number 33, 1956.
14. V. T. Chow, Editor, Handbook of Applied Hydrology, McGraw-Hill Book Company, New York, 1964.
15. National Oceanic and Atmospheric Administration, "Rainfall Frequency Atlas of the U.S. for Durations from 30 Minutes to 24 Hours and Return Periods from 1 to 100 Years," Technical Paper Number 40, 1961.
16. U.S. Army Corps of Engineers, "Illinois River, Illinois and Tributaries," Survey Report for Flood Control and Allied Water Uses, Volume 2: "Basic Data, Project Development, Cost Estimates," Unpublished Report, U.S. Army Engineer Divisions-North Central and Lower Mississippi Valley, 1961.
17. U.S. Army Corps of Engineers, "Illinois Waterway-Marseilles Pool Soundings," Sheet 8/40 from River Miles 248.8 to 249.5, U.S. Army Engineer District, Chicago, Illinois, 1951.
18. U.S. Army Corps of Engineers, "Computation of Freeboard Allowances for Waves in Reservoirs," Engineer Technical Letter ETL-1110-2-8, 1966.
- 18a. U.S. Army Corps of Engineers, "Waves in Inland Reservoirs," Technical Memorandum No. 132, Beach Erosion Board, November 1962.
19. U.S. Army Corps of Engineers, "Standard Project Flood Determinations," Civil Engineering Bulletin No. 52-8, EM-1110-2-1411, 1952, Revised 1965.

LSCS-UFSAR

20. U.S. Bureau of Reclamation, "Design of Small Dams," Denver, Colorado, 1974.
21. U.S. Army Corps of Engineers, "Hydraulic Design of Spillways," EM-1110-2-1603, March 1965.
22. U.S. Army Corps of Engineers, "Criteria for Riprap Channel Protection," ETL-1110-2-60, 1969.
23. U.S. Army Corps of Engineers, "Hydraulic Design of Flood Control Channels," EM-1110-2-1601, 1970.
24. U.S. Army Corps of Engineers, "Additional Guidance for Riprap Channel Protection," ETL-1110-2-120, 1971.
25. S. L. Wilbourn, Hydrologic Technician, U.S. Geological Survey, Champaign, Illinois, Unpublished Data on Illinois River at Marseilles transmitted to P. B. Singh, Sargent & Lundy Water Resources Engineer, October 7, 1975.
26. K. P. Singh and J. B. Stall, "The 7-Day 10-Year Low Flows of Illinois Streams," Bulletin 57, Illinois State Water Survey, Urbana, Illinois, 1973.
27. H. Krampitz, U.S. Corps of Engineers, Chicago, Illinois, Unpublished Tabulation of River Stages on the Illinois Waterway given to P. B. Singh, Sargent & Lundy Water Resources Engineer, August 14, 1975.
28. State of Illinois, "Summary of Data, 1971, Water Quality Network," Environmental Protection Administration, Volume 1: all Illinois basins except Lake Michigan Basin, Sanitary and Ship Canal Basin, and Des Plaines Basin, Springfield, Illinois, 1971.
29. Illinois Environmental Protection Agency, Inventory Sheets and Public Water Supply Data Sheets, from Illinois State Water Survey, open file.
30. R. Hanson, "Public Ground-Water Supplies in Illinois," Bulletin 40, Illinois State Water Survey, 1950.
31. J. P. Kempton, Geologist, Illinois State Geological Survey, Written Communication to D. L. Siefken, Sargent & Lundy, July 17, 1975, p. 3.
32. A. D. Randall, "Glacial Geology and Groundwater Possibilities in Southern LaSalle and Eastern Putnam Counties, Illinois," unpublished M. S. Thesis, University of Illinois, Urbana, Illinois, 1955, p. 58.

33. Ibid., p. 151.
34. Ibid., pp. 59-60.
35. Ibid., p. 14.
36. Ibid., Plate 2.
37. Ibid., p. 61.
38. Ibid., p. 62.
39. M. Knecht, Assistant Superintendent, Water and Streets, Grand Ridge, Illinois, Written Communication to A. Brewster, Geologist, Sargent & Lundy, September 15, 1975, p. 3.
40. Randall, p. 149.
41. Ibid., pp. 61-62.
42. S. Csallany, "Yields of Wells in Pennsylvanian and Mississippian Rocks in Illinois," Report of Investigation 55, Illinois State Water Survey, 1966, p. 4.
43. Randall, p. 72.
44. Ibid., p. 93.
45. M. Suter et al., "Preliminary Report on Ground-Water Resources of the Chicago Region, Illinois," Cooperative Groundwater Report 1, Illinois State Water Survey and Illinois State Geological Survey, 1959, p. 48.
46. I. S. Papadopoulos, W. R. Larsen, and F. C. Neil, "Ground-Water Stations--Chicagoland Deep Tunnel System," Ground Water, Vol., No. 5, October 1969, pp. 3-15, p. 5.
47. L. R. Hoover and R. J. Schicht, "Development in Deep Sandstone Aquifer along the Illinois River in LaSalle County," Report of Investigation 59, Illinois State Water survey, 1967, p. 8.
48. Ibid., p. 1.

LSCS-UFSAR

49. W. C. Walton and S. Csallany, "Yields of Deep Sandstone Wells in Northern Illinois," Report of Investigation 43, Illinois State Water Survey, 1962, p. 11.
50. Hoover and Schicht, p. 4, Table 1.
51. Walton and Csallany, p. 22.
52. Hoover and Schicht, p. 6.
53. Walton and Csallany, p. 21.
54. R. T. Sasman et al., "Water-Level Decline and Pumpage in Deep Wells in Northern Illinois, 1966-1971," Circular 113, Illinois State Water Survey, 1973, p. 4.
55. Hoover and Schicht, pp. 18-19.
56. Walton and Csallany, p. 8.
57. Hoover and Schicht, pp. 9-10.
58. Ibid., p. 12.
59. Ibid., p. 21.
60. Ibid., p. 60.
61. J. D. Alexander and J. E. Paschke, "Soil Survey: LaSalle County, Illinois," Soil Report 91, Illinois Agricultural Experiment Station, 1972, Sheet 60.
62. Illinois State Geological Survey, well logs, open file.
63. Hoover and Schicht, pp. 15-17.
64. Sasman et al., pp. 21, 31, and 35.
65. Hoover and Schicht, p. 18.
66. Illinois State Water Survey, domestic water well logs, open file.
67. D. K. Todd, Groundwater Hydrology, John Wiley & Sons, Inc., New York, 1955, p. 62.

LSCS-UFSAR

68. M. S. Hantush and C. E. Jacob, "Non-steady Radial Flow in an Infinite Leaky Aquifer," Vol. 36, No. 1, pp. 95-100, Transactions American Geophysical Union, 1955.
69. Hoover and Schicht, p. 10, pp. 18-19.
70. University of Illinois Agricultural Experimental Station, "LaSalle County - Soil Survey," May 1972.
71. W. D. Mitchell, "Unit Hydrographs in Illinois," State of Illinois, Division of Waterways, 1948.
72. R. P. Feser, Illinois Nitrogen Corporation, Telephone Conversation with J. Montgomery, Sargent & Lundy Cultural Resource Analyst, October 16, 1975.
73. R. P. Feser, Illinois Nitrogen Corporation, Telephone Conversation with J. Ruff, Sargent & Lundy Cultural Resource Analyst, December 20, 1976.
74. A. Burton, National Biscuit Company, Telephone Conversation with J. Montgomery, Sargent & Lundy Cultural Resource Analyst, October 16, 1975.
75. A. Burton, National Biscuit Co., Telephone Conversation with J. Ruff, Sargent & Lundy Cultural Resource Analyst, December 22, 1976.
76. R. Walden, Supervisor of Air and Water Pollution Control, Illinois Power Company, Telephone Conversation with A. Brearley, Sargent & Lundy Radioecologist, October 30, 1975.
77. R. Walden, Supervisor of Air and Water Pollution Control, Illinois Power Company, Telephone Conversation with J. Ruff, Sargent & Lundy Cultural Resource Analyst, December 20, 1976.
78. Foster Grant Company, Telephone Conversation with J. Montgomery, Sargent & Lundy Cultural Resource Analyst, September 3, 1975.
79. R. St. Martin, Westclox Corporation, Telephone Conversation with J. Montgomery, Sargent & Lundy Cultural Resource Analyst, October 16, 1975.
80. J. Renkosik, Westclox Corporation, Telephone Conversation with J. Ruff, Cultural Resource Analyst, Sargent & Lundy, December 21, 1976.

LSCS-UFSAR

81. P. Slingman, Jones & Laughlin Steel Corporation, Telephone Conversation with J. Montgomery, Sargent & Lundy Cultural Resource Analyst, October 16, 1975.
82. P. Slingman, Jones & Laughlin Steel Corporation, Telephone Conversation with J. Ruff, Cultural Resource Analyst, Sargent & Lundy, December 21, 1976.
83. U.S. Geological Survey, "Water Resources Data for Illinois," Champaign, Illinois, 1983.
84. U.S. Army Corps of Engineers, "Hydraulic Design of Reservoir Outlet Structures", EM-1110-2-1602, plate 13, 1963.
85. Hydrologic Engineering Center, 1997, HEC-RAS River Analysis System, U. S. Army Corps of Engineers, Davis, CA. Version 3.0 distributed by Haestad Methods, Waterbury, CT.

Additional References Not Cited in Text

1. H. W. King and E. F. Brater, Handbook of Hydraulics, Fifth Edition, McGraw-Hill Book Company, New York, 1963.
2. U.S. Army Corps of Engineers, "Flood Hydrograph Analysis and Computations," EM-1110-2, 1405, 1959.
3. Conestoga-Rovers & Associates, "Hydrogeologic Investigation Report Fleetwide Assessment LaSalle Generating Station Marseilles, Illinois.", Ref. No. 045136(16), September 2006.

LSCS-UFSAR

TABLE 2.4-1

CHARACTERISTICS OF ILLINOIS RIVER TRIBUTARIES*

STREAM	LOCATION ABOVE MOUTH OF PARENT STREAM (mi)	LENGTH OF STREAM (mi)	DRAINAGE AREA (mi ²)	ELEVATION OF SOURCE (ft MSL)	AVERAGE SLOPE (ft/mi)
Kankakee River	273	130	5,280	820	1.5
Iroquois River	38	94	2,175	680	0.8
Yellow River	101	70	560	860	2.9
Singleton Ditch	51	32	290	820	1
Des Plaines River	273	111	2,176	750	2.2
Du Page River	3	74	326	820	4.3
Hickory Creek	13	25	110	750	9.7
Spring Creek	2	13	20	785	19.6
Salt Creek	44	33	170	860	8.0
Mazon River (including East Fork)	264	50	548	710	4.5
West Fork	17	31	168	740	6.5
Gum Creek	248	3	3	720	40
Fox River	240	185	2,600	950	3
Ottawa Ravines	239	2	2	600	70
Vermilion River (including North Fork)	226	110	1,379	790	3.3
South Fork	75	21	188	780	6.4
Little Vermilion River	225	24	124	870	18.1
Bureau Creek	209	60	502	960	8.6
Coffee Creek	207	9	12	730	40
Brown Run	192	8	11	675	36
Crow Creek (West)	191	26	90	740	14
Gimlet Creek	189	6	6	700	45
Crow Creek (East)	182	38	126	730	8
Richland Creek	180	17	33	770	29
Ten Mile Creek	167	9	17	800	43
Farm Creek	162	19	60	800	19
Kickapoo Creek (Peoria County)	160	42	319	830	8.3
Mackinaw River	148	112	1,200	815	3.3
Copperas Creek	138	16	42	760	20.9
Spoon River	120	150	1,817	800	1.5
Sangamon River	98	250	5,410	836	1.6
Salt Creek	33	105	1,859	835	3.4
Sugar Creek	11	46	438	815	3.5
Kickapoo Creek (Logan County)	25	45	337	836	3.5
Lake Fork	32	39	279	720	1.4
North Fork	76	23	138	840	8.5
South Fork	86	87	1,130	690	2.1
Flat Branch	61	34	283	660	3.0
La Moine River (Crooked Creek)	84	97	1,360	750	1.4
Indian Creek	79	40	166	580	5.4
Willow Creek	72	8	6	580	20.1
McKee Creek	67	73	347	760	5.8
Mauvaise Terre Creek	63	40	168	700	7.0
Sandy Creek	50	29	139	690	7.2
Hurricane Creek	43	14	40	660	17.1
Apple Creek	38	62	440	690	4.4
Macoupin Creek	23	90	947	650	2.4
Otter Creek	15	14	116	640	15.8

* Source: Reference 1

LSCS-UFSAR

TABLE 2.4-2

INTAKES ON THE ILLINOIS RIVER WITHIN
50 RIVER MILES DOWNSTREAM OF THE SITE

RIVER MILE	INDUSTRY	WATER USAGE	AVERAGE** WATER USE (gpm)	POPULATION ASSOCIATED	REFERENCE
248.7	Illinois Nitrogen Corp.	Industrial		---	72, 73
		Potable	12000	90 employees	
		Sanitary		---	
246.7	National Biscuit Co.	Industrial	450	--	74, 75
246.6	Marseilles Hydroelectric Plant	Industrial	Negligible	--	76, 77
223.2	Foster Grant Co.*	--	--	--	78
223.0	Westclox Corp.	Industrial	300	--	79, 80
		Sanitary		--	
211.9	Hennepin Power Station	Industrial	164,350	--	76, 77
208.9	Jones & Laughlin Steel Corp.	Industrial	3000-3500	--	81, 82

* Water intake is not currently being used.

** References 72 through 82.

LSCS-UFSAR

TABLE 2.4-3

MAXIMUM READINGS ON ILLINOIS RIVER GAUGESPERIOD 1940-73*

GAUGE		MILE	MAXIMUM READING AT 8:00 a.m. (ft MSL)	DATE
Lockport	Upper	291.1	580.8	1/2/71
	Lower	291.0	544.4	4/5/47
Brandon Road	Upper	286.0	540.5	7/13/57
	Lower	285.9	513.3	7/13/57
Dresden Island	Upper	271.5	506.6	7/14/57
	Lower	271.4	504.7	7/14/57
Marseilles Dam	Upper	247.1	484.6	4/26/50
	Lower	247.0	480.5	7/14/57 - 7/15/57
Lock	Upper	244.6	485.0	4/26/50
	Lower	244.5	472.1	4/26/50 & 5/16/70
Ottawa		239.7	467.3	4/26/50
Starved Rock	Upper	231.0	463.9	5/16/70
	Lower	230.9	462.4	5/16/70
Utica Hwy. Bridge		229.6	461.8	5/22/43
La Salle Hwy. Bridge		224.7	461.0	5/22/43
Spring Valley		218.4	459.6	5/22/43
Hennepin		207.6	458.6	5/22/43

* Source: Reference 27

TABLE 2.4-4

LOCAL PROBABLE MAXIMUM PRECIPITATION AT THE LSCS SITE*

DURATION (min.)	CUMULATIVE PRECIPITATION	
	SUMMER PMP (AUGUST) (in.)	WINTER PMP (NOVEMBER) (in.)
5	4.3	1.7
10	6.6	2.7
15	8.3	3.3
30	11.6	4.6
60	14.8	5.9
120	18.6	7.5
360	26.9	10.8
12 (hours)	29.2	13.7
24 (hours)	32.1	17.4

* Source: References 13, 14 and 15.

LSCS-UFSAR

TABLE 2.4-5

STANDARD PROJECT FLOOD AND PROBABLE MAXIMUM FLOOD ESTIMATES
FOR ILLINOIS RIVER STATIONS*

STATION	RIVER MILEAGE	DRAINAGE AREA(mi ²)	PEAK FLOOD DISCHARGE	
			SPF (cfs)	PMF (cfs.)
Meredosia	71.1	25,300	225,000	452,000
Beardstown	88.6	23,400	210,000	420,000
Peoria	157.7	13,500	163,000	--

* Source: Reference 16.

LSCS-UFSAR

TABLE 2.4-6

DESIGN PRECIPITATION FOR COOLING LAKE*

STANDARD PROJECT STORM			PROBABLE MAXIMUM PRECIPITATION		
TIME(hr.)	24-HOUR RAINFALL (in.)	6-HOUR RAINFALL (in.)	TIME (hr.)	24-HOUR RAINFALL (in.)	6-HOUR RAINFALL (in.)
6		0.08	126		0.06
12		0.21	132		0.24
18		1.20	138		1.87
24	1.60	0.11	144	2.3	0.13
30		0.68	150		0.85
36		1.78	156		3.20
42		10.28	162		25.30
48	13.70	0.96	168	31.05	1.70
48-Hour TOTALS	15.30	15.30	48-Hour TOTALS	33.35	33.35

* Source: References 13 and 19 and 2.4 - 22.

** There is a 3-day rainless period between the end of SPS and the beginning of PMP.

LSCS-UFSAR

TABLE 2.4-7
(SHEET 1 OF 3)

STANDARD PROJECT INFLOW FLOOD HYDROGRAPH FOR COOLING LAKE

<u>TIME (hr)</u>	<u>DISCHARGE FROM DRAINAGE AREA (cfs)</u>	<u>DIRECT PRECIPITATION ON LAKE (cfs)</u>	<u>BASEFLOW (cfs)</u>	<u>TOTAL DISCHARGE (cfs)</u>
.25	0	27	2	29
.50	0	27	2	29
.75	0	27	2	29
1.00	0	27	2	29
1.25	0	27	2	29
1.50	0	27	2	29
1.75	0	27	2	29
2.00	0	27	2	29
2.25	0	27	2	29
2.50	0	27	2	29
2.75	0	27	2	29
3.00	0	27	2	29
3.25	0	27	2	29
3.50	0	27	2	29
3.75	0	27	2	29
4.00	0	27	2	29
4.25	0	27	2	29
4.50	0	27	2	29
4.75	0	27	2	29
5.00	0	27	2	29
5.25	0	27	2	29
5.50	0	27	2	29
5.75	0	27	2	29
6.00	0	27	2	29
6.25	0	73	2	75
6.50	0	73	2	75
6.75	0	73	2	75
7.00	0	73	2	75
7.25	0	73	2	75
7.50	0	73	2	75
7.75	0	73	2	75
8.00	0	73	2	75
8.25	0	73	2	75
8.50	0	73	2	75
8.75	0	73	2	75
9.00	0	73	2	75
9.25	0	73	2	75
9.50	0	73	2	75
9.75	0	73	2	75
10.00	0	73	2	75
10.25	0	73	2	75
10.50	0	73	2	75
10.75	0	73	2	75
11.00	0	73	2	75
11.25	0	73	2	75
11.50	0	73	2	75
11.75	0	73	2	75
12.00	0	73	2	75
12.25*	0	418	2	420
12.50	0	418	2	420
12.75	0	418	2	420
13.00	0	418	2	420
13.25	7	418	2	427
13.50	21	418	2	441
13.75	39	418	2	459
14.00	58	418	2	479
14.25	72	418	2	492
14.50	82	418	2	502
14.75	90	418	2	510
15.00	96	418	2	517
15.25	102	418	2	522
15.50	107	418	2	527
15.75	111	418	2	531
16.00	114	418	2	535
16.25	117	418	2	537
16.50	119	418	2	539
16.75	120	418	2	541
17.00	121	418	2	541
17.25	121	418	2	541
17.50	121	418	2	541
17.75	121	418	2	541
18.00	121	418	2	541
18.25	114	38	2	154

LSCS-UFSAR

TABLE 2.4-7
(SHEET 2 OF 3)

STANDARD PROJECT INFLOW FLOOD HYDROGRAPH FOR COOLING LAKE

TIME (hr)	DISCHARGE FROM DRAINAGE AREA (cfs)	DIRECT PRECIPITATION ON LAKE (cfs)	BASEFLOW (cfs)	TOTAL DISCHARGE (cfs)
18.50	100	38	2	140
18.75	82	38	2	122
19.00	63	38	2	102
19.25	49	38	2	89
19.50	39	38	2	79
19.75	31	38	2	71
20.00	25	38	2	64
20.25	19	38	2	59
20.50	14	38	2	54
20.75	10	38	2	50
21.00	7	38	2	46
21.25	4	38	2	44
21.50	2	38	2	42
21.75	1	38	2	40
22.00	0	37	2	40
22.25	0	38	2	40
22.50	0	38	2	40
22.75	0	38	2	40
23.00	0	38	2	40
23.25	0	38	2	40
23.50	0	38	2	40
23.75	0	38	2	40
24.00	0	38	2	40
24.25	0	230	2	232
24.50	0	230	2	232
24.75	0	230	2	232
25.00	0	230	2	232
25.25	0	230	2	232
25.50	0	230	2	232
25.75	0	230	2	232
26.00	0	230	2	232
26.25	0	230	2	232
26.50	0	230	2	232
26.75	0	230	2	232
27.00	0	230	2	232
27.25	0	230	2	232
27.50	0	230	2	232
27.75	0	230	2	232
28.00	0	230	2	232
28.25	0	230	2	232
28.50	0	230	2	232
28.75	0	230	2	232
29.00	0	230	2	232
29.25	7	230	2	239
29.50	21	230	2	253
29.75	39	230	2	271
30.00	58	230	2	290
30.25	78	627	2	708
30.50	103	627	2	732
30.75	129	627	2	758
31.00	155	627	2	784
31.25	174	627	2	803
31.50	188	627	2	818
31.75	201	627	2	830
32.00	211	627	2	840
32.25	219	627	2	848
32.50	226	627	2	855
32.75	231	627	2	861
33.00	235	627	2	865
33.25	238	627	2	867
33.50	240	627	2	869
33.75	241	627	2	871
34.00	242	627	2	871
34.25	242	627	2	871
34.50	242	627	2	871
34.75	242	627	2	871
35.00	242	627	2	871
35.25	242	627	2	871
35.50	242	627	2	871
35.75	242	627	2	871
36.00	242	627	2	871

LSCS-UFSAR

TABLE 2.4-7
(SHEET 3 OF 3)

STANDARD PROJECT INFLOW FLOOD HYDROGRAPH FOR COOLING LAKE

TIME (hr)	DISCHARGE FROM DRAINAGE AREA (cfs)	DIRECT PRECIPITATION ON LAKE (cfs)	BASEFLOW (cfs)	TOTAL DISCHARGE (cfs)
36.25	250	860	2	1112
36.50	293	1720	2	2015
36.75	372	1720	2	2094
37.00	468	1720	2	2190
37.25	561	1720	2	2283
37.50	627	1720	2	2349
37.75	705	2580	2	3287
38.00	804	2580	2	3386
38.25	940	3440	2	4383
38.50	1136	4361	2	5500
38.75	1517	9460	2	10979
39.00	2279	15481	2	17762
39.25	3154	10334	2	13490
39.50	3820	6819	2	10642
39.75	4040	4300	2	8342
40.00	3778	3440	2	7220
40.25	3382	2580	2	5964
40.50	3005	2580	2	5587
40.75	2676	1720	2	4398
41.00	2382	1720	2	4104
41.25	2133	1720	2	3855
41.50	1908	1720	2	3630
41.75	1691	860	2	2553
42.00	1465	860	2	2327
42.25	1222	335	2	1559
42.50	968	335	2	1305
42.75	743	335	2	1079
43.00	553	335	2	890
43.25	428	335	2	765
43.50	344	335	2	681
43.75	285	335	2	621
44.00	239	335	2	576
44.25	205	335	2	542
44.50	178	335	2	515
44.75	159	335	2	495
45.00	143	335	2	480
45.25	132	335	2	469
45.50	125	335	2	462
45.75	122	335	2	459
46.00	121	335	2	458
46.25	121	335	2	458
46.50	121	335	2	458
46.75	121	335	2	458
47.00	121	335	2	458
47.25	121	335	2	458
47.50	121	335	2	458
47.75	121	335	2	458
48.00	121	335	2	458
48.25	114	0	2	116
48.50	100	0	2	102
48.75	82	0	2	84
49.00	63	0	2	65
49.25	49	0	2	61
49.50	39	0	2	41
49.75	31	0	2	33
50.00	25	0	2	27
50.25	19	0	2	21
50.50	14	0	2	16
50.75	10	0	2	12
51.00	7	0	2	9
51.25	4	0	2	6
51.50	2	0	2	4
51.75	1	0	2	3
TOTALS	58475	127981	414	186870 cfs-intervals
	14619	31995	103	46718 cfs-hours
	1208	2644	9	3861 acre-ft

LSCS-UFSAR

TABLE 2.4-8
(SHEET 1 OF 3)

PROBABLE MAXIMUM INFLOW FLOOD HYDROGRAPH FOR COOLING LAKE

TIME(hr)	DISCHARGE FROM DRAINAGE AREA (cfs)	DIRECT PRECIPITATION ON LAKE (cfs)	BASEFLOW (cfs)	TOTAL DISCHARGE (cfs)
.25	0	21	2	23
.50	0	21	2	23
.75	0	21	2	23
1.00	0	21	2	23
1.25	0	21	2	23
1.50	0	21	2	23
1.75	0	21	2	23
2.00	0	21	2	23
2.25	0	21	2	23
2.50	0	21	2	23
2.75	0	21	2	23
3.00	0	21	2	23
3.25	0	21	2	23
3.50	0	21	2	23
3.75	0	21	2	23
4.00	0	21	2	23
4.25	0	21	2	23
4.50	0	21	2	23
4.75	0	21	2	23
5.00	0	21	2	23
5.25	0	21	2	23
5.50	0	21	2	23
5.75	0	21	2	23
6.00	0	21	2	23
6.25	0	84	2	86
6.50	0	84	2	86
6.75	0	84	2	86
7.00	0	84	2	86
7.25	0	84	2	86
7.50	0	84	2	86
7.75	0	84	2	86
8.00	0	84	2	86
8.25	0	84	2	86
8.50	0	84	2	86
8.75	0	84	2	86
9.00	0	84	2	86
9.25	0	84	2	86
9.50	0	84	2	86
9.75	0	84	2	86
10.00	0	84	2	86
10.25	0	84	2	86
10.50	0	84	2	86
10.75	0	84	2	86
11.00	0	84	2	86
11.25	0	84	2	86
11.50	0	84	2	86
11.75	0	84	2	86
12.00	0	84	2	86
12.25	14	648	2	665
12.50	44	648	2	694
12.75	82	648	2	733
13.00	122	648	2	773
13.25	150	648	2	801
13.50	171	648	2	822
13.75	188	648	2	839
14.00	202	648	2	853
14.25	214	648	2	865
14.50	224	648	2	875
14.75	233	648	2	883
15.00	240	648	2	890
15.25	246	648	2	896
15.50	250	648	2	900
15.75	253	648	2	903
16.00	254	648	2	904
16.25	254	648	2	904
16.50	254	648	2	904
16.75	254	648	2	904
17.00	254	648	2	904
17.25	255	669	2	926
17.50	256	669	2	927
17.75	258	669	2	929
18.00	260	669	2	931
18.25	246	42	2	290

* To find time from the start of SPS, add 120 to the time indicated.

LSCS-UFSAR

TABLE 2.4-8
(SHEET 2 OF 3)

PROBABLE MAXIMUM INFLOW FLOOD HYDROGRAPH FOR COOLING LAKE

<u>TIME (hr)</u>	<u>DISCHARGE FROM DRAINAGE AREA (cfs)</u>	<u>DIRECT PRECIPITATION ON LAKE (cfs)</u>	<u>BASEFLOW (cfs)</u>	<u>TOTAL DISCHARGE (cfs)</u>
18.50	216	42	2	260
18.75	177	42	2	221
19.00	135	42	2	179
19.25	107	42	2	151
19.50	85	42	2	129
19.75	68	47	2	112
20.00	53	42	2	97
20.25	41	42	2	85
20.50	31	42	2	75
20.75	22	42	2	66
21.00	15	42	2	59
21.25	9	42	2	53
21.50	4	42	2	48
21.75	1	42	2	45
22.00	0	42	2	44
22.25	0	42	2	44
22.50	0	42	2	44
22.75	0	42	2	44
23.00	0	42	2	44
23.25	0	63	2	65
23.50	0	63	2	65
23.75	0	63	2	65
24.00	0	63	2	65
24.25	3	293	2	298
24.50	8	293	2	303
24.75	16	293	2	310
25.00	23	293	2	318
25.25	29	293	2	323
25.50	33	293	2	327
25.75	36	293	2	331
26.00	39	293	2	333
26.25	41	293	2	336
26.50	43	293	2	338
26.75	44	293	2	339
27.00	46	293	2	341
27.25	47	293	2	342
27.50	48	293	2	342
27.75	48	293	2	343
28.00	48	293	2	343
28.25	48	293	2	343
28.50	48	293	2	343
28.75	48	293	2	343
29.00	48	293	2	343
29.25	49	314	2	365
29.50	50	314	2	366
29.75	52	314	2	368
30.00	54	314	2	370
30.25	81	1109	2	1192
30.50	136	1109	2	1247
30.75	206	1109	2	1317
31.00	280	1109	2	1390
31.25	331	1109	2	1441
31.50	369	1109	2	1480
31.75	400	1109	2	1511
32.00	426	1109	2	1537
32.25	448	1109	2	1558
32.50	466	1109	2	1577
32.75	482	1109	2	1593
33.00	495	1109	2	1605
33.25	505	1109	2	1616
33.50	513	1109	2	1623
33.75	518	1109	2	1628
34.00	520	1109	2	1631
34.25	520	1109	2	1631
34.50	520	1109	2	1631
34.75	520	1109	2	1631
35.00	520	1109	2	1631
35.25	522	1146	2	1670
35.50	524	1146	2	1672
35.75	527	1146	2	1675
36.00	531	1146	2	1679
36.25	565	2117	2	2683
36.50	701	4233	2	4936
36.75	931	4233	2	5166

* To find time from the start of SPS, add 120 to the time indicated

LSCS-UFSAR

TABLE 2.4-8
(SHEET 3 of 3)

PROBABLE MAXIMUM INFLOW FLOOD HYDROGRAPH FOR COOLING LAKE

TIME: (hr)	DISCHARGE FROM DRAINAGE AREA (cfs)	DIRECT PRECIPITATION ON LAKE (cfs)	BASEFLOW (cfs)	TOTAL DISCHARGE (cfs)
37.00	1204	4233	2	5439
37.25	1461	4233	2	5696
37.50	1642	4233	2	5878
37.75	1850	6350	2	8202
38.00	2108	6350	2	8460
38.25	2455	8466	2	10923
38.50	2946	10734	2	13682
38.75	3891	23283	2	27176
39.00	5773	38069	2	43845
39.25	7932	25433	2	33367
39.50	9575	16782	2	26360
39.75	10117	10583	2	20702
40.00	9474	8466	2	17943
40.25	8500	6350	2	14852
40.50	7571	6350	2	13923
40.75	6763	4233	2	10998
41.00	6040	4233	2	10275
41.25	5427	4233	2	9663
41.50	4871	4233	2	9107
41.75	4338	2117	2	6457
42.00	3782	2117	2	5900
42.25	3170	586	2	3758
42.50	7515	586	2	3103
42.75	1921	586	2	2509
43.00	1414	586	2	2002
43.25	1079	586	2	1667
43.50	850	586	2	1438
43.75	687	586	2	1274
44.00	561	586	2	1149
44.25	465	586	2	1053
44.50	389	586	2	976
44.75	332	586	2	920
45.00	287	586	2	875
45.25	254	586	2	842
45.50	232	586	2	820
45.75	223	586	2	810
46.00	218	586	2	805
46.25	218	586	2	805
46.50	218	586	2	805
46.75	218	586	2	805
47.00	218	586	2	805
47.25	219	627	2	849
47.50	222	627	2	851
47.75	226	627	2	855
48.00	229	627	2	859
48.25	219	0	2	221
48.50	192	0	2	194
48.75	157	0	2	159
49.00	120	0	2	122
49.25	95	0	2	97
49.50	76	0	2	78
49.75	61	0	2	63
50.00	48	0	2	50
50.25	37	0	2	39
50.50	28	0	2	30
50.75	20	0	2	22
51.00	13	0	2	15
51.25	8	0	2	10
51.50	4	0	2	6
51.75	1	0	2	3
TOTALS	144822	279026	414	424263 cfs-in
	36206	69757	103	106006 cfs-hour
	2992	5765	9	8766 acre-ft

*To find time from the start of SPS, add 120 to the time indicated

LSCS-UFSAR

TABLE 2.4-8a
(SHEET 1 OF 2)

LISTING OF INPUT DATA TO SPILLWAY RATING AND FLOOD ROUTING PROGRAM

CARD A	ITYSP	INDCON	ISPITW	IABCOA	ISPILN	ISRCD	ISPECTW	ITABLE		
	0	10	10	0	0	10	0	0		
ABUTMENT CONTRACTION COEFFICIENT										
KA	.005	.030	.053	.074	.092	.112	.123			
KA	.137	.150	1.62	.174	.182	.189	.184			
CARD B	NUMEL	NUMTW	NUMIN	QMIN1	QMIN2	CONMIN				
	16	2	300	180.	180.	0.				
C CARDS	ELEVATION – CAPACITY TABLE									
	ELEV	CT	ELEV	CT	ELEV	CT	ELEV	CT	ELEV	CT
	680.00	1883.	690.00	13211.	696.00	23717.	698.00	27632.	700.00	31706.
	700.50	32761.	701.00	33816.	701.50	34871.	702.00	35926.	702.50	37015.
	703.00	38104.	703.50	38218.	704.00	40332.	706.00	44875.	708.00	49465.
	710.00	54055.								
D CARDS	TAILWATER ELEVATION – DISCHARGE CURVE									
	TWEL	TWQ	TWEL	TWQ	TWEL	TWQ	TWEL	TWQ	TWEL	TWQ
	500.00	0.	505.00	40000.						
E CARDS	DESIGN FLOOD INFLOWS									
	29.	29.	29.	29.	29.	29.	75.	75.	75.	75.
	75.	75.	420.	452.	505.	529.	540.	541.	129.	76.
	52.	41.	40.	40.	232.	232.	232.	232.	232.	263.
	746.	823.	857.	870.	871.	871.	1853.	2827.	9656.	9923.
	5013.	3091.	1208.	661.	508.	462.	458.	458.	92.	38.
	14.	4.	2.	2.	2.	2.	2.	2.	2.	2.
	2.	2.	2.	2.	2.	2.	2.	2.	2.	2.
	2.	2.	2.	2.	2.	2.	2.	2.	2.	2.
	2.	2.	2.	2.	2.	2.	2.	2.	2.	2.
	2.	2.	2.	2.	2.	2.	2.	2.	2.	2.
	2.	2.	2.	2.	2.	2.	2.	2.	2.	2.
	2.	2.	2.	2.	2.	2.	2.	2.	2.	2.

LSCS-UFSAR

TABLE 2.4-8b

WIND WAVE CHARACTERISTICS ON COOLING LAKE

LOCATION*	EFFECTIVE FETCH (mi)	AVERAGE WATER DEPTH (ft)	SIGNIFICANT WAVE HEIGHT (ft)	WAVE PERIOD (sec)
A'	0.30	11.0	1.20	1.82
B'	0.18	11.0	0.80	1.54
C'	0.10	19.0	0.60	1.31
C ₁	0.44	30.0	1.26	2.04
C ₂	0.90	25.0	1.88	2.54
D	0.85	23.5	1.81	2.50
D ₂	1.35	23.0	2.36	2.89
E	1.41	23.3	2.40	2.93
E ₁	1.28	23.0	2.29	2.83
F	1.32	22.3	2.33	2.88
F ₁	0.93	24.0	1.90	2.56
F ₂	0.92	24.0	1.90	2.56
G ₁	0.72	18.0	1.65	2.36

* Location designations refer to Figure 2.4 - 14

WIND WAVE CHARACTERISTICS AT LAKE SCREENHOUSE
WITH PROBABLE MAXIMUM FLOOD

Effective fetch (mi)	0.270
Average depth (ft)	23.500
Overland wind speed (mph)	40.000
Significant wave height (H _s) (ft)	0.960
Wave period (sec)	1.750
Wave length (ft)	15.700
Maximum (1%) wave height (1.67 H _s) (ft)	1.600
Depth at structure (ft)	30.350
Slope of structure (°)	90,000
Wave runup for maximum wave:	
wave steepness	0.102
relative runup	1.100
wave runup (ft)	1.760
Wave setup (ft)	0.030
PMF level (ft MSL)	704.320
PMF level with setup plus runup (ft MSL)	706.110

TABLE 2.4-9

100-YEAR RECURRENCE INTERVAL LOW FLOWS OF
ILLINOIS RIVER AT MARSEILLES, ILLINOIS:
1921-1971, 12- MONTH PERIOD ENDING -MARCH 31*

<u>DURATION (days)</u>	<u>DISCHARGE (cfs)</u>
1	1,592
3	2,109
7	2,324
14	2,464
30	2,679

* Source: Reference 25

LSCS-UFSAR

TABLE 2.4-10

GROUNDWATER QUALITY IN THE CAMBRIAN-ORDOVICIAN AQUIFER*

		NUMBER OF ANALYSES	IRON (Fe)	CHLORIDE (Cl)	SULFATE (SO ₄)	ALKALINITY (as CaCO ₃)	HARDNESS (as CaCO ₃)	TOTAL DISSOLVED SOLIDS
West of La Salle Anticline	Max. Min. Mean	12	6.5 0.2 1.6	572 174 272	95 50 77	332 274 302	344 226 279	1369 685 869
East of La Salle Anticline (Pennsylvanian aquitard absent)	Max. Min. Mean	23	10.4 0.0 2.2	402 3 98	208 6 50	348 12 287	533 220 353	1104 328 582
East of La Salle Anticline (Pennsylvanian aquitard present)	Max. Min. Mean	20	10.0 0.0 1.4	2425 8 659	403 23 168	344 190 274	1485 312 636	5912 486 1709

* Data modified from Hoover and Schicht (Reference 47, pp. 20-21).
All concentrations reported as ppm.

TABLE 2.4-11

SURFACE ELEVATIONS AND MEASUREMENT DATES FOR OBSERVATION WELLS

WELL NO. ¹	ELEVATION, TOP OF WELL (ft, MSL)	WELL NO. ¹	ELEVATION, TOP OF WELL (ft, MSL)
1	684.1	11	659.7
2	688.8	12	663.0
3	692.0	13	663.2
4	691.1	14	678.8
5	673.5	15	693.6
6	670.6	16	727.2
7	673.3	17	728.2
8	672.3	18	714.7
9	651.4	19	682.3
10	679.9	20	686.1

DATES OF MEASUREMENT ²

1-17-75	7-21-75
2-13-75	8-23-75
3-17-75	9-22-75
4- 7-75	10-17-75
4-21-75	11-20-75
5-21-5	12-17-75
6-17-75	

NOTES

1. Observation wells were installed by Dames & Moore during December 1974.
2. Water levels in the observation wells are presently measured on a monthly basis.
3. Locations of observation wells are shown on Figure 2.4-21.
4. Water level fluctuations are plotted with daily precipitation in Figure 2.4 - 23

PHYSICAL CHARACTERISTICS OF LSCS WATER WELLS*

	WELL NO. 1**	WELL NO. 2
Location, plant coordinates	13,350N/4,615E	12,700N/5,350N
Date completed	1-11-74	5-25-72
Depth (ft)	1629	1620
Deepest hydrogeologic unit penetrated	Ironton-Galesville	Ironton-Galesville
Depth to bottom of casing (ft)	921	989
Lowest formation cased	Oneota	Oneota
Diameter below casing (in.)	12	11 3/4
Pump test data		
Date of test	2-11-74	5-25-72
Static water level (ft)	260	250
Pumping water level (ft)	498	305
Pumping rate (gpm)	447	508
Length of pump test (hr)	24	24
Specific capacity (gpm/ft)	1.88	9.24
Static water level (ft), November 21, 1975	271	284

* Water quality analyses for the LSCS water wells are presented in Table 2 4-13.

** Locations of the LSCS water wells are indicated on Figure 2.4-20.

TABLE 2.4-13

WATER QUALITY ANALYSES FOR LSCS WATER WELLS*

CHEMICAL CONSTITUENT**	WELL NO. 1+**	WELL NO. 2+
pH	8.1	7.0
Total Hardness (as CaCO ₃)	420	450
Total Alkalinity (as CaCO ₃)	239	288
Chloride	303	490
Sulfate	310	390
Sodium	250	340++
Iron	0.2	0.5
Silica	3.3	8.2
Total Dissolved Solids	1232	1200

* Locations of onsite water wells are indicated on Figure 2.4-20.

** All concentrations except pH are given in parts per million (ppm).

*** Analysis performed by Commercial Testing and Engineering Company on samples taken February 11, 1974

+ Analyses performed by NALCO Chemical Company on samples taken on May 31, 1972. The concentrations in the table are averages of five samples.

++ Sodium reported as Na₂O.

LSCS-UFSAR

TABLE 2.4-14
(SHEET 1 OF 2)

MAJOR MUNICIPAL AND INDUSTRIAL PUMPING CENTERS WITHIN 25 MILES

MUNICIPAL PUMPING CENTER*	DISTANCE FROM SITE (mi)	NUMBER OF PRODUCING WELLS	AQUIFER	AVERAGE DAILY USE (mgd)	TOTAL PUMPAGE, 1974 (mg)	POTENTIOMETRIC LEVELS (ft, MSL/date)**	REMARKS
La Salle	22	5	Alluvial	3.30	1,204	NA***	
Peru	24	3	Cambrian-Ordovician	1.83	666	Well no. 5: 427/10-63 412/10-71 333/6-75	New well, not yet in service, pumphouse under construction; potentiometric level in 1975 may be affected by adjacent pumping wells Includes Jonesville Public Water District
Oglesby	20	2	Cambrian-Ordovician	0.51	186	Well no. 1: 483/8-63 Well no. 3: 403/1974 Well no. 4: 445/10-71	
Utica	18	1	Cambrian-Ordovician	0.20	73	Well no. 1: 480+(flowing)/8-63 480+(flowing)/10-71 Well no. 2: 480+(flowing)/9-75	New well (No. 2) should be in service by May 1976
Naplate	12	1	Cambrian-Ordovician	0.04	15	Well no. 1: 431/10-71 426/11-75	Cross-connection with Ottawa water supply system
Ottawa	11	3	Cambrian-Ordovician	1.33	484	Well no. 9: 444/10-71 Well no. 10: 455/10-63 443/9-70	
Morris	15	3	Cambrian-Ordovician	1.00	365	Well no. 4: 429/10-71 370/1-75	

* Locations of pumping centers are shown on Figure 2.4-16

** Potentiometric levels were obtained from published and unpublished (open file) data collected by the Illinois State Water Survey or from a letter survey conducted by Sargent & Lundy during 1975

*** NA indicates data are not available

LSCS-UFSAR

TABLE 2.4-14
(SHEET 2 OF 2)

MAJOR MUNICIPAL AND INDUSTRIAL PUMPING CENTERS WITHIN 25 MILES

INDUSTRIAL PUMPING CENTER*	DISTANCE FROM SITE (mi)	NUMBER OF PRODUCING WELLS	AQUIFER	AVERAGE DAILY USE (mgd)	TOTAL PUMPAGE, 1974 (mg.)	POTENTIOMETRIC LEVELS (ft, MSL/date)**	REMARKS
Union Carbide Corporation (Ottawa)	12	2	Cambrian-Ordovician	2.00	725	Well No. 1: 415±/1-75 Well No. 2: 445/10-63 (Ottawa) 413/10-71	
Libbey-Owens-Ford Company (Ottawa)	12	2	Cambrian-Ordovician	0.43	157	Well No. 5: 445/1967 440/10-71 420 ± /1972	
Borg-Warner Chemical Co. (Marseilles)	7	3	Cambrian-Ordovician	1.89	690	Well No. 1: 411/12-75 Well No. 2: 415/12-75 Well No. 3: 467/1972 428/8-73 417/11-75	
Beker Industries (Marseilles)	5	1	Cambrian-Ordovician	1.00	350	Well No. 1: 435 ± /6-75	Not metered; average daily use and total pumpage are estimated
E. I. du Pont de Nemours & Company (Seneca)	7	4 3	Cambrian-Ordovician Glacial drift	1.46 0.54	730	Well No. 1: 446/10-71 412/7-75	Approximately 72.8% of total pumpage was from the Cambrian-Ordovician Aquifer

* Locations of pumping centers are shown on Figure 2.4-16

** Potentiometric levels were obtained from published and unpublished (open file) data collected by the Illinois State Water Survey or from a letter survey conducted by Sargent & Lundy during 1975.

LSCS-UFSAR

TABLE 2.4-15

PUBLIC GROUNDWATER SUPPLIES WITHIN 10 MILES

PUBLIC WATER SUPPLY*	DISTANCE FROM SITE (mi)	WELL NO.	DATE DRILLED	TOTAL DEPTH (ft)	LOWEST HYDROSTRATI-GRAPHIC UNIT PENETRATE D	SMALLEST DIAM.,(in)	CASING DEPTH (ft)	ELEVATION OF POTENTIOMETRIC SURFACE (ft, MSL/date)	PUMP TEST DATA				REMARKS	
									DATE	DRAW DOWN(ft)	PUMPING RATE (gpm)	SPECIFIC CAPACITY (gpm/ft)		AVERAGE DAILY USE (gpd)
Seneca	5	1	1927	700	Oneota	10	0-132	425/10-71	NA**					Wells are pumped alternately on 12-hour intervals
		2	1942	704	Oneota	10	0-135	443/11-63; 424/5-74	1975	100	285	2.9	200,000	
Marseilles	6	2	1920	670	Oneota	10	0-368	NA	NA					Standby
		3	1952	850	Potosi	12	0-365	460/1968; 470/10-71	NA				475,000	Wells No. 3 and 4 are pumped simultaneously
		4	1972	1466	Iron-ton-Galesville	12	0-548	487/9-63; 457/1972	1972	89	850	9.6		
Illini State Park	6	1	1934	440	NA	6	0-365	NA	NA				NA	Not used since 1972 may be used for new camp
		2	1936	500	New Richmond	6	0-365	477/10-71	NA					Not metered; pump column lowered below 140 ft after well went dry in 1974
Kinsman	6	3	1936	710?	St. Peter	6	137-335	510/10-71	NA					
		4	1972?	785	St. Peter	NA	NA	NA	NA				30,000	
Ransom	7	1	1907	325	Pennsylvanian	8	0-148	NA	NA					Standby
		2	1932	500	Galena-Platteville	10	0-366	NA	NA				35,000	Standby
		3	1946	280	Pennsylvanian	6	NA	555 ±/1974 or 1975	NA					wells No. 3 and 4 are pumped simultaneously
		4	1971	815	St. Peter	6	0-684	455 ±/1974 or 1975	1971	119	40.5	0.5		
Grand Ridge	9	1	1915	162	"Ticona"	10	0-150	526/1-75	1974	3	110	36.7		Standby, not metered
		2	1926	156	"Ticona"	10	0-145	NA	1943	9	75	8.3	105,000	Not operating; to be removed shortly
		3	1962	190	"Ticona"	12	0-165	522/2-75	1975	6	285	47.5		Gravel-pack well

* Locations of public water supplies within 10 miles are shown on Figure 2.4-16.
 ** NA indicates data are not available.

LSCS-UFSAR

TABLE 2.4-16
(SHEET 1 of 7)DOMESTIC WELL INVENTORY

WELL NO.	OWNER ¹	LOCATION ² (T, R, Sec)	DATE DRILLED	DEPTH (ft)	AQUIFER ³	SMALLEST CASING DIAMETER/DEPTH (in./ft)	REMARKS ⁷
1	Commonwealth Edison Company ⁴	32N, 5E, 17.6h	NA	181	P	6/NA	
2	Commonwealth Edison Company ⁵	32N, 5E, 18.1h	NA	22	D	60/brick-lined	
3	Commonwealth Edison Company ⁵	32N, 5E, 17.8h	NA	28.5	D	NA/brick-lined	Can be pumped dry, will fill overnight
4	Everett Caldwell ⁴	32N, 5E, 18.1g	NA	NA	NA	NA/NA	Land owned by M. F. Prentice.
5	Mrs. Lloyd Carr ⁵	32N, 5E, 18.1d	1912	255	P	3/120-160	
6	Commonwealth Edison Company ⁴	32N, 5E, 17.8c	NA	NA	NA	NA/NA	
7	Unknown ⁴	32N, 5E, 20.8h	NA	NA	NA	NA/NA	Land owned by Robert and Doris Gage
8	L. F. Gage ⁵	32N, 5E, 20.8g	NA	288	P	3/NA	Land owned by Robert and Doris Gage
9	W. T. Cordial ⁵	32N, 5E, 20.6h	1880	32	D	48/stone-lined	Land owned by William and Louise Patterson
10	Mrs. Alma C. Olsen	32N, 5E, 20.5h	1908	265	P	6/NA	Land owned by William and Louise Patterson; well yield increased after cleaning; yield appears to decrease with time
11	Vacant ⁴	32N, 5E, 20.1h	NA	NA	NA	NA/NA	Land owned by Truman Esmond; vacant house, no sign of well
12	Commonwealth Edison Company ⁴	32N, 5E, 17.1h	NA	190	D	6/NA	
13	Commonwealth Edison Company ⁴	32N, 5E, 16.5g	1959	560	ε-0	6/0-216	
14	Guillory & Hepner ⁴	32N or 33N, 5E, 19	1963	375	NA	5/0-315	Location uncertain. not plotted on Figure 2.4-20
15	Commonwealth Edison Company ⁴	32N, 5E, 17.7c	1964	175	P	6/0-163	

LSCS-UFSAR

TABLE 2.4-16
(SHEET 2 of 7)

DOMESTIC WELL INVENTORY

WELL NO.	OWNER ¹	LOCATION ² (T, R, Sec)	DATE DRILLED	DEPTH (ft)	AQUIFER ³	SMALLEST CASING DIAMETER/DEPTH (in./ft)	REMARKS ⁷
16	R.H. Schroeder ⁴	32N, 5E, 6.7f	1964	310	T	6/0-290	
17	Commonwealth Edison Company ⁴	32N, 5E, 16.1b	1947	562	ε-0	6/0-210	
18	J. Purdue ⁴	32N, 5E, 3.7a	1946	226	P	6/0-163	Land owned by Arthur Nelson
19	Franklin E. Read ⁴	32N, 5E, 18.8f	1954	265	P	6/0-238	
20	Commonwealth Edison Company ⁴	32N, 5E, 16.5g	1963	555	ε-0	6/0-218	
21	Commonwealth Edison Company	32N, 5E, 16.5g	NA	300	P	6/NA	
22	Commonwealth Edison Company ⁴	32N, 5E, 16.1d	1947	562	ε-0	6/0-210	
23	Herman B. Olsen ⁴	32N, 5E, 19.4h	1904	200	P	4/NA	Furnishes plenty of water
24	Commonwealth Edison Company ⁴	32N, 5E, 16.8h	NA	200	D	6/0-192	
25	Commonwealth Edison Company ⁴	32N, 5E, 9.7h	NA	216	P	6/NA	
26	Alvin Biros ⁴	32N, 5E, 5.5a	NA	160	D	NA/NA	
27	C. Gage Estate	32N, 5E, 7.1h	NA	30	D	NA/stone-lined	Land owned by Bryon F. Gage
28	C. Gage Estate	32N, 5E, 7.1h	1884	220	T	2/0-205	Land owned by Bryon F. Gage
29	I. N. Baughman	32N, 5E, 7.8h	NA	191.5	T	6/NA	Land owned by George and Margaret Foster
30	John Kuhn	32N, 5E, 7.8d	1894	255	P	4/NA	
31	Commonwealth Edison Company	32N, 5E, 8.4h	1911	187	P	5/NA	
32	Commonwealth Edison Company	32N, 5E, 9.6h	NA	55	D	42/stone- and tile-lined	Smells sulfurous
33	Commonwealth Edison Company	32N, 5E, 9.8a	NA	45	D	42/brick-lined	
34	Commonwealth Edison Company	32N, 5E, 9.1d	NA	183	P	NA/NA	

LSCS-UFSAR

TABLE 2.4-16
(SHEET 3 of 7)

DOMESTIC WELL INVENTORY

WELL NO.	OWNER ¹	LOCATION ² (T, R, Sec)	DATE DRILLED	DEPTH (ft)	AQUIFER ³	SMALLEST CASING DIAMETER/DEPTH (in./ft)	REMARKS ⁷
35	L. W. Laatz	32N, 5E, 19.6h	NA	320?	P	3/100-200	Land owned by G. E. Laatz; well capacity not sufficient during dry summer for domestic and farm purposes; will pump air
36	Dave Stevenson	32N, 5E, 20.8b	1907	188	P	3/NA	Land owned by James Budach
37	Commonwealth Edison Company	32N, 5E, 21.8h	NA	28	D	48/brick lined	
38	Commonwealth Edison Company	32N, 5E, 21.1b	1914	265	P	5/0-225	
39	Colleen Alvarado	32N, 5E, 18.8a	1966	254	P	NA/NA	
40	Commonwealth Edison Company	32N, 5E, 19.1a	1975	231	P	5/154-221	
41	Commonwealth Edison Company	32N, 5E, 21.2d	1974	580	ε-0	5/0-380	
42	E. Larson	32N, 5E, 1.1e	1924	240?	P	6/NA	Land owned by Edwin Farmer
43	E. Malady	32N, 5E, 1.8e	1919	187	P?	3/NA	Land owned by Dr. William M. Greenspan
44	E. Malady	32N, 5E, 1.8e	NA	40	D	48/brick lined	Land owned by Dr. William M. Greenspan
45	Edwin Farmer	32N, 5E, 1.1e	1954	130	P?	6/0-125	
46	Commonwealth Edison Company	32N, 5E, 2.7b	NA	200?	P	NA/NA	
47	Peter Kennedy	32N, 5E, 2.5c	1913	488	ε-0	6/0-232?	
48	Commonwealth Edison Company	32N, 5E, 2.8c	1919	217	P	6/0-200	
49	James Talty	32N, 5E, 2.1c	1914	560	ε-0	3/300-500	Land owned by Thomas Fitzgerald
50	Commonwealth Edison Company	32N, 5E, 3.1f	NA	30	D	72/stone-lined	
51	Thor Olson	32N, 5E, 3.2a	NA	186	P	6/NA	Land owned by Mrs. Thor Olson
52	Simon Barlo	32N, 5E, 4.4e	1929	275	P	6/NA	Land owned by Lewis Musear
53	Lambert Bros.	32N, 5E, 4.4d	NA	226	T?	4/NA	Land owned by Arthur Nelson

LSCS-UFSAR

TABLE 2.4-16
(SHEET 4 of 7)DOMESTIC WELL INVENTORY

WELL NO.	OWNER ¹	LOCATION ² (T, R, Sec)	DATE DRILLED	DEPTH (ft)	AQUIFER ³	SMALLEST CASING DIAMETER/DEPTH (in./ft)	REMARKS ⁷
54	William Madaus	32N, 5E, 5.8e	NA	22	D	30/tile lined	Land owned by State of Illinois
55	Commonwealth Edison Company	32N, 5E, 5.7a	NA	45	D	36/tile lined	
56	V. L. Briner	32N, 5E, 5.5a	NA	11	D	48/brick lined	Land owned by Alvin Biros
57	J. Jugd	32N, 5E, 6.4g	NA	28	D	48/brick lined	Land owned by Charles and Anita Bernardini
58	F. N. Shaver	32N, 5E, 6.6a	NA	46	D	27/brick lined	Land. owned by Floyd Shaver
59	Commonwealth Edison Company	32N, 5E, 10.5h	1929	238	P	6/0-238	
60	Commonwealth Edison Company	32N, 5E, 10.8h	1915	232	P	6/NA	
61	Commonwealth Edison Company	32N, 5E, 10.1d	NA	220	P	6/NA	
62	Tim Crowley	32N, 5E, 11.1f	NA	215	P	6/NA	Land owned by Clarence Killelea, et al.
63	Commonwealth Edison Company	32N, 5E, 11.6a	1894	200	P	3/NA	
64	E. Henry	32N, 5E, 12.1g	NA	NA	NA	6/NA	Land owned by John F. Praefcke, Estate
65	Talty Estate	32N, 5E, 12.6b	NA	90	P	5/NA	Land owned by Mary F. O'Laughlin
66	Dr. Twohey	32N, NE, 12.1c	1952	197	P	6/0-135	Land owned by Francis P. Twohey
67	C. Malady	32N, 5E, 13.1c	NA	40	D	48/lined	Land owned by A. W. Kuhn
68	Commonwealth Edison Company	32N, 5E, 14.8h	NA	160	P	6/0-150	
69	Commonwealth Edison Company	32N, 5E, 14.8d	1912	240	P	6/NA	
70	Commonwealth Edison Company	32N, 5E, 15.1h	NA	160	D	6/0-150?	
71	Commonwealth Edison Company	32N, 5E, 15.4a	NA	301	P	3/NA	
72	W. Spaulding	32N, 5E, 22.1h	NA	35	D	48/lined	Land owned by Roy Spaulding

LSCS-UFSAR

TABLE 2.4-16
(SHEET 5 of 7)DOMESTIC WELL INVENTORY

WELL NO.	OWNER ¹	LOCATION ² (T, R, Sec)	DATE DRILLED	DEPTH (ft)	AQUIFER ³	SMALLEST CASING DIAMETER/DEPTH (in./ft)	REMARKS ⁷
73	Commonwealth Edison Company	32N, 5E, 22.8h	NA	235	P	3/NA	
74	Joe Mair	32N, 5E, 22.4a	NA	35	D	48/lined	Land owned by Donald Muffler
75	George Darby	32N, 5E, 23.8g	1902	314	P	2.5/160-240	Land owned by Max and Colleen Ungolini
76	R. D. Mills	32N, 5E, 23.4a	1904	115	D	6/NA	Land owned by Clarence Frye
77	John J. Sheedy	32N, 5E, 24.5h	NA	675	ε-0	6/NA	Land owned by Elmer Sheedy
78	T. J. Dunn	32N, 5E, 24.8d	1904	100	D	6/NA	Land owned by William P. Dunn
79	Commonwealth Edison Company	32N, 5E, 4.5e	1974	410	ε-0	5/0-276	
80	Bruce Laatz	32N, 5E, 6.5h	1972	435	ε-0	5/0-280	Land owned by Linda Laatz
81	Kuhn	32N, 5E, 13.1c	1961	113	P	4/NA	Land owned by A. W. Kuhn
82	Tim Sheedy	32N, 5E, 13.5a	1970	180	P	5/0-118	
83	Commonwealth Edison Company	32N, 5E, 17.1g	NA	38	D	48/brick-lined	Well caved in 1931; 12-inch pipe driven through material; fast pumping produces air
84	Commonwealth Edison Company	32N, 5E, 17.1h	NA	212	P	6/NA	Plugged
85	Commonwealth Edison Company	32N, 5E, 16.7h	NA	17	D	36/lined	Partially plugged
86	Commonwealth Edison Company	32N, 5E, 9.8a	NA	22	D	36/lined	Partially plugged
87	Commonwealth Edison Company	32N, 5E, 9.8a	NA	NA	NA	NA/NA	Not plugged
88	Commonwealth Edison Company	32N, 5E, 16.1d	NA	24	D	48/lined	Partially plugged
89	Commonwealth Edison Company	32N, 5E, 16.1d	NA	NA	D	NA/NA	This is a cistern. not plugged
90	Commonwealth Edison Company	32N, 5E, 9.6b	NA	NA	NA	NA/NA	Not plugged
91	Commonwealth Edison Company	32N, 5E, 9.6b	NA	179	D	6/NA	Plugged

LSCS-UFSAR

TABLE 2.4-16
(SHEET 6 of 7)

DOMESTIC WELL INVENTORY

WELL NO.	OWNER ¹	LOCATION ² (T, R, Sec)	DATE DRILLED	DEPTH (ft)	AQUIFER ³	SMALLEST CASING DIAMETER/DEPTH (in./ft)	REMARKS ⁷
92	Commonwealth Edison Company	32N, 5E, 9.1b	NA	252?	P	6/NA	Obstruction at 252 ft, plugged
93	Commonwealth Edison Company	32N, 5E, 9.1b	NA	NA	D	NA/NA	This is a cistern, not plugged
94	Commonwealth Edison Company	32N, 5E, 10.1b	NA	189	P	6/NA	Plugged
95	Commonwealth Edison Company	32N, 5E, 11.6a	NA	NA	D	NA/NA	This is a cistern, not plugged
96	Commonwealth Edison Company	32N, 5E, 14.8h	NA	97?	D?	5/NA	Obstruction at 97 ft, plugged
97	Commonwealth Edison Company	32N, 5E, 9.6h	NA	204	P	6/NA	Plugged
98	Commonwealth Edison Company	32N, 5E, 9.6h	NA	32	D	60/lined	Partially plugged
99	Commonwealth Edison Company	32N, 5E, 9.7g	NA	NA	NA	NA/NA	Not plugged
100	Commonwealth Edison Company	32N, 5E, 17.6h	NA	NA	NA	NA/NA	Not plugged
101	Commonwealth Edison Company	32N, 5E, 10.1d	NA	NA	NA	NA/NA	This is a cistern, not plugged
102	Commonwealth Edison Company	32N, 5E, 11.8h	NA	164	P	5/NA	Plugged
103	Brookfield Township	32N, 5E, 21.1h	1974	540	ε-0	5/0-409	

NOTES

1. Commonwealth Edison Company is listed as the owner if the well is located on land owned by Commonwealth Edison Company at the end of 1974 as shown on the La Salle County plat sheet for Brookfield Township.
2. Locations within each section are based upon the system used by the Illinois State Water Survey illustrated below:

Well located in Sec. 17.3e

“See image for figure”

LSCS-UFSAR

TABLE 2.4-16
(SHEET 7 of 7)

DOMESTIC WELL INVENTORY

3. The following abbreviations are used: D is glacial drift; T is outwash deposits of the buried Ticona Bedrock Valley; P is Pennsylvanian strata; and ε-0 is Cambrian-Ordovician Aquifer.
4. Data are from an inventory conducted by Dames & Moore during July 1970.
5. These wells were also inventoried by Dames & Moore in 1970; however, data are from 1934 inventory by the Illinois State Water Survey. The remainder of the well data in the table is taken from the 1934 survey or from recent logs on file with the Illinois State Geological Survey. The owner's name, unless it is given as Commonwealth Edison Company, is from the 1934 inventory.
6. NA indicates that the data are not available.
7. Current land ownership, based upon the La Salle County plat sheet for Brookfield Township at the end of 1974, is given where it differs from the well owner's name.

LSCS-UFSAR

TABLE 2.4-17
(SHEET 1 of 2)PIEZOMETER INSTALLATION RECORDS AND MEASUREMENT DATES

BORING	SURFACE ELEVATION (ft, MSL)	DATE OF INSTALLATION	TESTED INTERVAL, ¹ DEPTH/ELEVATION (ft/ft MSL)	TIME INTERVAL FOR MEASUREMENT OF WATER LEVELS	TOTAL NUMBER OF MEASUREMENTS
2	708.3	5-28-70	20.0- 80.0/688.3-628.3 ²	6-29-70 to 7-15-70	3
3	677.5	6-9-70	130.0-150.0/547.5-527-5 ²	6-11-70 to 7-15-70	10
4	704.3	6-12-70	0- 80.0/704.3-624.3 ²	6-25-70	1
6-S	708.9	6-23-70	120.0-135.0/588.9-573.9 ²	6-30-70 to 7-15-70	3
6-D	708.9	6-23-70	180.0-260.0/528.9-448-9 ²	6-30-70 to 7-15-70	3
36	707.0	12-1-70	70.0-80.0/637.0-627.0	12-16-70 to 12-8-71	8
37	708.5	11-30-70	116.0-140.0/592.5-568.5 ²	12-3-70 to 5-25-71	7
41	708.6	12- 3-70	90.5-100.0/618.1-608.6	12-4-70 to 12-8-71	10
42	704.9	12-14-70	14.5-20.0/690.4-684.9	12-14-70 to 12-8-71	10
43	705.5	10-17-70	55.0- 60.0/650.5-645.5	12-17-70 to 12-8-71	8
44	704.8	12-14-70	35.0-40.0/669.8-664.8	12-14-70 to 12-8-71	10
82	682.5	10-22-73	1.0- 23.0/681.5-659.5	12-3-73 to 3-5-74	3
94	680.1	10-25-73	0- 26.0/680.1-654.1	12-3-73 to 3-5-74	3
105	665.8	10-15-73	1.0- 26.5/664.8-639.3	12-3-73 to 3-5-74	3
120	688.6	10-30-73	1.0- 21.0/687.6-667.3	12-3-73 to 3-5-74	3
129	674.8	10-26-72	1.0- 27.0/673.8-647.8	12-3-73 to 3-5-74	3
139	687.5	10-19-73	1.0- 25.5/686.5-662.0	12-3-73 to 3-5-74	3
8-B-01	677±	11-20-70	28-32/649-645	11-20-70 to 5-25-71	7
8-B-02	676±	11-23-70	28-32/648-644	11-23-70 to 5-25-71	8
9-A-01	679±	11-25-70	21-30/658-649	11-25-70 to 5-25-71	6
10-D-01	678±	11-19-70	1-32/677-646	11-19-70 to 5-25-71	10
10-D-02	678±	11-20-70	1-15/677-663	11-20-70 to 5-25-71	9
16-B-01	691±	11-24-70	3-30/688-661	11-24-70 to 2-17-71	9
16-B-02	705±	11-24-70	1-25/704-680	11-24-70 to 5-25-71	10
21-D-01	695±	11-17-70	1-27/694-668	11-17-70 to 5-25-71	13
21-D-02	691±	11-18-70	1-30/690-661	11-18-70 to 5-25-71	11
27-C-02	689±	11-17-70	1-21/688-668	11-17-70 to 5-25-71	9
27-D-01	692±	11-18-70	20-33/672-659	11-18-70 to 1-26-71	7
28-C-01	704±	11-16-70	1-21/703-683	11-16-70 to 5-25-71	14
D-5	667.3	7-14-71	61.0- 67.7/606.3-599.6	7-14-71 to -12-8-71	3
D-12	670.8	8-2-71	60.0-67.0/610.8-603.8	10-9-71 to 12- 8-71	2

PIEZOMETER INSTALLATION RECORDS AND MEASUREMENT DATES

NOTES

1. Except for the piezometer installed in Boring 3 and the deep piezometer in Boring 6 (6-D), the tested interval lies within the glacial drift aquitard. The piezometer in Boring 3 is installed in sand and gravel over the divide between the buried bedrock valleys that underlie part of the site; the deep piezometer in Boring 6 (6-D) is installed in the Pennsylvanian aquitard.
2. The depth and elevations are given for the slotted interval of the piezometer.
3. Locations of these piezometers are shown on Figure 2.4-21.
4. Potentiometric levels are plotted with daily precipitation in Figure 2.4-22 for the piezometers installed in the following borings: 42, 8-B-01, 8-B-02, 9-A-01, 10-D-01, 10-D-02, 16-B-01, 16-B-02, 21-D-01, 21-D-02, 27-C-02, 27-D-01 and 28-C-01. Groundwater levels for the other piezometers are presented in Table 2.4-18.

LSCS-UFSAR

TABLE 2.4-18
(SHEET 1 of 3)ADDITIONAL UNPLOTTED PIEZOMETER DATA

BORING ¹	SURFACE ELEVATION (ft, MSL)	DATE OF MEASUREMENT	DEPTH TO WATER (ft)	WATER LEVEL ELEVATION (ft, MSL)
2	708.3	6-29-70	21.0	687.3
		7-9-70	21.6	686.7
		7-15-70	22.0	686.3
3	677.5	6-11-70	85.5	592.0
		6-12-70	95.5	582.0
		6-12-70	113.0	564.5
		6-18-70	122.0	555.5
		6-23-70	131.0	546.5
		6-25-70	122.0	555.5
		6-26-70	132.0	545.5
		6-29-70	136.0	541.5
		7-7-70	139.0	538.5
		7-15-70	140.7	536.8
4	704.3	6-25-70	21.0	683.3
6-S	708.9	6-30-70	32.0	676.9
		7-9-70	33.4	675.5
		7-15-70	33.0	675.9
6-D	708.9	6-30-70	118.0	590.9
		7-9-70	118.0	590.9
		7-15-70	119.0	589.9
36	707.0	12-16-70	60.0	647.0
		12-17-70	60.0	647.0
		12-21-70	63.3	643.7
		12-28-70	60.9	646.1
		1-26-70	61.0	646.0
		2-17-71	61.3	645.7
		5-25-71	60.5	646.5
		12- 8-71	60.8	646.2
37	708.5	12-3-70	116.0	592.5
		12- 7-70	116.3	592.2
		12-16-70	114.5	594.0
		12-17-70	114.5	594.0
		12-21-70	114.5	594.0
		2-17-71	115.0	593.5
		5-25-71	114.5	594.0
		12- 8-71	blocked at 70 ft	

LSCS-UFSAR

TABLE 2.4-18
(SHEET 2 of 3)ADDITIONAL UNPLOTTED PIEZOMETER DATA

BORING ¹	SURFACE ELEVATION (ft, MSL)	DATE OF MEASUREMENT	DEPTH TO WATER (ft)	WATER LEVEL ELEVATION (ft, MSL)
41	708.6	12- 4-70	88.0	620.6
		12- 7-70	78.5	630.1
		12-16-70	75.9	632.7
		12-17-70	75.9	632.7
		12-21-70	77.5	631.1
		12-28-70	76.6	632.0
		1-26-71	76.0	632.6
		2-17-71	75.5	633.1
		5-25-71	74.0	634.6
		12- 8-71	73.9	634.7
43	705.5	12-17-70	dry	----
		12-18-70	49.5	656.0
		12-21-70	43.6	661.9
		12-28-71	43.1	662.4
		1-26-71	43.1	662.4
		2-17-71	43.0	662.5
		5-25-71	42.5	663.0
		12- 8-71	43.4	662.1
44	704.8	12-14-70	dry	----
		12-15-70	40.1	664.7
		12-17-70	39.8	665.0
		12-18-70	38.2	666.6
		12-21-70	37.6	667.2
		12-28-70	30.9	673.9
		1-26-71	20.0	684.8
		2-17-71	19.5	685.3
		5-25-71	19.5	685.3
		12- 8-71	21.3	683.5
D-5	667.3	7-14-71	dry	----
		7-30-71	dry	----
		12- 8-71	26.0	641.3
D-12	670.8	10- 9-71	dry	----
		12- 8-71	65.0	605.8

ADDITIONAL UNPLOTTED PIEZOMETER DATA

NOTES

1. Locations of piezometers are shown on Figure 2.4-21.
2. Date of installation and tested interval of each piezometer are given in Table 2.4-17.
3. Water levels in these piezometers were measured infrequently or over only short periods of time (Table 2.5-17); therefore, these data are not suitable for graphic presentation.

2.5 GEOLOGY, SEISMOLOGY, AND GEOTECHNICAL INFORMATION

2.5.1 Basic Geologic and Seismic Information

The LaSalle County Nuclear Generating Station - Units 1 and 2 is located at the north end of the Illinois Basin, in eastern LaSalle County, Illinois, approximately 5 miles south of the Illinois River in sections 20, 28, 29, 32, 33 of T33N, R5E and in sections 8, 9, 10, 11, 14, 15, 16, 17, 20, and 21 of T32N, R5E (Figure 2.5-1; Figure 2.5-2, Sheets 1 and 2).

The LSCS site is divided into a large southern gently rolling upland portion containing the plant buildings and cooling lake and a small portion to the north, in the Illinois River valley, containing the intake works. The maximum topographic relief between the two parts is about 250 feet.

Soil deposits in the upland portion of the LSCS site consist predominantly of 120 to 140 feet of Pleistocene till resting on Pennsylvanian bedrock or, in northern and southern portions of the site, on valley fill of the Ticona and Kempton Buried Bedrock Valleys. The till is locally interbedded with outwash deposits and locally covered by alluvium and colluvium, generally thinner than 10 feet, and by loess 0 to 4 feet thick.

Soil deposits in the valley bottoms portion of the LSCS site include Pleistocene alluvium, colluvium, terraces, and swamp deposits along the Illinois River valley (Figure 2.5-3). The alluvium is generally less than 20 feet thick, the terraces 10 to 40 feet thick, and the swamp deposits less than 3 feet thick (Reference 1, Willman, 1973). These units are not found in any strict stratigraphic sequence in the Illinois River valley, and locally any one of them may lie directly on Pennsylvanian bedrock.

The bedrock units at the LSCS site include nearly flat-lying Pennsylvanian cyclothem sequences (limestones, shales, sandstones, coals) unconformably overlying Ordovician limestones, shales, dolomites, and sandstones (Figure 2.5-4). These units are part of very gently dipping (less than 1°), broad folds related to the LaSalle Anticlinal Belt. The Pennsylvanian Carbondale Formation is exposed in narrow strips along the bluffs of the Illinois River (Figure 2.5-3).

As predicated in the PSAR, the tills of the Wedron Formation have provided excellent foundation material in which only a small volume of isolated sand pockets had to be replaced. The only significant new situations that developed in construction were the discovery of liquefaction-prone sands in the flume excavation (Subsections 2.5.4.5.1.3 and 2.5.4.3.1.3.1) and the decision to assume, conservatively, that these sands remain continuous under the main plant structures (Subsection 2.5.4.8.1).

LSCS-UFSAR

In the first case, all sands were replaced by clay backfill; in the second, a special analysis proved that liquefaction was impossible under stresses imposed by SSE.

Table 2.5-1 is a list of geotechnical investigations which have been conducted and the companies which performed the investigations.

2.5.1.1 Regional Geology

The regional area is herein defined as the area included within a 200-mile radius of the LaSalle County Station as shown in Figure 2.5-1. A distinction is made between the regional area, the site area (the area within a 20-mile radius of LSCS), and the site vicinity (the area within a 5-mile radius of the LSCS power block).

2.5.1.1.1 Regional Physiography

LSCS is located in the Bloomington Ridged Plain Subsection of the Till Plains section of the Central Lowland Physiographic Province. The Bloomington Ridged Plain is a region of relatively flat, undissected uplands of Wisconsinan till and terminal moraines that are cut by steep-sided valleys of major through streams. Topography is largely controlled by glacial deposition.

A few miles east of the site is the flat lake and outwash plains of the Kankakee Plain, Great Lakes Section. Further to the east is the Wheaton Morainal Country. Compared to the Wheaton Morainal Country, where drainage is poorly developed, drainage in the Bloomington Ridged Plain is well integrated.

The most conspicuous physiographic feature within the site vicinity is the east-west oriented Illinois River Valley. This valley was a major drainage way for melt waters of Woodfordian glaciers of the Lake Michigan lobe. The following subsections present details of physiographic classification of the regional area.

The regional area includes portions of two physiographic divisions, the Interior Plains and the Interior Highlands (Figure 2.5-5; Reference 2, Fenneman, 1946; Reference 3, Howe, 1969; Reference 4, Leighton, Ekblaw, and Horberg, 1948; Reference 5, Schneider, 1966). Each division is subdivided into provinces, sections, and subsections (Figure 2.5-5) based upon distinguishing physiographic features. The characteristics used to define the physiographic sections and subsections are often arbitrary and interpretive. Each state geological survey has developed its own criteria for the subdivision of provinces within its borders. Consequently, the physiographic sections and subsections of one state may or may not correspond to those of an adjacent state. To facilitate the discussion, a physiographic classification and correlation chart is presented in Table 2.5-2.

2.5.1.1.1.1 Interior Plains Physiographic Division

The regional area lies almost entirely within the Interior Plains Physiographic Division, except for the southwest corner, which lies in the Interior Highlands Physiographic Division (Figure 2.5-5). In the regional area, the Interior Plains Division is divided into the Central Lowland Province and the Interior Low Plateaus Province.

2.5.1.1.1.1.1 Central Lowland Province

The topography of the Central Lowland Province in the regional area is dominated by plains of low relief. These are depositional landforms resulting from Pleistocene glaciation. This distinguishes the Central Lowland Province from the Interior Low Plateaus Province, where the topography within the regional area is not controlled by deposits of glacial drift, but rather by exposures of bedrock. The Pleistocene deposits of the Central Lowland Province are underlain by generally flat-lying Paleozoic sedimentary strata.

In the regional area, the Central Lowland Province is divided into the Till Plains, the Great Lakes, the Dissected Till Plains, and the Western Young Drift Section (Reference 6, Fenneman, 1935; Reference 7, Thornbury, 1965).

The Till Plains Section is distinguished from the dissected Till Plains Section primarily by the degree of erosional dissection and secondarily by the differing ages of the glacial drift. In the Till Plains Section, glaciation was primarily Wisconsinan and Illinoian in age, whereas the glaciation was mostly Kansan in the Dissected Till Plains Section (Reference 6, Fenneman, 1935).

Although the glacial deposits in the Great Lake Section and the northern portion of the Till Plains Section are the same age, the conditions of deposition were different (Reference 6, Fenneman, 1935). This difference in depositional environment is reflected in the topography and provides the basis for differentiation of these sections. Generally, the topography of the Great Lakes Section is developed on late Wisconsinan glacial moraines which are concentric with the present basins of the Great Lakes. The drainage in this section is not yet well defined, and closed depressions are frequently present. In contrast, the topography of the Till Plains Section is developed on older Wisconsinan glacial drift and is characterized by a well-integrated drainage pattern with streams confined within steep-walled valleys (Reference 8, Willman, 1971).

2.5.1.1.1.1.1.1 Till Plains Section

The Till Plains section in the regional area (Table 2.5-2) includes the Bloomington Ridged Plain, the Springfield Plain, the Mt. Vernon Hill Country, the Galesburg Plain, the Green River Lowland, and the Rock River Hill Country in Illinois

(Reference 9, Leighton, Ekblaw, and Horberg, 1948), and the Tipton Till Plain, the Muscatatuck Regional Slope, the Scottsburg Lowland, and the Wabash Lowland in Indiana (Reference 10, Schneider, 1966). The LaSalle County Station site is in the Bloomington Ridged Plain (Figure 2.5-5). The following paragraphs describe these physiographic subsections. In some cases the physiographic subsections continue across state boundaries but have different names in each state. In these cases the contiguous subsections are described as one.

The Bloomington Ridged Plain and the Tipton Till Plain are characterized by low, broad morainic ridges with intervening wide stretches of relatively flat or gently undulatory ground moraine (Reference 11, Leighton, Ekblaw, and Horberg, 1948). Drainage development is generally in the initial stage. The glacial deposits are relatively thick throughout the area and include Wisconsinan, Illinoian, and older drift. Undrained basins are much less numerous than in the Wheaton Morainal Country (Great Lakes Section). The valleys of principal streams are larger and more numerous than in the Great Lakes Section (Reference 12, Leighton, Ekblaw, and Horberg, 1948).

The Springfield Plain is characterized by essentially flat upland areas developed on glacial drift; relatively broad, steep-walled valleys along major streams; and relatively shallow tributary valleys in the uplands. The glacial deposits are relatively thick throughout the area and, in general, completely conceal the underlying bedrock surface (Reference 13, Leighton, Ekblaw, and Horberg, 1948). The Springfield Plain is developed largely on Illinoian glacial deposits. It is differentiated from the Bloomington Ridged Plain, developed on Wisconsinan glacial deposits, primarily by the greater degree of dissection. Strongly developed moraines are also less common in the Springfield Plain than in the Bloomington Ridged Plain.

The Mt. Vernon Hill Country and the Wabash Lowlands are characterized by rolling to undulating upland areas and broad alluviated valleys along larger streams (Reference 13, Leighton, Ekblaw, and Horberg, 1948; Reference 14, Schneider, 1966). These areas are developed on Pennsylvanian sandstones, siltstones, and shales; the topography generally reflects the erosional bedrock surface. The uplands are capped by relatively thick deposits of loess which are locally underlain by till. The bedrock valleys are backfilled with lacustrine, outwash, and alluvial sediments.

The Galesburg Plain is level to undulatory with a few morainic ridges formed on Illinoian drift. The Illinoian drift is generally thick and is underlain by extensive Kansan and Nebraskan deposits, especially along buried preglacial valleys. Most of the irregularities of the preglacial surface are drift-filled so that in contrast with the Rock River Hill Country, only gross features of the bedrock topography are reflected in the present landscape (Reference 15, Leighton, Ekblaw, and Horberg, 1948).

The Green River Lowland is a topographically low, poorly drained plain with prominent sand ridges and dunes formed on the outwash plain related to the Bloomington moraine (Reference 12, Leighton, Ekblaw, and Horberg, 1948). The present lowland coincides with the broad bedrock lowland which was occupied by the Mississippi River up to the time of Wisconsinan glaciation.

The Rock River Hill Country is characterized by subdued rolling hills developed on a thin cover of Illinoian drift overlying bedrock. The Illinoian drift is without marked ridges, and most landforms are very localized. Major streams flow through relatively broad, steep-walled valleys to the Mississippi River on the west and the Rock River on the east and south. Most of the minor streams are narrow and V-shaped (Reference 16, Leighton, Ekblaw, and Horberg, 1948).

The Muscatatuck Regional Slope is characterized by steep-sided, moderately deep valleys and nearly flat to undulatory topography on the broad upland areas. It is a structural plain developed on resistant, gently dipping Devonian and Silurian carbonate rocks. The formational dip of the rock strata is approximately 20 ft/mi to the west. Relatively thin Illinoian till blankets the entire area such that the underlying rock strata are exposed only in dissected areas. Stream entrenchment and drainage development are noticeably less advanced in the eastern or upstream part of the area than farther west (Reference 17, Schneider, 1966).

The Scottsburg Lowland is characterized by low relief and broad, flat valleys with gently sloping valley walls. It is developed on westward-dipping nonresistant shales of Late Devonian and Early Mississippian age. The bedrock is overlain by a thin veneer of Illinoian till, and the extent and shape of the lowland are controlled by the bedrock structure and lithology (Reference 18, Schneider, 1966). The underlying rock strata are exposed only in strongly dissected areas.

2.5.1.1.1.1.2 Great Lakes Section

In the regional area, the Great Lakes section includes the Kankakee Plain, the Wheaton Morainal Country, and the Chicago Lake Plain in Illinois (Reference 9, Leighton, Ekblaw, and Horberg, 1948); the Calumet Lacustrine Plain, Valparaiso Morainal Areas, Kankakee Outwash and Lacustrine Plain, Steuben Morainal Lake Area, and the Maumee Lacustrine Plain in Indiana (Reference 10, Schneider, 1966); the Central Plain and the Eastern Ridges and Lowlands in Wisconsin (Reference 19, Martin, 1965); and the Lake Border Morainal Area, Valparaiso Morainal Area, Kankakee Morainal Area, and the Steuben Morainal Lake Area in Michigan. The following paragraphs describe these subsections. In some cases the physiographic subsections continue across state boundaries, but have different names in each state. In these cases the contiguous subsections are described as one.

The Kankakee Plain and the Kankakee Outwash and Lacustrine Plain are characterized by essentially flat topography that is developed predominantly on

outwash and lacustrine sand and silt. The surface topography has been locally modified by wind action which has reworked and distributed the sand into dunes (Reference 20, Schneider, 1966). The glacial deposits are relatively thick and, in general, completely conceal the underlying rock strata.

The Wheaton Morainal Country (Illinois) and the Valparaiso Morainal Area (Indiana-Michigan) are characteristically a complex area of broad, parallel moraines encircling the southern shoreline of Lake Michigan. The topography is determined essentially by 150 to 200 feet (Reference 21, Wayne, 1956) of Wisconsinan drift underlain by Illinoian age deposits in some areas and by bedrock in others. Small basins of extinct lakes and ponds underlain by stratified silts and clays are found throughout the area (Reference 22, Leighton, Ekblaw, and Horberg, 1948; Reference 23, Schneider, 1966).

The Calumet Lacustrine Plain (Indiana), the Lake Border Morainal Area (Michigan), and the Chicago Lake Plain (Illinois) are a generally flat surface of lacustrine deposits underlain largely by till (Reference 24, Leighton, Ekblaw, and Horberg, 1948). During the Pleistocene, these two areas formed the floor or bottom of glacial Lake Chicago (Reference 8, Willman, 1971). The nearly featureless plain is interrupted only by massive sand dunes which represent former beach lines of glacial Lake Chicago (Reference 25, Malott, 1922; Reference 26, Schneider, 1966). Rivers on the plain are without true valleys, and their courses are primarily determined by the position of the beach ridges (Reference 21, Wayne, 1956; Reference 22, Leighton, Ekblaw, and Horberg, 1948).

The Steuben Morainal Lake Area is characterized by knob-and-kettle topography developed on morainic ridges. Kettles or iceblock depressions serve as basins for thousands of lakes and peat bogs in the area. Local relief is commonly in excess of 100 to 150 feet. Small lacustrine plains are relatively common between the moraines (Reference 27, Schneider, 1966). The glacial deposits are relatively thick throughout the area and completely conceal the underlying rock strata. Most streams follow constructional depressions (Reference 11, Leighton, Ekblaw, and Horberg, 1948).

The Maumee Lacustrine Plain is characterized by nearly level topography developed on lacustrine deposits of sand and silt. These deposits are part of the abandoned floor of a large glacial lake which occupied the Lake Erie basin and spread across northwestern Ohio and northeastern Indiana in late Pleistocene time. The glacial deposits are relatively thick and completely conceal the underlying rock strata. Except for beaches which mark abandoned shorelines, the plains are virtually featureless (Reference 28, Schneider, 1966).

The Central Plain of Wisconsin is a relatively flat, arcuate area with many buttes and mesas formed by resistant sandstone beds overlying the carbonate rocks. It has

been extremely dissected by Holocene and glacial streams and was the site of glacial Lake Wisconsin (Reference 29, Martin, 1965).

The Eastern Ridges and Lowlands are characterized by a series of drift-covered cliffs and valleys formed on rocks of varying resistance which dip gently toward Lake Michigan (Reference 30, Fenneman, 1935). The more resistant layers form cuestas with steep western faces and gentle eastern backslopes. Glacial action has amplified these ridges and valleys, but glacial deposits have partially obscured the steep slopes.

2.5.1.1.1.1.3 Wisconsin Driftless Section

The Western Upland of Wisconsin is a region of high narrow ridges and deep, steep-sided valleys. The original flat-topped upland or plateau has been so thoroughly dissected that smooth upland areas of any extent are now absent (Reference 31, Martin, 1965). The higher elevations are normally formed on resistant sandstones and limestones. The dominant features of this region are the deeply incised valleys of the Wisconsin and Mississippi Rivers. The boundary of the Wisconsin Driftless section has been drawn to coincide with the boundary of the Western Upland, with extensions into eastern Iowa and northwestern Illinois. The Driftless Area is a dissected low plateau formed largely by stream erosion. The area apparently escaped the major effects of glaciation due to its position with respect to bordering uplands and troughs (Reference 32, Thornbury, 1965).

2.5.1.1.1.1.4 Dissected Till Plains Section

The Dissected Till Plains Section is characterized by a well-dissected glacial plain with a loess cover. Nebraskan and Kansan deposits have been eroded more extensively than the younger Wisconsinan and Illinoian tills of the Till Plains section, resulting in the lack of morainic topography found in the Till Plains section. The drift in the area is thin, and the topography closely reflects the ruggedness of the underlying bedrock upland (Reference 33, Leighton, Ekblaw, and Horberg, 1948).

2.5.1.1.1.1.5 Western Young Drift Section

The Western Young Drift Section is characterized by a partially dissected, immature glacial plain. The glacial plain is composed of Wisconsinan drift overlying Paleozoic bedrock. The Western Young Drift Section is readily distinguished from the more highly dissected Dissected Till Plains Section to the south. In the Young Drift section, topography is controlled by the pronounced terminal moraines separated by wide ground moraines (Reference 34, Fenneman, 1935).

2.5.1.1.1.1.2 Interior Low Plateaus Province

The Interior Low Plateaus Province is characterized by plateaus developed on relatively flat-lying strata of Pennsylvanian through Ordovician age. Surface topography is controlled by the bedrock structure and lithology (Reference 35, Fenneman, 1935). The province includes the Mitchell Plain, Crawford Upland (Subsection 2.5.1.1.6.2), and the Norman Upland in Indiana.

The Crawford Upland, Norman Upland, and the Mitchell Plain are characterized by undulating to rolling topography developed on Mississippian carbonates, sandstones, and shales. The Mississippian carbonates of the Mitchell Plain exhibit a high degree of karst development with extensive subsurface drainage (Reference 36, Schneider, 1966). The Crawford Upland is a maturely dissected westward-sloping plateau characterized by abundant stream valleys with wide floodplains and steep walls. The topography of the Norman Upland closely resembles that of the Crawford Upland, which has somewhat greater overall relief (Reference 37, Schneider, 1966). The Crawford and Norman Uplands are separated by the Mitchell Plain.

2.5.1.1.1.2 Interior Highlands Physiographic Division

The Interior Highlands Physiographic Division is represented in the regional area by the northeast corner of the Ozark Plateaus Province.

2.5.1.1.1.2.1 Ozark Plateaus Province

The Ozark Plateaus Province consists of an asymmetrical dome-shaped plateau which is moderately dissected and surrounded by lowlands. The Ozark Dome is the dominant topographic feature of the province (Reference 38, Fenneman, 1935).

In the regional area, the Ozark Plateaus Province forms a discontinuous upland along the southeastern margin of Illinois and represents the northeastern corner of an extensive upland in northern Missouri. These uplands are cuervas on pre-Pennsylvanian rocks ranging from driftless to thinly drift-covered. In the regional area, the Ozark Plateaus Province includes the Lincoln Hills Section and the Salem Plateau Section (Reference 38, Leighton, Ekblaw, and Horberg, 1948).

2.5.1.1.1.2.1.1 Lincoln Hills Section

The dominant topographic feature of the Lincoln Hills Section is the partially drift-covered, dissected plateau north of the junction of the Mississippi and Illinois Rivers in western Illinois. The surface of the plateau is generally rugged and broken by closely-spaced valleys and ridges. The eastern boundary of the Lincoln Hills Section follows the Illinoian drift border, and the southern boundary follows the Cap au Gres Faulted Flexure (Reference 39, Leighton, Ekblaw, and Horberg, 1948).

2.5.1.1.1.2.1.2 Salem Plateau Section

The portion of the Salem Plateau Section in the regional area is roughly dissected due to its proximity to the Mississippi River valley. Away from the regional area, the plateau is a modified peneplain whose original surface is marked by cuestas capped with resistant chert (Reference 40, Leighton, Ekblaw, and Horberg, 1948).

2.5.1.1.2 Regional Geologic Setting

The regional study area is centered almost entirely within the interior lowlands of the Central Stable Region as defined by King (Reference 41, 1951).

The interior lowlands are characterized by broad gentle arches and basins of regional extent developed in gently dipping sedimentary sequences and underlying Precambrian basement. To the north the interior lowlands are bordered by the Laurentian (Canadian) shield of exposed Precambrian crystalline basement; to the southeast and southwest respectively are the Paleozoic orogenic belts of the Appalachian and Ouachita-Wichita Mountains. On the south the interior lowlands are covered by Mesozoic and Cenozoic deposits of the Mississippi Embayment; on the west are the folded mountains of the Cordillera.

In all but its northernmost portion, the bedrock geology of the regional study area is dominated by Paleozoic systems.

The history of crustal deformations has been determined from the distribution and thickness of key stratigraphic units and from the structural configuration of principal stratigraphic horizons. These data indicate that the region has experienced several transgressions and regressions of the sea. Basins and arches were produced by gentle differential movement of areas within the region. Isolated basinal deposition continued until the end of the Paleozoic. The major faulting and folding on the Central Stable Region was contemporaneous with the Alleghenyan Orogeny, at the close of the Paleozoic Era.

2.5.1.1.3 Regional Stratigraphy

Over most of the regional area, bedrock is covered with Quaternary surficial deposits consisting of Pleistocene glacial drift, loess, lake sediments, and residual soils. The bedrock stratigraphic sequence in the regional area consists primarily of Paleozoic sedimentary rocks ranging in age from Pennsylvanian to Cambrian, with a major hiatus between Pennsylvanian and Ordovician in the site vicinity. In the northern portion of the regional area, Precambrian basement rocks are exposed at the surface.

The distribution and stratigraphic relationship of Pleistocene units in Illinois are shown in Figure 2.5-22. The distribution and stratigraphic relationship of the rock units in the regional area are shown in Figure 2.5-6. Maps depicting the generalized systemic distribution in both the surface and subsurface are presented in Figure 2.5-7. Geologic cross sections across the regional area are presented in Figure 2.5-8. A discussion of the regional historical geology is presented in Subsection 2.5.1.1.4. The ages given (Reference 42, Faul, 1966) represent broad time spans and are not intended to indicate only those portions of the time interval represented within the regional area.

2.5.1.1.3.1 Cenozoic Erathem (Present to 65 ± 2 Million Years Old)

2.5.1.1.3.1.1 Quaternary System (Present to 2 ± 1 Million Years Old)

Quaternary deposits within the regional area are largely glacial, aeolian, alluvial, and lacustrine in origin. The youngest sediments are the veneer of Holocene alluvial sediments deposited by presently active streams. All four major glacial advances covered most of the regional area with varying thicknesses of loess and glacial drift, with glacial drift being the major deposit. The Driftless Area lacks the features of erosion and deposition normally resulting from glaciation, although it has been suggested that the Driftless Area was glaciated (Reference 43, Trowbridge, 1966).

2.5.1.1.3.1.2 Tertiary System (2 ± 1 to 65 ± 2 Million Years Old)

There are scattered patches of alluvial chert gravels in northern and western Illinois. These deposits may contain some reworked early Pleistocene or Cretaceous gravels and are assigned a Pliocene-Pleistocene age (Reference 44, Willman et al., 1975). The gravels generally unconformably overlie Paleozoic bedrock of varying age and are overlain by Quaternary loess or drift.

2.5.1.1.3.2 Mesozoic Erathem (65 ± 2 to 225 ± 5 Million Years Old)

2.5.1.1.3.2.1 Cretaceous System (65 ± 2 to 135 ± 5 Million Years Old)

Within the regional area, Cretaceous deposits are present only in western Illinois, unconformably overlying Mississippian and Pennsylvanian age strata. These deposits are an outlier of similar deposits west of the regional area and consist exclusively of the Baylis Formation. The Baylis Formation is comprised of a basal gravel, overlain by sand, with lenses of silt and clay. Maximum thickness of these deposits is 100 feet (Reference 45, Frye, Willman, and Glass, 1964).

LSCS-UFSAR

2.5.1.1.3.2.2 Jurassic System (135 ± 5 to 190 ± 5 Million Years Old)

There are no known deposits of Jurassic age in the regional area.

2.5.1.1.3.2.3 Triassic System (190 ± 5 to 225 ± 5 Million Years Old)

There are no known deposits of Triassic age in the regional area.

2.5.1.1.3.3 Paleozoic Erathem (225 ± 5 to 600 (?) Million Years Old)

2.5.1.1.3.3.1 Permian System (225 ± 5 to 270 ± 5 Million Years Old)

There are no known deposits of Permian age in the regional area.

2.5.1.1.3.3.2 Pennsylvanian System (270 ± 5 to 320 ± 10 Million Years Old)

Strata of Pennsylvanian age within the regional area crop out widely in the Illinois and Michigan Basins but are absent in the structurally higher region between the two basins (Figures 2.5-6 through 2.5-9). The Pennsylvanian System in the regional area consists largely of cyclothemic sequences comprised of sandstones, shales, coals, and limestones. These strata rest unconformably on Mississippian, Devonian, Silurian, and Ordovician strata (Reference 46, Cohee, 1965; Reference 47, Kosanke et al., 1960). The Pennsylvanian strata are overlain in much of the area by Pleistocene surficial deposits.

2.5.1.1.3.3.3 Mississippian System (320 ± 10 to 340 ± 10 Million Years Old)

Strata of the Mississippian System crop out along the outer margins of the Illinois and Michigan Basins within the regional area, as well as being present in the subsurface of the basins. The Mississippian strata along the margins of the basins are very similar to the strata in the subsurface of the basins. Upper Mississippian strata consist of interbedded clastics and limestones. These grade into thick Middle Mississippian limestones and dolomites that include some interbedded sandstones. The Middle Mississippian strata are conformable with the underlying extensive shale unit of the Lower Mississippian Series, except in western Illinois, where the contact is marked by local unconformities (Reference 48, Willman et al., 1975).

2.5.1.1.3.3.4 Devonian System (340 ± 10 to 400 ± 10 Million Years Old)

In the regional area, strata of the Devonian System crop out in narrow belts along the outer margins of the Illinois and Michigan Basins. Devonian strata are also present beneath younger strata toward the basin interiors (Reference 49, Buschbach, 1971; Reference 50, Cohee, 1965). Within the regional area, the Upper and upper-Middle Devonian strata are composed of an extensive shale unit that spans the Mississippian-Devonian time boundary. There are extensive Devonian

evaporite deposits in the Michigan Basin. The mid-Middle Devonian strata consist of limestones and dolomites which unconformably overlie Lower Devonian and Middle and Upper Silurian strata (Reference 51, Kummel, 1970). If Lower Devonian strata were deposited within the Michigan Basin, they were subsequently eroded (Reference 50, Cohee, 1965). Lower Devonian strata are present in the subsurface of the Illinois Basin, but they do not crop out in the regional area.

2.5.1.1.3.3.5 Silurian System (400 ± 10 to 430 ± 10 Million Years Old)

Strata of Silurian age within the regional area crop out along the Kankakee Arch, the LaSalle Anticlinal Belt, in the Mississippi River region west and northwest of the Illinois Basin, and along the western edge of the Michigan Basin. Strata of the Silurian System are also present in the subsurface throughout most of the regional area (Reference 49, Buschbach, 1971; Reference 52, Cohee, 1965; Reference 53, Kummel, 1970). Generally, the lower and middle Silurian strata consist of thick sequences of limestones and dolomites, with some interbedded shales. Extensive evaporite deposits of late Silurian age occur in the subsurface of the Michigan Basin (Reference 52, Cohee, 1965). Along the arches which bound the Illinois Basin on the east and along the Wisconsin Dome to the north, middle Silurian strata (Niagaran Series) are characterized by large reef structures (Reference 53, Kummel, 1970; Reference 54, Buschbach, 1971).

2.5.1.1.3.3.6 Ordovician System (430 ± 10 to 500 (?) Million Years Old)

Within the regional area, Ordovician strata crop out along the margins of the Wisconsin Dome, with the outcrop pattern extending southward along the Wisconsin and Kankakee Arches. Ordovician strata are present throughout the southern two-thirds of the region in the subsurface (Reference 55, Eardley, 1962). The Upper and upper-Middle Ordovician Series consist of interbedded shales, limestones, dolomites, and a few bentonite beds (Reference 56, Templeton and Willman, 1963). The lower-Middle Ordovician Series is dominated by the St. Peter Sandstone. The St. Peter Sandstone unconformably overlies Lower Ordovician sandstones, dolomites, and Upper Cambrian dolomites (Reference 57, Buschbach, 1964).

2.5.1.1.3.3.7 Cambrian System (500 (?) to 600 (?) Million Years Old)

Within the regional area, outcrops of Cambrian strata are confined to the flanks of the Wisconsin Dome and along the Sandwich Fault in northern Illinois. Thickness and extent of the Cambrian deposits throughout the remainder of the region are known from deep boreholes. In northeastern Illinois, nearly 3,000 feet of Cambrian strata are present (Reference 58, Buschbach, 1971). The Upper Cambrian Series consists of sandy dolomites which grade downward to sandstones. These lower sandstones unconformably overlie Precambrian igneous and metamorphic basement rocks (Reference 57, Buschbach, 1964).

2.5.1.1.3.4 Precambrian Basement Complex (Over 600 (?) Million Years Old)

Within the regional area, Precambrian igneous and metasedimentary rocks are exposed along the Baraboo Syncline and in the valley of the Wisconsin River on the Wisconsin Dome. Throughout the remainder of the regional area, the structure and composition of the Precambrian complex are based upon interpretation of borehole data and geophysical investigations. Except for the Sangamon Arch, the basins, arches, and domes recognized in the Paleozoic strata in the regional area (Figure 2.5-9) reflect the bedrock surface of the basement complex (Figure 2.5-10). The Precambrian complex in the region generally consists of granite and rhyolite, with some basalts in Indiana (Reference 59, Muehlberger, Denison, and Lidiak, 1967). In the Baraboo area, the outcrops consist of varicolored quartzites, and in the Wisconsin River valley, they consist of volcanic rocks.

2.5.1.1.4 Historical Geology

The geologic history of the regional area is discussed by geologic eras, which are subdivided into periods. The strata formed during the periods are classified as time-rock units and are designated as systems. In the following discussions, the periods are divided into early, middle, and late; the corresponding strata are designated as series and referred to as lower, middle, and upper, respectively.

Regional stratigraphy is discussed in Subsection 2.5.1.1.3, and regional tectonic features are discussed in Subsection 2.5.1.1.5.1. A chart depicting the relative movement of tectonic features since Precambrian time is presented in Figure 2.5-11. Generalized systemic distribution maps for the regional area are presented in Figure 2.5-7.

The regional area is within the Central Stable Region (see Subsection 2.5.1.1.2). In general, the geological surveys of the states in the regional area agree that the region as a whole is in a period of relative tectonic quiescence. Most structural deformation is believed to have ceased by the close of the Paleozoic Era, approximately 225 ± 5 million years ago (Figure 2.5-11).

The ages given represent the broad time spans and are not intended to indicate only those portions of the time interval represented within the regional area.

2.5.1.1.4.1 Precambrian Era (Over 600 (?) Million Years Ago)

During the Precambrian there were numerous cycles of orogeny, igneous activity, erosion, and deposition (Reference 60, Kummel, 1970). The close of the Precambrian was marked by thick accumulations of sediment in downwarped areas developed on the periphery of the stable, continental interior, and by the general absence of orogenic activity (Reference 61, Kummel, 1970).

Except for a few isolated exposures in central Wisconsin, the Precambrian basement complex within the regional area is covered by younger strata. North of the regional area, the Precambrian surface has a relief of several hundred feet. South of the Precambrian exposures, draping and differential compaction of overlying Paleozoic sediments have resulted in structures that reflect the influence of the Precambrian surface (Reference 62, Atherton, 1971). There was a long period of erosion on the continental interior prior to Cambrian deposition.

2.5.1.1.4.2 Paleozoic Era (225 ± 5 to 600 (?) Million Years Ago)

2.5.1.1.4.2.1 Cambrian Period (500 (?) to 600 (?) Million Years Ago)

The Early Cambrian seas were confined to the periphery of the stable continental interior, leaving the vast central region emergent (Reference 63, Kummel, 1970). Within the regional area, deposition of sediments did not begin until Late Cambrian time, when the sea transgressed from the south.

The development of the Michigan and Illinois Basins began in Late Cambrian time when the two basins were connected. During this time a sequence of sandstones was deposited over the regional area. These were probably derived from the Precambrian surfaces to the north and west (Reference 64, Atherton, 1971; Reference 65, Cohee, 1965). These basal Cambrian clastics grade southward and upward into carbonates.

2.5.1.1.4.2.2 Ordovician Period (430 10 to 500 (?) Million Years Ago)

The pattern of Late Cambrian sedimentation continued into the Early Ordovician with no appreciable break in deposition (Reference 66, Cohee, 1965; Reference 67, Kummel, 1970). In the regional area, the Lower Ordovician Series is almost entirely limestones and dolomites (Reference 68, Ham and Wilson, 1967). The locus of deposition in the Illinois Basin during the Early Ordovician was centered in the Reelfoot Basin (Appendix A). This situation continued until Late Ordovician, when the center of deposition migrated northward to the Fairfield Basin (Reference 69, Schwalb, 1969). Lower Ordovician units are overlain unconformably by an extensive, clean quartz sandstone (St. Peter Sandstone) probably derived from the Canadian Shield or the Cambrian sandstones deposited along the margins of the shield (Reference 70, King, 1951). The unconformity at the base of the St. Peter is a result of pre-St. Peter emergence and erosion.

Subsidence throughout the regional area during Ordovician time was not uniform. Many of the positive structural features acquired structural relief by greater relative subsidence of the intervening basins rather than by actual uplift (Reference 71, Eardley, 1962; Reference 72, Kummel, 1970). During Middle Ordovician time, growth of the Kankakee Arch in northern Indiana began to separate the Illinois

Basin from the Michigan Basin (Reference 73, Atherton, 1971). The Wisconsin Dome also underwent significant uplift before deposition of the St. Peter Sandstone (Reference 74, Eardley, 1962). These tectonic features influenced sedimentation within the regional area during Middle and Late Ordovician. Late Ordovician deposition over much of the continental interior was largely confined to clastic sequences and more specifically to dark shales (Reference 75, Atherton, 1971).

2.5.1.1.4.2.3 Silurian Period (400 ± 10 to 430 ± 10 Million Years Ago)

During Silurian time, the continental interior was occupied by a vast, shallow sea. The Lower Silurian Series are predominantly dolomites with interbedded shales, whereas middle Silurian strata are characterized by organic reefs and bioherms which developed along the arches that bound the Illinois Basin (Reference 76, Kummel, 1970). Isolation of the Michigan Basin in late Silurian time caused deposition of thick evaporite sequences throughout most of the basin (Reference 77, Cohee, 1965). Some erosion took place on the structurally higher areas in the region during Late Silurian (Reference 78, Atherton, 1971). The Wisconsin Dome underwent a second period of significant uplift after deposition of Silurian beds. The Wisconsin Arch was formed as an extension of the Wisconsin Dome during this episode of the uplift (Reference 74, Eardley, 1962). Initial upwarp of the Sangamon Arch (2.5.1.1.5.1.1.6) in western Illinois may have occurred in the Late Silurian (Reference 79, Whiting and Stevenson, 1965). The development of the Lincoln Fold in eastern Missouri may have begun during the Silurian period (Reference 80, Krey, 1924).

2.5.1.1.4.2.4 Devonian Period (340 ± 10 to 400 ± 10 Million Years Ago)

Early Devonian sedimentation was restricted to deposition of limestones and cherts in the southern part of the Illinois Basin and thick evaporite deposits within the Michigan Basin (Reference 50, Cohee, 1965; Reference 78, Atherton, 1971). The positive structural areas were exposed and significantly eroded during this time.

The major unconformity in the Devonian System is at the base of the Middle Devonian. This extensive unconformity is the result of regional uplift and withdrawal of the seas.

Early Middle Devonian sedimentation in the Illinois and Michigan Basins was primarily of limestones and evaporites. In the late-Middle and Late Devonian, organic shales derived from material eroded from the Acadian highland to the east were deposited in the Illinois Basin (Reference 81, Willman et al., 1975). In the Late Devonian, extensive organic shales and limestones were deposited in the Michigan Basin (Reference 50, Cohee, 1965). The Kankakee, Sangamon, and Wisconsin Arches acted as barriers to the advancing sea and caused deposition to occur basinward from them (Reference 78, Atherton, 1971).

2.5.1.1.4.2.5 Mississippian Period (320 ± 10 to 340 ± 10 Million Years Ago)

In the continental interior, deposition of the Late Devonian shales continued into the Early Mississippian. The primary sources of the shales were the Acadian highlands to the east (Reference 82, King, 1951) and the Wisconsin Dome to the north and west (Reference 50, Cohee, 1965). Deposition in the Middle Mississippian was dominated by accumulation of limestone and dolomite sequences (Reference 83, Kummel, 1970). By Late Mississippian, the patterns of basins and arches in the continental interior had become accentuated and strongly affected sedimentation in the basins, as evidenced by the thicknesses and types of sediments deposited and by unconformities. Several transgressions and regressions of the continental seas are evidenced by cyclical alterations of sandstones and limestones (Reference 83, Kummel, 1970; Reference 84, Atherton, 1971; Reference 85, King, 1951). Late Mississippian deposition was largely alternating sandstones and limestones (Reference 83, Kummel, 1970). The close of the Mississippian was marked by a retreat of the sea and an interval of erosion. This interval saw the beginning of movement of the LaSalle Anticlinal Belt in the Illinois Basin, with the locus of deformation migrating southward from the LaSalle area (Reference 84, Atherton, 1971). Development of the Mississippi River Arch also began during the Mississippian and continued into the Pennsylvanian. The principal folding of the Cap Au Gres Faulted Flexure began in the Mississippian (Reference 84, Atherton, 1971).

2.5.1.1.4.2.6 Pennsylvanian Period (270 ± 5 to 320 ± 10 Million Years Ago)

In the regional area, Pennsylvanian strata lie unconformably on Mississippian and older strata. During Early Pennsylvanian time, deposition was restricted to the margins of the continent, giving rise to an unconformity throughout the continental interior (Reference 83, Kummel, 1970). Middle and Late Pennsylvanian strata were once very widespread, but present distribution is the product of erosion rather than deposition. The Pennsylvanian strata which have not been eroded are primarily cyclothemic sequences, both marine and nonmarine in origin (Reference 84, Atherton, 1971; Reference 86, King, 1951). Sedimentation probably continued from Pennsylvanian into Permian time, but these strata were subsequently removed by erosion (Reference 87, Atherton, 1971). Deformation along the LaSalle Anticlinal Belt within the Illinois Basin continued into the Pennsylvanian, with the locus of deformation migrating southward (Reference 84, Atherton, 1971; Reference 88, Eardley, 1962). Downwarping and deposition in the Fairfield Basin area of the Illinois Basin continued in the Pennsylvanian (Reference 87, Atherton, 1971).

2.5.1.1.4.2.7 Permian Period (225 ± 5 to 270 ± 5 Million Years Ago)

No deposits of Permian age have been found in the regional area. The apparent absence of deposits indicates that the Permian was a period of nondeposition or that Permian deposits in the area were eroded.

2.5.1.1.4.3 Mesozoic Era (65 ± 2 to 225 ± 5 Million Years Ago)

2.5.1.1.4.3.1 Triassic Period (190 ± 5 to 225 ± 5 Million Years Ago)

There are no deposits of Triassic age in the regional area. This was largely a period of erosion (Reference 89, Willman et al., 1975).

2.5.1.1.4.3.2 Jurassic Period (135 ± 5 to 190 ± 5 Million Years Ago)

There are no deposits of Jurassic age in the regional area. This was largely a period of erosion (Reference 89, Willman et al., 1975).

2.5.1.1.4.3.3 Cretaceous Period (65 ± 2 to 135 ± 5 Million Years Ago)

The Triassic and Jurassic periods were largely a time of erosion in Illinois (Reference 89, Willman et al., 1975). This is evidenced by the major unconformity at the base of the Cretaceous. Cretaceous rocks are present in western Illinois (Figure 2.5-6).

The Cretaceous rocks of western Illinois are primarily marine nearshore sands which were deposited by the eastward-advancing Cretaceous sea (Reference 90, Willman et al., 1975).

2.5.1.1.4.4 Cenozoic Era (Present to 65 ± 2 Million Years Ago)

2.5.1.1.4.4.1 Tertiary Period (2 ± 1 to 65 ± 2 Million Years Ago)

There are no deposits of the Paleocene, Eocene, Oligocene, or Miocene series present in the regional area. This was likely a period of erosion. Late Tertiary gravels of the Pliocene series are present (Reference 91, Willman et al., 1975). The Pliocene was primarily a time of erosion with some local areas of fluvial deposition. This deposition is represented by relict patches of chert and quartz gravel, part of which may be reworked from older Tertiary or Cretaceous gravels. Reworking of these Pliocene gravels may have continued into the early Pleistocene (Reference 91, Willman et al., 1975).

2.5.1.1.4.4.2 Quaternary Period (Present to 2 ± 1 Million Years Ago)

Prior to the onset of Pleistocene glaciation, Tertiary erosion cycles had left the Paleozoic sediments as an essentially planar surface dissected by stream valleys (Reference 92, Willman and Frye, 1970). Advances of the continental ice sheets during substages within the Nebraskan (oldest), Kansan, Illinoian, and Wisconsinan (youngest) stages have left a sequence of deposits collectively called drift (Figure 2.5-7; Reference 93, Flint et al., 1959; Reference 94, Willman and Frye,

1970). The glacial drift consists of till and outwash deposits. Deposits of loess and lacustrine clays are also present. In most cases the glaciofluvial outwash in present stream valleys is covered by Holocene alluvial and terrace deposits.

The glacial advances were separated by interglacial periods of weathering and major drainage which generally were of longer duration than the periods of glacial advance. Soil horizons formed during these periods are generally well-known and widely utilized stratigraphic horizons.

Glaciations altered the topography throughout much of the region, rearranged drainage patterns (including the Mississippi River), and produced many buried valleys (such as the Mahomet, Kempton, and Ticona Buried Bedrock valleys).

The glaciers which covered the site during the Illinoian and Wisconsinan glacial advances originated mainly from the Lake Michigan lobe of the Labradorian ice sheet. The present Lake Michigan basin was formed during these glaciations.

Isostatic rebound from glacial unloading has occurred in the vicinity of Lake Michigan in the regional area. As the Wisconsinan ice sheet advanced, bedrock was slightly downwarped under the load of the ice. As the load slowly decreased with the retreat of the ice sheet, bedrock was uplifted by isostatic rebound. Evidence for isostatic rebound is found along the pre-Holocene shorelines of Lake Michigan and other Great Lakes. Some of these shorelines rise in elevation as they are traced northward around the lake basins. This rise indicates that the shoreline region has been tilted since the beaches were formed (Reference 95, King, 1965).

2.5.1.1.5 Regional Structural Geology

The regional area is located within the Interior Lowlands tectonic province of the Central Stable Region as defined by King (Reference 96, 1951). This is an area of plains and plateaus having a cover of sedimentary rock over Precambrian basement. It extends south, southwest, and west from the Laurentian Shield into the central United States and the prairie provinces of Canada toward the Appalachian and Cordilleran ranges (see Subsection 2.5.1.1.2).

The distribution of bedrock strata on the regional bedrock geologic map of the region (Figure 2.5-6) indicates that the interior lowlands are comprised of irregular domes, basins, and arches. The domes are indicated by concentric outcrops of successively older Paleozoic rocks toward the structural centers, with some Precambrian exposures toward the centers; the basins are indicated by outcrop areas of successively younger rocks toward the structural centers; the arches are indicated by linear outcrop areas of successively older rocks toward the axes of the arches.

In broad terms, the tectonic history of the Central Stable Region is one of gentle, intermittent subsidence of basins, domes, and arches through the Paleozoic. Over long intervals of time the basins tended to subside more and accumulate greater thicknesses of sediments than the intervening arches and domes. These basins, arches, and domes in the sedimentary strata generally reflect corresponding basins, arches, and domes in the underlying Precambrian basement complex. The Precambrian basement complex has apparently formed the tectonic framework for the overlying Paleozoic strata. The development of tectonic features (basins, arches, and domes), folds, and faults within the regional area is generally restricted to the time interval prior to the close of the Paleozoic Era.

More detailed discussions of the regional tectonic features, i.e., basins, arches, domes, faults, and folds in the sedimentary strata, are presented in the following subsections. The boundaries of the tectonic features in the sedimentary strata have been defined in the literature according to the distribution and structure contours of various sedimentary strata and are shown in Figure 2.5-9. The boundary lines of any feature may change depending upon the sedimentary unit used for the definition of the feature. Within the regional area, no single sedimentary unit has been utilized throughout for the definition of the boundaries of the tectonic features.

Structural deformation is the response of the earth's crust to differential stress. The structural geology of an area is considered to be of primary importance in demonstrating the relationship between tectonic features, faulting, and seismicity.

2.5.1.1.5.1 Regional Tectonic Features

Establishment of the regional tectonic framework is essential to the evaluation of the tectonic conditions which can be postulated for a specific area. To establish this tectonic framework, an analysis was made of the relationship between the structural geology and seismicity (Subsection 2.5.2.3). The deformation features which are present resulted from the yielding of the crust in response to stress differences. The yielding may have been through plastic deformation or brittle fracture. Features produced by the yielding include areas of downwarping, referred to as basins or synclines, and areas of upwarping, referred to as arches, domes, or anticlines. The yielding that has resulted in the formation of a specific basin, arch, or dome may or may not have been accompanied by faulting and/or seismic events.

The tectonic framework within the regional area has been established through an analysis of the structural basins, arches, domes, synclines, anticlines, and faults mapped in the sedimentary sequence of strata.

The discussion of the tectonic features defined in the sedimentary strata is based on a compilation of voluminous surface and subsurface geotechnical data. The interpretations presented represent the presently accepted positions of the

appropriate state geological surveys. The discussion includes: structural basins, arches, and domes; folds; and faults.

2.5.1.1.5.1.1 Basins, Arches, and Domes

The distribution of major structural basins, arches, and domes as defined in the sedimentary strata is shown in Figure 2.5-9. A discussion of the structural characteristics of these features is presented in this section. The geologic history of the development of these structural features is discussed in Subsection 2.5.1.1.4 and presented graphically in Figure 2.5-11. Selected structural features outside of the regional are discussed in Appendix 2.5A.

2.5.1.1.5.1.1.1 Wisconsin Dome

The Wisconsin Dome is a broad uplifted area in central Wisconsin and the upper peninsula of Michigan. The broad exposures of Precambrian rocks in the northern portion of this uplift are a southern projection of the Canadian Shield. To the north and west, a Precambrian and Early Paleozoic basin on the basement surface structurally segregates the dome from the main portion of the Canadian Shield. On the eastern and southeastern flanks of the dome, Paleozoic strata dip toward the Michigan Basin. On the southern flanks of the dome, Paleozoic strata dip toward the Illinois Basin.

The Wisconsin Dome was probably active at several times during the Paleozoic. Eardley (Reference 74, 1962) proposes two significant pre-Devonian periods of uplift. The first uplift occurred prior to deposition of the St. Peter Sandstone in the Early Ordovician, and the second uplift followed deposition of the Silurian strata. By Mississippian time, the broad dome had become a significant positive feature supplying clastics to the neighboring Michigan Basin (Reference 50, Cohee, 1965). The Wisconsin Dome may also have been included in the broad regional uplift involving the Great Lakes region that occurred during the late Pennsylvanian (Reference 97, Eardley, 1962).

2.5.1.1.5.1.1.2 Wisconsin Arch

The outcrop pattern of lower Paleozoic rocks (Figure 2.5-6) and the topography of the Precambrian basement (Figure 2.5-10) indicate the Wisconsin Arch is a prominent nose-like extension of the Wisconsin Dome. The outline of the arch has not been specifically defined, but it trends southeastward through southern Wisconsin and northeastern Illinois. Strata on the northeastern flank of the arch dip into the Michigan Basin. Strata dip gently into the Illinois Basin along the crest of the arch. Uplift which produced the arch occurred after deposition of Silurian strata (Reference 74, Eardley, 1962).

2.5.1.1.5.1.1.3 Ashton Arch

The Ashton Arch is a major anticline which trends N 60° W across northern Illinois and exposes Cambrian and Lower Ordovician strata. The arch is bounded on the north by the Sandwich Fault Zone and on the south where strata dip steeply into the Illinois Basin. The Ashton Arch has a total length of 80 miles and a variable width of 17 to 25 miles. The structural relief on the southwestern side is about 1900 feet, and the maximum relief on the northern side is at least 900 feet (Reference 98, Willman and Templeton, 1951). Principal uplift of the Ashton Arch was at least post-Silurian and may be contemporaneous with development of the LaSalle Anticlinal Belt (post-Mississippian to pre-Pennsylvanian). Principal uplift was followed by additional uplift in post-Pennsylvanian time (Reference 99, Buschbach, 1973; Reference 100, Willman and Templeton, 1951).

2.5.1.1.5.1.1.4 Illinois Basin

The boundary of the Illinois Basin is shown on Figure 2.5-9 as the edge of the outcrop area of Pennsylvanian strata (Reference 101, Swann and Bell, 1958). The Illinois Basin is fringed by the shelf areas to the east. In the regional area, the LaSalle Anticlinal Belt trends northwest-southeast through the Illinois Basin. The Fairfield Basin is included within the Illinois Basin and is the deepest portion of the Illinois Basin. It is separated from the shallower western portion of the Illinois Basin by the DuQuoin Monocline.

To the north, the Illinois Basin rises gently to the Wisconsin Arch. To the northeast, the Illinois Basin is separated from the Michigan Basin by the Kankakee Arch. To the east, the Illinois Basin is separated from the Appalachian Basin by the eastern shelf and by the Cincinnati Arch, which is outside of the regional area. To the west, the Illinois Basin rises gently to the Mississippi River Arch (Reference 102, Bristol and Buschbach, 1971).

The Illinois Basin, as shown in Figure 2.5-9, is a roughly oval-shaped basin with the major long axis trending to N 25° W from northwestern Kentucky, through southwestern Indiana, to northwestern Illinois. The major axis of the basin is approximately 350 miles long and the minor axis approximately 250 miles long. In the site vicinity, east and west of the LaSalle Anticlinal Belt, the rock strata dip from 7 to 10 feet per mile inward toward the deepest portion of the basin, the Fairfield Basin (Reference 103, Bell et al., 1964). In the Fairfield Basin, sediments are 12,000 to 14,000 feet thick (Reference 104, Swann and Bell, 1958). Development of the Illinois Basin as a negative feature began during the Cambrian and continued intermittently to the end of the Pennsylvanian (Reference 105, Swann and Bell, 1958). The Reelfoot Basin (which lies outside the regional area) was the center of Cambrian and Ordovician sedimentation and was ancestral to the Illinois Basin (Reference 69, Schwalb, 1969). By the Late Ordovician, the

depositional center had migrated northward from the Reelfoot Basin to the developing Fairfield Basin.

2.5.1.1.5.1.1.5 LaSalle Anticlinal Belt

The LaSalle Anticlinal Belt is located in the eastern portion of the Illinois Basin and trends N 20° W into north central Illinois. The anticlinal belt is made up of numerous en echelon folds, some of which are shown in Figure 2.5-12. The belt is approximately 250 miles long and ranges from a few miles to approximately 24 miles wide (Reference 106, Bell et al., 1964; Reference 107, Clegg, 1965). It is asymmetrical to the west (almost monoclinial). Locally, strata dip as much as 2000 ft/mi (approximately 20°) to the west, but less than 25 to 50 ft/mi (less than 1°) to the east (Reference 108, Payne, 1942). The crest of the anticlinal belt plunges to the south-southeast (Reference 99, Buschbach, 1973). Development of the LaSalle Anticlinal Belt probably began during post-Mississippian time, with the locus of deformation migrating southward with time; renewed movements occurred intermittently until the close of the Paleozoic (Reference 99, Buschbach, 1973; Reference 109, Clegg, 1970).

2.5.1.1.5.1.1.6 Sangamon Arch

The Sangamon Arch is located in central and western Illinois. The crest of the arch trends northeast-southwest across the broad shelf area west of the Illinois Basin and toward the northern center of the Illinois Basin. Buschbach (Reference 99, Buschbach, 1973) defines the arch by the zero isopach of the Cedar Valley Limestone (Middle Devonian). The outline of the arch on Figure 2.5-9 is drawn on this isopach (Reference 110, Whiting and Stevenson, 1965).

The Sangamon Arch was formed by uplift during the Devonian and Early Mississippian. The arch is a relict structure that has been masked by post-Mississippian movement (Reference 99, Buschbach, 1973). Existence of the Sangamon Arch has been questioned (Reference 111, Calvert, 1974).

2.5.1.1.5.1.1.7 DuQuoin Monocline

The DuQuoin Monocline is a steep eastward-dipping monoclinial structure that trends north-south from northernmost Jackson County through Perry, Jefferson, and Marion Counties, Illinois (Figure 2.5-12, Ill. No. 19). A detailed discussion of the DuQuoin Monocline is presented in Subsection 2.5.1.1.5.1.3.2.1.

2.5.1.1.5.1.1.8 Mississippi River Arch

The Mississippi River Arch is a broad, corrugated fold which parallels the Mississippi River, with contiguous parts in Illinois, Iowa, and Missouri. Howell (Reference 112, 1935) outlined the arch on structure contours on the base of the

Mississippian Burlington Limestone (Figure 2.5-9). The eastern flanks of the arch subside into the Illinois Basin, while the western flanks subside into the Forest City Basin (Reference 113, McCracken, 1971). The arch is cut by numerous cross folds which trend northwest-southeast and plunge gently into the Illinois Basin. Development of the arch began in the Mississippian and continued into the Pennsylvanian as indicated by thinning of sedimentary strata which rise onto the arch from adjoining basins (Reference 84, Atherton, 1971). The arch was probably subjected to additional deformation at the close of the Paleozoic (Reference 99, Buschbach, 1973).

2.5.1.1.5.1.1.9 Lincoln Fold

The Lincoln Fold is an asymmetrical anticline located in eastern Missouri and western Illinois with a general regional axis striking N 45° W. The fold is not a simple anticlinal structure, but rather is a regional uplift upon which are superimposed anticlines, synclines, domes, and faults. The fold has a maximum structural relief of 1000 feet (Reference 114, McCracken, 1971). The southwest side of the fold is marked by comparatively steep dips and faulting. The northeast flank of the fold is marked by gentle dips, but faults are absent (Reference 114, McCracken, 1971). The fold is bounded on the south by the Cap au Gres Faulted Flexure (Subsection 2.5.1.1.5.1.2.8), on the east by the Illinois Basin, and on the west by the Forest City Basin. The fold plunges north and may extend in the subsurface to Iowa (Reference 115, McCracken, 1971). The Lincoln Fold is believed to have been formed during periods of regional warping from the Silurian through the Pennsylvanian, with major rise during post-Mississippian, pre-Pennsylvanian time (Reference 80, Krey, 1924).

2.5.1.1.5.1.1.10 Cap au Gres Faulted Flexure

The Cap au Gres Faulted Flexure is a monoclinial fold, broken by numerous faults, which lies to the west of the Illinois Basin. A detailed discussion of this feature is presented in Subsection 2.5.1.1.5.1.2.8.

2.5.1.1.5.1.1.11 Kankakee Arch

The Kankakee Arch branches off the Cincinnati Arch in north central Indiana. It trends approximately N 40° W from east central Indiana to northeastern Illinois, where it merges with the Wisconsin Arch (Reference 116, Bristol and Buschbach, 1971). The junction between the Kankakee Arch and the Cincinnati Arch is marked by the Logansport Sag (Reference 117, Eardley, 1962). The Kankakee Arch developed as a structurally positive area between the Illinois and the Michigan Basins. The Kankakee Arch is approximately 130 miles in length and 40 miles in width. Structural development of the Kankakee Arch began during the Middle Ordovician and continued through the Pennsylvanian (Reference 73, Atherton, 1971; Reference 105, Swann and Bell, 1958). The arch acquired its structural relief

chiefly by relatively greater subsidence of the adjacent basins rather than by actual uplift (Reference 117, Eardley, 1962).

2.5.1.1.5.1.1.12 Michigan Basin

The Michigan Basin is a roughly circular structural basin located in Michigan, northwestern Ohio, western Ontario, northeastern Illinois, and eastern Wisconsin. The basin is bordered on the southwest by the Kankakee Arch, on the south by the Indiana-Ohio Platform, on the southeast and east by the Findlay Arch and Algonquin Arch (not shown on Figure 2.5-9), and on the west by the Wisconsin Arch. The northern portion of the basin rises gently to the Precambrian rocks of the Canadian Shield. The basin is herein defined on the -1000-foot contour on top of the Trenton Limestone of Ordovician age (Reference 118, Cohee, 1965). Structure contours on the top of the Trenton Limestone indicate that the strata dip into the deepest part of the basin at approximately 60 ft/mi (approximately 0.65°). The deepest part of the basin is located just west of Saginaw Bay, Michigan, where approximately 14,000 feet of sediments overlie the Precambrian basement rocks (Reference 119, Cohee, 1965). The Michigan Basin began to develop during the Late Cambrian and continued as a negative structural feature until the Middle Pennsylvanian. There was additional accumulation of some sediment in the Michigan Basin outside the regional area during Jurassic time (Reference 120, Cohee, 1965).

2.5.1.1.5.1.2 Faults

The information presented herein regarding faulting in the sedimentary strata within the regional area has been compiled from various published and unpublished sources. It represents the accepted interpretations of the geological surveys of each state.

A map showing the distribution of reported faults having traces of 2 miles or greater in length is presented in Figure 2.5-13; the characteristics of these faults are summarized by state in Tables 2.5-3 through 2.5-7. These faults have all been interpreted within the sedimentary rock sequence.

An age is assigned to the faults in the following discussion on the basis of the age of the strata cut and on interpretation of regional geologic history. The faults in the regional area must postdate the youngest strata that they cut.

2.5.1.1.5.1.2.1 Faults in the Mississippi Valley of Wisconsin

Faults in the Mississippi Valley Lead-Zinc District are numerous, but most show displacements of less than 10 feet and have lengths of no more than several thousands of feet. These faults are associated with folds in the area, both spatially and genetically (Reference 121, Heyl et al., 1959). An unnamed fault in central

Grant County, Wisconsin, has a trace of approximately 15 miles trending northwest-southeast parallel to the axis of the Mineral Point Anticline (Figure 2.5-13, Wis. No. 6). Heyl et al. (Reference 121, 1959) described this fault as a thrust with total displacement of 30 feet at most. They postulate an area of much greater displacement at the northwestern end, the greater displacement suggested by a zone of intense fracturing and steeper tilting beds.

The Mifflin Fault is located in Iowa and Lafayette Counties, Wisconsin, and strikes N 40° W (Figure 2.5-13, Wis. No. 2; Reference 122, Dutton and Bradley, 1970). The fault trace is approximately 10 miles long. The southwest side of the fault is downdropped at least 65 feet, and there is about 1000 feet of strike-slip displacement (Reference 123, Heyl et al., 1959). Latest major movement is believed to be Late Paleozoic (Reference 124, Heyl et al., 1959).

2.5.1.1.5.1.2.2 Other Postulated Faults in Wisconsin

Thwaites' map of the buried Precambrian surface in Wisconsin (Reference 125, 1957) postulates the existence of four faulted areas in the southern and eastern sections of the state: the Janesville, Appleton, Waukesha, and Madison Faults. The Janesville (Wis. No. 5) and Waukesha (Wis. No. 4) Faults are shown in Figure 2.5-13. Ostrom (Reference 126, 1975) stated that Thwaites' map is diagrammatic and does not represent detailed study of each fault. He reported that differences in elevation of the basement, interpreted by Thwaites to be the result of faulting, are now believed to be due to topographic relief on the erosional basement surface.

2.5.1.1.5.1.2.3 Sandwich Fault Zone

The Sandwich Fault Zone is a complex fracture whose trace trends northwest-southeast through Illinois from southern Will County to central Ogle County (Figure 2.5-13, Ill. No. 2; Reference 127, Willman and Templeton, 1951). The nearest approach of the fault zone to the LSCS site is about 26 miles. The fault zone forms the northern boundary of the Ashton Arch and has a maximum downthrow of 900 feet. The throw decreases to 100 feet towards the southeastern end owing to a scissors effect which causes the southwestern block to be downthrown approximately 100 feet along a subsidiary fault (Reference 99, Buschbach, 1973). Movements along the fault zone occurred in the interval between post-Silurian and pre-Pleistocene. No rocks of intervening ages are present, which prevents better definition of the movements. However, major movements along the fault zone may have been contemporaneous with folding of the LaSalle Anticlinal Belt during post-Mississippian to pre-Pennsylvanian time (Reference 99, Buschbach, 1973; Reference 128, Willman and Templeton, 1951).

2.5.1.1.5.1.2.4 Plum River Fault Zone

The Plum River Fault Zone (formerly the Savanna Fault and Savanna-Sabula Anticline) is a generally east-west set of possibly en echelon faults extending from Leaf River (Ogle Co.), Illinois, to southeast of Maquoketa (Jackson Co.), Iowa (Figure 2.5-13, Ill. No. 3, Ia. No. 1; Reference 129, Kolata and Buschbach, 1976). The exact trace of the fault is not known, but it has 100 to 400 feet of displacement, north side down. The age of movement has been limited to post-middle Silurian to pre-middle Illinoian (Reference 130, Kolata, 1975). Four minor structural features are associated with the fault zone (Figure 2.5-12): the Forreston Dome (Ill. No. 29), the Brookville Dome (Ill. No. 30), the Leaf River Anticline (Ill. No. 31), and the Uptons Cave Syncline (Ill. No. 32).

2.5.1.1.5.1.2.5 Faults in the Chicago Metropolitan Area

Buschbach and Heim (Reference 131, 1972) present a series of 32 faults in the vicinity of Chicago, Illinois, which are mapped on the top of the Ordovician Galena Group on the basis of an extensive geophysical survey in portions of Cook, Du Page, and Will Counties, Illinois. Traces of the faults vary in length from approximately 2 to 10 miles. Trends of the faults are variable, and the traces are often arcuate. Displacements are generally less than 50 feet. Three of these faults have also been described by Bristol and Buschbach (Reference 132, 1973; Figure 2.5-13, Ill. Nos. 47, 48, and 49). Two of the faults form an arcuate graben in southern Cook County approximately 10 miles in length. The third fault, located in eastern Du Page County, is approximately 4 miles in length, trends N 60° W, and has been downdropped to the southwest. In accordance with the tectonic history of the Illinois Basin and the Kankakee Arch, movement along these faults is believed to be restricted to the post-Ordovician to post-Pennsylvanian time interval.

2.5.1.1.5.1.2.6 Centralia Fault

The Centralia Fault (Figure 2.5-13, Ill. No. 18) is a series of several north-south-trending faults in Marion and Jefferson Counties, Illinois. The faults have no surface expression and are known only from subsurface data, primarily mine records (Reference 133, Bell, 1927). The faulted zone is approximately 20 miles long and displays a maximum displacement of 200 feet, downthrown to the west (Reference 134, Brownfield, 1954). The faults appear to be the result of shear stresses formed after folding of the DuQuoin Monocline, a structure which parallels the fault 1 mile to the west. Faulting is believed to be post-Pennsylvanian but pre-Pleistocene in age (Reference 135, Brownfield, 1954; Reference 99, Buschbach, 1973).

2.3.1.1.5.1.2.7 St. Louis Fault

The St. Louis Fault (Figure 2.5-13, Mo. No. 2) is a north-south-trending fault (N 5° E) with the west side downthrown 10 feet. The fault is visible only in one exposure in St. Louis, Missouri, but has been traced geophysically for 45 miles north and south of the outcrop (Reference 136, Frank, 1948).

2.5.1.1.5.1.2.8 Cap au Gres Faulted Flexure

The Cap au Gres Faulted Flexure (Figure 2.5-13, Ill. No. 51, Mo. No. 1) is a sharp monoclinical fold broken by numerous faults which trend parallel to the strike of the beds (Reference 99, Buschbach, 1973). The traces of the faults trend southeast through Lincoln County, Missouri, then eastward through Calhoun and Jersey Counties, Illinois (Reference 99, Buschbach, 1973; Reference 137, McCracken, 1971; Reference 138, Rubey, 1952). The maximum amount of structural relief is 1000 to 1200 feet, with beds dipping steeply on the southern flank of the structure. The Lincoln Fold abuts the Cap au Gres Faulted Flexure near its northwestern end. The Dupo-Waterloo Anticline is also believed to abut the flexure but has been mapped only south of the trace of the flexure (Figure 2.5-12, Ill. No. 22). The Lincoln Fold and the Dupo-Waterloo Anticline are believed to be left-laterally offset approximately 30 miles by the Cap au Gres Faulted Flexure (Reference 139, McCracken, 1971). Major deformation along the faults occurred in post-Middle Mississippian, pre-Pennsylvanian time, with minor deformation during post-Pennsylvanian, pre-Pleistocene time (Reference 99, Buschbach, 1973).

2.5.1.1.5.1.2.9 Fortville Fault

The Fortville Fault (Figure 2.5-13, Ind. No. 1) trends N 30° E through central Indiana from southeastern Marion County to northeast Madison County. Dawson (Reference 140, 1971) interpreted the fault as a single trace approximately 54 miles long with an estimated vertical displacement of approximately 60 feet, downthrown to the southeast. His interpretation was based on structure contours on the top of the Ordovician Trenton Limestone. None of the wells drilled near the fault trace has cut the fault plane, and the drillers' logs for these wells contain no information which suggests the presence of features often associated with faulting (Reference 141, Becker, 1975). The fault displaces Middle Devonian strata but does not displace the overlying Pleistocene deposits (Reference 142, Gray, 1974). Interpretation of the geologic history of the Illinois Basin and the Cincinnati Arch suggests that crustal movement in Indiana and Illinois terminated sometime between late Paleozoic and early Mesozoic (Reference 87, Atherton, 1971); therefore, movement along the Fortville Fault is considered to have occurred during that time interval.

2.5.1.1.5.1.2.10 Royal Center Fault

The Royal Center Fault (Figure 2.5-13, Ind. No. 2) is a normal fault which trends approximately N 45° E across north central Indiana from Cass County to Kosciusko County. The Royal Center Fault is interpreted as a single trace approximately 47 miles long. On the basis of structure contours on the top of the Ordovician Trenton Limestone, the fault has a vertical displacement of approximately 100 feet, downthrown to the southeast (Reference 140, Dawson, 1971). None of the wells drilled near the fault trace has cut the fault plane, nor do the drillers' logs for these wells contain any information which suggests the presence of features often associated with faulting (Reference 141, Becker, 1975).

The Royal Center Fault cuts Ordovician and Middle Devonian strata but does not displace the overlying Pleistocene deposits (Reference 142, Gray, 1974). Interpretation of the geologic history of the Illinois Basin and the Cincinnati Arch suggests that crustal movement in Indiana and Illinois terminated sometime between late Paleozoic and early Mesozoic (Reference 87, Atherton, 1971); therefore, movement along the Royal Center Fault is considered to have occurred during that time interval.

2.5.1.1.5.1.2.11 Mt. Carmel Fault

The Mt. Carmel Fault (Figure 2.5-13, Ind. No. 3) is a normal fault which trends approximately N 25° W across south central Indiana from Washington County, north to Monroe County. The fault generally consists of a single trace. The fault plane dips approximately 70° W, downthrown to the west (Reference 143, Melhorn and Smith, 1959). Vertical displacement is approximately 150 feet and may locally exceed 200 feet (Reference 144, Melhorn and Smith, 1959). Melhorn and Smith (Reference 145, 1959) interpreted this fault on both surface and subsurface mapping and concluded that movement along the fault may have begun in Late Mississippian and probably concluded by Early Pennsylvanian. There is no evidence of faulting in the overlying Pleistocene deposits (Reference 142, Gray, 1974). The Mt. Carmel Fault is parallel to the structural trend of the LaSalle Anticlinal Belt in Illinois, and these structures may be genetically related (Reference 146, Melhorn and Smith, 1959).

2.5.1.1.5.1.2.12 Minor Faulting in the Site Area

According to Willman and Payne (Reference 147, 1942), faults of small displacement are not uncommon in the Pennsylvanian strata of the region. The largest displacement reported in the region is one of 10 feet on a fault located about 11 miles northwest of the site (Reference 147, Willman and Payne, 1942). This fault is a normal fault with an approximate north-south strike (Reference 307, Buschbach, 1976). About 9 miles west-northwest of the site, a small thrust fault with about 2 feet of displacement cuts Pennsylvanian strata along the west side of Covell Creek

(Reference 147, Willman and Payne, 1942). This fault strikes approximately east-west, with approximately 5 feet of throw to the south (Reference 307, Buschbach, 1976). The length of the fault is unknown because of the glacial cover (Reference 327, Buschbach, 1977c). The dip of the fault is to the north (Reference 327, Buschbach, 1977c). None of the documented faults was observed to extend into the overlying Pleistocene deposits (Reference 148, Willman, 1976). There is no recorded evidence of this type of faulting in available boreholes and wells from the site area.

In general, small displacements of this type appear to be due to differential compaction and structural adjustments (Reference 307, Buschbach, 1976). In general, structural adjustments along the LaSalle Anticline are divided into two periods (Reference 307, Buschbach, 1976). The first period began in late-Mississippian time and continued to the deposition of the Colchester No. 2 coal in Pennsylvanian time. About one half of the structural adjustment along the LaSalle Anticline took place in this interval. The second period began after the deposition of the No. 2 coal. The upper age limit on this period of structural adjustment is difficult to determine due to the absence of post-Pennsylvanian to pre-Cretaceous strata. No Pleistocene strata are involved in this type of faulting along the LaSalle Anticline, and the end of structural adjustment along the LaSalle Anticline is presumed to be late Paleozoic (Reference 307, Buschbach, 1976). The upper limit for the age of these minor faults is most likely late Paleozoic. Faults recognized at land surface in Illinois have shown no signs of dislocation during post-Cretaceous time (Reference 278, Heigold, 1972).

2.5.1.1.5.1.2.13 Cryptovolcanic or Astrobleme Structures

There are four cryptovolcanic or astrobleme structures within the regional area and its immediate periphery (Figure 2.5-13 and Table 2.5-3, 4, 6). These structures include: the Des Plaines Disturbance (Ill., No. 1), the Kentland Disturbance (Ind., No. 6), the Glovers Bluff Disturbance (Wis., No. 1), and the Glasford Structure (Ill., No. 50). Bucher (Reference 149, 1933) described several known cryptovolcanic structures and noted that they characteristically consist of a central uplift with intense structural derangement and a marginal, ring-shaped depression with irregular and local faulting. Eardley (Reference 150, 1962) noted that the faults composed both a concentric and a radial pattern and that the radial pattern generally is resolved strongly into a northwest-southeast orientation.

Bucher (Reference 151, 1933) proposed that the Kentland Structure was probably the result of a sudden liberation of gases under high pressure. Buschbach and Ryan (Reference 152, 1963) attribute the structures at Glasford, Illinois, to meteorite impact. Ekein and Thwaites (Reference 153, 1930) favored the idea of deformation along Precambrian lines of weakness in explaining the Glover Bluff Structure. Emrich and Bergstrom (Reference 154, 1962) stated that the Des Plaines Disturbance could be the result of meteorite impact during post-Pennsylvanian time. These structures are all probably of Late Paleozoic or Mesozoic age

(Reference 155, Buschbach and Ryan, 1963; Reference 150, Eardley, 1962; Reference 156, Emrich and Bergstrom, 1962).

2.5.1.1.5.1.2.14 Other Postulated Faults

Green (Reference 157, 1957) postulated two faults along the western flank of the LaSalle Anticlinal Belt, which he named the Tuscola Fault and the Oglesby Fault (Figure 2.5-80). The western sides of these faults were inferred to be downthrown. Stratigraphic and structural surveys by the Illinois State Geological Survey (Reference 158, Simon, 1974) encountered no faulting along Green's postulated faults.

Numerous underground gas storage projects have been developed along the west flank of the LaSalle Anticlinal Belt since 1957. Hundreds of structural test borings, many of them drilled to the top of the Galena Group (Trenton) in southern LaSalle, northern McLean, western Champaign, and western Douglas Counties encountered no faulting along the trace of Green's postulated faults (Reference 158, Simon, 1974). The observed differences in elevations of a structural datum on either side of Green's postulated faults can be explained by dips of a few to 10 degrees. Structure tests between the high and low points show intermediate and predictable depths to a structural datum, thus confirming that dipping beds rather than faults best explain the variations in elevations (Reference 158, Simon, 1974).

2.5.1.1.5.1.3 Folds

Information on folding in the sedimentary strata within the regional area has been compiled from various published and unpublished sources. Generalized and detailed maps showing the distribution of reported folds having axial traces of 2 miles or greater in length are presented in Figure 2.5-12. The characteristics of these folds are summarized by state in Tables 2.5-8 through 2.5-12. These folds have all been interpreted on the sedimentary rock sequence.

There are four directions of axial traces in the regional area and immediate periphery: a northwest-southeast group, a north-south group, an east-west group, and a northeast-southwest group. This grouping of folds by directional trend is for convenience in discussion and is not meant to imply a tectonic or genetic relationship.

2.5.1.1.5.1.3.1 Northwest-Southeast Folds

The folds of this group are those which compose the LaSalle Anticlinal Belt, the Leesville Anticline, the Dupo Anticline, the Pittsfield-Hadley Anticline, and a group of anticlines and synclines in southeast Iowa.

2.5.1.1.5.1.3.1.1. LaSalle Anticlinal Belt

A general discussion of the LaSalle Anticlinal Belt as a regional tectonic structure is presented in Subsection 2.5.1.1.5.1.1.5; a general discussion of the individual folds follows. The LaSalle Anticlinal Belt is a series of an echelon, northwest-southeast-trending anticlines, some intervening synclines, a monocline, and numerous domes (Reference 159, Clegg, 1970). The major folds are shown on Figure 2.5-12. The folds range from approximately 6 to 56 miles long. The folds trend approximately N 20° W from the northern boundary of Crawford County, Illinois, to the eastern boundary of Bureau County, Illinois. The greater concentration of folds is in the southern portion of the belt in Coles, Douglas, Edgar, and Clark Counties, Illinois. The concentration of folds decreases northward.

The site is located between two minor folds at the northwest end of the LaSalle Anticlinal Belt, the Ransom Syncline and the Odell Anticline (Figure 2.5-14). These two folds are described in detail in Subsection 2.5.1.2.4.1.

Development of the LaSalle Anticlinal Belt is probably post-Mississippian (Reference 84, Atherton, 1971), with the locus of deformation migrating progressively southward during the Pennsylvanian (Reference 99, Buschbach, 1973; Reference 109, Clegg, 1970). There was probably renewed intermittent activity of the LaSalle Anticlinal Belt until the close of the Paleozoic (Reference 99, Buschbach, 1973; Reference 109, Clegg, 1970).

2.5.1.1.5.1.3.1.2 Leesville Anticline

The Leesville Anticline is a structure that trends approximately N 15° W and extends from southeastern Lawrence to northern Monroe Counties in south central Indiana (Figure 2.5-12, Ind. No. 1). The Leesville Anticline is a major anticlinal structure composed of five domes in an approximate northwest-southeast alignment. The anticlinal structure lies approximately 1 to 2 miles west of, and parallel to, the Mt. Carmel Fault. Between the fault and the anticline there is a series of narrow synclines that close against the fault (Reference 160, Melhorn and Smith, 1959).

Melhorn and Smith (Reference 146, 1959) consider the disturbance along the Leesville Anticline and Mt. Carmel Fault to be genetically related to the LaSalle Anticlinal Belt. Therefore, deformation along the Leesville Anticline is Late Mississippian, pre-Mesozoic (Reference 146, Melhorn and Smith, 1959).

2.5.1.1.5.1.3.1.3 Dupo Anticline

The Dupo Anticline (or Dupo-Waterloo Anticline) is a fold trending approximately N 20° W which extends from Monroe County, Illinois, through St. Louis, Missouri (Figure 2.5-12, Ill. No. 22, Mo. No. 3). The northern end of the anticline is believed

to be offset by the Cap au Gres Faulted Flexure (Reference 99, Buschbach, 1973); however, the anticline has been mapped only south of the flexure (Subsection 2.5.1.1.5.1.1.10). Outcrop patterns show dips of 2° to 3° on the gentle eastern flank of the anticline, whereas the western flank dips 30° or more. Structural relief of the anticline is at least 500 feet near Waterloo, Illinois (Reference 99, Buschbach, 1973).

Major movements along the anticline probably occurred from Late Mississippian to pre-Pennsylvanian time, with renewed uplift in post-Pennsylvanian, pre-Pleistocene time (Reference 99, Buschbach, 1973).

2.5.1.1.5.1.3.1.4 Pittsfield-Hadley Anticline

The Pittsfield-Hadley Anticline is a fold that trends northwest-southeast (N 45° W) and crosses Lewis County, Missouri, and Adams and Pike Counties, Illinois (Figure 2.5-12, Ill. No. 23, Mo. No. 1). Pennsylvanian strata on the flanks of the anticline dip less steeply than those of the underlying Mississippian, suggesting post-Mississippian, pre-Pennsylvanian uplift. Total uplift exceeds 300 feet in some areas (Reference 99, Buschbach, 1973). Folds with similar directional trends but with uplift of slightly more than 100 feet occur in Adams County, Illinois, in Pike County, Missouri, and in Henderson County, Illinois (Media Anticline). The similarities of orientation and stratigraphy with the Pittsfield-Hadley Anticline suggest that the development of the Media Anticline and similar folds was contemporaneous with that of the Pittsfield-Hadley Anticline (Reference 99, Buschbach, 1973; Reference 161, McCracken, 1971).

2.5.1.1.5.1.3.1.5 Folds in Southeastern Iowa

Harris and Parker (Reference 162, 1964) have delineated five anticlines in southeastern Iowa by virtue of borehole data and structure contours on the Burlington Limestone (Early Mississippian). The five structures which generally parallel one another are numbered as follows on Figure 2.5-12: (1) Bentonsport, (2) Skunk River, (3) Burlington, (4) Sperry, and (5) Oquawka Anticlines. Axial trends of these folds vary from N 55° W to N 65° W. Harris and Parker (Reference 163, 1964) place formation of these features as late-Early Mississippian.

2.5.1.1.5.1.3.2 North-South Folds

The north-south folds are represented in the regional area by the intrabasinal structures of the Fairfield Basin: the DuQuoin Monocline and the Salem, Loudon, and Clay City Anticlines.

2.5.1.1.5.1.3.2.1 DuQuoin Monocline

The DuQuoin Monocline is a steep eastward-dipping monoclinical structure that trends north-south from northernmost Jackson County through Perry, Jefferson,

and Marion Counties, Illinois (Figure 2.5-12, Ill. No. 19). The DuQuoin Monocline is 48 miles long and separates the deepest part of the Illinois Basin, the Fairfield Basin, from the shallower western portion of the basin. Pennsylvanian strata east of the monocline are thicker than equivalent beds to the west (Reference 164, Brownfield, 1954).

The monocline is broken by subordinate faults (Reference 99, Buschbach, 1973). Flexure of the DuQuoin Monocline is considered to have begun in the Late Mississippian and was completed by the Middle Pennsylvanian (Reference 165, Brownfield, 1954).

2.5.1.1.5.1.3.2.2 Salem and Louden Anticlines

The Salem and Louden Anticlines (Figure 2.5-12, Ill. Nos. 17 and 18 respectively) are north-south-trending structural highs in the Fairfield Basin. The Salem Anticline extends from central Jefferson County to central Marion County in southern Illinois and is approximately 25 miles in length. The Louden Anticline is located 7 miles northeast of the Salem Anticline. The Louden Anticline extends from the northern county line of Marion County through east-central Fayette County, Illinois, and is approximately 19 miles long.

Pennsylvanian units thin over the Salem and Louden Anticlines, indicating that the two anticlines were uplifted during the Pennsylvanian (Reference 99, Buschbach, 1973).

2.5.1.1.5.1.3.2.3 Clay City Anticline

The Clay City Anticline is a prominent structure in the Fairfield Basin (Appendix 2.5A). It trends north-south from northeastern Hamilton County through Wayne County, Illinois, where it bends and trends N 27° E through Clay, Richland, and Jasper Counties, Illinois (Figure 2.5-12, Ill. No. 16). The axial trace of the Clay City Anticline is approximately 57 miles long.

The anticline is a semicontinuous series of anticlinal uplifts separated by saddles (Reference 166, Du Bois and Siever, 1955). Du Bois and Siever noted that the amplitude of the anticline increases with depth and decreases in the overlying Pennsylvanian strata. They interpreted this to imply that the structure developed during pre-Pennsylvanian time; however, the presence of the fold in the Pennsylvanian strata indicates some folding was Pennsylvanian and/or post-Pennsylvanian.

2.5.1.1.5.1.3.3 Northeast-Southwest Folds

The only northeast-southwest-trending structural feature in the regional area is the Baraboo Syncline.

2.5.1.1.5.1.3.3.1 Baraboo Syncline

The Baraboo Syncline is a complex, doubly plunging, asymmetric syncline. The fold has a trace of approximately 25 miles through Columbia and Sauk Counties, Wisconsin (Reference 167, Dalziel and Dott, 1970; Figure 2.5-12, Wis. No. 1). The north limb is nearly vertical, and the south limb dips gently to the north (Reference 161, Dalziel and Dott, 1970). The structure, which is Precambrian in age, forms a structural and topographic basin infilled with Paleozoic and Pleistocene sediments.

2.5.1.1.5.1.3.4 East-West Folds

East-west folds in the area are represented by a group of structures in southwestern Wisconsin, herein grouped as the Upper Mississippi Valley Folds.

2.5.1.1.5.1.3.4.1 Upper Mississippi Valley Folds

Heyl et al. (Reference 169, 1959) have delineated a complexly folded area in the Upper Mississippi Valley Lead-Zinc District. These folds are on a slight regional dip (18 ft/mi) to the south imposed by the Wisconsin Dome to the north. The folds are grouped into three orders of magnitude on the basis of amplitude and dimensions (Reference 170, Heyl et al., 1959). The folds range from 1 to 200 feet in amplitude, from 100 feet to 40 miles in length, and from 10 feet to 6 miles in width (Reference 171, Heyl et al., 1959).

The two first-order folds, the Mineral Point and Meekers Grove Anticlines (Figure 2.5-12, Wis. Nos. 2 and 3 respectively), are discussed below.

The Meekers Grove Anticline trends east-west from Dubuque County, Iowa, to Janesville County, Wisconsin. Its amplitude ranges from 100 to 200 feet, and it is approximately 65 miles long. The north limb of the anticline dips much more steeply than the south limb. Most of the first- and second-order folds in the district exhibit this asymmetry.

The Mineral Grove Anticline is believed to be continuous with the Allamakee Anticline in Iowa (Reference 172, Heyl et al., 1959; Figure 2.5-12, Ia. No. 6). Mapped as one on Figure 2.5-12, these two anticlines have a complexly curved axis which trends southeast from Allamakee County, Iowa, to Iowa County, Wisconsin, then east to Dane County, Wisconsin. The amplitude of the Mineral Grove Anticline ranges from 100 to 170 feet, and it is approximately 130 miles long. The north limb of the anticline dips more steeply than the south limb (Reference 173, Heyl et al., 1959).

Both the Meekers Grove and the Mineral Point Anticlines cross the Wisconsin Arch to the east. Heyl et al.(Reference 174, 1959) placed formation of these folds as post-Middle Pennsylvanian to pre-Cretaceous.

2.5.1.1.6 Regional Structure

2.5.1.1.6.1 Regional Tectonic Structures

The discussions of regional tectonic features (basins, arches, and domes), faults, and folds in the sedimentary strata are presented in Subsections 2.5.1.1.5.1.1, 2.5.1.1.5.1.2, and 2.5.1.1.5.1.3 respectively. The outlines of the basins, arches, and domes are presented in Figure 2.5-9. The regional fold and fault maps are shown in Figures 2.5-12 and 2.5-13 respectively. Descriptions of the faults and folds by states are presented in Tables 2.5-3 through 2.5-7 and 2.5-8 through 2.5-12 respectively.

2.5.1.1.6.2 Regional Karst

Karst is the type of topography that forms over carbonate strata as the result of solution activity. In well-developed karst areas, features such as sink holes, solution-enlarged joints, disappearing streams, and caves are common. Any carbonate outcrop may however be subject to solution to some degree.

In the regional area, the only true karst areas are the Crawford Upland and the Mitchell Plain of southern Indiana, some 140 miles from the site (Figure 2.5-5). There are areas of carbonate outcrop closer to the site but none within the site vicinity.

2.5.1.1.6.3 Landslides

The Illinois State Geological Survey has reported the occurrence of slump or rotational type landslides along the bluffs of the Illinois River, where Pennsylvanian clays and shales crop out (Reference 175, Du Montelle, Hester, and Cole, 1971; Reference 176, Willman, 1973). Five slide areas have been reported along the south bluff of the Illinois River west of LaSalle, more than 20 miles from the site (Reference 175, Du Montelle, Hester, and Cole, 1971). The slope failures occurred in the shales of the Pennsylvanian Bond and Modesto Formations. The slopes which failed were generally steeper than 20 degrees. Pennsylvanian shales, sandstones, and limestones of the Carbondale Formation crop out in the bluffs along the Illinois River 3 miles north of the site (Figure 2.5-3). The slopes on which the exposures are located are moderate to gentle, ranging from 5 to 16 degrees.

Some minor sliding has been observed in Quaternary deposits along the Illinois River near the site (Reference 177, Willman, 1976). The closest of these minor slides occurs approximately 4 miles northeast of the site near the mouth of Deadly Run

(Reference 177, Willman, 1976). Because of their size, these minor slides present no hazard to the site.

2.5.1.1.6.4 Man's Activities

There are no known cases of or potential possibilities for surface or subsurface subsidence, uplift, or collapse resulting from the activities of man within a 5-mile radius from the LaSalle County Station. Present activities within this area include removal of sand and gravel and the domestic use of groundwater. There are sand and gravel pits as well as clay or shale strip mines within 20 miles of the site.

All of these surface mines and pits are located along the floodplain and terraces of the Illinois River.

The closest sand and gravel pits to the plant are shown on Figure 2.5-16. The sources of sand and gravel are surface alluvial and terrace deposits. These pits may cover several acres, but are shallow and present no hazard to the plant due to subsidence or collapse.

Silica sand for industrial use is removed from quarries in the St. Peter Sandstone near Ottawa, approximately 16 miles west of the plant site (Reference 178, Willman, 1973). These quarries do not represent any possible hazard to the site.

The Colchester (No. 2) and Herrin (No. 6) Pennsylvanian coal beds have been removed from both strip mines and shaft mines within 20 miles of the plant. There are extensive strip mines of the Colchester coal near Morris, in Grundy County, approximately 14 miles northeast of the site. There are also strip mines south of Dayton, approximately 10 miles west of the site. The Herrin and Colchester coals have been mined in a shaft mine northeast of Marseilles and at Dayton, approximately 12 miles northwest of the site (Reference 179, Willman, 1973). The approximate elevations of the tops of the Herrin (No. 6) and Colchester (No. 2) coals at the plant site are +570 feet and +370 (MSL) feet respectively (Reference 180, Cady, 1952). At these depths the coal cannot be mined economically within the limits of known technology. There has been no mining of coal in LaSalle County since 1960 (Reference 181, Malhotra, 1974).

Clay and shale have been removed from shaft and strip mines within 20 miles of the plant site. In many cases they are underclays and have been mined with the overlying coal in the coal mines discussed previously (Reference 179, Willman, 1973). The closest mine to the plant site is a strip mine southeast of Dayton, approximately 10 miles northwest of the site. At this distance from the site, the mine presents no possible hazard.

Not all clay or shale mines are associated with coal mines, and LaSalle County presently produces a substantial tonnage of refractory clay. As with the coal beds,

the depths to the clay or shale horizons at the plant site are cost-prohibitive for mining.

No surface subsidence attributable to consolidation by groundwater withdrawal has been reported near the LSCS site. The largest present demands on the groundwater resource near the site are the municipal wells of Seneca and Marseilles, which pump an approximate average daily volume of 0.2 to 0.5 million gpd (Table 2.4-13). The two municipal wells at Seneca pump groundwater from the Cambrian-Ordovician Aquifer at a depth of 700 feet below the ground surface. The two groundwater production wells at the plant site utilize deeper portions of the Cambrian-Ordovician Aquifer to depths of 1620 and 1629 feet. These aquifer units are not susceptible to consolidation caused by groundwater withdrawal.

There is an underground natural gas storage reservoir (Troy Grove) located approximately 28 miles northwest of the site, but it presents no possible hazard. A map showing the locations of all gas storage facilities located in geologic structures within the radius of 30 miles from the site is presented in Figure 2.5-92. A summary of data on these gas storage fields is presented in Table 2.5-42.

The location of the LSCS site does not preclude the development of any known unique mineral deposits.

2.5.1.1.6.5 Regional Warping

There are no known instances of, or potential possibilities for, surface or subsurface subsidence, uplift, or collapse resulting from regional warping.

2.5.1.1.6.6 Regional Groundwater Conditions

Regional groundwater conditions are presented in various portions of Subsection 2.4.13. For a discussion of possible subsidence due to groundwater withdrawal, see Subsection 2.5.1.1.6.4.

2.5.1.2 Site Geology

To provide clarity and consistency in the remainder of Section 2.5, the following terms are defined here: site - the area within the LaSalle County Station property lines; site vicinity - the area within a 5-mile radius from the LaSalle County Station power block; and site area - the area within a 20-mile radius from the LaSalle County Station Units 1 and 2.

Geological and geophysical investigations were performed at the LaSalle County Station site to determine the lithologic, stratigraphic, and structural geologic conditions at the site. The thickness, physical characteristics, laboratory test

LSCS-UFSAR

results, and geologic history of the soil and rock units encountered at the site are presented here (Subsection 2.5.1.2).

Between May 1970 and December 1975, 293 borings were drilled at the site by Raymond International, Inc., and 11 borings by Layne Western Co. at the locations indicated on Figure 2.5-2, Sheets 1 and 2. Dames & Moore field-logged all Raymond borings, while A&H Engineering logged the Layne Western borings.

The boring logs are presented in Figure 2.5-19. The symbols used on the boring logs are explained on Figure 2.5-17. The method used for classifying the material is described in Figure 2.5-18. Approximately 19,000 feet of soil and rock were logged and sampled. The maximum depth penetrated in the boring program was 360 feet (Boring 2), of which about 165 feet was soil and 195 feet was rock. Boring 2 was completed at an elevation of 330 feet MSL. To supplement boring information, 43 test pits were excavated at the locations indicated on Figure 2.5-2 in which approximately 430 feet of soil and rock were sampled and logged. The test pit profiles are presented in Figure 2.5-21, with the notes on test pits shown in Figure 2.5-20. The test pit depths ranged from 7.5 to 12.0 feet and averaged 8.3 feet. Additional lithologic and stratigraphic information was obtained from records and logs of 83 water wells in the site vicinity.

At the LSCS site, there is approximately 150 feet of soil overlying Pennsylvanian bedrock. This is followed by approximately 3500 feet of sedimentary rock overlying the Precambrian basement.

Soil at the site is generally Holocene to Wisconsinan in age (Reference 182, Kempton, 1975), with minor amounts of Illinoian, Kansan, and pre-Kansan sediments reported in the area (Reference 183, Willman and Payne, 1942). Holocene sediments at the site are primarily alluvium and colluvium along the Illinois River valley. The Wisconsinan sediments are primarily glacial till and outwash deposits with minor amounts of loess, lacustrine, and ice-contact deposits, as well as some terrace gravels along the Illinois River (Reference 184, Willman and Payne, 1942; Reference 185, Willman, 1973).

The thickness of Pleistocene sediments penetrated in borings in the upland portion of the site ranged from 77 feet in Boring D-4 to 228 feet in Boring 33-C-02. The combined Pleistocene deposits have a maximum thickness of approximately 250 feet (Reference 186, Willman and Payne, 1942).

The soil deposits overlie approximately 3500 feet of Pennsylvanian, Ordovician, and Cambrian sedimentary strata, which are in turn underlain by a Precambrian igneous basement complex.

No geologic conditions are known to exist, nor were any discovered during the excavation and construction which adversely affected the design or construction of

LSCS-UFSAR

LSCS Units 1 and 2. Inspections of the excavations by geologists from Sargent & Lundy, Dames & Moore, and the Illinois State Geological Survey confirm that they are entirely within the Yorkville Till Member of the Wedron Formation, as identified in the PSAR-stage borings. The PSAR borings also indicated scattered occurrences of small sand and gravel pockets throughout the till. Inspections verified that these sand and gravel occurrences were in fact isolated pockets. Confirmation of this interpretation is presented in correspondence received from the Illinois State Geological Survey, who made site visits on April 11, 1974, and September 27, 1976 (see Appendices 2.5B and 2.5C respectively). These pockets have no effect on the design or construction of the main plant excavation. Three larger isolated deposits of sand and gravel exposed in the CSCS flume and pond are discussed in Subsection 2.5.4.14. Main plant excavation photos are presented in Figures 2.5-89 and 2.5-90.

2.5.1.2.1 Site Physiography

The LSCS site is in the Bloomington Ridged Plain subsection of the Till Plains section of the Central Lowland Province (Reference 6, Fenneman, 1935; Reference 187, Leighton, Ekblaw, and Horberg, 1948; Reference 188, Willman and Frye, 1970). The site may be divided into two portions, the upland portion on the Ransom Moraine, and the valley bottom portion on the floodplain of the Illinois River (Figure 2.5-2, Sheet 1). The power block, the discharge flume, and the cooling lake are on the upland portion; the river screen house is on the valley bottom portion. The upland moraine is topographically separated from the valley bottom floodplain by the Illinois River bluff. The maximum topographic relief from the upland moraine to the valley bottom floodplain is approximately 255 feet (Figure 2.5-2, Sheet 1).

2.5.1.2.1.1 Uplands

The upland portion of the site is located on the Ransom Moraine, part of the Marseilles Morainic System (Figure 2.5-22). The Ransom Moraine, which is Wisconsinan in age, is the youngest and most prominent moraine in the Marseilles Morainic System. This morainic system is part of the Peoria Sublobe, which belongs to the Lake Michigan Lobe of Woodfordian glacial deposits (Figure 2.5-23). At the site, the Ransom Moraine trends north-south and is deeply incised by the Illinois River. The moraine is 6 to 8 miles wide with a crest approximately 160 feet above the lake plains on either side (Figure 2.5-22). It has an asymmetrical shape, being steeper on the west, or front slope than on the east, or back slope. The contact with the Norway Moraine, which borders the front slope, is distinct, but the change to the ground moraine of the back slope is gradational. The upland portion of the site is located on the east slope of the Ransom Moraine.

The uplands topography is gently rolling and slopes gradually to the north and east. Upland topographic relief is low to moderate, with the greatest relief to the north

and west along tributaries of the Illinois River (Figure 2.5-2, Sheet 1). A maximum elevation of about 732 feet is reached on the west end of the site, towards the crest of the Ransom moraine. At the north end of the site, a minimum elevation of about 485 feet is reached in the Illinois River valley. In the area covered by LSCS Units 1 and 2, the relief is low, with elevation differences generally about 10 to 20 feet. Overall relief from LSCS Units 1 and 2 to the valley bottom along the Illinois River is approximately 250 feet. Upland surface drainage is well developed and flows toward the north and northeast to the Illinois River valley. Surface drainage to the north is through intermittent branches of South Kickapoo Creek, Spring Brook, and an unnamed stream (Figure 2.5-2, Sheet 1). Intermittent branches of Hog Run and Armstrong Run collect surface drainage to the east and northeast. All streams discharge into the Illinois River. Stream valleys in the upland portion of the site are broad, with gradients of approximately 20 feet per mile. Near the bluff of the Illinois River, valleys become more deeply incised and have higher gradients as the streams approach the base level of the Illinois River (elevation 483 feet MSL). Most of the streams on the upland portion of the site have valleys that are eroded entirely in glacial drift. In the north part of the site, some of the stream valleys may be eroded into Ticona Bedrock Valley fill. Valley walls are usually gently sloping because of the rapid erosion of drift by slopewash followed by the deposition of this material in the valley bottoms. These valleys are usually shallow with low walls and frequently develop a meandering course and broad bottom lands.

2.5.1.2.1.2 Valley Bottom

At the site, the Illinois River valley is characterized by moderately steep valley walls with slopes ranging from approximately 5° to 16°. Slopes are more gentle east of Marseilles (Figure 2.5-3), where the valley walls are composed largely of drift, although bedrock of Pennsylvanian age is exposed locally along their base (Reference 189, Willman and Payne, 1942). West of Marseilles, where bedrock of Pennsylvanian and Ordovician age comprises most of the valley walls, slopes are steeper (Reference 190, Willman and Payne, 1942). The height of the bluffs along the Illinois River valley at the site ranges from approximately 90 to 140 feet.

Within the Illinois River valley, the channel bends from side to side, sometimes impinging against the valley walls. Normal pool elevation of the Illinois River in the reach above the Marseilles Dam is approximately 483 to 484 feet MSL. The valley bottom is usually uniform in width, averaging about 7900 feet. In general it is broadest to the east of the site and narrowest to the west of the site. In the portion of the Illinois River valley at the site, bedrock usually underlies a few inches of sand and gravel in the deepest part of the river channel (Reference 191, Willman and Payne, 1942).

Much of the valley bottom consists of a series of terraces in which the present Illinois River occupies a narrow channel (Reference 192, Willman and Payne, 1942). The terraces are composed of glaciofluvial outwash and have been dissected as a

result of base level changes of the Illinois River. These terraces range from about 1300 to 2600 feet wide and 5 to 15 feet deep.

2.5.1.2.1.3 Site Karst

There is no evidence of karstic features at the site.

2.5.1.2.2 Site Stratigraphy

Stratigraphic descriptions of materials at the site are subdivided into two categories: soil and rock. The physical characteristics and the stratigraphic relationships have been determined from literature review, test boring data, inspection of test pits, inspection of plant excavations, data from site water wells, and from laboratory testing.

The LaSalle County Station, Units 1 and 2, is founded entirely on soil. The characteristics and engineering properties of the soil and rock are presented in Subsection 2.5.4.2. A map showing the distribution of soil units in the site vicinity is presented in Figure 2.5-3. Soil stratigraphic columns of the site area are presented in Figures 2.5-24 and 2.5-25. A map showing the distribution of agricultural soils, representing weathering modifications in the uppermost soil deposits, is presented in Figure 2.5-26. A description of these agricultural soils is included in Table 2.5-13. A map showing the distribution of the bedrock units in the site area is presented in Figure 2.5-4. A rock stratigraphic column in the site vicinity is presented in Figure 2.5-27. The stratigraphic nomenclature for the soil is based on Reference 90 (Willman and Frye, 1970); the stratigraphic nomenclature for the rock is based on Reference 193 (Willman et al., 1975).

2.5.1.2.2.1 Soil

The term soil in this subsection is being used in the engineering sense to indicate those deposits overlying the bedrock. The soil at the site has been subdivided into that present in the uplands and that present in the valley bottoms. Descriptions of the soil deposits include the stratigraphic classification, age, lithologic description, thickness, distribution, mode of origin, and stratigraphic relationships with overlying and/or underlying strata.

2.5.1.2.2.1.1 Uplands

The surficial soil stratigraphic units in the upland portion of the site are shown in Figure 2.5-3. The soil stratigraphic units present include the Cahokia Alluvium, Peyton Colluvium, Richland Loess, Wedron Formation, and the undifferentiated buried bedrock valley fill (Figure 2.5-24).

2.5.1.2.2.1.1.1 Cenozoic Erathem (Present to 65 ± 2 Million Years Old)

2.5.1.2.2.1.1.1.1 Quaternary System (Present to 2 ± 1 Million Years Old)

2.5.1.2.2.1.1.1.1.1 Pleistocene Series

2.5.1.2.2.1.1.1.1.1.1 Cahokia Alluvium

The Cahokia Alluvium is represented in the upland portion of the site by thin, silty, alluvial deposits along the stream valleys. Willman and Frye (Reference 194, 1970) state that the alluvium began to accumulate in many valleys as soon as they were free of ice. The alluvium may therefore range in age from Holocene to late Wisconsinan. Because the deposit is derived from loess and till, it is composed predominantly of silt and clay with a few sand lenses. The Cahokia Alluvium grades or interfingers into the Peyton Colluvium at the edges of stream floodplains and overlies either the Wedron Formation or buried bedrock valley fill.

2.5.1.2.2.1.1.1.1.1.2 Peyton Colluvium

The Peyton Colluvium is represented in the upland portion of the site by thin deposits of poorly sorted colluvial sediments along the bottoms of slopes of tributary stream valleys which have dissected the bluff. This formation is dominantly a pebbly, clayey silt, but its composition depends on the adjacent slope material. The Peyton Colluvium may range in age from Holocene to late Wisconsinan and grades or interfingers into the Cahokia Alluvium at floodplain level (Reference 195, Willman and Frye, 1970; Reference 196, Willman, 1973).

2.5.1.2.2.1.1.1.1.1.3 Richland Loess

The Richland Loess in the upland portion of the site consists of windblown silt. This unit has been modified by weathering to a slightly clayey silt. The Richland Loess may range in age from Woodfordian to Valderan (Reference 197, Willman and Frye, 1970). This deposit overlies the Wedron Formation and is the uppermost soil stratum in the upland portion of the site. The Richland Loess is locally absent to 4 feet thick. Occasionally, the loess measures up to 8 feet thick (Reference 198, Kempton, 1972).

2.5.1.2.2.1.1.1.1.1.4 Wedron Formation

The Wedron Formation is represented in the upland portion of the site by the Woodfordian age Yorkville, Malden, and Tiskilwa Till Members and their associated outwash deposits. In the power block and cooling lake areas, the thickness of the Wedron Formation ranges from 120 to 140 feet. The thickness of the formation decreases northward toward the dissected uplands where the unit has been eroded along tributary ravines and the bluff of the Illinois River.

The Wedron Formation was not differentiated into members on the boring logs; however, Dr. J. P. Kempton of the Illinois State Geological Survey identified the Yorkville, Malden, and Tiskilwa Till Members of the Wedron Formation using representative soil samples from Boring 4 (General Reference, Kempton, 1975).

Within the Wedron Formation in the power block area, some borings encountered a sand and gravel deposit, generally at elevation 595 feet MSL (Figure 2.5-56 and Table 2.5-29). This was described in the boring logs as ranging from a brown to gray, dense, silty sand with gravel to a brownish-gray, fine sandy silt with gravel. This sand and gravel deposit generally occurred in the lower portion of the Malden Till Member or at the contact between the Malden and Tiskilwa Till Members.

Inasmuch as these sands and gravels are quite possibly of glacial outwash origin, it is very likely that they occur in scattered disconnected bodies, considering the irregular pattern of glacial meltwater streams near ice fronts. Indeed, 9 of the 31 borings in the area (29%) did not encounter sand and gravel at this elevation. However, as the discontinuity of the sand and gravel deposit cannot be conclusively demonstrated in any practical way, the engineering analyses for design assumed, conservatively, that the granular material between the Malden and Tiskilwa tills is continuous under the main plant structures. As shown in Subsection 2.5.4.8.1, even with this most unfavorable assumption, the sands and gravels pose no threat to site stability.

2.5.1.2.2.1.1.1.1.4.1 Yorkville Till Member

The Yorkville Till Member is 90 feet thick in Boring 4 (Reference 198, Kempton, 1972), with the elevation of its base at about 610 feet MSL. Grain size and clay mineral analyses of Yorkville till samples collected from the power block excavation and site borings averaged 7% sand, 43% silt, and 50% clay for that portion finer than 2 mm, with 2% expandable clay minerals for that portion finer than two microns (Reference 199, Kempton, 1975).

At the top of the Yorkville Till Member and below the Richland Loess is a deposit interpreted to be ablation drift. This is a discontinuous deposit of sandy, gravelly, till-like material which ranges up to 4 feet in thickness along the face of the power block excavation (Reference 199, Kempton, 1975).

2.5.1.2.2.1.1.1.1.4.2 Malden Till Member

The thickness of the Malden Till Member is 35 feet in Boring 4 (Reference 198, Kempton, 1972). It is bounded above by the Yorkville Till Member and below by the Tiskilwa Till Member.

2.5.1.2.2.1.1.1.1.4.3 Tiskilwa Till Member

The thickness of the Tiskilwa Till Member is 30 feet in Boring 4 (Reference 198, Kempton, 1972). It is bounded above by the Malden Till Member, and over most of the upland portion of the site it unconformably overlies the Pennsylvanian-age Carbondale Formation.

2.5.1.2.2.1.1.1.1.5 Buried Bedrock Valley Fill

The LSCS site is located over a saddle in the bedrock divide separating the buried Ticona Bedrock Valley to the northwest and a tributary of the buried Kempton Bedrock Valley to the southeast (Figure 2.5-28).

The buried Ticona Bedrock Valley extends east-west across the site between the power block and the Illinois River valley. According to Randall (Reference 200, 1955), the main cutting of the Ticona Bedrock Valley occurred at least as early as Kansan. Although deposits as old as Kansan and pre-Kansan may be present (Reference 183, Willman and Payne, 1942), most of the sediments filling the Ticona Bedrock Valley are probably Wisconsinan and Illinoian (Reference 201, Randall, 1955).

In the site vicinity, the buried Ticona Bedrock Valley is 1.5 to 3 miles wide and is cut to an elevation of approximately 450 feet MSL (Reference 200, Randall, 1955). The valley is filled with glacial outwash to an elevation of roughly 540-560 feet MSL (Reference 202, Randall, 1955). As seen in Borings 5-B-01 and 33-C-02, the outwash consists mainly of sandy gravels and gravelly sands with lesser amounts of silt and clay in the matrix and in scattered thin layers. Randall (Reference 203, 1955) describes an exposure near Seneca (Geologic Section 33-5E-35-1g) which reveals 14 feet of sand and somewhat clayey gravel overlying 20 feet of very clean, very well-sorted medium sand.

A tributary of the buried Ticona Bedrock Valley extends under the north side of the site, and a tributary of the buried Kempton Bedrock Valley extends under the south side of the site (Figure 2.5-28). The outwash in these valleys is similar in composition to the outwash in the main buried bedrock valley (see Borings 1, 3, 68, 69, D-5, and D-8).

2.5.1.2.2.1.2 Valley Bottoms

The soil stratigraphic units in the valley bottom are shown in Figure 2.5-3. The soil stratigraphic units present include the Peyton Colluvium, Grayslake Peat, Cahokia Alluvium, and Henry Formation (Figure 2.5-25).

2.5.1.2.2.1.2.1 Cenozoic Erathem (Present to 65 ± 2 Million Years Old)

2.5.1.2.2.1.2.1.1 Quaternary System (Present to 2 ± 1 Million Years Old)

2.5.1.2.2.1.2.1.1.1 Pleistocene Series

2.5.1.2.2.1.2.1.1.1.1 Grayslake Peat

The Grayslake Peat is a discontinuous surficial deposit found on the floodplain of the Illinois River. It often has a high clay or silt content and is usually described as muck or silt rich in organic material, with beds of marl locally. The thickness of the peat in most areas is not known, but the peat deposits in the floodplain lakes and ponds probably do not exceed 5 to 10 feet in thickness (Reference 204, Willman, 1973). The Grayslake Peat ranges in age from Holocene to late Wisconsinan (Reference 205, Willman and Frye, 1970).

2.5.1.2.2.1.2.1.1.1.2 Peyton Colluvium

The Peyton Colluvium is represented in the valley bottom by linear deposits of poorly sorted colluvial sediments along the bottoms of the slopes of the Illinois River bluffs. The unit includes alluvial fan material found at the mouths of gullies along the valley walls (Reference 206, Willman, 1973). This formation is dominantly a pebbly, clayey silt, but its composition depends on the adjacent slope material. The thickness of the colluvium is variable, with a maximum thickness of about 40 feet. The Peyton Colluvium may range in age from Holocene to Woodfordian and grades or interfingers into the Cahokia Alluvium or the Henry Formation at floodplain or terrace level (Reference 195, Willman and Frye, 1970; Reference 196, Willman, 1973).

2.5.1.2.2.1.2.1.1.1.3 Cahokia Alluvium

The Cahokia Alluvium in the valley bottom is a discontinuous, surface valley fill deposit on the floodplain of the Illinois River. The unit includes alluvial fan material located at the mouths of tributary stream valleys (Reference 207, Willman, 1973). The alluvium is a poorly sorted sandy or clayey silt with lenses of sand and gravel. It ranges in age from Holocene to Woodfordian (Reference 194, Willman and Frye, 1970). In some areas on the floodplain, localized channel scouring has removed the Cahokia Alluvium and older soils and has exposed bedrock of the Pennsylvanian-age Carbondale Formation. Where present, the alluvium is generally 2 to 4 feet thick but may be thicker (4 to 20 feet) in abandoned channels and tributary alluvial fans.

2.5.1.2.2.1.2.1.1.4 Henry Formation

In the Illinois River valley, the Henry Formation occurs principally as low terraces (Reference 208, Willman, 1973). These terraces are composed of predominantly dolomitic, generally cobbly, coarse gravel (10 to 20 feet thick) underlain by finer sandy gravel. The terrace surface, 20 to 30 feet above the floodplain, is rough, with numerous ridges or bars as much as 20 feet high. In the valley bottom, the Henry Formation is mostly underlain by strata of the Carbondale Formation (Reference 209, Willman, 1973).

2.5.1.2.2.1.3 Soil Conservation Service Soil Series

Weathering processes have modified the upper portions of the soil units across the site. The U.S. Department of Agriculture, Soil Conservation Service (SCS), has classified the weathering profiles in the soil into soil series. A soil series is defined on the basis of those weathering profiles which are similar except for the texture of the uppermost horizon (A-horizon) and are developed from a particular type of parent material.

Soil series in LaSalle County have been mapped by the SCS in cooperation with the University of Illinois Agricultural Experiment Station. Sixteen of these soil series are present within the upland portion of the LaSalle County Station. All of these soil series are developed in loess overlying glacial till. The distribution of these soil series is shown on Figure 2.5-26. The characteristics and general engineering properties of each series are presented in Table 2.5-13. The information is derived from published data made available by the office of the SCS (Reference 210, 1973-1975) and by the U.S. Department of Agriculture, University of Illinois Agricultural Experiment Station (Reference 211, 1972). Descriptions and characteristics of the parent materials are presented in Subsection 2.5.1.2.2.1.1.

The upland portion of the LaSalle County Station is comprised predominantly of three soil series: the Swygert silt loam (Map No. 91), the Bryce silty clay (Map No. 235), and the Rutland silt loam (Map No. 375). Swygert soils are developed in loess over silty clay glacial till under prairie native vegetation (Reference 212, Alexander and Paschke, 1972); Bryce soils are developed in loess or silty material over silty clay glacial till under swamp grass native vegetation (Reference 213, Alexander and Paschke, 1972); the Rutland soils are developed in loess over silty clay and clay glacial till under prairie native vegetation (Reference 214, Alexander and Paschke, 1972).

2.5.1.2.2.2 Rock

At the LaSalle County Station site, the bedrock units encountered in 54 borings range in age from Pennsylvanian to Ordovician (Pennsylvanian strata unconformably overlies Ordovician strata at the site). Bedrock units below the

elevation penetrated by these borings are Ordovician and Cambrian sedimentary strata which rest unconformably on the Precambrian basement complex.

The geologic column showing the stratigraphic section in the site area is presented in Figure 2.5-27. This stratigraphic column includes several Pennsylvanian and Ordovician formations which may be present within 20 miles of the site but which were not present in the site borings due to periods of erosion in the time intervals between deposition of the various formations.

The discussion of site stratigraphy includes a generalized lithologic description of the Carbondale Formation, Spoon Formation, and Platteville Group as penetrated by 6 D-series borings, 24 R-series borings, and 24 plant site borings. Only one test boring (Boring 2) penetrated into the Platteville Group. The descriptions of the underlying units are summaries from Buschbach (Reference 215, 1964); Kosanke et al. (Reference 216, 1960); Willman et al. (Reference 217, 1967); and Willman et al. (Reference 193, 1975). Thicknesses of stratigraphic units below the Pennsylvanian strata are estimated from the logs of two nearby water wells, the Marseilles No. 3 municipal well and the E.I. du Pont No. 6 well (Reference 218, Illinois State Geological Survey), and from available literature (Figure 2.4-13 and Table 2.4-9).

Test borings drilled in the power block area of the site encountered bedrock at depths ranging from 150 to 180 feet (elevation 543 to 529 feet MSL). Borings drilled in the valley bottom portion of the site encountered bedrock at depths ranging from 1 to 13 feet (elevation 503 to 475 feet MSL). Between the power block area and the river, a few borings penetrated the buried Ticona Bedrock Valley and encountered bedrock at an elevation of about 450 feet MSL. Boundaries between strata encountered in the borings are usually gradational. The individual units are for the most part thinly bedded, displaying essentially horizontal bedding. The strata are very competent. Although several zones of joints were recorded on the core logs, no evidence of movement was noted.

In the following subsections, descriptions of rock strata are included for those formations penetrated by site borings and those formations which logs of the Marseilles municipal and du Pont industrial wells (Reference 218, Illinois State Geological Survey; Figure 2.4-13) or available literature indicate as underlying the site (Figure 2.5-27).

2.5.1.2.2.2.1 Paleozoic Erathem (225 ± 5 to 600 [?] Million Years Old)

2.5.1.2.2.2.1.1 Pennsylvanian System (270 ± 5 to 320 ± 10 Million Years Old)

2.5.1.2.2.2.1.1.1 Desmoinesian Series

2.5.1.2.2.2.1.1.1.1 Kewanee Group

2.5.1.2.2.2.1.1.1.1 Carbondale Formation

The Carbondale Formation forms the erosional bedrock surface for most of the site area (Figure 2.5-4). None of the borings penetrated a complete section of the formation. The unit outcrops north of the site in the Illinois River valley.

The Carbondale Formation is made up of five cyclothems, each of which represents a cycle of marine retreat followed by marine advance. In descending order these are the Brereton, the St. David, the Sumnum, the Lowell, and the Liverpool cyclothems. These cyclothems are composed of alternating strata of shale, sandstone, clay, coal, limestone, siltstone, and many intergradational types. A highly organic shale was encountered at about elevation 455 to 470 feet MSL and was used as a marker horizon to determine the position of the strata in the cyclothem series and for correlation and structural evaluation (Figures 2.5-29 through 2.5-31).

Toward the base of the Lowell cyclothem is a 3-foot-thick coal unit, the Colchester No. 2 Coal. The bottom of this coal unit marks the contact between the Carbondale Formation and the underlying Spoon Formation. Boring 2 was the only boring to reach the base of the Carbondale Formation (elevation 393 feet MSL). The thickness of the unit in this boring was 151 feet. The elevation of the erosional surface on the Carbondale Formation ranged from a maximum of about 550 feet MSL to a minimum of about 450 feet MSL in borings on the site. In the site borings, the formation was made up of approximately 83% shales, 9% siltstones, 4% sandstones, 2% limestones, and 2% coals.

2.5.1.2.2.2.1.1.1.2 Spoon Formation

The Spoon Formation exists throughout the site as a continuous subsurface unit. This unit forms the erosional bedrock surface in part of the buried Ticona Bedrock Valley about a mile north of the plant area (Figures 2.5-4 and 2.5-28). Outcrops of the unit occur locally in the Illinois River valley northwest of the site. The Spoon Formation has a total thickness of 25 feet in Boring 2, which was the only boring that fully penetrated the unit. The top of the formation was reached at an elevation of 393 feet MSL.

In Boring 2, the Spoon Formation is comprised of about 5 feet of underclay of the Colchester No. 2 Coal overlying about 20 feet of gray shale. The underclay is greenish to brownish, soft, and nonbedded. The shale is gray to green, massive, calcareous, fissile, organic, somewhat soft, and silty. The description of the underclay of the Colchester No. 2 Coal by Willman and Payne (Reference 219, 1942) suggests that the entire Spoon Formation at the site may belong to the lower part of the Liverpool cyclothem. In the site area, the base of the Spoon Formation rests unconformably on Ordovician limestone of the Platteville Group (Reference 220, Willman and Payne, 1942).

2.5.1.2.2.2.1.2 Ordovician System (430 ± 10 to 500 [?] Million Years Old)

2.5.1.2.2.2.1.2.1 Champlainian Series

2.5.1.2.2.2.1.2.1.1 Blackriveran Stage

2.5.1.2.2.2.1.2.1.1.1 Platteville Group

The Platteville Group exists throughout the site as a continuous subsurface unit. It was encountered in Boring 2 but was not fully penetrated.

The Platteville Group is composed of mottled light gray to dark gray limestones of Ordovician age. The limestones are dense and fine- to medium-grained with a small amount of clay and chert. Regionally, the group consists of (from top to bottom) the Quimbys Mill Formation, the Nachusa Formation, the Grand Detour Formation, the Mifflin Formation, and the Pecatonica Formation. The depth to the Platteville Group in Boring 2 was 341 feet (elevation 367 feet MSL). The thickness penetrated was only 19 feet. In Boring 2, the Platteville Group is a mottled light gray to gray, massive, slightly argillaceous, slightly dolomitic limestone.

The contact between the Platteville Group and the overlying Pennsylvanian strata represents a pre-Pennsylvanian erosional surface; thus, the thickness of the group is variable. A slightly weathered zone with an accumulation of chert fragments was encountered at the contact. Regional structure maps contoured on the top of the underlying Ancell Group indicate that the Platteville-Ancell contact is at approximately elevation 250 to 300 feet MSL, suggesting that the thickness of the Platteville Group at the site is on the order of 50 to 100 feet (Reference 221, Willman and Payne, 1942). The Platteville Group was 132 feet thick in the du Pont No. 6 well log but was absent in the Marseilles No. 3 well log (Reference 218, Illinois State Geological Survey). The contact with the underlying Ancell Group is unconformable (Reference 222, Willman and Payne, 1942).

2.5.1.2.2.2.1.2.1.1.1.1 Nachusa Formation

The Nachusa Formation consists primarily of thick-bedded, vuggy dolomite. The estimated thickness of the Nachusa Formation at the site is 15 feet (Reference 223, Willman et al., 1975).

2.5.1.2.2.2.1.2.1.1.1.2 Grand Detour Formation

The Grand Detour Formation consists primarily of medium-bedded, dolomitic, slightly argillaceous limestone. The estimated thickness of the formation at the site is 30 feet (Reference 224, Willman et al., 1975).

2.5.1.2.2.2.1.2.1.1.1.3 Mifflin Formation

The Mifflin Formation consists primarily of thin-bedded, shaly limestone. The estimated thickness of the Mifflin Formation at the site is 15 feet (Reference 225, Willman et al., 1975).

2.5.1.2.2.2.1.2.1.1.1.4 Pecatonica Formation

The Pecatonica Formation consists primarily of medium- to thick-bedded, vuggy dolomite. The estimated thickness of the Pecatonica Formation at the site is 20 feet (Reference 226, Willman et al., 1975).

2.5.1.2.2.2.1.2.1.1.2 Ancell Group

2.5.1.2.2.2.1.2.1.1.2.1. Glenwood Formation

The Glenwood Formation consists primarily of gray to white, rounded, pyritic sandstone. The estimated thickness of the formation at the site is 10 feet (Reference 218, Illinois State Geological Survey).

2.5.1.2.2.2.1.2.1.1.2.2 St. Peter Sandstone

The St. Peter Sandstone is a light gray to buff, fine- to medium-grained, friable sandstone. The St. Peter Sandstone is predominantly composed of fine to medium, poorly graded, well-rounded, frosted, exceptionally pure quartz sand (Reference 227, Willman et al., 1975). Locally the basal few feet consist mainly of sandy, dolomitic shales containing varicolored chert pebbles and some beds of conglomeratic sandstone (Reference 228, Willman and Payne, 1942).

The estimated thickness of the St. Peter Sandstone at the site is 225 feet (Reference 212, Illinois State Geological Survey). The St. Peter Sandstone lies unconformably on the Shakopee Dolomite (Reference 228, Willman and Payne, 1942).

2.5.1.2.2.2.1.2.2 Canadian Series

2.5.1.2.2.2.1.2.2.1 Prairie du Chien Group

2.5.1.2.2.2.1.2.2.1.1 Shakopee Dolomite

The Shakopee Dolomite is a light gray to light brown, fine-grained, cherty, somewhat sandy dolomite with some thin beds of dolomitic sandstone and shale (Reference 229, Buschbach, 1964; Reference 230, Willman and Payne, 1942). The estimated thickness of the formation at the site is 35 feet (Reference 218, Illinois State Geological Survey). The Shakopee Dolomite conformably overlies the New Richmond Sandstone.

2.5.1.2.2.2.1.2.2.1.2 New Richmond Sandstone

At the site, the New Richmond Sandstone consists of white or light gray to buff, friable, porous, somewhat dolomitic sandstone. The sandstone is fine- to coarse-grained, rounded, and slightly oolitic (Reference 231, Buschbach, 1964; Reference 232, Willman and Payne, 1942). The estimated thickness of the formation in the site vicinity is 80 feet (Reference 218, Illinois State Geological Survey). At the site, the New Richmond Sandstone conformably overlies the Oneota Dolomite.

2.5.1.2.2.2.1.2.2.1.3 Oneota Dolomite

The Oneota Dolomite is light gray to white, occasionally pink, fine- to coarse-grained, cherty dolomite (Reference 227, Willman and Payne, 1942). At the site, the estimated thickness of the formation is 230 feet (Reference 218, Illinois State Geological Survey). The Oneota Dolomite conformably overlies the Gunter Sandstone.

2.5.1.2.2.2.1.2.2.1.4 Gunter Sandstone

The Gunter Sandstone consists primarily of white, loosely cemented, fine- to medium-grained sandstone (Reference 234, Willman et al., 1975; Reference 218, Illinois State Geological Survey). The estimated thickness of the formation at the site is 20 feet (Reference 218, Illinois State Geological Survey). The Gunter Sandstone unconformably overlies the Eminence Formation.

2.5.1.2.2.2.1.3 Cambrian System (500 [?] to 600 [?] Million Years Old)

2.5.1.2.2.2.1.3.1 Croixian Series

2.5.1.2.2.2.1.3.1.1 Trempealeauan Stage

2.5.1.2.2.2.1.3.1.1.1 Eminence Formation

The Eminence Formation is a sandy, fine- to medium-grained dolomite with oolitic chert and thin beds of sandstone and shale (Reference 235, Willman et al., 1975). The estimated thickness of the formation at the site is 75 feet (Reference 218, Illinois State Geological Survey; Reference 236, Willman et al., 1975). The Eminence Formation conformably overlies the Potosi Dolomite.

2.5.1.2.2.2.1.3.1.1.2 Potosi Dolomite

The Potosi Dolomite, formerly included in the Trempealeau Formation, is a gray to pink, cherty, locally sandy, fine-grained dolomite with a few lenses of medium-grained, dolomitic sandstone. The estimated thickness at the site is 175 feet

(Reference 237, Willman et al., 1975; Reference 218, Illinois State Geological Survey). The Potosi Dolomite conformably overlies the Franconia Formation, and the contact between the stratigraphic units is gradational.

2.5.1.2.2.2.1.3.1.2 Franconian Stage

2.5.1.2.2.2.1.3.1.2.1 Franconia Formation

The Franconia Formation is a varicolored, fine-grained, glauconitic, dolomitic sandstone interbedded with varicolored, glauconitic dolomites and shales. At the site, the estimated thickness of the formation is 160 feet (Reference 238, Willman et al., 1975; Reference 218, Illinois State Geological Survey). The Franconia Formation conformably overlies the Ironton Sandstone.

2.5.1.2.2.2.1.3.1.2.2 Ironton Sandstone

The Ironton Sandstone is a medium-grained, well-graded, dolomite-cemented sandstone (Reference 239, Willman et al., 1975). At the site, the estimated thickness of the Ironton Sandstone is 75 feet (Reference 218, Illinois State Geological Survey). The Ironton Sandstone conformably overlies the Galesville Sandstone. The hydrogeologic properties of the Ironton Sandstone are presented in Subsection 2.4.13.1.1.5.

2.5.1.2.2.2.1.3.1.3 Dresbachian Stage

2.5.1.2.2.2.1.3.1.3.1 Galesville Sandstone

The Galesville Sandstone is a clean to locally silty, fine-grained, moderately poorly graded sandstone (Reference 240, Willman et al., 1975). At the site, the estimated thickness of the Galesville Sandstone is 80 feet (Reference 218, Illinois State Geological Survey). The hydrogeologic properties of the Galesville Sandstone are presented in Subsection 2.4.13.1.1.5.

2.5.1.2.2.2.1.3.1.3.2 Eau Claire Formation

The Eau Claire Formation is gray to pink, fine- to coarse-grained, sometimes glauconitic, dolomitic sandstone with varicolored, dolomitic, silty shale and gray to pink, sometimes sandy, fine-grained dolomite. At the site, the Eau Claire Formation is estimated to be 450 feet thick (Reference 241, Willman et al., 1975). The contact between the Eau Claire Formation and the underlying Mt. Simon Sandstone is slightly disconformable (Reference 242, Willman and Payne, 1942).

2.5.1.2.2.2.1.3.1.3.3 Mt. Simon Sandstone

The Mt. Simon Sandstone is varicolored, fine- to coarse-grained sandstone with some thinly bedded shale. At the site, the formation has an estimated thickness of 2500 feet (Reference 243, Willman et al., 1975). The Mt. Simon Sandstone unconformably overlies the Precambrian basement complex.

2.5.1.2.2.2.1.4 Precambrian Basement Complex (Over 600 [?] Million Years Old)

The regional Precambrian surface map (Figure 2.5-10) indicates that the elevation of the Precambrian surface at the site is approximately 3500 feet below mean sea level. Three deep boreholes in northern LaSalle County that have reached the Precambrian have encountered granite and granodiorite at 2788 to 3037 feet below mean sea level (Reference 244, Bradbury and Atherton, 1965).

2.5.1.2.3 Bedrock Topography

Based on data available from the literature, test borings at the site, and review of well logs on file with the Illinois State Geological Survey, the bedrock topography at the site can be described as an irregular erosional surface on the Pennsylvanian strata. The site is underlain by a bedrock divide (Figure 2.5-28) separating tributaries of the buried Ticona Bedrock Valley to the northwest and the buried Kempton Bedrock Valley to the southeast. Bedrock relief at the site is on the order of 150 to 200 feet. Bedrock relief under the power block is slight, varying from approximately 5 to 15 feet. Over the buried bedrock valleys at the site, the soil deposits may be as much as 300 feet thick, while over the bedrock divide, the soil deposits thin to a minimum of approximately 70 feet thick.

2.5.1.2.4 Site Structural Geology

The site lies on the northern end of the Illinois Basin (see Subsection 2.5.1.1.5.1.1.4) and on the eastern flank of the LaSalle Anticlinal Belt (see Subsection 2.5.1.1.5.1.1.5) between two lesser structures belonging to the LaSalle Anticlinal Belt: the Ransom Syncline to the west and the Odell Anticline to the east (Figure 2.5-14). Both are broad features regionally trending northwest to southeast parallel to the LaSalle Anticlinal Belt and plunging to the south into the Illinois Basin. These local structural features are discussed in Subsection 2.5.1.2.4.1. The LaSalle Anticlinal Belt and other regional structural features are discussed in Subsection 2.5.1.1.5.1.1. The strata at the site dip less than 1°, generally to the south and southwest, although some areas dip to the north (Figure 2.5-30). Strata that were encountered during the subsurface exploration program consisted of a thick series of soil deposited during the Pleistocene and underlain by shales, sandstones, siltstones, clays, coals, and limestones of Pennsylvanian age and limestones of Ordovician age. The geologic structure at the site consists of a sequence of gently undulating sedimentary strata (Figures 2.5-30 and 2.5-31). Site structural

correlations were made based on the organic shale marker bed encountered in the Carbondale Formation. Published structural contour maps of the site area (Reference 245, Willman and Payne, 1942) were also reviewed.

2.5.1.2.4.1 Site Folding

Cross sections made from borings at the site (Figures 2.5-30 and 2.5-31) and published structural contour maps of some of the bedrock units in the site vicinity (Reference 246, Willman and Payne, 1942) indicate that the bedrock at the site is characterized by broad, gentle, very minor folding related to the LaSalle Anticlinal Belt. A few miles west of the site, the post-St. Peter axis of the Ransom Syncline trends northwest to southeast (Figure 2.5-14). The syncline plunges less than 1° southeast. The pre-St. Peter axis of the syncline runs under the site, trending north to south (Figure 2.5-14). The axis of the Odell Anticline runs under the eastern edge of the site, trending northwest to southeast (Figure 2.5-14). The anticline plunges less than 1° southeast. The elevation differential measured from the trough of the post-St. Peter Ransom Syncline to the crest of the Odell Anticline (approximately 5 miles apart in the vicinity of the site) is between 50 and 100 feet (Reference 247, Willman and Payne, 1942). Small, localized folds have been reported in the Pennsylvanian strata in the vicinity of the site (Reference 248, Willman and Payne, 1942).

2.5.1.2.4.2 Site Jointing

Some fracture zones were present in cores of Pennsylvanian and Ordovician rock taken from the boreholes at the site. There was no evidence of movement along any of the fractures present in the cores taken from the site borings; therefore, these fractures are joints. There was no evidence of any solution enlargement of the joints in any of the core. In the site vicinity, two well-developed trends in the joint systems have been reported: N 50°-60° E and N 40°-60° W (Reference 248, Willman and Payne, 1942). Joints with these trends can be observed at or near the site where bedrock outcrops in the Illinois River valley. Joint systems at the site cannot be seen in aerial photographs because of the glacial cover.

Some faint indications of vertical jointing from the ground surface to about 20 feet in depth were observed in the Yorkville Till Member by Kempton (Reference 199, 1975). The Yorkville Till Member is approximately 90 feet thick and is underlain by an additional 40 to 50 feet of till. The nonsystematic joints die out below a depth of 20 feet and do not continue into the lower till units. Consequently, desiccation rather than tectonic processes is considered a better interpretation for the origin of the joints (Reference 308, Kempton, 1976). Flint (Reference 309, 1971) states that many tills, particularly tills rich in clay and silt, are cut by joints. Some are weakly developed (as are those at the LSCS site), while others are distinct. He further states that many, if not most, joints in till are the result of shrinkage caused by dessication.

The vertical joints in the upper 20 feet of the Yorkville Till Member are most likely dessication features, and there is absolutely no evidence to support a tectonic origin.

2.5.1.2.4.3 Site Faulting

There was no evidence of faulting in any of the core taken from boreholes at the site, nor is there any surficial evidence of faulting at the site.

2.5.1.2.5 Geologic Map

A bedrock geologic map is presented in Figure 2.5-4. A discussion of the stratigraphic units shown on the geologic map is presented in Subsection 2.5.1.2.2.2.

2.5.1.2.6 Site Historical Geology

The historical geology of the regional area is presented in Subsection 2.5.1.1.4. The historical geology at the site and its relationship to the regional area are presented in this subsection. Discussions of regional and site stratigraphy are presented in Subsections 2.5.1.1.3 and 2.5.1.2.2, respectively.

Knowledge of the strata that underlie the Ordovician Platteville Group (the oldest stratigraphic unit penetrated in the site borings) is extrapolated from deep wells in the general area surrounding the site, from outcrops in the regional area, and from general knowledge of depositional patterns of the various rock units.

The geologic history of the site is related to the history of the continental interior. The depositional environment during the Paleozoic can generally be characterized as a stable shelf-type environment over which several transgressions and regressions of the sea occurred. This was followed by a long period of weathering and erosion during the Mesozoic to Pleistocene time interval. The continental interior was subjected to widespread glaciation during Pleistocene time.

A detailed discussion of the geologic history is presented by geologic periods in the following subsections. Since there are no outcrops of Precambrian rocks and no wells near the site which encountered the Precambrian basement, knowledge of the Precambrian is based upon regional data. A discussion of the Precambrian basement complex is presented in Subsection 2.5.1.2.2.2.1.4.

2.5.1.2.6.1 Paleozoic Era (225 ± 5 to 600 [?] Million Years Ago)

2.5.1.2.6.1.1 Cambrian Period (500 [?] to 600 [?] Million Years Ago)

The continental interior was emergent and the Precambrian surface was exposed to erosion until Late Cambrian (Croixian) time. As the late Cambrian seas transgressed onto the continent, the first transgressive facies were sandstones (Mt. Simon Sandstone). The sandstones grade upward into finer sands, dolomites, and shales of the Eau Claire Formation. The coarse sandstones that were next deposited (Galesville and Ironton Sandstones) probably represent a regressing sea (Reference 249, Buschbach, 1964). The deposition of the Ironton Sandstone was followed by marine deposition of finer sand, shale, dolomite, and abundant glauconite of the Franconia Formation. Subsequent deposition of the relatively pure Potosi Dolomite took place in deeper marine water. During the deposition of the Eminence Formation, there were minor advances and retreats of the sea, giving rise to interbedded dolomites, shales, and sandstones. At the end of the Cambrian period, the area was again emergent, and the surface was exposed to erosion until the beginning of the Ordovician period (Reference 250, Willman and Payne, 1942).

2.5.1.2.6.1.2 Ordovician Period (430 ± 10 to 500 [?] Million Years Ago)

By the beginning of the Ordovician period (Canadian time), seas once again transgressed onto the continent depositing sandstones (Gunter Sandstone) and dolomites (Oneota Dolomite), followed by dolomitic sandstones (New Richmond Sandstone), which, in turn, were followed by dolomites with thin sandstone and shale beds (Shakopee Dolomite). To the north of the site, sometime between the end of Oneota deposition and the end of New Richmond deposition, the Marseilles Anticline (Figure 2.5-14) began to rise, causing a thinning of the New Richmond and Shakopee formations (Reference 251, Willman and Payne, 1942). At the close of Canadian time, the development of the Kankakee Arch and related structures caused uplift of the area, and much of the Shakopee Dolomite was removed by the resultant widespread erosion. During Champlainian time, the sea once again transgressed onto the continent, depositing a widespread blanket of sand (St. Peter Sandstone) as a nearly continuous succession of strandline deposits (Reference 252, Krumbein and Sloss, 1963). The source of the sand of this unit was probably the Canadian Shield or the Cambrian sandstones exposed to the north (Reference 70, King, 1951). The continued uplift of the Marseilles Anticline during Glenwood deposition caused a thinning of the formation to the north of the site (Reference 251, Willman and Payne, 1942). At the end of St. Peter deposition, development of a slight local emergence caused the site area to be subjected to a period of subaerial erosion. When the seas readvanced, a series of limestones and dolomites (Platteville Group) was deposited on the eroded surface of the Glenwood Formation. It is probable that carbonate strata of the overlying Galena Group were also deposited at the site and were later removed by erosion. The region was uplifted slightly at the close of Champlainian time and then resubmerged early in

Cincinnatian time. Sediments that may have been deposited at the site during Cincinnatian time (Maquoketa Shale Group) were later removed by erosion. At the close of the Ordovician period, continuing development of the Kankakee Arch and related structures caused uplift of the entire region.

2.5.1.2.6.1.3 Silurian Period through Mississippian Period (320 ± 10 to 430 ± 10 Million Years Ago)

During the Silurian, Devonian, and Mississippian Periods, the seas advanced and retreated several times. Units as young as Late Devonian in age may have been deposited, but these were subsequently removed by erosion. The major folding of the LaSalle Anticlinal Belt took place sometime between the close of the Devonian and the beginning of the Pennsylvanian (Reference 253, Willman and Payne, 1942). Evidence to the south of the site area suggests that most of the deformation took place in Late Mississippian (post-Chesterian) time (Reference 254, Payne, 1940).

2.5.1.2.6.1.4 Pennsylvanian Period (270 ± 5 to 320 ± 10 Million Years Ago)

During the Pennsylvanian Period, the site area was part of a vast plain that was repeatedly submerged by the sea. When the plain was submerged, rivers and streams carried clastic materials into a usually shallow sea where they accumulated as various marine deposits. When the sea receded, material continued to be deposited in brackish to freshwater swamps which covered the plain. Each sequence of deposits, or cyclothem, is usually composed of alternating strata of shale, sandstone, siltstone, clay, coal, limestone, and many intergradational types. During the deposition of the Spoon and Carbondale formations, the site area was subjected to as many as 15 cycles of marine advance and retreat. A considerable thickness of Pennsylvanian strata was deposited above the Carbondale Formation, but was subsequently removed by erosion (Reference 255, Willman and Payne, 1942). Deformation along the LaSalle Anticlinal Belt continued to take place intermittently throughout the Pennsylvanian Period.

2.5.1.2.6.1.5 Permian Period (225 ± 5 to 270 ± 5 Million Years Ago)

During the Permian Period, the last recognizable folding of the LaSalle Anticlinal Belt took place (Reference 255, Willman and Payne, 1942). Because of the lack of Mesozoic and Tertiary deposits, it cannot be determined if there was later deformation. It is possible that some Permian sediments were deposited in the area and were subsequently removed by erosion.

2.5.1.2.6.2 Mesozoic Era (65 ± 2 to 225 ± 5 Million Years Ago)

Throughout the Mesozoic Era, the dominant geologic processes in the site area were weathering and erosion. Although the site is believed to have been slightly above sea level for most of the Mesozoic Era (Reference 256, Willman and Payne, 1942),

there may have been a period of submergence during the Cretaceous Period. If any Cretaceous sediments were deposited in the area, they were subsequently removed by erosion. At the close of the Mesozoic Era, the site area was emergent (Reference 257, Willman and Payne, 1942).

2.5.1.2.6.3 Cenozoic Era (Present to 65 ± 2 Million Years Ago)

2.5.1.2.6.3.1 Tertiary Period (2 ± 1 to 65 ± 2 Million Years Ago)

During most of the Tertiary Period, the site area was subjected to subaerial erosion. By Late Tertiary (or Early Pleistocene), the area was reduced to a peneplain, termed the Dodgeville peneplain (Reference 258, Willman and Payne, 1942). A subsequent change in base level prior to Kansan glaciation caused the Dodgeville peneplain in the site area to be dissected (Reference 259, Willman and Payne, 1942).

2.5.1.2.6.3.2 Quaternary Period (Present to 2 ± 1 Million Years Ago)

The original bedrock topography at the LaSalle County Station site has been modified by many glacial advances and by interglacial weathering and erosion during the Pleistocene (Figure 2.5-11). Some Quaternary deposits that may have been left at the site by various glacial and interglacial events were subsequently removed by later glaciations. In order to describe these events and their effects on the site, some deposits outside of the site boundaries are discussed.

During the Nebraskan and Aftonian Ages (Figure 2.5-33), the site was subjected to subaerial erosion. The uplift of the Dodgeville peneplain and subsequent dissection in the site area occurred by this time. During the Kansan Age, or possibly the Nebraskan Age, the Ticona Valley originated as a glacial drainage system created as ice advanced from the east (Reference 260, Horberg, 1950).

Glacial ice covered the site during the Kansan Age (Figure 2.5-33). Originating in the Labradorean center, the ice moved over the site area from east or southeast and removed all of the soil and weathered material (Reference 261, Willman and Frye, 1970). During its retreat, the Kansan ice deposited a layer of drift at the site. Following Kansan glaciation, the site was subjected to a long period of subaerial erosion (Yarmouthian Age) during which the Yarmouth Soil was formed.

In the Illinoian Age, the site was successively covered by three major glacial advances, which originated in the Labradorean center (Figure 2.5-33). All or most of the Kansan drift was removed except in the bedrock valleys (Ticona and Kempton) (Reference 262, Willman and Payne, 1942). During the Sangamonian Age, the site area was subjected to a period of weathering and erosion during which the Sangamon Soil developed. Loess was deposited in the site area during Altonian, Farmdalian, and early Woodfordian time in the Wisconsinan Age, but was

subsequently eroded by advancing glaciers. During the first Woodfordian glacial advance (Shelbyville glaciation), up to 30 feet of sand and gravel outwash may have been deposited in preexisting valleys. As the glacier retreated, the Shelbyville Morainic System served as a dam across the Illinois River valley at Peoria behind which glacial Lake Kickapoo was formed (Reference 263, Willman and Payne, 1942). Some lacustrine deposits from the lake may have been deposited in the Ticona Valley at the site.

During Bloomington glaciation, the Tiskilwa Till Member of the Wedron Formation was deposited (Reference 264, Willman and Frye, 1970). The moraine of a subsequent glaciation (probably Dover or Mt. Palatine) made a dam across the Illinois River valley near Hennepin and formed Lake Illinois, which extended at one time to near Joliet (Reference 265, Willman and Frye, 1970). This lake may have deposited laminated silts and clays in the valleys near the site during several different glacial retreats.

The Malden Till Member of the Wedron Formation was deposited in the site area by eight successive Woodfordian glaciations: Normal, Eureka, Fletchers, El Paso, Varna, Minonk, Strawn, and Chatsworth (Reference 264, Willman and Frye, 1970). By the time of the retreat of Strawn glaciation (Middle Woodfordian), the present drainage of the Illinois River was established (Reference 266, Willman and Payne, 1942).

Glacial ice readvanced over the site at the onset of Marseilles glaciation and deposited a thick sequence of tills that make up the Yorkville Till Member of the Wedron Formation at the site (Reference 199, Kempton, 1975; Reference 264, Willman and Frye, 1970). Toward the end of Marseilles glaciation, Lake Illinois was drained when the Fox River Torrent eroded the drift dam (Reference 267, Willman and Payne, 1942). The Marseilles glacier was the last Woodfordian glacier to reach the site.

In late Woodfordian time, an unusually large volume of meltwater was issued by the Valparaiso glacier into the Kankakee, Des Plaines, Du Page, and Fox River valleys. This torrent, termed the Kankakee Flood (Reference 268, Willman and Frye, 1970), caused a backup of water in the Illinois River valley at both the Marseilles and Farm Ridge Moraines, which created Lake Wauponsee, Lake Ottawa, Lake Pontiac, and Lake Watseka. At many places along the Illinois River valley, the Kankakee Flood eroded intensively to carve benches and strip off glacial drift. In other places, terraces were developed, and in backwater areas, lacustrine silts and sands were deposited (Reference 269, Willman and Payne, 1942). The Illinois River became entrenched after the Kankakee Flood subsided. Subsequent late Woodfordian glaciations may have produced meltwater floods that formed lower terraces (Henry Formation) and widened the existing channel (Reference 270, Willman and Payne, 1942).

In the upland portion of the site, which was unaffected by glacial flooding, loess (Richland Loess) accumulated steadily following the retreat of the Marseilles glacier. Loess deposition continued through Twocreekan and Valderan time (Reference 271, Willman and Frye, 1970).

During late Wisconsinan and Holocene time, the Cahokia, Peyton, and Grayslake formations developed contemporaneously. The Cahokia Alluvium (Reference 272, Willman and Frye, 1970) is deposited in stream valleys on the site. This alluvium overlies or is unconformable laterally with the Richland Loess in the upland portion of the site and overlies the Henry Formation or Pennsylvanian bedrock in the valley bottom portion of the site.

The Peyton Colluvium developed along slope bottoms on the site (Reference 196, Willman, 1973). The colluvium overlies the Richland Loess or the Cahokia Alluvium. The Grayslake Peat is formed in lakes and ponds that occur on the floodplain of the Illinois River (Reference 273, Willman, 1973) and may overlie either the Cahokia Alluvium or the Henry Formation.

Agricultural soils on the site have been developed due to weathering on the Richland Loess and the Cahokia Alluvium from late Wisconsinan through Holocene time (Reference 274, Kempton, 1975; Reference 275, Willman and Frye, 1970; Reference 276, Willman and Payne, 1942).

2.5.1.2.7 Plot Plan

The locations of the Seismic Category I structures of the power plant and the locations of all borings and test pits are shown in Figure 2.5-2. Logs of the borings are presented in Figure 2.5-19. Logs of the test pits are presented in Figures 2.5-21.

2.5.1.2.8 Geologic Profiles

Geologic profiles of major foundations of the nuclear power plant are presented in Figure 2.5-51 and discussed in Subsection 2.5.4.5.

2.5.1.2.9 Excavation and Backfill

The excavations and backfill at the site are discussed in Subsection 2.5.4.5.

2.5.1.2.10 Engineering Geology

This subsection provides a discussion of those geologic factors which are significant to the design of the power plant. Where these factors are more appropriately discussed in other sections, the cross reference is provided.

2.5.1.2.10.1 Soil and Rock Behavior During Prior Earthquakes

The behavior of the soil and rock on the site during prior earthquakes is discussed in Subsections 2.5.2.1 and 2.5.2.3.

2.5.1.2.10.2 Evaluation of Joints Relative to Structural Foundations

Joints observed in the upper 20 feet of the Yorkville till (see Subsection 2.5.1.2.4.2) are most likely dessication features and will have no effect on structural foundations.

2.5.1.2.10.3 Evaluation of Weathering Profiles and Zones of Alteration or Structural Weakness

There are no known weathering profiles or zones of alteration or structural weakness at the site which will adversely affect the power station. The only documented weathering profile at the site is the Modern Soil profile, which is discussed in Subsection 2.5.1.2.2.1.3. The weathering of the tills within the soil profile may have increased their permeabilities. The permeabilities of the site soils are listed in Table 2.5-13.

2.5.1.2.10.4 Unrelieved Residual Stresses in Bedrock

Unrelieved residual stresses in the bedrock of the site region are discussed in Subsection 2.5.1.1.4.4.2. There is no evidence of unrelieved residual stresses in the strata underlying the LSCS site. The foundation excavation was entirely within the Yorkville Till Member of the Wedron Formation, with approximately 80 feet of till below the base of the foundation excavation. No indications of uplift, heave, or rebound of the excavation floor were observed by personnel conducting field surveillance at the site. A monitoring program was not installed for the purpose of obtaining in situ measurements of uplift, heave, or rebound of the excavation floor.

2.5.1.2.10.5 Stability of Soil and Rock

The stability of soil and rock at the site is discussed in Subsection 2.5.4.

2.5.1.2.10.6 Effects of Man's Activities

The effects of man's activities at the site are discussed in Subsection 2.5.1.1.6.4.

2.5.1.2.11 Site Groundwater Conditions

Site groundwater conditions are discussed in Subsection 2.4.13.

2.5.1.2.12 Geophysical Investigations

Geophysical investigations conducted at the LaSalle County Station site are discussed in Subsection 2.5.4.

2.5.1.2.13 Soil and Rock Properties

The soil and rock properties as determined in the field and in the laboratory are discussed in Subsection 2.5.4.2.

2.5.2 Vibratory Ground Motion

A discussion and evaluation of the seismic and tectonic characteristics of the site and surrounding region within 200 miles of the site is presented in this subsection. In order to facilitate the discussion of earthquake history and correlation of earthquakes with geologic structure, some areas outside the region are mentioned. The purpose of this investigation was to determine seismic design criteria for LSCS 1 and 2. The conclusions regarding the SSE and OBE are the same as those originally presented in the PSAR.

2.5.2.1 Seismicity

The site is located in an area of relative seismic stability. Within a 50-mile radius of the site, there have been only four epicenters recorded in the last 200 years (Figure 2.5-34). The largest and most recent of these was the 1972 event in Lee County (approximately 40 miles northwest of the site), which had an intensity of VI on the Modified Mercalli Intensity Scale (MM) (Table 2.5-14). The earthquake nearest the site (1912, approximately 20 miles northeast) had an epicentral intensity of VI (MM).

The regional area around the site is similarly stable, ranging from 0 to 3 epicenters per 10,000 km² in the last 200 years (Reference 277, King, 1965). Since the region has maintained a moderate population for the last 200 years, it is probable that all earthquakes of intensity V or greater have been reported during this period. Prior to this period, when the population was sparse, it is likely that all earthquakes of intensity IV or greater would have been reported in private journals or diaries. The absence of such documentation suggests that no significant earthquakes occurred in the region during this period. All the recorded earthquake epicenters within 200 miles of the site are listed in Table 2.5-15, and their locations are plotted in Figure 2.5-34.

All the epicentral intensities V or greater within the area bounded by 84.7° to 92.7° west longitude and 38.3° to 44.3° north latitude are shown in Figure 2.5-34 and listed in Table 2.5-17. All documented epicenters within the New Madrid area and areas peripheral to the New Madrid area bounded by 87.0° to 90.0° west longitude

and 36.5° to 39.5° north latitude are listed in Table 2.5-18 and are plotted in Figure 2.5-35.

There is no physical evidence of landslides, sand boils, subsidence, other mass movements, ground breakage, or any other feature at the site that would have resulted from past earthquakes.

2.5.2.2 Geologic Structures and Tectonic Activity

A discussion of the tectonic structures underlying the regional area is presented in Subsection 2.5.1.1.5.1. Seismicity within each tectonic structure is discussed in Subsection 2.5.2.3. A map showing epicenter locations and geologic structures is shown in Figure 2.5-36.

No capable faults are known to exist within 200 miles of the site. In Illinois, faults recognized at the surface have shown no signs of dislocation during post-Cretaceous time (Reference 278, Heigold, 1972). Faults in the region are identified in Subsection 2.5.1.1.5.1.2.

2.5.2.3 Correlation of Earthquake Activity with Geologic Structures or Tectonic Provinces

The LaSalle County site lies to the west of the LaSalle Anticlinal Belt within the Illinois Basin, which forms part of the Central Stable Region. The Central Stable Region is a vast area of low-lying country bounded to the north by the exposed Canadian Shield and to the south by the Gulf Coastal Plain. It consists of Precambrian basement rocks covered by a thin veneer of Paleozoic and later sedimentary rocks. Broad, slow movements have molded the sedimentary strata into arches (e.g., Cincinnati, Findlay, and Kankakee), basins (e.g., Illinois) and domes (Reference 310, Eardley, 1962).

Seismotectonic regions can be defined from the relationship of historic seismicity to basement structure, folds, faults, and other tectonic features. In the midwestern U.S., these regions generally correspond to the domes, basins, and arches. The largest earthquakes in the Illinois Basin Region have been Intensity VII. The Cincinnati, Findlay, and Kankakee Arches form a stable seismotectonic region in which the largest historic earthquakes, excluding those in the Anna, Ohio area, have been Intensity VI. The Anna, Ohio area is a distinct seismogenic region, located at the intersection of the Cincinnati, Findlay, and Kankakee Arches.

Five localized seismic zones characterized by large intensity earthquakes (Intensity V (MM) or greater) are described in the following subsections. Three of these seismic zones are relevant to the discussion of the seismicity of the LaSalle County site. The distinct seismic activity in the Keweenaw and Anna areas is also

discussed. The tectonic features in the following subsections which are not discussed in Subsection 2.5.1.1.5.1 are included in Appendix 2.5A.

2.5.2.3.1 The New Madrid Area

This area includes southeast Missouri, western Tennessee, extreme western Kentucky, and extreme southern Illinois (Figures 2.5-35 and 2.5-37). This area has been the source of very large earthquakes such as those of 1811-12 (Table 2.5-18).

The New Madrid area is a band 25 to 50 kilometers wide, extending approximately from Memphis, Tennessee, to just north of Cairo, Illinois. This area generally parallels the axis of the Mississippi Embayment (Figure 2.5-37). It crosses the Pascola Arch and continues north along the edge of the Reelfoot Basin-Ozark Dome to the approximate northern extent of these two features. The pattern of seismicity within the New Madrid area indicates a complex generating mechanism which seems to be centered at the intersection of the Pascola Arch-Ozark Dome-Reelfoot Basin with the axis of the Mississippi Embayment Syncline (Reference 279, Stearns and Wilson, 1972). The nearest approach of this area to the site is approximately 300 miles.

2.5.2.3.2 The Wabash Valley Area

Some earthquakes in southern Illinois and Indiana are clustered about the Wabash Valley Fault Zone (Figure 2.5-35). The Wabash Valley Fault Zone trends N 27° E, roughly parallel to the Wabash River in southeastern Illinois and southwestern Indiana. Theories regarding earthquake generation here (Reference 280, Schwab, 1974) suggest that the activity is due to interaction along the flanks of the Fairfield Basin and may not be directly related to Wabash Valley surficial faults. The nearest approach of this area to the site is 200 miles.

2.5.2.3.3 The St. Louis Area

Many earthquakes are clustered in St. Louis County in Missouri and neighboring Madison and St. Clair Counties in Illinois (Figure 2.5-34). This area is located near the Cap Au Gres Faulted Flexure and the St. Louis Fault, which are located between the Illinois Basin and the Ozark Dome. The earthquakes are believed to originate in the Precambrian basement complex at a depth of approximately 3000 feet (Reference 281, Heinrich, 1941).

2.5.2.3.4 Keweenaw Peninsula

This area lies approximately 400 miles north of the LaSalle County site.

An event associated with a mining area occurred in the Keweenaw Peninsula, Michigan, in 1906 (Reference 311, Hobbs, 1911). This type of event has been called

a rockburst. Rockbursts result exclusively from impulsive failure of rocks induced by mining operations and are not unique to northern Michigan. For example, a series of rockbursts occurred at Kirkland Lake, Ontario, in the Canadian Shield (Reference 312, Hodgson, 1953). Damage from the 1906 Keweenaw event was probably enhanced near the epicenter by the presence of underground mine workings. This resulted in classification as an epicentral Intensity MM VIII, whereas the total felt area was no greater than that of an average MM III-IV (Reference 313, Coffman and Von Hake, 1973; Reference 314, Nuttli and Zollweg, 1974).

2.5.2.3.5 Anna, Ohio, Seismogenic Region

This area lies approximately 235 miles east of the LaSalle County site.

The area around Anna, Ohio, has been quite seismically active. The largest event in this area occurred in 1937 and has been assigned a maximum intensity of VII-VIII by several authors (see e.g., Reference 313, Coffmann and Von Hake, 1973). However, as discussed in Subsection 2.5.2.4, it is the Applicant's position that the actual maximum intensity did not exceed VII.

The occurrence of several Intensity VII earthquakes and a larger number of lesser events, together with the absence of such activity in adjacent regions in the period 1776 to 1964 (Reference 315, Bradley and Bennett, 1965), suggests that the Anna events are associated with localized geologic structure at the intersection of the Cincinnati, Findlay, and Kankakee Arches. Geophysical and geological work (Reference 316, McGuire, 1975; Reference 317, Dames & Moore, 1976; Reference 318, Seismograph Service Corporation, 1976) indicates that the Anna seismogenic zone is bounded to the south by basement faulting, to the east by north-south-trending magnetic highs and lows, and to the north and west by basement geologic contacts.

From studies of seismic reflection data and stratigraphy from well logs, Stone & Webster (Reference 328, Stone & Webster, 1976) has independently concluded that the Anna seismogenic zone is bounded to the south by the 50-mile long, east-west trending Anna fault. They locate this feature slightly to the north of the fault location proposed by Seismograph Service Corporation (Reference 318, 1975). Stone & Webster interpret two other faults, the Auglaize and Logan-Hardin faults, as trending north from the Anna fault in Shelby and Logan counties and joining together 50 miles to the north in Hancock County. Until recently it has not been possible to tie down the seismicity in the Anna area to any particular proposed fault, since the historic earthquake information is in the form of felt reports. However, a telemetered array of six vertical short period seismometers was installed in the Anna area in 1976 by the University of Michigan Seismological Observatory under the direction of Drs. H. Pollack and F. Mauk. Results from the array show that at present the area is largely aseismic and only two events have

been positively identified: a February 2, 1976 magnitude 3 earthquake near Detroit-Windsor, and the recent June 17, 1977 3.2 event 30 miles from Anna at Salina, Ohio. The University of Michigan has recorded quarry blasts and has a reasonably accurate crustal model for p-wave velocities of 3.48 km/sec in the uppermost crust and 6.61 km/sec in the lower crust. As a result, the June 17, 1977 earthquake travel times have very small residuals, and the epicenter has been accurately located using HYPO71. The event coincides exactly with the Champaign-Anna fault proposed by Stone & Webster and the direction of motion on the fault plane is the same as that predicted (Stone & Webster, Reference 328, 1976) although insufficient data were recorded to form a full fault plane solution (Reference 329, Mauk, 1977). Therefore, the only recent earthquake in the Anna area has been tied to the Champaign-Anna fault.

By contrast, there are no known capable faults within 200 miles of the LSCS site. The site is located in a largely aseismic zone in which only four earthquakes are known to have occurred within a 50-mile radius of the site in the last 200 years (Subsection 2.5.2.1). Figure 2.5-13 shows only one known fault system close to the site at a minimum distance of 26 miles, the Sandwich Fault Zone System. From the above discussion and the discussion of tectonic structures underlying the site region (Subsection 2.5.1.1.5.1) it is quite clear that the LSCS site lies in a tectonic environment completely different from the Anna seismogenic zone.

2.5.2.4 Maximum Earthquake Potential

The most significant earthquakes that have affected the plant site are listed in Table 2.5-20.

The Fort Dearborn-Chicago earthquake of 1804 was reported as "quite a strong shock" (Reference 282, Shaler, 1869). It was also felt at Fort Wayne, Indiana (Reference 283, Coffman and Von Hake, 1973).

A zone of major activity is in the vicinity of New Madrid, Missouri, more than 300 miles to the south (Figure 2.5-37). The three earthquakes in 1811-1812 near New Madrid are considered to be the largest ever to have occurred in the central and eastern United States. It is reported that these shocks (epicentral intensities probably as high as Intensity XII) were felt in an area of 2,000,000 mi² and changed the surficial topography in an area of about 30,000 to 50,000 mi² (Reference 284, Coffman and Von Hake, 1973). The structural damage resulting from these earthquakes was small due to the lack of construction and habitation in the region. It is estimated that the intensities felt in the vicinity of the site from these shocks were the largest from any known seismic event and were probably on the order of VI (Reference 285, Nuttli, 1973a).

The northernmost extent of the large intensity New Madrid-type earthquakes was reevaluated in much greater detail after the LSCS PSAR was submitted. This

LSCS-UFSAR

reevaluation has been documented in the Sargent & Lundy report dated May 23, 1975, and entitled, "Supplemental Discussion Concerning the Limit of the Northern Extent of Large Intensity Earthquakes Similar to the New Madrid Events," (Reference 319). In addition, a meeting on this subject was held on January 26, 1976, in the offices of the Illinois State Geological Survey, Urbana, Illinois, at the request of Public Service Indiana. Representatives were present from the NRC, the Illinois State Geological Survey, the Indiana Geological Survey, the Kentucky Geological Survey, St. Louis University, Sargent & Lundy, Dames & Moore, and Seismograph Service Corporation (Birdwell Division). The scientific data presented clearly indicated that the New Madrid area, at the intersection of the Pascola Arch and the Ozark Dome, is tectonically unique, and that the northernmost extent of the structurally complex New Madrid area is conservatively taken as 37.3° N, and 89.2° W. It remains the applicant's interpretation, based on tectonic, geophysical, and seismic data, that the New Madrid-type events should not be extended along the Wabash Valley Fault System. These conclusions were also previously presented to the NRC on the following occasions:

- a. AEC staff review meeting in Bethesda, Maryland, for the Clinton Power Station, on June 17, 1974;
- b. ACRS Subcommittee Hearing in Urbana, Illinois, for the Clinton Power Station, on March 19, 1975;
- c. ACRS Subcommittee Hearing in Bethesda, Maryland, for the Clinton Power Station, on April 4, 1975;
- d. ACRS Subcommittee Hearing in Madison, Indiana, for the Marble Hill Nuclear Generating Station, on October 1, 1976; and
- e. ACRS Full Committee meeting in Washington, D.C., for the Marble Hill Nuclear Generating Station, on October 14, 1976.

More recent geophysical and seismological data also support the applicant's position. Interpretations of gravity and magnetic data in Illinois (Reference 320, McGinnis, et al., 1976; Reference 321, Heigold, 1976) support the view that the Rough Creek Fault Zone separates distinct crustal provinces. Interpretations of seismic data from a total of 330 earthquakes during the first 21 months of operation of a regional microearthquake network in the New Madrid seismic zone (Reference 322, Stauder, et al., 1976) indicate that there is little likelihood of a New Madrid-type event extending from New Madrid along the Wabash Valley Fault System. Furthermore, preliminary evidence from an NRC-funded ongoing study of the New Madrid region does not support the view that the New Madrid seismogenic region extends north of the Rough Creek Fault Zone (Reference 323, Buschbach, 1977b).

LSCS-UFSAR

However, in order to expedite the licensing, the applicant evaluated, as requested by the NRC, the effect of a New Madrid 1811-12 type earthquake occurring at Vincennes, Indiana, approximately 180 miles from the site. Using the same analytical procedure as for the Clinton and the Marble Hill power stations, the applicant estimated that a sustained maximum acceleration of 0.06g may be experienced at the LSCS site in response to a New Madrid type event centered at Vincennes. By comparing the spectra for the 0.2g regional earthquake and that of a distant earthquake which produces 0.1g sustained maximum acceleration at the site at a distance of only 110 miles, it was shown in the Marble Hill PSAR, Appendix 3C, that the distant event did not govern the design of the station. Clearly then, the distant earthquake at Vincennes, 180 miles from the LSCS site, causing a sustained maximum acceleration of 0.06g at the site would not govern the LSCS design, since the acceleration due to the regional earthquake used for design purposes is 0.2g.

The Charleston, Missouri earthquake of 1895 is considered the most severe shock in the site region since the New Madrid shocks of 1811-1812. The earthquake was felt over an area of 1,000,000 mi² and had an epicentral intensity of VIII (Reference 286, Coffman and Von Hake, 1973). The intensity observed at the site was probably IV or less.

The 1906 Keweenaw event, addressed in Subsection 2.5.2.3.4, is uniquely located in an area that is highly faulted and heavily mined. Recurrence of Keweenaw rockburst activity is rather unlikely. The greatest felt distance of any of the rockbursts was only 70 miles (Reference 324, Von Hake, 1973). Resumption of rockburst activity would not affect the LaSalle County Station 400 miles away.

Two significant earthquakes which occurred north of the site are the 1912 (Epicentral Intensity VI) northeastern Illinois shock, located approximately 20 miles northeast of the site, and the 1909 (Epicentral Intensity VII) shock occurring 85 miles to the north near Beloit, Wisconsin. Isoseismal maps of these two events are shown on Figure 2.5-38. The site intensity from these quakes is estimated to be VI. Detailed investigations of the shocks were conducted by J. A. Udden (1910) and A. D. Udden (1912). The isoseismal maps are drawn using the then current Rossi-Forel (1910 and 1912) intensities. The intensities of interest do not vary significantly from the Mercalli Scale in use today. To normalize the map to the Modified Mercalli Scale, see Table 2.5-14 for the corresponding Rossi-Forel intensities.

As stated in Subsection 2.5.2.3.5, all available evidence points to localized structural control of the Anna, Ohio, events. The largest Anna event of 1937 was felt over no more than 200,000 mi² (Reference 313, Coffmann and Von Hake, 1973; Reference 325, Docekal, 1970) which on the basis of empirical results (Reference 326, Nutti, 1974), should correspond to an epicentral intensity of less than VII (Reference 317, Dames & Moore, 1976). The LSCS site lies in the Illinois Basin

seismotectonic region, in which maximum events of MM VII occur. The Anna, Ohio area, on the east flank of the Cincinnati Arch, is separated from the LSCS site by other seismotectonic provinces: the Cincinnati Arch, the Eastern Shey of the Illinois Basin, and the LaSalle Anticlinal Belt. An intensity VII-VIII earthquake at Anna, 235 miles away from the LSCS site, would produce smaller ground accelerations than a random MM VII event in the Illinois Basin.

Another midcontinent shock affecting a large area of the central United States occurred on November 9, 1968. This earthquake, which was felt in 23 states, had a measured magnitude of 5.5 on the Richter scale and a maximum epicentral intensity of VII (MM). The instrumental epicenter was in south-central Illinois 50 miles west of Evansville, Indiana, and 105 miles northeast of New Madrid. Its epicentral distance from the plant site was 230 miles, and its observed site intensity in the site area was IV (Reference 287, Gordon et al., 1970).

On September 15, 1972, the Lee County, Illinois earthquake occurred. This earthquake had a measured magnitude of 4.6 on the Richter scale and a maximum epicentral intensity of VI (MM). Its epicentral distance from the plant site is approximately 47 miles, and the intensity in the site area was probably IV (MM) (Reference 288, Heigold, 1972).

Within the past 200 years, maximum reported earthquake intensity felt at the site has not exceeded VI on the Modified Mercalli Scale (MM) (Table 2.5-21).

All earthquakes with epicentral intensities greater than VII (MM) can be correlated with geologic structures that are peripheral to the regional area. The maximum site intensity produced by any of these events was VI (MM). The possibility exists that the 1909 shock at South Beloit, Illinois, (VII - MM) as well as other Intensity VI and VII shocks, may not be associated with any known or inferred geologic structures. Therefore, it is conceivable that earthquakes such as the one that occurred at South Beloit could occur in the vicinity of the site. The safe shutdown earthquake (SSE) for the site assumes the possibility of the occurrence of an earthquake of this type and intensity near the site. This assumption results in the maximum calculated ground motion for the site (see Subsection 2.5.2.6).

2.5.2.5 Seismic Wave Transmission Characteristics of the Site

The engineering properties of the soils and bedrock units at the site were evaluated using field geophysical measurements and laboratory testing; these properties are discussed in Subsections 2.5.4.4 and 2.5.4.2.2 respectively.

Geophysical investigations performed at the plant site are presented in Subsection 2.5.4.4 and consisted of a seismic refraction survey and a surface wave survey. The velocity of compressional and surface wave propagation and other dynamic properties of the natural subsurface conditions were evaluated from these

investigations and were used in analyzing the response of the materials to earthquake loading.

Dynamic moduli for the subsurface soil and rock at the site were calculated based on measured properties. The in situ field measurements were compared with laboratory tests on the same materials. In general, reasonable agreement was obtained between these two methods. These analyses are presented in Subsection 2.5.4.7.

Seismic wave velocities and densities for the deeper rock strata in the region have been measured by others (Reference 289, McGinnis, 1966). These data confirmed field measurements and were used in studies of site dynamic behavior.

2.5.2.6 Safe Shutdown Earthquake (SSE)

The assumption is made that an Intensity VII event similar to the South Beloit shock could occur in the vicinity of the site. Seismic Category I structures are designed for safe shutdown due to maximum horizontal ground accelerations at the foundation level of 20% of gravity, and the corresponding maximum vertical ground acceleration is 2/3 of horizontal. Based on an evaluation of the degree of ground motion that is remotely possible and considering both seismic and tectonic history and geologic structure, the applicant believes these accelerations are too high, but has accepted them in order to expedite licensing and construction of the facilities. The response spectra for the safe shutdown earthquake are shown in Figure 2.5-39.

2.5.2.7 Operating-Basis Earthquake (OBE)

The operating-basis earthquake is that event which the site could likely experience during the life of the facility. The OBE for this site is an earthquake that will have a maximum horizontal acceleration of 10% of gravity and a maximum vertical acceleration of 2/3 of horizontal. It is defined in the response spectra shown in Figure 2.5-40.

2.5.3 Surface Faulting

No evidence for surface faulting was noted at the site or the area surrounding the site. Further, faults recognized at land surface in Illinois have shown no sign of dislocation during post-Cretaceous time (Reference 278, Heigold, 1972). Some evidence of an "ice-shove" feature was seen in a borrow pit in the eastern part of the lake area by Sargent & Lundy personnel and members of the Illinois State Geological Survey during their site visit on September 27, 1976. The view that this feature, which occurs in the Wedron Formation, was caused by glacial advance is confirmed by the ISGS staff (General Reference, Buschbach, 1977). The nearest known fault in the region is approximately 9 miles west-northwest of the site and has a displacement of about 2 feet (Reference 290, Willman and Payne, 1942). The

nearest major fault in the region is the Sandwich Fault Zone; its nearest approach to the site is approximately 26 miles. There are no known capable faults in the regional area (200-mile radius).

2.5.3.1 Geologic Conditions of the Site

A discussion of the lithologic, stratigraphic, and structural geologic conditions and the geologic history of the site and the surrounding region is presented in Subsection 2.5.1.

2.5.3.2 Evidence of Fault Offset

There is no evidence of fault offset at or near the ground surface at the site. The nearest known fault to the site (see Subsection 2.5.1.1.5.1.2.12) is approximately 9 miles to the west-northwest with a displacement of about 2 feet (Reference 290, Willman and Payne, 1942). The structural geology at the site and surrounding region is discussed in Subsections 2.5.1.1.5 and 2.5.1.2.4.

2.5.3.3 Earthquakes Associated with Capable Faults

There have been no historically reported earthquakes within 200 miles of the site. No capable faulting is known to exist within 200 miles of the site.

2.5.3.4 Investigation of Capable Faults

No capable faulting is known to exist within 200 miles of the site.

2.5.3.5 Correlation of Epicenters with Capable Faults

No capable faulting is known to exist within 200 miles of the site, and no earthquake epicenter is known within 5 miles.

2.5.3.6 Description of Capable Faults

No capable faulting is known to exist within 200 miles of the site.

2.5.3.7 Zone Requiring Detailed Faulting Investigation

Geologic investigations of the site have not indicated evidence of capable faulting; therefore, the detailed fault investigation required for a capable fault is not needed.

2.5.3.8 Results of Faulting Investigation

Geologic investigations of the site and the area surrounding the site have indicated that a study of surface faulting is not required at the site.

2.5.4 Stability of Subsurface Materials and Foundations

This subsection presents an evaluation and summary of the geotechnical suitability and stability of the subsurface materials to support the plant foundations. An overall general site plan is shown on Figure 2.5-41.

2.5.4.1 Geologic Features

A detailed discussion of the geologic characteristics of the site is given in Subsection 2.5.1.2. A comprehensive field and laboratory investigation program including borings, test pits, geophysical surveys, field reconnaissance, and various static and dynamic laboratory tests was undertaken to determine the geologic features at the site and their significance with relation to site suitability and stability.

2.5.4.2 Properties of Subsurface Materials

This subsection presents the static and dynamic engineering properties of the underlying materials encountered in the borings and excavations at the LaSalle County Station site.

The soil properties are based upon a review and analysis of:

- a. available data from field and laboratory tests performed during this investigation,
- b. geophysical surveys performed during this investigation,
- c. latest available literature, and
- d. similar studies recently performed for nuclear power stations in the general area.

The soil material underlying all of the Seismic Category I structures, including the plant, the CSCS pipelines, and the CSCS pond and flume is similar except for isolated pockets of sand or clayey silt; thus, the general properties for the underlying material were considered to be similar.

2.5.4.2.1 Field Investigations

A program of field investigations was undertaken to evaluate the materials underlying the station site. A detailed discussion of the results of these investigations is given in Subsections 2.5.4.3 and 2.5.4.4.

2.5.4.2.2 Laboratory Tests

The laboratory testing program was conducted using procedures similar to the referenced ASTM designation where appropriate. Where no standard existed, the method used is explained in the text. The program consisted of the following:

- a. static tests:
 - 1. direct shear (ASTM D3080);
 - 2. unconfined compression (ASTM D2166, D2938, and D3148);
 - 3. triaxial compression (ASTM D2850);
 - 4. compaction (Modified Proctor ASTM D1557 and Relative Density ASTM D2049 were performed);
 - 5. consolidation (ASTM 2435);
 - 6. permeability (ASTM D2434, except both falling and constant head tests were performed);
 - 7. particle size analysis (ASTM D422);
 - 8. Atterberg limits (ASTM D423 and D424);
 - 9. moisture determinations (ASTM D2216); and
 - 10. density determinations (ASTM D2937).
- b. dynamic tests:
 - 1. cyclic triaxial compression,
 - 2. resonant column, and
 - 3. shockscope.

2.5.4.2.2.1 Static Tests

2.5.4.2.2.1.1 Direct Shear Tests

Direct shear tests were performed on selected samples of the underlying Wedron silty clay till to evaluate their shearing strength. The samples were sheared under

normal pressures approximately corresponding to their in situ vertical pressures. The test results, in terms of the normal pressure and maximum shearing strength, are given on the boring logs (Figure 2.5-19).

2.5.4.2.2.1.2 Unconfined Compression Tests

Unconfined compression tests were performed on representative rock cores from the Pennsylvanian and Ordovician strata to evaluate their strength and elasticity characteristics. The test results, including associated density determinations, are given in Table 2.5-22.

Unconfined compression tests were performed on representative Richland Loess and Wedron silty clay till samples to evaluate their strength characteristics. The test results are presented on the boring logs, Figures 2.5-19 and 2.5-79.

Unconfined compression tests were also performed on undisturbed Wedron silty clay till samples obtained from directly under the Seismic Category I mat foundations on an approximate 50-foot x 50-foot grid as shown in Figure 2.5-42. The samples were obtained by pushing 2-inch OD Shelby tubes into the freshly cut foundation materials. The results of these tests are also presented in Figure 2.5-42.

2.5.4.2.2.1.3 Triaxial Compression Tests

Representative undisturbed and disturbed samples of the uniform Wedron silty clay obtained at various elevations from several borings and test pits located throughout the site were used for triaxial compression tests to evaluate their in situ strength characteristics. Table 2.5-39 provides a summary of the data pertinent to each test sample, including the boring number, depth of sample, and index properties. Boring and test pit locations are shown in Figure 2.5-2.

Typical stress-strain curves for the strength tests are shown on Figure 2.5-84. The failure criterion used for the strength tests was the maximum effective stress ratio, $\bar{\sigma}_1 / \bar{\sigma}_3$, where $\bar{\sigma}_1$ is defined as the effective major principal stress and $\bar{\sigma}_3$ is defined as the effective minor principal stress.

Unconsolidated-undrained tests were performed on undisturbed samples. The test results, in terms of confining pressure and one-half maximum deviator stress, are given in the boring logs, Figures 2.5-19 and 2.5-79. Consolidated-undrained tests were also performed. The results of those tests in terms of effective parameters are shown on Figure 2.5-43, Sheet 1.

Consolidated-undrained triaxial compression tests were also performed on representative recompacted samples of the Wedron silty clay till to be used as backfill around the Seismic Category I structures compared to 95% of Modified

Proctor density. Their results in terms of effective parameter are shown in Figure 2.5-43, Sheet 2.

Consolidated-undrained triaxial compression tests were also performed on representative recompacted samples of the Wedron silty clay till to be used as embankment fill for the dikes compared to 90% of Modified Proctor density. Their results in terms of effective parameters are shown in Figure 2.5-43, Sheet 3.

2.5.4.2.2.1.4 Compaction Tests

Modified Proctor compaction tests were performed on the Wedron silty clay till to be used as backfill around the Seismic Category I structures and dike fill to determine the maximum density and the optimum moisture content of the material. The results of these tests are presented graphically in Figure 2.5-44, Sheet 1.

Relative density tests were performed on the granular backfill to determine the maximum (wet or dry) and the minimum densities to be used for controlling the granular earthwork in the field. The results of these tests are presented graphically in Figure 2.5-44, Sheet 2.

Modified Proctor compaction tests were performed on the sand from an offsite source to be used for the drainage blanket in the dike. The purpose of the tests was to determine the maximum density and the optimum moisture content of the material. The results are shown in Figure 2.5-44, Sheet 3.

2.5.4.2.2.1.5 Consolidation Tests

Consolidation tests were performed on selected undisturbed samples of Wedron silty clay till to provide data for settlement computations. The results of these tests are shown in Figure 2.5-45, Sheets 1 through 24.

2.5.4.2.2.1.6 Permeability Tests

Permeability tests were performed on undisturbed and remolded soil samples to provide data for seepage studies.

The results of a laboratory constant-head permeability test on a sample consolidated to the existing overburden pressure are presented in Table 2.5-23, Part A. The silty clay sample had a coefficient of permeability of 2×10^{-7} cm/sec.

Additional laboratory falling head and constant head permeability tests on undisturbed samples were performed which indicate that the coefficient of permeability ranges from 7.3×10^{-7} to 5.3×10^{-9} cm/sec, as shown in Table 2.5-23, Part A.

Constant head permeability tests on remolded samples of Wedron silty clay till to be used as fill were performed, giving values for the coefficient of permeability ranging from 1.30×10^{-6} to 8.60×10^{-11} cm/sec for the embankment fill as provided in Table 2.5-23, Part B.

2.5.4.2.2.1.7 Particle Size Analyses

Representative soil samples from the dike drainage blanket, the Wedron silty clay till, and the Ticona Valley fill were analyzed to determine their grain size distribution. The results of these tests as presented in Figure 2.5-46, Sheets 1 through 3, illustrate the range in grain sizes for the various materials used on site.

2.5.4.2.2.1.8 Atterberg Limits

Atterberg limits were determined for representative soil samples of the Richland Loess and the Wedron silty clay till to evaluate their plasticity characteristics and to classify the material. The results of these tests are shown on the boring logs, Figure 2.5-19.

2.5.4.2.2.1.9 Moisture Determinations

Natural moisture contents of selected soil samples from the Richland Loess and the Wedron silty clay till were determined for soil classification purposes. The test results are given on the boring logs, Figure 2.5-19.

2.5.4.2.2.1.10 Density Determinations

The in situ dry densities of selected soil samples from the Richland Loess and the Wedron silty clay till were determined for soil classification purposes. The test results are given on the boring logs, Figure 2.5-19.

2.5.4.2.2.2 Dynamic Tests

2.5.4.2.2.2.1 Cyclic Triaxial Compression Tests

The dynamic properties of the Wedron silty clay till were evaluated by conducting cyclic triaxial compression tests on undisturbed samples in 1970. Due to the limitation of testing equipment at that time, very high backpressures could not be applied, thus saturation of the test specimens was not achieved. The samples were allowed to consolidate under confining pressures representative of in situ conditions. A range of pulsating axial loads was applied to each sample, and the load (stress) and the deflection (strain) were recorded. The hysteresis loop produced under each cyclic axial load was determined and the shear modulus of rigidity and percent damping for the various strain levels were determined. The samples were not allowed to drain during testing. The test results are presented in Table 2.5-24.

Typical curves for one test showing axial load and deflection of test specimen during a test are provided in Figure 2.5-85. Since the sample could not be saturated, no pore pressure response was measured and recorded on the stripchart.

Static residual undrained shear strength was measured at the conclusion of the cyclic triaxial tests. The test data indicate no loss of static strength for the glacial till after cyclic loading.

2.5.4.2.2.2 Resonant Column Tests

Tests were performed on selected soil samples from the Wedron silty clay till and rock cores from Pennsylvanian and Ordovician strata to evaluate the shear modulus of rigidity of these materials. The samples were subjected to steady-state sinusoidal and torsional forces applied to the top of the sample. For each test the frequency of the applied force was varied until the resonant frequency (the frequency associated with the maximum steady state amplitude) was attained. The shear modulus was then computed from the resonant frequency of the sample. The results of these tests are presented in Table 2.5-25.

2.5.4.2.2.3 Shockscope Tests

Selected samples of Wedron silty clay till and Pennsylvanian and Ordovician rock cores were tested to measure the velocity of propagation of compressional waves. The velocity of compressional wave propagation observed in the laboratory was used for correlation purposes with the field velocity measurements obtained in the seismic refraction survey.

The samples were subjected to a physical shock under a range of confining pressures, and the time necessary for the shock wave to travel the length of the samples was measured with an oscilloscope. The velocity of compressional wave propagation was then computed. For sound rock, the velocities were independent of confining pressure. The test results are presented in Table 2.5-26.

2.5.4.3 Exploration

The surface and subsurface field exploration programs consisted of the following:

- a. geologic reconnaissance of the site, excavations, and the surrounding area, including mapping of the CSCS flume and the western portion of the pond;
- b. soil and rock borings;
- c. test pits;

- d. groundwater measurements; and
- e. geophysical measurements.

2.5.4.3.1 Geologic Reconnaissance

The geologic reconnaissance of the site and surrounding area was undertaken to examine surface features for an evaluation of the geologic conditions at the site. The reconnaissance included inspection of the topography, surface drainage, surface soils, excavations, and rock outcrops in the Illinois River Valley. A detailed discussion of the reconnaissance findings is given in Subsection 2.5.1.2.

2.5.4.3.2 Soil and Rock Borings

The soil, rock, and groundwater conditions at the plant site were explored by drilling 304 borings to depths ranging from 4.5 to 360 feet below the existing ground surface at the locations indicated in Figure 2.5-2, Sheets 1 through 3. The borings were drilled with truck-mounted auger and rotary wash equipment; rock was cored with double-tube NX coring equipment.

Soil samples suitable for laboratory testing were obtained by using either a Dames & Moore sampler or a Shelby tube. A standard 2-inch-diameter split-spoon sampler was used to obtain samples in very compact soils which could not be penetrated by the Dames & Moore sampler or the Shelby Tube. Samples were taken with either the Dames & Moore sampler or the Shelby tube either by hydraulically pushing the sampler or by driving the sampler with a 340-pound weight falling 30 inches. Samples were taken with the standard split-spoon sampler by driving the sampler with either a 340-pound weight falling 30 inches or a 140-pound weight falling 30 inches. The type of sampling method used for each sample is indicated on the boring logs, as shown on the Notes on Logs of Borings, Figure 2.5-17, Sheets 1 through 3.

A graphical representation of the soils and rock encountered in the borings, including penetration test data and sampling and coring information, as well as some of the laboratory data, is presented in Figure 2.5-19. The method utilized in classifying the soils and rock is described in Figure 2.5-18.

2.5.4.3.3 Test Pits

Forty-three test pits were excavated in the vicinity of the plant to better determine the geologic and soil classifications of the materials underlying the area. Test results obtained from samples gathered from the test pits were used to help select suitable borrow areas for the lake embankment. Samples were tested for Atterberg limits, moisture content, permeability, compaction, and shear strength

(consolidated undrained triaxial). It was also necessary to dig the test pits to obtain bulk soil samples for testing purposes.

The test pits ranged in depth from 7.5 to 12.0 feet below the existing ground surface at the locations indicated in Figure 2.5-2, Sheet 1. The test pits were dug with back hoes. The notes on test pits are shown on Figure 2.5-20, and the test pit profiles are shown on Figure 2.5-21, Sheets 1 through 12.

Because modified Proctor density tests indicated that the material could be compacted at the natural moisture content without any preconditioning, test fills were not deemed necessary.

2.5.4.3.4 Groundwater Measurements

Piezometers were installed in 29 of the borings to measure groundwater levels in the glacial drift. One piezometer was also placed in the underlying rock. Details of piezometer design and installation are presented on the appropriate boring logs, Figure 2.5-19. The results of the groundwater monitoring program are discussed in detail in Subsection 2.4.13.2.2.3.2. In addition, 20 observation wells were installed in the glacial drift during December 1974 to measure groundwater fluctuations around the cooling lake.

Falling head type permeability tests were performed in the field using piezometers; the results are shown in Table 2.5-27. The zones of percolation ranged from 5 to 15 feet below the ground surface. As shown in the table, the calculated coefficients of permeability ranged from 2.6×10^{-7} to 1.6×10^{-8} cm/sec for the in situ soil conditions.

2.5.4.3.5 Geophysical Measurements

A program of integrated geophysical explorations was conducted at the station site to evaluate the characteristics of the foundation soils and rocks. A detailed explanation of these is given in Subsection 2.5.4.4.

2.5.4.4 Geophysical Surveys

Geophysical explorations were made to determine the dynamic characteristics of the underlying soils and rocks. The explorations conducted included geophysical refraction surveys and shear wave velocity surveys. The purposes of the explorations were to measure compressional and shear wave velocities, interval velocities, and the predominant period of ground motion at the site. The locations of these surveys and observations are shown in Figure 2.5-47.

2.5.4.4.1 Refraction Surveys

A 12-channel Porta-seis Refraction Seismograph was used to record the results of the deep seismic refraction surveys. The surveys were performed along survey lines 1, 2, 2A, 2B, 3, and 3A in Figure 2.5-47 for a total length of approximately 10,300 feet. Explosive charges (Nitronome) were placed in the drill holes at the ends of the lines at depths of 20 feet. Standard geophones were located at 100-foot intervals along these lines. The time-distance data obtained from the surveys were plotted, with average straight-line slopes being drawn through the plotted points. The velocity of compressional wave propagation in the upper soils and underlying rocks was computed from the plotted data. The results of the deep geophysical refraction survey are presented in Figure 2.5-48, Sheets 1 through 6.

2.5.4.4.2 Shear Wave Velocity Survey

Shear wave velocities were computed from the records of an Electrotech 12-channel Refraction Seismograph. Seismometers were located at 100-foot intervals along portions of the refraction survey lines. The shot holes were located at a distance up to 4,750 feet from the farthest geophone. The results of the survey are presented in Figure 2.5-49.

2.5.4.4.3 Surface Wave Survey

A surface wave survey along a 4750-foot length, designated lines 4, 4A, 4B, 4C, 5, and 5A in Figure 2.5-47, investigated components of the surface waves at the site.

Small explosive charges placed in drilled holes at depths of 20 feet were used to excite surface waves at the site. Two Sprengnether Engineering Seismographs were used to record the resultant waves. This instrument has a flat response between 2-100 Hertz. Each instrument recorded the seismic waves as detected by three tri-mode seismometers buried just below the surface of the ground. The recording stations were 350 feet apart along the lines. Explosions for the seismic refraction survey were utilized for this survey.

The surface waves recorded at the site have the following characteristics:

- a. an M_2 (Sezawa) branch of the Rayleigh wave which has progressive elliptical motion and an apparent surface velocity of 1,100 fps, with predominant motion on the radial trace;
- b. a very weak set of waves which are probably Love waves with an indeterminate velocity lower than the M_2 waves; and
- c. an M_1 branch of the Rayleigh waves which has a retrograde elliptical motion and an apparent surface velocity of 900 fps.

The approximately 165-foot depth of soil and the bedrock at the site apparently form a strong wave guide system for the conditions which excited the site. This wave guide system produces strong M_1 type waves with a frequency of 4 to 6 Hertz.

2.5.4.4.4 Micromotion Studies

Ambient vibration at the site was not observed, but the Sprengnether Engineering Seismograph records were inspected for the presence of low-frequency "resonance" in their coda portions. The predominant frequencies present are from 4 to 7 Hertz.

The theoretical amplification spectra peak between 2 to 5 Hertz.

2.5.4.5 Excavations and Backfill

The earthwork for the LaSalle County Station site consisted of excavating, including clearing, grubbing, and stripping; dewatering; and backfilling to attain a nominal plant grade of 710 feet MSL. A quality control program was followed for all excavations and backfill operations at the site. In-place moisture/density tests were performed on samples of all backfill during placement and compaction by a continuous program of field testing and inspection.

2.5.4.5.1 Excavations

The surface conditions at the plant site at design grades were considered to be suitable for the support of the power station facilities. Based on an evaluation of subsurface information in the immediate plant area, major structures were founded on the very stiff to hard Wedron silty clay till at design foundation elevations.

In order to assure the suitability of the foundation materials, a quality control program was followed for the excavations. The excavation limits were defined on S&L excavation design drawings. Reproductions of these are presented on Figure 2.5-50. The excavations for foundations were continuously inspected and approved by representatives of CECo Station Construction personnel for unsuitable bearing material. They directed the contractor in removing any isolated small pockets of sand and silt and replacing them with lean concrete. When an area was opened to final subgrade level, A&H Engineering Corporation performed unconfined compression tests on representative soil samples taken at a predetermined grid location. The results of these tests are given in Subsection 2.5.4.2.2.1.2. During the course of the excavation operations, periodic checks of the testing and foundation materials were made by S&L representatives to verify design assumptions. The excavations were also inspected by the Illinois State Geological Survey to confirm the geologic conditions (General References, Buschbach, 1977 and Kempton, 1975). As a result of this inspection, which confirmed the uniformity of the till member as predicted from the PSAR-stage borings, detailed mapping of the main plant excavation was

determined to be unnecessary. The walls and floors of the main plant excavation were entirely within the Yorkville Till Member (see Subsection 2.5.1.2). There were no large deposits of sand and gravel observed in the main plant excavation. Occasionally a few scattered thin lenses of silt and a few pods of sand and gravel were included within the till. The observed sand and gravel pods ranged up to 3 feet across and did not appear to have any predictable occurrence in the excavation (General Reference, Kempton, 1975).

Temporary excavation slopes were established as 1:1 (horizontal-to-vertical) with a minimum safety factor of 3.

As expected, no significant dewatering problems were encountered, the reason being the impervious nature of the Wedron silty clay till. Surface runoff water and groundwater from isolated pockets of sand or silt were collected in a system of collector ditches and sumps and then pumped out of the excavation. When the excavation was opened, isolated pockets had a tendency to seep and weep for a short time, but there were no local slides or quick conditions resulting from the exposure of these local silt and sand pockets.

2.5.4.5.1.1 Main Plant Site

The main plant is located on the upland portion of the site. The excavation for the main plant site extended into the Wedron silty clay till to a maximum depth of 60 feet below final plant surface grade as shown on Figures 2.5-50, Sheet 1, and 2.5-51, Sheets 1 and 2. Within the main building excavation, individual cuts for auxiliary buildings ranged from 5 feet to 30 feet in depth.

Excavation for the main plant commenced in the fall of 1973 and was carried to within 1 foot of final grade using heavy construction equipment. In the spring of 1974, the final 1 foot was excavated using light equipment for minimum disturbance of the final design bearing surface.

A total of 118 unconfined compression tests were performed on undisturbed samples of Wedron silty clay till taken at foundation grade immediately after final excavation, as described in Subsection 2.5.4.2.2.1.2.

The final bearing surfaces were protected with insulated blankets until the protective mud mat was poured. The mud mat, consisting of a 1-foot layer of lean concrete, was placed within 24 hours of final foundation grading. It was extended 10 feet beyond the outside wall lines to protect the bearing surface from water and frost and to provide a working area for construction.

2.5.4.5.1.2 Seismic Category I Pipelines

The excavations for Seismic Category I pipelines were extended to various depths into the Wedron silty clay till in the form of trenches with temporary 1:1 (horizontal-to-vertical) side slopes. The trenches were excavated under the same quality control program as implemented for the main plant excavation (see Subsection 2.5.4.5.1.1).

Pipelines were installed from the main plant to the CSCS pond as shown in Figures 2.5-50 (Sheets 1 and 2) and 2.5-51 (Sheets 1 and 2).

A discussion of the potential effects to the Seismic Category I pipeline of earthquake ground motions causing liquefaction of isolated sand pockets is presented in Subsection 2.5.4.5.2.2.

2.5.4.5.1.3 Seismic Category I Intake Flume and Pond

The excavation for the intake structure extends into the Wedron silty clay till from 5 feet to 40 feet below final plant grade as shown on Figure 2.5-50, Sheet 2, and Figure 2.5-51, Sheet 2.

Excavation for the intake structure commenced in the fall of 1974 and was completed in the spring of 1976.

Excavation slopes were established utilizing computer stability analysis methods, as described in Subsection 2.5.5. The analyses indicated side slopes of 4:1 (horizontal-to-vertical) would be stable. To assure that the original soil conditions assumed during design were appropriate, qualified soil engineers and geologists monitored and mapped the excavation as discussed in Subsection 2.5.4.14. Any deviation from the previously assumed soil design conditions was reported. Within the excavations, three areas were uncovered within the Wedron till which contained material significantly different from what had been proposed during the initial design. These were: two sand and gravel outwash deposits located on the excavated slopes of the intake flume and the wall of the pond (see Figure 2.5-50, Sheet 2, and Figure 2.5-52), and a clayey silt lacustrine deposit overlain by sand on the walls of the excavated intake flume (see Figure 2.5-50, Sheet 2, and Figure 2.5-53).

Both the sand and gravel outwash and the lacustrine deposits are located on a westward-dipping surface between the two portions of the Yorkville Till Member that were probably formed by minor, successive advances of the same glacier. It was found during excavation that both outwash and lacustrine deposits have their greatest extent in the north-south direction. However, as shown in Figures 2.5-81 and 2.5-82, these deposits are less extensive in an east-west direction and are not connected in the flume walls.

2.5.4.5.1.3.1 Outwash Deposit

The sand and gravel deposit in the flume was postulated to be liquefaction-prone when subjected to dynamic loadings equivalent to the SSE. It was therefore excavated to the limits shown on Figures 2.5-86 and 2.5-87 and replaced with controlled, compacted, cohesive Wedron silty clay till fill compacted to a minimum 95% of Modified Proctor density to a configuration as shown on Figure 2.5-68, Sheet 4. The overlying Wedron silty clay till was excavated, stockpiled, and reused. The sand and gravel were removed and spoiled. Stability analyses were performed to determine the extent of overexcavation required to meet minimum required factors of safety as discussed in Subsection 2.5.5.2.3.

The sand and gravel outwash deposit in the northwestern portion of the wall of the pond (see Figure 2.5-50, Sheet 2) was postulated to be liquefaction-prone when subjected to dynamic loadings equivalent to SSE. Since the deposit was small and would be below final lake level, it was completely excavated and cut back on 4:1 horizontal-to-vertical slopes.

2.5.4.5.1.3.2 Lacustrine Deposit

Since the sand deposit encountered above the clayey silt will be removed, it was neglected in the evaluation of the effect of the lacustrine deposit on the overall slope stability as shown on Figure 2.5-68, Sheet 2.

Stability analyses were not performed on the sand strata since they were encountered at a shallower depth than the outwash deposit and hence at a less critical depth. The sand was also considered to be liquefaction-prone when subject to dynamic loadings equivalent to the SSE and was excavated to the limits shown on Figure 2.5-88 and replaced with fill as discussed in Subsection 2.5.4.5.1.3.1.

Based on the results of the stability analysis, the strength of the lacustrine deposit is adequate to ensure stability with a minimum factor of safety of 1.167 as shown on Figure 2.5-68, Sheet 2, for the postulated event of rapid drawdown combined with an SSE of 0.2 g.

2.5.4.5.2 Backfill

The majority of the backfill material used at the LaSalle County site consisted of the excavated Wedron silty clay till from the plant site excavation, which had been stockpiled for this purpose. Well-graded sand from an offsite source in the Ticona Valley Fill located at Illinois Route 170 and the south bank of the Illinois River was also utilized for select areas.

The Wedron silty clay till backfill was placed loose in 6-inch lifts and compacted to a minimum of 95% of the Modified Proctor density with sheepsfoot rollers. Areas inaccessible to large compaction equipment were hand compacted to the specified density with power hand tampers. The envelopes of the Modified Proctor densities and the grain sizes for all clay fill are shown on Figure 2.5-44, Sheet 1, and Figure 2.5-46, Sheet 1, respectively. The average compaction achieved in the field was equivalent to 97% Modified Proctor density.

The sand backfill was placed loose in 12-inch and 6-inch lifts, depending upon the size of the available vibratory rollers or compactors. The sand fill was compacted to a minimum of 75% of its maximum relative density with vibratory rollers or power hand tampers. The envelopes of the relative densities and the grain sizes for the sand fill are shown on Figure 2.5-44, Sheet 2, and Figure 2.5-46, Sheet 2. The average relative density achieved in the field was 85%.

The placement and compaction of the backfill was continuously supervised to ensure that it was placed and compacted as specified.

2.5.4.5.2.1 Main Plant Site

The backfill around the main buildings consisted of the previously excavated and stockpiled Wedron silty clay till. Where underground piping would be installed, backfilling with Wedron till was restricted to depths above pipelines in order to avoid excessive settlement. The remaining depth to the bottom of the excavations was backfilled with Ticona Valley sand. This is illustrated in Figure 2.5-50, Sheet 1, and Figure 2.5-51, Sheets 1 and 2.

2.5.4.5.2.2 Seismic Category I Pipelines

For support of the Seismic Category I pipelines, a special lean concrete mix was used to encase the piping. The mix consisted of fly ash, sand, and cement which hardened to an unconfined compressive strength of more than 200 psi at 28 days. The pipelines were first laid on blocks to facilitate welding. The piping was then completely encased in the lean concrete mix from the outside wall of the trench up to 1 foot above the pipe to ensure complete bearing under the pipe. This monolithic encasement has the inherent ability to resist potential deformations of any isolated sand pockets, should they exist. However, as discussed in Subsection 2.5.4.8.3, these isolated pockets do not deform during a postulated earthquake. The remainder of the trench was backfilled to finished grade with compacted Wedron silty clay till or Ticona Valley sand fill as shown in Figure 2.5-51, Sheets 1 and 2.

2.5.4.5.2.3 Seismic Category I Intake Flume and Pond

Wedron silty clay till backfill was used in the flume and pond to replace the excavated sand and gravel pocket in the flume, as described in Subsection 2.5.4.5.1.3.

The only backfill placed that was not Ticona Valley sand fill or Wedron silty clay till was behind the concrete gravity retaining wall in the intake flume, as shown in Figure 2.5-54. Pea gravel from an offsite source was placed here to ensure proper drainage behind the wall and thus keep the hydrostatic pressure at a minimum while reducing the lateral loading on the wall, as described in Subsection 2.5.4.10.3.3.

2.5.4.6 Groundwater Conditions

Piezometers and groundwater observation wells were installed to establish and evaluate the groundwater conditions at the site. The piezometers were used to monitor the groundwater fluctuations at the site prior to plant construction. The observation wells were installed to evaluate the groundwater conditions outside the cooling lake after construction had started. A detailed discussion of these site groundwater conditions and of regional groundwater conditions is given in Subsection 2.4.13.2.2.3.2.

2.5.4.7 Response of Soil and Rock to Dynamic Loading

The parameters utilized in the soil-rock-structure interaction analyses are presented in Table 2.5-28 and Figure 2.5-55, Sheets 1 and 2. These figures present strain-related dynamic moduli and damping values. Static soil properties, presented in Table 2.5-28, were evaluated based on the results of laboratory tests, such as the static triaxial tests and the resonant column tests. These were subsequently compared with test results reported in the literature for similar materials. The selected design properties reflect both the results of the laboratory tests performed during this investigation and properties previously developed for similar soils.

2.5.4.8 Liquefaction Potential

Presented in the following subsections are the results of detailed analyses of the liquefaction potential of onsite granular soils which occur as pockets within the Wedron till. These analyses were performed to verify that the sands that locally underlie the Seismic Category I structures will not liquefy during the SSE.

2.5.4.8.1 Sand Deposit Under Main Plant Foundation

2.5.4.8.1.1 Subsurface Conditions

The subsurface conditions in the area of the main plant mat foundations have been investigated with numerous borings; the boring logs are presented on Figure 2.5-19. Those borings which penetrated a sand deposit near the station's mat foundations are located on Figure 2.5-56.

The Wisconsin Wedron silty clay till beneath the station site occurs from approximately elevation 710 feet to elevations 530 to 540 feet MSL. Between the Malden and Tiskilwa Till Members of the Wedron Formation at a general elevation of approximately 595 ± 10 feet MSL, some boring logs in the plant area encountered localized sand and gravel deposits as shown on Figure 2.5-56. These deposits are possibly of glacial outwash origin. Considering the irregular pattern of glacial meltwater streams near the ice front, it is very likely that the sand and gravel deposits occur as scattered disconnected bodies. However, as this cannot be conclusively demonstrated in any practical way, the following discussion assumes, conservatively, that the granular material between the Malden and Tiskilwa tills is continuous under the main plant structures.

2.5.4.8.1.2 Soil Characteristics Influencing Liquefaction

It is an established fact that liquefaction potential of soil deposits due to earthquake motion depends on the characteristics of the soil, the degree of saturation, the initial stresses acting on the soil, and the characteristics of the earthquake involved (Reference 291, Seed and Idriss, 1970). Significant factors include:

a. The relative density

Relative density is the most important physical characteristic that determines the liquefaction potential of a soil. The higher the relative density, the less susceptible the soil is to liquefaction.

b. The soil type

Fine sands and fine to medium sands tend to liquefy more easily than do coarse sands, gravelly soils, fine silts, or clays. There is some evidence to show that poorly graded materials are more susceptible to liquefaction than well-graded materials.

c. The initial confining pressure

The liquefaction potential of a soil is reduced by an increase in confining pressure. State-of-the-art evaluation of soil characteristics for seismic response analyses (Reference 292, Shannon & Wilson, Inc. and Agbanian-Jacobsen Associates, 1972) states, "From field observations it has generally been concluded by a number of investigators that even in a saturated sand deposit below a depth of 50 to 60 feet, sands are not likely to liquefy." These depths are in general agreement with Kishida (Reference 293, 1969), who states that "a saturated sandy soil is not liquefiable if the value of the effective overburden pressure exceeds 2 kg/cm^2 ($2 \text{ kg/cm}^2 \cong 60 \text{ ft of soil below water table} \cong 4.1 \text{ kips/ft}^2$)."

Characteristics of earthquakes for this site are defined in Subsection 2.5.2 and are not repeated here.

2.5.4.8.1.3 Liquefaction Potential Of Sand Deposit

The sand deposit under the main plant foundation is characterized by appreciable fines (passing U.S. Sieve No. 200) ranging up to 55%. The high blow counts (25 to 200 for 4-inch penetration) in the deposit are substantiated by high values of dry densities obtained from density measurements on relatively undisturbed samples in the laboratory, as shown on the boring logs, Figure 2.5-19.

In Table 2.5-29, a description of the sand deposit has been tabulated to show the elevations at which it has been found, the thickness, the corresponding boring numbers, and the blow counts. A study of the sand deposit under the plant was performed which utilized the following parameters:

- a. soil description,
- b. soil classification,
- c. penetration values, and
- d. depth at which the deposits exist.

The top of the deposit ranges from elevation 572 feet to elevation 603 feet, which is 138 to 107 feet below finished grade. Its thickness varies from 2 to 22 feet, giving a mean layer elevation of 595 feet MSL. The soil description, generalized from the 40 samples, is gray brown coarse sand with some silt and gravel and is classified in the Unified System as sands ranging from uniform (SP) sands and well-graded (SW) clean sands to silty (SM) sands.

In order to determine the representative relative density of the deposit and accurately represent the soil properties, a statistical analysis was performed on the

various penetration values. This type of analysis allows for variations in the testing procedure and will yield a probabilistic range of values.

The first step in this procedure is to reduce the field test data. Forty standard penetration tests and Dames & Moore samples were taken in the sand deposit, which appears, by soil description and elevation similarity, to be the same deposit. The corrected standard penetration blow counts were used to compute statistically a mean value to be used in relative density calculations. Values greater than 200 blows per foot were conservatively rounded down to 200.

The analysis was performed assuming a normal distribution for the blow counts within the deposit. There is a 95% confidence level that a random blow count value will be greater than 119 blows per foot. This analysis was performed with the methods illustrated in Reference 294 (Benjamin and Cornell, 1970).

Utilizing the average unit weights for the tills in the area and for the depths indicated on the boring logs, the vertical effective overburden pressure was found to be 8.8 kips/ft².

With the blow count value and calculated vertical effective overburden pressure, the Gibbs and Holtz relationship (Reference 295, Gibbs and Holtz, 1957) was used to calculate the relative density of the material.

An average relative density greater than 90% was obtained. Sands with a relative density of 90% or greater are unlikely to liquefy under the given confining pressures and anticipated loadings (Reference 293, Kishida, 1969).

2.5.4.8.1.4 Conclusions

Sand deposits under the plant site have been examined for:

- a. relative density,
- b. soil type, and
- c. initial confining pressure.

From the numerous studies conducted on sands both in the laboratory and in the field, these three are the principal soil characteristics affecting liquefaction of sand deposits under earthquake loading. The properties of sand under the foundation mat have been examined for these characteristics and it has been found that the deposit will not liquefy under the earthquake loading.

The consistency of the deposit, based on standard penetration test values, has a relative density greater than 90%. The dense nature of the sands is borne out by a

limited number of in situ dry density values, in which dry densities were found to be more than 115 pcf. This is indicative of relative densities greater than 91% for this sand deposit.

The material in the deposit is usually a well-graded fine to coarse sand, with some fine gravel and silt, making it resistant to the liquefaction process.

The sand deposit is at a depth exceeding 115 feet with an effective overburden pressure of more than 8.8 kips/ft². With the plant foundation loads applied, the effective overburden pressure would exceed by more than 2 times the pressure (4.1 kips/ft²), which according to Kishida (Reference 293, 1969) will prevent saturated sandy soils from liquefying.

It is therefore concluded that these sand deposits will not liquefy under the site earthquake loading. In addition, no additional settlement is anticipated due to seismic loads.

2.5.4.8.2 Sand Deposits in Intake Flume Slopes

The sand deposits encountered in the Wedron silty clay till during the excavations in the flume, as described in Subsection 2.5.4.5.1.3, were considered to be liquefaction-prone and were removed to ensure the stability of the flume slopes.

2.5.4.8.3 Liquefaction Potential of Isolated Sand Deposits

Sand deposits are found only rarely in borings throughout the Wedron silty clay till. These sand deposits will not completely liquefy and flow due to their confinement and will therefore not be a vehicle for instability. The shear stress produced by an earthquake may cause initial liquefaction. This initial liquefaction would be followed by "arching" of the load to the stiffer material, silty clay; further liquefaction of the postulated sand will not occur. Therefore, the integrity of the plant pipeline and flume will be unaffected by the confined sand deposits.

2.5.4.9 Earthquake Design Basis

Detailed analyses of the SSE and the OBE are presented in Subsections 2.5.2.6 and 2.5.2.7, respectively.

2.5.4.10 Static Stability

The subsurface conditions at the plant site are considered to be suitable for the foundation support of the proposed nuclear power station facilities. Based on an evaluation of subsurface information from borings drilled in the immediate plant area, confirmed by observations during construction, major plant structures were supported on or excavated into the very stiff to hard glacial tills. A comprehensive

LSCS-UFSAR

investigation was performed to develop the design criteria used for the foundations for the Seismic Category I structures, which are:

- a. main plant structures including the reactor, auxiliary, and diesel-generator buildings;
- b. Seismic Category I pipelines; and
- c. Seismic Category I intake flume and pond.

2.5.4.10.1 Main Plant Structures

The main plant structures are supported by a concrete mat founded on the glacial till.

2.5.4.10.1.1 Bearing Capacity

Final foundation levels and gross static dead loads for all the main structures including non-Seismic Category I are listed in Table 2.5-30. The dimensions of the loaded areas are shown on Figure 2.5-57. The net static foundation dead loading, shown in Table 2.5-30, is equal to the gross applied static dead loading minus the hydrostatic uplift pressure. Final plant grade is established at elevation 710 feet MSL and the operational lake level at elevation 700 feet MSL. Thus, the hydrostatic uplift pressures have been calculated assuming that the long-term water table at the plant site will be at elevation 700 feet MSL.

The ultimate bearing capacity values shown in Table 2.5-30 were established using the bearing capacity equation as defined by Terzaghi, which is based on the angle of internal friction and the cohesion of the material determined from laboratory testing performed on samples from the underlying foundation soils, as described in Subsection 2.5.4.2.2.

The equation used to obtain the ultimate bearing capacity was:

$$Q_d = cN_c + \bar{\gamma}_1 D_f + 1/2 \bar{\gamma}_2 B N_\gamma$$

where:

Q_d = ultimate bearing capacity, in kips/ft²,

c = cohesion, in kips/ft²,

$\bar{\gamma}_1$ = effective soil unit weight above mat elevation, in kips/ft³

D_f = depth of mat below final grade, in feet,

LSCS-UFSAR

$\bar{\gamma}_2$ = effective soil unit weight below the mat elevation, in kips/ft³,

B = least dimension of the mat, in feet, and

N_c , N_q and N_γ = Terzaghi bearing capacity factors (Reference 296, Terzaghi and Peck, 1967).

For total strength parameters of the Wedron silty clay till of $\phi = 0$ (where ϕ is the angle of internal friction),

c = 3000 psf.

The tabulated factors of safety were determined by assuming that each structure, or portion of it with a variable mat elevation, is isolated from the adjacent structure.

The foundation loading during seismic loading conditions will not exceed 200% of the foundation dead loads tabulated in Table 2.5-30. Thus, factors of safety under seismic or live loading will not be less than one half of the values in Table 2.5-30.

From a bearing capacity failure standpoint, the conditions are most favorable for the support of the structures.

2.5.4.10.1.2 Settlement Analyses

Detailed static settlement analyses have been performed to determine the settlement of the plant structures according to the construction sequence. The excavation for the plant structures commenced in the fall of 1973. Excavation was completed in about 6 months. Construction of plant structures then followed.

The elevation of ground surface at the plant site is at 710 feet. The groundwater table is at elevation 700 feet (Subsection 2.4.13.5). There is no dewatering involved due to the impervious nature of the Wedron Silty Clay till (see Subsection 2.5.4.5.1).

Final foundation levels, dimensions, and static loads for the plant structures are shown in Table 2.5-30 and Figure 2.5-57. The settlement due to construction is computed based on the increase in effective stress equal to the gross foundation pressure minus the uplift pressure.

The settlement analyses were performed using Janbu's tangent modulus method (Reference 297, Janbu, 1967). The consolidation parameters of the foundation subsurface materials used in the analysis are evaluated from the results of laboratory consolidation tests (summarized in Table 2.5-40). The actual computations were made using the computer program SETTLE developed by

Sargent & Lundy. The description of the SETTLE program is presented in Appendix F.

The foundation settlement has been investigated by assuming the structural foundation system to be either completely rigid or completely flexible. The actual field settlement behavior of the main plant is bounded by these two extreme cases.

For both foundation cases, the effective foundation pressure is placed directly at the base of the structure. For the completely flexible case, the rigidity of foundation and superstructure system is neglected. For the completely rigid foundation case, the distribution of contact pressure due to the effect of the foundation rigidity is taken into account by considering linear settlement. An iterative procedure is used so as to make the settlement pattern of the foundation and the subsoil compatible. The iterative procedure is illustrated by a flowchart shown in Figure 2.5-91. This iterative procedure has been included in the computer program SETTLE.

The computed maximum rebound values range from 0.84 to 2.76 inches. Based on the estimated time-rate of consolidation data (Table 2.5-40), the rebounds occur quickly with the excavation operations. These excavations also remove all the rebounded soil. Because foundations are placed at their design elevation, these rebounds will not affect the subsequent settlement due to the construction of plant structures.

The final settlement contours due to construction for the major structures at the plant site are shown in Figure 2.5-58, Sheets 1 and 2. The predicted maximum and minimum final settlements are 0.88 inches to 2.46 inches for a rigid foundation and 0.24 inches to 3.37 inches for a flexible foundation.

The settlements are monitored by the subsurface instrumentation program described in Subsection 2.5.4.13. The settlement readings for all monument points are presented in Figure 2.5-67. The comparison of theoretical final settlements and latest measured settlements at the monument points are presented in Table 2.5-41. The theoretical settlement agree reasonably with the measured values.

Theoretical time-settlement curves have been plotted for measurement point TR2 within the turbine building mat and measurement point R1 within the reactor building. The actual measured settlements and theoretical time-settlement histories for these two measurement points are shown in Figures 2.5-58a and 2.5-58b.

As can be seen from these figures, the measured time-settlement histories compare reasonably well with the theoretical ones. In addition, a review of the plant settlement readings (Figure 2.5-67), indicates that the movement of all benchmarks has been within 0.02 feet over the last 2 years. This shows that the main plant settlements have stabilized.

The preconsolidated, cohesive soil deposits which underlie the plant area are susceptible to negligible additional consolidation under short-term earthquake loading conditions.

2.5.4.10.1.3 Lateral Pressures

Subsurface walls were designed to resist both the static and the dynamic lateral pressures resulting from the surrounding earth and water. The total pressure on the walls was obtained by adding the incremental dynamic pressure distributions to the static pressure distributions.

2.5.4.10.1.3.1 Static Lateral Pressures

The total static pressure was obtained by combining soil and water pressures determined in Subsections 2.5.4.10.1.3.1.1 and 2.5.4.10.1.3.1.2.

2.5.4.10.1.3.1.1 Static Earth Pressures

Since rigid walls were being backfilled with compacted material, static earth pressures were computed using at-rest earth pressure coefficients. The horizontal soil pressure coefficients were equal to two-thirds and one-half for the compacted clay and sand, respectively. The static earth pressures have a hydrostatic triangular distribution with its resultant acting at one-third the height of the wall above the base.

The equation used to obtain the static and passive earth pressures from the soil was:

$$P = \bar{\gamma}hk \pm 2\bar{c}\sqrt{k}$$

where:

P = static lateral soil pressure, in psf per unit width of wall,

$\bar{\gamma}$ = effective unit weight of soil, in pcf,

h = depth below ground surface, in feet,

k = horizontal soil pressure coefficient,

\bar{c} = effective cohesion (in psf),

+ = passive side of wall, and

- = active side of wall.

Subsurface walls were also designed to resist pressures from an areal surface live load of 1000 psf and from all adjacent structures within a distance of one-half the wall height. The lateral earth pressure distribution from the surcharge loading is constant with depth, with the resultant acting midheight between the surface elevation and the base of the wall.

The equation used to obtain the pressure from the surface or adjacent structure loads was:

$$p = qk$$

where:

q = areal surface or adjacent structure load, in psf.

2.5.4.10.1.3.1.2 Static Water Pressure

Pressure due to water below the water table, elevation 700 feet MSL, was calculated using the equation:

$$p = 62.4 (h-h_1)$$

where:

p = static water pressure, in psf per unit width of wall,

h = depth below ground surface, in feet, and

h₁ = depth below ground surface to water table, in feet.

2.5.4.10.1.3.2 Incremental Dynamic Lateral Pressures

The total incremental dynamic pressure was obtained by combining soil and water pressures determined in Subsections 2.5.4.10.1.3.2.1 and 2.5.4.10.1.3.2.2.

2.5.4.10.1.3.2.1 Dynamic Earth Pressure

The dynamic lateral earth pressure increment on the walls of the structures was obtained by methods similar to those developed by Mononobe (Reference 298, 1929) and Okabe (Reference 299, 1926) and modified by Seed and Whitman (Reference 300, 1970). The equation used to obtain the dynamic forces for dry material was:

$$\Delta P_{AE} = 1/2 \bar{\gamma} H^2 \Delta K_{AE}$$

where:

ΔP_{AE} = dynamic lateral force, in kips per unit width of wall,

$\bar{\gamma}$ = effective unit weight of soil, in kips/ft³,

H = height of wall, in feet, and

ΔK_{AE} = dynamic increment in earth pressure coefficient.

Values of ΔK_{AE} are a function of horizontal acceleration. For practical purposes, ΔK_{AE} was taken as:

$$\Delta K_{AE} = \frac{3}{4} K_h$$

where:

K_h = horizontal earthquake ground acceleration divided by the acceleration of gravity, g.

The dynamic earth pressures have an inverted hydrostatic triangular distribution, with the resultant acting at two-thirds the height of the wall above the base. The pressure distribution is based on the inertia forces of the soil representing the "at rest" condition. The pressures were obtained by multiplying the effective unit weight of the soil wedge by 75% of the horizontal earthquake acceleration.

2.5.4.10.1.3.2.2 Incremental Dynamic Water Pressure

At the time of the design of the plant, the technique described in Matuo and Ohara (Reference 302, 1960) was used to compute the incremental dynamic water pressures on subsurface walls. Their analysis is based upon the assumption that the wall is fixed, not allowing any relative displacement against the ground, and that there is no resonance between the ground motion and the earth pressure. These conditions may not always be satisfied, but the results of their experiments nearly coincide with their theoretical computations for a fixed wall.

The Westergaard Theory for the dynamic water pressure on the face of a concrete dam during earthquakes, modified by the soil reduction coefficient of Matuo and Ohara, was used to compute the incremental dynamic water pressure for the backfilled side of subsurface structural walls and the land side of lake retaining

walls. From this analysis, the increase of the water pressure on the backfilled side of the walls at any depth, y , is given as:

$$\Delta P_w = 0.70 CK_h (H_1 y)^{1/2}$$

where:

ΔP_w = dynamic water pressure, in pounds per foot per unit width of wall,

$$C = \frac{51}{\left[1 - 0.72 \frac{H_1}{1000 t_e}\right]^{1/2}} \text{ in pcf,}$$

t_e = earthquake period, in seconds,

H_1 = height of water table, in feet, and

y = depth below water table, in feet.

The Westergaard Theory, modified by the negative coefficient of Matuo and Ohara, was used to compute the incremental dynamic water pressure for the water side of the lake retaining walls. For the water side of walls the reduction of the water pressure is given by:

$$\Delta P_w = - CK_h (H_1 y)^{1/2}$$

2.5.4.10.2 Seismic Category I Pipelines

The essential service water supply pipelines are Seismic Category I structures from the cooling water intake screen house to the cooling water pumps as indicated on Figure 2.5-59. Outside of the structures, they are buried in an excavated trench in the Wedron Silty clay till. They are covered with a minimum of 5 feet of cover to protect them from frost action. These supply lines are separated by safety divisions. Each safety division has its own supply line.

The routing of the CSCS cooling water return pipelines is indicated on Figure 2.5-59. These lines return to a remote end of the pond to facilitate the flow pattern in the pond and terminate in an outfall structure above the 700-foot elevation. This structure is a concrete base for water impingement at the entry to the pond, as shown in Figure 2.5-51, Sheet 2, Section 1E-E, and Figure 2.5-60.

2.5.4.10.2.1 Bearing Capacity

There is no bearing capacity problem with the buried pipeline, since the weight of the pipeline filled with water is approximately equal to the weight of the volume of existing soil removed.

2.5.4.10.2.2 Settlement

There is no settlement problem with the buried pipeline, since the weight of the pipeline filled with water is approximately equal to the weight of the volume of existing soil removed.

2.5.4.10.2.3 Lateral and Vertical Pressures

The pipeline was designed to resist the lateral pressures described in detail in Subsection 2.5.4.10.1.3. The pipeline was also designed to resist the overburden pressure above the pipeline, which is equal to the weight of the backfill over the pipe plus the incremental dynamic inertia load from the vertical seismic accelerations. The pipeline was also designed to resist the uplift pressures from groundwater if the pipeline is empty.

2.5.4.10.3 Seismic Category I Intake Flume and Pond

The cooling pond is connected to the generating plant intake structure by an intake flume as shown on Figures 2.5-41, 2.5-59, 2.5-60, and 2.5-61. Cross sections through the CSCS pond and flume are shown on Figures 2.5-52 through 2.5-54 and 2.5-62 through 2.5-65. Foundation details of the intake structure are shown on Figure 2.5-51, Sheet 2, Section D-D'. The foundation details of the outlet chute structure are shown on Figure 2.5-51, Sheet 2, Section E-E'. The CSCS cooling pond water emergency level has been established at elevation 690.0 feet MSL.

The flume invert was established at elevation 678.5 feet, and the length of the flume is approximately 2500 feet.

The flume consists of a 90-foot wide channel excavated into the underlying Wedron silty clay till. The side slopes of the flume range in vertical height from less than 20 feet at the east end, where the flume meets the pond, to approximately 40 feet at the point where the flume meets the lake intake structure.

At the lake screen house, the sides of the flume are formed by a concrete gravity retaining wall on the south and a double row of tied sheet piling on the north.

The CSCS pond was designed to be an extension of the flume with a bottom at elevation 685 feet. The pond has a surface area of approximately 83 acres and a depth of about 5 feet. The side slopes of the CSCS cooling pond range in vertical

height from less than 10 feet along the eastern side of the pond to approximately 20 feet at the point where the pond meets the intake flume.

The purpose of the pond is to contain a sufficient quantity of water for a safe shutdown of the reactors in the extremely unlikely event that the peripheral dike is breached. The intake flume and pond have been designed to provide an uninterrupted supply of emergency cooling water to the two reactors. They have been designed for the most severe possible loading combination of rapid drawdown in the lake, in combination with the SSE.

The excavation of the flume and pond were continuously monitored during construction, assuring compliance with the design requirements, as described in Subsection 2.5.4.5.1.3.

2.5.4.10.3.1 Bearing Capacity

There are three structures on the circumference of the pond and flume that have their foundations bearing on soil. They are:

- a. the lake intake screen house,
- b. the concrete gravity retaining wall, and
- c. the CSCS pipeline outlet chute.

Final foundation levels and static dead loads for the structures are listed in Table 2.5-30. The dimensions of the loaded areas are shown in Figures 2.5-54, 2.5-57, 2.5-60, and 2.5-64. The net static foundation dead loading, shown in Table 2.5-30, is equal to the gross applied static loading minus the hydrostatic uplift pressure. The ultimate bearing capacity values have been calculated by methods described in Subsection 2.5.4.10.1.1.

The peak foundation loading during seismic loading conditions for the lake screen house and the CSCS pipeline outfall structure will not exceed 150% of the foundation dead loads as tabulated in Table 2.5-30. Thus, factors of safety under seismic or live loading will not be less than two-thirds of the values tabulated.

The concrete retaining wall bearing pressures were obtained using lateral loading conditions described in Subsection 2.5.4.10.3.3.

2.5.4.10.3.2 Settlement Analyses

The lake screen house is supported by a mat foundation 187 feet by 102 feet 7 inches founded at elevation 670 feet. The average design gross static bearing pressure is 2,700 psf. The groundwater table is assumed to be at elevation 700 feet

(Subsection 2.4.13.5). The method for computing settlements is discussed in Subsection 2.5.4.10.1.2.

The analysis showed that the maximum calculated rebound due to the excavation for this structure is 1.60 inches. The excavation operations remove the rebounded soil. The maximum computed settlement due to the construction of this structure is 1.46 inches. Overconsolidated cohesive soil underlying the lake screen house will be subjected to negligible additional consolidation under short-term earthquake loading conditions.

The settlement of the lake pumphouse is monitored by a settlement monitoring program described in Subsection 2.5.4.13. The settlement readings for monument point LSH3 at the lake screen house are presented in Figure 2.5-67. The comparison of theoretical final settlement and latest measured settlement at monument point LSH3 is presented in Table 2.5-41. The comparison shows the computed settlement to be in good agreement with the measured value.

Settlement of the CSCS outlet chute structure is not a problem, since the foundation bearing loads are approximately equal to the weight of the overburden soil that was excavated.

The maximum calculated settlement at the toe of the critical section of the retaining wall would be less than 0.6 inch. Since the expected settlement was of such a small magnitude, it was concluded that this small settlement would not cause a problem. However, based upon an NRC request, the settlement of the wall will be monitored by a similar program, as described in Subsection 2.5.4.13.

2.5.4.10.3.3 Lateral Pressures

The lateral pressures used in the design of the lake intake screen house and the CSCS pipeline outlet chute were calculated using the methods discussed in Subsection 2.5.4.10.1.3 and the effective strength parameters shown in Table 2.5-31.

The concrete retaining wall and steel sheet piling wall were designed using the dynamic incremental pressures discussed in Subsection 2.5.4.10.1.3.2. The static water pressures were obtained using methods discussed in Subsection 2.5.4.10.1.3.1.2. The static earth pressures on the retaining walls were computed based upon active and passive earth pressure coefficients of 0.33 and 2.56, respectively, since cohesionless backfill was used against the wall on the active side and cohesive backfill was used on the passive side (the flume side). The static and additional dynamic lateral pressure distribution diagrams for a critical section through the concrete retaining wall are shown on Figure 2.5-83, Sheets 1 and 2 respectively.

The static earth pressures on the sheet piling, from the in situ cohesive soil, were computed based upon an active earth pressure coefficient of 0.42 and a passive coefficient of 2.37. The coefficients were based on strength parameters from triaxial tests on many undisturbed soil samples from the immediate area. The static and additional dynamic lateral pressure distribution diagrams for a critical section through the sheet piling wall are shown on Figure 2.5-83, Sheets 3 and 4 respectively.

2.5.4.11 Design Criteria

The criteria and methods used in the design of Seismic Category I structures are discussed in the following Subsections:

- a. liquefaction potential, Subsection 2.5.4.8;
- b. bearing capacity, Subsection 2.5.4.10.1.1;
- c. settlement analyses, Subsection 2.5.4.10.1.2;
- d. lateral pressures, Subsection 2.5.4.10.1.3; and
- e. slope stability, Subsection 2.5.5.2.

2.5.4.12 Techniques to Improve Subsurface Conditions

Information regarding the excavation, removal, and replacement of unsuitable material is discussed in Subsection 2.5.4.5.

2.5.4.13 Subsurface Instrumentation

The subsurface instrumentation programs used at the LaSalle County Station consist of groundwater observation wells, as described in Subsection 2.5.4.6, and settlement readings in the main plant area and the lake screen house. The locations of the settlement monuments are shown in Figure 2.5-66. Settlements are being measured by first-order surveying techniques from bench marks not affected by station loading. Present readings of these surveys are given in Figure 2.5-67.

Settlement monuments used at LSCS typically consisted of a scribe mark at the top of a column base plate or an "X" marked in a concrete floor or wall slab. A total of 12 monuments were installed in 1975. The dates of their installation and a brief summary of the related construction schedule are provided in Table 2.5-38.

The monuments, which were simply points of known elevation on existing structures, did not require specific protection during construction. Construction considerations occasionally required relocation of a particular settlement

monument. Readings were taken at the old and new monuments at the time of relocation to ensure that readings on the new monument could be correlated with previous readings on the old monument. No problems were encountered with the settlement monument system.

2.5.4.14 Construction Notes

Surveillance of the CSCS flume and pond was initiated during the 1975 construction season. Three significant deposits of lacustrine silts and outwash sands and gravels, shown on Figure 2.5-50, Sheet 2, were observed and a detailed investigation was undertaken to delineate the extent of these deposits and to determine their characteristics. This program included detailed geologic mapping of the exposed flume walls illustrated in Figures 2.5-81 and 2.5-82, the drilling of 64 additional test borings shown on Figure 2.5-19, Sheets 218 through 261, and laboratory testing of representative samples included on the boring logs.

The locations of these lacustrine and outwash deposits are shown in Figure 2.5-50, Sheet 2. The lacustrine deposits consist of gray to brown laminated clayey silt and fine to medium sand. The outwash deposits consists of gray to brown fine to coarse sand and gravel. Remedial measures necessitated by the exposure of the deposits are discussed in Subsection 2.5.5.2.3.

Isolated small deposits of silt, sand and gravel are scattered throughout the CSCS excavation, as shown on the geologic maps. These deposits vary from less than 0.5 foot to about 5 feet in thickness and up to 10 feet in width. These deposits are surrounded by till and are therefore not laterally continuous. They are not liquefaction prone as discussed in Subsection 2.5.4.8.3.

After stripping operations along the northeast side of the CSCS pond, it was discovered that a section of the crest of the excavated pond was below the required minimum elevation of 690 feet. Hence, it was required to add a 1-foot-high berm in this section as illustrated on Figures 2.5-59 and 2.5-65. No stability analyses were performed on this berm, since it has side slopes of 10:1 (horizontal-to-vertical), is only 1 foot in height, and has been constructed to the same requirements as discussed in Subsection 2.5.4.5.2.

2.5.5 Stability of Slopes

The LaSalle County Station site is located within a very gently sloping open area. The plant is located in the upland area of the site. It is founded on the Wisconsin Wedron Till, with final plant grade established at elevation 710.0 feet, which is approximately the same elevation as the existing ground before construction. Therefore, there are no natural slopes subject to failure during the SSE.

2.5.5.1 Slope Characteristics

There are no cut or fill slopes whose postulated failure could adversely affect the safe shutdown of the unit following the SSE. Slopes of interest to the safe operation and shutdown of the unit are the manmade cuts forming the sides of the submerged CSCS pond and intake flume, which is part of the core standby cooling system.

The side slopes of the CSCS cooling pond range in vertical height from less than 10 feet along the eastern side of the pond to about 20 feet at the point where the pond joins the intake flume.

The side slopes of the intake flume range in vertical height from about 20 feet at the CSCS pond to 40 feet where the flume meets the intake structure.

The pond and flume are shown in Figure 2.5-59. The CSCS pond and flume were constructed by the excavation of the glacial silty clay. The CSCS cooling pond water level has been established at elevation 690 feet for emergency operations. Under normal operations, the water level is the same as that of the cooling lake, elevation 700 feet.

The flume invert was established at elevation 678.5 feet at the pond, and the length of the flume is 2500 feet. The invert elevation of the flume at the intake screen house was established at elevation 674 feet. The CSCS pond is designed to be an extension of the flume, with its bottom at elevation 685 feet. The pond and flume have a combined surface area of approximately 85 acres and a depth of 5 feet. With the normal lake level at elevation 700 feet, the CSCS pond and cut slopes will be submerged under operating conditions.

2.5.5.2 Design Criteria and Analyses

The excavated slopes of the pond and flume were designed to be stable under all conditions of emergency operations. Stability analyses were performed in order to determine the final slope configurations. The various slopes were investigated under the following loading conditions:

- a. end of construction;
- b. full cooling lake (steady seepage), water elevation 700 feet;
- c. empty cooling lake (rapid drawdown), from elevation 700 feet to elevation 690 feet;
- d. steady seepage, water elevation 700 feet, combined with the basic seismic ground acceleration of 0.2g applied as a pseudo-static coefficient; and

LSCS-UFSAR

- e. rapid drawdown, from elevation 700 feet to elevation 690 feet, combined with the basic seismic ground acceleration of 0.2g applied as a pseudo-static seismic coefficient.

The effective soil strength parameters used in the above analyses were based on field borings and laboratory tests and are presented in Table 2.5-31.

For the extremely unrealistic postulated event of sudden drawdown and the earthquake equivalent to the SSE (.20), the most critical cut slope had factors of safety in excess of 1.04 as shown in Table 2.5-32. Although this condition was examined and found to be safe, the probability of these simultaneous events occurring is much less than other probabilities required for other portions of the station. This is confirmed by statements made by the U.S. Army Corps of Engineers (Reference 303, 1970).

The computed factors of safety shown in Table 2.5-32 were greater than the required minimums and are based on established computer methods of analyses.

2.5.5.2.1 Excavated Slopes

The factors of safety against sliding for the excavated slopes were obtained by using the simplified Bishop method, as implemented by the ICES-SLOPE computer program. In this program the failure surface is assumed to be an arc of a circle, and the factor of safety is computed as the ratio of the moment (about the center) of the available resisting forces along the failure arc to the moment tending to cause sliding.

The stability analyses were performed using circular or modified circular arcs because of the homogeneity of the material within the slopes. This method was also used for the evaluation of the foundation stability because the foundation materials are over consolidated, flat-lying, and homogeneous fine-grained soils. The circular arc method is applicable for analyzing homogeneous earth dams on thick deposits of fine-grained materials. The "Wedge method" was not used because it is generally used for rock fill dams, earth dams, or foundations containing stratified soil profiles as discussed in Reference 304 (U.S. Department of the Army Corps of Engineers, 1970) and Reference 305 (U.S. Department of the Navy Naval Facilities Engineering Command, 1971).

Based on the results of the stability analyses, the excavated side slopes of 4:1 (horizontal-to-vertical) for the CSCS cooling pond and flume were found to be adequate to ensure stability with a minimum factor of safety of 1.04 for all conditions. The factors of safety obtained for the various loading conditions in the pond are summarized in Table 2.5-32 and shown on Figure 2.5-68, Sheets 1 and 2.

2.5.5.2.2 Excavated Slopes With Retaining Wall

The factor of safety against sliding of the slopes with the retaining wall on it was obtained by using the Morgenstern and Price Method, as implemented by the ICES-SLOPE computer program.

Due to the geometry of the problem, the failure surface is assumed to be noncircular, i.e., straight-line segments. The factor of safety was computed as the ratio of the sum of the available resisting forces to the driving forces on the various sliding blocks.

Based on the results of the stability analyses, slopes of 4:1 (horizontal-to-vertical) for the backfill material on the flume side of the retaining wall were also found to be adequate to ensure stability with a minimum factor of safety of 1.02 for the worst condition, as shown on Figure 2.5-68, Sheet 3.

2.5.5.2.3 Rebuilt Slopes

Deposits of sand and gravel were found and excavated in the CSCS flume, as discussed in Subsection 2.5.4.5.1.3.1. Stability analyses were performed to determine the extent of overexcavation required to meet minimum required factors of safety. The factors of safety against sliding for the rebuilt slopes were obtained by using the simplified Bishop method, as implemented by the ICES-SLOPE computer program. In this program the failure surface is assumed to be an arc of a circle, and the factor of safety is computed as the ratio of the moment (about the center of rotation) of the available resisting forces along the failure arc to the moment tending to cause sliding.

Based on the results of the stability analyses with overexcavation slopes of 1:1 (horizontal-to-vertical), excavating 50 feet back of the crest of the slope was found to be adequate to ensure stability with a minimum factor of safety of 1.069, as shown on Figure 2.5-68, Sheet 4, for the conservatively postulated events of rapid drawdown combined with an SSE of 0.2 g.

2.5.5.2.4 Slope Protection

The slopes of the flume were protected against wave action by means of riprap with a median weight of 70 pounds. It is 18 inches in thickness measured perpendicular to the slope and placed over a 6-inch crushed stone bedding course extending from elevation 694 feet MSL to the top of slope, as shown in Figure 2.5-59. The riprap design is discussed in Subsection 2.5.6.4.3. The riprap gradation used for the flume is given in Table 2.5-33 as Riprap Gradation Number 1. The bedding gradation is also given in Table 2.5-33.

Riprap was placed over a section of the pond slopes on the eastern side of the pond to protect it against erosion in the event that the main dike is breached. This riprap has a median weight of 2 pounds and a thickness of 9 inches measured perpendicular to the slope and extends from elevation 689 feet MSL to the top of the slope, as shown in Figure 2.5-59. It is Riprap Gradation Number 3 as given in Table 2.5-33.

2.5.5.2.5 CSCS Pond Flume Failure Analysis

In accordance with NRC staff requirements, an analysis was made which postulated a mechanistic side slope failure in the power plant intake flume. This was done in order to examine the effect of partial blockage of the waterway, consequent reduction in the CSCS pond capacity, and blockage of flow to the intake structure. The analysis is shown on Figure 2.5-69, which indicates the postulated slope failure conditions.

Detailed slope stability analyses have shown that for all cases the factor of safety is above 1.0, including the extremely improbable combination of simultaneous sudden drawdown in the flume and a 0.2g earthquake. However, to be conservative, the slope was assumed to fail and the resulting conditions were examined.

The cut for the flume is the deepest at the entrance to the lake intake screen house, hence this section was chosen as the slope failure zone. The flume, which has a normal bottom width of 90 feet, widens to a bottom width of approximately 120 feet at the critical section.

The depth of the cut for the rest of the intake flume is smaller due to lower ground elevations and higher flume bottom elevations. Consequently, a mechanistic slope failure at other locations in the flume will involve smaller masses of soil sliding into the flume, which could reduce flow of the cooling water.

For the section in question, as shown in Figure 2.5-69, the postulated slide would block an area of 1856 ft² out of a total waterway area of 2078 ft². The unobstructed flow area of 222 ft² is adequate to pass the emergency cooling water flow of 80,000 gpm (178 cfs) with a velocity of 0.80 fps. Hence, an adequate supply of cooling water under emergency conditions was ensured in this design.

As indicated in UFSAR Figure 2.5-59, a net is installed across the CSCS Cooling Pond, extending 1400 feet approximately between two anchor bulk heads. The mesh size is selected to deter and prevent Gizzard Shad Run from intruding into the plant components. It does not entrap or capture the fish (Shad). Maintaining the Shad alive in this manner is vital in preventing the buildup of solid wall of dead fish bodies which would restrict the water flow through the net.

LSCS-UFSAR

a. Net Failure due Seismic Event

The shad net is not seismically designed, however, a concurrent shad run and seismic event is not credible. Net failure due to seismic without a shad run has been evaluated and found to not affect safety related equipment.

b. Net Failure due Tornado

The shad net is not designed to resist tornado loads, however, a concurrent shad run and tornado is not credible. Net failure due to tornado has been evaluated and found not to affect safety related equipment.

c. Net Failure due to Aging/Deterioration

The net has been constructed from materials suitable for the conditions it will see. However, the possibility of failure due to aging/deterioration exists. Because of the continuous maintenance program in-place, the possibility of a catastrophic failure of the net due to aging/deterioration is remote and need not be considered. Small local failures (seams in the net opening, small holes, etc.) could occur. If these were to occur concurrent with a shad run, a small number of shad could get through the net. The Traveling Screens at the intake could handle such occurrences, and thus preventing any blockage of the intake. Such local failures would be repaired in a short time due to the continuous net maintenance program.

d. Net Failure due to Algae Buildup

Failure due to algae buildup need not be considered due to the continuous maintenance program in-place for the net.

e. Net Failure due to Icing Conditions

Icing conditions which may form a dam on the upper section of the net was considered. The blocked area during winter freeze as calculated and found to be bound by UFSAR section 2.5.5.2.5 failure analysis which assumed 90% blockage of flow area. The ice dam could cause failure of the shad net. Shad runs do not occur in the winter months. Therefore loss of the shad net due to this ice dam will not result in a shad run at the Lake Screen House. Net failure due to a ice dam has been evaluated and found not to affect safety related equipment.

f. Silt Carryover

The design basis of the UHS flume/pond with the shad net in-place reflects a low velocity at low velocity at the bottom of the flume/pond which is less than silt carryover velocity.

g. Gizzard Shad Blocking the Net

Protecting the Gizzard shad school from perishing by stopping them at the shad net serves an important criteria beside the main purpose deterring them away from the traveling screen. Live Gizzard shad are constantly in motion in spite of the large concentrated number. This dynamics allows for the water to flow through the net. Because the water's approach velocity at the net is low (less than 0.1 fps assuming the net 50% blocked), the shad will be able to swim away from the net, thus not blocking it.

During a dike breach, some of the total fish population within the lake will seek refuge in the UHS. A breach concurrent with a design basis event will result in thermal loading of the UHS causing the fish to begin to experience thermal stress. During the 30 day coping period following the accident, it is expected that the majority of the fish within the UHS will succumb to thermal stress. As fish begin to perish, different species of fish will float and/or sink at different decomposition periods. Since the water velocities through the net are low, little movement of the floating dead fish is expected.

However, under specific meteorological conditions (winds from east to west) floating fish have the potential to build up on the east face of the shad net. While this is not the prevailing wind direction, a maintenance strategy has been developed which uses monitoring and maintenance measures that will reduce the number of floating fish within the UHS to minimize the effects on the shad net. As discussed in UFSAR Section 2.5.5.2.5 and UFSAR Figure 2.5-69, 90% flow area blockage in the CSCS Intake Flume at the Lake Screen house intake would still allow adequate emergency cooling water flow in emergency conditions for safe shutdown. Therefore, ensuring a portion of the shad net is clear of dead fish is sufficient to ensure adequate flow in emergency conditions as bounded by failure analysis discussed above.

h. Concurrent Net Failure and Shad Run

In the above failure discussions, it is concluded that catastrophic failure of the net (due to seismic or tornado) concurrent with a shad run is not credible. However, in the unlikely event of this occurrence, the scenario would be as follows. The shad would fill/block the traveling screens. As this blockage would continue, the flow at the intake would slow. At this slow flow, the traveling screens would act as a barrier to the shad without killing them. Protecting the Gizzard shad school from perishing by stopping them at the traveling screens is important. Live Gizzard shad are constantly in motion in spite the large concentrated number. This dynamic allows for the water to flow through the traveling screen as is discussed above. Therefore, no safety related equipment will be affected by a net failure and concurrent shad run.

2.5.5.2.6 CSCS Pond Surveillance Program

The CSCS pond was constructed by excavating natural soil to form the pond. The pool level for the CSCS pond is elevation 690 feet. The existing ground elevations outside the CSCS pond are all higher than elevation 690 feet.

LSCS-UFSAR

The CSCS pond was constructed to the slopes at the locations specified on construction drawings which are in accordance with information presented in this UFSAR.

A total of 242 borings has been completed in which both disturbed and undisturbed samples were obtained for laboratory analysis. A comprehensive review of the boring logs and laboratory data indicated a uniform deposition of materials with similar properties which agree with the other project borings. To assure the validity of prior investigations, the entire excavation of the flume and pond was monitored by a soils engineer in residence (see Subsection 2.5.4.14). Any deviation from the conditions expected was reported for further interpretation and analysis as required.

Prior to lake filling, a survey was made of the perimeter of the CSCS pond to confirm the elevations of the ground on the exterior of the pond. This survey was done at 50-foot intervals around the perimeter, with cross sections taken starting at the bottom of the CSCS pond and outward to a distance of 50 feet beyond the outside of the nominal pond boundary.

After the lake was filled, a survey of the pond was made to confirm the previous ground elevations. Thereafter, surveys will be made once every 24 months by hand sounding, by means of a fathometer, or by other comparable methods to attest CSCS pond integrity. All surveys will be thoroughly documented, showing a location plan for the CSCS pond, the method of surveying, and the survey results. If it is verified that the CSCS pond elevations are changing, remedial measures will be taken to maintain the minimum required volume of water.

2.5.5.2.7 CSCS Pond Turbidity

The CSCS pond was excavated entirely in the Wedron silty clay till materials. This clay does not go into suspension during normal operation or during earthquakes because of its highly plastic nature. Furthermore, in order to transport silt or soils, which would reduce the efficiency of the pumps, the intake velocity would have to be increased about 16 times the present design velocity in the flume.

Since the lake structure is not supplied by natural stream runoff, siltation due to natural erosion is improbable in terms of creating turbid water after seismic excitation.

Transport of fines created by water flow during the unlikely event of a dike break also would not cause siltation within the CSCS pond. Material deposition would flow away from the CSCS pond, since the natural shoreline of the lake abuts the CSCS pond. Even so, the CSCS intake pumps are designed to operate under a turbidity equivalent of 750 ppm.

2.5.5.2.8 Seepage

The seepage from the CSCS pond and flume during the safe shutdown of the LaSalle County Station is expected to be negligible. This conclusion is based upon the following conditions associated with the surrounding area:

- a. During the normal operation of the plant, the lake elevation will be 700 feet MSL. This constant water level will have the effect of somewhat stabilizing the phreatic surface at this elevation in the immediate area of the pond and flume. In the event of a breach in the peripheral dike or similar occurrence that would cause water in the cooling lake to be released from storage, the water level in the CSCS pond and flume would be lowered to the design elevation of 690 feet MSL. Owing to the low permeabilities associated with the soil in the pond area, the phreatic surface would drop very slowly from elevation 700 feet to the lower elevation of 690 feet.
- b. Since the pond and flume are almost totally excavated areas in the Wedron silty clay till (except for a small berm on the east side of the pond), the existing ground surface is higher than the design level of the pond. This would dictate seepage to be into the pond and flume rather than away from it for the 30 days.
- c. The section on the east side of the CSCS pond as shown on Figure 2.5-59 is a 1-foot-high berm constructed to maintain the design elevation of 690 feet MSL. Since the design elevation of the bottom of the pond is 685 feet MSL, the maximum head for seepage is only 1 foot. This fact, coupled with the low permeabilities of the Wedron silty clay till, indicates that very little seepage, if any, will occur through this area of the pond.

2.5.5.3 Logs of Borings

The logs of borings drilled within the CSCS pond and intake flume area are presented in Figure 2.5-19. Figure 2.5-2, Sheet 3, shows the location of these borings.

2.5.5.4 Compacted Fill

The sand and gravel outwash deposits exposed in the flume were removed and replaced with compacted Wedron silty clay till. This is discussed in Subsection 2.5.4.5.1.3.

2.5.6 Embankments and Dams

2.5.6.1 General

The cooling lake at the LaSalle County Station is located in the upland area, covering an area of 2058 acres, as shown in Figure 2.5-41, and has been sized to serve two nuclear units. The total length of the peripheral dikes on the north, east, and south sides of the lake is 37,942 feet. The natural topography will serve as the shoreline on the west side. Three baffle dikes, 22,623 feet in total length, were constructed within the lake to circulate the flow of water.

A typical cross section of the peripheral dike is shown on Figure 2.5-70. The variation of the peripheral dike heights and crest elevations in relation to the existing ground surface along the dike centerline stationing is given in Table 2.5-34 and Figures 2.4-15 and 2.5-41.

The top of the peripheral dike is not level, but varied, depending upon the wave runup height for the various directions around the lake. The top of the dike ranges from elevation 705 feet to elevation 706.58 feet MSL, as shown in Figure 2.4-15.

2.5.6.2 Exploration

A comprehensive program of both field exploration and laboratory testing was undertaken to determine the subsurface conditions existing at the LaSalle lake site.

2.5.6.2.1 Field Investigations

A geologic reconnaissance of the immediate lake site was performed, as described in Subsection 2.5.1.2, to obtain surficial geologic information.

Exploratory soil borings and samples were taken at 500-foot centers along the peripheral dike centerline, as described in Subsection 2.5.4.3.2. Additional borings were made at major swale crossings and other areas of topographic depressions. The borings ranged in depth from 15 to 30 feet below existing ground surface.

Test pits, dug with a back hoe, were excavated at various locations within the lake to determine the index properties of the underlying material, as discussed in Subsection 2.5.4.3.3.

Observation wells have been established at various locations outside of the lake area to monitor groundwater fluctuations both before and after the lake was filled, as discussed in Subsection 2.4.13.2.2.3.2.

2.5.6.2.2 Laboratory Tests

Subsection 2.5.4.2.2 describes the various laboratory tests that were performed on the material obtained from the borings and test pits.

2.5.6.3 Foundation and Abutment Treatment

Foundation areas for the dikes were stripped of all vegetation, topsoil, loess, and organic or other foreign and deleterious materials. All unsuitable materials were removed before fill placement.

A cutoff trench, shown in Figure 2.5-70, was excavated beneath the dike centerline into the Wedron silty clay till to a minimum depth of 4 feet. It served as an inspection trench to examine the subsoil conditions and to help locate and remove buried farm tiles along the dike alignment. The major portion of the cutoff trench was excavated without encountering any unusual soil conditions; however, additional excavation was required in several locations to remove unsuitable material exposed in the bottom of the cutoff trench.

No significant quantity of groundwater was encountered during the excavations for the dike foundations and cutoff trenches. All water that was encountered was removed with a sump and pump to allow the excavations to be performed in the dry.

In addition, a perimeter drainage ditch at a distance of 15 feet from the downstream dike toe, as shown in Figure 2.5-70, was provided to intercept the surface runoff and the seepage from the downstream toe. It varied in depth from 2 to 12 feet and also served as an additional inspection trench beyond the downstream toe.

2.5.6.4 Embankment

A typical cross section of the peripheral dike is shown in Figure 2.5-70. Integral with the peripheral dike is the 300-foot wide auxiliary spillway structure, as described in Subsection 2.4.8.2.7.

2.5.6.4.1 Construction

All fill material used in the construction of the dikes was selected from designated borrow areas within the lake boundaries. Fill material consisted of Wedron silty clay till. Borrow areas were at a minimum distance of 500 feet from the toe of the dike. The fill material was placed loose in maximum 6-inch layers and compacted to a density of not less than 90% of the maximum dry density as determined in accordance with ASTM D-1557 method of compaction. The envelopes of the Modified Proctor densities and the grain sizes for the clay embankment and sand drainage blanket are shown in Figure 2.5-44, Sheets 1 and 2, and Figure 2.5-46, Sheets 1 and 2. The placement and compaction of the embankment material were

continuously supervised and monitored by in-place density tests performed in order to ensure that the field compaction complied with the design specifications. Figure 2.5-41 illustrates the locations of the borrow areas. The average compaction achieved in the field was equivalent to 94% Modified Proctor density for both the sand drainage blanket and the clay embankment.

2.5.6.4.2 Settlement

A settlement analysis was performed to estimate the probable settlement due to the consolidation of the soil beneath the peripheral dikes and the embankment material itself. In this study, the subsoil conditions along the dike alignment and the variable heights of the dike were considered.

Embankment consolidation was determined to be 0.6% of the height of the proposed dike. This conservative value is consistent with published data that is based on past experience, as described in the design manual (Reference 306, U.S. Department of the Navy Naval Facilities Engineering Command, 1971). This manual suggests a range of 0.3% to 0.6% of the dike height based on embankments with crest widths less than 20% of the embankment height. A value of 0.6% corresponds to approximately 3 inches of settlement for the maximum dike height of 40 feet.

The foundation consolidation has been determined from representative laboratory consolidation test data from the Wedron silty clay till. The upper portion of the Wedron silty clay till was found to consolidate a maximum of 5 inches during the plant life of 40 years. This settlement calculation is based on a total dike height of 40 feet, which represents only 2% of the total dike length.

The lower portion of the Wedron silty clay till has been heavily overconsolidated which, when loaded with the light loads due to the embankment, will produce negligible settlement. Computation of this settlement is based on time settlement data which corresponds to 68% of the total consolidation for the 40-year plant life. The percentage of consolidation at 10, 20, and 30 years is 35%, 50%, and 59% respectively. The settlements occur over a very long period of time and do not endanger the structural stability of the dike. As the heights of the peripheral dike are variable, the settlements along the dike alignment vary. Combined settlement estimates for the foundation and the embankment were made for different dike heights, and a camber (as shown in Table 2.5-35 and Figure 2.5-41) was provided along the longitudinal direction of the peripheral dikes to compensate for the variable settlements. This was to ensure that there was the required freeboard above the maximum water level in the lake and to maintain an adequate crest elevation at all times. Settlement monuments and foundation settlement measuring devices were established along the entire dike system to monitor the vertical movements of the soil mass in the dike and in the base, as described in Subsection 2.5.6.8.

2.5.6.4.3 Slope Protection

The upstream slope of the peripheral dike was protected against wave action by means of riprap 18 inches in thickness measured perpendicular to the slope over a crushed stone bedding course extending from elevation 694 feet MSL to the crest, as shown in Figure 2.5-70. The riprap was designed, using the United States Army Corps of Engineers publication, Shore Protection Manual (1973), to withstand wave action due to 40-mph winds coincident with the probable maximum water level in the lake. The design-significant wave height was calculated to be 2.4 feet, which corresponds to a maximum effective fetch of 1.4 miles for the most critical point on the dike.

Riprap for the embankment is placed on crushed stone bedding. The bedding is placed on the embankment composed of compacted cohesive material. A bedding layer may have two functions as a filter material and as a load-transferring gravel blanket.

The bedding layer is not required to act as a filter because the embankment is composed of a compacted cohesive material ($LL > 30$) which is resistant to surface erosion (Reference 331). The bedding layer, therefore, was provided to satisfy the requirements of a well-graded, load-transferring gravel blanket with gradation limits as outlined in Reference 332.

Riprap with a median weight of 70 pounds was placed on the dike from Stations 99 + 00 to 161 + 64 over a 9-inch-thick bedding course as shown in Figure 2.4-15. The riprap gradation used for this section is given in Table 2.5-33 as Riprap Gradation Number 1. The bedding gradation is also shown in Table 2.5-33.

Up to dike Station 99 + 00 and beyond dike Station 161 + 64, as shown on Figure 2.4-15, the riprap, with a median weight of 40 pounds, was placed over a 6-inch-thick crushed stone bedding course. The change in gradation is due to a smaller wave height and a maximum effective fetch of 1.9 feet and 0.9 miles, respectively. This gradation is provided in Table 2.5-33 as Riprap Gradation Number 2. The bedding gradation used for this section is the same gradation used for the rest of the dike.

The riprap and bedding material consisted of quarried Silurian-age Joliet dolomite that was free from structural defects.

The riprap and bedding material was subjected to:

- a. the sodium sulfate soundness test, ASTM C 88, "Test for Soundness of Aggregates by Use of Sodium Sulfate or Magnesium Sulfate," and showed a loss of not more than 10% after 5 cycles; and
- b. the freezing and thawing test, AASHTO T 103, "Soundness of Aggregates by Freezing and Thawing," and showed a loss of not more than 10% after 50 cycles.

The downstream slope of the peripheral dike and drainage ditches were covered with 4 inches of topsoil. This was seeded to provide vegetation cover for protection against the action of wind and rainwater falling on the dike. Fertilizer and mulch were placed on all areas that were seeded. These areas were watered, maintained, repaired, and reseeded until a uniform stand of grass, dense enough to protect the downstream dike slope, had established itself.

After the grass was established on the peripheral dikes, a maintenance program was instituted. During the first full year following the start of the maintenance program, observation of the peripheral dikes was carried out on a monthly basis to verify that the grass cover had not deteriorated. Reseeding will be done where and when required as indicated by lack of grass cover. After the first year, the inspection will be at 1-year intervals or following a severe drought or rainstorm.

2.5.6.4.4 Dike Failure Analysis

The possible consequences of a failure of the peripheral dike were studied in the PSAR even though the matter was not one of nuclear safety. The slope failure of the dike is highly improbable based on the results of the stability analyses, as discussed in Subsection 2.5.6.5. Failure due to overtopping is also highly improbable in light of the design freeboard of the crest above maximum lake levels to retain the design waves and maximum design precipitation, as discussed in Subsection 2.4.8.2.8. It was therefore concluded that the design safety factors were more than adequate to protect against breaching due to any probable realistic set of circumstances.

2.5.6.4.5 Makeup and Blowdown Pipeline Peripheral Dike Penetrations

To ensure the integrity of the concrete blowdown and makeup pipelines, the pipeline sections through the peripheral dike embankment are steel pipe. The pipe joints were made watertight by complete penetration butt welds.

The pipes were completely encased in concrete. The concrete not only helps support the pipe, but it also prevents the external deterioration of the pipe and permits the

placement and compaction of the dike fill against the vertical sides of the encasement. It was recognized that buried steel pipe is vulnerable to deterioration from electrolytic action, even when rust-resisting treatments or protective coatings are provided.

In the present case, the concrete also guarantees, regardless of the nature of the excavated trench, that the contact of the poured-in-place concrete with the bottom and sides of the trench forms a watertight bond free of void spaces or uncompacted areas. Additionally, to ensure that the conduit can sustain movement and settlement without excessive seepage through the embankment, vertical concrete cutoff collars were provided which completely surround the encasement concrete block. These collars were poured monolithically with the encasement. Concrete reinforcement was made continuous across the collars and encasement to prevent cracking.

The embankment crossings were located where the overburden from the dike is the least so that there would be a minimum of foundation and dike settlement. At the locations of the makeup and blowdown crossings, the dike is 10.9 feet and 15 feet in height, respectively.

The makeup pipeline was embedded in the uppermost portions of the embankment extending to the centerline of the dike and ending in the outfall structure, as illustrated in Figures 2.5-71 and 2.5-72. Hence, a uniform compacted foundation, the dike embankment, exists under this pipe. The settlement of the embankment and foundation at the centerline has been determined to be approximately 1.5 inches.

The blowdown pipeline penetration, illustrated on Figures 2.5-73 and 2.5-74, extends completely under the dike, thus the greater length of it was constructed on undisturbed material. Wherever material was uncovered that was not suitable, it was removed to a depth where competent material was found and replaced by suitable fill. The settlement of the foundation at the centerline of the dike has been determined to be approximately 1.5 inches.

The conduits were designed with sufficient strength to withstand the load of the embankment overlying the pipes. They were also designed to resist the internal hydrostatic pressure loading equal to the full calculated head on the pipes.

2.5.6.4.6 Auxiliary Spillway

An overflow auxiliary spillway has been provided and is located between dike Stations 344 + 10 and 347 + 85 of the peripheral dike. A detailed discussion of the spillway is presented in Subsection 2.4.8.2.7.

2.5.6.5 Slope Stability

The slopes of the peripheral dikes were designed so as to be stable under all conditions of reservoir operations. Stability analyses were performed in order to determine the final slope configuration for the dikes under the following loading conditions:

- a. end of construction,
- b. steady seepage with normal pool at elevation 700 feet,
- c. rapid drawdown from normal pool at elevation 700 feet to the bottom of the upstream toe, and
- d. steady seepage combined with basic seismic ground acceleration of 0.1g (OBE) applied as a pseudostatic seismic coefficient.

In this analysis, the simplified Bishop Method, as implemented by the ICES-SLOPE computer program, was used.

The effective soil strength parameters used were based on field borings and laboratory tests. The parameters used are shown in Table 2.5-31.

The failure surface is assumed to be an arc of a circle, and the factor of safety is computed as the ratio of the moment about the center of the available resisting forces along the failure arc to the moment tending to cause sliding.

Based on the results of the stability analyses, a side slope of 3:1 (horizontal-to-vertical) for the peripheral dikes was found to be adequate to ensure stability with a minimum factor of safety of 1.66 for steady seepage, as shown on Figure 2.5-75. The highest dike section, 40.1 feet (rounded to 40 feet) in the most critical section. As shown in Table 2.5-34, this occurs at only one point, dike station 163 + 08, as illustrated in Figure 2.5-41. The factors of safety for the various loading conditions are summarized in Table 2.5-36.

2.5.6.6 Seepage Control

Analyses were performed to estimate the quantity of seepage through the dike and subsoil beneath the dike. In this study a two-dimensional computer program, SEEPAGE, was used. The permeability of the materials was determined from tests performed on undisturbed and remolded samples of Wedron silty clay till obtained from the test borings and test pits in the lake area.

The methods used for the evaluation of the field permeability are consistent with the procedures described in Reference 136. The borings established the

homogeneity of the stratum from which a representative permeability was established.

Numerous permeability tests were performed on the foundation embankment material, as discussed in Subsections 2.5.4.2.2.1.6 and 2.5.4.3.4.

The values of 6.0×10^{-6} and 6.0×10^{-7} cm/sec used for the horizontal and vertical coefficients of permeability, respectively, in the foundation design assured a conservative approach and encompassed the complete range of values obtained from both field and laboratory testing.

The values of 1.22×10^{-6} and 1.22×10^{-7} cm/sec used for the horizontal and vertical coefficients of permeability, respectively, of the dike material were conservative values based on the range of values obtained from the laboratory tests.

The analysis indicated that the quantity of seepage through the dike and the base would be 1 gallon per day or 1.5×10^{-6} cfs per foot of length of dike. The quantity of seepage through the lake bottom would be negligible because of the relatively impermeable Wedron silty clay till underlying the lake.

A cutoff trench as described in Subsection 2.5.6.3 was provided beneath the dike.

A pervious drainage blanket, as shown in Figure 2.5-70, was also provided at the existing grade elevation in the downstream slopes of the peripheral dikes where the dike heights were greater than 20 feet to provide controlled drainage for the seepage water. The drainage blanket also lowers the phreatic line and prevents seepage from emerging in the downstream slope of the dike. Thus, softening and erosion of the downstream slope are prevented.

The adequacy of the blanket drain has been determined by a seepage analysis. The design of the downstream drainage system was governed by the height of the dike, the permeability of the foundation, and the capacity of the drainage blanket to carry away the anticipated seepage flow with an ample margin of safety. As described in the design manual (Reference 306, U.S. Department of the Navy Naval Facilities Engineering Command, 1971), the permeability of the blanket drain should be at least 10 to 100 times more pervious than the embankment material. The blanket drain for the dike consisted of sand, with a gradation as shown in Figure 2.5-55, which has a minimum difference in average permeability equal to 10,000 times the permeability of the embankment material.

The blanket drain was not provided for dike embankments less than 20 feet in height because the slope stability analyses have shown that under normal pool conditions, the factor of safety against failure is greater than 1.5.

In addition, a perimeter drainage ditch as described in Subsection 2.5.6.3 was provided. Drainage from this ditch enters the natural stream beds at a number of points around the perimeter of the lake, as shown in Figure 2.5-76. Drainage ditches were designed to have a capacity equal to the maximum 100-year storm runoff. The ditch was provided with a grass covering having erosion-resistant characteristics as discussed in Subsection 2.5.6.4.3.

Observation wells were established outside of the lake to monitor groundwater fluctuations before and after the filling of the lake, as described in Subsection 2.4.13.2.2.3.2.

2.5.6.7 Diversion and Closure

The peripheral dike was relatively free from problems of control of groundwater during construction. At two sections, namely Station 264 + 00 and Station 371 + 00, provisions were required to permit placement of the dike fill. These sections are the locations where the Armstrong Run Creek Branch and the South Kickapoo Creek Branch intersect the dike alignment, respectively.

A 24-inch-diameter corrugated steel culvert and a small diversion cofferdam were constructed at the Armstrong Run Branch where it passed across the peripheral dike. The water flowed through the culvert, enabling construction of the dike in the dry during the rainy season. Final closure of the dike was made during a dry period. The culvert was removed and the dike fill was placed to the design level.

At the South Kickapoo Creek Branch, flows were very low and permitted construction without diversion. At final closure, construction of a small cofferdam ponded the runoff while the peripheral dike fill was placed in the dry.

Minor surface runoff from the existing farmland drainage system offered no problems. Placement of fill was accomplished at periods when the ditches were dry.

As noted in Subsection 2.4.13.2.2.3.2, quantity of groundwater inflow did not require special measures to permit construction to progress in the dry.

2.5.6.8 Instrumentation

Foundation settlement and embankment consolidation measuring devices, as shown in Figure 2.5-77, were stationed along the dike to monitor vertical movements of the soil mass.

Observation wells, as shown in Figure 2.5-77, were established at various locations outside of the lake to monitor groundwater fluctuations. They were placed in two concentric rings approximately 500 feet and 2000 feet from the dike centerline.

LSCS-UFSAR

Continuous monitoring before and after lake filling will ensure measurement of effects from the cooling lake, as discussed in Subsection 2.4.13.2.2.3.2.

2.5.6.9 Construction Notes

At approximately station 291+00 of the peripheral dike, a large deposit of granular material was discovered in the bottom of the key trench as shown on Figure 2.5-78. This deposit was excavated to the lines shown and replaced with cohesive embankment material to form an impermeable cutoff wall beneath the dike.

2.5.7 References

2.5.7.1 Key to References Cited in Text

1. H. B. Willman, "Geology Along the Illinois Waterway - A Basis for Environmental Planning," Circular 478, Illinois Geological Survey, Plate 1, 1973.
2. N. M. Fenneman, "Physical Divisions of the United States," United States Geological Survey Map, 1946.
3. W. B. Howe, Relief Map, State of Missouri, Missouri Geological Survey and Water Resources, 1969.
4. M. M. Leighton, G. E. Ekblaw, and L. Horberg, "Physiographic Divisions of Illinois," *Journal of Geology*, Vol. 56, No. 1, January 1948.
5. A. F. Schneider, "Physiography," The Indiana Sesquicentennial Volume, pp. 40-56, Indiana Academy of Science, 1966.
6. N. M. Fenneman, Physiography of the Eastern United States, McGraw-Hill, New York, 1935, p. 455.
7. W. D. Thornbury, Regional Geomorphology of the United States, John Wiley & Sons, New York, 1965, p. 228.
8. H. B. Willman, "Summary of the Geology of the Chicago Area," Circular 460, Illinois State Geological Survey, 1971, p. 63.
9. Leighton, Ekblaw, and Horberg, Figure 1.
10. Schneider, Figure 14.
11. Leighton, Ekblaw, and Horberg, p. 24.

LSCS-UFSAR

12. Ibid., p. 25.
13. Ibid., p. 27.
14. Schneider, pp. 48-49.
15. Leighton, Ekblaw, and Horberg, p. 26.
16. Ibid., pp. 25-26.
17. Schneider, p. 44.
18. Ibid., p. 45.
19. L. Martin, The Physical Geography of Wisconsin, University of Wisconsin Press, Madison and Milwaukee, 1932, 2nd ed. 1965, p. 33.
20. Schneider, p. 52.
21. W. J. Wayne, "Thickness of Drift and Bedrock Physiography of Indiana North of the Wisconsinan Glacial Boundary," Report of Progress No. 7, Indiana Department of Conservation Geological Survey, 1956, p. 17.
22. Leighton, Ekblaw, and Horberg, p. 23.
23. Schneider, pp. 51-52.
24. Leighton, Ekblaw, and Horberg, p. 21.
25. C. A. Malott, "The Physiography of Indiana," Handbook of Indiana Geology, pp. 59-256, Indiana Department of Conservation Publication 21, Part 2, 1922, p. 113.
26. Schneider, p. 50.
27. Ibid., pp. 52-53.
28. Ibid., pp. 53-55.
29. Martin, pp. 317-366.
30. Fenneman, 1935, pp. 458-460.
31. Martin, p. 45.

LSCS-UFSAR

32. Thornbury, p. 244.
33. Leighton, Ekblaw, and Horberg, p. 28.
34. Fenneman, 1935, p. 559.
35. Ibid., p. 411.
36. Schneider, p. 46.
37. Ibid., p. 48.
38. Fenneman, 1935, p. 631.
39. Leighton, Ekblaw, and Horberg, p. 29.
40. Ibid., p. 648.
41. P. B. King, The Tectonics of Middle North America, Princeton University Press, Princeton, N. J., 1951, p. 3.
42. H. Faul, Ages of Rocks, Planets, and Stars, McGraw-Hill, New York, 1966, pp. 59-61.
43. A. C. Trowbridge, "Glacial Drift in the 'Driftless Area' of Northeast Iowa," Report of Investigation 2, Iowa Geological Survey, 1966, p. 28.
44. H. B. Willman et al., "Handbook of Illinois Stratigraphy," Bulletin 95, Illinois State Geological Survey, 1975, p. 209.
45. J. C. Frye, H. B. Willman, and H. D. Glass, "Cretaceous Deposits and the Illinoian Glacial Boundary in Western Illinois," Circular 364, Illinois State Geological Survey, 1964, pp. 2-7.
46. G. V. Cohee, "Geologic History of the Michigan Basin," Journal of the Washington Academy of Science, Vol. 55, pp. 211-223, 1965.
47. R. M. Kosanke et al., "Classification of the Pennsylvanian Strata of Illinois," Report of Investigation 214, Illinois State Geological Survey, 1960, p. 27.
48. Willman et al, 1975, p. 127.

LSCS-UFSAR

49. T. C. Buschbach, "Stratigraphic Setting of the Eastern Interior Region of the United States," Background Materials for Symposium on Future Petroleum Potential of NCP Region 9 (Illinois Basin, Cincinnati Arch, and Northern Part of Mississippi Embayment), Illinois Petroleum 96, pp. 3-20, Illinois State Geological Survey, 1971, Figure 6.
50. Cohee, 1965, p. 218.
51. B. Kummel, History of the Earth: an Introduction to Historical Geology, Freeman and Co., San Francisco, 1970, p. 141.
52. Cohee, 1965, p. 217.
53. Kummel, p. 135.
54. Buschbach, 1971, p. 7.
55. A. J. Eardley, Structural Geology of North America, Harper & Brothers, New York, 1962, Plates 2 and 4.
56. J. S. Templeton and H. B. Willman, "Champlainian Series (Middle Ordovician) in Illinois," Bulletin 89, Illinois State Geological Survey, 1963, p. 204.
57. T. C. Buschbach, "Cambrian and Ordovician Strata of Northeastern Illinois," Report of Investigation 218, Illinois State Geological Survey, 1964, Figure 4.
58. Buschbach, 1971, p. 9.
59. W. R. Muehlberger, R. E. Denison, and E. G. Lidiak, "Basement Rocks in Continental Interior of United States," American Association of Petroleum Geologists Bulletin, Vol. 51, No. 12, pp. 2351-2380, 1967, p. 2371.
60. Kummel, p. 119.
61. Ibid., p. 121.
62. E. T. Atherton, "Tectonic Development of the Eastern Interior Region of the United States," Background Materials for Symposium on Future Petroleum Potential of NCP Region 9, Illinois Petroleum No. 96, pp. 29-43, Illinois State Geological Survey, 1971, p. 32.
63. Kummel, p. 120.

LSCS-UFSAR

64. Atherton, p. 31.
65. Cohee, 1965, pp. 215-216.
66. Ibid., p. 216.
67. Kummel, p. 125.
68. W. E. Ham and J. C. Wilson, "Paleozoic Epeirogeny and Orogeny in the Central United States," *American Journal of Science*, Vol. 265, pp. 332-407, 1967, pp. 344-345.
69. H. R. Schwalb, "Paleozoic Geology of the Jackson Purchase Region, Kentucky, with Reference to Petroleum Possibilities," Series X, Report of Investigation 10, Kentucky Geological Survey, 1969, p. 160.
70. King, 1951, p. 31.
71. Eardley, p. 36.
72. Kummel, p. 130.
73. Atherton, p. 37.
74. Eardley, p. 39.
75. Atherton, pp. 37-40.
76. Kummel, p. 134.
77. Cohee, 1965, pp. 217-218.
78. Atherton, p. 39.
79. L. L. Whiting and D. L. Stevenson, "The Sangamon Arch," Circular 383, Illinois State Geological Survey, 1965, p. 1.
80. F. Krey, "Structural Reconnaissance of the Mississippi Valley Area from Old Monroe, Missouri, to Nauvoo, Illinois," Bulletin No. 45, Illinois State Geological Survey, 1924, pp. 50-52.
81. Willman et al., 1975, p. 107.
82. King, 1951, p. 32.

LSCS-UFSAR

83. Kummel, 1970, p. 153.
84. Atherton, p. 40.
85. King, 1951, p. 33.
86. Ibid., p. 34.
87. Atherton, p. 41.
88. Eardley, p. 45.
89. Willman et al., 1975, p. 201.
90. Ibid., p. 202.
91. Ibid., p. 209.
92. H. B. Willman and J. C. Frye, "Pleistocene Stratigraphy of Illinois," Bulletin 94, Illinois State Geological Survey, 1970, p. 14.
93. R. F. Flint et al., "Glacial Map of the United States East of the Rocky Mountains," Geological Society of America, 1959.
94. Willman and Frye.
95. P. B. King, "Quaternary Tectonics in Middle-North America," Quaternary of the U.S., (Ed. by H. E. Wright, Jr. and P. G. Fry), Princeton University Press, Princeton, N. J., 1965, pp. 834-835.
96. King, 1951, p. 27.
97. Eardley, p. 50.
98. H. B. Willman and J. S. Templeton, "Cambrian and Lower Ordovician Exposures in northern Illinois," Illinois Academy of Sciences Transactions, Vol. 44, pp. 109-125, 1951, p. 121.
99. T. C. Buschbach, Illinois State Geological Survey, unpublished report, 1973.
100. Willman and Templeton, p. 123.

LSCS-UFSAR

101. D. H. Swann and A. H. Bell, "Habitat of Oil in the Illinois Basin," Reprint 1958-W, Illinois Geological Survey, 1958, pp. 448-449.
102. H. M. Bristol and T. C. Buschbach, "Structural Features of the United States," Illinois Petroleum No. 96, pp. 21-28, Illinois State Geological Survey, 1971, p. 27.
103. A. H. Bell et al., "Deep Oil Possibilities of the Illinois Basin," Circular 368, Illinois State Geological Survey, 1964, Figure 2.
104. Swann and Bell, p. 447.
105. Ibid., p. 450.
106. Bell et al., p. 6.
107. K. E. Clegg, "Subsurface Geology and Coal Resources of the Pennsylvanian System in Clark and Edgar Counties, Illinois, Circular 380, Illinois Geological Survey, 1965, p. 41.
108. J. N. Payne, "Structure of the Herrin (No. 6) Coal Bed in Madison County and Western Bond, Western Clinton, Southern Macoupin, Southwestern Montgomery, Northern St. Clair, and Northwestern Washington Counties, Illinois," Circular No. 88, Illinois State Geological Survey, 1942, p. 183.
109. K. E. Clegg, "The LaSalle Anticlinal Belt," Depositional Environments in Parts of the Carbondale Formation, Western and Northern Illinois, Illinois State Geological Survey Guidebook Series 8, pp. 106-110, 1970, p. 109.
110. Whiting and Stevenson, Figure 9.
111. W. L. Calvert, "Sub-Trenton Structure of Ohio, with Views on Isopach Maps and Stratigraphic Sections as Basis for Structural Myths in Ohio, Illinois, New York, Pennsylvania, West Virginia, and Michigan," American Association of Petroleum Geologists Bulletin, Vol. 58, No. 6, pp. 957-972, 1974.
112. J. V. Howell, "The Mississippi River Arch," Guidebook, Ninth Annual Field Conference, Kansas Geological Society, pp. 386-389, 1935, Figure 237.

LSCS-UFSAR

113. M. H. McCracken, "Structural Features of Missouri," Report of Investigation No. 49, Missouri Geological Survey and Water Resources, 1971, pp. 44-45.
114. McCracken, p. 41.
115. Ibid., p. 3.
116. Bristol and Buschbach, 1971, p. 22.
117. Eardley, p. 51.
118. Cohee, 1965, p. 214.
119. Ibid., p. 213.
120. Ibid., pp. 215-220.
121. A. V. Heyl et al., "The Geology of the Upper Mississippi Valley Zinc-Lead District," Professional Paper No. 309, U.S. Geological Survey, 1959, p. 35.
122. C. E. Dutton and R. E. Bradley, "Lithologic, Geophysical and Mineral Commodity Maps of Precambrian Rocks in Wisconsin," Map I-631, Miscellaneous Geological Investigations, U.S. Geological Survey, 1970, Plate 5.
123. Heyl et al., p. 37.
124. Ibid., p. 54.
125. F. T. Thwaites, Map of the Pre-Cambrian of Wisconsin, Wisconsin Geological and Natural History Survey, 1957.
126. M. E. Ostrom, Wisconsin Geological and Natural History Survey, Madison, Wisconsin, Written Communication, 1975.
127. Willman and Templeton, p. 122.
128. Ibid., pp. 122-123.
129. D. R. Kolata and T. C. Buschbach, "Plum River Fault Zone of Northwestern Illinois," Circular 491, Illinois State Geological Survey, 1976, p. 1.

LSCS-UFSAR

130. D. R. Kolata, Illinois State Geological Survey, Urbana, Illinois, Written Communication, 1975.
131. T. C. Buschbach and G. E. Heim, "Preliminary Geologic Investigations of Rock Tunnel Sites for Flood and Pollution Control in the Greater Chicago Area," Illinois State Geological Survey Environmental Geological Notes, No. 52, 1972.
132. H. M. Bristol and T. C. Buschbach, "Ordovician Galena Group (Trenton) of Illinois - Structure and Oil Fields," Illinois Petroleum No. 99, Illinois State Geological Survey, 1973, Plate 1.
133. A. H. Bell, "Structure of Centralia and Sandoval Oil Fields", Illinois Petroleum No. 10, Illinois State Geological Survey, 1927.
134. R. L. Brownfield, "Structural History of the Centralia Area," Report of Investigation 172, Illinois State Geological Survey, 1954, pp. 15-16.
135. Ibid., pp. 27-28.
136. A. J. Frank, "Faulting on the Northeastern Flank of the Ozarks (Missouri)" (Abstract), Geological Society of America Bulletin, Vol. 59, No. 12, December 1948, p. 1322.
137. McCracken, Plate 1.
138. W. W. Rubey, "Geology and Mineral Resources of the Hardin and Brussels Quadrangles in Illinois," Professional Paper 218, U.S. Geological Survey, 1952.
139. McCracken, pp. 16-17.
140. T. A. Dawson, Map of Indiana showing structure on top of Trenton Limestone, Miscellaneous Investigation Map 17, Indiana Geological Survey, 1971.
141. L. E. Becker, Indiana Geological Survey, Bloomington, Indiana, Written Communication, 1975.
142. H. H. Gray, Indiana Geological Survey, Bloomington, Indiana, Written Communication, 1974.
143. W. N. Melhorn and N. M. Smith, "The Mt. Carmel Fault and Related Structural Features in South Central Indiana," Report of Progress 16, Indiana Geological Survey, 1959, p. 5.

LSCS-UFSAR

144. Melhorn and Smith, pp. 16-17.
145. Ibid.
146. Ibid., p. 21.
147. H. B. Willman and J. N. Payne, "Geology and Mineral Resources of Marseilles, Ottawa, and Streator Quadrangles," Bulletin 66, Illinois Geological Survey, 1942, p. 188.
148. H. B. Willman, Illinois State Geological Survey, Urbana, Illinois, Personal Communication, 1976.
149. W. H. Bucher, "Cryptovolcanic Structures in the United States," Reports of the 16th International Geological Congress, Vol. 2, pp. 1055-1084, 1933, p. 1055.
150. Eardley, p. 257.
151. Bucher, pp. 1072-1074.
152. T. C. Buschbach and R. Ryan, "Ordovician Explosion Structure at Glasford, Illinois," American Association of Petroleum Geologists Bulletin, Vol. 47, No. 12, pp. 2015-2022, 1963, p. 2020.
153. G. L. Ekein and F. T. Thwaites, "The Glover Bluff Structure, a Disturbed Area in the Paleozoics of Wisconsin," Transactions of the Wisconsin Academy of Science, Arts, and Letters, Vol. 25, pp. 89-97, 1930, p. 47.
154. G. H. Emrich and R. E. Bergstrom, "Des Plaines Disturbance, Northeastern Illinois," Geological Society of America Bulletin, Vol. 73, pp. 959-968, 959-968, 1962, pp. 967-968.
155. Buschbach and Ryan, p. 2021.
156. Emrich and Bergstrom, p. 968.
157. D. A. Green, "Trenton Structure in Ohio, Indiana, and Northern Illinois," American Association of Petroleum Geologists Bulletin, Vol. 41, No. 4, pp. 627-642, 1957.
158. Simon, Written Communication, 1974.

LSCS-UFSAR

159. Clegg, 1970, p. 107.
160. Melhorn and Smith, p. 18.
161. McCracken, p. 8.
162. S. E. Harris and M. C. Parker, "Stratigraphy of the Osage Series in Southeastern Iowa," Report of Investigation No. 1, Iowa Geological Survey, 1964, Plate 2.
163. Harris and Parker, p. 41.
164. Brownfield, p. 23.
165. Ibid., p. 30.
166. E. P. Du Bois and R. Siever, "Structure of the Shoal Creek Limestone and Herrin (No. 6) Coal in Wayne County, Illinois," Report of Investigation 182, Illinois State Geological Survey, 1955, p. 6.
167. I. W. Dalziel and R. H. Dott, Jr., "Geology of the Baraboo District, Wisconsin," Information Circular No. 14, Wisconsin Geological and Natural History Survey, 1970, Plate 4.
168. Ibid., p. 4.
169. Heyl et al.
170. Ibid., p. 27.
171. Ibid., pp. 27 and 29.
172. Ibid., Figure 12.
173. Ibid., p. 31.
174. Ibid., p. 54.
175. P. B. Du Montelle, N. C. Hester, and R. E. Cole, "Landslides along the Illinois River Valley South and West of LaSalle and Peru, Illinois," Environmental Geological Notes, No. 48, Illinois State Geological Survey, 1971, p. 14.
176. Willman, 1973, p. 31.

LSCS-UFSAR

177. Willman, 1976.
178. Willman, 1973, p. 34.
179. Ibid., p. 37.
180. G. H. Cady, "Minaible Coal Reserves of Illinois," Bulletin 78, Illinois State Geological Survey, 1952, p. 53.
181. R. Malhotra, "Illinois Mineral Industry in 1972," Illinois Minerals Note 58, Illinois State Geological Survey, 1974, p. 16.
182. J. P. Kempton, Illinois State Geological Survey, Urbana, Illinois, Written Communication, 1975, pp. 2-3.
183. Willman and Payne, pp. 151-153.
184. Ibid., pp. 152-153.
185. Willman, 1973, pp. 24-26.
186. Willman and Payne, p. 144.
187. Leighton, Ekblaw, and Horberg, pp. 24-25.
188. Willman and Frye, pp. 101-102.
189. Willman and Payne, p. 41.
190. Ibid., p. 41.
191. Ibid., p. 26.
192. Ibid., p. 43.
193. Willman et al., 1975.
194. Willman and Frye, p. 75.
195. Ibid., p. 79.
196. Willman, 1973, pp. 30-31.
197. Willman and Frye, p. 66.

LSCS-UFSAR

198. J. P. Kempton, Illinois State Geological Survey, Urbana, Illinois, Written Communication, 1972, p. 2.
199. Kempton, 1975, p. 2.
200. A. D. Randall, Glacial Geology and Groundwater Possibilities in Southern LaSalle and Eastern Putnam Counties, Illinois, unpublished master's thesis, University of Illinois, Urbana, Illinois, 1955, p. 14.
201. Randall, pp. 36-46.
202. Ibid., p. 59.
203. Ibid., p. 60.
204. Willman, 1973, p. 29.
205. Willman and Frye, p. 77.
206. Willman, 1973, p. 30.
207. Ibid., p. 28.
208. Ibid., pp. 25-26.
209. Ibid., p. 26.
210. U. S. Department of Agriculture, Soil Conservation Service, "Established Series Revisions," in cooperation with University of Illinois Agricultural Experiment Station, 1973, 1974, 1975.
211. University of Illinois Agricultural Experiment Station, "Soil Survey: LaSalle County, Illinois," Urbana, Illinois, 1972.
212. J. D. Alexander and J. E. Paschke, Soil Report 91, University of Illinois Agricultural Experiment Station, Urbana, Illinois, 1972, p. 87.
213. Ibid., p. 30.
214. Ibid., p. 73.
215. Buschbach, 1964.
216. Kosanke et al.

LSCS-UFSAR

217. H. B. Willman et al., Geologic Map of Illinois, Illinois State Geological Survey, 1967.
218. Illinois State Geological Survey, open file.
219. Willman and Payne, pp. 96-97.
220. Ibid., p. 64.
221. Ibid., Plate 22.
222. Ibid., pp. 61-62.
223. Willman et al., 1975, p. 71.
224. Ibid., p. 70.
225. Ibid., p. 69.
226. Ibid., p. 68.
227. Ibid., p. 62.
228. Willman and Payne., p. 61
229. Buschbach, 1964, p. 47.
230. Willman and Payne, p. 60.
231. Buschbach, 1964, pp. 45-46.
232. Willman and Payne, p. 59.
233. Ibid., pp. 58-59.
234. Willman et al., 1975, p. 51.
235. Ibid., p. 46.
236. Ibid., Figure E13.
237. Ibid., Figure E12.
238. Ibid., Figure E11.

239. Ibid., p. 44.
240. 233a. Ibid., p. 43.
241. Ibid., Figure E8.
242. Willman and Payne, p. 55.
243. Willman et al., 1975, Figure E6.
244. J. C. Bradbury and E. Atherton, "The Precambrian Basement of Illinois," Circular 382, Illinois State Geological Survey, 1965, Table 1.
245. Willman and Payne, Plates 12, 15, 19, and 22.
246. Ibid., Plates 12, 15, 19, 22, and 24.
247. Ibid., p. 184.
248. Ibid., p. 188.
249. Buschbach, 1964, p. 65.
250. Willman and Payne, p. 192.
251. Ibid., pp. 192-193.
252. W. C. Krumbein and L. L. Sloss, Stratigraphy and Sedimentation, Freeman and Co., San Francisco, 1963, p. 550.
253. Willman and Payne, p. 195.
254. J. N. Payne, "The Age of the LaSalle Anticline," Circular No. 60, Illinois State Geological Survey, 1940, pp. 5-7.
255. Willman and Payne, p. 203.
256. Ibid., pp. 203-204.
257. Ibid., p. 204.
258. Ibid., pp. 204-205.
259. Ibid., p. 205.

LSCS-UFSAR

260. L. Horberg, "Bedrock Topography of Illinois," Bulletin 73, Illinois State Geological Survey, 1950, pp. 56-57.
261. Willman and Frye, pp. 24-26.
262. Willman and Payne, p. 210.
263. Ibid., p. 212.
264. Willman and Frye, p. 97.
265. Ibid., p. 34.
266. Willman and Payne, p. 215.
267. Ibid., p. 220.
268. Willman and Frye, pp. 34-35.
269. Willman and Payne, pp. 222-225.
270. Ibid., pp. 225-228.
271. Willman and Frye, pp. 66-67.
272. Ibid., pp. 75-77.
273. Willman, 1973, p. 29.
274. Kempton, 1975, p. 3.
275. Willman and Frye, pp. 88-89.
276. Willman and Payne, pp. 228-229.
277. King, 1965, Figure 2.
278. P. C. Heigold, "Notes on the Earthquake of September 15, 1972, in Northern Illinois," Environmental Geological Notes 59, Illinois State Geological Survey, 1972, p. 6.
279. R. G. Stearns and C. W. Wilson, "Relationship of Earthquakes and Geology in West Tennessee and Adjacent Areas," Tennessee Valley Authority, 1972, p. 2.9A-65.

LSCS-UFSAR

280. H. R. Schwalb, Kentucky Geological Survey, Lexington, Kentucky, Written Communication, 1974.
281. R. R. Heinrich, "A Contribution to the Seismic History of Missouri," Seismological Society of America Bulletin, Vol. 31, No. 3, pp. 187-224, 1941, p. 219.
282. N. S. Shaler, "Earthquakes of the Western United States," The Atlantic Monthly, Vol. 24, p. 550, 1869.
283. J. L. Coffman and C. A. Von Hake, Earthquake History of the United States, Publication 41-1 (revised through 1970), National Oceanic and Atmospheric Administration, 1973, p. 46.
284. Ibid., p. 43.
285. O. W. Nuttli, "The Mississippi Valley Earthquakes of 1811 and 1812, Intensities, Ground Motion, and Magnitude," Seismological Society of America Bulletin, Vol. 63, No. 1, pp. 227-248, 1973.
286. Coffman and Von Hake, p. 39.
287. D. W. Gordon et al., "The South-Central Illinois Earthquake of November 9, 1969, Macroseismic Studies," Seismological Society of America Bulletin, Vol. 60, No. 3, pp. 953-971, 1970, p. 958.
288. Heigold, 1972.
289. L. D. McGinnis, "Crustal Tectonics and Precambrian Basement in Northeastern Illinois," Report of Investigation 219, Illinois Geological Survey, 1966.
290. Willman and Payne, p. 188.
291. H. B. Seed and I. M. Idriss, "A Simplified Procedure for Evaluating Soil Liquefaction Potential," Report No. EERC 70-9, University of California, Berkeley, Cal., 1970.
292. Shannon & Wilson, Inc. and Agbanian-Jacobsen Associates, "Soil Behavior Under Earthquake Loading Conditions: State of the Art Evaluation of Soil Characteristics for Seismic Response," prepared for the U. S. Atomic Energy Commission, 1972.

LSCS-UFSAR

293. H. Kishida, "Characteristics of Liquefied Sands During Mino-Owari, Tohnankai and Fukui Earthquakes," Soils and Foundations (Japan), Vol. 9, No. 1, pp. 75-92, 1969.
294. J. R. Benjamin and C. A. Cornell, Probability, Statistics and Decision for Civil Engineers, New York, 1970.
295. H. J. Gibbs and W. G. Holtz, "Research on Determining the Density of Sand by Spoon Penetration Testing," Proceedings of 4th International Conference on Soil Mechanics and Foundation Engineering, Vol. I, pp. 35-39, London, 1957.
296. K. Terzaghi and R. B. Peck, Soil Mechanics in Engineering Practice, John Wiley & Sons, New York, New York, 1967.
297. N. Janbu, "Settlement Calculation Based on the Tangent Modulus Concept," Three guest lectures at Moscow State University, Bulletin No. 2 of Soil Mechanics and Foundations Engineering of the Technical University of Norway, Trondheim, Norway, 1967.
298. N. Mononobe, "Earthquake-Proven Construction of Masonry Dams", Proceedings, World Engineering Conference, Vol. 9, p. 275, 1929.
299. S. Okabe, "General Theory of Earth Pressure", Journal of Japanese Society of Civil Engineers, Vol. 12, No. 1, 1926.
300. H. B. Seed and R. V. Whitman, "Design of Earth-Retaining Structures for Dynamic Loads," Proceedings of the ASCE Specialty Conference on Lateral Stresses in the Ground and Design of Earth-Retaining Structures, 1970.
301. H. M. Westergaard, "Water Pressures on Dams During Earthquakes," Transactions ASCE Vol. 98, 1933, p. 418.
302. H. Matuo and S. Ohara, "Lateral Earth Pressure and Stability of Quay Walls During Earthquakes," Proceedings of the Second World Conference on Earthquake Engineering, Vol. 1, Japan, 1960.
303. U. S. Department of the Army Corps of Engineers, "Engineering and Design Stability of Earth and Rock-Fill Dams," EM 1110-2-1902, 1970, p. 25.
304. U. S. Department of the Army Corps of Engineers, 1970, pp. 14-15.

LSCS-UFSAR

305. U. S. Department of the Navy Naval Facilities Engineering Command, "Design Manual, Soil Mechanics, Foundations, and Earth Structures," NAVFAC DM-7, 1971, p. 7-7-3.
306. U. S. Department of the Navy Naval Facilities Engineering Command.
307. T. C. Buschbach, Illinois State Geological Survey, Urbana, Illinois, Personal Communication, 1976.
308. J. P. Kempton, Illinois State Geological Survey, Urbana, Illinois, Personal Communication, 1976.
309. R. F. Flint, Glacial and Quaternary Geology, John Wiley and Sons, New York, 1971, pp. 159-160.
310. Eardley, 1962.
311. W. H. Hobbs, Michigan Geological and Biological Survey, Publication 5, Geological Series, 1911.
312. J. H. Hodgson, A Seismic Survey in the Canadian Shield: 1. Refraction Studies Based on Rock Bursts at Kirkland Lake, Ontario, Vol. 6, pp. 167-181, Publ. Dom. Obs., Ottawa, Ontario, 1953.
313. J. L. Coffman and C. A. Von Hake, Earthquake History of the United States, Publication 41-1 (revised through 1970), National Oceanic and Atmospheric Administration, 1973.
314. O. W. Nuttli and J. E. Zollweg, "The Relation Between Felt Area and Magnitude for Central United States Earthquakes: Seismological Society of America Bulletin, Vol. 64, pp. 1189-1208, 1974.
315. E. A. Bradley and T. J. Bennett, "Earthquake History of Ohio:" Seismological Society of America Bulletin, Vol. 55, No. 4, pp. 745-752, 1965.
316. D. McGuire, "Geophysical Survey of the Anna, Ohio, Area:" Unpublished M.S. Thesis, Bowling Green University, Bowling Green, Ohio, 1975.
317. Dames & Moore, "Interpretation of Mechanisms for the Anna, Ohio, Earthquakes for the Marble Hill Generating Station:" in: PSAR for Marble Hill Nuclear Generating Station, 1976.

LSCS-UFSAR

318. Seismograph Service Corporation, "A Review of a Geophysical Survey of the Anna, Ohio, Area:" in: PSAR for Marble Hill Nuclear Generating Station, 1976.
319. Sargent & Lundy, Supplemental Discussion Concerning the Limit of the Northern Extent of Large Intensity Earthquakes Similar to the New Madrid Events, 1975.
320. L. D. McGinnis, P. C. Heigold, C. P. Ervin, and M. Heidari, "The Gravity Field and Tectonics of Illinois:" Illinois State Geological Survey Circular 494, 1976.
321. P. C. Heigold, "An Aeromagnetic Survey of Southwestern Illinois:" Illinois State Geological Survey Circular 495, 1976.
322. W. Stauder, M. Kramer, G. Fisher, S. Schaefer, and S. T. Morrissey, "Seismic Characteristics of Southeast Missouri as Indicated by a Regional Telemetered Microearthquake Array:" Seismological Society of America Bulletin, Vol. 66, No. 6, pp. 1953-1964, 1976.
323. T. C. Buschbach, 1977b, Illinois State Geological Survey, Urbana, Illinois, Personal Communication, 1977b.
324. C. A. Von Hake, "Earthquake History of Michigan:" Earthquake Information Bulletin, Vol. 5, No. 6, pp. 25-27, 1973.
325. J. Docekal, "Earthquakes of the Stable Interior, with Emphasis on the Midcontinent:" Unpublished Ph.D. Thesis, University of Nebraska, 1970.
326. O. W. Nuttli, "Magnitude Recurrence Relation for Central Mississippi Valley Earthquakes," Seismological Society of America Bulletin, Vol. 64, No. 4, pp. 1189-1207, 1974.
327. T. S. Buschbach, Illinois State Geological Survey, Urbana, Illinois, Personal Communication, 1977c.
328. Stone & Webster, "Faulting in the Anna, Ohio, region," Amendment 12, Appendix 21 of PSAR for WUP, Koshkonong Station, 1976.
329. F. Mauk, University of Michigan Seismological Observatory, Personal Communication, July 14, 1977.

LSCS-UFSAR

330. T. C. Buschbach and D.C. Bond, "Underground Storage of Natural Gas in Illinois - 1973," Illinois Petroleum 101, Illinois State Geological Survey, Urbana, Illinois, 1974.
331. U.S. Department of the Navy, Naval Facilities Engineering Command, "Design Manual, Soil Mechanics, Foundation, and Earth Structures," NAVFAC, DM-7, p. 7-9-13, 1971.
332. U.S. Bureau of Reclamation, "Earth Manual," Denver, Colorado, Section 73d, 1968.
333. Design Analysis L-003842, Revision 000, "Ultimate Heat Sink Fish Mortality Evaluation"

2.5.7.2 References Consulted in Preparation of Text (Listed Alphabetically)

J. D. Alexander and J. E. Paschke, Soil Report 91, University of Illinois Agricultural Experiment Station, Urbana, Illinois, 1972.

American Society for Testing and Materials, 1975 Annual Book of ASTM Standards, Natural Building Stones; Soil and Rock; Peat, Mosses, and Humus, Part 19.

D. H. Amos, Geologic of parts of the Shetlerville and Rosiclare quadrangles, Kentucky: U. S. Geological Survey Geological Quadrangle Map GQ-400, 1965.

D. H. Amos, Geologic map of the Golconda quadrangle, Kentucky-Illinois, and the part of the Brownfield quadrangle in Kentucky: U. S. Geological Survey Geological Quadrangle Map GQ-546, 1966.

D. H. Amos, Geologic map of part of the Smithland quadrangle, Livingston County, Kentucky: U. S. Geological Survey Geological Quadrangle Map GQ-657, 1967.

E. T. Atherton, "Tectonic Development of the Eastern Interior Region of the United States," Background Materials for Symposium on Future Petroleum Potential of NCP Region 9, Illinois Petroleum No. 96, pp. 29-43, Illinois State Geological Survey, 1971.

W. A. Bailey, "ICES Slope," McDonnell Douglas Automation Company, 1974.

J. W. Baxter and G. A. Desborough, "Areal Geology of the Illinois Fluorspar District, Part 2 - Karbers Ridge and Rosiclare Quadrangles:" Circular 385, Illinois State Geological Survey, 1965.

L. E. Becker, Indiana Geological Survey, Bloomington, Indiana, Written Communication, 1975.

LSCS-UFSAR

- A. H. Bell, "Structure of Centralia and Sandoval Oil Fields", Illinois Petroleum No. 10, Illinois State Geological Survey, 1927.
- A. H. Bell and G. V. Cohee, "Recent Petroleum Development in Illinois:" Illinois State Geological Survey, Illinois Petroleum 32, 1938.
- A. H. Bell et al., "Deep Oil Possibilities of the Illinois Basin," Circular 368, Illinois State Geological Survey, 1964.
- J. R. Benjamin and C. A. Cornell, Probability, Statistics and Decision for Civil Engineers, New York, 1970.
- M. W. Bergendahl, Geology of the Cloverport quadrangle, Kentucky-Indiana and the Kentucky part of the Cannelton quadrangle: U. S. Geological Survey Geological Quadrangle Map GA-273, 1965.
- J. C. Bradbury and E. Atherton, "The Precambrian Basement of Illinois," Circular 382, Illinois State Geological Survey, 1965.
- E. A. Bradley and T. J. Bennett, "Earthquake History of Ohio:" Seismological Society of America Bulletin, Vol. 55, No. 4, pp. 745-752, 1965.
- H. M. Bristol, Base of the Beech Creek (Barlow) Limestone in Illinois: Illinois Petroleum 88, pl. 1, Illinois State Geological Survey, 1967.
- H. M. Bristol, Oil and gas development maps, Mt. Carmel and Allendale area, base of Barlow: Illinois State Geological Survey unpublished map, 1972.
- H. M. Bristol, Illinois State Geological Survey unpublished preliminary map, 1974a.
- H. M. Bristol, Oil and Gas Development Map (unpublished), Albion Area, Base of Barlow, Illinois State Geological survey, 1974b.
- H. M. Bristol and T. C. Buschbach, "Ordovician Galena Group (Trenton) of Illinois - Structure and Oil Fields," Illinois Petroleum No. 99, Illinois State Geological Survey, 1973.
- H. M. Bristol and T. C. Buschbach, "Structural Features of the United States," Illinois Petroleum No. 96, pp. 21-28, Illinois State Geological Survey, 1971.
- H. M. Bristol and R. H. Howard, "Paleogeographic Map of the Sub-Pennsylvania Chesterian (Upper Mississippian) Surface in the Illinois Basin," Circular 458, Illinois State Geological Survey, 1971.
- R. L. Brownfield, "Structural History of the Centralia Area," Report of Investigation 172, Illinois State Geological Survey, 1954.

LSCS-UFSAR

W. H. Bucher, "Cryptovolcanic Structures in the United States," Reports of the 16th International Geological Congress, Vol. 2, pp. 1055-1084, 1933.

T. C. Buschbach, "Cambrian and Ordovician Strata of Northeastern Illinois," Report of Investigation 218, Illinois State Geological Survey, 1964.

T. C. Buschbach and D. C. Bond, Underground Storage of Natural Gas in Illinois: Illinois Petroleum 86, Illinois State Geological Survey, 1962.

T. C. Buschbach, "Stratigraphic Setting of the Eastern Interior Region of the United States," Background Materials for Symposium on Future Petroleum Potential of NCP Region 9 (Illinois Basin, Cincinnati Arch, and Northern Part of Mississippi Embayment), Illinois Petroleum 96, pp. 3-20, Illinois State Geological Survey, 1971.

T. C. Buschbach, Illinois State Geological Survey, unpublished report, 1973a.

T. C. Buschbach, Illinois State Geological Survey, Written Communication, Urbana, Illinois, 1973b.

T. C. Buschbach, Illinois State Geological Survey, Urbana, Illinois, Written Communication, 1974.

T. C. Buschbach, Illinois State Geological Survey, Urbana, Illinois, Written Communication, 1975.

T. C. Buschbach, Illinois State Geological Survey, Personal Communication, 1976.

T. C. Buschbach, Illinois State Geological Survey, Urbana, Illinois, Written Communication, 1977a.

T. C. Buschbach, Illinois State Geological Survey, Urbana, Illinois, Personal Communication, 1977b.

T. C. Buschbach, Illinois State Geological Survey, Urbana, Illinois, Personal Communication 1977c.

T. C. Buschbach, "Observations Made by the ISGS Staff During their Visit to the LaSalle County Site on September 26, 1976," Illinois State Geological Survey, Urbana, Illinois, 1977.

T. C. Buschbach and G. E. Heim, "Preliminary Geologic Investigations of Rock Tunnel Sites for Flood and Pollution Control in the Greater Chicago Area," Illinois State Geological Survey Environmental Geological Notes, No. 52, 1972.

T. C. Buschbach and R. Ryan, "Ordovician Explosion Structure at Glasford, Illinois," American Association of Petroleum Geologists Bulletin, Vol. 47, No. 12, pp. 2015-2022, 1963.

LSCS-UFSAR

C. Butts, "Geology and Mineral Resources of the Equality-Shawneetown Area (Parts of Gallatin and Saline Counties):" Bulletin 57, Illinois State Geological Survey, 1925.

G. H. Cady, "Mirable Coal Reserves of Illinois," Bulletin 78, Illinois State Geological Survey, 1952.

G. H. Cady et al., "Subsurface Geology and Coal Resources of the Pennsylvanian System in Wabash County, Illinois:" Report of Investigation 183, Illinois State Geological Survey, 1955.

W. L. Calvert, "Sub-Trenton Structure of Ohio, with Views on Isopach Maps and Stratigraphic Sections as Basis for Structural Myths in Ohio, Illinois, New York, Pennsylvania, West Virginia, and Michigan," American Association of Petroleum Geologists Bulletin, Vol. 58, No. 6, pp. 957-972, 1974.

Chicago Tribune, September 16, 1972.

K. E. Clegg, "Subsurface Geology and Coal Resources of the Pennsylvanian System in Douglas, Coles, and Cumberland Counties, Illinois:" Circular 271, Illinois State Geological Survey, 1959.

K. E. Clegg, "Subsurface Geology and Coal Resources of the Pennsylvanian System in Clark and Edgar Counties, Illinois," Circular 380, Illinois State Geological Survey, 1965.

K. E. Clegg, "The LaSalle Anticlinal Belt," Depositional Environments in Parts of the Carbondale Formation, Western and Northern Illinois, Illinois State Geological Survey Guidebook Series 8, pp. 106-110, 1970.

K. E. Clegg, "Subsurface Geology and Coal Resources of the Pennsylvanian System in De Witt, McLean, and Piatt Counties, Illinois," Circular 473, Illinois State Geological Survey, 1972.

J. L. Coffman and C. A. Von Hake, Earthquake History of the United States, Publication 41-1 (revised through 1970), National Oceanic and Atmospheric Administration, 1973.

G. V. Cohee, "Geologic History of the Michigan Basin," Journal of the Washington Academy of Science, Vol. 55, pp. 211-223, 1965.

G. V. Cohee et al., "Tectonic map of the United States," prepared by U. S. Geological Survey and American Association of Petroleum Geologists, 1962.

LSCS-UFSAR

C. V. Cohee and C. W. Carter, "Structural Trends in the Illinois Basin:" Circular 59, Illinois Geological Survey, 1940.

E. M. Cushing, E. H. Boswell, and R. I. Hosman, "General Geology of the Mississippi Embayment," Professional Paper 448-B, U. S. Geological Survey, 1964.

C. G. Dahm, "The Southeastern Illinois Earthquake of October 29, 1934": Seismological Society of America Bulletin, Vol. 25, pp. 253-257, 1935.

I. W. Dalziel and R. H. Dott, Jr., "Geology of the Baraboo District, Wisconsin," Information Circular No. 14, Wisconsin Geological and Natural History Survey, 1970.

Dames & Moore, "Interpretation of Mechanisms for the Anna, Ohio, Earthquakes for the Marble Hill Generating Station:" in: PSAR for Marble Hill Nuclear Generating Station, 1976.

T. A. Dawson, Map of Indiana showing structure on top of Trenton Limestone, Miscellaneous Investigation Map 17, Indiana Geological Survey, 1971.

T. A. Dawson, Preliminary well location map of Posey County, Indiana: unpublished map, Indiana Geological Survey, 1973.

T. A. Dawson and G. I. Carpenter, "Underground Storage of Natural Gas in Indiana." Special Report No. 1, Indiana Geological Survey, 1963.

G. A. Desborough, "Faulting in the Pomona area, Jackson County, Illinois:" Illinois Academy of Science Transactions, Vol. 50, pp. 199-204, 1957.

J. Docekal, "Earthquakes of the Stable Interior, with Emphasis on the Midcontinent": Unpublished Ph.D. thesis, University of Nebraska, 1970.

J. A. Dorr and D. F. Eschman, Geology of Michigan, University of Michigan Press, Ann Arbor, Michigan, 1971.

E. P. Du Bois, "Geology and Coal Resources of a Part of the Pennsylvanian System in Shelby, Moultrie, and Portions of Effingham and Fayette Counties, Illinois," Report of Investigation 156, Illinois State Geological Survey, 1951.

E. P. Du Bois and R. Siever, "Structure of the Shoal Creek Limestone and Herrin (No. 6) Coal in Wayne County, Illinois," Report of Investigation 182, Illinois State Geological Survey, 1955.

LSCS-UFSAR

P. B. Du Montelle, N. C. Hester, and R. E. Cole, "Landslides along the Illinois River Valley South and West of LaSalle and Peru, Illinois," Environmental Geology Notes, No. 48, Illinois State Geological Survey, 1971.

C. E. Dutton and R. E. Bradley, "Lithologic, Geophysical and Mineral Commodity Maps of Precambrian Rocks in Wisconsin," Map I-631, Miscellaneous Geological Investigations, U. S. Geological Survey, 1970.

A. J. Eardley, Structural Geology of North America, Harper & Brothers, New York, 1962.

G. L. Ekein and F. T. Thwaites, "The Glover Bluff Structure, a Disturbed Area in the Paleozoics of Wisconsin," Transactions of the Wisconsin Academy of Science, Arts, and Letters, Vol. 25, pp. 89-97, 1930.

G. H. Emrich, "Ironton and Galesville (Cambrian) Sandstones in Illinois and Adjacent Areas," Circular 403, Illinois State Geological Survey, 1966.

G. H. Emrich and R. E. Bergstrom, "Des Plaines Disturbance, Northeastern Illinois," Geological Society of America Bulletin, Vol. 73, pp. 959-968, 1962.

R. A. Eppley, Earthquake History of the United States - Part 1, Stronger Earthquakes of the United States (exclusive of California and Nevada), U. S. Coast and Geodetic Survey Publication S. P. 41-1 (revised edition through 1963).

H. Faul, Ages of Rocks, Planets, and Stars, McGraw-Hill, New York, 1966.

N. M. Fenneman, Physiography of the Eastern United States, McGraw-Hill, New York, 1935.

N. M. Fenneman, "Physical Divisions of the United States," U. S. G. S. Survey Map, 1946.

W. I. Finch, Geologic map of the Paducah West and part of the Metropolis quadrangles, Kentucky-Illinois: U. S. Geological Survey Geological Quadrangle Map GQ-557, 1966.

W. I. Finch, "Engineering Geology of the Paducah West and Metropolis Quadrangles in Kentucky:" Bulletin 1258-B, U. S. Geological Survey, 1968a.

R. F. Flint et al., "Glacial Map of the United States East of the Rocky Mountains," Geological Society of America, 1959.

R. F. Flint, Glacial and Quaternary Geology, John Wiley and Sons, New York, 1971.

LSCS-UFSAR

P. Flawn, "Basement Map of the United states," American Association of Petroleum Geologists and U. S. Geological Survey, 1967.

A. J. Frank, "Faulting on the Northeastern Flank of the Ozarks (Missouri)" (Abstract), Geological Society of America Bulletin, Vol. 59, No. 12.

J. C. Frye, H. B. Willman, and H. D. Glass, "Cretaceous Deposits and the Illinoian Glacial Boundary in Western Illinois," Circular 364, Illinois State Geological Survey, 1964.

F. M. Fryxell, "The Earthquakes of 1934 and 1935 in Northwestern Illinois and Adjacent Parts of Iowa" Seismological Society of America Bulletin, Vol. 30, No. 3, pp. 213-218, 1940.

M. L. Fuller, "The New Madrid Earthquake", U. S. Geological Survey Bulletin 494, 1912.

H. J. Gibbs and W. G. Holtz, "Research on Determining the Density of Sand by Spoon Penetration Testing," Proceedings of 4th International Conference on Soil Mechanics and Foundation Engineering, Vol. I, pp. 35-39, London, 1957.

D. W. Gordon et al., "The South-Central Illinois Earthquake of November 9, 1968, Macroseismic Studies," Seismological Society of America Bulletin, Vol. 60, No. 3, pp. 953-971, 1970.

H. H. Gray, Indiana Geological Survey, Bloomington, Indiana, Written Communication, 1974.

H. H. Gray, W. J. Wayne, and C. E. Wier, Geologic map of the 1° x 2° Vincennes quadrangle and parts of adjoining quadrangles, Indiana and Illinois, showing bedrock and unconsolidated deposits: Regional Geology Map No. 3, Vincennes sheet, Indiana Geological Survey, 1970.

D. A. Green, "Trenton structure in Ohio, Indiana, and Northern Illinois," American Association of Petroleum Geologists Bulletin, Vol. 41, No. 4, pp. 627-642, 1957.

W. E. Ham and J. C. Wilson, "Paleozoic Epeirogeny and Orogeny in the Central United States," American Journal of Science, Vol. 265, pp. 332-407, 1967.

W. B. Harland, A. G. Smith and B. Wilcock, (eds.) The Phanerozoic Time-Scale, Geological Society of London, 1964.

H. B. Harris, The Grenville Fault area, unpublished M. S. thesis, Indiana University, Bloomington, Indiana, 1948.

LSCS-UFSAR

S. E. Harris and M. C. Parker, "Stratigraphy of the Osage Series in Southeastern Iowa," Report of Investigation No. 1, Iowa Geological Survey, 1964.

J. A. Harrison "Subsurface Geology and Coal Resources of the Pennsylvanian System in White County, Illinois:" Report of Investigation 153, Illinois State Geological Survey, 1951.

P. C. Heigold, "Notes on the Earthquake of November 9, 1968, in Southern Illinois", Illinois Geological Survey Environmental Notes #24.

P. C. Heigold, " A Gravity Survey of Extreme Southeastern Illinois:" Circular 450, Illinois State Geological Survey, 1970.

P. C. Heigold, "Notes on the Earthquake of September 15, 1972, in Northern Illinois," Environmental Geology Notes 59, Illinois State Geological Survey, 1972.

P. C. Heigold, Illinois State Geological Survey, Urbana, Illinois, Written Communication, 1975.

P. C. Heigold, "An Aeromagnetic Survey of Southwestern Illinois:" Illinois State Geological Survey Circular 495, 1976.

P. C. Heigold, L. D. McGinnis, and R. H. Howard, "Geologic Significance of the Gravity Field in DeWitt-McLean County area, Illinois," Circular 369, Illinois State Geological Survey, 1964.

R. R. Heinrich, "A Contribution to the Seismic History of Missouri," Seismological Society of America Bulletin, Vol. 31, pp. 1-8, 1949.

R. R. Heinrich, "Three Ozark Earthquakes", Seismological Society of America Bulletin, Vol. 39, No. 1, pp. 1-8, 1949.

R. R. Heinrich, "The Mississippi Valley Earthquakes of June, 1947", Seismological Society of America Bulletin, Vol. 40, pp. 7-19, 1950.

A. V. Heyl, "The 38th Parallel Lineament and its Relationship to Ore Deposits:" Economic Geology, Vol. 67, pp. 879-894, 1972.

A. V. Heyl et al., "The Geology of the Upper Mississippi Valley Zinc-Lead District:" Professional Paper No. 309, U. S. Geological Survey, 1959.

A. V. Heyl et al., "Regional Structure of the Southeast Missouri and Illinois-Kentucky Mineral Districts:" Bulletin 1202B, U. S. Geological Survey, 1965.

LSCS-UFSAR

W. H. Hobbs, Michigan Geological and Biological Survey, Publication 5, Geological Series, 1911.

J. H. Hodgson, A Seismic Survey in the Canadian Shield: 1. Refraction Studies Based on Rock Bursts at Kirkland Lake, Ontario, Vol. 6, pp. 167-181, Publ. Dom. Obs. Ottawa, Ontario, 1953.

L. Horberg, "Bedrock Topography of Illinois," Bulletin 73, Illinois State Geological Survey, 1950.

W. B. Howe, Relief Map, State of Missouri, Missouri Geological Survey and Water Resources, 1969.

J. V. Howell, "The Mississippi River Arch," Guidebook, Ninth Annual Field Conference, Kansas Geological Society, pp. 386-389, 1935.

W. Huang, P. V. Manam and L. A. Loziuk, "Two-Dimensional Steady-State Seepage Analysis (SEEPAGE)," unpublished computer program, Sargent & Lundy Engineers, 1974.

H. C. Hutchinson, "Distribution, Structure, and Mined Areas of Coals in Perry County, Indiana," Indiana Geological Survey, Preliminary Coal Map No. 14, 1971.

Indiana Geological Survey, unpublished manuscript.

Illinois State Geological Survey, open file.

N. Janbu, "Settlement Calculation Based on the Tangent Modulus Concept," Three Guest Lectures at Moscow State University, Bulletin No. 2 of Soil Mechanics and Foundation Engineering of the Technical University of Norway, Trondheim, 1967.

J. P. Kempton, Illinois State Geological Survey, Urbana, Illinois, Written Communication, 1972.

J. P. Kempton, Illinois State Geological Survey, Urbana, Illinois, Written Communication, 1975.

J. P. Kempton, "Characteristics of the Surficial Deposits Relative to the Development of the Commonwealth Edison Nuclear Power Plant in LaSalle County, Illinois," Illinois State Geological Survey, Urbana, Illinois, 1975.

J. P. Kempton, Illinois State Geological Survey, Urbana, Illinois, Personal Communication, 1976.

P. B. King, The Tectonics of Middle North America, Princeton University Press, Princeton, N. J., 1951.

P. B. King and H. M. Beikman, Geologic Map of the United States, U.S. Geological Survey, 1974.

P. B. King, "Quaternary Tectonics in Middle-North America," Quaternary of the U.S., (Ed. by H. E. Wright, Jr. and P. G. Fry), Princeton University Press, Princeton, N. J., 1965.

H. Kishida, "Characteristics of Liquefied Sands During Mino-Owari, Tohnankai and Fukui Earthquakes," Soils and Foundations (Japan), Vol. 9, No. 1, pp. 75-92, 1969.

D. R. Kolata, Illinois State Geological Survey, Urbana, Illinois, Written Communication, 1975.

D. R. Kolata and T. C. Buschbach, "Plum River Fault Zone of Northwestern Illinois," Circular 491, Illinois State Geological Survey, 1976.

R. M. Kosanke et al., "Classification of the Pennsylvanian Strata of Illinois," Report of Investigation 214, Illinois State Geological Survey, 1960.

F. Krey, "Structural Reconnaissance of the Mississippi Valley Area from Old Monroe, Missouri, to Nauvoo, Illinois," Bulletin No. 45, Illinois State Geological Survey, 1924.

W. C. Krumbein and L. L. Sloss, Stratigraphy and Sedimentation, Freeman and Co., San Francisco, 1963.

B. Kummel, History of the Earth: an Introduction to Historical Geology, Freeman and Co., San Francisco, 1970.

M. M. Leighton, G. E. Ekblaw, and L. Horberg, "Physiographic Divisions of Illinois," Journal of Geology, Vol. 56, No. 1, January, 1948.

R. Malhotra, "Illinois Mineral Industry in 1972," Illinois Minerals Note 58, Illinois State Geological Survey, 1974.

C. A. Malott, "The Physiography of Indiana," Handbook of Indiana Geology, pp. 59-256, Indiana Department Conservation Publication 21, Part 2, 1922.

C. A. Malott, "Geologic structure in the Indian and Trinity Springs locality, Martin County, Indiana": Indiana Academy of Science Proceedings, 46th Annual Meeting, Vol. 40, pp. 217-231, 1931.

L. Martin, The Physical Geography of Wisconsin, University of Wisconsin Press, Madison and Milwaukee, 1932, 2nd ed. 1965.

LSCS-UFSAR

H. Matuo and S. Ohara, "Lateral Earth Pressure and Stability of Quay Walls During Earthquakes," Proceedings of the Second World Conference on Earthquake Engineering, Vol. 1, Japan, 1960.

F. Mauk, University of Michigan Seismological Observatory, Personal Communication, July 14, 1977.

G. R. McCarthy, "Three Forgotten Earthquakes", Seismological Society of America Bulletin, Vol. 53, No. 3, pp. 687-692, 1963.

S. M. McClure, "The Illinois Earthquake," The Mineralogist, No. 1, pp. 420-422, 1940.

M. H. McCracken, "Structural Features of Missouri," Report of Investigation No. 49, Missouri Geological Survey and Water Resources, 1971.

L. D. McGinnis, "Crustal Tectonics and Precambrian Basement in Northeastern Illinois," Report of Investigation 219, Illinois State Geological Survey, 1966.

L. D. McGinnis, Northern Illinois University, DeKalb, Illinois, Personal Communication, 1974.

L. D. McGinnis, P. C. Heigold, C. P. Ervin, and M. Heidari, "The Gravity Field and Tectonics of Illinois:" Illinois State Geological Survey Circular 494, 1976.

D. McGuire, "Geophysical Survey of the Anna, Ohio, Area:" Unpublished master's thesis, Bowling Green University, Bowling Green, Ohio, 1975.

W. N. Melhorn and N. M. Smith, "The Mt. Carmel Fault and Related Structural Features in South Central Indiana," Report of Progress 16, Indiana Geological Survey, 1959.

B. C. Moneymaker, "Some Earthquakes in Tennessee and Adjacent States (1699 to 1850)", Journal of the Tennessee Academy of Science, Vol. 29, No. 3, pp. 224-233, 1954.

B. C. Moneymaker, "Earthquakes in Tennessee and Nearby Sections of Neighboring States - 1851-1900," Journal of the Tennessee Academy of Science, Vol. 30, No. 3, pp. 222-233, 1955.

B. C. Moneymaker, "Earthquakes in Tennessee and Nearby Sections of Neighboring States - 1901-1925," Journal of the Tennessee Academy of Science, Vol. 32, No. 2, pp. 91-105, 1957.

LSCS-UFSAR

B. C. Moneymaker, "Earthquakes in Tennessee and Nearby Sections of Neighboring States - 1926-1950," Journal of the Tennessee Academy of Science, Vol. 33, No. 3, pp. 224-239, 1958.

B. C. Moneymaker, Unpublished Manuscript, 1964.

N. Mononobe, "Earthquake-Proven Construction of Masonry Dams", Proceedings, World Engineering Conference, Vol. 9, p. 275, 1929.

R. C. Moore, Historical Geology, McGraw-Hill, New York, 1958.

W. R. Muehlberger, R. E. Denison, and E. G. Lidiak, "Basement Rocks in Continental Interior of United States," A.A.P.G., Vol. 51, No. 12, pp. 2351-2380, 1967.

O. W. Nuttli, "The Mississippi Valley Earthquakes of 1811 and 1812, Intensities, Ground Motion, and Magnitude," Seismological Society of America Bulletin, Vol. 63, No. 1, pp. 227-248, 1973.

O. W. Nuttli, "Magnitude Recurrence Relation for Central Mississippi Valley Earthquakes," Seismological Society of America Bulletin, Vol. 64, No. 4, pp. 1189-1207, 1974.

O. W. Nuttli, State-of-the-Art for Assessing Earthquakes; Hazards in the United States: Dep. 1, Design Earthquakes for the Central United States, U. S. Army Engineer Waterways Experiment Station, 1973.

O. W. Nuttli and J. E. Zollweg, "The Relation Between Felt Area and Magnitude for Central United States Earthquakes: Seismological Society of America Bulletin, Vol. 64, pp. 1189-1208, 1974.

S. Okabe, "General Theory of Earth Pressure", Journal of Japanese Society of Civil Engineers, Vol. 12, No. 1, 1926.

W. W. Olive, Geology of the Elva Quadrangle, Kentucky, U.S. Geological Survey Geological Quad Map GQ 230, 1963.

W. W. Olive, "Geology of the Jackson Purchase Region, Kentucky," Geological Society of Kentucky, Annual Springfield Conference, April 6-8, 1972.

M. E. Ostrom, Geology Field Trip, Southwestern Dane County, University of Wisconsin Geological and Natural History Survey, p. 15, 1971.

M. E. Ostrom, Wisconsin Geological and Natural History Survey, Madison, Wisconsin, Written Communication, 1975.

LSCS-UFSAR

J. N. Payne, "The Age of the LaSalle Anticline," Circular No. 60, pp. 5-7, Illinois State Geological Survey, 1940.

J. N. Payne, "Structure of the Herrin (No. 6) Coal Bed in Madison County and Western Bond, Western Clinton, Southern Macoupin, Southwestern Montgomery, Northern St. Clair, and Northwestern Washington Counties, Illinois," Circular No. 88, Illinois State Geological Survey, 1942.

R. L. Powell, "Caves of Indiana," Circular 8, Indiana Department of Conservation Geological Survey, 1961.

W. A. Pryor, "Groundwater Geology of White County, Illinois", Report of Investigation 196, Illinois State Geological Survey, 1956.

M. W. Pullen, "Subsurface Geology and Coal Resources of the Pennsylvanian System in certain counties in the Illinois Basin - Gallatin County", Report of Investigation 148, pp. 69-95, Illinois State Geological Survey, 1951.

A. D. Randall, Glacial Geology and Groundwater Possibilities in Southern LaSalle and Eastern Putnam Counties, Illinois, unpublished master's thesis, University of Illinois, Urbana, Illinois, 1955.

E. A. Riggs, Major Basins and Structural Features of the United States, Geographical Press, New Jersey.

M. F. Robertson, "The Missouri-Tennessee Earthquake of January 30, 1937", Proceedings, Missouri Academy of Science, 1938.

W. W. Rubey, "Geology and Mineral Resources of the Hardin and Brussels Quadrangles in Illinois," Professional Paper 218, U.S. Geological Survey, 1952.

A. J. Rudman, C. H. Summerson and W. J. Hinze, "Geology of Basement in Midwestern U.S.," American Association of Petroleum Geologists, Vol. 49, No. 7, pp. 894-904, 1965.

Sargent & Lundy, Supplemental Discussion Concerning the Limit of the Northern Extent of Large Intensity Earthquakes Similar to the New Madrid Events, 1975.

F. J. Sawleins, "Sulfide Ore Deposits in Relation to Plate Tectonics", Journal of Geology, Vol. 80, No. 4, pp. 377-397, 1972.

A. F. Schneider, "Physiography," The Indiana Sesquicentennial Volume, pp. 40-56, Indiana Academy of Science, 1966.

LSCS-UFSAR

H. R. Schwalb, "Paleozoic Geology of the Jackson Purchase Region, Kentucky, with Reference to Petroleum Possibilities," Series X, Report of Investigation 10, Kentucky Geological Survey, 1969.

H. R. Schwalb, Kentucky Geological Survey, Lexington, Kentucky, Written Communication, 1974.

H. R. Schwalb, E. N. Wilson, and D. G. Sutton, "Oil and Gas Map of Kentucky", Series X, Sheet 1, Western Part, Kentucky Geological Survey, 1971.

H. R. Schwalb, E. N. Wilson, and D. G. Sutton, "Oil and Gas Map of Kentucky", Series X, Kentucky Geological Survey, 1972.

H. B. Seed and I. M. Idriss, "A Simplified Procedure for Evaluating Soil Liquefaction Potential," Report No. EERC 70-9, University of California, Berkeley, Cal., 1970.

H. B. Seed and I. M. Idriss, "Soil Moduli and Damping Factors for Dynamic Response Analyses," Earthquake Engineering Research Center Report No. 70-10, University of California, Berkeley, 1970.

H. B. Seed and R. V. Whitman, "Design of Earth-Retaining Structures for Dynamic Loads," Proceedings of the ASCE Specialty Conference on Lateral Stresses in the Ground and Design of Earth-Retaining Structures, 1970.

D. A. Seeland, Geologic map of part of the Repton quadrangle in Crittenden County, Kentucky: U. S. Geological Survey Geological Quadrangle Map GQ-754, 1968.

Seismograph Service Corporation, "A Review of a Geophysical Survey of the Anna, Ohio, Area:" in: PSAR for Marble Hill Nuclear Generating Station, 1976.

H. A. Sellin, V. H. Jones and H. B. Willman, Map: Road Material Resources of LaSalle County, Illinois State Geological Survey, 1931.

N. S. Shaler, "Earthquakes of the Western United States," The Atlantic Monthly, Vol. 24, p. 550, 1869.

Shannon & Wilson, Inc. and Agbanian-Jacobsen Associates, "Soil Behavior Under Earthquake Loading Conditions: State of the Art Evaluation of Soil Characteristics for Seismic Response," prepared for the U. S. Atomic Energy Commission, 1972.

E. M. Shepard, "The New Madrid Earthquakes" Journal of Geology, Vol. 13, pp 45-62, 1905.

Simon, Written Communication, 1974.

LSCS-UFSAR

H. L. Smith and G. H. Cady, "Subsurface Geology and Coal Resources of the Pennsylvanian System in Certain Counties in the Illinois Basin - Edwards County:" Report of Investigation 148, pp. 51-68, Illinois State Geological Survey, 1951.

W. H. Smith, "Strippable Coal Resources of Illinois, Part 1 - Gallatin, Johnson, Pope, Saline, and Williamson Counties:" Circular 228, Illinois State Geological Survey, 1957.

F. G. Snyder, "Tectonic History of Mid-Continental United States," Journal, No. 1, University of Missouri at Rolla, 1968.

W. Stauder, M. Kramer, G. Fischer, S. Schaefer, and S. T. Morrissey, "Seismic Characteristics of Southeast Missouri as Indicated by a Regional Telemetered Microearthquake Array:" Seismological Society of America Bulletin, Vol. 66, No. 6, pp. 1953-1964, 1976.

R. G. Stearns and M. W. Marcher, "Late Cretaceous and Subsequent Structural Development of the Northern Mississippi Embayment Area," Tennessee Division of Geology Report of Investigation 18 (reprinted from Geological Society of America Bulletin, Vol. 75, pp. 1387-1394), 1962.

R. G. Stearns and C. W. Wilson, "Relationship of Earthquakes and Geology in West Tennessee and Adjacent Areas," Tennessee Valley Authority, 1972.

P. B. Stockdale, "The Borden (Knobstone) Rocks of Southern Indiana:" Publication 98, Indiana Department of Conservation Division of Geology, 1931.

H. B. Stonehouse and G. M. Wilson, "Faults and Other Structures in Southern Illinois - a Compilation", Circular 195, Illinois State Geological Survey, 1955.

R. L. Street, R. B. Herrman, and O. W. Nuttli, "Earthquake Mechanics in the Central United States," Science, Vol. 184, pp. 1285-1287, 1974.

D. H. Swann and A. H. Bell, "Habitat of Oil in the Illinois Basin," Reprint 1958-W, Illinois State Geological Survey, 1958.

J. S. Templeton and H. B. Willman, "Champlainian Series (Middle Ordovician) in Illinois," Bulletin 89, Illinois State Geological Survey, 1963.

K. Terzaghi and R. B. Peck, Soil Mechanics in Engineering Practice, John Wiley & Sons, New York, New York, 1967.

W. D. Thornbury, Regional Geomorphology of the United States, John Wiley & Sons, New York, 1965.

LSCS-UFSAR

F. T. Thwaites, "Physiography of the Baraboo District," Guidebook for Ninth Annual Field Conference, Kansas Geological Society, pp. 395-404, 1935.

F. T. Thwaites, Map of the Pre-Cambrian of Wisconsin, Wisconsin Geological and Natural History Survey, 1957.

A. C. Trowbridge, "Glacial Drift in the 'Driftless Area' of Northeast Iowa," Report of Investigation 2, Iowa Geological Survey, 1966.

A. P. Udden, "On the Earthquake of January 2, 1912, in the Upper Mississippi Valley," Illinois Academy of Sciences Transactions, Vol. 5, pp. 111-115, 1912.

University of Illinois Agricultural Experiment Station, "Soil survey: LaSalle County, Illinois", Urbana, Illinois, 1972.

U. S. Department of the Army Corps of Engineers, "Engineering and Design Stability of Earth and Rock-Fill Dams," EM 1110-2-1902, 1970.

U. S. Department of the Army Corps of Engineers, Shore Protection Manual, Volume II, 1973.

U. S. Department of Agriculture, Soil Conservation Service, "Description of Soil Types," in cooperation with University of Illinois Agricultural Experiment Station.

U. S. Department of Agriculture, Soil Conservation Service, "Established Series Revisions," in cooperation with University of Illinois Agricultural Experiment Station, 1973, 1974, 1975.

U. S. Department of the Navy Naval Facilities Engineering Command, "Design Manual, Soil Mechanics, Foundations, and Earth Structures," NAVFAC DM-7, 1971.

U. S. Bureau of Reclamation, Earth Manual, Designation E 18, 1968.

C. A. Von Hake, "Earthquake History of Michigan:" Earthquake Information Bulletin, Vol. 5, No. 6, pp. 25-27, 1973.

W. C. Walton, "Groundwater Recharge and Runoff in Illinois," Report of Investigation 48, Illinois State Water Survey, 1965.

H. R. Wanless, "Regional Variations in Pennsylvanian Lithology," Journal of Geology, No. 3, 1955.

LSCS-UFSAR

W. J. Wayne, "Thickness of Drift and Bedrock Physiography of Indiana North of the Wisconsinan Glacial Boundary," Report of Progress No. 7, Indiana Department of Conservation Geological Survey, 1956.

J. M. Weller, Geology and Oil Possibilities of Extreme Southern Illinois - Union, Johnson, Pope, Hardin, Alexander, Pulaski, and Massac Counties", Report of Investigation 71, Illinois State Geological Survey, 1940.

J. M. Weller, R. M. Grogan, and F. E. Tippie, "Geology of the Fluorspar deposits of Illinois", Bulletin 76, Illinois State Geological Survey, 1952.

H. M. Westergaard, "Water Pressures on Dams During Earthquakes, Transactions ASCE, Vol. 98, 1933, p. 418.

A. J. Westland and R. R. Henrich, "Macroseismic Study of the Ohio Earthquakes of March, 1937," Seismological Society of America Bulletin, Vol. 30, pp. 251-260, 1940.

L. L. Whiting and D. L. Stevenson, "The Sangamon Arch," Circular 383, Illinois State Geological Survey, 1965.

H. B. Willman and J. S. Templeton, "Cambrian and Lower Ordovician Exposures in Northern Illinois," Illinois Academy of Sciences Transactions, Vol. 44, pp. 109-125, 1951.

H. B. Willman and J. C. Frye, "Pleistocene Stratigraphy of Illinois," Bulletin 94, Illinois State Geological Survey, 1970.

H. B. Willman and J. N. Payne, "Geology and Mineral Resources of Marseilles, Ottawa, and Streator Quadrangles," Bulletin 66, Illinois Geological Survey, 1942.

H. B. Willman, "Summary of the Geology of the Chicago Area," Circular 460, Illinois State Geological Survey, 1971.

H. B. Willman, "Geology Along the Illinois Waterway - A Basis for Environmental Planning," Circular 478, Illinois Geological Survey, 1973.

H. B. Willman et al., Geologic Map of Illinois, Illinois State Geological Survey, 1967.

H. B. Willman et al., "Handbook of Illinois Stratigraphy," Bulletin 95, Illinois State Geological Survey, 1975.

H. B. Willman, Illinois State Geological Survey, Urbana, Illinois, Personal Communication, 1976.

LSCS-UFSAR

E. N. Wilson, Kentucky Geological Survey, Lexington, Kentucky, Written Communication, 1974.

E. N. Wilson, Kentucky Geological Survey, Lexington, Kentucky, Written Communication, 1975.

G. P. Woollard, A Catalogue of Earthquakes in the United States Prior to 1925, Based on Unpublished Data Compiled by Harry Fielding Reid and Published Sources Prior to 1930: Hawaii Institute of Geophysics, University of Hawaii, 1968.

G. P. Woollard, United States Earthquakes Coast and Geodetic Survey, U. S. Department of Commerce, 1925 to present.

L. E. Workman and A. H. Bell, "Deep Drilling and Deeper Oil Possibilities in Illinois," American Association of Petroleum Geologists Bulletin, Vol. 32, No. 11, pp. 2041-2062, 1948.

LSCS-UFSAR

TABLE 2.5-1

SCOPE OF WORK

<u>INVESTIGATION</u>	<u>PERFORMED BY*</u>
Geologic literature review	Sargent & Lundy, Dames & Moore
Topographic mapping	Air Map, Inc.
Geologic reconnaissance	Dames & Moore
Drilling and sampling	Sargent & Lundy (flume boring), Dames & Moore, Raymond International, Inc.
Test pit excavations	Dames & Moore
Geophysical surveys	Dames & Moore
Laboratory testing - soils	Dames & Moore, A&H Engineering Corp., H. H. Holmes Testing Laboratories
Groundwater	Dames & Moore, Commercial Testing and Engineering Co.** , NALCO Chemical Co., State Water Survey*** , Sargent & Lundy
Vibratory ground motion	Sargent & Lundy, Dames & Moore
Stability of subsurface materials	Sargent & Lundy, Dames & Moore
Foundation conditions	Sargent & Lundy, Dames & Moore

* PSAR work performed by Dames & moore, FSAR work performed by Sargent & Lundy

** Chicago, Illinois

*** Urbana, Illinois

LSCS-UFSAR

TABLE 2.5-2
(SHEET 1 OF 2)

PHYSIOGRAPHIC CLASSIFICATION AND CORRELATION CHART*

DIVISION	PROVINCE	ILLINOIS	INDIANA	WISCONSIN	IOWA	MISSOURI	MICHIGAN**
Interior Plains	Central Lowland	Till Plains Section	Till Plains Section				
		Bloomington Ridged Plain	Tipton Till Plain				
		Springfield Plain					
		Mount Vernon Hill Country	Wabash Lowland				
		Rock River Hill Country					
		Galesburg Plain					
		Green River Lowland					
		Great Lakes Section	Great Lakes Section	Great Lakes Section			Kankakee Moraine Area
		Kankakee Plain	Kankakee Outwash and Lacustrine Plain				
		Wheaton Morainal Country	Valparaiso Morainal Area				Valparaiso Moraine Area
		Chicago Lake Plain	Calumet Lacustrine Plain				Lake Border Moraine Area
		Dissected Till Plains			Dissected Till Plains	Dissected Till Plains	
		Driftless Area		Western Upland	Driftless Area		
			Maumee Lacustrine Plain				
			Steuben Morainal Lake Area				
				Eastern Ridges and Lowlands			

LSCS-UFSAR

TABLE 2.5-2
(SHEET 2 OF 2)

PHYSIOGRAPHIC CLASSIFICATION AND CORRELATION CHART*

DIVISION	PROVINCE	ILLINOIS	INDIANA	WISCONSIN	IOWA	MISSOURI	MICHIGAN**
					Western Young Drift Section		
				Central Plain			
	Interior Low Plateau		Norman Upland				
			Mitchell Plain				
			Crawford Upland				
Interior Highlands	Ozark Plateaus	Lincoln Hills				Lincoln Hills	
		Salem Plateau				Salem Plateau	

* Interstate correlation are listed by state on the same horizontal line. These correlations are by Sargent & Lundy.

** The subdivision of Michigan is by Sargent & Lundy. References for the physiographic subdivisions of the other states are given in the text

LSCS-UFSAR

TABLE 2.5-3
(SHEET 1 OF 8)

TABULATION OF FAULTS IN ILLINOIS

MAP NUMBER	NAME	LOCATION (COUNTY)	IDENTIFICATION ^{1,2}	LENGTH (mi)	STRIKE	DIP ³	TYPE ⁴	RELATIVE DISPLACEMENT	AGE OF MOVEMENT	REMARKS
1	DesPlaines Disturbance	Cook	Sc (Willman et al., 1967, Oga)							Cryptovolcanic or astrobleme.
2	Sandwich	Dale, Lee, DeKalb Kendall, Will	Sc (William et al., 1967, Oga)	90	N53°W to N65°W		S	Northern end NE Side down 900 ft.	Post-Silurian, Pre-Pleistocene (Buschbach, 1973)	
3	Plum River Fault Zone	Ill.-Carroll, Ogle Ia. - Jackson	B, S (Kolata and Buschbach 1976, Oga)	60	N84°E	H	G	North side down 100 to 400 ft. (Kolata and Buschbach, 1976)	Post-Niagaran, Pre-mid-Illinoian (Kolata and Buschbach, 1976)	Formerly named Savanna Fault (Wilman et al 1967).
4		Pope, Johnson	U (Stonehouse and Wilson, 1955)	19	N43°E. to N49°E				Post-Pennsylvanian, Pre-Late Cretaceous (Buschbach, 1973a, 1973b)	Bifurcating branches.
5		Johnson, Pulaski	U (Stonehouse and Wilson, 1955)	31	N11°E.			Because of branching W & E side down	Post-Pennsylvanian, Pre-Late Cretaceous (Buschbach, 1973a, 1973b)	Bifurcating branches, produces graben structure.
6		Johnson	U (Stonehouse and Wilson, 1955)	10	N29°W.			SW side down	Post-Pennsylvanian, Pre-Late Cretaceous (Buschbach, 1973a, 1973b)	
7	St. Genevieve Fault Zone	Alexander, Union	Sc (Bristol and Buschbach, 1973, Ot) U (Stonehouse and Wilson, 1955)	6	N21°W.			NE side down 100 to 400 ft.	Post-Pennsylvanian, Pre-Late Devonian (Buschbach, 1973)	
8	St. Genevieve Fault Zone	Union	U (Stonehouse and Wilson, 1955)	4	N0° to N10°W				Post-Pennsylvanian, Pre-Late Devonian (Buschbach, 1973)	
9	St. Genevieve Fault Zone	Union	U (Stonehouse and Wilson, 1955)	4	N19°W. to N50°W			NE side down	Post-Pennsylvanian, Pre-Late Devonian (Buschbach, 1973)	Two Bifurcating branches 4 miles in length.
10	Rattlesnake Ferry	Union, Jackson	S (Desborough, 1957) U (Stonehouse and Wilson, 1955)	11	N50°W.			NE side down 10 to 125 ft.	Post-Pennsylvanian, Pre-Late Devonian (Desborough, 1957; Buschbach, 1973)	Three Bifurcating branches 3 to 6 miles long, striking N9°E to N21°W.
11	St. Genevieve Fault Zone	Union, Jackson Williamson	U (Stonehouse and Wilson, 1955)	4	N30°W. to N37°W			NE side down	Post-Pennsylvanian, Pre-Late Devonian (Buschbach, 1973)	Bifurcating branch 2 miles long, N34°E, NW side down.

LSCS-UFSAR

TABLE 2.5-3
(SHEET 2 OF 8)

TABULATION OF FAULTS IN ILLINOIS

MAP NUMBER	NAME	LOCATION (COUNTY)	IDENTIFICATION ^{1,2}	LENGTH (mi)	STRIKE	DIP ³	TYPE ⁴	RELATIVE DISPLACEMENT	AGE OF MOVEMENT	REMARKS
12	St. Genevieve Fault Zone	Union, Johnson	U (Stonehouse and Wilson, 1955)	4	N50°E		G	NW side down	Post-Pennsylvanian, Pre-Late Devonian (Buschbach, 1973b)	Bifurcating branch 3 miles in length striking N9°E
13	Cottage Grove Fault Zone	Randolph, Jackson	Sc (Bristol and Buschbach, 1973, Ot) U (Stonehouse and Wilson, 1955; Heyl et al., 1965)	20	Varies 180°			N side down 50 to 100 ft.	Post-Pennsylvanian, Pre-Late Cretaceous (Buschbach, 1973a)	13 miles of fault are doubtful.
14	Cottage Grove Fault Zone	Perry, Jackson	U (Stonehouse and Wilson, 1955; Heyl et al., 1965)	4	N16°E.			NW side down	Post-Pennsylvanian, Pre-Late Cretaceous (Buschbach, 1973a)	
15	Cottage Grove Fault Zone	Jackson	U (Stonehouse and Wilson, 1955; Heyl et al., 1965)	2	N37°W.				Post-Pennsylvanian, Pre-Late Cretaceous (Buschbach, 1973a)	
16	Lusk Creek Fault Zone and Dixon Springs Graben	Ill.-Massac, Pope, Hardin, Gallatin Ky.-Ballard, McCracken	U (Weller, Grogan, and Tippie, 1952; Stonehouse and Wilson, 1955; Hely et al., 1965; Baxter and Desborough, 1965; Schwalb, Wilson and Sutton, 1971)	43	N10°E. to N73°E			SE side down	Post-Pennsylvanian, Pre-Cretaceous (Buschbach, 1973a, 1973b)	Southern 14 miles north of Ohio River comprise Dixon Springs Graben; numerous bifurcating branches less than 2 to 20 miles in length, strikes vary 180°. Corresponds to Ky.-2.
17	Ridge, Lee, Hamp	Ill.-Massac, Pope, Hardin, Gallatin Ky.- McCracken	U (Stonehouse and Wilson, 1955; Heyl et al., 1965; Schwalb, Wilson, and Sutton, 1971; 1972)	49	N36°E. to N72°E			NW side down; Northeast part SE side down	Post-Pennsylvanian, Pre-Late Cretaceous (Buschbach, 1973a, 1973b)	Numerous bifurcating branches less than 2 miles in length. Corresponds to Ky.-3.
18	Centralia	Jefferson, Franklin	B (Brownfield, 1954) Sc (Brownfield, 1954, Mgcc; Bristol and Buschbach, 1973, Ot)	28	N6°E. to N9°W			W side down 50 to 100 ft.	Post-Pennsylvanian, Pre-Pleistocene (Buschbach, 1973a)	
19	Greathouse Island Pitcher Lake	Ill.-White Ind. - Posey	Sc (Dawson, 1973, Mc; Bristol, 1973, 1974a, 1974b, Mgcc)	5	N27°E			NE side down	Post-Pennsylvanian, Pre-Pleistocene (Buschbach, 1973a, 1973b)	Two Parallel fault traces Greathouse Island and Pitcher Lake, less than 20 miles apart, 5 and 2 miles in length respectively. Greathouse Island is northern-most fault. Corresponds to Ind.-12.
20	Owaha Graben	Gallatin, White	Sc (Bristol, 1974a, Mgcc)	2	N3°E. to N7°W		G		Post-Pennsylvanian, Pre-Pleistocene (Buschbach, 1973a, 1973b)	Two bifurcating branches less than 2 miles apart, and 2 miles in length.

LSCS-UFSAR

TABLE 2.5-3
(SHEET 3 OF 8)

TABULATION OF FAULTS IN ILLINOIS

MAP NUMBER	NAME	LOCATION (COUNTY)	IDENTIFICATION ^{1,2}	LENGTH (mi)	STRIKE	DIP ³	TYPE ⁴	RELATIVE DISPLACEMENT	AGE OF MOVEMENT	REMARKS
21		Ill.-Alexander, White Mo.-Mississippi	Sc (Bristol and Buschbach, 1973, Ot)	13	N4°E to N34°E			SE side down 200 ft.	Post-Pennsylvanian, Pre-Pleistocene (Buschbach, 1973a, 1973b)	One bifurcating branch 8 miles in length, striking N50°E to N62°E.
22	Equality, Herald-Phillips-town	Gallatin, White, Edwards	Sc (Harrison, 1951; Pc: Bristol and Buschbach, 1973, Ot; Bristol, 1974a, Mgcc; 1974b, Mgcc) U (Stonehouse and Wilson, 1955)	40	N53°E to N43°W			SE side down 50 to 200 ft.	Post-Pennsylvanian, Pre-Pleistocene (Buschbach, 1973, 1973a)	
23	Hill, Junction East	Gallatin	Sc (Bristol and Buschbach, 1973, Ot; Bristol, 1974a, Mgcc) U (Stonehouse and Wilson, 1955)	6	N17°W. to N38°E		G	SE sides down 50 ft.	Post-Pennsylvanian, Pre-Pleistocene (Buschbach, 1973a, 1973b)	One parallel fault trace less than 2 miles apart, 6 miles in length, striking N30°E to N40°E. Main trace borders graben with Ill.-27. Hill is westernmost trace.
24	Ridgeway, Cottonwood	Gallatin, White	Sc (Bristol, 1974a, Mgcc) U (Stonehouse and Wilson, 1955)	17	N12°E. to N14°W		G	Ridgeway-SE side down; Cottonwood NW side down	Post-Pennsylvanian, Pre-Pleistocene (Buschbach, 1973a, 1973b)	Main trace is Ridgeway, composed of three en echelon traces. 5 to 17 miles in length, striking N35°E to N14°W. Cottonwood is parallel fault trace less than 2 miles apart, 9 miles in length, striking N10°E to N16°E, with one bifurcating branch less than 2 miles apart, 4 miles in length, striking N10°E to N16°E, bordering grabens.
25	Inman East	Ill.-Gallatin Ind.-Posey	B (Pullen, 1951) Sc (Pullen, 1951, Pc; Bristol 1967, Mgcc; 1974a, Mgcc; Dawson, 1973; Mc; Bristol and Buschbach, 1973, Ot) U (Stonehouse and Willson, 1955; Gray, Wayne, and Weir, 1970)	18	N12°E. to N42°E	60°S E		SE side down 50 to 100 ft.	Post-Pennsylvanian, Pre-Pleistocene (Buschbach, 1973a, 1973b)	Corresponds to Ind.-10.

LSCS-UFSAR

TABLE 2.5-3
(SHEET 4 OF 8)

TABULATION OF FAULTS IN ILLINOIS

MAP NUMBER	NAME	LOCATION (COUNTY)	IDENTIFICATION ^{1,2}	LENGTH (mi)	STRIKE	DIP ³	TYPE ⁴	RELATIVE DISPLACEMENT	AGE OF MOVEMENT	REMARKS
26	Mr. Carmel	Wabash	B (Cady et al., 1955) Sc (Cady et al., 1955, Pml; Bristol, 1967, Mgcc; 1972, Mgcc; Bristol and Buschbach, 1973, Ot) U (Gray, Wayne, and Weir, 1970)	8	N11°E to N40°E	H	N	NW side down 20 to 50 ft.	Post-Pennsylvanian, Pre-Pleistocene (Buschbach, 1973a, 1973b)	
27	Inman	Gallatin	Sc (Bristol and Buschbach, 1973, Ot; Bristol, 1974a, Mgcc) U (Stonehouse and Wilson, 1955)	10			G	W side down	Post-Pennsylvanian, Pre-Pleistocene (Buschbach, 1973a, 1973b)	
28	Cottage Grove Fault Zone	Gallatin, Saline	U (Stonehouse and Wilson, 1955; Heyl et al., 1965)	16	N70°E. to N75°W		H	50 to 250 ft.	Post-Pennsylvanian, Pre-Late Cretaceous (Buschbach, 1973a)	Two fault traces, less than 1 mile apart, border horst. Three bifurcating branches, less than 2 to 3 miles in length, striking N40°E.
29	Cottage Grove Fault Zone	Saline	U (Stonehouse and Wilson, 1955; Heyl et al., 1965)	4	N77°W.				Post-Pennsylvanian, Pre-Late Cretaceous (Buschbach, 1973a)	Bifurcating branch N40°W, 2 miles in length.
30	Cottage Grove Fault Zone	Saline, Williamson, Franklin	U (Stonehouse and Wilson, 1955; Heyl et al., 1965)	15	N54°W. to N68°W				Post-Pennsylvanian, Pre-Late Cretaceous (Buschbach, 1973a)	Numerous fault traces, less than 2 miles in length, compose the fault pattern. Numerous bifurcating branches less than 2 miles in length striking N12°E to N38°W.
31	Cottage Grove Fault Zone	Saline	U (Stonehouse and Wilson, 1955; Heyl et al., 1965)	5	N47°W.			E side down	Post-Pennsylvanian, Pre-Late Cretaceous (Buschbach, 1973a)	
32	Cottage Grove Fault Zone	Saline	U (Stonehouse and Wilson, 1955; Heyl et al., 1965)	5	N25°E. to N47°W				Post-Pennsylvanian, Pre-Late Cretaceous (Buschbach, 1973a)	Numerous fault traces less than 1 mile apart comprise fault pattern.

LSCS-UFSAR

TABLE 2.5-3
(SHEET 5 OF 8)

TABULATION OF FAULTS IN ILLINOIS

MAP NUMBER	NAME	LOCATION (COUNTY)	IDENTIFICATION ^{1,2}	LENGTH (mi)	STRIKE	DIP ³	TYPE ⁴	RELATIVE DISPLACEMENT ⁵	AGE OF MOVEMENT	REMARKS
33		Union	Sc (Bristol and Buschbach, 1973, Ot)	6	N20°W to N30°W			NE side down 400 ft.	Post-Pennsylvanian, Pre-Pleistocene (Buschbach, 1973a, 1973b)	
34	Shawneetown-Rough Creek Fault Zone	Ill.-Gallatin Saline, Pope Ky.-McLean, Webster, Union	U (Stonehouse and Wilson, 1955; Heyl et al., 1965; Schwalb, 1972)	83	Varies 180°			N and S side down over 2500 ft. (McFarlan, 1943, p. 145)	Post-Pennsylvanian, Pre-Late Cretaceous (Buschbach, 1973a, 1973b)	Corresponds to Ky.-42.
35	Wallace Branch, Illinois Furnace, Goose Creek, Interstate, Three Mile Creek, Hogthief Creek, Rock Creek Graben	Ill.-Massac, Pope, Hardin Ky.-McCracken, Livingston	U (Weller, Grogan, and Tippie, 1952; Stonehouse and Wilson, 1955; Baxter and Desborough, 1965; Heyl et al., 1965; Schwalb, Wilson, and Sutton, 1971)	47	Varies 180°	70° to 80°, H	G	50 to 500 ft. down	Post-Pennsylvanian, Pre-Late Cretaceous (Buschbach, 1973a, 1973b)	Numerous bifurcating branches less than 2 to 35 miles in length, strikes vary 180°. Borders NW side of graben with Ill.-36, corresponds to Ky.-5.
36	Big Creek, Steele, Blue Diggings, Argo, Rosiclare, Hillside, Eureka, Rock Creek Graben	Ill.-Massac, Pope, Hardin Ky.-McCracken, Livingston	Sc (Amos, 1965, Mbs; 1966; Mbs; 1967, Mbs; Finch, 1966, K-T) U (Weller, Grogan, and Tippie, 1952; Stonehouse and Wilson, 1955; Baxter and Desborough, 1965; Heyl et al., 1965; Schwalb, Wilson, and Sutton, 1971)	30	Varies 180°	70° to 80°, H	G	50 to 1000 ft. down		Numerous bifurcating branches less than 2 to 35 miles in length, strikes vary 180°. Borders NW side of graben with Ill.-36, corresponds to Ky.-5.
37	Peters Creek	Ill.-Hardin Ky.- Union	U (Weller, Grogan, and Tippie, 1952; Stonehouse and Wilson, 1955; Baxter and Desborough, 1965; Heyl et al., 1965; Schwalb, Wilson, and Sutton, 1971)	17	N36°E		G	NW side down 1000 ft.	Post-Pennsylvanian, Pre-Late Cretaceous (Buschbach, 1973a, 1973b)	Borders SE side of northernmost extent of Rock Creek Graben. Five bifurcating branches less than 2 miles apart, less than 2 to 8 miles in length, striking N36°E to N60°E. Corresponds to Ky.-7.
38	Paducah Graben	Ill.-Massac, Pope Ky.-Livingston, Crittenden	B (Finch, 1968a) Sc (Amos, 1965, Mbs; 1966, Mbs; 1967, Mbs; Finch, 1966, K-T) U (Stonehouse and Wilson, 1955; Heyl et al., 1965; Schwalb, Wilson, and Sutton, 1971)	38	Varies 180°		G		Post-Pennsylvanian, Pre-Late Cretaceous (Buschbach, 1973a, 1973b)	Southern 10 miles in graben structure, numerous bifurcating branches, less than 2 miles in length, strikes vary 180°. Corresponds to Ky.-8.

LSCS-UFSAR

TABLE 2.5-3
(SHEET 6 OF 8)

TABULATION OF FAULTS IN ILLINOIS

MAP NUMBER	NAME	LOCATION (COUNTY)	IDENTIFICATION ^{1,2}	LENGTH (mi)	STRIKE	DIP ³	TYPE ⁴	RELATIVE DISPLACEMENT	AGE OF MOVEMENT	REMARKS
39		Ill.-Hardin Ky.-Livingston, Crittenden, Union	S (Seeland, 1968a) U (Heyl et al., 1955; Schwalb, Wilson, and Sutton, 1971)	25	N58°E to N62°E			NW side down	Post-Pennsylvanian, Pre-Late Cretaceous (Buschbach, 1973a, 1973b)	Corresponds to Ky.-110.
40	Grindstaff	Gallatin	B (Butts, 1925; Smith, 1957) S (Butts, 1925) U (Stonehouse and Wilson, 1955)	7	N34°E to N39°E			SE side down	Post-Pennsylvanian, Pre-Late Cretaceous (Buschbach, 1973a, 1973b)	
41	New Harmony	Ill.-Wabash, White Ind.- Posey	B (Cady et al., 1955) Sc (Cady et al., 1955, Pml; Bristol, 1967, Mgcc; 1972 Mgcc; Dawson, 1973, Mc)	21	N11°E to N23°E	H	N	NE side down	Post-Pennsylvanian, Pre-Pleistocene (Buschbach, 1973a, 1973b)	Ill.-41 and 42 are referred to as the Maunie Fault in Ind. (Gray, Wayne, and Weir, 1970). Corresponds to Ind.-5.
42	Manuie	Ill.-White Ind.- Posey	B (Pryor, 1956) Sc (Pryor, 1956, Pml; Bristol 1967, Mgcc; Dawson, 1973, Mc) U (Gray, Wayne, and Weir, 1970)	18	N7°E to N40°E	80° to 85°, H	N	NW side down 50 ft.	Post-Pennsylvanian, Pre-Pleistocene (Buschbach, 1973a, 1973b)	Ill.-41 and 42 are referred to as the Maunie Fault in Ind. (Gray, Wayne, and Weir, 1970). Corresponds to Ind.-5.
43	Harod	Hardin, Pope	U (Weller, Grogan, and Tippie, 1952; Stonehouse and Wilson, 1955; Heyl et al., 1965)	10	N27°E to N66°E			SE side down 100 ft.	Post-Pennsylvanian, Pre-Late Cretaceous (Buschbach, 1973a, 1973b)	
44	Wolrab Mill	Ill.-Massac, Pope, Hardin, Gallatin Ky.-McCracken	U (Weller, Grogan, and Tippie, 1952; Stonehouse and Wilson, 1955; Baxter and Desborough, 1965; Heyl et al., 1965; Schwalb, Wilson, and Sutton, 1971; 1972)	46	N23°E to N88°E			NW side down	Post-Pennsylvanian, Pre-Late Cretaceous (Buschbach, 1973a, 1973b)	Numerous bifurcating branches less than 2 miles apart, 2 to 6 miles in length, strikes vary 180°, bordering grabens. Corresponds to Ky.-4.

LSCS-UFSAR

TABLE 2.5-3
(SHEET 7 OF 8)

TABULATION OF FAULTS IN ILLINOIS

MAP NUMBER	NAME	LOCATION (COUNTY)	IDENTIFICATION ^{1,2}	LENGTH (mi)	STRIKE	DIP ³	TYPE ⁴	RELATIVE DISPLACEMENT	AGE OF MOVEMENT	REMARKS
45	Albion Fault Zone	Edwards, White	B (Pullen, 1951; Smith and Cady, 1956; Pryor, 1956, Stonehouse and Wilson, 1955) Sc (Pullen, 1951, Pc, Smith and Cady, 1951, Pc; Pryor, 1956, Pmlm; Bristol and Buschbach, 1973, Ot; Bristol, 1974b, Mgcc) U (Stonehouse and Wilson, 1955; Heyl et al., 1965)	52	N0° to N40°E			SE side down 50 to 200 ft.	Post-Pennsylvanian, Pre-Pleistocene (Buschbach, 1973a, 1973b)	
46		Union	U (Stonehouse and Wilson, 1955)	2	N10°W			E side down	Post-Pennsylvanian, Pre-Late Cretaceous (Buschbach, 1973a, 1973b)	
47		DuPage	Gs (Buschbach & Heim, 1972)	15	N10°W			Slight to 50 feet S. side down	Post-Silurian (Buschbach & Heim, 1972, p. 21)	
48		Cook	Sc (Bristol and Buschbach, 1973, Oga)	12	N85°E to N50°W			S. side down	Post-Late Ordovician (Bristol and Buschbach, 1973, p.5)	Numerous other faults in Cook Co. area, trends vary 180°
49		Cook	Sc (Bristol and Buschbach, 1973, Oga)	5	N70°E to N50°W			N side down	Post-Late Ordovician (Bristol and Buschbach, 1973, p.5)	Numerous other faults in Cook Co. area, trends vary 180°
50	Glasford Disturbance	Peoria	Sc (Buschbach and Ryan, 1963, Om) B (Buschbach and Ryan, 1963)	2.5 (dia)			RD		Late Ordovician (Buschbach and Ryan, 1963, p. 2020)	Meteorite impact structure (Buschbach and Ryan, 1963, p. 2020)
51	Cap au Gres Faulted Flexure	Ill.-Jersey, Calhoun and Pike Mo.-Lincoln	Sc (Bristol and Buschbach, 1973, pl. 1; McCracken, 1971, pl. 1, Oga)	45	N30°W to N80°W			1000 ft. (Rubey, 1952, p. 139)	Post-Middle-Mississippian, Pre-Pennsylvanian (Buschbach, 1973)	Corresponds to no. 1 in Mo.

LSCS-UFSAR

TABLE 2.5-3
(SHEET 8 OF 8)

TABULATION OF FAULTS IN ILLINOIS

NOTES

- | | |
|---|---|
| <p>1. A = aerial photography
 B = borehole
 Gg = gravity
 Gm = magnetics
 Gs = seismic
 S = surface
 Sc = structure contours
 U = undifferentiated</p> | <p>4. G = graben
 H = horst
 N = normal
 S = scissors
 Rd = radial</p> |
| <p>5. Some of the faults listed in the table are outside of the regional area and are not shown on Figure 2.5-13</p> | |

2. Stratigraphic symbols, ranked by geological system only; no attempt is made to list the stratigraphic units chronologically within each system because of the local variations in systemic stratigraphy and the regional extent of the fault study:

Cretaceous-Tertiary:	K-T-	Cretaceous-Tertiary erosional surfaces
Pennsylvanian:	Pc -	Carbondale Formation
	Pml	- McLeansboro Group
	Pmlm	- Mt. Carmel Sandstone Member, McLeansboro Group
	Pmlt	- Trivoli Sandstone Member, McLeansboro Group
Mississippian:	Mbs	- Bethel Sandstone
	Mc -	Cypress Formation
	Mgcc	- Beech Creek Limestone Member, Golconda Formation
Ordovician:	Oga	- Galena Group
	Ot -	Trenton Limestone
	Og -	Glenwood Formation

LSCS-UFSAR

TABLE 2.5-4

TABULATION OF FAULTS IN WISCONSIN

MAP NUMBER	NAME	LOCATION (COUNTY)	IDENTIFICATION ^{1,2}	LENGTH (mi)	STRIKE	DIP ³	TYPE ⁴	RELATIVE DISPLACEMENT	AGE OF MOVEMENT	REMARKS
1	Glovers Bluff Disturbance	Marquette	S (Ekein and Thwaites, 1930, Cfr)	1/2 (dia)		H	Rd	Maximum of 200 ft.	Post-Cambrian (Ekein and Thwaites, 1930, p. 97)	Origin unknown but shows structure similar to crypto-volcanic structure.
2	Mifflin	Lafayette, Iowa	S (Dutton and Bradley, 1970, pl. 5, Og-Op)	10	N60°W			South side down 65 ft.		
3		Iowa, Lafayette, Grant	S (Dutton and Bradley, 1970 pl. 5, Og-Op)	11	N45°E			South side down 50 ft.		
4	Waukesha	Waukesha, Milwaukee	S (Dutton and Bradley, 1970 pl. 5, Og-Op)	30	N40°E			South side down 27 ft. (Ostrom, 1975)		
5	Janesville	Rock, Green	S (Ostrom, 1975) Sc (Heyl, 1959, Og)	40	N50°E to N80°E			60 to 150 ft.		Known from one exposure and traced geophysically (Ostrom, 1975)
6	Unnamed	Grant	S (Heyl, 1959, p. 35)	15	N50°W			South side down 30 ft.		

NOTES

1. S = Surface
 Sc = Structure

2. Stratigraphic symbols, ranked by geologic system only; no attempt is made to list the stratigraphic units chronologically within each system because of the local variations in the systemic stratigraphy and the regional extent of the fault study.

Cambrian: Cfr = Franconian Sandstone
 Ordovician: Og = Galena Group
 Op = Platteville Group

3. H = High angle

4. Rd = Radial

5. The locations of the faults are shown on Figure 2.5-13.

LSCS-UFSAR

TABLE 2.5-5

TABULATION OF FAULTS IN MISSOURI

MAP NUMBER	NAME	LOCATION (COUNTY)	IDENTIFICATION ^{1,2}	LENGTH (mi)	STRIKE	DIP ³	TYPE ⁴	RELATIVE DISPLACEMENT	AGE OF MOVEMENT	REMARKS
1	Cap au Gres Faulted Flexure	Ill.-Jersey, Calhoun and Pike, Mo.-Lincoln	Sc (Bristol and Buschbach, 1973, Pl. I; Rubey, 1952, Og)	45	N30°W to N80°W			1000 ft. (Rubey, 1952, p. 139)	Post Middle Mississippian, Pre-Pennsylvanian (Buschbach, 1973a)	Corresponds to No.51 in Ill
2	St. Louis Fault	St. Louis	S (McCracken, 1971, Pl. I)	45	N5°E	H		West side down 10 ft.		Two nearly vertical, fault planes (Mc-Cracken, 1971, p. 57).

NOTES

1. S = Surface
Sc = Structure contours
2. Stratigraphic symbols
Ordovician: Ot - Trenton Group
Og - Galena Group
3. H = High angle
4. The locations of the faults are shown on Figure 2.5-12.

LSCS-UFSAR

TABLE 2.5-6

TABULATION OF FAULTS IN IOWA

MAP NUMBER	NAME	LOCATION (COUNTY)	IDENTIFICATION ^{1,2}	LENGTH (mi)	STRIKE	DIP ³	TYPE ⁴	RELATIVE DISPLACEMENT	AGE OF MOVEMENT	REMARKS
1	Savanna	Ill.-Carroll, Ogle Ia.-Jackson	B, S (Kolata and Buschbach, 1976, Og)	60	Approx. N84°E	H	G	North side down 100 to 400 feet. (Kolata, 1975)	Post-Niagaran, Pre-mid-Illinoian (Kolata and Busch-bach, 1976)	Series of en echelon faults with indistinct trace. Corresponds to no. 3 in Ill. Formerly named Savanna Fault (Willman et al., 1976)

NOTES:

1. B = Boring
S = Surface

2. Stratigraphic symbols, ranked by geologic system only; no attempt is made to list the stratigraphic units chronologically within each system because of the local variations in the systemic stratigraphy and the regional extent of the fault study.
Ordovician: Og = Glenwood Formation

3. H = High Angle

4. G = Graben

5. The location of the faults are shown on the Figure 2.5-13.

LSCS-UFSAR

TABLE 2.5-7
(SHEET 1 OF 2)

MAP NUMBER	NAME	LOCATION (COUNTY)	IDENTIFICATION ^{1,2}	LENGTH (mi)	STRIKE	DIP ³	TYPE ⁴	RELATIVE DISPLACEMENT	AGE OF MOVEMENT	REMARKS
1	Fortville	Marion, Hancock, Madison, Grant	Sc (Dawson, 1971, Ot)	55	N8°E to N38°E			SE side down 40 to 60 ft.	Probably Pre-Early Cretaceous (Gray, 1974)	
2	Royal Center	Cass, Fulton, Kosciusko, Marshall	Sc (Dawson and Carpenter, 1963, pl. 1, Osp; Dawson, 1971, Ot)	48	N44°E			SE side down 80 to 100 ft.	Probably Pre-Early Cretaceous (Gray, 1974)	
3	Mt. Carmel	Washington, Lawrence	S (Melhorn and Smith, 1959, pl. 1, l) Sc (Melhorn and Smith, 1959, pl. 1, Mbg; Dawson, 1971, Ot)	56	N9°W to N62°W	69°W		SW side down 80 to 175 ft. (Melhorn and Smith, 1959, p. 5)	Late-Mississippian, Pre-Early Pennsylvanian (Melhorn and Smith, 1959, p. 5)	
4		Ind.-Perry Ky.-Hancock	Sc (Bergendahl, 1965, Mbw; Hutchinson, 1971, P-M) U (Gray, Wayne, and Weir, 1970; Schwalb, Wilson, and Sutton, 1972)	12	N27°E			NW side down 10 to 160 ft.		Corresponds with Ky.-37.
5	Maunie	Ind.-Gibson, Posey, Ill.-Wabash, White	Sc (Cady et al., 1955, Pml; Bristol, 1967, Mgcc; 1972, Mgcc; Dawson, 1973, Mc) U (Gray, Wayne, and Weir, 1970)		N11°E to N36°E					Corresponds to Ill.-41 and 42, referred to as New Harmony and Maunie Faults in Ill. (Cady et al., 1955; Bristol, 1974a, 1974b) Cryptovolcanic or astrobleme
6	Kentland Disturbance	Newton	S (Bucher, 1933) Sc (Dawson, 1971, Ot)	2 (dia)			P, Rd			
7		Ind.-Posey, Vanderburgh Ky.-Henderson	Sc (Dawson, 1973, Mc) U (Gray, Wayne, and Weir, 1970; Schwalb, Wilson, and Sutton, 1972)	19	N17°E to N46°E			NW side down 50 to 100 ft.		Corresponds with Ky.-19.
8		Ind.-Posey Ky.-Union	Sc (Dawson, 1973, Mc) U (Stonehouse and Wilson, 1955; Schwalb, Wilson, and Sutton, 1971)	22	N18°E to N40°E			SE side down 75 to 300 ft.		Two fault traces less than 2 miles apart, 5 and 8 miles in length. Corresponds with Ky.-217.
9		Ind.-Posey Ky.-Union, Henderson	U (Gray, Wayne, and Weir, 1970; Schwalb, Wilson, and Sutton, 1971)	22	N27°E to N57°E			NW side down		Corresponds with Ky.-119.

LSCS-UFSAR

TABLE 2.5-7
(SHEET 2 OF 2)

MAP NUMBER	NAME	LOCATION (COUNTY)	IDENTIFICATION ^{1,2}	LENGTH (mi)	STRIKE	DIP ³	TYPE ⁴	RELATIVE DISPLACEMENT	AGE OF MOVEMENT	REMARKS
10	Inman East	Ind.-Posey Ill.-Gallatin	B (Pullen, 1951) Sc (Pullen, 1951, Pc, Bristol, 1967, Mgcc; 1974a, Mgcc; Bristol and Buschbach, 1973, Ot; Dawson, 1973, Mc) U (Gray, Wayne, and Weir, 1970)	18	N10°E to N47°E			SE side down 50 to 100 ft.	Post-Pennsylvanian, Pre-Pleistocene (Buschbach, 1973a, 1973b)	Corresponds with Ill.-25.
11	Greeneville	Floyd	S (Harris, 1948) Sc (Stockdale, 1931, Mbg) U (Gray, Wayne, and Weir, 1970)	2	N20°W			NE side down 40 to 70 ft.		
12	Greathouse Island, Pitcher Lake	Ind.-Posey Ill.-White	Sc (Dawson, 1973, Mc; Bristol, 1974a, 1974b, Mgcc)	5	N27°E			NE sides down		Two parallel fault traces, Greathouse Island and Pitcher Lake, less than 2 miles apart, 5 and 2 miles in length respectively. Greathouse Island is northeastern-most fault; corresponds with Ill.-19.

NOTES:

1.

A	=	aerial photography
B	=	borehole
Gg	=	gravity
Gm	=	magnetics
Gs	=	seismic
S	=	surface
Sc	=	structure contours
U	=	undifferentiated

3. N	=	normal
Rd	=	radial
P	=	peripheral
2. Stratigraphic symbols, ranked by geological system only; no attempt is made to list the stratigraphic units chronologically within each system because of the local variations in systemic stratigraphy and the regional extent of the fault study:

- | | | |
|------------------------------|--|---|
| Pennsylvanian: | | Pc - Carbondale Formation |
| | | Pml - McLeansboro Group |
| Pennsylvanian-Mississippian: | | P-M - Pennsylvanian Mississippian |
| Mississippian: | | Mbg - Borden Group |
| | | Mbw - Buffalo Wallow Formation |
| | | Mc - Cypress Formation |
| | | Mgcc - Beech Creek Limestone Member, Golconda Formation |
| Ordovician: | | Osp - St. Peter Sandstone |
| | | Ot - Trenton Limestone |

LSCS-UFSAR

TABLE 2.5-8
(SHEET 1 OF 4)TABULATION OF FOLDS IN ILLINOIS

MAP NUMBER	NAME	LOCATION (COUNTY)	IDENTIFICATION ^{1,2}	LENGTH (mi)	STRIKE	PLUNGE	AGE OF MOVEMENT	REMARKS
1	Marshall Syncline	Clark, Edgar	Sc (Clegg, 1965, p. 5, P)	49		Doubly, N-S	Post-Mississippian, pre- Mesozoic (Buschbach, 1973a)	Smaller domes are present along both flanks.
2	Mattoon Anticline	Cumberland, Coles	U (Clegg, 1959, p. 3; 1965, p. 6)	18	N0° to N34°E		Post-Mississippian, Pre-Mesozoic (Buschbach, 1973a)	
3	Cooks Mills Anticline	Coles, Douglas	U (Clegg, 1959, p.3; 1965, p. 6)	9	N11°E to N30°W		Post-Mississippian, Pre-Mesozoic (Buschbach, 1973a)	
4	Tuscola Anticline	Coles, Douglas	U (Clegg, 1965, p. 6)	30	N0° to N33°W	SE	Post-Mississippian, Pre- Mesozoic (Buschbach, 1973a)	
5	Murdock Syncline	Coles, Douglas	U (Clegg, 1965, p. 6)	26	N15°E to N15°W	S	Post-Mississippian, Pre-Mesozoic (Buschbach, 1973a)	
6	Oakland Anticline	Clark	U (Bell and Cohee, 1938, p. 652; Clegg, 1965, p. 6)	6	N7°E to N25°W		Post-Mississippian, Pre-Mesozoic (Buschbach, 1973a)	A composite structure consisting of several anticlines, synclines, domes, and some poorly defined basins.
7	Oakland Anticline	Cumberland, Clark, Coles	U (Bell and Cohee, 1938, p. 652; Clegg, 1959, p. 3; 1965, p. 6)	32	N45°E to N35°W		Post-Mississippian, Pre-Mesozoic (Buschbach, 1973a)	A composite structure consisting of several anticlines, synclines, domes, and some poorly defined basins.
8	Oakland Anticline	Clark, Edgar	U (Bell and Cohee, 1938, p. 652; Clegg, 1959, p. 3; 1965, p. 6)	39	N40°E to N29°W		Post-Mississippian, Pre-Mesozoic (Buschbach, 1973a)	A composite structure consisting of several anticlines, synclines, domes, and some poorly defined basins.
9	Hicks Dome	Hardin	Gg (Heigold, 1970, p. 11) U (Weller, 1940, p. 8; Stonehouse and Wilson, 1955; Heyl et al., 1965; Heyl, 1972, p. 886)	dia		Doubly	Late Paleozoic, Late Cretaceous (Buschbach, 1973a)	
10	Oregon Anticline	Ogle	U (William and Templeton, 1951)	32	N54°W to N82°W	SE		
11	Harrison Creek Anticline	Alexander, Union	U (Weller, 1940, p. 8; Stonehouse and Wilson, 1955; Heyl et al., 1965)	7	N25°E to N34°W	Doubly	Late Mississippian, Pre-Mesozoic (Weller, 1940, p. 11)	

LSCS-UFSAR

TABLE 2.5-8
(SHEET 2 OF 4)TABULATION OF FOLDS IN ILLINOIS

MAP NUMBER	NAME	LOCATION (COUNTY)	IDENTIFICATION ^{1,2}	LENGTH (mi)	STRIKE	PLUNGE	AGE OF MOVEMENT	REMARKS
12	Johnson Anticline	Johnson	U (Weller, 1940, p. 8; Stonehouse and Wilson, 1955; Heyl et al., 1965)	10	N68°E to N75°E		Late Mississippian, Pre-Mesozoic (Weller, 1940, p. 11)	Previously New Burnside anticline (Weller, 1940, p. 8)
13	Stoneport Anticline	Saline, Pope	U (Weller, 1940, p. 8; Stonehouse and Wilson, 1955; Heyl et al., 1965)	10	Varies 180°		Late Mississippian, Pre-Mesozoic (Weller, 1940, p. 11)	
14	McCormick Anticline	Pope	U (Weller, 1940, p. 8; Stonehouse and Wilson, 1955; Heyl et al., 1965)	5	Varies 180°		Late Mississippian, Pre-Mesozoic (Weller, 1940, p. 11)	
15	Omaha Dome	Gallatin	U (Stonehouse and Wilson, 1955; Heyl et al., 1965)			D		
16	Clay City Anticline	Hamilton, Wayne, Clay, Richland, Jasper, White	U (Cady, 1952, p. 40; DuBois and Siever, 1955, p. 6; Clegg, 1970, p. 3; Bristol and Howard, 1971, p. 4)	57	N16°E to N21°E		Post-Mississippian, Post-Pennsylvanian (Bristol and Howard, 1971, p. 1)	
17	Salem Anticline	Marion, Jefferson	U (Bell et al., 1964, p. 6; Bristol and Howard, 1971, p. 4)	25	N20°E to N8°W		Post-Mississippian, Post-Pennsylvanian (Bristol and Howard, 1971, p. 1)	
18	Louden Anticline	Fayette	U (DuBois, 1951, pp. 23-28; Bell et al., 1964, p. 6; Bristol and Howard, 1971, p. 4; Clegg, 1972, p. 3)	19	N8°E to N15°W		Post-Mississippian, Post-Pennsylvanian (Bristol and Howard, 1971, p. 1)	
19	DuQuoin Monocline	Marion, Jefferson, Perry, Jackson	U (Cady, 1952, p. 40; Brownfield, 1954; Bell et al., 1964, p. 6; Bristol and Howard, 1971, p. 4; Clegg, 1972)	48	N20°E to N5°W	E	Post-Mississippian, Middle Pennsylvanian (Brownfield, 1954, p. 30)	
20	Lincoln Anticline, Troy-Brussels Syncline	Ill.-Jersey, Calhoun Mo.-Lincoln	U (Krey, 1924, pp. 46-50; Rubey, 1952, pp. 137-140)	30	Varies 180°		Late Mississippian, Post-Pennsylvanian (Rubey, 1952, p. 143)	
21	Mississippi River Arch	Ill.-Rock Island, Mercer, Henderson, Hancock Ia.-DesMoines, Muscatine, Lee	Sc (Howell, 1935, p. 387, Mbg)		N10°E to N20°E		Pennsylvanian, possible Pleistocene (Howell, 1935, p. 388)	

LSCS-UFSAR

TABLE 2.5-8
(SHEET 3 OF 4)

TABULATION OF FOLDS IN ILLINOIS

MAP NUMBER	NAME	LOCATION (COUNTY)	IDENTIFICATION ^{1,2}	LENGTH (mi)	STRIKE	PLUNGE	AGE OF MOVEMENT	REMARKS
22	Dupo-Waterloo Anticline	Ill.-Monroe, St. Clair Mo.-St. Louis	U (Clegg, 1972, p. 3)	27	N15°W to N30°W	SE	Late Mississippian, Pre-Pleistocene (Bushback, 1973a)	
23	Pittsfield-Hadley Anticline	Pike	U (Krey, 1924, p. 49; Clegg, 1972 p. 3)	24	N58°W to N61°W		Late Mississippian, Post-Pennsylvanian (Cohee and Carter, 1940, p. 4; Buschbach, 1973a)	
24	Osman Monocline	Platt, McLean, Livingston	U (Clegg, 1972, pp. 20-22)	33	N15°E to N12°W	W	Mississippian, Post-Pennsylvanian (Clegg, 1972, p. 23)	
25	Colfax Syncline	Platt, McLean	U (Clegg, 1972, pp. 20-22)	45	N12°E to N25°W		Mississippian, Post-Pennsylvanian (Clegg, 1972, p. 3)	One bifurcating branch, 10 miles in length, striking N10°W to N12°W.
26	Downs Anticline	Platt, DeWitt, McLean	Gg (Heigold, McGinnis, and Howard, 1964) U (Clegg, 1972, pp. 20-22)	56	Varies 180°		Mississippian, Post-Pennsylvanian (Clegg, 1972, p. 3)	Presence of five domes throughout its course.
27	Clinton Syncline	DeWitt, McLean	U (Clegg, 1972, pp. 20-21)	38	N37°E to N45°W		Mississippian, Post-Pennsylvanian (Clegg, 1972, p. 3)	
28	Herscher Dome	Kankakee	U (Buschbach and Bond, 1967, pp. 36-37; Clegg, 1972, p.3)	5 (dia)		Doubly		
29	Forreston Dome	Ogle	U (Kolata and Buschbach, 1976, p. 12)	10 (dia)		Doubly		
30	Brookville Dome	Ogle	U (Kolata and Buschbach, 1976, p. 12)	4 (dia)		Doubly		
31	Leaf River Anticline	Carroll	U (Kolata and Buschbach, 1976, p. 13)	8	E-W			
32	Uptons Cave Syncline	Carroll	U (Kolata and Buschbach, 1976, p. 10)	10	E-W			
33	LaSalle Anticline	LaSalle, Bureau	U (Willman and Templeton, 1951, p. 112; Clegg, 1972, p. 3)	25	N0° to N28°W			

TABULATION OF FOLDS IN ILLINOIS

NOTES

1. A = serial photography
- B = borehole
- Cg = gravity
- Gm = magnetics
- Gs = seismic
- S = surface
- Sc = structure
- U = undifferentiated

2. Stratigraphic symbols, ranked by geologic system:

Pennsylvanian: P = Pennsylvanian erosional surfaces

Mississippian: Mgb = Borden Group

3. Some of the folds listed in the table are outside of the regional area and are not shown on Figure 2.5-12.

LSCS-UFSAR

TABLE 2.5-9

TABULATION OF FOLDS IN WISCONSIN

MAP NUMBER	NAME	LOCATION (COUNTY)	IDENTIFICATION ^{1,2}	LENGTH (mi)	STRIKE	PLUNGE	AGE OF MOVEMENT	REMARKS
1	Baraboo Syncline	Sauk, Columbia	Sc (Dalziel and Dott, 1970, pC)	25	N51°E to N90°E		Precambrian (Dalziel and Dott, 1970, p. 16)	
2	Mineral Point Anticline	Wi.-Crawford, Grant Iowa, Lafayette, Dane Ia.-Allamakee	Sc (Heyl and others, 1959, pl. 8, Odc)	110	Varies 180°		Late Paleozoic (Heyl and others, 1959, p. 54)	Corresponds to no. 6 in Iowa.
3	Meekers Grove Anticline	Wi.-Grant, Lafayette, Green, Rock Ia.-Dubuque	Sc (Heyl and others, 1959, pl. 8, Odc)	95	Roughly N80°E but varies to N80°W		Late Paleozoic (Heyl and others, 1959, p. 54)	Corresponds to no. 6 in Iowa.

NOTES

1. Sc = structure

2. Stratigraphic symbols:

Precambrian: pC - Precambrian undifferentiated
 Ordovician: Odc - Decorah Shale

LSCS-UFSAR

TABLE 2.5-10

TABULATION OF FOLDS IN MISSOURI

MAP NUMBER	NAME	LOCATION (COUNTY)	IDENTIFICATION ^{1,2}	LENGTH (mi)	STRIKE	PLUNGE	AGE OF MOVEMENT	REMARKS
1	Pittsfield-Hadley Anticline	Mo.-Lewis	S (Krey, 1924, p. 49)	18	N55°W	SE	Post-Mississippian, Pre-Pennsylvanian to Post-Pennsylvanian (Buschbach, 1973)	Corresponds to No. 23 in Ill.
2	Troy-Brussels Syncline	Mo.-Lincoln Ill.-Jersey, Calhoun	S (Krey, 1924, p. 49)	12	N68°W	E	Late Mississippian to Post-Pennsylvanian (Buschbach, 1973)	Corresponds to No. 20 in Ill.
3	Dupo-Waterloo Anticline	Mo.-St. Louis Ill.-St. Clair	Sc (McCracken, 1971, pl. 1.0; Buschbach, 1975)	19	N18°W		Silurian to Post-Pennsylvanian, Post-Pennsylvanian to Pre-Pleistocene, (Buschbach, 1973)	Corresponds to No. 22 in Ill.

NOTES

1. S = Surface

Sc = Structure

2. Stratigraphic symbols:

O - Ordovician

LSCS-UFSAR

TABLE 2.5-11

TABULATION OF FOLDS IN IOWA

MAP NUMBER	NAME	LOCATION (COUNTY)	IDENTIFICATION ^{1,2}	LENGTH (mi)	STRIKE	PLUNGE	AGE OF MOVEMENT	REMARKS
1	Bentonsport Anticline	Van Buren, Lee	B (Harris and Parker, 1964, pl. 2) Sc (Harris and Parker, 1964, pl. 2, Mob)	45	N50°W to N71°W		Prior to or during Late- Early Mississippian (Harris and Parker, 1964, p. 41)	
2	Skunk River Anticline	Keokuk, Jefferson, Henry, Lee, Des Moines	B (Harris and Parker, 1964, pl. 2) Sc (Harris and Parker, 1964, pl. 2, Mob)	70	N37°W to N75°W		Prior to or during Late-Early Mississippian (Harris and Parker, 1964, p. 41)	
3	Burlington Anticline	Jefferson, Henry, Des Moines	B (Harris and Parker, 1964, pl. 2) Sc (Harris and Parker, 1964, pl. 2, Mob)	41	N57°W to N61°W		Prior to or during Late-Early Mississippian (Harris and Parker, 1964, p. 41)	
4	Sperry Anticline	Washington, Henry, Des Moines	B (Harris and Parker, 1964, pl. 2) Sc (Harris and Parker, 1964, pl. 2, Mob)	50	N52°W to N69°W		Prior to or during Late-Early Mississippian (Harris and Parker, 1964, p. 41)	
5	Oquawka Anticline	Washington, Louisa, Henry, Des Moines	B (Harris and Parkker, 1964, pl. 2) Sc (Harris and Parker, 1964, pl. 2, Mob)	60	N42°W to N59°W		Prior to or during Late-Early Mississippian (Harris and Parker, 1964, p. 41)	
6	Allamakee Anticline	Ia.-Allamakee Wi.-Crawford	Sc (Heyl et al., 1959, pl. 8, Odc)	25	N40°W to N60°W		Late Paleozoic (Heyl et al., 1959, p. 54)	Extends into Minnesota and corresponds to No.2 in Wis.
7		Ia.-Allamakee	Sc (Heyl et al., 1959, pl. 8, Odc)	20	N35°W to N50°W		Late Paleozoic (Heyl et al., 1959, p. 54)	
8	Meekers Grove Anticline	Wi.-Grant Lafayette, Green Rock Ia.-Dubuque	Sc (Heyl et al., 1959, pl. 8, Odc)	95	Roughly N80°E but varies to N80°W		Late Paleozoic (Heyl et al., 1959, p. 54)	Corresponds to No.2 in Wis.
9	Mississippi River Arch	Ia.-Des Moines, Muscatine, Lee Ill.-Rock Island, Mercer, Henderson, Hancock	Sc (Howell, 1935, pl. 387, Mbg)		N10°E to N20°E		Pennsylvanian, possibly Pleistocene	Corresponds to No.21 in Ill.

NOTES

1. B = borehole
Sc = structure

2. Stratigraphic symbols:
Ordovician: Odc - Decorah Shale
Mississippian: Mob Osage Series Burlington Limestone

LSCS-UFSAR

TABLE 2.5-12

TABULATION OF FOLDS IN INDIANA

MAP NUMBER	NAME	LOCATION (COUNTY)	IDENTIFICATION ^{1,2}	LENGTH (mi)	STRIKE	PLUNGE	AGE OF MOVEMENT	REMARKS
1	Leesville Anticline	Lawrence, Monroe	S (Melhorn and Smith, 1959, pl. 1) Sc (Melhorn and Smith 1959, pl. 1, Mbg, Dl; Dawson 1971, Ot)	41	N21°E to N55°W		Late Mississippian, Early Pennsylvanian (Melhorn and Smith, 1959, p. 5)	Made up of a series of 5 domes located 1 to 2 miles west of the Mt. Carmel Fault and parallel to it. From north to south the domes are: Hindustan, Unionville, Knight Ridge, Dutch Ridge, and Dennison. Leesville Anticline was previously referred to as the Dennison Anticline (Stockdale, 1931, p. 314, pl. 7). Axial trace drawn on the closure of the -40-ft contour on the top of the Devonian limestone sequence (Melhorn and Smith, 1959).
2	Indian Springs Anticline, Bear Hill Syncline	Martin	Sc (Malott, 1931, p. 226, Mgcc)	3	N31°E to N56°E			Anticline and syncline less than 2 miles apart, each 3 miles in length, southernmost trace is Bear Hill, striking N15°E to N57°E.

NOTES

- A = aerial photography
 B = borehole
 Gg = gravity
 Gm = magnetics
 Gs = seismic
 S = surface
 Sc = structure
 U = undifferentiated

- Stratigraphic symbols, ranked by geologic system only; no attempt is made to list the stratigraphic units chronologically within each system because of the local variations in systemic stratigraphy and the regional extent of the fold study:

Mississippian: Mbg - Borden Group
 Mgcc - Beech Creek Limestone Member,
 Golconda Formation

Devonian: Dl - Devonian limestone sequence
 Ordovician: Ot - Trenton Limestone

- The location of the folds is shown on Figure 2.5-12.

LSCS-UFSAR

TABLE 2.5-13
(SHEET 1 OF 2)

ESTIMATED PHYSICAL AND CHEMICAL PROPERTIES AND INTERPRETATIONS
OF AGRICULTURAL SOILS AS CONSTRUCTION MATERIALS (1)

MAP NUMBER	SOIL SERIES	DEPTH TO SEASONAL HIGH WATER TABLE (ft)	DEPTH FROM SURFACE (in)	SOIL TEXTURAL CLASSIFICATION		PERMEABILITY (in/hr)	REACTION (pH)	SHRINK-SWELL POTENTIAL	CORROSION POTENTIAL FOR CONCRETE CONDUITS (3)	WORKABILITY AS A CONSTRUCTION MATERIAL AND COMPACTION CHARACTERISTICS	SHEARING STRENGTH WHEN COMPACTED	COMPRESSIBILITY WHEN COMPACTED AND SATURATED
				USDA	UNIFIED							
23	Blount	1 to 3	0-7 7-28 28-40	Silt loam Silty clay Silty clay loam	ML or CL CH or CL CL	.60-2.00 .060-.20 .20-.60	5.6-6.5 5.1-6.0 Calc.	Low Moderate Low	Moderate Low	Fair Fair to poor Fair	Low Low Low	Medium Medium to high Medium
67	Harpster	0 to 1 (2)	0-19 19-36 36-50	Silty clay loam Silty clay loam Silty loam or loam	CL or CH CL ML or CL	.60-2.00 .60-2.00 .60-2.00	Calc. Calc. Calc.	Moderate Moderate Low	Low Low	Poor to fair Fair Fair	Low Low Low	Medium to high Medium Medium
91	Swygert	1 to 3	0-8 8-28 29-40	Silty loam Silty clay Silty clay	CL CH CH	.20-.60 .060-.20 >.20	5.6-7.3 5.6-7.3 Calc.	Low to moderate Moderate Moderate	Moderate Low	Fair Poor Poor	Low Low Low	Medium High High
146	Elliott	1 to 3	0-13 13-29 29-40	Silty loam Silty clay Silty clay loam	ML or CL CL or CH CL	.60-2.00 .20-.60 .20-.60	6.1-7.3 5.6-6.5 Calc.	Low Moderate to high Low	Moderate Low	Fair Fair to poor Fair	Low Low Low	Medium Medium to high Medium
148	Proctor	Over 3	0-10 10-43 43-70	Silt loam Silty clay loam to clay loam Sandy loam to loam	CL CL SM, SC, or CL	.60-2.00 .60-2.00 .60-6.30	6.1-7.3 5.6-6.5 6.6-7.8	Low Moderate Low	Moderate Low	Fair Fair Fair	Low Low Low to medium	Medium Medium Medium
149	Brenton	1 to 3	0-14 14-41 41-46	Silt loam Silty clay loam to clay loam Sandy loam to loam	CL or ML CL SM, SC, or CL	.60-2.00 .60-2.00 .60-2.00	6.1-7.3 6.1-6.5 6.6-7.8	Low Moderate Low	Moderate Low	Fair Fair Fair to good	Low Low Low to medium	Medium Medium Medium
154	Flanagan	1 to 3	0-14 14-42 42-60	Silt loam Silty clay loam Loam and silty clay loam	ML or CL CL CL	.60-2.00 .60-2.00 .20-2.00	6.1-7.3 5.6-6.5 Calc.	Low Moderate to high Low	Moderate Low	Fair Fair Fair	Low Low Low	Medium Medium Medium
198	Elburn	1 to 3	0-14 14-56 56-66	Silt loam Silty clay loam Sandy loam to silt loam	CL CL SM or ML	.60-2.00 .60-2.00 .60-6.30	6.1-7.3 5.1-6.0 6.1-7.8	Low Moderate Low	Moderate Low	Fair Fair Fair	Low Low Medium to low	Medium Medium Medium
223	Varna	Over 3	0-10 10-32 32-45	Silt loam Silty clay loam Silty clay loam	CL CL or CH CL	.20-2.00 .20-.60 .20-.60	6.1-7.3 5.6-6.5 Calc.	Low Moderate Low	Moderate Low	Fair Fair to poor Fair	Low Low Low	Medium Medium to high Medium
232	Ashkum	0 to 1(2)	0-20 20-33 33-50	Silty clay loam Silty clay Silty clay loam	CL or MH CL or CH CL	.60-2.00 .20-.60 .20-.60	6.1-7.3 6.1-7.3 Calc.	Moderate to high Moderate to high Moderate	Low Low	Fair to poor Fair to poor Fair	Low Low Low	Medium to high Medium to high Medium
235	Bryce	0 to 1(2)	0-15 15-41 41-50	Silty clay Silty clay Silty clay	CH or MH CH CH or CL	.20-.60 .060-.20 .060-.20	6.1-7.3 6.1-7.3 Calc.	Moderate to high High Moderate to high	Moderate Low	Poor Poor Poor to fair	Low Low Low	High High High to medium

LSCS-UFSAR

TABLE 2.5-13
(SHEET 2 OF 2)

ESTIMATED PHYSICAL AND CHEMICAL PROPERTIES AND INTERPRETATIONS
OF AGRICULTURAL SOILS AS CONSTRUCTION MATERIALS (1)

				SOIL TEXTURAL CLASSIFICATION								
MAP NUMBER	SOIL SERIES	DEPTH TO SEASONAL HIGH WATER TABLE (ft)	DEPTH FROM SURFACE (in)	USDA	UNIFIED	PERMEABILITY (in/hr)	REACTION (pH)	SHRINK-SWELL POTENTIAL	CORROSION POTENTIAL FOR CONCRETE CONDUITS (3)	WORKABILITY AS A CONSTRUCTION MATERIAL AND COMPACTION CHARACTERISTICS	SHEARING STRENGTH WHEN COMPACTED	COMPRESSIBILITY WHEN COMPACTED AND SATURATED
238	Rantoul	0 to 1 ⁽²⁾	0-30 30-40 40-60	Silty clay Silty clay Silty clay	CH or CL CH or CL CH or CL	.20-.60 > .20 > .20	6.1-7.3 6.6-7.8 6.6-7.8	High High High	Moderate Low	Poor to fair Poor to fair Poor to fair	Low Low Low	High to medium High to medium High to medium
295	Mokena	1 to 3	0-13 13-34 34-46	Silt loam Clay loam Silty clay	ML or CL CL or CH CH	.60-2.00 .60-2.00 > 20	6.1-7.3 6.1-7.3 Calc.	Low Moderate Moderate	Low Low	Fair Fair to poor Poor	Low Low Low	Medium Medium to high High
320	Frankfort	1 to 3	0-9 9-24 24-40	Silt loam Silty clay Silty clay	ML or CL CH CH or CL	.20-2.00 > .20 > .20	5.6-7.3 5.6-7.3 Calc.	Low Moderate Low to Moderate	Low Low	Fair Poor Poor to fair	Low Low Low	Medium High Medium to high
330	Peotone	0 to 1 ⁽²⁾	0-22 2-44 44-60	Silty clay loam Silty clay loam Silty clay loam	CL CL or CH CL	.60-2.00 .20-.60 .20-.60	6.6-7.3 6.6-7.8 Calc.	Moderate Moderate Moderate	Low Low	Fair Fair to poor Fair	Low Low Low	Medium Medium to high Medium
375	Rutland	Over 3	0-19 19-46 46-65	Silt loam Silty clay loam Silty clay	CL or ML CL CH	.60-2.00 .20-.60 > .060	5.6-7.3 5.1-6.5 Calc.	Low Moderate to high Moderate	Moderate Low	Fair Fair Poor	Low Low Low	Medium Medium High

NOTES:

1. Modified from J.D. Alexander and J. E. Paschke, Soil Survey, 1972: LaSalle County, Illinois, University of Illinois Agricultural Experiment Station, Soil Report 91, pp. 112-119.
2. Variable, depends on artificial (tile or open ditch) drainage provided.
3. Estimated only for soil horizons in which conduits might be placed.

LSCS-UFSAR

TABLE 2.5-14
(SHEET 1 OF 2)

MODIFIED MERCALLI INTENSITY (DAMAGE)

SCALE OF 1931 (ABRIDGED)

- I. Not felt except by a very few under especially favorable circumstances. (I Rossi-Forel Scale)
- II. Felt only by a few persons at rest, especially on upper floors of buildings. Delicately suspended objects may swing. (I to II Rossi-Forel Scale)
- III. Felt quite noticeably indoors, especially on upper floors of buildings, but not recognized by many people as an earthquake. Standing motorcars may rock slightly. Vibration like passing of truck. Duration estimated. (III Rossi-Forel Scale)
- IV. During the day felt indoors by many, outdoors by few. At night some awakened. Dishes, windows, doors disturbed; walls creaked. Sensation like heavy truck striking building. Standing motorcars rocked noticeably. (IV to V Rossi-Forel Scale)
- V. Felt by nearly everyone, many awakened. Some dishes, windows, etc., broken; a few instances of cracked plaster; unstable objects overturned. Disturbances of trees, poles, and other tall objects sometimes noticed. Pendulum clocks may stop. (V to VI Rossi-Forel Scale)
- VI. Felt by all, many frightened and may run outdoors. Some heavy furniture moved; a few instances of fallen plaster or damaged chimneys. Damage slight. (VI to VII Rossi-Forel Scale)
- VII. Everybody may run outdoors. Damage negligible in buildings of good design and construction; slight to moderate in well-built ordinary structures; considerable in poorly built or badly designed structures; some chimneys broken. Noticed by persons driving motorcars. (VIII Rossi-Forel Scale)
- VIII. Damage slight in specially designed structures; considerable in ordinary substantial buildings with partial collapse; great in poorly built structures. Panel walls thrown out of frame structures. Fall of chimneys, factory stacks, columns, monuments, walls. Heavy furniture overturned. Sand and mud ejected in small amounts. Changes in well water. Persons driving motorcars disturbed. (VIII+ to IX- Rossi-Forel Scale)

LSCS-UFSAR

TABLE 2.5-14
(SHEET 2 OF 2)

MODIFIED MERCALLI INTENSITY (DAMAGE)

SCALE OF 1931 (ABRIDGED)

- IX. Damage considerable in specially designed structures; well-designed frame structures thrown out of plumb; great in substantial buildings, with partial collapse. Buildings shifted off foundations. Ground cracked conspicuously. Underground pipes broken. (IX+ Rossi-Forel Scale)
- X. Some well-built wooden structures destroyed; most masonry and frame structures destroyed with foundations; ground badly cracked. Rails bent. Land-slides considerable from river banks and steep slopes. Shifted sand and mud. Water splashed (slopped) over banks. (X Rossi-Forel Scale)
- XI. Few, if any, (masonry) structures may remain standing. Bridges destroyed. Broad fissures in ground. Underground pipelines completely out of service. Earth slumps and land slips in soft ground. Rails bent greatly.
- XII. Damage total. Waves seen on ground surface. Lines of sight and level distorted. Objects thrown upward into the air.

LSCS-UFSAR

TABLE 2.5-15
(SHEET 1 OF 5)

TABULATION OF EARTHQUAKE EPICENTERS
(84.7° - 92.7° West Longitude 38.3° - 44.3° North Latitude)

YEAR	DATE		LATITUDE	LONGITUDE	LOCALITY		FELT AREA (mi ²)	EPICENTRAL INTENSITY	REFERENCES*
1804	08	24	41.9	87.6	Fort Dearborn (Chicago)	Ill.	30,000	VI	2, 12, 27
1818	04	11	38.6	90.2	St. Louis	Mo.	7,600	III+	12
1827	07	05	38.6	90.2	St. Louis	Mo.		IV+	12
1827	07	05	38.3	85.8	New Albany	Ind.	167,000		12
1827	08	06	38.3	85.8	New Albany	Ind.		VI	2, 8, 12, 27
1827	08	07	38.3	85.8	New Albany	Ind.		VI	2, 8, 12, 27
1827	08	14	38.6	90.2	St. Louis	Mo.		III	2, 12
1838	06	09	39.0	89.5	Montgomery - Bond County	Ill.	300	VI	12
1843	02	16	38.6	90.2	St. Louis	Mo.	101,300	IV+	2, 12
1850	04	04	38.3	85.8	Louisville	Ky.		IV	12, 19
1857	10	08	38.7	89.2	Clinton County	Ill.	35,500	VI+	2, 12
1871	07	25	38.5	90.0	St. Clair County	Ill.	10,000	III	12, 27
1876	09	24	38.5	87.9	Wabash County	Ill.		VI	12, 27
1876	09	25	38.5	87.6	Knox County	Ind.	60,000	VI	2, 8, 16
1876	09	26	38.5	87.9	Wabash County	Ill.		III	12, 27
1881	04	20	41.6	85.8	Goshen	Ind.		IV	12
1881	05	27	41.3	89.1	LaSalle	Ill.		VI	12, 27
1882	09	27	39.0	90.0	Macoupin County	Ill.	40,000	VI	2, 8, 12, 16
1882	10	14	39.0	90.0	Macoupin County	Ill.	40,000	V	2, 8, 12, 16
1882	10	15	39.0	90.0	Macoupin County	Ill.	40,000	V	2, 8, 12, 16
1882	10	22	38.9	89.4	Greenville	Ill.		III	2, 12, 27
1882	11	15	38.6	90.2	St. Louis	Mo.	1,200	III	12
1883	02	04	42.3	85.6	Kalamazoo County	Mich.	152,000	VI	2, 12
1883	11	14	38.6	90.2	St. Louis	Mo.	1,200	IV	12
1883	12	28	40.5	87.0	Bloomington	Ill.		III	26
1884	03	31	39.6	84.8	Preble County	Ohio		II	12
1885	12	26	40.5	89.0	Bloomington	Ill.		III	12, 27
1886	03	01	39.0	85.5	Butlerville	Ind.		III+	12, 27
1886	08	13	39.8	86.2	Indianapolis	Ind.		III+	12
1887	02	06	38.7	87.5	Vincennes	Ind.	75,000	VI	2, 8, 12, 16
1897	10	31	41.8	86.3	Niles	Mich.			12
1899	02	08	41.9	87.6	Chicago	Ill.			12, 27
1899	02	09	41.9	87.6	Chicago	Ill.			12, 27

* See Table 2.5-16 for key.

LSCS-UFSAR

TABLE 2.5-15
(SHEET 2 OF 5)

TABULATION OF EARTHQUAKE EPICENTERS
(84.7° - 92.7° West Longitude 38.3° - 44.3° North Latitude)

<u>YEAR</u>	<u>DATE</u>	<u>LATITUDE</u>	<u>LONGITUDE</u>	<u>LOCALITY</u>		<u>FELT AREA (mi²)</u>	<u>EPICENTRAL INTENSITY</u>	<u>REFERENCES*</u>
1899	04 29	38.5	87.0	Dubois County	Ind.	40,000	VI+	8, 12, 16, 20, 27
1899	10 10	42.1	86.5	St. Joseph	Mich.		IV	12
1899	10 12	42.6	87.8	Kenosha	Wis.			12
1902	01 24	38.6	90.3	Maplewood	Mo.	50,500	VI	2, 12
1902	03 10	39.9	85.2	Hagerstown	Ind.		III+	12
1903	01 01	39.9	85.2	Hagerstown	Ind.		II+	12
1903	02 08	38.6	90.2	St. Louis	Mo.	65,900	VI	2, 12, 27
1903	03 17	39.2	89.5	Hillsboro	Ill.		III+	12, 27
1903	09 20	39.4	86.3	Morgantown	Ind.		IV	12, 27
1903	09 21	38.7	88.1	Olney	Ill.		IV	12, 27
1903	11 04	38.6	90.2	St. Louis	Mo.	137,000	VI+	2, 12
1903	11 20	39.4	86.3	Morgantown	Ind.			12
1903	12 11	39.1	88.5	Effingham	Ill.		II	12, 27
1903	12 31	41.6	88.1	Fairmont	Ill.			12, 27
1905	04 13	40.4	91.4	Keokuk	Iowa	5,100	V	2, 12
1905	08 22	39.9	91.4	Quincy	Ill.		II	12, 27
1906	02 23	39.7	92.4	Anabel	Mo.		III	12
1906	03 06	39.7	91.4	Hannibal	Mo.		IV	12
1906	04 22	43.0	87.9	Milwaukee	Wis.			12
1906	04 24	43.0	87.9	Milwaukee	Wis.			12
1906	05 08	39.5	85.8	Shelby County	Ind.	600	III+	12, 27
1906	05 09	39.2	85.9	Columbus	Ind.		IV	12
1906	05 11	38.5	87.3	Petersburg	Ind.	1,200	V	2, 12
1906	05 19	43.0	85.7	Grand Rapids	Mich.			12
1906	05 21	38.7	88.5	Flora	Ill.	600	V	2, 8, 12, 27
1906	08 13	39.6	86.9	Greencastle	Ind.		IV	12, 27
1906	09 07	38.3	87.7	Owensville	Ind.	500	IV	12, 27
1906	11 23	39.7	92.4	Anabel	Mo.		III	12
1907	01 29	39.5	86.6	Morgan County	Ind.		V	12, 27
1907	01 30	38.9	89.4	Greenville	Ill.		V	12, 27
1907	11 20	42.3	89.8	Stephenson County	Ill.	100	IV	12
1907	11 28	42.3	89.8	Stephenson County	Ill.	100	IV	12, 27
1907	12 10	38.6	90.2	St. Louis	Mo.		IV	12
1909	05 26	42.5	89.0	South Beloit	Ill.	172,400	VII	2, 12, 27
1909	07 18	40.2	90.0	Mason County	Ill.	35,500	VII	2, 8, 12, 20,27
1909	08 16	38.3	90.2	Monroe County	Ill.	18,350	IV+	2, 12
1909	09 22	38.7	86.5	Lawrence County	Ind.	4,100	V	2, 12
1909	09 27	39.0	87.7	Robinson	Ill.	30,000	VII	8,12,17
1909	09 27	38.7	87.5	Vincennes	Ind.	4,100	V	2, 8, 12,17, 27

* See Table 2.5-16 for key.

LSCS-UFSAR

TABLE 2.5-15
(SHEET 3 OF 5)TABULATION OF EARTHQUAKE EPICENTERS
(84.7° - 92.7° West Longitude 38.3° - 44.3° North Latitude)

YEAR	DATE	LATITUDE	LONGITUDE	LOCALITY	FELT AREA (mi ²)	EPICENTRAL INTENSITY	REFERENCES*	
1909	10 22	41.8	89.7	Sterling		III.	IV+	12
1909	10 23	39.0	87.7	Robinson		III.	V	2, 12, 27
1911	02 28	38.7	90.3	St. Louis County		Mo.	IV	12
1911	07 29	41.9	87.6	Chicago		III.	IV	12, 27
1912	01 02	41.5	88.5	Kendall County	40,000	III	VI	2, 12, 25, 27
1912	09 25	42.3	89.1	Rockford		III.	III+	12
1913	10 16	41.8	89.7	Sterling	4,100	III.	III+	12, 27
1913	11 11	38.3	85.8	Louisville		Ky.	IV	12
1914	10 07	43.1	89.4	Madison		Wis.	IV	12
1915	04 15	38.7	88.1	Olney	3,000	III.	II(??)	12, 27
1916	01 07	39.1	87.0	Worthington	3,000	Ind.	II(??)	12, 27
1916	05 31	43.1	89.4	Madison		Wis.	II	12
1918	07 01	39.7	91.4	Hannibal		Mo.	IV	12
1919	05 25	38.5	87.5	Knox County	25,500	Ind.	V	2, 8, 12, 27
1920	04 30	38.5	89.1	Centralia	4,100	III.	IV	12, 27
1920	05 01	38.5	90.5	St. Louis County	23,000	Mo.	V	2, 12, 27
1921	03 14	40.0	86.9	Crawfordsville	25,500	Ind.	IV	12, 27
1921	03 14	40.0	88.0	Danville		III.	IV	8
1921	09 08	38.3	90.2	Waterloo	4,100	III.	IV	12, 27
1921	10 09	38.3	90.2	Waterloo	3,000	III.	III	12, 27
1922	04 10	40.9	90.7	Monmouth		III.	II	12, 27
1922	07 07	43.8	88.5	Fond du Lac		Wis.	V	12
1923	03 08	38.9	89.4	Greenville	4,100	III.	III+	12, 27
1923	11 09	39.9	89.9	Tallula	500	III.	V	2, 8, 12, 27
1925	01 26	42.5	92.3	Waterloo	200	Iowa	II	12
1925	03 03	42.0	87.7	Evanston		III.	II+	12
1925	07 13	38.8	90.0	Edwardsville		III.	V	12
1926	10 03	38.4	87.6	Princeton		Ind.	III	12
1928	01 23	42.0	90.0	Near Mount Carroll	400	III.	IV	12
1928	03 17	38.6	90.2	St. Louis		Mo.	I	12
1929	02 14	38.3	87.6	Near Princeton	1,000	Ind.	III+	12
1930	05 28	39.7	91.3	Near Hannibal		Mo.	III	12
1930	08 08	39.6	91.4	Near Hannibal		Mo.	III+	12
1930	12 23	38.6	90.5	Near St. Louis	1,000	Mo.	III+	12
1931	01 05	39.0	86.9	Elliston	500	Ind.	V	2, 12, 28
1931	10 18	43.1	89.4	Madison		Wis.	III-	12
1931	12 17	38.6	90.2	St. Louis		Mo.	II	12
1931	12 31	38.5	87.3	Petersburg		Ind.		12
1933	11 16	38.6	90.6	Grover	1,500	Mo.	III+	12

* See Table 2.5-16 for key.

LSCS-UFSAR

TABLE 2.5-15
(SHEET 4 OF 5)TABULATION OF EARTHQUAKE EPICENTERS
(84.7° - 92.7° West Longitude 38.3° - 44.3° North Latitude)

<u>YEAR</u>	<u>DATE</u>	<u>LATITUDE</u>	<u>LONGITUDE</u>	<u>LOCALITY</u>		<u>FELT AREA (mi²)</u>	<u>EPICENTRAL INTENSITY</u>	<u>REFERENCES*</u>
1933	12 06	42.9	89.2	Stoughton	Wis.	400	III+	12
1934	11 12	41.5	90.6	Rock Island	Ill.	5,000	V+	2, 12
1935	01 05	41.5	90.5	Moline	Ill.	200	III+	12
1935	02 26	40.8	91.2	Burlington	Iowa		III-	12
1935	10 29	39.6	90.8	Pike County	Ill.			12
1937	06 29	40.7	89.6	Peoria	Ill.		II	12
1937	08 05	38.5	90.2	Near St. Louis	Mo.		II+	12
1937	08 05	38.7	90.2	Granite City	Ill.		II	12
1937	11 17	38.6	89.1	Near Centralia	Ill.	8,000	V	2, 8, 12, 28
1938	02 12	41.6	87.0	Porter County	Ind.	6,600	V	12, 28
1938	11 07	42.5	90.7	Dubuque	Iowa			12
1939	11 24	41.5	90.6	Davenport	Iowa		II	12
1940	01 08	38.3	85.8	Louisville	Ky.		II+	12
1940	05 27	38.3	85.8	Louisville	Ky.		II	12
1941	10 04	38.6	90.2	St. Louis	Mo.		I	12
1941	11 15	38.3	90.2	Waterloo	Ill.		III	12
1942	01	39.0	90.7	Winfield	Mo.		III	12
1942	01 14	38.6	90.2	St. Louis	Mo.	600		12
1942	01 29	38.6	90.2	St. Louis	Mo.			12
1942	01 30	38.6	90.2	St. Louis	Mo.			12
1942	03 01	41.2	89.9	Kewanee	Ill.	3,800	IV+	12, 28
1942	11 17	38.6	90.2	East St. Louis	Ill.	200	III+	12
1942	12 27	38.6	90.3	Maplewood	Mo.		II	12
1943	04 13	38.3	85.8	Louisville	Ky.		IV	12, 19
1943	04 18	38.3	90.2	Waterloo	Ill.		I	12
1943	05 20	38.9	90.2	West Alton	Mo.		I	12
1943	05 24	38.9	90.2	West Alton	Mo.		I	12
1943	06 08	38.6	90.4	Webster Groves	Mo.		III+	12
1943	06 15	38.4	90.6	House Springs	Mo.		I	12
1943	06 18	38.4	90.6	House Springs	Mo.		I	12
1943	09 14	38.7	90.3	Near St. Louis	Mo.		I	12
1944	03 16	42.0	88.3	Elgin	Ill.		II	12
1944	09 25	38.6	90.2	St. Louis	Mo.	25,500	IV	12
1945	03 27	38.6	90.2	St. Louis	Mo.		II+	12
1945	05 21	38.7	90.2	Near St. Louis	Mo.		III+	12
1946	02 24	38.5	89.1	Centralia	Ill.	1,500	IV+	12
1947	03 16	42.1	88.3	Kane County	Ill.		IV	12
1947	05 06	43.0	87.9	Milwaukee	Wis.	3,000	V	12
1947	06 29	38.4	90.2	Near St. Louis	Mo.	15,200	VI	2, 12

* See Table 2.5-16 for key.

LSCS-UFSAR

TABLE 2.5-15
(SHEET 5 OF 5)

TABULATION OF EARTHQUAKE EPICENTERS
(84.7° - 92.7° West Longitude 38.3° - 44.3° North Latitude)

<u>YEAR</u>	<u>DATE</u>	<u>LATITUDE</u>	<u>LONGITUDE</u>	<u>LOCALITY</u>		<u>FELT AREA (mi²)</u>	<u>EPICENTRAL INTENSITY</u>	<u>REFERENCES*</u>
1947	08 09	42.0	85.0	Branch County	Mich.	71,000	VI	2, 12
1948	01 05	38.5	89.1	Centralia	Ill.	300	IV+	12
1948	01 15	43.2	89.7	Madison County	Wis.		IV+	12
1948	04 20	41.7	91.5	Iowa City	Iowa		III+	12
1949	08 11	38.7	90.3	Clayton	Mo.		II	12
1949	08 26	38.6	90.8	Defiance	Mo.		II+	12
1951	09 19	38.9	90.2	Near Florissant	Mo.	1,200	III+	12
1952	01 07	40.3	88.3	Champaign County	Ill.		II+	12
1953	09 11	38.6	90.1	Near Roxana	Ill.	6,100	VI	2, 12
1953	12 30	38.5	89.1	Centralia	Ill.	1,200	IV	12
1954	08 09	38.5	87.3	Petersburg	Ind.		IV+	12
1956	03 13	40.5	90.2	Fulton County	Ill.	2,000	IV	
1956	07 18	43.6	87.8	Oostburg	Wis.		IV	12
1956	10 13	42.8	87.9	Near Milwaukee	Wis.		IV	12
1957	01 08	43.6	88.7	Waupun	Wis.		III+	12
1958	11 07	38.4	87.9	Wabash County	Ill.	33,400	VI	2, 12, 20
1959	01 06	38.8	90.4	St. Louis County	Mo.		II+	12
1967	08 05	38.3	90.6	Jefferson County	Mo.		II	12
1968	12 11	38.3	85.8	Louisville	Ky.		V	12
1971	02 12	38.5	87.9	Wabash County	Ill.	1,300	IV	12
1972	09 15	41.6	89.4	Lee County	Ill.	40,600	VI-	12
1973	04 18	38.5	90.2	St. Clair County	Ill.		II+	12

* See Table 2.5-16 for key.

LSCS-UFSAR

TABLE 2.5-16
(SHEET 1 OF 3)

REFERENCE LIST FOR TABLES 2.5-15 THROUGH 2.5-21

1. Chicago Tribune, September 16, 1972.
2. Coffman, J. L., and Von Hake, C. A., 1973, Earthquake History of the United States: National Oceanic and Atmospheric Administration Publication 41-1 (revised edition through 1970).
3. Dahm, C. G., 1935 "The Southeastern Illinois Earthquake of October 29, 1934": Seismological Society of America Bulletin, Vol. 25, pp. 253-257.
4. Eppley, R. A., 1965, Earthquake History of the United States - Part 1, Stronger Earthquakes of the United States (exclusive of California and Nevada), U. S. Coast and Geodetic Survey (Pub.) S. P. 41-1 (revised edition through 1963), 120 p.
5. Fryxell, F. M., 1940, "The Earthquakes of 1934 and 1935 in Northwestern Illinois and Adjacent Parts of Iowa", Seismological Society of America Bulletin, Vol. 30, No. 3, pp. 213-218.
6. Fuller, M. L., 1912, "The New Madrid Earthquake", U. S. Geological Survey Bulletin 494.
7. Heigold, P. C., 1968, "Notes on the Earthquake of November 9, 1968, in Southern Illinois", Illinois Geological Survey Environmental Notes # 24.
8. Heinrich, R. R., 1941, "A Contribution to the Seismic History of Missouri", Seismological Society of America Bulletin, Vol 31, No. 3, pp. 187-224.
9. Heinrich R. R., 1949, "Three Ozark Earthquakes", Seismological Society of America Bulletin, Vol. 39, No. 1, pp. 1-8.
10. Heinrich, R. R., 1950, "The Mississippi Valley Earthquakes of June, 1947", Seismological Society of America Bulletin, Vol. 40, pp. 7-19.
11. Hobbs, W. H., 1911, Michigan Geological and Biological Survey, Publication 5, Geological Series.
12. Indiana Geological Survey, unpublished. manuscript.
13. McCarthy, G. R., 1963, "Three Forgotten Earthquakes" Seismological Society of America Bulletin, Vol. 53, No. 3, pp. 687-692.

LSCS-UFSAR

TABLE 2.5-16
(SHEET 2 OF 3)

14. McClure, S. M., 1940, "The Illinois Earthquake", *The Mineralogist*, No. 1, pp. 420-422.
15. Moneymaker, B. C., 1954, "Some Earthquakes in Tennessee and Adjacent States (1699 to 1850)", *Journal of the Tennessee Academy of Science*, Vol. 29, No. 3, pp. 224-233.
16. Moneymaker, B. C., 1955, "Earthquakes in Tennessee and Nearby Sections of Neighboring States - 1851-1900", *Journal of the Tennessee Academy of Science*, Vol. 30, No. 3, pp. 222-233.
17. Moneymaker, B. C., 1957, "Earthquakes in Tennessee and Nearby Sections of Neighboring States - 1901-1925", *Journal of the Tennessee Academy of Science*, Vol. 32, No. 2, pp. 91-105.
18. Moneymaker, B. C., 1958, "Earthquakes in Tennessee and Nearby Sections of Neighboring States - 1926-1950", *Journal of the Tennessee-Academy of Science*, Vol. 33, No. 3, pp. 224-239.
19. Moneymaker, B. C., 1964, unpublished manuscript.
20. Nuttli, O. W., 1973, "State-of-the-art for Assessing Earthquakes; Hazards in the United States", Dep. 1, Design Earthquakes for the Central United States U. S. Army Engineer Waterways Experiment Station.
21. Nuttli, O. W., 1974, "Magnitude Recurrence Relation for Central Mississippi Valley Earthquakes", *Seismological Society of America Bulletin*, Vol. 64, No. 4, pp. 1189-1207.
22. Robertson, M. F., 1938, "The Missouri-Tennessee Earthquake of January 30, 1937", proceedings, Missouri Academy of Science.
23. Sawkins, F. J., 1972, "Sulfide Ore Deposits in Relation to Plate Tectonics", *Journal of Geology*, Vol. 80, No. 4, pp. 377-397.
24. Shepard, E. M., 1905, "The New Madrid Earthquakes", *Journal of Geology*, Vol. 13, pp. 45-62.
25. Udden, A. P., 1912, "On the Earthquake of January 2, 1912, in the Upper Mississippi Valley", *Illinois Academy of Science Transactions* Vol. 5, pp. 111-115.
26. Westland, A. J., and Henrich, R. R., 1940, "A Macroseismic Study of the Ohio Earthquakes of March 1937",

LSCS-UFSAR

TABLE 2.5-16
(SHEET 3 OF 3)

Seismological Society of America Bulletin, Vol. 30, pp. 251-260.

27. Woollard G. P., 1968, "A Catalogue of Earthquakes in the United States Prior to 1925 (Based on Unpublished Data Compiled by Harry Fielding Reid and Published Sources Prior to 1930)", Hawaii Institute of Geophysics, University of Hawaii.
28. Woollard, G. P., 1925 to present, "United States Earthquakes", Coast and Geodetic Survey, U. S. Dept. of Commerce.

LSCS-UFSAR

TABLE 2.5-17
(SHEET 1 OF 2)

TABULATION OF EARTHQUAKE EPICENTERS OF INTENSITY V (MM) AND GREATER
(84.7° - 92.7° West Longitude 38.3° - 44.3° North Latitude)

<u>YEA</u> <u>R</u>	<u>DATE</u>	<u>LATITUDE</u>	<u>LONGITUDE</u>	<u>LOCALITY</u>		<u>FELT AREA (mi²)</u>	<u>EPICENTRAL</u> <u>INTENSITY</u>	<u>REFERENCES*</u>	
1804	08	24	41.9	87.6	Fort Dearborn (Chicago)	Ill.	30,000	VI	2, 12, 27
1827	08	06	38.3	85.8	New Albany	Ind.		VI	2, 8, 12, 27
1827	08	07	38.3	85.8	New Albany	Ind.		VI	2, 8, 12, 27
1838	06	09	39.0	89.5	Montgomery - Bond County	Ill.	300	VI	12
1857	10	08	38.7	89.2	Clinton County	Ill.	35,500	VI+	2, 12
1876	09	24	38.5	87.9	Wabash County	Ill.		VI	12, 27
1876	09	25	38.5	87.6	Knox County	Ind.	60 000	VI	2, 8, 16
1881	05	27	41.3	89.1	LaSalle	Ill.		VI	12, 27
1882	09	27	39.0	90.0	Macoupin County	Ill.	40,000	VI	2, 8, 12, 16
1882	10	14	39.0	90.0	Macoupin County	Ill.	40,000	V	2, 8, 12, 16
1882	10	15	39.0	90.0	Macoupin County	Ill.	40,000	V	2, 8, 12, 16
1883	02	04	42.3	85.6	Kalamazoo Country	Mich.	152,000	VI	2, 12
1887	02	06	38.7	87.5	Vincennes	Ind.	75,000	VI	2, 8, 12, 16
1899	04	29	38.5	87.0	Dubois County	Ind.	40,000	VI+	8, 12, 16, 20, 27
1902	01	24	38.6	90.3	Maplewood	Mo.	50,500	VI	2, 12
1903	02	08	38.6	90.2	St. Louis	Mo.	65,900	VI	2, 12, 27
1903	11	04	38.6	90.2	St. Louis	Mo.	137,000	VI+	2, 12
1905	04	13	40.4	91.4	Keokuk	Iowa	5,100	V	2, 12
1906	05	11	38.5	87.3	Petersburg	Ind.	1,200	V	2, 12
1906	05	21	38.7	88.5	Flora	Ill.	600	V	2, 8, 12, 27
1907	01	29	39.5	86.6	Morgan County	Ind.		V	12, 27
1907	01	30	38.9	89.4	Greenville	Ill.		V	12, 27
1909	05	26	42.5	89.0	South Beloit	Ill.	500,000	VII	2, 12, 27
1909	07	18	40.2	90.0	Mason County	Ill.	35,500	VII	2, 8, 12, 20, 27
1909	09	22	38.7	86.5	Lawrence County	Ind.	4,100	V	2, 12
1909	09	27	39.0	87.7	Robinson	Ill	30,000	VII	8, 12, 17
1909	09	27	38.7	87.5	Vincennes	Ind.	4,100	V	2, 8, 12, 17, 27
1909	10	23	39.0	87.7	Robinson	Ill.	14,100	V	2, 12, 27
1912	01	02	41.5	88.5	Kendall County	Ill.	40,000	VI	2, 12, 24, 27
1919	05	25	38.5	87.5	Knox County	Ind.	25,500	V	2, 8, 12, 27
1920	05	01	38.5	90.5	St. Louis County	Mo.	23,000	V	2, 12, 27
1922	07	07	43.8	88.5	Fond du Lac	Wis.		V	12
1923	11	09	39.9	89.9	Tallula	Ill.	500	V	2, 8, 12, 27
1925	07	13	38.8	90.0	Edwardsville	Ill.		V	12
1931	01	05	39.0	86.9	Elliston	Ind.	500	V	2, 12, 28
1934	11	12	41.5	90.6	Rock Island	Ill.	5,100	V+	2, 12

* See Table 2.5-16 for key.

LSCS-UFSAR

TABLE 2.5-17
(SHEET 2 OF 2)

TABULATION OF EARTHQUAKE EPICENTERS OF INTENSITY V (MM) AND GREATER
(84.7° - 92.7° West Longitude 38.3° - 44.3° North Latitude)

<u>YEAR</u>	<u>DATE</u>		<u>LATITUDE</u>	<u>LONGITUD</u> <u>E</u>	<u>LOCALITY</u>		<u>FELT AREA (mi²)</u>	<u>EPICENTRAL</u> <u>INTENSITY</u>	<u>REFERENCES*</u>
1937	11	17	38.6	89.1	Near Centralia	Ill.	8,000	V	2, 8, 12, 28
1938	02	12	41.6	87.0	Porter County	Ind.	6,600	V	12, 28
1947	05	06	43.0	87.9	Milwaukee	Wis.	3,000	V	12
1947	06	29	38.4	90.2	Near St. Louis	Mo.	15,200	VI	2, 12
1947	08	09	42.0	85.0	Branch County	Mich.	71,000	VI	2, 12
1953	09	11	38.6	90.1	Near Roxana	Ill.	6,100	VI	2, 12
1958	11	07	38.4	87.9	Wabash County	Ill.	33,400	VI	2, 12, 20
1968	12	11	38.8	85.8	Louisville	Ky.		V	12
1972	09	15	41.6	89.4	Lee County	Ill.	40,600	VI-	12

* See Table 2.5-16 for key.

LSCS-UFSAR

TABLE 2.5-18
(SHEET 1 OF 7)

TABULATION OF EARTHQUAKE EPICENTERS

(87.0° - 90.0° West Longitude 36.5° - 39.5° North Latitude)

<u>YEAR</u>	<u>DATE</u>		<u>LATITUDE</u>	<u>LONGITUDE</u>	<u>LOCALITY</u>		<u>FELT AREA (mi²)</u>	<u>EPICENTRAL INTENSITY</u>	<u>REFERENCES*</u>
1795	01	08	37.9	89.0	Franklin County	Ill.	4,500	IV+	2, 12, 27
1811	12	16	36.6	89.5	New Madrid	Mo.	2,000,000	X- to XII	2, 12, 27
1812	01	23	36.6	89.5	New Madrid	Mo.	2,000,000	IX+ to XII	2, 12, 27
1812	02	07	36.6	89.5	New Madrid	Mo.	2,000,000	X to XII	2, 12, 27
1816			36.6	89.5	New Madrid	Mo.		III	12
1816	07	25	36.6	89.5	New Madrid	Mo.		III+	12
1818	03		36.2	89.7	Caruthersville	Mo.	30,300	III	12
1819	09	02	37.7	89.7	Perry County	Mo.	15,200	IV	12
1819	09	16	38.1	89.8	Randolph County	Ill.	9,600	IV	12
1819	09	17	38.1	89.8	Randolph County	Ill.		III+	12
1820	11	09	37.3	89.5	Cape Girardeau	Mo.	5,100	IV	2, 8, 12
1820			36.6	89.5	New Madrid	Mo.	1,500	III+	12
1829	05		35.6	88.8	Jackson	Ind.			12
1839	09	05	36.7	88.6	Mayfield	Ky.		IV	12
1841	12	27	36.5	89.2	Near Hickman	Ky.	5,100	V	2, 12
1842	03	27	36.5	89.2	Near Hickman	Ky.		IV	12
1842	11	04	36.5	89.2	Near Hickman	Ky.		V	12
1842	11	04	36.5	89.2	Near Hickman	Ky.	7,600	V	12
1843	06	13	36.5	89.2	Near Hickman	Ky.		III	12
1843	08	09	35.8	88.2	Henderson County	Tenn.	15,200	III+	12
1846	03	26	36.6	89.5	New Madrid	Mo.		II+	12
1848	01	26	36.5	89.2	Near Hickman	Ky.		III+	12
1849	01	24	36.6	89.2	Hickman	Ky.		V	19
1853	08	28	36.5	89.2	Near Hickman	Ky.		III	12
1853	09	21	36.5	89.2	Lineshore	Ky.		VII	19
1853	12	18	36.5	89.2	Near Hickman	Ky.	40,600	IV+	12
1855	05	02	37.0	89.2	Cairo	Ill.		IV	12
1855	05	03	37.0	89.2	Cairo	Ill.		III	12
1856	11	09	36.6	89.5	New Madrid	Mo.	30,300	IV	12
1857	02		36.6	89.5	New Madrid	Mo.		IV	12
1858	09	21	36.5	89.2	Near Hickman	Ky.		VI	12
1860	08	07	37.8	87.6	Henderson	Ky.	30,300	V	12, 19
1865	08	17	36.0	89.5	Dyer County	Tenn.	81,400	VII	2, 12, 16, 27
1865	09	07	36.5	89.5	Near New Madrid	Mo.		III+	12, 16
1868	11	21	36.5	89.2	Near Hickman	Ky.		III	12
1870	12	14	36.5	89.2	Near Hickman	Ky.		III+	12

*See Table 2.5-16 for key.

LSCS-UFSAR

TABLE 2.5-18
(SHEET 2 OF 7)

TABULATION OF EARTHQUAKE EPICENTERS

(87.0° - 90.0° West Longitude 36.5° - 39.5° North Latitude)

<u>YEAR</u>	<u>DATE</u>	<u>LATITUDE</u>	<u>LONGITUDE</u>	<u>LOCALITY</u>		<u>FELT AREA (mi²)</u>	<u>EPICENTRAL INTENSITY</u>	<u>REFERENCES*</u>
1871	07	24	37.0	89.2	Cairo	Ill.		12
1871	07	25	38.5	90.0	St. Clair County	Ill.	1,000	12
1872	02	08	37.0	89.2	Cairo	Ill.		12, 27
1872	03	26	37.1	88.6	Paducah	Ky.		12, 27
1873	05	03	36.1	89.6	Dyer County	Tenn.	12,100	12
1874	07	09	37.0	89.2	Cairo	Ill.		12, 27
1875	10	07	36.1	89.6	Dyer County	Tenn.	20,200	12, 27
1876	09	24	38.5	87.9	Wabash County	Ill.		12, 27
1876	09	25	38.5	87.6	Knox County	Ind.	60,900	2, 12, 27
1876	09	26	38.5	87.9	Wabash County	Ill.		12, 27
1877	05	26	38.1	87.9	New Harmony	Ind.		12, 27
1877	07	15	37.7	89.2	Carbondale	Ill.	9,600	12, 27
1877	07	15	36.6	89.5	New Madrid	Mo.	25,500	12
1877	11	19	37.0	89.2	Cairo	Ill.		12
1878	01	08	37.0	89.2	Cairo	Ill.	3,000	12, 27
1878	03	12	36.8	89.2	Near Columbus	Ky.	15,200	2, 12, 27
1878	11	19	37.0	89.2	Cairo	Ill.		2, 12
1879	07	26	37.0	89.2	Cairo	Ill.	310	12, 27
1880	11	30	35.6	87.3	Maury County	Tenn.		12
1882	07	20	38.0	90.0	Randolph County	Ill.	15,200	2, 8, 12, 16
1883	01	10	37.5	89.3	Union County	Ill.		12, 27
1883	01	11	37.0	89.2	Cairo	Ill.	55,500	2, 8, 12, 16, 27
1883	04	12	37.0	89.2	Cairo	Ill.		2, 8, 12, 16, 27
1883	07	06	37.0	89.2	Cairo	Ill.		12
1883	07	14	37.0	89.1	Wickliffe	Ky.	10,000	12, 27
1884	11	29	35.6	89.7	Covington	Tenn.	4,500	12
1886	03	17	37.6	89.2	Makanda	Ill.	400	12, 27
1886	03	18	37.0	89.2	Cairo	Ill.	3,000	12, 27
1887	08	02	37.0	89.2	Cairo	Ill.	65,800	2, 8, 12, 16
1889	06	06	35.9	88.1	Benton County	Tenn.	750	12
1891	07	26	38.0	87.6	Evansville	Ind.		2, 8, 12
1891	09	26	37.0	89.2	Cairo	Ill.	V	2, 12, 16
1895	10	17	36.6	89.5	New Madrid	Mo.		12
1895	10	31	37.0	89.4	Near Charleston	Mo.	1,000,000	2, 12, 16, 20, 27
1895	11	02	37.0	89.4	Near Charleston	Mo.		12
1895	11	17	37.0	89.4	Near Charleston	Mo.		12
1897	04	25	35.8	89.6	LauderdaleCounty	Tenn.	8,200	12
1898	06	14	36.6	89.5	New Madrid	Mo.	45,700	12
1899	04	29	38.5	87.0	Dubois County	Ind.	30,300	2, 8, 12, 16, 20, 27

* See Table 2.5-16 for key.

LSCS-UFSAR

TABLE 2.5-18
(SHEET 3 OF 7)

TABULATION OF EARTHQUAKE EPICENTERS

(87.0° - 90.0° West Longitude 36.5° - 39.5° North Latitude)

<u>YEAR</u>	<u>DATE</u>	<u>LATITUDE</u>	<u>LONGITUDE</u>	<u>LOCALITY</u>		<u>FELT AREA (mi²)</u>	<u>EPICENTRAL INTENSITY</u>	<u>REFERENCES*</u>	
1901	02	14	36.0	90.0	Dunklin County	Mo.	11,650	IV	12
1903	11	03	37.8	89.3	Murphysboro	Ill.		III+	12
1903	11	24	36.6	89.5	New Madrid	Mo.		III	12, 27
1903	11	25	36.6	89.5	New Madrid	Mo.		II+	12
1903	11	27	36.6	89.5	New Madrid	Mo.	11,200	V	2, 12, 17, 27
1905	08	21	36.9	89.6	Sikeston	Mo.	126,600	VI+	2, 8, 12, 17, 27
1906	05	11	38.5	87.3	Petersburg	Ind.	1,242	V	2, 12
1906	09	07	38.3	87.7	Owensville	Ind.	500	IV	12, 27
1908	09	28	36.6	89.5	New Madrid	Mo.	5,100	IV+	2, 8, 12, 17, 27
1908	10	27	37.0	89.2	Cairo	Ill.	5,100	V	2, 8, 12, 17, 27
1908	12	27	36.9	87.5	Hopkinsville	Ky.	3,000	IV	12, 27
1908	12	27	37.0	89.0	Ballard County	Ky.		IV	12
1908	12	31	37.0	89.0	Ballard County	Ky.		III	12
1909	10	23	37.0	89.5	Scott County	Mo.	55,500	V	2, 8, 12, 17, 27
1913	06	09	35.8	88.9	Humboldt	Tenn.	4,100	III	12
1915	02	05	37.7	88.5	Harrisburg	Ill.	400	IV	12
1915	02	18	37.1	89.2	Mound City	Ill.	350	IV	12, 27
1915	04	28	36.6	89.5	New Madrid	Mo.	200	IV+	2, 8, 12, 17
1915	10	26	36.7	88.6	Mayfield	Ky.		V	2, 8, 12, 17, 27
1915	12	07	36.7	89.1	Hickman County	Ky.	45,700	V+	2, 8, 12, 27
1916	02	17	37.6	88.8	Near New Burnside	Ill.		III	12, 27
1916	05	21	36.6	89.5	New Madrid	Mo.	7,600	IV	12, 27
1916	08	24	37.0	89.2	Cairo	Ill.	4,100	IV	12, 27
1916	10	19	36.7	88.6	Mayfield	Ky.		III	12, 27
1916	12	18	36.6	89.3	Near Hickman	Ky.		VI+	2, 12, 17, 20
1917	06	09	36.8	89.4	Mississippi County	Mo.	18,350	IV	12, 27
1918	02	17	37.0	89.2	Cairo	Ill.	3,000	III	12, 27
1919	02	10	37.8	87.5	Henderson County	Ky.	2,000	III+	12, 27
1919	05	23	36.6	89.2	Hickman	Ky.	3,000	III	12, 27
1919	05	24	36.6	89.2	Hickman	Ky.	3,000	III	12, 27
1919	05	25	38.5	87.5	Knox County	Ind.	25,500	V	2, 8, 12
1919	05	26	36.8	89.2	Near Cairo	Ill.	3,000	III	12
1919	05	28	36.6	89.2	Hickman	Ky.	3,000	III	12
1919	05	28	36.4	89.5	Tiptonville	Tenn.	3,000	III	12
1920	04	07	36.3	88.2	Near Springville	Tenn.	3,000	II	12
1920	04	30	38.5	89.1	Centralia	Ill.	4,100	IV	12
1921	01	09	36.4	89.5	Tiptonville	Tenn.	2,000	IV	12
1921	02	27	37.0	89.2	Cairo	Ill.	3,000	III	12
1921	03	31	37.9	87.9	Mount Vernon	Ind.		IV	12
1921	10	01	37.7	88.5	Harrisburg	Ill.	4,100	IV	12

* See Table 2.5-16 for key.

LSCS-UFSAR

TABLE 2.5-18
(SHEET 4 OF 7)

TABULATION OF EARTHQUAKE EPICENTERS

(87.0° - 90.0° West Longitude 36.5° - 39.5° North Latitude)

<u>YEAR</u>	<u>DATE</u>	<u>LATITUDE</u>	<u>LONGITUDE</u>	<u>LOCALITY</u>		<u>FELT AREA (mi²)</u>	<u>EPICENTRAL INTENSITY</u>	<u>REFERENCES*</u>	
1922	01	10	37.9	87.9	Mount Vernon	Ind.	9,600	IV+	12
1922	03	22	37.3	88.6	Pope County	Ill.		V	2, 12
1922	03	22	37.3	88.9	Massac County	Ill.	60,900	V	2, 8, 12, 17
1922	03	22	37.3	88.9	Massac County	Ill.	V	2, 12, 17	
1922	03	23	37.0	88.9	Ballard County	Ky.	20,200	V	2, 12, 17
1922	03	30	36.1	89.6	Dyer County	Tenn.	15,200	IV+	2, 12, 17
1922	11	26	37.8	88.4	Eldorado	Ill.	50,500	VI+	12, 17
1923	05	06	37.0	89.2	Cairo	Ill.	4,100	III+	12
1923	05	15	37.0	89.2	Cairo	Ill.	3,000	II+	12
1923	11	28	37.5	87.3	Calhoun	Ky.		III	12
1923	11	29	37.0	89.2	Mississippi County	Mo.		IV	12
1924	03	02	36.9	89.1	Carlisle County	Ky.	30,300	V	2, 8, 12, 17
1924	04	02	37.1	88.6	Paducah	Ky.		IV	12
1924	06	06	36.4	89.5	Tiptonville	Tenn.	9,600	IV+	12
1925	04	26	38.0	87.5	Vanderburgh County	Ind.	85,800	V+	2, 12
1925	05	13	36.7	88.6	Mayfield	Ky.	3,800	V	2, 8, 12
1925	09	02	37.8	87.6	Henderson County	Ky.	75,800	V+	2, 8, 12, 17
1925	09	20	37.8	87.6	Henderson County	Ky.	9,600	IV	12
1926	03	22	37.7	88.5	Harrisburg	Ill.	4,100	IV	12
1926	04	27	36.2	89.0	Kenton	Tenn.	4,100	IV	12
1926	10	03	38.4	87.6	Princeton	Ind.	III	12	
1926	12	13	36.6	89.8	Parma	Mo.	3,000	III	12
1926	12	17	36.4	89.5	Tiptonville	Tenn.	4,000	IV	12
1927	01	31	37.4	89.7	Jackson	Mo.	4,100	IV	12
1927	04	18	36.3	89.5	Ridgely	Tenn.	4,100	IV	12
1927	05	07	36.5	89.0	Obion County	Tenn.	40,600	VII	2, 8, 12, 18
1927	08	13	36.4	89.5	Tiptonville	Tenn.	25,500	V	8, 12, 13
1928	04	15	37.4	89.7	Near Cape Girardeau	Mo.		III+	12
1928	04	15	36.6	89.5	New Madrid	Mo.		III+	12
1928	04	23	36.6	89.3	Near Hickman	Ky.		IV	12
1928	05	31	36.6	89.5	New Madrid	Mo.		III+	12
1929	02	14	38.3	87.6	Near Princeton	Ind.	1,000	III+	12
1929	05	12	36.4	89.5	Tiptonville	Tenn.	2,000	IV-	12
1930	01	02	35.8	89.6	Near Ripley	Tenn.		II	12
1930	02	25	37.0	89.5	Near Cairo	Ill.		III	12
1930	04	02	36.2	89.7	Caruthersville	Mo.		III+	12
1930	08	13	36.6	89.5	New Madrid	Mo.		II	12
1930	08	29	37.0	89.1	Near Blandville	Ky.	4,100	V+	8, 12, 18, 28
1930	09	01	36.4	89.4	Near Marston	Mo.	4,100	IV+	12
1930	09	03	37.0	89.1	Near Blandville	Ky.		II+	12
1931	04	01	36.7	88.6	Mayfield	Ky.	2,000	III+	12
1931	04	06	36.8	89.1	Berkeley	Ky.	400	III+	12
1931	07	18	36.4	89.5	Tiptonville	Tenn.	1,900	IV	12

* See Table 2.5-16 for key

LSCS-UFSAR

TABLE 2.5-18
(SHEET 5 OF 7)

TABULATION OF EARTHQUAKE EPICENTERS

(87.0° - 90.0° West Longitude 36.5° - 39.5° North Latitude)

<u>YEAR</u>	<u>DATE</u>	<u>LATITUDE</u>	<u>LONGITUDE</u>	<u>LOCALITY</u>		<u>FELT AREA (mi²)</u>	<u>EPICENTRAL INTENSITY</u>	<u>REFERENCES*</u>	
1931	12	10	35.9	89.9	Blytheville	Ark.	2,000	III+	12
1931	12	31	38.5	87.3	Petersburg	Ind.			12
1933	07	13	37.9	90.0	St. Marys	Mo.		II+	12
1933	08	03	37.9	90.0	St. Marys	Mo.	400	III+	12
1933	10	24	37.3	89.5	Cape Girardeau	Mo.		III	12
1934	04	17	37.9	90.0	St. Marys	Mo.		III	12
1934	05	15	37.9	90.0	St. Marys	Mo.		III+	12
1934	07	03	36.2	89.7	Hayti	Mo.		II-	12
1934	08	19	37.0	89.2	Near Rodney	Mo.	33,400	VI	2, 8, 12, 18
1934	08	19	37.0	89.2	Cairo	Ill.		III-	12
1934	10	29	37.5	88.5	Pope County	Ill.	1,500	IV	12
1935	07	23	36.4	89.5	Tiptonville	Tenn.		III	12
1936	02	16	36.2	89.7	Hayti	Mo.		III	12
1936	08	02	36.7	89.3	Near Tiptonville	Tenn.	8,200	II+	12
1936	10	20	36.6	89.5	New Madrid	Mo.		I	12
1936	12	20	37.3	89.5	Cape Girardeau	Mo.		II	12
1937	01	30	36.2	89.7	Caruthersville	Mo.	2,000	III+	12
1937	03	18	37.7	89.9	Perryville	Mo.		II+	12
1937	06	23	36.4	89.5	Tiptonville	Tenn.		II+	12
1937	10	05	36.6	89.5	New Madrid	Mo.		II+	12
1938	01	16	37.7	89.9	Perryville	Mo.		II+	12
1938	03	16	36.6	89.5	New Madrid	Mo.		II	12
1938	06	17	35.8	89.9	Burdette	Ark.		II+	12
1938	09	28	36.6	90.0	Malden	Mo.		III	12
1939	04	15	36.6	89.5	New Madrid	Mo.	400	III	12
1939	09	19	36.4	89.5	Tiptonville	Tenn.		III	12
1940	02	04	37.3	89.5	Cape Girardeau	Mo.		II+	12
1940	02	14	35.9	89.9	Blytheville	Ark.		II+	12
1940	05	31	37.1	88.6	Paducah	Ky.	1,000	IV+	12
1940	09	19	36.6	89.5	New Madrid	Mo.			12
1940	10	10	36.6	89.5	New Madrid	Mo.			12
1940	12	28	37.9	87.4	Near Evansville	Ind.	700	III	12
1941	10	08	36.2	89.7	Caruthersville	Mo.	1,200	IV	12
1941	10	21	37.0	89.2	Cairo	Ill.	1,200	III+	12
1941	10	26	37.3	89.5	Cape Girardeau	Mo.		II+	12
1941	11	16	35.6	89.7	Covington	Tenn.	20,200	V+	2, 12, 18
1941	11	22	37.3	89.5	Cape Girardeau	Mo.		II+	12
1942	03	29	37.7	88.5	Harrisburg	Ill.	200	III+	12
1942	08	31	37.0	89.2	Cairo	Ill.		III+	12
1942	11	30	36.6	89.5	New Madrid	Mo.			12
1944	01	07	37.5	89.7	Near Jackson	Mo.	900	III+	12
1944	12	23	36.2	89.7	Caruthersville	Mo.		IV	12, 28

* See Table 2.5-16 for key

LSCS-UFSAR

TABLE 2.5-18
(SHEET 6 OF 7)TABULATION OF EARTHQUAKE EPICENTERS

(87.0° - 90.0° West Longitude 36.5° - 39.5° North Latitude)

<u>YEAR</u>	<u>DATE</u>		<u>LATITUDE</u>	<u>LONGITUDE</u>	<u>LOCALITY</u>		<u>FELT AREA (mi²)</u>	<u>EPICENTRAL INTENSITY</u>	<u>REFERENCES*</u>
1945	05	02	36.5	89.6	Marston	Mo.	2,000	IV	12
1945	07	24	37.7	88.3	Gallatin County	Ill.		I	12
1945	08	06	36.4	89.0	Union City	Tenn.		III	12
1945	08	06	36.2	89.7	Caruthersville	Mo.		III	12
1945	09	23	37.0	89.2	Cairo	Ill.		III+	12
1945	10	27	36.5	89.6	Near New Madrid	Mo.		III	12
1945	11	13	37.0	89.2	Cairo	Ill.	11,200	III+	12
1946	02	24	38.5	89.1	Centralia	Ill.	1,500	IV+	12
1947	01	16	37.0	89.2	Cairo	Ill.		II+	12
1947	03	26	37.0	88.4	Paducah	Ky.		VI	18
1948	01	05	38.5	89.1	Centralia	Ill.	300	IV+	12
1949	01	13	36.2	89.7	Caruthersville	Mo.	15,200	V-	12, 18, 28
1949	08	13	36.2	89.7	Caruthersville	Mo.		II+	12
1950	05	01	36.5	89.9	Gideon	Mo.		II+	12
1950	09	16	35.7	90.0	Mississippi County	Ark.	3,000	III+	12
1951	12	17	36.0	90.0	Dunklin County	Mo.		II+	12
1951	12	18	36.0	90.0	Dunklin County	Mo.		II+	2, 12, 20, 28
1952	02	20	36.4	89.5	Tiptonville	Tenn.	13,100	V	12
1952	05	28	36.7	89.2	Mississippi County	Mo.	1,800	III+	2, 12, 20, 28
1952	07	16	36.2	89.6	Near Dyersburg	Tenn.		VI	2, 12
1952	10	17	36.0	89.4	Dyersburg	Tenn.	400	IV	12
1952	12	24	36.1	90.0	Near Blytheville	Ark.	9,200	IV	12
1952	12	25	36.1	90.0	Near Blytheville	Ark.		II	12
1952	12	28	36.8	89.3	Mississippi County	Mo.		III	12
1953	01	26	36.0	89.5	Finley	Tenn.		III	12
1953	02	11	36.6	89.5	New Madrid	Mo.	1,200	IV	12
1953	02	17	36.0	89.5	Finley	Tenn.		IV	12
1953	02	18	36.0	89.5	Finley	Tenn.		IV	12
1953	05	06	37.0	89.2	Cairo	Ill.		III	12
1953	05	15	37.0	89.2	Cairo	Ill.		III	12
1953	12	30	38.5	89.1	Centralia	Ill.	1,200	IV	12
1954	01	17	36.0	89.4	Dyersburg	Tenn.	400	IV	12
1954	08	09	38.5	87.3	Petersburg	Ind.		IV	12
1955	03	29	36.0	89.5	Finley	Tenn.	4,100	VI	2, 12, 20, 28
1955	04	09	38.1	89.8	Near Sparta	Ill.	20,200	VI	2, 12, 20, 28
1955	04	11	37.7	88.5	Harrisburg	Ill.		II	12
1955	05	29	38.1	88.4	Ewing	Ill.		IV-	12
1955	09	05	36.0	89.5	Finley	Tenn.		V	2, 12, 20, 28
1955	09	05	36.0	89.5	Finley	Tenn.		IV+	2, 12
1955	09	24	36.4	89.5	Tiptonville	Tenn.		IV	12
1955	12	13	36.0	89.5	Finley	Tenn.		V	2, 12, 20

* See Table 2.5-16 for key.

LSCS-UFSAR

TABLE 2.5-18
(SHEET 7 OF 7)

<u>YEAR</u>	<u>DATE</u>	<u>LATITUDE</u>	<u>LONGITUDE</u>	<u>LOCALITY</u>		<u>FELT AREA (mi²)</u>	<u>EPICENTRAL INTENSITY</u>	<u>REFERENCES*</u>
1956	01	23	36.2	89.7	Caruthersville	Mo.		12
1956	01	28	35.6	89.6	Tipton County	Tenn.	5,100	2, 12, 20
1956	10	29	36.2	89.7	Caruthersville	Mo.		2, 12, 20
1957	03	26	37.1	88.6	Paducah	Ky.	300	2, 12, 20
1957	08	17	36.2	89.4	Dyer County	Tenn.		12
1958	01	27	37.0	89.0	Ballard County	Ky.	15,200	2, 12, 20
1958	04	08	36.3	89.2	Obion County	Tenn.	800	2, 12
1958	04	26	36.3	89.5	Lake County	Tenn.	700	2, 12, 20
1958	11	07	38.4	87.9	Wabash County	Ill.	33,400	2, 12, 20
1959	01	21	36.3	89.5	Ridgely	Tenn.		12
1959	02	13	36.2	89.4	Bogota	Tenn.		2, 12, 20
1959	07	20	35.9	89.9	Blytheville	Ark.		12
1959	12	21	36.0	89.5	Finley	Tenn.	400	2, 12, 20
1960	01	28	36.0	89.4	Dyersburg	Tenn.	300	2, 12, 20
1960	04	21	36.4	89.5	Tiptonville	Tenn.		2, 12, 20
1962	02	02	36.5	89.6	Near New Madrid	Mo.	45,650	2, 12, 20
1962	06	26	37.7	88.5	Saline County	Ill.	17,800	2, 12, 20
1962	07	23	36.1	89.8	Pemiscot County	Mo.	4,100	2, 12, 20
1963	04	06	36.4	89.8	New Madrid County	Mo.		12
1963	05	02	36.7	89.4	New Madrid Country	Mo.		12
1963	08	02	37.0	88.8	McCracken County	Ky.	2,700	2, 12, 20
1963	12	05	37.2	87.0	Muhlenberg Country	Ky.		12
1964	03	16	36.2	89.7	Caruthersville	Mo.		12
1964	05	23	36.5	89.9	New Madrid County	Mo.		12
1965	03	25	36.4	89.5	Tiptonville	Tenn.		12
1965	08	13	36.3	89.5	Lake County	Tenn.		12
1965	08	14	37.1	89.2	Pulaski County	Ill.	400	2, 12, 20
1965	08	15	37.4	89.5	Cape Girardeau County	Mo.		2, 12, 20
1966	02	11	35.9	90.0	Near Gosnell	Ark.	2,800	12
1966	02	13	35.6	89.7	Covington	Tenn.		12
1968	02	09	36.5	89.9	New Madrid County	Mo.		12
1968	11	09	38.0	88.5	Hamilton County	Ill.	580,000	2, 12, 20
1970	03	26	36.5	89.7	Near New Madrid	Mo.		12
1970	11	16	35.9	89.9	Blytheville	Ark.	36,300	2, 12
1970	12	24	36.7	89.5	Near New Madrid	Mo.		12, 28
1971	02	12	38.5	87.9	Wabash County	Ill.	1,300	12
1972	03	29	36.1	89.8	Pemiscot County	Mo.		12
1972	05	07	35.9	90.0	Mississippi County	Ark.		12
1972	06	19	37.0	89.1	Ballard County	Ky.		12
1973	01	07	37.4	87.3	Hopkins County	Ky.		12
1973	10	03	35.9	90.0	Mississippi County	Ark.		12
1973	10	09	36.6	89.5	New Madrid	Mo.		12
1973	12	20	36.2	89.7	Pemiscot. County	Mo.		12

* See Table 2.5-16 for key

LSCS-UFSAR

TABLE 2.5-19
(SHEET 1 OF 4)AREAS OF MANY EARTHQUAKE EPICENTERSA. NEW MADRID AREA (SE MISSOURI, NW TENNESSEE)

<u>DATE OF OCCURRENCE</u>	<u>EPICENTRAL INTENSITY (MM)</u>	<u>NUMBER OF EVENTS (IF MORE THAN ONE)</u>
1811	X- to XIII	
1812	IX+ to XII	2
1816	III	
1816	III+	
1820	III+	
1846	II+	
1856	IV	
1857	IV	
1865	VII	
1865	V	
1873	IV	
1875	III+	
1877	III+	
1895	III	
1898	IV	
1903	III	
1903	II+	
1903	V	
1908	V	
1915	IV+	
1916	IV	
1919	III	
1921	IV	
1922	IV+	
1924	IV+	
1926	IV	
1927	IV	
1927	V	
1928	III+	2
1929	IV-	
1930	II	
1931	IV	
1935	III	
1936	II+	
1936	I	
1937	II+	2
1938	II	
1939	III	2
1940		2
1942		
1945	IV	
1945	III	

LSCS-UFSAR

TABLE 2.5-19
(SHEET 2 OF 4)

AREAS OF MANY EARTHQUAKE EPICENTERS

A. NEW MADRID AREA (Cont'd)

<u>DATE OF OCCURRENCE</u>	<u>EPICENTRAL INTENSITY (MM)</u>	<u>NUMBER OF EVENTS (IF MORE THAN ONE)</u>
1952	V	
1952	VI	
1953	IV	
1955	IV	
1958	V	
1959	IV	
1960	V	
1962	VI	
1963		2
1964	IV+	
1965	II	
1965	VI	
1968	IV	
1970	IV-	
1970	IV+	
1973	IV	
1974	VI	

B. HICKMAN AREA (SW KENTUCKY)

1841	V	
1842	IV	2
1842	V	
1843	III	
1848	III+	
1849	V	
1853	III	
1853	VII	
1853	V	
1858	VI	
1868	III	
1870	III+	
1915	VI	
1916	VI+	
1919	III	3
1928	IV	

LSCS-UFSAR

TABLE 2.5-19
(SHEET 3 OF 4)AREAS OF MANY EARTHQUAKE EPICENTERSC. CAIRO AREA (SE MISSOURI, SW KENTUCKY)

<u>DATE OF OCCURRENCE</u>	<u>EPICENTRAL INTENSITY (MM)</u>	<u>NUMBER OF EVENTS (IF MORE THAN ONE)</u>
1855	IV	
1855	III	
1871	III	
1872	III	
1874	III+	
1877	II+	
1878	III+	
1878	III	
1879	II+	
1883	VI	
1883	VI+	
1883	III	
1883	IV+	
1886	III+	
1887	V	
1891	V	
1895	III+	2
1895	VII to IX	
1908	V	
1908	IV	
1908	III	
1909	V	
1916	IV	
1918	III	
1919	III	
1921	III	
1922	V	
1923	III+	
1923	II+	
1923	IV	
1930	III	
1930	V	
1930	II+	
1934	III-	2
1941	III+	
1942	III+	
1945	III+	2
1947	II+	
1953	III	2
1958	V	
1972	IV	

LSCS-UFSAR

TABLE 2.5-19
(SHEET 4 OF 4)

AREAS OF MANY EARTHQUAKE EPICENTERS

D. CAIRO AREA (SE MISSOURI, NW TENNESSEE)

<u>DATE OF OCCURRENCE</u>	<u>EPICENTRAL INTENSITY</u> <u>(MM)</u>	<u>NUMBER OF EVENTS (IF</u> <u>MORE THAN ONE)</u>
1818	III	
1930	III+	
1934	II	
1936	III	
1937	III	
1941	IV	
1944	IV	
1945	III	
1949	V-	
1949	II+	
1956	II	
1956	V	
1962	VI	
1964	IV	
1972	V	
1973	III+	

LSCS-UFSAR

TABLE 2.5-20

SIGNIFICANT EARTHQUAKES

<u>DATE</u>	<u>EPICENTRAL INTENSITY (MM)</u>	<u>LOCALITY</u>	<u>LATITUDE</u>	<u>LONGITUDE</u>	<u>FELT AREA (mi²)</u>
1804 (August 24)	VI	Ft. Dearborn, Ill.	42.0	87.8	30,000
1811 (December 16)	X- to XII	New Madrid Mo.	36.6	89.5	2,000,000
1812 (January 23)	IX+ to XII	New Madrid, Mo.	36.6	89.5	2,000,000
1812 (February 7)	X to XII	New Madrid, Mo.	36.6	89.5	2,000,000
1895 (October 31)	VII to IX	Charleston, Mo.	37.0	89.4	1,000,000
1909 (May 26)	VII	South Beloit, Ill.	42.5	89.0	500,000
1912 (January 2)	VI	Kendall County, Ill.	41.5	88.5	40,000
1968 (November 9)	VII-	Southern Illinois	38.0	88.5	580,000
1972 (September 15)	VI-	Lee County, Ill.	41.6	89.4	40,600

LSCS-UFSAR

TABLE 2.5-21

RECORDED EARTHQUAKE EPICENTERS WITHIN 50 MILES OF THE SITE

<u>DATE</u>	<u>LOCATION</u>	<u>LATITUDE</u>	<u>LONGITUDE</u>	<u>INTENSITY</u>	<u>REFERENCES *</u>
1881 (May 27)	LaSalle County, Ill.	41.3	89.1	VI	12
1903 (December 31)	Fairmont, Ill.	41.6	88.1		12
1912 (January 2)	Kendall County, Ill.	41.5	88.5	VI	2, 12, 26
1972 (September 15)	Lee County, Ill.	41.6	89.4	VI	12

* See Table 2.5-16 for key.

LSCS-UFSAR

TABLE 2.5-22

ROCK UNCONFINED COMPRESSION TEST RESULTS

<u>BORING NUMBER</u>	<u>ELEVATION (ft MSL)</u>	<u>DEPTH (ft)</u>	<u>GENERAL ROCK DESCRIPTION</u>	<u>STRATIC-GRAPHIC UNIT</u>	<u>DENSITY (pcf)</u>	<u>MAXIMUM COMPRESSIVE STRENGTH (psf)</u>	<u>MODULUS OF ELASTICITY (psf)</u>	<u>POISSON'S RATIO*</u>
2	521.3	187	Silty shale	Carbondale Formation	148	8.90 x 10 ⁵	45 x 10 ⁶	0.07
2	500.3	208	Silty shale	Carbondale Formation	141	9.45 x 10 ⁵	71 x 10 ⁶	0.10
2	464.3	244	Shale	Carbondale Formation	139	1.02 x 10 ⁵	16 x 10 ⁶	0.04
2	444.3	264	Silty shale	Carbondale Formation	177	24.3 x 10 ⁵	1440 x 10 ⁶	0.29
2	435.3	273	Silty shale	Carbondale Formation	155	6.88 x 10 ⁵	85 x 10 ⁶	0.12
2	414.3	294	Silty shale	Carbondale Formation	154	11.0 x 10 ⁵	136 x 10 ⁶	0.17
2	394.3	314	Coal	Carbondale Formation	87	4.15 x 10 ⁵	---	--
2	389.3	319	Clayey shale	Spoon Formation	142	1.88 x 10 ⁵	---	--
2	364.3	344	Shale	Spoon Formation	153	5.60 x 10 ⁵	205 x 10 ⁶	0.03
2	353.3	355	Limestone	Platteville Group	176	24.8 x 10 ⁵	1770 x 10 ⁶	0.17
3	509.5	168	Siltstone	Carbondale Formation	138	8.25 x 10 ⁵	57 x 10 ⁶	0.10

* At 40% of ultimate load

LSCS-UFSAR

TABLE 2.5-23
(SHEET 1 OF 2)

LABORATORY PERMEABILITY DATA

PART A: UNDISTURBED MATERIAL

BORING NUMBER	DEPTH (ft)	ELEVATION (ft MSL)	SOIL TYPE	STRATIGRAPHIC UNIT	TYPE OF TEST	FIELD MOISTURE CONTENT (%)	FIELD DRY DENSITY (pcf)	BACK PRESSURE (psi)	AVERAGE COEFFICIENT OF PERMEABILITY AT 20° C K (cm/sec)
8-B-01	7	670	CL	Richland Loess	Constant head	21.3	108	5.0	5.26x10 ⁻⁹
9-A-01	6.5	672	CL	Wedron Formation	Constant head	29.8	92	13.9	9.50x10 ⁻⁸
21-D-01	6.5	688	ML	Wedron Formation	Falling head	26.7	95	--	7.33x10 ⁻⁷
78	6.5	684	CL	Wedron Formation	Falling head	16.7	138.2	--	4.08x10 ⁻⁸
94	3.0	677.1	CL-ML	Richland Loess	Falling head	18.0	106.2	--	4.08x10 ⁻⁸
114	4.5	667.2	ML	Wedron Formation	Falling head	33.6	86.7	--	8.40x10 ⁻⁸
148	4.5	684.6	CL-ML	Richland Loess	Falling head	21.3	106.8	--	4.08x10 ⁻⁸
2*	60.5	647.8	silty clay with some gravel	Wedron Formation	Constant head	--	--	--	2.00x10 ⁻⁷

* Run at existing overburden pressure

LSCS-UFSAR

TABLE 2.5-23
(SHEET 2 OF 2)

LABORATORY PERMEABILITY DATA

PART B: REMOLDED MATERIAL

TEST PIT NO.	DEPTH (ft)	ELEVATION (ft MSL)	SOIL TYPE	STRATIGRAPHIC UNIT	REMOLDED DATA DRY - DENSITY (pcf)	PERCENT OF COMPACTION	MOISTURE CONTENT* (%)	BACK PRESSURE (psi)	AVERAGE COEFFICIENT OF PERMEABILITY AT 20° C K (cm/sec)
5	1.5	685	CL-ML	Wedron Formation	99.2	87	23.0	1.0	1.30x10 ⁻⁶
11	4.0	691	CL	Wedron Formation	113.3	94	18.2	19.0	8.6x10 ⁻¹¹
14	4.0	700.5	CL-ML	Wedron Formation	111.1	92	18.4	1.0	7.08x10 ⁻⁸
15	4.0	696.2	ML	Wedron Formation	116.4	92	14.3	14.0	4.77x10 ⁻⁸
3	8.0-8.5	692.5-693	ML-CL	Wedron Formation	109	91	12.0	40	2.93x10 ⁻⁶
4	2.0-2.5	690.5-691	ML-CL	Richland Loess	108	89	14.1	40	4.50x10 ⁻⁷
6	4.0-4.5	696.5-697	CL	Wedron Formation	117	95	12.9	40	2.28x10 ⁻⁶

* Moisture content at compaction prior to being tested

LSCS-UFSAR

TABLE 2.5-24
(SHEET 1 OF 2)

DYNAMIC TRIAXIAL COMPRESSION TEST DATA*

BORING NUMBER	DEPTH (ft)	ELEVATION (ft MSL)	SOIL TYPE	STRATI-GRAPHIC UNIT	MOISTURE CONTENT (%)	DRY DENSITY (pcf)	SINGLE AMPLITUDE SHEAR STRAIN (%)	MODULUS OF RIGIDITY (psf)	DAMPING** (%)
2	55	653.3	CL	Wedron Formation	15.3	120	0.0088	2.85x10 ⁶	8
							0.0240	2.10x10 ⁶	6
							0.0573	1.40x10 ⁶	11
							0.1264	0.78x10 ⁶	15
							0.4160	0.30x10 ⁶	18
							0.7627	0.20x10 ⁶	20
							1.5147	0.10x10 ⁶	18
							1.8880	0.09x10 ⁶	--
2	80	628.3	CL	Wedron Formation	16.4	116	0.0112	3.10x10 ⁶	--
							0.0444	1.52x10 ⁶	8
							0.3343	0.46x10 ⁶	17
							0.7162	0.25x10 ⁶	19
							0.8285	0.18x10 ⁶	19
							0.5440	0.20x10 ⁶	19
							0.3044	0.25x10 ⁶	21
							0.5764	0.19x10 ⁶	17
							0.8784	0.17x10 ⁶	15
							2.2584	0.09x10 ⁶	17
38	84	624.7	CL	Wedron Formation	15.7	117	0.0055	12.55x10 ⁶	9
							0.0065	14.19x10 ⁶	9
							0.0103	11.36x10 ⁶	12
							0.0178	7.43x10 ⁶	--
							0.0312	4.79x10 ⁶	15
							0.0439	3.57x10 ⁶	17
							0.2637	0.59x10 ⁶	16
							0.5820	0.27x10 ⁶	17
							2.9296	0.05x10 ⁶	17

* See Figure 2.5-85 for a typical test result.

** Expressed as a percentage of critical damping.

LSCS-UFSAR

TABLE 2.5-24
(SHEET 2 OF 2)

DYNAMIC TRIAXIAL COMPRESSION TEST DATA*

BORING NUMBER	DEPTH (ft)	ELEVATION (ft MSL)	SOIL TYPE	STRATI-GRAPHIC UNIT	MOISTURE CONTENT (%)	DRY DENSITY (pcf)	SINGLE AMPLITUDE SHEAR STRAIN (%)	MODULUS OF RIGIDITY (psf)	DAMPING* (%)
39	49	659.0	CL	Wedron Formation	19.6	113	0.0131	3.09x10 ⁶	--
							0.0229	2.85x10 ⁶	--
							0.0499	1.81x10 ⁶	--
							0.0554	1.66x10 ⁶	15
							0.1185	0.68x10 ⁶	16
							0.2032	0.51x10 ⁶	--
							1.7773	0.06x10 ⁶	15
							2.5156	0.05x10 ⁶	19
5.7969	0.02x10 ⁶	19							
59	134	574.8	ML	Wedron Formation	10.1	133	0.0125	9.33x10 ⁶	11
							0.0264	7.92x10 ⁶	10
							0.0415	6.67x10 ⁶	14
							0.1038	2.76x10 ⁶	11
							0.1745	1.87x10 ⁶	14
							0.2288	1.56x10 ⁶	15
							0.2807	1.51x10 ⁶	14
							1.0096	0.45x10 ⁶	17

* See Figure 2.5-85 for a typical test result.

* Expressed as a percentage of critical damping.

LSCS-UFSAR

TABLE 2.5-25

RESONANT COLUMN TEST RESULTS

BORING NUMBER	DEPTH (ft)	ELEVATION (ft MSL)	SAMPLE DESCRIPTION	STRATI-GRAPHIC UNIT	CONFINING PRESSURE (psf)	MODULUS OF RIGIDITY (psf)	DRY DENSITY (pcf)	MOISTURE CONTENT (%)
2	70	638.3	CL	Wedron Formation	2000 4000 6000 8000	1.831 x 10 ⁶ 2.336 x 10 ⁶ 2.836 x 10 ⁶ 3.783 x 10 ⁶	120	14.5
2	188	520.3	Shale	Carbondale Formation	0	4.60 x 10 ⁷	146.6	--
2	292	416.3	Shale	Carbondale Formation	0	6.17 x 10 ⁷	142.4	--

LSCS-UFSAR

TABLE 2.5-26

SHOCKSCOPE TEST RESULTS

BORING NUMBER	DEPTH (ft)	ELEVATION (ft MSL)	SAMPLE DESCRIPTION	STRATIGRAPHIC UNIT	CONFINING PRESSURE (lb/ft ²)	VELOCITY OF COMPRESSIONAL WAVE PROPAGATION (ft/sec)
2	173	535.3	Siltstone	Carbondale Formation	0	5,800
					2000	6,200
						6,700
2	198	510.3	Shale	Carbondale Formation	0	5,900
					2000	6,200
					6000	6,300
2	261	447.3	Shale	Carbondale Formation	0	7,900
					2000	8,300
					6000	8,900
2	293	415.3	Shale	Carbondale Formation	0	7,900
					2000	8,200
					6000	8,500
2	357	351.3	Limestone	Platteville Group	0	17,300
					2000	17,300
					6000	17,300
2	106	602.3	Silty Clay (CL)	Wedron Formation	0	4,700
					2000	4,700
					4000	4,700
					6000	4,700
2	136.5	571.8	Silt and gravel with some sand (GM)	Wedron Formation	0	5,050
					2000	5,050
					4000	5,050
					6000	5,050
6	46	662.9	Clay (CL)	Wedron Formation	0	5,800
					2000	5,800
					4000	5,600
					6000	5,600
6	75.5	633.4	Clay (CL)	Wedron Formation	0	5,350
					2000	5,350
					4000	5,350
					6000	5,200
7	66	644.1	Clay (CL)	Wedron Formation	0	5,300
					2000	5,300
					4000	5,300
					6000	5,300

TABLE 2.5-26

LSCS-UFSAR

TABLE 2.5-27

IN SITU FIELD PERMEABILITY TESTS*

PERMEABILITY TEST HOLE	GROUND SURFACE ELEVATION (ft)	ZONE OF PERCOLATION ELEVATION (ft)	STRATIGRAPHIC UNIT	SOIL TYPE**	NUMBER OF READINGS	AVERAGE COEFFICIENT OF PERMEABILITY K (cm/sec)
D-4	671±	666 to 661	Richland Loess	A	6	2.75 x 10 ⁻⁷
	671±	661 to 656	Wedron Formation	B	31	2.23 x 10 ⁻⁸
D-5	668±	663 to 658	Richland Loess	A	4	2.68 x 10 ⁻⁷
	668±	658 to 653	Wedron Formation	B	31	1.61 x 10 ⁻⁸
D-6	668±	663 to 658	Wedron Formation	A	6	2.57 x 10 ⁻⁷

* Permeability test holes were augered adjacent to the dike borings indicated above.

** Key to soil types:

A - Brown and gray silty clay with some sand and fine gravel.

B - Gray silty clay with some sand and fine gravel.

LSCS-UFSAR

TABLE 2.5-28

PARAMETERS FOR ANALYSIS OF ROCK-SOIL-STRUCTURE INTERACTION

LAYERS	ELEVATION 710-690	ELEVATION 690-620	ELEVATION 620-590	ELEVATION 590-560	ELEVATION 560 TO ROCK
Density (pcf)	134	134	134	134	134
Poisson's Ratio	0.45	0.45	0.45	0.45	0.45
Dynamic Modulus Of Rigidity	See Figure 2.5-55, Sheet 1				
Damping	See Figure 2.5-55, Sheet 2				

LSCS-UFSAR

TABLE 2.5-29
(SHEET 1 OF 3)

SUMMARY OF BORING INFORMATION FOR SAND DEPOSIT NEAR
ELEVATION 595 FT-MSL IN VICINITY OF MAIN PLANT

BORING ¹	TOP ELEVATION OF SAND (ft)	THICKNESS OF SAND (ft)	SAMPLER ^{2,3}	AVERAGE BLOW COUNT N OF LAYER (IN FIELD)	N-STANDARD PENETRATION CORRESPONDING TO D&M VALUES
1	592	4	D&M	143	123
2	588.3	22	D&M	120/6 in.	200 ⁴
2	588.3	22	D&M	230/6 in.	200 ⁴
2	588.3	22	D&M	200/9 in.	200 ⁴
2	588.3	22	D&M	230/6 in.	200 ⁴
2	588.3	22	D&M	200/4 in.	200 ⁴
2	588.3	22	D&M	200/6 in.	200 ⁴
2	588.3	22	D&M	200/6 in.	200 ⁴
3	603	5	D&M	160/3 in.	200 ⁴
4	593	3	D&M	130	112
6	595	18	D&M	135	116
6	595	18	D&M	54	46
6	595	18	D&M	119	102
6	595	18	D&M	120	103
7	596	10	D&M	38	33
7	596	10	D&M	173	149
10	582	5	D&M	150/4 in.	200 ⁴
11	572	9	D&M	71/6 in.	122
11	572	9	D&M	97	83
11	572	9	D&M	125/6 in.	200 ⁴
13	592	15	D&M	150/7 in.	200 ⁴

LSCS-UFSAR

TABLE 2.5-29
(SHEET 2 OF 3)

SUMMARY OF BORING INFORMATION FOR SAND DEPOSIT NEAR
ELEVATION 595 FT-MSL IN VICINITY OF MAIN PLANT

BORING ¹	TOP ELEVATION OF SAND (ft)	THICKNESS OF SAND (ft)	SAMPLER ^{2,3}	AVERAGE BLOW COUNT N OF LAYER (IN FIELD)	N-STANDARD PENETRATION CORRESPONDING TO D&M VALUES
13	592	15	SS	102/10 in.	142
13	592	15	SS	84	84
17	593	7	D&M	150/6 in.	200 ⁴
17	593	7	D&M	150/4 in.	200 ⁴
17	593	7	SS	200/6 in.	200 ⁴
19	595	9	D&M	83	71
19	595	9	SS	122/10 in.	170
20	591	4	SS	50	50
23	605	7+	D&M	42	36
31	596	3	No sample	-	-
31	583	5	SS	29/6 in.	58
32	584	5	D&M	120/7 in.	177
35	591	8	D&M	25	21
37	596	5	D&M	38	33
38	595	7	D&M	100/5 in.	200 ⁴
39	589	3	D&M	130	112
51	583	2	D&M	183	157
52	583	4	D&M	47	40
53	591	15	D&M	134	115
53	591	15	D&M	80	69
53	591	15	SS	77	77
55	597	10	D&M	55	47
55	597	10	D&M	152	131
59	597	9	D&M	156	134

LSCS-UFSAR

TABLE 2.5-29
(SHEET 3 OF 3)

SUMMARY OF BORING INFORMATION FOR SAND DEPOSIT NEAR
ELEVATION 595 FT-MSL IN VICINITY OF MAIN PLANT

BORING ¹	TOP ELEVATION OF SAND (ft)	THICKNESS OF SAND (ft)	SAMPLER ^{2,3}	AVERAGE BLOW COUNT N OF LAYER (IN FIELD)	N-STANDARD PENETRATION CORRESPONDING TO D&M VALUES
59	577	9	D&M	150/6 in.	200 ⁴
60	590	3	No sample	-	-
61	591	1	D&M	70	60
62	592	5	D&M	113	97

1

Notes:

1. Figure 2.5-56 shows the boring locations.
2. D&M - Dames & Moore's Type "U" sampler.
SS - Standard split-spoon sampler.
3. Correction factor for D&M sampler was 0.86.
4. Values conservatively estimated at 200.

LSCS-UFSAR

TABLE 2.5-30

ULTIMATE BEARING CAPACITIES

FOUNDATION LOADING AREA	FOUNDATION ELEVATION	GROSS APPLIED STATIC FOUNDATION LOADING ¹ (kips/ft ²)	NET STATIC FOUNDATION LOADING ² (kips/ft ²)	ULTIMATE BEARING CAPACITY (kips/ft ²)	INDICATED FACTOR OF SAFETY
Reactor	666	9.3	7.2	22.3	3.1
Turbine	656	4.8	2.1	23.1	11.0
Turbine	662	5.2	2.9	26.3	9.1
Turbine	656	7.9	5.2	25.3	4.9
Diesel generator	669	2.6	0.7	23.4	33.4
Auxiliary	656	4.8	2.1	23.1	11.0
Radwaste	657	7.4	4.8	24.1	5.0
Radwaste	658	7.4	4.8	25.4	5.3
Service	663	2.5	0.2	24.0	120.0
Service	674	2.5	0.9	22.1	24.6
Off-gas filter	673	3.8	2.1	23.8	11.3
Lake screen house	670	2.7	2.7	17.6	6.5
Flume retaining wall	669	5.4	5.4	17.0	3.1
CSCS outlet chute	699	1.0	1.0	20.4	20.4

Notes: 1. Foundation loadings for the various structures are shown in the plan on Figure 2.5-57.

2. Net static foundation loading is equal to the gross applied static foundation loading minus the hydrostatic uplift pressure.

LSCS-UFSAR

TABLE 2.5-31

EFFECTIVE SOIL PARAMETERS

<u>MATERIAL</u>	<u>TOTAL UNIT WEIGHTS (lb)</u>	<u>COHESION (psf)</u>	<u>ANGLE OF INTERNAL FRICTION (°)</u>
Natural Wedron silty clay till	134	400	24.0
Natural lacustrine clayey silt deposit	134	1300	11.0
Embankment compacted silty clay to 90% of Modified Proctor	125	100	25.0
Embankment compacted granular to 90% of Modified Proctor	122	---	30.0*
Backfill - compacted silty clay to 95% of Modified Proctor	130	280	26.0
Backfill - compacted granular to 75% of relative density	122	---	30.0*

* Assumed.

LSCS-UFSAR

TABLE 2.5-32

SUMMARY OF RESULTS OF STABILITY ANALYSIS OF
CSCS COOLING POND AND FLUME FOR MAXIMUM CUT HEIGHT
AND SIDE SLOPES OF 4:1

<u>CONDITION</u>	<u>FACTOR OF SAFETY</u>	<u>REQUIRED MINIMUM FACTOR OF SAFETY</u>
End of construction	2.01	1.5
Full cooling lake-steady seepage	2.83	1.5
Empty cooling lake-rapid drawdown	2.29	1.1
Full cooling lake + .2 Earthquake	1.14	1.1
Empty cooling lake + .2 Earthquake	1.04	1.0

LSCS-UFSAR

TABLE 2.5-33

RIPRAP AND BEDDING GRADATIONS

Riprap Gradation No. 1

<u>Approximate Weight (lb)</u>	<u>Percent Passing by Weight</u>
290	100
170	60-100
120	35- 80
70	10- 50
50	0- 40
15	0- 2

Riprap Gradation No. 2

<u>Approximate Weight (lb)</u>	<u>Percent Passing by Weight</u>
150	95-100
100	90-100
50	40- 95
30	5- 35
10	0- 5
3	0- 2

Riprap Gradation No. 3

<u>Sieve Size (in)</u>	<u>Percent Passing by Weight</u>
3	100
2	45-100
1-1/2	0- 30
1	0- 5

Bedding Gradation

<u>Sieve Size (in)</u>	<u>Percent Passing by Weight</u>
1-1/2	75-100
3/4	60- 80
3/8	40- 60
#4	25- 40
#16	5- 20
#40	0- 10

LSCS-UFSAR

TABLE 2.5-34

VARIATION OF PERIPHERAL DIKE HEIGHT

<u>STATION</u>	<u>HEIGHT (ft)</u>	<u>STATION</u>	<u>HEIGHT (ft)</u>
- 0+09	1.0	- 198+15	35.6
- 2+19	1.4	- 208+15	25.9
- 12+15	9.6	- 218+20	29.5
- 22+19	12.9	- 228+19	22.6
- 32+10	18.6	- 238+11	20.0
- 42+10	22.9	- 248+09	16.6
- 52+10	21.5	- 258+03	8.8
- 62+19	26.8	- 263+45	7.8
- 72+10	21.8	- 269+60	18.2
- 82+19	24.6	- 281+09	29.4
- 92+19	24.8	- 293+20	38.4
- 103+30	27.7	- Makeup Water Outlet	
- 113+30	25.6	- 302+30	10.9
- 123+35	30.1	- Blowdown Line Crossing	
- 133+35	35.9	- 304+90	15.0
- 143+38	27.5	- 309+60	26.2
- 153+30	27.2	- 321+00	14.6
- 163+08	40.1	- 327+30	17.1
- 173+05	36.0	- Auxiliary Spillway	
- 179+85	38.4	- 346+65	6.0
- 183+35	36.9	- 353+80	15.0
- 195+85	38.4	- 355+00	14.0
		- 365+25	13.1
		- 371+20	20.9
		- 375+40	16.6
		- 379+42	2.2

LSCS-UFSAR

TABLE 2.5-35

SUMMARY OF PERIPHERAL DIKE CAMBER

<u>COORDINATE</u>	<u>CAMBER* (in.)</u>
0+00	0
42+10	4
121+30	4
123+35	8
157+80	8
186+05	8
207+85	8
214+40	4
280+38	4
282+63	8
293+50	8
295+75	4
325+45	4
366+70	4
372+10	4
377+97	0

* No camber has been provided for the auxiliary spillway portion of the dike (from Station 344+10 to 347+85) since the dike height is only 6 feet. This ensures a spillway flush crest elevation of 702 feet 6 inches MSL at the time of construction and precludes a lake level in excess of the probable maximum water level of 704.3 feet MSL if camber is provided.

LSCS-UFSAR

TABLE 2.5-36

SUMMARY OF RESULTS OF STABILITY ANALYSIS
OF PERIPHERAL DIKE FOR MAXIMUM DIKE HEIGHT
AND SIDE SLOPE OF 3:1

<u>CONDITION</u>	<u>FACTOR OF SAFETY</u>	<u>REQUIRED MINIMUM FACTOR OF SAFETY</u>
End of construction	2.93	1.5
Full cooling lake - steady seepage	1.65	1.5
Empty cooling lake - rapid drawdown	1.11	1.1
Full cooling lake + .1g earthquake	1.20	1.1

LSCS-UFSAR

TABLE 2.5-37
(SHEET 1 OF 5)

REFERENCE LIST FOR TABLES
2.5-3 THROUGH 2.5-12

- D. H. Amos, Geology of parts of the Shetlerville and Rosiclare quadrangles, Kentucky: U.S. Geological Survey Geological Quadrangle Map GQ-400, 1965.
- D. H. Amos, Geologic map of the Golconda quadrangle, Kentucky-Illinois, and the part of the Brownfield quadrangle in Kentucky: U.S. Geological Survey Geological Quadrangle Map GQ-546, 1966.
- D. H. Amos, Geologic map of part of the Smithland quadrangle, Livingston County, Kentucky: U.S. Geological Survey Geological Quadrangle Map GQ-657, 1967.
- J. W. Baxter and G. A. Desborough, Areal geology of the Illinois fluorspar district, Part 2 - Karbers Ridge and Rosiclare quadrangles: Illinois Geological Survey Circular 385, 1965.
- A. H. Bell and G. V. Cohee, Recent petroleum development in Illinois: Illinois Geological Survey, Illinois Petroleum 32, 1938.
- A. H. Bell et al., Deep oil possibilities of the Illinois Basin: Illinois Geological Survey Circular 368, 1964.
- M. W. Bergendahl, Geology of the Cloverport quadrangle, Kentucky-Indiana and the Kentucky part of the Cannelton quadrangle: U.S. Geological Survey Geological Quadrangle Map GA-273, 1965.
- H. M. Bristol, Base of the Beech Creek (Barlow) Limestone in Illinois: Illinois Geological Survey, Illinois Petroleum 88, pl.1, 1967.
- H. M. Bristol, Oil and gas development maps, Mt. Carmel and Allendale area, base of Barlow: Illinois Geological Survey unpublished map, 1972.
- H. M. Bristol, Illinois Geological Survey unpublished preliminary map, 1974a.
- H. M. Bristol and T. C. Buschbach, Ordovician Galena Group (Trenton) of Illinois - structure and oil fields: Illinois Geological Survey, Illinois Petroleum 99, 1973.
- H. M. Bristol and R. H. Howard, Paleogeologic map of the sub-Pennsylvanian Chesterian (Upper Mississippian) surface in the Illinois Basin: Illinois Geological Survey Circular 458, 1971.
- R. L. Brownfield, Structural history of the Centralia area: Illinois Geological Survey Report of Investigation 172, 1954.

LSCS-UFSAR

TABLE 2.5-37
(SHEET 2 OF 5)

- W. H. Bucher, Cryptovolcanic structures in the United States: 16th International Geological Congress, United States 1933, Reports, Vol. 2, pp. 1055-1084 (1936), 1933.
- T. C. Buschbach, Illinois Geological Survey unpublished report, 1973a.
- T. C. Buschbach, Written Communication, Illinois Geological Survey, Urbana, Illinois, 1973b.
- T. C. Buschbach and G. E. Heim, Preliminary geologic investigations of rock tunnel sites for flood and pollution control in the greater Chicago area: Illinois Geological Survey Environmental Geology Notes, No. 52, 1972.
- T. C. Buschbach and R. Ryan, Ordovician explosion structure at Glasford, Illinois: American Association of Petroleum Geologists Bulletin, Vol. 47., No. 12, pp. 2015-2022, 1963.
- C. Butts, Geology and mineral resources of the Equality-Shawneetown area (parts of Gallatin and Saline Counties): Illinois Geological Survey Bulletin 57, 1925.
- G. H. Cady et al., Subsurface geology and coal resources of the Pennsylvanian System in Wabash County, Illinois: Illinois Geological Survey Report of Investigation 183, 1955.
- K. E. Clegg, Subsurface geology and coal resources of the Pennsylvanian System in Douglas, Coles, and Cumberland Counties, Illinois: Illinois Geological Survey Circular 271, 1959.
- K. E. Clegg, Subsurface geology and coal resources of the Pennsylvanian System in Clark and Edgar Counties, Illinois: Illinois Geological Survey Circular 380, 1965.
- C. V. Cohee and C. W. Carter, Structural trends in the Illinois Basin: Illinois Geological Survey Circular 59, 1940.
- I. W. Dalziel and R. H. Dott, Jr., Geology of the Baraboo District, Wisconsin: Wisconsin Geology and Natural History Survey Information Circular 14, 1970.
- T. A. Dawson, Map of Indiana showing structure on top of Trenton Limestone: Indiana Geological Survey Miscellaneous Geological Investigation Map 17, 1971.
- T. A. Dawson, Preliminary well location map of Posey County, Indiana: Indiana Geological Survey unpublished map, 1973.
- T. A. Dawson and G. I. Carpenter, Underground storage of natural gas in Indiana: Indiana Geological Survey Special Report No. 1, 1963.

LSCS-UFSAR

TABLE 2.5-37
(SHEET 3 OF 5)

G. A. Desborough, Faulting in the Pomona area, Jackson County, Illinois: Illinois Academy of Science Transactions, Vol. 50, pp. 199-204, 1957.

E. P. DuBois and R. Siever, Structure of the Shoal Creek Limestone and Herrin (no.6) coal in Wayne County, Illinois: Illinois Geological Survey Report of Investigation 182, 1955.

C. E. Dutton and R. E. Bradley, Lithologic, geophysical, and mineral commodity maps of pre-Cambrian rocks in Wisconsin: U. S. Geological Survey Miscellaneous Geological Investigation Map I- 631, 1970.

G. L. Ekein and F. T. Thwaites, The Glover Bluff structure, a disturbed area in the Paleozoics of Wisconsin: Transactions of the Wisconsin Academy of Science, Arts, and Letters, Vol. 25, pp. 89-97, 1930.

W. I. Finch, Geologic map of the Paducah West and part of the Metropolis quadrangles, Kentucky-Illinois: U. S. Geological Survey Geological Quadrangle Map GQ-557, 1966.

W. I. Finch, Engineering geology of the Paducah West and Metropolis quadrangles in Kentucky: U.S. Geological Survey Bulletin 1258-B, 1968a.

H. H. Gray, Written Communication, Indiana Geological Survey, Bloomington, Indiana, 1974.

H. H. Gray, W. J. Wayne, and C. E. Wier, Geologic map of the 1° x 2° Vincennes quadrangle and parts of adjoining quadrangles, Indiana and Illinois, showing bedrock and unconsolidated deposits: Indiana Geological Survey Regional Geology Map No. 3, Vincennes sheet, 1970.

H. B. Harris, The Grenville Fault area: unpublished M.S. thesis, Indiana University, Bloomington, Indiana, 1948.

S. E. Harris and M. C. Parker, Stratigraphy of the Osage Series in southeastern Iowa: Iowa Geological Survey Report of Investigation No. 1., 1964.

J. A. Harrison, Subsurface geology and coal resources of the Pennsylvanian System in White County, Illinois: Illinois Geological Survey Report of Investigation 153, 1951.

P. C. Heigold, A gravity survey of extreme southeastern Illinois: Illinois Geological Survey Circular 450, 1970.

P. C. Heigold, L. D. McGinnis, and R. H. Howard, Geologic significance of the gravity field in DeWitt-McLean County area, Illinois: Illinois Geological Survey Circular 369, 1964.

LSCS-UFSAR

TABLE 2.5-37
(SHEET 4 OF 5)

A. V. Heyl, The 38th parallel lineament and its relationship to ore deposits: *Economic Geology*, Vol. 67, pp. 879-894, 1972.

A. V. Heyl et al., The geology of the Upper Mississippi Valley Zinc-Lead District: U.S. Geological Survey Professional Paper No. 309, 1959.

A. V. Heyl et al., Regional structure of the southeast Missouri and Illinois Kentucky mineral districts: U.S. Geological Survey Bulletin 1202B, 1965.

J. V. Howell, The Mississippi River Arch: *Kansas Geological Society Guidebook*, 9th Annual Field Conference, pp. 386-389, 1935.

F. Krey, Structural reconnaissance of the Mississippi Valley area from Old Monroe, Missouri, to Nauvoo, Illinois: *Illinois Geological Survey Bulletin* 45, 1924.

C. A. Malott, Geologic structure in the Indian and Trinity Springs locality, Martin County, Indiana: *Indiana Academy of Science Proceedings*, 46th Annual Meeting, Vol. 40, pp. 217-231, 1931.

M. H. McCracken, Structural features of Missouri: *Missouri Geological Survey Report of Investigation* 49, 1971.

W. N. Melhorn and N. M. Smith, The Mt. Carmel Fault and related structural features in south-central Indiana: *Indiana Geological Survey Report of Progress* 16, 1959.

M. E. Ostrom, Written Communication, Wisconsin Geology and Natural History Survey, Madison, Wisconsin, 1975.

W. A. Pryor, Groundwater geology of White County, Illinois: *Illinois Geological Survey Report of Investigation* 196, 1956.

M. W. Pullen, Subsurface geology and coal resources of the Pennsylvanian System in certain counties in the Illinois Basin - Gallatin County: *Illinois Geological Survey Report of Investigation* 148, pp. 69-95, 1951.

W. W. Rubey, Geology and mineral resources of the Hardin and Brussels quadrangles (in Illinois): U.S. Geological Survey Professional Paper 218, 1952.

H. R. Schwalb, E. N. Wilson, and D. G. Sutton, Oil and gas map of Kentucky: *Kentucky Geological Survey*, Series X, Sheet 1, western part, 1971.

LSCS-UFSAR

TABLE 2.5-37
(SHEET 5 OF 5)

D. A. Seeland, Geologic map of part of the Repton quadrangle in Crittenden County, Kentucky: U.S. Geological Survey Geological Quadrangle Map GQ-754, 1968.

H. L. Smith and G. H. Cady, Subsurface geology and coal resources of the Pennsylvanian System in certain counties in the Illinois Basin - Edwards County: Illinois Geological Survey Report of Investigation 148, pp. 51-68, 1951.

W. H. Smith, Strippable coal resources of Illinois, part 1 - Gallatin, Johnson, Pope, Saline, and Williamson Counties: Illinois Geological Survey Circular. 228, 1957.

P. B. Stockdale, The Borden (Knobstone) rocks of southern Indiana: Indiana Department of Conservation Division of Geology Publication 98, 1931.

H. B. Stonehouse and G. M. Wilson, Faults and other structures in southern Illinois - a compilation: Illinois Geological Survey Circular 195, 1955.

J. M. Weller, Geology and oil possibilities of extreme southern Illinois - Union, Johnson, Pope, Hardin, Alexander, Pulaski, and Massac Counties: Illinois Geological Survey Report of Investigation 71, 1940.

J. M. Weller, R. M. Grogan, and F. E. Tippie, Geology of the Fluorspar deposits of Illinois: Illinois Geological Survey Bulletin 76, 1952.

H. B. Willman and J. S. Templeton, Cambrian and Lower Ordovician exposures in northern Illinois: Illinois Academy of Science Transactions, Vol. 44, pp 109-125, 1951.

H. B. Willman et al., Geologic map of Illinois: Illinois Geological Survey, 1967.

LSCS-UFSAR

TABLE 2.5-38

INSTALLATION DATES* FOR
MAIN PLANT SETTLEMENT MONUMENTSCONSTRUCTION OF BUILDING

<u>BUILDING</u>	<u>MONUMENT NUMBER</u>	<u>MONUMENT INSTALLED</u>	<u>START</u>	<u>FINISH OF BASE SLAB</u>	<u>FINISH TO ELEVATION 710 ft.</u>	<u>REMARKS</u>
Service building	SB2	8-75	3-75	4-75	10-75	SB3 was a replacement for SB2 due to construction.
	SB3	10-75				
Turbine building	T1A	6-75	5-74	2-75	10-75	
	TR1	8-75				Relocated 2-76
	TR2	8-75	(9-74)	(3-75)	(3-76)	Relocated 2-76
Auxiliary building	Aux	2-75	4-74	9-74	10-75	Relocated 2-76
			(5-74)	(1-75)	(2-76)	
Off-gas filter building	OG	2-75	5-74	8-74	9-75	OG2 was a replacement for
	OG2	10-75				OG due to construction.
Lake screen house	LSH2	6-75	10-74	11-74	10-75	LSH3 was a replacement for LSH2 due to construction.
	LSH3	10-75				
Reactor Containment	R1	2-75				Relocated 2-76
	R2	2-75				Relocated 2-76

*Dates in parentheses are for unit 2.

LSCS-UFSAR

TABLE 2.5-39
(SHEET 1 OF 3)INDEX PROPERTIES FOR MATERIALS USED IN TRIAXIAL TESTSPART A: IN SITU MATERIAL*

<u>KEY**</u>	<u>BORING</u>	<u>SURFACE ELEVATION (ft)</u>	<u>DEPTH (ft)</u>	<u>TRIAXIAL CONFINING PRESSURE (psf)</u>	<u>LL %</u>	<u>PL %</u>	<u>PI %</u>
1	69	691.3	10.0	1000	-	-	-
2	67	698.5	26.0	2000	31.4	15.0	16.4
3	69	691.3	34.0	3000	30.3	14.7	15.6
4	D-2	681.4	40.5	4000	-	-	-
5	D-2	681.4	20.5	5500	29.5	16.1	13.4
6	D-5	667.3	39.5	5500	28.7	15.6	13.1
7	D-8	680.6	15.0	3000	-	-	-
8	D-8	680.6	45.0	7000	-	-	-
9	F-402A	707.1	29.0	9504	19	14	5
10	D-4	670.8	20.5	4000	-	-	-
11	D-6	668.0	20.5	8000	-	-	-
12	D-5	667.3	2.5	1500	-	-	-
13	D-8	680.6	7.0	3500	32.4	22.0	10.4

* Undisturbed samples of Wedron silty clay till.

** Key numbers correspond to Mohr circle numbers shown on Figure 2.5-43, Sheet 1.

LSCS-UFSAR

TABLE 2.5-39
(SHEET 2 OF 3)

INDEX PROPERTIES FOR MATERIALS USED IN TRIAXIAL TESTS

PART B: COMPACTED TO 95% of MODIFIED PROCTOR.*

<u>KEY**</u>	<u>TRIAxIAL CONFINING PRESSURE</u>	<u>LL%</u>	<u>PL%</u>	<u>PI%</u>
1	1008	37	18	19
2	2016	37	18	19
3	3024	37	18	19
4	1008	37	18	19
5	2016	37	18	19
6	3024	37	18	19

* Material compacted to 95% of modified Proctor-ASTM D-1557.

** Key numbers correspond to Mohr Circle numbers shown on Figure 2.5-43, Sheet 2.

LSCS-UFSAR

TABLE 2.5-39
(SHEET 3 OF 3)

INDEX PROPERTIES FOR MATERIALS USED IN TRIAXIAL TESTS

PART C: COMPACTED TO 90% OF MODIFIED PROCTOR*

<u>KEY**</u>	<u>TEST PIT</u>	<u>SURFACE ELEVATION (ft)</u>	<u>DEPTH (ft)</u>	<u>TRIAxIAL CONFINING PRESSURE(psf)</u>	<u>LL %</u>	<u>PL%</u>	<u>PI%</u>
1	4	693±	2.0-2.5	1000	35.5	24.1	11.4
2	9	685±	2.75-3.0	2000	46.8	18.4	28.4
3	11	695±	3.0-3.5	1000	34.4	19.3	15.1
4	6	691±	4.0-4.5	2000	26.2	16.4	9.8
5	5	685±	3.75-4.25	1000	-	-	-
6	6	691±	8.0-8.5	2000	-	-	-
7	19	717.4	6.5-7.0	2500	38.0	16.7	21.3
8	19	717.4	6.5-7.0	1500	38.0	16.7	21.3
9	21	705.6	3.0-3.5	3000	39.8	17.5	22.3
10	21	705.6	3.0-3.5	6000	39.8	17.5	22.3
11	15	700.2	8.5-9.0	2000	58.4	19.8	38.7
12	15	700.2	8.5-9.0	4000	58.4	19.8	38.7
13	22	700.8	2.2-2.5	1500	50.7	16.1	34.6
14	22	700.8	2.2-2.5	2500	50.7	16.1	34.6

* Material compacted to 90% of modified Proctor-ASTM D-1557.

** Key numbers correspond to Mohr Circle numbers shown on Figure 2.5-43, Sheet 3.

LSCS-UFSAR

TABLE 2.5-40

CONSOLIDATION PARAMETERS FOR SETTLEMENT ANALYSIS

		<u>RELOADING BELOW P_o AND REBOUND</u>	<u>RELOADING ABOVE P_o BUT BELOW P_c</u>
C _R / i+e _o	Above elevation 620 feet	.005	.012
	Elevation 590 to 620 feet	.005	.007
	Elevation 560 to 590 feet	.001	.004
	Elevation 540 to 560 feet	.001	.001
C _v (ft ² /day)		2.0	2.0

LSCS-UFSAR

TABLE 2.5-41

COMPARISON OF THEORETICAL AND MEASURED SETTLEMENT

<u>BUILDING</u>	<u>MONUMENT NUMBER</u>	<u>THEORETICAL FINAL SETTLEMENT</u> (in.)		<u>MEASURED SETTLEMENT</u> (in.)	<u>LAST MEASUREMENT</u>	<u>ESTIMATED COMPLETION OF BUILDING CONSTRUCTION</u>
		<u>FLEXIBLE MAT</u>	<u>RIGID MAT</u>			
Service building	SB3	0.60	0.91	1.13	May 1981	100%
Turbine building	T1A*	1.73	1.73	0.86	August 1976	100%
	TR1	2.10	1.84	1.49	May 1981	
	TR2	1.38	1.74	2.05	May 1981	
Auxiliary building	AUX	2.37	1.96	2.66	May 1981	100%
Reactor building	R1	2.91	2.30	2.46	May 1981	100%
	R2	2.99	2.06	2.50	May 1981	
Off-gas building	OG2	0.95	2.48	0.60	May 1981	100%
Lake screen house	LSH3	1.20	---	0.23	May 1981	100%

* Settlement readings for monument T1A were discontinued after the August 1976 reading.

LSCS-UFSAR

TABLE 2.5-42

SUMMARY OF GAS STORAGE FIELDS WITHIN 30 MILES

<u>GAS STORAGE FIELD</u>	<u>GEOLOGIC STRUCTURE</u>	<u>STORAGE RESERVOIR</u>	<u>APPROXIMATE ELEVATION TOP OF STORAGE RESERVOIR (ft MSL)</u>	<u>THICKNESS OF CAPROCK(ft)</u>	<u>CLOSURE (ft)</u>	<u>DISTANCE FROM SITE (MILES)</u>
Ancona	Asymmetrical anticline with two domes at crest	Mt. Simon Sandstone	-1550	400	290; 96 on dome near Ancona, 89 on dome near Garfield	18
Herscher-Northwest	Doubly plunging anticline	Mt Simon Sandstone	-1590	161	58	27
Pontiac	Anticline	Mt. Simon Sandstone	-2280	125	100	27
Troy Grove	Elongated dome	Mt. Simon Sandstone	- 740	180	100	28

LSCS-UFSAR

APPENDIX 2.5A

SELECTED STRUCTURES

OUTSIDE THE 200-MILE RADIUS

APPENDIX 2.5A

TABLE OF CONTENTS

	<u>PAGE</u>
I. <u>PASCOLA ARCH</u>	2.5A-1
II. <u>REELFOOT BASIN</u>	2.5A-1
III. <u>OZARK DOME</u>	2.5A-2
IV. <u>MISSISSIPPI EMBAYMENT SYNCLINE</u>	2.5A-2
V. <u>FAIRFIELD BASIN</u>	2.5A-2
VI. <u>WABASH VALLEY FAULT ZONE</u>	2.5A-3

SELECTED STRUCTURES OUTSIDE THE 200-MILE RADIUS

I. PASCOLA ARCH

The Pascola Arch is a feature that trends N 50° W and is located in the southeastern corner of Missouri and western Tennessee. It is connected to the Ozark Dome and forms the southern edge of the Reelfoot Basin.

Stratigraphic evidence indicates the arch developed from Pennsylvanian time through pre-Cretaceous time (Schwalb, 1969, p. 16). By the Late Cretaceous, the arch was a physiographic extension of the Ozark Dome (Stearns and Marcher, 1962, p. 1392). Based upon reconstruction of the paleostructure of the arch, Stearns and Marcher (1962) estimated that about 4000 feet of Paleozoic sediments had been eroded from the arch by Late Cretaceous, exposing Cambrian and Ordovician strata along the crest of the arch. During the formation of the Mississippi Embayment Syncline, the arch was downwarped as much as 2000 feet, and the underlying Paleozoic strata were covered by younger sediments.

II. REELFOOT BASIN

The Reelfoot Basin (Schwalb, 1969) is bounded on the south by the Pascola Arch. It is fringed on the east by a broad shelf area, on the north by the Moorman Syncline, and on the west by the Ozark Dome (a broad uplift area which has exposed Precambrian-age rocks at the surface in southeastern Missouri). The elevation of the Precambrian surface varies from lower than 12,000 feet below sea level in the Reelfoot Basin to approximately 4,000 feet below sea level over the Pascola Arch to 1,700 feet above sea level in the Ozark Dome in southeastern Missouri.

Stratigraphic evidence indicates the Reelfoot Basin was a depositional center from Cambrian time throughout Ordovician time, and this area continued to receive sediments through Pennsylvanian time (Schwalb, 1969). After a period of erosion, deposition again took place in this area during Cretaceous time through Tertiary (mid-Eocene) time (Cushing, Boswell, and Hosman, 1964). These younger sediments, referred to as the Mississippi Embayment sediments, were deposited in the Mississippi Embayment Syncline. This syncline overlies the Reelfoot Basin and the Pascola Arch. Deposition of alluvial sediments by the Mississippi River is still occurring within the Mississippi Embayment Syncline.

III. OZARK DOME

The Ozark Dome is a broad, asymmetric dome located in southeastern Missouri. The Precambrian surface is exposed in Missouri at a maximum elevation of approximately 1700 feet above sea level.

The dome was present in Precambrian time and continued to develop intermittently throughout the Paleozoic. Cenozoic structural development included a major movement in the Tertiary (pre-Pliocene). Intermittent movement continued into the Holocene (McCracken, 1971).

IV. MISSISSIPPI EMBAYMENT SYNCLINE

The Mississippi Embayment Syncline is a southward-plunging syncline with the axis trending approximately N 25° E, generally parallel to the Mississippi River. The syncline, an extension of the Gulf Coast Geosyncline, is a wedge-shaped region that includes parts of Alabama, Arkansas, Illinois, Kentucky, Louisiana, Mississippi, Missouri, Tennessee, and Texas (Cushing, Boswell, and Hosman, 1964).

Development of the Mississippi Embayment Syncline began at its southwestern end, possibly as early as the end of the Paleozoic Era (Cushing, Boswell, and Hosman, 1964). The syncline developed to its northernmost extent by the Late Cretaceous, and development continued intermittently until the end of the Eocene (Cushing, Boswell, and Hosman). The maximum thickness of post-Paleozoic strata in the Mississippi Embayment Syncline north of the Pascola Arch is approximately 2000 feet.

Interpretation of gravity data suggests that the crust beneath the Mississippi Embayment is unusually thick in comparison to areas to the north (McGinnis, 1974). This is a further indication of the uniqueness of this area.

V. FAIRFIELD BASIN

The Fairfield Basin is a deep portion of the Illinois Basin. It is bounded on the east and northeast by the LaSalle Anticlinal Belt, on the west by the Du Quoin Monocline, and on the south by the Cottage Grove-Shawneetown-Rough Creek Fault Zones (Rough Creek Lineament). Principal movements along the LaSalle and Du Quoin flexures occurred during Pennsylvanian and post-Pennsylvanian time. The structural development of the Fairfield Basin was the result of the relative uplift of bordering structures. Latest movements and maximum displacements on the faults along the Rough Creek Lineament occurred in post-Pennsylvanian time, and this faulting formed the southern boundary of the Fairfield Basin. The elevation of the Precambrian surface is lower than 13,000 feet below sea level at the deepest point in the Fairfield Basin (Buschbach, 1975).

VI. WABASH VALLEY FAULT ZONE

The Wabash Valley Fault Zone trends N 27° E, roughly parallel to the Wabash River in southeastern Illinois and southwestern Indiana.

The Wabash Valley Fault Zone consists of parallel, high-angle, normal faults that border horst and graben structures. The fault zone is approximately 60 miles long and 30 miles wide. Individual faults tend to be less than 30 miles long (Bristol, 1974). The east-west spacing between the faults varies from 1 to 4 miles. Vertical displacements along these faults are commonly 200 feet or less, but some are as much as 400 feet (Buschbach, 1974; Bristol, 1974; Schwalb, 1974). The displacements of these faults generally decrease north and south along strike. The Wabash Valley Fault Zone is not known to intersect the Rough Creek-Shawneetown Fault Zones in Illinois (Bristol, 1974).

The faults in the Wabash Valley Fault Zone displace Mississippian and Pennsylvanian strata but do not displace overlying Pleistocene sediments. The age of movement is therefore from post-Pennsylvanian to pre-Pleistocene (Buschbach, 1974).



**LA SALLE COUNTY STATION
 UPDATED FINAL SAFETY ANALYSIS REPORT**

FIGURE 2.1-1

**LOCATION OF THE SITE WITHIN
 THE STATE OF ILLINOIS**

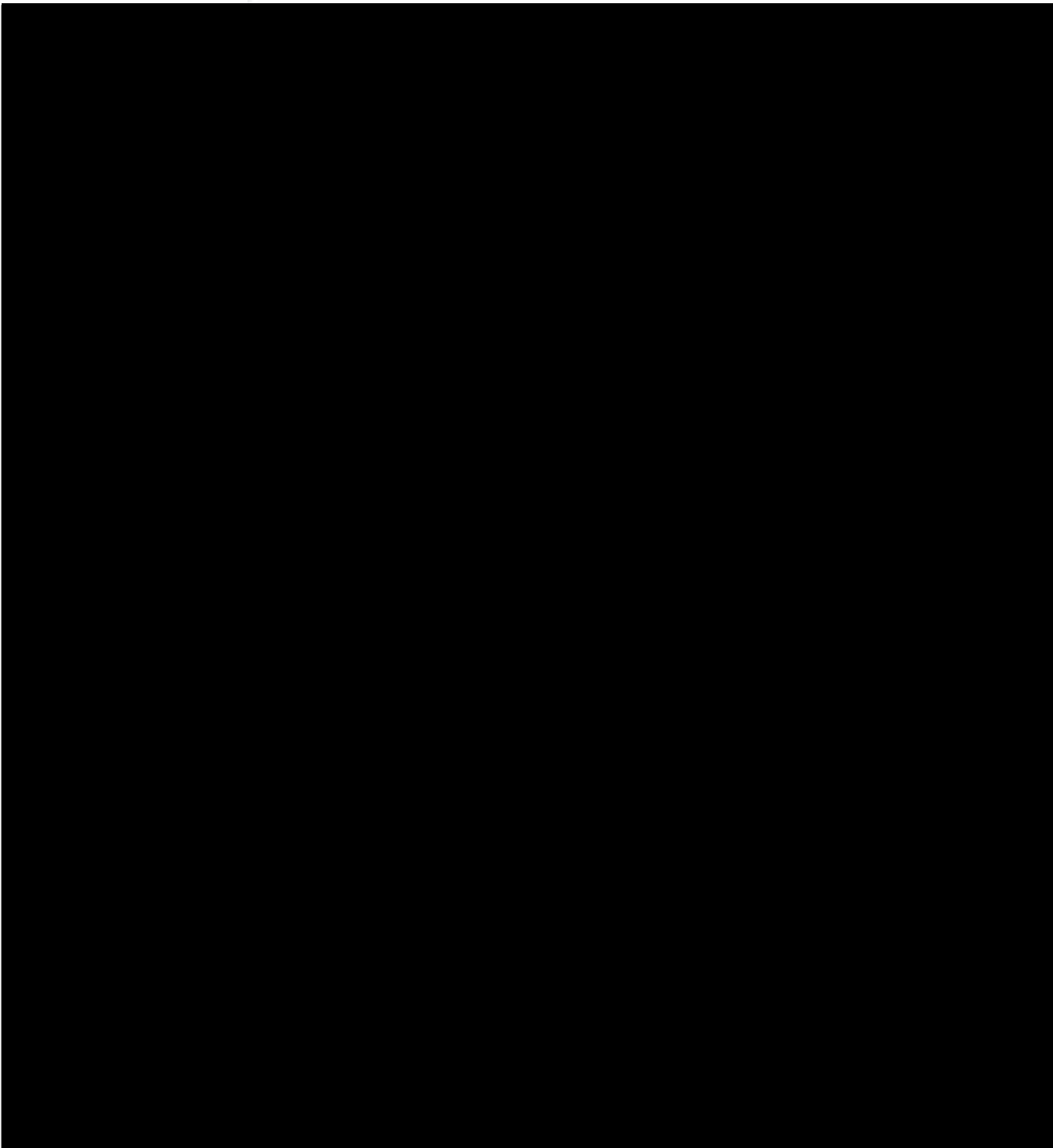

**LA SALLE COUNTY STATION
UPDATED FINAL SAFETY ANALYSIS REPORT**

FIGURE 2.1-2

**LOCATION OF THE SITE WITH RESPECT TO
LA SALLE COUNTY AND BROOKFIELD TOWNSHIP**

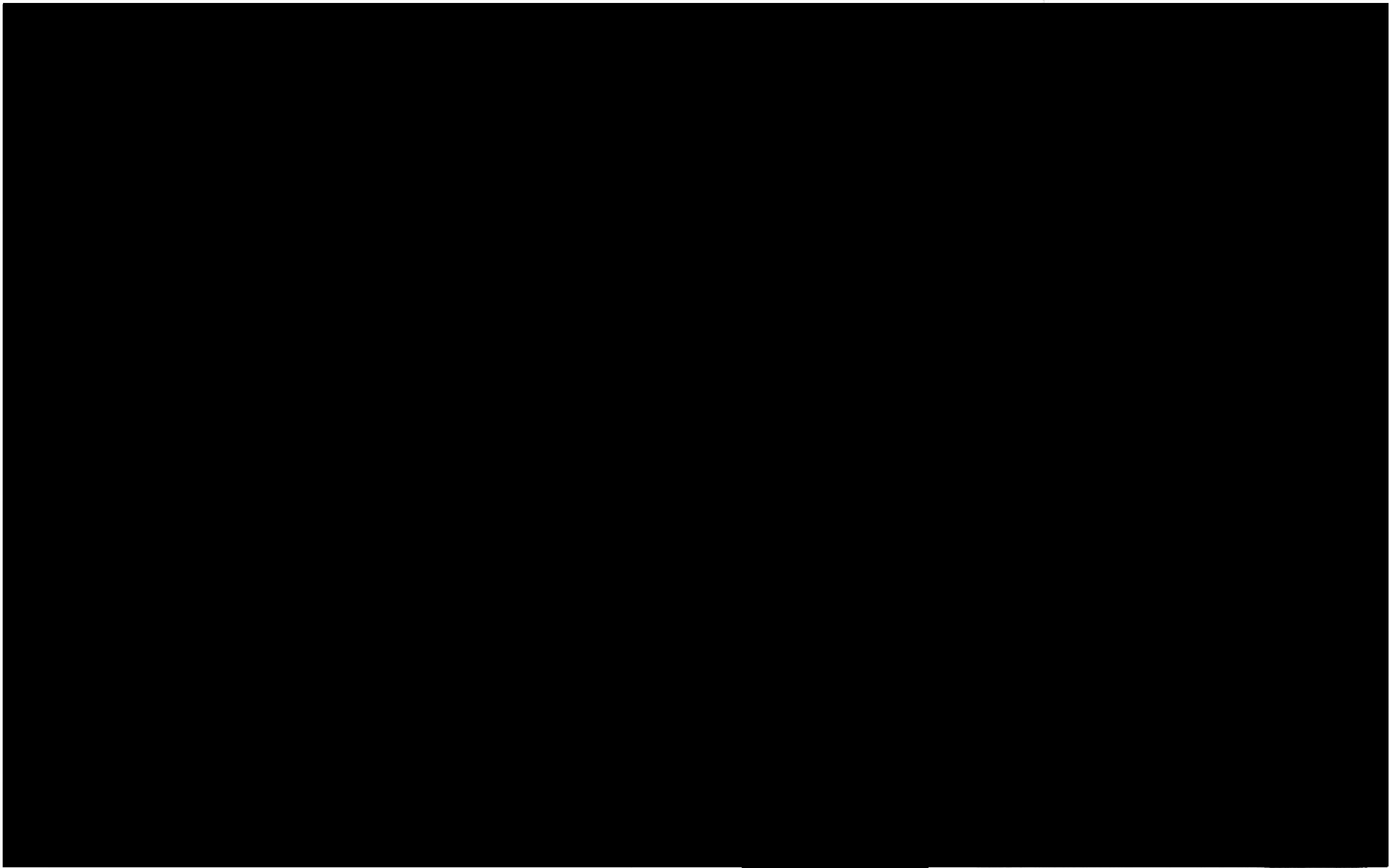

LASALLE COUNTY STATION
UPDATED FINAL SAFETY ANALYSIS REPORT

FIGURE 2.1-3

MAJOR STRUCTURES AND SITE LAYOUT

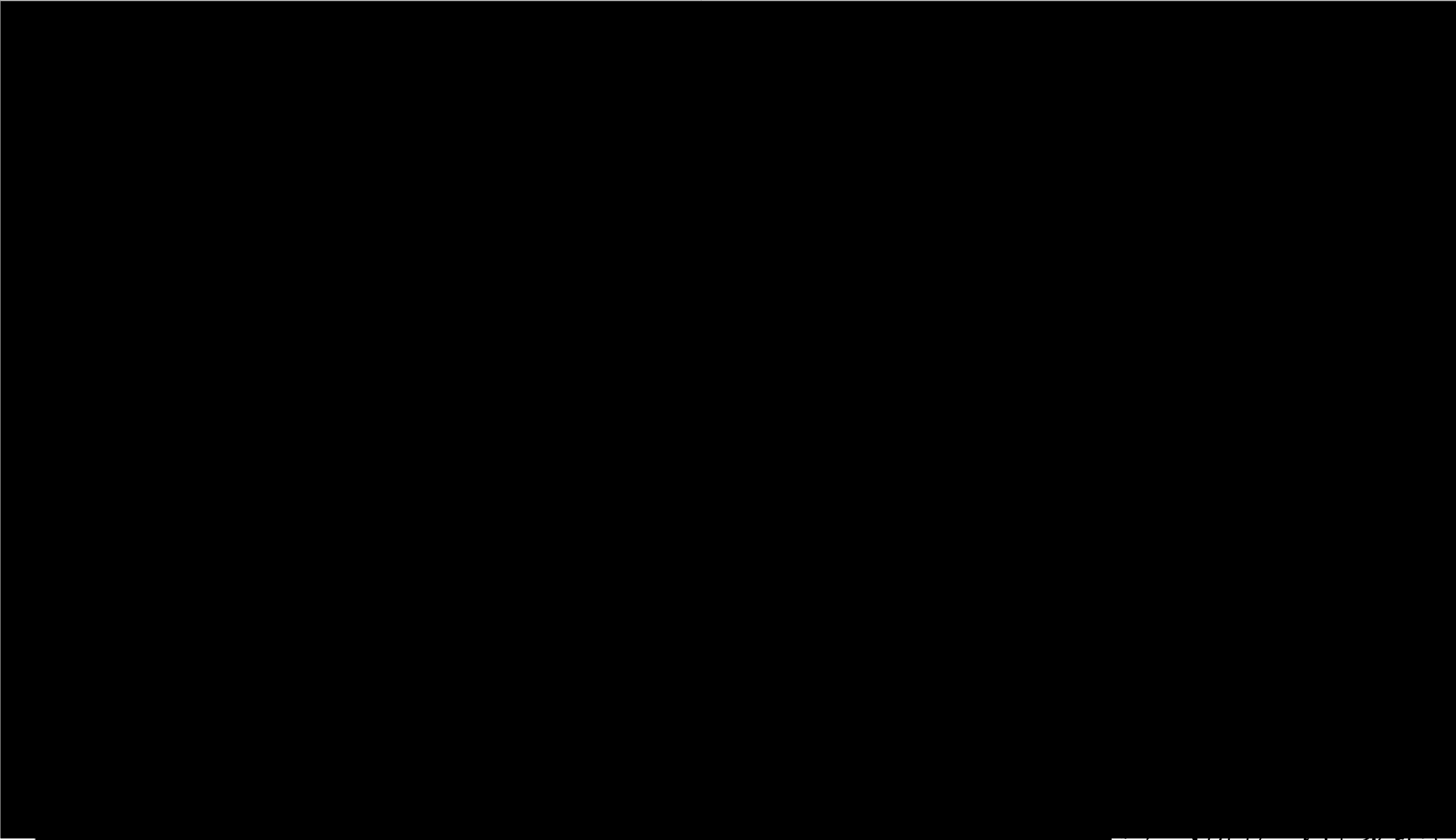

LASALLE COUNTY STATION
UPDATED FINAL SAFETY ANALYSIS REPORT

FIGURE 2.1-4

EXCLUSION AREA

**LA SALLE COUNTY STATION
UPDATED FINAL SAFETY ANALYSIS REPORT**

**FIGURE 2.1-5
TRANSPORTATION ROUTES
IN THE SITE VICINITY**

REV. 0 - APRIL 1984

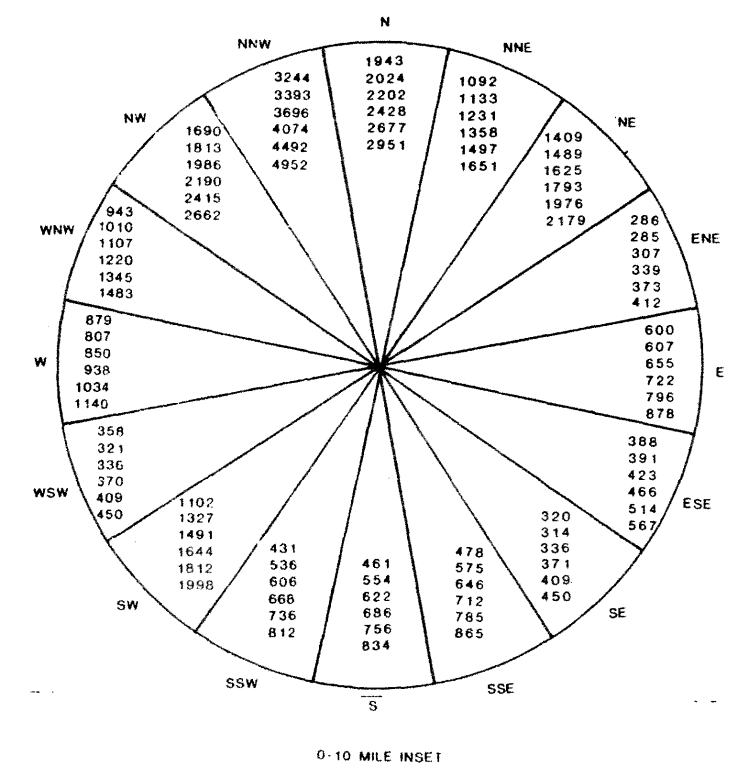
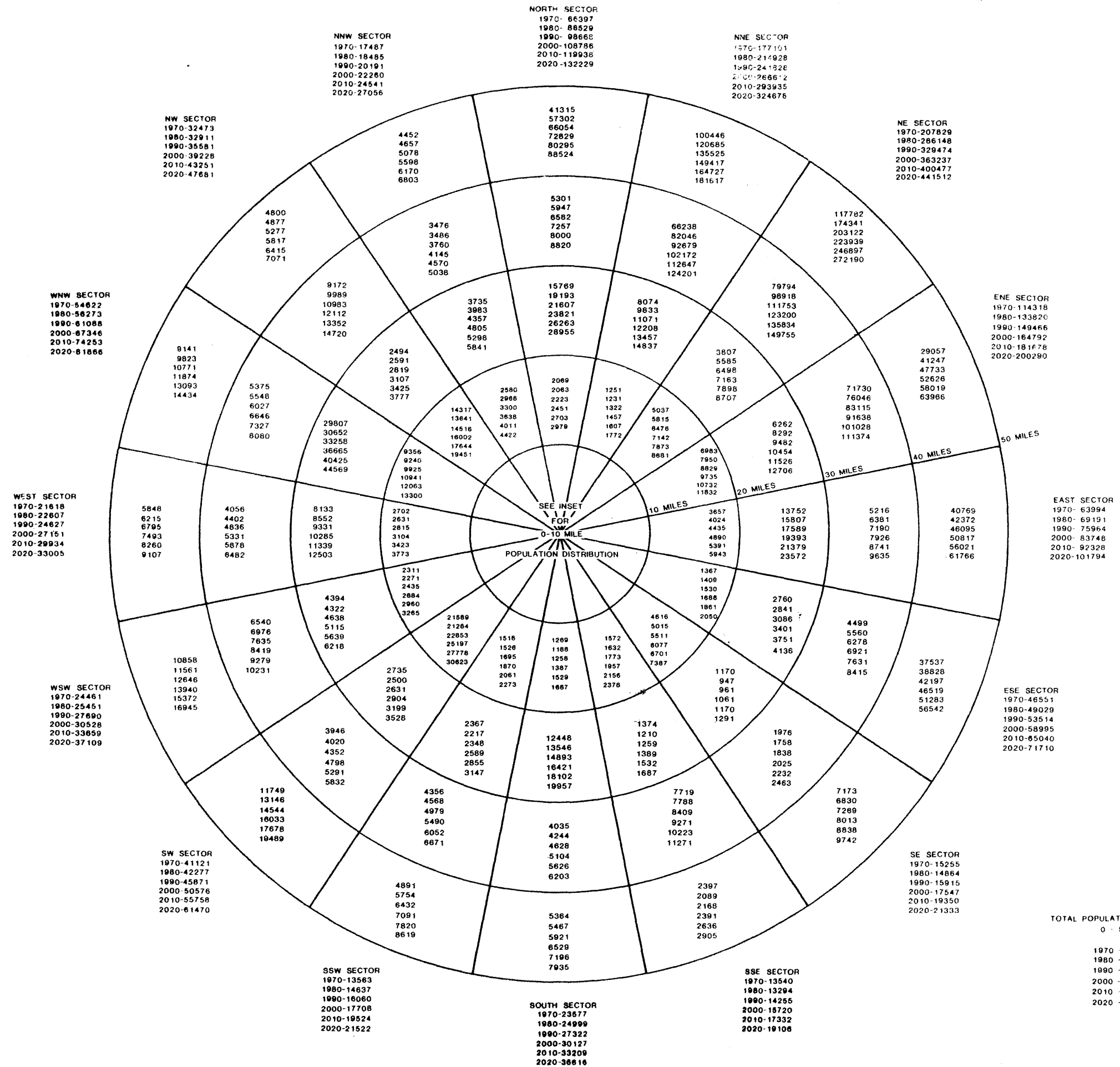

TOTAL POPULATION DISTRIBUTION
0 - 50 MILES

1970 -	933907
1980 -	1105443
1990 -	1237514
2000 -	1364361
2010 -	1504207
2020 -	1658377

**LA SALLE COUNTY STATION
UPDATED FINAL SAFETY ANALYSIS REPORT**

**FIGURE 2.1-6
1970 AND PROJECTED POPULATIONS
WITHIN 50 MILES**

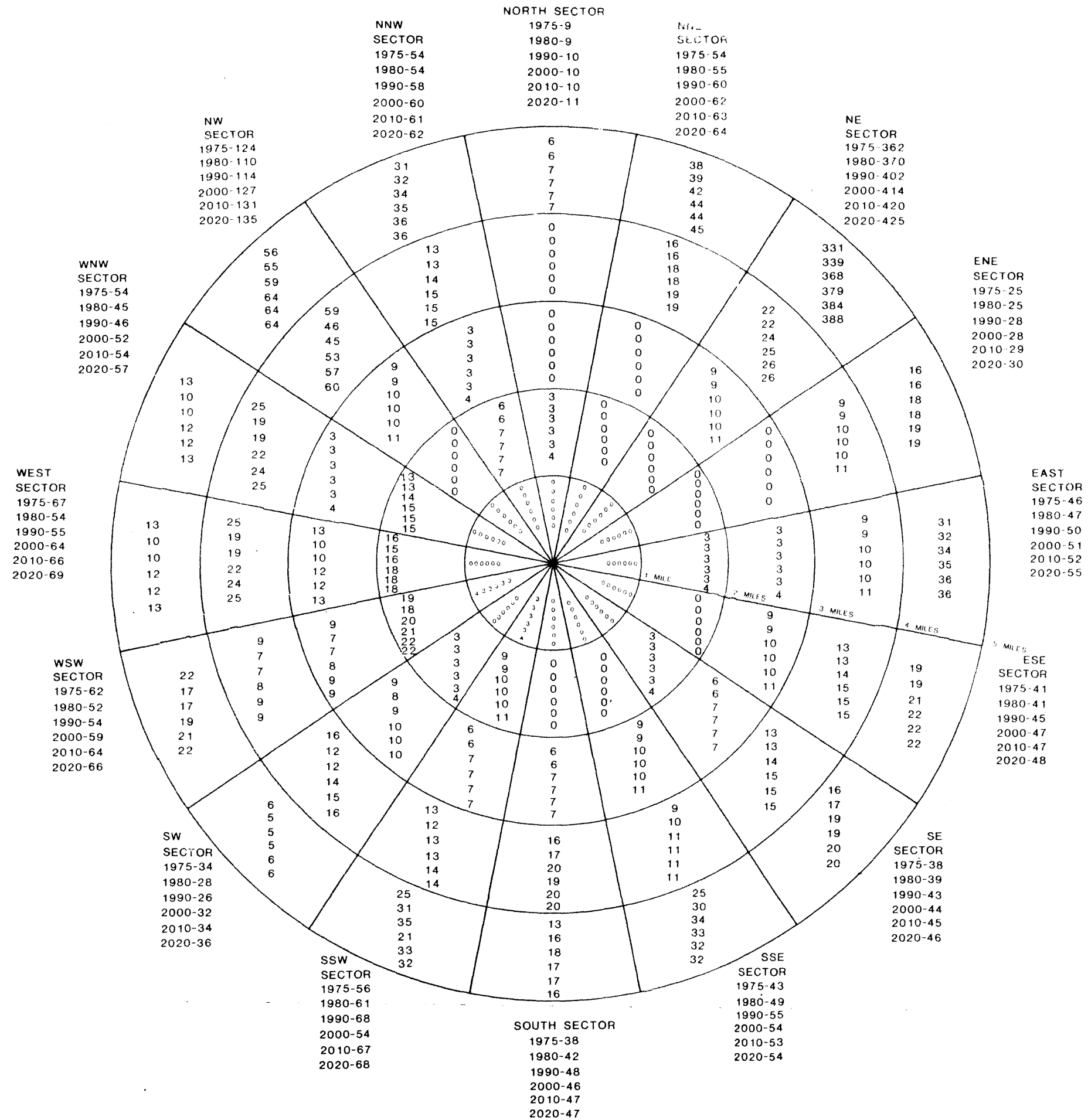

LA SALLE COUNTY STATION
 UPDATED FINAL SAFETY ANALYSIS REPORT

FIGURE 2.1-7
 PRESENT (1975) AND PROJECTED POPULATIONS

LA SALLE COUNTY STATION
UPDATED FINAL SAFETY ANALYSIS REPORT

FIGURE 2.1-8
CITIES WITHIN 10 MILES OF THE SITE

REV. 0 - APRIL 1984

601/2/10

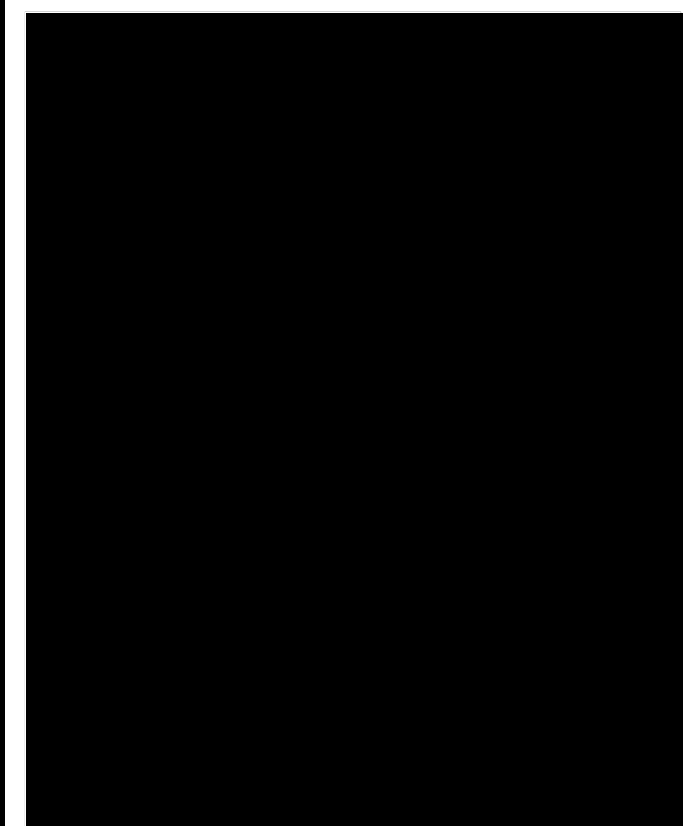

LA SALLE COUNTY STATION
UPDATED FINAL SAFETY ANALYSIS REPORT

FIGURE 2.1-9
PRESENT AND PROJECTED POPULATION
CENTERS WITHIN 50 MILES OF THE SITE



LA SALLE COUNTY STATION
UPDATED FINAL SAFETY ANALYSIS REPORT

FIGURE 2.1-10
TOPOGRAPHIC FEATURES AND TRANSPORTATION
ROUTES WITHIN THE LPZ

REV. 0 - APRIL 1984

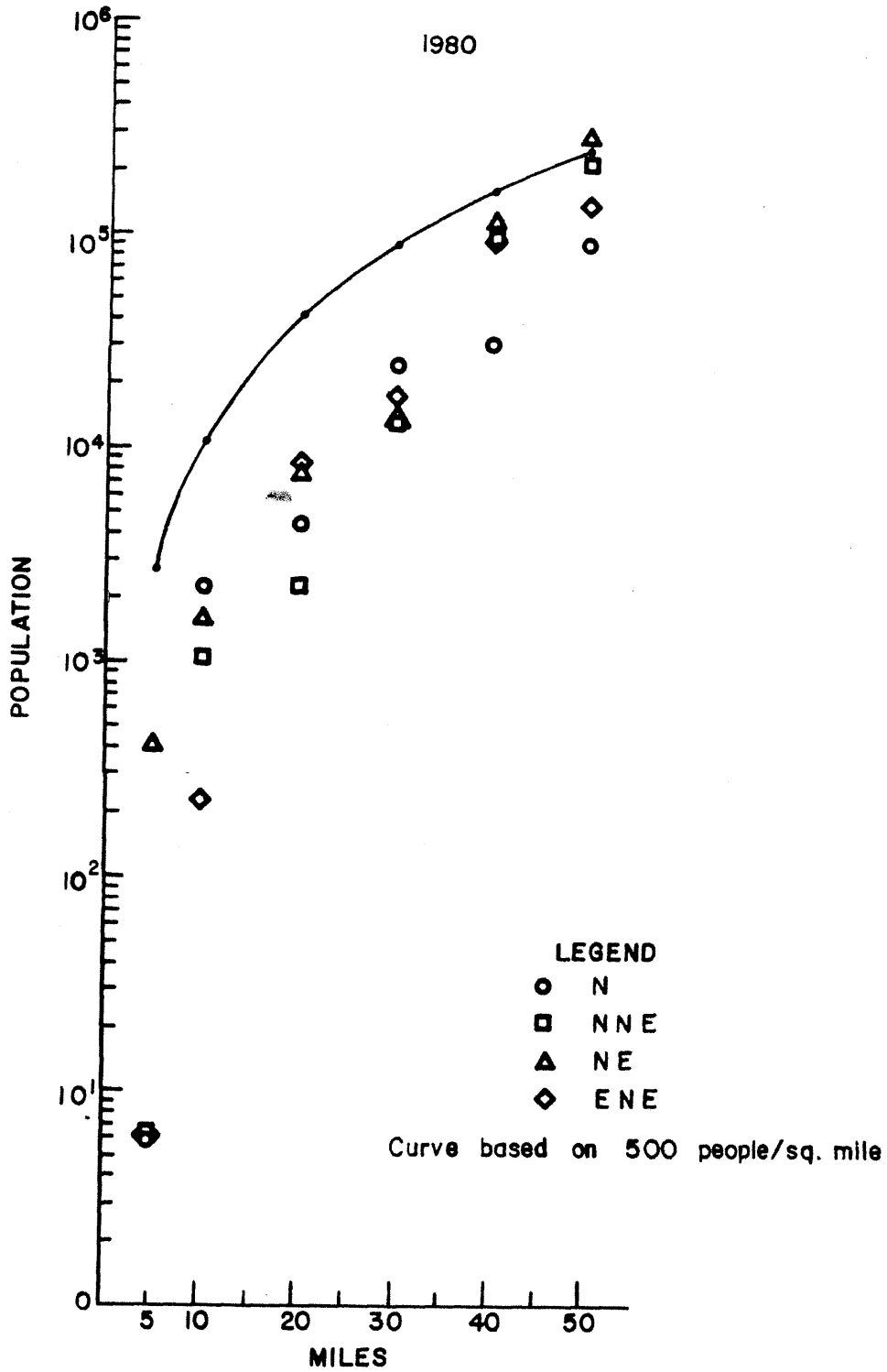

LA SALLE COUNTY STATION
 UPDATED FINAL SAFETY ANALYSIS REPORT

FIGURE 2.1-11
 1980 POPULATION DENSITY WITHIN
 50 MILES OF THE SITE

(SHEET 1 of 4)

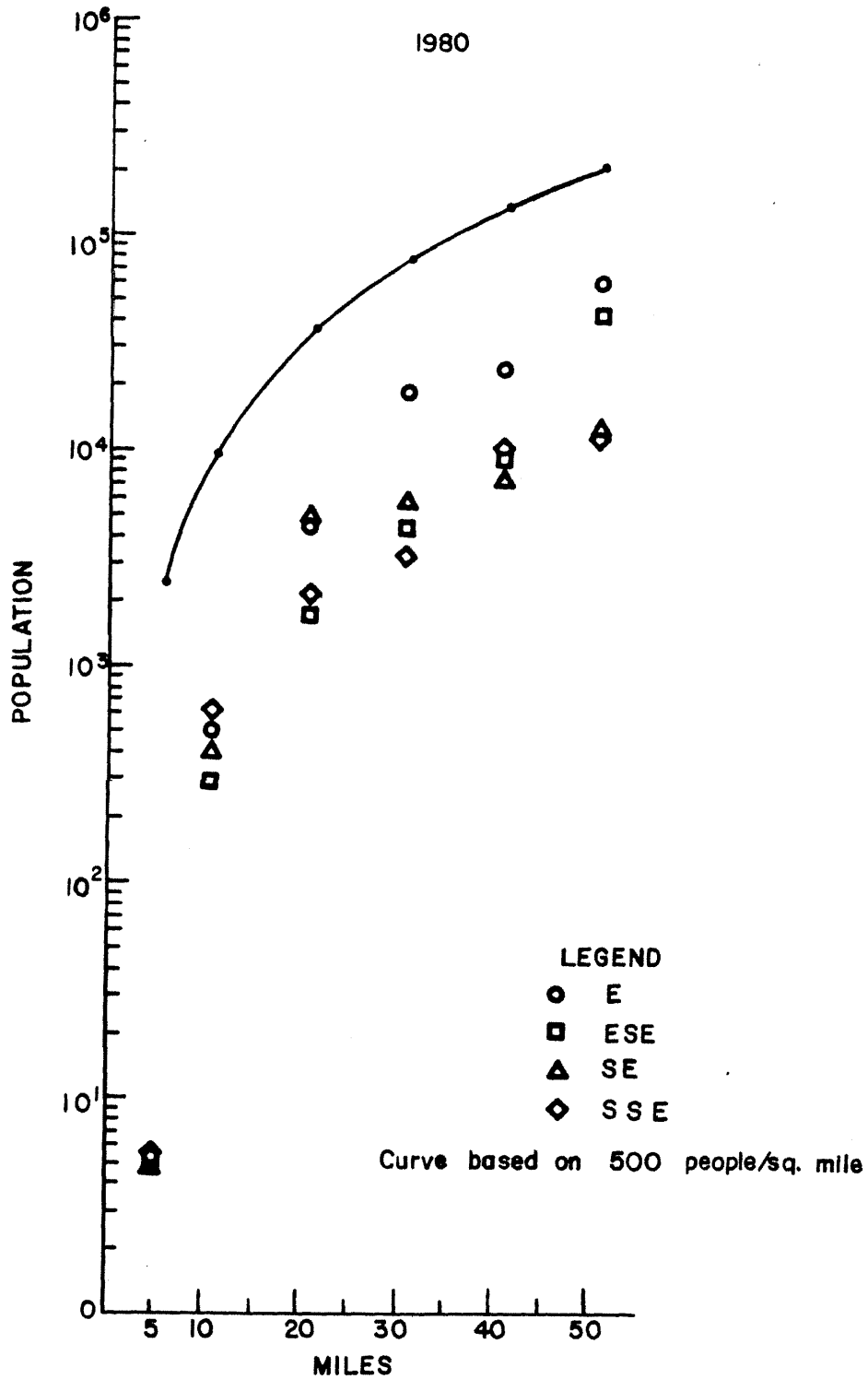

LA SALLE COUNTY STATION
 UPDATED FINAL SAFETY ANALYSIS REPORT

FIGURE 2.1-11

1980 POPULATION DENSITY WITHIN
 50 MILES OF THE SITE

(SHEET 2 of 4)

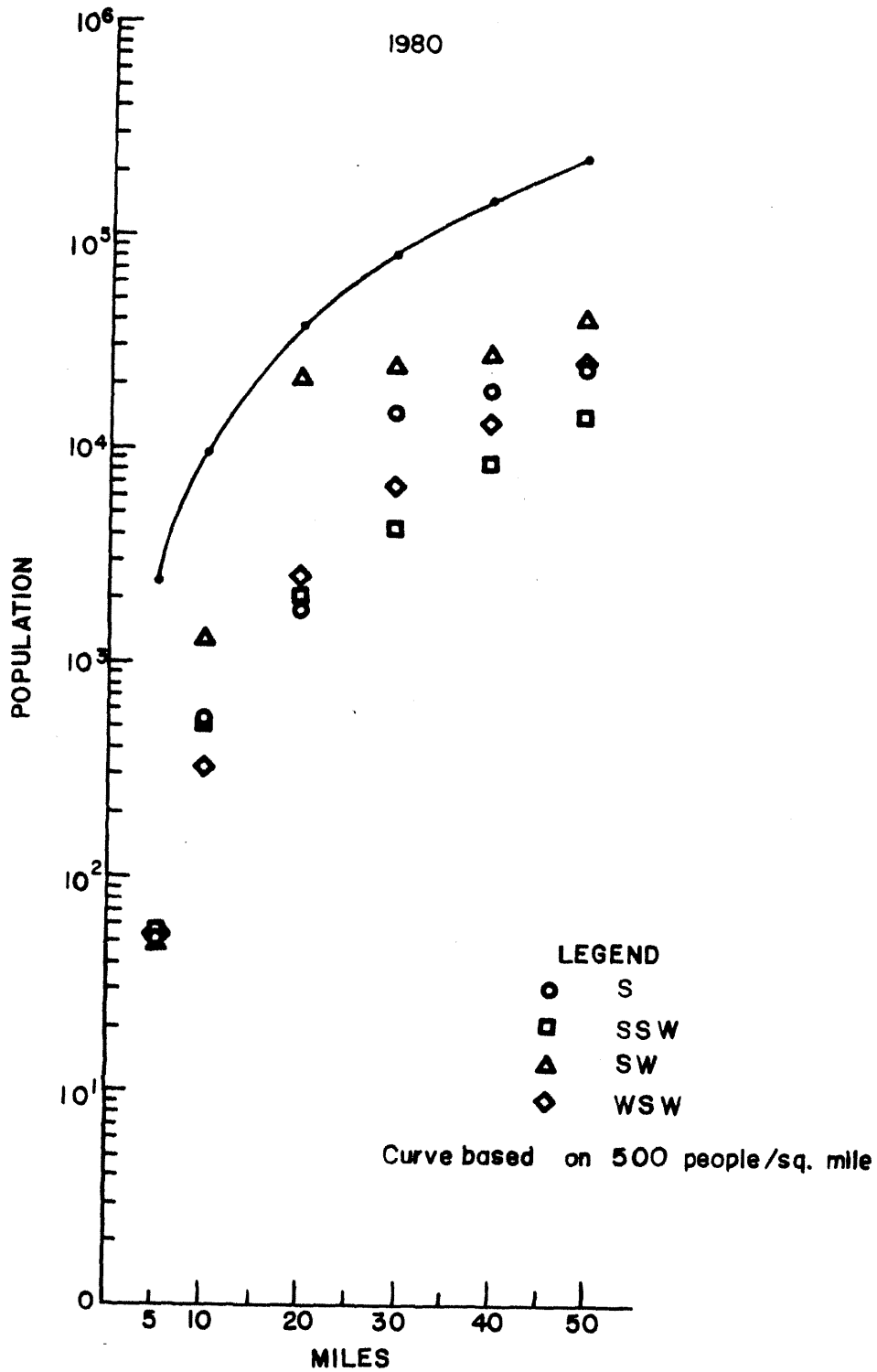

LA SALLE COUNTY STATION
 UPDATED FINAL SAFETY ANALYSIS REPORT

FIGURE 2.1-11
 1980 POPULATION DENSITY WITHIN
 50 MILES OF THE SITE
 (SHEET 3 of 4)

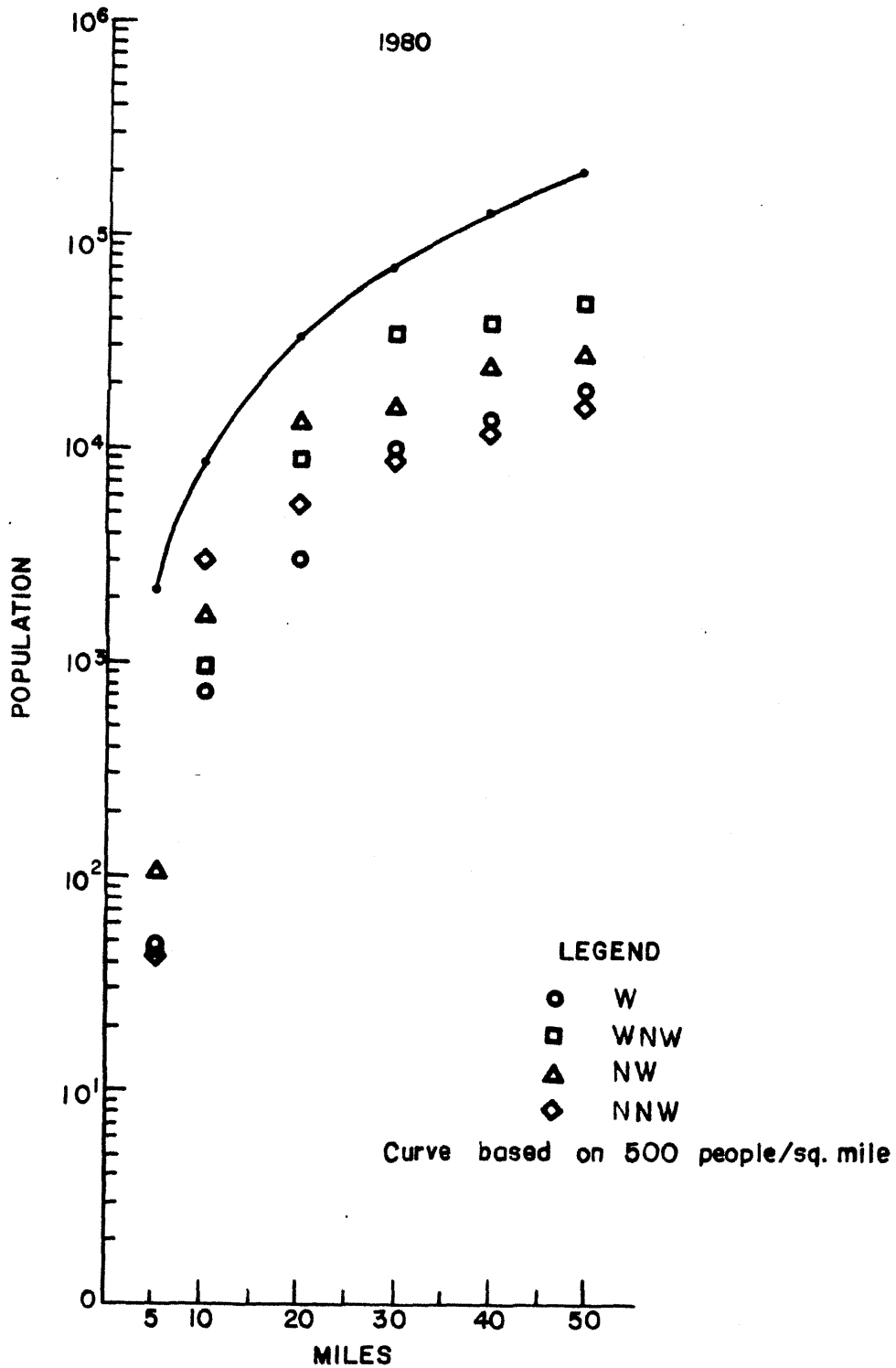

**LA SALLE COUNTY STATION
UPDATED FINAL SAFETY ANALYSIS REPORT**

FIGURE 2.1-11
1980 POPULATION DENSITY WITHIN
50 MILES OF THE SITE
(SHEET 4 of 4)

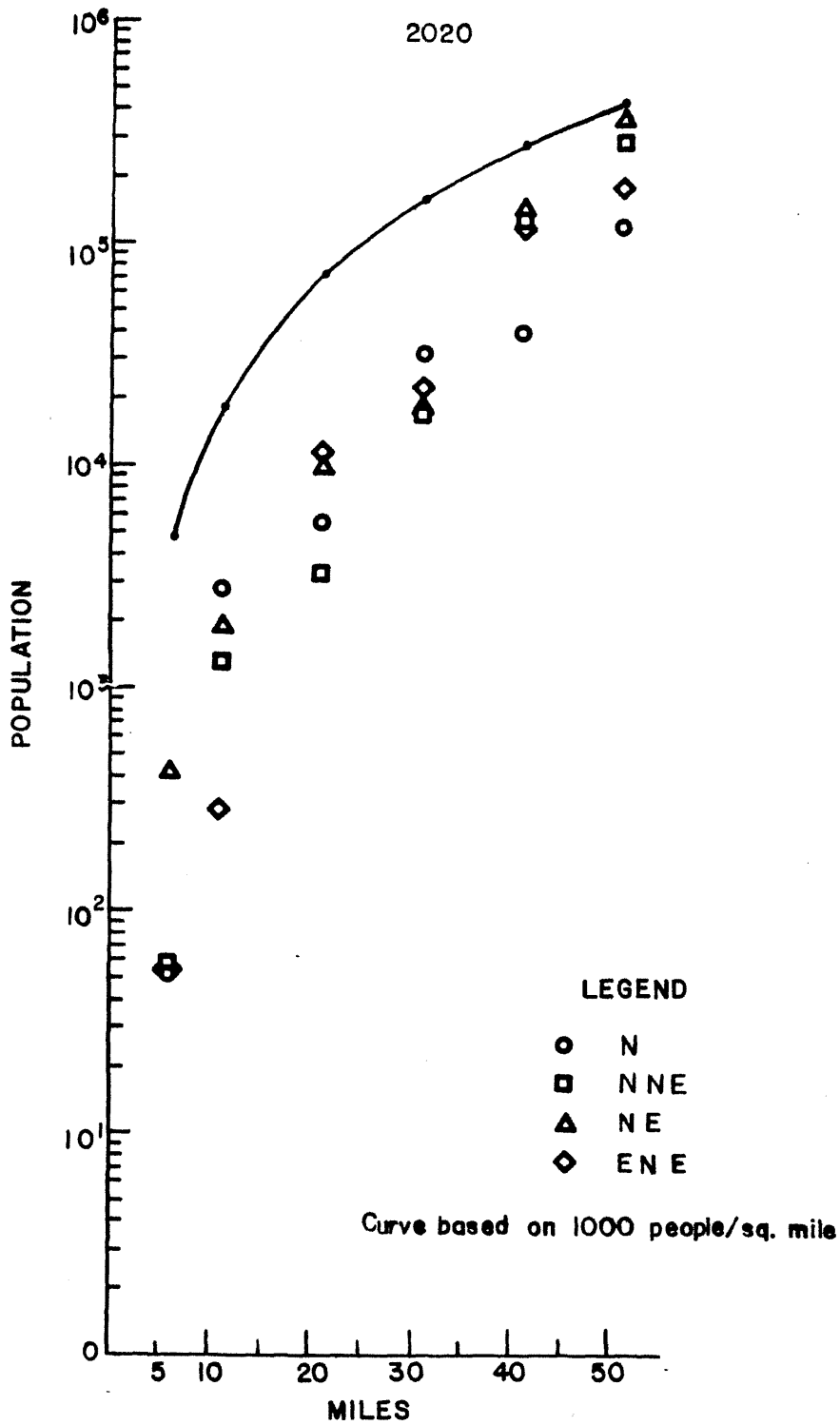

LA SALLE COUNTY STATION
 UPDATED FINAL SAFETY ANALYSIS REPORT

FIGURE 2.1-12

2020 POPULATION DENSITY WITHIN
 50 MILES OF THE SITE

(SHEET 1 of 4)

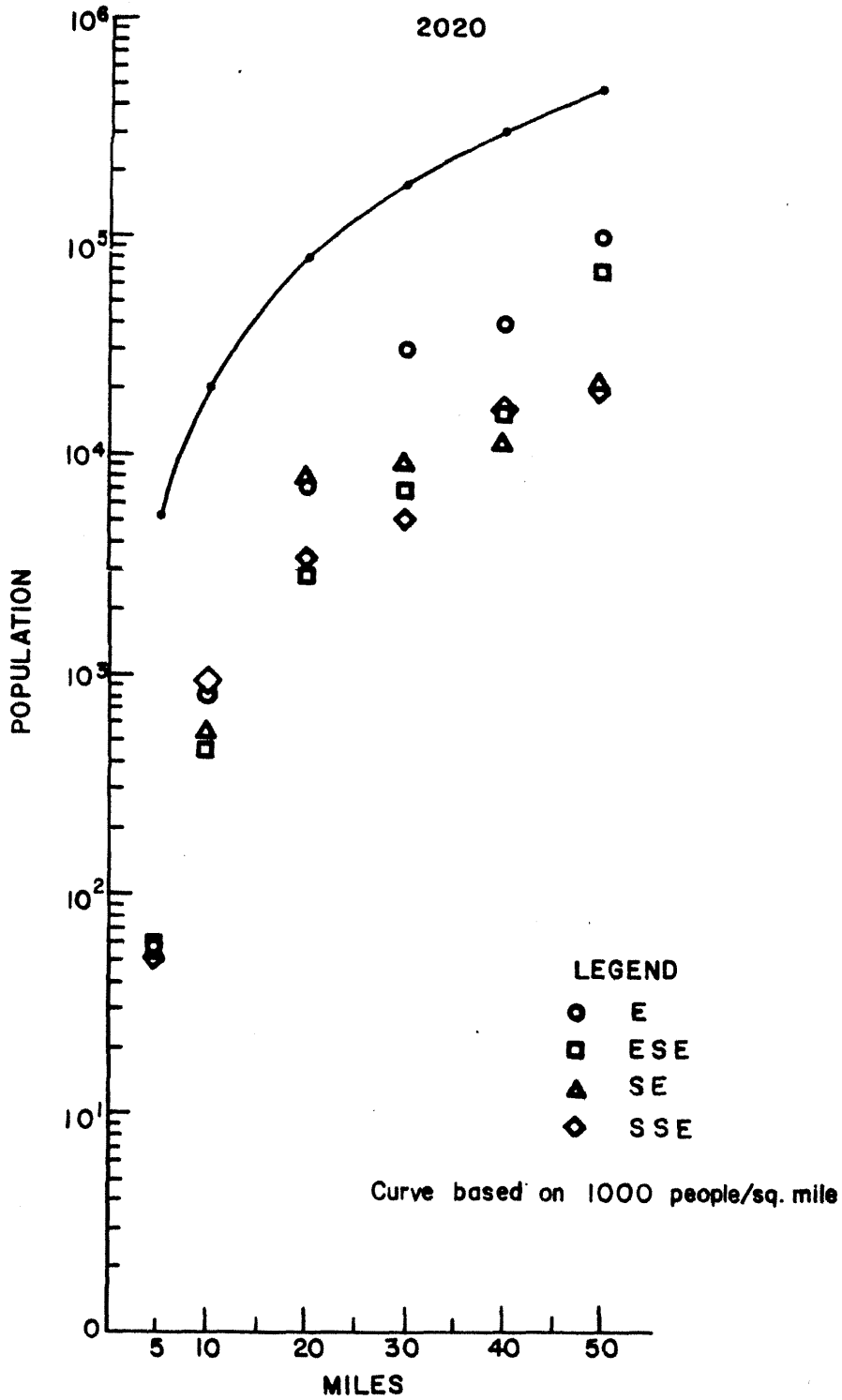

**LA SALLE COUNTY STATION
UPDATED FINAL SAFETY ANALYSIS REPORT**

FIGURE 2.1-12
2020 POPULATION DENSITY WITHIN
50 MILES OF THE SITE
(SHEET 2 of 4)

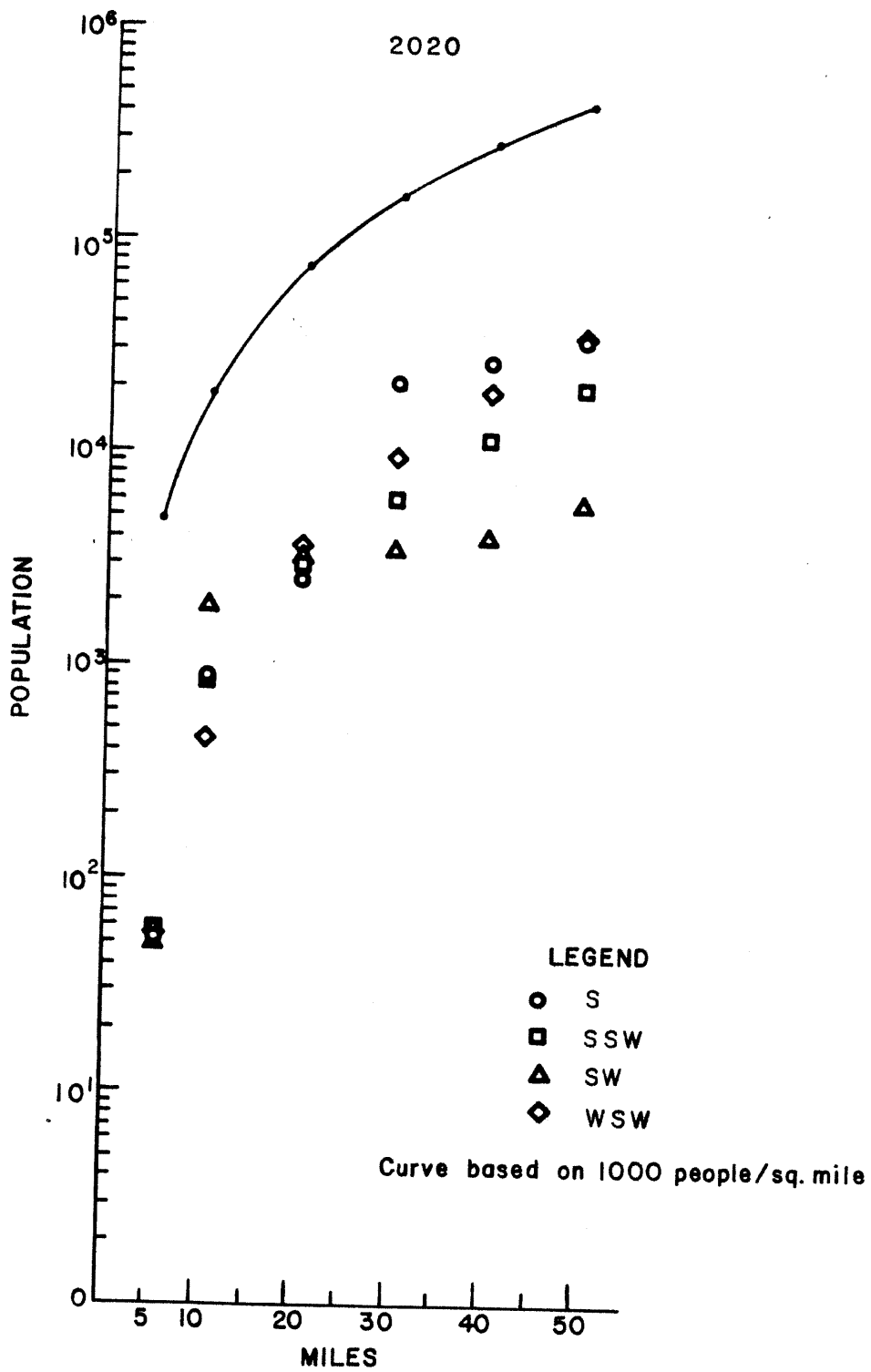

LA SALLE COUNTY STATION
 UPDATED FINAL SAFETY ANALYSIS REPORT

FIGURE 2.1-12
 2020 POPULATION DENSITY WITHIN
 50 MILES OF THE SITE
 (SHEET 3 of 4)

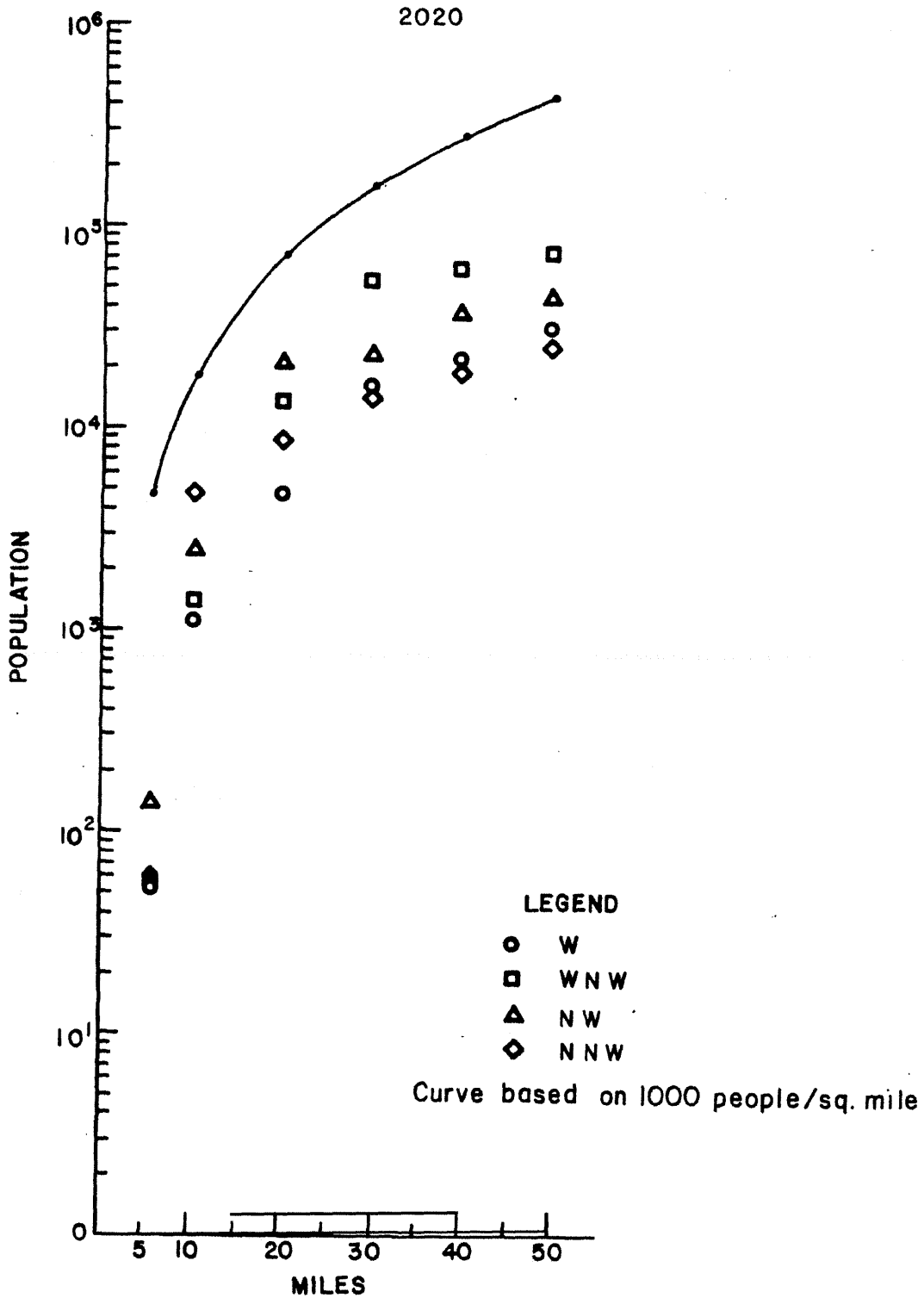

**LA SALLE COUNTY STATION
UPDATED FINAL SAFETY ANALYSIS REPORT**

FIGURE 2.1-12

2020 POPULATION DENSITY WITHIN
50 MILES OF THE SITE

(SHEET 4 of 4)

REV. 0 - APRIL 1984

LA SALLE COUNTY STATION
UPDATED FINAL SAFETY ANALYSIS REPORT

FIGURE 2.2-1

AIRPORTS AND FLIGHT PATTERNS WITHIN
20 MILES OF THE SITE

REV. 2 - APRIL 1986

LA SALLE COUNTY STATION
UPDATED FINAL SAFETY ANALYSIS REPORT

FIGURE 2.2-2
MILITARY FACILITIES AND
GAS PIPELINES WITHIN 10 MILES
OF THE SITE

REV. 18 - APRIL 2010

**NO. OF TORNADOES
PER COUNTY (1916-1969)
54 YEAR PERIOD**

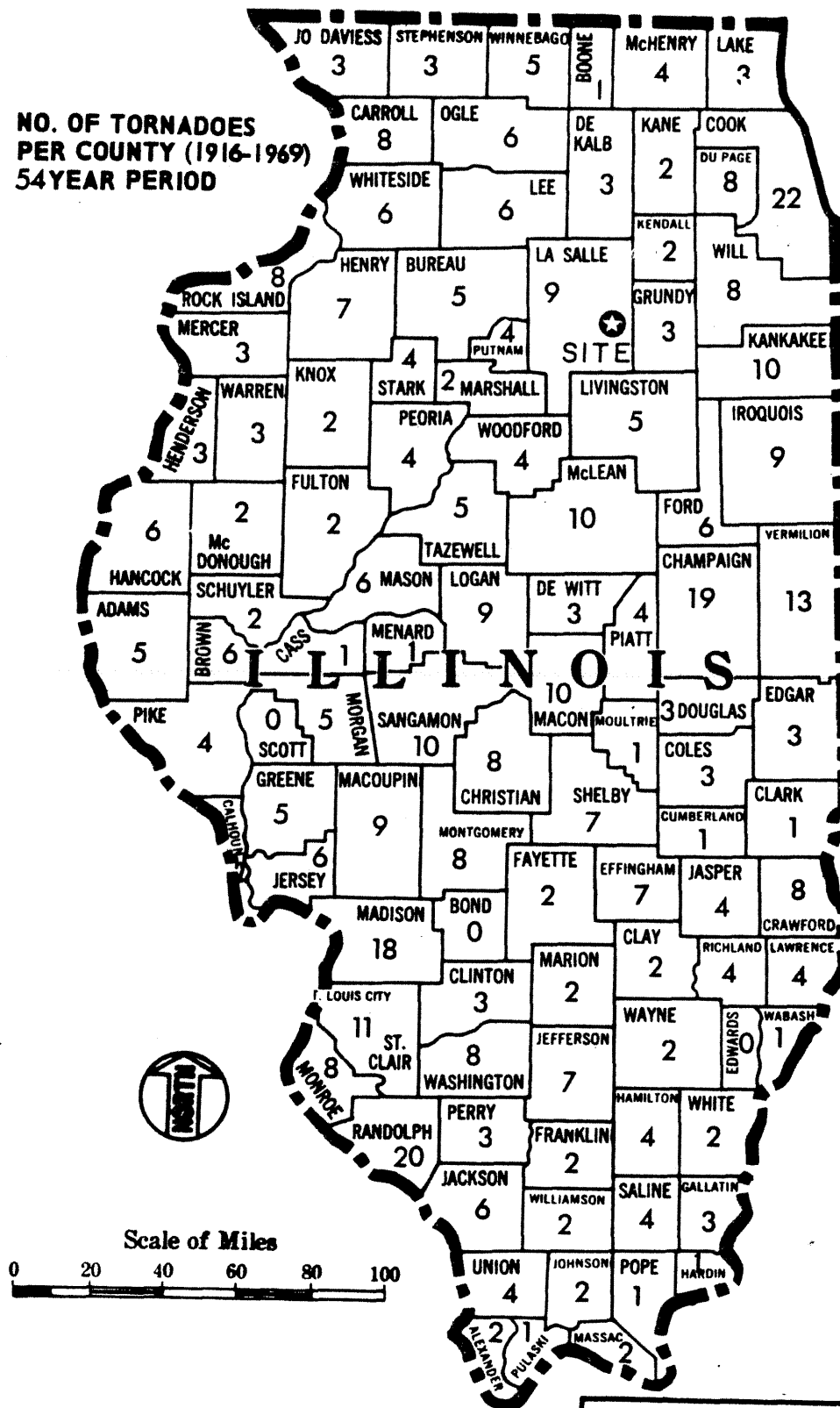

**LA SALLE COUNTY STATION
UPDATED FINAL SAFETY ANALYSIS REPORT**

— FIGURE 2.3-1
NUMBER OF TORNADOES PER COUNTY

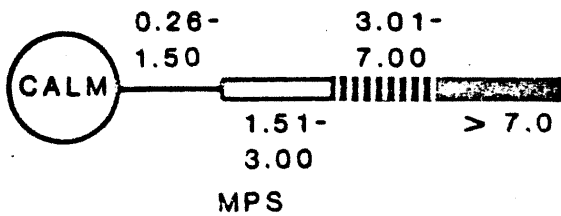
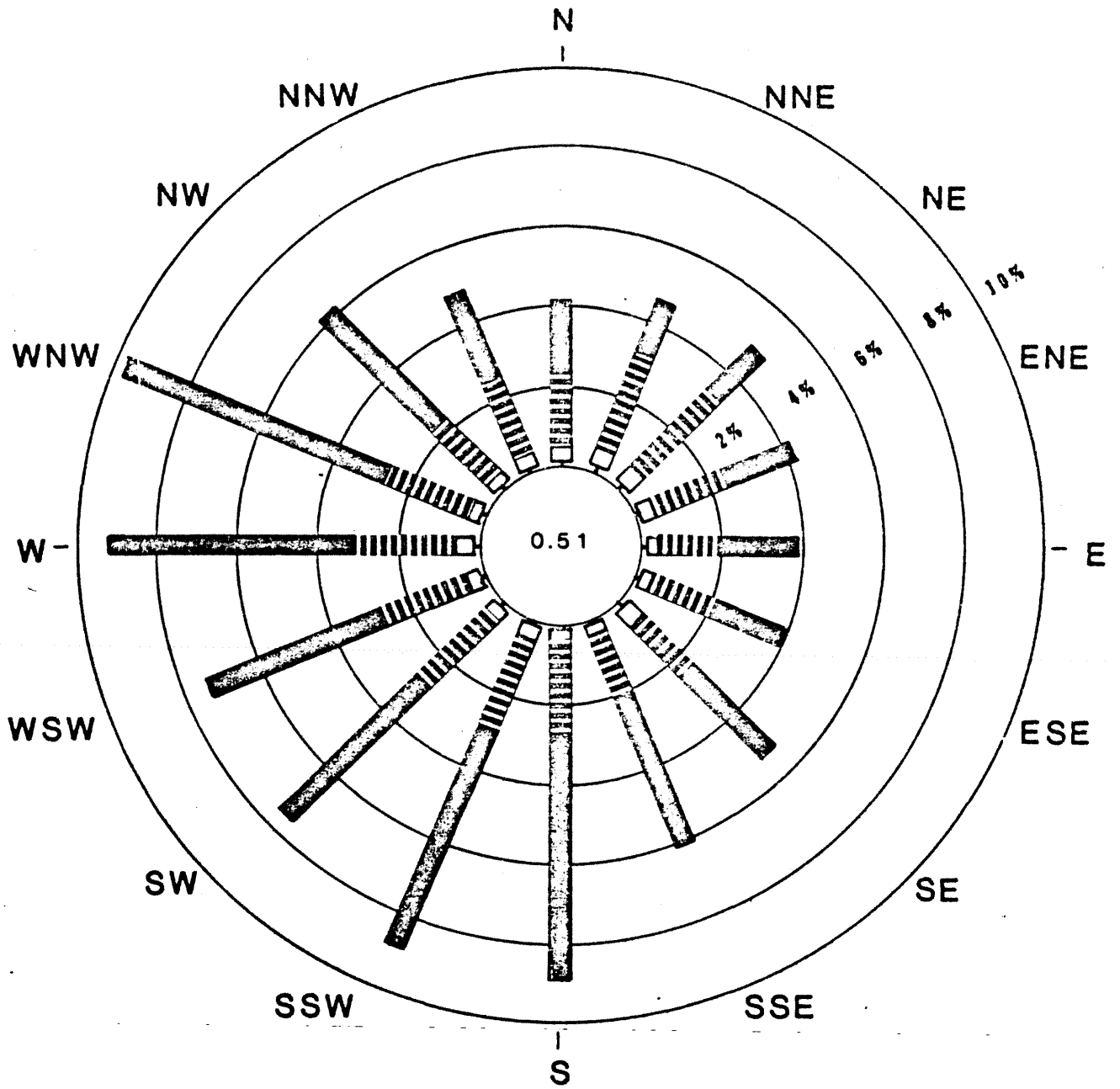

NOTE:
 ANNUAL VALUES BASED ON
 DATA COLLECTED OCTOBER 1, 1976
 THROUGH SEPTEMBER 30, 1978

LA SALLE COUNTY STATION
 UPDATED FINAL SAFETY ANALYSIS REPORT

FIGURE 2.3-2
 ANNUAL WIND ROSE 375-FOOT LEVEL

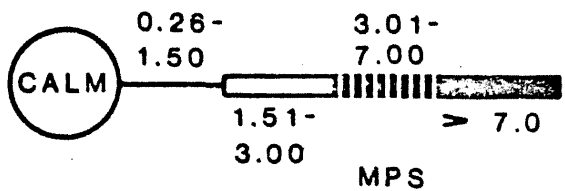
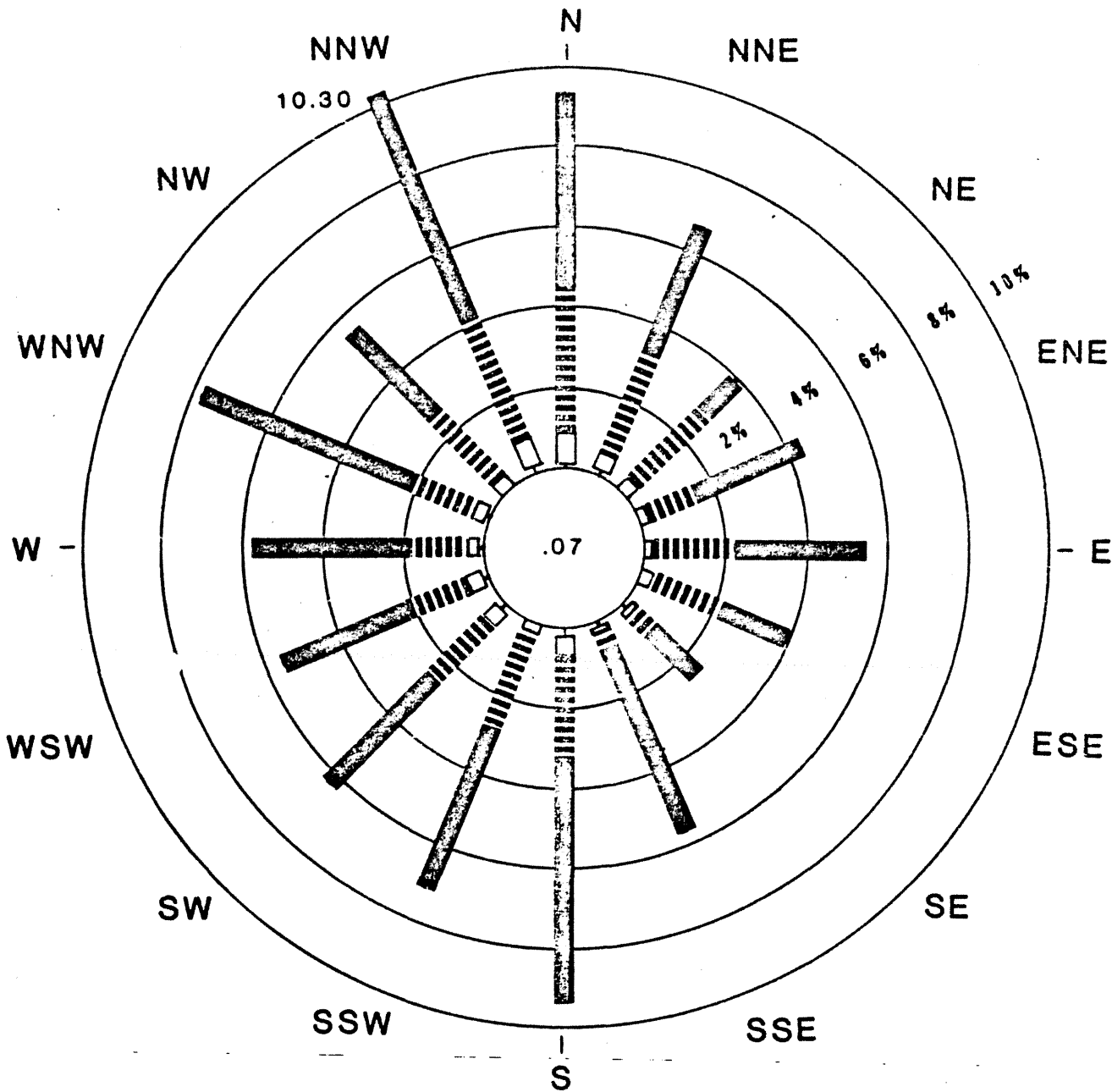

LA SALLE COUNTY STATION
 UPDATED FINAL SAFETY ANALYSIS REPORT

FIGURE 2.3-3

OCTOBER 1976 AND OCTOBER 1977
 WIND ROSE 375-FOOT LEVEL

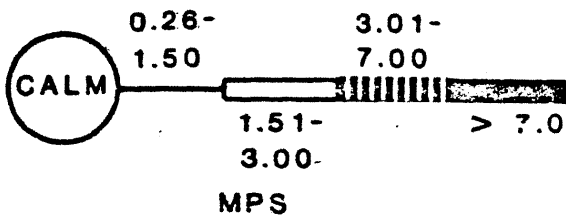
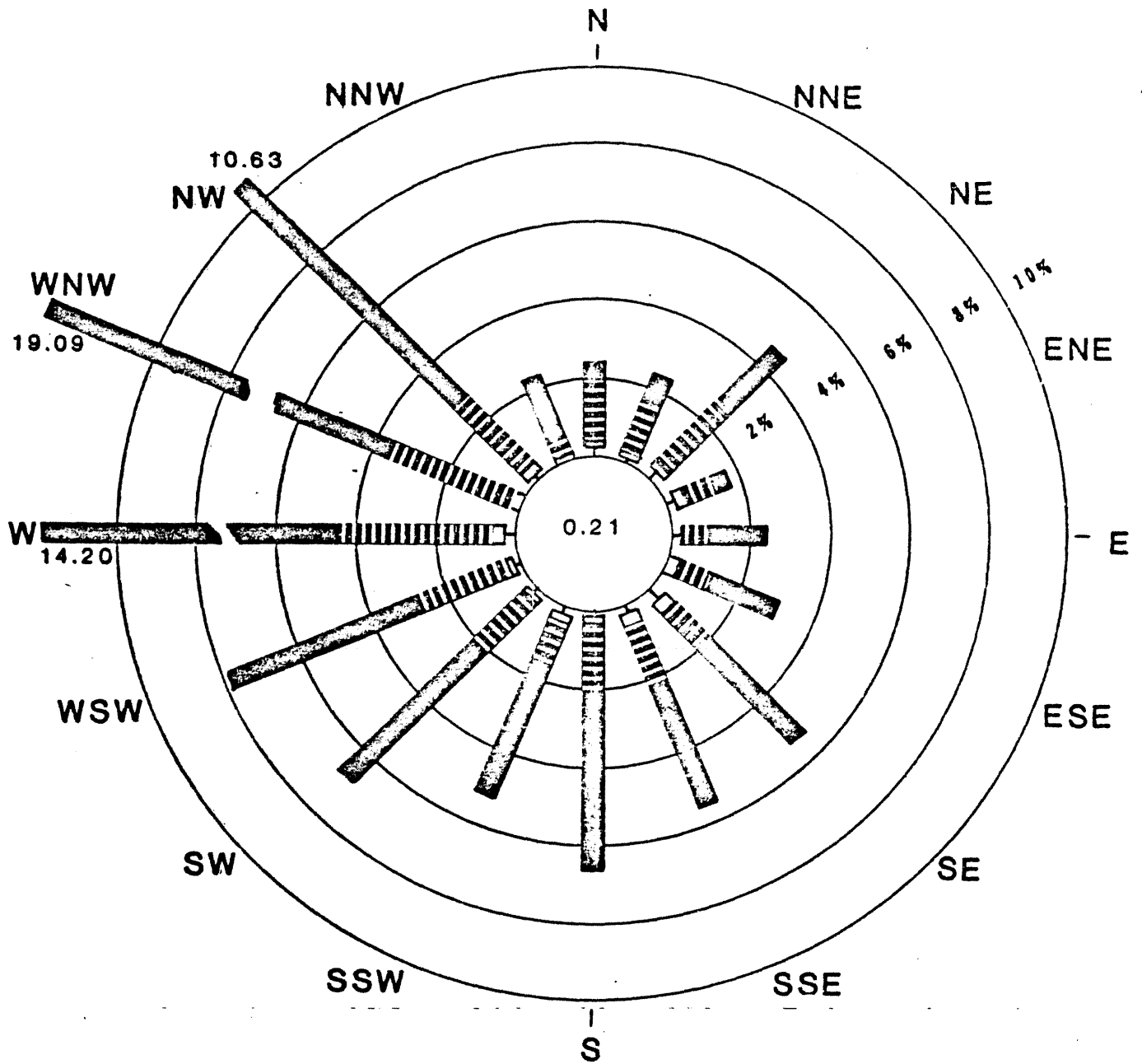

LA SALLE COUNTY STATION
 UPDATED FINAL SAFETY ANALYSIS REPORT

FIGURE 2.3-4

NOVEMBER 1976 AND NOVEMBER 1977
 WIND ROSE 375-FOOT LEVEL

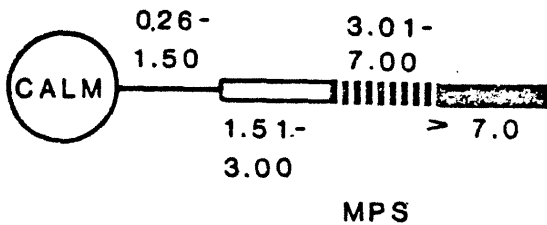
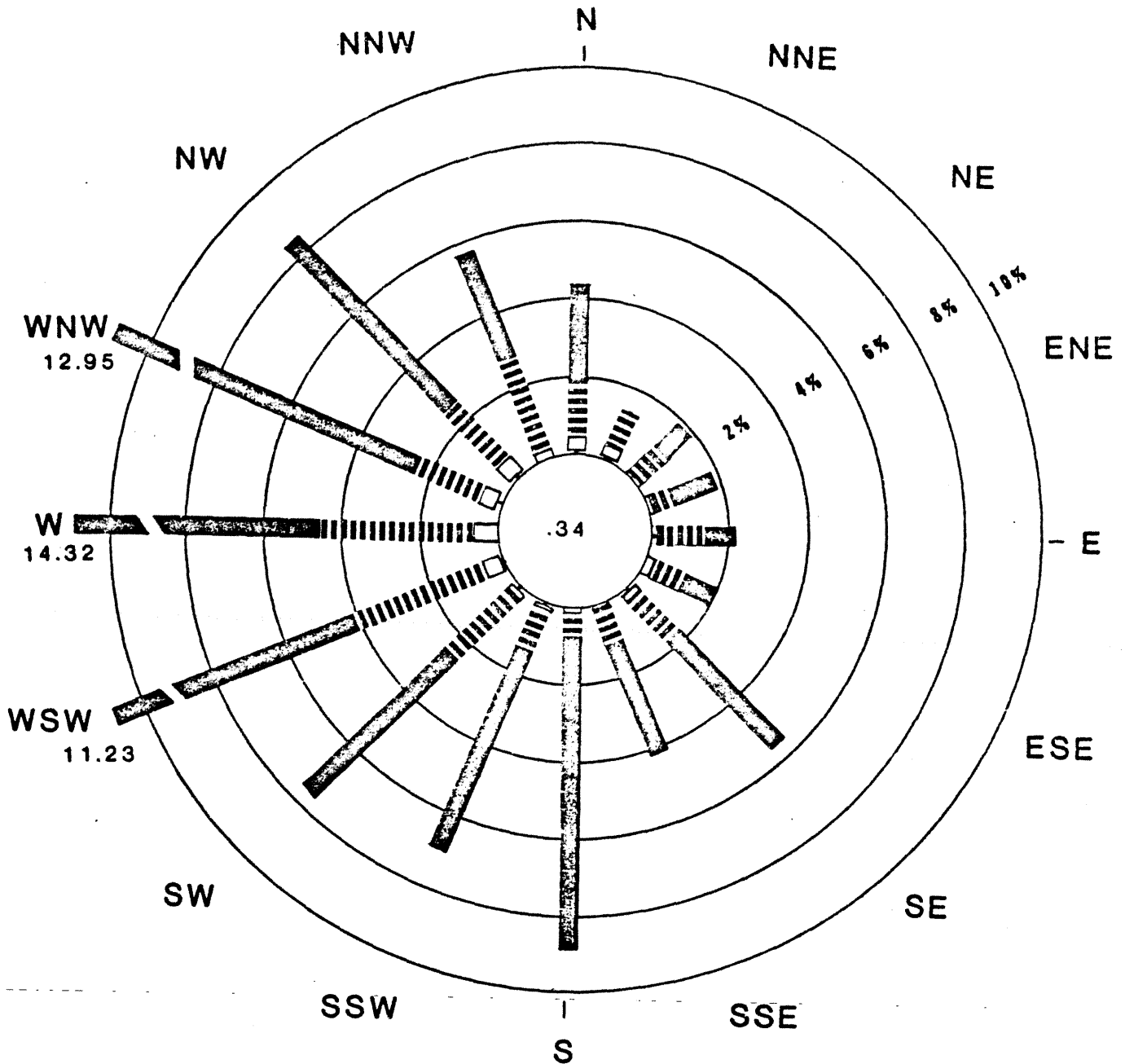

LA SALLE COUNTY STATION
 UPDATED FINAL SAFETY ANALYSIS REPORT

FIGURE 2.3-5

DECEMBER 1976 AND DECEMBER 1977
 WIND ROSE 375-FOOT LEVEL

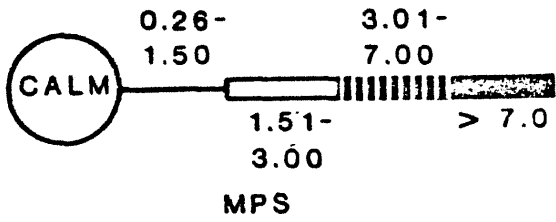
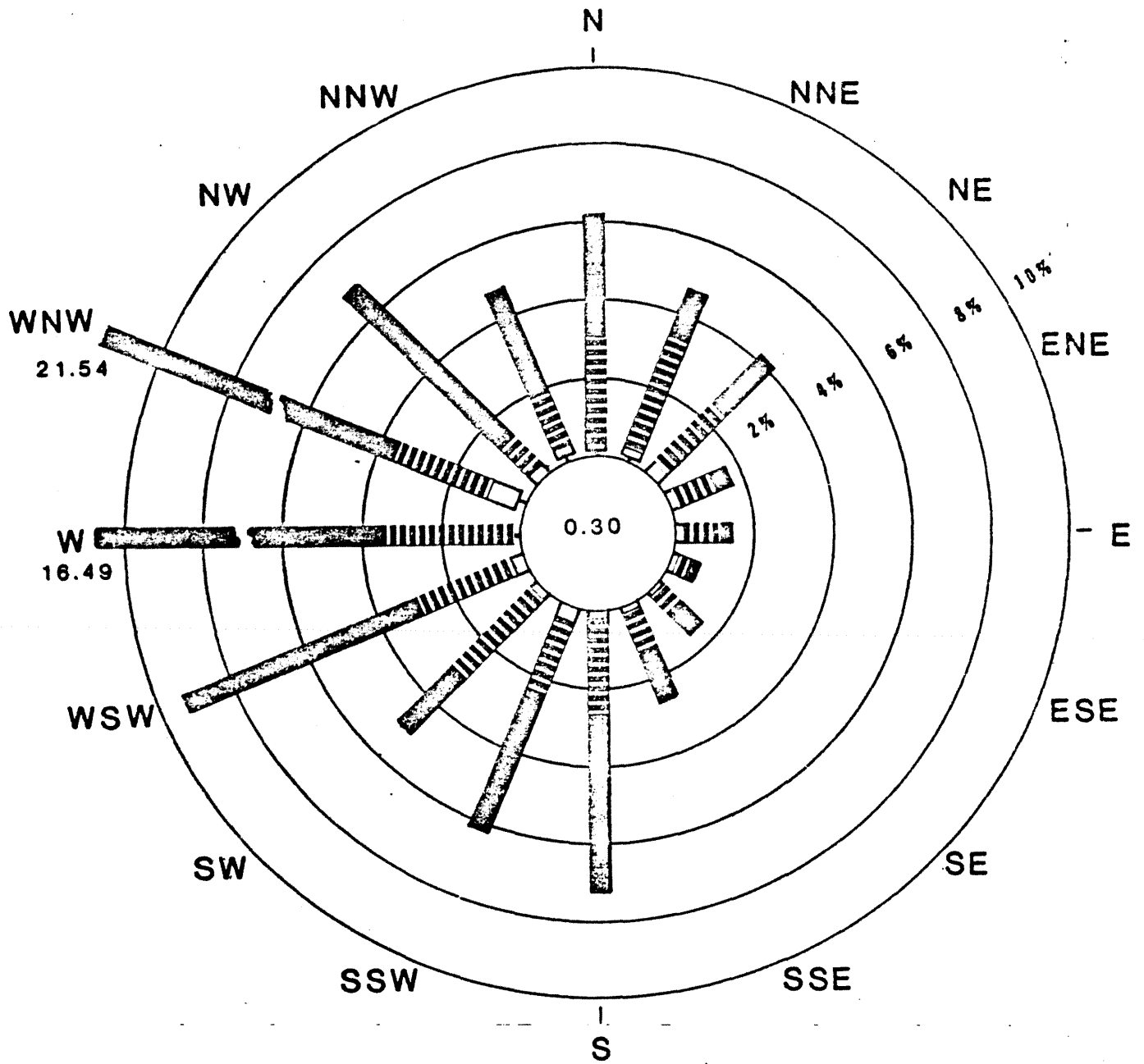

LA SALLE COUNTY STATION
 UPDATED FINAL SAFETY ANALYSIS REPORT

FIGURE 2.3-6

JANUARY 1977 AND JANUARY 1978
 WIND ROSE 375-FOOT LEVEL

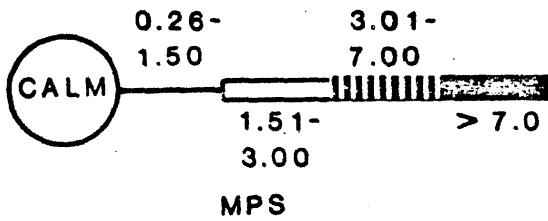
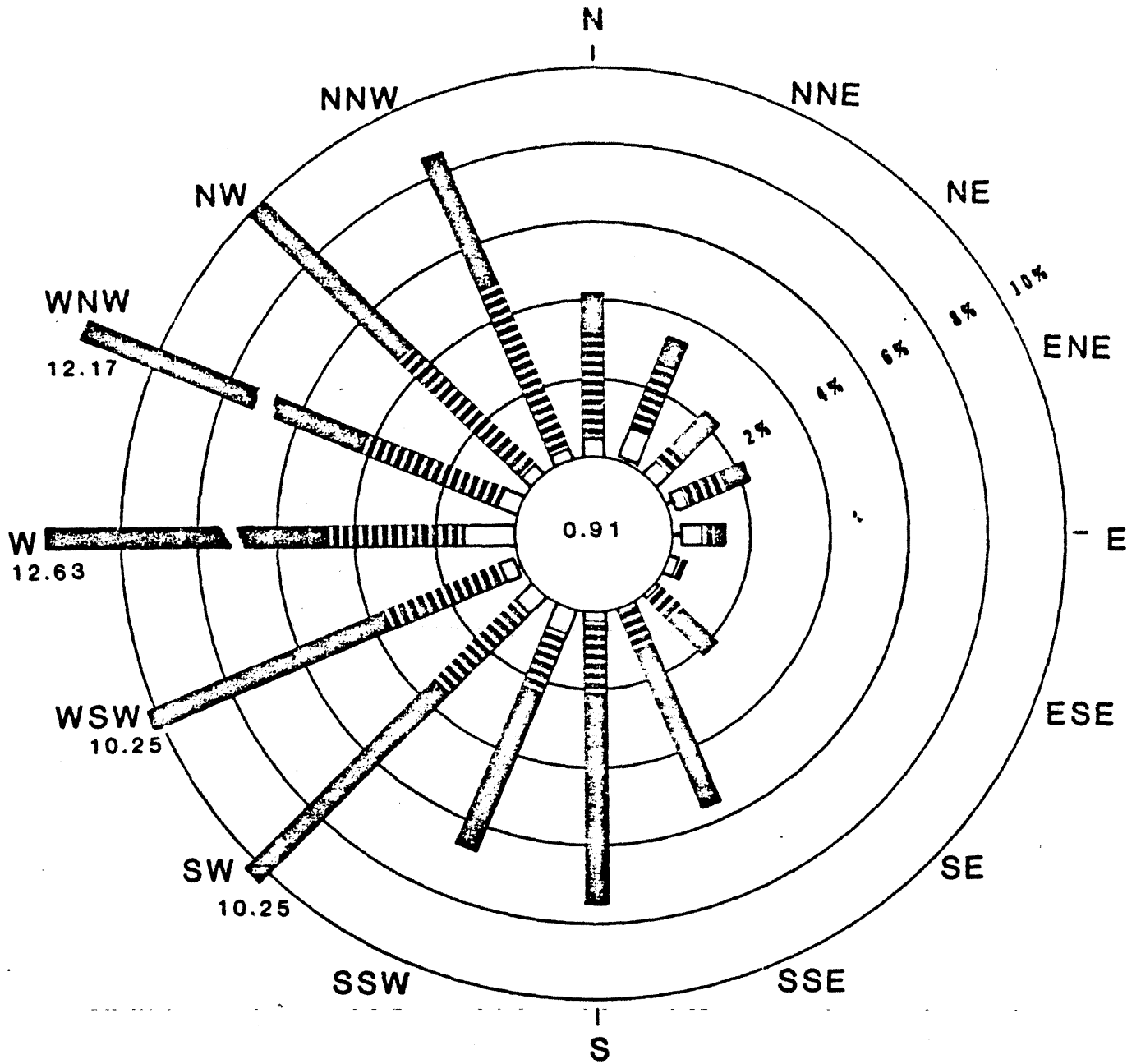

LA SALLE COUNTY STATION
 UPDATED FINAL SAFETY ANALYSIS REPORT

FIGURE 2.3-7

FEBRUARY 1977 AND FEBRUARY 1978
 WIND ROSE 375-FOOT LEVEL

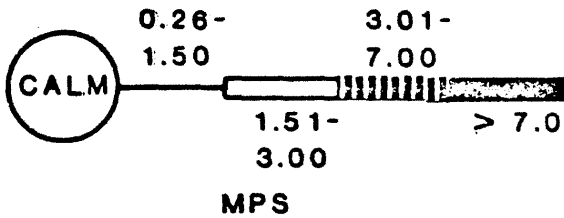
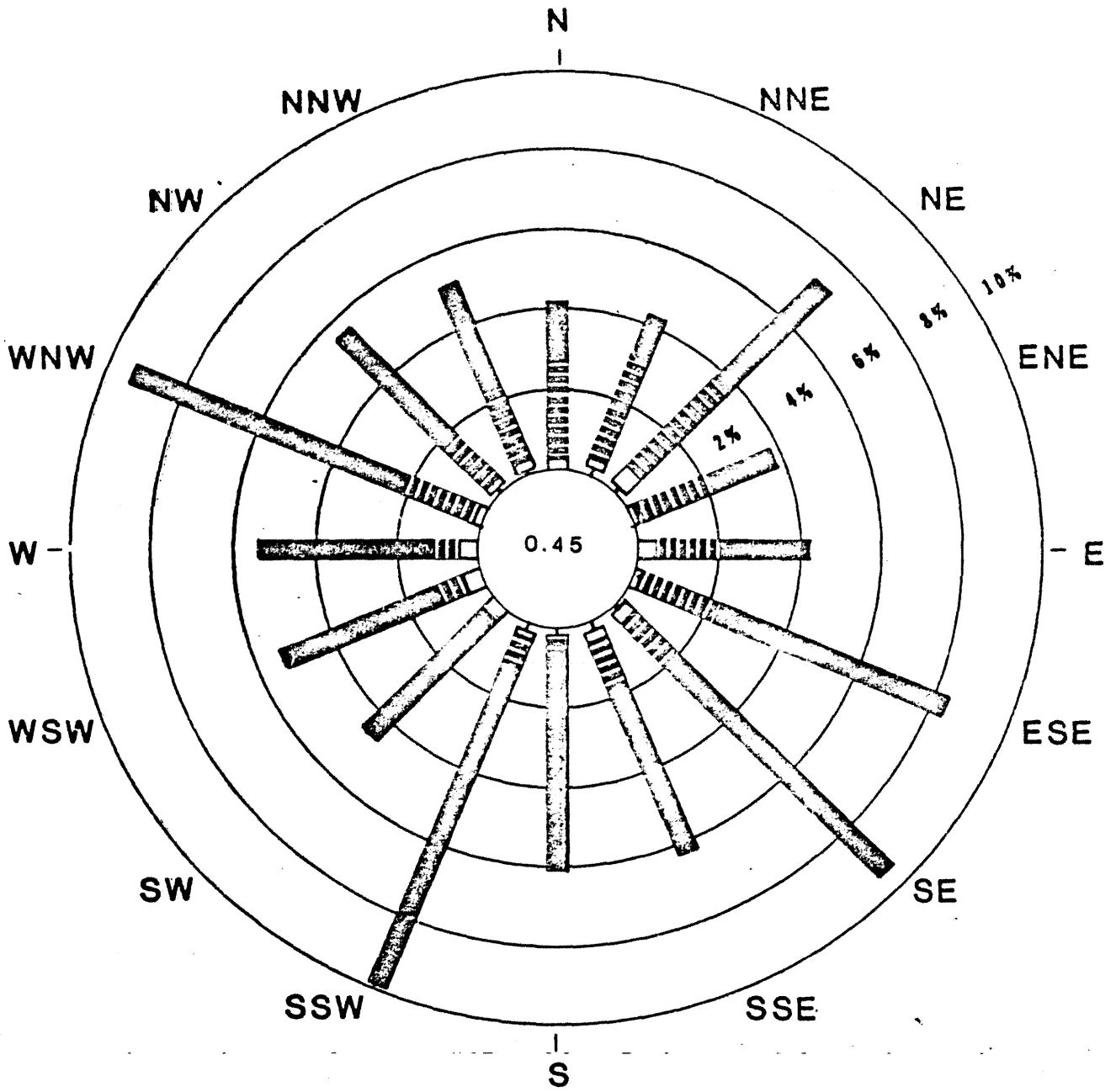

LA SALLE COUNTY STATION
 UPDATED FINAL SAFETY ANALYSIS REPORT

FIGURE 2.3-8

MARCH 1977 AND MARCH 1978
 WIND ROSE 375-FOOT LEVEL

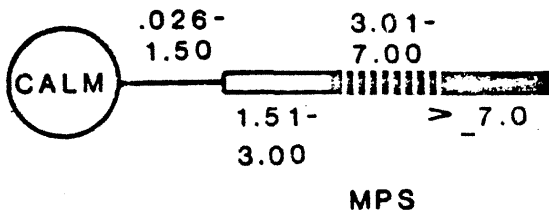
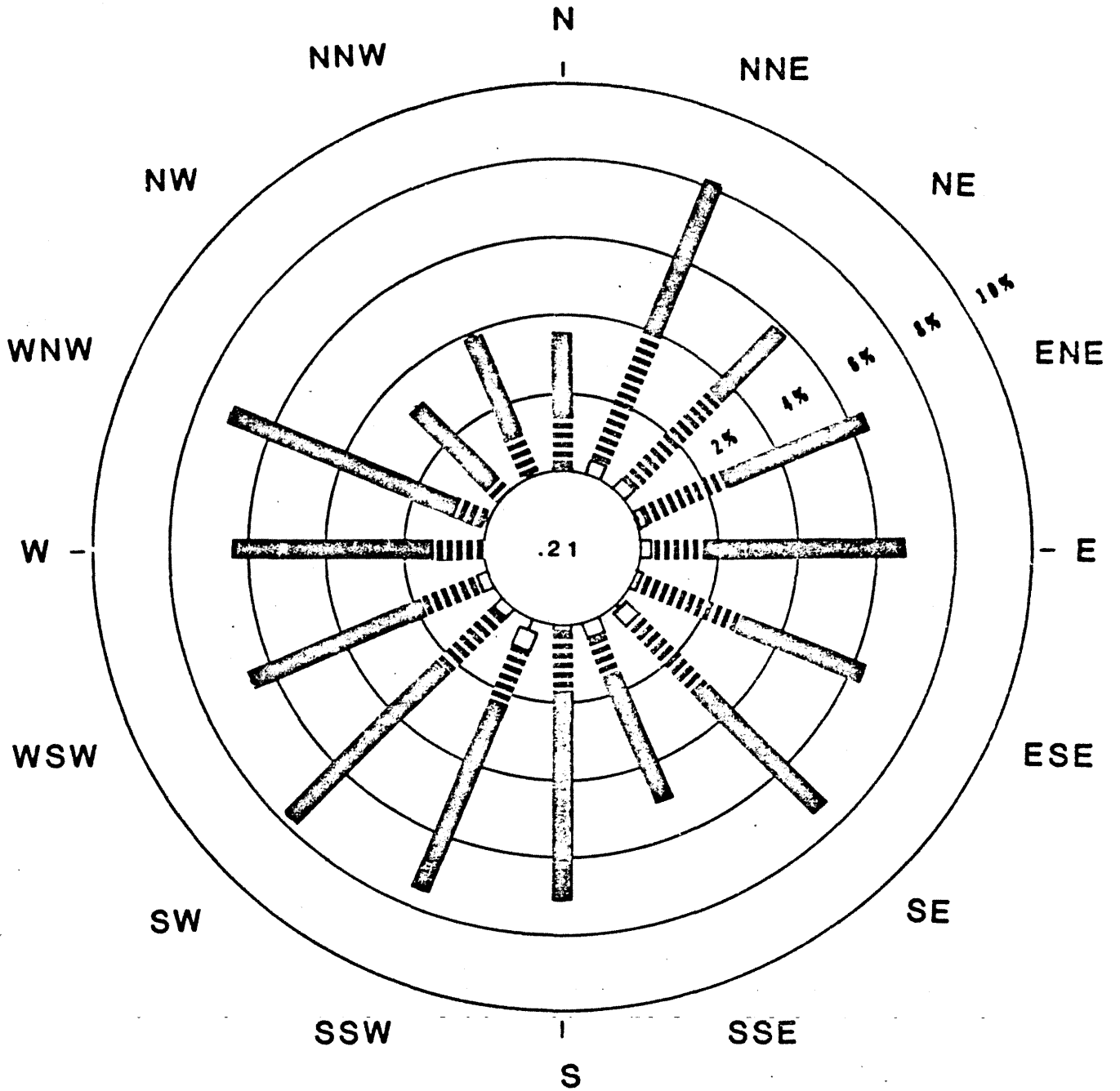

LA SALLE COUNTY STATION
 UPDATED FINAL SAFETY ANALYSIS REPORT
 FIGURE 2.3-9
 APRIL 1977 AND APRIL 1978
 WIND ROSE 375-FOOT LEVEL

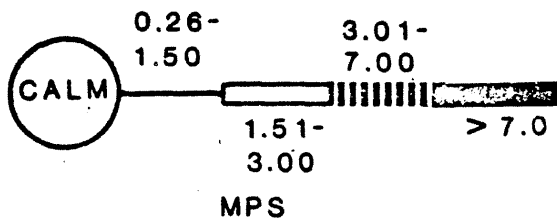
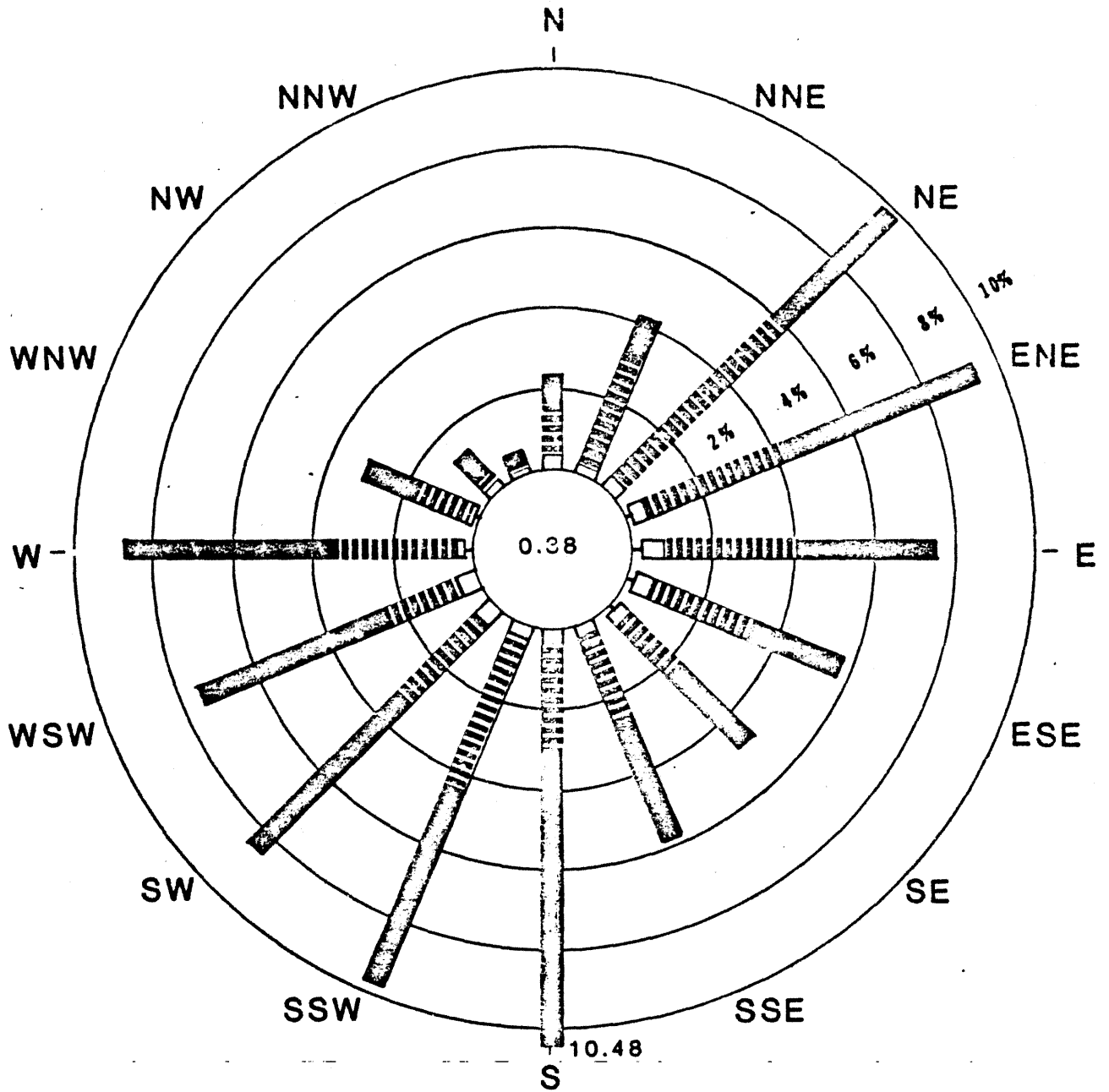

LA SALLE COUNTY STATION
 UPDATED FINAL SAFETY ANALYSIS REPORT

FIGURE 2.3-10

MAY 1977 AND MAY 1978
 WIND ROSE 375-FOOT LEVEL

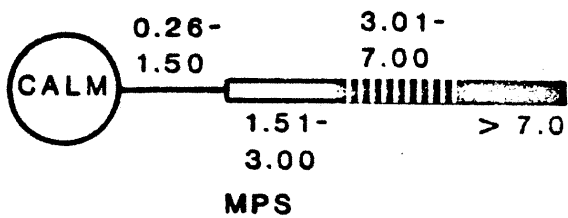
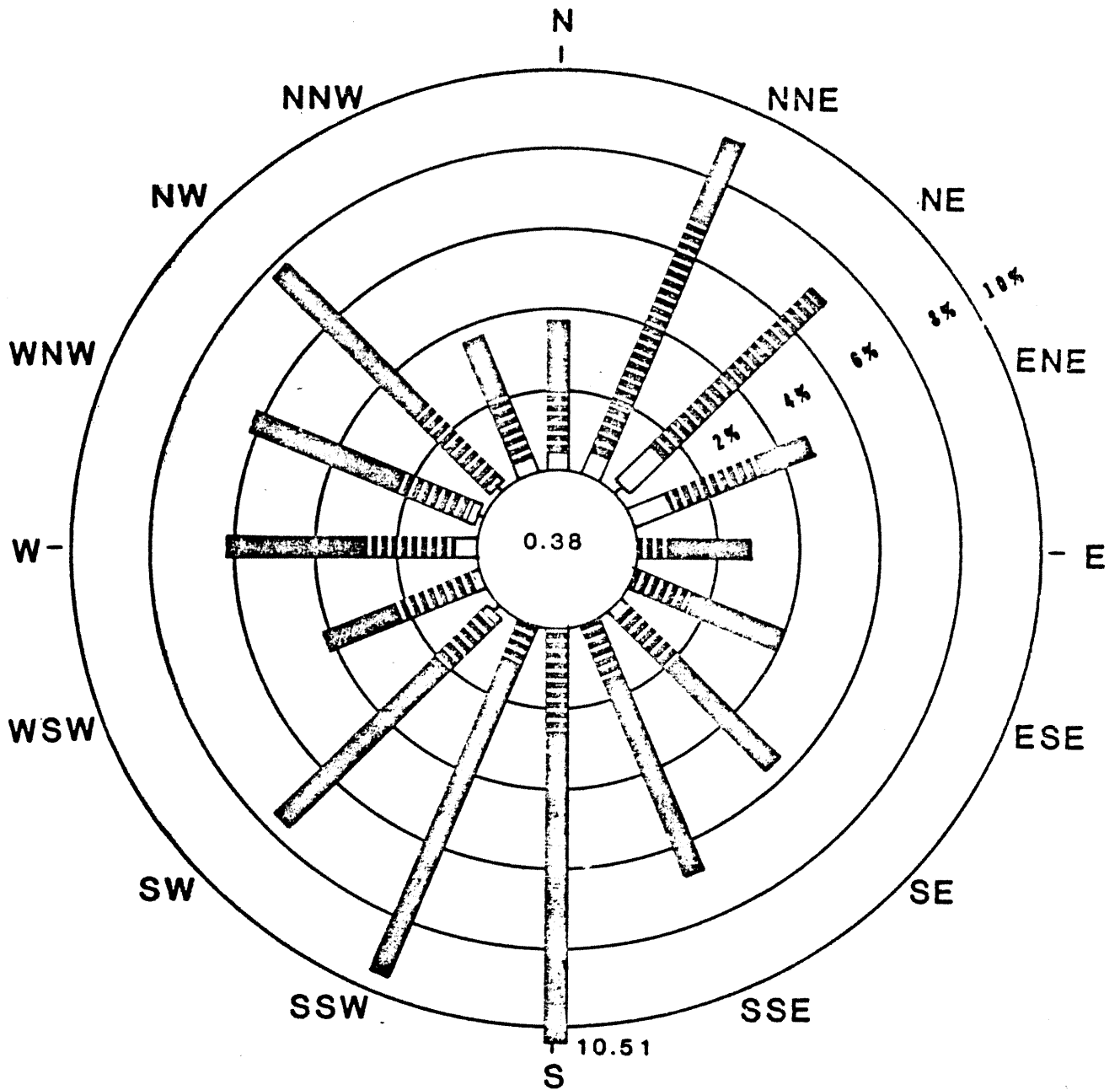

LA SALLE COUNTY STATION
 UPDATED FINAL SAFETY ANALYSIS REPORT

FIGURE 2.3-11

JUNE 1977 AND JUNE 1978
 WIND ROSE 375-FOOT LEVEL

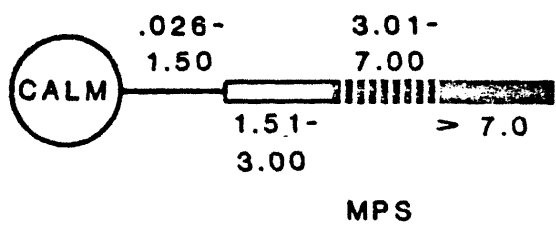
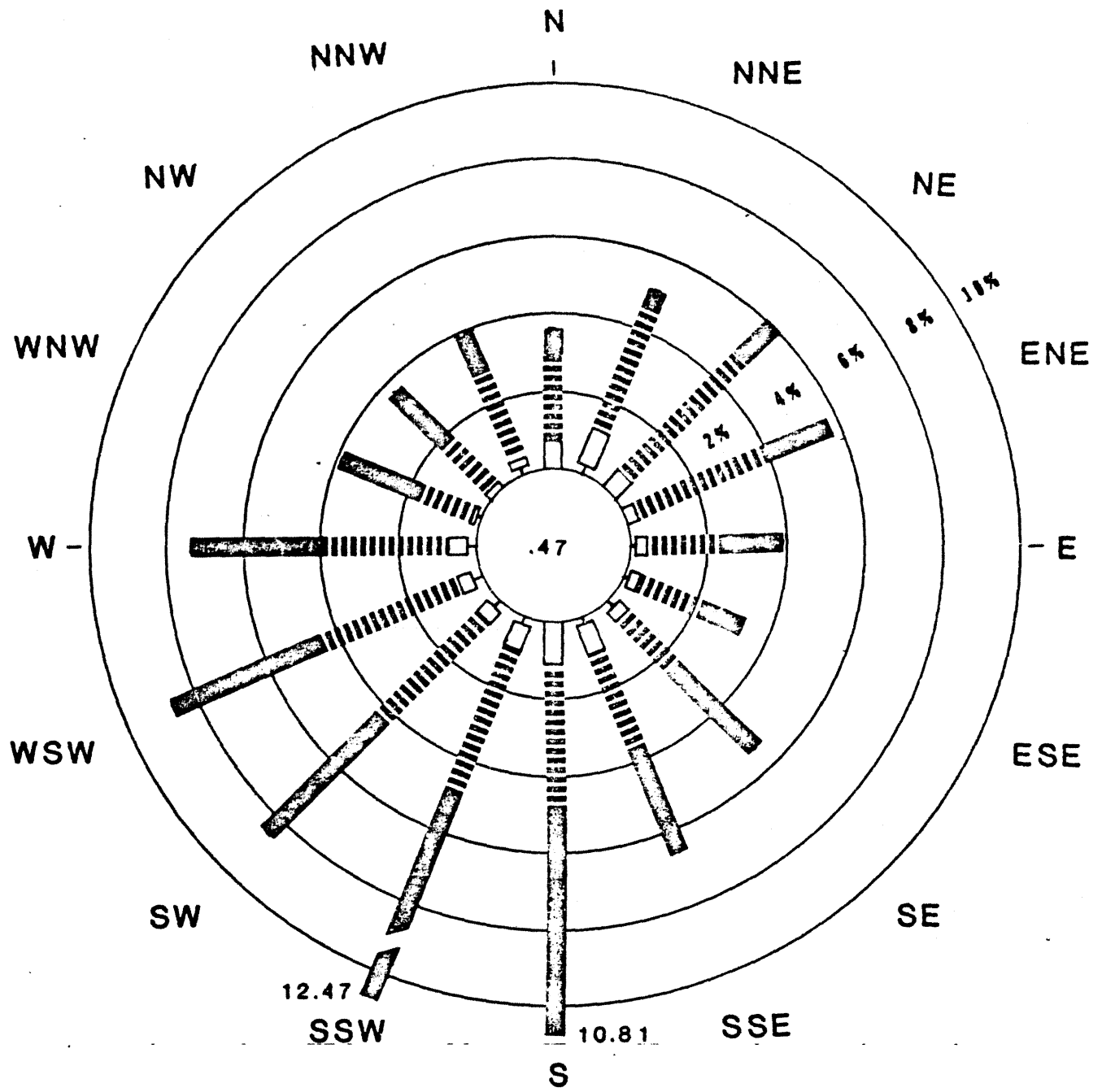

LA SALLE COUNTY STATION
 UPDATED FINAL SAFETY ANALYSIS REPORT

FIGURE 2.3-12

JULY 1977 AND JULY 1978
 WIND ROSE 375-FOOT LEVEL

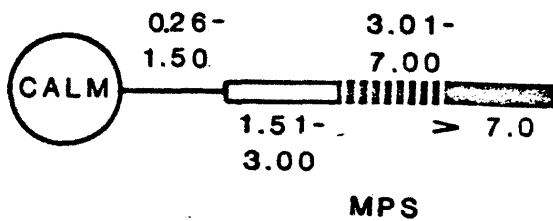
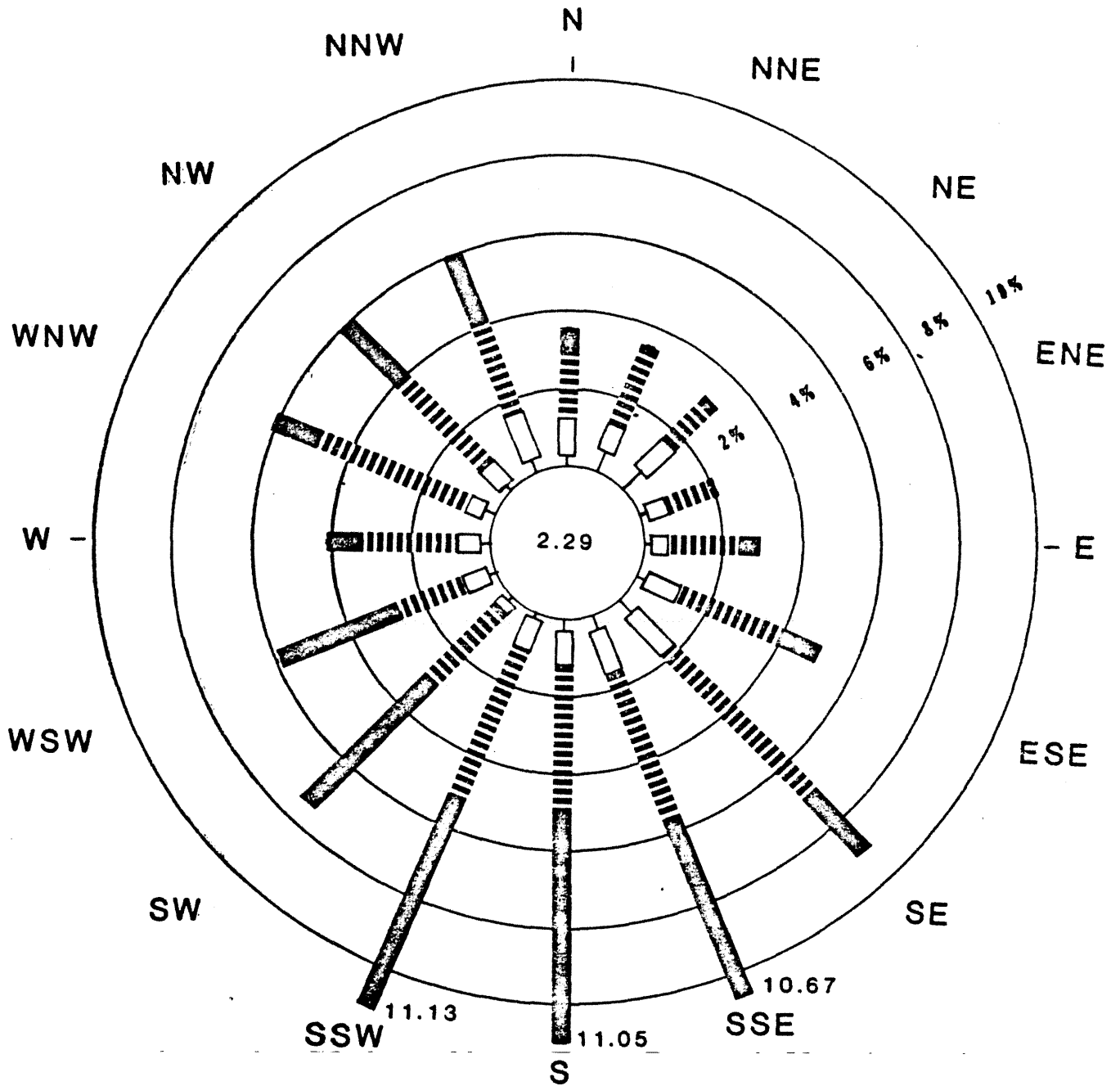

LA SALLE COUNTY STATION
 UPDATED FINAL SAFETY ANALYSIS REPORT

FIGURE 2.3-13

AUGUST 1977 AND AUGUST 1978
 WIND ROSE 375-FOOT LEVEL

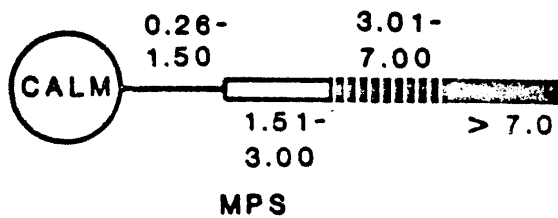
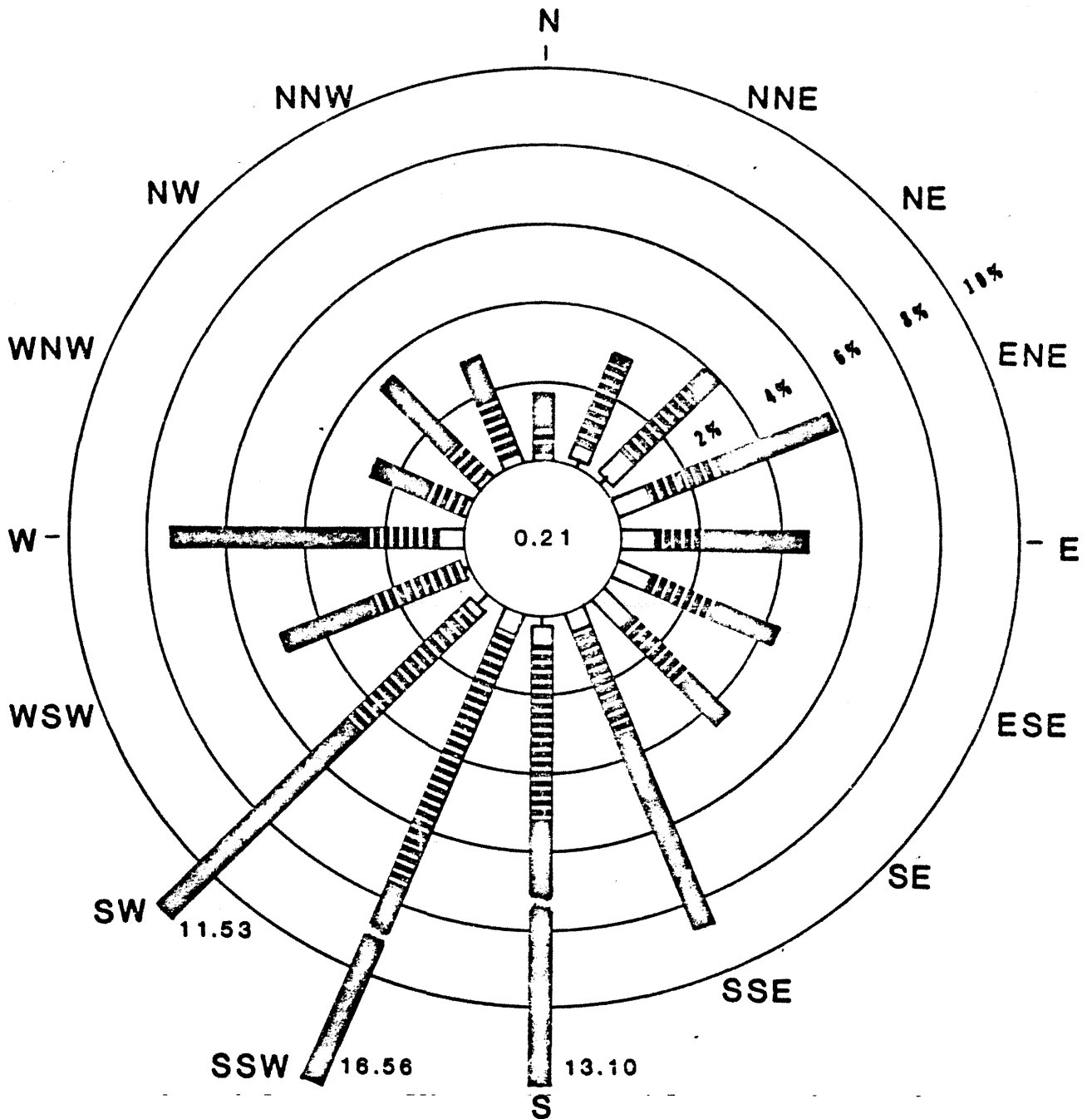

LA SALLE COUNTY STATION
 UPDATED FINAL SAFETY ANALYSIS REPORT

FIGURE 2.3-14

SEPTEMBER 1977 AND SEPTEMBER 1978
 WIND ROSE 375-FOOT LEVEL

PLANT GRADE EL. 710'-0"

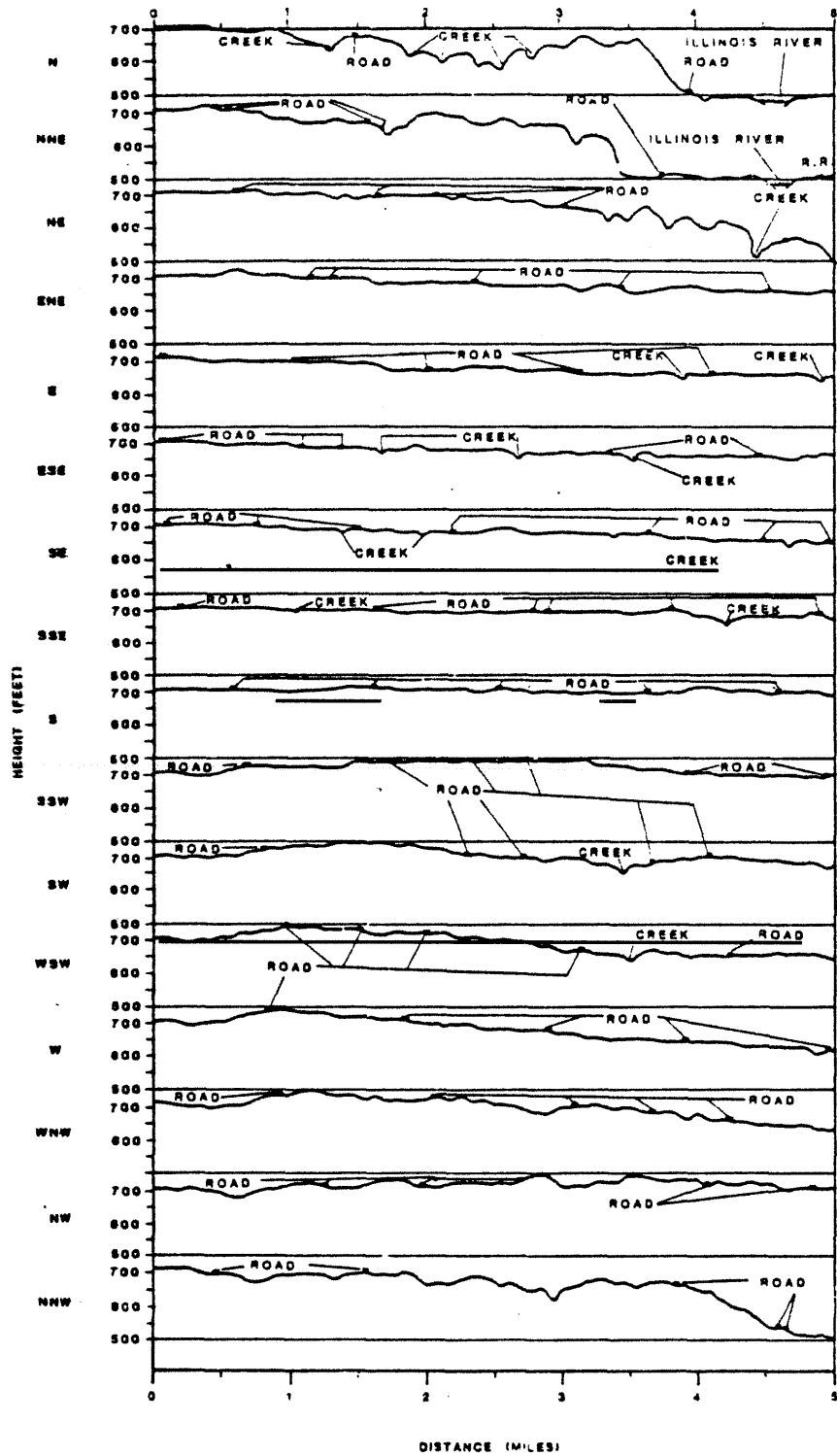

LA SALLE COUNTY STATION
UPDATED FINAL SAFETY ANALYSIS REPORT

FIGURE 2.3-15

TOPOGRAPHIC PROFILES OF THE AREA 0 TO
5 MILES FROM THE LA SALLE COUNTY STATION

REV. 0 - APRIL 1984

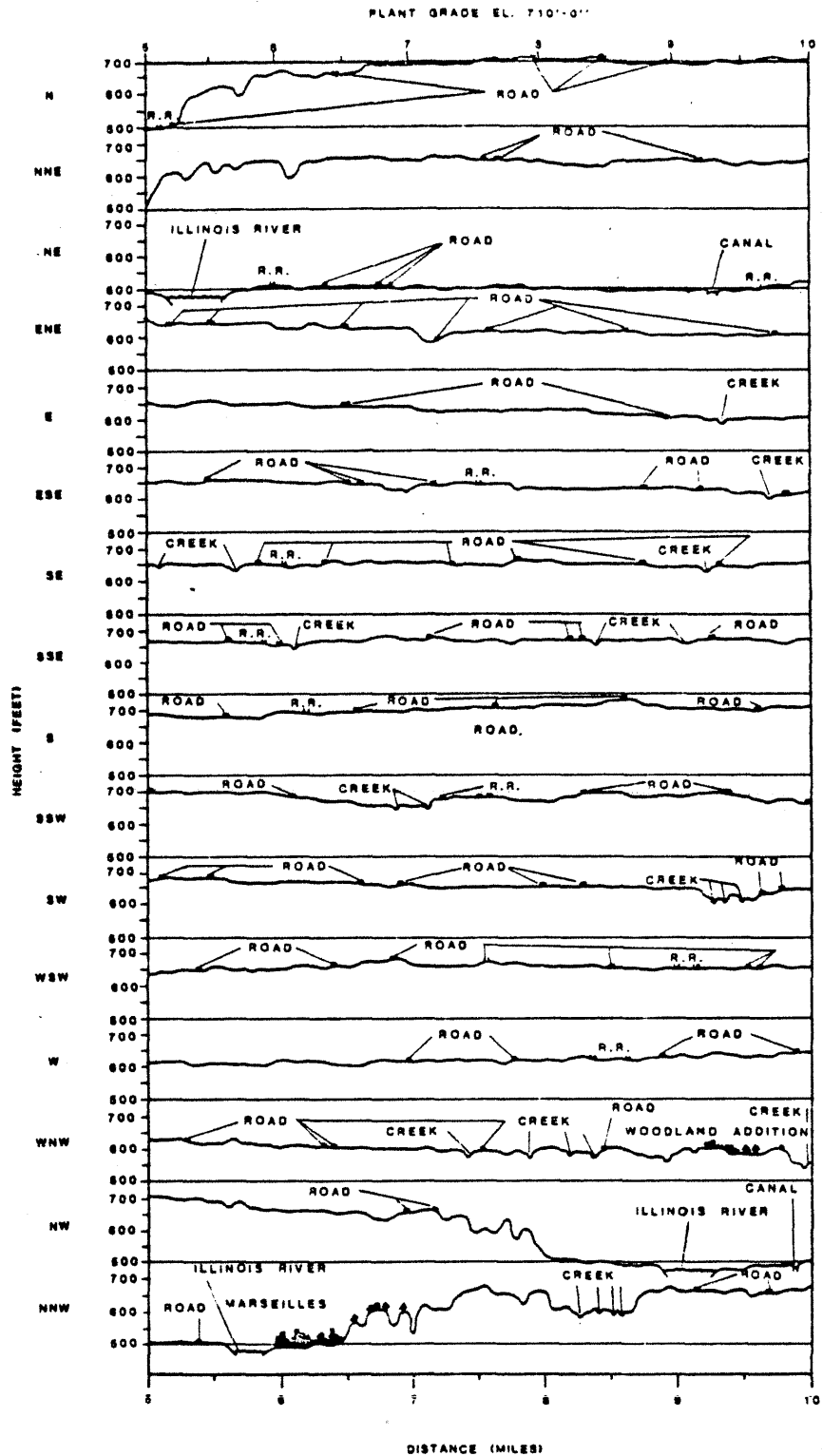

LA SALLE COUNTY STATION
UPDATED FINAL SAFETY ANALYSIS REPORT

FIGURE 2.3-16

TOPOGRAPHIC PROFILES OF THE AREA 5 TO 10
 MILES FROM THE LA SALLE COUNTY STATION

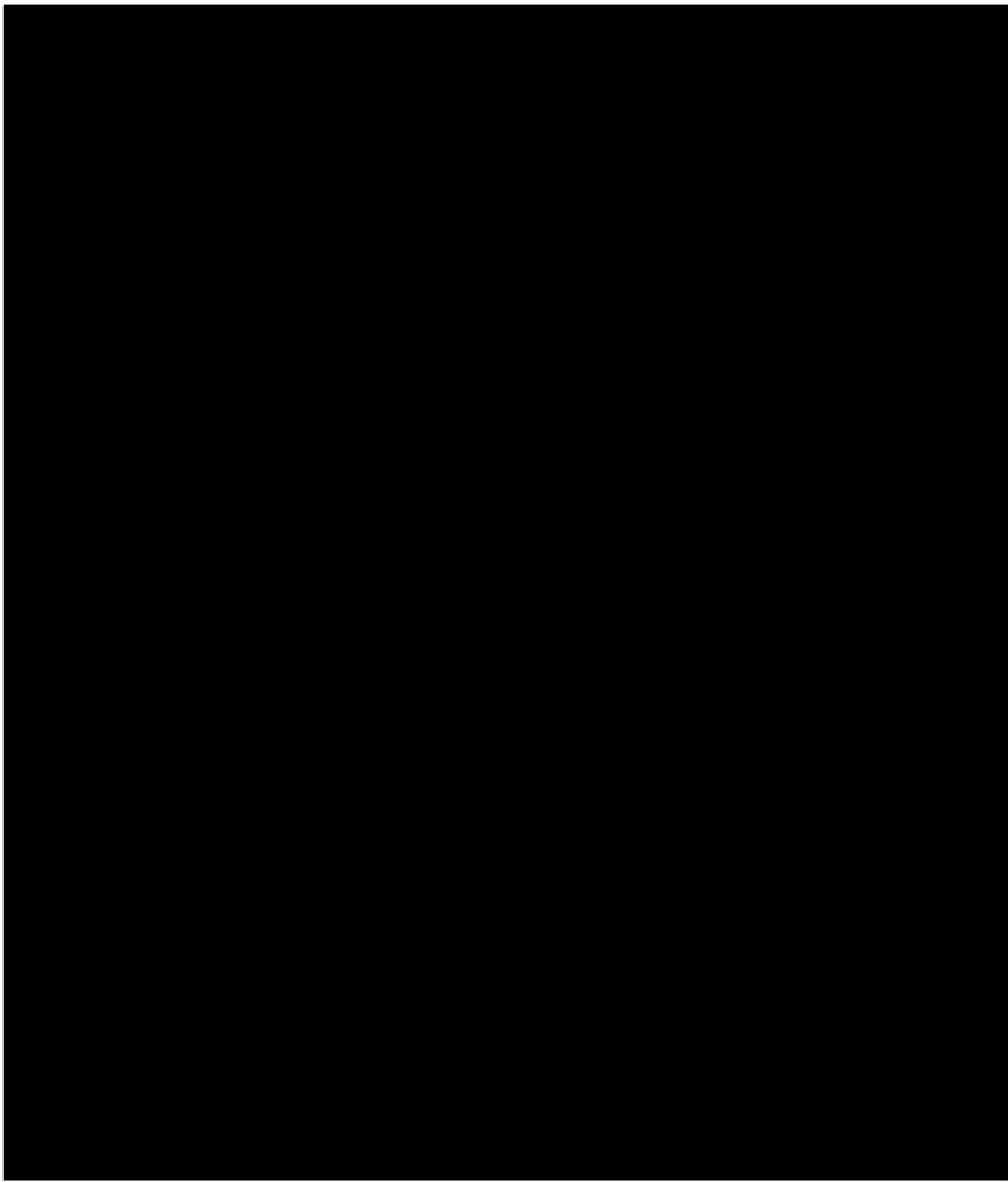

LA SALLE COUNTY STATION
UPDATED FINAL SAFETY ANALYSIS REPORT

FIGURE 2.3-17

TOPOGRAPHIC FEATURES WITHIN A 10-MILE
RADIUS OF THE LA SALLE COUNTY STATION

REV. 0 - APRIL 1984

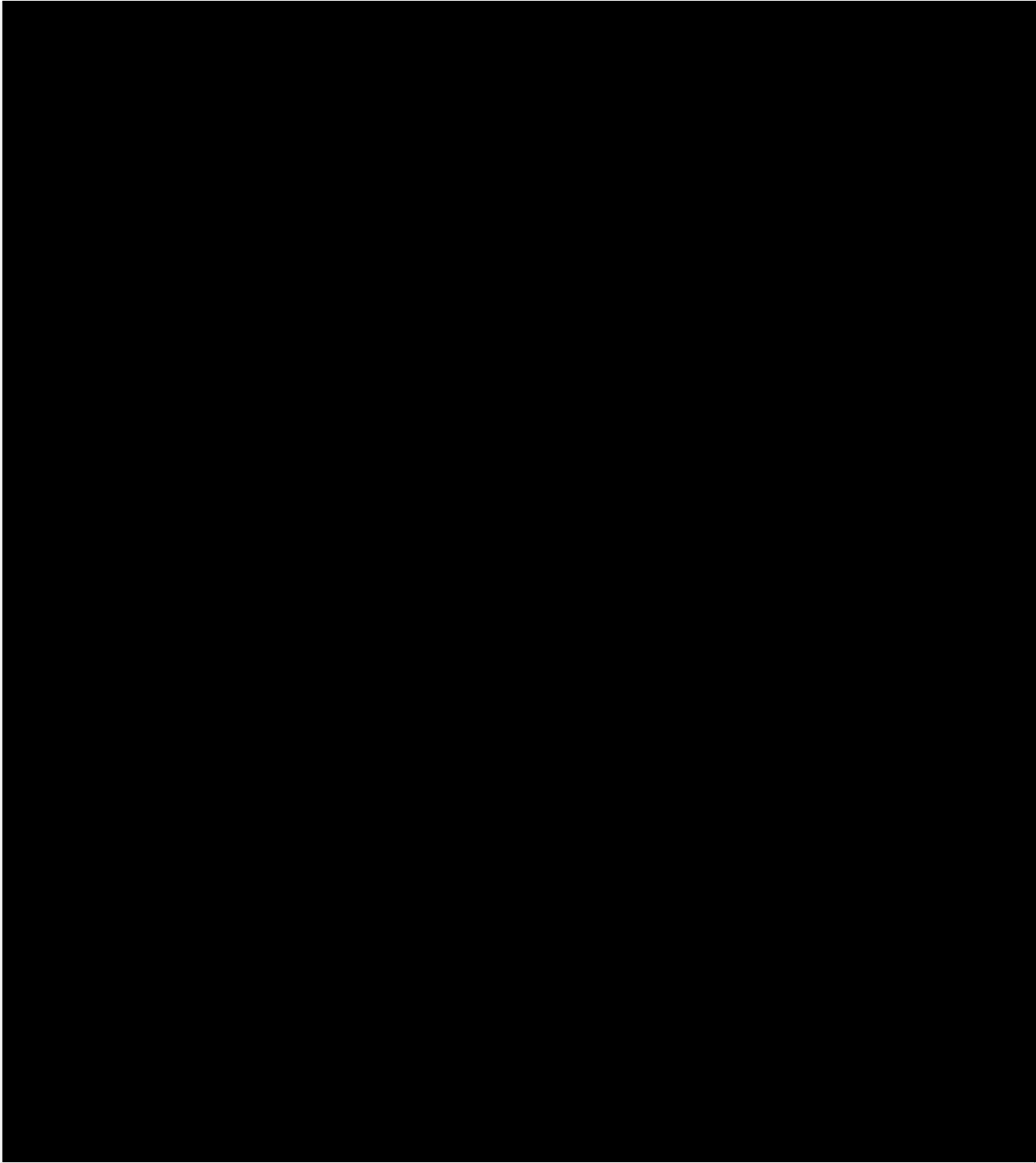

**LA SALLE COUNTY STATION
UPDATED FINAL SAFETY ANALYSIS REPORT**

**FIGURE 2.4-1
SITE LOCATION PLAN**

REV. 0 - APRIL 1984

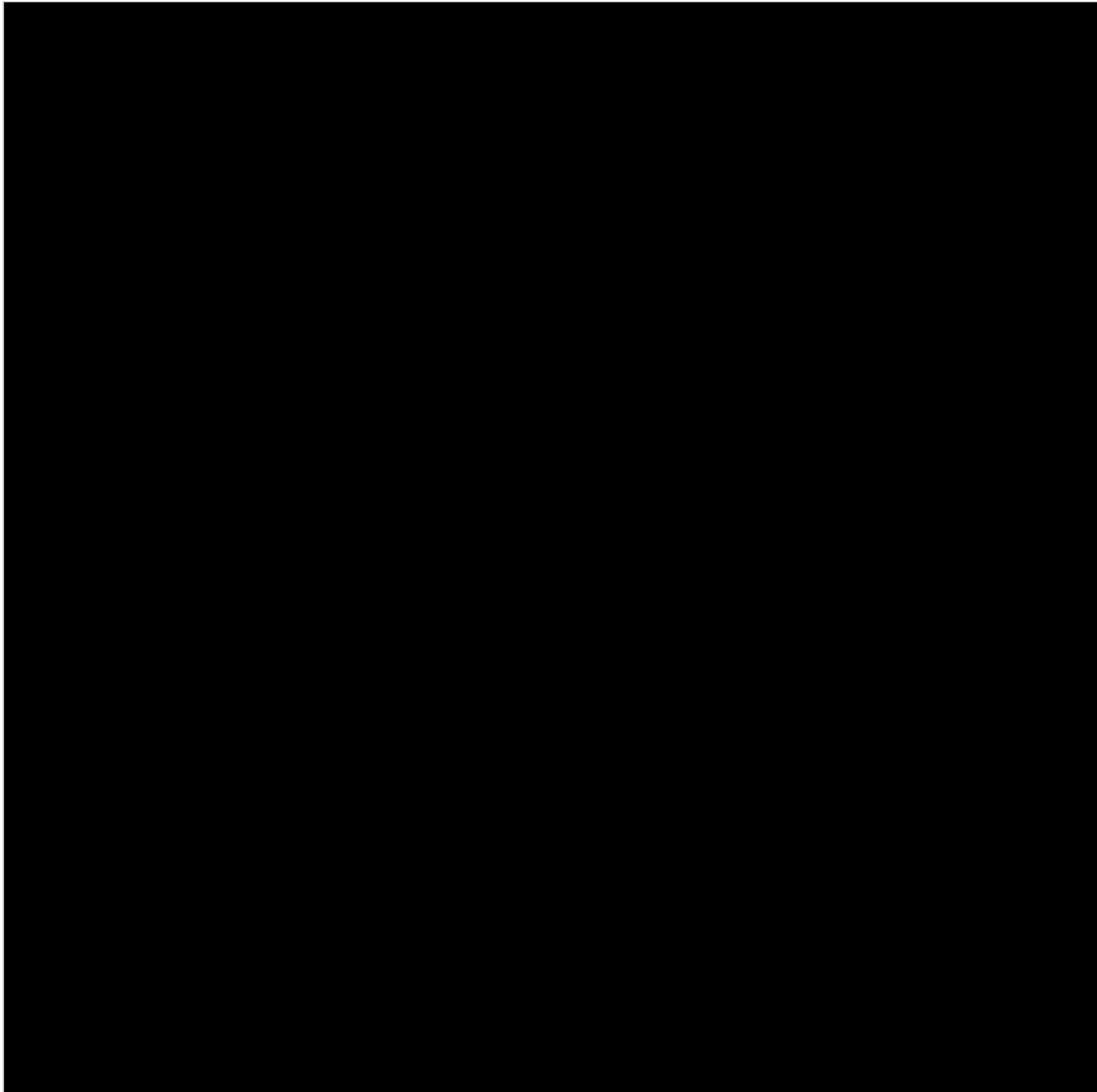

LA SALLE COUNTY STATION
UPDATED FINAL SAFETY ANALYSIS REPORT

FIGURE 2.4-2
HYDROSPHERE

REV. 0 - APRIL 1984

LA SALLE COUNTY STATION
UPDATED FINAL SAFETY ANALYSIS REPORT

FIGURE 2.4-2a

SURFACE WATER BODIES WITHIN A
5-MILE RADIUS OF THE PLANT SITE

REV. 0 - APRIL 1984

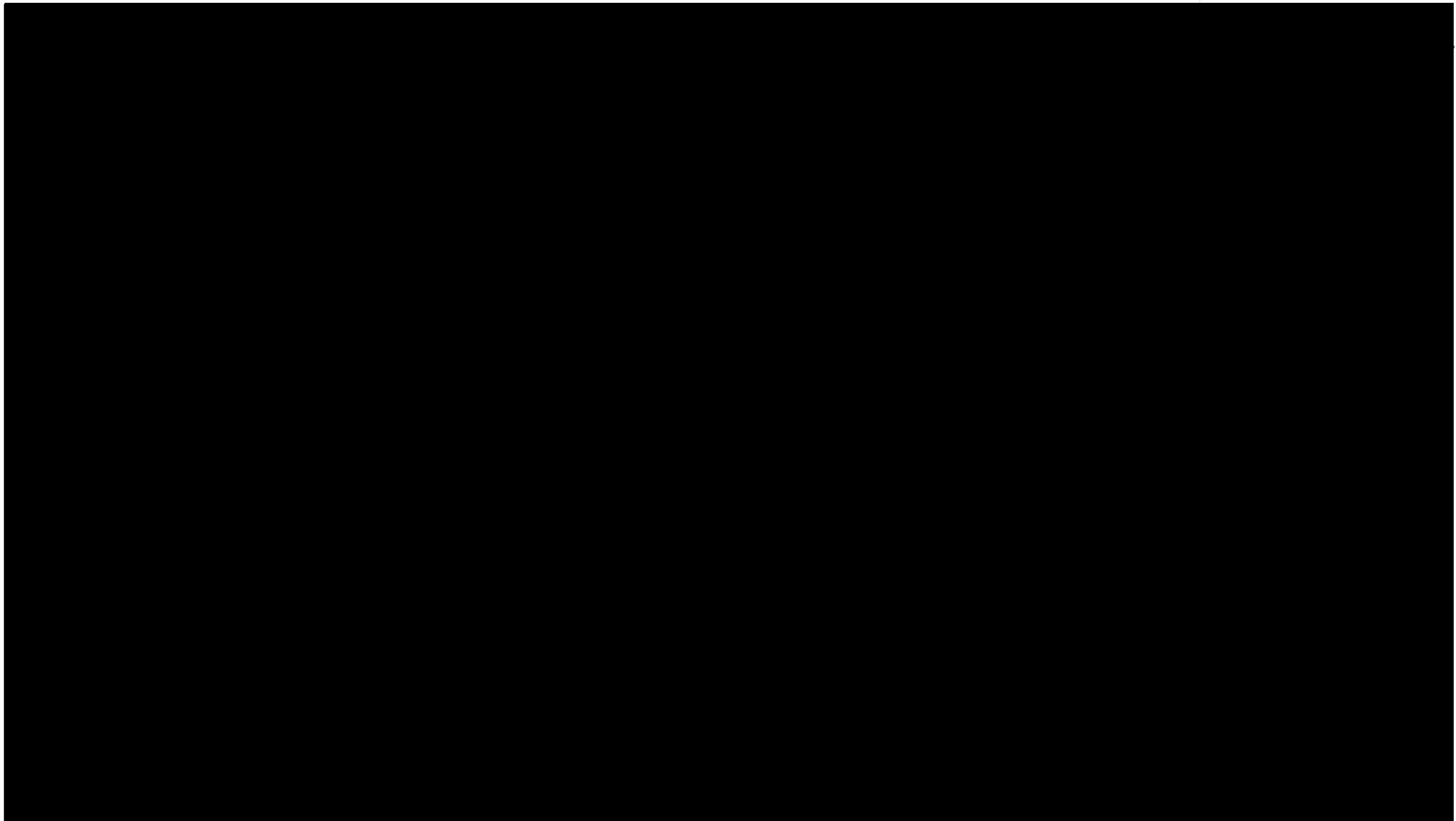

LA SALLE COUNTY STATION
UPDATED FINAL SAFETY ANALYSIS REPORT

FIGURE 2.4-3
GENERAL SITE PLAN

REV. 23 - APRIL 2018

LA SALLE COUNTY STATION
UPDATED FINAL SAFETY ANALYSIS REPORT

FIGURE 2.4-4

DRAINAGE AREA

REV. 0 - APRIL 1984

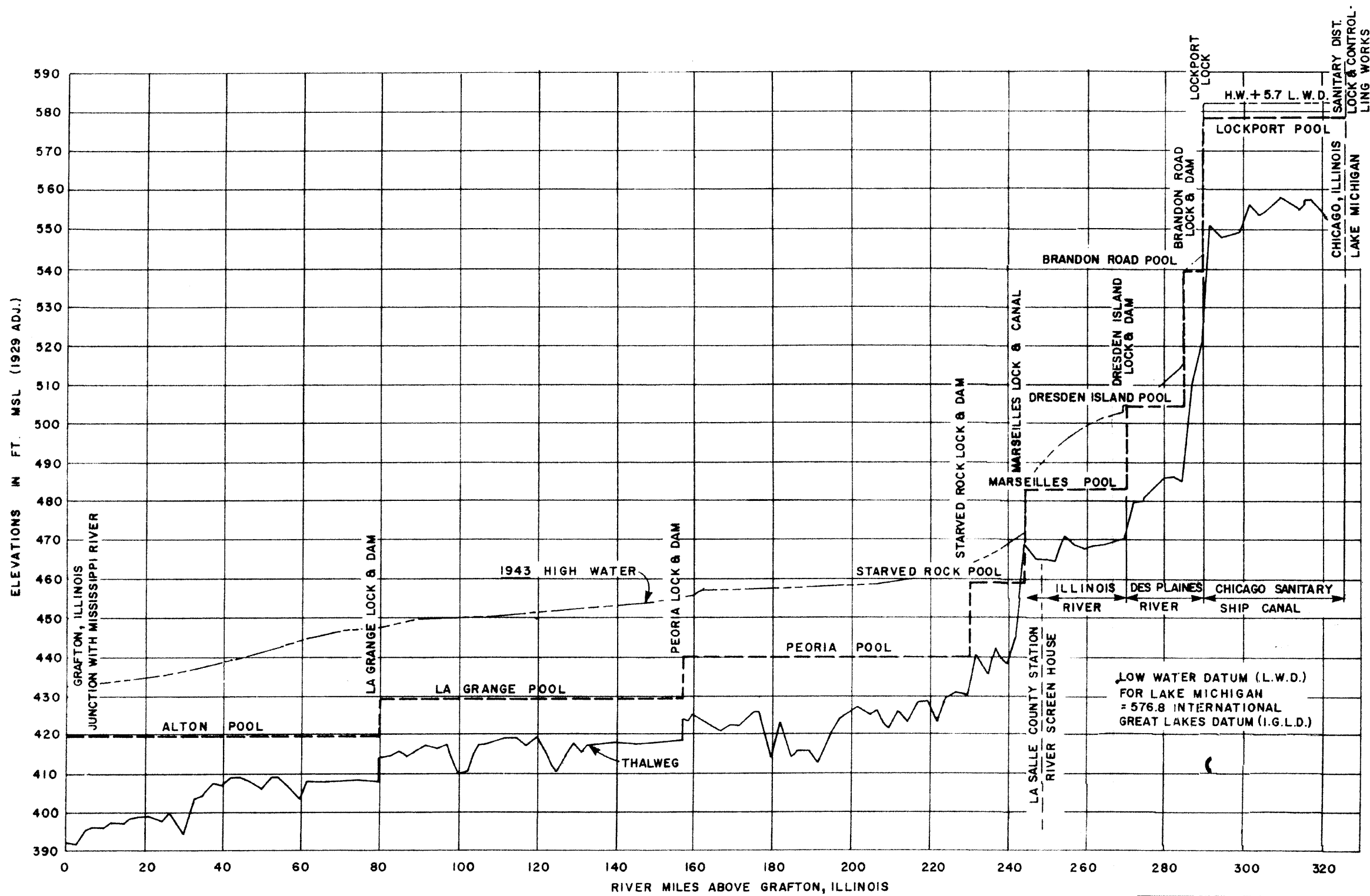

SOURCE: REFERENCE 2.4-1

LA SALLE COUNTY STATION
 UPDATED FINAL SAFETY ANALYSIS REPORT

FIGURE 2.4-5
 ILLINOIS WATERWAY PROFILE

REV. 0 - APRIL 1984

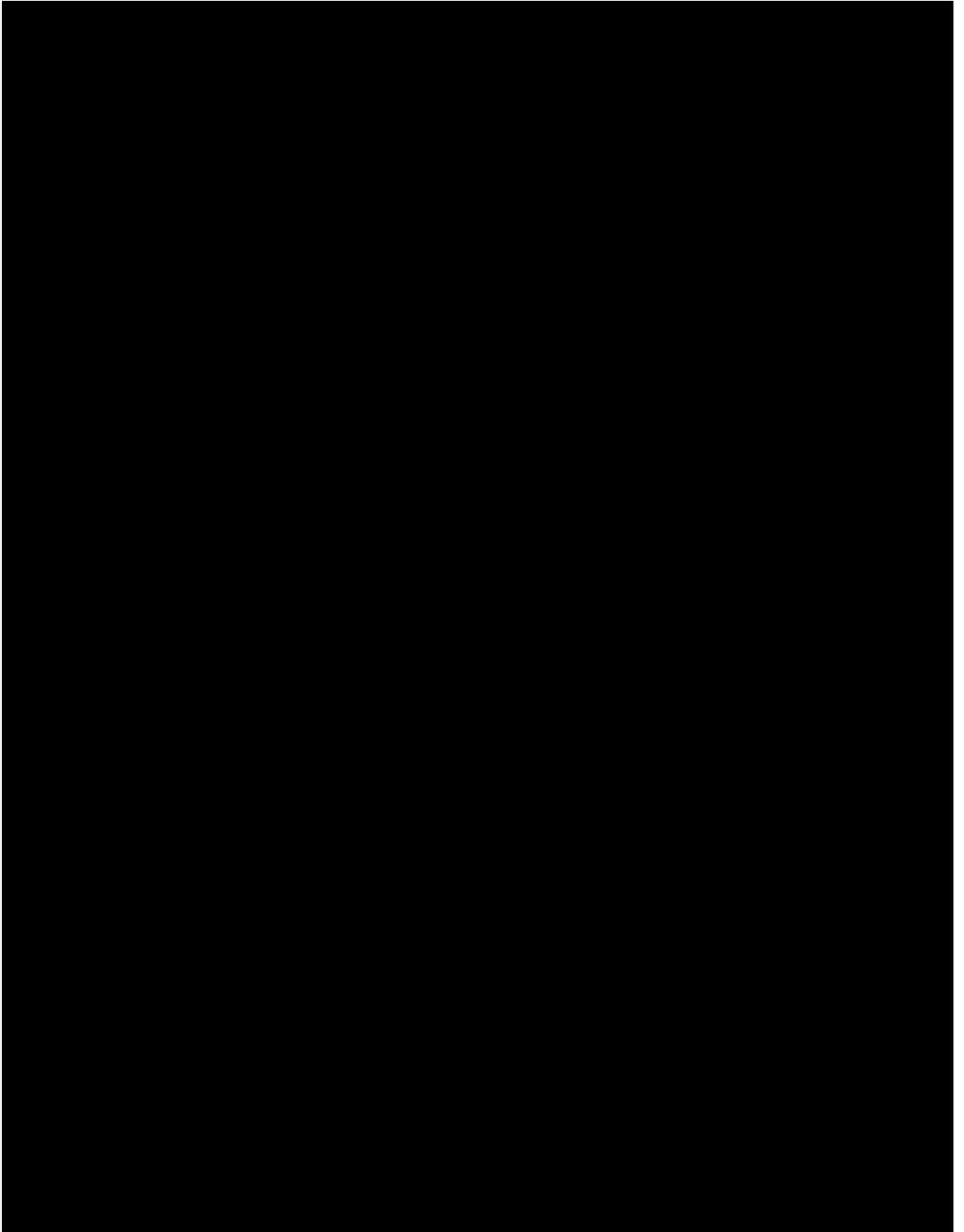

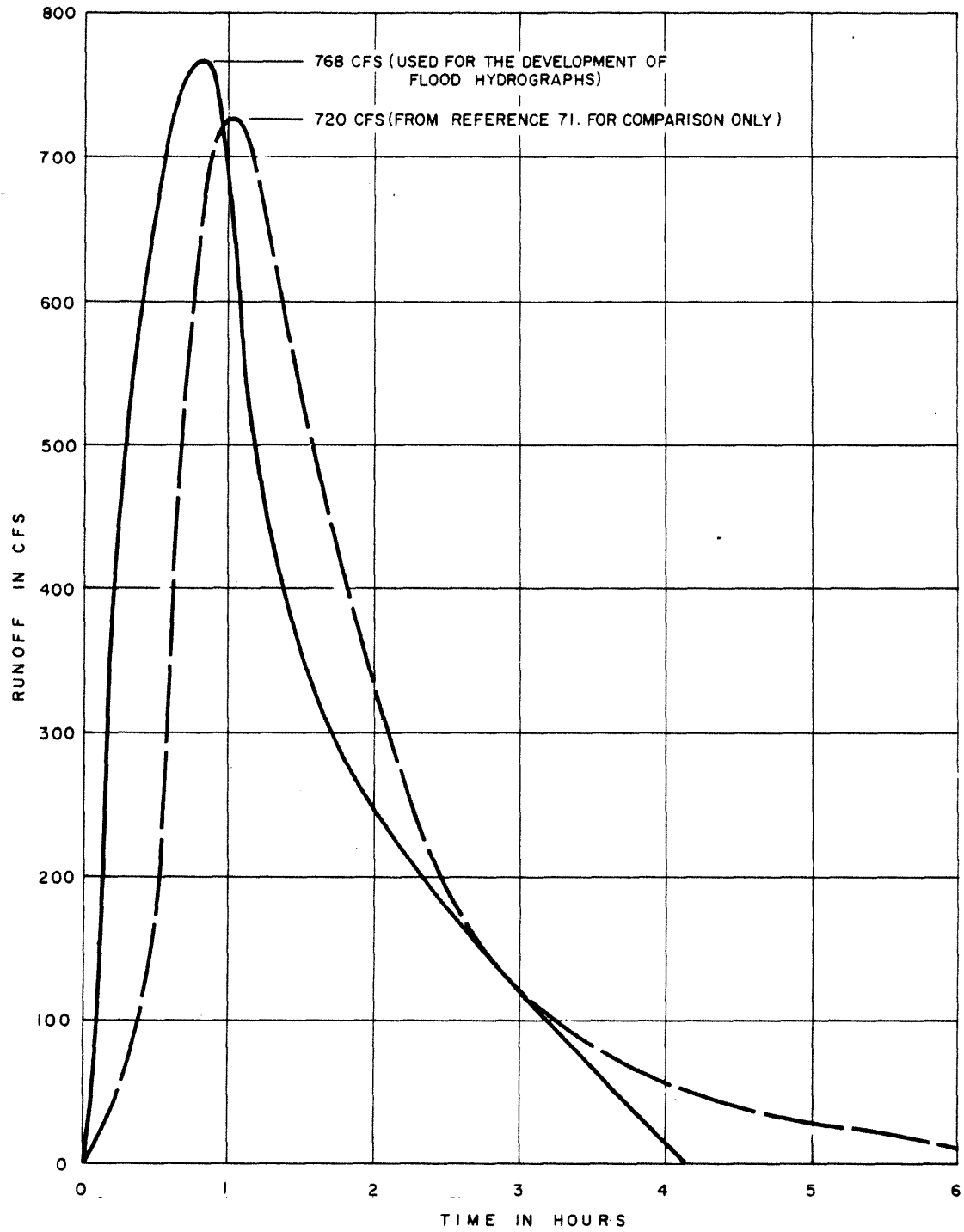

LA SALLE COUNTY STATION
 UPDATED FINAL SAFETY ANALYSIS REPORT

FIGURE 2.4-7
 15-MINUTE UNIT HYDROGRAPHS

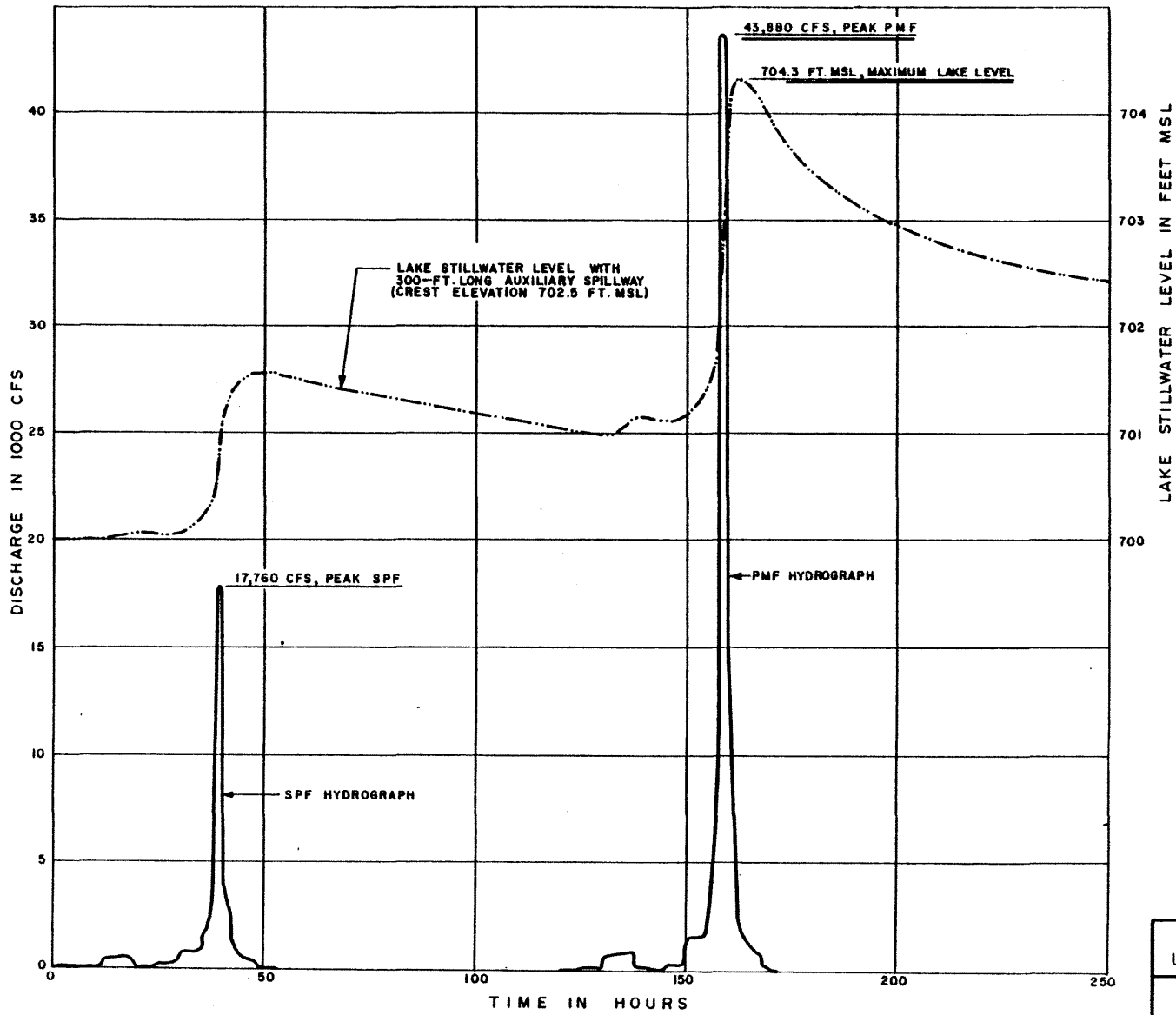

LA SALLE COUNTY STATION
 UPDATED FINAL SAFETY ANALYSIS REPORT

FIGURE 2.4-8
 HYDROGRAPH OF PMF WITH ANTECEDENT SPF
 AND VARIATION OF LAKE LEVEL WITH TIME

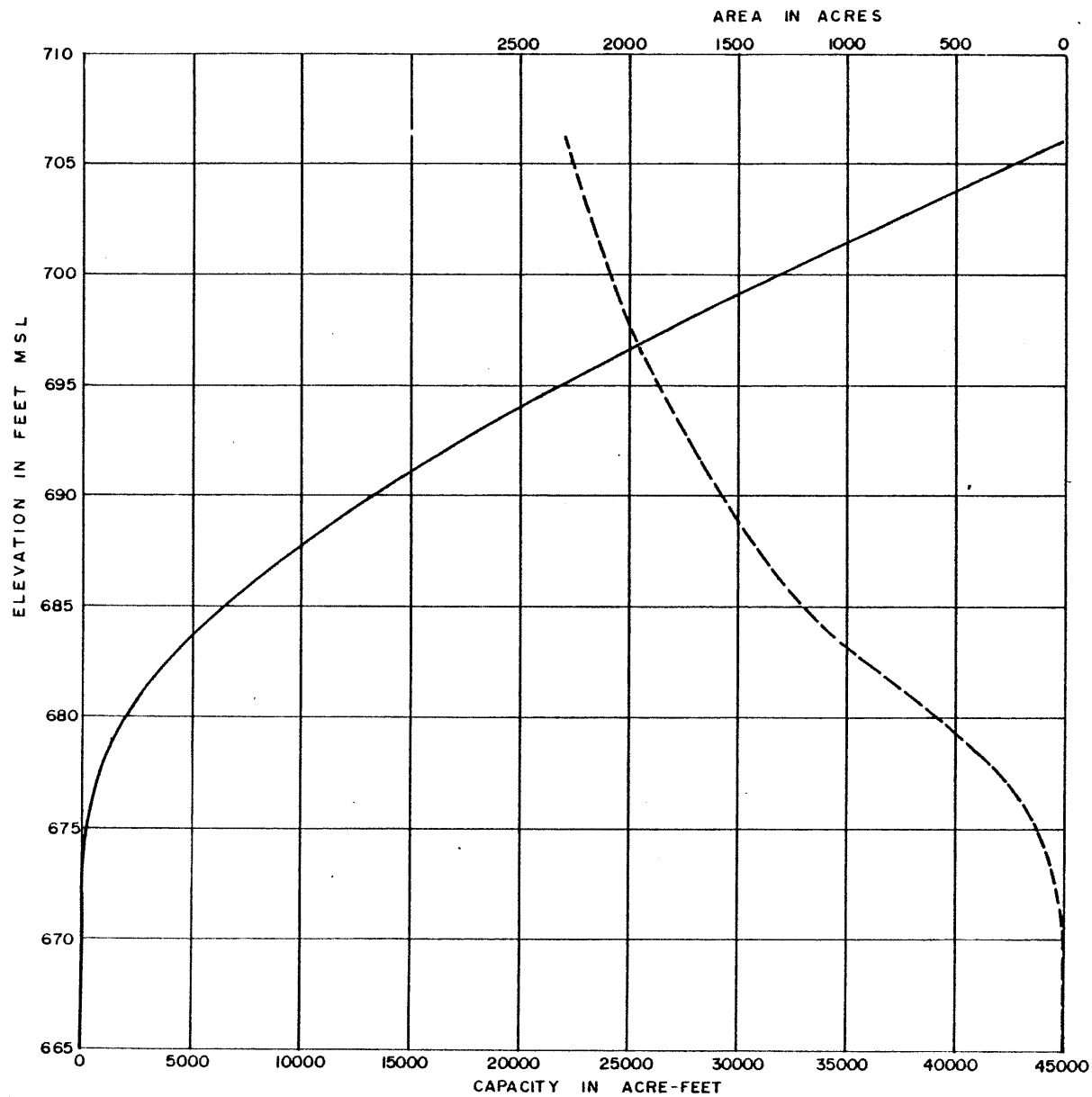

ELEVATION (FEET MSL)	AREA (ACRES)	CAPACITY (ACRE-FEET)
670	15	20
680	572	1883
690	1537	13211
700	2058	31706
702	2162	35926
703	2195	38104
704	2248	40332
706	2295	44875

LEGEND

————— CAPACITY

- - - - - AREA

LA SALLE COUNTY STATION
 UPDATED FINAL SAFETY ANALYSIS REPORT

FIGURE 2.4-9
 AREA AND CAPACITY OF LAKE

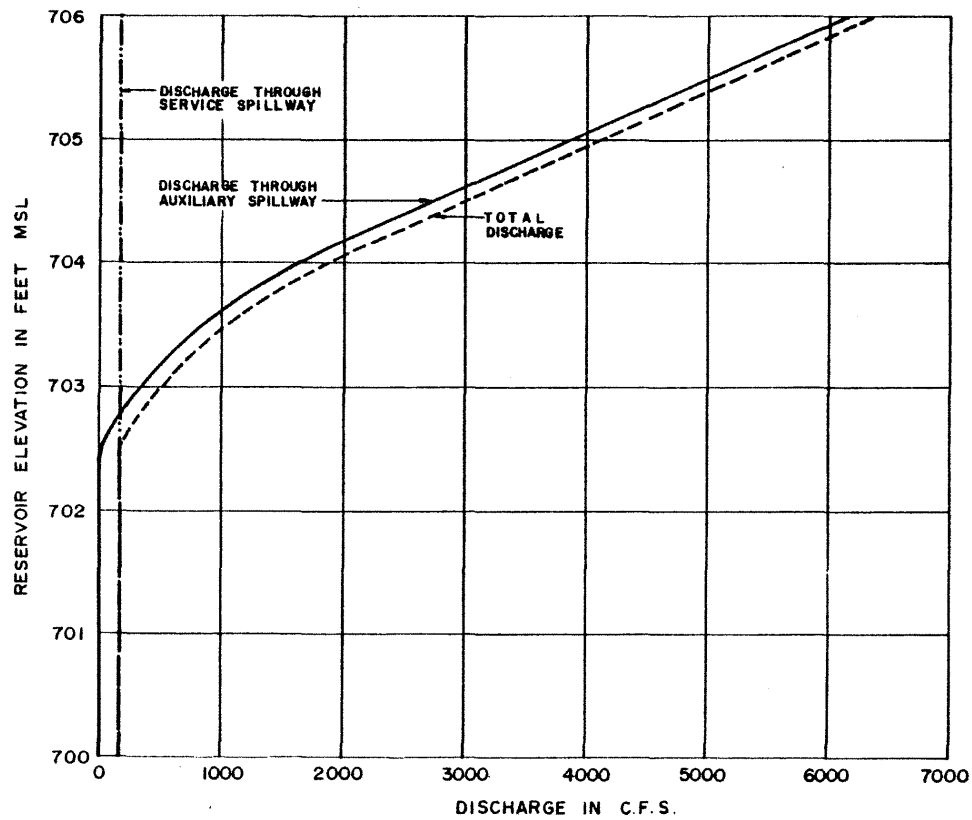

ELEVATION (FEET MSL)	RATE OF FLOW IN CFS		
	THROUGH AUXILIARY SPILLWAY	THROUGH SERVICE SPILLWAY	TOTAL
700.0	0	180	180
701.0	0	180	180
702.0	0	180	180
702.5	0	180	180
703.0	314	182	496
704.0	1667	182	1849
706.0	6175	183	6358

LA SALLE COUNTY STATION
 UPDATED FINAL SAFETY ANALYSIS REPORT

FIGURE 2.4-10
 OUTFLOW RATING

LA SALLE COUNTY STATION
UPDATED FINAL SAFETY ANALYSIS REPORT

FIGURE 2.4-11
PLAN OF AUXILIARY SPILLWAY

REV. 0 - APRIL 1984

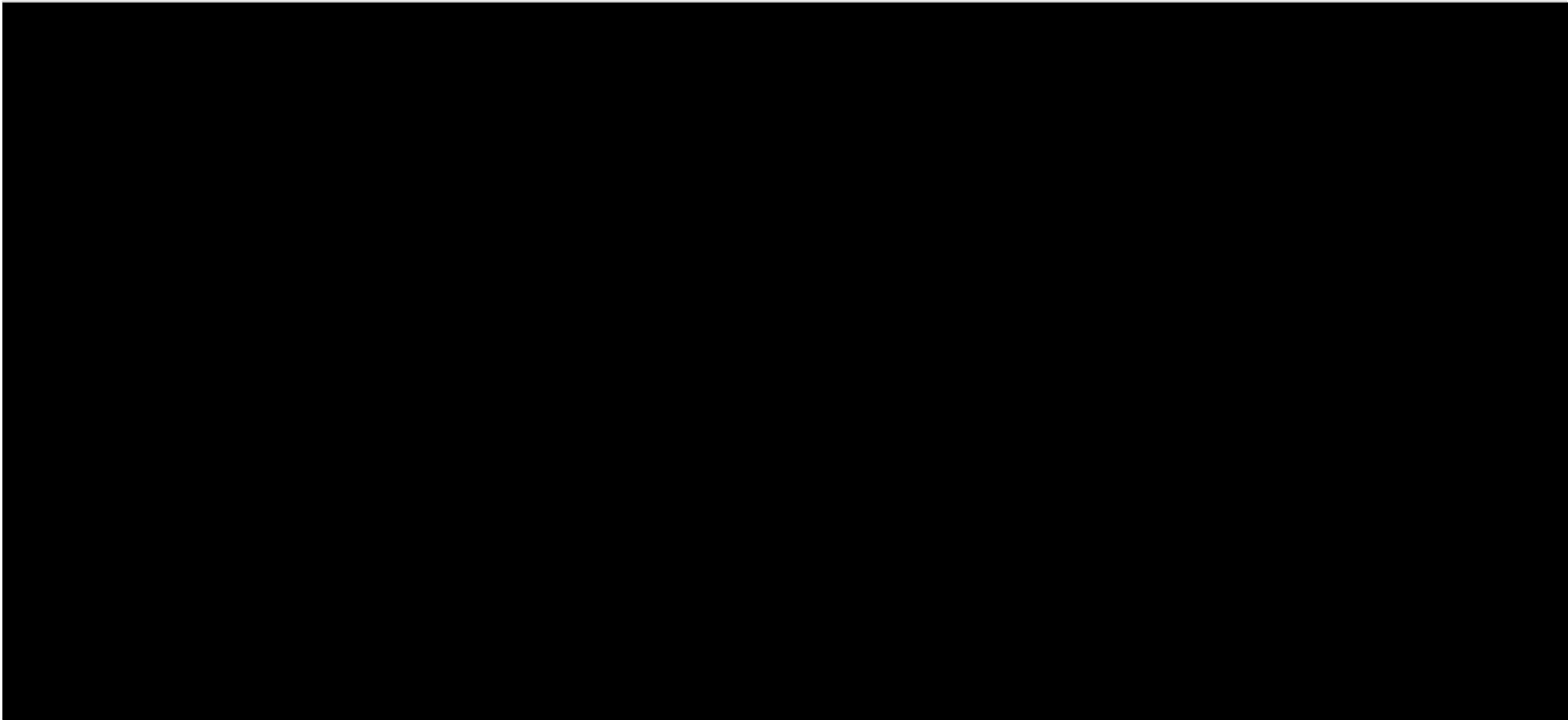

LA SALLE COUNTY STATION
UPDATED FINAL SAFETY ANALYSIS REPORT

FIGURE 2.4-12
CENTERLINE SECTION OF
AUXILIARY SPILLWAY

REV. 0 - APRIL 1984

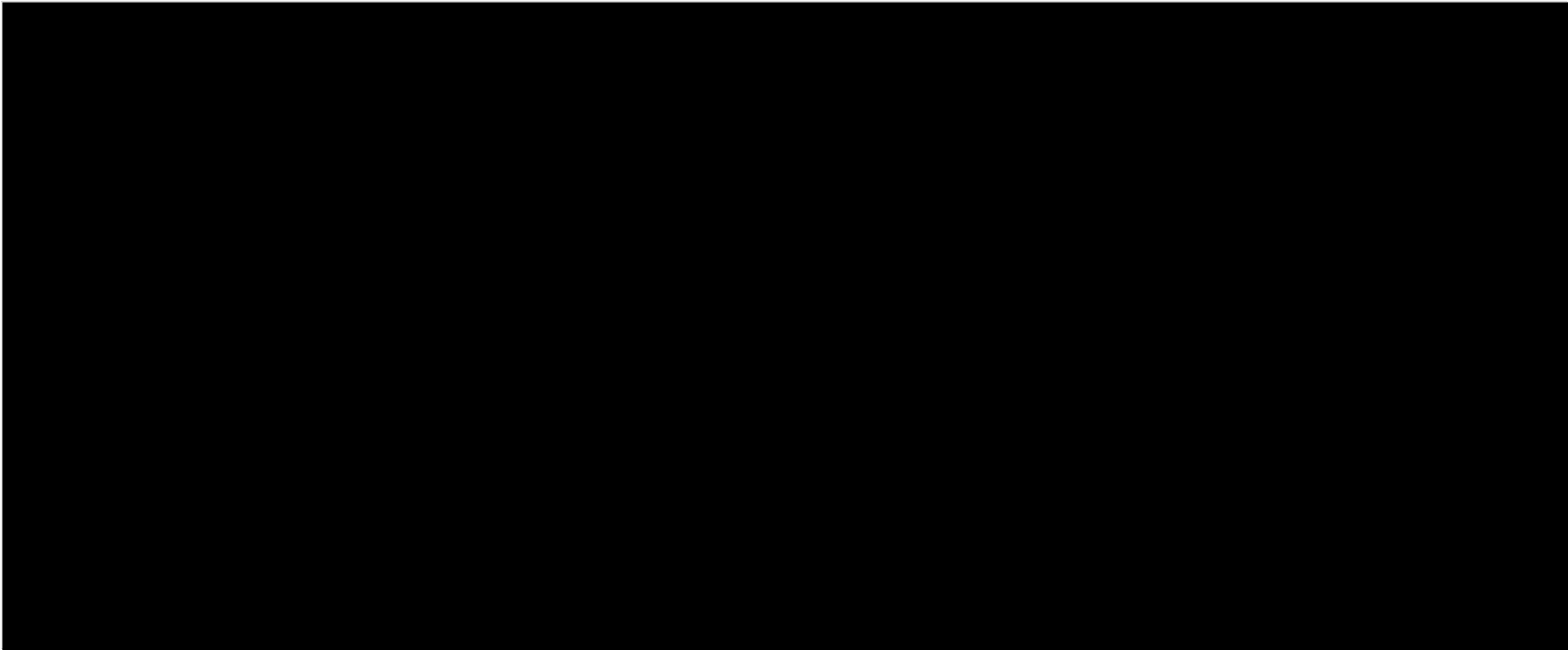

LA SALLE COUNTY STATION
UPDATED FINAL SAFETY ANALYSIS REPORT

FIGURE 2.4-12a

CENTERLINE SECTION OF
AUXILIARY SPILLWAY
(MODIFIED)

REV. 0 - APRIL 1984

**LA SALLE COUNTY STATION
UPDATED FINAL SAFETY ANALYSIS REPORT**

FIGURE 2.4-13

**LONGITUDINAL SECTION OF
AUXILIARY SPILLWAY**

REV. 0 - APRIL 1984

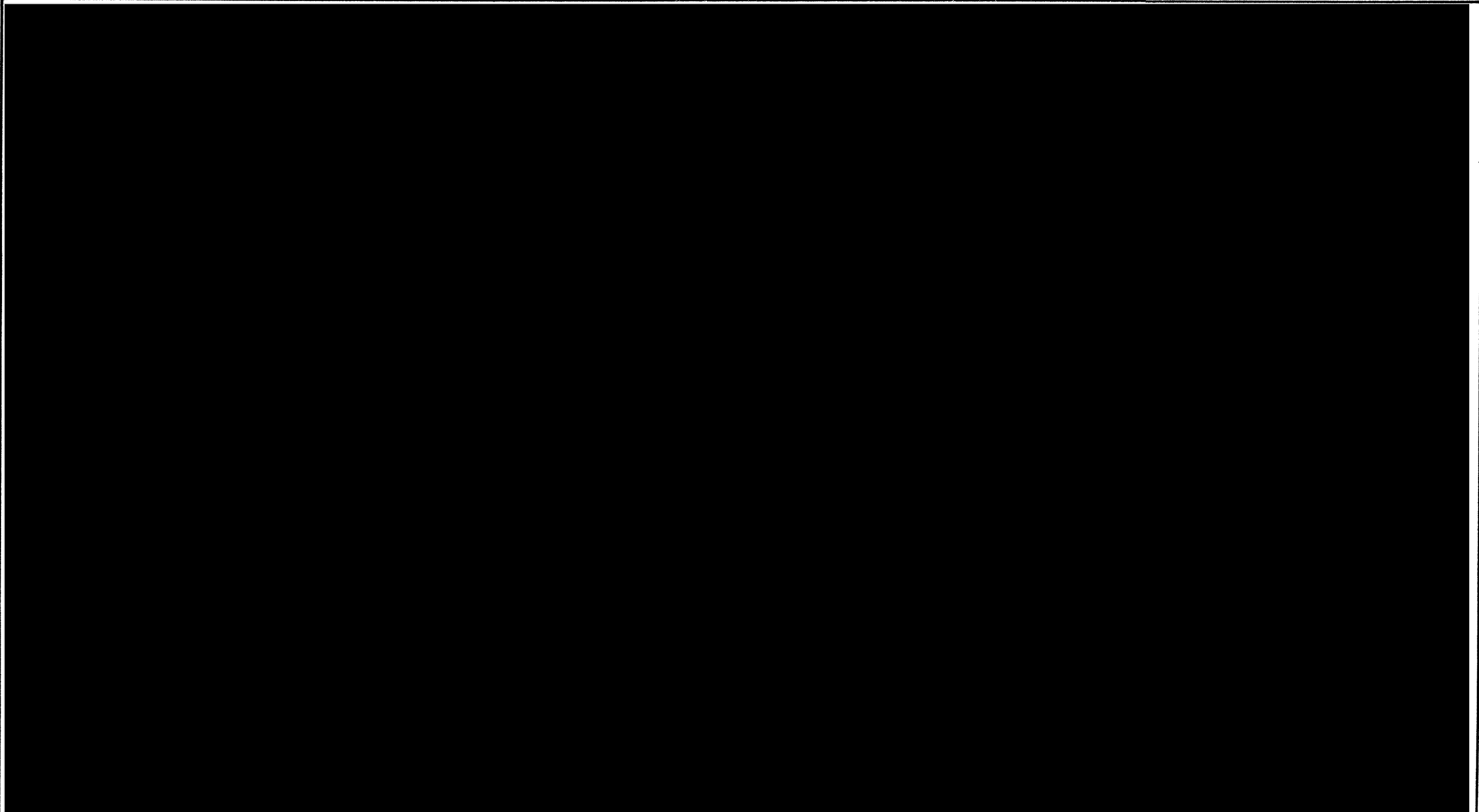

LA SALLE COUNTY STATION
UPDATED FINAL SAFETY ANALYSIS REPORT

FIGURE 2.4-13a
SERVICE SPILLWAY PLAN

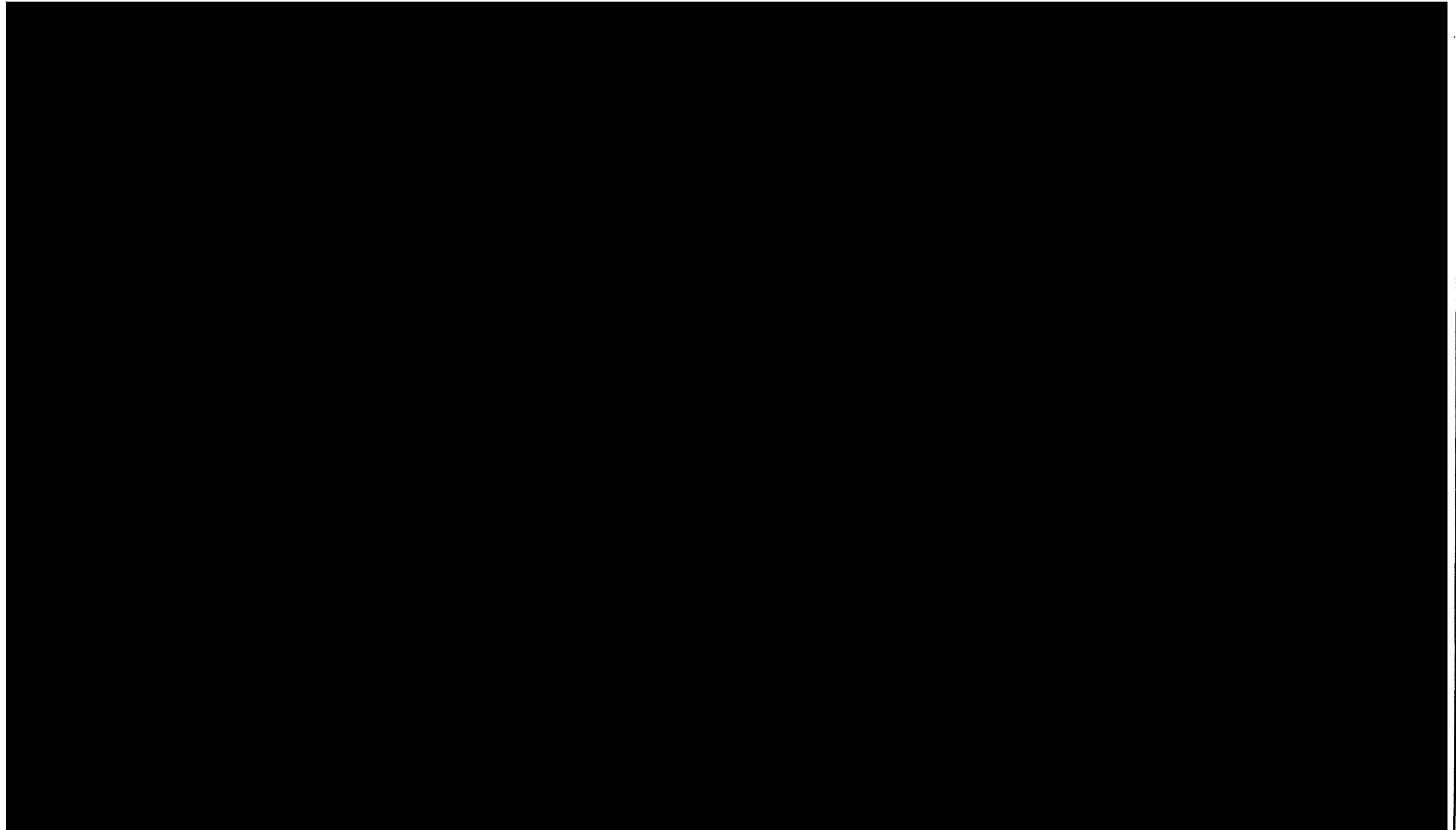

LA SALLE COUNTY STATION
UPDATED FINAL SAFETY ANALYSIS REPORT

FIGURE 2.4-13b
SERVICE SPILLWAY SECTIONS

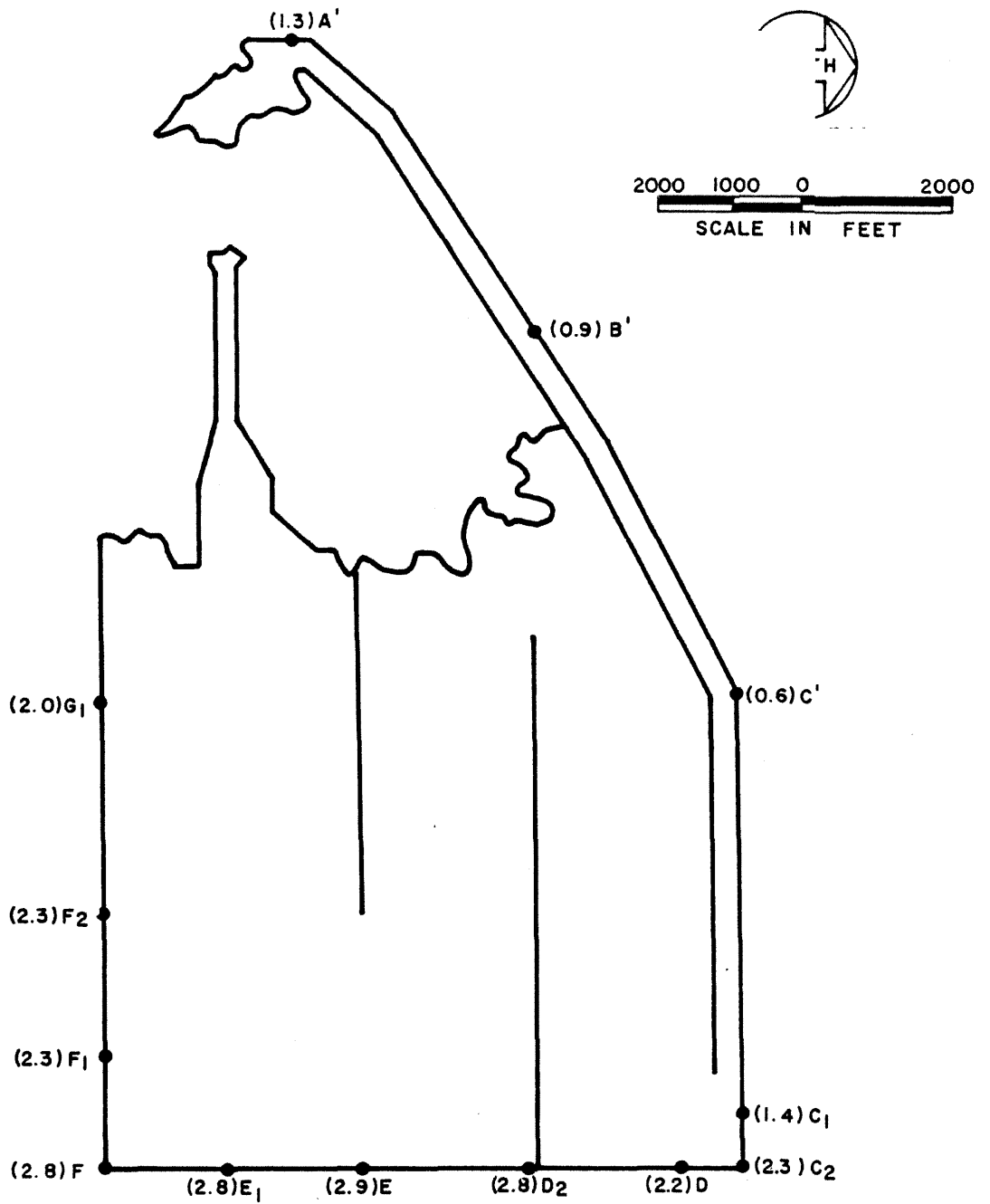

() FREEBOARD REQUIRED IN FEET
FOR 40MPH SUSTAINED OVERLAND
WINDS IN MOST CRITICAL DIRECTION

LA SALLE COUNTY STATION
UPDATED FINAL SAFETY ANALYSIS REPORT

FIGURE 2.4-14
FREEBOARD REQUIREMENTS

REV. 0 - APRIL 1984

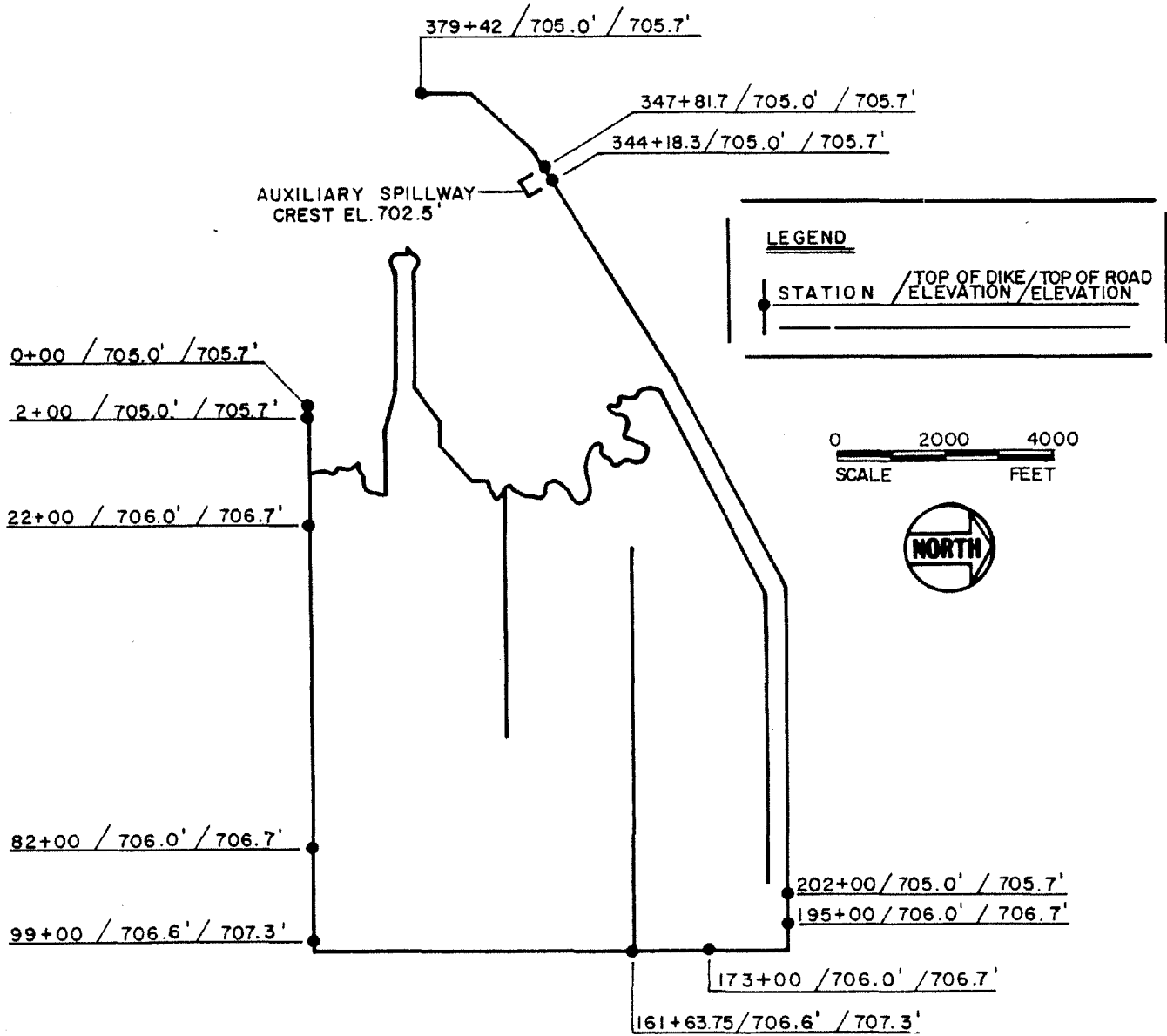

**LA SALLE COUNTY STATION
UPDATED FINAL SAFETY ANALYSIS REPORT**

**FIGURE 2.4-15
TOP-OF-DIKE AND TOP-OF-ROAD
ELEVATIONS**

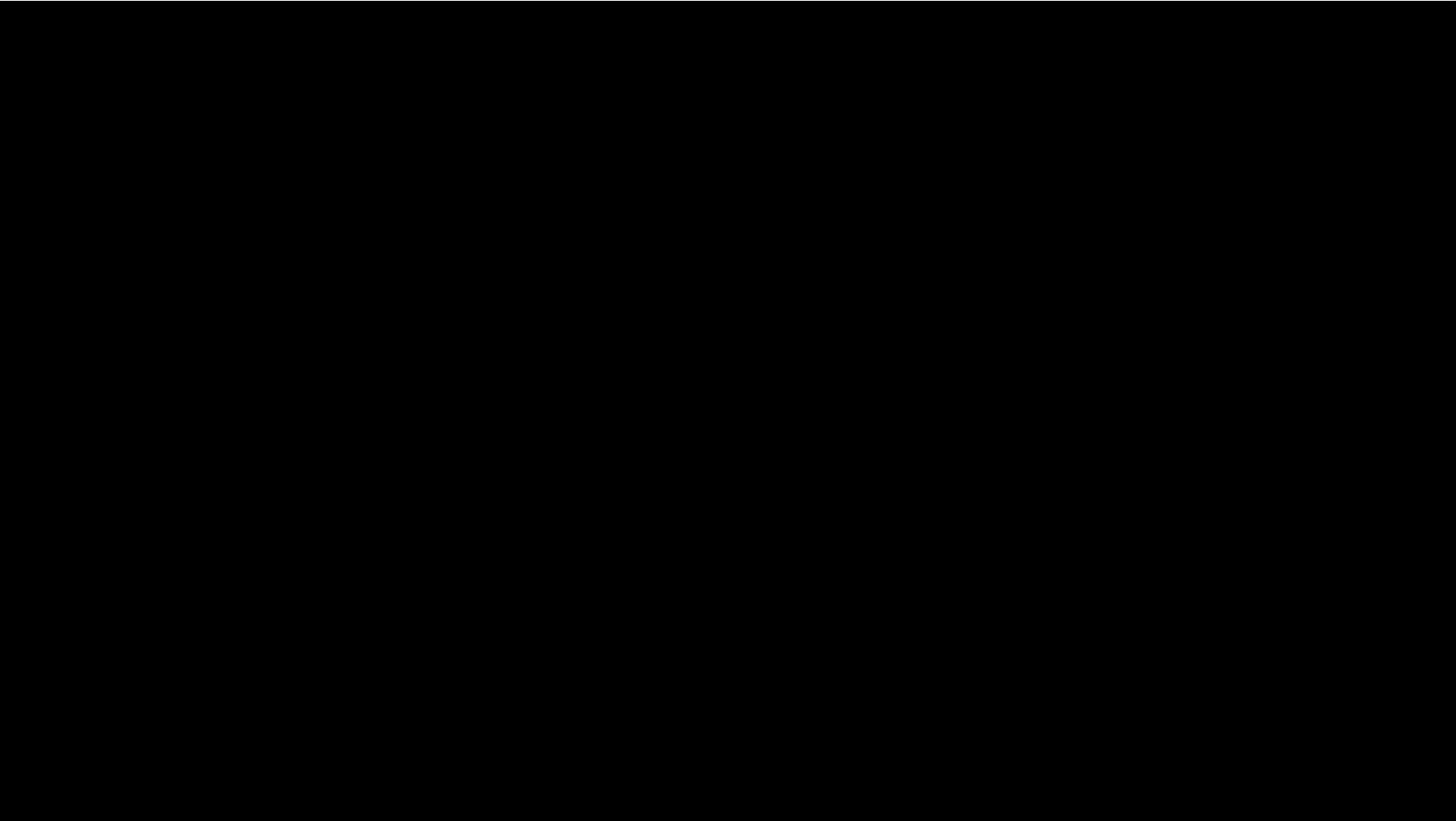

LA SALLE COUNTY STATION
UPDATED FINAL SAFETY ANALYSIS REPORT

FIGURE 2.4-16
MUNICIPAL AND INDUSTRIAL GROUNDWATER
USE WITHIN 25 MILES

REV. 0 - APRIL 1984

SYSTEM	SERIES	GROUP OR FORMATION	HYDROGEOLOGIC UNIT		DESCRIPTION	HYDROGEOLOGIC CHARACTERISTICS
QUATERNARY	Pleistocene	Richland Loess	Glacial Drift Aquitard	-----	Silty clay or clayey silt	Ground water occurs predominantly in thin sand and gravel pockets within the glacial drift. Yields are quite variable and typically low, suitable only for domestic and farm purposes. Wells or cisterns that intersect the more permeable zones may exhibit high, short-term yields. The glacial drift aquitard locally overlies the buried bedrock valley aquifers.
		Wedron Formation			Silty clay or clayey silt with interspersed sand and gravel, some thin sand and gravel pockets	
			Buried Bedrock Valley Aquifers	Sand and gravel, some silt	The buried bedrock valley aquifers consist of sand and gravel deposited in channels cut into the underlying Pennsylvanian strata. Ground water occurs under water table conditions. Where the glaciofluvial deposits are clean and well-sorted, yields of 100 gpm or more can be sustained.	
PENNSYLVANIAN	Missourian	Modesto Formation	Pennsylvanian Aquitard		Principally shale, with some interbedded under-clay, sandstone, lime-stone, and coal	Ground water occurs primarily in thin sandstone beds and occasionally in joints in thin limestone beds. Ground water occurs under leaky artesian conditions. The high proportion of shales make the Pennsylvanian strata generally unfavorable as aquifers. Yields are low and are suitable only for domestic and farm purposes.
	Desmoinesian	Carbondale Formation				
		Spoon Formation				
Atokan	Abott Formation					
ORDOVICIAN	Champlainian	Galena Group	Galena-Platteville dolomites	Cambrian-Ordovician Aquifer	Dolomite and limestone, locally cherty, sandy at base, shale partings	Ground water occurs under leaky artesian conditions in the sandstones and in joints in the dolomites. Yields are variable and depend upon which units are open to the well.
		Platteville Group				
	Anceel Group	Glenwood-St. Peter sandstone	Sandstone, shale at top, little dolomite, locally cherty at base			
Canadian	Prairie du Chien Group	Prairie du Chien, Eminence, Potosi, and Franconia dolomites	Sandy dolomite, dolomitic sandstone, cherty at top, interbedded shale in lower part			
CAMBRIAN	Croixan		Eminence Formation	Ironton-Galesville sandstone	Sandstone, upper part dolomite	In terms of the total yield of a well penetrating the entire thickness of the Cambrian-Ordovician Aquifer, the Glenwood-St. Peter sandstone supplies about 15 percent, the Prairie du Chien, Eminence, Potosi, and Franconia dolomites collectively supply about 35 percent, and the Ironton-Galesville sandstone supplies about 50 percent.
		Potosi Dolomite				
		Franconia Formation				
		Ironton Sandstone				
		Galesville Sandstone				
Eau Claire Formation	Eau Claire Aquitard (upper and middle beds)	Shales, dolomites, and shaly dolomitic sandstone	Insignificant amounts of ground water may occur in joints. These beds act as a confining layer between the Cambrian-Ordovician Aquifer and the Mt. Simon Aquifer.			
Mt. Simon Sandstone	Mt. Simon Aquifer			Sandstone	Ground water occurs under leaky artesian conditions. Ground water in this aquifer is too highly mineralized for most purposes. Adequate supplies for municipal and industrial use are more easily obtained from shallower aquifers.	

NOTE

1. Modified from Willman et al., 1975; Hoover and Schicht, 1967, p. 4; and Csallany, 1966, p. 4

LA SALLE COUNTY STATION UPDATED FINAL SAFETY ANALYSIS REPORT
FIGURE 2.4-17
SITE STRATIGRAPHIC UNITS AND THEIR HYDROGEOLOGIC CHARACTERISTICS

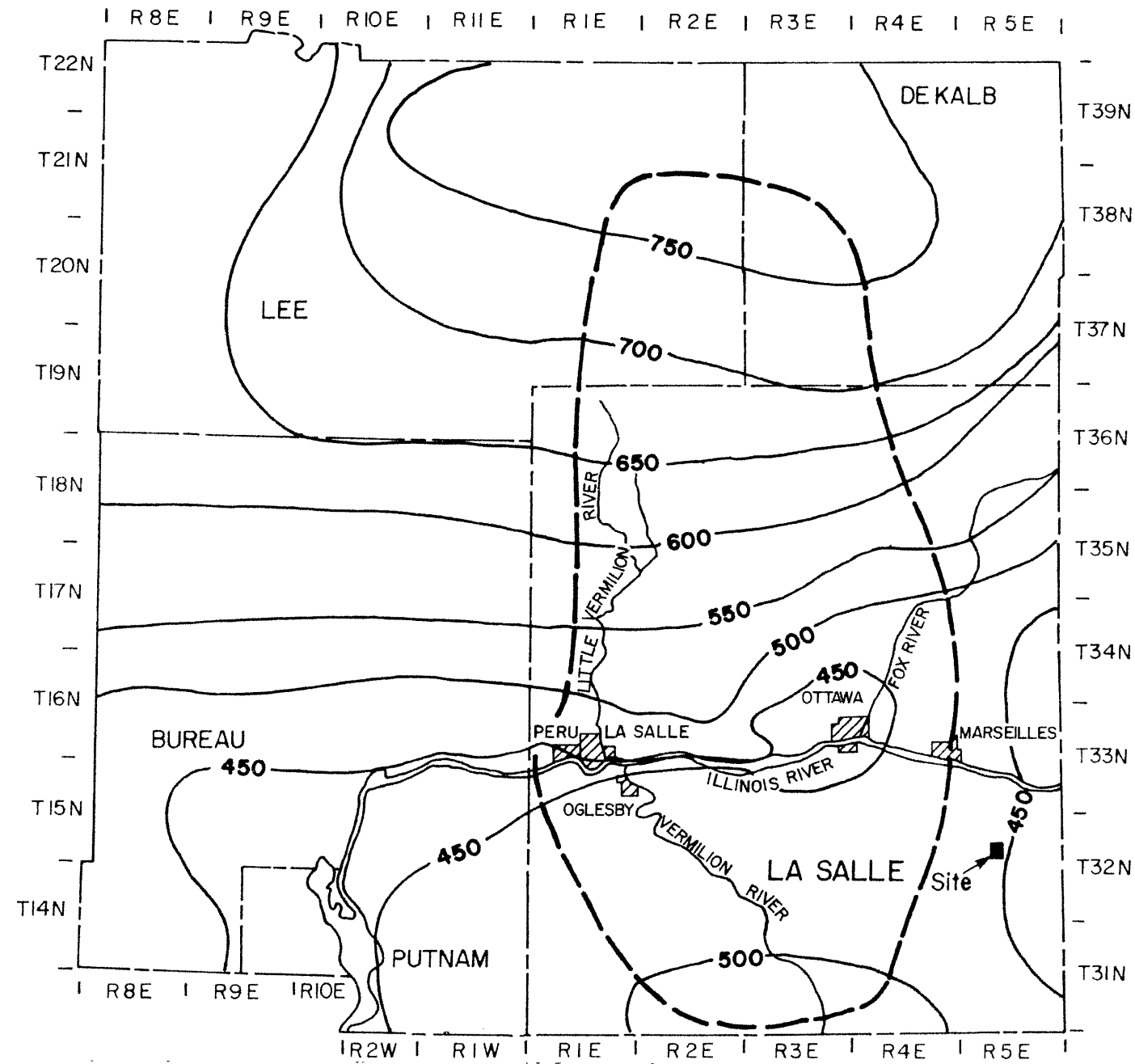

LEGEND

- 450 Potentiometric surface contour, Cambrian - Ordovician Aquifer, Fall, 1963.
- Boundary of area of diversion due to ground water withdrawals.

NOTES

1. Modified from Hoover and Schicht, 1967, p.16, Figure 24.
2. Contour interval is 50 feet.
3. Datum is mean sea level.
4. Elevation of Illinois River at Marseilles Dam is 483.25 feet MSL.
5. Ground water within the area of diversion flows toward pumping centers along the Illinois River.



LA SALLE COUNTY STATION
 UPDATED FINAL SAFETY ANALYSIS REPORT

FIGURE 2.4-18

POTENTIOMETRIC SURFACE OF THE
 CAMBRIAN-ORDOVICIAN AQUIFER, FALL 1963

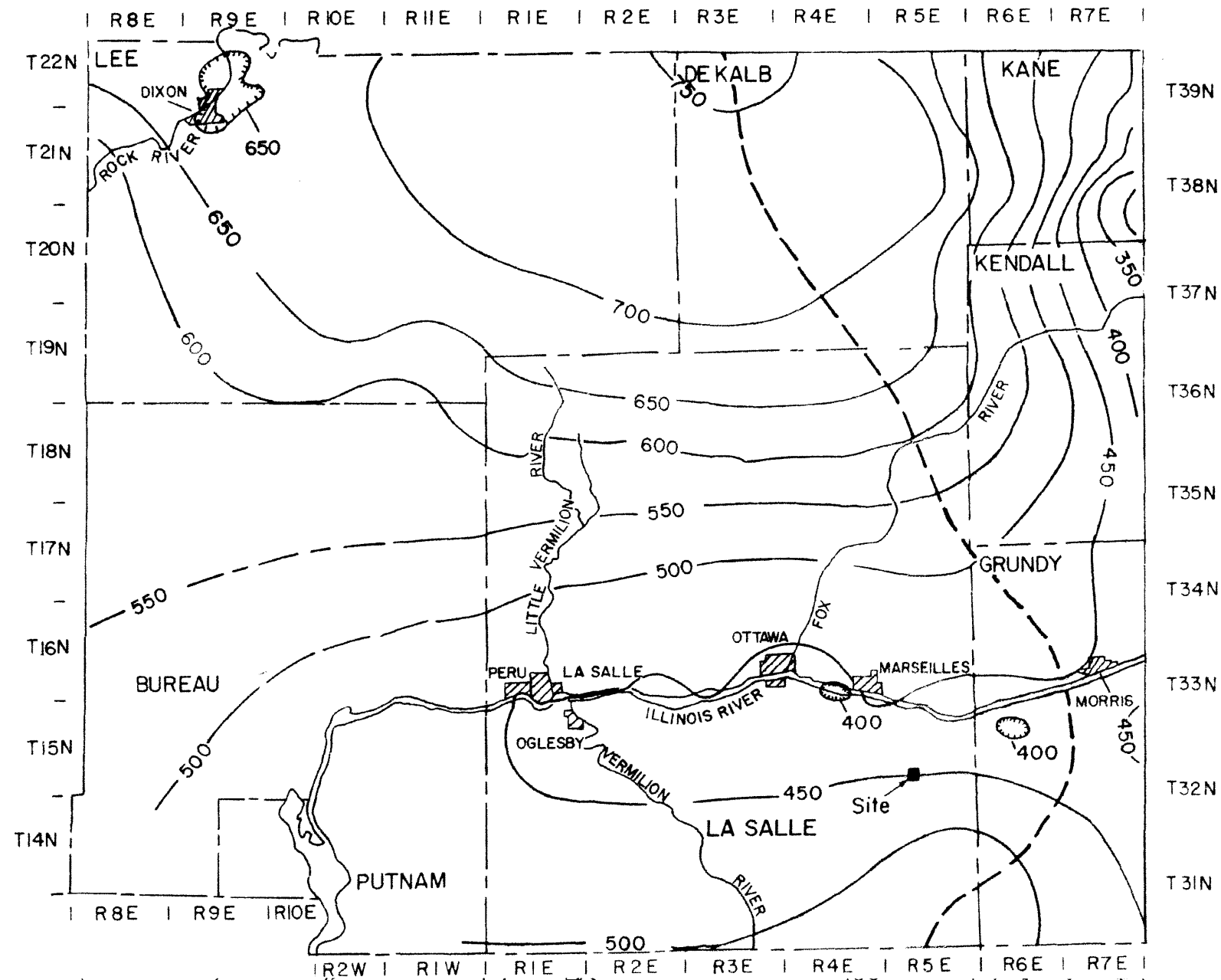

LEGEND

- 650 — Potentiometric surface contour, Cambrian - Ordovician Aquifer, October, 1971
- - - - - Ground water divide

NOTES

1. Modified from Sasman et al., 1973, p.21, Figure 10.
2. Contour interval is 50 feet.
3. Datum is mean sea level.
4. Elevation of Illinois River at Marseilles Dam is 483.25 feet MSL.
5. Ground water east of the ground water divide flows to the east-southeast toward large cones of depression developed in the greater metropolitan region around Chicago; west of the divide, ground water flows to the south, and locally to the north, toward pumping centers located along the Illinois River.

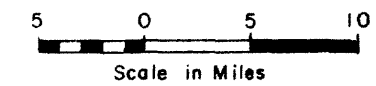

LA SALLE COUNTY STATION
 UPDATED FINAL SAFETY ANALYSIS REPORT

 FIGURE 2.4-19
 POTENTIOMETRIC SURFACE OF THE
 CAMBRIAN-ORDOVICIAN AQUIFER, OCTOBER 1971

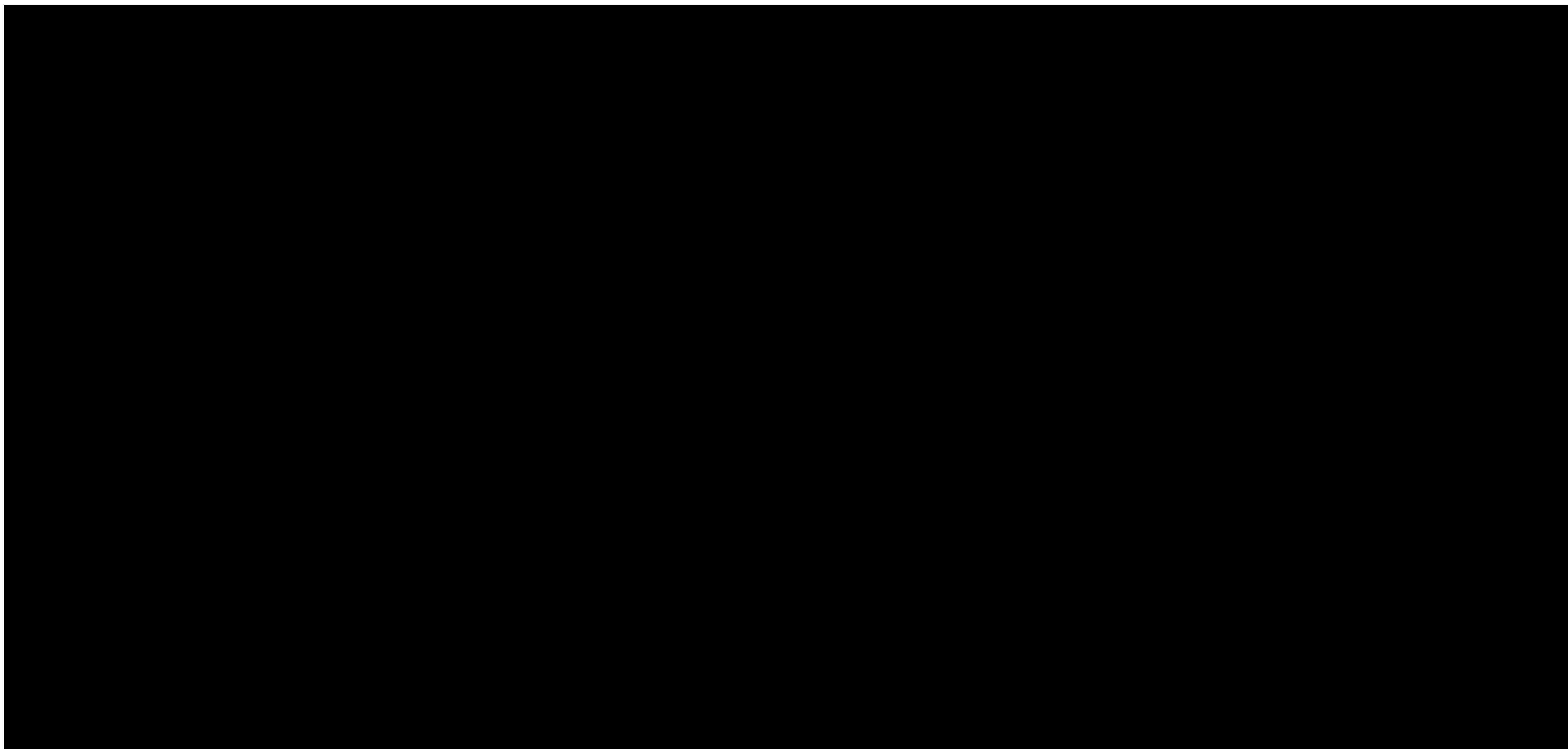

LA SALLE COUNTY STATION
UPDATED FINAL SAFETY ANALYSIS REPORT

FIGURE 2.4-20
DOMESTIC WELL INVENTORY, INCLUDING
LSCS WATER WELLS

REV. 0 - APRIL 1984

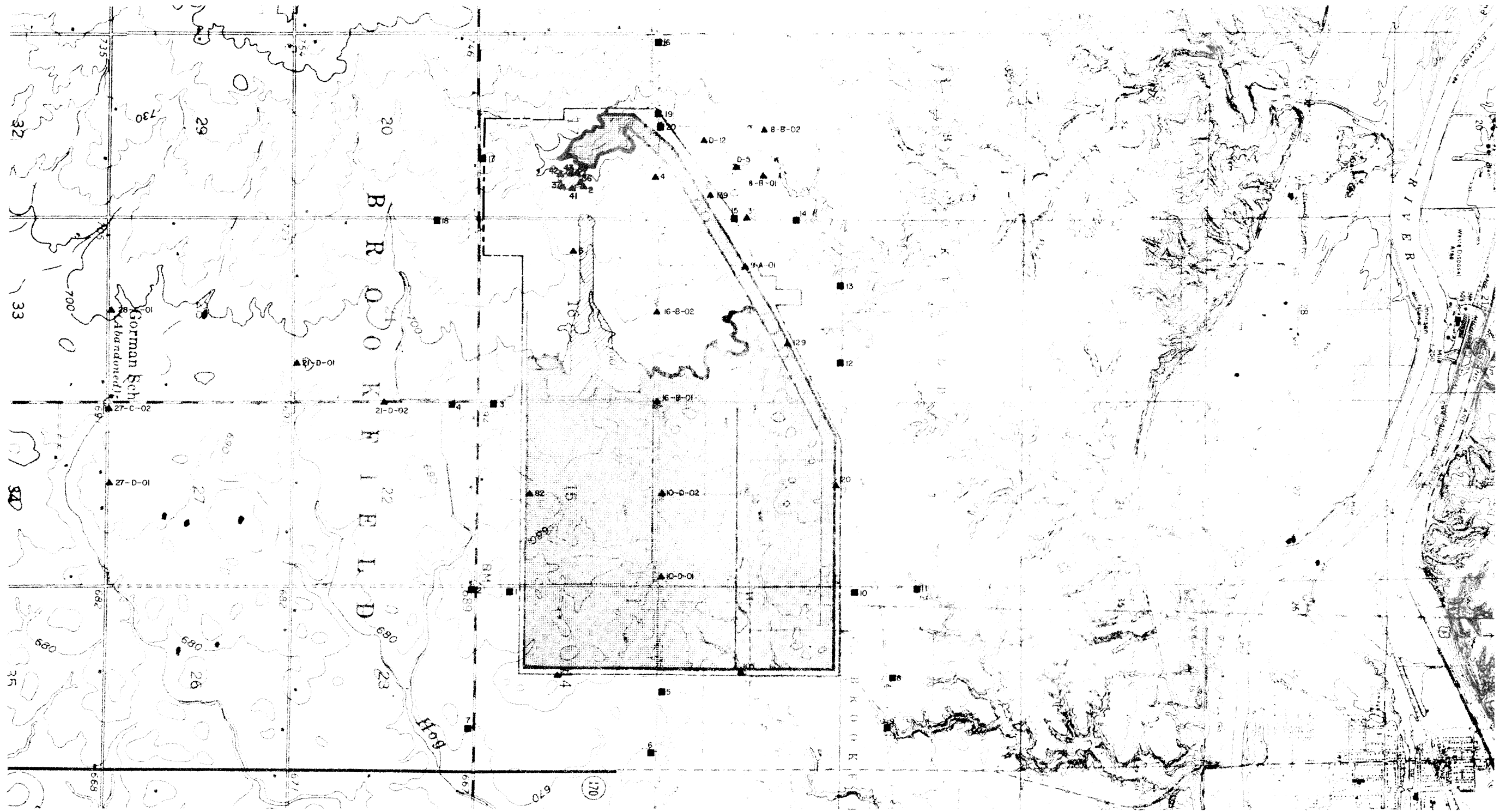

LEGEND

- ▲ Piezometer installed May 28, 1970 through October 30, 1973.
- Observation well, installed December, 1974.
- Property line
- ▨ Category I Structure
- ▩ Cooling lake

NOTES

1. Dates of piezometer installation and frequency of measurement are given in Table 2.4-16.
2. Dates of water level measurement are shown in Table 2.4-17.
3. Water level fluctuations in selected piezometers are shown in Figure 2.4-22; additional unplotted piezometer data are presented in Table 2.4-18.
4. Water level fluctuations in the observation wells are shown in Figure 2.4-23.
5. Contour interval is 10 feet.



LA SALLE COUNTY STATION
UPDATED FINAL SAFETY ANALYSIS REPORT

FIGURE 2.4-21
**LOCATIONS OF PIEZOMETERS AND
 OBSERVATION WELLS**

REV. 0 - APRIL 1984

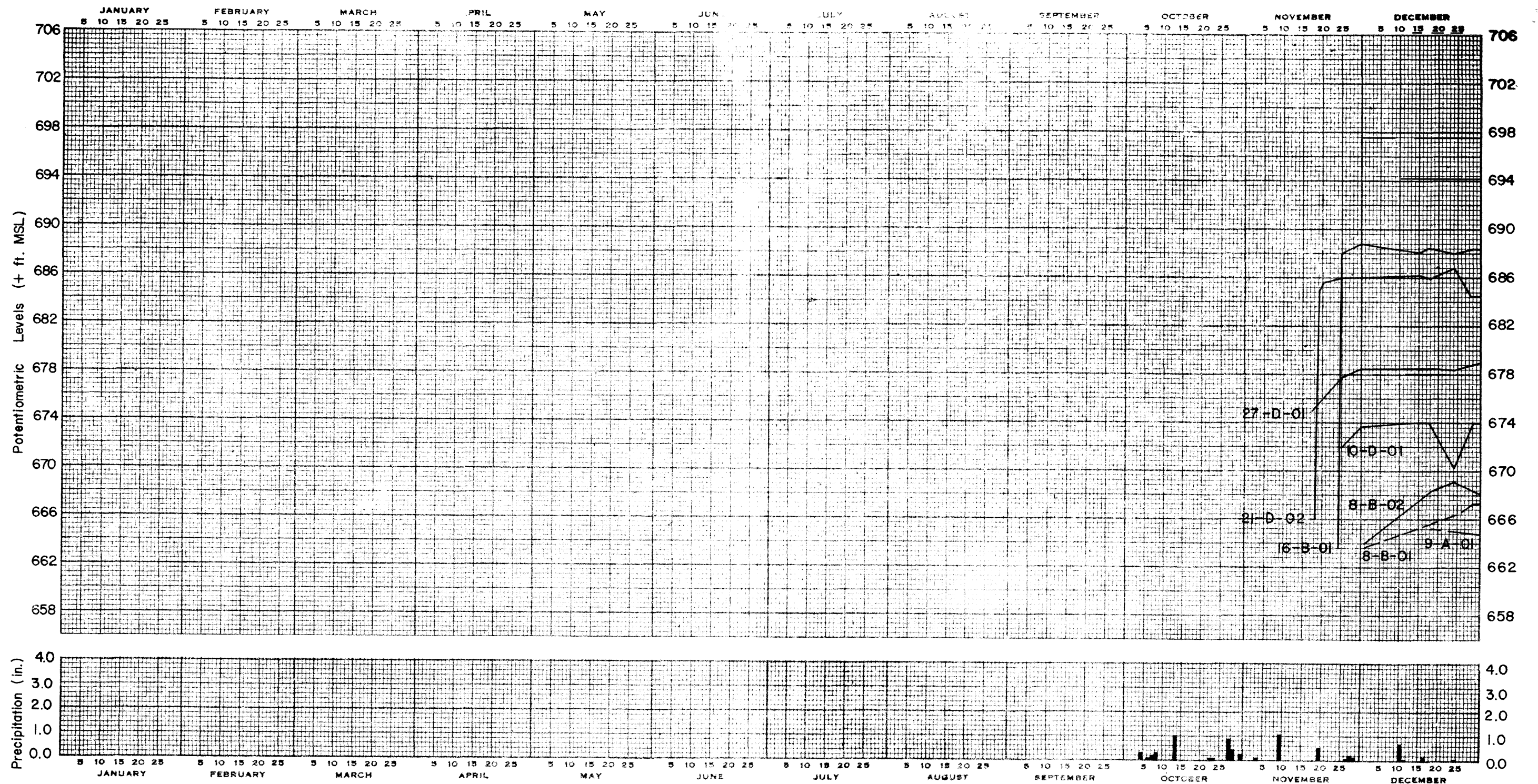

NOTES

1970

1. Locations of piezometers are shown in Figure 2.4-21.
2. Dates of installation, surface elevations, tested intervals, and frequency of water level measurements are given in Table 2.4-16.
3. Potentiometric levels are inferred between dates of measurement.
4. Precipitation data were recorded at the Marseilles Lock, 41° 21' N Lat., 88° 45' W Long.

5. All piezometers are installed within the glacial drift aquitard.

LA SALLE COUNTY STATION
 UPDATED FINAL SAFETY ANALYSIS REPORT

 FIGURE 2.4-22
 DAILY PRECIPITATION AND FLUCTUATIONS
 OF WATER LEVELS IN PIEZOMETERS
 (SHEET 1 of 4)

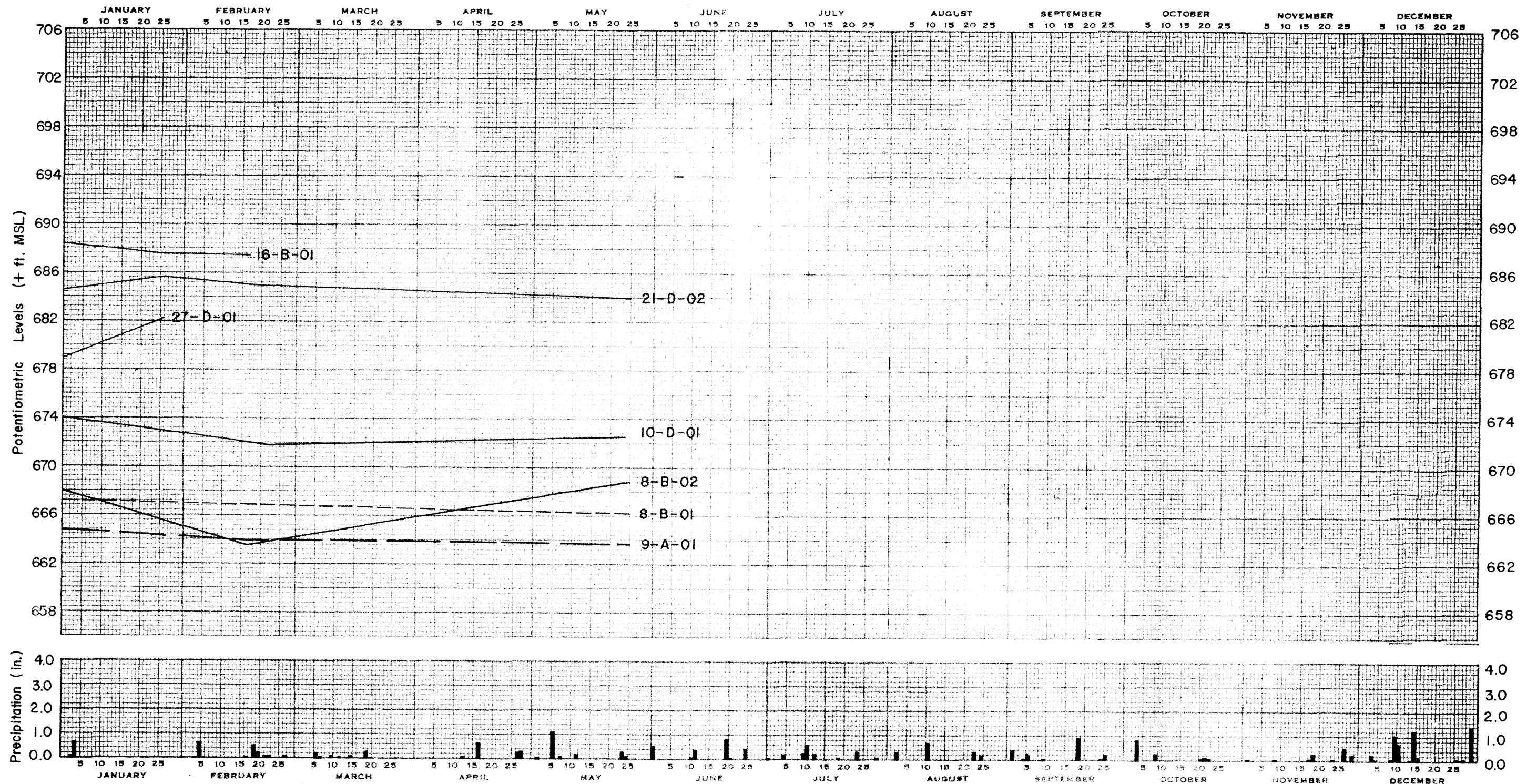

NOTES

1. Locations of piezometers are shown in Figure 2.4-21.
2. Dates of installation, surface elevations, tested intervals, and frequency of water level measurements are given in Table 2.4-16.
3. Potentiometric levels are inferred between dates of measurement.
4. Precipitation data were recorded at the Marseilles Lock, 41° 21' N Lat., 88° 45' W Long.

5. All piezometers are installed within the glacial drift aquitard.

LA SALLE COUNTY STATION
 UPDATED FINAL SAFETY ANALYSIS REPORT

FIGURE 2.4-22
 DAILY PRECIPITATION AND FLUCTUATIONS
 OF WATER LEVELS IN PIEZOMETERS
 (SHEET 2 of 4)

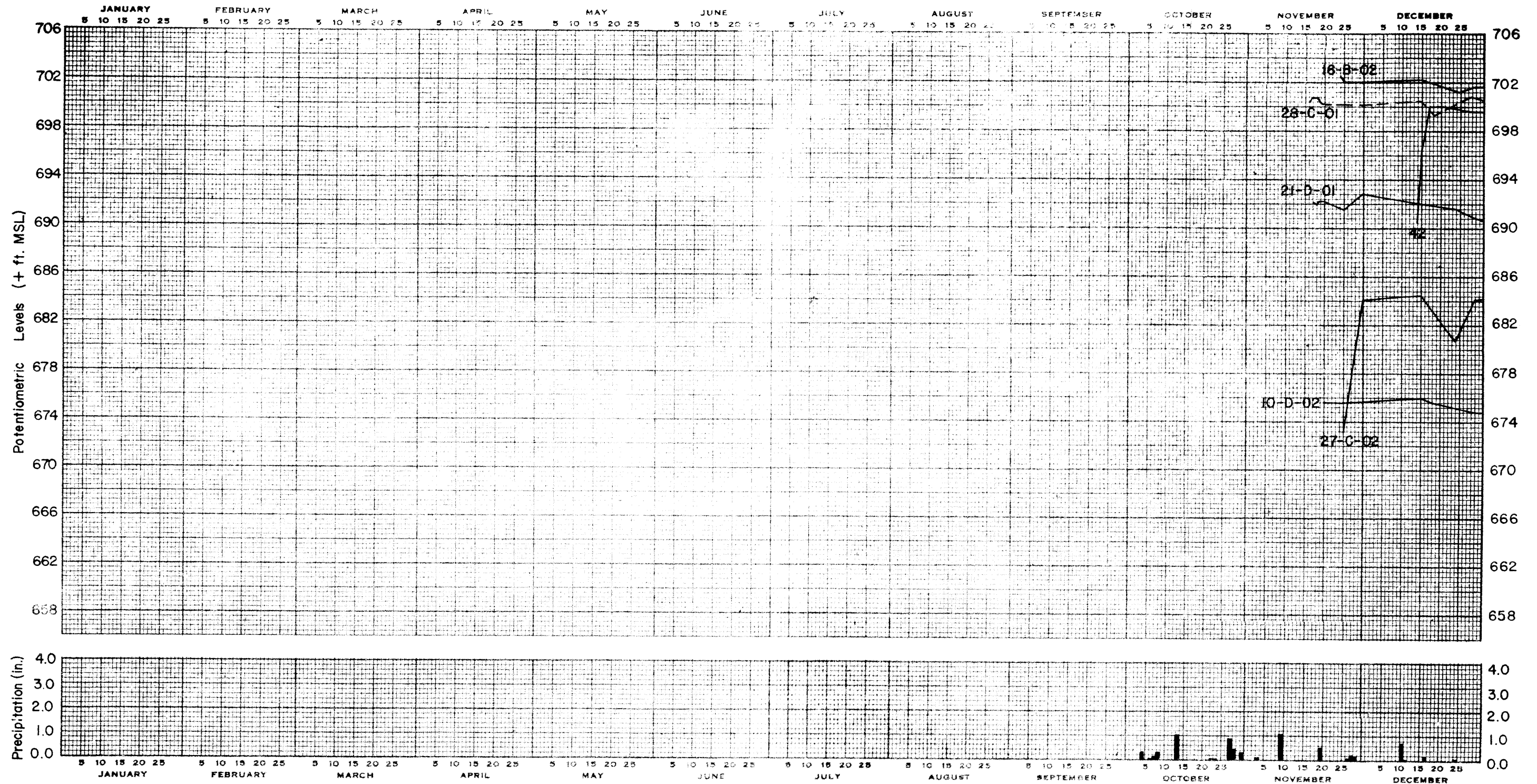

NOTES

1970

1. Locations of piezometers are shown in Figure 2.4-21.
2. Dates of installation, surface elevations, tested intervals, and frequency of water level measurements are given in Table 2.4-16.
3. Potentiometric levels are inferred between dates of measurement.
4. Precipitation data were recorded at the Marseilles Lock, 41° 21' N Lat., 88° 45' W Long.
5. All piezometers are installed within the glacial drift aquitard.

LA SALLE COUNTY STATION
 UPDATED FINAL SAFETY ANALYSIS REPORT

 FIGURE 2.4-22
 DAILY PRECIPITATION AND FLUCTUATIONS
 OF WATER LEVELS IN PIEZOMETERS
 (SHEET 3 of 4)

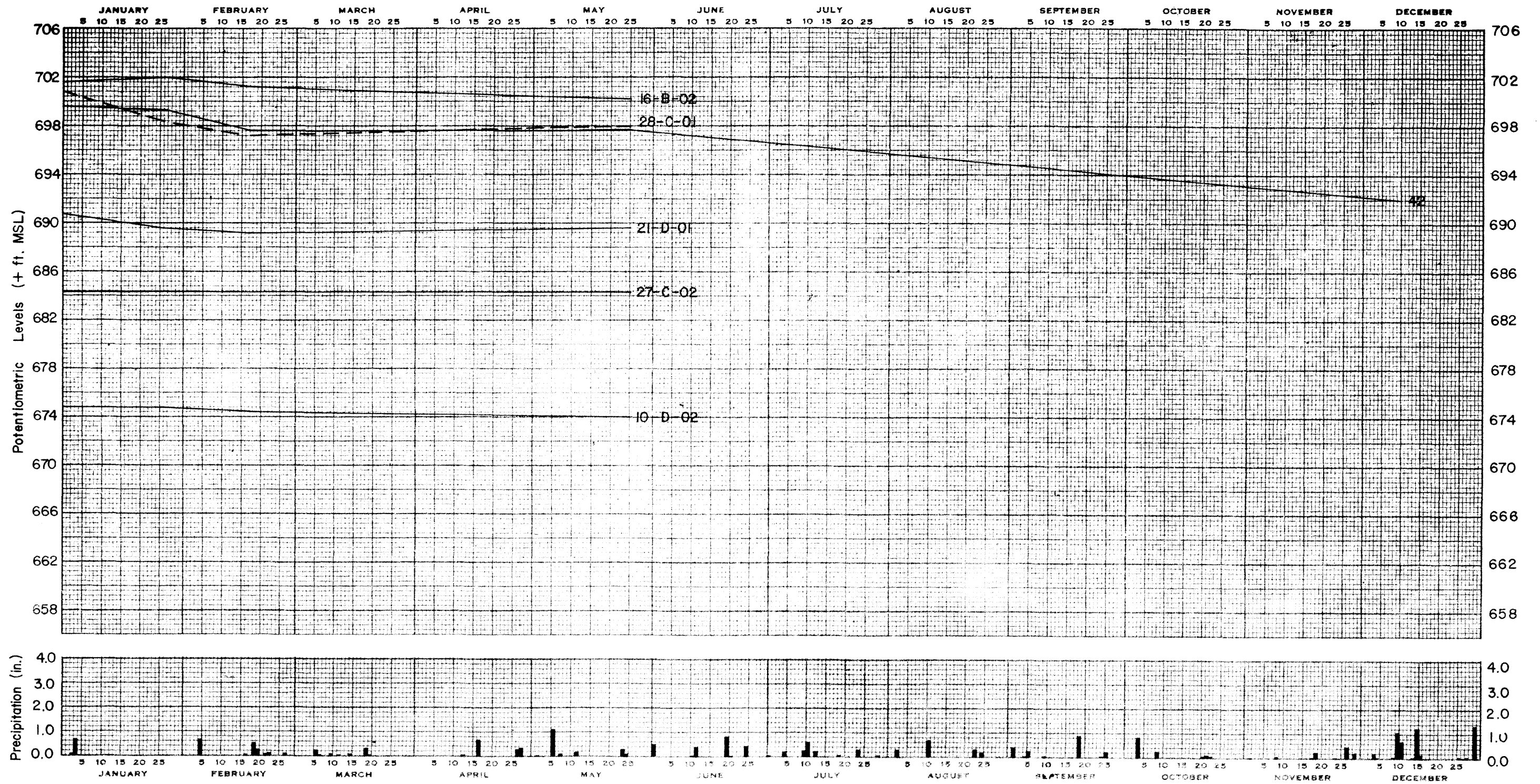

NOTES

1. Locations of piezometers are shown in Figure 2.4-21.
2. Dates of installation, surface elevations, tested intervals, and frequency of water level measurements are given in Table 2.4-16.
3. Potentiometric levels are inferred between dates of measurement.
4. Precipitation data were recorded at the Marseilles Lock, 41° 21' N Lat., 88° 45' W Long.
5. All piezometers are installed within the glacial drift aquitard.

LA SALLE COUNTY STATION
 UPDATED FINAL SAFETY ANALYSIS REPORT

FIGURE 2.4-22
 DAILY PRECIPITATION AND FLUCTUATIONS
 OF WATER LEVELS IN PIEZOMETERS
 (SHEET 4 of 4)

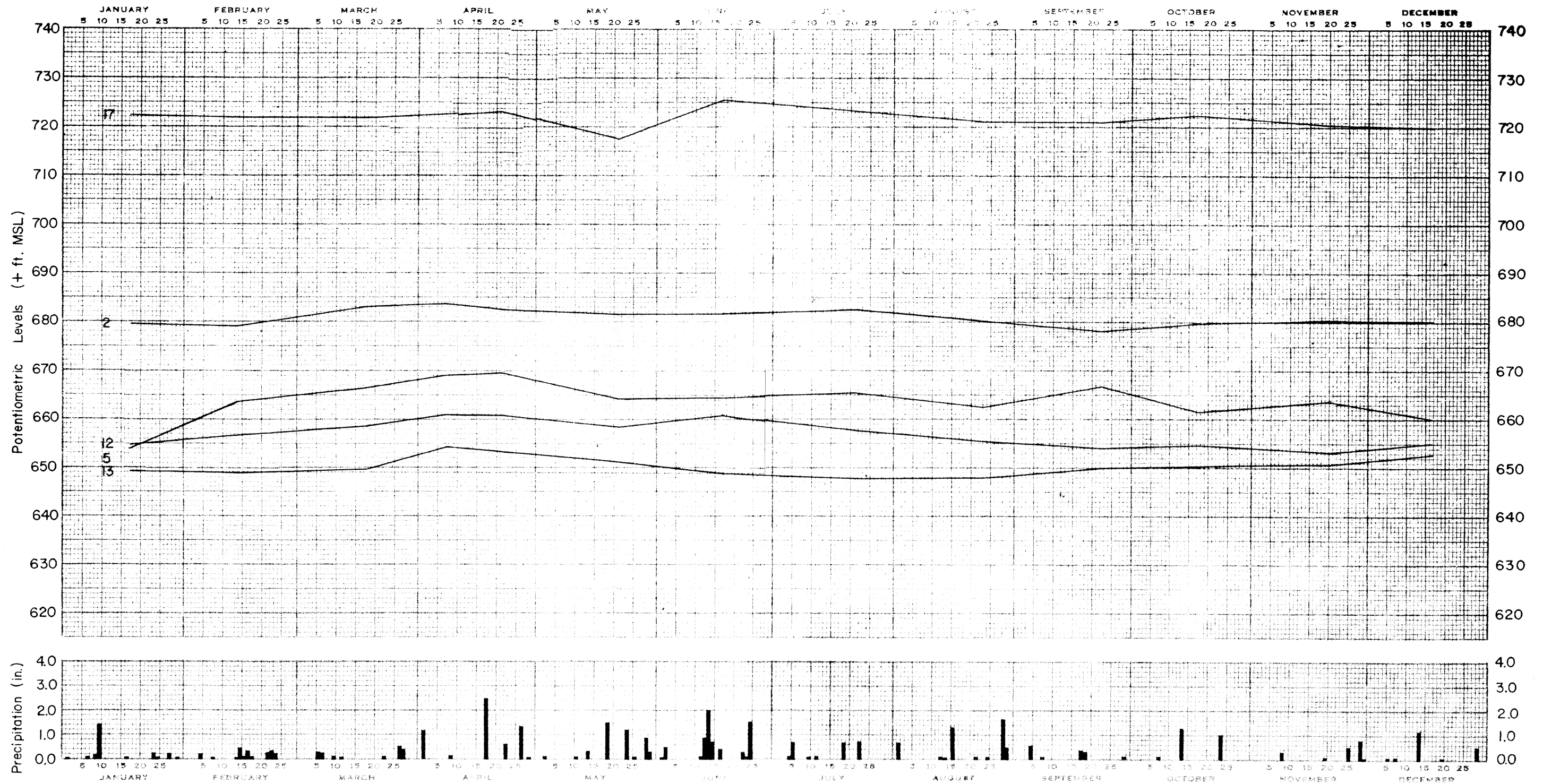

1975

NOTES

1. Locations of observation wells are shown in Figure 2.4-21.
2. Surface elevations of the observation wells are given in Table 2.4-17.
3. Observation wells were installed during December, 1974. The average depth is 25 ft.; granular backfill was placed around the lower 8 ft. of each observation well. All observation wells are installed in the glacial drift aquitard.
4. Dates of water level measurements are shown in Table 2.4-17; potentiometric levels are inferred between dates of measurement.
5. Precipitation data were recorded at the Marseilles Lock, 41°21'N., 88°45'W.

LA SALLE COUNTY STATION
 UPDATED FINAL SAFETY ANALYSIS REPORT

FIGURE 2.4-23

DAILY PRECIPITATION AND FLUCTUATIONS
 OF WATER LEVELS IN OBSERVATION WELLS
 (SHEET 1 of 4)

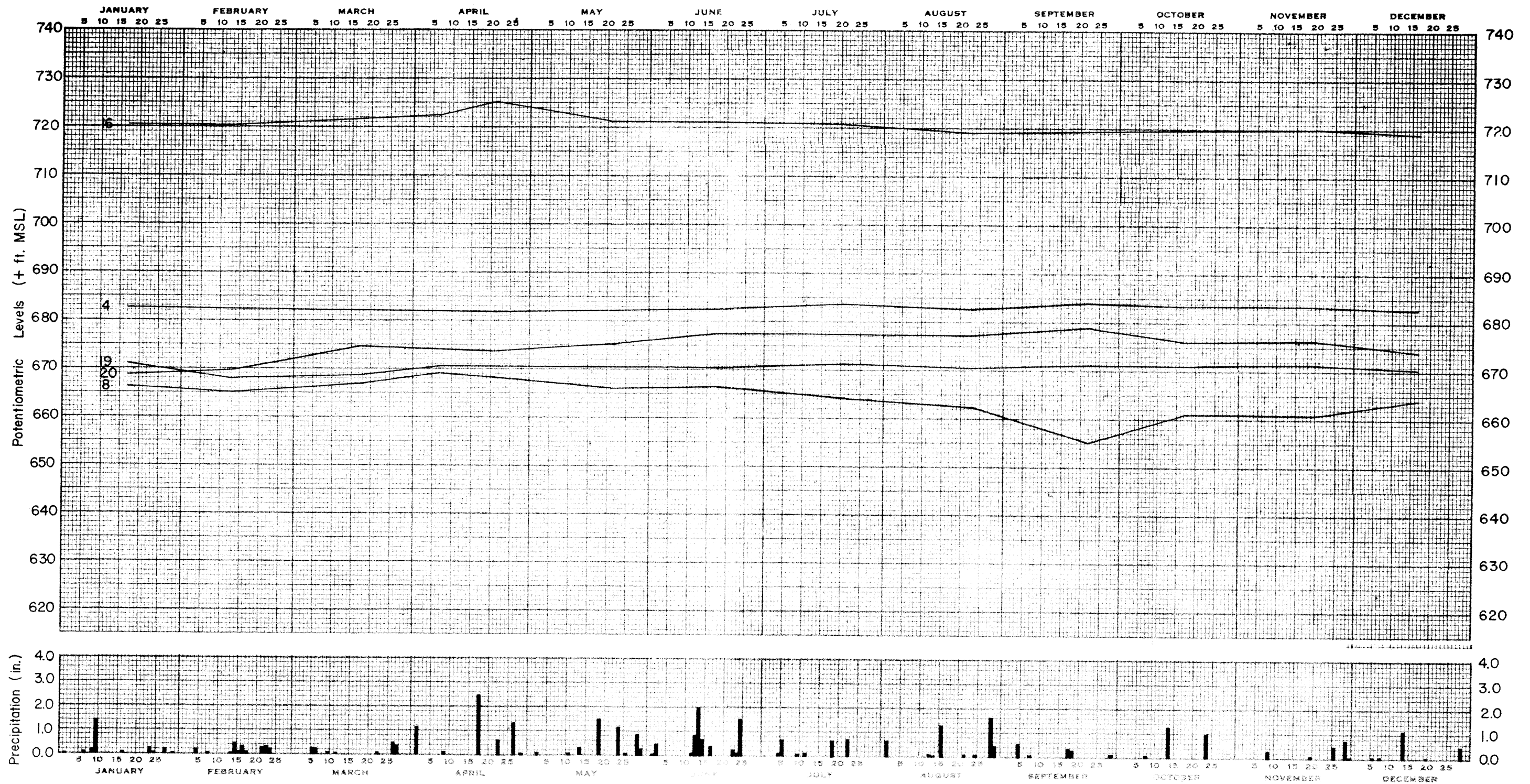

NOTES

1. Locations of observation wells are shown in Figure 2.4-21.
2. Surface elevations of the observation wells are given in Table 2.4-17.
3. Observation wells were installed during December, 1974. The average depth is 25 ft.; granular backfill was placed around the lower 8 ft. of each observation well. All observation wells are installed in the glacial drift aquitard.

1975

4. Dates of water level measurements are shown in Table 2.4-17; potentiometric levels are inferred between dates of measurement.
5. Precipitation data were recorded at the Marseilles Lock, 41°21'N., 88°45'W.

LA SALLE COUNTY STATION
 UPDATED FINAL SAFETY ANALYSIS REPORT

FIGURE 2.4-23
 DAILY PRECIPITATION AND FLUCTUATIONS
 OF WATER LEVELS IN OBSERVATION WELLS
 (SHEET 2 of 4)

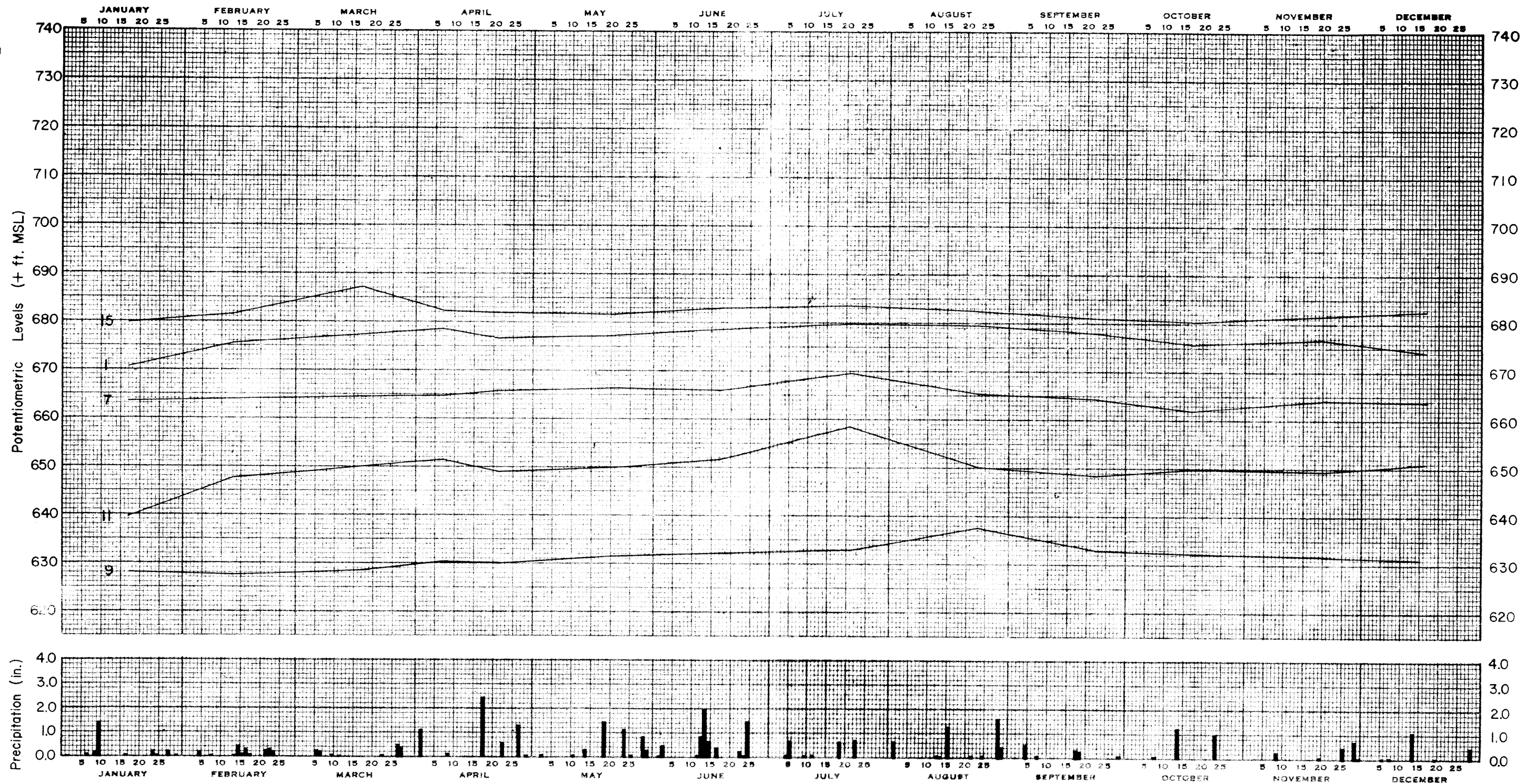

NOTES

1. Locations of observation wells are shown in Figure 2.4-21.
2. Surface elevations of the observation wells are given in Table 2.4-17.
3. Observation wells were installed during December, 1974. The average depth is 25 ft.; granular backfill was placed around the lower 8 ft. of each observation well. All observation wells are installed in the glacial drift aquitard.
4. Dates of water level measurements are shown in Table 2.4-17; potentiometric levels are inferred between dates of measurement.
5. Precipitation data were recorded at the Marseilles Lock, 41° 21' N., 88° 45' W.

LA SALLE COUNTY STATION
 UPDATED FINAL SAFETY ANALYSIS REPORT

FIGURE 2.4-23

DAILY PRECIPITATION AND FLUCTUATIONS
 OF WATER LEVELS IN OBSERVATION WELLS
 (SHEET 3 of 4)

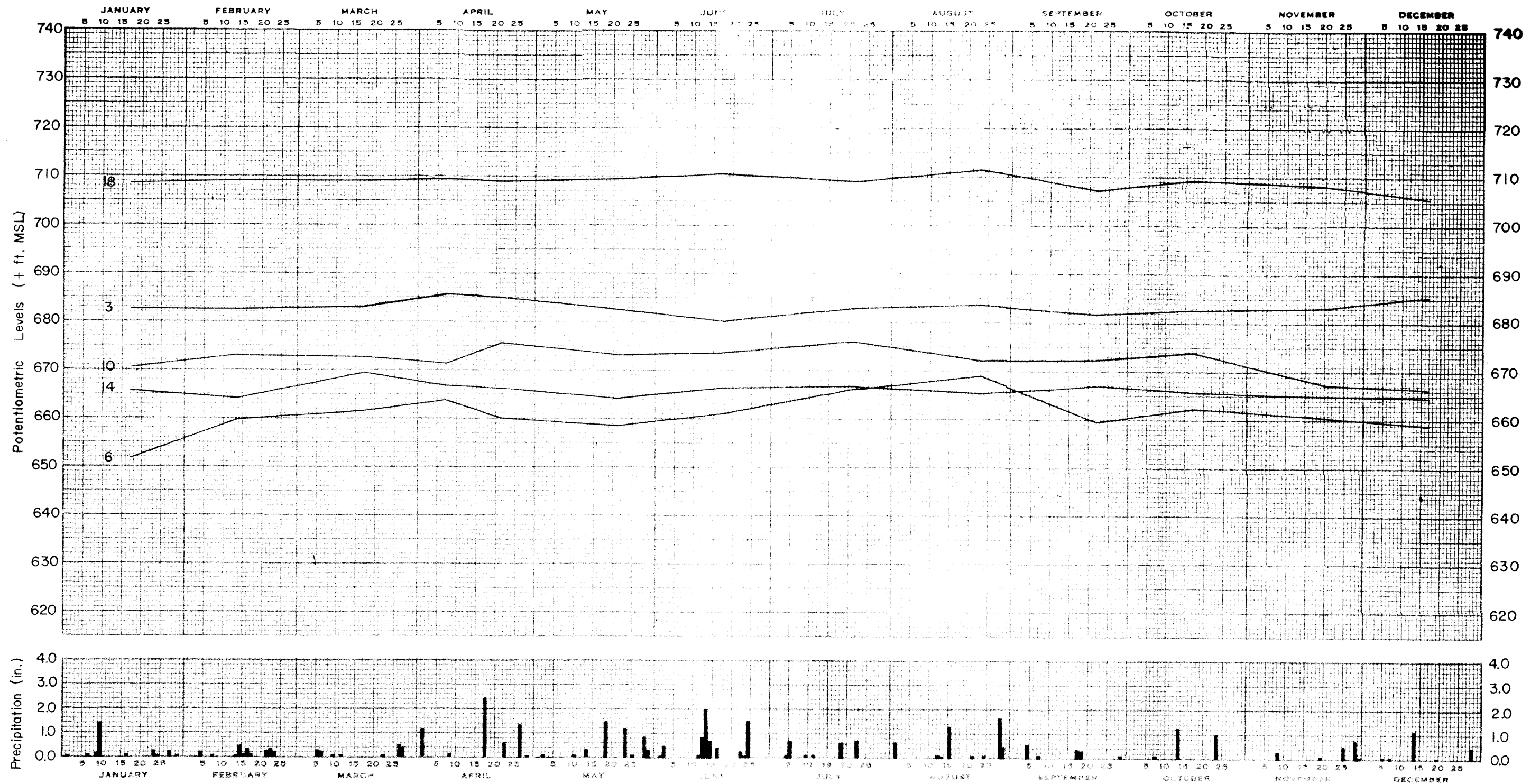

NOTES

1975

1. Locations of observation wells are shown in Figure 2.4-21.
2. Surface elevations of the observation wells are given in Table 2.4-17.
3. Observation wells were installed during December, 1974. The average depth is 25 ft.; granular backfill was placed around the lower 8 ft. of each observation well. All observation wells are installed in the glacial drift aquitard.
4. Dates of water level measurements are shown in Table 2.4-17; potentiometric levels are inferred between dates of measurement.
5. Water level measurements in well no. 18 after July 21, 1975, may be affected by a broken cap.
6. Precipitation data were recorded at the Marseilles Lock, 41°21' N., 88°45' W.

LA SALLE COUNTY STATION
 UPDATED FINAL SAFETY ANALYSIS REPORT

FIGURE 2.4-23
 DAILY PRECIPITATION AND FLUCTUATIONS
 OF WATER LEVELS IN OBSERVATION WELLS
 (SHEET 4 of 4)

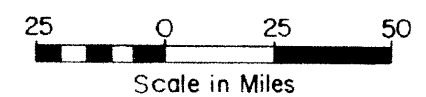
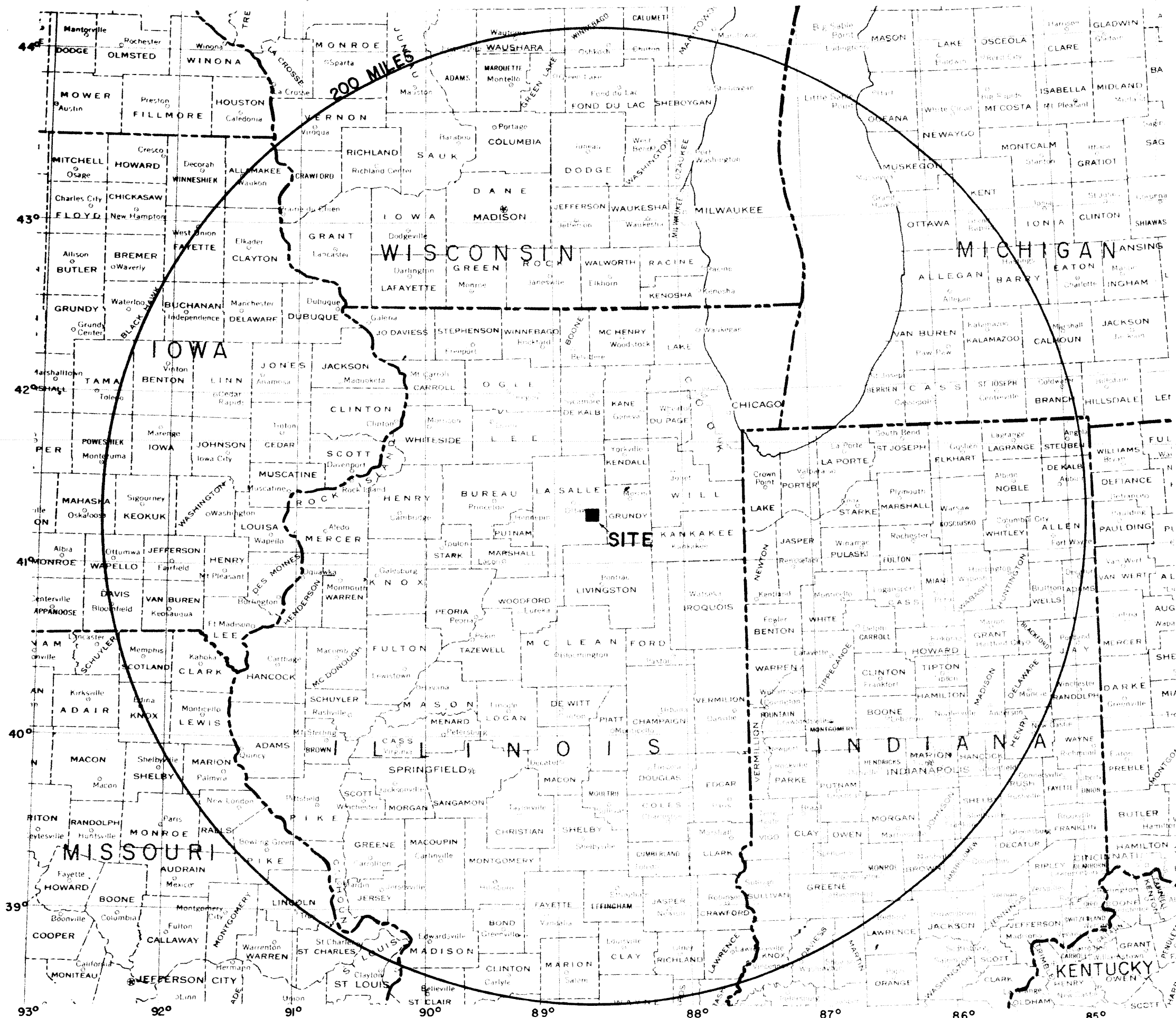

**LA SALLE COUNTY STATION
UPDATED FINAL SAFETY ANALYSIS REPORT**

**FIGURE 2.5-1
GENERAL SITE LOCATION**

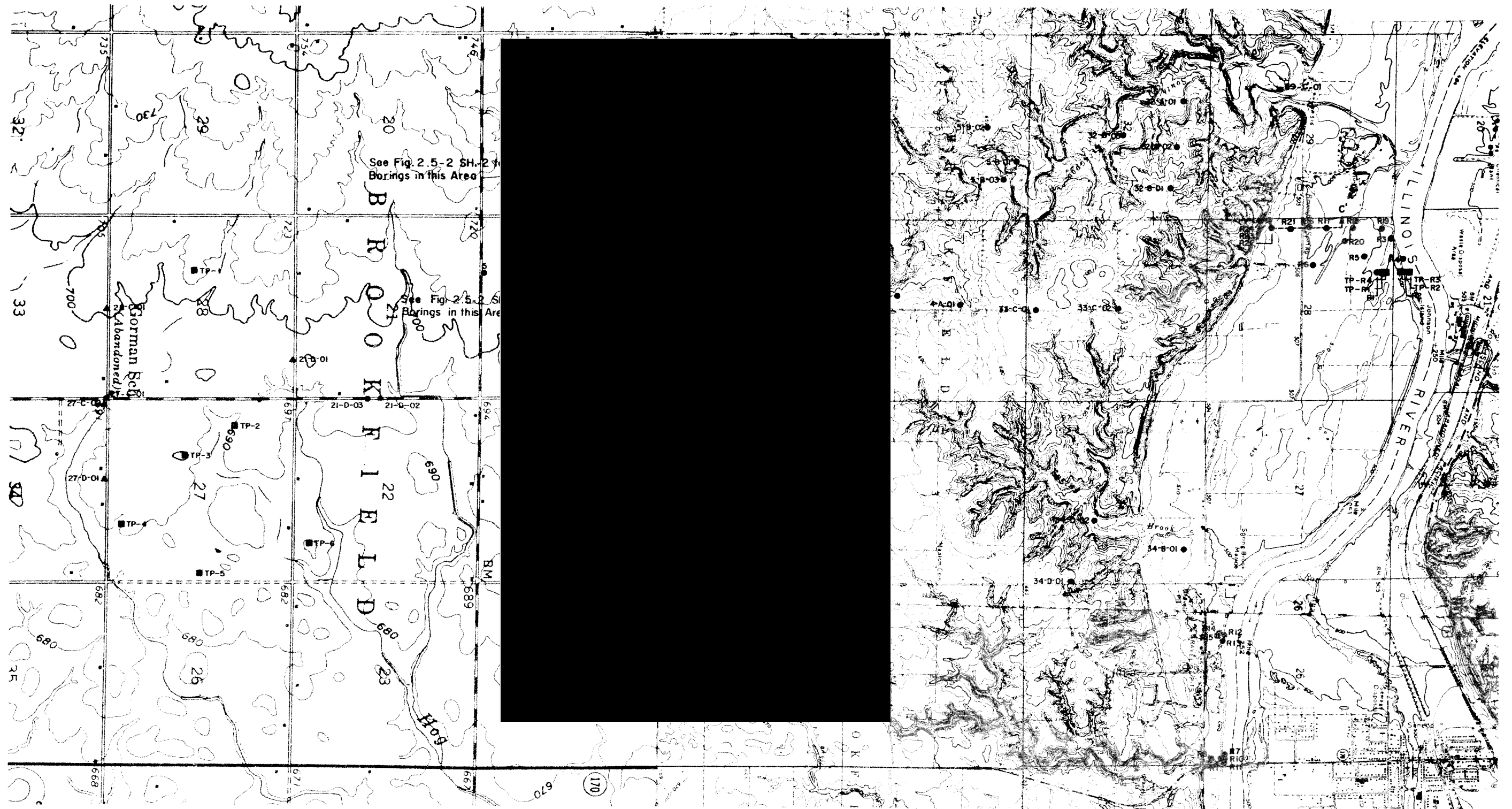

LEGEND

- Test Pit
- Boring
- ▲ Boring with Piezometer Installation
- Cross Section (Figure 2.5-15)
- ▨ Category I Structure
- - - - - CSCS Piping

NOTE

Source of Base Map:
 U.S. Geol. Surv., 1970, Marseilles Quad.
 Illinois, topog. map, 7.5 min. ser.
 U.S. Geol. Surv., 1958, Odell Quad.
 Illinois, topog. map, 15 min. ser.
 U.S. Geol. Surv., 1970, Seneca Quad.
 Illinois, topog. map, 7.5 min ser.

LA SALLE COUNTY STATION
 UPDATED FINAL SAFETY ANALYSIS REPORT

FIGURE 2.5-2
 PLOT PLAN
 (SHEET 1 of 3)

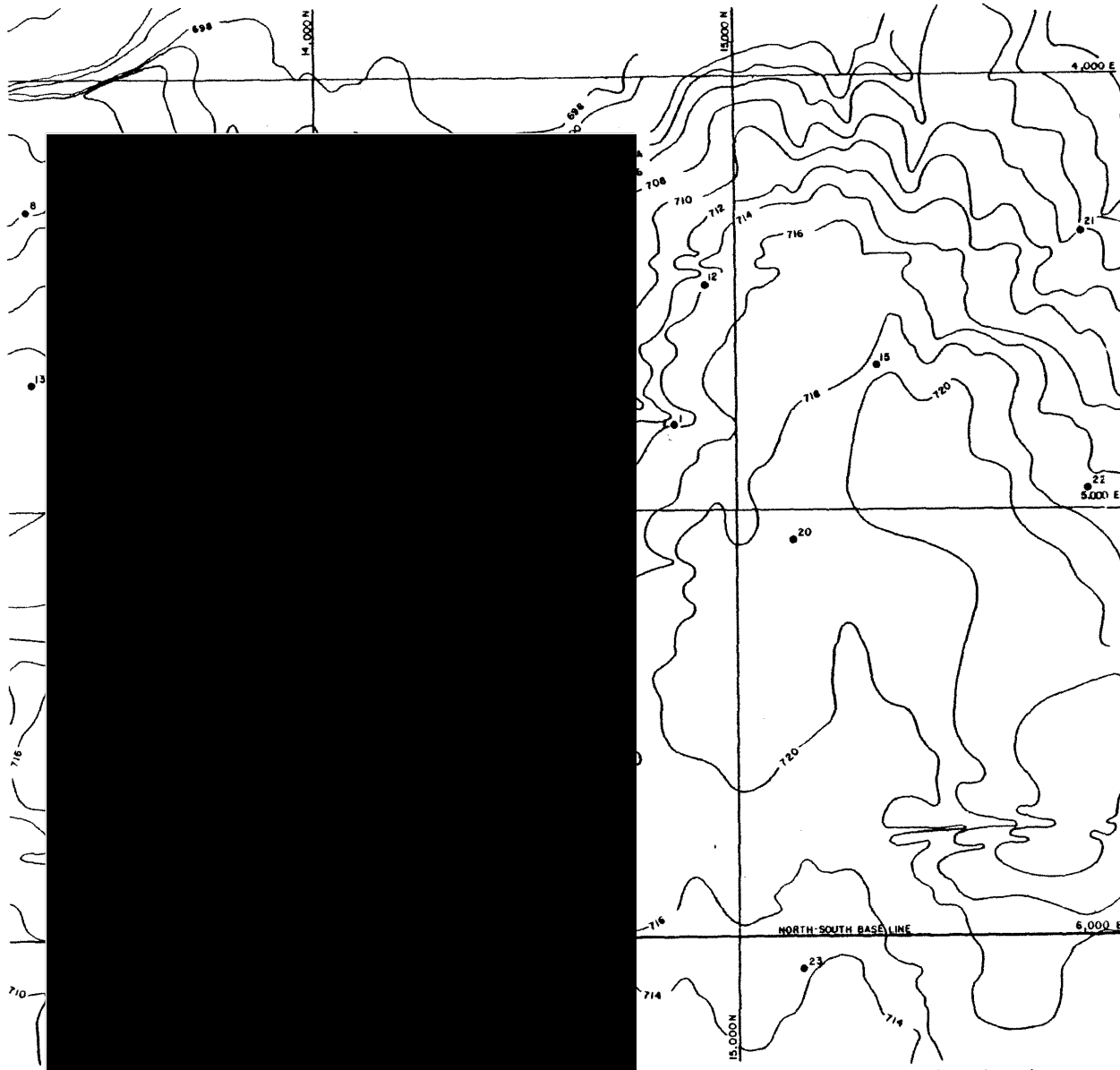

LEGEND

- ²⁰ Boring location
- ▲³⁷ Boring with piezometer installation
- ▨ Category I Structure

NOTES

1. For surrounding area, see Figure 2.5-2, Sheet 1.
2. Contour interval 2 feet.
3. Source of base map: Air Maps, Inc.



<p>LA SALLE COUNTY STATION UPDATED FINAL SAFETY ANALYSIS REPORT</p>
<p>FIGURE 2.5-2 PLOT PLAN (SHEET 2 of 3)</p>

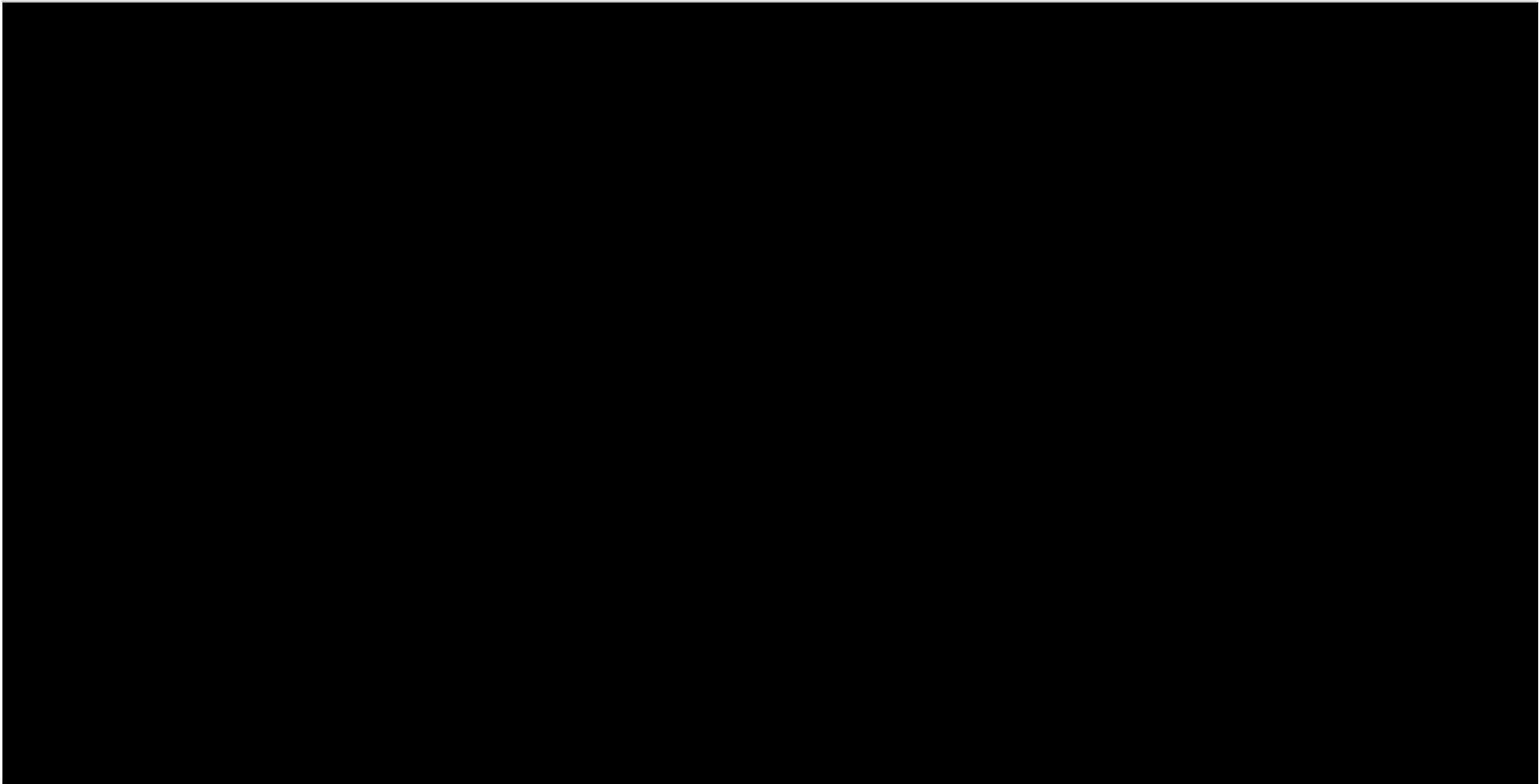

LA SALLE COUNTY STATION UPDATED FINAL SAFETY ANALYSIS REPORT
FIGURE 2.5-2 PLOT PLAN (SHEET 3 of 3)

REV. 0 - APRIL 1984

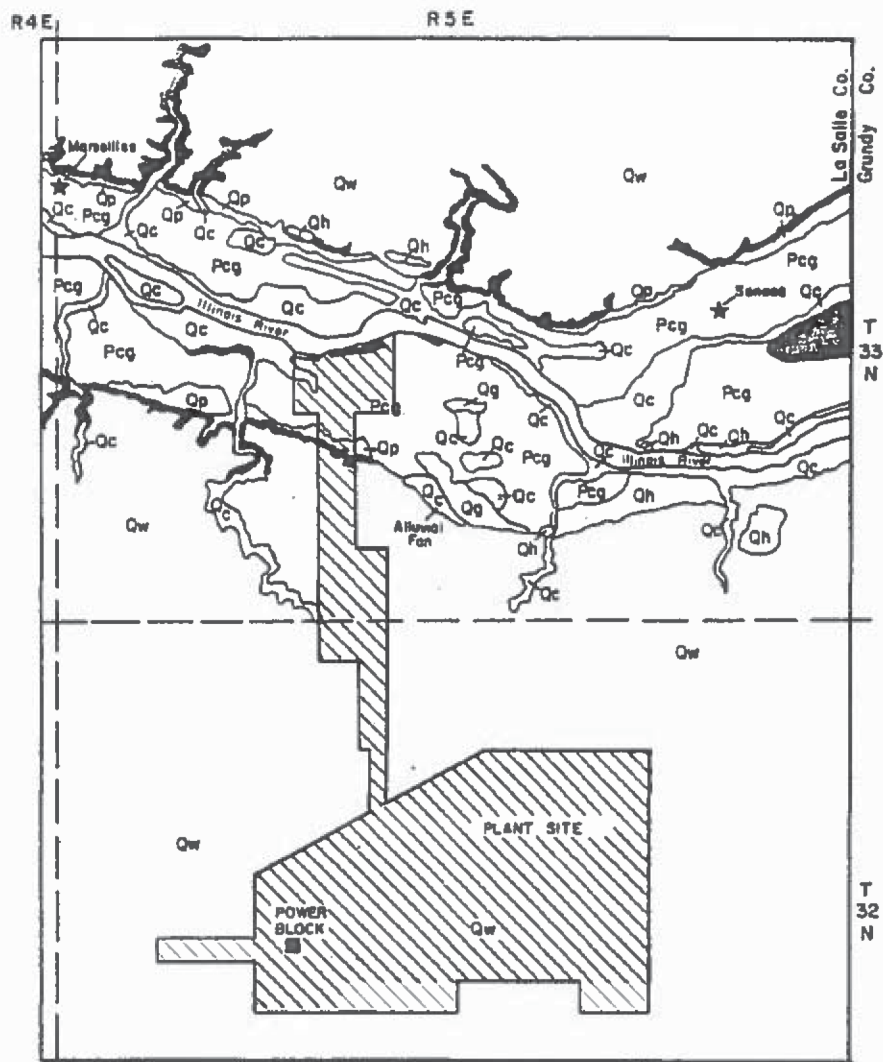

LEGEND

- | | | |
|---------------|-----|---|
| Quaternary | Qc | Cahokia Alluvium |
| | Qp | Peyton Colluvium |
| | Qh | Henry Formation |
| | Qg | Graylake Peat |
| | Qw | Wedron Formation overlain by Richland Laess |
| Pennsylvanian | Pcq | Carbondale Formation overlain by thin sand and gravel |
| | Pc | Carbondale Formation outcrop |
| | | Geologic contact |
| | | Plant Site |

NOTE

1. Map modified from Willman, 1973, Plate I



**LA SALLE COUNTY STATION
UPDATED FINAL SAFETY ANALYSIS REPORT**

**FIGURE 2.5-3
SITE AREA SURFICIAL GEOLOGIC MAP**

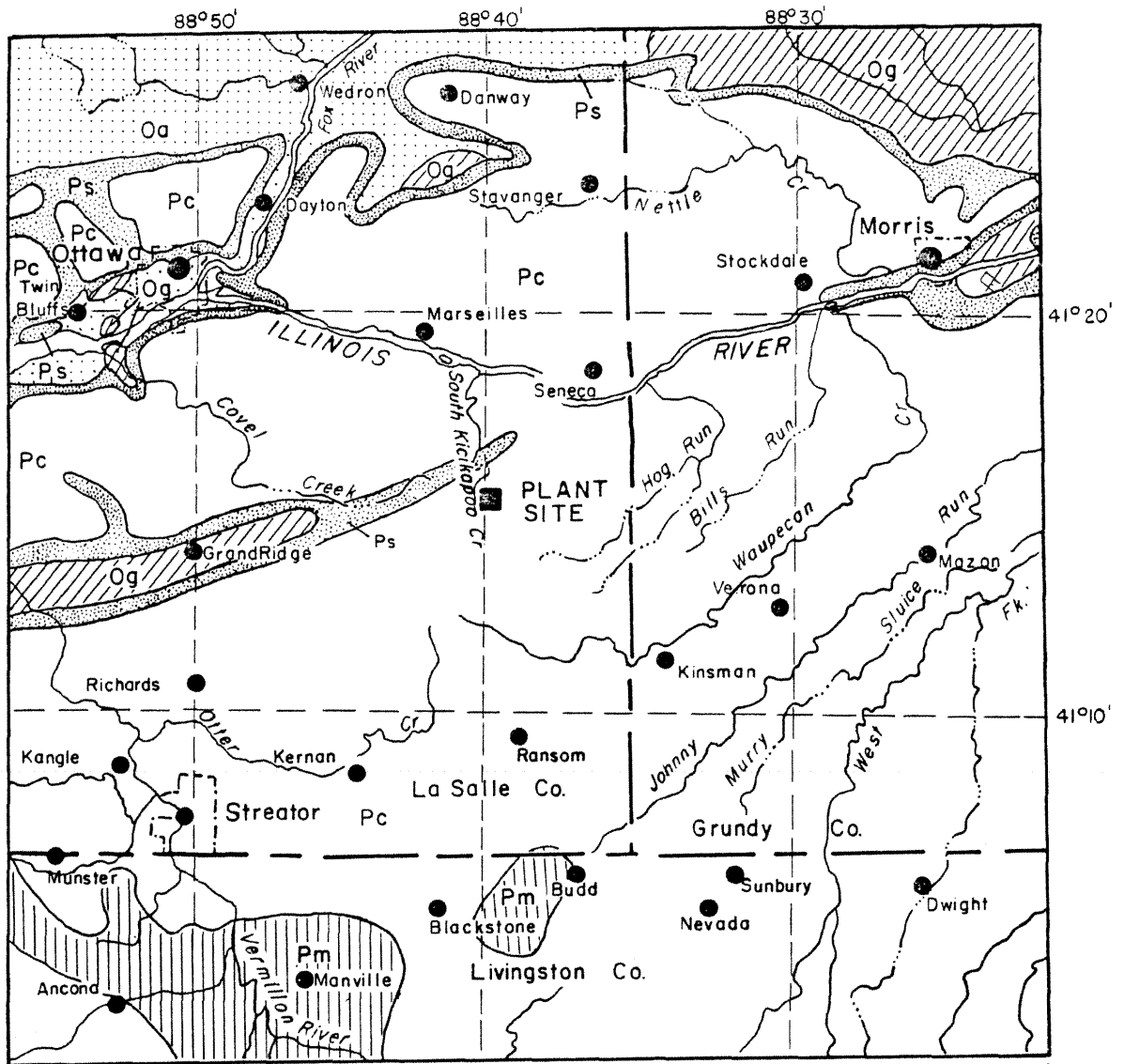

LEGEND

Pennsylvanian

- Pm Modesto Formation
- Pc Carbondale Formation
- Ps Spoon Formation

Ordovician

- Og Galena and Platteville Groups
- Oa Ancell Group

NOTE:

1. Modified from Willman, et al., 1967.

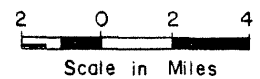

LA SALLE COUNTY STATION
UPDATED FINAL SAFETY ANALYSIS REPORT

FIGURE 2.5-4
SITE AREA BEDROCK GEOLOGY



LEGEND

- Divisions
- Provinces
- Sections
- - - Sub-sections

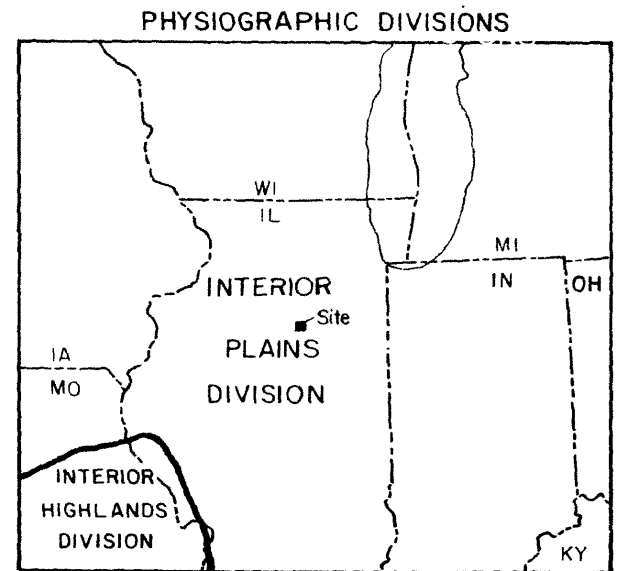

- NOTES**
- Adapted from Fenneman, N.M., 1935; Thornbury, W.D., 1965; Leighton, M.M., Ekblaw, G.E. and Horberg, L., 1948; Schneider, A.F., 1966; Mallot, C.A., 1922,
 - Subsections of Great Lakes Section in Michigan by Sargent & Lundy.

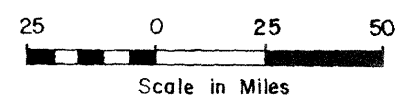

**LA SALLE COUNTY STATION
UPDATED FINAL SAFETY ANALYSIS REPORT**

**FIGURE 2.5-5
REGIONAL PHYSIOGRAPHY MAP**

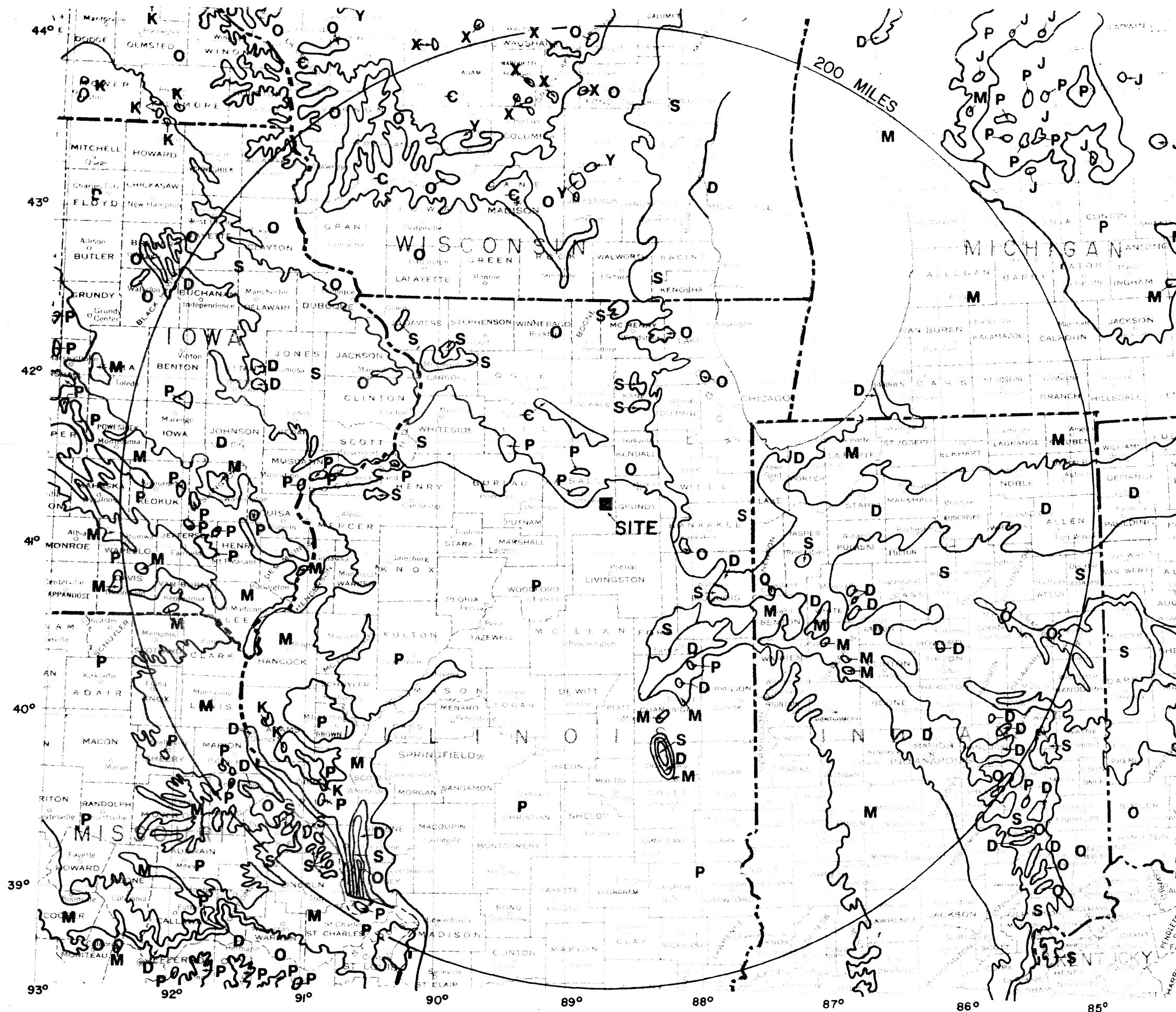

LEGEND	
ERATHEM	SYSTEM
CENOZOIC	Quaternary*
	Tertiary*
MESOZOIC	K Cretaceous gravel, sand
	J Jurassic shales, sandstones, clay, evaporites
	P Pennsylvanian cyclothem, sandstones, shales, limestones, coals
	M Mississippian limestones, dolomites, sandstones, shales
PALEOZOIC	D Devonian limestones, dolomites, shales, evaporites
	S Silurian limestones, dolomites, shales
	O Ordovician dolomites, shales, sandstones, limestones
	Є Cambrian dolomites, gravels, sands, clays
PRECAMBRIAN	Y Precambrian (about 800 to 1,600 MY) sedimentary rocks, metamorphic rocks,
	X Precambrian (about 1,600 to 2,500 MY) metamorphic rocks, volcanic rocks
~~~~~ Geologic contact	

**NOTES**

1. Quaternary and Tertiary deposits were not mapped, see Figure 2.5-3 for Quaternary deposits in the site area.
2. Map modified from King, P.B. and Beikman, H.M., 1974.

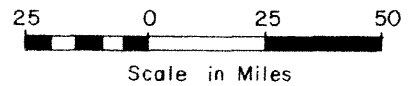

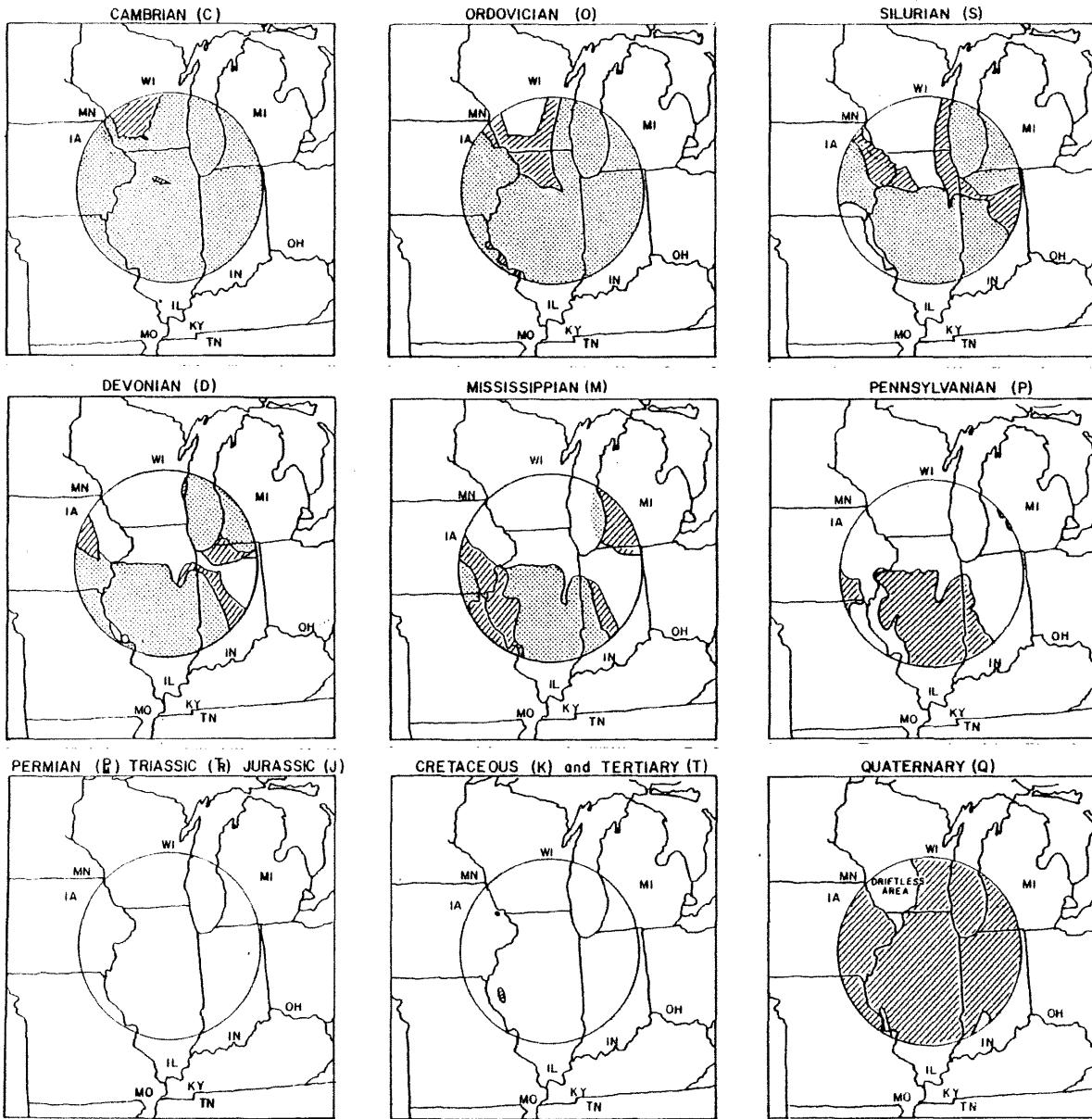

**LA SALLE COUNTY STATION  
UPDATED FINAL SAFETY ANALYSIS REPORT**

**FIGURE 2.5-6  
REGIONAL BEDROCK GEOLOGY**



**LEGEND**

-  Absent
-  Present at surface or covered only by Quaternary drift
-  Known or inferred to be present in the subsurface

**NOTES**

1. Modified from Moore, R.C., 1958
2. Limit of Pleistocene glaciation taken from Flint et al., 1959
3. Outcrops of Tertiary rocks are too small to be shown at this scale (see Willman et al., 1975, p. 207)



0 100 200 300 400  
Approximate Scale in Miles

LA SALLE COUNTY STATION  
UPDATED FINAL SAFETY ANALYSIS REPORT

FIGURE 2.5-7  
GENERALIZED REGIONAL SYSTEMIC  
DISTRIBUTION MAP

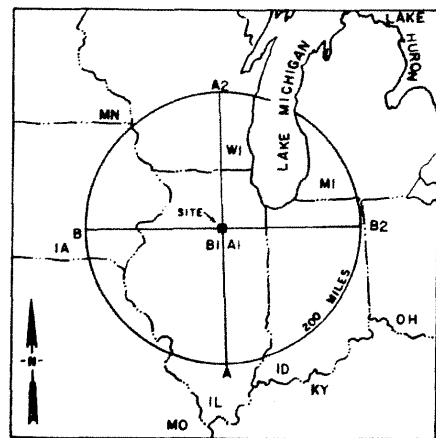
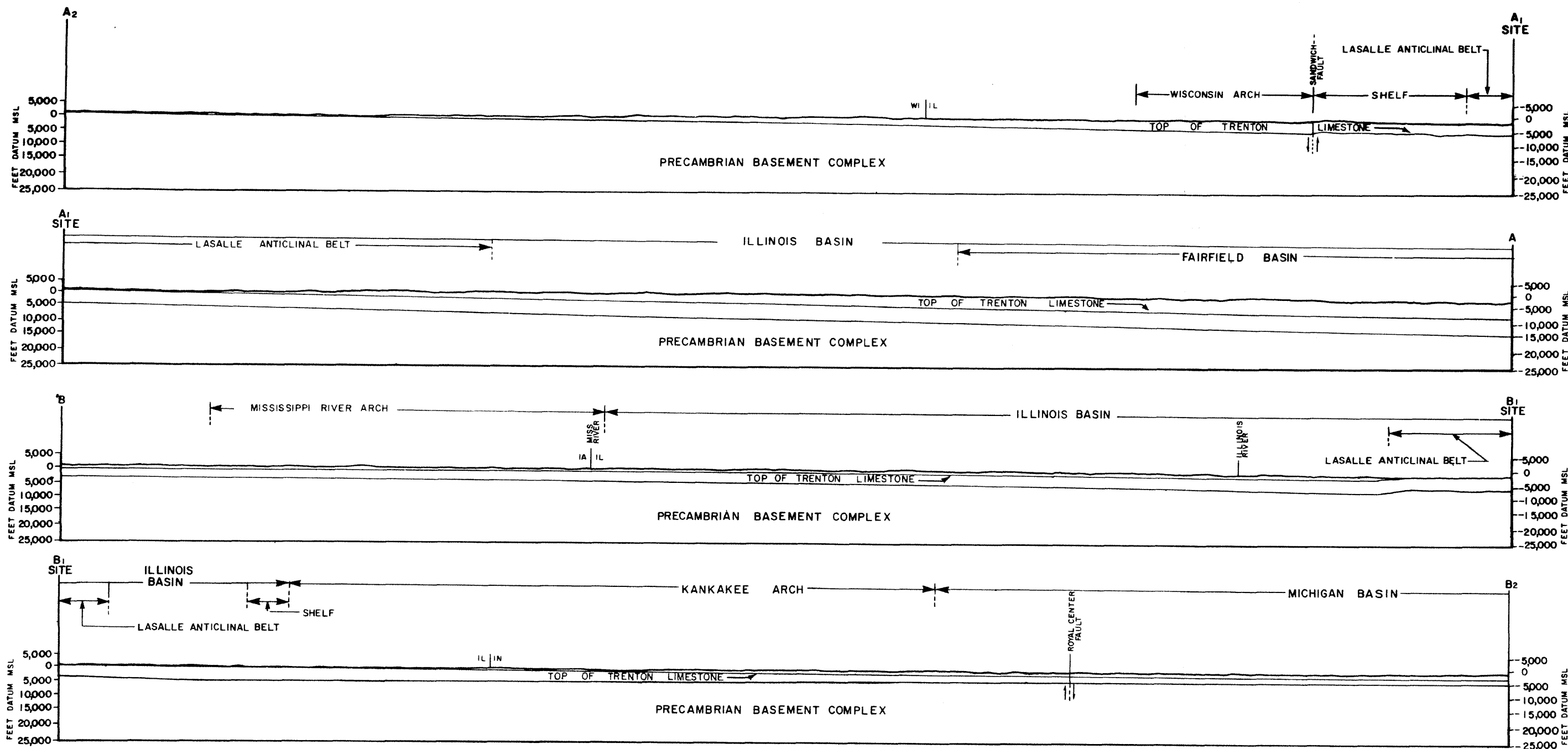

KEY PLAN

**NOTES**

1. Topography derived from the following US Geological Survey Topographic Maps:  
 Madison, 1963 (NK 16-1),  
 Rockford, 1963 (NK 16-4),  
 Davenport, 1963 (NK 15-9),  
 Chicago, 1954 (NK 16-8),  
 Fort Wayne, 1953 (NK 16-19),  
 Illinois Base Map 1948,  
 Iowa Base Map 1966.
2. Topography of basement complex modified from Atherton, 1971, Bristol & Buschbach, 1973, Flawn, 1967, Thwaites, 1957.
3. Top of Trenton derived from Bristol and Buschbach, (1973) and Cohee et al., (1962). The Trenton Limestone is a Middle Ordovician carbonate (Bristol and Buschbach, 1973).
4. Tectonic features taken from Regional Tectonic Map Basins and Arches in Paleozoic Rocks, Figure 2.5-9.

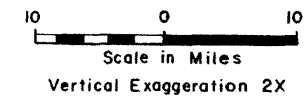

LA SALLE COUNTY STATION  
 UPDATED FINAL SAFETY ANALYSIS REPORT

FIGURE 2.5-8  
 REGIONAL GEOLOGIC CROSS SECTIONS

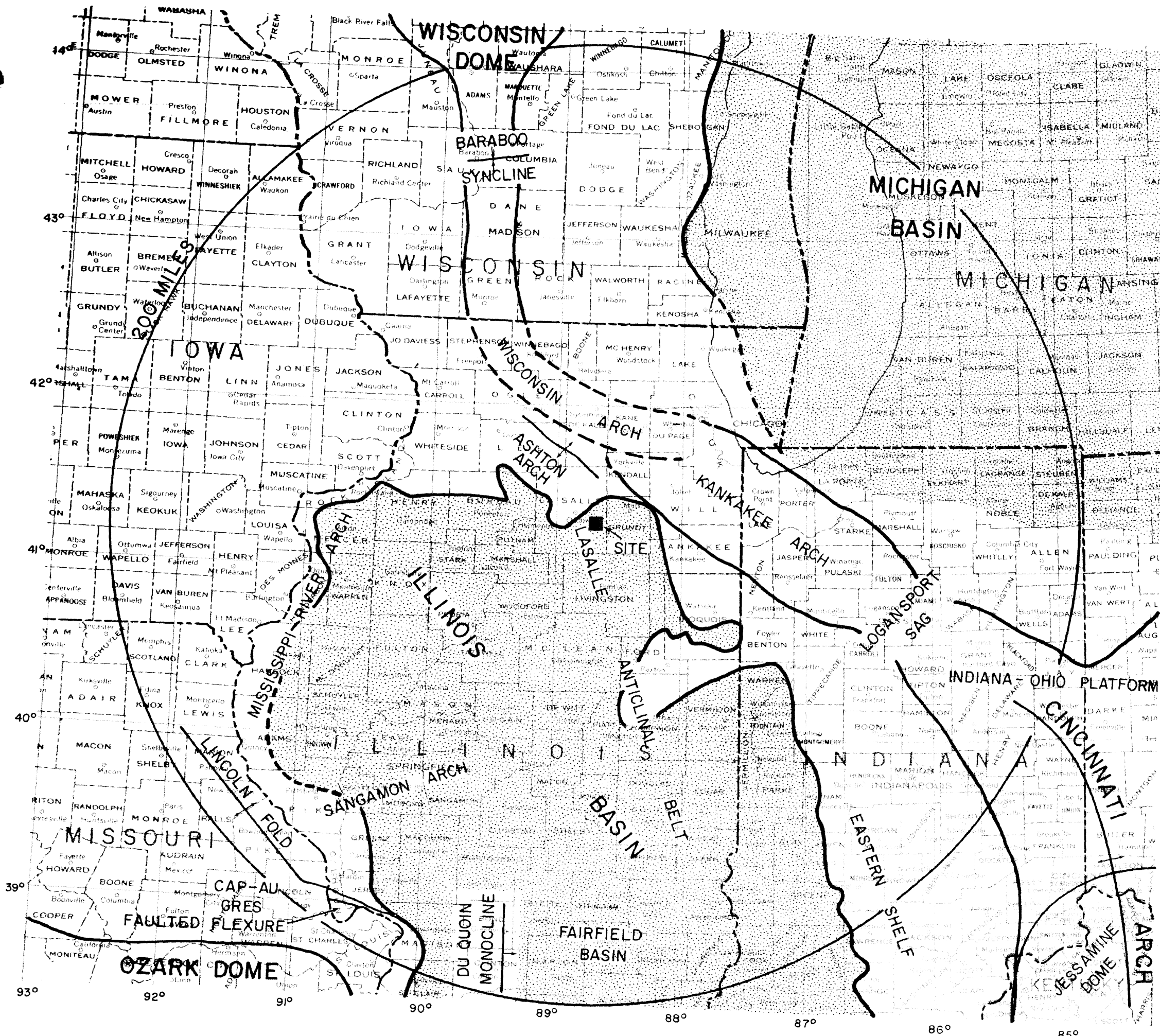

**LEGEND**

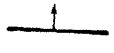
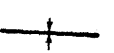
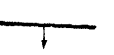
-  Basins
-  Approximate axis of anticline or arch
-  Approximate axis of syncline or trough
-  Approximate axis of monocline

**NOTES**

1. From: Cohee et al., 1962; Eardley, A.J., 1962; Riggs, E.A., 1960
2. Definitions of selected features are given in Section 2.5.1.1.5.1.

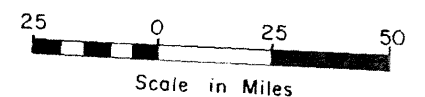





**LA SALLE COUNTY STATION**  
 UPDATED FINAL SAFETY ANALYSIS REPORT

FIGURE 2.5-9

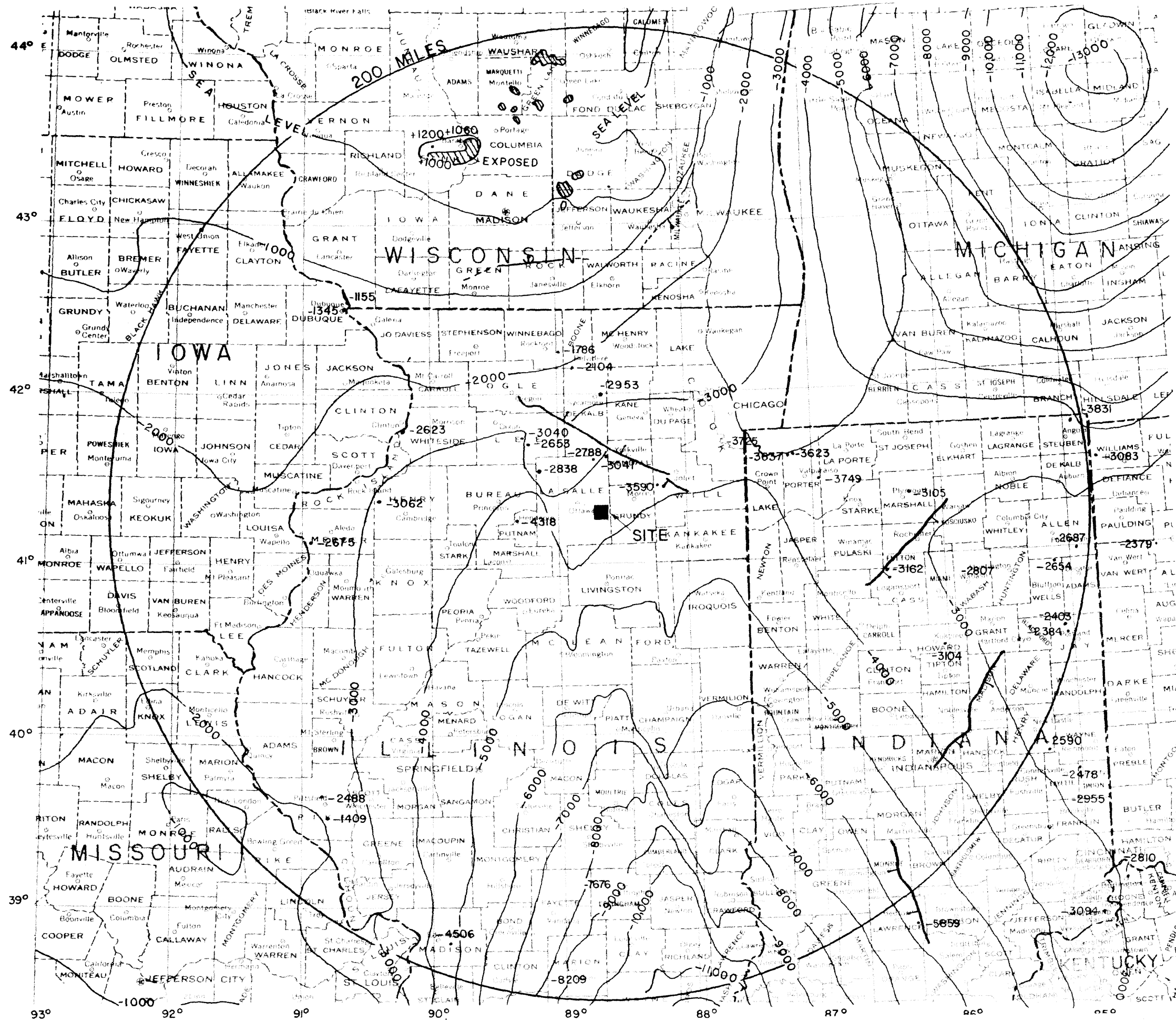
REGIONAL TECTONIC MAP  
 BASINS AND ARCHES - PALEOZOIC ROCKS

REV. 0 - APRIL 1984



- LEGEND**
-  Precambrian exposed
  -  Contour, interval 1000 feet datum mean sea level.
  -  Fault, ball and bar on downthrown side
  -  -2583 Location of wells penetrating basement with corresponding basement elevation; data from published well logs.

**NOTE:**

Modified from Atherton, 1971  
 Buschbach, 1971; Eardley, 1962  
 Flawn, 1967; Ostrom, 1971

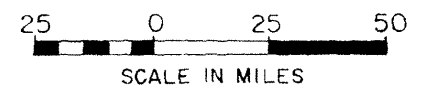
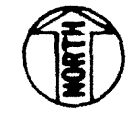

**LA SALLE COUNTY STATION  
 UPDATED FINAL SAFETY ANALYSIS REPORT**

**FIGURE 2.5-10  
 REGIONAL PRECAMBRIAN SURFACE**

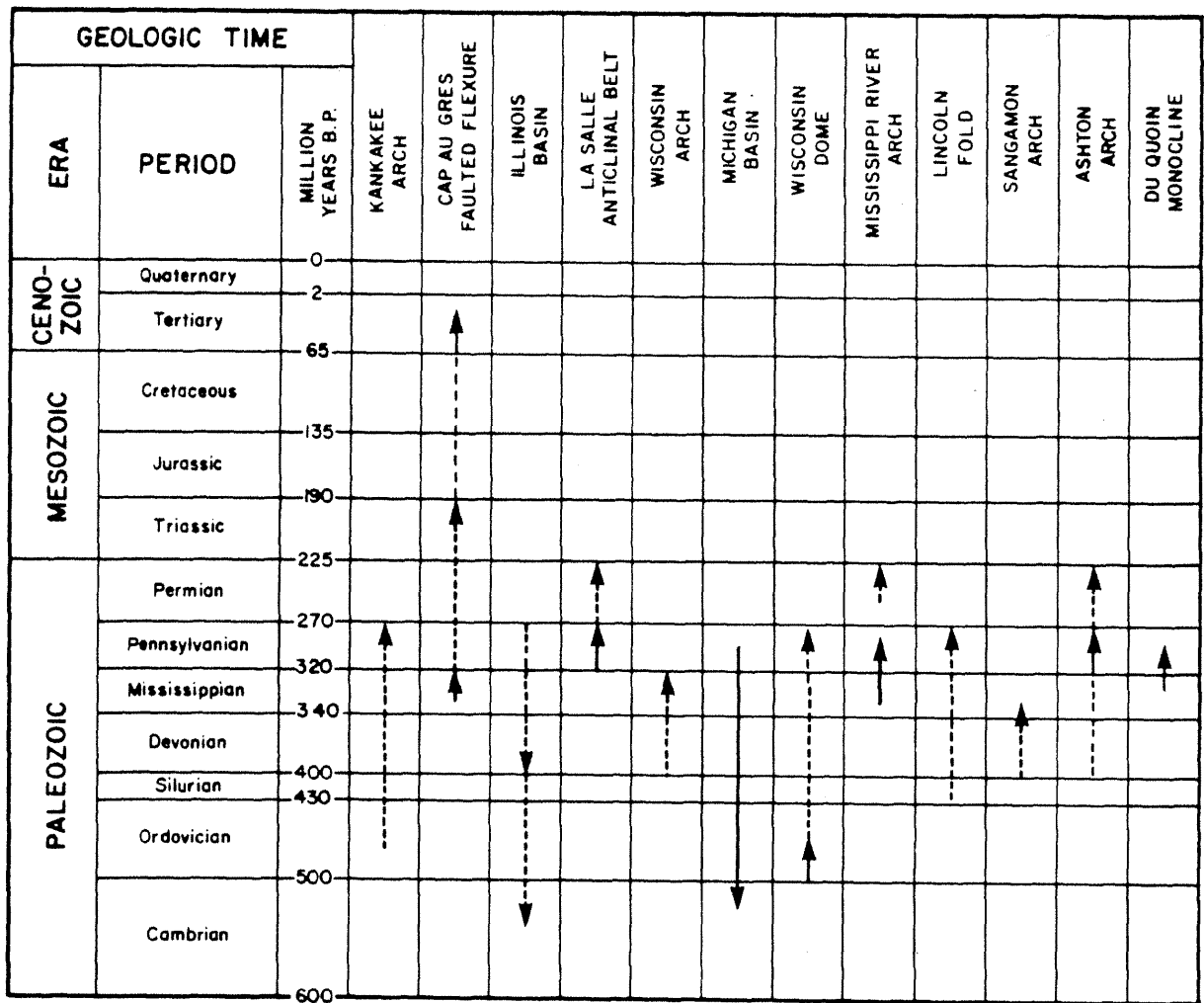

**LEGEND**

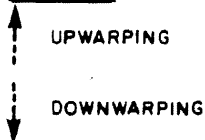

**NOTES**

1. Solid line indicates major movement, dashed line indicates intermittent movement.
2. Discussion of these features is presented in subsection 2.5.1.1.5.1 and their locations are shown on Figure 2.5-9.

**LA SALLE COUNTY STATION**  
 UPDATED FINAL SAFETY ANALYSIS REPORT

FIGURE 2.5-11

RELATIVE MOVEMENT OF REGIONAL  
 TECTONIC FEATURES



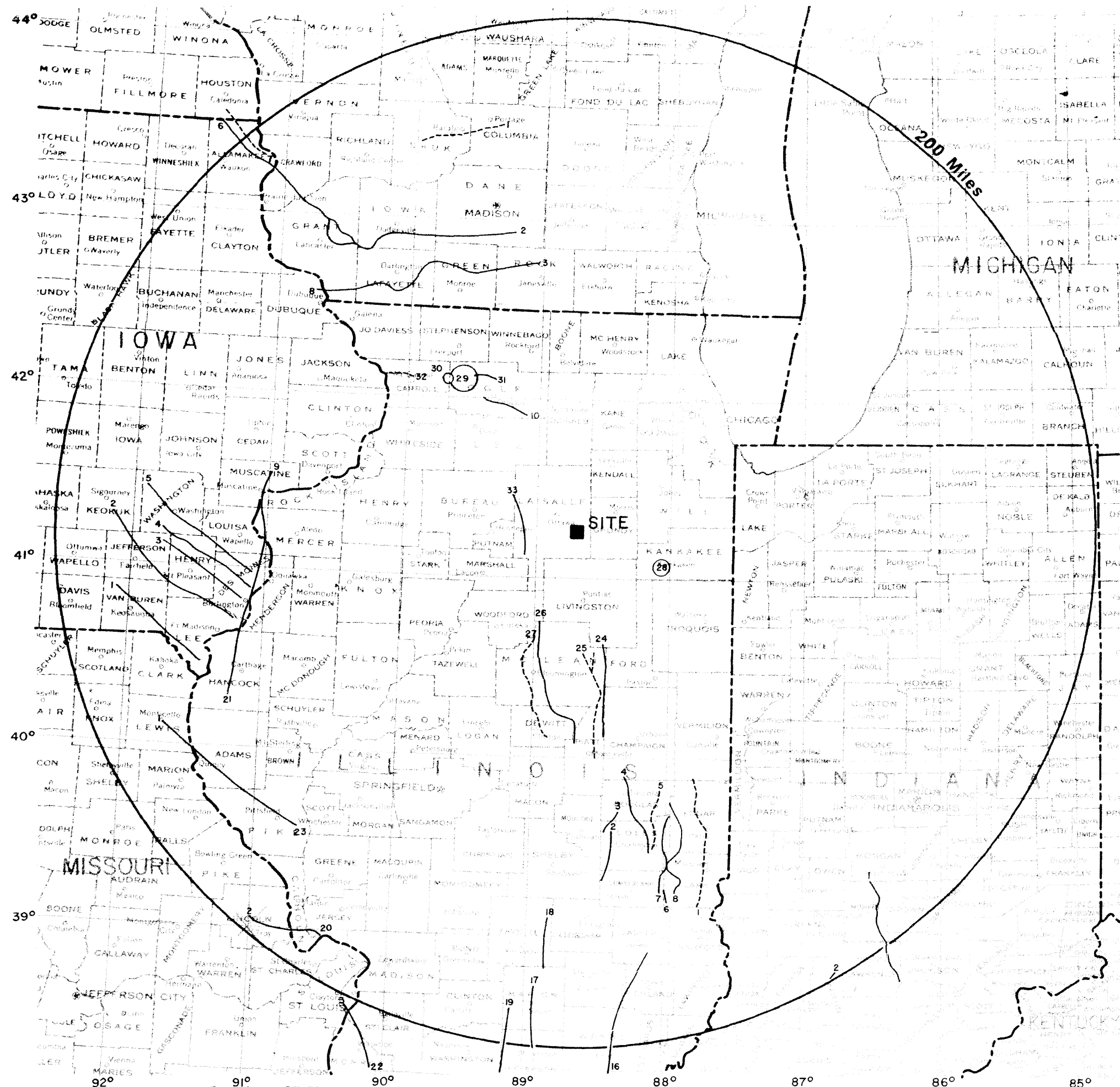

**LEGEND**

- Trace of Anticline Axis
- - - Trace of Syncline Axis
- Domes

**NOTES**

1. Only folds having axis two miles or longer are shown.
2. Folds are numbered according to state.
3. Data are summarized by state in Tables 2.5-8 through 2.5-12.

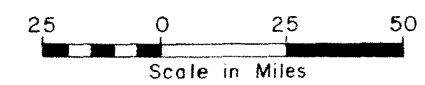

**LA SALLE COUNTY STATION**  
 UPDATED FINAL SAFETY ANALYSIS REPORT

FIGURE 2.5-12  
 REGIONAL TECTONIC MAP - FOLDS

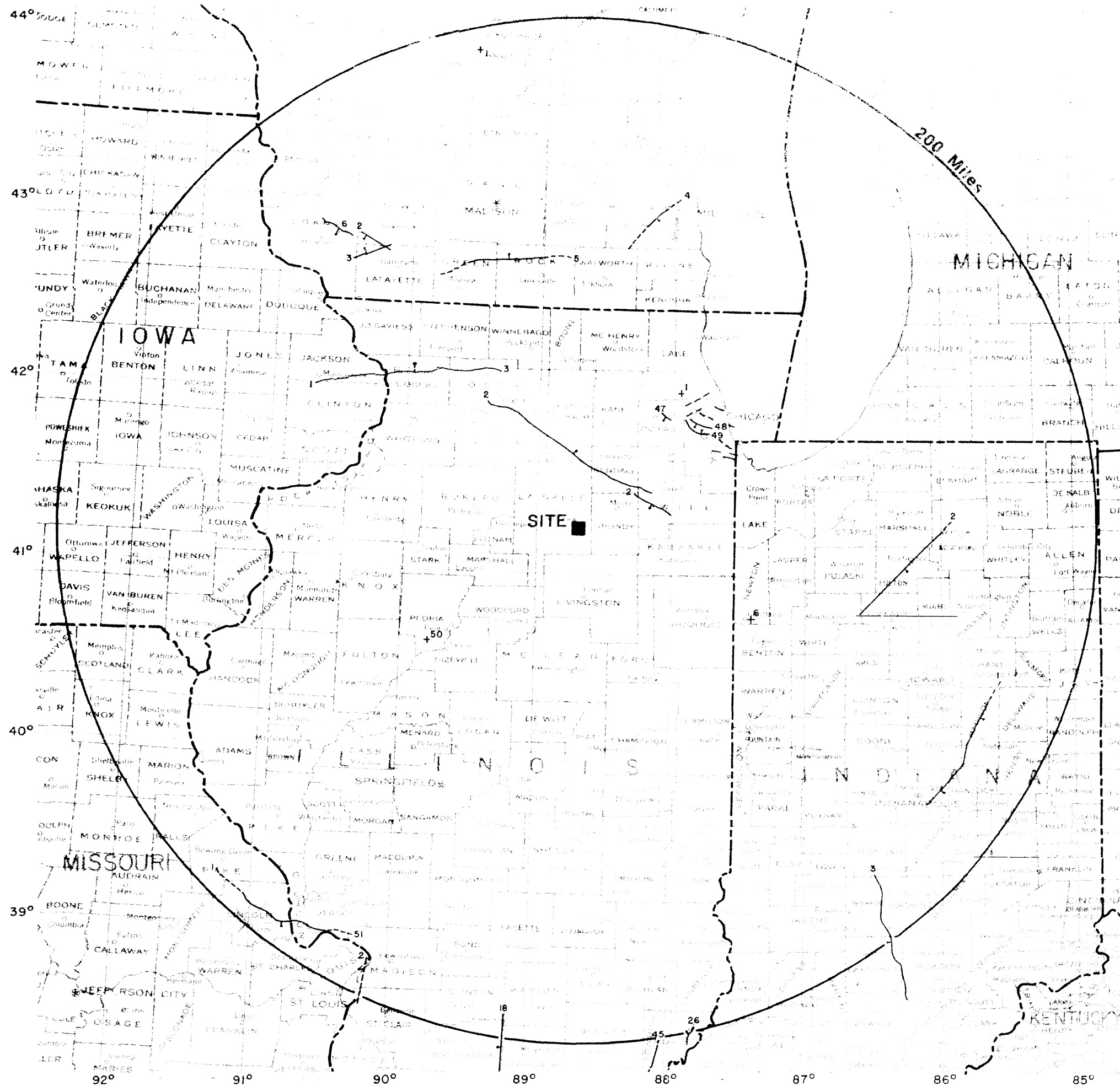

**LEGEND**

- Fault, solid where positively or approximately located; dashed where inferred. Ball and bar on downthrown side.
- + Faulted complex, astrobleme or cryptovolcanic.
- 2 Fault identification number.

**NOTES**

1. Only faults having traces two miles or longer are shown.
2. Faults are numbered according to state.
3. Data are summarized by state in Tables 2.5-3 through 2.5-7.

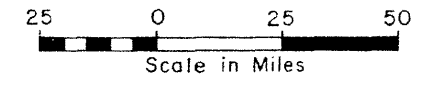

**LA SALLE COUNTY STATION**  
**UPDATED FINAL SAFETY ANALYSIS REPORT**  
  
**FIGURE 2.5-13**  
**REGIONAL TECTONIC MAP - FAULTS**



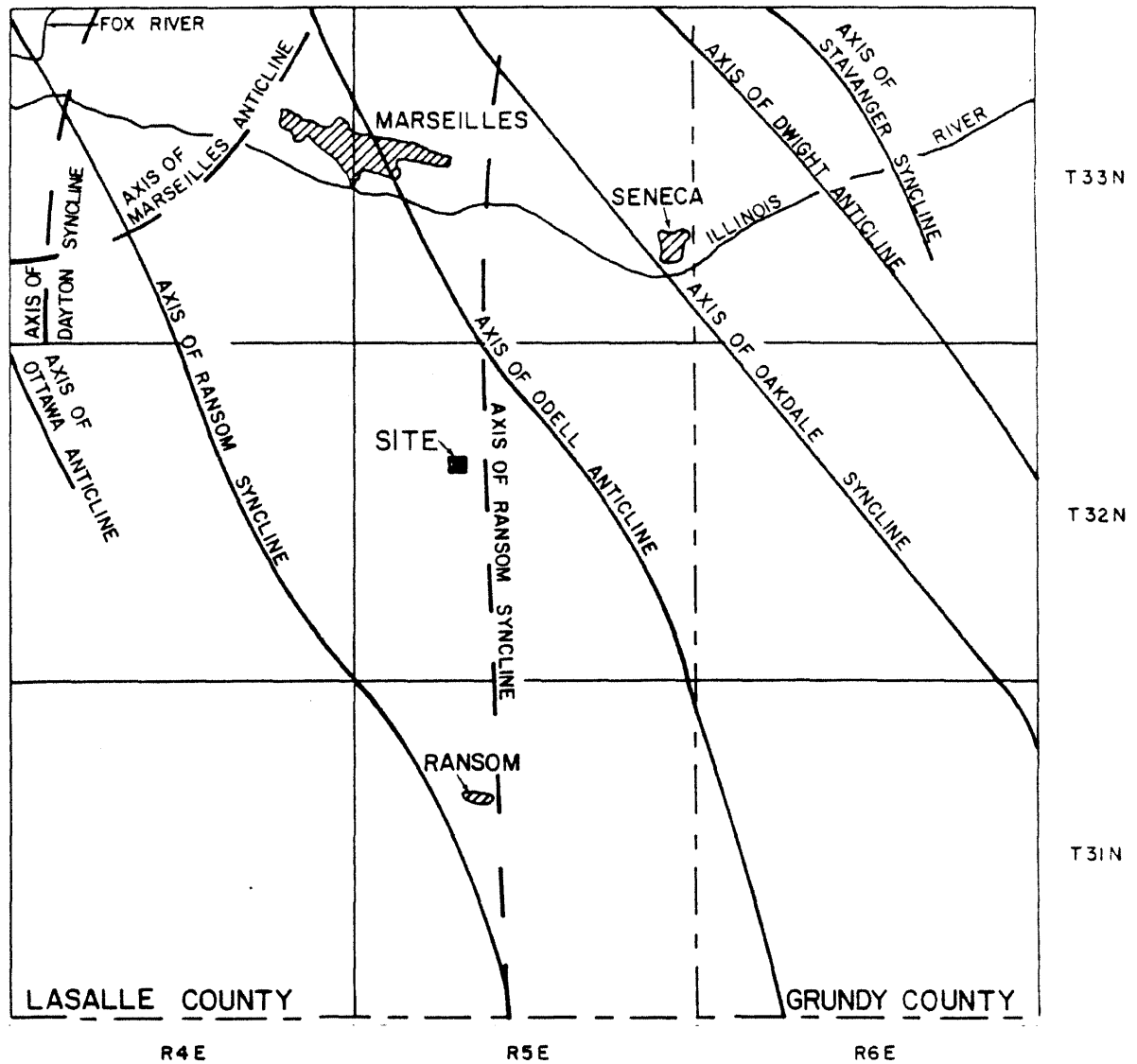

**LEGEND**

- Pre-St. Peter structure
- Post-St. Peter structure

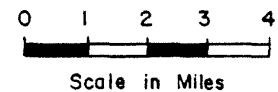

**NOTE**

1. Modified from Willman and Payne,  
1942, p. 182

**LA SALLE COUNTY STATION**  
**UPDATED FINAL SAFETY ANALYSIS REPORT**

---

FIGURE 2.5-14  
 SITE STRUCTURAL GEOLOGY

REV. 0 - APRIL 1984

**FOR INFORMATION ONLY**

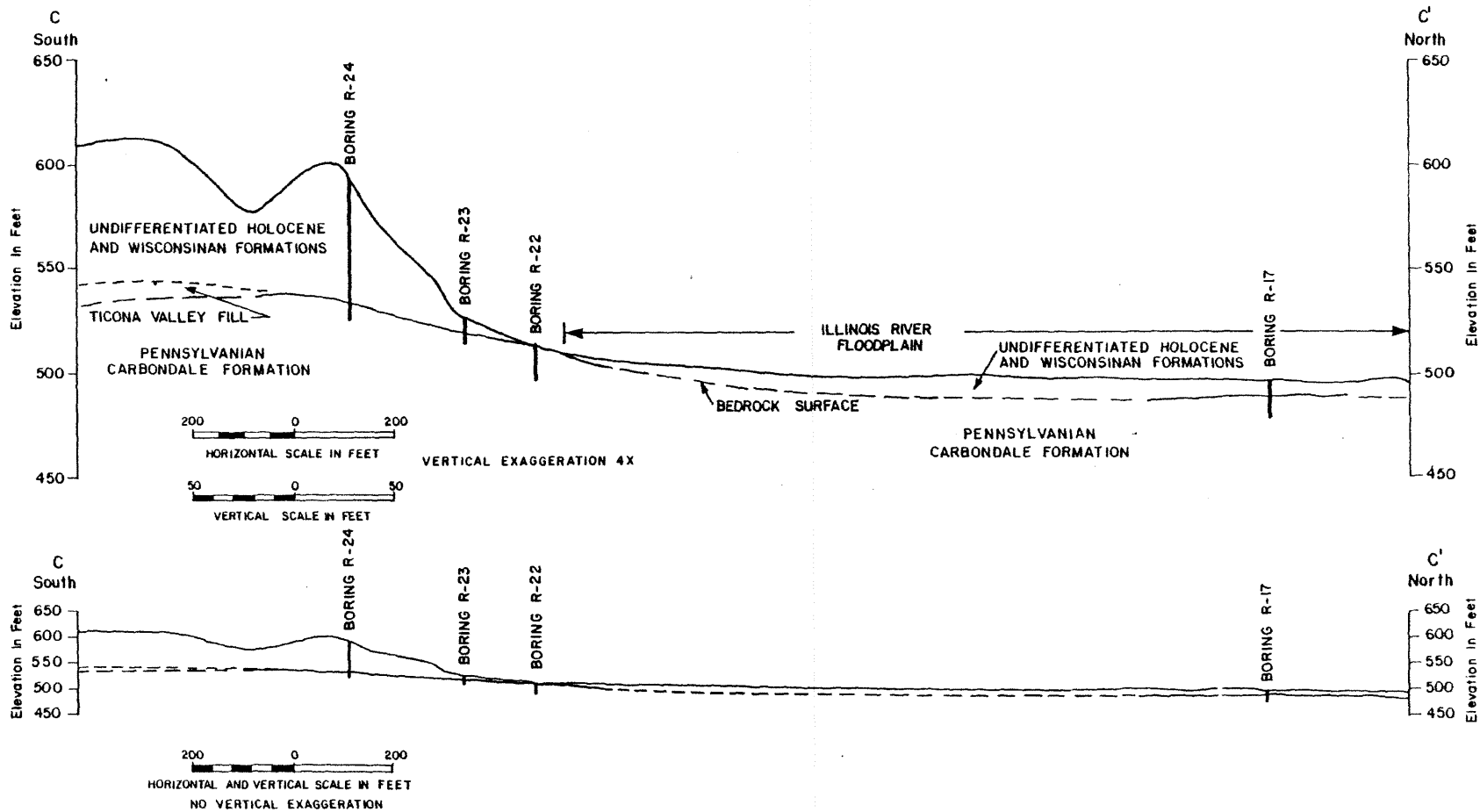

**NOTES**

1. Cross section location shown on Figure 2.5-2, Sheet 1.
2. Datum mean sea level.
3. Holocene and Wisconsinan deposits were not identified on a formation level in the boring logs.

LA SALLE COUNTY STATION UPDATED FINAL SAFETY ANALYSIS REPORT
FIGURE 2.5-15 CROSS SECTION - SOUTH BLUFF OF ILLINOIS RIVER

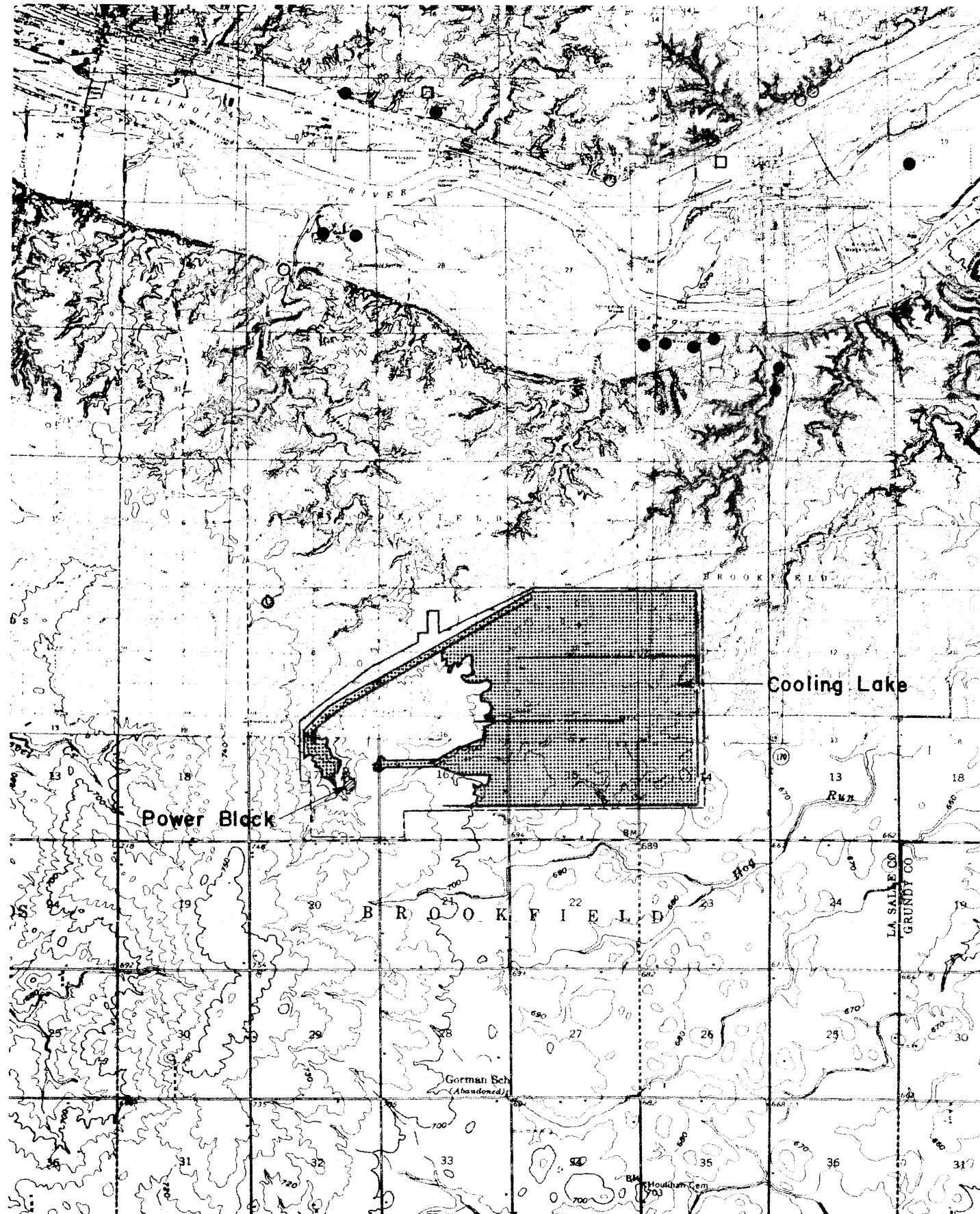

**LEGEND**

- Gravel Pit
- Gravel Pit (abandoned)
- Surface Mine (abandoned)

**NOTES**

1. Base map derived from U.S.G.S. Topographic Maps (Illinois): 7.5 Minute Series, Ottawa, 1970; Marselles, 1970; Seneca, 1970; 15 Minute Series, Streator, 1925; Odell, 1958.
2. Locations of pits and mines from U.S.G.S topographic base maps and from Sellin, et al., 1931 and Willman, 1973.

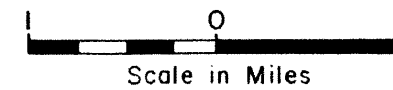

**LA SALLE COUNTY STATION**  
 UPDATED FINAL SAFETY ANALYSIS REPORT

FIGURE 2.5-16

ECONOMIC GEOLOGY IN SITE VICINITY

## EXPLANATION OF BORING LOGS

Shear  
Strength  
Column  
Key



- a. Shear strength defined as one-half the peak axial compressive stress (deviator stress), in PSF, as determined by unconsolidated undrained triaxial compression tests. Values in parentheses represent shear stress defined as one-half the axial compressive stress at 10 percent axial strain (for all tests in which the peak axial compressive stress occurred at axial strain levels greater than 10 percent).
- b. Cell pressure in PSF for unconsolidated undrained triaxial tests.
- c. Shear strength defined as one-half the peak axial compressive stress, in PSF, as determined by unconfined compression tests. Values in parentheses represent shear stress defined as one-half the axial compressive stress at 10 percent axial strain (for all tests in which the peak axial compressive stress occurred at axial strain levels greater than 10 percent).
- d. Shear strength defined as cohesion, the PSF, as determined by a pocket penetrometer used in the field as samples were obtained. Values in parentheses or in excess of 4500 PSF are estimated strengths.
- d₁. Shear strength defined as cohesion, in PSF, as determined by a torvane. Values in excess of 5000 PSF are indicated by (5000+).
- e. Shear strengths defined as the yield shear stress, in PSF, as determined by direct shear tests.
- f. Normal pressure, in PSF, for direct shear tests.

<b>LA SALLE COUNTY STATION</b>
<b>UPDATED FINAL SAFETY ANALYSIS REPORT</b>
<b>FIGURE 2.5-17</b>
<b>EXPLANATION OF BORING LOGS</b>
<b>(SHEET 1 OF 3)</b>

LEGEND

- Indicates the number of blows required to drive a Dames & Moore type U sampler one foot (except as noted) with a 340-pound hammer falling 24 inches. Blow count column marked * indicates the number of blows required to drive the sampler one foot with a 350-pound hammer falling 30 inches. Blow count column marked ** indicates the number of blows required to drive the sampler one foot with a 350-pound hammer falling 24 inches. Blow count marked ( ) indicates the number of blows required to drive the sampler one foot with a 340-pound hammer falling 30 inches.
- 15 ■ Indicates depth of undisturbed sample obtained with Dames & Moore type U sampler (3.25" O.D., 2.42" I.D. Split Spoon Sampler).
- P Indicates sampler was hydraulically pushed to obtain sample
- Indicates the number of blows required to Drive a standard penetration test sampler one foot (except as noted) with a 340-pound hammer falling 24 inches. Blow count column marked * indicates the number of blows required to drive the sampler one foot with a 350-pound hammer falling 30 inches. Blow count column marked ** indicates the number of blows required to drive the sampler one foot with a 350-pound hammer falling 24 inches. Blow count column marked * indicates the number of blows required to drive the sampler one foot with a 140-pound hammer falling 30 inches. Blow count marked ( ) indicates the number of blows required to drive the sampler one foot with a 340-pound hammer falling 30 inches.
20. ▣ Indicates depth of standard penetration test (2" O.D. Split Spoon Sampler).
- ⊗ Indicates recovery of disturbed sample.
- ⊘ or □ Indicates depth of sampling attempt with no recovery.

<p>LA SALLE COUNTY STATION UPDATED FINAL SAFETY ANALYSIS REPORT</p>
<p>FIGURE 2.5-17 EXPLANATION OF BORING LOGS (SHEET 2 OF 3)</p>

	Indicates depth of sample obtained by pushing a standard shelby tube (thinwall 3" I.D. 36" tube)
	Indicates a gradational contact
95%	Indicates depth, length and percent of core run recovered for NX diamond drill rock coring.
RQD	Rock Quality Designation Sum of pieces of sound rock 4 inches or more in length divided by the total length in inches of the core run, expressed as a percentage.
LL	Indicates the Liquid Limit
PL	Indicates the Plastic Limit
PI	Indicates the Plasticity Index
B	Type of tests and test results reported in Section 2.5.4.2.2
C	Indicates consolidation test
MA	Indicates Mechanical Analysis
MA (H)	Indicates Mechanical Analysis and Hydrometer Analysis
TX/CU	Indicates Consolidated Undrained Triaxial Test
TX/CU/PP	Indicates Consolidated Undrained Triaxial Test with Pore Pressure Measurements
PERM	Indicates Permeability Test

NOTES

1. Elevations refer to mean seal level datum (1968 local adjustment).
2. Rock stratigraphic units, discussed at a formational level in the Section 2.5.1.2.2, have not been identified on the boring logs.

<b>LA SALLE COUNTY STATION</b>
<b>UPDATED FINAL SAFETY ANALYSIS REPORT</b>
<b>FIGURE 2.5-17</b>
<b>EXPLANATION OF BORING LOGS</b>
<b>(SHEET 3 OF 3)</b>

MAJOR DIVISIONS			GRAPH SYMBOL	LETTER SYMBOL	TYPICAL DESCRIPTIONS	
COARSE GRAINED SOILS	GRAVEL AND GRAVELLY SOILS	CLEAN GRAVELS (LITTLE OR NO FINES)		GW	WELL-GRADED GRAVELS, GRAVEL-SAND MIXTURES, LITTLE OR NO FINES	
		GRAVELS WITH FINES (APPRECIABLE AMOUNT OF FINES)		GP	POORLY-GRADED GRAVELS, GRAVEL-SAND MIXTURES, LITTLE OR NO FINES	
		GRAVELS WITH FINES (APPRECIABLE AMOUNT OF FINES)		GM	SILTY GRAVELS, GRAVEL-SAND-SILT MIXTURES	
	SAND AND SANDY SOILS	CLEAN SAND (LITTLE OR NO FINES)		SW	WELL-GRADED SANDS, GRAVELLY SANDS, LITTLE OR NO FINES	
				SP	POORLY-GRADED SANDS, GRAVELLY SANDS, LITTLE OR NO FINES	
		SANDS WITH FINES (APPRECIABLE AMOUNT OF FINES)		SM	SILTY SANDS, SAND-SILT MIXTURES	
				SC	CLAYEY SANDS, SAND-CLAY MIXTURES	
				ML	INORGANIC SILTS AND VERY FINE SANDS, ROCK FLOUR, SILTY OR CLAYEY FINE SANDS OR CLAYEY SILTS WITH SLIGHT PLASTICITY	
		FINE GRAINED SOILS	SILTS AND CLAYS		CL	INORGANIC CLAYS OF LOW TO MEDIUM PLASTICITY, GRAVELLY CLAYS, SANDY CLAYS, SILTY CLAYS, LEAN CLAYS
					OL	ORGANIC SILTS AND ORGANIC SILTY CLAYS OF LOW PLASTICITY
	MH			INORGANIC SILTS, MICACEOUS OR DIATOMACEOUS FINE SAND OR SILTY SOILS		
SILTS AND CLAYS			CH	INORGANIC CLAYS OF HIGH PLASTICITY, FAT CLAYS		
			OH	ORGANIC CLAYS OF MEDIUM TO HIGH PLASTICITY, ORGANIC SILTS		
HIGHLY ORGANIC SOILS				PT	PEAT, HUMUS, SWAMP SOILS WITH HIGH ORGANIC CONTENTS	

**NOTES**

- DUAL SYMBOLS ARE USED TO INDICATE BORDERLINE CLASSIFICATIONS.
- WHEN SHOWN ON THE BORING LOGS, THE FOLLOWING TERMS ARE USED TO DESCRIBE THE CONSISTENCY OF COHESIVE SOILS AND THE RELATIVE COMPACTNESS OF COHESIONLESS SOILS.

**COHESIVE SOILS**

(APPROXIMATE SHEARING STRENGTH IN KSF)

VERY SOFT	LESS THAN 0.25
SOFT	0.25 TO 0.5
MEDIUM STIFF	0.5 TO 1.0
STIFF	1.0 TO 2.0
VERY STIFF	2.0 TO 4.0
HARD	GREATER THAN 4.0

**COHESIONLESS SOILS**

VERY LOOSE	THESE ARE USUALLY BASED ON AN EXAMINATION OF SOIL SAMPLES, PENETRATION RESISTANCE, AND SOIL DENSITY DATA
LOOSE	
MEDIUM DENSE	
DENSE	
VERY DENSE	

**LA SALLE COUNTY STATION**  
**UPDATED FINAL SAFETY ANALYSIS REPORT**

---

FIGURE 2.5-18  
**SOIL CLASSIFICATION SYSTEM**

BORING 1  
SURFACE ELEVATION 712.2

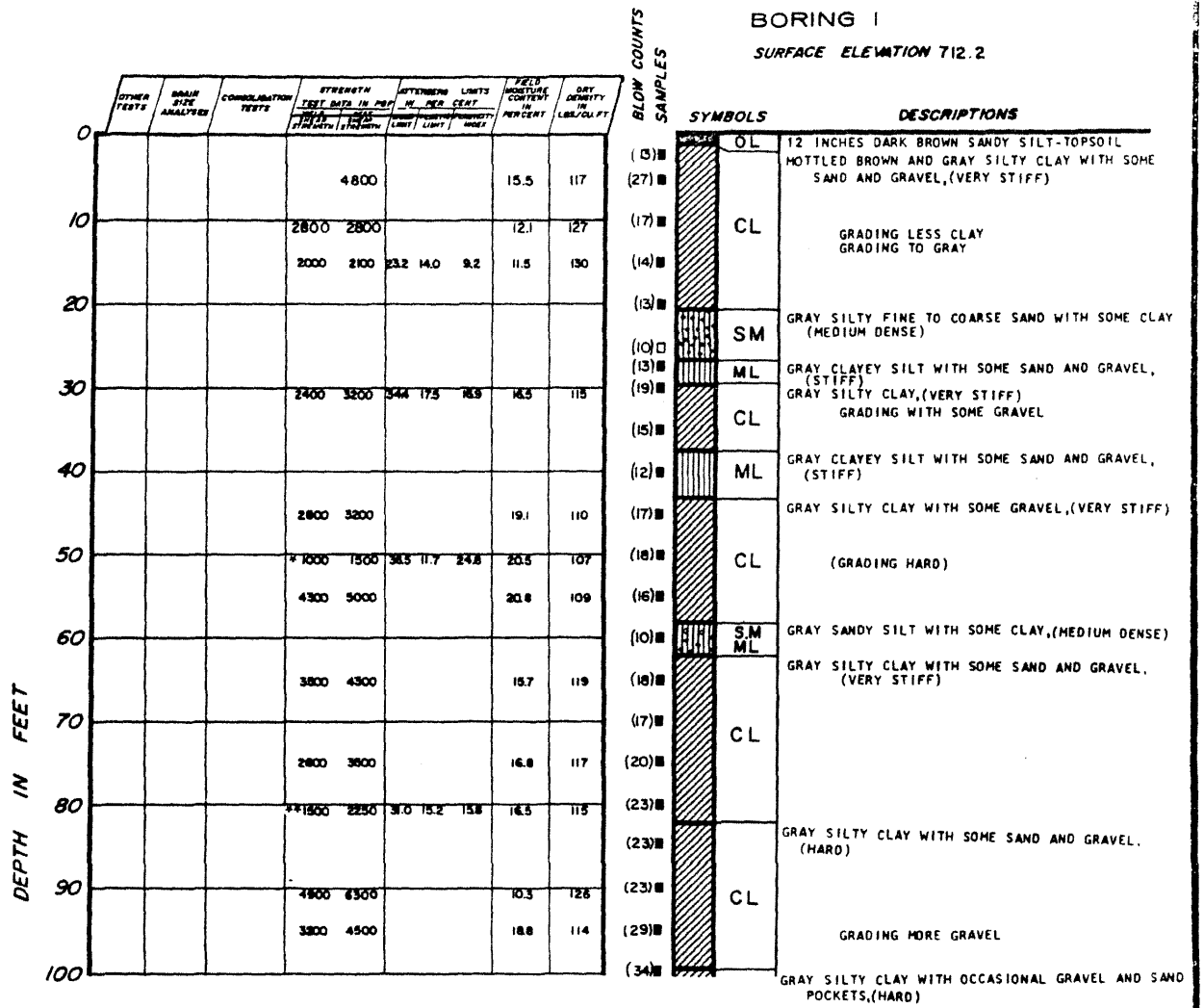

* DIRECT SHEAR TEST  
CONFINING PRESSURE = 3000 PSF  
** DIRECT SHEAR TEST  
CONFINING PRESSURE = 5000 PSF

LA SALLE COUNTY STATION  
UPDATED FINAL SAFETY ANALYSIS REPORT

FIGURE 2.5-19  
LOGS OF BORINGS  
(SHEET 1)





BORING 2  
SURFACE ELEVATION 708.3

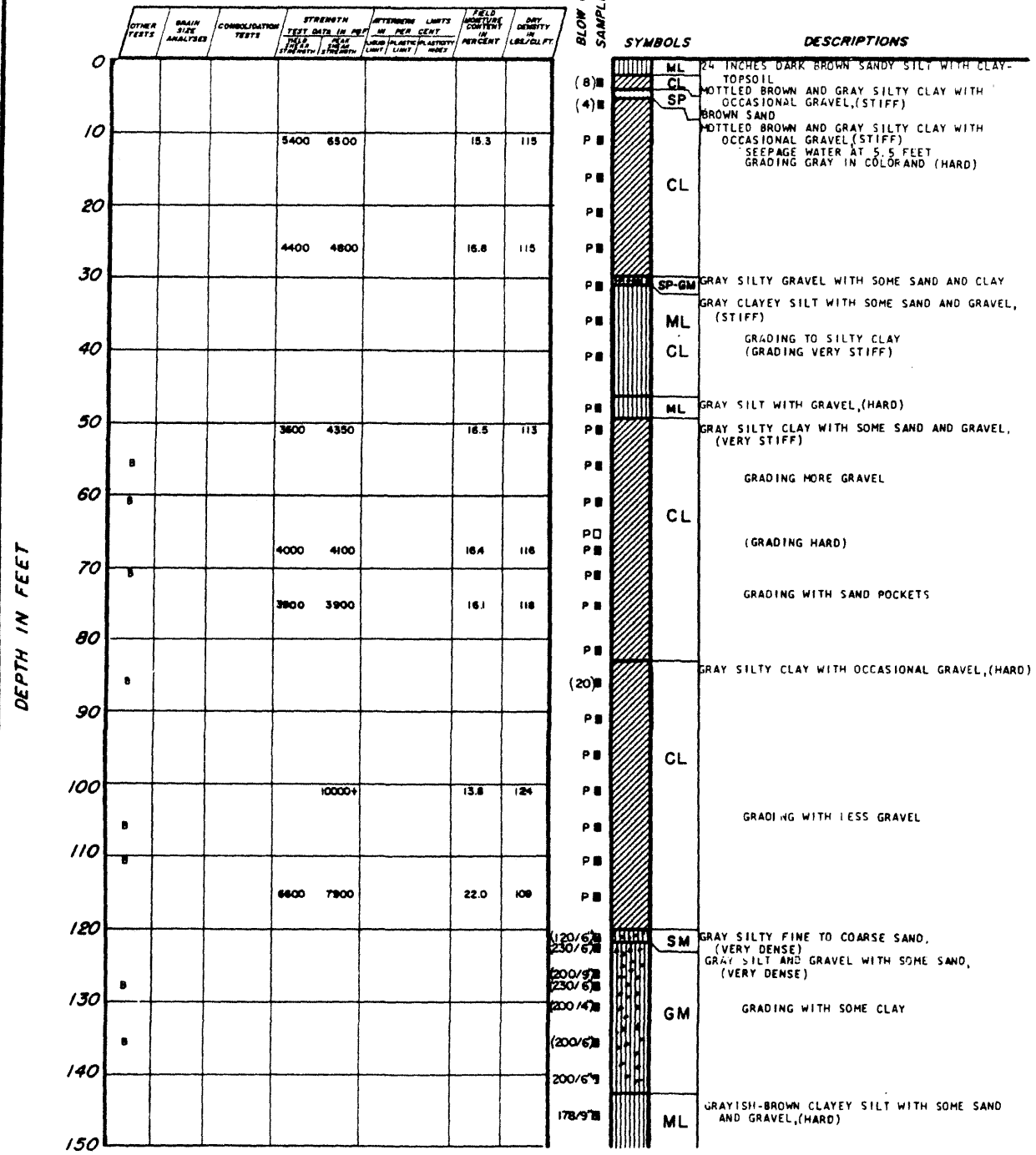

LA SALLE COUNTY STATION  
UPDATED FINAL SAFETY ANALYSIS REPORT

FIGURE 2.5-19  
LOGS OF BORINGS  
(SHEET 3)

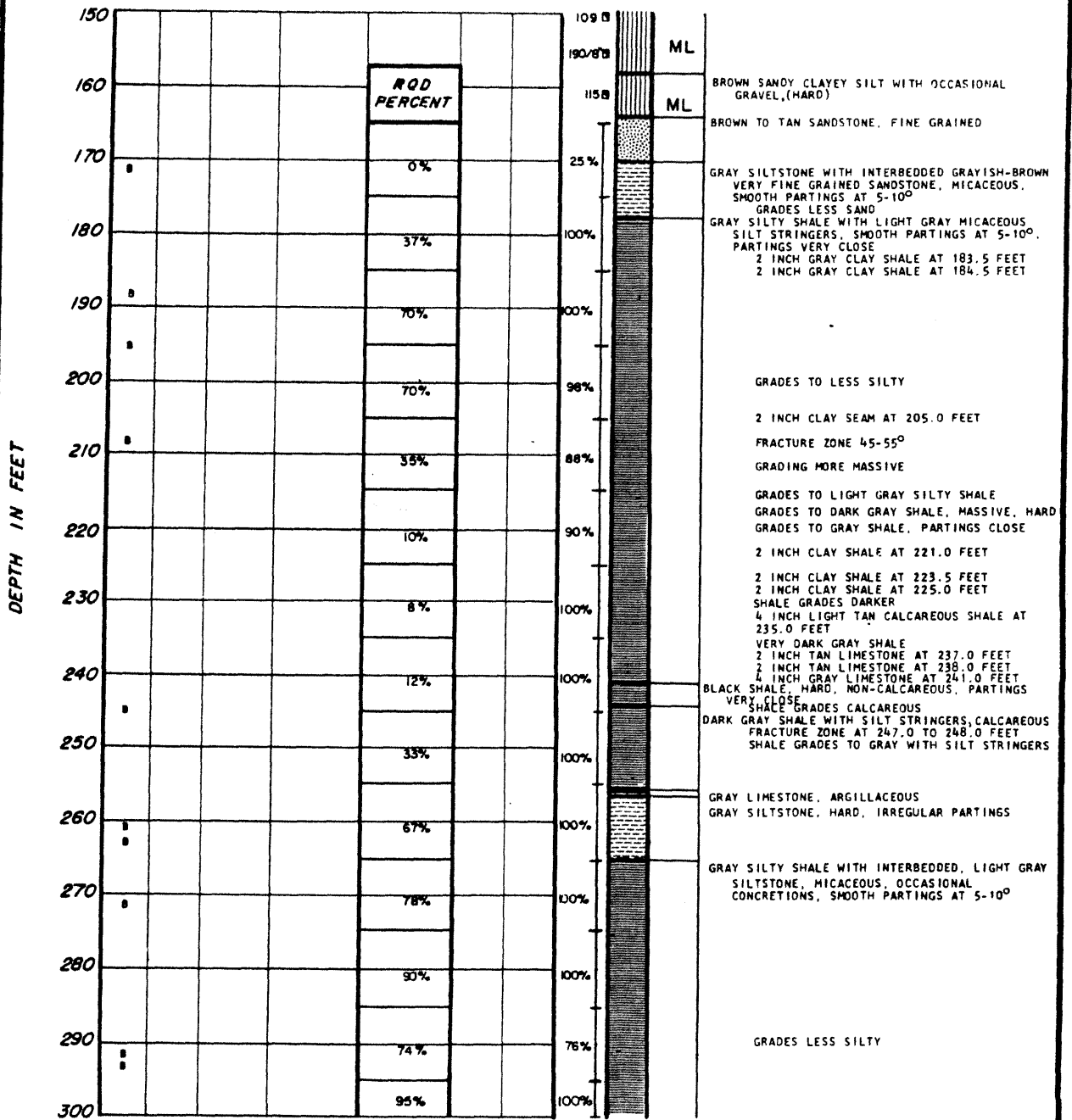

LA SALLE COUNTY STATION  
UPDATED FINAL SAFETY ANALYSIS REPORT

FIGURE 2.5-19  
LOGS OF BORINGS  
(SHEET 4)

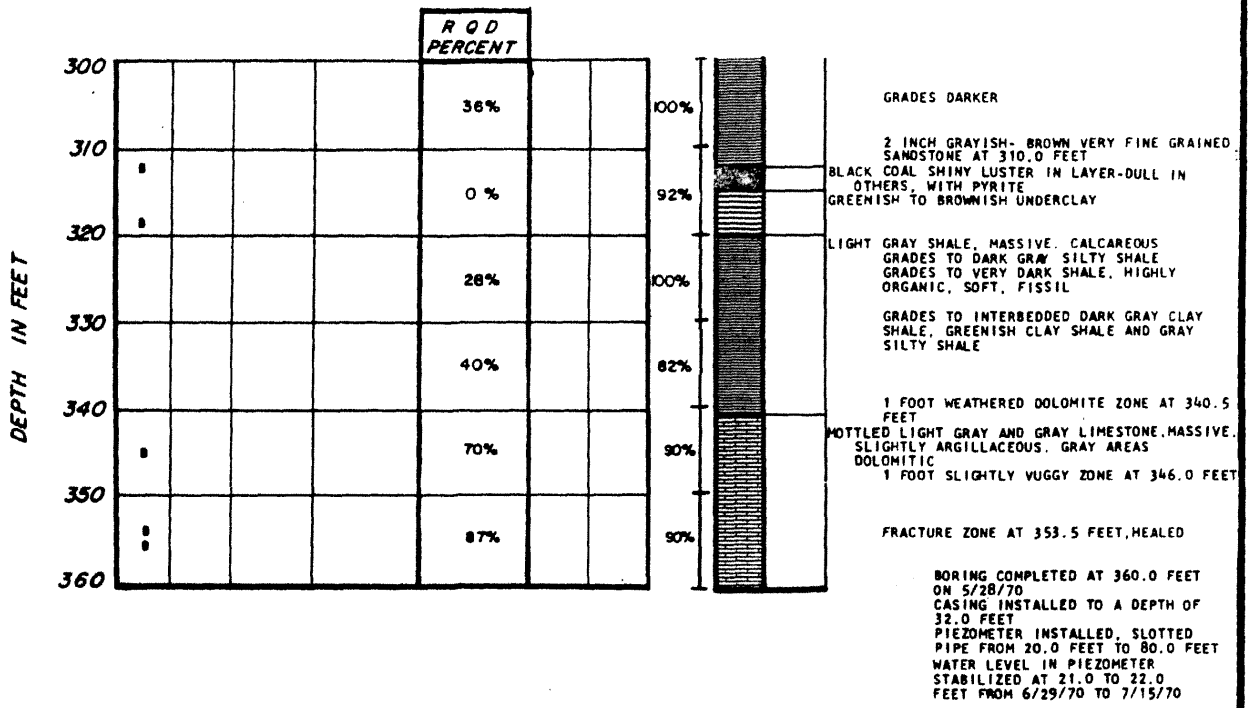

LA SALLE COUNTY STATION  
 UPDATED FINAL SAFETY ANALYSIS REPORT

FIGURE 2.5-19  
 LOGS OF BORINGS  
 (SHEET 5)

BORING 3  
SURFACE ELEVATION 677.5

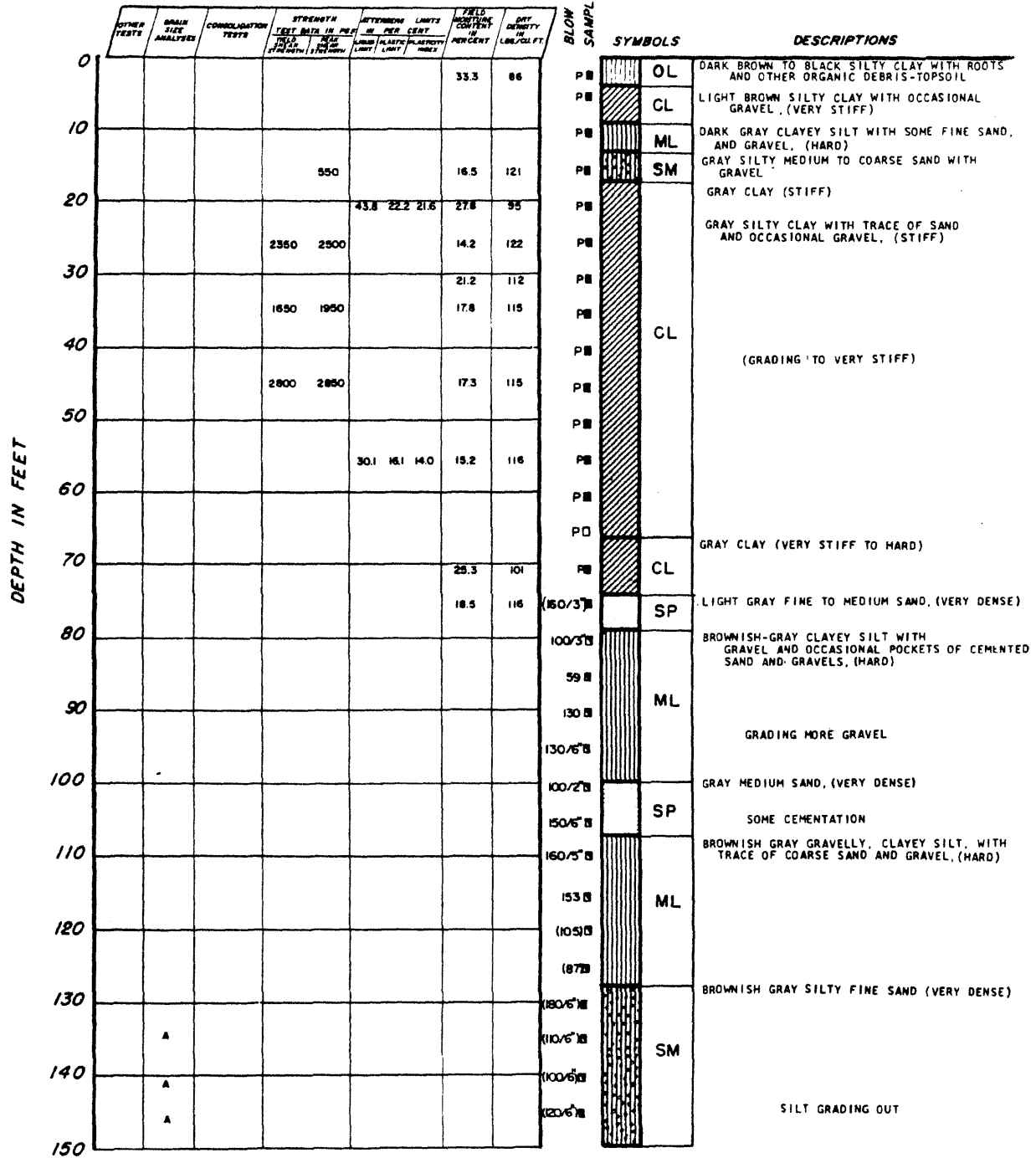

LA SALLE COUNTY STATION

FIGURE 2.5-19  
LOGS OF BORINGS  
(SHEET 6)

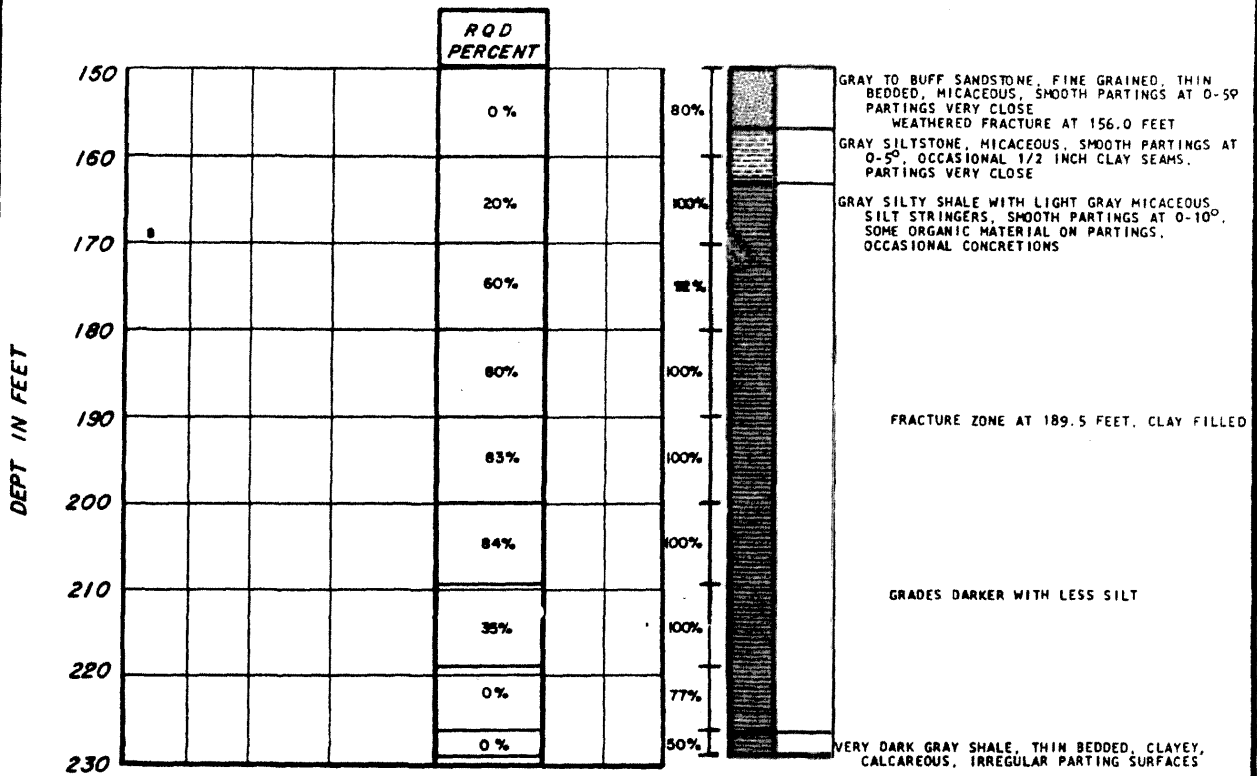

BORING COMPLETED AT 229.0 FEET ON 6/9/70  
 CASING INSTALLED TO A DEPTH OF 20.0 FEET  
 PIEZOMETER INSTALLED, SLOTTED PIPE FROM 130.0 FEET TO 150.0 FEET  
 WATER LEVEL READINGS

DATE	DEPTH IN FEET
6/11/70	85.5
6/12/70	95.5
6/16/70	113.0
6/18/70	122.0
6/23/70	131.0
6/25/70	122.0
6/26/70	132.0
6/29/70	136.0
7/7/70	139.0
7/15/70	140.7

LA SALLE COUNTY STATION  
 UPDATED FINAL SAFETY ANALYSIS REPORT

FIGURE 2.5-19  
 LOGS OF BORINGS  
 (SHEET 7)

BORING 4  
SURFACE ELEVATION TO 4.3

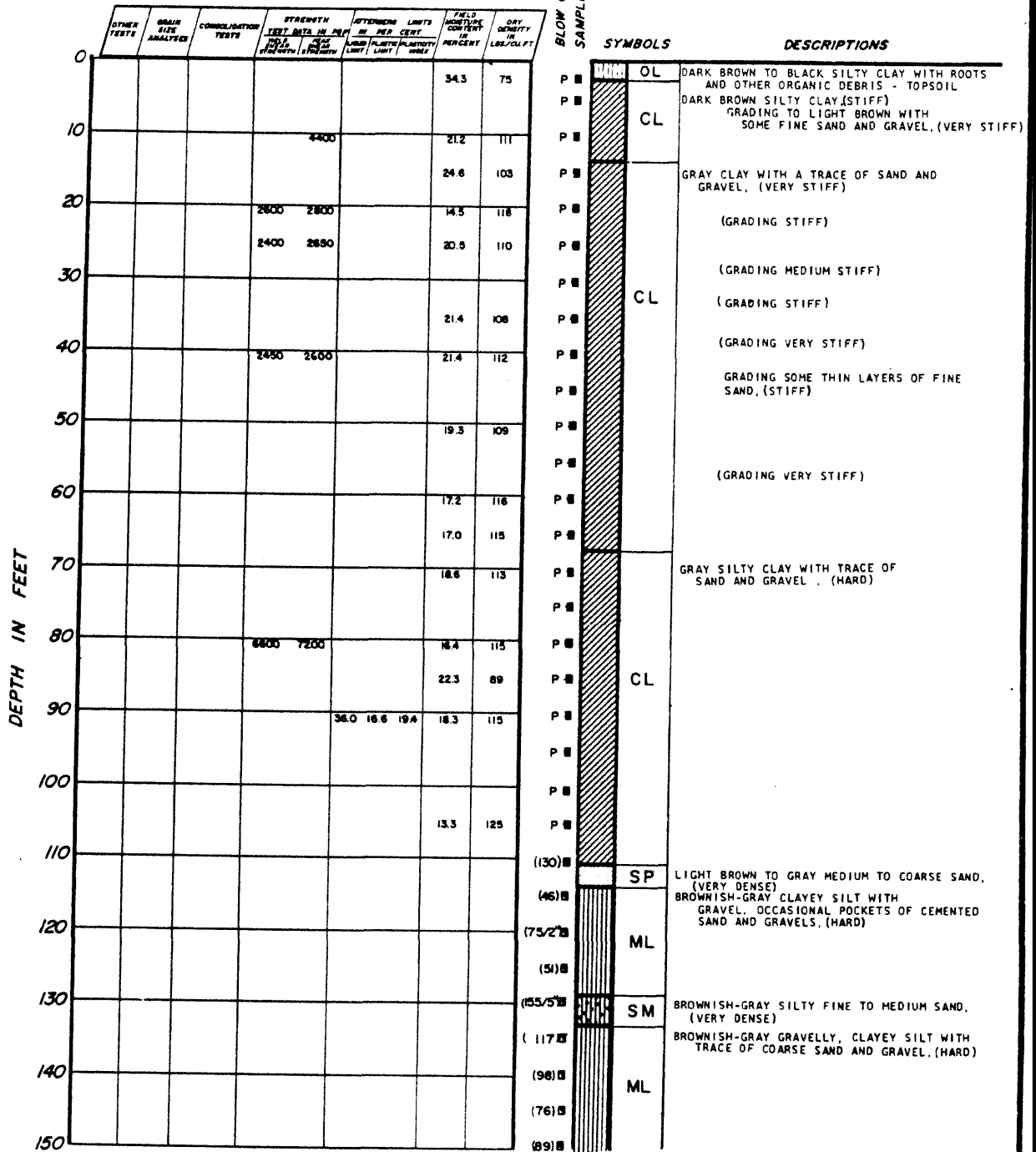

LA SALLE COUNTY STATION  
UPDATED FINAL SAFETY ANALYSIS REPORT

FIGURE 2.5-19  
LOGS OF BORINGS  
(SHEET 8)

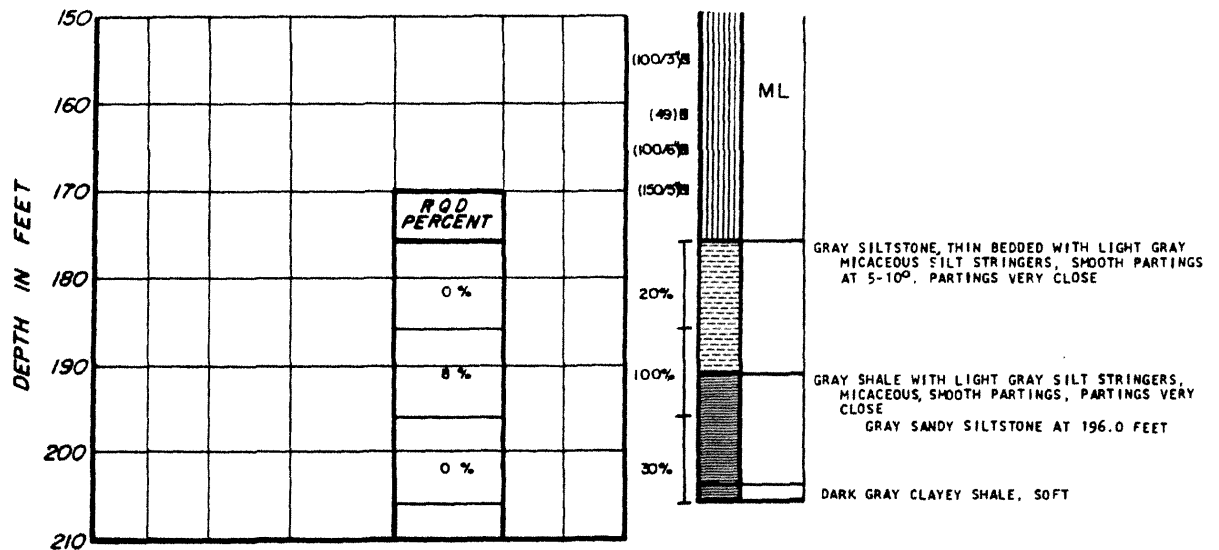

BORING COMPLETED AT 206.0 FEET  
 ON 6/12/70  
 PIEZOMETER INSTALLED, SLOTTED PIPE  
 FROM 0 TO 80.0 FEET  
 WATER LEVEL AT 21.0 FEET ON 6/25/70

**BORING 5**  
 SURFACE ELEVATION 713.7

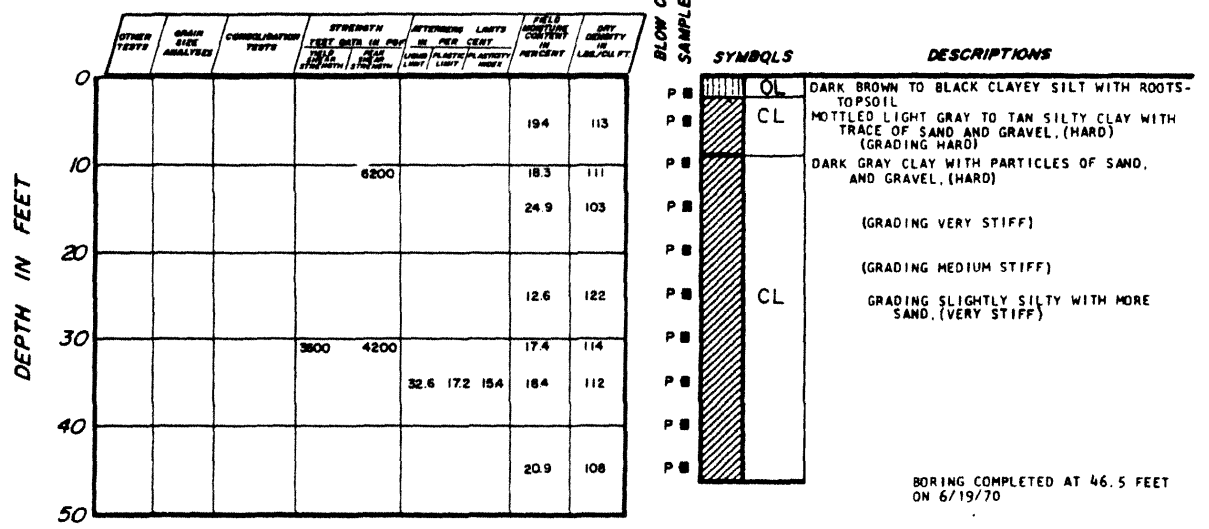

BORING COMPLETED AT 46.5 FEET  
 ON 6/19/70

**LA SALLE COUNTY STATION**  
 UPDATED FINAL SAFETY ANALYSIS REPORT

FIGURE 2.5-19  
 LOGS OF BORINGS  
 (SHEET 9)





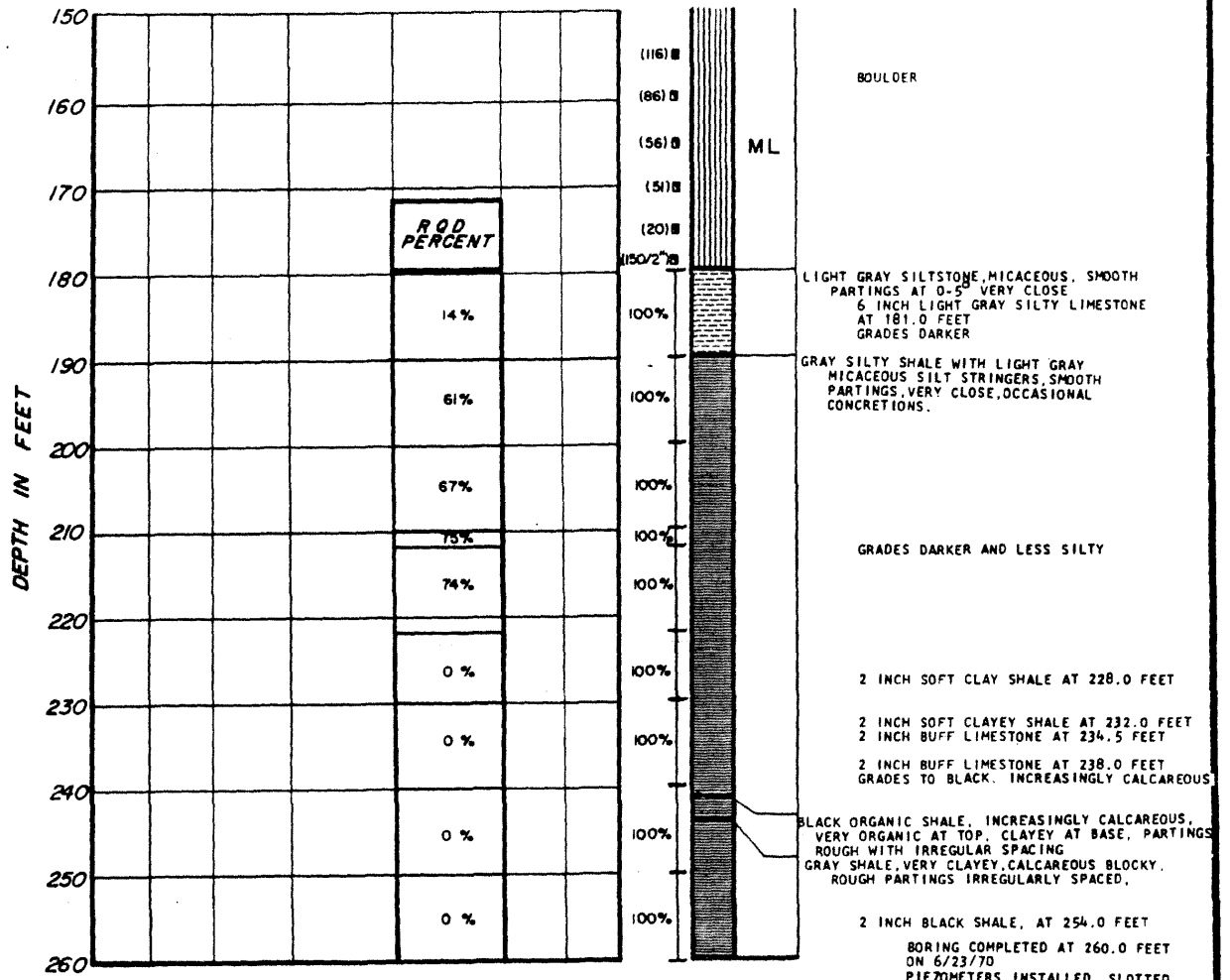

BORING COMPLETED AT 260.0 FEET ON 6/23/70  
PIEZOMETERS INSTALLED, SLOTTED PIPE FROM 120.0 FEET TO 135.0 FEET AND FROM 180.0 FEET TO 260.0 FEET  
WATER LEVEL READINGS  
UPPER PIEZOMETER

DATE	DEPTH IN FEET
6/30/70 TO 7/15/70	32.0 TO 33.0 FEET

WATER LEVEL READINGS  
LOWER PIEZOMETER

DATE	DEPTH IN FEET
6/30/70 TO 7/15/70	118.0 TO 119.0 FEET

LA SALLE COUNTY STATION  
UPDATED FINAL SAFETY ANALYSIS REPORT

FIGURE 2.5-19  
LOGS OF BORINGS  
(SHEET 11)

**BORING 7**  
SURFACE ELEVATION 710.1

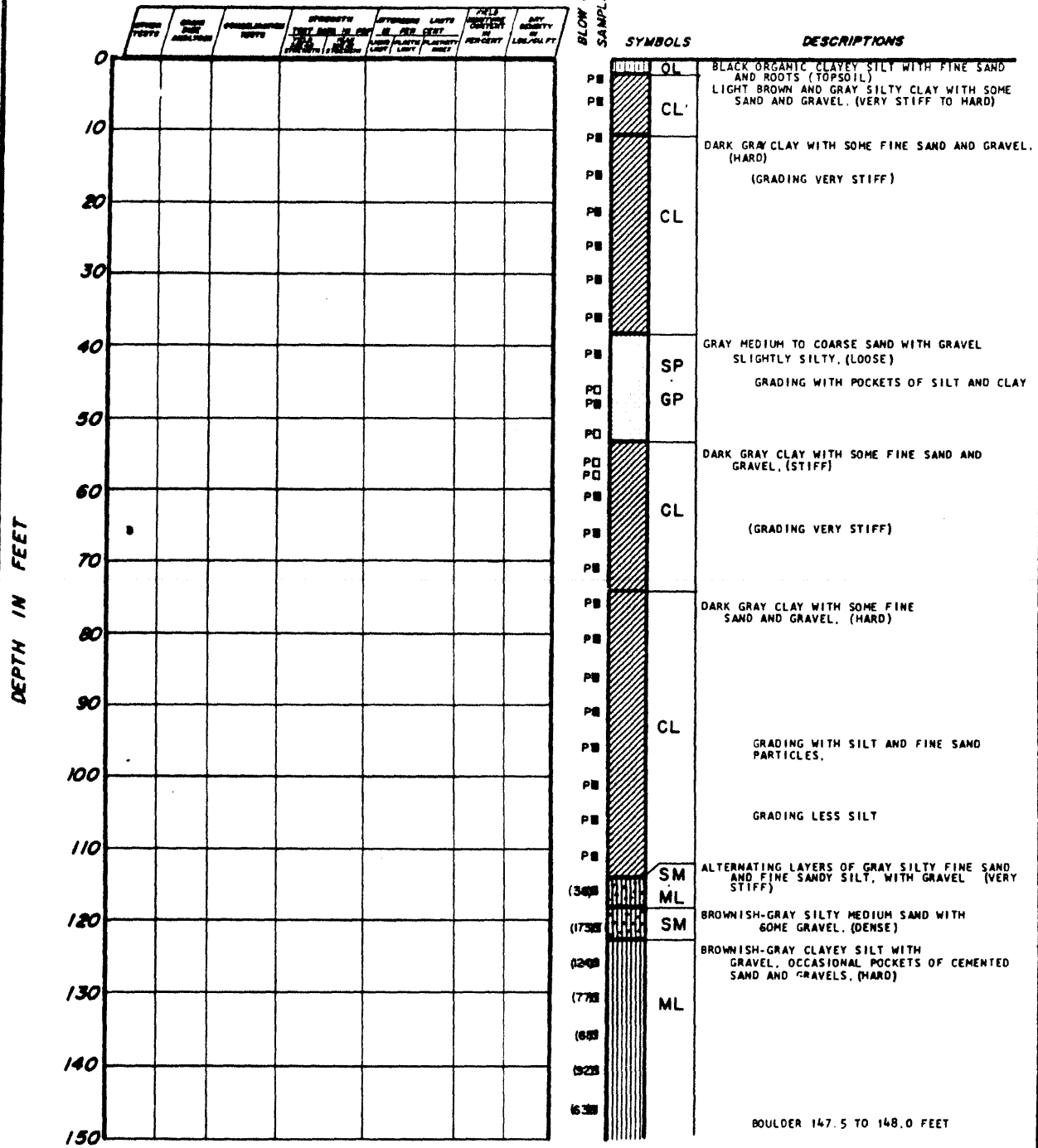

**LA SALLE COUNTY STATION**  
**UPDATED FINAL SAFETY ANALYSIS REPORT**

FIGURE 2.5-19  
 LOGS OF BORINGS  
 (SHEET 12)

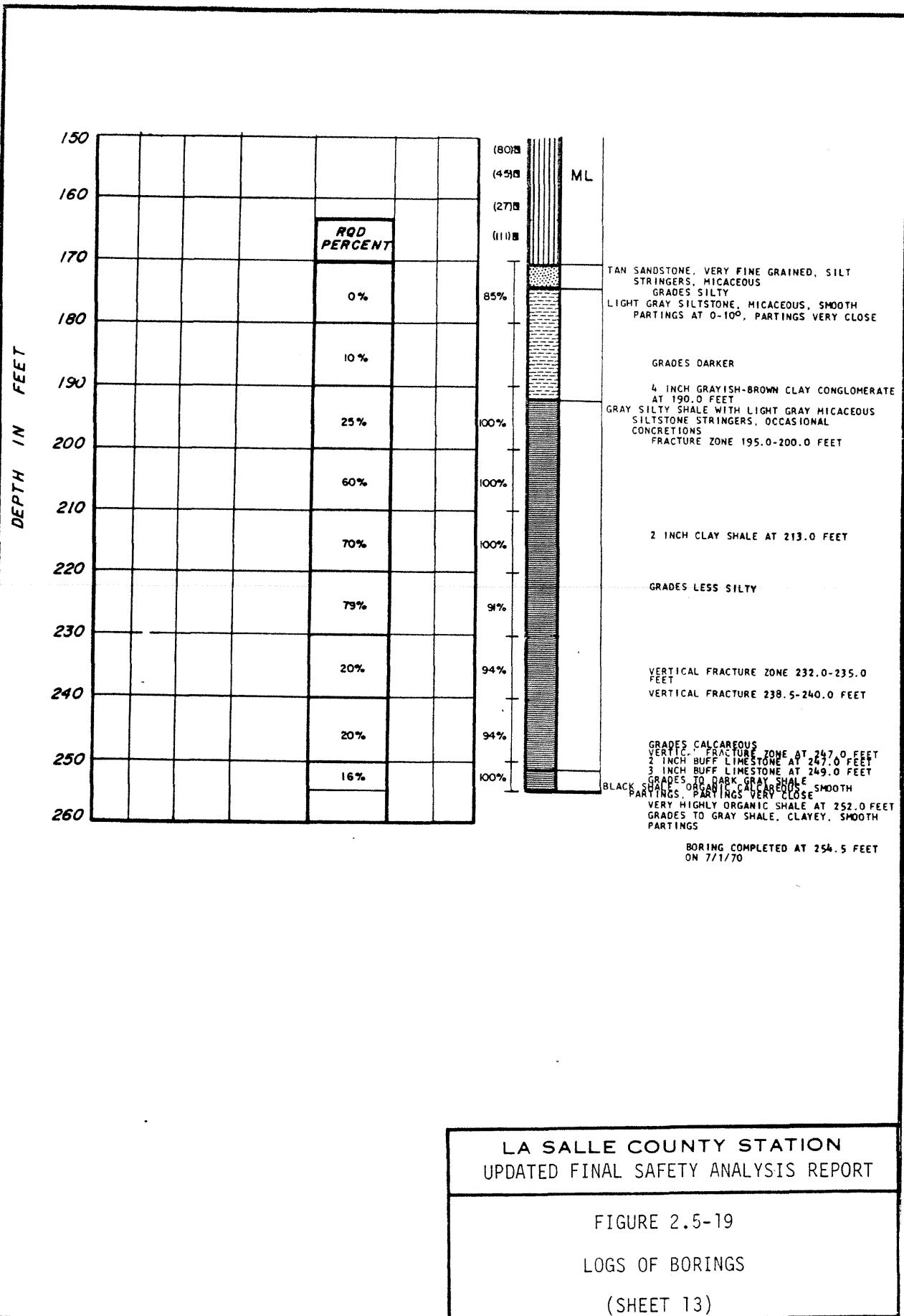

LA SALLE COUNTY STATION  
 UPDATED FINAL SAFETY ANALYSIS REPORT

FIGURE 2.5-19  
 LOGS OF BORINGS  
 (SHEET 13)

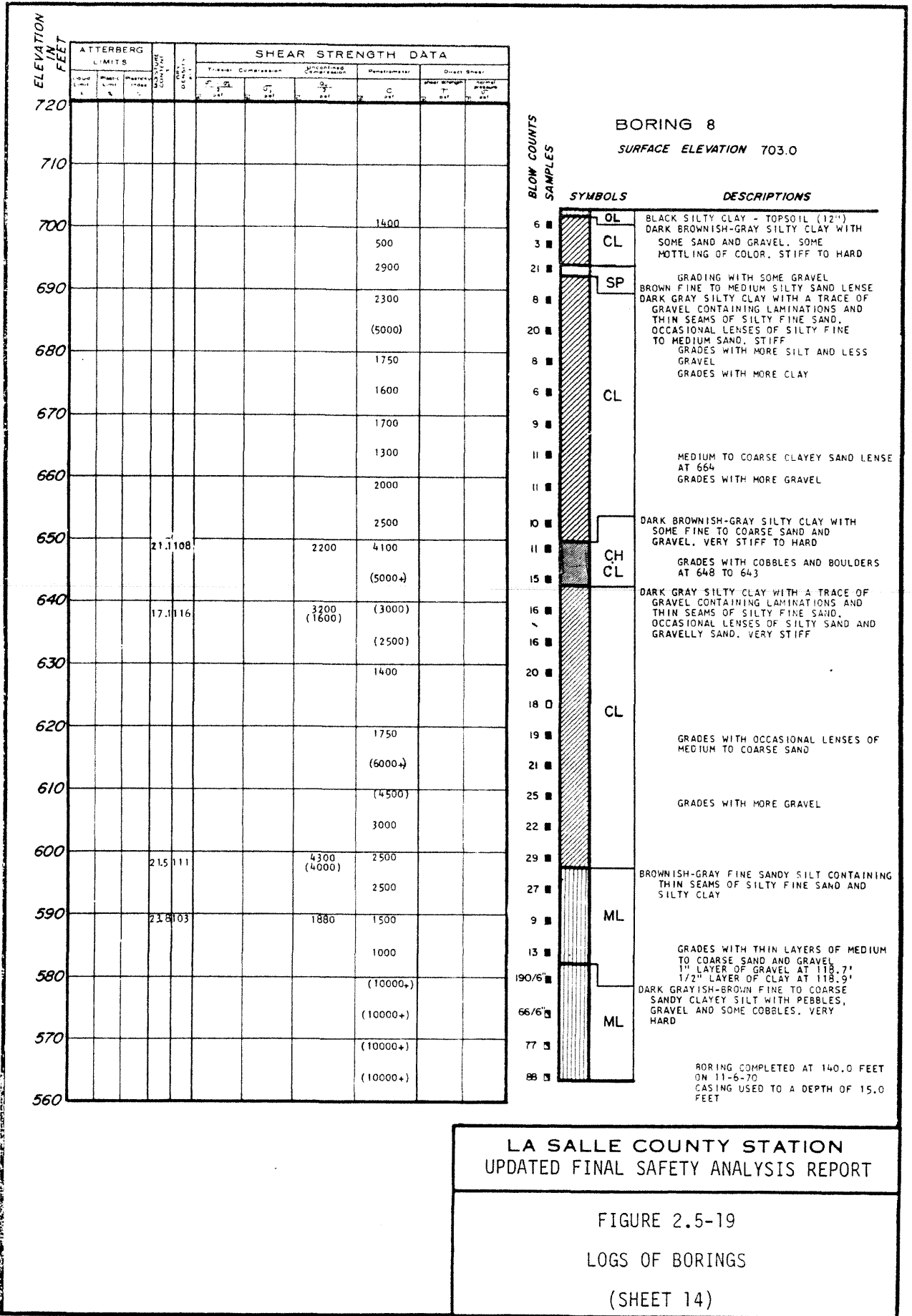

**LA SALLE COUNTY STATION  
UPDATED FINAL SAFETY ANALYSIS REPORT**

FIGURE 2.5-19  
LOGS OF BORINGS  
(SHEET 14)

ELEVATION  
FEET

720  
710  
700  
690  
680  
670  
660  
650  
640  
630  
620  
610  
600  
590  
580

ATTERBERG LIMITS			WATER CONTENT (%)	DENSITY (pcf)	SHEAR STRENGTH DATA							
Liquid Limit (%)	Plastic Limit (%)	Plastic Index (%)			Triaxial Compression		Unconfined Compression		Penetration		Direct Shear	
					$\sigma_1$ (psf)	$\sigma_3$ (psf)	$q_u$ (psf)	$c$ (psf)	$\tau$ (psf)	Horizontal $\sigma_3$ (psf)		
								2900				
								(7000)				
								2100				
								1300				
								1600				
								2300				
								1500				
								3100				
								2000 (6000)				
								3400				
								2200				
								2900				
								1800				
								2700				
								3000				
								2800				
								2200				
								2700				
								(4600)				
								(4500)				
								(4500)				
								(4500)				
								3100				
								(10000)				

BLOW COUNTS  
SAMPLES

BORING 9  
SURFACE ELEVATION 701.7

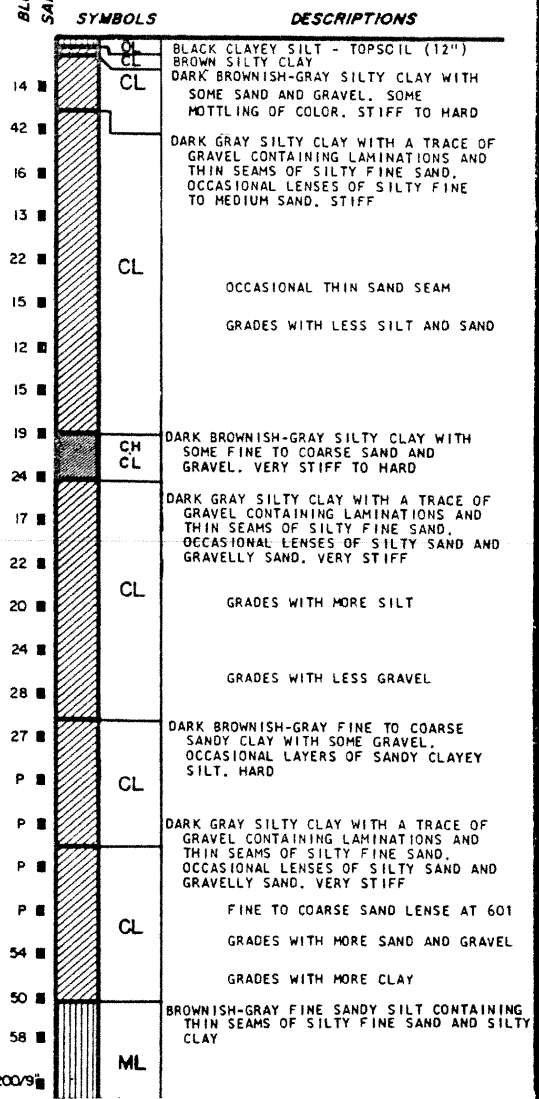

LA SALLE COUNTY STATION  
UPDATED FINAL SAFETY ANALYSIS REPORT

FIGURE 2.5-19  
LOGS OF BORINGS  
(SHEET 15)









BORING II CONTINUED

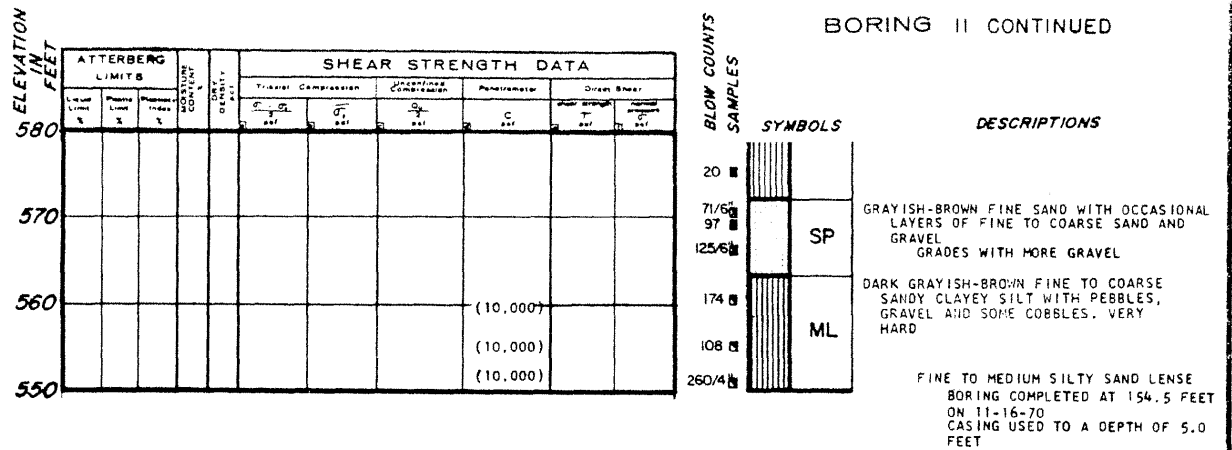

LA SALLE COUNTY STATION  
 UPDATED FINAL SAFETY ANALYSIS REPORT

FIGURE 2.5-19  
 LOGS OF BORINGS  
 (SHEET 19)

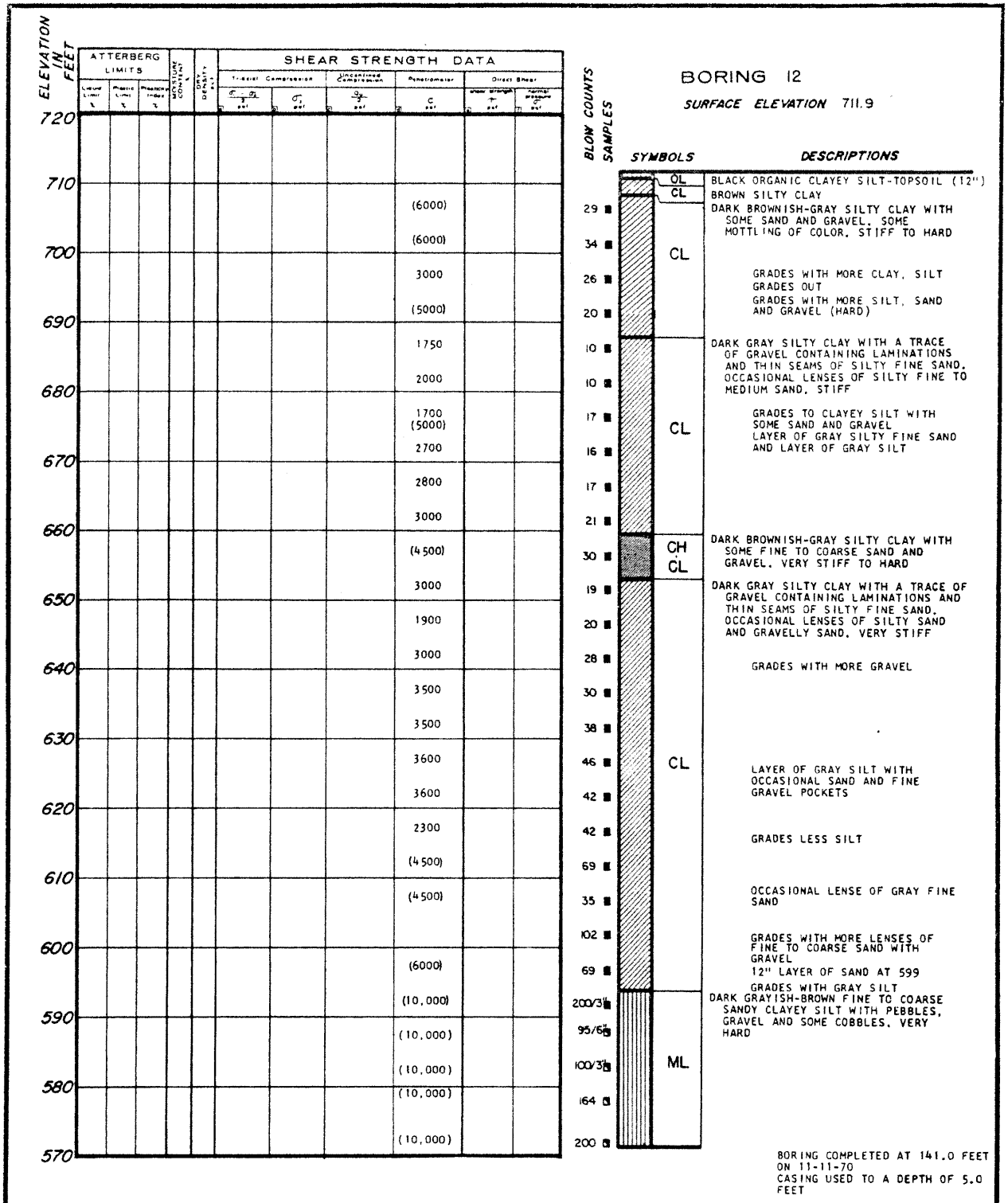

**LA SALLE COUNTY STATION**  
UPDATED FINAL SAFETY ANALYSIS REPORT

FIGURE 2.5-19  
LOGS OF BORINGS  
(SHEET 20)





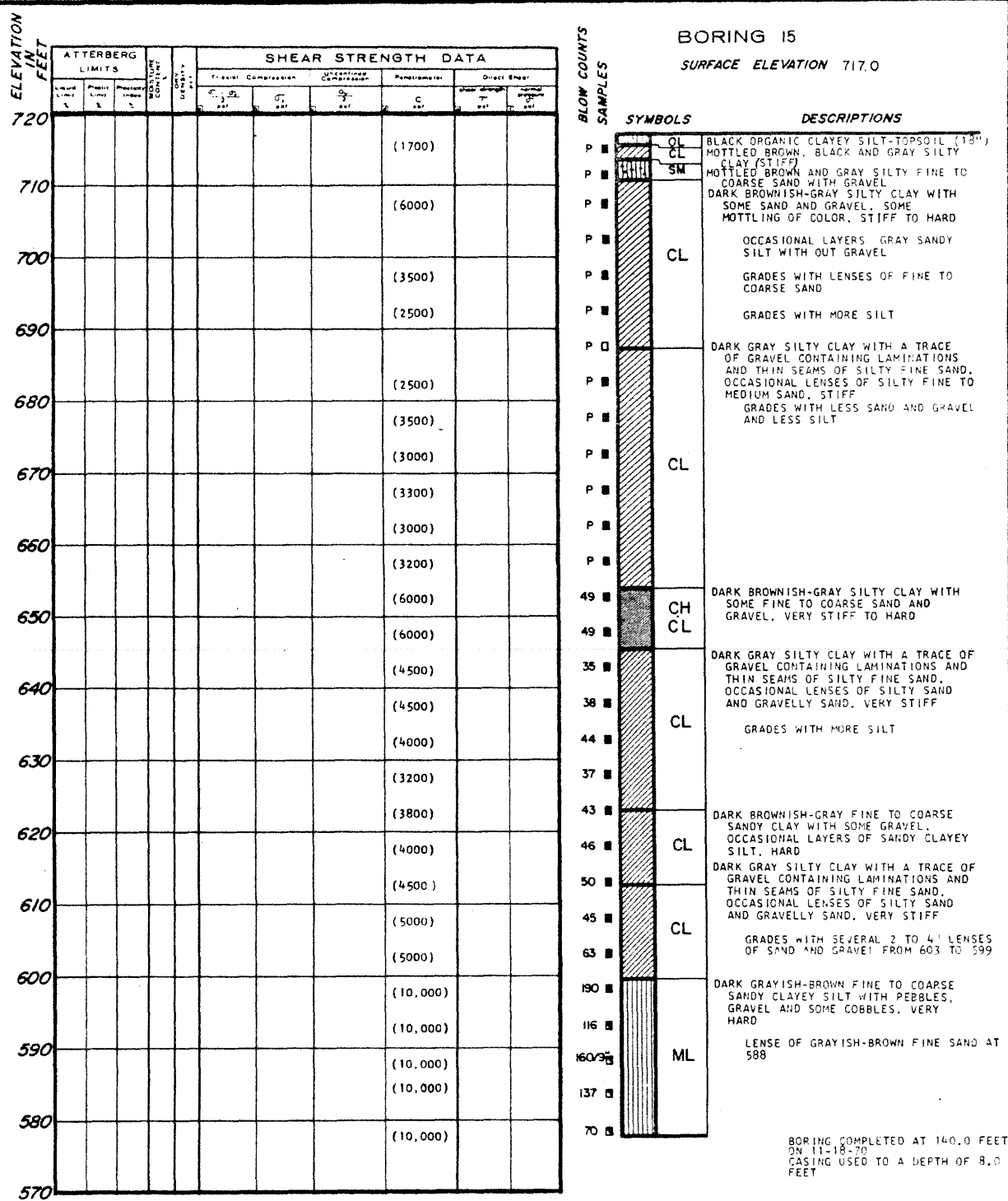

**LA SALLE COUNTY STATION**  
**UPDATED FINAL SAFETY ANALYSIS REPORT**

FIGURE 2.5-19  
LOGS OF BORINGS  
(SHEET 23)



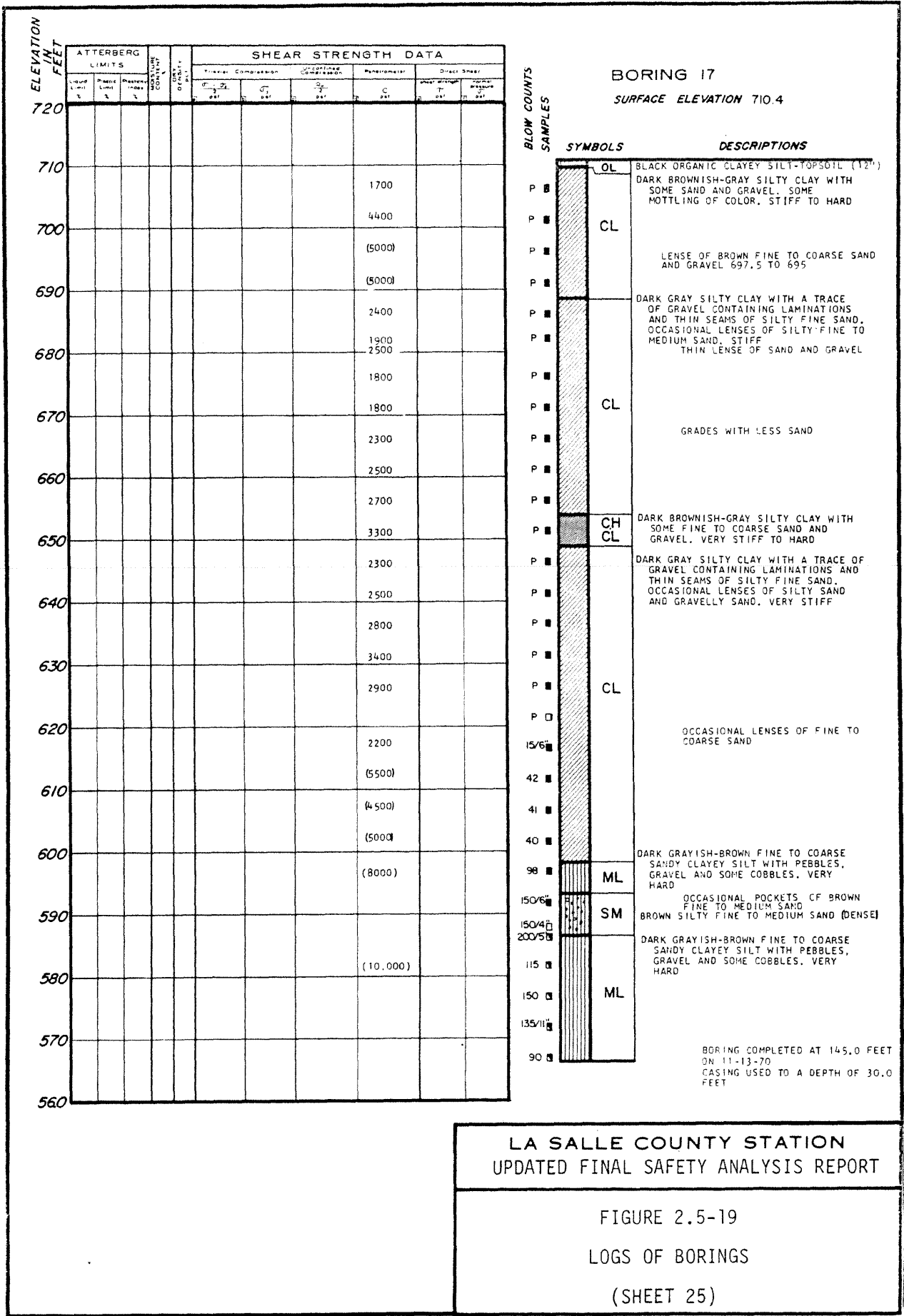

**LA SALLE COUNTY STATION  
UPDATED FINAL SAFETY ANALYSIS REPORT**

FIGURE 2.5-19  
LOGS OF BORINGS  
(SHEET 25)











ELEVATION  
IN  
FEET

720  
710  
700  
690  
680  
670  
660  
650  
640  
630  
620  
610

ATTERBERG LIMITS				SHEAR STRENGTH DATA													
Liquid Limit %	Plastic Limit %	Plastic Index %	SHrinkage Constant	Triaxial Compression					Unconfined Compression			Penetration		Direct Shear			
				$\sigma_1$ (psi)	$\sigma_3$ (psi)	$\sigma_c$ (psi)	$q$ (psi)	$c$ (psi)	$T$ (psi)	$T$ (psi)	$T$ (psi)						
																	(6000)
																	(2500)
																	(2200)
																	(2300)
																	(2500)
																	(3000)
																	(2500)
																	(4300)
																	(2800)
																	(2300)
																	(2200)
																	(2300)
																	(3000)
																	(3300)
																	(3500)

BORING 22  
SURFACE ELEVATION 716.6

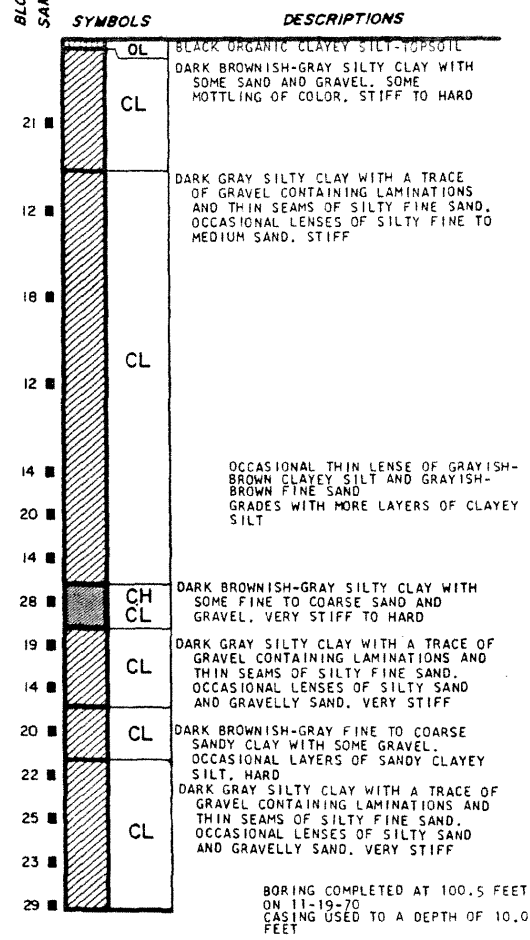

LA SALLE COUNTY STATION  
UPDATED FINAL SAFETY ANALYSIS REPORT

FIGURE 2.5-19  
LOGS OF BORINGS  
(SHEET 30)

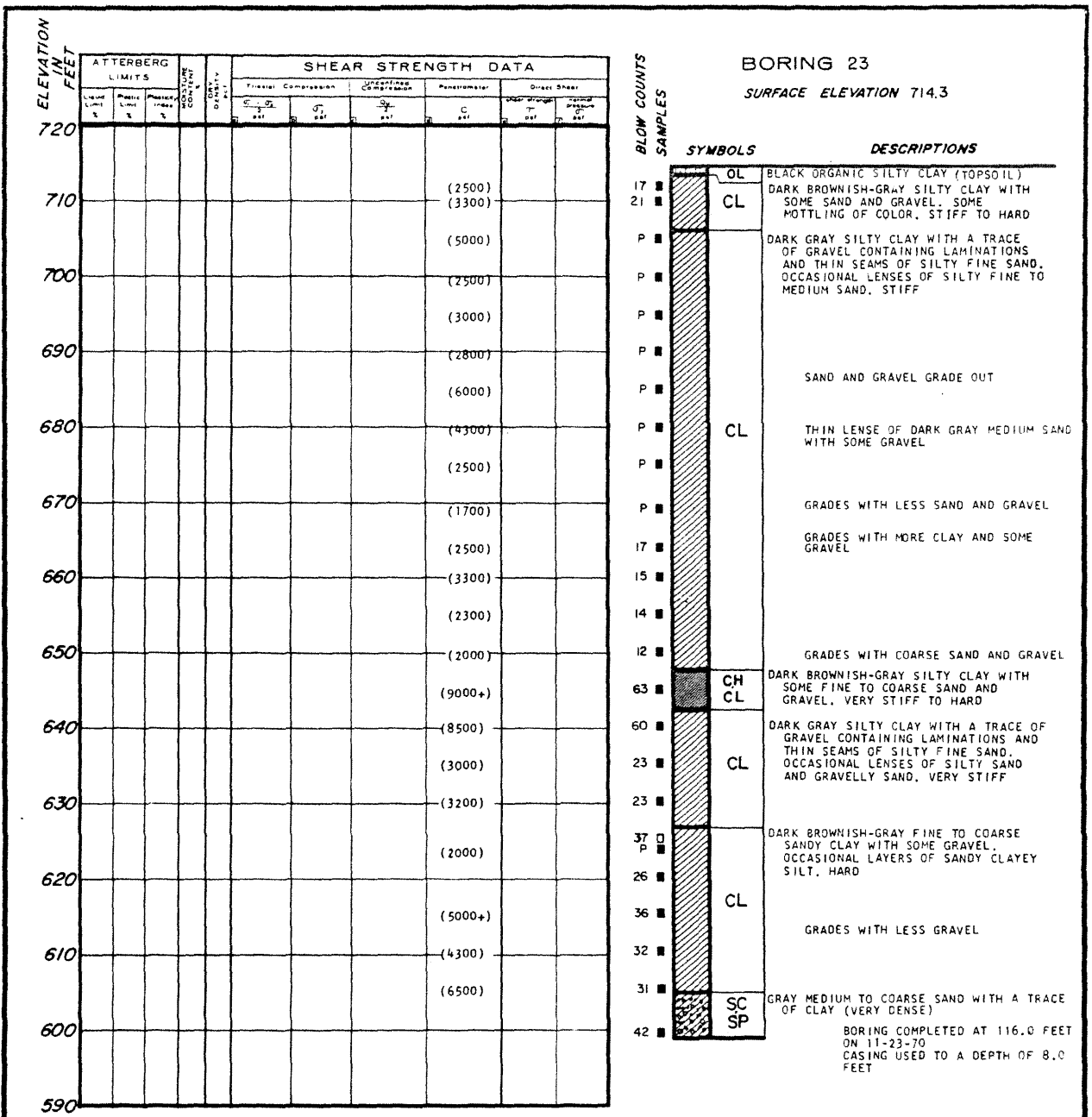

**LA SALLE COUNTY STATION**  
UPDATED FINAL SAFETY ANALYSIS REPORT

FIGURE 2.5-19.  
LOGS OF BORINGS  
(SHEET 31)



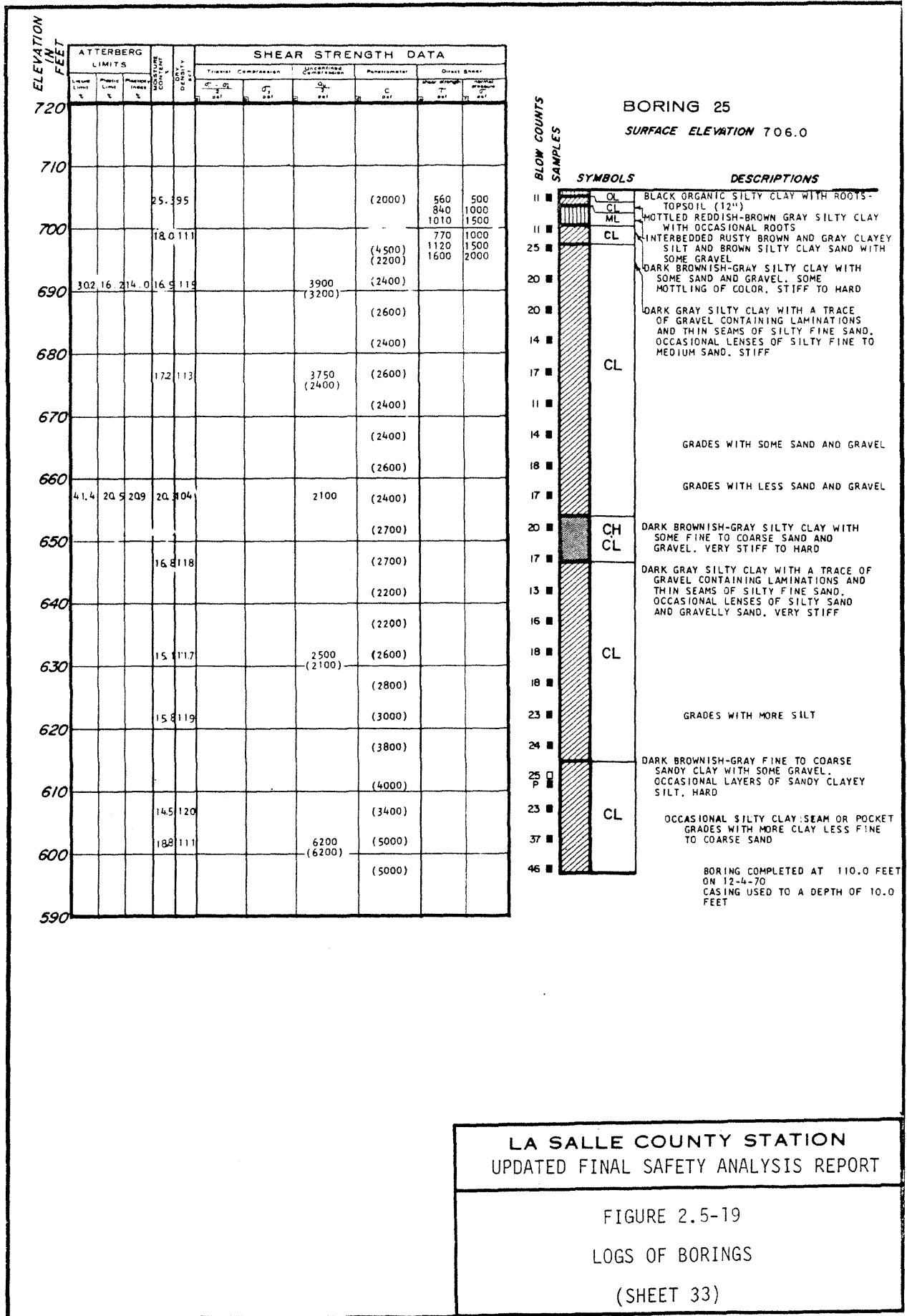

**LA SALLE COUNTY STATION**  
UPDATED FINAL SAFETY ANALYSIS REPORT

FIGURE 2.5-19  
LOGS OF BORINGS  
(SHEET 33)



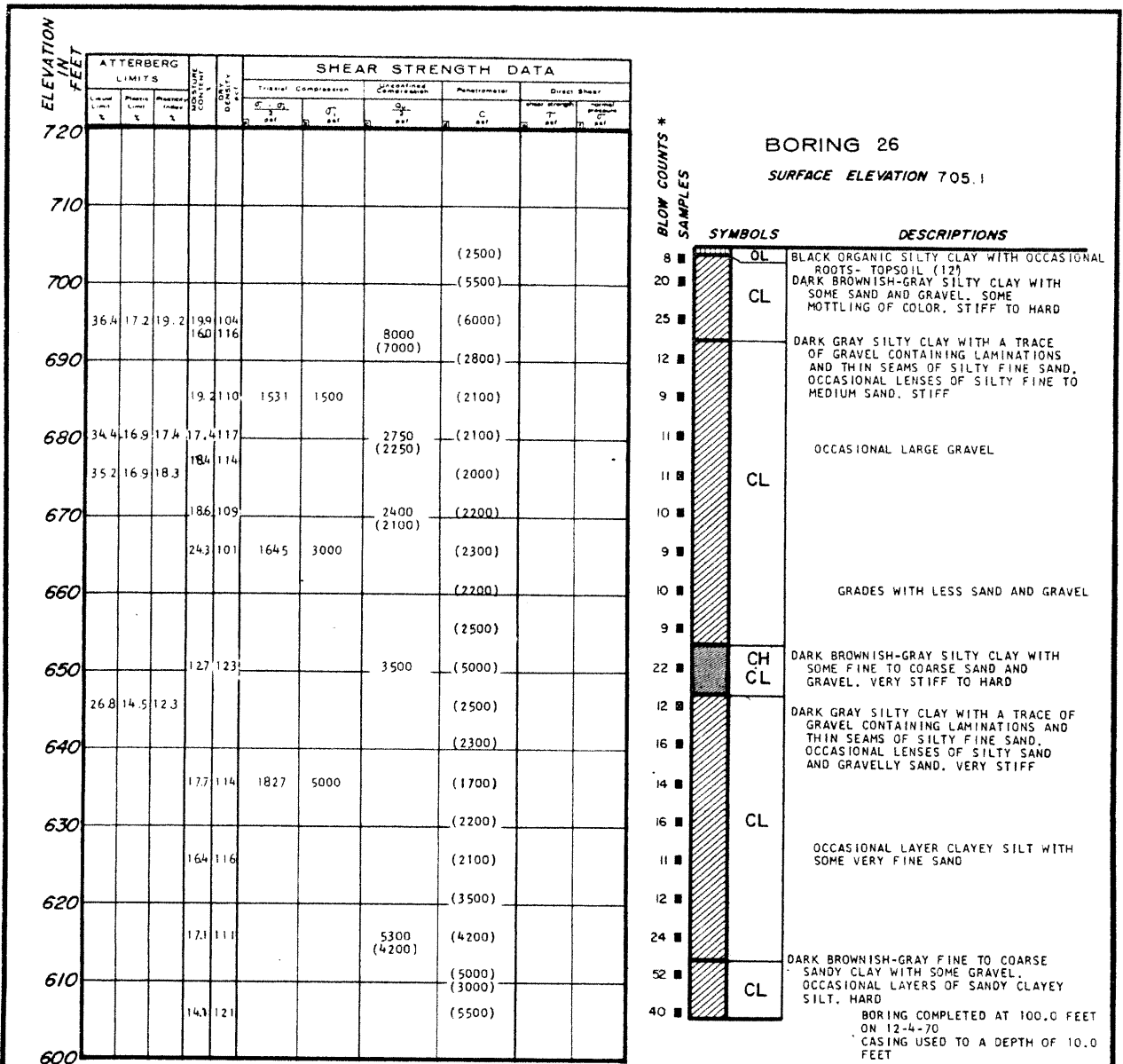

**LA SALLE COUNTY STATION**  
**UPDATED FINAL SAFETY ANALYSIS REPORT**

FIGURE 2.5-19  
LOGS OF BORINGS  
(SHEET 34)

ELEVATION  
IN  
FEET

ATTERBERG LIMITS				SHEAR STRENGTH DATA									
Liquid Limit %	Plastic Limit %	Plasticity Index %	MOISTURE CONTENT %	SHRINKAGE INDEX	Triaxial Compression			Uniaxial Compression		Penetration		Direct Shear	
					$\sigma_1$ (PSF)	$\sigma_3$ (PSF)	$q_u$ (PSF)	$q_u$ (PSF)	$C$ (PSF)	$T$ (PSF)	$T$ (PSF)	$T$ (PSF)	
			16.1	107						(4200)	860	1000	
			15.2	118				5800 (5500)		(6000)	1200 2000	2000 4000	
										(3500)			
										(2400)			
										(2500)			
			19.2	110	1160	2000				(2500)			
										(2500)			
			20.1	107				3400 (2500)		(2300)			
										(2000)			
			27.5	96	1966	3500				(2500)			
27.3	18.3	9.5								(2500)			
			14.9	119						(3800)			
			14.2	121				3400 (2600)		(2600)			
			16.8	116	2241	5000				(2500)			
										(2600)			
			17.0	117						(2800)			
										(3000)			
37.5	21.4	16.1	27.1	100				3240 (3000)		(4500)			
			14.1	123						(5500)			

BORING 27  
SURFACE ELEVATION 705.7

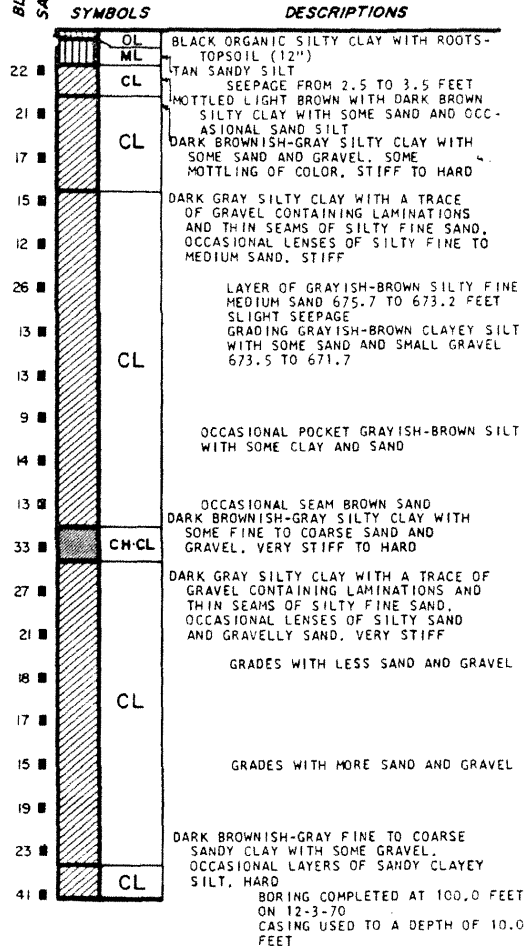

LA SALLE COUNTY STATION  
UPDATED FINAL SAFETY ANALYSIS REPORT

FIGURE 2.5-19  
LOGS OF BORINGS  
(SHEET 35)

ELEVATION  
IN  
FEET

ATTERBERG LIMITS			SHEAR STRENGTH DATA											
Liquid Limit %	Plastic Limit %	Plasticity Index %	Moisture Content %	Density g/cm ³	Triaxial Compression			Unconfined Compression			Penetration		Direct Shear	
					C (psi)	Q (psi)	φ (deg)	C _u (psi)	Q _u (psi)	φ _u (deg)	C (psi)	φ (deg)	τ (psi)	σ _v (psi)
			50	91								700	400	500
												3300	1480	1800
			149	117								3700		
												2600		
			172	115								2200		
												2000		
			184	110								2400		

BLOW COUNTS  
SAMPLES

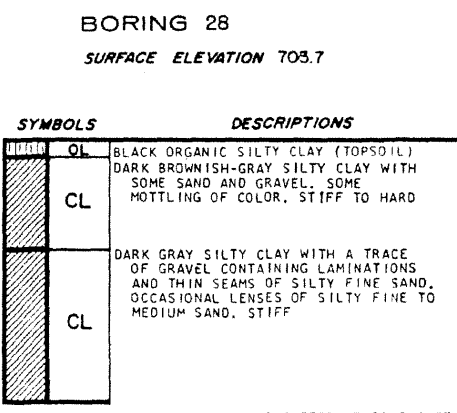

BORING COMPLETED AT 30.0 FEET ON 12-7-70  
NO CASING USED

LA SALLE COUNTY STATION  
UPDATED FINAL SAFETY ANALYSIS REPORT

FIGURE 2.5-19  
LOGS OF BORINGS  
(SHEET 36)

ELEVATION  
IN  
FEET

720  
710  
700  
690  
680  
670  
660  
650  
640  
630  
620  
610  
600

ATTERBERG LIMITS				SHEAR STRENGTH DATA								
Liquid Limit (%)	Plastic Limit (%)	Plastic Index (%)	MOISTURE CONTENT (%)	DRY DENSITY (pcf)	Triaxial Compression			Unconfined Compression		Parametric	Direct Shear	
					$\sigma_1$ (pcf)	$\sigma_3$ (pcf)	$\sigma_1 - \sigma_3$ (pcf)	$q_u$ (pcf)	$c$ (pcf)		Shear Strength (pcf)	Normal Pressure (pcf)
43.3	21.1	22.2	59	97						2200	620	1000
										1500	1040	2000
			16.6	109						(4500)	1500	4000
										(4500)		
			22.9	104						2600		
										2900		
			14.1	121						3000		
										3100		
			19.5	112						3200		
										3500		
			24.0	104						2800		
										3700		
			8.7	122						4000		
										8300 (7600)	(5000)	
			15.5	120						2500		
										3200		
										2700		
										3000		
			16.5	118						2500		
32.7	17.1	15.6								3700		
			16.3	118						5000 (3600)	(5500)	

BLOW COUNTS  
SAMPLES

SYMBOLS	DESCRIPTIONS
OL	BLACK ORGANIC SILTY CLAY WITH SAND (TOPSOIL)
CL	MOTTLED REDDISH-BROWN AND GRAY SILTY CLAY WITH SOME SAND AND GRAVEL GRADES WITH GRAVEL
CL	DARK BROWNISH-GRAY SILTY CLAY WITH SOME SAND AND GRAVEL. SOME MOTTLING OF COLOR. STIFF TO HARD
CL	DARK GRAY SILTY CLAY WITH A TRACE OF GRAVEL CONTAINING LAMINATIONS AND THIN SEAMS OF SILTY FINE SAND. OCCASIONAL LENSES OF SILTY FINE TO MEDIUM SAND. STIFF GRADES WITH LESS SAND
CL	GRADES WITH SOME SAND AND OCCASIONAL GRAVEL
CL	OCCASIONAL POCKET OF SAND WITH SOME GRAVEL
CH CL	DARK BROWNISH-GRAY SILTY CLAY WITH SOME FINE TO COARSE SAND AND GRAVEL. VERY STIFF TO HARD
CL	LAYER OF GRAY GRAVELLY SILTY SAND 650-648 GRAVEL SEAM 647 - 646.5 DARK GRAY SILTY CLAY WITH A TRACE OF GRAVEL CONTAINING LAMINATIONS AND THIN SEAMS OF SILTY FINE SAND. OCCASIONAL LENSES OF SILTY SAND AND GRAVELLY SAND. VERY STIFF
CL	OCCASIONAL THIN SEAMS OF GRAY CLAYEY SAND AND GRAVEL
CL	OCCASIONAL SAND POCKET

BORING 29  
SURFACE ELEVATION 708.1

BORING COMPLETED AT 105.5 FEET ON 12-7-70 CASING USED TO A DEPTH OF 7.0 FEET

LA SALLE COUNTY STATION  
UPDATED FINAL SAFETY ANALYSIS REPORT

FIGURE 2.5-19  
LOGS OF BORINGS  
(SHEET 37)

ELEVATION  
IN  
FEET

720  
710  
700  
690  
680  
670  
660  
650  
640  
630  
620  
610  
600  
590  
580  
570  
560

ATTERBERG LIMITS			UNIFORMITY COEFFICIENT	DENSITY	SHEAR STRENGTH DATA							
Liquid Limit (%)	Plastic Limit (%)	Plasticity Index (%)			Unconfined Compression				Penetration		Direct Shear	
					q _u (PSF)	q _u (KIP/FT ² )	q _u (PSF)	q _u (KIP/FT ² )	c (PSF)	c (KIP/FT ² )	τ (PSF)	τ (KIP/FT ² )
			21	96						1800	620	500
			8.1	107				7800	(5500)			
			18.4	113	1962	1000				2700		
										2700		
22.2	13.8	8.4	8.1	112				3000	(2600)	2300		
										2800		
										3000		
			9.8	110	2079	3000				2600		
			4.3	106						2500		
										3300		
			20.1	115				2125	(6000)			
			16.4	117	2272	4500				2400		
25.9	14.2	11.7	16.7	118				2800	(2200)	2300		
			15.9	119						3300		
			16.9	117				5200	(3600)			
										2800		
										2700		
										2800		
			16.0	118	3422	6000				3500		
										3500		
			20.4	110				7400	(7200)	(6000)		
										4000		
			27.8	13.5	14.3	11.3	125			8800	(5500)	
										(7600)	(6000)	
										(6000)		
			23.7	108						(6000)		
										2200		
			7.8	137						(8000)		
										(10000+)		
										(10000+)		
										(10000+)		
14.9	11.2	3.7								(10000+)		
										(10000+)		

BORING 30  
SURFACE ELEVATION 706.4

BLOW COUNTS  
SAMPLES

	SYMBOLS	DESCRIPTIONS
7	OL	BLACK ORGANIC SILTY CLAY (TOPSOIL)
5	CL	MOTTLED YELLOWISH-BROWN AND BROWN SILTY CLAY WITH SOME ORGANIC MATERIAL SLIGHT SEEPAGE FROM SAND SEAM
P	CL	DARK BROWNISH-GRAY SILTY CLAY WITH SOME SAND AND GRAVEL, SOME MOTTLING OF COLOR, STIFF TO HARD
P		DARK GRAY SILTY CLAY WITH A TRACE OF GRAVEL CONTAINING LAMINATIONS AND THIN SEAMS OF SILTY FINE SAND, OCCASIONAL LENSES OF SILTY FINE TO MEDIUM SAND, STIFF
P		
P	CL	OCCASIONAL MEDIUM TO COARSE SAND SEAM
P		SAND AND GRAVEL GRADING OUT
P		GRADES WITH SOME SAND AND OCCASIONAL GRAVEL
P		SAND AND GRAVEL GRADING OUT
P		OCCASIONAL SAND AND GRAVEL SEAM
P	CH	DARK BROWNISH-GRAY SILTY CLAY WITH SOME FINE TO COARSE SAND AND GRAVEL, VERY STIFF TO HARD
P	CL	
P		DARK GRAY SILTY CLAY WITH A TRACE OF GRAVEL CONTAINING LAMINATIONS AND THIN SEAMS OF SILTY FINE SAND, OCCASIONAL LENSES OF SILTY SAND AND GRAVELLY SAND, VERY STIFF
P		
P	CL	LENSE OF GRAY CLAYEY SAND WITH SOME GRAVEL 663 TO 661
P		
P		GRADES WITH OCCASIONAL GRAVEL
P		SEVERAL SEAMS OF GRAY MEDIUM TO COARSE SAND WITH SOME GRAVEL
P		
P		
P		DARK BROWNISH-GRAY FINE TO COARSE SANDY CLAY WITH SOME GRAVEL, OCCASIONAL LAYERS OF SANDY CLAYEY SILT, HARD
P	CL	
P		GRADES WITH OCCASIONAL SAND
P		LENSE OF BROWNISH-GRAY GRAVELLY SAND WITH TRACE OF SILTY CLAY
P		
P		SEAM OF GRAY SILTY SAND WITH GRAVEL
19	CL	DARK GRAY SILTY CLAY WITH A TRACE OF GRAVEL CONTAINING LAMINATIONS AND THIN SEAMS OF SILTY FINE SAND, OCCASIONAL LENSES OF SILTY SAND AND GRAVELLY SAND, VERY STIFF
125		
107/2		DARK GRAYISH-BROWN, FINE TO COARSE SANDY CLAYEY SILT WITH PEBBLES, GRAVEL AND SOME COBBLES, VERY HARD
114		
129	ML	OCCASIONAL COBBLE
195		GRADES LESS GRAVEL
180		GRADES TO REDDISH-BROWN

LA SALLE COUNTY STATION  
UPDATED FINAL SAFETY ANALYSIS REPORT

FIGURE 2.5-19  
LOGS OF BORINGS  
(SHEET 38)





BORING 31 CONTINUED

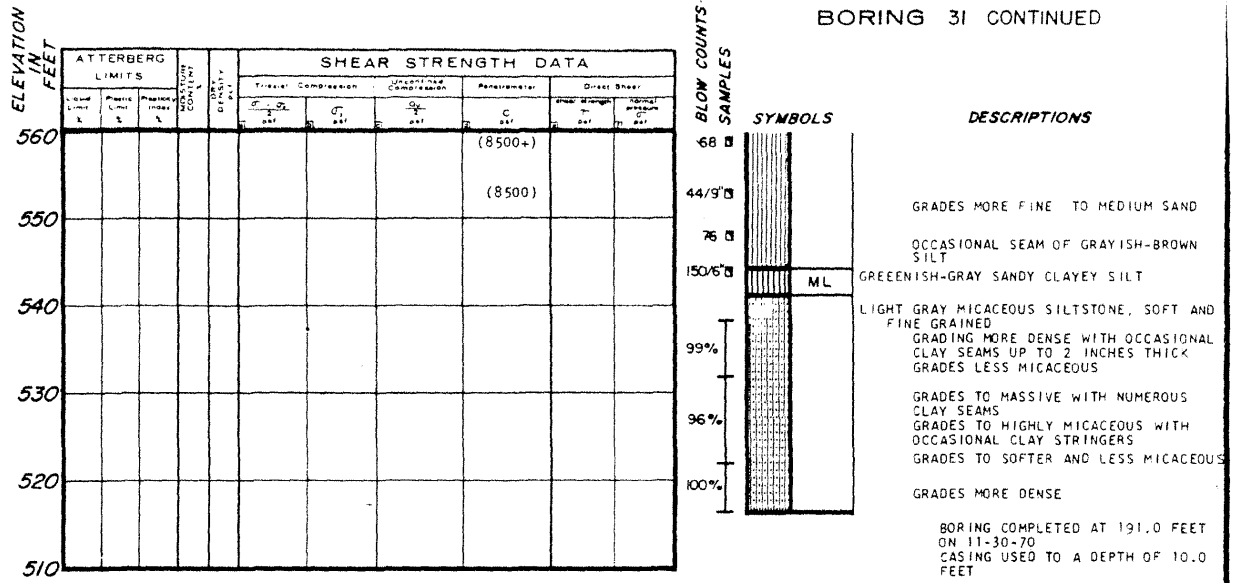

LA SALLE COUNTY STATION  
 UPDATED FINAL SAFETY ANALYSIS REPORT

FIGURE 2.5-19  
 LOGS OF BORINGS  
 (SHEET 41)





BORING 32 CONTINUED

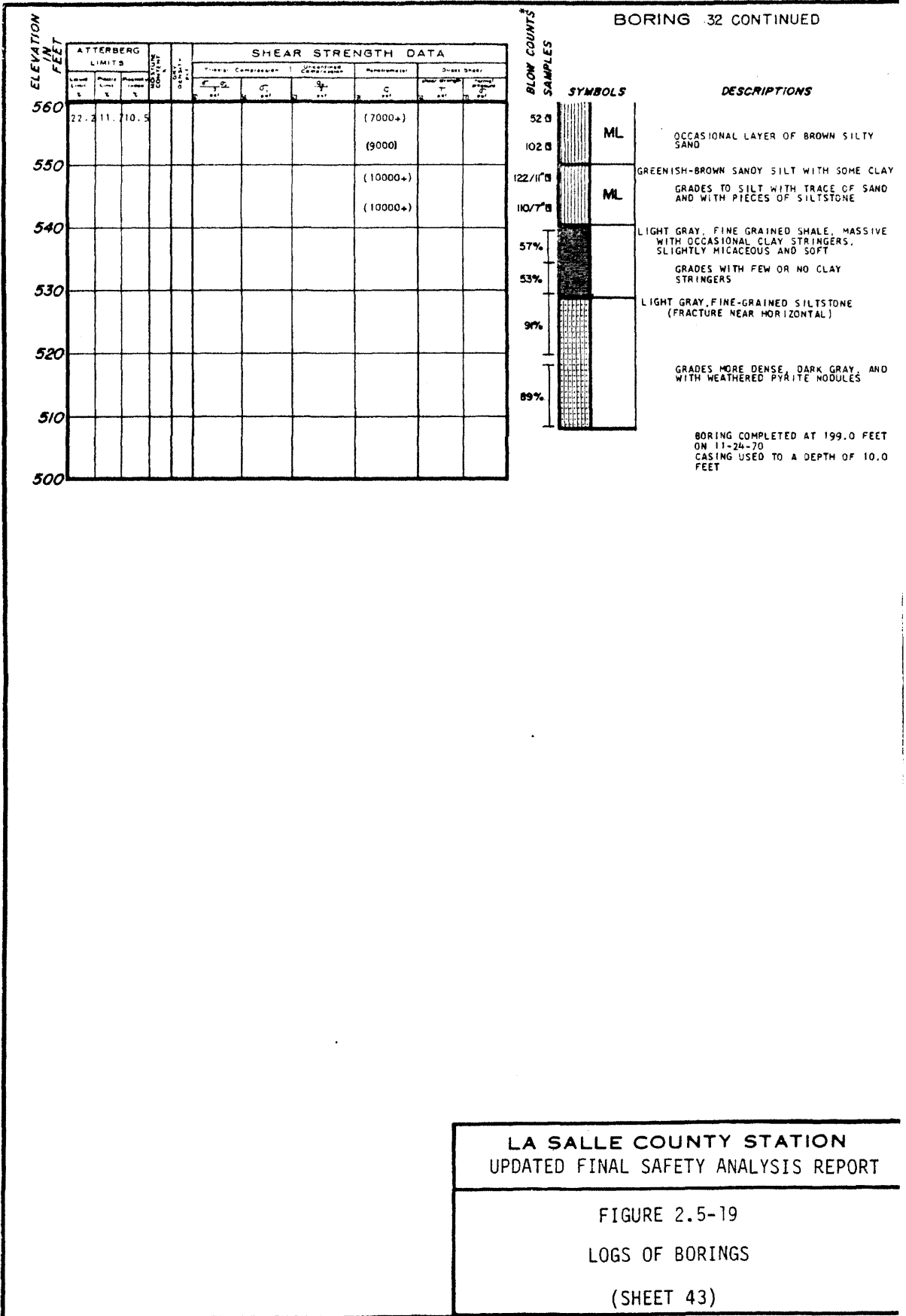

LA SALLE COUNTY STATION  
UPDATED FINAL SAFETY ANALYSIS REPORT

FIGURE 2.5-19  
LOGS OF BORINGS  
(SHEET 43)

ELEVATION IN FEET

ATTERBERG LIMITS				SHEAR STRENGTH DATA							
Liquid Limit %	Plastic Limit %	Plastic Index	Liquid Limit - Plastic Limit	Triaxial Compression				Penetration		Direct Shear	
				$\sigma_1$ (PSF)	$\sigma_3$ (PSF)	$q$ (PSF)	$c_u$ (PSF)	$C$ (PSF)	Shear Strength (PSF)	Correlation Coefficient	
			16.2					4100	1350	2000	
			15.9					(5000)	1500	3000	
			14.2					3400	1750	4000	
								3000			
			19.6					2800			
								1900			
								2400			
			11.0					2800			
			26.0					2400			
								2000			
25.7	15.8	9.9	11.0					3000 (2350)	2400		
								2600			
			17.5					3100 (2400)	2600		
								2400			
			17.6					5000 (3500)	3400		
28.9	16.7	12.2						3100			
								3800			
			12.2					4000			
								3500			
			18.8					(5000)			

BORING 33  
SURFACE ELEVATION 705.6

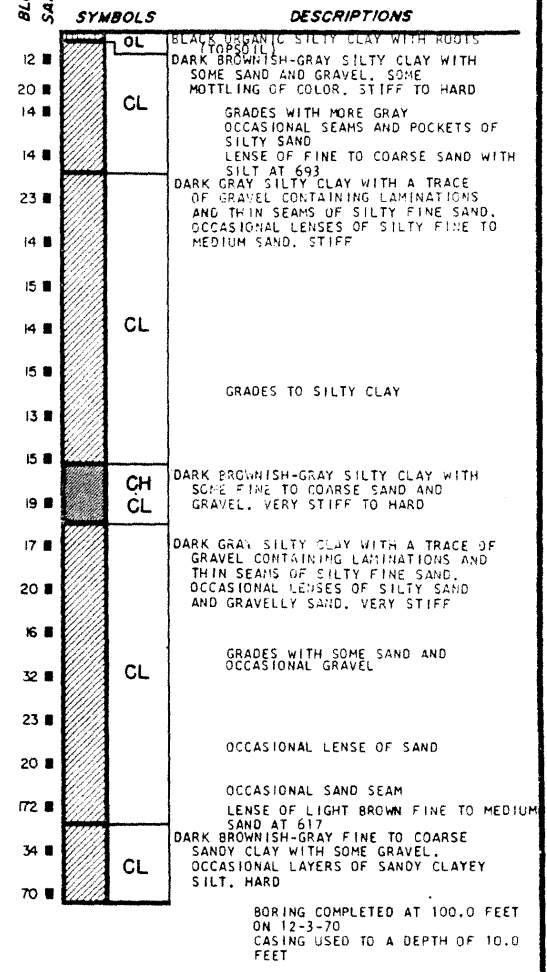

LA SALLE COUNTY STATION  
UPDATED FINAL SAFETY ANALYSIS REPORT

FIGURE 2.5-19  
LOGS OF BORINGS  
(SHEET 44)

ELEVATION  
IN  
FEET

ATTERBERG LIMITS			SHEAR STRENGTH DATA																	
Liquid Limit %	Plastic Limit %	Plastic Index %	COHESIVE CONTENT %	DENSITY (pcf)	Triaxial Compression			Unconfined Compression			Penetration		Direct Shear							
					$Q_1$ (pcf)	$Q_2$ (pcf)	$Q_3$ (pcf)	$Q_u$ (pcf)	$Q_v$ (pcf)	$Q_w$ (pcf)	$C$ (pcf)	$\phi$ (deg)	$\phi$ (deg)							
67.0	24.8	42.2													1700					
															2800					
															4000					
			15.9	119											4100					
29.9	15.9	14.0													2400					
															2600					
			19.5	112											2800					
34.3	11.6	9	17.4												2400					
															2500					
															2500					
			2.3	105											2700					
															3600					
															6000	(5000)				
			4.1	121											2600					
			16.1	118											3500					
															5000 (4300)	3300				
			16.7	117											3600					
															3300					
			15.8	119											3700	(6000)				
															6000					
23.3	15.7	7.6																		

BORING 34  
SURFACE ELEVATION 708.3

BLOW COUNTS  
SAMPLES

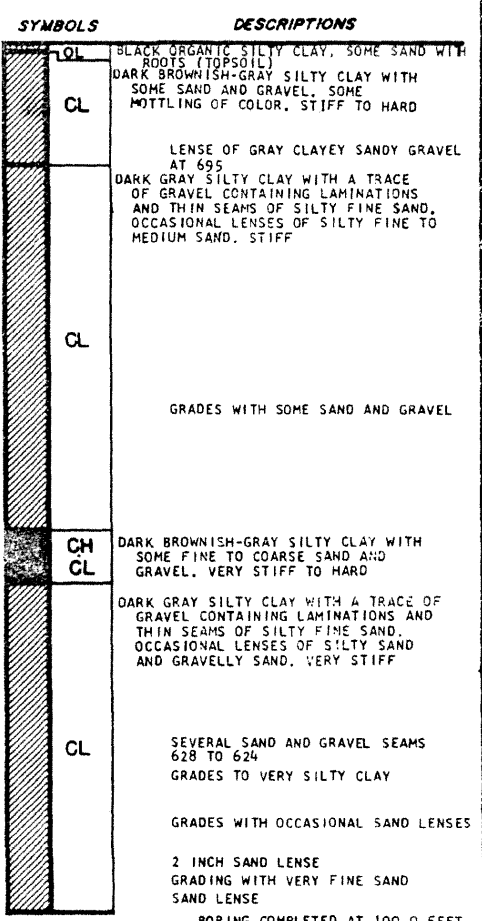

BORING COMPLETED AT 100.0 FEET  
ON 12-4-70  
CASING USED TO A DEPTH OF 7.0 FEET

LA SALLE COUNTY STATION  
UPDATED FINAL SAFETY ANALYSIS REPORT

FIGURE 2.5-19  
LOGS OF BORINGS  
(SHEET 45)

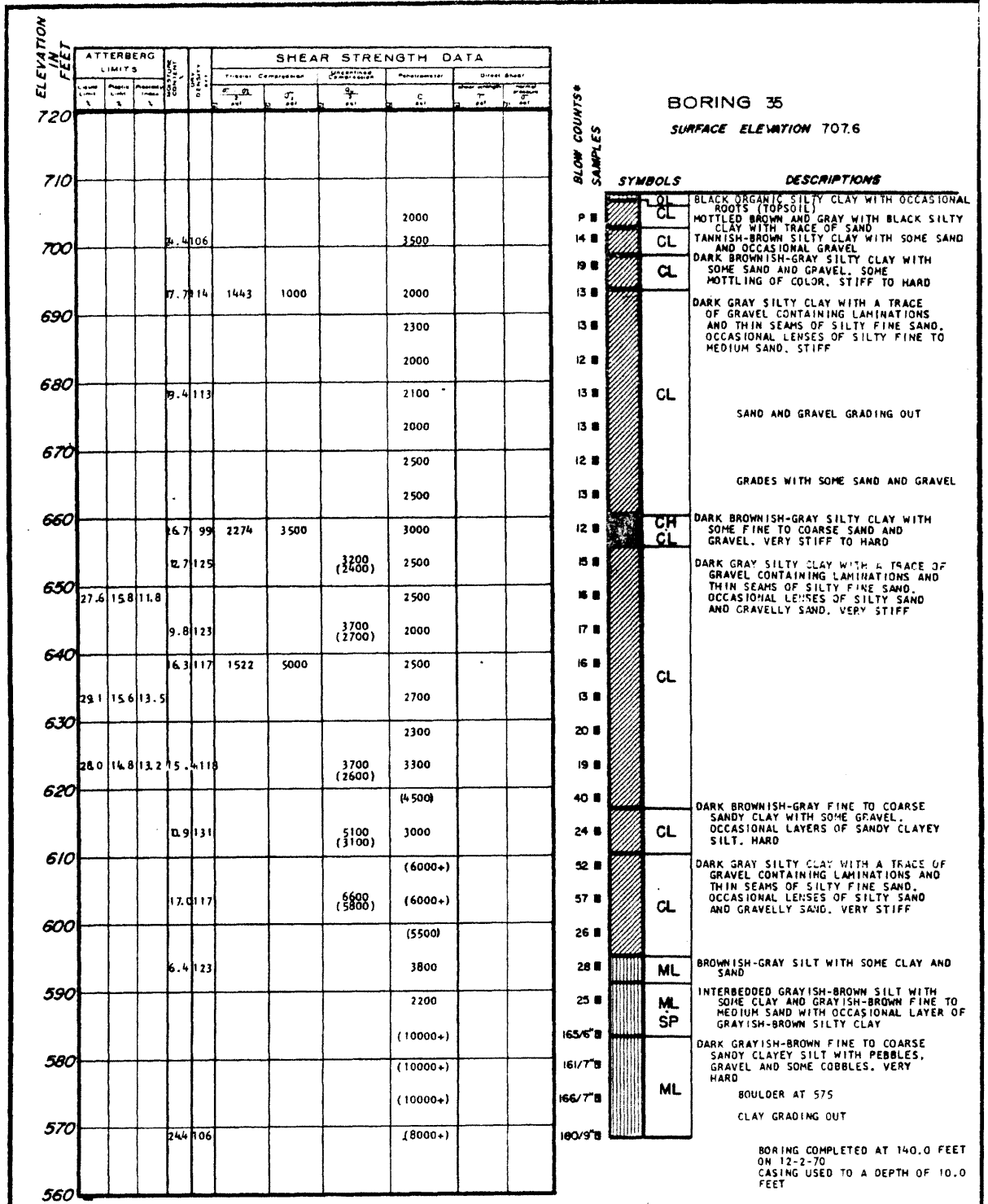

**LA SALLE COUNTY STATION**  
UPDATED FINAL SAFETY ANALYSIS REPORT

FIGURE 2.5-19  
LOGS OF BORINGS  
(SHEET 46)

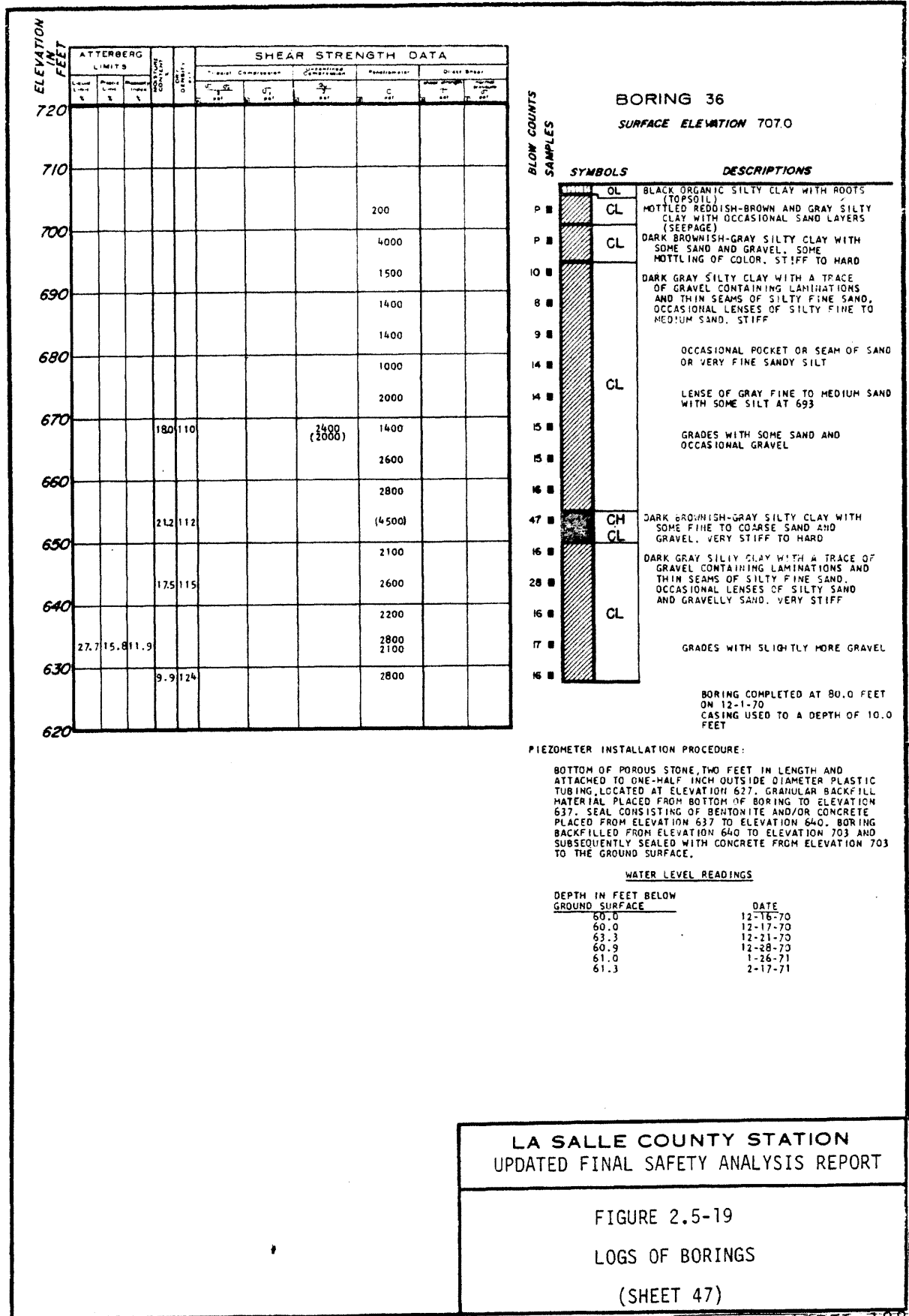







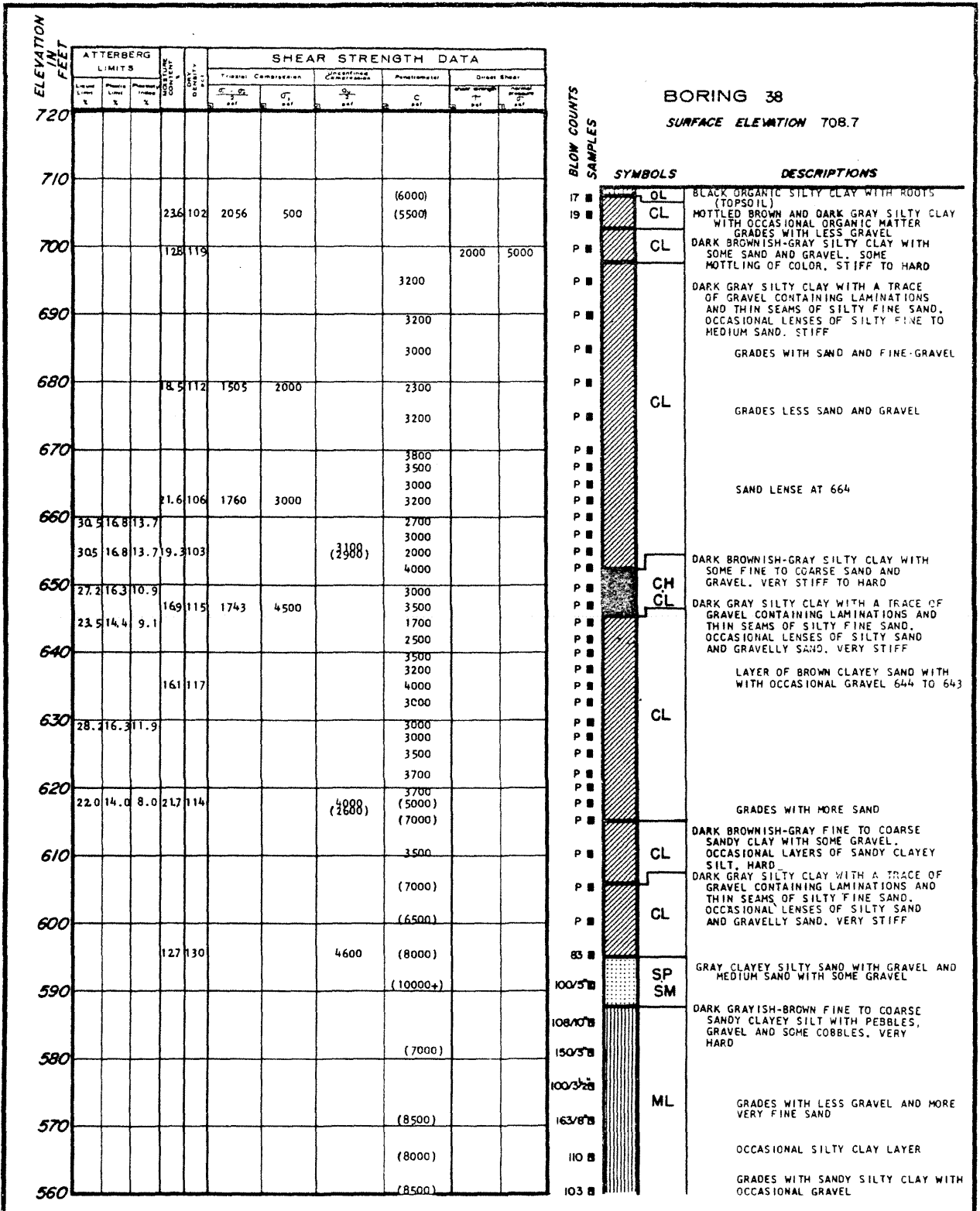

**LA SALLE COUNTY STATION**  
UPDATED FINAL SAFETY ANALYSIS REPORT

FIGURE 2.5-19  
LOGS OF BORINGS  
(SHEET 50)

ELEVATION  
IN  
FEET

ATTERBERG LIMITS				SHEAR STRENGTH DATA								
Liquid Limit %	Plastic Limit %	Plastic Index	MOHRIE COUNTRY CLASSIFICATION	Triaxial Compression			Unconfined Compression		Penetration		Direct Shear	
				$\sigma_1$ (PSF)	$\sigma_3$ (PSF)	$\sigma_1 - \sigma_3$ (PSF)	$q_u$ (PSF)	$C$ (PSF)	$\tau$ (PSF)	$\sigma_v$ (PSF)	$\tau$ (PSF)	

BLOW COUNTS  
SAMPLES

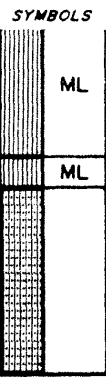

DESCRIPTIONS

GRADES BROWN VERY SANDY SILT WITH OCCASIONAL SILTY CLAY AND OCCASIONAL SILTY SAND LAYERS

GREENISH-GRAY MICACEOUS, SANDY, CLAYEY SILT

ALTERNATE LAYERS OF SOFT LIGHT GRAY SILTSTONE AND GREENISH-GRAY SANDY CLAYEY SILT

LIGHT GRAY MICACEOUS SANDY SILTSTONE, FINE TO MEDIUM GRAINED AND SOFT GRADES LESS SANDY, MORE DENSE AND TO FINE GRAINED SILTSTONE

OCCASIONAL CLAY STRINGERS (FRACTURES NEAR HORIZONTAL) GRADES TO DARKER GRAY, SOFTER WITH MORE CLAY AND LESS MICA

BORING COMPLETED AT 188.5 FEET ON 12-2-70 CASING USED TO A DEPTH OF 8.0 FEET

LA SALLE COUNTY STATION  
UPDATED FINAL SAFETY ANALYSIS REPORT

FIGURE 2.5-19  
LOGS OF BORINGS  
(SHEET 51)

ELEVATION IN FEET	ATTERBERG LIMITS			SHEAR STRENGTH DATA								
	Liquid Limit %	Plastic Limit %	Plastic Index %	CORRECTED CORRECTION CORRECTION CORRECTION	Triaxial Compression			Unconfined Compression		Penetration C psi	Direct Shear	
					$\sigma_1 - \sigma_3$ psi	$\sigma_3$ psi	$\sigma_1$ psi	$\sigma_3$ psi	$\tau$ psi		$\sigma_v$ psi	
720												
710				259					1500			
700				169	117	2096	500		4000			
690				162	116			7000 (3600)	(5000)			
680				201	109			2200	1600			
670	34.8	15.8	19.0			1044	2500		2000			
660									2200			
650				155	118			4700 (3400)	(4500)			
640				181	114	1327	4500		1300			
630									3100			
620	28.4	15.3	13.1						2100			
610				206	108			4500 (3900)	4400			
600				146	121				4000			
590									(4500)			
580									(6000)			
570									(6000)			
560									(10000+)			

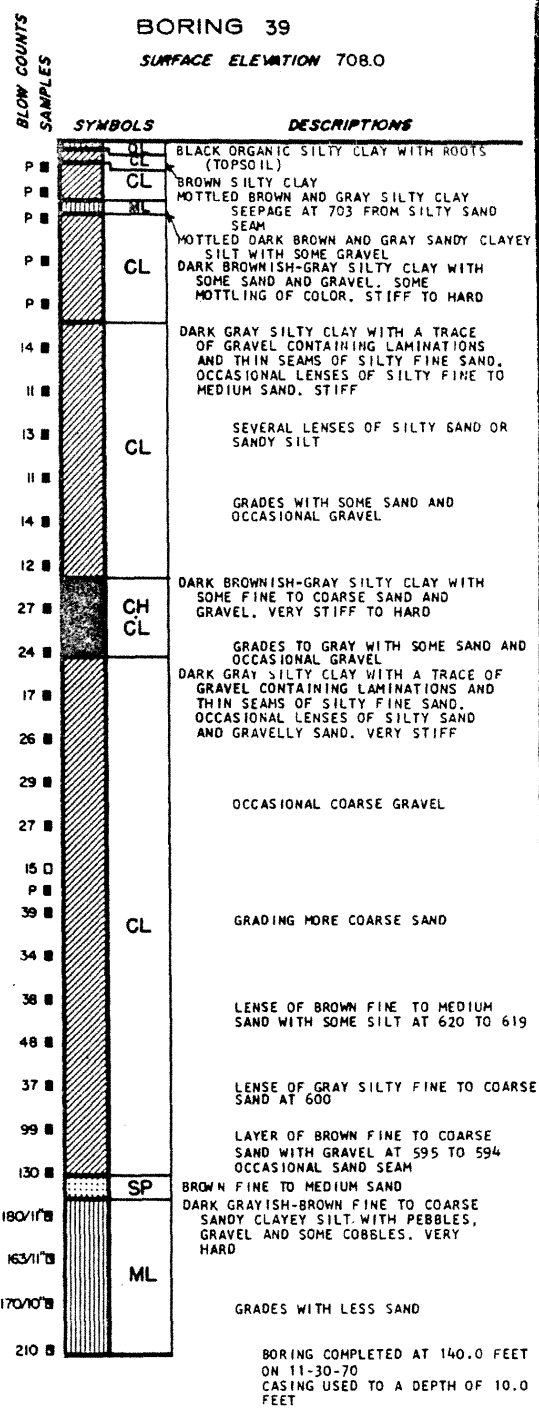

**LA SALLE COUNTY STATION**  
UPDATED FINAL SAFETY ANALYSIS REPORT

FIGURE 2.5-19  
LOGS OF BORINGS  
(SHEET 52)

ELEVATION  
IN  
FEET

ELEVATION IN FEET	ATTERBERG LIMITS			SHEAR STRENGTH DATA													
	Liquid Limit %	Plastic Limit %	Plasticity Index %	MOISTURE CONTENT %	DRY DENSITY pcf	Triaxial Compression					Unconfined Compression		Penetration		Direct Shear		
						σ ₁ psi	σ ₃ psi	c _u psi	φ _u °	σ _u psi	c _u psi	φ _u °	q _t psi	C _t psi	σ ₁ psi	σ ₃ psi	φ _s °
	W _L	W _P	W _{P-L}	W _c	γ _d	σ ₁	σ ₃	c _u	φ _u	σ _u	c _u	φ _u	q _t	C _t	σ ₁	σ ₃	φ _s
720																	
710				21.7	94										680	500	
															1200	1500	
															1450	2500	
700				25.2	99					2600		(6000)					
												(4500)					
690				17.2	112										3200		
															7500		
															1700		
680				20.7	111					2800		2500					
												2500					
670				18.9	112							3200					
	32.1	17.2	14.9									2500					
660				21.7	106					3300		3000					
										(2800)							
				15.1	118					4600		4000					
										(4000)							
650				17.6	113					2000		3000					
	26.4	14.7	11.7									2000					
640				16.7	116					3700		2400					
										(2500)							
630	28.8	15.2	13.6									2000					
				18.3	112					2300		2200					
										(2000)							
620				20.1	111					4300		4000					
												3200					
610				12.8	127							(4500)					

BORING 40  
SURFACE ELEVATION 709.0

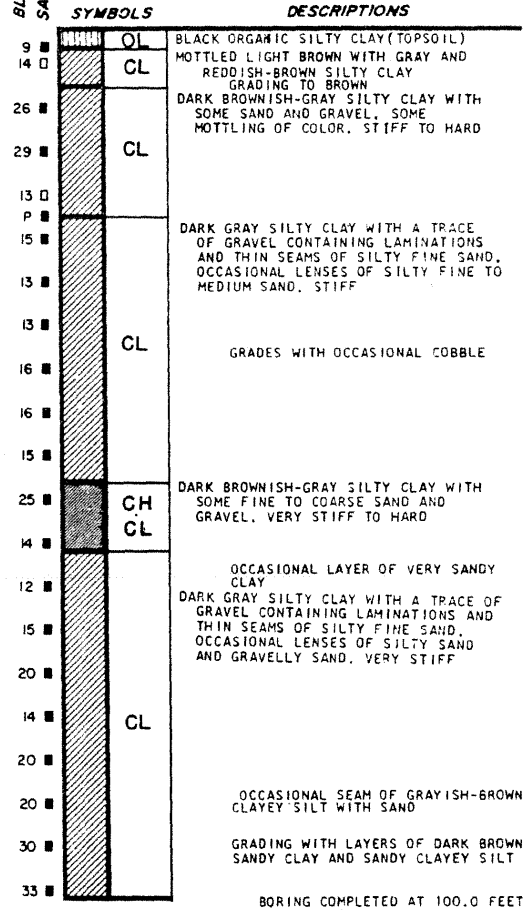

BORING COMPLETED AT 100.0 FEET  
ON 12-7-70  
CASING USED TO A DEPTH OF 8.0  
FEET

LA SALLE COUNTY STATION  
UPDATED FINAL SAFETY ANALYSIS REPORT

FIGURE 2.5-19  
LOGS OF BORINGS  
(SHEET 53)

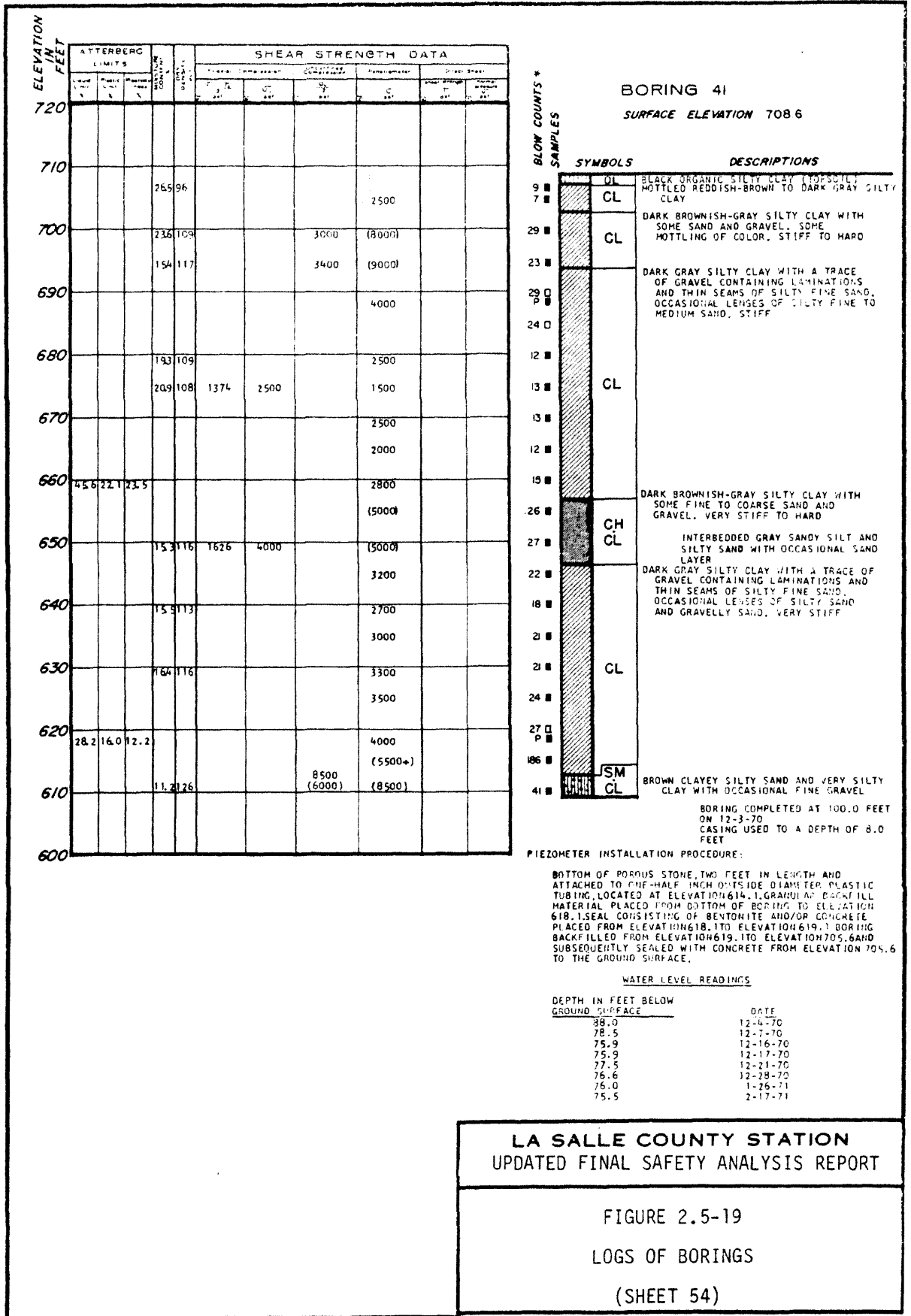

ELEVATION IN FEET	ATTERBERG LIMITS				SHEAR STRENGTH DATA																	
	Liquid Limit W _L	Plastic Limit W _P	Shrinkage Limit W _S	Liquid Plasticity Index I _p	Triaxial Compression					Uniaxial Compression			Piezometer		Direct Shear							
					σ ₁ psi	σ ₃ psi	τ _{max} psi	φ _c deg	c _u psi	σ _c psi	C psi	σ ₁ psi	σ ₃ psi	τ _{max} psi	φ _s deg	c _s psi						
																	σ ₁ psi	σ ₃ psi	τ _{max} psi	φ _s deg	c _s psi	
720																						
710																						
700				26.9	96										1800							
690				17.5	115										(4500)							
680				18.0	115										2700							

**BORING 42**  
SURFACE ELEVATION 704.9

BLOW COUNTS SAMPLES	SYMBOLS	DESCRIPTIONS
7	OL	BLACK ORGANIC SILTY CLAY WITH ROOTS (TOPSOIL)
5	CL	MOTTLED LIGHT GRAY AND BROWN SILTY CLAY WITH OCCASIONAL FINE ROOTS
22	SP	BROWN SAND
15	CL	DARK BROWNISH-GRAY SILTY CLAY WITH SOME SAND AND GRAVEL, SOME MOTTLING OF COLOR, STIFF TO HARD
15	CL	DARK GRAY SILTY CLAY WITH A TRACE OF GRAVEL CONTAINING LAMINATIONS AND THIN SEAMS OF SILTY FINE SAND, OCCASIONAL LENSES OF SILTY FINE TO MEDIUM SAND, STIFF

PIEZOMETER INSTALLATION PROCEDURE:  
BOTTOM OF POROUS STONE, TWO FEET IN LENGTH AND ATTACHED TO THREE-QUARTER INCH OUTSIDE DIAMETER PLASTIC TUBING, LOCATED AT ELEVATION 685.4. GRANULAR BACKFILL MATERIAL PLACED FROM BOTTOM OF BORING TO ELEVATION 690.4 SEAL CONSISTING OF BENTONITE AND/OR CONCRETE PLACED FROM ELEVATION 690.4 TO ELEVATION 693.4. BORING BACKFILLED FROM ELEVATION 693.4 TO ELEVATION 700.9 AND SUBSEQUENTLY SEALED WITH CONCRETE FROM ELEVATION 700.9 TO THE GROUND SURFACE.

**WATER LEVEL READINGS**

DEPTH IN FEET BELOW GROUND SURFACE	DATE
14.5	12-14-70
8.5	12-15-70
4.8	12-17-70
4.8	12-18-70
4.8	12-21-70
5.3	12-28-70
5.5	1-26-71
6.2	2-17-71

**LA SALLE COUNTY STATION**  
**UPDATED FINAL SAFETY ANALYSIS REPORT**

FIGURE 2.5-19  
LOGS OF BORINGS  
(SHEET 55)

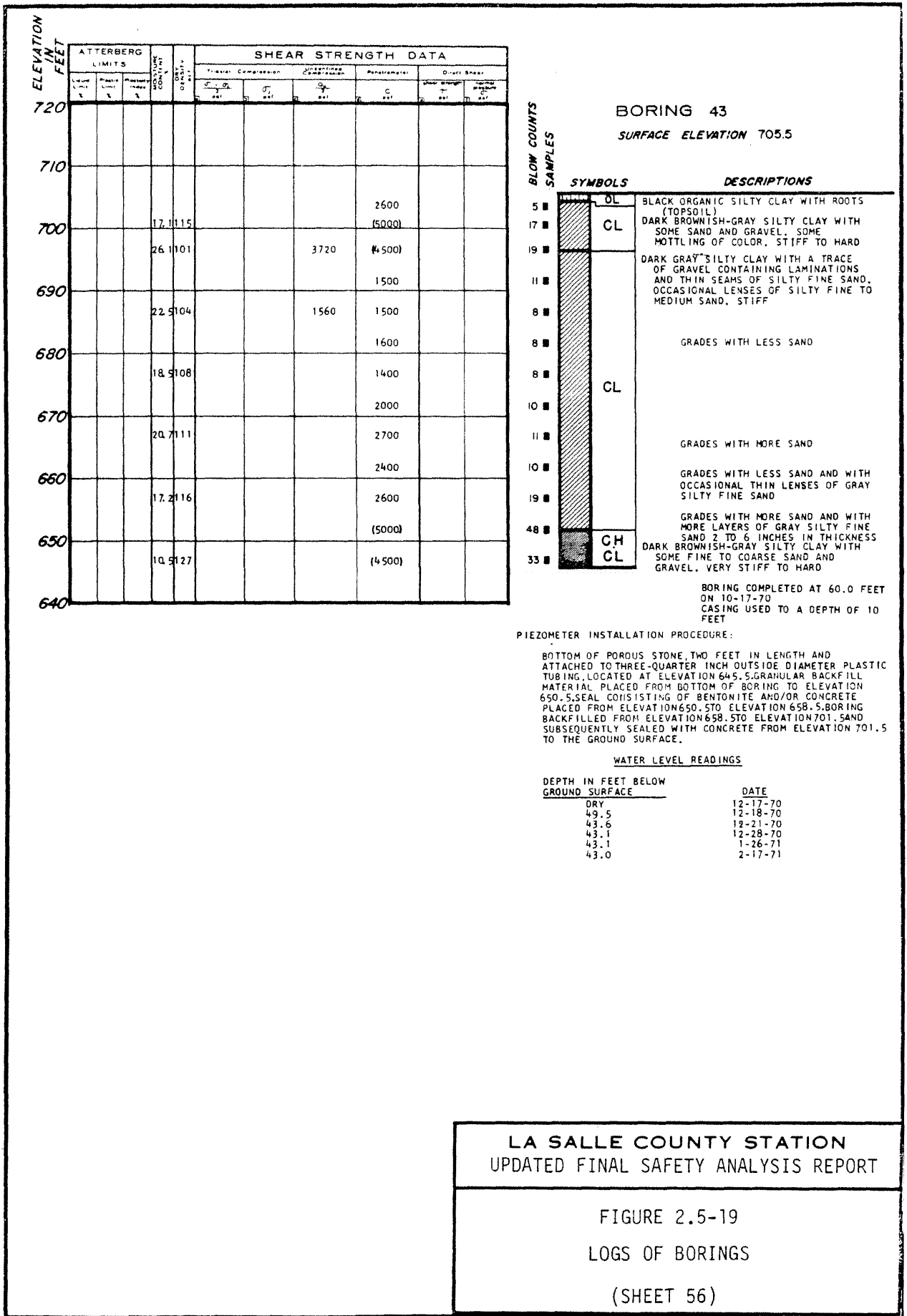





ELEVATION  
IN IN  
FEET

720  
710  
700  
690  
680  
670  
660  
650  
640  
630  
620  
610  
600

ATTERBERG LIMITS				SHEAR STRENGTH DATA														
Liquid Limit (%)	Plastic Limit (%)	Plasticity Index (%)	Moisture Content (%)	Triaxial Compression					Direct Shear			Penetration		Direct Shear				
				$\sigma_1$ (psi)	$\sigma_3$ (psi)	$\sigma_1 - \sigma_3$ (psi)	$\sigma_1 + \sigma_3$ (psi)	$\sigma_1 - \sigma_3$ (psi)	$\sigma_1 + \sigma_3$ (psi)	$\sigma_1$ (psi)	$\sigma_3$ (psi)	$\sigma_1 - \sigma_3$ (psi)	$\sigma_1 + \sigma_3$ (psi)					
			314.87														2300	
																	(5000)	
			164.113														(5500)	
																	(6000)	
																	2400	
			173.112														2700 (2040)	1600
			206.110	1330	2000												1500	
																	2400	
			178.109														2800	2400
			138.120														3200 (2500)	(4500)
																	2400	
																	2400	
			144.119														3820 (2640)	3300
																	2800	
																	2500	
																	2400	
			239.105														(4500)	
			105.131														6980 (5320)	
																	4000	

BLOW COUNTS  
SAMPLES

BORING 45  
SURFACE ELEVATION 703.2

BLOW COUNTS SAMPLES	SYMBOLS	DESCRIPTIONS
5	OL	BLACK ORGANIC SILTY CLAY WITH ROOTS (TOPSOIL)
17	CL	DARK BROWN SILTY CLAY WITH ORGANIC MATTER
35	CL	DARK BROWNISH-GRAY SILTY CLAY WITH SOME SAND AND GRAVEL, SOME MOTTLING OF COLOR, STIFF TO HARD
27		DARK GRAY SILTY CLAY WITH A TRACE OF GRAVEL CONTAINING LAMINATIONS AND THIN SEAMS OF SILTY FINE SAND, OCCASIONAL LENSES OF SILTY FINE TO MEDIUM SAND, STIFF
14		
12		
15	CL	OCCASIONAL SEAMS OF VERY SILTY SAND WITH CLAY
16		
15		LAYER OF GRAY SILTY FINE TO COARSE SAND WITH SOME THIN LAYERS OF GRAY SILTY CLAY AT 659
16	CH CL	DARK BROWNISH-GRAY SILTY CLAY WITH SOME FINE TO COARSE SAND AND GRAVEL, VERY STIFF TO HARD
17		
19		DARK GRAY SILTY CLAY WITH A TRACE OF GRAVEL CONTAINING LAMINATIONS AND THIN SEAMS OF SILTY FINE SAND, OCCASIONAL LENSES OF SILTY SAND AND GRAVELLY SAND, VERY STIFF
20		
22		
24	CL	
20		
27		LAYERS OF GRAY SILTY FINE TO COARSE SAND WITH SOME GRAVEL GRADES WITH NO SAND AND GRAVEL
100		
36	SP ML	ALTERNATING LAYERS OF BROWN FINE TO MEDIUM SAND AND CLAYEY SILT WITH SAND
38	CL	DARK BROWNISH-GRAY FINE TO COARSE SANDY CLAY WITH SOME GRAVEL, OCCASIONAL LAYERS OF SANDY CLAYEY SILT, HARD

BORING COMPLETED AT 100.0 FEET  
ON 12-8-70  
CASING USED TO A DEPTH OF 10.0 FEET

LA SALLE COUNTY STATION  
UPDATED FINAL SAFETY ANALYSIS REPORT

FIGURE 2.5-19  
LOGS OF BORINGS  
(SHEET 58)

ELEVATION  
IN  
FEET

ATTERBERG LIMITS				SHEAR STRENGTH DATA							
Liquid Limit %	Plastic Limit %	Plasticity Index %	MOHRIEUX CONSISTENCY	UNSATURATED WATER CONTENT (%)	SHRINKAGE (%)	Triaxial Compression			Penetration	Direct Shear	
						$\sigma_1$ (PSI)	$\sigma_3$ (PSI)	$\tau$ (PSI)		Shear Strength (PSI)	Normal Pressure (PSI)
									1200		
									1700		
									(5000)		
									3500		
									2200		
									2600		
									1700		
									1500		
									2000		
									2300		
									2700		
									3100		
									2400		
									2200		
									2300		
									2600		
									2800		
									3000		
									3400		
									3500		
									4000		

BORING 46  
SURFACE ELEVATION 706.5

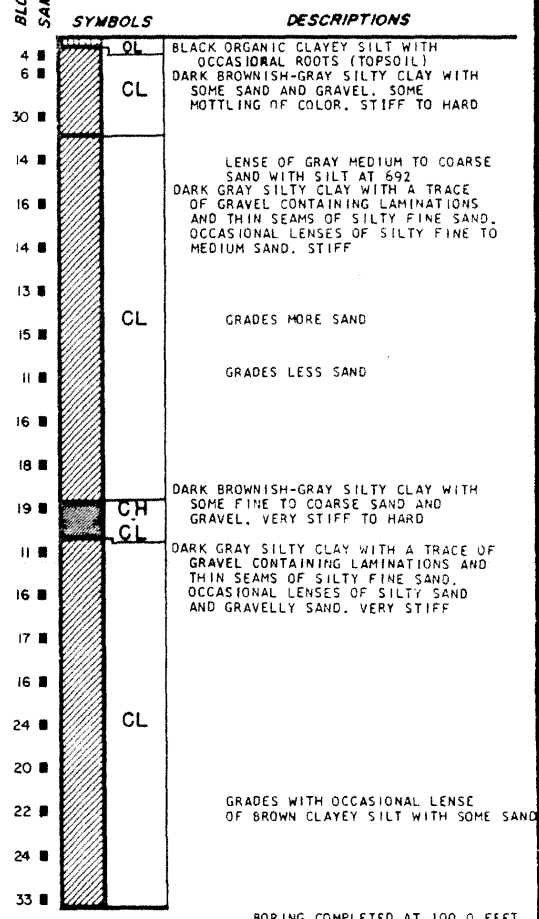

BORING COMPLETED AT 100.0 FEET  
ON 12-29-70  
CASING USED TO A DEPTH OF 20.0 FEET

LA SALLE COUNTY STATION  
UPDATED FINAL SAFETY ANALYSIS REPORT

FIGURE 2.5-19  
LOGS OF BORINGS  
(SHEET 59)

ELEVATION  
IN  
FEET

720  
710  
700  
690  
680  
670  
660  
650  
640  
630  
620  
610  
600

ATTERBERG LIMITS				SHEAR STRENGTH DATA							
Liquid Limit (%)	Plastic Limit (%)	Plastic Index (%)	Consistency Limits	Triaxial Compression			Unconfined Compression		Penetration	Direct Shear	
				$\sigma_1$ (PSF)	$\sigma_3$ (PSF)	$\sigma_c$ (PSF)	$C$ (PSF)	$\phi$ (DEG)		$\phi$ (DEG)	
			169	113					2800		
									2300		
			200	107					2600		
									2200		
			138	123					4000		
									4000		
			138	120					3500		
									3100		
			140	116					3000		
									3200		
			139	120					(5000)		
									(5000)		
			109	130					(4500)		

BORING 47  
SURFACE ELEVATION 707.0

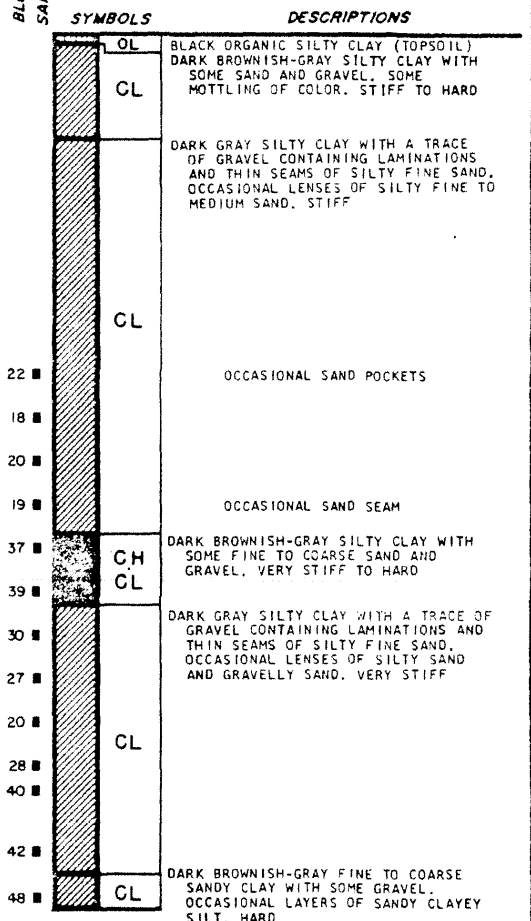

BORING COMPLETED AT 100.5 FEET  
ON 12-15-70  
CASING USED TO A DEPTH OF 7.0 FEET

LA SALLE COUNTY STATION  
UPDATED FINAL SAFETY ANALYSIS REPORT

FIGURE 2.5-19  
LOGS OF BORINGS  
(SHEET 60)

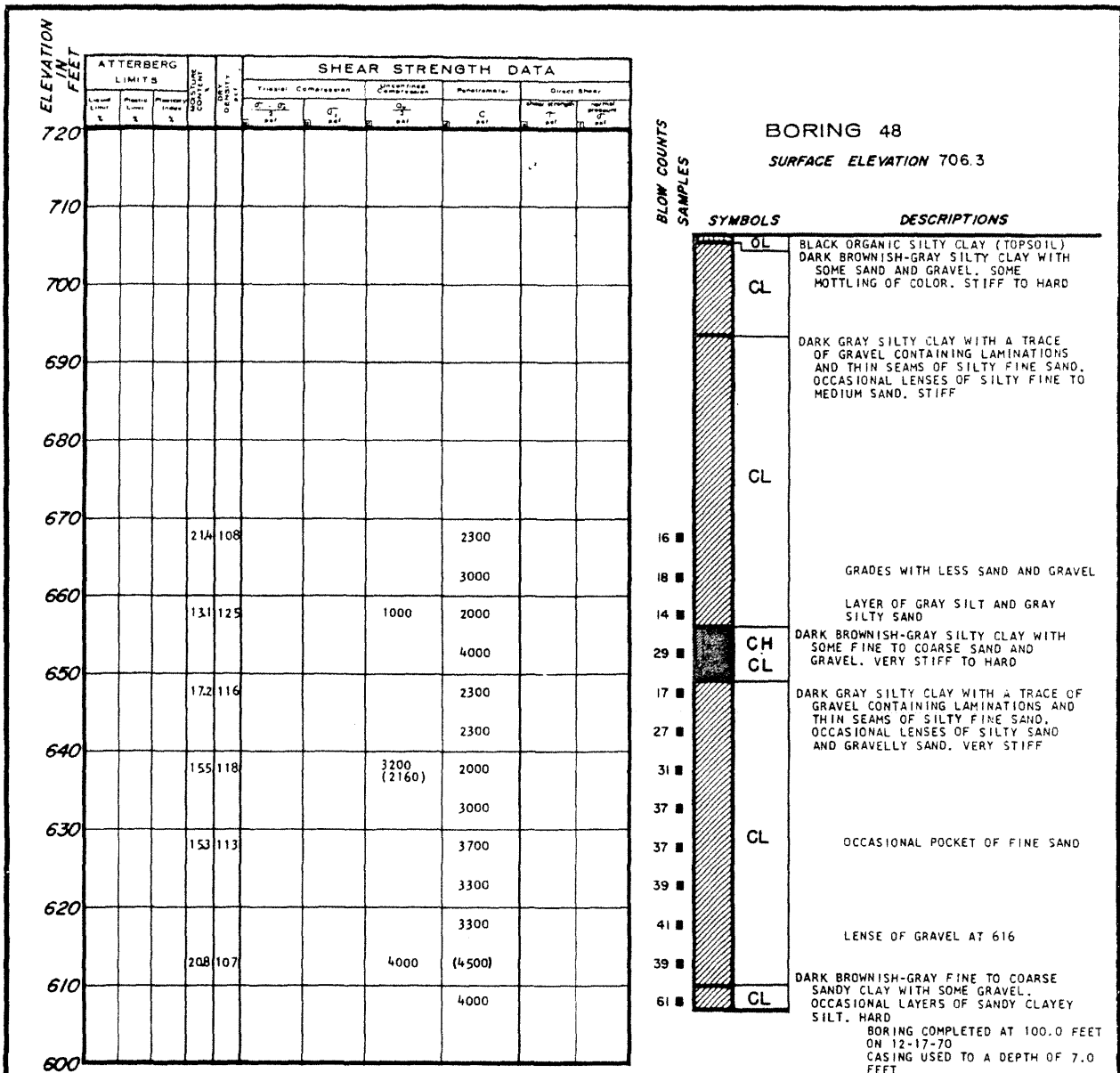

LA SALLE COUNTY STATION  
UPDATED FINAL SAFETY ANALYSIS REPORT

FIGURE 2.5-19  
LOGS OF BORINGS  
(SHEET 61)



ELEVATION  
IN  
FEET

720  
710  
700  
690  
680  
670  
660  
650  
640  
630  
620  
610  
600

ATTERBERG LIMITS				SHEAR STRENGTH DATA									
Liquid Limit (%)	Plastic Limit (%)	Plastic Index (%)	MOISTURE CONTENT (%)	DENSITY (pcf)	Triaxial Compression			Uniaxial Compression		Penetration		Direct Shear	
					σ ₁ (psf)	σ ₃ (psf)	σ ₁ (psf)	σ ₃ (psf)	q (psf)	C (psf)	σ ₁ (psf)	σ ₃ (psf)	
			168	109						1900			
										2500			
										3200			
			185	108						2750			
										(4500)			
										2250			
			151	117						2750			
										3100			
			150	120						3750			
										4000			
										(4500)			
			10.0	132						(5000)			

BORING 50  
SURFACE ELEVATION 705.7

BLOW COUNTS  
SAMPLES

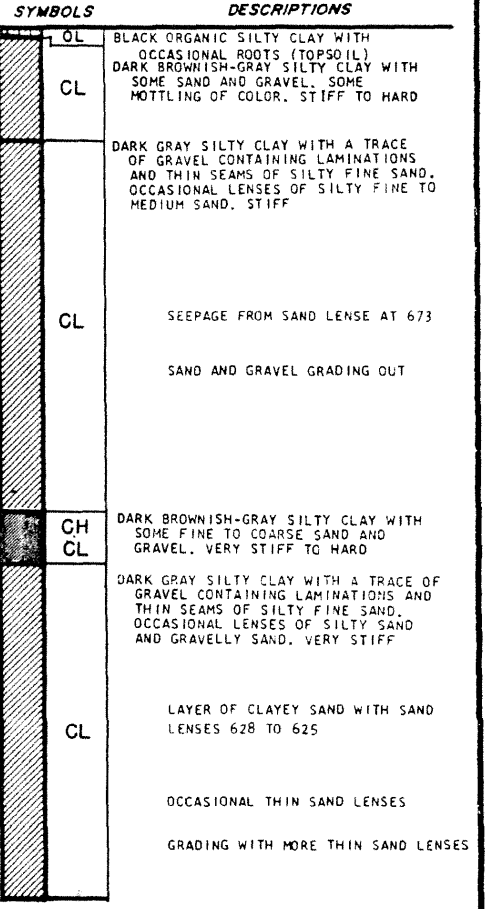

BORING COMPLETED AT 100.0 FEET  
ON 12-22-70  
CASING USED TO A DEPTH OF 7.0 FEET

LA SALLE COUNTY STATION  
UPDATED FINAL SAFETY ANALYSIS REPORT

FIGURE 2.5-19  
LOGS OF BORINGS  
(SHEET 63)

ELEVATION  
IN  
FEET

ATTERBERG LIMITS				SHEAR STRENGTH DATA							
Liquid Limit %	Plastic Limit %	Plastic Index %	MOISTURE CONTENT %	SHRINKAGE RATIO	Triaxial Compression		Unconfined Compression		Penetration	Direct Shear	
					$\bar{C}_u$ (psi)	$\bar{C}_t$ (psi)	$\bar{C}_u$ (psi)	$\bar{C}_t$ (psi)		$\bar{C}$ (psi)	$\bar{C}$ (psi)
			16.8	116			4700 (2400)		1500 (4500)		
									(5000)		
27.5	17.6	9.9							2300		
			20.8	107	1320	1500			2000		
			22.8	106			1900 (1400)		1500		
									1800		
23.7	17.1	12.6	21.3	108					2300		
									2500		
									2800		
			30.6	95			1300		2300		
									4000 3100		
			15.4	119			3900 (1600)		3100		
									3200		
19.3	15.2	4.1	14.1	120					3300		
									3500		
									3300		
									3500		
							3900 (1600)		3800		
									3500		
									5000		
			11.3	129			5400 (3500)		(5000)		
									3800		
									3700		
			18.4	111					(8000)		
									2750		
									(10000+)		
									(8000)		
									(10000+)		
									(10000+)		

BORING 51  
SURFACE ELEVATION .706.1

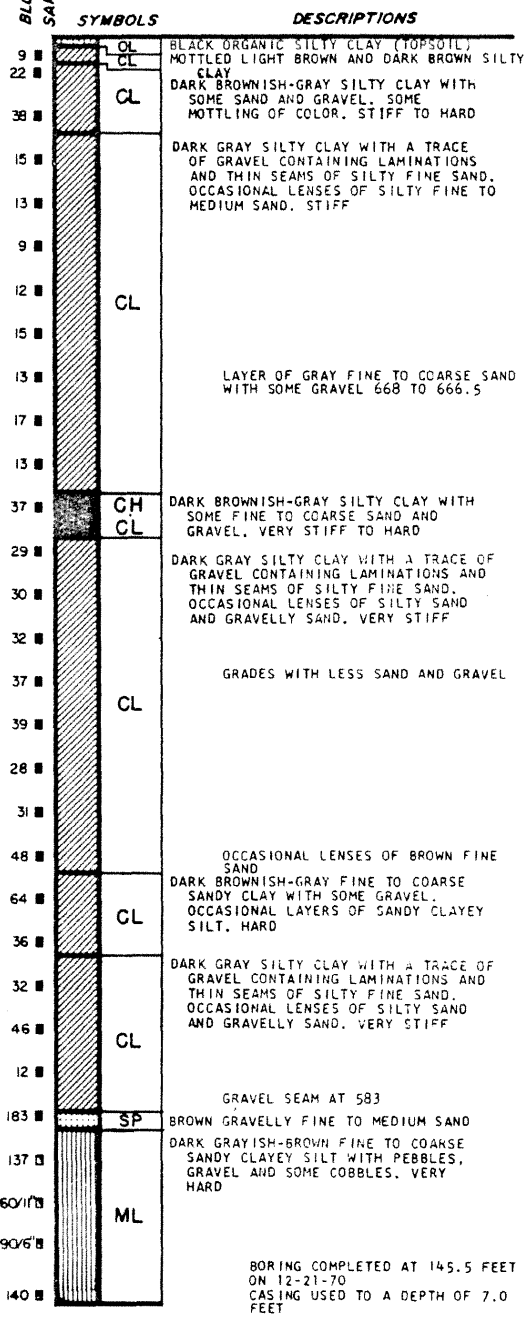

LA SALLE COUNTY STATION  
UPDATED FINAL SAFETY ANALYSIS REPORT

FIGURE 2.5-19  
LOGS OF BORINGS  
(SHEET 64)

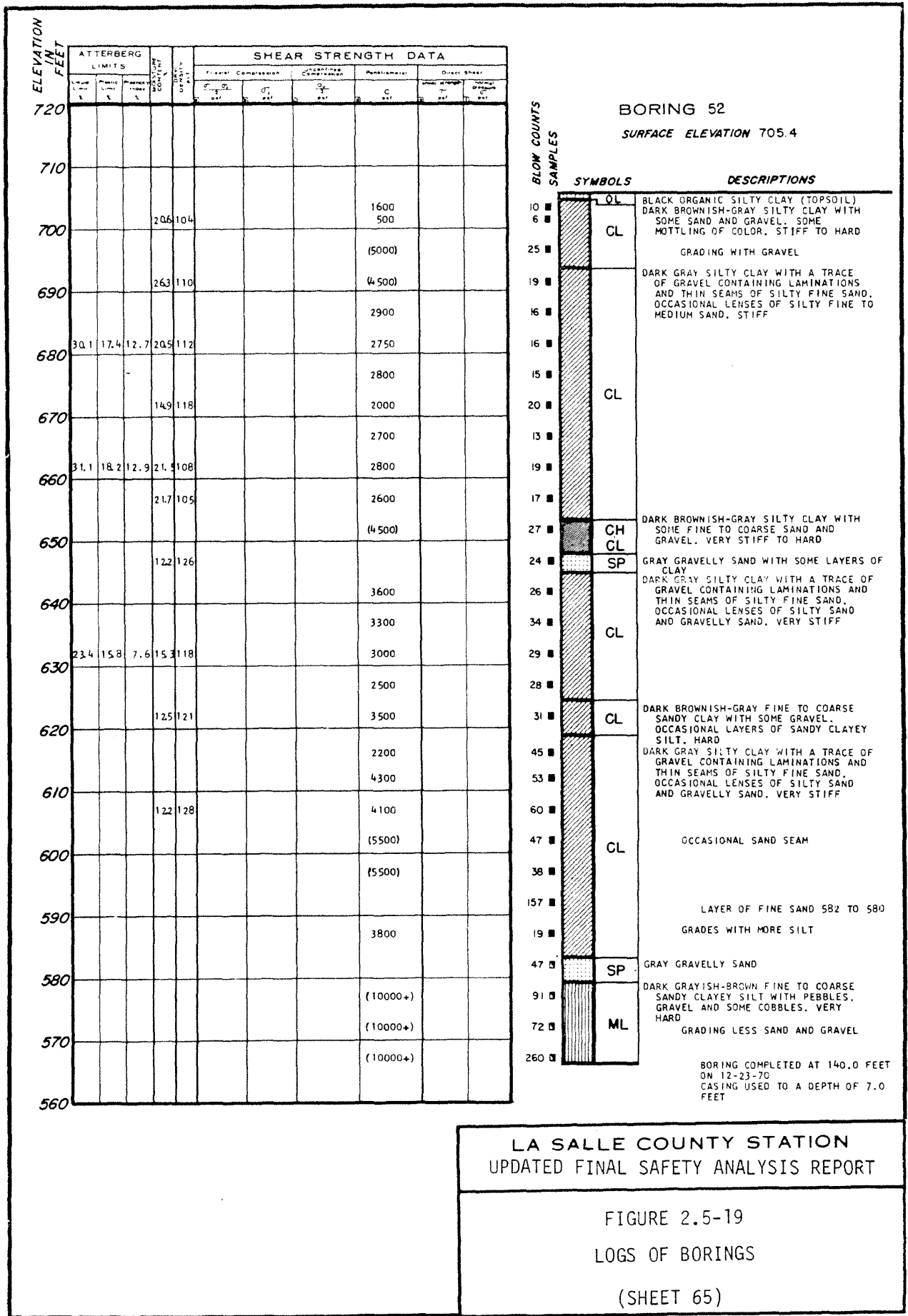



ELEVATION  
FEET

720  
710  
700  
690  
680  
670  
660  
650  
640  
630  
620  
610  
600  
590  
580  
570  
560

ATTERBERG LIMITS			LIQUID LIMIT (%)	PLASTICITY INDEX	SHEAR STRENGTH DATA									
WATER CONTENT (%)	FLUIDITY (%)	PLASTICITY (%)			Triaxial Compression			Unconfined Compression			Penetration		Direct Shear	
W	U	P	q _u	q _v	q _h	q _u	q _v	q _h	C	φ	σ _v	τ	σ _v	τ
			125	115					1500					
									(5000)					
27.1	16.5	10.6	164	117					(4600)					
									(5000)					
			193	111	850	1500			1000					
			150	114			2200		1700					
			197	110	890	2000			1500					
			222	106	1350	2500			1700					
28.5	18.5	10.0	196	110					2700					
									2300					
			198	111	700	3500			2100					
			114	124			3300		1800					
							(2600)		1500					
									2000					
23.6	16.1	7.5	152	119					3000					
									3100					
									3300					
			114	122					3400					
									3400					
									4000					
30.0	21.2	8.8	21.9	106					4200					
									(5800)					
									(6500)					
			163	110					(5000)					
									(7000)					
									(10000+)					
									(10000+)					
									(10000+)					

BLOW COUNTS  
SAMPLES

SYMBOLS	DESCRIPTIONS
9 ■	OL BLACK ORGANIC CLAYEY SILT WITH OCCASIONAL ROOTS (TOPSOIL)
19 ■	CL DARK BROWNISH-GRAY SILTY CLAY WITH SOME SAND AND GRAVEL, SOME MOTTLING OF COLOR, STIFF TO HARD
25 ■	
13 ■	CL DARK GRAY SILTY CLAY WITH A TRACE OF GRAVEL CONTAINING LAMINATIONS AND THIN SEAMS OF SILTY FINE SAND, OCCASIONAL LENSES OF SILTY FINE TO MEDIUM SAND, STIFF
8 ■	
10 ■	
9 ■	
6 ■	
9 ■	
14 ■	
12 ■	
18 ■	CH CL DARK BROWNISH-GRAY SILTY CLAY WITH SOME FINE TO COARSE SAND AND GRAVEL, VERY STIFF TO HARD
19 ■	
15 ■	CL DARK GRAY SILTY CLAY WITH A TRACE OF GRAVEL CONTAINING LAMINATIONS AND THIN SEAMS OF SILTY FINE SAND, OCCASIONAL LENSES OF SILTY SAND AND GRAVELLY SAND, VERY STIFF
22 ■	
16 ■	
19 ■	
21 ■	
16 ■	GRADES MORE SAND
24 ■	
29 ■	CL DARK BROWNISH-GRAY FINE TO COARSE SANDY CLAY WITH SOME GRAVEL, OCCASIONAL LAYERS OF SANDY CLAYEY SILT, HARD
85 ■	
47 ■	CL DARK GRAY SILTY CLAY WITH A TRACE OF GRAVEL CONTAINING LAMINATIONS AND THIN SEAMS OF SILTY FINE SAND, OCCASIONAL LENSES OF SILTY SAND AND GRAVELLY SAND, VERY STIFF
37 ■	
134 ■	SP BROWN FINE TO MEDIUM SAND WITH TRACE OF SILT
80 ■	
77 ■	
105/9' ■	ML OCCASIONAL THIN LAYER OF BROWN SANDY SILT DARK GRAYISH-BROWN FINE TO COARSE SANDY CLAYEY SILT WITH PEBBLES, GRAVEL AND SOME COBBLES, VERY HARD OCCASIONAL LENSES OF BROWNISH-GRAY SILTY SAND
110/9' ■	
82 ■	

BORING 53  
SURFACE ELEVATION 706.4

BORING COMPLETED AT 145.0 FEET  
ON 12-28-70  
CASING USED TO A DEPTH OF 145.0 FEET

LA SALLE COUNTY STATION  
UPDATED FINAL SAFETY ANALYSIS REPORT

FIGURE 2.5-19  
LOGS OF BORINGS  
(SHEET 66)

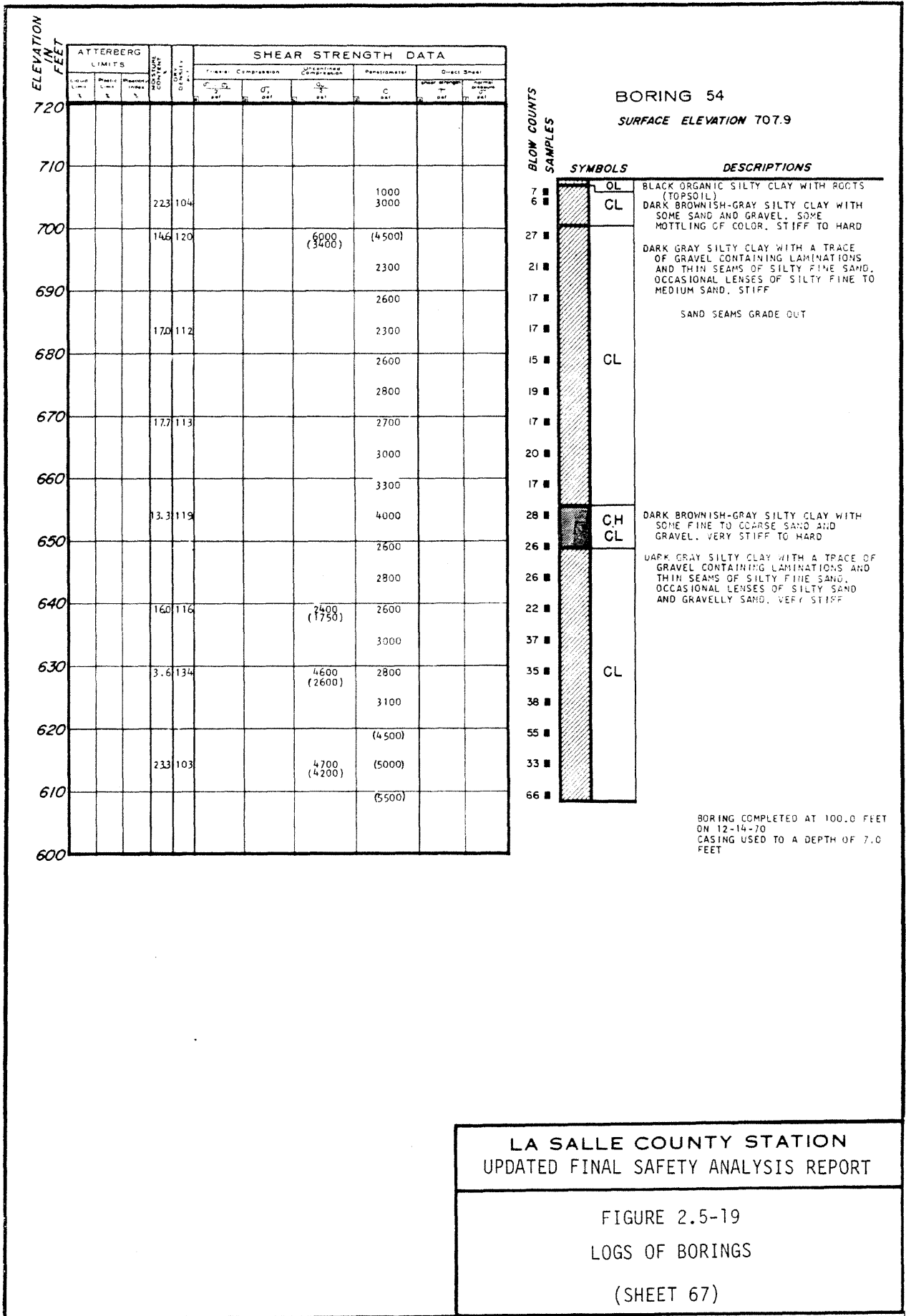

**LA SALLE COUNTY STATION**  
UPDATED FINAL SAFETY ANALYSIS REPORT

FIGURE 2.5-19  
LOGS OF BORINGS  
(SHEET 67)



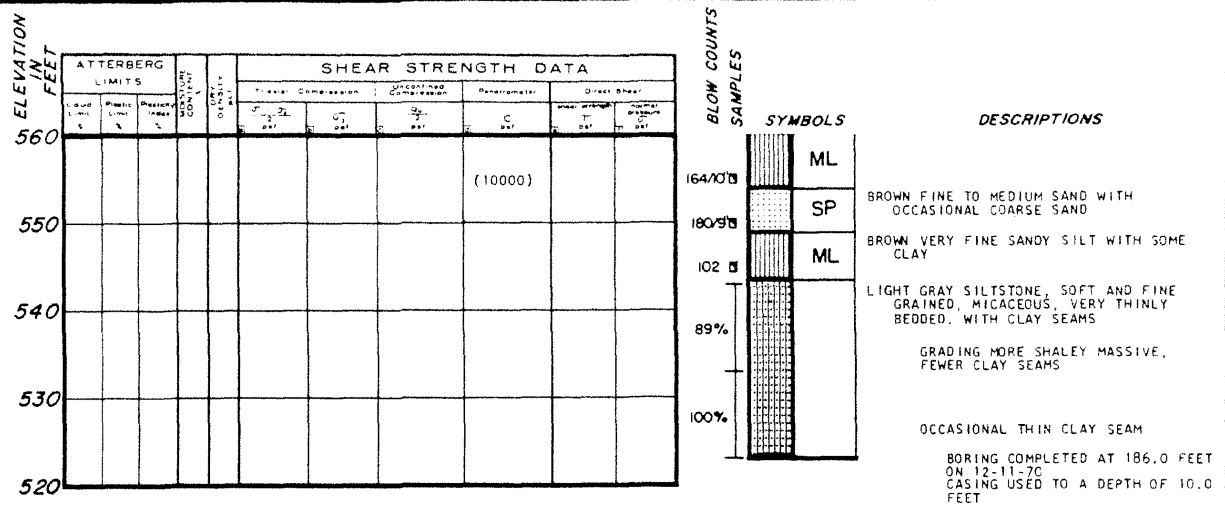

**LA SALLE COUNTY STATION**  
 UPDATED FINAL SAFETY ANALYSIS REPORT  
  
 FIGURE 2.5-19  
 LOGS OF BORINGS  
 (SHEET 69)

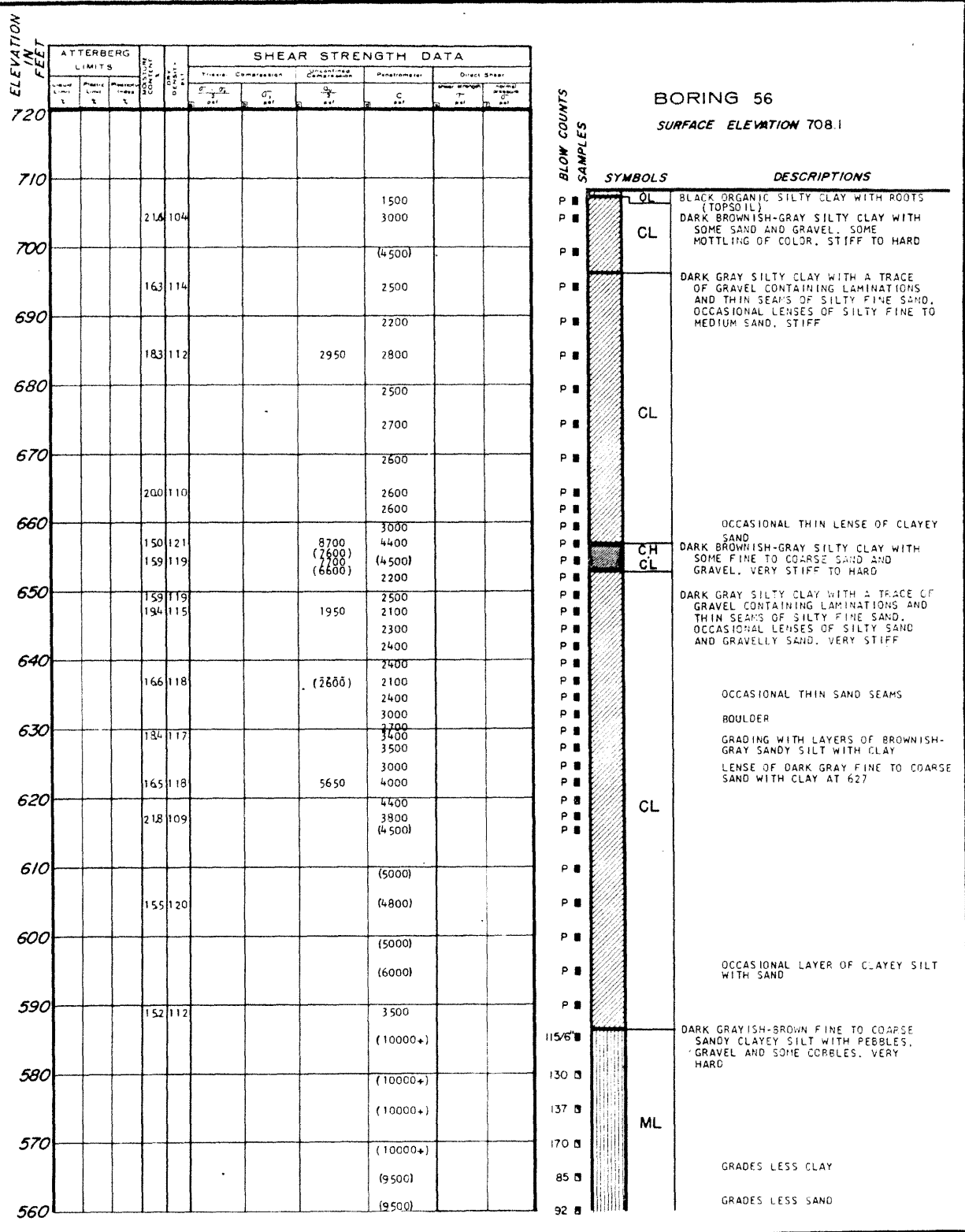

**LA SALLE COUNTY STATION**  
**UPDATED FINAL SAFETY ANALYSIS REPORT**

FIGURE 2.5-19  
 LOGS OF BORINGS  
 (SHEET 70)

ELEVATION  
IN  
FEET

ATTERBERG LIMITS			WATER CONTENT (%)	DENSITY (pcf)	SHEAR STRENGTH DATA							
Liquid Limit (%)	Plastic Limit (%)	Shrinkage (%)			Triaxial Compression		Unconfined Compression		Penetration		Direct Shear	
$w_p$	$w_L$	$w_s$			$\sigma_1$ (pcf)	$\sigma_3$ (pcf)	$q_u$ (pcf)	$C$ (pcf)	$T$ (pcf)	$\tau$ (pcf)	$\phi$ (deg)	
								(8000)				
								(10000+)				

BLOW COUNTS  
SAMPLES

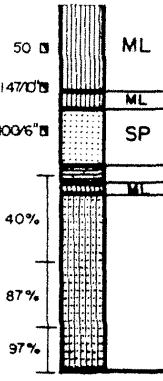

**SYMBOLS**

**DESCRIPTIONS**

ML  
GRAY WITH SOME GRAYISH-BROWN CLAYEY SILT WITH SOME SAND AND OCCASIONAL GRAVEL  
SP  
LIGHT BROWN FINE SAND WITH SOME SILT  
ML  
LIMESTONE BOULDER FROM 540 TO 538 BROWN SANDY SILT WITH SOME CLAY LIGHT GRAY SILTSTONE, SOFT AND FINE GRAINED, VERY THINLY BEDDED  
40%  
GRADING MICACEOUS  
GRADING SHALEY OCCASIONAL CLAY SEAMS  
87%  
GRADING SOFTER THINNER BEDDING  
GRADING MORE MASSIVE  
SLIGHTLY CARBONACEOUS  
97%  
OCCASIONAL THIN CLAY SEAMS  
GRADING LESS SHALEY, LESS MICA

BORING COMPLETED AT 191.0 FEET ON 12-15-70 CASING USED TO A DEPTH OF 8.0 FEET

LA SALLE COUNTY STATION  
UPDATED FINAL SAFETY ANALYSIS REPORT

FIGURE 2.5-19  
LOGS OF BORINGS  
(SHEET 71)

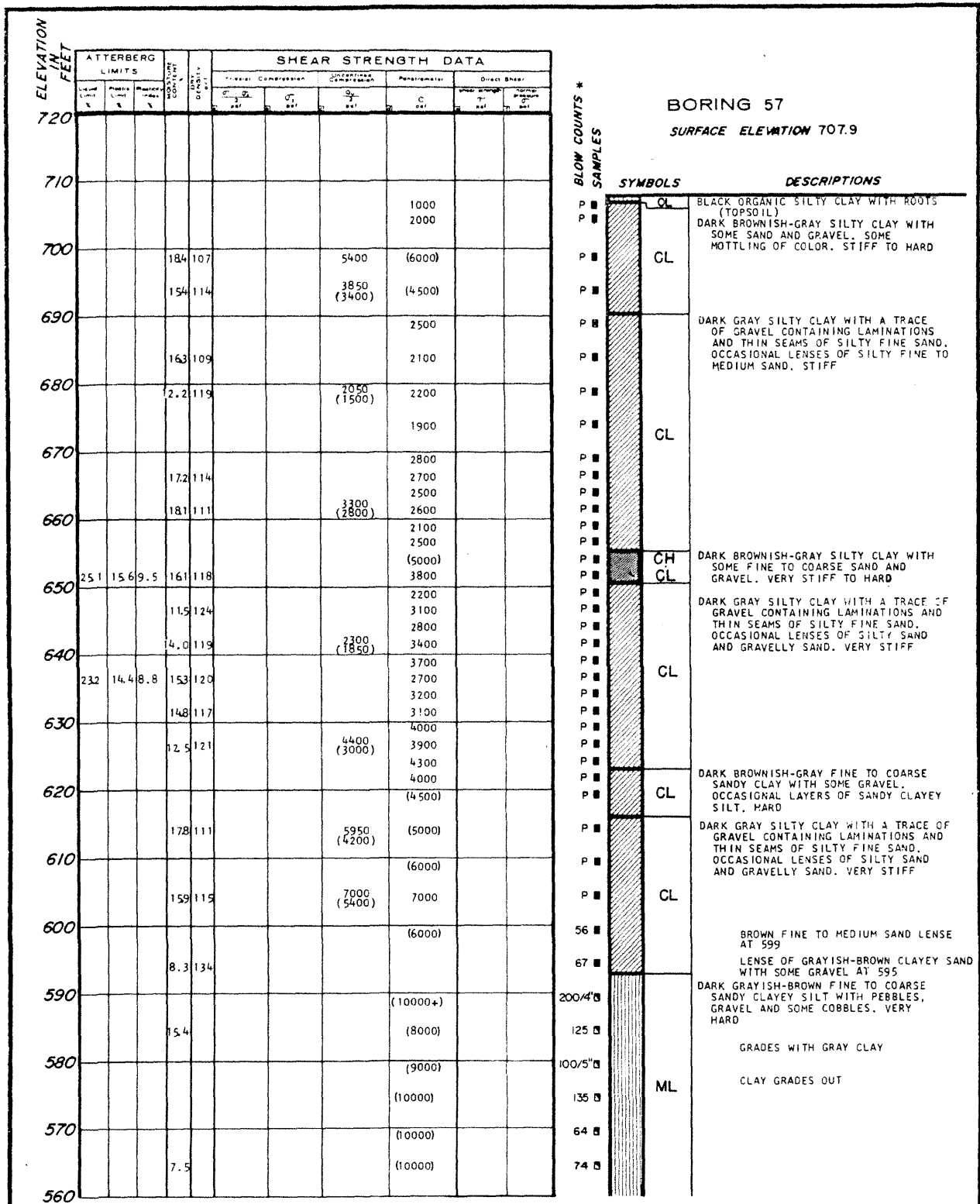

**LA SALLE COUNTY STATION**  
**UPDATED FINAL SAFETY ANALYSIS REPORT**

FIGURE 2.5-19  
 LOGS OF BORINGS  
 (SHEET 72)

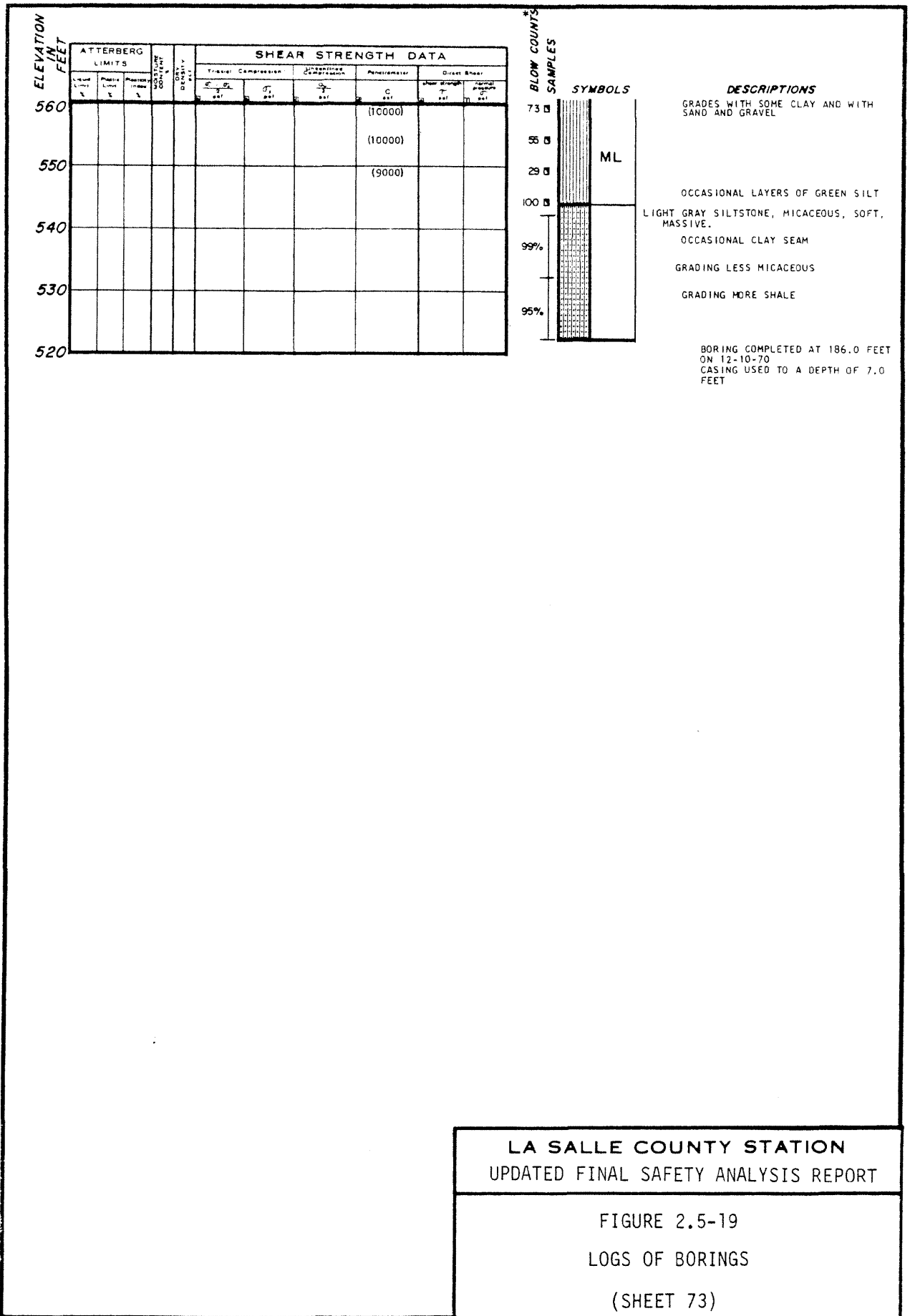

**LA SALLE COUNTY STATION**  
 UPDATED FINAL SAFETY ANALYSIS REPORT

FIGURE 2.5-19  
 LOGS OF BORINGS  
 (SHEET 73)





ELEVATION  
IN  
FEET

ATTERBERG LIMITS				SHEAR STRENGTH DATA							
Liquid Limit %	Plastic Limit %	Plastic Index	MOHRIE COUNTRY CLAY INDEX	Triaxial Compression			Uniaxial Compression		Penetration	Direct Shear	
				$Q_1$ (PSF)	$Q_2$ (PSF)	$Q_3$ (PSF)	$Q_u$ (PSF)	$Q_v$ (PSF)		$T$ (PSF)	$T_v$ (PSF)
			265	94					1000		
									1500		
									3000		
			155	117					2700		
									3000		
									2600		
			145	115			(2700)		2800		
			191	110			2400 (2000)		2000 1700		
									2700		
18.9	13.4	5.5	131	96					2000		
									2800		
			132	120			5100 (3800)		3600		
									2500		
									2800		
			147	117			4450 (3050)		2400		
									2200		
									3000		
			149	119					2400		
									3500		
			211	105			(5300)	(6000)	(5000)		
									(7600)		
			123	123			7600 (6000)	6000	6000		
									(8000)		
			6.6	143					(10000)		
									(10000+)		
									(10000+)		
									(10000+)		
									(10000+)		
									(10000+)		

BORING 59  
SURFACE ELEVATION 708.8

BLOW COUNTS  
SAMPLES

SYMBOLS	DESCRIPTIONS
9	OL BLACK ORGANIC SILTY CLAY WITH ROOTS (TOPSOIL)
5	CL DARK BROWNISH-GRAY SILTY CLAY WITH SOME SAND AND GRAVEL, SOME MOTTLING OF COLOR. STIFF TO HARD
11	ML BROWN SANDY SILT WITH SOME GRAVEL
16	SM BROWN SILTY SAND
14	CL DARK GRAY SILTY CLAY WITH A TRACE OF GRAVEL CONTAINING LAMINATIONS AND THIN SEAMS OF SILTY FINE SAND, OCCASIONAL LENSES OF SILTY FINE TO MEDIUM SAND. STIFF
14	
14	
12	
13	LENSE OF BROWNISH-GRAY CLAYEY SAND WITH SILT AND OCCASIONAL SILTY CLAY POCKETS AT 670
11	
15	GRADES WITH SOME SAND AND OCCASIONAL GRAVEL
21	CH DARK BROWNISH-GRAY SILTY CLAY WITH SOME FINE TO COARSE SAND AND GRAVEL. VERY STIFF TO HARD
19	CL
19	CL DARK GRAY SILTY CLAY WITH A TRACE OF GRAVEL CONTAINING LAMINATIONS AND THIN SEAMS OF SILTY FINE SAND, OCCASIONAL LENSES OF SILTY SAND AND GRAVELLY SAND. VERY STIFF
20	
20	
20	CL
22	
26	
28	
35	CL DARK BROWNISH-GRAY FINE TO COARSE SANDY CLAY WITH SOME GRAVEL, OCCASIONAL LAYERS OF SANDY CLAYEY SILT. HARD
100/6"	CL DARK GRAY SILTY CLAY WITH A TRACE OF GRAVEL CONTAINING LAMINATIONS AND THIN SEAMS OF SILTY FINE SAND, OCCASIONAL LENSES OF SILTY SAND AND GRAVELLY SAND. VERY STIFF
97	CL
156	SW GRAY FINE TO COARSE SAND WITH GRAVEL
150/6"	ML GRAY BROWN CLAYEY SILT WITH FINE SAND
150/6"	SM GRAY BROWN SILTY SAND WITH SOME SMALL GRAVEL
170/6"	ML DARK GRAYISH-BROWN FINE TO COARSE SANDY CLAYEY SILT WITH PEBBLES, GRAVEL AND SOME COBBLES. VERY HARD
140/6"	
90/6"	
110/7"	ML OCCASIONAL LAYER OF SILTY CLAY

BORING COMPLETED AT 139.0 FEET  
ON 12-9-70  
CASING USED TO A DEPTH OF 8.0 FEET

LA SALLE COUNTY STATION  
UPDATED FINAL SAFETY ANALYSIS REPORT

FIGURE 2.5-19  
LOGS OF BORINGS  
(SHEET 75)

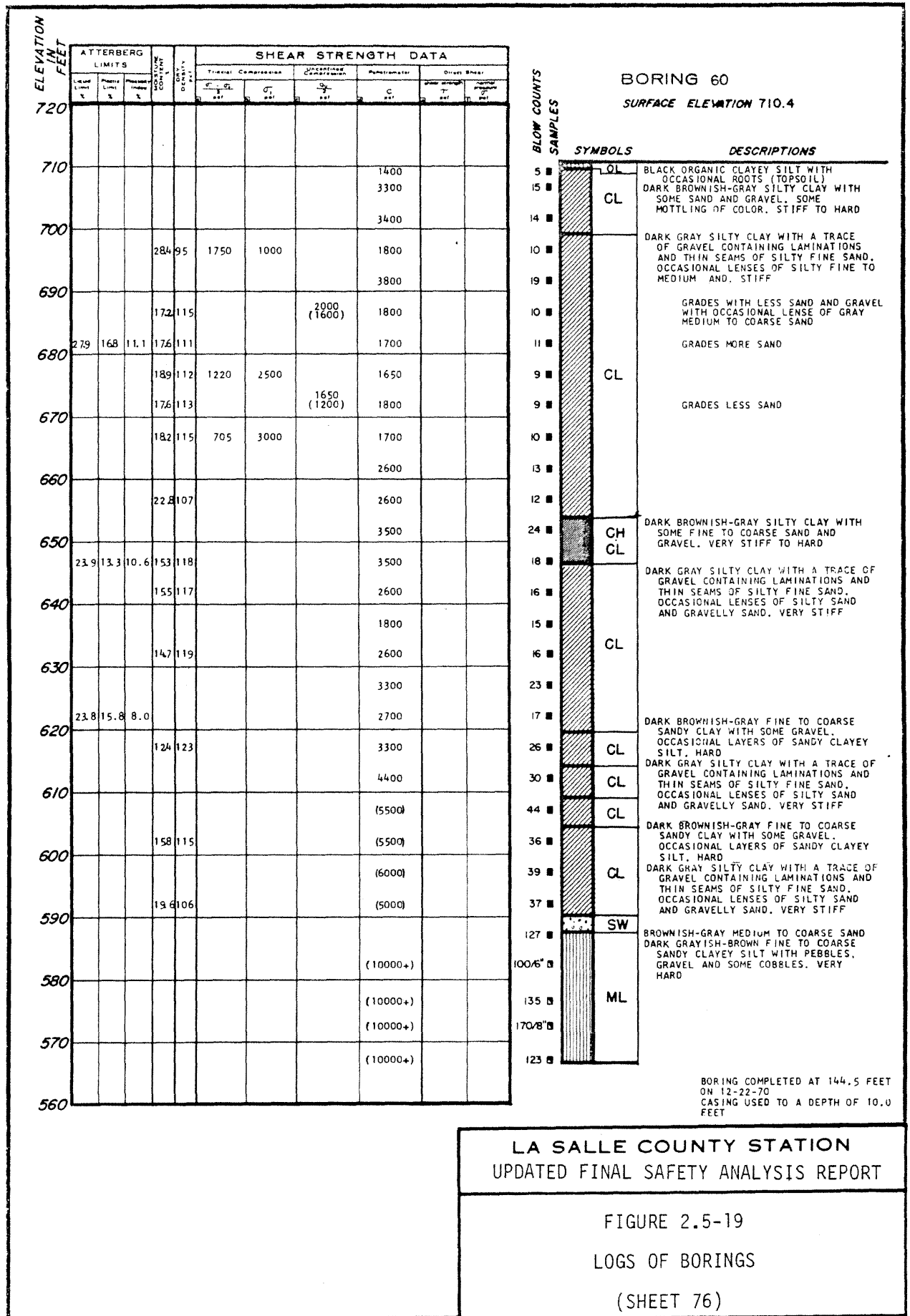

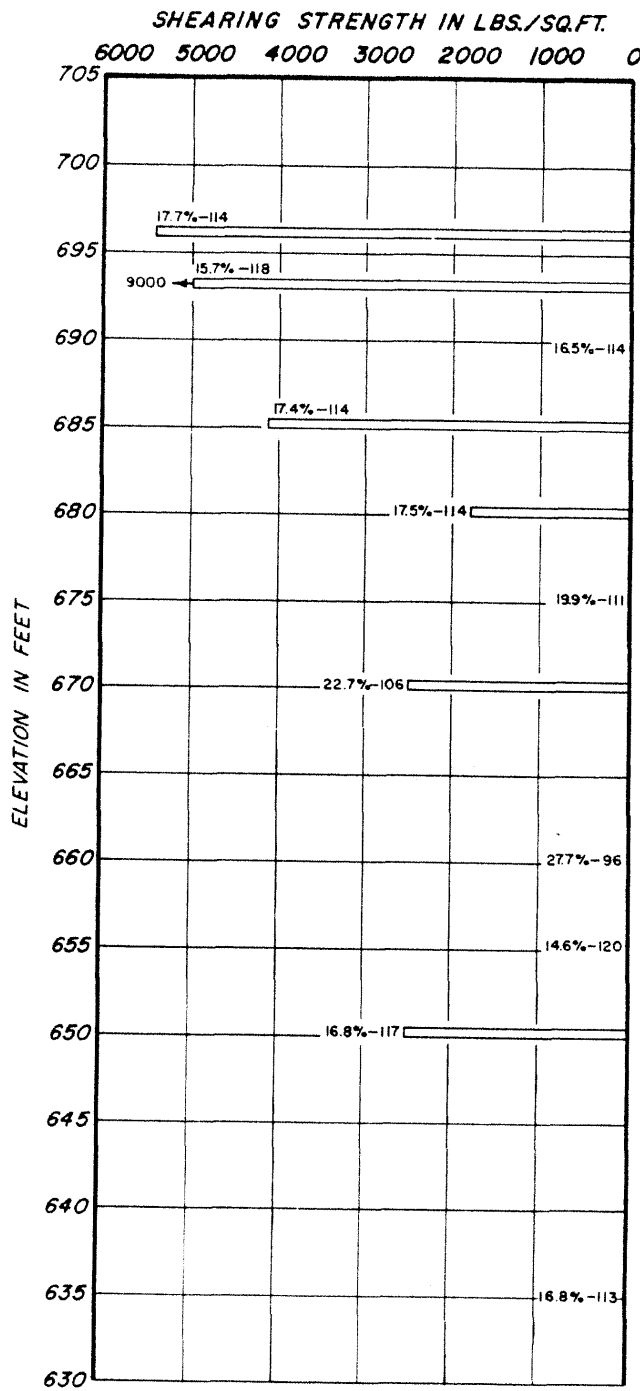

**BORING 61**

SURFACE ELEVATION 700.8

BLOW COUNTS **	SYMBOLS	DESCRIPTIONS
9	OL	DARK BROWN ORGANIC CLAYEY SILT WITH SOME SAND AND ROOTS-TOPSOIL 16"
11	CL ML	BROWN SILTY CLAY WITH SOME SAND AND TRACE OF GRAVEL
26		GRADES TO MOTTLED BROWN AND GRAY
26	ML	GRADES TO GRAYISH-BROWN WITH MORE GRAVEL
27		GRAY SILTY CLAY WITH SOME SAND AND GRAVEL 1/2 INCH BROWN SILT LENSE
18	CL	
10		
9	CL	OCCASIONAL FINE SAND LENSES
10		
9		OCCASIONAL SILT LENSES
11	CL ML	GRADES WITH LESS SAND AND GRAVEL
15		GRAY VERY SILTY CLAY WITH SAND AND GRAVEL
13	ML	GRAY SILTY CLAY WITH SOME SAND AND GRAVEL
13		
13	CL	
14		
14		
15		

**LA SALLE COUNTY STATION**  
 UPDATED FINAL SAFETY ANALYSIS REPORT

FIGURE 2.5-19  
 LOGS OF BORINGS  
 (SHEET 77)

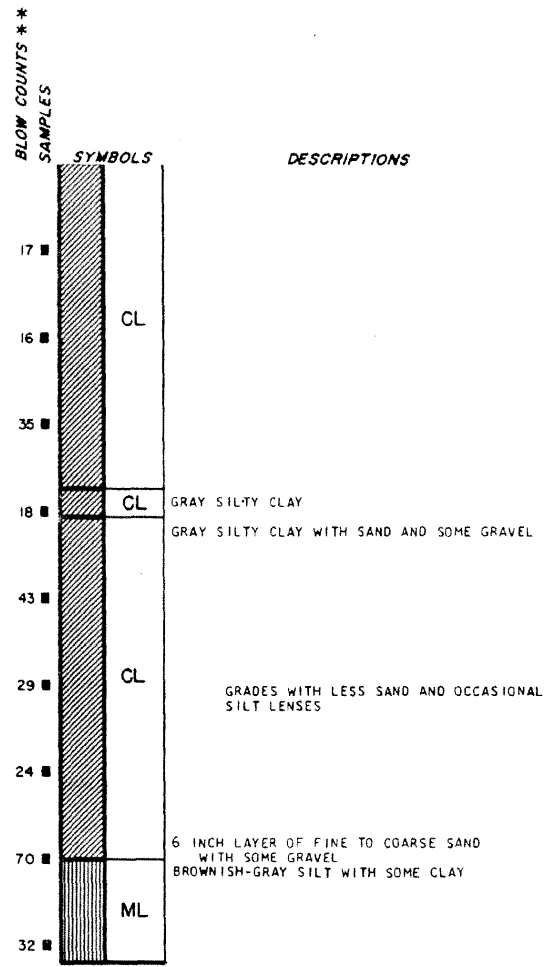
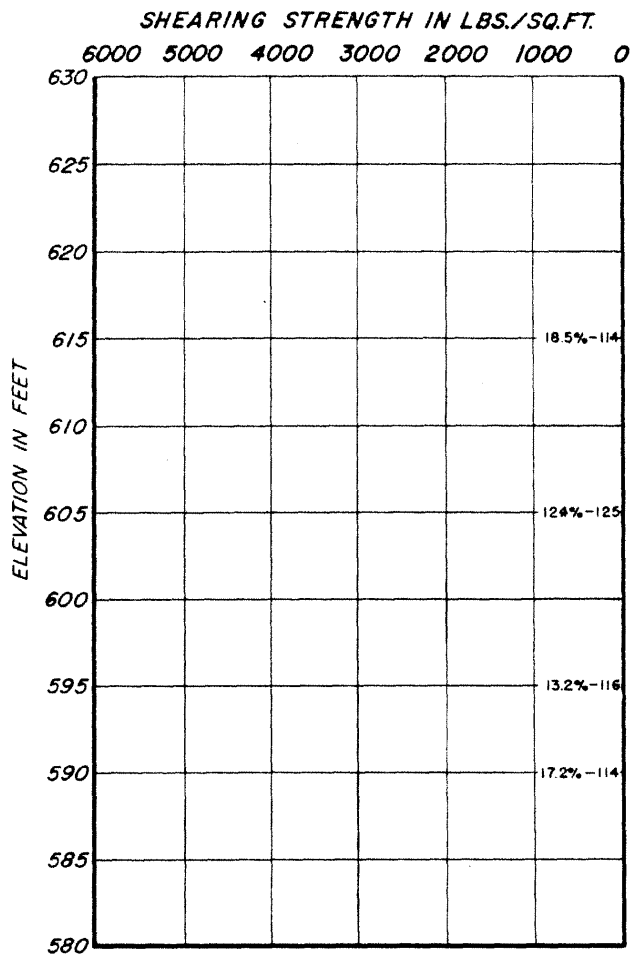

BORING COMPLETED AT 116.5 FEET ON 7-9-71  
CASING USED TO A DEPTH OF 10.0 FEET  
WATER LEVEL RECORDED AT A DEPTH OF 35 FEET ON 7-14-71

**LA SALLE COUNTY STATION**  
UPDATED FINAL SAFETY ANALYSIS REPORT

FIGURE 2.5-19  
LOGS OF BORINGS  
(SHEET 78)

**SHEARING STRENGTH IN LBS./SQ.FT.**  
 6000 5000 4000 3000 2000 1000 0

**BORING 62**  
 SURFACE ELEVATION 712.1

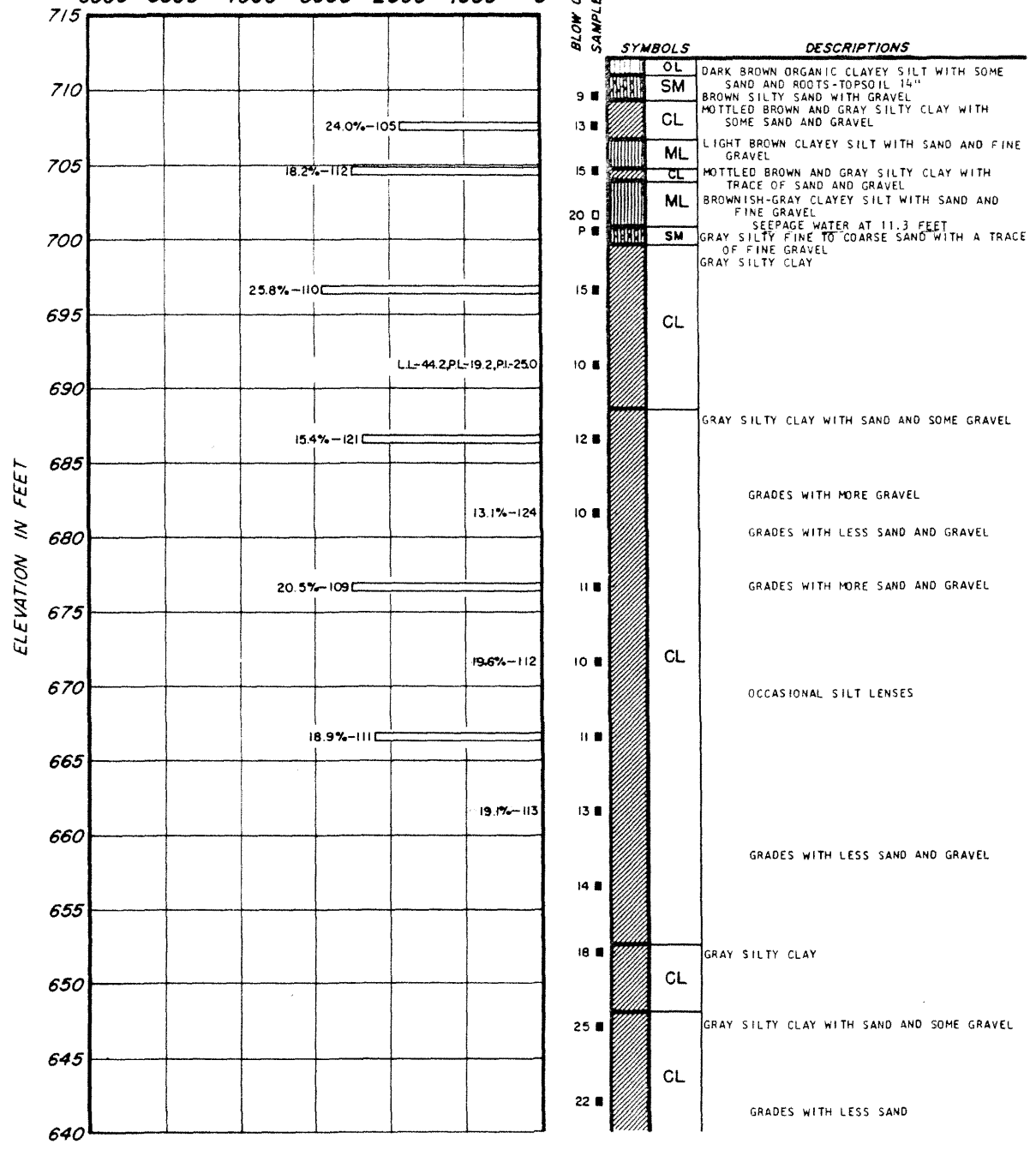

**LA SALLE COUNTY STATION**  
 UPDATED FINAL SAFETY ANALYSIS REPORT

---

FIGURE 2.5-19  
 LOGS OF BORINGS

---

(SHEET 79)

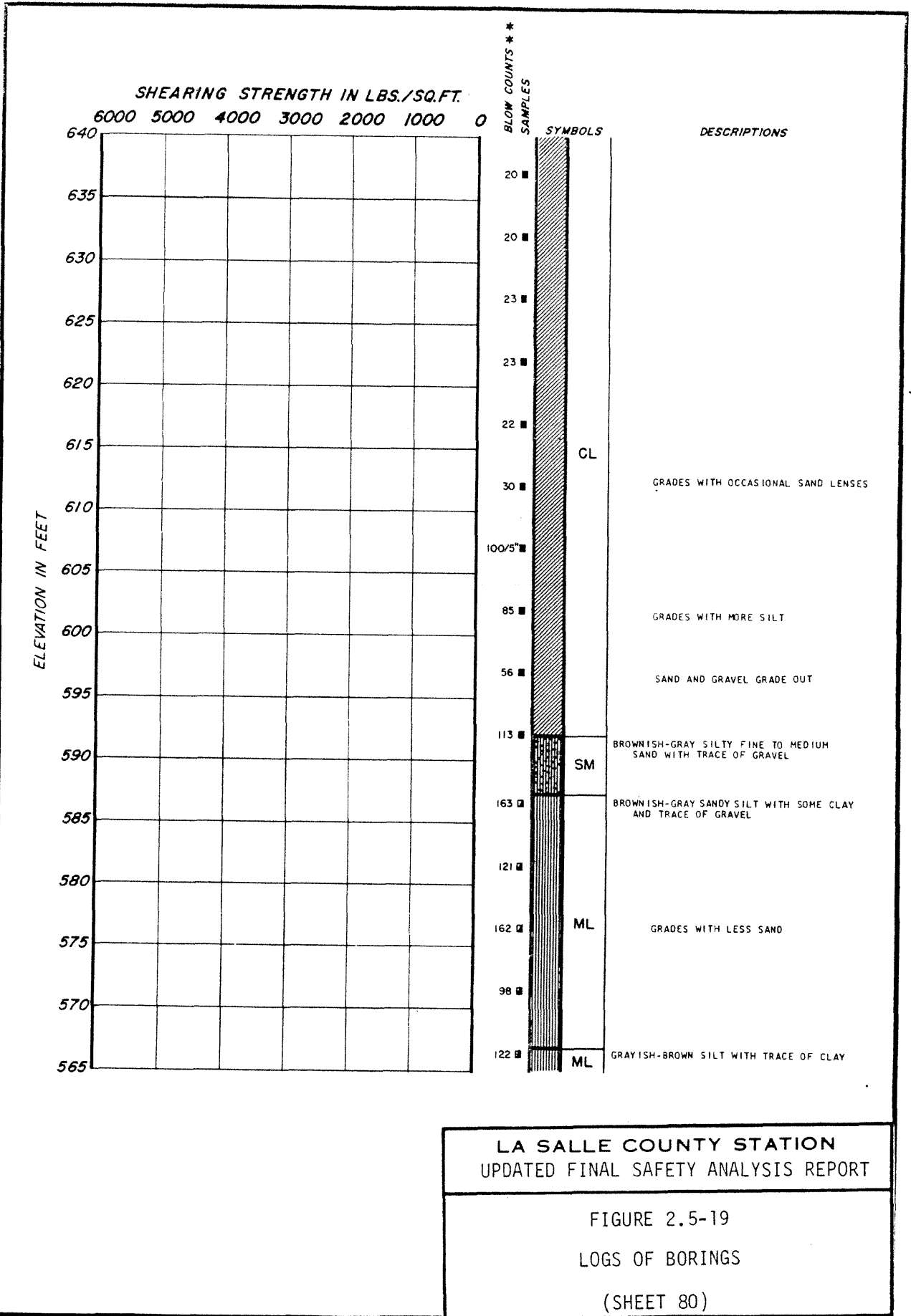

**LA SALLE COUNTY STATION  
UPDATED FINAL SAFETY ANALYSIS REPORT**

FIGURE 2.5-19  
LOGS OF BORINGS  
(SHEET 80)

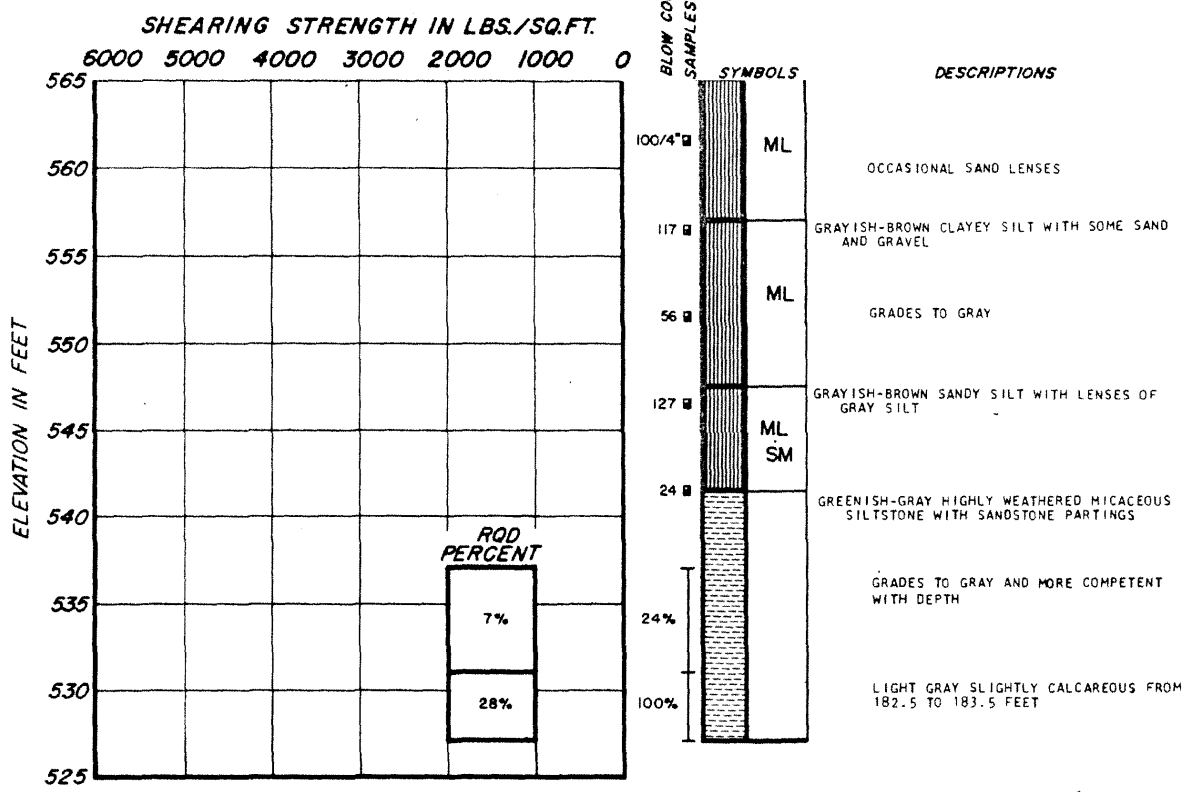

BORING COMPLETED AT 185.0 FEET  
ON 7-20-71  
CASING USED TO A DEPTH OF 15.0 FEET  
WATER LEVEL NOT RECORDED

**LA SALLE COUNTY STATION**  
UPDATED FINAL SAFETY ANALYSIS REPORT

FIGURE 2.5-19  
LOGS OF BORINGS  
(SHEET 81)



BORING 63  
SURFACE ELEVATION 714.5

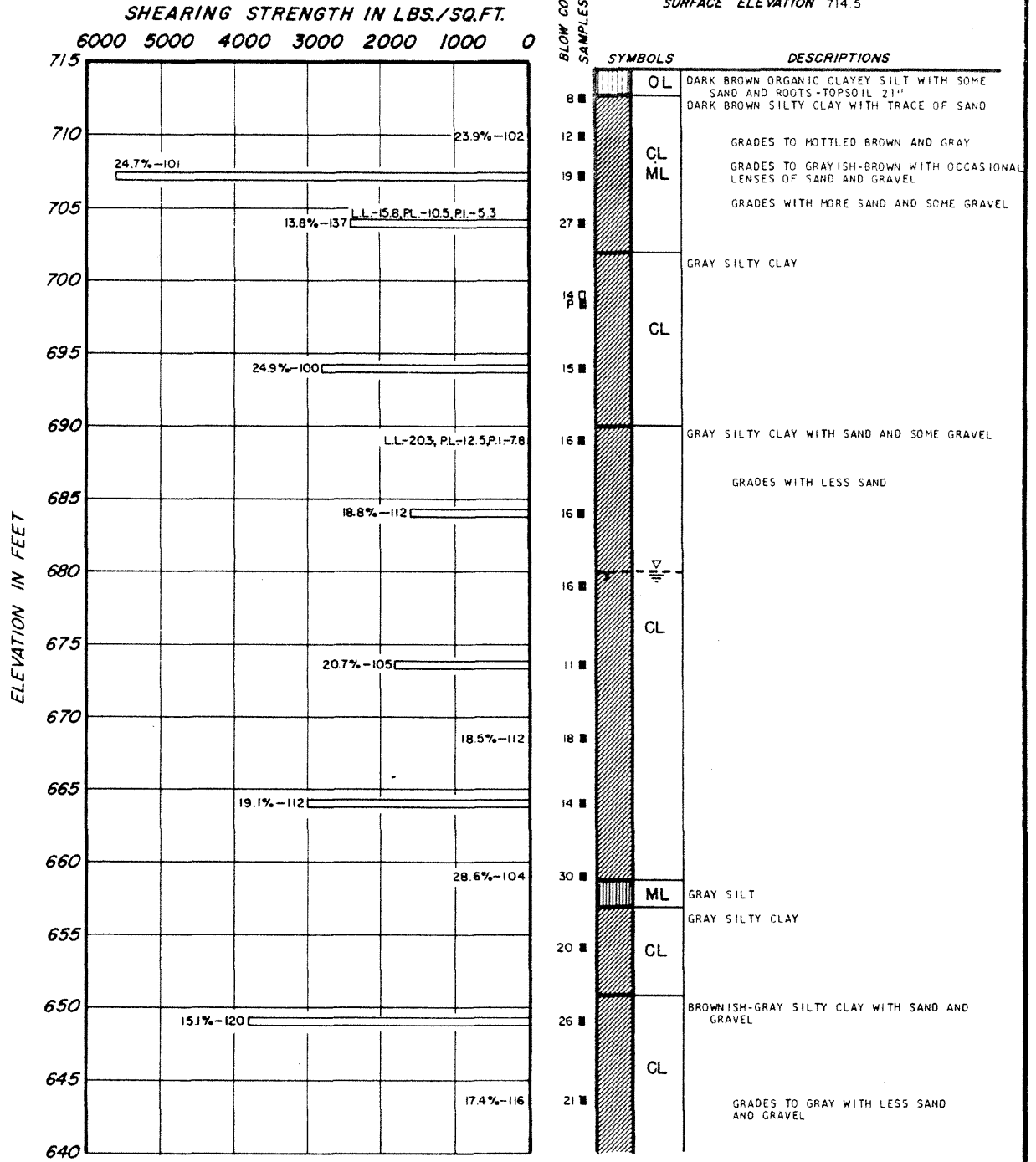

LA SALLE COUNTY STATION  
UPDATED FINAL SAFETY ANALYSIS REPORT

FIGURE 2.5-19  
LOGS OF BORINGS  
(SHEET 82)

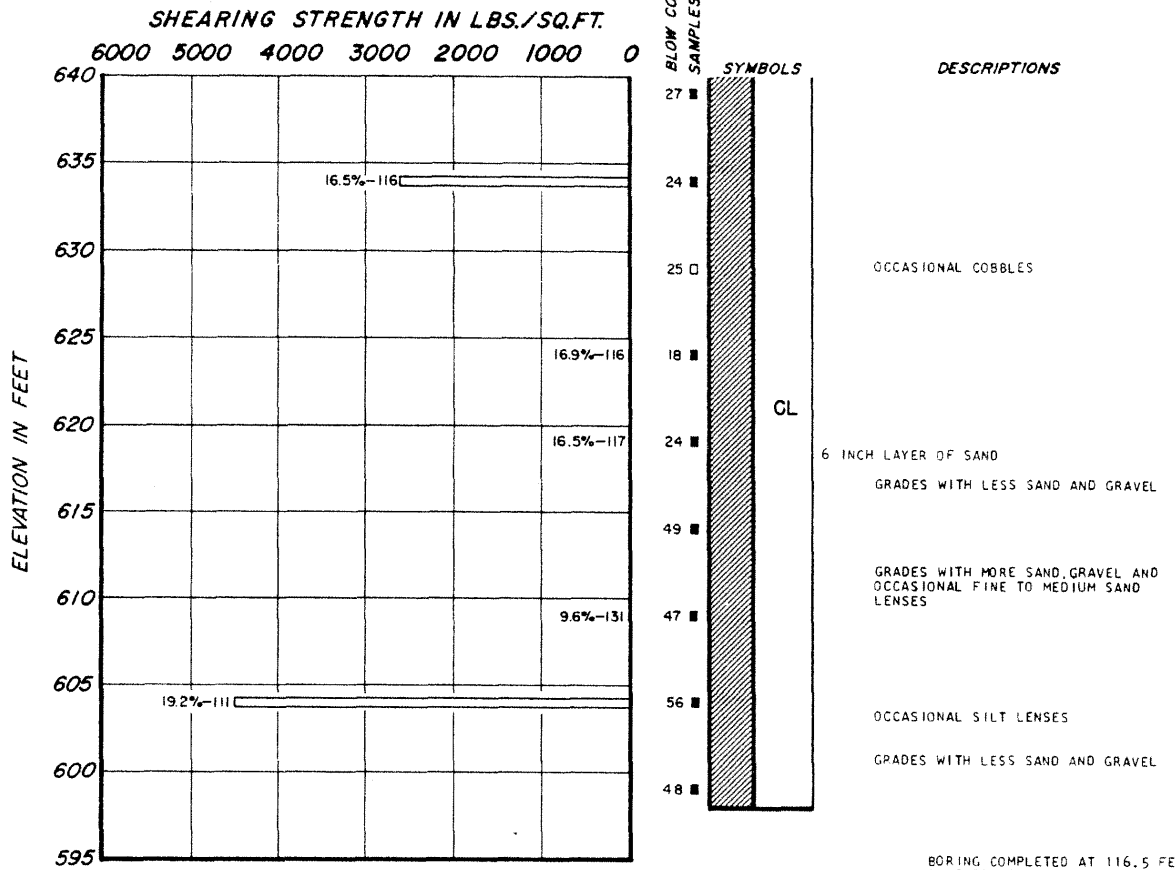

BORING COMPLETED AT 116.5 FEET ON 7-13-71  
 CASING USED TO A DEPTH OF 10.0 FEET  
 WATER LEVEL RECORDED AT A DEPTH OF 34.5 FEET ON 7-16-71

**LA SALLE COUNTY STATION**  
**UPDATED FINAL SAFETY ANALYSIS REPORT**

FIGURE 2.5-19  
 LOGS OF BORINGS  
 (SHEET 83)

**BORING 64**  
SURFACE ELEVATION 714.1

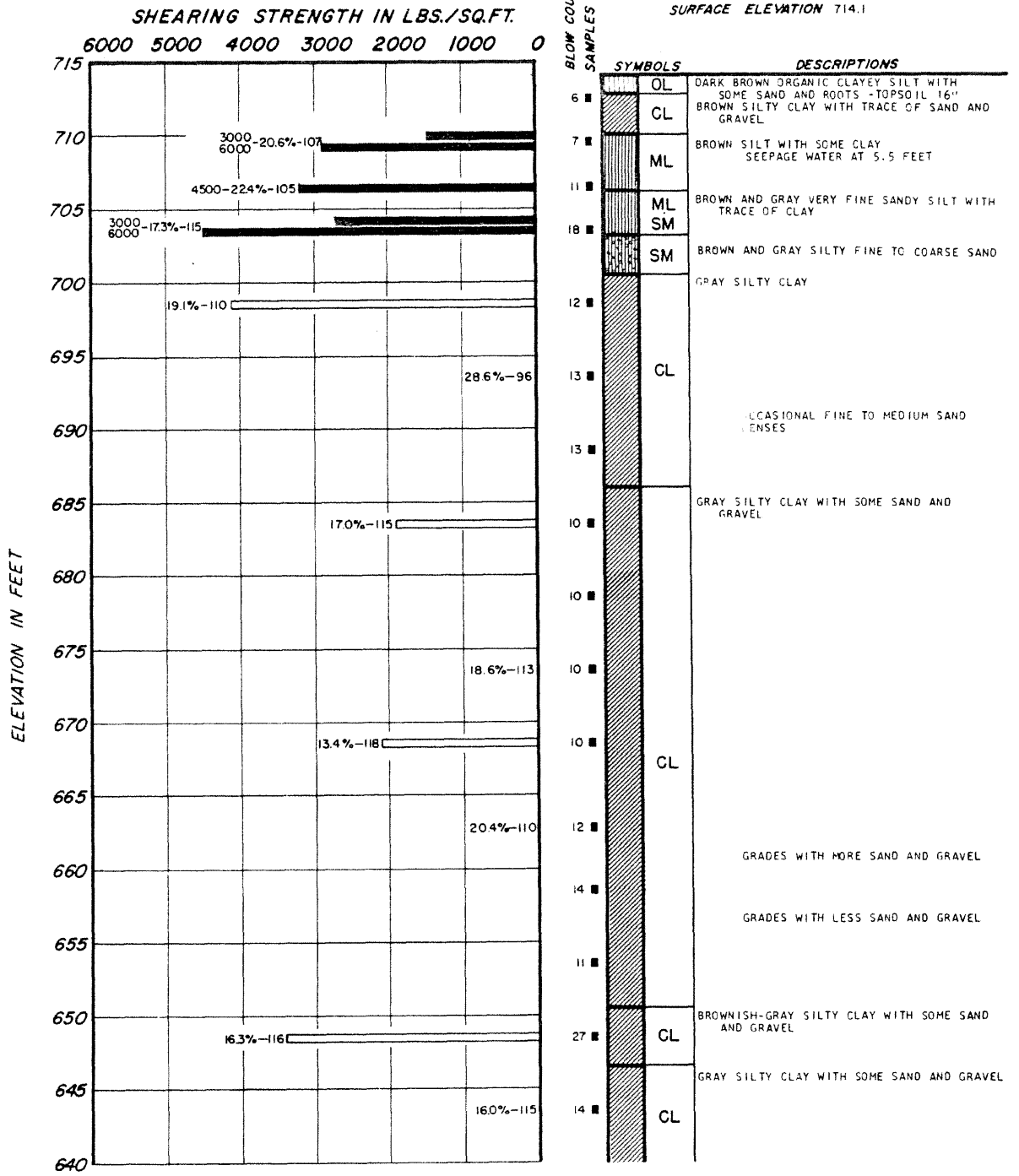

**LA SALLE COUNTY STATION**  
UPDATED FINAL SAFETY ANALYSIS REPORT

FIGURE 2.5-19  
LOGS OF BORINGS  
(SHEET 84)

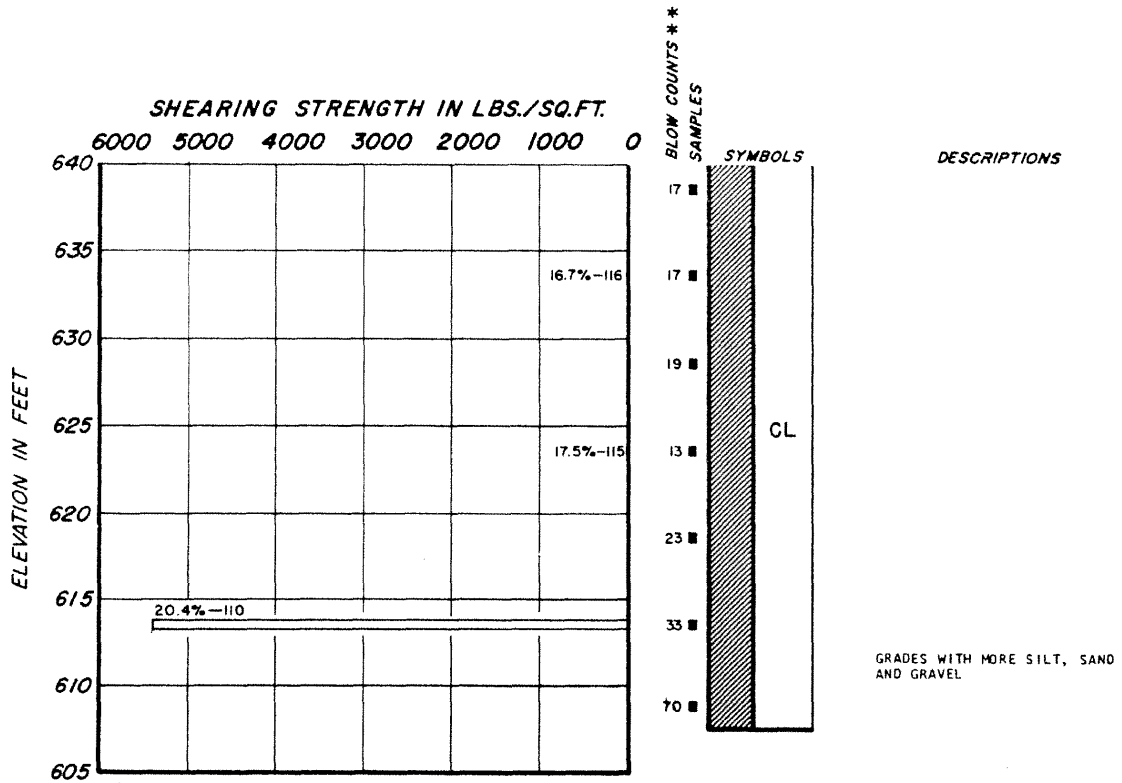

BORING COMPLETED AT 106.5 FEET  
ON 7-16-71  
CASING USED TO A DEPTH OF 10.0  
FEET  
WATER LEVEL NOT RECORDED

**LA SALLE COUNTY STATION**  
**UPDATED FINAL SAFETY ANALYSIS REPORT**

FIGURE 2.5-19  
 LOGS OF BORINGS  
 (SHEET 85)

**SHEARING STRENGTH IN LBS./SQ.FT.**  
 6000 5000 4000 3000 2000 1000 0

**BORING 65**  
 SURFACE ELEVATION 715.3

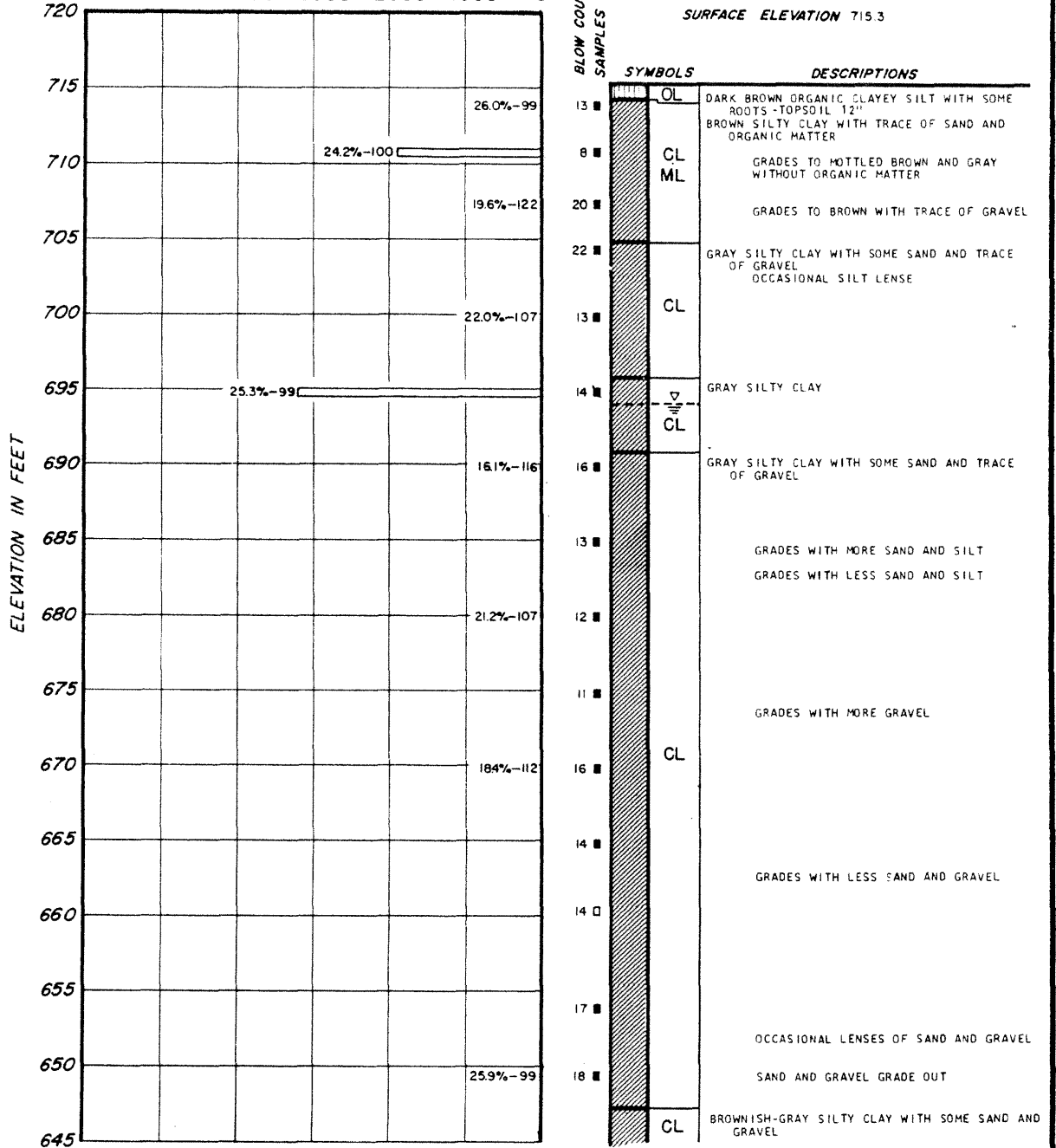

**LA SALLE COUNTY STATION**  
 UPDATED FINAL SAFETY ANALYSIS REPORT

FIGURE 2.5-19  
 LOGS OF BORINGS  
 (SHEET 86)

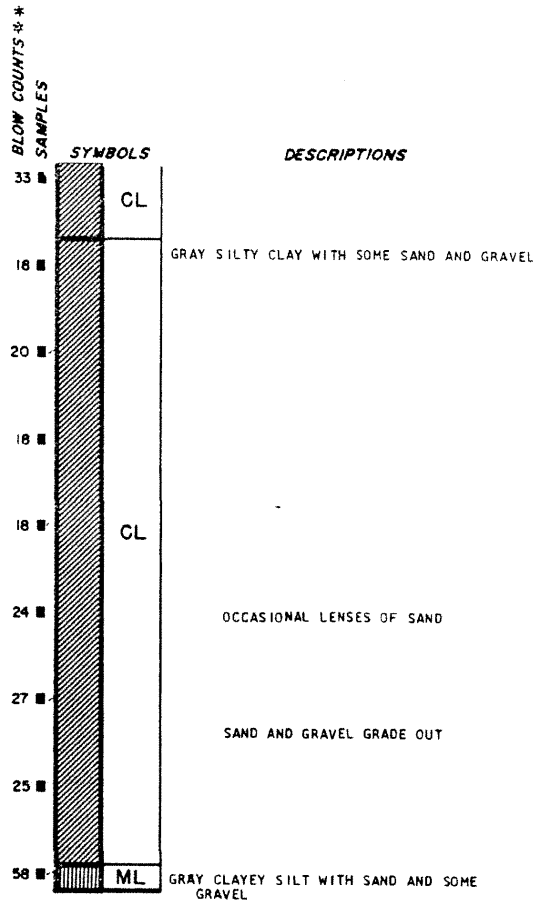
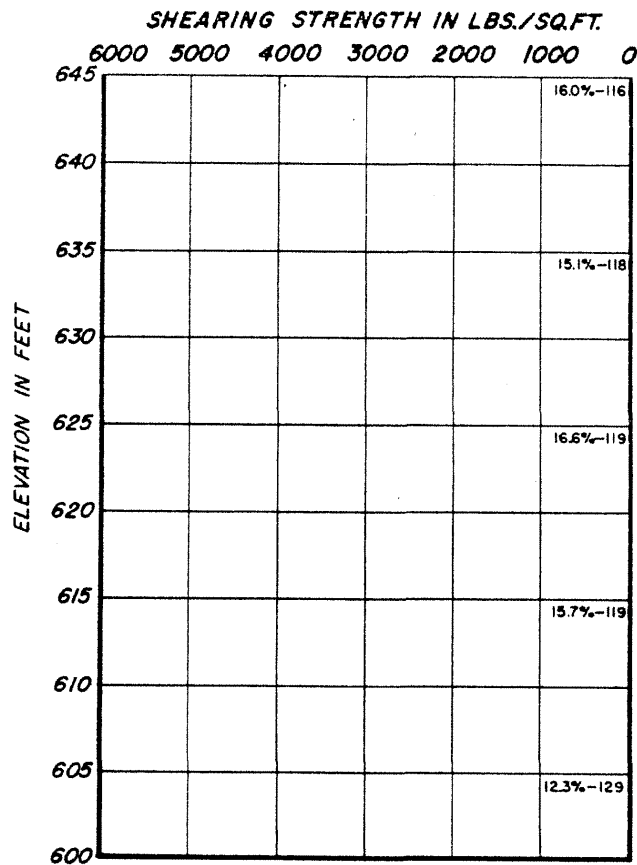

BORING COMPLETED AT 112.0 FEET  
ON 7-22-71  
CASING USED TO A DEPTH OF 10.0  
FEET  
WATER LEVEL RECORDED AT A DEPTH  
OF 21.3 FEET ON 7-30-71

**LA SALLE COUNTY STATION**  
UPDATED FINAL SAFETY ANALYSIS REPORT

FIGURE 2.5-19  
LOGS OF BORINGS  
(SHEET 87)

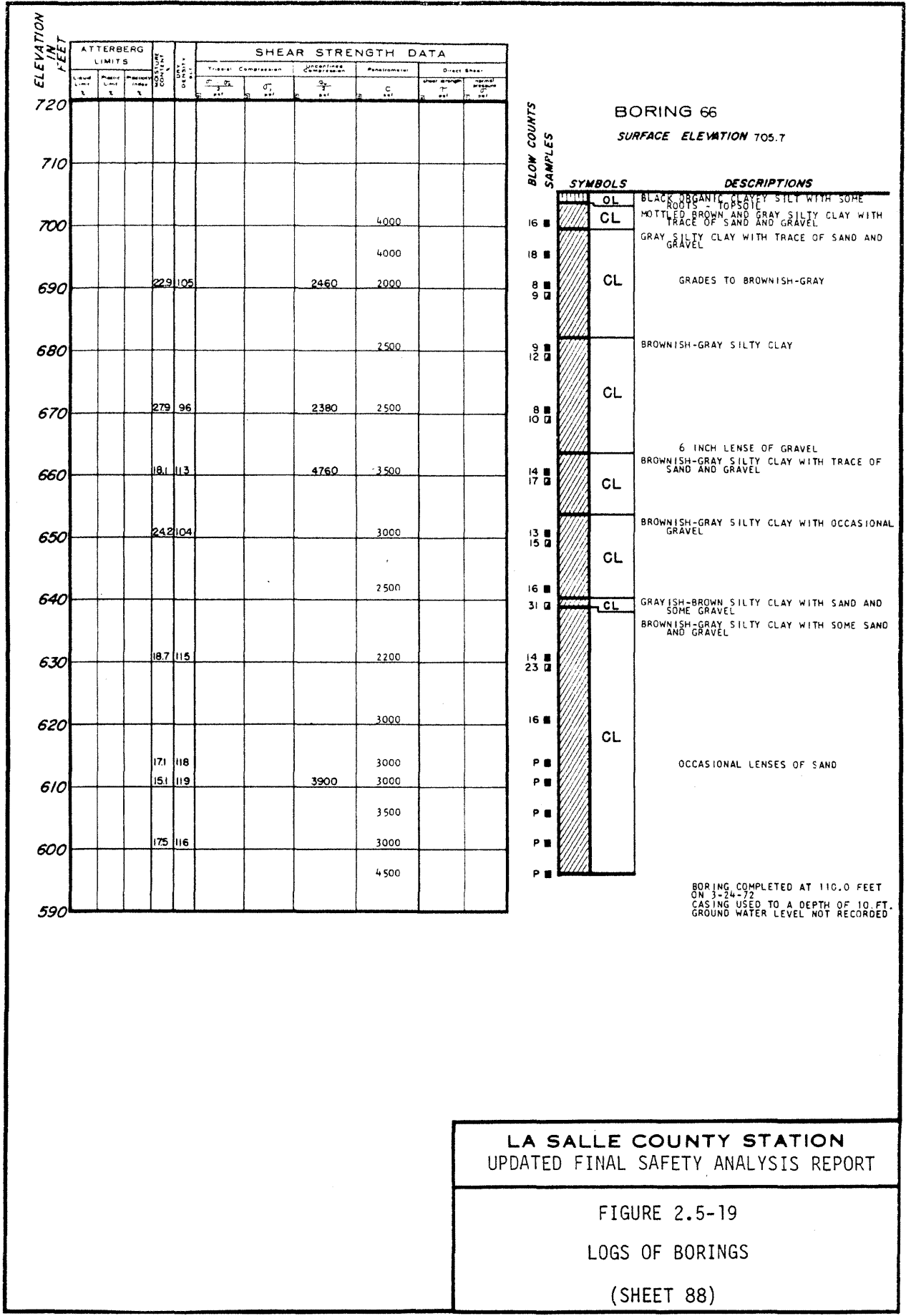

**LA SALLE COUNTY STATION**  
UPDATED FINAL SAFETY ANALYSIS REPORT

FIGURE 2.5-19  
LOGS OF BORINGS  
(SHEET 88)

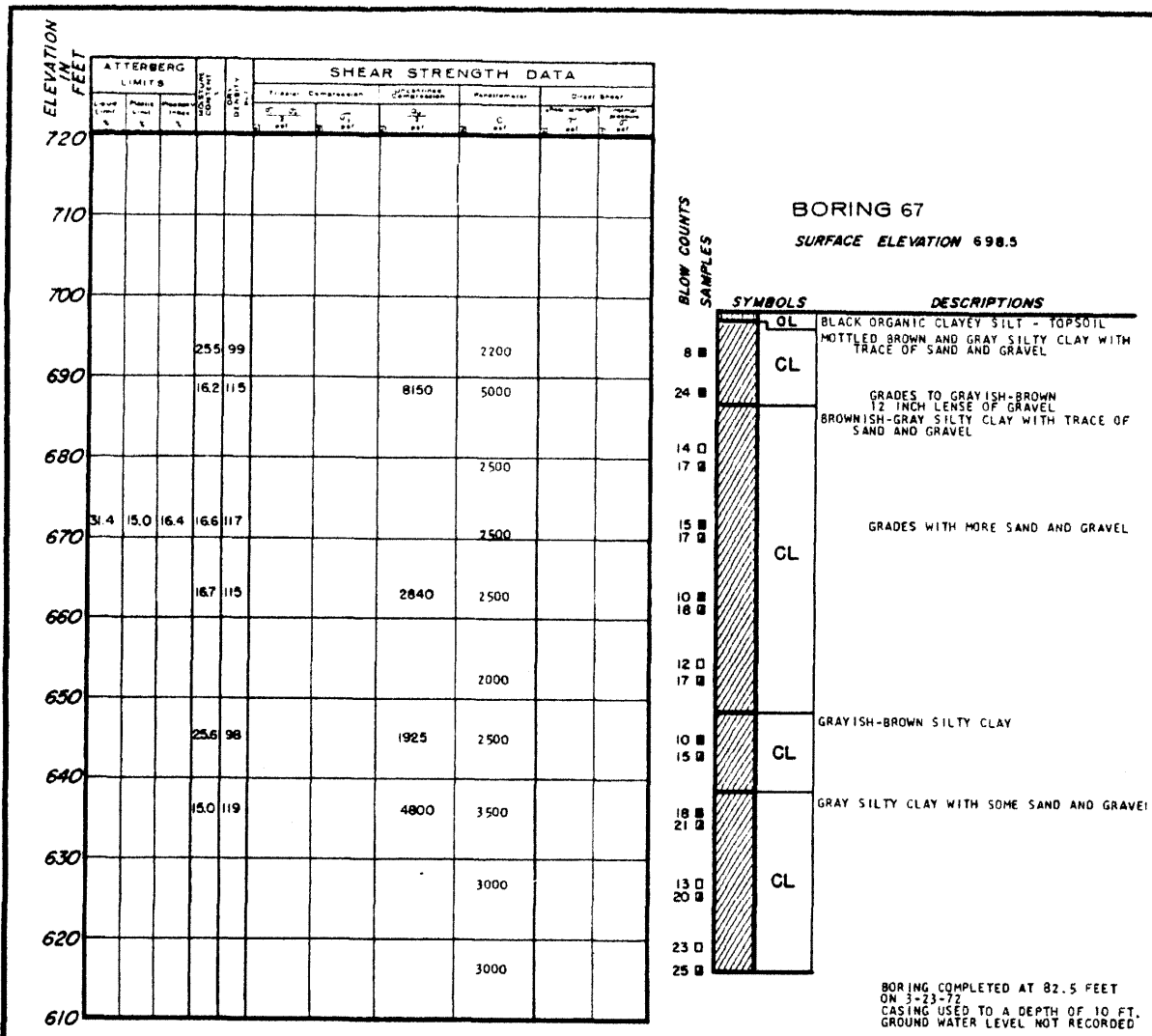

**LA SALLE COUNTY STATION**  
**UPDATED FINAL SAFETY ANALYSIS REPORT**

FIGURE 2.5-19  
 LOGS OF BORINGS  
 (SHEET 89)



ELEVATION  
IN  
FEET

720  
710  
700  
690  
680  
670  
660  
650  
640  
630  
620  
610  
600  
590  
580  
570  
560

ATTERBERG LIMITS			SHEAR STRENGTH DATA							
Liquid Limit (%)	Plastic Limit (%)	Plastic Index (%)	MOISTURE CONTENT (%)		Unconsolidated		Cohesion (lb/ft ² )	C (lb/ft ² )	Direct Shear	
			W _L	W _P	q _u	q _v			τ ₁	τ ₂
			23.9	10.0		2460	2500	1800		
								4500+		
			14.7	10.9				1500		
			16.6	11.5		1930	2750			
			14.1	11.9		1820	3750			
								2000		
			17.3	11.7				3500		
								3000		
			19.8	11.3				4500+		
								4000		
			15.1	12.3						
								4500+		

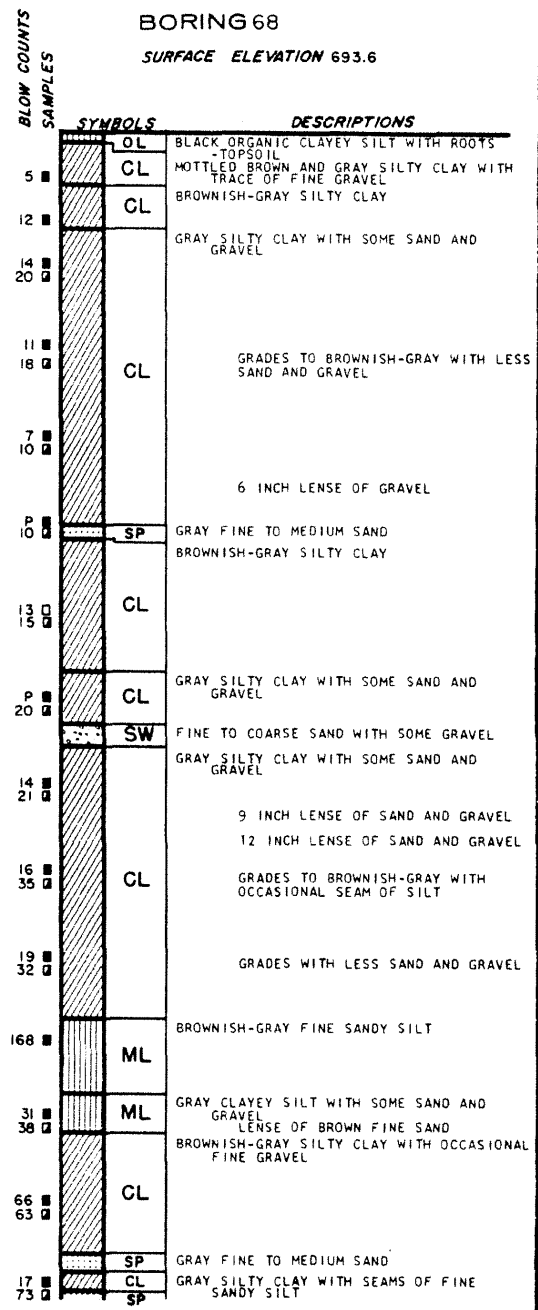

**LA SALLE COUNTY STATION**  
UPDATED FINAL SAFETY ANALYSIS REPORT

FIGURE 2.5-19  
LOGS OF BORINGS  
(SHEET 90)

ELEVATION IN FEET	ATTERBERG LIMITS				SHEAR STRENGTH DATA								
	Liquid Limit %	Plastic Limit %	Plasticity Index %	MOISTURE CONTENT %	DRY DENSITY pcf	Triaxial Compression		Unconfined Compression		Penetration		Direct Shear	
						$\sigma_1$ psf	$\sigma_3$ psf	$q_u$ psf	$c$ psf	$\tau$ psf	$\phi$ psf		
560													
550													
540													
530													
520													
510													
500													
490													

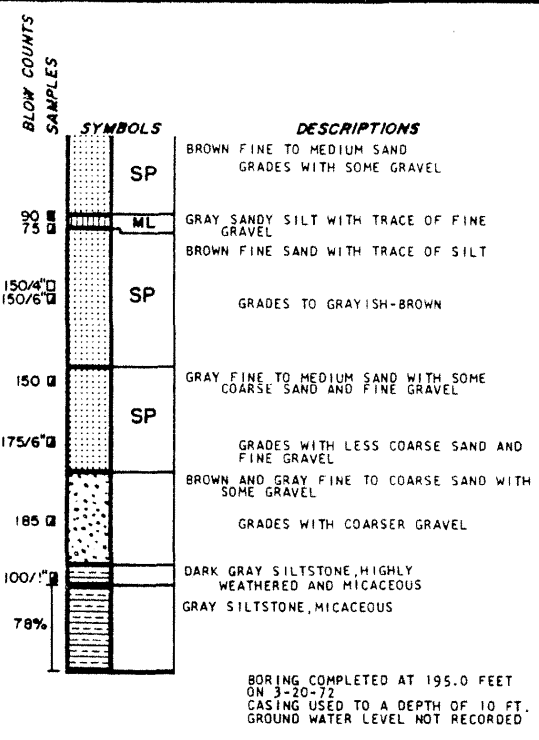

**LA SALLE COUNTY STATION**  
**UPDATED FINAL SAFETY ANALYSIS REPORT**

FIGURE 2.5-19  
 LOGS OF BORINGS  
 (SHEET 91)

ELEVATION  
IN  
FEET

ELEVATION IN FEET	ATTERBERG LIMITS			LIQUIDITY LIMITS		SHEAR STRENGTH DATA							
	Liquid Limit %	Plastic Limit %	Plasticity Index %	Liquid Limit %	Plasticity Index %	Triaxial Compression		Casagrande Compression		Penetration		Direct Shear	
						$\sigma_1$ psi	$\sigma_3$ psi	$q_c$ psi	$S_u$ psi	$C$ psi	Shear strength $\tau$ psi	Normal pressure $\sigma_v$ psi	
720													
710													
700													
690	57	22.4	34.6	276	97					3000			
680				12.9	126					3300			
670										1800			
660	30.3	14.7	15.6	17.9	114					3000			
650				18.2	110					2630	3000		
640				24.7	99					2280	2500		
630										4500			
620													
610				16.4	112					4000			
600										5500			
590													
580				16.3	121					6000+			
570				17.7	114								
560													

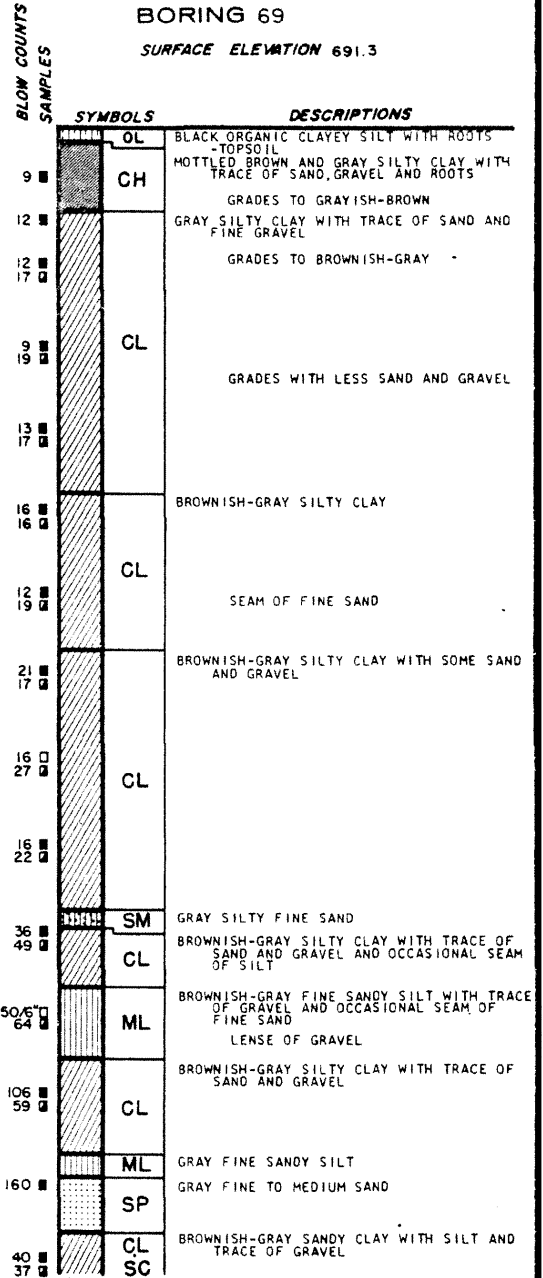

**LA SALLE COUNTY STATION**  
UPDATED FINAL SAFETY ANALYSIS REPORT

FIGURE 2.5-19  
LOGS OF BORINGS  
(SHEET 92)



ELEVATION  
IN  
FEET

720  
710  
700  
690  
680  
670  
660  
650  
640  
630  
620  
610  
600  
590  
580  
570  
560

ATTERBERG LIMITS			SHEAR STRENGTH DATA									
Liquid Limit %	Plastic Limit %	Plasticity Index %	MOISTURE CONTENT %	SOLIDS DENSITY (pcf)	Triaxial Compression		Unconfined Compression		Penetration		Direct Shear	
					$\bar{C}$	$\bar{\phi}$	$\bar{C}$	$\bar{\phi}$	$\bar{C}$	$\bar{\phi}$	Shear Strength $\bar{c}$	Normal Stress $\bar{\sigma}$
			24.1	97			1240		1500			
			13.6	120			6840		3500			
			16.6	115			2400		2500			
									2500			
			19.6	109					3000			
									3000			
			14.1	120			5040		3800			
			17.9	110					2000			
									2200			
									2000			
			20.6	111					4500			
									8000+			
			9.4	134								
									10,000+			

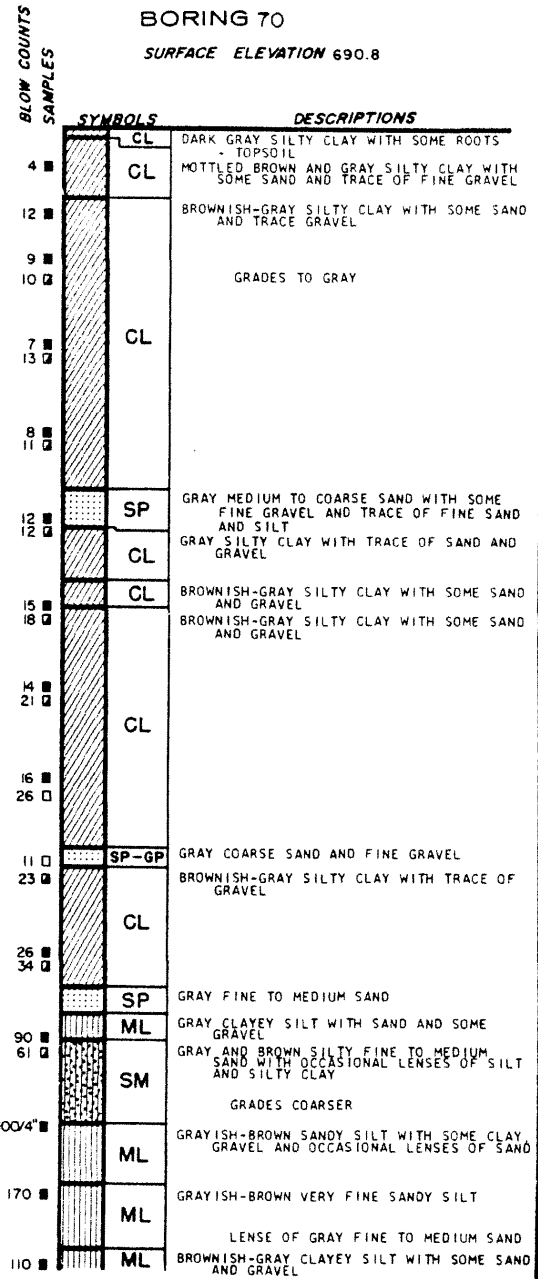

**LA SALLE COUNTY STATION**  
UPDATED FINAL SAFETY ANALYSIS REPORT

FIGURE 2.5-19  
LOGS OF BORINGS  
(SHEET 94)

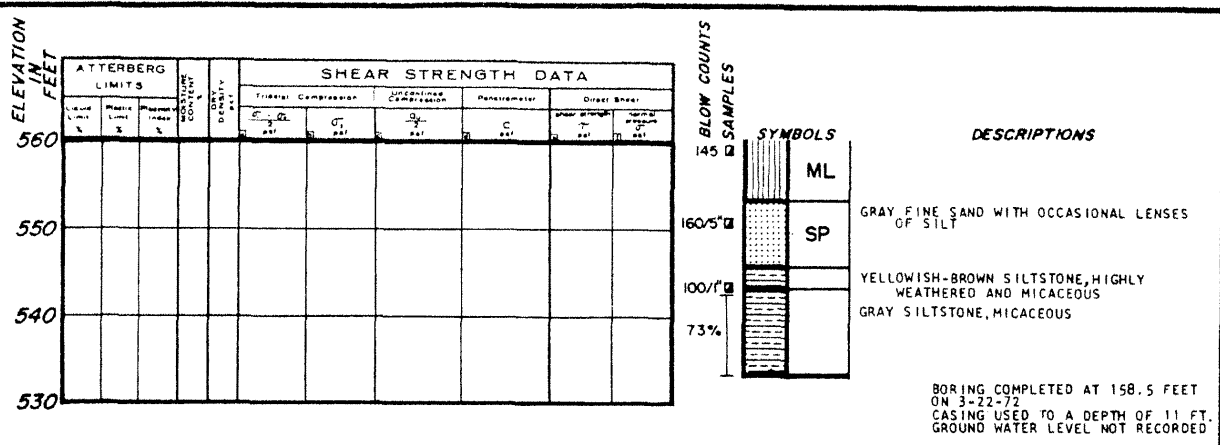

**LA SALLE COUNTY STATION**  
 UPDATED FINAL SAFETY ANALYSIS REPORT

FIGURE 2.5-19  
 LOGS OF BORINGS  
 (SHEET 95)

ELEVATION  
IN  
FEET

ELEVATION IN FEET	ATTERBERG LIMITS				SHEAR STRENGTH DATA							
	Liquid Limit %	Plastic Limit %	Plasticity Index %	SOIL CLASSIFICATION	Triaxial Compression		Unconfined Compression		Penetration		Direct Shear	
					$\sigma_1$ psi	$\sigma_3$ psi	$q_u$ psi	$S_u$ psi	C psi	$\phi$ deg	$\tau$ psi	$\phi$ deg
720												
710												
700												
690												
680				22.4 104			1040	2250		3250		
670				174 113								
660										2250		
650				19.1 111			1330	1500				
640				22.1 102			2260	2250				
630	23.9	15.1	8.8	12.9 122			5400	4500+				
620				15.5 118			1630	3000				
610										3250		
600				19.4 107								
590												
580				10.7 133								
570												
560												

BLOW COUNTS  
SAMPLES

BORING 71  
SURFACE ELEVATION 689.4

SYMBOLS		DESCRIPTIONS
1110	OL	BLACK ORGANIC CLAYEY SILT WITH ROOTS - TOPSOIL
9	CL	MOTTLED BROWN AND GRAY SILTY CLAY WITH SOME SAND AND FINE GRAVEL
5		FINE GRAVEL GRADES OUT GRADES WITH SILT LENSES
13		GRAY SILTY CLAY WITH SOME SAND AND FINE GRAVEL
13	CL	
11		
11		
9		GRADES TO BROWNISH-GRAY GRAYISH-BROWN SILTY CLAY
12		
9	CL	
12		
21	CL	GRAY SILTY CLAY WITH SOME SAND AND GRAVEL
22		
21		BROWNISH-GRAY SILTY CLAY WITH SOME SAND AND GRAVEL
27		
21	CL	
48		
25		
48	CL	
26		GRADES WITH LESS SAND AND GRAVEL
26		
75	SP	BROWN AND GRAY FINE TO MEDIUM SAND WITH TRACE OF FINE GRAVEL, COARSE SAND AND SILT
57		
30	ML	GRAY VERY FINE SANDY SILT
39		LENSE OF GRAY MEDIUM SAND WITH SOME GRAVEL
30	ML	BROWNISH-GRAY CLAYEY SILT WITH SAND AND SOME GRAVEL
39		
155/150	ML	BROWNISH-GRAY FINE SANDY SILT WITH TRACE OF GRAVEL
150/31		
120	ML	
110/9		GRAY SILTY FINE SAND
120	SM	
135/11	CL	BROWN SILTY CLAY WITH SOME SAND, FINE GRAVEL AND OCCASIONAL COBBLES

LA SALLE COUNTY STATION  
UPDATED FINAL SAFETY ANALYSIS REPORT

FIGURE 2.5-19  
LOGS OF BORINGS  
(SHEET 96)

ELEVATION  
IN  
FEET

ATTERBERG LIMITS					SHEAR STRENGTH DATA							
Liquid Limit %	Plastic Limit %	Plastic Index %	MOHRIEY CONSISTENCY INDEX	UNSATURATED SHREY	Triaxial Compression			Unconfined Compression		Penetration	Direct Shear	
W	P	I	CI	U	$\sigma_1$ PSF	$\sigma_3$ PSF	$\sigma_c$ PSF	$q_u$ PSF	C PSF	$\tau$ PSF	$\sigma_v$ PSF	$\tau$ PSF
21.0	10.5	10.5	10.1	135								

BLOW COUNTS  
SAMPLES

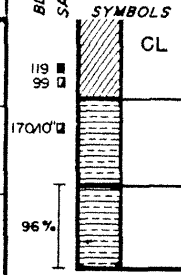

DESCRIPTIONS

GREEN AND GRAY SILTSTONE, HIGHLY WEATHERED AND MICACEOUS

GRAY SILTSTONE, MICACEOUS

BORING COMPLETED AT 158.5 FEET ON 3-10-72  
CASING USED TO A DEPTH OF 10 FT.  
GROUND WATER LEVEL RECORDED AT A DEPTH OF 7.1 FT. ON 3-9-72

LA SALLE COUNTY STATION  
UPDATED FINAL SAFETY ANALYSIS REPORT

FIGURE 2.5-19  
LOGS OF BORINGS  
(SHEET 97)



ELEVATION  
IN  
FEET

ELEVATION IN FEET	ATTERBERG LIMITS			MOISTURE CONTENT %	SHRINKAGE SWELL %	SHEAR STRENGTH DATA								
	Liquid Limit %	Plastic Limit %	Plasticity Index %			Triaxial Compression			Unconfined Compression		Penetration C psi	Direct Shear		
						$\sigma_1 - \sigma_3$ psi	$\sigma_3$ psi	$\sigma_3$ psi	$c_u$ psi	$\phi$ psi		Shear Strength psi	Normal Pressure psi	
720														
710														
700														
690														
680				21.5	107		3220							
670				18.1	110									
660				16.8	99									
650				18.1	114		1780							
640				17.5	115									
630				16.9	105									
620				27.3	98		1690							
610				17.1										
				16.1										
				14.7	107									

BLOW COUNTS  
SAMPLES

BORING 72  
SURFACE ELEVATION 695.2

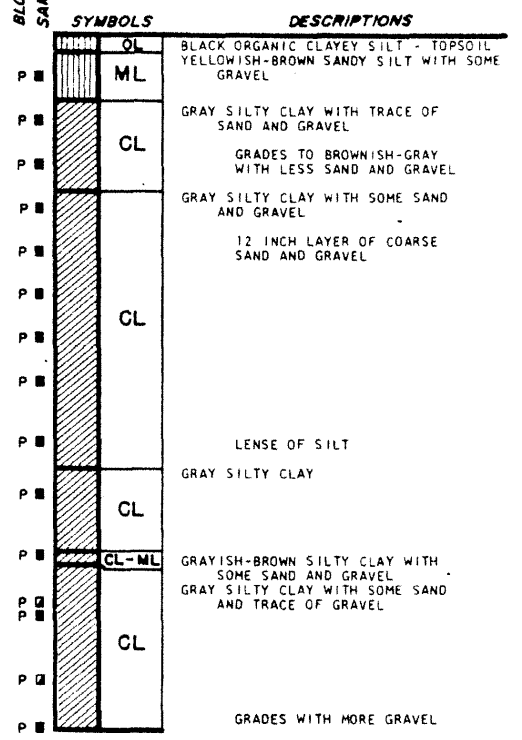

BORING COMPLETED AT 80.0 FEET  
ON 3-30-72  
CASING USED TO A DEPTH OF 10 FT  
GROUND WATER LEVEL NOT RECORDED

LA SALLE COUNTY STATION  
UPDATED FINAL SAFETY ANALYSIS REPORT

FIGURE 2.5-19  
LOGS OF BORINGS  
(SHEET 98)

ELEVATION  
FEET

720  
710  
700  
690  
680  
670  
660  
650  
640  
630  
620  
610

ATTERBERG LIMITS			SHEAR STRENGTH DATA									
Liquid Limit %	Plastic Limit %	Plastic Index %	Triaxial Compression		Unconfined Compression		Penetration		Direct Shear		Density	
W _L	W _P	PI	σ ₁ (PSF)	σ ₃ (PSF)	σ _u (PSF)	q (PSF)	C (PSF)	τ (PSF)	σ _v (PSF)			
						8350					14.1	121
						4900					15.1	117
						4220					15.1	119
						2250					16.6	116
						2820					15.4	120
						2900					16.9	118
											16.1	116
											13.4	128

BLOW COUNTS  
SAMPLES

BORING 73  
SURFACE ELEVATION 693.4

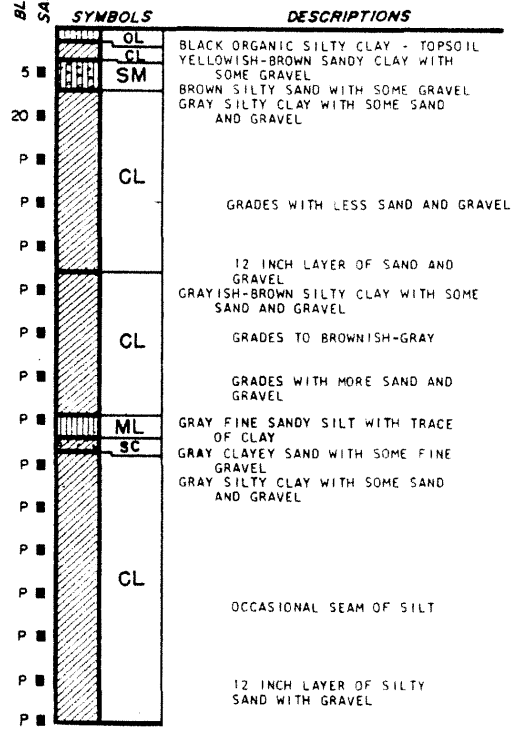

BORING COMPLETED AT 80.0 FEET ON 3-28-72  
CASING USED TO A DEPTH OF 10 FT.  
GROUND WATER LEVEL NOT RECORDED

LA SALLE COUNTY STATION  
UPDATED FINAL SAFETY ANALYSIS REPORT

FIGURE 2.5-19  
LOGS OF BORINGS  
(SHEET 99)

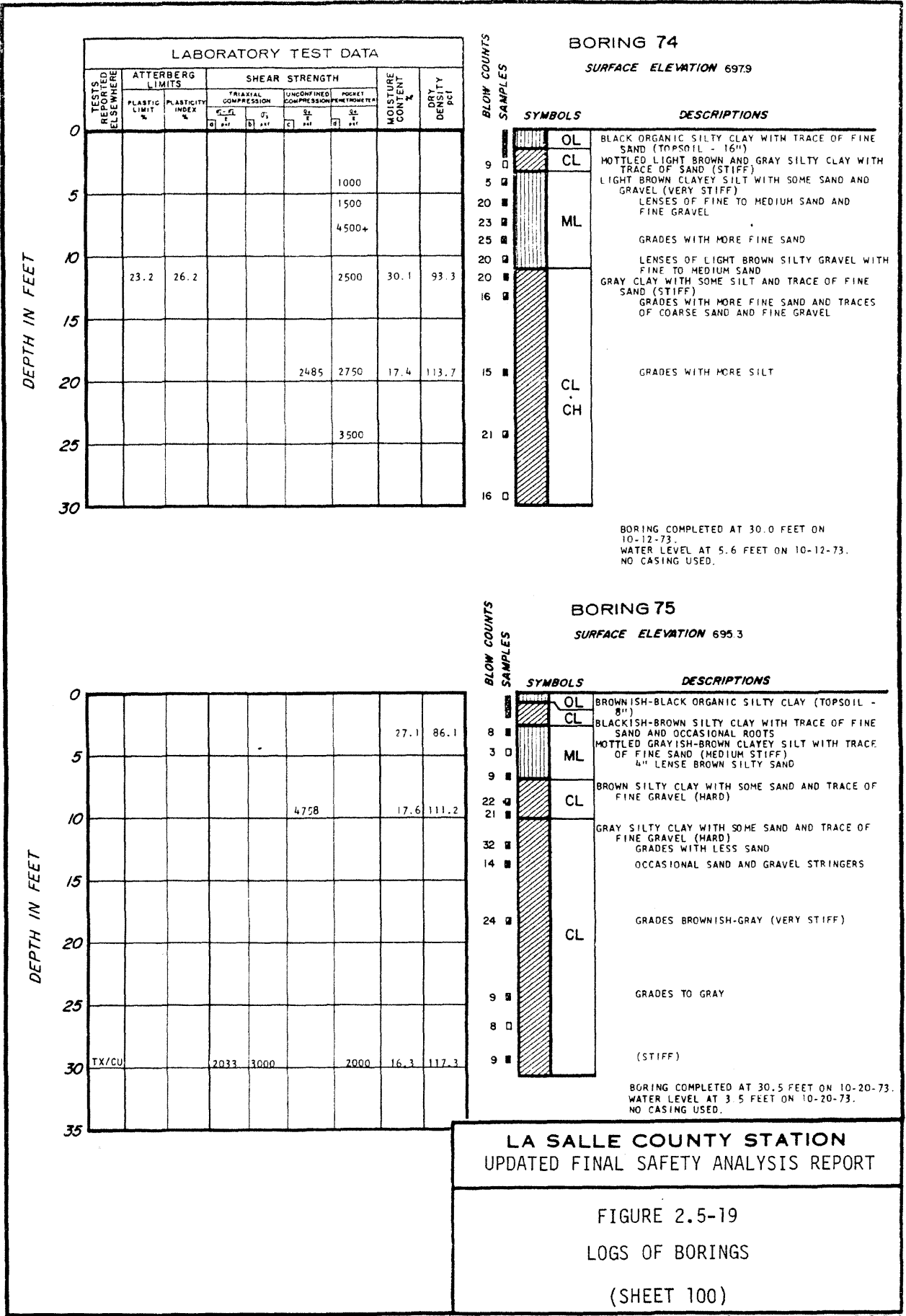

**LA SALLE COUNTY STATION**  
UPDATED FINAL SAFETY ANALYSIS REPORT

FIGURE 2.5-19  
LOGS OF BORINGS  
(SHEET 100)

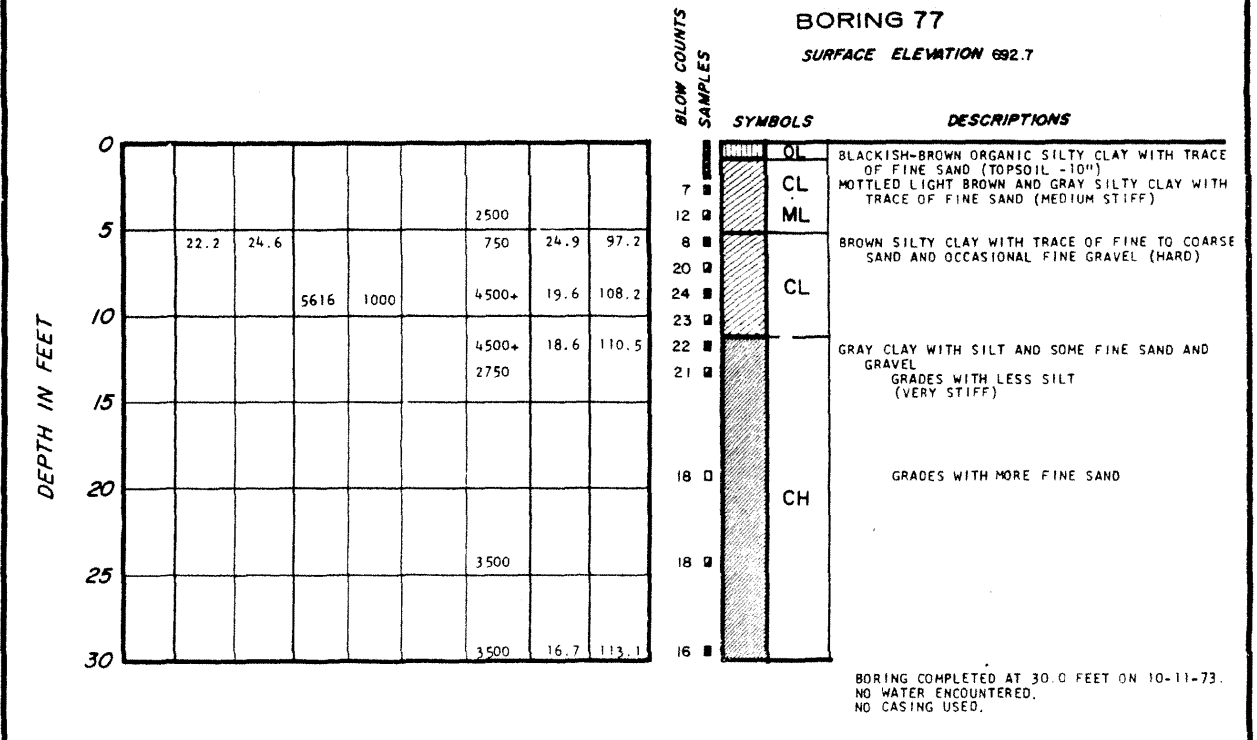
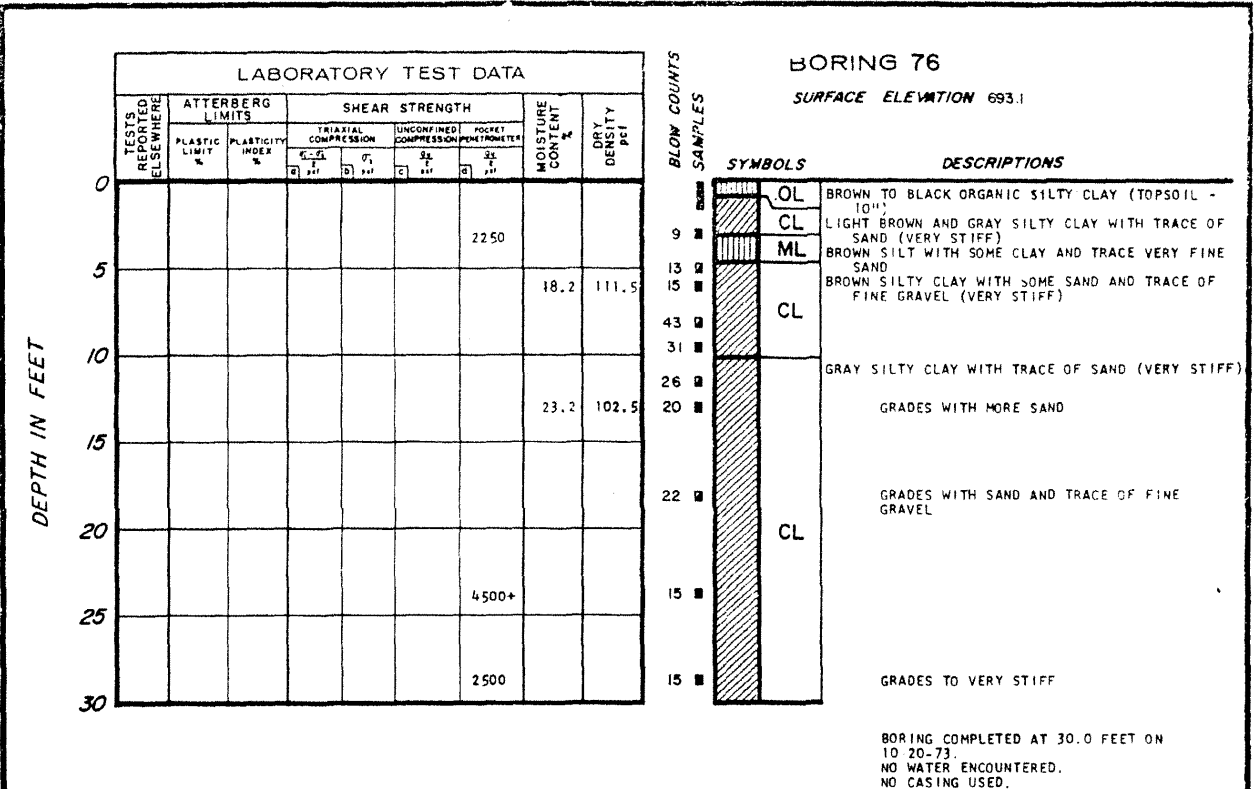

LA SALLE COUNTY STATION  
UPDATED FINAL SAFETY ANALYSIS REPORT

FIGURE 2.5-19  
LOGS OF BORINGS  
(SHEET 101)

REV. 0 - APRIL 1984

**LABORATORY TEST DATA**

TESTS REPORTED ELSEWHERE	ATTERBERG LIMITS		SHEAR STRENGTH						MOISTURE CONTENT %	DRY DENSITY pcf	
	PLASTIC LIMIT %	PLASTICITY INDEX %	TRIAxIAL COMPRESSION			UNCONFINED COMPRESSION					POCKET COMPRESSION PENETROMETER
			σ ₁ (psf)	σ ₃ (psf)	σ ₁ (psf)	σ ₂ (psf)	σ ₃ (psf)				
								σ ₁ (psf)			
								1260	20.1	103.2	
PERM								4500+	17.0	115.1	
								2500			
								4000			
								3500			
								3500	15.6	116.4	
								2750			

DEPTH IN FEET

**BORING 78**  
SURFACE ELEVATION 690.5

BLOW COUNTS  
SAMPLES

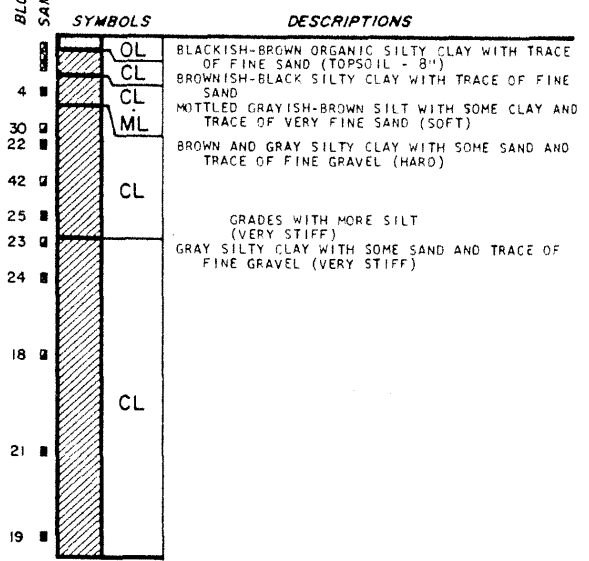

BORING COMPLETED AT 30.0 FEET ON 10-20-73.  
NO WATER ENCOUNTERED.  
NO CASING USED.

								2000			
								4500+	14.3	117.2	
								8922	4500+	16.4	114.0
								4500+			
								4500+	18.5	110.3	
								1500			

DEPTH IN FEET

**BORING 79**  
SURFACE ELEVATION 686.8

BLOW COUNTS  
SAMPLES

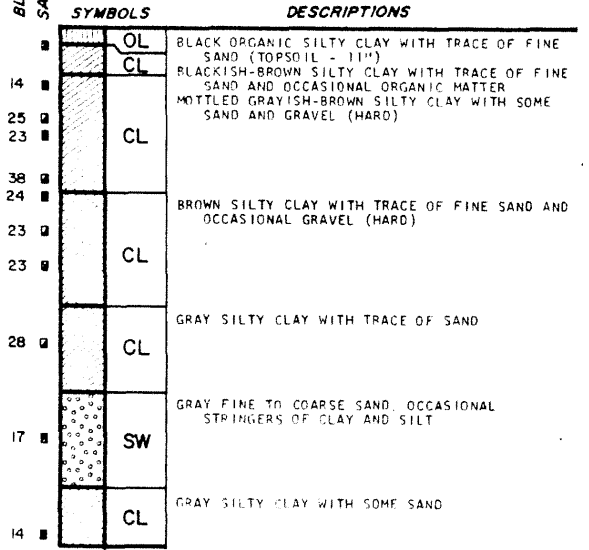

BORING COMPLETED AT 30.0 FEET ON 10-22-73  
WATER LEVEL RECORDED AT 23.5 FEET ON 10-22-73  
NO CASING USED.

**LA SALLE COUNTY STATION**  
**UPDATED FINAL SAFETY ANALYSIS REPORT**

FIGURE 2.5-19  
LOGS OF BORINGS  
(SHEET 102)

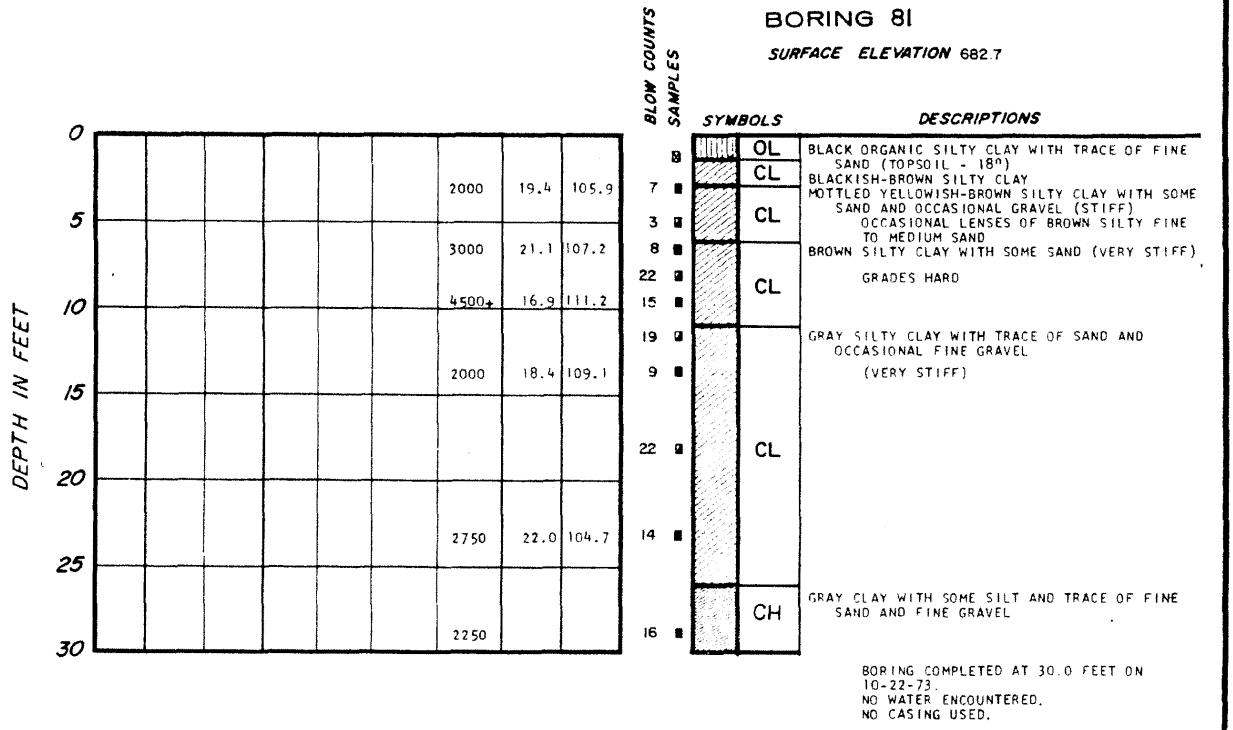
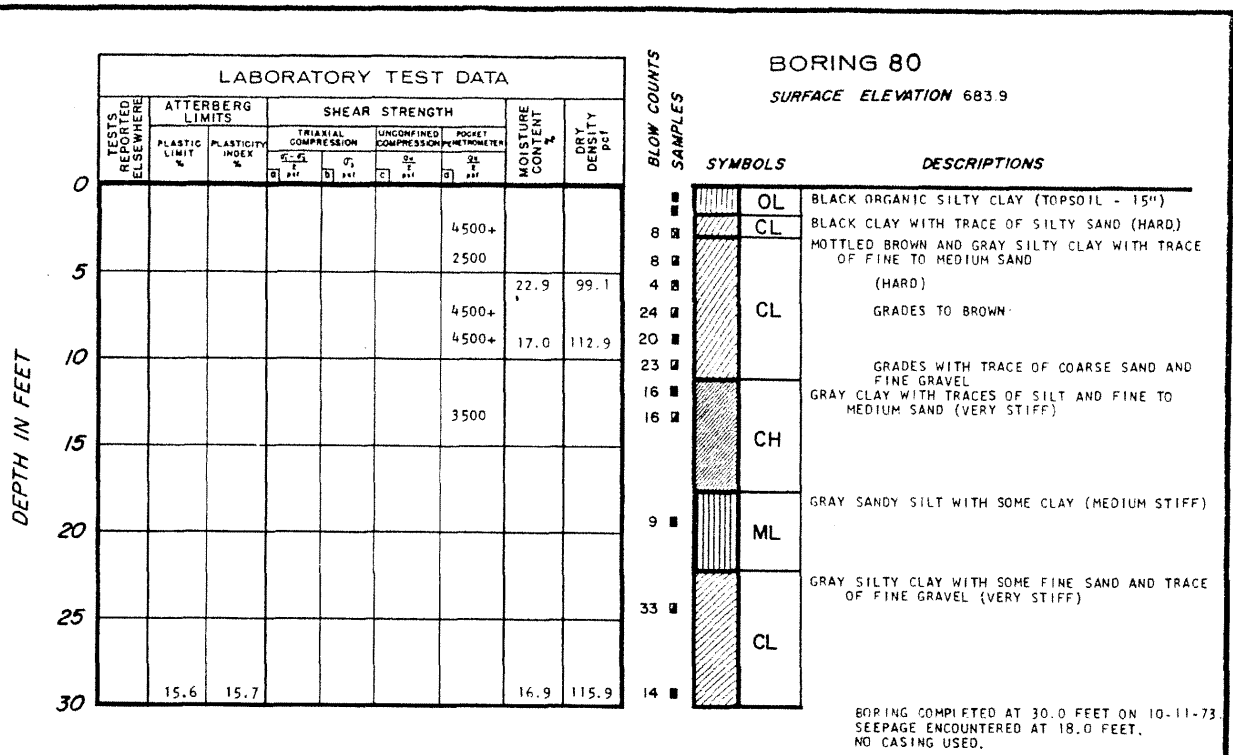

LA SALLE COUNTY STATION  
UPDATED FINAL SAFETY ANALYSIS REPORT

FIGURE 2.5-19  
LOGS OF BORINGS  
(SHEET 103)

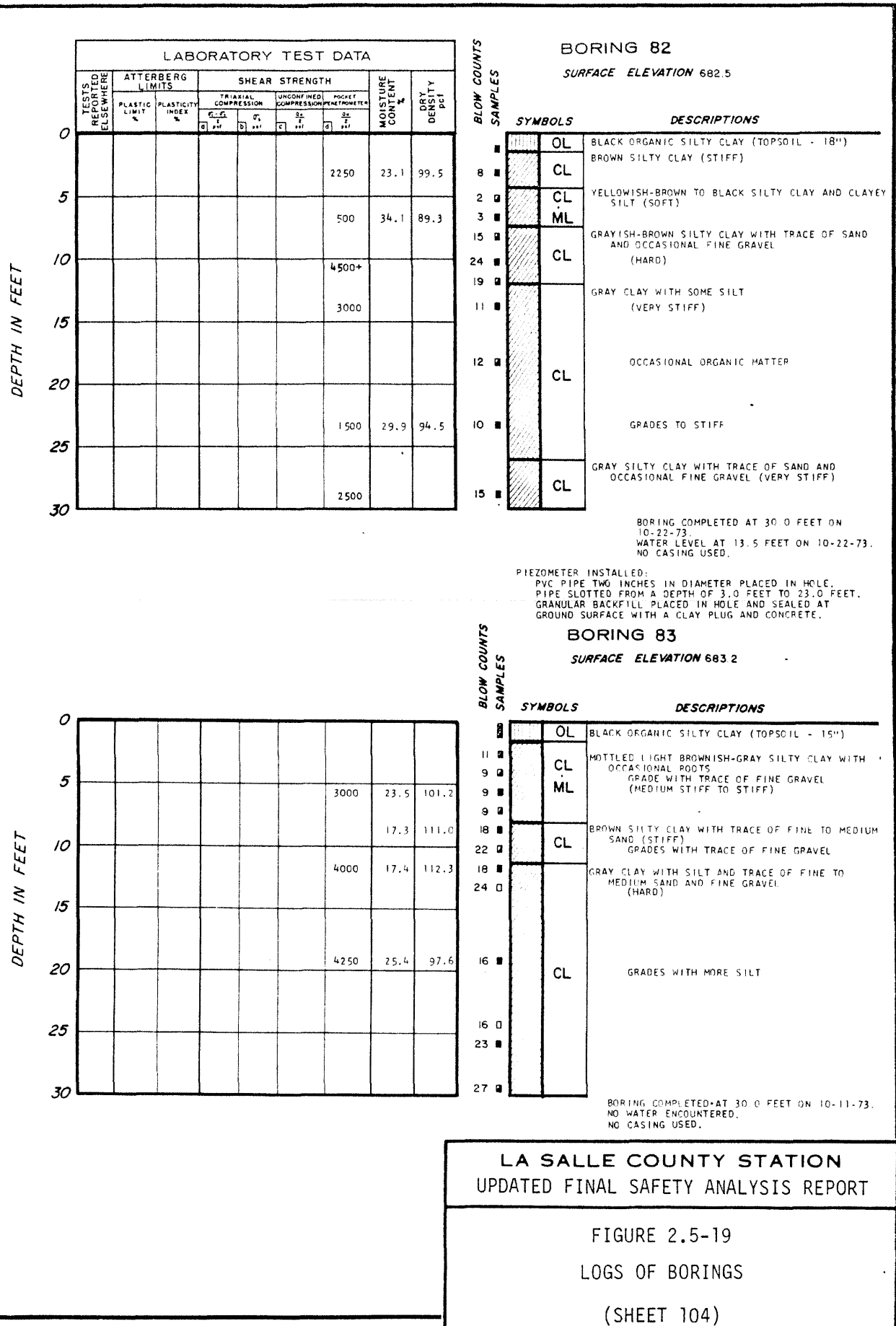

**LABORATORY TEST DATA**

TESTS PERFORMED ELEVATION	ATTERBERG LIMITS		SHEAR STRENGTH						MOISTURE CONTENT %	DRY DENSITY pcf	
	PLASTIC LIMIT %	PLASTICITY INDEX %	TRIAxIAL COMPRESSION			UNCONFINED COMPRESSION					
			q ₁ psi	q ₂ psi	q ₃ psi	q ₁ psi	q ₂ psi	q ₃ psi			
0									22.50	23.1	99.5
5									500	34.1	89.3
10									4500+		
15									3000		
25									1500	29.9	94.5
30									2500		

**BORING 82**

*SURFACE ELEVATION 682.5*

DEPTH IN FEET

BLOW COUNTS  
SAMPLES

BLOW COUNTS SAMPLES	SYMBOLS	DESCRIPTIONS
0	OL	BLACK ORGANIC SILTY CLAY (TOPSOIL - 18")
8	CL	BROWN SILTY CLAY (STIFF)
2	CL	YELLOWISH-BROWN TO BLACK SILTY CLAY AND CLAYEY SILT (SOFT)
3	ML	
15	CL	GRAYISH-BROWN SILTY CLAY WITH TRACE OF SAND AND OCCASIONAL FINE GRAVEL (HARD)
19		
11		GRAY CLAY WITH SOME SILT (VERY STIFF)
12	CL	OCCASIONAL ORGANIC MATTER
10		GRADES TO STIFF
15	CL	GRAY SILTY CLAY WITH TRACE OF SAND AND OCCASIONAL FINE GRAVEL (VERY STIFF)

BORING COMPLETED AT 30.0 FEET ON 10-22-73.  
WATER LEVEL AT 13.5 FEET ON 10-22-73.  
NO CASING USED.

PIEZOMETER INSTALLED:  
PVC PIPE TWO INCHES IN DIAMETER PLACED IN HOLE.  
PIPE SLOTTED FROM A DEPTH OF 3.0 FEET TO 23.0 FEET.  
GRANULAR BACKFILL PLACED IN HOLE AND SEALED AT  
GROUND SURFACE WITH A CLAY PLUG AND CONCRETE.

**BORING 83**

*SURFACE ELEVATION 683.2*

DEPTH IN FEET

BLOW COUNTS  
SAMPLES

BLOW COUNTS SAMPLES	SYMBOLS	DESCRIPTIONS
0	OL	BLACK ORGANIC SILTY CLAY (TOPSOIL - 15")
11		
9	CL	MOTTLED LIGHT BROWNISH-GRAY SILTY CLAY WITH OCCASIONAL ROOTS
9	ML	GRADE WITH TRACE OF FINE GRAVEL (MEDIUM STIFF TO STIFF)
9		
18	CL	BROWN SILTY CLAY WITH TRACE OF FINE TO MEDIUM SAND (STIFF)
22		GRADES WITH TRACE OF FINE GRAVEL
18		
24		GRAY CLAY WITH SILT AND TRACE OF FINE TO MEDIUM SAND AND FINE GRAVEL (HARD)
16	CL	GRADES WITH MORE SILT
16		
23		
27		

BORING COMPLETED AT 30.0 FEET ON 10-11-73.  
NO WATER ENCOUNTERED.  
NO CASING USED.

**LA SALLE COUNTY STATION  
UPDATED FINAL SAFETY ANALYSIS REPORT**

FIGURE 2.5-19  
LOGS OF BORINGS  
(SHEET 104)

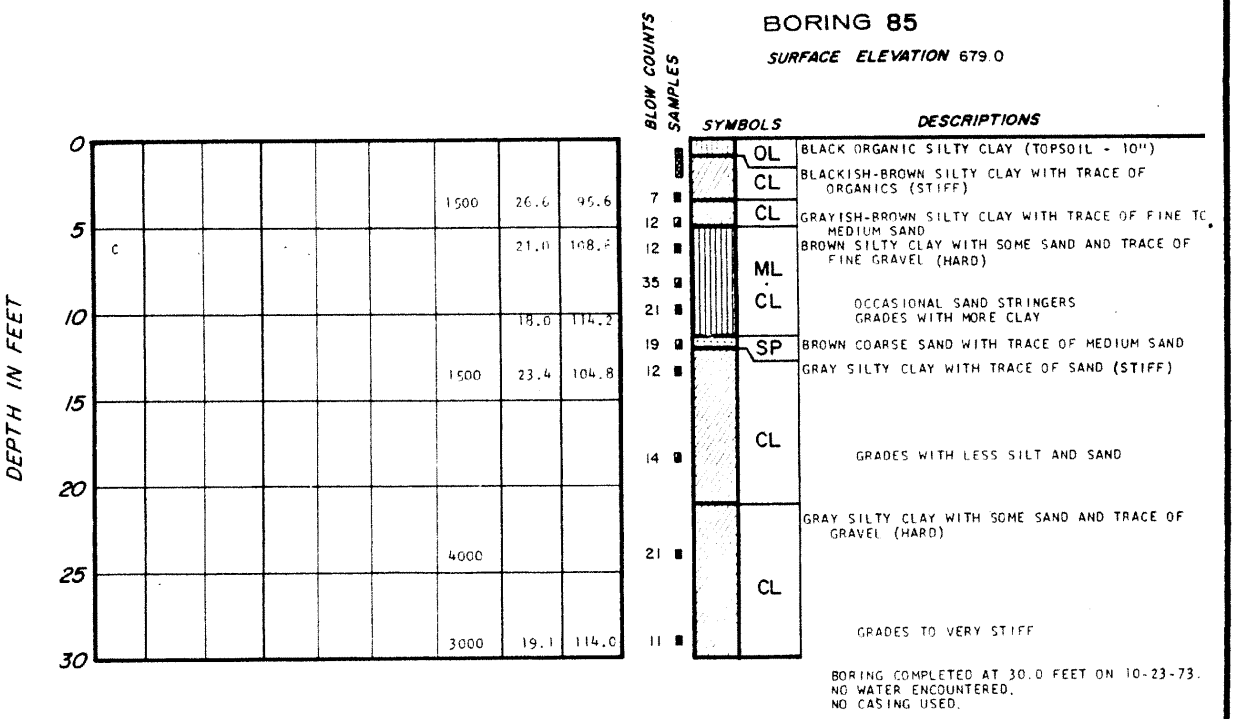
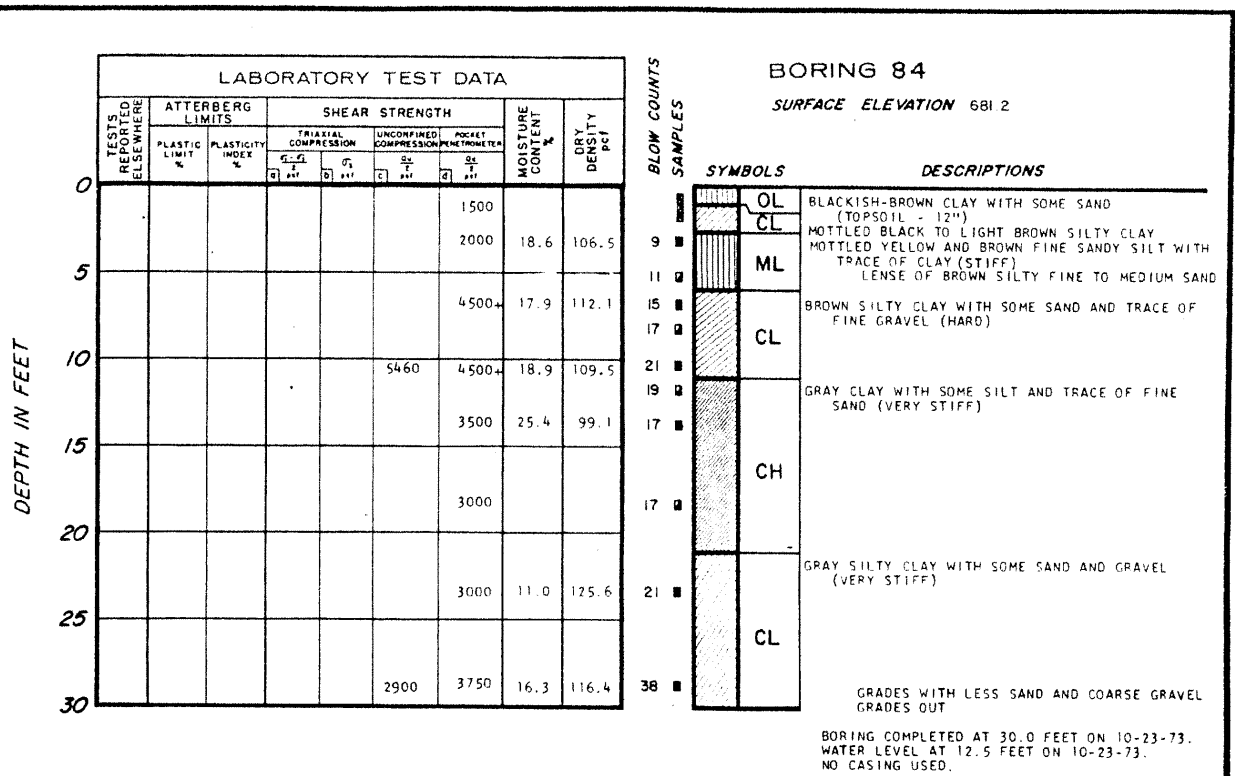

**LA SALLE COUNTY STATION**  
**UPDATED FINAL SAFETY ANALYSIS REPORT**

FIGURE 2.5-19  
 LOGS OF BORINGS  
 (SHEET 105)



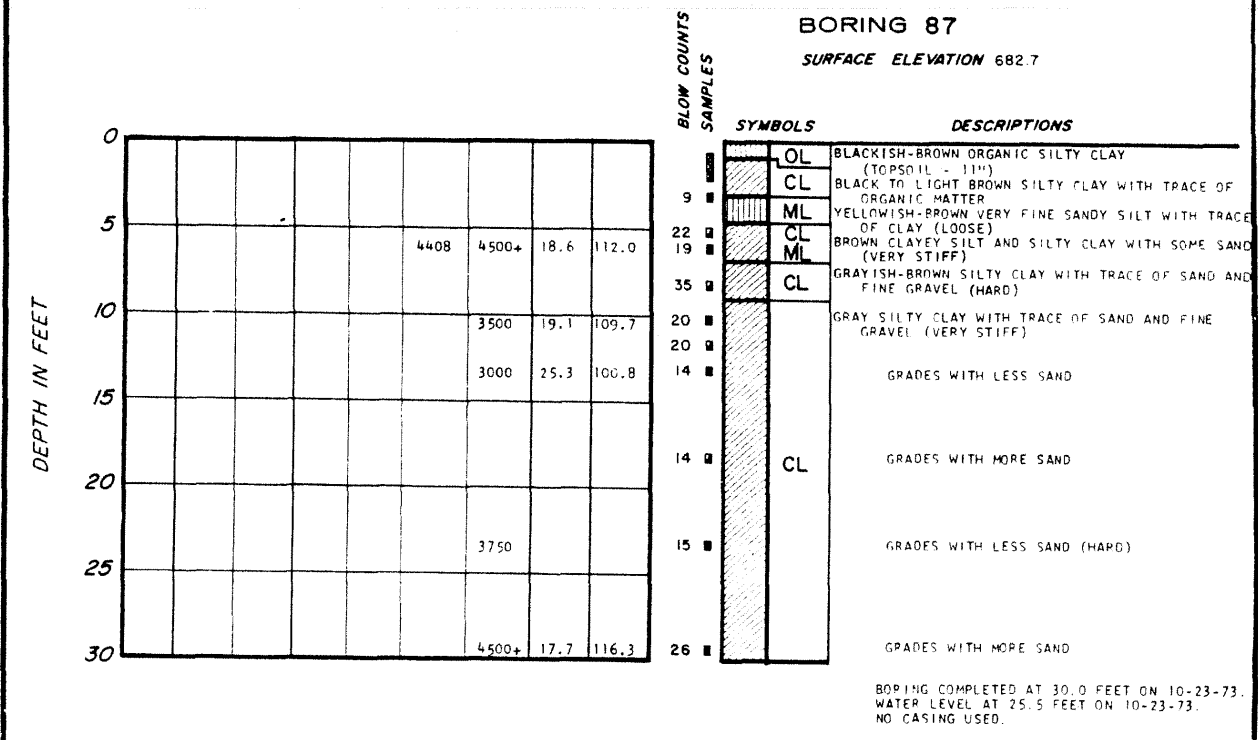
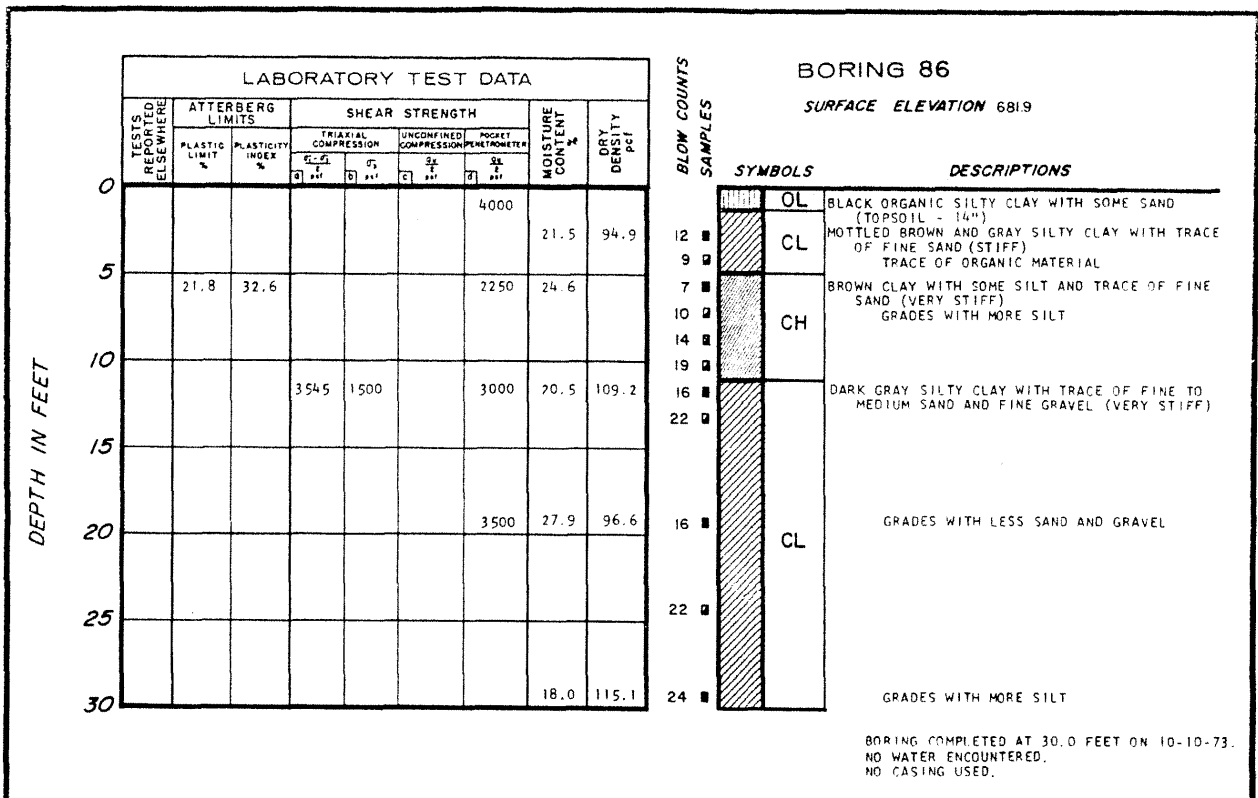

**LA SALLE COUNTY STATION**  
UPDATED FINAL SAFETY ANALYSIS REPORT

FIGURE 2.5-19  
LOGS OF BORINGS  
(SHEET 106)

REV. 0 - APRIL 1984

TESTS REPORTED ELSEWHERE	ATTERBERG LIMITS		SHEAR STRENGTH				MOISTURE CONTENT %	DRY DENSITY PSI
	PLASTIC LIMIT %	PLASTICITY INDEX %	TRIAxIAL COMPRESSION		UNCONFINED COMPRESSION	POCKET PENETROMETER		
			$\frac{q_1 - p_1}{3}$	$\frac{q_2 - p_2}{3}$	$\frac{q_3 - p_3}{3}$	$\frac{q_4 - p_4}{3}$		
			q	p	q	p		
							23.6	98.5
							1000	
							18.0	114.4
							3500	
							4500+	15.3 119.9

DEPTH IN FEET

**BORING 88**  
SURFACE ELEVATION 682.0

BLOW COUNTS  
SAMPLES

SYMBOLS	DESCRIPTIONS
OL	BLACKISH-BROWN ORGANIC SILTY CLAY (TOPSOIL - 10")
CL	BLACK TO LIGHT BROWN SILTY CLAY WITH TRACE OF FINE TO MEDIUM SAND
ML	MOTTLED GRAYISH-BROWN SILTY CLAY AND CLAYEY SILT WITH TRACE OF FINE SAND (MEDIUM STIFF)
CL	YELLOWISH-BROWN VERY FINE SANDY SILT WITH TRACE OF CLAY (VERY LOOSE)
CL	BROWN SILTY CLAY WITH SOME SAND AND OCCASIONAL FINE GRAVEL (VERY STIFF)
CL	GRAY SILTY CLAY WITH SOME SAND AND OCCASIONAL GRAVEL (HARD)
CL	GRADES WITH LESS SILT AND SAND
CH	GRAY CLAY WITH SOME SILT
CL	GRAY SILTY CLAY WITH SOME SAND AND OCCASIONAL GRAVEL (HARD)

BORING COMPLETED AT 30.0 FEET ON 10-24-73.  
WATER LEVEL AT 25.5 FEET ON 10-24-73.  
NO CASING USED.

TESTS REPORTED ELSEWHERE	ATTERBERG LIMITS		SHEAR STRENGTH				MOISTURE CONTENT %	DRY DENSITY PSI
	PLASTIC LIMIT %	PLASTICITY INDEX %	TRIAxIAL COMPRESSION		UNCONFINED COMPRESSION	POCKET PENETROMETER		
			$\frac{q_1 - p_1}{3}$	$\frac{q_2 - p_2}{3}$	$\frac{q_3 - p_3}{3}$	$\frac{q_4 - p_4}{3}$		
			q	p	q	p		
							3700	
							2700	26.4 93.4
							3500	
	17.1	17.8					1250	23.1 104.5
							2000	20.1 108.3
							4500+	

DEPTH IN FEET

**BORING 89**  
SURFACE ELEVATION 680.9

BLOW COUNTS  
SAMPLES

SYMBOLS	DESCRIPTIONS
OL	BLACK ORGANIC SANDY CLAY (TOPSOIL - 18")
CL	GRADES WITH SOME SILT
CL	DARK BROWN CLAYEY SILT WITH TRACE OF SAND (VERY STIFF)
CL	MOTTLED LIGHT BROWN AND GRAY SILTY CLAY WITH SOME SAND AND TRACE OF FINE GRAVEL
CL	GRADES WITH MORE SILT AND FINE SAND (VERY STIFF)
CL	GRADES WITH LESS SILT
CL	GRAY SILTY CLAY WITH FINE SAND AND OCCASIONAL GRAVEL (HARD)

BORING COMPLETED AT 30.0 FEET ON 10-10-73.  
WATER LEVEL AT 19.0 FEET ON 10-10-73.  
NO CASING USED.

**LA SALLE COUNTY STATION**  
**UPDATED FINAL SAFETY ANALYSIS REPORT**

FIGURE 2.5-19  
LOGS OF BORINGS  
(SHEET 107)

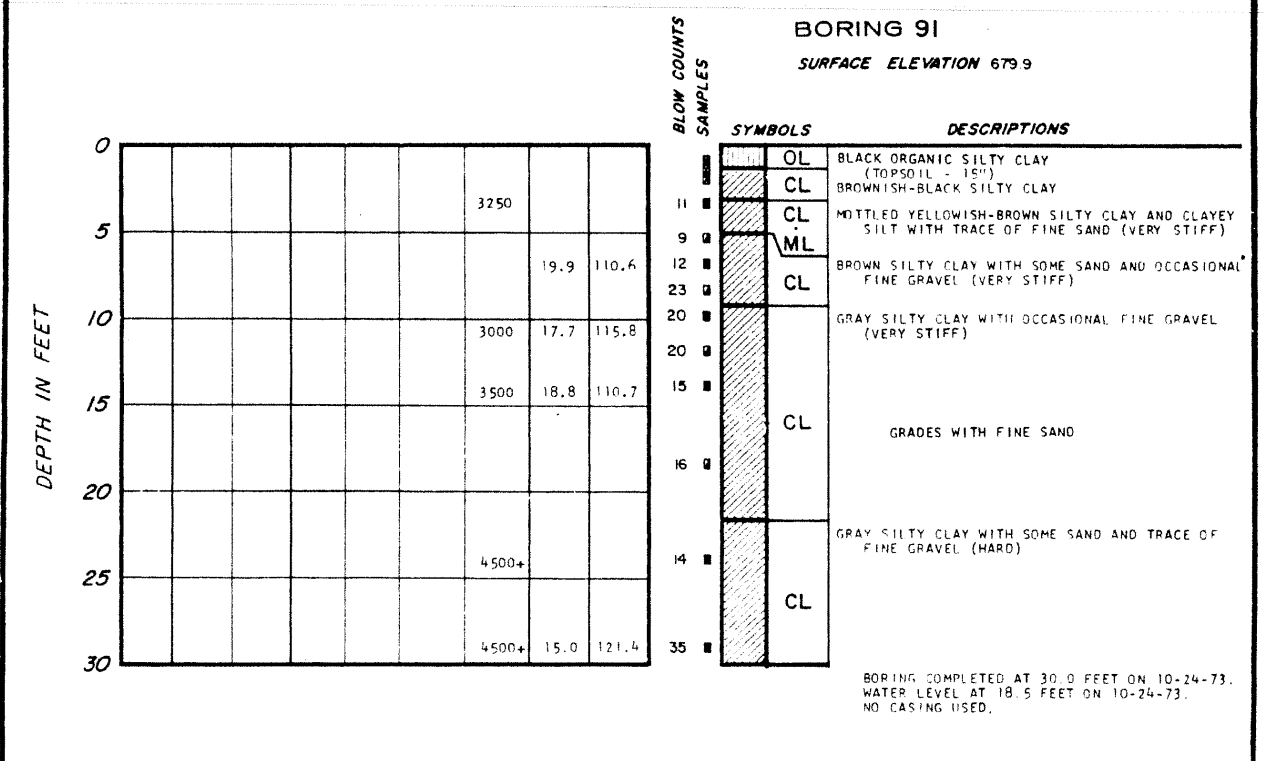
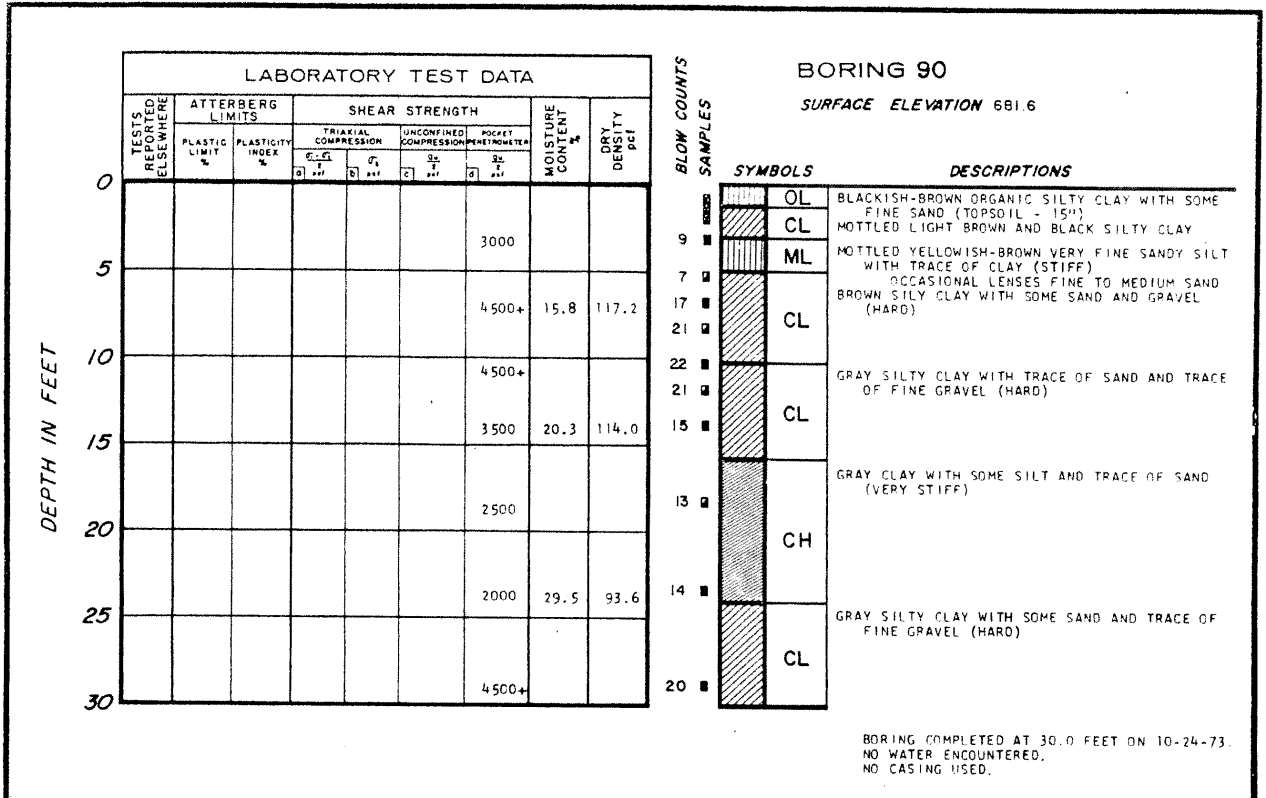

**LA SALLE COUNTY STATION**  
 UPDATED FINAL SAFETY ANALYSIS REPORT  
  
 FIGURE 2.5-19  
 LOGS OF BORINGS  
 (SHEET 108)

**LABORATORY TEST DATA**

TESTS REPORTED ELSEWHERE	ATTERBERG LIMITS		SHEAR STRENGTH				MOISTURE CONTENT %	DRY DENSITY PCF	
	PLASTIC LIMIT %	PLASTICITY INDEX %	TRIAxIAL COMPRESSION		UNCONFINED COMPRESSION	POCKET PENETROMETER			
			$\frac{q_1 - q_3}{2}$	$q_3$	$\frac{q_u}{2}$	$\frac{q_p}{2}$			
							2750	34.0	87.6
			1150	500			1700	18.8	108.3
					1980		2200	18.3	111.5
							3750	26.0	98.8
	27.1	21.9							

DEPTH IN FEET

**BORING 92**  
SURFACE ELEVATION 6799

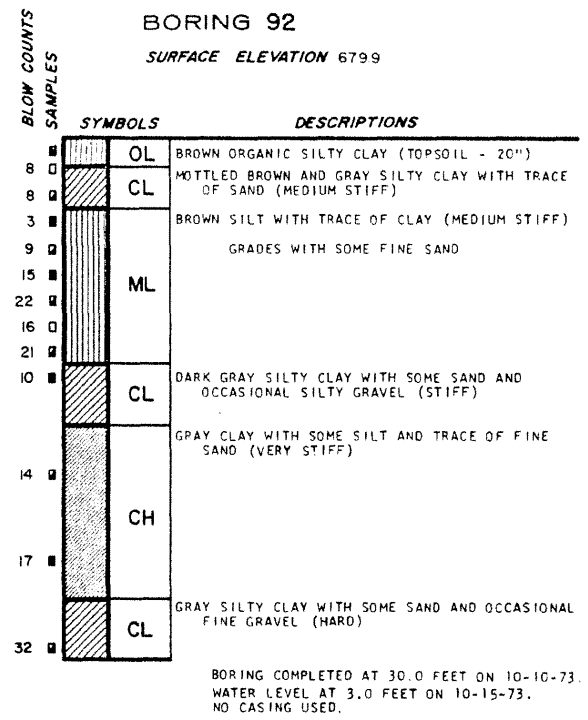

TESTS REPORTED ELSEWHERE	ATTERBERG LIMITS		SHEAR STRENGTH				MOISTURE CONTENT %	DRY DENSITY PCF	
	PLASTIC LIMIT %	PLASTICITY INDEX %	TRIAxIAL COMPRESSION		UNCONFINED COMPRESSION	POCKET PENETROMETER			
			$\frac{q_1 - q_3}{2}$	$q_3$	$\frac{q_u}{2}$	$\frac{q_p}{2}$			
							4500+	13.8	93.0
			1550	500			4500+	16.7	115.1
							4500+	15.7	115.6
							3750		
							4000		
							1500	16.6	114.1

DEPTH IN FEET

**BORING 93**  
SURFACE ELEVATION 679.0

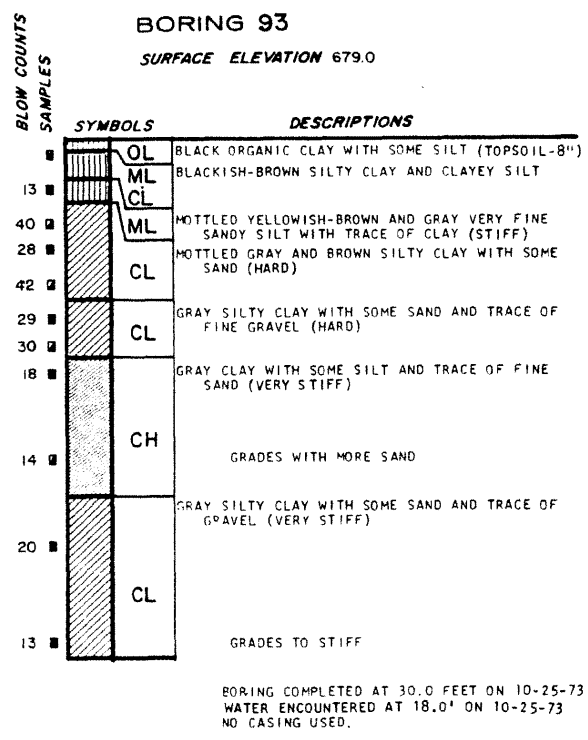

**LA SALLE COUNTY STATION**  
**UPDATED FINAL SAFETY ANALYSIS REPORT**

FIGURE 2.5-19  
LOGS OF BORINGS  
(SHEET 109)

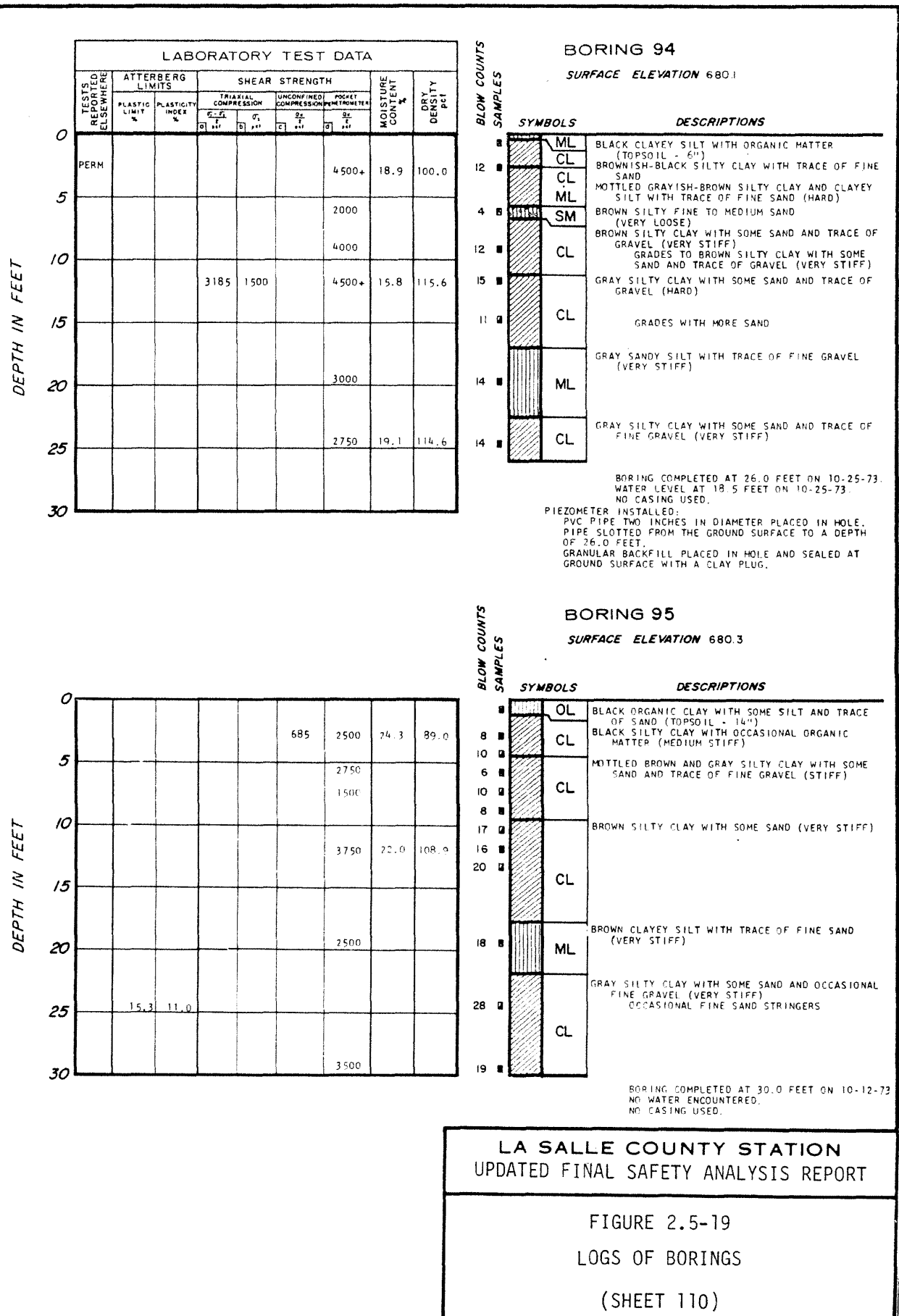

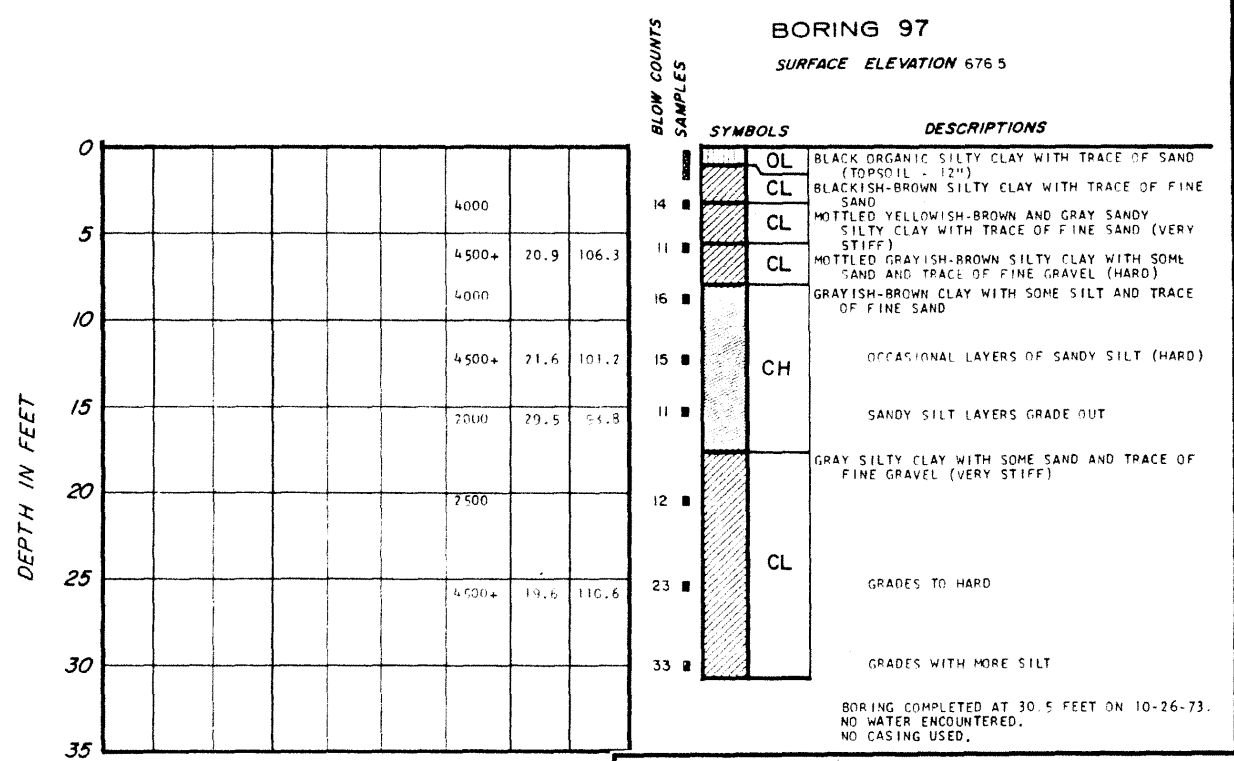
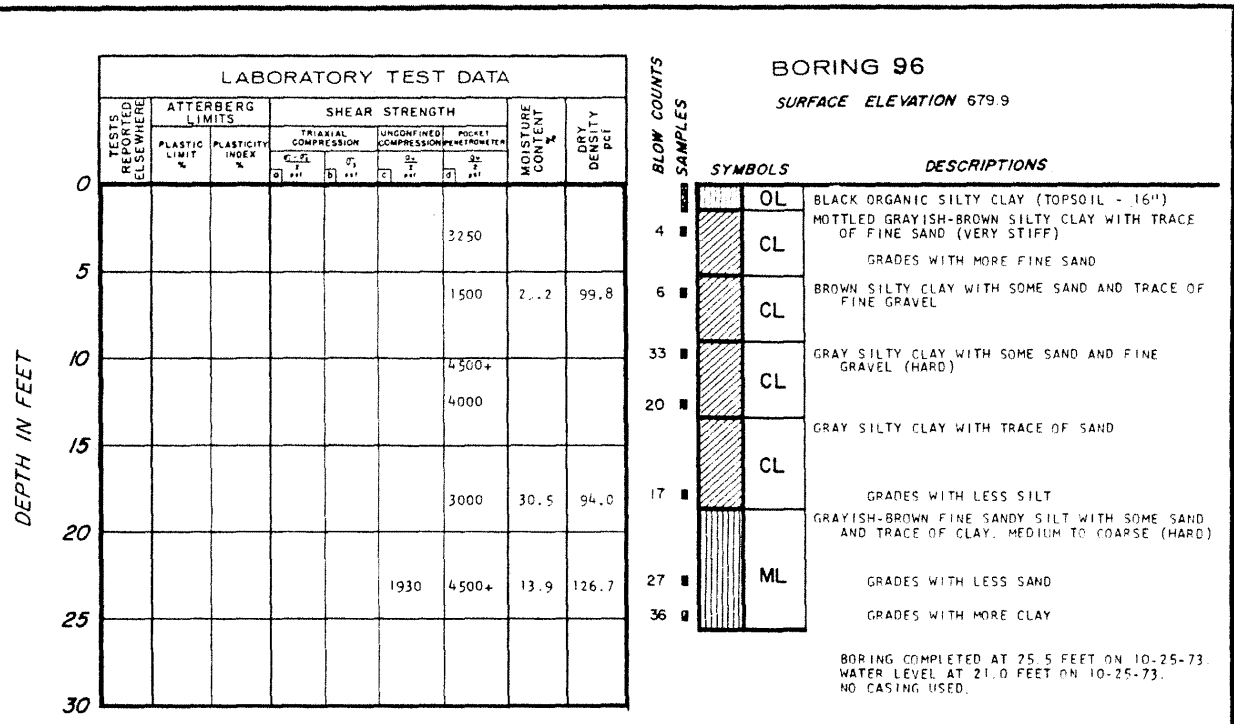

**LA SALLE COUNTY STATION**  
**UPDATED FINAL SAFETY ANALYSIS REPORT**

FIGURE 2.5-19  
 LOGS OF BORINGS  
 (SHEET 111)

**LABORATORY TEST DATA**

TESTS REPORTED ELSEWHERE	ATTERBERG LIMITS		SHEAR STRENGTH						MOISTURE CONTENT %	DRY DENSITY pcf	
	PLASTIC LIMIT %	PLASTICITY INDEX %	TRIAxIAL COMPRESSION			UNCONFINED COMPRESSION					POCKET PENETROMETER
			σ ₁ pcf	σ ₃ pcf	σ ₂ pcf	σ ₁ pcf	σ ₂ pcf	σ ₃ pcf			
	19.8	7.0							2000	40.1	84.1
									1500	28.5	91.7
								3205	2500	18.3	109.5
										22.1	104.6
									4500+	16.3	118.6
									4000		
									4000	25.3	105.9

DEPTH IN FEET

**BORING 98**  
SURFACE ELEVATION 676.0

BLOW COUNTS  
SAMPLES

BLOW COUNTS SAMPLES	SYMBOLS	DESCRIPTIONS
0	OL	DARK BROWN ORGANIC SILTY CLAY (TOPSOIL - 12")
11	CL	DARK BROWN SILTY CLAY WITH TRACE OF FINE SAND
13	CL	MOTTLED LIGHT BROWN AND GRAY SILTY CLAY WITH TRACE OF FINE SAND (STIFF)
16	ML	GRADES WITH OCCASIONAL FINE GRAVEL
15	ML	
23	CL	BROWN SILTY CLAY WITH SOME SAND AND OCCASIONAL FINE GRAVEL (VERY STIFF)
22	CL	BROWN CLAY WITH SOME SILT AND TRACE OF FINE SAND (STIFF)
12	CH	
14	CH	
21	CL	GRAY SILTY CLAY WITH TRACE OF SAND AND OCCASIONAL FINE GRAVEL (VERY STIFF)
22	CL	GRADES WITH MORE SAND
22	CL	1" LENSE OF BROWN SILTY SAND AT 29'6"

BORING COMPLETED AT 30.0 FEET ON 10-12-73  
WATER ENCOUNTERED AT 18.5 FEET.  
NO CASING USED.

TESTS REPORTED ELSEWHERE	ATTERBERG LIMITS		SHEAR STRENGTH						MOISTURE CONTENT %	DRY DENSITY pcf	
	PLASTIC LIMIT %	PLASTICITY INDEX %	TRIAxIAL COMPRESSION			UNCONFINED COMPRESSION					POCKET PENETROMETER
			σ ₁ pcf	σ ₃ pcf	σ ₂ pcf	σ ₁ pcf	σ ₂ pcf	σ ₃ pcf			
									4500+	14.2	120.1
								2500		18.1	115.0
								3000			
									5060	23.2	100.9

DEPTH IN FEET

**BORING 99**  
SURFACE ELEVATION 671.1

BLOW COUNTS  
SAMPLES

BLOW COUNTS SAMPLES	SYMBOLS	DESCRIPTIONS
0	OL	BLACK ORGANIC SILTY CLAY (TOPSOIL - 4")
	CL	DARK GRAY SILTY CLAY WITH TRACE OF FINE SAND
4	CL	MOTTLED GRAYISH-BROWN SILTY CLAY WITH TRACE OF FINE SAND (SOFT)
6	SP	LIGHT BROWN MEDIUM SAND WITH SOME SILT GRADES TO COARSE SAND (LOOSE)
18	CL	GRAY SILTY CLAY WITH SOME SAND AND TRACE OF FINE GRAVEL (HARD)
16	CL	GRADES WITH MORE CLAY
14	CL	
8	CL	(GRADES TO VERY STIFF)
16	ML	GRAY CLAYEY SILT WITH TRACE OF FINE SAND (SOFT)
21	CL	GRAY SILTY CLAY WITH SOME SAND AND TRACE OF FINE GRAVEL (VERY STIFF)

BORING COMPLETED AT 30.5 FEET ON 10-26-73.  
WATER LEVEL AT 3.5 FEET ON 10-26-73.  
NO CASING USED.

**LA SALLE COUNTY STATION**  
**UPDATED FINAL SAFETY ANALYSIS REPORT**

FIGURE 2.5-19  
LOGS OF BORINGS  
(SHEET 112)

LABORATORY TEST DATA											
TESTS REPORTED ELSEWHERE	ATTERBERG LIMITS		SHEAR STRENGTH						MOISTURE CONTENT %	DRY DENSITY PCF	
	PLASTIC LIMIT %	PLASTICITY INDEX %	TRIAxIAL COMPRESSION			UNCONFINED COMPRESSION					POCKET PENETROMETER
			$\sigma_1$	$\sigma_3$	$\sigma_1$	$\sigma_3$	$\sigma_1$	$\sigma_3$			
									2200	26.3	97.9
									4500+		
								2201	2200	12.5	118.5
									3500		
									4500+	15.6	118.2
									7600		
									3000	19.1	109.4
									4500+		

DEPTH IN FEET

**BORING 100**  
SURFACE ELEVATION 676.5

BLOW COUNTS SAMPLES

SYMBOLS		DESCRIPTIONS
0	OL	BLACK ORGANIC SILTY CLAY (TOPSOIL - 12")
7	CL	MOTTLED LIGHT BROWN AND GRAY SILTY CLAY AND SILT WITH TRACE OF CLAY AND TRACE OF FINE SAND (STIFF)
5	MH	
9	CL	BROWN SILTY CLAY WITH SOME SAND AND TRACE OF FINE GRAVEL (HARD)
12	CL	GRADES WITH MORE SAND (VERY STIFF)
15	CH	MOTTLED BROWN AND GRAY CLAY WITH TRACE OF SILT
14	CL	GRAY SILTY CLAY WITH SAND AND TRACE OF FINE GRAVEL (HARD)
13	CL	GRADES WITH LESS SAND
12	CL	GRADES TO VERY STIFF
23	CL	GRADES TO HARD

BORING COMPLETED AT 30.0 FEET ON 11-1-73. NO WATER ENCOUNTERED. NO CASING USED.

LABORATORY TEST DATA												
TESTS REPORTED ELSEWHERE	ATTERBERG LIMITS		SHEAR STRENGTH						MOISTURE CONTENT %	DRY DENSITY PCF		
	PLASTIC LIMIT %	PLASTICITY INDEX %	TRIAxIAL COMPRESSION			UNCONFINED COMPRESSION					POCKET PENETROMETER	
			$\sigma_1$	$\sigma_3$	$\sigma_1$	$\sigma_3$	$\sigma_1$	$\sigma_3$				
									4500+			
	20.5	24.2							4250	19.7	103.3	
								5165	1500	4500+	13.2	121.4

DEPTH IN FEET

**BORING 101**  
SURFACE ELEVATION 679.6

BLOW COUNTS SAMPLES

SYMBOLS		DESCRIPTIONS
0	OL	DARK BROWN ORGANIC SILTY CLAY (TOPSOIL - 12")
9	CL	BROWN SILTY CLAY WITH TRACE OF SAND (MEDIUM STIFF)
14	CL	MOTTLED LIGHT BROWN AND GRAY SILTY CLAY WITH SOME SAND AND OCCASIONAL FINE GRAVEL (VERY STIFF)
15	CL	
31	CL	BROWNISH-GRAY CLAY WITH TRACE OF SILT AND FINE SAND (HARD)
20	CH	
22	CL	
21	CL	
23	CL	GRAY SILTY CLAY WITH SOME SAND AND FINE GRAVEL (HARD)
19	CL	GRADES WITH LESS SAND
13	CL	
23	CL	

BORING COMPLETED AT 31.5 FEET ON 10-15-73. WATER ENCOUNTERED AT 18.5 FEET. NO CASING USED.

**LA SALLE COUNTY STATION  
UPDATED FINAL SAFETY ANALYSIS REPORT**

FIGURE 2.5-19  
LOGS OF BORINGS  
(SHEET 113)



LABORATORY TEST DATA									
TESTS REPORTED ELSEWHERE	ATTERBERG LIMITS		SHEAR STRENGTH				MOISTURE CONTENT %	DRY DENSITY pcf	
	PLASTIC LIMIT %	PLASTICITY INDEX %	TRIAxIAL COMPRESSION		UNCONFINED COMPRESSION	POCKET PENETROMETER			
			$\sigma_1$	$\sigma_3$	$q_u$	$q_p$			
							2700	36.6	80.2
							2900		
			5847	1200			4500+	16.8	113.7
							4500+		
							3900	24.2	100.8
							4500+		
							3900	22.5	101.7
							4400	15.0	118.5

DEPTH IN FEET

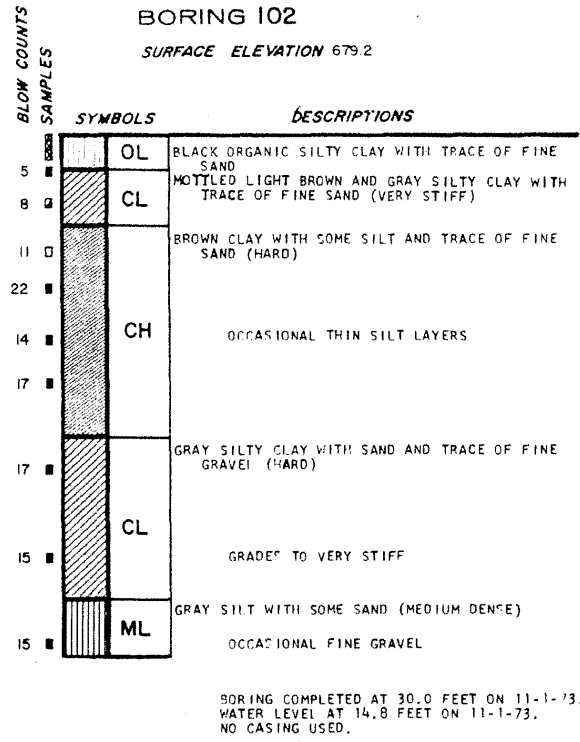

							4200		
							3800	21.6	100.3
							4500+		
							4500+	21.4	107.0
							4500+		
			2027	3400			26.3	92.4	
							4500+		
			6066	4500+			14.9	117.3	
							4500+		

DEPTH IN FEET

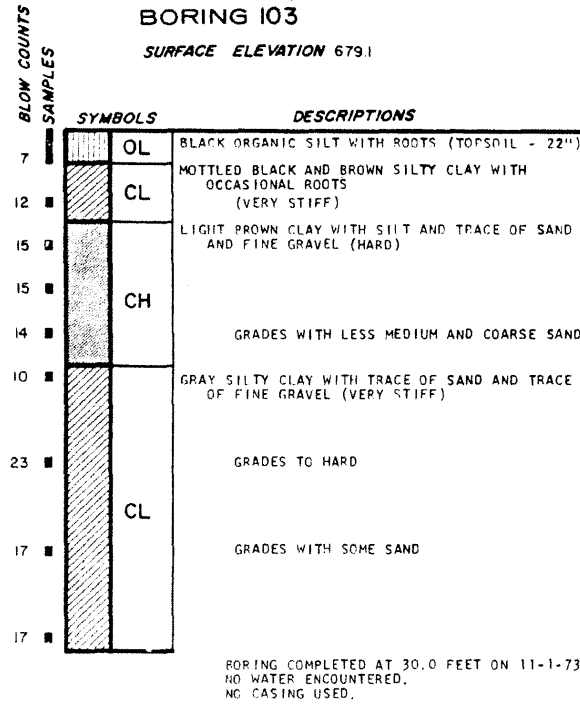

**LA SALLE COUNTY STATION**  
UPDATED FINAL SAFETY ANALYSIS REPORT

FIGURE 2.5-19  
LOGS OF BORINGS  
(SHEET 114)

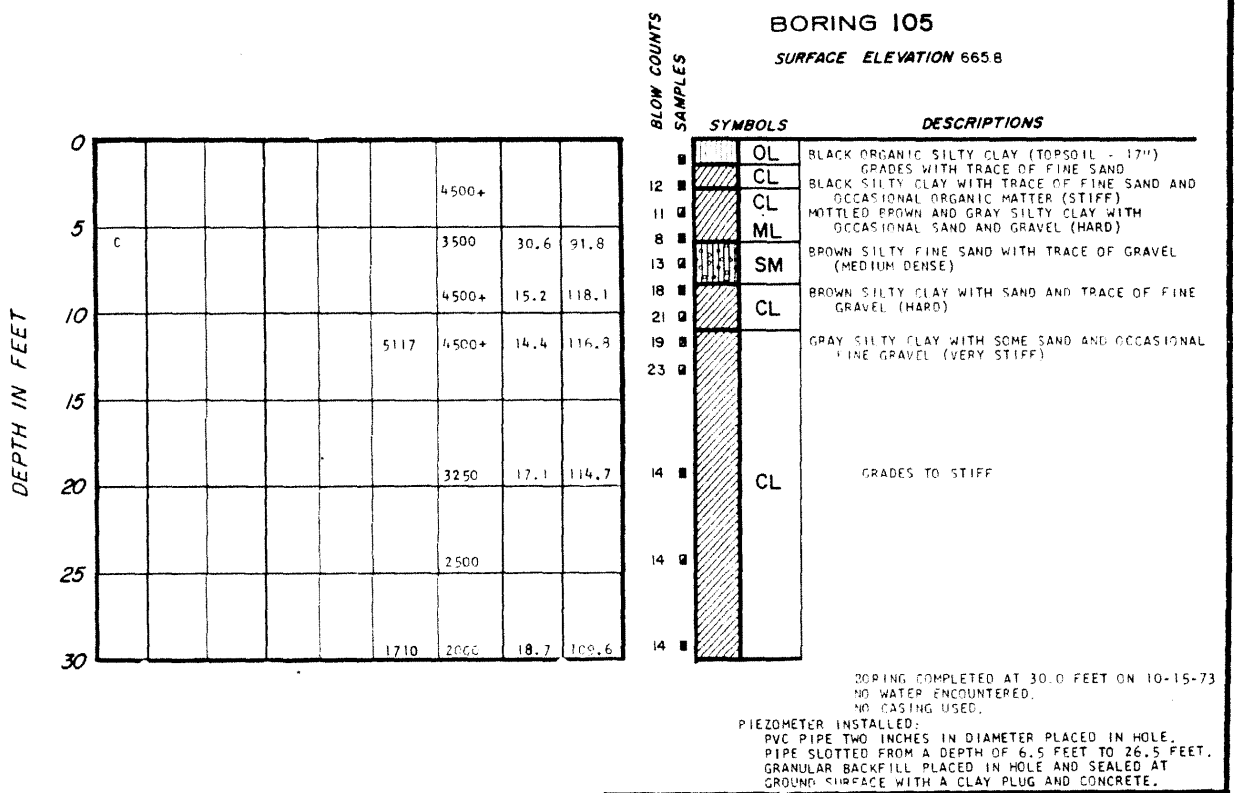
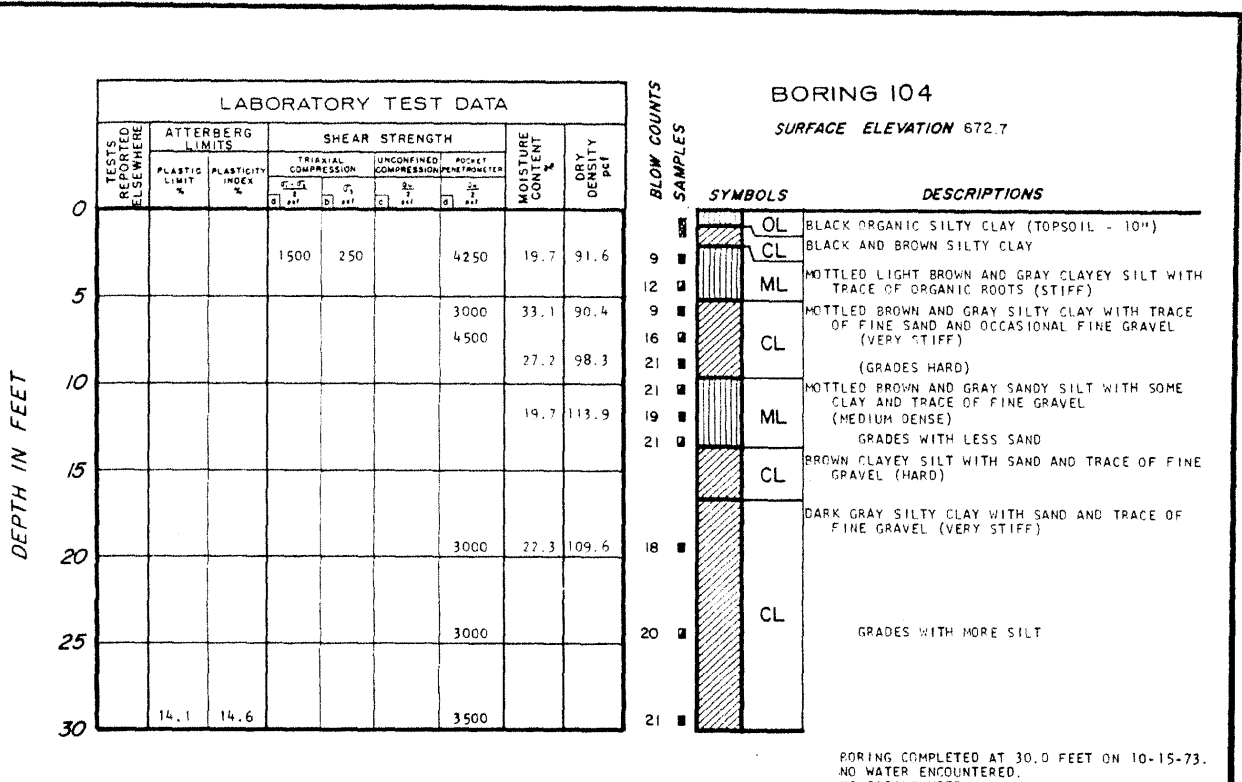

**LA SALLE COUNTY STATION**  
**UPDATED FINAL SAFETY ANALYSIS REPORT**

FIGURE 2.5-19  
 LOGS OF BORINGS  
 (SHEET 115)

REV. 0 - APRIL 1984

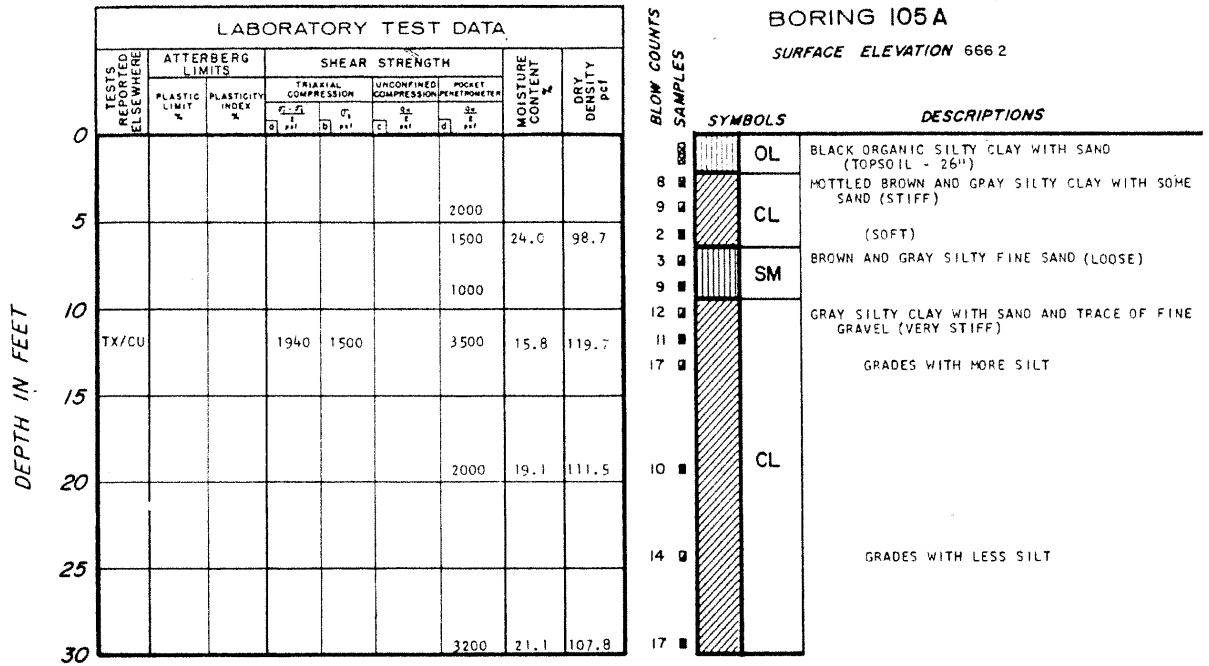

BORING COMPLETED AT 30.0 FEET ON 10-17-73.  
 WATER ENCOUNTERED AT 6.8 FEET.  
 NO CASING USED.

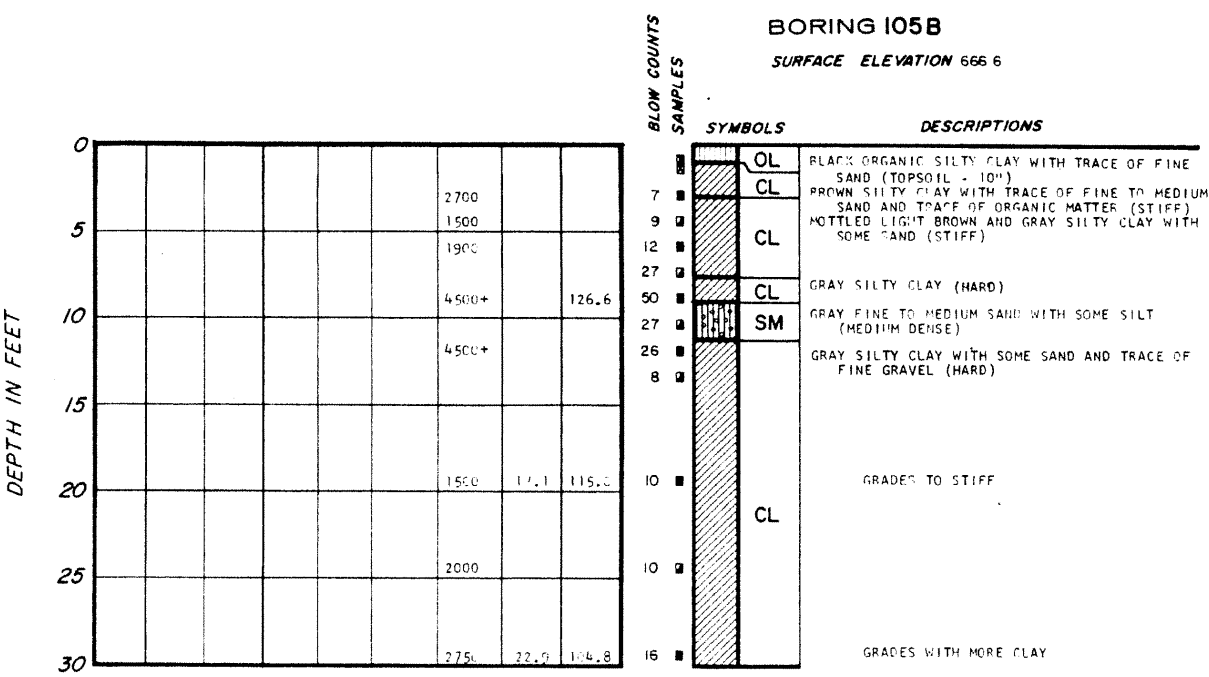

BORING COMPLETED AT 30.0 FEET ON 10-15-73.  
 NO WATER ENCOUNTERED.  
 NO CASING USED.

LA SALLE COUNTY STATION  
 UPDATED FINAL SAFETY ANALYSIS REPORT

FIGURE 2.5-19  
 LOGS OF BORINGS  
 (SHEET 116)

**LABORATORY TEST DATA**

TESTS RUN AT OR ELSEWHERE	ATTERBERG LIMITS		SHEAR STRENGTH				MOISTURE CONTENT %	DRY DENSITY pcf	
	PLASTIC LIMIT %	PLASTICITY INDEX %	TRIAxIAL COMPRESSION		UNCONFINED COMPRESSION	POCKET COMPRESSION			
			$\sigma_1$ T psi	$\sigma_3$ T psi					$\sigma_c$ T psi
							2000	29.6	87.8
							3500		
			1683	1000			2500	22.5	104.0
							4500+	28.0	93.6
							1500		
							4500+		
							4500+	14.0	120.6

DEPTH IN FEET

0  
5  
10  
15  
20  
25  
30

**BORING 106**  
SURFACE ELEVATION 674.1

BLOW COUNTS  
SAMPLES

BLOW COUNTS SAMPLES	SYMBOLS	DESCRIPTIONS
8	OL	BLACK ORGANIC SILTY CLAY WITH TRACE OF FINE SAND (TOPSOIL-18")
19	ML	LIGHT BROWN CLAYEY SILT WITH TRACE OF VERY FINE SAND (VERY STIFF)
27		MOTTLED LIGHT BROWN AND GRAY SILTY CLAY WITH SOME FINE SAND, OCCASIONAL FINE GRAVEL (VERY STIFF)
18	CL	GRADES BROWN, WITH LESS SILT AND SAND
17		
24		BROWNISH-GRAY CLAY WITH TRACE OF SILT (VERY STIFF)
15	CH	GRADES HARD
18		
	SC	GRAY CLAYEY SAND WITH OCCASIONAL FINE GRAVEL
19	SW	GRAYISH-BROWN FINE TO COARSE SAND WITH OCCASIONAL FINE GRAVEL, TRACE OF SILT
11	SP	GRAY LAMINATED FINE SAND AND SILT PARTINGS
	ML	
28		GRAY SILTY CLAY WITH SOME SAND, OCCASIONAL FINE GRAVEL (HARD)
28	CL	
31		GRADES WITH MORE SAND, SOME FINE GRAVEL
34		

BORING COMPLETED AT 28.0 FEET ON 2-11-74.  
WATER LEVEL AT 6.3 FEET ON 2-11-74.  
NO CASING USED.

DEPTH IN FEET

0  
5  
10  
15  
20  
25  
30

**BORING 107**  
SURFACE ELEVATION 668.9

BLOW COUNTS  
SAMPLES

BLOW COUNTS SAMPLES	SYMBOLS	DESCRIPTIONS
6	OL	BLACK ORGANIC SILTY CLAY WITH TRACE OF FINE SAND, ROOTS (TOPSOIL-20")
5	CL	MOTTLED BROWN AND GRAY SILTY CLAY WITH TRACE OF FINE SAND (VERY STIFF)
14	SC	LIGHT BROWN FINE TO MEDIUM SAND WITH CLAY, OCCASIONAL FINE GRAVEL
	SW	BROWN FINE TO COARSE SAND WITH SOME GRAVEL, TRACE OF SILT
19		BROWN CLAY WITH TRACE OF SILT, FINE SAND (HARD)
12	CH	GRADES GRAY AND BROWN
15		
15	SC	GRAY FINE TO COARSE SAND WITH FINE GRAVEL, SOME CLAY
12		GRAY SILTY CLAY WITH SOME SAND, TRACE OF FINE GRAVEL (VERY STIFF)
24		GRADES WITH LESS SILT AND SAND
18	CL	GRADES HARD
30		GRADES VERY STIFF
33		

BORING COMPLETED AT 30.0 FEET ON 2-12-74.  
WATER LEVEL AT 2.5 FEET ON 2-12-74.  
NO CASING USED.

**LA SALLE COUNTY STATION**  
**UPDATED FINAL SAFETY ANALYSIS REPORT**

FIGURE 2.5-19  
LOGS OF BORINGS  
(SHEET 117)

LABORATORY TEST DATA										
TESTS REPORTED ELSEWHERE	ATTERBERG LIMITS		SHEAR STRENGTH						MOISTURE CONTENT %	DRY DENSITY PCF
	PLASTIC LIMIT %	PLASTICITY INDEX %	TRIAxIAL COMPRESSION			UNCONFINED COMPRESSION		POCKET COMPRESSION		
			σ ₁ #1	σ ₃ #1	σ ₁ #2	σ ₃ #2	σ ₁ #3			
									2500	
									4500+	21.1 129.4
							1067	2000		11.0 129.4
										13.6 123.7
			2115						4500+	21.5 104.7
									4500+	
									4500+	

DEPTH IN FEET

**BORING 108**  
SURFACE ELEVATION 667.7

BLOW COUNTS SAMPLES

SYMBOLS	DESCRIPTIONS
OL	BLACK ORGANIC SILTY CLAY WITH TRACE OF FINE SAND; ROOTS (TOPSOIL - 26")
CL	MOTTLED BROWN AND GRAY SILTY CLAY WITH TRACE OF FINE SAND (VERY STIFF)
CL	LIGHT BROWN SILTY CLAY WITH SAND, SOME FINE TO MEDIUM GRAVEL (HARD) GRADES WITH SAND AND GRAVEL
CL	GRADES VERY STIFF
SM	ORANGE FINE TO COARSE SAND WITH GRAVEL, SILT, TRACE OF CLAY
CL	GRAY SILTY CLAY WITH SOME SAND, TRACE OF FINE GRAVEL, OCCASIONAL FINE SAND PARTING (HARD) GRADES WITH LESS SILT AND SAND
CL	GRADES WITH SILT, TRACE OF FINE SAND
CL	GRADES SILTY, WITH SOME SAND
SC	GRAY FINE TO COARSE SAND WITH GRAVEL, CLAY

BORING COMPLETED AT 30.0 FEET ON 2-12-74. WATER LEVEL AT 4.0 FEET ON 2-12-74. NO CASING USED.

TESTS REPORTED ELSEWHERE	ATTERBERG LIMITS		SHEAR STRENGTH						MOISTURE CONTENT %	DRY DENSITY PCF
	PLASTIC LIMIT %	PLASTICITY INDEX %	TRIAxIAL COMPRESSION			UNCONFINED COMPRESSION		POCKET COMPRESSION		
			σ ₁ #1	σ ₃ #1	σ ₁ #2	σ ₃ #2	σ ₁ #3			
									2000	
	15.2	7.1							4500	14.1 121.6
			4005	1500					2000	15.1 119.3
									3200	11.9 121.8
									3000	
									12223	4500+ 13.9 120.7
									2500	18.6 111.3

DEPTH IN FEET

**BORING 109**  
SURFACE ELEVATION 669.6

BLOW COUNTS SAMPLES

SYMBOLS	DESCRIPTIONS
OL	BLACK ORGANIC SILTY CLAY WITH FINE SAND, ROOTS (TOPSOIL-21")
CL	MOTTLED BROWN AND GRAY SILTY CLAY WITH TRACE OF FINE SAND (VERY STIFF)
CL	GRADES WITH OCCASIONAL FINE GRAVEL
CL	MOTTLED BROWN AND GRAY CLAY WITH TRACE OF SILT, FINE SAND (VERY STIFF)
CL	BROWN SILTY CLAY WITH SOME SAND, OCCASIONAL FINE GRAVEL (HARD)
CL	GRADES VERY STIFF, WITH SOME FINE TO MEDIUM GRAVEL
CL	GRADES WITH GRAY
CL	GRAY SILTY CLAY WITH SOME SAND, FINE GRAVEL (VERY STIFF)
CL	GRADES WITH LESS SILT AND SAND
CL	GRADES HARD
CL	GRADES VERY STIFF

BORING COMPLETED AT 30.0 FEET ON 2-12-74. NO WATER ENCOUNTERED. NO CASING USED.

**LA SALLE COUNTY STATION**  
UPDATED FINAL SAFETY ANALYSIS REPORT

FIGURE 2.5-19  
LOGS OF BORINGS  
(SHEET 118)

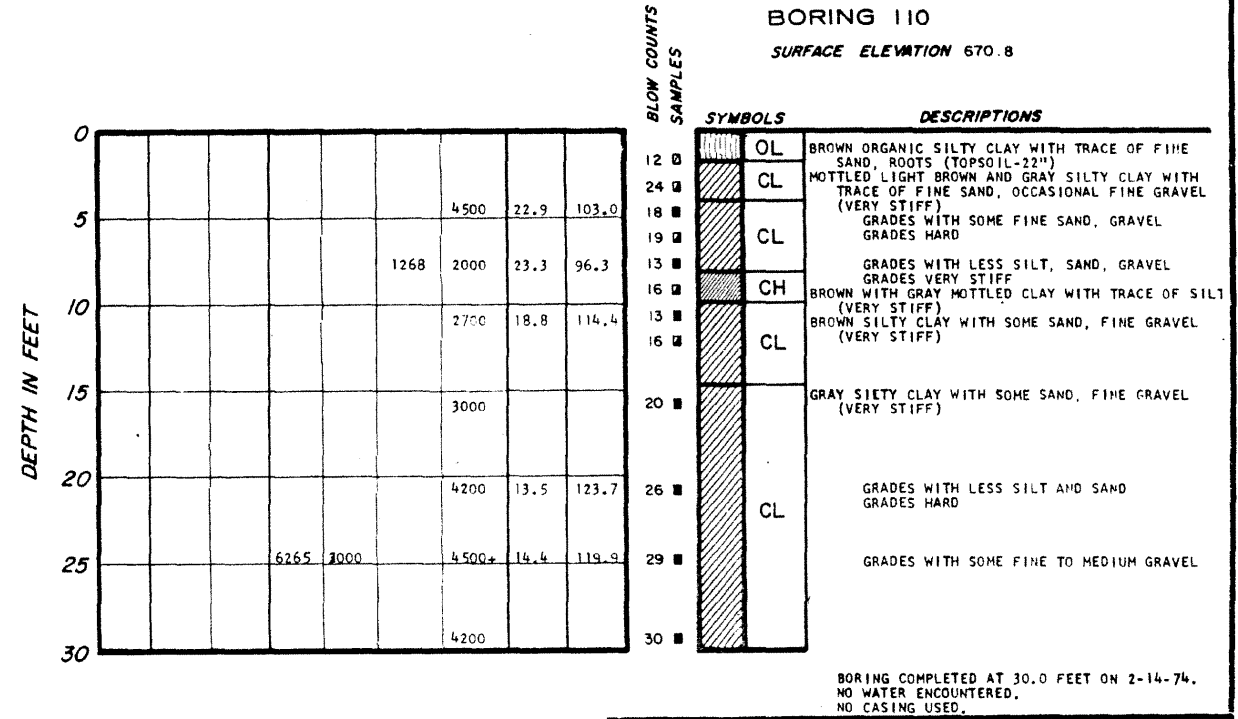
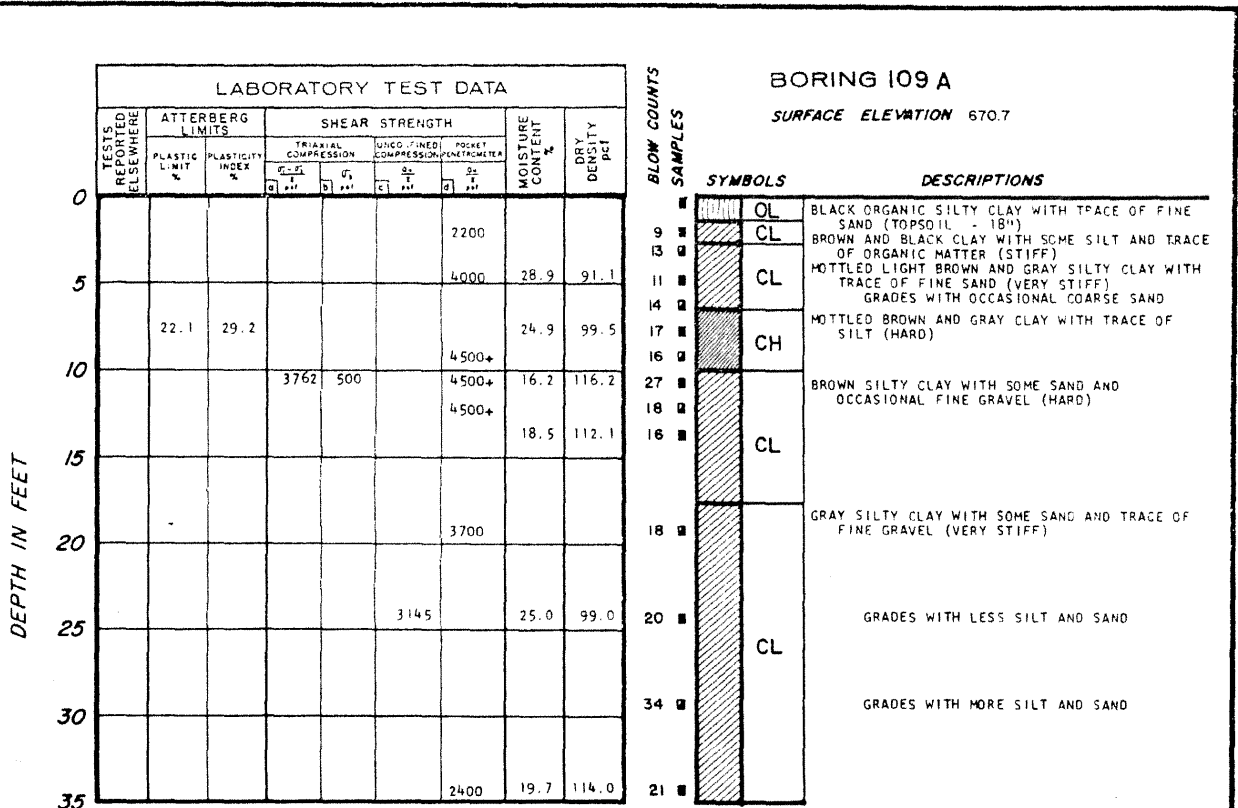

**LA SALLE COUNTY STATION**  
 UPDATED FINAL SAFETY ANALYSIS REPORT

FIGURE 2.5-19  
 LOGS OF BORINGS  
 (SHEET 119)

REV. 0 - APRIL 1984

LABORATORY TEST DATA									
TESTS REPORTED ELSEWHERE	ATTERBERG LIMITS		SHEAR STRENGTH					MOISTURE CONTENT %	DRY DENSITY PCF
	PLASTIC LIMIT %	PLASTICITY INDEX %	TRIAxIAL COMPRESSION		UNCONFINED COMPRESSION	POCKET METROMETER			
			σ ₁ (PSI)	σ ₃ (PSI)			σ ₁ (PSI)		
							1500		
							4250	27.2	94.9
	24.7	24.0							
c							4000	26.3	98.0
							4000	15.8	119.7
							4500+		

DEPTH IN FEET

0  
5  
10  
15  
20  
25  
30

**BORING 111**  
SURFACE ELEVATION 671.8

BLOW COUNTS SAMPLES

SYMBOLS	DESCRIPTIONS
OL	BLACK ORGANIC SILTY CLAY WITH TRACE OF FINE SAND, ROOTS (TOPSOIL-18")
CL	LIGHT BROWN CLAY WITH SOME SILT, TRACE OF FINE SAND, ORGANICS (STIFF)
CL	MOTTLED BROWN AND GRAY SILTY CLAY WITH TRACE OF FINE SAND, OCCASIONAL FINE GRAVEL (HARD)
CH	BROWN WITH GRAY MOTTLED CLAY WITH TRACE OF SILT (HARD)
ML	DARK BROWN AND GRAY FINE TO MEDIUM SANDY SILT WITH SOME FINE GRAVEL, TRACE OF CLAY, OCCASIONAL SAND PARTINGS
CL	4" SEAM OF COARSE SAND AND FINE GRAVEL GRAY SILTY CLAY WITH FINE TO MEDIUM SAND, TRACE OF FINE GRAVEL (VERY STIFF)
CL	GRADES HARD WITH OCCASIONAL FINE TO COARSE SAND SEAMS GRADES WITH SOME FINE SAND, LESS SILT

BORING COMPLETED AT 27.0 FEET ON 2-15-74.  
WATER LEVEL AT 15.0 FEET ON 2-15-74.  
NO CASING USED.

LABORATORY TEST DATA										
TESTS REPORTED ELSEWHERE	ATTERBERG LIMITS		SHEAR STRENGTH					MOISTURE CONTENT %	DRY DENSITY PCF	
	PLASTIC LIMIT %	PLASTICITY INDEX %	TRIAxIAL COMPRESSION		UNCONFINED COMPRESSION	POCKET METROMETER				
			σ ₁ (PSI)	σ ₃ (PSI)			σ ₁ (PSI)			σ ₃ (PSI)
							23.5		93.8	
							4500+	18.7	114.3	
	23.5	29.9					4500+	27.5	97.4	
							2500	27.5	96.7	
							2770	4500+	27.4	96.2
							4000	12.8	124.8	

DEPTH IN FEET

0  
5  
10  
15  
20  
25  
30

**BORING 112**  
SURFACE ELEVATION 677.6

BLOW COUNTS SAMPLES

SYMBOLS	DESCRIPTIONS
OL	BLACK ORGANIC CLAYEY SILT (TOPSOIL)
CL	BLACKISH-BROWN CLAYEY SILT WITH TRACE OF FINE SAND
CL	MOTTLED BROWN SILTY CLAY WITH TRACE OF SAND AND OCCASIONAL FINE GRAVEL (HARD)
ML	LIGHT BROWN CLAYEY SILT WITH TRACE OF GRAVEL (HARD)
CH	MOTTLED BROWN CLAY WITH TRACE OF SAND (VERY STIFF)
CH	
CL	GRAY SILTY CLAY WITH TRACE OF SAND AND FINE GRAVEL (HARD)
CL	

BORING COMPLETED AT 30.0 FEET ON 11-5-73.  
NO WATER ENCOUNTERED.  
NO CASING USED.

**LA SALLE COUNTY STATION**  
UPDATED FINAL SAFETY ANALYSIS REPORT

FIGURE 2.5-19  
LOGS OF BORINGS  
(SHEET 120)

**LABORATORY TEST DATA**

DEPTH IN FEET	TESTS REPORTED ELSEWHERE	ATTERBERG LIMITS		SHEAR STRENGTH						MOISTURE CONTENT %	DRY DENSITY pcf	
		PLASTIC LIMIT %	PLASTICITY INDEX %	TRIAxIAL COMPRESSION			UNCONFINED COMPRESSION		POCKET PENETROMETER			
				σ ₁ pcf	σ ₃ pcf	σ ₂ pcf	q _u pcf	q _v pcf				
0										2250		
5							287			2250	21.5	101.7
10	TX/CU			2149	1500					4500+	23.5	104.6
25										4500+	12.9	126.4
30										4500+	16.0	117.0

**BORING 113**  
SURFACE ELEVATION 679.1

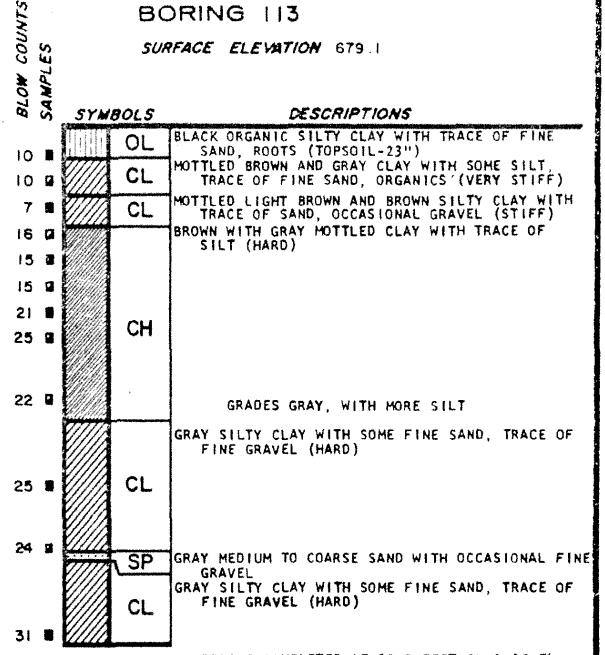

BORING COMPLETED AT 30.0 FEET ON 2-15-74.  
WATER LEVEL AT 18.1 FEET ON 2-15-74.  
NO CASING USED.

DEPTH IN FEET	TESTS REPORTED ELSEWHERE	ATTERBERG LIMITS		SHEAR STRENGTH						MOISTURE CONTENT %	DRY DENSITY pcf	
		PLASTIC LIMIT %	PLASTICITY INDEX %	TRIAxIAL COMPRESSION			UNCONFINED COMPRESSION		POCKET PENETROMETER			
				σ ₁ pcf	σ ₃ pcf	σ ₂ pcf	q _u pcf	q _v pcf				
0										2000		
5	PERM									500		
10							900			2500	24.0	102.9
15										4500+	25.1	102.2
20												
25		14.4	7.7	2889	2000					4000	14.1	121.4
30												

**BORING 114**  
SURFACE ELEVATION 674.7

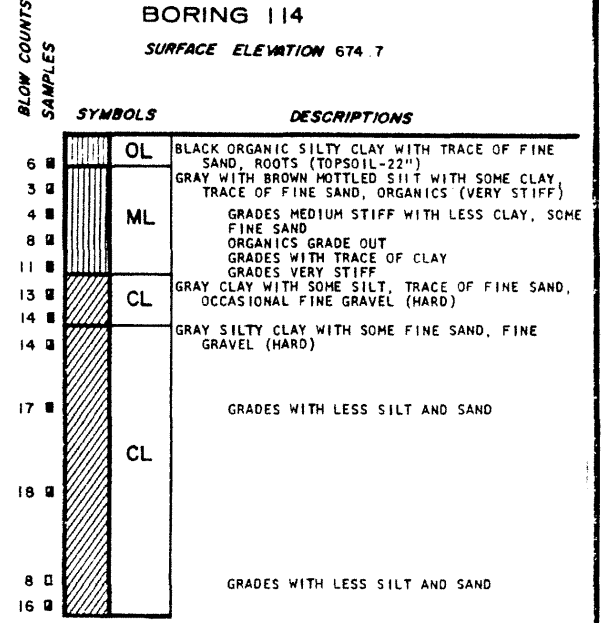

BORING COMPLETED AT 28.0 FEET ON 2-15-74.  
WATER LEVEL AT 6.0 FEET ON 2-15-74.  
NO CASING USED.

**LA SALLE COUNTY STATION**  
UPDATED FINAL SAFETY ANALYSIS REPORT

FIGURE 2.5-19  
LOGS OF BORINGS  
(SHEET 121)



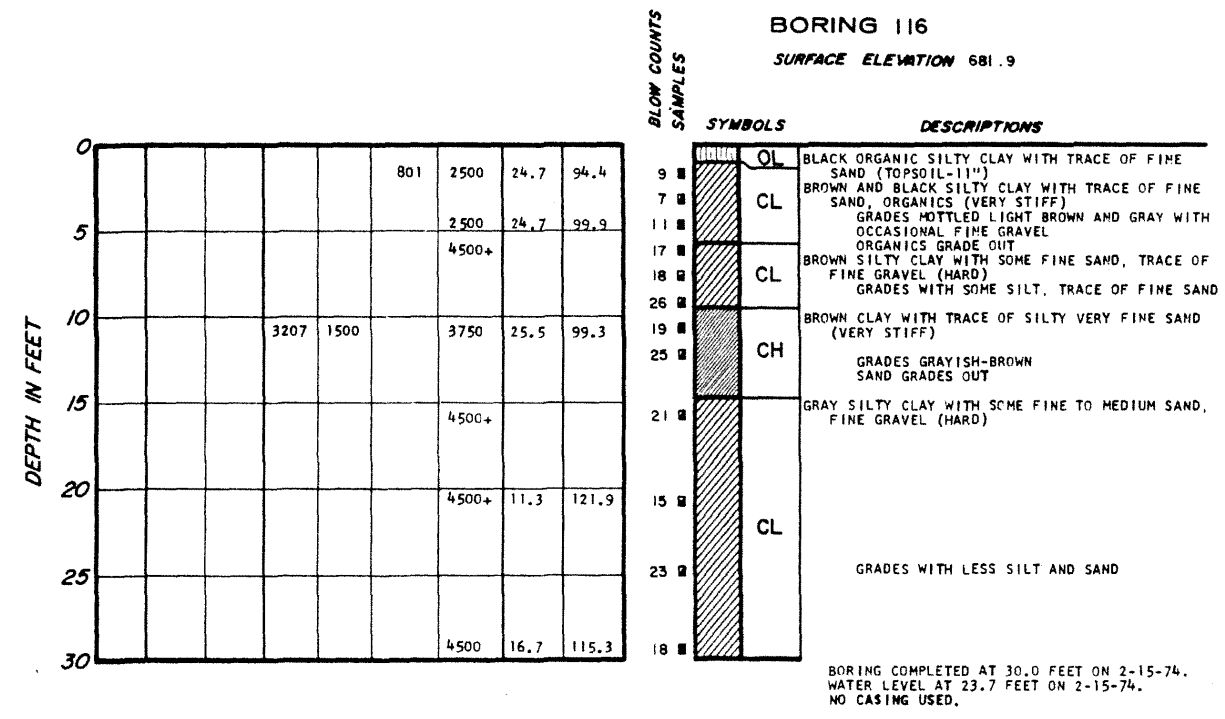
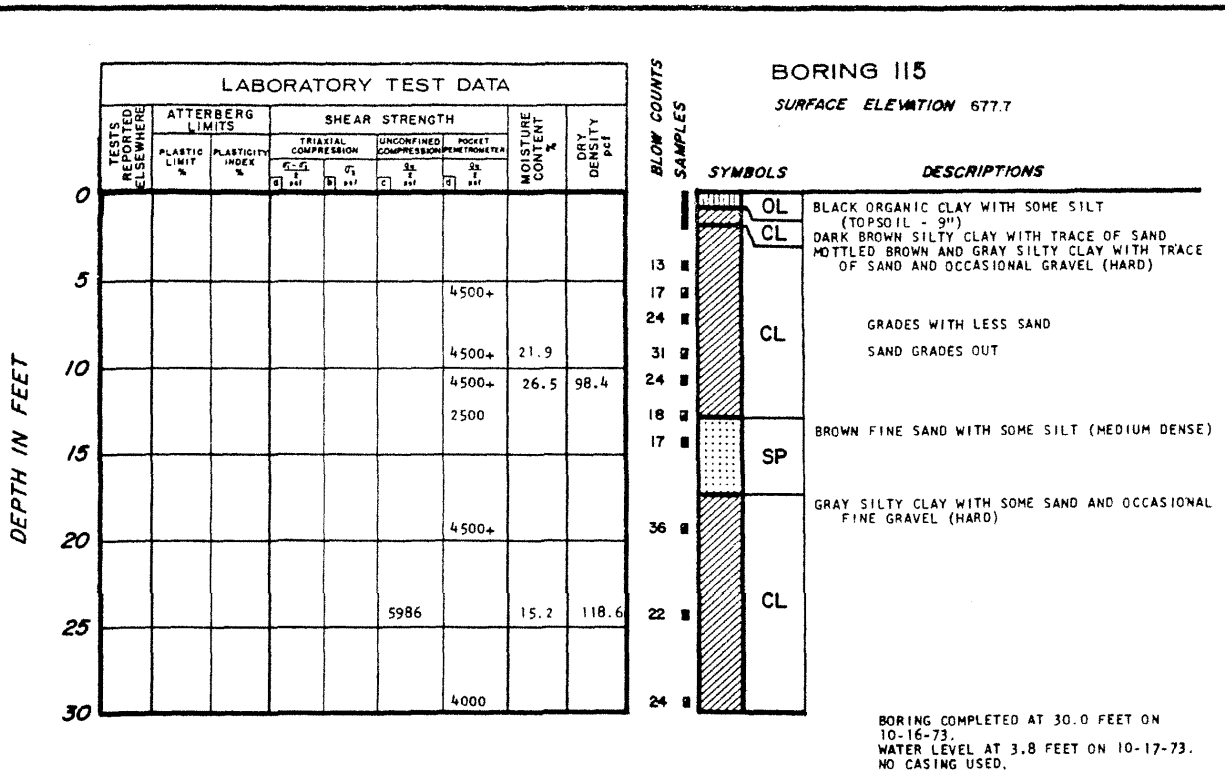

**LA SALLE COUNTY STATION**  
UPDATED FINAL SAFETY ANALYSIS REPORT

FIGURE 2.5-19  
LOGS OF BORINGS  
(SHEET 122)

DEPTH IN FEET	LABORATORY TEST DATA									
	TESTS REPORTED ELSEWHERE	ATTERBERG LIMITS		SHEAR STRENGTH					MOISTURE CONTENT %	DRY DENSITY pcf
		PLASTIC LIMIT %	PLASTICITY INDEX %	TRIAxIAL COMPRESSION		UNCONFINED COMPRESSION	POCKET PENETROMETER			
				q ₁ pcf	q ₂ pcf			q _u pcf		
0										
5			6734	500			4500+	18.6	107.7	
10							4500+	19.9	108.1	
15								21.0	107.7	
20										
25										
30										

**BORING I17**  
SURFACE ELEVATION 682.9

BLOW COUNTS SAMPLES	SYMBOLS	DESCRIPTIONS
0-12"	OL	BLACK ORGANIC SILTY CLAY WITH TRACE OF FINE SAND (TOPSOIL - 12")
12-16"	CL	BLACKISH-BROWN SILTY CLAY WITH TRACE OF FINE SAND AND TRACE OF ORGANIC MATTER (MEDIUM STIFF)
16-24"	CL	LIGHT BROWN SILTY CLAY WITH SAND AND TRACE OF FINE GRAVEL (HARD) GRADES WITH LESS SAND
24-31"	CL	
31-33"	SW	BROWN SAND WITH SOME FINE GRAVEL AND TRACE OF SILT (VERY LOOSE)
33-14'	ML	GRAYISH-BROWN SILT WITH TRACE OF FINE SAND AND FINE GRAVEL GRADES WITH MORE SAND
14'-13'	ML	OCCASIONAL 2" BROWN SAND LENSES
13'-26'	CL	GRAY SILTY CLAY WITH SAND AND TRACE OF FINE GRAVEL (VERY STIFF)
26'-23'	CL	
23'-22'	CL	

BORING COMPLETED AT 30.0 FEET ON 11-5-73.  
WATER ENCOUNTERED AT 11.0 FEET  
NO CASING USED.

DEPTH IN FEET	LABORATORY TEST DATA									
	TESTS REPORTED ELSEWHERE	ATTERBERG LIMITS		SHEAR STRENGTH					MOISTURE CONTENT %	DRY DENSITY pcf
		PLASTIC LIMIT %	PLASTICITY INDEX %	TRIAxIAL COMPRESSION		UNCONFINED COMPRESSION	POCKET PENETROMETER			
				q ₁ pcf	q ₂ pcf			q _u pcf		
0								29.7	92.0	
5		19.4	15.8					20.4	20.9	106.9
10								27.3	103.2	
15						3455	4000	15.5	110.3	
20							3000			
25										
30							3500			

**BORING I18**  
SURFACE ELEVATION 684.7

BLOW COUNTS SAMPLES	SYMBOLS	DESCRIPTIONS
0-7"	OL	BLACK ORGANIC SILTY CLAY (TOPSOIL - 20")
7-17"	CL	MOTTLED GRAYISH-BROWN SILTY CLAY (STIFF)
17-21"	CL	BROWN SILTY CLAY WITH TRACE OF FINE SAND AND OCCASIONAL FINE GRAVEL (HARD)
21-36"	CL	GRADES WITH LESS SAND
36-13'	CL	MOTTLED GRAY AND BROWN CLAY WITH SOME SILT (VERY STIFF)
13'-25'	CH	
25'-11'	CH	
11'-18'	CL	GRAY SILTY CLAY WITH SOME SAND AND TRACE OF FINE GRAVEL (VERY STIFF)
18'-23'	SM	GRAY SILTY SAND WITH OCCASIONAL FINE GRAVEL (MEDIUM DENSE)
23'-20'	CL	GRAY SILTY CLAY WITH SOME SAND AND TRACE OF FINE GRAVEL (VERY STIFF)

BORING COMPLETED AT 30.0 FEET ON 10-17-73.  
WATER ENCOUNTERED AT 5.3 FEET.  
NO CASING USED.

**LA SALLE COUNTY STATION**  
UPDATED FINAL SAFETY ANALYSIS REPORT

FIGURE 2.5-19  
LOGS OF BORINGS  
(SHEET 123)

LABORATORY TEST DATA									
TESTS RUN ELSEWHERE	ATTERBERG LIMITS		SHEAR STRENGTH				MOISTURE CONTENT %	DRY DENSITY PCT	
	PLASTIC LIMIT %	PLASTICITY INDEX %	TRIAxIAL COMPRESSION		UNCONFINED COMPRESSION	POCKET PENETROMETER			
			σ ₁ PSI	σ ₃ PSI	q _u PSI	SP PSI			
			1980	250		2500	24.3	91.3	
						3500			
						5856	4500+	21.2	105.7
						4500+			
						4500+			
						4500+	12.8	124.4	
						4500+			
						4500+	14.9	121.0	

DEPTH IN FEET

**BORING I19**  
SURFACE ELEVATION 686.5

BLOW COUNTS  
SAMPLES

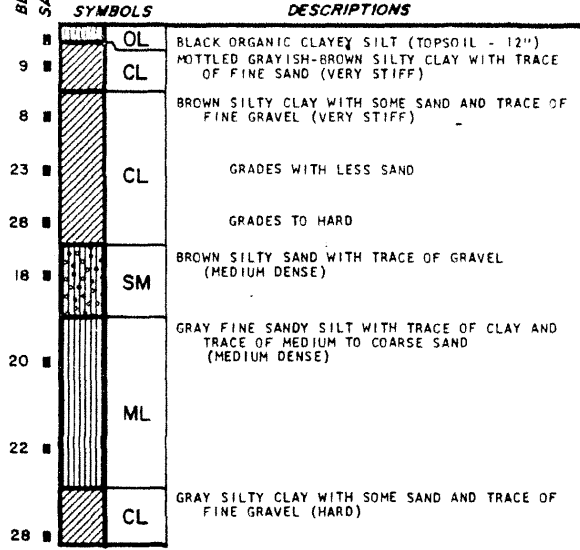

BORING COMPLETED AT 30.0 FEET ON 10-30-73.  
WATER LEVEL AT 27.0 FEET ON 10-30-73.  
NO CASING USED.

						3250	25.0	94.4	
						4500+	18.0	110.4	
						3000			
						2716	4500+	22.5	102.0
						3000			

DEPTH IN FEET

**BORING I20**  
SURFACE ELEVATION 688.6

BLOW COUNTS  
SAMPLES

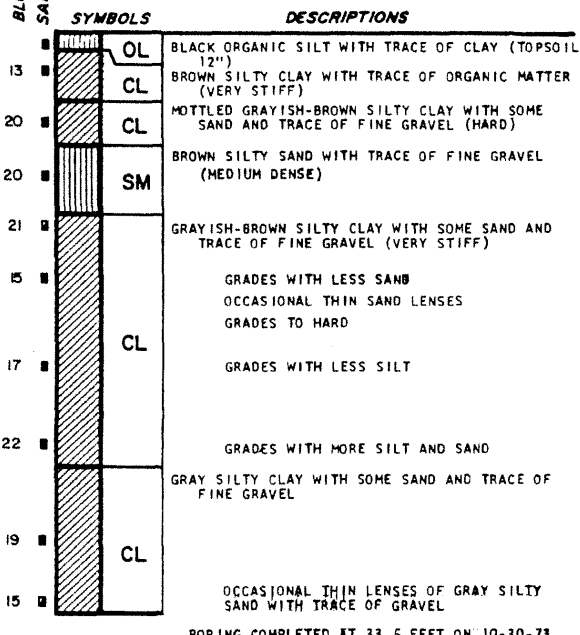

BORING COMPLETED AT 33.5 FEET ON 10-30-73.  
WATER ENCOUNTERED AT 12.0 FEET.  
NO CASING USED.

PIEZOMETER INSTALLED:  
PVC PIPE TWO INCHES IN DIAMETER PLACED IN HOLE.  
PIPE SLOTTED FROM A DEPTH OF 1.0 FEET TO 21.0 FEET.  
GRANULAR BACKFILL PLACED IN HOLE AND SEALED AT  
GROUND SURFACE WITH A CLAY PLUG AND CONCRETE.

**LA SALLE COUNTY STATION**  
**UPDATED FINAL SAFETY ANALYSIS REPORT**

FIGURE 2.5-19  
LOGS OF BORINGS  
(SHEET 124)

LABORATORY TEST DATA									
TESTS REPORTED ELSEWHERE	ATTERBERG LIMITS		SHEAR STRENGTH					MOISTURE CONTENT %	DRY DENSITY PCF
	PLASTICITY LIMIT %	PLASTICITY INDEX %	TRIAxIAL COMPRESSION		UNCONFINED COMPRESSION	POCKET PENETROMETER			
			$\sigma_1$ (PSI)	$\sigma_3$ (PSI)			$\sigma_c$ (PSI)		
								28.7	93.5
							1750	40.8	81.2
	21.3	20.8					4500+		
			3150	750			4500+	26.7	96.8
								29.3	94.0
							4500+		
								17.5	114.8
								3750	

DEPTH IN FEET

**BORING I21**  
SURFACE ELEVATION 689.0

BLOW COUNTS SAMPLES

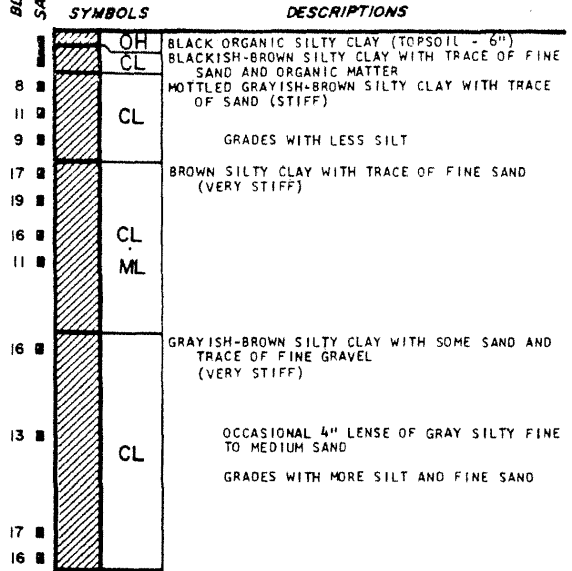

BORING COMPLETED AT 31.0 FEET ON 10-17-73.  
WATER LEVEL AT 15.0 FEET ON 10-17-73.  
NO CASING USED.

								2250	24.2	96.2
								4250	20.4	107.1
								4500+	19.4	109.2
								4500+		
								4500+	23.7	102.5
								3000	26.7	96.7
								4500	11.8	123.4

DEPTH IN FEET

**BORING I22**  
SURFACE ELEVATION 692.0

BLOW COUNTS SAMPLES

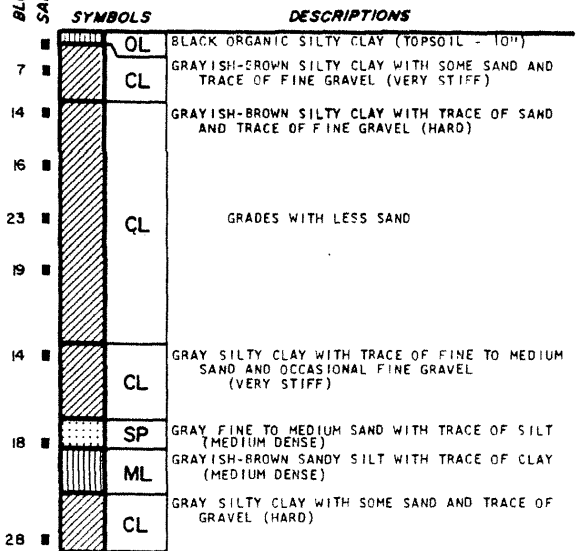

BORING COMPLETED AT 30.0 FEET ON 10-29-73.  
WATER ENCOUNTERED AT 24.0 FEET.  
NO CASING USED.

**LA SALLE COUNTY STATION**  
UPDATED FINAL SAFETY ANALYSIS REPORT

FIGURE 2.5-19  
LOGS OF BORINGS  
(SHEET 125)

LABORATORY TEST DATA									
TESTS REPORTED ELSEWHERE	ATTERBERG LIMITS		SHEAR STRENGTH				MOISTURE CONTENT %	DRY DENSITY PCF	
	PLASTIC LIMIT %	PLASTICITY INDEX %	TRIAxIAL COMPRESSION		UNCONFINED COMPRESSION	POCKET PENETROMETER			
			$\sigma_1$ (pcf)	$\sigma_3$ (pcf)	$q_u$ (pcf)	$q_p$ (pcf)			
					6424	4500+	16.6	110.6	
						4500+	17.7	112.4	
						4500+			
						4500+	21.9	101.6	
						4500			
			2430	3000		4500+	12.9	119.1	
						4500+			

DEPTH IN FEET

**BORING 123**  
SURFACE ELEVATION 696.9

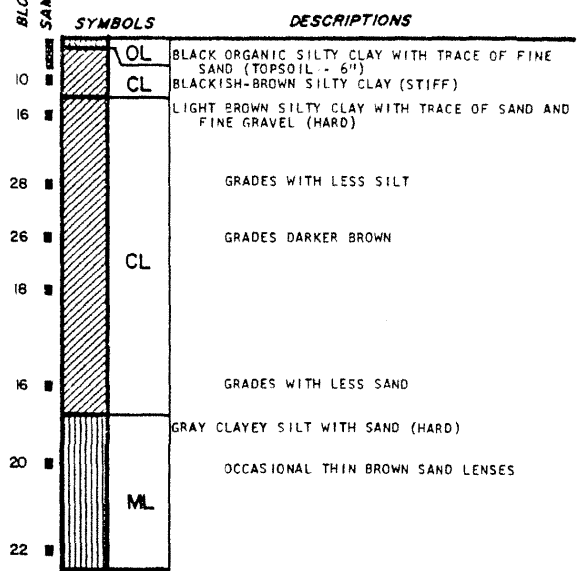

BORING COMPLETED AT 30.5 FEET ON 10-29-73.  
WATER LEVEL AT 27.5 FEET ON 10-29-73.  
NO CASING USED.

LABORATORY TEST DATA									
TESTS REPORTED ELSEWHERE	ATTERBERG LIMITS		SHEAR STRENGTH				MOISTURE CONTENT %	DRY DENSITY PCF	
	PLASTIC LIMIT %	PLASTICITY INDEX %	TRIAxIAL COMPRESSION		UNCONFINED COMPRESSION	POCKET PENETROMETER			
			$\sigma_1$ (pcf)	$\sigma_3$ (pcf)	$q_u$ (pcf)	$q_p$ (pcf)			
							27.5	83.1	
						4500+	19.4	111.0	
						4500+			
							17.6	113.6	
							18.7	107.4	
						4250			
	12.2	4.3					13.7	124.1	
					5814		12.2	125.9	

DEPTH IN FEET

**BORING 124**  
SURFACE ELEVATION 696.8

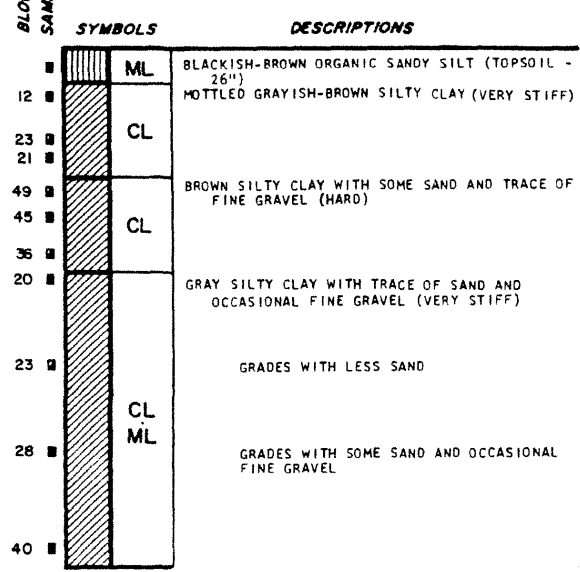

BORING COMPLETED AT 30.0 FEET ON 10-18-73.  
WATER ENCOUNTERED AT 20.0 FEET.  
NO CASING USED.

**LA SALLE COUNTY STATION**  
UPDATED FINAL SAFETY ANALYSIS REPORT

FIGURE 2.5-19  
LOGS OF BORINGS  
(SHEET 126)

DEPTH IN FEET	LABORATORY TEST DATA									
	TESTS REPORTED ELSEWHERE	ATTERBERG LIMITS		SHEAR STRENGTH				MOISTURE CONTENT %	DRY DENSITY PCF	
		PLASTIC LIMIT %	PLASTICITY INDEX %	TRIAxIAL COMPRESSION		UNCONFINED COMPRESSION				
				$\sigma_1$ (k)	$\sigma_3$ (k)	$\sigma_1$ (k)	$\sigma_3$ (k)			
0								4400	22.5	100.7
5								3500	20.0	107.3
10								4500+		
15								4500+	17.3	114.5
20										
25										
30									19.1	111.9

**BORING 125**  
SURFACE ELEVATION 684.7

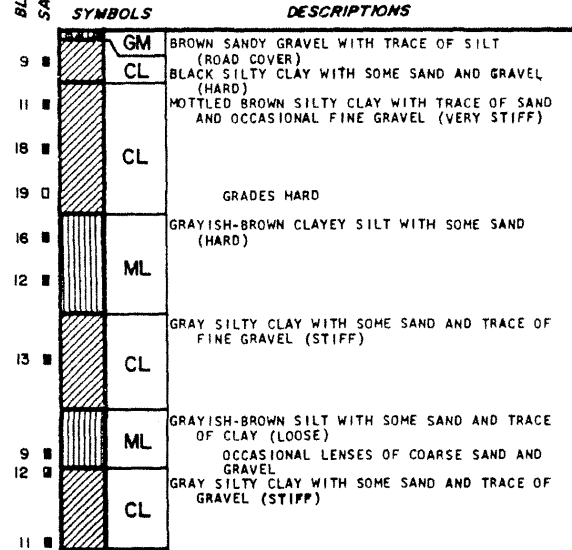

BORING COMPLETED AT 30.0 FEET ON 11-6-73. WATER ENCOUNTERED AT 17.5 FEET. NO CASING USED.

DEPTH IN FEET	LABORATORY TEST DATA									
	TESTS REPORTED ELSEWHERE	ATTERBERG LIMITS		SHEAR STRENGTH				MOISTURE CONTENT %	DRY DENSITY PCF	
		PLASTIC LIMIT %	PLASTICITY INDEX %	TRIAxIAL COMPRESSION		UNCONFINED COMPRESSION				
				$\sigma_1$ (k)	$\sigma_3$ (k)	$\sigma_1$ (k)	$\sigma_3$ (k)			
0								2600	27.5	91.9
5								3200	22.3	105.2
10								4500+		
15	TX/CU		2162	1500				3800	21.6	101.9
20								3250		
25								2500	18.6	111.2
30										

**BORING 126**  
SURFACE ELEVATION 676.6

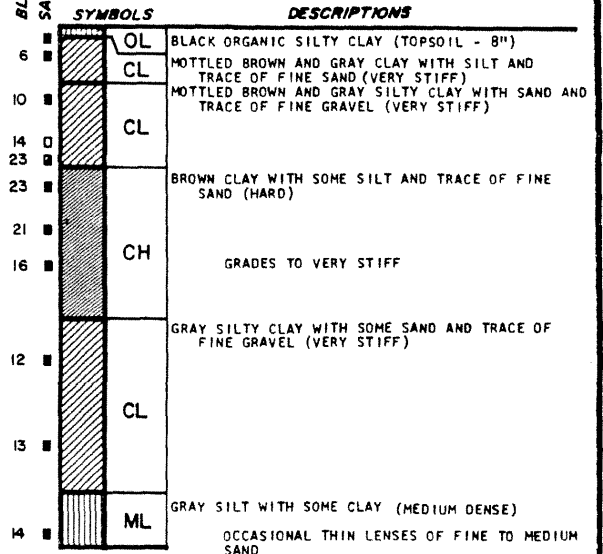

BORING COMPLETED AT 30.0 FEET ON 10-27-73. WATER LEVEL AT 29.0 FEET ON 10-27-73. NO CASING USED.

LA SALLE COUNTY STATION  
UPDATED FINAL SAFETY ANALYSIS REPORT

FIGURE 2.5-19  
LOGS OF BORINGS  
(SHEET 127)

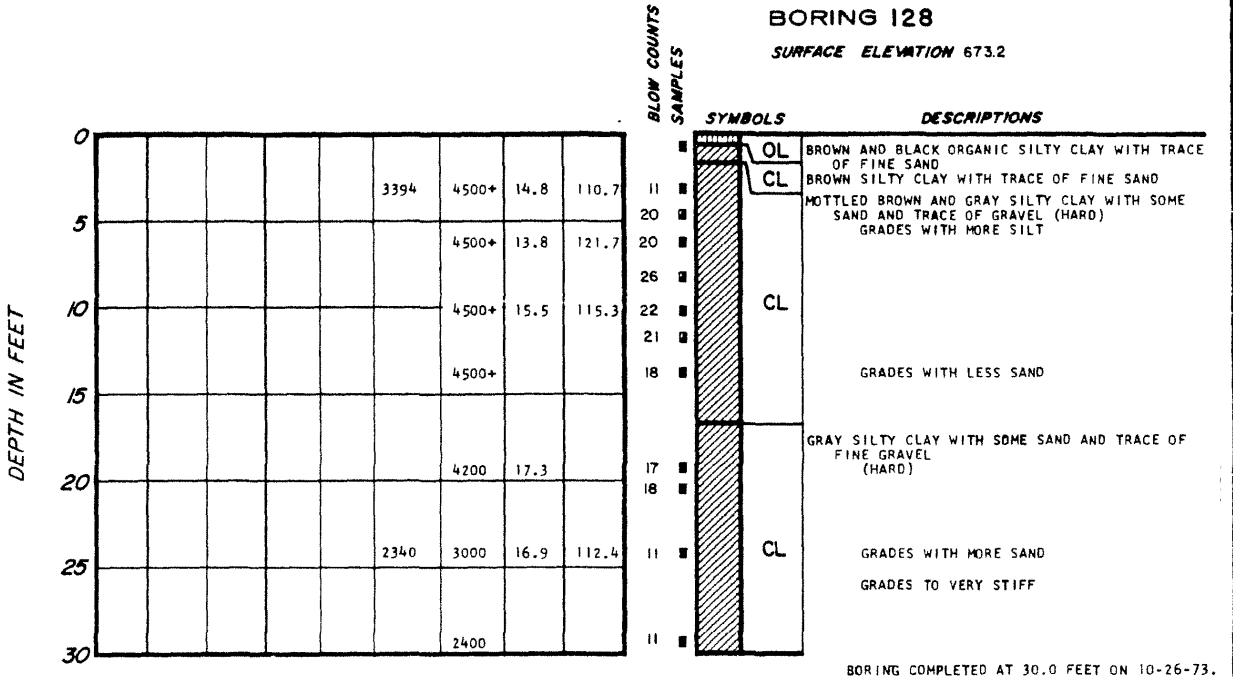
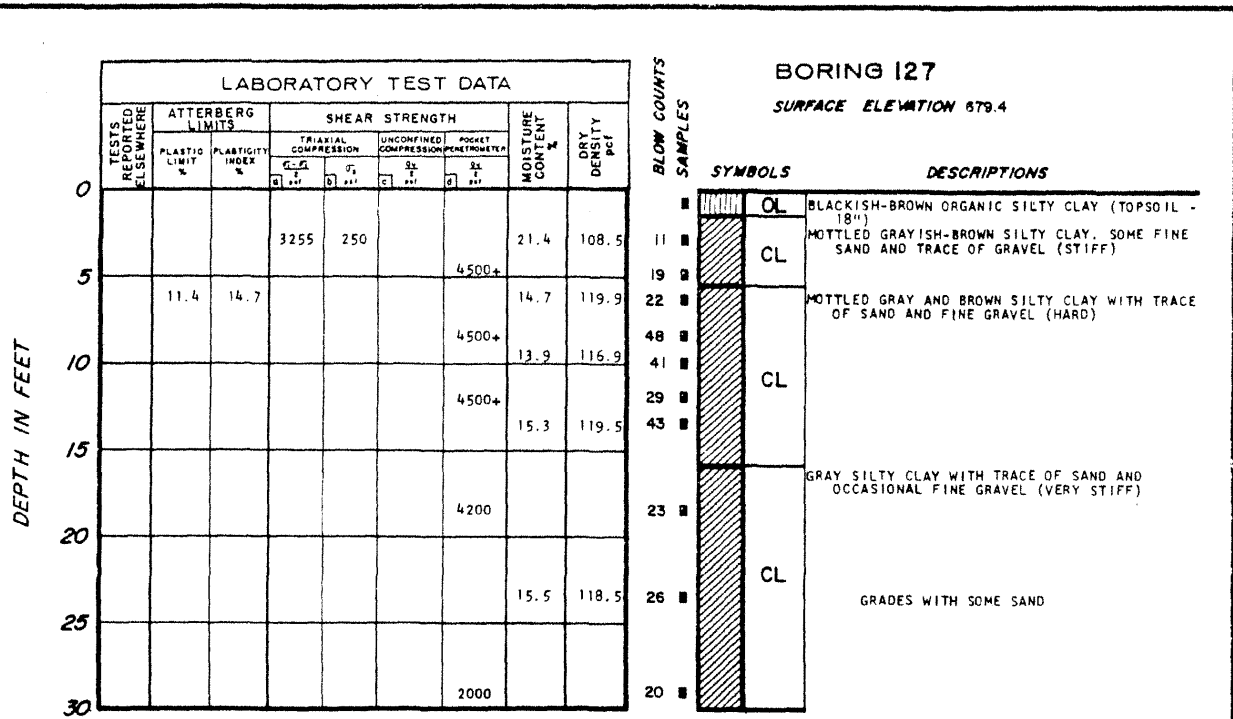

**LA SALLE COUNTY STATION**  
 UPDATED FINAL SAFETY ANALYSIS REPORT

FIGURE 2.5-19  
 LOGS OF BORINGS  
 (SHEET 128)

LABORATORY TEST DATA										
TESTS REPORTED ELSEWHERE	ATTERBERG LIMITS		SHEAR STRENGTH				MOISTURE CONTENT %	SHRINKAGE %	DETERMINED BY	DATE
	PLASTIC LIMIT %	PLASTICITY INDEX %	TRIAxIAL COMPRESSION		UNCONFINED COMPRESSION	POCKET PENETROMETER				
			$\sigma_1$ x 100	$\sigma_3$ x 100						
							4500+	16.9	104.7	
							4500+	17.0	111.7	
							4500+	21.0	106.0	
							4500+	21.0	103.0	
							2000			
							3500			
							3500	24.1	99.4	
								17.4	112.9	

DEPTH IN FEET

**BORING I29**  
SURFACE ELEVATION 674.8

BLOW COUNTS SAMPLES

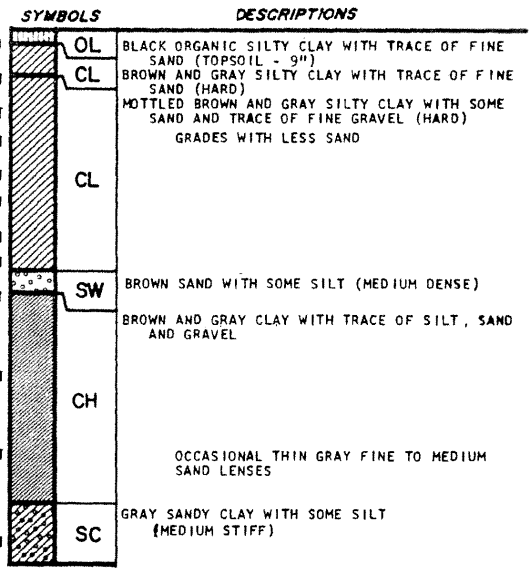

BORING COMPLETED AT 30.5 FEET ON 10-26-73.  
WATER LEVEL AT 14.0 FEET ON 10-26-73.  
NO CASING USED.  
PIEZOMETER INSTALLED:  
PVC PIPE TWO INCHES IN DIAMETER PLACED IN HOLE.  
PIPE SLOTTED FROM A DEPTH OF 7.0 FEET TO 27.0 FEET.  
GRANULAR BACKFILL PLACED IN HOLE AND SEALED AT GROUND SURFACE WITH A CLAY FLUG AND CONCRETE.

**BORING I30**  
SURFACE ELEVATION 668.3

BLOW COUNTS SAMPLES

								10.9	120.0
							4500+		
							4950	14.0	120.3
							4500+		
								15.8	117.9
							4000		
								19.8	113.6

DEPTH IN FEET

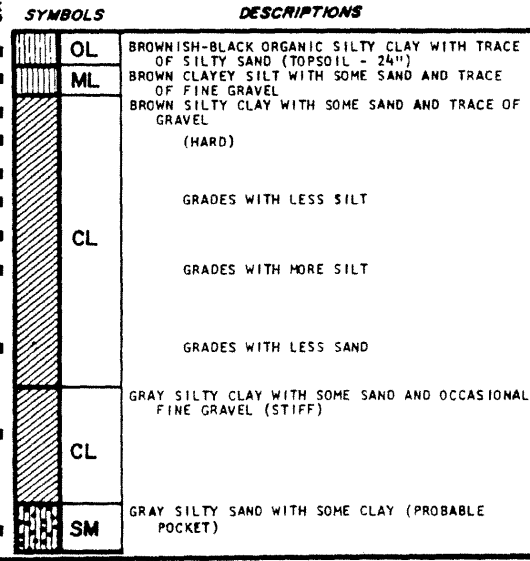

BORING COMPLETED TO 30.0 FEET ON 10-19-73  
WATER ENCOUNTERED AT 19.0 FEET.  
NO CASING USED.

**LA SALLE COUNTY STATION**  
UPDATED FINAL SAFETY ANALYSIS REPORT

FIGURE 2.5-19  
LOGS OF BORINGS  
(SHEET 129)



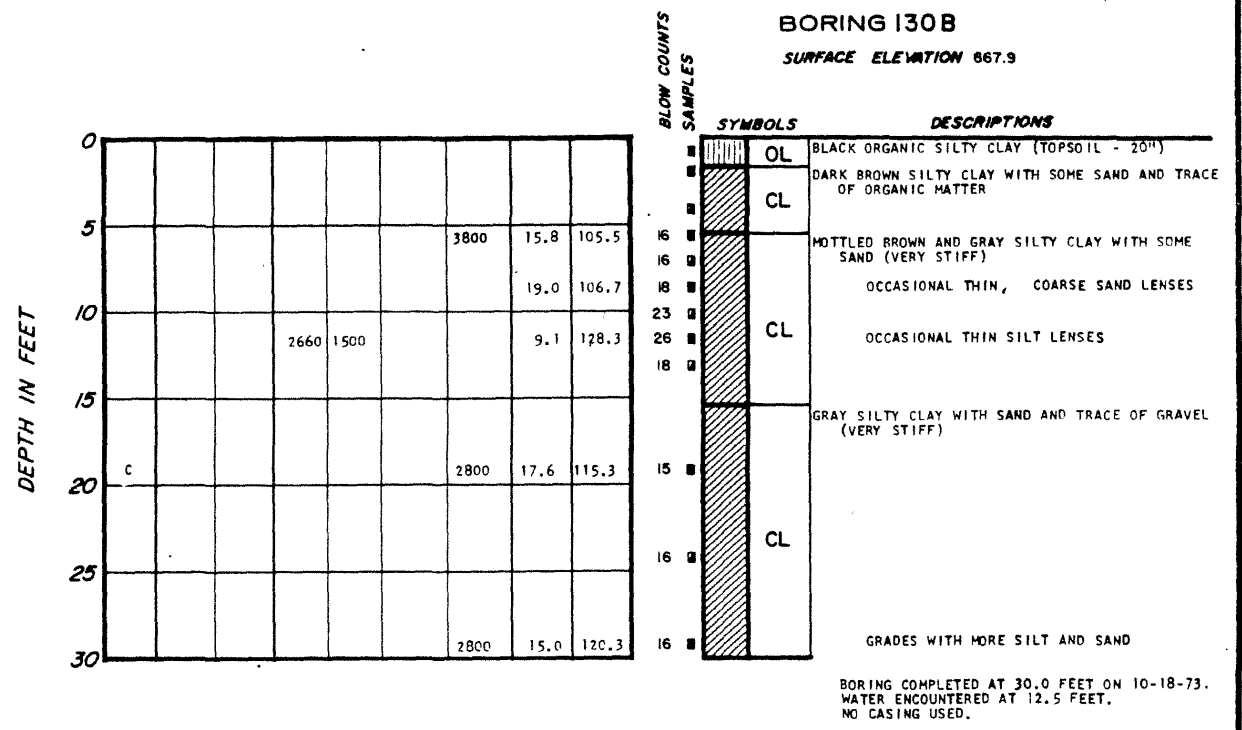
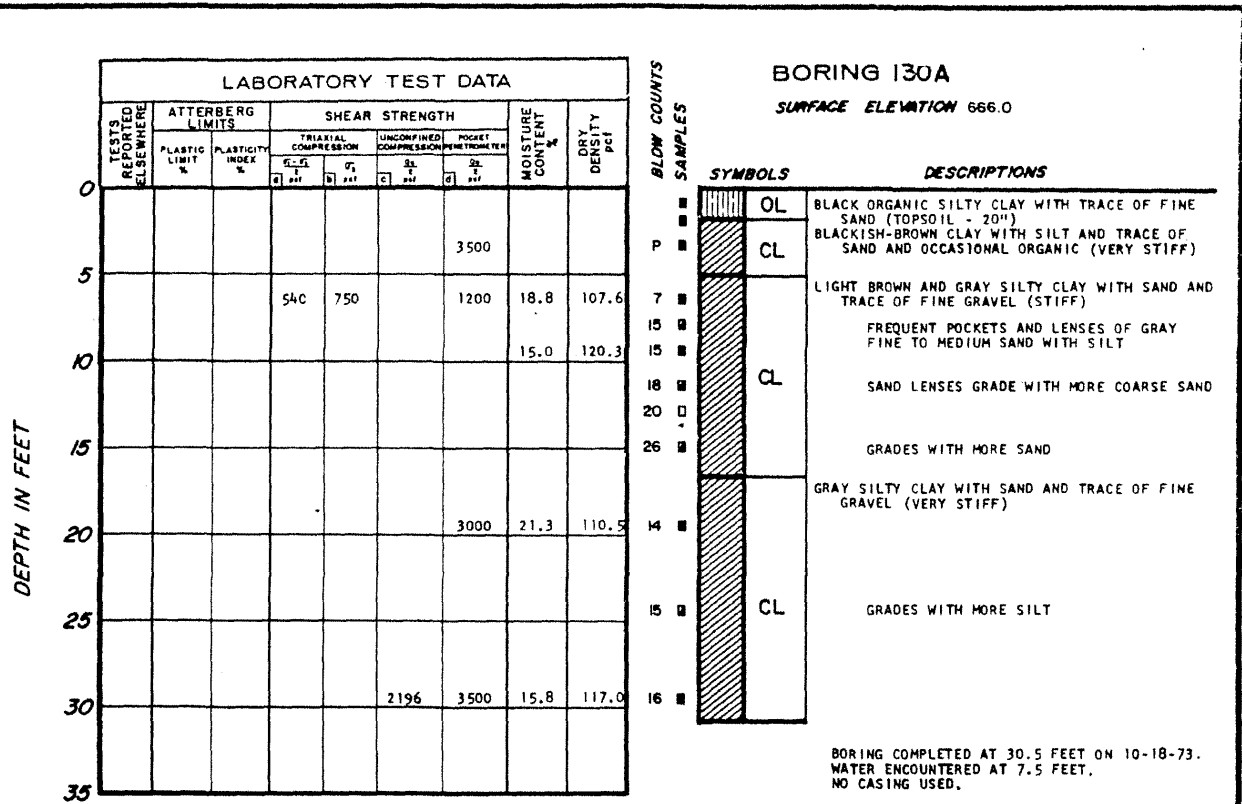

**LA SALLE COUNTY STATION**  
 UPDATED FINAL SAFETY ANALYSIS REPORT

FIGURE 2.5-19  
 LOGS OF BORINGS  
 (SHEET 130)

LABORATORY TEST DATA										
TESTS REPORTED ELSEWHERE	ATTERBERG LIMITS		SHEAR STRENGTH					MOISTURE CONTENT %	DRY DENSITY pcf	
	PLASTIC LIMIT %	PLASTICITY INDEX %	TRIAxIAL COMPRESSION		UNCONFINED COMPRESSION		POCKET PENETROMETER			
			q ₁ psi	q ₂ psi	q _u psi	q _u psi				
								4500+	19.3	105.4
								3500	25.2	99.1
								4500+	13.9	121.0
								4300		
								4500+	15.2	118.6

DEPTH IN FEET

**BORING 131**  
SURFACE ELEVATION 679.1

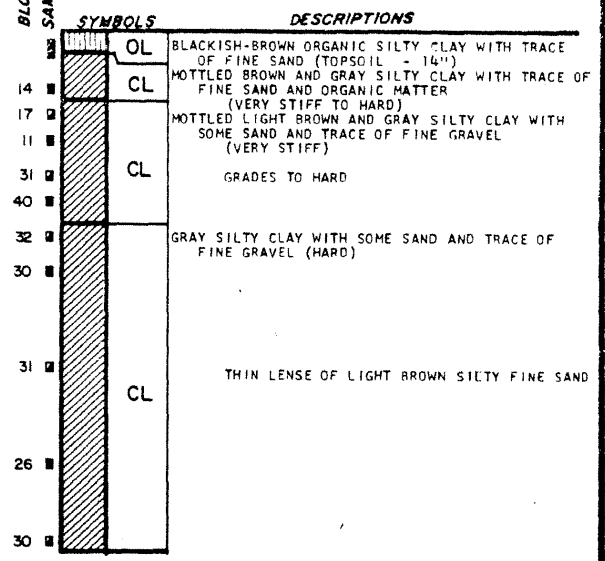

BORING COMPLETED AT 30.0 FEET ON 10-25-73. WATER ENCOUNTERED AT 22.0 FEET. NO CASING USED.

								4200	21.7	99.1	
								2416	4250	22.0	101.6
								3500	24.9	98.0	
								4500+	16.0	115.8	
								4500+	16.6	116.8	

DEPTH IN FEET

**BORING 132**  
SURFACE ELEVATION 693.2

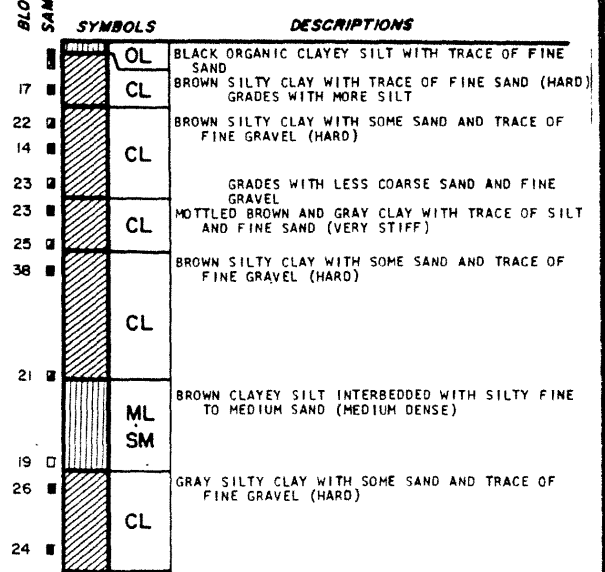

BORING COMPLETED AT 30.5 FEET ON 10-24-73. WATER ENCOUNTERED AT 25.0 FEET. NO CASING USED.

**LA SALLE COUNTY STATION**  
UPDATED FINAL SAFETY ANALYSIS REPORT

FIGURE 2.5-19  
LOGS OF BORINGS  
(SHEET 131)

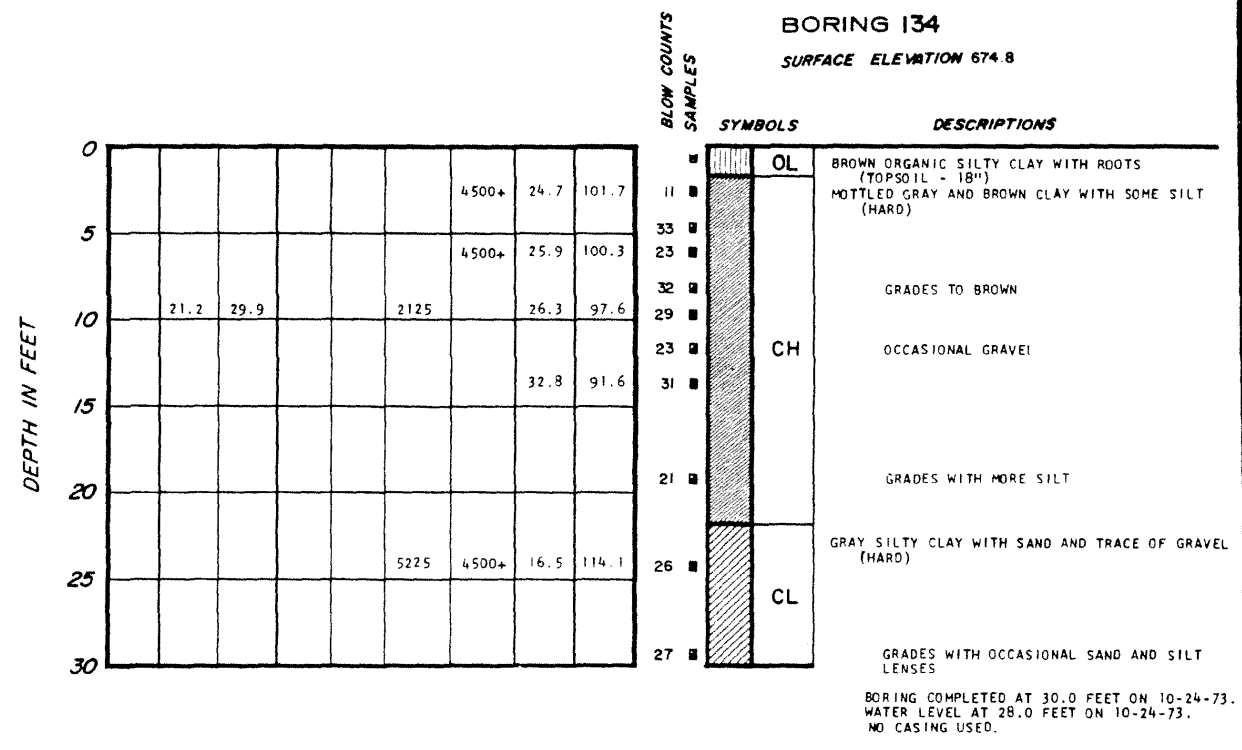
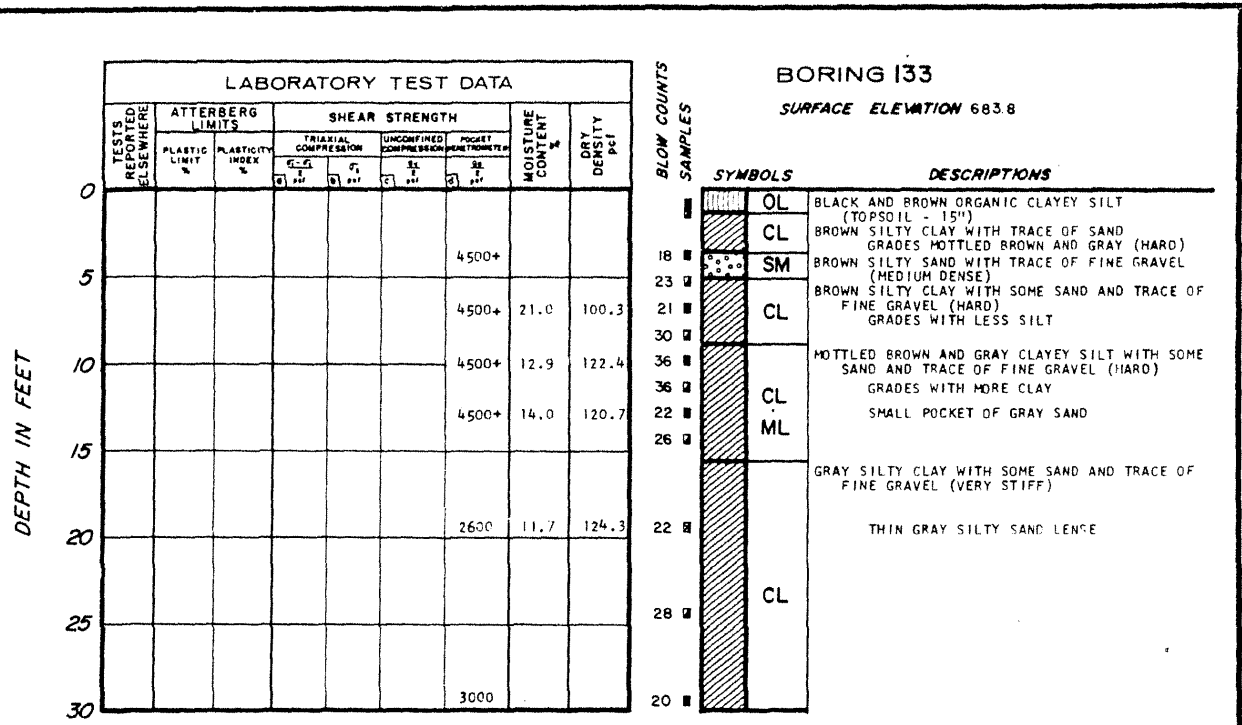

**LA SALLE COUNTY STATION**  
UPDATED FINAL SAFETY ANALYSIS REPORT

FIGURE 2.5-19  
LOGS OF BORINGS  
(SHEET 132)

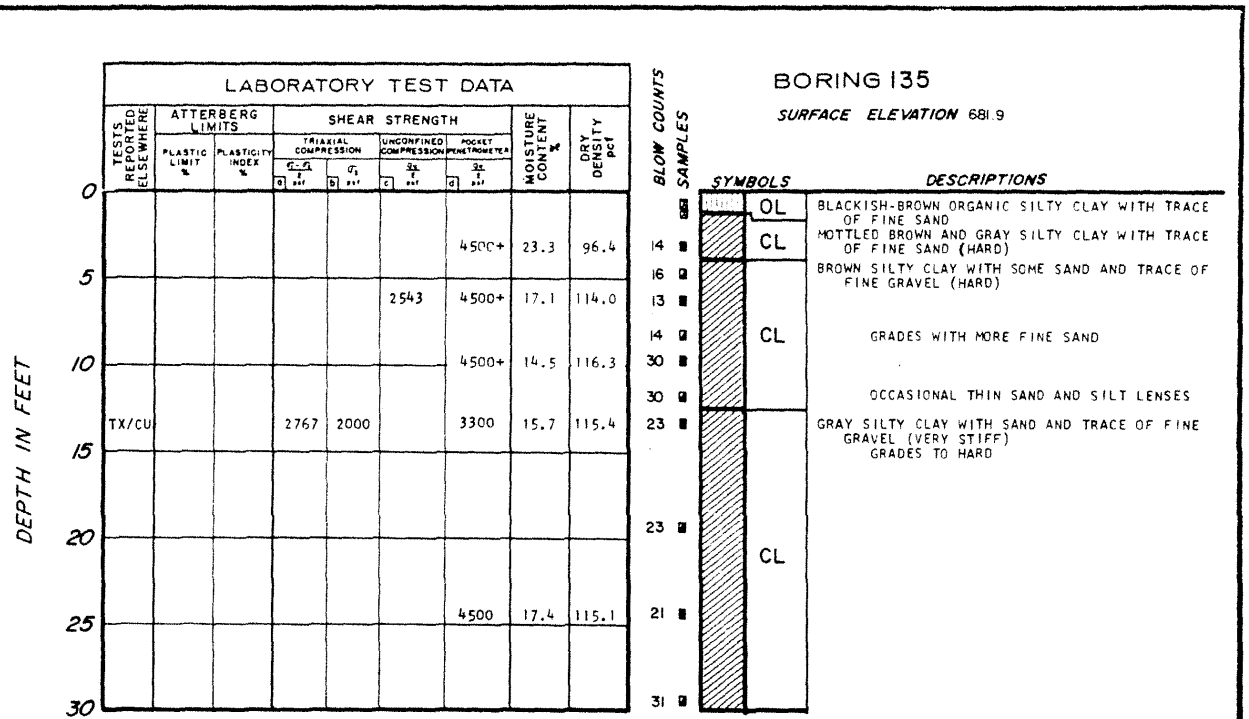

BORING COMPLETED AT 30.0 FEET ON 10-23-73. NO WATER ENCOUNTERED. NO CASING USED.

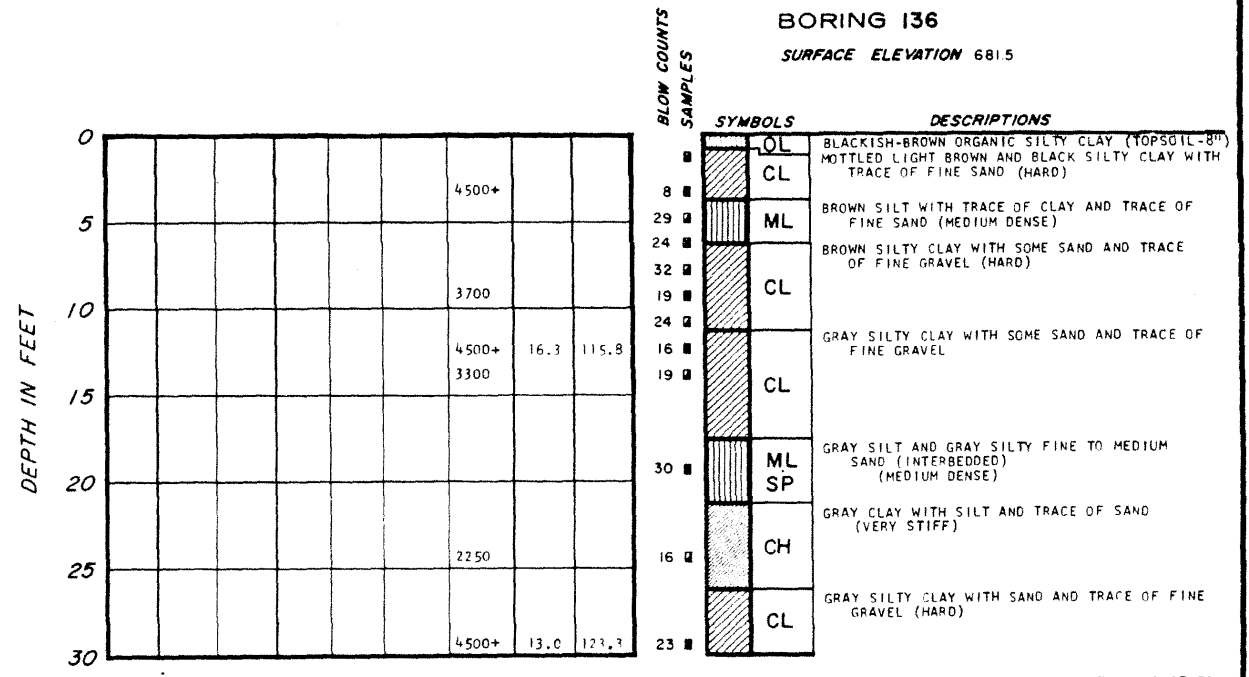

BORING COMPLETED AT 30.0 FEET ON 10-17-73. WATER LEVEL AT 28.0 FEET ON 10-17-73. NO CASING USED.

**LA SALLE COUNTY STATION**  
 UPDATED FINAL SAFETY ANALYSIS REPORT

FIGURE 2.5-19  
 LOGS OF BORINGS  
 (SHEET 133)

LABORATORY TEST DATA									
TESTS REPORTED ELSEWHERE	ATTERBERG LIMITS		SHEAR STRENGTH				MOISTURE CONTENT %	DRY DENSITYpcf	
	PLASTIC LIMIT %	PLASTICITY INDEX %	TRIAxIAL COMPRESSION		UNCONFINED COMPRESSION	POCKET PENETROMETER			
			$\sigma_1$ psf	$\sigma_3$ psf	$q_u$ psf	$q_p$ psf			
							3600	26.3	95.2
	14.2	23.3					4500+	23.2	106.7
	14.2	10.6						13.2	122.3
						1440	2700	18.0	112.5
							4500+		

DEPTH IN FEET

**BORING 137**  
SURFACE ELEVATION 683.7

BLOW COUNTS SAMPLES	SYMBOLS	DESCRIPTIONS
0	OL	BLACK ORGANIC CLAYEY SILT WITH TRACE OF FINE SAND (TOPSOIL - 18")
8	CL	BROWN SILTY CLAY WITH TRACE OF FINE SAND GRADES WITH MORE SILT (VERY STIFF)
22	CL	GRAY SILTY CLAY WITH GRAY SAND AND GRAVEL AND DARK BROWN ORGANIC SILTY CLAY (VERY STIFF)
19	OL	
18	OL	
13	SP	BROWN FINE SAND WITH TRACE OF SILT AND OCCASIONAL FINE GRAVEL (MEDIUM DENSE)
17	SM	BROWN SILTY FINE SAND WITH OCCASIONAL FINE GRAVEL (MEDIUM DENSE)
19	CL	GRAY SILTY CLAY WITH TRACE OF SAND AND OCCASIONAL FINE GRAVEL (STIFF)
29	CL	
17	CL	OCCASIONAL COARSE GRAVEL
26	CL	
28	ML	GRAY CLAYEY SILT WITH TRACE OF SAND AND OCCASIONAL FINE GRAVEL (VERY STIFF)
28	CL	GRAY SILTY CLAY WITH TRACE OF SAND AND OCCASIONAL FINE GRAVEL (HARD)

BORING COMPLETED AT 30.5 FEET ON 10-23-73.  
WATER ENCOUNTERED AT 10.0 FEET.  
NO CASING USED.

LABORATORY TEST DATA									
TESTS REPORTED ELSEWHERE	ATTERBERG LIMITS		SHEAR STRENGTH				MOISTURE CONTENT %	DRY DENSITYpcf	
	PLASTIC LIMIT %	PLASTICITY INDEX %	TRIAxIAL COMPRESSION		UNCONFINED COMPRESSION	POCKET PENETROMETER			
			$\sigma_1$ psf	$\sigma_3$ psf	$q_u$ psf	$q_p$ psf			
							2000	23.5	98.5
							4300	12.4	117.2
						2137	2700	15.9	116.9
							3000	19.9	110.4

DEPTH IN FEET

**BORING 138**  
SURFACE ELEVATION 685.6

BLOW COUNTS SAMPLES	SYMBOLS	DESCRIPTIONS
0	OL	BLACK ORGANIC SILTY CLAY WITH TRACE OF FINE SAND (TOPSOIL - 12")
9	CL	BLACK TO LIGHT BROWN SILTY CLAY WITH TRACE OF FINE SAND (VERY STIFF)
8	ML	LIGHT BROWN SILT WITH SOME CLAY, AND TRACE OF SAND (MEDIUM STIFF)
14	CL	MOTTLED BROWN AND GRAY SILTY CLAY WITH SAND AND TRACE OF FINE GRAVEL (HARD)
18	CL	
17	CL	GRAY SILTY CLAY WITH SOME SAND AND TRACE OF FINE GRAVEL (VERY STIFF TO HARD)
26	CL	
12	CL	
18	CL	
10	CL	
14	CL	GRADES WITH LESS SAND
22	ML	GRAY CLAYEY SILT WITH SOME SAND AND TRACE OF FINE GRAVEL (VERY STIFF)
21	ML	

BORING COMPLETED AT 32.0 FEET ON 10-22-73  
WATER ENCOUNTERED AT 7.0 FEET.  
NO CASING USED.

**LA SALLE COUNTY STATION**

FIGURE 2.5-19  
LOGS OF BORINGS  
(SHEET 134)

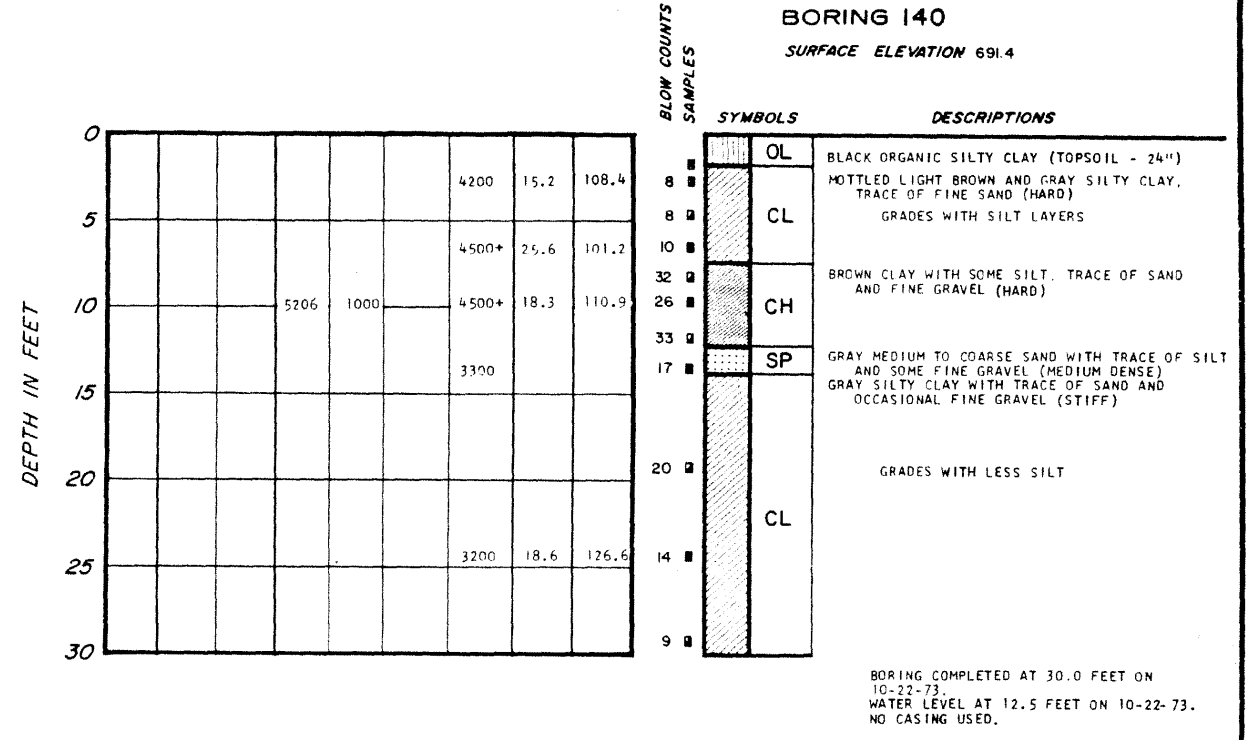
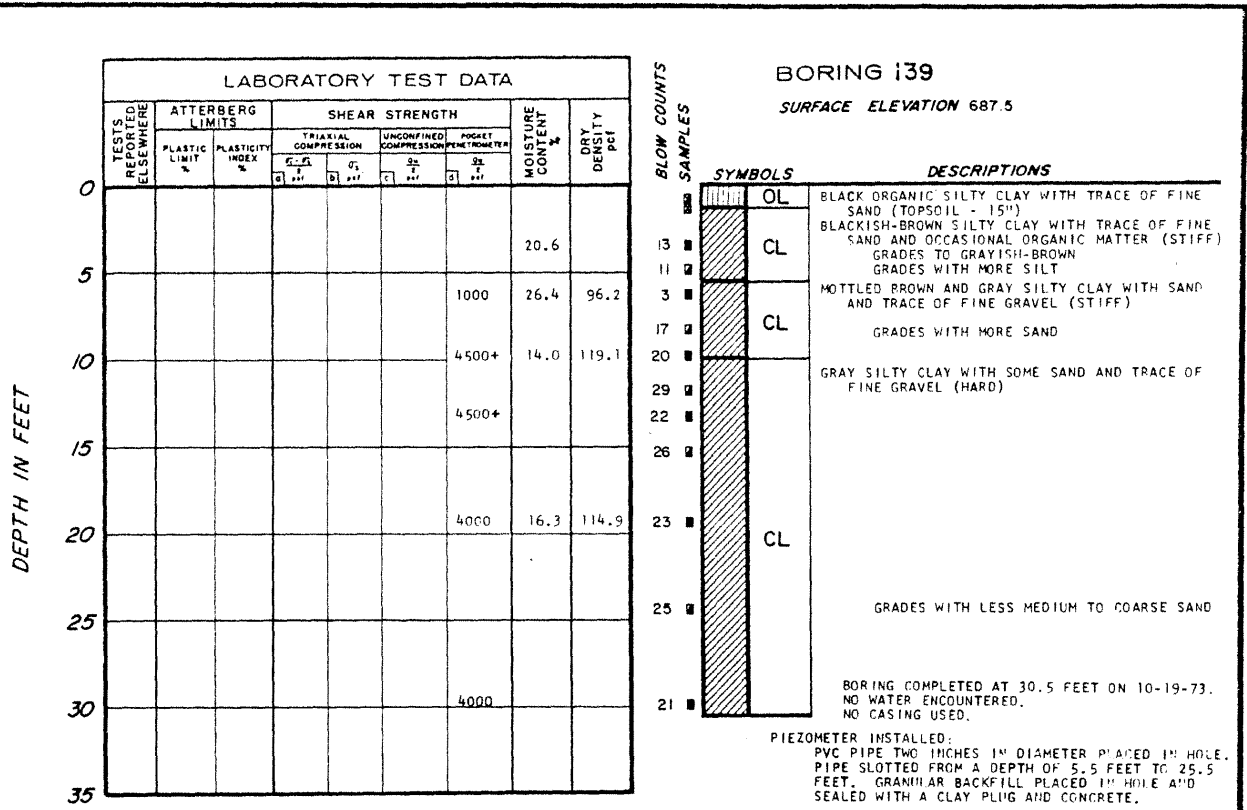

**LA SALLE COUNTY STATION**  
**UPDATED FINAL SAFETY ANALYSIS REPORT**

FIGURE 2.5-19  
 LOGS OF BORINGS  
 (SHEET 135)

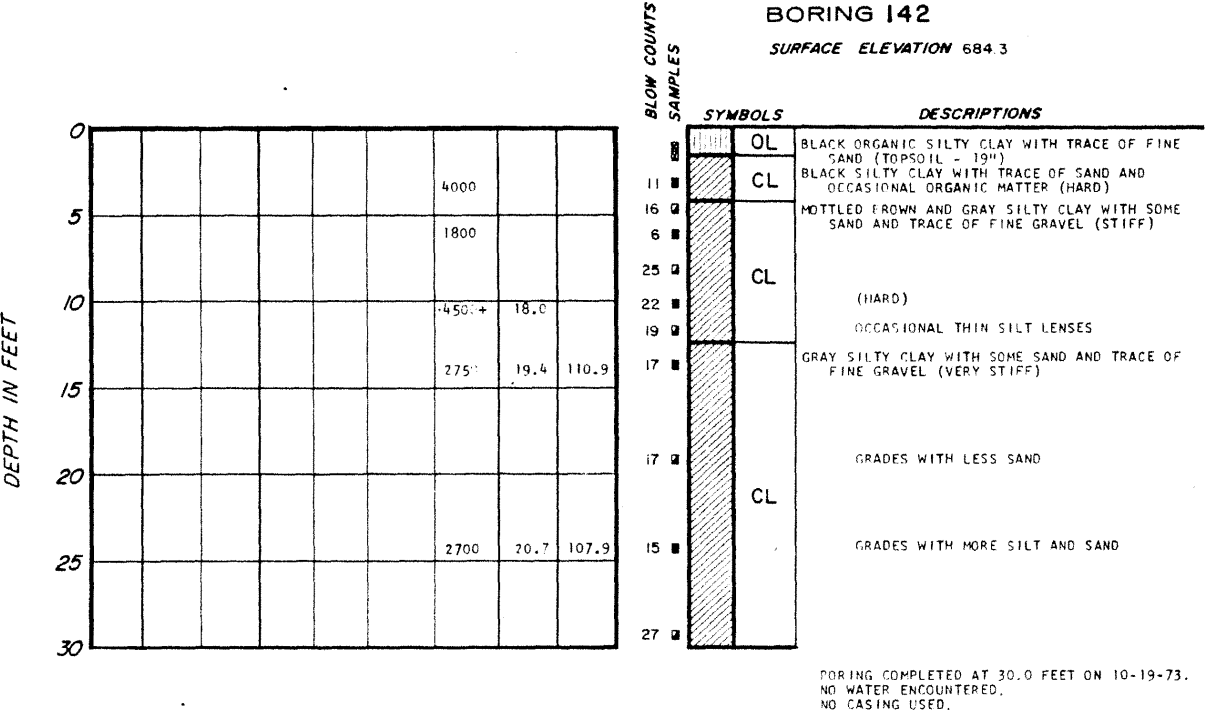
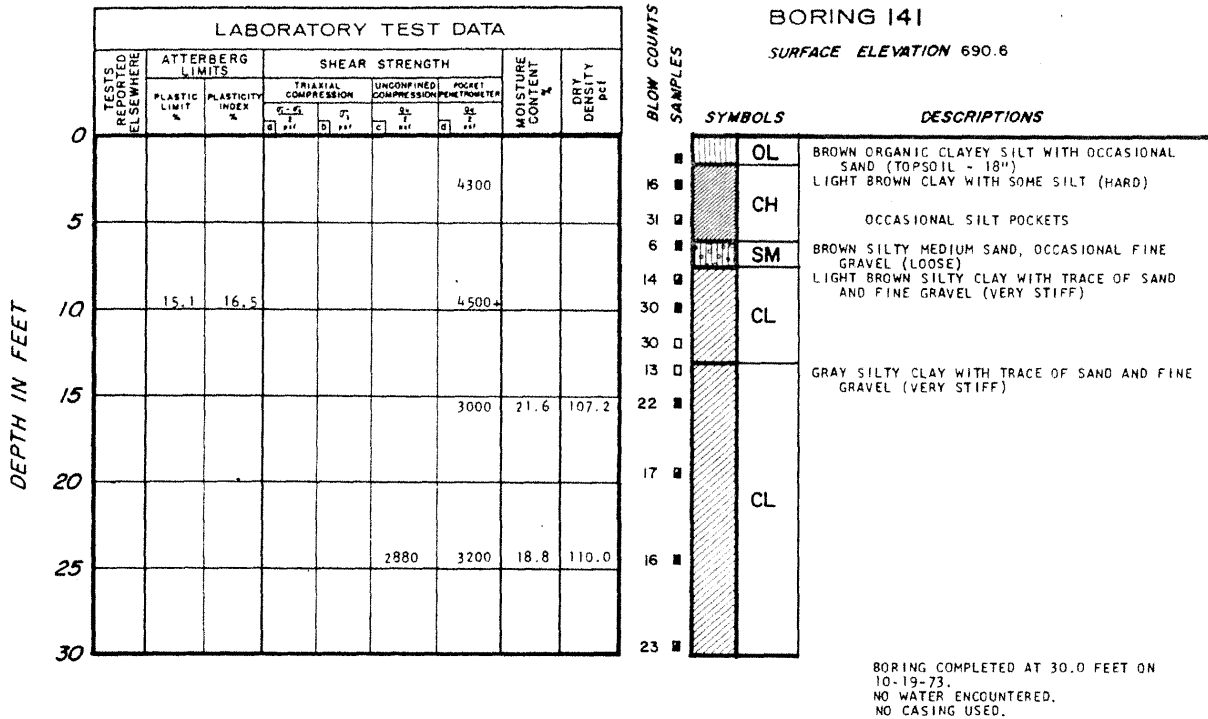

**LA SALLE COUNTY STATION**  
**UPDATED FINAL SAFETY ANALYSIS REPORT**

FIGURE 2.5-19  
 LOGS OF BORINGS  
 (SHEET 136)

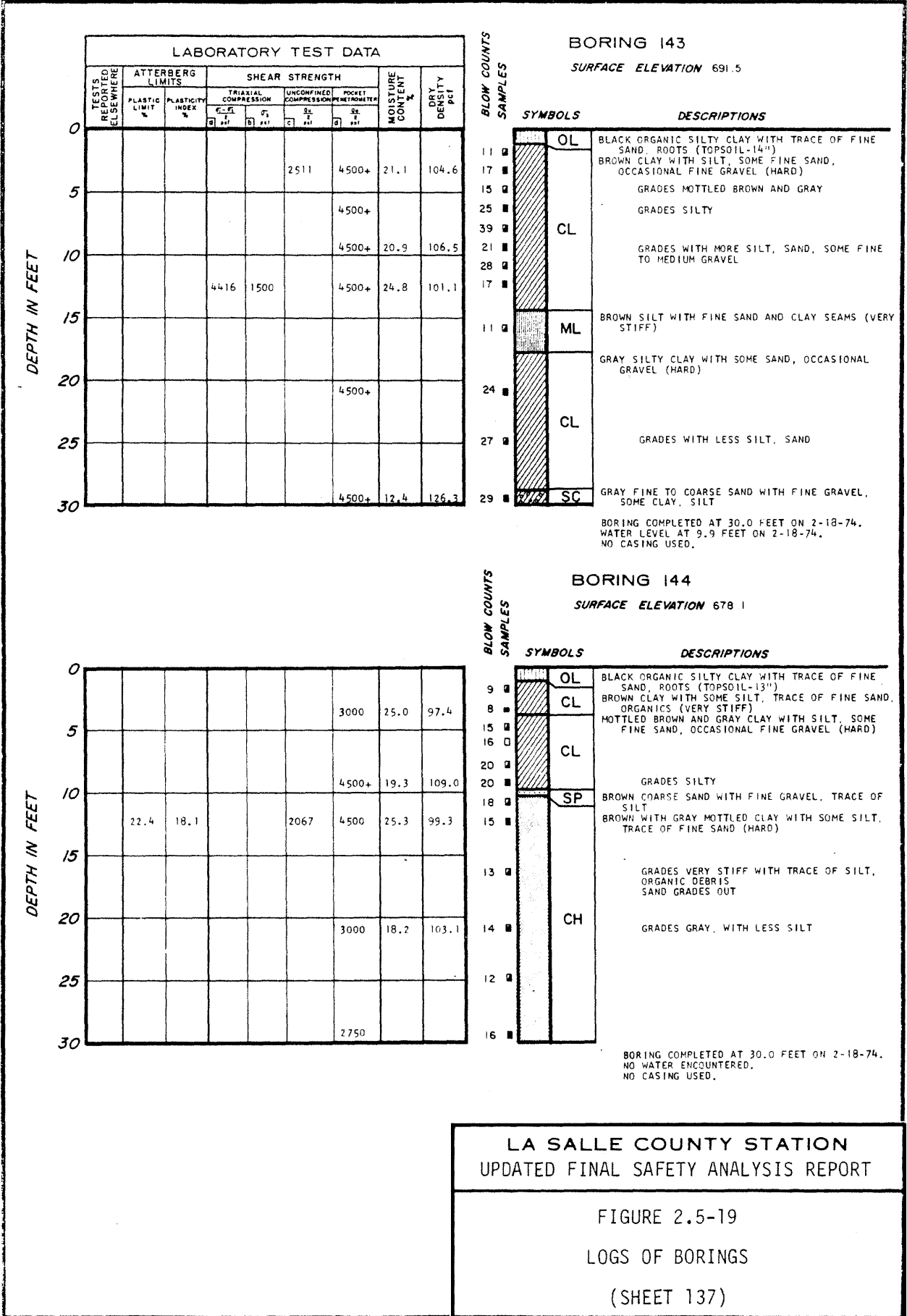



LABORATORY TEST DATA										
TESTS REPORTED ELSEWHERE	ATTERBERG LIMITS		SHEAR STRENGTH					MOISTURE CONTENT %	DRY DENSITY PCF	
	PLASTIC LIMIT %	PLASTICITY INDEX %	TRIAxIAL COMPRESSION		UNCONFINED COMPRESSION		POCKET PENETROMETER			
			$\sigma_1$ T	$\sigma_3$ T	$\sigma_c$ T	$\sigma_c$ T				
								1500	33.8	84.1
								2250		
						6544	4500+	15.2	118.4	
							4500+			
							3000			
	16.7	13.6					4500	15.7	118.6	
							2500	12.9	120.5	

DEPTH IN FEET

BORING 145  
SURFACE ELEVATION 679.7

BLOW COUNTS  
SAMPLES

SYMBOLS		DESCRIPTIONS
6	OL	BLACK ORGANIC SILTY CLAY WITH TRACE OF FINE SAND, ROOTS (TOPSOIL-20")
13	CL	DARK BROWN SILTY CLAY WITH TRACE OF FINE SAND, ORGANICS (STIFF) GRADES MOTTLED BROWN AND GRAY WITH SOME FINE SAND GRADES VERY STIFF ORGANICS GRADE OUT
17	CL	GRADES WITH SILT, OCCASIONAL FINE GRAVEL
27	CL	BROWN SILTY CLAY WITH SOME SAND, FINE GRAVEL (HARD) GRADES WITH SOME FINE TO MEDIUM GRAVEL
24		
21		GRAY SILTY CLAY WITH SOME SAND, FINE TO MEDIUM GRAVEL (VERY STIFF)
30		GRADES HARD, WITH MORE SILT AND SAND
12	CL	
14		GRADES VERY STIFF, WITH LESS SILT, SAND (MEDIUM STIFF)
23		GRADES WITH OCCASIONAL COARSE SAND AND FINE GRAVEL SEAMS

BORING COMPLETED AT 30.0 FEET ON 2-16-74.  
NO WATER ENCOUNTERED.  
NO CASING USED.

DEPTH IN FEET

BORING 146  
SURFACE ELEVATION 689.9

BLOW COUNTS  
SAMPLES

SYMBOLS		DESCRIPTIONS
9	OL	BLACK ORGANIC SILTY CLAY WITH TRACE OF FINE SAND, ROOTS (TOPSOIL-13")
20	CL	DARK BROWN SILTY CLAY WITH TRACE OF FINE SAND, ORGANICS (VERY STIFF) GRADES HARD MOTTLED LIGHT BROWN AND GRAY, WITH OCCASIONAL FINE GRAVEL
21		
18		MOTTLED BROWN AND GRAY CLAY WITH TRACE OF SILT (HARD) GRADES GRAYISH-BROWN
28	CH	
18		GRADES WITH OCCASIONAL FINE GRAVEL
16		
23	CL	GRAYISH-BROWN SILTY CLAY WITH SOME FINE TO COARSE SAND, FINE GRAVEL (HARD)
14		
13	CL	GRAY SILTY CLAY WITH SOME FINE SAND, TRACE OF FINE GRAVEL (VERY STIFF)
25		GRADES WITH LESS SILT AND SAND

BORING COMPLETED AT 30.0 FEET ON 2-16-74.  
WATER LEVEL AT 30.0 FEET ON 2-16-74.  
NO CASING USED.

LA SALLE COUNTY STATION  
UPDATED FINAL SAFETY ANALYSIS REPORT

FIGURE 2.5-19  
LOGS OF BORINGS  
(SHEET 138)



**LABORATORY TEST DATA**

TESTS REPORTED ELSEWHERE	ATTERBERG LIMITS		SHEAR STRENGTH						MOISTURE CONTENT %	DRY DENSITY pcf	
	PLASTIC LIMIT %	PLASTICITY INDEX %	TRIAxIAL COMPRESSION			UNCONFINED COMPRESSION					POCKET PENETROMETER
			σ ₁ (psi)	σ ₃ (psi)	σ ₁ (psi)	σ ₃ (psi)	σ ₁ (psi)	σ ₃ (psi)			
								1500			
								4500+	21.7	104.1	
	17.3	11.0						4500+	14.1	120.3	
								4500+			
								2000	20.6	108.3	
								2000	21.0	108.0	

**BORING 149**  
SURFACE ELEVATION 692.5

DEPTH IN FEET

BLOW COUNTS  
SAMPLES

SYMBOLS	DESCRIPTIONS
OL	BLACK ORGANIC SILTY CLAY WITH TRACE OF FINE SAND, ROOTS (TOPSOIL-15")
CL	MOTTLED LIGHT AND DARK BROWN SILTY CLAY WITH TRACE OF SAND, ORGANICS (STIFF) GRADES WITH OCCASIONAL FINE GRAVEL GRADES HARD WITH SILT
CL	BROWN SILTY CLAY WITH SOME FINE AND COARSE SAND, FINE GRAVEL (HARD) GRADES WITH SOME FINE TO MEDIUM GRAVEL
CL	GRAY SILTY CLAY WITH SOME FINE SAND, FINE TO COARSE GRAVEL (HARD)
SC	GRAY MEDIUM TO COARSE SAND WITH SOME FINE GRAVEL, CLAY GRAY SILTY CLAY WITH SOME FINE SAND, OCCASIONAL FINE GRAVEL (VERY STIFF)
CL	GRADES WITH LESS SILT, TRACE OF FINE SAND

BORING COMPLETED AT 30.0 FEET ON 2-20-74.  
WATER LEVEL AT 20.0 FEET ON 2-20-74.  
NO CASING USED.

TESTS REPORTED ELSEWHERE	ATTERBERG LIMITS		SHEAR STRENGTH						MOISTURE CONTENT %	DRY DENSITY pcf	
	PLASTIC LIMIT %	PLASTICITY INDEX %	TRIAxIAL COMPRESSION			UNCONFINED COMPRESSION					POCKET PENETROMETER
			σ ₁ (psi)	σ ₃ (psi)	σ ₁ (psi)	σ ₃ (psi)	σ ₁ (psi)	σ ₃ (psi)			
	18.8	15.7							17.2	111.5	
								2966	14.9	117.1	
								2955	14.0	120.7	
									20.8	107.9	

**BORING 150**  
SURFACE ELEVATION 691.1

DEPTH IN FEET

BLOW COUNTS  
SAMPLES

SYMBOLS	DESCRIPTIONS
OL	BLACK ORGANIC SILTY CLAY WITH TRACE OF FINE SAND, ROOTS (TOPSOIL-17")
CL	BROWN SILTY CLAY WITH TRACE OF FINE SAND, ORGANICS (STIFF)
ML	MOTTLED LIGHT BROWN AND GRAY CLAYEY SILT WITH SOME FINE SAND, OCCASIONAL FINE GRAVEL (VERY STIFF) GRADES HARD
CL	BROWN SILTY CLAY WITH SOME FINE AND COARSE SAND, FINE GRAVEL (HARD) GRADES WITH MORE SAND, GRAVEL
CL	GRAY SILTY CLAY WITH SOME FINE AND COARSE SAND, FINE GRAVEL (HARD)
CL	GRADES WITH LESS SILT AND SAND
CL	GRADES VERY STIFF
CL	GRADES WITH SILT, TRACE OF FINE SAND, FINE GRAVEL

BORING COMPLETED AT 30.0 FEET ON 2-20-74.  
WATER LEVEL AT 20.5 FEET ON 2-20-74.  
NO CASING USED.

**LA SALLE COUNTY STATION  
UPDATED FINAL SAFETY ANALYSIS REPORT**

FIGURE 2.5-19  
LOGS OF BORINGS  
(SHEET 140)

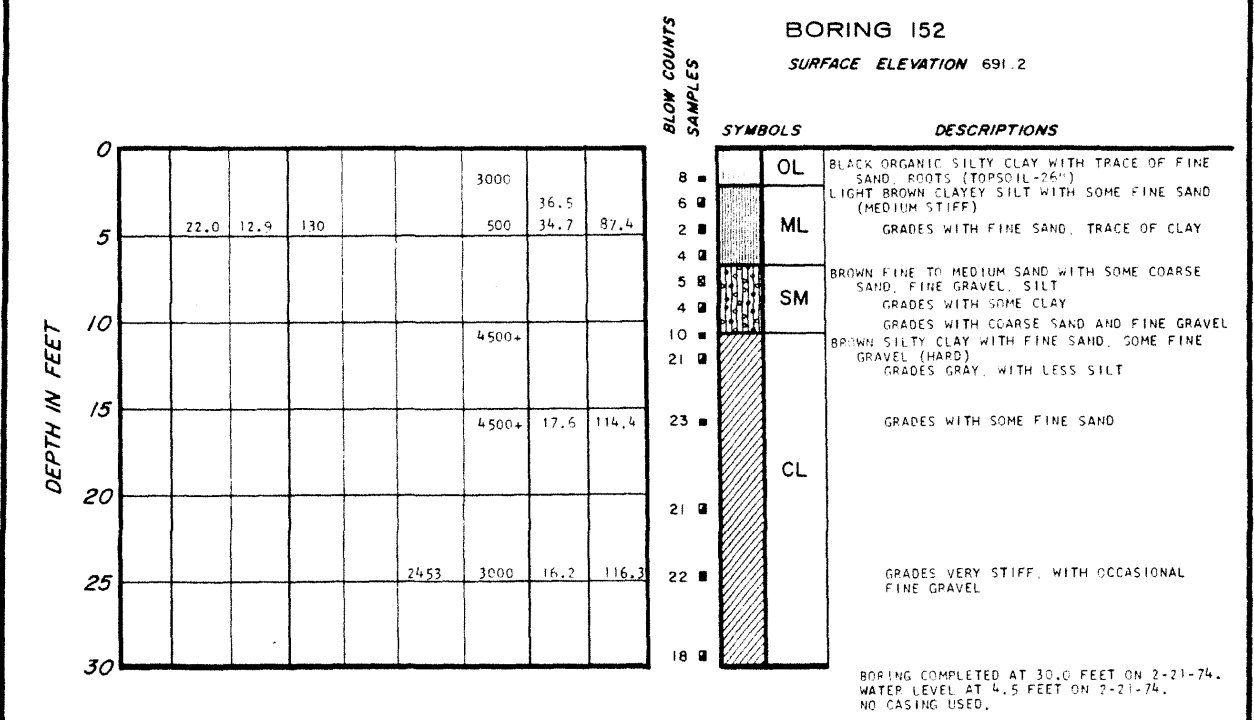
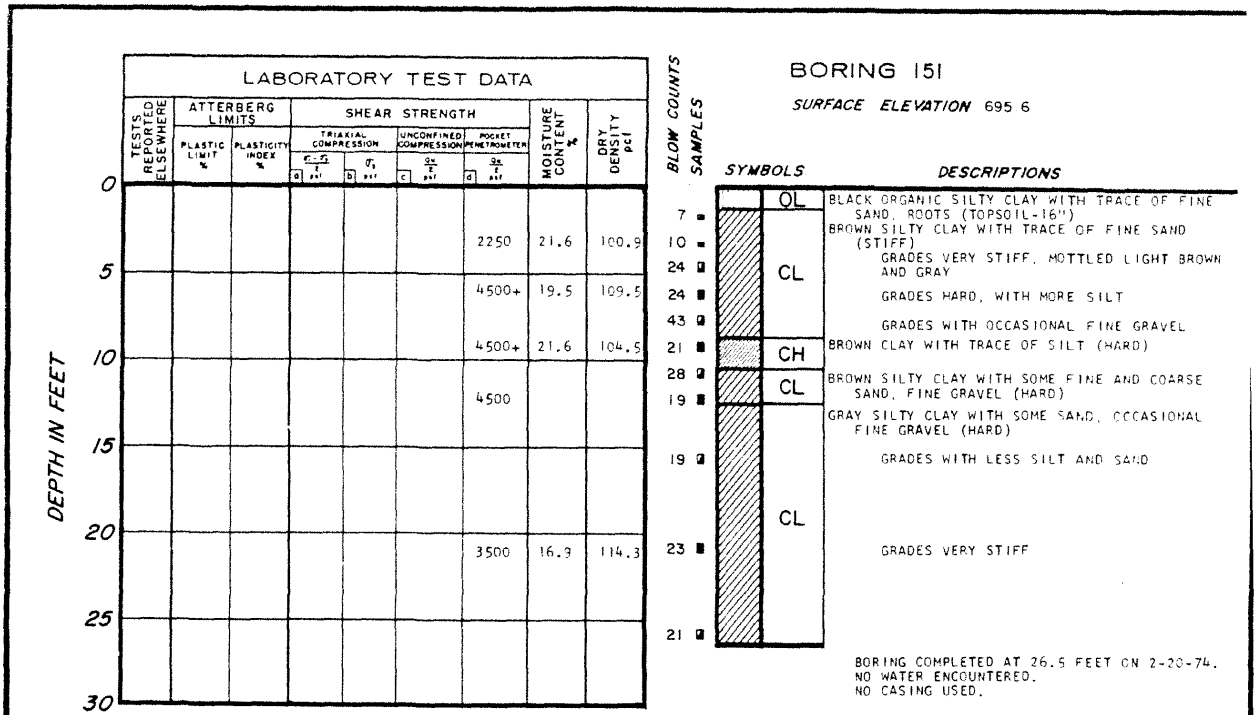

**LA SALLE COUNTY STATION**  
 UPDATED FINAL SAFETY ANALYSIS REPORT  
  
 FIGURE 2.5-19  
 LOGS OF BORINGS  
 (SHEET 141)

LABORATORY TEST DATA									
TESTS REPORTED ELSEWHERE	ATTERBERG LIMITS		SHEAR STRENGTH				MOISTURE CONTENT %	DRY DENSITY pcf	
	PLASTIC LIMIT %	PLASTICITY INDEX %	TRIAxIAL COMPRESSION		UNCONFINED COMPRESSION				POCKET PENETROMETER
			$\sigma_1$ psi	$\sigma_3$ psi	$\sigma_c$ psi	$\sigma_u$ psi			
							4500+	15.8	117.5
						2183	4500+	17.2	115.3
							4500+		
							3500	19.0	111.4
	16.8	12.8					2000	19.8	112.0

DEPTH IN FEET

BORING 153  
SURFACE ELEVATION 691.1

BLOW COUNTS SAMPLES

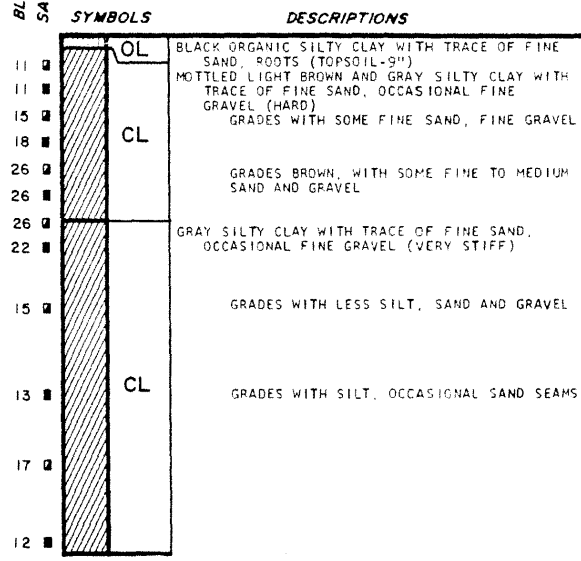

BORING COMPLETED AT 30.0 FEET ON 2-25-74.  
WATER LEVEL AT 23.0 FEET ON 2-25-74.  
NO CASING USED.

LABORATORY TEST DATA										
TESTS REPORTED ELSEWHERE	ATTERBERG LIMITS		SHEAR STRENGTH				MOISTURE CONTENT %	DRY DENSITY pcf		
	PLASTIC LIMIT %	PLASTICITY INDEX %	TRIAxIAL COMPRESSION		UNCONFINED COMPRESSION				POCKET PENETROMETER	
			$\sigma_1$ psi	$\sigma_3$ psi	$\sigma_c$ psi	$\sigma_u$ psi				
							750	26.8	95.5	
							2000	33.1		
						678	500	2500	27.6	96.7
								4500+		
								20.9		
								3500		
							1530	2250	22.4	104.3

DEPTH IN FEET

BORING 154  
SURFACE ELEVATION 687.9

BLOW COUNTS SAMPLES

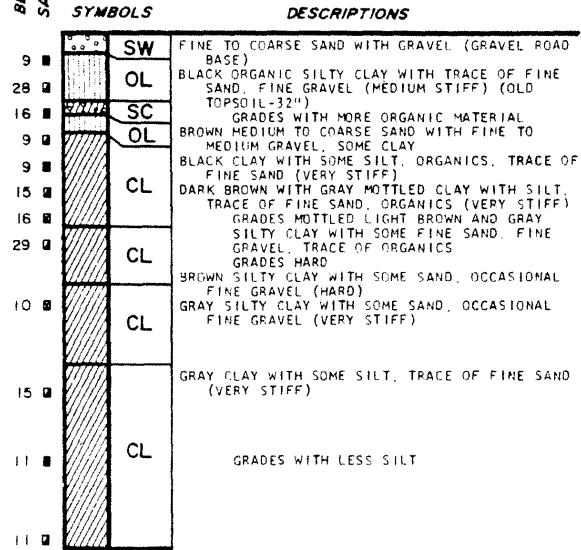

BORING COMPLETED AT 30.0 FEET ON 2-25-74.  
WATER LEVEL AT 22.0 FEET ON 2-25-74.  
NO CASING USED.

LA SALLE COUNTY STATION  
UPDATED FINAL SAFETY ANALYSIS REPORT

FIGURE 2.5-19  
LOGS OF BORINGS  
(SHEET 142)

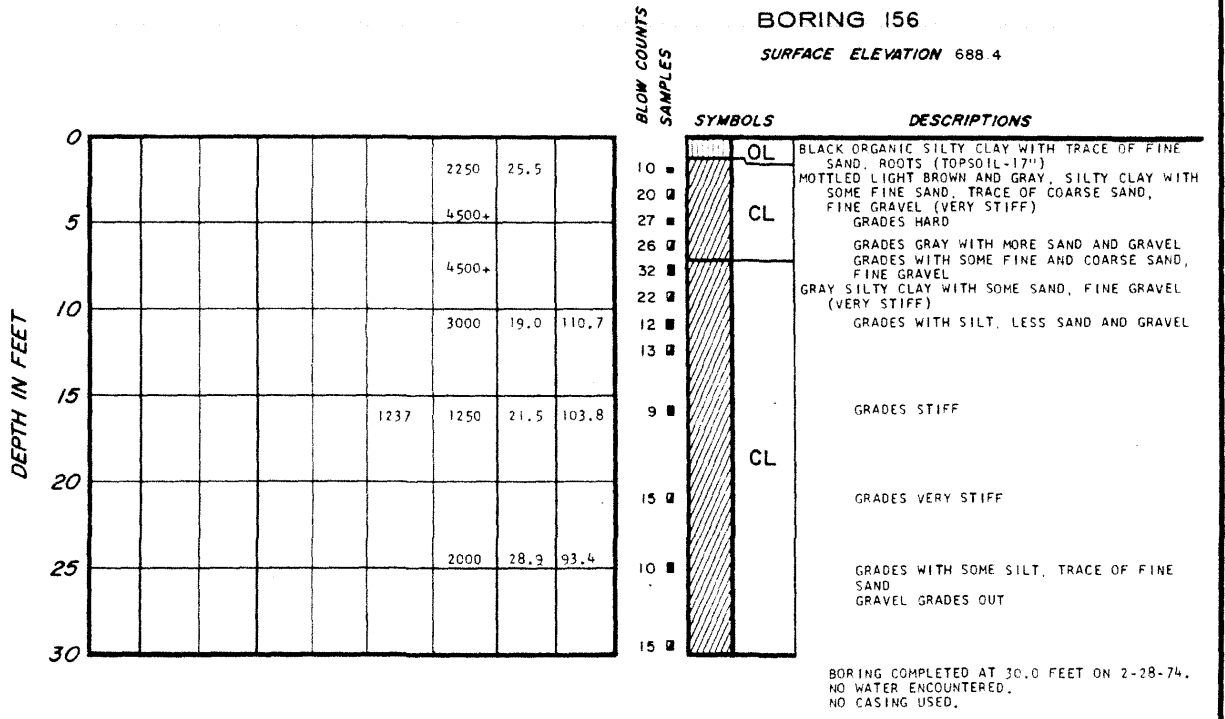
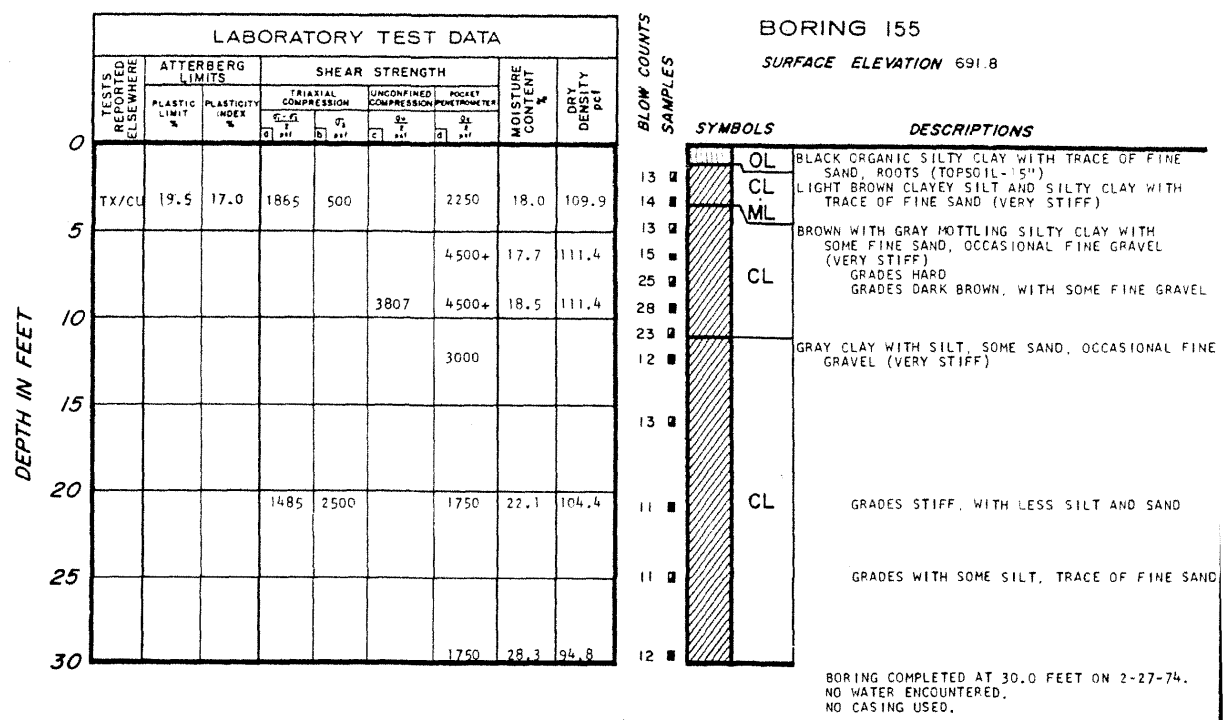

**LA SALLE COUNTY STATION**  
UPDATED FINAL SAFETY ANALYSIS REPORT

FIGURE 2.5-19  
LOGS OF BORINGS  
(SHEET 143)



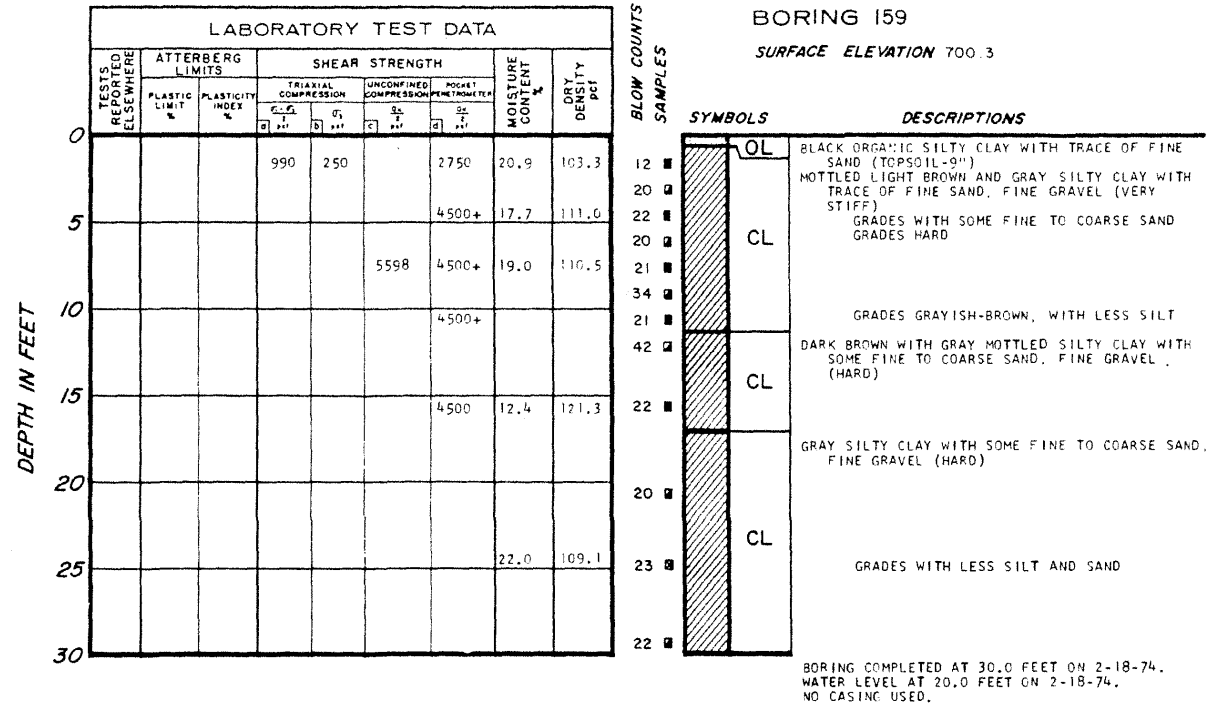

**LA SALLE COUNTY STATION**  
 UPDATED FINAL SAFETY ANALYSIS REPORT

FIGURE 2.5-19  
 LOGS OF BORINGS  
 (SHEET 145)



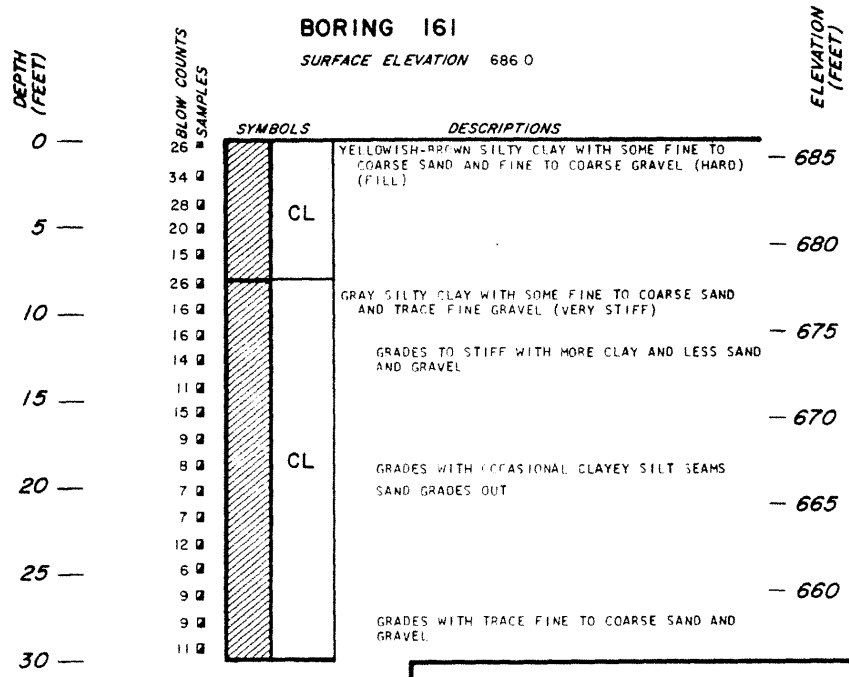
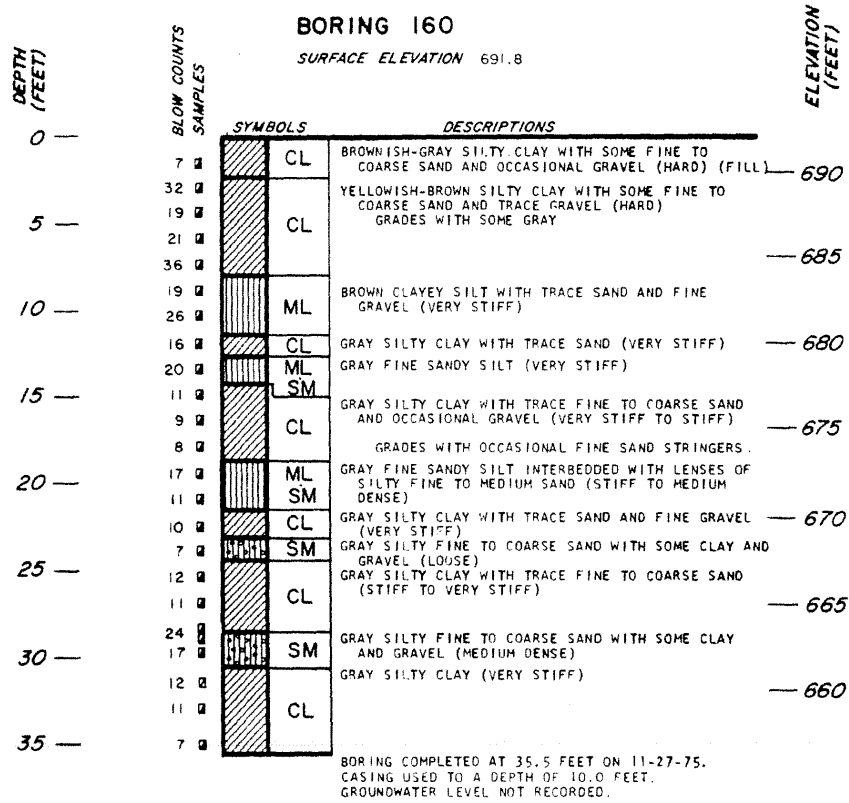

BORING COMPLETED AT 30.0 FEET ON 11-22-75.  
NO CASING USED.  
HOLE DRY UPON COMPLETION.

**LA SALLE COUNTY STATION**  
**UPDATED FINAL SAFETY ANALYSIS REPORT**

FIGURE 2.5-19  
LOGS OF BORINGS  
(SHEET 146)

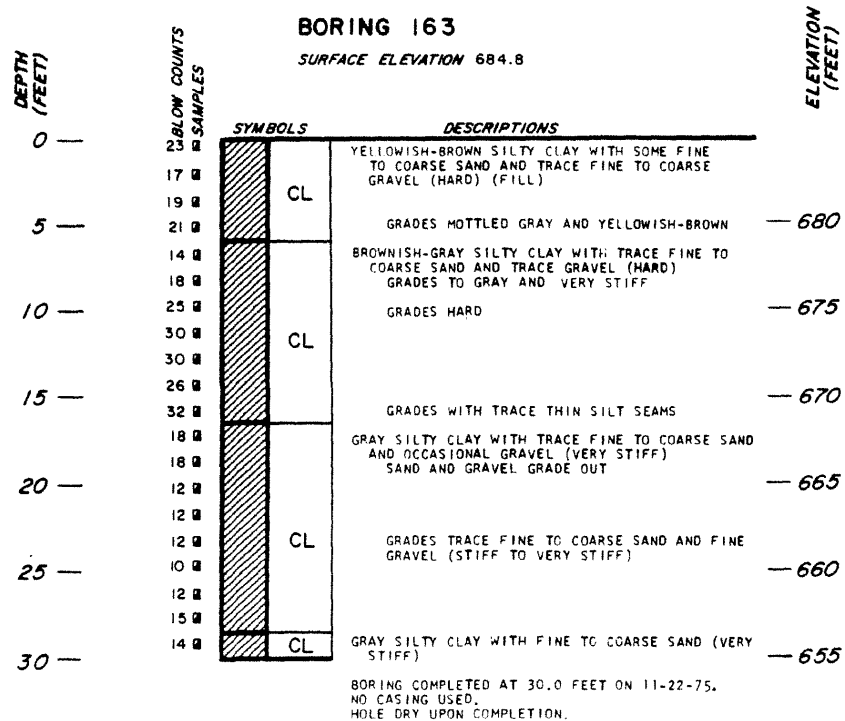
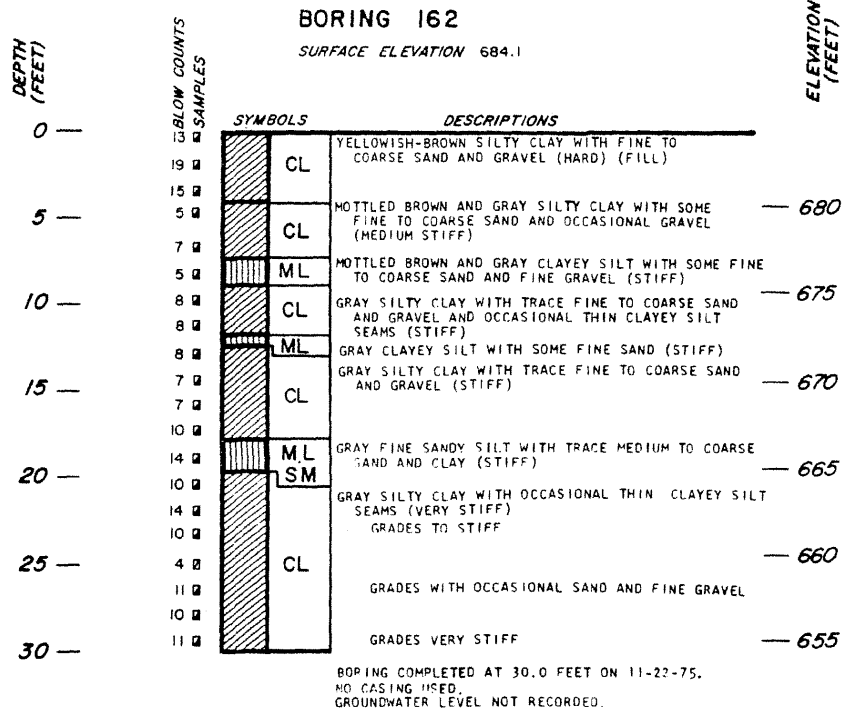

**LA SALLE COUNTY STATION**  
UPDATED FINAL SAFETY ANALYSIS REPORT

FIGURE 2.5-19  
LOGS OF BORINGS  
(SHEET 147)

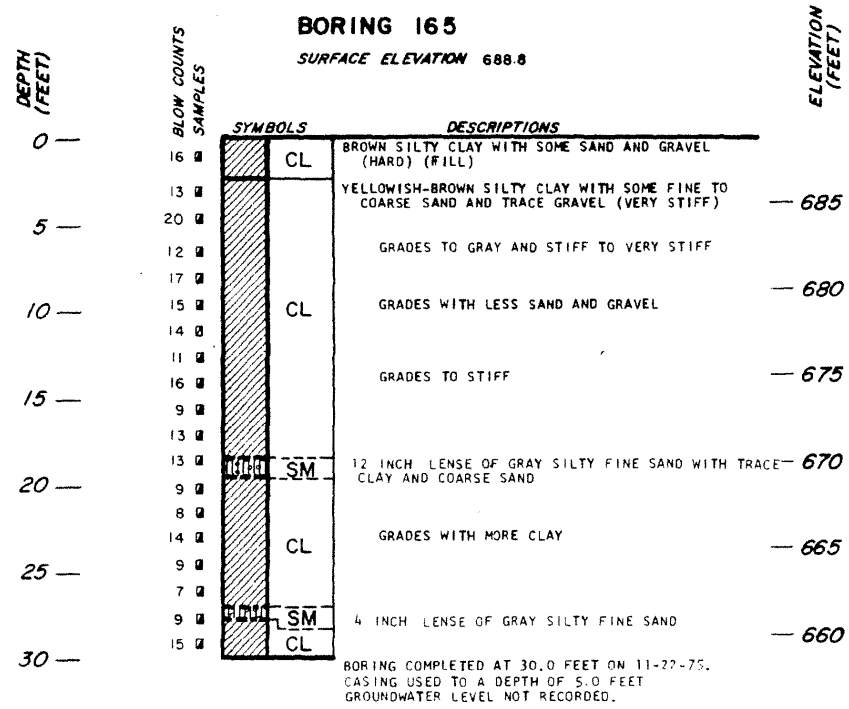
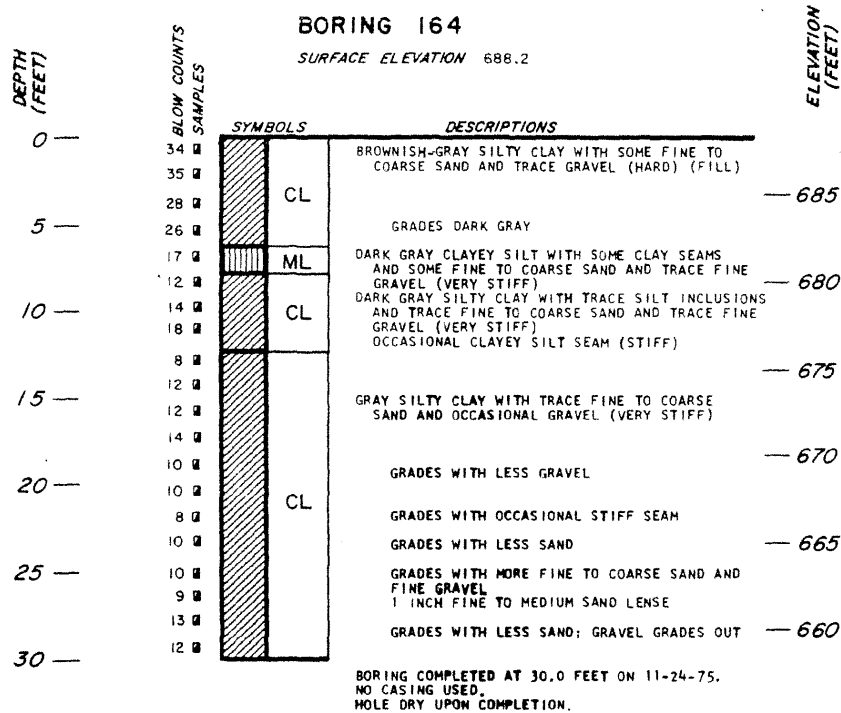

**LA SALLE COUNTY STATION**  
UPDATED FINAL SAFETY ANALYSIS REPORT

FIGURE 2.5-19  
LOGS OF BORINGS  
(SHEET 148)

**BORING 166**  
SURFACE ELEVATION 690.7

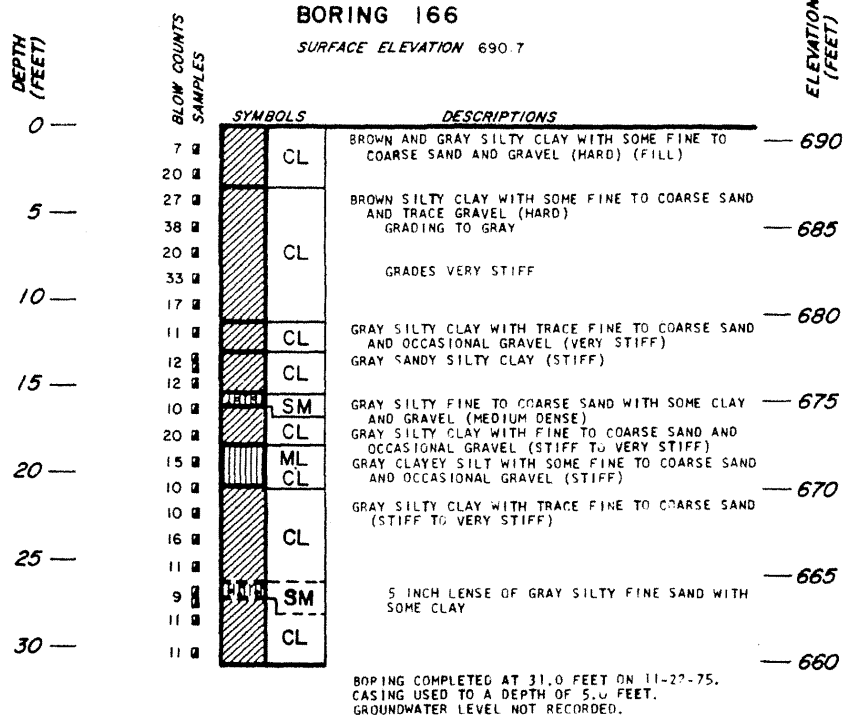

**BORING 167**  
SURFACE ELEVATION 696.4

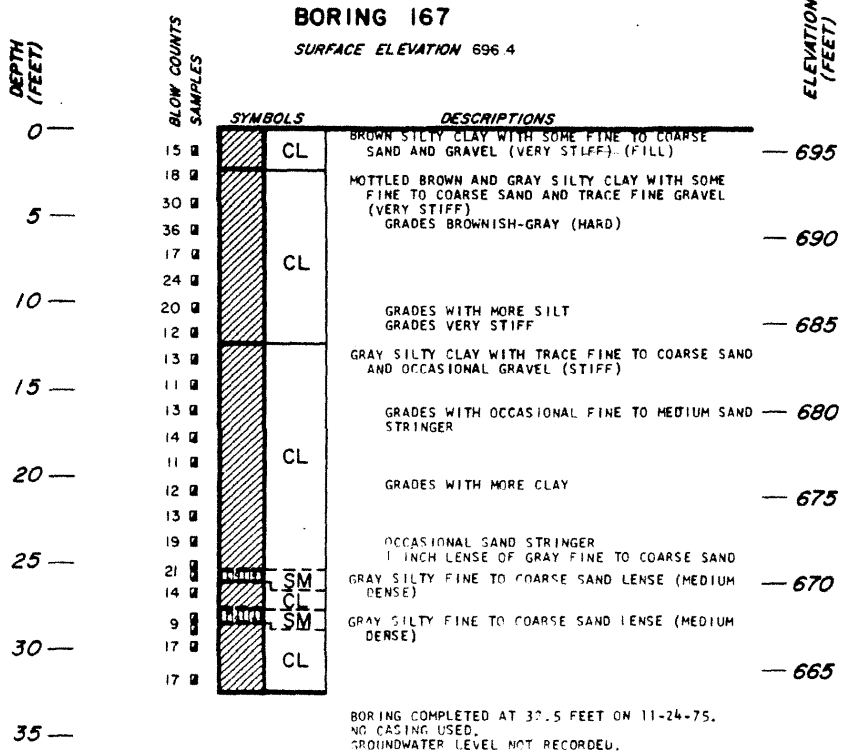

LA SALLE COUNTY STATION  
UPDATED FINAL SAFETY ANALYSIS REPORT

FIGURE 2.5-19  
LOGS OF BORINGS  
(SHEET 149)

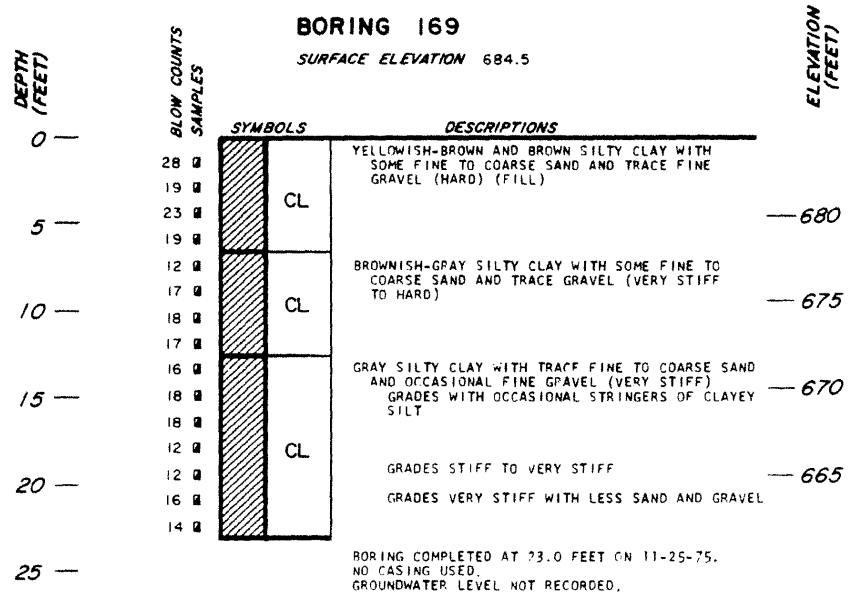
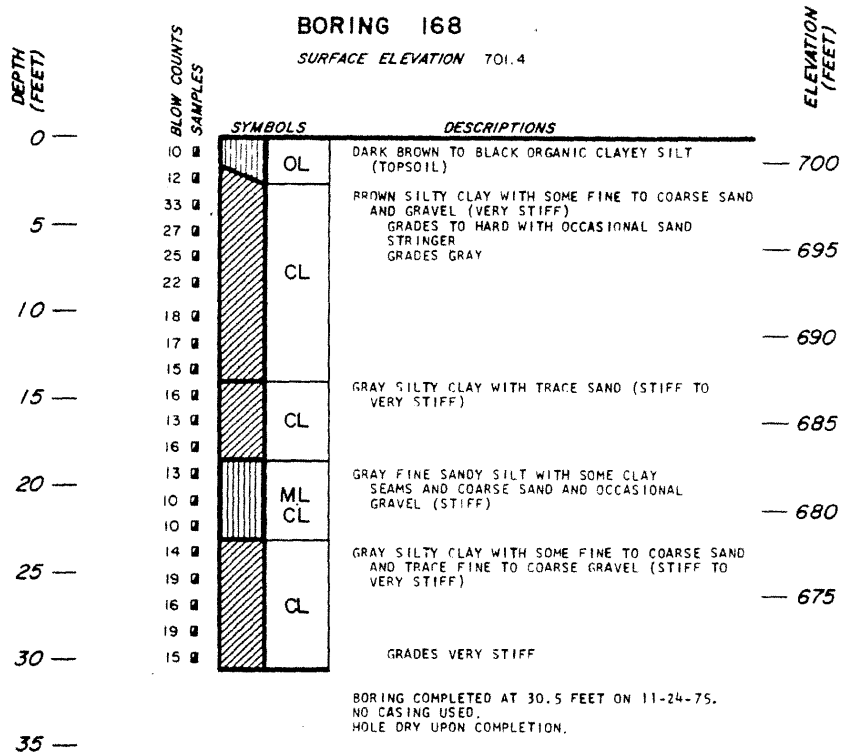

**LA SALLE COUNTY STATION**  
UPDATED FINAL SAFETY ANALYSIS REPORT

FIGURE 2.5-19  
LOGS OF BORINGS  
(SHEET 150)

**BORING 170**

SURFACE ELEVATION 684.3

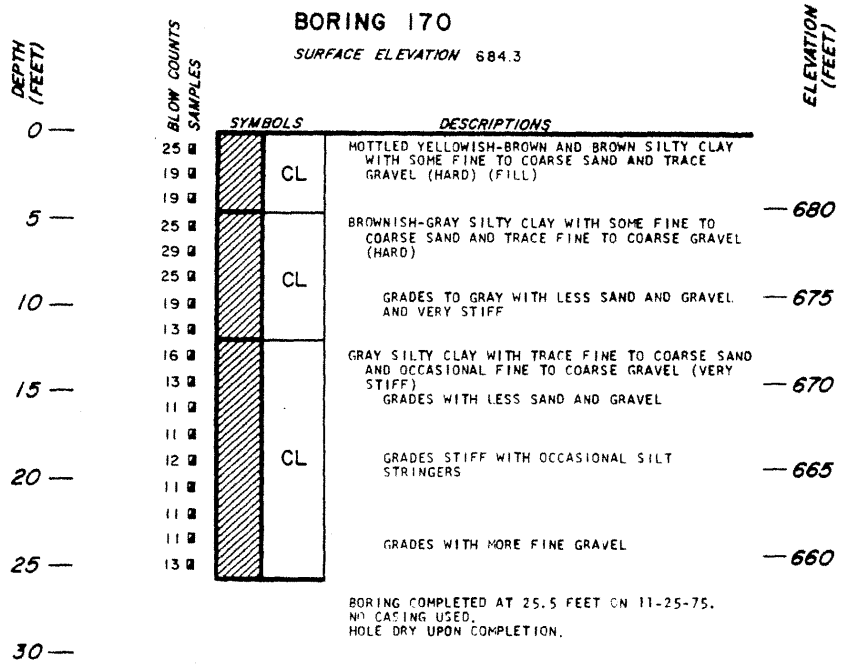

BORING COMPLETED AT 25.5 FEET ON 11-25-75.  
NO CASING USED.  
HOLE DRY UPON COMPLETION.

LA SALLE COUNTY STATION  
UPDATED FINAL SAFETY ANALYSIS REPORT

FIGURE 2.5-19  
LOGS OF BORINGS  
(SHEET 151)



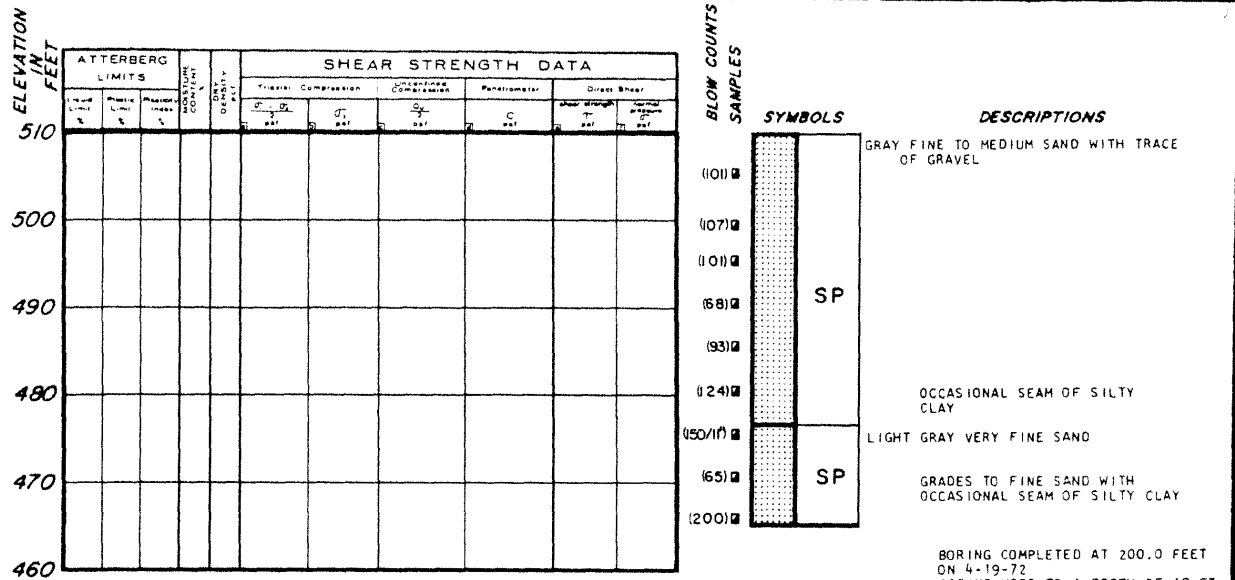

**LA SALLE COUNTY STATION**  
**UPDATED FINAL SAFETY ANALYSIS REPORT**

FIGURE 2.5-19  
 LOGS OF BORINGS  
 (SHEET 153)





**BORING 5-B-01**  
SURFACE ELEVATION 594.1

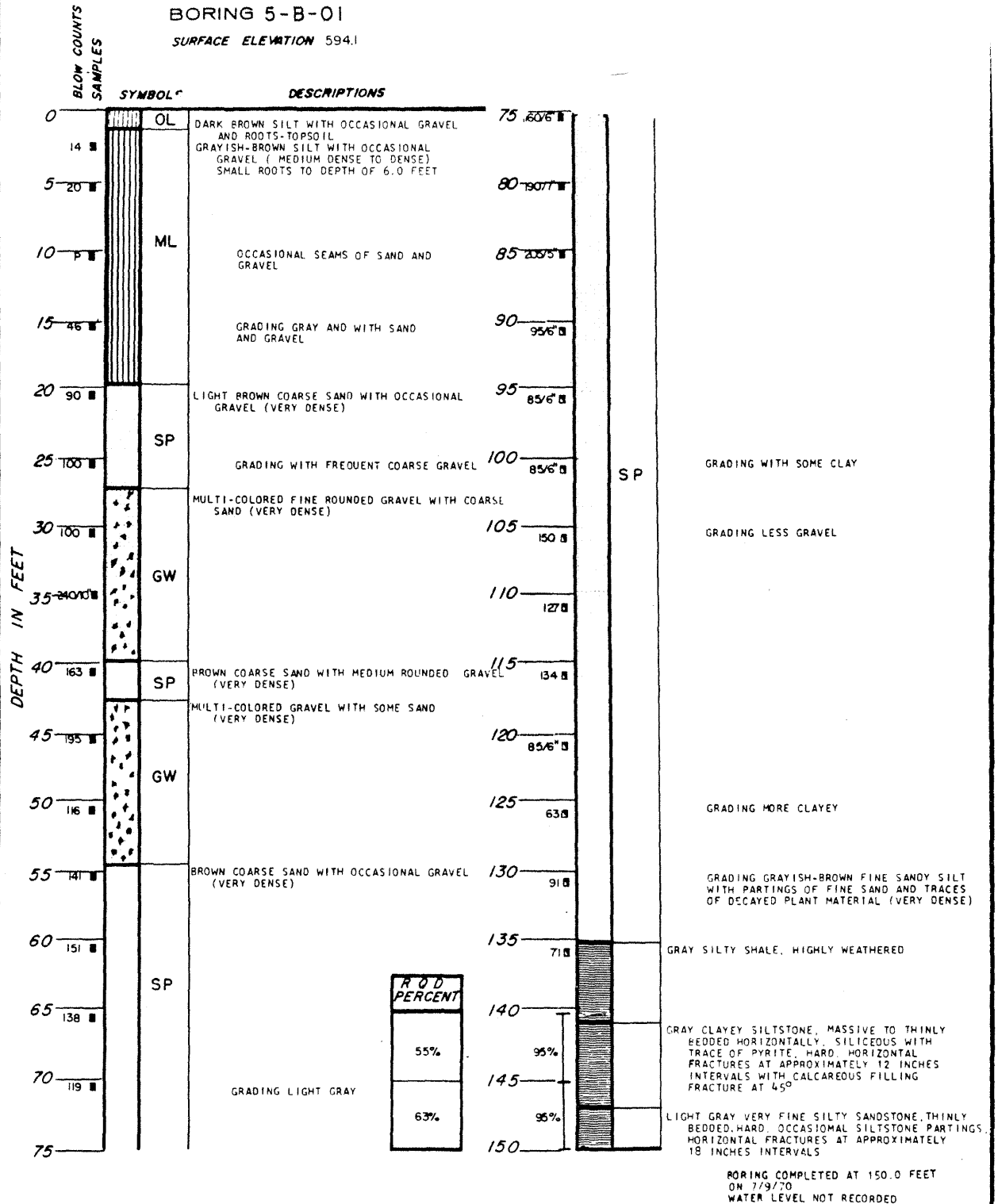

ROD PERCENT
55%
63%

BORING COMPLETED AT 150.0 FEET ON 7/9/70  
WATER LEVEL NOT RECORDED

**LA SALLE COUNTY STATION**  
UPDATED FINAL SAFETY ANALYSIS REPORT

FIGURE 2.5-19  
LOGS OF BORINGS  
(SHEET 155)

**BORING 5-B-02**  
SURFACE ELEVATION 668.1

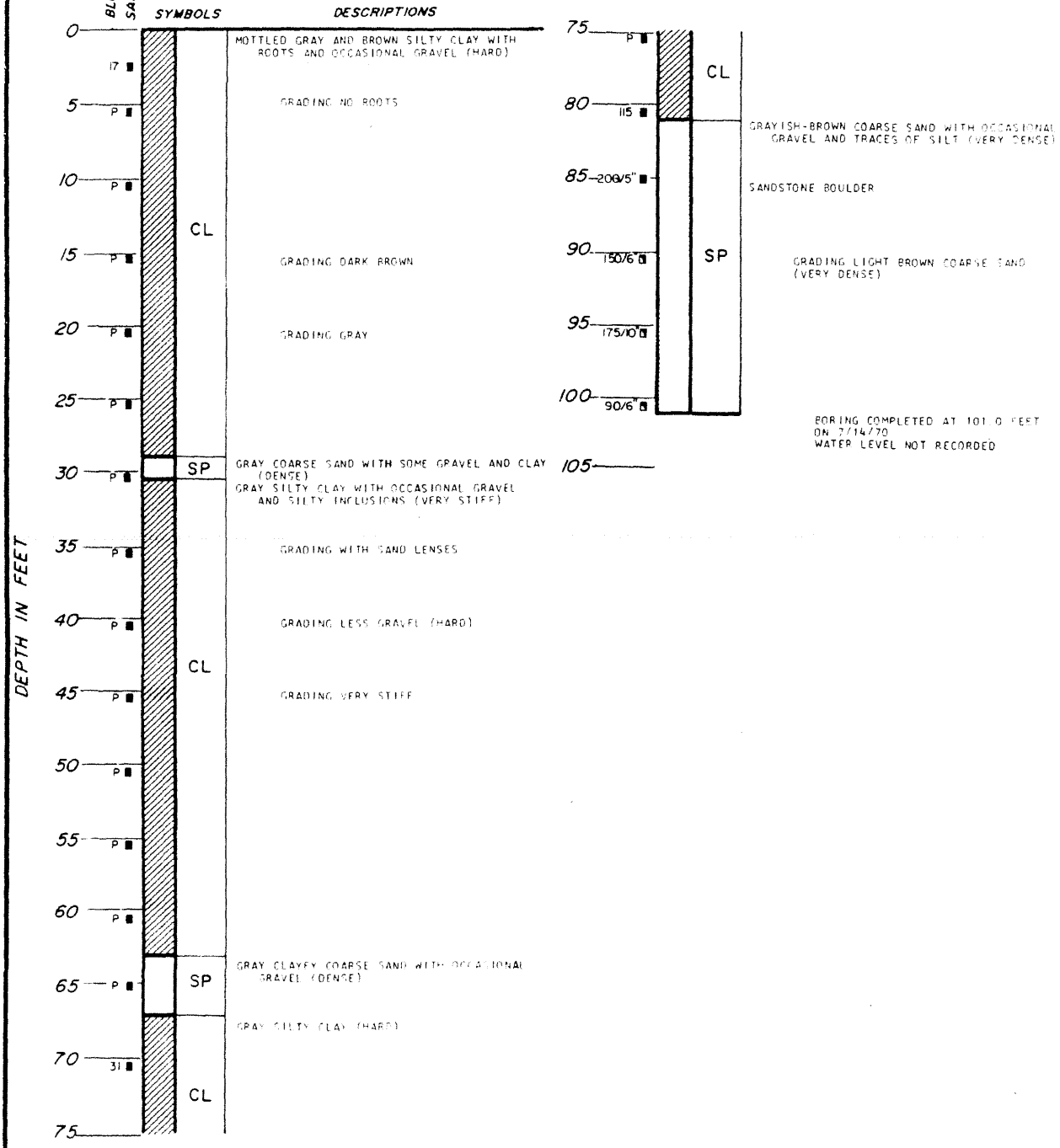

**LA SALLE COUNTY STATION**  
UPDATED FINAL SAFETY ANALYSIS REPORT

FIGURE 2.5-19  
LOGS OF BORINGS  
(SHEET 156)

BORING 5-B-03

SURFACE ELEVATION 623.5

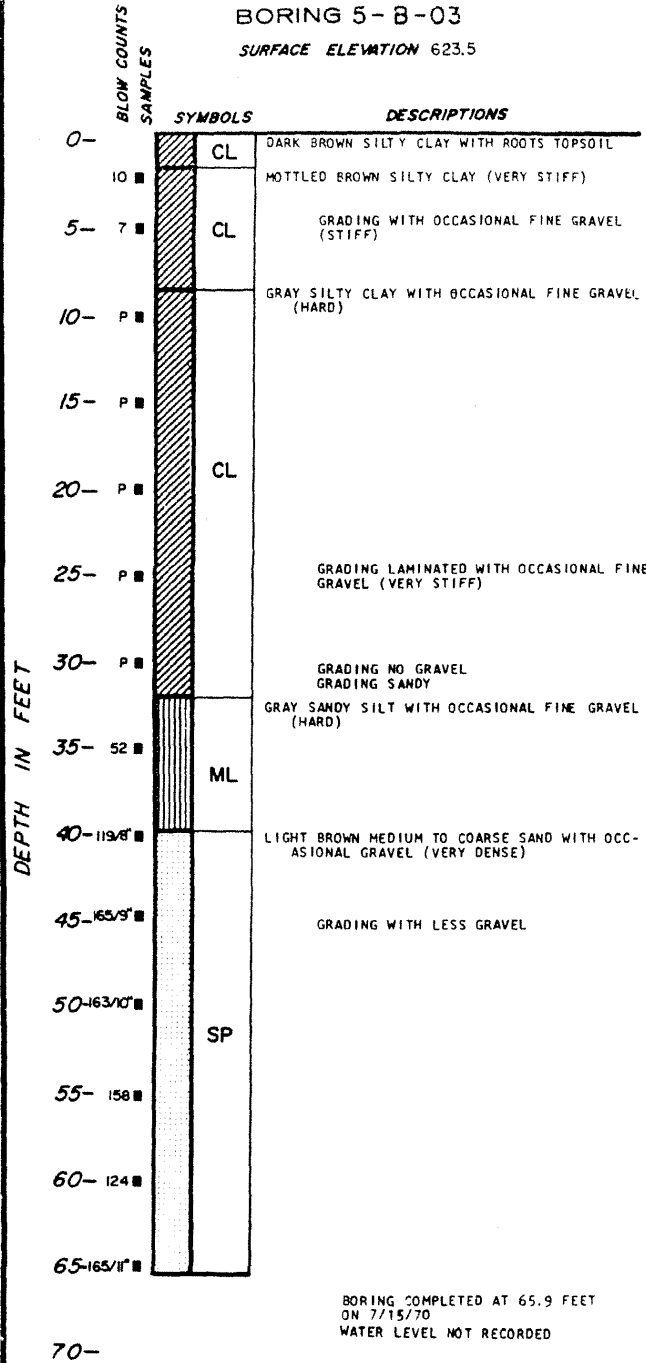

LA SALLE COUNTY STATION  
UPDATED FINAL SAFETY ANALYSIS REPORT

FIGURE 2.5-19  
LOGS OF BORINGS  
(SHEET 157)

BORING 8-B-01  
SURFACE ELEVATION 677±

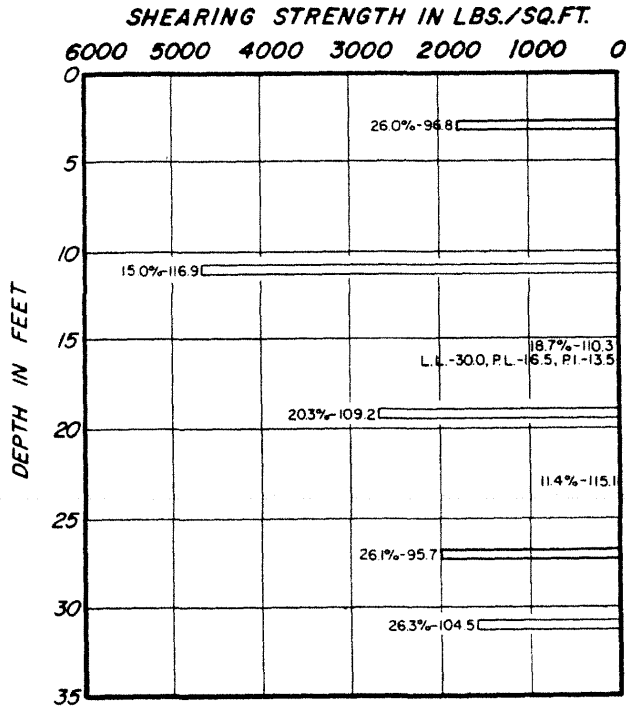

BLOW COUNTS  
SAMPLES

SYMBOLS	DESCRIPTIONS
OL	BLACK ORGANIC SILTY CLAY WITH ROOTS (TOPSOIL-24 INCHES)
CL	MOTTLED BROWN AND YELLOWISH-BROWN SILTY CLAY WITH SOME ROOTS
CL	GRADES TO BROWN
CL	GRAYISH-BROWN SILTY CLAY WITH SOME SAND AND OCCASIONAL SILT SEAMS WITH FINE ROOTS
CL	GRADING TO BROWNISH-GRAY
CL	GRAY SILTY CLAY WITH SOME FINE TO COARSE SAND AND OCCASIONAL GRAVEL
CL	OCCASIONAL SEAM OF COARSE SAND

BORING COMPLETED AT 32.0 FEET ON 11/20/70  
NO CASING USED

PIEZOMETER INSTALLED:  
BOTTOM OF POROUS STONE, TWO FEET IN LENGTH, PLACED AT A DEPTH OF 32 FEET. GRANULAR BACKFILL PLACED TO A DEPTH 28 FEET. SEAL CONSISTING OF BENTONITE AND/OR CONCRETE PLACED FROM 28 FEET TO 26 FEET. HOLE BACKFILLED AND SEALED AT GROUND SURFACE.

WATER LEVEL READINGS

DEPTH IN FEET BELOW GROUND SURFACE	DATE
DRY	11-20-70
13.3	12-1-70
11.5	12-18-70
10.8	12-24-70
9.9	12-29-70

**LA SALLE COUNTY STATION  
UPDATED FINAL SAFETY ANALYSIS REPORT**

FIGURE 2.5-19  
LOGS OF BORINGS  
(SHEET 158)

**BORING 8-B-02**  
**SURFACE ELEVATION 676±**

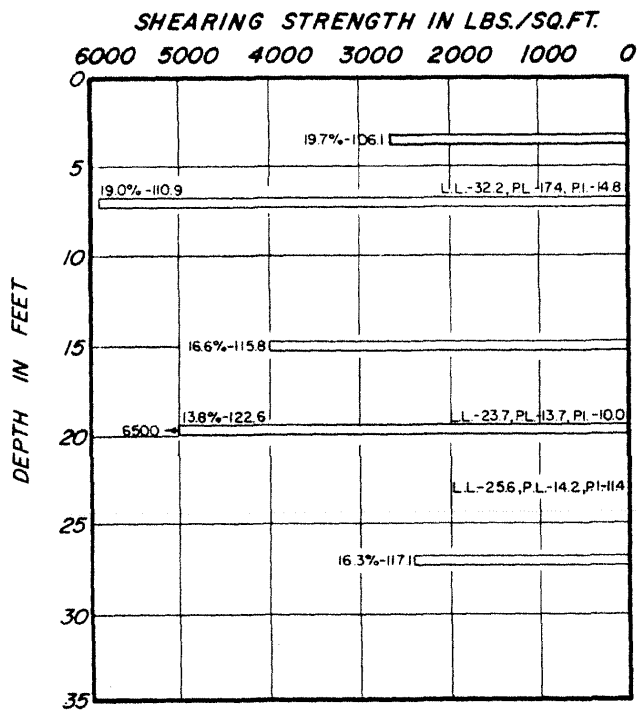

BLOW COUNTS SAMPLES	SYMBOLS	DESCRIPTIONS
8	OL	BLACK ORGANIC CLAYEY SILT WITH ROOTS TO 30" (TOPSOIL-30 INCHES)
9	CL OL	MOTTLED GRAY AND BROWN SILTY CLAY WITH ORGANIC MATTER
18	CL	BROWN SILTY CLAY WITH TRACES OF SAND AND GRAVEL
20		OCCASIONAL POCKET OF GRAY CLAYEY SILT
21		GRAY SILTY CLAY
22		GRADES WITH SOME SAND AND OCCASIONAL GRAVEL
14	CL	
19		
17		

BORING COMPLETED AT 32 FEET ON 11/23/70  
 NO CASING USED

PIEZOMETER INSTALLED:  
 BOTTOM OF POROUS STONE, TWO FEET IN LENGTH, PLACED AT A DEPTH OF 32 FEET. GRANULAR BACKFILL PLACED TO A DEPTH OF 28 FEET. SEAL CONSISTING OF BENTONITE AND /OR CONCRETE PLACED FROM 28 FEET TO 25 FEET. HOLE BACKFILLED AND SEALED AT GROUND SURFACE.

**WATER LEVEL READINGS**

DEPTH IN FEET BELOW GROUND SURFACE	DATE
DRY	11-23-70
DRY	11-25-70
12.0	12-1-70
7.7	12-18-70
6.9	12-24-70
7.5	12-29-70

**LA SALLE COUNTY STATION**  
 UPDATED FINAL SAFETY ANALYSIS REPORT

FIGURE 2.5-19  
 LOGS OF BORINGS  
 (SHEET 159)

**BORING 9-A-01**  
**SURFACE ELEVATION 679±**

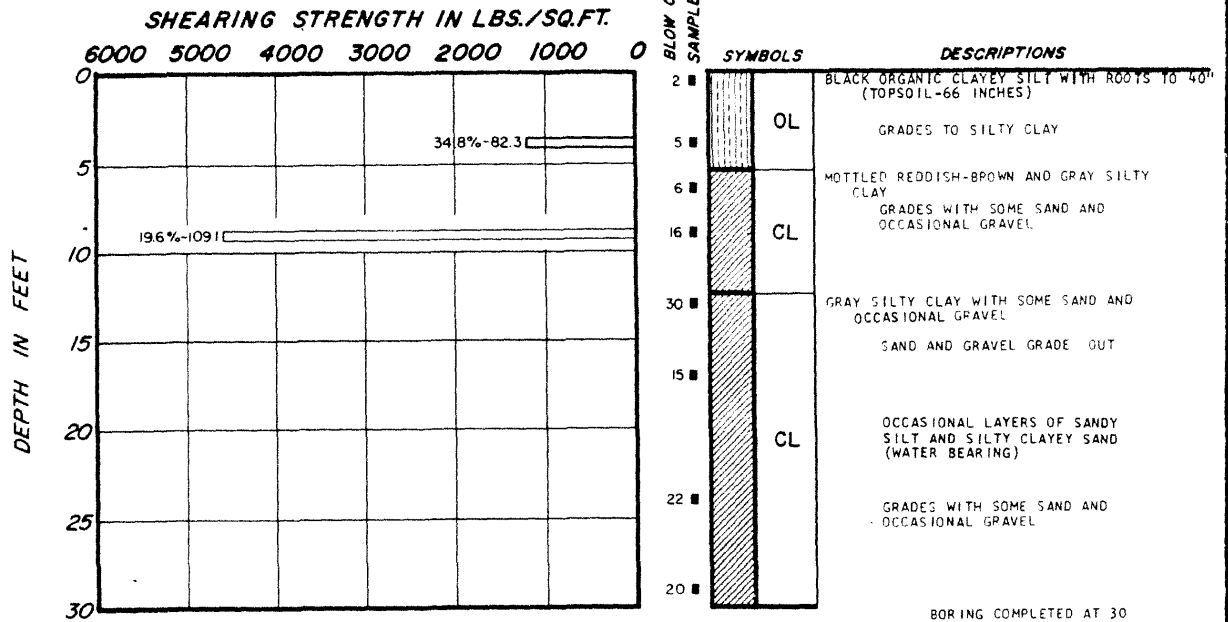

BORING COMPLETED AT 30 FEET ON 11/25/70  
NO CASING USED

PIEZOMETER INSTALLED:  
BOTTOM OF POROUS STONE, TWO FEET IN LENGTH,  
PLACED AT A DEPTH OF 30 FEET. GRANULAR BACKFILL  
PLACED TO A DEPTH OF 21 FEET. SEAL CONSISTING OF  
BENTONITE AND/OR CONCRETE PLACED FROM 21 FEET  
TO 19 FEET. HOLE BACKFILLED AND SEALED AT GROUND  
SURFACE.

**WATER LEVEL READINGS**

DEPTH IN FEET BELOW GROUND SURFACE	DATE
DRY	11-25-70
13.7	12-18-70
13.8	12-24-70
14.1	12-29-70

**LA SALLE COUNTY STATION**  
**UPDATED FINAL SAFETY ANALYSIS REPORT**

FIGURE 2.5-19  
LOGS OF BORINGS  
(SHEET 160)

REV. 0 -  
APRIL 1984

**BORING 10-D-01**  
**SURFACE ELEVATION 678±**

**SHEARING STRENGTH IN LBS./SQ.FT.**  
 6000 5000 4000 3000 2000 1000 0

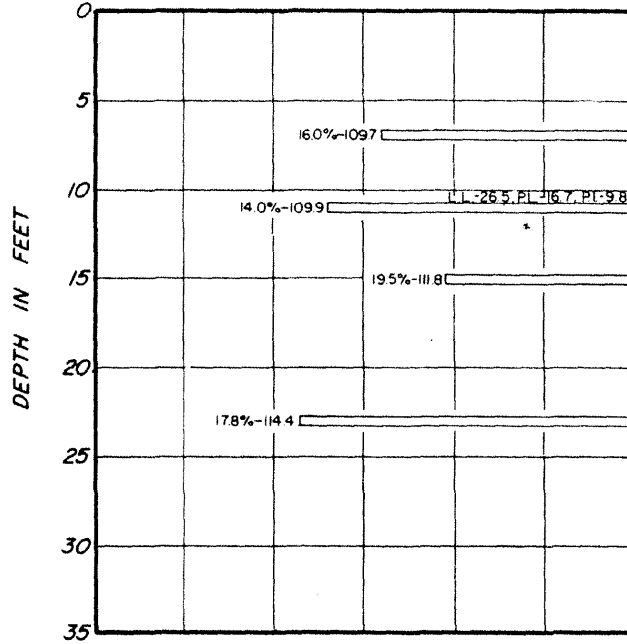

**BLOW COUNTS**  
**SAMPLES**

**SYMBOLS**

**DESCRIPTIONS**

10	OL	BLACK ORGANIC CLAYEY SILT WITH ROOTS (TOPSOIL-12 INCHES)
10	CL OL	GRAYISH-BROWN SILTY CLAY WITH ORGANIC MATTER
27	CL	MOTTLED GRAY AND BROWN SILTY CLAY WITH SOME SAND AND OCCASIONAL GRAVEL
13		GRAY SILTY CLAY WITH SOME SAND AND GRAVEL
13	CL	GRADES TO BROWNISH-GRAY
31		
22		GRADES TO GRAY
15		
15		

BORING COMPLETED AT 32 FEET ON 11/19/70  
 NO CASING USED  
 PIEZOMETER INSTALLED:  
 GALVANIZED PIPE ONE AND ONE-QUARTER INCHES IN DIAMETER PLACED IN HOLE. PIPE SLOTTED FROM A DEPTH OF 5 FEET TO 32 FEET. GRANULAR BACKFILL PLACED IN HOLE AND SEALED AT GROUND SURFACE WITH BENTONITE AND/OR CONCRETE.

**WATER LEVEL READINGS**

DEPTH IN FEET BELOW GROUND SURFACE	DATE
DRY	11-19-70
6.1	11-25-70
4.3	11-30-70
4.0	12-15-70
4.0	12-18-70
4.2	12-29-70

**LA SALLE COUNTY STATION**  
**UPDATED FINAL SAFETY ANALYSIS REPORT**

FIGURE 2.5-19

LOGS OF BORINGS

(SHEET 161) REV. 0 -  
 APRIL 1984



**BORING 10-D-02**  
**SURFACE ELEVATION 678±**

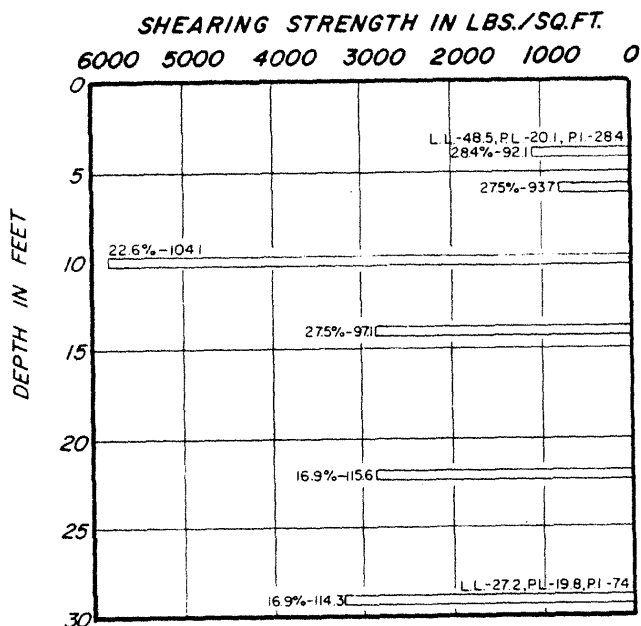

BLOW COUNTS SAMPLES	SYMBOLS	DESCRIPTIONS
0-18	OL	BLACK ORGANIC SILTY CLAY WITH ROOTS (TOPSOIL - 18 INCHES)
18-20	CL	MODIFIED BROWN AND GRAY SILTY CLAY WITH OCCASIONAL ORGANIC MATTER
20-22	CH	OCCASIONAL SILT LENS
22-25	ML	BROWN SANDY SILT (WATER BEARING)
25-30	SM	BROWN TO GRAY SILTY CLAY
30-32		GRADED TO DARK GRAY WITH SOME SAND AND OCCASIONAL GRAVEL
32-38	CL	

BORING COMPLETE AT 30 FEET ON 11/20/70  
 NO CASING USED

**PUMPING TEST:**  
 INTAKE NOZZLE PLACED AT A DEPTH OF 5.3 FEET.  
 TEST NO. 1 PUMPED 15 GALLONS IN 12 MINUTES.  
 TEST NO. 2 PUMPED 40 GALLONS IN 30 MINUTES.

**PIEZOMETER INSTALLED:**  
 GALVANIZED PIPE ONE AND ONE-QUARTER INCHES IN DIAMETER PLACED IN HOLE. PIPE SLOTTED FROM A DEPTH OF 5 FEET TO 15 FEET. GRANULAR BACKFILL PLACED IN HOLE AND SEALED AT GROUND SURFACE WITH BENTONITE AND/OR CONCRETE.

WATER LEVEL READINGS

DEPTH IN FEET BELOW GROUND SURFACE	DATE
2.5	11-20-70
2.5	11-25-70
2.2	12-15-70
2.5	12-18-70
2.8	12-24-70
3.2	12-29-70

**LA SALLE COUNTY STATION**  
 UPDATED FINAL SAFETY ANALYSIS REPORT

FIGURE 2.5-19  
 LOGS OF BORINGS  
 (SHEET 162)      REV. 0 -  
 APRIL 1984

**SHEARING STRENGTH IN LBS./SQ.FT.**  
6000 5000 4000 3000 2000 1000 0

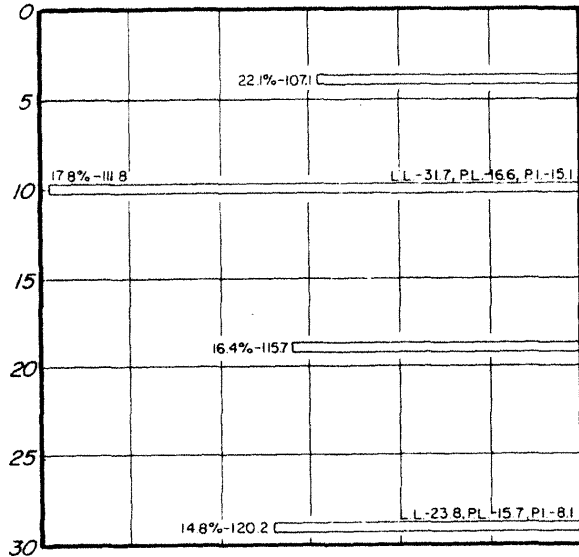

BLOW COUNTS  
SAMPLES

**BORING 16-B-01**  
SURFACE ELEVATION 691±

DEPTH (ft)	SYMBOLS	DESCRIPTIONS
0 - 9	OL	BLACK ORGANIC SILTY CLAY WITH ROOTS TO 12" (TOPSOIL-18 INCHES)
9 - 16	CL	MOTTLED BROWN AND GRAY SILTY CLAY WITH TRACE OF SAND AND GRAVEL
16 - 15	SM	BROWN SILTY SAND WITH SOME GRAVEL (WATER BEARING)
15 - 26		GRAY SILTY CLAY WITH SOME SAND AND OCCASIONAL GRAVEL
26 - 17		SAND AND GRAVEL GRADE OUT
17 - 17	CL	GRAVELS WITH SOME SAND AND OCCASIONAL GRAVEL
17 - 20		
20 - 20		
20 - 30		

BORING COMPLETED AT 30 FEET ON 11/24/70  
NO CASING USED

PIEZOMETER INSTALLED:  
BOTTOM OF POROUS STONE, TWO FEET IN LENGTH, PLACED AT A DEPTH OF 30 FEET. GRANULAR BACKFILL PLACED TO A DEPTH OF 3 FEET. SEAL CONSISTING OF BENTONITE AND / OR CONCRETE PLACED FROM 3 FEET TO GROUND SURFACE.

**WATER LEVEL READINGS**

DEPTH IN FEET BELOW GROUND SURFACE	DATE
29.5	11-24-70
29.0	3:30 PM
29.0	3:35 PM
28.5	3:40 PM
28.0	3:45 PM
27.8	3:50 PM
27.5	3:55 PM
27.5	4:00 PM
3.0	11-25-70
2.3	11-30-70
3.0	12-15-70
2.5	12-18-70
2.8	12-24-70
2.6	12-29-70

**LA SALLE COUNTY STATION**  
UPDATED FINAL SAFETY ANALYSIS REPORT

FIGURE 2.5-19

LOGS OF BORINGS

(SHEET 163) REV. 0-  
APRIL 1984

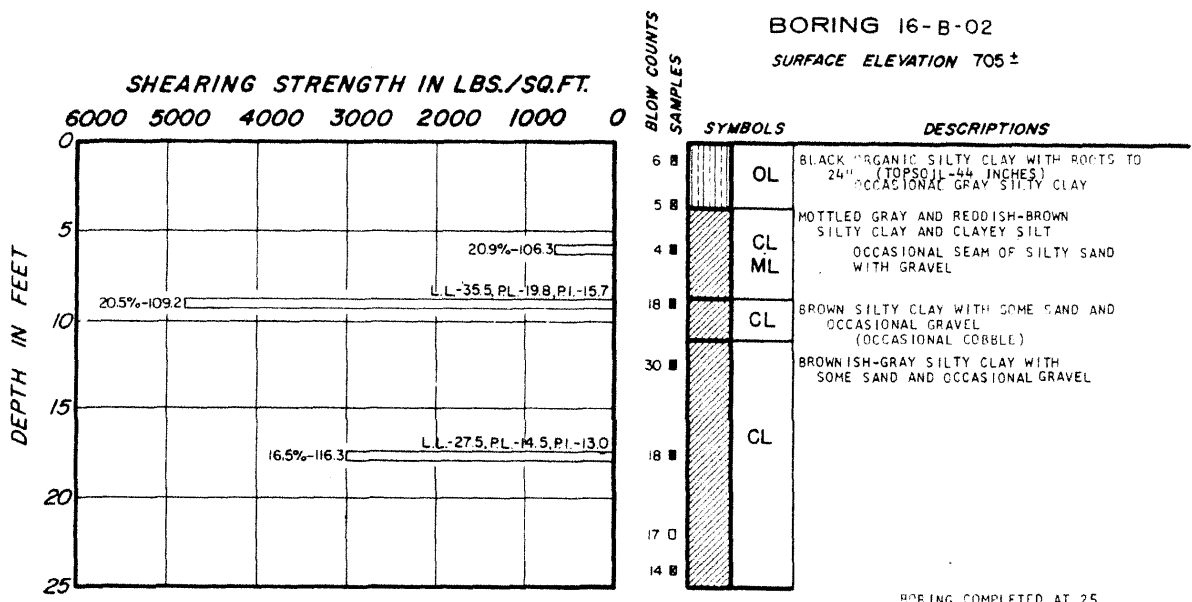

BORING COMPLETED AT 25 FEET ON 11/24/70  
NO CASING USED

**PUMPING TEST:**  
INTAKE NOZZLE PLACED AT A DEPTH OF 6.5 FEET. PUMPED APPROXIMATELY 300 GALLONS BEFORE WATER CLEARED AND A STEADY RATE OF OUTFLOW WAS OBTAINED. PUMPING TEST WERE THEN PERFORMED.

TEST NO.1-PUMPED 62 GALLONS IN 14 MINUTES.  
TEST NO.2-PUMPED 51 GALLONS IN 14 MINUTES.

**PIEZOMETER INSTALLED:**  
GALVANIZED PIPE ONE AND ONE-QUARTER INCHES IN DIAMETER PLACED IN HOLE. PIPE SLOTTED FROM A DEPTH OF 5 FEET TO 25 FEET. GRANULAR BACKFILL PLACED IN HOLE AND SEALED AT GROUND SURFACE WITH BENTONITE AND/OR CONCRETE.

WATER LEVEL READINGS

DEPTH IN FEET BELOW GROUND SURFACE	DATE
2.6	11-24-70
3.0	11-25-70
2.9	11-30-70
2.8	12-15-70
3.0	12-18-70
3.7	12-24-70
3.5	12-29-70

**LA SALLE COUNTY STATION**  
**UPDATED FINAL SAFETY ANALYSIS REPORT**

FIGURE 2.5-19  
LOGS OF BORINGS  
(SHEET 164)

REV. 0 -  
APRIL 1984

BORING 21-D-01  
SURFACE ELEVATION 695±

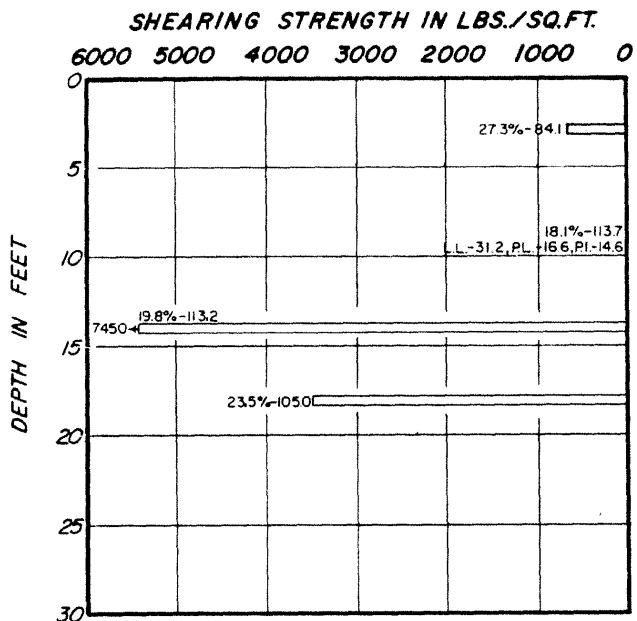

BLOW COUNTS SAMPLES	SYMBOLS	DESCRIPTIONS
9	OL	BLACK ORGANIC CLAYEY SILT WITH ROOTS (TOPSOIL-20 INCHES)
11	CL	MOTTLED GRAY AND REDDISH-BROWN SILTY CLAY
3	ML	MOTTLED REDDISH-BROWN AND GRAY SILT WITH FINE SAND AND SOME CLAY
9	CL	4" LAYER SILTY FINE TO COARSE SAND AND GRAVEL
	CL	BROWN SILTY CLAY WITH SAND AND GRAVEL
32		GRAY VERY SILTY CLAY WITH TRACE OF SAND AND OCCASIONAL GRAVEL
18	CL	
21		
17		

BORING COMPLETED AT 27 FEET ON 11/17/70  
NO CASING USED

**PUMPING TEST:**  
INTAKE NOZZLE PLACED AT A DEPTH OF 7.0 FEET

- TEST NO. 1-PUMPED 4 GALLONS IN 1.0 MINUTE.
- TEST NO. 2-PUMPED 3 GALLONS IN 1.0 MINUTE.
- TEST NO. 3-PUMPED 4 GALLONS IN 1.0 MINUTE.
- TEST NO. 4-PUMPED 15 GALLONS IN 5.0 MINUTES.
- TEST NO. 5-PUMPED 17.5 GALLONS IN 5.5 MINUTES.
- TEST NO. 6-PUMPED 25 GALLONS IN 10.0 MINUTES.
- TEST NO. 7-PUMPED 27 GALLONS IN 11.5 MINUTES.
- TEST NO. 8-PUMPED 20 GALLONS IN 10.0 MINUTES.

**PIEZOMETER INSTALLED:**  
GALVANIZED PIPE ONE AND ONE-QUARTER INCHES IN DIAMETER PLACED IN HOLE. PIPE SLOTTED FROM A DEPTH OF 5 FEET TO 27 FEET. GRANULAR BACKFILL PLACED IN HOLE AND SEALED AT GROUND SURFACE WITH BENTONITE AND/OR CONCRETE.

WATER LEVEL READINGS

DEPTH IN FEET BELOW GROUND SURFACE	DATE
2.8	11-17-70
3.0	11-18-70
2.8	11-19-70
2.8	11-20-70
3.3	11-25-70
2.2	11-30-70
2.8	12-15-70
3.1	12-18-70
3.4	12-24-70
4.3	12-29-70

**LA SALLE COUNTY STATION**  
UPDATED FINAL SAFETY ANALYSIS REPORT

FIGURE 2.5-19  
LOGS OF BORINGS  
(SHEET 165)

REV. 0 -  
APRIL 1984

BORING 21-D-02  
SURFACE ELEVATION 691±

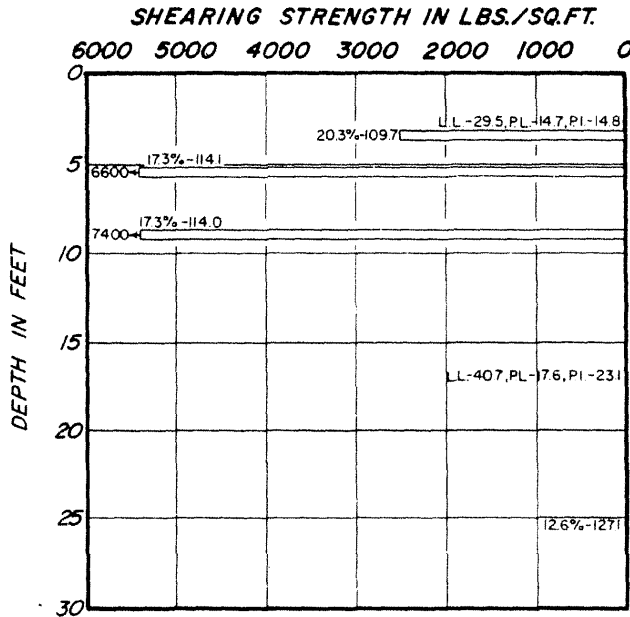

BLOW COUNTS SAMPLES	SYMBOLS	DESCRIPTIONS
10	OL	BLACK ORGANIC SILTY CLAY WITH ROOTS (TOPSOIL-18 INCHES)
13		MOTTLED GRAY AND BROWN SILTY CLAY WITH SOME SAND AND GRAVEL
18		
26	CL ML	GRADES TO BROWNISH-GRAY
19		GRADES LESS SAND AND GRAVEL
19	CL ML	GRAY VERY SILTY CLAY
10	SM	GRAY SILTY FINE SAND WITH SOME CLAY
20		GRAY CLAYEY SILT WITH SAND AND GRAVEL
38	ML	GRADE MORE CLAY

BORING COMPLETED AT 30 FEET ON 11/18/70  
NO CASING USED

PIEZOMETER INSTALLED:  
GALVANIZED PIPE ONE AND ONE-QUARTER INCHES IN DIAMETER PLACED IN HOLE. PIPE SLOTTED FROM A DEPTH OF 5 FEET TO 30 FEET. GRANULAR BACK-FILL PLACED IN HOLE AND SEALED AT GROUND SURFACE WITH BENTONITE AND/OR CONCRETE.

WATER LEVEL READINGS

DEPTH IN FEET BELOW GROUND SURFACE	DATE
30.0	11-18-70
29.0	9:45AM
28.5	9:50
28.0	9:55
27.0	10:00
26.3	10:05
25.8	10:10
25.3	10:15
25.0	10:26
6.0	10:37
5.5	11-19-70
5.0	11-20-70
4.8	11-25-70
4.8	12-15-70
4.8	12-18-70
4.3	12-24-70

LA SALLE COUNTY STATION  
UPDATED FINAL SAFETY ANALYSIS REPORT

FIGURE 2.5-19  
LOGS OF BORINGS  
(SHEET 166)

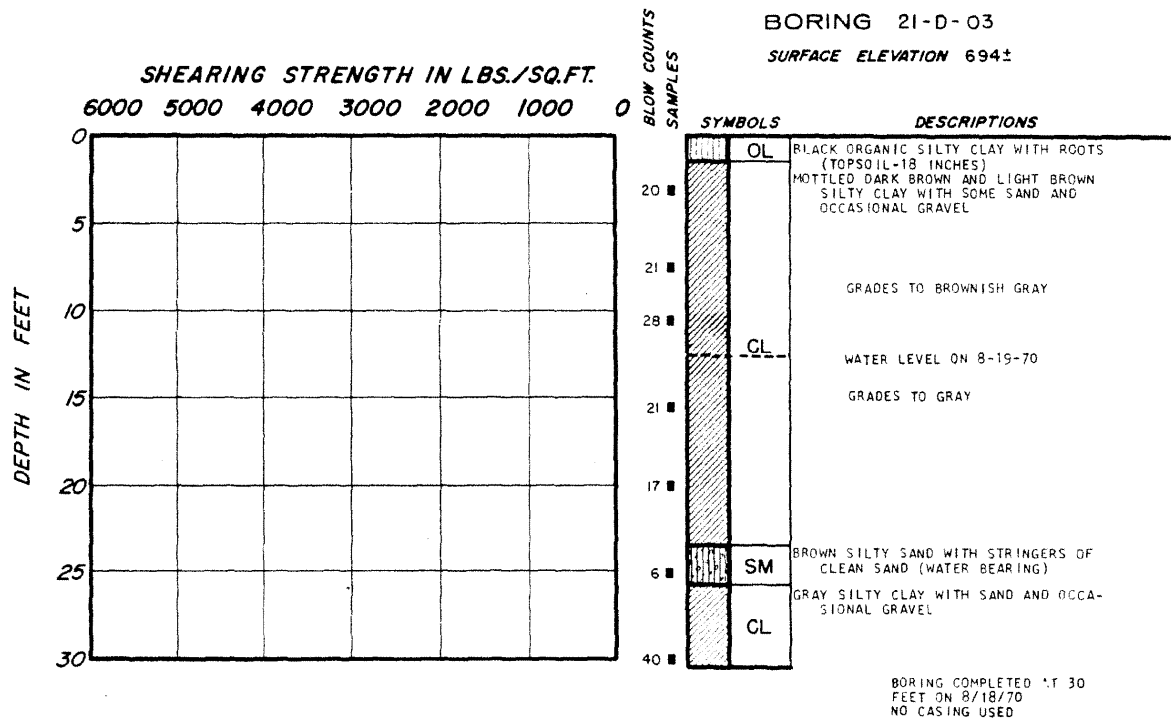

**LA SALLE COUNTY STATION**  
**UPDATED FINAL SAFETY ANALYSIS REPORT**

FIGURE 2.5-19  
LOGS OF BORINGS  
(SHEET 167)

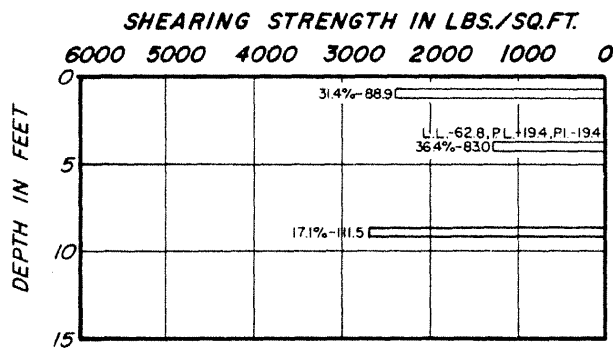

**BORING 27-C-01**  
SURFACE ELEVATION 690±

BLOW COUNTS SAMPLES	SYMBOLS	DESCRIPTIONS
9	OL	BLACK AND GRAY ORGANIC SILTY CLAY WITH ROOTS (TOPSOIL-54 INCHES) OCCASIONAL LAYER OF BROWN SILTY CLAY
4	CH	
4	SM	WATER LEVEL ON 12-18-70 GRAY VERY SILTY SAND WITH OCCASIONAL GRAVEL
3	CL	MOTTLED BROWN AND GRAY SILTY CLAY WITH TRACE OF SAND
9		

BORING COMPLETED AT 10.5 FEET ON 11/18/70  
NO CASING USED

**LA SALLE COUNTY STATION**  
UPDATED FINAL SAFETY ANALYSIS REPORT

FIGURE 2.5-19  
LOGS OF BORINGS  
(SHEET 168)

**BORING 27-C-02**  
**SURFACE ELEVATION 689±**

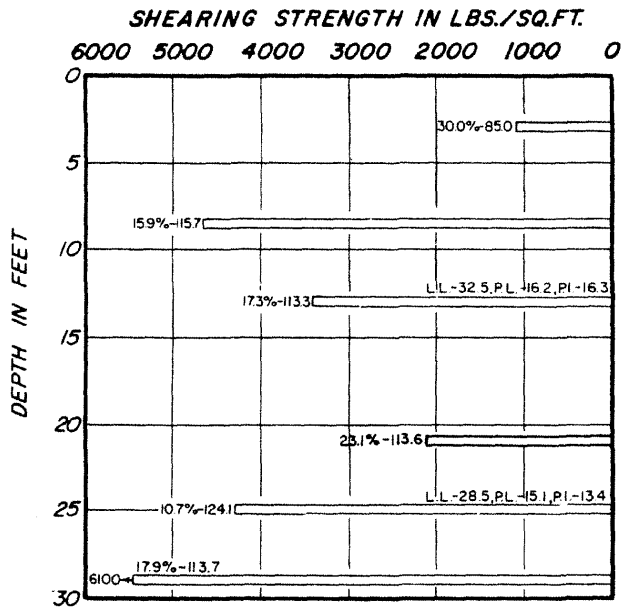

BLOW COUNTS  
SAMPLES

SYMBOLS	DESCRIPTIONS
OL	BLACK ORGANIC SILTY CLAY WITH ROOTS (TOPSOIL-30 INCHES)
CL OL	INTERBEDDED BLACKISH-GRAY ORGANIC SILTY CLAY AND BROWN CLAYEY SILT AND SILTY CLAY OCCASIONAL STRINGER OF SILTY SAND
	MOTTLED GRAY AND BROWN SILTY CLAY WITH TRACE OF SAND
	GRADES TO GRAY WITH MORE SAND AND OCCASIONAL GRAVEL
	GRADES MORE SAND
CL	
CL	BROWNISH-GRAY SILTY CLAY WITH SOME SAND AND TRACE OF GRAVEL OCCASIONAL POCKET OR STRINGER OF SILTY SAND GRADES MORE BROWN

BORING COMPLETED AT 30 FEET ON 11/17/70  
NO CASING USED

**PIEZOMETER INSTALLED:**  
 GALVANIZED PIPE ONE AND ONE-QUARTER INCHES IN DIAMETER PLACED IN HOLE. PIPE SLOTTED FROM A DEPTH OF 5 FEET TO 21 FEET. GRANULAR BACKFILL PLACED IN HOLE AND SEALED AT GROUND SURFACE WITH BENTONITE AND/OR CONCRETE.

WATER LEVEL READINGS

DEPTH IN FEET BELOW GROUND SURFACE	DATE
DRY	11-17-70
DRY	11-20-70
15.7	11-25-70
4.9	11-30-70
4.5	12-15-70
4.7	12-29-70

**LA SALLE COUNTY STATION**  
 UPDATED FINAL SAFETY ANALYSIS REPORT

FIGURE 2.5-19  
 LOGS OF BORINGS  
 (SHEET 169)



6000 5000 4000 3000 2000 1000 0

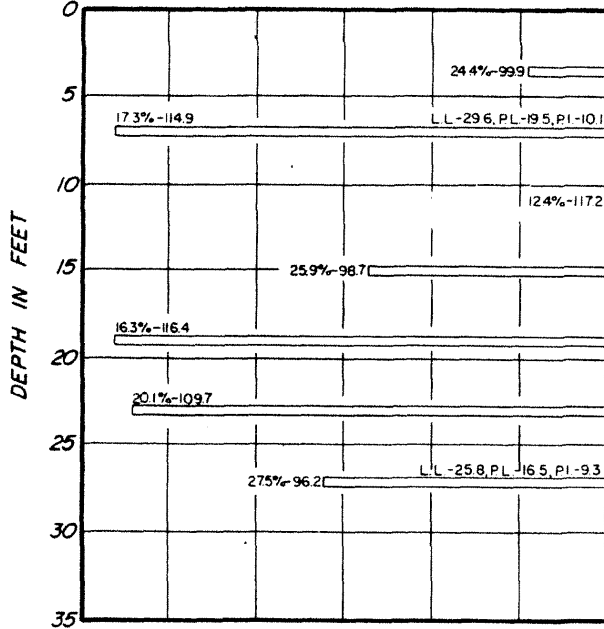

BORING 27-D-01  
SURFACE ELEVATION 692±

BLOW COUNTS  
SAMPLES

DEPTH IN FEET	SYMBOLS	DESCRIPTIONS
9	OL	BLACK ORGANIC SILTY CLAY WITH ROOTS (TOPSOIL-24 INCHES)
8	OL CL	INTERBEDDED BLACK ORGANIC SILTY CLAY AND BROWN SILTY CLAY WITH TRACE OF SAND
22	CL	MOTTLED GRAY AND REDDISH-BROWN SILTY CLAY WITH TRACE OF SAND
16	CL	GRADES TO BROWNISH-GRAY WITH MOTTLED LIGHT GRAY AND BROWN SILT WITH SOME CLAY
17	CL	GRADES TO GRAY SILTY CLAY
18	ML CL	GRAY VERY CLAYEY SILT WITH SAND AND OCCASIONAL GRAVEL
29	ML CL	GRAY SILTY CLAY
15	CL	GRAY SANDY SILT WITH SOME CLAY
10	ML SM	OCCASIONAL LAYER OF SAND AND GRAVEL
45	CL	GRAY SILTY CLAY WITH SOME SAND AND GRAVEL

BORING COMPLETED AT 34 FEET ON 11/18/70  
NO CASING USED

PIEZOMETER INSTALLED:  
BOTTOM OF POROUS STONE, TWO FEET IN LENGTH, PLACED AT A DEPTH OF 33 FEET. GRANULAR BACKFILL PLACED TO A DEPTH OF 20 FEET. SEAL CONSISTING OF BENTONITE AND/OR CONCRETE PLACED FROM 20 FEET TO 17 FEET. HOLE BACK-FILLED AND SEALED AT GROUND SURFACE.

WATER LEVEL READINGS

DEPTH IN FEET BELOW GROUND SURFACE	DATE
20.0	11-18-70
14.2	11-25-70
13.5	11-30-70
13.5	12-18-70
13.7	12-24-70
13.2	12-29-70

LA SALLE COUNTY STATION  
UPDATED FINAL SAFETY ANALYSIS REPORT

FIGURE 2.5-19  
LOGS OF BORINGS  
(SHEET 170)

**BORING 28-C-01**  
**SURFACE ELEVATION 704±**

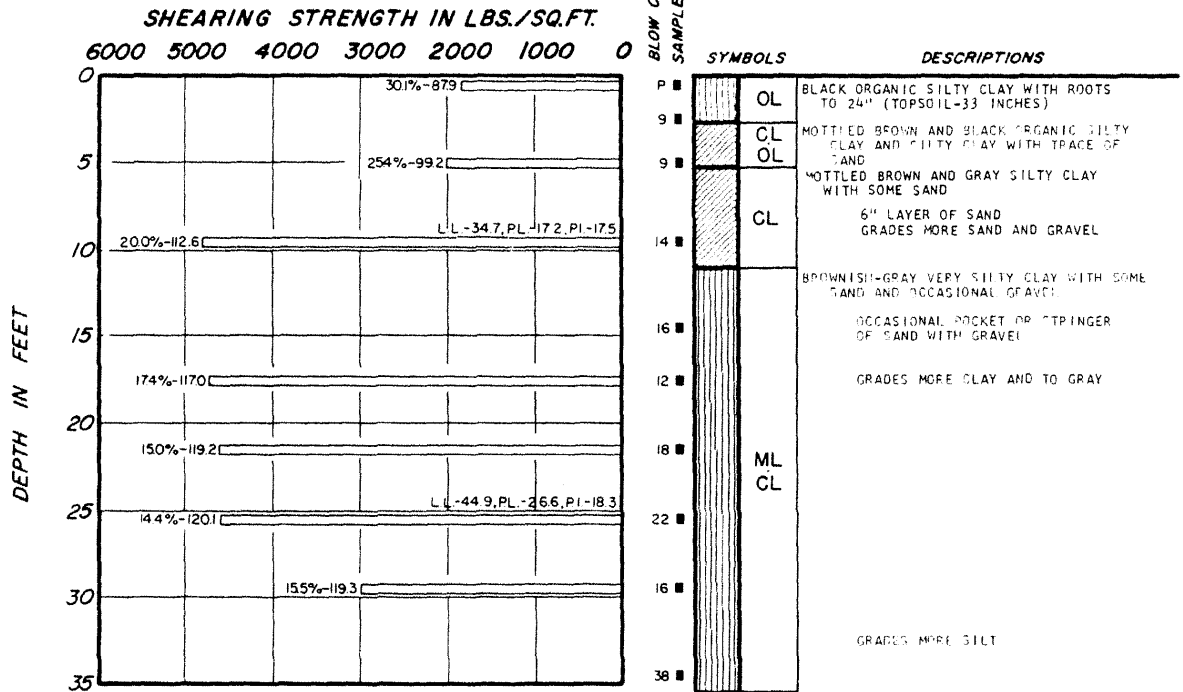

BORING COMPLETED AT 35.5 FEET ON 11/16/70  
NO CASING USED

PIEZOMETER INSTALLED:  
GALVANIZED PIPE ONE AND ONE-QUARTER INCHES IN DIAMETER PLACED IN HOLE. PIPE SLOTTED FROM A DEPTH OF 5 FEET TO 21 FEET. GRANULAR BACKFILL PLACED IN HOLE AND SEALED AT GROUND SURFACE WITH BENTONITE AND/OR CONCRETE.

WATER LEVEL READINGS

DEPTH IN FEET BELOW GROUND SURFACE	DATE
3.5	11-16-70
3.2	11-17-70
3.3	11-18-70
3.7	11-19-70
3.8	11-20-70
3.8	11-25-70
3.8	11-30-70
3.6	12-15-70
4.8	12-18-70
4.0	12-24-70
4.8	12-28-70

**LA SALLE COUNTY STATION**  
**UPDATED FINAL SAFETY ANALYSIS REPORT**

FIGURE 2.5-19  
 LOGS OF BORINGS  
 (SHEET 171)

BORING 29-C-01  
SURFACE ELEVATION 559.5

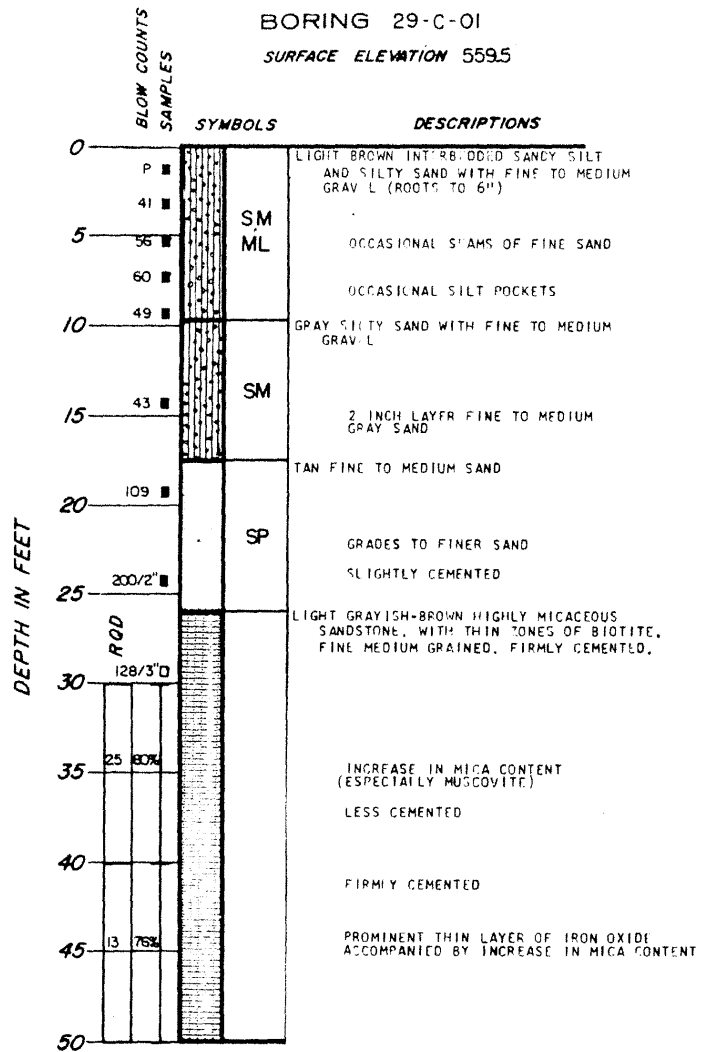

BORING COMPLETED AT 50.0 FEET  
CASING USED TO A DEPTH OF 24.0 FEET  
WATER LEVEL NOT RECORDED

LA SALLE COUNTY STATION  
UPDATED FINAL SAFETY ANALYSIS REPORT

FIGURE 2.5-19  
LOGS OF BORINGS

(SHEET 172) REV. 0 -  
APRIL 1984

**BORING 32-A-01**

*SURFACE ELEVATION 555.4*

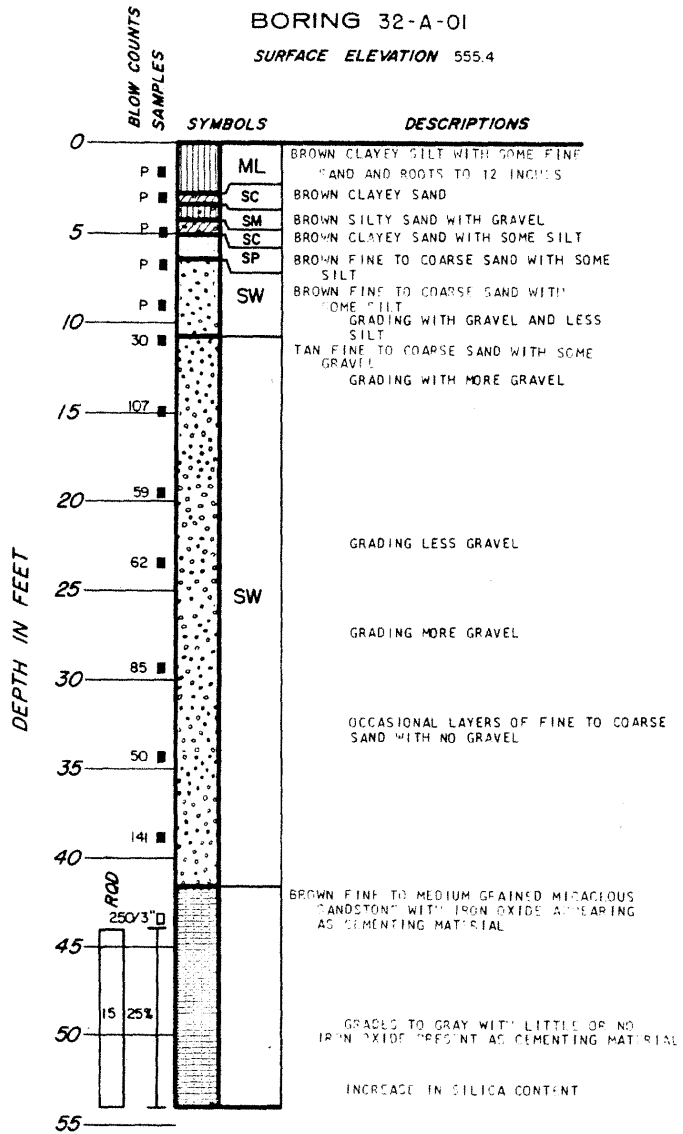

BORING COMPLETED AT 54.0 FEET  
ON 10/29/70  
CASING USED TO A DEPTH OF 42.0 FEET.  
WATER LEVEL NOT RECORDED

**LA SALLE COUNTY STATION  
UPDATED FINAL SAFETY ANALYSIS REPORT**

FIGURE 2.5-19  
LOGS OF BORINGS  
(SHEET 173)

REV. 0  
APRIL 1984

BORING 32-B-01

SURFACE ELEVATION 650.8

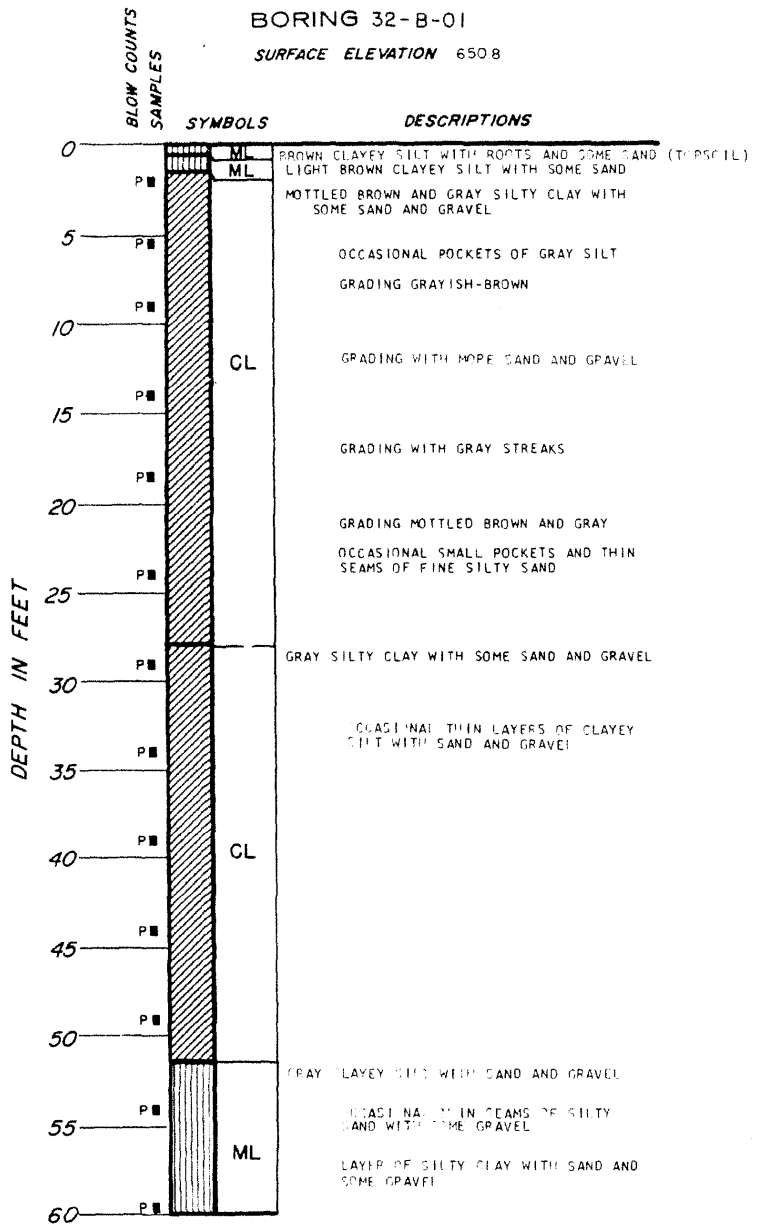

BORING COMPLETED AT 60.0 FEET  
ON 10/26/70  
NO CASING USED  
WATER LEVEL NOT RECORDED

LA SALLE COUNTY STATION  
UPDATED FINAL SAFETY ANALYSIS REPORT

FIGURE 2.5-19

LOGS OF BORINGS

(SHEET 174)

REV. 0 -  
APRIL 1984

BORING 32-B-02  
SURFACE ELEVATION 620.3

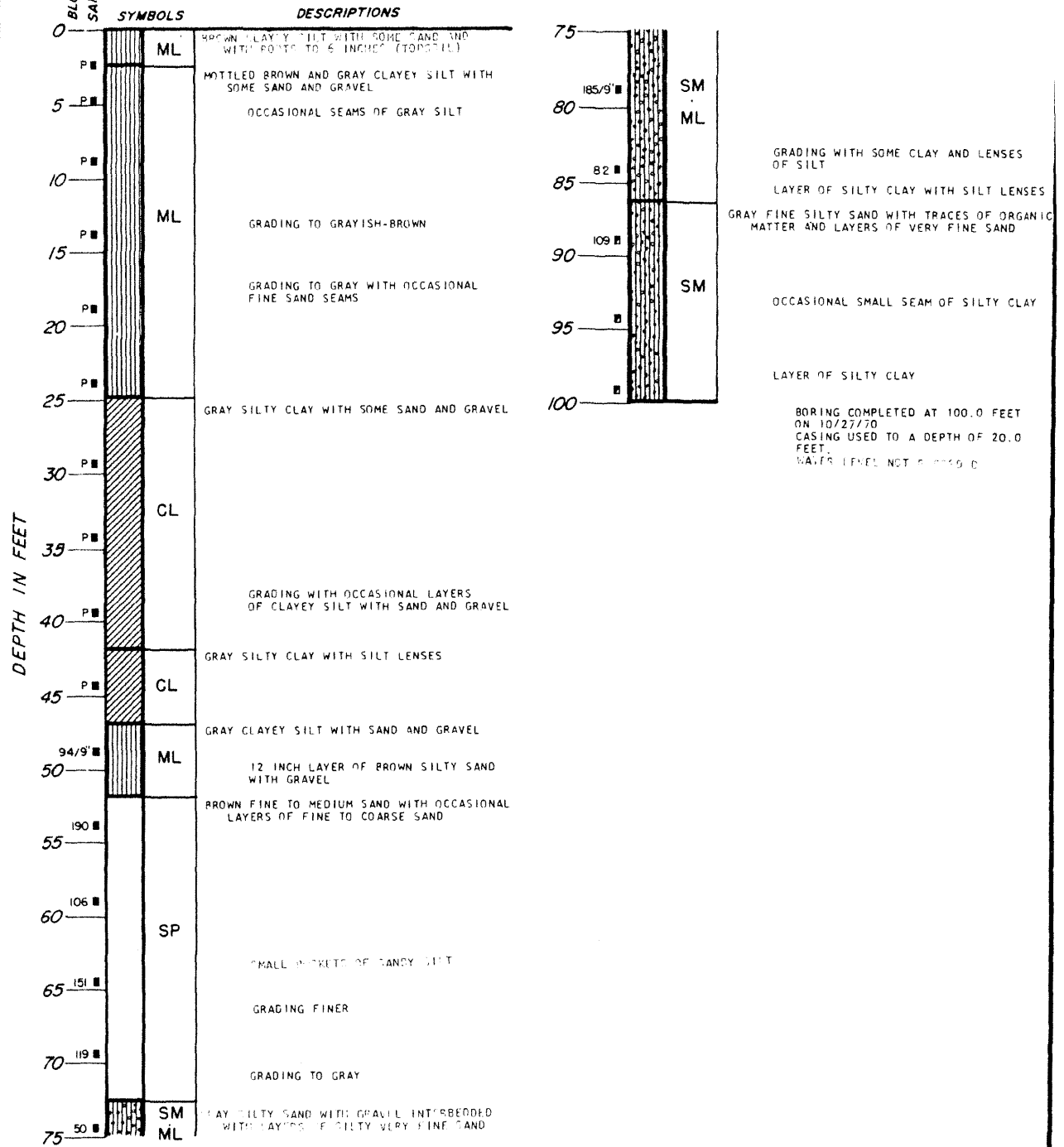

LA SALLE COUNTY STATION  
UPDATED FINAL SAFETY ANALYSIS REPORT

FIGURE 2.5-19  
LOGS OF BORINGS  
(SHEET 175)

REV. 0 -  
APRIL 1984

BORING 32-B-03

SURFACE ELEVATION 555.4

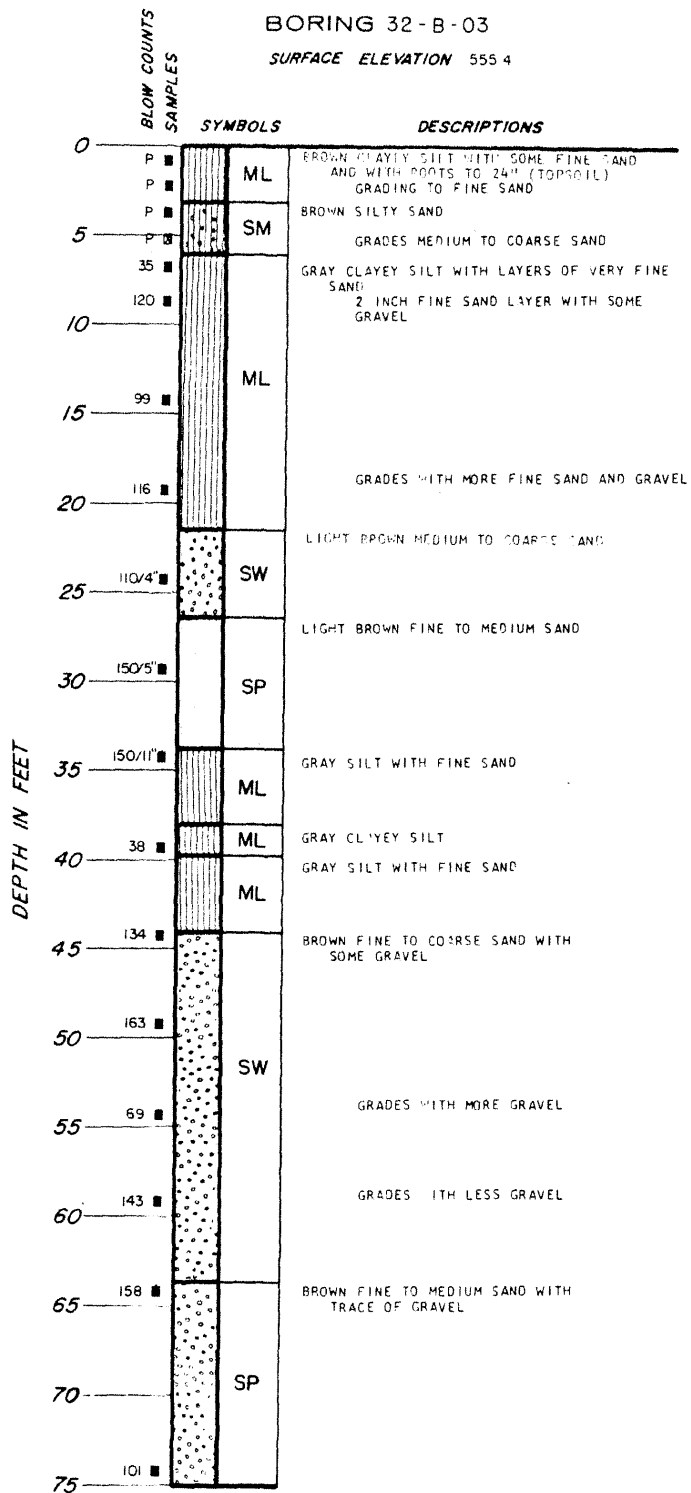

BORING COMPLETED AT 5.0 FEET  
ON 11/27/70  
NO CASING USED  
WATER LEVEL NOT RECORDED

LA SALLE COUNTY STATION  
UPDATED FINAL SAFETY ANALYSIS REPORT

FIGURE 2.5-19  
LOGS OF BORINGS

(SHEET 176)

REV. 0 -  
APRIL 1984

ELEVATION IN FEET

ATTERBERG LIMITS			SHEAR STRENGTH DATA									
Liquid Limit (%)	Plastic Limit (%)	Plasticity Index (%)	WATER CONTENT (%)	DENSITY (pcf)	Triaxial Compression		Unconfined Compression		Penetration		Direct Shear	
					$\sigma_1$ (psf)	$\sigma_3$ (psf)	$q_u$ (psf)	$c_u$ (psf)	$T$ (psf)	Vertical Pressure (psf)		
										4500 +		
										4500 +		
										4400		
										4400		
										3600		
										4200		
										4500		
										3500		
										2500		
										4250		
										3500		

BORING 33-C-01  
SURFACE ELEVATION 692 ±

BLOW COUNTS SAMPLES

SYMBOLS	DESCRIPTIONS
ML	BROWN CLAYEY SILT WITH FINE ROOTS - TOPSOIL
CL	MOTTLED BROWN AND GRAY SILTY CLAY WITH SOME SAND AND GRAVEL
	GRADES TO MOSTLY BROWN AND WITH MORE SAND GRADES WITH LESS SAND
CL	GRAY SILTY CLAY WITH SOME SAND AND GRAVEL
	GRADES WITH MORE GRAVEL
CL	GRADES WITH LESS GRAVEL
	GRAY SILTY CLAY

BORING COMPLETED AT 60.0 FEET ON 4-24-72  
CASING USED TO A DEPTH OF 13 FT.  
WATER LEVEL NOT RECORDED

LA SALLE COUNTY STATION  
UPDATED FINAL SAFETY ANALYSIS REPORT

FIGURE 2.5-19  
LOGS OF BORINGS  
(SHEET 177)



BORING 33-C-02  
SURFACE ELEVATION 689.3

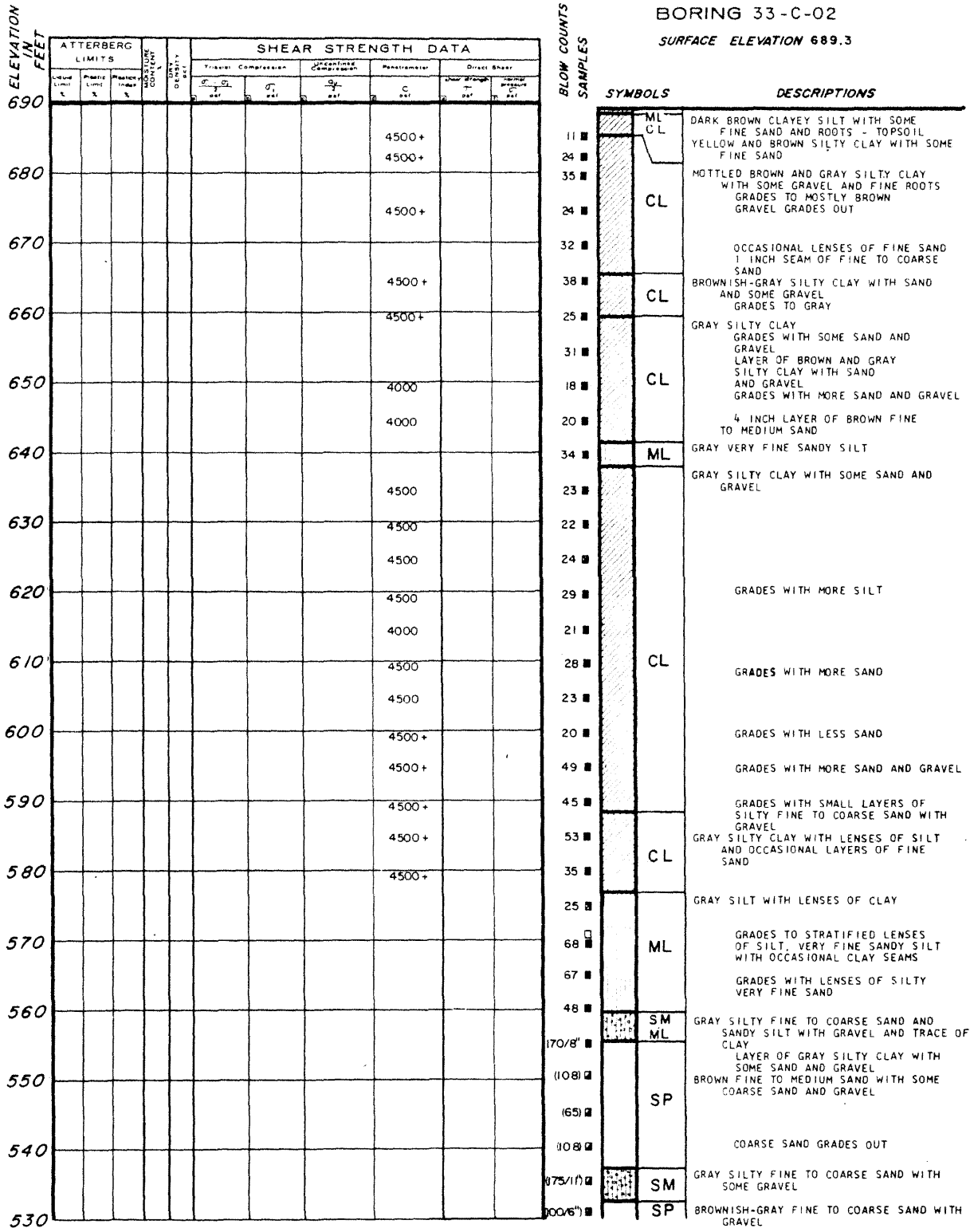

LA SALLE COUNTY STATION  
UPDATED FINAL SAFETY ANALYSIS REPORT

FIGURE 2.5-19  
LOGS OF BORINGS  
(SHEET 178)

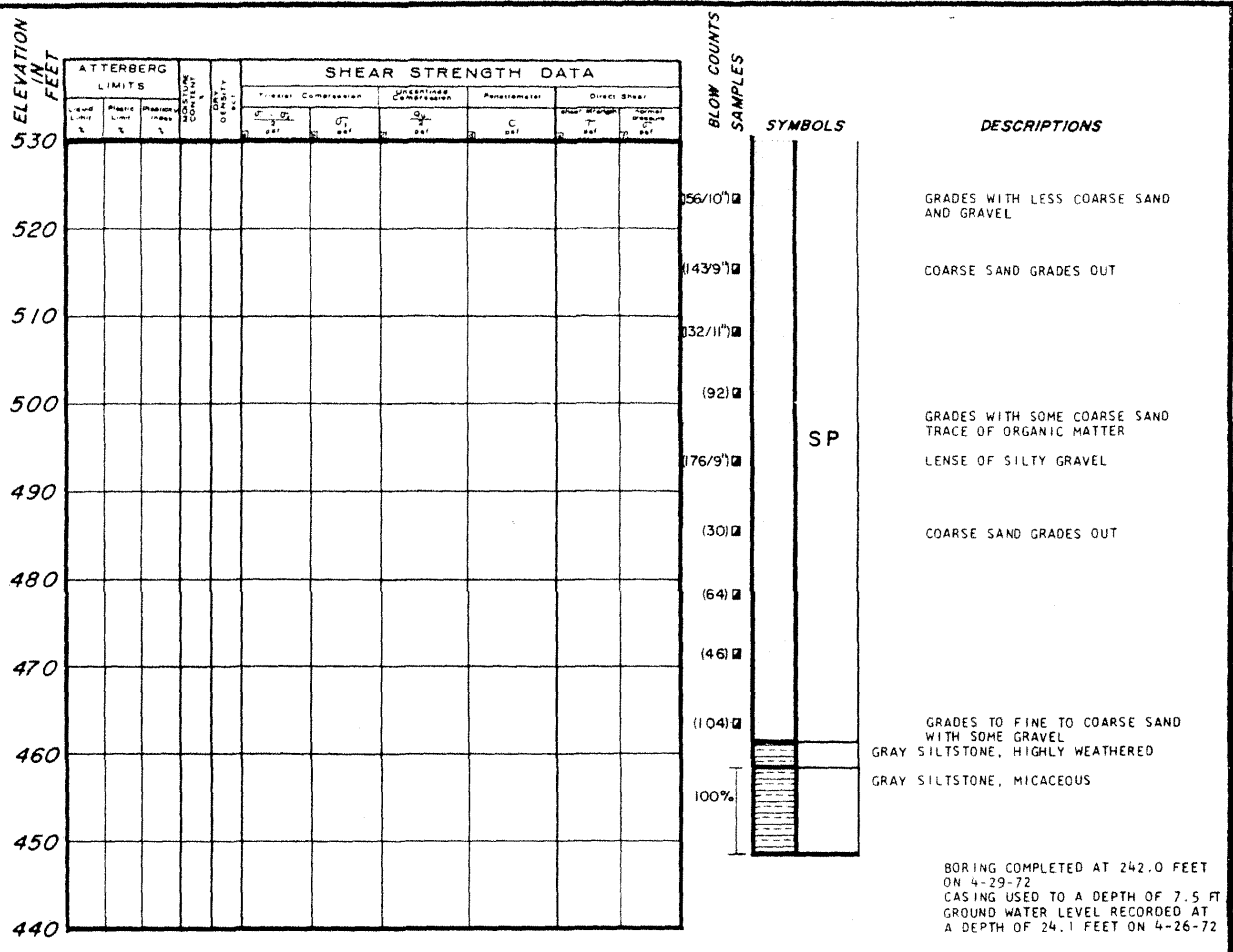

BORING COMPLETED AT 242.0 FEET  
ON 4-29-72  
CASING USED TO A DEPTH OF 7.5 FT  
GROUND WATER LEVEL RECORDED AT  
A DEPTH OF 24.1 FEET ON 4-26-72

LA SALLE COUNTY STATION  
UPDATED FINAL SAFETY ANALYSIS REPORT

FIGURE 2.5-19  
LOGS OF BORINGS  
(SHEET 179)

**BORING 34-B-01**

SURFACE ELEVATION 502.2

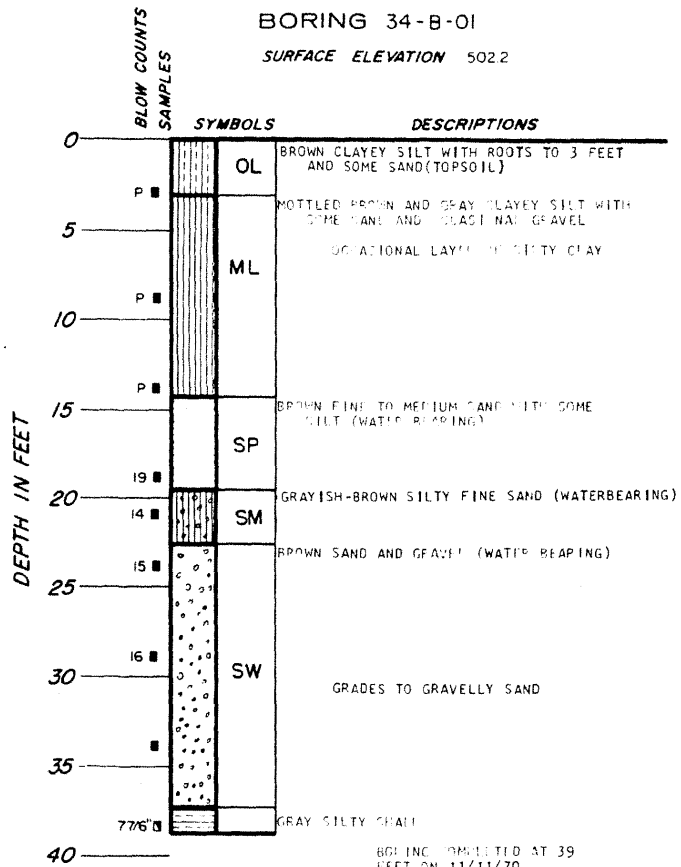

BORING COMPLETED AT 39 FEET ON 11/11/70  
WATER LEVEL @ 13.7' ON 11/10/70

**LA SALLE COUNTY STATION  
UPDATED FINAL SAFETY ANALYSIS REPORT**

FIGURE 2.5-19  
LOGS OF BORINGS  
(SHEET 180)

BORING 34-D-01

SURFACE ELEVATION 660± (est)

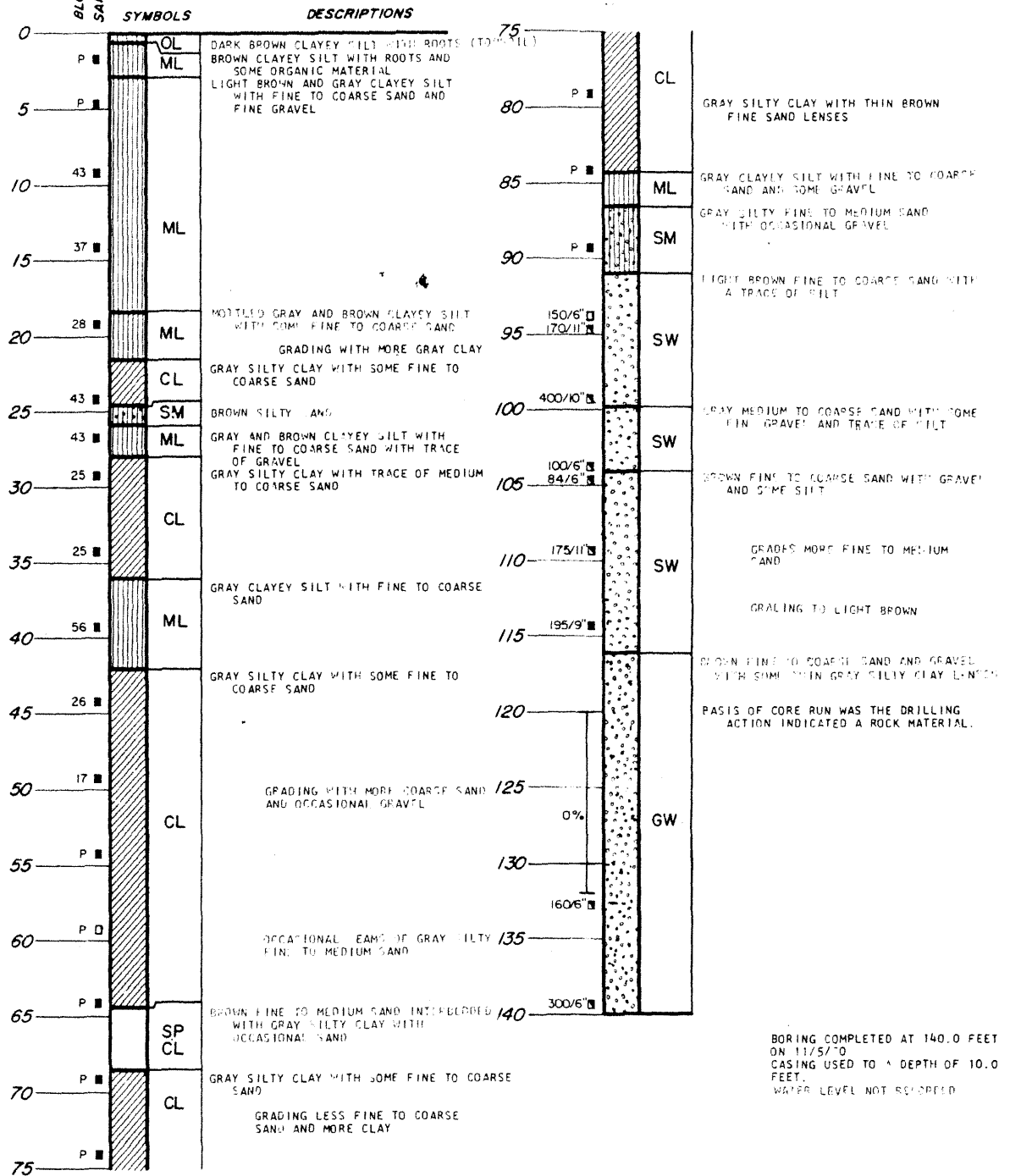

BORING COMPLETED AT 140.0 FEET ON 11/5/70 CASING USED TO A DEPTH OF 10.0 FEET. WATER LEVEL NOT RECORDED

LA SALLE COUNTY STATION  
UPDATED FINAL SAFETY ANALYSIS REPORT

FIGURE 2.5-19  
LOGS OF BORINGS  
(SHEET 181)

BORING 34-D-02  
SURFACE ELEVATION 527.4

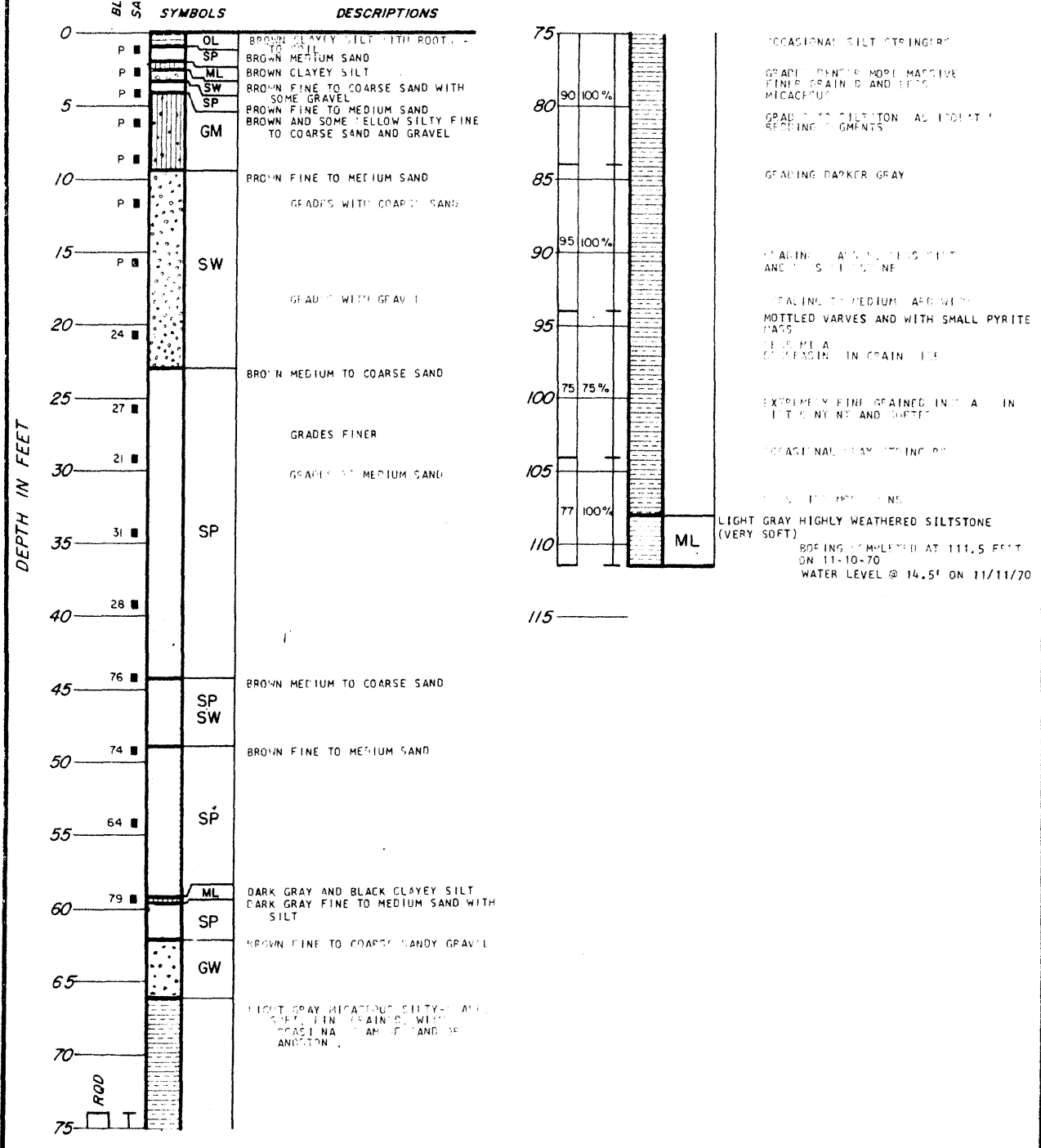

LA SALLE COUNTY STATION  
UPDATED FINAL SAFETY ANALYSIS REPORT

FIGURE 2.5-19  
LOGS OF BORINGS REV. 0 -  
(SHEET 182) APRIL 1984

ELEVATION  
IN  
FEET

ATTERBERG LIMITS			SHEAR STRENGTH DATA							
Liquid Limit %	Plastic Limit %	Plastic Index %	MOISTURE CONTENT %	DENSITY g/cc	Triaxial Compression			Terzaghi	Direct Shear	
					$\sigma_1 - \sigma_3$ psf	$q_f$ psf	$c_u$ psf		Major principal stress psf	Minor principal stress psf
			16.8	114			(5100)	3750		
								1250		
								4500		
								(5000+)		
			15.0	120				(5000+)		
			12.8	122			1450	2750		
			13.9	119				2500		
								2500		
			15.6	117			(2200)	2750		
			16.8	116				2750		
			16.5	115				3500		
								2500		
								3500		
			20.7	107			(3000)	4250		
								3750		
			16.2	118				3750		
			8.7	134			9400	4500		
								(5000+)		

BORING D-1  
SURFACE ELEVATION 680.1

BLOW COUNTS  
SAMPLES

BLOW COUNTS SAMPLES	SYMBOLS	DESCRIPTIONS
10	OL	DARK BROWN ORGANIC CLAYEY SILT WITH SOME SAND AND ROOTS-TOPSOIL 26"
7	CL	BROWN SILTY CLAY WITH SOME SAND AND TRACE OF FINE GRAVEL
16		GRADES TO MOTTLED BROWN AND GRAY GRADES TO BROWNISH-GRAY WITH MORE GRAVEL
24		GRAY SILTY CLAY WITH SOME SAND AND GRAVEL
26	CL	OCCASIONAL SILT LENSES
15	CL	GRAY SILTY CLAY
14		GRAY SILTY CLAY WITH SAND AND GRAVEL OCCASIONAL POCKETS OF SAND AND GRAVEL
9		GRADES WITH MORE SILT AND OCCASIONAL SILT LENSES
15		GRADES WITH LESS SILT
17	CL	
16		
14		
15		OCCASIONAL SILT AND SAND LENSES
18		
17	SW	BROWN FINE TO COARSE SAND WITH GRAVEL
17		GRAY SILTY CLAY WITH SOME SAND AND GRAVEL
19	CL	OCCASIONAL POCKETS OF SAND AND GRAVEL
24		
25		
41	ML	GRAY CLAYEY SILT WITH SOME SAND AND GRAVEL
74		

BORING COMPLETED AT 96.5 FEET  
ON 7-6-71  
CASING USED TO A DEPTH OF 10.0  
FEET  
GROUND WATER LEVEL NOT RECORDED

LA SALLE COUNTY STATION  
UPDATED FINAL SAFETY ANALYSIS REPORT

FIGURE 2.5-19  
LOGS OF BORINGS

(SHEET 183)

REV. 0 -  
APRIL 1984



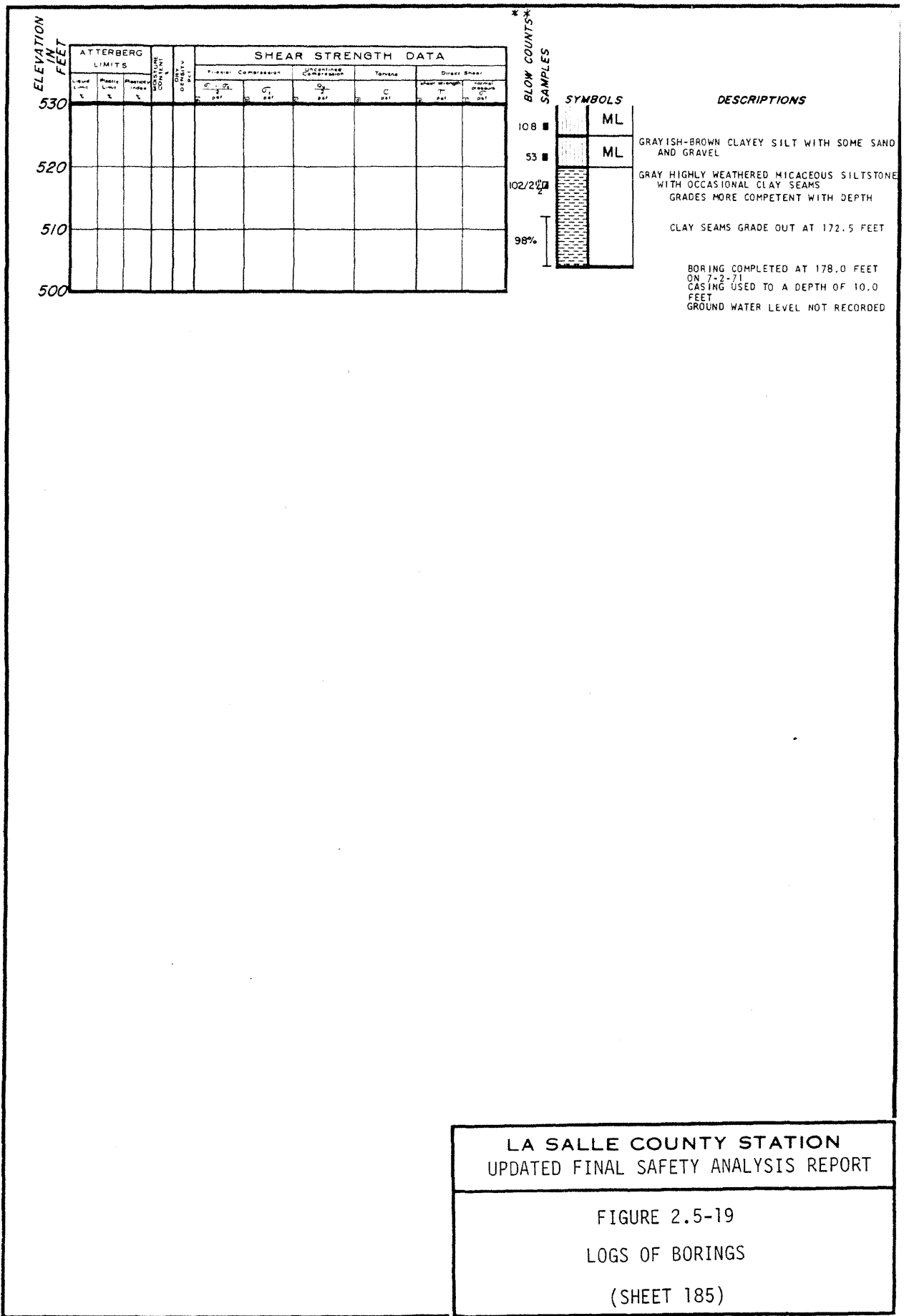

LA SALLE COUNTY STATION  
 UPDATED FINAL SAFETY ANALYSIS REPORT

FIGURE 2.5-19  
 LOGS OF BORINGS  
 (SHEET 185)





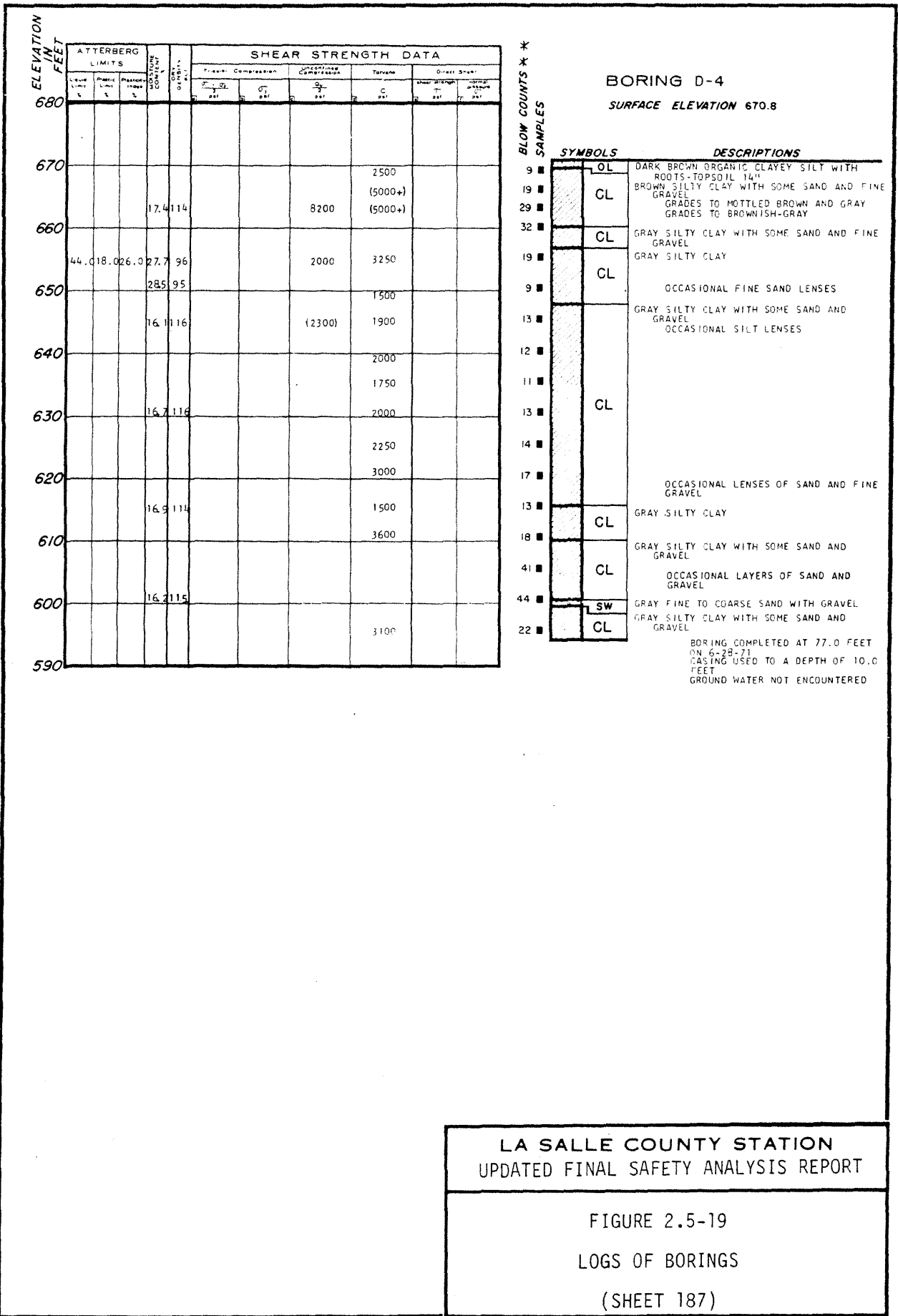

**LA SALLE COUNTY STATION**  
**UPDATED FINAL SAFETY ANALYSIS REPORT**

FIGURE 2.5-19  
LOGS OF BORINGS  
(SHEET 187)

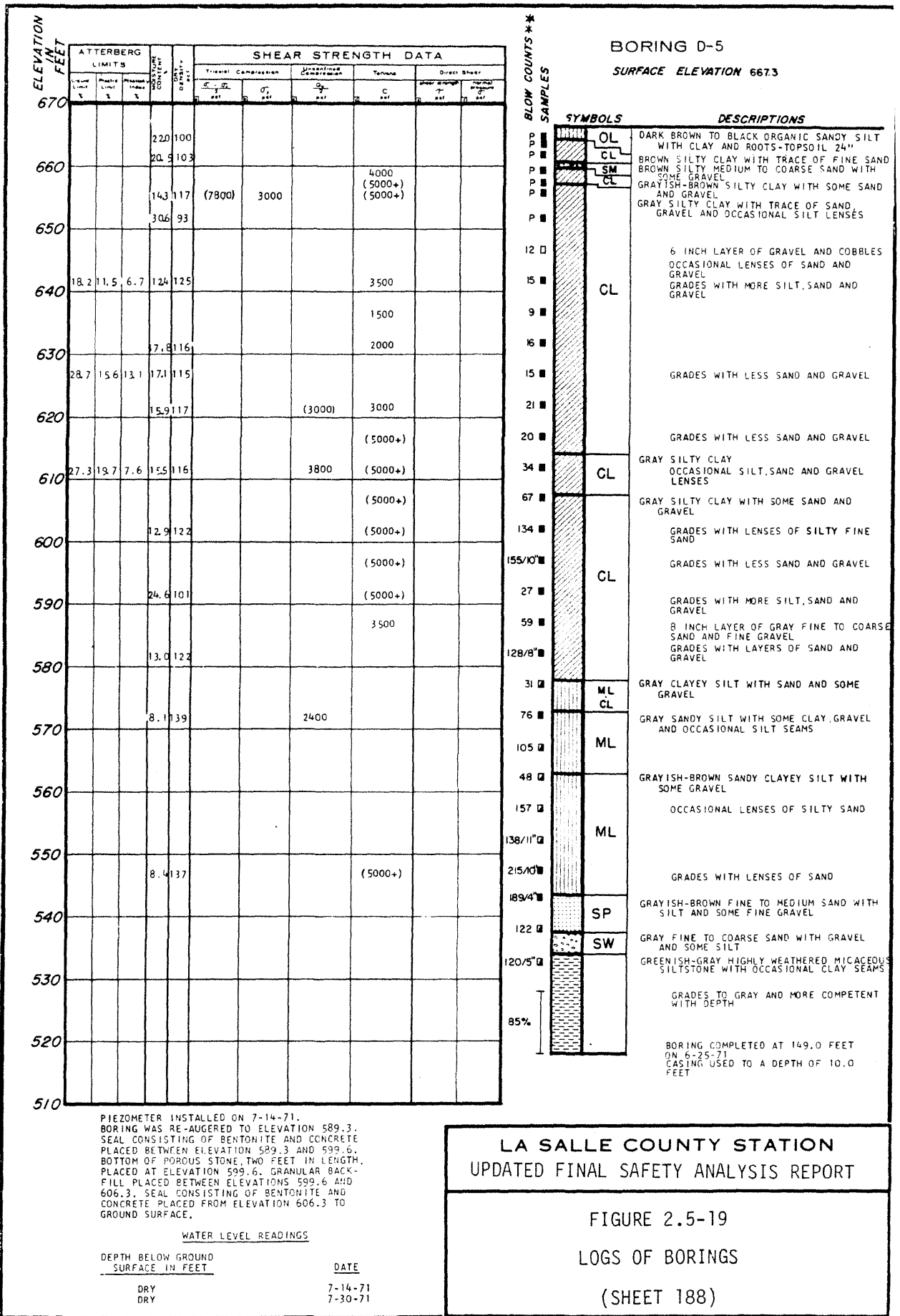

ELEVATION  
IN  
FEET

670  
660  
650  
640  
630  
620  
610  
600  
590  
580  
570

ATTERBERG LIMITS			MOISTURE CONTENT (%)	DENSITY (pcf)	SHEAR STRENGTH DATA																
Liquid Limit (%)	Plastic Limit (%)	Plasticity Index (%)			Triaxial Compression		Decompression		Torsion		Direct Shear										
					$\sigma_1$ (psf)	$\sigma_3$ (psf)	$\sigma_1$ (psf)	$\sigma_3$ (psf)	C (psf)	$\phi$ (deg)	$\sigma_1$ (psf)	$\sigma_3$ (psf)									
			19.8	10.8					(5000+)												
			18.9	11.2					(5000+)												
44.5	21.0	23.5	24.0	10.1				3800	4250												
			27.5	9.7						3500											
										1750											
			16.8	11.6						2000											
										2500											
			16.7	11.3						2150											
			26.9	9.6						2900											
														3000	5000						
			10.8	12.7																	
			13.3	11.1																	
			15.5	11.8						(5000+)											
			9.1	13.6																	

BLOW COUNTS  
SAMPLES

14  
13  
17  
22  
15  
9  
36  
20  
16  
15  
15  
21  
18  
15  
100/2"  
125/6"  
137  
52  
136  
105  
100/6"

SYMBOLS	DESCRIPTIONS
OL	DARK BROWN ORGANIC CLAYEY SILT WITH SOME SAND AND ROOTS-TOPSOIL 24"
CL	BROWN SILTY CLAY WITH SOME SAND AND GRAVEL
CL	GRADES TO MOTTLED BROWN AND GRAY GRADES TO BROWNISH-GRAY WITH LESS SAND AND GRAVEL
CL	GRAY SILTY CLAY
CL	GRADES WITH TRACE OF FINE SAND AND GRAVEL
SP	BROWN FINE TO MEDIUM SAND WITH TRACE OF COARSE SAND AND FINE GRAVEL
CL	GRAY SILTY CLAY WITH SOME SAND AND GRAVEL
CL	12 INCH SAND LAYER
CL	OCCASIONAL SILT LAYERS
CL	
CL	GRAY SILTY CLAY
ML SM CL	ALTERNATING LAYERS OF GRAY SILT, SILTY SAND, AND SILTY CLAY WITH SOME SAND AND GRAVEL
CL	GRAY SILTY CLAY WITH SOME SAND AND GRAVEL
CL	6 INCH LAYER OF SILTY SAND OCCASIONAL SILT LENSES
ML CL	GRAY CLAYEY SILT WITH SAND AND SOME GRAVEL
ML CL	6 INCH LAYER OF FINE TO COARSE SAND
ML CL	6 INCH LAYER OF GRAY SILTY FINE SAND

BORING D-6  
SURFACE ELEVATION 668.0

BORING COMPLETED AT 90.5 FEET ON 6-29-71. CASING USED TO A DEPTH OF 10.0 FEET. GROUND WATER LEVEL NOT RECORDED.

LA SALLE COUNTY STATION  
UPDATED FINAL SAFETY ANALYSIS REPORT

FIGURE 2.5-19  
LOGS OF BORINGS  
(SHEET 189)

ELEVATION  
IN  
FEET

ATTERBERG LIMITS			SHEAR STRENGTH DATA													
Liquidity Limit %	Plasticity Index %	Flow Index %	Moisture Content %	Density g/cm ³	Triaxial Compression			Unconfined Compression			Tensile		Direct Shear			
					σ ₁ (kPa)	σ ₃ (kPa)	σ _c (kPa)	σ _u (kPa)	σ _c (kPa)	τ ₁ (kPa)	τ ₂ (kPa)					
			15.2	1.13						(5000+)						
			16.5	1.16				8800		(5000+)						
			14.2	1.19				2400		(5000+)						
											3750					
											3250					
			20.4	1.10							3000					
											3250					
			20.9	1.10							3750					
											3500					
			13.3	1.24												
											3500					
			16.2	1.18							3250					
											2500					
											3500					
			18.6	1.12							3250					
											3500					
			6.6	1.37												

BORING D-7  
SURFACE ELEVATION 682.9

BLOW COUNTS  
SAMPLES

SYMBOLS	DESCRIPTIONS
OL	DARK BROWN TO BLACK ORGANIC CLAYEY SILT WITH SOME SAND AND ROOTS-TOPSOIL 18"
CL	MOTTLED BROWN AND GRAY SILTY CLAY WITH SOME SAND AND GRAVEL GRADES TO GRAYISH-BROWN GRADES TO BROWNISH-GRAY
CL	GRAY SILTY CLAY WITH SOME SAND AND GRAVEL
CL	GRAY SILTY CLAY WITH SAND AND SOME GRAVEL OCCASIONAL LENSES OF COARSE SAND WITH GRAVEL
SP	GRAY FINE TO MEDIUM SAND WITH SOME GRAVEL
CL	GRAY SILTY CLAY
CL	GRAY SILTY CLAY WITH TRACE OF SAND AND GRAVEL 6 INCH LAYER OF SAND AND GRAVEL OCCASIONAL LAYERS OF FINE TO COARSE SAND WITH GRAVEL AND SILT BORING COMPLETED AT 80.0 FEET ON 6-23-71 CASING USED TO A DEPTH OF 15.0 FEET GROUND WATER LEVEL NOT RECORDED

LA SALLE COUNTY STATION  
UPDATED FINAL SAFETY ANALYSIS REPORT

FIGURE 2.5-19  
LOGS OF BORINGS  
(SHEET 190)

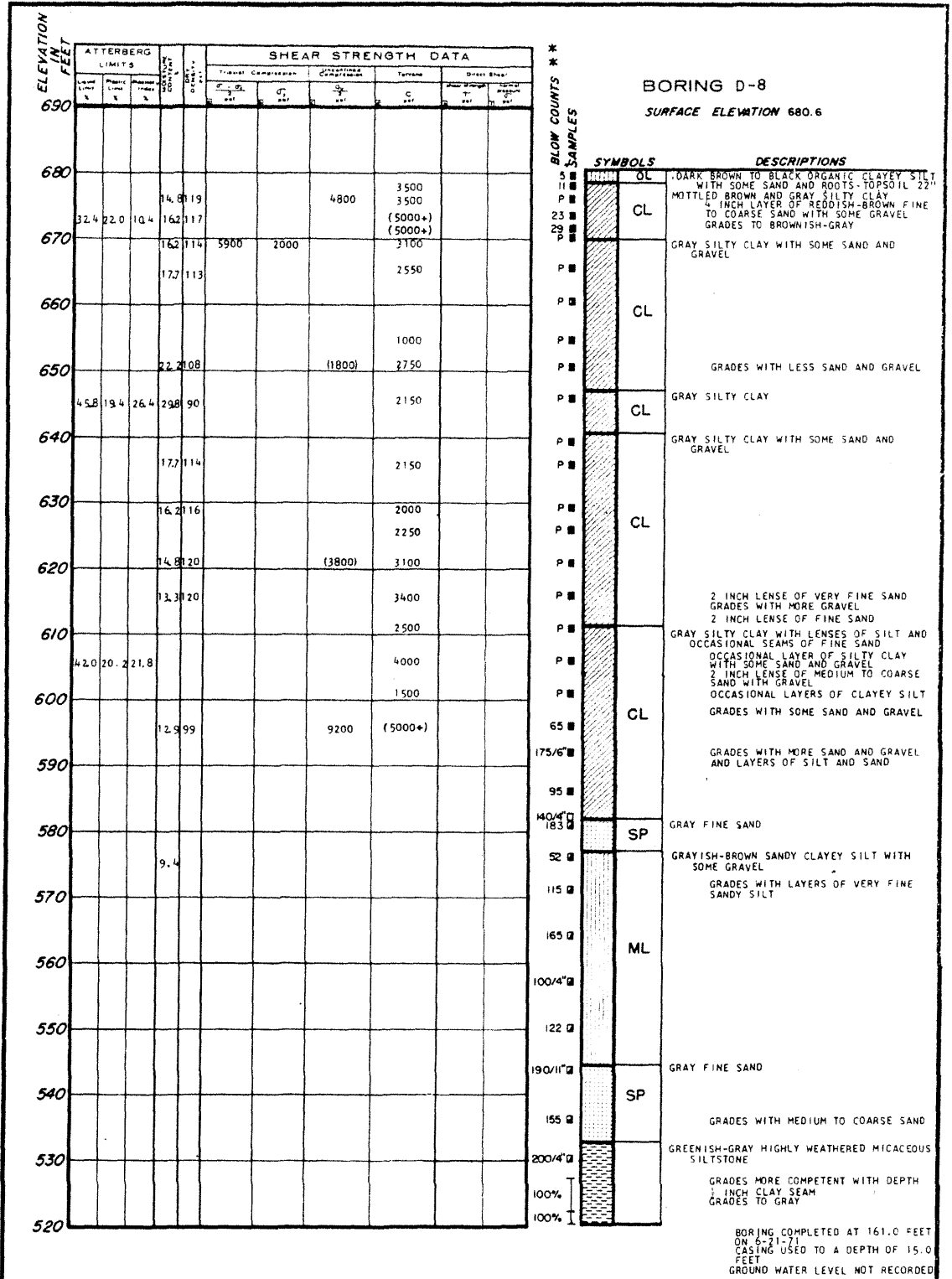

**LA SALLE COUNTY STATION**  
 UPDATED FINAL SAFETY ANALYSIS REPORT  
  
 FIGURE 2.5-19  
 LOGS OF BORINGS  
 (SHEET 191)

ELEVATION  
IN  
FEET

690  
680  
670  
660  
650  
640  
630  
620  
610  
600

ATTERBERG LIMITS			WATER CONTENT %	DENSITY (pcf)	SHEAR STRENGTH DATA						
Liquid Limit %	Plastic Limit %	Plasticity Index %			Triaxial Compression			Uniaxial Compression		Torsion	
					$\sigma_1 - \sigma_3$ (psf)	$\sigma_3$ (psf)	$\sigma_1$ (psf)	$\sigma_1$ (psf)	$C$ (psf)	$\phi$ (deg)	
			22.5	102					4500		
			26.7	99			3300		3500		
			17.6	112			(3600)		(5000+)		
			19.1	112					2500		
			12.2	122					2250		
									2500		
			15.4	118					3500		
			14.5	119					2500		
									2500		
									2750		
			15.6	118					3500		
									3750		
			24.3	101					4500		
									(5000+)		

BLOW COUNTS  
SAMPLES

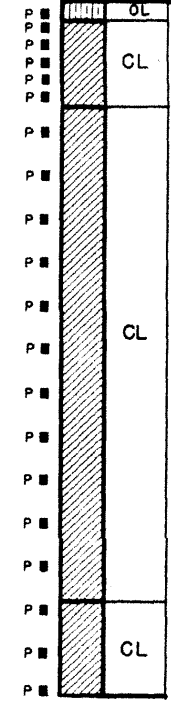

BORING D-9  
SURFACE ELEVATION 680.2

SYMBOLS	DESCRIPTIONS
OL	DARK BROWN TO BLACK ORGANIC CLAYEY SILT WITH SOME SAND AND ROOTS-TOPSOIL 26" MOTTLED BROWN AND GRAY SILTY CLAY WITH SOME SAND AND TRACE OF FINE GRAVEL
CL	GRADES TO BROWNISH-GRAY
CL	GRAY SILTY CLAY WITH SOME SAND AND GRAVEL
CL	OCCASIONAL LENSES OF SAND AND GRAVEL
CL	GRADES WITH MORE SAND AND GRAVEL
CL	6 INCH LAYER OF SILT LAYER OF VERY FINE SAND AND OCCASIONAL LAYERS OF CLAYEY SILT AND SILT
CL	GRAY SILTY CLAY
CL	OCCASIONAL LENSES OF SILT AND CLAYEY SILT

BORING COMPLETED AT 80.0 FEET ON 6-22-71  
CASING USED TO A DEPTH OF 15.0 FEET  
GROUND WATER LEVEL NOT RECORDED

LA SALLE COUNTY STATION  
UPDATED FINAL SAFETY ANALYSIS REPORT

FIGURE 2.5-19  
LOGS OF BORINGS  
(SHEET 192)

REV. 0 -  
APRIL 1984





BORING D-10 Continued

ELEVATION IN FEET	ATTERBERG LIMITS			MOISTURE CONTENT W _p %	DENSITY P _a pcf	SHEAR STRENGTH DATA								
	Liquid Limit %	Plastic Limit %	Plasticity Index %			Triaxial Compression			Tensile C pcf	Direct Shear				
						$\sigma_1$ pcf	$\sigma_3$ pcf	$\sigma_1$ pcf		$\tau$ pcf	$\tau$ pcf			
	1	2	3			4	5	6	7	8	9			
520														
510														
500														
490														

* BLOW COUNTS #  
SAMPLES

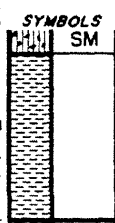

DESCRIPTIONS

GRAY HIGHLY WEATHERED MICACEOUS SILT-  
STONE WITH OCCASIONAL CLAY SEAMS AND  
SHALE PARTINGS

GRADES MORE COMPETENT WITH DEPTH

1/2 INCH CLAY SEAM  
1/2 INCH CLAY SEAM  
1/2 INCH CLAY SEAM

BORING COMPLETED AT 177.0 FEET  
ON 7-28-71  
CASING USED TO A DEPTH OF 10.0  
FEET  
GROUND WATER LEVEL NOT RECORDED

LA SALLE COUNTY STATION  
UPDATED FINAL SAFETY ANALYSIS REPORT

FIGURE 2.5-19  
LOGS OF BORINGS  
(SHEET 194)

REV. 0 -  
APRIL 1984

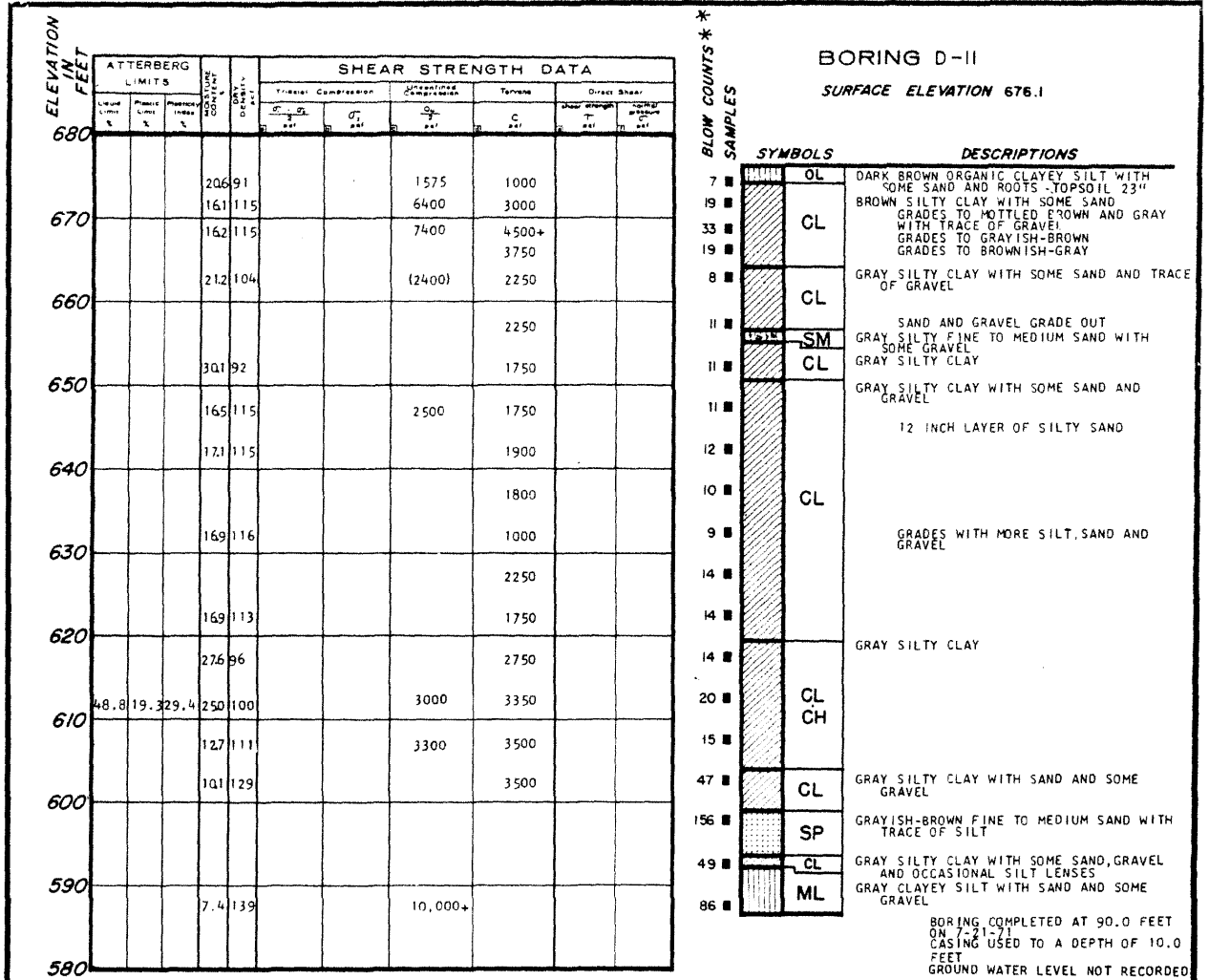

**LA SALLE COUNTY STATION**  
UPDATED FINAL SAFETY ANALYSIS REPORT

FIGURE 2.5-19  
LOGS OF BORINGS

REV. 0 -  
APRIL 1984

(SHEET 195)

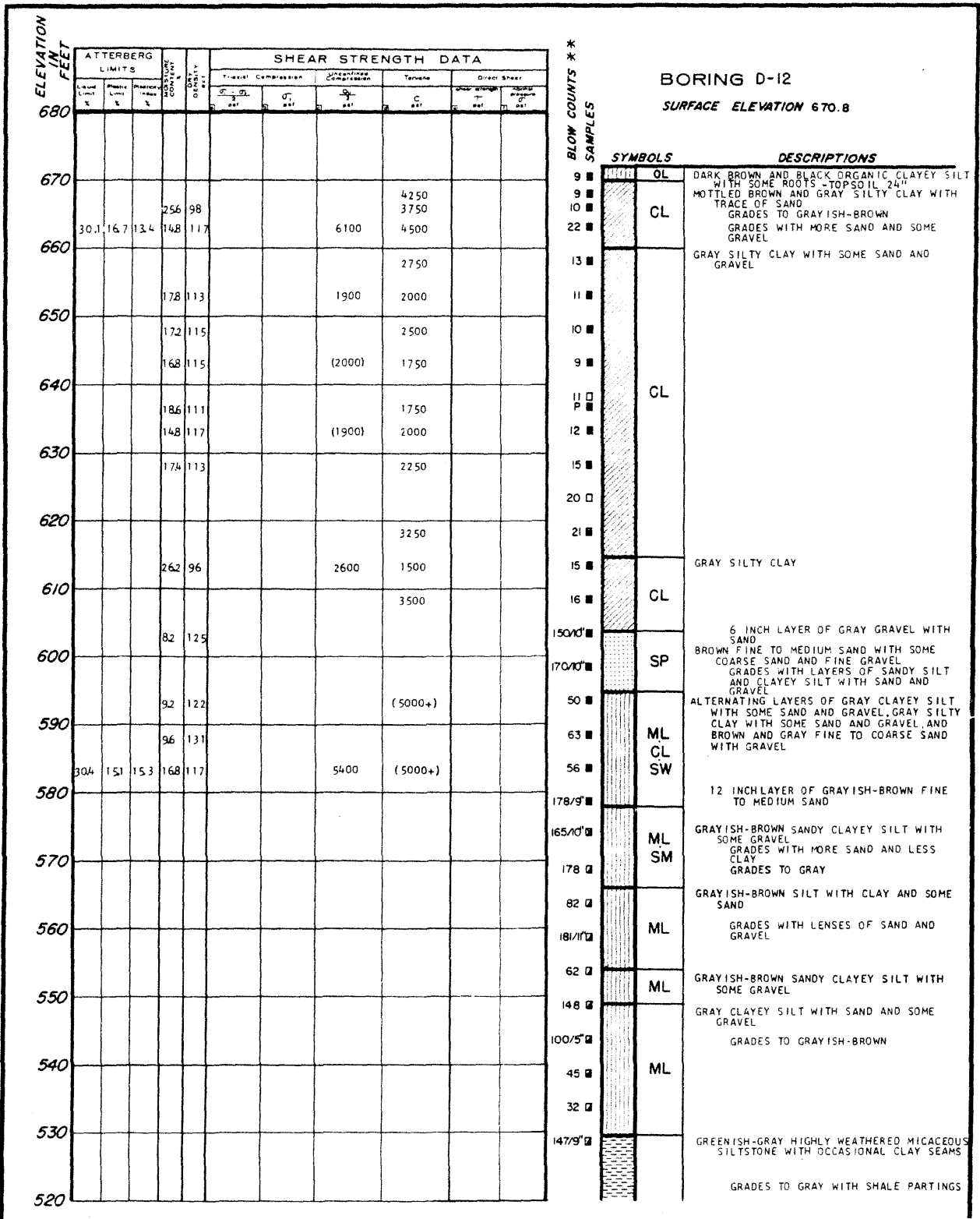

**LA SALLE COUNTY STATION**  
UPDATED FINAL SAFETY ANALYSIS REPORT

FIGURE 2.5-19  
LOGS OF BORINGS

REV. 0 -  
APRIL 1984

(SHEET 196)

ELEVATION  
IN  
FEET

ATTERBERG LIMITS			MOISTURE CONTENT	DRY DENSITY	SHEAR STRENGTH DATA							
Liquid Limit %	Plastic Limit %	Plastic Index			Triaxial Compression		Unconfined Compression		Torsion	Direct Shear		
					$\sigma_1$ (psf)	$\sigma_3$ (psf)	$\sigma_c$ (psf)	$\sigma_c$ (psf)		$\tau$ (psf)	$\sigma_v$ (psf)	

BLOW COUNTS  
SAMPLES

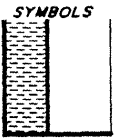

**DESCRIPTIONS**

HIGHLY FRACTURED ZONE FROM 157.0 TO 157.5 FEET  
GRADES TO MORE COMPETENT ROCK  
1/2 INCH CLAY SEAM AT 161.0 FEET

BORING COMPLETED AT 165.0 FEET  
ON 7-29-71  
CASING USED TO A DEPTH OF 10.0 FEET  
PIEZOMETER INSTALLED ON 8-2-71.  
BORING WAS RE-AUGERED TO ELEVATION 595.8.  
SEAL CONSISTING OF BENTONITE AND CONCRETE  
PLACED BETWEEN ELEVATIONS 595.8 AND 603.8.  
BOTTOM OF POROUS STONE, TWO FEET IN LENGTH,  
PLACED AT ELEVATION 604.8. GRANULAR BACK-FILL  
PLACED BETWEEN ELEVATIONS 603.8 AND 610.8.  
SEAL CONSISTING OF BENTONITE AND CONCRETE  
PLACED FROM ELEVATION 610.8 TO GROUND SURFACE.

WATER LEVEL READINGS

DEPTH BELOW GROUND SURFACE IN FEET	DATE
DRY	10-9-71

**LA SALLE COUNTY STATION**  
**UPDATED FINAL SAFETY ANALYSIS REPORT**

FIGURE 2.5-19  
 LOGS OF BORINGS  
 (SHEET 197)



ELEVATION  
IN  
FEET

690  
680  
670  
660  
650  
640  
630  
620  
610  
600  
590  
580  
570  
560  
550  
540  
530

ATTERBERG LIMITS				SHEAR STRENGTH DATA								
Liquid Limit %	Plastic Limit %	Plastic Index %	Moisture Content %	Dry Density g/cm ³	Field Compression		Laboratory Compression		Tensile		Direct Shear	
					$\sigma_v$ psf	$\sigma'_v$ psf	$\sigma_v$ psf	$\sigma'_v$ psf	C psf	$\tau$ psf	$\tau$ psf	Normal Stress psf
			106	102			2100		4750 (5000+)			
			117	122			6600					
			207	109			1600		1800			
			212	109					1850			
			276	96			1800		1800			
			170	118					1750			
									1100			
			164	116			(1850)		2000			
			176	113					1750			
									750			
			164	116			(2300)		2750			
									2350			
									3500			
458	167	291	242	101			4500		4000			
			108	129								
									4750			
			129	125					(5000+)			

BLOW COUNTS * *  
SAMPLES

8  
27  
25  
16  
16  
10  
9  
10  
10  
13  
12  
14  
22  
18  
20  
32  
99  
41  
175/8  
70  
86  
167/1  
42  
16  
39  
59  
102  
69  
86  
63  
101  
175/3

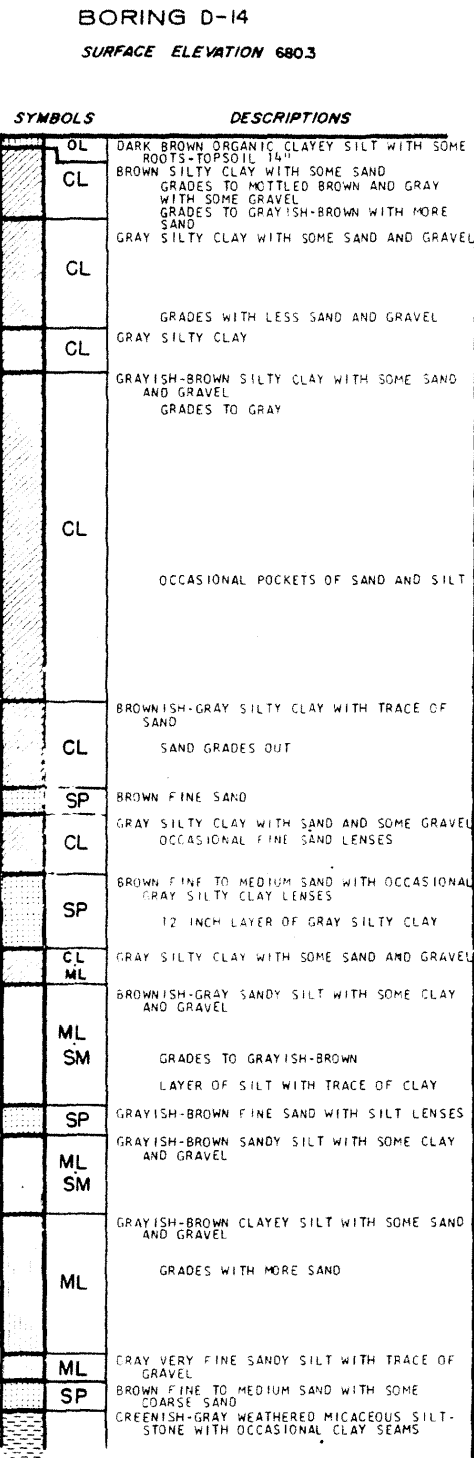

**LA SALLE COUNTY STATION**  
UPDATED FINAL SAFETY ANALYSIS REPORT

FIGURE 2.5-19  
LOGS OF BORINGS  
(SHEET 199)

ELEVATION IN FEET	ATTERBERG LIMITS			MOISTURE CONTENT	DRY DENSITY	SHEAR STRENGTH DATA											
	Liquid Limit %	Plastic Limit %	Plasticity Index %			Triaxial Compression		Unconfined Compression		Torsion		Direct Shear					
						$\sigma_1$ PSF	$\sigma_3$ PSF	$\sigma_1$ PSF	$\sigma_3$ PSF	C PSF	$\phi$ PSF	Shear Strength PSF	Normal Pressure PSF				
530																	
520																	
510																	

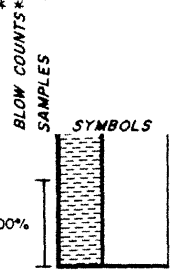

**DESCRIPTIONS**

GRADES TO GRAY  
 GRADES MORE COMPETENT WITH DEPTH  
 1/2 INCH CLAY SEAM  
 1/2 INCH CLAY SEAM  
 2 INCH BROWN SANDSTONE STRINGER

BORING COMPLETED AT 165.0 FEET  
 ON 7-30-71  
 CASING USED TO A DEPTH OF 10.0  
 FEET  
 GROUND WATER LEVEL NOT RECORDED

LA SALLE COUNTY STATION  
 UPDATED FINAL SAFETY ANALYSIS REPORT

FIGURE 2.5-19  
 LOGS OF BORINGS  
 (SHEET 200)

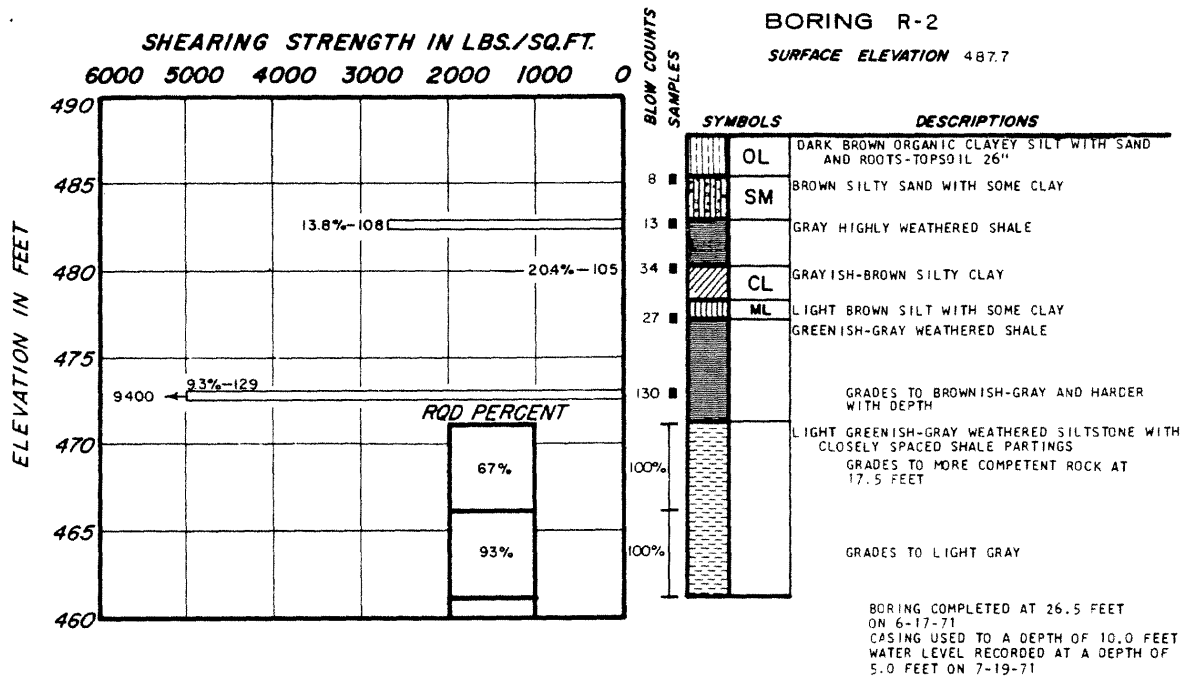
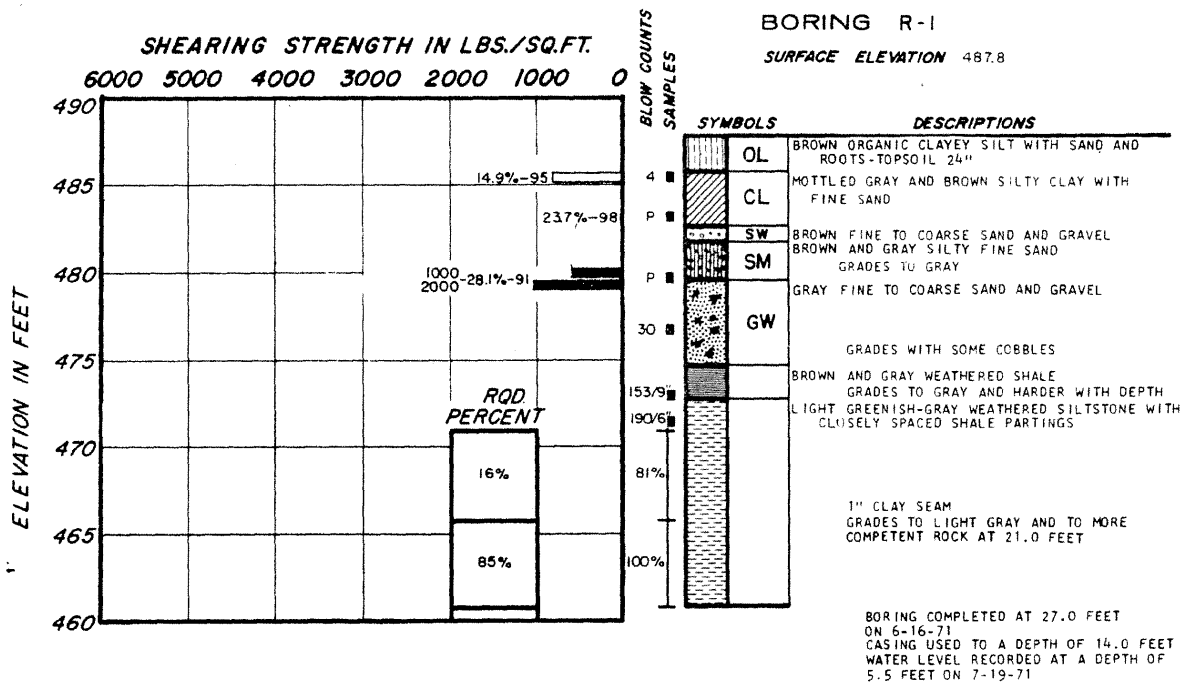

**LA SALLE COUNTY STATION**  
UPDATED FINAL SAFETY ANALYSIS REPORT

FIGURE 2.5-19  
LOGS OF BORINGS  
(SHEET 201)



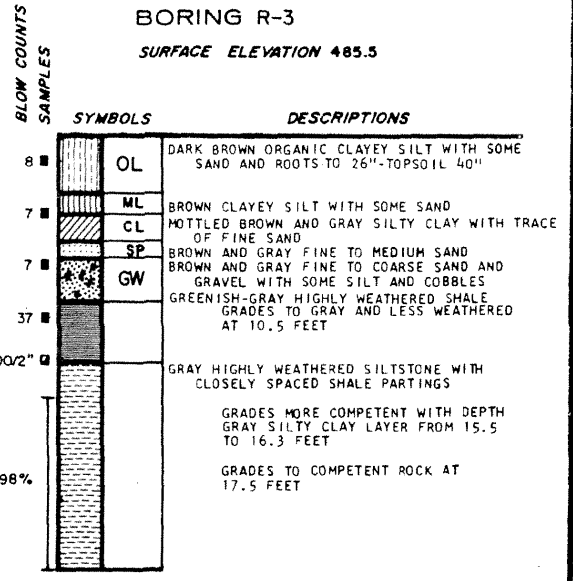
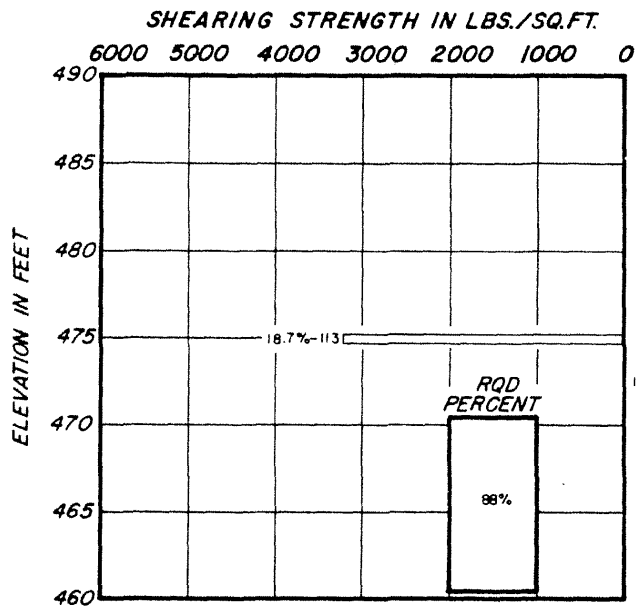

BORING COMPLETED AT 25.0 FEET ON 8-3-71  
CASING USED TO A DEPTH OF 14.0 FEET  
WATER LEVEL RECORDED AT A DEPTH OF 4.2 FEET ON 8-2-71

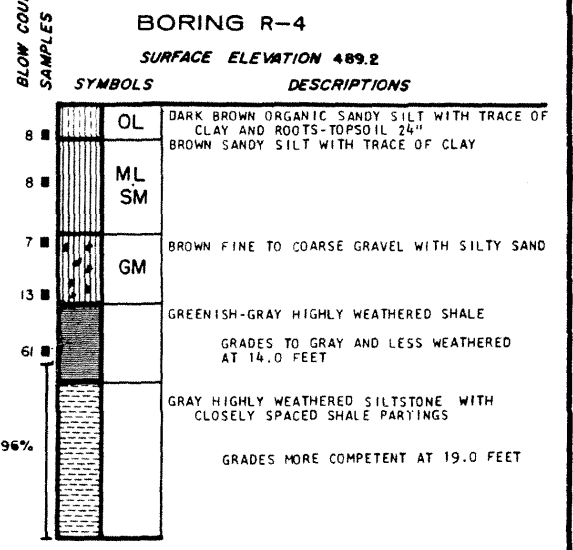
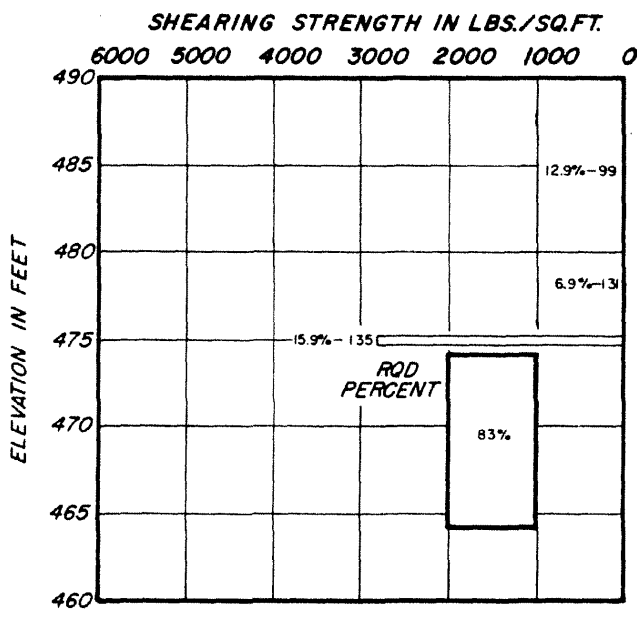

BORING COMPLETED AT 25.0 FEET ON 8-2-71  
CASING USED TO A DEPTH OF 14.0 FEET  
WATER LEVEL RECORDED AT A DEPTH OF 6.0 FEET ON 8-2-71

**LA SALLE COUNTY STATION**  
UPDATED FINAL SAFETY ANALYSIS REPORT

FIGURE 2.5-19  
LOGS OF BORINGS  
(SHEET 202)

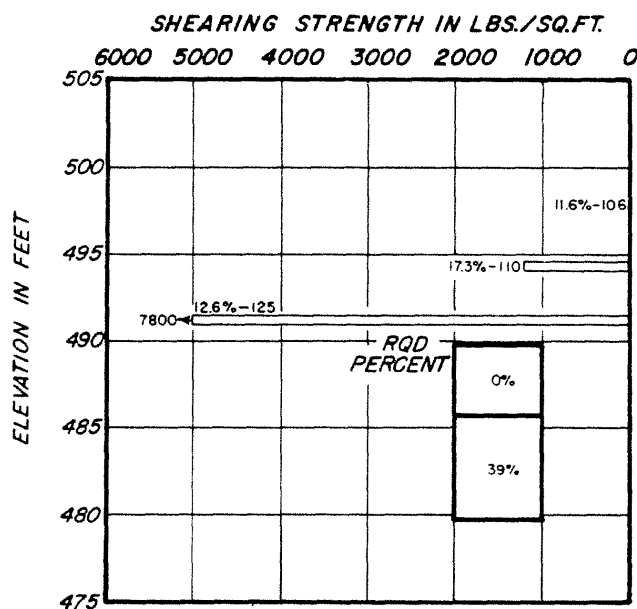

**BORING R-5**  
SURFACE ELEVATION 501.8

BLOW COUNTS SAMPLES	SYMBOLS	DESCRIPTIONS
16	SM	LIGHT REDDISH-BROWN SILTY SAND WITH ROOTS-TOPSOIL 14"
50/6"		LIGHT REDDISH BROWN HIGHLY WEATHERED SILTY SANDSTONE
		GRADES TO BROWN AND GRAY
32		GREENISH-GRAY HIGHLY WEATHERED SHALE
148/9"		GRADES TO GRAY AND LESS WEATHERED AT 10.0 FEET
77%		
93%		GRADES DARKER GRAY AND LESS WEATHERED AT 18.0 FEET

BORING COMPLETED AT 22.0 FEET ON 8-3-71  
CASING USED TO A DEPTH OF 8.5 FEET  
NO WATER ENCOUNTERED

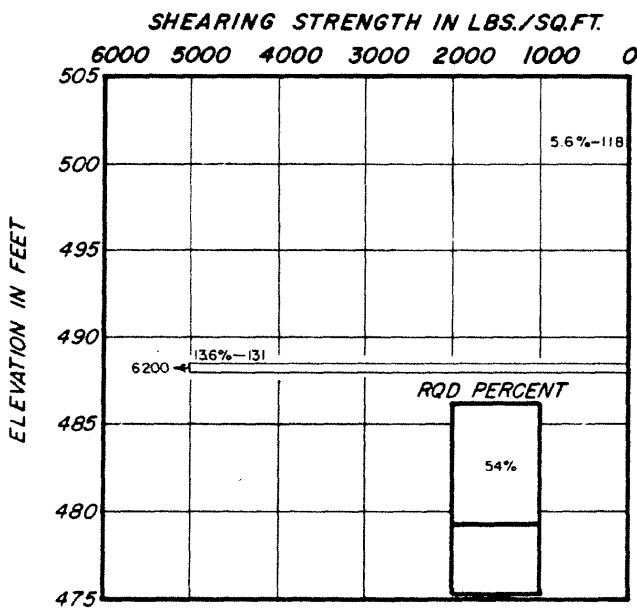

**BORING R-6**  
SURFACE ELEVATION 503.2

BLOW COUNTS SAMPLES	SYMBOLS	DESCRIPTIONS
15		BROWN CLAYEY SILT WITH SAND-FILL
		END OF FILL
10	OL	DARK BROWN ORGANIC CLAYEY SILT WITH SOME FINE SAND
100/3"		LIGHT REDDISH-BROWN HIGHLY WEATHERED SILTY SANDSTONE
100/6"		
100/5"		GRADES TO GRAY
100/5"		GREENISH-GRAY HIGHLY WEATHERED SHALE
71		GRADES TO GRAY AND LESS WEATHERED AT 15.0 FEET
		GRADES TO DARK GRAY
95%		GRADES MORE COMPETENT AT 21.3 FEET
		GRAY WEATHERED SILTSTONE WITH CLOSELY SPACED SHALE PARTINGS

BORING COMPLETED AT 28.0 FEET ON 8-4-71  
CASING USED TO A DEPTH OF 8.5 FEET  
NO WATER ENCOUNTERED

**LA SALLE COUNTY STATION**  
UPDATED FINAL SAFETY ANALYSIS REPORT

FIGURE 2.5-19  
LOGS OF BORINGS  
(SHEET 203)



ELEVATION  
IN FEET

ATTERBERG LIMITS			SHEAR STRENGTH DATA							
Liquid Limit %	Plastic Limit %	Plasticity Index %	Moisture Content %	Density g/cm ³	Triaxial Compression			Penetration	Direct Shear	
					$\sigma_1$ (psf)	$\sigma_3$ (psf)	$\sigma_c$ (psf)	C (psf)	$\tau$ (psf)	$\phi$ (psf)
520										
510										
500										
490										
480										
470										
460										
450										
440										
430										

**BORING R-8**  
SURFACE ELEVATION 488.6

BLOW COUNTS  
SAMPLES

	SYMBOLS	DESCRIPTIONS
	OL	DARK BROWN ORGANIC CLAYEY SILT
	ML	DARK BROWN SILT
P	SM	BROWN SILTY FINE SAND WITH SOME GRAVEL
10	SW	BROWN FINE TO COARSE SAND WITH SOME GRAVEL AND TRACE OF SILT
10	SP	BROWN FINE TO MEDIUM SAND WITH TRACE OF GRAVEL
19	SP	GRADES WITH LESS GRAVEL
59	SP	REDDISH-BROWN FINE SAND WITH SOME GRAVEL
122		DARK GRAY SILTSTONE, WEATHERED
71/11		GRAY SILTSTONE, MICACEOUS, SLIGHTLY WEATHERED
82%		GRADES MORE COMPETENT WITH DEPTH

BORING COMPLETED 48.5 FEET ON 3-31-72  
CASING USED TO A DEPTH OF 15 FT.  
GROUND WATER LEVEL NOT RECORDED

LA SALLE COUNTY STATION  
UPDATED FINAL SAFETY ANALYSIS REPORT

FIGURE 2.5-19  
LOGS OF BORINGS  
(SHEET 205)

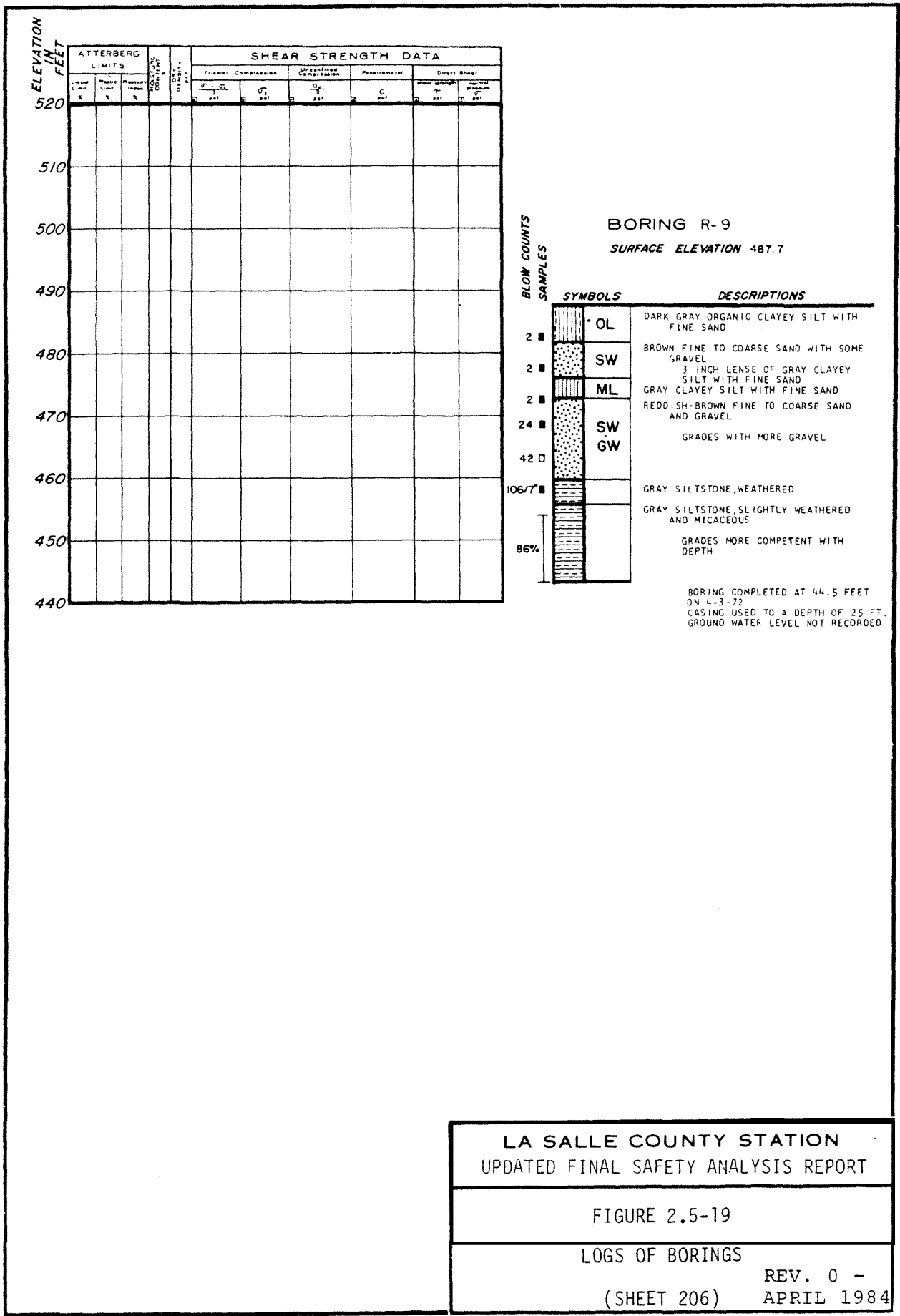

LA SALLE COUNTY STATION  
UPDATED FINAL SAFETY ANALYSIS REPORT

FIGURE 2.5-19

LOGS OF BORINGS

REV. 0 -  
(SHEET 206) APRIL 1984

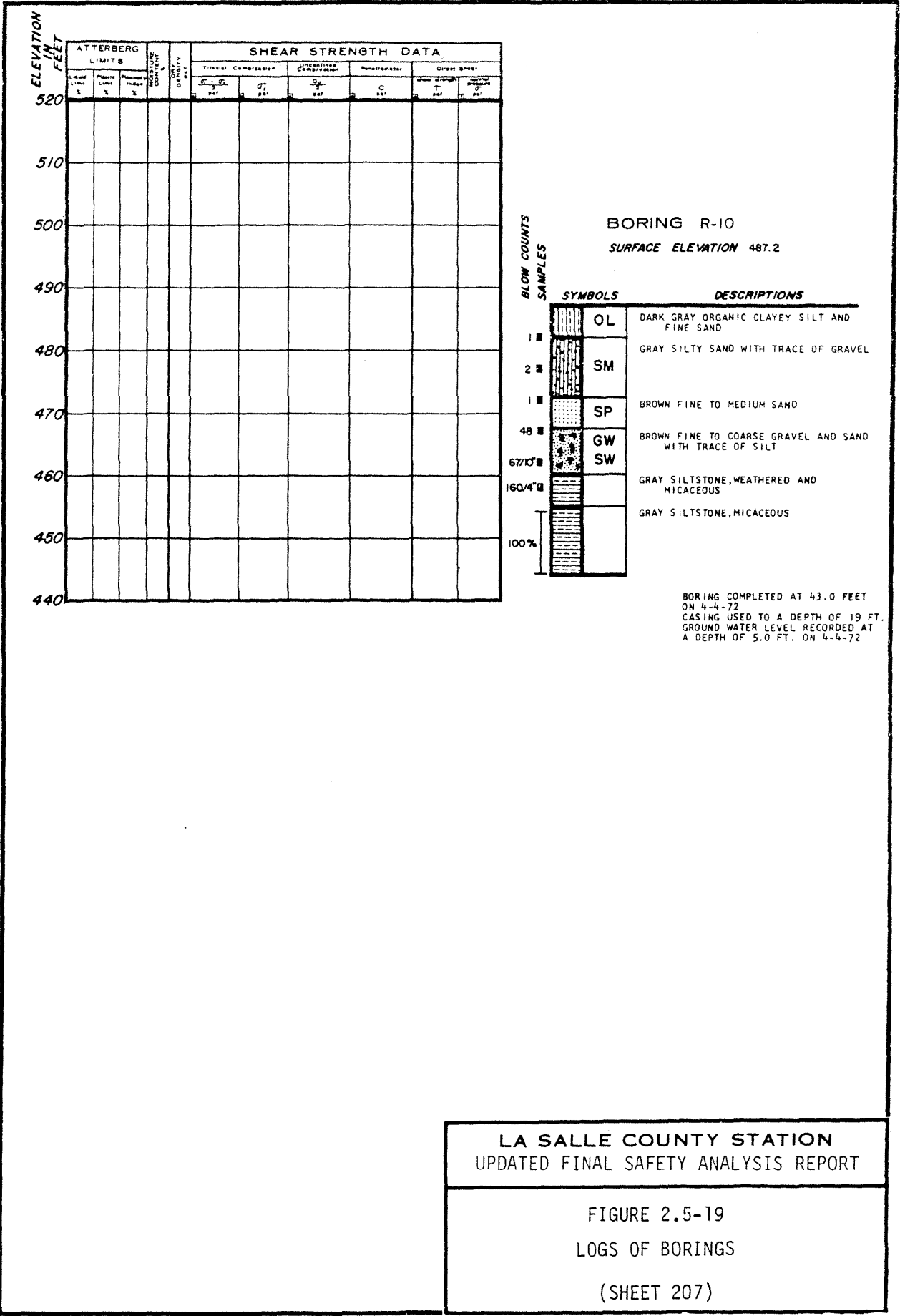

**LA SALLE COUNTY STATION**  
UPDATED FINAL SAFETY ANALYSIS REPORT

FIGURE 2.5-19  
LOGS OF BORINGS  
(SHEET 207)

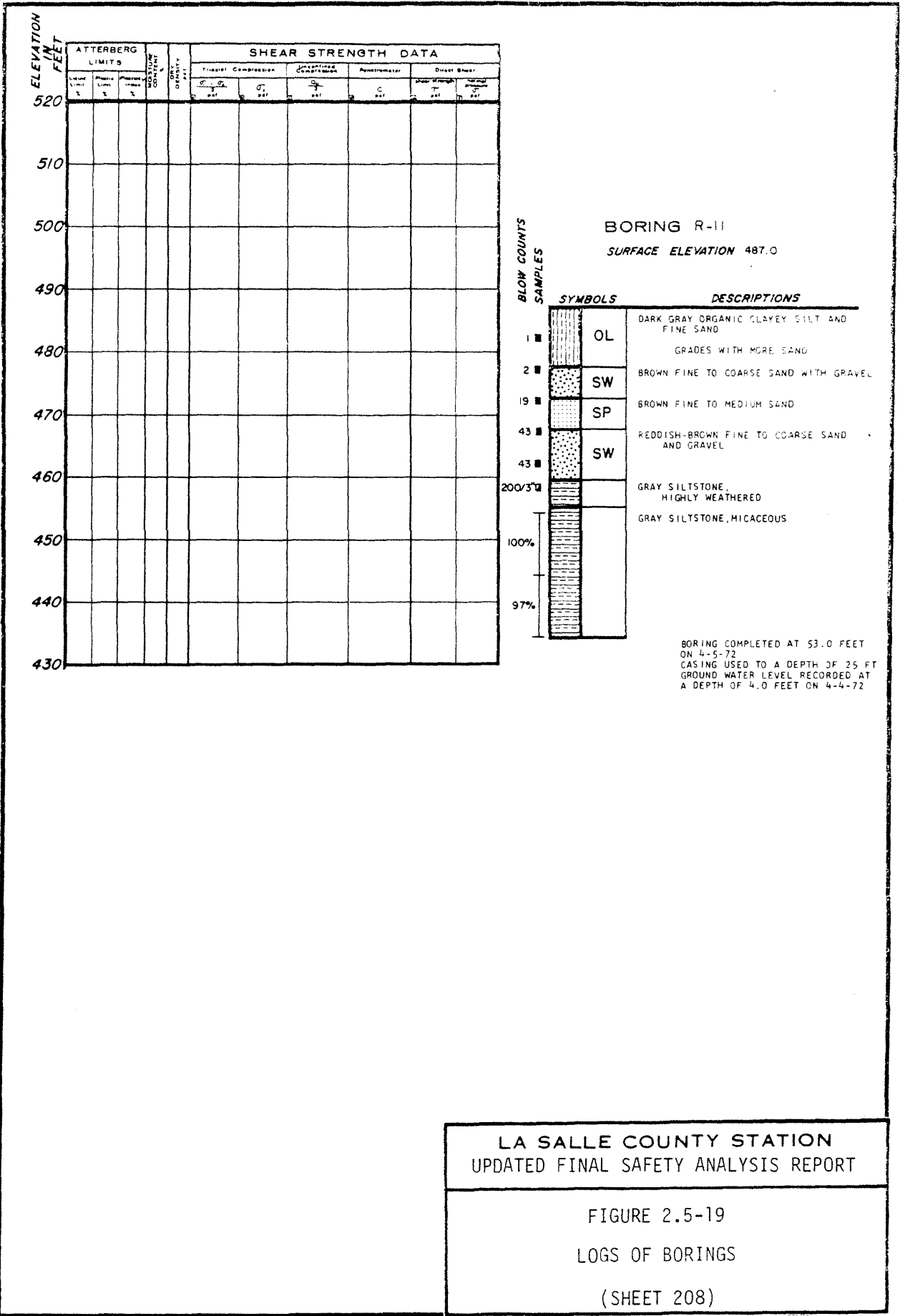

**LA SALLE COUNTY STATION**  
UPDATED FINAL SAFETY ANALYSIS REPORT

FIGURE 2.5-19  
LOGS OF BORINGS  
(SHEET 208)









ELEVATION IN FEET	ATTERBERG LIMITS					SHEAR STRENGTH DATA											
	Liquid Limit %	Plastic Limit %	Plasticity Index %	MOISTURE CONTENT %	DENSITY pcf	Triaxial Compression			Unconfined Compression		Penetration	Direct Shear					
						$\sigma_1$ pcf	$\sigma_3$ pcf	$\phi$ deg	$c_u$ pcf	$c$ pcf		$\phi$ deg	$\tau$ pcf	$\phi$ deg			
	1	2	3	4	5	6	7	8	9	10	11	12					
495																	
490																	
485																	
480																	
475																	
470																	
465																	
460																	
455																	
450																	
445																	

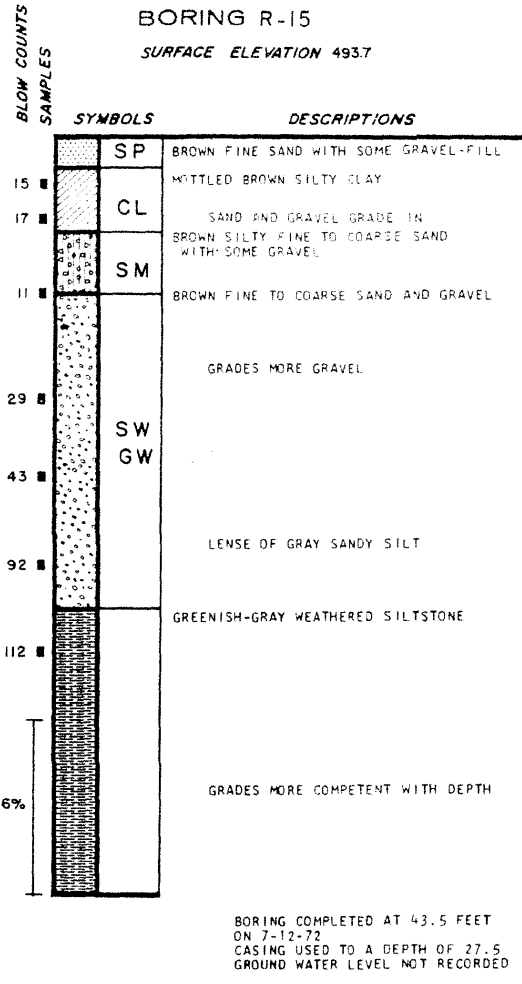

ELEVATION IN FEET	ATTERBERG LIMITS					SHEAR STRENGTH DATA											
	Liquid Limit %	Plastic Limit %	Plasticity Index %	MOISTURE CONTENT %	DENSITY pcf	Triaxial Compression			Unconfined Compression		Penetration	Direct Shear					
						$\sigma_1$ pcf	$\sigma_3$ pcf	$\phi$ deg	$c_u$ pcf	$c$ pcf		$\phi$ deg	$\tau$ pcf	$\phi$ deg			
	1	2	3	4	5	6	7	8	9	10	11	12					
500																	
495																	
490																	
485																	
480																	

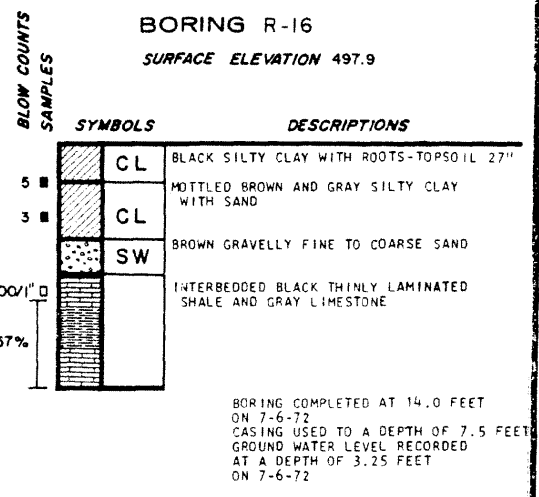

**LA SALLE COUNTY STATION**  
**UPDATED FINAL SAFETY ANALYSIS REPORT**

FIGURE 2.5-19  
LOGS OF BORINGS  
(SHEET 212)

ELEVATION IN FEET	ATTERBERG LIMITS			QUALITY COUNT	DENSITY pcf	SHEAR STRENGTH DATA												
	Liquid Limit %	Plastic Limit %	Plastic Index %			Triaxial Compression		Unconfined Compression		Penetration		Direct Shear						
						$\sigma_1$ psf	$\sigma_3$ psf	$q_u$ psf	$q_c$ psf	$C$ psf	$\phi$ deg	$\sigma_1$ psf	$\sigma_3$ psf					
500																		
495																		
490																		
485																		
480																		
475																		
470																		

**BORING R-17**  
SURFACE ELEVATION 495.6

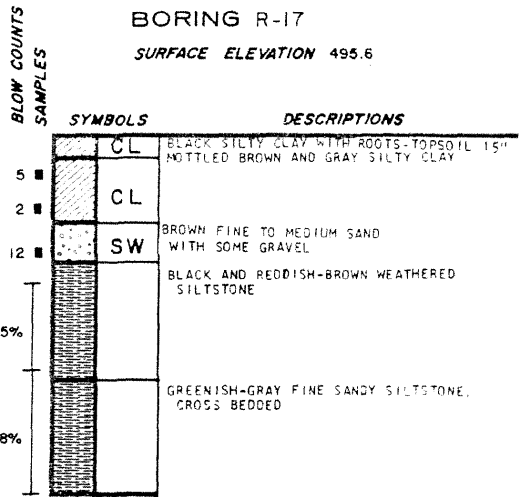

BORING COMPLETED AT 20.5 FEET ON 7-10-72  
CASING USED TO A DEPTH OF 8 FEET  
GROUND WATER LEVEL RECORDED AT A DEPTH OF 4.0 FEET ON 7-6-72

ELEVATION IN FEET	ATTERBERG LIMITS			QUALITY COUNT	DENSITY pcf	SHEAR STRENGTH DATA												
	Liquid Limit %	Plastic Limit %	Plastic Index %			Triaxial Compression		Unconfined Compression		Penetration		Direct Shear						
						$\sigma_1$ psf	$\sigma_3$ psf	$q_u$ psf	$q_c$ psf	$C$ psf	$\phi$ deg	$\sigma_1$ psf	$\sigma_3$ psf					
505																		
500																		
495																		
490																		
485																		
480																		
475																		

**BORING R-18**  
SURFACE ELEVATION 503.9

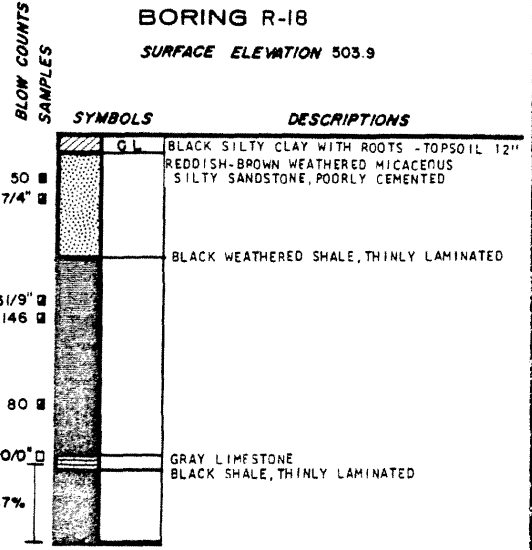

BORING COMPLETED AT 23.5 FEET ON 7-10-72  
CASING USED TO A DEPTH OF 9 FEET  
GROUND WATER NOT ENCOUNTERED

LA SALLE COUNTY STATION  
UPDATED FINAL SAFETY ANALYSIS REPORT

FIGURE 2.5-19  
LOGS OF BORINGS  
(SHEET 213)

ELEVATION IN FEET	ATTERBERG LIMITS			LIQUID LIMIT %	PLASTIC LIMIT %	PLASTICITY INDEX %	UNSATURATED WATER CONTENT %	DENSITY pcf	SHEAR STRENGTH DATA										
	Liquid Limit	Plastic Limit	Plasticity Index						Triaxial Compression			Unconfined Compression		Penetrometer		Direct Shear			
									σ ₁ psf	σ ₃ psf	σ ₁ psf	σ ₃ psf	C psf	φ deg	T psf	U psf			
490																			
485																			
480																			
475																			
470																			
465																			

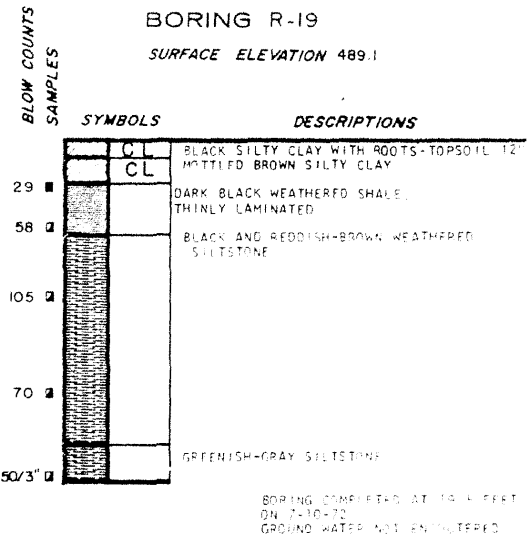

ELEVATION IN FEET	ATTERBERG LIMITS			LIQUID LIMIT %	PLASTIC LIMIT %	PLASTICITY INDEX %	UNSATURATED WATER CONTENT %	DENSITY pcf	SHEAR STRENGTH DATA										
	Liquid Limit	Plastic Limit	Plasticity Index						Triaxial Compression			Unconfined Compression		Penetrometer		Direct Shear			
									σ ₁ psf	σ ₃ psf	σ ₁ psf	σ ₃ psf	C psf	φ deg	T psf	U psf			
505																			
500																			
495																			
490																			
485																			
480																			

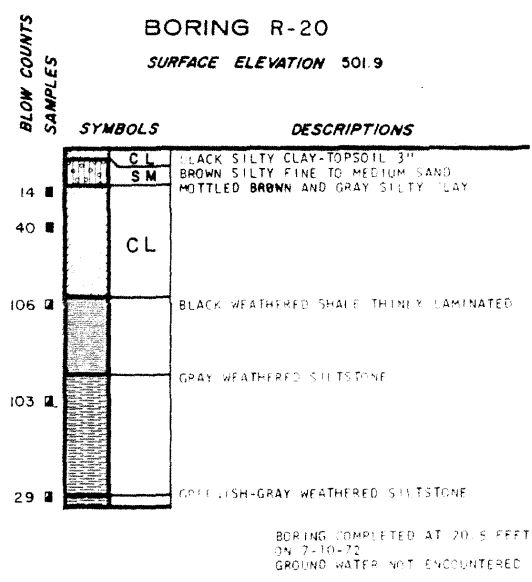

**LA SALLE COUNTY STATION**  
UPDATED FINAL SAFETY ANALYSIS REPORT

FIGURE 2.5-19  
LOGS OF BORINGS  
(SHEET 214)

ELEVATION IN IN FEET	ATTERBERG LIMITS					SHEAR STRENGTH DATA													
	Liquid Limit %	Plastic Limit %	Plasticity Index %	MOISTURE CONTENT %	SHRINKAGE INDEX %	Compression					Parameters			Direct Shear					
						$\sigma_c$ PSF	$\sigma_{c1}$ PSF	$\sigma_{c2}$ PSF	$\sigma_{c3}$ PSF	$\sigma_{c4}$ PSF	C PSF	$\phi$ DEG	T PSF	$\phi$ DEG					
															$\sigma_c$ PSF	$\sigma_{c1}$ PSF	$\sigma_{c2}$ PSF		
505																			
500																			
495																			
490																			
485																			
480																			
475																			

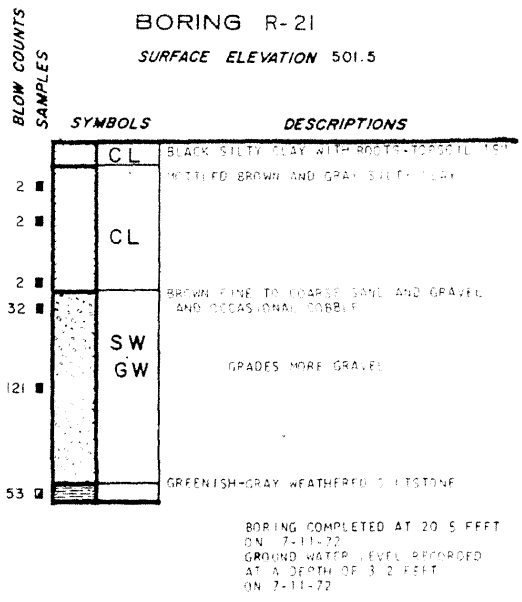

ELEVATION IN IN FEET	ATTERBERG LIMITS					SHEAR STRENGTH DATA													
	Liquid Limit %	Plastic Limit %	Plasticity Index %	MOISTURE CONTENT %	SHRINKAGE INDEX %	Compression					Parameters			Direct Shear					
						$\sigma_c$ PSF	$\sigma_{c1}$ PSF	$\sigma_{c2}$ PSF	$\sigma_{c3}$ PSF	$\sigma_{c4}$ PSF	C PSF	$\phi$ DEG	T PSF	$\phi$ DEG					
															$\sigma_c$ PSF	$\sigma_{c1}$ PSF	$\sigma_{c2}$ PSF		
515																			
510																			
505																			
500																			
495																			
490																			

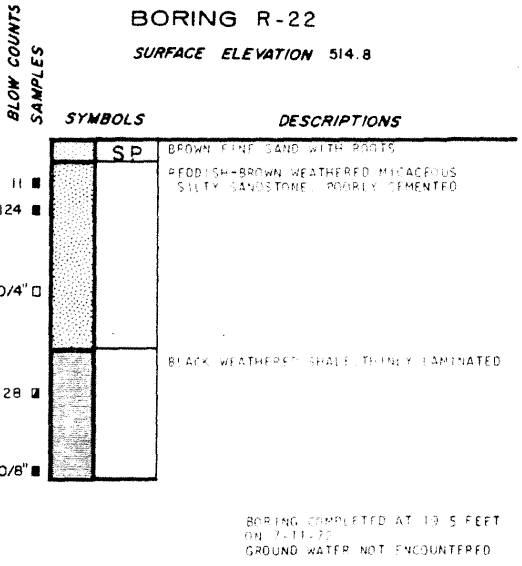

**LA SALLE COUNTY STATION**  
**UPDATED FINAL SAFETY ANALYSIS REPORT**

FIGURE 2.5-19  
LOGS OF BORINGS  
(SHEET 215)

ELEVATION  
IN  
FEET

ATTERBERG LIMITS			SHEAR STRENGTH DATA								
Liquid Limit %	Plastic Limit %	Plastic Index	SHRINKAGE CONSTANT	UNIFORMITY COEFFICIENT	Triaxial Compression		Unconfined Compression		Penetration	Direct Shear	
					$\sigma_1$ (PSF)	$\sigma_3$ (PSF)	$S_u$ (PSF)	$S_u$ (PSF)		Shear Strength (PSF)	Normal Pressure (PSF)

BORING R-23  
SURFACE ELEVATION 527.8

BLOW COUNTS  
SAMPLES

	SYMBOLS	DESCRIPTIONS
	CL	BLACK SILTY CLAY-TOPSOIL 6"
7	ML	BROWN SANDY SILT WITH SOME GRAVEL
24	SM	BROWN SILTY FINE SAND
84/8"		BROWN WEATHERED MICACEOUS SILTY SANDSTONE, PARTLY CEMENTED
129		GRAY WEATHERED SILTSTONE
120/4"		

BORING COMPLETED AT 129.5 FEET  
ON 7-11-72  
GROUND WATER LEVEL RECORDED  
AT A DEPTH OF 40 FEET  
ON 7-11-72

LA SALLE COUNTY STATION  
UPDATED FINAL SAFETY ANALYSIS REPORT

FIGURE 2.5-19  
LOGS OF BORINGS  
(SHEET 216)





DEPTH (FEET)	OTHER TESTS	SHEAR STRENGTH PSF	ATTEBERG LIMITS			FIELD MOISTURE CONTENT %	DRY DENSITY PCF
			LIQUID LIMIT %	PLASTIC LIMIT %	PLASTICITY INDEX %		
0							
5							
10							
15							
20							
25							
30							
35							
40							

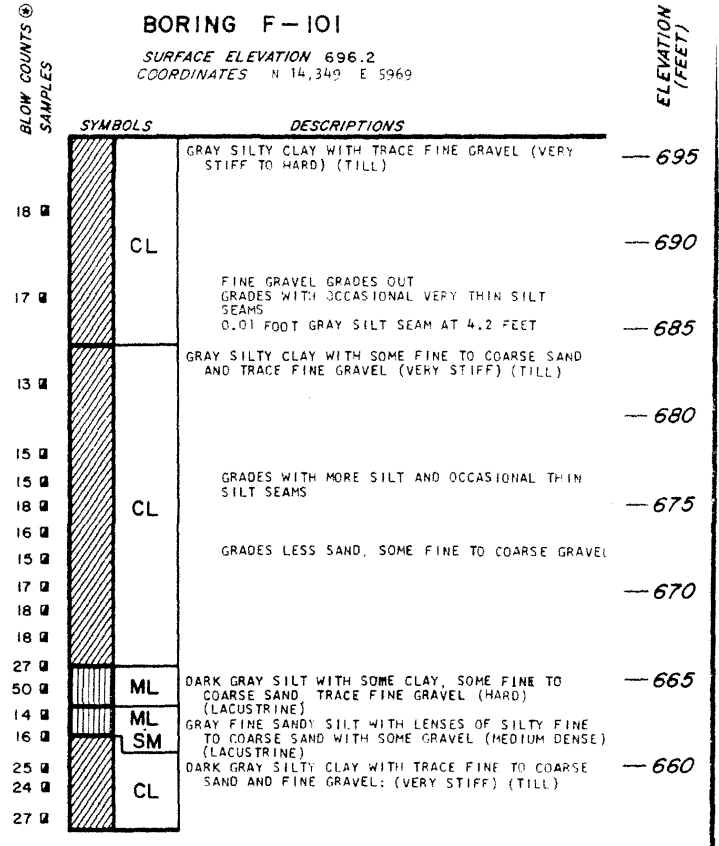

BORING COMPLETED AT 40.0 FEET ON 11-21-75.  
NO CASING USED.  
GROUNDWATER ENCOUNTERED AT 32.5 FEET.

**LA SALLE COUNTY STATION**  
UPDATED FINAL SAFETY ANALYSIS REPORT

FIGURE 2.5-19  
LOGS OF BORINGS  
(SHEET 218)

DEPTH (FEET)	OTHER TESTS	SHEAR STRENGTH PSF	ATTERBERG LIMITS			FIELD MOISTURE CONTENT %	DRY DENSITY PCF
			LIQUID LIMIT %	PLASTIC LIMIT %	PLASTICITY INDEX %		
0							
5							
10							
15							
20							
25							
30							
35							
40							
45							

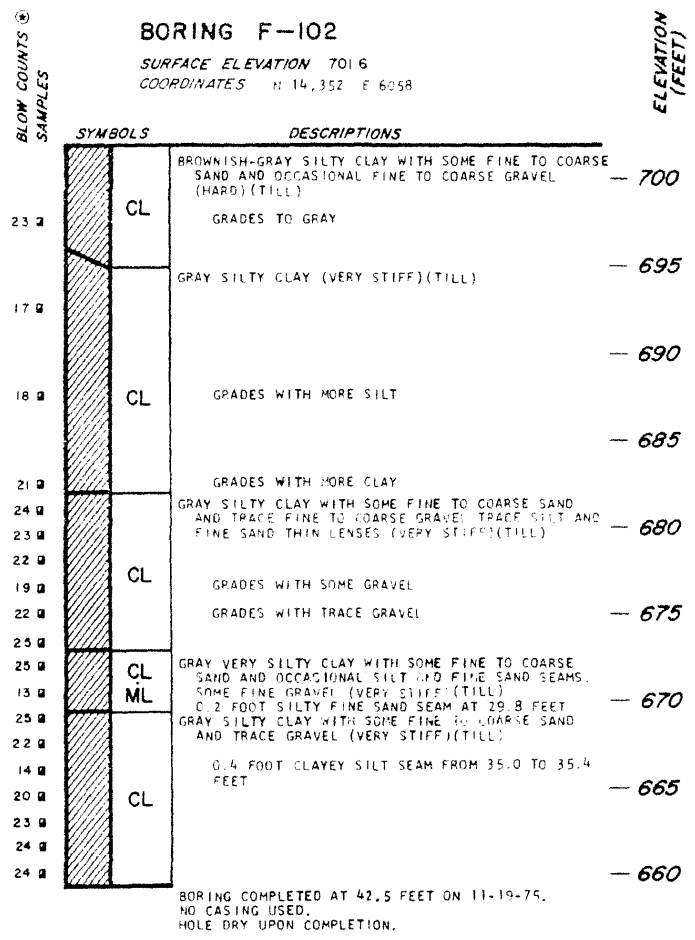

**LA SALLE COUNTY STATION**  
**UPDATED FINAL SAFETY ANALYSIS REPORT**

---

FIGURE 2.5-19

---

LOGS OF BORINGS  
(SHEET 219) REV. 0 -  
APRIL 1984

DEPTH (FEET)	OTHER TESTS	SHEAR STRENGTH PSF	ATTERBERG LIMITS			FIELD MOISTURE CONTENT %	DRY DENSITY PCF
			LIQUID LIMIT %	PLASTIC LIMIT %	PLASTICITY INDEX %		
0							
5							
10							
15							
20							
25							
30							
35							
40							
45							
50							
55							

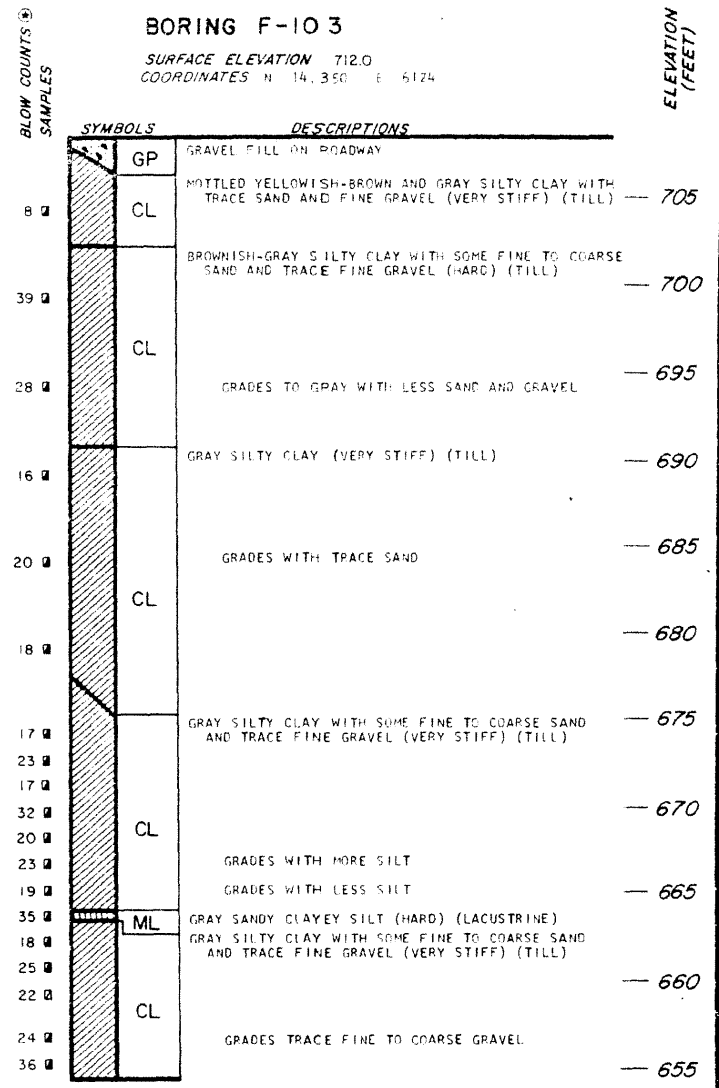

BORING COMPLETED AT 54.0 FEET ON 11-21-75.  
 CASING USED TO A DEPTH OF 10.0 FEET.  
 GROUNDWATER LEVEL NOT RECORDED.

**LA SALLE COUNTY STATION**  
 UPDATED FINAL SAFETY ANALYSIS REPORT

FIGURE 2.5-19  
 LOGS OF BORINGS  
 (SHEET 220)

REV. 0 -  
 APRIL 1984

DEPTH (FEET)	OTHER TESTS	SHEAR STRENGTH PSF	ATTERBERG LIMITS			FIELD MOISTURE CONTENT %	DRY DENSITY PCF			
			LIQUID LIMIT %	PLASTIC LIMIT %	PLASTICITY INDEX %					
0										
5										
10										
15										
20										
25										

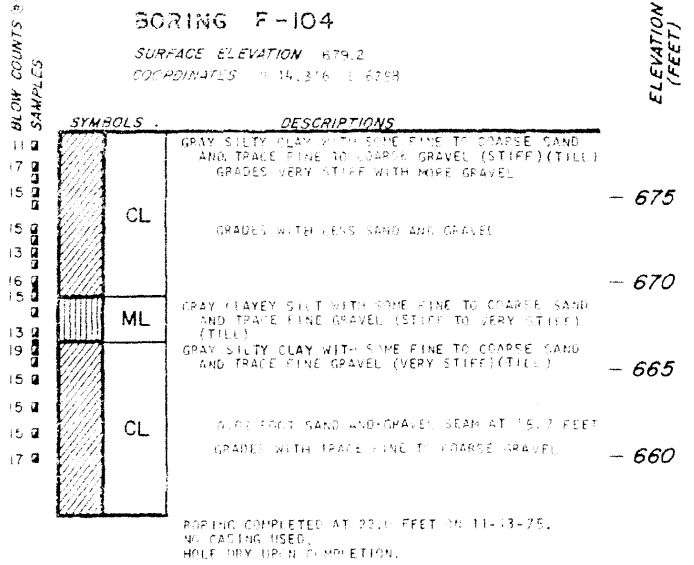

DEPTH (FEET)	OTHER TESTS	SHEAR STRENGTH PSF	ATTERBERG LIMITS			FIELD MOISTURE CONTENT %	DRY DENSITY PCF			
			LIQUID LIMIT %	PLASTIC LIMIT %	PLASTICITY INDEX %					
0										
5										
10										
15										
20										
25										

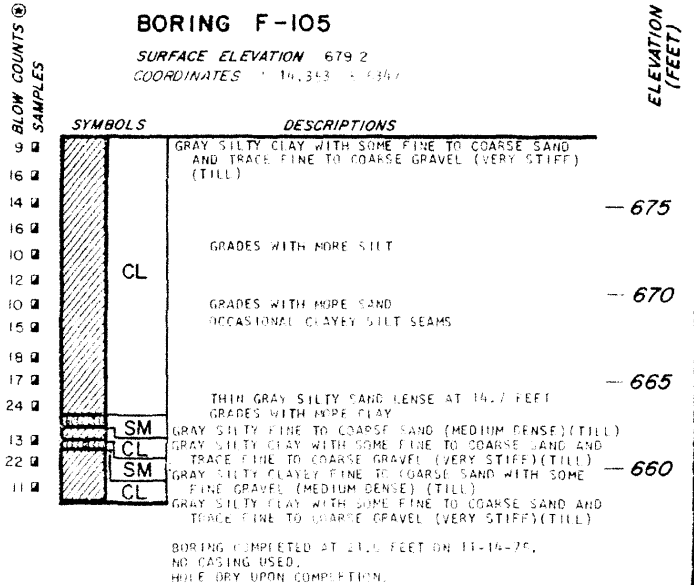

**LA SALLE COUNTY STATION**  
**UPDATED FINAL SAFETY ANALYSIS REPORT**

FIGURE 2.5-19

LOGS OF BORINGS REV. 0 -  
 (SHEET 221) APRIL 1984

DEPTH (FEET)	OTHER TESTS	SHEAR STRENGTH PSF	ATTERBERG LIMITS			FIELD MOISTURE CONTENT %	DRY DENSITY PCF
			Liquid Limit %	Plastic Limit %	Plasticity Index %		
0							
5							
10							
15							
20							
25							

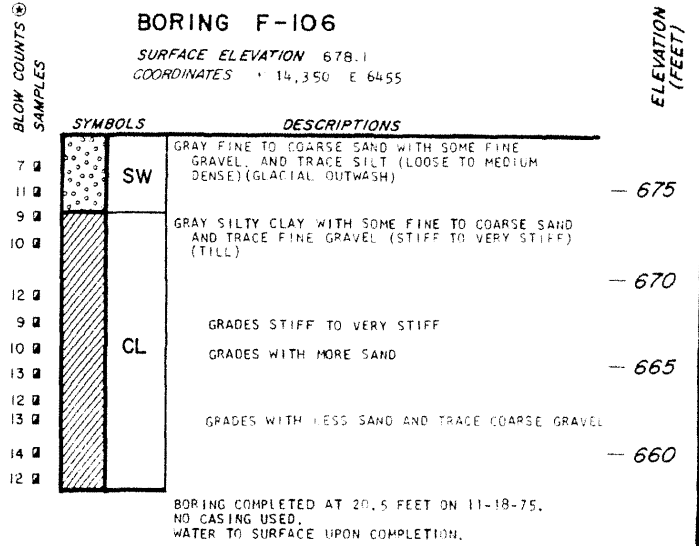

DEPTH (FEET)	OTHER TESTS	SHEAR STRENGTH PSF	ATTERBERG LIMITS			FIELD MOISTURE CONTENT %	DRY DENSITY PCF
			Liquid Limit %	Plastic Limit %	Plasticity Index %		
0							
5							
10							
15							
20							

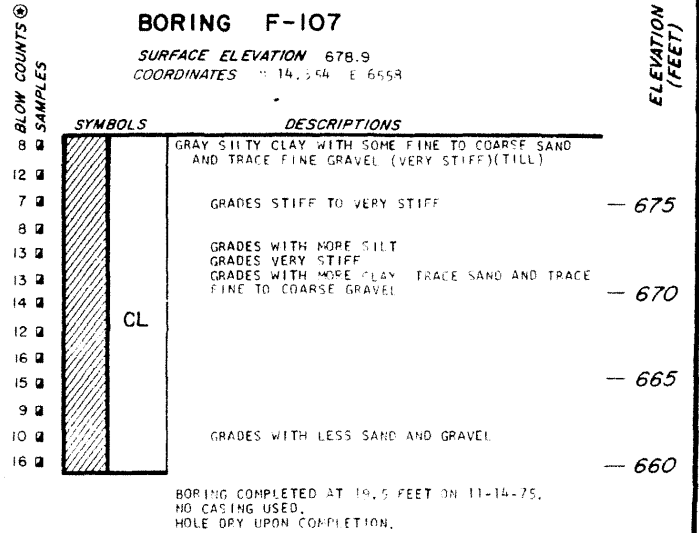

**LA SALLE COUNTY STATION**  
**UPDATED FINAL SAFETY ANALYSIS REPORT**

FIGURE 2.5-19  
LOGS OF BORINGS REV. 0 -  
(SHEET 222) APRIL 1984

DEPTH (FEET)	OTHER TESTS	SHEAR STRENGTH PSF	ATTERBERG LIMITS			FIELD MOISTURE CONTENT %	DRY DENSITY PCF
			LIQUID LIMIT %	PLASTIC LIMIT %	PLASTICITY INDEX %		
0							
5							
10							
15							
20							

BLOW COUNTS  
SAMPLES

**BORING F-108**

SURFACE ELEVATION 678.8  
COORDINATES 14.350 E 6655

ELEVATION  
(FEET)

SYMBOLS		DESCRIPTIONS		
14	CL	GRAY SILTY CLAY WITH SOME FINE TO COARSE SAND AND TRACE FINE TO COARSE GRAVEL (VERY STIFF)(TILL) 0.01 FOOT MEDIUM SAND SEAMS AT 2.1 AND 4.0 FEET	- 675	
20		GRADES WITH MORE CLAY		
14				
10				
11				
13			GRADES STIFF TO VERY STIFF	- 670
10				
12			GRADES VERY STIFF WITH MORE COARSE SAND	
15				
14			GRADES LESS COARSE GRAVEL	- 665
13				
16				
14				- 660

BORING COMPLETED AT 19.5 FEET ON 11-18-75.  
NO CASING USED.  
HOLE DRY UPON COMPLETION.

DEPTH (FEET)	OTHER TESTS	SHEAR STRENGTH PSF	ATTERBERG LIMITS			FIELD MOISTURE CONTENT %	DRY DENSITY PCF
			LIQUID LIMIT %	PLASTIC LIMIT %	PLASTICITY INDEX %		
0							
5							
10							
15							
20							

BLOW COUNTS  
SAMPLES

**BORING F-109**

SURFACE ELEVATION 678.7  
COORDINATES 14.350 E 6755

ELEVATION  
(FEET)

SYMBOLS		DESCRIPTIONS		
7	CL	GRAY SILTY CLAY WITH SOME FINE TO COARSE SAND AND TRACE FINE TO COARSE GRAVEL (VERY STIFF) (TILL)	- 675	
10		GRADES STIFF TO VERY STIFF		
11		GRADES STIFF WITH MORE SILT		
7				
10				
13			GRADES VERY STIFF	- 670
15				
13				
10			GRADES STIFF	
15			GRADES VERY STIFF WITH LESS SILT AND GRAVEL	- 665
22				
14				
17				- 660

BORING COMPLETED AT 20.0 FEET ON 11-18-75.  
NO CASING USED.  
HOLE DRY UPON COMPLETION.

LA SALLE COUNTY STATION  
UPDATED FINAL SAFETY ANALYSIS REPORT

FIGURE 2.5-19

LOGS OF BORINGS  
(SHEET 223)

REV. 0 -  
APRIL 1984

DEPTH (FEET)	OTHER TESTS	SHEAR STRENGTH PSF	ATTERBERG LIMITS			FIELD MOISTURE CONTENT %	DRY DENSITY PCF
			LIQUID LIMIT %	PLASTIC LIMIT %	PLASTICITY INDEX %		
0							
5							
10							
15							
20							
25							

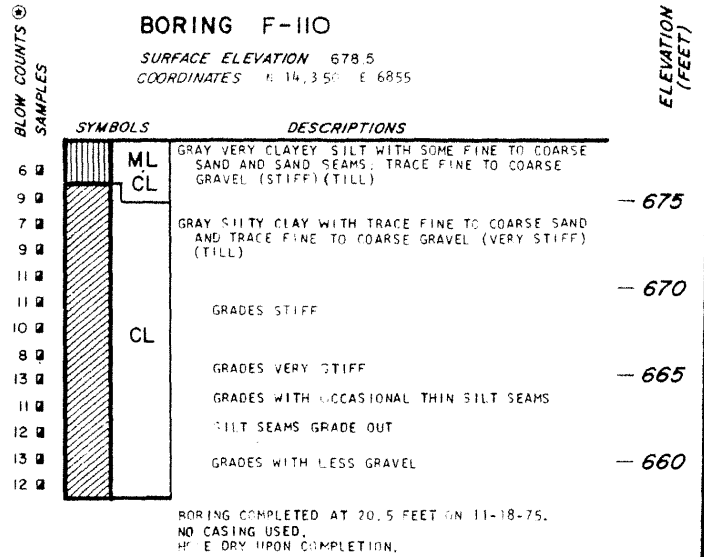

DEPTH (FEET)	OTHER TESTS	SHEAR STRENGTH PSF	ATTERBERG LIMITS			FIELD MOISTURE CONTENT %	DRY DENSITY PCF
			LIQUID LIMIT %	PLASTIC LIMIT %	PLASTICITY INDEX %		
0							
5							
10							
15							
20							

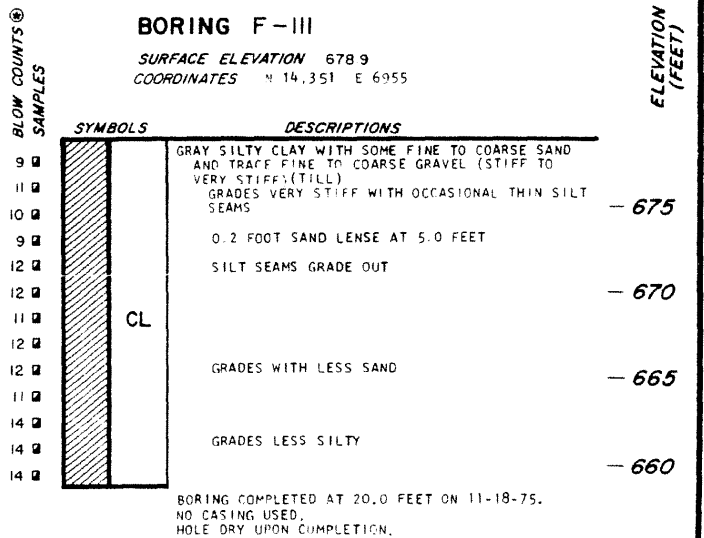

**LA SALLE COUNTY STATION**  
**UPDATED FINAL SAFETY ANALYSIS REPORT**

FIGURE 2.5-19  
LOGS OF BORINGS REV. 0 -  
(SHEET 224) APRIL 1984

DEPTH (FEET)	OTHER TESTS	SHEAR STRENGTH PSF	ATTERBERG LIMITS			FIELD MOISTURE CONTENT %	DRY DENSITY PCF
			LIQUID LIMIT %	PLASTIC LIMIT %	PLASTICITY INDEX %		
0							
5							
10							
15							
20							

BLOW COUNTS  
SAMPLES

**BORING F-112**

SURFACE ELEVATION 678.3  
COORDINATES 14,351 E 7055

ELEVATION  
(FEET)

SYMBOLS	DESCRIPTIONS	ELEVATION (FEET)
CL	GRAY SILTY CLAY WITH SOME FINE TO COARSE SAND AND TRACE FINE GRAVEL (STIFF TO VERY STIFF)(TILL) GRADES WITH OCCASIONAL SILT SEAMS	- 675
	GRADES WITH LESS SAND AND GRAVEL: SILT SEAMS GRADE OUT	
		- 670
		- 665
		- 660

BORING COMPLETED AT 19.5 FEET ON 11-19-75.  
NO CASING USED.  
HOLE DRY UPON COMPLETION.

DEPTH (FEET)	OTHER TESTS	SHEAR STRENGTH PSF	ATTERBERG LIMITS			FIELD MOISTURE CONTENT %	DRY DENSITY PCF
			LIQUID LIMIT %	PLASTIC LIMIT %	PLASTICITY INDEX %		
0							
5							
10							
15							
20							
25							

BLOW COUNTS  
SAMPLES

**BORING F-113**

SURFACE ELEVATION 678.4  
COORDINATES 14,354 E 7159

ELEVATION  
(FEET)

SYMBOLS	DESCRIPTIONS	ELEVATION (FEET)
CL	GRAY SILTY CLAY (STIFF)(TILL)	- 675
	GRADES VERY STIFF WITH TRACE MEDIUM TO COARSE SAND AND TRACE FINE GRAVEL	
	GRADES VERY STIFF TO HARD	- 670
	GRADES WITH TRACE FINE SAND	
ML CL	GRAY CLAYEY SILT WITH SILTY CLAY SEAMS AND OCCASIONAL THIN LENSES OF FINE SAND AND SILT (VERY STIFF TO HARD)(LACUSTRINE) 0.3 FOOT SILTY FINE SAND SEAM AT 15.0 FEET	- 665
	GRAY SILTY CLAY WITH SOME FINE TO COARSE SAND AND TRACE FINE TO COARSE GRAVEL (VERY STIFF) (TILL)	- 660
CL		

BORING COMPLETED AT 21.5 FEET ON 11-19-75.  
NO CASING USED.  
GROUNDWATER ENCOUNTERED AT 15.0 FEET.

LA SALLE COUNTY STATION  
UPDATED FINAL SAFETY ANALYSIS REPORT

FIGURE 2.5-19  
LOGS OF BORINGS  
(SHEET 225) REV. 0 -  
APRIL 1984



DEPTH (FEET)	OTHER TESTS	SHEAR STRENGTH PSF	ATTERBERG LIMITS			FIELD CONTENT	
			LIQUID LIMIT %	PLASTIC LIMIT %	PLASTICITY INDEX %	MOISTURE %	DRY DENSITY PCF
0							
5							
10							
15							
20							

BLOW COUNTS  
SAMPLES

**BORING F-114**

SURFACE ELEVATION 678.8  
COORDINATES N 14.350 E 7255

ELEVATION  
(FEET)

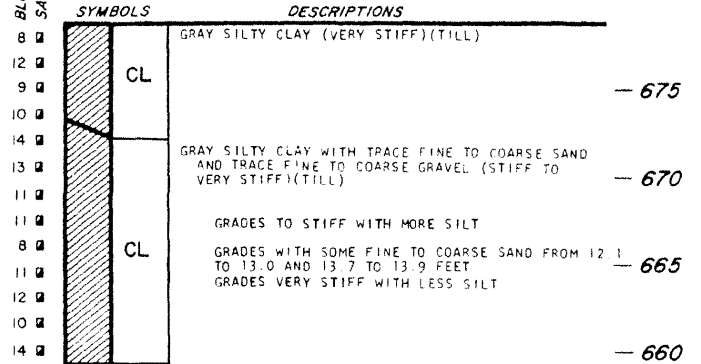

BORING COMPLETED AT 19.5 FEET ON 11-19-75.  
NO CASING USED.  
HOLE DRY UPON COMPLETION.

DEPTH (FEET)	OTHER TESTS	SHEAR STRENGTH PSF	ATTERBERG LIMITS			FIELD CONTENT	
			LIQUID LIMIT %	PLASTIC LIMIT %	PLASTICITY INDEX %	MOISTURE %	DRY DENSITY PCF
0							
5							
10							
15							
20							

BLOW COUNTS  
SAMPLES

**BORING F-115**

SURFACE ELEVATION 678.4  
COORDINATES N 14.350 E 7355

ELEVATION  
(FEET)

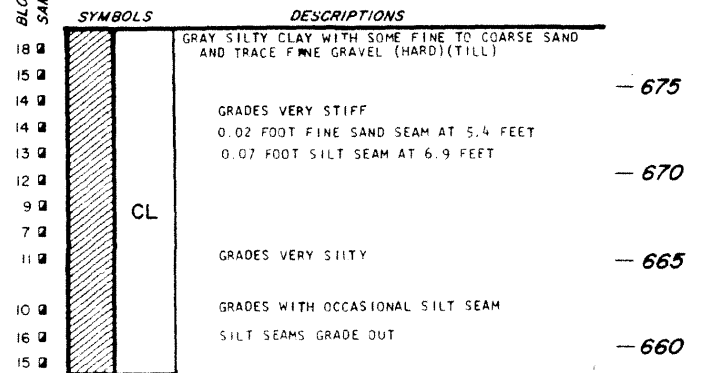

BORING COMPLETED AT 20.0 FEET ON 11-19-75.  
NO CASING USED.  
HOLE DRY UPON COMPLETION.

**LA SALLE COUNTY STATION  
UPDATED FINAL SAFETY ANALYSIS REPORT**

FIGURE 2.5-19

LOGS OF BORINGS  
(SHEET 226)

REV. 0 -  
APRIL 1984

DEPTH (FEET)	OTHER TESTS	SHEAR STRENGTH PSF	ATTERBERG LIMITS			FIELD MOISTURE CONTENT %	DRY DENSITY PCF
			LIQUID LIMIT %	PLASTIC LIMIT %	PLASTICITY INDEX %		
0							
5							
10							
15							
20							

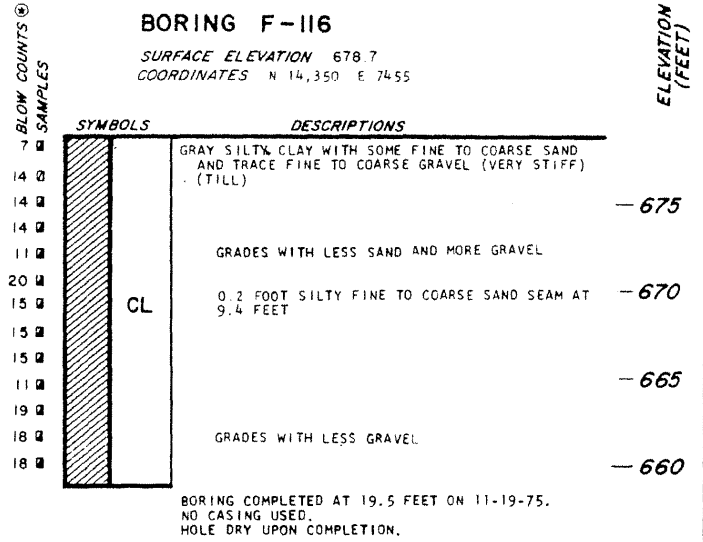

DEPTH (FEET)	OTHER TESTS	SHEAR STRENGTH PSF	ATTERBERG LIMITS			FIELD MOISTURE CONTENT %	DRY DENSITY PCF
			LIQUID LIMIT %	PLASTIC LIMIT %	PLASTICITY INDEX %		
0							
5							
10							
15							
20							
25							

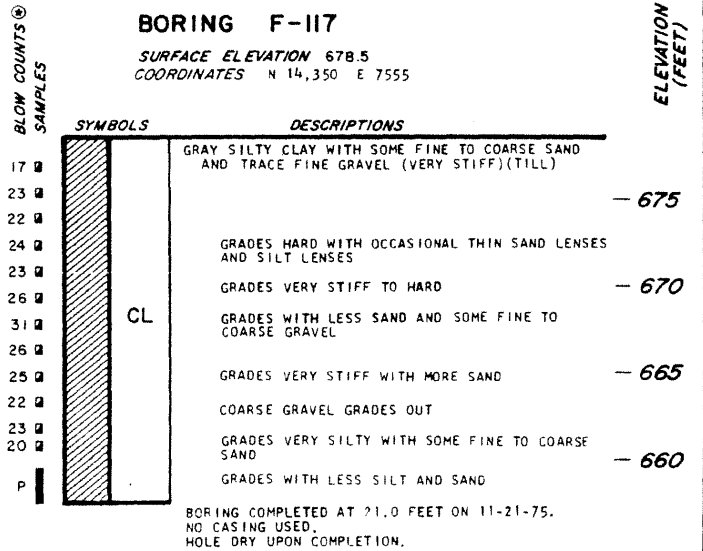

**LA SALLE COUNTY STATION**  
 UPDATED FINAL SAFETY ANALYSIS REPORT

FIGURE 2.5-19  
 LOGS OF BORINGS  
 (SHEET 227) REV. 0 -  
 APRIL 1984

DEPTH (FEET)	OTHER TESTS	SHEAR STRENGTH PSF	ATTERBERG LIMITS			FIELD MOISTURE CONTENT %	DRY DENSITY PCF
			Liquid Limit %	Plastic Limit %	Plasticity Index %		
0							
5							
10							
15							
20							
25							

BLOW COUNTS  
SAMPLES

**BORING F-118**

SURFACE ELEVATION 678.7  
COORDINATES N 14.350 E 7655

ELEVATION  
(FEET)

BLOW COUNTS SAMPLES	SYMBOLS	DESCRIPTIONS	ELEVATION (FEET)
9	CL	GRAY SILTY CLAY WITH SOME FINE TO COARSE SAND AND TRACE FINE TO COARSE GRAVEL (VERY STIFF) (TILL)	
10		GRADES WITH SOME FINE TO COARSE GRAVEL	675
11			
12			
13	ML	GRADES WITH TRACE FINE TO COARSE GRAVEL	
14		GRADES WITH SOME SAND AND FINE GRAVEL	665
15	CL	GRAY SANDY SILT WITH SOME CLAY AND SOME FINE TO COARSE GRAVEL (STIFF) (TILL)	660
16		GRAY SILTY CLAY WITH SOME FINE TO COARSE SAND AND TRACE FINE TO COARSE GRAVEL (VERY STIFF) (TILL)	

BORING COMPLETED AT 22.5 FEET ON 11-17-75.  
NO CASING USED.  
HOLE DRY UPON COMPLETION.

DEPTH (FEET)	OTHER TESTS	SHEAR STRENGTH PSF	ATTERBERG LIMITS			FIELD MOISTURE CONTENT %	DRY DENSITY PCF
			Liquid Limit %	Plastic Limit %	Plasticity Index %		
0							
5							
10							
15							
20							
25							

BLOW COUNTS  
SAMPLES

**BORING F-119**

SURFACE ELEVATION 680.4  
COORDINATES N 14.350 E 7754

ELEVATION  
(FEET)

BLOW COUNTS SAMPLES	SYMBOLS	DESCRIPTIONS	ELEVATION (FEET)
16	CL	GRAY SILTY CLAY WITH SOME FINE TO COARSE SAND AND TRACE FINE TO COARSE GRAVEL (VERY STIFF) (TILL)	680
17		GRADES WITH LESS SAND AND WITH OCCASIONAL THIN SAND AND SILT LENSES	675
18			
19	ML CL	GRAY CLAYEY SILT INTERBEDDED WITH GRAY VERY SILTY CLAY LENSES AND WITH OCCASIONAL SILTY FINE SAND LENSES AND OCCASIONAL FINE TO COARSE SAND LENSES (STIFF) (LACUSTRINE)	670
20		0.3 FOOT SAND AND FINE GRAVEL SEAM AT 13.0 FEET	
21	CL	GRAY SILTY CLAY WITH SOME FINE TO COARSE SAND AND TRACE GRAVEL (VERY STIFF) (TILL)	665
22		GRAY VERY SILTY CLAY WITH OCCASIONAL SILT LENSES AND TRACE FINE TO COARSE SAND (STIFF) (LACUSTRINE)	
23	SM ML	GRAY SILTY FINE TO COARSE SAND AND GRAVEL AND GRAY FINE SANDY SILT LENSES (STIFF TO MEDIUM DENSE) (GLACIAL OUTWASH)	660
24		GRAY VERY SILTY CLAY (STIFF) (LACUSTRINE)	
25	CL CL	GRAY SILTY CLAY WITH SOME FINE TO COARSE SAND AND TRACE FINE GRAVEL (VERY STIFF) (TILL)	
26			

BORING COMPLETED AT 24.0 FEET ON 11-17-75.  
NO CASING USED.  
GROUNDWATER LEVEL NOT RECORDED.

**LA SALLE COUNTY STATION  
UPDATED FINAL SAFETY ANALYSIS REPORT**

FIGURE 2.5-19

LOGS OF BORINGS

(SHEET 228)

REV. 0 -  
APRIL 1984

DEPTH (FEET)	OTHER TESTS	SHEAR STRENGTH PSF	ATTERBERG LIMITS			FIELD MOISTURE % CONTENT	FIELD DENSITY PCF
			LIQUID LIMIT %	PLASTIC LIMIT %	PLASTICITY INDEX %		
0							
5							
10							
15							
20							
25							
30							

BLOW COUNTS  
SAMPLES

### BORING F-119 A

SURFACE ELEVATION 678.5  
COORDINATES N 14,354 E 7752

ELEVATION  
(FEET)

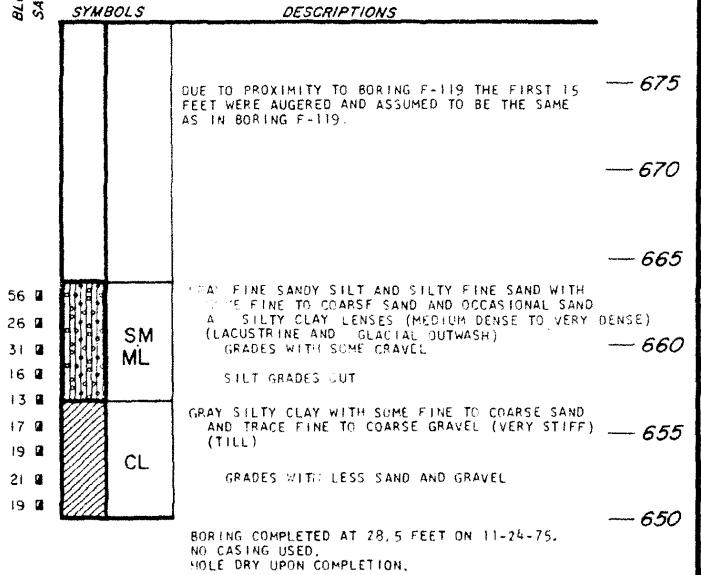

DEPTH (FEET)	OTHER TESTS	SHEAR STRENGTH PSF	ATTERBERG LIMITS			FIELD MOISTURE % CONTENT	FIELD DENSITY PCF
			LIQUID LIMIT %	PLASTIC LIMIT %	PLASTICITY INDEX %		
0							
5							
10							
15							
20							
25							
30							

BLOW COUNTS  
SAMPLES

### BORING F-120

SURFACE ELEVATION 685.0  
COORDINATES N 14,351 E 7855

ELEVATION  
(FEET)

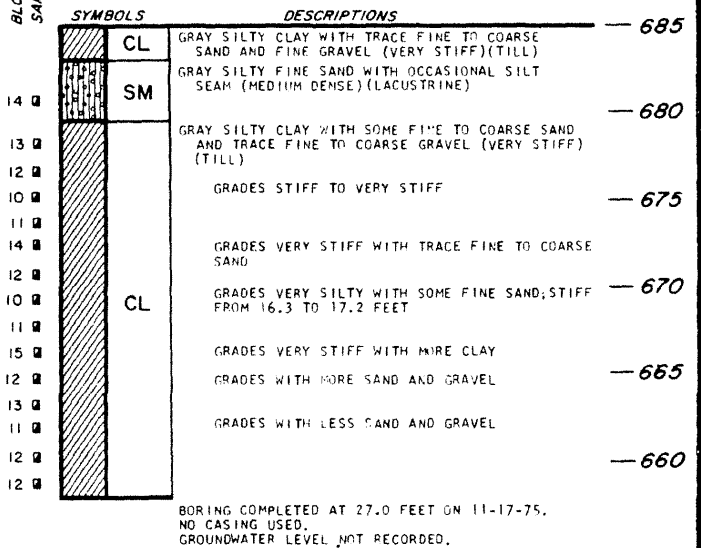

## LA SALLE COUNTY STATION UPDATED FINAL SAFETY ANALYSIS REPORT

FIGURE 2.5-19

LOGS OF BORINGS

(SHEET 229)

REV. 0 -  
APRIL 1984

DEPTH (FEET)	OTHER TESTS	SHEAR STRENGTH PSF	ATTERBERG LIMITS			FIELD MOISTURE % CONTENT	DRY DENSITY PCF
			LIQUID LIMIT %	PLASTIC LIMIT %	PLASTICITY INDEX %		
0							
5							
10							
15							
20							
25							
30							
35							

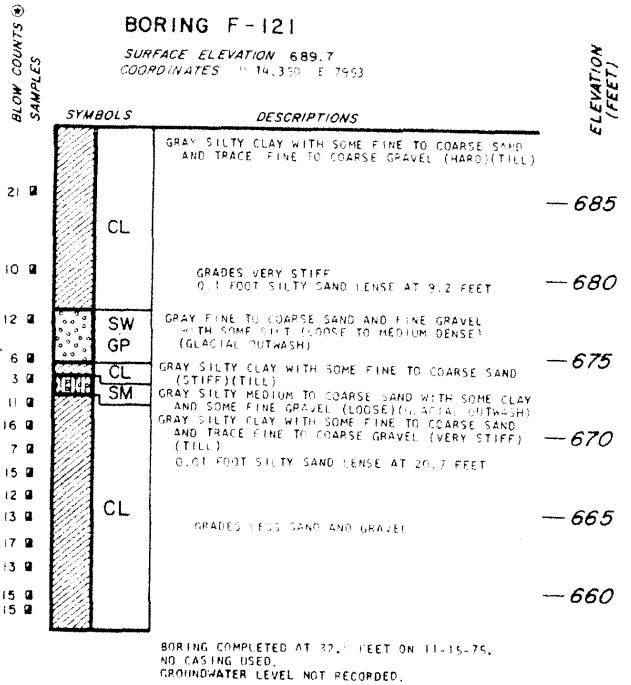

DEPTH (FEET)	OTHER TESTS	SHEAR STRENGTH PSF	ATTERBERG LIMITS			FIELD MOISTURE % CONTENT	DRY DENSITY PCF
			LIQUID LIMIT %	PLASTIC LIMIT %	PLASTICITY INDEX %		
0							
5							
10							
15							
20							
25							
30							
35							

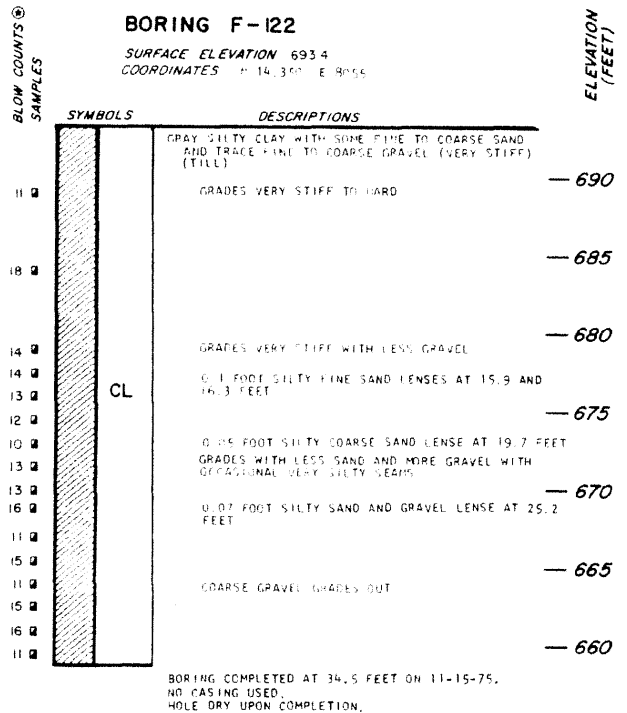

**LA SALLE COUNTY STATION  
UPDATED FINAL SAFETY ANALYSIS REPORT**

FIGURE 2.5-19

LOGS OF BORINGS

(SHEET 230) REV. 0 -  
APRIL 1984

DEPTH (FEET)	OTHER TESTS	SHEAR STRENGTH PSF	ATTERBERG LIMITS			FIELD MOISTURE CONTENT %	DRY DENSITY PCF
			LIQUID LIMIT %	PLASTIC LIMIT %	PLASTICITY INDEX %		
0							
5							
10							
15							
20							
25							
30							
35							
40							

DEPTH (FEET)	OTHER TESTS	SHEAR STRENGTH PSF	ATTERBERG LIMITS			FIELD MOISTURE CONTENT %	DRY DENSITY PCF
			LIQUID LIMIT %	PLASTIC LIMIT %	PLASTICITY INDEX %		
0							
5							
10							
15							
20							
25							
30							
35							
40							

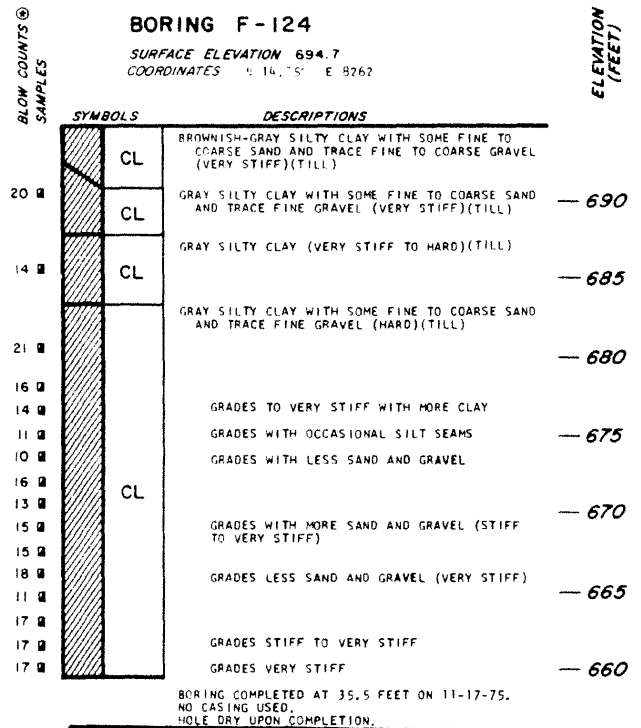
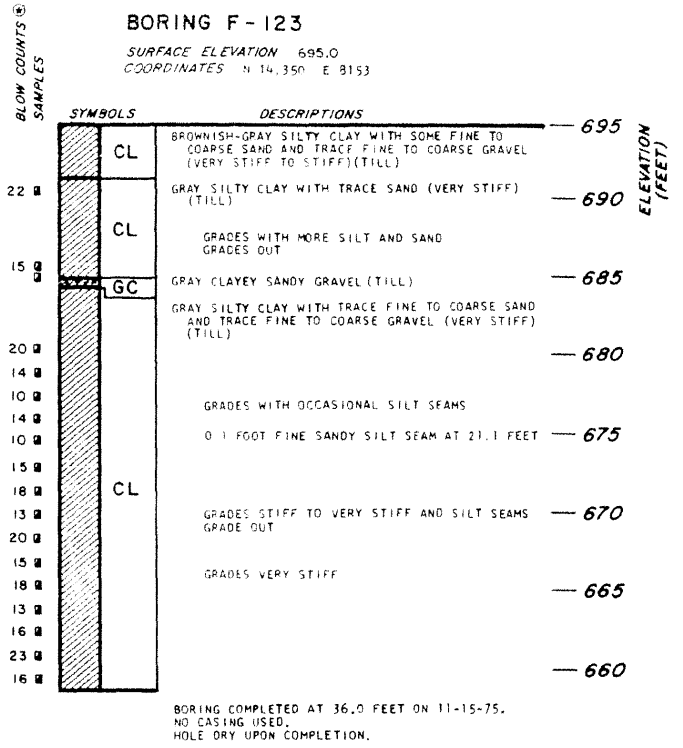

**LA SALLE COUNTY STATION  
 UPDATED FINAL SAFETY ANALYSIS REPORT**

FIGURE 2.5-19

LOGS OF BORINGS  
 (SHEET 231)

REV. 0 -  
 APRIL 1984

DEPTH (FEET)	OTHER TESTS	SHEAR STRENGTH PSF	ATTERBERG LIMITS			FIELD CONTENT MOISTURE %	DRY DENSITY PCF
			LIQUID LIMIT %	PLASTIC LIMIT %	PLASTICITY INDEX %		
0							
5							
10							
15							
20							
25							
30							
35							
40							

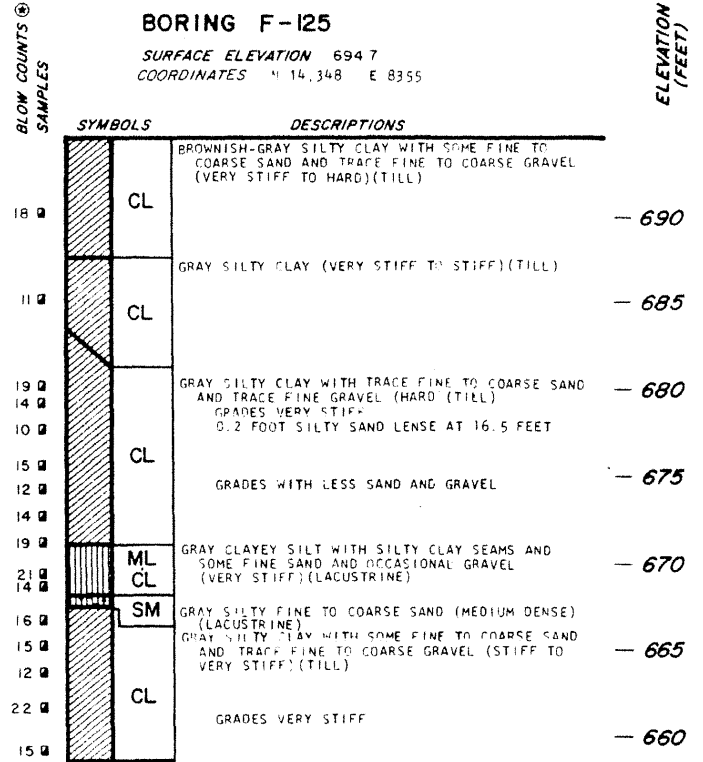

BORING COMPLETED AT 36.0 FEET ON 11-14-75.  
 NO CASING USED.  
 GROUNDWATER LEVEL NOT RECORDED.

**LA SALLE COUNTY STATION**  
 UPDATED FINAL SAFETY ANALYSIS REPORT

FIGURE 2.5-19  
 LOGS OF BORINGS  
 (SHEET 232)

DEPTH (FEET)	OTHER TESTS	SHEAR STRENGTH PSF	ATTERBERG LIMITS			FIELD MOISTURE CONTENT %	DRY DENSITY PCF
			LIQUID LIMIT %	PLASTIC LIMIT %	PLASTICITY INDEX %		
0							
5							
10							
15							
20							
25							
30							
35							
40							

DEPTH (FEET)	OTHER TESTS	SHEAR STRENGTH PSF	ATTERBERG LIMITS			FIELD MOISTURE CONTENT %	DRY DENSITY PCF
			LIQUID LIMIT %	PLASTIC LIMIT %	PLASTICITY INDEX %		
0							
5							
10							
15							
20							
25							
30							
35							

**BORING F-201**

SURFACE ELEVATION 710.3  
COORDINATES N 14,640 E 6380

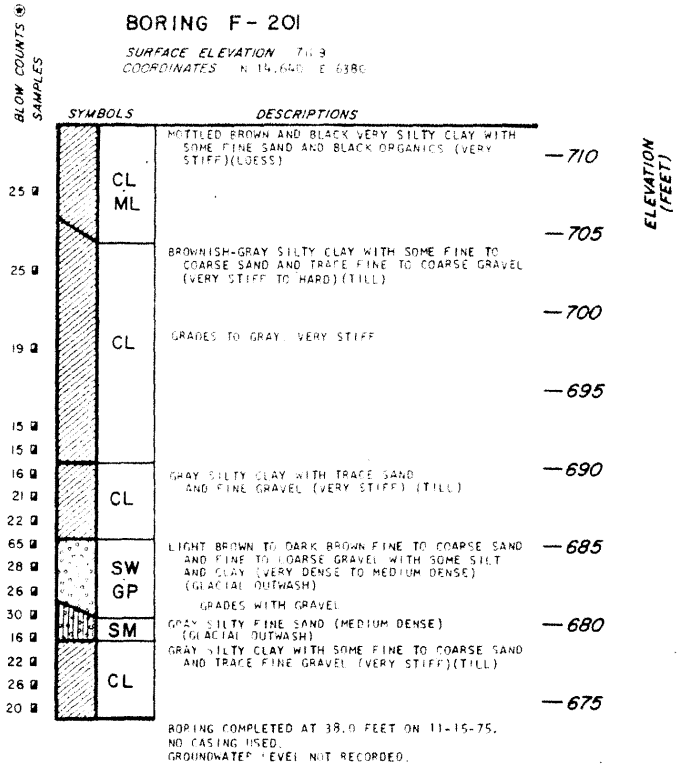

**BORING F-202**

SURFACE ELEVATION 710.4  
COORDINATES N 14,640 E 6580

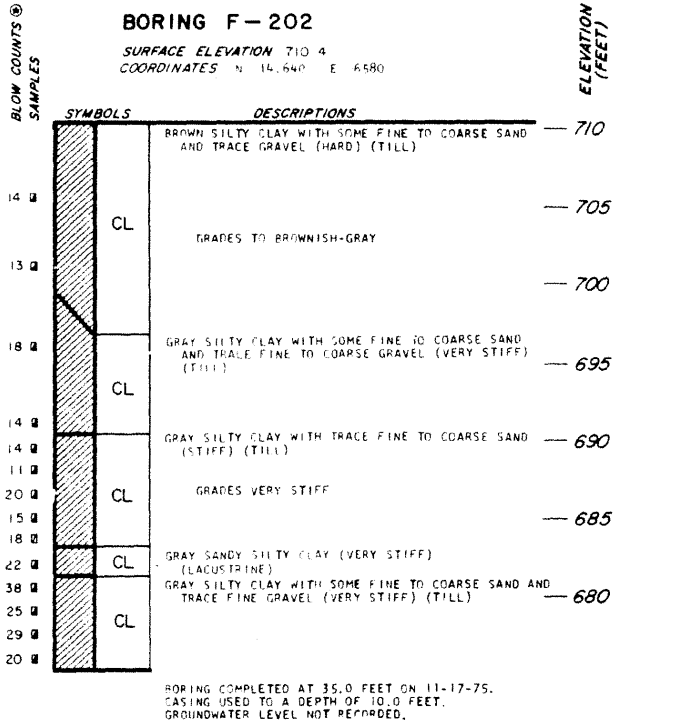

**LA SALLE COUNTY STATION  
UPDATED FINAL SAFETY ANALYSIS REPORT**

FIGURE 2.5-19  
LOGS OF BORINGS  
(SHEET 233)



DEPTH (FEET)	OTHER TESTS	SHEAR STRENGTH PSF	ATTERBERG LIMITS			FIELD MOISTURE %	DRY DENSITY PCF
			LIQUID LIMIT %	PLASTIC LIMIT %	PLASTICITY INDEX %		
0							
5							
10							
15							
20							
25							
30							
35							
40							

DEPTH (FEET)	OTHER TESTS	SHEAR STRENGTH PSF	ATTERBERG LIMITS			FIELD MOISTURE %	DRY DENSITY PCF
			LIQUID LIMIT %	PLASTIC LIMIT %	PLASTICITY INDEX %		
0							
5							
10							
15							
20							
25							
30							
35							

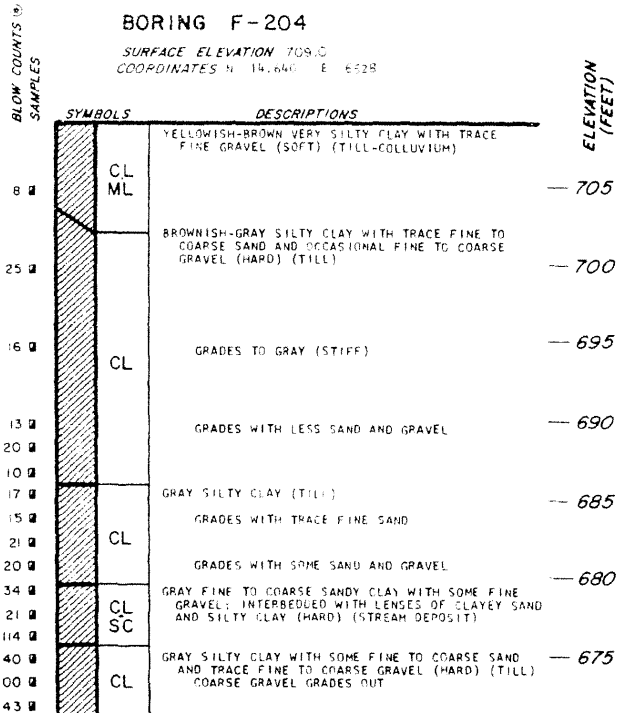

BORING COMPLETED AT 38.0 FEET ON 11-17-75.  
CASING USED TO A DEPTH OF 10.0 FEET.  
GROUNDWATER ENCOUNTERED AT 4.0 FEET.

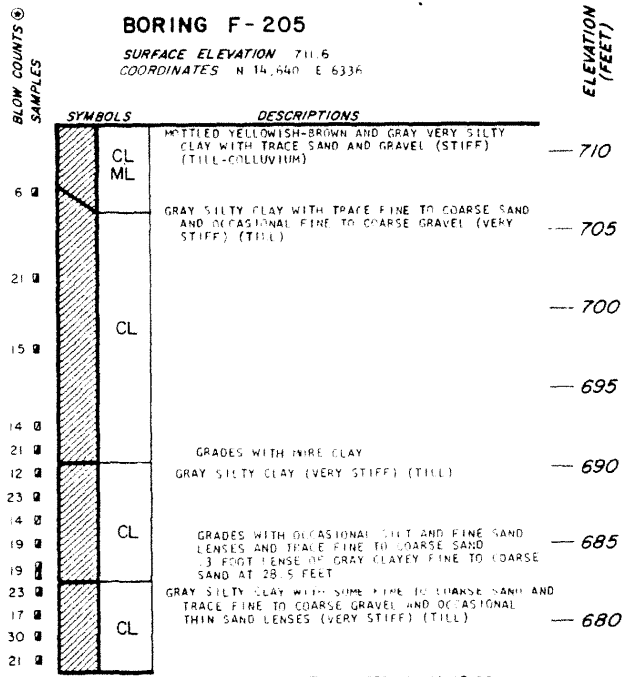

BORING COMPLETED AT 35.0 FEET ON 11-18-75.  
CASING USED TO A DEPTH OF 10.0 FEET.  
GROUNDWATER ENCOUNTERED AT 5.5 FEET.

**LA SALLE COUNTY STATION**  
**UPDATED FINAL SAFETY ANALYSIS REPORT**

FIGURE 2.5-19  
LOGS OF BORINGS  
(SHEET 234)

DEPTH (FEET)	OTHER TESTS	SHEAR STRENGTH PSF	ATTERBERG LIMITS			FIELD MOISTURE CONTENT %	DRY DENSITY PCF
			LIQUID LIMIT %	PLASTIC LIMIT %	PLASTICITY INDEX %		
0							
5							
10							
15							
20							
25							
30							
35							
40							

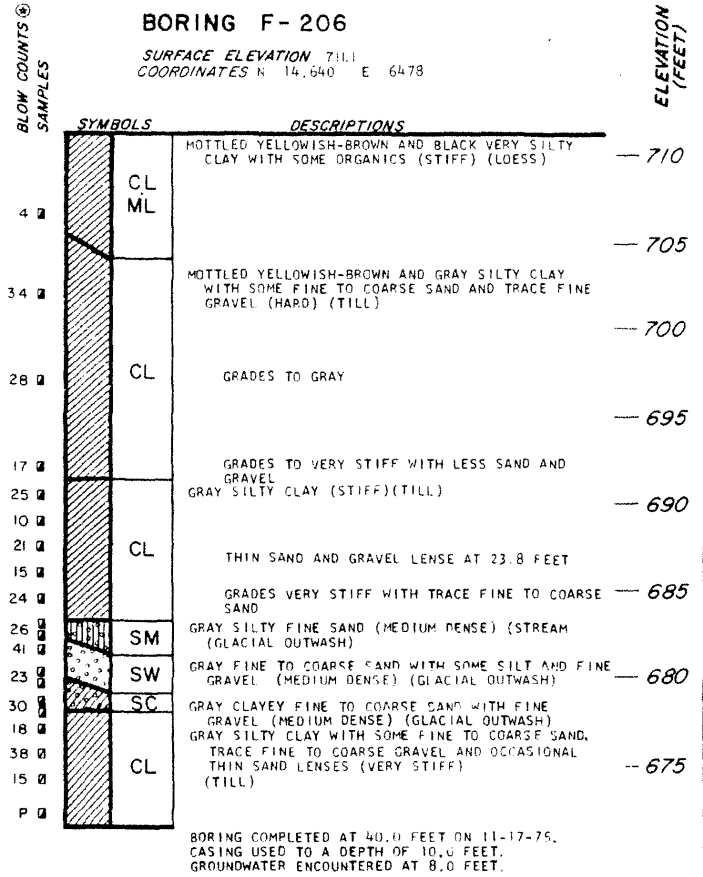

**LA SALLE COUNTY STATION**  
 UPDATED FINAL SAFETY ANALYSIS REPORT

FIGURE 2.5-19  
 LOGS OF BORINGS  
 (SHEET 235)

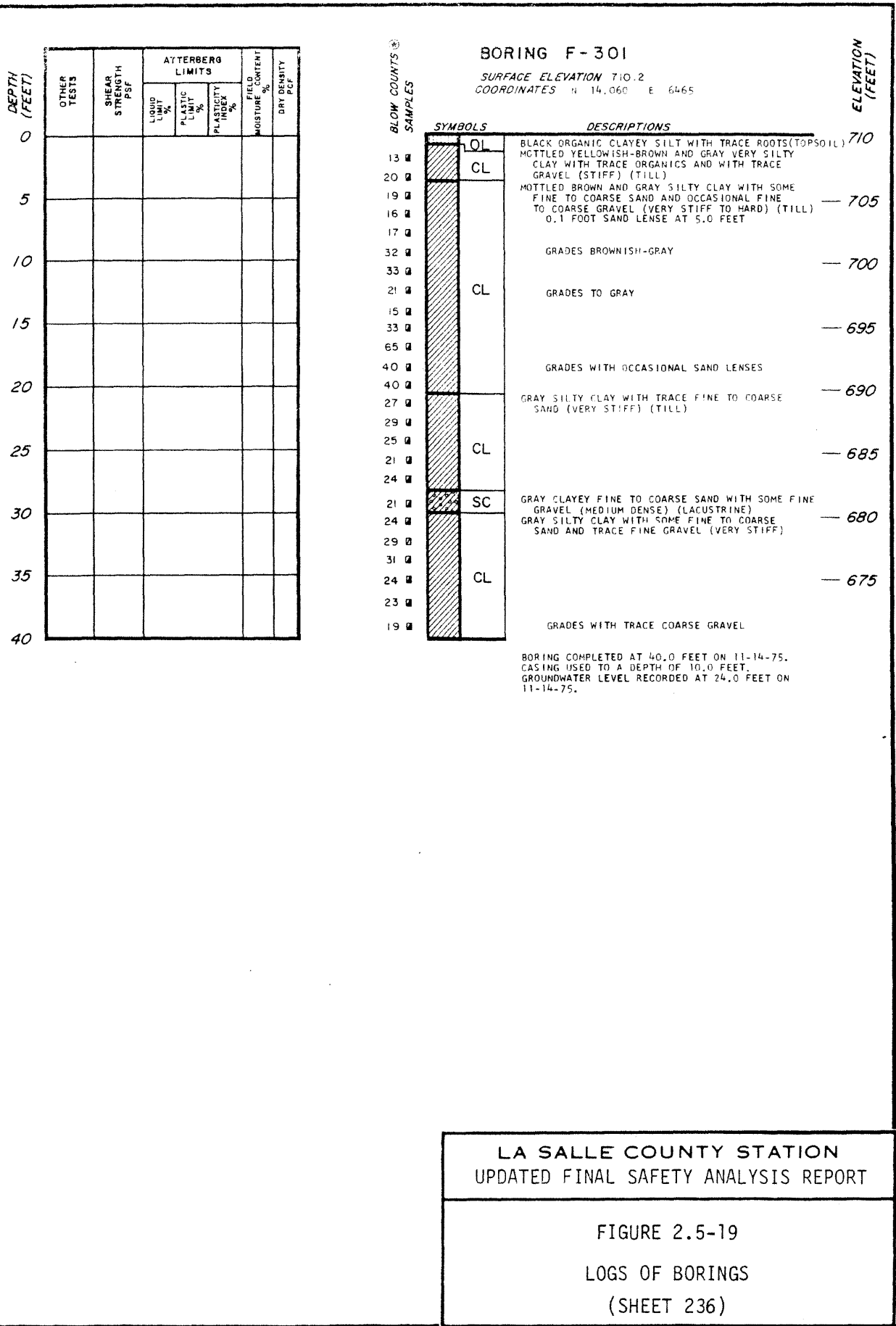

**LA SALLE COUNTY STATION**  
UPDATED FINAL SAFETY ANALYSIS REPORT

FIGURE 2.5-19  
LOGS OF BORINGS  
(SHEET 236)

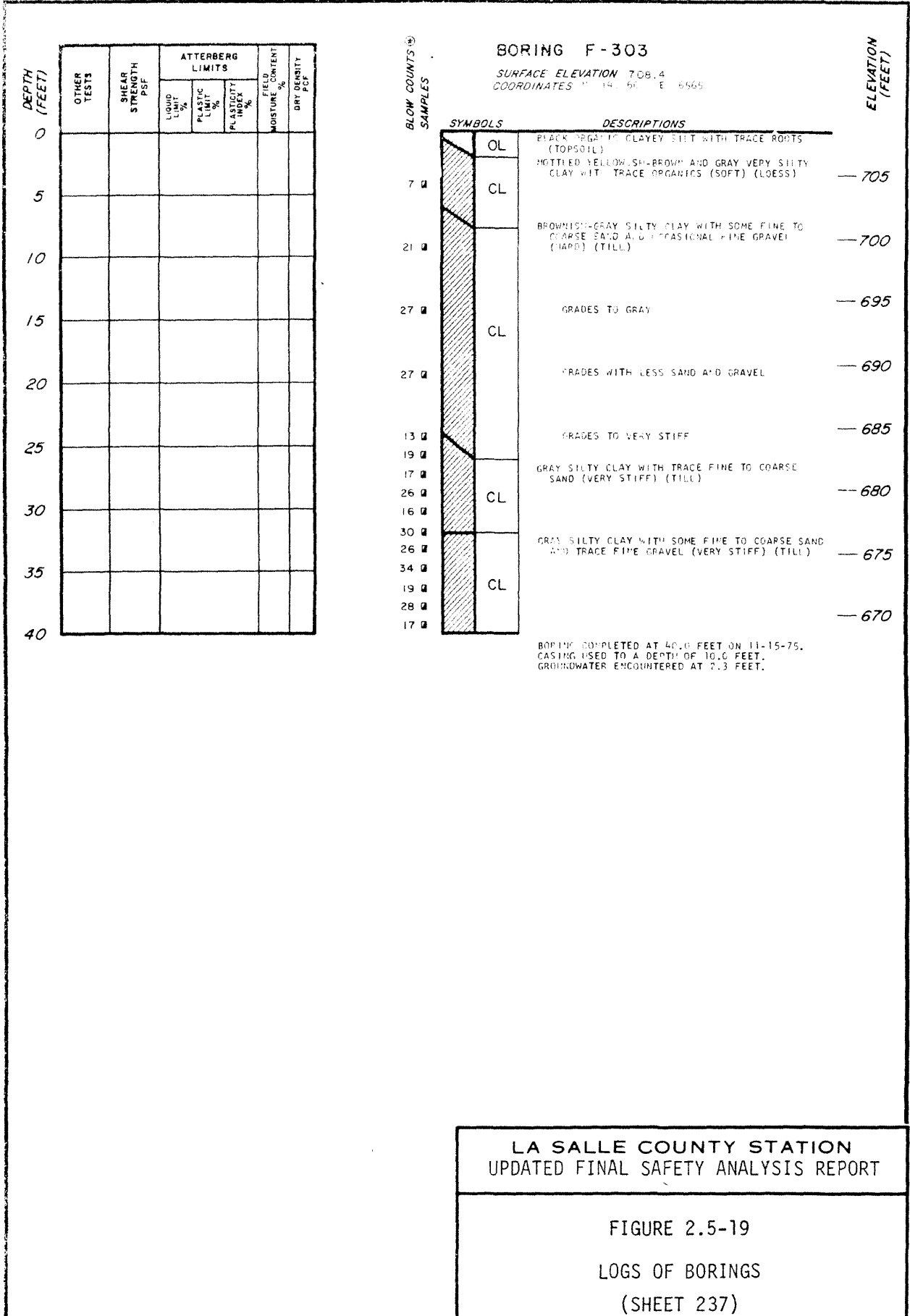

**LA SALLE COUNTY STATION  
UPDATED FINAL SAFETY ANALYSIS REPORT**

FIGURE 2.5-19  
LOGS OF BORINGS  
(SHEET 237)

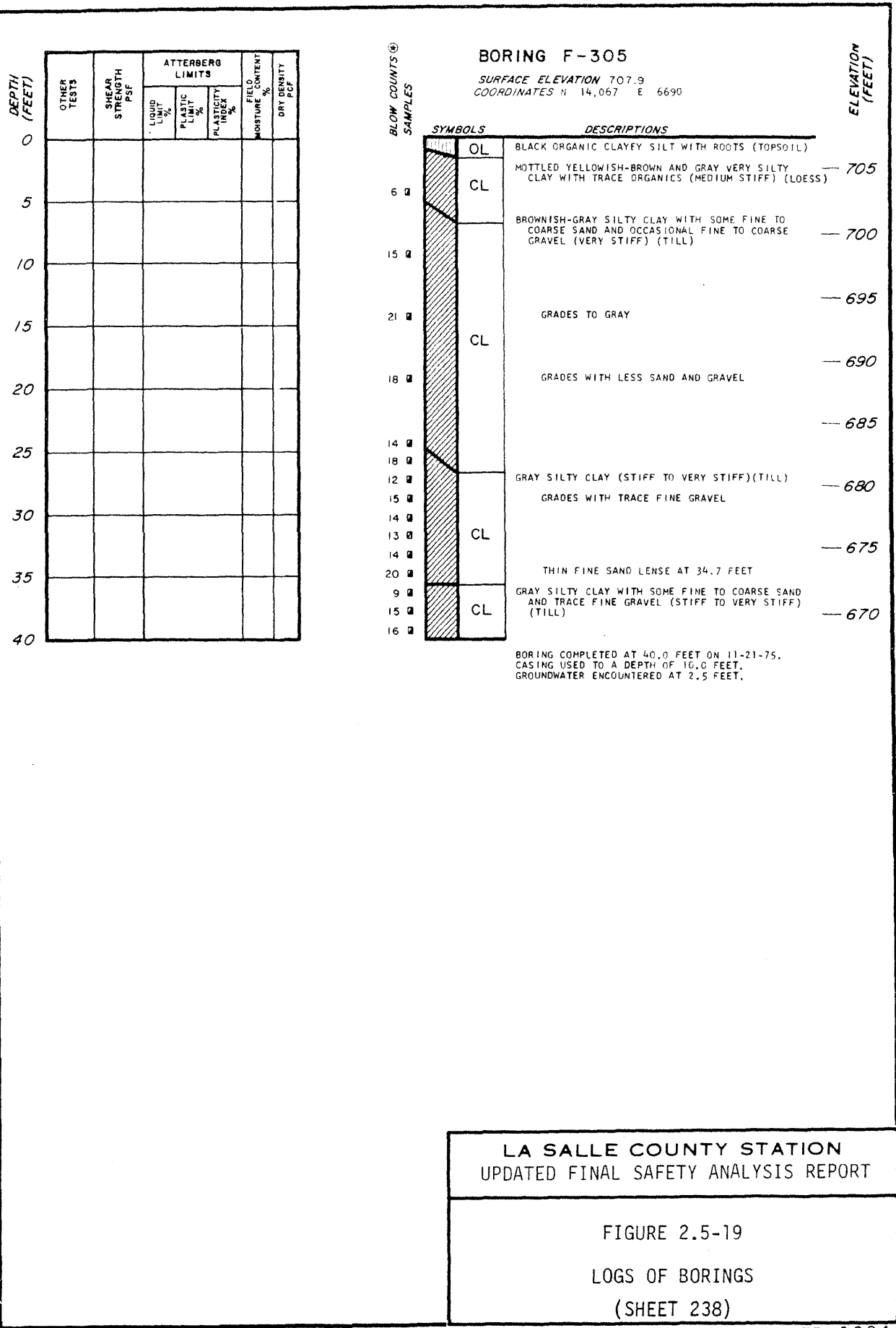

**LA SALLE COUNTY STATION**  
UPDATED FINAL SAFETY ANALYSIS REPORT

FIGURE 2.5-19  
LOGS OF BORINGS  
(SHEET 238)

DEPTH (FEET)	OTHER TESTS	SHEAR STRENGTH PSF	ATTERBERG LIMITS			FIELD MOISTURE %	DRY DENSITY PCF
			LIQUID LIMIT %	PLASTIC LIMIT %	PLASTICITY INDEX %		
0							
5							
10							
15							
20							
25							
30							
35							
40							
45							

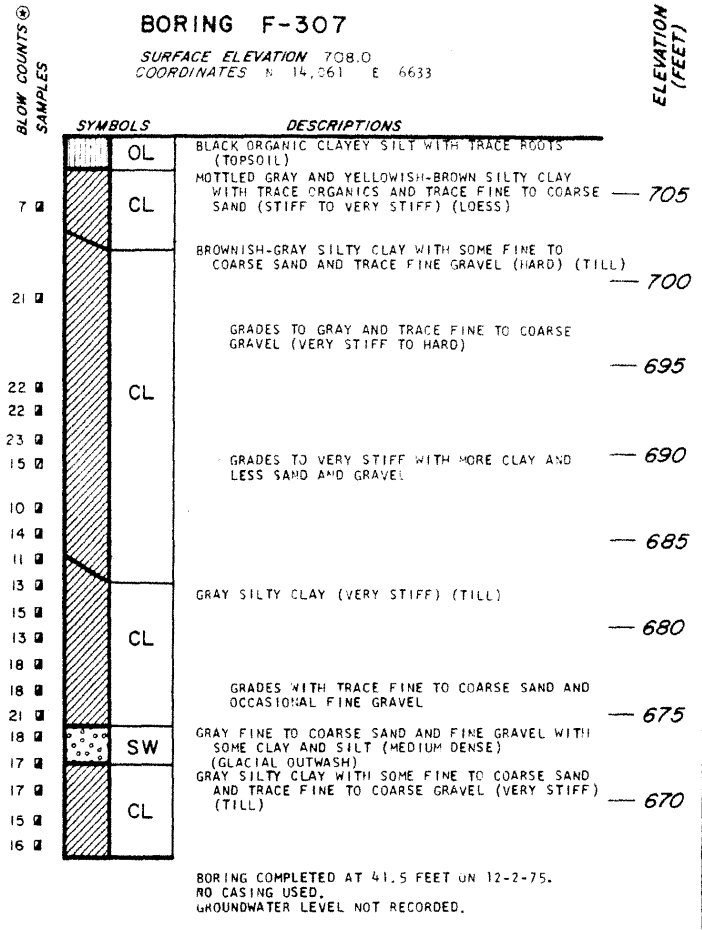

**LA SALLE COUNTY STATION**  
 UPDATED FINAL SAFETY ANALYSIS REPORT

FIGURE 2.5-19  
 LOGS OF BORINGS  
 (SHEET 239)

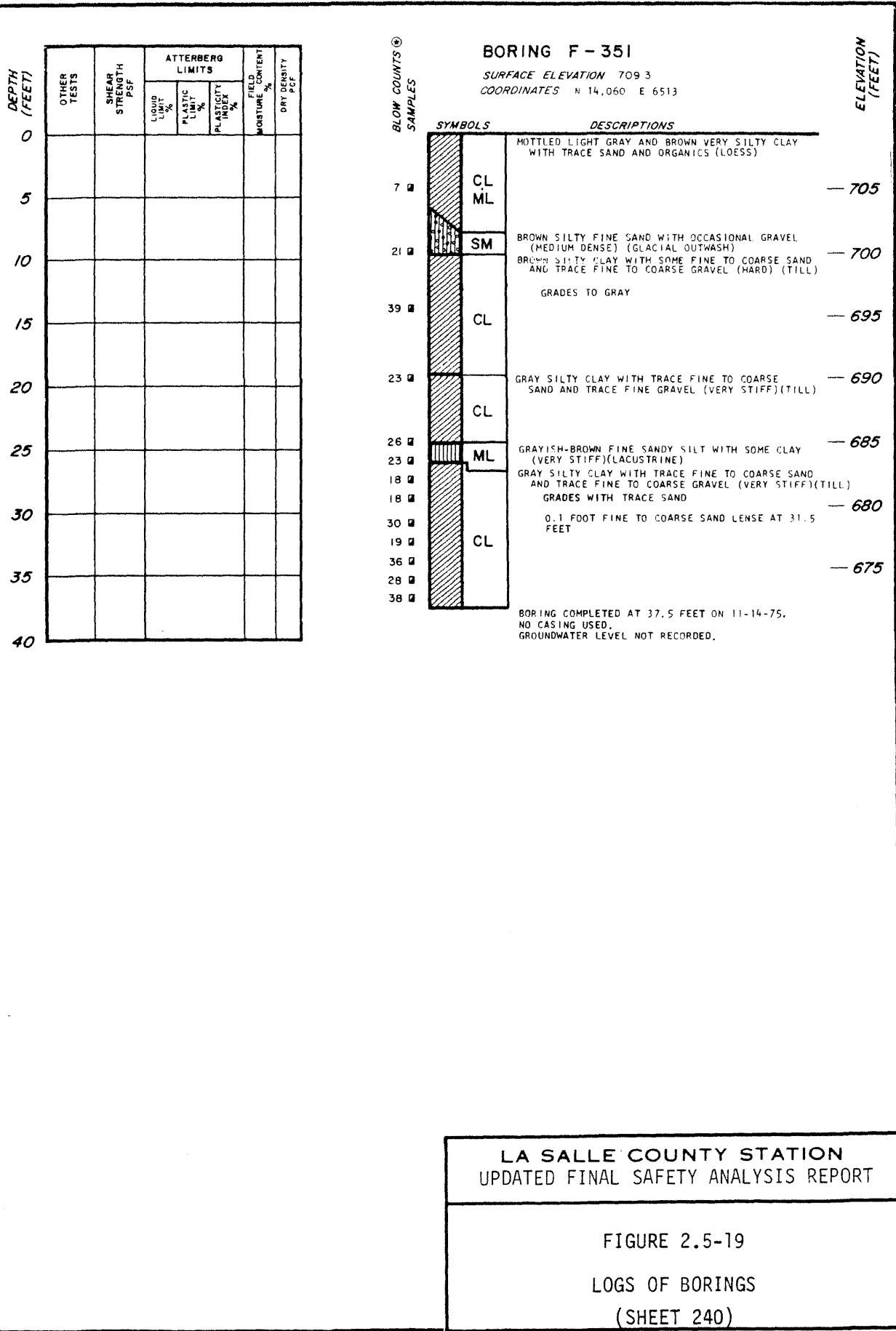

**LA SALLE COUNTY STATION**  
 UPDATED FINAL SAFETY ANALYSIS REPORT

FIGURE 2.5-19  
 LOGS OF BORINGS  
 (SHEET 240)

DEPTH (FEET)	OTHER TESTS	SHEAR STRENGTH PSF	ATTENBERG LIMITS			FIELD MOISTURE %	DRY DENSITY PCF
			LIQUID LIMIT %	PLASTIC LIMIT %	PLASTICITY INDEX %		
0							
5							
10							
15							
20							
25							
30							
35							

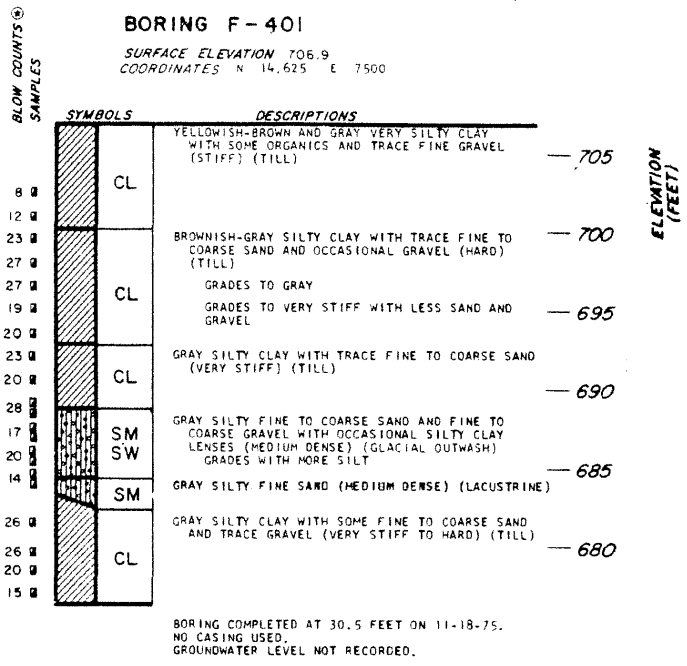

DEPTH (FEET)	OTHER TESTS	SHEAR STRENGTH PSF	ATTENBERG LIMITS			FIELD MOISTURE %	DRY DENSITY PCF
			LIQUID LIMIT %	PLASTIC LIMIT %	PLASTICITY INDEX %		
0							
5							
10							
15							
20							
25							
30							

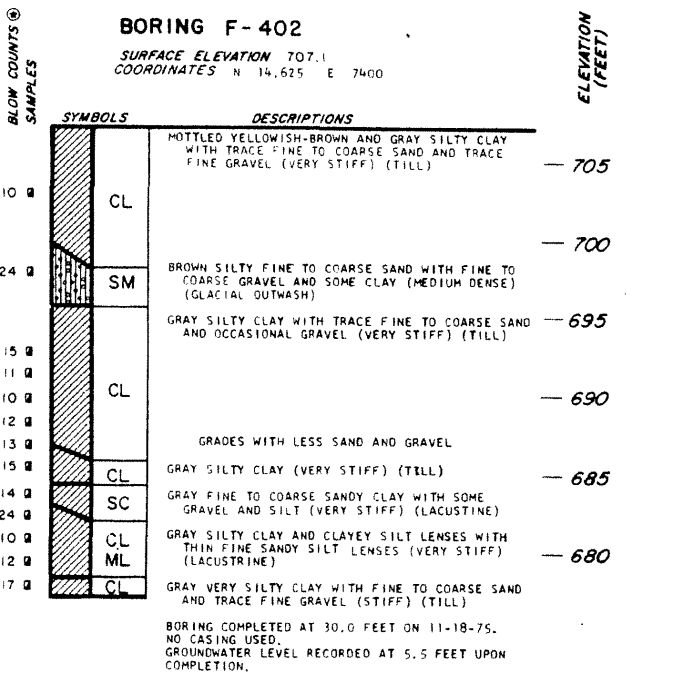

**LA SALLE COUNTY STATION**  
 UPDATED FINAL SAFETY ANALYSIS REPORT

FIGURE 2.5-19  
 LOGS OF BORINGS  
 (SHEET 241)



DEPTH (FEET)	OTHER TESTS	SHEAR STRENGTH PSF	ATTENBERG LIMITS			FIELD MOISTURE %	DRY DENSITY PCF
			LIQUID LIMIT %	PLASTIC LIMIT %	PLASTICITY INDEX %		
0							
5							
10							
15							
20							
25	PS	2319 (CU) 2484 (CU) 3958 (CU)	35 35 19	19 20 14	16 15 5	24.3 25.6 14.8	99 98 119
30							
35							
40							

DEPTH (FEET)	OTHER TESTS	SHEAR STRENGTH PSF	ATTENBERG LIMITS			FIELD MOISTURE %	DRY DENSITY PCF
			LIQUID LIMIT %	PLASTIC LIMIT %	PLASTICITY INDEX %		
0							
5							
10							
15							
20							
25							
30							
35							

**BORING F-402 A**  
 SURFACE ELEVATION 707.1  
 COORDINATES N 14,623 E 7406

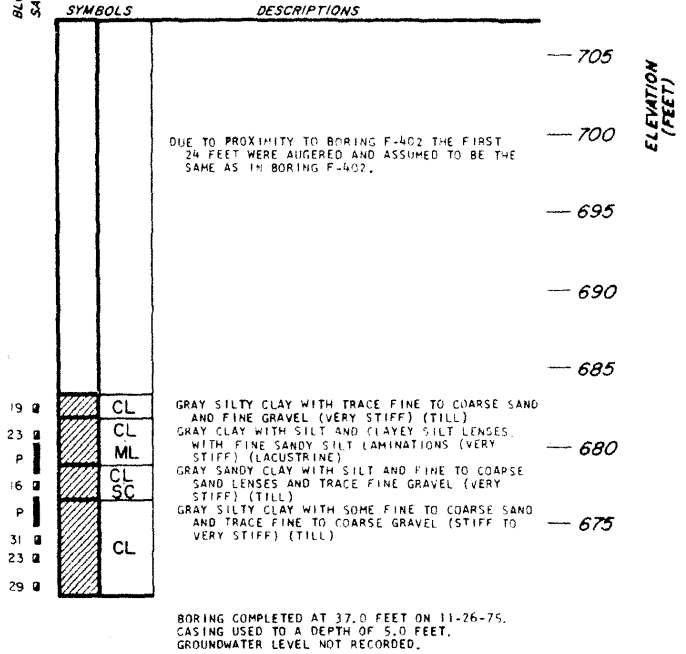

**BORING F-403**  
 SURFACE ELEVATION 705.6  
 COORDINATES N 14,625 E 7600

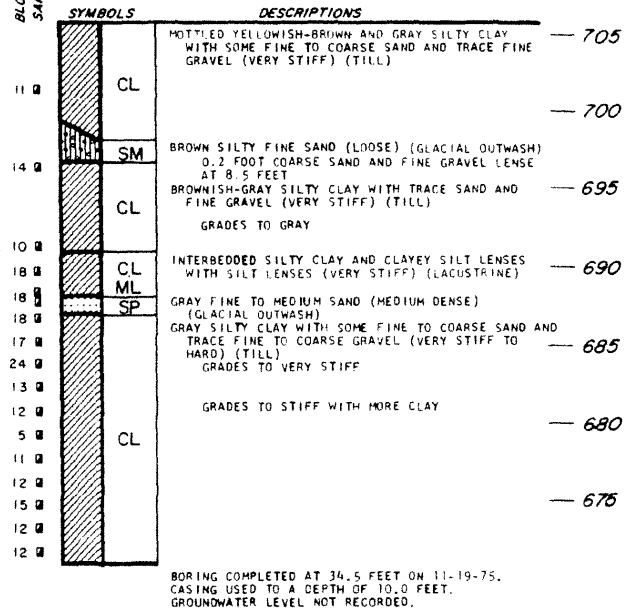

**LA SALLE COUNTY STATION  
 UPDATED FINAL SAFETY ANALYSIS REPORT**

**FIGURE 2.5-19  
 LOGS OF BORINGS  
 (SHEET 242)**

DEPTH (FEET)	OTHER TESTS	SHEAR STRENGTH PSF	ATTERBERG LIMITS			FIELD MOISTURE CONTENT %	DRY DENSITY PCF
			LIQUID LIMIT %	PLASTIC LIMIT %	PLASTICITY INDEX %		
0							
5							
10							
15							
20							
25							
30							
35							
40							

BLOW COUNTS @  
SAMPLES

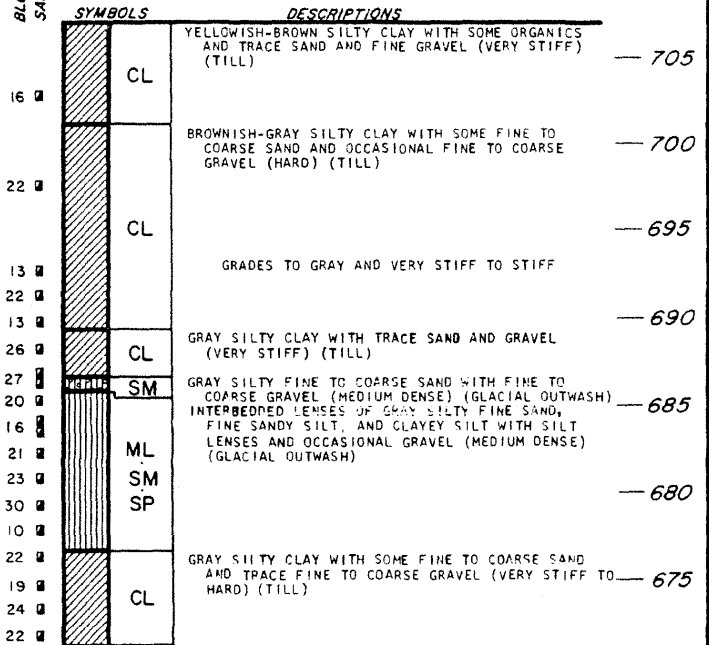

BORING COMPLETED AT 36.0 FEET ON 11-19-75.  
CASING USED TO A DEPTH OF 25.0 FEET.  
GROUNDWATER LEVEL NOT RECORDED.

**LA SALLE COUNTY STATION**  
UPDATED FINAL SAFETY ANALYSIS REPORT

FIGURE 2.5-19  
LOGS OF BORINGS  
(SHEET 243)

DEPTH (FEET)	OTHER TESTS	SHEAR STRENGTH PSF	ATTERBERG LIMITS			FIELD MOISTURE - CONTENT %	DRY DENSITY PCF
			LIQUID LIMIT %	PLASTIC LIMIT %	PLASTICITY INDEX %		
0							
5							
10							
15							
20							
25							
30							
35							
40							
45							

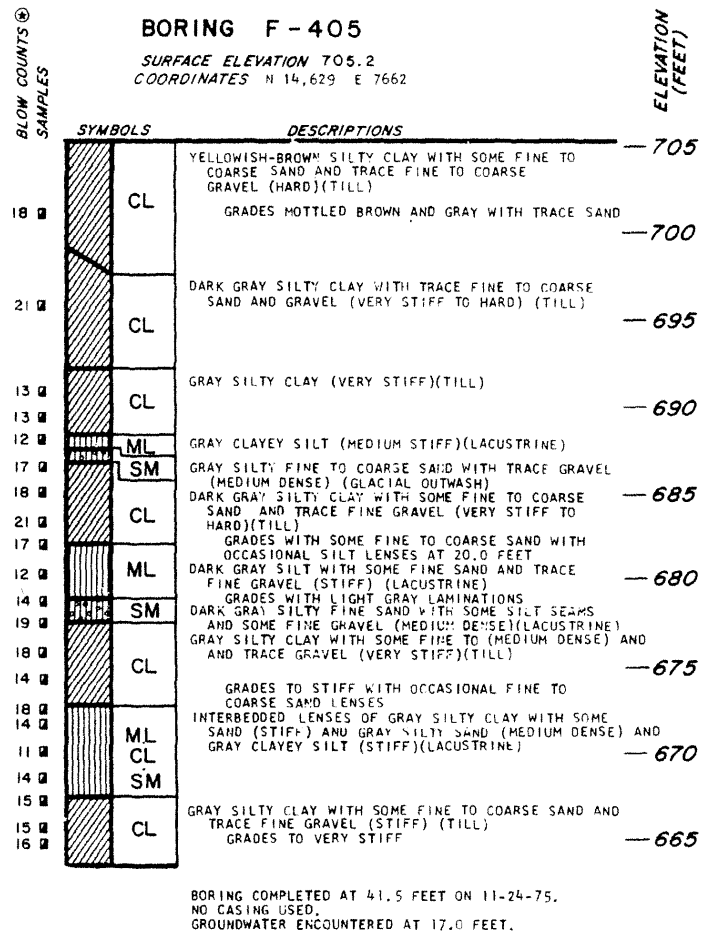

**LA SALLE COUNTY STATION**  
UPDATED FINAL SAFETY ANALYSIS REPORT

FIGURE 2.5-19  
LOGS OF BORINGS  
(SHEET 244)

DEPTH (FEET)	OTHER TESTS	SHEAR STRENGTH PSF	ATTENBERG LIMITS			FIELD MOISTURE CONTENT %	DRY DENSITY PCF
			LIQUID LIMIT %	PLASTIC LIMIT %	PLASTICITY INDEX %		
0							
5							
10							
15							
20							
25	PS	1151(UU)			22.2	113	
25	PS	2745(UU)			14.8	118	
30							
35							

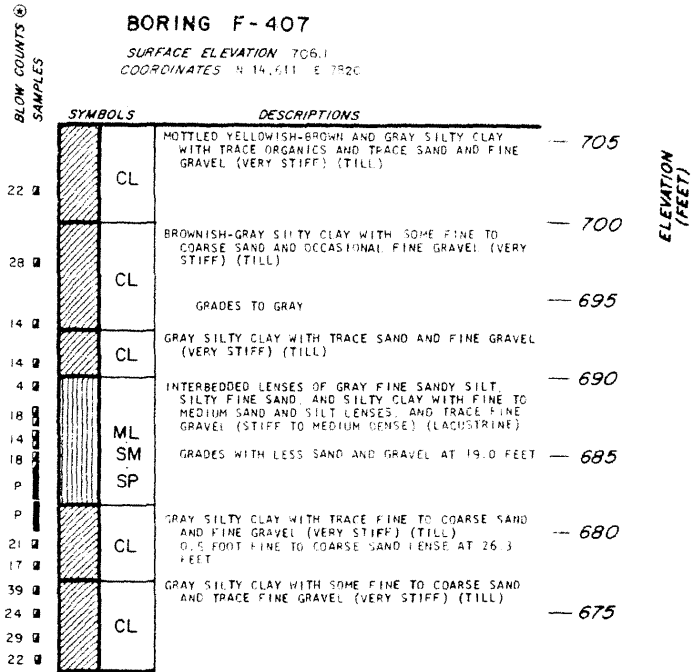

DEPTH (FEET)	OTHER TESTS	SHEAR STRENGTH PSF	ATTENBERG LIMITS			FIELD MOISTURE CONTENT %	DRY DENSITY PCF
			LIQUID LIMIT %	PLASTIC LIMIT %	PLASTICITY INDEX %		
0							
5							
10							
15							
20							
25							
30							
35							

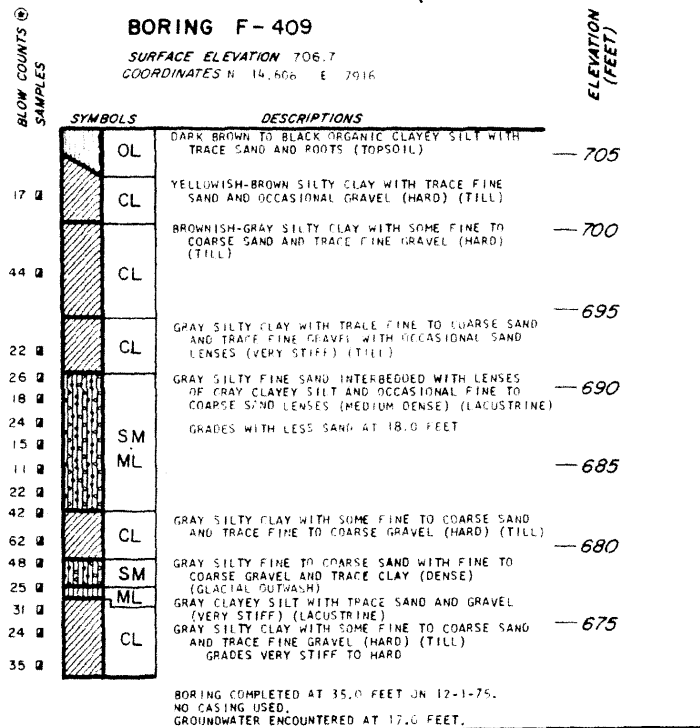

**LA SALLE COUNTY STATION  
UPDATED FINAL SAFETY ANALYSIS REPORT**

FIGURE 2.5-19  
LOGS OF BORINGS  
(SHEET 245)

DEPTH (FEET)	OTHER TESTS	SHEAR STRENGTH PSF	ATTENBERG LIMITS			FIELD MOISTURE %	FIELD CONTENT %	DRY DENSITY PCF
			LIQUID LIMIT %	PLASTIC LIMIT %	PLASTICITY INDEX %			
0								
5								
10								
15								
20	PS	527(UU)				20.3	109	
25	PS	1584(UU)				21.0	109	
30								
35								

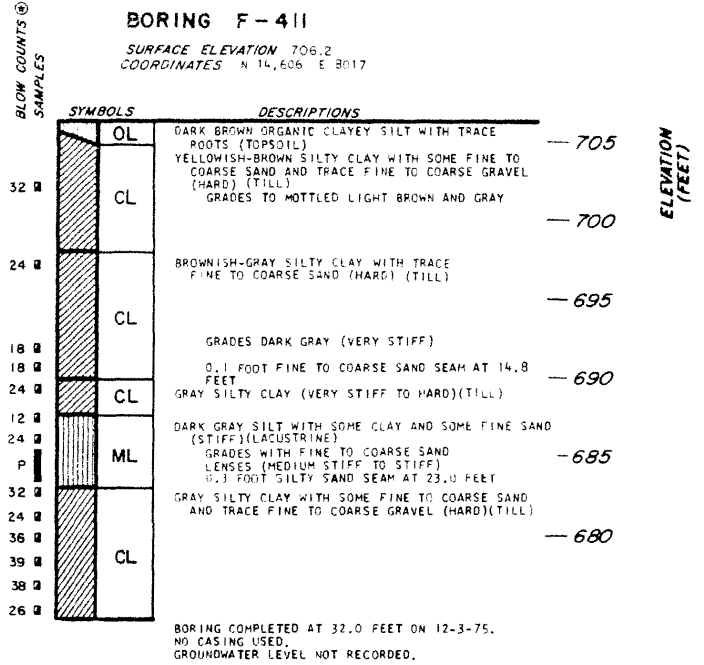

DEPTH (FEET)	OTHER TESTS	SHEAR STRENGTH PSF	ATTENBERG LIMITS			FIELD MOISTURE %	FIELD CONTENT %	DRY DENSITY PCF
			LIQUID LIMIT %	PLASTIC LIMIT %	PLASTICITY INDEX %			
0								
5								
10								
15								
20								
25								
30								
35								

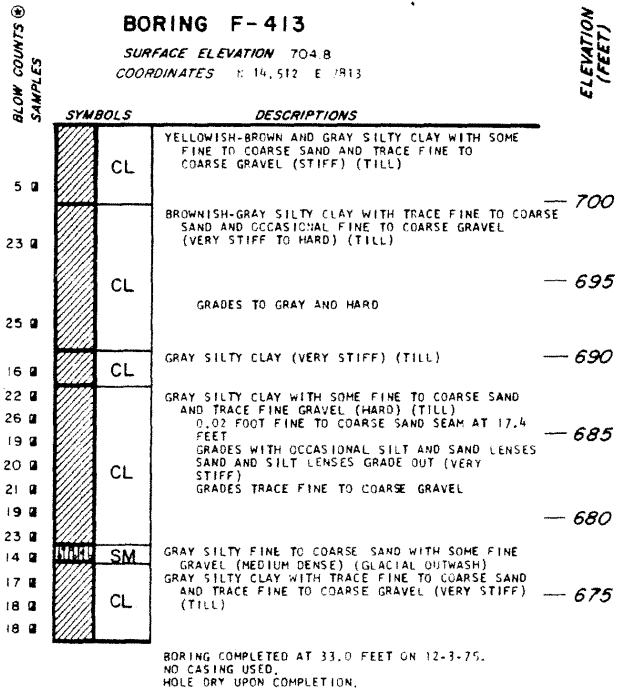

**LA SALLE COUNTY STATION**  
**UPDATED FINAL SAFETY ANALYSIS REPORT**

FIGURE 2.5-19  
LOGS OF BORINGS  
(SHEET 246)

DEPTH (FEET)	OTHER TESTS	SHEAR STRENGTH PSF	ATTERBERG LIMITS			FLUID CONTENT %	MOISTURE CONTENT %	DRY DENSITY PCF
			LIQUID LIMIT %	PLASTIC LIMIT %	PLASTICITY INDEX %			
0								
5								
10								
15								
20	PS PS	784 (UU) 1835 (UU)				17.2 21.8	104 104	
25								
30								
35								

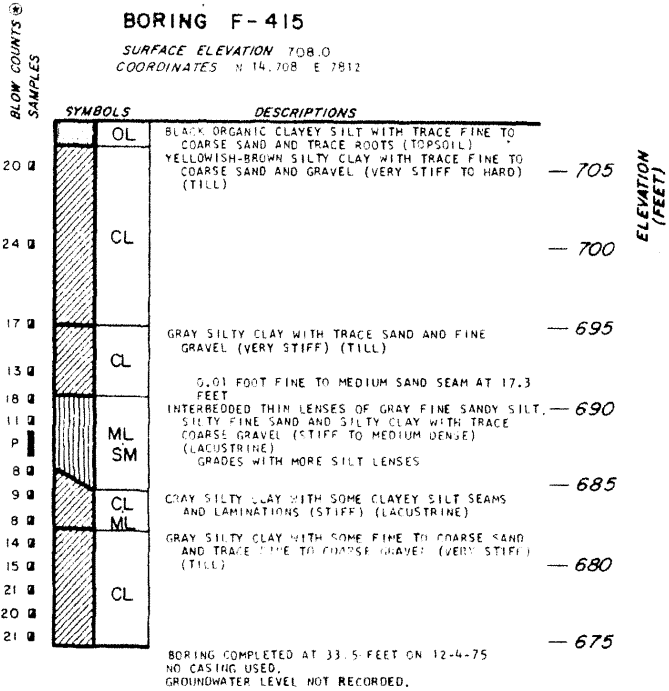

DEPTH (FEET)	OTHER TESTS	SHEAR STRENGTH PSF	ATTERBERG LIMITS			FLUID CONTENT %	MOISTURE CONTENT %	DRY DENSITY PCF
			LIQUID LIMIT %	PLASTIC LIMIT %	PLASTICITY INDEX %			
0								
5								
10								
15								
20								
25								
30								
35								

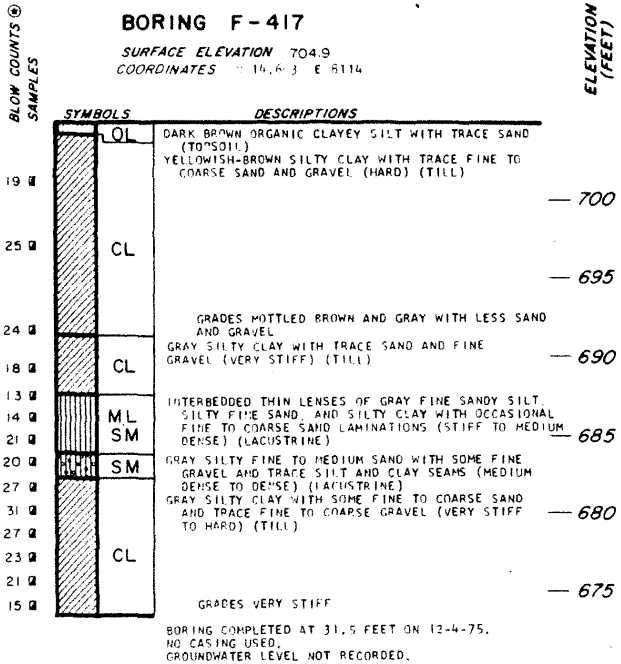

**LA SALLE COUNTY STATION**  
**UPDATED FINAL SAFETY ANALYSIS REPORT**

FIGURE 2.5-19  
LOGS OF BORINGS  
(SHEET 247)

DEPTH (FEET)	OTHER TESTS	SHEAR STRENGTH PSF	ATTENBERG LIMITS			FIELD MOISTURE %	DRY DENSITY PCF
			LIQUID LIMIT %	PLASTIC LIMIT %	PLASTICITY INDEX %		
0							
5							
10							
15							
20	PS PS	555 (UU) 1578 (UU)			17.7 17.1	115 111	
25							
30							
35							

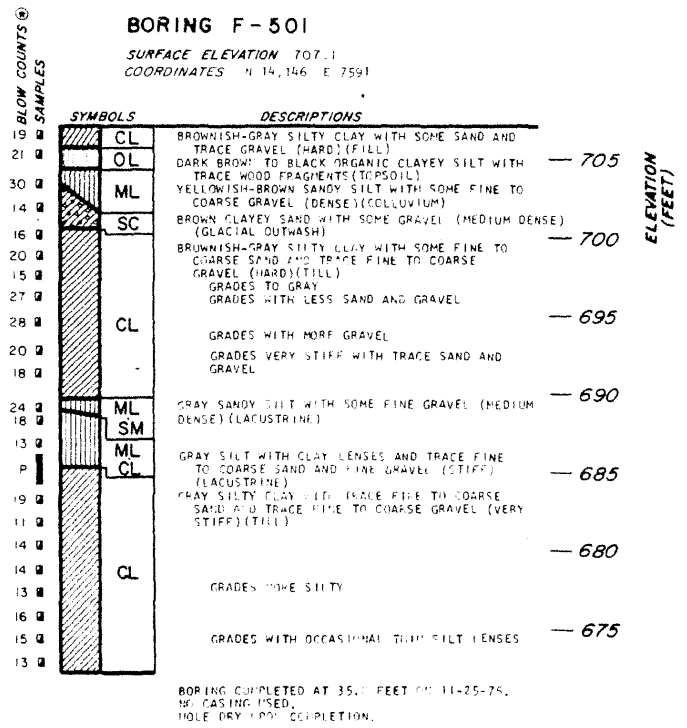

DEPTH (FEET)	OTHER TESTS	SHEAR STRENGTH PSF	ATTENBERG LIMITS			FIELD MOISTURE %	DRY DENSITY PCF
			LIQUID LIMIT %	PLASTIC LIMIT %	PLASTICITY INDEX %		
0							
5							
10							
15							
20	PS PS	920 (UU) 2454 (UU)			11.3 10.2	114 122	
25							
30							
35							

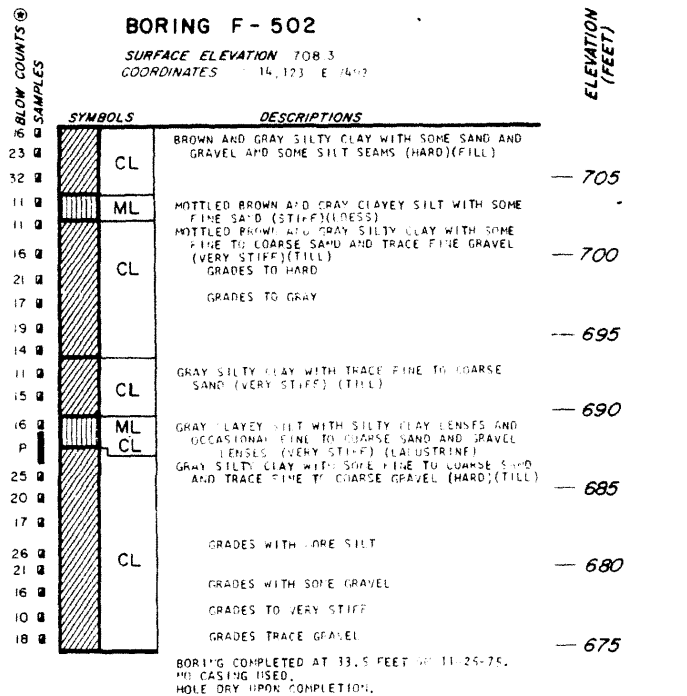

**LA SALLE COUNTY STATION**  
**UPDATED FINAL SAFETY ANALYSIS REPORT**

FIGURE 2.5-19  
LOGS OF BORINGS  
(SHEET 248)

DEPTH (FEET)	OTHER TESTS	SHEAR STRENGTH PSF	ATTENBERG LIMITS			FIELD MOISTURE CONTENT %	DRY DENSITY PCF
			LIQUID LIMIT %	PLASTIC LIMIT %	PLASTICITY INDEX %		
0							
5							
10							
15							
20	PS	1346(UU)	26	17	9	18.5	112
25							
30							
35							

DEPTH (FEET)	OTHER TESTS	SHEAR STRENGTH PSF	ATTENBERG LIMITS			FIELD MOISTURE CONTENT %	DRY DENSITY PCF
			LIQUID LIMIT %	PLASTIC LIMIT %	PLASTICITY INDEX %		
0							
5							
10							
15							
20							
25							
30							
35							
40							

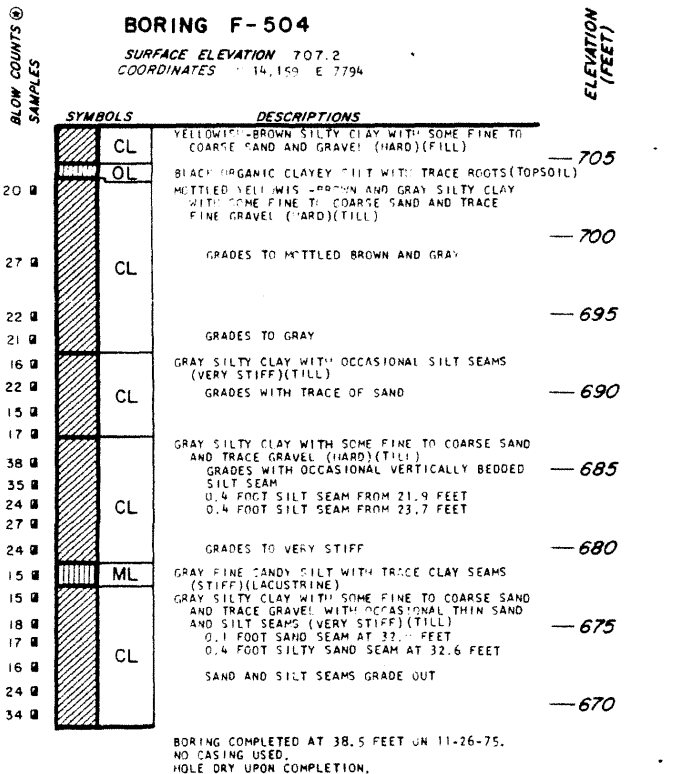
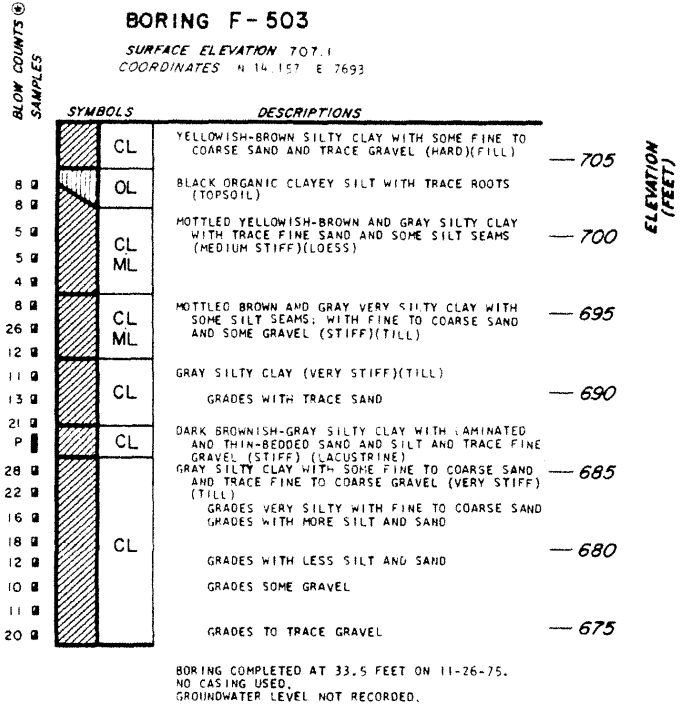

**LA SALLE COUNTY STATION**  
**UPDATED FINAL SAFETY ANALYSIS REPORT**

FIGURE 2.5-19  
LOGS OF BORINGS  
(SHEET 249)





Boring F-1

Project Name: LaSalle County Station Date of Boring: 9-26-75

Site: Flume Area N144+16 E65+33 Project No.: _____

DESCRIPTION	DEPTH	SAMPLE	N	Q _u	Q _p	M _c	REMARKS
SURFACE Elev 684.3							
Gray CLAY		1-SS	9				
		2-SS	23				
Fine to coarse SAND, some fine gravel		3-SS	19				
	5	4-SS	12				
Gray Sandy CLAY		5-SS	13				
Gray CLAY, trace sand & gravel		6-SS	11				
	10						
	15						

LA SALLE COUNTY STATION  
 UPDATED FINAL SAFETY ANALYSIS REPORT

FIGURE 2.5-19  
 LOGS OF BORINGS  
 (SHEET 251)

Boring F-2

Project Name: LaSalle County Station Date of Boring: 9-26-75

Site: Flume Area N143+62 E65+02 Project No.: _____

DESCRIPTION	DEPTH	SAMPLE	N	Qu	Qp	Mc	REMARKS
SURFACE Elev. 680.2							
Gray coarse to fine SAND, some fine gravel		1-SS	6				
		2-SS	8				
Coarse to fine Clayey SAND some fine gravel		3-SS	14				
Gray CLAY, trace sand & gravel	5	4-SS	8				
	10						
	15						

LA SALLE COUNTY STATION  
 UPDATED FINAL SAFETY ANALYSIS REPORT

FIGURE 2.5-19  
 LOGS OF BORINGS  
 (SHEET 252)



Boring F-4

Project Name: LaSalle County Station Date of Boring: 9-26-75

Site: Flume Area N143+17 E65+47 Project No.: _____

DESCRIPTION	DEPTH	SAMPLE	N	Q _u	Q _p	M _c	REMARKS
SURFACE Elev. 682.7							
Coarse to fine SAND & fine GRAVEL		1-SS	4				
Gray CLAY		2-SS	15				
Gray coarse to fine SAND & fine GRAVEL	5	3-SS	11				
Gray Sandy CLAY		4-SS	11				
Gray CLAY trace sand							
	10						

**LA SALLE COUNTY STATION**  
 UPDATED FINAL SAFETY ANALYSIS REPORT  
  
 FIGURE 2.5-19  
 LOGS OF BORINGS  
 (SHEET 254)

Boring F-5

Project Name: LaSalle County Station Date of Boring: 9-26-75

Site: Flume Area N142+37 E65+61 Project No.: _____

DESCRIPTION	DEPTH	SAMPLE	N	Q _u	Q _p	M _c	REMARKS	
SURFACE Elev. 693.9								
Gray CLAY trace gravel		1-SS	11					
		2-SS	13					
		3-SS	13					
	5	4-SS	11					
		5-SS	14					
		6-SS	13					
	10	7-SS	15					
		8-SS	19					
		9-SS	25					
	Fine to coarse SAND & fine GRAVEL	15	10-SS	25				
			11-SS	20				
			12-SS	22				
	Gray CLAY		13-SS	14				
20								

LA SALLE COUNTY STATION  
 UPDATED FINAL SAFETY ANALYSIS REPORT

FIGURE 2.5-19  
 LOGS OF BORINGS  
 (SHEET 255)

Boring F-6

Project Name: LaSalle County Station Date of Boring: 9-30-75

Site: Flume Are N141+70 E65+64 Project No.: _____

DESCRIPTION	DEPTH	SAMPLE	N	Q _u	Q _p	M _c	REMARKS
SURFACE Elev. 708.8							
No Sampling	5						
	10						
	15						
	20						
	25						
Gray CLAY		1-SS	15				
		2-SS	15				
		3-SS	21				
		4-SS	18				
	30						

**LA SALLE COUNTY STATION  
UPDATED FINAL SAFETY ANALYSIS REPORT**

FIGURE 2.5-19  
LOGS OF BORINGS  
(SHEET 256)

Boring F-7

Project Name: LaSalle County Station Date of Boring: 9-30-75

Site: Flume Area N145+31 E-64+95 Project No.: _____

DESCRIPTION	DEPTH	SAMPLE	N	Q _u	Q _p	M _c	REMARKS
SURFACE Elev. 709.6							
No Sampling	5						
	10						
	15						
	20						
	25						
Gray CLAY some gravel	30	1-SS	32				
Coarse to fine Silty SAND		2-SS	23				
Gray Sandy CLAY, trace fine gravel	35	3-SS	26				
Gray Silty CLAY, trace fine gravel		4-SS	45				
		5-SS	38				

**LA SALLE COUNTY STATION**  
 UPDATED FINAL SAFETY ANALYSIS REPORT

FIGURE 2.5-19  
 LOGS OF BORINGS  
 (SHEET 257)



Boring F-8

Project Name: LaSalle County Station Date of Boring: 9-30-75

Site: Flume Area N146+15 E64+55 Project No.: _____

DESCRIPTION	DEPTH	SAMPLE	N	Q _u	Q _p	M _c	REMARKS
SURFACE Elev. 711.2							
No Sampling	5						
	10						
	15						
	20						
	25						
	Gray Silty CLAY		1-SS	31			
	Coarse to fine Silty SAND		2-SS	35			
			3-SS	30			
Coarse to fine Clayey SAND		4-SS	24				
Coarse to fine SAND		5-SS	24				
		6-SS	28				
Gray Silty CLAY trace fine gravel and sand		7-SS	15				
		8-SS	20				
	40						

**LA SALLE COUNTY STATION**  
 UPDATED FINAL SAFETY ANALYSIS REPORT

FIGURE 2.5-19  
 LOGS OF BORINGS  
 (SHEET 258)

Project Name: LaSalle County Station Date of Boring: 9-30-75

Site: Flume Area N141+66 E65+44 Project No.: _____

DESCRIPTION	DEPTH	SAMPLE	N	Q _u	Q _p	M _c	REMARKS
SURFACE Elev. 709.1							
No Sampling	5						
	10						
	15						
	20						
	25						
	30						
Gray Silty CLAY		1-SS	17				
		2-SS	22				
		3-SS	20				
Gray medium to coarse Silty SAND	35	4-SS	23				
		5-SS	18				
Gray Silty CLAY		6-SS	21				
	40						

LA SALLE COUNTY STATION  
 UPDATED FINAL SAFETY ANALYSIS REPORT

FIGURE 2.5-19  
 LOGS OF BORINGS  
 (SHEET 259)

Boring F-10

Project Name: LaSalle County Station Date of Boring: 9-30-75

Site: Flume Area N141+02 E65+66 Project No.: _____

DESCRIPTION	DEPTH	SAMPLE	N	Q _u	Q _p	M _c	REMARKS
SURFACE Elev. 708.3							
No Sampling	5						
	10						
	15						
	20						
	25						
	30						
	Gray Silty CLAY		1-ST				
		2-ST					
35		3-SS	21				
		4-SS	18				
		5-SS	18				
40		6-SS	22				
		7-SS	20				
	45						

**LA SALLE COUNTY STATION**  
 UPDATED FINAL SAFETY ANALYSIS REPORT  
  
 FIGURE 2.5-19  
 LOGS OF BORINGS  
 (SHEET 260)

Boring F-11

Project Name: LaSalle County Station Date of Boring: 9-30-75

Site: Flume Area (approx. 50' West of F-10) Project No.: _____

DESCRIPTION	DEPTH	SAMPLE	N	Q _u	Q _p	M _c	REMARKS
SURFACE Elev.							
	5						
	10	1-ST					
	15						
	20	2-ST					
	25						
	30						
Gray Silty CLAY	35	3-SS	19				
	40						

**LA SALLE COUNTY STATION  
UPDATED FINAL SAFETY ANALYSIS REPORT**

FIGURE 2.5-19  
LOGS OF BORINGS  
(SHEET 261)

EXPLANATION OF TEST PIT LOGS

↓	Indicates the moisture content expressed as a percentage of the dry weight of soil.
15.0% ☒	Indicates 50 pound bulk sample removed for testing purposes.
PL	Indicates Plastic Limit.
PI	Indicates Plasticity Index.
MC	Indicates Natural Moisture Content.
TX/CU/PP	Indicates Consolidated Undrained Triaxial Test with Pore Pressure Measurements conducted on remolded samples.
PERM	Indicates Permeability Test conducted on remolded samples.
*	Indicates Compaction Test performed in accordance with A.A.S.H.O. T-180 method of compaction.

NOTE

1. All elevations are approximate and refer to mean sea level datum (1968 local adjustment).

<b>LA SALLE COUNTY STATION</b>
<b>UPDATED FINAL SAFETY ANALYSIS REPORT</b>
<b>FIGURE 2.5-20</b>
<b>EXPLANATION OF TEST PIT LOGS</b>

TEST PIT 1

SURFACE ELEVATION 719±

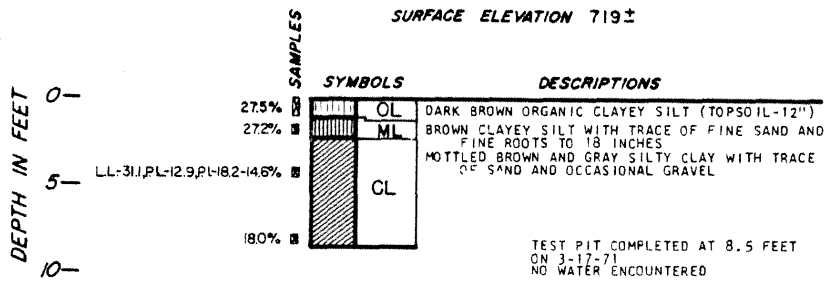

TEST PIT 2

SURFACE ELEVATION 696±

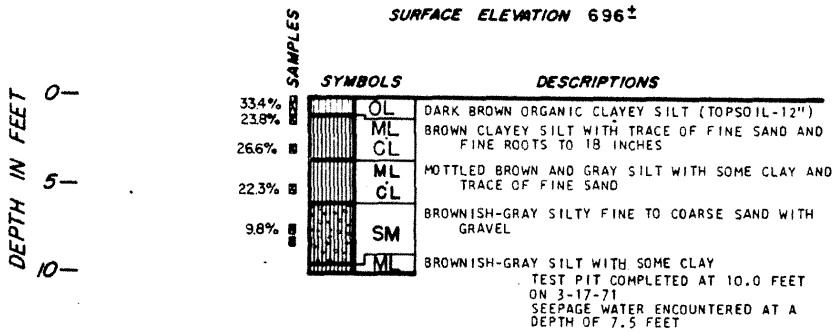

TEST PIT 3

SURFACE ELEVATION 701±

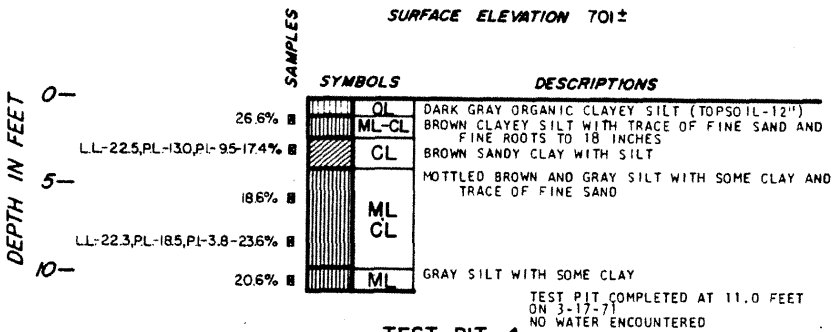

TEST PIT 4

SURFACE ELEVATION 693±

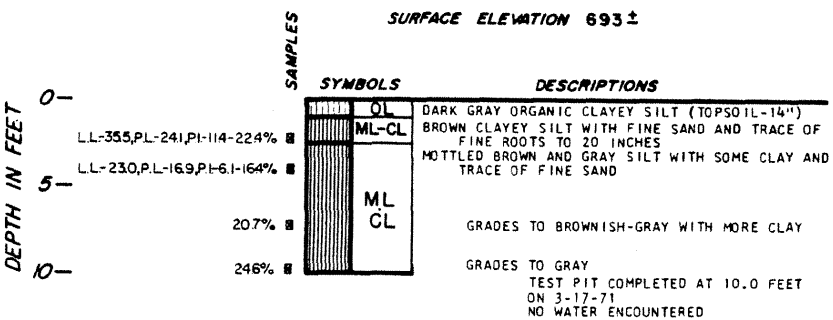

LA SALLE COUNTY STATION  
UPDATED FINAL SAFETY ANALYSIS REPORT

FIGURE 2.5-21  
LOGS OF TEST PITS  
(SHEET 1)

TEST PIT 5

SURFACE ELEVATION 686±

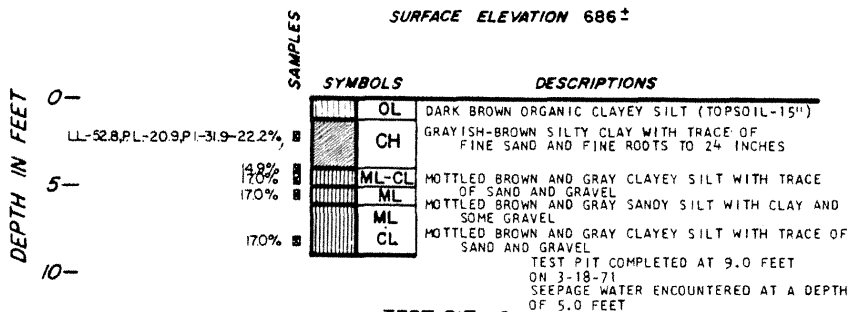

TEST PIT 6

SURFACE ELEVATION 691±

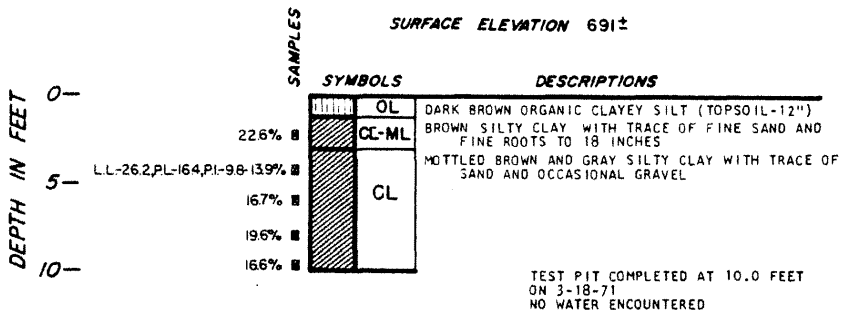

TEST PIT 7

SURFACE ELEVATION 698±

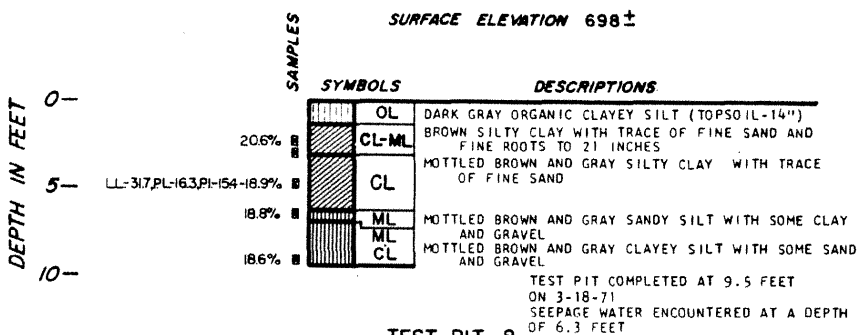

TEST PIT 8

SURFACE ELEVATION 724±

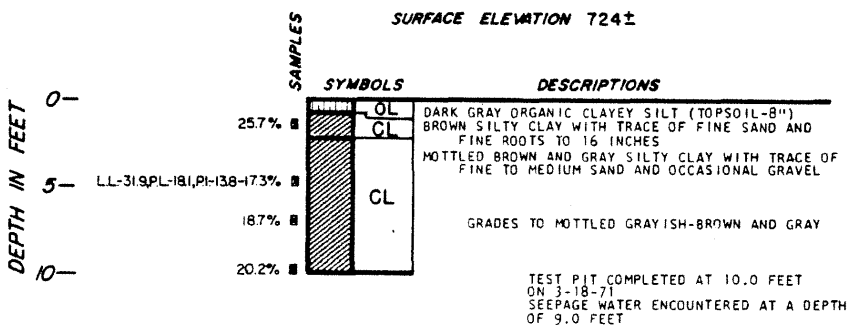

LA SALLE COUNTY STATION  
UPDATED FINAL SAFETY ANALYSIS REPORT

FIGURE 2.5-21  
LOGS OF TEST PITS  
(SHEET 2)

TEST PIT 9

SURFACE ELEVATION 685±

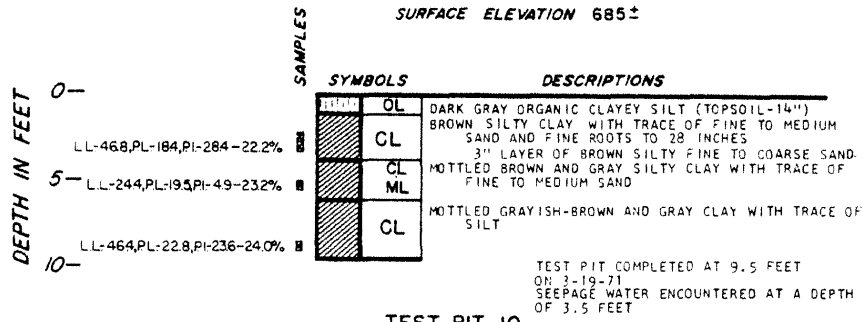

TEST PIT 10

SURFACE ELEVATION 682±

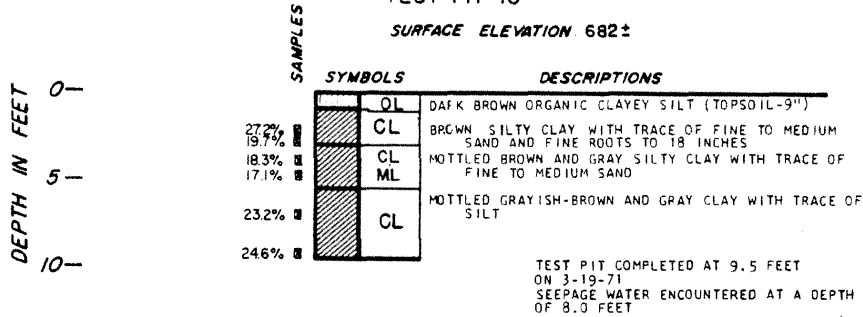

TEST PIT 11

SURFACE ELEVATION 695±

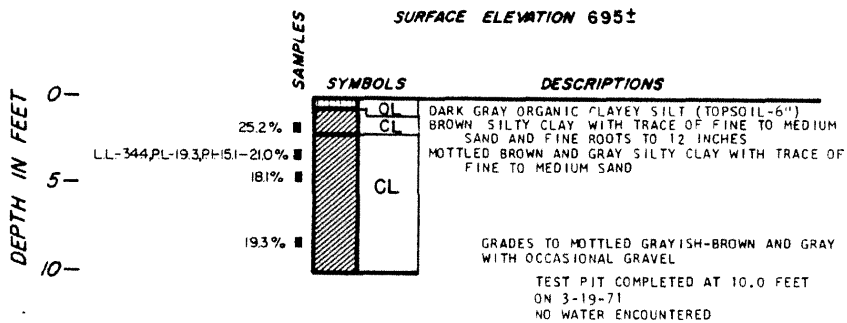

TEST PIT 12

SURFACE ELEVATION 695±

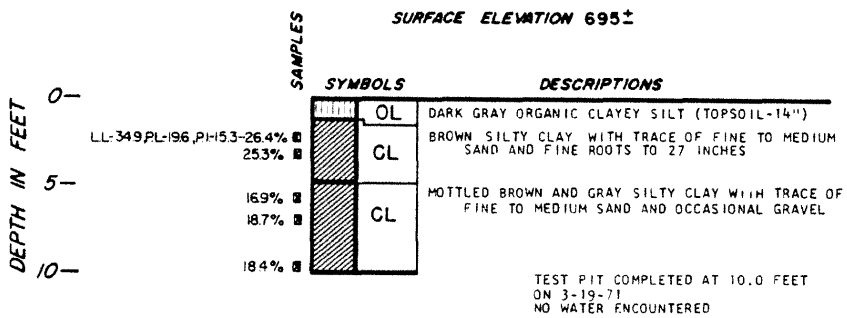

LA SALLE COUNTY STATION  
UPDATED FINAL SAFETY ANALYSIS REPORT

FIGURE 2.5-21  
LOGS OF TEST PITS  
(SHEET 3)



TEST PIT 13

SURFACE ELEVATION 706.4

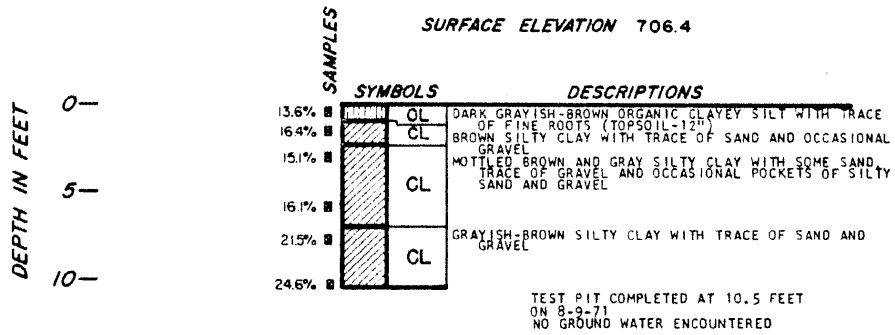

TEST PIT 14

SURFACE ELEVATION 704.5

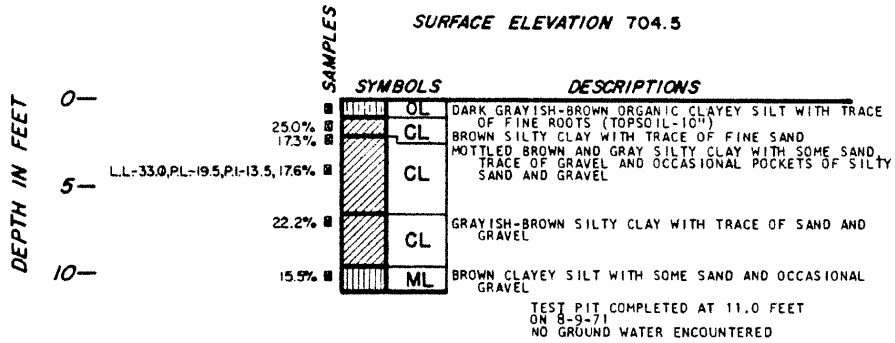

TEST PIT 15

SURFACE ELEVATION 700.2

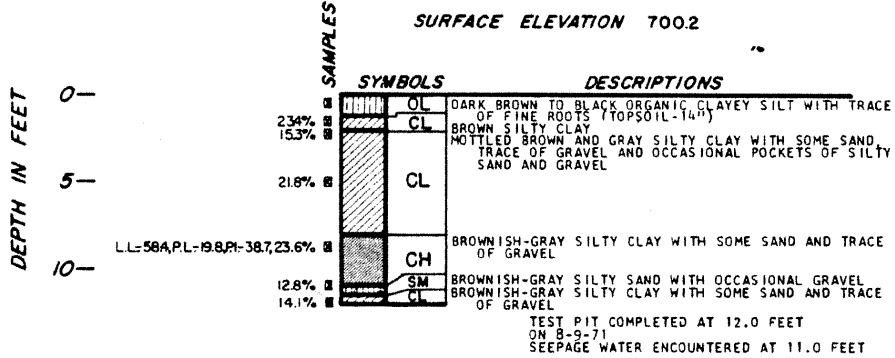

TEST PIT 16

SURFACE ELEVATION 706.4

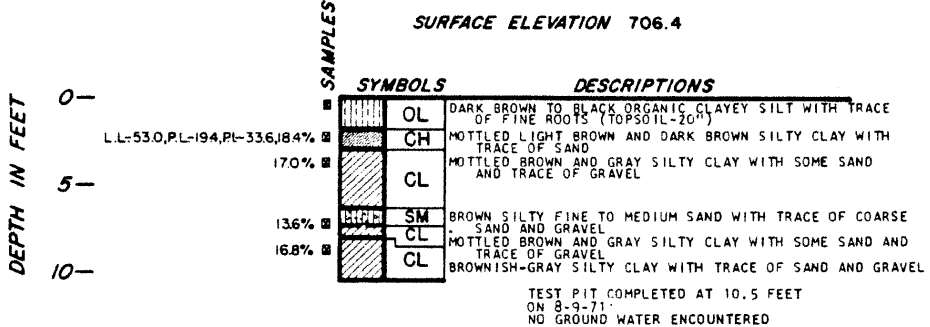

LA SALLE COUNTY STATION  
UPDATED FINAL SAFETY ANALYSIS REPORT

FIGURE 2.5-21

LOGS OF TEST PITS

(SHEET 4)

REV. 0 -  
APRIL 1984

TEST PIT 17  
SURFACE ELEVATION 705.7

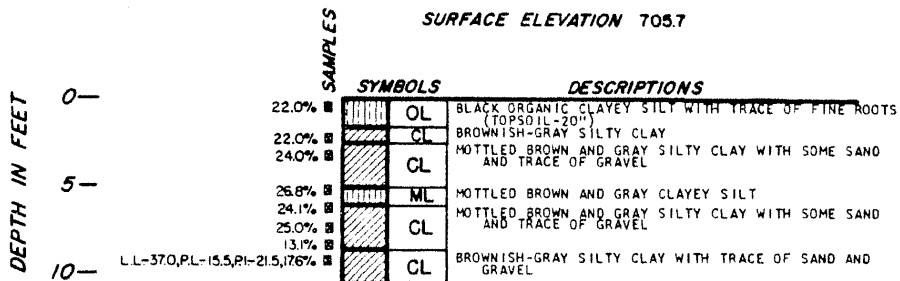

TEST PIT COMPLETED AT 10.5 FEET ON 8-9-71  
SEEPAGE WATER ENCOUNTERED FROM 6.0 TO 8.5 FEET

TEST PIT 18  
SURFACE ELEVATION 702.9

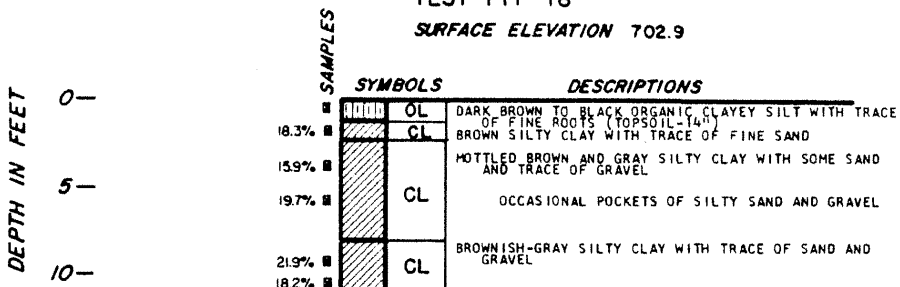

TEST PIT COMPLETED AT 11.0 FEET ON 8-10-71  
NO GROUND WATER ENCOUNTERED

TEST PIT 19  
SURFACE ELEVATION 717.4

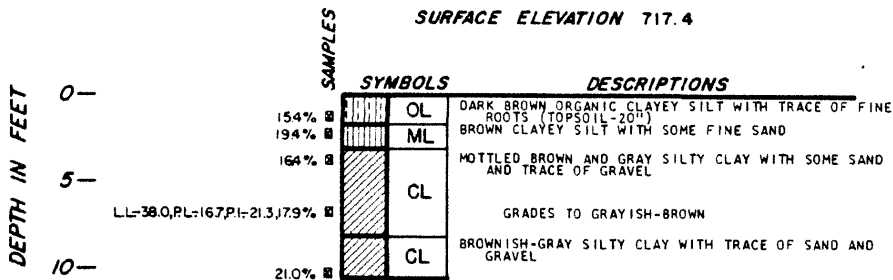

TEST PIT COMPLETED AT 10.5 FEET ON 8-9-71  
NO GROUND WATER ENCOUNTERED

TEST PIT 20  
SURFACE ELEVATION 713.6

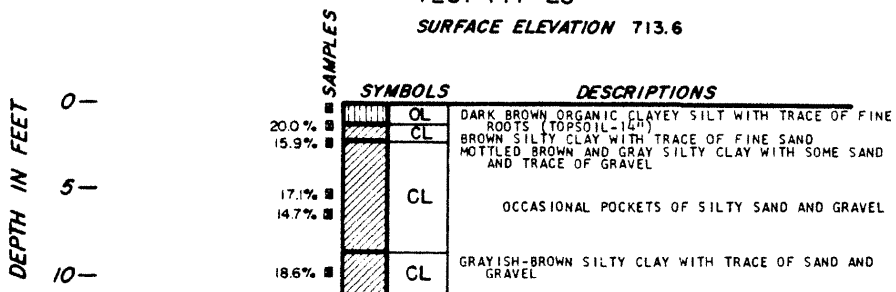

TEST PIT COMPLETED AT 11.0 FEET ON 8-9-71  
NO GROUND WATER ENCOUNTERED

LA SALLE COUNTY STATION  
UPDATED FINAL SAFETY ANALYSIS REPORT

FIGURE 2.5-21

LOGS OF TEST PITS

(SHEET 5)

REV. 0 -  
APRIL 1984

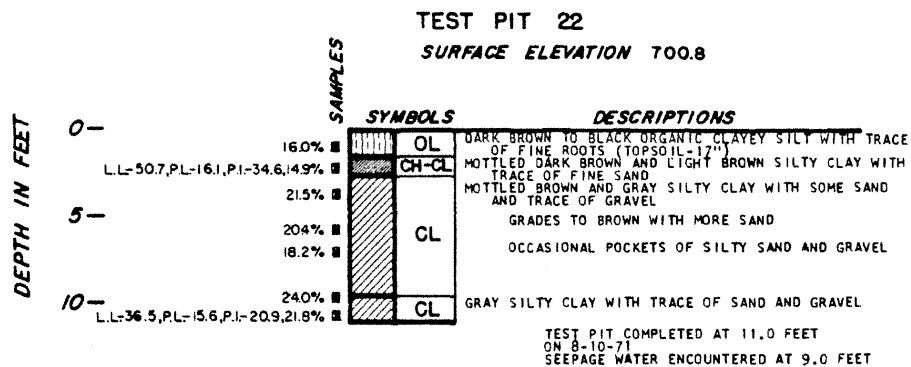
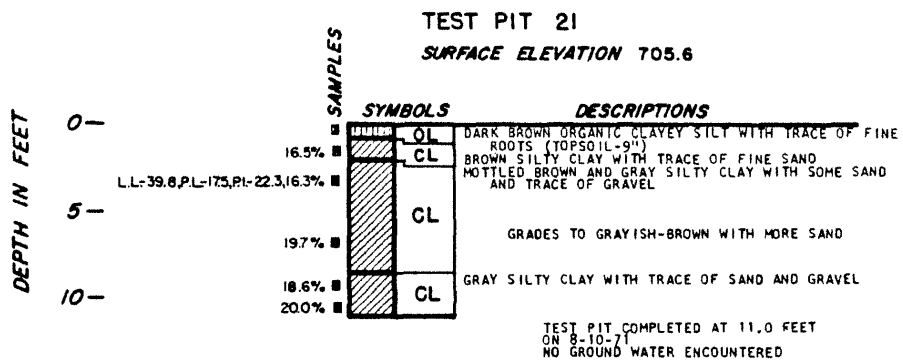

**LA SALLE COUNTY STATION**  
UPDATED FINAL SAFETY ANALYSIS REPORT

FIGURE 2.5-21  
LOGS OF TEST PITS  
(SHEET 6)

**TEST PIT A-1**

SURFACE ELEVATION 708.2

DEPTH IN FEET  
0—  
5—  
10—

PL-27.8, PI-19.0, MC-20.5

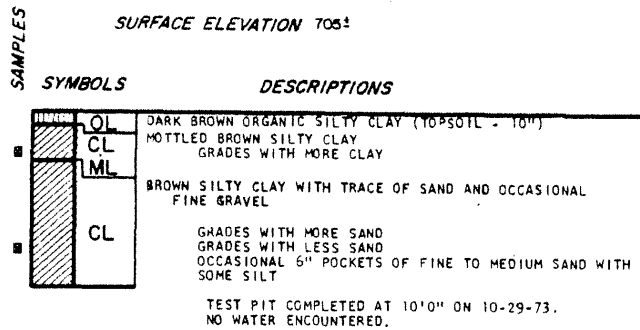

**TEST PIT A-2**

SURFACE ELEVATION 707.2

DEPTH IN FEET  
0—  
5—  
10—  
15—

MC-15.6

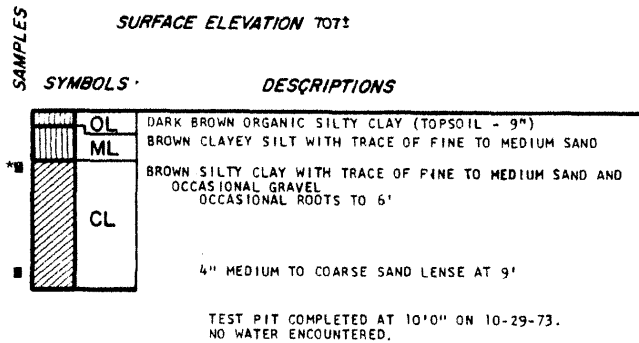

**TEST PIT A-3**

SURFACE ELEVATION 690.2

DEPTH IN FEET  
0—  
5—  
10—  
15—

MC-22.2

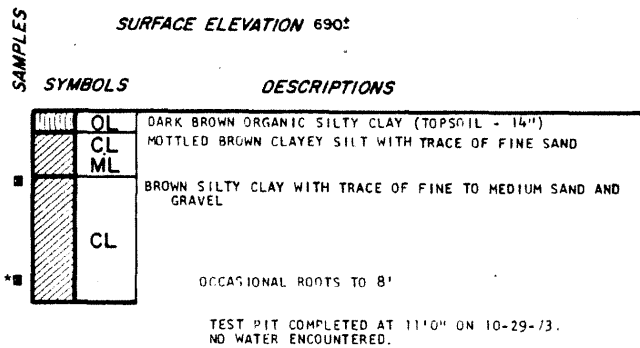

**TEST PIT A-4**

SURFACE ELEVATION 680.2

DEPTH IN FEET  
0—  
5—  
10—

MC-26.4

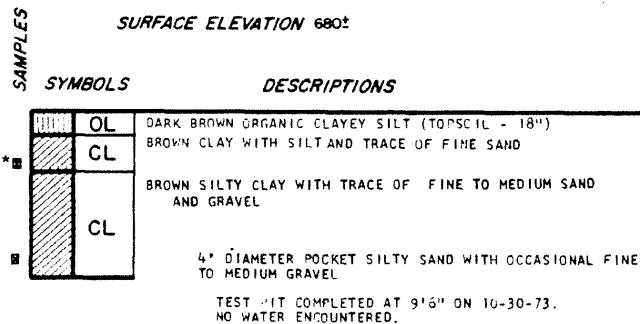

LA SALLE COUNTY STATION  
UPDATED FINAL SAFETY ANALYSIS REPORT

FIGURE 2.5-21  
LOGS OF TEST PITS  
(SHEET 7)

**TEST PIT A-5**

SURFACE ELEVATION 684±

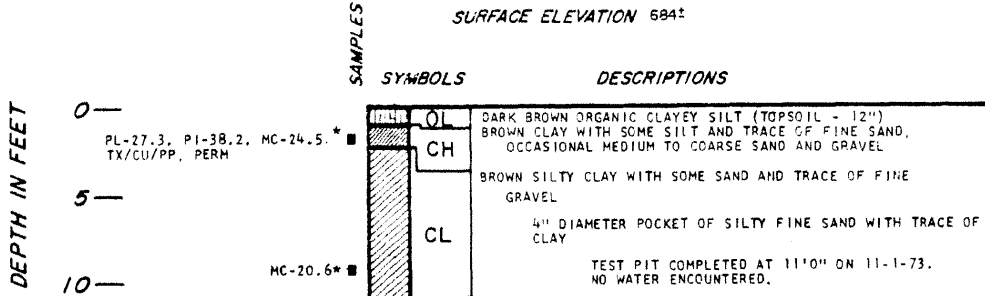

**TEST PIT A-6**

SURFACE ELEVATION 681±

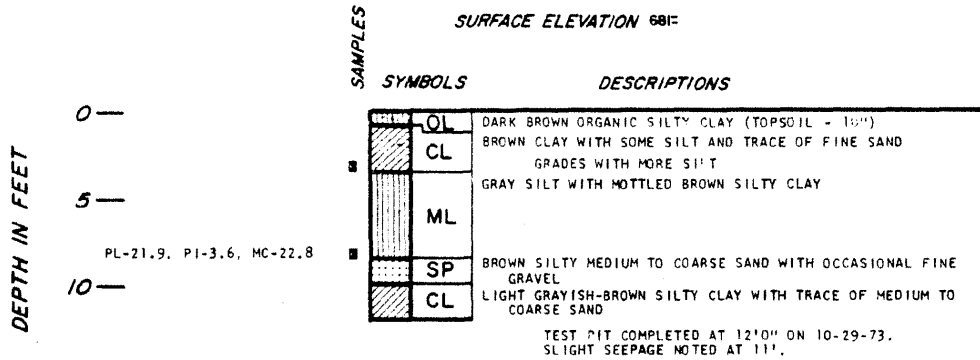

**TEST PIT A-7**

SURFACE ELEVATION 685±

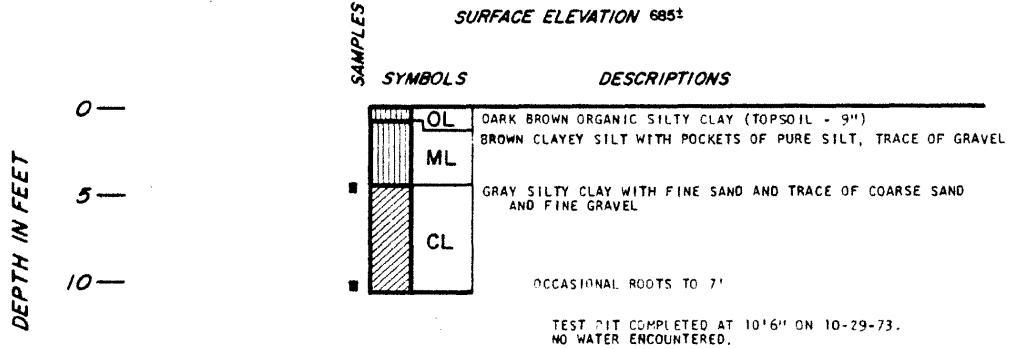

**TEST PIT A-8**

SURFACE ELEVATION 677±

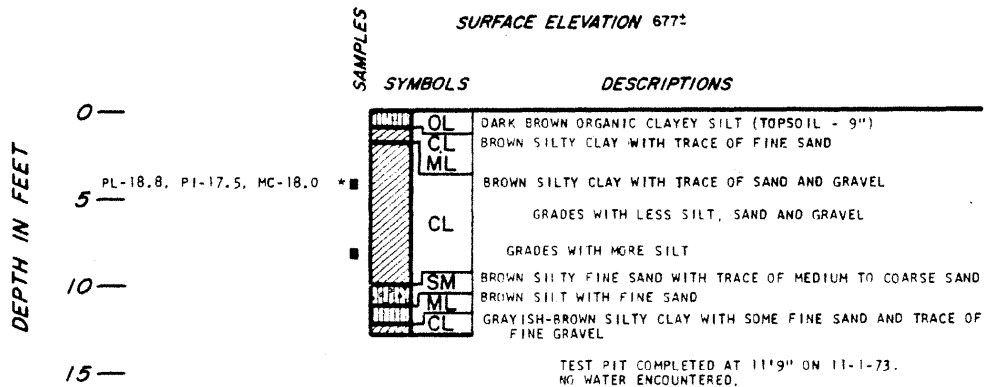

LA SALLE COUNTY STATION  
UPDATED FINAL SAFETY ANALYSIS REPORT

FIGURE 2.5-21  
LOGS OF TEST PITS

(SHEET 8)

**TEST PIT A-9**

*SURFACE ELEVATION 666±*

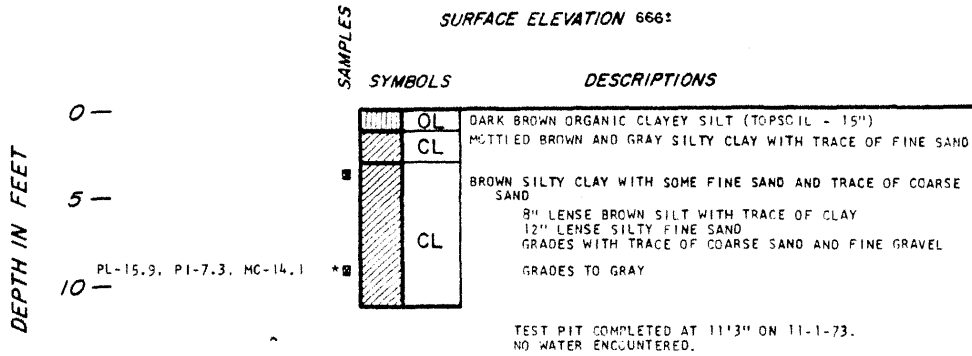

**TEST PIT A-10**

*SURFACE ELEVATION 690±*

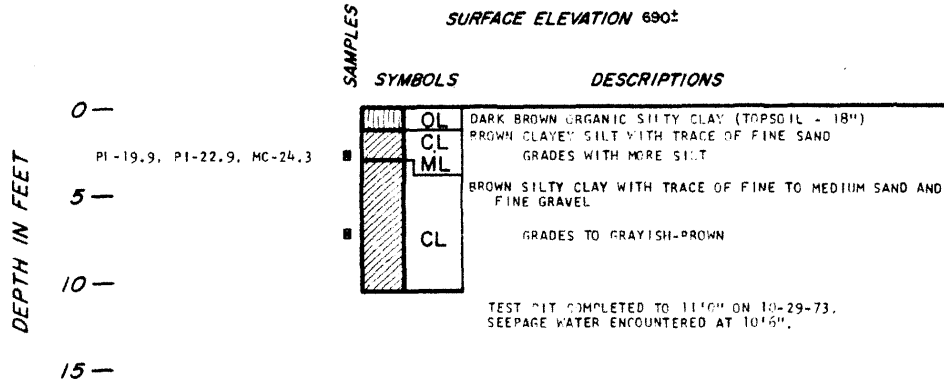

**TEST PIT A-11**

*SURFACE ELEVATION 696±*

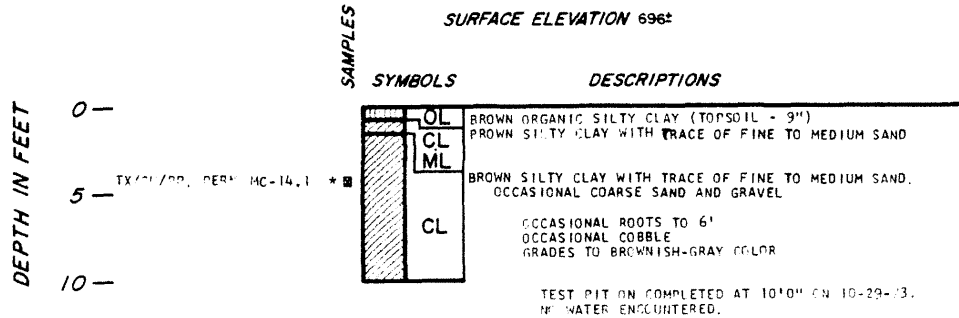

**LA SALLE COUNTY STATION**  
**UPDATED FINAL SAFETY ANALYSIS REPORT**

FIGURE 2.5-21  
LOGS OF TEST PITS

(SHEET 9)

**TEST PIT A-12**

*SURFACE ELEVATION*

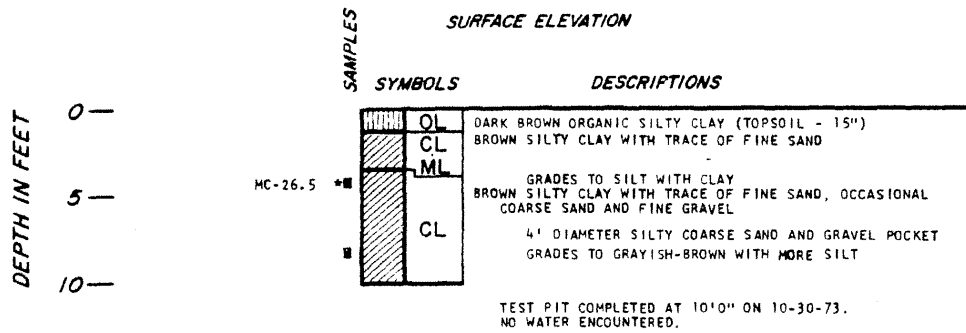

**TEST PIT A-13**

*SURFACE ELEVATION*

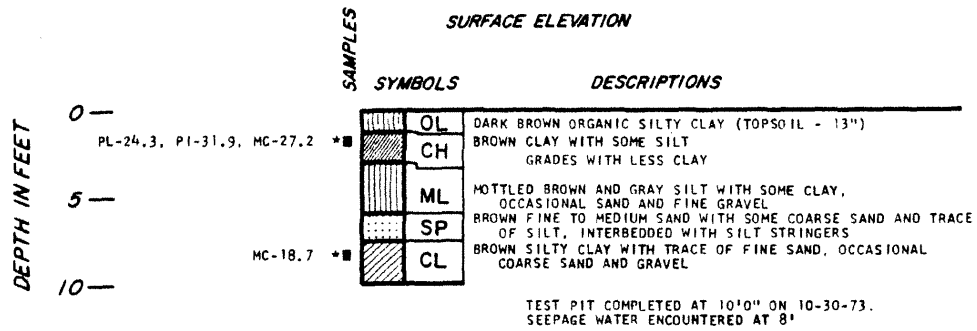

**TEST PIT A-14**

*SURFACE ELEVATION*

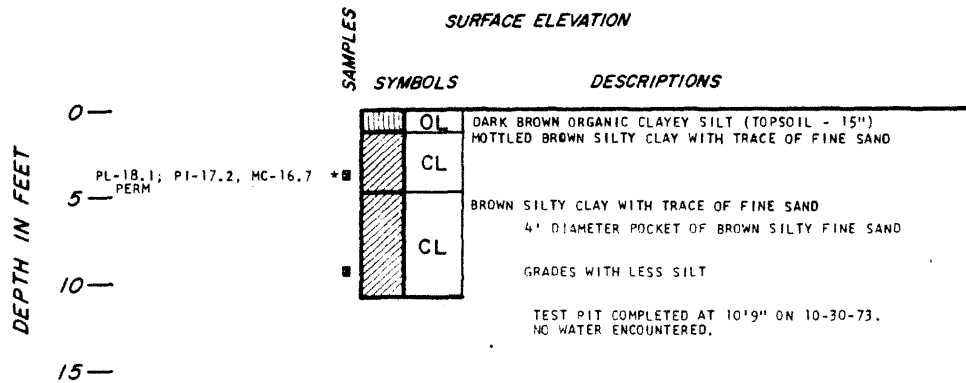

**LA SALLE COUNTY STATION**  
**UPDATED FINAL SAFETY ANALYSIS REPORT**

FIGURE 2.5-21  
LOGS OF TEST PITS  
(SHEET 10)

**TEST PIT A-15**

*SURFACE ELEVATION 682'*

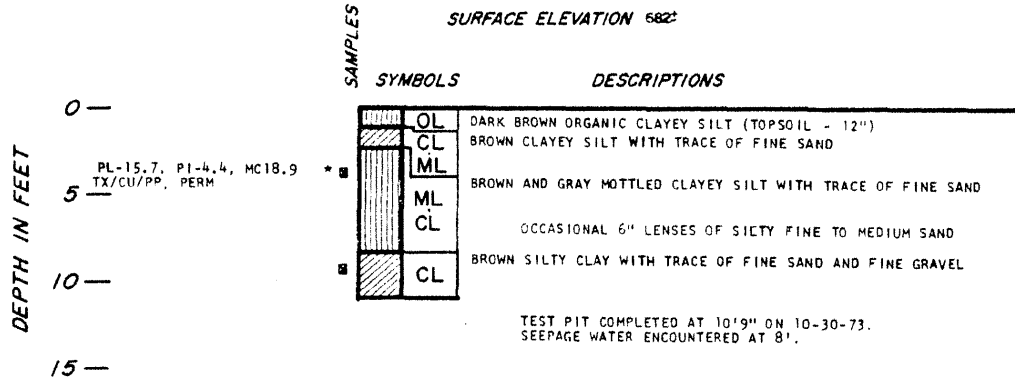

**TEST PIT A-16**

*SURFACE ELEVATION 683'*

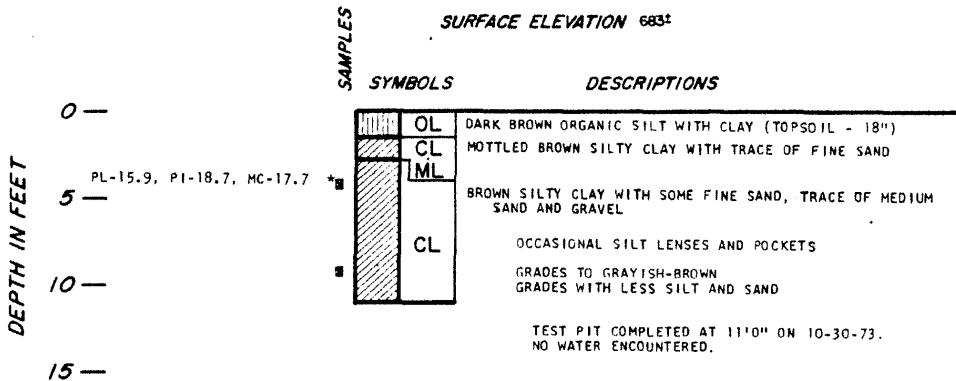

**TEST PIT A-17**

*SURFACE ELEVATION 684'*

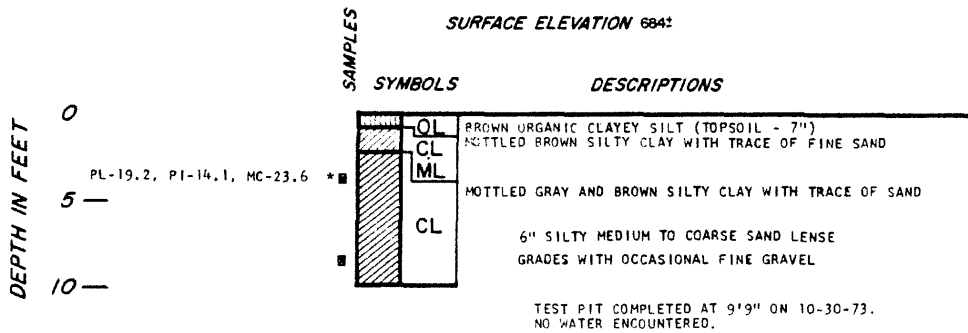

LA SALLE COUNTY STATION  
UPDATED FINAL SAFETY ANALYSIS REPORT

FIGURE 2.5-21  
LOGS OF TEST PITS  
(SHEET 11)



**TEST PIT R-1**  
**LOCATION: 36,985 N., 6866 E.**  
**SURFACE ELEVATION: 488 ±**

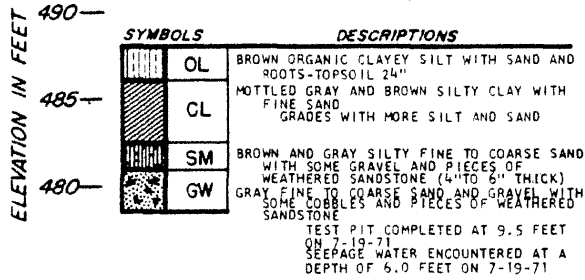

**TEST PIT R-2**  
**LOCATION: 37,812 N., 6850 E.**  
**SURFACE ELEVATION: 488 ±**

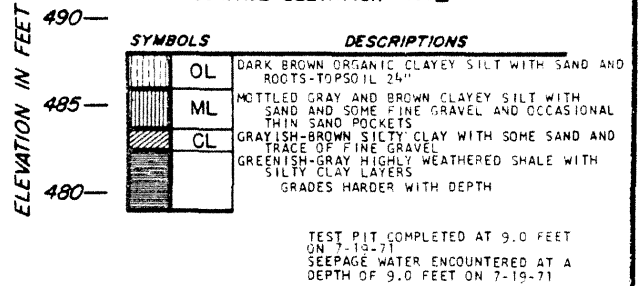

**TEST PIT R-3**  
**LOCATION: 37,792 N., 6850 E.**  
**SURFACE ELEVATION: 488 ±**

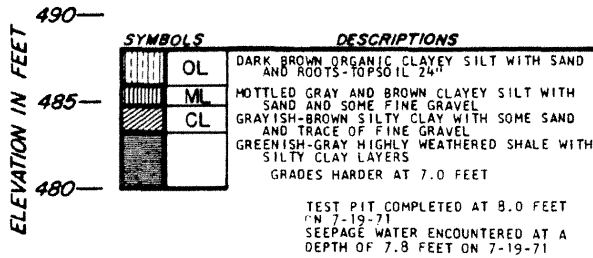

**TEST PIT R-4**  
**LOCATION: 37,079 N., 6866 E.**  
**SURFACE ELEVATION: 488 ±**

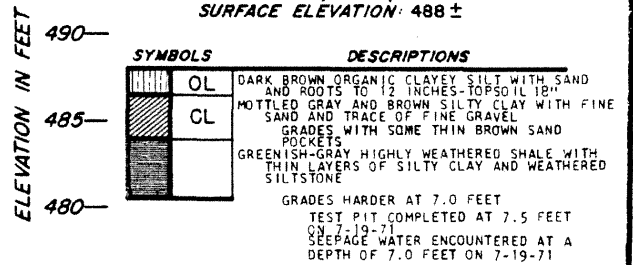





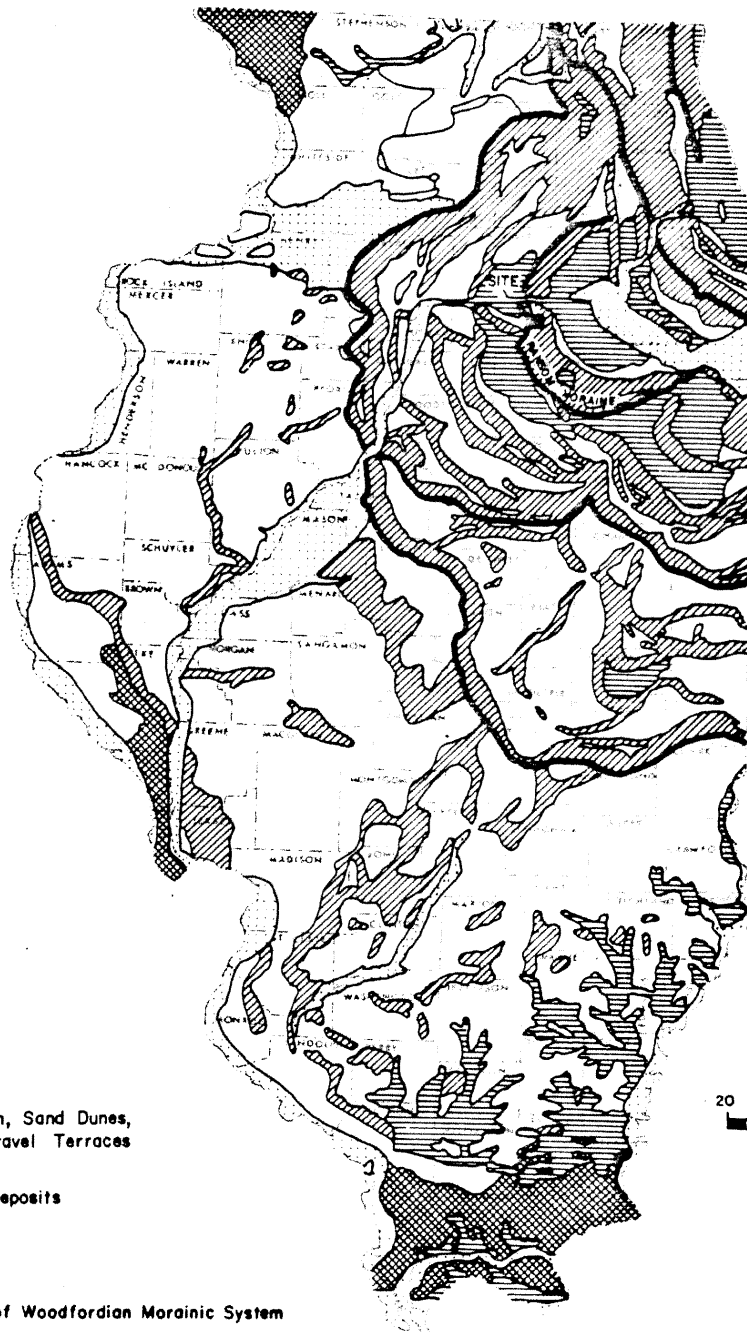

**LA SALLE COUNTY STATION**  
**UPDATED FINAL SAFETY ANALYSIS REPORT**

FIGURE 2.5-21  
 LOGS OF TEST PITS  
 (SHEET 12)



**LEGEND**

-  Alluvium, Sand Dunes, and Gravel Terraces
-  Lake Deposits
-  Moraine
-  Front of Woodfordian Morainic System
-  Ground Moraine
-  Driftless Area

**NOTE**

1. Modified from Willman, H. B., and Frye, J.C., 1970, pl. 2.

LA SALLE COUNTY STATION  
 UPDATED FINAL SAFETY ANALYSIS REPORT

---

FIGURE 2.5-22  
 GLACIAL MAP OF ILLINOIS

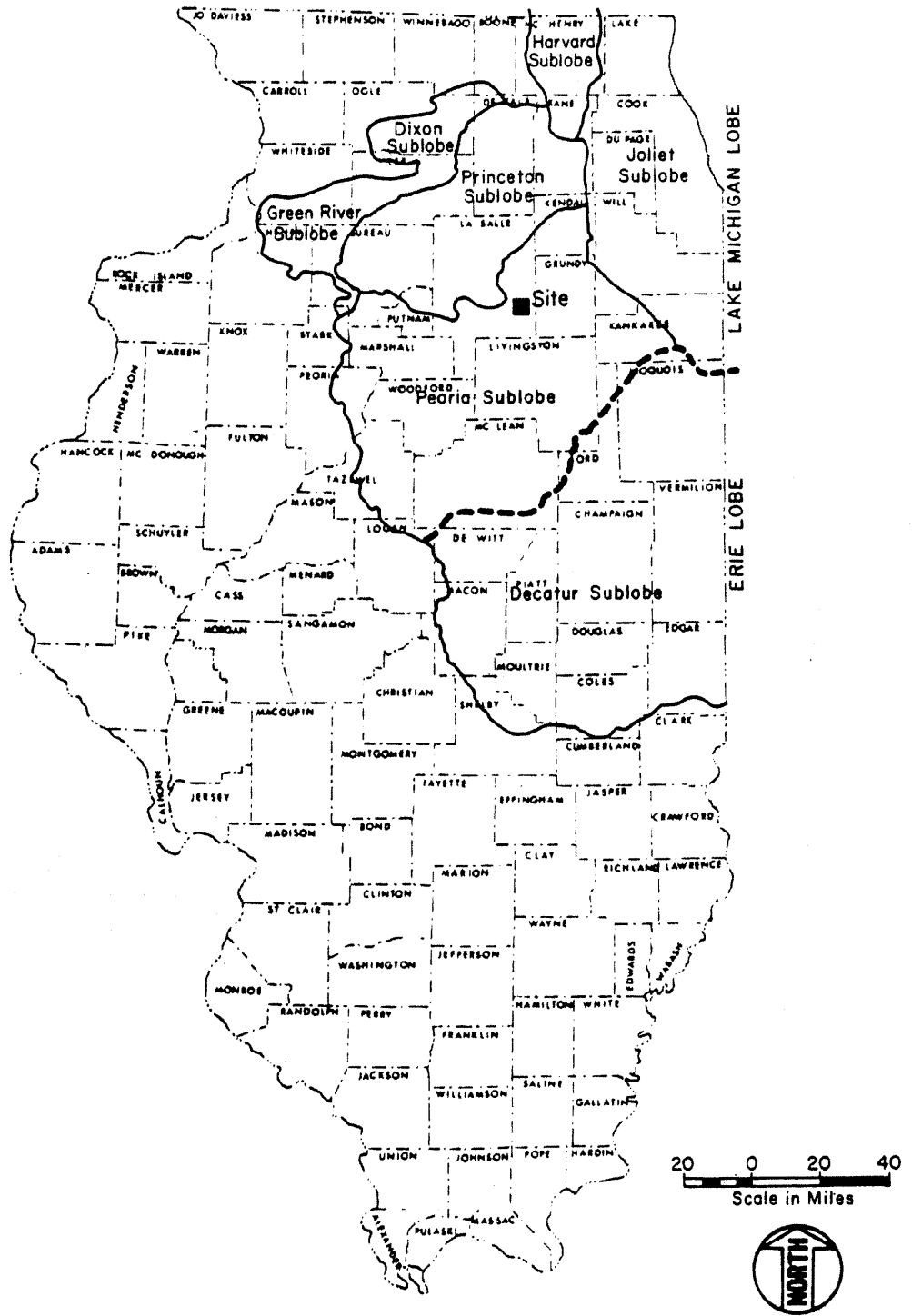

**NOTE**

From William, H.B., and Frye, J.C.,  
 1970, p. 90.

<p><b>LA SALLE COUNTY STATION</b>  <b>UPDATED FINAL SAFETY ANALYSIS REPORT</b></p>
<p><b>FIGURE 2.5-23</b>  <b>WOODFORDIAN LOBES AND SUBLOBES</b>  <b>OF ILLINOIS</b></p>

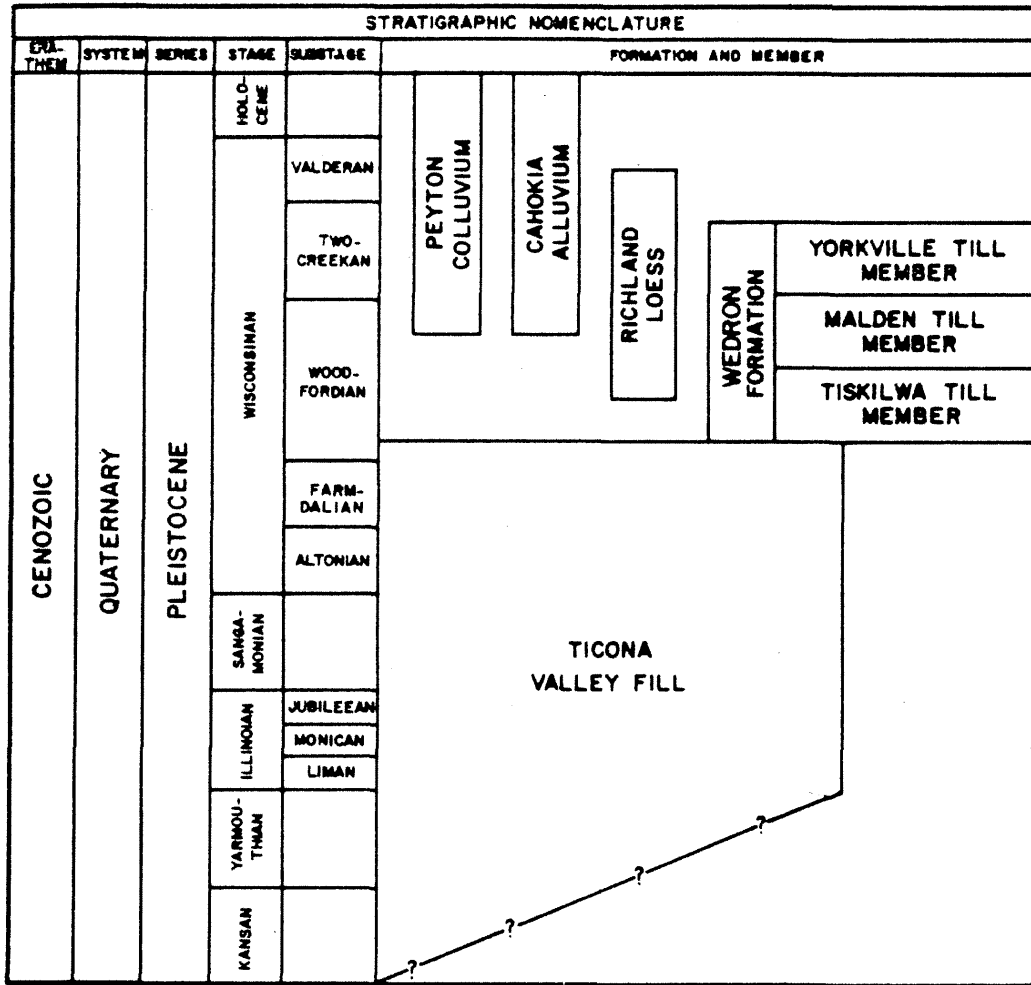

**LEGEND**

Unit	Thickness (Feet)	Predominant Soil Type
Peyton Colluvium	0-40	Pebbly, clayey, silt
Cahokia Alluvium	0-20	Silt and clay with sand lenses
Richland Loess	0-4	Clayey silt
<b>Wedron Formation</b>		
Yorkville Till Member	75-140	Silty clay
Malden Till Member	25-30	Silty clay with sand and gravel at base locally
Tiskilwa Till Member	30	Silty clay with sand and gravel at base
Ticono Valley Fill	0-110	Sandy gravel or gravelly sand and silty clay

**LA SALLE COUNTY STATION**  
 UPDATED FINAL SAFETY ANALYSIS REPORT

---

FIGURE 2.5-24  
 SITE VICINITY SOIL STRATIGRAPHIC  
 COLUMN - UPLANDS

**NOTES**

1. From Willman, H.B., 1973.
2. From Willman, H.B., and Frye, J.C. 1970.

STRATIGRAPHIC NOMENCLATURE					
ERA-THEM	SYSTEM	SERIES	STAGE	SUBSTAGE	FORMATION AND MEMBER
CENOZOIC	QUATERNARY	PLEISTOCENE	HOLOCENE		PEYTON COLLUVIUM GRAYSLAKE PEAT CAHOKIA ALLUVIUM HENRY FORMATION
				VALDERAN	
			WISCONSINAN	TWO-CREEKAN	
				WOOD-FORDIAN	
				FARM-DALIAN	
				ALTONIAN	
				SANGAMONIAN	
			ILLINOIAN	JUBILEEAN	
				MONICAN	
				LIMAN	
			YARMOUTHIAN		
			KANSAN		

**LEGEND**

Unit	Thickness (Feet)	Predominant Soil Type
Peyton Colluvium	0 - 40	Pebbly, clayey, silt
Grayslake Peat	0 - 10	Organic silt
Cahokia Alluvium	0 - 20	Sandy or clayey silt with sand and gravel lenses
Henry Formation	0 - 40	Gravel and sandy gravel

**NOTES**

1. From Willman, H.B., 1973.
2. From Willman, H.B., and Frye, J.C., 1970.

<b>LA SALLE COUNTY STATION</b> UPDATED FINAL SAFETY ANALYSIS REPORT
FIGURE 2.5-25  SITE VICINITY SOIL STRATIGRAPHIC COLUMN - VALLEY BOTTOMS

**LEGEND**

**SOIL SERIES**

- 23 Blount silt loam
- 67 Harpster silty clay loam
- 91 Swygert silt loam
- 146 Elliott silt loam
- 148 Proctor silt loam
- 149 Brenton silt loam
- 154 Flanagan silt loam
- 198 Elburn silt loam
- 223 Varna silt loam
- 232 Ashkum silty clay loam
- 235 Bryce silty clay
- 238 Rantoul silty clay
- 295 Mokena silt loam
- 320 Frankfort silt loam
- 330 Peotone silty clay loam
- 375 Rutland silt loam

**NOTE**

1. From Alexander, J.D. and Paschke, J.E. 1973.
2. Engineering properties and characteristics of soil series are presented in Table 2.5-13

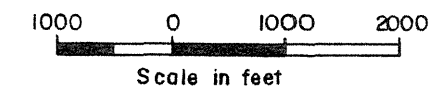
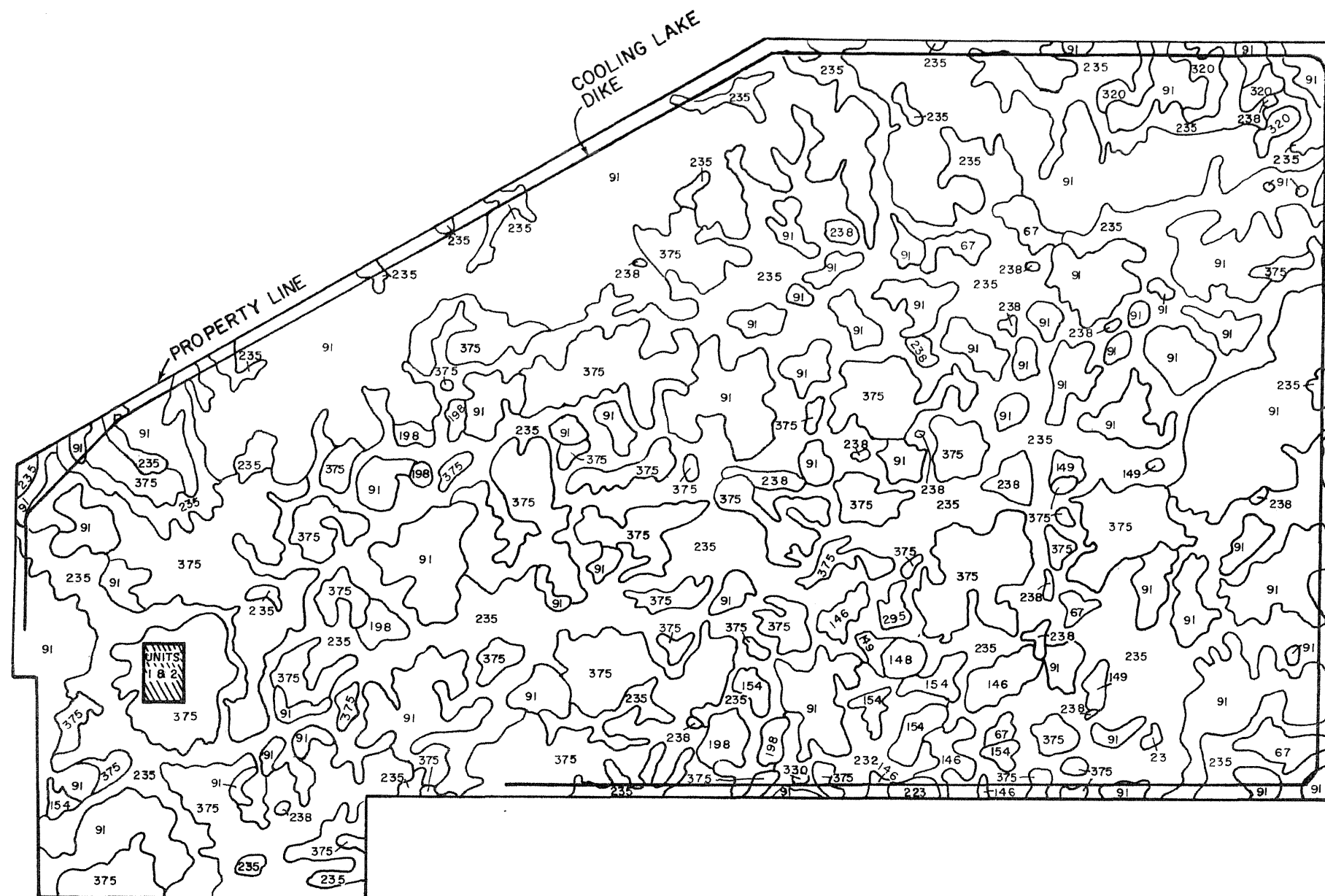

**LA SALLE COUNTY STATION**  
 UPDATED FINAL SAFETY ANALYSIS REPORT

FIGURE 2.5-26  
 UPLAND AGRICULTURAL SOILS

ERA-THEM	STRATIGRAPHIC NOMENCLATURE					LITHOLOGIC SYMBOL	THICKNESS FEET	PREDOMINANT ROCK TYPES											
	SYSTEM	SERIES	STAGE	GROUP	FORMATION														
PALEOZOIC	PENNSYLVANIAN	DESMOINESIAN		McLEANS BORO	Modesto Formation		125-200	Shale, Limestone, Sandstone, Coal											
				KEWANEE	*Carbondale Formation		125-230	Shale, Limestone, Sandstone, Coal											
					*Spoon Formation		2-110	Shale, Limestone, Sandstone, Coal											
		ATOKAN			McCORMICK	Abbott Formation		2-85	Sandstone, Shale, Coal										
		ORDOVICIAN	CINCINNATIAN		RICHMONDIAN	Brainard Shale		0-100	Shale, Siltstone, Dolomite										
						Fort Atkinson Limestone		0-40	Limestone and Dolomite										
	MAYSVILLIAN				Scales Shale		50-150	Shale, Limestone, Sandstone, Siltstone											
	EDENIAN				Dubuque Formation		0-45	Dolomite											
	CHAMPLAINIAN		TRENTONIAN		GALENA	Wise Lake Formation		65-75	Dolomite										
						Dunleith Formation		100-150	Dolomite										
						Guttenburg Formation		0-16	Limestone and Dolomite										
						Spechts Ferry Formation		0-15	Shale and Dolomite										
						Quimbys Mill Formation		3-35	Limestone										
						Nachusa Formation		0-75	Dolomite										
						Grand Detour Formation		15-210	Limestone										
			BLACKRIVERIAN		*PLATTE-VILLE	Mifflin Formation		10-120	Limestone										
						Pecatonica Formation		15-140	Dolomite										
						Glenwood Formation		0-160	Sandstone, Shale, and Dolomite										
						ANCELL			St. Peter Sandstone		30-710	Sandstone							
									CANADIAN	PRAIRIE DU CHIEN	Shakopee Dolomite		0-2000	Dolomite					
											New Richmond Sandstone		0-150	Sandstone					
											Oneota Dolomite		200-500	Dolomite					
	Gunter Sandstone		0-25	Sandstone															
	CAMBRIAN	TREMPEALEAUAN			Eminence Formation		50-250	Dolomite											
					Potosi Dolomite		100-300	Dolomite											
					Franconia Formation		50-600	Sandstone and Dolomite											
					Ironton Sandstone		0-150	Sandstone											
					Galesville Sandstone		0-100	Sandstone											
		CROIXAN	DRESBACHIAN			Eau Claire Formation		300-1000	Sandstone and Dolomite										
						Mt. Simon Sandstone				500-2600	Sandstone								
												PRECAMBRIAN							Granite and Granodiorite
												PRECAMBRIAN							Granite and Granodiorite
												PRECAMBRIAN							Granite and Granodiorite
PRECAMBRIAN							Granite and Granodiorite												
PRECAMBRIAN							Granite and Granodiorite												

NOTES

1. Taken from:

Buschbach, T.C., 1964.

Kosanke, R.M. et al., 1960.

William, H.B. et al., 1967.

William, H.B. et al., 1975.

2. Not to scale.

3. *Formations or groups encountered in the site exploration program.

4. Croixan = Late Cambrian

Canadian = Early Ordovician



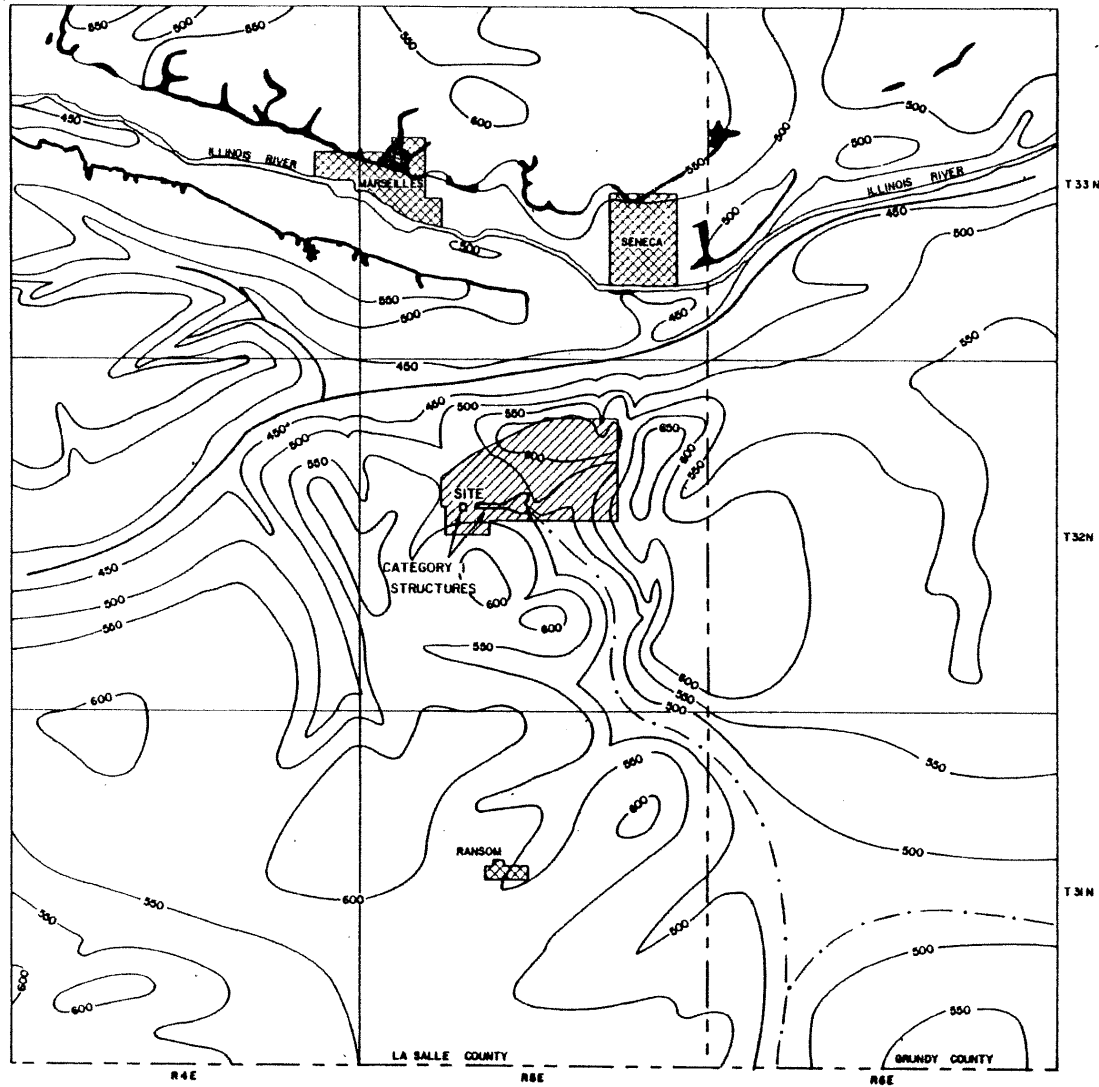

ChAMPLAINIAN = Middle Ordovician

CINCINNATIAN = Late Ordovician

LA SALLE COUNTY STATION  
 UPDATED FINAL SAFETY ANALYSIS REPORT  
 FIGURE 2.5-27  
 SITE AREA ROCK STRATIGRAPHIC COLUMN



**LEGEND**

-  Bedrock outcrop
-  Plant Site
-  Towns
-  Axis of Buried Ticono Bedrock Valley
-  Axis of Buried Kempton Bedrock Valley

**NOTE**

1. Reference. Modified from Randall, A.D., 1955.

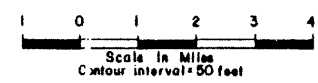

LA SALLE COUNTY STATION  
 UPDATED FINAL SAFETY ANALYSIS REPORT

FIGURE 2.5-28  
 BEDROCK TOPOGRAPHY MAP



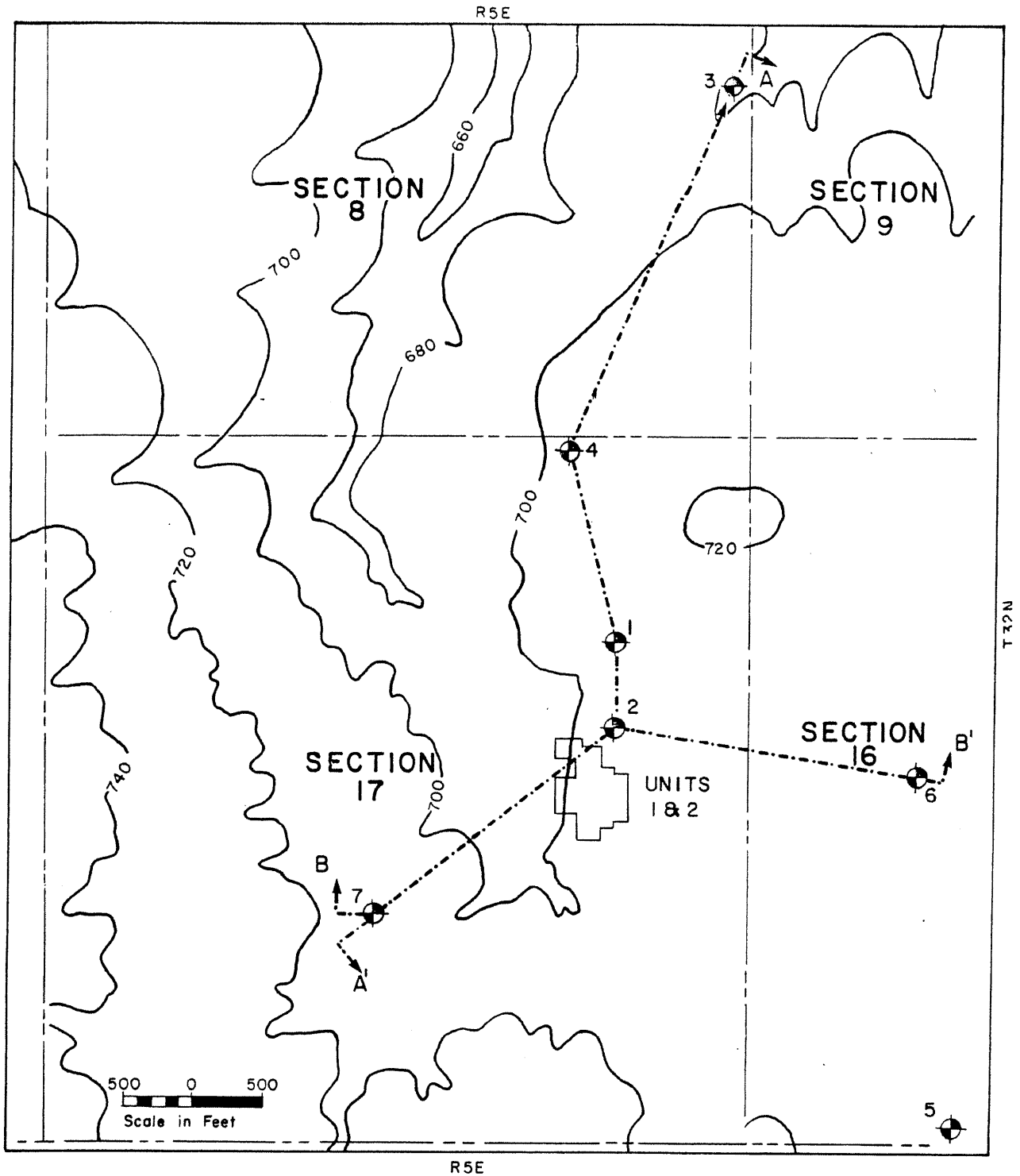

**LEGEND**

- Cross-Section Line
- ⊕ Boring Designation

**NOTES**

1. Section A-A' shown in Figure 2.5-30.
2. Section B-B' shown in Figure 2.5-31.



<p>LA SALLE COUNTY STATION          UPDATED FINAL SAFETY ANALYSIS REPORT</p>
<p>FIGURE 2.5-29          PLOT PLAN OF GEOLOGIC SECTIONS</p>

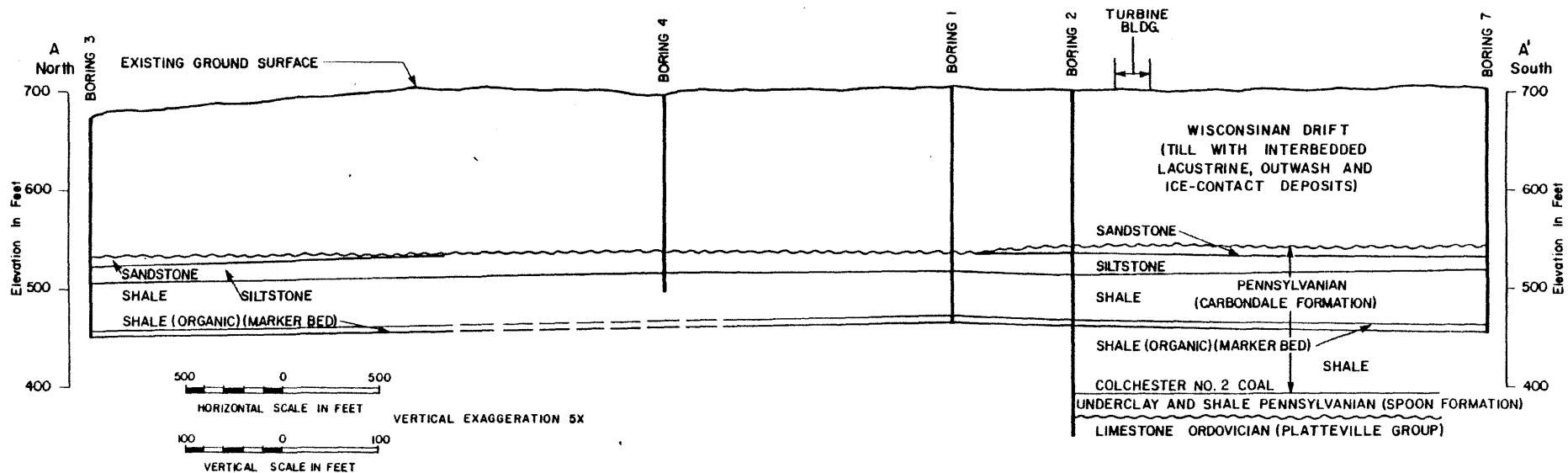

**LEGEND**

~~~~~ Unconformity

NOTES

1. Datum mean sea level
2. Ground surface elevations are correct only at test boring locations.
3. The depth and thickness of the soil strata and the depth of the rock strata indicated on the subsurface sections were obtained

by interpolating between test borings. Information on actual soil and rock conditions exists only at the test boring locations and it is possible that the soil and rock conditions may vary from those indicated.

4. Boring locations shown in Figure 2.5-29.

LA SALLE COUNTY STATION
 UPDATED FINAL SAFETY ANALYSIS REPORT

FIGURE 2.5-30
 SITE GEOLOGIC SECTION A-A'

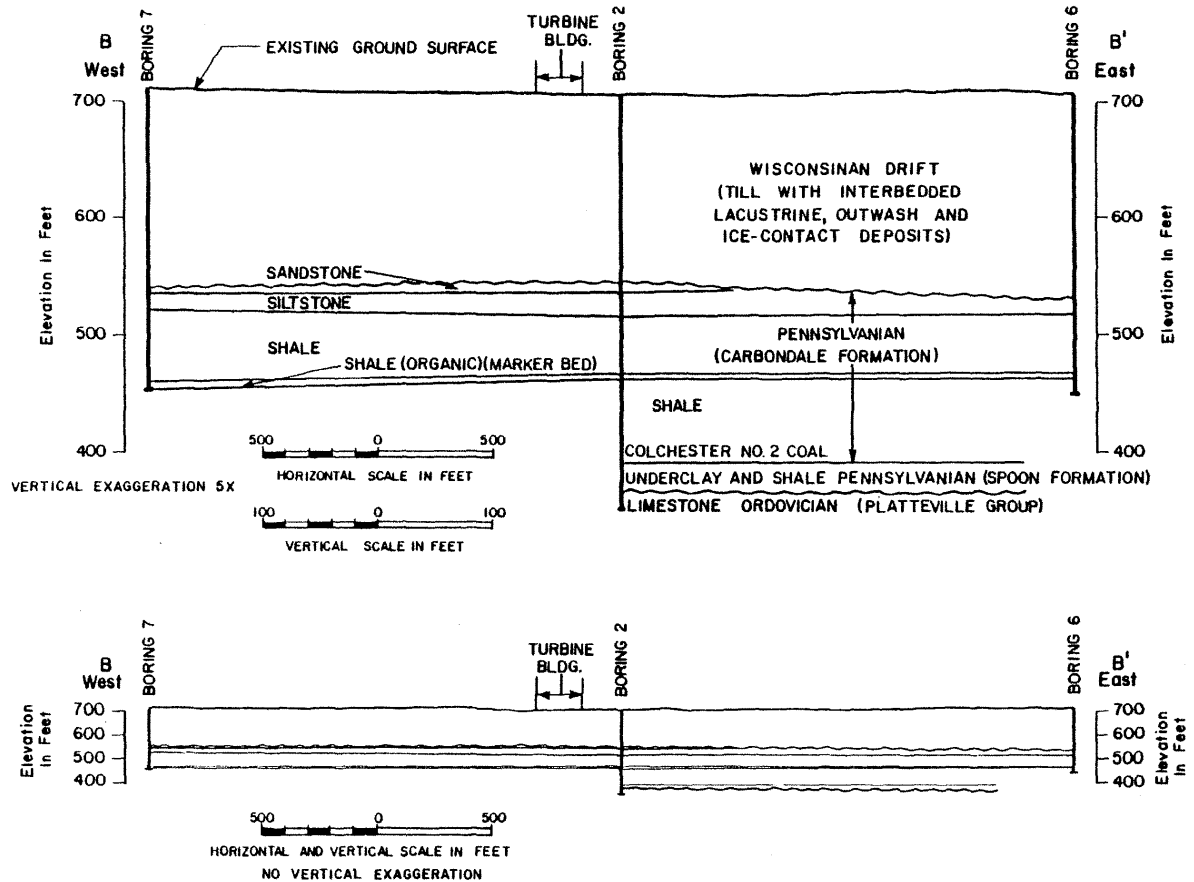

LEGEND
 ~~~~~ Unconformity

- NOTES**
1. Datum mean sea level.
  2. Ground surface elevations are interpolated between borings.
  3. The depth and thickness of the soil strata and the depth of the rock strata indicated on the subsurface sections were obtained by interpolating between test borings. Information on actual soil and rock conditions exists only at the test boring locations and it is possible that the soil and rock conditions may vary from those indicated.
  4. Boring locations shown on Figure 2.5-29.

LA SALLE COUNTY STATION  
 UPDATED FINAL SAFETY ANALYSIS REPORT  
  
 FIGURE 2.5-31  
 SITE GEOLOGIC SECTION B-B'

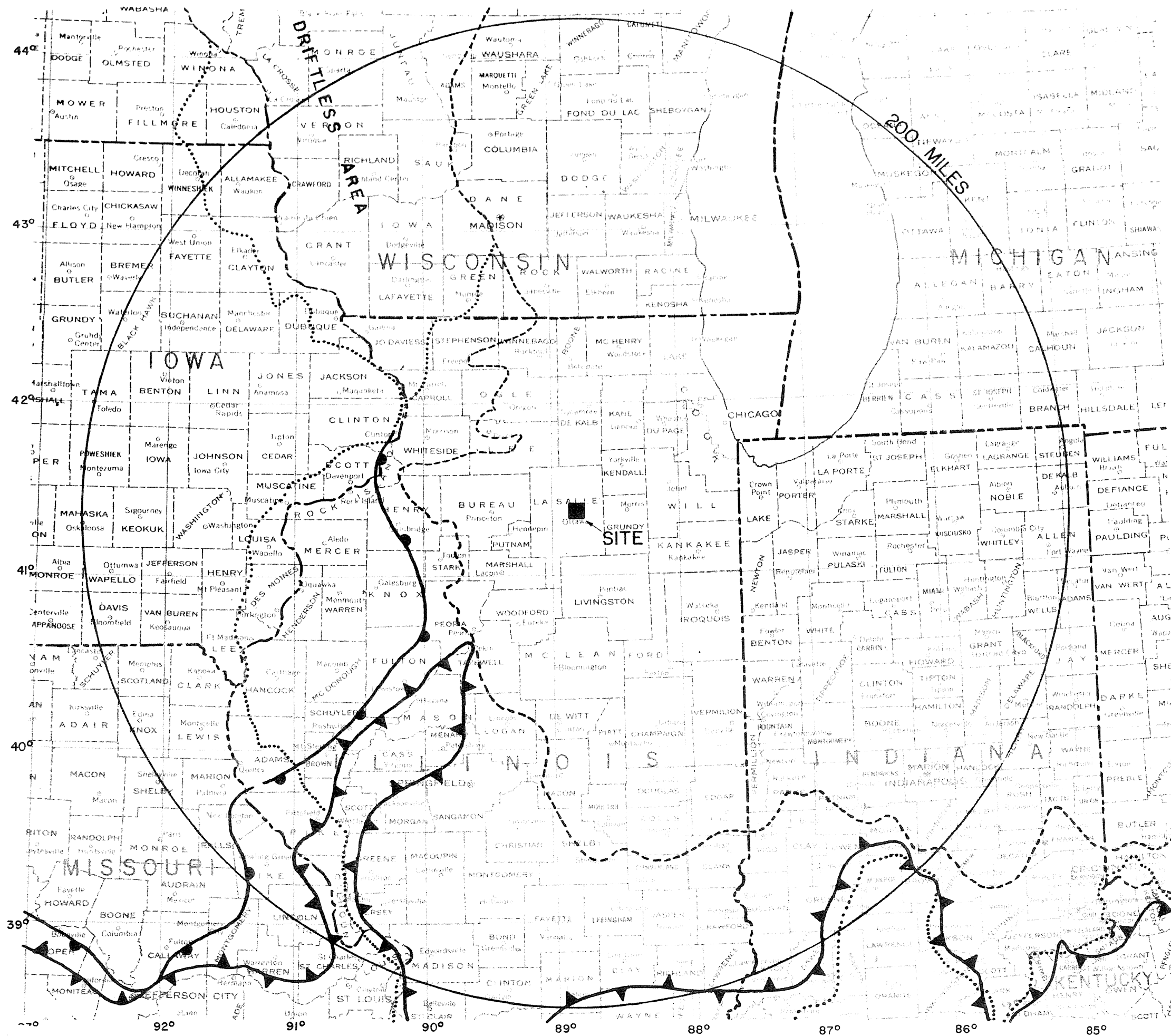

**LEGEND**

- Maximum Limits of Glaciation
- Wisconsinan Stage
  - ..... Illinoian Stage
  - ▲▲▲ Kansan Stage
  - Nebraskan Stage

**NOTE**

- References:
- Flint, R.F., 1971, p.545.
  - Willman, H. B. and Frye, J. C., 1970, p. 50.

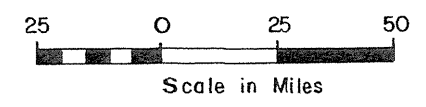

**LA SALLE COUNTY STATION  
UPDATED FINAL SAFETY ANALYSIS REPORT**

**FIGURE 2.5-32  
LIMITS OF PLEISTOCENE GLACIATION**

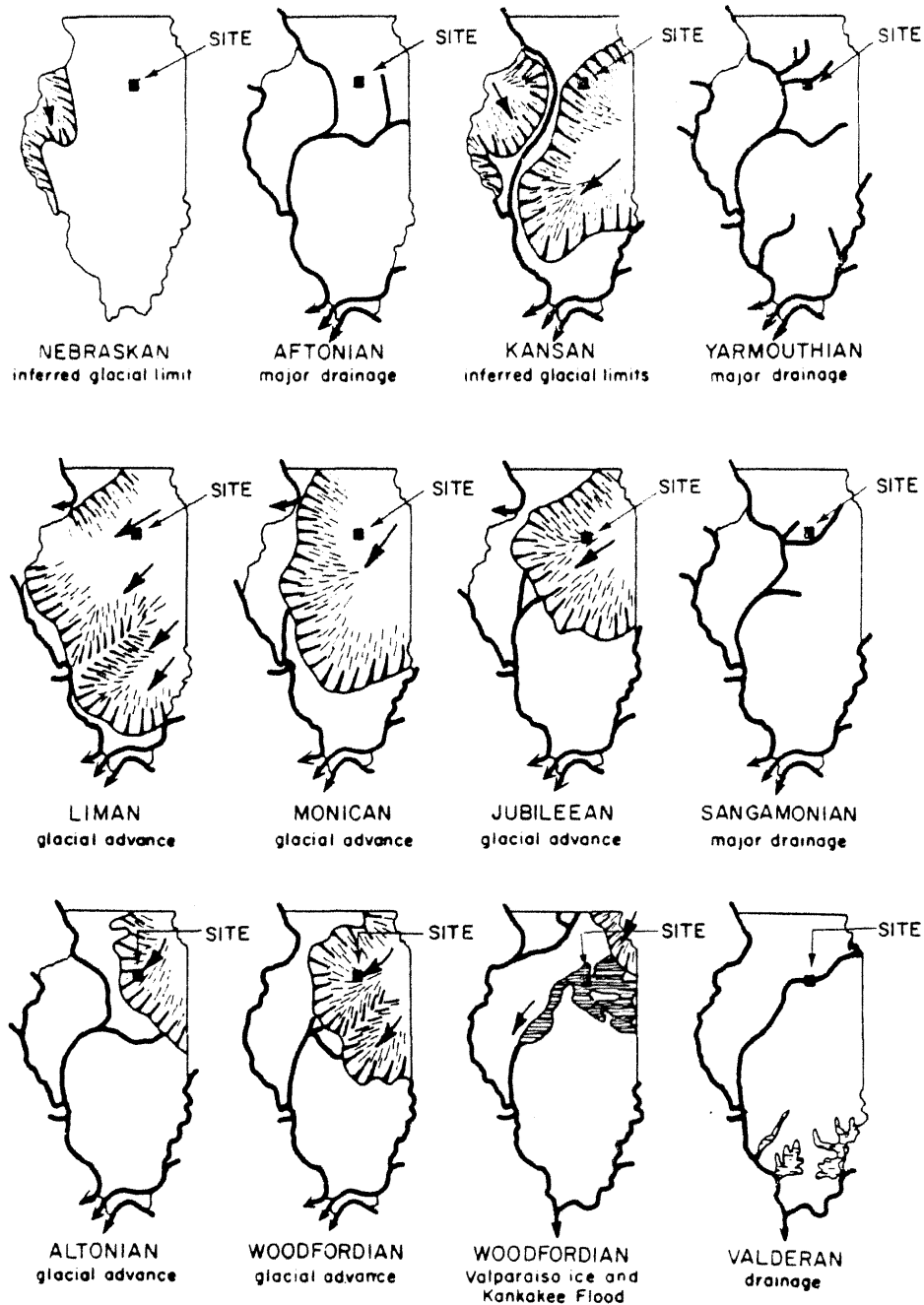

**LEGEND**

- Ice Front
- Major Drainage Routes
- Flood Waters
- Lake Waters

**NOTE**

I. Reference: Williman, H.B., and Frye, J.C., 1970, p.



**LA SALLE COUNTY STATION  
UPDATED FINAL SAFETY ANALYSIS REPORT**

---

FIGURE 2.5-33

SEQUENCE OF GLACIATIONS AND  
INTERGLACIAL DRAINAGE IN ILLINOIS

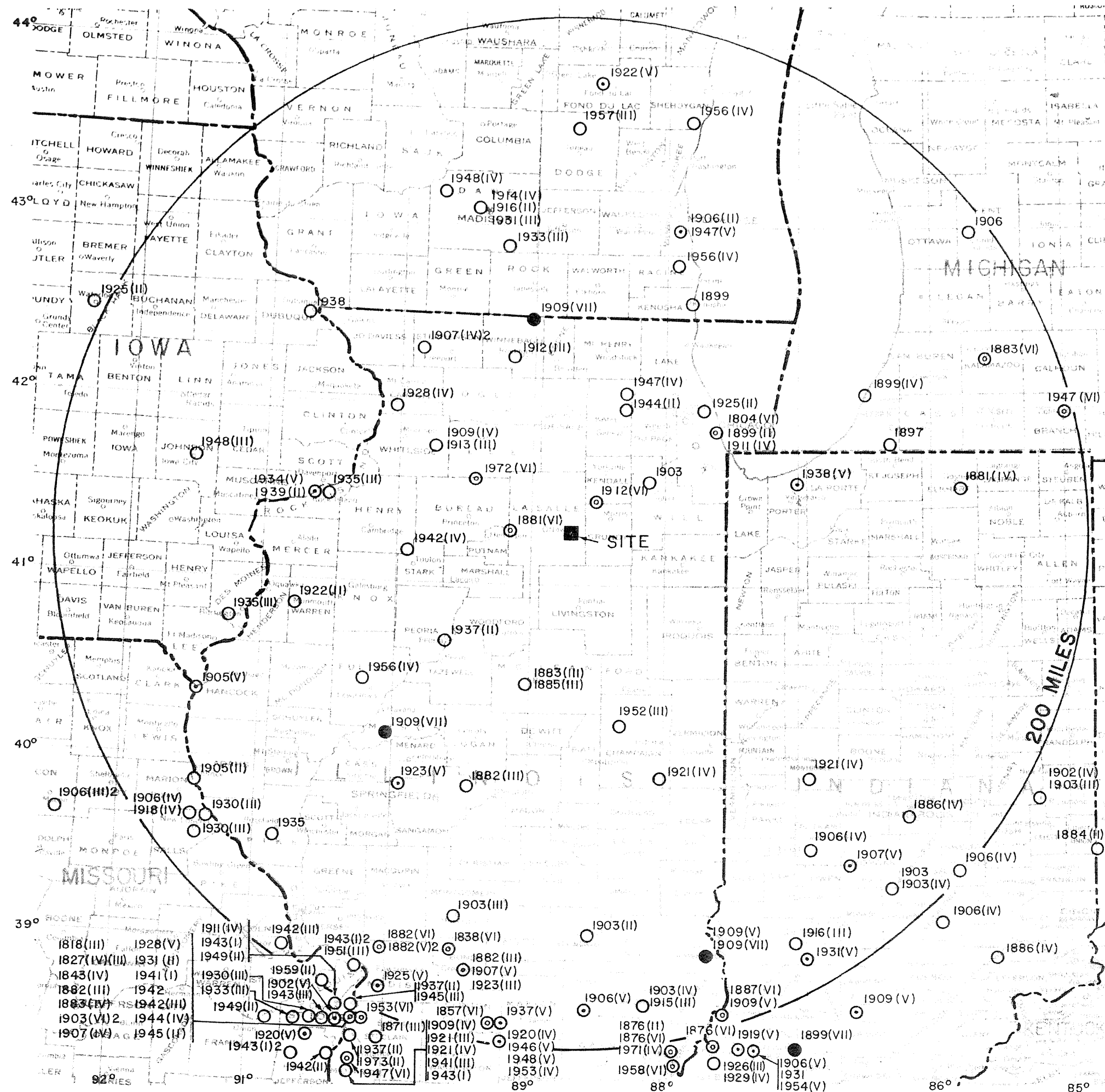

**LEGEND**

■ Center of study area

**INTENSITY (MM)**

- VII
- ⊙ VI
- ⊙ V
- IV and less

**NOTES**

1. Earthquake data compiled from the literature.
2. Earthquake data are summarized in Tables 2.5-15 through 2.5-21.
3. An earthquake epicenter map for the New Madrid, Missouri, area is presented in Figure 2.5-35

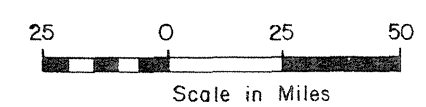

**LA SALLE COUNTY STATION**  
 UPDATED FINAL SAFETY ANALYSIS REPORT

FIGURE 2.5-34  
 EARTHQUAKE EPICENTER MAP

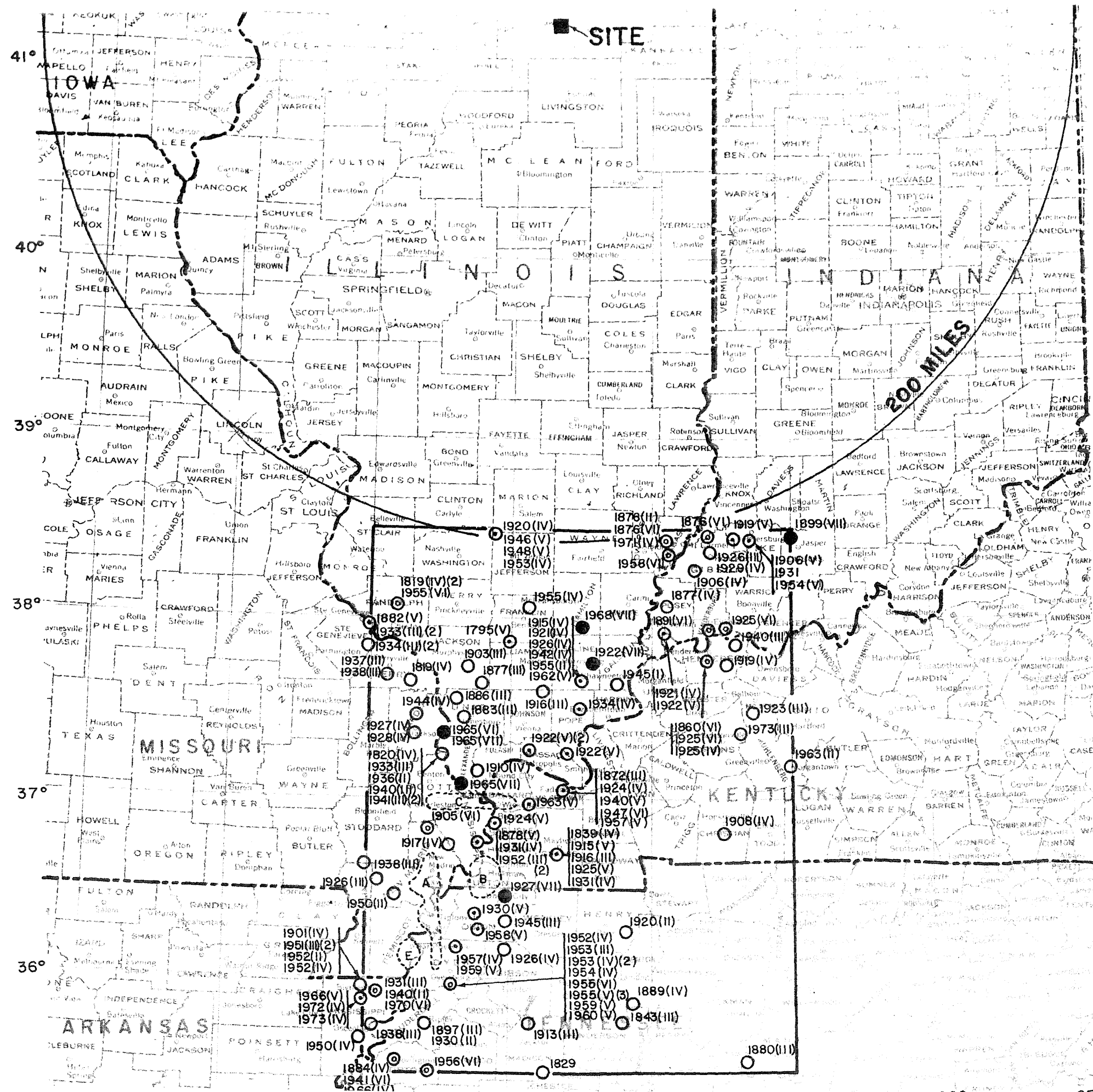

**LEGEND**

- Center of study area
- Zone of higher seismicity near the Regional Area

**INTENSITY (MM)**

- VII
- ⊙ VI
- V
- IV and less

⊙ (B) Area of earthquakes listed in Table 2.5-19

**NOTE**

1. Earthquake data compiled from the literature.
2. Earthquake data and references are presented in Tables 2.5-15 through 2.5-21.

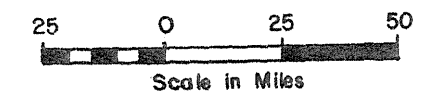

LA SALLE COUNTY STATION  
 UPDATED FINAL SAFETY ANALYSIS REPORT

FIGURE 2.5-35

EARTHQUAKE EPICENTER MAP  
 35.5° TO 38.5° NORTH LATITUDE  
 87.0° TO 90.0° WEST LONGITUDE



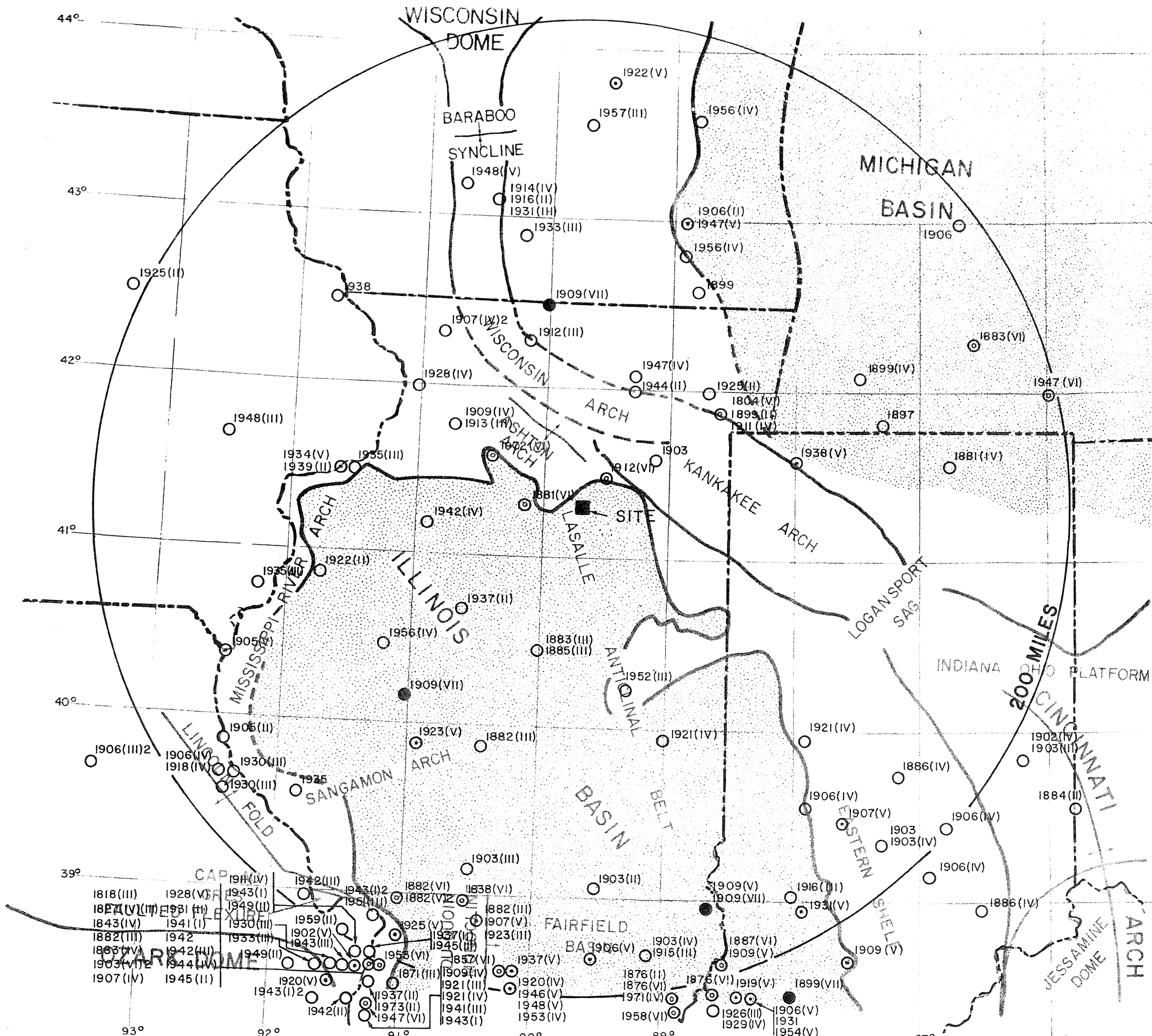

**LEGEND**

■ Center of study area

**INTENSITY (MM)**

- VII
- ⊙ VI
- ⊙ V
- IV and less

**NOTE**

1. Earthquake data compiled from the literature.
2. Earthquake data are summarized in Tables 2.5-15 through 2.5-21.
3. For legend of Regional Tectonic Features see Figure 2.5-9

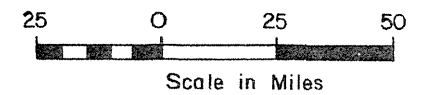

**LA SALLE COUNTY STATION**  
 UPDATED FINAL SAFETY ANALYSIS REPORT

FIGURE 2.5-36

EARTHQUAKE EPICENTER AND REGIONAL  
 TECTONIC MAP



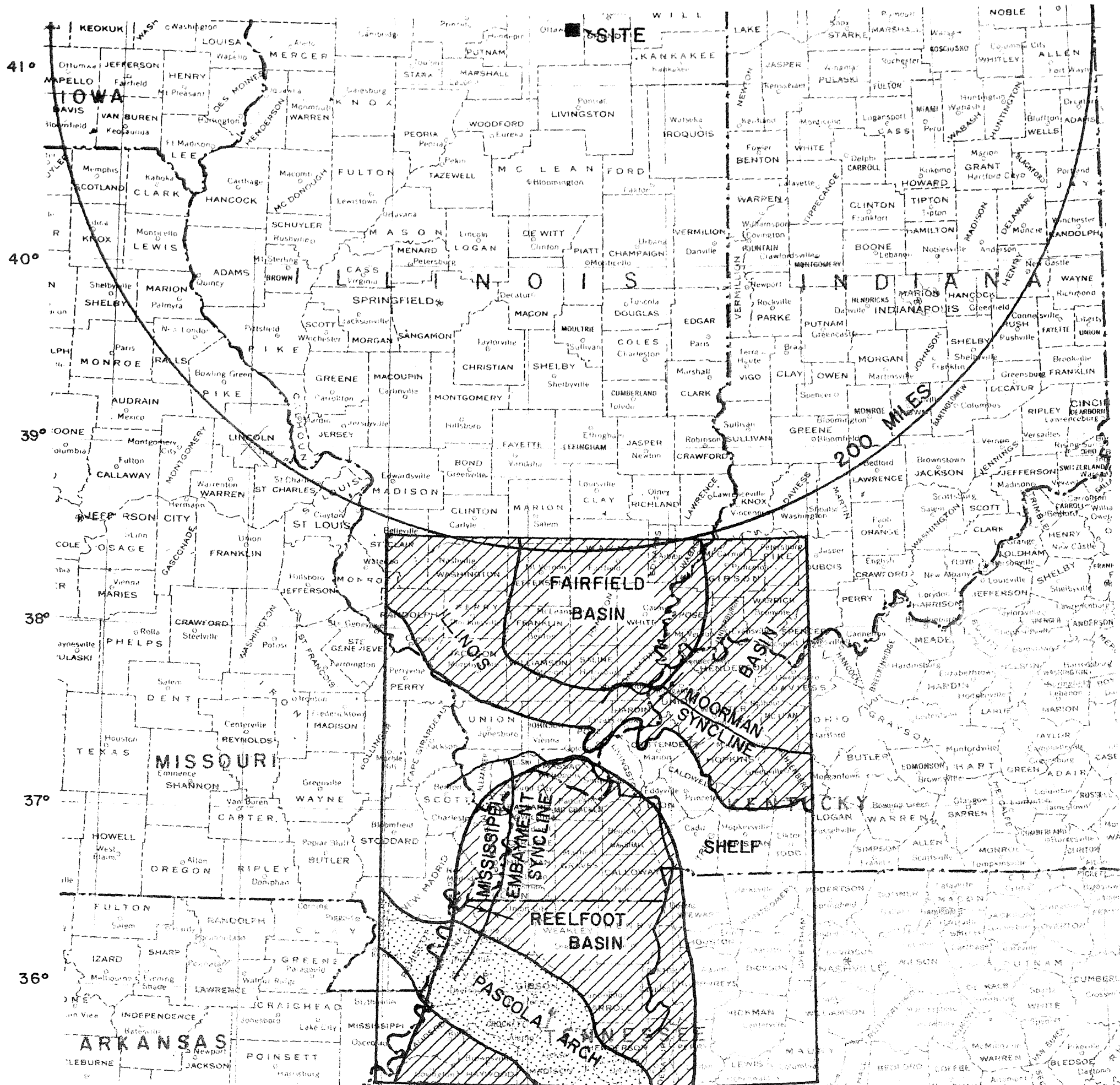

**LEGEND**

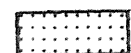

Arches and Domes

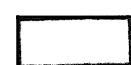

Shelf areas



Basins



Approximate axis of syncline or trough

**NOTE**

- I. For map of Regional Tectonic Features see Figure 2.5-9.

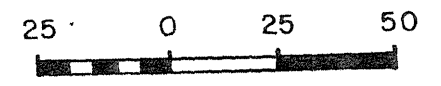

Scale in Miles

**LA SALLE COUNTY STATION**  
**UPDATED FINAL SAFETY ANALYSIS REPORT**

**FIGURE 2.5-37**  
**BASINS AND ARCHES**  
**35.5° TO 38.5° NORTH LATITUDE**  
**87.0° TO 90.0° WEST LONGITUDE**

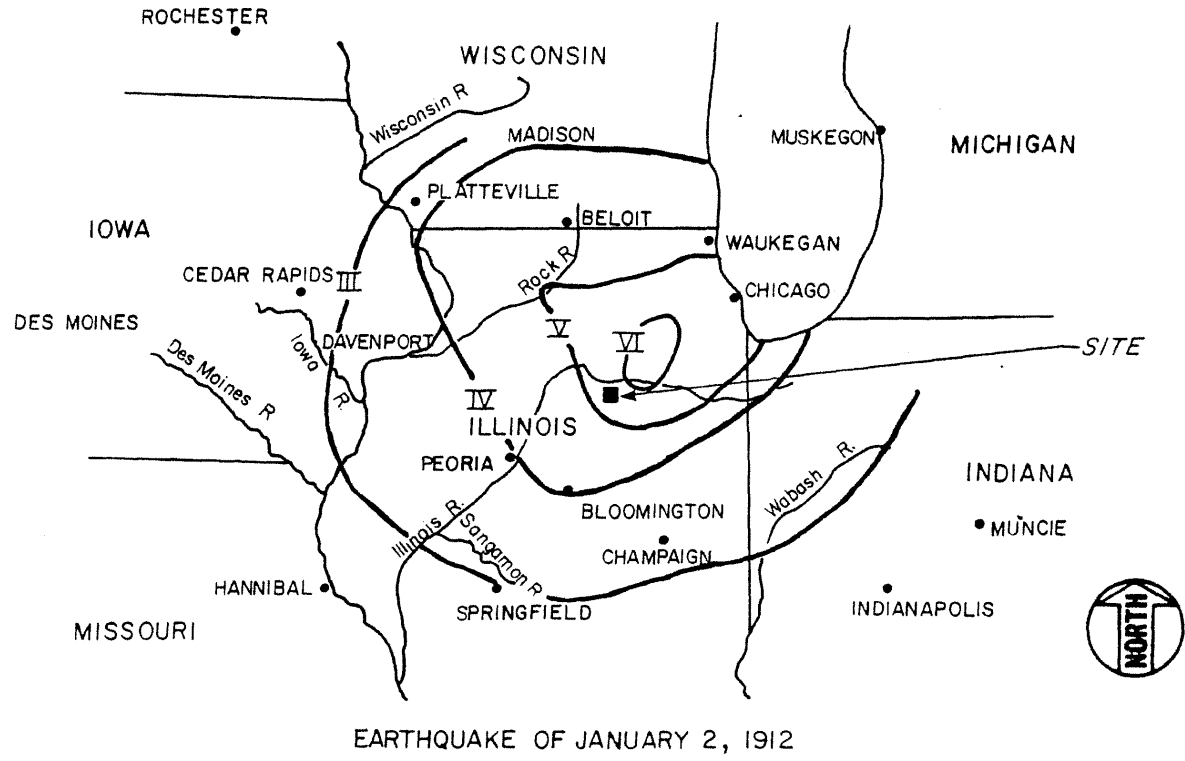
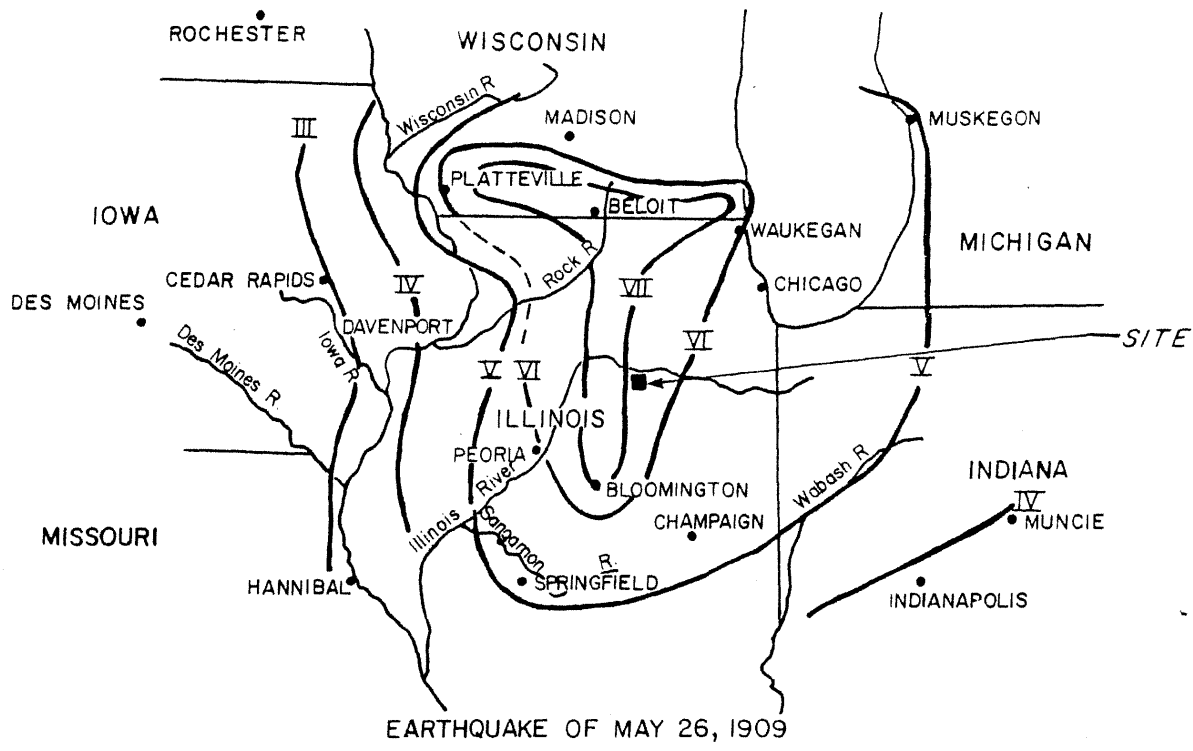

**NOTES**

- 1, Reference: J.A. Udden, Transactions of the Illinois State Academy of Science, 1910 and 1912.
2. Rossi-Forel Intensities. See Modified Mercalli Scale for definition of Rossi-Forel Intensities.

|                                                                                                                                 |
|---------------------------------------------------------------------------------------------------------------------------------|
| <b>LA SALLE COUNTY STATION</b><br><b>UPDATED FINAL SAFETY ANALYSIS REPORT</b>                                                   |
| <b>FIGURE 2.5-38</b><br><b>GENERALIZED ISOSEISMAL MAPS OF 1909</b><br><b>AND 1912 - NORTHERN</b><br><b>ILLINOIS EARTHQUAKES</b> |

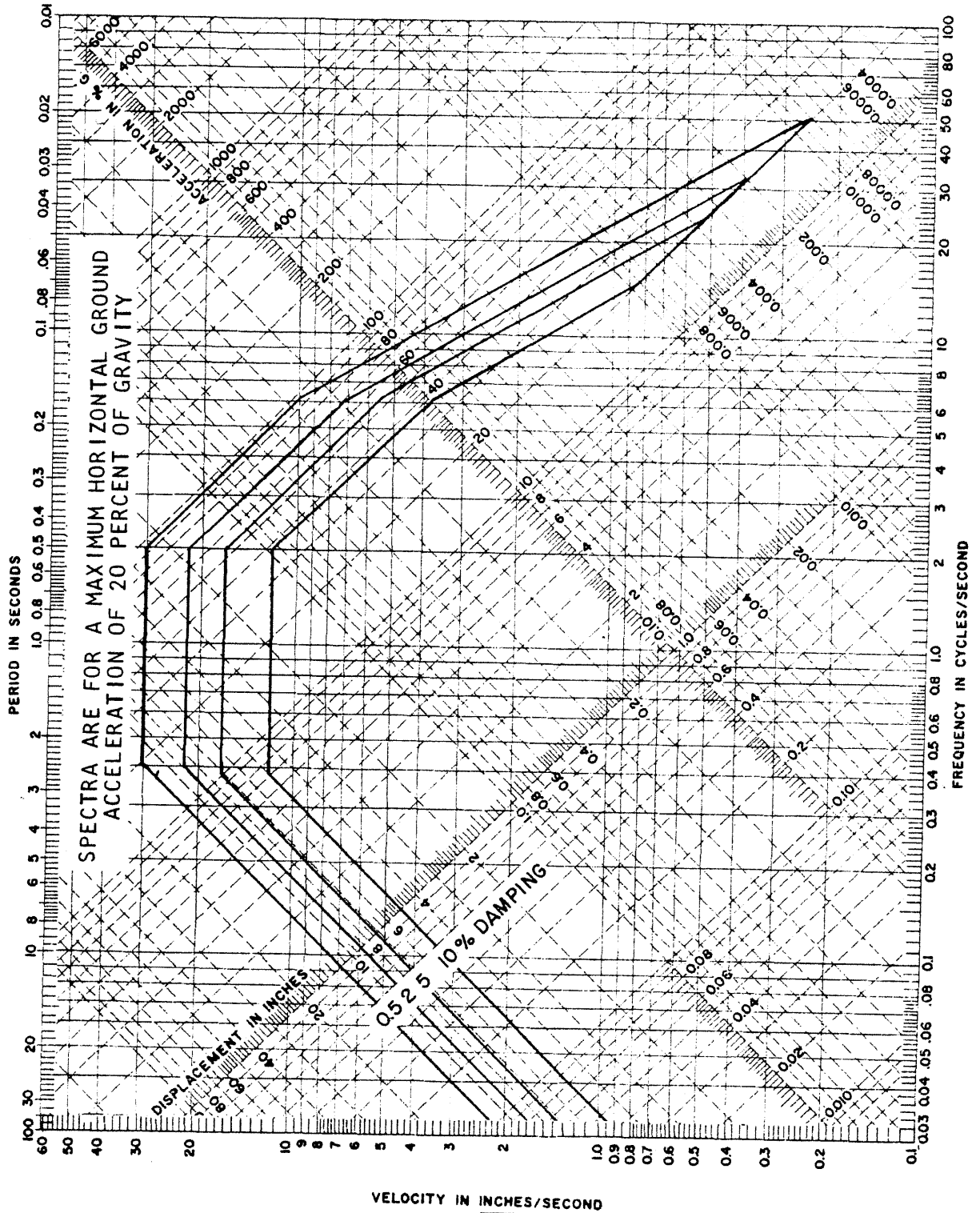

LA SALLE COUNTY STATION  
UPDATED FINAL SAFETY ANALYSIS REPORT

---

FIGURE 2.5-39  
RESPONSE SPECTRA - SAFE  
SHUTDOWN EARTHQUAKE

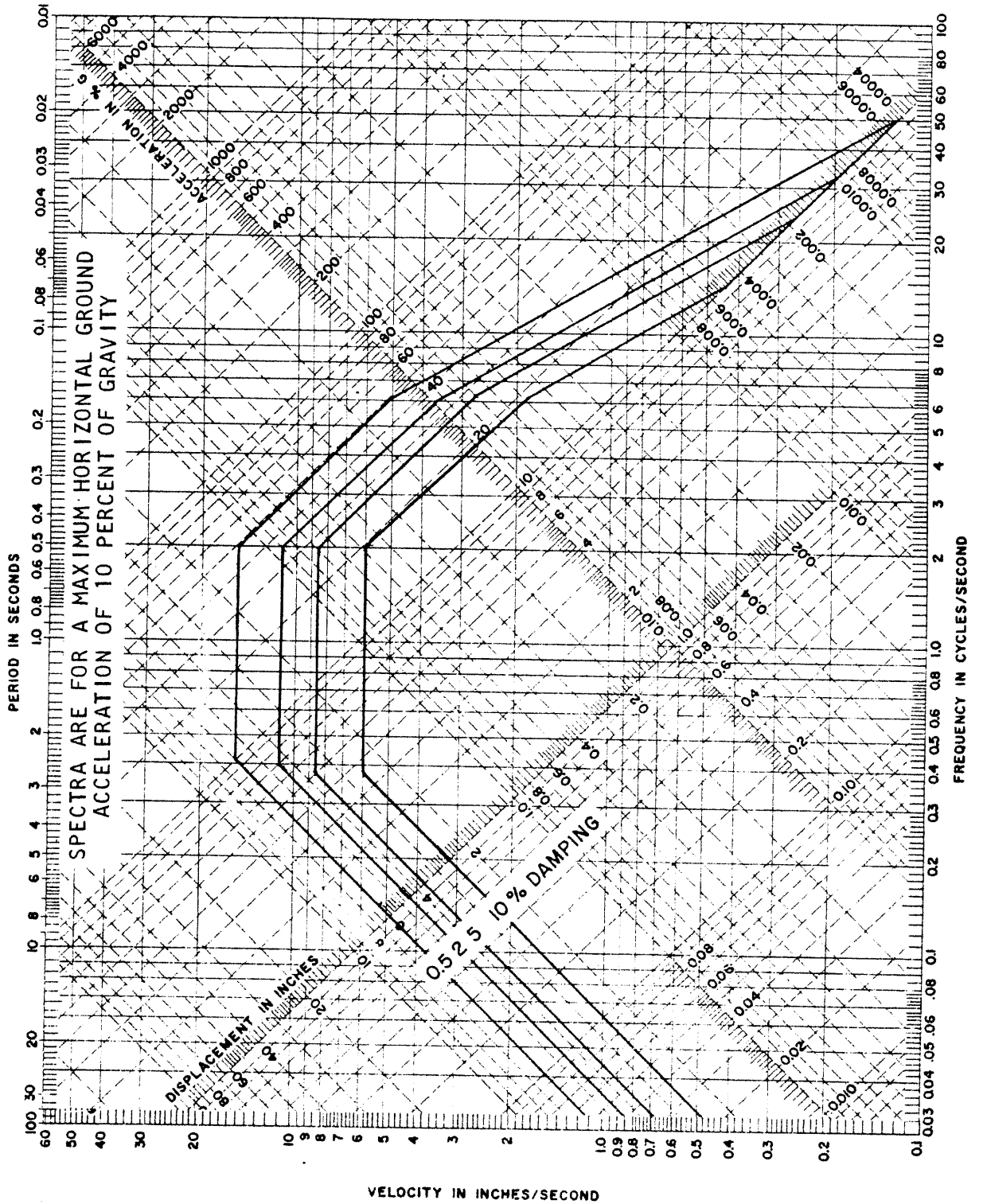

LA SALLE COUNTY STATION  
UPDATED FINAL SAFETY ANALYSIS REPORT

FIGURE 2.5-40

RESPONSE SPECTRA - OPERATING  
BASIS EARTHQUAKE

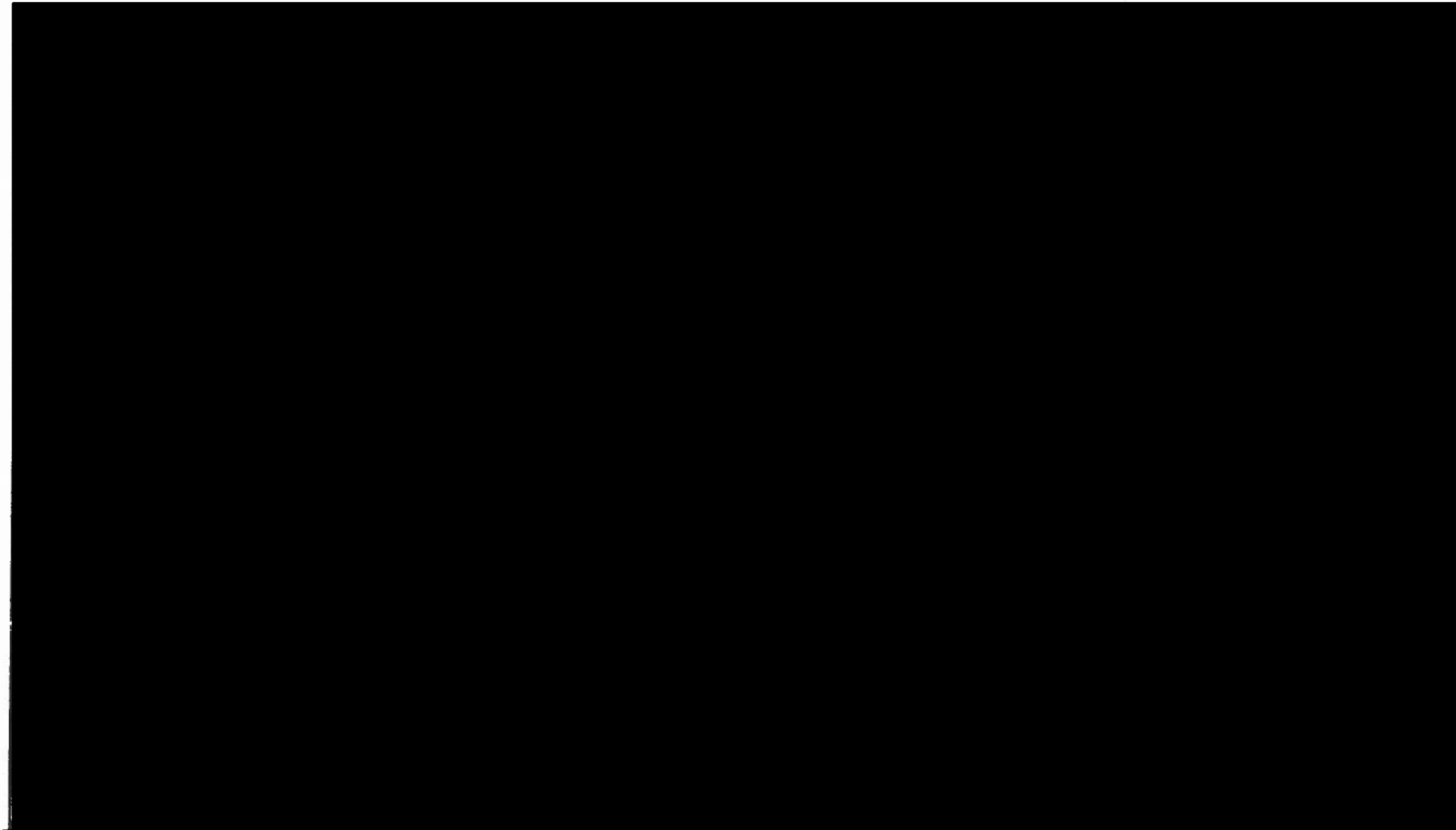

LA SALLE COUNTY STATION  
UPDATED FINAL SAFETY ANALYSIS REPORT

FIGURE 2.5-41  
GENERAL SITE PLAN

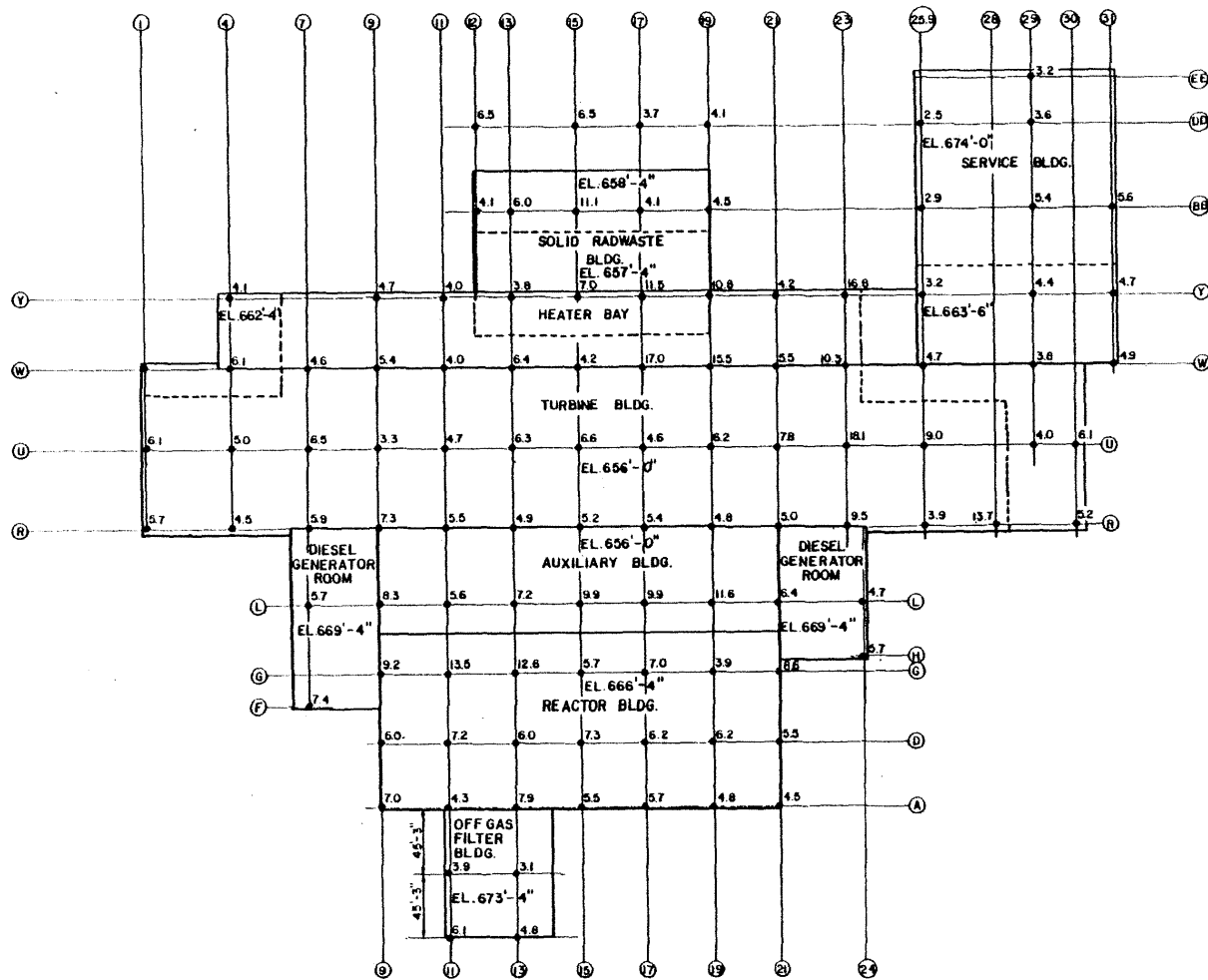

**LEGEND**

• Indicates location that unconfined compressive tests on representative Wedron silty clay till samples at the bearing elevation were performed.

5.4 Indicates unconfined compressive values in kips per square foot.

③ Column rows

EL. 674'-0" indicates bottom of mat

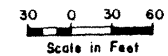

LA SALLE COUNTY STATION  
 UPDATED FINAL SAFETY ANALYSIS REPORT

FIGURE 2.5-42  
 UNCONFINED COMPRESSION TEST  
 PLOT PLAN AND DATA  
 (SHEET 1 of 2)

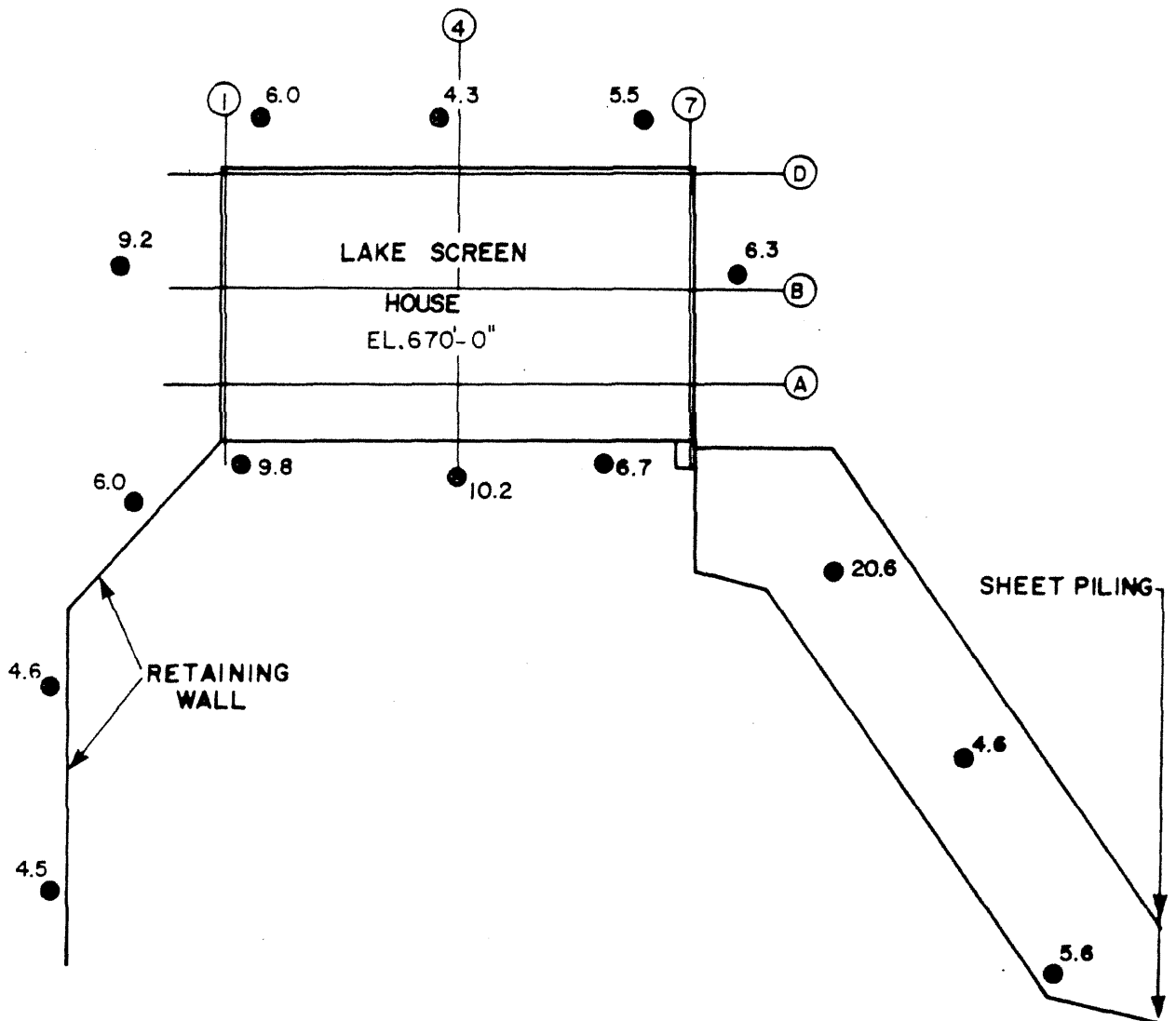

**LEGEND**

● Indicates location that unconfined compressive tests on representative Wedron silty clay till samples at the bearing elevation were performed.

5.5 Indicates unconfined compressive values in kips per square foot.

Ⓐ Column Rows

EL. 670'-0" Refers to bottom of mat elevation.

LA SALLE COUNTY STATION  
 UPDATED FINAL SAFETY ANALYSIS REPORT

FIGURE 2.5-42  
 UNCONFINED COMPRESSION TEST  
 PLOT PLAN AND DATA  
 (SHEET 2 of 2)

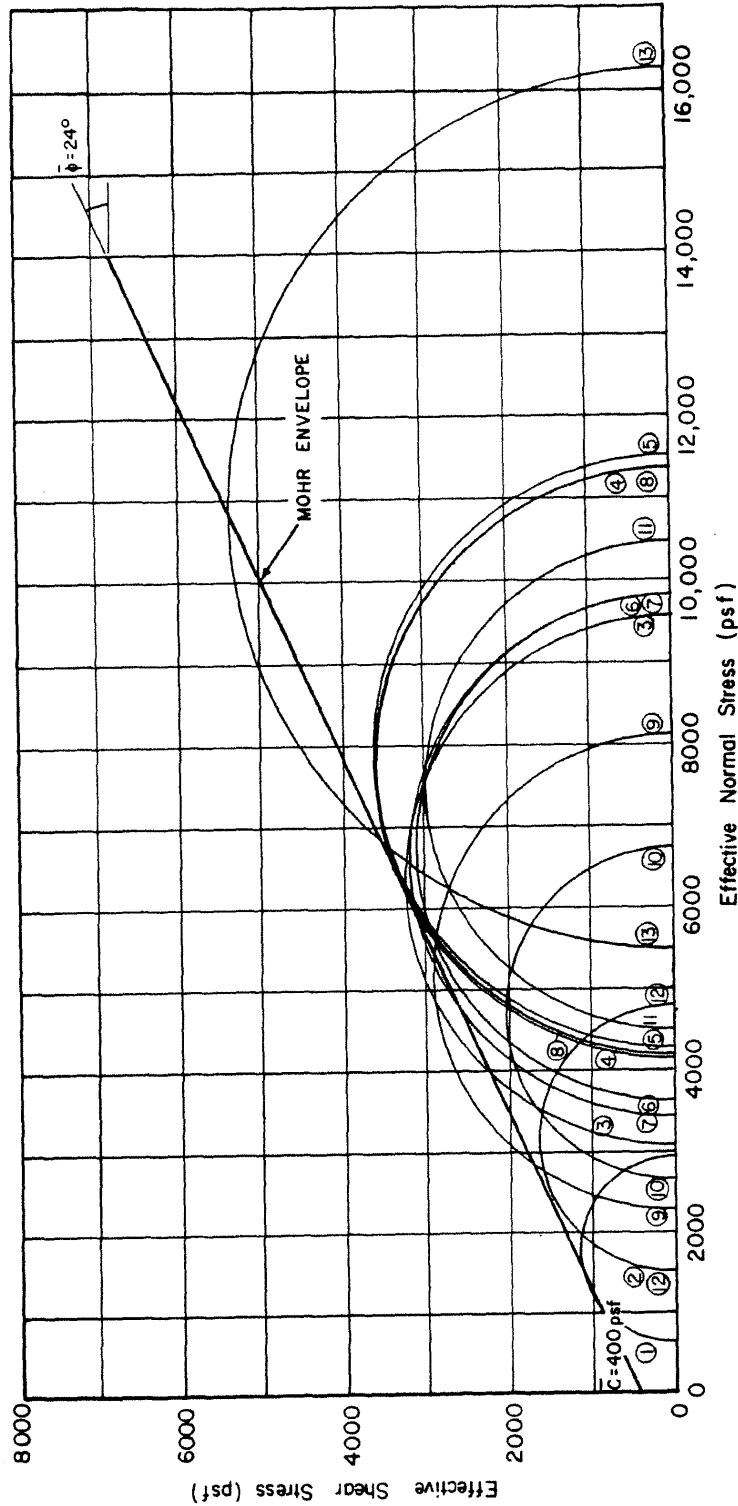

**NOTES**

1. Data obtained from 13 tests on undisturbed Wedron silty clay till.
2. ① - Key numbers correspond to samples listed in Table 2.5-39 Part A.
3. Typical stress-strain curves from triaxial tests shown on Figure 2.5-84, SH.I.

**LA SALLE COUNTY STATION**  
**UPDATED FINAL SAFETY ANALYSIS REPORT**

---

**FIGURE 2.5-43**  
**ENVELOPE OF TRIAXIAL**  
**COMPRESSION TESTS**  
**(SHEET 1 of 3)**



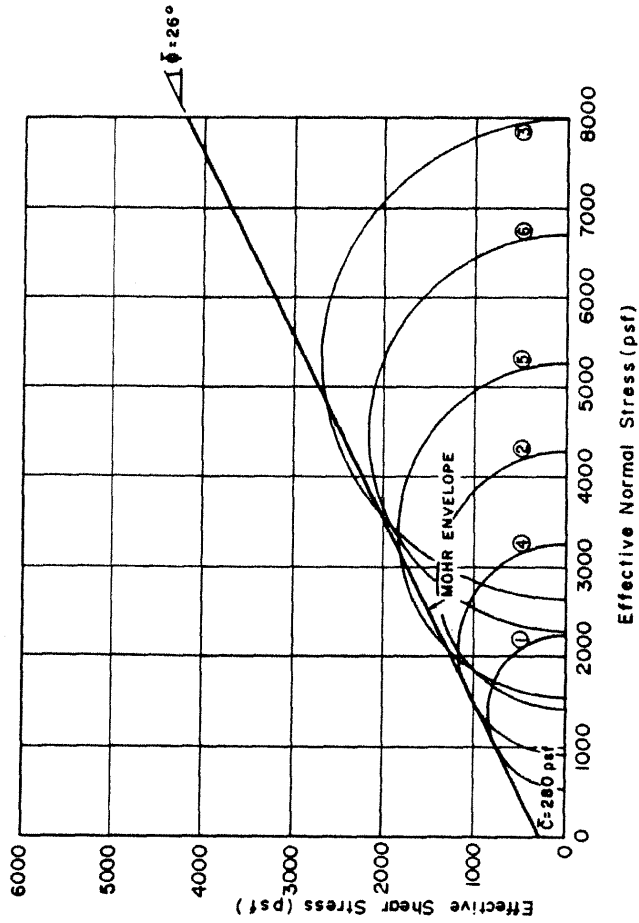

**NOTES**

1. Data obtained from 6 tests on Remolded Wedron silty clay till compacted to 95% of modified Proctor density.
2. ① - Key numbers correspond to samples listed in Table 2.5-39 Part B.
3. Typical stress-strain curves from triaxial tests shown on Figure 2.5-84, SH. 2.

**LA SALLE COUNTY STATION**  
 UPDATED FINAL SAFETY ANALYSIS REPORT  
  
**FIGURE 2.5-43**  
**ENVELOPE OF TRIAXIAL**  
**COMPRESSION TESTS**  
 (SHEET 2 of 3)

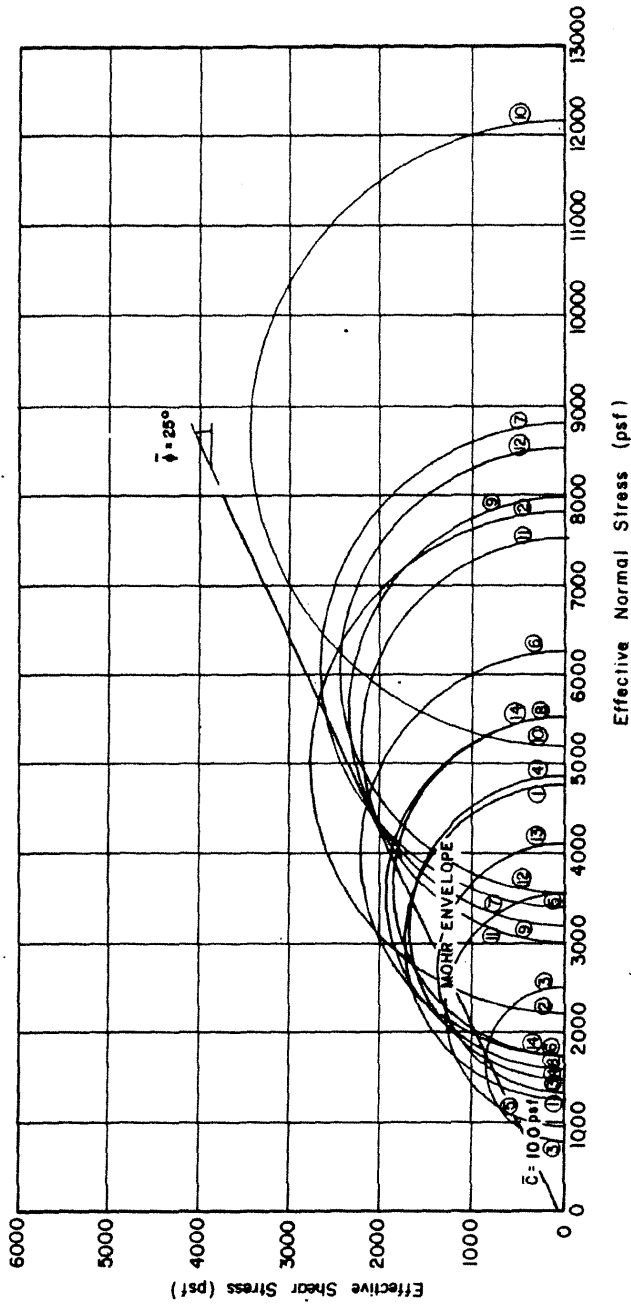

**NOTES**

1. Data obtained from 14 tests on Remolded Wedron silty clay till compacted to 90% of modified Proctor density.
2. ①- Key numbers correspond to samples listed in Table 2.5-39 Part C.
3. Typical stress-strain curves from triaxial tests shown on Figure 2.5-64, SH.3.

**LA SALLE COUNTY STATION**  
 UPDATED FINAL SAFETY ANALYSIS REPORT  
  
 FIGURE 2.5-43  
 ENVELOPE OF TRIAXIAL  
 COMPRESSION TESTS  
 (SHEET 3 of 3)

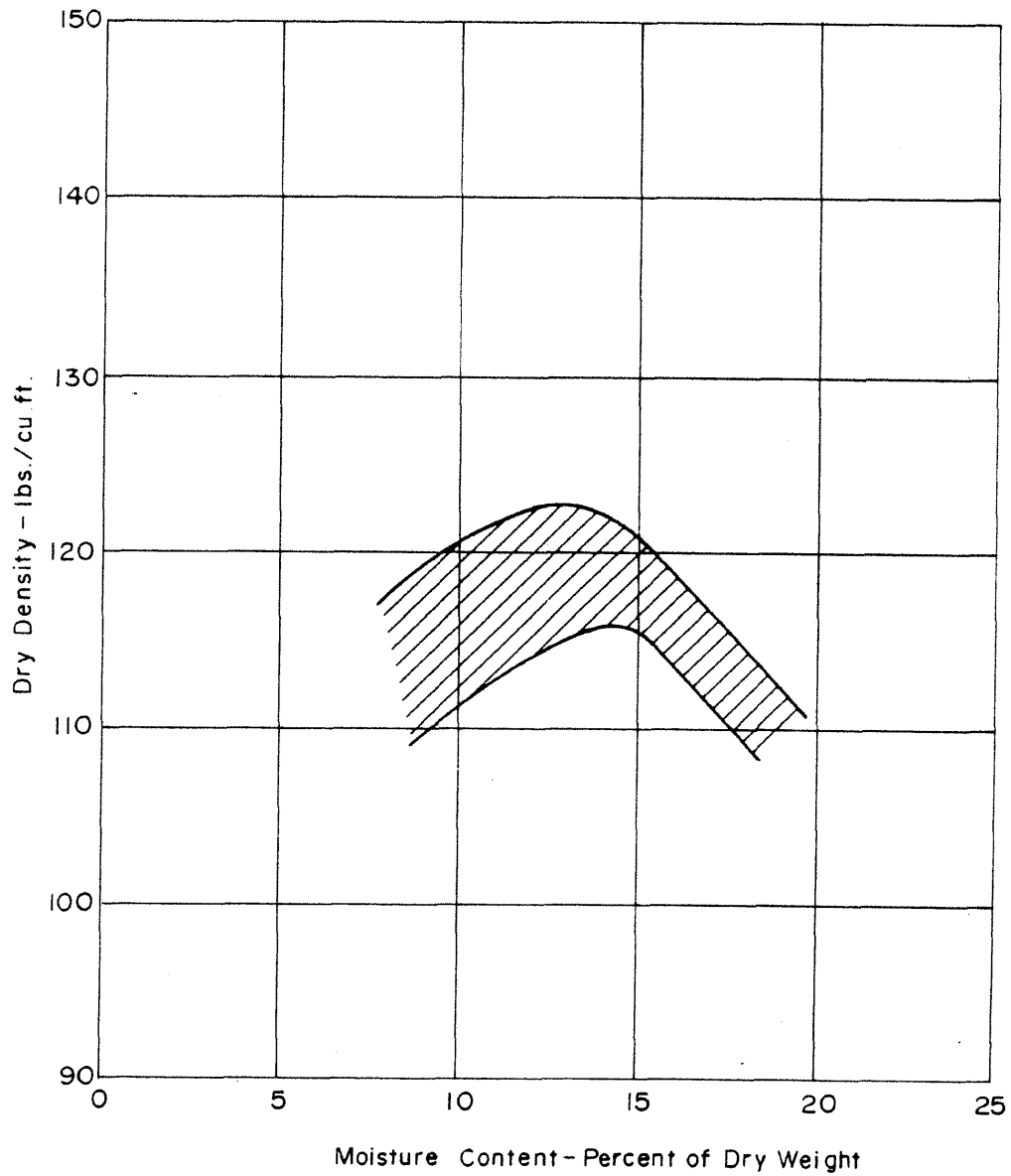

**NOTE**

1. Data obtained from 243 tests.
2. Wedron silty clay till compacted to modified Proctor density.

**LA SALLE COUNTY STATION  
UPDATED FINAL SAFETY ANALYSIS REPORT**

**FIGURE 2.5-44  
ENVELOPE OF COMPACTION TESTS**

**(SHEET 1 of 3)**

**REV. 0 - APRIL 1984**

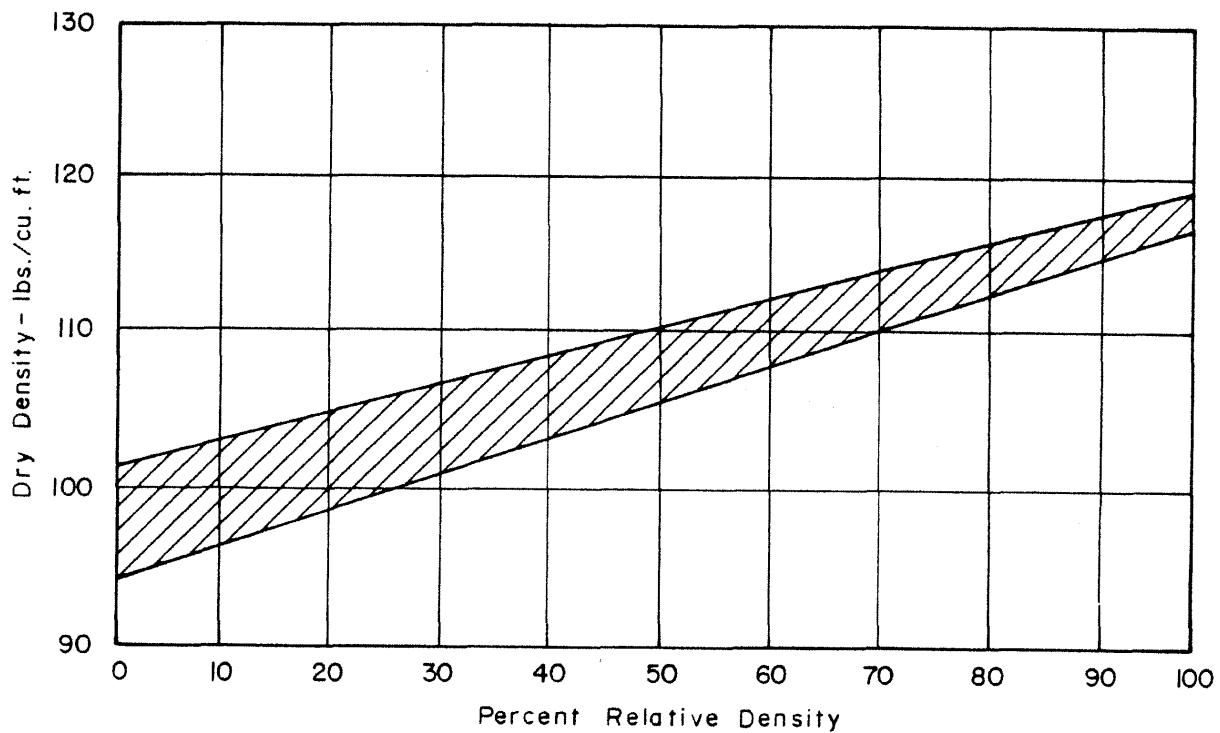

**NOTE**

1. Data obtained from 8 tests.
2. Ticona Valley fill densified to relative density.

LA SALLE COUNTY STATION  
 UPDATED FINAL SAFETY ANALYSIS REPORT

FIGURE 2.5-44  
 ENVELOPE OF COMPACTION TESTS  
 (SHEET 2 of 3)

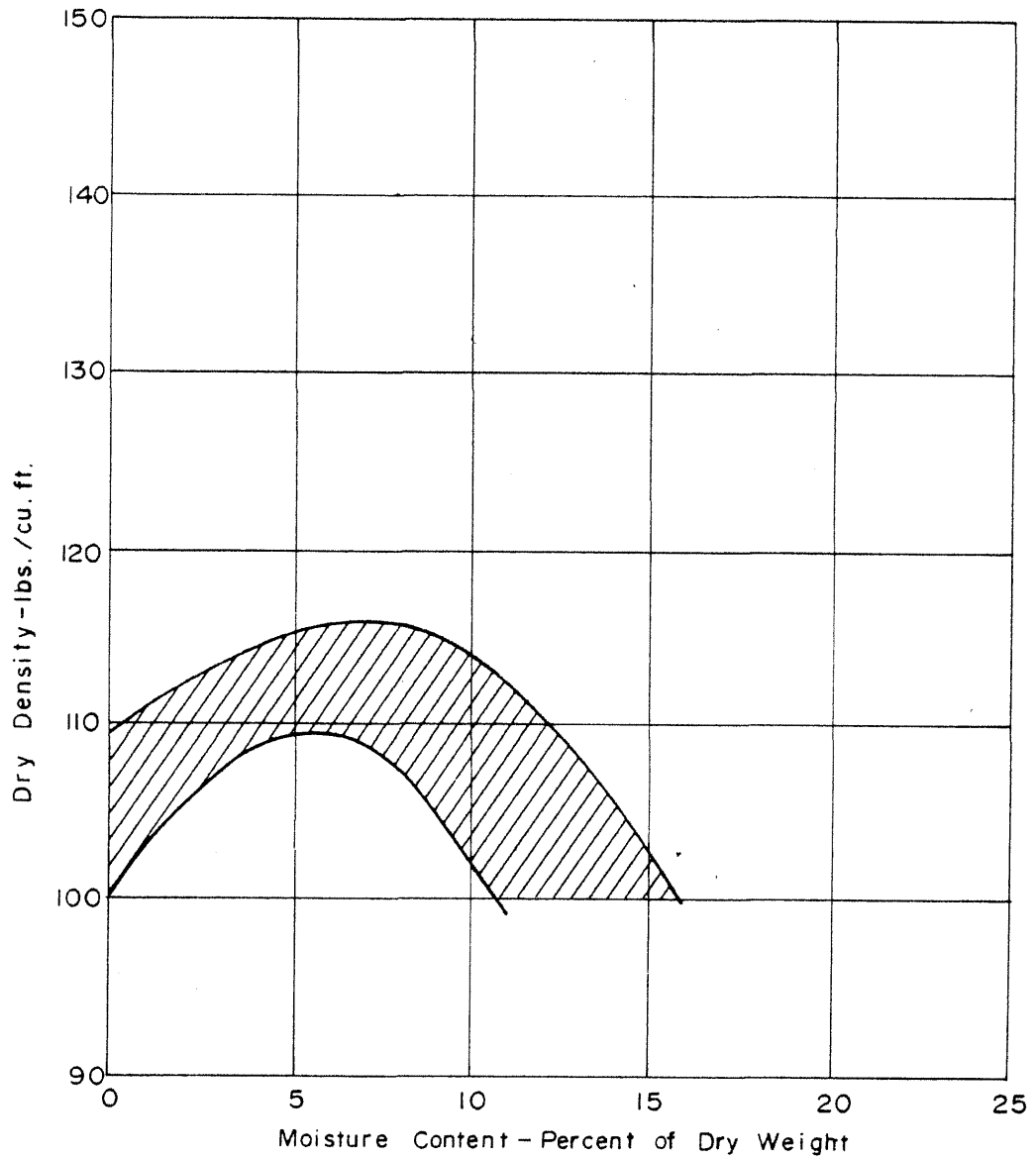

**NOTE**

1. Data obtained from 10 tests.
2. Sand drainage blanket material compacted to modified Proctor density.

**LA SALLE COUNTY STATION  
UPDATED FINAL SAFETY ANALYSIS REPORT**

**FIGURE 2.5-44  
ENVELOPE OF COMPACTION TESTS  
(SHEET 3 of 3)**

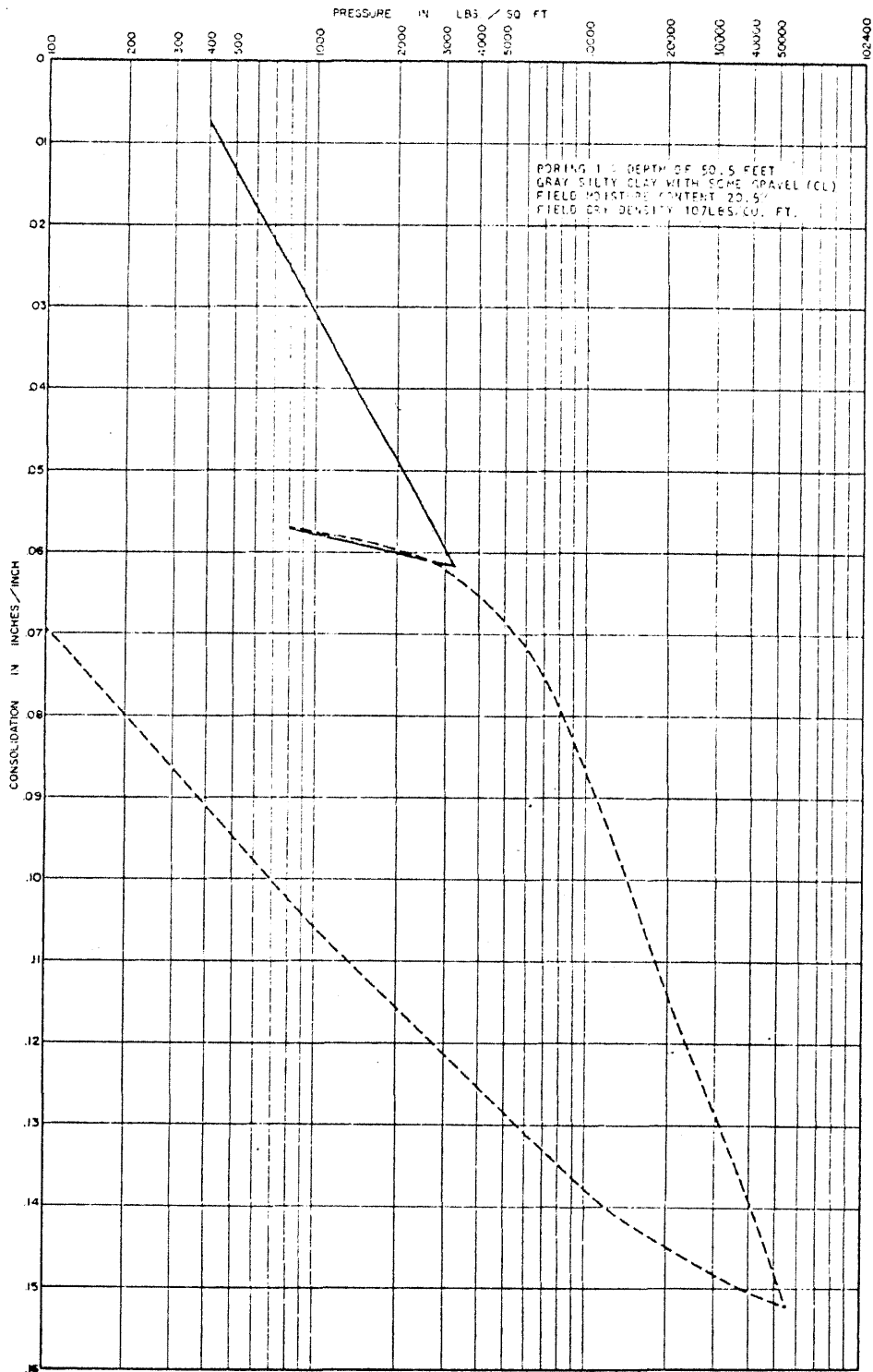

**LA SALLE COUNTY STATION**  
 UPDATED FINAL SAFETY ANALYSIS REPORT

FIGURE 2.5-45  
 CONSOLIDATION TEST DATA  
 (SHEET 1)

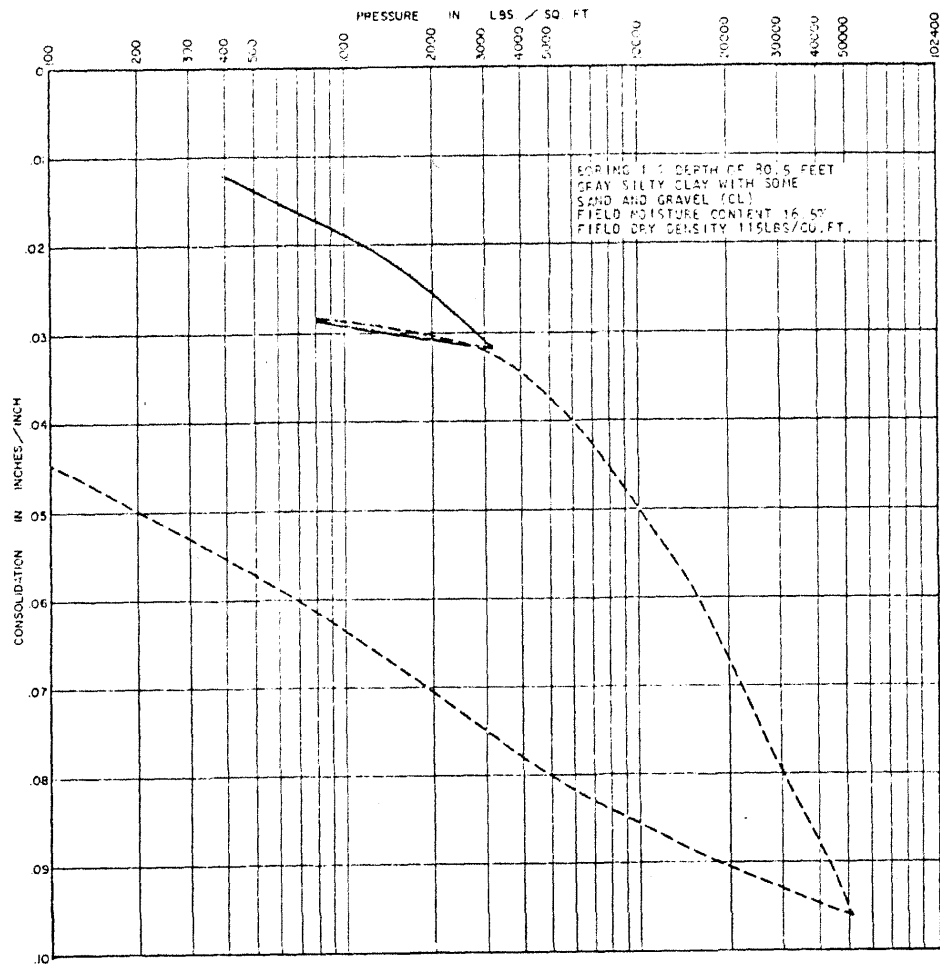

**LA SALLE COUNTY STATION**  
 UPDATED FINAL SAFETY ANALYSIS REPORT

FIGURE 2.5-45  
 CONSOLIDATION TEST DATA  
 (SHEET 2)

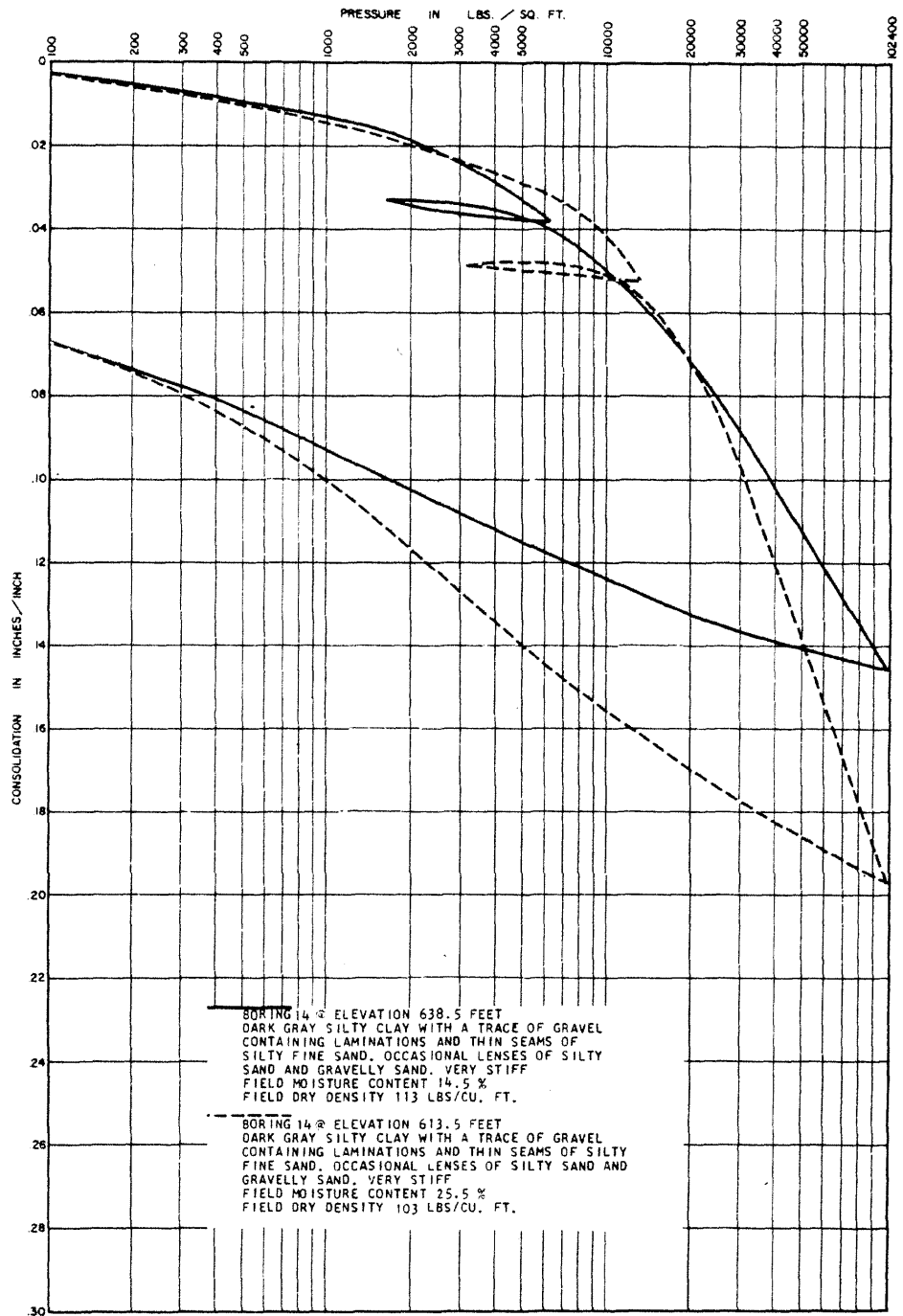

**LA SALLE COUNTY STATION**  
 UPDATED FINAL SAFETY ANALYSIS REPORT

FIGURE 2.5-45  
 CONSOLIDATION TEST DATA  
 (SHEET 3)



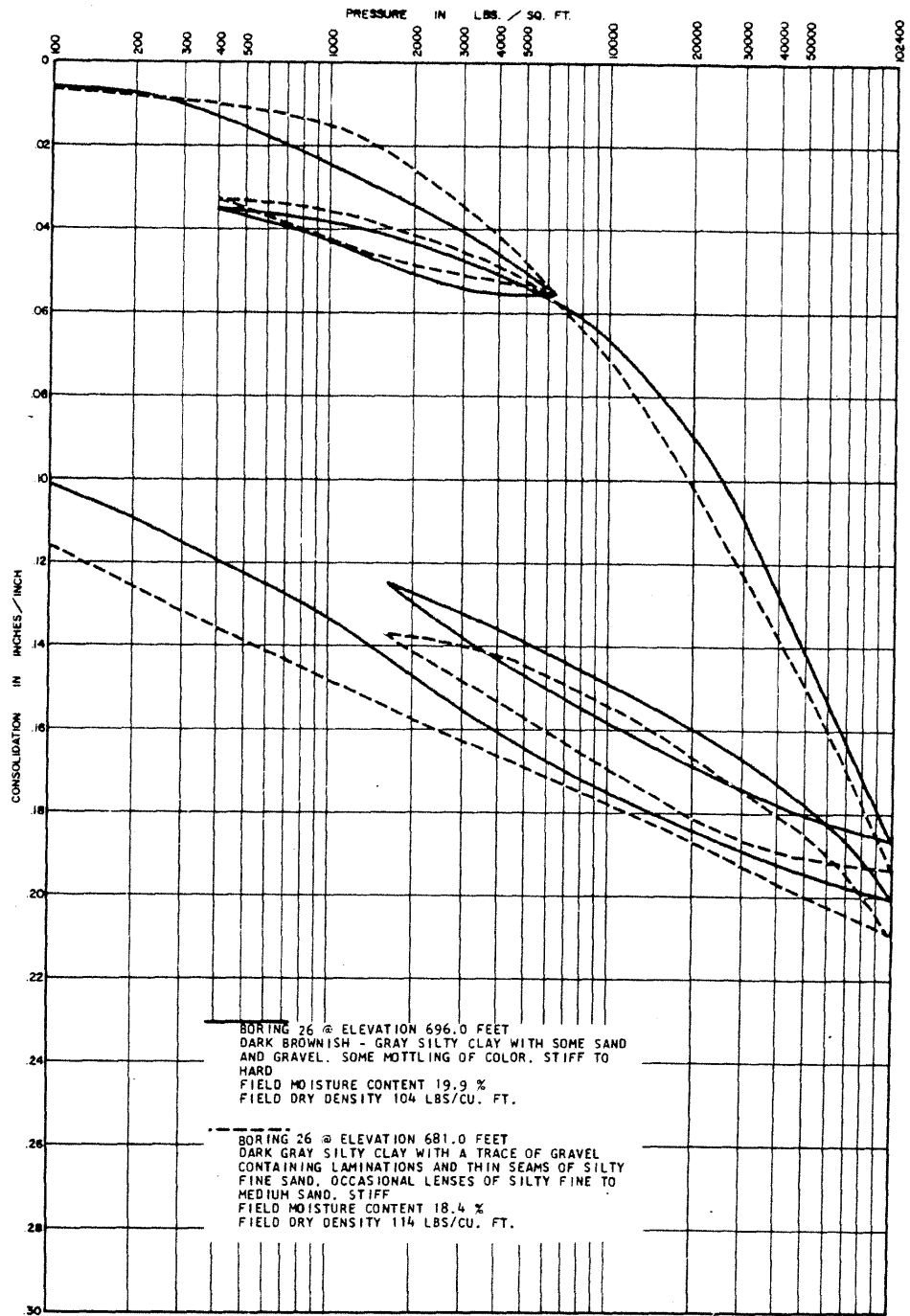

**LA SALLE COUNTY STATION**  
 UPDATED FINAL SAFETY ANALYSIS REPORT

---

FIGURE 2.5-45  
 CONSOLIDATION TEST DATA  
 (SHEET 4)

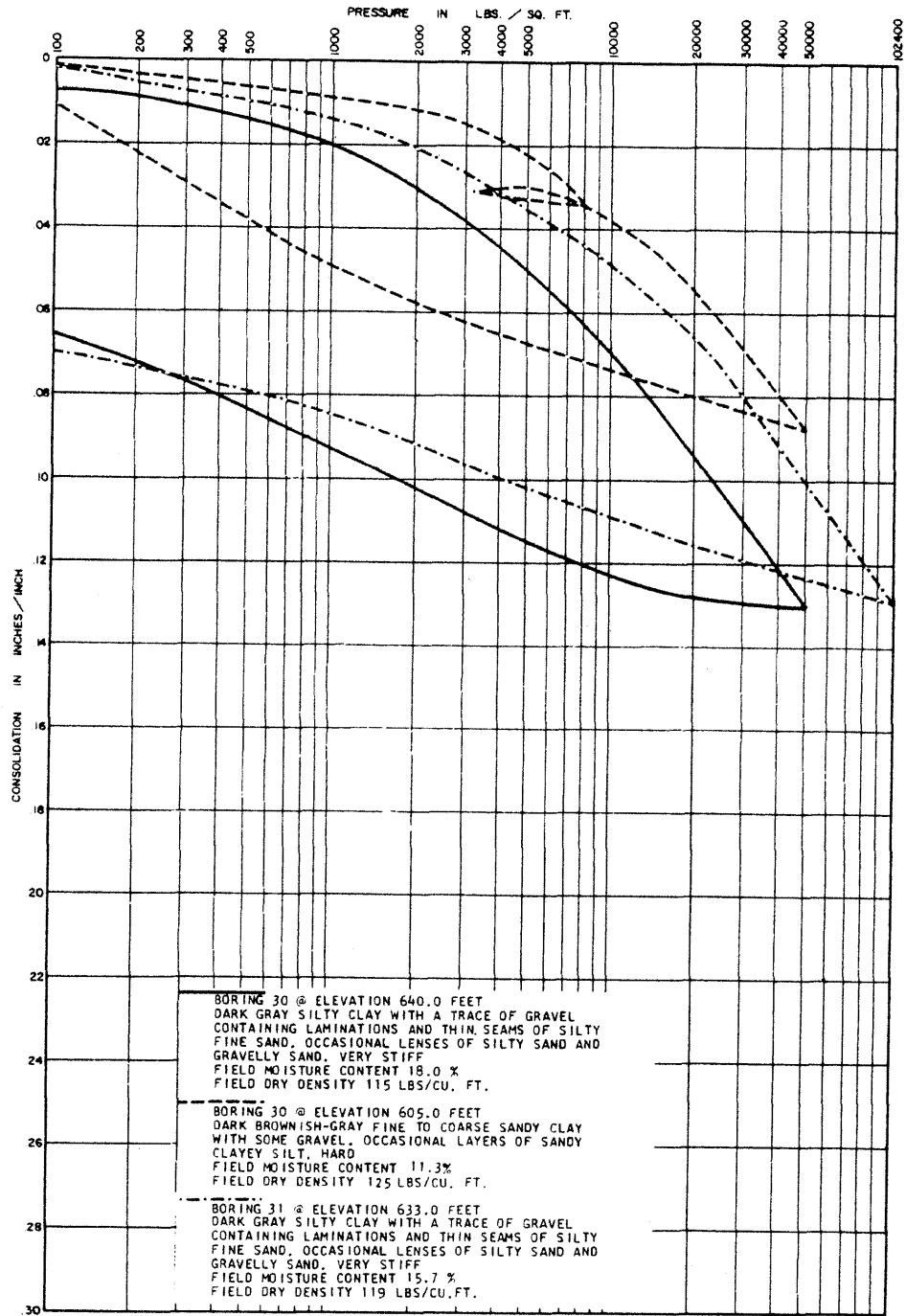

**LA SALLE COUNTY STATION**  
 UPDATED FINAL SAFETY ANALYSIS REPORT

FIGURE 2.5-45  
 CONSOLIDATION TEST DATA  
 (SHEET 5)

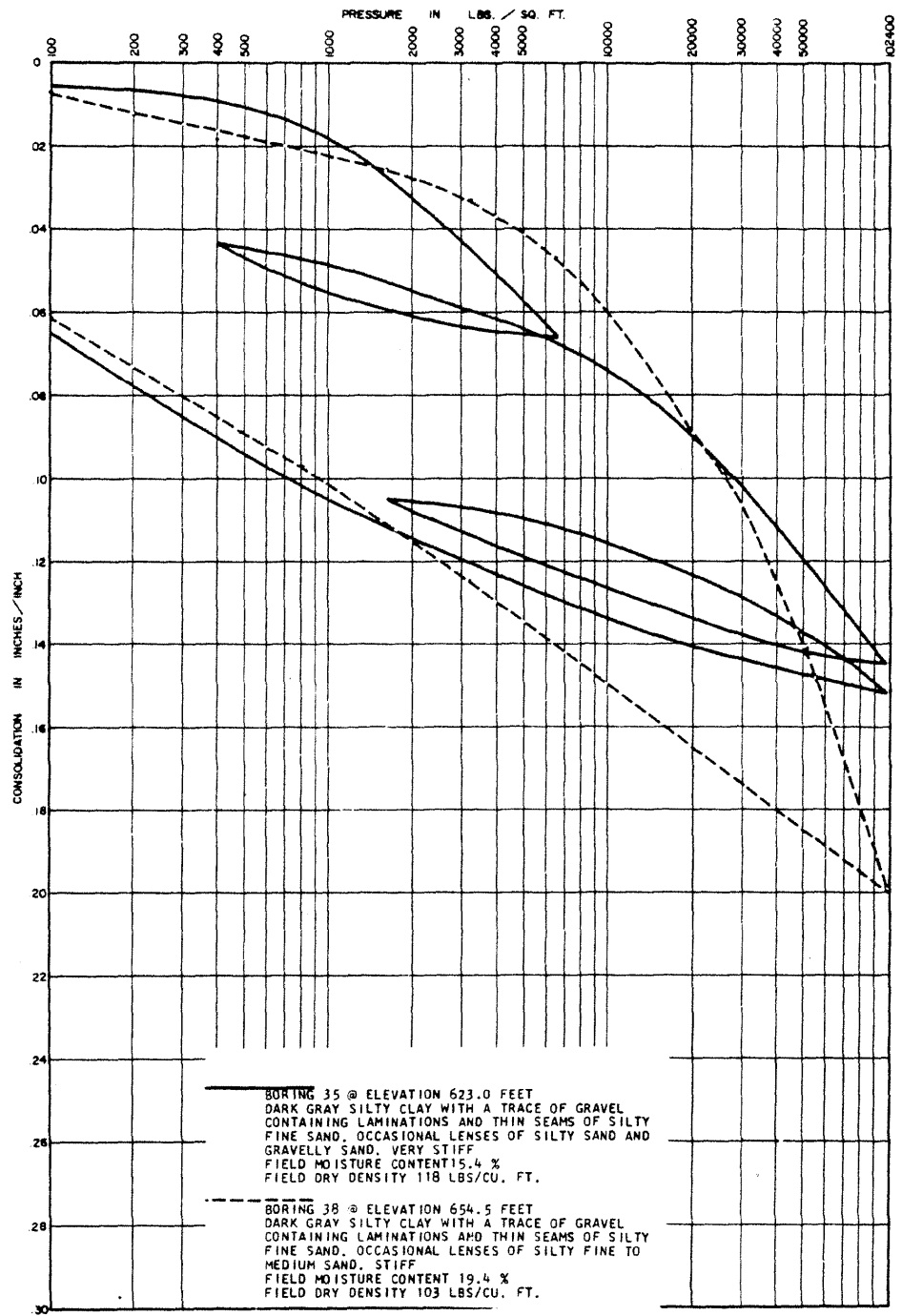

**LA SALLE COUNTY STATION**  
 UPDATED FINAL SAFETY ANALYSIS REPORT

---

FIGURE 2.5-45  
 CONSOLIDATION TEST DATA  
 (SHEET 6)

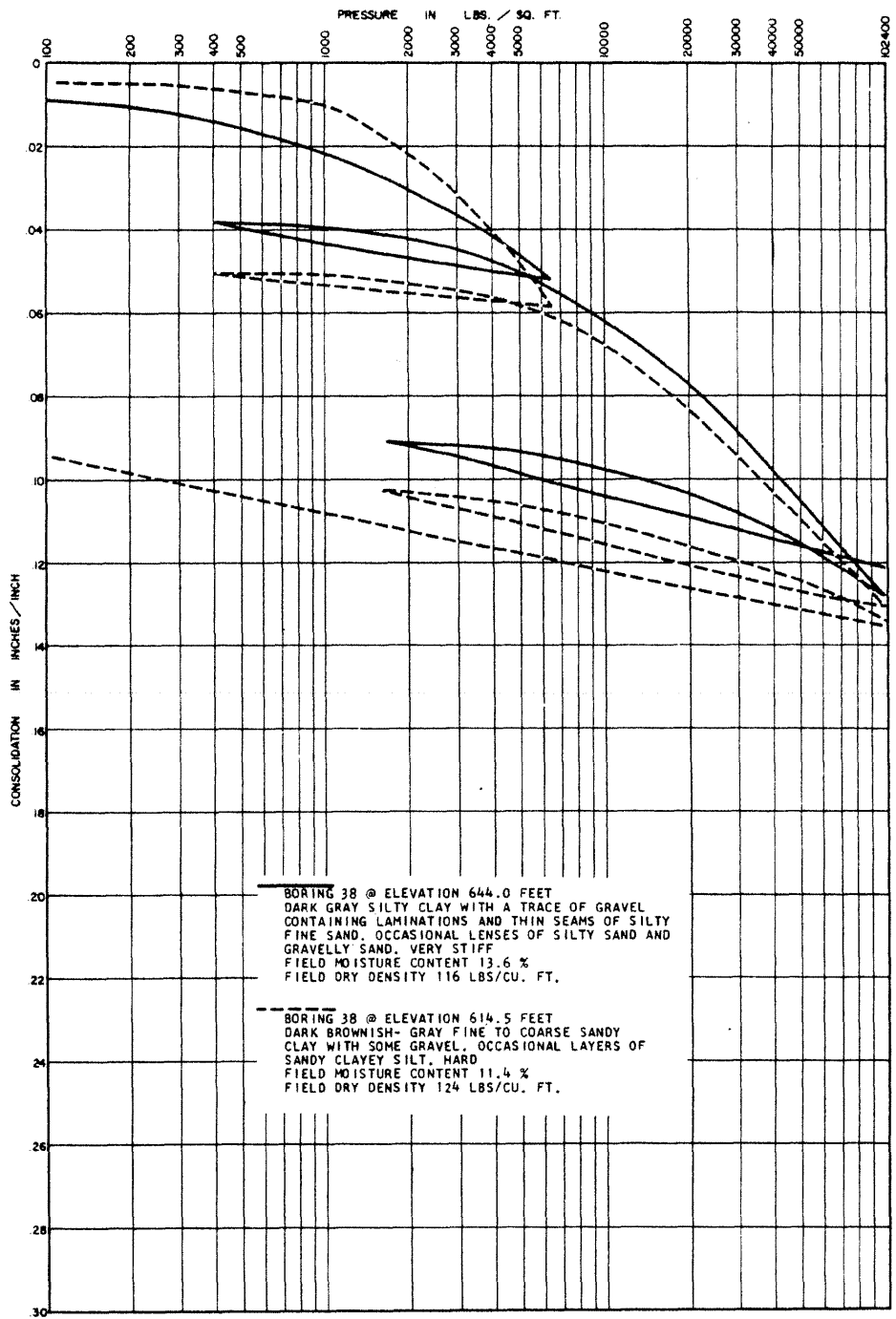

**LA SALLE COUNTY STATION**  
 UPDATED FINAL SAFETY ANALYSIS REPORT

FIGURE 2.5-45  
 CONSOLIDATION TEST DATA  
 (SHEET 7)

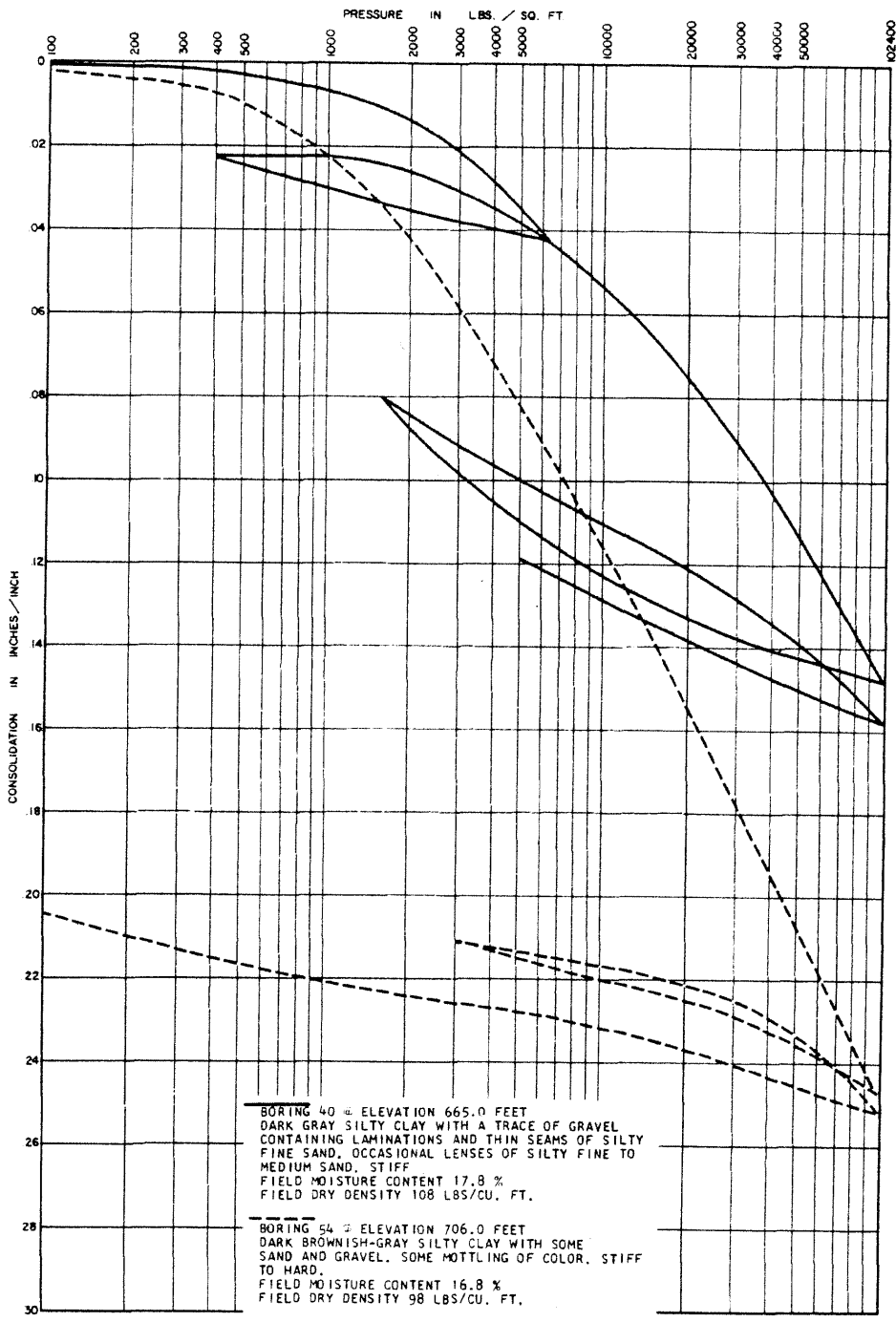

**LA SALLE COUNTY STATION**  
 UPDATED FINAL SAFETY ANALYSIS REPORT

---

FIGURE 2.5-45  
 CONSOLIDATION TEST DATA  
 (SHEET 8)

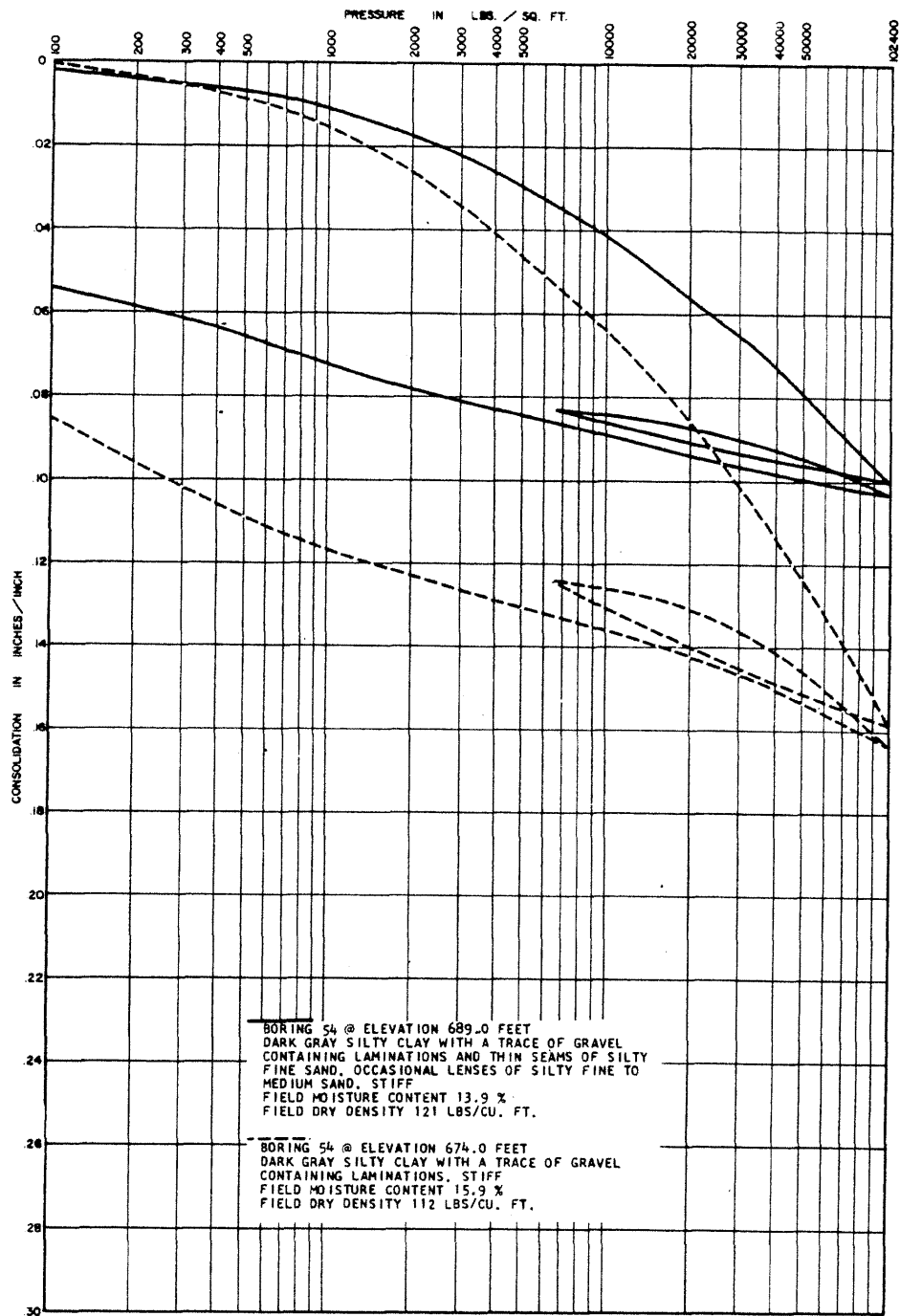

**LA SALLE COUNTY STATION**  
**UPDATED FINAL SAFETY ANALYSIS REPORT**

FIGURE 2.5-45  
 CONSOLIDATION TEST DATA  
 (SHEET 9)

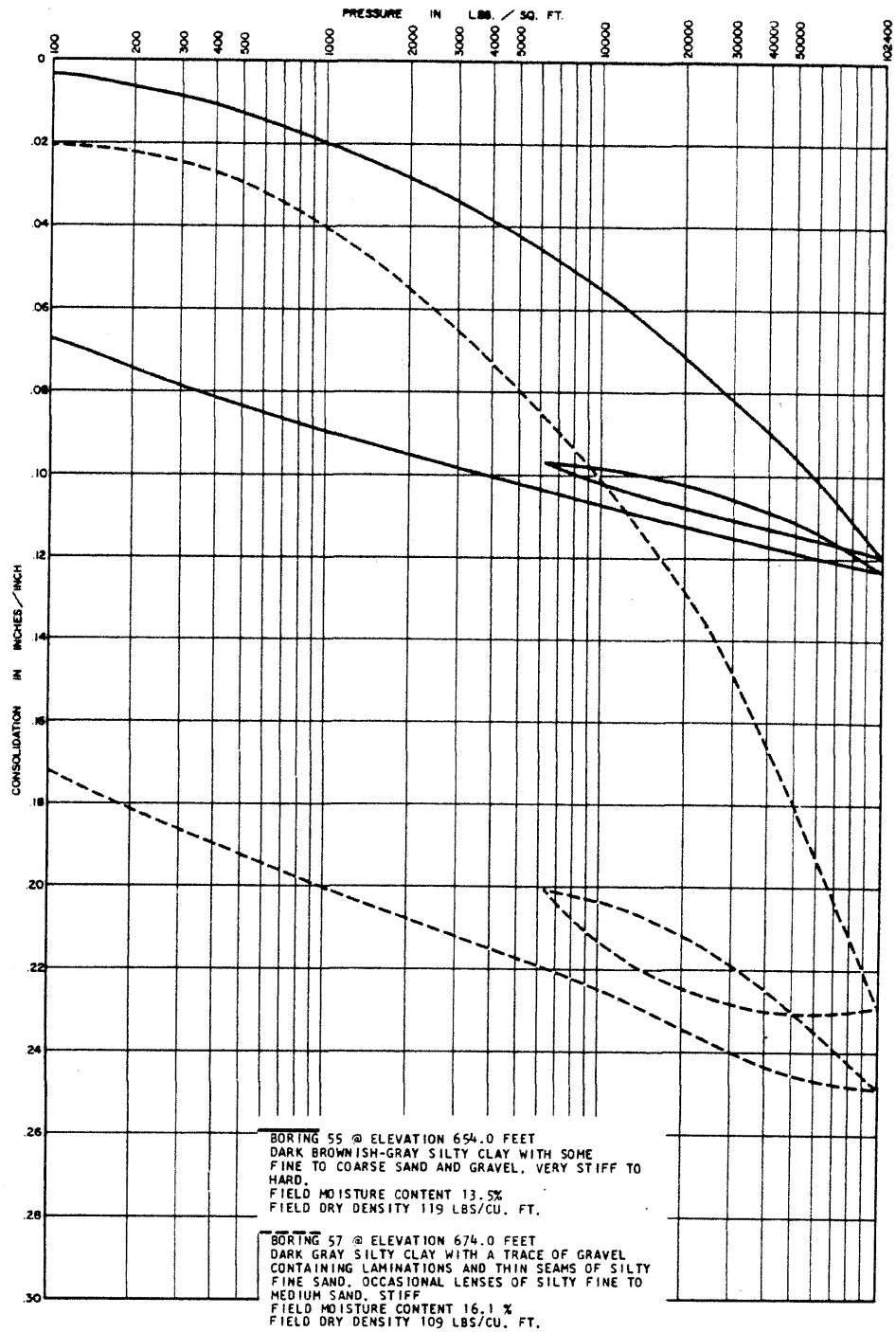

**LA SALLE COUNTY STATION**  
 UPDATED FINAL SAFETY ANALYSIS REPORT

FIGURE 2.5-45  
 CONSOLIDATION TEST DATA  
 (SHEET 10)

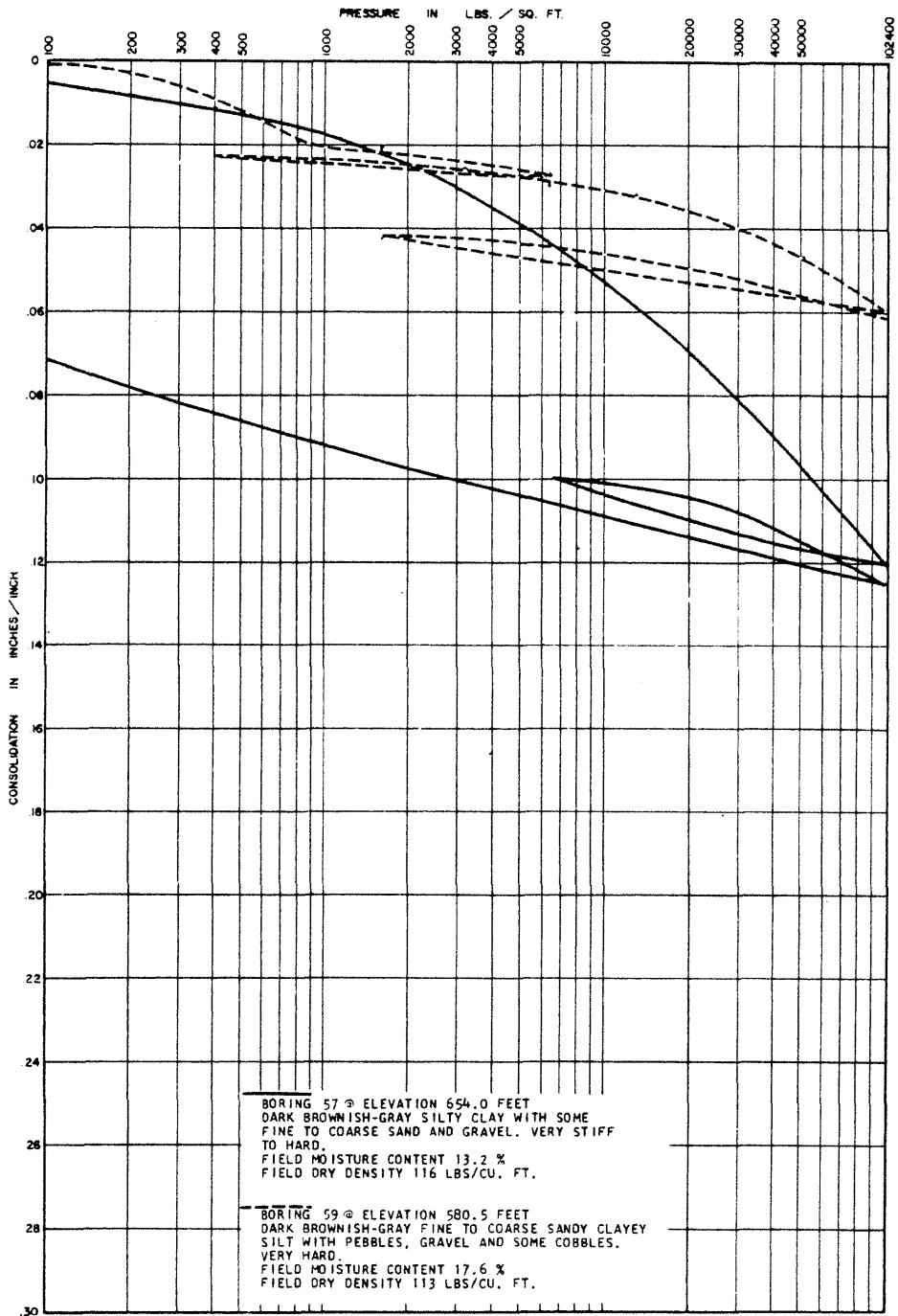

**LA SALLE COUNTY STATION**  
 UPDATED FINAL SAFETY ANALYSIS REPORT

FIGURE 2.5-45  
 CONSOLIDATION TEST DATA  
 (SHEET 11)



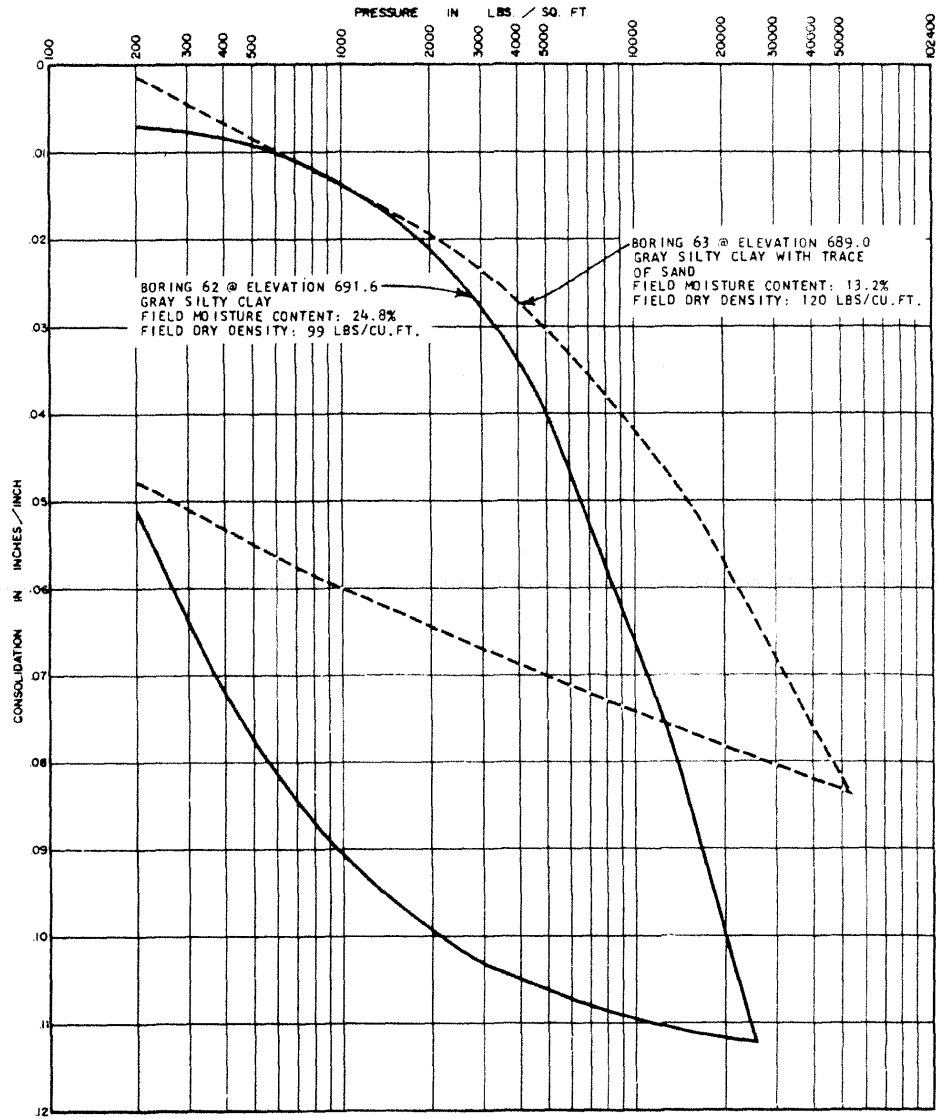

**LA SALLE COUNTY STATION**  
 UPDATED FINAL SAFETY ANALYSIS REPORT

FIGURE 2.5-45  
 CONSOLIDATION TEST DATA  
 (SHEET 12)

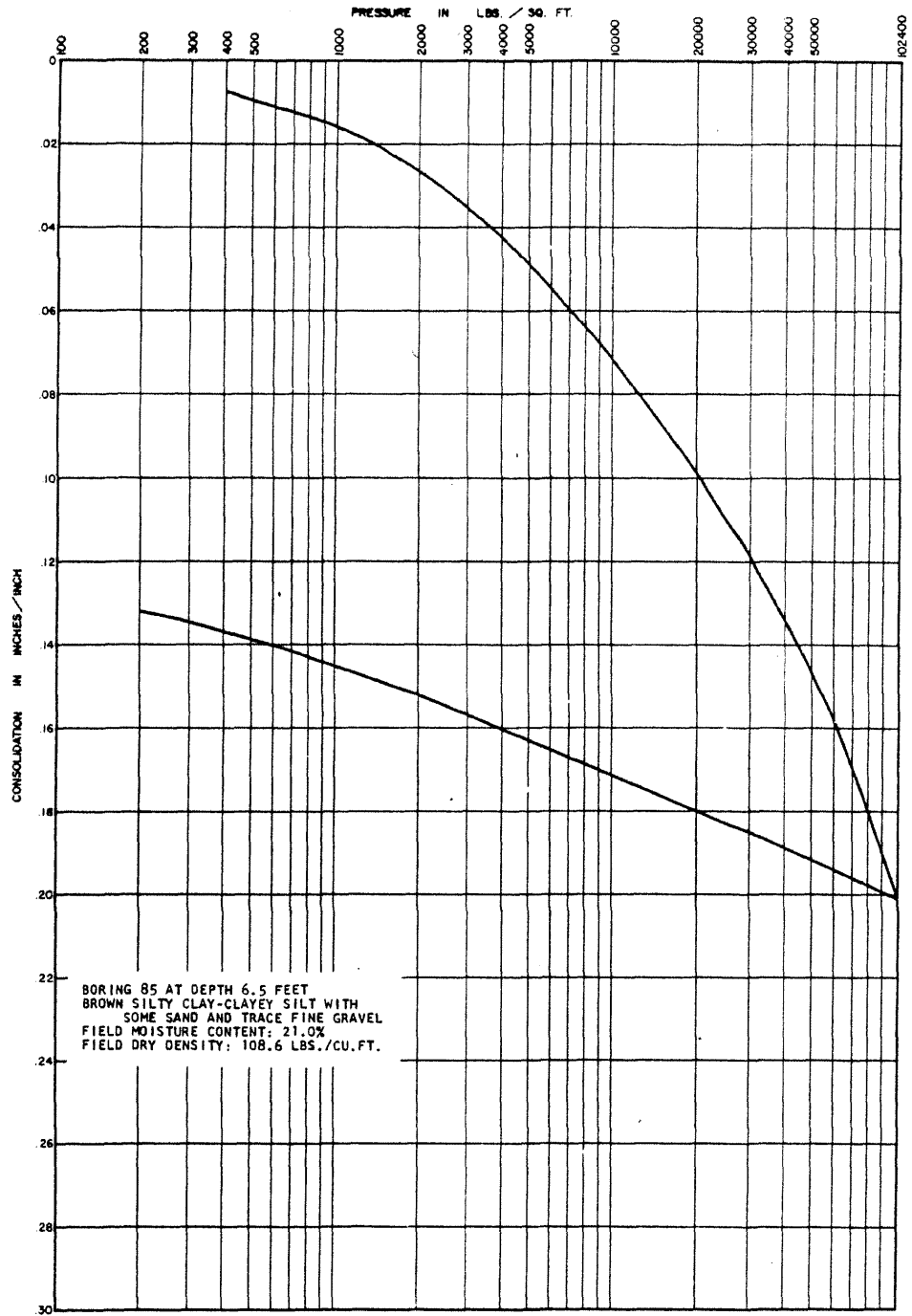

**LA SALLE COUNTY STATION**  
 UPDATED FINAL SAFETY ANALYSIS REPORT

FIGURE 2.5-45  
 CONSOLIDATION TEST DATA  
 (SHEET 13)

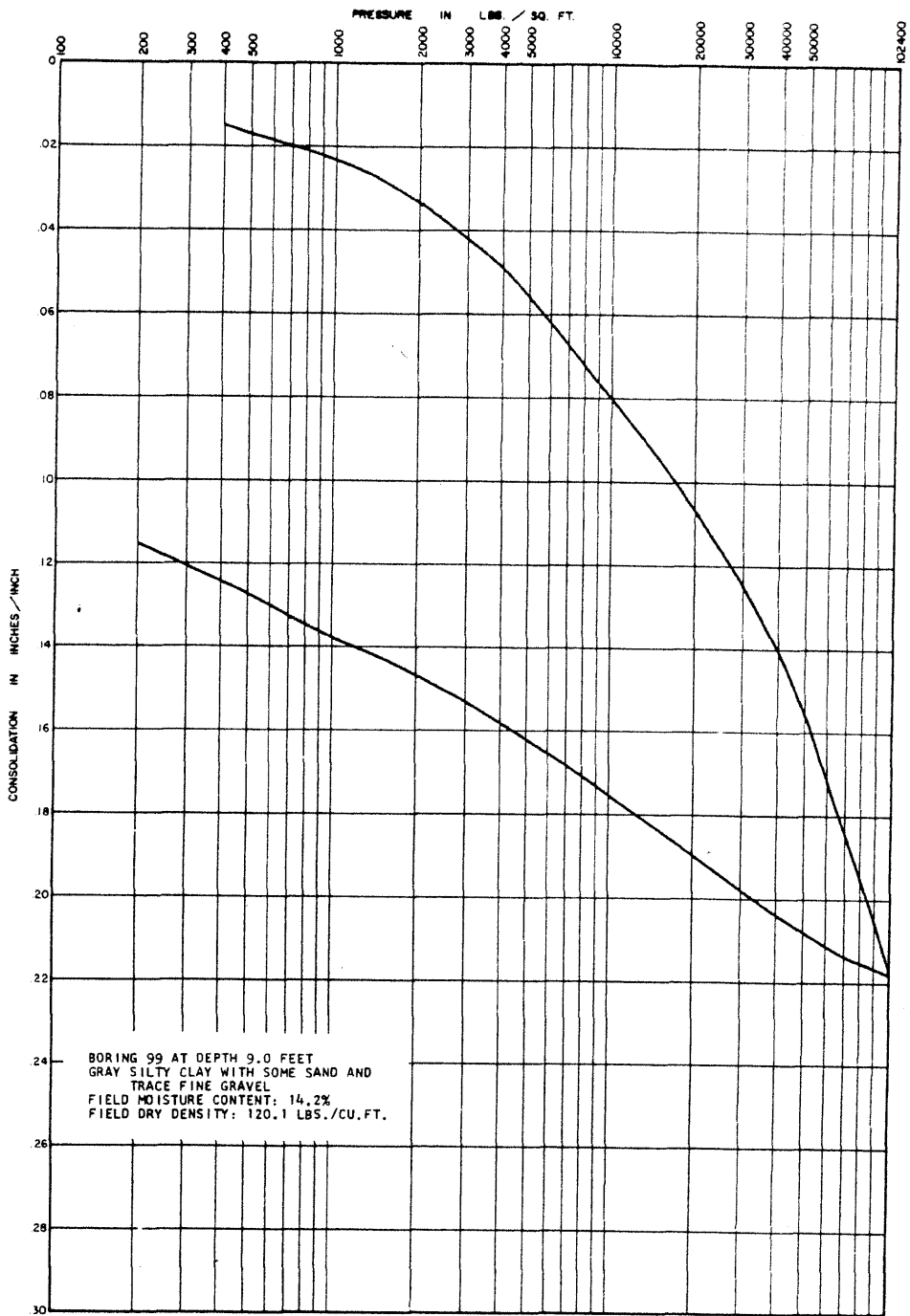

**LA SALLE COUNTY STATION**  
 UPDATED FINAL SAFETY ANALYSIS REPORT

FIGURE 2.5-45  
 CONSOLIDATION TEST DATA  
 (SHEET 14)

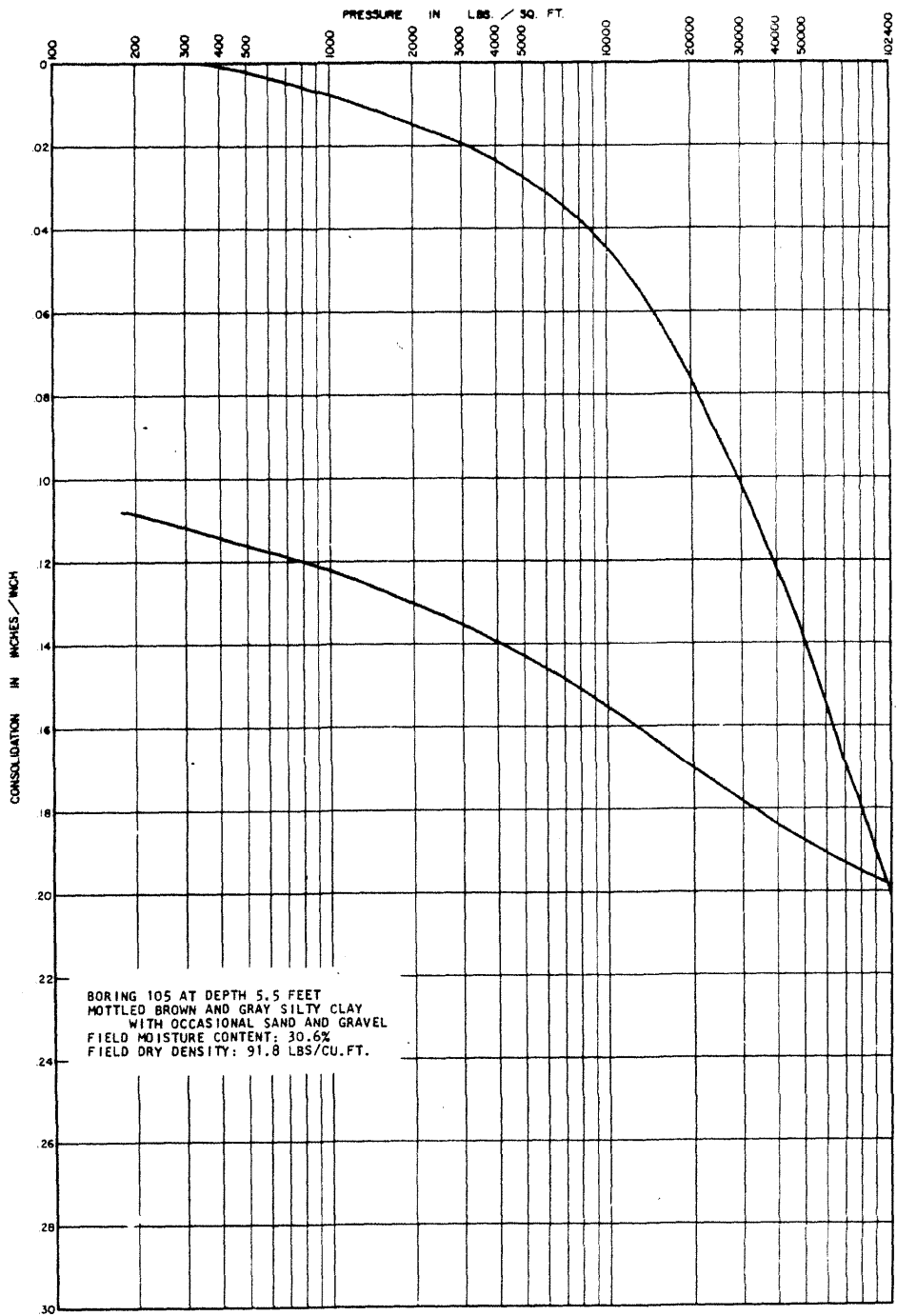

**LA SALLE COUNTY STATION**  
 UPDATED FINAL SAFETY ANALYSIS REPORT

FIGURE 2.5-45

CONSOLIDATION TEST DATA  
 (SHEET 15)

REV. 0 - APRIL 1984

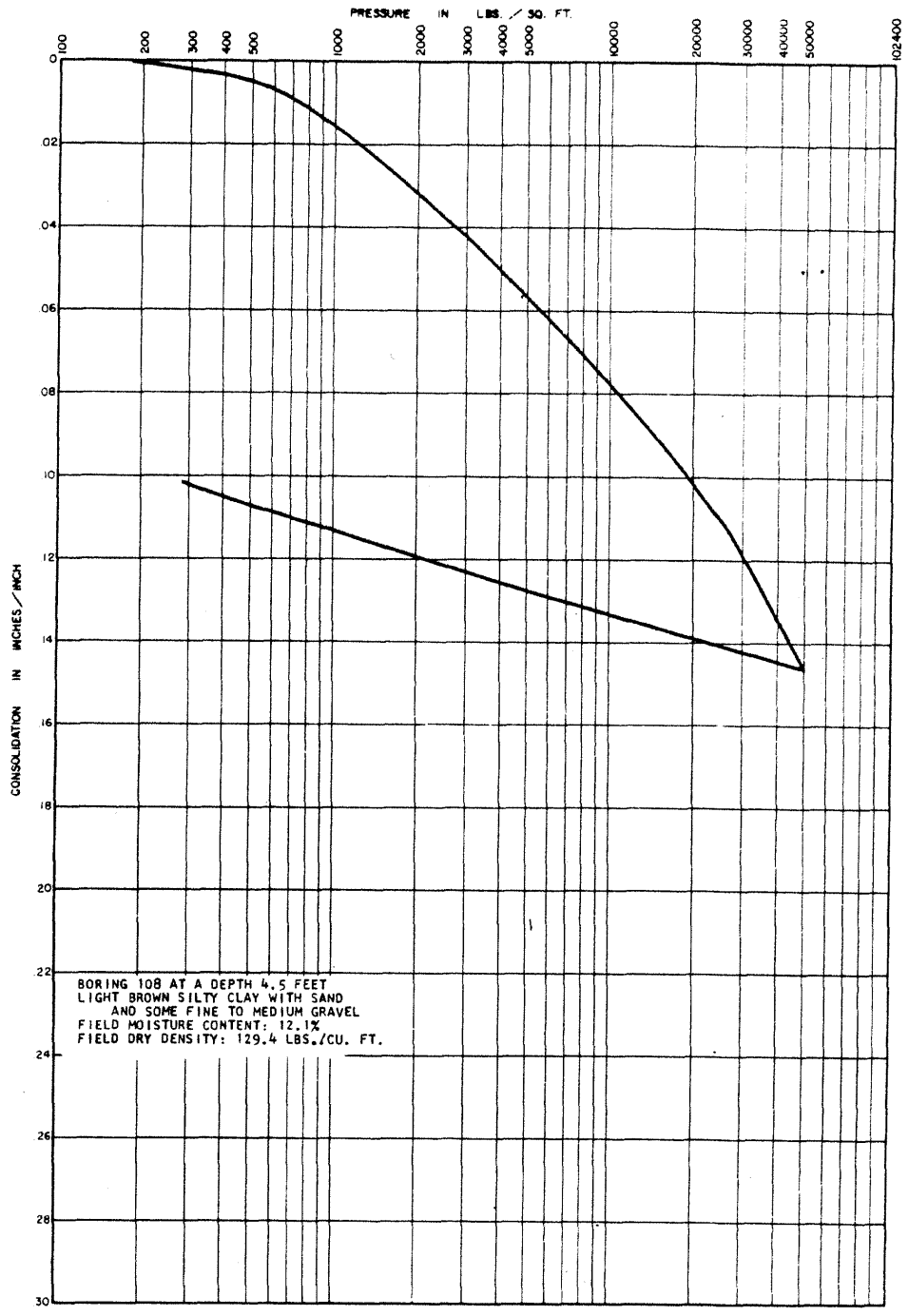

**LA SALLE COUNTY STATION**  
 UPDATED FINAL SAFETY ANALYSIS REPORT

---

FIGURE 2.5-45  
 CONSOLIDATION TEST DATA  
 (SHEET 16)

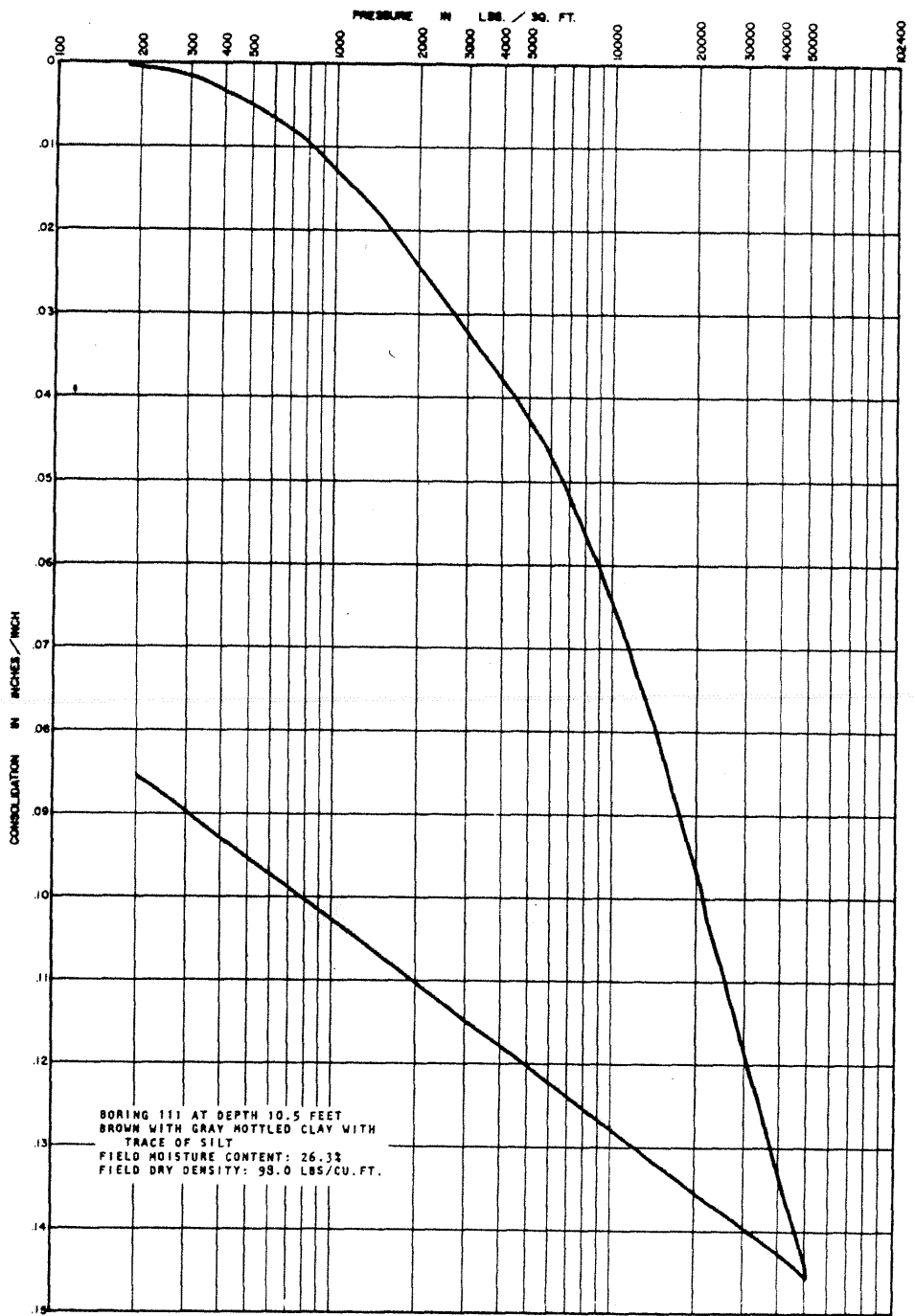

**LA SALLE COUNTY STATION**  
 UPDATED FINAL SAFETY ANALYSIS REPORT

---

FIGURE 2.5-45  
 CONSOLIDATION TEST DATA  
 (SHEET 17)

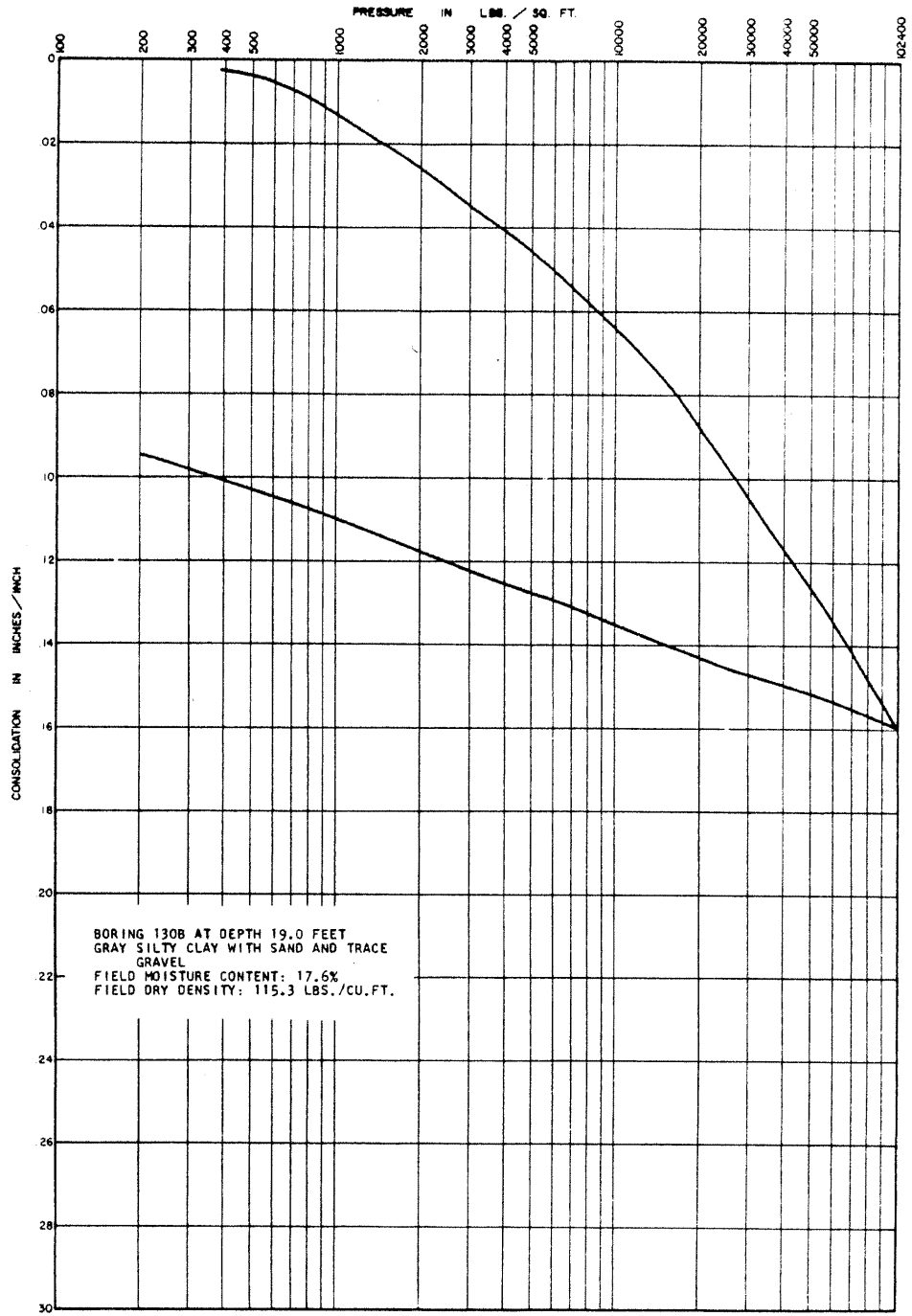

**LA SALLE COUNTY STATION**  
 UPDATED FINAL SAFETY ANALYSIS REPORT

---

FIGURE 2.5-45  
 CONSOLIDATION TEST DATA  
 (SHEET 18)

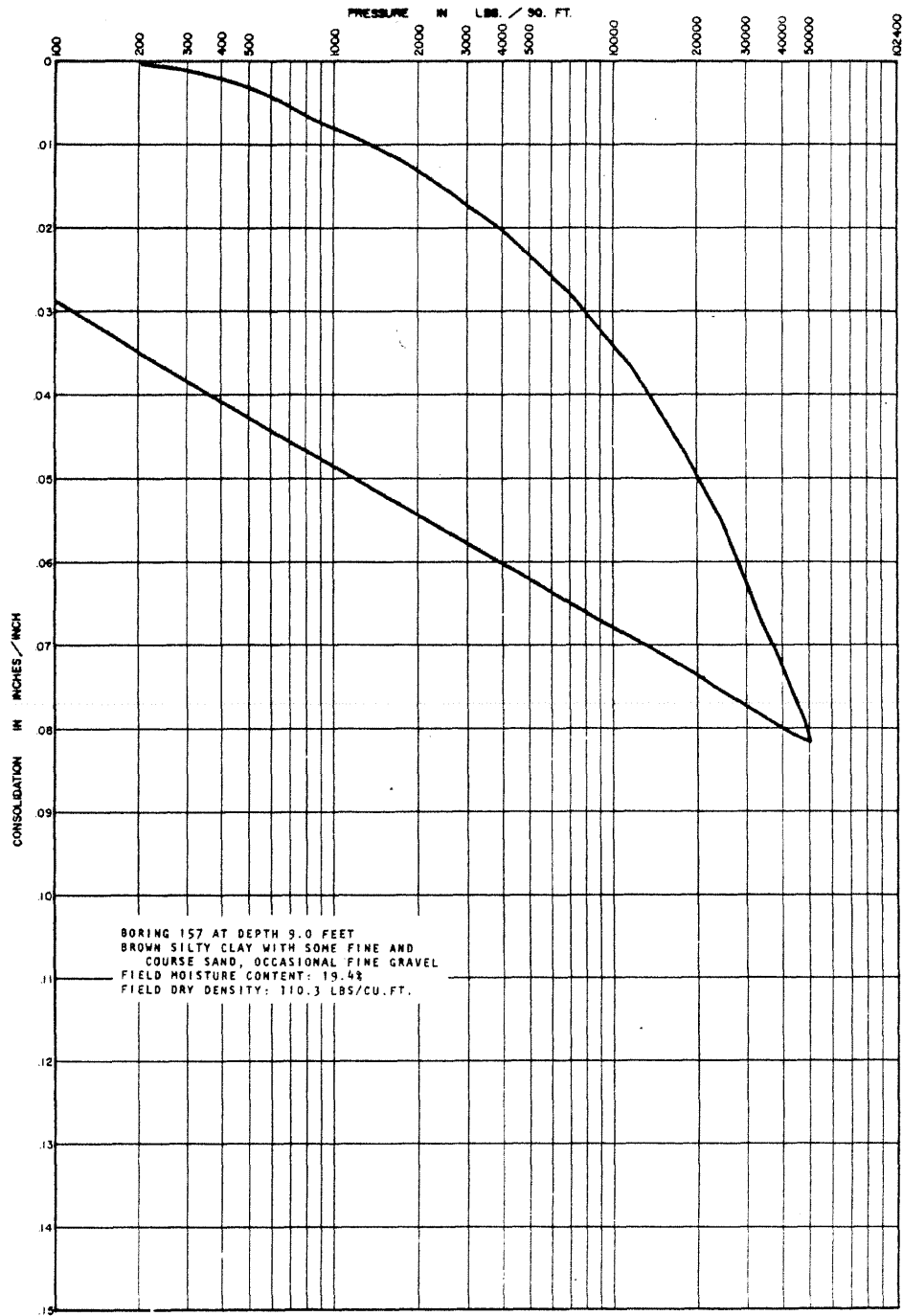

**LA SALLE COUNTY STATION**  
 UPDATED FINAL SAFETY ANALYSIS REPORT

---

FIGURE 2.5-45  
 CONSOLIDATION TEST DATA  
 (SHEET 19)



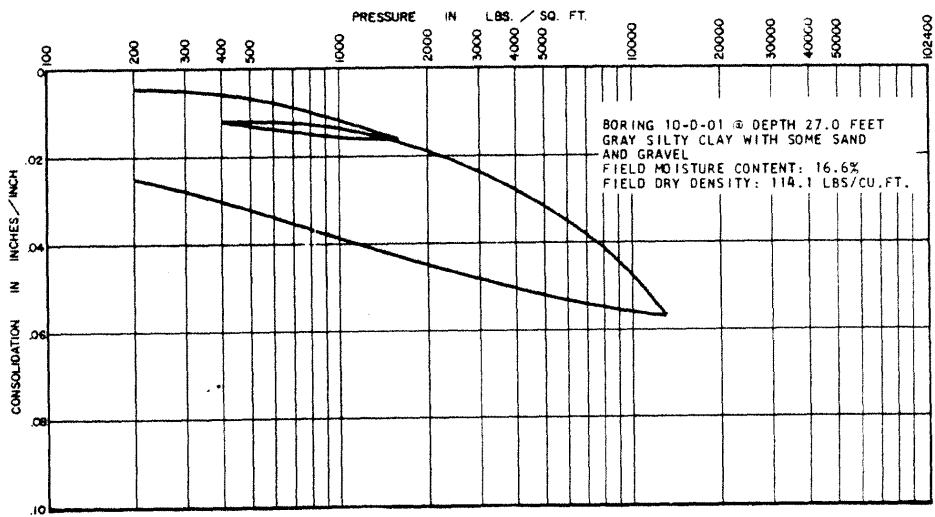
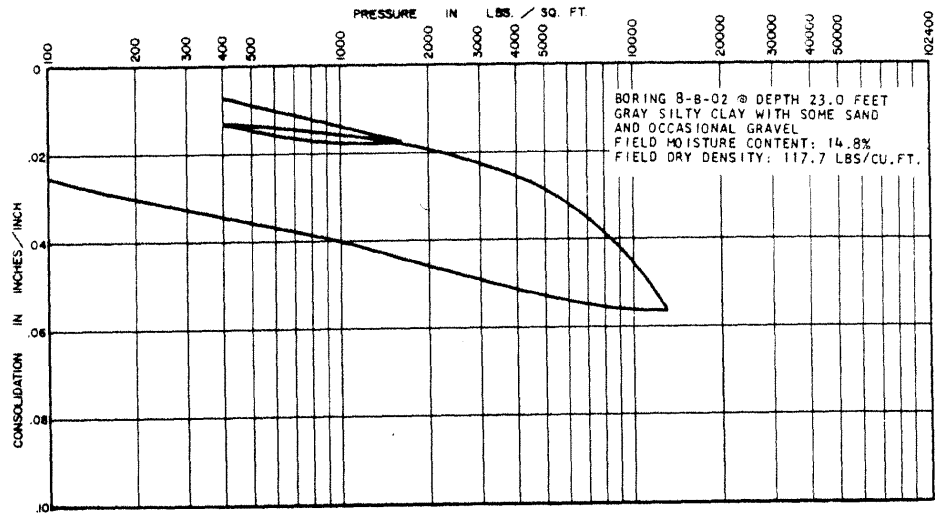

**LA SALLE COUNTY STATION**  
 UPDATED FINAL SAFETY ANALYSIS REPORT

---

FIGURE 2.5-45  
 CONSOLIDATION TEST DATA  
 (SHEET 20)

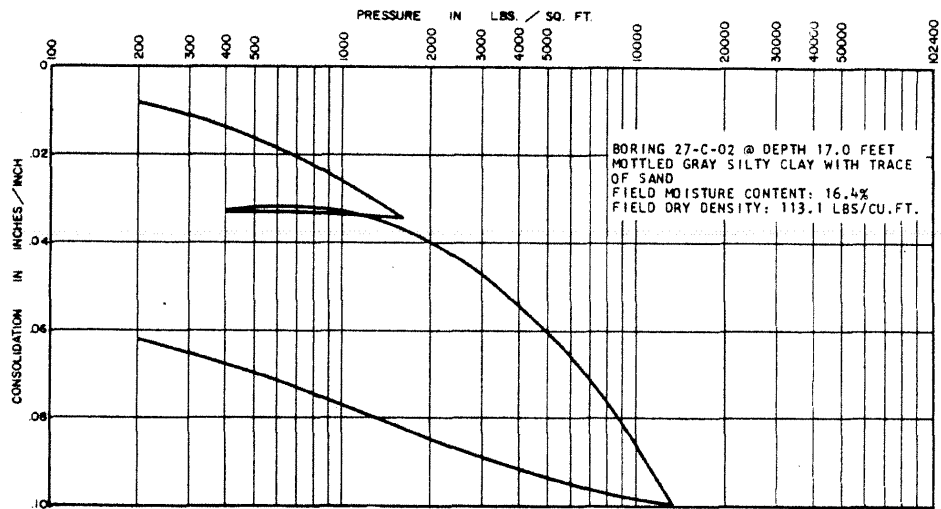

**LA SALLE COUNTY STATION**  
 UPDATED FINAL SAFETY ANALYSIS REPORT

FIGURE 2.5-45

CONSOLIDATION TEST DATA  
 (SHEET 21)

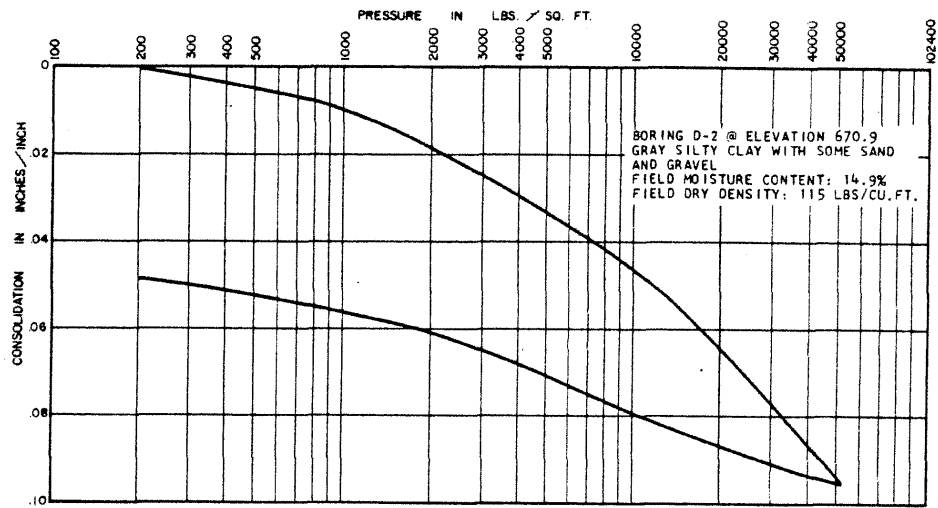
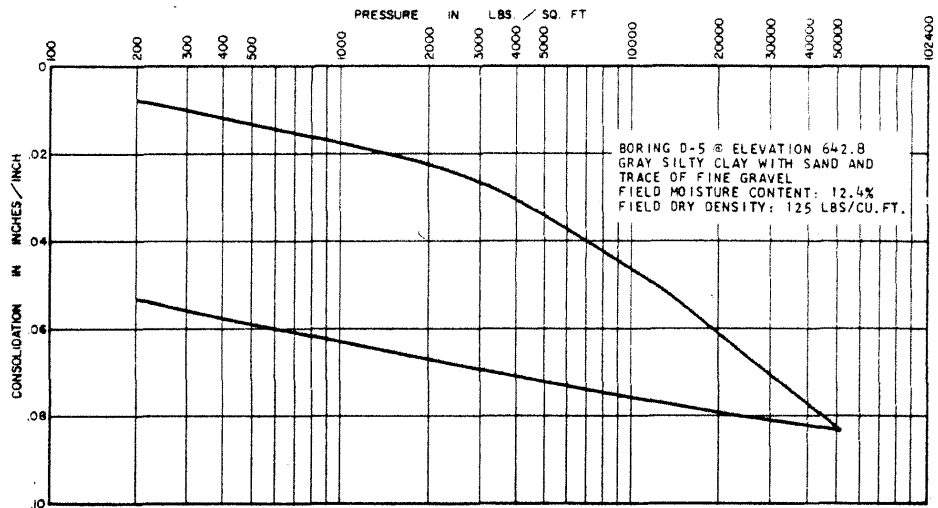

**LA SALLE COUNTY STATION**  
 UPDATED FINAL SAFETY ANALYSIS REPORT

---

FIGURE 2.5-45  
 CONSOLIDATION TEST DATA  
 (SHEET 22)

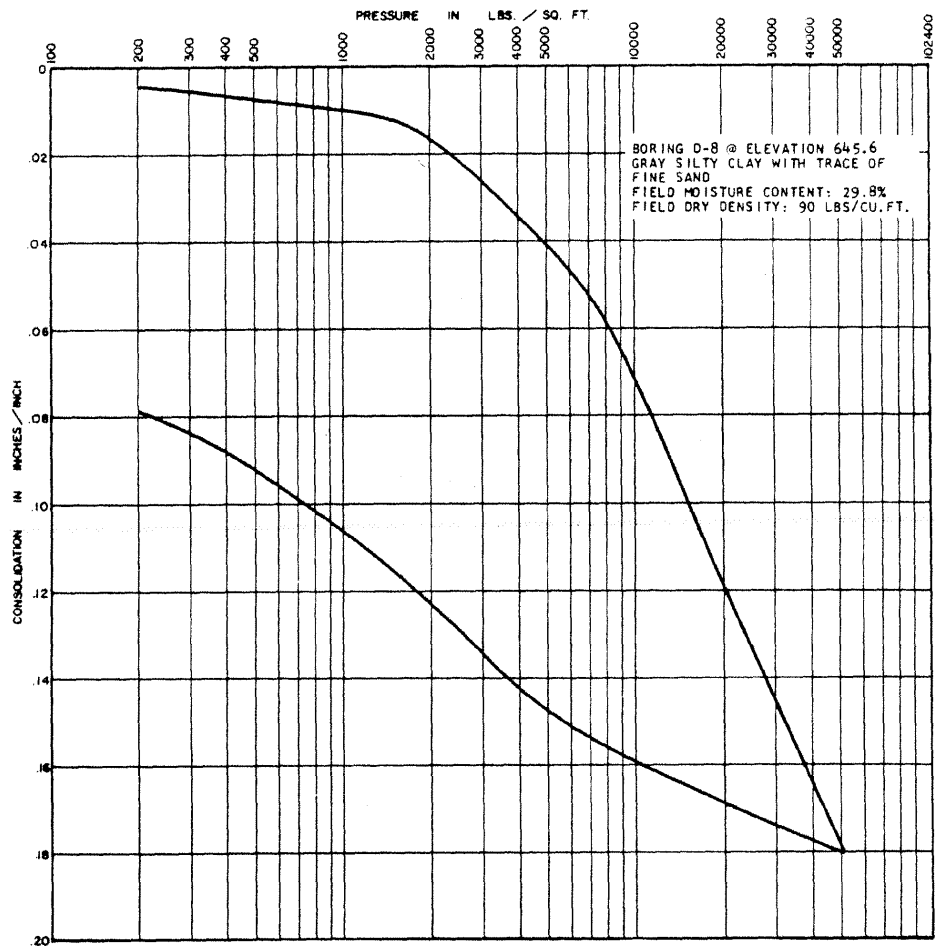

**LA SALLE COUNTY STATION**  
 UPDATED FINAL SAFETY ANALYSIS REPORT

---

FIGURE 2.5-45  
 CONSOLIDATION TEST DATA  
 (SHEET 23)

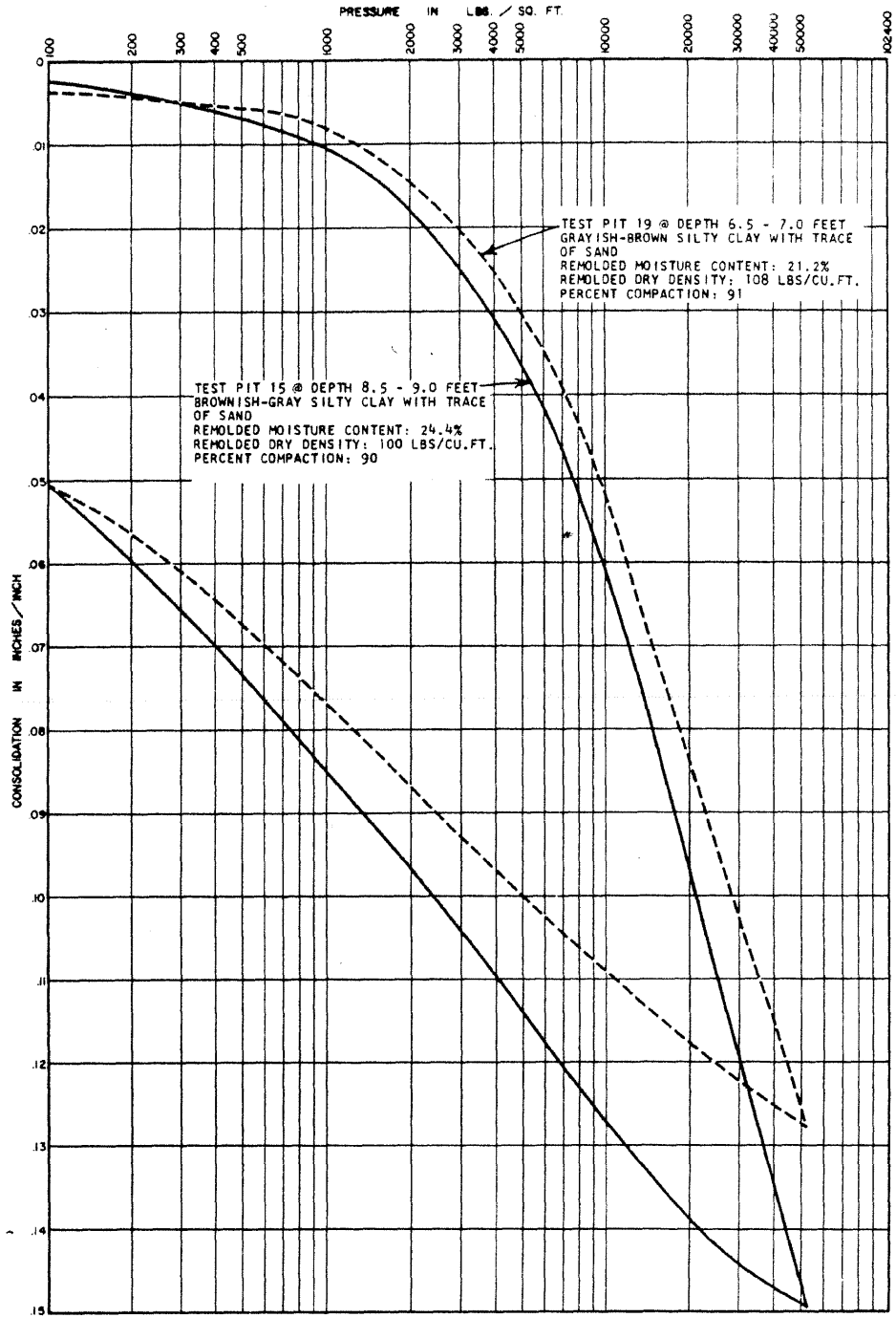

**LA SALLE COUNTY STATION**  
 UPDATED FINAL SAFETY ANALYSIS REPORT

FIGURE 2.5-45  
 CONSOLIDATION TEST DATA  
 (SHEET 24)

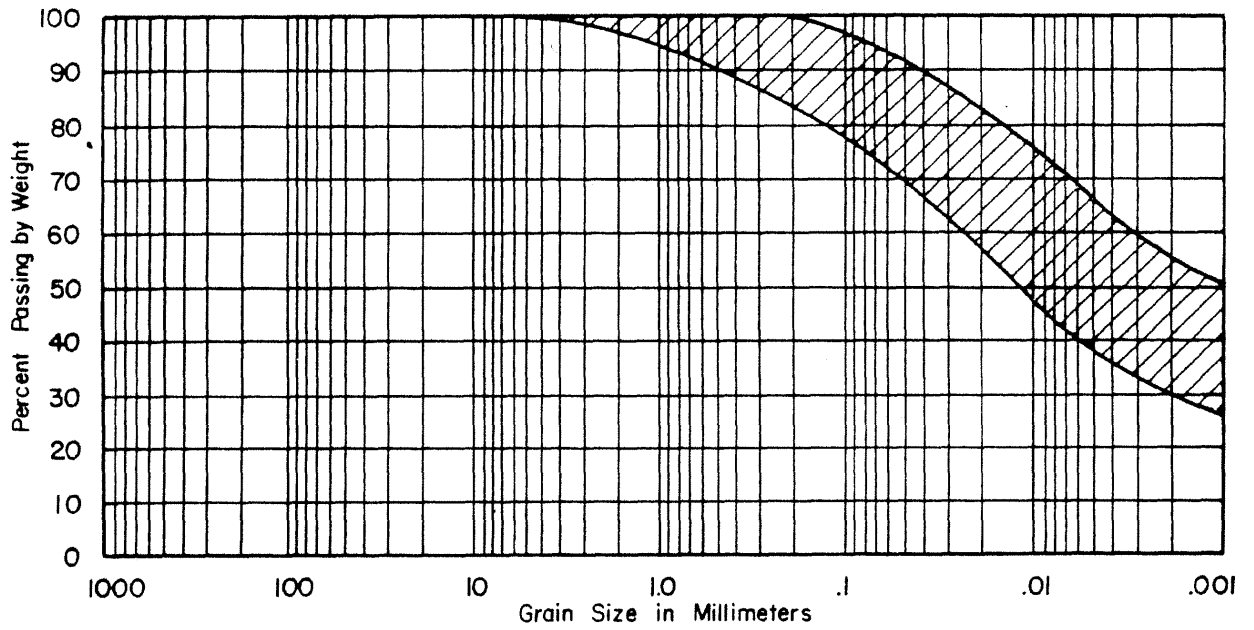

NOTE

1. Data obtained from 36 tests on  
Wedron silty clay till.

LA SALLE COUNTY STATION  
 UPDATED FINAL SAFETY ANALYSIS REPORT

FIGURE 2.5-46  
 ENVELOPE OF GRAIN SIZES  
 (SHEET 1 of 3)

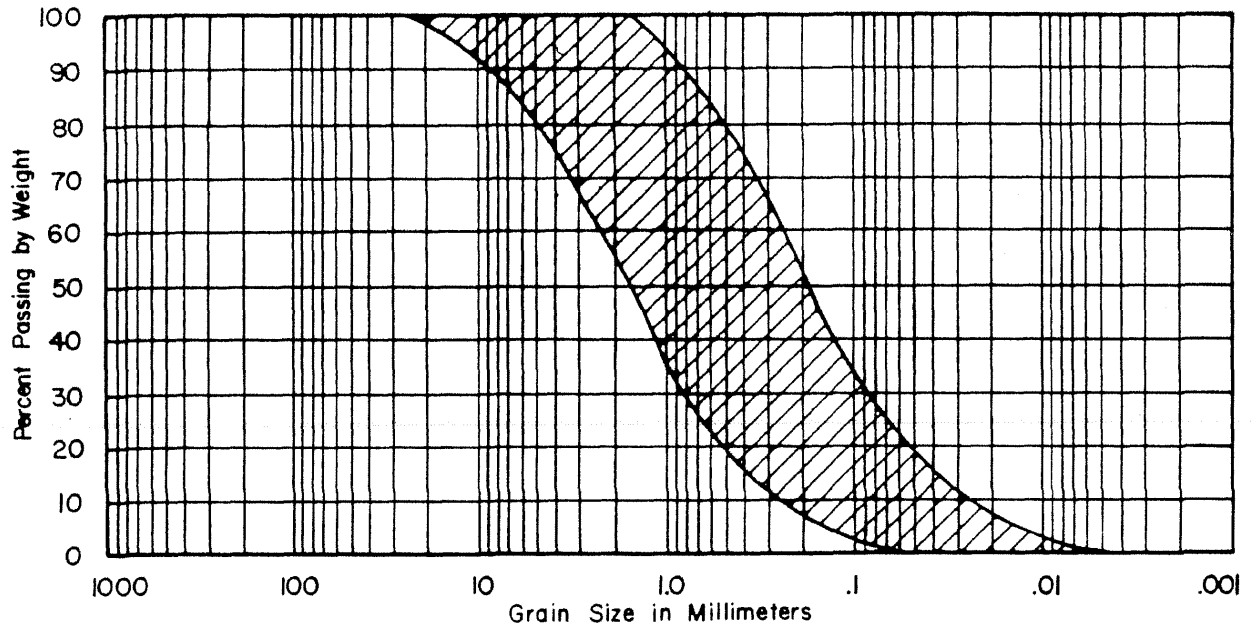

NOTE

1. Data obtained from 14 tests on Ticona Valley fill.

LA SALLE COUNTY STATION  
 UPDATED FINAL SAFETY ANALYSIS REPORT

FIGURE 2.5-46  
 ENVELOPE OF GRAIN SIZES  
 (SHEET 2 of 3)

REV. 0 - APRIL 1984

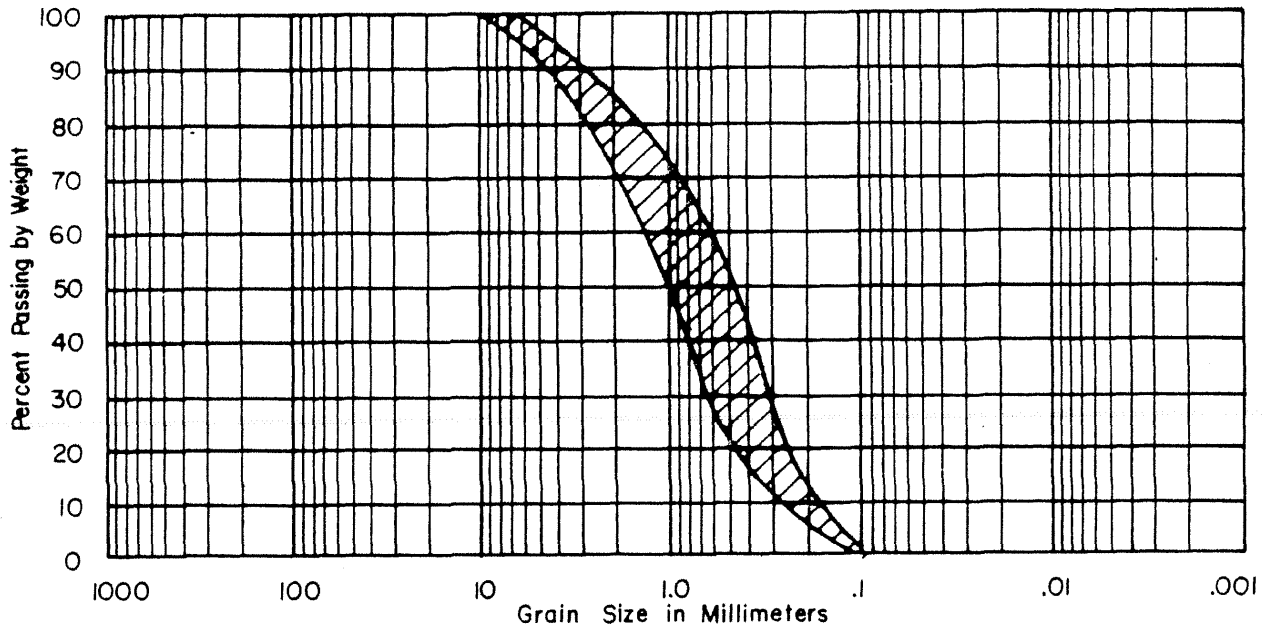

NOTE

1. Data obtained from 68 tests on sand drainage blanket.

|                                                                        |
|------------------------------------------------------------------------|
| <b>LA SALLE COUNTY STATION</b><br>UPDATED FINAL SAFETY ANALYSIS REPORT |
| FIGURE 2.5-46<br>ENVELOPE OF GRAIN SIZES<br>(SHEET 3 of 3)             |



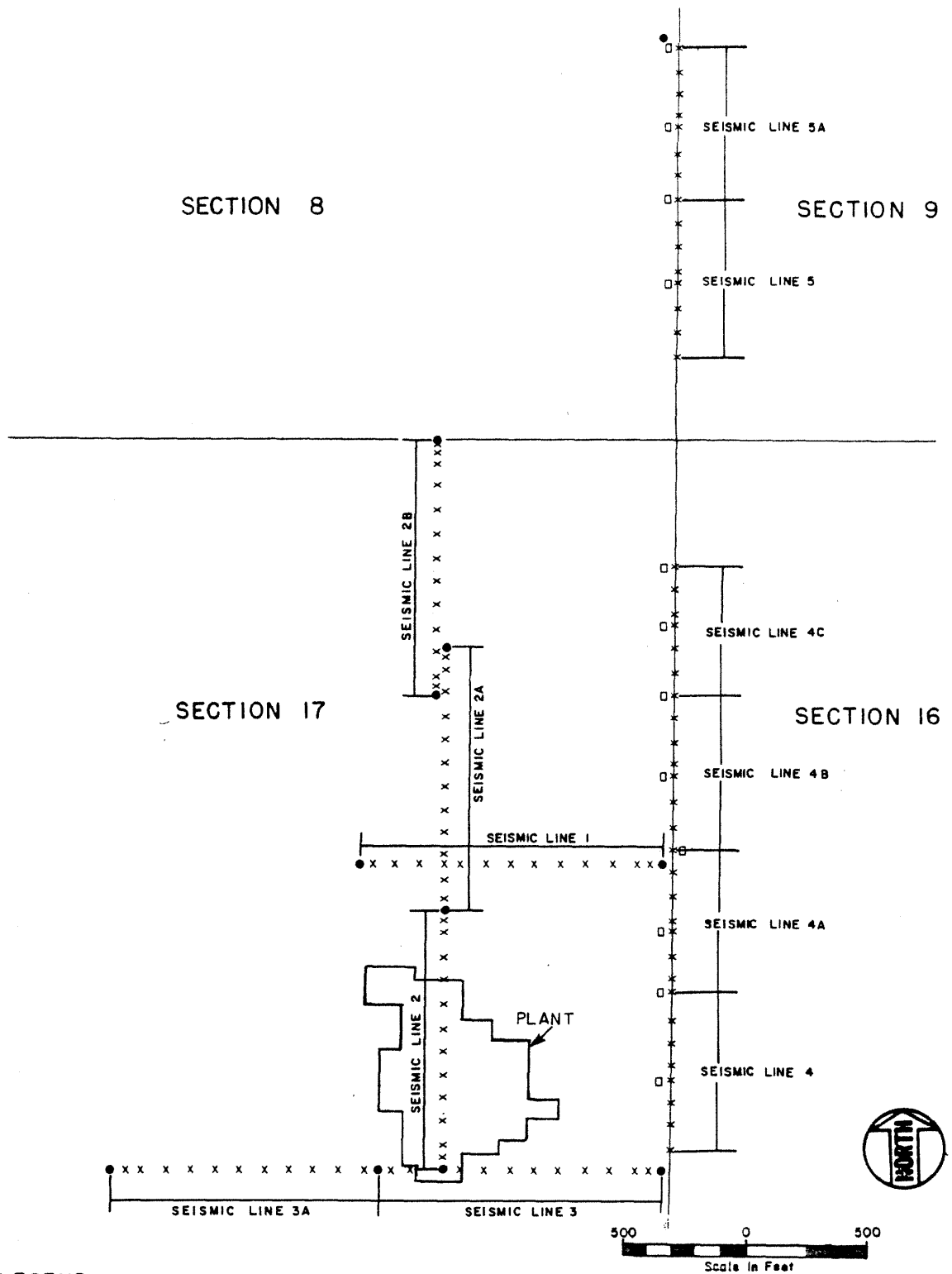

**LEGEND**

- Shot hole location
- Tri-mode seismometer locations
- × Geophone location

**NOTE**

1. See Figure 2.5-2, Sheet 2 for boring locations.

**LA SALLE COUNTY STATION**  
 UPDATED FINAL SAFETY ANALYSIS REPORT

---

FIGURE 2.5-47

PLOT PLAN OF GEOPHYSICAL EXPLORATIONS

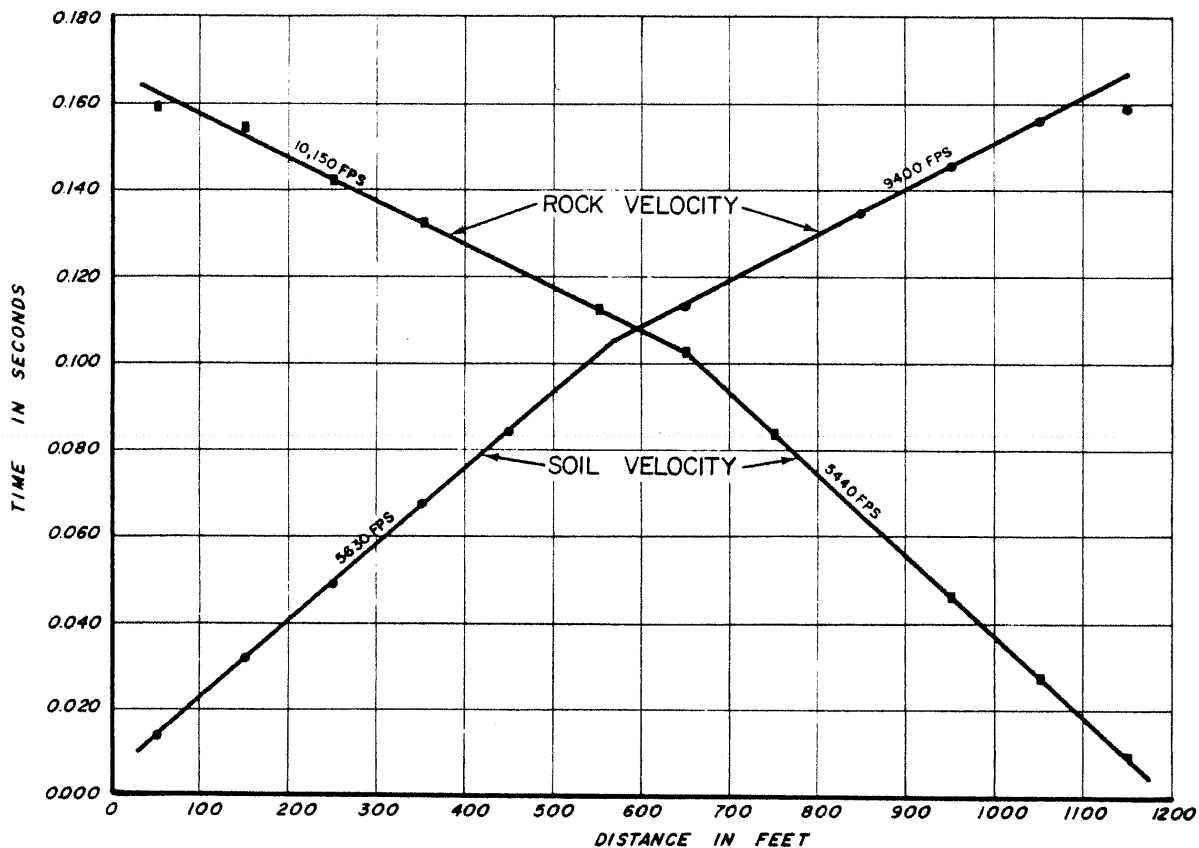

**NOTE**

1. For location of seismic line see Figure 2.5-47.
2. Seismic line no. 1.

**LA SALLE COUNTY STATION**  
 UPDATED FINAL SAFETY ANALYSIS REPORT

FIGURE 2.5-48  
 SEISMIC REFRACTION SURVEY DATA  
 (SHEET 1 of 6)

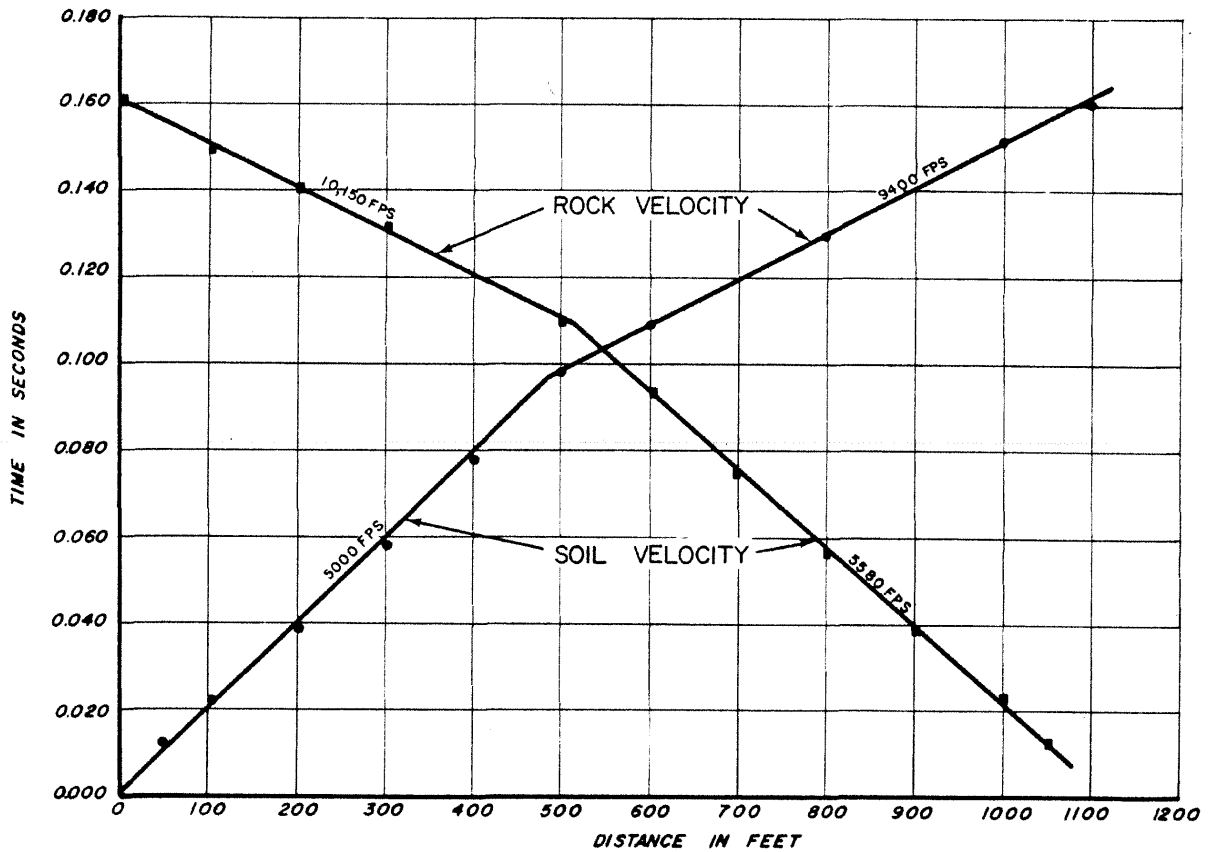

**NOTE**

1. For location of seismic line see Figure 2.5-47.
2. Seismic line no.2.

LA SALLE COUNTY STATION  
 UPDATED FINAL SAFETY ANALYSIS REPORT

FIGURE 2.5-48  
 SEISMIC REFRACTION SURVEY DATA  
 (SHEET 2 of 6)

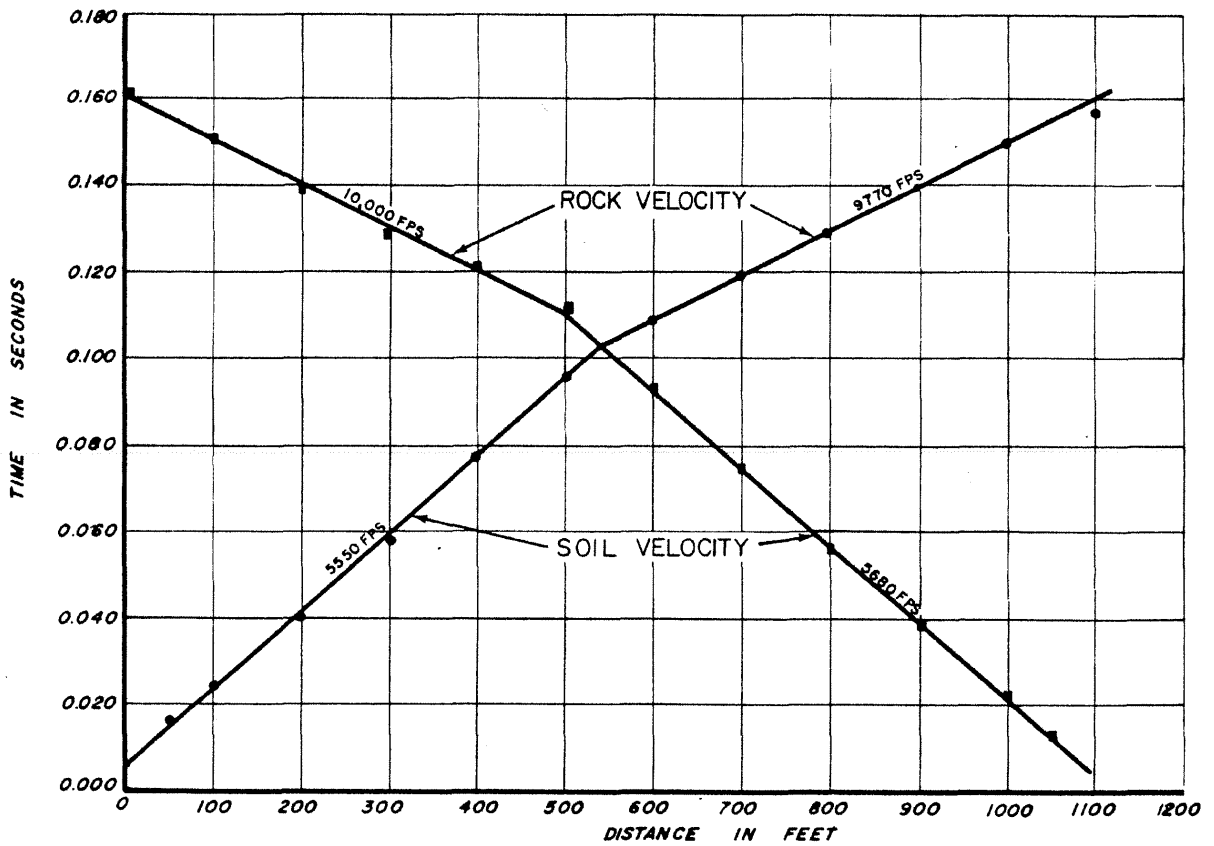

NOTE

1. For location of seismic line see Figure 2.5-47.
2. Seismic line no. 2A.

|                                                                                              |
|----------------------------------------------------------------------------------------------|
| <p><b>LA SALLE COUNTY STATION</b><br/>         UPDATED FINAL SAFETY ANALYSIS REPORT</p>      |
| <p>FIGURE 2.5-48<br/>         SEISMIC REFRACTION SURVEY DATA<br/>         (SHEET 3 of 6)</p> |

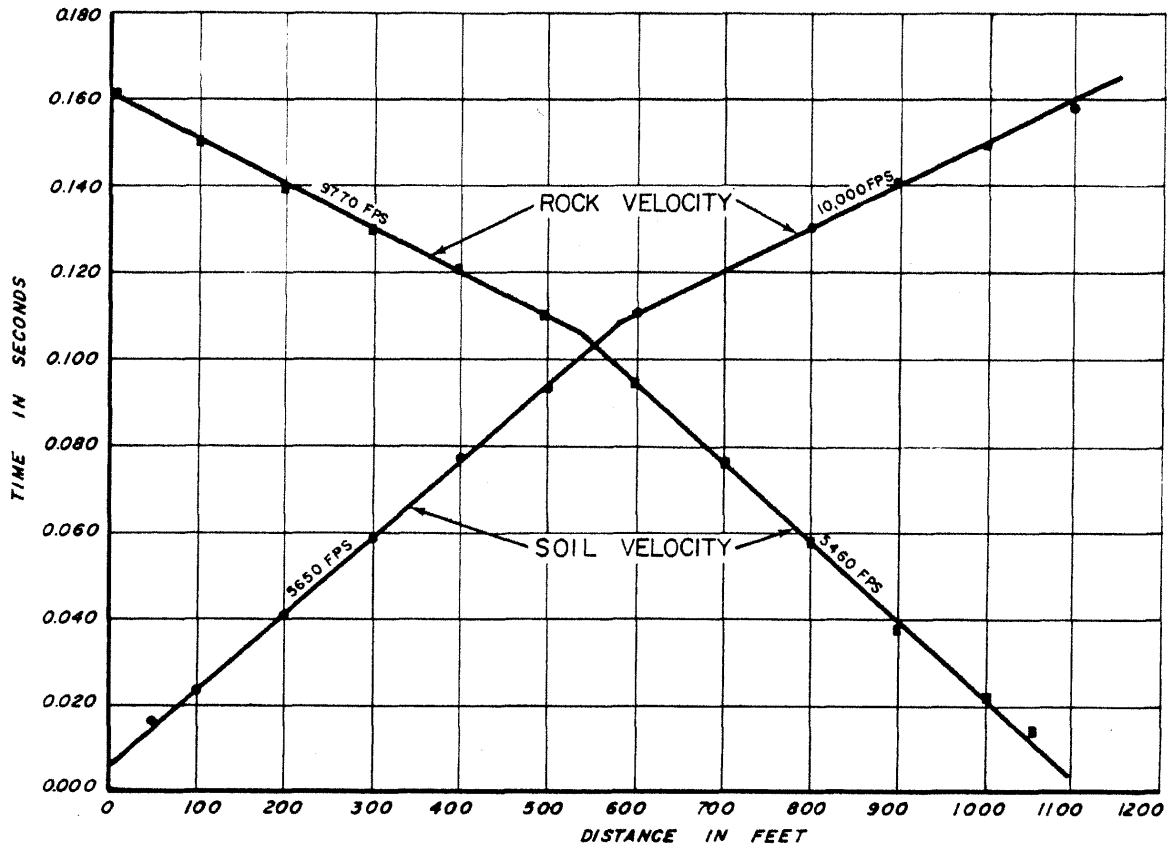

**NOTE**

1. For location of seismic line see Figure 2.5-47.
2. Seismic line no. 2B.

**LA SALLE COUNTY STATION**  
 UPDATED FINAL SAFETY ANALYSIS REPORT  
  
 FIGURE 2.5-48  
 SEISMIC REFRACTION SURVEY DATA  
 (SHEET 4 of 6)

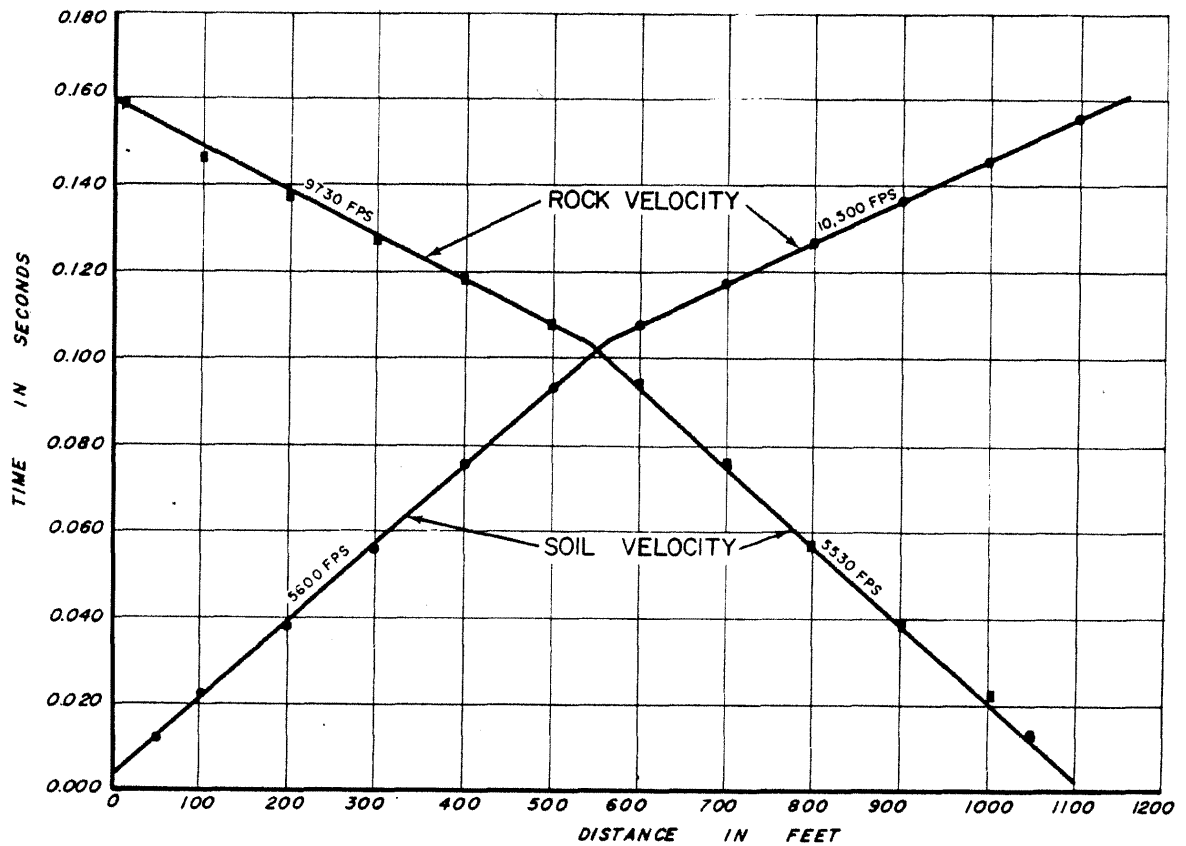

**NOTE**

1. For location of seismic line see Figure 2.5-47.
2. Seismic line no. 3.

**LA SALLE COUNTY STATION**  
 UPDATED FINAL SAFETY ANALYSIS REPORT  
  
 FIGURE 2.5-48  
 SEISMIC REFRACTION SURVEY DATA  
 (SHEET 5 of 6)

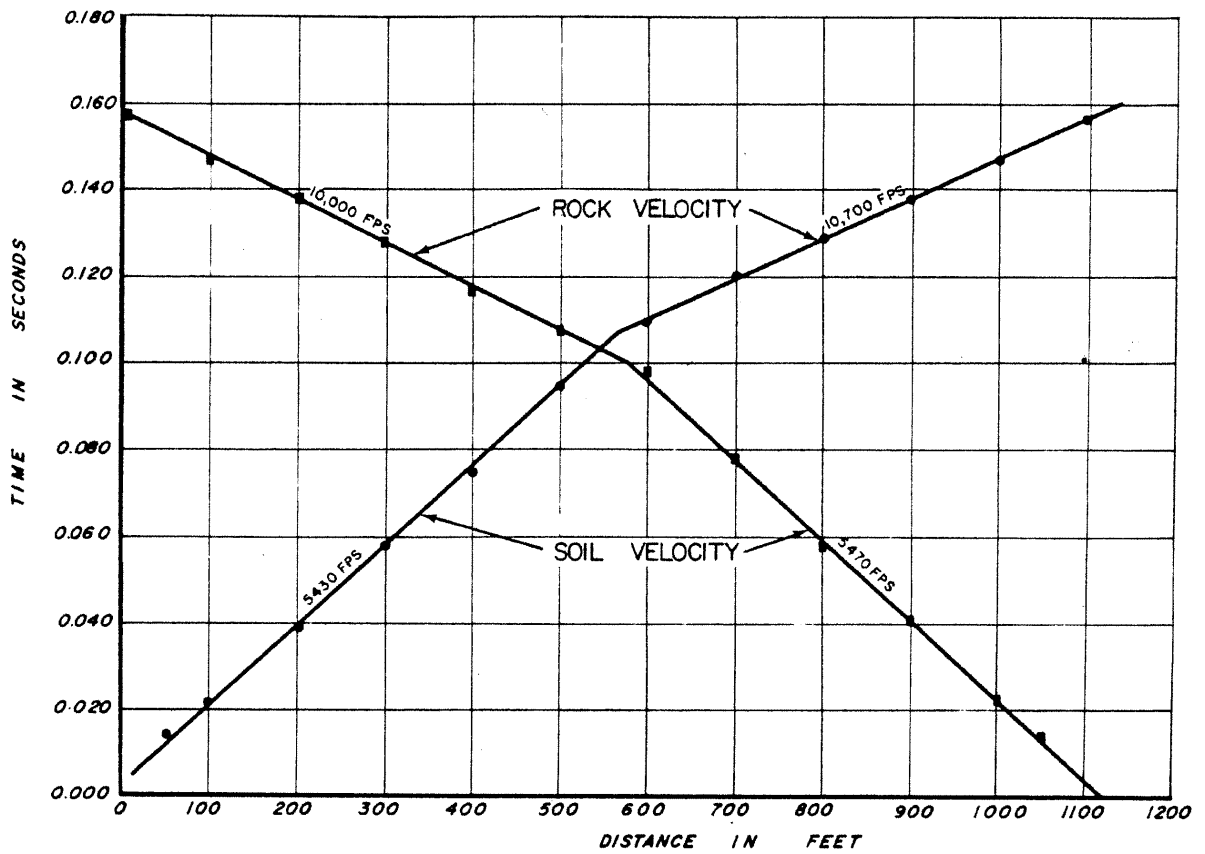

**NOTE**

1. For location of seismic line see Figure 2.5-47.
2. Seismic line no. 3A.

**LA SALLE COUNTY STATION  
UPDATED FINAL SAFETY ANALYSIS REPORT**

FIGURE 2.5-48  
SEISMIC REFRACTION SURVEY DATA  
(SHEET 6 of 6)

REV. 0 - APRIL 1984

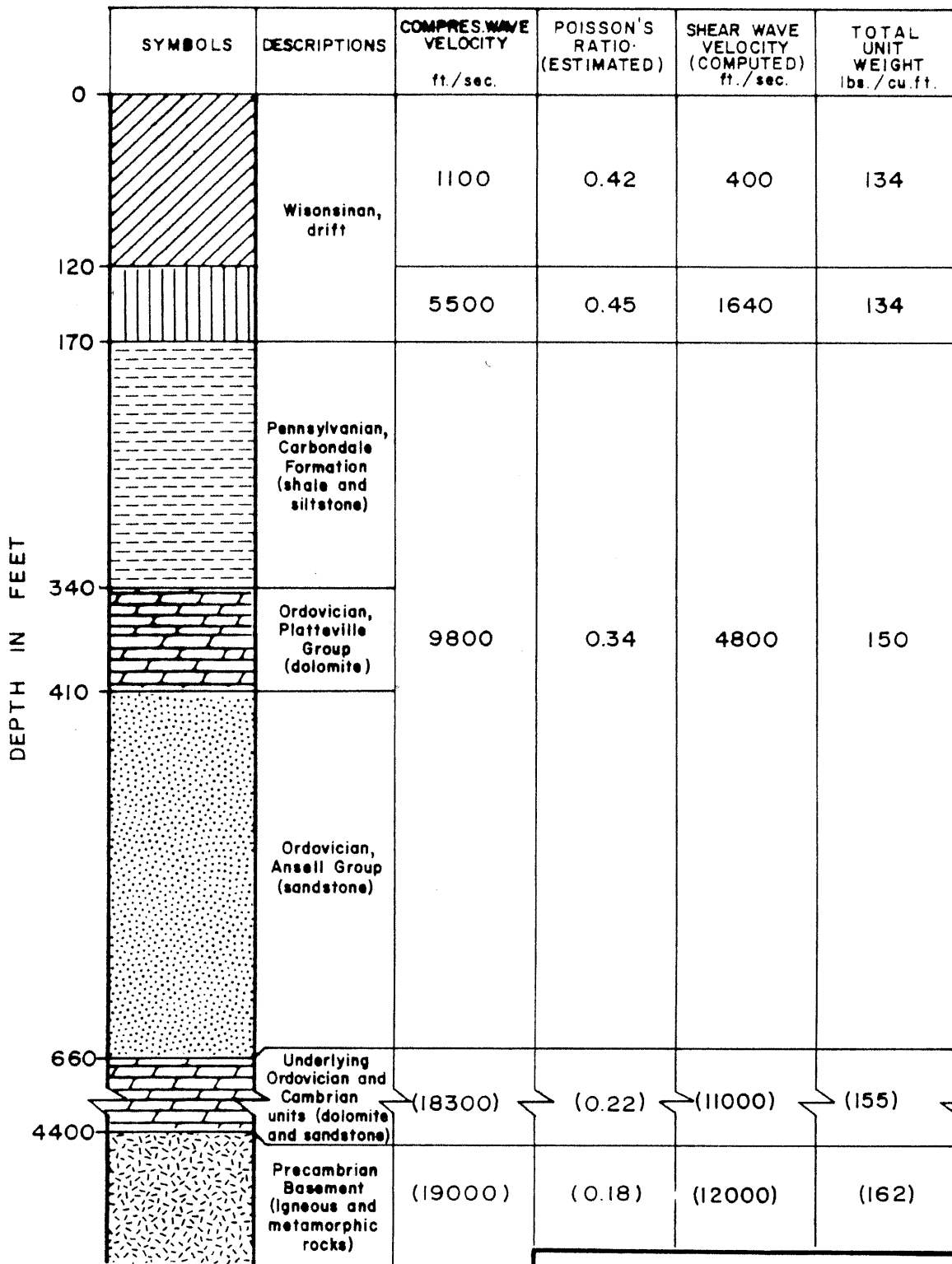

**NOTE**

1. Physical properties are measured values except values enclosed by parentheses.

**LA SALLE COUNTY STATION**  
 UPDATED FINAL SAFETY ANALYSIS REPORT.



FIGURE 2.5-49

STRATIGRAPHIC COLUMN WITH  
 GEOPHYSICAL DATA SUMMARY

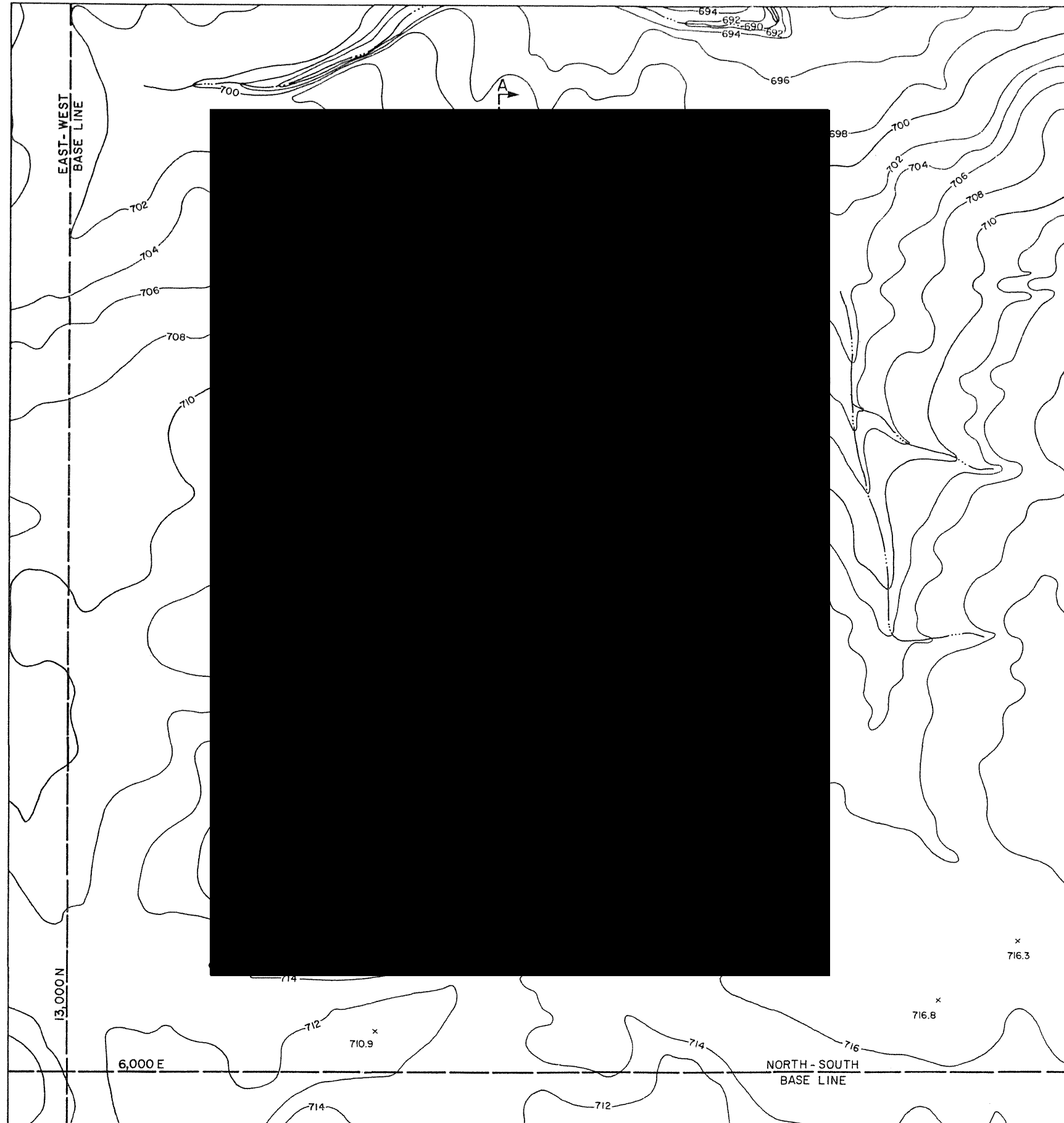



**LEGEND**

-  Granular backfill area around main plant
-  Photo view location showing coverage, direction of view, and Figure number of photo

**NOTES**

1. Slopes, one horizontal to one vertical unless noted.
2. See Figure 2.5-51, Sheets 1 and 2 for Cross-Sections.
3. Coordinates are plant coordinates.
4. For continuation of drawing see Figure 2.5-50, Sheets 2 and 3.
5. Excavation elevations shown under structures on this figure are rough excavation elevations, final mat elevations are one foot lower.

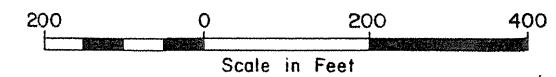

**LA SALLE COUNTY STATION**  
**UPDATED FINAL SAFETY ANALYSIS REPORT**  
  
**FIGURE 2.5-50**  
**EXCAVATION PLAN**  
  
**(SHEET 1 of 3)**

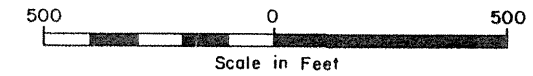

**LEGEND**

 Areas where outwash and lacustrine deposits are found

**NOTES**

1. All slopes four horizontal to one vertical unless noted.
2. Coordinates are plant coordinates.
3. See Figure 2.5-50, SH.3 and 2.5-61 for Screen House detail.
4. See Cross Section A-A' on Figure 2.5-52.
5. See Cross Section B-B' on Figure 2.5-53.
6. See Cross Section D-D' on Figure 2.5-51, Sheet 2.
7. See Cross Section E-E' on Figure 2.5-51, Sheet 2.
8. For continuation of drawing see Figure 2.5-50, Sheet 1.



|                                                                                         |
|-----------------------------------------------------------------------------------------|
| <p><b>LA SALLE COUNTY STATION</b><br/>         UPDATED FINAL SAFETY ANALYSIS REPORT</p> |
| <p>FIGURE 2.5-50<br/>         EXCAVATION PLAN<br/>         (SHEET 2 of 3)</p>           |

REV. 0 - APRIL 1984

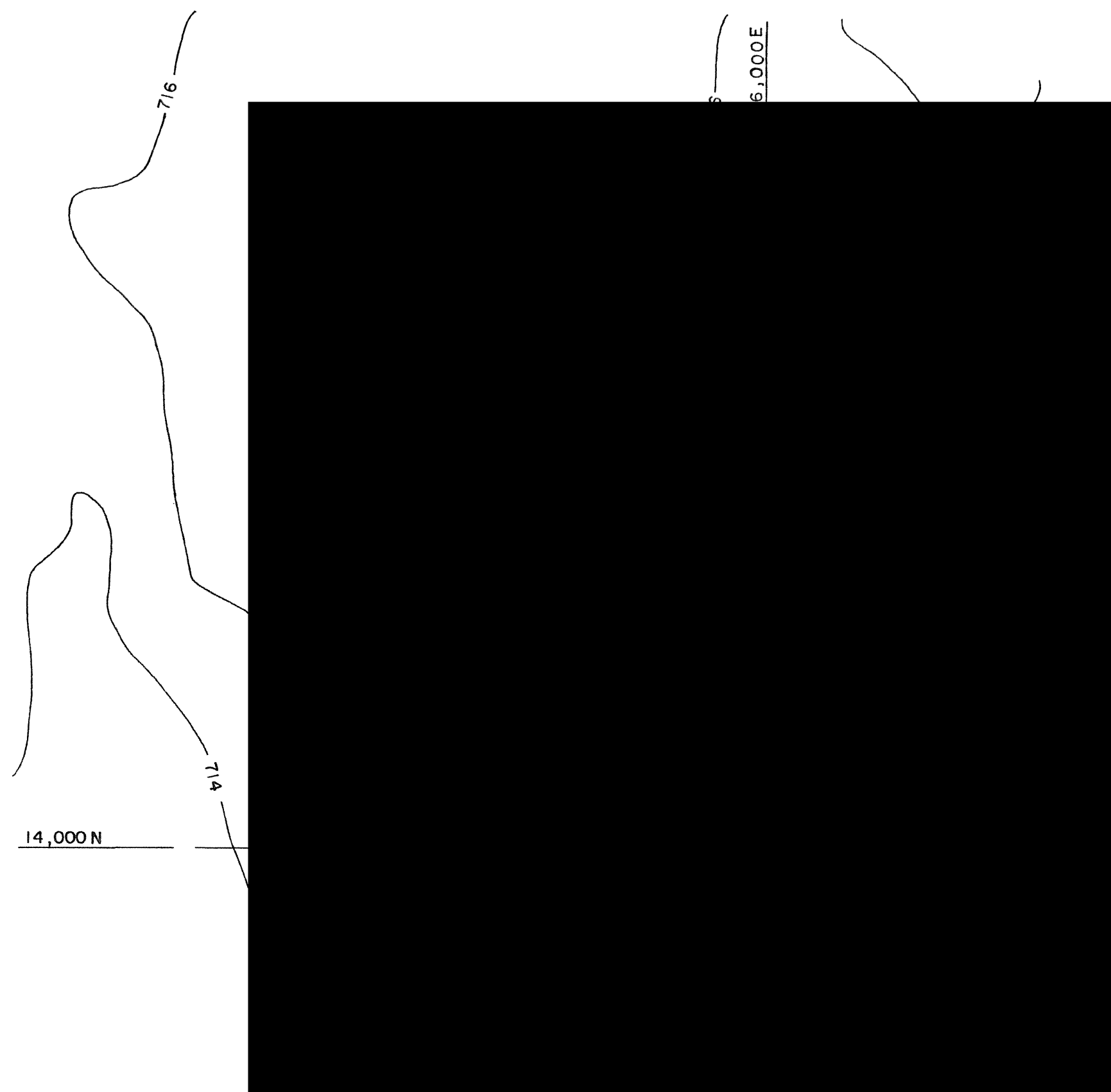

**NOTES**

1. Slopes, one horizontal to one vertical unless noted.
2. Coordinates are plant coordinates.
3. For continuation of drawing see Figure 2.5-50, Sheets 1 and 2.

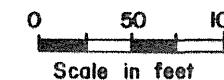

|                                                                                  |
|----------------------------------------------------------------------------------|
| <p>LA SALLE COUNTY STATION<br/>         UPDATED FINAL SAFETY ANALYSIS REPORT</p> |
| <p>FIGURE 2.5-50<br/>         EXCAVATION PLAN<br/>         (SHEET 3 of 3)</p>    |

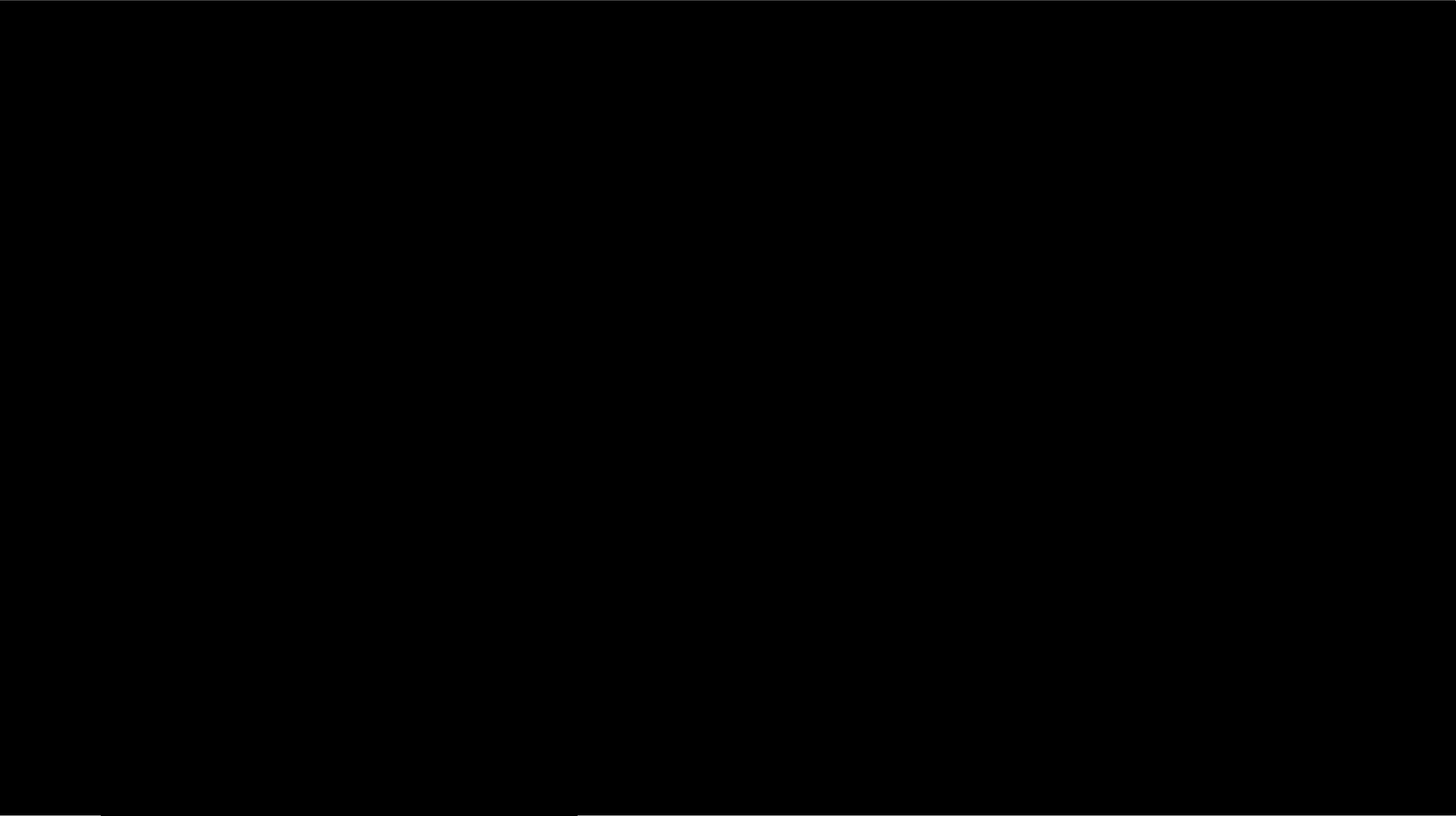

LA SALLE COUNTY STATION  
UPDATED FINAL SAFETY ANALYSIS REPORT

FIGURE 2.5-51  
GEOLOGIC PROFILES OF  
MAJOR FOUNDATIONS  
(SHEET 1 of 2)



**LA SALLE COUNTY STATION**  
UPDATED FINAL SAFETY ANALYSIS REPORT

FIGURE 2.5-51  
GEOLOGIC PROFILES OF MAJOR FOUNDATIONS  
(SHEET 2 of 2)

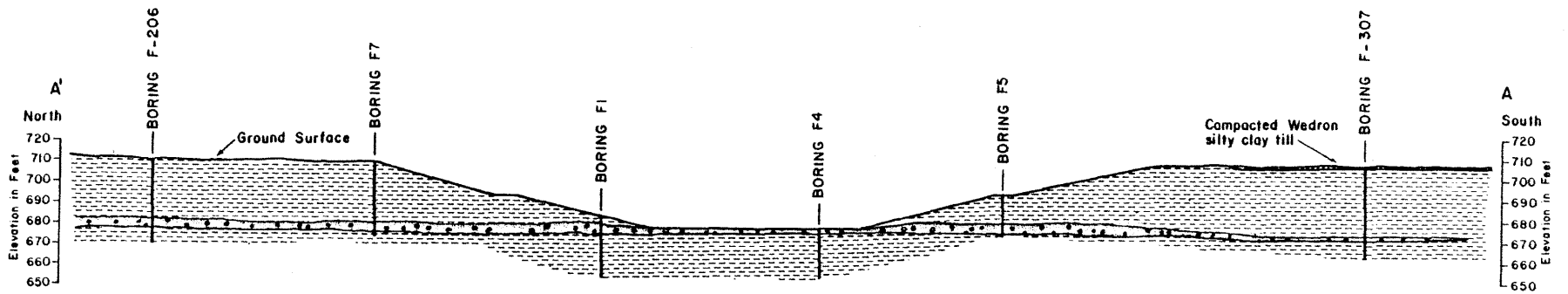
REV. 0 - APRIL 1984



**LEGEND**

-  Wedron silty clay till
-  Fine to coarse sand and gravel outwash deposit
-  Compacted Wedron silty clay till

**NOTES**

1. See Figure 2.5-50, Sheet 2 for location of Cross-Section.
2. Boring locations are projected

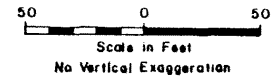

LA SALLE COUNTY STATION  
UPDATED FINAL SAFETY ANALYSIS REPORT



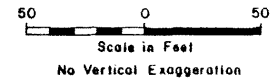
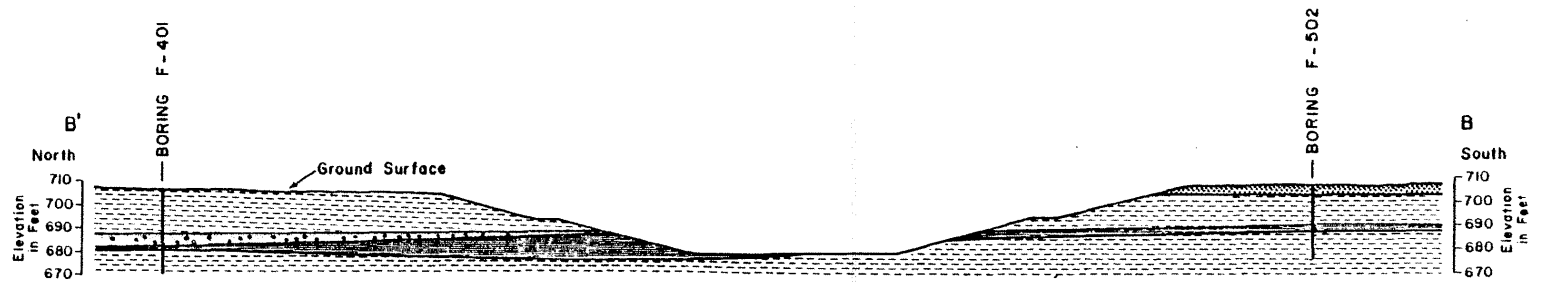

---

FIGURE 2.5-52

PROFILE OF SAND DEPOSIT EXPOSED IN  
BOTTOM OF CSCS INTAKE FLUME



**LEGEND**

-  Compacted Wedron silty clay till
-  Wedron silty clay till
-  Lacustrine clayey silt deposit
-  Lacustrine sand deposit

**NOTE**

- I. See Figure 2.5-50, Sheet 2 for location of Cross-Section.

LA SALLE COUNTY STATION  
 UPDATED FINAL SAFETY ANALYSIS REPORT

FIGURE 2.5-53  
 PROFILE OF LACUSTRINE DEPOSIT EXPOSED  
 ON BANKS OF CSCS INTAKE FLUME

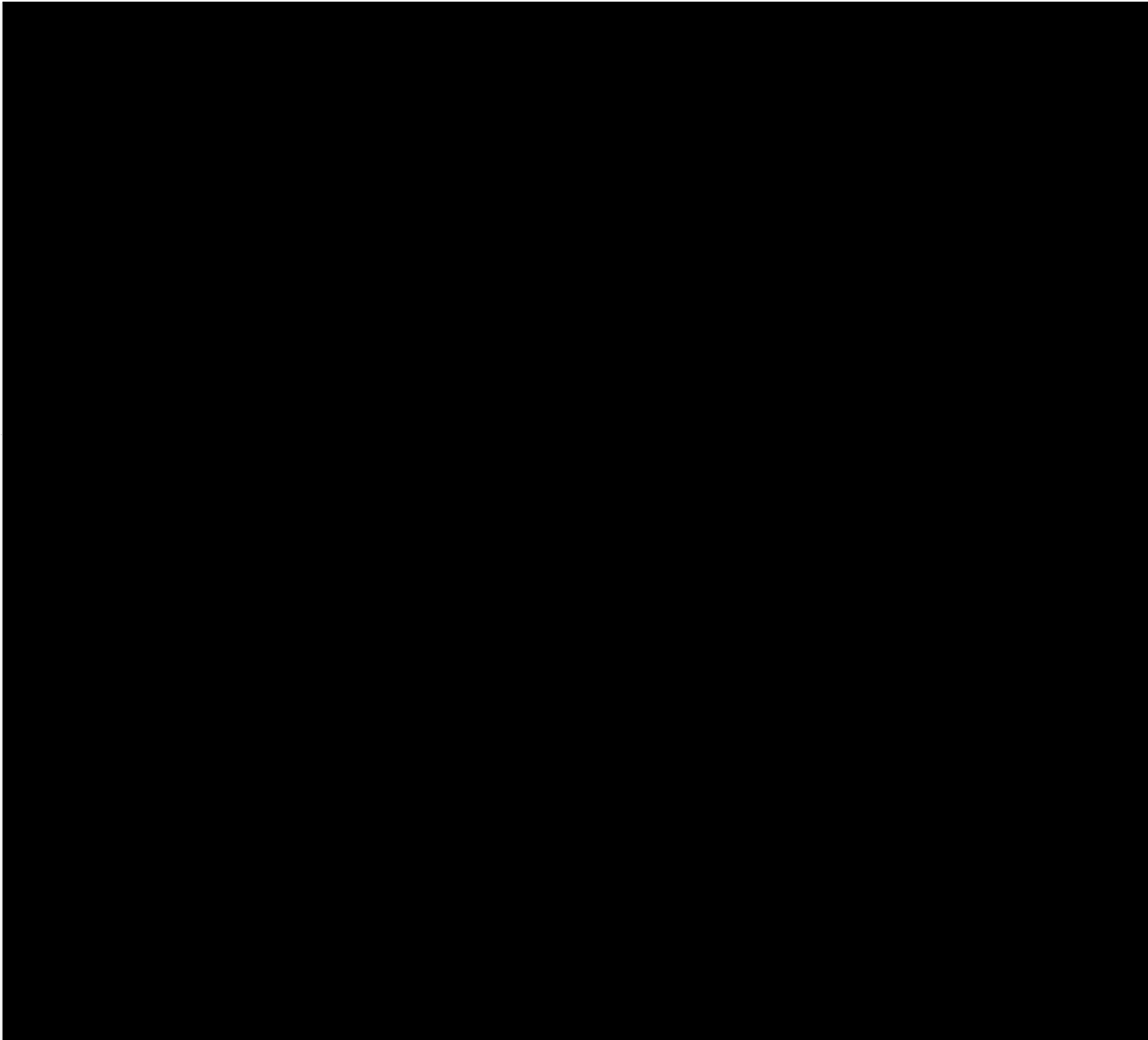

LA SALLE COUNTY STATION  
UPDATED FINAL SAFETY ANALYSIS REPORT

FIGURE 2.5-54  
SECTION THROUGH CONCRETE RETAINING WALL

REV. 0 - APRIL 1984



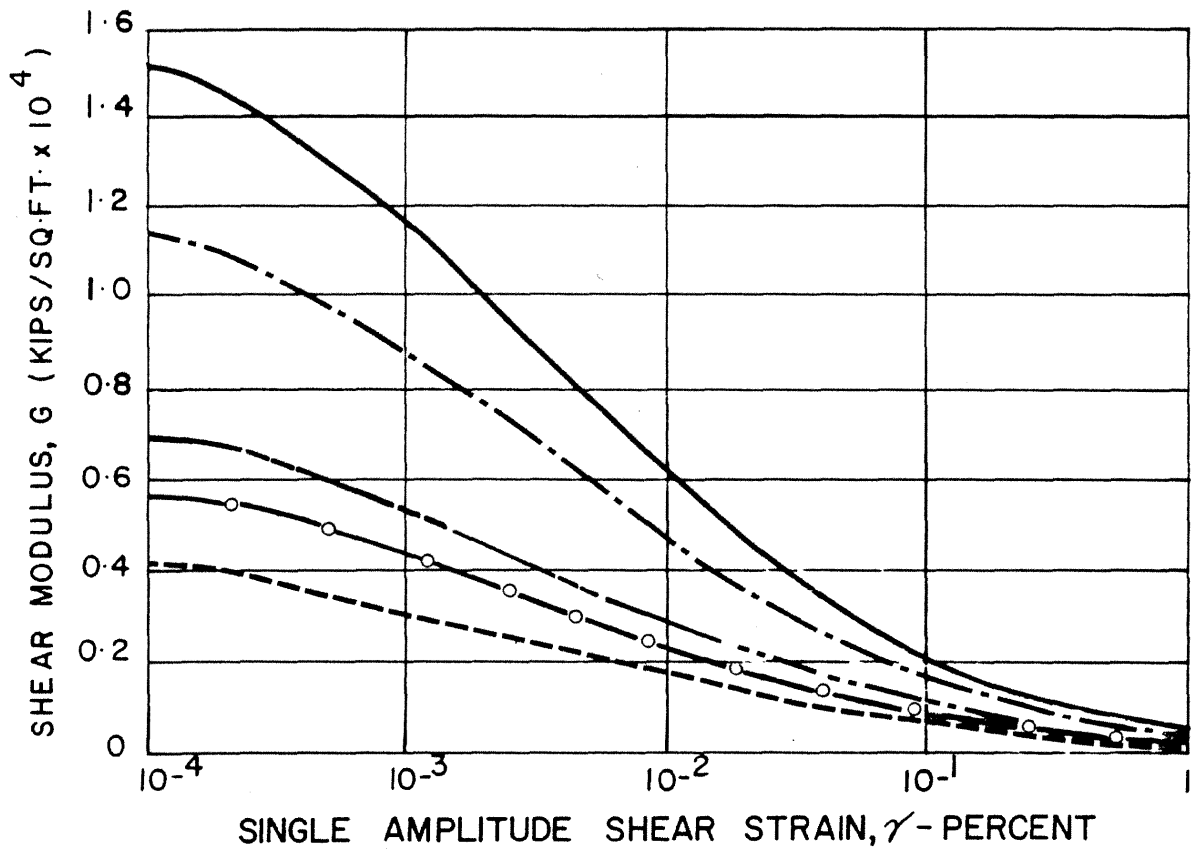

- EL: 560-540
- · - · - · EL: 590-560
- EL: 620-590
- EL: 710-690
- EL: 690-620

**LA SALLE COUNTY STATION**  
 UPDATED FINAL SAFETY ANALYSIS REPORT

---

FIGURE 2.5-55  
 SOIL-STRUCTURE INTERACTION PARAMETERS  
 (SHEET 1 of 2)

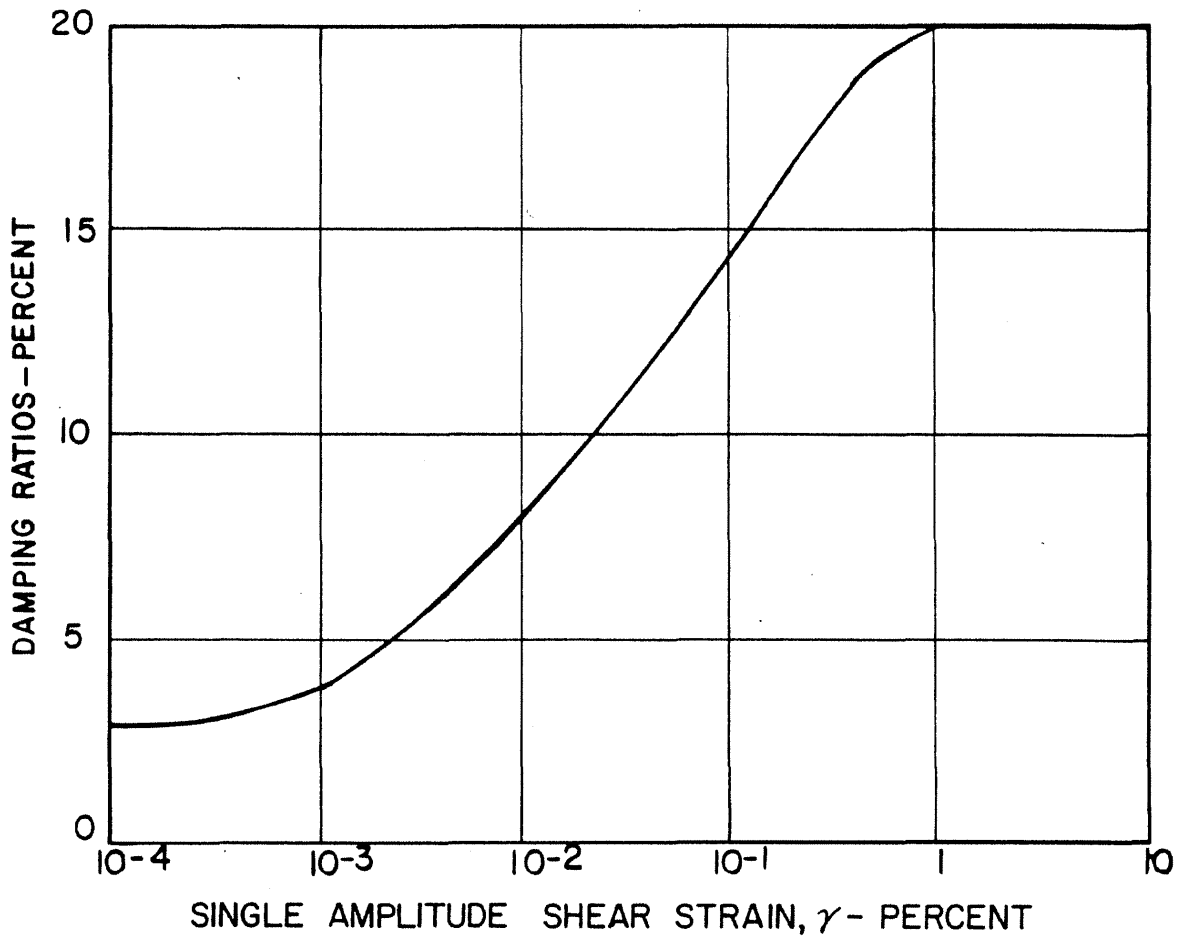

LA SALLE COUNTY STATION  
 UPDATED FINAL SAFETY ANALYSIS REPORT

FIGURE 2.5-55  
 SOIL-STRUCTURE INTERACTION PARAMETERS  
 (SHEET 2 of 2)

REV. 0 - APRIL 1984

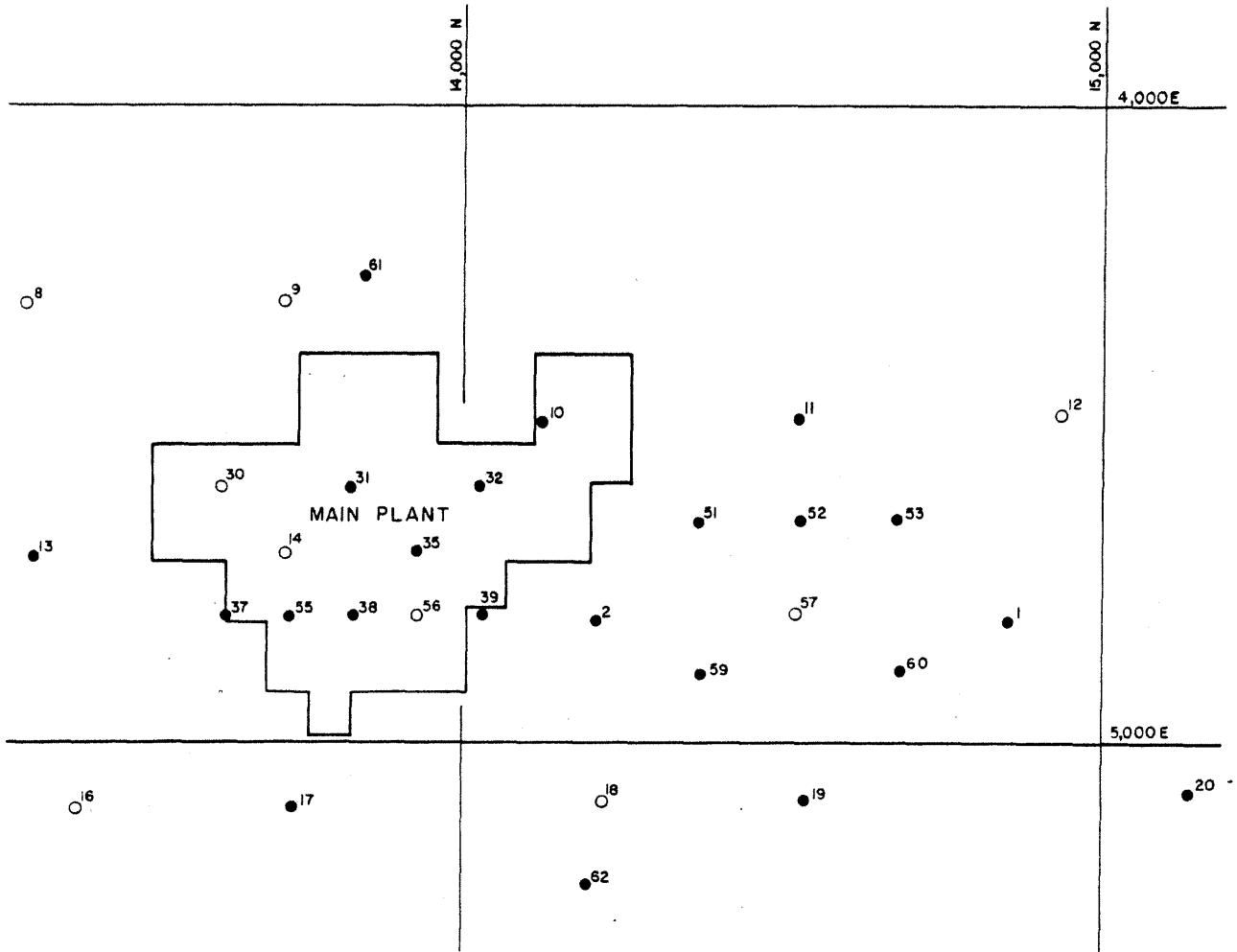

**LEGEND**

- Boring that encountered sand deposit near elevation 595 ft. MSL
- Boring in which sand deposit was not present near elevation 595 ft. MSL

**NOTES**

1. Only those borings deep enough to reach the sand deposits near elevation 595 ft. MSL are shown in this figure.
2. The elevation and thickness of the sand deposits in the borings are presented in Table 2.5-29 (sheets 1 and 2).
3. Coordinates are plant coordinates.

**LA SALLE COUNTY STATION**  
**UPDATED FINAL SAFETY ANALYSIS REPORT**

---

FIGURE 2.5-56

BORINGS PENETRATING SAND DEPOSIT NEAR  
 ELEVATION 595 FT. MSL IN VICINITY  
 OF MAIN PLANT

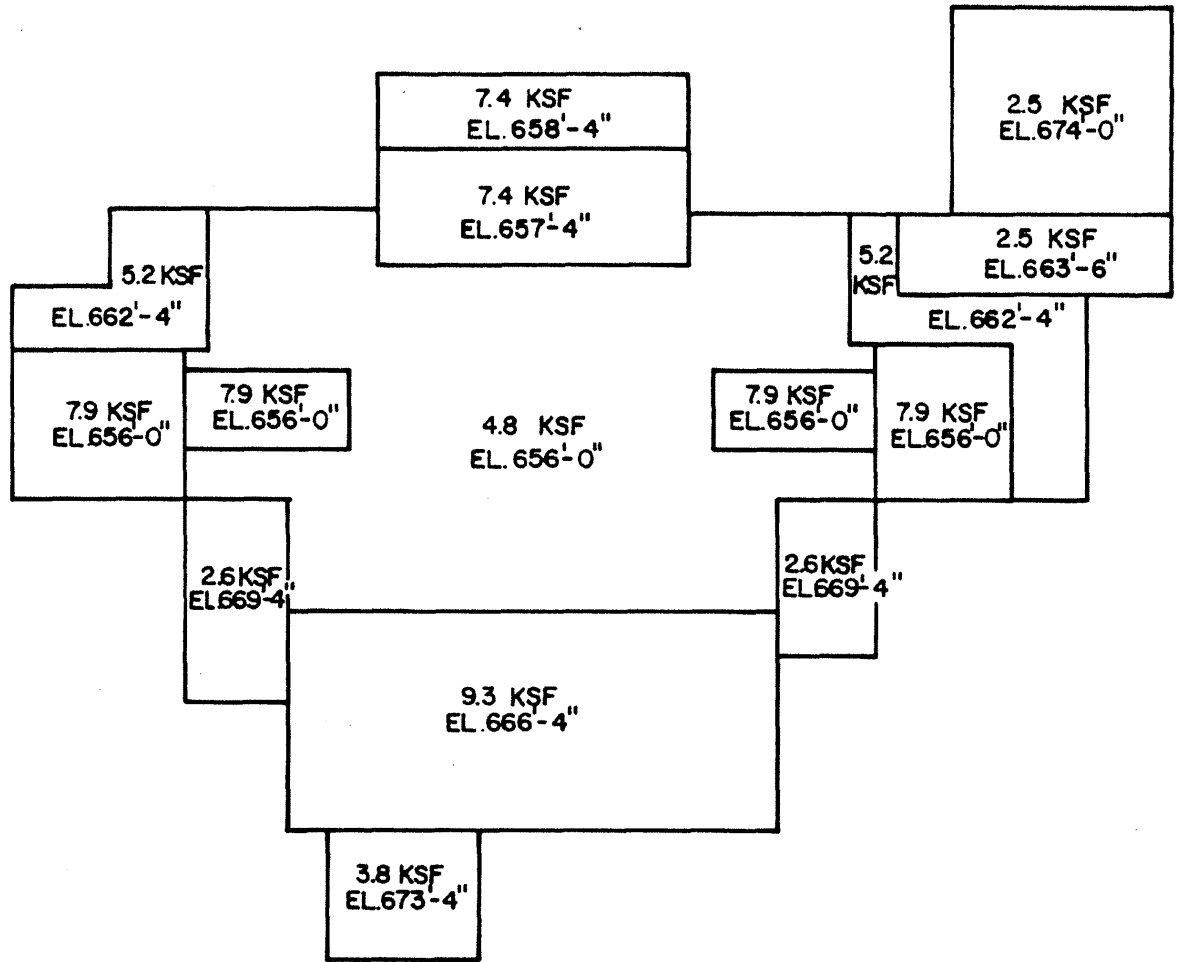

MAIN PLANT

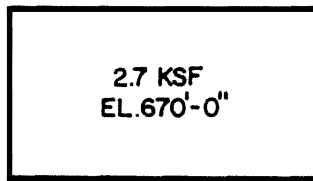

LAKE SCREEN HOUSE

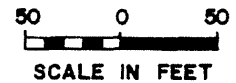
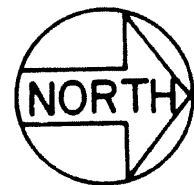

LEGEND

- EL. 670'-0" Indicates bottom of mat
- 2.7 KSF Indicates static foundation loading

|                                                                                  |
|----------------------------------------------------------------------------------|
| <p>LA SALLE COUNTY STATION<br/>         UPDATED FINAL SAFETY ANALYSIS REPORT</p> |
| <p>FIGURE 2.5-57<br/>         GROSS APPLIED STATIC FOUNDATION LOADING</p>        |

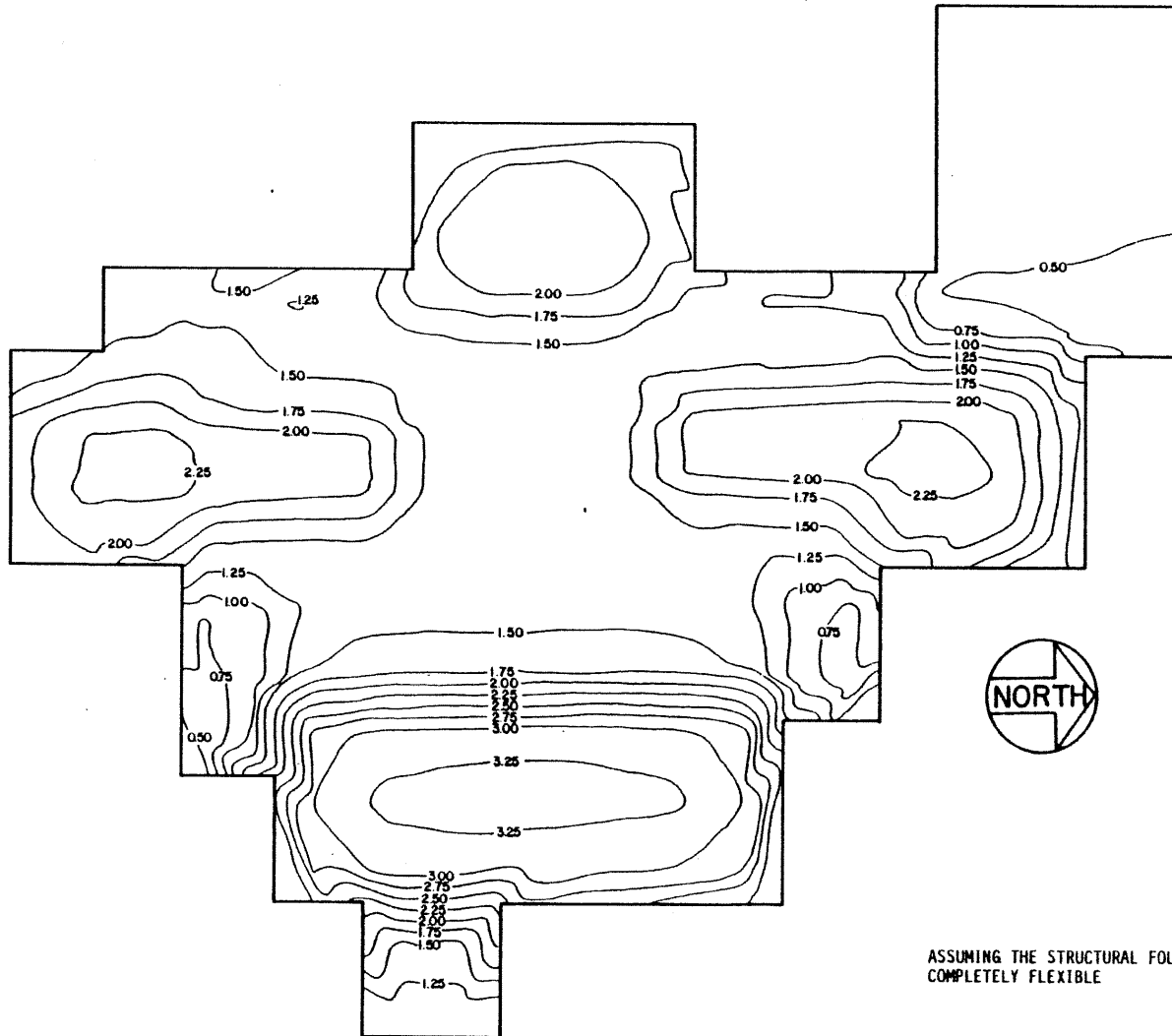

**NOTES:**

1. UNITS OF SETTLEMENTS ARE INCHES,  
POSITIVE NUMBERS ARE SETTLEMENTS.

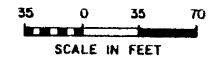

ASSUMING THE STRUCTURAL FOUNDATION  
COMPLETELY FLEXIBLE

|                                                                         |
|-------------------------------------------------------------------------|
| <p>LA SALLE COUNTY STATION<br/>UPDATED FINAL SAFETY ANALYSIS REPORT</p> |
| <p>FIGURE 2.5-58<br/>CONSOLIDATION SETTLEMENT<br/>(SHEET 1 of 2)</p>    |

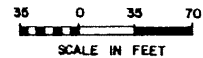
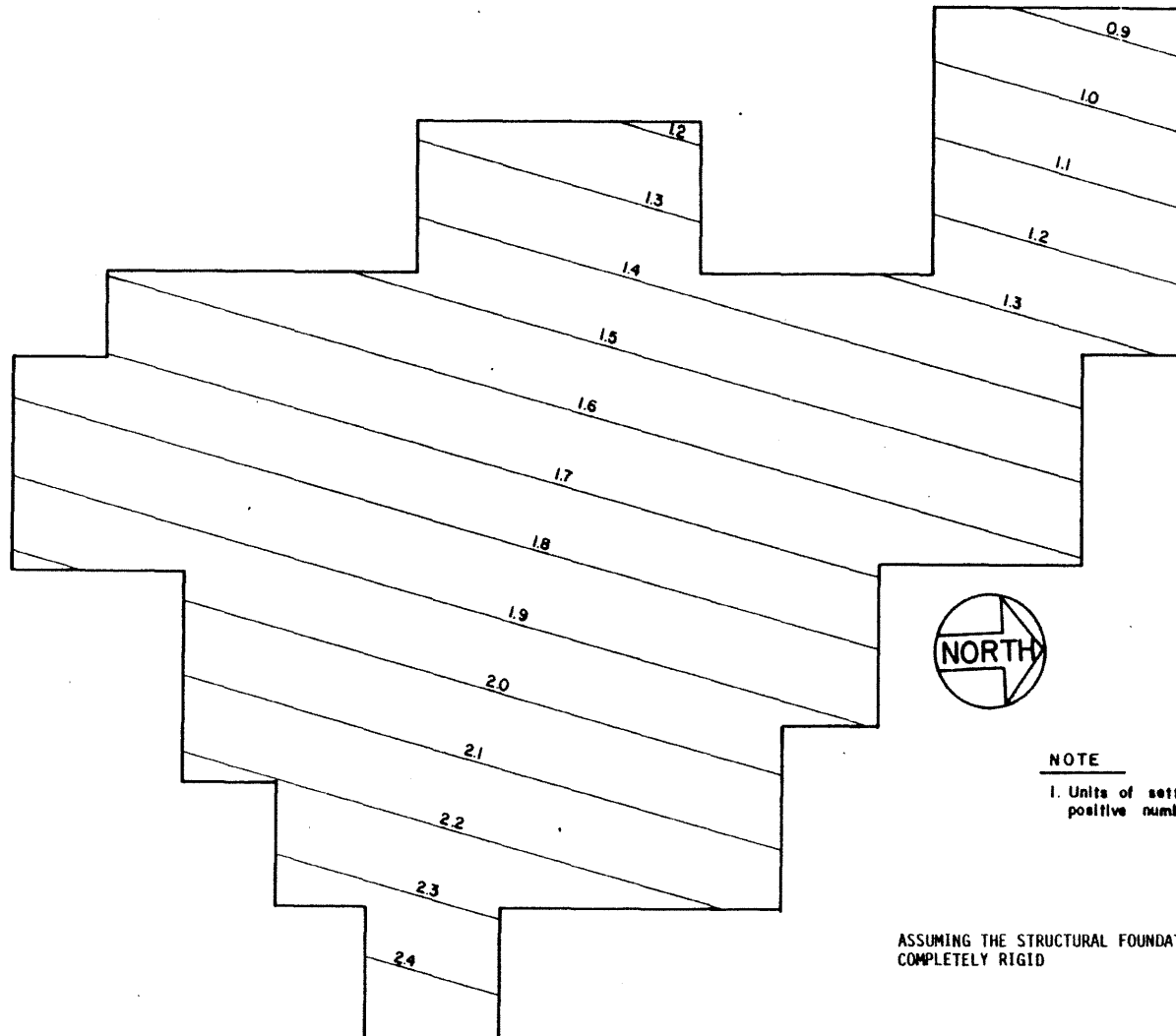

**NOTE**

1. Units of settlements are inches,  
positive numbers are settlements

ASSUMING THE STRUCTURAL FOUNDATION  
COMPLETELY RIGID

|                                                                 |
|-----------------------------------------------------------------|
| LA SALLE COUNTY STATION<br>UPDATED FINAL SAFETY ANALYSIS REPORT |
| FIGURE 2.5-58<br>CONSOLIDATION SETTLEMENT<br>(SHEET 2 of 2)     |

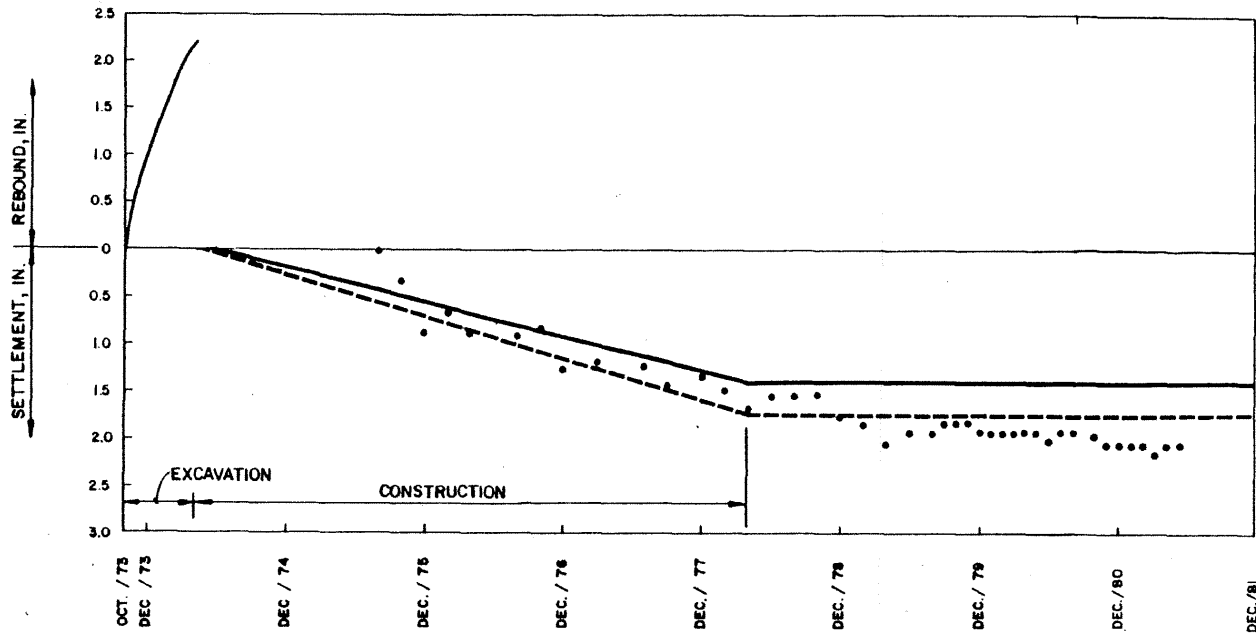

**LEGEND**

- MEASURED
- THEORETICAL, FLEXIBLE MAT
- - - THEORETICAL, RIGID MAT

LA SALLE COUNTY STATION  
 UPDATED FINAL SAFETY ANALYSIS REPORT

FIGURE 2.5-58a

THEORETICAL & MEASURED SETTLEMENTS AT  
 SETTLEMENT MONUMENT TR2

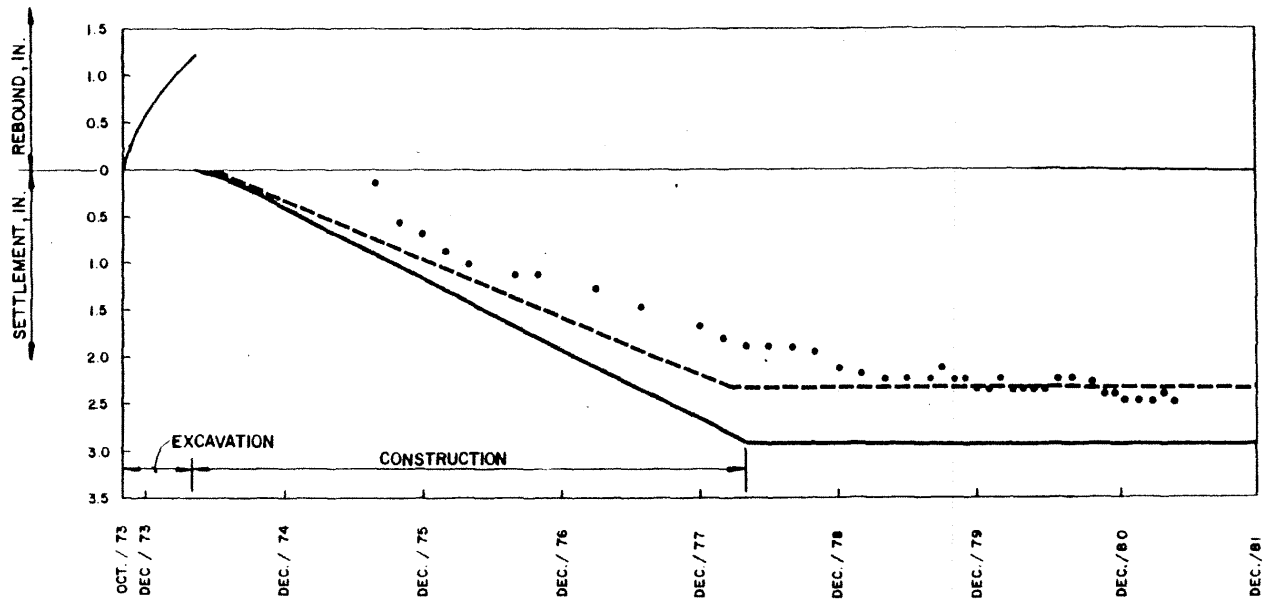

**LEGEND**

- MEASURED
- THEORETICAL, FLEXIBLE MAT
- - - THEORETICAL, RIGID MAT

LA SALLE COUNTY STATION  
 UPDATED FINAL SAFETY ANALYSIS REPORT

FIGURE 2.5-58b

THEORETICAL & MEASURED SETTLEMENTS AT  
 SETTLEMENT MONUMENT R1



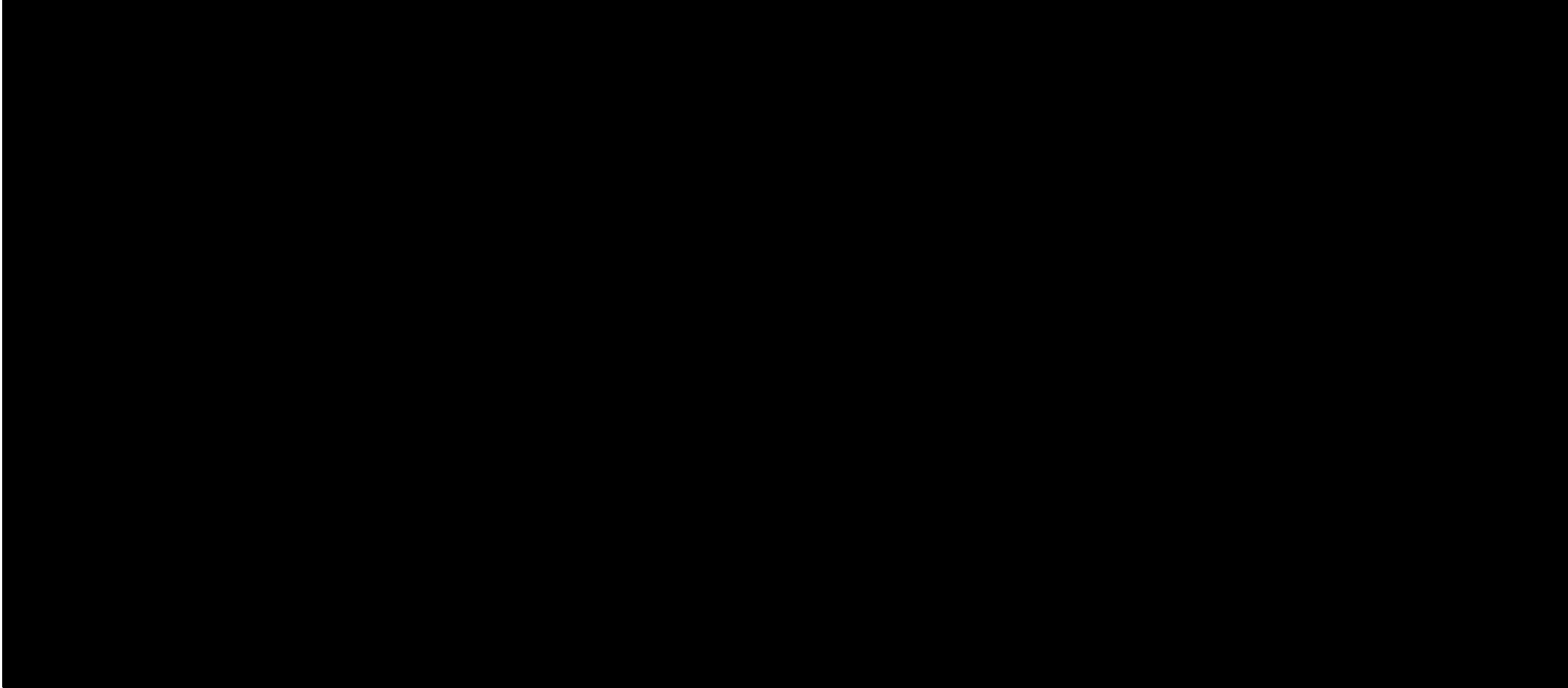

LEGEND

 Riprap

NOTES

1. See Figure 2.5-61 for details around Lake Intake Screen House.
2. See Figure 2.5-65 for Section A-A.

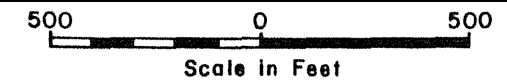

|                                                                 |
|-----------------------------------------------------------------|
| LA SALLE COUNTY STATION<br>UPDATED FINAL SAFETY ANALYSIS REPORT |
| FIGURE 2.5-59<br>CSCS COOLING POND AND PIPELINES                |

REV. 13

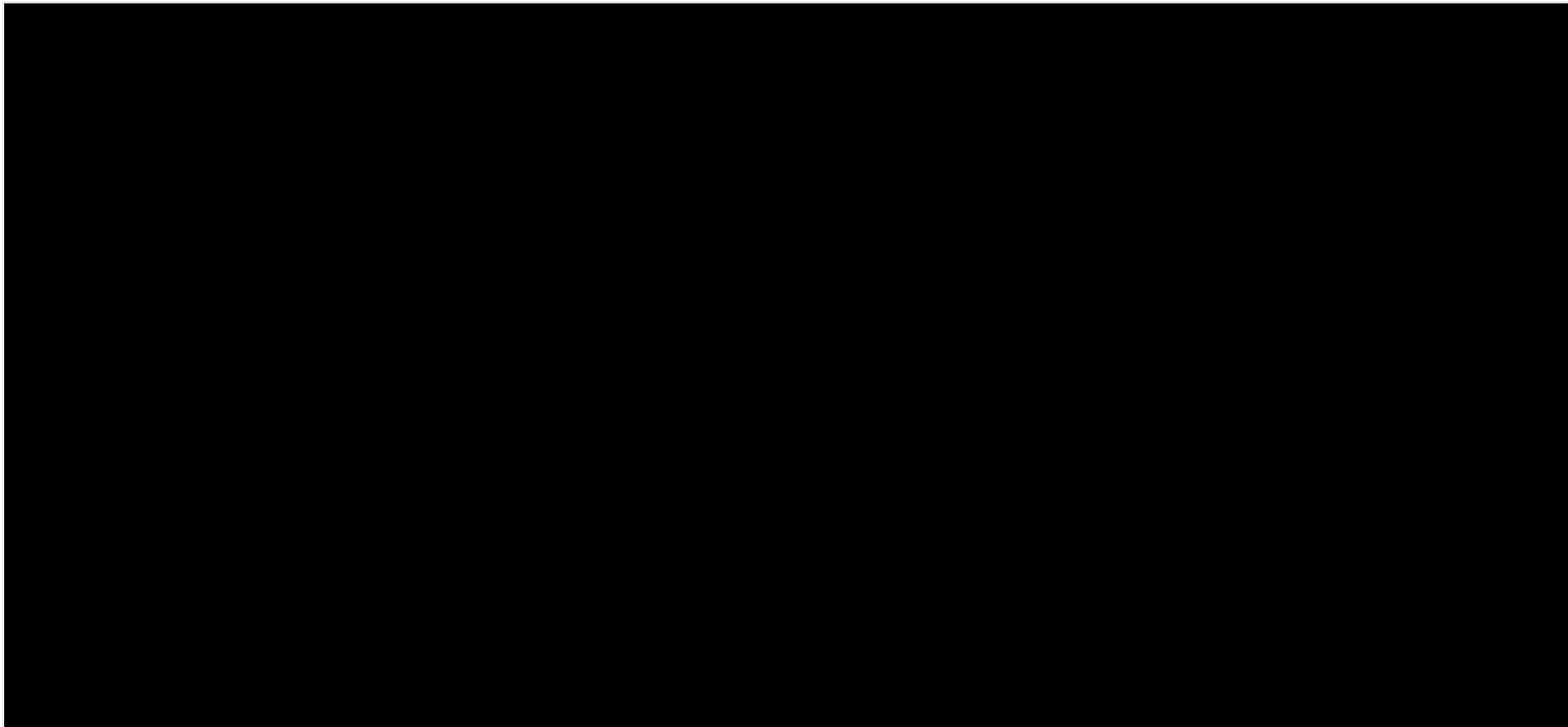

|                                                                 |
|-----------------------------------------------------------------|
| LA SALLE COUNTY STATION<br>UPDATED FINAL SAFETY ANALYSIS REPORT |
| FIGURE 2.5-60<br>PLAN OF CSCS OUTLET CHUTE STRUCTURE            |

LA SALLE COUNTY STATION  
UPDATED FINAL SAFETY ANALYSIS REPORT

FIGURE 2.5-61

PLAN OF INTAKE FLUME AT  
LAKE SCREEN HOUSE

REV. 0 - APRIL 1984

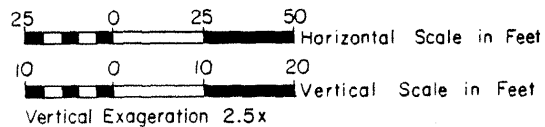
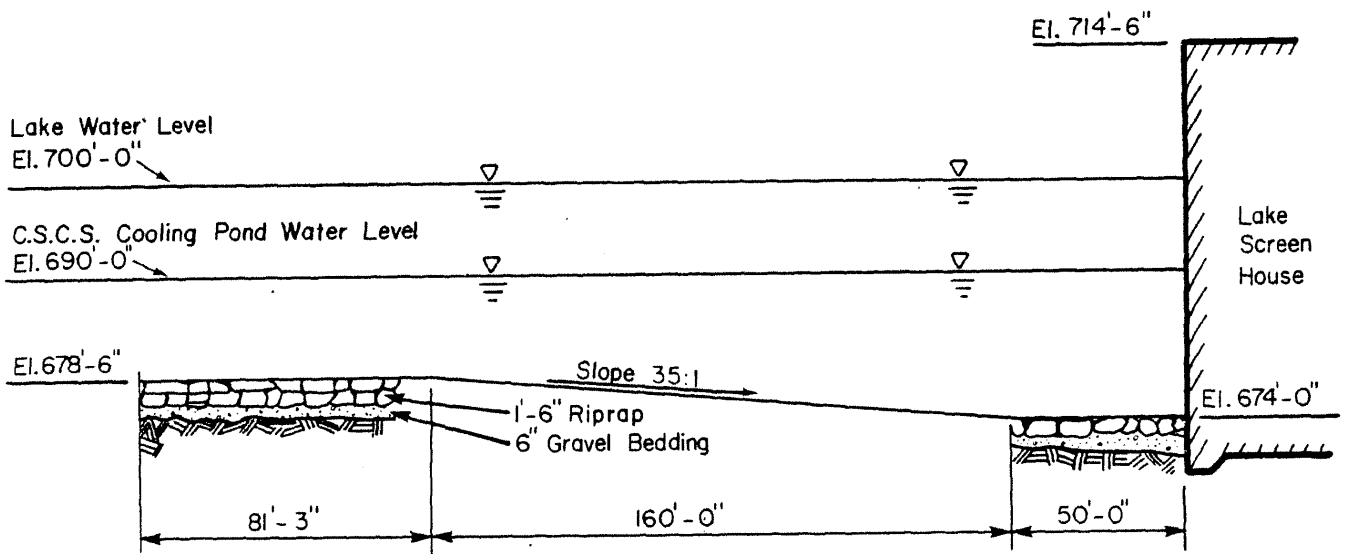

**NOTE**

1. See Figure 2.5-61 for location.

LA SALLE COUNTY STATION  
 UPDATED FINAL SAFETY ANALYSIS REPORT

---

FIGURE 2.5-62

PROFILE OF INTAKE FLUME AT  
 LAKE SCREEN HOUSE

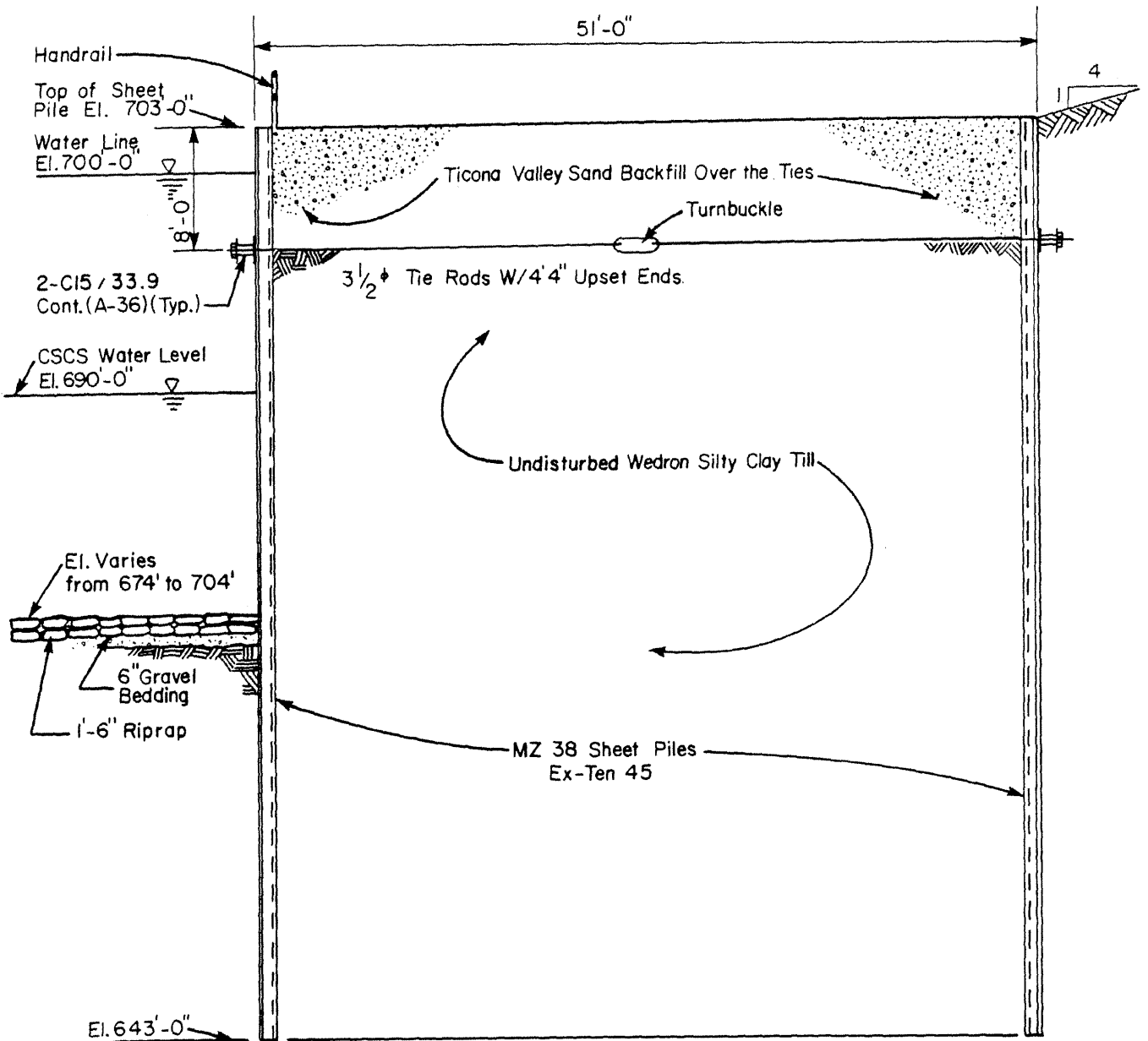

5 0 5 10  
 Scale in Feet  
 No Vertical Exaggeration

**NOTE**

1. See Figure 2.5-61 for location.

**LA SALLE COUNTY STATION**  
 UPDATED FINAL SAFETY ANALYSIS REPORT

FIGURE 2.5-63  
 SECTION THROUGH SHEET PILING  
 RETAINING WALL



A'  
East

A  
West

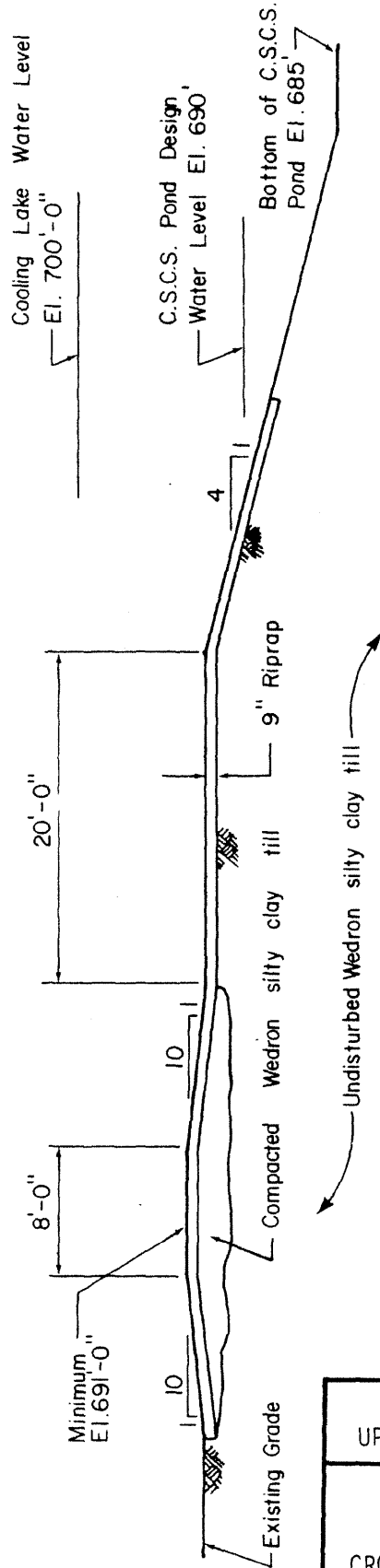

NOTE

1. See Figure 2.5-59 for location of Cross-Section.

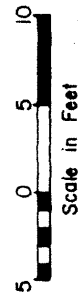

LA SALLE COUNTY STATION  
UPDATED FINAL SAFETY ANALYSIS REPORT

FIGURE 2.5-65  
CROSS SECTION THROUGH C.S.C.S. POND BERM

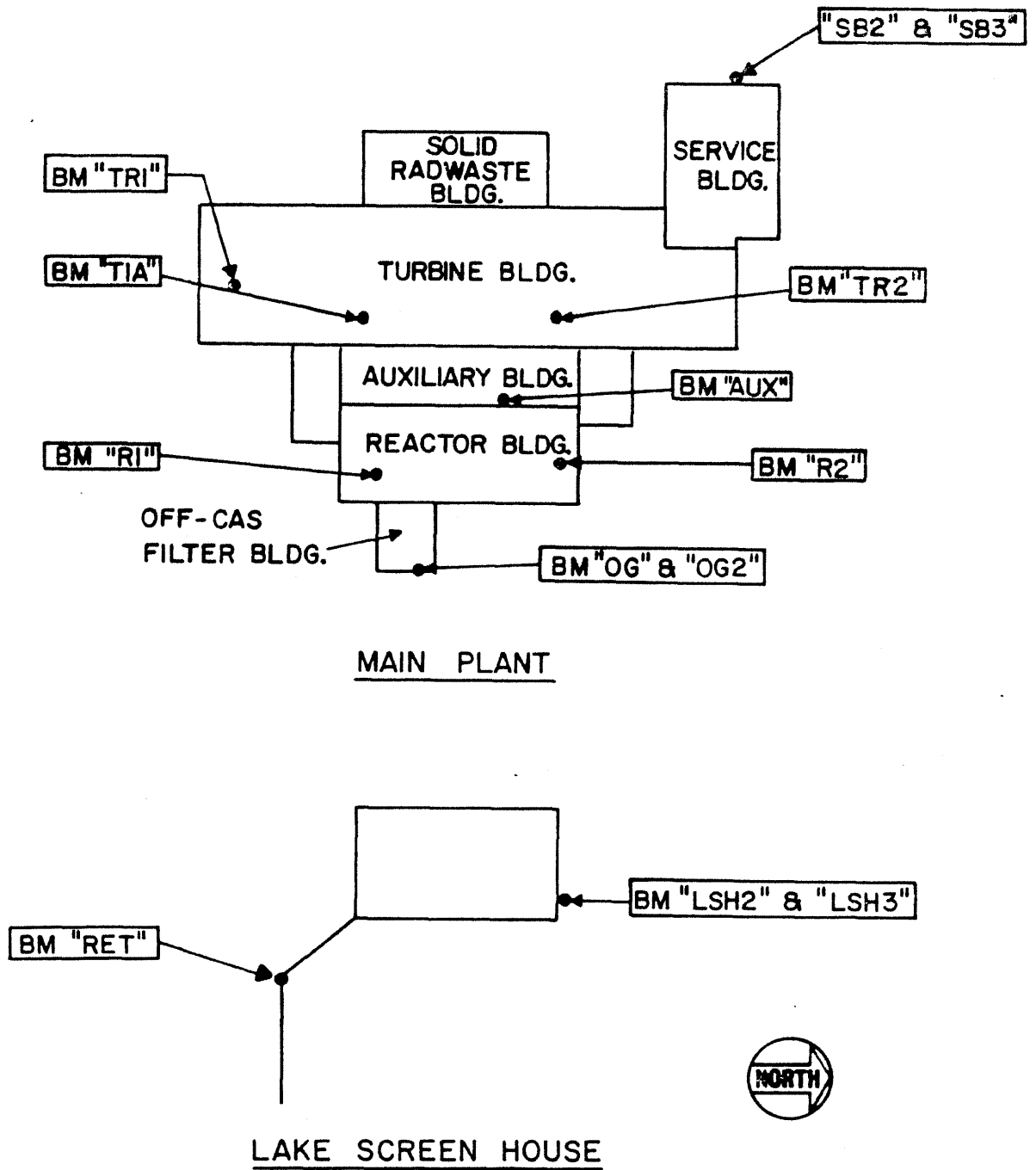

NOTES

1. Not to scale.
2. See Figure 2.5-67, Sheets 1 through 3 for settlement readings.

|                                                                                  |
|----------------------------------------------------------------------------------|
| <p>LA SALLE COUNTY STATION<br/>         UPDATED FINAL SAFETY ANALYSIS REPORT</p> |
| <p>FIGURE 2.5-66<br/>         LOCATIONS OF PLANT SETTLEMENT MONUMENTS</p>        |





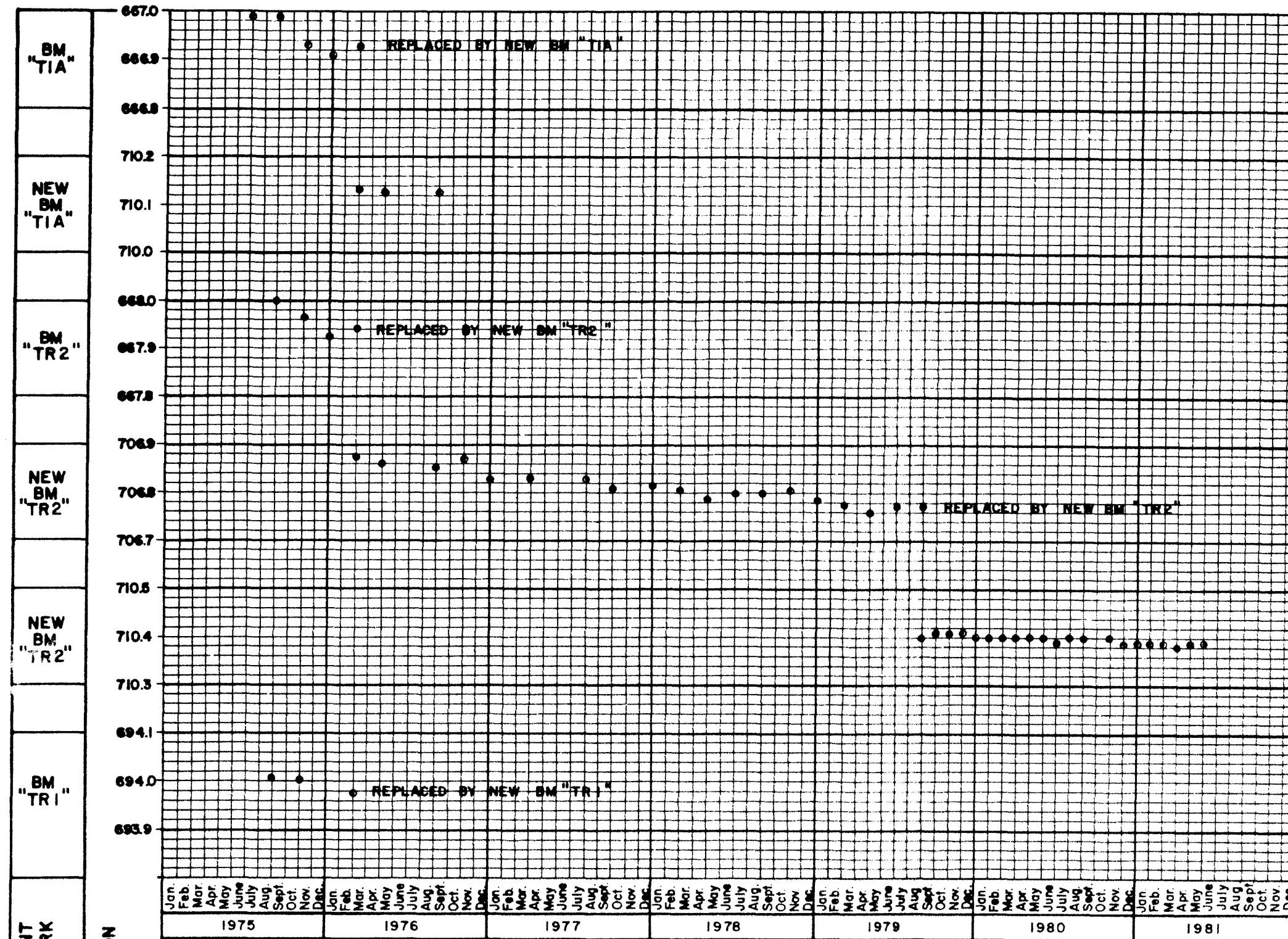

**NOTE :**

1. SEE FIGURE 2.5-66 FOR LOCATION OF BENCH MARKS

LA SALLE COUNTY STATION  
 UPDATED FINAL SAFETY ANALYSIS REPORT

FIGURE 2.5-67  
 PLANT SETTLEMENT READINGS  
 (SHEET 2 of 3)

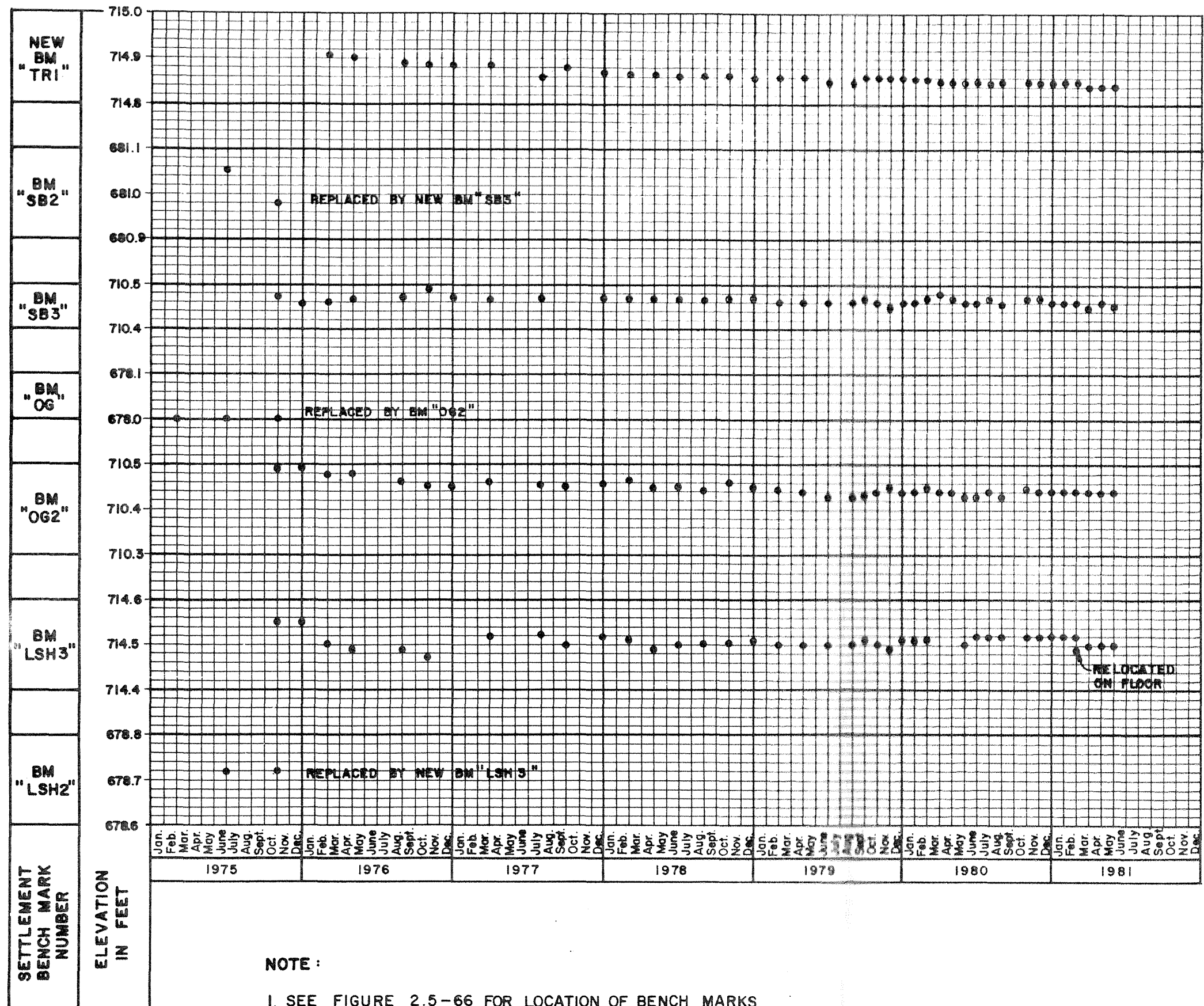

NOTE :

I. SEE FIGURE 2.5-66 FOR LOCATION OF BENCH MARKS

LA SALLE COUNTY STATION  
 UPDATED FINAL SAFETY ANALYSIS REPORT

FIGURE 2.5-67  
 PLANT SETTLEMENT READINGS  
 (SHEET 3 of 3)

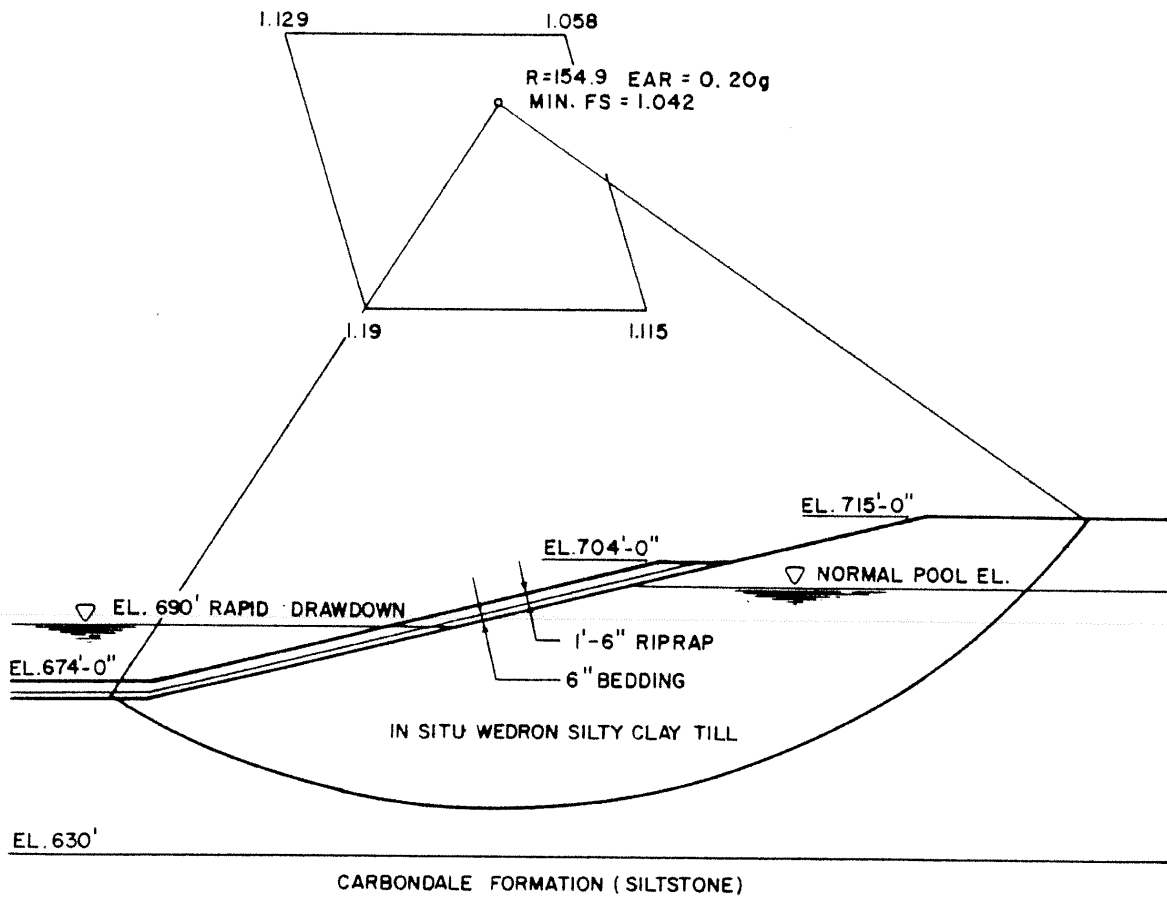

**NOTE**

1. See Figure 2.5-61 for location.

|                                                                                                                                  |
|----------------------------------------------------------------------------------------------------------------------------------|
| <p align="center"><b>LA SALLE COUNTY STATION</b><br/>         UPDATED FINAL SAFETY ANALYSIS REPORT</p>                           |
| <p align="center">FIGURE 2.5-68<br/>         CRITICAL FAILURE SURFACES<br/>         INTAKE FLUME<br/>         (SHEET 1 of 4)</p> |

REV. 0 - APRIL 1984

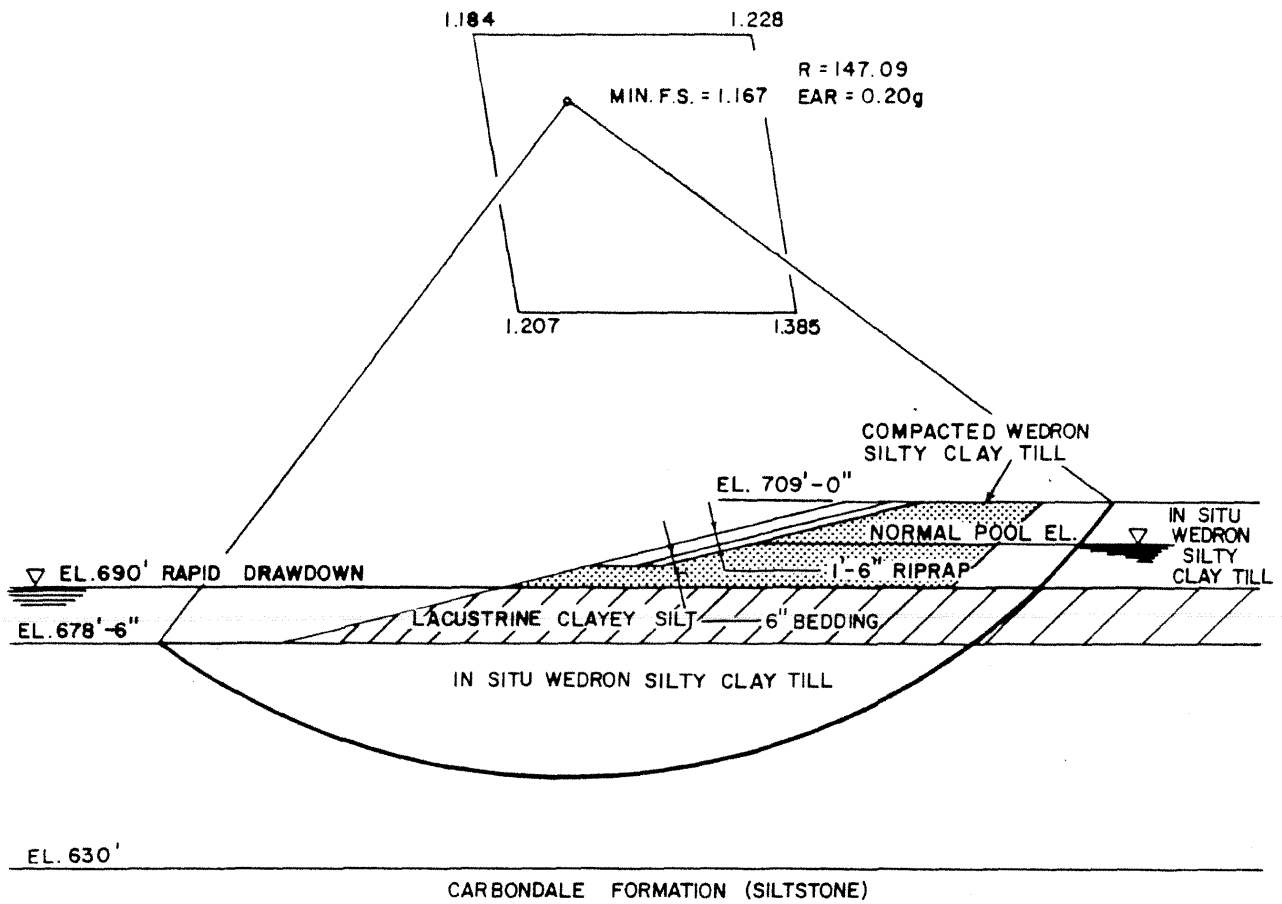

**NOTE**

1. See Figure 2.5-50, Sheet 2 for location.

|                                                                                                                                                            |
|------------------------------------------------------------------------------------------------------------------------------------------------------------|
| <p align="center"> <b>LA SALLE COUNTY STATION</b><br/> <b>UPDATED FINAL SAFETY ANALYSIS REPORT</b> </p>                                                    |
| <p align="center">           FIGURE 2.5-68<br/>           CRITICAL FAILURE SURFACES<br/>           INTAKE FLUME<br/>           (SHEET 2 of 4)         </p> |



**LA SALLE COUNTY STATION  
UPDATED FINAL SAFETY ANALYSIS REPORT**

FIGURE 2.5-68

CRITICAL FAILURE SURFACES  
INTAKE FLUME  
(SHEET 3 of 4)

REV. 0 - APRIL 1984

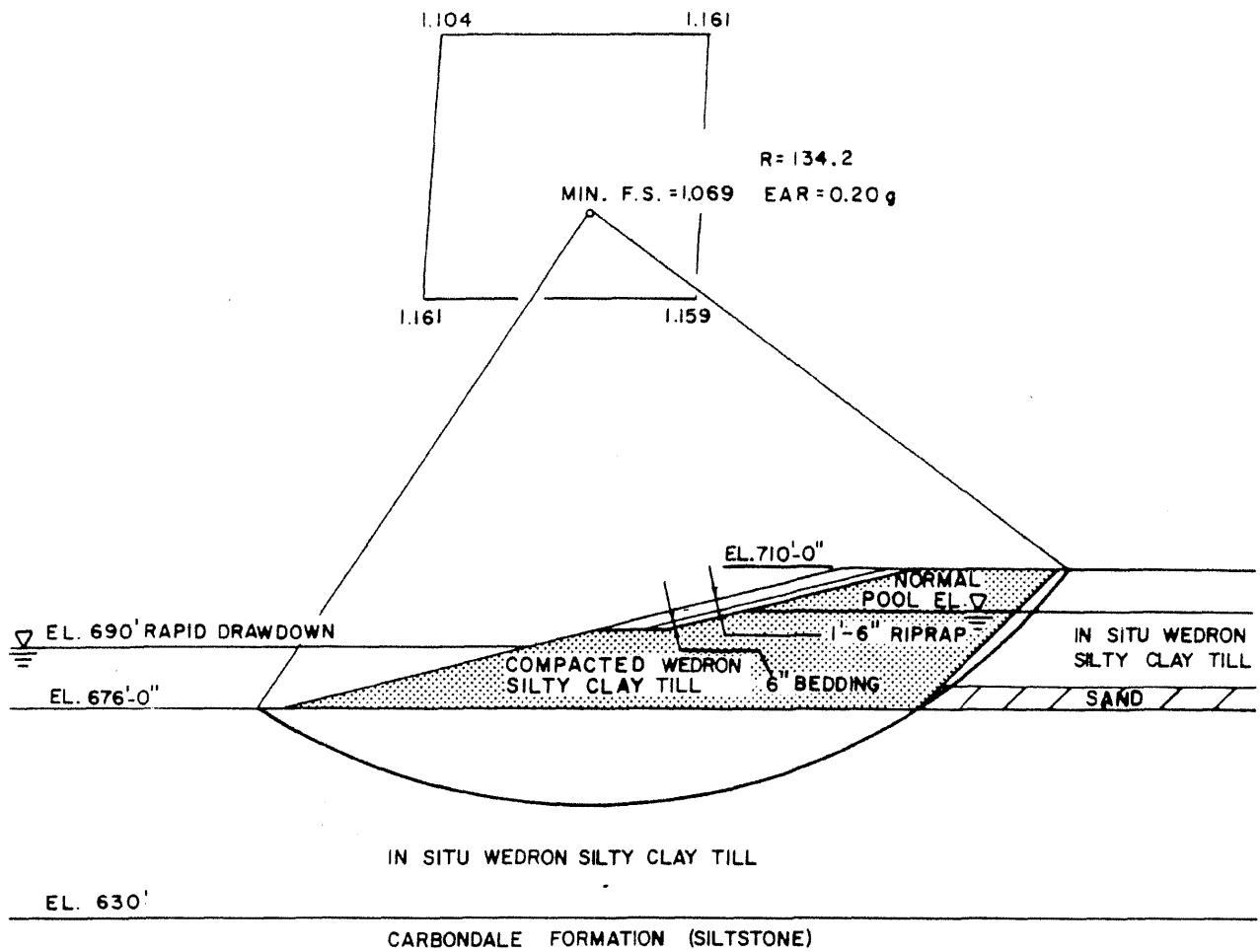

**NOTE**

1. See Figure 2.5-50, Sheet 2 for location.

**LA SALLE COUNTY STATION**  
 UPDATED FINAL SAFETY ANALYSIS REPORT

FIGURE 2.5-68  
 CRITICAL FAILURE SURFACES  
 INTAKE FLUME  
 (SHEET 4 of 4)

Total Area = 2078 ft.²  
 Blockage Area = 1856 ft.²  
 Unblocked Area = 222 ft.²

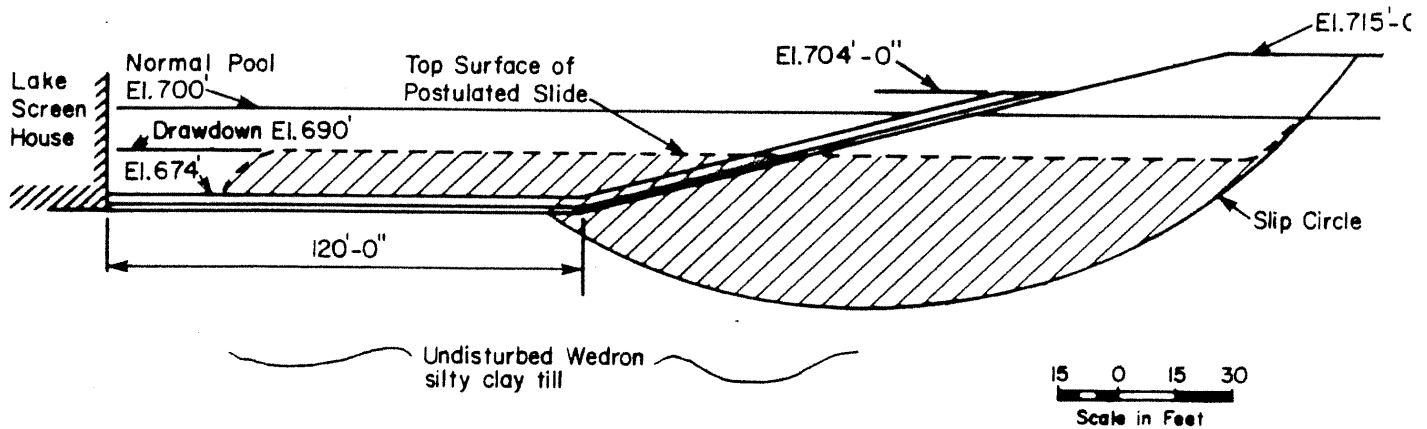

**LEGEND**

 Failed Mass

**NOTE**

1. See Figure 2.5-61 for Cross-Section location.

|                                                                                                                            |
|----------------------------------------------------------------------------------------------------------------------------|
| <p align="center"><b>LA SALLE COUNTY STATION</b><br/>         UPDATED FINAL SAFETY ANALYSIS REPORT</p>                     |
| <p align="center">FIGURE 2.5-69</p> <p align="center">POSTULATED CSCS POND INTAKE<br/>         FLUME FAILURE CONDITION</p> |



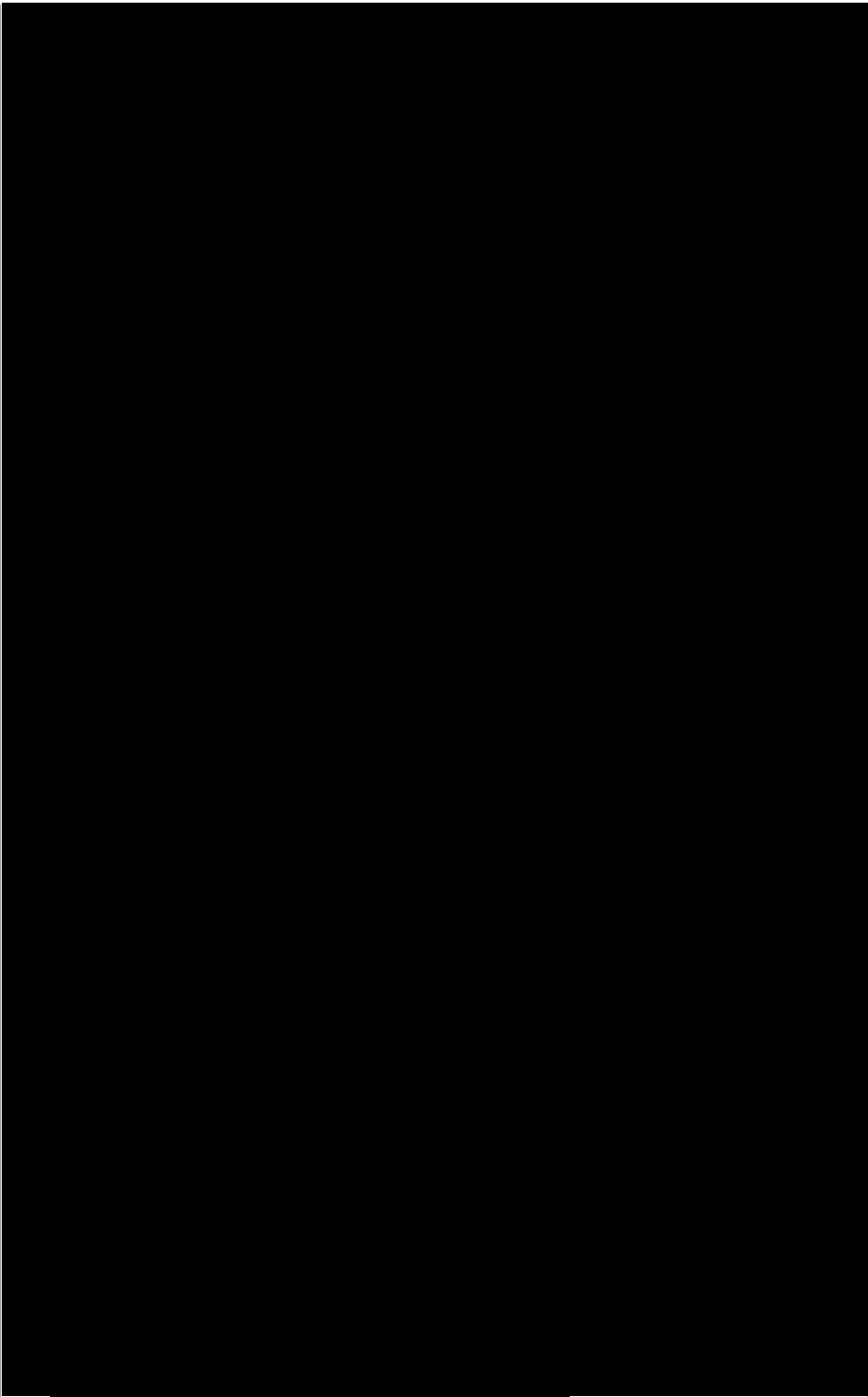

LA SALLE COUNTY STATION  
UPDATED FINAL SAFETY ANALYSIS REPORT

FIGURE 2.5-70  
TYPICAL PERIPHERAL DIKE CROSS SECTION

REV. 0 - APRIL 1984

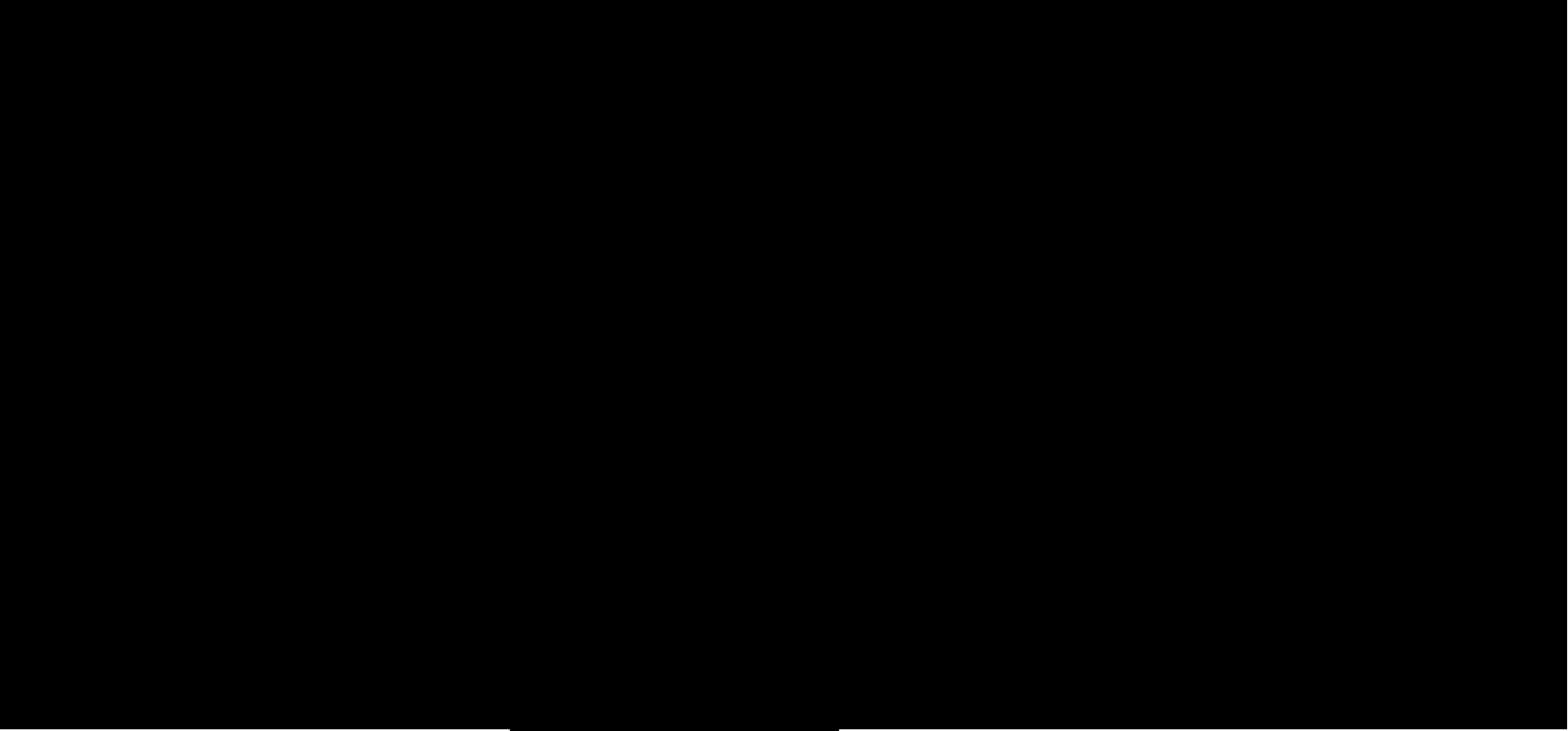

|                                                                 |
|-----------------------------------------------------------------|
| LA SALLE COUNTY STATION<br>UPDATED FINAL SAFETY ANALYSIS REPORT |
| FIGURE 2.5-71<br>PLAN OF MAKEUP PIPELINE<br>DIKE PENETRATION    |

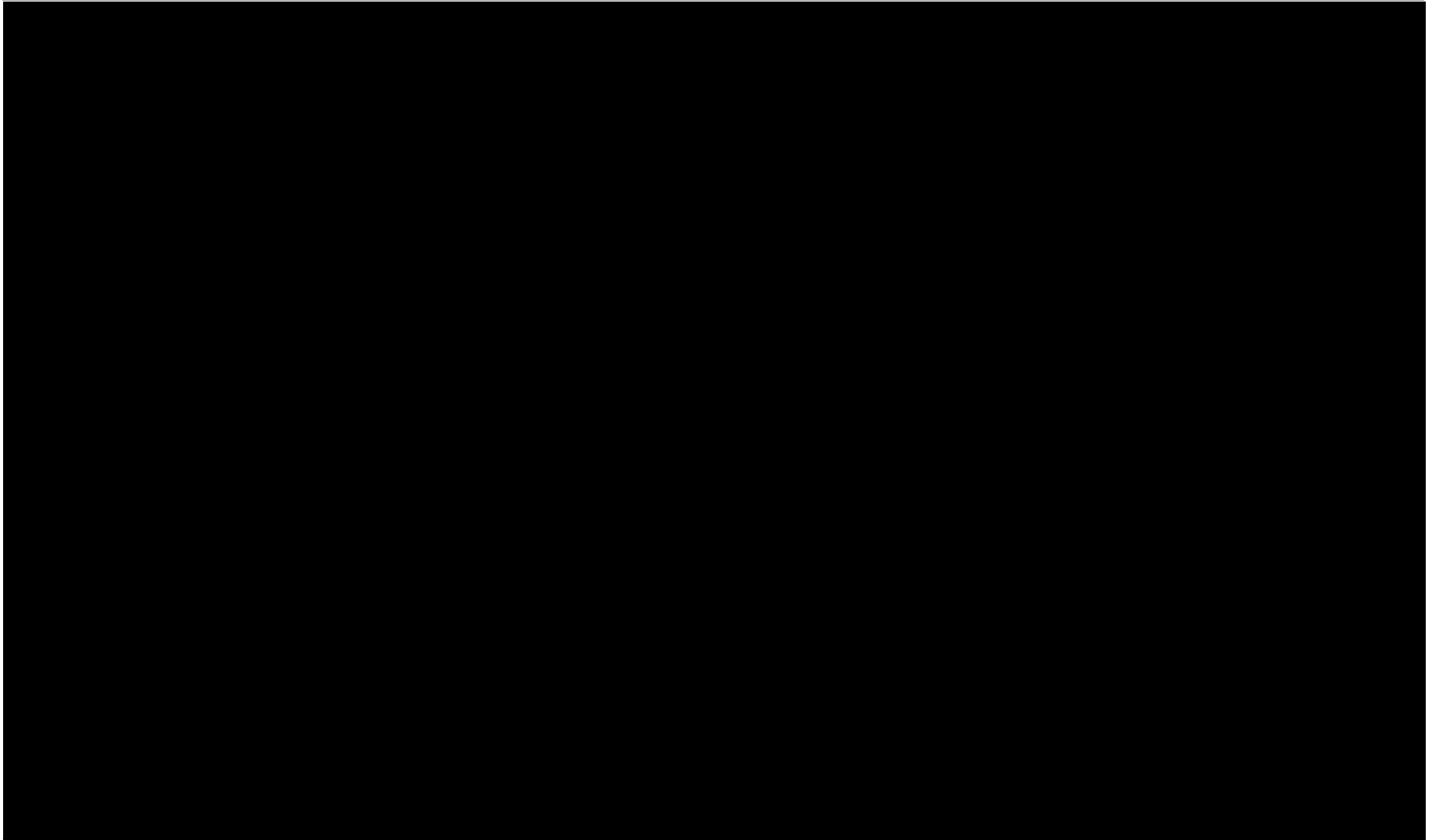

|                                                                 |
|-----------------------------------------------------------------|
| LA SALLE COUNTY STATION<br>UPDATED FINAL SAFETY ANALYSIS REPORT |
| FIGURE 2.5-72<br>MAKEUP PIPELINE CROSS SECTION                  |

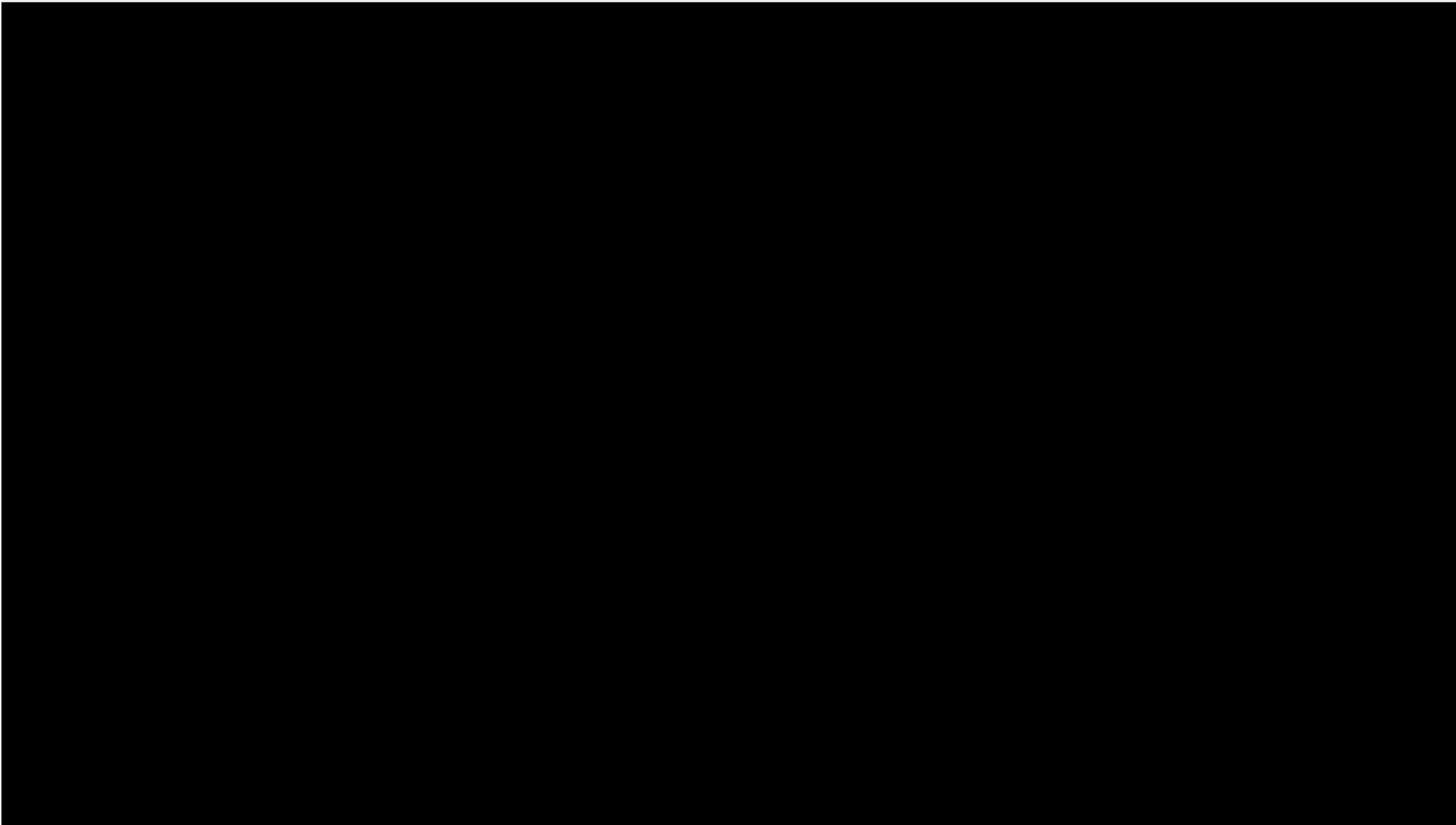

LA SALLE COUNTY STATION  
UPDATED FINAL SAFETY ANALYSIS REPORT

FIGURE 2.5-73

PLAN OF BLOWDOWN PIPELINE  
DIKE PENETRATION

REV. 0 - APRIL 1984

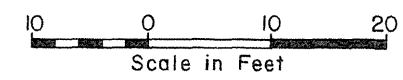
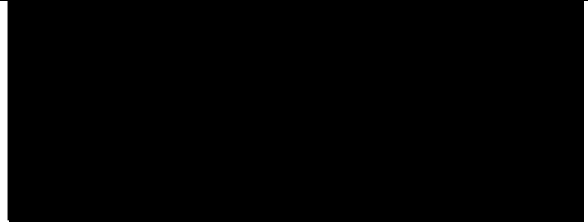

LA SALLE COUNTY STATION  
UPDATED FINAL SAFETY ANALYSIS REPORT

FIGURE 2.5-74  
BLOWDOWN PIPELINE CROSS SECTION

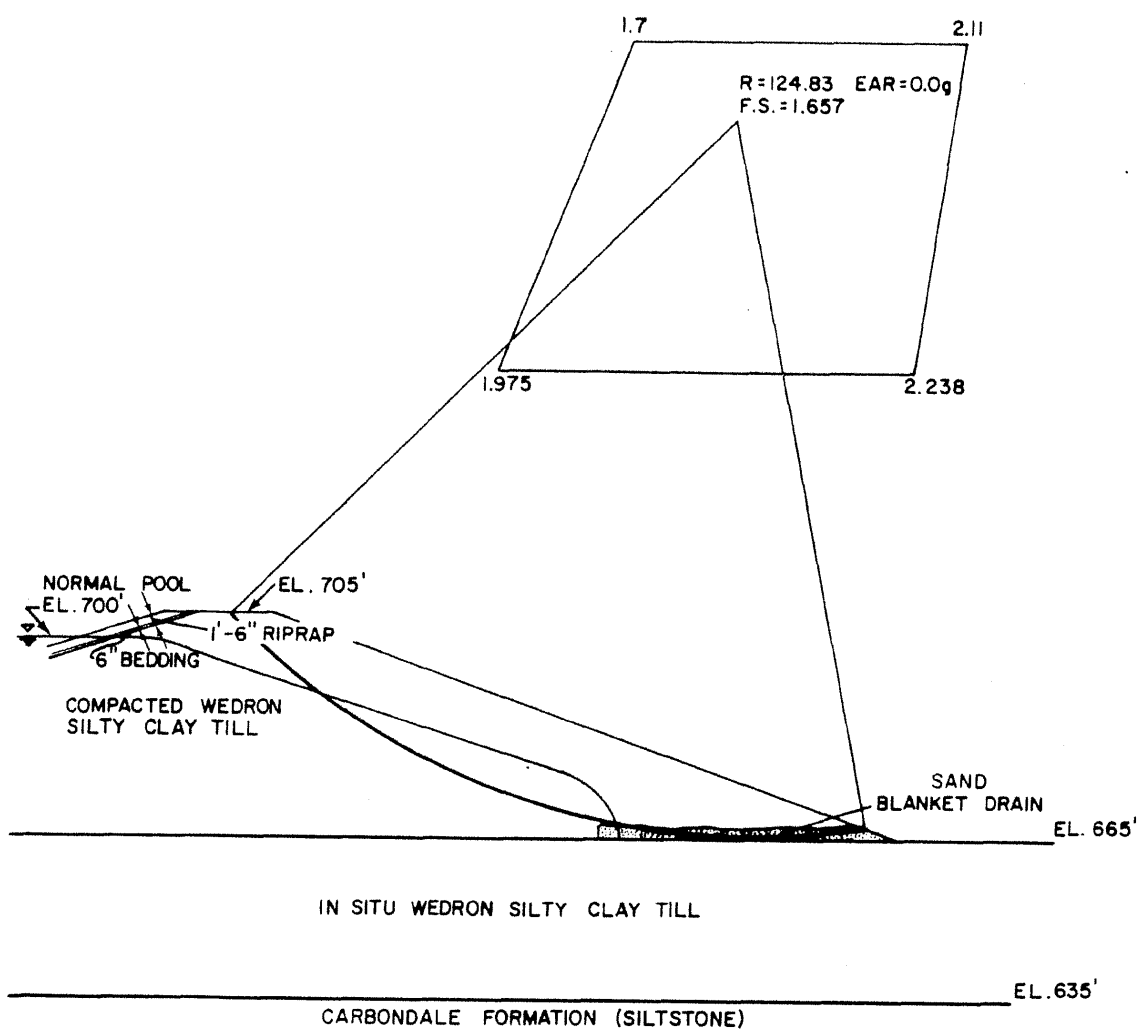

**LA SALLE COUNTY STATION**  
 UPDATED FINAL SAFETY ANALYSIS REPORT  
 FIGURE 2.5-75  
 PERIPHERAL DIKE CRITICAL FAILURE  
 SURFACE - STEADY SEEPAGE CONDITION

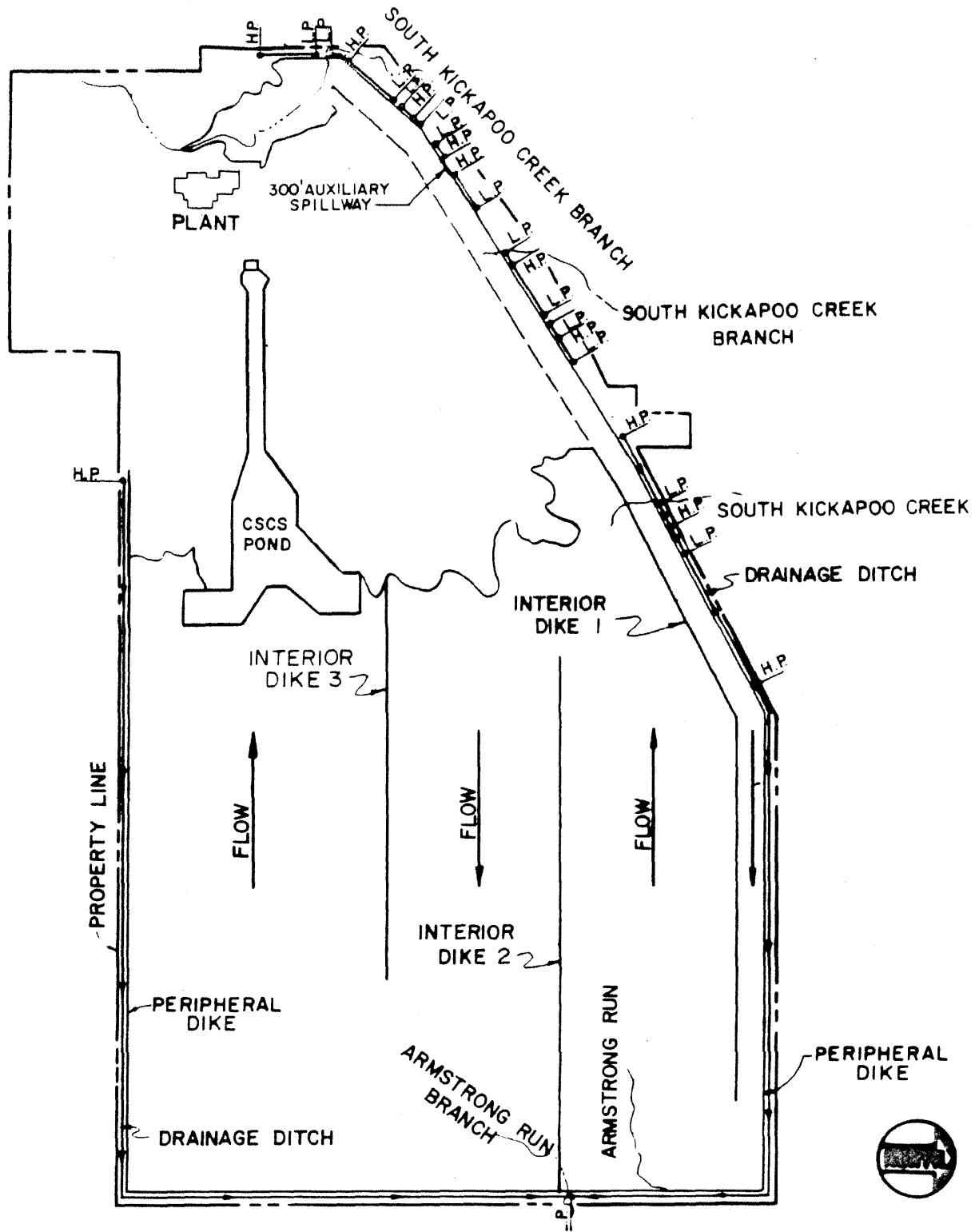

LA SALLE COUNTY STATION  
 UPDATED FINAL SAFETY ANALYSIS REPORT

FIGURE 2.5-76  
 PERIPHERAL DIKE DRAINAGE DITCHES

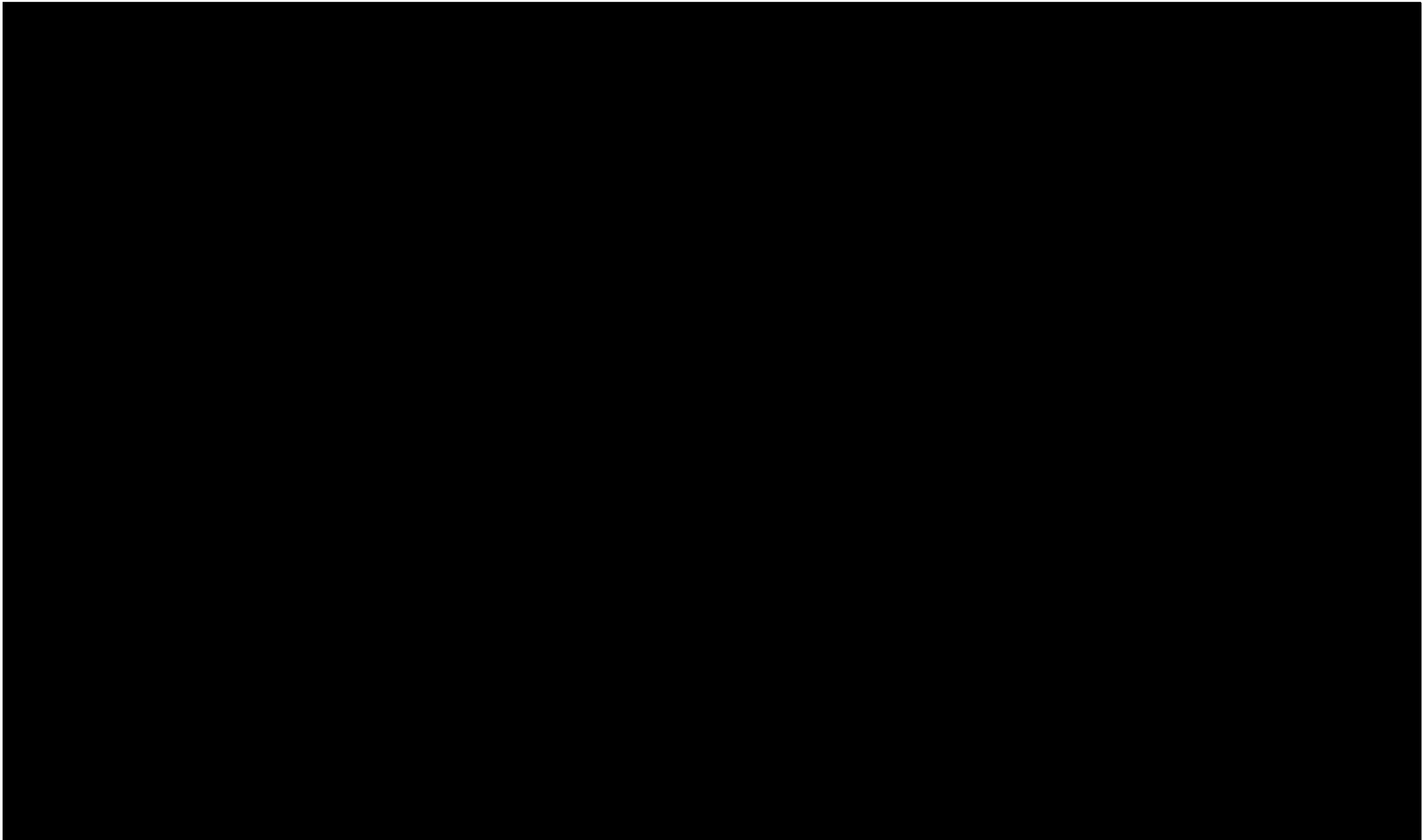

LA SALLE COUNTY STATION  
UPDATED FINAL SAFETY ANALYSIS REPORT

FIGURE 2.5-77



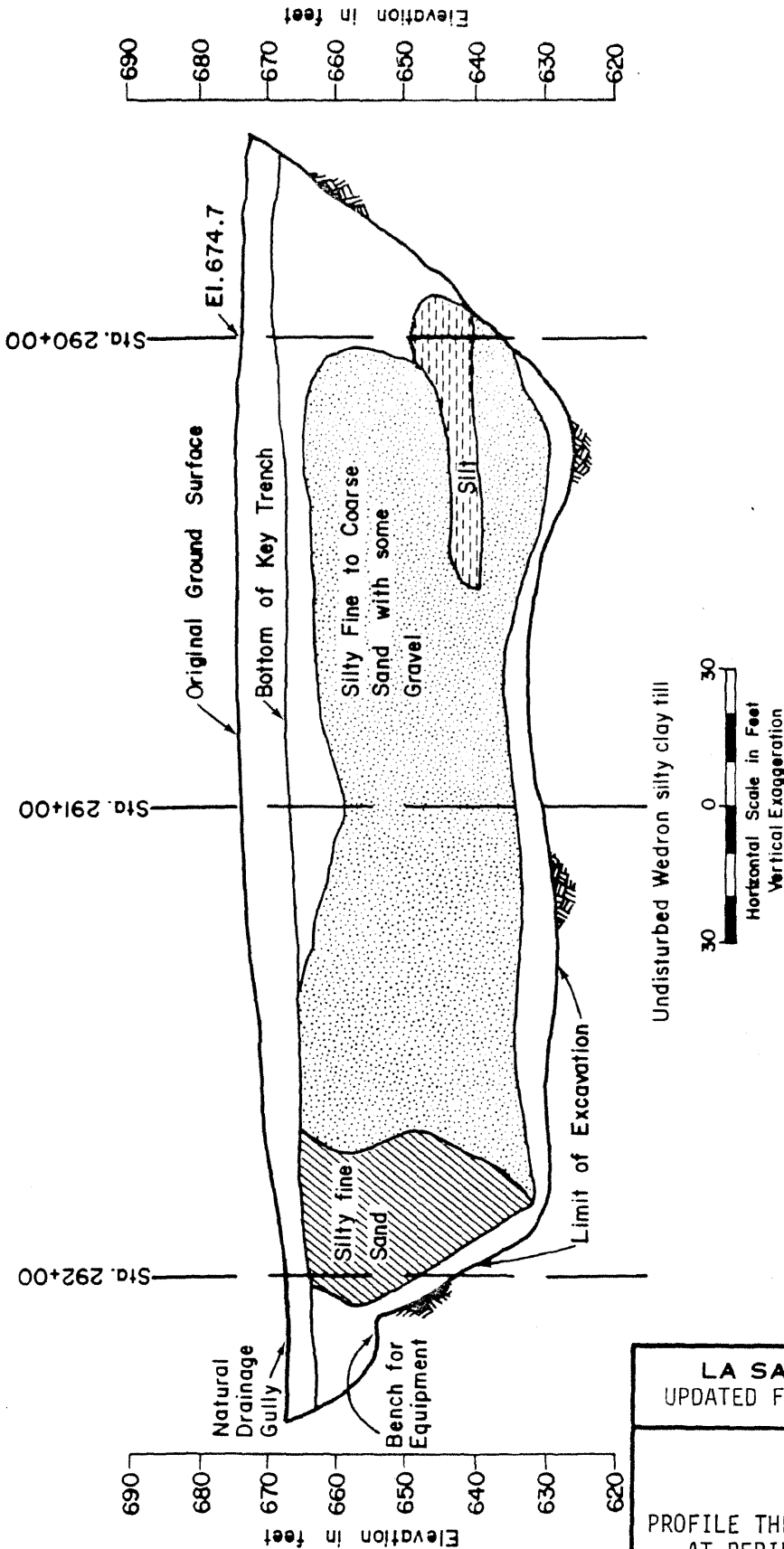

LOCATIONS OF OBSERVATION WELLS  
AND SETTLEMENT MONUMENTS

REV. 0 - APRIL 1984





**LEGEND**

-  Silty fine sand
-  Silty fine to coarse sand with some gravel
-  Silt
-  Wedron silty clay till

**NOTE**

- i. See Figure 2.5-41 for location.

**LA SALLE COUNTY STATION**  
 UPDATED FINAL SAFETY ANALYSIS REPORT

---

FIGURE 2.5-78

PROFILE THROUGH SAND AND GRAVEL DEPOSIT  
 AT PERIPHERAL DIKE STATION 291+00

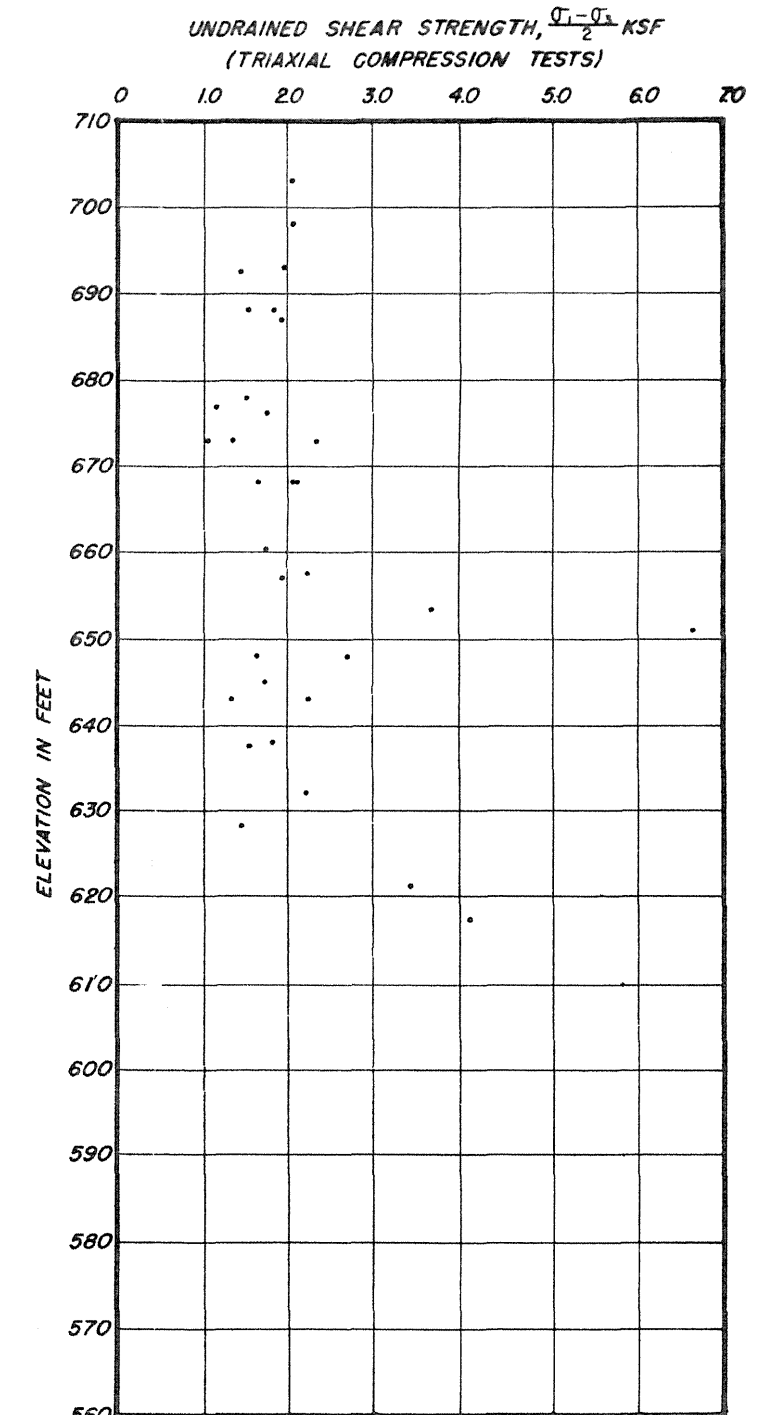
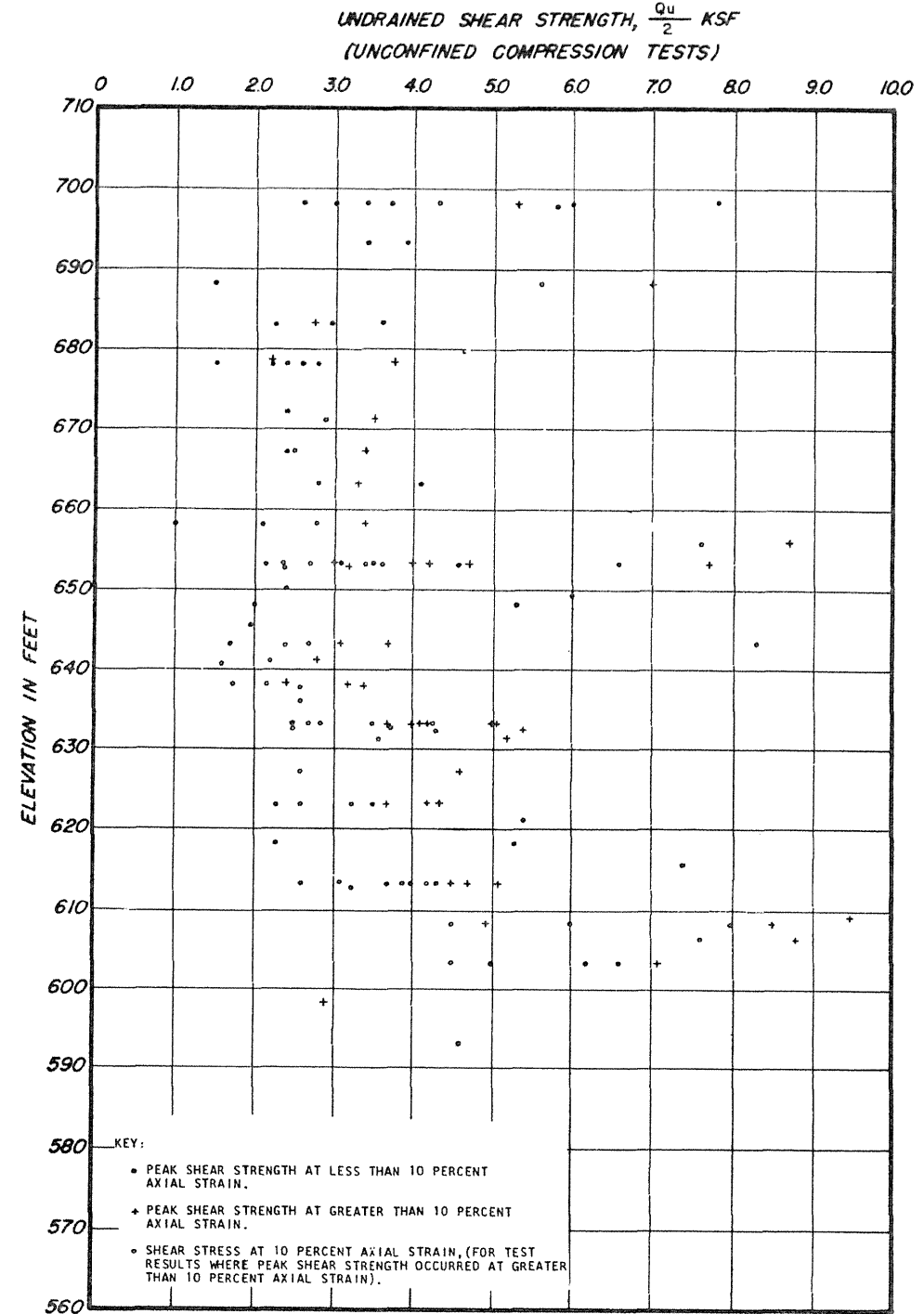
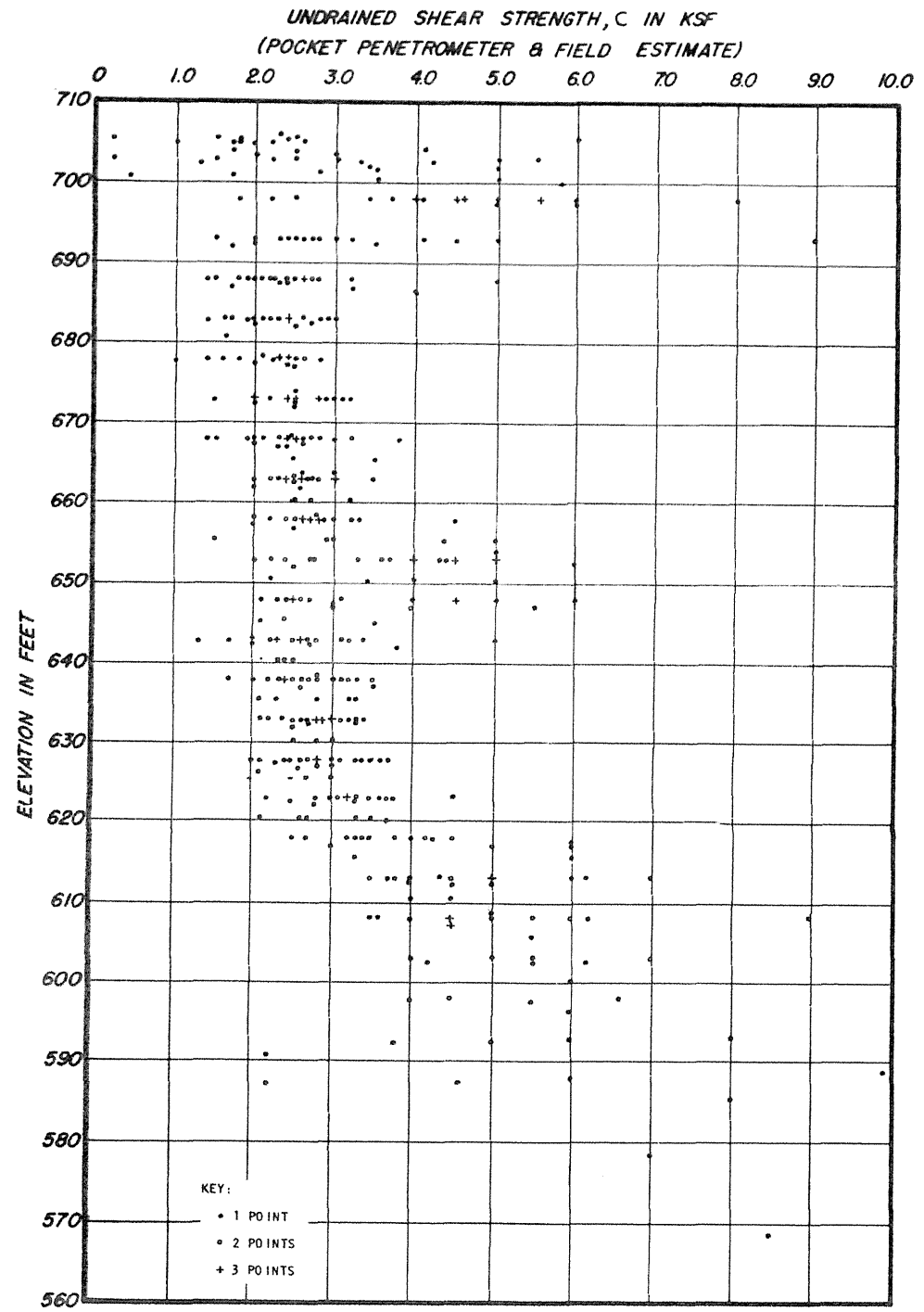

LA SALLE COUNTY STATION  
 UPDATED FINAL SAFETY ANALYSIS REPORT

FIGURE 2.5-79  
 UNDRAINED SHEAR STRENGTH VS. DEPTH

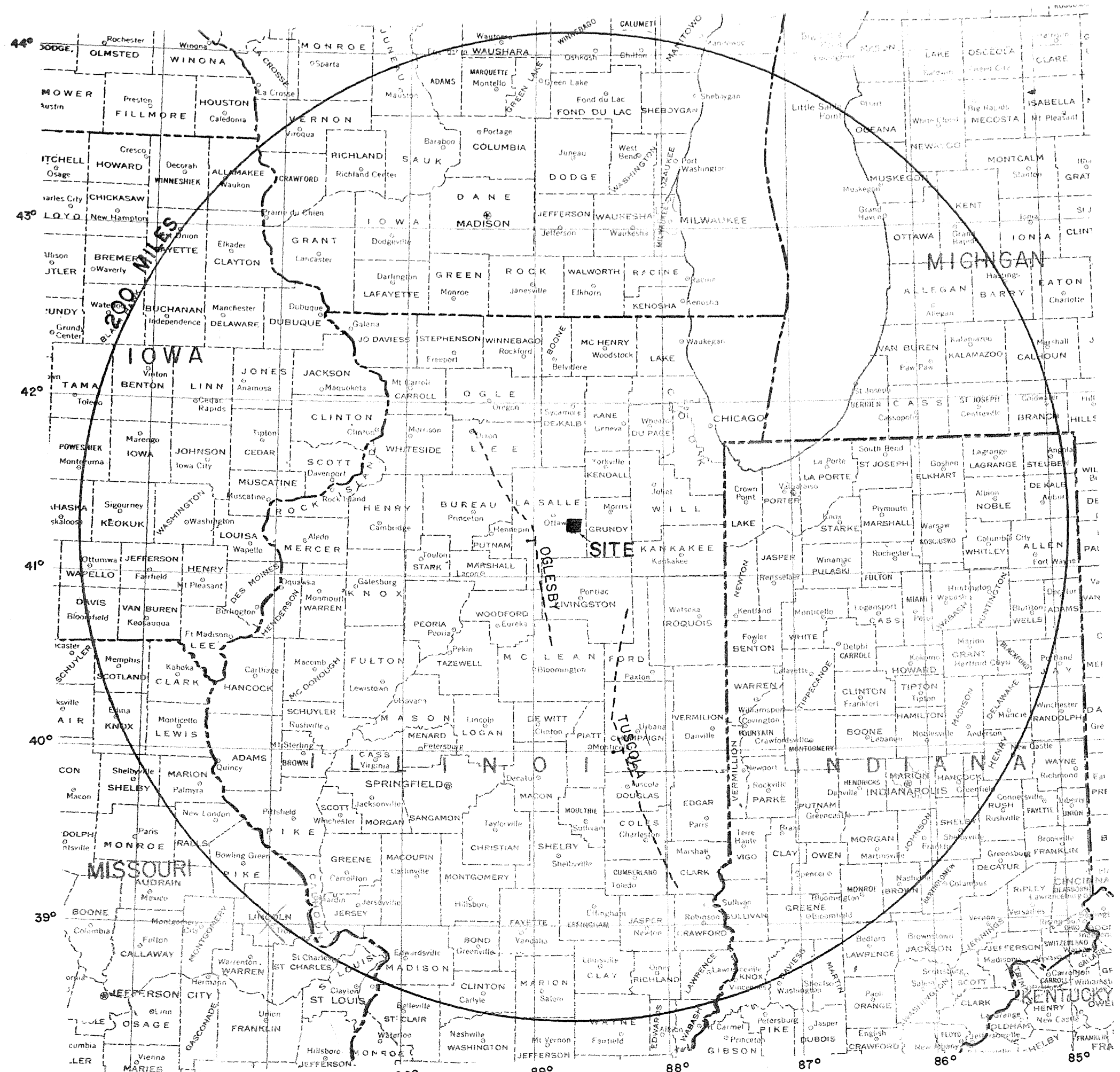

**LEGEND**

Implied Fault, ball and bar on side reported to be downthrown.

**NOTE**

Details and references for each implied fault are given in the text Section 2.5.1.1.5.1.2.14.

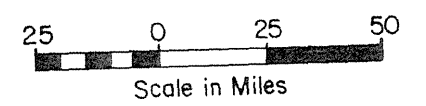

**LA SALLE COUNTY STATION  
UPDATED FINAL SAFETY ANALYSIS REPORT**

**FIGURE 2.5-80  
OTHER PROPOSED FAULTS**

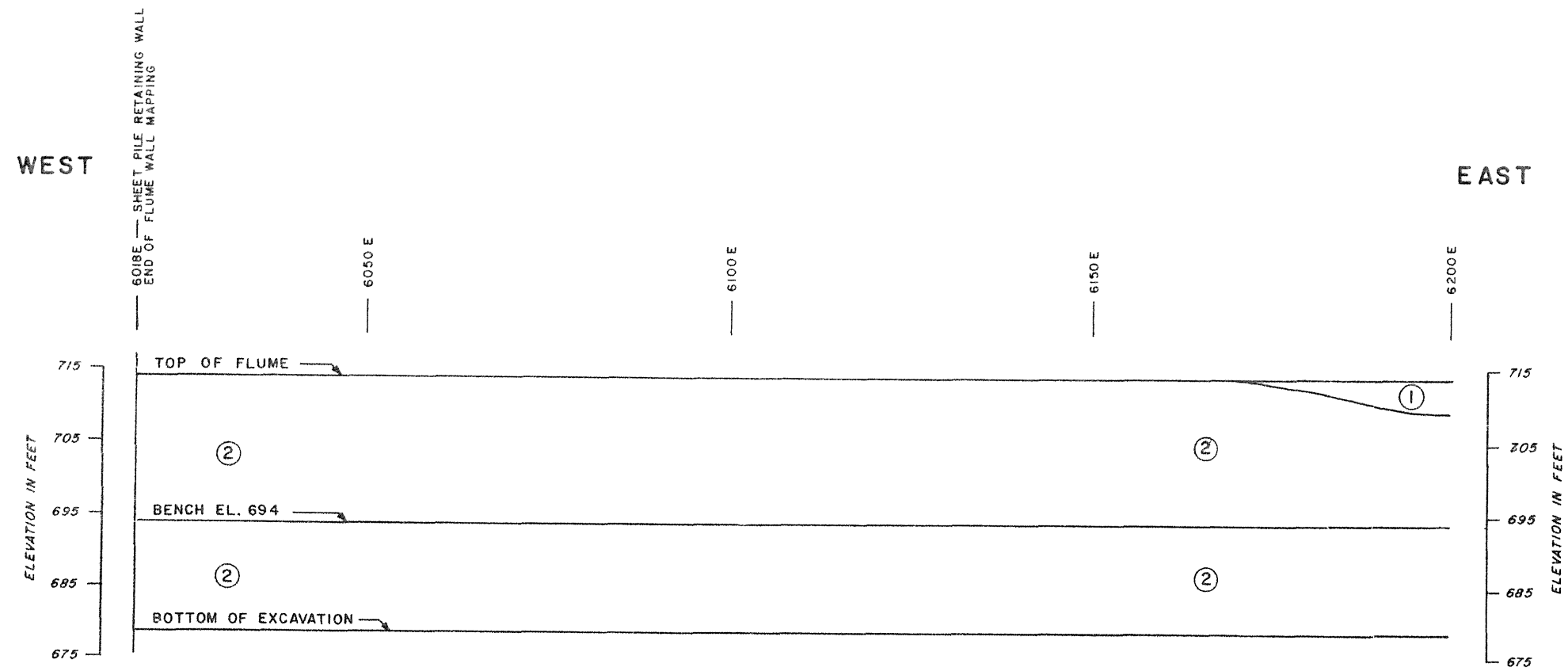

EXPLANATION:

- ① FILL - REWORKED SILTY CLAY WITH SOME FINE TO COARSE SAND AND TRACE FINE TO COARSE GRAVEL (VERY STIFF TO HARD)
- ② TILL - SILTY CLAY AND TRACE FINE TO COARSE SAND TRACE FINE TO COARSE GRAVEL



NOTE:

1. SEE FIGURE 2.5-50, SHEET 2 OF 3 FOR LOCATION

LA SALLE COUNTY STATION  
 UPDATED FINAL SAFETY ANALYSIS REPORT

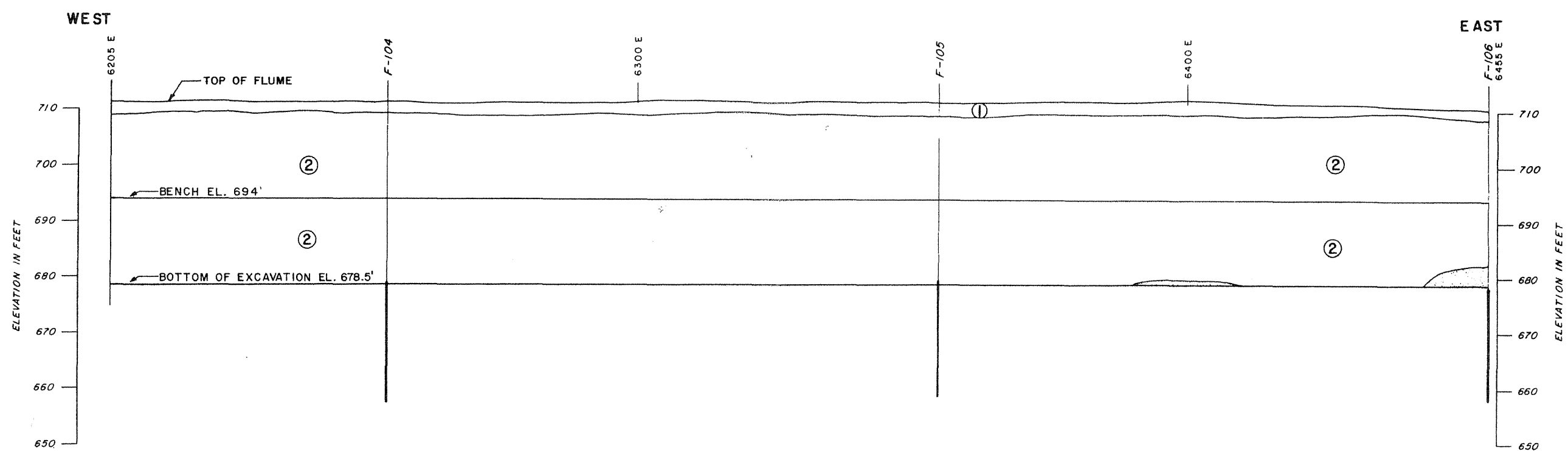
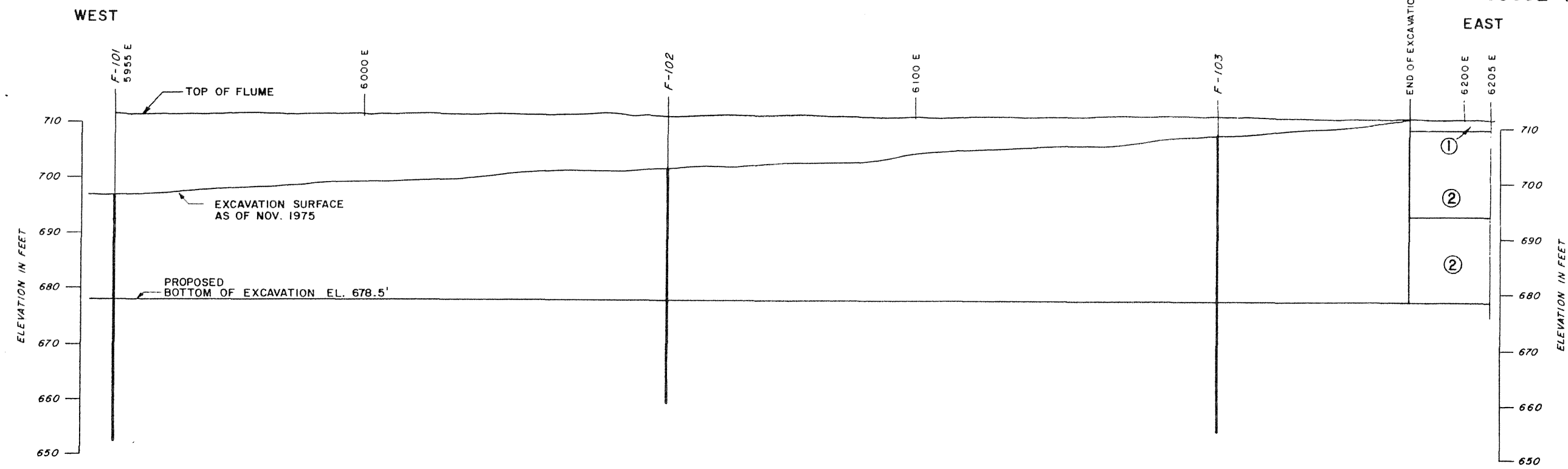
FIGURE 2.5-81  
 GEOLOGIC MAP OF NORTH FLUME WALL  
 (SHEET 1 of 9)



- EXPLANATION:
- ① FILL - REWORKED SILTY CLAY WITH SOME FINE TO COARSE SAND AND TRACE FINE TO COARSE GRAVEL (VERY STIFF TO HARD)
  - ② TILL - SILTY CLAY WITH SOME FINE TO COARSE SAND TRACE FINE TO COARSE GRAVEL
  -  LACUSTRINE - PRIMARILY SILT WITH OCCASIONAL INTERBEDDED SILTY CLAY AND FINE SILTY SAND (MEDIUM STIFF TO STIFF)
  -  GLACIAL OUTWASH - FINE TO COARSE SAND AND GRAVEL WITH OCCASIONAL LAYERS OF SILT AND SILTY SAND (LOOSE TO DENSE)
  - ⊙ LOCATION OF BULK SAMPLE

NOTE:  
1. SEE FIGURE 2.5-50, SHEET 2 OF 3 FOR LOCATION.



LA SALLE COUNTY STATION  
UPDATED FINAL SAFETY ANALYSIS REPORT

FIGURE 2.5-81  
GEOLOGIC MAP OF NORTH FLUME WALL  
(SHEET 2 of 9)

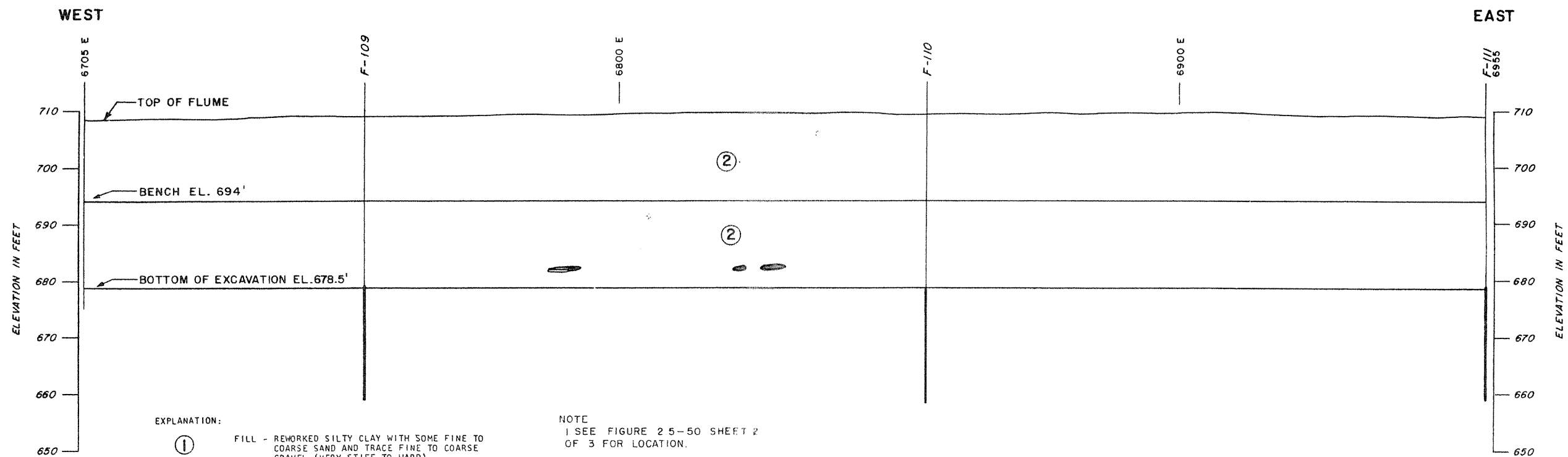
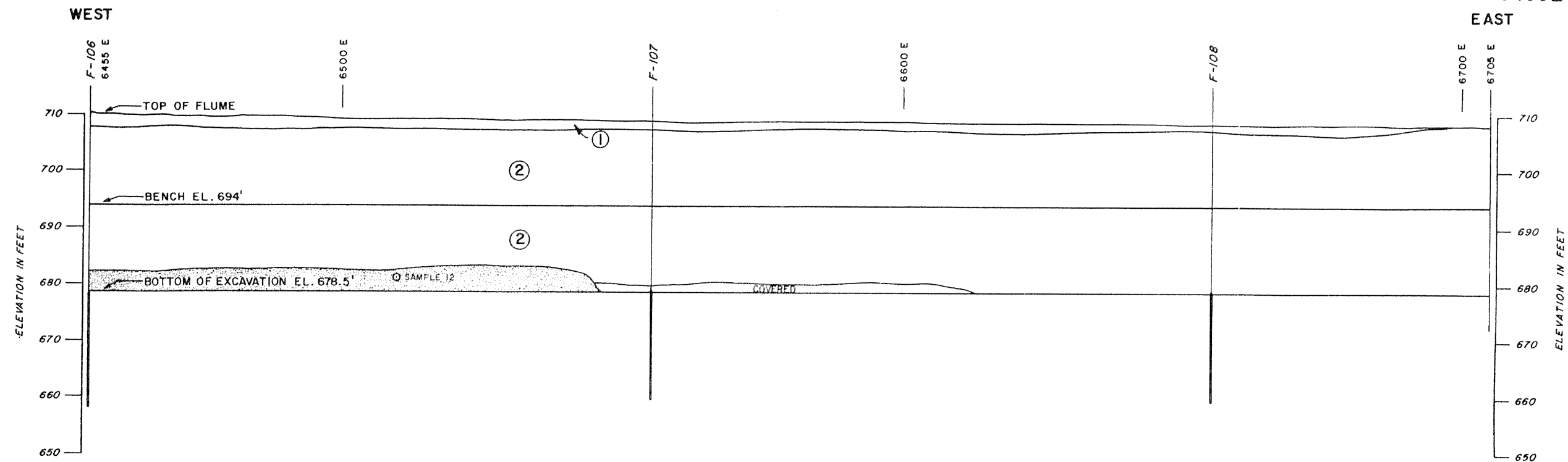

EXPLANATION:

- ① FILL - REWORKED SILTY CLAY WITH SOME FINE TO COARSE SAND AND TRACE FINE TO COARSE GRAVEL (VERY STIFF TO HARD)
- ② TILL - SILTY CLAY WITH SOME FINE TO COARSE SAND TRACE FINE TO COARSE GRAVEL
- [Hatched pattern] LACUSTRINE - PRIMARILY SILT WITH OCCASIONAL INTERBEDDED SILTY CLAY AND FINE SILTY SAND (MEDIUM STIFF TO STIFF)
- [Dotted pattern] GLACIAL OUTWASH - FINE TO COARSE SAND AND GRAVEL WITH OCCASIONAL LAYERS OF SILT AND SILTY SAND (LOOSE TO DENSE)
- LOCATION OF BULK SAMPLE

NOTE  
1 SEE FIGURE 2.5-50 SHEET 2 OF 3 FOR LOCATION.



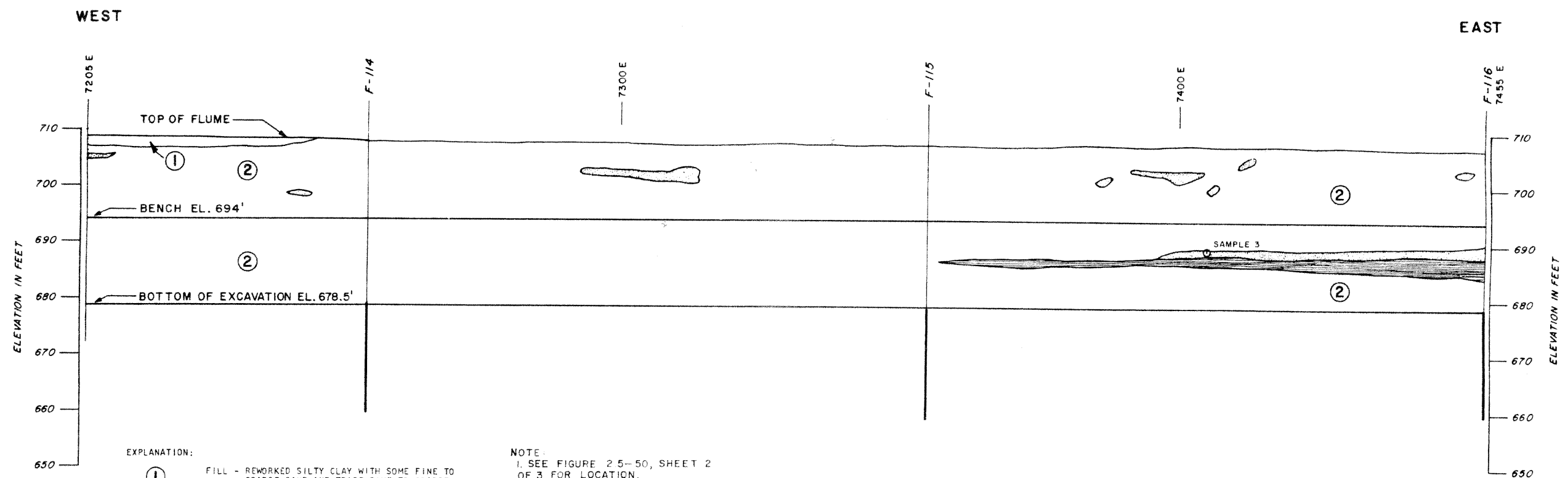
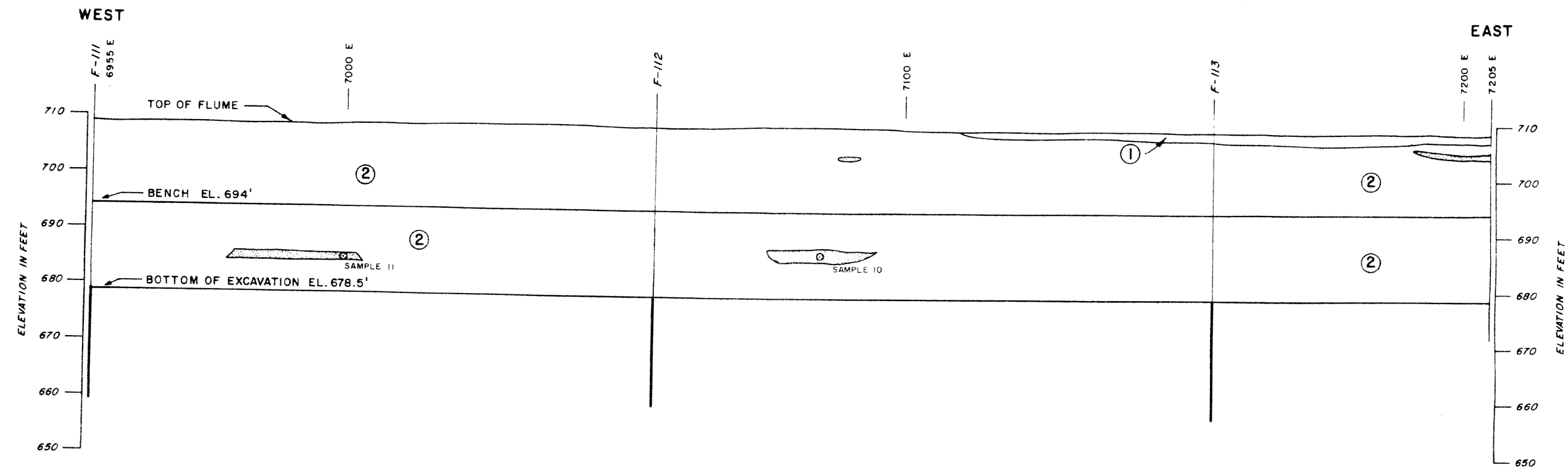

LA SALLE COUNTY STATION  
UPDATED FINAL SAFETY ANALYSIS REPORT

FIGURE 2.5-81  
GEOLOGIC MAP OF NORTH FLUME WALL  
(SHEET 3 of 9)



EXPLANATION:

- ① FILL - REWORKED SILTY CLAY WITH SOME FINE TO COARSE SAND AND TRACE FINE TO COARSE GRAVEL (VERY STIFF TO HARD)
- ② TILL - SILTY CLAY WITH SOME FINE TO COARSE SAND TRACE FINE TO COARSE GRAVEL
-  LACUSTRINE - PRIMARILY SILT WITH OCCASIONAL INTERBEDDED SILTY CLAY AND FINE SILTY SAND (MEDIUM STIFF TO STIFF)
-  GLACIAL OUTWASH - FINE TO COARSE SAND AND GRAVEL WITH OCCASIONAL LAYERS OF SILT AND SILTY SAND (LOOSE TO DENSE)
- LOCATION OF BULK SAMPLE

NOTE:  
1. SEE FIGURE 2.5-50, SHEET 2 OF 3 FOR LOCATION.



LA SALLE COUNTY STATION  
UPDATED FINAL SAFETY ANALYSIS REPORT

FIGURE 2.5-81  
GEOLOGIC MAP OF NORTH FLUME WALL  
(SHEET 4 of 9)

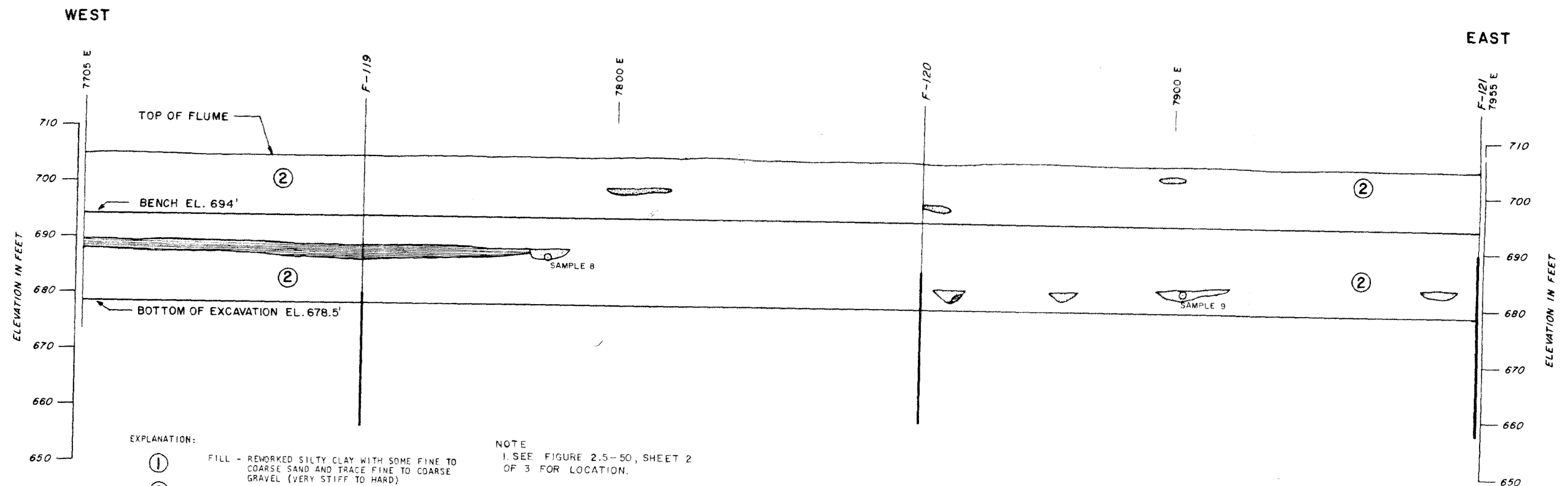
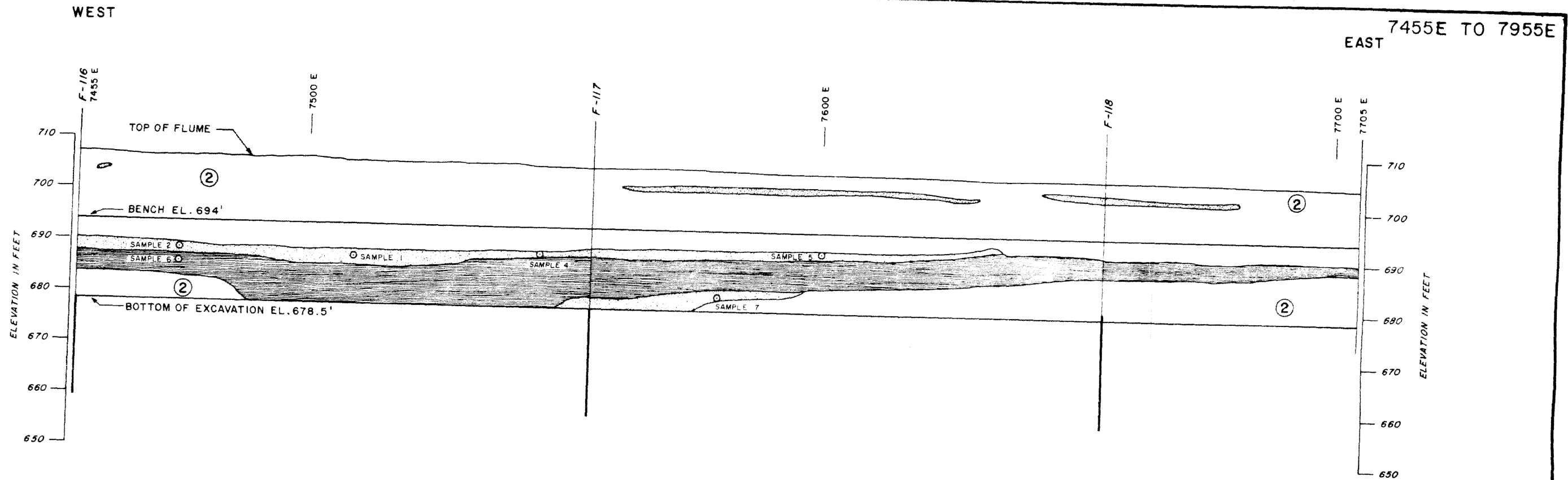

EXPLANATION:

- ① FILL - REMORDED SILTY CLAY WITH SOME FINE TO COARSE SAND AND TRACE FINE TO COARSE GRAVEL (VERY STIFF TO HARD)
- ② TILL - SILTY CLAY WITH SOME FINE TO COARSE SAND TRACE FINE TO COARSE GRAVEL
- [Stippled pattern] LACUSTRINE - PRIMARILY SILT WITH OCCASIONAL INTERBEDDED SILTY CLAY AND FINE SILTY SAND (MEDIUM STIFF TO STIFF)
- [Cross-hatched pattern] GLACIAL OUTWASH - FINE TO COARSE SAND AND GRAVEL WITH OCCASIONAL LAYERS OF SILT AND SILTY SAND (LOOSE TO DENSE)
- LOCATION OF BULK SAMPLE

NOTE  
1. SEE FIGURE 2.5-50, SHEET 2 OF 3 FOR LOCATION.



LA SALLE COUNTY STATION  
UPDATED FINAL SAFETY ANALYSIS REPORT

FIGURE 2.5-81  
GEOLOGIC MAP OF NORTH FLUME WALL  
(SHEET 5 of 9)



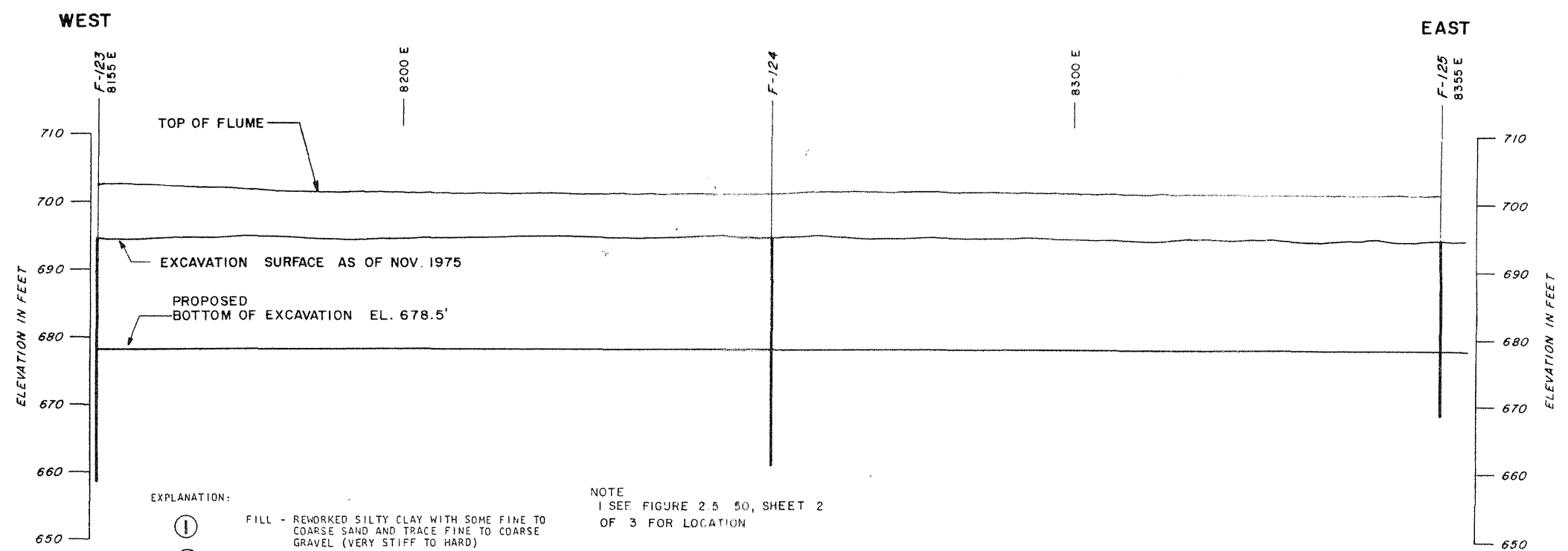
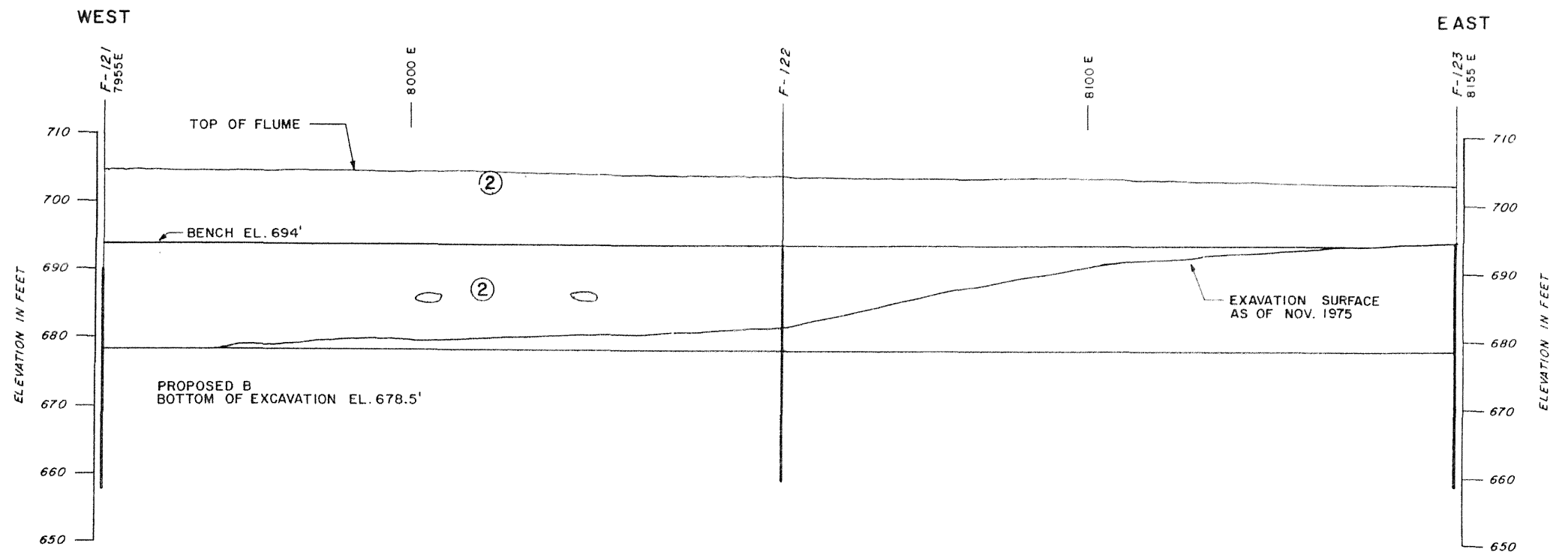

- EXPLANATION:
- ① FILL - REWORKED SILTY CLAY WITH SOME FINE TO COARSE SAND AND TRACE FINE TO COARSE GRAVEL (VERY STIFF TO HARD)
  - ② TILL - SILTY CLAY WITH SOME FINE TO COARSE SAND TRACE FINE TO COARSE GRAVEL
  - [Hatched pattern] LACUSTRINE - PRIMARILY SILT WITH OCCASIONAL INTERBEDDED SILTY CLAY AND FINE SAND TRACE FINE TO COARSE GRAVEL
  - [Dotted pattern] GLACIAL OUTWASH - FINE TO COARSE SAND AND GRAVEL WITH OCCASIONAL LAYERS OF SILT AND SILTY SAND (LOOSE TO DENSE)
  - LOCATION OF BULK SAMPLE

NOTE  
1 SEE FIGURE 2.5 50, SHEET 2  
OF 3 FOR LOCATION



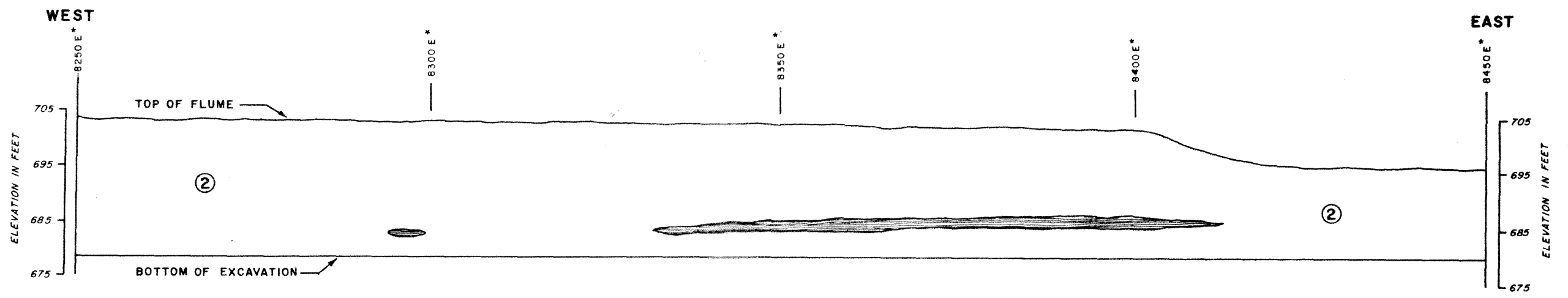
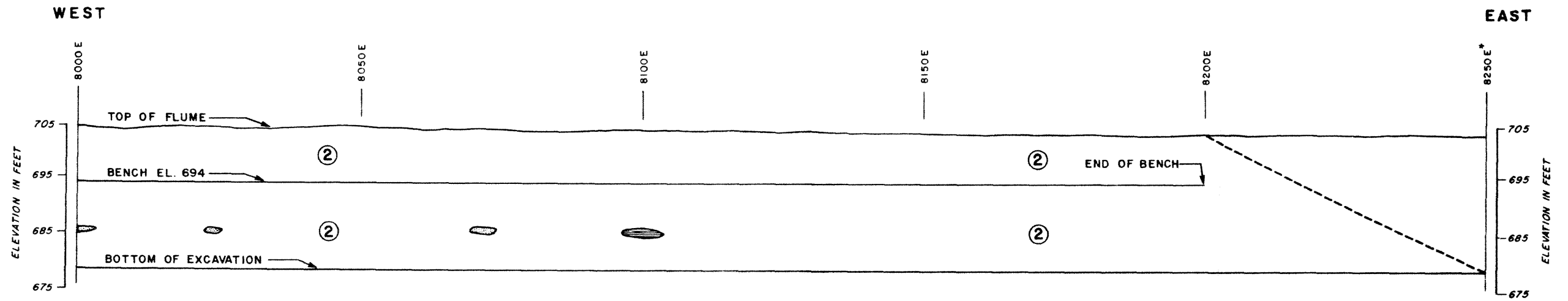

LA SALLE COUNTY STATION  
UPDATED FINAL SAFETY ANALYSIS REPORT

FIGURE 2.5-81  
GEOLOGIC MAP OF NORTH FLUME WALL  
(SHEET 6 of 9)



* NOTE: EAST OF APPROXIMATE COORDINATE 8250 E THE FLUME WALL TRENDS NORTHEAST AND THE COORDINATE SYSTEM INTERSECTS THE FLUME WALL OBLIQUELY. THESE COORDINATES SHOULD BE USED ONLY FOR REFERENCE, NOT MEASUREMENT.

EXPLANATION:

- ② TILL - SILTY CLAY WITH SOME FINE TO COARSE SAND, TRACE FINE TO COARSE GRAVEL
-  LACUSTRINE - PRIMARILY SILT WITH OCCASIONAL INTERBEDDED SILTY CLAY AND FINE SILTY SAND (MEDIUM STIFF TO STIFF)
-  GLACIAL OUTWASH - FINE TO COARSE SAND AND GRAVEL WITH OCCASIONAL LAYERS OF SILT AND SILTY SAND (LOOSE TO DENSE)
- APPROXIMATE LOCATION OF BEND IN FLUME WALL.

NOTE:  
1. SEE FIGURE 2.5-5C, SHEET 2 OF 3 FOR LOCATION.



**LA SALLE COUNTY STATION**  
 UPDATED FINAL SAFETY ANALYSIS REPORT

FIGURE 2.5-81  
 GEOLOGIC MAP OF NORTH FLUME WALL  
 (SHEET 7 of 9)

5643-067-07

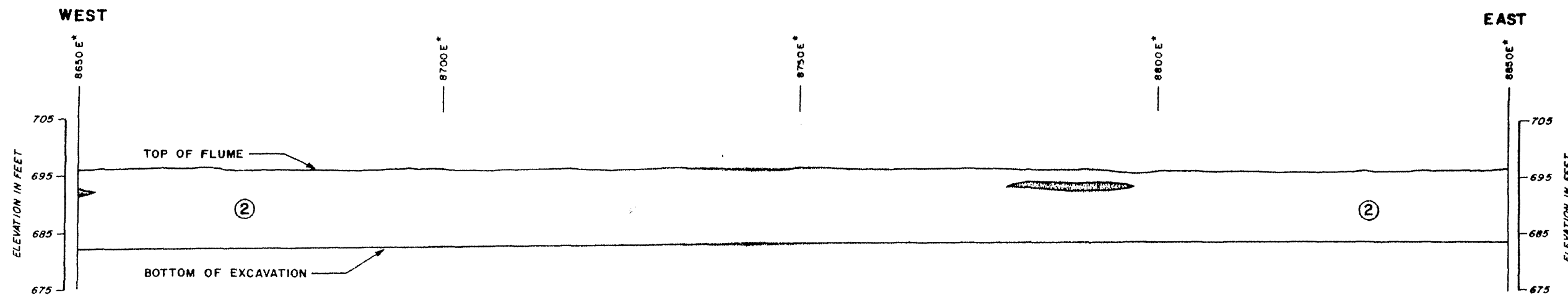
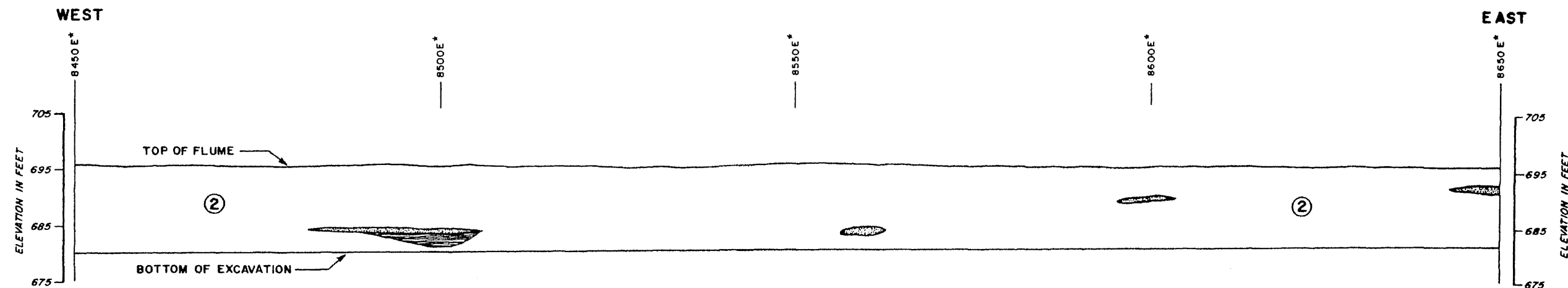

* NOTE: EAST OF APPROXIMATE COORDINATE 8250 E THE FLUME WALL TRENDS NORTHEAST AND THE COORDINATE SYSTEM INTERSECTS THE FLUME WALL OBLIQUELY. THESE COORDINATES SHOULD BE USED ONLY FOR REFERENCE, NOT MEASUREMENT.



EXPLANATION:

- ② TILL - SILTY CLAY WITH SOME FINE TO COARSE SAND, TRACE FINE TO COARSE GRAVEL
- [Hatched pattern] LACUSTRINE - PRIMARILY SILT WITH OCCASIONAL INTERBEDDED SILTY CLAY AND FINE SILTY SAND (MEDIUM STIFF TO STIFF)
- [Dotted pattern] GLACIAL OUTWASH - FINE TO COARSE SAND AND GRAVEL WITH OCCASIONAL LAYERS OF SILT AND SILTY SAND (LOOSE TO DENSE)

NOTE:  
1. SEE FIGURE 2.5-50, SHEET 2 OF 3 FOR LOCATION.

LA SALLE COUNTY STATION  
UPDATED FINAL SAFETY ANALYSIS REPORT

FIGURE 2.5-81  
GEOLOGIC MAP OF NORTH FLUME WALL  
(SHEET 8 of 9)

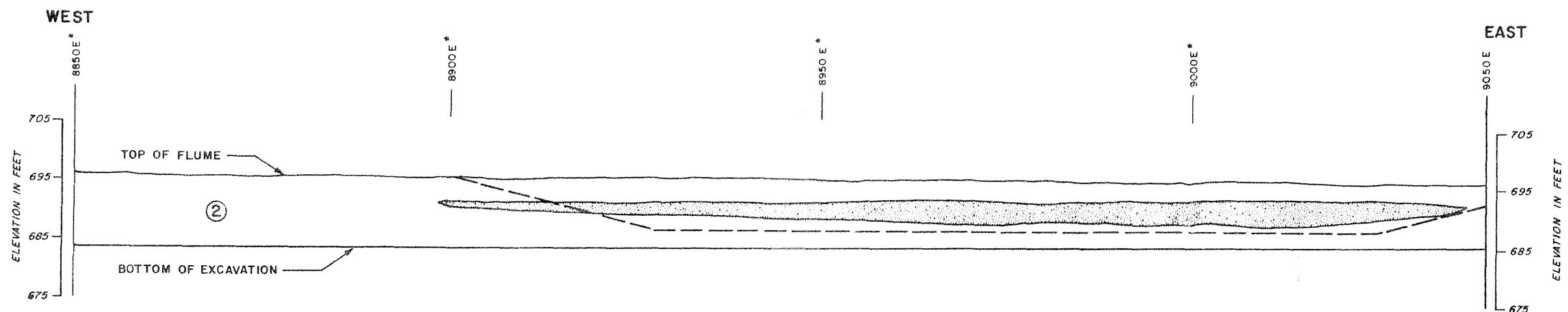

* NOTE: EAST OF APPROXIMATE COORDINATE 8250 E THE FLUME WALL TRENDS NORTHEAST AND THE COORDINATE SYSTEM INTERSECTS THE FLUME WALL OBLIQUELY. THESE COORDINATES SHOULD BE USED ONLY FOR REFERENCE, NOT MEASUREMENT



NOTE:  
1. SEE FIGURE 2.5-50, SHEET 2 OF 3 FOR LOCATION.

EXPLANATION:

- ② TILL - SILTY CLAY WITH SOME FINE TO COARSE SAND, TRACE FINE TO COARSE GRAVEL
- GLACIAL OUTWASH - FINE TO COARSE SAND AND GRAVEL WITH OCCASIONAL LAYERS OF SILT AND SILTY SAND (LOOSE TO DENSE)
- - - - - LIMITS OF REMEDIAL EXCAVATION

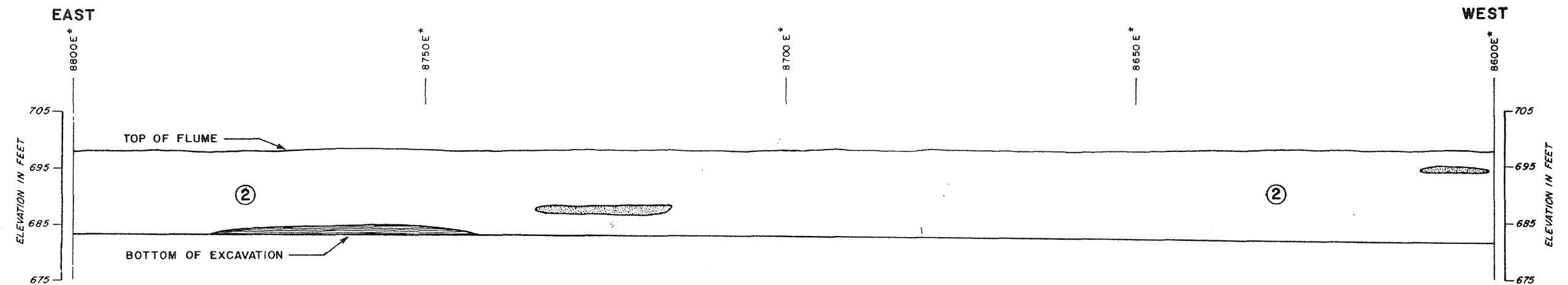
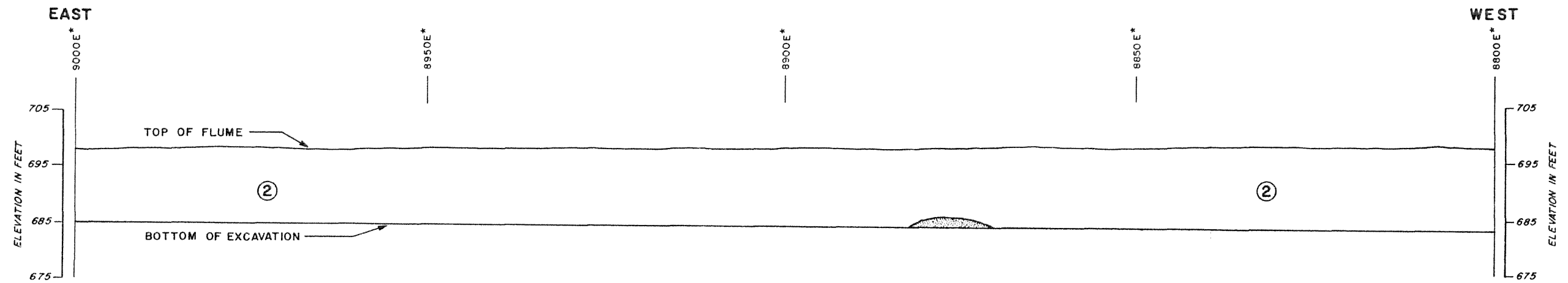

|                                                                              |
|------------------------------------------------------------------------------|
| <p>LA SALLE COUNTY STATION<br/>UPDATED FINAL SAFETY ANALYSIS REPORT</p>      |
| <p>FIGURE 2.5-81<br/>GEOLOGIC MAP OF NORTH FLUME WALL<br/>(SHEET 9 of 9)</p> |



* NOTE: EAST OF APPROXIMATE COORDINATE 8250 E THE FLUME WALL TRENDS SOUTHEAST AND THE COORDINATE SYSTEM INTERSECTS THE FLUME WALL OBLIQUELY. THESE COORDINATES SHOULD BE USED ONLY FOR REFERENCE, NOT MEASUREMENT.



EXPLANATION:

- ② TILL - SILTY CLAY WITH SOME FINE TO COARSE SAND, TRACE FINE TO COARSE GRAVEL
-  LACUSTRINE - PRIMARILY SILT WITH OCCASIONAL INTERBEDDED SILTY CLAY AND FINE SILTY SAND (MEDIUM STIFF TO STIFF)
-  GLACIAL OUTWASH - FINE TO COARSE SAND AND GRAVEL WITH OCCASIONAL LAYERS OF SILT AND SILTY SAND (LOOSE TO DENSE)

NOTE:  
1. SEE FIGURE 2.5-50, SHEET 2 OF 3 FOR LOCATION.

**LA SALLE COUNTY STATION**  
**UPDATED FINAL SAFETY ANALYSIS REPORT**

FIGURE 2.5-82  
 GEOLOGIC MAP OF SOUTH FLUME WALL  
 (SHEET 1 of 9)

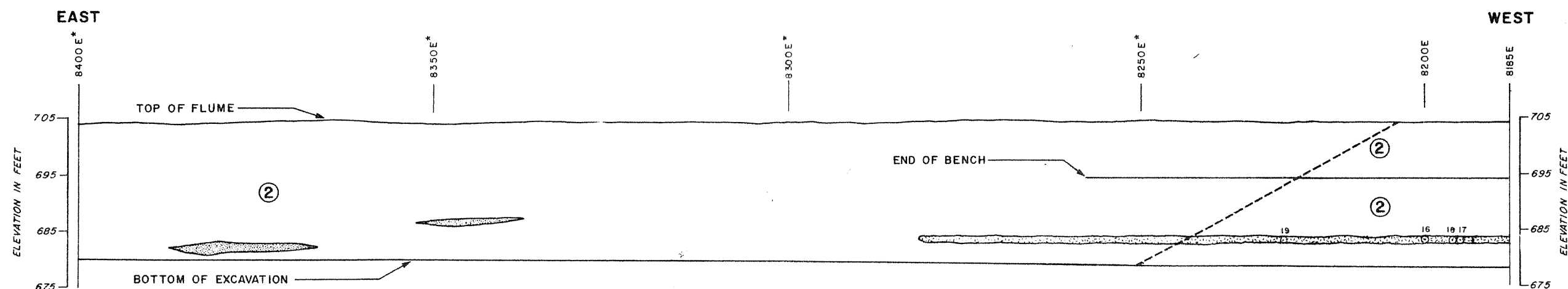
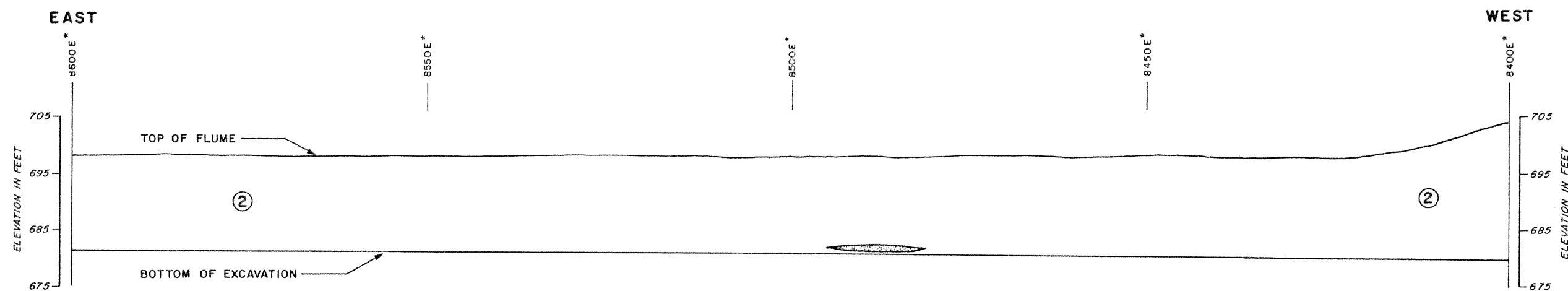

* NOTE: EAST OF APPROXIMATE COORDINATE 8250 E THE FLUME WALL TRENDS SOUTHEAST AND THE COORDINATE SYSTEM INTERSECTS THE FLUME WALL OBLIQUELY. THESE COORDINATES SHOULD BE USED ONLY FOR REFERENCE, NOT MEASUREMENT.



EXPLANATION:

- ② TILL - SILTY CLAY WITH SOME FINE TO COARSE SAND, TRACE FINE TO COARSE GRAVEL
- GLACIAL OUTWASH - FINE TO COARSE SAND AND GRAVEL WITH OCCASIONAL LAYERS OF SILT AND SILTY SAND (LOOSE TO DENSE)
- ZONE OF SMALL ISOLATED OUTWASH AND LACUSTRINE DEPOSITS  
LACUSTRINE - PRIMARILY SILT WITH OCCASIONAL INTERBEDDED SILTY CLAY AND FINE SILTY SAND (MEDIUM STIFF TO STIFF)
- GLACIAL OUTWASH - SILTY FINE TO COARSE SAND WITH GRAVEL AND SOME CLAY
- - - - - APPROXIMATE LOCATION OF BEND IN FLUME WALL
- LOCATION OF BULK SAMPLE

NOTE:

1. SEE FIGURE 2.5-50, SHEET 2 OF 3 FOR LOCATION.

LA SALLE COUNTY STATION  
UPDATED FINAL SAFETY ANALYSIS REPORT

FIGURE 2.5-82  
GEOLOGIC MAP OF SOUTH FLUME WALL  
(SHEET 2 of 9)

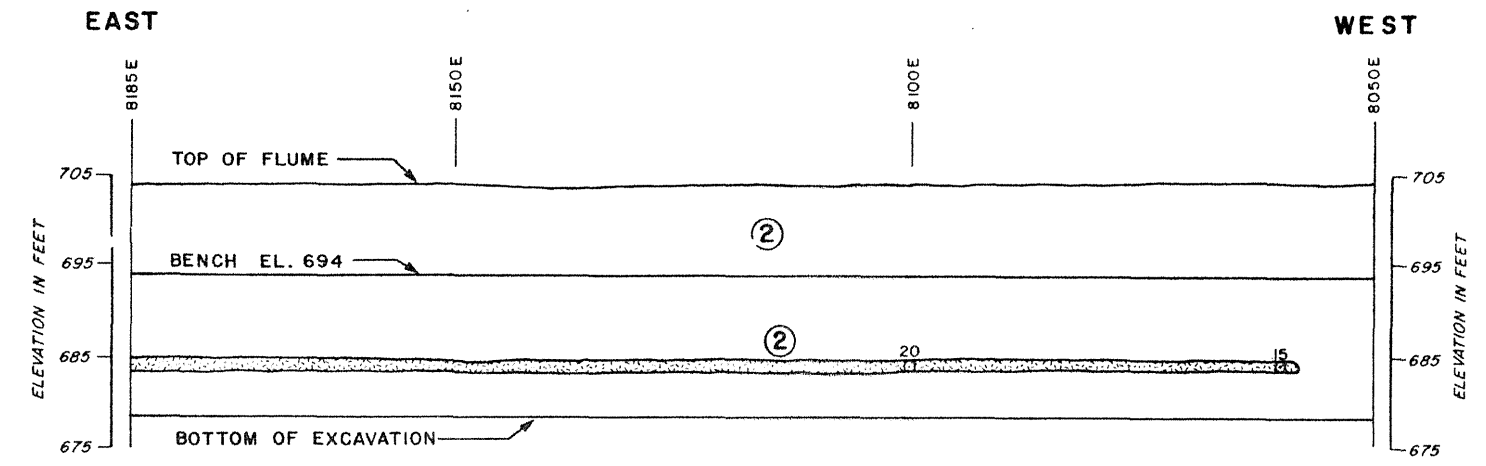

NOTE: BULK SAMPLE 21 WAS TAKEN AT 8043 E.

EXPLANATION:

- ② TILL - SILTY CLAY WITH SOME FINE TO COARSE SAND, TRACE FINE TO COARSE GRAVEL
-  ZONE OF SMALL ISOLATED OUTWASH AND LACUSTRINE DEPOSITS
- LACUSTRINE - PRIMARILY SILT WITH OCCASIONAL INTERBEDDED SILTY CLAY AND FINE SILTY SAND (MEDIUM STIFF TO STIFF)
- GLACIAL OUTWASH - SILTY FINE TO COARSE SAND WITH GRAVEL AND SOME CLAY
- ⊙ LOCATION OF BULK SAMPLE

NOTE:  
1. SEE FIGURE 2.5-50, SHEET 2 OF 3 FOR LOCATION.

|                                                                                                                |
|----------------------------------------------------------------------------------------------------------------|
| <p><b>LA SALLE COUNTY STATION</b><br/>                 UPDATED FINAL SAFETY ANALYSIS REPORT</p>                |
| <p>FIGURE 2.5-82<br/>                 GEOLOGIC MAP OF SOUTH FLUME WALL<br/>                 (SHEET 3 of 9)</p> |

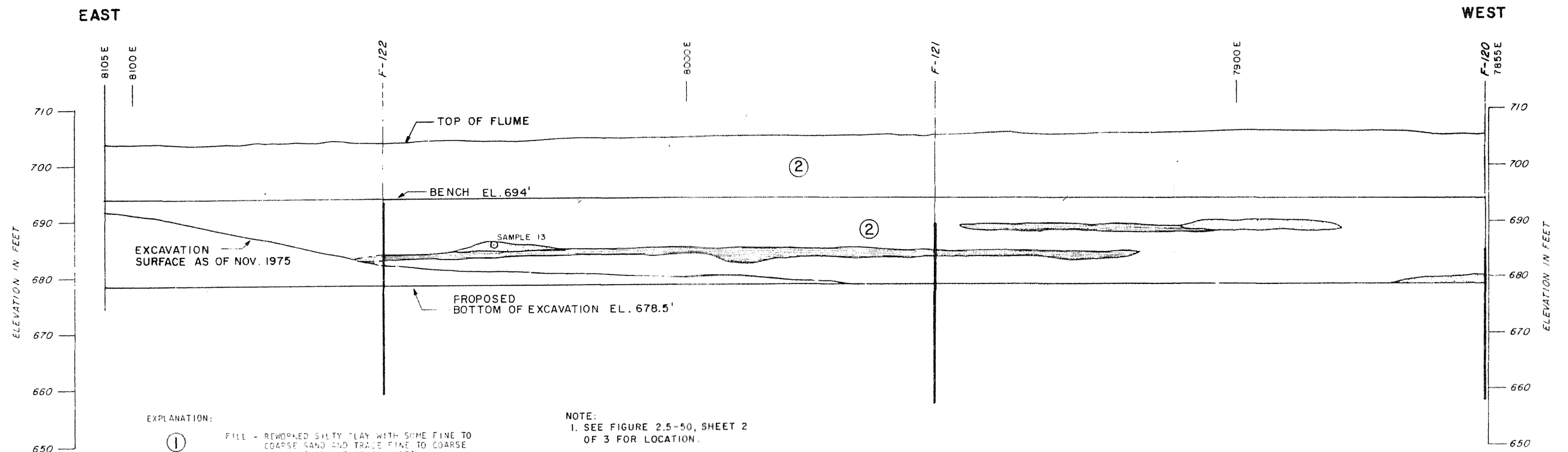
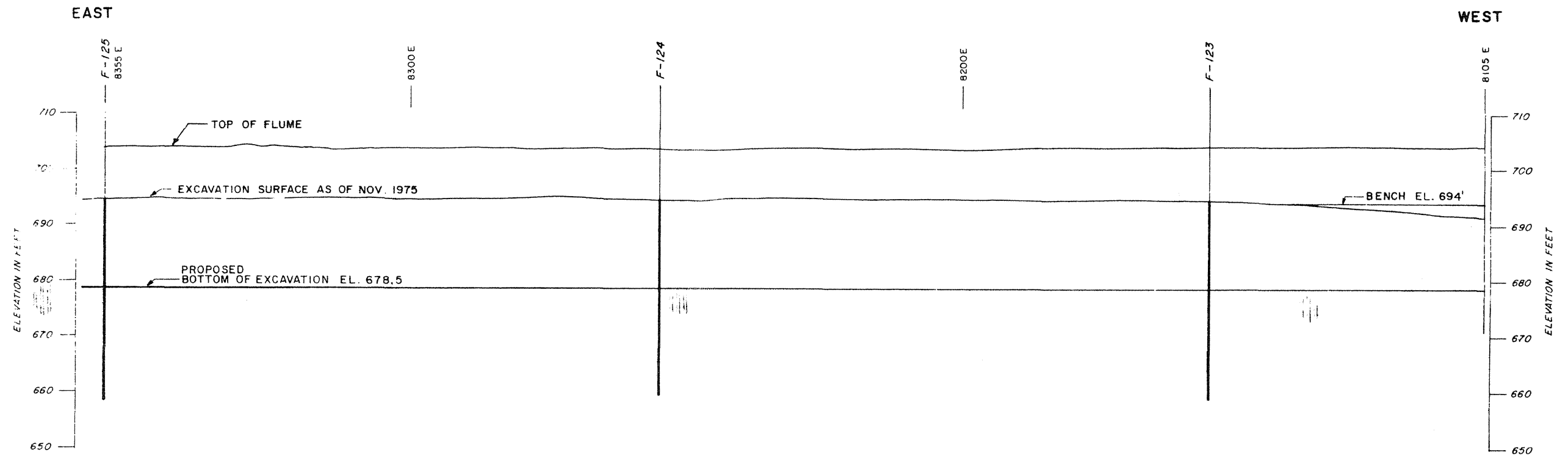

- EXPLANATION:
- ① FILL - REWORKED SILTY CLAY WITH SOME FINE TO COARSE SAND AND TRACE FINE TO COARSE GRAVEL (VERY STIFF TO HARD)
  - ② TILL - SILTY CLAY WITH SOME FINE TO COARSE SAND TRACE FINE TO COARSE GRAVEL
  - LACUSTRINE - PRIMARILY SILT WITH OCCASIONAL INTERBEDDED SILTY CLAY AND FINE SILTY SAND (MEDIUM STIFF TO STIFF)
  - GLACIAL OUTWASH - FINE TO COARSE SAND AND GRAVEL WITH OCCASIONAL LAYERS OF SILT AND SILTY SAND (LOOSE TO DENSE)
  - ⊙ LOCATION OF BULK SAMPLE

NOTE:  
1. SEE FIGURE 2.5-50, SHEET 2 OF 3 FOR LOCATION.





LA SALLE COUNTY STATION  
UPDATED FINAL SAFETY ANALYSIS REPORT

FIGURE 2.5-82  
GEOLOGIC MAP OF SOUTH FLUME WALL  
(SHEET 4 of 9)

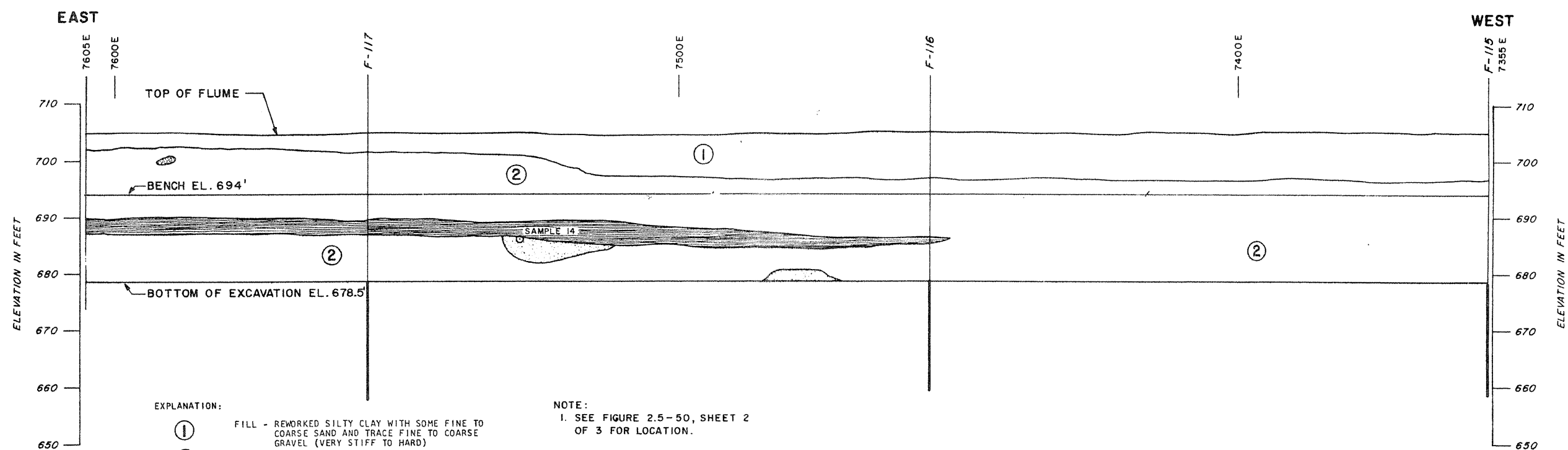
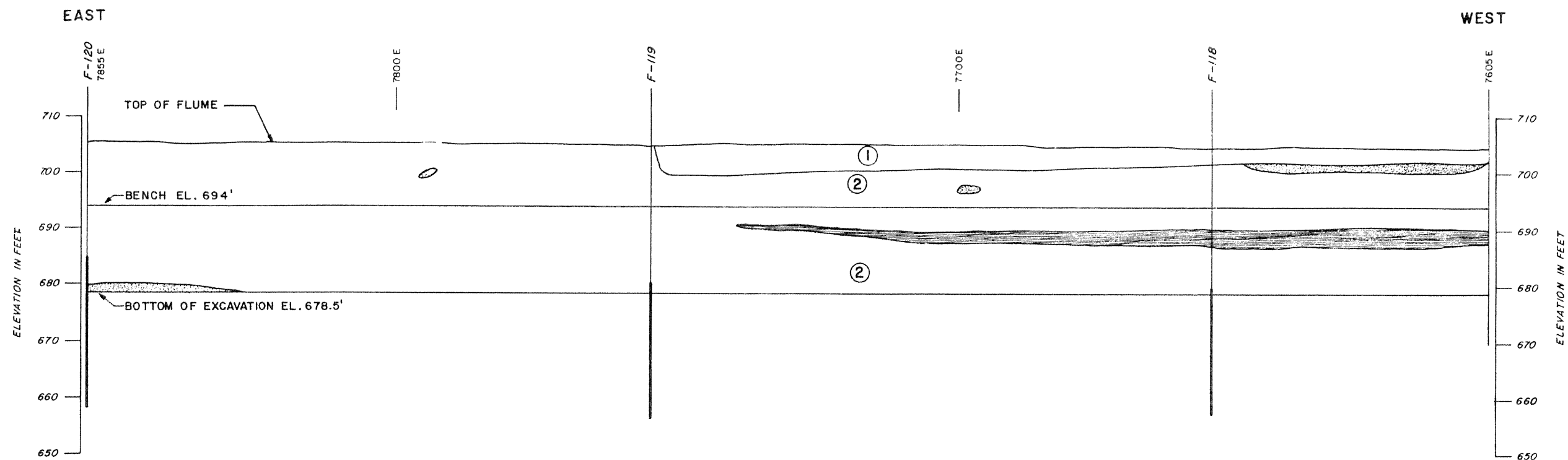



EXPLANATION:

- ① FILL - REWORKED SILTY CLAY WITH SOME FINE TO COARSE SAND AND TRACE FINE TO COARSE GRAVEL (VERY STIFF TO HARD)
- ② TILL - SILTY CLAY WITH SOME FINE TO COARSE SAND TRACE FINE TO COARSE GRAVEL
-  LACUSTRINE - PRIMARILY SILT WITH OCCASIONAL INTERBEDDED SILTY CLAY AND FINE SILTY SAND (MEDIUM STIFF TO STIFF)
-  GLACIAL OUTWASH - FINE TO COARSE SAND AND GRAVEL WITH OCCASIONAL LAYERS OF SILT AND SILTY SAND (LOOSE TO DENSE)
- LOCATION OF BULK SAMPLE

NOTE:



1. SEE FIGURE 2.5-50, SHEET 2 OF 3 FOR LOCATION.

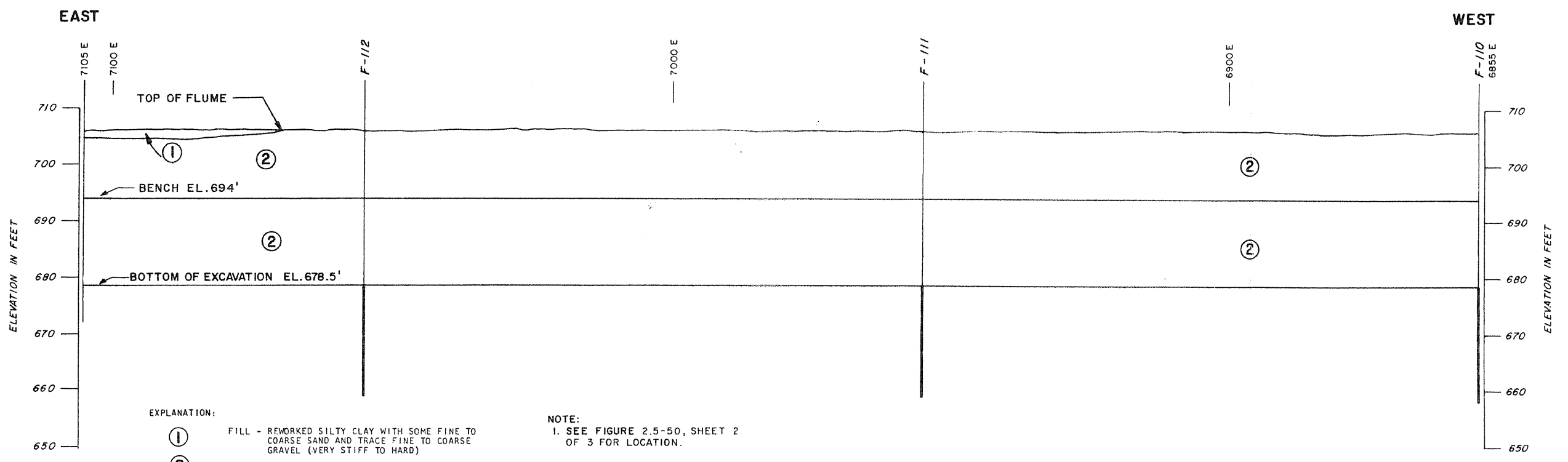
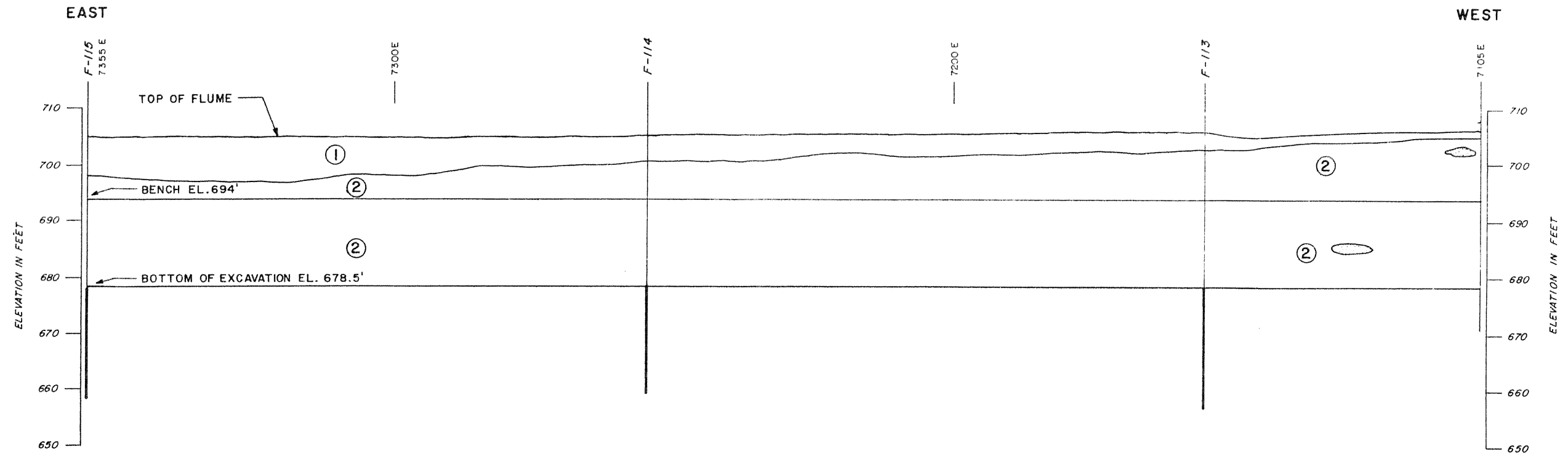

LA SALLE COUNTY STATION  
UPDATED FINAL SAFETY ANALYSIS REPORT

FIGURE 2.5-82  
GEOLOGIC MAP OF SOUTH FLUME WALL  
(SHEET 5 of 9)



- EXPLANATION:
- ① FILL - REWORKED SILTY CLAY WITH SOME FINE TO COARSE SAND AND TRACE FINE TO COARSE GRAVEL (VERY STIFF TO HARD)
  - ② TILL - SILTY CLAY WITH SOME FINE TO COARSE SAND TRACE FINE TO COARSE GRAVEL
  -  LACUSTRINE - PRIMARILY SILT WITH OCCASIONAL INTERBEDDED SILTY CLAY AND FINE SILTY SAND (MEDIUM STIFF TO STIFF)
  -  GLACIAL OUTWASH - FINE TO COARSE SAND AND GRAVEL WITH OCCASIONAL LAYERS OF SILT AND SILTY SAND (LOOSE TO DENSE)
  - LOCATION OF BULK SAMPLE

NOTE:  
1. SEE FIGURE 2.5-50, SHEET 2 OF 3 FOR LOCATION.



LA SALLE COUNTY STATION  
UPDATED FINAL SAFETY ANALYSIS REPORT

FIGURE 2.5-82  
GEOLOGIC MAP OF SOUTH FLUME WALL  
(SHEET 6 of 9)

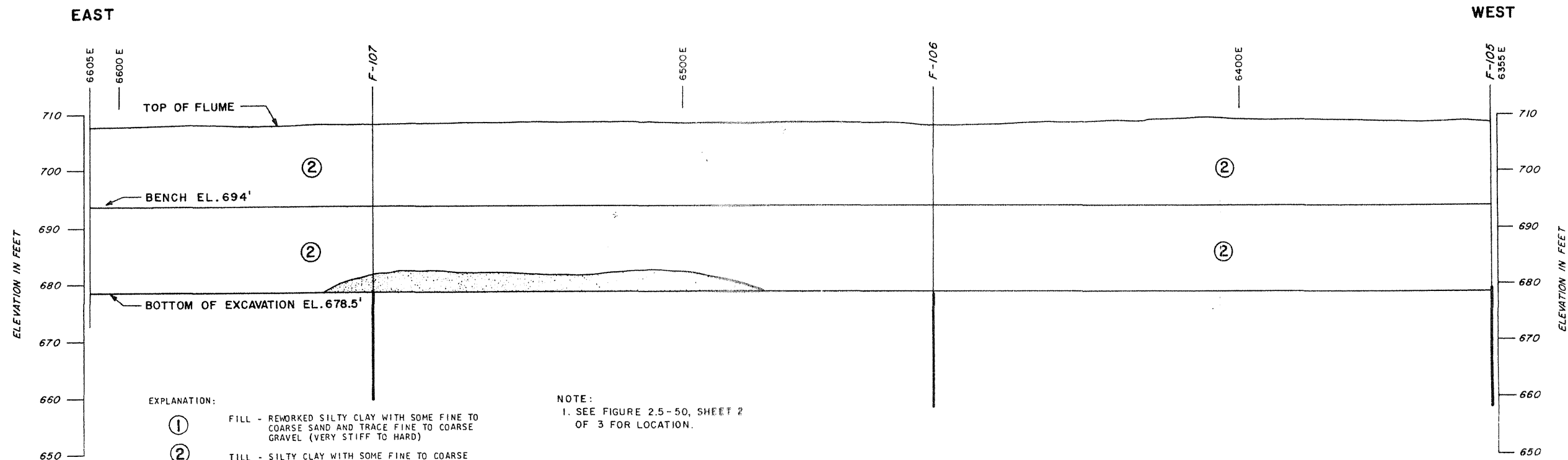
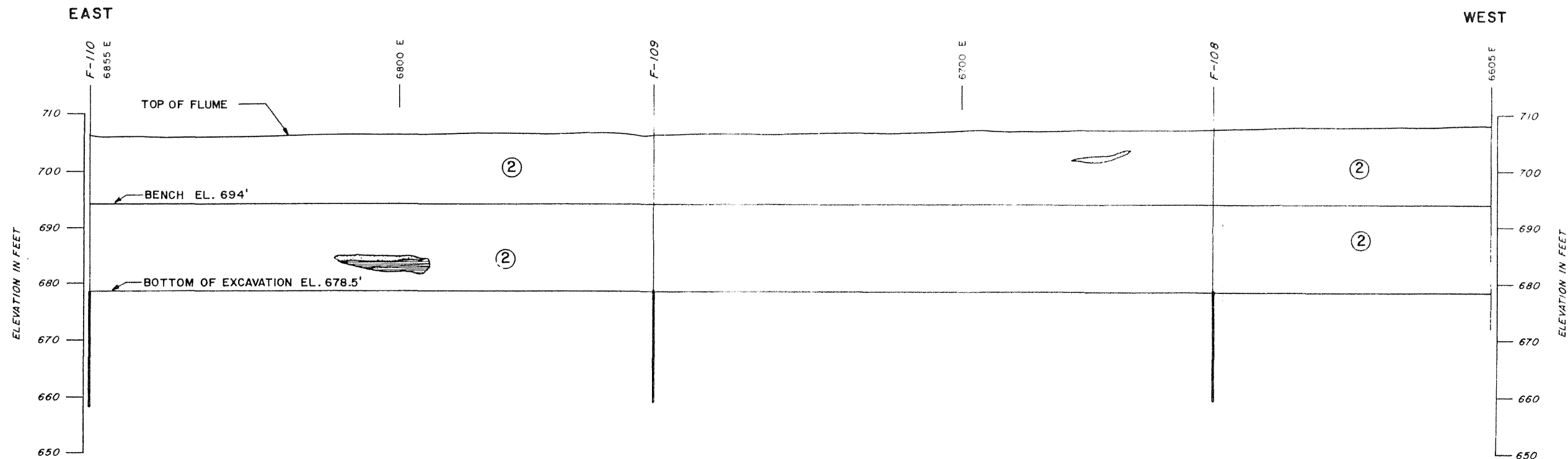

- EXPLANATION:
- ① FILL - REWORKED SILTY CLAY WITH SOME FINE TO COARSE SAND AND TRACE FINE TO COARSE GRAVEL (VERY STIFF TO HARD)
  - ② TILL - SILTY CLAY WITH SOME FINE TO COARSE SAND TRACE FINE TO COARSE GRAVEL
  - LACUSTRINE - PRIMARILY SILT WITH OCCASIONAL INTERBEDDED SILTY CLAY AND FINE SILTY SAND (MEDIUM STIFF TO STIFF)
  - GLACIAL OUTWASH - FINE TO COARSE SAND AND GRAVEL WITH OCCASIONAL LAYERS OF SILT AND SILTY SAND (LOOSE TO DENSE)
  - LOCATION OF BULK SAMPLE

NOTE:  
1. SEE FIGURE 2.5-50, SHEET 2 OF 3 FOR LOCATION.



LA SALLE COUNTY STATION  
UPDATED FINAL SAFETY ANALYSIS REPORT

FIGURE 2.5-82  
GEOLOGIC MAP OF SOUTH FLUME WALL  
(SHEET 7 of 9)

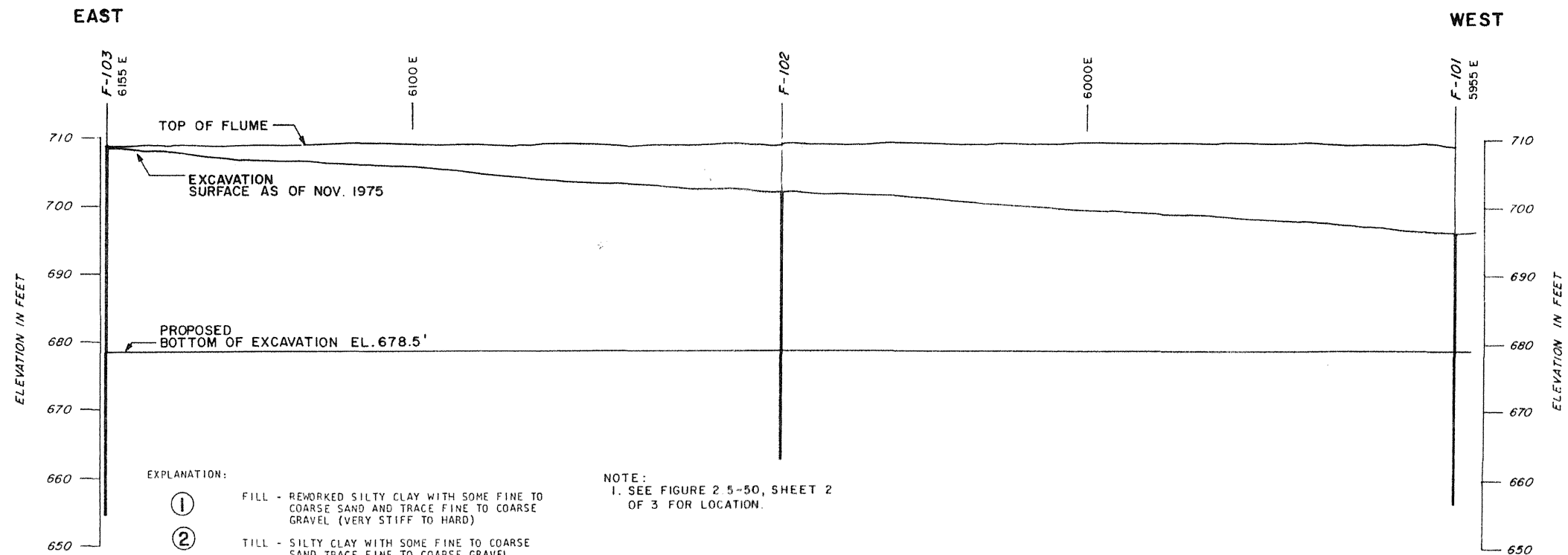
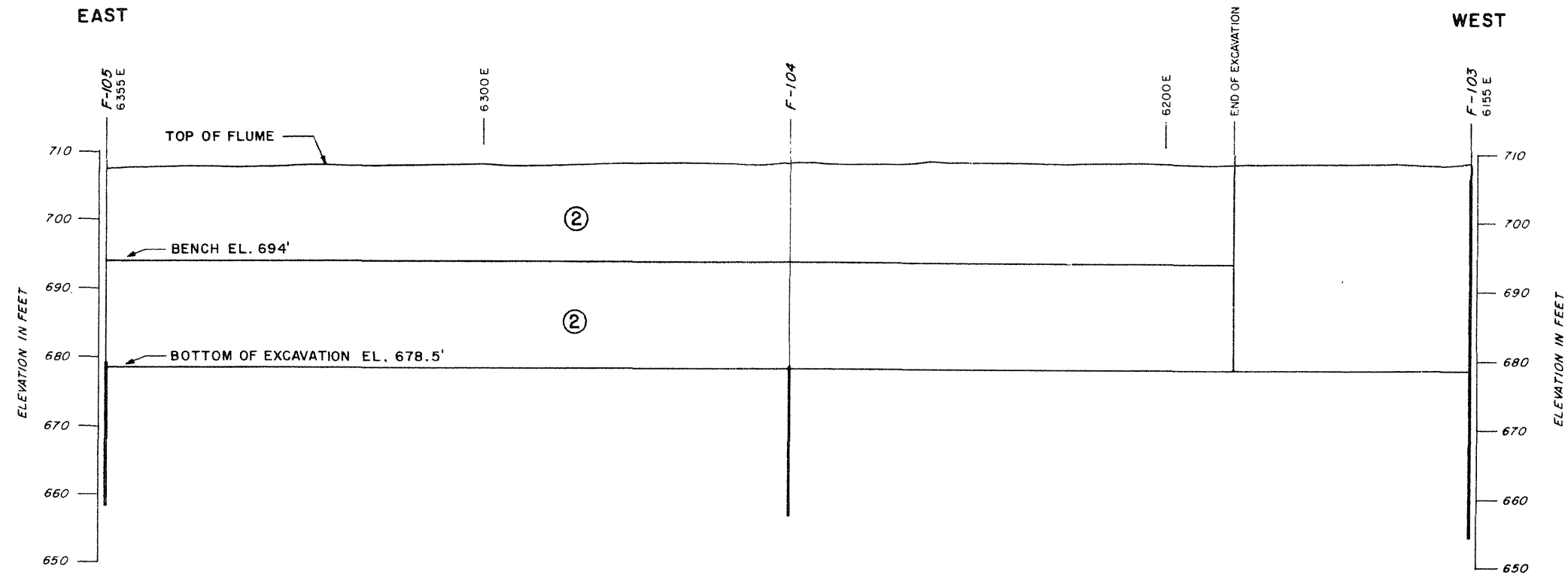

EXPLANATION:

- ① FILL - REMORKED SILTY CLAY WITH SOME FINE TO COARSE SAND AND TRACE FINE TO COARSE GRAVEL (VERY STIFF TO HARD)
- ② TILL - SILTY CLAY WITH SOME FINE TO COARSE SAND TRACE FINE TO COARSE GRAVEL
- [Patterned Box] LACUSTRINE - PRIMARILY SILT WITH OCCASIONAL INTERBEDDED SILTY CLAY AND FINE SILTY SAND (MEDIUM STIFF TO STIFF)
- [Patterned Box] GLACIAL OUTWASH - FINE TO COARSE SAND AND GRAVEL WITH OCCASIONAL LAYERS OF SILT AND SILTY SAND (LOOSE TO DENSE)
- LOCATION OF BULK SAMPLE

NOTE:  
1. SEE FIGURE 2.5-50, SHEET 2 OF 3 FOR LOCATION.



LA SALLE COUNTY STATION  
 UPDATED FINAL SAFETY ANALYSIS REPORT

FIGURE 2.5-82  
 GEOLOGIC MAP OF SOUTH FLUME WALL  
 (SHEET 8 of 9)

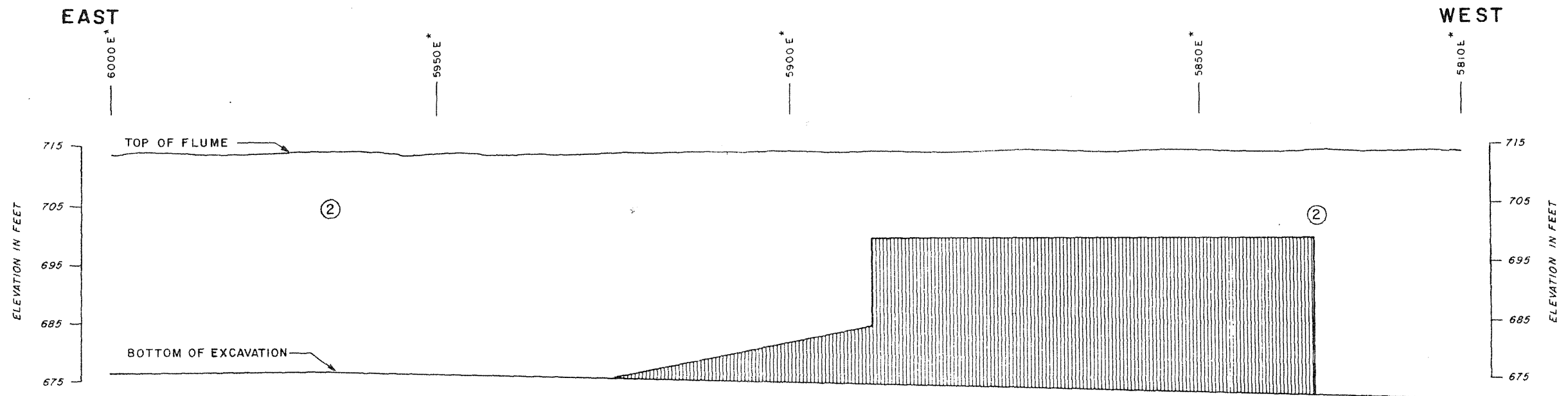
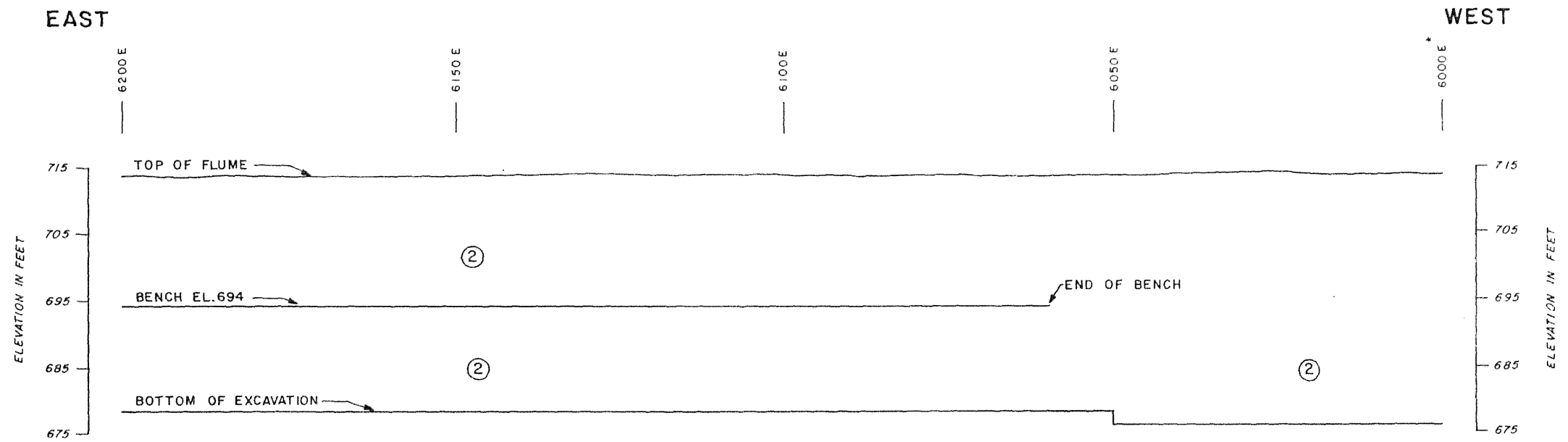

* NOTE: WEST OF APPROXIMATE COORDINATE 6000 E THE FLUME WALL TRENDS SOUTHWEST AND THE COORDINATE SYSTEM INTERSECTS THE FLUME WALL OBLIQUELY. THESE COORDINATES SHOULD BE USED ONLY FOR REFERENCE, NOT MEASUREMENT.



EXPLANATION:

② TILL - SILTY CLAY WITH SOME FINE TO COARSE SAND, TRACE FINE TO COARSE GRAVEL

▨ FILL - CONTROLLED, COMPACTED. SEE TEXT FOR DESCRIPTION AND APPENDIX FOR SUMMARY OF IN-PLACE DENSITY TEST RESULTS

NOTE:

1. SEE FIGURE 2.5-50, SHEET 2 OF 3 FOR LOCATION.

LA SALLE COUNTY STATION  
UPDATED FINAL SAFETY ANALYSIS REPORT

FIGURE 2.5-82  
GEOLOGIC MAP OF SOUTH FLUME WALL  
(SHEET 9 of 9)

5643-067-07

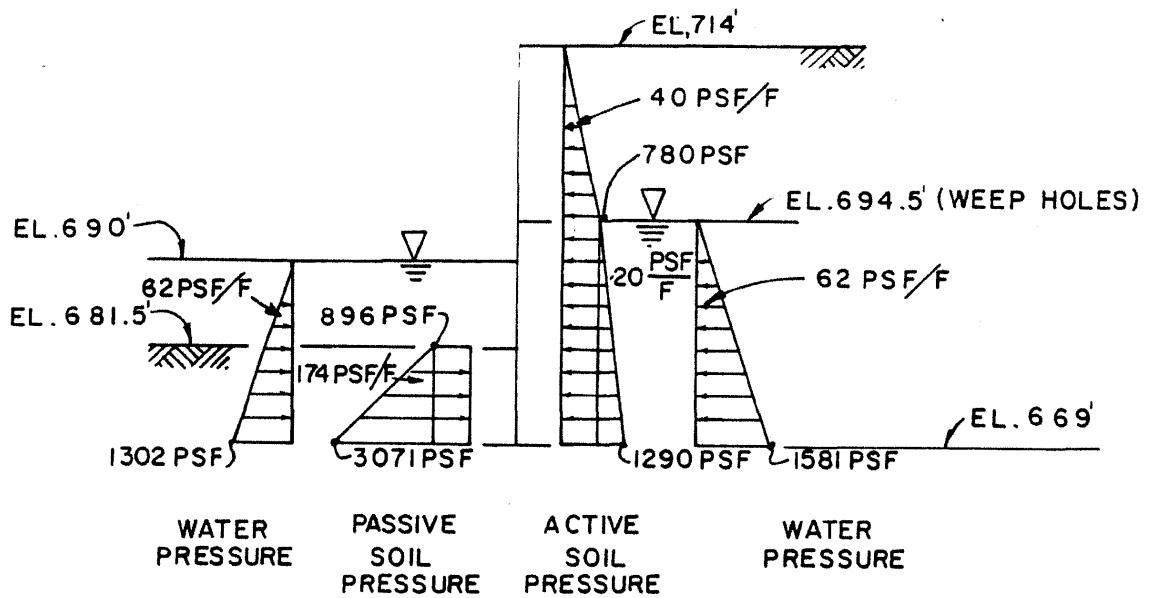

STATIC

NOTES

1. See Figure 2.5-54 for Section through Concrete Retaining Wall.
2. See Figure 2.5-83, Sheet 2 for Dynamic Lateral Pressure Distribution.

|                                                                                                                            |
|----------------------------------------------------------------------------------------------------------------------------|
| <p>LA SALLE COUNTY STATION<br/>         UPDATED FINAL SAFETY ANALYSIS REPORT</p>                                           |
| <p>FIGURE 2.5-83<br/>         CRITICAL LATERAL PRESSURE<br/>         DISTRIBUTION DIAGRAMS<br/>         (SHEET 1 of 4)</p> |

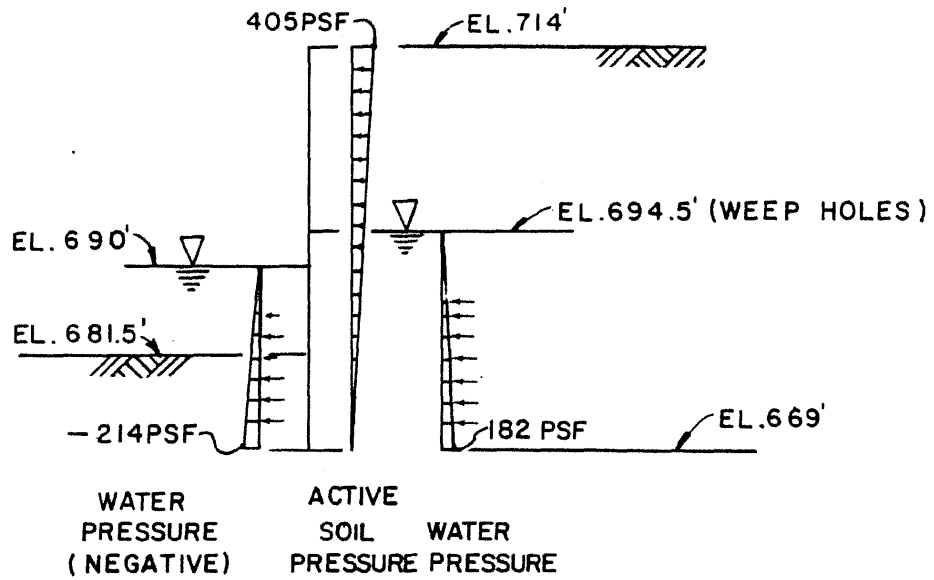

DYNAMIC

NOTES:

1. See Figure 2.5-83, Sheet 1 for Static Lateral Pressure Distribution.
2. See Figure 2.5-54 for Section through Concrete Retaining Wall.

LA SALLE COUNTY STATION  
UPDATED FINAL SAFETY ANALYSIS REPORT

FIGURE 2.5-83

CRITICAL LATERAL PRESSURE  
DISTRIBUTION DIAGRAMS  
(SHEET 2 of 4)

REV. 0 - APRIL 1984

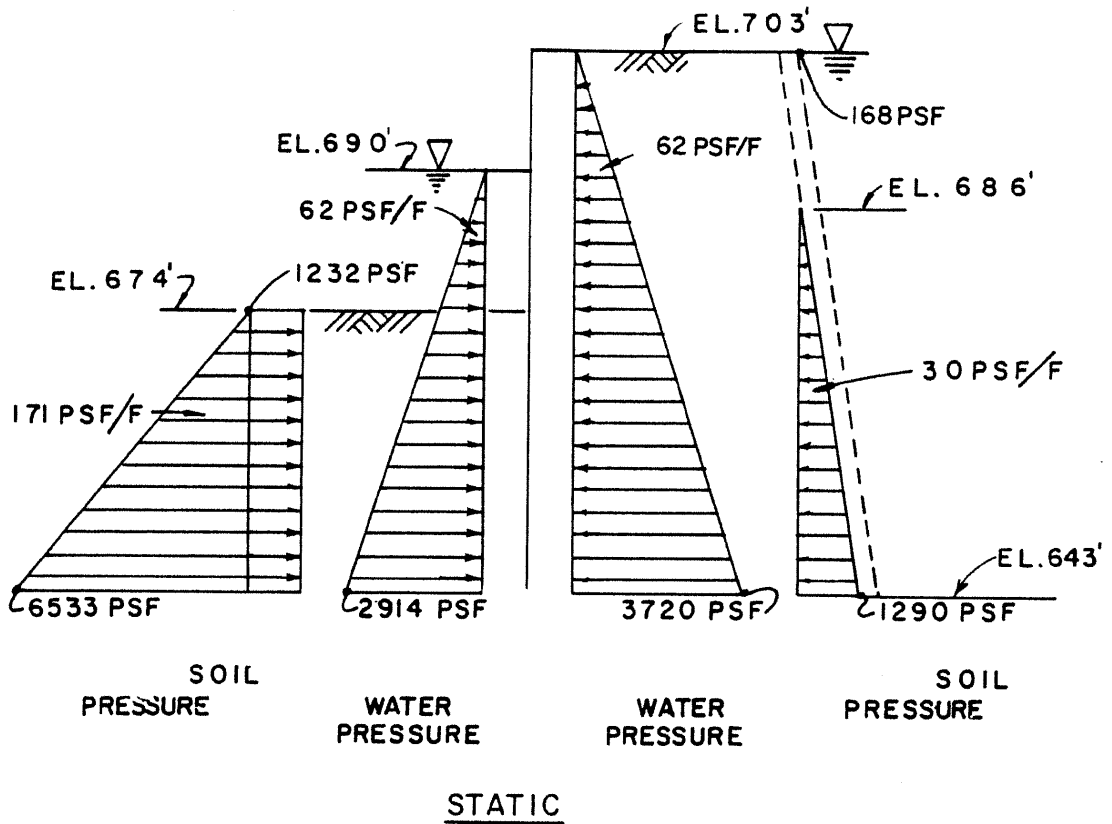

**NOTES:**

1. See Figure 2.5-63 for Section through Sheet Piling Retaining Wall.
2. See Figure 2.5-83, Sheet 4 for Dynamic Lateral Pressure Distribution.

LA SALLE COUNTY STATION  
 UPDATED FINAL SAFETY ANALYSIS REPORT

---

FIGURE 2.5-83  
 CRITICAL LATERAL PRESSURE  
 DISTRIBUTION DIAGRAMS  
 (SHEET 3 of 4)



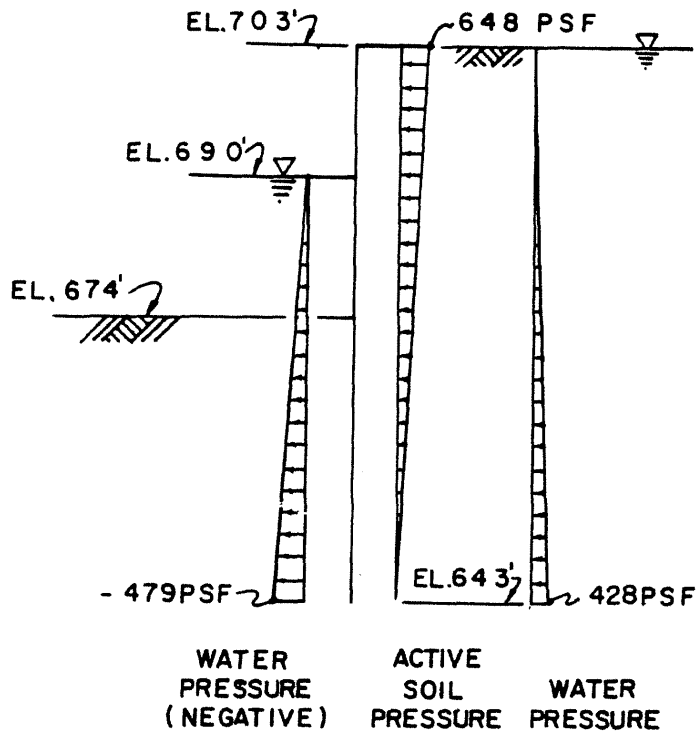

DYNAMIC

NOTES:

1. See Figure 2.5-83, Sheet 3 for Static Lateral Pressure Distribution.
2. See Figure 2.5-63 for Section through Sheet Piling Retaining Wall.

|                                                                                                     |
|-----------------------------------------------------------------------------------------------------|
| <b>LA SALLE COUNTY STATION</b><br>UPDATED FINAL SAFETY ANALYSIS REPORT                              |
| FIGURE 2.5-83<br><b>CRITICAL LATERAL PRESSURE</b><br><b>DISTRIBUTION DIAGRAMS</b><br>(SHEET 4 of 4) |

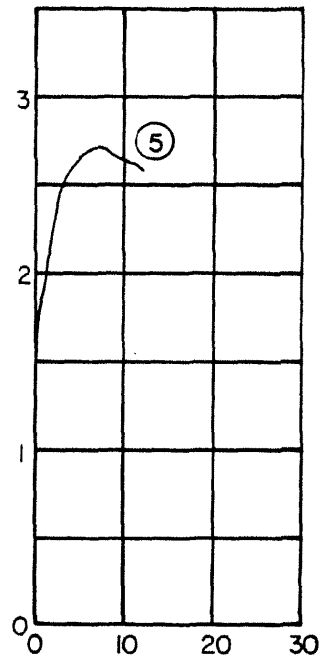
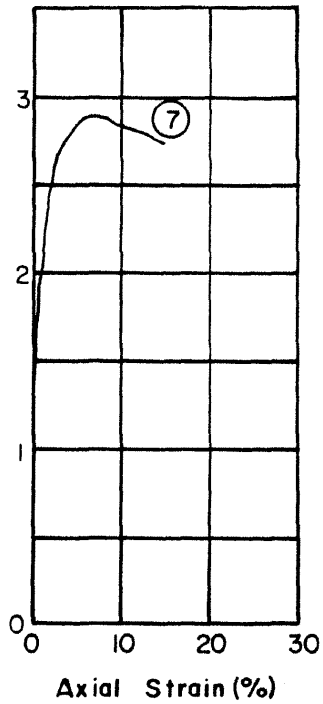
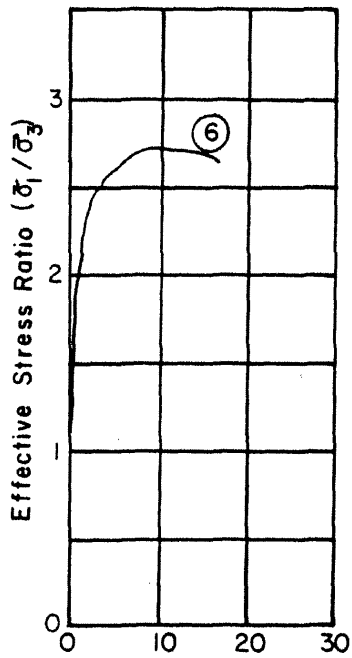

NOTES

1. Sample numbers listed in Table 2.5-39, Part A.
2. Mohr circle diagrams shown on Figure 2.5-43, Sheet 1 of 3.
3. Undisturbed samples of Wedron silty clay till.

|                                                                                                                       |
|-----------------------------------------------------------------------------------------------------------------------|
| <p><b>LA SALLE COUNTY STATION</b><br/>         UPDATED FINAL SAFETY ANALYSIS REPORT</p>                               |
| <p>FIGURE 2.5-84</p> <p>TYPICAL STRESS-STRAIN CURVES<br/>         FROM TRIAXIAL TESTS<br/>         (SHEET 1 of 3)</p> |

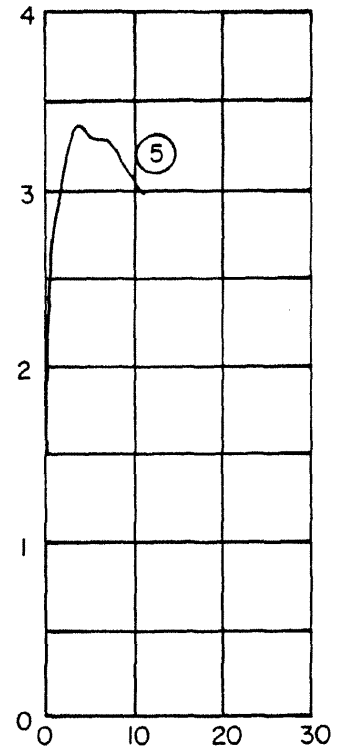
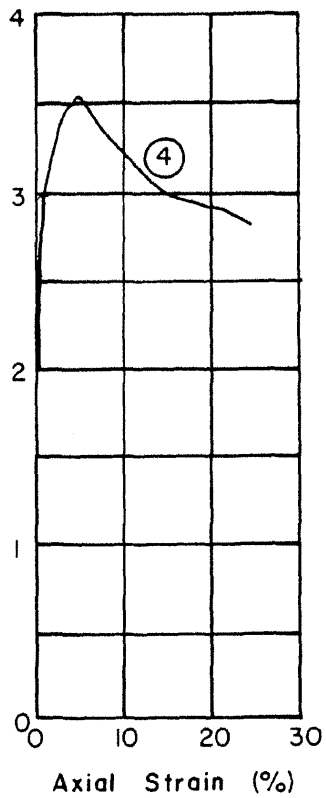
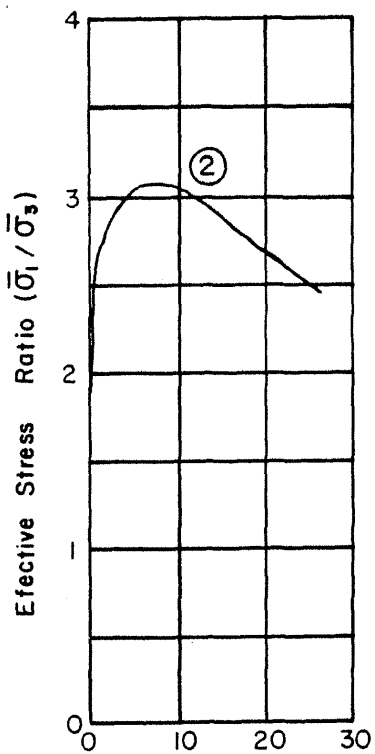

NOTES

1. Sample numbers listed in Table 2.5-39, Part B .
2. Mohr circle diagrams shown on Figure 2.5-43, Sheet 2 of 3.
3. Samples compacted to 95% of modified Proctor density.

|                                                                                                                             |
|-----------------------------------------------------------------------------------------------------------------------------|
| <p>LA-SALLE COUNTY STATION<br/>         UPDATED FINAL SAFETY ANALYSIS REPORT</p>                                            |
| <p>FIGURE 2.5-84<br/>         TYPICAL STRESS-STRAIN CURVES<br/>         FROM TRIAXIAL TESTS<br/>         (SHEET 2 of 3)</p> |

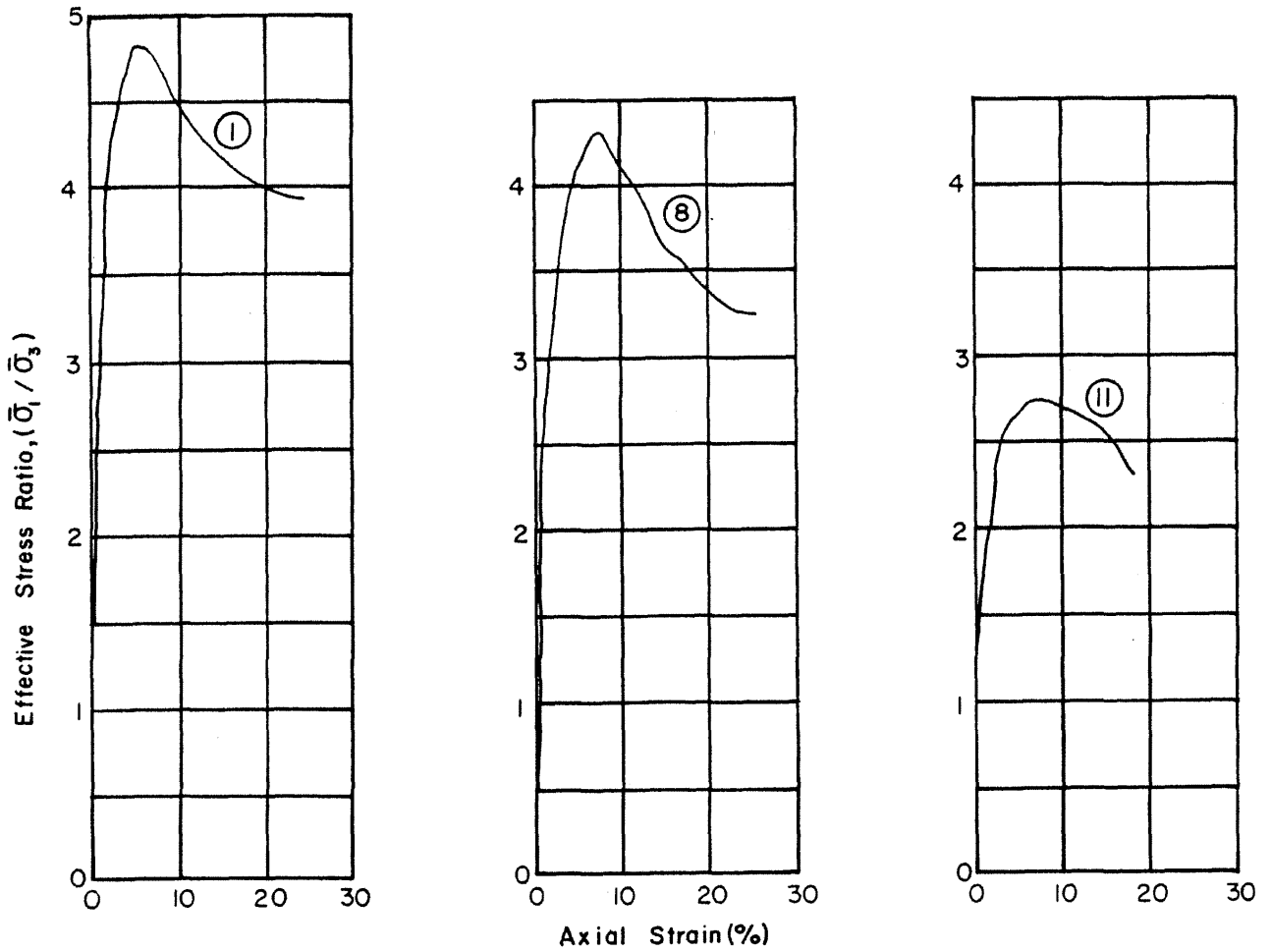

NOTES

1. Sample numbers listed in Table 2.5-39, Part C.
2. Mohr circle diagrams shown on Figure 2.5-43, Sheet 3 of 3.
3. Samples compacted to 90% of modified Proctor density.

|                                                                                        |
|----------------------------------------------------------------------------------------|
| <b>LA SALLE COUNTY STATION.</b><br>UPDATED FINAL SAFETY ANALYSIS REPORT                |
| FIGURE 2.5-84<br>TYPICAL STRESS-STRAIN CURVES<br>FROM TRIAXIAL TESTS<br>(SHEET 3 of 3) |

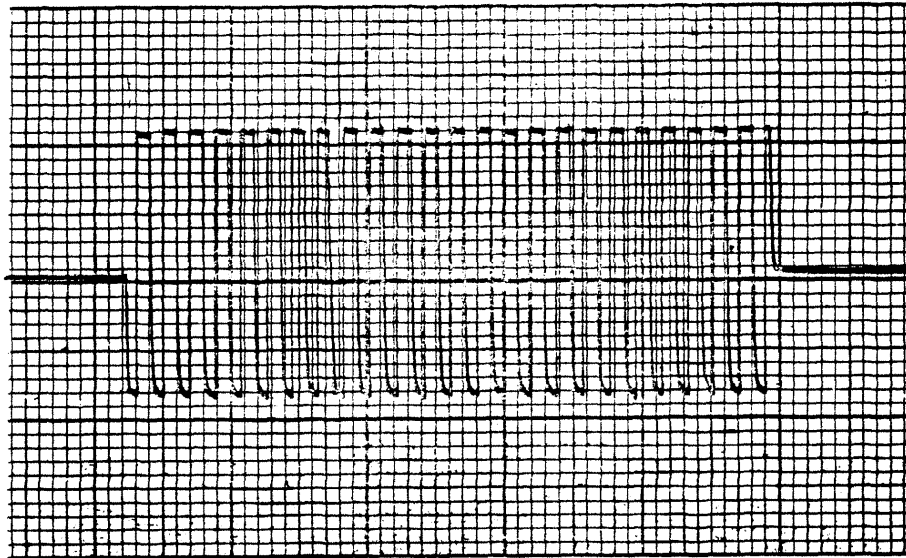

Stress plot (1 Div. = 266.7 psf)

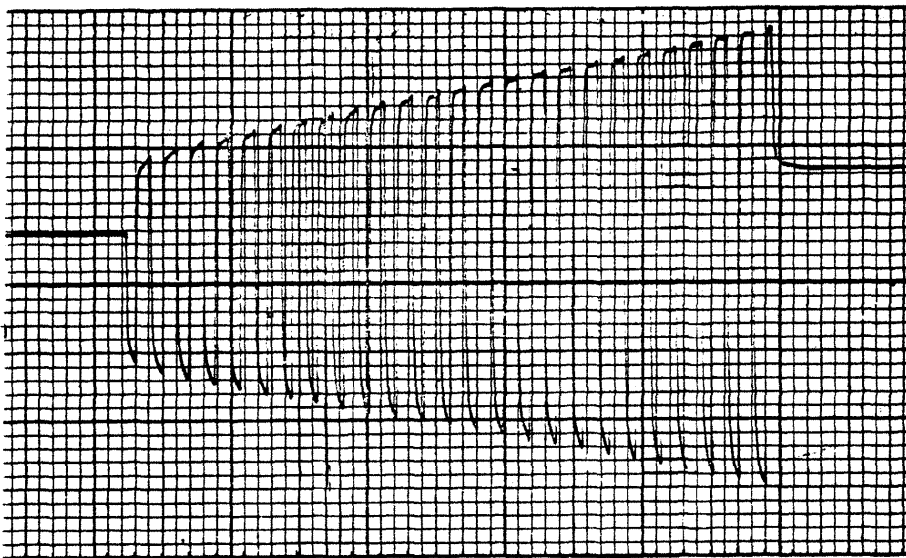

Displacement plot (1 Div. = 0.001 in.)

Notes:

1. Boring No. 2, Sample No. 12, Cyclic test No. 5, Depth of Sample 55 ft.
2. Confining pressure: 5500 psf, Height of Sample: = 5.31 in.
3. See Table 2.5-24 for Dynamic Triaxial Compression Test Data.

LA SALLE COUNTY STATION  
 UPDATED FINAL SAFETY ANALYSIS REPORT

FIGURE 2.5-85

TYPICAL CYCLIC TRIAXIAL TEST DATA

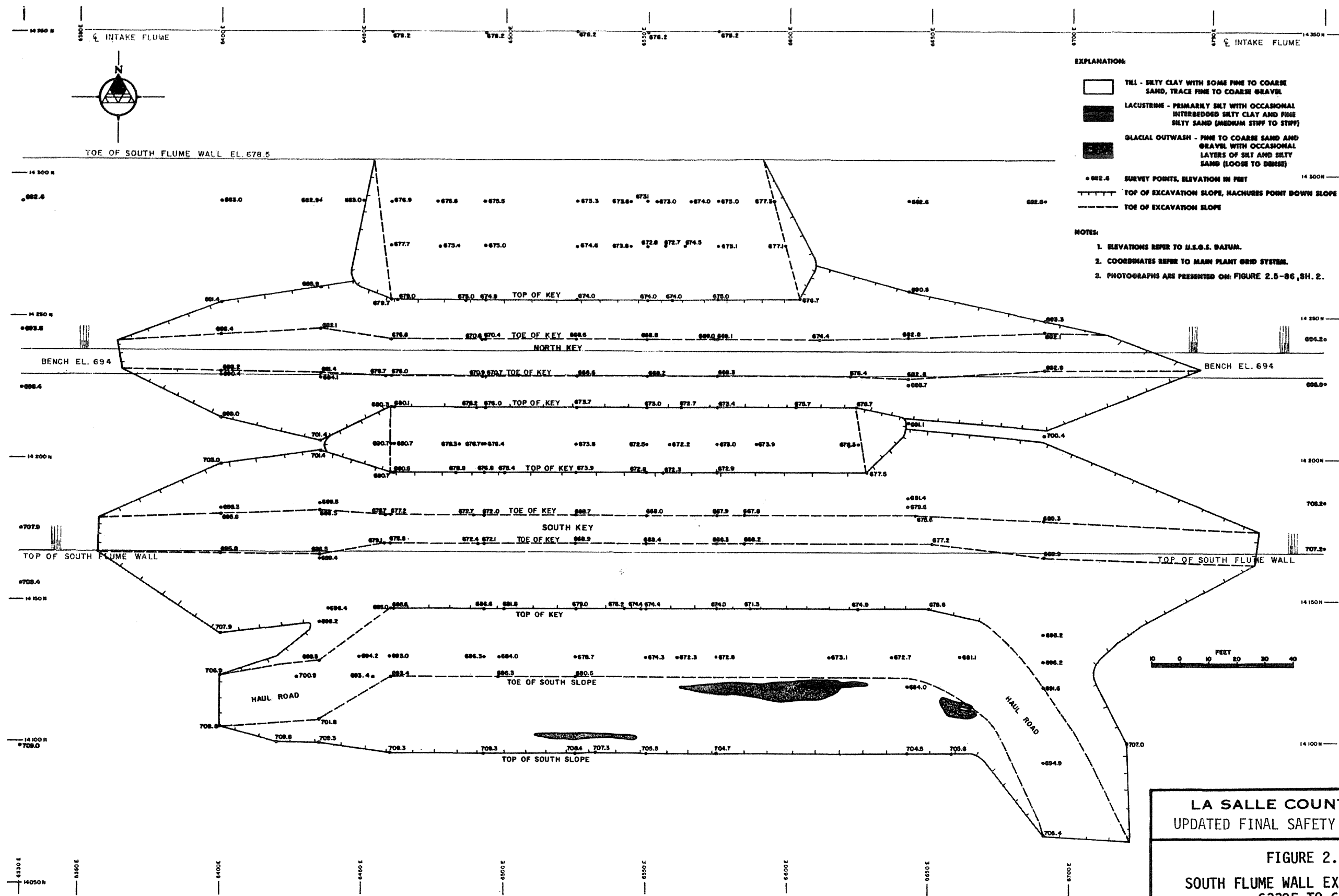

**EXPLANATION:**

TRL - SILTY CLAY WITH SOME FINE TO COARSE SAND, TRACE FINE TO COARSE GRAVEL  
 LACUSTRINE - PRIMARILY SILT WITH OCCASIONAL INTERBEDDED SILTY CLAY AND FINE SILTY SAND (MEDIUM STIFF TO STIFF)  
 GLACIAL OUTWASH - FINE TO COARSE SAND AND GRAVEL WITH OCCASIONAL LAYERS OF SILT AND SILTY SAND (LOOSE TO DENSE)  
 SURVEY POINTS, ELEVATION IN FEET  
 TOP OF EXCAVATION SLOPE, MACHURSE POINT DOWN SLOPE  
 TOE OF EXCAVATION SLOPE

**NOTES:**

- ELEVATIONS REFER TO U.S.G.S. DATUM.
- COORDINATES REFER TO MAIN PLANT GRID SYSTEM.
- PHOTOGRAPHS ARE PRESENTED ON: FIGURE 2.5-86, SH. 2.



**LA SALLE COUNTY STATION**  
 UPDATED FINAL SAFETY ANALYSIS REPORT  
  
**FIGURE 2.5-86**  
**SOUTH FLUME WALL EXCAVATION FROM**  
**6330E TO 6790E**  
**(SHEET 1 of 2)**

SOUTH

NORTH

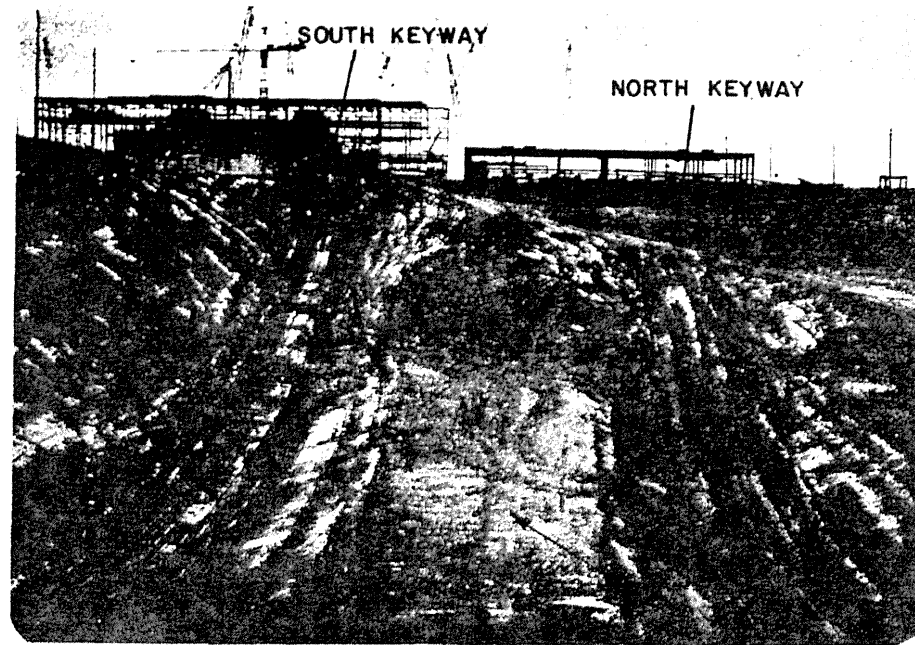

WEST WALL OF EXCAVATION  
(VIEW IS TO THE WEST FROM EAST WALL)

NORTH

SOUTH

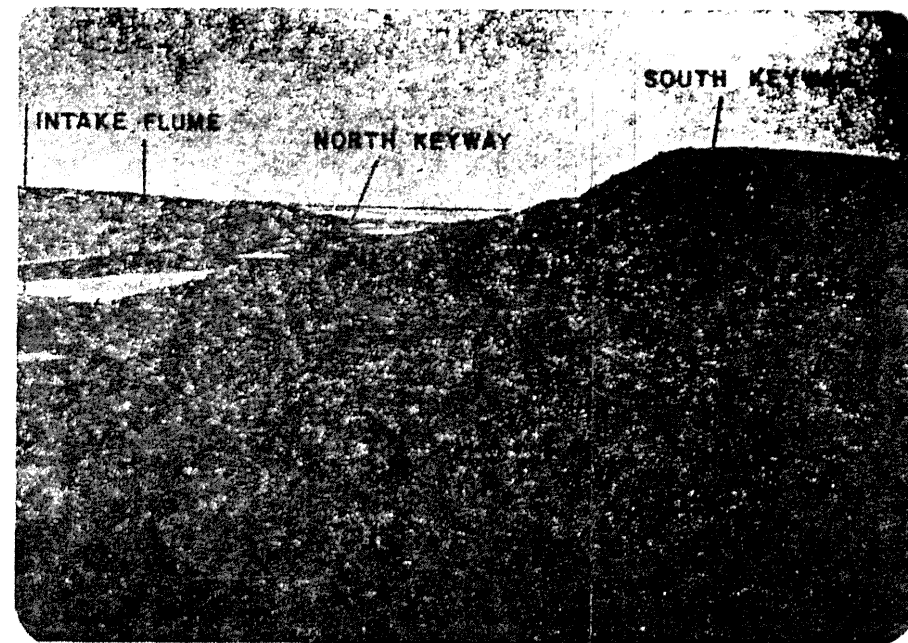

EAST WALL OF EXCAVATION  
(VIEW IS TO THE EAST FROM WEST WALL)

EAST

WEST

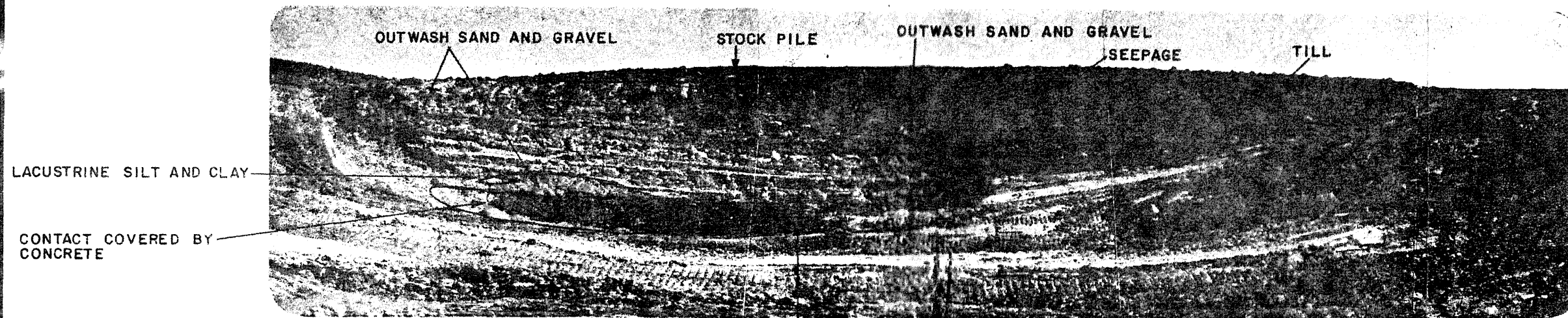

SOUTH WALL OF EXCAVATION  
(VIEW IS TO THE SOUTH FROM CENTER OF EXCAVATION)

LA SALLE COUNTY STATION  
UPDATED FINAL SAFETY ANALYSIS REPORT

FIGURE 2.5-86  
SOUTH FLUME WALL EXCAVATION FROM  
6330E TO 6790E  
(SHEET 2 of 2)

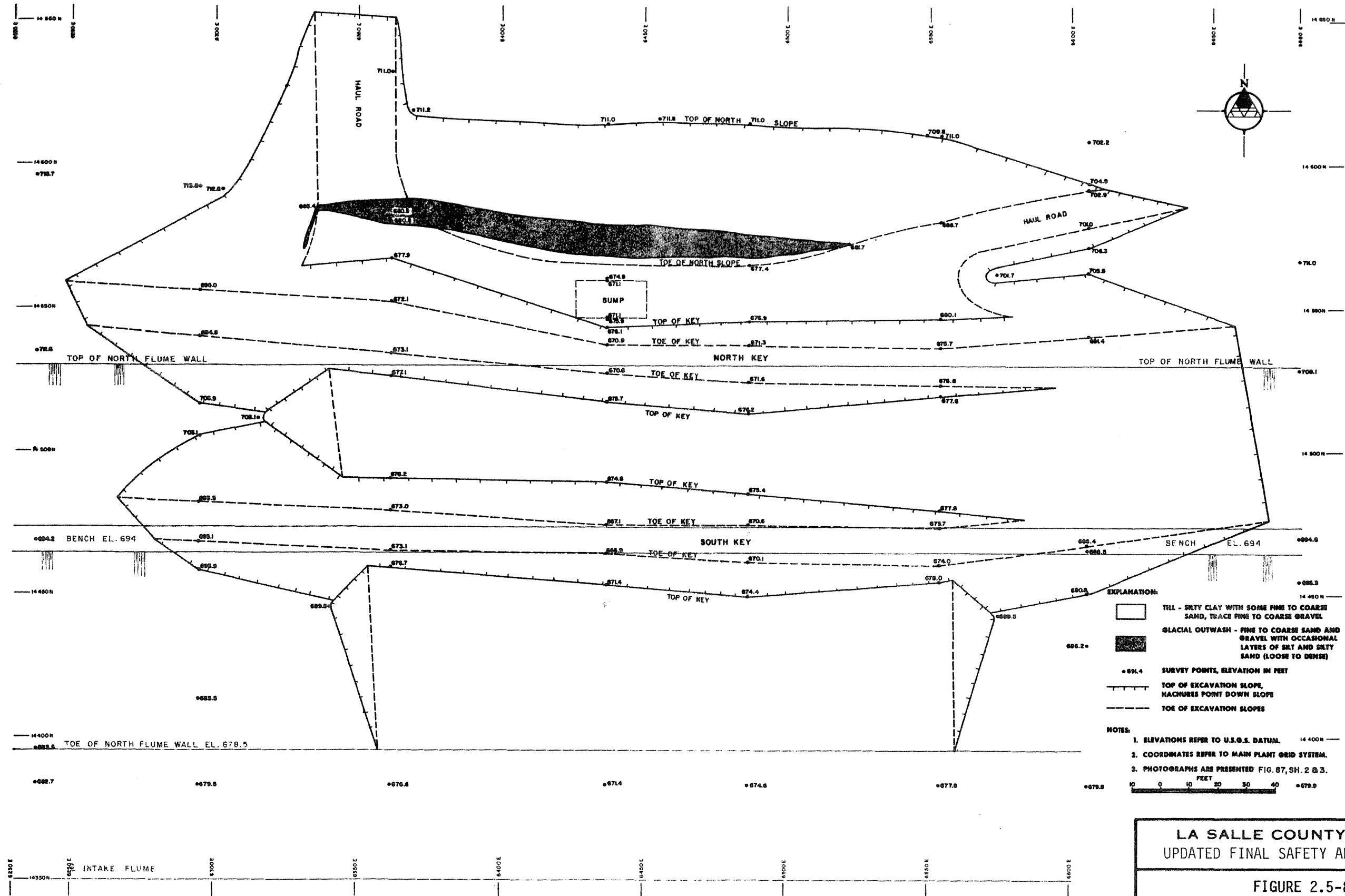

- EXPLANATION:**
- TILL - SILTY CLAY WITH SOME FINE TO COARSE SAND, TRACE FINE TO COARSE GRAVEL
  - GLACIAL OUTWASH - FINE TO COARSE SAND AND GRAVEL WITH OCCASIONAL LAYERS OF SILT AND SILTY SAND (LOOSE TO DENSE)
  - SURVEY POINTS, ELEVATION IN FEET
  - TOP OF EXCAVATION SLOPE, MACHINES POINT DOWN SLOPE
  - TOE OF EXCAVATION SLOPES

- NOTES:**
1. ELEVATIONS REFER TO U.S.S. DATUM.
  2. COORDINATES REFER TO MAIN PLANT GRID SYSTEM.
  3. PHOTOGRAPHS ARE PRESENTED FIG. 87, SH. 2 & 3.

**LA SALLE COUNTY STATION**  
 UPDATED FINAL SAFETY ANALYSIS REPORT

FIGURE 2.5-87  
 NORTH FLUME WALL EXCAVATION FROM  
 6230E TO 6680E  
 (SHEET 1 of 3)



SOUTH

NORTH

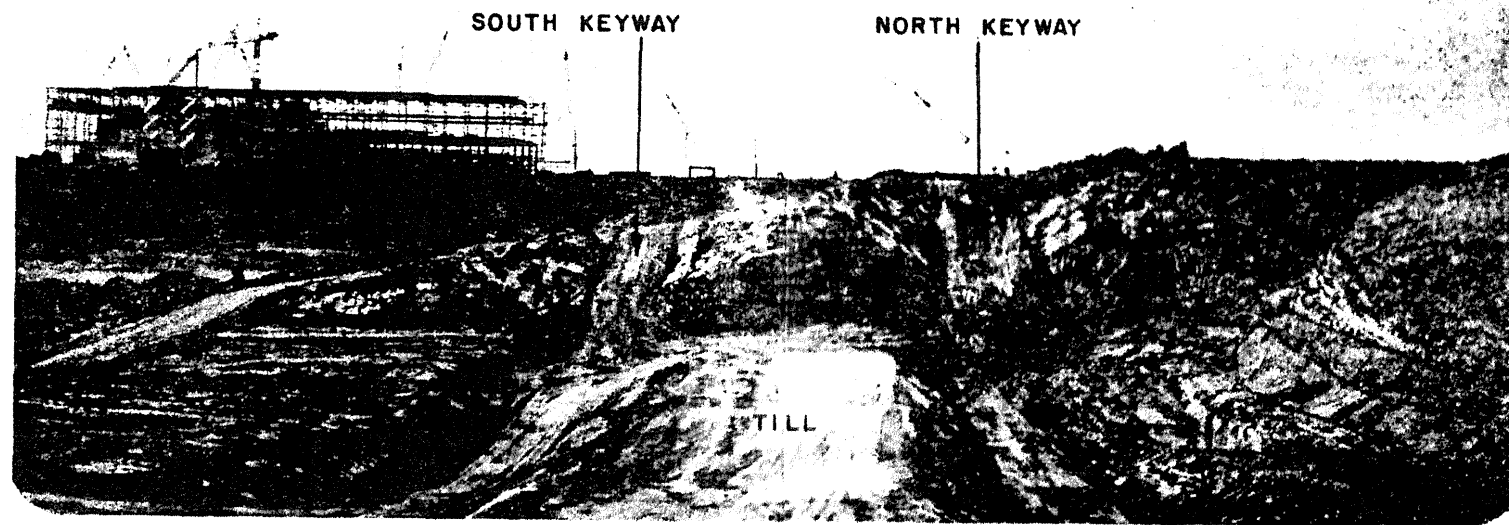

— OUTWASH SAND AND GRAVEL  
 — CONCRETE SEEPAGE BARRIER  
 — SUMP

WEST WALL OF EXCAVATION  
 (VIEW IS TO THE WEST FROM EAST WALL)

NORTH

SOUTH

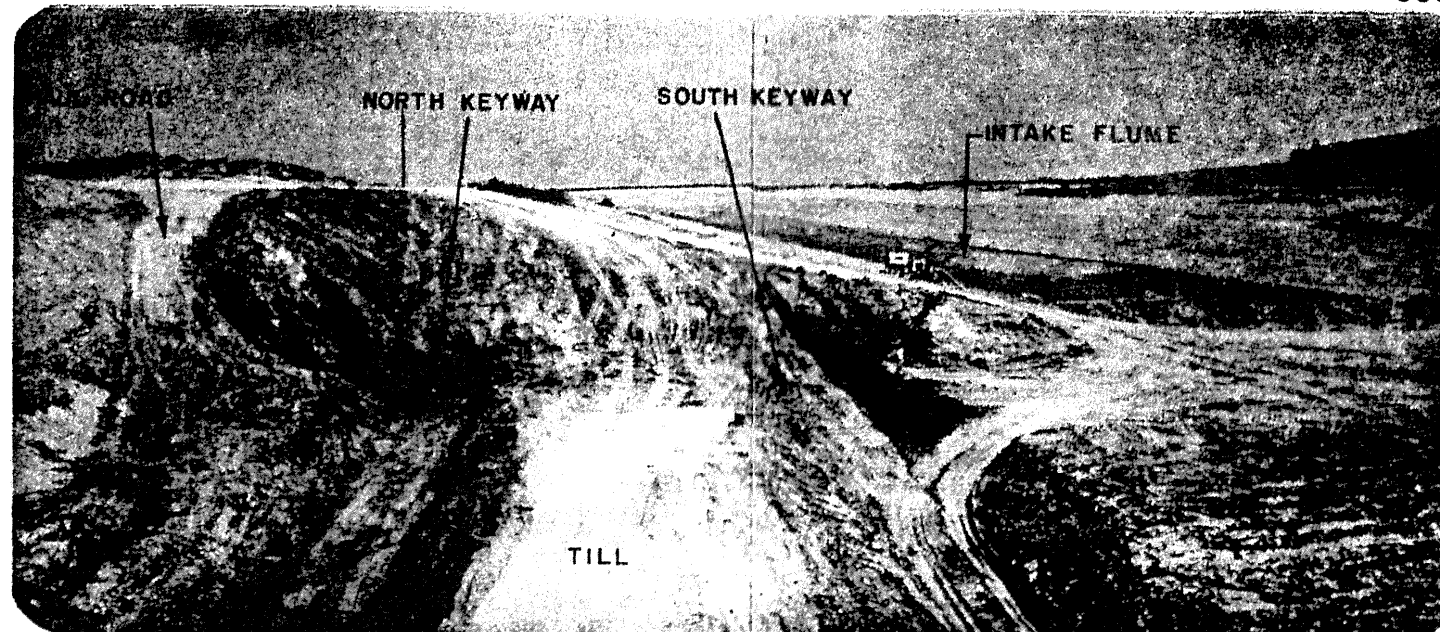

EAST WALL OF EXCAVATION  
 (VIEW IS TO THE EAST FROM WEST WALL)

LA SALLE COUNTY STATION  
 UPDATED FINAL SAFETY ANALYSIS REPORT

FIGURE 2.5-87  
 NORTH FLUME WALL EXCAVATION FROM  
 6230E to 6680E  
 (SHEET 2 of 3)

WEST

EAST

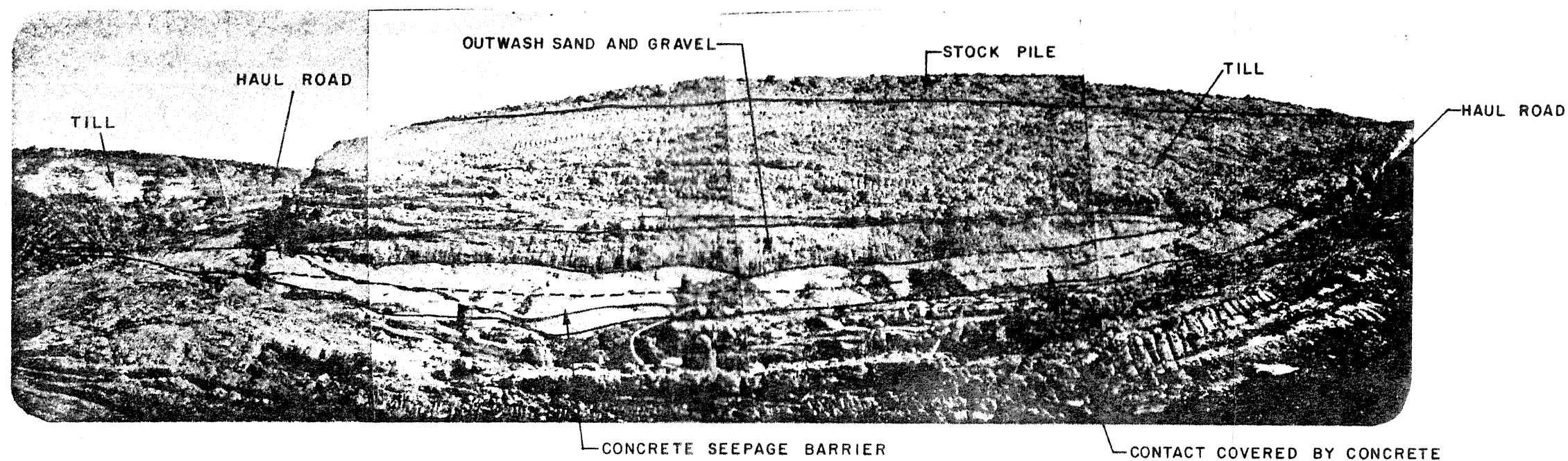

NORTH WALL OF EXCAVATION  
(VIEW IS TO THE NORTH FROM CENTER OF EXCAVATION)

LA SALLE COUNTY STATION  
UPDATED FINAL SAFETY ANALYSIS REPORT

FIGURE 2.5-87  
NORTH FLUME WALL EXCAVATION FROM  
6230E to 6680E  
(SHEET 3 of 3)

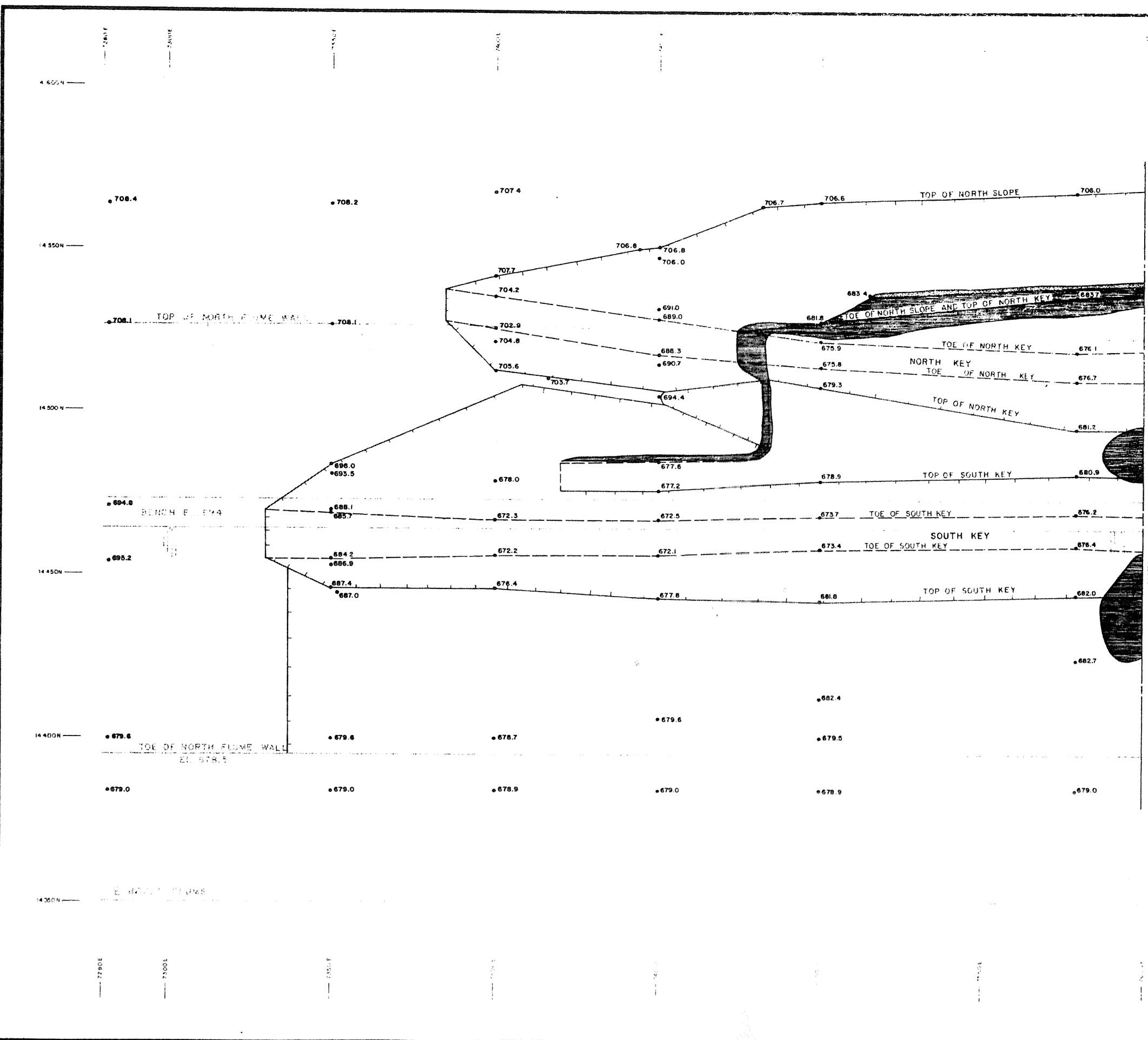
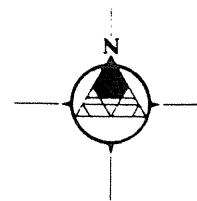

EXPLANATION:

- TILL - SILTY CLAY WITH SOME FINE TO COARSE SAND, TRACE FINE TO COARSE GRAVEL
- LACUSTRINE - PRIMARILY SILT WITH OCCASIONAL INTERBEDDED SILTY CLAY AND FINE SILTY SAND (MEDIUM STIFF TO STIFF)
- GLACIAL OUTWASH - FINE TO COARSE SAND AND GRAVEL WITH OCCASIONAL LAYERS OF SILT AND SILTY SAND (LOOSE TO DENSE)
- SURVEY POINTS, ELEVATION IN FEET
- TOP OF EXCAVATION SLOPE, MACHURES POINT DOWN SLOPE
- TOE OF EXCAVATION SLOPE

NOTES:

1. ELEVATIONS REFER TO U.S.G.S. DATUM.
2. COORDINATES REFER TO MAIN PLANT GRID SYSTEM.
3. PHOTOGRAPHS ARE PRESENTED ON FIGURE 2.5-88, SHEETS 3 & 4.







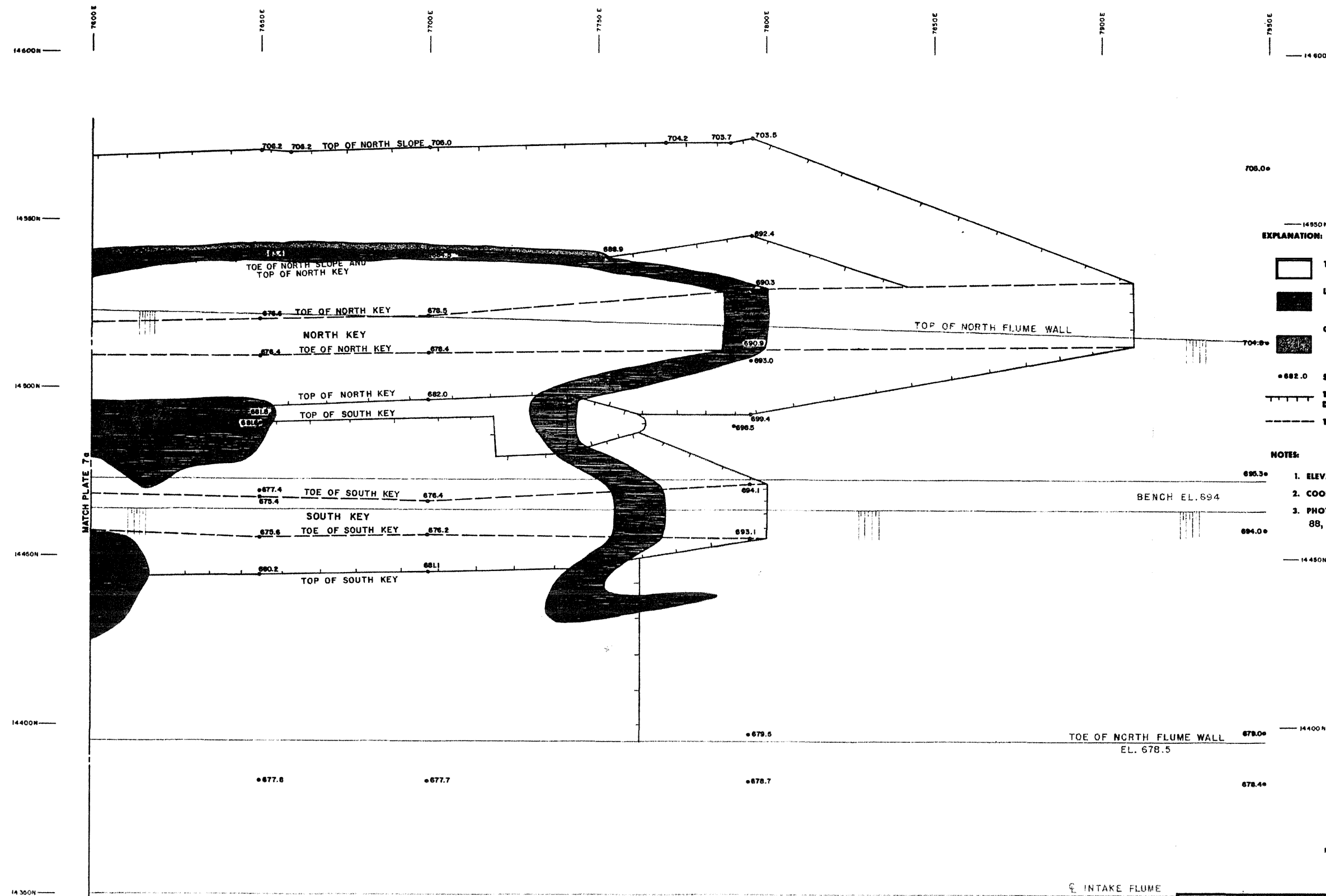
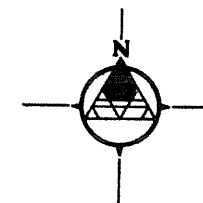

LA SALLE COUNTY STATION  
 UPDATED FINAL SAFETY ANALYSIS REPORT

FIGURE 2.5-88  
 NORTH FLUME WALL EXCAVATION FROM  
 7280E TO 7950E  
 (SHEET 1 of 4)

7600E TO 7950E



EXPLANATION:

-  TILL - SILTY CLAY WITH SOME FINE TO COARSE SAND, TRACE FINE TO COARSE GRAVEL
-  LACUSTRINE - PRIMARILY SILT WITH OCCASIONAL INTERBEDDED SILTY CLAY AND FINE SILTY SAND (MEDIUM STIFF TO STIFF)
-  GLACIAL OUTWASH - FINE TO COARSE SAND AND GRAVEL WITH OCCASIONAL LAYERS OF SILT AND SILTY SAND (LOOSE TO DENSE)
-  SURVEY POINTS, ELEVATION IN FEET
-  TOP OF EXCAVATION SLOPE, HACHURES POINT DOWN SLOPE
-  TOE OF EXCAVATION SLOPE

NOTES:

1. ELEVATIONS REFER TO U.S.G.S. DATUM.
2. COORDINATES REFER TO MAIN PLANT GRID SYSTEM.
3. PHOTOGRAPHS ARE PRESENTED ON FIGURE 2.5-88, SHEETS 3 & 4.

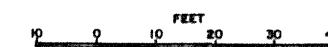

LA SALLE COUNTY STATION  
 UPDATED FINAL SAFETY ANALYSIS REPORT

FIGURE 2.5-88  
 NORTH FLUME WALL EXCAVATION FROM  
 7280E TO 7950E  
 (SHEET 2 of 4)



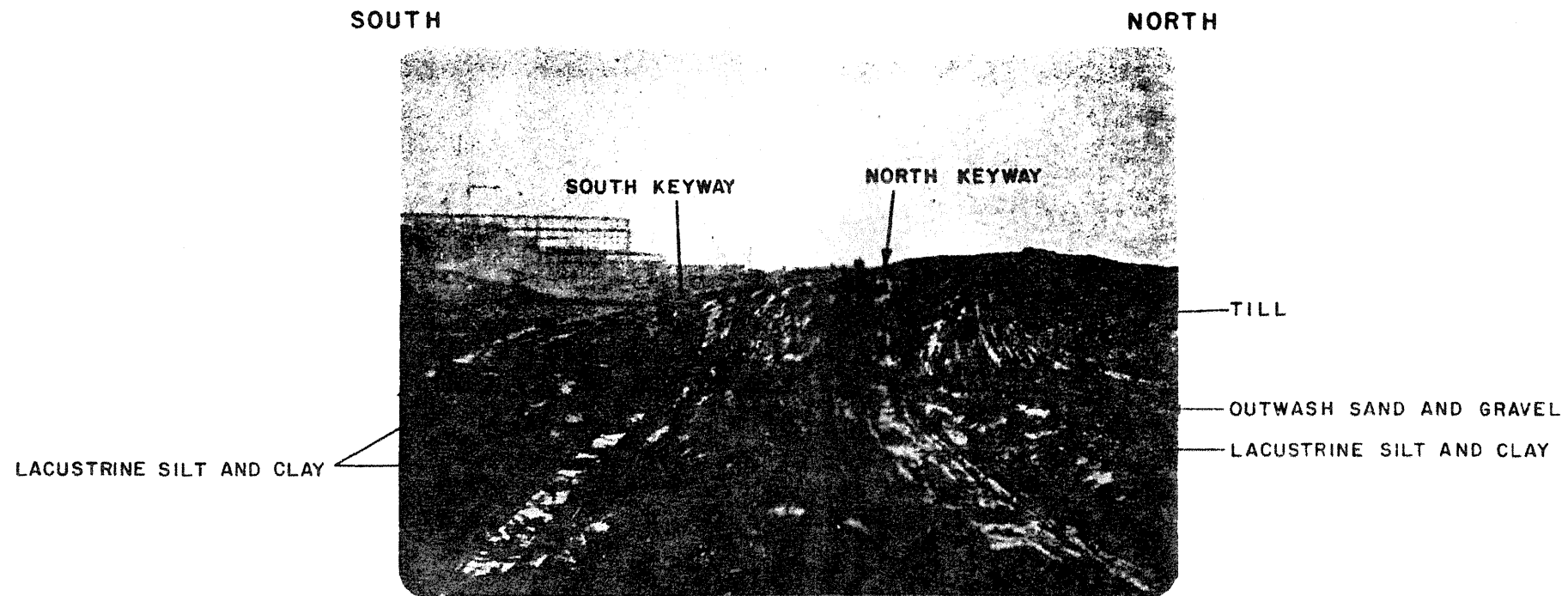

WEST WALL OF EXCAVATION  
(VIEW IS TO THE WEST FROM EAST WALL)

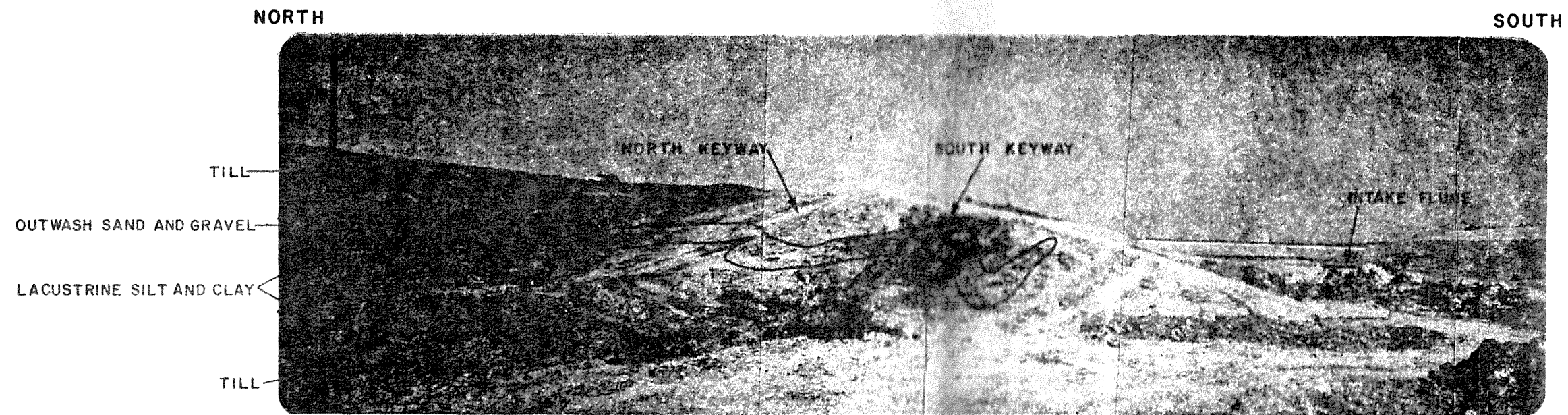

EAST WALL OF EXCAVATION  
(VIEW IS TO THE EAST FROM CENTER OF EXCAVATION)

|                                                                                       |
|---------------------------------------------------------------------------------------|
| LA SALLE COUNTY STATION<br>UPDATED FINAL SAFETY ANALYSIS REPORT                       |
| FIGURE 2.5-88<br>NORTH FLUME WALL EXCAVATION FROM<br>7280E TO 7950E<br>(SHEET 3 of 4) |

WEST

LACUSTRINE SILT AND CLAY

OUTWASH SAND AND GRAVEL

NORTH KEYWAY

SUMP

TILL

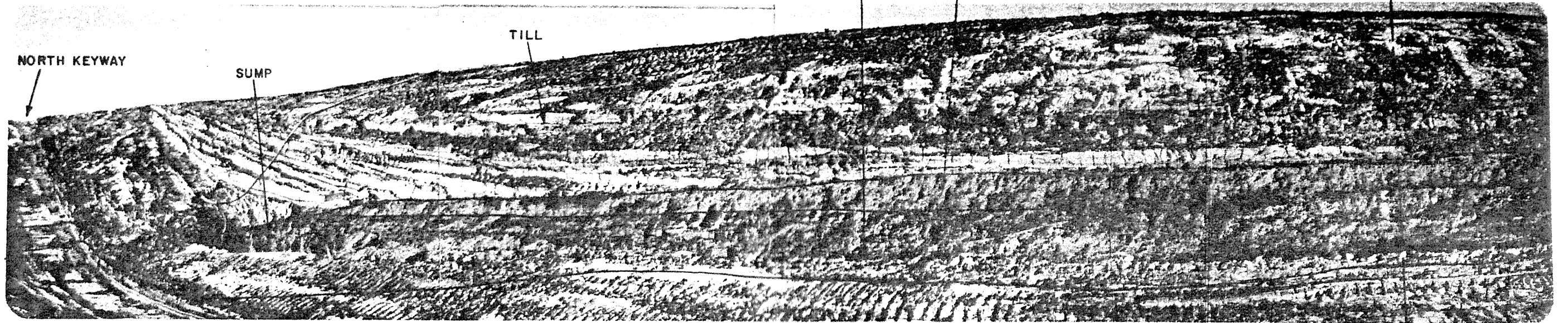

MATCH LINE

EAST

TILL

OUTWASH SAND AND GRAVEL

LACUSTRINE SILT AND CLAY

NORTH KEYWAY

MATCH LINE

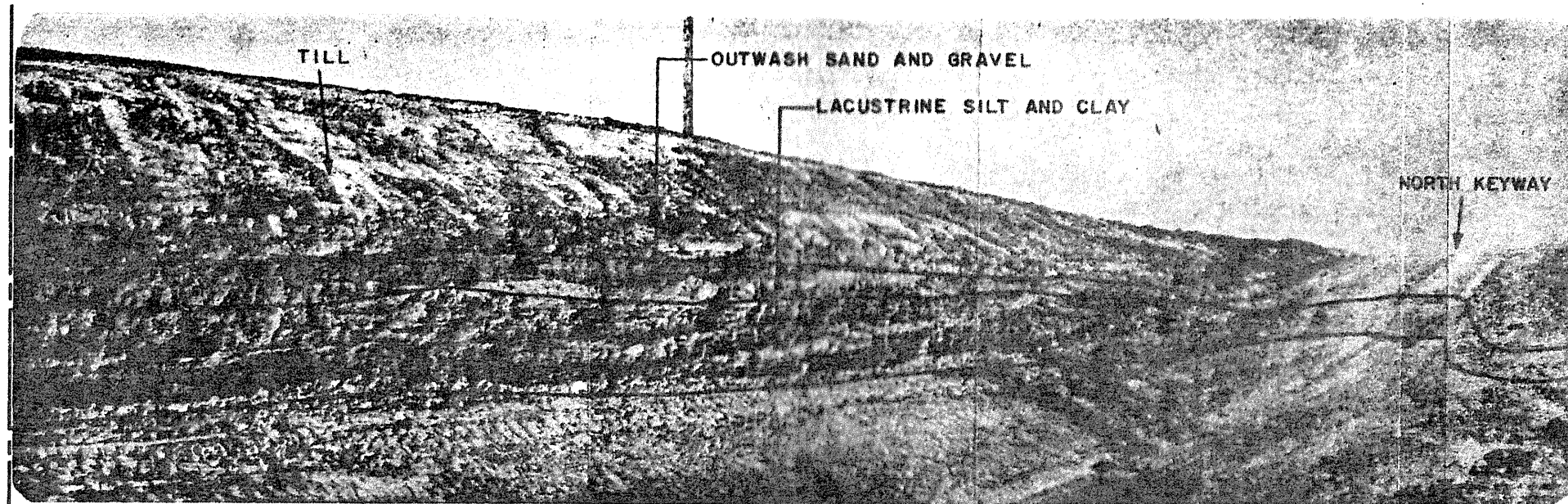

TILL

NORTH WALL OF EXCAVATION  
 (VIEW IS TO THE NORTH FROM CENTER OF EXCAVATION)

LA SALLE COUNTY STATION  
 UPDATED FINAL SAFETY ANALYSIS REPORT

FIGURE 2.5-88  
 NORTH FLUME WALL EXCAVATION FROM  
 7280E TO 7950E  
 (SHEET 4 of 4)

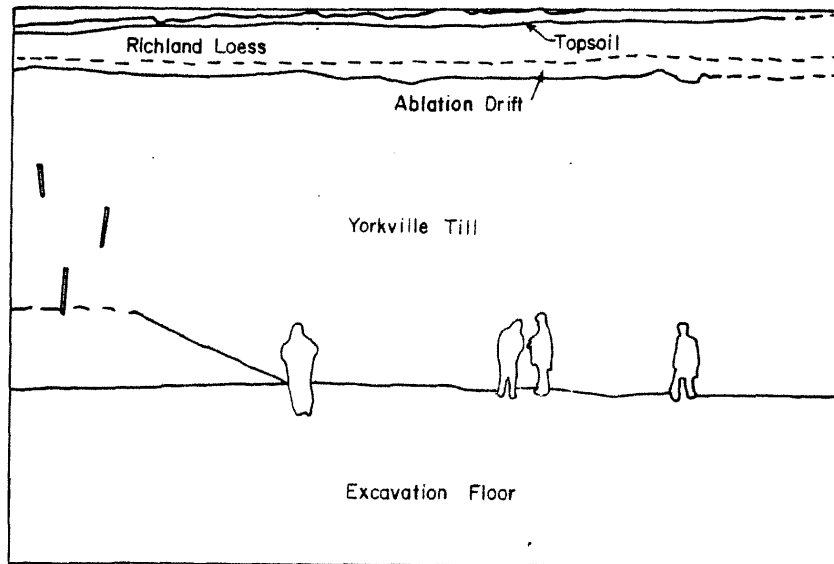
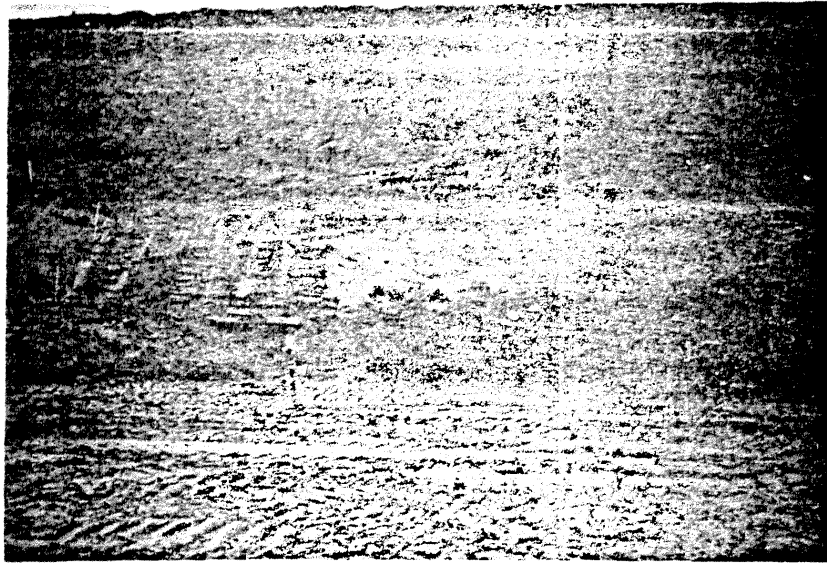

**NOTE**

1. See Figure 2.5-50, sheet 1, for location of photo view.

|                                                                         |
|-------------------------------------------------------------------------|
| <p>LA SALLE COUNTY STATION<br/>UPDATED FINAL SAFETY ANALYSIS REPORT</p> |
| <p>FIGURE 2.5-89<br/>MAIN PLANT EXCAVATION<br/>WEST WALL</p>            |



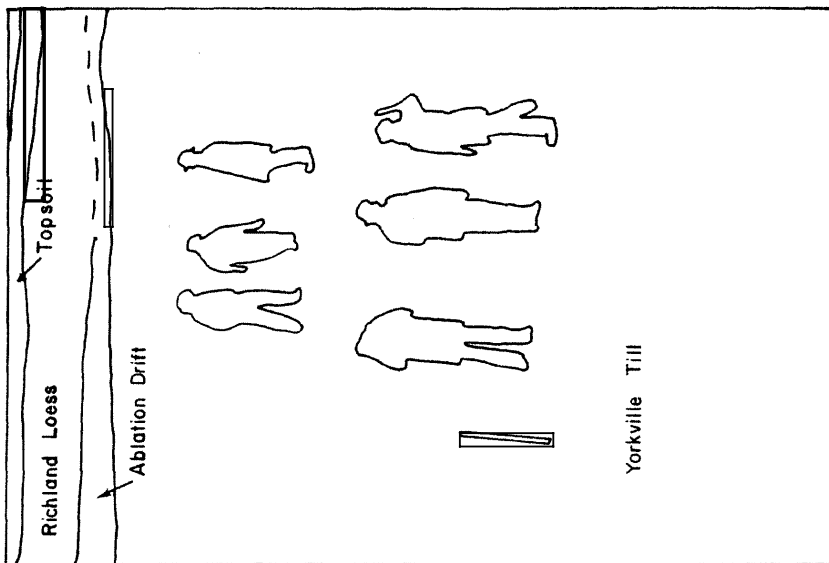
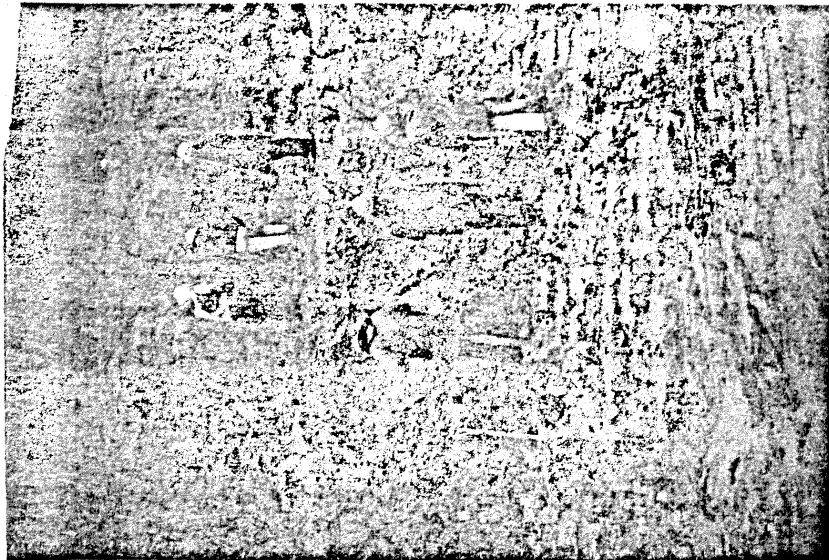

**NOTE**

1. See Figure 2.5-50, sheet 1, for location of photo view.

**LA SALLE COUNTY STATION  
UPDATED FINAL SAFETY ANALYSIS REPORT**

FIGURE 2.5-90

MAIN PLANT EXCAVATION  
NORTH WALL



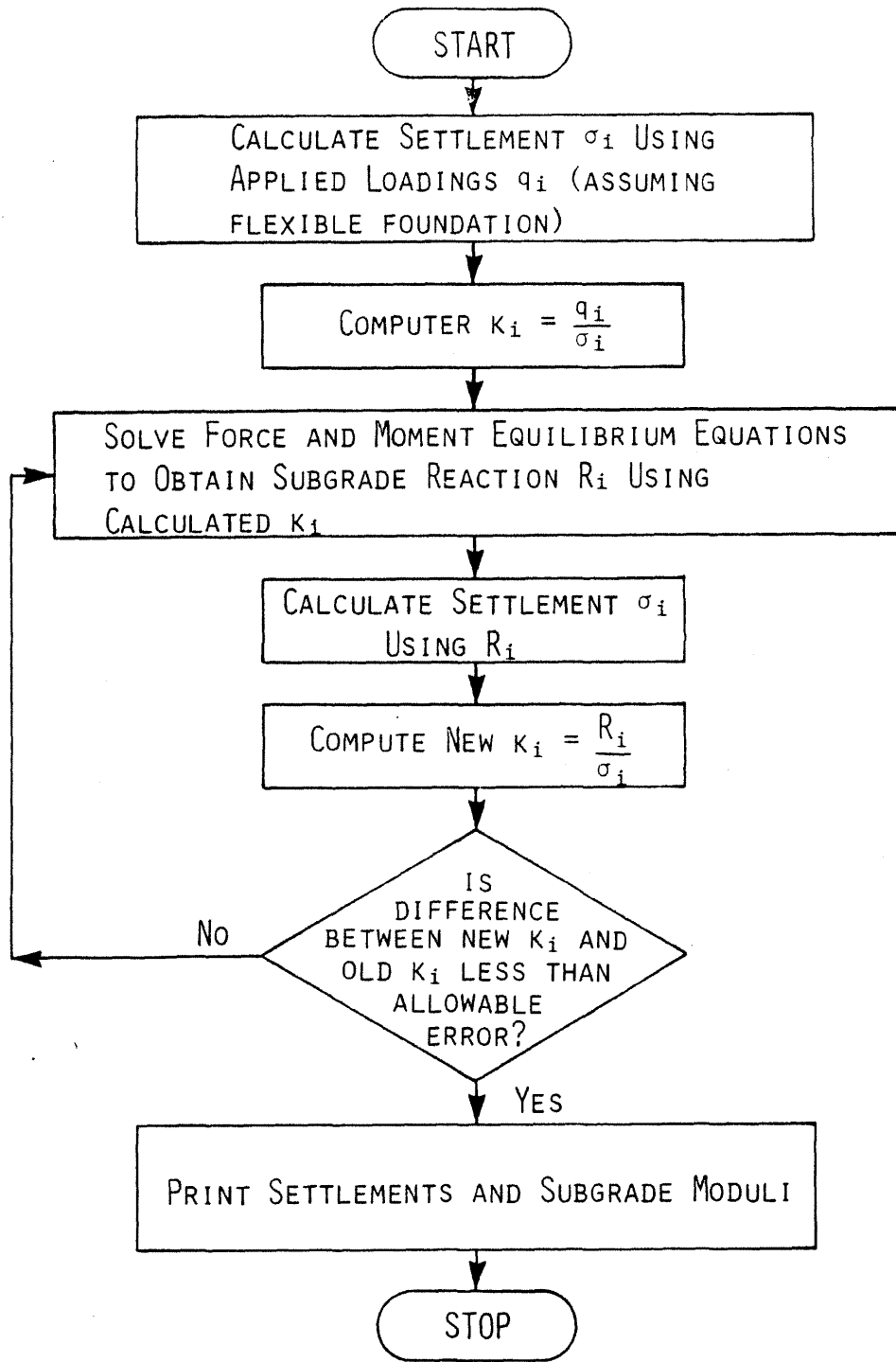

LA SALLE COUNTY STATION  
 UPDATED FINAL SAFETY ANALYSIS REPORT

FIGURE 2.5-91

FLOWCHART FOR THE SETTLEMENT  
 CALCULATION FOR RIGID FOUNDATION

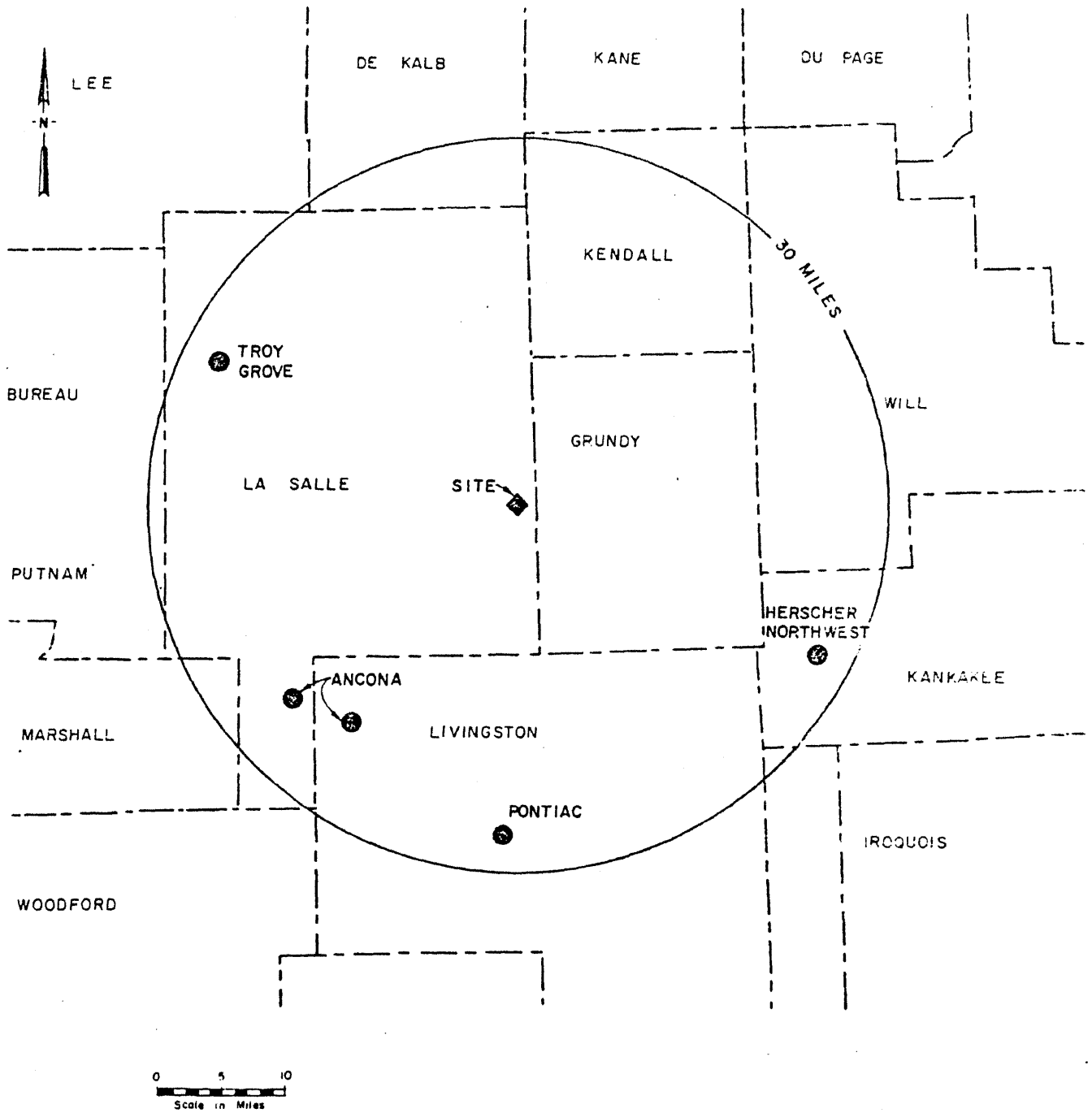

**LEGEND**

☒ Gas Storage Field

**NOTE**

1. Base map from: Meents, W F, 1977, Oil and Gas Industry in Illinois, Illinois State Geological Survey.

LA SALLE COUNTY STATION  
 UPDATED FINAL SAFETY ANALYSIS REPORT

FIGURE 2.5-92  
 GAS STORAGE FIELDS  
 WITHIN 30 MILES

REV. 0 - APRIL 1984