

6.0	ENGINEERED SAFETY FEATURES	1
6.1	ENGINEERED SAFETY FEATURES MATERIALS	1
6.1.1	METALLIC MATERIALS	1
6.1.1.1	Materials Selection and Fabrication	1
6.1.1.2	Composition, Compatibility and Stability of Containment and Core Spray Coolants	2
6.1.2	ORGANIC MATERIALS	3
6.1.2.1	Balance of Plant Organic Materials	3
6.1.2.2	NSSS Organic Materials	4
	REFERENCES: SECTION 6.1	5
6.2	CONTAINMENT SYSTEMS	5
6.2.1	CONTAINMENT FUNCTIONAL DESIGN	5
6.2.1.1	Containment Structure	5
6.2.1.2	Containment Subcompartments.....	19
6.2.1.2a	Evaluation of SGR/PUR	24
6.2.1.3	Mass and Energy Release Analyses for Postulated Loss-of-Coolant Accidents	26
6.2.1.4	Mass and Energy Release Analysis For Postulated Secondary System and Pipe Ruptures.....	37
6.2.1.5	Minimum Containment Pressure Analysis for Performance Capability Studies of Emergency Core Cooling System	41
6.2.2	CONTAINMENT HEAT REMOVAL SYSTEM	43
6.2.2.1	Design Bases	44
6.2.2.2	System Design	45
6.2.2.3	System Design Evaluation	52
6.2.2.4	Testing and Inspection	56
6.2.2.5	Instrumentation Requirements	57
6.2.3	SECONDARY CONTAINMENT FUNCTIONAL DESIGN.....	58
6.2.4	CONTAINMENT ISOLATION SYSTEM.....	58
6.2.4.1	Design Bases	58
6.2.4.2	System Design	60

6.2.4.3 Design Evaluation 68

6.2.4.4 Tests and Inspections 69

6.2.5 COMBUSTIBLE GAS CONTROL IN CONTAINMENT 69

6.2.5.1 Design Bases 70

6.2.5.2 System Design 73

6.2.5.4 Test and Inspections 76

6.2.5.5 Instrumentation Requirements 76

6.2.5.6 Materials..... 76

6.2.6 CONTAINMENT LEAKAGE TESTING..... 76

6.2.6.1 Containment Integrated Leakage Rate Test (Type A Test) 76

6.2.6.2 Containment Penetration Leakage Rate Tests (Type B Tests)..... 80

6.2.6.3 Containment Isolation Valve Leakage Rate Tests (Type C Tests)..... 81

6.2.6.4 Scheduling and Reporting of Periodic Tests 83

REFERENCES: SECTION 6.2 84

APPENDIX 6.2A 86

REFERENCES: APPENDIX 6.2A 86

6.3 EMERGENCY CORE COOLING SYSTEM 87

6.3.1 DESIGN BASES..... 87

6.3.2 SYSTEM DESIGN..... 90

6.3.2.1 Schematic Piping and Instrumentation Diagrams 90

6.3.2.2 Equipment and Component Descriptions..... 91

6.3.2.3 Applicable Codes and Classifications 100

6.3.2.4 Material Specifications and Compatibility..... 100

6.3.2.5 System Reliability 100

6.3.2.6 Protection Provisions 105

6.3.2.7 Provisions for Performance Testing 105

6.3.2.8 Manual Actions..... 106

6.3.3 PERFORMANCE EVALUATION..... 113

6.3.3.1 Inadvertent Opening of a Steam Generator Relief or Safety Valve..... 114

6.3.3.2 Small Break LOCA 115

6.3.3.3 Large Break LOCA..... 115

6.3.3.4	Major Secondary System Pipe Failure	116
6.3.3.5	Steam Generator Tube Failure	117
6.3.3.6	Existing Criteria Used to Judge the Adequacy Of the ECCS. Criteria from 10CFR50.46	118
6.3.3.7	Use of Dual Function Components	119
6.3.3.8	Limits on System Parameters	120
6.3.3.9	Time Sequence for the Operation of the ECCS Components.....	120
6.3.4	TEST AND INSPECTIONS	121
6.3.4.1	ECCS Performance Tests.....	121
6.3.4.2	Reliability Tests and Inspections.....	122
6.3.5	INSTRUMENTATION REQUIREMENTS.....	124
6.3.5.1	Temperature Indication	124
6.3.5.2	Pressure Instrumentation	124
6.3.5.3	Flow Indication	125
6.3.5.4	Level Indication	125
6.3.5.5	Valve Position Indication	126
REFERENCES: SECTION 6.3.....		127
6.4	HABITABILITY SYSTEMS.....	127
6.4.1	DESIGN BASIS	127
6.4.2	SYSTEM DESIGN.....	130
6.4.2.1	Control Room Envelope	130
6.4.2.2	Ventilation System Design	130
6.4.2.3	Leak Tightness.....	131
6.4.2.4	Interaction with Other Zones and Pressure-Containing Equipment.....	132
6.4.2.5	Shielding Design	132
6.4.3	SYSTEM OPERATIONAL PROCEDURES.....	132
6.4.4	DESIGN EVALUATION.....	133
6.4.4.1	Radiological Protection	133
6.4.4.2	Toxic Gas Protection.....	133
6.4.5	TESTING AND INSPECTIONS.....	134
6.4.5.1	Emergency HEPA/Charcoal Filter Trains.....	134

6.4.5.2	Water Chillers.....	135
6.4.5.3	Fan or Fan Coil Units	135
6.4.5.4	Pumps	135
6.4.5.5	Considerations Leading to the Selected Test Frequency.....	135
6.4.6	INSTRUMENTATION REQUIREMENT	135
6.5	FISSION PRODUCT REMOVAL AND CONTROL SYSTEMS.....	137
6.5.1	ENGINEERED SAFETY FEATURE (ESF) FILTER SYSTEMS	137
6.5.1.1	Design Bases	137
6.5.1.2	System Design	139
6.5.1.3	Design Evaluation	144
6.5.1.4	Test and Inspection.....	145
6.5.1.6	Materials.....	147
6.5.2	CONTAINMENT SPRAY SYSTEM	147
6.5.2.1	Design Bases	147
6.5.2.2	System Design	148
6.5.2.3	Design Evaluation	149
6.5.2.4	Testing and Inspection	153
6.5.2.5	Instrumentation Requirement.....	153
6.5.2.6	Materials.....	153
6.5.3	FISSION PRODUCT CONTROL SYSTEMS.....	154
6.5.3.1	Primary Containment	154
6.5.3.2	Secondary Containment.....	154
6.5.4	ICE CONDENSER AS A FISSION PRODUCT CLEANUP SYSTEM	154
	REFERENCES: SECTION 6.5.....	155
6.6	INSERVICE INSPECTION OF CLASS 2 AND 3 COMPONENTS	155
6.6.1	COMPONENTS SUBJECT TO EXAMINATION.....	155
6.6.2	ACCESSIBILITY.....	155
6.6.3	EXAMINATION TECHNIQUES AND PROCEDURES	156
6.6.4	INSPECTION INTERVALS	156

6.6.5 EXAMINATION CATEGORIES 156

6.6.6 EVALUATION OF EXAMINATION RESULTS 156

6.6.7 SYSTEM PRESSURE TESTS 157

6.6.8 AUGMENTED INSERVICE INSPECTION TO PROTECT AGAINST
POSTULATED PIPING FAILURES..... 157

6.7 MAIN STEAM LINE ISOLATION VALVE LEAKAGE CONTROL SYSTEM..... 157

6.0 ENGINEERED SAFETY FEATURES

6.1 ENGINEERED SAFETY FEATURES MATERIALS

6.1.1 METALLIC MATERIALS

6.1.1.1 Materials Selection and Fabrication

Typical materials specifications used for components in the engineered safety features (ESF) are listed in Table 6.1.1-1. For NSSS supplied equipment, this list of materials may not be totally inclusive; however, the listed specifications are representative of those materials used. Identification of the actual materials used in Class 2 and 3 components is available in the SHNPP Site QA records. The utilized materials conform to the applicable requirements of the American Society of Mechanical Engineers (ASME) Boiler and Pressure Vessel Code.

Table 6.1.1-1 lists materials utilized by ESF components within the Containment that would be exposed to core cooling water and containment sprays in the unlikely event of a loss-of-coolant accident (LOCA). These components are manufactured primarily of stainless steel or other corrosion-resistant material. The integrity of the materials of construction for ESF equipment when exposed to post-design basis accident (DBA) conditions has been evaluated. Post-DBA conditions were conservatively represented by test conditions. The test program performed by Westinghouse considered spray and core cooling solutions of the design chemical compositions, as well as the design chemical compositions contaminated with corrosion and deterioration products which may be transferred to the solution during recirculation. The effects of sodium (free caustic), chlorine (chloride), and fluorine (fluoride) on austenitic stainless steels were considered. Based on the results of this investigation, as well as testing by Oak Ridge National Laboratory and others, the behavior of austenitic stainless steels in the post-DBA environment will be acceptable. The inhibitive properties of alkalinity (hydroxyl ion) with respect to chloride cracking have been demonstrated.

All parts of components in contact with borated water are fabricated of, or clad with, austenitic stainless steel or equivalent corrosion-resistant material. The integrity of the safety related components of the ESF is maintained during all stages of component manufacture. Austenitic stainless steel is utilized in the final heat-treated condition as required by the respective ASME Code, Section II, material specification for the particular type or grade of alloy. Furthermore, it is required that austenitic stainless steel materials used in the ESF components be handled, protected, stored, and cleaned according to recognized and accepted methods that are designed to minimize contamination which could lead to stress corrosion cracking. The rules covering these controls are discussed in Section 5.2.3. Additional information concerning austenitic stainless steel, including the avoidance of sensitization and the prevention of intragranular attack, can be found in Section 5.2.3.

The welding materials used for joining the ferritic base materials of the ESF conform to or are equivalent to ASME Code Section II, Part C, Material Specifications SFA 5.1, 5.5, 5.17, 5.18 and 5.20. The welding materials used for joining nickel-chromium-iron alloy in similar base material combination and for joining dissimilar ferritic or austenitic base material combination conform to ASME Code, Section II, Part C, Material Specifications SFA 5.11 and 5.14. The welding materials used for joining the austenitic stainless steel base material conform to ASME Code, Section II, Part C, Material Specifications SFA 5.4 and 5.9. These materials are tested and qualified to the requirements of the ASME Code and are used in procedures which have

been qualified to these same rules. The methods utilized to control delta ferrite content and to avoid hot cracking (fissuring) in austenitic stainless steel weldments are discussed in Section 5.2.3 for Westinghouse supplied equipment, and in Sections 10.3 and 1.8 (Regulatory Guide 1.31) for piping and Ebasco specified equipment.

Materials for Class 2 and 3 components are selected for their compatibility with core and containment spray solutions, as described in ASME Code, Section III, Articles NB-2160 and NB-3120; the materials are selected from those which are included in Appendix I to Section III. The mechanical properties of materials specified for use in Class 2 and 3 components are as indicated in ASME Code, Section III, Appendix I or ASME Code, Section II, Parts A, B or C

All materials for ESF components which are in contact with core cooling and/or containment spray water are considered compatible with the cooling solutions as described below:

- a) Austenitic stainless steels and nickel base alloys are not subject to significant corrosion in borated water or borated water with sodium hydroxide additives.
- b) Any carbon steel components, requiring protective coatings will be coated to meet the intent of Regulatory Guide 1.54.

The integrity of ESF components is maintained during all stages of component manufacture and reactor construction. Specific assurance of integrity is based on compliance with Regulatory Guides 1.31, 1.36, 1.37 and 1.44 as described in Section 1.8. Additionally, all austenitic stainless steels are provided in the solution annealed condition. Yield strengths for these materials are of the order of 30,000 to 50,000 psi. No cold-worked austenitic stainless steels having yield strengths greater than 90,000 psi are used for components of the ESF. Any cold bent piping is re-solution annealed after cold bending, except where the piping is bent to a radius of at least 20 times the pipe radius, in which case the resulting strain in the outer pipe fibers is under 2.5 percent, which causes no significant increase in yield strength.

Information regarding the selection, procurement, testing, storage, and installation of nonmetallic thermal insulation, and demonstrating that the leachable concentrations of chloride, fluoride, sodium, and silicate are comparable to the recommendations of the Regulatory Guide 1.36, is contained in Section 5.2.3 for Westinghouse supplied insulation and in Section 1.8 for all other insulation.

Use of aluminum and zinc will be minimized in the Containment. An aluminum and zinc inventory in the Containment is given in Table 6.1.1-2.

6.1.1.2 Composition, Compatibility and Stability of Containment and Core Spray Coolants

The pH of the containment spray will be adjusted during the injection mode by the addition of a 27-29 weight-percent sodium hydroxide (NaOH) solution to provide a minimum pH of 7.0. A discussion of the NaOH addition design basis is provided in Section 6.5.2.3.3. In no case will the solution pH fall outside the range of 7.0 to 11.0.

The refueling water storage tank is the source of borated cooling water during injection. The boron concentration, as boric acid, is 2,400 - 2,600 ppm. The tank is maintained above 40F, thus ensuring that the boric acid remains soluble.

In order to ensure materials compatibility during storage, the sodium hydroxide chemical additive is contained in a stainless steel tank.

The spray additive solution is not corrosive to the stainless steel components of the system with which it comes into contact. The spray and sump solutions will tend to severely corrode aluminum alloys, but will not attack stainless steel or copper-nickel alloys.

Hydrogen release within the Containment due to corrosion of materials by the sprays and cooling water in the event of a LOCA is controlled as described in Section 6.2.5. The use of aluminum within the Containment is minimized to the greatest extent practical, thereby precluding concern over excessive hydrogen generation due to the corrosion of aluminum.

The vessels used for storing engineered safety features coolant include the accumulators, the boron injection tank, and the refueling water storage tank (RWST).

The accumulators are carbon steel clad with austenitic stainless steel and the boron injection tank is austenitic stainless steel. Because of the corrosion resistance of these materials, significant corrosive attack of the storage vessels is not expected.

The accumulators are vessels filled with borated water and pressurized with nitrogen gas. The boron concentration, as boric acid, is 2400 - 2600 ppm. Samples of the solution in the accumulators are taken periodically for checks of boron concentration. Principal design parameters of the accumulators are listed in Table 6.3.2-1.

Principal design parameters of the boron injection tank are listed in Table 6.3.2-1.

6.1.2 ORGANIC MATERIALS

6.1.2.1 Balance of Plant Organic Materials

Significant quantities of organic materials that exist within the primary containment consist of lubricants and protective coatings for containment surfaces, equipment and pipe.

Protective coatings applied to major equipment, piping, steel surfaces and concrete surfaces have been applied in accordance with the applicable guidelines included in ANSI N101.4-1972, "Quality Assurance for Protective Coatings Applied to Nuclear Facilities," and Regulatory Guide 1.54, "Quality Assurance Requirements for Protective Coatings Applied to Water-Cooled Nuclear Power Plants," with the exception of areas which are not accessible for the required preparation, application, or inspection. Such areas will be prepared and coated as best as possible with approved coatings using manufacturers' recommendations and industry standards as guidelines. In addition, the coatings used to meet the requirements of ANSI N101.2-1972 "Protective Coatings (Paints) for Light Water Nuclear Reactor Containment Facilities" for the design basis accident (DBA) are resistant to an integrated radiation exposure of 4.2×10^6 rads. over a period of 25 hours (5.5×10^5 rad./hr. initial dose rate).

In the event coatings repair work (touch up) is required, (for both steel and concrete surfaces), the damaged coatings will be replaced and recoated in accordance with the manufacturer's recommendations. Film thickness is checked with a nondestructive film thickness gauge, where applicable.

Based on tests conducted in accordance with the requirements of ANSI N101.2 and ANSI N512 "Protective Coatings (Paints) for the Nuclear Industry," no materials (gases or others) were reported to be released and no decomposition by radiation or chemical reaction was reported when exposed to 1×10^9 rads.

Test panels were also inspected for any breakdown on the coating system, i.e., flaking, peeling, delamination and blistering (allowable blisters - few intact, Size No. 4 per ASTM D714). None of the foregoing occurred.

Compliance with Regulatory Guide 1.54 is discussed in Section 1.8. Any equipment, excluding small valves, pumps, motors and other small miscellaneous items, not coated in accordance with Regulatory Guide 1.54 will be recoated at the site with an acceptable system.

All thermal insulation jacketing material will be stainless steel. This is applicable to all insulated equipment including pressurizers and steam generators.

The design life of all applied thermal insulation is 40 years. The construction is such that it will not sag, settle, corrode or disintegrate during its design life. The aging management reviews for insulation within the scope of License Renewal determined that the insulation has no aging effects requiring management. Therefore, the insulation is capable of performing its intended function through the period of extended operation.

Quantities of miscellaneous organic materials such as diaphragms, valve packing and O-rings for mechanical nuclear equipment are not considered significant.

The total weight of electrical cable insulation materials and their chemical compositions, along with a breakdown of cable diameters and associated conductor cross sections is given in Table 6.1.2-2.

The RCPs are not required following a DBA, therefore, the lubricating oil need not perform its function under DBA conditions.

Likewise, steam generator snubbers are not required under post DBA conditions and therefore the snubber oil need not perform its function. During a DBA, the snubber and oil will perform satisfactorily.

6.1.2.2 NSSS Organic Materials

Quantification of significant amounts of protective coatings on Westinghouse supplied components located inside the Containment Building is given in Table 6.1.2-1; the painted surfaces of Westinghouse supplied equipment comprise a small percentage of the total painted surfaces inside Containment.

For large equipment requiring protective coatings (specifically itemized in Table 6.1.2-1), Westinghouse specifies or approves the type of coating systems utilized; requirements with which the coating system must comply are stipulated in Westinghouse specifications. For these components, the generic types of coatings used are zinc rich silicate or epoxy based primer with or without chemically-cured epoxy and epoxy modified phenolic top coat.

The remaining equipment requires protective coatings on much smaller surface areas and is procured from numerous vendors; for this equipment, Westinghouse specifications require that high quality coatings be applied using good commercial practices. Table 6.1.2-1 includes identification of this equipment and total quantities of protective coatings on such equipment.

Protective coatings for use in the Containment have been evaluated as to their suitability in post-design basis accident conditions. Tests have shown that certain epoxy and modified phenolic systems are satisfactory for in containment use. This evaluation (Reference 6.1.2-1) considered resistance to high temperature and chemical conditions anticipated during a LOCA as well as high radiation resistance.

Information regarding compliance with Regulatory Guide 1.54 is discussed in Section 1.8. Further compliance information has been submitted to the NRC for review via Reference 6.1.2-2 and accepted via Reference 6.1.2-3.

REFERENCES: SECTION 6.1

- 6.1.2-1 Picone, L. F., "Evaluation of Protective Coatings for Use in Reactor Containment," WCAP-7198-L (Proprietary), April, 1968 and WCAP-7825 (Non-Proprietary), December, 1971.
- 6.1.2-2 Letter NS-CE-1352, dated February 1, 1977, C. Eicheldinger (Westinghouse) to C. J. Heltemes, Jr. (NRC).
- 6.1.2-3 Letter dated April 27, 1977, C. J. Heltemes, Jr. (NRC) to C. Eicheldinger (Westinghouse).
- 6.1.2-4 Whyte, D. D. and Picone, L. F., "Behavior of Austenitic Stainless Steel in Post Hypothetical Loss-Of-Coolant Accident Environment," WCAP-7798-L (Proprietary), November, 1971 and WCAP-7803 (Non-Proprietary), December, 1971.

6.2 CONTAINMENT SYSTEMS

6.2.1 CONTAINMENT FUNCTIONAL DESIGN

6.2.1.1 Containment Structure

6.2.1.1.1 Design Bases

The containment systems protect the public from the consequences of any postulated break in the Reactor Coolant System. The containment systems consist of the steel lined concrete Containment Building, and the Engineered Safety Feature Systems which include the Containment Heat Removal System (Containment Spray System and Containment Cooling System), the Containment Isolation System, and the Containment Hydrogen Control System.

The containment structure provides biological shielding and missile protection for the Nuclear Steam Supply System. A physical description of the Containment and the design criteria relating to construction techniques, static loads, and seismic loads are provided in Section 3.8. This section pertains to those aspects of containment design, testing, and evaluation that relate to the accident mitigation function.

The containment structure is designed to withstand the pressure and temperature transient calculated to exist after a design basis accident (DBA). Post-accident conditions are determined by evaluating the combined influence of the energy sources, heat sinks, and engineered safety features (ESF) operation.

The capability of the containment structure to maintain design leaktight integrity and to provide a predictable environment for the operation of ESF systems is ensured by a comprehensive design, analysis, and testing program. This program considers the results of both the peak containment pressures and temperatures resulting from a LOCA or a main steam line break (MSLB) and the maximum containment external (differential) pressure resulting from inadvertent containment heat removal system operation that reduces containment internal pressure below outside atmospheric pressure.

The containment systems are designed to provide protection to the public from the consequences of a loss-of-coolant accident (LOCA) up to and including a double-ended rupture of the largest reactor coolant pipe assuming unobstructed discharge from both ends coincident with the safe shutdown earthquake (SSE), loss of normal offsite power, and any single active component failure. The containment structure and the engineered safety features ensure that the radiological exposure to the public resulting from such an occurrence is below the guidelines established in 10CFR 50.67.

The spectrum of postulated accidents considered in determining the design containment peak pressure and temperature, the subcompartment peak pressure, the containment external (differential) pressure, and the ECCS minimum containment pressure analysis are summarized in Table 6.2.1-1. The spectrum of break sizes was chosen to establish the upper bounds of containment pressure and temperature following a design basis accident (DBA). For postulated subcompartment pipe break accidents, a discussion of the criteria for selecting break locations is given in Section 6.2.1.2.

The accident controlling design for each of the categories of containment peak pressure, containment peak temperature, subcompartment peak pressure, containment external (differential) pressure, and containment minimum pressure is defined as a design basis accident (DBA), and is that case which produces the most severe loadings for the spectrum of accidents postulated. The margin between values calculated for a DBA and design values is established by comparing Tables 6.2.1-2 and 6.2.1-3. Table 6.2.1-2 defines the DBA for each design category and Table 6.2.1-3 gives the margin and the formula used as the bases for calculating margin.

For the containment structure peak pressure analysis, subcompartment peak pressure analyses, containment peak temperature analysis, and the ECCS minimum containment pressure analysis, it is assumed that each accident is concurrent with the most limiting single active failure. No two accidents are assumed to occur simultaneously or consecutively.

For the LOCA maximum injection case, one containment spray system train and four containment fan coolers were assumed to operate in conjunction with both trains of safety injection (i.e., one containment spray pump failure). For the LOCA minimum injection case, one containment spray system train and two containment fan coolers were assumed to operate in conjunction with one train of safety injection (i.e., one diesel generator failure).

The time dependent LOCA mass and energy release for the postulated accidents under the categories of containment peak pressure and temperature analyses are referenced in Table 6.2.1-1. The computer codes and assumptions used for deriving each of the mass and the energy release tables are discussed in Section 6.2.1.3.

Energy released to the containment atmosphere as a result of the postulated pipe break accidents is transferred to the containment sump by the Containment Heat Removal System discussed in Section 6.2.2. During recirculation, energy is removed from the containment sump and atmosphere by the Residual Heat Removal System (RHRS) used in conjunction with the Containment Cooling System (i.e., fan coolers).

For the purpose of the LOCA containment peak pressure analysis, the most restrictive single active failure is the failure of one onsite diesel generator (and therefore, one containment spray train and two fan coolers) resulting in minimum containment heat removal capability. Assuming this most restrictive single active failure, the Containment Heat Removal System is capable of reducing post-LOCA pressures to less than 50 percent of the containment peak calculated pressure within 24 hours following the postulated accident. This capability, demonstrated by containment pressure response curves, is consistent with the offsite radiological consequences discussed in Chapter 15.

The most severe containment peak pressure results from a LOCA while the most severe temperature results from a main steam line break (MSLB). The most limiting single active failure for the MSLB's are discussed in Sections 6.2.1.1.3 and 6.2.1.4. The time dependent MSLB mass and energy release for the postulated accidents under the categories of containment peak pressure and temperature analyses are referenced in Table 6.2.1-1 and discussed in Section 6.2.1.4.

The analysis of containment minimum pressure is based on confirming the ECCS core reflood capability under the conservative set of assumptions that maximize the heat removal effectiveness of ESF systems, structural heat sinks, and other potential heat removal processes. These assumptions are discussed in Section 6.2.1.5.

6.2.1.1.2 Design Features

The design bases and design measures taken to assure that the containment structure is adequately protected against the dynamic effects of postulated accidents are discussed in Sections 3.5 and 3.6. The codes, standards, and guides applied in the design of the containment structure and internal structures are described in Section 3.8.

Redundant containment vacuum breakers have been provided for protection against loss of containment integrity under external loading conditions. Calculations of containment pressure following an inadvertent operation of the Containment Spray System have resulted in pressures within the containment design external (differential) allowable pressure. Details of this evaluation are provided in Section 6.2.1.1.3. The margin between calculated and design pressure differentials is shown in Table 6.2.1-3.

The Containment Cooling System, discussed in Section 6.2.2, maintains the containment and subcompartment atmospheres within required pressure and temperature limits during normal plant operation. This system recirculates air in the upper Containment through fan coolers which are located above the operating floor. The Containment Cooling System and the

containment ventilation system during normal plant operation is functionally capable of maintaining the pressure and temperature within the limits used for equipment design and assumed for DBA analyses. The systems used for normal containment ventilation include the Containment Purge System and Containment Cooling System. The limiting containment conditions for normal plant operation are contained in the Technical Specifications.

During the injection phase, water entering the reactor cavity is trapped from returning to the containment recirculation sump. The volume of trapped liquid has been determined to be 53,600 gals. This quantity of water has been accounted for in determining the available NPSH for the recirculation pumps.

Water entering the refueling cavity will be directed to the recirculation sump via a locked open floor drain. This drain will be manually closed during refueling operations and a separate normally closed drain will be provided which will direct decontamination washdown to the equipment drain. The arrangement is shown on Figure 9.1.3-3.

The range, accuracy, and response time of instrumentation provided which is capable of operating in the post-accident environment for monitoring containment atmosphere and containment sump water temperature, is listed in Table 6.2.1-65.

Continuous indication and display of containment wide range [(-5) to 135 psig] pressure will be provided in the Control Room. This recorded range will be three (3) times the design pressure of the Shearon Harris concrete containment of 45 psig.

Containment wide range pressure monitoring instrumentation will consist of two (2) redundant Class 1E pressure transmitters. The transmitters will be physically located inside the containment building. The accuracy of the transmitter to be used is ± 0.5 percent (normal) and ± 10 percent (accident) of calibrated span. The pressure transmitter output signal will be processed by a process instrumentation control system (PIC) which in turn will furnish signals for the Class 1E indicator and the Safety Parameters Display System CRT in the control room. The operator has the capability for continuous recording if desired for trending.

The containment pressure monitoring channels shall meet the design and qualification criteria of Reg. Guide 1.97, Revision 3 Appendix A.

Additionally, for a narrower range, redundant Class 1E indicators and non-1E (seismic only) recorders whose inputs are derived from signals used in the Engineered Safety Features System are provided in the Control Room for a maximum available pressure range of 0 - 55 psig.

Another set of redundant indicators which monitor the effectiveness of the Containment Vacuum Relief System are provided on the main control board panel having a range of ± 5 inches of water column.

Continuous Class 1E indication of containment water level is provided in the Main Control Room as follows:

Containment Recirculation Sumps (Narrow Range Level Monitoring) - The recirculation sumps are provided with one Level Transmitter each (LT-7160A/B). The 219'4" and 224'4" Elevations correspond to 0% and 100% indicated level, respectively. The corresponding level indicators

are LI-7160A/B. A low level alarm occurs at 43% indicated level (i.e., 221.5') if a recirculation sump isolation valve is open. These low level alarms are annunciated on monitor light boxes in the Main Control Room.

Containment Wide Range Sump Level Monitoring - The containment wide range level instruments are provided for post-accident monitoring and consist of Level Transmitters LIT-7162A/B. The 211'9-3/4" and 230'3-3/4" Elevations correspond to 0% and 100% indicated levels, respectively. The corresponding level indicators are LI-7162A/B. A high level alarm occurs at 88% indication level (i.e., 228'1"). These alarms are annunciated via the plant computer.

Non-1E indication of containment sump level is also available from the same level instrumentation via isolated inputs to the plant computer.

Qualification is in accordance with the criteria for Class IE transmitters located inside Containment. The narrow range monitors will meet the requirement of Regulatory Guide 1.89.

6.2.1.1.3 Design Evaluation

6.2.1.1.3.1 Containment Pressure - Temperature Analysis

In the event of a postulated loss-of-coolant accident (LOCA), or main steam line break (MSLB), the release of coolant from the rupture area causes the high pressure fluid to flash to steam. This release of mass and energy raises the temperature and pressure of the containment atmosphere. The severity of the resulting temperature and pressure peaks developed depends upon the nature, location, and size of the postulated rupture.

In order to establish the controlling rupture for containment design, the spectrum of primary and secondary breaks described in Table 6.2.1-1 were analyzed to determine their significance in selecting the containment design basis accidents. Table 6.2.1-4 presents the results (the calculated pressure, temperature, time of peak pressure) of these analyses and the containment design basis accidents are noted in Table 6.2.1-2. Additional information for the selection of break size, location, etc. is provided in 6.2.1.3 (LOCA) and 6.2.1.4 (MSLB).

The calculated transients following a postulated accident are a direct consequence of the energy balance within the Containment. Of particular importance are the initial conditions postulated at the start of the accident, the ability of the heat sinks within the Containment to absorb energy during the accident, and the capability of the Containment Heat Removal System to reduce the total energy within the Containment, thus bringing the containment heat sinks, sump water, and atmosphere into thermal equilibrium.

The containment pressure analysis input data are based upon plant design features. A conservative prediction of consequences was assured by determining upper and lower bounding values of containment initial conditions, geometric parameters, and thermodynamic properties, and by applying these values in the manner producing maximum pressure and temperature results.

6.2.1.1.3.2 LOCA Analysis

LOCA analyses were re-performed for SGR/PUR. The initial conditions within the Containment and Reactor Coolant Systems prior to accident initiation are given in Table 6.2.1-5. The minimum containment volume is assumed to be at the highest value of operating pressure for both LOCA peak pressure and temperature cases since a sensitivity study indicates that the initial Containment pressure had negligible impact on the peak temperature case, but does result in higher peak pressures with a high initial Containment pressure. Sensitivity studies are performed to determine the conservative initial humidity and temperature for each analysis. The maximum operating temperature was assumed to exist in all heat sinks. The heat sink temperatures were chosen to reflect the initial containment air temperature for each case. For the LOCA analysis, the assumed reactor coolant system inventory is based on design overpower of 102 percent with normal liquid levels. The surface area of the liquid pool formed in the bottom of the containment following a LOCA is calculated with GOTHIC's default calculations. The following additional assumptions are made in performing the containment LOCA analysis:

- a) No leakage into or out of the Containment occurs;
- b) The mass diffusion calculation of the GOTHIC computer code is used for the heat transfer coefficient between the containment vapor and the sump liquid region; and
- c) Hot metal surfaces in the NSSS not cooled by safety injection water, such as the reactor vessel above the nozzles, are simulated as hot walls in contact with the containment steam-air mixture.

A sensitivity study was performed varying free volume and the size of the heat sinks within the Containment (Reference 6.2.1-1). The results show that the containment free volume is the principal factor responsible for large changes in the peak containment pressure and temperature responses. In the sensitivity study, the surface area of the heat sinks in the Containment was varied over a range of ± 20 percent. Two sets of analyses were done, one in which only the surface area of the internal heat sinks was varied and the other in which all heat sinks, including the size of the containment height were varied with a proportional change in the free volume. For the change of ± 20 percent in the surface area of the internal heat sinks the peak pressure was found to vary by ± 5 percent. For the change of all the heat sinks and a proportional variation of the free volume of about 25 percent, the peak pressure varied by about ± 25 percent.

For the purpose of the LOCA analyses, the ECCS and the Containment Heat Removal Systems were assumed to operate maximizing the containment pressure response. The operating assumptions are discussed below. For the Containment Heat Removal System, minimum system capacity shown in Table 6.2.1-6 is conservative for calculating the containment peak pressure response. Therefore, the Containment Heat Removal System was assumed to be affected by the most restrictive single active failure which has been determined to be a loss of a diesel generator (one containment spray train and two fan coolers).

For LOCA analyses, the following describes the conservative assumptions made with respect to ESF system operations and parameters:

1. The contents of all 3 accumulators including nitrogen gas discharge into the reactor coolant system when reactor coolant system pressure drops below the tank pressure setpoint.
2. All ECCS pumps are assumed to operate for the maximum injection case, and only one train of ECCS pumps are assumed to operate for the minimum injection case.
3. One containment spray pump operates and sprays 1730 gpm of water at 125°F into the Containment until the start of recirculation. This assumes the limiting single active failure of one containment spray train a maximum refueling water storage tank temperature, minimum refueling water storage tank level, and peak containment pressure equal to design pressure of containment (45 psig.)

For the maximum safety injection case, four containment fan coolers are assumed to operate. For the minimum safety injection case, two containment fan coolers are assumed to operate.

4. For the maximum injection case, both residual heat removal pumps circulate water through their associated RHR heat exchangers during recirculation. For the minimum injection case, one RHR pump circulates water through its associated RHR heat exchanger during recirculation.

The faulted overall heat transfer coefficient (UA) of the heat exchanger is calculated internally by the GOTHIC code, and the heat exchanger is assumed to be supplied with cooling water flowing with the maximum recirculation component cooling water temperature. Refer to Table 6.2.1-6.

5. The time until initiation of the recirculation mode is calculated on the basis of a minimum refueling water storage tank volume and ESF pumps operating as specified in b) and c) above. This volume is assumed to be injected into Containment before a recirculation actuation signal is generated. At this time, the containment spray water is drawn from the containment sump.
6. The Containment Spray System was assumed to commence spray at 58.4 seconds following a LOCA. This time delay takes into account signal process time, diesel starting time, sequencer delay time, breaker closing time, pump start up time and spray line fill up time. No credit was applied for partial containment spray heat removal during fill up of the spray headers.

The sizing of the Containment Spray System was based on the heat removal rate necessary to keep the peak pressure reached during a LOCA less than the design pressure of the Containment. The peak pressure occurs during the DBA LOCA blowdown or reflood phase. This peak is larger than the rise in containment pressure that occurs during the recirculation period, when the containment energy balance is coming into equilibrium.

7. The Containment Isolation Activation Signal (CIAS), (T), H1-1 (3-0 psig) setpoint is reached within 1 second after the postulated ruptures for the most severe temperature and pressure cases. The fan coolers are assumed in full operation 70 seconds (Reference ESR9400546) after the CIAS setpoint. Note: Although the service water

valves have stroked sufficiently at 70 seconds to allow full flow to the fan coolers, the occurrence of two-phase flow during a LOCA coincident with a LOOP delays full flow to the coolers until 110 seconds. This input has been included in the latest containment accident analysis for both MSLB and LOCA.

The containment heat sink data used in accident analyses are described in Tables 6.2.1-7 and 6.2.1-8. Table 6.2.1-7 is a detailed list of the geometry of each heat sink and Table 6.2.1-8 describes the resulting simplified heat sink models used for computer input. Node spacing used for concrete, steel and steel-lined concrete heat sinks is fine enough to ensure an accurate representation of the thermal gradient in each slab.

The given values for surface area and thickness reflect the total areas and surface area weighted thicknesses for all steel exposed to the containment atmosphere from all sources. These sources include structural steel, polar crane and moving platform structures, instrumentation and control equipment (cabinet, tubes), HVAC equipment (duct, fan coolers, valves), refueling machine, miscellaneous piping, and containment penetration nozzles.

All steel is coated with a layer of paint and finisher. All steel except the primary containment liner is assumed to be insulated on one side and in contact with the containment atmosphere by a condensing heat transfer coefficient on the other. The initial temperature is 135°F.

The given values of the concrete surface area and thickness reflect total areas and surface-area weighted thicknesses of all concrete within the Containment. This concrete includes the unlined reactor cavity wall, primary and secondary shield, walls, pressurizer room, regenerative heat exchanger room, valve room, pipe tunnel, reactor sump pump wall, and the steam generator foundation.

All concrete is coated with paint. The concrete is assumed to have a zero temperature gradient at the center. The concrete is exposed to the containment atmosphere with a condensing heat transfer coefficient or to the sump water with a free convection heat transfer coefficient.

Table 6.2.1-8 also lists values for surface area and thickness of the remaining heat sinks which represent the total surface area and mass-weighted mean thickness of the similar heat sinks in the Containment. The initial temperatures given likewise reflect a mass-weight average. Initially, a free convection heat transfer correlation was used for the heat sink with initial thermal gradients.

A complete list of the thermophysical properties used in the analysis is also given in Table 6.2.1-8. No credit was taken for heat transfer to reinforcing steel in the internal concrete structures and a low value of thermal conductivity was used for these structures.

The node spacing within a heat sink is dependent upon the gradient of temperature within the sink. To ensure an accurate representation of the temperature gradient, a maximum number of node points are placed where the temperature gradient is at a maximum. Too few node points simulate a more gradual slope implying excessive energy stored within the heat sink.

An accurate energy balance ensures the adequacy of the node spacing. The node spacing for all conductors is such that the calculated Biot number for each node is less than 0.1.

The high thermal conductivity and relative thinness of the steel heat sinks results in a rapidly uniform temperature distribution throughout the sink. It is, therefore, only necessary to provide for sufficient nodes to adequately define its relative thickness (in relation to other heat sinks).

A complete tight contact between the steel liner and the concrete wall has been assumed in the analysis since no steel liner buckling has been calculated to occur (see Section 3.8.1).

Blowdown mass and energy release rates for LOCA are discussed in Section 6.2.1.3.

The containment accident analyses are performed using the GOTHIC computer code (Reference 6.2.1-23). A description of the computer code is contained in Appendix 6.2A.

The containment pressure and temperature response and containment sump water temperature response versus time are given on Figures 6.2.1-1 through 6.2.1-6b for the most severe LOCA's. Pipe break locations, peak pressures and temperatures, and times of peak pressure, are summarized in Table 6.2.1-4 for each LOCA analyzed for SGR/PUR conditions. The DBA's are identified in Table 6.2.1-2.

Similar passive heat sinks listed in Table 6.2.1-7 were combined into larger heat sinks. The resultant heat sink model would maintain the sum of the combined heat sinks surface area, with a volume-weighted thickness. Heat Sinks No. 4 through 11 in Table 6.2.1-8 are resultant heat sink models used in the containment functional analyses.

Figures 6.2.1-11 and 6.2.1-12 are plots of the containment condensing heat transfer coefficient versus time for the most severe LOCA. The Direct heat transfer option with the DLM (Diffusion Layer Model) condensation option as described in Appendix 6.2A is applied for all LOCA analyses.

For the primary system breaks (LOCA), the containment pressure reaches a peak near the end of the blowdown period. Continued heat removal by the concrete and steel heat sinks and the Containment Spray System after initiation results in a decrease of this pressure peak. For the double ended pump suction guillotine (DEPSLG) break case, further mass and energy release from the break during the core reflood period causes the pressure to rise once more until a new balance between energy release and energy removal is reached. Continued heat absorption by the steel and concrete and the Containment Spray System results in a decrease of this second pressure peak.

The long-term results for the peak pressure DBA were evaluated to verify the ability of the Containment Heat Removal System (CHRS) to maintain the Containment below the design conditions. These evaluations were based upon the conservatively assumed performance of the engineered safety features as discussed above.

The mechanism by which heat from the Containment is assumed to be rejected to the outside environment during the accident is the following:

1. The heat from the Containment is rejected to the Component Cooling Water System by the water/water heat transfer in the RHR heat exchanger.
2. For the maximum injection case, four containment fan coolers are assumed to be supplied with 95°F service water. For the minimum injection case, two containment fan

coolers are assumed to be supplied with 95°F service water. This is conservative-based on a maximum operational service water inlet temperature of 94°F. For the maximum injection case, each RHR heat exchanger was conservatively assumed to be supplied with 120°F component cooling water. For the minimum injection case, one RHR heat exchanger was also conservatively assumed to be supplied with 120°F component cooling water.

3. The CCWS heat exchanger serves as the mechanism by which heat is rejected to the outside environment. As part of the accident heat removal system the CCWS heat exchanger performance is included in the determination of the RHR heat exchanger outlet temperature.
4. A maximum coolant inlet temperature and minimum coolant inlet flow are assumed so as to minimize the heat being removed during the recirculation phase.

At the start of the recirculation mode, water is drawn from the containment sump by the RHR pumps and returned to the core after passing through the RHR heat exchangers. Simultaneously the containment spray pump takes suction from the sump and sprays the water back into Containment.

As a result of the higher safety injection system (charging) pump inlet temperature at the start of recirculation, steam continues to be generated in the reactor core at a high rate, due primarily to the release of decay heat and stored energy in the system internals. This causes the containment pressure to rise. The higher temperature of the recirculation containment spray further contributes to this pressure rise by reducing the ability of the sprays to remove heat from the containment atmosphere.

This rise in containment pressure and temperature occurs until a heat balance is reached. For the containment peak pressure LOCA, the maximum heat load on the RHR heat exchanger occurs when the containment sump water temperature is at maximum and, hence, a maximum temperature difference exists in the RHR heat exchanger. The Component Cooling Water System is designed to accept this peak post-LOCA heat load from the RHR heat exchanger and the heat generated by station emergency auxiliaries. This rise in pressure is reversed when the combined RHR heat exchanger and structural heat removal rate becomes greater than the net heat addition to the Containment.

The containment pressure and temperature responses out to 10 million seconds are calculated for the LOCA-DBA, identified in Table 6.2.1-4, with the ESF performance mode in Table 6.2.1-6.

The same initial conditions are used in the analysis of the pump suction leg, and hot leg breaks. Figures 6.2.1-1 through 6.2.1-6b show the calculated transient containment temperature, containment sump temperature, and containment pressure for the most severe hot leg break. In contrast to the pump suction leg breaks, for the hot leg break there is no physical mechanism to rapidly remove the residual steam generator secondary energy either during or after reflood.

Accident chronologies for the most severe reactor coolant system breaks are provided in Table 6.2.1-9. It is assumed that time equals zero at the start of each accident.

Figure 6.2.1-13 provides a typical rate of energy distribution inside Containment for the LOCA containment pressure DBA (does not represent the latest analysis). The long-term performance

is essentially the same for all the primary system break cases. All mechanisms of energy storage within the Containment are addressed. Included are the vapor energy (steam plus air), containment sump (liquid) energy, and energy contained in heat sinks.

6.2.1.1.3.3 Main steam line breaks

The following breaks were postulated for the SGR/Uprate:

- Double-ended ruptures (1.4 ft²) at 100.34%, 68.6%, 29.4%, and 0% power
- Split rupture (0.687 ft²) at 100.34% power
- Split rupture (0.675 ft²) at 68.6% power
- Split rupture (0.666 ft²) at 29.4% power
- Split rupture (0.558 ft²) at 0% power

However, previous studies indicate that a full double-ended break at a given power is more severe than a corresponding split break. Consequently, only the double-ended breaks at the four power levels were analyzed for the SGR/Uprate. Small double-ended ruptures were not postulated since they result in Containment pressure and temperature responses that are less severe than those associated with full double-ended and split breaks.

Mass and Energy release data used in the analysis for each of the four postulated double-ended breaks reflects the failure of the faulted-loop main steam isolation valve (MSIV). In addition to the consequences of this initial MSLB and MSIV failure assumption, the analyses include the following additional single failures:

- An active failure of a main feedwater isolation valve (MFIV); or
- An active failure of a feedwater flow control valve (MFCV or MFBCV at 0% power); or
- A single failure of one cooling train for heat removal.

The peak containment pressure and temperature are calculated to occur following the DBA MSLB indicated in Table 6.2.1-2. The containment pressure and temperature transients for the most severe MSLB cases are shown on Figures 6.2.1-9 through 6.2.1-10b. Figure 6.2.1-14 shows a typical transient containment liner surface temperature for the maximum MSLB containment temperature DBA. Pipe break areas, peak pressures and temperatures, times of peak pressure, initial power level, and single active failure assumed are summarized in Table 6.2.1-4 for each MSLB analyzed.

Figure 6.2.1-12 is a plot of the condensing heat transfer coefficient versus time for the containment temperature DBA. The Uchida heat transfer coefficient contained in the CONTEMPT computer code has been used for the analysis of all secondary system breaks (MSLBs).

The containment analyses for the MSLBs have been performed using all the containment initial conditions, heat sinks and methodology assumed for the LOCA analyses except for the following:

1. For the MFIV failure case, both containment heat removal trains (four fan coolers and two spray pumps) are assumed to operate. For the cases of one heat removal system train failure, two fan coolers and one spray pump are assumed to operate.
2. The mass and energy release rates for the MSLB Containment transient are calculated with the assumption of the availability of the offsite power, as further described in Section 6.2.1.4.8. The Containment Isolation Actuation Signal (CIAS) (T), HI-1 (3.0 psig) setpoint or low steamline press (LSP), is reached within 1 second after the postulated ruptures for both the most severe temperature and the most severe pressure cases.
3. The CONTEMPT-LT/28 computer code was used in the analyses since CONTEMPT-LT/26 code has excess conservatism.
4. The mass diffusion calculation of the CONTEMPT-LT computer code for the containment vapor-sump heat and mass transfer was conservatively omitted for all MSLB analyses.
5. The most severe MSLB containment transients were evaluated using a conservative in fan cooler capacity, fan cooler start up delay time, the containment spray flow rates and fill up time, feedwater control valve and feedwater isolation valve closure times, and FW and AFW flow rates.
6. A sensitivity study indicates that the MSLB peak pressure case is more severe with a high containment initial pressure and a low initial relative humidity (same as for LOCA analyses). However, the study also indicates that for the MSLB temperature case, the peak temperature is obtained assuming a low initial containment pressure and a high initial relative humidity.

As discussed in 6.2.1.4, feedwater addition to the faulted steam generator includes unisolable feedwater piping volumes and pumped feedwater addition until isolation (FW and AFW). The amounts of feedwater added to the faulted steam generator for the 100.34%, 68.6%, and 29.4% power levels have been calculated using the RELAP5 computer code. Feedwater addition at 0% power was determined based upon a conservative hand calculation.

Since the dryout times for the MFCV failure case are significantly smaller than those for the MFIV failure case, the consequences of the MFCV failure cases are enveloped by the MFIV failure cases and are not analyzed.

The most limiting MSLB cases are the full double-ended break at 30% power for maximum pressure and the full double-ended break at 102% power for the maximum temperature.

For all MSLBs analyzed following blowdown of the ruptured steam generator unit, the RCS decay heat is transferred to the intact units which, in turn, vent to the atmosphere when their safety relief valves open. Therefore, there is no physical mechanism for the release of significant amounts of mass or energy to the Containment after the end of blowdown. Main feedwater line breaks (MFWLB) are not analyzed since such breaks result in a blowdown less

limiting than the MSLB because the pipe break mass flow for the MFWLB is limited by the steam generator internals design. Fluid enthalpy for the MFWLB is also less than the enthalpy of the fluid in the MSLB.

A discussion of the computer codes, and the assumptions, including all assumed single active failures, used in deriving the MSLB mass and energy releases are discussed in Section 6.2.1.4.

Accident chronologies for the most severe secondary system break are provided in Table 6.2.1-9. It is assumed that time equals zero at the start of the accident.

The instrumentation provided to monitor and record the post-accident containment pressure and temperature is discussed in Section 7.5. This instrumentation is designed and qualified for the SSE and the environmental conditions discussed in Section 3.11.

6.2.1.1.3.4 Containment external (differential) pressure analysis

An analysis was made of the transient for a positive external containment differential pressure which results from actuation of the Containment Spray System during normal plant operation. The analysis was performed using the Ebasco modified version of the CONTEMPT computer code described in Appendix 6.2A.

The assumptions used in the analysis of an inadvertent containment spray system actuation are listed in Table 6.2.1-11. The calculated external (differential) pressure transient, is shown as a function of time on Figure 6.2.1-15. The containment external (differential) pressure design provides substantial margin over this conservatively calculated value as shown in Table 6.2.1-3. There is no single failure which could result in the operation of both containment spray trains as was assumed for the purposes of this analysis.

To evaluate the adequacy of the containment design and the containment vacuum relief system, sensitivity analyses were performed with different parameters, such as varying initial temperature and humidity from the minimum value to the maximum value. The worst case of combining the most severe parameters resulted in a negative pressure differential of 1.814 psid. This case considered the simultaneous application of the worst summer and winter conditions which would not occur in a real situation. Since there are additional conservatisms in the calculation model, such as ignoring the heat-sink effect and keeping the RAB at the worst initial conditions etc., the containment design margin for the external pressure differential should be more than 0.07 psid.

The transient for the vacuum relief system is the accidental initiation of the containment spray system (both pumps) while the containment is at its calculated bulk average temperature of 135°F. The containment spray pumps are assumed to reach full runout flow (4293 gpm total for both) instantaneously, the initial humidity is assumed to be 65 percent, with an initial pressure of negative 4 inches w.g. and one (1) vacuum relief subsystem is assumed not operating. This is the worst combination for negative pressure. The outside air is taken as 105°F and 100 percent humidity. The temperature of the spray water is taken as 40°F and the temperature of the service water to the fans is taken as 33°F; both are the lowest and the most conservative temperatures. For other assumptions and data see Table 6.2.1-11.

An analysis was performed to verify the sizing of the vacuum relief system. Calculations were performed with the computer code CONTEMPT-LT which considers conditions in the

Containment and allows only leakage from atmosphere to Reactor Auxiliary Building and from Reactor Auxiliary Building to the Containment. Refer to Sections 6.2.1.1 and 6.2.1.2 for a discussion of the Containment subcompartment analysis. As a result of the analysis, the use of a 24-inch nominal vacuum relief valve was verified.

Protection of the containment vessel against excessive external pressure is provided by two independent vacuum relief lines, each sized to prevent the differential pressure between the containment and the outside atmosphere from exceeding the design value of negative 2.0 psid. The vacuum system conforms to the requirements of Paragraph NE-7116 of ASME Section III.

The containment vacuum relief system is shown on Figure 6.2.2-3. The system consists of a check valve and an automatic air operated butterfly valve outside the containment building. The check valve is provided with a short pipe spool permanently attached to the valve, and a removable test flange.

Actuation of the butterfly valves are controlled by differential pressure between the outside atmosphere and the containment. Safety grade differential pressure transmitters, as described in FSAR Section 7.3.1.5.12, are provided, two for monitoring and two for control. One set of transmitters provide a signal for control action to open the butterfly valves when the differential pressure between the containment and outside reaches (-) 2.5 inches water gauge (w.g.). The second set of transmitters, which are of a different manufacturer, provide a continuous signal to the MCB for indication and will alarm Hi Containment Vacuum when the differential pressure between the containment and the outside atmosphere reaches (-) 1.0 inches w.g.

The vacuum relief check valve is set to open at a differential pressure of 1.5 in. w.g. and the butterfly valve is set to open at a differential pressure of 2.5 in. w.g. The total loss coefficients for the Containment Vacuum Relief System are shown on Table 6.2.1-11 for the components illustrated in Figure 6.2.1 306.

Both the vacuum relief check valves inside the Containment and the butterfly valves outside the Containment perform the dual safety functions of providing an open flow path for relieving negative containment pressure and providing containment pressure integrity for positive containment pressures. These valves are designed to satisfy Safety Class 2 and Seismic Category I requirements. Each valve is designed to take the full containment design pressure.

Since the containment vacuum relief check valves also perform as containment isolation valves in the event of a LOCA, the pneumatically operated butterfly valves are designed to fail closed. A Seismic Category I air accumulator is provided for each butterfly valve to ensure a reliable energy source for operation of each valve. Each air accumulator is sized to allow three cycles of operation of its associated air operated valve. The Seismic Class I air supply is isolated from the normal Non-Seismic Class I air supply system by a set of check valves which will prevent the loss of air from the accumulator in the event of failure of the Non-Seismic Category I air supply system. Refer to Table 6.2.1-64 for a single failure analysis of the Containment Vacuum Relief System.

Each vacuum relief assembly is provided with independent instrumentation and controls in accordance with IEEE-279 requirements. The electrical supply for the control operations of each valve is from a separate emergency 125V DC bus. No single failure of system component can prevent operation of the Containment Vacuum Relief System.

The Containment Vacuum Relief System pre-operational tests are described in Section 14.2.12.1.67. Periodic tests as required by the Technical Specifications in Section 16.2 will be performed. In-service inspection will be performed in accordance with Section 6.6 and valve testing requirements in Section 3.9.6 will be followed.

6.2.1.2 Containment Subcompartments*

6.2.1.2.1 Design bases

The containment subcompartments are subject to pressure transients and jet impingement forces caused by the mass and energy releases from postulated high energy pipe ruptures within their boundaries. Subcompartments within which high energy ruptures are postulated include the reactor cavity, the pressurizer subcompartment, and the three steam generator subcompartments.

The original HNP design and license bases did not apply leak-before-break (LBB) methodology. As a result, dynamic effects of large RCS pipe breaks (DECLG, DEPSG, DEHLG, and 150 sq. in. hot/cold leg) were considered in the structural design basis for containment subcompartment analysis.

Since LBB has subsequently been approved for application at HNP, the large RCS breaks are eliminated from consideration (Reference 6.2.1-15). Instead, for SGR/PUR, evaluation of postulated breaks in the pressurizer surge and spray lines, RHR lines, and accumulator nozzles were performed to demonstrate that the associated dynamic effects are bounded by the original design bases.

Discussions and referenced tables and figures in Section 6.2.1.2 reflect the original design basis subcompartment analysis. Section 6.2.1.2a discusses results of SGR/PUR evaluations.

Analyses were made to determine the peak pressure that could be produced by a line break discharging into the subcompartments. Venting of these chambers is employed to keep the differential pressures within structural limits. In addition, restraints on the reactor coolant pipes, reactor vessel, steam generators, and other pressurized equipment are designed so that neither pipe whip nor other forces transmitted through component supports threaten the integrity of the containment structures (see Section 3.6).

Break locations for the pressurization analyses were chosen to maximize the pressures. The inherent stiffness of the systems, together with the pipe whip restraints, limits the break openings to no more than the break sizes considered. The spectrum of pipe breaks analyzed for each subcompartment are listed in Table 6.2.1-1. The location and characteristics of the reactor coolant pipe ruptures were determined mechanistically in accordance with the methods and criteria of Reference 6.2.1-3. The accident that resulted in the maximum differential pressure across the walls of a respective compartment is designated as the subcompartment design basis accident (DBA).

*Section 6.2.1.2a presents discussion of a subsequent evaluation to assess the effects of plant operation with Steam Generator Replacement and Power Uprate.

Calculated DBA differential pressures are compared to the design differential pressure values used in the structural design of subcompartment walls and equipment to ensure that calculated values are less than design values.

6.2.1.2.2 Design features

Plan and elevation drawings for each subcompartment showing detailed design, nodes, and component and equipment locations are shown on Figures 6.2.1-18 through 6.2.1-20.

The reactor cavity is a heavily reinforced concrete structure that performs the dual function of providing reactor vessel support and radiation shielding. Figures 6.2.1-21 and 6.2.1-22 show the reactor cavity model.

The walls of the steam generator compartments are constructed of reinforced concrete that serves to support the equipment enclosed and provides radiation shielding. Figures 6.2.1-23 and 6.2.1-27 present the steam generator subcompartment model.

There are three steam generator compartments, each having different geometry. Since the pressurizer subcompartment is immediately adjacent to the Loop 2 SG compartment and the opening between the compartments is fairly large, the pressurizer subcompartment model has been incorporated into the SG subcompartment model as shown on Figure 6.2.1-27. Due to the small mass and energy release rates associated with the pressurizer line breaks and due to the routing of these lines and the location of the connection to the pressurizer vessel, the pressurization inside the pressurizer compartment was found to be less severe than that of the Double Ended Hot Leg Guillotine Break inside the Loop 2 SG compartment.

As can be seen from Table 6.2.1-27, the peak pressure differential across the pressurizer compartment wall for the case of DEHLG Break inside the Loop 2 SG compartment is higher than the other two pressurizer line break cases. Figures 6.2.1-249 through 6.2.1-301 are the results of DEHLG in Loop 2 SG compartment, therefore, the pressures in some SG subcompartments can be higher than the peak pressures inside the pressurizer subcompartment.

The bounding peak pressurizer compartment pressure was found to be resulted from the DEHLG break side of the Loop 2 SG compartment.

The calculated DBA differential pressure for the Loop 2 SG compartment is, therefore, considered as the calculated DBA differential pressure for the pressurizer compartment as shown in Tables 6.2.1-2 and 6.2.1-3.

6.2.1.2.3 Design evaluation*

1. Computer Codes - The analytical model used to calculate mass and energy release rates is fully described in Reference 6.2.1-3. Tables 6.2.1-12 through 6.2.1-18 provide a tabulation of mass and energy release rates versus time.

* See Section 6.2.1.2a for subsequent evaluation, with Steam Generator Replacement and Power Uprate.

Analysis of the pressure transients in the reactor cavity, the steam generator subcompartment, and the pressurizer subcompartment were performed using the RELAP-4 Mod 6 computer code, Reference 6.2.1-4. The options used in running the code are:

- a. The RELAP-4 CONTAINMENT option.
- b. The compressible single-stream form of the momentum equation with momentum flux, except where flow oscillations are present. For this case the RELAP-4 manual recommends use of the incompressible single-stream form of the momentum equation.
- c. The thermal homogeneous equilibrium critical choked flow correlation for air-steam-water mixtures.

Two sub-compartment-analyses which yielded the maximum Δp between two compartments (1. Steam Generator Loop 3; double ended cold leg guillotine break and 2. Reactor Cavity; 150 in² cold leg guillotine break) were chosen for sensitivity studies using minimum humidity. The maximum pressure differences were found to be the same. Similar sensitivity studies with an initial pressure of 14.841 psia (maximum normal operating pressure inside the containment) in the volumes were carried out; the Δp_{\max} was found to be smaller by a negligible amount. Therefore, the assumed initial pressures and humidities do not affect the calculated Δp_{\max} .

An initial pressure of 14.7 psia, an initial temperature of 120 F and a 100 percent initial humidity have been used in all the subcompartment pressure analyses.

The junction effective inertia ($1/A$) was calculated in a manner consistent with the methods included in RELAP-4. For a pair of volumes v_i and v_k , with cross-sectional areas, A_i and A_k , and lengths in the direction of flow, l_i and l_k and a junction with area A_j and length l_j , where $A_j \neq A_i, A_k$ and $l_j < l_i, l_k$, the inertia coefficient $1/A$, was computed as:

$$\frac{l}{A} = \frac{l_i}{2A_i} + \frac{l_j}{A_j} + \frac{l_k}{2A_k} \quad (1)$$

Flow coefficients for the subcompartment analysis were computed in a manner consistent with the calculations done by the RELAP-4 code. The junction friction coefficient utilized in the analyses is a combination of the wall friction losses (K_f), and any irreversible friction losses (K_T) such as area changes, flow obstructions due to turns and gratings. The wall friction loss is computed as:

$$K_{Fi} = \frac{fl_i}{2D_{Hi}} \left[\frac{A_j}{A_i} \right]^2 \quad (2)$$

$$K_{Fj} = \frac{fl_j}{D_{Hj}} \quad (3)$$

$$K_{Fk} = \frac{fl_k}{2D_{Hk}} \left[\frac{A_j}{A_k} \right]^2 \quad (4)$$

where D_{Hk} are the hydraulic diameters of the system and f is conservatively assumed to be 0.02. K_T is drawn from References 6.2.1-5 and 6.2.1-6 and is chosen to account for all friction loss within the associated volumes as well as loss within the junction itself.

The total friction loss coefficient at a junction (K_{RELAP}) is then represented as:

$$K_{RELAP} = K_{Fi} + K_{Fj} + K_{Fk} + K_T \left[\frac{A_j}{A_T} \right]^2$$

where A_T represents the reference area to which K_T applies.

2. Subcompartment Modeling - Subcompartment nodalization models are principally determined by physical flow restrictions within each compartment. These flow restrictions consider the presence of steel and concrete obstructions, doorways, vent shafts, grating, reactor coolant pumps, piping, the steam generator, the pressurizer, the reactor vessel, and the reactor cavity missile and neutron shields. By choosing node boundaries at the various physical flow restrictions in a manner consistent with the flow model used by RELAP-4, calculated differential pressures and consequent support loads are realistically maximized. The nodalization sensitivity study performed in the SHNPP PSAR showed that the peak calculated differential pressure is very sensitive to an increasing number of nodes until that number equals the number of critical physical restrictions to flow. Increasing the number of nodes beyond the number of critical physical restrictions does not result in increased pressure differentials. It is therefore concluded that further arbitrary increase in the number of subcompartment nodes modeled is neither sensible nor realistic unless additional physical flow obstructions exist. The subcompartment models, discussed below, take into account all critical physical flow obstructions present.

For all analyses, insulation was assumed to remain in place and was included in the volume and vent area calculations. No displaced objects are assumed to exist.

1. Reactor Vessel Cavity* - For the analyses of the pressure transient in the reactor cavity following a line break, the flow models are illustrated on Figures 6.2.1-21 and 6.2.1-22. The control volume and vent path descriptions are given in Tables 6.2.1-19 and 6.2.1-20. The mass and energy release for the affected piping system, location and size for each break is given in Tables 6.2.1-12 and 6.2.1-13. Vertical and horizontal forces on the reactor vessel and the moment which arises are provided in Reference 6.2.1-12. Detailed information concerning the computer codes used are also contained in Reference 6.2.1-12.

2. Steam Generator Compartments* - For the analysis of the pressure transient in the three steam generator compartments following a LOCA, the flow models used are shown on Figures 6.2.1-23 through 6.2.1-26. Each control volume and vent path is shown in Tables 6.2.1-21 through 6.2.1-24. The mass and energy release for the affected piping system, location, and size for each break is given in Tables 6.2.1-14 through 6.2.1-16.

3. Pressurizer Compartment* - For analysis of the pressurizer subcompartment pressure transient and uplift force, the pressurizer compartment was modeled as depicted on Figure 6.2.1-27. Control volume and vent path descriptions are given in Tables 6.2.1-25 and 6.2.1-26. The mass and energy release for the affected piping system, location, and size for each break is given in Tables 6.2.1-17 and 6.2.1-18. The breaks considered for the analyses were a double ended pressurizer surge line guillotine break within the pressurizer skirt area, a pressurizer spray line system breaks in the pressurizer subcompartment.

* See Section 6.2.1.2a for subsequent evaluation, with Steam Generator Replacement and Power Uprate.

In the subcompartment pressurization analysis, the insulation for Reactor Vessel and piping system was assumed to remain in place and the volume occupied by the insulation was deducted from the free volume of each subcompartment. The reflecting mirror type insulation used inside the containment cannot sustain any pressure buildup. During the subcompartment pressure transient, the insulation near the pipe break will be most likely crushed to near zero occupied volume or torn loose and carried to adjacent volumes. In either case, the net free volume of the subcompartment where the pipe break is located will be substantially increased and the junction area to the adjacent volume will also be enlarged accordingly. Both will cause the reduction in pressure inside the break subcompartment. Since the peak pressure inside the break subcompartment has been used as the representing pressure for the comparison with the design pressure, the assumptions used in the current subcompartment analysis are believed to be conservative and justified.

The neutron streaming shield is located below the postulated nozzle rupture elevation for a reactor cavity pressurization transient. For this reason it is considered to remain in place during the transient. The effects of the shielding blockage and occupied volumes were considered in the reactor cavity subcompartment modeling.

A Permanent Cavity Seal Ring (PCSR) has been installed within the cavity annulus at the refueling seal ledge. This seal ring has eight open hatches for venting during normal operation. With credit for "Leak Before Break" approach, (see Section 6.2.1-2a), no large RCS loop piping break is postulated within the primary shield wall. The primary shield wall piping penetrations provide a vent path for a break of smaller attached lines to the reactor coolant loop in the steam generator/pressurizer cubicle subcompartments. This results in some flow through the PCSR. These effects have been evaluated and have been determined to be acceptable.

Due to the small mass and energy release associated with the pressurizer spray line guillotine, (see Table 6.2.1-18), and due to the routing of these lines and location of their connections to the pressurizer vessel, this break is not capable of producing significant lateral pressure differentials across the pressurizer.

Results* - The design value and peak calculated values for pressure in the subcompartments is shown in Tables 6.2.1-2, 6.2.1-3, and 6.2.1-27.

Graphs of the subcompartment pressure response versus time for the limiting break for the reactor cavity, steam generator loop 1, steam generator loop 3, steam generator loop 2, and pressurizer subcompartments are given in Figures 6.2.1-28 through 6.2.1-75, Figures 6.2.1-76 through 6.2.1-132, Figures 6.2.1-133 through 6.2.1-195, Figures 6.2.1-196 through 6.2.1-248, and Figures 6.2.1-249 through 6.2.1-301, respectively. Peak pressure differentials for all cases analyzed are given in Table 6.2.1-27. The peak calculated differential pressure is limited to a small portion of the total wall area and is less than the design pressures.

The external asymmetric loadings to the reactor pressure vessel are the result of the pressure differentials inside the reactor cavity throughout the cavity pressurization transient. The worst loadings would be caused by the 150 in.² break at the Second-loop Inlet (Cold Leg) Nozzle. The component pressure forces acting on the reactor vessel are calculated by multiplying the pressure in each volume with the appropriate projected areas. Since the vessel insulation is considered to remain in place throughout the transient, the projected areas are conservatively

**See Section 6.2.1.2a for subsequent evaluation with Steam Generator Replacement and Power Update.

calculated by using the insulation surface area rather than the vessel surface area. The values of the projected areas used in the component force calculation are listed in Table 6.2.1-20A. The forces are assumed to act through the midpoint of the vessel insulation located in each volume. The coordinate system used in the force and moment calculation is identified in Figure 6.2.1-21. The component forces in each volume were then summed to form the resultant forces in X, Y, Z directions. These resultant forces are shown in Figure 6.2.1-307. They should be applied to the vessel through the origin of the coordinate system. They also include the pressure differential forces across the nozzles and the primary pipings inside the cavity. The resultant moments about X and Y axes (shown in Figure 6.2.1-308) were calculated by summing up the product of the component forces and the appropriate lever arms. The lever arms for each volume is determined by the vertical distance between the nozzle center line elevation (Elevation 253.75 ft.) and the elevation of the insulation midpoint in each volume.

The values of the lever arms used in the moment calculation are presented in Table 6.2.1-20B. The magnitude of M_z is relatively small and it has been neglected in the evaluation.

Westinghouse assumed a 150 in.² rupture area when analyzing for asymmetric loads in the reactor cavity. Using this area as the maximum allowable break area, Ebasco designed the reactor vessel hot and cold leg restraints. Using geometric parameters from the restraints, Westinghouse then calculated the actual rupture areas of approximately 32 in.² for the hot leg and 90 in.² for the cold leg. Since these areas are enveloped by the assumed 150 in.² break area the reactor cavity subcompartment analysis is conservative.

6.2.1.2a Evaluation of SGR/PUR

The short-term LOCA-related Mass and Energy releases are used as input to the subcompartment analyses, which are performed to ensure that the walls of a subcompartment can maintain their structural integrity during the short pressure pulse (generally less than 3 seconds) accompanying a high-energy line pipe rupture within that subcompartment. The subcompartments evaluated include the steam generator (SG) compartment, the reactor cavity region, and the pressurizer compartment. For the SG compartment and the reactor cavity region, the fact that the HNP is approved for leak-before-break (LBB) was used to qualitatively demonstrate that any changes associated with the SGR/Uprating program are offset by the LBB benefit of using the smaller RCS nozzle breaks. This demonstrates that the current licensing bases for these subcompartments remain bounding. For the pressurizer compartment, the Reference 6.2.1-3 methodology was applied to calculate pressurizer spray line and surge line Mass and Energy (M&E) releases. The results of this reanalysis are discussed below.

A reanalysis was conducted to determine the effect of the SGR/Uprating on the short-term LOCA-related M&E releases that support the pressurizer subcompartment analyses for HNP FSAR, 6.2.1.2a. Since HNP was licensed for LBB by Reference 6.2.1-15, only breaks in the largest branch lines are analyzed (the pressurizer surge line and spray line break). The RCL breaks have been eliminated by LBB and therefore, the original design bases (pre LBB) M&E releases associated with these breaks would bound any RCS primary break considered under the LBB exemption. This evaluation addresses the impact of the SGR/Uprating and other relevant issues on the current licensing basis for HNP.

The magnitude of the pressure differential across the walls is a function of several parameters, which include the blowdown M&E release rates, the subcompartment volume, vent areas, and vent flow behavior. The blowdown M&E release rates are affected by the initial RCS

temperature conditions. Since short-term releases are linked directly to the critical mass flux, which increases with decreasing temperatures, the short-term LOCA releases would be expected to increase due to any reductions in RCS coolant temperature conditions. Short-term blowdown transients are characterized by a peak M&E release rate that occurs during a subcooled condition. Therefore, using lower temperatures, which maximizes the short-term LOCA M&E releases, data representative of the lowest inlet and outlet temperatures (with uncertainty subtracted) were used for the HNP SGR/Uprating analysis.

The evaluation considered a temperature operating range of 572°F to 588.2°F for the RCS average temperature. For this evaluation, an RCS pressure of 2301 psia (2250 + 51 psi uncertainty), a vessel outlet temperature of 598.2°F, and a vessel/core inlet temperature of 530.6°F were considered for the uprating, which includes consideration of the lower end of the operating range with the temperature uncertainty of 6°F.

Additionally, due to the short time period (0-3 seconds) that these events are analyzed for, the ECCS system is not modeled. Since the ECCS will not start in this short time period, single failures in the ECCS and Engineering Safeguards are not of a concern and are not considered.

The M&E data for the pressurizer surge line and spray line break analyses are given in Tables 6.2.1-17a and 6.2.1-18a. The methodology described in Reference 6.2.1-3 was used. Per Reference 6.2.1-15, HNP is approved for LBB. LBB eliminates the dynamic effects of postulated primary loop pipe ruptures from the design basis. This means that the current breaks (a double-ended circumferential rupture of the reactor coolant cold leg, hot leg, and the steam generator inlet nozzle, used for the SG compartments, and a 150 in² RV inlet break for the reactor cavity region) no longer have to be considered for the short-term effects. Since the RCL piping has been eliminated from consideration, the large branch nozzles must then be considered. This includes the surge line, accumulator line, and the RHR line. These smaller breaks, which are outside the cavity region, would result in minimal asymmetric pressurization in the reactor cavity region. Additionally, compared to the large RCL double-ended ruptures, the differential loadings are significantly reduced. For example, peak compartment pressure can be reduced by a factor of greater than 2, and the peak differential across an adjacent wall can be reduced by a factor of greater than 3, if only the nozzle breaks are considered. Therefore, since the HNP is approved for LBB, the decrease in M&E releases associated with the smaller RCL nozzle breaks, as compared to the larger RCL pipe breaks, more than offsets any increased releases associated with the lower RCS temperatures as a result of the SGR/Uprating. The current licensing basis subcompartment analyses that consider breaks in the RCL remain bounding, as discussed below:

Reactor Cavity

The design basis for the Reactor cavity is a 150 in² break in the RCS piping. The break sizes associated with the postulated Surge line, the RHR lines, Pressurizer Spray line, accumulator nozzle are outside the cavity and are significantly smaller than 150 in². Therefore, the lower Mass and Energy releases from these smaller RCS breaks would offset any changes associated with SGR/Power Uprate. Consequently, the existing design basis subcompartment differential pressures and associated forces and moments envelope those due to smaller breaks outside the cavity.

Steam Generator Compartment

The original design basis analysis considered a double-ended rupture in hot-leg, cold-leg, and pump suction of the RCS piping. The Mass and Energy release rates for these breaks are significantly larger than those due to postulated breaks in RHR, Pressurizer Spray and Pressurizer Surge lines. Although modifications have been made in the geometry (such as installing different type of insulation on the SG and rerouting feedwater pipe inside the cubicle), the subcompartment pressurization and associated forces and moments obtained in the original design basis analysis remain bounding.

Pressurizer Compartment

The original design basis for the Pressurizer compartment is the double-ended pump suction break which enveloped the postulated breaks in the Surge and the Spray lines. FSAR Tables 6.2.1-17a and 6.2.1-18a, provide Mass and Energy releases for the Surge line and Spray line breaks for Power Uprate/SGR conditions. A review of the new Mass and Energy release rates reveals the new rates are actually lower than those used in the original design basis calculation up to 0.1 second into transient. Since the peak pressure in the Pressurizer compartment occurs at 0.0175 second after the break, the new differential peak pressure would be lower than 7 psid calculated previously (see Table 6.2.1-27). The blowdown data for the Spray line has increased due to Power uprate by about 15%. This increase is expected to increase the peak differential pressure from 0.9 psid to about 1.2 psid. However, this peak differential pressure is much lower than those due to Pump Suction and Surge line breaks.

6.2.1.3 Mass and Energy Release Analyses for Postulated Loss-of-Coolant Accidents

The analysis for the SGR/Uprating program, used Westinghouse generated mass and energy (M&E) releases using the March 1979 model, described in Reference 6.2.1-10, which includes the NRC review and approval letter. This methodology has previously been applied to the HNP (Reference 6.2.1-18).

Input Parameters and Assumptions

The mass and energy release analysis is sensitive to the assumed characteristics of various plant systems, in addition to other key modeling assumptions. Where appropriate, bounding inputs are utilized and instrumentation uncertainties are included. For example, the Reactor Coolant System (RCS) operating temperatures are chosen to bound the highest average coolant temperature range of all operating cases, and a temperature uncertainty allowance of (+6.0°F) is then added. Nominal parameters are used in certain instances. For example, the RCS pressure in this analysis is based on a nominal value of 2250 psia plus an uncertainty allowance (+51 psi). All input parameters are chosen consistent with accepted analysis methodology.

Some of the most-critical items are the RCS initial conditions, core decay heat, safety injection flow, and primary and secondary metal mass and steam generator heat release modeling. Specific assumptions concerning each of these items are discussed next.

The core rated power of 2958 MWt which includes calorimetric error was used in the analysis. As previously noted, the use of RCS operating temperatures to bound the highest average coolant temperature range were used as bounding analysis conditions. The use of higher

temperatures is conservative because the initial fluid energy is based on coolant temperatures that are at the maximum levels attained in steady state operation. Additionally, an allowance to account for instrument error and deadband is reflected in the initial RCS temperatures. The selection of 2250 psi, plus an uncertainty allowance, as the limiting pressure is considered to affect the blowdown phase results only, since this represents the initial pressure of the RCS. The RCS rapidly depressurizes from this value until the point at which it equilibrates with containment pressure.

The rate at which the RCS blows down is initially more severe at the higher RCS pressure. Additionally the RCS has a higher fluid density at the higher pressure (assuming a constant temperature) and subsequently has a higher RCS mass available for releases. Thus, 2250 psia plus uncertainty was selected for the initial pressure as the limiting case for the long-term M&E release calculations.

The selection of the fuel design features for the long-term M&E release calculation is based on the need to conservatively maximize the energy stored in the fuel at the beginning of the postulated accident (i.e., to maximize the core stored energy). The margin in core-stored energy was chosen to be +15 percent. Thus, the analysis very conservatively accounts for the stored energy in the core.

Margin in RCS volume of 3 percent (1.6 percent allowance for thermal expansion and 1.4 percent for uncertainty) is modeled.

The LOCA transient is typically divided into four phases:

- (a) Blowdown - which includes the period from accident occurrences (when the reactor is at steady state operation) to the time when the total break flow stops.
- (b) Refill - the period of time when the lower plenum is being filled by accumulator and safety injection water. (This phase is conservatively neglected in computing mass and energy releases for containment evaluations).
- (c) Reflood - begins when the water from the lower plenum enters the core and when the core is completely quenched.
- (d) Post-Reflood - begins immediately after the core is quenched and continues until primary and secondary energy has been removed to 212°F.

A uniform steam generator tube plugging (SGTP) level of 0 percent is modeled. This assumption maximizes the reactor coolant volume and fluid release by considering the RCS fluid in all SG tubes. During the post-blowdown period the steam generators are active heat sources, as significant energy remains in the secondary metal and secondary mass that has the potential to be transferred to the primary side. The 0-percent SGTP assumption maximizes heat transfer area and therefore, the transfer of secondary head across the SG tubes. Additionally, this assumption reduces the reactor coolant loop resistance, which reduces the pressure drop upstream of the break for the pump suction breaks and increases break flow. Thus, the analysis very conservatively accounts for the level of SGTP.

The following assumptions were employed to ensure that the M&E releases are conservatively calculated for the limiting hot leg break case and DEPS maximum SI case thereby maximizing energy release to containment:

1. Maximum expected operating temperature of the RCS (100-percent full-power conditions)
2. Allowance for RCS temperature uncertainty (+6.0°F)
3. Margin in RCS volume of 3 percent (which is composed of 1.6-percent allowance for thermal expansion, and 1.4 percent for uncertainty)
4. Core rated power of 2958 MWt including calorimetric error.
5. Deleted by Amendment No. 58.
6. Conservative heat transfer coefficients (i.e., steam generator primary/secondary heat transfer and reactor coolant system metal heat transfer)
7. Allowance in core-stored energy for effect of fuel densification
8. A margin in core-stored energy
9. An allowance for RCS initial pressure uncertainty (+51 psi)
10. A maximum containment backpressure equal to design pressure (45 psig)
11. Allowance for RCS flow uncertainty (-2.1 percent)
12. SGTP leveling (0-percent uniform)
 - Maximizes reactor coolant volume and fluid release
 - Maximizes heat transfer area across the SG tubes
 - Reduces coolant loop resistance, which reduces the ΔP upstream of the break for the pump suction breaks and increases break flow

Later analyses considering measurement uncertainty recapture demonstrated that the hot leg break described above remains the limiting break relative to peak LOCA containment pressure. The pump suction break with minimum safeguards peak pressure, while still less than the hot leg break pressure, was not bounded. This analysis contained the following assumptions to ensure that M&E releases were conservatively calculated:

1. Maximum expected operating temperature of the RCS (100 percent full-power conditions)
2. Allowance for RCS temperature uncertainty (+3.8°F)
3. Margin in RCS volume of 3 percent (which is composed of 1.6 percent allowance for thermal expansion and 1.4 percent for uncertainty)

4. Bounding upper core power of 2958 MWt
5. Conservative heat transfer coefficients (i.e., steam generator primary/secondary heat transfer and reactor coolant system metal heat transfer)
6. Allowance in core-stored energy for effect of fuel densification
7. A margin in core-stored energy
8. An allowance for RCS initial pressure uncertainty (+51 psi)
9. A maximum containment backpressure equal to design pressure (45 psig) during blowdown, and 42 psig during post-blowdown
10. Allowance for RCS flow uncertainty (-2.1 percent)
11. SGTP leveling (0 percent uniform)
 - Maximizes reactor coolant volume and fluid release
 - Maximizes heat transfer area across the SG tubes
 - Reduces coolant loop resistance, which reduces the ΔP upstream of the break for the pump suction breaks and increase break flow
12. The steam generator secondary metal mass was modeled to include only the portion of the steam generators which is in contact with the fluid on the secondary side. Portions of the steam generators such as the elliptical head, upper shell and miscellaneous internals have poor heat transfer due to location. The heat stored in these areas available for release to containment will not be able to effectively transfer energy to the RCS, thus the energy will be removed at a much slower rate and time period (>10000 seconds).

Thus based on the previously discussed conditions and assumptions, a bounding analysis for the HNP was made for the release of M&E from the RCS in the event of a LOCA at 2958 MWt.

LOCA mass and Energy Release Phases

The containment system receives mass and energy releases following a postulated rupture in the RCS. These releases continue over the time period, which, for the LOCA M&E analysis, is typically divided into four phases.

1. Blowdown - the period of time from accident initiation (when the reactor is at steady state operation) to the time that the RCS and containment reach an equilibrium state.
2. Refill - the period of time when the lower plenum is being filled by accumulator and Emergency Core Cooling System (ECCS) water. At the end of blowdown, a large amount of water remains in the cold legs, downcomer, and lower plenum. To conservatively consider the refill period for the purpose of containment M&E releases, it is assumed that this water is instantaneously transferred to the lower plenum along with sufficient accumulator water to completely fill the lower plenum. This allows an uninterrupted release

of M&E to containment. Thus, the refill period is conservatively neglected in the M&E release calculation.

3. Reflood - begins when the water from the lower plenum enters the core and ends when the core is completely quenched.
4. Post-reflood (Froth) - describes the period following the reflood phase. For the pump suction break, a two-phase mixture exits the core, passes through the hot legs, and is superheated in the steam generators prior to exiting the break as steam. After the broken loop steam generator cools, the break flow becomes two-phase.

Computer Codes

The Reference 6.2.1-10 mass and energy release evaluation model is comprised of M&E release versions of the following codes: SATAN VI, WREFLOOD, FROTH, and EPITOME. These codes were used to calculate the long-term LOCA M&E releases for HNP SGR/Upgrading program.

SATAN VI calculates blowdown, the first portion of the thermal-hydraulic transient following break initiation, including pressure, enthalpy, density, M&E flowrates, and energy transfer between primary and secondary systems as a function of time.

The WREFLOOD code addresses the portion of the LOCA transient where the core reflooding phase occurs after the primary coolant system has depressurized (blowdown) due to loss of water through the break and when water supplied by the ECCS refills the reactor vessel and provides cooling to the core. The most important feature of WREFLOOD is the steam/water mixing model.

FROTH models the post-reflood portion of the transient. The FROTH code is used for the steam generator heat addition calculation from the broken and intact loop steam generators.

EPITOME continues the FROTH post-reflood portion of the transient from the time at which the secondary equilibrates to containment design pressure to the end of the transient. It also compiles a summary of data on the entire transient, including formal instantaneous M&E release tables and M&E balance tables with data at critical times.

Break Size and Location

Generic studies (Reference 6.2.1-10, Section 3) have been performed with respect to the effect of postulated break size on the LOCA M&E releases. The double-ended guillotine break has been found to be limiting due to larger mass flow rates during the blowdown phase of the transient. During the reflood and froth phases, the break size has little effect on the releases.

Three distinct locations in the reactor coolant system loop can be postulated for pipe rupture for any release purposes:

1. Hot leg (between vessel and steam generator)
2. Cold leg (between pump and vessel)

3. Pump suction (between steam generator and pump)

The break locations analyzed for this program are the DEPS rupture (10.48 ft²) and the DEHL rupture (9.18 ft²). Break M&E releases have been calculated for the blowdown, reflood, and post-reflood phases of the LOCA for the DEPS cases. For the DEHL case, the releases were calculated only for the blowdown. The following information provides a discussion of each break location.

- The DEHL rupture has been shown in previous studies (Reference 6.2.1-10, Section 3.1) to result in the highest blowdown M&E release rates. Although the core flooding rate would be the highest for this break location, the amount of energy released from the steam generator secondary is minimal because the majority of fluid that exits the core vents directly to containment, bypassing the steam generators. As a result, the reflood M&E releases are reduced significantly as compared to either the pump suction, or cold-leg break locations where the core exit mixture must pass through the steam generators before venting through the break. For the hot-leg break, generic studies have confirmed that there is no reflood peak (i.e., from the end of the blowdown period the containment pressure would continually decrease). Therefore, only the M&E releases for the hot-leg break blowdown phase are calculated.
- The cold-leg break location has also been found in previous studies (Reference 6.2.1-10, Section 3.1) to be much less limiting in terms of the overall containment energy releases. The cold-leg blowdown is faster than that of the pump suction break, and more mass is released into the containment. However, the core heat transfer is greatly reduced, and this results in a considerably lower energy release into containment. Studies have determined that the blowdown transient for the cold leg is, in general, less limiting than that for the pump suction break. During reflood, the flooding rate is greatly reduced, and the energy release rate into the containment is reduced. Therefore, the cold-leg break is bounded by other breaks and no further evaluation is necessary.
- The pump suction break combines the effects of the relatively high core-flooding rate, as in the hot-leg break, and the additional stored energy in the steam generators. As a result, the pump suction break yields the highest energy flow rates during the post-blowdown period by including all of the available energy of the RCS in calculating the releases to containment.

Application of Single-Failure Criterion

An inherent assumption in the generation of the mass and energy release is that offsite power is lost. This results in the actuation of the emergency diesel generators, required to power the safety injection system. This is not an issue for the blowdown period, which is limited by the DEHL break, since the combination of signal delay, plus diesel delay and additional delays in starting the ECCS pumps result in an SI delivery time after the end of blowdown.

Generally, two cases are analyzed to assess the effects of a single failure. The first case assumes minimum safeguards SI flow based on the postulated single failure of an emergency diesel generator. This results in the loss of one train of safeguards equipment. The other case assumes maximum safeguards SI flow based on no postulated failures that would impact the amount of ECCS flow.

Acceptance Criteria

A large LOCA is classified as an ANS Condition IV event, an infrequent fault. To satisfy the NRC acceptance criteria presented in the Standard Review Plan Section 6.2.1.3, the relevant requirements are as follows:

- 10 CFR 50, Appendix A
- 10 CFR 50, Appendix K, paragraph I.A

In order to meet these requirements, the following must be addressed:

- Sources of energy
- Break size and location
- Calculation of each phase of the accident

6.2.1.3.1 Mass and Energy Release Data

The SATAN-VI code is used for computing the blowdown transient. The code utilizes the control volume (element) approach with the capability for modeling a large variety of thermal fluid system configurations. The fluid properties are considered uniform, and thermodynamic equilibrium is assumed in each element. A point kinetics model is used with weighted feedback effects. The major feedback effects include moderator density, moderator temperature, and Doppler broadening. A critical flow calculation for subcooled (modified Zaloudek), two-phase (Moody), or superheated break flow is incorporated into the analysis. The methodology for the use of this model is described in Reference 6.2.1-10.

Table 6.2.1-33 presents the calculated mass and energy release for the blowdown phase of the DEHL break. For the hot-leg break M&E release tables, break path 1 refers to the M&E exiting from the reactor vessel side of the break; and break path 2 refers to the M&E exiting from the steam generator side of the break.

Table 6.2.1-29a presents the calculated M&E releases for the blowdown phase of the DEPS break with maximum ECCS flows. Table 6.2.1-29b presents the calculated M&E releases for the blowdown phase of the DEPS break with minimum ECCS flows. For the pump suction breaks, break path 1 in the M&E release tables refers to the M&E exiting from the steam generator side of the break; break path 2 refers to the M&E exiting from the pump side of the break.

The WREFLOOD code is used for computing the reflood transient. The WREFLOOD code consists of two basic hydraulic models--one for the contents of the reactor vessel and one for the coolant loops. The two models are coupled through the interchange of the boundary conditions applied at the vessel outlet nozzles and at the top of the downcomer. Additional transient phenomena, such as pumped safety injection and accumulators, reactor coolant pump performance, and steam generator releases are included as auxiliary equations that interact with the basic models are required. The WREFLOOD code permits the capability to calculate variations during the core reflooding transient of basic parameters such as core flooding rate, core and downcomer water levels, fluid thermodynamic conditions (pressure, enthalpy, density) throughout the primary system, and mass flowrates through the primary system. The code

permits hydraulic modeling of the two flow paths available for discharging steam and entrained water from the core to the break, the path through the broken loop and the path through the unbroken loops.

A complete thermal equilibrium mixing condition for the steam and ECCS injection water during the reflood phase has been assumed for each loop receiving ECCS water. This is consistent with the usage and application of the Reference 6.2.1-10 M&E release evaluation model in recent analyses, for example, D. C. Cook Docket (Reference 6.2.1-19). Even though the Reference 6.2.1-10 model credits steam/water mixing only in the intact loop and not in the broken loop, the justification, applicability, and NRC approval for using the mixing model in the broken loop has been documented (Reference 6.2.1-19). Moreover, this assumption is supported by test data and is further discussed below.

The model assumes a complete mixing condition (i.e., thermal equilibrium) for the steam/water interaction. The complete mixing process, however, is made up of two distinct physical processes. The first is a two-phase interaction with condensation of steam by cold ECCS water. The second is a single-phase mixing of condensate and ECCS water. Since the steam release is the most important influence to the containment pressure transient, the steam condensation part of the mixing process is the only part that needs to be considered. (Any spillage directly heats only the sump.)

The most applicable steam/water mixing test data has been reviewed for validation of the containment integrity reflood steam/water mixing model. This data, generated in 1/3-scale tests (Reference 6.1.1-20), are the largest scale data available and thus, most clearly simulate the flow regimes and gravitational effects that would occur in a Pressurized Water Reactor (PWR). These tests were designed specifically to study the steam/water interaction for PWR reflood conditions.

A group of 1/3-scale tests corresponds directly to containment integrity reflood conditions. The injection flowrates for this group cover all phases and mixing conditions calculated during the reflood transient. The data from these tests were reviewed and discussed in detail in Reference 6.2.1-10. For all of these tests, the data clearly indicate the occurrence of very effective mixing with rapid steam condensation. The mixing model used in the containment integrity reflood calculation is therefore wholly supported by the 1/3-scale steam/water mixing data.

Additionally, the following justification is also noted. The double ended pump suction break results in the highest containment pressure post-blowdown. For this break, there are two flowpaths available in the RCS by which mass and energy may be released to containment. One is through the outlet of the steam generator, the other via reverse flow through the reactor coolant pump. Steam that is not condensed by ECCS injection in the intact RCS loops passes around the downcomer and through the broken loop cold leg and pump in venting to containment. This steam also encounters ECCS injection water as it passes through the broken loop cold leg, complete mixing occurs and a portion of it is condensed. It is this portion of steam that is condensed that is taken credit for in this analysis. This assumption is justified based upon the postulated break location, and the actual physical presence of the ECCS injection nozzle. Descriptions of the test and test results are contained in References 6.2.1-10 and 6.2.1-19.

Table 6.2.1-36 presents the calculated M&E release for the reflood phase of the pump suction double-ended rupture with minimum safeguards.

Table 6.2.1-35 presents the calculated M&E release for the reflood phase of the pump suction double-ended rupture with maximum safeguards.

The transient responses of the principal parameters during reflood are given in Table 6.2.1-49 for the DEPS maximum safeguards case.

The FROTH code (Reference 6.2.1-3) is used for computing the post-reflood transient. The FROTH code calculates the heat release rates resulting from a two-phase mixture present in the steam generator tubes. The M&E releases that occur during this phase are typically superheated due to the depressurization and equilibration of the broken-loop and intact-loop steam generators. During this phase of the transient, the RCS has equilibrated with the containment pressure, but the steam generators contain a secondary inventory at an enthalpy that is much higher than the primary side. Therefore, there is a significant amount of reverse heat transfer that occurs. Steam is produced in the core due to core decay heat. For a pump suction break, a two-phase fluid exits the core, flows through the hot legs, and becomes superheated as it passes through the steam generator. Once the broken loop cools, the break flow becomes two-phase. During the FROTH calculation, ECCS injection is addressed for both the injection phase and the recirculation phase. The FROTH code calculation stops when the secondary side equilibrates to the saturation temperature (T_{sat}) at the containment design pressure. After this point, the EPITOME code completes the SG depressurization.

The methodology for the use of this model is described in Reference 6.2.1-10. The M&E release rates are calculated by FROTH and EPITOME until the time of containment depressurization. After containment depressurization (14.7 psia), the M&E release available to containment is generated directly from core boil-off/decay heat. Table 6.2.1-41 presents the two-phase post-reflood M&E release data for the pump suction double-ended case minimum safeguards case. Table 6.2.1-40 presents the two-phase post-reflood M&E release data for the pump suction double-ended case maximum safeguards case.

The maximum safeguards mass & energy release data was subsequently reevaluated using a higher cold leg re-circulation flowrate than that assumed in the above analysis as documented in Reference 6.2.1-22. The evaluation concluded that the impact on Containment pressure and temperature, due to a higher cold leg re-circulation flowrate, remains non-limiting with respect to the pressure & temperature of the minimum safeguards case.

Decay Heat Model

On November 2, 1978, the Nuclear Power Plant Standards Committee (NUPPSCO) of the American Nuclear Society approved ANS Standard 5.1 (Reference 6.2.1-21) for the determination of decay heat. This standard was used in the M&E release. Table 6.2.1-66 lists the decay heat curve used in the M&E release analysis, post blowdown, for the HNP SGR/Uprating program.

Significant assumptions in the generation of the decay heat curve for use in the LOCA M&E releases analysis include the following:

1. Decay heat sources considered are fission product decay and heavy element decay of U-239 and Np-239.

2. Decay heat power from the following fissioning isotopes are included: U-238, U-235 and Pu-239.
3. Fission rate is constant over the operating history of maximum power level.
4. The factor accounting for neutron capture in fission products has been taken from Equation 11 of Reference 6.2.1-21, up to 10,000 seconds and from Table 10 of Reference 6.2.1-21, beyond 10,000 seconds.
5. The fuel has been assumed to be at full power for 1096 days.
6. The number of atoms of U-239 produced per second has been assumed to be equal to 70 percent of the fission rate.
7. The total recoverable energy associated with one fission has been assumed to be 200 MeV/fission.
8. Two-sigma uncertainty (two times the standard deviation) has been applied to the fission product decay.

Based upon NRC staff review, Safety Evaluation Report (SER) of the March 1979 evaluation model (Reference 6.2.1-10), use of the ANS Standard-5.1, November 1979 decay heat model was approved for the calculation of M&E releases to the containment following a LOCA. A plant specific decay heat curve was developed for Shearon Harris in support of the rework necessary for the Shearon Harris measurement uncertainty recapture (MUR). The decay heat fraction as a function of time was calculated using ANS 1979 decay heat curve with plant specific parameters. Bounding values used to generate the decay heat fractions include the following:

1. A core average burnup of 50,000 MDW/MTU
2. A minimum average core enrichment of 3.0%
3. A maximum core fuel loading of 74 MTU
4. Standard 17 x 17 Westinghouse fuel, which has a nearly equal pellet diameter to the AREVA fuel used at Shearon Harris
5. A two sigma uncertainty has been applied

Steam Generator Equilibration and Depressurization

Steam generator equilibration and depressurization is the process by which secondary side energy is removed from the steam generators in stages. The FROTH computer code calculates the heat removal from the secondary mass until the secondary temperature is the saturation temperature (T_{sat}) at the containment design pressure. After the FROTH calculations, the EPITOME code continues the FROTH calculation for SG cooldown removing steam generator secondary energy at different rates (i.e., first and second stage rates). The first stage rate is applied until the steam generator reaches T_{sat} at the user specified intermediate equilibration pressure, when the secondary pressure is assumed to reach the actual containment pressure. Then the second stage rate is used until the final depressurization, when the secondary reaches

the reference temperature of T_{sat} at 14.7 psia, or 212°F. The heat removal of the broken-loop and intact-loop steam generators are calculated separately.

During the FROTH calculations, steam generator heat removal rates are calculated using the secondary side temperature, primary side temperature, and a secondary side heat transfer coefficient determined using a modified McAdam's correlation. Steam generator energy is removed during the FROTH transient until the secondary side temperature reaches saturation temperature at the containment design pressure. The constant heat removal rate used during the first heat removal stage is based on the final heat removal rate calculated by FROTH. The SG energy available to be released during the first stage interval is determined by calculating the difference in secondary energy available at the containment design pressure and that at the (lower) user specified intermediate equilibration pressure, assuming saturated conditions. The intermediate equilibrium pressures are selected as discussed in Reference 6.2-10, Section 2.2. This energy is then divided by the first stage energy removal rate, resulting in an intermediate equilibrium time. At this time, the rate of energy release drops substantially to the second stage rate. The second stage rate is determined as the fraction of difference in secondary energy available between the intermediate equilibration and final depressurization at 212°F, and the time difference from the time of the intermediate equilibration to the user-specified time of the final depressurization at 212°F. With current methodology (Reference 6.2.1-10), all of the secondary energy remaining after the intermediate equilibration is conservatively assumed to be released by imposing a mandatory cooldown and subsequent depressurization down to atmospheric pressure at 3600 seconds, i.e., 14.7 psia and 212°F.

Sources of Mass and Energy

The sources of mass consideration in the LOCA M&E release analysis are given in Tables 6.2.1-47, 6.2.1-44 and 6.2.1-43. These sources are the reactor coolant system, accumulators, and pumped safety injection.

The energy inventories considered in the LOCA M&E release analysis are given in Tables 6.2.1-55, 6.2.1-52, and 6.2.1-51. The energy sources are listed below.

- RCS water
- Accumulator water (all three inject)
- Pumped SI water
- Decay heat
- Core stored energy
- RCS metal (includes SG tubes)
- SG metal (includes transition cone, shell, wrapper, and other internals)
- SG secondary energy (includes fluid mass and steam mass)
- Secondary transfer of energy (feedwater into, and steam out of, the SG secondary)

The energy reference points are as follows.

- Available energy: 212°F; 14.7 psia
- Total energy content: 32°F; 14.7 psia

The mass and energy inventories are presented at the following times, as appropriate:

- Time zero (initial conditions)
- End of blowdown time
- End of refill time
- End of reflood time
- Time of broken loop steam generator equilibration to pressure setpoint
- Time of full depressurization (3600 seconds)

In the M&E release data presented, no Zirc-water reaction heat was considered because the clad temperature is assumed not to rise high enough for the rate of the Zirc-water reaction heat to be of any significance.

6.2.1.4 Mass and Energy Release Analysis For Postulated Secondary System and Pipe Ruptures

6.2.1.4.1 Mass and energy data

A complete analysis of main steam line breaks inside Containment has been performed using the methods described in WCAP-8822, including Supplement 1 and Supplement 2 (Reference 6.2.1-17). A total of 12 cases covering four power levels, two break types, and two single failures have been analyzed. However, as discussed in 6.2.1.1.33 previous studies have indicated that a full double-ended break at a given power is more severe than a corresponding split break. Consequently, only the double-ended breaks at the four power levels were analyzed for the SGR/Uprate. (A confirmatory split break case at 29.4% power and a cooling train failure was evaluated to ensure it was bounded by full DER cases at 29.4% power levels.)

Mass and energy release data used in the analysis of SGR/Uprate conditions for each of the four postulated double-ended breaks reflects the failure of the faulted-loop main steam isolation valve (MSIV). In addition to the MSLB and MSIV failure assumption, the SGR/Uprate analyses include the following additional single failures:

- An active failure of a main feedwater isolation valve (MFIV); or
- An active failure of feedwater flow control valve (MFCV)(or MFBCV at 0% power) or;
- A single failure of one cooling train for heat removal.

Tables 6.2.1-58A and 6.2.1-58B present the blowdown data for the mass and energy release rates for the most limiting MSLB cases are the full double-ended break at 29.4% power for maximum pressure and the full double-ended break at 100.34% power for the maximum temperature respectively.

The actual integrated mass & energy releases for these two cases are different, primarily due to the differences in the initial steam/water mass in the faulted steam generator and the pumped feedwater addition until isolation.

All the blowdown used in the analysis was conservatively assumed to consist of dry steam although entrainment can be expected on the double-ended rupture. The significant parameters

affecting the mass and energy releases to containment following a steam line break are discussed below.

6.2.1.4.2 Plant power level

Steam line breaks can be postulated to occur with the plant in any operating condition ranging from zero to full power. Since steam generator mass decreases with increasing power levels, breaks occurring at lower power generally result in a greater total mass release to the Containment. However, because of increased energy storage in the primary plant, increased heat transfer in the steam generators, and the additional energy generation in the nuclear fuel, the energy release to the Containment from breaks postulated to occur during power operation may be greater than for breaks occurring with the plant at lower power levels. Additionally, pressure in the steam generators changes with increasing power and has a significant influence on the rate of blowdown.

Because of the opposing effects of changing power level on steam line break mass and energy releases, no single power level can be singled out as a worst case initial condition for a steam line break. Therefore, a spectrum of power levels spanning the operating range (100.34%, 68.6%, and 29.4%), as well as zero power, has been considered.

6.2.1.4.3 Break type, area, and location

1. Break Type - There are two possible types of pipe ruptures which must be considered in evaluating steam line breaks.

The first is a split rupture in which a hole opens at some point on the side of the steam pipe, but does not result in a complete severance of the pipe. A single, distinct break area is fed uniformly by all steam generators until steam line isolation occurs. The blowdown from the individual steam generators is not independent since fluid coupling exists among all steam lines. Because of the flow-limiting orifices in each steam generator, the largest possible split rupture can have an effective area, prior to isolation, that is not greater than the throat area of the flow restrictor times the number of reactor coolant loops. Following isolation, the effective break area for the steam generator with the broken line can be no greater than the flow restrictor throat area. However, split ruptures have been evaluated to be non-limiting cases.

The second break type is the double-ended guillotine rupture in which the steam pipe is completely severed and the ends of the break displace from each other. Guillotine ruptures are characterized by two distinct break locations, each of equal area, but are fed by different steam generators. The largest possible guillotine rupture can have an effective area no greater than the throat area of one steam line flow restrictor for each steam generator.

2. Break Area - Two break areas (one full double-ended, and one split rupture) have been analyzed at each of the four initial power levels, as follows:
 - a. A full double-ended pipe rupture downstream of the steam line flow restrictor. For this case, the actual break area equals the cross sectional area of the steam line, but the blowdown from the steam generator with the broken line is controlled by the flow restrictor throat area (1.4 ft.²). The reverse flow from the intact steam generators is

controlled by the smaller of the pipe cross section, or the total flow restrictor throat area for both the intact loops.

- b. A split break that represents the largest break which will not generate a steam line isolation signal from the primary protection equipment. Steam and feedwater line isolation signals will be generated by high containment pressure signals for these cases. However, split ruptures have been determined to be non-limiting cases.
3. Break Location - Break location affects steam line blowdown by virtue of the pressure losses which would occur in the length of piping between the steam generator and the break. The effect of the pressure loss is to reduce the effective break area seen by the steam generator. Although this would reduce the rate of blowdown, it would not significantly change the total release of energy to the Containment. Therefore, piping loss effects have been conservatively ignored in all blowdown results.

6.2.1.4.4 Main feedwater addition prior to feedwater line isolation

All of the double-ended ruptures generate main steam and feedwater isolation signals very quickly following the break. Isolation of these lines is assumed to be complete following a time delay sufficiently long to allow for instrument response time and signal processing delay (2 seconds) and valve closing time. The total delay to complete isolation of the steam lines is 7 seconds including the instrument response and signal processing delay. The total delay to complete isolation of the feedwater lines is 10 seconds including the instrument response and signal processing delay. (For steam line breaks initiated at zero power, the total feedwater isolation delay is 12 seconds.)

For the split ruptures, the feedwater isolation signal and the main steam line isolation signal result from high containment pressure protective trips. The containment pressure setpoints for feedwater line and steamline isolation signals is assumed to be 3.0 psig. The isolation is assumed to be complete 7 seconds (instrument/signal delay and valve closure time) after the setpoint is reached for the main steam lines and 10 seconds after the setpoint is reached for the feedwater lines. (For the steam line breaks initiated at zero power, the total feedwater isolation delay is 12 seconds.)

Prior to complete isolation, the depressurization of the steam generator results in significant amount of feedwater being added to the broken loop steam generator through the Feedwater System. The quantity of feedwater added is conservatively evaluated using the following assumptions:

1. Two main feedwater pumps operating and feedwater control valve position is the same as that expected for normal operation at a given power level. At zero power, two pumps are assumed to be operating, however flow is controlled by the feedwater control bypass valve and the main control valve is closed. An alternate flow path at zero power using the AFW pump and AFW valves to control flow was evaluated and found to be bounded by the mass addition using the MFW pumps and MFCBV flow alignment.
2. The feedwater control valves in the intact loops maintain their initial flow until feedwater isolation signal is received. Immediate closure of the feedwater isolation valves and control valves in the intact loops upon receipt of the isolation signal.

3. In the faulted steam generator loop, three failure scenarios are postulated:

For the cooling train failure case, both MFIV and MFCV (or MFBCV) are expected to function and isolate feedwater upon receipt of a MFIS. Flow reduction through the valves is not credited as they stroke closed.

For the MFIV failure case, the MFCV (or MFBCV) is expected to close upon receipt of a MFIS. Flow reduction through the valve is not credited as it strokes closed.

For the MFCV failure case (or MFBCV failure at 0% power), the MFCV (MFBCV) is assumed to ramp open immediately upon a MSLB and feedwater flow to the faulted steam generator increases. The MFIV is assumed to close upon receipt of a MFIS. Flow reduction through the valve is not credited as it strokes closed.

4. The pressure in the intact loop steam generators remains at the level existing prior to a double-ended guillotine rupture, while the broken loop steam generator depressurizes. The pressure in the intact loop steam generators decays at the same rate as the broken loop steam generator pressure subsequent to a split rupture.

These assumptions were used along with the feedwater system hydraulic resistances and pump performance curves to determine the amount of feedwater added to the steam generator with the broken loop. The amounts of main feedwater added to the faulted steam generator for the 100.34%, 68.6%, and 29.4% power levels have been calculated using the RELAP5 computer code. Feedwater addition at 0% power was determined based upon a conservative calculation.

6.2.1.4.5 Auxiliary feedwater system design

Generally within the first minute following a steam line break, the Auxiliary Feedwater System is initiated on any one of several protection system signals. Addition of auxiliary feedwater to the steam generators increases the secondary mass available for release to the Containment as well as increasing the heat transferred to the secondary fluid. A conservative bounding AFW flowrate of 3000 gpm was assumed to enter the faulted steam generator from all 3 AFW pumps up until the time of isolation. After isolation, the AFW isolation valves were assumed to leak, and a leak flow of 20 gpm was assumed to enter the faulted steam generator.

Auxiliary feedwater flow is assumed up until the time automatic auxiliary feedwater isolation takes place. For a description of the automatic auxiliary feedwater isolation logic see Section 10.4.9.

6.2.1.4.6 Fluid stored in the feedwater piping prior to isolation

The unisolated feedwater line volume between the steam generator and the isolation valve is a source of additional high energy fluid to be discharged through the break. This volume was assumed to be 245 cubic feet. For the MFIV failure case, an additional 455 cubic feet of fluid stored in the piping between the MFIV and the MFCV was also assumed to be discharged through the break. In addition a purge volume of 50 cubic feet of AFW piping between the steam generator and AFW isolation valve was also assumed to be discharged into the faulted steam generator and out of the break.

6.2.1.4.7 Limiting feedwater valve failure

As a result of the pumped feedwater and unisolable feedwater piping volume, the analysis addresses the maximum amounts of feedwater addition to the faulted steam generator in calculating the dry out time. Since the dryout times for the MFCV failure case are significantly smaller than those for the MFIV failure case, the consequences of the MFCV failure cases are enveloped by the MFIV failure cases and were not analyzed.

6.2.1.4.8 Fluid stored in the steam piping prior to isolation

For the double-ended ruptures, all the steam in the steam lines up to the turbine stop valve (9415 ft³) is assumed to be released to the containment following the break. The split ruptures that do not assume a failure of the MSIV use the steam between the steam generator and the MSIV (1025 ft³) as the unisolable volume.

6.2.1.4.9 Availability of offsite power

Loss of offsite power following a steam line rupture would result in tripping of the reactor coolant pumps, motor-driven main feedwater pumps, and a possible delay of auxiliary feed initiation due to standby diesel generator starting delays. Each of these occurrences aids in mitigating the effects of the steam line break releases by either reducing the fluid inventory available to feed the blowdown or reducing the energy transferred from the Reactor Coolant System to the steam generators. Thus, blowdowns occurring in conjunction with a loss of station power are less severe than cases where offsite power is available; these cases are not presented.

6.2.1.5 Minimum Containment Pressure Analysis for Performance Capability Studies of Emergency Core Cooling System

The containment backpressure for the limiting case for the ECCS analysis is calculated using the methods and assumptions described in Section 15.6.5. Input parameters including the containment initial conditions, net free containment volume, passive heat sink materials, thicknesses, surface areas, starting time, and number of containment heat removal systems used in the analysis are described below.

The large break LOCA ECCS performance analysis was performed with a loss of offsite power as the most limiting condition with respect to margin to the 10CFR50.46 acceptance criteria. That is, a more challenging PCT results from assuming a loss of offsite power (reactor coolant pumps trip) rather than offsite power being available (reactor coolant pumps running). This results from core thermal hydraulics behavior during blowdown and is true even though the calculated containment pressure may be lower when offsite power is available due to faster actuation of the engineered safeguards.

For the ECCS performance analysis, a dominant effect during the blowdown phase is the time to critical heat flux (CHF). The time to CHF significantly affects the amount of stored energy released to the coolant prior to entering the subsequent core heatup and reflood phase. The remaining stored energy at the end of blowdown significantly affects the peak clad temperature (PCT). If offsite power is lost at event initiation, an immediate flow reversal occurs as reactor coolant system mass exits the cold leg break. The flow reversal results in flow stagnation in the core decreasing the time to CHF and reducing clad-to-coolant heat transfer. The shorter time to

CHF minimizes the stored energy released from the fuel rods during blowdown and presents a greater challenge to the PCT acceptance criterion.

For the offsite power available scenario, faster actuation of the engineered safeguards can result in a small decrease in containment pressure which leads to a small decrease in core reflood rate and a small increase in PCT. However, the time to CHF is significantly delayed if the reactor coolant pumps remain running since flow reversal and stagnation do not occur. The more dominant effect on PCT of delayed time to CHF more than offsets the secondary effect of slightly reduced containment pressure. The PCT is less challenging to the 10CFR50.46 acceptance criterion when offsite power is available.

Thus, the overall effect of assuming offsite power is available during a large break LOCA event is to obtain a more favorable result. The ECCS performance analysis assumption of loss of offsite power is limiting and the results presented in Section 15.6.5 demonstrate compliance with 10CFR50.46 for this limiting case.

6.2.1.5.1 Mass and energy release data

The mathematical models which calculate the mass and energy releases to the Containment are described in Section 15.6.5. Since the requirements of Appendix K of 10 CFR 50 are very specific in regard to the modeling of the RCS during blowdown and the models used are in conformance with Appendix K, no alterations to those models have been made in regard to the mass and energy releases. A break spectrum analysis is performed (see references in Section 15.6.5) that analyzes various break sizes, break locations, and Moody discharge coefficients for the double ended cold leg guillotines which do affect the mass and energy released to the Containment. This effect is considered for each case analyzed. During reflood, the effect of steam-water mixing between the safety injection water and the steam flowing through the RCS intact loops reduces the available energy released to the containment vapor space and therefore tends to minimize containment pressure.

6.2.1.5.2 Initial containment internal conditions

The following initial values were used in the analysis:

Containment pressure	14.0 psia
Containment temperature	80°F
RWST temperature (ECCS)	82.5°F
RWST temperature (sprays)	40°F
Outside temperature	60°F
Initial Relative Humidity	100 %

The combination of containment initial conditions used in the analysis are conservative relative to the values anticipated during normal full power operation.

6.2.1.5.3 Containment volume

The volume used in the analysis is 2.344×10^6 ft.³.

6.2.1.5.4 Active heat sinks

The Containment Spray System and the containment fan coolers operate to remove heat from the Containment.

Pertinent data for these systems which were used in the analysis are presented in Table 6.2.1-62. The heat removal capability of each fan cooler is presented in Figure 6.2.1-303.

The containment sump temperature was not used in the analysis because the maximum peak cladding temperature occurs prior to initiation of the recirculation mode for Containment Spray System. In addition, heat transfer between the sump water and the containment vapor space was not considered in the analysis.

6.2.1.5.5 Steam-water mixing

Water spillage rates from the broken loop accumulator are determined as part of the core reflooding calculation and are included in the containment code calculation model.

6.2.1.5.6 Passive heat sinks

The passive heat sinks used in the analysis, with their thermophysical properties, are given in Table 6.2.1-63.

Concrete thermophysical properties utilized were taken directly from BTP CSB 6 1. A carbon steel thermal conductivity value of 26Btu/hr-ft-F is specified for the temperature range of interest for Shearon Harris from Reference 6.2.5-5; likewise, a volumetric heat capacity value is obtained from that reference. The values shown in Table 6.2.1-63 were used in the analysis.

6.2.1.5.7 Heat transfer to passive heat sinks

The condensing heat transfer coefficients used for heat transfer to the steel containment structures were calculated in accordance with NRC Branch Technical Position CSB6-1.

6.2.1.5.8 Containment purging during a LOCA

The containment purge system consists of two 8-inch diameter lines and associated isolation valves. During the time between event initiation and complete closure of the isolation valves, containment purging occurs which can adversely affect the core reflood rate and PCT for a large break LOCA by reducing containment backpressure. Over the short period of time that the isolation valves are open, the pressure decrease resulting from containment purging is small and will have an insignificant effect on the core reflood rate and PCT.

6.2.1.5.9 Other parameters

No other parameters have a substantial effect on the minimum containment pressure analysis.

6.2.2 CONTAINMENT HEAT REMOVAL SYSTEM

The purpose of the Containment Heat Removal System (CHRS), is to rapidly reduce the containment pressure and temperature following a reactor or steam generator energy release

and to maintain them at acceptably low levels. The CHRS also serves to limit offsite radiation levels by reducing the pressure differential between the containment atmosphere and the external environment, thereby decreasing the driving force for fission product leakage across the Containment. In addition, airborne iodine following a loss-of-coolant accident (LOCA) is removed by spraying borated sodium hydroxide solution into the Containment. The fission product removal function is carried out by the Iodine Removal System (IRS) as discussed in Section 6.5.2.

The systems provided for containment heat removal include the Containment Cooling System (CCS) and Containment Spray System (CSS). The Containment Cooling System is designed to operate during both normal plant operations and under LOCA or main steam line break (MSLB) conditions. The operations of the CCS are discussed in Section 6.2.2.2.1. The CSS is designed to operate during accident conditions only. The operation of the CSS is discussed in Section 6.2.2.2.2.

6.2.2.1 Design Bases

The CCS and the CSS are designed to remove heat from the containment atmosphere following a LOCA accident or a secondary system rupture inside Containment, as required by General Design Criteria 38. The CCS also provides a supply of cooling air to the annular clearance between the reactor vessel and primary shield wall, the reactor vessel supports and the annular space between the reactor coolant legs and the concrete wall.

- 1) The sources and amounts of energy released to the Containment as a function of time which were used as the basis for sizing the Containment Heat Removal System are given in Sections 6.2.1.3 and 6.2.1.4. The CCS is designed to remove its heat load while the essential portions of the Service Water System (SWS) is providing cooling water to the CCS at 95°F. This is conservative-based on a maximum operational Service Water Inlet temperature of 94°F. A description of the SWS is presented in Section 9.2.1.
- 2) The heat removal capacity of either train of the CCS and CSS is sufficient to keep the containment temperature and pressure below design conditions for any size break up to and including a double ended break of the largest reactor coolant pipe. The system is also designed to mitigate the consequences of any size break in the secondary systems, up to and including a double ended break of the largest main steam line inside Containment.
- 3) The CCS and CSS each consist of two redundant loops and are designed such that failure of any single active or passive component will not prevent adequate post-accident cooling of the containment atmosphere.
- 4) The safety related portions of the CCS and CSS are designed to Safety Class 2, Seismic Category I requirements.
- 5) The CCS and CSS are protected against the dynamic effects associated with postulated fluid system piping failures as described in Section 3.6.
- 6) Protection of the CCS and CSS from the effects of missiles is described in Section 3.5.
- 7) Protection of the CCS and CSS from the effects of wind/tornado and flooding is described in Sections 3.4 and 3.5.

- 8) Both the CCS and CSS are designed to permit periodic inspection and testing as described in Section 6.2.2.4.
- 9) The essential portions of the CCS and CSS located inside the Containment are designed to withstand the containment environment resulting from a LOCA or MSLB. The environmental conditions resulting from a LOCA or MSLB are described in Section 3.11.
- 10) The Primary Shield Cooling system and the Reactor Supports Cooling System are designed to supply cooling air to the annular clearance between the reactor vessel and primary shield wall, the reactor vessel supports and the annular space between the reactor coolant legs and the concrete wall. The systems are designed to limit the temperature of the shielding concrete, instrumentation and concrete base at the reactor vessel supports to a maximum of 150°F. The systems are designed to Safety Class 3 and Seismic Category I requirements.
- 11) The CSS is capable of withstanding the dynamic effects associated with hydraulic instabilities occurring during any mode of operation.

6.2.2.2 System Design

6.2.2.2.1 Containment Cooling System (CCS)

6.2.2.2.1.1 Functional description

The CCS has the following functions:

1. In the event of a design basis accident, LOCA or MSLB, containment fan coolers are designed to remove heat in the following manner:
 - a. Four containment fan coolers will operate with one of the two fans in each cooler running at half speed (the other fans are idle). Heat removal capacity per containment fan cooler is stated in FSAR Table 6.2.2 1.
 - b. In the case of single train failure, two containment fan coolers will operate with one of the two fans in each cooler running at half speed (the other fans are idle).
2. During normal operation, the CCS is designed to maintain the indicated containment temperature below 120°F.
3. Mixing the containment atmosphere following an accident.

6.2.2.2.1.2 Design description

The CCS consists of four safety related fan cooler units and three non-safety fan coil units.

Following a design basis accident only the safety related fan cooler units are required to operate. During normal power operation, safety related units operate in conjunction with the non-safety units to maintain required containment temperature. See Table 6.2.2-1 for major system components. Figure 6.2.2-3 describes the extent of essential portions of the ductwork and equipment for the CCS. Air is supplied to the steam generator and pressurizer subcompartments, the operating floor, the ground floor and the mezzanine floor. Figures 6.2.2-10 through 6.2.2-16 describe the plan and elevation drawings of the Containment showing the

routing of air distribution ductwork. A portion of supply air is tapped to serve the Reactor Support Cooling System and Primary Shield Cooling System described in Section 6.2.2.2.3.

Two of the four safety related fan cooler units are located at Elevation 236', the remaining two safety related units are located at Elevation 286'.

Two separate trains are provided, each consisting of two fan cooler units with each unit supplying air to an independent, vertical concrete air shaft.

Train A Components

Train B Components

Fan Cooler	AH-2	Fan Cooler	AH-1
Fan Cooler	AH-3	Fan Cooler	AH-4
Service Water	Loop A	Service Water	Loop B
Emergency Power	Diesel A	Emergency Power	Diesel B

Train selection of each fan cooler with its respective water supply is under administrative control.

Each fan cooler is served by water from the Service Water System. A detailed description of the Service Water System is given in Section 9.2.1.

Each safety related fan cooler consists of cooling coil sections and two direct driven vane axial flow fans. Unit performance data is shown in Table 6.2.2 1. Each fan is equipped with a two speed motor enabling half speed operation at DBA conditions and integrated leak rate test conditions. A gravity damper is provided at the discharge side of each fan to prevent air flow in the reverse direction when only one fan per unit is required to operate. Both fans of the unit discharge into a common duct which is connected to a concrete air shaft through a locked open damper. A branch duct connection is provided to serve as a post-accident discharge nozzle and is normally isolated by means of a separate pneumatically operated, fail open damper.

The three non-nuclear safety fan-coil units are all located at the same elevation. These units are required to operate during normal plant operating conditions only; their air is directed to Reactor Coolant Pump and Steam Generator Compartments. The fan-coil units are served by the Service Water System. A detailed description of Service Water System is given in Section 9.2.1. Each unit has cooling coil section and two one hundred percent capacity, direct driven, vane axial fans. Unit performance is shown in Table 6.2.2-1.

6.2.2.1.2.1 Post-accident operation

During post-accident operation, four fan cooler units operate with one fan per unit running at half speed. The system can operate in this mode as long as both emergency diesel generators and both service water system trains are available.

In the event of failure of one of the emergency diesel generators or one service water system train only two fan cooler units will operate. The damper in the post-accident discharge branch duct will be opened. The post-accident discharge duct is provided with high velocity nozzles to diffuse air to accelerate the temperature mixing inside containment. These nozzles are directed to selected areas of heat release, to achieve thorough mixing of containment atmosphere. The

high velocity nozzles direct turbulent air jets from discharge points at two levels inside containment where two separate trains of containment fan coolers are located. Two sets of nozzles are located at Elevation 286 ft. as shown on Figure 6.2.2-14, Sections C-14-1 and C-12-1, and the other two nozzles are shown on Figure 6.2.2-10 (plan at Elevation 221.00 ft.) as post-accident discharge nozzles. Seismic Category I ductwork is used from the fan coolers to the discharge outlets.

As the post-accident containment atmosphere steam-air mixture passes through the system cooling coils, it is cooled and a portion of the steam is condensed. In the event of a single active failure in one train, one containment spray pump and two containment fan coolers will provide the adequate cooling capacity. The fan cooler units receive electric power from the diesel generators approximately 15 seconds after SIAS generation through a timer-sequencer. However, due to a time delay relay a fan running in high speed will be allowed to coast down for 15 seconds to allow for low speed synchronization. Approximately 8 additional seconds are required to bring the fans to the operational speed.

The containment fan cooler performance data, showing the energy removal rate is shown on Figure 6.2.2-4 and Table 6.2.2-3.

6.2.2.2.1.2.2 Normal operation

During normal power operation, three non-safety fan coil units are in continuous operation along with two of or all four of safety-related fan cooler units. The following describes their operation:

- a) When containment average temperature is 118°F or below: Normally two fan cooler units will operate with both fans of the unit running at full speed. Each of the two vertical concrete air shafts is served by an operating fan cooler unit. In this mode of operation, the idle train is serving as standby. Each shaft supply air damper is locked open and each nozzle damper is closed.
- b) When the containment average temperature is above 118°F or if additional cooling is desired, additional coolers will be operated. Fan cooler units located at floor Elevation 236 ft. will operate with one of the two fans of the units running at full speed and the other fan is on standby. Each shaft supply damper is locked open and each nozzle damper is closed. The other two fan cooler units located at Elevation 286 ft. will operate with both fans per unit operating at full speed. Each shaft supply damper is locked open and each nozzle damper is open. If containment average temperature continues to rise or if additional cooling is desired, the two standby fans of the fan coolers at Elevation 236 ft. will be manually energized to operate at full speed and the nozzle dampers will remain closed.
- c) With (2) safety related fan cooler units and (3) non-safety related fan coil units operating at a service water temperature of 50°F, their total heat removal capacity is approximately 11.1×10^6 Btu/hr. These capacities are based on air entering the units at 80°F DB and between 48°F and 67°F WB.

The containment heat gain is approximately 13.8×10^6 Btu/hr. This includes heat contributed from equipment, lighting, piping, motors as well as fan motors.

Since heat gain is greater than the heat removal rate the temperature in the Containment cannot fall below 80°F.

6.2.2.2.2 Containment Spray System (CSS)

6.2.2.2.2.1 Functional description

The purpose of the CSS is to spray borated sodium hydroxide solution into the Containment to cool the atmosphere and to remove the fission products that may be released into the containment atmosphere following a LOCA or MSLB. A summary of the design and performance data for the CSS is presented in Section 6.2.1. The fission product removal effectiveness and the pH control of the containment sump water of the CSS is described in Section 6.5.2.

6.2.2.2.2.2 Design description

The CSS consists of two independent and redundant loops each containing a spray pump, piping, valves, spray headers, and spray valves. Figure 6.2.2-1 provides the process flow and instrumentation details of the system.

The operation of the CSS is automatically initiated by the containment spray actuation signal (CSAS) which occurs when a containment pressure HI-3 signal is reached. Section 7.3 describes the design bases criteria for the CSAS. Upon receipt of a CSAS, the containment spray pumps start operation and the containment spray isolation valves open.

The CSS has two principal modes of operation which are:

- a) The initial injection mode, during which time the system sprays borated water which is taken from the refueling water storage tank (RWST). Section 6.2.2.3.2.3 describes the criteria used for sizing the RWST.
- b) The recirculation mode, which is initiated when low-low level is reached in the RWST. Pump suction is transferred from the RWST to the containment sump by opening the recirculation line valves and closing the valves at the outlet of the refueling water storage tank. This switch over is accomplished automatically. See Section 7.3 for further details.

Upon receipt of the CSAS the containment spray pumps are started and borated water from the RWST is discharged into the Containment through the containment spray headers. The CSAS starts the two containment spray pumps and opens the motor operated containment spray isolation valves. Upon reaching full speed of the containment spray pumps, water will reach the nozzles and start spraying within approximately 33 seconds. The spray headers are located to maximize heat removal. Each train at the CSS has two headers which conform to the shape of the Containment and contain a total of 106 spray nozzles per train. The number of spray nozzles in the system provides 100 percent redundancy for effective heat removal and iodine removal. Figure 6.2.2-2 provides the location of spray piping and nozzles and the resulting spray pattern. Refer to Section 6.5.2 for a discussion of Containment sprayed and unsprayed volumes.

A flow element is installed in each containment spray pump's discharge line to monitor the system operation.

The spray nozzles, which are of open throat design, without any moving parts (minimum inside diameter of approximately 0.375 in.), break the flow into small droplets, which increases the cooling effectiveness on the containment atmosphere. As these droplets fall through the containment atmosphere they absorb heat until they reach the temperature of the containment air-steam mixture. The spray nozzles are protected from clogging by the following means:

There are two independent sumps which serve as reservoirs and provide suction to the ECCS and Containment Spray (CT) system pumps during the recirculation mode of operation. The recirculation sumps are located inside the containment building outside the secondary shield wall at elevation 221'-0" and at azimuths 2250° and 3150°. The sumps are covered with checker plate steel covers. Before water enters the fine strainer assemblies, it passes through coarse trash racks which are vertical. The vertical trash racks have approximately 2" x 2" openings except that the bottom 12" of these racks have been removed to assure that water is always able to flow under them even if the openings become plugged (Figure 6.2.2-19).

The fine strainer assemblies behind the trash racks consist of a total of one hundred thirty-six (136)(68 per sump) high-performance top hat style assemblies and four (4) top hat inspection port assemblies (2 per sump) which will provide a total net effective surface area of approximately 6,000 ft² (3,000 ft² per sump) (Figure 6.2.2-20). A concrete wall is located inside each recirculation sump separating the Residual Heat Removal (RHR) pump intake from the containment spray (CT) pump intake. Thirty five vertical top hats are located on each side of the concrete wall for a total of 70 top hats per sump. Since RHR flows exceeds CT flow, there is a 4" x 18" opening in the concrete wall connecting the two sides of the sump to allow water to flow from the CT side to the RHR side of the sump.

The top hats are 66 inches long with a 13 1/4" x 14 1/2" flange (baseplate) on one end. The high-performance top hat assemblies consist of four tubes (12-inch, 10-inch, 7-inch and 5-inch diameter) fabricated from perforated stainless steel plate with 3/32" perforations. The top hat inspection port assemblies consist of three tubes (12-inch, 10-inch, and 7-inch) fabricated from perforated stainless steel plate plus a non-perforated tube (5-inch) with a blank flange on top that can be removed to look through the top hat. A top hat support frame is anchored to the sump walls with vertical supports going to the recirculation sump floor at elevation 216'-4 1/2". In this design, water enters through the perforated plate surfaces of the strainers and travels through the annuli created between the two outer tubes and the two inner tubes (note that the top hat inspection port assemblies do not contain a 5-inch inner perforated tube). The flow then travels underneath the support frame to the RHR and CT suction intakes.

A vortex suppressor made from standard floor grating is installed above the vertical top hat modules in each recirculation sump to prevent air from being drawn into the top hat modules.

A curb approximately 18 in. high and located 2 ft. in front of the screen structure is provided to prevent heavy or sunken debris from impingement upon the screens. The floor outside of the curb slopes away from the sump to minimize debris from entering the sump.

The containment recirculation sumps have been designed and constructed to ensure the functional capability of the sumps to provide an adequate supply of water during the recirculation mode of operation for the Containment Spray System and the Residual Heat

Removal System. In addition, the containment recirculation sumps have been evaluated against the guidelines provided in NUREG 0869, Revision 1 "Unresolved Safety Issue A-43 Regulatory Analysis". This evaluation concluded that post-LOCA insulation debris will not degrade either the performance of the containment sumps or that of the RHR pumps and the CS pumps.

The evaluation demonstrates that based upon sump location, containment building layout and the jet impingement effects associated with a postulated LOCA, SHNPP insulation cannot be transported to the sump screens either in the short-term as a direct result of blowdown forces, or during long-term recirculation since the 0.1 ft/sec velocity of the water as it approaches the sumps is less than that required to transport insulation debris to the screens.

The sump structures and screens are designed to withstand the effects of a Safe Shutdown Earthquake (SSE) without loss of structural integrity. Thus, the sump screens are designed to the Seismic Category I structural criteria.

Figures 6.2.2-7, 6.2.2-8, and 6.2.2-9 show the plan and section views of the containment sump.

Piping and equipment insulation is considered to be the primary source of post-accident debris inside Containment which could potentially clog the sump screening. The possibility of paint chips peeling off has been minimized by requiring proper surface preparation and by painting larger surface components with coatings which have been qualified under design basis accident condition.

Non-NSSS-supplied thermal insulation inside Containment consists primarily of metallic reflective insulation. The insulation is constructed of stainless steel interior and exterior sheets. All insulation assemblies are designed to be self-supporting from the associated piping and equipment or from adjacent removable or permanent covering. Permanent insulation assemblies are attached by stainless steel straps and fasteners of the expansion type which prevent overstressing of the bands or damage to the coverings due to thermal expansion of the equipment surface. Removable assemblies are attached by means of stainless steel buckles or other fasteners of the quick release type which vary depending upon installation requirements.

Each insulation assembly is jacketed in heavy gage stainless steel or stainless steel wire mesh for the RSG primary side channel heads and designed to withstand vibration and seismic shock associated with postulated accident conditions inside Containment. With the exception of local failure in the vicinity of postulated pipe ruptures, insulation assemblies are expected to remain intact during and after an accident.

Westinghouse-supplied insulation for inside containment equipment application consists mainly of stainless steel reflective panels of various sizes ranging from 12 by 18 inches to 24 by 48 inches. The thickness ranges from 3 to 3 1/2 inches. This type of insulation may be found on the pressurizer, reactor coolant pump casings, and the primary piping consisting of the hot, cold, and crossover legs and the pressurizer surge line. As a result of the steam generator replacement, the steam generators are insulated with fiberglass blanket insulation with stainless steel jacketing (or wiremesh for the primary side channel heads).

The reactor vessel is also covered with this type of insulation with the exception of the beltline region, from the nozzles down approximately 48 inches. In this region, the vessel is covered with a heavier sandwich design consisting of Microtherm thermal insulation and Ricorad neutron

shielding encapsulated in stainless steel. The Microtherm insulation is closest to the reactor vessel and is approximately 1 to 1 1/2 inches thick. Surrounding this is 1 to 2 inches of Ricorad shielding. The stainless steel exists both around and between this combination.

This heavier insulation paneling is supported from the reactor vessel nozzles through inter-fastening of sheet metal screws to adjacent panels and by vertical support straps. The sizes for these panels fall within the sizes given for the reflective panels.

Cutouts are provided in the insulation for equipment, seismic supports, and tie downs.

The containment sump has screens with 3/32in. openings. This is adequate because there are no openings in the ECCS or containment spray system that are more restrictive than 3/32in. Adequate means are provided for convenient access to the sump for inspection and maintenance purposes. The containment recirculation sumps are periodically inspected as delineated in the Technical Specifications.

6.2.2.2.3 Primary shield and reactor supports cooling system

The Primary Shield Cooling System and the Reactor Supports Cooling System are shown on Figure 6.2.2-3.

6.2.2.2.3.1 Primary shield cooling system

The Primary Shield Cooling System consists of two Safety Class 3, 100 percent capacity, direct driven supply fans. Each fan serves as a standby for the other fan and is served by a separate power channel. Fan design data are provided in Table 6.2.2-4. Each fan is provided with a locked open inlet damper and a gravity type discharge damper to prevent air recirculation through the standby fan. Each axial supply fan draws 18,000 cfm cool air from the vertical concrete air shaft and supplies it to the annular clearance between the reactor vessel and primary shield wall through connecting ductwork. The cooling provided by the Primary Shield Cooling System minimizes the possibility of concrete dehydration and subsequent faulting.

6.2.2.2.3.2 Reactor Supports Cooling System

The Reactor Supports Cooling System consists of two Safety Class 3, 100 percent capacity direct driven vane axial fans. Each fan serves as a standby for the other fan. Fan design data are presented in Table 6.2.2-5. Each fan is provided with a locked open inlet damper and a gravity type discharge damper to prevent air recirculation to the idle fan.

The system draws 27,600 cfm of cooling air from the vertical concrete air shaft and supplies 21,600 cfm of air to the reactor vessel supports and 1000 cfm each to the annular space between reactor coolant legs (nozzle) and sleeves. Cool air is forced through these spaces uniformly by means of a ductwork distribution system.

The cooling provided by the Reactor Supports Cooling System limits thermal expansion of the reactor vessel supporting steelwork.

6.2.2.3 System Design Evaluation

6.2.2.3.1 Containment Cooling System (CCS)

Cooling units, with associated piping, valves, and instrumentation, are located outside the primary shield and above the maximum possible post-accident water height to provide protection against flooding.

Although the ECCS is designed to rapidly cool the water in the core below saturation temperature following a LOCA, the CCS design is based on the assumption that all core residual heat appears as steam in the Containment.

The CCS cooling coil design provides for rapid drainage of large quantities of condensed steam, preventing loss of capacity and maintaining cooling water temperatures below the boiling point. A relief valve is provided to prevent excess tube pressure. Since the cooling coils are in constant use, tube clogging during an accident is highly unlikely. Surface fouling on the secondary side of the fan cooler heat exchanger by the cooling water is minimized by the use of Cu Ni 90/10 tubes. Performance of the cooling unit was predicted assuming a fouling factor of .001.

Service water flow to the cooling unit coils is unregulated to eliminate the possibility of a failure due to a modulating valve or controller malfunction. Each containment fan cooling unit has a separate branch supply and return run through the containment wall, with an isolation valve located outside the Containment.

High reliability is maintained through careful quality control and assurance procedures and by general arrangement of equipment and piping to provide access for inspection and maintenance. Safety-related components are designed to operate in, and to withstand, post-accident environment, resulting from postulated design basis accidents. See Section 3.11 for a description of the design basis for environmental considerations.

All safety-related dampers are pneumatically operated. Dampers will fail in the safe (either closed or open) position in the event that electrical power or air is lost to the damper operator.

The heat sink for the containment cooling units is the Service Water System. Failure of an inlet or outlet valve to a containment cooling coil will be detected due to flow reduction since water side flowrates are monitored via appropriate instrumentation.

During the post-accident period, most of the containment cooling ductwork system is not required. Cooling air is reapportioned by means of Safety Class 2 dampers to discharge nozzles adjacent to the fan discharge. With the exception of a small amount of ductwork between the fan outlet and concrete air shaft, the major portion of the ductwork which could collapse and damage other safety-related systems is provided with Seismic Category I duct supports. The essential portions of the CCS ductwork and equipment housings are designed for a two psid pressure differential to prevent overpressurization.

No single failure in the CCS would render the containment heat removal system incapable of performing its post-accident cooling function. See Table 6.2.2-6.

6.2.2.3.2 Containment Spray System CSS

The single failure characteristics of the CSS have been evaluated to show that failure of any single active component will not prevent adequate post-accident cooling of the containment atmosphere during the injection phase. No single active or passive failure (not in addition to a single active failure in the injection phase) during the recirculation phase will render the Containment Heat Removal System incapable of performing its required safety function. See Table 6.2.2-7. One containment spray pump and two of the containment cooling units will provide at least 100 percent cooling capacity.

One of two spray additive eductors will supply adequate sodium hydroxide solution to provide minimum required iodine removal. See Section 6.5.2 for further details.

The containment spray pumps take suction from the refueling water storage tank during the injection phase. The pumps take suction from the containment sumps during the recirculation phase. Each pump has a separate suction line from its associated sump.

Class 1E level instruments LE-7160 SA & SB are provided in containment sumps 1A & 1B, respectively. These level instruments provide indication in the main control room of the water level in the respective sumps upstream of the strainer screens.

The containment recirculation sumps are located at the outer perimeter of containment floor Elevation 221.00 feet. Any water from pipe breaks, drain flow or spray flow will be intercepted at higher elevations and directed to the reactor cavity sump by means of the floor drains system. Water must then flow radially out to the recirculation sump location which guarantees uniform flow approach.

Figures 1.2.2-3 and 6.2.2-7, 6.2.2-8 and 6.2.2-9 provide additional details on sump layout and location.

The containment sumps will be inspected following extended shutdowns for any materials which have the potential for becoming debris capable of blocking the recirculation of coolant following a LOCA. There will also be a periodic inspection of sump components such as screens and intake structures in accordance with Regulatory Guide 1.82.

Figure 6.2.2-1 indicates the containment isolation valves provided for each of the independent lines leading from the containment sump to the suction of the containment spray pumps.

There is one motor operated isolation valve located on each line external to the Containment. A secondary containment boundary, which incorporates an airtight protective valve chamber is provided. This secondary boundary completely encloses the sump line and the isolation valve and is not open to the containment atmosphere.

Figure 6.2.2-1 indicates the containment isolation valves provided for each of the independent lines leading from the containment sump to the suction of the containment spray pumps.

There is one motor operated isolation valve located on each line external to the Containment. A secondary containment boundary, which incorporates an airtight protective valve chamber is provided. This secondary boundary completely encloses the sump line and the isolation valve and is not open to the containment atmosphere.

The design basis fabrication requirements and quality control procedures for the containment secondary boundaries and valve chambers are identical to those used for the containment liner and the other containment penetrations (see Section 3.8).

No single failure in the CSS sump lines or isolation valves during the recirculation phase will result in a loss of containment integrity.

Reliability of the containment spray actuation signal is discussed in Section 7.3. Accidental initiation of the spray system will not affect the safety of the plant since all engineered safety feature instruments will be designed to operate in the resulting environment. All piping or equipment insulation which may come in contact with sprays will be covered with lagging to prevent large quantities of water from penetrating the insulation. Small amounts of seepage will not cause thermal shock to hot equipment.

Receipt of the containment spray actuation signal will be alarmed. If the operator determines that initiation was inadvertent he may terminate spray flow, thus minimizing the amount of water entering the Containment. The procedures for terminating inadvertent containment spray are based on criteria, which require at least two operator errors to effect incorrect termination of the CCS. No automatic corrective systems to account for operator error are provided. The decision to terminate containment spray will be made only if a) the containment pressure, as indicated at least by three channels of the containment pressure instrument is less than the containment HI 3 pressure setpoint, or b) the containment pressure on two channels of the containment pressure instrumentation is less than the HI-3 pressure setpoint and a high pressure alarm is not activated.

6.2.2.3.2.1 CSS NPSH Requirements

The NPSH requirements of the containment spray pumps have been evaluated for both the injection and recirculation phase following a loss-of-coolant accident. The minimum NPSH requirements and the available NPSH, (based upon final design) and the maximum expected flow through the pumps are listed in Table 6.2.2-8.

As indicated in Table 6.2.2-8, recirculation operation gives the limiting NPSH conditions. The formulae and parameters used in the evaluation of the NPSH during both the injection phase and recirculation phase are the same as in the case of the low head injection pumps. No reliance is placed on the containment pressure for meeting the NPSH requirements for the containment spray pumps (however, credit is taken for the pressure necessary to maintain the fluid in its liquid phase, i.e., liquid vapor pressure).

a) Injection phase:

$$\begin{aligned} \text{NPSH available} &= h_{\text{rwst}} + h_{\text{static}} - h_{\text{friction}} - h_{\text{vapor pressure}} \\ &= 34.3 + 70.6 - 8.4 - (4.5) \\ &= 92.0 \text{ ft.} \end{aligned}$$

b) Recirculation phase:

$$\text{NPSH available} = h_{\text{containment}} + h_{\text{static}} - h_{\text{friction}} - h_{\text{vapor pressure}}$$

$$= h_{\text{containment}} + 28.1 - 2.6 - h_{\text{vapor pressure}}$$

Where:

$$h_{\text{containment}} = h_{\text{vapor pressure}}$$

$$\text{NPSH}_{\text{available}} = 25.5 \text{ ft.}$$

The minimum NPSH requirements are 13.0 ft. and 12.4 ft. for the injection phase and recirculation phase respectively. Positive net positive suction head margin is maintained with a postulated debris bed on the recirculation sump screens.

6.2.2.3.2.2 CSS spray coverage

Two sets of spray nozzles are provided, each set oriented for effective coverage of the containment volume. Each spray header is located inside the containment dome. Figure 6.2.2-2 indicates the location of the spray nozzles within the Containment and indicates the expected spray pattern. The average height above the operating deck for containment spray trains A and B is 133 ft. and 140 ft. respectively. The average fall height of the spray droplets is conservatively taken as 125 ft. for determination of the iodine removal coefficient.

The Spray Engineering Company spray nozzle, model number 1713A, is used for the CSS. Each spray nozzle is designed for a flow rate of 15.2 gpm with a 40 psi pressure drop across the nozzles. The nozzles are designed to produce droplets of approximately 700 microns mean diameter at the rated system conditions. Figure 6.2.2-6 is a sample spray nozzle drop size histogram.

Reference 6.2.2-1 describes and presents the results of the spray nozzle test program performed by Spray Engineering Company which predicts the performance of the nozzle and the analytical methods employed to determine the mean spray drop size.

6.2.2.3.2.3 Refueling Water Storage Tank (RWST)

The RWST capacity was determined on the basis of the following requirements:

- a) The tank must provide a minimum inventory to assure adequate containment sump level for proper recirculation phase operation. The tank will also provide that quantity of water required for at least 20 minutes of operation during the injection phase, with two high-head safety injection pumps, two low-head safety injection pumps and two containment spray pumps in operation.
- b) The tank must provide a quantity of water required to fill the Refueling Cavity, the Fuel Transfer Tube and the Fuel Transfer Canal, during refueling.
- c) The tank must provide an alternate source of boration for plant shutdown.
- d) The tank must provide a minimum inventory to assure a post-LOCA containment sump boron concentration sufficient to meet core subcriticality requirements for long-term cooling.

The RWST is designed for a 469,260 gallon capacity with a minimum water inventory of 434,302 gallons maintained during all normal modes. This minimum inventory will only be

removed from the RWST during unit refueling after shutdown and will always be maintained for post-accident recirculation mode operation and system testing.

The two RWST vent lines are protected from freezing by redundant ambient sensing heat tracing on each vent line. The power supply for the heat tracing on each vent line is supplied by separate trains.

The water in the RWST will be maintained at a temperature of not less than 40 F utilizing heaters, the minimum temperature for injection of borated water during emergency core cooling as indicated in Section 6.3. The freezing point of 2400 ppm boron solution, 1.37 weight percent boric acid, is below the normal freezing point of water, therefore a 40 F minimum temperature precludes freezing. In addition, the solubility temperature for a 2400-2600 ppm boron, 1.37-1.49 weight percent boric acid solution is below 40 F.

The refueling water storage tank is a Seismic Category I field-fabricated tank of stainless steel construction. It is designed, fabricated, erected, and tested in accordance with the requirements of ASME Boiler and Pressure Vessel Code Section III, Winter Addenda 1971, Class 2.

The RWST is designed for the horizontal and vertical seismic loads for both the Design and Operating Basis Earthquakes. The RWST would not be required for plant shutdown following a tornado. The tank is therefore, not designed for tornado winds or pressure drops.

The major design parameters for the refueling water storage tank are indicated in Table 6.2.2-9.

6.2.2.3.2.4 Primary shield and reactor supports cooling system

The Primary Shield and Reactor Support Cooling Systems are safety related and designed to Safety Class 3 and Seismic Category I requirements.

Each system is provided with redundant fans to assure continuity and reliability of operation. Each fan is supplied with onsite emergency power from the diesel generators, in the event of loss of offsite power.

6.2.2.4 Testing and Inspection

6.2.2.4.1 Containment cooling system CCS

The CCS undergoes preoperational startup tests as described in Section 14.2.12. Periodic tests are required as described in the Technical Specifications. Inservice inspection requirements are described in Section 6.6 and pump and valve testing requirements of Section 3.9.6 will apply. Factory tests verify cooling coil and motor performance.

6.2.2.4.2 Containment Spray System CSS

See Section 6.5.2.4 for the testing and inspection requirements of the CSS.

6.2.2.4.3 Primary Shield and Reactor Supports Cooling System

Refer to Section 14.2 for a discussion of testing provisions as they apply to the Primary Shield and Reactor Supports Cooling System.

6.2.2.5 Instrumentation Requirements

6.2.2.5.1 Containment Cooling System CCS

The instrumentation details and design requirements of the CCS are discussed in Section 7.3.

6.2.2.5.2 Containment Spray System CSS

The following control room indications, utilizing the four containment pressure channels, aid the operator in determining pressure status.

- a) The four containment pressure channels activate the CSS (see Section 7.3) on the HI-3 pressure. The output of these four channels are shown on four indicators located on the control board.
 - 1) These outputs activate one common annunciator alarm.
 - 2) Each channel has individual trip status lights.
- b) Three of these channels are utilized for SIS generation on high pressure.
 - 1) Any of the three channels activates one common annunciator alarm.
 - 2) Each channel has individual trip status lights.
- c) Three channels (the same as in b above) are also utilized for main steam line isolation (2 out of 3 operation) on "HI-2" pressure.
 - 1) These outputs activate one common annunciator alarm.
 - 2) Each channel has individual trip status lights.

Flow measurement devices are provided, one on each of the two independent and redundant CSS loops. The containment spray flow is indicated by the ERFIS.

The control room instrumentation which indicates RCS pressure is as follows:

- a) Three protection channels which supply signals to three pressurizer pressure indicators.
- b) Two control channels which supply signals to two pressurizer pressure indicators.
- c) The two control channels supply signals to low and high pressurizer pressure annunciation.

The control room operator may utilize the following Control Room instrumentation to determine whether the "HI-3" containment pressure is a result of a steam line break or a primary system break (LOCA).

The control room instrumentation which indicates steam generator pressure is as follows:

- a) Three channels and three pressure indicators.

- b) Three high differential pressure alarms.
- c) A low pressure alarm for each of the three steam generators.

The control room instrumentation which indicates containment radiation is as follows:

- a) Containment radioactive air particulate indication.
- b) Containment area radiation monitoring.
- c) Containment room alarm for high radiation from above instrumentation.

6.2.2.5.3 Primary Shield and Reactor Supports Cooling System

Indicator lights are provided to show blower status.

6.2.3 SECONDARY CONTAINMENT FUNCTIONAL DESIGN

This section is not applicable to the Shearon Harris Nuclear Power Plant.

6.2.4 CONTAINMENT ISOLATION SYSTEM*

6.2.4.1 Design Bases

The Containment Isolation System consists of the valves and actuators required to isolate the Containment following a loss-of-coolant accident, steam line rupture, or fuel handling accident inside the Containment.

The Containment Isolation System is designed to the following bases:

- a) The Containment Isolation System provides isolation of lines penetrating Containment, which are not required to be open for operation of the Engineered Safety Features Systems, to limit the release of radioactive materials to the atmosphere during a loss-of-coolant accident (LOCA).
- b) Upon failure of a main steam line, the Main Steam Line Isolation System, described in Section 7.3, isolates the faulted steam generator to prevent excessive cooldown of the Reactor Coolant System or overpressurization of the Containment, and as described in Section 7.3, the Containment Isolation System isolates the Containment.
- c) Upon failure of a main feedwater line, the Main Feedwater Isolation System, described in Section 7.3, isolates the faulted steam generator, and as described in Section 7.3, the Containment Isolation System isolates the Containment.
- d) Upon detection of high containment atmosphere radioactivity, isolation valves in the Containment Atmosphere Purge Exhaust System, discussed in Section 9.4.7, are shut to control release of radioactivity to the environment. The Containment Purge Isolation Actuation System is discussed in Section 7.3. Airborne radioactivity monitoring is discussed in Section 12.3.4.

* Further information is contained in the TMI Appendix.

All containment purge and vent isolation valves with the exception of those serving the Hydrogen Purge System as discussed in Section 6.2.5.1 close automatically on a high radiation signal generated as a result of inputs from containment airborne radiation sensors. All the automatically actuated valves have status indication lights in the Main Control Room.

- e) The Containment Isolation System is designed in accordance with 10 CFR 50, Appendix A, General Design Criterion 54 and Westinghouse Systems Standard Design Criteria, Number 1.14, Rev. 2.
- f) There are no lines that are part of the reactor coolant pressure boundary (RCPB) that penetrate the Containment (i.e., no safety class 1 lines), therefore GDC 55 is not applicable to SHNPP. However, for lines such as charging, safety injection, and letdown there is not an applicable GDC because these lines are connected to the RCPB but not part of the RCPB. Each line that is connected to the reactor coolant pressure boundary, and instrument lines as discussed in FSAR Section 6.2.4.2.4 is provided with containment isolation valves in accordance with 10 CFR 50, Appendix A, General Design Criterion 55, with the exception of the RHR hot leg suction lines as described below.
- g) Each line that connects directly to the containment atmosphere and penetrates Containment, with the exception of the residual heat removal and containment spray recirculation sump lines as discussed below and instrument lines as discussed in FSAR Section 6.2.4.2.4, is provided with containment isolation valves in accordance with 10 CFR 50, Appendix A, General Design Criterion 56.
- h) Each line that forms a closed system inside Containment, with the exception of the containment pressure sensing lines as described below, is provided with containment isolation valves in accordance with 10 CFR 50, Appendix A, General Design Criterion 57.
- i) Emergency power from the diesel generators is provided to ensure system operation in the event of a loss of offsite power.
- j) All air/spring-actuated valves are designed to fail to their required position to perform their safety function upon loss of the instrument air supply and/or electrical power.
- k) The containment isolation system design is such that the containment design leakage rate is not exceeded during a design basis accident.
- l) The Containment Isolation System is designed to remain functional during and following the safe shutdown earthquake.
- m) Closure times for containment isolation valves are established on the basis to minimize the release of containment atmosphere to the environment, to mitigate the offsite radiological consequences, and to assure that emergency core cooling system effectiveness is not degraded by a reduction in the containment back-pressure.
- n) Relief valves which are located between containment isolation valves are designed to meet the requirements for containment isolation valves.
- o) The steam generator shell and lines connected to the secondary side of the steam generator are considered to be an extension of the Containment and therefore, need no containment isolation valves located inside the Containment.

- p) The welding and qualification requirements for all welds associated with the spare penetration sleeve assemblies listed in Table 6.2.4-1 are in accordance with the appropriate requirements of Section III of the ASME B & PV Code. Provisions are made for leak testing the weld between the closure plate/cap and the embedded wall sleeve. The design requirements for spare penetration sleeves including their closure plates/caps listed in FSAR Table 6.2.4-1 are further described in Sections 3.8.2.2 through 3.8.2.7 inclusive, for Type II penetrations.
- q) The containment setpoint pressure that initiates containment isolation for nonessential penetrations must be reduced to the minimum compatible with normal operating conditions. A conservative value of 3.0 psig was established based on inputs to the Shearon Harris containment accident analysis. This value was selected to optimize: a) ability of safety injection systems to maintain containment within maximum allowable pressure and b) provide sufficient response time for instruments.

The pressure setpoint is above the maximum expected pressure inside containment during normal operation so that inadvertent containment isolation will not occur during normal operation as a result of instrument drift, pressure fluctuations and instrument errors.

The containment isolation setpoint pressure is established along with the plant Technical Specifications because of its association with other parameters. The basis for this setpoint has been established.

6.2.4.2 System Design

The Containment Isolation System, in general, closes fluid penetrations that support those systems not required for emergency operation. Fluid penetrations supporting Engineered Safety Features (ESF) Systems have remote manual isolation valves which may be closed from the Control Room, if necessary. Automatic isolation valves close upon receipt of an isolation signal from a sensor. All power operated isolation valves have position indication in the Control Room.

Design information regarding the containment isolation provisions for fluid system lines and fluid instrument lines penetrating the Containment is presented in Table 6.2.4-1.

6.2.4.2.1 Codes and standards

The portions of the Containment Isolation System which are a part of the reactor coolant pressure boundary are designed and constructed in accordance with Quality Group A recommendations of Regulatory Guide 1.26. The remainder of the Containment Isolation System is designed and constructed in accordance with Quality Group B recommendations of Regulatory Guide 1.26.

The Containment Isolation System is designed in accordance with Seismic Category I requirements as discussed in Section 3.2.1.

6.2.4.2.2 System integrity

All containment isolation valves are located inside either the Containment, the Reactor Auxiliary Building, or the Fuel Handling Building. These structures are of Seismic Category I design and

are protected against damage from missiles. The reinforced concrete containment provides a major mechanical barrier for protection against missiles which may be generated external to the Containment. Protection against damage from missiles is provided for the penetrations and associated piping, tubing, and isolation valves, actuators, and controls. Refer to Section 3.5 for a discussion of missile protection. Section 3.6 contains a discussion of protection provided against dynamic effects of pipe-whip, while Section 3.7 contains a discussion of the seismic design analysis performed on containment penetration piping.

Screens are provided on the open-ended containment atmosphere purge exhaust system lines inside Containment to minimize the debris entering the lines and, in turn, entering the purge isolation valves.

6.2.4.2.3 Valve Operability

Each containment isolation valve is designed to ensure its performance under all anticipated environmental conditions including maximum differential pressure, seismic occurrences, steam-laden atmosphere, high temperature, and high humidity. Section 3.11 presents a discussion of the environmental conditions, both normal and accident, for which the Containment Isolation System is designed.

Dynamic analysis procedures, used in the design of Seismic Category I mechanical equipment, are discussed in Section 3.9.1. The analytic and empirical methods used for design of valves are discussed in Section 3.9.3. A discussion of the vibration operational test program to verify that the piping and piping restraints have been designed to withstand dynamic effects for valve closures is included in Section 3.9.2. A discussion of the inservice testing program for valves to assure their operability is included in Section 3.9.6.

The valve types utilized for containment isolation service are designs which provide rapid closure and near zero leakage. Therefore, essentially no leakage is anticipated through the containment isolation valves when in closed position. Verification that actual leakage rates from the Containment are within design limits is provided by periodic leakage rate testing in accordance with 10 CFR 50, Appendix J as described in Section 6.2.6.

Plant conditions and loads which the valves are expected to withstand are delineated in Sections 3.10 and 3.11, and will be described in the Equipment Qualification Report.

6.2.4.2.4 Isolation Barriers

As stated in Section 6.2.4.1, the design of isolation valving for lines penetrating the Containment follows the intent of GDC 54 through 57, and Westinghouse Systems Standard Design Criteria Number 1.14, Rev. 2. Isolation valving for instrument lines which penetrate the Containment follows the guidance of Regulatory Guide 1.11. Those cases where literal interpretation of GDC 54 through 57 have not been followed are included in the following discussions.

6.2.4.2.4.1 General Design Criterion 54

All piping penetrations meet the intent of GDC 55, 56, or 57. In doing so, they also conform to the intent of GDC 54 to the extent that all piping systems penetrating the Containment are provided with containment isolation capabilities which reflect the importance to safety isolating

these piping systems. In addition, Table 6.2.4-1 lists each piping penetration to be tested periodically in accordance with 10 CFR 50, Appendix J.

In some penetrations, sealed closed barriers are used. Sealed closed barriers include blind flanges and locked closed isolation valves, which may be closed manual valves, closed remote-manual valves, and closed automatic valves which remain closed after a loss-of-coolant accident. Locked closed isolation valves are under administrative control to assure that they cannot be inadvertently opened.

6.2.4.2.4.2 General Design Criterion 55

Lines which are connected to the reactor coolant pressure boundary are shown in Table 6.2.4-1. Each penetration is provided with one of the following valve arrangements conforming to the requirements of 10 CFR 50, Appendix A, General Design Criterion 55, as follows:

- a) One locked-closed-isolation valve inside and one locked-closed-isolation valve outside Containment; or
- b) One automatic-isolation valve inside and one locked-closed-isolation valve outside Containment; or
- c) One locked-closed-isolation valve inside and one automatic-isolation valve outside Containment; a simple check valve is not used as the automatic isolation valve outside Containment; or
- d) One automatic-isolation valve inside and one automatic-isolation valve outside Containment; a simple check valve is not used as the automatic isolation valve outside Containment.

Isolation valves are located as close to the Containment as practical and, upon loss of actuating power, solenoid and air-operated automatic-isolation valves fail closed.

An exception of GDC 55 is taken for the RHR suction lines. The lines from the RCS hot legs to the RHR pump suction each contain two remote manual (motor operated) valves, which are locked closed during normal plant power operation and are under administrative control to assure that they cannot be inadvertently opened, in accordance with SRP Section 6.2.4 Item II.f. The valves are interlocked such that they cannot be opened when the RCS pressure is greater than the design pressure of the RHR system. This valve arrangement is provided in accordance with Westinghouse Systems Standard Design Criteria, Number 1.14, Revision 2 and Appendix B of ANSI Standard N271-1976.

An exception to Criterion 55 is taken for several isolation valves in lines which penetrate Containment and are required to perform safeguards functions following an accident. Lines which fall into this category include the RHR and safety injection lines, and RCP seal injection lines. Since these valves must remain open or be opened, a trip signal cannot be used. Instead, each of these motor operated valves is capable of remote manual operation. Upon completion of the safeguards function of the line, the operator can close the isolation valve from the Control Room. Leak detection capabilities for these lines is discussed in Section 5.2.5.

An exception to GDC 55 is taken for the Reactor Vessel Level Instrumentation System (RVLIS) sensing lines. The six sensing lines penetrate the containment and are required to remain

functional following a LOCA or steam break. These lines sense reactor vessel level and reactor coolant pressure, and are connected to pressure and level transmitters outside Containment. Although the RVLIS instrumentation does not prevent or mitigate the consequences of an accident, it provides an important post-accident function of providing indication of reactor vessel level and approach to inadequate core cooling. In view of this function, it is essential that the lines remain open and not be isolated following an accident. Based on this requirement, sealed sensing lines as described below are used:

Each of the two sets of three sensing lines has a separate penetration, with pressure and level transmitters located immediately outside the containment wall in Seismic Category I instrument racks.

The transmitters are connected to a sealed bellows located inside Containment by means of a hydraulic isolator and a sealed fluid filled tube. This arrangement provides a double barrier (one inside and one outside) between the Containment and the outside atmosphere should a leak occur outside Containment. The sealed bellows inside Containment, which is designed to withstand full reactor coolant design pressure, will prevent the escape of reactor coolant. Should a leak occur inside Containment, the diaphragm in the hydraulic isolator, which is designed to withstand full reactor coolant design pressure, will prevent any escape from Containment. This arrangement provides automatic double barrier isolation without operator action and without sacrificing any reliability with respect to its function (i.e., no valves to be inadvertently closed or to close spuriously). Both the bellows and tubing inside Containment and the transmitters and hydraulic isolators outside Containment are protected against missiles and pipe whip.

Because of this sealed fluid filled system, a postulated severance of the line during either normal operation or accident conditions will not result in any release from Containment.

If the fluid in the tubing is heated during the accident, the flexible bellows will allow for expansion of the fluid without overpressurizing the system. Temperature sensors have been placed in critical vertical sensing line runs to compensate for temperature induced effects on system accuracy.

The RVLIS instrument lines are capillaries, not pipes, and as such are not subject to ASME code requirements. They are the same as Westinghouse has historically supplied for this application. The Westinghouse qualification groups follow the ANS definitions. The capillaries are made of Type 304 stainless steel and are procured to ASME SA-213. Although these capillaries do not fit ASME Safety Class 2 definition, they are seismically designed, and thus, it is appropriate to designate them as safety related.

6.2.4.2.4.3 General Design Criterion 56

The lines that penetrate the Containment and communicate directly with both the atmosphere inside and outside of the Containment are of two types. The first type communicates directly with the atmospheres inside and outside of Containment, i.e., the atmosphere purge line. The second type encompasses those penetrations for non-nuclear safety class lines penetrating the Containment, i.e., service air, fire protection, etc.

As stated in GDC 56, two isolation valves, one inside and one outside Containment, are required in lines which penetrate the Containment and connect directly to the containment

atmosphere. However, GDC 56 allows for alternatives to these explicit isolation requirements where the acceptable basis for each alternative is defined. The following are alternatives to explicit conformance with GDC 56.

An exception is taken to Criterion 56 for the lines from the containment recirculation sumps to the suctions of the residual heat removal (RHR) pumps and containment spray pumps. Each line is provided with motor operated gate valves. These valves are enclosed in valve chambers that are leaktight at containment design pressure. Each line from the containment sump to the valve is enclosed in a separate concentric guard pipe which is also leaktight. A seal is provided so that neither the chamber nor the guard pipe is connected directly to the containment sump or to the containment atmosphere. This design arrangement is provided in accordance with Westinghouse Systems Standard Design Criteria Number 1.14, Revision 2 and Appendix B of ANSI Standard N271-1976.

The vacuum relief lines to the Containment are essential for containment integrity. Isolation is provided through a power-to-open, spring-to-close butterfly valve and a check valve inside Containment. Power from divisional electrical buses is applied to the butterfly valves at all times to keep the valves closed, except when air is required to relieve a vacuum inside the Containment.

The four containment vacuum relief sensing lines associated with the containment vacuum relief lines and the containment purge sensing lines associated with normal containment pressure control utilize an alternative arrangement to those described in GDC-56. These lines, although they do not prevent or mitigate the consequences of an accident, provide important functions. The vacuum relief sensing lines support the function of providing vacuum relief in the event of an inadvertent containment spray actuation while the purge sensing lines support the function of maintaining the containment pressure within design limits during normal operation. Commensurate with this function the sensing lines meet Quality Group B standards. The piping, tubing, isolation valves, actuators, and controls associated with these lines are Seismic Category I, Class 2, as applicable, and are protected against missiles and pipe whip. The lines are open to the containment atmosphere and their containment isolation arrangement is detailed on FSAR Table 6.2.4-1. A locked open manual shut-off valve in series with a manual reset type excess flow check valve is provided outside the Containment. The excess flow check valve closes on excess flow. Open/Closed Status indication is provided in the control room for the excess flow check valve. The lines utilize a Type II mechanical penetration.

The Class 1E differential pressure transmitters include an isolation diaphragm which is qualified to assure post-accident operability and structural integrity. The transmitters are designated safety class 2 components as defined in ANS-51.8/ANSI N18.2a-75 and ANSI 18.2-73. The transmitters, sensing lines, and isolation valves associated with containment vacuum relief sensing are designated seismic Category 1 and are protected from missiles and pipe break effects.

When relief valves are provided in fluid system penetrations as overpressure protection devices, the relief set point is greater than 1.5 times the containment design pressure. Because of the orientation required, each of these relief valves are isolation valves for the applicable penetration. The piping and valve designs are Quality Group B, Seismic Category I, and will withstand temperatures and pressures at least equal to the containment design pressure and temperature. Should the postulated loss-of-coolant accident occur, containment pressure would

be felt on the downstream side of a relief valve inside the Containment and would act in conjunction with the spring pressure setting of the relief valve to further enhance seating.

6.2.4.2.4.4 General Design Criterion 57

Closed systems used as an isolation barrier, inside the Containment, meet the following requirements:

1. The systems are protected against postulated missiles and pipe-whip.
2. The systems are designed to Seismic Category I.
3. The systems meet Safety Class 2 standards and are inservice inspected as described in Section 6.6.
4. The systems are designed to at least the maximum temperature and pressure of the Containment.
5. The systems will be leak tested in accordance with Section 6.6.

In addition, closed systems inside Containment meet the following requirements:

1. They are designed to withstand external pressure from the Containment structural integrity test.
2. They are designed to withstand the design basis accident and accompanying environment.
3. They do not communicate with either the Reactor Coolant System or the containment atmosphere.

The steam generator shell, and all connected lines are designed as Seismic Category I, Quality Group B, and are missile protected. This design allows these components to be considered as an extension of the Containment. Isolation valves are provided outside Containment on all lines emanating from the steam generator. These valves are either normally closed or close automatically to effect steam generator isolation, except for steam supply lines to auxiliary feed pump turbine and safety valve lines which may operate intermittently. During a LOCA, the secondary side of the steam generator will be pressurized to a greater pressure than the containment atmosphere by the Auxiliary Feedwater System. This pressure within the steam generator constitutes an additional barrier to the release of the containment atmosphere.

All feedwater lines including all associated branch lines are provided with positive isolation valves (gate or globe type valves) which are either automatically or remote-manually operated, and located outside the containment as close as possible to the containment. This design complies with GDC 57 criteria for containment isolation provisions. Further details are shown on Table 6.2.4-1 and Figure 10.1.0-3.

There are four instrument lines which penetrate the Containment and are required to remain functional following a LOCA or steam break. These lines sense the pressure of containment atmosphere and are connected to pressure transmitters outside Containment. Signals from

these transmitters can initiate safety injection and containment isolation on high containment pressure, HI-1. They also, upon HI-3 containment pressure, produce the signal to initiate containment spray. In view of this function, it is essential that the line remain open and not be isolated following an accident. Based on this requirement, a sealed sensing line as described below is used.

Each of the four channels has a separate penetration and each pressure transmitter is located immediately outside the containment wall. The transmitter is connected to a sealed bellows located immediately adjacent to the inside containment wall by means of a sealed fluid filled tube. This arrangement provides a double barrier (one inside and one outside) between the Containment and the outside atmosphere. Should a leak occur outside Containment, the sealed bellows inside Containment, which is designed to withstand full containment design pressure, will prevent the escape of containment atmosphere. Should a leak occur inside Containment, the diaphragm in the transmitter, which is designed to withstand full containment design pressure, will prevent any escape from Containment. This arrangement provides automatic double barrier isolation without operator action and without sacrificing any reliability with regard to its safeguards functions (i.e. no valves to be inadvertently closed or to close spuriously). Both the bellows and tubing inside Containment and the transmitter and tubing outside Containment are enclosed by protective shielding. This shielding (box, channel or guard pipe, etc.) prevents mechanical damage to the components from missiles, water jets, dropped tools, etc.

Because of this sealed fluid filled system, a postulated severance of the line during either normal operation or accident conditions will not result in any release from the Containment.

If the fluid in the tubing is heated during the accident, the flexible bellows will allow for expansion of the fluid without overpressurizing the system and without significant detriment to the accuracy of the transmitter.

The RHR, Containment Spray, and Safety Injection are closed loop systems, outside Containment. The systems are designed to Seismic Category I standards, classified as Quality Group B and C, and will maintain their integrity should the Containment experience its design temperature and pressure transient.

All portions of the CSS which are subject to containment pressure meet the requirements of SRP Section 6.2.4 and ANSI-N271 to qualify as a closed system. Due to the use of eductors, the NaOH suction flow is drawn into the recirculation piping of the CSS pump and thus this portion of the system does not provide a leakage path for release of containment atmosphere. The NaOH system has been designed to Safety Class 3 criteria and is capable of withstanding a design basis earthquake. In addition, the entire CSS is subject to inservice inspection.

The containment pressure instrument lines are capillaries, not pipes, and as such are not subject to ASME Code requirements. They are the same as Westinghouse has historically supplied for this application. The Westinghouse qualification groups follow the ANS definitions. The capillaries are made of SA-316 stainless steel and are procured to ASTM A-269. Although these capillaries do not fit the ASME Safety Class 2 definition, they are seismically designed, and thus it is appropriate to designate them as safety-related.

Provisions to detect possible leakage from these systems include instruments to measure flow rate, containment sump water level, temperature, pressure, and radiation level. The systems will be periodically leak tested as described in Section 6.6.

6.2.4.2.5 Valve Closure Times

The containment isolation valve closure times have been selected to assure rapid isolation of the Containment following postulated accidents. A closure time of 3.5 seconds has been established for the normal containment purge make-up and exhaust lines which provide an open path from the Containment to the environment. The Pre-Entry Purge make-up and exhaust lines have a closure time of 15 seconds but are normally locked closed per NUREG-0737. Isolation valve closing times are verified during the functional performance tests prior to reactor startup. Upon receipt of the actuating signals, automatic valves will close within the times indicated in Table 6.2.4-1.

The historical basis evaluation of radiological consequences of a LOCA during purge for compliance with Branch Technical Position CSB 6-4 were evaluated and are reported in Section 6.2.4.2.7.

6.2.4.2.6 Valve redundancy and actuation

The Containment Isolation System is automatically actuated by signals developed by the Engineered Safety Features Actuation System, described in Section 7.3. The sequence of events and diversity in the parameters sensed which culminates in the initiation of containment isolation is discussed fully in Section 6.2.1 and 7.3.

Redundancy and physical separation are provided in the electrical and mechanical design to ensure that no single failure in the Containment Isolation System prevents the system from performing its intended functions.

Where a penetration is part of a redundant train in an ESF system, isolation valves for that train may receive power from a single electrical division. This is desirable so that a single failure of an electrical division cannot disable both trains of the ESF system. In these cases, a redundant mechanical barrier (that is closed systems beyond the isolation valves) exists so that containment isolation is not lost as a result of a single electrical failure.

Emergency power is supplied from the diesel generators in the event of loss of offsite power as discussed in Section 8.3.1. When an automatic phase A containment isolation signal is actuated, the standby diesels are started concurrently as described in Section 7.3. The power train assignment for each isolation valve is shown on Table 6.2.4-1. Diesel generator 1 supplies power to Train A and diesel generator 2 supplies power to Train B.

Automatic actuation causes required containment isolation valves to function. In addition, containment isolation valves equipped with power operators may be controlled individually by positioning hand switches in the Control Room. Also, in the case of certain valves with actuators, a manual override is installed to permit manual control of the associated valve. The override control function can be performed as described in Section 7.3. Containment isolation valves with power operators are provided with open/closed indication which is displayed in the Control Room. The valve mechanism also provides a local, mechanical indication of valve

position. Air/spring operated isolation valves are driven to the closed position on loss of actuating power by a self-contained spring actuator.

6.2.4.2.7 Evaluation of containment purge system design

Based on guidance given in Branch Technical Position CSB 6-4, the following historical basis analysis was performed to justify the containment purge system design:

1. An analysis of the radiological consequences of a loss-of-coolant accident. The analysis was performed using the following assumptions and parameters:
 - a. The Containment was assumed to be filled with a steam at a fission product concentration of 60 $\mu\text{Ci/gm}$ of I-131 equivalent.
 - b. The temperature and pressure inside the Containment were given in Figures 6.2.1-1 and 6.2.1-2 for the most severe hot leg break.
 - c. Steam was released unfiltered through the normal containment purge and purge makeup 8 in. lines prior to isolation of the Containment.
 - d. The purge line isolation valves were assumed to remain fully open for 2 sec. following a containment isolation signal (CIS) and were to be fully closed with 5.5 sec. following a CIS.
 - e. The steam was assumed to be discharged by adiabatic flow through an abrupt inlet with a frictional resistance of 0.5 velocity heads. Conservatively, all other frictional losses were neglected. The amount of steam released to the environment was calculated by the method described on Pages 380 and 381 of chemical Engineers' Handbook, J. H. Perry, Editor, Third Edition, McGraw-Hill Book Company, Inc., 1950. The amount of steam released was calculated to be 98 lbs. Using the atmospheric dilution factors in Table 2.3.4-5 and the dose calculation method described in Appendix 15.0A of the original version of the HNP FSAR, this release was calculated to result in offsite inhalation thyroid doses of 0.85 rem at the exclusion area boundary and 0.2 rem at the boundary of the low population zone.

The eight (8) inch butterfly valves used for continuous purge were evaluated against the operability criteria set forth in BTP CSB 6-4. This was a one-time only evaluation showing overall acceptability of the containment purge system design, and has therefore not been repeated or updated for changes to dose analysis methods.

When analytical methods are used in fulfillment of the provisions of the component operability assurance program, they will meet the requirements of NUREG-0737.

6.2.4.3 Design Evaluation

The purpose of the Containment Isolation System is to provide a minimum of one protective barrier between the Containment and the environment. To fulfill its role as a barrier, the Containment is designed to remain intact before, during, and subsequent to any failure involving fluid systems, either inside or outside the Containment. Where fluid lines penetrate the Containment, the penetration has the same integrity as the containment structure itself. In

addition, the fluid line isolation valves perform the containment isolation function for leakage through the fluid lines.

Since a rupture of a large line connected to the Reactor Coolant System may be postulated, isolation valves for lines of this type are required to be located within the Containment. These isolation valves are required to close automatically on various indications of reactor coolant loss or high energy line break. Additional reliability is added when a second valve, located outside and as close as practical to the Containment, is included. This second valve also closes automatically. A single active failure can be accommodated since a second valve is available to perform the containment isolation function. By physically separating the two valves, there is little likelihood that a failure of one valve would cause failure of the second. Series valves of this type are provided with independent power sources.

6.2.4.4 Tests and Inspections

Components of the Containment Isolation System are tested for correct functional performance during the preoperational test program described in Section 14.2.

A capability is provided to operate the isolation valves in order to verify continued availability in accordance with the requirements of the inservice test program described in Section 3.9.6 and the Technical Specifications. The capability and test procedures used to verify that the leaktightness of containment isolation valves is in accordance with 10 CFR 50, Appendix J, as described in Sections 6.2.6 and the Technical Specifications. Provisions are made to allow ASME Code Class 2 and 3 inservice inspection per ASME B&PV Code Section XI as described in Section 6.6.

6.2.5 COMBUSTIBLE GAS CONTROL IN CONTAINMENT *

Following a beyond design-basis accident, hydrogen gas may be generated inside Containment by reactions such as Zirconium metal with water, corrosion of materials of construction, and radiolysis of aqueous solution in the core and containment sump. This subsection describes the systems that are provided in accordance with General Design Criteria 41 to control the buildup of hydrogen within the Containment.

Three mechanisms for monitoring and controlling hydrogen inside the Containment are considered in the SHNPP design:

1. Containment hydrogen purge.
2. Containment hydrogen mixing and,
3. Containment hydrogen monitoring.

The design basis for each of these mechanisms is described in the following subsections.

*Further information is contained in the TMI Appendix.

6.2.5.1 Design Bases

6.2.5.1.1 Deleted By Amendment 62

6.2.5.1.2 Containment Hydrogen purge system

The following design bases apply to the containment hydrogen purge system.

1. The system up to the first isolation valve outside Containment is Safety Class 2, Seismic Category I, designed to retain its integrity and operability under all conditions following a design basis loss-of-coolant accident. The remainder of the system is non-safety-related.
2. The system is designed to exhaust the air and hydrogen from the Containment and replace it with air from the outside.
3. Functional and operational redundancy of the system is not provided. The system may be used to control hydrogen inside Containment following a beyond design-basis accident.
4. Since the control power is disconnected by a remotely operated key locked switch, the air-operated containment hydrogen purge isolation valve inside containment is "sealed closed" during normal plant operation. The keylock switch will restore the power and allow the remote manual opening of the valve from the main control room. Valve status and keylock switch position indication is provided in the main control room. The outside containment isolation valves are normally locked closed and are manually operated locally.
5. All materials and equipment required by this system inside Containment are compatible with the environmental conditions anticipated during normal operation and accident conditions and are suitable for a lifetime consistent with that of the plant.

6.2.5.1.3 Hydrogen monitoring system

The following design bases apply to the hydrogen monitoring system.

1. The Hydrogen Analyzer is non-safety-related but qualified using the methodology of IEEE-323-1974. It is designed to be functional, reliable, and capable of continuously measuring the concentration of hydrogen in the containment atmosphere following a significant beyond design-basis accident for combustible gas control and accident management, including emergency planning. The Hydrogen Analyzer is powered through associated circuits from a 1E source.
2. The hydrogen analyzer system's lines between and including the containment isolation valves for the sample feed header and sample return line are ASME Section III, Class 2, Seismic Cat I and are designed to retain their integrity and operability under all conditions following a design basis accident. Portions downstream of both the inboard and outboard containment isolation valves, beyond the safety-related boundary, up to and including the next analyzed point meet the requirements of RG 1.29 C.3 (Quality Class A-12)

3. All materials and equipment required by this system are selected to be compatible with the environmental conditions anticipated during accident operation and are suitable for a lifetime consistent with that of the plant.
4. The system samples containment air, providing the means to measure the containment air hydrogen concentration and to alert the operator in the event that a high hydrogen concentration is detected, in accordance with the requirements of Regulatory Guide 1.7.
5. Containment isolation valves for the A Train hydrogen analyzer are normally open and fail closed on loss of electrical power. The containment isolation valves for the B Train analyzer are normally shut. They will fail shut on a loss of electrical power when open. Means are provided to reopen valves, when required, after power is restored. In the event of a containment isolation signal, valves 2SP-V301 SA-1 and 2SP-V349SA-1 close and isolate containment penetration 73B. Valves 2SP-V300 SA-1 and 2SP-V348 SA-1 close to isolate penetration 73A. On power failure, all valves fail closed, insuring isolation.

The hydrogen analyzer cabinet, tag number AT-1SP-7438A, is qualified for beyond design-basis accident operation. The sample line coming from and going to penetrations 73A and 73B respectively, contain only train A associated valves. Likewise, containment penetrations 86A and 86B use only train B associated valves on the hydrogen analyzer sample lines.

As a result, if one train fails then the redundancy for hydrogen sampling is still provided. If the associated valves fail to close when they should close, safety is not compromised since the hydrogen analyzer is qualified for beyond design-basis accident operation.

6. The Hydrogen Analyzer System consists of two identical units which are completely independent of each other and are powered from independent onsite sources to assure process capability is available to monitor the hydrogen concentration in the Containment. See Table 6.2.5-7 which provides a failure modes and effects analysis.
7. The system is designed for remote-manual sampling capability with an intermittent cycle of Hydrogen indication for six (6) different sample points. The Hydrogen Analyzer will have a continuous sampling and indicating capability for a single sample point. The sample point locations are as follows:
 - a. Dome
 - b. Reactor Coolant Pump and Steam Generator 1A
 - c. Reactor Coolant Pump and Steam Generator 1B
 - d. Reactor Coolant Pump and Steam Generator 1C
 - e. Pressurizer
 - f. Area Below Flux Mapping Room Floor

These points are located on various elevations providing a broad coverage of the Containment for monitoring of Hydrogen Concentration in a beyond design-basis accident.

8. Remote control, readout, alarm, and recording will be from the Main Control Room. An alarm will be activated for the Hydrogen Analyzer malfunction, loss of power, and high H₂ Concentration.
9. The H₂ Analyzers will be capable of measuring in the 0-10 percent H₂ range by volume, with an accuracy of ± 2.0 percent of full scale and a sensitivity of 0.1 percent H₂ by volume.
10. Provisions will be made for Containment air grab sample via Remote Sample Dilution Panel to be diluted, cooled, and transported to the laboratory for analyses.

The Remote Sample Dilution Panel was designed in accordance with the criteria stated in Regulatory Guide 1.97 Rev. 3 and NUREG-0737, Section II.B.3 to meet the following requirements:

- a) To provide, with sufficient rapidity, a sample of containment atmosphere, so that analysis can be completed within 3 hours from the time of decision to take a sample, without requiring the use of an isolated auxiliary system.
- b) To obtain samples suitable for analysis for hydrogen, and for gamma spectrum analysis for noble gases and iodines.
- c) To obtain, and permit analysis of, a sample without a dose to any person exceeding the criteria of GDC-19 of Appendix A to 10 CFR 50 (i.e., 5 rem whole body, 75 rem extremities) assuming a fission product release per Regulatory Guide 1.4, Rev. 2.
- d) To provide samples such that background radiation will be low enough to permit sample analysis with an error of approximately a factor of two.
- e) To be capable of providing at least one sample per day for seven days and at least one sample per week for the duration of the accident condition.
- f) To give design consideration:
 - 1) provisions for purging, reducing plateout, and preventing blockage in sample lines.
 - 2) samples that are representative of the containment atmosphere following a transient or accident.
 - 3) minimizing the volume of gas taken from containment and returning residues to containment.
 - 4) providing ventilation exhaust from the panel filtered with charcoal and HEPA filters.
- g) The RSDP is classified in Regulatory Guide 1.97 Rev. 3 as Category 3 which specifies "high quality commercial grade" construction "selected to withstand the specific service environment." This equipment is, therefore, classified as Non-Nuclear Safety and is

non-seismic Category I. The valves isolating this system from the Containment Hydrogen Analyzer System are Class 1E and operated from a Class 1E power source.

11. Capability will be provided for obtaining samples under both positive and negative containment pressure condition.
12. Proper shielding and other provisions will be incorporated into the design to assure that personnel exposure does not exceed the limits of GDC 19, and that the required radiological analysis can be performed on the containment air sample.
13. A hydrogen monitoring system capable of diagnosing beyond design-basis accidents is installed at Harris Nuclear PLant (HNP). HNP committed to maintain a containment spray hydrogen monitoring system as part of the justification for the removal of the requirements for these monitors from the Technical Specifications, which was approved in License Amendment No. 131. HNP's containment hydrogen monitoring system will comply with the Category 3 criteria of Regulatory Guide 1.97, as categorized by the Commission and published in the Model Safety Evaluation for TSTF-447, Revision 1 (Federal Register 55418).

6.2.5.1.4 Containment hydrogen mixing

The following design basis applies to mechanisms or systems for mixing of hydrogen bearing gases inside the reactor containment.

1. Local hydrogen concentrations inside the reactor containment shall be maintained at less than 4 percent by volume.
2. The Containment Cooling System which provides heat removal and active mixing of containment air meets the redundancy, environmental, seismic, and quality requirements described in Section 6.2.2.1.

6.2.5.2 System Design

6.2.5.2.1 Deleted By Amendment 62

6.2.5.2.2 Containment hydrogen purge system

The Containment Hydrogen Purge System is provided as a means of purging the hydrogen from the Containment.

The system consists of a purge make-up penetration line, an exhaust penetration line and a filtered exhaust system; it is shown on Figure 6.2.2-3. Design data for principal system components are presented in Table 6.2.5-2.

The filtered exhaust system includes in the direction of air flow, a demister, electrical heating coil, a medium efficiency filter, HEPA pre-filter, a charcoal adsorber, a HEPA after-filter, a motorized isolation valve and a centrifugal fan.

The filtered system draws 100 cfm from the Containment, mixes with 400 cfm dilution air from Reactor Auxiliary Building and discharges to the vent stack. A motorized isolation valve, and a check valve are provided in the dilution air line from the Reactor Auxiliary Building.

The hydrogen purge filtered exhaust unit is located in the Reactor Auxiliary Building and the hydrogen purge intake point is located inside the containment building. The intake is fastened to the inside of the Containment and routed through its containment penetration.

The system is actuated by opening the inboard containment isolation valve in the exhaust line by a remote keylock manual action from the Control Room, manually opening the locked closed outboard containment isolation valves in both the exhaust and make-up lines and then starting the exhaust fan. The operator would make the decision to use the purge system based on readings from the containment hydrogen analyzers and the containment pressure indicators.

The inboard isolation valve is a normally closed remote keylock manually air operated valve which is defined as a sealed closed barrier per SRP Section 6.2.4 Item II.3.f. Administrative control is provided on the outboard containment isolation valve in the form of a locked closed manual valve. Both of these valves will be used only post-beyond design-basis accidents.

The only portions of the system which would be exposed to the post LOCA or a beyond design-basis accident environment in the Containment are the system isolation valves and associated piping. The isolation valves and associated piping are safety-related and seismically supported.

The following items will be locked closed and will be verified that they are closed at least every 31 days as required by NUREG-0737, Item II.E.4.2:

- a) The local air supply isolation valves to the 42-inch pre-entry purge and makeup valves 2CP-B4SB-1 and 2CP-B8SB-1 (outside containment).
- b) The manual remote keylock switches for the 42-inch pre-entry purge and makeup valves 2CP-B3SA-1 and 2CP-B7SA-1 (inside containment).
- c) The manual operated hydrogen purge exhaust and makeup valves 2CM-B4SA-1 and 2CM-B6SA-1 (outside containment).
- d) The manual remote keylock switch for the hydrogen purge air operated exhaust valve 2CM-B5SA-1 (inside containment).

6.2.5.2.3 Containment Hydrogen Monitoring System

The Hydrogen Monitoring System consists of containment sampling valve manifolds, containment isolation valves, Hydrogen Analyzers, remote control panel, sample dilution panel, and sample return line. The hydrogen monitor system will be placed in service upon direction by the plant Emergency Operating Procedures (EOPs) following a beyond design-basis accident upon diagnosis of inadequate core cooling and prior to venting noncondensibles from the reactor vessel head. When placed in service, the system will provide continuous indication and recording of containment hydrogen concentration. Samples will be taken from six (6) various Containment locations to monitor H₂ concentration or provide a sample for laboratory analysis. The hydrogen analyzer system's lines between and including the containment isolation valves for the sample feed header and sample return line are ASME Section III, Class

2, Seismic Cat 1 and are designed to retain their integrity and operability under all conditions following a design basis accident. Portions downstream of both the inboard and outboard containment isolation valves, beyond the safety-related boundary, up to and including the next analyzed point meet the requirements of RG 1.29 C.3 (Quality Class A-12). The sample point is selected from the Main Control Room on the Remote Control Panel automatic sequencing and manually available by opening the appropriate valve. The system has provisions for purging and for returning the residue of the sample to the containment. The H₂ concentration is then measured by an in line Analyzer with the result displayed on the local panel. Hydrogen concentration is recorded and displayed on the remote control panel located within the main control room envelope. The sampling is repeated at specified intervals for each location to establish a trend in hydrogen generation and subsequent control. A high hydrogen concentration (3 volume percent) at any sample point will activate an alarm in the Main Control Room. A recorder will be provided to record the H₂ concentration at each sample point. A remote sample dilution panel is provided to cool and dilute the sample as required to obtain a containment air sample for laboratory analyses. The sample dilution panel is connected to one of the hydrogen analyzers.

The sample for analysis is collected via syringe and a sample septum. The sample will then be immediately injected into a preevacuated vial for transport to the laboratory. Because the sample is diluted, shielding for transporting to the laboratory and for analysis is minimized, as is exposure to personnel collecting the sample.

Equipment specifically designated for hydrogen and radioisotopic analysis of radioactive samples in the laboratory will be provided.

The Post-Accident Hydrogen Monitoring System is schematically shown on Figure 6.2.5 7.

6.2.5.2.4 Containment hydrogen mixing

As described in Section 6.2.5.3.3, thorough mixing of hydrogen generated by metal-water reactions, radiolysis and corrosion of metals in the Containment does not rely on any active systems. Mass diffusion of hydrogen from the source of generation within the Containment Building is sufficient to ensure thorough and uniform mixing of hydrogen to ensure that local concentrations do not exceed four volume percent.

The internal structures of the Containment were designed to provide vertical compartments around each of the steam generators and the reactor vessel, which project upward from the basemat. Following beyond design-basis accidents, the lower portions of the Containment will be flooded. The surface of the water is assumed to be the main source of Hydrogen Gas. The use of grating in applicable areas promotes the circulation of air.

The design of the containment is such that there are no rooms where hydrogen could accumulate in concentrations in excess of four volume percent. During the accident mitigation period mass diffusion is sufficient for thorough and uniform mixing; however, the Safety Class 2, Seismic Category I Containment Cooling System, described in Section 6.2.2, provides heat removal and active containment air mixing. Natural circulation when coupled with the active mixing provided by the containment fan coolers and the containment sprays assure proper uniform mixing of hydrogen with steam and air inside the containment throughout the beyond design-basis accident. Therefore, these local concentrations will never exceed the bulk containment concentration, which remains well below the four percent limit.

6.2.5.4 Test and Inspections

6.2.5.4.1 Deleted By Amendment 62

6.2.5.4.2 Hydrogen Purge System

All safety-related equipment is qualified by the vendor to meet the codes and standards required by the system classification. Functional testing is performed after installation, but prior to plant startup to verify the system performance capability. Preoperational tests are described in Section 14.2.12.1.68. Periodic testing of the system components will be performed in accordance with manufacturer's recommendations.

6.2.5.4.3 Hydrogen Monitoring System

All equipment for this system is vendor qualified to meet the codes and standards required by the system classification. Functional and preoperational testing is performed after installation and prior to plant startup to verify the system performance capability. Preoperational tests are described in Section 14.2.12.1.68.

6.2.5.5 Instrumentation Requirements

6.2.5.5.1 Deleted By Amendment 62

6.2.5.5.2 Hydrogen Purge System

All instrumentation and controls for this system are located outside of the Containment in the Reactor Auxiliary Building or in the Control Room. Control switches and status indication for the fans, isolation valves, and control valves are provided in the Control Room.

6.2.5.6 Deleted By Amendment 62

6.2.6 CONTAINMENT LEAKAGE TESTING

The Containment and containment penetrations are designed to permit periodic leakage rate testing in accordance with General Design Criteria (GDC) 52 and 53 and Appendix J to 10 CFR 50.

Testing requirements for piping penetration isolation barriers and valves have been established by using the intent of GDC 54, as interpreted in Appendix J to 10 CFR 50. Exceptions taken to Appendix J for Type A, B, or C tests are described and justified in Subsections 6.2.6.1, 6.2.6.2, and 6.2.6.3, respectively.

6.2.6.1 Containment Integrated Leakage Rate Test (Type A Test)

The design leakage rate for the Containment is 0.1 weight percent per day. The actual leakage rate is tested and verified using the methods and requirements of Appendix J to 10 CFR 50 for Type A tests.

In accordance with Appendix J, a margin for possible deterioration of the Containment integrity during the service intervals between integrated leakage rate test (ILRT) is provided. The

measured leak rate (L_{am} at peak test pressure) shall not exceed 0.75 of the maximum allowable value.

The structural integrity test (SIT) is conducted during the same test program as the preoperational peak pressure integrated leakage rate test. The SIT is conducted in conformance with the descriptions contained in Section 3.8.1 and with the exceptions taken to Regulatory Guide 1.18 as specified in Section 1.8. After the SIT peak pressure requirements and the containment stabilization at required pressurization are completed, the initial peak calculated pressure (P_a) ILRT and SIT depressurization phase of the test are conducted. This sequence of testing is chosen to satisfy paragraph II.F of Appendix J to 10 CFR 50, which specifies that the initial ILRT shall be conducted after the Containment is completed and is ready for operation.

Subsequent peak calculated pressure tests are conducted as specified in Section 6.2.6.4.

Reduced pressure ILRT's (as described in paragraphs III.A.4 and III.A.5 of Appendix J to 10 CFR 50) are not performed during pre-operational testing or during periodic ILRT's. Industry experience has shown that extrapolation factors used to correlate the reduced and full pressure tests are not reliable and may be erroneous in some cases.

6.2.6.1.1 Pretest requirements

The performance of Local Leak Rate Tests (LLRT) is not a prerequisite to the ILRT. If a Containment Boundary (isolation valve, airlock seal, etc.) is repaired prior to the ILRT and during the same outage as the ILRT, then the difference between the measured local leak rates before and after the repair are used to adjust the subsequent ILRT measured Type A Leakage Rate to determine the "As-Found" Leakage Rate. The calculated difference is based upon minimum pathway leakage for the affected containment barriers. Minimum pathway leakage is the smaller leakage rate of in-series barriers tested individually, one-half the leakage rate of in-series barriers tested simultaneously by pressurizing between them, and the combined leakage rate for barriers tested in parallel.

The primary prerequisite for conducting an ILRT is a general inspection of the accessible interior and exterior surfaces of the containment structures and components to uncover any evidence of structural deterioration which may affect either the structural integrity or leaktightness of the Containment. If there is evidence of structural deterioration, Type A tests shall not be performed until corrective action is taken in accordance with repair procedures, nondestructive examinations, and tests as specified in the applicable code specified in 10 CFR 50.55a.

6.2.6.1.2 Valve positioning for the ILRT

The containment isolation valves are positioned to their post-accident position by the normal method with no accompanying adjustments. Normal, LOCA, and ILRT positions for each isolation valve are shown on Table 6.2.4-1.

6.2.6.1.3 System preparation for Type A tests

Systems are properly isolated, drained, or vented to reflect their worst potential status following a LOCA to assure that the Type A test results accurately reflect the most restricting LOCA conditions. Systems required to maintain the Unit in a cold shutdown condition are operable in

their normal mode and are not vented or drained. However, any of these system penetrations that require Type C local leakage tests as defined in Section 6.2.4 have the results of the local leakage tests added to the result of the Type A test. Per ANSI/ANS-56.8-1994, Systems that are not vented or drained during the Type A test which could become exposed to the containment atmosphere during a LDBA shall be Type C tested and the Type C test leakage rate for the penetration path shall be added to UCL. The leakage shall be based on minimum pathway leakage and shall include instrumentation system error. Systems used during the Type A test for sensing the leakage are not lined up in the post-accident positions. Any leakage from the isolation valves in these systems is determined by local methods and the results are added to the Type A test. Systems that operate in post-accident conditions filled with fluid as defined in Section 6.2.4 need not be vented or drained for the Type A test. Systems which form closed Seismic Category I systems inside Containment (as defined by GDC 57) are not vented to the containment atmosphere.

Leakage testing of instrumentation lines that penetrate Containment is done in conjunction with the Type A test. These lines will be open to the containment atmosphere. Liner plate weld leak chase channels will not be vented during the Type A test.

All systems which are provided with isolation capabilities to satisfy GDC 55 or 56 are either normally open to the containment atmosphere or are vented to the containment atmosphere during the Type A tests, except those systems required to maintain the unit in a cold shutdown condition and those penetrations that are water sealed. Table 6.2.4-1 contains the applicable GDC or other defined criteria for the isolation valve arrangements provided.

The electrical penetration pressurization system, supplied by dry pressurized nitrogen, serves to exclude moisture-laden air from each containment electrical penetration. During the Type A test, the nitrogen pressure in each electrical penetration will be locked in by shutting each penetration's nitrogen supply valve. Nitrogen supply to the penetration pressurization system will be isolated and the system headers vented to the outside atmosphere.

During a type A test, the steam generator secondary side is to be vented outside the containment atmosphere. The systems connected to the secondary side of the steam generator are identified in Table 6.2.4-1.

The service water lines to the emergency containment air coolers are neither vented or drained, as these lines are designed to GDC 57. The coolers may be required to cool the containment atmosphere during the Type A test.

Pressurized gas and water systems are isolated downstream of the outside isolation valve for the system and vented outside of the Containment. This is done to preclude inleakage into the Containment and to expose the outside isolation valve to an atmospheric back pressure to obtain accurate leakage characteristics.

The reactor coolant drain tank, pressurizer relief tank, and the accumulator tanks are vented to the containment atmosphere. This is done to protect the tanks from the external pressure of the test and to preclude leakage to or from the tanks to help assure the accuracy of the test results.

The following systems are considered closed systems inside containment that need not be vented and drained for a Type A test:

- a) Main Feedwater System
- b) Auxiliary Feedwater System
- c) Steam Generator Blowdown System
- d) Safety-Related Portion of SW. System to and from emergency fan coolers AH 1 through AH-4
- e) Portion of component Cooling Water System (to and from Reactor Coolant Drain Tank HX and Excess Letdown HX)
- f) Portion of the Steam Generator Sampling System Inside Containment Out to the Containment Isolation Valve

The system design meets the following requirements of SRP 6.2.4.II.0 for a closed system inside containment:

- a) The system does not communicate with either the reactor coolant system or the containment atmosphere.
- b) The system is protected against missiles and pipe whip.
- c) The system is designated seismic category I.
- d) The system is classified Safety Class 2.
- e) The system is designed to withstand temperature at least equal to the containment design temperature.
- f) The system is designed to withstand the external pressure from the containment structural acceptance test,
- g) The system is designed to withstand the loss-of-coolant-accident transient and environment.

6.2.6.1.4 ILRT test method

The air used to pressurize the Containment is conditioned for temperature and water vapor to prevent moisture condensation in the Containment at the test pressure. The air used to pressurize the Containment is essentially oil-free to prevent coating of the containment wall with oil or interfering with the test instrumentation.

Sensing devices are located at different locations in the Containment to measure average temperature and humidity. Location of the temperature and humidity sensors are made with consideration to their respective patterns in the Containment. These patterns are employed in determination of the mean representative temperature and humidity for the absolute method of leakage rate testing. These data are periodically monitored during the test and analyzed as they are taken so that the leakage rate and its statistical significance is known as the test progresses.

The leakage rate test period extends to 24 hours of sustained internal pressure. If it is demonstrated to the satisfaction of the NRC that the leakage rate can be accurately determined during a shorter test period, the agreed upon shorter period may be used.

At the conclusion of the leakage rate test, the accuracy of the Type A test is verified by either of the supplemental test methods described in ANSI/ANS 56.8-1994, Appendix C. The supplemental test bleeds from the Containment an accurately measured amount of air. The supplemental test method selected is conducted for a sufficient duration to establish accurately the change in leakage rate between Type A test and the supplemental test. The difference between the supplemental test data and the Type A test data shall agree within 0.25 L_a.

Except as noted below, the following aspects of Type A testing follow 10 CFR 50, Appendix J guidelines are adhered to:

- a) Pretest requirements including a general inspection
- b) Conduct of tests
- c) Acceptance criterion
- d) Periodic retest schedule
- e) Inspection and reporting of test

Corrective actions and test frequencies for Type A tests will be determined as specified in Technical Specifications.

6.2.6.2 Containment Penetration Leakage Rate Tests (Type B Tests)

Each of the following containment penetrations are tested with a Type B test.

- a) Personnel air locks
- b) Emergency air locks
- c) Equipment hatch
- d) Fuel transfer tube
- e) Residual heat and containment spray valve chambers
- f) Electrical penetrations
- g) Refueling access sleeve (M-66)
- h) Refueling access sleeve (M-102)

All other mechanical penetrations do not incorporate any expansion joints or resilient seals. They consist of sleeve embedded in the containment wall and welded to the liner with the process pipe passing through the sleeve and sealed by welding to the sleeve as described in

3.8.1. These penetrations are tested by a Type C test performed on the isolation valves as described in Section 6.2.6.3.

The test pressure for Type B tests is the calculated peak pressure for the containment, P_a . The combined leakage rate for all Type B and C tests will be less than $0.6 L_a$ (maximum allowable leakage rate). The individual leakage rate testing performed and the acceptance criteria on the personnel air lock and the emergency air lock is as described in Technical Specifications.

The test equipment utilized to perform the Type B tests is the same equipment used for Type C tests. The test equipment is described in Section 6.2.6.3. The test procedure is the same as the one used for Type C tests.

Type B tests are performed in accordance with Appendix J to 10 CFR 50, with the following addition and exception:

- a) An additional test method may be used. This method measures the air flow rate to maintain the test volume at a constant pressure.
- b) Air locks subject to Type B testing, in accordance with Section III.B.1, as required by Section III.D.2, may use the method for testable seals described in Section III.D.2(b)(iii) to fulfill the Type B test requirement, subject to all time interval restrictions contained therein.
- c) Periodic leakage testing of containment penetrations (except air locks) need not be done during a refueling outage, but may be scheduled at any time during an operating cycle. However, the test interval for any penetration shall not exceed 2 years.

6.2.6.3 Containment Isolation Valve Leakage Rate Tests (Type C Tests)

Table 6.2.4-1 lists all valves which are associated with the penetrating piping systems. Table 6.2.4-1 also indicates for all valves listed which are considered to be containment isolation valves and which of the containment isolation valves are to be subjected to Type C test.

The valves associated with Penetrations 15 and 16 are not Type C leak tested. The lines passing through Penetrations 15 and 16 terminate at the suction to the RHR pumps. At this elevation (RHR pump suction), the Refueling Water Storage Tank (RWST) provides a water seal during the Engineered Safety Features (ESF) injection phase and the containment sumps provide a water seal during the ESF recirculation phase. A single active failure of any valve or pump in the RHR system will not affect the existence of this water seal. The RHR system is a closed system outside containment in accordance with FSAR Section 6.2.4.2.4.4.

The valves associated with Penetrations 47, 48, 49, and 50 are not Type C leak tested. The lines passing through Penetrations 47, 48 (residual heat removal (RHR)/low pressure safety injection (LPSI) recirculation) 49, and 50 (containment spray recirculation) are connected to the containment sump. During and after a LOCA, the sump will provide a water seal to the associated isolation valves. A single active failure of any component will not affect the existence of this water seal nor will activation of the recirculation modes in either system. The RWST also provides a water seal to the piping system outside containment for each of these penetrations during the ESF injection phase. This seal is applied directly to the containment

isolation valve on Penetrations 49 and 50. It is applied to the valves immediately downstream of the containment isolation valve on Penetrations 47 and 48.

The containment isolation valves for the high head safety injection lines (Penetrations 17, 20, 21, and 22), the low head safety injection penetrations (13, 14, and 18), and the RCP seal injection penetrations (9, 10, and 11) are not Type C leak tested. These penetrations are provided with a pressurized water seal at a pressure greater than 1.10 Pa for a minimum of 30 days following an accident. This water seal is provided by the ECCS LHSI pumps via the piping to these penetrations and with the post-accident lineup specified in FSAR Section 6.3.1. The water supply to these penetrations is virtually unlimited because the LHSI pumps are supplied initially from the RWST and then from the containment recirculation sumps after transfer to the recirculation mode. No single active failure can prevent penetration pressurization via this pressurized water seal.

The containment isolation valves on the LHSI and HHSI injection lines are gate valves with a single piece wedge. Upon closure and pressurization, the wedge seals the downstream seat (toward containment). The upstream seat is not seated and this allows the packing and body/bonnet gasket to be pressurized above 1.10 Pa. Thus, the containment atmosphere does not enter the valves nor is it released to the outside environment through the packing or gasket.

Service Water to and from the fan coolers is a closed ASME Class 2 system inside containment in accordance with FSAR paragraph 6.2.4.2.4.4. No single active failure of any component could provide a potential leakage path for post-LOCA containment atmosphere. This system is described in FSAR Section 9.2.1. General Design Criterion 57 is applicable to this system as discussed in FSAR Section 6.2.4.

The containment pressure transmitters are designed to meet the requirements of Regulatory Guide 1.11 and are described in Section 7.3. These lines have no isolation valves and rely on closed systems both inside and outside of the Containment to preclude the release of the containment atmosphere. The integrity of these closed systems is verified during the periodic Type A tests. These lines penetrate the Containment at penetrations 69, 70, 71, and 72.

The Containment Isolation Valves on the Component Cooling Water lines which provide cooling water to the Reactor Coolant Drain Tank and CVCS Excess Letdown Heat Exchangers via penetrations M-37 and M-38 are not leak tested. The components inside Containment provide a closed system designed in accordance with General Design Criteria 57. Two simultaneous passive failures of Class 2, or better, systems is not considered a credible event. A LOCA is a passive failure of the Reactor Coolant System, and therefore, it is not credible to assume a simultaneous passive failure of the CCW closed system. Therefore, the closed system inside Containment is sufficient to insure that the containment atmosphere is not released to the environment following an accident.

As noted in Subsection 6.2.4.2.4.4, all portions of the secondary side of the steam generators are considered an extension of the Containment. These systems penetrate the containment shell at penetrations numbered 1 through 6, 51 through 56, and 108 through 110. These systems provide a closed system designed in accordance with General Design Criteria 57. They are not leak tested because the closed system inside Containment is sufficient to insure that the containment atmosphere is not released to the environment following an accident.

The test, vent and drain (TVD) connections that are used to facilitate local leak testing are under administrative control, and subject to periodic surveillance, to assure their integrity and verify the effectiveness of administrative controls. These procedures meet the requirements of SRP Section 6.2.6 Item II.

The test equipment to be used during the Type C tests consists of a connection to an air supply source, pressure regulator, pressure gauge, flow indicator, and associated valving or equivalent test setup.

Isolation valves are positioned to their post-accident position by the normal method with no accompanying adjustments. Fluid systems are properly drained and vented with the valves aligned to provide a test volume and atmospheric air back pressure on the isolation valve(s) being tested.

The test volume is pressurized to the test pressure P_a . The pressure regulator(s) maintain the test volume at a minimum of the calculated peak pressure for the containment, P_a . The air flow rate into the test volume is recorded, as is the pressure reading, at the intervals specified on the data form. These records are utilized to determine the leakage rate in cubic centimeters per minute.

For larger test volumes, a pressure decay method may be utilized to determine the leakage rate.

The total leakage rate for Type B and C tests will be less than $0.6 L_a$. The individual testing performed on valves requiring a Type C test is described in Technical Specifications.

In accordance with 10 CFR 50 Appendix J III.C.1, valves may be tested in the non-accident pressure direction when it can be determined that the results from the tests for the pressure applied in the non-accident direction will provide equivalent or more conservative results. The packing leakage for any valve tested in the non-accident direction shall be included in the reported leak rate for that valve if the packing provides a leakage path from the containment atmosphere to the outside environment (i.e., packing is part of containment isolation boundary).

The criteria for determining the direction in which the test pressure is applied to the isolation valves is as follows:

- a) Check, ball, plug, and non-wedge disc gate valves are tested in the accident pressure direction.
- b) Wedge disc gate, butterfly, and diaphragm valves are tested in either direction since seat leakage is the same in either direction.
- c) Globe valves may be tested in the non-accident pressure direction if the test pressure would tend to unseat the valve and the accident pressure would tend to seat the valve.

6.2.6.4 Scheduling and Reporting of Periodic Tests

Types A, B, and C tests will be conducted at the intervals specified in Technical Specifications. These intervals are in accordance with Appendix J to 10 CFR 50, with the exception of the testing of the air locks as described in Section 6.2.6.2.

Periodic leak testing of the containment isolation valves need not be done during a refueling outage but may be scheduled at any time during an operating cycle. However, the test interval for any valve shall not exceed two years.

The test results will be the subject of a summary report filed on site approximately three months after each Type A test.

The preoperational test report will contain a schematic of the leak measuring system, instrumentation used, supplemental test method, test program, and analysis and interpretation of the leakage test data for the Type A test.

REFERENCES: SECTION 6.2

- 6.2.1-1 Waterford Steam Electric Station Unit 3 PSAR, Docket 5382, letter LPL 2656.
- 6.2.1-2 Whent, L. L., et.al, CONTEMPT-LT-A Computer Code for Predicting Containment Pressure-Temperature Response to a Loss-of-Coolant Accident, Acrojet Nuclear Company, ANCR-1219, June, 1975
- 6.2.1-3 Shepard, R. M., Massie, H. W., Mark R. H. and Docherty, P. J., "Westinghouse Mass and Energy Release Data for Containment Design," WCAP 8264 P A (Proprietary) and WCAP 8312 A (Non-Proprietary), Revision 2, August, 1975.
- 6.2.1-4 RELAP-4/Mode 6 - A Computer Program for Transient Thermal-Hydraulic Analysis of Nuclear Reactors and Related Systems - Users Manual, EG&G Idaho, Inc., CDAP TR003, January, 1978.
- 6.2.1-5 Crane Technical Paper No. 410 - Flow of Fluids Through Valves, Fittings and Pipe, 1978.
- 6.2.1-6 Idel Chik, I.E. Handbook of Hydraulic Resistance and of Friction, Translation, Israel Program for Scientific Translations, Jerusalem, 1966 AEC-TR-6630.
- 6.2.1-7 Westinghouse ECCS Evaluation Model, February 1978 Version WCAP-9220, February 1978
- 6.2.1-8 F. M. Bordelon, et al., SATAN-VI Program: Comprehensive Space Time Dependent Analysis of Loss-of-Coolant, WCAP-6174, June 1974.
- 6.2.1-9 G. Collier, et al, Calculation Model for Core Reflooding After a Loss-of-coolant accident (WREFLOOD Code), WCAP-8170, June 1974.
- 6.2.1-10 WCAP -10325-P-A, (Proprietary), WCAP-10326-A (Nonproprietary), "Westinghouse LOCA Mass & Energy Release Model for Containment Design-March 1979 Version," May 1983.
- 6.2.1-11 Deleted By Amendment No. 51
- 6.2.1-12 "Dynamic Analysis of RPV for Postulated Loss-of-coolant accidents," WCAP-9192.

- 6.2.1-13 Shapiro, A.H., "The Dynamics and Thermodynamics of Compressible Fluid Flow, Volume 1, p. 85.
- 6.2.1-14 1967 ASME Steam Tables, p. 301.
- 6.2.1-15 NRC Docket 50-400, Letter from George W. Knighton of NRC to Mr. E. E. Utley of CP&L, "Request for Exemption from a Portion of General Design Criteria 4 of Appendix A to 10 CFR 50 Regarding the Need to Analyze Large Primary Loop Pipe Ruptures as Structural Design Basis for Shearon Harris Nuclear Power Plant, Unit 1", June 5, 1985.
- 6.2.1-16 Deleted By Amendment No. 51
- 6.2.1-17 Land, R.E., "Mass and Energy Releases Following a Steam Line Rupture," WCAP-8822 (Proprietary) and WCAP-8860 (Nonproprietary), September 1976; Osborne, M.P. and Love, D.S., "Supplement 1 - Calculations of Steam Superheat in Mass/Energy Releases Following a Steam Line Rupture," WCAP-8822-S1-P-A (Proprietary) and WCAP-8860-S1-A (Non-proprietary), September 1986; Butler, J.C. and Linn, P.A., "Supplement 2 - Impact of Steam Superheat in Mass/Energy Releases Following a Steam Line Rupture for Dry and Subatmospheric Containment Designs," WCAP-8822-S2-P-A (Proprietary) and WCAP-8860-S2-A (Nonproprietary), September 1986.
- 6.2.1-18 NUREG-1038, "Safety Evaluation Report Related to the Operation of Shearon Harris Nuclear Plant, Units 1 and 2," Section 6.2.1.3, November 1983.
- 6.2.1-19 Docket No. 50-315, "Amendment No. 126, Facility Operating License No. DPR-58 (TAC No. 7106), for D.C. Cook Nuclear Plant Unit 1," June 9, 1989
- 6.2.1-20 EPRI 294-2, "Mixing of Emergency Core Cooling Water with Steam; 1/3-Scale Test and Summary," (WCAP-8423), Final Report, June 1975.
- 6.2.1-21 ANSI/ANS-5.1 1979, "American National Standard for Decay Heat Power in Light Water Reactors," August 1979.
- 6.2.1-22 Westinghouse letter, CQL-01-130, dated November 21, 2001, "Double Ended Pump Suction LOCA with Revised Maximum ECCS Recirculation Flow.
- 6.2.1-23 "GOTHIC Thermal Hydraulic Package," Version 8.2 (QA), Electric Power Research Institute, October 2016.
- 6.2.2-1 Spray Nozzle Performance Test Results - SPRACO Model 1713A Nozzle, by Spray Engineering Company, dated January 1, 1973.

APPENDIX 6.2A

GOTHIC COMPUTER CODE

The containment pressure and temperature transient analyses are performed with the GOTHIC computer code.

In this computer code, the containment volume is divided into two regions, the atmosphere region (water vapor and air mixture) and the sump region (liquid water). Each region is assumed to be completely mixed and in thermal equilibrium. The temperature of each region may be different. Mass and energy additions are made to the appropriate region to simulate the mass and energy release from the Reactor Coolant System or Secondary System during and after blowdown with the contribution of the Safety Injection System (SIS) and Containment Spray System (CSS) water, and decay energy from the core. Account is taken of boiling in the liquid region and condensing in the vapor region, and mass and energy transfers between regions are considered.

The model represents the heat conducting and absorbing materials in the Containment by dividing them into segments with appropriate heat transfer coefficients and heat capacities. Thermal behavior is described by the one-dimensional, multi-region, transient heat conduction equation. The heat conducting segments are used to describe materials and surfaces in the Containment which act as heat sinks. The model mechanistically simulates cooling of the containment atmosphere by fan coolers and/or by water sprays, and cooling of the containment sump water being recirculated to the SIS by the RHR heat exchangers. The GOTHIC computer code has been qualified for the design of the containment liner and concrete structure by simulated design basis accident tests such as the Carolinas Virginia Tube Reactor (CVTR) (see References 6.2A-1 through 6.2A-3) blowdown experiment.

Calculations are begun by computing initial steady state containment atmosphere conditions. Subsequent calculations are performed at incremental time steps. Following the pipe rupture, the mass and energy addition to the atmosphere or liquid region is determined for each time interval. Heat losses or gains due to heat-conducting segments are calculated. Then the mass and energy balance equations are solved to determine containment pressure, temperature of the liquid and vapor region, and heat and mass transfer between regions.

The Direct heat transfer option with the DLM (Diffusion Later Model) condensation option is used for all containment passive heat sinks except the sump floor. With the Direct option, all condensate goes directly to the liquid pool at the bottom of the volume. The effects of the condensate film on the heat and mass transfer are incorporated in the formulation of the DLM option. Under the DLM option, the condensation rate is calculated using a heat and mass transfer analogy to account for the presence of noncondensing gases. It compares well with Nusselt's theory for the condensation of pure steam where the rate is controlled by the heat transfer through the condensate film. The DLM option generally under predicts the condensation rate.

REFERENCES: APPENDIX 6.2A

- 6.2A 1 Norberg, J. A., Bingham, G. E., Schmitt, R. C., Waddoups, D. A., Simulated Design Basis Accident Tests of the Carolinas Virginia Tube Reactor Containment Preliminary Results, Idaho Nuclear Corporation, IN 1325, October, 1969.

- 6.2A 2 Schmitt, R. C., Bingham, G. E., Norberg, J. A., Simulated Design Basis Accident Tests of the Carolinas Virginia Tube Reactor Containment Final Report, Idaho Nuclear Corporation, IN-1403, December, 1970.
- 6.2A 3 Krotiuk, W. J., Rubin, M. B., "Condensing Heat Transfer Following a LOCA", Nuclear Technology, February, 1978.
- 6.2A 4 through 6.2A 12 deleted by Amendment No. 63.

6.3 EMERGENCY CORE COOLING SYSTEM

6.3.1 DESIGN BASES

The Emergency Core Cooling System (ECCS) is designed to cool the reactor core and provide shutdown capability following initiation of the following accident conditions:

- a) Loss-of-coolant accident (LOCA) including a pipe break or a spurious relief or safety valve opening in the Reactor Coolant System (RCS) which would result in a discharge larger than that which could be made up by the normal makeup system.
- b) Rupture of a control rod drive mechanism causing a rod cluster control assembly ejection accident.
- c) Steam or feedwater system break accident including a pipe break or a spurious power operated relief or safety valve opening in the secondary steam system which would result in an uncontrolled steam release or a loss of feedwater.
- d) A steam generator tube failure.

The primary function of the ECCS is to remove the stored and fission product decay heat from the reactor core during accident conditions.

The ECCS provides shutdown capability for the accidents above by means of boron injection. The system is designed to tolerate a single active failure (injection phase), or a single active or passive failure (recirculation phase). Table 6.3.1-1 provides a failure modes and effects analysis which demonstrates the capability of the ECCS to perform following a single active failure. This analysis also shows that single failures occurring during ECCS operation do not compromise the ability to prevent or mitigate accidents. The capabilities are accomplished by a combination of suitable redundancy, instrumentation for indication and/or alarm of abnormal conditions, and relief valves to protect piping and components against malfunctions. The ECCS can meet its minimum required performance level with onsite or offsite electrical power.

The ECCS consists of the centrifugal charging pumps, residual heat removal pumps, accumulators, a boron injection tank, residual heat removal heat exchangers, a refueling water storage tank, along with associated piping, valves, instrumentation and other related equipment.

See Section 1.3.1 for comparison of the SHNPP ECCS with similar facility designs.

The design bases for selecting the functional requirements of the ECCS are derived from data which is consistent with 10CFR50 Appendix K limits following any of the above accidents as

delineated in 10CFR50.46. The subsystem functional parameters are integrated such that the Appendix K requirements are met over the range of anticipated accidents and single failure assumptions.

Redundant components are provided where the loss of one component would impair reliability. Valves are provided in series where isolation is desired and in parallel when redundant flow paths are to be established for ECCS performance. Redundant sources of the ECCS actuation signal are available so that the proper and timely operation of the ECCS will not be inhibited. Sufficient instrumentation is available so that a failure of an instrument will not impair readiness of the system. The active components of the ECCS are powered from separate buses which are energized from offsite power supplies. In addition, redundant sources of auxiliary onsite power are available through the use of the standby diesel generators to assure adequate power for all ECCS requirements. Each diesel generator is capable of driving all pumps, valves and necessary instruments associated with one train of the ECCS.

Spurious movement of a motor operated valve due to the actuation of its positioning device coincident with a loss-of-coolant has been analyzed and found not to be credible for consideration in design.

Since there are two valves in each RHR sump line, the opening of one of them would have no impact. There is not a credible failure that would open both valves at once.

In compliance with BTP ICSB-18(PSB), power is locked out of the ECCS valves noted below. Further information regarding this BTP and its application to other manually operated valves may be found in Section 8.3.1.2.38. Information regarding valve monitoring may be found in Sections 6.3.5.5 and 7.5.1.10.

<u>Valve</u>	<u>Position During Normal Operation</u>
8808 A, B, and C	Open
8886	Closed
8885	Closed
8884	Closed
8889	Closed
8888 A and B	Open

To prevent their spurious operation in the event of certain postulated fires, power is normally removed from Charging Pump Suction and Discharge Header Crossover valves 8130 A/B, 8131 A/B, 8132 A/B and 8133 A/B. Power to these manually-controlled, electrically-operated valves has been interrupted by locking the valve motor operator supply breaker in the OFF position at Motor Control Centers 1A35-SA and 1B35-SB. The intent is that the operator must restore power to the valves to enable closure as required, thus preventing spurious operation.

These valves are provided with diverse valve position monitoring capability in the control room. A 125 VDC powered valve position limit switch provides out-of-position annunciation on ALB-3 for each valve. In addition, a separate valve position limit switch provides a white monitor light for each valve that indicates when the valve is not open. For a description of these monitor lights, refer to Section 7.5.1.10.3.

Inadvertent opening of motor operated valving to the containment spray pumps could not allow the draining of the RWST into the containment because whenever a signal is generated, either automatically or manually, to open the sump valves a close signal is simultaneously sent to

Valves 2CT-V2SA and 2CT-V3SB (see FSAR Figure 6.2.2-1) which isolate the RWST. Also, Class 1E level monitors in the sump provide level indication and alarm in the Control Room such that the postulated event would be known to the operators at an early stage.

The spurious opening of the containment sump motor operated valving to the containment spray pumps is not considered possible due to the design of the control system servicing the operators. The valves in question, 2CT-V6SA and 2CT-V7SB are automatically opened on a two out of four "low-low" signal in the RWST provided that the Containment Spray pumps are running. Remote manual opening of the sump valves from the Control Room is possible at any time regardless of whether the CS pumps are running or not, but the operator must refer to sump level indication beforehand.

For these valves to open, power must be applied to the MCC output relays servicing the motor operators. There is no way for this to occur other than by the normal means. It is not possible for a loss of power to the logic cabinets associated with the RWST level detectors to cause a false two out of four signal to be generated to open the valves because the output bistables and output relays must be energized to operate.

All the equipment associated with the RWST and Containment Spray System is designed to safety grade standards as described in Chapters 3 and 6 of the FSAR to assure maximum reliability.

The elevated temperature of the sump solution during recirculation is well within the design temperature of all ECCS components. In addition, consideration has been given to the potential for corrosion of various types of metals exposed to the fluid conditions prevalent immediately after the accident or during long-term recirculation operations.

ECCS equipment, which is located inside the Containment and which is required to operate following a LOCA, is environmentally qualified as discussed in Section 3.11.

To prevent hot leg injection during the ECCS cold leg injection phase as well as SI initiation following Safeguards Actuation, power lockout in accordance with Branch Technical Position ICSB-18 will ensure that motor-operated hot leg recirculation isolation valves 8886 and 8884 are, or will remain, in the correct position, which is closed; and will not be subject to inadvertent operator mispositioning. Further information regarding compliance with BTP ICSB-18 may be found in Section 8.3.1.2.38. Additionally, these valves have monitor panel position indication and alarms should they be mispositioned during normal operation. The monitor panel position indication is in addition to the normal red-green position indication, and is provided via stem mounted limit switches which are independent of the normal limit torque position switches.

There are no instruments, valves, or valve motors required for ECCS/RHR operation which will be flooded following a postulated LOCA. The following instruments, which have been provided for operator information only (per Regulatory Guide 1.97), will be below flood level and have been designed for submerged conditions.

TE-7133ASA	
TE-7133BSB	Containment sump water temperature
LE-7160ASA	
LE-7160BSB	Containment sump water level

The RHR pumps and the safety injection system piping provide a pressurized water seal to containment penetrations M-9, M-10, M-11, M-13, M-14, M-17, M-18, M-20, M-21, and M-22 for a minimum period of 30 days following a design basis accident. This seal is maintained following any single active failure. This water seal ensures that the containment atmosphere cannot leak to the environment following a design basis accident (see Section 6.2.6). The requirement to maintain this seal imposes the following restrictions on valve positions during the specified period.

- a) The charging pump suction header crossover valves must remain open during a post-accident injection and recirculation modes. An additional benefit of these valves being open is that a failure of an RHR pump in the recirculation modes will not result in loss of a charging pump because one RHR pump can provide sufficient flow and NPSH for two charging pumps.
- b) At least one of the boron injection tank inlet isolation valves must remain open during the post-accident injection and recirculation modes.
- c) The RHR system crossover valves at the connection to the line supplying flow to the RCS hot legs for hot leg recirculation must remain open during the post-accident injection and recirculation modes.
- d) A motor-operated Containment Isolation Valve on one of the low head flow paths to the RCS cold legs must be closed during the post-accident cold leg recirculation mode to prevent RHR pump runout should a single active failure of an RHR pump occur.

6.3.2 SYSTEM DESIGN

The ECCS is designed to tolerate a single active failure (injection phase) or a single active or passive failure (recirculation phase). The redundant onsite standby diesel generators assure adequate emergency power to at least one train of electrically operated components in the event that a loss of offsite power occurs simultaneously with a LOCA.

6.3.2.1 Schematic Piping and Instrumentation Diagrams

Flow diagrams of the ECCS are shown in Figures 6.3.2-1 through 6.3.2-3. Pertinent design and operating parameters for the components of the ECCS are given in Table 6.3.2-1. The codes and standards to which the individual components of the ECCS are designed are listed in Table 3.2.1-1.

The component interlocks used in different modes of system operation are listed below:

- a) The safety injection signal, "S", is interlocked with the following components and initiates the indicated action:
 - 1) Centrifugal charging pumps start on "S" signal.
 - 2) Refueling water storage tank suction valves to charging pumps open on "S" signal.
 - 3) Boron injection tank discharge parallel isolation valves open on "S" signal.

- 4) Normal charging path valves close on "S" signal.
- 5) Normal charging pump miniflow valves close on "S" signal.
- 6) Alternate miniflow path valves open/close on "S" signal coincident with RCS pressure.
- 7) Residual heat removal pumps start on "S" signal.
- 8) Any closed accumulator isolation valves open on "S" signal.
- 9) Volume control tank outlet isolation valves close on "S" signal.
- b) Switchover from injection mode to recirculation involves the following interlocks:
 - 1) The suction valves from the containment sump open when two out of four low level transmitters indicate a low-low level in the RWST in conjunction with an "S" signal.
 - 2) The charging pump suction (recirculation line) isolation valve from the RHR pump discharge line cannot be opened unless one of the RHR suction isolation valves from the RCS hot legs is closed.
 - 3) The recirculation flow paths from the RHR pumps discharge to the charging pump suction is interlocked such that the isolation valves in these lines cannot be opened unless the alternate miniflow paths are isolated.

6.3.2.2 Equipment and Component Descriptions

The component design and operating conditions are specified as the most severe conditions to which each respective component is exposed during either normal plant operation or during operation of the ECCS. For each component, these conditions are considered in relation to the code to which it is designed. By designing the components in accordance with applicable codes, and with due consideration for the design and operating conditions, the fundamental assurance of structural integrity of the ECCS components is maintained. Components of the ECCS are designed to withstand the appropriate seismic loadings in accordance with their safety class as given in Table 3.2.1-1.

The discussion of each major mechanical component of the ECCS follows below:

6.3.2.2.1 Accumulators

The accumulators are pressure vessels partially filled with borated water and pressurized with nitrogen gas. During normal operation each accumulator is isolated from the RCS by two check valves in series. Should the reactor coolant system pressure fall below the accumulator pressure, the check valves open and borated water is forced into the RCS. One accumulator is attached to each of the cold legs of the RCS. Mechanical operation of the swing disc check valves is the only action required to open the injection path from the accumulators to the core via the cold leg.

Connections are provided for remotely adjusting the level and boron concentration of the borated water in each accumulator during normal plant operation as required. Accumulator

water level may be adjusted either by draining to the refueling water storage tank or by pumping borated water from the refueling water storage tank to the accumulator. Samples of the solution in the accumulators are taken periodically for checks of boron concentration.

Accumulator pressure is provided by a supply of nitrogen gas, and can be adjusted as required during normal plant operation; however, the accumulators are normally isolated from this nitrogen supply. Gas relief valves on the accumulators protect them from pressures in excess of design pressure.

The accumulators are located within the Containment, but outside of the secondary shield wall which protects them from missiles.

Accumulator gas pressure is monitored by indicators and alarms. The operator can take action as required to maintain plant operation within the requirements of the Technical Specification covering accumulator operability.

6.3.2.2.2 Boron Injection Tank

The boron injection tank is connected to the discharge of the centrifugal charging pumps. Upon actuation of the safety injection signal, the charging pumps deliver boric acid solution from the refueling water storage tank into the RCS by way of the boron injection tank.

In the original design of the ECCS, the boron injection tank contained a high concentration boric acid solution (12% wt.). This highly concentrated boric acid solution was determined to be unnecessary and has been eliminated. The boron injection tank has been left in place but it serves no function other than being part of the safety injection flow path.

In the steam line break accident analysis (Section 15.1.5) the system was analyzed assuming the BIT boron concentration was 0 ppmB. This assumption provides the most limiting case for this analysis; however, the BIT may contain a boron concentration within the range of 0 - 2600 ppmB.

6.3.2.2.3 Deleted by Amendment No. 27

6.3.2.2.4 Residual heat removal pumps

In the event of a LOCA the residual heat removal pumps are started automatically on receipt of an "S" signal. The residual heat removal pumps take suction from the refueling water storage tank during the injection phase and from the containment sump during the recirculation phase. Each residual heat removal pump is a single stage vertical position centrifugal pump.

A minimum flow bypass line is provided for the pumps to recirculate and return the pump discharge fluid to the pump suction should these pumps be started with the reactor coolant system pressure above their shutoff head. Once flow satisfies an established setpoint, the bypass line is automatically closed. This line prevents deadheading of the pumps and permits pump testing during normal operation.

The safety intent of Regulatory Guide 1.1 is met by the design of the ECCS such that adequate net positive suction head is provided to system pumps. The most limiting condition with respect to net positive suction head exists when the residual heat removal pumps are switched to the

recirculation mode of operation. In addition to considering the static head and suction line pressure drop, the calculation of available net positive suction head in the recirculation mode assumes that the vapor pressure of the liquid in the sump is equal to the containment ambient pressure. This ensures that the actual available net positive suction head is always greater than the calculated net positive suction head. Available and required net positive suction head for the residual heat removal pumps is indicated on Table 6.3.2-1.

ECCS pump specifications include a specified maximum required NPSH which the pump is required to meet. Pump vendors have verified that the required NPSH for the Shearon Harris pumps is less than the maximum required NPSH through testing in accordance with the criteria established by the Hydraulic Institute Standards.

Ample experience with the same vendors and similar ECCS pumps has shown the variability in their NPSH requirements to be minimal. Pumps are deemed acceptable based on their vendor certified NPSH requirements being less than the maximum allowable specified by the ECCS designers. Although one specific pump may vary slightly from the certified curve, the curve is representative of all the pumps supplied and is always lower than the maximum available specified by the system designers. Furthermore, this number specified to the vendor is conservative compared to the ECCS layout criteria. The vendor supplied curve, which is used to confirm that the actual system piping provides adequate NPSH, is derived from repeated testing of the same type of pump. In addition to random testing to demonstrate that variation in pump performance is insignificant, each impeller casting is inspected to ensure that dissimilarity from one pump to the next is minimized.

For the RHR pump NPSH calculation, when taking suction from the containment sump, in equilibrium with containment ambient pressure (i.e., no credit is taken for subcooling of the sump fluid), the equation is:

$$\text{NPSH}_{\text{available}} = h_{\text{static head}} - h_{\text{line losses}}$$

For other system pumps, or for RHR pump NPSH when operating in other modes, this equation becomes:

$$\text{NPSH}_{\text{available}} = h_{\text{ambient pressure}} + h_{\text{static head}} - h_{\text{line losses}} - h_{\text{vapor pressure}}$$

The net positive suction head of the residual heat removal pumps is evaluated for normal plant cooldown operation, and for both the injection and recirculation modes of operation for the design basis accident. Recirculation operation gives the limiting net positive suction head requirement and the net positive suction head available is determined from the containment water level relative to the pump elevation and the pressure drop in the suction piping from the sump to the pumps. Positive net positive suction head margin is maintained with a postulated debris bed on the recirculation sump screens.

The residual heat removal pumps are discussed further in Section 5.4.7. A pump design performance curve is given in Figure 6.3.2-8.

6.3.2.2.5 Centrifugal charging pumps

In the event of an accident, the charging pumps are started automatically on receipt of an "S" signal and are automatically aligned to take suction from the refueling water storage tank during

injection. During recirculation, suction is provided from the residual heat removal pump discharge.

These high head pumps deliver flow through the boron injection tank to the RCS at the prevailing reactor coolant system pressure. Each centrifugal charging pump is a multistage diffuser design, barrel-type casing with vertical suction and discharge nozzles.

A minimum flow bypass line is provided on each pump discharge to recirculate flow to the pump suction after cooling via the seal water heat exchanger during normal plant operation. Each charging pump has double valve isolation on the minimum flow bypass line. Safety injection signal closes the valves to isolate the normal charging line and volume control tank and opens the charging pump-refueling water storage tank suction valves to align the high head portion of the ECCS for injection. The charging pumps may be tested during power operation via the minimum flow bypass line or the normal charging line.

The two operable charging pumps are each provided with an alternate miniflow path which is automatically aligned on receipt of an "S" signal plus an RCS pressure permissive signal. Simultaneously, the normal miniflow paths are isolated. Each of the alternate miniflow motor operated isolation valves is powered from the same train as the pump it is protecting. This control logic is intended to ensure maximum safety injection flow while providing pump protection against a dead head condition. The orifice in the alternate miniflow path prevents the charging pump from reaching a runout condition.

Net positive suction head design considerations for the charging pumps are similar to those for the RHR pumps discussed in Section 6.3.2.2.4. The net positive suction head for the centrifugal charging pumps is evaluated for both the injection and recirculation modes of operation for the design basis accident. The end of the injection mode of operation gives the limiting net positive suction head available (minimum static head). The net positive suction head available is determined from the elevation head and vapor pressure of the water in the refueling water storage tank, which is at atmospheric pressure, and the pressure drop in the suction piping from the tank to the pumps.

A pump design performance curve for the centrifugal charging pumps is presented in Figure 6.3.2-9.

6.3.2.2.6 Positive displacement hydrostatic test pump

The positive displacement hydrostatic test pump is provided to accomplish two non-safety related functions. It is designed primarily for use in hydrotesting the RCS. This pump is also used to initially fill and maintain level in the three SIS accumulators. The suction of this pump is permanently connected to a branch line from the RWST discharge header and its discharge is permanently connected to the accumulator fill line header. The discharge pressure of the pump is regulated by an air operated control valve located in a return line to the pump suction.

6.3.2.2.7 Deleted by Amendment No. 27

6.3.2.2.8 Residual heat exchangers

The residual heat exchangers are conventional shell and U-tube type units. During normal cooldown operation, the residual heat removal pumps recirculate reactor coolant through the

tube side while component cooling water flows through the shell side. During emergency core cooling recirculation operation, water from the containment sump flows through the tube side. The tubes are seal welded to the tube sheet.

A further discussion of the residual heat exchangers is found in Section 5.4.7.

6.3.2.2.9 Valves

Design parameters for all types of valves used in the ECCS are given in Table 6.3.2 1.

Design features employed to minimize valve leakage include:

- 1) Where possible, packless valves are used.
- 2) Other valves which are normally open, except check valves and those which perform a control function, are provided with backseats to limit stem leakage.
- 3) Normally closed globe valves are installed with recirculation fluid pressure under the seat to prevent stem leakage of recirculated (radioactive) water.
- 4) Relief valves are enclosed, i.e., they are provided with a closed bonnet.

6.3.2.2.9.1 Motor operated valves

The seating design of motor operated gate valves is of the flexible wedge design. This design releases the mechanical holding force during the first increment of travel so that the motor operator works only against the frictional component of the hydraulic unbalance on the disc and the packing box friction. The disc is guided throughout the full disc travel to prevent chattering and to provide ease of gate movement. The seating surfaces are hard faced to prevent galling and to reduce wear. Motor operators may also be installed on globe valves.

Where a gasket is employed for the body to bonnet joint, it is either a fully trapped, controlled compression, spiral wound asbestos gasket with provisions for seal welding, or it is of the pressure seal design with provisions for seal welding.

Generally, the motor operator incorporates a "hammer blow" feature that assists with opening gate valves. This feature allows the motor to attain its operational speed prior to exerting a force on the stem to unseat the valve disc.

The NRC issued Generic Letter (GL) 89-10 which impacted select safety-related motor operated valves (MOV). The GL recommended development and implementation of a program which ensures that MOV switch settings are set and maintained such that they will operate under design-basis conditions for the life of the plant. As part of the program, valves were tested under static and dynamic conditions, where practicable, to determine performance characteristics. This test information was used to assist in establishing appropriate MOV switch settings. The GL (89 10 recommendations have been completed in accordance with plant-specific commitments (see References 6.3.2-3, 6.3.2-4 and 6.3.2-5.

NRC Generic Letter 96-05 requests the establishment of a program to verify on a periodic basis that safety-related MOVs continue to be capable of performing their safety functions within the

current licensing basis. The Harris Nuclear Plant has committed to implement the Periodic Verification (PV) program developed by the Joint Owners Group (JOG) in response to Generic Letter 96-05.

6.3.2.2.9.2 Manual globes, gates, and check valves

Gate valves employ a wedge design and are straight through. The wedge is either split or solid. Gate valves have backseats and outside screw and yoke construction. Globe valves, "T" and "Y" style are full ported with outside screw and yoke construction.

Check valves are spring loaded lift piston types for sizes 2 in. and smaller, swing type for sizes 2-1/2 in. to 4 in., and tilting disc type for sizes 4 in. and larger. Stainless steel check valves have no penetration welds other than the inlet, outlet, and bonnet. The check hinge is serviced through the bonnet.

The stem packing and gasket of the stainless steel manual globe and gate valves are similar to those described above for motor operated valves. Carbon steel manual valves are employed to pass nonradioactive fluids only and therefore do not contain the double packing and seal weld provisions.

6.3.2.2.9.3 Accumulator check valves (Swing-Disc)

The accumulator check valve is designed with a low pressure drop configuration with all operating parts contained within the body.

Design considerations and analyses which assure that leakage across the check valves located in each accumulator injection line will not impair accumulator availability are as follows:

1. During normal operation the check valves are in the closed position with a nominal differential pressure across the disc of approximately 1650 psi. Since the valves remain in this position except for testing or when called upon to open following an accident and are therefore not subject to the abuse of flowing operation or impact loads caused by sudden flow reversal and seating, they do not experience significant wear of the moving parts, and are expected to function with minimal backleakage. This backleakage can be checked via the test connection as described in Section 6.3.4.
2. When the RCS is being pressurized during the normal plant heatup operation, the check valves are tested for leakage in accordance with Technical Specifications prior to exceeding 1000 psi RCS pressure. This test confirms the seating of the disc and whether or not there has been an increase in the leakage since the last test. When this test is completed, the accumulator discharge line motor operated isolation valves are opened and the RCS pressure increase is continued. There should be no increase in leakage from this point on since increasing reactor coolant pressure increases the seating force and decreases the probability of leakage.
3. The experience derived from the check valves employed in the emergency injection systems indicate that the system is reliable and workable; check valve leakage has not been a problem. This is substantiated by the satisfactory experience obtained from operation of the Robert Emmett Ginna and subsequent plants where the usage of check valves is identical to SHNPP.

4. The accumulators can accept some in-leakage from the RCS without affecting availability. Continuous in-leakage would require, however, that the accumulator water volume be adjusted periodically to Technical Specification requirements.

6.3.2.2.9.4 Relief valves

Relief valves are installed in various sections of the ECCS to protect lines which have a lower design pressure than the RCS. The valve stem and spring adjustment assembly are isolated from the system fluids by a bellows seal between the valve disc and spindle. The closed bonnet provides an additional barrier for enclosure of the relief valves. Table 6.3.2-2 lists the system's relief valves with their capacities and setpoints.

6.3.2.2.9.4.1 Accumulator relief valves

Accumulator relief valves are procured to specifications requiring certain gas relieving capacities at certain temperatures (60 - 120 F). Water relief is not a design basis for the accumulator relief valves.

The maximum fill rate for the accumulator at the relief valve setpoint (700 psi) is 35 gpm or 4.7 scfm (liquid). This additional water volume increase during an event which requires relief capacity can be assumed to be negligible compared to the relief valve capacity of 1500 scfm. Since the design transient is the case of maximum nitrogen make-up to the accumulator, a coincident water fill operation has a very small effect on the relief valve capability. If these valves had to relieve water, it is expected that they would do so at rates of from 50 to 150 gpm at temperatures of 60° to 120° F.

6.3.2.2.9.5 Butterfly valves

Each main residual heat removal line has an air operated butterfly valve which is normally open and is designed to fail to the open position. The actuator is arranged such that air pressure on the diaphragm overcomes the spring force, causing the linkage to move the butterfly to the closed position. Upon loss of air pressure, the spring returns the butterfly to the open position. These valves are left in the full open position during normal operation to maximize flow from this system to the RCS during the injection mode of the ECCS operation. These valves are used during normal residual heat removal system (RHRS) operation to control cooldown flowrate.

Each residual heat removal heat exchanger bypass line has an air operated butterfly valve which is normally closed and is designed to fail closed. Those valves are used during normal cooldown to avoid thermal shock to the residual heat exchanger.

6.3.2.2.9.6 Accumulator motor operated valve controls

As part of the plant shutdown administrative procedures, the operator is required to close these valves. This prevents a loss of accumulator water inventory to the RCS and is done shortly after the RCS has been depressurized below 1000 psig. The redundant pressure and level alarms on each accumulator would remind the operator to close these valves, if any were inadvertently left open. Power is disconnected after the valves are closed.

During plant startup, the operator is instructed via procedures to energize and open these valves before the RCS pressure reaches 1000 psig. Monitor lights in conjunction with an

audible alarm will alert the operator should any of these valves be left inadvertently closed once the RCS pressure increases beyond the safety injection unblock setpoint.

The accumulator isolation valves are not required to move during power operation or in a post-accident situation except for valve testing. For a discussion of limiting conditions for operation and surveillance requirements of these valves, refer to the Technical Specifications.

For further discussions of the instrumentation associated with these valves refer to Sections 6.3.5 and 7.6.1.2.

6.3.2.2.9.7 Motor operated valves and controls

Remotely operated valves for the injection mode which are under manual control (i.e., valves which normally are in their ready position and do not require a safety injection signal) have their positions indicated on a common portion of the main control board. If a component is out of its proper position, its monitor light will indicate this on the control panel. At any time during operation when one of these valves is not in the ready position for injection, this condition is shown visually on the board, and an audible alarm is sounded in the Control Room.

The ECCS delivery lag times are given in Chapter 15.0. The accumulator injection time varies as the size of the assumed break varies since the RCS pressure drop will vary proportionately to the break size.

Inadvertent mispositioning of a motor operated valve due to a malfunction in the control circuitry in conjunction with an accident has been analyzed and found not to be a credible event for use in design.

Table 6.3.2-3 is a listing of motor operated isolation valves in the ECCS showing interlocks, automatic features, and position indications.

6.3.2.2.10 Auxiliary Systems Required for Operation and Support of the ECCS

6.3.2.2.10.1 Primary Auxiliary Systems

The primary auxiliary systems required to support the ECCS are as follows:

- a) The engineered safety features (ESF) electrical buses; to provide electric power to the ECCS pumps and motor operated valves. If offsite power is available, loading of the emergency diesel generators onto the ESF buses is not required (see Section 8.3.1).
- b) The component cooling water system; to provide cooling to the RHR pumps and RHR heat exchangers (in recirculation mode only). The standby component cooling water pump is started by the "S" signal. Flow to the RHR heat exchangers is initiated by the operator prior to the switch to recirculation.
- c) The chilled water system (see Section 9.2.8) to provide cooling water to the ECCS pump room cooling system air handling units. The standby chiller and standby chilled water pump are started by the "S" signal.

- d) The service water system (see Section 9.2.1) to provide bearing and gear oil cooling for the charging pumps.

6.3.2.2.10.2 Secondary Auxiliary Systems

Secondary auxiliary systems required to directly support the primary auxiliary systems listed above:

- a) The emergency diesel generators (see Section 8.3.1); to provide electric power to the ESF buses in the event of loss of offsite power. The emergency diesel generators are started upon receipt of the "S" signal. Supporting systems for operation of the emergency diesel generators and methods for actuation of these systems are as follows:
 - 1) Diesel generator fuel oil storage and transfer system; started by a low level signal from the day tank. (See Section 9.5.4).
 - 2) Diesel generator cooling water system; cooling water is supplied by operation of the associated service water system cooling loop. (See Section 9.5.5).
 - 3) Diesel generator starting system; started by the "S" signal. (See Section 9.5.6).
 - 4) Diesel generator lubrication system; components are engine driven. (See Section 9.5.7).
 - 5) Diesel generator combustion air intake and exhaust system; system is passive and includes no operating components. (See Section 9.5.8).
 - 6) Diesel generator building ventilation system; fans start when diesel generators start.
- b) The service water system; to supply cooling water to the following:
 - 1) Component cooling heat exchangers.
 - 2) Diesel generator starting system air compressor aftercoolers.
 - 3) Diesel generator lubrication system oil coolers.
 - 4) Chilled water system water chiller condensers.

The emergency service water pump is started by the "S" signal.

- c) ECCS pump room air handling unit fans for the charging pump rooms and residual heat removal/reactor building spray pump rooms to provide ventilation and cooling for the ECCS pumps. These fans are operated during normal plant conditions and are started by the "S" signal.
- d) Ventilation systems for the control room, relay room and ESF switchgear rooms (see Sections 9.4.1.2.1, 9.4.1.2.2 and 9.4.5.2.2); to provide ventilation for controls associated with ECCS equipment.

Table 6.3.2-10 is a list of pumps and valves required for ECCS operation along with their safety classification. Each component is Seismic Category I.

6.3.2.3 Applicable Codes and Classifications

Applicable industry codes and classifications for the ECCS are discussed in Section 3.2.

6.3.2.4 Material Specifications and Compatibility

Materials employed for components of the ECCS are given in Table 6.3.2-4. Materials are selected to meet the applicable material requirements of the codes in Table 3.2.1-1 and the following additional requirements:

- a) All parts of components in contact with borated water are fabricated of or clad with austenitic stainless steel or equivalent corrosion resistant material. See Table 6.1.1-1.
- b) All parts of components in contact (internal) with sump solution during recirculation are fabricated of austenitic stainless steel or equivalent corrosion resistant material. See Table 6.1.1-1.
- c) Valve seating surfaces are hard faced to prevent galling and to reduce wear.
- d) Valve stem materials are selected for their corrosion resistance, high tensile properties, and resistance to surface scoring by the packing.

6.3.2.5 System Reliability

a) General - Reliability of the ECCS is considered in all aspects of the system from initial design to periodic testing of the components during plant operation. The ECCS is a two train, fully redundant standby safeguard feature. The system has been designed and proven by analysis to withstand any single credible active failure during injection or active or passive failure during recirculation and maintain the performance objectives desired in Section 6.3.1. Two trains of pumps, heat exchangers, and flow paths are provided for redundancy. Only one train is required to satisfy the performance requirements. Due to this concept, either of the two subsystems can be isolated and removed from service if maintenance is required on any ECCS component. The initiating signals for the ECCS are derived from independent sources measured from process variables (e.g., low pressurizer pressure) or environmental variables (e.g., containment pressure). Redundant as well as functionally independent variables are measured to initiate the safeguards signals. Each train is physically separated and protected where necessary so that a single event cannot initiate a common failure. Power sources for the ECCS are divided into two independent trains supplied from offsite power via the emergency buses. Sufficient diesel generating capacity is also maintained onsite to provide required power to each train. The diesel generators and their auxiliary systems are completely independent and each supplies power to one of the two ECCS trains.

Each compartment is provided with adequate radiation shielding such that access to any compartment for required maintenance is permissible during the recirculation phase. To obtain access to a given compartment, pumps in that compartment would be stopped and the lines flushed with water from the RWST. Provisions for washing down the floors and walls are provided to reduce contamination in the event that a leak occurs in a compartment during the

recirculation phase. Adequate ventilation is provided to permit access for maintenance. The piping and valves associated with the pumps (refer to FSAR Figure 5.4.7-1) are arranged so that the system can be drained and flushed prior to maintenance. To meet this requirement, manual valves are provided with extended reach rods so that they can be operated from a position external to the pump compartments.

The quality assurance program, as approved by the NRC during the construction permit review, assures receipt of components only after manufacture and test to the applicable codes and standards. The reliability program extends to the procurement of the ECCS components such that only designs which have been proven by past use in similar applications are acceptable. For example, the equipment specification for the ECCS pumps (safety injection, centrifugal charging, and residual heat removal pumps) require them to be capable of performing their long-term cooling function for one year. The same type of pump has been used extensively in other operating plants. Their function during recurrent normal power and cooldown operations in such plants as Zion, D. C. Cook, Trojan, and Farley has successfully demonstrated their performance capability. Reliability tests and inspections (see Subsection 6.3.4.1) further confirm their long-term operability. Nevertheless, design provisions are included that would allow maintenance on ECCS pumps, if necessary, during long-term operation.

All of the Westinghouse active pump applications have gathered extensive operating time. These pumps are seismically qualified by a combination of analysis and tests which includes structural and operability analysis. Each pump is tested in the vendor's shop to verify hydraulic and mechanical performance. Performance is again checked at the plant site during preoperational system checks and quarterly per ASME Section XI. Pump design is specified, with strong consideration given to shaft critical speed, bearing, and seal design. Thermal transient and 100-hour endurance tests have been completed on the centrifugal charging and the safety injection pumps. Additional rotor dynamics tests have been performed on the centrifugal charging pumps which are the highest speed applications. A thermal transient analysis has been performed on the RHR pump; this analysis is supported by the vendor's test on a similar design.

Endurance and leak determination testing has been completed on the mechanical seals by the seal supplier. This testing included various temperature, pressure, radiation, and boric acid concentration levels. These conditions were all substantially elevated over those expected during normal or post-accident conditions.

The preoperational testing program assures that the systems as designed and constructed meet the functional requirements as calculated in design.

The ECCS is designed with the ability for on-line testing of most components so the availability and operational status can be readily determined.

All ECCS equipment has been designed to perform its system operating function at least one year without any periodic maintenance. The two independent ECCS subsystems/or trains allow maintenance to be performed on any pump, if it is necessary, during long-term operation.

In addition to the above, the integrity of the ECCS is assured through examination of critical components during the routine inservice inspection.

6.3.2.5.1 Active failure criteria

The ECCS is designed to accept a single failure following an incident without loss of its protective function. The system design will tolerate the failure of any single active component in the ECCS itself or in the necessary associated service systems at any time during the period of required system operations following an incident.

A failure modes and effects analysis for a single active failure is presented in Table 6.3.1-1, and demonstrates that the ECCS can sustain the failure of any single active component in either the injection or recirculation phase and still meet the required level of performance for core cooling.

Since the operation of the active components of the ECCS following a steam line rupture is identical to that following a LOCA, the same analysis is applicable and the ECCS can sustain the failure of any single active component and still meet the required level of performance for the addition of shutdown reactivity.

6.3.2.5.2 Passive failure criteria

As discussed in the following, sufficient redundancy is provided in ECCS component and system arrangement to meet the intent of the General Design Criteria on single failure as it specifically applies to failure of passive components. Thus, for the recirculation phase, the system design is based on accepting either a passive or an active failure.

The non-safety section of the SI pumps miniflow header is seismically designed and analyzed pipe; failure is thus not expected.

6.3.2.5.2.1 Redundancy of Flow Paths and Components for Long-term Emergency Core Cooling

In design of the ECCS, the following criteria are utilized:

- 1) During the long-term cooling period following a loss of coolant (recirculation phase), the emergency core cooling flow paths shall be separable into two subsystems, either of which can provide minimum core cooling functions and return spilled water from the floor of the Containment back to the RCS.
- 2) Either of the two subsystems can be isolated and removed from service in the event of a leak outside the Containment.
- 3) Adequate redundancy of check valves is provided to tolerate passive failure of a check valve during recirculation.
- 4) Should one of these two subsystems be isolated in this long-term period, the other subsystem remains operable.
- 5) Provisions are also made in the design to detect leakage from components outside the Containment, collect this leakage and to provide for maintenance of the affected equipment.

Thus, for the long-term emergency core cooling function, adequate core cooling capacity exists with one flow path removed from service.

6.3.2.5.2.2 Subsequent Leakage from Components in Safeguards Systems

With respect to piping and mechanical equipment outside the Containment, considering the provisions for visual inspection and leak detection, leaks will be detected before they propagate to major proportions. A review of the equipment in the system indicates that the largest sudden leak potential would be the sudden failure of a pump shaft seal. Evaluation of leak rate assuming only the presence of a seal retention ring around the pump shaft showed flows less than 50 gpm would result. Piping leaks, valve packing leaks, or flange gasket leaks usually build up slowly with time and are considered less severe than the pump seal failure.

Larger leaks in the ECCS are prevented by the following:

- 1) The piping is classified in accordance with ANS Safety Class 2 and receives the ASME Class 2 quality assurance program associated with this safety class.
- 2) The piping, equipment and supports are designed to ANS Safety Class 2, Seismic Category I permitting no loss of function for the design basis earthquake.
- 3) The system piping is located within a controlled area on the plant site.
- 4) The piping system receives periodic pressure tests and is accessible for periodic visual inspection.
- 5) The piping is austenitic stainless steel which, due to its ductility, can withstand severe distortion without failure.

Based on this review, the design of the Reactor Auxiliary Building and related equipment is based upon handling of leaks up to a maximum of 50 gpm. Means are also provided to detect and isolate such leaks in the emergency core cooling flow path within four hours.

A single passive failure analysis is presented in Table 6.3.2-5. It demonstrates that the ECCS can sustain a single passive failure during the recirculation phase and still retain an intact flow path to the core to supply sufficient flow to maintain the core covered and affect the removal of decay heat. The procedure followed to establish the alternate flow path also isolates the component which failed.

Figures 6.3.2-4 through 6.3.2-7 are simplified illustrations of the ECCS. The notes provided with Figures 6.3.2-4 through 6.3.2-7 contain information relative to the operation of the ECCS in its various modes. The modes of operation illustrated are full operation of all ECCS components, cold leg recirculation with residual heat removal pump number 2 operating, and hot leg recirculation with residual heat removal pump number 1 operating. These are representative of the operation of the ECCS during accident conditions.

Lag times for initiation and operation of the ECCS are limited by pump startup time and consequential loading sequence of these motors onto the emergency buses. Most valves are normally in the position conducive to safety, therefore valve opening time is not considered for these valves. If the normal offsite power supply is available, all pump motors and valve motors

are started immediately upon receipt of the "S" signal. Without offsite power, a 10 second delay is assumed for diesel generator startup, then pumps and valves are loaded according to the sequencer. In any case, full injection flow is achieved within 27 seconds of reaching the safety parameter setpoint. In both the large and small break LOCA analyses, full injection flow was conservatively assumed to occur within 29 seconds.

ECCS piping is designed such that normal system operation and testing assures that the systems remain water-filled to preclude the effects of water hammer. Interfaces with normally pressurized non-ECCS systems preclude a loss of water from ECCS systems. Leakage from ECCS systems through valve packing, pump seals, etc., will be detected by any number of methods including: 1) normal operator rounds, 2) performance during testing, 3) the plant leak reduction inspection program, 4) various sump level alarms, 5) decreasing water levels in various tanks. Should significant leakage be discovered, where an introduction of air into the system could have occurred, provisions have been made in the system design to permit refilling and venting of the affected components or piping following repair to the source of leakage.

6.3.2.5.2.3 Potential boron precipitation

Boric acid buildup considerations during long-term cooling have been addressed in the letter from C. Caso of Westinghouse to T. Novak of NRC dated April 1, 1975. This letter presents the method, assumptions, and results of analysis for a typical plant. During cold leg recirculation for a cold leg pipe break the analysis shows that boric acid concentrations within the reactor vessel and core regions remain at acceptable levels up to the time of the initiation of hot leg recirculation.

An analysis has been performed for Shearon Harris to determine the maximum boron concentration in the reactor vessel following a hypothetical LOCA.

The analysis considers the increase in boric acid concentration in the reactor vessel during the long-term cooling phase of a LOCA assuming a conservatively small effective vessel volume including only the free volumes of the reactor core and the upper plenum below the bottom of the hot leg nozzles. This assumption conservatively neglects the mixing of boric acid solution with directly connected volumes, such as the reactor vessel lower plenum. The calculation of boric acid concentration in the reactor vessel considers a cold leg break of the reactor coolant system in which steam is generated in the core from decay heat while the boron associated with the boric acid solution is completely separated from the steam and remains in the effective vessel volume.

The results of the analysis show that the maximum allowable boric acid concentration established by the NRC, which is the boric acid solubility limit minus 4 w/o, will not be exceeded in the vessel if hot leg recirculation is initiated when the following criteria are met:

1. The Safety Injection System has previously been aligned for cold leg recirculation (meaning that the Refueling Water Storage Tank level has been depleted), and
2. Approximately 6.5 hours have passed since the beginning of the event, and
3. Safety Injection has not been terminated such that a single Charging Safety Injection Pump has been realigned to the charging header (meaning that Reactor Coolant System subcooling and Pressurizer level have been established).

(Reference 6.3.1-1) (See Sections 6.3.2.8 and 15.6.5.2)

The SHNPP will utilize alternating hot and cold leg recirculation to prevent excessive concentration in the reactor vessel during long-term operation following a LOCA. The switch between hot leg recirculation and cold leg recirculation should occur approximately every 6.5 hours after the initiation of hot leg recirculation. This method of preventing boron concentration complies with the requirements of the NRC staff position concerning boron dilutions.

The amount of flow which must be maintained through the core at the time of hot leg switchover is greater for a hot leg break than for a cold leg break. If at least one RHR pump and one CSIP are successfully aligned to the hot leg, sufficient flow is maintained through the core for either the hot or cold leg break (Reference 6.3.1-1).

Sufficient flow cannot be maintained through the core with only one CSIP aligned to the hot legs if the break is at the hot leg. In order to establish Low Head Safety Injection to the hot legs, a single motor operated valve must be remotely opened by the operator. If this valve fails to open, the operator is directed by the Emergency Operating Procedures to re-establish flow from the RHR pump to the cold leg. This action ensures that sufficient flow is maintained for a hot leg break. The operator is also directed to complete the alignment of the CSIP to the hot leg to ensure sufficient flow is maintained for a cold leg break (Reference 6.3.1-1).

Discussions of hot leg and cold leg recirculation modes of the ECCS are presented in Section 6.3.

Since the ECCS is designed to meet the single failure criterion, no back up means to prevent the buildup of boron concentration is provided.

All components of the ECCS are ANS Safety Class 2.

ECCS testing is discussed in Section 6.3.4.

6.3.2.6 Protection Provisions

The provisions taken to protect the system from damage that might result from dynamic effects of pipe rupture are discussed in Section 3.6. The provisions taken to protect the system from missiles are discussed in Section 3.5. The provisions to protect the system from seismic damage are discussed in Sections 3.7, 3.9 and 3.10. The provisions to protect the system from flooding are discussed in Section 3.4. Thermal stresses on the RCS are discussed in Section 5.2.

6.3.2.7 Provisions for Performance Testing

Test lines are provided for performance testing of the ECCS as well as individual components. These test lines and instrumentation are shown in Figures 6.3.2-1 through 6.3.2-3. All pumps have miniflow lines for use in testing operability. Additional information on testing can be found in Section 6.3.4.2.

6.3.2.8 Manual Actions

The plant emergency operating procedures include instructions and verification steps to ensure proper manual realignment of the ECCS for recirculation by the operator. The failure to perform one step or the performance of one step out of order, as a single failure, should not reduce ECCS recirculation capability below minimum safeguards. Should the operator fail to take any action following automatic ECCS switchover initiation, the consequences will be the loss of the safety injection (charging) pumps. The residual heat removal pumps will be protected from damage by automatic ECCS switchover initiation.

In the unlikely event of losing all high head injection capability, the situation could lead from a small break LOCA to core uncovering and inadequate core cooling. Analyses have been performed and are addressed in WCAP-9691 as the loss of the Emergency Coolant Recirculation (ECR) function following a small break LOCA. Inadequate Core Cooling guidelines instruct the operator on the appropriate actions to be taken for this event.

No manual actions are required of the operator for proper operation of the ECCS during the injection mode of operation. Only limited manual actions are required by the operator to realign the system for the cold leg recirculation mode of operation, and for the hot leg recirculation mode of operation. These actions are delineated in Table 6.3.2 6.

Subsequent to establishing recirculation mode of operation, re-injection from the RWST may be necessary to compensate for ECCS leakage outside of containment in order to maintain adequate recirculation sump inventory. Re-injection can be accomplished by manually aligning a CT pump (preferred) for injection from the RWST.

The changeover from the injection mode to recirculation mode is initiated automatically and completed manually by operator action from the Control Room.

The design of the Refueling Water Storage Tank (RWST) at Shearon Harris Nuclear Plant includes allowances to account for working and transfer water allowance, instrument error, single failure and the unusable volume of water present in the bottom of the tank. Consideration has been given to the amount of water required for core reflood and cooling and the pH requirements for water entrained in the containment sump. Additionally, the positioning of the instrument (alarm) levels permits sufficient time for appropriate operator action required for ECCS switchover to recirculation. The shortest times available for ECCS injection and switchover are as follows:

- a) Injection Mode Allowance - The safety injection mode of ECCS operation consists of the ECCS pumps (charging pumps and residual heat removal pumps) and the containment spray pumps taking suction from the refueling water storage tank (RWST) and delivering to the reactor coolant system (RCS) and containment, respectively. In order to analyze the shortest time available for injection mode operation, the following conservative bases are established:
 - 1) The minimum RWST volume available for injection mode operation is 266,625 gallons.
 - 2) To maximize flow out of the RWST, the following conservative assumptions are utilized:

- a. Containment spray flowrate is based on a containment pressure equal to the Containment Spray Actuation Signal Pressure which occurs when a containment pressure HI-3 signal is reached.
- b. Charging and RHR pumps are operating in their minimum resistance configuration, with 0.0 psig Containment and RCS backpressure.

3a) Minimum safeguards response-Flow out of the RWST during the injection mode includes conservative allowances for one pump of each type operating at the following flow rates:

Charging pump	-	685 gpm per pump
RHR pump	-	4410 gpm per pump
Spray pump	-	2127 gpm per pump

Total RWST outflow during injection mode operation is 7222 gpm.

Based on the above minimum available RWST volume for injection mode operation and the maximum total flow rate out of the RWST, the shortest injection mode operation time for single train ECCS operation is approximately 2215 sec. or 36.92 minutes

3b) Maximum safeguards response -Flow out of the RWST during the injection mode includes conservative allowance for pumps operating at the following flow rates:

Charging Pump	-	426 gpm per pump (two pumps)
RHR Pump	-	3096 gpm per pump (two pumps)
Containment Spray Pump		4417 gpm for both pumps

Total outflow during injection mode operation is 11,461 gpm. The Containment Spray flow rates are based on discharge to a backpressure of 0.0 psig.

Based on the above minimum available RWST volume for injection mode operation and the maximum total flow rate out of the RWST, the shortest injection mode operation time for maximum safeguards operation is approximately 23 minutes. For conservatism this was reduced to 20 minutes in the containment pressure - temperature transient analysis.

- b) Transfer Allowance - During the safety injection mode of ECCS operation, the operator monitors the RWST level and containment recirculation sump level in anticipation of switchover. During this time, the operator normally opens the component cooling water inlet isolation valves to the residual heat removal (RHR) heat exchanger.

The ECCS switchover from safety injection to cold leg recirculation is initiated automatically upon receipt of the RWST low-low level signal in conjunction with the safety injection signal and is completed via timely operator action at the main control board.

Switchover is initiated via automatic opening of the containment recirculation sump isolation Valves (8811 A/B and 8812 A/B). This automatic action aligns the suction of the RHR pumps to the containment recirculation sump to ensure continued availability of a suction source.

The low-low RWST level signal, which initiated the automatic opening of the containment sump valves, also provides an alarm to inform the operator that he must initiate the manual actions required to complete switchover.

Manual actions of Table 6.3.2-6 must be performed following switchover initiation prior to loss of the RWST transfer allowance to ensure that all ECCS pumps are protected with suction flow available from the containment sump. The ECCS switchover procedure is structured so that the operator simultaneously switches both trains of the ECCS from injection to recirculation, repositioning functionally similar switches as part of the same procedural steps.

The time available for switchover is dependent on the flow rate out of the RWST as the switchover manual actions are performed. As ECCS valves are repositioned, the flow rate out of the RWST is reduced in magnitude. In order to analyze the shortest time available for switchover, the following conservative bases are established:

- 1) Valve stroke times used are conservative design values.
- 2) The RWST water volume "required" for switchover is approximately 64,688 gallons.
- 3) To maximize the RWST outflow and thus minimize the switchover duration, the RCS is assumed to be at 0 psig, and the containment pressure equal to the Containment Spray Actuation Signal pressure. Thus, no credit is taken for the reduction in RWST outflow that will result with the higher containment and RCS pressure following a large break.

The same conservative assumption is made for the small break conditions (except that RCS pressure is assumed to be greater than RHR pump shutoff head resulting in no RHR pump flow to the RCS for small break conditions).

- 4) Flow out of the RWST during switchover includes allowances for both pumped flow to the RCS and containment and backflow to the containment sump based on the 0 psig containment pressure assumption. Average flow rates are assumed during switchover and include the following conservative flow rate allowances assuming two pumps of each type are operating:

Charging pump	-	426 gpm per pump
RHR pump	-	3096 gpm per pump
Spray pump	-	2137 gpm per pump

Backflow to the containment sump may occur during ECCS switchover based on the 0 psig containment pressure assumption and ECCS operating conditions. Backflow, if it occurs, will vary as the switchover proceeds depending on ECCS alignment.

- 5) Flow rate out of the RWST for the worst ECCS single failure condition is determined assuming one of the RWST/RHR isolation valves (8809A or 8809B) fails to close on demand. This single failure maximizes RWST outflow during switchover. Flow rates out of the RWST assume no operator corrective action to mitigate the single failure (i.e., stop the affected RHR pump and close the appropriate sump isolation valves).

Based on the criteria, the calculated flow rates out of the RWST as a function of switchover manual action are itemized in Table 6.3.2-9 for large breaks. The large break with single failure constitutes the condition where RWST outflow is the greatest. Flow rate data for small breaks is less than for large breaks and is not included in Table 6.3.2-9. Table 6.3.2-9 also identifies the operator action time assumed per switchover step and shows the change in RWST volume per switchover step. Analyzing the flow rate out of the RWST for large LOCA with single failure indicates that approximately 64,688 gallons are consumed in switchover. The volume of water available (transfer allowance) between the nominal RWST "Lo-Lo" level setpoint and the nominal "Empty" level setpoint is approximately 84,000 gallons. This shows that the switchover steps necessary to protect all ECCS pumps can be accomplished before the transfer allowance is depleted.

Protection logic is provided to automatically open the ECCS recirculation containment sump isolation valves when two out of four refueling water storage tank level channels indicate a refueling water storage tank level less than a low-low level setpoint in conjunction with the initiation of the safety injection actuation signal ("S" signal). This automatic action aligns the two RHR pumps to take suction directly from the containment sump.

The charging pumps will continue to take suction from the RWST, following the above automatic action, until manual operator action is taken to align these pumps in series with the RHR pumps. The low-low RWST level signal, which initiated the automatic opening of the containment sump valves, also provides an alarm to inform the operator that he must initiate the manual actions required to realign the RHR and charging pumps for the recirculation phase. The manual switchover sequence is delineated in Tables 6.3.2-6, 6.3.2-9, and 6.3.2-10. The RHR pumps would continue to operate during this changeover from injection mode to recirculation mode. Following the automatic and manual switchover sequence, the two RHR pumps would take suction from the containment sump and deliver borated water directly to the RCS cold legs. The RHR pump discharge flow would be used to provide suction to the two charging pumps which would also deliver directly to the RCS cold legs.

The hot leg recirculation phase will be initiated when the following criteria are met:

1. The safety injection system has previously been aligned for cold leg recirculation (meaning that the Refueling Water Storage Tank level has been depleted), and
2. Approximately 6.5 hours have passed since the beginning of the event, and
3. Safety Injection has not been terminated such that a single Charging Safety Injection Pump has been realigned to the charging header (meaning that Reactor Coolant System subcooling and Pressurizer level have been established). (Reference 6.3.1-1) (See Sections 6.3.2.8 and 15.6.5.2)

The refueling water storage tank level protection logic consists of four level channels with each level channel assigned to a separate process control protection set. Four refueling water storage tank level transmitters provide

level signals to corresponding normally deenergized level channel bistables. Each level channel bistable would be energized on receipt of a refueling water storage tank level signal less than the low-low level setpoint.

A two out of four coincident logic is utilized in both protection cabinets A and B to ensure a trip signal in the event that two out of the four level channel bistables are energized. This trip signal, in conjunction with the "S" signal, provides the actuation signal to automatically open the corresponding containment sump isolation valves.

As part of the manual switchover procedure, the discharge of the residual heat removal pumps are aligned to the suctions of the charging pumps. Charging pump discharge header cross connect valves are closed in order to establish two separate and redundant high head recirculation systems. The suction header cross connect valves are not closed to ensure that subsequent RHR pump failure does not cause an immediate charging pump failure.

During startup and shutdown operation, the normal alignment of Emergency Core Cooling System (ECCS) equipment is changed from that which is available during power operation. Only shutdown is discussed here since shutdown conditions would be more limiting than startup due to the higher decay heat level following reactor shutdown.

During the Reactor Coolant System (RCS) cooldown and depressurization following reactor shutdown, the low pressurizer pressure and low steamline pressure safety injection (SI) actuation logic is manually blocked when below the P 11 setpoint of 2000 psig. This action disarms the SI signal from the pressurizer and steamline pressure transmitters to prevent automatic SI initiation during the subsequent RCS cooldown and depressurization. The containment high pressure SI signal will actuate SI if the setpoint is exceeded. Manual SI actuation is also available for RCS temperatures above 200°F. At 1000 psig, the ECCS accumulator isolation valves are locked out to prevent accumulator injection when the RCS pressure is reduced below the accumulator pressure. For temperatures above 350°F, the Technical Specifications require that both ECCS subsystems (each subsystem consists of one centrifugal charging pump, one RHR pump, and one RHR heat exchanger) be operable, whereas only one ECCS subsystem is required to be operable for RCS temperatures between 200°F and 350°F. Also below 325°F only one centrifugal charging pump is allowed to be operable by the Technical Specifications to reduce the possibility of overpressurizing the RCS at low temperature conditions. The residual heat removal (RHR) pumps may also be in the RHR cooling mode where suction is drawn from the RCS hot legs when the temperature is less than 350°F.

If a steamline rupture occurs while both the low pressurizer pressure and low steamline pressure SI actuation signals are blocked, steamline isolation will occur on high negative steam pressure rate. An alarm for steamline isolation will alert the operator of the accident. Although a steamline rupture may result in a significant cooldown of the RCS, there is no danger of uncovering the core, and thus the ECCS is not required for core cooling. The ECCS is also not required for post-accident reactivity control for this case since procedural requirements provide for boration of the RCS to cold shutdown conditions prior to blocking the SI actuation signals. Thus, if a steamline rupture occurs with the SI actuation signals blocked, there would not be any return to criticality, and the core would be protected.

With regards to a LOCA, it has been determined that shutdown operating conditions are so far below the conditions for which the RCS has been designed that a large LOCA is not credible and for all practical purposes can be assumed not to occur. With the equipment status described above, it is concluded that operator actions can be taken for a credible LOCA to avoid exceeding the ECCS performance criteria. The supporting information for these statements is presented below.

A rupture in the RCS pressure boundary piping greater than 6 inches in nominal diameter is considered to be highly unlikely even at normal operating pressure. Engineering studies and operating experience have shown that through wall cracks in the RCS Class 1 pressure boundary piping greater than 6 inches in nominal pipe diameter are highly unlikely. A leak-before-break analysis has been performed for the Shearon Harris plant and approved by the NRC. In addition, leak-before-break analyses have been performed for the RCS pressure boundary piping down to 10 inches in nominal pipe diameter for the McGuire and Catawba plants. It is expected that a similar analysis for the RCS pressure boundary piping down to 12 inches in diameter for the Shearon Harris plant would yield results comparable to those for the McGuire and Catawba plants. The results of the leak-before-break analyses demonstrated that even if a through wall crack is postulated at normal operating pressure, RCS pressure boundary leakage would be detected with existing leak detection systems and the crack will remain stable (i.e., not propagate to a pipe rupture). The maximum size leak which could occur in the piping down to 12 inches in diameter without being detected would be very small (i.e., less than 1 inch in equivalent diameter). Since there is no 10 inch or 8 inch nominal diameter piping in the Shearon Harris RCS pressure boundary, the next smaller piping size to be considered is 6 inches in nominal diameter (5.187 inches inside diameter). Thus, based on the available leak-before-break analyses, the maximum size pipe which could be assumed to rupture is the 6-inch piping which would result in a 5.187 inch diameter LOCA.

Below the RCS normal operating pressure, a rupture in the RCS pressure boundary piping greater than 6 inches in nominal diameter is considered even more unlikely. Normal operation at 2000-2250 psig serves as a more severe condition which demonstrates that pipe ruptures below normal operating pressures are highly unlikely since additional margins of safety exist at the lower pressures. The condition which could lead to a pipe rupture, a large through wall crack, would be identified during operation. However, even with the presence of such a crack, the piping system would remain stable and a piping rupture would be unlikely at the reduced RCS pressure. Therefore, based on the above information, it is concluded that the maximum credible LOCA to be considered for the RCS pressure boundary during shutdown operations is 5.187 inches in diameter, corresponding to the rupture of a 6-inch pipe.

The above information is not applicable to the Class 2 portions of the RHR system piping since it is not operated at the higher system pressures and has not been subjected to a leak before break analysis. The design pressure of the RHR system is approximately 600 psig and due to the nature of the operation of the system is considered a moderate energy system. Large ruptures of moderate energy system piping have not been considered as a part of the design basis of Westinghouse supplied PWRs. Breaks of relatively small size have been considered.

Any leakage of the RHR system piping would be expected to occur when the system is initially pressurized at less than 400 psig. The RCS conditions are under manual control by the reactor operator and the operator will be monitoring the pressurizer level and the RCS loop pressure so that any significant leakage would be immediately detected. If a break is detected, the operator would isolate the RHR system from the RCS, terminating the loss of coolant, and initiate safety injection, if necessary. Based on the results from small LOCA studies provided in various plant license applications, the operator will have ample time to take these actions. Further discussions on shutdown LOCA are considered to be applicable to only breaks in the RCS inside containment which are not isolable.

For a credible LOCA, the RCS break flow rate and depressurization rate is significantly less than for a design basis large break LOCA. For shutdown conditions, the break flow and

depressurization rates would be further reduced due to the lower initial RCS pressure and temperature. In addition, the initial fuel rod temperatures and decay heat level would be significantly less than for full power since the reactor would have been shutdown for a period of time. Automatic SI actuation may not occur since the pressurizer pressure SI signal is blocked and the high containment pressure SI signal may not be operable or may not be reached for lower initial RCS temperatures. Operator action would be relied upon to initiate sufficient SI flow to maintain sufficient reactor vessel inventory for adequate core cooling. The indications available to the operator that there is a small or medium LOCA in progress would be the following:

1. Loss of pressurizer level
2. Decrease of RCS pressure
3. Loss of RCS subcooling
4. Radiation alarms inside containment
5. RVLIS

Other potential indications include an increase in containment pressure and sump water level increasing. However, the reduced break flow rate and reduced energy in the break flow for small breaks at low initial RCS temperatures may not noticeably increase the containment pressure or increase the sump water level at a rate which would be readily detected.

If a credible LOCA should occur during shutdown conditions when the RCS temperature is above 350°F, the operators would only have to manually initiate SI since both ECCS subsystems would be available and the suction flow path would be automatically aligned to the RWST upon the SI signal. The accumulators would also be available for injection for initial RCS conditions above 1000 psig. Adequate ECCS performance is also expected below 1000 psig without the accumulators because of the lower decay heat levels which would exist due to the longer cooldown and depressurization time required to achieve this condition.

Below 350°F, the operators would have to manually align the suction of the available SI pumps to the RWST and manually align required SI flow. Actuating SI is not desired due to isolating instrument air and nitrogen to the Pressurize PORVs, which may be needed to mitigate a cold repressurization event. Follow-up action would also be required to restore the remaining SI pumps or the accumulators to service. The RHR pumps will be aligned in the RHR cooling mode during part of the operating time below 350°F. Since the RHR pumps may be damaged by operating with highly voided flow, they will be tripped as soon as possible following a loss of RCS subcooling. This will ensure that the RHR pumps are available for long-term core cooling during the recirculation phase of operation. Thus, if the RHR pumps are operating in the RHR cooling mode, the operator would first have to stop the RHR pumps and then perform the actions indicated above to provide SI flow.

The indications noted above will alert the operators to a LOCA so that they can perform the required manual actions. It is expected that the operators can complete the manual actions to align SI, align the flow path from the RWST, and restore the SI equipment to operable status as required during shutdown conditions such that the level of protection for a LOCA during shutdown conditions will be equivalent to that during power operation. However, the cooldown

period necessary to assure safe operation in ECCS mode is not consistent with this design, therefore operation is restricted to the highest indicated RHR hot leg temperature of 201°F or 200°F if ERFIS is not available. At temperatures between 201°F and 350°F, one train of RHR is maintained in the ECCS mode to assure its capability to quickly respond in an ECCS injection function. To provide instruction to the operators on the above, procedures and training are provided.

However, instrumentation is available to aid in detecting problems including recirculation sump level, RHR and Containment Spray Pumps discharge pressure and flow indications (all of which are on the main control board) and local indications of RHR and Containment Spray Pumps' suction pressure. An unexplained decrease in the discharge pressure and flow of any RHR or Containment Spray pump coupled with abnormal recirculation sump level at its corresponding intake might be indicative of vortex formation or screen blockage. The operator in this situation would closely monitor the recirculation flow and discharge pressure of the affected pump to ensure that it is stopped before damage occurs. The facility is designed for recirculation using only one RHR or CS train; therefore, this single train operation could be performed while the situation is diagnosed and appropriate corrective actions taken.

Maintaining one train of RHR in ECCS mode above an indicated RCS temperature of 201°F (200°F without ERFIS) ensures that this train is not subject to fluid flashing and can perform its ECCS injection-mode function following a large-break LOCA and an associated rapid depressurization of the RCS and connected RHR piping.

On plant start-up, placing an RHR train in ECCS mode prior to exceeding an indicated RCS temperature of 249°F (245°F without ERFIS), together with forced cooling of that train of specified minimum duration, ensures that excessive fluid flashing will not occur in the RHR suction piping of that train once it is realigned to the comparatively low-pressure RWST.

See Section 7.5 for process information available to the operator in the Control Room following an accident.

6.3.3 PERFORMANCE EVALUATION

Accidents which require ECCS operation are as follows:

1. Inadvertent opening of a steam generator power operated relief or safety valve (see Section 15.1.4).
2. Small break LOCA (see Section 15.6.5).
3. Large break LOCA (see Section 15.6.5).
4. Major secondary system pipe failure (see Section 15.1.5).
5. Steam generator tube failure (see Section 15.6.3).

6.3.3.1 Inadvertent Opening of a Steam Generator Relief or Safety Valve

The most severe core conditions resulting from an accidental depressurization of the Main Steam Supply System are associated with an inadvertent opening of a single steam dump, power operated relief or safety valve.

A safety injection system actuation can occur from any of the following:

1. Low pressurizer pressure signal.
2. Low steam line pressure.
3. Hi-I containment pressure.
4. Manual actuation.

A safety injection signal will rapidly trip the main turbine, close all feedwater control valves, trip the main feedwater pumps, and close the feedwater isolation discharge valves.

Following the actuation signal, the isolation valves between the RWST and charging pump suction open and the suction of the centrifugal charging pumps is diverted from the volume control tank to the refueling water storage tank. Simultaneously, the valves isolating the boron injection tank from the injection header automatically open. After the isolation valves between the RWST and charging pump suction are opened, the charging pumps then force boric acid solution from the refueling water storage tank through the header and injection line (including the boron injection tank) and into the cold legs of each loop. The passive injection system (accumulators) and the low head system provide no flow during these events since reactor coolant system pressure remains relatively high.

This event is described in further detail in FSAR Section 15.1.4.

The steam dump control circuitry is designed on a de-energize to close principle, so that the preferred failure mode on loss of energy source is to close. Although the single failure criteria is not a design basis for control grade circuitry such as the steam dump controller, a review of credible single failures will show that the probability of failure (open) of more than one steam dump valve is low. A malfunction in the steam dump controller that causes the steam dump open initiating signal to be present when either a turbine load decreased or a turbine trip has not occurred will not cause steam dump to fail open. This is because the steam dump is blocked by the loss of load interlock unless a large turbine load decrease has occurred. Likewise a failure of the loss of load interlock will not cause the steam dump to fail open when the control signal is not introduced. In the unlikely event that control system failure opens the steam dump, the Protection System provides diverse protection grade actuation signals, that is, low-low T_{AVE} Block of Steam Dump and Main Steamline Isolation (MSLI) that prevent a sustained cooldown.

The low probability of failure of more than one steam dump valve recognizes that there is a distinction between potential non-design basis systems interaction and a random single failure of a component. An unanticipated systems interaction is not ruled out. The review shows that if more than one steam dump valve were to open, it would not be the effect of a single random failure of a component.

6.3.3.2 Small Break LOCA

A LOCA is defined as a rupture of the RCS piping or of any line connected to the system. Ruptures of a small cross section will cause expulsion of the coolant at a rate which can be accommodated by the charging pumps which would maintain an operational water level in the pressurizer permitting the operator to execute an orderly shutdown.

The maximum break size for which the reactor coolant makeup system can maintain the pressurizer level is obtained by comparing the calculated flow from the RCS through the postulated break against the charging pump makeup flow at normal RCS pressure, i.e., 2250 psia. A makeup flow rate from one centrifugal charging pump is adequate to sustain pressurizer level at 2250 psia for a break through a 0.375 in. diameter hole. This break results in a loss of approximately 17.5 lb./sec. (127 gpm at 130°F and 2250 psia). Although automatic makeup to the VCT is set less than or equal to 120 gpm, the charging pumps are automatically realigned to the RWST upon receipt of a low VCT level signal. The makeup capability of the CSIPs when taking suction from the RWST is in excess of 127 gpm.

The safety injection signal stops normal feedwater flow by closing the main feedwater line isolation valves and initiates emergency feedwater flow by starting auxiliary feedwater pumps.

The small break analyses (Section 15.6.5) deals with breaks ranging from a 0.75-inch pipe size up to a 9.0-inch pipe size, where the charging pumps play an important role in the initial core recovery because of the slower depressurization of the RCS.

The analysis of this accident has shown that the high head portion of the ECCS, together with accumulators, provide sufficient core flooding to keep the calculated peak clad temperature below required limits of 10CFR50.46. Hence, adequate protection is afforded by the ECCS in the event of a small break LOCA. The SBLOCA spectrum includes break sizes where RHR injection occurs, however, the limiting breaks have only high head injection and SI accumulators.

6.3.3.3 Large Break LOCA

A major LOCA is defined as a rupture of the RCS piping including the double ended rupture of the largest pipe in the RCS or of any line connected to that system. The boundary considered for LOCA as related to connecting piping is defined in Section 3.6.

Should a major break occur, depressurization of the RCS results in a pressure decrease in the pressurizer. Reactor trip occurs and the safety injection system is actuated when the pressurizer low pressure trip or Hi I containment pressure setpoints are reached. These countermeasures will limit the consequences of the accident in three ways:

1. Reactor trip and borated water injection provide additional negative reactivity insertion to supplement void formation in causing rapid reduction of power to a residual level corresponding to fission product decay heat.
2. Injection of borated water ensures sufficient flooding of the core to prevent excessive clad temperatures.

3. During long-term recirculation and cooling, borated water serves to maintain the core sub-critical.

When the pressure falls below approximately 600 psi the accumulators begin to inject borated water. The conservative assumption is made that accumulator water injected bypasses the core and goes out through the break until the termination of the blowdown phase. This conservatism is again consistent with 10CFR50 Appendix K.

The pressure transient in the Containment during a LOCA affects ECCS performance in the following ways. The time at which end of blowdown occurs is determined by zero break flow which is a result of achieving pressure equilibrium between the RCS and the Containment. In this way the amount of accumulator water bypass is also affected by the containment pressure, since the amount of accumulator water discharged during blowdown is dependent on the length of the blowdown phase and RCS pressure at end of blowdown. During the reflood phase of the transient, the density of the steam generated in the core is dependent on the existing containment pressure. The density of this steam affects the amount of steam which can be vented from the core to the break for a given downcomer head, the core reflooding process, and, thus, the ECCS performance. It is through these effects that containment pressure affects ECCS performance.

For breaks up to and including the double-ended severance of a reactor coolant pipe, the ECCS will limit the clad temperature to well below the melting point and assure that the core will remain in place and substantially intact with its essential heat transfer geometry preserved.

For breaks up to and including the double-ended severance of a reactor coolant pipe, the ECCS will meet the acceptance criteria as presented in 10CFR50 Appendix K. That is:

1. The calculated peak fuel element clad temperature provides margin to the requirement of 2200°F.
2. The calculated total amount of hydrogen generated from the chemical reaction of the cladding with water or steam shall not exceed 0.01 times the hypothetical amount that would be generated if all the metal in the cladding cylinders surrounding the fuel, excluding the cladding surrounding the plenum volume, were to react.
3. The clad temperature transient is terminated at a time when the core geometry is still amenable to cooling. The cladding oxidation limits of 17 percent are not exceeded during or after quenching.
4. The core temperature is reduced and decay heat is removed for an extended period of time, as required by the long-lived radioactivity remaining in the core.

6.3.3.4 Major Secondary System Pipe Failure

The steam release arising from a rupture of a main steam pipe would result in energy removal from the RCS causing a reduction of coolant temperature and pressure. In the presence of a negative moderator temperature coefficient, the cooldown results in a reduction of core shutdown margin. There is an increased possibility that the core will become critical and return to power. A return to power following a steam pipe rupture is a potential problem. The core is ultimately shut down by the boric acid injection delivered by the Safety Injection System.

For the cases where offsite power is assumed, the sequence of events in the safety injection system is the following. After the generation of the safety injection signal (appropriate delays for instrumentation, logic, and signal transport included), the appropriate valves begin to operate and the high head safety injection (charging) pumps start. In 12 seconds after initiation of a safety injection signal, the high head safety injection discharge valves are assumed to be in their final position and the pumps are assumed to be at full speed. The RWST to charging pump suction valves are fully open 17 seconds after initiation of a safety injection signal. This delay, described above, is inherently included in the modeling.

The VCT is isolated from the charging pump suction in 10 additional seconds after the RWST to CSIP suction valves are fully open. This delay and the transport delay for boron from the RWST to the core are included in the modeling.

In cases where offsite power is not available, an additional 10 second delay is assumed to start the diesel generators and to load the necessary safety injection equipment.

The analysis has shown that even assuming a stuck rod cluster control assembly with or without offsite power, and assuming a single failure in the engineered safeguards the core remains in place and intact. Radiation doses will not exceed 10 CFR 50.67 guidelines.

Departure from nucleate boiling and possible clad perforation following a steam rupture are not necessarily unacceptable and not precluded in the criterion. The detailed analysis of whether departure from nucleate boiling may be expected to occur is presented in Section 15.1.5.

6.3.3.5 Steam Generator Tube Failure

The accident examined is the complete severance of a single steam generator tube at power.

Assuming normal operation of the various plant control systems, the following sequence of events is initiated by a tube failure:

1. Pressurizer low pressure and low level alarms are actuated and charging pump flow increases in an attempt to maintain pressurizer level. On the secondary side there is a steam flow/feedwater flow mismatch before trip as feedwater flow to the affected steam generator is reduced due to the break flow which is now being supplied to that steam generator from the primary side.
2. The condenser vacuum pump effluent radiation monitor, steam generator blowdown line radiation monitor, and/or main steamline radiation monitor will alarm, indicating a sharp increase in radioactivity in the secondary system.
3. Continued loss of reactor coolant inventory leads to a reactor trip signal generated by low pressurizer pressure or by overtemperature ΔT . Resultant plant cooldown following reactor trip leads to a rapid decrease in RCS pressure and pressurizer level. A safety injection (SI) signal, initiated by low pressurizer pressure, follows soon after the reactor trip. The SI signal automatically terminates steam generator blowdown, normal feedwater supply and initiates auxiliary feedwater (AFW) addition via the motor-driven AFW pumps. If the steam generator level decreases below the low-low level setpoint in two of the three steam generators or a loss of off-site power occurs, the turbine-driven AFW pump will also be started.

4. The reactor trip automatically trips the turbine and if off site power is available, the steam dump valves open permitting steam dump to the condenser. In the event of a coincident loss of off site power, the steam dump valves would automatically close to protect the condenser. The steam generator pressure would rapidly increase resulting in steam discharge to the atmosphere through the steam generator power operated relief valves (and safety valves if their setpoint is reached).
5. Following reactor trip and SI actuation, the continued action of the AFW supply and borated SI flow (supplied from the refueling water storage tank) provide a heat sink which absorbs some of the decay heat. This reduces the amount of steam bypass to the condenser or in the case of loss of off site power, steam relief to the atmosphere.
6. SI flow results in stabilization of the RCS pressure and pressurizer water level, and the RCS pressure trends toward an equilibrium value where the SI flow rate equals the break flow rate.

In the event of an SGTR, the plant operators must diagnose the SGTR and perform the required recovery actions to stabilize the plant and terminate the primary to secondary leakage. The operator actions for SGTR recovery are provided in the plant Emergency Operating Procedures. The major operator actions include identification and isolation of the ruptured steam generator, cooldown and depressurization of the RCS to restore inventory, and termination of SI to stop primary to secondary leakage.

A steam generator tube rupture will cause no subsequent damage to the RCS or the reactor core. An orderly recovery from the accident can be completed even assuming simultaneous loss of offsite power.

6.3.3.6 Existing Criteria Used to Judge the Adequacy Of the ECCS. Criteria from 10CFR50.46

1. Peak clad temperature calculated shall not exceed 2200°F.
2. The calculated total oxidation of the clad shall nowhere exceed 0.17 times the total clad thickness before oxidation.
3. The calculated total amount of hydrogen generated from the chemical reaction of the clad with water or steam shall not exceed 0.01 times the hypothetical amount that would be generated if all of the metal in the clad cylinders surrounding the fuel, excluding the clad around the plenum volume, were to react.
4. Calculated changes in core geometry shall be such that the core remains amenable to cooling.
5. After any calculated successful initial operation of the ECCS, the calculated core temperature shall be maintained at an acceptable low value and decay heat shall be removed for the extended period of time required by long lived radioactivity remaining in the core.

In addition to and as an extension of the final acceptance criteria of 10 CFR 50 Appendix K, two accidents have more specific criteria as shown below.

In the case of the inadvertent opening of a steam generator power operated relief or safety valve, an additional criteria for adequacy of the ECCS is: Assuming a stuck rod clustered control assembly, offsite power available, and a single failure in the engineered safety features, there will be no return to criticality after reactor trip for a steam release equivalent to the spurious opening with failure to close, of the larger of a single steam dump power operated relief, or safety valve.

For a major secondary system pipe failure, the added criteria is: Assuming a stuck RCCA with or without offsite power, and assuming a single failure in the engineered safeguards, the core remains in place and intact.

6.3.3.7 Use of Dual Function Components

The ECCS contains components which have no other operating function as well as components which are shared with other systems. Components in each category are as follows:

1. Components of the ECCS which perform no other function are:
 - a. One accumulator for each loop which discharges borated water into its respective cold leg of the reactor coolant loop piping.
 - b. One boron injection tank.
 - c. Associated piping, valves and instrumentation.
2. Components which also have a normal operating function are as follows:
 - a. Residual heat removal pumps and the residual heat exchangers - These components are normally used during the latter stages of normal reactor cooldown and when the reactor is held at cold shutdown for core decay heat removal or for flooding the refueling cavity. However, during all other plant operating periods, they are aligned to perform the low head injection function.
 - b. Centrifugal charging pumps - These pumps are normally aligned for charging service. As a part of the Chemical and Volume Control System, the normal operation of these pumps is discussed in Section 9.3.4. During safety injection conditions, however, they are aligned with the RWST to perform the high head injection function.
 - c. Refueling water storage tank (RWST) - This tank is used to fill the refueling cavity for refueling operations and to provide borated makeup to the spent fuel pools. However, during all other plant operating periods it is aligned to the suction of the residual heat removal pumps. The charging pumps are automatically aligned to the suction of the refueling water storage tank upon receipt of the safety injection signals or volume control tank low level alarm. During normal operation they take suction from the volume control tank.
3. Positive Displacement Hydrostatic Test Pump - Normally this pump takes suctions from the RWST. It serves three functions, none of which are safety related. By temporary connections at the discharge of the pump to the Chemical and Volume Control System,

this pump is used for hydrotesting the high pressure parts of the Reactor Coolant System. Permanent connections to the accumulators provide for using the hydrostatic test pump in supplying borated water to the accumulators. Also through the permanent connection, this pump provides a high pressure source for leak testing ECCS pressure isolation valves. A locked closed manual boundary isolation valve, 2CT V144SAB-1, separates the safety related RWST and the non-safety, non-seismically qualified hydrostatic test pump. Strict administrative controls are invoked by plant procedures whenever this valve is opened in modes when the RWST is required operable.

An evaluation of all components required for operation of the ECCS demonstrates that either:

1. The component is not shared with other systems, or
2. If the component is shared with other systems, it is either aligned during normal plant operation to perform its accident function or if not aligned to its accident function, two valves in parallel are provided to align the system for injection. These valves are automatically actuated by the safety injection signal.

Table 6.3.2-7 indicates the alignment of components during normal operation, and the realignment required to perform the accident function.

In all cases of component operation, safety injection has the priority usage such that an "S" signal will override all other signals and start or align systems for injection.

6.3.3.8 Limits on System Parameters

The analyses show that the design basis performance characteristic of the ECCS is adequate to meet the requirements for core cooling following a LOCA with the minimum engineered safety features equipment operating. In order to ensure this capability in the event of the simultaneous failure of any single active component to operate, Technical Specifications are established for reactor operation.

Normal operating status of ECCS components is given in Table 6.3.2-8.

The ECCS components are available whenever the coolant energy is high and the reactor is critical. During low temperature physics tests, there is a negligible amount of stored energy in the coolant and low decay heat; therefore, an accident comparable in severity to accidents occurring at operating conditions is not possible and ECCS components are not required.

The principal system parameters and the number of components which may be out of operation in test, quantities and concentrations of coolant available, and allowable time in a degraded status are specified in the Technical Specifications. If efforts to repair the faulty component are not successful the plant is placed into a lower operational status.

6.3.3.9 Time Sequence for the Operation of the ECCS Components

The ECCS response times supported in the Chapter 15 non-LOCA safety analysis are 12 seconds if offsite power is assumed available and 27 seconds if offsite power is assumed to be lost. The respective response times account for trip logic delays, valve alignment and the time

of the SI pumps to reach full speed. In addition, if offsite power is lost, a delay time for starting the diesel generators and loading the SI pumps is included.

These times are verified by the procedures in the plant Technical Specifications.

For the steam generator tube rupture (SGTR), immediate actuation of the ECCS on an SI signal is assumed in the analysis and is conservative for a SGTR.

In large and small break LOCA analyses it is conservatively assumed that offsite power is lost. Following a loss of offsite power the diesel generators must activate automatically and then be loaded with the ECCS components sequentially. The current Small Break and Large Break LOCA analyses are conservatively based on a 29 second SI response time.

Refer to section 6.3.3.4 for discussion of additional time delay for injection of borated water from RWST to suction of charging pumps.

6.3.4 TEST AND INSPECTIONS

6.3.4.1 ECCS Performance Tests

6.3.4.1.1 Preoperational Test Program at Ambient Conditions

Preliminary operational testing of the ECCS is conducted during the hot functional testing of the RCS following flushing and hydrostatic testing, with the system cold and the reactor vessel head removed. Provision will be made for excess water to drain into the reactor cavity. The ECCS must be aligned for normal power operation with the boron injection tank filled with refueling water. Simultaneously, the safety injection block switch is reset and the breakers on the lines supplying offsite power are tripped manually so that operation of the standby diesel generators is tested in conjunction with the safety injection system. This test will provide information including the following facets:

- a) Satisfactory safety injection signal generation and transmission.
- b) Proper operation of the standby diesel generators, including sequential load pickup.
- c) Valve operating times.
- d) Pump starting times.
- e) Pump delivery rates at ECCS design flows (one point on the operating curve).

Recirculation tests of the ECCS are performed under the requirements of Reg. Guide 1.79 with exceptions/clarifications as noted in Section 14.2.7(g). Testing of the containment recirculation sumps, to demonstrate vortex control and acceptable pressure drops across screening and suction lines and valves, is provided in Section 14.2.12.1.66.

6.3.4.1.2 Components

- a) Pumps - Separate flow tests of the pumps in the ECCS are conducted during the operational startup testing (with the reactor vessel head off) to check capability for

sustained operation. The centrifugal charging, and residual heat removal pumps will discharge into the reactor vessel through the injection lines, the overflow from the reactor vessel passing into the reactor cavity. Each pump will be tested separately with water drawn from the refueling water storage tank. Data will be taken to determine pump head and flow at this time. Pumps will then be run on miniflow circuits and data taken to determine a second point on the head flow characteristic curve.

- b) Accumulators - Each accumulator is filled with water from the refueling water storage tank and pressurized with the motor operated valve on the discharge line closed. Then the valve is opened and the accumulator allowed to discharge into the reactor vessel as part of the operational startup testing with the reactor cold and the vessel head off.

6.3.4.2 Reliability Tests and Inspections

6.3.4.2.1 Description of tests planned

Routine periodic testing of the ECCS components and all necessary support systems at power is planned. Valves which operate after a LOCA are operated through a complete cycle, and pumps are operated individually in this test on their miniflow lines except the charging pumps which are tested by their normal charging function. If such testing indicates a need for corrective maintenance, the redundancy of equipment in these systems permits such maintenance to be performed without shutting down or reducing load under certain conditions. These conditions include considerations such as: the period within which the component should be restored to service, and the capability of the remaining equipment to provide the minimum required level of performance during such a period.

The operation of the remote stop valve and the check valve in each accumulator tank discharge line, may be tested by opening the remote test line valves just downstream of the stop valve and check valve respectively. Flow through the test line can be observed on instruments and the opening and closing of the discharge line stop valve could be sensed on this instrumentation if other methods of position indication were suspect.

Where series pairs of check valves form the high pressure to low pressure isolation barrier between the RCS and safety injection system piping outside the Containment, periodic testing of these check valves must be performed to provide assurance that certain postulated failure modes will not result in a loss of coolant from the low pressure system outside Containment with a simultaneous loss of safety injection pumping capacity. The tests performed verify that each of the series check valves can independently sustain differential pressure across its disc, and also verify that the valve is in its closed position. The required periodic tests are to be performed after each refueling just prior to plant startup, after the RCS has been pressurized.

To implement the periodic component testing requirements, Technical Specifications have been established. During periodic system testing, a visual inspection of pump seals, valve packings, flanged connections, and relief valves is made to detect leakage. Inservice inspection provides further confirmation that no significant deterioration is occurring in the ECCS fluid boundary.

Design measures have been taken to assure that the following testing can be performed:

- a) Active components may be tested periodically for operability (e.g., pumps on miniflow, certain valves, etc.).

- b) An integrated system actuation test can be performed when the plant is cooled down and the RHRS is in operation. The ECCS will be arranged so that no flow will be introduced into the RCS for this test. Details of the testing of the sensors and logic circuits associated with the generation of a safety injection signal together with the application of this signal to the operation of each active component are given in Section 7.2.
- c) A coordinated full flow test of the ECCS operational sequence can be performed at refuelings. However, normally only the high and low head safety injection lines will be tested for delivery of coolant to the vessel.

The design features which further assure this test capability are specifically:

- a) Power sources are provided to permit individual actuation of each active safety related component of the ECCS.
- b) The residual heat removal pumps are used every time the RHRS is put into operation. They can also be tested periodically when the plant is at power either by using the miniflow recirculation lines or a full flow recirculation path.
- c) The centrifugal charging pumps are either normally in use for charging service or can be tested periodically on miniflow to ensure operability.
- d) Remote operated valves can be exercised during routine plant maintenance and normal operation.
- e) Redundant level and pressure instrumentation is provided for each accumulator tank, for continuous monitoring of these parameters during plant operation.
- f) Flow from each accumulator tank can be directed through a test line in order to determine valve operability. The test line can be used, when the RCS is pressurized, to ascertain backleakage through each of the accumulator check valves individually.
- g) A flow indicator is provided in the common charging pump, the SI BIT flowpath, the alternate SI flowpath, and each residual heat removal pump headers. Pressure instrumentation is also provided in these lines.
- h) An integrated system test can be performed when the plant is cooled down and the RHRS is in operation. This test demonstrates the operation of the valves, pump circuit breakers, and automatic circuitry including diesel generator starting and the automatic loading of ECCS components on the diesel generators (by simultaneously simulating a loss of offsite power to the emergency electrical buses).

A closeout inspection procedure is established to perform an inspection of the containment, in particular the containment sump area, to identify any materials having the potential to become debris capable of blocking the containment sump when required for recirculation. This inspection will be performed at the end of each shutdown as soon as practical before containment isolation. A procedure for inspection of the structural components of the containment recirculation sump will be established in accordance with Regulatory Guide 1.82.

See the Technical Specifications, and Section 3.9.6 for the selection of test frequency, acceptability of testing, and measured parameters of pumps and valves. The inservice inspection program described in Section 6.6 is also included in the Technical Specifications. ECCS components and systems are designed to meet the intent of the ASME Code, Section XI for inservice inspection.

6.3.5 INSTRUMENTATION REQUIREMENTS

Instrumentation and associated analog and logic channels employed for initiation of ECCS operation is discussed in Section 7.3. This section describes the instrumentation employed for monitoring ECCS components during normal plant operation and also ECCS post-accident operation. All alarms are annunciated in the Control Room.

6.3.5.1 Temperature Indication

6.3.5.1.1 Deleted by Amendment No. 26.

The fluid temperature at both the inlet and the outlet of each residual heat exchanger is recorded in the Control Room. The outlet temperature of each residual heat exchanger is also indicated locally.

6.3.5.2 Pressure Instrumentation

6.3.5.2.1 Deleted by Amendment No. 26.

6.3.5.2.2 Charging Pump Inlet, Discharge Pressure

There is local pressure indication at the suction and discharge of each centrifugal charging pump.

6.3.5.2.3 Accumulator Pressure

Duplicate pressure channels are installed on each accumulator. Pressure indication in the Control Room and high and low pressure alarms are provided by each channel.

6.3.5.2.4 Test Line Pressure

A local pressure indicator used to check for proper seating of the accumulator check valves between the injection lines and the RCS is installed on the leakage test line.

6.3.5.2.5 Residual Heat Removal Pump Suction Pressure

Local pressure indication is provided at the inlet to each residual heat removal pump.

6.3.5.2.6 Residual Heat Removal Pump Discharge Pressure

Residual heat removal discharge pressure for each pump is indicated locally and remotely in the Control Room. A high pressure alarm is actuated by each channel.

6.3.5.3 Flow Indication

6.3.5.3.1 Deleted by Amendment No. 26.

6.3.5.3.2 Charging Pump Injection Flow

Injection flow to the reactor cold legs is indicated in the Control Room. These flow indicators are non-safety and are operable with and without offsite power. They are powered by the uninterruptable power supply and are backed up by a DC battery, which is connectable to the diesel generator.

6.3.5.3.3 Test Line Flow

Local indication of the leakage test line flow is provided to check for proper seating of the accumulator check valves between the injection lines and the RCS.

6.3.5.3.4 Residual Heat Removal Pump Hot Leg Injection Flow

Indication of the flow recirculated to the RCS hot legs by the residual heat removal pumps is provided on the main control board.

6.3.5.3.5 Residual Heat Removal Pump Cold Leg Injection Flow

The flow from each residual heat removal subsystem to the RCS cold legs is indicated in the Control Room. These instruments also control the residual heat removal bypass valves, maintaining constant return flow to the RCS during normal cooldown.

6.3.5.3.6 Residual Heat Removal Pump Minimum Flow

The flowmeter installed in each residual heat removal pump discharge header provides control for the valve located in the pump minimum flow line.

These flow indicators are non-safety and are operable with and without off site power. They are powered by the uninterruptable power supply and are backed up by a DC battery, which is connectable to the diesel generator.

6.3.5.4 Level Indication

6.3.5.4.1 Refueling water storage tank level

There are four safety related locally mounted level transmitters provided for the RWST. These four level transmitters are used to provide inputs to the RWST low level protection logic. The RWST low level protection logic produces an actuation signal to automatically open the containment recirculation sump isolation valves when two of four RWST level channel bistables receive an RWST level signal lower than a predetermined low-low level setpoint in conjunction with an "S" signal. There are level alarms for high, low, low-low, 2 out of 4 low-low, and empty levels. The high level alarm is provided to warn of possible overflow of the RWST. The low level alarm is provided to assure that a sufficient volume of water is always available in the RWST in conformance with the Technical Specifications. The low-low level alarms alerts the operator to realign the ECCS from the injection to the recirculation mode following an accident

and automatically opens the containment sump isolation valves. The empty alarm indicates that the useable volume of the RWST has been exhausted. Each channel also provides level indication in the Control Room. A local level indication is also provided. Two of the four channels provide input signals to the recorder in the Control Room.

6.3.5.4.2 Accumulator water level

Duplicate water level channels are provided for each accumulator. Both channels provide indication in the Control Room and actuate high and low water level alarms.

6.3.5.4.3 Deleted by Amendment No. 26

6.3.5.5 Valve Position Indication

Valve position for those valves provided with engineering safety features monitoring lights (see Section 7.5) are indicated on the main control board by an on/off system, i.e., should the valve be out of position, the associated light will be different (on or off) from the other valves with which it is grouped and, thus, provide a highly visible indication to the operator. Valve position for remote manual ECCS valves is also indicated on the main control board by red and green indicator lights. Certain "critical" valves also have an annunciator to indicate and alarm in the Control Room a change to the wrong position.

6.3.5.5.1 Accumulator isolation valve position indication

The accumulator motor operated isolation valves are provided with red (open) and green (closed) position indicating lights located at the control module for each valve. These lights are powered by separate Class IE, 120 VAC supply and actuated via valve motor operator limit switches, in order to maintain valve position indication during normal operation when valve power is locked out. A white indicating light is also provided at the control module, powered by the valve control power, to indicate a thermal overload condition at the MCC breaker. Redundant red and green position indicating lights for these valves are also provided at the MCB, via separate Class IE stem mounted limit switches and powered by separate 125 volt DC power.

In addition, a white monitor light is provided for each valve to indicate that valve is not in fully open position. These lights are combined to indicate the proper valve positions for the safeguard operation. The total array of lights is powered from a separate Class IE, 120 Volt AC source and actuated via valve motor operated limit switches. For description of these monitor lights, refer to FSAR subsection 7.5.1.10.3.

An alarm annunciator point is activated by both a valve motor-operator limit switch and by a valve position limit switch activated by stem travel whenever an accumulator valve is not fully open for any reason with the system at pressure (the pressure at which the safety injection block is unblocked is approximately 1900 psig). A separate annunciator point is used for each accumulator valve. This alarm will be recycled at approximately 1 hour intervals to continuously remind the operator of the improper valve lineup, until corrective action is taken.

REFERENCES: SECTION 6.3

- 6.3.1-1 Carolina Power and Light Harris Nuclear Plant Steam Generator Replacement/Upgrading Analysis and Licensing Project NSSS Engineering Report, WCAP-14778, Revision 1, September, 2000.
- 6.3.2-1 Geets, J. M., "MARVEL, A Digital Computer Code for Transient Analysis of a Multiloop PWR System," WCAP-7909, June, 1972.
- 6.3.2-2 Deleted by Amendment No. 55
- 6.3.2-3 Letter from CP&L's W. R. Robinson to the NRC, dated July 15, 1994, NLS-94-055.
- 6.3.2-4 Letter from CP&L's W. R. Robinson to the NRC, dated February 28, 1995, HNP-95-027.
- 6.3.2-5 Letter from CP&L's W. R. Robinson to the NRC, dated December 7, 1995, HNP-95-077.
- 6.3.3-1 "VCT to RWST Alignment for Steam Line Break," FCQL-465, April 13, 1987.

6.4 HABITABILITY SYSTEMS

The Control Room Habitability Systems include equipment, supplies and procedures which give assurance that the control room operators can remain in the Control Room and take effective actions to operate the nuclear power plant safely under normal conditions and maintain the facility in a safe condition following a postulated accident as required by the General Design Criterion 19 contained in Appendix A to 10 CFR 50.

The habitability systems and provisions include:

- a) Control Room Air Conditioning System (which includes the Emergency Filtration System).
- b) Radiation protection
- c) Food and water storage
- d) Kitchen and sanitary facilities
- e) Breathing apparatus

The above systems and provisions provide adequate operator protection under normal and emergency operating conditions (including the design basis loss-of-coolant accident) and postulated release of toxic gases and smoke.

6.4.1 DESIGN BASIS

The habitability systems for the control room include shielding, air handling and filtration systems, temperature control, dehumidifiers, instrumentation to protect against airborne

radioactivity, air breathing apparatus, sufficient storage for food and water, and other provisions for extended occupancy by control room personnel, including kitchen and sanitary facilities.

The bases upon which the functional design of these systems and provisions are designed include the following:

Control Room Envelope:

The control room envelope includes, in addition to the Control Room, the following auxiliary spaces:

- a) Office areas
- b) Relay and termination cabinet rooms
- c) Kitchen and sanitary facilities
- d) Component cooling water surge tank room

Period of Habitability

The period of habitability for control room operators is based on the habitability systems' capability to provide protection from the introduction into the control room envelope of airborne contaminants that present an immediate danger to life or health. The most severe hazards are posed by airborne radioactivity. After the detection of airborne radioactivity the control room envelope will be pressurized and all air will be filtered through charcoal adsorbers. This system will ensure that the control room operators will not receive doses of radiation in excess of the limits specified in GDC 19 of Appendix A to 10 CFR 50 during the time required for the safe shutdown of the plant.

Capacity

The Control Room has been designed (1) to allow continuous occupancy of five persons for a seven-day period following a design basis accident and (2) for replacement of the crews following the seven days. This includes sufficient food, water, medical supplies and sanitary facilities.

Food, Water, Medical Supplies, and Sanitary Facilities

For habitability of the Control Room during certain emergencies, a seven day supply of food and potable water is provided within the control room area.

Basic medical supplies, kitchen and sanitary facilities are provided within the control room envelope.

Radiation Protection

The Control Room envelope has been designed to ensure continuous occupancy during normal operation and extended occupancy throughout the duration of any one of the following postulated design basis accidents:

- a) Loss-of-coolant accident (LOCA)
- b) Fuel handling accident
- c) Radioactive releases due to radwaste system failure

The radiation exposures shall not exceed 5 rem TEDE for the duration of any of the above accidents.

As documented in the SHNPP SER (NUREG-1038 Supplement 2), the postulated design basis LOCA event has been established as the most limiting event for demonstrating compliance with the Control Room Habitability Dose Criteria. Dose to the Control Room personnel resulting from a LOCA is discussed in Section 15.6.5.4.4.

Respiratory, Eye, and Skin Protection for Emergencies

An adequate number of respirators is provided in the Control Room for emergency use.

Habitability System Operation During Emergencies

The Control Room Air Conditioning System is safety related and designated as Safety Class 3 and Seismic Category I. The system is capable of performing its functions assuming an active component single failure.

The air conditioning system will not promote the propagation of smoke and fire from other areas in the Reactor Auxiliary Building to the control room envelope. Refer to Section 9.5.1 for a discussion of fire protection criteria for the Control Room. Provisions have been made for control room smoke purge operation, as described in Section 9.4.1.2.3.

The system has been designed to maintain the ambient temperature in the Control Room at 75 F DB and 50 percent (max.) relative humidity during normal conditions and a design basis accident.

During a postulated LOCA, the Control Room is pressurized to 1/8 in. wg. by the capability of introducing a maximum of 400 cfm outside air into the Control Room which will keep the carbon dioxide and oxygen concentrations within safe levels. Calculations of CO₂ and O₂ concentrations within the Control Room consider that the concentrations of these gases are homogenous within the control room envelope, excluding the air above the hung ceiling. Design maximum concentration of carbon dioxide is taken as 1.0 percent. Design minimum concentration of oxygen will be taken as 17 percent.

The Control Room has been designed to protect the control room operators from all design basis natural phenomena and design basis accidents.

Emergency Monitors and Control Equipment

Provisions have been made to detect radioactivity and smoke in the Control Room air intake. Following detection, the control room envelope is automatically isolated. Sensitivities of the detectors and isolation time including delays in the control circuits are designed to meet the requirements of GDC 19.

6.4.2 SYSTEM DESIGN

6.4.2.1 Control Room Envelope

The control room envelope includes those areas listed in Section 6.4.1. During an emergency, the areas which the control room operator could require access to are the Control Room, office areas, kitchen and sanitary facilities and control room emergency air intake valves located in the relay and termination and cabinet rooms.

6.4.2.2 Ventilation System Design

The control room envelope air conditioning process includes an environmental control operation and an emergency air cleanup operation. The environmental control operation is the primary function of the air conditioning system and it is accomplished by the use of redundant air conditioning trains. The Control Room will be isolated upon receipt of a Safety Injection Signal, following a detection of radioactivity or smoke at the Normal Outside Air Intake (OAI), or following a detection of radioactivity at the Emergency Outside Air Intakes. A loss of power to any of the OAI Radiation Monitors will also result in a Control Room Isolation. Redundant, motorized butterfly valves are provided in the control room envelope outside air intake and exhaust ducts for automatic isolation of the system from the surrounding atmosphere.

Redundant trains of the Control Room Air Conditioning System are provided for the system to fulfill its essential functions. The redundant filtration train is located in a separate equipment room. The system is located within the Reactor Auxiliary Building which is designed to withstand effects of the safe-shutdown earthquake and other design basis natural phenomena.

To assure continued operation following a design basis accident, the Control Room Air Conditioning System is designed to Seismic Category I requirements. This includes equipment and ductwork up to and including the connection into the Control Room (except portions of the normal exhaust and smoke purge fans). The air intakes and exhaust of the Control Room Areas Ventilation System are tornado and missile protected.

Active system components meet the single failure criteria as described in IEEE 279-71. Refer to Table 9.4.1-4 for a single failure analysis of the Control Room Air Conditioning System.

The redundant air conditioning units are served by separate Essential Services Chilled Water Systems so that loss of one train of the chilled water systems will not affect the ability of the system to control the thermal environment in the control room envelope.

The Control Room Area Ventilation System including equipment, ductwork, valves, and air flows for both normal and emergency modes is discussed in detail in Section 9.4.1. Design data for principal components of the Control Room Area Ventilation System are presented in Table 9.4.1-1. The airflow diagram for the Control Room Area Ventilation System is shown on Figure 9.4.1-1.

The Emergency Filtration System is discussed in Section 9.4.1.2. The operational status of valves, fans and corresponding airflow rates for the Control Room Air Conditioning System and Emergency Filtration System are presented in Table 9.4.1-2. The design data is presented in Table 9.4.1-1.

The degree of compliance of the Emergency Filtration System with the requirements of Regulatory Guide 1.52 is discussed in Section 6.5.1.

The layout drawings of the Control Room showing doors, corridors, stairwells, shield walls, and the placement and type of equipment within the Control Room are shown on Figure 1.2.2-35. Elevation and plan views showing building dimensions and the location of control room air intakes are also presented on Figure 1.2.2-35.

Under a completely isolated Control Room, occupied with up to ten people, the CO₂ concentration would build up from zero to one percent in 71 hours. This buildup time is based upon a net control room envelope of 0.71 x 10⁵ ft³) which includes space above the egg crate hung ceiling and a breathing rate of 30 ft³/hr to generate 1 ft³/hr CO₂ per person. Considering there are no postulated design conditions which would require that the control room envelope be isolated for an extended period of time, 71 hours provides more than adequate time of the operator actions required to reestablish control room ventilation.

A ventilation rate of 3.4 cfm fresh air per person will maintain the carbon monoxide level in the control room below 0.5 percent. Since the emergency pressurization mode of the Control Room Ventilation System permits the continuous introduction of up to 400 cfm (outside air from the uncontaminated air intake) through the control room emergency air cleaning unit, there will be no excessive buildup of CO₂ in the control room. The actual pressurization flow rate will be determined by testing to maintain a positive pressure differential of 1/8 inch of water gauge.

A ventilation rate of 0.5 cfm fresh air per person will maintain the oxygen level in the Control Room at 17 percent, min. The design ventilation rate capability of up to 400 cfm is therefore adequate.

Smoke purge fans are provided to expedite firefighting efforts. Refer to Section 9.4.1.2.3 for a detailed discussion of the smoke purge operation.

Adequate bottled air capacity (of at least six hours) is readily available onsite for the five Control Room occupants to assure that sufficient time is available to locate and transport bottled air from offsite locations. This offsite supply is capable of delivering several hundred hours of bottled air to the members of the emergency crew.

6.4.2.3 Leak Tightness

The control room envelope is pressurized to 1/8 in. of water gauge differential pressure relative to the adjacent areas at all times during normal plant operation and outside air is continuously introduced to the control room envelope. During a postulated LOCA, a maximum rate of 400 cfm may be required in order to maintain 1/8 inch of water gauge. The control room is automatically isolated following a design basis radionuclide accident. In case of a radionuclide accident, the operator will re-pressurize the control room by drawing in filtered outside air through one of two emergency air intakes. The 400 cfm pressurization flow rate is approximately 0.34 volume change per hour.

All openings to the Control Room have a low leakage design. This includes doors, valves, penetrations and walls. The control room leakage rate estimate through valves, doors, penetrations and walls is shown in Tables 6.4.2-1 and 6.4.2-2. The estimate is based on AEC R&D Report NAA-SR-101000.

A maximum of 400 cfm makeup air will not make the overall doses to the control room operator exceed the radiation dose limit of General Design Criterion 19 of Appendix A to 10 CFR 50 under design basis accidents. An acceptance test is performed at startup to verify that the control room leakage rate is less than the value assumed in the analysis.

6.4.2.4 Interaction with Other Zones and Pressure-Containing Equipment

The following provisions are taken into consideration in the Control Room Area Ventilation System design to assure that there are no toxic or radioactive gases and other hazardous material that would transfer into the Control Room:

- a) The control room envelope is pressurized to 1/8 in. w.g. relative to the adjacent areas.
- b) The Control Room Area Ventilation system is independent and completely separated from other adjacent ventilation zones.
- c) There is no other HVAC equipment within the Control Room envelope that serves other ventilation zones.
- d) All doors, duct and cable penetrations are of low leakage design.
- e) On a Control Room Isolation Signal, initiated on either a Safety Injection Signal or following a detection of radioactivity or smoke at the Outside Air Intakes, the RAB Normal Ventilation System is secured, and the RAB Emergency Exhaust System (RABEES) is started. The RAB Normal Ventilation System must be secured to preclude the possibility of postulated system failures from impacting the ability of the Control Room Envelope (CRE) to maintain a positive pressure of $\geq 1/8$ INWG relative to adjacent areas. When the RAB Normal Ventilation System is secured, the RAB Emergency Exhaust System is initiated to maintain the potentially contaminated areas of the RAB at sub-atmospheric pressure in an effort to limit outleakage and to remove radon gas from the RAB.

6.4.2.5 Shielding Design

The Control Room envelope is shielded against direct sources of radiation which are present during normal operating conditions and following a postulated accident.

There are no significant sources of direct or streaming radiation near the control room envelope during normal operating conditions. The shielding walls and floor provided for the accident conditions are more than sufficient to limit the dose rates to less than 0.25 mr/hr. in the Control Room during normal operation. Refer to Section 12.3.2.14 for a discussion of the control room shielding design.

6.4.3 SYSTEM OPERATIONAL PROCEDURES

The normal operation of the Control Room Areas Ventilation System is discussed in detail in Section 9.4.1.2.1; the post-accident operation and smoke purge operation are discussed in detail in Sections 9.4.1.2.2 and 9.4.1.2.3.

Upon failure of the normal power supply, all electrically operated safety related components of the system will be automatically switched to their respective emergency power source.

Upon receipt of a Safety Injection Actuation Signal (SIAS) or a high radiation signal from the radiation monitor located within each air intake (one Normal OAI and two Emergency OAIs), all outside air intakes and exhausts will be automatically isolated, and the Emergency Filtration System will be put into operation. In addition, the RAB Normal Ventilation System will be secured, and the RAB Emergency Exhaust System (RABEES) will be started. The RAB Normal Ventilation System must be secured to preclude the possibility of postulated system failures from impacting the ability of the Control Room Envelope (CRE) to maintain a positive pressure of $\geq 1/8$ INWG relative to adjacent areas. When the RAB Normal Ventilation System is secured, the RAB Emergency Exhaust System is initiated to maintain the potentially contaminated areas of the RAB at sub-atmospheric pressure in an effort to limit outleakage and to remove radon gas from the RAB.

After a high radiation signal has automatically isolated the Control Room Air Conditioning System (CRACS) the operator will monitor the CRACS air intake radiation detectors and select the emergency air intake from which to draw the least radioactive make-up air. This selection will be based on the readings of the radiation detectors located in the redundant air intakes on either side of the Reactor Auxiliary Building. The control room operator will manually open the selected closed air intake allowing up to a maximum of 400 cfm of the outside air into the control room envelope. To maintain a positive pressure of 1/8 inch water gauge, a make-up air rate within the range of 71 to 132 cfm is required. The actual control room boundary leakage shall be determined by testing and is expected to be well below the 400 cfm make-up air assumed in the radiological analysis.

6.4.4 DESIGN EVALUATION

6.4.4.1 Radiological Protection

The evaluation of the radiological exposure to the control room operators is presented in the control room accident dose analysis given in Chapter 15. Section 15.6.5.4.4 shows the doses following the design basis accident (LOCA) and demonstrates compliance with GDC 19.

6.4.4.2 Toxic Gas Protection

Accidents involving off-site hazardous chemical releases are discussed in Section 2.2.3. A summary analysis of off-site and on-site toxic chemical hazards that may impact control room habitability, performed in accordance with Regulatory Guide 1.78, is contained in Calculation 9-CRH. The analysis found no impact on control room habitability from toxic chemical sources.

The leakage rate of the control room HVAC valves are given in Tables 6.4.2-1 and 6.4.2-2. The valves that isolate the control room outside air intakes and exhausts are designed with a 15 second closure time. The Control Room Area Ventilation System is discussed in detail in Section 9.4.1.

Toxic chemicals stored onsite are listed in Table 6.4.4 1. Sulfuric acid and sodium hydroxide do not present dangers to control room habitability because they are non-volatile. Hydrogen and nitrogen are simple asphyxiants and would pose a threat to control habitability only if they were to appreciably reduce the oxygen concentration in the control room, while carbon dioxide levels

of up to 1% can be tolerated for a limited period of time. Since an analysis based on Regulatory Guide 1.78 shows that the concentration of these gases in the Control Room will be below one percent under the condition of accidental release, these gases have no potential for adversely affecting control room habitability (Calculation CPL-X-5).

Refer to Section 1.8 for the SHNPP position on Regulatory Guide 1.78.

Chlorine Detection System

Since Shearon Harris no longer stores chlorine in large quantities on site, the chlorine detection system is no longer required at the Shearon Harris Nuclear Power Plant. The chlorine leak detectors, both local and remote, have been deactivated and the equipment is abandoned in place.

6.4.5 TESTING AND INSPECTIONS

The major items of equipment required to maintain the habitability of the Control Room are the emergency HEPA/charcoal filter trains, mechanical refrigeration water chillers, fans and fan coil units, and chilled water pumps. These units are thoroughly tested in a program consisting of the following:

- a) Shop component qualification test.
- b) Field preoperational tests.

These systems and their components, which maintain Control Room habitability, are subjected to documented preoperational testing and in-service surveillance to ensure continued integrity. Testing and inspection is also discussed in Sections 6.6, 9.4.1.4, and 14.2.12. Pump and valve testing is delineated in Section 3.9.6.

Tests are conducted to verify the following for both normal and emergency conditions.

- a) System integrity and leaktightness.
- b) Inplace testing of emergency filter trains to establish leaktightness and removal efficiency of the high-efficiency particulate air and charcoal filters.
- c) Proper functioning of system components and control devices.
- d) Proper electrical and control wiring.
- e) System balance for design airflow, water flow and operational pressures.

6.4.5.1 Emergency HEPA/Charcoal Filter Trains

Initial performance verification and periodic surveillance tests are conducted to ensure operability and performance of both emergency HEPA/charcoal filter systems. Components in these filter systems have been designed to, and are tested in accordance with, the codes and requirements cited within Regulatory Guide 1.52 (see Section 1.8), with the exceptions listed in Table 6.5.1-2.

6.4.5.2 Water Chillers

During shop testing the water chiller impellers are subjected to an overspeed test and dynamic balancing. This overspeed test is in excess of 125 percent of the impeller operating speed. The rotor part of the compressor drive motor is dynamically balanced. Preoperational testing in the field is discussed in Section 14.2. Inservice inspection on the safety Class 3 components of the chillers will be performed in accordance with Section 6.6.

6.4.5.3 Fan or Fan Coil Units

Cooling coils are hydrostatically pressurized and leak tested. A performance test or manufacturer's certified rating in accordance with Air Moving and Conditioning Association (AMCA) or Air Conditioning and Refrigeration Institute (ARI) standards is required. Preoperational testing is delineated in Section 14.2.12. Operating fan or fan coil units will be checked periodically for unusual vibration.

6.4.5.4 Pumps

Each chilled water pump is tested to verify the pump performance characteristics. Preoperational testing shall be delineated in Section 14.2.12. Operating pumps will be observed for leaks, suction and discharge pressures, and flowrates. The pumps will be rotated periodically.

6.4.5.5 Considerations Leading to the Selected Test Frequency

The frequency of performing the surveillance tests is determined by the following considerations:

- a) Preoperational test data.
- b) Normal control room area ventilation system performance data.
- c) Continuous monitoring of the Control Room Area Ventilation System, which gives an indication of building tightness and system performance.

6.4.6 INSTRUMENTATION REQUIREMENT

The control room air conditioning system instrumentation is designed to assist the operator to monitor habitability conditions in the Control Room. System instrumentation, control switches and alarms on the Main Control Board provide the operator with the information concerning the status of the system and enables the operator to take the proper course of action.

System instrumentation and control switches, with the exception of those for the emergency filtration trains and emergency intake valves, are located on the auxiliary control panel/auxiliary transfer panels for use when the Control Room is evacuated.

The radiation monitors are provided with adjustable setpoints and associated alarms such that the operator is notified if any predetermined increase in radiation levels occurs at the air intakes. In the event that the high radiation setpoint is reached, the normal outside air and emergency air intakes and exhausts are automatically isolated. The operator will override the isolation signal

and open the emergency air intake that has the least radioactive level to pressurize the control room envelope.

The radiation detectors and displays meet the requirements for the post-accident monitoring systems including IEEE-279, as discussed in Sections 7.3, 11.5 and 12.5.

Redundant flow indicators are provided for the emergency air intake flow to show the operator the make-up air flowrate required for pressurization.

Smoke detectors are provided at the normal outside air intake and throughout the control room area. In the event of a smoke alarm in the control room area, the operator manually initiates the smoke purge fans which convert the Control Room HVAC System to a "once through" system. If smoke is detected at the normal outside air intake, the Control Room isolation signal is activated as described in Section 7.3.1.

The following Control Room Air Conditioning System parameters are monitored and alarmed when abnormal conditions exist:

- a) Normal outside and emergency air intake radiation level
- b) Normal outside air intake smoke concentration
- c) Control room area smoke concentration
- d) Control room air handling unit prefilter differential pressure
- e) Control room air handling unit inlet temperature
- f) Control room air handling unit entering heating and leaving cooling coil temperature
- g) Control room air handling unit fan failure (low flow)
- h) Control room exhaust fan failure (low flow)
- i) Control room purge fan failure (low flow)
- j) Control room pressure (relative to the adjacent area)
- k) Emergency air intake fan failure (low flow)
- l) Emergency air filtration train status (diff. press.)
- m) Emergency air filtration train humidity
- n) Emergency air filtration train inlet temperature
- o) Emergency air filtration train charcoal filter status
- p) Control room isolation train actuation status

Refer to Sections 7.3 and 7.5 for a more detailed discussion of the control room air conditioning system instrumentation and controls.

6.5 FISSION PRODUCT REMOVAL AND CONTROL SYSTEMS

6.5.1 ENGINEERED SAFETY FEATURE (ESF) FILTER SYSTEMS

All filters that are required to perform a safety related function following a DBA are discussed in this section. The Engineered Safety Filter Systems include the following:

1. FHB Emergency Exhaust System which is discussed in Sections 6.5.1.1.1 and 6.5.1.2.1.
2. RAB Emergency Exhaust System which is discussed in Sections 6.5.1.1.2 and 6.5.1.2.2.
3. Control Room Emergency Filtration System which is discussed in Section 9.4.1.

6.5.1.1 Design Bases

6.5.1.1.1 FHB emergency exhaust system

The FHB Emergency Exhaust System is designed to the following bases:

1. The system is designed to mitigate the consequences of the fuel handling accident by removing the airborne radioactivity from the FHB exhaust air prior to releasing to the atmosphere.
2. The system is designed to maintain the site boundary dose within the guidelines of 10 CFR 50.67 following a fuel handling accident. The fuel handling accident analysis, in accordance with the guidance given in Regulatory Guide 1.183, is presented in Section 15.7.
3. The components of the system are designed and sized in accordance with Regulatory Guide 1.52, Revision 2, with the exceptions listed in Table 6.5.1-2.
4. The fission product removal capacity of the filters is based on the requirements of Regulatory Guide 1.52, Revision 2, with the exceptions listed in Table 6.5.1-2.
5. The system is designed to satisfy all applicable requirements of GDC 61 of 10CFR50, Appendix A.
6. The system establishes and maintains the operating floor of the FHB under negative pressure following a fuel handling accident to prevent unfiltered outleakage of airborne radioactive materials. The FHB will only be held under negative pressure following an event involving the release of radioactivity in the FHB atmosphere.
7. The system is designed to withstand the SSE without loss of function.
8. Any single active failure in the FHB Emergency Exhaust System will not impair the ability of the system to comply with design bases 1 to 7 above.

9. Components and piping or ducting have sufficient physical separation or barriers to protect essential portions of the system from missiles and pipe whip.
10. Failures of non-Seismic Category I equipment or components will not affect the FHB Emergency Exhaust System.

6.5.1.1.2 RAB emergency exhaust system

The RAB Emergency Exhaust System serves to limit the post-accident radiological releases from selected potentially contaminated portions of the RAB. These areas include the charging pump, RHR heat exchanger, containment spray and RHR pump room, mechanical, electrical and H&V rooms and mechanical, electrical and H&V penetration areas. Since leakage in these areas following a SIAS is a potential source of additional offsite dose, the RAB Emergency Exhaust System is provided to ensure that such airborne leakage is filtered prior to release to the environment.

Portions of the Post-accident ECCS Recirculation flow path are outside of the RAB Emergency Exhaust System boundary. These areas include the mezzanine above the CSIP rooms and the CVCS filter area and valve galleries. Other areas affected or potentially affected by the ECCS recirculation flow path pressure boundary include various heat exchanger rooms and valve galleries. Postulated leakage from components in these areas (valves, strainers, filters) is not filtered and will be limited to 2 gallons per hour. Radiological consequences of leakage from ECCS is discussed in 15.6.5.4.

The RAB Emergency Exhaust System will meet the following design bases:

1. The system is designed to maintain the post-accident radiological releases within the guidelines of 10CFR50.67, if a postulated leak occurs in the containment sump water recirculation system. The guidance provided in SRP 15.6.5, Appendix B, has been followed in assessing the offsite doses.
2. The system is designed to satisfy all applicable requirements of GDC 61 of 10CFR50, Appendix A.
3. The fission product removal capacity of the filters is based on the requirements of Regulatory Guide 1.52, Revision 2, with the exceptions listed in Table 6.5.1-2.
4. The system establishes and maintains selected potentially contaminated areas of the RAB below atmospheric pressure following a SIAS, minimizing unfiltered outleakage of airborne radioactive materials.
5. The system is designed with sufficient redundancy to meet single active failure criteria.
6. The system is designed to withstand the SSE without loss of function.
7. The components of the system are designed and sized in accordance with Regulatory Guide 1.52, Revision 2 with the exceptions listed in Table 6.5.1-2.

6.5.1.1.3 Control room emergency filtration system

Refer to Section 9.4.1 for a discussion of the Control Room Emergency Filtration System.

6.5.1.2 System Design

6.5.1.2.1 FHB emergency exhaust system

The FHB Emergency Exhaust System is shown on Figure 9.4.2-1 and consists of two 100 percent capacity redundant fan and filter subsystems.

Each of the two subsystem filter trains includes a manual locked open inlet butterfly valve, demister, electric heating coil, medium efficiency pre-filter, HEPA pre-filter, charcoal adsorber, HEPA after-filter, and decay heat cooling air connection. System component design data are shown in Table 6.5.1-1.

Connected to each subsystem outlet is a centrifugal fan with a motor operated butterfly valve on its inlet and a back draft damper on its outlet to prevent reverse airflow through the inactive fan. The fan is furnished with variable inlet vanes and an air flow monitor to control and measure air flow.

Interconnecting duct between the two emergency air cleaning units was originally provided, as shown in the system flow diagram, to allow one air cleaning unit to draw a small quantity of bleed air through the second inactive filtration train for decay heat cooling. However, the actual temperature increase of the carbon in the shutdown unit is calculated to be well below minimum auto-ignition or desorption temperatures. Therefore, the interconnecting duct is not needed and is blanked off at each unit.

Following a fuel handling accident radioactivity released from fuel rods will be detected by the radiation monitors located around the fuel pools. These radiation monitors will then signal the switchover from the normal to the emergency ventilation and filtration system. The switchover time is 30 seconds for the emergency ventilation and filtration system to become fully operational. The isolation of the normal ventilation system is accomplished in ≤ 10 seconds. Either train may then be manually de-energized from the Control Room and placed on standby. Negative pressure is established at 1/8 in. wg. by continuously exhausting air from the operating floor. Pressure is then controlled by the Airflow Control System which adjusts the variable inlet vanes of the exhaust fans.

Operating procedures ensure that no irradiated fuel (outside of sealed casks) will be handled or transported inside the FHB unless the operating floor hatch to the unloading area is in place. See Section 9.1.4.2.

System design compliance with Regulatory Guide 1.52, Revision 2, is discussed in Table 6.5.1-2.

The total travel time for radioactive gases to travel from the spent fuel pool surface to the isolation damper was conservatively calculated to be 29.95 seconds; however, the closure time of the normal ventilation isolation damper is ≤ 10 seconds. Thus no radioactive gases are released through the normal ventilation pathway.

To initiate operation of the emergency ventilation system and terminate normal ventilation system operation, radiation monitors are provided at appropriate locations as shown in Figure 12.3.2-9 (four sets of three for safety function). The radiation detectors are located on the FHB walls and are extended low range GM tube detectors as described in Section 11.5.2.5.2, monitoring the air volume over the fuel pools. In the event of a fuel handling accident the gaseous radioactive material that is assumed to be released into the fuel pool will rise to the pool surface and be swept up into the FHB ventilation system. The radiation (gamma) that would emanate from the gaseous cloud of radioactive material in the airflow would cause alarms when the exposure rate exceeded preset limits. The detectors high radiation alarm will actuate switchover from normal FHB ventilation to emergency ventilation system operation. The radiation detectors are described in FSAR Section 11.5.2.5.2 and 12.3.4.1.8.3. The monitor's range is 1×10^{-2} through 1×10^3 mr/hr with the high alarm set-point at 1×10^2 mr/hr. The capability of the GM tube detectors was based on assuming the activity releases from the accident discussed in Section 15.7.4. This assumed source provides an exposure rate for the GM tube detectors to monitor. The time required for the accident released activity to provide an exposure rate to exceed the high alarm set-point for the monitors and initiate switchover is such that any doses will be within required limits as discussed in Section 15.7.4. The FHB operating floor, spent and new fuel pool areas are provided with two ventilation systems each of which have Particulate, Iodine, Gas (PIG) airborne effluent monitors monitoring the ventilation exhausts as described in Sections 11.5.2.7.2.2 and 11.5.2.7.2.3. The FHB normal exhaust is provided with effluent airborne monitoring for indication of airborne activity to operations personnel. Operations personnel have the capability to initiate the FHB Emergency Exhaust System from the Control Room as described in Section 7.3.1.3.4. The FHB Emergency Exhaust is provided with a PIG monitor for monitoring effluent exhaust downstream of the emergency exhaust systems HEPA-Charcoal filter units. The particulate and iodine channels of the PIG have been abandoned in place and are not used. Only the gas channel is used. This airborne effluent monitor measures effluent releases during and after a fuel handling accident. Any airborne activity release by the FHB normal ventilation system prior to switchover to the emergency exhaust system will be monitored by the FHB normal exhaust monitors. After switchover the FHB ventilation exhaust will also be monitored. The analyses performed to determine the adequacy of the 30 second switchover time for the FHB ventilation system is described in Section 6.5.1.2.1.1. The two analyses determine the following:

- a) The time of travel of radioactive gases from the spent fuel pool surface to the normal ventilation intake vents isolation damper; (calculated conservatively assuming these dampers remain open).
- b) The maximum allowable bypass period following a fuel handling accident.

The ventilation system for the Fuel Handling Building (FHB) shown on Figures 9.4.2-1 and 9.4.2-2 shows applicable areas covered by the FHB ventilation system. The control drawing for the ventilation system switchover from normal ventilation to emergency exhaust is shown on Figures 7.3.1-13 and 7.3.1-14.

The FHB operating floor area has GM tube area monitors at appropriate locations on the FHB walls, monitoring the building volume by the spent and new fuel pools. As described in Section 12.3.4.1.8.3 these GM tube area monitors will detect gamma radiation emanating from airborne material being drawn up into the FHB ventilation system from a fuel handling accident. When preset levels are reached, a high alarm signal will initiate switchover from normal ventilation to emergency ventilation. The FHB normal and emergency ventilation exhausts are monitored by

airborne effluent Particulate, Iodine, Gas (PIG) monitors in the exhaust ducts as described in Sections 11.5.2.7.2.2 and 11.5.2.7.2.3. The capability to initiate the emergency ventilation system is provided in the Control Room as described in Section 7.3.1.3.4. The FHB emergency ventilation system switchover time and the FHB normal ventilation dampers isolation time of ≤ 10 seconds is within an acceptable duration that limits offsite doses to less than 10 CFR 50.67 limits as described in Section 15.7.4.

6.5.1.2.1.1 Time of Travel of Radioactive Gases

Time for radioactive gases to travel from the spent fuel pool surface to the isolation damper of the normal ventilation system consists of travel time from the pool surface to the intake header and from there to the isolation damper through the length of ventilation duct. These times are evaluated as follows:

a) Travel Time from Refueling Pool Surface to Exhaust Duct

The equation of flow for round hoods is obtained from reference No. 5 of NUREG-0800 "Industrial Ventilation," 8th edition, by the American Conference of Governmental Industrial Hygienists. The velocity profile is given by:

$$V = \frac{Q}{10 \times X^2 + A} \quad (1)$$

where,

V = Centerline velocity at distance X from hood, ft/min.

X = Distance outward along axis, ft (equation is accurate only for limited distance of X, where X is within 1.5D, where D is duct diameter or side of rectangular register).

Q = Air flow rate, cfm.

A = Area of hood opening, ft².

D = Diameter of round hoods or side of essentially square hood, ft.

Using Equation (1) above, the average velocity between the hood and any distance X can be obtained as follows:

$$V_{avg} = \frac{1}{X'} \int_0^{X'} \frac{Q}{10X^2 + A} dx$$

$$V_{avg} = \frac{Q}{X'(10A)^{1/2}} \tan^{-1} \frac{X(10A)^{1/2}}{A} \quad \begin{matrix} X = X' \\ X = 0 \end{matrix}$$

The distance between pool surface and intake header is 44 ft.

$$X = 1.5D = 1.5 \text{ ft.}$$

(X is evaluated using the smaller side of the intake header.)

$$Q = 2,300 \text{ cfm.}$$

$$A = 2 \text{ ft}^2.$$

$V_{\text{avg.}}$ in the first 1.5 ft. of the distance from the intake header equals:

$$V_{\text{avg.}} = 439.2 \text{ ft/min}$$

Travel time for the first 1.5 ft. of the vertical distance from the exhaust register to the fuel pool surface becomes:

$$t_1 = \frac{1.5}{439.2} \times 60 = 0.2 \text{ sec.}$$

Air velocity at 1.5 ft. given by Equation (1) is:

$$V_{1.5 \text{ ft.}} = 94 \text{ ft/min}$$

Conservatively assuming that velocity beyond 1.5 ft. does not decrease, then travel time required for balance of the distance can be calculated as follows:

$$t_2 = \frac{44-1.5}{94} \times 60 = 27.1 \text{ sec.}$$

The travel time, t_3 , from the intake header to the isolation damper is calculated to be 2.65 sec. The total travel time is then:

$$t_{\text{total}} = t_1 + t_2 + t_3 = 29.95 \text{ sec.}$$

The exposure rate from a FHA will be almost instantaneous at the fuel pool surface, and therefore, the gaseous puff of activity will have just breached the fuel pool water surface and not have ascended toward the exhaust duct any significant distance before the monitors will have sensed the activity and initiated ventilation isolation and de-energization. It was conservatively assumed that half the distance to the exhaust register (22 feet) was required to provide an exposure rate to the radiation detectors to initiate damper closure. However, calculations show a point source at the pool surface provides exposure rates from Xe-133 and I-131 to be well in excess of the monitor setpoint. At this exposure rate and a detector sensitivity of 10^3 cpm/mr/hr, the monitor response time will be 0.6 seconds. Assuming the maximum distance traveled by the FHA radioactive gas is half the total distance to the exhaust register, the resulting travel time is 13.65 seconds. This is the longest time considered possible before the radiation detectors initiate an alarm signal to isolate. The time for the normal ventilation dampers to fully close once receiving an isolation signal is 10 seconds. Therefore, the total time for isolation is 24.25 seconds.

b) Conclusions of Analysis of the Switchover Period Following Fuel Handling Accident.

The analysis of the bypass time was performed using the guidance given in Regulatory Guide 1.25. Bypass time is defined as the time period during which gaseous radioactivity is released unfiltered, therefore bypassing the Emergency Exhaust Filtration System. The time for FHA radioactive gas to actuate the radiation detectors and initiate ventilation damper isolation until the damper closes (24.75 seconds) is less than the total time calculated for the FHA radioactive gas to travel from the fuel pool surface to the first isolation damper (29.95 seconds). Therefore, there is zero bypass time, assuring that no unfiltered bypass leakage of radioactive gases can be released through the normal ventilation system.

6.5.1.2.2 RAB Emergency Exhaust System

The RAB Emergency Exhaust System is shown on Figure 9.4.3-2 and consists of redundant 100 percent capacity fan and filter subsystems. Design data for principal system components are presented in Table 6.5.1-3.

Each of the two subsystem filter trains includes a motor operated butterfly valve, decay heat cooling air connection, demister, electric heating coil, medium efficiency filter, HEPA pre-filter, charcoal adsorber and HEPA after filter. Connected to each filter train outlet is a centrifugal fan with a motor operated butterfly valve on its inlet and a backdraft damper on its outlet to prevent reverse airflow through the inactive fan.

Upon receipt of a Safety Injection Actuation Signal (SIAS) or a Control Room Isolation Signal (CRIS), air operated valves on the normal ventilation penetrations into the areas containing equipment essential for safe shutdown close and both RAB Emergency Exhaust Systems are automatically energized. Either unit may then be manually de-energized from the Control Room, and placed on standby.

Access into the areas in the RAB Emergency Exhaust System pressure seal boundary from other parts of the RAB is through leaktight doors under administrative controls.

All penetrations into the enclosed area are provided with proper seals which limit the amount of inleakage. The seals permit differential movement between the penetration and the wall due to thermally or seismically induced motion.

Negative pressure is established at 1/8 in. wg. by continuously exhausting air. Pressure is then controlled by the Airflow Control System which adjusts the variable inlet vane of the exhaust system.

The system is provided with a locked open cross connection line that, in the original system design, allowed for room air to be drawn into either filter train after it had been shut down in order to provide for decay heat removal. It has since been shown that forced air flow is not required for decay heat removal and the room air lines have been permanently isolated. However, the cross connection line remains in place.

Cooling for all areas exhausted by RAB Emergency Exhaust System is provided by the RAB ESF Equipment Cooling System. Refer to Section 9.4.5 for a detailed discussion.

System design compliance with Regulatory Guide 1.52, Revision 2, is discussed in Table 6.5.1-2.

6.5.1.2.3 Control Room Emergency Filtration System

Refer to Section 9.4.1 for a detailed discussion of Control Room Emergency Filtration System. System design compliance with Regulatory Guide 1.52, Revision 2, is discussed in Table 6.5.1-2.

6.5.1.3 Design Evaluation

6.5.1.3.1 FHB Emergency Exhaust System

Two 100 percent capacity subsystems are provided for the FHB Emergency Exhaust System, either of which is capable of meeting the design bases. The subsystems are located within the FHB which protects them from the effect of natural phenomena and missiles. The system components are designed to meet the applicable environmental conditions specified in Section 3.11. All components, ductwork and piping of each subsystem are physically separated from one another so that a single active failure in any component will not impair the system's ability to meet the design bases. A single failure analysis for the FHB Emergency Exhaust System is presented in Table 6.5.1-4.

Instruments and controls and power to the redundant subsystems are electrically separated and powered from separate onsite power sources. The subsystems are actuated through separate channels of high radiation signals or FHB operating floor isolation signals.

The FHB Emergency Exhaust System is designed to meet Safety Class 3 and Seismic Category I requirements.

The temperature of air leaving each charcoal adsorber assembly is monitored. If the temperature rises above a pre*high or high level, an alarm on a local detection panel and in the Control Room will be annunciated.

Interconnecting duct between the two emergency air cleaning units was originally provided, as shown in the system flow diagram, to allow one air cleaning unit to draw a small quantity of bleed air through the second inactive filtration train for decay heat cooling. However, the actual temperature increase of the carbon in the shutdown unit is calculated to be well below minimum auto-ignition or desorption temperatures. Therefore, the interconnecting duct is not needed and is blanked off at each unit.

The HEPA filters meet ASME AG-1 or military specification MIL-F-51068 and MIL-F-51079 and are of fire and water resistant construction in accordance with UL-586, Class 1. They are individually factory tested and certified to have an efficiency not less than 99.97 percent when tested with 0.3 micron dioctylphthalate smoke in accordance with military Standard MIL-STD-282 and USAEC Health and Safety Bulletin, Issue No. 120.306.

Charcoal adsorbers are filled with activated coconut shell charcoal. Laboratory tests of representative samples of charcoal are conducted to demonstrate their capability to attain the decontamination efficiency as indicated in Table 2 of Regulatory Guide 1.52 Revision 2, with the exceptions listed in Table 6.5.1 2.

Each air cleaning unit is designed to be tested in place to verify that the unit meets the particulate filtration, iodine adsorption and leaktightness requirements.

6.5.1.3.2 RAB Emergency Exhaust System

Two 100 percent capacity subsystems are provided for the RAB Emergency Exhaust System, either of which is capable of meeting the design bases.

The subsystems are located in separate compartments within the RAB which protects them from the effects of natural phenomena and missiles. All components are qualified to meet the applicable environmental conditions specified in Section 3.11.

Instruments and controls and power to the redundant subsystems are electrically separated and powered from separate onsite power sources. The subsystems are actuated through separate channels of the Safety Injection Logic or the Control Room Isolation Logic.

A single active failure in any component of the RAB Emergency Exhaust System will not impair the system's ability to fulfill the objectives given in the design bases. A single failure analysis is presented in Tables 6.5.1-4, and 6.5.1-5.

The RAB Emergency Exhaust System is designed to meet Seismic Category I and Safety Class 3 requirements.

The temperature of air leaving each charcoal adsorber assembly is monitored. If temperature rises above a pre-high or high level, an alarm on a local detection panel and in the Control Room will be annunciated.

The maximum decay heat load in the RABEES charcoal filters has been shown to remain low enough that forced air cooling is not required for these units.

The HEPA filters meet ASME AG-1 or military Specification MIL-F-51068 and MIL-F-51079 and are of fire and water resistant construction in accordance with UL-586, Class 1. They are individually factory tested and certified to have an efficiency not less than 99.97 percent when tested with 0.3 micron dioctylphthalate smoke in accordance with military standard MIL-STD-282 and USAEC Health and Safety Bulletin, Issue No. 120.306.

Charcoal adsorbers are filled with activated coconut shell charcoal. Laboratory tests of representative samples of charcoal are conducted to demonstrate their capability to attain the decontamination efficiency as indicated in Table 2 of Regulatory Guide 1.52, Revision 2 (see Table 6.5.1 2).

Each air cleaning unit is designed to be tested in place to verify the unit meets the particulate filtration, iodine adsorption and leaktightness requirements.

6.5.1.3.3 Control Room Emergency Filtration System

Refer to Section 9.4.1 for a detailed discussion of the Control Room Emergency Filtration System. Safety evaluation is described in Section 9.4.1.3.

6.5.1.4 Test and Inspection

Testing and maintenance are primary factors in assuring the reliability and the post-accident fission product removal capability of the Emergency Exhaust Systems.

The qualification tests of filtration system components comply to the requirements of Regulatory Guide 1.52, Revision 2, with the exceptions listed in Table 6.5.1-2.

The in-place airflow distribution test for HEPA filters and charcoal adsorbers, DOP test for HEPA filters, leak test for charcoal adsorber section and laboratory test for activated carbon are in accordance with Sections 5 and 6 of Regulatory Guide 1.52, Revision 2, with the exceptions listed in Table 6.5.1-2.

The system will undergo preoperational and start-up tests as described in Section 14.2.12.1.58. Periodic tests as required by the Technical Specifications will be performed. Inservice inspection will be performed in accordance with Section 6.6 and the valve testing requirements of Section 3.9.6 will apply.

6.5.1.5 Instrumentation Requirements for the RAB and FHB Emergency Exhaust Systems

Indication is provided in the Control Room for the normal flow and low flow conditions for each filtration train. A low flow signal from the operating train initiates an alarm on the main control board.

A Fire Detection Control System is provided for the adsorber section. The temperature of air leaving each charcoal adsorber assembly is monitored by a thermister wire traced over each charcoal adsorber outlet. On temperature rising above a pre-high or high level, an alarm on the detection panel and in the Control Room is annunciated. This will permit initiation, if necessary, of procedures that will prevent high temperature iodine desorption.

Thermometers are provided for the filtration unit inlet downstream of charcoal adsorber.

Indicators and recorders are provided in the Control Room for temperature of air entering and leaving the electric heating coil. If the leaving air temperature from the electric heating coil reaches a dangerous level, the temperature alarm for the charcoal adsorber will alert the Control Room Operator to survey the appropriate temperature indicator and manually de-energize the fan serving the subsystem with the high temperature.

A relative humidity controller, Hydrocon-1, with a Chemical Research Corp. PCR-55 relative humidity sensor is provided for the charcoal adsorber section. High relative humidity annunciation is provided in the Control Room. This ensures that the relative humidity of the air stream is maintained within a range of 0-70 percent in order that an acceptable methyl iodide trapping efficiency is maintained.

Pressure differential indicators and alarms in the Control Room are provided for the following components of the filtration unit.

- a) Prefilter - Alarm
- b) HEPA Prefilter - Indicator, Alarm
- c) Entire Filtration Unit - Indicator, Alarm

Refer to Chapter 7 for further discussion of Emergency Exhaust System instrumentation.

6.5.1.6 Materials

The ESF Filter Systems are located outside the Containment Building. The system operates at a relatively low working temperature and the radiolytic or pyrolytic decomposition of the system material does not therefore pose any significant problem.

Filtration components excluding filter media meet the material requirements described in ANSI/ASME N509-1976.* The ESF filter, housing, frames and floor are made of stainless steel. Refer to Tables 6.5.1-1 and 6.5.1-3 for component material description.

6.5.2 CONTAINMENT SPRAY SYSTEM

6.5.2.1 Design Bases

The Containment Spray System (CSS) performs the dual functions of removing heat and fission products from a post-accident containment atmosphere (fission products are discussed in Section 15.6). The heat removal capability of this system is discussed in Section 6.2.2 (Containment Heat Removal). The fission product removal function is carried out by the Iodine Removal System (IRS) in conjunction with containment heat removal. The IRS removes radioiodines from the containment atmosphere following a loss-of-coolant accident (LOCA) by adding controlled amounts of sodium hydroxide (NaOH) to the containment spray water. The design bases for the Containment Spray System as a fission product removal system are as follows:

1. To provide adequate capability for the fission product scrubbing of the containment atmosphere following a LOCA so that offsite doses and doses to operators in the Control Room are within the guidelines of 10 CFR 50.67. The radioactive material release assumptions of Regulatory Guide 1.183 (see Section 1.8 for compliance) are used in determining system capability. The fission product inventories in the containment are discussed in Section 15.6.
2. To blend Sodium Hydroxide (NaOH) into the spray stream to enhance absorption and retention of iodine by chemical reaction by maintaining a pH value of not less than 7.0 and not more than 11.0 during the long-term recirculation period (the pH range is discussed in greater detail in Section 6.5.2.3.3). The fission product iodine removed from the containment atmosphere remains mixed in the spray solution and will not evolve back into the containment atmosphere.
3. To remove elemental iodines and particulates with the minimum first order removal coefficients in accordance with WASH 1329 as follows:

<u>Iodine Form</u>	<u>First Order Removal Coefficient</u>
Elemental	20 hours ⁻¹
Particulate	3.938 hours ⁻¹

*Filter media meets the material requirements described in ANSI/ASME N509-1980. Except that, ANSI requires HEPA filters to be in accordance with MIL-F-51068, and MIL-F-51068 has been canceled and replaced by ASME AG-1. Therefore, HEPA filters will be allowed to either specification.

4. To meet all removal requirements based on an effective spray coverage of 85.9 percent of the containment free volume. This includes volumes beneath areas of grating in the operating floor (Elevation 286 ft.). The specified grating has 80 percent free area.
5. To perform its function following a LOCA, assuming a single active component failure coincident with loss of offsite power.
6. To perform its function following a safe shutdown earthquake.
7. To perform its function under the post-accident environmental conditions specified in Section 3.11.
8. To provide system materials which are compatible with fluid chemistry and applied codes and standards. System component design data parameters are given in Table 6.5.2-1.

6.5.2.2 System Design

The system flow diagram is shown on Figure 6.2.2-1. System component design data parameters are given in Table 6.5.2-1.

A discussion of the spray header design including a description of the number of nozzles per header, nozzle spacing, and nozzle is contained in Section 6.2.2.

System operation is automatically initiated by a HI 3 signal. The signal starts the two spray pumps and the motor operated spray isolation valves. Within approximately 33 seconds after the spray pumps reach full speed, water will reach the nozzles and start spraying (see Section 6.2.2). The motor operated NaOH isolation valves will be opened automatically by the HI-3 signal.

After the opening of the NaOH Isolation valve, the kinetic energy in the eductor will create a negative pressure to draw the Sodium Hydroxide solution (NaOH) from the containment spray additive tank, NaOH solution will be injected into the Containment Spray System (CSS) lines just upstream of the CS pump suction at a rate sufficient to provide the required range of pH for the containment spray. Turbulence in the fluid passing through the pump is sufficient to assure complete and uniform mixing of the fluid. The NaOH isolation valves will automatically close when the containment spray additive tank is empty. Additional NaOH can be added to the tank or through an emergency NaOH addition line outside the Tank Building. If necessary, the operator may reopen these NaOH isolation valves at any later time. The containment spray pumps initially take suction from the refueling water storage tank (RWST). The minimum operating capacity of the RWST (see Section 6.2.2) is more than adequate to supply enough water for the injection mode of operation. When low-low level tank water level is reached in the RWST, pump suction is transferred to containment recirculating sump automatically by opening the recirculation line valves and closing the valves at the outlet of the RWST.

The Containment Spray System can provide one year of operation if required.

The layout of the containment spray system headers and nozzle orientation (see Section 6.2.2) provides a minimum spray coverage of 92.6 percent of the containment free volume and 95 percent of the surface area of the operating floor (Elevation 286 ft.) with only one spray train in

operation. This includes the volume beneath the grating in the operating floor. The specified grating has 80 percent free area. The drop size spectrum is discussed in Section 6.2.2.

Forced air ventilation is provided to avoid stagnant air regions (see Section 6.2.2).

The small amount of aluminum in Containment reacting with the spray solution will not form a colloidal suspension or a precipitate which could subject the nozzles to clogging.

6.5.2.3 Design Evaluation

6.5.2.3.1 Theory of iodine removal by containment spray

Using the models described in WASH 1329, an evaluation of the effectiveness of the IRS in removing radioiodines from the containment atmosphere post LOCA has been performed.

The removal of radioiodine is considered to be a first order rate phenomenon and is mathematically described below:

$$\frac{dC}{dt} = -\lambda C$$

which integrates to:

$$C = C_0 e^{-\lambda t}$$

where

C = airborne concentration

λ = removal rate constant

C_0 = initial concentration

t = time of spray operation (injection phase)

The iodine removal rate constant (λ) is a function of the iodine absorption efficiency of the spray droplets (E), the iodine partition coefficient (H), the flow rate of the Containment Spray System (F), and the containment volume (V).

The iodine absorption efficiency of the spray droplets (E) takes into account the mass mixture transport process of iodine from the containment air stream to the spray drops and within the drops themselves, and the hydrodynamic and aerodynamic behavior of the drops as they fall through the Containment. The mass transfer model used to calculate the transfer of iodine considers both the interface gas film resistance and the liquid phase resistance of the drops. The effect of drop saturation inhibiting mass transfer rates is not considered since calculations show that saturation does not occur in the time interval of drop transit through the containment atmosphere.

The partition coefficient, H, is defined as the equilibrium ratio of the concentration of iodine in the liquid phase to concentration in the gas phase. It is a function of temperature, pH, and iodine concentration.

6.5.2.3.2 Effectiveness of Fission Product Cleanup by the Spray System

a) Introduction

This section discusses the removal of airborne iodine by the Containment Spray System. In the event of a design basis accident, large amounts of steam and possibly a substantial amount of radioactive iodine (typically, I-131), particulates, and noble gases will be released to the containment atmosphere.

The CSS is actuated by Hi-3 containment atmosphere pressure signal. A basic borate solution will be pumped through spray nozzles located near the top of the Containment Building at one or more intermediate levels in the building. In falling through the Containment to the floor below, the spray droplets will cool the containment atmosphere and remove from the atmosphere the inorganic (molecular) iodine (I_2), particulate iodines, and other particulates released in the accident.

The model used to compute the rate of Elemental iodine removal by the spray solution is based on guidance in SRP 6.5.2, Section III.4.

Elemental Iodine Spray Removal Coefficient

The following formula, used in the FSAR at the time of this calculation, is the functional equivalent of that provided in SRP 6.5.2, Section III.4.c(1):

$$\lambda_s = 1470 \frac{V_t}{u_t} \frac{Fh}{V_c d}$$

1470 Constant for conversions to yield consistent units

0.0235 = V_t/u_t

1730 = F = Spray Flow (gpm)

125 = h = fall height (ft) [Average fall height to operating floor]

2,013,730 = V_c = Sprayed Volume of Containment (ft³)

0.1 = d = Droplet diameter (cm)

37.1 = λ_s = calculated spray removal coefficient (1/hr)

20 = λ_s = used in accident analysis (1/hr), max allowed per SRP 6.5.2, Section III.4.c(1)

Particulate Spray Removal Coefficient

The model used to compute the rate of Particulate removal by the spray solution is based on guidance in SRP 6.5.2, Section III.4.c(4)

The following formula determines the Particulate Spray Removal Coefficient in units of 1/hr:

$$\lambda_p = \frac{3hFE}{2VD}$$

Where,

E/D is a dimensionless collection efficiency E / average spray drop diameter D:

- 10 Initial Value (1/meter)
- 1 Value after particulate depletion factor of 50 obtained
- 13,876 = F = spray flow (cu. ft./hr)@ 1730 gpm * 60 min/hr / 7.481 gal/cu.ft.
- 38.1 = h = fall height (meters) [from lowest spray ring to operating deck] = 125 ft.
- 2,013,730 = V = Sprayed Volume of Containment (ft³)
- 3.938 = initial λ_p (1/hr) used in accident analysis
- 0.3938 = λ_p (1/hr) after particulate DF of 50 obtained used in accident analysis

The spray flow rate used in the calculations is 1730 gpm, the flow with only one of the two containment spray system pumps operating at maximum containment internal pressure. The majority of the spray droplets will fall a distance of 125 ft., which is the average distance from the spray headers located in the hemispherical containment dome to the operating floor. Some of the droplets will fall through the open areas in the operating floor and some of the droplets will be stopped above the operating floor.

The spray system is designed to deliver droplets with an average diameter of 1000 μ at rated flow with a minimum available nozzle pressure of 40 psi above the actual containment pressure. The average drop size assumed in the spray calculation is 0.10 cm or 1000 μ .

6.5.2.3.3 Injection of spray solution

The Containment Spray System (CSS) is designed to deliver a spray to the Containment during the short-term injection phase and the initial period of recirculation with a minimum pH of approximately 7.0 to enhance the absorption of iodine and to prevent stress-corrosion cracking of austenitic stainless steel. To assure long-term retention of iodine, the CSS is designed to assure a minimum pH of 7.0 in the sump solution at the onset of the recirculation mode and at the completion of NaOH addition from the Spray Additive Tank (SAT). The maximum spray or sump pH will not exceed 11.0. This pH range is maintained by the controlled addition of sodium hydroxide to the spray solution.

The containment spray eductors are sized to deliver sodium hydroxide into each of the two containment spray loops as discussed in Section 6.5.2.2. Figures 6.5.2-2 and 6.5.2-3 show the

pH time history of the water both in the containment spray and in the containment sump for the following cases:

1. Case 1 - Minimum pH, longest time
2. Case 2 - Maximum pH, shortest time

The time history curves assume total mixing in the sump for the minimum and maximum RWST volumes.

The figures indicate that the containment spray in all cases achieves a long-term recirculation phase pH within the range of 8.5 - 11.0 (see Figures 6.5.2-2 and 6.5.2-3).

Fission products and sump pH may be monitored, via the sumps connected to the Safety Injection System, from samples taken at the discharge of the RHR heat exchangers (see Sections 5.4.7, 6.3, and 9.3.2).

The pH of the water in the sump during recirculation and after the contents of the spray additive tank have been introduced into the Containment can be determined by using known volumes and chemical compositions of the Reactor Coolant System, refueling water storage tank, accumulators, and spray additive tank. If necessary, additional sodium hydroxide may be added to the Containment and recirculated sump fluid.

If additional sodium hydroxide must be added to the recirculated water in excess of the amount injected from the spray additive tank, this can be accomplished by utilizing the emergency sodium hydroxide addition connections (see Figure 6.2.2-1).

The emergency addition connections are fitted with a hose connector. If it is determined (by sampling and pH measurement, in conjunction with trend monitoring of the recirculation fluid) that additional sodium hydroxide will be required, a tank truck of sodium hydroxide will be obtained from a local supplier. A hose will be run from the truck unloading area to an emergency addition connection. After the hose connection is made, the sodium hydroxide will be added to the system utilizing the tank truck pump.

A 30 weight percent NaOH solution has a freezing point of approximately 32°F, and a boiling point of 240°F at atmospheric pressure. The NaOH is stored in the containment spray additive tank in the RAB; thus, no special provisions for temperature control are installed on the tank. An N₂ blanket is maintained in the tank to assure solution stability and to prevent degradation during long-term storage. The 30 weight percent sodium hydroxide solution used has no fire or flash point, and thus does not pose a fire hazard.

The system components are fabricated of corrosion-resistant materials. They are designed to operate in the environment to which they will be exposed following the worst postulated design basis accident as discussed in Section 3.11.

A cavitating venturi is installed downstream of each CS pump to ensure that both the motor and pump will not exceed the limit of operation during the short term initial injection mode.

Both the containment spray pump and cavitating venturi characteristics are given in Section 6.2.2.

6.5.2.3.4 Single failure analysis

The single failure characteristics of the Containment Spray System have been evaluated in Section 6.2.2.

One of two spray additive eductors will supply adequate sodium hydroxide solution to provide minimum required iodine removal.

6.5.2.4 Testing and Inspection

The Containment Spray System will undergo preoperational and startup tests as described in Section 14.2.12. Periodic tests as required by the Technical Specifications, Section 16.2, will be performed. Inservice inspection will be performed in accordance with Section 6.6 and the pump and valves testing requirements of Section 3.9.6 will apply.

6.5.2.5 Instrumentation Requirement

Instrumentation is provided for monitoring the actuation and performance of the Iodine Removal System. The instrumentation is as follows:

Instrumentation	Function
1. Sodium Hydroxide (NaOH) Tank Pressure	Indicates pressure *** and alarms** on high and low N ₂ cover gas pressure
2. NaOH Tank Level	Indicates level** and alarms** on low level and empty
3. NaOH Flow	Indicates flow rate**
* Local and Control Room	
** Control Room	
*** Local	

Instrumentation is provided to monitor NaOH Tank N₂ pressure and tank level. Refer to Section 7.5, Safety Related Display Instrumentation, for the detailed descriptions of these monitors. Also refer to Section 7.3 for the interface between the system instrumentation and operation. The following abnormal operating conditions will be alarmed in the Control Room: high or low N₂ NaOH tank pressure, and low or empty NaOH tank level.

6.5.2.6 Materials

The materials used in the Iodine Removal System are compatible with the NaOH solution and the environment for the following reasons:

- a) The specifications restrict metals to austenitic stainless steel, Type 316, 304 or an acceptable alternative material.
- b) None of the materials used are subject to decomposition by the radiation or thermal environment. The specifications require that the materials be unaffected when exposed to the equipment design temperature, the total integrated radiation dose, and the boric acid and NaOH solution.

A listing of all the materials utilized in the Iodine Removal System is provided on Table 6.5.2-1.

A complete discussion of the materials utilized in the engineered safety features systems is provided in Section 6.1.

6.5.3 FISSION PRODUCT CONTROL SYSTEMS

6.5.3.1 Primary Containment

For a discussion of the primary containment structural and functional design and other containment systems, refer to the following sections:

Concrete Containment	3.8.1
Containment Functional Design	6.2.1
Containment Heat Removal System	6.2.2
Containment Isolation System	6.2.4
Combustible Gas Control in Containment	6.2.5
Containment Leakage Testing	6.2.6
Containment Ventilation System	9.4.7

A summary of the Containment's capacity to control fission product releases following a design basis accident is shown in Table 6.5.3-1.

Refer to Sections 6.2.2 and 6.5.2 for a discussion of Containment Spray System. Credit is taken for Containment Spray System as a safety related fission product removal system.

A non-nuclear safety airborne radioactivity removal system is provided for the Containment to maintain the fission product activity at low level for safe personnel entry during normal operation. The system is discussed in Section 9.4.7.

Another non-nuclear safety Containment Atmosphere Purge Exhaust System (CAPES) is provided for the Containment to dilute the noble gases and other airborne containment concentrations by continuously venting the Containment to the vent stack. The Containment Atmosphere Purge Exhaust System consists of two subsystems. One is used for low flow during normal operation and the other is used for high flow during reactor shutdown. The former is referred to as the Normal Containment Purge System (NCP) and the latter as the Containment Pre-Entry Purge System (CPP). Both are discussed in Section 9.4.7.

6.5.3.2 Secondary Containment

The Shearon Harris Nuclear Power Plant does not utilize a secondary containment system. Refer to Figures 1.2.2-3 through 1.2.2-18 for the general arrangements of the Containment.

6.5.4 ICE CONDENSER AS A FISSION PRODUCT CLEANUP SYSTEM

This section is not applicable to the Shearon Harris Nuclear Power Plant.

REFERENCES: SECTION 6.5

- 6.5.2-1 J.F. Croft, et al, "Experiments on the Deposition of Airborne Iodine of High Concentration," AEEW-R265, June, 1963.
- 6.5.2-2 J. D. McCormack, R. K. Hilliard, "Natural Removal of Fission Products Released from UO₂ Fuel in Condensing Steam Environments," International Symposium on Fission Product and Transport Under Accident Conditions," CONF-650407, April, 1965.

6.6 INSERVICE INSPECTION OF CLASS 2 AND 3 COMPONENTS

This section discusses the inservice inspection program for ASME Class 2 and 3 components. Preservice inspection will be conducted in accordance with ASME Code Section XI, 1980 edition through Winter '81 addenda, except where specific relief is requested. Inservice inspection will be conducted in accordance with the ASME Section XI Edition required by 10CFR50.55a(g) as detailed in the Technical Specifications.

6.6.1 COMPONENTS SUBJECT TO EXAMINATION

The scope of the program encompasses those ASME Class 2 and 3 components which are within the boundaries of safety-related systems. Safety-related systems and components are those required to (1) permit safe reactor shutdown, (2) mitigate the consequences of an accident, and (3) limit the radiation dose at the site boundary to the limits of 10CFR50.67.

ASME Class 2 components are exempted from inservice examination requirements in accordance with IWC-1220 and the Examination Plan. ASME Class 3 components are exempted from inservice examination requirements in accordance with IWD-1220 and the Examination Plan.

Detailed inservice examinations will be performed on ASME Class 2 non-exempt components in accordance with Table IWC-2500-1 except that RHRS, ECCS, and CHRS category C-F welds will be examined in accordance with the requirements of this section and the Examination Plan. Detailed inservice examinations will be performed in ASME Class 3 components in accordance with Table IWD-2500-1.

ASME Code Category C-F has been subsumed by the adoption of EPRI Technical Report TR-I 12657, Rev. 8-A methodology, which is supplemented by Code Case N-578-1, for implementing risk-informed inservice inspections. This approach replaces the categorization, selection, examination volume requirements for portions of ASME Section XI Examination Categories B-F, B-J, C-F-I, and C-F-2 applicable to HNP with Examination Category R-A as defined in Code Case N-578-1. Implementation of the RISI program is in accordance with Relief Request 13R-02. Detailed Examination Plan, including information on areas subject to examination, method of examination, and extent and frequency of examination, will be provided.

6.6.2 ACCESSIBILITY

The design and arrangement of ASME Class 2 components provide adequate clearance in accordance with IWA-1500 to conduct the required examination and inspections of Subsection

IWC. Where volumetric or surface examinations are performed, direct access to the component has been provided.

The design and arrangement of ASME Class 3 components also provide adequate clearances in accordance with IWA-1500 to conduct the required examinations and inspections of Subsection IWD.

A continuing program of radiation surveys during the refueling programs will be performed to ensure that any possible future problem areas are detected at an early stage. Should additional experience in the maintenance and inspection of operating plants indicate that areas exist where access will be either limited or impossible, requests for relief from Section XI requirements will be made.

6.6.3 EXAMINATION TECHNIQUES AND PROCEDURES

Examination techniques and procedures for ASME Class 2 and 3 components will be in accordance with IWA-2200, IWC-2500 and IWD-2500, and are identical with those of ASME Class 1 as discussed in Section 5.2.4.3.

6.6.4 INSPECTION INTERVALS

An inspection program for ASME Class 2 components will be developed in accordance with the guidance of IWC-2400 and Table IWC-2500-1. The inspection program will be based upon "Inspection Program B" given in Table IWC-2412-1.

An inspection program for ASME Class 3 components will be developed in accordance with the guidance of IWD-2400 and Table IWD-2500-1.

6.6.5 EXAMINATION CATEGORIES

The inservice inspection categories for ASME Class 2 components are in agreement with Table IWC-2500-1 and as noted above. The inservice inspection categories for ASME Class 3 components are in agreement with IWD-2500 and Table IWD 2500-1.

The examination categories and inspection requirements are described in the Examination Plan.

6.6.6 EVALUATION OF EXAMINATION RESULTS

Articles IWC-3000 and IWD-3000, concerning evaluation of examination results on ASME Class 3 components, have not yet been prepared. After their publication, this article will be reviewed and incorporated in this section as applicable.

In the meantime, the evaluation of examination results for ASME Class 2 and 3 components will be performed in accordance with IWA-3000, IWB-3000, and IWC-3000.

The repair procedures for ASME Class 2 components will comply with the requirements of IWA-4000. The repair procedures for ASME Class 3 components will comply with the requirements of IWA-4000.

6.6.7 SYSTEM PRESSURE TESTS

System leakage and hydrostatic tests of ASME Class 2 and 3 components are conducted per the requirements of ASME Section XI Articles IWA-5000, IWC-5000 and IWD-5000.

6.6.8 AUGMENTED INSERVICE INSPECTION TO PROTECT AGAINST POSTULATED PIPING FAILURES

High-energy fluid system piping between containment isolation valves or from the Containment to the first valve outside Containment for piping without an isolation valve inside Containment and piping in the break exclusion region receive an augmented ISI as follows:

- a) Protective measures or structures do not prevent the access necessary for conducting the inservice inspection in accordance with Section XI.
- b) HNP has adopted EPRI Topical Report TR-1006937, Rev. 0-A methodology for additional guidance for adoption of the RISI evaluation process to Break Exclusion Region(BER) piping, also referred to as the High Energy Link Break (HELB) region. This change to the BER program was made under 10CFR50.59 evaluation criteria. The RISI evaluation for BER piping is in effect for the entire third ten-year 1st interval. One hundred percent of all pipe welds that are greater than 4 in. nps in the break exclusion region of main steam and feedwater shown in Figure 3.6.2 1 will be 100 percent volumetrically inspected within each inspection interval.
- c) One hundred percent of all welds that are less than or equal to 4 in. nps and greater than 1 in. nps in the break exclusion regions of Main Steam and Feedwater shown in Figure 3.6.2-1 and in the break exclusion regions of Steam Generator Blowdown and CVCS Letdown (at the containment wall in the mechanical penetration area) and all socket welds will receive a surface inspection within each inspection interval.
- d) Welded attachments, if any, in the inspection area will receive surface examination.
- e) Guard pipe is not used on the SHNPP piping system.
- f) The areas subject to examination are defined in accordance with Examination Categories C-F for Class 2 welds in Table IWC-2500-1 of Section XI.

6.7 MAIN STEAM LINE ISOLATION VALVE LEAKAGE CONTROL SYSTEM

This section is not applicable to the Shearon Harris Nuclear Power Plant.

TABLE	TITLE
6.1.1-1	ENGINEERED SAFETY FEATURES MATERIALS
6.1.1-2	ALUMINUM AND ZINC INVENTORY INSIDE CONTAINMENT
6.1.2-1	PROTECTIVE COATINGS ON WESTINGHOUSE SUPPLIED EQUIPMENT INSIDE CONTAINMENT
6.1.2-2	ELECTRICAL CABLE INSULATION MATERIALS INVENTORY INSIDE CONTAINMENT
6.2.1-1	POSTULATED ACCIDENTS FOR CONTAINMENT DESIGN
6.2.1-2	CALCULATED VALUES FOR CONTAINMENT PARAMETERS
6.2.1-3	PRINCIPAL CONTAINMENT DESIGN PARAMETERS
6.2.1-4	CALCULATED CONTAINMENT PRESSURE & TEMPERATURE
6.2.1-5	INITIAL CONDITIONS FOR CONTAINMENT PEAK PRESSURE-TEMPERATURE ANALYSIS
6.2.1-6	ENGINEERED SAFETY FEATURE SYSTEMS OPERATING ASSUMPTIONS FOR CONTAINMENT PEAK PRESSURE ANALYSIS
6.2.1-7	CONTAINMENT PASSIVE HEAT SINKS
6.2.1-8	SUMMARY OF PASSIVE HEAT SINKS USED IN THE CONTAINMENT ANALYSES
6.2.1-9	ACCIDENT CHRONOLOGIES
6.2.1-10	DELETED BY AMENDMENT NO. 51
6.2.1-11	ASSUMPTIONS USED IN ANALYSIS OF INADVERTENT CONTAINMENT SPRAY SYSTEM ACTUATION
6.2.1-12	REACTOR CAVITY SUBCOMPARTMENT MASS AND ENERGY RELEASE FROM REACTOR VESSEL COLD LEG NOZZLE 150 IN ² BREAK
6.2.1-13	REACTOR CAVITY SUBCOMPARTMENT MASS AND ENERGY RELEASE FROM REACTOR VESSEL HOT LEG NOZZLE 150 IN ² BREAK
6.2.1-14	STEAM GENERATOR SUBCOMPARTMENT DOUBLE ENDED HOT LEG GUILLOTINE BREAK MASS AND ENERGY RELEASE DATA
6.2.1-15	STEAM GENERATOR SUBCOMPARTMENT DOUBLE-ENDED PUMP SUCTION LEG GUILLOTINE BREAK MASS AND ENERGY RELEASE DATA
6.2.1-16	STEAM GENERATOR SUBCOMPARTMENT DOUBLE-ENDED COLD LEG GUILLOTINE BREAK MASS AND ENERGY RELEASE DATA
6.2.1-17	PRESSURIZER SUBCOMPARTMENT DOUBLE-ENDED SURGE LINE GUILLOTINE BREAK MASS AND ENERGY RELEASE RATES FOR ORIGINAL DESIGN BASES
6.2.1-17a	PRESSURIZER SUBCOMPARTMENT DOUBLE-ENDED SURGE LINE GUILLOTINE BREAK MASS AND ENERGY RELEASES FOR SGR/PUR
6.2.1-18	PRESSURIZER SUBCOMPARTMENT SPRAY LINE DOUBLE ENDED PRESSURIZER BREAK MASS

TABLE	TITLE
	AND ENERGY RELEASE RATES FOR ORIGINAL DESIGN BASES
6.2.1-18a	PRESSURIZER SUBCOMPARTMENT SPRAY LINE DOUBLE ENDED PRESSURIZER BREAK MASS AND ENERGY RELEASE RATES FOR SGR/PUR
6.2.1-19	REACTOR CAVITY SUBCOMPARTMENT PRESSURIZATION MODEL RELAP-4 VOLUME INPUT DATA
6.2.1-20	REACTOR CAVITY SUBCOMPARTMENT PRESSURIZATION MODEL RELAY-4 JUNCTION INPUT DATA
6.2.1-20A	LIST OF PROJECTED AREAS
6.2.1-20B	LIST OF LEVER ARMS
6.2.1-21	STEAM GENERATOR - LOOP 1 SUBCOMPARTMENT ANALYSIS-VOLUME INPUT DATA
6.2.1-22	STEAM GENERATOR LOOP 1 SUBCOMPARTMENT ANALYSIS JUNCTION INPUT DATA
6.2.1-23	STEAM GENERATOR - LOOP 3 SUBCOMPARTMENT ANALYSIS VOLUME DATA
6.2.1-24	STEAM GENERATOR LOOP 3 SUBCOMPARTMENT ANALYSIS JUNCTION INPUT DATA
6.2.1-25	STEAM GENERATOR AND PRESSURIZER LOOP – 2 SUBCOMPARTMENT ANALYSIS VOLUME DATA
6.2.1-26	STEAM GENERATOR AND PRESSURIZER LOOP 2 SUBCOMPARTMENT ANALYSIS JUNCTION INPUT DATA
6.2.1-27	SUMMARY OF CALCULATED SUBCOMPARTMENT PEAK PRESSURES FOR ORIGINAL DESIGN BASES
6.2.1-28	CASE ANALYZED AND RESULTS
6.2.1-29a	DOUBLE-ENDED PUMP SUCTION BREAK BLOWDOWN M&E RELEASES (SAME FOR ALL DEPS RUNS-MAX. AND MIN. S.I.)
6.2.1-29b	DOUBLE-ENDED PUMP SUCTION BREAK BLOWDOWN M&E RELEASES (SAME FOR ALL DEPS RUNS-MAX. AND MIN. S.I.)
6.2.1-30	DELETED BY AMENDMENT NO. 51
6.2.1-31	DELETED BY AMENDMENT NO. 51
6.2.1-32	DELETED BY AMENDMENT NO. 51
6.2.1-33	DOUBLE ENDED HOT-LEG BREAK BLOWDOWN MASS AND ENERGY RELEASES
6.2.1-34	DELETED BY AMENDMENT NO. 51
6.2.1-35	DOUBLE-ENDED PUMP SUCTION BREAK MAXIMUM SAFEGUARDS REFLOOD MASS AND ENERGY RELEASES
6.2.1-36	DOUBLE-ENDED PUMP SUCTION BREAK MINIMUM SAFEGUARDS REFLOOD MASS AND

TABLE	TITLE
	ENERGY RELEASES
6.2.1-37	DELETED BY AMENDMENT NO. 51
6.2.1-38	DELETED BY AMENDMENT NO. 51
6.2.1-39	DELETED BY AMENDMENT NO. 51
6.2.1.40	DOUBLE-ENDED PUMP SUCTION BREAK MAXIMUM SAFEGUARDS POST-REFLOOD MASS AND ENERGY RELEASES
6.2.1-41	DOUBLE-ENDED PUMP SUCTION BREAK MIN SAFEGUARDS POST-REFLOOD MASS AND ENERGY RELEASES
6.2.1-42	DELETED BY AMENDMENT NO. 51
6.2.1-43	DOUBLE-ENDED PUMP SUCTION BREAK MASS BALANCE MAXIMUM SAFEGUARDS
6.2.1-44	DOUBLE-ENDED PUMP SUCTION BREAK MASS BALANCE MINIMUM SAFEGUARDS
6.2.1-45	DELETED BY AMENDMENT NO. 51
6.2.1-46	DELETED BY AMENDMENT NO. 51
6.2.1-47	DOUBLE-ENDED HOT LEG BREAK MASS BALANCE
6.2.1-48	DELETED BY AMENDMENT NO. 51
6.2.1-49	DOUBLE-ENDED PUMP SUCTION BREAK, MAXIMUM SAFEGUARDS PRINCIPAL PARAMETERS DURING REFLOOD
6.2.1-50	DELETED BY AMENDMENT NO. 63
6.2.1-51	DOUBLE-ENDED PUMP SUCTION BREAK ENERGY BALANCE -MAXIMUM SAFEGUARDS
6.2.1-52	DOUBLE-ENDED PUMP SUCTION BREAK ENERGY BALANCE -MINIMUM SAFEGUARDS
6.2.1-53	DELETED BY AMENDMENT NO. 51
6.2.1-54	DELETED BY AMENDMENT NO. 51
6.2.1-55	DOUBLE-ENDED HOT LEG BREAK ENERGY BALANCE
6.2.1-56	DELETED BY AMENDMENT NO. 51
6.2.1-57	DELETED BY AMENDMENT NO. 51
6.2.1-58A	MSLB FULL DOUBLE-ENDED RUPTURE (1.4 FT ²) AT 102% POWER (WITH MFIV FAILURE)
6.2.1-58B	MSLB FULL DOUBLE-ENDED RUPTURE (1.4 FT ²) AT 30% POWER (WITH MFIV FAILURE)
6.2.1-59	DELETED BY AMENDMENT NO. 46
6.2.1-60	DELETED BY AMENDMENT NO. 46

TABLE	TITLE
6.2.1-61	DELETED BY AMENDMENT NO. 46
6.2.1-62	ACTIVE HEAT SINK DATA FOR MINIMUM POST-LOCA CONTAINMENT PRESSURE
6.2.1-63	PASSIVE HEAT SINK DATA FOR MINIMUM POST-LOCA CONTAINMENT PRESSURE
6.2.1-64	SINGLE FAILURE ANALYSIS - CONTAINMENT VACUUM RELIEF SYSTEM
6.2.1-65	POST-ACCIDENT MONITORING CONTAINMENT ATMOSPHERE TEMPERATURE AND CONTAINMENT SUMP WATER TEMPERATURE
6.2.1-66	LOCA M&E RELEASE ANALYSIS CORE DECAY HEAT FRACTION
6.2.2-1	CONTAINMENT COOLING SYSTEM COMPONENTS
6.2.2-2	DELETED BY AMENDMENT NO. 48
6.2.2-3	CONTAINMENT FAN COOLER PERFORMANCE DATA
6.2.2-4	PRIMARY SHIELD COOLING SYSTEM COMPONENTS SAFETY CLASS - 3 UNITS
6.2.2-5	REACTOR SUPPORTS COOLING SYSTEM COMPONENTS SAFETY CLASS 3 UNITS
6.2.2-6	SINGLE FAILURE ANALYSIS CONTAINMENT COOLING SYSTEM
6.2.2-7	SINGLE FAILURE ANALYSIS CONTAINMENT SPRAY SYSTEM
6.2.2-8	CSS PUMP NPSH EVALUATION
6.2.2-9	CONTAINMENT SPRAY SYSTEM COMPONENT PARAMETERS
6.2.2-10	DELETED BY AMENDMENT NO. 43
6.2.2-11	DELETED BY AMENDMENT NO. 43
6.2.4-1	CONTAINMENT ISOLATION SYSTEM DATA
6.2.4-2	CONTAINMENT ISOLATION VALVE POSITION FOLLOWING AN ACCIDENT
6.2.5-1	DELETED BY AMENDMENT NO. 62
6.2.5-2	CONTAINMENT HYDROGEN PURGE SYSTEM COMPONENTS NON NUCLEAR SAFETY UNITS
6.2.5-3a	POST-LOCA CONTAINMENT TEMPERATURES
6.2.5-4	ALUMINUM INVENTORY IN CONTAINMENT
6.2.5-5	GALVANIZED ZINC INVENTORY IN CONTAINMENT
6.2.5-6	ZINC-BASE PAINT INVENTORY IN CONTAINMENT
6.2.5-7	FAILURE MODE AND EFFECTS ANALYSIS HYDROGEN MONITORING SYSTEM

TABLE	TITLE
6.2B-1	DELETED BY AMENDMENT NO. 51
6.2B-2	DELETED BY AMENDMENT NO. 51
6.3.1-1	EMERGENCY CORE COOLING SYSTEM FAILURE MODES AND EFFECTS ANALYSIS
6.3.2-1	EMERGENCY CORE COOLING SYSTEM COMPONENT PARAMETERS
6.3.2-2	EMERGENCY CORE COOLING SYSTEM RELIEF VALVE DATA
6.3.2-3	MOTOR OPERATED ISOLATION VALVES IN THE EMERGENCY CORE COOLING SYSTEM
6.3.2-4	MATERIALS EMPLOYED FOR EMERGENCY CORE COOLING SYSTEM COMPONENTS
6.3.2-5	EMERGENCY CORE COOLING SYSTEM RECIRCULATION PIPING PASSIVE FAILURE ANALYSIS
6.3.2-6	SEQUENCE OF SWITCHOVER OPERATION FROM INJECTION TO RECIRCULATION
6.3.2-7	EMERGENCY CORE COOLING SYSTEM SHARED FUNCTIONS EVALUATION
6.3.2-8	NORMAL OPERATING STATUS OF EMERGENCY CORE COOLING SYSTEM COMPONENTS FOR CORE COOLING
6.3.2-9	RWST OUTFLOW LARGE BREAK - NO FAILURES
6.3.2-10	PUMPS AND VALVES REQUIRED FOR ECCS OPERATION
6.4.2-1	CONTROL ROOM BUTTERFLY VALVES LEAKAGE RATE ESTIMATE
6.4.2-2	SUMMARY OF MAIN CONTROL ROOM LEAK RATE CALCULATION
6.4.4-1	TOXIC CHEMICALS STORED ONSITE
6.5.1-1	DESIGN DATA FOR FUEL HANDLING BUILDING EMERGENCY EXHAUST SYSTEM
6.5.1-2	COMPARISON OF FUEL HANDLING BUILDING EMERGENCY EXHAUST SYSTEM, REACTOR AUXILIARY EMERGENCY EXHAUST SYSTEM AND CONTROL ROOM EMERGENCY FILTRATION SYSTEM WITH REGULATORY POSITIONS OF R.G. 1.52, REVISION 2
6.5.1-3	DESIGN DATA FOR REACTOR AUXILIARY BUILDING EMERGENCY EXHAUST SYSTEM
6.5.1-4	FUEL HANDLING BUILDING EMERGENCY EXHAUST SYSTEM SINGLE FAILURE ANALYSIS
6.5.1-5	REACTOR AUXILIARY BUILDING EMERGENCY EXHAUST SYSTEM SINGLE FAILURE ANALYSIS
6.5.2-1	IODINE REMOVAL SYSTEM COMPONENTS
6.5.3-1	PRIMARY CONTAINMENT OPERATION FOLLOWING A DESIGN BASIS ACCIDENT

TABLE 6.1.1-1 ENGINEERED SAFETY FEATURES MATERIALS
Materials Employed for Safety Injection and Containment Spray Systems Components

<u>Component</u>	<u>Material</u>
<u>Pumps</u>	
Containment spray	SA-351, Grade CF8 or CF8M; SA182, Grade F304 or F316
<u>NSSS Vendor Supplied Pumps</u>	
Pump casing and heads	SA-351, Grade CF8 or CF8M; SA-182, Grade F304 or F316
Flanges and nozzles	SA-182, Grade F304 or F316; SA-403, Grade WP316L Seamless
Piping	SA-312, Grade TP304 or TP316 Seamless
Stuffing or packing box cover	SA-351, Grade CF8 or CF8M; SA-240, Type 304 or Type 316; SA-182, Grade F304
Pipe fittings	SA-403, Grade WP316L Seamless; SA-213, Grade TP304, TP304L, TP316 or TP316L
Closing bolting and nuts	SA-193, Grade B6, B7 or B8M; SA-104, Grade 2H or 8M; SA-453, Grade 660 and Nuts SA-194, Grade 2H, 6, 7, or 8M
<u>NSSS Vendor Supplied Heat Exchangers</u>	
Heads	SA-240, Type 304
Nozzle necks	SA-182, Grade F304; SA-312, Grade TP 304; SA-240, Type 304
Tubes	SA-213, Grade TP304; SA-249, Grade TP304
Tube sheets	SA-182, Grade F304; SA-240, Type 304; SA-516, Grade 70 with Stainless Steel Cladding A-7 Analysis
Shells	SA-240 and SA-312, Grade TP304 and SA-351, Grade CF8
Pressure retaining bolting	SA-193, Grade B7
<u>Valves</u>	
Containing radioactive fluids:	
Pressure-containing parts	Type 316 and 304
Seating surfaces	Stellite No. 6 or equivalent
Stems	Type 410 or 17-4PH stainless (Type 630)
Containing nonradioactive, boron-free fluids:	
Pressure-retaining parts	SA-216 Grade WCB
<u>NSSS Vendor Supplied Valves</u>	
Bodies	SA-182, Grade F316 or SA-351, Grade CF8 or CF8M
Bonnets	SA-182, Grade F316 or SA-351, Grade CF8 or CF8M
Discs	SA-182, Grade F316 or SA-564, Grade 630 or SA-351, Grade CF8 or CF8M

TABLE 6.1.1-1 ENGINEERED SAFETY FEATURES MATERIALS
Materials Employed for Safety Injection and Containment Spray Systems Components

Pressure retaining bolting	SA-453, Grade 660
Pressure retaining nuts	SA-453, Grade 660 or SA-194, Grade 6
<u>Component</u>	<u>Material</u>
<u>Relief Valves</u>	
Bodies	SA-182, Type F316 or SA-351, Grade CF8 or CF8M
All nozzles, discs, spindles, and guides	SA-182, Type F316 or SA-564, Grade 630
Bonnets for stainless steel valves without a balancing bellows	SA-182, Type F316 or SA-351, Grade CF8 or CF8M
<u>Piping</u>	
All piping in contact with borated water	SA-312, SA-376 or 358 Class 1, Type 304 or 316

| Deleted in Amendment 62

Materials Employed for Containment System

Reinforcing Steel	A-615, Grade 60
Containment liner	SA-516 Grade 70
<u>NSSS Vendor Supplied Pressure Vessels, Tanks, Filters, etc.</u>	
Shells and heads	SA-351, Grade CF8A; SA-240, Type 304; SA-264 Clad Plate of SA-537, Class 1 with SA-240, Type 304 Clad and Stainless Steel Weld Overlay A-8 Analysis
Flanges and nozzles	SA-182, Grade F304; SA-350, Grade LF2 or LF3 with SA-240, Type 304 and Stainless Steel Weld Overlay A-8 Analysis
Piping	SA-312 and SA-240, Grade TP304 or TP316 Seamless
Pipe fittings, Closure bolting, and nuts	SA-403, Grade WP304 Seamless SA-193, Grade B7 and SA-194, Grade 2H

TABLE 6.1.1-2

ALUMINUM AND ZINC INVENTORY INSIDE CONTAINMENT*

<u>Components</u>	<u>Surface ft.²</u>	<u>Weight (lbs.)</u>	<u>Material</u>
Flux Mapping Drive System	75	171	Al
Source Intermediate and Power Range Detectors	83	244	Al
Control Rod Drive Mech Conn	65	191	Al
Rod Position Indicators	79	178	Al
Miscellaneous Valves	86	230	Al
Contingency	75	200	Al
Polar Crane	37.25	71.5	Al
Jib Crane - Removed	0	0	
Hoist (Estimate)	26	50	Al
Elevator (Estimate)	26	10	Al

TOTAL WEIGHT OF ALUMINUM = 1345.5 pounds

<u>Components</u>	<u>Surface ft.²</u>	<u>Weight (lbs.)</u>	<u>Material</u>
Cable Trays	8776	4 Mils	Zn
Conduits	20531	1.5 Mils	Zn
Pull and Junction Boxes	1166	2 Mils	Zn
Pull and Junction Boxes	2180	2 Mils	Zn
Pull and Junction Boxes	530	2 Mils	Zn
Pull and Junction Boxes	103	5 Mils	Zn
Ductwork over Elevation 228.14 ft.	8960	.8-.9 oz/ft. ²	Zn
from Elevation 236 ft. to 261 ft.	7226	.8-.9 oz/ft. ²	Zn
	1728	.8-.9 oz/ft. ²	Zn
	672	.8-.9 oz/ft. ²	Zn
	614	.8-.9 oz/ft. ²	Zn
	2106	.8-.9 oz/ft. ²	Zn
from Elevation 261 ft. to 286 ft.	1656	.8-.9 oz/ft. ²	Zn
	1058	.8-.9 oz/ft. ²	Zn
	4514	.8-.9 oz/ft. ²	Zn
	540	.8-.9 oz/ft. ²	Zn
from Elevation 286 ft. - Up	1128	.8-.9 oz/ft. ²	Zn
	5366	.8-.9 oz/ft. ²	Zn
	1876	.8-.9 oz/ft. ²	Zn
Ductwork Miscellaneous	2648	.8-.9 oz/ft. ²	Zn
Grating & Stair Treads	51400	1.7 Mils	Zn

* Refer to Tables 6.2.5-5 and 6.2.5-6 for inventories used in post-LOCA hydrogen generation analysis.

TABLE 6.1.2-1

PROTECTIVE COATINGS ON WESTINGHOUSE
SUPPLIED EQUIPMENT INSIDE CONTAINMENT

<u>Component</u>	<u>Painted Surface Area (ft.²)</u>
RCS component supports	7600
Reactor coolant pump motors/motor supports	2550
Accumulator tanks	4050
Manipulator crane	2600
Other refueling equipment	2125
Remaining equipment (such as valves, auxiliary tanks and heat exchanger supports, transmitters, alarm horns, small instruments)	<1300

TABLE 6.1.2-2 ELECTRICAL CABLE INSULATION MATERIALS INVENTORY INSIDE CONTAINMENT

CABLE B/M NO.	DESCRIPTION	MAX OD (in)	WEIGHT (LBS)				NOTES
			INSULATION		JACKET		
			TRAY	COND	TRAY	CONDUIT	
D10-01	1/C 750 MCM	1.62	796	153	655	124	1. Insulation is EPR material 2. Jacket is CPE material
D25-02	3/C # 10	0.65	31	69	69	155	1. HTK Insulation (N-98 material (Kerite)
D25-03	1/C # 6	0.47	55	9	130	22	2. Jacket is Vulcanized Chlorinated Rubber Material (Kerite)
D25-04	3/C # 6	0.87	49	40	74	61	
D25-06	3/C # 2	1.15	360	542	616	929	
D25-07	1/C - 4/0	0.85	422	59	669	93	
D25-08	3/C - 4/0	1.84	40	131	63	209	
D25-09	1/C - 350 MCM	1.05	595	249	745	311	
D50-01	2/C # 10	0.58	46	94	92	190	1. HTK Insulation (N-98) material (Kerite)
D50-02	4/C # 10	0.70	4	21	4	32	2. Jacket is Vulcanized Chlorinated Rubber Material (Kerite)
D50-06	2/C # 12	0.52	111	168	240	362	
D50-07	4/C # 12	0.63	148	208	251	354	
D50-08	7/C # 12	0.75	332	477	431	619	
D50-09	10/C # 12	1.00	139	321	209	483	
D50-10	12/C # 12	1.03	26	45	29	51	1. HTK Insulation (N-98) material (Kerite)
D50-11	2/C # 16	0.435	90	99	311	342	2. Jacket is Vulcanized Chlorinated Rubber material (Kerite)
D50-12	4/C # 16	0.495	43	70	85	140	
D50-13	7/C # 16	0.54	112	128	127	146	
D50-14	10/C # 16	0.74	13	9	18	14	
D50-15	12/C # 16	0.76	126	55	153	67	
D61-01	1 Pr # 16	0.38	69	87	318	400	1. Insulation material is EPR
D61-02	2 Pr # 16	0.69	35	85	129	305	2. Jacket is CPE material
D61-04	4 Pr # 16	0.77	188	194	544	561	
D61-05	3/C # 16	0.39	107	157	382	562	
D61-07	16/C # 16	0.76	5	11	7	16	
D61-08	32/C # 16	1.06	87	22	91	23	
D65-01	1 Quad # 16	0.45	126	181	241	346	1. Insulation material is EPR 2. Jacket is CPE Material
D86-01	22C # 20+ 2C # 12	0.96	508	4	484	4	1. Insulation is EPR material
D86-02	11C # 20+ 2C #12	0.70	269	-	349	-	2. Jacket is CPE
D88-02	1 Pr # 16	0.34	4	1	15	2	1. Insulation material is FR-EP 2. Jacket is CPE material

TABLE 6.1.2-2 ELECTRICAL CABLE INSULATION MATERIALS INVENTORY INSIDE CONTAINMENT

CABLE B/M NO.	DESCRIPTION	MAX OD (in)	WEIGHT (LBS)				NOTES
			INSULATION		JACKET		
			TRAY	COND	TRAY	CONDUIT	
D84-01	Triaxial	0.469	218	393	126	227	1. Insulation is tefzel 2. Jacket is chlorosulphonated polyethylene
D80-01	4/C # 10+ 2/C # 8	0.801	239	-	311	-	1. Insulation is EPR material
D80-04	4/C # 4+ 2/C #8	1.303	343	282	446	367	2. Jacket is CPE.
D82-02	1/C # 2	0.505	87	13	21	3	1. Jacket is glass braid 2. Insulation is silicon rubber
D70-01	1 Pr # 16	0.354	94	94	291	263	1. Jacket is hypalon 2. Insulation is FR-EPDM
D97-01	1/C # 14	0.15	6	1	7	1	1. Insulation material is HTK (Kerite)
D97-02	12/C # 12	1.20	9	9	10	10	2. Jacket material is Vulcanized Chlorinated Rubber
D98-01	1/C # 14	0.15	7	1	23	3	1. Insulation material is EPR
-03	16/C # 16	0.73	25	6	23	6	2. Jacket material is CPE
-04	26/C # 16	0.89	49	12	43	11	
D59-02	1/C # 10	0.37	9	2	30	7	1. Insulation material is HTK
D59-04	1/C # 2	0.59	10	6	22	12	2. Jacket material is Vulcanized Chlorinated Rubber
D99-01	15/C # 18	0.52	6	7	7	8	1. Insulation material is FR-EP
D99-33	STQ	0.80	38	1	42	2	2. Jacket material is CPE
D99-61	3 PR # 16 & 1/C # 16	0.45	2	11	2	12	
D99-67	19/30 # 18	0.63	11	19	13	21	
D99-90	35/C # 20	0.68	18	34	20	38	
D87-04	17/C # 16	0.79	36	12	38	13	1. Insulation material is FR-EP 2. Jacket material is CPE
D91-02	RG-59U (Coax)	0.24	22	39	24	44	1. Insulation material is FR-EP 2. Jacket material is CPE
D90-01	32/C # 16	0.98	1	22	1	20	1. Insulation material is FR-EP 2. Jacket material is CPE

CABLE B/M NO.	DESCRIPTION	MAX OD (in)	LIGHTNING CABLE		NOTES
			WEIGHT (lbs) JACKET	WEIGHT (lbs) INSULATION	
D25-20 thru D-25-23	1/C # 4	0.43	155	233	1. Jacket is Hypalon.
D25-24 thru D25-31	1/C # 6	0.38	169	510	2. Insulation is EPR.
D25-32 thru D25-40 & D25-49	1/C # 10	0.24	104	208	3. All B/M's in conduit only.
D25-41 thru D25-48	1/C # 12	0.22	24	46	

TABLE 6.2.1-1

POSTULATED ACCIDENTS FOR CONTAINMENT DESIGN

Containment Design Parameter	Postulated Accidents	Mass and Energy Release Reference
A. Containment Peak Pressure Temperature	<u>Loss-of Coolant Accidents (LOCA)</u>	
	Double-ended pump suction leg guillotine (DESLG) with maximum safety injection (SI)	Section 6.2.1.3
	Double-end pump suction leg guillotine (DESLG) with minimum safety injection	Section 6.2.1.3
	Double-ended hot leg guillotine(DEHLG) with minimum safety injection	Section 6.2.1.3
	<u>Main Stem Line Breaks (MSLB)</u>	
	Full double-ended rupture, 100.34% power	Section 6.2.1.4
	0.687 ft. ² split rupture, 100.34% power	Section 6.2.1.4
	Full double-ended rupture, 68.6% power	Section 6.2.1.4
	0.675 ft. ² split rupture 68.6 % power	Section 6.2.1.4
	Full double-ended rupture 29.4% power	Section 6.2.1.4
	0.666 ft. ² split rupture 29.4% power	Section 6.2.1.4
	Full double-ended rupture zero power	Section 6.2.1.4
	0.558 ft. ² split rupture zero power	Section 6.2.1.4
	B. Subcompartment Peak Pressure	<u>Reactor Cavity</u>
150 in. ² hot leg break		Section 6.2.1.2
150 in. ² hot leg break		Section 6.2.1.2
<u>Steam Generator Compartment</u>		
Double-ended hot leg guillotine (DEHLG)		Section 6.2.1.2
Double-ended suction leg guillotine (DESLG)		Section 6.2.1.2
Double-ended cold leg guillotine (DECLG)		Section 6.2.1.2
<u>Pressurizer Subcompartment</u>		
Pressurizer surge line guillotine		Section 6.2.1.2
Pressurizer spray line break		Section 6.2.1.2
C. External (Differential) Pressure	<u>Inadvertent Operation of the Containment Heat Removal System (Both trains)</u>	N/A
D. Containment ECCS Minimum Pressure	<u>Refer to Section 6.2.1.5</u>	N/A

TABLE 6.2.1-2

CALCULATED VALUES FOR CONTAINMENT PARAMETERS

Parameter	Design Basis Accident	Calculated Value
Peak Containment Atmosphere Pressure (LOCA)	DEHLG	41.8 psig
Peak Pressure (MSLB)	30% Power full DE Rupture MSIV and MFIV Failure	41.3 psig
Peak Containment Atmosphere Temperature (LOCA)	DEHLG	258.9°F
Peak Temperature (MSLB)	102% Power Full DE Rupture MSIV and MFIV Failure	364.4°F
Peak Subcompartment Differential Pressure		
Reactor Cavity	150 in. ² CLG	29.8 psid
Steam Generator (Loop 1)	DEHLG	22.2 psid
Steam Generator (Loop 2) and Pressurizer	DESLG	22.4 psid
Steam Generator (Loop 3)	DECLG	29.7 psid
External Differential Pressure		
Containment	Inadvertent Operation of the Containment Heat Removal System	1.814 psid
Minimum Pressure		See Section 6.2.1.5

TABLE 6.2.1-3

PRINCIPAL CONTAINMENT DESIGN PARAMETERS

Parameter	Design	Margin ⁽¹⁾
Containment	45.0	7.1%
Internal Design pressure, psig (LOCA) (MSLB)	45.0	8.2%
External design pressure differential, psid	2.0	9.3%
Net free volume, 10 ⁶ ft. ³	2.266	Not Applicable
Design leak rate, percent free volume per day at 45.0 psig	0.1	Not Applicable
Subcompartments		
Reactor cavity design wall loading, psid	64.0	53.4%
Steam generator compartment design wall loading, psid		
Loop 1	38	41.6%
Loop 2 (Including pressurizer compartment)	38	41.1%
Loop 3	38	21.8%

Notes:

⁽¹⁾ Margin (%) = $100 \frac{\text{Design value} - \text{peak calculated value}^*}{\text{peak design value}}$

Actual margin, i.e., the margin between design values and peak calculated* values when using realistic or median parameter values would be much larger.

* From Table 6.2.1-2.

TABLE 6.2.1-4

CALCULATED CONTAINMENT PRESSURE AND TEMPERATURE

Full D/E MSLB - Cooling Train Failure

Percent Power	102	70	30	0
Peak Pressure (psia)	49.8	50.8	53.0	52.6
Peak Temperature (F)	364.4	361.3	359.3	355.7
Time of Peak Pressure (sec)	108.2	124.7	149.2	291.5

Full D/E MSLB - Main Feedwater Isolation Valve Failure

Power Level (%)	102	70	30	0
Peak Pressure (psia)	52.5	53.9	56.0	54.5
Peak Temperature (F)	364.4	361.3	359.3	355.7
Time of Peak Pressure (sec)	132.7	150.2	176.2	365.0

Full DEHLG LOCA

Power Level (%)	102
Peak Pressure (psia)	56.5
Peak Temperature (°F)	258.9
Time of Peak Pressure (sec)	18.5

Full DEPSLG LOCA⁽¹⁾ Minimum ECCS

Power Level (%)	102 ⁽²⁾
Peak Pressure (psia)	53.6
Peak Temperature (°F)	257.9
Time of Peak Pressure (sec)	18.5

Notes:

- 1) The DEPSLG minimum ECCS case peak pressure is most limiting post blowdown but still bounded by the DEHLG case. See Figure 6.2.1-4.
- 2) Corresponds to a bounding core power of 2958 MWt.

TABLE 6.2.1-5

INITIAL CONDITIONS FOR CONTAINMENT PEAK
PRESSURE-TEMPERATURE ANALYSIS

Parameter	Value
Reactor Coolant System and Secondary System*	
Reactor power level, Mwt	2958
Core Inlet Temperature, F	560.4
Steam Pressure, psia	1011
Containment	
Pressure,*** max. (psig)	1.6
min. (in. W.G.)	-1.0
Temperature***, F	138**
Relative humidity, % max.	75
min.	20
Component cooling water temperature, F	120
Refueling water storage tank temperature, F	125
Net free volume (minimum), x 10 ⁶ ft. ³	2.266
Stored Water	
Minimum RWST volume available for Safety Injection, gal.	266,625

*NOTE: Values include uncertainties, where applicable.

**138°F represents the bulk average atmosphere temperature when the indicated temperature is at the Technical Specification limit of 120°F, plus uncertainty.

***Values used in the analyses depends on DBA (MSLB or LOCA) and peak temperature or pressure case.

TABLE 6.2.1-6

ENGINEERED SAFETY FEATURE SYSTEMS OPERATING ASSUMPTIONS FOR
CONTAINMENT PEAK PRESSURE ANALYSIS

<u>System/Item</u>	<u>Full Capacity</u>	<u>Value Used for Peak Pressure Analyses</u>
Containment Spray System		
Number of lines	2	1
Number of pumps	2	1
Number of headers	2	1
Spray Flow rate, gpm/pump	Pump A – 1740 Pump B – 1730	1730
Containment Fan Coolers		
Number of units	4	2
Air side flow rate, acfm/unit	31,250	31,250
Heat removal rate, 10 ⁶ Btu/hr.	See Figure 6.2.1 16*	See Figure 6.2.1 16*
Fouling factor	0.001	0.001
Cooling water flow rates, gpm/unit	1,300	1,300
Source of cooling water	Service Water	Service Water
Cooling water temperature, F	95	95

*The cooling water flow rate assumed for Figure 6.2.1-16 is 1360 gpm. For SGR/PUR a more conservative value of 1300 gpm is assumed with one tube bundle plugged per safety train. Consequently a slightly lower heat removal rate is assumed in the analysis compared to that provided in Figure 6.2.1-16 and Table 6.2.2-3.

<u>System/Item</u>	<u>Full Capacity⁽³⁾</u>	<u>Value Used for LOCA Analyses</u>
Heat Exchangers		
Shutdown heat exchangers (shell and U-tube)		
Number		1*
Overall heat transfer coefficient, Btu/hr.-F (UA) per heat exchanger:		Calculated in GOTHIC ⁽¹⁾⁽²⁾
Flow Rates per heat exchanger:		
Recirculation side, gpm		3650 ⁽¹⁾
Exterior side, gpm		4850 ⁽¹⁾
Temperature:		
Exterior side, F		120 (max)
Source of cooling water		Component Cooling Water
CCWS flow begins, sec. (Loss of offsite power)		28

NOTES:

- (1) These numbers are design minimum values. Actual values are greater than or equal to the design values. CCW flow rates do not reflect CCW flow to SFPHX after re-alignment.
- (2) The overall heat transfer coefficient used in the analysis varies due to recirculation side fluid (containment sump water) temperature and CCW temperature varying throughout the transient.
- (3) The full heat removal capacity of the RHR heat exchangers was modeled in the analysis of the Safety Injection temperature during the re-circulation phase of a LOCA used for determining the long-term mass and energy release data. The full capacity (maximum safeguards case) used the single train containment sump temperature-time history and the single train case heat exchanger removal rates, but utilized the two-train SI flowrate. The temperature of the SI flow for the full

capacity case would thus be conservatively high and therefore the containment atmospheric and sump temperatures would also be conservatively high.

*This is based on single train operation.

TABLE 6.2.1-7 CONTAINMENT PASSIVE HEAT SINKS

Component	Surface Area(ft. ²)	Total ⁽¹⁾ Thickness (in.)	Thermal Conductivity Btu/hr.-ft. ² -F	Volumetric Heat Capacity Btu/ft. ³ -F
A. Steel				
Containment Cylinder Liner	64038.20	0.375	25.9	53.5
Containment Dome Cylinder Liner	26015.08	0.50	25.9	53.5
Exposed Steel Liner in Refueling Cavity and Primary Shield Wall	6621.0	0.1875	25.9	53.5
Grating	52493.0	0.088	25.9	53.5
		0.001	64.0	40.6
Structural	5716.0	0.03125	25.9	53.5
Steel Columns	12687.0	0.0625	25.9	53.5
Equipment Supports,	21211.0	0.125	25.9	53.5
Platform Framing,	18267.0	0.1875	25.9	53.5
Elevator Shafts	23097.0	0.25	25.9	53.5
Equipment Hatch	13689.3	0.3125	25.9	53.5
	13230.0	0.375	25.9	53.5
	2528.0	0.432	25.9	53.5
	3696.0	0.4375	25.9	53.5
	17070.0	0.50	25.9	53.5
	2090.3	0.5625	25.9	53.5
	3289	0.625	25.9	53.5
	1656.0	0.6875	25.9	53.5
	6106.0	0.75	25.9	53.5
	1232.0	0.8125	25.9	53.5
	134.0	0.875	25.9	53.5
	1793.00	0.9375	25.9	53.5
	6161.0	1.0	25.9	53.5
	2765.0	1.125	25.9	53.5
	348.0	1.1875	25.9	53.5
	3330.0	1.25	25.9	53.5
	2821.0	1.50	25.9	53.5
	154.0	1.782	25.9	53.5
	885.0	0.40116	8.6	54
HVAC (Duct and Equipment)	17039.1	0.05704	25.9	53.5
		0.0013	64.0	40.6
Plumbing Piping	8573.1	0.1248	25.9	53.5
	2240.0	0.1046	8.6	54
	1210.5	0.0617	8.6	54

TABLE 6.2.1-7 CONTAINMENT PASSIVE HEAT SINKS

Component	Surface Area(ft. ²)	Total ⁽¹⁾ Thickness (in.)	Thermal Conductivity Btu/hr.-ft. ² -F	Volumetric Heat Capacity Btu/ft. ³ -F)
A. Steel (continued)				
Instrument and Control Equipment (Including Racks)	3240.0	0.125	25.9	53.5
Electrical Conduits, Cable Trays and Equipment	11062.0	0.4277	25.9	53.5
Fuel Trans. Sys. Control Panel	46.1	7.18	25.9	53.5
Manipulator Crane	1641.0	13.545	25.9	53.5
React. Lower Core Int.Stand	175.0	2.835	25.9	53.5
React. Upper Core Int.Stand	350.0	1.155	25.9	53.5
Fire Hose Racks	118.13	1.995	25.9	53.5
Internals Lifting Rig	603.75	1.575	25.9	53.5
RC Pump Motor and Drive	541.63	15.23	25.9	53.5
Flux Mapping Room Equip. and Thimbles	933.63	1.05	25.9	53.5
Neutron Detect. Pos. Device	262.5	0.525	25.9	53.5
RCCA Changing Fixture	12.25	1.365	25.9	53.5
RC Pump Handling Fixture	502.25	16.17	25.9	53.5
Control Rod Drive Shafts (6 Spare)	68.25	0.42	25.9	53.5
Reactor Vessel Hd. Guide Stud (3)	80.50	1.47	25.9	53.5
RCCA Thimble Plug Handling Tool	21.88	1.47	25.9	53.5
Full-Length CRD Shaft Unlatching Tool	12.25	2.73	25.9	53.5
Irradiation Sample Handling Tool	23.63	0.945	25.9	53.5
Head and Internals Lifting Rig Load Cell Linkage Assembly	46.38	3.15	25.9	53.5
Stud Tensioners (3)	215.25	4.095	25.9	53.5
Stud Tensioner Hydraulic Unit	35.0	4.2	25.9	53.5
Primary Loop Hot Leg Restr.	209.13	0.945	25.9	53.5
RC Pump Tie-Rods and Brackets	126.88	1.365	25.9	53.5
Pri Loop Restr. X-Over Leg Vert.Leg	61.25	1.26	25.9	53.5
Prim. Loop Restr. SG; RC Pump	35.88	0.945	25.9	53.5
Prim. Loop Restr. SG; Side Elbow	42.88	0.945	25.9	53.5
SG Upper Lat. Support	538.13	1.05	25.9	53.5
SG Lower Lat. Support	357.88	2.73	25.9	53.5
SG MWY Cover Supports	14.88	2.205	25.9	53.5
Reactor Vessel Supports	286.13	3.465	25.9	53.5
Triaxial Accelerograph	57.75	4.725	25.9	53.5
SG Vertical Column, Supports and Adaptors	898.63	1.68	25.9	53.5
RC Pump Vertical Column, Supports and Adaptors	636.13	1.365	25.9	53.5
Pressurizer Supports	52.5	1.785	25.9	53.5
Pipes and Equipment below LOCA flood line	5894.2	0.322	25.9	53.5
Misc. Stainless Piping	451.0	0.204	8.6	54.0
Piping with Refractory Insulation	17325.0	0.2562	8.6	54.0

TABLE 6.2.1-7 CONTAINMENT PASSIVE HEAT SINKS

Component	Surface Area(ft. ²)	Total ⁽¹⁾ Thickness (in.)	Thermal Conductivity Btu/hr.-ft. ² -F	Volumetric Heat Capacity Btu/ft. ³ -F
A. Steel (continued)				
Misc. Piping	5210.0	0.2829	25.9	53.5
Seismic Restraints and Hangers	70322.0	0.21	25.9	53.5
B. Concrete Above Water Level				
			Total Thickness (ft.)	
CRDM and Flux Mapping RM				
Wall	4413.92	1.5	1.0	31.9
Slab	1688.54	1.5	1.0	31.9
SG Shield Wall	8745.52	2.0	1.0	31.9
Operation Floor	7793.94	2.0	1.0	31.9
Pressurizer Room				
Wall	2984.1	1.25	1.0	31.9
Slab	560.56	2.0	1.0	31.9
Air Duct Shaft Wall	1373.96	1.5	1.0	31.9
	1275.96	0.75		
RCP Pedestal	2078.58	5.5	1.0	31.9
SG Pedestal	2511.74	6.0	1.0	31.9
Heat Exchanger Room				
Wall	1858.08	1.0	1.0	31.9
Slab	1208.34	0.75	1.0	31.9
RC Drain Tank Room				
Wall	587.0	0.875	1.0	31.9
Slab	433.16	1.0	1.0	31.9
Personal Shield	422.0	1.25	1.0	31.9
Wall	117.6	0.75	1.0	31.9
Secondary Shield Wall	25071.34	2.0	1.0	31.9
Primary Shield Wall (Unlined Portion)	3012.52	4.625	1.0	31.9
	2837.1	2.25	1.0	31.9
Refueling Cavity Wall				
	1568.0	2.0	1.0	31.9
	3670.1	2.5	1.0	31.9
	1205.4	3.0	1.0	31.9
	666.4	3.75	1.0	31.9
Refueling Cavity Slab	754.6	2.5	1.0	31.9
C. Concrete Below Water Level				
Air Duct Shaft Wall	176.4	1.5	1.0	31.9
	186.2	0.75	1.0	31.9
RCP Pedestal	934.92	5.5	1.0	31.9

TABLE 6.2.1-7 CONTAINMENT PASSIVE HEAT SINKS

Component	Surface Area(ft. ²)	Total ⁽¹⁾ Thickness (in.)	Thermal Conductivity Btu/hr.-ft. ² -F	Volumetric Heat Capacity Btu/ft. ³ -F
<u>C. Concrete Below Water Level (continued)</u>				
SG Pedestal	1420.02	6.0	1.0	31.9
Internal Mat	10844.68	5.0	1.0	31.9
Pit Wall and Slab	141.12	1.5	1.0	31.9
Personal Shield Wall	3735.76	1.25	1.0	31.9
	823.2	0.75	1.0	31.9
Secondary Shield Wall	3483.9	2.0	1.0	31.9
Primary Shield Wall	1244.6	4.625	1.0	31.9
Refueling Cavity Wall	1229.9	2.5	1.0	31.9
	443.0	3.0	1.0	31.9

TABLE 6.2.1-8 SUMMARY OF PASSIVE HEAT SINKS USED IN THE CONTAINMENT ANALYSES

Structure	Thickness ⁽¹⁾	Surface Area Exposed to Containment Interior(ft. ²)	Thermal Conductivity (Btu/hr.-ft.-F)	Volumetric Heat Capacity (Btu/ft. ³ -F)
A. Heat Sinks				
1. Containment Primary Dome	Paint film – 10 mils.	26,546	1.379	43.75
	Steel liner - 0.5 in.		25.9	53.5
	Concrete – 2.5 ft.		1.0	31.9
2. Containment Primary Cylinder	Paint film – 10 mils.	61,220	1.379	43.75
	Steel liner - .375 in.		25.9	53.5
	Concrete – 4.5 ft.		1.0	31.9
3. Concrete Mat (Floor slab)	Paint film – 27 mils.	12,256	1.379	43.75
	Concrete – 4.6 ft.			
4. Concrete exposed to Containment Sump water for LOCA or Containment atmosphere for MSLB (shield walls and foundations under flood line)	Paint film – 27 mils.	13,678	0.16	14.93
	Concrete – 2.67 ft.		1.0	31.9
5. Concrete exposed to Containment Atmosphere (shield walls and concrete pads above flood line)	Paint film – 27 mils.	76,858	0.16	14.93
	Concrete – 2.17 ft.		1.0	31.9
6. Stainless Steel (Refueling Pool and Piping)	Stainless Steel 0.016963 ft.	2,546	8.6	54.0
7. Steel Lined Concrete	Paint film – 13 mils.	6,621	0.13833	10.55
	Steel – 0.015625 ft.		25.9	53.5
	Concrete – 2.2933 ft.		1.0	31.9
8. Galvanized Steel (conduit cable trays)	Zinc – 1.35 mils	17,039	64.0	40.6
	Steel – 0.00453 ft		25.9	53.5
8. Galvanized Steel (conduit cable trays) (continued)	Zinc – 1.35 mils	52,493	64.0	40.6

TABLE 6.2.1-8 SUMMARY OF PASSIVE HEAT SINKS USED IN THE CONTAINMENT ANALYSES

Structure	Thickness ⁽¹⁾	Surface Area Exposed to Containment Interior(ft. ²)	Thermal Conductivity (Btu/hr.-ft.-F)	Volumetric Heat Capacity (Btu/ft. ³ -F)
	Steel – 0.00733 ft		25.9	53.5
	Zinc – 1.5 mils	11,062	64.0	40.6
	Steel – 0.0354 ft		25.9	53.5
9. Structured + Miscellaneous Exposed Steel				
Paint film	10 mils	80,978	1.379	43.75
Steel (A&S)	0.0132 ft		25.9	53.5
Paint film	10 mils	70,322	0.078	28.8
Steel (MN-Hangers, etc)	0.0175 ft		25.9	53.5
Paint film	10 mils	5,210	0.078	28.2
Steel (MN-Equipment)	0.023574 ft		25.9	53.5
Paint film	10 mils	50,213	1.379	43.75
Steel (A&S)	0.03384 ft		25.9	53.5
Paint film	10 mils	22,461	1.379	43.75
Steel (A&S)	0.06644 ft		25.9	53.5
Paint film	10 mils	9,418	1.379	43.75
Steel (A&S)	0.11792 ft		25.9	53.5
Paint film	12 mils	11,813	0.2333	38.4
Steel (HVAC Ductwork)	0.0104 ft		25.9	53.5
10. Steel exposed to Containment Sump Water for LOCA or Containment atmosphere for MSLB (below flood line)	Paint film – 13 mils Steel – 0.0268 ft	8,134	0.13833 25.9	10.55 53.5
11. MN Piping with refractory insulation (steel initial at 422.5 F)	Insulation – 0.16887 ft ⁽²⁾ Stainless steel – 0.021352 ft ⁽²⁾	17,325	0.01 8.6	0.00127 54.0

NOTES:

(1) One side insulated (Coating thickness at the maximum allowed by installation specification has a negligible effect)

(2) Total thickness

TABLE 6.2.1-9

ACCIDENT CHRONOLOGIES

A. Worst Case Hot Leg Break (DEHLG)

<u>Time (Seconds)</u>	<u>Event</u>
0.0	Break occurs
18.5	Peak containment pressure (blowdown)
20.40	End of blowdown start of pumped injection

B. Worst Case Suction Leg Break (DESLG)

<u>Assuming Max. SI Time (Seconds)</u>	<u>Assuming Min. SI Time (Seconds)</u>	<u>Event</u>
0.0	0.0	Break occurs
18.0	18.5	Peak containment pressure during blowdown
21.4	20.2	End of blowdown
32.4	32.3	Start of pumped injection
58.4	58.4	Start containment spray injection
58.4	58.4	Containment spray reaches full flow
110.0	110.0	Start of containment fan coolers
223.8	206.6	End of core reflood
1000.0	1000.0	Peak containment pressure subsequent to end of blowdown (2nd peak)
1283.5	1003.28	The time when the broken loop steam generator reaches thermal reaches 1 st intermediate pressure during EPITOME period.
1200.00	2210.0	Start ECCS recirculation
1200.00	2210.0	End containment spray injection
1200.00	2210.0	Start containment spray recirculation
9500 (approx.)	24500 (approx.)	50 percent of containment design pressure (29.85 psia) reached
14500 (approx.)	40000 (approx.)	50 percent of containment peak calculated pressure (26.8 psia) reached

Table 6.2.1-9(Continued)

D. Worst Pressure Case MSLB (Full DEB, MFIV and MSIV Failure, 30% Power)

<u>Time(Seconds)</u>	<u>Event</u>
0.0	Break occurs
1.0	Main Steam Isolation Signal
1.0	Main Feedwater Isolation Signal
1.0	Containment Isolation Actuation Signal (CIAS)
3.0	MFIV's start to close
3.0	MSIV's start to close
8.0	MSIV's closed
11.0	MFIV's closed
58.4	Start Containment spray injection
58.4	Containment spray reaches full flow
110.0	Start of Containment fan coolers
176.2	Peak Containment Pressure
176.2	End of blowdown

E. Worst Temperature Case MSLB (Full DEB, MSIV and MFIV Failure, 102% Power)

<u>Time(Seconds)</u>	<u>Event</u>
0.0	Break occurs
1.00	Main Steam Isolation Signal
1.00	Main Feedwater Isolation Signal
1.00	CIAS Signal
3.0	MFIV's start to close
8.0	MSIV's closed
11.0	MFIV's closed
58.40	Start of containment spray injection
58.40	Containment spray reaches full flow
58.40	Peak containment temperature
132.7	End of blowdown

TABLE 6.2.1-11

ASSUMPTIONS USED IN ANALYSIS OF INADVERTENT CONTAINMENT
SPRAY SYSTEM ACTUATION

Item	Assumed Value
<u>Containment</u>	
Initial temperature, F	135
Initial pressure, inches w.g.	-4
Relative humidity, %	65
Net free volume (minimum) ft. ³	2.266 x 10 ⁶
Passive heat sinks	ignored for conservatism
<u>Containment Spray System</u>	
Number of trains in operation	2
Flow rate per train, gpm	2146.5
Refueling water temperature, F	40
Spray efficiency, %	100
<u>Containment Vacuum Breaker System Connecting to the RAB</u>	
No. of vacuum breaker systems	2
No. assumed failed	1
Setpoint differential pressure to start opening vacuum breaker system.	2.75 in. w.g.
Delay time to start opening vacuum breaker system.	5.5 sec.
Vacuum breaker system exit flow area	425 in. ²
Fully open loss coefficient referenced to exit flow area	3.912
<u>Reactor Auxiliary Building (RAB)</u>	
Initial temperature, F	104
Initial pressure, psia	14.7
Relative humidity, %	100
Net free volume (minimum), ft. ³	65033
Passive heat sinks	ignored for conservatism
Setpoint differential pressure to open HVAC damper.	3.75 in. w.g.
Delay time to open HVAC damper.	10.5 sec.
<u>Vent Connecting the RAB to the Outside Environment</u>	
Exit Flow area, in. ²	2304
Loss coefficient referenced to exit area.	15.017
<u>Outside Environment</u>	
Temperature, F	105
Pressure, psia	14.7
Relative humidity, %	100

TABLE 6.2.1-12 REACTOR CAVITY SUBCOMPARTMENT MASS AND ENERGY RELEASE FROM REACTOR VESSEL COLD LEG NOZZLE 150 IN²-BREAK

TIMES(S)	MASS FLOW (lb./S)	AVG ENTHALPY (Btu/lb.)
.0000	0.	0.00
.00101	8.8319843E+03	557.61
.00200	1.2459125E+04	557.40
.00300	1.2857556E+04	557.52
.00400	1.4251487E+04	557.41
.00502	1.5723959E+04	557.18
.00600	1.6310674E+04	556.84
.00700	1.7785577E+04	556.94
.00802	1.9498763E+04	556.90
.00902	2.0097690E+04	556.60
.01004	2.0531009E+04	556.35
.01102	2.1053367E+04	556.14
.01202	2.1309527E+04	555.82
.01303	2.1338598E+04	555.52
.01402	2.1975745E+04	555.51
.01502	2.3248402E+04	555.72
.01603	2.4329433E+04	555.76
.01702	2.4700207E+04	555.57
.01803	2.4666827E+04	555.27
.01901	2.4485169E+04	554.95
.02001	2.4259530E+04	554.64
.02104	2.3992691E+04	554.33
.02203	2.3822256E+04	554.11
.02303	2.3846373E+04	553.99
.02401	2.4001944E+04	553.92
.02508	2.4185665E+04	553.86
.02607	2.4312700E+04	553.79
.02701	2.4441169E+04	553.74
.02801	2.4672517E+04	553.75
.02904	2.5047176E+04	553.82
.03002	2.5467242E+04	553.92
.03106	2.5879331E+04	554.01
.03202	2.6173354E+04	554.06
.03307	2.6426705E+04	554.08
.03404	2.6599390E+04	554.08
.03504	2.6702468E+04	554.04
.03604	2.6719592E+04	553.97
.03708	2.6663322E+04	553.87
.03802	2.6568524E+04	553.76
.03902	2.6449194E+04	553.65
.04010	2.6322343E+04	553.53
.04104	2.6241842E+04	553.46
.04207	2.6226095E+04	553.43
.04306	2.6286025E+04	553.43
.04403	2.6400784E+04	553.47
.04503	2.6551812E+04	553.52
.04604	2.6705544E+04	553.57
.04710	2.6849091E+04	553.61
.04805	2.6940198E+04	553.62
.04902	2.6986217E+04	553.61
.05004	2.6978871E+04	553.58
.05101	2.6919492E+04	553.52
.05204	2.6804340E+04	553.44
.05307	2.6643852E+04	553.34

TABLE 6.2.1-12 REACTOR CAVITY SUBCOMPARTMENT MASS AND ENERGY RELEASE FROM REACTOR VESSEL COLD LEG NOZZLE 150 IN²-BREAK

TIMES(S)	MASS FLOW (lb./S)	AVG ENTHALPY (Btu/lb.)
.05405	2.6459392E+04	553.24
.05501	2.6261653E+04	553.13
.05607	2.6037337E+04	553.02
.05701	2.5854529E+04	552.93
.05802	2.5687588E+04	552.84
.05909	2.5526689E+04	552.77
.06003	2.5418755E+04	552.72
.06106	2.5323801E+04	552.68
.06200	2.5253101E+04	552.65
.06306	2.5187103E+04	552.62
.06403	2.5138770E+04	552.60
.06506	2.5100388E+04	552.59
.06603	2.5076526E+04	552.59
.06710	2.5062696E+04	552.59
.06808	2.5061362E+04	552.60
.06901	2.5066571E+04	552.61
.07011	2.5076735E+04	552.62
.07105	2.5084422E+04	552.63
.07211	2.5086728E+04	552.63
.07300	2.5079173E+04	552.63
.07402	2.5055283E+04	552.62
.07503	2.5010718E+04	552.59
.07607	2.4939836E+04	552.56
.07706	2.4846454E+04	552.52
.07802	2.4731583E+04	552.47
.07907	2.4583651E+04	552.40
.08001	2.4430026E+04	552.34
.08105	2.4248123E+04	552.26
.08205	2.4061514E+04	552.18
.08302	2.3886047E+04	552.11
.08400	2.3719146E+04	552.04
.08502	2.3557007E+04	551.98
.08611	2.3395041E+04	551.92
.08706	2.3255793E+04	551.87
.08802	2.3139040E+04	551.84
.08904	2.3032509E+04	551.80
.09007	2.2940099E+04	551.78
.09106	2.2862772E+04	551.75
.09204	2.2798691E+04	551.74
.09305	2.2740750E+04	551.72
.09409	2.2686062E+04	551.71
.09501	2.2641867E+04	551.70
.09603	2.2591886E+04	551.69
.09710	2.2534477E+04	551.68
.09804	2.2483379E+04	551.66
.09912	2.2425274E+04	551.65
.10010	2.2373914E+04	551.64
.10205	2.2291706E+04	551.62
.10402	2.2247664E+04	551.62
.10600	2.2255536E+04	551.65
.10809	2.2307643E+04	551.69
.11007	2.2363727E+04	551.73
.11206	2.2399816E+04	551.76
.11415	2.2413579E+04	551.77
.11606	2.2426812E+04	551.78

TABLE 6.2.1-12 REACTOR CAVITY SUBCOMPARTMENT MASS AND ENERGY RELEASE FROM REACTOR VESSEL COLD LEG NOZZLE 150 IN²-BREAK

TIMES(S)	MASS FLOW (lb./S)	AVG ENTHALPY (Btu/lb.)
.11806	2.2471239E+04	551.81
.12001	2.2559629E+04	551.86
.12208	2.2706561E+04	551.93
.12406	2.2879532E+04	552.00
.12607	2.3046557E+04	552.07
.12810	2.3187022E+04	552.12
.13001	2.3283942E+04	552.16
.13204	2.3360162E+04	552.18
.13404	2.3426168E+04	552.20
.13604	2.3495058E+04	552.22
.13803	2.3566056E+04	552.24
.14011	2.3637109E+04	552.26
.14214	2.3698584E+04	552.28
.14409	2.3738841E+04	552.29
.14609	2.3753420E+04	552.28
.14801	2.3735735E+04	552.26
.15009	2.3679773E+04	552.22
.15201	2.3595450E+04	552.18
.15401	2.3487359E+04	552.12
.15601	2.3372949E+04	552.07
.15807	2.3256413E+04	552.02
.16008	2.3156955E+04	551.98
.16203	2.3082081E+04	551.95
.16412	2.3027569E+04	551.94
.16601	2.3000076E+04	551.93
.16813	2.2995843E+04	551.94
.17010	2.3013489E+04	551.96
.17213	2.3048841E+04	551.99
.17418	2.3094130E+04	552.01
.17604	2.3136716E+04	552.04
.17801	2.3170910E+04	552.06
.18012	2.3189743E+04	552.06
.18203	2.3189483E+04	552.06
.18405	2.3173520E+04	552.05
.18604	2.3146530E+04	552.03
.18803	2.3115602E+04	552.02
.19005	2.3085559E+04	552.00
.19209	2.3059161E+04	551.99
.19419	2.3036158E+04	551.98
.19607	2.3018022E+04	551.97
.19811	2.2999305E+04	551.97
.20008	2.2980931E+04	551.96
.20507	2.2938673E+04	551.94
.21010	2.2933443E+04	551.95
.21512	2.2954971E+04	551.97
.22014	2.2950058E+04	551.96
.22502	2.2928353E+04	551.95
.23010	2.2952581E+04	551.97
.23506	2.3072520E+04	552.02
.24003	2.3281157E+04	552.11
.24504	2.3515535E+04	552.20
.25013	2.3643062E+04	552.23
.25502	2.3592732E+04	552.18
.26003	2.3390515E+04	552.06
.26509	2.3118090E+04	551.94

TABLE 6.2.1-12 REACTOR CAVITY SUBCOMPARTMENT MASS AND ENERGY RELEASE FROM REACTOR VESSEL COLD LEG NOZZLE 150 IN²-BREAK

TIMES(S)	MASS FLOW (lb./S)	AVG ENTHALPY (Btu/lb.)
.27008	2.2877506E+04	551.84
.27502	2.2720679E+04	551.79
.28017	2.2678034E+04	551.79
.28510	2.2747790E+04	551.84
.29003	2.2876473E+04	551.91
.29507	2.3010287E+04	551.97
.30007	2.3139240E+04	552.02
.30509	2.3310172E+04	552.08
.31005	2.3521898E+04	552.16
.31506	2.3682144E+04	552.21
.32016	2.3762989E+04	552.22
.32503	2.3747359E+04	552.19
.33004	2.3622728E+04	552.12
.33508	2.3384402E+04	551.99
.34006	2.3046295E+04	551.85
.34503	2.2720192E+04	551.72
.35010	2.2511082E+04	551.66
.35510	2.2501211E+04	551.69
.36005	2.2675792E+04	551.79
.36503	2.2924189E+04	551.91
.37017	2.3141922E+04	551.99
.37511	2.3264067E+04	552.03
.38011	2.3285253E+04	552.02
.38500	2.3215051E+04	551.97
.39001	2.3074833E+04	551.89
.39502	2.2918005E+04	551.83
.40012	2.2837686E+04	551.80
.40508	2.2886282E+04	551.84
.41007	2.3014952E+04	551.91
.41500	2.3146622E+04	551.97
.42013	2.3253525E+04	552.01
.42505	2.3319116E+04	552.03
.43010	2.3342656E+04	552.02
.43502	2.3315102E+04	552.00
.44007	2.3242087E+04	551.95
.44511	2.3148182E+04	551.91
.45013	2.3064584E+04	551.87
.45508	2.3005936E+04	551.85
.46005	2.2971344E+04	551.85
.46507	2.2960760E+04	551.85
.47001	2.2975247E+04	551.86
.47506	2.3020589E+04	551.89
.48001	2.3091317E+04	551.92
.48524	2.3171808E+04	551.96
.49015	2.3235774E+04	551.98
.49507	2.3274173E+04	551.99
.50012	2.3307522E+04	552.00
.51012	2.3457884E+04	552.06
.52006	2.3552873E+04	552.08
.53004	2.3491859E+04	552.03
.54000	2.3282689E+04	551.92
.55007	2.3105522E+04	551.86
.56004	2.3135759E+04	551.90
.57008	2.3257830E+04	551.96
.58007	2.3258786E+04	551.95

TABLE 6.2.1-12 REACTOR CAVITY SUBCOMPARTMENT MASS AND ENERGY RELEASE FROM REACTOR VESSEL COLD LEG NOZZLE 150 IN²-BREAK

TIMES(S)	MASS FLOW (lb./S)	AVG ENTHALPY (Btu/lb.)
.59001	2.3180063E+04	551.90
.60006	2.3111914E+04	551.88
.61000	2.3174064E+04	551.92
.62012	2.3324087E+04	551.99
.63011	2.3422696E+04	552.01
.64000	2.3433127E+04	552.00
.65010	2.3390772E+04	551.97
.66005	2.3355244E+04	551.96
.67002	2.3367725E+04	551.96
.68009	2.3374377E+04	551.96
.69006	2.3368667E+04	551.96
.70013	2.3344088E+04	551.94
.71003	2.3315262E+04	551.93
.72011	2.3307913E+04	551.93
.73004	2.3319851E+04	551.94
.74004	2.3350128E+04	551.95
.75011	2.3378937E+04	551.96
.76004	2.3437804E+04	551.98
.77000	2.3475805E+04	551.99
.78015	2.3461859E+04	551.97
.79002	2.3411475E+04	551.95
.80017	2.3363249E+04	551.93
.81000	2.3358638E+04	551.93
.82002	2.3375038E+04	551.94
.83013	2.3397300E+04	551.95
.84016	2.3414859E+04	551.95
.85001	2.3412072E+04	551.95
.86004	2.3408072E+04	551.94
.87019	2.3410564E+04	551.95
.88002	2.3427685E+04	551.95
.89005	2.3437173E+04	551.95
.90001	2.3430893E+04	551.95
.91013	2.3421783E+04	551.95
.92016	2.3419358E+04	551.95
.93017	2.3421140E+04	551.95
.94008	2.3418732E+04	551.95
.95006	2.3411082E+04	551.95
.96005	2.3405128E+04	551.94
.97005	2.3399867E+04	551.94
.98004	2.3397928E+04	551.94
.99010	2.3399184E+04	551.95
1.00005	2.3404374E+04	551.95

TABLE 6.2.1-13 REACTOR CAVITY SUBCOMPARTMENT MASS AND ENERGY RELEASE FROM REACTOR VESSEL HOT LEG NOZZLE 150 IN2 BREAK

<u>TIMES(S)</u>	<u>MASS FLOW (lb./S)</u>	<u>AVG ENTHALPY (Btu/lb.)</u>
.0000	0.	0.00
.00100	1.0105250E+04	655.29
.00202	1.0610067E+04	655.26
.00301	1.0582770E+04	655.22
.00401	1.0558857E+04	655.19
.00502	1.0555990E+04	655.23
.00601	1.0586959E+04	655.30
.00701	1.0638869E+04	655.38
.00800	1.3771204E+04	655.92
.00901	1.2249198E+04	656.04
.01001	1.4499344E+04	656.38
.01100	1.4998327E+04	656.44
.01200	1.5540535E+04	656.51
.01302	1.5704632E+04	656.54
.01402	1.6151012E+04	656.73
.01502	1.7039374E+04	657.04
.01601	1.7868204E+04	657.22
.01701	1.8317086E+04	657.26
.01800	1.8197483E+04	657.10
.01901	1.7730485E+04	656.88
.02004	1.7230573E+04	656.70
.02103	1.6835673E+04	656.56
.02200	1.6508443E+04	656.44
.02303	1.6043866E+04	656.25
.02402	1.5469954E+04	656.06
.02502	1.5071526E+04	656.00
.02600	1.5113559E+04	656.09
.02700	1.5457384E+04	656.23
.02806	1.5892300E+04	656.39
.02902	1.6253449E+04	656.51
.03006	1.6557081E+04	656.59
.03103	1.6774392E+04	656.65
.03207	1.6925314E+04	656.68
.03306	1.6968386E+04	656.66
.03406	1.6903047E+04	656.60
.03502	1.6761249E+04	656.52
.03602	1.6565467E+04	656.43
.03708	1.6333301E+04	656.32
.03805	1.6119994E+04	656.24
.03903	1.5935794E+04	656.18
.04001	1.5819048E+04	656.15
.04108	1.5787209E+04	656.15
.04201	1.5817878E+04	656.17
.04301	1.5877223E+04	656.20
.04406	1.5950923E+04	656.23
.04508	1.6018533E+04	656.25
.04600	1.6061413E+04	656.26
.04709	1.6065018E+04	656.24
.04801	1.6026494E+04	656.22
.04903	1.5951212E+04	656.17
.05004	1.5854454E+04	656.13

TABLE 6.2.1-13 REACTOR CAVITY SUBCOMPARTMENT MASS AND ENERGY RELEASE FROM REACTOR VESSEL HOT LEG NOZZLE 150 IN2 BREAK

<u>TIMES(S)</u>	<u>MASS FLOW (lb./S)</u>	<u>AVG ENTHALPY (Btu/lb.)</u>
.05106	1.5742200E+04	656.08
.05200	1.5626358E+04	656.03
.05304	1.5498947E+04	655.98
.05404	1.5392633E+04	655.94
.05505	1.5316719E+04	655.92
.05602	1.5281903E+04	655.91
.05710	1.5286845E+04	655.93
.05809	1.5317933E+04	655.95
.05902	1.5359169E+04	655.97
.06005	1.5408450E+04	655.99
.06105	1.5446950E+04	656.01
.06203	1.5465310E+04	656.01
.06307	1.5458102E+04	656.01
.06404	1.5428972E+04	655.99
.06509	1.5377479E+04	655.97
.06605	1.5317925E+04	655.94
.06703	1.5249735E+04	655.92
.06807	1.5176995E+04	655.89
.06909	1.5111902E+04	655.87
.07002	1.5066013E+04	655.86
.07109	1.5028739E+04	655.85
.07213	1.5010312E+04	655.85
.07303	1.5005336E+04	655.85
.07402	1.5005746E+04	655.86
.07508	1.5003829E+04	655.86
.07610	1.4990368E+04	655.86
.07707	1.4960781E+04	655.84
.07803	1.4909122E+04	655.82
.07905	1.4829243E+04	655.79
.08005	1.4729065E+04	655.75
.08102	1.4611445E+04	655.71
.08201	1.4477009E+04	655.66
.08302	1.4331003E+04	655.61
.08405	1.4180635E+04	655.56
.08502	1.4043072E+04	655.52
.08607	1.3905251E+04	655.48
.08705	1.3799552E+04	655.44
.08804	1.3698738E+04	655.42
.08901	1.3610579E+04	655.40
.09011	1.3542166E+04	655.38
.09107	1.3486022E+04	655.37
.09208	1.3428712E+04	655.36
.09303	1.3390308E+04	655.35
.09404	1.3335577E+04	655.34
.09503	1.3278101E+04	655.33
.09604	1.3225822E+04	655.32
.09702	1.3165525E+04	655.30
.09802	1.3095734E+04	655.29
.09910	1.3031588E+04	655.27
.10009	1.2969180E+04	655.26
.10503	1.2768948E+04	655.22
.11001	1.2697740E+04	655.22
.11510	1.2479383E+04	655.14
.12002	1.2108701E+04	655.02
.12501	1.1892632E+04	654.98

TABLE 6.2.1-13 REACTOR CAVITY SUBCOMPARTMENT MASS AND ENERGY RELEASE FROM REACTOR VESSEL HOT LEG NOZZLE 150 IN2 BREAK

<u>TIMES(S)</u>	<u>MASS FLOW (lb./S)</u>	<u>AVG ENTHALPY (Btu/lb.)</u>
.13015	1.1780754E+04	654.95
.13507	1.1709595E+04	654.95
.14000	1.1690491E+04	654.95
.14500	1.1614640E+04	654.93
.15007	1.1440950E+04	654.89
.15504	1.1287310E+04	654.86
.16005	1.1158492E+04	654.83
.16501	1.1022980E+04	654.81
.17000	1.0927623E+04	654.81
.17502	1.0867090E+04	654.81
.18000	1.0795204E+04	654.80
.18505	1.0645821E+04	654.77
.19011	1.0643389E+04	654.79
.19501	1.0635996E+04	654.81
.20004	1.0625862E+04	654.82
.21001	1.0605421E+04	654.83
.22002	1.0592801E+04	654.84
.23004	1.0588173E+04	654.86
.24017	1.0587078E+04	654.88
.25015	1.0603374E+04	654.92
.26001	1.1284612E+04	655.18
.27003	1.0949213E+04	654.98
.28000	1.0754729E+04	654.91
.29004	1.0643705E+04	654.88
.30004	1.0629268E+04	654.89
.31008	1.0620766E+04	654.89
.32014	1.0621174E+04	654.91
.33010	1.0616396E+04	654.90
.34005	1.0606236E+04	654.89
.35024	1.0589862E+04	654.88
.36018	1.0577181E+04	654.87
.37013	1.0583748E+04	654.89
.38018	1.0603201E+04	654.93
.39001	1.0623727E+04	654.96
.40000	1.0849992E+04	654.99
.41001	1.0886893E+04	654.96
.42003	1.0878688E+04	654.93
.43015	1.0852306E+04	654.92
.44001	1.0763823E+04	654.78
.45013	1.0736766E+04	654.69
.46001	1.0722672E+04	654.57
.47002	1.0695395E+04	654.26
.48009	1.0717358E+04	654.18
.49003	1.0818851E+04	654.08
.50001	1.0970746E+04	654.22
.51000	1.1159034E+04	654.52
.52003	1.1054592E+04	654.65
.53004	1.1033647E+04	654.75
.54020	1.1018892E+04	654.82
.55001	1.1001423E+04	654.87
.56018	1.0986136E+04	654.92
.57017	1.0983624E+04	654.97
.58015	1.0952771E+04	655.01
.59011	1.0946959E+04	655.07
.60011	1.0974916E+04	655.14

TABLE 6.2.1-13 REACTOR CAVITY SUBCOMPARTMENT MASS AND ENERGY RELEASE FROM REACTOR VESSEL HOT LEG NOZZLE 150 IN2 BREAK

<u>TIMES(S)</u>	<u>MASS FLOW (lb./S)</u>	<u>AVG ENTHALPY (Btu/lb.)</u>
.61006	1.1000097E+04	655.22
.62008	1.1018301E+04	655.30
.63008	1.1035912E+04	655.38
.64004	1.1040225E+04	655.46
.65026	1.1035395E+04	655.53
.66006	1.1037813E+04	655.59
.67008	1.1097994E+04	655.64
.68000	1.1091621E+04	655.64
.69000	1.1089756E+04	655.61
.70001	1.1108036E+04	655.58
.71012	1.1142844E+04	655.54
.72009	1.1183058E+04	655.48
.73014	1.1223983E+04	655.41
.74019	1.1256362E+04	655.32
.75005	1.1282482E+04	655.22
.76015	1.1319898E+04	655.15
.77007	1.1376847E+04	655.12
.78012	1.1431539E+04	655.10
.79007	1.1471538E+04	655.09
.80008	1.1505581E+04	655.08
.81017	1.1540554E+04	655.08
.82004	1.1577494E+04	655.09
.83001	1.1618296E+04	655.09
.84012	1.1640193E+04	655.10
.85015	1.1659614E+04	655.10
.86018	1.1684006E+04	655.11
.87011	1.1719357E+04	655.12
.88005	1.1758180E+04	655.14
.89006	1.1790857E+04	655.15
.90001	1.1816577E+04	655.17
.91012	1.1841744E+04	655.18
.92013	1.1869260E+04	655.20
.93008	1.1897816E+04	655.22
.94012	1.1927211E+04	655.24
.95012	1.1946374E+04	655.28
.96002	1.1967142E+04	655.34
.97000	1.1990573E+04	655.40
.98005	1.2011992E+04	655.47
.99006	1.2027742E+04	655.54
1.00011	1.2041494E+04	655.61
1.01012	1.2055686E+04	655.70
1.02023	1.2058832E+04	655.78
1.03000	1.2065277E+04	655.86
1.04009	1.2068659E+04	655.94
1.05000	1.2071642E+04	656.02
1.06004	1.2080042E+04	656.10
1.07020	1.2094119E+04	656.17
1.08022	1.2108985E+04	656.24
1.09006	1.2122129E+04	656.29
1.10008	1.2140506E+04	656.34
1.11008	1.2160923E+04	656.37
1.12001	1.2180334E+04	656.40
1.13006	1.2201204E+04	656.41
1.14004	1.2222397E+04	656.41
1.15001	1.2244078E+04	656.41

TABLE 6.2.1-13 REACTOR CAVITY SUBCOMPARTMENT MASS AND ENERGY RELEASE FROM REACTOR VESSEL HOT LEG NOZZLE 150 IN2 BREAK

<u>TIMES(S)</u>	<u>MASS FLOW (lb./S)</u>	<u>AVG ENTHALPY (Btu/lb.)</u>
1.16015	1.2268080E+04	656.40
1.17008	1.2294679E+04	656.38
1.18011	1.2321863E+04	656.36
1.19006	1.2348034E+04	656.34
1.20012	1.2373848E+04	656.33
1.21004	1.2395820E+04	656.35
1.22001	1.2415994E+04	656.38
1.23028	1.2435956E+04	656.44
1.24020	1.2455882E+04	656.50
1.25006	1.2475352E+04	656.57
1.26014	1.2495104E+04	656.64
1.27000	1.2514710E+04	656.71
1.28004	1.2535229E+04	656.80
1.29021	1.2553077E+04	656.88
1.30004	1.2565603E+04	656.97
1.31008	1.2574253E+04	657.05
1.32005	1.2594828E+04	657.14
1.33003	1.2600002E+04	657.23
1.34010	1.2602730E+04	657.33
1.35003	1.2608563E+04	657.42
1.36002	1.2616603E+04	657.52
1.37003	1.2626860E+04	657.63
1.38004	1.2638778E+04	657.74
1.39020	1.2649592E+04	657.85
1.40010	1.2652172E+04	657.98
1.41006	1.2656618E+04	658.11
1.42004	1.2663442E+04	658.26
1.43002	1.2666051E+04	658.40
1.44009	1.2665171E+04	658.55
1.45008	1.2666734E+04	658.71
1.46009	1.2664616E+04	658.86
1.47009	1.2664805E+04	659.01
1.48011	1.2664564E+04	659.16
1.49003	1.2660979E+04	659.31
1.50012	1.2656865E+04	659.46
1.51010	1.2655918E+04	659.61
1.52015	1.2657492E+04	659.75
1.53011	1.2659966E+04	659.89
1.54011	1.2663688E+04	660.03
1.55003	1.2668902E+04	660.16
1.56010	1.2675711E+04	660.29
1.57005	1.2683652E+04	660.42
1.58012	1.2691736E+04	660.55
1.59006	1.2698101E+04	660.67
1.60011	1.2703562E+04	660.79
1.61001	1.2708449E+04	660.92
1.62029	1.2713135E+04	661.05
1.63006	1.2715022E+04	661.19
1.64003	1.2714929E+04	661.35
1.65006	1.2713582E+04	661.52
1.66014	1.2711390E+04	661.70
1.67010	1.2708673E+04	661.89
1.68004	1.2705441E+04	662.08
1.69003	1.2701664E+04	662.27
1.70000	1.2698115E+04	662.47

TABLE 6.2.1-13 REACTOR CAVITY SUBCOMPARTMENT MASS AND ENERGY RELEASE FROM REACTOR VESSEL HOT LEG NOZZLE 150 IN2 BREAK

<u>TIMES(S)</u>	<u>MASS FLOW (lb./S)</u>	<u>AVG ENTHALPY (Btu/lb.)</u>
1.71030	1.2692309E+04	662.68
1.72007	1.2684034E+04	662.88
1.73015	1.2675491E+04	663.09
1.74012	1.2666637E+04	663.30
1.75001	1.2653944E+04	663.51
1.76017	1.2637858E+04	663.72
1.77020	1.2622373E+04	663.94
1.78011	1.2606850E+04	664.16
1.79005	1.2589699E+04	664.38
1.80005	1.2572196E+04	664.60
1.81011	1.2554261E+04	664.83
1.82011	1.2536563E+04	665.06
1.83009	1.2521042E+04	665.29
1.84002	1.2504470E+04	665.53
1.85011	1.2496217E+04	665.77
1.86013	1.2492896E+04	666.01
1.87009	1.2478238E+04	666.25
1.88012	1.2459728E+04	666.49
1.89008	1.2444107E+04	666.73
1.90005	1.2427676E+04	666.98
1.91008	1.2411993E+04	667.23
1.92011	1.2394744E+04	667.48
1.93009	1.2377802E+04	667.73
1.94012	1.2360450E+04	667.98
1.95014	1.2346708E+04	668.24
1.96007	1.2333988E+04	668.50
1.97006	1.2318036E+04	668.77
1.98012	1.2299479E+04	669.03
1.99011	1.2278152E+04	669.30
2.00012	1.2257038E+04	669.58
2.01015	1.2234090E+04	669.85
2.02001	1.2210620E+04	670.13
2.03015	1.2186273E+04	670.42
2.04009	1.2161208E+04	670.70
2.05003	1.2138423E+04	670.99
2.06004	1.2117643E+04	671.29
2.07011	1.2096290E+04	671.59
2.08018	1.2074929E+04	671.90
2.09015	1.2051989E+04	672.21
2.10012	1.2032288E+04	672.52
2.11002	1.2008044E+04	672.83
2.12011	1.1981719E+04	673.15
2.13007	1.1958063E+04	673.48
2.14005	1.1938307E+04	673.81
2.15000	1.1902313E+04	674.13
2.16000	1.1871376E+04	674.46
2.17018	1.1840380E+04	674.80
2.18028	1.1813980E+04	675.14
2.19002	1.1779106E+04	675.48
2.20008	1.1746437E+04	675.82
2.21011	1.1717815E+04	676.17
2.22007	1.1682224E+04	676.52
2.23009	1.1656145E+04	676.88
2.24010	1.1635537E+04	677.24
2.25000	1.1606759E+04	677.59

TABLE 6.2.1-13 REACTOR CAVITY SUBCOMPARTMENT MASS AND ENERGY RELEASE FROM REACTOR VESSEL HOT LEG NOZZLE 150 IN2 BREAK

<u>TIMES(S)</u>	<u>MASS FLOW (lb./S)</u>	<u>AVG ENTHALPY (Btu/lb.)</u>
2.26017	1.1566030E+04	677.96
2.27013	1.1529150E+04	678.32
2.28008	1.1506706E+04	678.69
2.29015	1.1470585E+04	679.05
2.30003	1.1426224E+04	679.42
2.31006	1.1196024E+04	679.69
2.32001	1.1138844E+04	679.92
2.33009	1.1308279E+04	680.21
2.34005	1.1273368E+04	680.55
2.35005	1.1197207E+04	680.88
2.36005	1.1153269E+04	681.42
2.37007	1.1157151E+04	681.97
2.38021	1.1151873E+04	682.50
2.39024	1.1144881E+04	682.99
2.40010	1.1136913E+04	683.44
2.41008	1.1133399E+04	683.92
2.42006	1.1133273E+04	684.39
2.43011	1.1131634E+04	684.88
2.44003	1.1127026E+04	685.36
2.45003	1.1122502E+04	685.85
2.46002	1.1121341E+04	686.37
2.47011	1.1124320E+04	686.91
2.48001	1.1128375E+04	687.44
2.49004	1.1129679E+04	687.99
2.50010	1.1126662E+04	688.52
2.51011	1.1120319E+04	689.08
2.52007	1.1115835E+04	689.65
2.53004	1.1111082E+04	690.22
2.54005	1.1107080E+04	690.80
2.55011	1.1100815E+04	691.40
2.56005	1.1093406E+04	691.98
2.57004	1.1088308E+04	692.61
2.58007	1.1091970E+04	693.24
2.59021	1.1091308E+04	693.88
2.60011	1.1085872E+04	694.50
2.61002	1.1077456E+04	695.14
2.62006	1.1071304E+04	695.78
2.63011	1.1064348E+04	696.42
2.64013	1.1055587E+04	697.08
2.65002	1.1046906E+04	697.72
2.66009	1.1039075E+04	698.38
2.67009	1.1032599E+04	699.08
2.68009	1.1030332E+04	699.77
2.69003	1.1027265E+04	700.45
2.70014	1.1020499E+04	701.14
2.71010	1.1009593E+04	701.81
2.72005	1.0994752E+04	702.50
2.73010	1.0986299E+04	703.20
2.74015	1.0981456E+04	703.91
2.75009	1.0976227E+04	704.62
2.76018	1.0969251E+04	705.34
2.77022	1.0959540E+04	706.06
2.78007	1.0946830E+04	706.77
2.79002	1.0933509E+04	707.50
2.80001	1.0923801E+04	708.24

TABLE 6.2.1-13 REACTOR CAVITY SUBCOMPARTMENT MASS AND ENERGY RELEASE FROM REACTOR VESSEL HOT LEG NOZZLE 150 IN2 BREAK

<u>TIMES(S)</u>	<u>MASS FLOW (lb./S)</u>	<u>AVG ENTHALPY (Btu/lb.)</u>
2.81001	1.0915605E+04	708.99
2.82004	1.0911554E+04	709.75
2.83006	1.0916234E+04	710.52
2.84005	1.0911481E+04	711.27
2.85002	1.0899235E+04	712.00
2.86100	1.0881568E+04	712.72
2.87025	1.0864099E+04	713.45
2.88021	1.0846173E+04	714.19
2.89017	1.0835129E+04	714.95
2.90016	1.0927215E+04	715.73
2.91016	1.0815027E+04	716.50
2.92019	1.0799955E+04	717.29
2.93008	1.0782872E+04	718.08
2.94006	1.0770177E+04	718.92
2.95017	1.0754933E+04	719.76
2.96001	1.0744940E+04	710.61
2.97003	1.0736345E+04	711.50
2.98006	1.0730031E+04	722.38
2.99001	1.0724229E+04	723.27
3.00001	1.0716026E+04	724.15

**TABLE 6.2.1-14 STEAM GENERATOR SUBCOMPARTMENT DOUBLE ENDED
HOT LEG GUILLOTINE BREAK - MASS AND ENERGY RELEASE DATA**

<u>TIMES(S)</u>	<u>MASS FLOW (lb./S)</u>	<u>AVG ENTHALPY (Btu/lb.)</u>
.0000	1.1024200E+04	647.51
.00100	6.0345458E+04	645.59
.00200	8.4532187E+04	645.51
.00301	8.8837001E+04	645.01
.00401	8.5213433E+04	644.35
.00501	7.8995087E+04	644.16
.00601	7.3606154E+04	645.02
.00701	7.0689097E+04	646.42
.00800	7.0271191E+04	647.45
.00902	7.1149568E+04	647.90
.01002	7.2017922E+04	648.08
.01100	7.2586755E+04	648.30
.01200	7.2894144E+04	648.64
.01302	7.3063533E+04	649.06
.01402	7.3250654E+04	649.49
.01502	7.3566696E+04	649.87
.01602	7.4025054E+04	650.17
.01702	7.4541059E+04	650.40
.01801	7.5021506E+04	650.59
.01900	7.5446979E+04	650.75
.02000	7.5828421E+04	650.91
.02101	7.6175152E+04	651.07
.02202	7.6485820E+04	651.22
.02301	7.6762416E+04	651.38
.02400	7.7013151E+04	651.53
.02500	7.7239288E+04	651.69
.02603	7.7440885E+04	651.84
.02703	7.7612024E+04	651.98
.02801	7.7760440E+04	652.11
.02902	7.7892833E+04	652.24
.03003	7.8011961E+04	652.36
.03101	7.8118668E+04	652.47
.03202	7.8220542E+04	652.57
.03302	7.8311089E+04	652.67
.03400	7.8389499E+04	652.76
.03502	7.8455142E+04	652.85
.03602	7.8503090E+04	652.95
.03701	7.8533679E+04	653.04
.03803	7.8548369E+04	653.14
.03902	7.8549141E+04	653.24
.04002	7.8540922E+04	653.35
.04101	7.8528741E+04	653.47
.04201	7.8517443E+04	653.60
.04300	7.8513601E+04	653.75
.04404	7.8522438E+04	653.92
.04500	7.8547709E+04	654.10
.04602	7.8598019E+04	654.31
.04705	7.8678656E+04	654.53
.04802	7.8787056E+04	654.75
.04902	7.8940381E+04	654.99
.05002	7.9143466E+04	655.22

**TABLE 6.2.1-14 STEAM GENERATOR SUBCOMPARTMENT DOUBLE ENDED
HOT LEG GUILLOTINE BREAK - MASS AND ENERGY RELEASE DATA**

<u>TIMES(S)</u>	<u>MASS FLOW (lb./S)</u>	<u>AVG ENTHALPY (Btu/lb.)</u>
.05103	7.9402317E+04	655.45
.05204	7.9713095E+04	655.65
.05303	8.0060956E+04	655.83
.05402	8.0451400E+04	655.98
.05501	8.0884873E+04	656.10
.05603	8.1380615E+04	656.18
.05705	8.1908338E+04	656.23
.05800	8.2428466E+04	656.24
.05903	8.3013314E+04	656.22
.06001	8.3582930E+04	656.17
.06101	8.4173855E+04	656.10
.06205	8.4785291E+04	656.00
.06306	8.5372076E+04	655.90
.06404	8.5932593E+04	655.78
.06501	8.64659313E+04	655.66
.06601	8.7009247E+04	655.52
.06703	8.7537158E+04	655.37
.06803	8.8021412E+04	655.22
.06903	8.8474746E+04	655.08
.07004	8.8844812E+04	654.92
.07102	8.9199095E+04	654.78
.07203	8.9563003E+04	654.65
.07302	8.9902776E+04	654.53
.07401	9.0213915E+04	654.41
.07506	9.0517151E+04	654.28
.07600	9.0762604E+04	654.18
.07707	9.1011445E+04	654.06
.07802	9.1211308E+04	653.96
.07903	9.1398073E+04	653.87
.08000	9.1559811E+04	653.78
.08102	9.1709583E+04	653.69
.08202	9.1838578E+04	653.61
.08300	9.1949386E+04	653.53
.08404	9.2048213E+04	653.45
.08500	9.2122263E+04	653.39
.08602	9.2181252E+04	653.32
.08704	9.2220281E+04	653.26
.08803	9.2240201E+04	653.20
.08901	9.2244722E+04	653.15
.09005	9.2235370E+04	653.09
.09109	9.2214176E+04	653.04
.09202	9.2186144E+04	653.00
.09309	9.2146638E+04	652.96
.09405	9.2104726E+04	652.92
.09503	9.2056998E+04	652.88
.09609	9.2001425E+04	652.84
.09708	9.1945643E+04	652.81
.09804	9.1889123E+04	652.78
.09900	9.1828949E+04	652.75
.10002	9.1763167E+04	652.72
.10509	9.1418960E+04	652.56
.11008	9.1082248E+04	652.36
.11509	9.0685692E+04	652.07
.12011	9.0047466E+04	651.73
.12500	8.9088521E+04	651.45

**TABLE 6.2.1-14 STEAM GENERATOR SUBCOMPARTMENT DOUBLE ENDED
HOT LEG GUILLOTINE BREAK - MASS AND ENERGY RELEASE DATA**

<u>TIMES(S)</u>	<u>MASS FLOW (lb./S)</u>	<u>AVG ENTHALPY (Btu/lb.)</u>
.13002	8.7917136E+04	651.25
.13506	8.6813094E+04	651.12
.14003	8.5889536E+04	651.01
.14504	8.5084409E+04	650.89
.15017	8.4363565E+04	650.73
.15511	8.3757206E+04	650.55
.16002	8.3313163E+04	650.39
.16507	8.2828675E+04	650.15
.17002	8.2435660E+04	649.91
.17510	8.2127364E+04	649.64
.18010	8.1907487E+04	649.35
.18516	8.1751221E+04	649.01
.19017	8.1616559E+04	648.64
.19514	8.1470640E+04	648.25
.20017	8.1296682E+04	647.85
.21007	8.0875772E+04	647.10
.22018	8.0352270E+04	646.38
.23003	7.9766161E+04	645.71
.24006	7.9126450E+04	645.06
.25004	7.8531830E+04	644.44
.26017	7.7993138E+04	643.78
.27002	7.7517288E+04	643.14
.28019	7.7043431E+04	642.49
.29021	7.6575871E+04	641.86
.30011	7.6116015E+04	641.27
.31021	7.5666476E+04	640.69
.32021	7.5251120E+04	640.13
.33015	7.4876385E+04	639.59
.34022	7.4523285E+04	639.05
.35009	7.4191459E+04	638.54
.36023	7.3861019E+04	638.03
.37025	7.3549326E+04	637.56
.38001	7.3267132E+04	637.10
.39021	7.3000331E+04	636.63
.40012	7.2766750E+04	636.18
.41005	7.2549020E+04	635.75
.42009	7.2343573E+04	635.31
.43019	7.2134293E+04	634.89
.44013	7.1916544E+04	634.51
.45021	7.1684609E+04	634.16
.46022	7.1448775E+04	633.83
.47008	7.1219459E+04	633.53
.48022	7.0992367E+04	633.23
.49005	7.0779993E+04	632.95
.50023	7.0567669E+04	632.66
.51020	7.0358933E+04	632.39
.52028	7.0141691E+04	632.12
.53019	6.9916584E+04	631.88
.54022	6.9673933E+04	631.66
.55010	6.9419968E+04	631.45
.56013	6.9149595E+04	631.27
.57005	6.8874145E+04	631.10
.58013	6.8590390E+04	630.95
.59014	6.8309118E+04	630.81
.60009	6.8032346E+04	630.68

**TABLE 6.2.1-14 STEAM GENERATOR SUBCOMPARTMENT DOUBLE ENDED
HOT LEG GUILLOTINE BREAK - MASS AND ENERGY RELEASE DATA**

<u>TIMES(S)</u>	<u>MASS FLOW (lb./S)</u>	<u>AVG ENTHALPY (Btu/lb.)</u>
.61001	6.7760825E+04	630.56
.62016	6.7487651E+04	630.45
.63006	6.7226833E+04	630.35
.64001	6.6971944E+04	630.27
.65008	6.6724623E+04	630.21
.66012	6.6424666E+04	630.15
.67002	6.6204897E+04	630.13
.68015	6.6019069E+04	630.12
.69031	6.5852324E+04	630.15
.70023	6.5713585E+04	630.19
.71010	6.5593430E+04	630.27
.72031	6.5487015E+04	630.36
.73028	6.5411988E+04	630.49
.74005	6.5361694E+04	630.63
.75037	6.5320448E+04	630.80
.76009	6.5286330E+04	630.98
.77010	6.5250534E+04	631.17
.78008	6.5207849E+04	631.38
.79033	6.5150591E+04	631.60
.80001	6.5080698E+04	631.82
.81023	6.4988834E+04	632.06
.82010	6.4881089E+04	632.30
.83006	6.4752780E+04	632.54
.84017	6.4602522E+04	632.78
.85020	6.4433998E+04	633.01
.86021	6.4247611E+04	733.24
.87024	6.4044061E+04	633.46
.88008	6.3829954E+04	633.67
.89003	6.3601424E+04	633.88
.90012	6.3360257E+04	634.08
.91010	6.3115084E+04	634.28
.92002	6.2868417E+04	634.47
.93015	6.2616753E+04	634.66
.94004	6.2374563E+04	634.84
.95021	6.3132634E+04	635.03
.96022	6.1904266E+04	635.23
.97008	6.1690561E+04	635.42
.98006	6.1485413E+04	635.62
.99012	6.1289450E+04	635.83
1.00000	6.1106371E+04	636.03
1.10005	5.9398440E+04	638.07
1.20014	5.7440815E+04	640.04
1.30003	5.5876625E+04	643.14
1.40024	5.4101666E+04	646.93
1.50008	5.1897498E+04	650.14
1.60013	5.0012016E+04	651.58
1.70014	4.8545063E+04	652.06
1.80016	4.7316810E+04	652.68
1.90007	4.6196784E+04	653.17
2.00021	4.5167348E+04	653.27
2.10034	4.4196706E+04	652.95
2.20004	4.3278882E+04	652.46
2.30003	4.2403800E+04	652.07
2.40007	4.1594908E+04	651.90
2.50020	4.0877363E+04	651.91

TABLE 6.2.1-14 STEAM GENERATOR SUBCOMPARTMENT DOUBLE ENDED HOT LEG GUILLOTINE BREAK - MASS AND ENERGY RELEASE DATA

<u>TIMES(S)</u>	<u>MASS FLOW (lb./S)</u>	<u>AVG ENTHALPY (Btu/lb.)</u>
2.60005	4.0298576E+04	651.90
2.70029	3.9805653E+04	651.73
2.80021	3.9341807E+04	651.61
2.90022	3.8837692E+04	651.67
3.00001	3.8391596E+04	651.66

Note

(1) Tabulated mass flow rates include a 10% margin, added by Westinghouse. For all subcompartment analyses, using the Double Ended Hot Leg Guillotine Break Mass Release Data, are reduced by a factor of 0.90910 to remove the 10% margin.

TABLE 6.2.1-15 STEAM GENERATOR SUBCOMPARTMENT DOUBLE-ENDED PUMP SUCTION LEG GUILLOTINE BREAK - MASS AND ENERGY RELEASE DATA

<u>TIMES(S)</u>	<u>MASS FLOW (lb./S)</u>	<u>AVG ENTHALPY (Btu/lb.)</u>
.0000	9.3240000E+03	558.10
.00101	4.0524818E+04	553.41
.00201	5.8641831E+04	553.56
.00301	6.9038021E+04	553.67
.00402	7.4940058E+04	553.71
.00501	7.8151491E+04	553.69
.00600	7.9777886E+04	553.62
.00702	8.0390754E+04	553.54
.00800	8.0396615E+04	553.44
.00903	8.0003216E+04	553.33
.01004	7.9368163E+04	553.22
.01101	7.8594360E+04	553.11
.01200	7.7704920E+04	553.01
.01302	7.6755870E+04	552.91
.01403	7.5810000E+04	552.83
.01503	7.4915768E+04	552.76
.01602	7.4093202E+04	552.73
.01707	7.3364284E+04	552.70
.01802	7.2784237E+04	552.70
.01904	7.2342149E+04	552.72
.02005	7.2028741E+04	552.75
.02102	7.1844018E+04	552.80
.02202	7.1756271E+04	552.84
.02300	7.1726549E+04	552.87
.02404	7.1790534E+04	552.90
.02505	7.1911886E+04	552.91
.02606	7.2047660E+04	552.91
.02703	7.2163902E+04	552.89
.02807	7.2265460E+04	552.88
.02902	7.2328098E+04	552.86
.03001	7.2363317E+04	552.83
.03104	7.2371342E+04	552.81
.03205	7.2356728E+04	552.80
.03301	7.2327175E+04	552.79
.03405	7.2282264E+04	552.78
.03500	7.2234161E+04	552.78
.03605	7.2177208E+04	552.79
.03704	7.2124971E+04	552.80
.03802	7.2077306E+04	552.81
.03904	7.2036558E+04	552.82
.04001	7.2007572E+04	552.83
.04102	7.1990994E+04	552.84
.04202	7.1987955E+04	552.85
.04302	7.1998413E+04	552.86
.04402	7.2020808E+04	552.87
.04501	7.2053373E+04	552.87
.04601	7.2094186E+04	552.87
.04702	7.2141437E+04	552.86
.04802	7.2189397E+04	552.86
.04902	7.2236163E+04	552.85

TABLE 6.2.1-15 STEAM GENERATOR SUBCOMPARTMENT DOUBLE-ENDED PUMP SUCTION LEG GUILLOTINE BREAK - MASS AND ENERGY RELEASE DATA

<u>TIMES(S)</u>	<u>MASS FLOW (lb./S)</u>	<u>AVG ENTHALPY (Btu/lb.)</u>
.05001	7.2279684E+04	552.85
.05102	7.2320339E+04	552.84
.05202	7.2356686E+04	552.83
.05301	7.2387088E+04	552.82
.05401	7.2410978E+04	552.82
.05501	7.2428213E+04	552.81
.05602	7.2437962E+04	552.80
.05701	7.2439388E+04	552.79
.05803	7.2432507E+04	552.79
.05902	7.2417619E+04	552.78
.06001	7.2395333E+04	552.77
.06102	7.2365952E+04	552.77
.06202	7.2330702E+04	552.76
.06303	7.2289539E+04	552.76
.06402	7.2244552E+04	552.76
.06503	7.2197072E+04	552.75
.06604	7.2149289E+04	552.75
.06703	7.2098784E+04	552.75
.06804	7.2048644E+04	552.75
.06904	7.2002443E+04	552.75
.07002	7.1957255E+04	552.75
.07102	7.1912108E+04	552.75
.07201	7.1869418E+04	552.75
.07307	7.1827168E+04	552.76
.07402	7.1791578E+04	552.76
.07502	7.1756338E+04	552.76
.07600	7.1723584E+04	552.77
.07705	7.1690533E+04	552.78
.07804	7.1661002E+04	552.79
.07905	7.1632229E+04	552.80
.08000	7.1605788E+04	552.81
.08100	7.1579246E+04	552.82
.08205	7.1552302E+04	552.83
.08308	7.1527092E+04	552.85
.08401	7.1505759E+04	552.86
.08501	7.1484586E+04	552.88
.08602	7.1464931E+04	552.90
.08708	7.1448041E+04	552.93
.08801	7.1436754E+04	552.95
.08907	7.1428702E+04	552.98
.09003	7.1426647E+04	553.00
.09105	7.1430726E+04	553.03
.09206	7.1441798E+04	553.06
.09302	7.1459175E+04	553.09
.09406	7.1486298E+04	553.12
.09502	7.1519647E+04	553.15
.09602	7.1561712E+04	553.18
.09707	7.1616307E+04	553.22
.09802	7.1675605E+04	553.24
.09909	7.1746181E+04	553.27
.10003	7.1816384E+04	553.30
.10207	7.1987044E+04	553.35
.10402	7.2159440E+04	553.39
.10604	7.2338291E+04	553.43

TABLE 6.2.1-15 STEAM GENERATOR SUBCOMPARTMENT DOUBLE-ENDED PUMP SUCTION LEG GUILLOTINE BREAK - MASS AND ENERGY RELEASE DATA

<u>TIMES(S)</u>	<u>MASS FLOW (lb./S)</u>	<u>AVG ENTHALPY (Btu/lb.)</u>
.10802	7.2510237E+04	553.46
.11000	7.2677439E+04	553.49
.11203	7.2842062E+04	553.51
.11400	7.2997323E+04	553.54
.11606	7.3153938E+04	553.55
.11803	7.3297562E+04	553.57
.12008	7.3440044E+04	553.59
.12207	7.3572665E+04	553.60
.12400	7.3695376E+04	553.61
.12603	7.3818278E+04	553.63
.12807	7.3936712E+04	553.64
.13007	7.4045274E+04	553.66
.13208	7.4156446E+04	553.67
.13407	7.4258593E+04	553.69
.13603	7.4355862E+04	553.71
.13807	7.4453117E+04	553.73
.14009	7.4545568E+04	553.75
.14204	7.4630838E+04	553.77
.14412	7.4715983E+04	553.80
.14609	7.4791570E+04	553.82
.14805	7.4858228E+04	553.85
.15009	7.4918108E+04	553.87
.15209	7.4967134E+04	553.90
.15409	7.5007709E+04	553.93
.15602	7.5039961E+04	553.96
.15803	7.5067434E+04	554.00
.16005	7.5090314E+04	554.03
.16211	7.5110508E+04	554.07
.16401	7.5127519E+04	554.11
.16604	7.5145772E+04	554.15
.16804	7.5164912E+04	554.20
.17003	7.5187669E+04	554.24
.17202	7.5210518E+04	554.29
.17401	7.5239158E+04	554.34
.17601	7.5272690E+04	554.39
.17801	7.5313914E+04	554.45
.18000	7.5369749E+04	554.54
.18200	7.5469826E+04	554.63
.18401	7.5643771E+04	554.74
.18608	7.5886838E+04	554.83
.18802	7.6139351E+04	554.90
.19001	8.1490935E+04	555.04
.19202	7.7895991E+04	555.02
.19401	8.0581493E+04	555.13
.19602	8.1949739E+04	555.40
.19800	8.1739509E+04	555.55
.20002	8.1667397E+04	555.57
.20502	8.2119006E+04	555.65
.21003	8.1677496E+04	555.72
.21502	8.0771243E+04	555.84
.22001	8.0233868E+04	556.02
.22504	8.0339564E+04	556.17
.23001	8.0505049E+04	556.31
.23502	8.0933790E+04	556.48

TABLE 6.2.1-15 STEAM GENERATOR SUBCOMPARTMENT DOUBLE-ENDED PUMP SUCTION LEG GUILLOTINE BREAK - MASS AND ENERGY RELEASE DATA

<u>TIMES(S)</u>	<u>MASS FLOW (lb./S)</u>	<u>AVG ENTHALPY (Btu/lb.)</u>
.24007	8.1724803E+04	556.67
.24508	8.1981692E+04	556.78
.25006	8.1622762E+04	556.87
.25504	8.1432305E+04	556.97
.26000	8.1444665E+04	557.07
.26501	8.1601549E+04	557.17
.27001	8.1796453E+04	557.26
.27506	8.1997200E+04	557.35
.28008	8.2109578E+04	557.41
.28501	8.1936018E+04	557.45
.29000	8.1499004E+04	557.49
.29501	8.1082489E+04	557.55
.30010	8.0692508E+04	557.66
.30503	8.0211034E+04	557.79
.31010	7.9514336E+04	557.94
.31508	7.8733516E+04	558.11
.32009	7.7920017E+04	558.31
.32510	7.7155883E+04	558.52
.33006	7.6529340E+04	558.74
.33503	7.6092806E+04	558.97
.34003	7.5667555E+04	559.20
.34507	7.5164458E+04	559.43
.35001	7.4733004E+04	559.67
.35513	7.4381709E+04	559.93
.36010	7.4077393E+04	560.18
.36500	7.3799692E+04	560.43
.37004	7.3520636E+04	560.70
.37509	7.3234390E+04	560.95
.38012	7.2959480E+04	561.20
.38509	7.2725426E+04	561.45
.39000	7.2521810E+04	561.68
.39505	7.2329933E+04	561.90
.40001	7.2166141E+04	562.12
.40515	7.2060184E+04	562.35
.41001	7.1991945E+04	562.57
.41504	7.1859041E+04	562.79
.42000	7.1695083E+04	563.01
.42506	7.1516928E+04	563.23
.43003	7.1341627E+04	563.44
.43505	7.1184213E+04	563.66
.44010	7.1020662E+04	563.88
.44506	7.0864483E+04	564.09
.45011	7.0730762E+04	564.32
.45507	7.0631767E+04	564.54
.46002	7.0602771E+04	564.78
.46509	7.0546227E+04	565.00
.47002	7.0444621E+04	565.21
.47512	7.0363249E+04	565.41
.48003	7.0294940E+04	565.60
.48501	7.0235997E+04	565.78
.49005	7.0145287E+04	565.96
.49501	7.0029850E+04	566.14
.50008	6.9884963E+04	566.33
.51003	7.0039203E+04	566.77

**TABLE 6.2.1-15 STEAM GENERATOR SUBCOMPARTMENT DOUBLE-ENDED
PUMP SUCTION LEG GUILLOTINE BREAK - MASS AND ENERGY RELEASE
DATA**

<u>TIMES(S)</u>	<u>MASS FLOW (lb./S)</u>	<u>AVG ENTHALPY (Btu/lb.)</u>
.52003	6.9731868E+04	567.18
.53012	6.9423078E+04	567.63
.54001	6.9140583E+04	568.12
.55007	6.8889484E+04	568.63
.56019	6.8664647E+04	569.12
.57017	6.8528725E+04	569.62
.58003	6.8507295E+04	570.13
.59009	6.8463834E+04	570.62
.60006	6.8378898E+04	571.10
.61000	6.8311163E+04	571.58
.62011	6.8272669E+04	572.06
.63012	6.8246816E+04	572.54
.64021	6.8221713E+04	573.00
.65009	6.8181963E+04	573.46
.66002	6.8132677E+04	573.91
.67012	6.8079209E+04	574.36
.68001	6.8025255E+04	574.78
.69008	6.7967724E+04	575.21
.70008	6.7905900E+04	575.63
.71002	6.7837950E+04	576.04
.72012	6.7760362E+04	576.45
.73012	6.7674460E+04	576.85
.74012	6.7581245E+04	577.24
.75009	6.7482820E+04	577.63
.76005	6.7383600E+04	578.02
.77010	6.7284210E+04	578.40
.78010	6.7185273E+04	578.78
.79008	6.7084243E+04	579.14
.80000	6.6983330E+04	579.49
.81003	6.6873004E+04	579.85
.82006	6.6759893E+04	580.20
.83007	6.6641933E+04	580.53
.84008	6.6518861E+04	580.87
.85012	6.6390083E+04	581.19
.86008	6.6258298E+04	581.52
.87005	6.6125310E+04	581.84
.88010	6.5990875E+04	582.15
.89006	6.5857848E+04	582.46
.90013	6.5723411E+04	582.76
.91009	6.5588268E+04	583.06
.92009	6.5451003E+04	583.35
.93004	6.5312934E+04	583.63
.94013	6.5170572E+04	583.91
.95000	6.5028819E+04	584.19
.96004	6.4882992E+04	584.46
.97007	6.4736852E+04	584.73
.98011	6.4590890E+04	584.99
.99066	6.4446435E+04	585.25
1.00012	6.4302055E+04	585.50

**TABLE 6.2.1-16 STEAM GENERATOR SUBCOMPARTMENT DOUBLE-ENDED
COLD LET GUILLOTINE BREAK - MASS AND ENERGY RELEASE DATA**

<u>TIMES(S)</u>	<u>MASS FLOW (lb./S)</u>	<u>AVG ENTHALPY (Btu/lb.)</u>
.0000	1.1324200E+04	553.81
.00100	4.4570762E+04	549.06
.00201	5.8805967E+04	549.08
.00301	6.4643873E+04	549.02
.00401	6.6481865E+04	548.88
.00501	6.6210787E+04	548.67
.00602	6.4790242E+04	548.40
.00700	6.2800952E+04	548.11
.00801	6.0591591E+04	547.90
.00901	5.8565061E+04	547.81
.01001	5.6928264E+04	547.88
.01101	5.5882027E+04	548.05
.01201	5.5469769E+04	548.28
.01301	5.5592852E+04	548.47
.01401	5.6036132E+04	548.59
.01512	5.6607215E+04	548.64
.01602	5.7144545E+04	548.66
.01703	5.7621577E+04	548.66
.01801	5.8010549E+04	548.67
.01905	5.8371809E+04	548.69
.02001	5.8677514E+04	548.72
.02102	5.8981775E+04	548.75
.02204	5.9293260E+04	548.81
.02301	5.9600001E+04	548.87
.02401	5.9927980E+04	548.92
.02504	6.0272597E+04	548.97
.02602	6.0612532E+04	549.01
.02701	6.0946329E+04	549.04
.02802	6.1263000E+04	549.05
.02901	6.1590646E+04	549.07
.03000	6.1885777E+04	549.08
.03104	6.2167943E+04	549.10
.03200	6.2431527E+04	549.11
.03301	6.2676997E+04	549.11
.03401	6.2902121E+04	549.13
.03502	6.3110234E+04	549.14
.03600	6.3308269E+04	549.16
.03703	6.3499393E+04	549.19
.03801	6.3672417E+04	549.21
.03903	6.3841553E+04	549.23
.04004	6.4101957E+04	549.26
.04101	6.4153357E+04	549.29
.04205	6.4312203E+04	549.33
.04304	6.4460158E+04	549.36
.04406	6.4610597E+04	549.39
.04507	6.4756613E+04	549.42
.04601	6.4894032E+04	549.46
.04701	6.5051944E+04	549.49
.04800	6.5200557E+04	549.53
.04900	6.5355294E+04	549.62
.05000	6.5525905E+04	549.76
.05100	6.5903704E+04	550.45
.05201	6.6627876E+04	550.55
.05300	6.7402684E+04	550.59
.05401	6.8107118E+04	550.60
.05501	7.6646458E+04	554.68

**TABLE 6.2.1-16 STEAM GENERATOR SUBCOMPARTMENT DOUBLE-ENDED
COLD LET GUILLOTINE BREAK - MASS AND ENERGY RELEASE DATA**

<u>TIMES(S)</u>	<u>MASS FLOW (lb./S)</u>	<u>AVG ENTHALPY (Btu/lb.)</u>
.05601	8.8017305E+04	550.87
.05701	8.4391009E+04	551.90
.05801	8.7244787E+04	550.76
.05900	8.7601522E+04	551.41
.06000	8.9796330E+04	551.21
.06100	8.9630540E+04	550.88
.06201	8.8424914E+04	550.82
.06302	8.8446761E+04	550.82
.06401	8.8933971E+04	550.84
.06500	8.9486174E+04	550.81
.06600	8.9042705E+04	550.61
.06702	8.9536751E+04	550.81
.06802	9.0402921E+04	550.88
.06901	9.1428447E+04	550.85
.07003	9.1832417E+04	550.83
.07105	9.2055693E+04	550.82
.07200	9.2489197E+04	550.84
.07302	9.2906966E+04	550.83
.07401	9.3094290E+04	550.85
.07505	9.3367771E+04	550.82
.07605	9.3858842E+04	550.86
.07705	9.4461599E+04	550.90
.07803	9.5062428E+04	550.92
.07903	9.5553439E+04	550.96
.08007	9.6195924E+04	551.00
.08105	9.6695119E+04	551.00
.08206	9.6963151E+04	550.97
.08304	9.7089364E+04	550.95
.08403	9.7243229E+04	550.94
.08507	9.7467380E+04	550.95
.08601	9.7696605E+04	550.95
.08702	9.7969430E+04	550.96
.08806	9.8279560E+04	550.98
.08908	9.8557361E+04	550.98
.09007	9.8727314E+04	550.96
.09107	9.8790135E+04	550.93
.09202	9.8782186E+04	550.90
.09303	9.8735463E+04	550.87
.09407	9.8678267E+04	550.85
.09501	9.8664334E+04	550.83
.09605	9.8735706E+04	550.84
.09706	9.8887470E+04	550.85
.09806	9.9066325E+04	550.86
.09905	9.9233805E+04	550.86
.10000	9.9350001E+04	550.85
.10507	9.9499448E+04	550.78
.11011	1.0010712E+05	550.78
.11506	1.0031991E+05	550.74
.12008	1.0095196E+05	550.79
.12507	1.0166041E+05	550.87
.13006	1.0251943E+05	550.99
.13501	1.0306787E+05	551.08
.14009	1.0340576E+05	551.15
.14503	1.0363687E+05	551.19
.15011	1.0397515E+05	551.23
.15509	1.0424490E+05	551.23

**TABLE 6.2.1-16 STEAM GENERATOR SUBCOMPARTMENT DOUBLE-ENDED
COLD LET GUILLOTINE BREAK - MASS AND ENERGY RELEASE DATA**

<u>TIMES(S)</u>	<u>MASS FLOW (lb./S)</u>	<u>AVG ENTHALPY (Btu/lb.)</u>
.16002	1.0438370E+05	551.20
.16508	1.0440389E+05	551.17
.17002	1.0449549E+05	551.16
.17515	1.0471349E+05	551.17
.18006	1.0497644E+05	551.18
.18513	1.0517078E+05	551.18
.19002	1.0528063E+05	551.17
.19511	1.0536931E+05	551.16
.20016	1.0546367E+05	551.15
.21008	1.0549102E+05	551.11
.22011	1.0533798E+05	551.07
.23014	1.0541258E+05	551.09
.24018	1.0588407E+05	551.19
.25004	1.0624301E+05	551.24
.26017	1.0605490E+05	551.22
.27012	1.0573770E+05	551.18
.28016	1.0564751E+05	551.18
.29016	1.0579764E+05	551.19
.30001	1.0582758E+05	551.18
.31002	1.0567966E+05	551.16
.32006	1.0539162E+05	551.13
.33004	1.0506220E+05	551.13
.34007	1.0475672E+05	551.19
.35002	1.0444833E+05	551.09
.36009	1.0403821E+05	551.07
.37009	1.0357630E+05	551.05
.38001	1.0329455E+05	551.05
.39006	1.0328083E+05	551.13
.40001	1.0334067E+05	551.14
.41002	1.0324684E+05	551.15
.42013	1.0302244E+05	551.14
.43008	1.0279151E+05	551.14
.44011	1.0252723E+05	551.14
.45004	1.0216415E+05	551.14
.46013	1.0173280E+05	551.14
.47009	1.0133983E+05	551.15
.48014	1.0103725E+05	551.17
.49001	1.0078626E+05	551.19
.50015	1.0050443E+05	551.21
.51007	1.0015614E+05	551.22
.52006	9.9740042E+04	551.24
.53015	9.9340565E+04	551.26
.54006	9.8996919E+04	551.29
.55014	9.8648668E+04	551.32
.56011	9.8275012E+04	551.36
.57009	9.7897646E+04	551.40
.58020	9.7795723E+04	551.48
.59014	9.7935754E+04	551.57
.60010	9.7993358E+04	551.63
.61001	9.7897358E+04	551.67
.62017	9.7802629E+04	551.73
.63013	9.7801473E+04	551.80
.64000	9.7822131E+04	551.87
.65005	9.7783336E+04	551.94
.66013	9.7622208E+04	552.00
.67009	9.7482789E+04	552.06

**TABLE 6.2.1-16 STEAM GENERATOR SUBCOMPARTMENT DOUBLE-ENDED
COLD LET GUILLOTINE BREAK - MASS AND ENERGY RELEASE DATA**

<u>TIMES(S)</u>	<u>MASS FLOW (lb./S)</u>	<u>AVG ENTHALPY (Btu/lb.)</u>
.68001	9.7261452E+04	552.13
.69013	9.7237632E+04	552.21
.70015	9.7153080E+04	552.28
.71011	9.6924792E+04	552.34
.72004	9.6704687E+04	552.42
.73000	9.6622454E+04	552.52
.74006	9.6587028E+04	552.62
.75006	9.6489190E+04	552.71
.76009	9.6368978E+04	552.81
.77009	9.6303788E+04	552.91
.78001	9.6265856E+04	553.01
.79012	9.6178043E+04	553.10
.80000	9.6015706E+04	553.21
.81012	9.5810031E+04	553.30
.82000	9.5630221E+04	553.42
.83012	9.5499675E+04	553.54
.84004	9.5363709E+04	553.66
.85005	9.5164832E+04	553.77
.86011	9.4933621E+04	553.89
.87009	9.4735902E+04	554.02
.88006	9.4551854E+04	554.15
.89004	9.4326286E+04	554.28
.90008	9.4062638E+04	554.42
.91009	9.3815232E+04	554.57
.92006	9.3668819E+04	554.72
.93005	9.3418315E+04	554.86
.94004	9.3112967E+04	555.01
.95013	9.2726414E+04	555.16
.96005	9.2348072E+04	555.31
.97001	9.2008405E+04	555.47
.98008	9.1668053E+04	555.63
.99002	9.1301622E+04	555.80
1.00008	9.0909494E+04	555.98
1.10004	8.8562339E+04	557.85
1.20017	8.5142881E+04	559.79
1.30011	8.4053473E+04	561.78
1.40004	8.1079123E+04	563.86
1.50002	7.8671323E+04	565.77
1.60002	7.5824157E+04	567.54
1.70003	7.0812834E+04	569.50
1.80013	6.8119105E+04	571.19
1.90001	6.5842281E+04	572.74
2.00002	6.1686321E+04	574.53
2.10003	6.0056342E+04	575.88
2.20006	5.8469684E+04	577.33
2.30000	5.6960079E+04	579.33
2.40013	5.5545962E+04	581.72
2.50018	5.4351353E+04	584.79
2.60023	5.2420102E+04	588.92
2.63024	5.1916010E+04	590.25

Notes:

(1) Tabulated mass flow rates include a 10% margin, added by Westinghouse. For all subcompartment analyses using the Double Ended Cold Leg Guillotine Break blowdown data, mass flow rates are reduced by a factor of 0.9091 to remove the 10% margin.

TABLE 6.2.1-17

PRESSURIZER SUBCOMPARTMENT DOUBLE-ENDED SURGE LINE GUILLOTINE BREAK
MASS AND ENERGY RELEASE RATES FOR ORIGINAL DESIGN BASES

<u>TIMES(S)</u>	<u>MASS FLOW (lb./S)</u>	<u>AVG ENTHALPY (Btu/lb.)</u>
.00000	0.	0.00
.00501	1.5865294E+04	679.56
.01102	2.0984553E+04	672.55
.01502	2.0322874E+04	672.22
.02003	1.9080382E+04	672.68
.02501	1.9588253E+04	671.76
.03005	2.0057482E+04	671.02
.03501	2.0522881E+04	670.40
.04110	2.0931338E+04	669.88
.05003	2.083487 E+04	669.74
.06007	2.0274783E+04	670.06
.07009	2.0007795E+04	670.26
.08001	1.9772454E+04	670.45
.09011	1.9213386E+04	670.97
.10007	1.9518224E+04	670.68
.15004	1.7950590E+04	672.12
.20001	1.6006467E+04	674.98
.30032	1.5635467E+04	675.35
.40050	1.5562509E+04	675.11
.50022	1.5499026E+04	674.85
.60041	1.5421848E+04	674.56
.70011	1.5366345E+04	674.22
.80033	1.5312382E+04	673.88
.90031	1.5242365E+04	673.55
1.00009	1.5175989E+04	673.22
2.00007	1.4471182E+04	669.87

Notes:

(1) Tabulated mass flow rates include 10% margin, added by Westinghouse. For the pressurizer subcompartment analysis using the double ended surge line guillotine break, the mass flow rates reduced by a factor of 0.90910 to remove the 10% margin.

TABLE 6.2.1-17a

Pressurizer Subcompartment Double-Ended Surge Line Guillotine Break
Mass and Energy Releases for SGR/PUR

<u>Time (sec)</u>	<u>Break Flow (lbm/sec)</u>	<u>Break Energy (Btu/sec)</u>	<u>Enthalpy (Btu/lbm)</u>
0.00000	0.000000E+00	0.000000E+00	0.00
0.00100	2.1103676E+03	1.3534502E+06	641.33
0.00904	9.4237946E+03	6.0692558E+06	644.04
0.01004	9.8820135E+03	6.3686254E+06	644.47
0.02004	1.3838759E+04	8.9630591E+06	647.68
0.03003	1.4863396E+04	9.6634563E+06	650.15
0.04003	1.6093160E+04	1.0502445E+07	652.60
0.05001	1.6159154E+04	1.0577799E+07	654.60
0.06002	1.6553060E+04	1.0864070E+07	656.32
0.07001	1.6655118E+04	1.0953752E+07	657.68
0.08006	1.6433660E+04	1.0835927E+07	659.37
0.09004	1.6416382E+04	1.0846517E+07	660.71
0.10002	1.6907343E+04	1.1180615E+07	661.29
0.20005	1.4938162E+04	1.0006279E+07	669.85
0.30001	1.4111884E+04	9.4848110E+06	672.12
0.40005	1.4341020E+04	9.6094731E+06	670.07
0.50001	1.4291815E+04	9.5529874E+06	668.42
0.60001	1.4319763E+04	9.5477666E+06	666.75
0.70001	1.4293723E+04	9.5143628E+06	665.63
0.80003	1.4305338E+04	9.5119696E+06	664.92
0.90017	1.4272873E+04	9.4888186E+06	664.81
1.00000	1.4151129E+04	9.4151449E+06	665.33
1.10016	1.3962764E+04	9.3022100E+06	666.22
1.20014	1.3846967E+04	9.2358276E+06	666.99
1.30006	1.3682495E+04	9.1379399E+06	667.86
1.40019	1.3597790E+04	9.0918136E+06	668.62
1.50001	1.3546720E+04	9.0685560E+06	669.43
1.60021	1.3469738E+04	9.0282535E+06	670.26
1.70011	1.3380283E+04	8.9786760E+06	671.04
1.90006	1.3193815E+04	8.8690636E+06	672.21
2.00049	1.3130329E+04	8.8308523E+06	672.55

Note: The tabulated energy releases should be increased 8.35% in order to bound operation at a Tavg of 572°F with a -6.0°F temperature uncertainty.

TABLE 6.2.1-18

PRESSURIZER SUBCOMPARTMENT SPRAY LINE DOUBLE ENDED PRESSURIZER
BREAK - MASS AND ENERGY RELEASE RATES FOR ORIGINAL DESIGN BASES

<u>TIMES(S)</u>	<u>MASS FLOW (lb./S) x 10³</u>	<u>AVG ENTHALPY (Btu/lb.)</u>
.00000	0.	0.00
.05003	4.864	611.05
.10011	4.980	609.82
.15001	4.740	612.01
.20062	4.726	612.03
.25024	4.734	611.80
.30016	4.644	612.62
.35000	4.667	612.22
.40023	4.650	612.26
.45080	4.670	611.88
.50011	4.689	611.52
.55038	4.671	611.56
.60015	4.677	611.34
.65025	4.671	611.25
.70026	4.667	611.14
.75041	4.665	611.02
.80005	4.650	611.05
.85031	4.645	610.95
.90033	4.635	610.93
.95038	4.622	610.93
1.00004	4.617	610.86
1.05002	4.599	610.93
1.10003	4.589	610.90
1.15004	4.579	610.89
1.20016	4.565	610.95
1.25006	4.556	610.91
1.30023	4.543	610.94
1.35011	4.530	610.97
1.40018	4.522	610.95
1.45020	4.508	611.00
1.50020	4.497	611.02
1.55112	4.487	611.02
1.60021	4.474	611.07
1.65033	4.463	611.09
1.70032	4.453	611.11
1.76012	4.440	611.17
1.80021	4.429	611.20
1.85040	4.418	611.24
1.90010	4.404	611.30
1.95032	4.393	611.34
2.00001	4.382	611.40

TABLE 6.2.1-18a

Pressurizer Subcompartment Spray Double-Ended Pressurizer Break
Mass and Energy Release Rates for SGR/PUR

<u>Time (sec)</u>	<u>Break Flow (lb/sec)</u>	<u>Break Energy (Btu/sec)</u>	<u>Avg. Enthalpy (Btu/lb)</u>
0.00000	0.000000E+00	0.000000E+00	0.00
0.01103	5.5518493E+03	3.2905004E+06	592.69
0.02003	5.7362822E+03	3.3924253E+06	591.40
0.03004	5.7848213E+03	3.4191326E+06	591.05
0.04012	5.8059940E+03	3.4305494E+06	590.86
0.05008	5.6819445E+03	3.3609717E+06	591.52
0.06007	5.6565506E+03	3.3467035E+06	591.65
0.07002	5.7317091E+03	3.3884934E+06	591.18
0.08006	5.7132020E+03	3.3780441E+06	591.27
0.09004	5.6174032E+03	3.3245990E+06	591.84
0.10006	5.5866929E+03	3.3074862E+06	592.03
0.20007	5.5623287E+03	3.2933991E+06	592.09
0.30000	5.4512179E+03	3.2308583E+06	592.69
0.40009	5.3230373E+03	3.1592006E+06	593.50
0.50001	5.2181352E+03	3.1007846E+06	594.23
0.60009	5.1229225E+03	3.0478652E+06	594.95
0.70015	5.0239055E+03	2.9929317E+06	595.74
0.80014	4.9453679E+03	2.9493564E+06	596.39
0.90018	4.8895171E+03	2.9183478E+06	596.86
1.00013	4.9513805E+03	2.9521263E+06	596.22
1.10003	4.9736299E+03	2.9641328E+06	595.97
1.20003	5.0045052E+03	2.9809611E+06	595.66
1.30005	5.0311580E+03	2.9955387E+06	595.40
1.40002	5.0433071E+03	3.0021727E+06	595.28
1.50009	5.0585074E+03	3.0105403E+06	595.14
1.60003	5.0654476E+03	3.0143923E+06	595.09
1.70006	5.0667942E+03	3.0151892E+06	595.09
1.80003	5.0675444E+03	3.0156876E+06	595.10
1.90011	5.0613076E+03	3.0123487E+06	595.17
2.00022	5.0532974E+03	3.0080471E+06	595.26

Note: The tabulated energy releases should be increased 0.4% in order to bound operation at a Tavg of 572°F with a -6.0°F temperature uncertainty.

TABLE 6.2.1-19

REACTOR CAVITY SUBCOMPARTMENT PRESSURIZATION MODEL
RELAP-4 VOLUME INPUT DATA

<u>Analysis(1)</u> <u>Volume No.</u>	<u>GA Drawing</u> <u>Vol. No.</u>	<u>Net Free</u> <u>Volume (ft.2)</u>	<u>Vol. Height</u> <u>(ft.)</u>	<u>Vol. Floor</u> <u>Elev. (ft.)</u>
01	2	4250.18	12.00	211.50
02	1	2224.30	12.00	211.50
03	3a	43.55	10.29	223.50
04	3b	74.50	10.29	223.50
05	3c	48.55	10.29	223.50
06	3d	74.50	10.29	223.50
07	3e	48.55	10.29	223.50
08	3f	74.50	10.29	223.50
09	4a	7.73	8.52	223.79
10	4b	5.82	8.52	233.79
11	4c	7.73	8.52	233.79
12	4d	12.82	8.52	233.79
13	4e	7.73	8.52	233.79
14	4f	6.82	8.52	233.79
15	5a	8.56	6.82	242.31
16	5b	11.99	6.82	242.31
17	5c	8.56	6.82	242.31
18	5d	11.99	6.82	242.31
19	5e	8.56	6.82	242.31
20	5f	11.99	6.82	242.31
21	6a	379.59	11.07	249.13
22	6b	559.26	11.07	249.13
23	6c	378.59	11.07	249.13
24	6d	565.11	11.07	249.13
25	6e	378.59	11.07	249.13
26	6f	560.26	11.07	249.13
27	7a	1233.07	25.80	260.20
28	7b	1818.83	25.80	260.20
29	7c	1185.92	25.80	260.20
30	7d	1672.06	25.80	260.20
31	7e	1178.33	25.80	260.20
32	7f	30861.21	25.80	260.20
33	Vol. outside of Reactor Cavity	2252715.00	220.000	221.000

NOTE: 1. See Figure 6.2.1-22

**TABLE 6.2.1-20 REACTOR CAVITY SUBCOMPARTMENT PRESSURIZATION MODEL
RELAY-4 JUNCTION INPUT DATA**

Junction No.	Volume		Area	Elev.	Inertia Coefficient	Loss Coefficient	
	From	To				Forward	Reverse
01	27	33	13.430	286.000	0.2729	1.3647	1.0232
02	28	33	48.980	286.000	0.1885	1.1805	0.6071
03	29	33	41.060	286.000	0.2729	1.0467	0.5219
04	30	33	57.480	286.000	0.1966	1.0442	0.5212
05	31	33	41.060	286.000	0.2729	1.0467	0.5219
06	32	33	820.350	286.000	0.0192	0.9234	0.4829
07	21	27	34.270	260.200	0.4044	0.0220	0.0353
08	22	28	50.530	260.200	0.2807	0.0226	0.0362
09	23	29	34.270	260.200	0.4044	0.0220	0.0353
10	24	30	47.980	260.200	0.2888	0.0220	0.0352
11	25	31	34.270	260.200	0.4044	0.0131	0.0353
12	26	32	47.980	260.200	0.1114	0.9119	0.4840
13	15	21	0.700	249.130	2.4259	0.9991	0.6985
14	16	22	0.980	249.130	1.7296	0.9990	0.6978
15	17	23	0.700	249.130	2.4259	0.9991	0.6985
16	18	24	0.980	249.130	1.7296	0.9990	0.6978
17	19	25	0.700	249.130	2.4259	0.9991	0.6985
18	20	26	0.980	249.130	1.7296	0.9990	0.6978
19	9	15	1.190	242.310	5.1477	0.2175	0.2175
20	10	16	1.670	242.310	3.6699	0.2234	0.2234
21	11	17	1.190	242.310	5.1477	0.2175	0.2175
22	12	18	1.670	242.310	3.6699	0.2234	0.2234
23	13	19	1.190	242.310	5.1477	0.2175	0.2175
24	14	20	1.670	242.310	3.6699	0.2234	0.2234
25	3	9	1.190	233.790	3.0554	0.5981	1.0321
26	4	10	1.670	233.790	2.1785	0.5980	1.0318
27	5	11	1.190	233.790	3.0554	0.5981	1.0321
28	6	12	1.670	233.790	2.1785	0.5981	1.0319
29	7	13	1.190	233.790	3.0554	0.5981	1.0313
30	8	14	1.670	233.790	2.1785	0.5981	1.0319
31	2	3	22.260	223.500	5.6630	0.3485	0.6499
32	2	4	31.160	223.500	4.0460	0.3519	0.6533
33	2	5	22.260	223.500	5.6630	0.3485	0.6499
34	2	6	31.140	223.500	4.0460	0.3514	0.6524
35	2	7	22.260	223.500	5.6630	0.3485	0.6499
36	2	8	31.140	223.500	4.0460	0.3514	0.6524
37	32	27	210.610	273.100	0.0690	0.3444	0.4547
38	26	21	27.060	254.670	0.2149	0.4458	0.4458
39	20	15	1.410	245.720	5.2278	0.3027	0.3027
40	14	9	1.620	238.050	4.1877	0.2569	0.2569
41	8	3	14.750	228.650	0.4589	0.2423	0.2423
42	27	28	122.880	273.100	0.0742	0.0172	0.0172
43	21	22	26.780	254.670	0.2149	0.4537	0.4537
44	15	16	1.410	245.720	5.2278	0.3025	0.3025
45	9	10	1.620	238.050	4.1877	0.2568	0.2568
46	3	4	14.750	228.650	0.4589	0.2423	0.2423
47	28	29	122.880	273.100	0.0742	0.0172	0.0172
48	22	23	27.060	254.670	0.2149	0.4458	0.4458
49	16	17	1.410	245.720	5.2278	0.3027	0.3027
50	10	11	1.620	238.050	4.1877	0.2569	0.2569
51	4	5	14.750	228.650	0.4589	0.2423	0.2423
52	29	30	122.880	273.100	0.0742	0.0172	0.0172
53	23	24	26.780	254.670	0.2149	0.4537	0.4537

**TABLE 6.2.1-20 REACTOR CAVITY SUBCOMPARTMENT PRESSURIZATION MODEL
RELAY-4 JUNCTION INPUT DATA**

Junction No.	Volume		Area	Elev.	Inertia Coefficient	Loss Coefficient	
	From	To				Forward	Reverse
54	17	18	1.410	245.720	5.2278	0.3027	0.3027
55	11	12	1.620	238.050	4.1877	0.2569	0.2569
56	5	6	14.750	228.650	0.4589	0.2423	0.2423
57	30	31	122.880	273.100	0.0742	0.0172	0.0172
58	24	25	27.060	254.670	0.2149	0.4458	0.4458
59	18	19	1.410	245.720	5.2278	0.3026	0.3026
60	12	13	1.620	238.050	4.1877	0.2568	0.2568
61	6	7	14.750	228.650	0.4589	0.2422	0.2422
62	31	32	210.610	273.100	0.0690	0.4547	0.3443
63	25	26	26.780	254.670	0.2149	0.4537	0.4537
64	19	20	1.410	245.720	5.2278	0.3026	0.3026
65	13	14	1.620	238.050	4.1877	0.2569	0.2569
66	7	8	14.750	228.650	0.4589	0.2422	0.2422
67	2	1	152.873	217.500	0.107	0.0504	0.1097
68	21	33	2.5252	253.750	1.787	1.6899	1.6899
69	22	33	2.2814	253.750	1.965	1.9007	1.9007
70	23	33	2.9708	253.750	1.552	1.6643	1.6643
71	24	33	2.2814	253.700	1.965	1.9007	1.9007
72	25	33	2.5252	253.700	1.552	1.6643	1.6643
73	26	33	2.2814	253.700	3.009	2.0087	2.0086
74	1	33	30.0000	223.500	0.040	1.5000	1.5000
75	0	23	0.5000	253.750	0.000	0.0000	0.0000
76	0	24	0.5000	253.750	0.000	0.0000	0.0000
Fill Junctions for Cold Leg Guill. Break							
75	0	22	0.5000	253.750	0.0	0.0	0.0
76	0	23	0.5000	253.750	0.0	0.0	0.0
Fill Junctions for Hot Leg Guill. Break							

Note: (1) See Figure 6.2.1-22

TABLE 6.2.1-20A
LIST OF PROJECTED AREAS

Volume Number	Projected Area for Force Calculation (in ²)		
	in X-direction	in Y-direction	in Z-direction
3	6448.26	4515.12	4042.21
4	931.14	10643.03	5659.09
5	7134.34	3326.80	4042.21
6	8751.57	6127.91	5659.09
7	686.08	7841.92	4042.21
8	9682.71	4515.12	5659.09
9	6428.62	4501.37	N/A
10	928.31	10610.62	N/A
11	7112.61	3316.67	N/A
12	8724.91	6109.25	N/A
13	683.99	7818.04	N/A
14	9653.22	4501.37	N/A
15	5140.38	3599.34	N/A
16	742.28	8484.35	N/A
17	5687.31	2652.04	N/A
18	6976.52	4885.01	N/A
19	546.92	6251.37	N/A
20	7718.81	3599.34	N/A
21	8855.03	6200.36	N/A
22	1278.69	14615.47	N/A
23	9797.18	4568.50	N/A
24	12018.03	8415.11	N/A
25	942.15	10768.87	N/A
26	13296.71	6200.36	N/A
27	6364.25	4456.29	4042.21
28	919.01	10504.37	5659.09
29	7041.38	3283.45	4042.21
30	8637.54	6048.07	5659.09
31	677.14	7739.75	4042.21
32	9556.55	4456.29	5659.09

TABLE 6.2.1-20B
LIST OF LEVER ARMS

<u>Volume Number</u>	<u>Lever Arms (ft) relative to nozzle elevation (253.75')</u>
3,4,5,6,7,8	-24.24
9,10,11,12,13,14	-15.70
15,16,17,18,19,20	- 8.03
21,22,23,24,25,26	+ 0.92
27,28,29,30,31,32	10.43

TABLE 6.2.1-21

STEAM GENERATOR - LOOP 1
SUBCOMPARTMENT ANALYSIS-VOLUME INPUT DATA

Analysis ⁽¹⁾ Vol. No.	GA Drawing ⁽²⁾ Vol. No.	Net Free Volume (Ft. ³)	Vol. Height (Ft.)	Volume Floor Elev. (Ft.)
01	11	8093.87	15.000	221.000
02	13	6034.32	15.000	221.000
03	71	10412.70	23.500	221.000
04	15	4041.25	61.000	221.000
05	21	1288.29	17.750	236.000
06	2	4250.48	12.000	211.500
07	12	18857.39	35.000	221.000
08	10	22158.22	41.500	221.000
09	9	4386.33	15.000	221.000
10	22	499.66	17.750	236.000
11	16	5421.03	61.000	221.000
12	20	4049.88	17.750	236.000
13	70	1694856.7	159.000	282.000
14	23,24,25,26,40,41,42,43, 57,58,59,60,8(a to d)	51912.30	76.750	236.000
15	27,28,29,30,31,32,44,45, 46,47,48,49,61,62,63,64,65,66	24833.40	46.000	236.000
16	1,3 (a to f), 4 (a to f), 5 (a to f)	2703.75	37.630	211.500
17	6 (a to f), 7 (a to f)	40770.82	36.870	249.130
18	14,33,50	365478.26	65.000	221.000
19	67b	8155.33	35.450	298.670
20	67a	2748.20	16.670	282.000
21	51	452.87	8.000	274.000
22	52	503.50	8.000	274.000
23	53	951.99	8.000	274.000
24	54	1343.48	8.000	274.000
25	55	602.85	8.000	274.000
26	56	248.35	8.000	274.000
27	34	1177.05	20.250	253.750
28	35	1059.99	20.250	253.750
29	36	1934.60	20.250	253.750
30	37	3602.54	20.250	253.750
31	38	1135.39	20.250	253.750
32	39	380.78	20.250	253.750
33	17	1652.62	17.750	236.000
34	18	1760.31	17.750	236.000
35	19	2646.17	17.750	236.000

Notes:

- 1) See Figures 6.2.1-23 and 6.2.1-24
- 2) See Figures 6.2.1-18 through 6.2.1-20

TABLE 6.2.1-22

STEAM GENERATOR LOOP 1
SUBCOMPARTMENT ANALYSIS JUNCTION INPUT DATA

Junction No.	Analysis Volume		Area (Ft. ²)	Elev. (Ft.)	Inertia Coef.	Loss Coefficient		Remarks
	From	To				Forward	Reverse	
01	9	18	103.275	227.000	0.0294	1.4567	1.1665	
02	8	18	138.516	227.000	0.0417	1.4658	1.2916	
03	1	18	255.850	227.000	0.0361	1.5365	1.1124	
04	7	18	98.600	227.000	0.0584	1.4485	1.2745	
05	2	18	135.006	227.000	0.0652	1.5438	1.1219	
06	4	18	58.650	228.950	0.1601	1.3883	1.4121	
07	3	18	137.513	231.000	0.0479	1.2868	0.8502	
08	1	14	540.838	236.000	0.0563	0.3512	0.2941	
09	8	18	17.850	239.500	0.2369	1.5126	1.4881	
10	7	18	17.850	227.000	0.2419	1.5089	1.4748	
11	24	26	78.200	278.000	0.1453	0.1424	0.1327	
12	13	17	1022.35	286.000	0.0204	0.4730	0.9629	
13	13	15	153.746	282.000	0.0794	1.1050	1.4097	
14	2	4	6.851	230.639	0.6553	1.4997	1.5061	
15	11	18	58.225	231.096	0.0753	1.4662	1.3439	
16	9	11	14.161	227.833	0.3653	1.4492	1.3758	
17	8	9	262.650	228.500	0.0922	0.3741	0.5268	
18	3	11	4.301	232.667	1.4107	1.5607	1.4853	
19	1	8	161.925	228.500	0.0711	0.9698	0.7475	
20	1	7	203.150	228.500	0.0692	0.8348	0.6230	
21	6	7	30.000	223.500	0.0562	1.3500	1.2897	
22	13	26	12.912	282.000	0.4686	0.7736	1.2568	
23	11	13	5.313	282.000	1.1878	1.4999	1.3565	
24	11	18	7.650	271.000	0.5294	1.5248	1.4765	
25	4	18	63.376	276.743	0.1588	1.4265	1.4247	
26	2	7	315.988	229.625	0.0452	0.4695	0.3402	
27	11	18	46.750	279.167	0.0921	1.4737	1.3741	
28	13	18	2534.30	286.000	0.0140	0.5660	0.8635	
29	6	16	152.873	217.500	0.1708	0.0597	0.0998	
30	16	17	5.024	249.130	2.2410	2.5071	2.4934	
31	8	30	57.639	258.125	0.0437	0.1146	0.1722	
32	28	17	2.525	253.750	2.1257	1.6995	1.6762	
33	8	32	62.934	258.125	0.0274	0.1142	0.1718	
34	11	33	3.400	253.750	0.7843	1.4929	1.5080	
35	11	28	13.235	270.750	0.8223	1.2996	1.3976	
36	25	13	63.750	282.000	0.1244	1.0006	0.5078	
37	4	15	4.726	260.781	0.8930	1.5629	1.5479	
38	8	31	70.661	258.125	0.0438	0.1175	0.1751	
39	3	15	81.983	236.000	0.1296	1.3465	1.2987	
40	7	15	356.762	244.875	0.0239	0.7580	0.6776	
41	7	14	347.302	244.875	0.0317	0.7922	0.7011	
42	8	14	375.063	244.875	0.0336	0.7612	0.6926	
43	13	14	171.340	282.000	0.0501	1.1753	1.4287	
44	13	14	201.348	310.875	0.1829	1.2545	1.4727	
45	2	15	332.257	236.000	0.1095	0.2551	0.2520	
46	8	10	133.238	244.875	0.0241	0.1027	0.1603	
47	8	5	142.375	244.875	0.0430	0.1141	0.1717	
48	8	12	103.352	244.875	0.0406	0.1139	0.1715	
49	34	3	28.900	240.250	0.2765	1.2806	1.1582	
50	19	13	1577.12	319.385	0.0088	0.9380	0.5448	
51	19	13	246.500	334.120	0.0455	1.4584	0.8599	
52	20	19	49.742	298.670	0.2340	0.7127	0.7109	

Junction No.	Analysis Volume		Area (Ft. ²)	Elev. (Ft.)	Inertia Coef.	Loss Coefficient		Remarks
	From	To				Forward	Reverse	
53	9	33	58.327	236.000	0.1237	0.5288	0.8415	
54	9	34	28.492	236.000	0.1568	0.9041	1.1647	
55	9	35	58.752	236.000	0.0953	0.6865	0.9303	
56	9	12	99.450	236.000	0.0710	0.6219	0.7380	
57	9	5	18.012	236.000	0.1648	0.9816	1.2477	
58	9	10	7.438	236.000	0.6975	0.6538	1.1593	
59	33	35	143.225	244.875	0.0817	0.1385	0.1385	
60	35	5	63.682	244.875	0.0810	0.7327	0.7327	
61	33	34	143.225	244.875	0.0516	0.1368	0.1368	
62	35	12	128.622	244.875	0.0348	0.6165	0.6165	
63	5	10	62.722	244.875	0.0608	0.3223	0.4100	
64	33	27	75.310	253.750	0.0801	0.0102	0.0102	
65	34	28	56.610	253.750	0.2853	0.1868	0.1328	
66	34	12	148.249	244.875	0.0486	0.3432	0.2835	
67	12	30	159.205	253.750	0.1014	0.1258	0.0634	
68	12	10	140.820	244.875	0.0337	0.2848	0.2848	
69	10	32	10.540	253.750	1.0548	0.3777	0.3152	
70	5	31	53.414	253.750	0.3024	0.0260	0.0260	
71	35	29	105.213	253.750	0.1535	0.0136	0.0136	
72	27	29	81.796	263.875	0.1193	0.1905	0.2231	
73	29	31	57.690	263.875	0.0957	0.7414	0.6870	
74	31	32	57.690	263.875	0.0924	0.1356	0.1369	
75	29	30	131.470	263.875	0.0401	0.4837	0.5564	
76	27	28	71.596	263.875	0.1370	0.1551	0.2033	
77	30	32	124.848	263.875	0.0401	0.2597	0.2673	
78	28	30	105.383	263.875	0.0943	0.3581	0.3048	
79	32	26	22.593	274.000	0.5079	0.0173	0.0173	
80	31	25	53.414	274.000	0.2127	0.1035	0.1646	
81	30	24	114.164	274.000	0.0829	0.1987	0.1560	
82	299	23	92.157	274.000	0.1221	0.1361	0.0737	
83	28	22	37.400	274.000	0.2429	0.2326	0.2056	
84	27	21	53.338	274.000	0.1780	0.2083	0.1677	
85	21	23	27.200	278.000	0.3266	0.2718	0.2644	
86	23	25	47.600	278.000	0.2421	0.1014	0.1614	
87	21	22	27.200	278.000	0.3390	0.1696	0.2114	
88	23	24	73.100	278.000	0.1014	0.2517	0.2488	
89	25	26	47.600	278.000	0.1161	0.0112	0.0112	
90	21	20	30.107	282.000	0.1277	0.3171	0.3966	
91	22	20	23.817	282.000	0.1548	0.3179	0.3974	
92	22	24	47.600	278.000	0.1577	0.2514	0.2586	
93	23	20	26.699	282.000	0.1008	0.3150	0.3945	
94	24	20	34.153	282.000	0.0937	0.3158	0.3953	
95	23	13	18.785	282.000	0.2615	1.4207	1.1930	
96	24	13	11.747	282.000	0.3776	1.4668	1.3446	
97	0	34	0.22727	253.750	0.0	0.0	0.0	Fill junctions used for analyzing the double-ended hot leg guillotine break
98	0	12	0.22727	253.750	0.0	0.0	0.0	
99	0	28	0.22727	253.750	0.0	0.0	0.0	
100	0	30	0.22727	253.750	0.0	0.0	0.0	
97	0	12	0.50000	244.500	0.0	0.0	0.0	Fill junctions used for analyzing the double-ended pump guillotine break
98	0	35	0.50000	244.500	0.0	0.0	0.0	
97	0	10	0.22727	253.750	0.0	0.0	0.0	Fill junctions used for analyzing the double-ended cold leg guillotine break
98	0	12	0.22727	253.750	0.0	0.0	0.0	
99	0	30	0.22727	253.750	0.0	0.0	0.0	
100	0	32	0.22727	253.750	0.0	0.0	0.0	

TABLE 6.2.1-23

STEAM GENERATOR - LOOP 3
SUBCOMPARTMENT ANALYSIS VOLUME DATA

Analysis ⁽¹⁾ Vol. No.	GA Drawing ⁽²⁾ Vol. No.	Net Free Volume (Ft. ³)	Vol. Height (Ft.)	Volume Floor Elev. (Ft.)
01	16	5421.03	61.000	221.000
02	10	22158.22	36.000	221.000
03	12	18857.39	35.000	221.000
04	13	6034.32	15.000	221.000
05	71	10412.70	23.500	221.000
06	15	4041.25	61.000	221.000
07	70	1696555.5	159.000	282.000
08	6 (a to f), 7 (a to f)	40770.75	36.870	249.130
09	1,3 (a to f), 4 (a to f), 5 (a to f)	2703.75	37.630	211.500
10	9,17,18,19,20,21,22,34,35,36, 37,38,39,51,52,53,54,55,56	29712.56	61.000	221.000
11	11,23,24,25,26,40,41,42,43,57, 58,59,60, 8(a to d)	60006.17	91.750	221.000
12	14,33,50	365478.26	65.000	221.000
13	69b	6456.48	35.450	298.670
14	69a	2748.20	16.670	282.000
15	61	585.54	8.000	274.000
16	62	474.95	8.000	274.000
17	63	1005.05	8.000	274.000
18	64	1519.79	8.000	274.000
19	65	706.09	8.000	274.000
20	66	202.38	8.000	274.000
21	44	1802.53	20.250	253.750
22	45	1132.92	20.250	253.750
23	46	2052.32	20.250	253.750
24	47	2240.17	20.250	253.750
25	48	1434.65	20.250	253.750
26	49	180.16	20.250	253.750
27	27	1948.98	17.750	236.000
28	28	1647.16	17.750	236.000
29	29	2471.24	17.750	236.000
30	30	3514.28	17.750	236.000
31	31	1533.70	17.750	236.000
32	32	381.49	17.750	236.000
33	2	4250.48	12.000	211.500

Notes:

1. See Figures 6.2.1-25 and 6.2.1-26
2. See Figures 6.2.1-18 through 6.2.1-20

TABLE 6.2.1-24 STEAM GENERATOR LOOP 3 SUBCOMPARTMENT ANALYSIS JUNCTION INPUT DATA

Junction No.	Analysis Volume		Area (Ft. ²)	Elev. (Ft.)	Inertia Coef. (Ft. ⁻¹)	Loss Coefficient		Remarks
	From	To				Forward	Reverse	
01	10	12	103.275	227.000	0.0623	1.3990	1.1088	
02	2	12	138.516	227.000	0.0373	1.4423	1.2668	
03	11	12	255.850	227.000	0.0337	1.2893	0.8652	
04	3	12	98.600	227.000	0.0523	1.4534	1.2794	
05	4	12	135.006	227.000	0.0607	1.3190	0.8971	
06	6	12	58.650	228.950	0.1575	1.3886	1.3899	
07	5	12	137.513	231.000	0.0479	1.2868	0.8501	
08	32	5	24.183	240.250	0.4143	1.3698	1.1279	
09	2	12	17.850	239.500	0.2033	1.5122	1.4877	
10	3	12	17.850	239.500	0.2083	1.5089	1.4748	
11	18	20	68.000	278.000	0.1048	0.1080	0.1063	
12	19	7	56.687	282.000	0.0619	1.1074	0.5531	
13	7	10	107.194	282.000	0.1072	1.0768	1.3715	
14	4	6	6.851	230.639	0.5677	1.4990	1.5054	
15	1	12	58.225	230.096	0.0650	1.4662	1.3439	
16	1	10	14.161	227.833	0.1967	1.4909	1.4738	
17	2	10	641.614	237.375	0.0260	0.1757	0.2138	
18	1	5	4.301	232.667	1.2014	1.5620	1.5607	
19	2	11	606.050	239.000	0.0292	0.3786	0.3112	
20	3	11	550.452	237.375	0.0273	0.4224	0.3280	
21	31	5	28.900	240.250	0.3568	1.3897	1.2461	
22	20	7	8.364	282.000	0.2156	1.2964	0.8319	
23	1	7	5.313	282.000	1.0749	1.4999	1.3941	
24	1	12	7.650	271.000	0.4510	1.5248	1.5079	
25	6	12	46.750	278.667	0.1612	1.4108	1.4119	
26	3	4	268.175	228.500	0.0452	0.0054	0.0054	
27	1	12	46.750	279.167	0.0793	1.4737	1.3741	
28	7	12	2534.30	286.000	0.0140	0.4270	0.6771	
29	33	9	152.873	217.500	0.1708	0.0597	0.0998	
30	9	8	5.024	249.130	2.2410	2.5071	2.4934	
31	18	7	4.675	282.000	0.0284	1.5044	1.4662	
32	7	8	1022.353	286.000	0.0204	0.4730	0.9629	
33	6	12	16.626	271.333	0.1942	1.4721	1.4725	
34	1	10	3.400	254.000	0.7666	1.5278	1.5237	
35	1	10	13.235	270.750	0.2093	1.4900	1.4739	
36	7	10	58.520	282.000	0.3055	0.9404	1.4344	
37	6	19	1.326	278.000	3.1636	1.5212	1.5549	
38	6	25	2.125	263.875	1.9624	1.5241	1.5354	
39	6	31	1.275	244.875	3.2235	1.5612	1.5701	
40	3	27	164.586	244.875	0.0431	0.2205	0.2358	
41	16	18	64.600	278.000	0.1432	0.1560	0.1548	
42	17	14	30.158	282.000	0.0967	0.3650	0.5293	
43	7	11	86.267	282.000	0.0899	1.3566	1.4582	
44	7	11	69.850	310.875	0.2369	1.0017	1.4116	
45	30	5	28.900	240.250	0.3752	1.4900	1.4238	
46	18	14	33.847	282.000	0.0852	0.3652	0.5295	
47	17	7	24.650	282.000	0.0417	1.3985	1.1194	
48	3	28	192.177	244.875	0.0418	0.2197	0.2350	
49	5	10	28.900	240.250	0.1965	1.3691	1.3419	
50	13	7	187.000	334.120	0.0324	0.9278	1.6630	
51	13	7	1376.72	319.385	0.0061	0.1615	0.1043	

TABLE 6.2.1-24 STEAM GENERATOR LOOP 3 SUBCOMPARTMENT ANALYSIS JUNCTION INPUT DATA

Junction No.	Analysis Volume		Area (Ft. ²)	Elev. (Ft.)	Inertia Coef. (Ft. ⁻¹)	Loss Coefficient		Remarks
	From	To				Forward	Reverse	
52	14	13	49.742	298.670	0.4455	0.3093	0.3827	
53	4	27	66.462	236.000	0.0916	0.2537	0.2537	
54	4	28	39.466	236.000	0.1064	0.2516	0.2516	
55	4	29	75.013	236.000	0.0794	0.2527	0.2527	
56	4	30	107.950	236.000	0.0611	0.2523	0.2523	
57	4	31	22.967	236.000	0.1227	0.2511	0.2511	
58	4	32	8.500	236.000	0.3897	0.2523	0.2523	
59	27	29	131.750	244.875	0.0806	0.2147	0.2194	
60	29	31	78.770	244.875	0.0813	0.6248	0.5841	
61	27	28	128.138	244.875	0.0568	0.1899	0.1424	
62	29	30	128.622	244.875	0.0436	0.5892	0.6526	
63	31	32	50.184	244.875	0.0673	0.6293	0.6703	
64	27	21	99.382	253.750	0.1583	0.1174	0.0577	
65	28	22	82.820	253.750	0.2087	0.1722	0.1138	
66	28	30	193.239	244.875	0.0668	0.1641	0.1728	
67	29	23	116.858	253.750	0.1332	0.1200	0.0586	
68	30	32	114.223	244.875	0.0615	0.2950	0.3446	
69	32	26	6.392	253.750	0.9005	0.8140	0.8758	
70	31	25	59.313	253.750	0.2442	0.2063	0.2041	
71	30	24	147.985	253.750	0.0981	0.1923	0.1897	
72	21	23	148.096	263.875	0.0835	0.1752	0.1755	
73	23	25	91.477	263.875	0.0937	0.4251	0.4790	
74	25	26	39.840	263.875	0.0653	0.8113	0.8768	
75	23	24	131.470	263.875	0.0462	0.5342	0.6655	
76	21	22	77.495	263.875	0.0613	0.6947	0.6689	
77	24	26	100.938	263.875	0.0503	0.2582	0.2617	
78	22	24	142.044	263.875	0.0565	0.2595	0.2613	
79	26	20	16.218	274.000	0.6973	0.7189	0.7759	
80	25	19	60.843	274.000	0.1878	0.1033	0.1638	
81	24	18	151.428	274.000	0.0781	0.0457	0.1052	
82	23	17	95.226	274.000	0.1065	0.2091	0.2114	
83	22	16	64.073	274.000	0.1753	0.1265	0.0645	
84	21	15	77.427	274.000	0.1305	0.1823	0.1275	
85	15	17	27.200	278.000	0.2113	0.7335	0.7310	
86	17	19	47.600	278.000	0.2373	0.2385	0.2518	
87	15	16	25.500	278.000	0.1552	0.8092	0.7842	
88	17	18	73.100	278.000	0.1170	0.8437	1.1364	
89	19	20	40.800	278.000	0.1428	0.4042	0.3513	
90	15	14	37.094	282.000	0.1078	0.3670	0.5310	
91	16	14	15.164	282.000	0.1170	0.3637	0.5280	
92	3	33	30.000	223.500	0.0562	1.2897	1.3500	
93	8	22	2.525	253.750	1.7853	1.6371	1.6455	
94	8	24	2.281	253.750	2.6804	1.4780	1.7824	
95	3	21	22.474	254.875	0.0470	0.9914	0.4979	
96	3	22	25.339	254.875	0.2183	0.2183	0.2337	
97	0	22	0.22727	253.750	0.0	0.0	0.0	Double-ended Hot
98	0	24	0.22727	253.750	0.0	0.0	0.0	Leg Guillotine
99	0	28	0.22727	253.750	0.0	0.0	0.0	Break Fill
100	0	30	0.22727	253.750	0.0	0.0	0.0	Junctions
97	0	29	0.50000	244.500	0.0	0.0	0.0	Double-Ended
98	0	29	0.50000	244.500	0.0	0.0	0.0	Pump Suction Leg Guillotine Break

TABLE 6.2.1-24 STEAM GENERATOR LOOP 3 SUBCOMPARTMENT ANALYSIS JUNCTION INPUT DATA

Junction No.	Analysis Volume		Area (Ft. ²)	Elev. (Ft.)	Inertia Coef. (Ft. ⁻¹)	Loss Coefficient		Remarks
	From	To				Forward	Reverse	
								Fill Junctions
97	0	24	0.22727	253.750	0.0	0.0	0.0	Double-Ended
98	0	26	0.22727	253.750	0.0	0.0	0.0	Cold Leg Guillotine
99	0	30	0.22727	253.750	0.0	0.0	0.0	Break Fill
100	0	32	0.22727	253.750	0.0	0.0	0.0	Junctions

TABLE 6.2.1-25

STEAM GENERATOR AND PRESSURIZER - LOOP 2
SUBCOMPARTMENT ANALYSIS VOLUME DATA

Analysis ⁽¹⁾ Vol. No.	GA Drawing ⁽²⁾ Vol. No.	Net Free Volume (Ft. ³)	Vol. Height (Ft.)	Volume Floor Elev. (Ft.)
01	70	1674527.50	159.00	282.00
02	9	4386.33	15.00	221.00
03	10	22158.22	36.00	221.00
04	11	8093.87	15.00	221.00
05	12	18857.39	35.00	221.00
06	13	6034.32	15.00	221.00
07	14	81093.87	19.62	216.38
08	15	4041.25	61.00	221.00
09	16	5421.03	61.00	221.00
10	33	146321.08	25.00	236.00
11	50	138063.31	25.00	261.00
12	71	10412.70	23.50	221.00
13	69	9204.68	52.12	282.00
14	67	10903.53	52.12	282.00
15	2	4250.48	12.00	211.50
16	1,3 (a to f), 4 (a to f), 5 (a to f)	2703.75	37.63	211.50
17	6 (a to f), 7 (a to f)	40770.82	36.87	249.13
18	68b	8232.45	35.45	298.67
19	68a	2892.02	16.67	282.00
20	8a	5143.46	25.00	261.00
21	8b	2492.45	10.00	286.00
22	8c	2042.40	8.25	296.00
23	8d	2229.41	8.50	304.25
24	57	2172.09	8.00	274.00
25	58	952.56	8.00	274.00
26	59	1617.60	8.00	274.00
27	60	2543.61	8.00	274.00
28	40	5457.70	20.25	253.75
29	41	1962.58	20.25	253.75
30	42	2647.43	20.25	253.75
31	43	6001.73	20.25	253.75
32	23	5211.83	17.75	236.00
33	24	2478.92	17.75	236.00
34	25	4054.02	17.75	236.00
35	26	4904.51	17.75	236.00
36	17, 18, 19, 20, 21, 22, 34, 35, 36, 37, 38, 39, 51, 52, 53, 54, 55, 56	25326.23	46.00	236.00
37	27, 28, 29, 30, 31, 32, 44, 45, 46, 47, 48, 49, 61, 62, 63, 64, 65, 66	24833.40	46.00	236.00

NOTES:

1. See Figure 6.2.1-27

2. See Figures 6.2.1-18 through 6.2.1-20

TABLE 6.2.1-26 STEAM GENERATOR AND PRESSURIZER LOOP 2 SUBCOMPARTMENT ANALYSIS JUNCTION INPUT DATA

Junction No.	Analysis Volume		Area (Ft. ²)	Elev. (Ft.)	Inertia Coef. (Ft. ⁻¹)	Loss Coefficient		Remarks
	From	To				Forward	Reverse	
01	2	7	136.85	227.00	0.035	1.032	0.932	
02	3	7	138.55	227.00	0.038	0.944	0.858	
03	4	7	255.85	227.00	0.024	0.962	0.797	
04	5	7	98.60	227.00	0.027	0.974	0.974	
05	6	7	135.01	227.00	0.044	0.875	0.791	
06	7	8	46.75	232.50	0.045	0.918	0.962	
07	7	12	110.53	228.50	0.174	0.035	0.964	
08	7	10	3167.87	236.00	0.004	0.191	0.191	
09	3	10	17.85	239.50	0.025	1.461	1.455	
10	5	10	17.85	239.50	0.017	1.452	1.443	
11	10	12	26.99	238.50	0.230	0.771	1.449	
12	1	17	1022.35	286.00	0.0204	0.4730	0.9629	
13	1	13	1376.72	319.39	0.192	0.972	1.974	
14	6	8	2.55	229.75	0.243	1.482	1.508	
15	7	9	4.75	230.83	0.042	0.975	1.064	
16	2	9	14.16	227.83	0.091	1.304	1.332	
17	2	3	262.65	228.50	0.073	1.068	0.769	
18	9	12	4.30	232.67	0.020	1.489	1.477	
19	3	4	162.35	228.50	0.097	0.753	0.881	
20	4	5	203.15	228.50	0.101	0.863	0.784	
21	5	15	51.00	223.50	0.073	1.073	1.175	
22	10	11	3701.34	261.00	0.004	0.192	0.192	
23	1	9	5.31	282.00	0.066	1.372	1.491	
24	1	14	1577.11	319.39	0.141	0.965	1.865	
25	8	11	46.75	278.67	0.030	0.751	0.694	
26	5	6	268.18	228.50	0.088	0.793	1.123	
27	9	11	7.65	271.00	0.051	1.448	1.424	
28	1	11	2534.30	286.00	0.003	0.503	1.131	
29	15	16	152.87	217.50	0.1708	0.0597	0.0998	
30	16	17	5.024	249.13	2.2410	2.5071	2.4934	
31	8	37	1.33	278.17	0.456	1.505	1.478	
32	1	23	201.35	310.88	0.012	0.552	1.115	
33	8	37	3.40	254.00	0.096	1.508	1.493	
34	13	37	58.52	282.00	0.286	0.087	1.410	
35	6	37	320.36	236.00	0.072	0.151	0.190	
36	12	37	81.98	240.25	0.042	1.085	1.112	
37	5	37	404.57	246.00	0.046	0.491	0.345	
38	5	35	347.30	244.88	0.046	0.103	0.076	
39	12	36	28.90	240.25	0.200	0.967	1.108	
40	2	36	270.47	236.00	0.071	0.147	0.188	
41	3	36	570.20	249.25	0.039	1.494	0.821	
42	14	36	58.52	282.00	0.367	0.803	0.873	
43	9	36	3.40	254.00	0.076	1.500	1.491	
44	1	18	223.98	334.12	0.098	0.686	1.735	
45	1	18	1496.96	319.39	0.098	1.337	1.506	

TABLE 6.2.1-26 STEAM GENERATOR AND PRESSURIZER LOOP 2 SUBCOMPARTMENT ANALYSIS JUNCTION INPUT DATA

Junction No.	Analysis Volume		Area (Ft. ²)	Elev. (Ft.)	Inertia Coef. (Ft. ⁻¹)	Loss Coefficient		Remarks
	From	To				Forward	Reverse	
46	22	23	192.30	304.25	0.031	0.093	0.130	
47	21	22	202.02	296.00	0.028	0.010	0.008	
48	20	21	119.46	286.00	0.047	0.468	0.565	
49	20	24	170.00	278.00	0.060	0.507	0.010	
50	20	28	265.86	267.50	0.037	0.485	0.023	
51	18	19	59.37	298.67	0.379	0.828	0.982	
52	19	24	60.88	282.00	0.073	0.679	0.416	
53	19	25	29.33	282.00	0.078	0.675	0.412	
54	19	26	25.93	282.00	0.072	0.674	0.411	
55	24	25	27.20	278.00	0.264	0.518	0.343	
56	25	26	73.10	278.00	0.106	0.233	0.246	
57	25	27	47.60	278.00	0.338	0.006	0.007	
58	26	27	129.20	278.00	0.092	0.002	0.002	
59	27	31	250.60	274.00	0.047	0.034	0.015	
60	26	30	182.22	274.00	0.065	0.024	0.007	
61	25	29	88.29	274.00	0.132	0.046	0.020	
62	24	28	238.54	274.00	0.050	0.004	0.009	
63	24	26	64.60	278.00	0.114	0.345	0.346	
64	28	29	81.80	263.88	0.088	0.539	0.539	
65	29	30	131.47	263.88	0.042	0.479	0.524	
66	30	31	241.61	263.88	0.037	0.200	0.473	
67	29	31	57.69	263.88	0.133	0.534	0.534	
68	28	32	265.91	253.75	0.062	0.088	0.024	
69	29	33	106.40	253.75	0.168	0.046	0.037	
70	30	34	192.29	253.75	0.086	0.009	0.030	
71	31	35	246.71	253.75	0.065	0.018	0.010	
72	28	30	140.32	263.88	0.060	0.431	0.431	
73	3	32	375.06	244.88	0.048	0.017	0.006	
74	32	33	143.23	244.88	0.106	0.036	0.036	
75	33	34	128.62	244.88	0.047	0.252	0.284	
76	34	35	240.77	244.88	0.043	0.089	0.089	
77	33	35	48.59	244.88	0.151	0.562	0.562	
78	32	34	194.23	244.88	0.401	0.093	0.093	
79	4	32	185.04	236.00	0.062	0.097	0.154	
80	4	33	58.75	236.00	0.180	0.211	0.214	
81	4	34	118.35	236.00	0.093	0.151	0.194	
82	4	35	178.70	236.00	0.067	0.082	0.087	
83	3	28	69.06	255.38	0.297	0.027	0.020	
84	1	36	107.19	282.00	0.109	0.661	1.211	
85	1	25	13.45	282.00	0.078	0.984	1.349	
86	1	26	13.69	282.00	0.038	1.222	0.925	
87	1	27	74.66	282.00	0.013	1.019	1.360	
88	1	37	94.38	282.00	0.098	0.780	1.271	
89	1	14	246.50	334.12	0.141	0.774	1.372	
90	1	13	187.00	334.12	0.192	0.781	1.405	
91	9	36	13.23	270.75	0.048	1.424	1.407	

TABLE 6.2.1-26 STEAM GENERATOR AND PRESSURIZER LOOP 2 SUBCOMPARTMENT ANALYSIS JUNCTION INPUT DATA

Junction No.	Analysis Volume		Area (Ft. ²)	Elev. (Ft.)	Inertia Coef. (Ft. ⁻¹)	Loss Coefficient		Remarks
	From	To				Forward	Reverse	
92	9	11	46.75	279.17	0.051	0.986	0.887	
93	8	11	16.63	271.33	0.025	1.238	1.263	
94	28	17	2.525	253.75	1.9250	1.6842	1.6929	
95	31	17	2.281	253.75	2.1151	1.6729	1.6808	
96	0	28	0.22727	253.75	0.0	0.0	0.0	Double-Ended Hot
97	0	30	0.22727	253.75	0.0	0.0	0.0	Leg Guillotine
98	0	32	0.22727	253.75	0.0	0.0	0.0	Break Fill
99	0	34	0.22727	253.75	0.0	0.0	0.0	Junctions
96	0	33	0.50000	244.50	0.0	0.	0.0	Double-Ended
97	0	34	0.50001	244.50	0.0	0.0	0.0	Pump Suction Guillotine Break Fill Junctions
96	0	30	0.22727	253.75	0.0	0.0	0.0	Double-Ended
97	0	31	0.22727	253.75	0.0	0.0	0.0	Cold Leg Guillotine
98	0	34	0.22727	253.75	0.0	0.0	0.0	Break Fill
99	0	35	0.22727	253.75	0.0	0.0	0.0	Junctions
96	0	20	0.90910	261.50	0.0	0.0	0.0	Double-Ended Surge Line Guillotine Break Fill Junction Spray Line
96	0	23	1.0000	306.13	0.0	0.0	0.0	Double-Ended Break Fill Junction

TABLE 6.2.1-27

SUMMARY OF CALCULATED SUBCOMPARTMENT PEAK PRESSURES
FOR ORIGINAL DESIGN BASES

Containment Compartment	Blowdown	Peak Pressure Differ. (psid) $\Delta P = P_{v_A} - P_{v_B}$	Time of Occurrence (sec.)	Subcompartment Analysis Volume No.	
				P_{v_A}	P_{v_B}
Loop 1	DEHLG	22.2	0.010	28	17
Loop 1	DESLG	18.3	0.010	35	18
Loop 1	DECLG	14.3	0.005	32	18
Loop 2	DEHLG	11.3	0.029	33	10
Loop 2	DESLG	22.4	0.014	33	10
Loop 2	DECLG	7.6	0.085	31	17
Loop 3	DEHLG	16.0	0.008	22	08
Loop 3	DESLG	18.9	0.013	29	12
Loop 3	DECLG	29.7	0.005	26	08
Pressurizer	P SUR GB	7.0	0.018	20	01
Pressurizer	P SPR LB	0.9(See Note 1)	0.053	23	01
Pressurizer	DEHLG	8.7	0.038	20	01
Reactor Cavity	150 in. ² CLG	29.8	0.019	23	33
Reactor Cavity	250 in. ² HLG	25.6	0.019	22	33

Note 1: Refer to section 6.2.1-2a for the evaluation and results for SGR/PUR.

TABLE 6.2.1-28
CASES ANALYZED AND RESULTS

	<u>Case</u>	<u>Blowdown</u>	<u>Reflood</u>	<u>Post Reflood</u>	<u>Balances</u>	
					<u>Mass</u>	<u>Energy</u>
A	Double Ended Pump Suction Max. S.I.	6.2.1-29a ⁽¹⁾	6.2.1-35	6.2.1-40	6.2.1-43	6.2.1-51
B	Double Ended Pump Suction Min. S.I.	6.2.1-29b ⁽¹⁾	6.2.1-36	6.2.1-41	6.2.1-44	6.2.1-52
C	Double Ended Hot Leg	6.2.1-33	-	-	6.2.1-47	6.2.1-55

NOTES

1) Double ended refers to the size and type of break.

TABLE 6.2.1-29a

DOUBLE ENDED PUMP SUCTION BREAK
BLOWDOWN MASS AND ENERGY RELEASES (Maximum Safeguards)

Time (sec)	Break Path No. 1 Flow*		Break Path No. 2 Flow**	
	(lbm/sec)	(Thousand Btu/sec)	(lbm/sec)	(Thousand Btu/sec)
0.00000	0.0	0.0	0.0	0.0
0.00102	92463.8	51485.9	40808.9	22659.2
0.00209	42572.8	23639.1	42166.4	23411.3
0.101	42230.4	23509.3	21593.0	11977.5
0.201	43036.6	24088.9	24339.8	13513.6
0.301	45457.6	25620.3	24771.9	13767.7
0.501	45811.1	26285.6	22806.4	12697.9
0.701	45947.9	26903.5	21102.6	11756.3
0.902	45086.2	26887.8	20243.6	11286.3
1.20	41912.3	25628.0	19759.7	11019.8
2.00	34787.9	22749.2	19342.1	10781.9
2.30	30697.4	20945.5	18738.3	10443.4
2.40	28263.4	19597.2	18335.2	10217.0
2.50	24063.3	16949.4	17767.9	9900.3
2.60	21095.3	15133.5	17472.9	9737.4
2.80	17157.2	12691.7	16980.6	9466.0
3.00	15029.1	11341.2	16485.0	9194.2
3.20	13842.7	10580.6	16106.8	8989.3
3.50	12676.2	9845.0	15550.9	8688.6
4.00	11360.4	9072.2	14676.1	8218.1
4.40	10583.5	8612.8	14578.8	8184.8
4.60	10270.6	8412.5	15940.2	8956.5
5.20	9807.0	8030.8	15032.2	8473.6
5.60	9623.0	7799.4	14607.6	8252.7
6.00	10323.8	8371.1	14478.0	8182.5
6.40	8675.0	7822.4	13902.4	7842.3
6.60	8565.5	7627.3	13748.1	7754.5
7.00	8889.9	7434.6	13352.2	7524.9
7.80	9919.5	7427.4	12618.0	7095.4
8.40	9731.5	7070.2	12176.3	6837.1
9.80	8255.6	6168.3	11248.9	6300.8
11.0	6936.7	5332.5	10207.0	5715.0
13.2	5686.6	4439.0	8872.5	5013.5
14.0	5240.2	4397.4	7716.0	4524.6
14.6	4334.0	4340.9	6611.3	3819.7
15.0	3377.8	3948.0	5996.9	3142.1
15.4	2633.2	3253.1	5328.1	2578.0
15.8	2068.6	2580.7	4590.7	2104.4
16.2	1673.1	2099.8	3986.9	1736.5
16.6	1426.1	1797.1	2580.7	1019.1
16.8	1314.9	1659.6	2272.5	836.3
17.4	967.6	1226.2	2389.1	784.6
17.8	719.0	913.8	3202.4	998.9
18.0	521.7	663.3	3219.9	977.8
18.6	0.0	0.0	1313.0	388.5
19.0	0.0	0.0	234.3	69.8
19.6	0.0	0.0	398.6	121.3
20.0	0.0	0.0	253.5	78.2
21.0	0.0	0.0	237.8	75.3

Time (sec)	Break Path No. 1 Flow*		Break Path No. 2 Flow**	
	(lbm/sec)	(Thousand Btu/sec)	(lbm/sec)	(Thousand Btu/sec)
21.4	0.0	0.0	0.0	0.0

* M&E exiting the SG side of the break

** M&E exiting the RV side of the break

TABLE 6.2.1-29b

DOUBLE ENDED PUMP SUCTION BREAK
BLOWDOWN MASS AND ENERGY RELEASES (Minimum Safeguards)

Time (sec)	Break Path No. 1 Flow*		Break Path No. 2 Flow**	
	(lbm/sec)	(Btu/sec)	(lbm/sec)	(Btu/sec)
0.0	0	0	0	0.0000E+00
0.001	92904.62	5.14E+07	40021.14	2.2077E+07
0.002	42111.88	2.32E+07	41727.12	2.3017E+07
0.1	41775.36	2.31E+07	21383.11	1.1785E+07
0.2	42434.96	2.36E+07	24027.03	1.3254E+07
0.3	44296.81	2.48E+07	24482.87	1.3519E+07
0.4	44484.33	2.50E+07	23775.81	1.3142E+07
0.5	44756.41	2.54E+07	22713.19	1.2564E+07
0.6	44857.21	2.57E+07	21879.42	1.2108E+07
0.7	45221.76	2.62E+07	21126.29	1.1694E+07
0.8	45220.21	2.64E+07	20607.74	1.1412E+07
0.9	44768.93	2.64E+07	20257.06	1.1221E+07
1.0	43926.74	2.61E+07	19994.91	1.1077E+07
1.1	42990.71	2.57E+07	19834.07	1.0989E+07
1.2	42033.37	2.54E+07	19761.59	1.0950E+07
1.3	41123.67	2.50E+07	19730.07	1.0933E+07
1.4	40262.59	2.47E+07	19676.48	1.0903E+07
1.5	39432.86	2.43E+07	19598.86	1.0859E+07
1.6	38593.39	2.40E+07	19547.18	1.0829E+07
1.7	37749.23	2.36E+07	19534.42	1.0821E+07
1.8	36929.36	2.33E+07	19503.61	1.0804E+07
1.9	36128.61	2.30E+07	19399.08	1.0744E+07
2.0	35168.7	2.26E+07	19243.53	1.0656E+07
2.1	33968.88	2.21E+07	19084.29	1.0567E+07
2.2	32591.36	2.15E+07	18928.85	1.0481E+07
2.3	31171.78	2.09E+07	18680.8	1.0342E+07
2.4	29035.76	1.98E+07	18293.02	1.0125E+07
2.5	24244.16	1.67E+07	17697.32	9.7938E+06
2.6	21059.5	1.48E+07	17400.18	9.6303E+06
2.7	18726.77	1.34E+07	17137.07	9.4852E+06
2.8	16851.18	1.23E+07	16866.01	9.3358E+06
2.9	15537.18	1.14E+07	16590.26	9.1841E+06
3.0	14575.96	1.08E+07	16349.04	9.0521E+06
3.1	13866.62	1.04E+07	16134.28	8.9348E+06

3.2	13315.52	1.01E+07	15929.25	8.8230E+06
3.3	12854.67	9759914	15718.17	8.7076E+06
3.4	12465.45	9516896	15559.53	8.6221E+06
3.5	12141.96	9320690	15444.52	8.5605E+06
3.6	11845.04	9140668	15241.89	8.4495E+06
3.7	11553.47	8961791	15053.96	8.3470E+06
3.8	11295	8808386	14812.26	8.2150E+06
3.9	11083.43	8689816	14672.57	8.1397E+06
4.0	10882	8573856	14537.04	8.0664E+06
4.2	10514.27	8360908	14268.92	7.9215E+06
4.4	10182.85	8172337	14163.25	7.8668E+06
4.6	9853.062	7971689	15593.25	8.6701E+06
4.8	9552.499	7776162	15544.78	8.6430E+06
5.0	9339.392	7619816	15122.46	8.4122E+06
5.2	9219.103	7511356	14993.72	8.3445E+06
5.4	9132.269	7421199	14747.31	8.2116E+06
5.6	9278.075	7509970	14623.42	8.1486E+06
5.8	9775.336	7935800	14631.98	8.1588E+06
6.0	9138.131	7999520	14372.72	8.0151E+06
6.2	8120.285	7558701	14075.95	7.8488E+06
6.4	7916.252	7306096	13879.19	7.7392E+06
6.6	7997.763	7159023	13713.27	7.6467E+06
6.8	8187.296	7065130	13544.99	7.5512E+06
7.0	8437.297	7016812	13339.36	7.4333E+06
7.2	8709.262	7005002	13142.57	7.3207E+06
7.4	8952.062	7000054	12974.56	7.2248E+06
7.6	9130.552	6980516	12801.97	7.1262E+06
7.8	9221.261	6929837	12626.62	7.0260E+06
8.0	9212.234	6839897	12474.49	6.9392E+06
8.2	9101.602	6709368	12341.66	6.8632E+06
8.4	8950.122	6582546	12221.98	6.7944E+06
8.6	8802.578	6482830	12081.18	6.7135E+06
8.8	8628.309	6378026	11944.32	6.6354E+06
9.0	8449.852	6278278	11817.56	6.5634E+06
9.2	8267.771	6177818	11671.53	6.4808E+06
9.4	8083.11	6075873	11537.09	6.4049E+06
9.6	7900.68	5975670	11402.86	6.3292E+06
9.8	7718.878	5876232	11263.89	6.2508E+06
10.0	7522.295	5766084	11089.76	6.1527E+06
10.2	7316.43	5648842	10917.55	6.0563E+06
10.4	7112.608	5526236	10762.57	5.9699E+06
10.6	6917.401	5396420	10597.41	5.8774E+06

10.8	6752.821	5277266	10431.94	5.7847E+06
11.0	6603.161	5156164	10272.33	5.6953E+06
11.2	6468.664	5037476	10108.02	5.6033E+06
11.4	6348.755	4926110	9963.724	5.5228E+06
11.6	6241.504	4822795	9831.32	5.4490E+06
11.8	6140.548	4724484	9673.41	5.3607E+06
12.0	6062.111	4645379	9616.331	5.3297E+06
12.2	5988.198	4571698	9455.626	5.2405E+06
12.4	5914.275	4504352	9393.91	5.2081E+06
12.6	5838.567	4441787	9259.228	5.1353E+06
12.8	5759.927	4384204	9181.57	5.0961E+06
13.0	5677.502	4331408	9068.448	5.0386E+06
13.2	5590.516	4283017	8976.836	4.9954E+06
13.4	5497.694	4237823	8870.274	4.9468E+06
13.6	5402.477	4197675	8775.678	4.9088E+06
13.8	5310.542	4165651	8445.241	4.7463E+06
14.0	5228.808	4149578	8312.26	4.7245E+06
14.2	5153.193	4164698	7860.201	4.5084E+06
14.4	5024.887	4190134	7700.128	4.4166E+06
14.6	4825.918	4203247	7453.152	4.2167E+06
14.8	4583.533	4206397	7275.305	4.0239E+06
15.0	4315.399	4199916	7125.843	3.8346E+06
15.2	3980.644	4130737	6806.493	3.5546E+06
15.4	3526.648	3951140	6344.497	3.2039E+06
15.6	3068.72	3676747	5919.004	2.9144E+06
15.8	2706.987	3327979	5520.761	2.6624E+06
16.0	2387.094	2956656	5139.264	2.4333E+06
16.2	2133.476	2653902	4778.308	2.2229E+06
16.4	1932.445	2411330	4420.575	2.0199E+06
16.6	1773.314	2217876	3735.696	1.6493E+06
16.8	1631.728	2044964	3095.36	1.2621E+06
17.0	1495.529	1877200	2911.343	1.1071E+06
17.2	1357.029	1706152	3071.554	1.1161E+06
17.4	1225.151	1542811	2876.564	1.0169E+06
17.6	1101.284	1388813	2589.467	9.0040E+05
17.8	985.6415	1244339	2745.666	9.3551E+05
18.0	857.2459	1084240	3159.863	1.0419E+06
18.2	738.6794	935289.6	3470.16	1.1038E+06
18.4	631.8585	800794	3524.288	1.0867E+06
18.6	526.1107	667279.4	3136.854	9.4555E+05
18.8	429.6469	545383.8	2700.743	8.0026E+05
19.0	347.7749	441805.6	2350.773	6.8605E+05

19.2	285.0069	362366.9	1951.271	5.6150E+05
19.4	262.1233	333504.1	1516.271	4.3082E+05
19.6	200.8088	255638.3	1032.456	2.9041E+05
19.8	159.5739	203336.6	492.2412	1.3771E+05
20.0	104.9937	133989.8	0	0.0000E+00
20.2	112.6208	143925.2	0	0.0000E+00
20.4	0	0	0	0.0000E+00

TABLE 6.2.1-33

DOUBLE-ENDED HOT-LEG BREAK - BLOWDOWN M&E RELEASES

Time (sec)	Break Path No. 1 Flow*		Break Path No. 2 Flow**	
	(lbm/sec)	(Btu/sec)	(lbm/sec)	(Btu/sec)
0	0	0	0	0
1.00E-03	43688.44	2.85E+07	43687.19	2.85E+07
2.09E-03	47321.3	3.09E+07	46979.03	3.06E+07
0.1012072	39202.57	2.59E+07	27844.44	1.81E+07
0.2016874	36958.98	2.44E+07	24045.26	1.55E+07
0.30157	35700.72	2.35E+07	21537.16	1.37E+07
0.4016626	34450.62	2.27E+07	20272.73	1.27E+07
0.5011847	33750.91	2.22E+07	19540.41	1.21E+07
0.6013104	33629.93	2.21E+07	19078.68	1.16E+07
0.7010645	33277.37	2.19E+07	18678.92	1.12E+07
0.8021625	32629.22	2.16E+07	18444.73	1.10E+07
0.9015223	32179.52	2.13E+07	18166.1	1.07E+07
1.001001	31781.62	2.12E+07	17975.91	1.05E+07
1.101134	31318.08	2.10E+07	17818.96	1.04E+07
1.202022	30772.77	2.07E+07	17700.96	1.03E+07
1.302057	30212.57	2.05E+07	17617.87	1.02E+07
1.401172	29616.68	2.02E+07	17575	1.01E+07
1.501605	28935.77	1.99E+07	17559.58	1.01E+07
1.602025	28197.88	1.95E+07	17565.08	1.00E+07
1.702078	27446.86	1.91E+07	17585.53	1.00E+07
1.801534	26696.02	1.87E+07	17610.96	9986452
1.901582	25927.11	1.83E+07	17636.62	9975202
2.001132	25153.17	1.79E+07	17659.7	9965092
2.102046	24383.73	1.74E+07	17678.47	9954695
2.202007	23638.41	1.70E+07	17691.96	9943932
2.302126	22927.73	1.66E+07	17698.96	9931795
2.40195	22229.81	1.62E+07	17698.1	9917478
2.501767	21563.74	1.58E+07	17684.54	9898077
2.601148	20974.5	1.54E+07	17658.12	9873457
2.701902	20452.37	1.50E+07	17618.02	9842890
2.801979	20001.97	1.47E+07	17563.4	9806016
2.90169	19629.72	1.44E+07	17493.73	9762371
3.001117	19315.48	1.42E+07	17408.03	9711327

3.10147	19059.91	1.40E+07	17303.72	9651353
3.201951	18855.89	1.38E+07	17180.35	9582147
3.301385	18698.64	1.36E+07	17038.02	9503704
3.401954	18581.02	1.35E+07	16865.84	9409873
3.502226	18499.63	1.33E+07	16667.2	9302571
3.601166	18450.26	1.32E+07	16458.88	9191126
3.701886	18434.34	1.32E+07	16236.93	9073354
3.801023	18461.9	1.31E+07	16013.92	8955895
3.901815	18580.6	1.31E+07	15779.64	8833137
4.002116	18736.04	1.31E+07	15541.34	8708825
4.200067	19056.76	1.31E+07	15097.42	8480102
4.402387	19429.93	1.32E+07	14613.58	8229352
4.60138	19832.56	1.33E+07	14029.98	7921374
4.800666	20260.04	1.34E+07	13470.24	7628088
5.000408	20864.93	1.36E+07	12910.34	7335176
5.200418	15538.79	1.11E+07	12385.5	7061230
5.400113	15824.68	1.12E+07	11893.18	6804416
5.600178	16024.41	1.13E+07	11438.75	6567634
5.800522	16246.63	1.13E+07	11046.44	6364623
6.000829	16450.43	1.13E+07	10679.84	6173444
6.200135	16708.9	1.13E+07	10349.23	6000062
6.400867	16943.47	1.14E+07	10054.79	5845420
6.600744	17144.7	1.14E+07	9788.913	5705173
6.802117	17064.19	1.13E+07	9543.329	5575148
7.001101	17384.61	1.14E+07	9318.732	5455814
7.200984	17658.84	1.15E+07	9104.526	5341619
7.401012	17930.24	1.15E+07	8902.196	5233696
7.600245	18267.85	1.17E+07	8700.18	5125267
7.800224	18570.39	1.18E+07	8491.396	5013054
8.001768	18344.9	1.16E+07	8275.066	4897368
8.20004	17645.11	1.12E+07	8057.417	4781948
8.400576	15782.59	1.01E+07	7832.872	4664023
8.602201	15507.1	9954610	7609.89	4548586
8.801587	15547.18	9942111	7390.665	4436594
9.00193	15572.89	9929198	7182.175	4331928
9.200268	15575.31	9905857	6981.686	4231672
9.401546	15512.82	9847560	6783.328	4132893
9.601906	15227.57	9671024	6588.509	4035974
9.805025	14470.51	9245470	6391.597	3938246
10.00153	13748.38	8842994	6210.81	3849943

10.20095	13396.29	8635079	6027.533	3761202
10.40022	13177.88	8501138	5850.784	3677035
10.60278	12948.9	8366344	5677.693	3595673
10.80236	12660.65	8203820	5512.13	3518203
11.00169	12295.35	8003456	5351.882	3443363
11.20192	11881.82	7780744	5196.395	3371134
11.40024	11476.42	7565134	5047.114	3302028
11.60276	11097.75	7367152	4899.979	3234558
11.80278	10747.16	7188022	4758.789	3170232
12.00241	10373.63	7034326	4623.638	3109343
12.20265	9595.021	6794880	4490.47	3049399
12.40053	9121.757	6638823	4362.469	2991924
12.60178	8694.217	6468444	4235.013	2934589
12.80217	8179.366	6230320	4108.249	2877552
13.00118	7599.651	5956289	3980.227	2820365
13.20063	7069.965	5726657	3841.534	2758715
13.4003	6546.679	5523690	3686.082	2691981
13.60148	5947.967	5271796	3508.801	2621254
13.80067	5381.146	4872683	3305.53	2546066
14.00167	4862.264	4511506	3077.764	2468870
14.20092	4425.477	4236427	2831.621	2389324
14.40087	4069.554	4006095	2573.996	2307772
14.60033	3767.698	3797650	2320.814	2230362
14.80085	3523.746	3604592	2086.706	2152756
15.00015	3280.382	3404238	1885.775	2074668
15.20079	3007.536	3200691	1715.463	1986217
15.40059	2712.642	2982759	1576.453	1888573
15.60072	2396.906	2742627	1452.93	1773989
15.80065	2117.364	2493038	1348.352	1660556
16.0002	1886.449	2257668	1248.008	1544872
16.2005	1711.418	2074086	1145.972	1423289
16.40085	1591.614	1950431	1052.229	1310371
16.60076	1501.408	1852779	975.9382	1217948
16.8005	1391.564	1724180	915.0459	1143892
17.00005	1284.553	1600832	867.8073	1086740
17.20078	1187.933	1486122	835.7102	1048068
17.4005	1101.133	1378778	819.3569	1028686
17.60022	1011	1268316	813.6566	1022182
17.80008	934.9639	1177410	804.3359	1010682
18.00011	875.3536	1103760	763.9021	959784.5

18.20043	802.9268	1015315	678.7601	853080.2
18.40074	710.7604	900126.2	611.5388	770560.6
18.60028	624.6891	791752.1	570.4488	719463.1
18.80079	525.5437	666314.9	514.0261	649313.5
19.00025	480.1958	609251.5	434.6844	548613.8
19.20018	420.3883	534551.8	334.4438	423800
19.4003	362.6664	461871.8	217.2682	275748.7
19.60033	297.6432	380188.3	146.0993	186414.9
19.80039	230.924	295942.8	80.2612	103335.4
20.00016	153.5174	197554.2	0	0
20.20012	53.98095	70014.02	0	0
20.40027	0	0	0	0

* M&E exiting from the RV side of the break

** M&E exiting from the SG side of the break

TABLE 6.2.1-35 DOUBLE-ENDED PUMP SUCTION BREAK - MAXIMUM SAFEGUARDS REFLOOD M&E RELEASES

Time (sec)	Break Path No. 1 Flow*		Break Path No. 2 Flow**	
	(lbm/sec)	(Thousand Btu/sec)	(lbm/sec)	(Thousand Btu/sec)
21.4	.0	.0	.0	.0
21.9	.0	.0	.0	.0
22.0	.0	.0	.0	.0
22.2	.0	.0	.0	.0
22.3	.0	.0	.0	.0
22.4	43.9	51.7	.0	.0
22.5	32.2	37.9	.0	.0
22.6	28.1	33.1	.0	.0
22.7	30.9	36.4	.0	.0
22.8	35.7	42.1	.0	.0
22.9	43.1	50.8	.0	.0
23.0	49.8	58.7	.0	.0
23.1	56.7	66.7	.0	.0
23.2	62.8	74.0	.0	.0
23.3	69.3	81.7	.0	.0
23.4	73.3	86.4	.0	.0
23.5	77.3	91.1	.0	.0
23.6	81.2	95.6	.0	.0
23.7	84.8	99.9	.0	.0
23.8	88.4	104.1	.0	.0
23.9	91.9	108.2	.0	.0
24.0	95.2	112.2	.0	.0
24.1	98.5	116.0	.0	.0
24.2	101.6	119.7	.0	.0
24.3	104.7	123.4	.0	.0
24.4	107.7	126.9	.0	.0
24.5	110.6	130.3	.0	.0
25.5	136.7	161.1	.0	.0
26.0	147.5	173.9	.0	.0
26.5	380.3	450.0	3827.1	514.9
27.6	435.3	515.6	4380.7	609.0
28.6	425.8	504.3	4283.7	599.5
29.6	415.2	491.6	4176.5	588.0
30.0	410.9	486.6	4133.4	583.3
30.6	404.7	479.1	4069.3	576.2
31.6	394.5	467.0	3964.7	564.5
32.7	434.5	514.6	4406.8	604.6
33.7	421.1	498.7	4269.0	591.6
34.7	421.6	488.5	4182.8	581.8
35.6	405.2	479.8	4108.1	573.2
35.7	404.4	478.8	4099.9	572.2
36.7	396.7	469.5	4020.0	563.1
37.7	389.2	460.7	3943.2	554.2
38.7	382.1	452.2	3869.1	545.6
39.7	375.3	444.1	3797.6	537.4
40.7	368.8	436.4	3728.7	529.4
41.7	362.6	428.9	3662.1	521.7
42.2	359.5	425.3	3629.6	517.9
42.7	356.6	421.8	3597.7	514.2
43.7	350.8	414.9	3535.4	507.0

TABLE 6.2.1-35 DOUBLE-ENDED PUMP SUCTION BREAK - MAXIMUM SAFEGUARDS REFLOOD M&E RELEASES

Time (sec)	Break Path No. 1 Flow*		Break Path No. 2 Flow**	
	(lbm/sec)	(Thousand Btu/sec)	(lbm/sec)	(Thousand Btu/sec)
44.7	345.2	408.3	3475.0	500.0
45.7	339.9	401.9	3416.5	493.2
46.7	334.7	395.7	3359.7	486.6
47.7	329.7	389.8	3304.5	480.1
48.7	324.9	384.1	3250.9	473.9
49.7	320.2	378.5	3198.7	467.8
50.7	315.7	373.1	3147.9	461.8
51.7	311.3	367.9	3098.4	456.0
52.7	307.1	362.9	3050.2	450.4
53.7	303.0	358.0	3003.1	444.8
54.7	205.5	242.4	500.9	141.9
55.7	208.9	246.5	494.1	141.2
56.7	207.5	244.8	496.7	141.4
57.7	206.0	243.1	499.3	141.7
58.6	204.7	241.5	501.7	141.9
58.7	204.5	241.3	502.0	142.0
59.7	203.0	239.5	504.7	142.3
60.7	201.5	237.7	507.4	142.6
61.7	199.9	235.8	510.2	142.9
62.7	198.3	233.9	513.0	143.2
63.7	196.7	232.0	515.8	143.5
64.7	195.1	230.1	518.6	143.8
65.7	193.4	228.1	521.5	144.2
66.7	191.7	226.1	524.5	144.5
67.7	190.0	224.1	527.4	144.9
68.7	188.3	222.0	530.5	145.2
69.7	186.5	219.9	533.5	145.6
70.7	184.6	217.7	536.6	146.0
71.7	182.8	215.6	539.8	146.4
72.7	180.9	213.3	543.0	146.8
73.7	179.0	211.0	546.3	147.2
74.7	177.0	208.7	549.6	147.7
75.7	175.0	206.3	553.0	148.1
76.7	172.9	203.9	556.4	148.6
77.7	170.8	201.4	559.9	149.1
78.7	168.7	198.9	563.5	149.6
79.7	166.5	196.3	567.1	150.1
80.4	164.9	194.4	569.7	150.5
80.7	164.2	193.6	570.8	150.6
81.7	161.9	190.9	574.7	151.2
82.7	159.5	188.0	578.6	151.8
84.7	157.8	186.0	581.8	151.8
86.7	157.2	185.3	583.2	151.6
88.7	156.6	184.6	584.7	151.3
90.7	156.0	183.9	586.1	151.1
92.7	155.5	183.2	587.5	150.9
94.7	154.9	182.6	588.9	150.6
96.7	154.3	181.9	590.4	150.4
98.7	153.7	181.2	591.8	150.1
100.7	153.1	180.5	593.2	149.9
102.7	152.5	179.8	594.6	149.6
104.7	151.9	179.1	596.0	149.4
105.4	151.7	178.9	596.4	149.3

TABLE 6.2.1-35 DOUBLE-ENDED PUMP SUCTION BREAK - MAXIMUM SAFEGUARDS REFLOOD M&E RELEASES

Time (sec)	Break Path No. 1 Flow*		Break Path No. 2 Flow**	
	(lbm/sec)	(Thousand Btu/sec)	(lbm/sec)	(Thousand Btu/sec)
106.7	151.3	178.4	597.3	149.1
108.7	150.8	177.7	598.7	148.9
110.7	150.2	177.0	600.1	148.6
112.7	149.6	176.3	601.5	148.4
114.7	148.9	175.6	602.9	148.1
116.7	148.3	174.8	604.3	147.8
118.7	147.7	174.1	605.6	147.6
120.7	147.1	173.4	607.0	147.3
122.7	146.5	172.7	608.4	147.1
124.7	145.9	172.0	609.7	146.8
126.7	145.3	171.2	611.1	146.5
128.7	144.7	170.5	612.4	146.3
130.7	144.1	169.8	613.8	146.0
132.7	143.4	169.1	615.1	145.8
132.8	143.4	169.0	615.2	145.7
134.7	142.8	168.3	616.5	145.5
136.7	142.2	167.6	617.8	145.2
138.7	141.6	166.9	619.2	145.0
140.7	141.0	166.1	620.5	144.7
142.7	140.3	165.4	621.9	144.4
144.7	139.7	164.7	623.2	144.2
146.7	139.1	163.9	624.5	143.9
148.7	138.5	163.2	625.9	143.6
150.7	137.8	162.4	627.2	143.4
152.7	137.2	161.7	628.5	143.1
154.7	136.5	160.9	629.9	142.8
156.7	135.9	160.2	631.2	142.6
158.7	135.3	159.4	632.5	142.3
160.7	134.6	158.6	633.9	142.0
162.7	134.0	157.9	635.2	141.8
163.0	133.9	157.8	635.4	141.7
164.7	133.3	157.1	636.5	141.5
166.7	132.7	156.4	637.8	141.2
168.7	132.0	155.6	639.2	141.0
170.7	131.4	154.8	640.5	140.7
172.7	130.7	154.1	641.8	140.4
174.7	130.1	153.3	643.1	140.2
176.7	129.4	152.5	644.4	139.9
178.7	128.8	151.8	645.7	139.7
180.7	128.1	151.0	647.1	139.4
182.7	127.5	150.2	648.4	139.1
184.7	126.8	149.4	649.7	138.9
186.7	126.2	148.7	651.0	138.6
188.7	125.5	147.9	652.3	138.3
190.7	124.9	147.1	653.6	138.1
192.7	124.2	146.4	654.9	137.8
194.7	123.6	145.6	656.2	137.6
196.7	122.9	144.8	657.5	137.3
197.0	122.8	144.7	657.7	137.3
198.7	122.2	144.0	658.8	137.1
200.7	121.6	143.3	660.1	136.8
202.7	120.9	142.5	661.4	136.5
204.7	120.3	141.7	662.7	136.3

TABLE 6.2.1-35 DOUBLE-ENDED PUMP SUCTION BREAK - MAXIMUM SAFEGUARDS REFLOOD M&E RELEASES

Time (sec)	Break Path No. 1 Flow*		Break Path No. 2 Flow**	
	(lbm/sec)	(Thousand Btu/sec)	(lbm/sec)	(Thousand Btu/sec)
206.7	119.6	140.9	664.0	136.0
208.7	118.9	140.1	665.3	135.8
210.7	118.3	139.3	666.6	135.5
212.7	117.6	138.5	667.9	135.3
214.7	116.9	137.8	669.2	135.0
216.7	116.2	137.0	670.5	134.8
218.7	115.6	136.2	671.7	134.5
220.7	114.9	135.4	673.0	134.3
222.7	114.2	134.6	674.3	134.0
223.8	113.9	134.2	675.0	133.9

* M&E exiting from the SG side of the break

** M&E exiting from the RV side of the break

TABLE 6.2.1-36 DOUBLE-ENDED PUMP SUCTION BREAK - MINIMUM SAFEGUARDS REFLOOD MASS AND ENERGY RELEASES

Time (sec)	Break Path No. 1 Flow*		Break Path No. 2 Flow**	
	(lbm/sec)	(Btu/sec)	(lbm/sec)	(Btu/sec)
20.4	0	0	0	0.0000E+00
20.9	4.59E-04	0.5399843	9.18E-05	9.14E-03
21.1	4.59E-04	0.5399857	9.18E-05	9.14E-03
21.2	4.59E-04	0.5399864	9.18E-05	9.14E-03
21.3	4.59E-04	0.5400019	9.18E-05	9.11E-03
21.3	4.59E-04	0.5399752	9.18E-05	9.11E-03
21.4	75.31432	88635.78	9.18E-05	1.01E-02
21.5	27.59599	32466.84	9.18E-05	9.46E-03
21.6	27.16997	31964.96	9.18E-05	9.47E-03
21.8	31.65934	37247.23	9.18E-05	9.53E-03
21.9	38.78347	45629.97	9.18E-05	9.63E-03
22.0	45.33939	53345.19	9.18E-05	9.71E-03
22.1	52.0619	61257.02	9.18E-05	9.80E-03
22.2	58.06995	68329.14	9.18E-05	9.88E-03
22.3	63.33302	74524.86	9.18E-05	9.96E-03
22.4	67.37204	79280.49	9.18E-05	1.00E-02
22.5	71.30774	83914.51	9.18E-05	1.01E-02
22.5	73.21647	86162.05	9.18E-05	1.01E-02
22.6	75.08839	88366.34	9.18E-05	1.01E-02
22.7	78.72913	92653.83	9.18E-05	1.02E-02
22.8	82.24329	96792.59	9.18E-05	1.02E-02
22.9	85.64216	100795.9	9.18E-05	1.03E-02
23.0	88.9355	104675.3	9.18E-05	1.03E-02
23.1	92.13176	108440.7	9.18E-05	1.04E-02
23.2	95.23832	112100.6	9.18E-05	1.04E-02
23.3	98.26167	115662.9	9.18E-05	1.05E-02
23.4	101.2075	119134.2	9.18E-05	1.05E-02
23.5	104.081	122520.5	9.18E-05	1.06E-02
24.5	129.6525	152668.5	9.18E-05	1.10E-02
25.5	262.6908	309967.2	2535.821	320096.4
26.6	418.5477	495464.8	4309.344	578783.2
27.6	411.685	487281.5	4234.953	572976.4

28.6	402.6697	476522.1	4140.938	563385.9
29.6	393.5205	465606.6	4045.038	553277.3
30.6	384.5591	454919.1	3950.402	543140.4
31.1	380.19	449710	3903.98	538129.7
31.6	375.9062	444603.5	3858.265	533177.2
32.6	386.9898	457906	4021.158	550007.8
33.6	387.0697	457911.6	3996.533	545528.6
34.6	379.681	449101.8	3918.124	536891.7
35.6	372.6035	440665.8	3842.425	528533
36.6	365.8243	432587.7	3769.359	520448.5
36.8	364.502	431012.3	3755.042	518862.6
37.6	359.3232	424843.2	3698.761	512623.9
38.6	353.0885	417418.2	3630.567	505053.9
39.6	347.0946	410281.9	3564.54	497715.5
40.6	341.3322	403423	3500.654	490603.8
41.6	335.7876	396825.1	3438.805	483708
42.6	330.4485	390473.2	3378.876	477017.3
43.6	325.3019	384351.9	3320.761	470520.2
44.6	320.3359	378446.6	3264.358	464205.9
45.6	315.5394	372744.1	3209.573	458064.2
46.6	310.9022	367232.2	3156.319	452085.6
47.6	306.4147	361899.3	3104.513	446261.2
48.6	298.4865	352442	277.6143	145466.2
49.6	302.0064	356661.7	278.5453	147242.4
50.6	297.5015	351310.5	276.9011	144947
51.1	295.2643	348653.3	276.0872	143811.2
51.6	293.0448	346017.5	275.2814	142687.2
52.6	288.6543	340804.1	273.6916	140472.1
53.6	284.3152	335652.9	272.1263	138294.2
54.6	279.9856	330513.8	270.5705	136133.1
55.6	275.608	325318.7	269.0065	133960.4
56.6	271.6819	320660.3	267.6054	132018
57.6	267.8364	316098.4	266.2379	130124.8
58.6	264.0636	311623.6	264.9013	128276.4
59.6	260.3628	307234.8	263.5952	126472.3
60.6	256.7295	302926.8	262.3181	124710.4
61.6	253.1589	298693.8	261.0683	122988
62.6	249.6579	294544	259.8477	121307.7
63.6	246.2263	290477	258.6561	119669
64.6	242.8639	286492.8	257.4932	118071.4

65.6	239.5706	282590.9	256.3587	116514.5
66.6	236.3462	278771.2	255.2524	114997.7
67.6	233.1906	275033.5	254.174	113520.7
68.6	230.1036	271377.6	253.1233	112083
69.6	227.0851	267803.3	252.1001	110684.1
70.6	224.1349	264310.4	251.104	109323.6
71.6	221.2529	260898.6	250.1348	108001.1
72.6	218.439	257567.8	249.1923	106716
73.6	215.6928	254317.6	248.2761	105467.9
74.6	213.0142	251147.7	247.3859	104256.2
75.6	210.4028	248057.7	246.5215	103080.5
76.6	207.8584	245047.4	245.6825	101940.4
77.6	205.3806	242116.1	244.8686	100835.1
78.6	202.9683	239262.6	244.0792	99763.96
79.6	200.6217	236487.1	243.3142	98726.62
80.6	198.3374	233785.6	242.5725	97721.59
81.6	196.1118	231153.7	241.8527	96746.95
83.6	191.8509	226115.6	240.4821	94892.82
85.6	187.8394	221373.4	239.2008	93161.6
87.6	184.0717	216919.9	238.0053	91548.23
89.6	180.5409	212747.2	236.8922	90047.57
90.1	179.6944	211746.9	236.6263	89689.4
91.6	177.2401	208846.7	235.8576	88654.36
93.6	174.1615	205209.4	234.8981	87363.36
95.6	171.2972	201825.5	234.0099	86169.32
97.6	168.6387	198685.2	233.1892	85067.05
99.6	166.1773	195778.1	232.4325	84051.42
101.6	163.8925	193079.7	231.7332	83113.48
103.6	161.7803	190585.3	231.0889	82249.89
105.6	159.8382	188292.1	230.498	81458.34
107.6	158.0575	186189.6	229.9572	80734.25
109.6	156.4297	184267.7	229.4633	80073.37
111.6	154.9461	182516.1	229.0133	79471.47
113.6	153.5982	180925	228.6043	78924.57
115.6	152.378	179484.5	228.2334	78428.88
115.7	152.3202	179416.3	228.2159	78405.38
117.6	151.2775	178185.5	227.8981	77980.81
119.6	150.289	177018.7	227.5957	77576.96
121.6	149.4052	175975.5	227.324	77214.11
123.6	148.6191	175047.7	227.0807	76889.26

125.6	147.9239	174227.1	226.8637	76599.56
127.6	147.3132	173506.4	226.671	76342.37
129.6	146.781	172878.3	226.5007	76115.2
131.6	146.3215	172336	226.3512	75915.73
133.6	145.9294	171873.2	226.2208	75741.8
135.6	145.5996	171484	226.1081	75591.4
137.6	145.3272	171162.5	226.0116	75462.66
139.6	145.1078	170903.6	225.93	75353.84
141.6	144.926	170689	225.8595	75259.74
143.6	144.7825	170519.7	225.7999	75180.24
144.2	144.7477	170478.7	225.7843	75159.49
145.6	144.6806	170399.4	225.752	75116.33
147.6	144.6169	170324.2	225.7148	75066.73
149.6	144.5882	170290.4	225.6875	75030.3
151.6	144.5919	170294.7	225.6693	75005.94
153.6	144.625	170333.8	225.6594	74992.66
155.6	144.6853	170404.9	225.6571	74989.52
157.6	144.7703	170505.3	225.6618	74995.73
159.6	144.8781	170632.5	225.6729	75010.49
161.6	145.0066	170784.1	225.6899	75033.08
163.6	145.1539	170958	225.7122	75062.83
165.6	145.3185	171152.3	225.7395	75099.12
167.6	145.4988	171365	225.7713	75141.38
169.6	145.6933	171594.5	225.8071	75189.11
171.6	146.0324	171994.5	225.8853	75291.21
173.6	146.7846	172882.4	226.4977	75626.09
174.5	147.0687	173217.7	226.9471	75791.86
175.6	147.4194	173631.6	227.6468	76023.54
177.6	148.0708	174400.4	229.3034	76520.81
179.6	148.7208	175167.6	231.3793	77095.97
181.6	149.3299	175886.4	233.7845	77720.52
183.6	149.8741	176528.8	236.4426	78373
185.6	150.337	177075.2	239.2915	79037.26
187.6	150.7023	177506.4	242.2841	79700.27
189.6	150.959	177809.4	245.3873	80353.42
191.6	151.1003	177976.2	248.5791	80991.48
193.6	151.1221	178002	251.8451	81611.7
195.6	151.0225	177884.4	255.1766	82212.98
197.6	150.8007	177622.6	258.568	82795.29
199.6	150.4565	177216.3	262.0156	83359.12

201.6	149.9901	176665.9	265.5164	83905.3
203.6	149.4023	175972	269.0676	84434.74
205.6	148.6937	175135.7	272.6658	84948.34
206.1	148.4978	174904.5	273.5723	85074.38

* M&E exiting the SG side of the break

** M&E exiting the RV side of the break

TABLE 6.2.1-40 DOUBLE-ENDED PUMP SUCTION BREAK MAXIMUM SAFEGUARDS POST-REFLOOD MASS AND ENERGY RELEASES

Time (sec)	Break Path No. 1 Flow*		Break Path No. 2 Flow**	
	(lbm/sec)	(Thousand Btu/sec)	(lbm/sec)	(Thousand Btu/sec)
228.8	125.2	158.8	736.2	142.8
233.8	124.9	158.4	736.6	142.8
238.8	126.2	160.0	735.2	142.3
243.8	125.9	159.6	735.6	142.3
248.8	125.5	159.2	735.9	142.2
253.8	125.2	158.7	736.3	142.2
258.8	124.9	158.3	736.6	142.2
263.8	124.5	157.9	737.0	142.1
268.8	124.2	157.4	737.3	142.1
273.8	125.5	159.1	736.0	141.6
278.8	125.1	158.6	736.3	141.6
283.8	124.8	158.2	736.7	141.6
288.8	124.4	157.8	737.0	141.5
293.8	124.1	157.3	737.4	141.5
298.8	123.7	156.9	737.7	141.5
303.8	125.0	158.5	736.5	141.0
308.8	124.6	158.0	736.8	141.0
313.8	124.3	157.6	737.2	140.9
318.8	123.9	157.1	737.5	140.9
323.8	123.6	156.7	737.9	140.9
328.8	124.8	158.3	736.6	140.4
333.8	124.5	157.8	737.0	140.4
338.8	124.1	157.4	737.4	140.4
343.8	123.7	156.9	737.7	140.3
348.8	123.4	156.4	738.1	140.3
353.8	123.0	156.0	738.4	140.3
358.8	124.2	157.5	737.2	139.8
363.8	123.9	157.1	737.6	139.8
368.8	123.5	156.6	738.0	139.8
373.8	123.1	156.1	738.3	139.7
378.8	122.8	155.7	738.7	139.7
383.8	122.4	155.2	739.1	139.7
388.8	123.6	156.7	737.9	139.2
393.8	123.2	156.2	738.2	139.2
398.8	122.8	155.8	738.6	139.2
403.8	122.6	155.4	738.9	139.1
408.8	122.3	155.1	739.2	139.1
413.8	122.1	154.8	739.4	139.0
418.8	123.4	156.4	738.1	138.5
423.8	123.1	156.1	738.4	138.5
428.8	122.8	155.7	738.6	138.4
433.8	122.6	155.4	738.9	138.4
438.8	122.3	155.1	739.2	138.3
443.8	122.0	154.7	739.4	138.3
448.8	121.8	154.4	739.7	138.2
453.8	123.1	156.0	738.4	137.8
458.8	122.8	155.7	738.7	137.7
463.8	122.5	155.3	738.9	137.7
468.8	122.2	155.0	739.2	137.6
473.8	122.0	154.6	739.5	137.6

TABLE 6.2.1-40 DOUBLE-ENDED PUMP SUCTION BREAK MAXIMUM SAFEGUARDS POST-REFLOOD MASS AND ENERGY RELEASES

Time (sec)	Break Path No. 1 Flow*		Break Path No. 2 Flow**	
	(lbm/sec)	(Thousand Btu/sec)	(lbm/sec)	(Thousand Btu/sec)
478.8	121.7	154.3	739.8	137.5
483.8	121.4	154.0	740.0	137.4
488.8	122.7	155.5	738.8	137.0
493.8	122.4	155.2	739.1	136.9
498.8	122.1	154.8	739.4	136.9
503.8	121.8	154.4	739.6	136.8
508.8	121.5	154.1	739.9	136.8
513.8	121.2	153.7	740.2	136.7
518.8	122.4	155.3	739.0	136.3
523.8	122.2	154.9	739.3	136.2
528.8	121.9	154.5	739.6	136.2
533.8	121.6	154.1	739.9	136.1
538.8	121.3	153.8	740.2	136.1
543.8	121.0	153.4	740.5	136.0
548.8	122.1	154.9	739.3	135.6
553.8	121.8	154.5	739.6	135.6
558.8	121.5	154.1	739.9	135.5
563.8	121.2	153.7	740.2	135.5
568.8	120.9	153.3	740.5	135.4
573.8	120.6	153.0	740.8	135.4
578.8	121.8	154.4	739.7	134.9
583.8	121.4	154.0	740.0	134.9
588.8	121.1	153.6	740.3	134.8
593.8	120.8	153.2	740.7	134.8
598.8	120.5	152.8	741.0	134.7
603.8	121.6	154.2	739.8	134.3
608.8	121.3	153.8	740.1	134.3
613.8	121.0	153.5	740.4	134.2
618.8	120.8	153.1	740.7	134.2
623.8	120.5	152.8	741.0	134.1
628.8	120.2	152.4	741.3	134.0
633.8	121.3	153.8	740.2	133.6
638.8	121.0	153.4	740.5	133.6
643.8	120.7	153.0	740.8	133.5
648.8	120.4	152.7	741.1	133.5
653.8	120.1	152.3	741.4	133.4
658.8	121.1	153.6	740.3	133.0
663.8	120.8	153.2	740.6	133.0
668.8	120.5	152.8	740.9	132.9
673.8	120.2	152.4	741.2	137.1
678.8	119.9	152.0	741.6	137.0
683.8	120.9	153.3	740.6	136.6
688.8	120.6	152.9	740.9	136.6
693.8	120.3	152.5	741.2	136.5
698.8	119.9	152.1	741.5	136.4
703.8	119.6	151.6	741.9	136.4
708.8	120.6	152.9	740.9	136.0
713.8	120.20	152.4	741.2	135.9
718.8	119.9	152.0	741.6	135.9
723.8	119.5	151.5	741.9	135.8
728.8	120.4	152.7	741.0	135.4

TABLE 6.2.1-40 DOUBLE-ENDED PUMP SUCTION BREAK MAXIMUM SAFEGUARDS POST-REFLOOD MASS AND ENERGY RELEASES

Time (sec)	Break Path No. 1 Flow*		Break Path No. 2 Flow**	
	(lbm/sec)	(Thousand Btu/sec)	(lbm/sec)	(Thousand Btu/sec)
733.8	120.1	152.3	741.4	135.3
738.8	119.7	151.8	741.7	135.3
743.8	119.4	151.3	742.1	135.2
748.8	120.2	152.5	741.2	134.9
753.8	119.9	152.0	741.6	134.8
758.8	119.5	151.5	742.0	134.8
763.8	120.3	152.6	741.1	134.4
768.8	119.9	152.1	741.5	134.3
773.8	119.5	151.6	741.9	134.3
778.8	119.1	151.1	742.3	134.2
783.8	119.9	152.1	741.5	133.9
788.8	119.5	151.5	741.9	133.8
793.8	119.1	151.0	742.4	133.8
798.8	119.9	152.0	741.6	133.4
803.8	119.4	151.4	742.0	133.4
808.8	119.0	150.9	742.4	133.3
813.8	119.7	151.8	741.7	133.0
818.8	119.3	151.3	742.1	133.0
823.8	118.9	150.7	742.6	132.9
828.8	119.6	151.6	741.9	132.6
833.8	119.1	151.0	742.4	132.6
838.8	118.6	150.4	742.8	132.5
843.8	119.3	151.2	742.2	132.2
848.8	118.8	150.6	742.7	132.2
853.8	119.4	151.4	742.1	131.8
858.8	118.9	150.7	742.6	131.8
863.8	119.4	151.4	742.0	131.5
868.8	118.9	150.8	742.6	131.5
873.8	119.4	151.4	742.0	131.2
878.8	118.9	150.7	742.6	131.2
883.8	119.3	151.3	742.1	130.9
888.8	118.7	150.6	742.7	130.9
893.8	119.2	151.1	742.3	130.6
898.8	118.5	150.3	742.9	130.6
903.8	118.9	150.8	742.6	130.4
908.8	118.3	149.9	743.2	130.4
913.8	118.6	150.3	742.9	130.2
918.8	118.8	150.7	742.6	133.8
923.8	119.1	151.0	742.4	133.6
928.8	118.3	150.0	743.1	133.6
933.8	118.5	150.2	743.0	133.3
938.8	118.6	150.4	742.8	133.1
943.8	118.7	150.5	742.8	132.9
948.8	118.7	150.5	742.8	132.7
953.8	118.7	150.5	742.8	132.6
958.8	118.6	150.4	742.9	132.4
963.8	118.5	150.2	743.0	132.3
968.8	118.3	149.9	743.2	132.1
973.8	118.0	149.6	743.5	132.0
978.8	118.4	150.2	743.0	131.7
983.8	118.0	149.6	743.5	131.7

TABLE 6.2.1-40 DOUBLE-ENDED PUMP SUCTION BREAK MAXIMUM SAFEGUARDS POST-REFLOOD MASS AND ENERGY RELEASES

Time (sec)	Break Path No. 1 Flow*		Break Path No. 2 Flow**	
	(lbm/sec)	(Thousand Btu/sec)	(lbm/sec)	(Thousand Btu/sec)
988.8	118.2	149.9	743.2	131.4
993.8	118.3	150.1	743.1	131.2
998.8	118.3	150.0	743.2	131.0
1003.8	118.1	149.7	743.4	130.9
1008.8	117.7	149.3	743.7	130.8
1013.8	117.8	149.4	743.6	130.6
1018.8	64.3	81.5	797.2	144.4
1198.8	61.9	78.5	799.5	144.4
1200.0	61.9	78.5	735.1	183.1
1283.4	61.9	78.5	735.1	183.1
1283.5	71.0	88.8	726.0	180.3
1285.0	70.9	88.8	726.0	180.3
1786.3	70.9	88.8	726.0	180.3
1786.4	65.0	74.8	731.9	121.8
3599.9	54.9	63.1	742.1	123.6
3600.0	54.9	63.1	742.1	123.6
3600.1	43.4	49.9	753.6	112.4
10000.0	31.5	36.3	765.4	114.1
18000.0	27.0	31.1	770.0	114.8
18000.1	26.4	30.4	776.7	97.9
18001.0	26.4	30.4	776.7	97.9
18001.1	26.5	30.5	775.3	101.6
30000.0	23.6	27.1	778.2	102.0
30000.1	23.4	26.9	780.3	96.8
106400.0	16.2	18.6	787.4	97.7
106400.1	16.0	18.4	790.4	89.4
1000000.0	7.0	8.0	799.4	90.4
1000000.1	6.9	7.9	802.8	79.6
2592000.0	4.7	5.4	805.0	79.8
2592000.1	4.7	5.4	805.1	79.5
10000000.0	2.2	2.5	807.6	79.7

* M&E exiting from the SG side of the break

** M&E exiting from the RV side of the break

**TABLE 6.2.1-41 DOUBLE-ENDED PUMP SUCTION BREAK
MINIMUM SAFEGUARDS POST-REFLOOD MASS AND ENERGY
RELEASES**

Time (sec)	Break Path No. 1 Flow*		Break Path No. 2 Flow**	
	(lbm/sec)	(Btu/sec)	(lbm/sec)	(Btu/sec)
206.2	158.8785	199070.5	375.0221	107467.9
211.2	158.2352	198264.4	375.6654	107491.3
216.2	157.5905	197456.7	376.31	107514.8
221.2	158.2797	198320.2	375.6208	107193.3
226.2	157.6228	197497.1	376.2777	107219.5
231.2	156.9643	196672	376.9362	107245.7
236.2	156.3046	195845.3	377.596	107272.1
241.2	155.6433	195016.8	378.2572	107298.6
246.2	154.9806	194186.5	378.92	107325.2
251.2	154.3541	193401.5	379.5464	107344.2
256.2	153.845	192763.6	380.0556	107339.1
261.2	154.6281	193744.8	379.2725	106999.8
266.2	154.1055	193090	379.795	106997.6
271.2	153.5815	192433.4	380.3191	106995.5
276.2	153.0557	191774.6	380.8449	106993.6
281.2	152.5282	191113.7	381.3723	106991.9
286.2	151.999	190450.6	381.9016	106990.4
291.2	151.4681	189785.4	382.4325	106989
296.2	150.9354	189117.9	382.9652	106987.8
301.2	150.4009	188448.2	383.4997	106986.8
306.2	149.8646	187776.2	384.036	106986.1
311.2	149.3265	187102.1	384.574	106985.4
316.2	148.7865	186425.4	385.1141	106985.1
321.2	148.2448	185746.7	385.6558	106984.8
326.2	147.7009	185065.1	386.1997	106984.9
331.2	147.1553	184381.6	386.7452	106985.1
336.2	146.6075	183695.2	387.2931	106985.6
341.2	146.058	183006.6	387.8426	106986.3
346.2	145.5063	182315.4	388.3943	106987.3
351.2	144.9525	181621.6	388.948	106988.4
356.2	144.397	180925.5	389.5036	106989.9

361.2	145.0177	181703.3	388.8828	106686.9
366.2	144.446	180986.9	389.4546	106692
371.2	143.8729	180268.8	390.0277	106697
376.2	143.2984	179549	390.6021	106702.2
381.2	142.722	178826.8	391.1786	106707.5
386.2	142.1409	178098.7	391.7597	106713.8
391.2	141.5571	177367.2	392.3435	106720.4
396.2	140.9712	176633	392.9294	106727.4
401.2	140.3821	175895	393.5185	106734.8
406.2	139.7908	175154.1	394.1098	106742.6
411.2	139.1972	174410.3	394.7034	106750.6
416.2	138.6003	173662.4	395.3003	106759.2
421.2	138.0011	172911.6	395.8995	106768.1
426.2	137.3994	172157.7	396.5012	106777.3
431.2	136.7943	171399.5	397.1063	106787.2
436.2	136.1866	170638.1	397.714	106797.4
441.2	135.5763	169873.4	398.3243	106808
446.2	134.9627	169104.6	398.9379	106819
451.2	134.3643	168354.8	399.5363	106826.9
456.2	133.8212	167674.3	400.0793	106823.4
461.2	133.2753	166990.3	400.6253	106820.2
466.2	132.7252	166301.1	401.1754	106817.9
471.2	132.1722	165608.1	401.7284	106816
476.2	131.6161	164911.3	402.2845	106814.6
481.2	131.0565	164210.3	402.844	106813.7
486.2	130.4928	163503.9	403.4078	106813.6
491.2	129.9257	162793.4	403.9749	106814.1
496.2	129.3553	162078.6	404.5453	106815.1
501.2	128.7813	161359.4	405.1193	106816.8
506.2	128.2024	160634.1	405.6982	106819.4
511.2	127.6198	159904.2	406.2808	106822.6
516.2	127.0335	159169.5	406.8671	106826.5
521.2	126.4432	158429.9	407.4573	106831
526.2	125.8483	157684.5	408.0523	106836.5
531.2	125.2485	156932.9	408.6521	106842.9
536.2	123.7128	155008.8	410.1877	107090.8
541.2	137.8955	172779.3	396.0051	107542.9
546.2	137.9269	172818.7	395.9737	107370.6
551.2	137.0137	171674.5	396.8868	107442.2
556.2	136.0901	170517.2	397.8104	107516

561.2	136.0371	170450.8	397.8635	107364.5
566.2	135.0711	169240.4	398.8295	107448.6
571.2	134.9508	169089.6	398.9498	107313.6
576.2	133.9355	167817.6	399.965	107409.6
581.2	133.7417	167574.7	400.1588	107292.9
586.2	132.676	166239.4	401.2246	107401.1
591.2	132.4051	165900	401.4955	107303.7
596.2	131.2824	164493.3	402.6181	107425.8
601.2	130.9326	164055	402.968	107348.3
606.2	129.7816	162612.9	404.1189	107479
611.2	129.3671	162093.5	404.5334	107418.8
616.2	128.8896	161495.2	405.011	107374.6
621.2	128.3454	160813.3	405.5552	107347.3
626.2	127.7267	160038.1	406.1738	107338.7
631.2	127.0312	159166.7	406.8694	107349.6
636.2	126.2549	158194	407.6457	107381
641.2	125.3919	157112.7	408.5086	107434.3
646.2	124.4357	155914.5	409.4649	107511.4
651.2	124.0055	155375.5	409.8951	107452.1
656.2	123.4061	154624.4	410.4945	107436
661.2	122.6155	153633.8	411.2851	107469.1
666.2	121.6187	152384.9	412.2819	107554.9
671.2	120.9314	151523.8	412.9691	107560.3
676.2	120.4203	150883.3	413.4803	107519.9
681.2	119.4311	149643.9	414.4695	107602.4
1003.18	119.4311	149643.9	414.4695	107602.4
1003.28	70.50493	87516.83	463.3956	116459.9
1006.2	70.46474	87466.48	463.4358	118343.1
1529.426	70.46474	87466.48	463.4358	118343.1
1529.526	63.50435	73069.16	470.3962	51987.08
2210	57.84757	66560.38	476.053	53007.66
2210.1	57.84706	66559.79	435.0529	75371.42
3600	50.75419	58398.61	442.1458	76651.09
3600.1	41.24524	47457.46	451.6548	65986.76
3610	41.19645	47401.32	451.7036	65993.89
3610.1	41.11409	47306.56	452.4859	65203.22
10000	29.94601	34456.38	463.654	66812.54
18000	26.94063	30998.34	466.6594	67245.62
18000.1	26.51904	30513.24	469.481	60140.51
18001	26.51869	30512.85	469.4813	60140.55

18001.1	26.49274	30482.99	469.7072	59699.79
30000	23.73453	27309.34	472.4655	60050.36
30000.1	23.52762	27071.27	474.1724	55999.76
100000	16.90459	19450.71	480.7954	56781.94
106400	16.64603	19153.2	481.054	56812.47
106400.1	16.5006	18985.86	482.7994	52625.14
1000000	7.104993	8175.124	492.195	53649.25
1.00E+07	2.283075	2626.944	497.0169	54174.84
1.00E+07	2.257072	2597.025	498.6429	48368.36

* M&E exiting from the SG side of the break

** M&E exiting from the RV side of the break

TABLE 6.2.1-43

DOUBLE-ENDED PUMP SUCTION BREAK
MASS BALANCE MAXIMUM SAFEGUARDS

		Time (Sec)						
		.00	21.40 ¹	21.40 ²	223.8 ³	1283.51 ⁴	1786.30 ⁵	3600.00 ⁶
		Mass (Thousand lbm)						
Initial	In RCS & Accumulator	623.83	623.83	623.83	623.83	623.83	623.83	623.83
Added Mass	Pumped Injection	.00	.00	.00	162.65	1070.16	1470.87	2916.35
	Total Added	.00	.00	.00	162.65	1070.16	1470.87	2916.35
Total Available		623.83	623.83	623.83	786.48	1693.99	2094.70	3540.18
Distribution	Reactor Coolant	426.13	49.29	56.88	106.91	106.91	106.91	106.91
	Accumulator	197.70	146.24	138.65	.00	.00	.00	.00
	Total Contents	623.83	195.53	195.53	106.91	106.91	106.91	106.91
Effluent	Break Flow	.00	428.28	428.28	670.90	1578.41	1979.08	3424.56
	ECCS Spill	0.00	0.00	0.00	0.00	0.00	0.00	0.00
	Total Effluent	.00	428.28	428.28	670.90	1578.41	1979.08	3424.56
Total Accountable*		623.83	623.81	623.81	777.80	1685.31	2085.99	3531.47

1-End of Blowdown

2-Bottom of core recovery time, which is identical to the end of blowdown time due to the assumption of instantaneous refill

3-End of Reflood

4-Time at which the Broken Loop SG equilibrates at the first intermediate pressure.

5-Time at which the Intact Loop SG equilibrates at the second intermediate pressure.

6-Time at which both SGs equilibrate to 14.7 psia.

*-The difference between total available mass and total accountable mass at later times in the calculation reflect calculation error due to round off, time step changes, ect.

TABLE 6.2.1-44

DOUBLE-ENDED PUMP SUCTION BREAK
MASS BALANCE MINIMUM SAFEGUARDS

		Time (Sec)						
		0.00	20.40	20.40	206.13	1003.28	1529.43	3600.00
		Mass (Thousand lbm)						
Initial	In RCS & Accumulator	624.11	624.11	624.11	624.11	624.11	624.11	624.11
Added Mass	Pumped Injection	0.00	0.00	0.00	90.33	515.89	796.80	1845.29
	Total Added	0.00	0.00	0.00	90.33	515.89	796.80	1845.29
Total Available		624.11	624.11	624.11	714.45	1140.01	1420.92	2469.41
Distribution	Reactor Coolant	426.40	37.40	69.04	118.70	118.70	118.70	118.70
	Accumulator	197.72	156.73	125.09	0.00	0.00	0.00	0.00
	Total Contents	624.11	194.13	194.13	118.70	118.70	118.70	118.70
Effluent	Break Flow	0.00	429.97	429.97	586.90	1012.47	1293.37	2341.87
	ECCS Spill	0.00	0.00	0.00	0.00	0.00	0.00	0.00
	Total Effluent	0.00	429.97	429.97	586.90	1012.47	1293.37	2341.87
Total Accountable		624.11	624.10	624.10	705.60	1131.17	1412.08	2460.57

TABLE 6.2.1-47
DOUBLE-ENDED HOT-LEG BREAK
MASS BALANCE

		Time (Sec)		
		0.00	20.40	20.40*
		Mass (Thousand lbm)		
Initial	In RCS and ACC	624.11	624.11	624.11
Added Mass	Pumped Injection	0.00	0.00	0.00
	Total Added	0.00	0.00	0.00
Total Available		624.11	624.11	624.11
Distribution	Reactor Coolant	426.40	64.78	96.42
	Accumulator	197.72	145.57	113.93
	Total Contents	624.11	210.35	210.35
Effluent	Break Flow	0.00	413.75	413.75
	ECCS Spill	0.00	0.00	0.00
	Total Effluent	0.00	413.75	413.75
Total Accountable**		624.11	624.10	624.10

*-This time is the bottom of core recovery time, which is identical to the end of blowdown time due to the assumption of instantaneous refill.

** -The difference between total available energy and total accountable energy at later times in the calculation reflect calculational error due to round off, time step changes, etc.

TABLE 6.2.1-49

DOUBLE-ENDED PUMP SUCTION BREAK, MAXIMUM SAFEGUARDS
PRINCIPAL PARAMETERS DURING REFLOOD

Time(sec)	Flooding		Carrover Fraction	Core Height(ft)	Downcomer Height(ft)	FlowFrac	Total	Injection Accum	Spill	Enthalpy (Btu/lbm)
	Temp(°F)	Rate(in/sec)								
21.4	223.6	.000	.000	.00	.00	.333	.0	.0	.0	.00
22.2	219.0	26.896	.000	.80	1.83	.000	7558.9	7558.9	.0	99.35
22.3	217.9	28.689	.000	1.03	1.82	.000	7521.3	7521.3	.0	99.35
23.5	216.0	2.751	.316	1.50	5.91	.430	7041.5	7041.5	.0	99.35
24.4	215.7	2.651	.436	1.63	9.10	.451	6771.0	6771.0	.0	99.35
27.6	214.4	4.679	.654	2.03	15.59	.684	5293.1	5293.1	.0	99.35
28.6	214.0	4.409	.682	2.15	15.59	.682	5115.4	5115.4	.0	99.35
31.6	213.0	3.928	.722	2.45	15.59	.671	4675.1	4675.1	.0	99.35
32.7	212.8	4.153	.732	2.55	15.59	.692	5163.7	4396.8	.0	98.40
38.7	212.3	3.671	.751	3.05	15.59	.670	4515.8	3732.7	.0	98.25
45.7	212.9	3.323	.758	3.55	15.59	.653	3988.1	3187.7	.0	98.07
53.7	214.6	3.037	.760	4.05	15.59	.635	3514.6	2700.3	.0	97.88
54.7	214.8	2.427	.754	4.11	15.59	.547	848.2	.0	.0	92.99
55.7	215.1	2.439	.754	4.16	15.59	.550	846.4	.0	.0	92.99
62.7	217.8	2.348	.755	4.50	15.59	.541	849.0	.0	.0	92.99
73.7	223.5	2.190	.756	5.01	15.59	.523	853.6	.0	.0	92.99
86.7	231.6	2.014	.756	5.56	15.59	.500	858.3	.0	.0	92.99
98.7	239.2	1.957	.760	6.04	15.59	.501	858.3	.0	.0	92.99
110.7	245.9	1.901	.763	6.50	15.59	.501	858.3	.0	.0	92.99
124.7	252.6	1.836	.766	7.02	15.59	.502	858.3	.0	.0	92.99
138.7	258.2	1.772	.769	7.51	15.59	.503	858.3	.0	.0	92.99
154.7	263.8	1.699	.772	8.04	15.59	.504	858.4	.0	.0	92.99
170.7	268.5	1.626	.776	8.54	15.59	.504	858.5	.0	.0	92.99
186.7	272.4	1.554	.779	9.01	15.59	.505	858.6	.0	.0	92.99
204.7	276.3	1.474	.782	9.51	15.59	.505	858.7	.0	.0	92.99
223.8	279.7	1.389	.786	10.00	15.59	.505	858.9	.0	.0	92.99

TABLE 6.2.1-51
DOUBLE-ENDED PUMP SUCTION BREAK
ENERGY BALANCE - MAXIMUM SAFEGUARDS

		Time (sec)						
		.00	21.40 ¹	21.40 ²	223.8 ³	1283.51 ⁴	1786.30 ⁵	3600.00 ⁶
		Energy (Million Btu)						
Initial Energy	In RCS, Acc, SG	736.00	736.00	736.00	736.00	736.00	736.00	736.00
Added Energy	Pumped Injection	.00	.00	.00	15.13	103.25	163.01	378.56
	Decay Heat	.00	5.78	5.78	25.89	98.27	126.30	212.65
	Heat From Secondary	.00	-.35	-.35	-.35	4.65	6.22	6.22
	Total Added	.00	5.42	5.42	40.66	206.17	295.54	597.43
Total Available		736.00	741.42	741.42	776.66	942.16	1031.53	1333.43
Distribution	Reactor Coolant	254.23	10.77	11.53	28.01	28.01	28.01	28.01
	Accumulator	19.64	14.54	13.78	0.01	-0.01	0.01	0.00
	Core Stored	21.51	12.21	12.21	3.91	3.74	3.51	2.71
	Primary Metal	125.65	118.82	118.82	99.51	62.17	53.11	41.37
	Secondary Metal	83.41	83.06	83.06	76.67	49.38	40.48	31.68
	Steam Generator	231.56	230.29	230.29	208.93	132.41	110.07	87.03
	Total Contents	736.00	469.69	469.69	417.04	275.70	235.19	190.80
Effluent	Break Flow	.00	271.25	271.25	351.92	658.77	779.73	1127.39
	ECCS Spill	.00	.00	.00	.00	.00	.00	.00
	Total Effluent	.00	271.25	271.25	351.92	658.77	779.73	1127.39
Total Accountable*		736.00	740.93	740.93	768.96	934.47	1014.91	1318.18

1-End of Blowdown

2-Bottom of core recovery time. This time is identical to the end of blowdown time due to the assumption of instantaneous refill.

3-End of Reflood

4-Time at which the Broken Loop SG equilibrates at the first intermediate pressure.

5-Time at which the Intact Loop SG equilibrates at the second intermediate pressure.

6-Time at which both SGs equilibrate to 14.7 psia.

*-The difference between total available energy and total accountable energy at later times in the calculation reflect calculational error due to round off, time step changes, etc.

TABLE 6.2.1-52
DOUBLE-ENDED PUMP SUCTION BREAK
ENERGY BALANCE - MINIMUM SAFEGUARDS

		Time (sec)						
		0.00	20.40	20.40	206.13	1003.28	1529.43	3600.00
		Energy (Million Btu)						
Initial Energy	In RCS, Acc, SG	703.47	703.47	703.47	703.47	703.47	703.47	703.47
Added Energy	Pumped Injection	0.00	0.00	0.00	8.40	47.97	74.10	207.98
	Decay Heat	0.00	5.58	5.58	23.69	79.13	109.09	205.22
	Heat From Secondary	0.00	3.39	3.39	3.39	7.15	9.23	9.23
	Total Added	0.00	8.97	8.97	35.47	134.26	192.42	422.44
Total Available		703.47	712.43	712.43	738.94	837.72	895.89	1125.90
Distribution	Reactor Coolant	252.95	8.51	11.51	30.12	30.12	30.12	30.12
	Accumulator	19.64	15.57	12.57	0.00	0.00	0.00	0.00
	Core Stored	21.43	11.90	11.90	3.86	3.70	3.50	2.71
	Primary Metal	135.07	127.76	127.76	100.42	64.91	54.35	41.77
	Secondary Metal	42.40	41.47	41.47	38.01	26.30	20.83	15.94
	Steam Generator	231.97	237.20	237.20	212.23	143.66	116.31	89.83
	Total Contents	703.47	442.41	442.41	384.64	268.69	225.11	180.38
Effluent	Break Flow	0.00	269.55	269.55	337.26	552.00	661.81	937.56
	ECCS Spill	0.00	0.00	0.00	0.00	0.00	0.00	0.00
	Total Effluent	0.00	269.55	269.55	337.26	552.00	661.81	937.56
Total Accountable		703.47	711.95	711.95	721.91	820.69	886.92	1117.94

TABLE 6.2.1-55

DOUBLE-ENDED HOT LEG BREAK
ENERGY BALANCE

		Time (sec)		
		0.00	20.40	20.40*
		Energy (Million Btu)		
Initial Energy	In RCS, Acc, SG	703.47	703.47	703.47
Added Energy	Pumped Injection	0	0	0
	Decay Heat	0	5.89	5.89
	Heat From Secondary	0	2.72	2.72
	Total Added	0	8.61	8.61
Total Available		703.47	712.08	712.08
Distribution	Reactor Coolant	252.95	14.18	17.18
	Accumulator	19.64	14.46	11.46
	Core Stored	21.43	8.69	8.69
	Primary Metal	135.07	125.76	125.76
	Secondary Metal	42.4	40.74	40.74
	Steam Generator	231.97	232.1	232.1
	Total Contents	703.47	435.93	435.93
Effluent	Break Flow	0	275.65	275.65
	ECCS Spill	0	0	0
	Total Effluent	0	275.65	275.65
Total Accountable		703.47	711.59	711.59

*-This time is the bottom of core recovery time, which is identical to the end of blowdown time due to the assumption of instantaneous refill.

** -The difference between total available energy and total accountable* energy at later times in the calculation reflect calculation error due to round off, time step changes, ect.

TABLE 6.2.1-58A

MSLB Full Double-Ended Rupture (1.4 ft²) at 100.34% Power (with MFIV failure)

Forward Flow

Time (sec)	Flow (lbm/sec)	Enthalpy (Bthu/lbm)
0.0	0.0	0.0
0.2	9222.0	1189.5
0.4	9060.0	1190.9
0.6	8956.0	1191.4
0.8	8855.0	1191.4
1.0	8759.0	1191.9
1.4	8581.0	1192.2
1.8	8410.0	1192.6
6.2	7163.0	1197.8
6.6	7085.0	1198.0
7.0	7010.0	1198.3
7.4	6938.0	1198.5
7.8	6867.0	1198.8
8.0	6832.0	1198.9
8.2	2203.0	1199.7
8.4	2192.0	1199.8
8.6	2181.0	1199.9
8.8	2170.0	1200.0
9.0	2160.0	1200.0
9.2	2149.0	1200.1
11.0	2050.0	1201.0
11.2	2039.0	1200.6
11.4	2032.0	1200.8
18.6	1651.0	1203.5
18.8	1642.0	1203.4
19.0	1632.0	1204.0
19.2	1623.0	1203.3
19.8	1595.0	1204.4
20.0	1586.0	1204.3
20.2	1578.0	1203.4
20.7	1563.0	1203.5
21.2	1542.0	1204.3
34.7	1169.0	1203.6
35.2	1160.0	1204.3
35.7	1151.0	1204.2
36.2	1143.0	1203.8
36.7	1135.0	1204.4
44.2	1041.0	1204.6
48.2	1008.0	1204.4
48.7	1005.0	1203.0
49.2	1001.0	1203.8
49.7	997.8	1203.6
132.7	963.0	1203.5
132.8	2.75	1150.0
2210.0	2.75	1150.0

The above forward mass & energy releases include the effects of feedwater addition until isolation. They also include mass & energy releases via the main steam header from the intact steam generator until main steam isolation.

Reverse flow mass & energy releases from the initial blowdown of the main steam header itself are to be added to the above forward flow M&E releases. These are 10,743.8 lbm/sec and 12.795 x 10⁶BThU/sec for a duration of 2.084 sec's.

TABLE 6.2.1-58B

MSLB Full Double-Ended Rupture (1.4 ft²) at 29.4% Power (with MFIV failure)Forward Flow

Time (sec)	Flow (lbm/sec)	Enthalpy (BThu/lbm)
0.00	0.00	0.00
0.20	9735.00	1187.47
0.40	9482.00	1188.57
0.60	9316.00	1189.35
0.80	9159.00	1190.09
1.00	9007.00	1190.19
2.00	8332.00	1193.59
3.00	7781.00	1195.73
4.00	7316.00	1197.38
5.00	6920.00	1198.55
7.60	6124.00	1201.01
7.80	1918.00	1202.29
8.00	1902.00	1202.42
10.00	1759.00	1202.96
15.00	1581.00	1204.30
20.00	1399.00	1204.43
30.20	1153.00	1204.68
40.20	1017.00	1203.54
50.20	949.20	1203.12
86.20	955.70	1203.31
176.20	954.60	1203.6
176.30	0.0	0.0
2210.00	0.0	0.0

The above forward flow mass & energy releases include the effects of feedwater addition until isolation. They also include mass & energy releases via the main steam header from the intact steam generator until main steam isolation.

Reverse flow mass & energy releases from the initial blowdown of the main steam header itself are to be added to the above forward flow M&E releases. These are 11,398.9 lbm/sec and 13.547×10^6 BThu/sec for a duration of 2.094 sec's.

TABLE 6.2.1-62

ACTIVE HEAT SINK DATA
FOR MINIMUM POST-LOCA CONTAINMENT PRESSURE

I	Containment Spray System Parameters	
	A. Maximum spray system flow, total	5000 gpm
	B. Fastest post LOCA initiation of Containment Spray System	0.0 sec.
II	Fan Coolers	
	A. Maximum number of fan coolers operating	4
	B. Fastest post LOCA initiation of fan coolers	0.0 sec.
	C. Performance data	

See Figure 6.2.1-303 for fan cooler atmosphere heat removal rate.

TABLE 6.2.1-63

PASSIVE HEAT SINK DATA
FOR MINIMUM POST-LOCA CONTAINMENT PRESSURE

Heat Sink Description				
Slab Number	Description	Slab* Material	Material Thickness (in.)	Surface Area, ft ²
1.	Containment Dome	Carbon Steel ⁽²⁾	.50	26546
		Concrete	30	
2.	External Cylinder Wall	Carbon Steel ⁽²⁾	.375	63065
		Concrete	54	
3.	1" Steel Liner	Carbon Steel ⁽²⁾	1.0	2280
		Concrete	54	
4.	Concrete	Concrete	45	82525
5.	Stainless Steel Liner	Stainless Steel	.1872	6756
		Concrete	.60	
6.	Sump	Concrete	45	29320
7.	Piping	Carbon Steel ⁽³⁾	.19656	5703
8.	Piping	Carbon Steel ⁽³⁾	.41808	3870
9.	Structural Heat Sink	Carbon Steel ⁽²⁾	.312	53810
10.	Electrical	Carbon Steel ⁽⁵⁾	.17448	33066
11.	Embedded Stainless	Stainless Steel	.39024	1030
		Concrete	3.2244	
12.	Not Embedded Stainless	Stainless Steel	.40068	3242
13.	Structural Heat Sinks	Carbon Steel ⁽²⁾	1.0	30300
14.	Not Embedded Structural	Carbon Steel ⁽²⁾	.17375	119467
15.	Structural Heat Sinks	Carbon Steel ⁽²⁾	.5004	66753
16.	Embedded Structural	Carbon Steel ⁽²⁾	.3405	3472
		Concrete	3.2244	
17.	Embedded Structural	Carbon Steel ⁽²⁾	1.444	13899
		Concrete	3.2244	
18.	Ductwork	Carbon Steel ⁽⁴⁾	.1248	5430
19.	Ductwork	Galvanized ⁽⁵⁾	.029028	39672
		Carbon Steel		
20.	Seismic Hangers	Carbon Steel ⁽²⁾	.18756	84386

*Metal Coatings for individual slabs are defined via superscripts (2), (3), (4), (5). Properties of the coatings are provided in the thermophysical property listing by number.

Table 6.2.1-63 (Continued)

Thermophysical Properties

- (1) Metal Thermal Conductivity:
 - Carbon Steel: 26 Btu/hr.-ft.-F
 - Stainless Steel: 9.4 Btu/hr.-ft.-F
 - Thermal Capacity: 53.9 BTU/cu.ft. F)
- (2) Paint is applied to outer and inner surfaces of the bare carbon steel plate casing.
 - Thickness Range: 5 mils
 - Thermal Capacity: 42.6 BTU/cu.ft - F
 - Thermal Conductivity (Paint System): .23 BTU/hr-ft-F
- (3) Paint is applied only to outer surface of carbon steel, uninsulated pipe
 - Paint Thickness Range: 5 mils
 - Thermal Capacity: 147 BTU/cu.ft-F
 - Thermal Conductivity: .23 BTU/hr-ft-F
- (4) Paint is applied to outer only of bare carbon steel sheet metal,
 - Thickness Range: 8 mils
 - Thermal Capacity: 42.6 BTU/cu.ft-F
 - Thermal Conductivity (Paint System): .23 BTU/hr-ft-F
- (5) Galvanizing: Zinc is applied according to ASTM A 525 coating designation 90 (commercial) coating thickness is approximately 0.90 Oz./ft² galvanized on both sides.
 - Thickness Range: 1.513 mils
 - Thermal Capacity: 40.6 BTU/cu.ft-F
 - Thermal Conductivity: 64 BTU/hr.-ft-F
- (6) Concrete Thermal Conductivity: .92 BTU/hr-ft-F
 - Thermal Capacity: 22.62 BTU/cu.ft-F

TABLE 6.2.1-64

SINGLE FAILURE ANALYSIS-
CONTAINMENT VACUUM RELIEF SYSTEM

<u>Component Identification and Quantity</u>	<u>Failure Mode</u>	<u>Effect on System</u>	<u>Method of Detection</u>	<u>Monitor</u>	<u>Remarks</u>
Compressed air system	Fails	Loss of normal air supply to accumulators	Low air pressure alarm	CRI*	Seismic Class I accumulators have sufficient stored air to operate their respective vacuum valves
Air accumulator	Fails	Loss of one vacuum relief subsystem	Periodic testing	CRI	Redundant vacuum relief subsystem available
Vacuum relief valve or check valve	Fails to open	Loss of one vacuum relief subsystem	Valve position indication plus high ΔP alarm	CRI	Redundant vacuum relief subsystem available
Vacuum relief outside to containment ΔP switch	Fails	Loss of one vacuum relief subsystem	Periodic testing	CRI	Redundant vacuum relief ΔP switch available
Differential pressure sensor	Fails	Loss of one valve actuation signal		CRI	Redundant vacuum relief subsystem available
Outside air damper	Fails to open	Partial loss of outside air	Damper position indication	CRI	Redundant vacuum relief subsystem available

* CRI = Control Room Indication.

TABLE 6.2.1-65

POST-ACCIDENT MONITORING CONTAINMENT
ATMOSPHERE TEMPERATURE AND CONTAINMENT
SUMP WATER TEMPERATURE

<u>Tag. No.</u>	<u>Instrumentation</u>	<u>Service</u>	<u>Time Response</u>	<u>Range</u>	<u>Accuracy</u>
TE-7541A,B,C TE-7542A,B,C	Thermocouple	Cont. Dome Temp.	1 Second	0-400 F	± 2 1/4 F → 32-600 F ± 3/8% → 600 -1600 F
TT-7541A,B,C TT-7542A,B,C	Thermocouple Amplifier	Cont. Dome Temp.	10 millisecond	2-100 mV 0-400 F	± 0.1% at 5m VDC input span
TY-7541 TY-7542	Isolator	Cont. Dome Temp.	N/A	(-) 10 - 0 - 10 VDC	± 0.1% of signal span
TS-7541 TS-7542	Signal Comparator	Cont. Dome Temp.	10 millisecond	0 - 10 VDC 0-400 F	± 0.35% of input span
TR-0005	Temperature Recorder	Cont. Dome Temp.	0.5 Second Full Scale	0 - 10 VDC 0-400 F	± 0.25% of span
TI-7541 TI-7542	Temperature Indicator	Cont. Dome Temp.	N/A	0 - 10 VDC 0-400 F	±1% of span
TE-7133A TE-7133B	Thermocouple	CS Recirc. Sump Temp.	1 Second	50-250 F	± 1 1/4 F → 32-600 F ± 3/8% → 600 F - 1600 F

TABLE 6.2.1-66 LOCA M&E RELEASE ANALYSIS CORE DECAY HEAT FRACTION

Time (sec)	Decay Heat Generation Rate (Btu/hr)
1.0000E+00	.65709E-01
1.2000E+00	.64706E-01
1.4000E+00	.63757E-01
1.6000E+00	.62939E-01
1.8000E+00	.62245E-01
2.0000E+00	.61586E-01
2.5000E+00	.60288E-01
3.0000E+00	.59144E-01
3.5000E+00	.58123E-01
4.0000E+00	.57203E-01
4.5000E+00	.56401E-01
5.0000E+00	.55668E-01
6.0000E+00	.54367E-01
7.0000E+00	.53255E-01
8.0000E+00	.52275E-01
9.0000E+00	.51427E-01
1.0000E+01	.50663E-01
1.2000E+01	.49337E-01
1.4000E+01	.48212E-01
1.6000E+01	.47242E-01
1.8000E+01	.46392E-01
2.0000E+01	.45633E-01
2.5000E+01	.44044E-01
3.0000E+01	.42749E-01
3.5000E+01	.41652E-01
4.0000E+01	.40701E-01
4.5000E+01	.39875E-01
5.0000E+01	.39136E-01
6.0000E+01	.37860E-01
7.0000E+01	.36793E-01
8.0000E+01	.35879E-01
9.0000E+01	.35085E-01
1.0000E+02	.34386E-01
1.2000E+02	.33212E-01
1.4000E+02	.32250E-01
1.6000E+02	.31442E-01
1.8000E+02	.30749E-01
2.0000E+02	.30143E-01
2.5000E+02	.28914E-01
3.0000E+02	.27943E-01
3.5000E+02	.27138E-01
4.0000E+02	.26445E-01
4.5000E+02	.25828E-01
5.0000E+02	.25274E-01
6.0000E+02	.24303E-01
7.0000E+02	.23482E-01
8.0000E+02	.22762E-01
9.0000E+02	.22108E-01
1.0000E+03	.21517E-01

TABLE 6.2.1-66 LOCA M&E RELEASE ANALYSIS CORE DECAY HEAT FRACTION

Time (sec)	Decay Heat Generation Rate (Btu/hr)
1.2000E+03	.20493E-01
1.4000E+03	.19622E-01
1.6000E+03	.18862E-01
1.8000E+03	.18192E-01
2.0000E+03	.17599E-01
2.5000E+03	.16384E-01
3.0000E+03	.15440E-01
3.5000E+03	.14685E-01
4.0000E+03	.14068E-01
4.5000E+03	.13545E-01
5.0000E+03	.13103E-01
6.0000E+03	.12391E-01
7.0000E+03	.11850E-01
8.0000E+03	.11417E-01
9.0000E+03	.11055E-01
1.0000E+04	.10748E-01
1.2000E+04	.10619E-01
1.4000E+04	.10230E-01
1.6000E+04	.99059E-02
1.8000E+04	.96274E-02
2.0000E+04	.93890E-02
2.5000E+04	.88946E-02
3.0000E+04	.85120E-02
3.5000E+04	.81995E-02
4.0000E+04	.79355E-02
4.5000E+04	.77038E-02
5.0000E+04	.75007E-02
6.0000E+04	.71598E-02
7.0000E+04	.68673E-02
8.0000E+04	.66223E-02
9.0000E+04	.64093E-02
1.0000E+05	.62238E-02
1.2000E+05	.58963E-02
1.4000E+05	.56287E-02
1.6000E+05	.53990E-02
1.8000E+05	.51969E-02
2.0000E+05	.50192E-02
2.5000E+05	.46447E-02
3.0000E+05	.43460E-02
3.5000E+05	.40984E-02
4.0000E+05	.38880E-02
4.5000E+05	.37081E-02
5.0000E+05	.35506E-02
6.0000E+05	.32873E-02
7.0000E+05	.30768E-02
8.0000E+05	.29035E-02
9.0000E+05	.27605E-02
1.0000E+06	.26387E-02
1.2000E+06	.24400E-02
1.4000E+06	.22838E-02

TABLE 6.2.1-66 LOCA M&E RELEASE ANALYSIS CORE DECAY HEAT FRACTION

Time (sec)	Decay Heat Generation Rate (Btu/hr)
1.6000E+06	.21563E-02
1.8000E+06	.20489E-02
2.0000E+06	.19560E-02
2.5000E+06	.17679E-02
3.0000E+06	.16229E-02
3.5000E+06	.15069E-02
4.0000E+06	.14117E-02
4.5000E+06	.13335E-02
5.0000E+06	.12668E-02
6.0000E+06	.11579E-02
7.0000E+06	.10731E-02
8.0000E+06	.10026E-02
9.0000E+06	.94319E-03
1.0000E+07	.89113E-03

TABLE 6.2.2-1

CONTAINMENT COOLING SYSTEM COMPONENTS

NOTE: All air quantities are actual cfm.

CONTAINMENT FAN COOLER SAFETY CLASS 2 UNITS

No. of Units	Normal Operating Conditions	Design Basis ⁽⁴⁾ Accident Conditions
	2 fans per unit and 2 units operating	1 fan per unit half speed, 4 units starting and 2 units operating
Fan Cooler Unit Operating Capacity ACFM	125,000	31,250
Actual Air Mixture Flow (ACFM) at Fan Inlet	62,500	31,250
Design Ambient Pressure, psig	0	45.0(1)
Ambient Temp, F	120	258
Total Pressure, in. WG	7.9	5.1
Fan RPM	1770	870
Outlet Velocity, FPM	5800	2560
Brake HP	101.2	32.8
Motor HP	125	62.5
Cooling Water Flow - GPM	1360	1360
Entering Water Temp. F	95	95
Leaving Water Temp. F	98	179
Number of Coil Banks	4	4
Number of Rows	6	6
Fins per inch	6	6
Face Area (Sq. Ft.)	160	160
No. of Coils High	4	4
Coil Size (L x W)	60" x 24"	60" x 24"
Cooling Coil Entering Air Mixture Temp. DB/WB, F	120/98.4	258/258
Water Pressure Drop Coil and Manifolds (Ft H ₂ O)	31	31
Cooling Coil Leaving Air Mixture Temp. DB/WB, F	103.21/97.4	248/248
Entering Air Mixture Flow lb/hr	-	422,400
Steam Condensed lb/hr	-	56,746
Btu/hr at 95F Entering WaterTemp.	$2.19 \times 10^{6(2)}$	55.5×10^6 at 45.0 psig ⁽⁴⁾⁽⁵⁾ . See figures 6.2.1-16, 6.2.2-4 and Table 6.2.2-3
Btu/hr at 95F Entering Water Temp. and one fan running full speed	$1.35 \times 10^{6(2)}$	-

Table 6.2.2-1 (Continued)

CONTAINMENT FAN-COIL NNS UNITS

	<u>Normal Operating Conditions</u>	<u>Design Basis⁽⁴⁾ Accident Conditions</u>
No. of Units	3 units with 2 fans per unit (one standby and one operating fan)	-
Actual Airflow at Inlet (ACFM)	91,000	-
Outlet Velocity, FPM	3218	-
Motor Brake HP	81	-
Motor HP	100	-
Fan RPM	1170	-
Cooling Coil Entering Air Temp. DB/WB,F	120/98.4	-
Cooling Coil Leaving Air Temp. DB/WB,F	99.8/95.0	-
Coil Capacity Btu/hr	1.866 x 10 ⁶	-
Face Area (Sq. Ft.)	110	-
Entering Water Temp. F	95	-
Leaving Water Temp. F	99.7	-
Water Flow GPM	800	-
Water Pressure Drop (Ft. H ₂ O)	16.8	-
No. of Coils	4	-
Size of each Coil (L x W)	94 1/2" x 42 3/4"	-
No. of Rows	8	-
Fins per Inch	10	0

EQUIPMENT TABULATION

Safety Related Fan Coolers

Each of 4 identical units containing the following:

1. Supply Fan
 - Quantity 2 fans per unit
 - Type Axial
 - Material Carbon Steel
 - Air Flow, Each Fan, cfm 62,500 nominal/31,250 accident
 - Code AMCA -Air Moving and Conditioning Association
AFBMA -Anti-Friction Bearing Manufacturers Association

2. Supply Fan Motor
 - Quantity Per Fan 1
 - Capacity 125/62.5 HP, 460 V, 60 Hz, 3ph., 2 speed
 - Insulation Class RN
 - Enclosure TEAO (Totally enclosed air over)
 - Code NEMA MG-1 IEEE 334

3. Cooling Coil
 - Type (Service Water) fin tube
 - Material Cu/Ni-90/10 tubes, copper fins

Table 6.2.2-1 (Continued)Non Safety Related Fan Coil Units

Each Unit containing the following:

Quantity	3 Identical Units
1. <u>Supply Fan</u>	2 fans per unit (1 Standby)
Type	Axial
Material	Carbon Steel
Air Flow, Each Fan, cfm	91,000
Total Pressure, in. wg	5.0
Code	Air Moving and Conditioning Association (AMCA), Anti-Friction Bearing Manufacturers Association (AFBMA)
2. <u>Supply Fan Motors</u>	
Quantity Per Fan	1
Capacity	100 HP, 460 V, 60 Hz, 3 ph
Insulation	Type F
Enclosure	TEAO
Code	NEMA MG-1 IEEE 334
3.	
Type	(Service Water) fin tube
Material	Cu/Ni 90/10 tubes, copper fins
Air Flow. acfm per coil bank	22,750

NOTES:

- (1) 45.0 psig is the design pressure for the containment structure. This pressure is used to establish the design conditions for cooling capacity.
- (2) For two fans the entering condition for normal operation is 120°F, 265 grains moisture per lbm of dry air. For one fan the entering condition for normal operation is 120°F, 120 grains moisture per lbm of dry air.
- (3) DELETED BY AMENDMENT No. 51
- (4) Fan cooler performance assumed for the peak pressure & temperature containment analyses for MSLB and LOCA DBA's assume a more conservative degraded performance than listed in the above Table 6.2.2-1. Refer to Table 6.2.1-6 for actual performance assumed.
- (5) The fan cooler performance at 45 psig and 258°F is shown conservatively instead of at higher LOCA/MSLB temperatures resulting from power uprate.

TABLE 6.2.2-3
CONTAINMENT FAN COOLER PERFORMANCE DATA⁽¹⁾⁽²⁾⁽³⁾

CONTAINMENT PRESSURE PSIA	GAS CONDITIONS				WATER TEMPERATURE		HEAT LOAD BTU/HX10
	FLOW X 1000 CFM		TEMPERATURE		IN °F	OUT °F	
	IN	OUT	IN °F	OUT °F			
59.7	38.46	31.25	258	248	95	179	55.5
41.3	38.15	31.25	220	204	95	153	38.6
30.2	36.55	31.25	180	158	95	128	22.1
25.3	34.74	31.25	150	129	95	112	11.7
16.1	33.24	31.25	120	106	95	101	4.2
59.7	39.06	31.25	258	247	80	171	60.2
41.3	38.87	31.25	220	202	80	144	42.8
30.2	37.38	31.25	180	154	80	118	25.5
25.3	35.57	31.25	150	123	80	101	14.5
16.1	34.33	31.25	120	98	80	90	6.5

NOTE

- (1) The fan cooler performance data at 59.7 psia and 258°F is shown conservatively instead of at higher LOCA/MSLB temperatures resulting from power uprate.
- (2) Based on cooling water flow rate of 1360 gpm/unit.
- (3) Refer to Figure 6.2.2-4 for graphical plots.

TABLE 6.2.2-4

PRIMARY SHIELD COOLING SYSTEM COMPONENTS
SAFETY CLASS - 3 UNITS

1. Supply Fans

Quantity	2 (one standby)
Type	Axial
Material	Carbon Steel
Air flow, each fan, acfm	18,000
Code	Air Moving and Conditioning Association (AMCA), Anti-Friction Bearing Manufacturers Association (AFBMA)

2. Supply Fan Motors

Quantity per fan	1
Capacity	40 Hp, 460 V, 60 Hz, 3 ph
Insulation	Class H, Type RH, Class H
Enclosure	TEAO
Code	NEMA MG-1 IEEE Std. 334

Note: All air quantities are actual cfm.

TABLE 6.2.2-5

REACTOR SUPPORTS COOLING SYSTEM COMPONENTS
SAFETY CLASS 3 UNITS

1. Supply Fans

Quantity	2 (one standby)
Type	Axial
Material	Carbon Steel
Air Flow, each fan, acfm	27,600
Code	Air Moving and Conditioning Association (AMCA), Anti-Friction Bearing Manufacturers Association (AFBMA)

2. Supply Fan Motors

Quantity per Fan	1
Capacity	50 HP, 460 volt, 60 HZ, 3 ph
Insulation	Class RH
Enclosure	TEAO
Code	NEMA MG-1 IEEE Std. 334

TABLE 6.2.2-6

SINGLE FAILURE ANALYSIS CONTAINMENT COOLING SYSTEM

Component	Malfunction	Comments
a) Injection Phase		
1) Active failure		
(a) Containment cooling unit fan	Fails to start	There are two fans in each cooling unit. Only one fan in each unit is required for accident cooling. The operator can select the alternate fan in the event of fan failure.
(b) One emergency electric train	Fails	There are redundant power sources. Four equal capacity containment cooling units are provided with two connected to each train.
(c) Damper	Fails to achieve safe position	There is redundancy in the ventilation distribution system. Failure of a single damper will not prevent system from providing adequate air distribution within containment.
b) Recirculation		
1) Active failure		
(a) Containment cooling unit fan	Fails to operate	Same as A.1)a).
(b) One emergency electric train	Fails	Same as A.1)b)
(c) Damper	Fails to achieve safe position	Same as A.1)c)
2) Passive		
(a) Fan shaft, blade, etc	Fails	Same as A.1)a).
(b) Component cooling unit cooling coil	Clogs, rupture or major leakage	Same as A.1)b). The operator would be alerted and the affected unit could be isolated.
(c) Electric cable, (worst case for a complete train)	Fails	Same as A.1)b)

TABLE 6.2.2-7

SINGLE FAILURE ANALYSIS CONTAINMENT SPRAY SYSTEM

Component	Malfunction	Comments
A. Injection Phase		
1) Active failure		
a) Containment spray pump	Fails to start	Two equal capacity pumps are provided. A single pump operating in combination with the Containment Cooling System will provide the required heat and iodine removal capability.
b) CSS header isolation valve	Fails to open	Two equal capacity headers are provided. A single header operating in combination with the Containment Cooling System will provide the required heat and iodine removal capability.
c) Spray additive tank isolation valve	Fails to open	Two valves are provided in parallel.
d) Containment spray pump injection supply valve	Fails to open	Same as A.1)b).
e) One emergency electric power train	Fails	A redundant emergency diesel generator and associated electric distribution system will supply power for minimum system requirements.
B. Recirculation Phase		
1) Active failure		
a) Containment spray pump	Fails to operate	Same as A.1)a).
b) Containment spray pump recirculation supply valve	Fails to open	Same as A.1)b).
c) One emergency power train	Fails to operate	Same as A.1)e)
2) Passive Failure		
a) Spray nozzles	Clogged	Redundant spray nozzles are provided to fulfill minimum system requirements.
b) Recirculation piping or spray piping; valve body, or pump casing	Ruptures or major leakage	Same as A.1)b).
c) Spray additive educator	Fails to operate	Two are provided, one for each header.
d) CSS pump shaft	Fractures	Same as A.1)a)
e) Electric cable (worst case for a complete train)	Fails	Same as A.1)e)

TABLE 6.2.2-8

CSS PUMP NPSH EVALUATION

	Flow* (GPM/Pump)	Minimum NPSH Required (FT)	NPSH Available (Ft)
(A) During the Injection Phase of Containment Spray	2464	13.0	92.0
(B) During Recirculation Phase of Containment Spray	2251	12.4	25.5

*The maximum expected flow based on conservative assumptions is used to calculate minimum NPSH required.

TABLE 6.2.2-9

CONTAINMENT SPRAY SYSTEM COMPONENT PARAMETERS

A. Containment Spray Pumps	
Number of Pumps	2
Type of Pump	Centrifugal
Design Flow, gpm	2275
Design Head, ft	425
Driver	Electric Motor
Driver horsepower (approximate)	350
Material (casing)	SA-182 Type F 304
Code	ASME III, Safety Class 2
B. Refueling Water Storage Tank	
Quantity	1
Material	Stainless Steel Type 304
Maximum Volume, gal	469,260
Minimum Volume, (solution) gal.	434,302
Normal Pressure, psig	Atmospheric
Operating Temperature, F	40-125
Design Pressure, psig	Atmospheric
Design Temperature, F	200
Boric Acid (as ppm B)	2400-2600 ppm
Code	ASME III, Code Class 2
C. Cavitating Venturi	
Quantity (per train)	1
Size, inches	8
Design Flow, gpm	2770
Material	316 SS
Code	ASME III, Class 2
D. Containment Spray Nozzles	
Quantity (per train)	106
Nozzle size, inches	3/8
Design Flow, gpm	15.2
Material	ASME A-351 GrCF8
Code	ASME III, Class 2
E. Motor Operated Isolation Valves	
Quantity, (per train)	1
Size, inches	8
Type	Gate
Design, Pressure, psig	300
Design Temperature, F	300
Material	304 SS
Code	ASME III, Class 2
Operator	Motor

SIGNAL INDEX FOR TABLE 6.2.4-1

1. Containment isolation Phase A (Signal 'T')
2. Containment isolation Phase 8 (Signal 'P')
3. Safety injection actuation (Signal 's')
4. Two out of four RWST low-low level
5. Main steam line isolation
6. Two out of three low-low level in any steam generator
7. Loss of main feedwater pumps
8. Containment ventilation isolation
9. Containment inside/outside differential pressure < - 2.5 in. wg.
10. Containment inside/outside differential pressure < - 0.25 in. wg.
11. Containment spray actuation
12. (Deleted)
13. Main feedwater line isolation
14. Auxiliary feedwater isolation
15. Loss of offsite power
16. Any steam generator low-low level

DEFINITIONS FOR TABLE 6.2.4-1

1. ACCIDENT SIGNAL - A signal which automatically initiates positioning of valves other than containment isolation valves to positions required to perform their safety-related function.
2. AUTOMATIC ACTUATION - Initiation of a power-operated valve by automatic means without any action by a plant operator upon receipt of an accident/isolation signal from a protection system.
3. CLOSED SYSTEM - A safety-related piping system which penetrates and is a closed system either inside or outside the Containment. The system is subject to the pump and valve operability test requirements and the inservice inspection requirements of the ASME Code Section XI. Under normal operating or LOCA conditions for closed systems inside Containment, the fluid in the system does not communicate directly with either the Reactor Coolant System or containment atmosphere. Under normal operating or LOCA conditions for closed systems outside Containment, the fluid in the system does not communicate directly with the environs.
4. CONTAINMENT ISOLATION SIGNAL - A signal which automatically initiates positioning of valves other than engineered safety feature valves to positions required to perform their containment isolation function.
5. CONTAINMENT ISOLATION VALVE - A valve which establishes a mechanical barrier in appropriate fluid systems penetrating the Containment, which could otherwise represent open paths to the environment from inside the Containment for fission products.
6. LEAKAGE PATH - A penetration that is not part of a safety-related closed system and that could provide a direct path to the environment.
7. LOCKED CLOSED ISOLATION VALVE - A valve that is in a closed position by administrative controls by one of the following:
 - a. A mechanical device locking the valve in the closed position.
 - b. A normally closed valve with a seal or lock on any manual override, if present, and a seal or lock on the power breaker or power source in a manner that prevents power from being supplied to the valve.
8. POWER TRAIN - The source of emergency electrical power from one or both of the redundant A and B emergency buses. See Section 8.3.
9. REMOTE MANUAL ACTUATION - Initiation of a Power-operated valve by a discrete manual action such as operation of a control switch.
10. RESPONSE TIME - Maximum stroke time for a valve to move to its safety-related position. Valves that close on automatic actuation that are not required to close within specific times by assumptions in accident analysis are indicated as closing in 60 seconds or less. Table 16.3-5 "Containment Isolation Valves" establishes a typical maximum isolation time (sec) of 60 seconds. Standard Review Plan Section 6.2.4 makes a general recommendation of "less than 1 minute, regardless of valve size."
11. TYPE C TEST - 10CFR50 Appendix J test as described in Section 6.2.6.

NOTES FOR TABLE 6.4.2-1

1. The inside containment barrier is a closed system inside Containment. The closed system is subject to the inservice inspection requirements of ASME Section XI. The system remains at a pressure greater than 45 psig post-LOCA.
2. The outside containment isolation barrier is a closed ESF system outside the Containment. The system is subject to the pump and valve operability test requirements and the inservice inspection requirements of the ASME Code Section XI.
3. Valves which do not require a Type C test because they do none of the following:
 - a. Provide a direct connection between the inside and outside atmospheres of the primary reactor containment under normal operation.
 - b. Are required to close automatically upon receipt of a containment isolation signal in response to controls intended to effect containment isolation.
 - c. Are required to operate intermittently under post accident conditions.
4. Remote manual instrument isolation valve. Valve is maintained open for both normal and post-LOCA operation.
5. Manual or remote-manual which is locked (physically locked or administratively controlled) and remains locked post-LOCA.
6. The valve is used periodically during operation. Any leakage through the valve would be detected during normal operation.
7. Valve is only opened when adding water to the pressurizer relief tank or RCP standpipe. It is interlocked to close on a Phase A containment isolation signal.
8. Valve is only opened when adding water to the accumulators. It is interlocked to close on a Phase A containment isolation signal.
9. Valve is opened only to verify leaktightness of accumulator check valve. It is interlocked to close a Phase A containment-isolation signal.
10. Valve is opened only when charging nitrogen to the accumulators. It is interlocked to close on a Phase A containment isolation signal.
11. Center shaft butterfly valve may be tested in the reverse direction. Leakage is equivalent since the same sealing surfaces are tested when test pressure is applied from either direction.

NOTES TO TABLE 6.2.4-1 (Continued)

12. Wedge-disk gate valve tested in the reverse direction. Results obtained in this configuration are equivalent to testing in the accident direction. Because of the disk seat design, testing in either direction measures the leakage across both seating surfaces.
13. Globe valve tested in the reverse direction. The results obtained are conservative since test pressure tends to unseat the valve disk.
14. Diaphragm valve tested in the reverse direction. Leakage is equivalent since the same seating surface is tested when test pressure is applied from either direction.
15. These penetrations are connected directly to the sump. During an accident, they will be filled with water. This water seal will exist during the entire post-accident period.
16. Both the pressure sensor and the hydraulic isolators have an internal bellows which serve as isolation barriers for the capillary tubes.
17. The isolation valve is sealed with a seal-fluid with sufficient fluid inventory to assure the sealing function for at least 30 days at 1.10 Pa.
18. Valves which may be opened by operator action for post-accident long-term cooling.
19. Valves are closed on containment Phase A isolation signal. They are then opened remote manually for intermittent sampling.
20. Valves AF-VI89, 190, and 191 are opened for steam generator Wet-Layup.
21. The system fluid is water. However, the penetration is drained before the isolation valves are closed. (Reference ESR 9600537 and Generic Letter 96-06)
22. The valve stroke time at degraded voltage for valves VB and V9 is 76.9 seconds. At nominal voltage, the stroke time is 60.7 seconds. These stroke times will ensure these valves can perform their safety function in the required response time. For the AFW actuation times, refer to plant operating manual procedure PLP-106.

ABBREVIATIONS FOR TABLE 6.2.4-1

<u>Fluid</u>	<u>Valve Type</u>
A – Air	BF – Butterfly
G – Gas	CK – Check
S – Steam	DA – Diaphragm
W – Water	GA – Gate
CF – Capillary Filling	GL – Globe
	RG – Regulating
<u>Actuator</u>	RL – Relief
AO – Air Operator	XC – Excess Flow Check Valve
EH – Electro-hydraulic	
M – Manual	Primary/Secondary
MO – Motor Operator	<u>Actuation Modes</u>
SA – Self-Actuating	A – Automatic
SO – Solenoid Operator	M – Manual
	RF – Reverse Flow
<u>Valve Position</u>	RM – Remote Manual
AI – As Is	
C – Closed	
Cy – Cycle	
LC – Locked Closed	
LO – Locked Open	
O – Open	
TH - Throttled	
TL – Locked Throttled	

TABLE 6.2.4-1 CONTAINMENT ISOLATION SYSTEM DATA																																			
PENETRATION DATA						VALVE DATA																													
PENETRATION DETAIL	FD NUMBER	GENERAL DESIGN CRITERION	FLUID	HIGH ENERGY LINE	BYPASS LEAKAGE PATH	SYSTEM TITLE	VALVE NUMBER	POWER TRAIN	LENGTH OF PIPE, FT.	VALVE TYPE	ACTUATOR	PRIMARY ACTUATION MODE	SECONDARY ACTUATION MODE	ISOLATION SIGNAL	ACCIDENT SIGNAL	RESPONSE TIME	Valve Position					ENGINEERED SAFETY FEATURE	CONTAINMENT ISOLATION VALVE	TYPE C TEST	NOTE										
																	NORMAL	SHUTDOWN	POST-ACCIDENT	POWER FAILURE	ILRT														
	042	57	S	YES	NO	MAIN STEAM LOOP A	R1	-	4'	RL	SA	-	-	-	-	-	-	C	C	C	C	C	YES	YES	NO	1									
							R4	-	6'	RL	SA	-	-	-	-	-	-	-	-	-	-	-	C	C	C		C	C	YES	YES	NO				
							R7	-	8'	RL	SA	-	-	-	-	-	-	-	-	-	-	-	-	C	C		C	C	C	YES	YES	NO			
							R10	-	10'	RL	SA	-	-	-	-	-	-	-	-	-	-	-	-	-	C		C	C	C	C	YES	YES	NO		
							R13	-	13'	RL	SA	-	-	-	-	-	-	-	-	-	-	-	-	-	-		C	C	C	C	C	YES	YES	NO	
							P18	A		GL	EH	A	RM	-	-	-	-	-	-	-	-	-	-	-	C		C	CY	C	-	NO	YES	NO		
							V1	A&B	27'	GL	AO	A	RM	5	-	5	0	C	C	C	C	C	C	C	C		C	C	C	NO	YES	NO			
							F1	A&B	37'	GL	AO	A	RM	5	-	10	C	C	C	C	C	C	C	C	C		C	C	NO	YES	NO				
							V59	A&B	25'	GL	AO	A	RM	5	-	60	0	C	C	C	C	C	C	C	C		C	C	NO	YES	NO				
V122	A&B	4	GL	AO	A	RM	1	-	60	0	C	C	C	C	C	C	C	C	C	C	NO	YES	NO												
	042	57	S	YES	NO	MAIN STEAM LOOP B	R2	-	4'	RL	SA	-	-	-	-	-	-	-	C	C	C	C	C	YES	YES	NO	1								
							R5	-	6'	RL	SA	-	-	-	-	-	-	-	-	-	-	-	-	C	C	C		C	C	YES	YES	NO			
							R8	-	8'	RL	SA	-	-	-	-	-	-	-	-	-	-	-	-	-	C	C		C	C	C	YES	YES	NO		
							R11	-	10'	RL	SA	-	-	-	-	-	-	-	-	-	-	-	-	-	-	C		C	C	C	C	YES	YES	NO	
							R14	-	13'	RL	SA	-	-	-	-	-	-	-	-	-	-	-	-	-	-	-		C	C	C	C	C	YES	YES	NO
							P19	B	30'	GL	EH	A	RM	-	-	-	-	-	-	-	-	-	-	-	-	C		C	CY	C	-	NO	YES	NO	
							V2	A&B	27'	GL	AO	A	RM	5	-	5	0	C	C	C	C	C	C	C	C	C		C	C	NO	YES	NO			
							F2	A&B	37'	GL	AO	A	RM	5	-	10	C	C	C	C	C	C	C	C	C	C		C	NO	YES	NO				
							V60	A&B	28'	GL	AO	A	RM	5	-	60	0	C	C	C	C	C	C	C	C	C		C	NO	YES	NO				
							V8	A	26'	GA	MO	A	RM	-	15,6	60.7	C	C	O	AI	C	C	C	C	C	C		C	YES	YES	NO				
V124	A&B	4	GL	AO	A	RM	1	-	60	0	C	C	C	C	C	C	C	C	C	C	NO	YES	NO	22											

TABLE 6.2.4-1 CONTAINMENT ISOLATION SYSTEM DATA

PENETRATION DATA						VALVE DATA																											
PENETRATION DETAIL	FD NUMBER	GENERAL DESIGN CRITERION	FLUID	HIGH ENERGY LINE	BYPASS LEAKAGE PATH	SYSTEM TITLE	VALVE NUMBER	POWER TRAIN	LENGTH OF PIPE, FT.	VALVE TYPE	ACTUATOR	PRIMARY ACTUATION MODE	SECONDARY ACTUATION MODE	ISOLATION SIGNAL	ACCIDENT SIGNAL	RESPONSE TIME	Valve Position					ENGINEERED SAFETY FEATURE	CONTAINMENT ISOLATION VALVE	TYPE C TEST	NOTE								
																	NORMAL	SHUTDOWN	POST-ACCIDENT	POWER FAILURE	ILRT												
	042	57	S	YES	NO	MAIN STEAM LOOP C	R3	-	4'	RL	SA	-	-	-	-	-	-	C	C	C	C	C	YES	YES	NO	1 22							
							R6	-	6'	RL	SA	-	-	-	-	-	-	-	-	-	-	-	C	C	C		C	C	YES	YES	NO		
							R9	-	8'	RL	SA	-	-	-	-	-	-	-	-	-	-	-	-	C	C		C	C	C	YES	YES	NO	
							R12	-	10'	RL	SA	-	-	-	-	-	-	-	-	-	-	-	-	-	C		C	C	C	C	YES	YES	NO
							R15	-	13'	RL	SA	-	-	-	-	-	-	-	-	-	-	-	-	-	C		C	C	C	C	YES	YES	NO
							P20	A	30'	GL	EH	A	RM	-	-	-	-	-	-	-	-	-	-	-	C		C	CY	C	-	NO	YES	NO
							V3	A&B	27'	GL	AO	A	RM	5	-	5	O	C	C	C	C	C	C	C	C		C	C	C	NO	YES	NO	
							F3	A&B	37'	GL	AO	A	RM	5	-	10	C	C	C	C	C	C	C	C	C		C	C	C	NO	YES	NO	
							V61	A&B	28'	GL	AO	A	RM	5	-	60	O	C	C	C	C	C	C	C	C		C	C	C	NO	YES	NO	
V9	B	26'	GA	MO	A	RM	-	15,6	60.7	C	C	O	AI	C	C	C	C	C	C	C	YES	YES	NO										
	044	57	W	YES	NO	FEEDWATER LOOP A	V26	A&B	4	GA	EH	A	RM	13	-	8	O	C	C	C	C	C	NO	YES	NO	1							
							V89	-	9	GL	M	M	-	-	-	-	LC	LC	LC	LC	LC	LC	LC	LC	LC		LC	NO	YES	NO			
							V90	-	4	GL	M	M	-	-	-	-	LC	LC	LC	LC	LC	LC	LC	LC	LC		LC	LC	NO	YES	NO		
	044	57	W	YES	NO	FEEDWATER LOOP B	V27	A&B	4	GA	EH	A	RM	13	-	8	O	C	C	C	C	C	NO	YES	NO	1							
							V91	-	9	GL	M	M	-	-	-	-	LC	LC	LC	LC	LC	LC	LC	LC	LC		LC	NO	YES	NO			
							V92	-	4	GL	M	M	-	-	-	-	LC	LC	LC	LC	LC	LC	LC	LC	LC		LC	LC	NO	YES	NO		

TABLE 6.2.4-1 CONTAINMENT ISOLATION SYSTEM DATA

PENETRATION DATA						VALVE DATA																							
PENETRATION DETAIL	FD NUMBER	GENERAL DESIGN CRITERION	FLUID	HIGH ENERGY LINE	BYPASS LEAKAGE PATH	SYSTEM TITLE	VALVE NUMBER	POWER TRAIN	LENGTH OF PIPE, FT.	VALVE TYPE	ACTUATOR	PRIMARY ACTUATION MODE	SECONDARY ACTUATION MODE	ISOLATION SIGNAL	ACCIDENT SIGNAL	RESPONSE TIME	Valve Position					ENGINEERED SAFETY FEATURE	CONTAINMENT ISOLATION VALVE	TYPE C TEST	NOTE				
																	NORMAL	SHUTDOWN	POST-ACCIDENT	POWER FAILURE	ILRT								
	044	57	W	YES	NO	FEEDWATER LOOP C	V28	A&B	4	GA	EH	A	RM	13	-	8	O	C	C	C	C	NO	YES	NO	1				
							V93	-	9	GL	M	M	-	-	-	-	LC	LC	LC	LC	LC	LC	LC	LC		NO	YES	NO	
							V94	-	4	GL	M	M	-	-	-	-	LC	LC	LC	LC	LC	LC	LC	LC		LC	NO	YES	NO
	803	55	W	YES	NO	CVCS - NORMAL LETDOWN	R500	-	17	RL	SA	-	-	-	-	-	C	C	C	C	C	NO	YES	YES					
							V511	A	17	GL	AO	A	RM	1	-	10	CY	C	C	C	C	C	C	C		C	NO	YES	YES
							V512	A	16	GL	AO	A	RM	1	-	10	O	C	C	C	C	C	C	C		C	NO	YES	YES
							V513	A	16	GL	AO	A	RM	1	-	10	CY	C	C	C	C	C	C	C		C	NO	YES	YES
							V518	B	1	GL	AO	A	RM	1	-	10	O	C	C	C	C	C	C	C		C	NO	YES	YES
	803	55	W	YES	NO	CVCS - NORMAL CHARGING	V515	-	2	CK	SA	-	-	-	-	-	O	C	C	-	C	NO	YES	YES					
							V610	A	1	GA	MO	A	RM	3	-	10	O	C	C	AI	C	NO	YES	YES					
	803	55	W	YES	NO	CVCS - SEAL WATER TO RCP 'A'	V25	-	2	CK	SA	-	-	-	-	-	O	O	O	-	C	YES	YES	NO	2, 17				
							V522	B	1	GL	MO	RM	M	-	-	-	O	O	O	AI	C	YES	YES	NO					

TABLE 6.2.4-1 CONTAINMENT ISOLATION SYSTEM DATA

PENETRATION DATA						VALVE DATA																				
PENETRATION DETAIL	FD NUMBER	GENERAL DESIGN CRITERION	FLUID	HIGH ENERGY LINE	BYPASS LEAKAGE PATH	SYSTEM TITLE	VALVE NUMBER	POWER TRAIN	LENGTH OF PIPE, FT.	VALVE TYPE	ACTUATOR	PRIMARY ACTUATION MODE	SECONDARY ACTUATION MODE	ISOLATION SIGNAL	ACCIDENT SIGNAL	RESPONSE TIME	Valve Position					ENGINEERED SAFETY FEATURE	CONTAINMENT ISOLATION VALVE	TYPE C TEST	NOTE	
																	NORMAL	SHUTDOWN	POST-ACCIDENT	POWER FAILURE	ILRT					
	803	55	W	YES	NO	CVCS - SEAL WATER TO RCP 'B'	V26	-	2	CK	SA	-	-	-	-	-	-	O	O	O	-	C	YES	YES	NO	2, 17
							V523	B	1	GL	MO	RM	M	-	-	-	O	O	O	AI	C	YES	YES	NO		
	803	55	W	YES	NO	CVCS - SEAL WATER TO RCP 'C'	V27	-	2	CK	SA	-	-	-	-	-	-	O	O	O	-	C	YES	YES	NO	2, 17
							V524	B	1	GL	MO	RM	M	-	-	-	O	O	O	AI	C	YES	YES	NO		
	803	55	W	NO	NO	CVCS - SEAL WATER RETURN & EXCESS LETDOWN	V67	-	4	CK	SA	-	-	-	-	-	-	C	C	C	-	C	NO	YES	YES	
							V516	A	2	GL	MO	A	RM	1	-	10	O	O	C	AI	C	NO	YES	YES		
							V517	B	2	GL	MO	A	RM	1	-	10	O	O	C	AI	C	NO	YES	YES		
	810	55	W	YES	NO	SAFETY INJECTION - LOW HEAD TO COLD LEGS	V581	-	1	CK	SA	-	-	-	-	-	-	C	O	O	-	O	YES	YES	NO	2, 17
							V579	A	4	GA	MO	RM	M	-	-	-	O	O	O	AI	O	YES	YES	NO		
	810	55	W	YES	NO	SAFETY INJECTION - LOW HEAD TO COLD LEGS	V580	-	1	CK	SA	-	-	-	-	-	-	C	O	O	-	O	YES	YES	NO	2, 17
							V578	B	4	GA	MO	RM	M	-	-	-	O	O	O	AI	O	YES	YES	NO		
	824	55	W	YES	NO	RHR SUCTION FROM HOT LEG	R501	-	4	RL	SA	-	-	-	-	-	-	C	C	C	-	C	NO	YES	NO	2, 18
							V502	B	100	GA	MO	RM	M	-	-	-	C	O	C	AI	O	YES	NO	NO		
							V503	A	12	GA	MO	RM	M	-	-	-	C	O	C	AI	O	YES	YES	NO		

TABLE 6.2.4-1 CONTAINMENT ISOLATION SYSTEM DATA

PENETRATION DATA						VALVE DATA																									
PENETRATION DETAIL	FD NUMBER	GENERAL DESIGN CRITERION	FLUID	HIGH ENERGY LINE	BYPASS LEAKAGE PATH	SYSTEM TITLE	VALVE NUMBER	POWER TRAIN	LENGTH OF PIPE, FT.	VALVE TYPE	ACTUATOR	PRIMARY ACTUATION MODE	SECONDARY ACTUATION MODE	ISOLATION SIGNAL	ACCIDENT SIGNAL	RESPONSE TIME	Valve Position					ENGINEERED SAFETY FEATURE	CONTAINMENT ISOLATION VALVE	TYPE C TEST	NOTE						
																	NORMAL	SHUTDOWN	POST-ACCIDENT	POWER FAILURE	ILRT										
	824	55	w	YES	NO	RHR SUCTION FROM HOT LEG	R500	-	4	RF	SA	-	-	-	-	-	-	C	C	C	-	C	NO	YES	NO	2, 18					
							V500	B	100	GA	MO	RM	M	-	-	-	-	-	-	-	-	C	O	C	AI		O	YES	NO	NO	
							V501	A	12	GA	MO	RM	M	-	-	-	-	-	-	-	-	-	C	O	C		AI	O	YES	YES	NO
	808	55	W	YES	NO	SAFETY INJECTION - HIGH HEAD TO COLD LEG	V17	-	126	CK	SA	-	-	-	-	-	-	C	C	O	-	C	YES	YES	NO	2, 17					
							V23	-	26	CK	SA	-	-	-	-	-	-	-	-	-	-	-	C	C	O		-	C	YES	YES	NO
							V29	-	145	CK	SA	-	-	-	-	-	-	-	-	-	-	-	C	C	O		-	C	YES	YES	NO
							V440	-	124	GL	M	M	-	-	-	-	-	-	-	-	-	-	TL	TL	TL		-	TL	YES	YES	NO
							V439	-	25	GL	M	M	-	-	-	-	-	-	-	-	-	-	TL	TL	TL		-	TL	YES	YES	NO
							V438	-	144	GL	M	M	-	-	-	-	-	-	-	-	-	-	TL	TL	TL		-	TL	YES	YES	NO
							V505	B	2	GA	MO	A	RM	-	3	10	C	C	O	AI	C	YES	YES	NO							
V506	A	3	GA	MO	A	RM	-	3	10	C	C	O	AI	C	YES	YES	NO														
	810	55	W	YES	NO	SAFETY INJECTION - LOW HEAD TO HOT LEGS	V510	-	53	CK	SA	-	-	-	-	-	-	C	C	C	-	C	YES	YES	NO	2, 17, 18					
							V511	-	55	CK	SA	-	-	-	-	-	-	-	-	-	-	-	C	C	C		-	C	YES	YES	NO
							V587	A	1	GA	MO	RM	M	-	-	-	-	-	-	-	-	-	C	C	C		AI	C	YES	YES	NO
19						SPARE																									

TABLE 6.2.4-1 CONTAINMENT ISOLATION SYSTEM DATA																															
PENETRATION DATA						VALVE DATA																									
PENETRATION DETAIL	FD NUMBER	GENERAL DESIGN CRITERION	FLUID	HIGH ENERGY LINE	BYPASS LEAKAGE PATH	SYSTEM TITLE	VALVE NUMBER	POWER TRAIN	LENGTH OF PIPE, FT.	VALVE TYPE	ACTUATOR	PRIMARY ACTUATION MODE	SECONDARY ACTUATION MODE	ISOLATION SIGNAL	ACCIDENT SIGNAL	RESPONSE TIME	Valve Position					ENGINEERED SAFETY FEATURE	CONTAINMENT ISOLATION VALVE	TYPE C TEST	NOTE						
																	NORMAL	SHUTDOWN	POST-ACCIDENT	POWER FAILURE	ILRT										
	808	55	W	YES	NO	SAFETY INJECTION - HIGH HEAD TO HOT LEGS	V84	-	82	CK	SA	-	-	-	-	-	-	C	C	C	-	C	YES	YES	NO						
							V90	-	36	CK	SA	-	-	-	-	-	-	-	-	-	-	-	C	C	C	-	C	YES	YES	NO	
							V96	-	140	CK	SA	-	-	-	-	-	-	-	-	-	-	-	-	C	C	C	-	C	YES	YES	NO
							V431	-	81	GL	M	M	-	-	-	-	-	-	-	-	-	-	-	TL	TL	TL	-	TL	YES	YES	NO
							V430	-	35	GL	M	M	-	-	-	-	-	-	-	-	-	-	-	TL	TL	TL	-	TL	YES	YES	NO
							V429	-	139	GL	M	M	-	-	-	-	-	-	-	-	-	-	-	TL	TL	TL	-	TL	YES	YES	NO
	808	55	W	YES	NO	SAFETY INJECTION - HIGH HEAD TO HOT LEGS	V39	-	122	CK	SA	-	-	-	-	-	-	C	C	C	-	C	YES	YES	NO						
							V45	-	34	CK	SA	-	-	-	-	-	-	-	-	-	-	-	C	C	C	-	C	YES	YES	NO	
							V51	-	136	CK	SA	-	-	-	-	-	-	-	-	-	-	-	-	C	C	C	-	C	YES	YES	NO
							V434	-	120	GL	M	M	-	-	-	-	-	-	-	-	-	-	-	TL	TL	TL	-	TL	YES	NO	NO
							V433	-	31	GL	M	M	-	-	-	-	-	-	-	-	-	-	-	TL	TL	TL	-	TL	YES	NO	NO
							V432	-	138	GL	M	M	-	-	-	-	-	-	-	-	-	-	-	TL	TL	TL	-	TL	YES	NO	NO
	808		W	YES	NO	SAFETY INJECTION - HIGH HEAD TO COLD LEGS	V63	-	155	CK	SA	-	-	-	-	-	-	C	C	C	-	C	YES	YES	NO						
							V69	-	24	CK	SA	-	-	-	-	-	-	-	-	-	-	-	C	C	C	-	C	YES	YES	NO	
							V75	-	153	CK	SA	-	-	-	-	-	-	-	-	-	-	-	-	C	C	C	-	C	YES	YES	NO
							V437	-	152	GL	M	M	-	-	-	-	-	-	-	-	-	-	-	TL	TL	TL	-	TL	YES	NO	NO
							V436	-	23	GL	M	M	-	-	-	-	-	-	-	-	-	-	-	TL	TL	TL	-	TL	YES	NO	NO
							V435	-	80	GL	M	M	-	-	-	-	-	-	-	-	-	-	-	TL	TL	TL	-	TL	YES	NO	NO
	050	56	W	YES	NO	CONTAINMENT SPRAY	V27	-	3	CK	SA	-	-	-	-	-	-	C	C	O	-	C	YES	YES	YES						
							V21	A	2	GA	MO	A	RM	-	11	10	C	C	O	AI	C	YES	YES	YES							

TABLE 6.2.4-1 CONTAINMENT ISOLATION SYSTEM DATA																										
PENETRATION DATA						VALVE DATA																				
PENETRATION DETAIL	FD NUMBER	GENERAL DESIGN CRITERION	FLUID	HIGH ENERGY LINE	BYPASS LEAKAGE PATH	SYSTEM TITLE	VALVE NUMBER	POWER TRAIN	LENGTH OF PIPE, FT.	VALVE TYPE	ACTUATOR	PRIMARY ACTUATION MODE	SECONDARY ACTUATION MODE	ISOLATION SIGNAL	ACCIDENT SIGNAL	RESPONSE TIME	Valve Position					ENGINEERED SAFETY FEATURE	CONTAINMENT ISOLATION VALVE	TYPE C TEST	NOTE	
																	NORMAL	SHUTDOWN	POST-ACCIDENT	POWER FAILURE	ILRT					
	050	56	W	YES	NO	CONTAINMENT SPRAY	V51	-	3	CK	SA	-	-	-	-	-	-	C	C	O	-	C	YES	YES	YES	
							V43	B	2	GA	MO	A	RM	-	11	10	C	C	O	AI	C	YES	YES	YES		
	047	57	W	NO	NO	SERVICE WATER TO FAN COOLER AH-3	B46	A	1	BF	MO	RM	M	-	-	-	O	O	O	AI	O	YES	YES	YES	1, 3	
	047	57	W	NO	NO	SERVICE WATER TO FAN COOLER AH-2	B45	A	1	BF	MO	RM	M	-	-	-	O	O	O	AI	O	YES	YES	NO	1, 3	
	047	57	W	NO	NO	SERVICE WATER TO FAN COOLER AH-1	B52	B	1	BF	MO	RM	M	-	-	-	O	O	O	AI	O	YES	YES	NO	1, 3	
	047	57	W	NO	NO	SERVICE WATER TO FAN COOLER AH-4	B51	B	1	BF	MO	RM	M	-	-	-	O	O	O	AI	O	YES	YES	NO	1, 3	

TABLE 6.2.4-1 CONTAINMENT ISOLATION SYSTEM DATA																									
PENETRATION DATA						VALVE DATA																			
PENETRATION DETAIL	FD NUMBER	GENERAL DESIGN CRITERION	FLUID	HIGH ENERGY LINE	BYPASS LEAKAGE PATH	SYSTEM TITLE	VALVE NUMBER	POWER TRAIN	LENGTH OF PIPE, FT.	VALVE TYPE	ACTUATOR	PRIMARY ACTUATION MODE	SECONDARY ACTUATION MODE	ISOLATION SIGNAL	ACCIDENT SIGNAL	RESPONSE TIME	Valve Position					ENGINEERED SAFETY FEATURE	CONTAINMENT ISOLATION VALVE	TYPE C TEST	NOTE
																	NORMAL	SHUTDOWN	POST-ACCIDENT	POWER FAILURE	ILRT				
	047	57	W	NO	NO	SERVICE WATER FROM FAN COOLER AH-3	B47	A	1	BF	MO	RM	M	-	-	-	O	O	O	AI	O	YES	YES	NO	1, 3
							R1	-	1	RF	SA	-	-	-	-	-	C	C	C	-	C	YES	YES	NO	
	047	57	W	NO	NO	SERVICE WATER FROM FAN COOLER AH-2	B49	A	1	BF	MO	RM	M	-	-	-	O	O	O	AI	O	YES	YES	NO	1, 3
							R3	-	1	RF	SA	-	-	-	-	-	C	C	C	-	C	YES	YES	NO	
	047	57	W	NO	NO	SERVICE WATER FROM FAN COOLER AH-1	B48	B	1	BF	MO	RM	M	-	-	-	O	O	O	AI	O	YES	YES	NO	1, 3
							R2	-	1	RF	SA	-	-	-	-	-	C	C	C	-	C	YES	YES	NO	
	047	57	W	NO	NO	SERVICE WATER FROM FAN COOLER AH-4	B50	B	1	BF	MO	RM	M	-	-	-	O	O	O	AI	O	YES	YES	NO	1, 3
							R4	-	1	RF	SA	-	-	-	-	-	C	C	C	-	C	YES	YES	NO	
	052	56	A	NO	YES	GAS SAMPLE RETURN FROM POST ACCIDENT SKID #2	V408	B	2	GL	SO	A	RM	1	-	5	C	C	CY	C	C	NO	YES	YES	19
							V409	A	2	GL	SO	A	RM	1	-	5	C	C	CY	C	C	NO	YES	YES	

TABLE 6.2.4-1 CONTAINMENT ISOLATION SYSTEM DATA																										
PENETRATION DATA						VALVE DATA																				
PENETRATION DETAIL	FD NUMBER	GENERAL DESIGN CRITERION	FLUID	HIGH ENERGY LINE	BYPASS LEAKAGE PATH	SYSTEM TITLE	VALVE NUMBER	POWER TRAIN	LENGTH OF PIPE, FT.	VALVE TYPE	ACTUATOR	PRIMARY ACTUATION MODE	SECONDARY ACTUATION MODE	ISOLATION SIGNAL	ACCIDENT SIGNAL	RESPONSE TIME	Valve Position					ENGINEERED SAFETY FEATURE	CONTAINMENT ISOLATION VALVE	TYPE C TEST	NOTE	
																	NORMAL	SHUTDOWN	POST-ACCIDENT	POWER FAILURE	ILRT					
	416	56	A	NO	YES	ILRT ROTOMETER	V2	-	3	G	M	M	-	-	-	-	-	LC	LC	LC	-	O	NO	YES	YES	5
	821	56	W	NO	NO	COMPONENT COOLING WATER - TO RCP	V171	-	1	CK	SA	-	-	-	-	-	-	O	O	C	-	C	NO	YES	YES	
							V170	B	2	GA	MO	A	RM	2	-	10	O	O	C	AI	C	NO	YES	YES		
	821	56	W	NO	NO	COMPONENT COOLING WATER FROM RCP	V51	-	3	CK	SA	-	-	-	-	-	-	C	C	C	-	C	NO	YES	YES	
							V184	A	2	GA	MO	A	RM	2	-	10	O	O	C	AI	C	NO	YES	YES		
							V183	B	2	GA	MO	A	RM	2	-	10	O	O	C	AI	C	NO	YES	YES		
	821	57	W	NO	NO	COMPONENT COOLING WATER TO REACTOR COOLANT DRAIN TANK AND EXCESS LETDOWN HEAT EXCHANGERS	V173	-	2	CK	SA	-	-	-	-	-	-	O	O	C	-	C	NO	NO	NO	
							V172	B	2	GA	MO	A	RM	1	-	10	O	O	C	AI	C	NO	YES	NO		
							V182	B	2	GA	MO	A	RM	1	-	10	O	C	C	AI	C	NO	YES	NO		
							R5	-	42	RL	SA	-	-	-	-	-	C	C	C	-	C	NO	YES	NO		
R6	-	60	RL	SA	-	-	-	-	-	C	C	C	-	C	NO	YES	NO									
	821	56	W	NO	NO	COMPONENT COOLING WATER FROM RCP THERMAL BARRIERS	V50	-	3	CK	SA	-	-	-	-	-	-	C	C	C	-	C	NO	YES	YES	
							V191		2	GA	MO	A	RM	2	-	10	O	O	C	AI	C	NO	YES	YES		
							V190		1	GA	MO	A	RM	2	-	10	O	O	C	AI	C	NO	YES	YES		

TABLE 6.2.4-1 CONTAINMENT ISOLATION SYSTEM DATA

PENETRATION DATA						VALVE DATA																				
PENETRATION DETAIL	FD NUMBER	GENERAL DESIGN CRITERION	FLUID	HIGH ENERGY LINE	BYPASS LEAKAGE PATH	SYSTEM TITLE	VALVE NUMBER	POWER TRAIN	LENGTH OF PIPE, FT.	VALVE TYPE	ACTUATOR	PRIMARY ACTUATION MODE	SECONDARY ACTUATION MODE	ISOLATION SIGNAL	ACCIDENT SIGNAL	RESPONSE TIME	Valve Position					ENGINEERED SAFETY FEATURE	CONTAINMENT ISOLATION VALVE	TYPE C TEST	NOTE	
																	NORMAL	SHUTDOWN	POST-ACCIDENT	POWER FAILURE	ILRT					
	801	56	W	NO	YES	DEMIN WATER TO PRT	V525		8	CK	SA	-	-	-	-	-	-	O	C	C	-	C	NO	YES	YES	7
							D525		4	DA	AO	A	RM	1	-	60	O	C	C	C	C	NO	YES	YES		
	300	56	A	NO	YES	SERVICE AIR	V15	-	2	CK	SA	-	-	-	-	-	-	C	C	C	-	C	NO	YES	YES	5
							V14	-	8	GL	M	M	-	-	-	-	LC	LC	LC	-	LC	NO	YES	YES		
	813	56	W	NO	YES	RCDT PUMP DISCHARGE	D653	-	6	DA	M	M	-	-	-	-	-	O	O	O	-	O	NO	NO	NO	
							D654	-	4	DA	M	M	-	-	-	-	O	O	O	-	O	NO	NO	NO		
							D651	-	7	DA	M	M	-	-	-	-	LC	LC	LC	-	LC	NO	YES	YES		
							L600	A	6	GL	AO	A	RM	1	-	10	O	O	O	C	C	NO	YES	YES		
							D650	B	4	DA	AO	A	RM	1	-	10	O	O	O	C	C	NO	YES	YES		
43						SPARE																				
	061	56	A	NO	YES	REFUELING CAVITY CLEAN-UP	D164	-	1	DA	M	M	-	-	-	-	-	LC	LC	LC	-	LC	NO	YES	YES	5, 14, 21
							D165	-	2	DA	M	M	-	-	-	-	LC	LC	LC	-	LC	NO	YES	YES		
	061	56	A	NO	YES	REFUELING CAVITY CLEAN-UP	D25	-	2	DA	M	M	-	-	-	-	-	LC	LC	LC	-	LC	NO	YES	YES	5, 14, 21
							D26	-	2	DA	M	M	-	-	-	-	LC	LC	LC	-	LC	NO	YES	YES		
46						SPARE																				

TABLE 6.2.4-1 CONTAINMENT ISOLATION SYSTEM DATA

PENETRATION DATA						VALVE DATA																			
PENETRATION DETAIL	FD NUMBER	GENERAL DESIGN CRITERION	FLUID	HIGH ENERGY LINE	BYPASS LEAKAGE PATH	SYSTEM TITLE	VALVE NUMBER	POWER TRAIN	LENGTH OF PIPE, FT.	VALVE TYPE	ACTUATOR	PRIMARY ACTUATION MODE	SECONDARY ACTUATION MODE	ISOLATION SIGNAL	ACCIDENT SIGNAL	RESPONSE TIME	Valve Position					ENGINEERED SAFETY FEATURE	CONTAINMENT ISOLATION VALVE	TYPE C TEST	NOTE
																	NORMAL	SHUTDOWN	POST-ACCIDENT	POWER FAILURE	ILRT				
	810	56	W	YES	NO	CONTAINMENT SUMP TO RHR PUMP	V571	A	35	GA	MO	A	RM	-	3, 4	20	C	C	O	AI	C	YES	YES	NO	15
	810	56	W	YES	NO	CONTAINMENT SUMP TO RHR PUMP	V570	B	35	GA	MO	A	RM	-	3, 4	20	C	C	O	AI	C	YES	YES	NO	15
	050	56	W	YES	NO	CONTAINMENT SUMP TO CT PUMP	V6	A	32	GA	MO	A	RM	-	4	102	C	C	O	AI	C	YES	YES	NO	15
	050	56	W	YES	NO	CONTAINMENT SUMP TO CT PUMP	V7	B	32	GA	MO	A	RM	-	4	102	C	C	O	AI	C	YES	YES	NO	15

TABLE 6.2.4-1 CONTAINMENT ISOLATION SYSTEM DATA

PENETRATION DATA						VALVE DATA																			
PENETRATION DETAIL	FD NUMBER	GENERAL DESIGN CRITERION	FLUID	HIGH ENERGY LINE	BYPASS LEAKAGE PATH	SYSTEM TITLE	VALVE NUMBER	POWER TRAIN	LENGTH OF PIPE, FT.	VALVE TYPE	ACTUATOR	PRIMARY ACTUATION MODE	SECONDARY ACTUATION MODE	ISOLATION SIGNAL	ACCIDENT SIGNAL	RESPONSE TIME	Valve Position					ENGINEERED SAFETY FEATURE	CONTAINMENT ISOLATION VALVE	TYPE C TEST	NOTE
																	NORMAL	SHUTDOWN	POST-ACCIDENT	POWER FAILURE	ILRT				
	051	57	W	YES	NO	STEAM GENERATOR 'A' BLOWDOWN	P6	B	55	GL	AO	A	RM	3	-	60	0	0	C	C	C	NO	NO	NO	1
							V3	-	55	GL	M	M	-	-	-	-	C	C	C	-	C	NO	NO	NO	
							V11	A	10	GL	AO	A	RM	3	-	60	0	0	C	C	C	NO	YES	NO	
							V183	-	10																
	051	57	W	YES	NO	STEAM GENERATOR 'B' BLOWDOWN	P7	B	26	GL	AO	A	RM	3	-	60	0	0	C	C	C	NO	NO	NO	1
							V15	A	9	GL	AO	A	RM	3	-	60	0	0	C	C	C	NO	YES	NO	
							V184	-	9	GL	M	M	-	-	-	-	C	C	C	-	C	NO	YES	NO	
	051	57	W	YES	NO	STEAM GENERATOR 'C' BLOWDOWN	P8	B	51	GL	AO	A	RM	3	-	60	0	0	C	C	C	NO	NO	NO	1
							V9	-	52	GL	M	M	-	-	-	-	C	C	C	-	C	NO	NO	NO	
							V19	A	10	GL	AO	A	RM	3	-	60	0	0	C	C	C	NO	YES	NO	
							V185	-	10	GL	M	M	-	-	-	-	C	C	C	-	C	NO	YES	NO	

TABLE 6.2.4-1 CONTAINMENT ISOLATION SYSTEM DATA

PENETRATION DATA						VALVE DATA																					
PENETRATION DETAIL	FD NUMBER	GENERAL DESIGN CRITERION	FLUID	HIGH ENERGY LINE	BYPASS LEAKAGE PATH	SYSTEM TITLE	VALVE NUMBER	POWER TRAIN	LENGTH OF PIPE, FT.	VALVE TYPE	ACTUATOR	PRIMARY ACTUATION MODE	SECONDARY ACTUATION MODE	ISOLATION SIGNAL	ACCIDENT SIGNAL	RESPONSE TIME	Valve Position					ENGINEERED SAFETY FEATURE	CONTAINMENT ISOLATION VALVE	TYPE C TEST	NOTE		
																	NORMAL	SHUTDOWN	POST-ACCIDENT	POWER FAILURE	ILRT						
	051	57	W	YES	NO	STEAM GENERATOR 'A' SAMPLE	V89	-	56	GL	M	M	-	-	-	-	-	O	O	O	-	O	NO	NO	NO	1, 19	
							V117	-	54	GL	M	M	-	-	-	-	-	-	O	O	O	-	O	NO	NO		NO
							V90	B	54	GA	AO	A	RM	3, 6, 7*	-	60	C	C	C	C	C	C	NO	NO	NO		
							V91	B	53	GA	AO	A	RM	3, 6, 7*	-	60	O	O	C	C	C	C	NO	NO	NO		
V120	A	1	GL	SO	A	RM	3, 6, 7* *15,16	-	60	O	O	C	C	C	C	NO	YES	NO									
	051	57	W	YES	NO	STEAM GENERATOR 'B' SAMPLE	V84	-	34	GL	M	M	-	-	-	-	-	O	O	O	-	O	NO	NO	NO	1, 19	
							V118	-	34	GL	M	M	-	-	-	-	-	-	O	O	O	-	O	NO	NO		NO
							V85	B	33	GA	AO	A	RM	3, 6, 7*	-	60	C	C	C	C	C	C	NO	NO	NO		
							V86	B	33	GA	AO	A	RM	3, 6, 7*	-	60	O	O	C	C	C	C	NO	NO	NO		
V121	A	1	GL	SO	A	RM	3, 6, 7* *15,16	-	60	O	O	C	C	C	C	NO	YES	NO									
	051	57	W	YES	NO	STEAM GENERATOR 'C' SAMPLE	V79	-	64	GL	M	M	-	-	-	-	-	O	O	O	-	O	NO	NO	NO	1, 19	
							V119	-	64	GL	M	M	-	-	-	-	-	-	O	O	O	-	O	NO	NO		NO
							V80	B	62	GA	AO	A	RM	3, 6, 7*	-	60	C	C	C	C	C	C	NO	NO	NO		
							V81	B	62	GA	AO	A	RM	3, 6, 7*	-	60	O	O	C	C	C	C	NO	NO	NO		
V122	A	1	GL	SO	A	RM	3, 6, 7* *15,16	-	60	O	O	C	C	C	C	NO	YES	NO									

TABLE 6.2.4-1 CONTAINMENT ISOLATION SYSTEM DATA

PENETRATION DATA						VALVE DATA																			
PENETRATION DETAIL	FD NUMBER	GENERAL DESIGN CRITERION	FLUID	HIGH ENERGY LINE	BYPASS LEAKAGE PATH	SYSTEM TITLE	VALVE NUMBER	POWER TRAIN	LENGTH OF PIPE, FT.	VALVE TYPE	ACTUATOR	PRIMARY ACTUATION MODE	SECONDARY ACTUATION MODE	ISOLATION SIGNAL	ACCIDENT SIGNAL	RESPONSE TIME	Valve Position					ENGINEERED SAFETY FEATURE	CONTAINMENT ISOLATION VALVE	TYPE C TEST	NOTE
																	NORMAL	SHUTDOWN	POST-ACCIDENT	POWER FAILURE	ILRT				
	517	56	A	NO	YES	CONTAINMENT ATMOSPHERE PURGE MAKE-UP	B1	A	2	BF	AO	A	RM	8, 10	-	3.5	CY	C	C	C	C	NO	YES	YES	11
							B3	A	3	BF	AO	A	RM	8	-	15	LC	O	LC	LC	LC	NO	YES	YES	
							B4	B	3	BF	AO	A	RM	8	-	15	LC	O	LC	LC	LC	NO	YES	YES	
							B2	B	3	BF	AO	A	RM	8, 10	-	3.5	CY	C	C	C	C	NO	YES	YES	
	517	56	A	NO	YES	CONTAINMENT ATMOSPHERE PURGE EXHAUST	B7	A	3	BF	AO	A	RM	8	-	15	LC	O	LC	LC	LC	NO	YES	YES	11
							B5	A	3	BF	AO	A	RM	8	-	3.5	O	C	C	C	C	NO	YES	YES	
							B8	B	3	BF	AO	A	RM	8	-	15	LC	O	LC	LC	LC	NO	YES	YES	
							B6	B	3	BF	AO	A	RM	8	-	3.5	O	C	C	C	C	NO	YES	YES	
	517	56	A	NO	YES	CONTAINMENT VACUUM RELIEF	V1	-	3	CK	SA	-	-	-	-	-	C	C	C	-	C	NO	YES	YES	
							B2	B	3	BF	AO	A	RM	8	9	5	C	C	C	C	C	NO	YES	YES	
60						SPARE																			
	517	56	A	NO	YES	H ₂ PURGE MAKE-UP	V1	-	1	CK	SA	-	-	-	-	-	C	C	C	-	C	NO	YES	YES	
							B6	-	4	BF	M	M	-	-	-	-	LC	LC	LC	-	LC	NO	YES	YES	

TABLE 6.2.4-1 CONTAINMENT ISOLATION SYSTEM DATA																										
PENETRATION DATA						VALVE DATA																				
PENETRATION DETAIL	FD NUMBER	GENERAL DESIGN CRITERION	FLUID	HIGH ENERGY LINE	BYPASS LEAKAGE PATH	SYSTEM TITLE	VALVE NUMBER	POWER TRAIN	LENGTH OF PIPE, FT.	VALVE TYPE	ACTUATOR	PRIMARY ACTUATION MODE	SECONDARY ACTUATION MODE	ISOLATION SIGNAL	ACCIDENT SIGNAL	RESPONSE TIME	Valve Position					ENGINEERED SAFETY FEATURE	CONTAINMENT ISOLATION VALVE	TYPE C TEST	NOTE	
																	NORMAL	SHUTDOWN	POST-ACCIDENT	POWER FAILURE	ILRT					
	416	56	A	NO	YES	ILRT	V4	-	3	G	M	M	-	-	-	-	-	LC	LC	LC	-	O	NO	YES	YES	5
	517	56	A	NO	YES	H ₂ PURGE EXHAUST	B5	A	2	BF	AO	RM	-	-	-	-	-	LC	LC	LC	LC	LC	NO	YES	YES	5
							B4	-	5	BF	M	M	-	-	-	-	-	-	-	-	-	-	LC	LC	LC	
64						SPARE																				
65						FUEL TRANSFER TUBE	-	-	-	-	-	-	-	-	-	-	-	-	-	-	-	-	-	-	TYPE B TEST	
						REFUELING ACCESS SLEEVE	-	-	-	-	-	-	-	-	-	-	-	-	-	-	-	-	-	TYPE B TEST	OPENABLE DURING OUTAGES FOR ACCESS REF. DWG: 2165-G-065	
67						SPARE																				
68						SPARE																				

TABLE 6.2.4-1 CONTAINMENT ISOLATION SYSTEM DATA																									
PENETRATION DATA						VALVE DATA																			
PENETRATION DETAIL	FD NUMBER	GENERAL DESIGN CRITERION	FLUID	HIGH ENERGY LINE	BYPASS LEAKAGE PATH	SYSTEM TITLE	VALVE NUMBER	POWER TRAIN	LENGTH OF PIPE, FT.	VALVE TYPE	ACTUATOR	PRIMARY ACTUATION MODE	SECONDARY ACTUATION MODE	ISOLATION SIGNAL	ACCIDENT SIGNAL	RESPONSE TIME	Valve Position					ENGINEERED SAFETY FEATURE	CONTAINMENT ISOLATION VALVE	TYPE C TEST	NOTE
																	NORMAL	SHUTDOWN	POST-ACCIDENT	POWER FAILURE	ILRT				
	-	57	CF	NO	NO	CONTAINMENT PRESSURE SENSING RPS-IV	-	-	-	-	-	-	-	-	-	-	-	-	-	-	-	-	-	TYPE A TEST	
	-	57	CF	NO	NO	CONTAINMENT PRESSURE SENSING RPS-II	-	-	-	-	-	-	-	-	-	-	-	-	-	-	-	-	-	TYPE A TEST	
	-	57	CF	NO	NO	CONTAINMENT PRESSURE SENSING RPS-I	-	-	-	-	-	-	-	-	-	-	-	-	-	-	-	-	-	TYPE A TEST	

TABLE 6.2.4-1 CONTAINMENT ISOLATION SYSTEM DATA

PENETRATION DATA						VALVE DATA																				
PENETRATION DETAIL	FD NUMBER	GENERAL DESIGN CRITERION	FLUID	HIGH ENERGY LINE	BYPASS LEAKAGE PATH	SYSTEM TITLE	VALVE NUMBER	POWER TRAIN	LENGTH OF PIPE, FT.	VALVE TYPE	ACTUATOR	PRIMARY ACTUATION MODE	SECONDARY ACTUATION MODE	ISOLATION SIGNAL	ACCIDENT SIGNAL	RESPONSE TIME	Valve Position					ENGINEERED SAFETY FEATURE	CONTAINMENT ISOLATION VALVE	TYPE C TEST	NOTE	
																	NORMAL	SHUTDOWN	POST-ACCIDENT	POWER FAILURE	ILRT					
	-	57	CF	NO	NO	CONTAINMENT PRESSURE SENSING RPS-III	-	-	-	-	-	-	-	-	-	-	-	-	-	-	-	-	-	-	TYPE A TEST	
73 (SEE PAGE NUMBER 19 OF THIS TABLE)																										
	185	56	W	NO	YES	CONTAINMENT SUMP PUMP DISCHARGE	V36	A	1	GA	MO	A	RM	1	-	60	O	O	C	AI	C	NO	YES	YES		
							V77	B	5	GA	MO	A	RM	1	-	60	O	O	C	AI	C	NO	YES	YES		
75						SPARE																				
	809	56	W	YES	YES	ACCUMULATOR FILL FROM RWST	V150	-	3	CK	SA	-	-	-	-	-	C	C	C	-	C	NO	YES	YES	8	
							V554	B	2	GL	AO	A	RM	1	-	10	C	C	C	C	C	NO	YES	YES		
	809	56	W	YES	YES	ACCUMULATOR TO RWST	V555	A	2	GL	AO	A	RM	1	-	10	C	C	C	C	C	NO	YES	YES	9	
							V550	B	1	GL	AO	A	RM	1	-	10	C	C	C	C	C	NO	YES	YES		

TABLE 6.2.4-1 CONTAINMENT ISOLATION SYSTEM DATA																										
PENETRATION DATA						VALVE DATA																				
PENETRATION DETAIL	FD NUMBER	GENERAL DESIGN CRITERION	FLUID	HIGH ENERGY LINE	BYPASS LEAKAGE PATH	SYSTEM TITLE	VALVE NUMBER	POWER TRAIN	LENGTH OF PIPE, FT.	VALVE TYPE	ACTUATOR	PRIMARY ACTUATION MODE	SECONDARY ACTUATION MODE	ISOLATION SIGNAL	ACCIDENT SIGNAL	RESPONSE TIME	Valve Position					ENGINEERED SAFETY FEATURE	CONTAINMENT ISOLATION VALVE	TYPE C TEST	NOTE	
																	NORMAL	SHUTDOWN	POST-ACCIDENT	POWER FAILURE	ILRT					
	809	56	G	YES	YES	NITROGEN TO ACCUMULATORS	V188	-	3	CK	SA	-	-	-	-	-	-	CY	C	C	-	C	NO	YES	YES	10
							V530	B	1	GL	AO	A	RM	1	-	10	CY	C	C	C	C	C	NO	YES	YES	
	801	56	G	NO	YES	PRESSURIZER RELIEF TANK CONNECTION	D528	A	4	DA	AO	A	RM	1	-	10	C	C	C	C	C	NO	YES	YES		
							D529	B	3	DA	AO	A	RM	1	-	10	C	C	C	C	C	NO	YES	YES		
	813	56	G	NO	YES	RCDT H ₂ SUPPLY	D590	A	3	DA	AO	A	RM	1	-	10	O	C	C	C	C	NO	YES	YES		
							D291	B	3	DA	AO	A	RM	1	-	10	O	C	C	C	C	NO	YES	YES		
	052	55	W	YES	YES	REACTOR COOLANT SAMPLE	V111	B	19	GL	SO	A	RM	1	-	60	O	C	C	C	C	NO	YES	YES	19	
							V23	A	3	GL	SO	A	RM	1	-	60	O	C	C	C	C	NO	YES	YES		
	052	55	W	YES	YES	PRESSURIZER LIQUID SAMPLE	V11	B	4	GL	SO	A	RM	1	-	60	C	C	C	C	C	NO	YES	YES		
							V12	A	3	GL	SO	A	RM	1	-	60	C	C	C	C	C	NO	YES	YES		

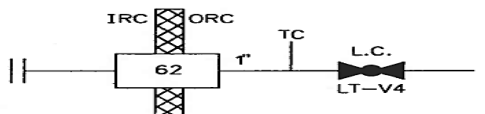
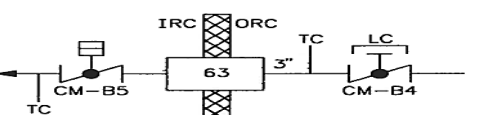
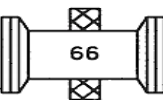
TABLE 6.2.4-1 CONTAINMENT ISOLATION SYSTEM DATA																									
PENETRATION DATA						VALVE DATA																			
PENETRATION DETAIL	FD NUMBER	GENERAL DESIGN CRITERION	FLUID	HIGH ENERGY LINE	BYPASS LEAKAGE PATH	SYSTEM TITLE	VALVE NUMBER	POWER TRAIN	LENGTH OF PIPE, FT.	VALVE TYPE	ACTUATOR	PRIMARY ACTUATION MODE	SECONDARY ACTUATION MODE	ISOLATION SIGNAL	ACCIDENT SIGNAL	RESPONSE TIME	Valve Position					ENGINEERED SAFETY FEATURE	CONTAINMENT ISOLATION VALVE	TYPE C TEST	NOTE
																	NORMAL	SHUTDOWN	POST-ACCIDENT	POWER FAILURE	ILRT				
	052	55	S	YES	YES	PRESSURIZER STEAM SAMPLE	V1	B	2	GL	SO	A	RM	1	-	60	C	C	C	C	C	NO	YES	YES	
							V2	A	3	GL	SO	A	RM	1	-	60	C	C	C	C	C	NO	YES	YES	
	052	55	W	YES	YES	ACCUMULATOR SAMPLE	V113	B	9	GL	SO	A	RM	1	-	60	O	C	C	C	C	NO	YES	YES	
							V114	B	3	GL	SO	A	RM	1	-	60	O	C	C	C	C	NO	YES	YES	
							V115	B	3	GL	SO	A	RM	1	-	60	O	C	C	C	C	NO	YES	YES	
							V116	A	3	GL	SO	A	RM	1	-	60	O	C	C	C	C	NO	YES	YES	
	388	56	W	NO	YES	FIRE WATER STANDPIPE SUPPLY	V48	-	3	CK	SA	-	-	-	-	-	C	O	C	-	C	NO	YES	YES	
							V44	-	1	GA	M	M	-	-	-	-	LC	O	LC	C	LC	NO	YES	YES	
	301	56	A	NO	YES	INSTRUMENT AIR SUPPLY	V33	-	3	CK	SA	-	-	-	-	-	O	O	C	C	C	NO	YES	YES	
							V192	A	2	GL	AO	A	RM	1	-	60	O	O	C	C	C	NO	YES	YES	
81						SPARE																			
82						SPARE																			
83 (SEE PAGE 6.2.4-31C)																									

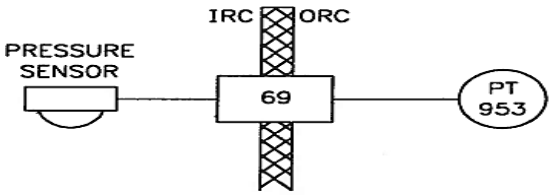
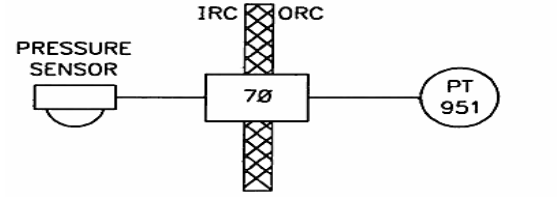
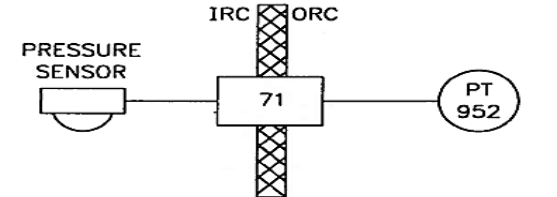
TABLE 6.2.4-1 CONTAINMENT ISOLATION SYSTEM DATA

PENETRATION DATA						VALVE DATA																			
PENETRATION DETAIL	FD NUMBER	GENERAL DESIGN CRITERION	FLUID	HIGH ENERGY LINE	BYPASS LEAKAGE PATH	SYSTEM TITLE	VALVE NUMBER	POWER TRAIN	LENGTH OF PIPE, FT.	VALVE TYPE	ACTUATOR	PRIMARY ACTUATION MODE	SECONDARY ACTUATION MODE	ISOLATION SIGNAL	ACCIDENT SIGNAL	RESPONSE TIME	Valve Position					ENGINEERED SAFETY FEATURE	CONTAINMENT ISOLATION VALVE	TYPE C TEST	NOTE
																	NORMAL	SHUTDOWN	POST-ACCIDENT	POWER FAILURE	ILRT				
84						SPARE																			
85						SPARE																			
86 (SEE PAGE 6.2.4-31B)																									
87						SPARE																			
	052	56	W	NO	YES	LIQUID SAMPLE RETURN FROM POST ACCIDENT SKID #1	V406	B	3	GL	SO	A	RM	1	-	5	C	C	CY	C	C	NO	YES	YES	19
							V407	A	2	GL	SO	A	RM	1	-	5	C	C	CY	C	C	NO	YES	YES	
89						SPARE																			
	299	56	W	NO	YES	DEMIN WATER SUPPLY	V121	-	1	CK	SA	-	-	-	-	-	C	C	C	-	C	NO	YES	YES	5
							V120	-	5	GA	M	M	-	-	-	-	LC	LC	LC	-	LC	NO	YES	YES	
	047	56	W	NO	YES	SERVICE WATER FROM NNS FAN COILS	B89	A	2	BF	AO	A	RM	1	-	60	O	C	C	C	C	NO	YES	YES	11
							B90	B	1	BF	AO	A	RM	1	-	60	O	C	C	C	C	NO	YES	YES	
							R18	-	-	RL	SA	-	-	-	-	-	C	C	C	C	C	NO	YES	YES	

TABLE 6.2.4-1 CONTAINMENT ISOLATION SYSTEM DATA

PENETRATION DATA						VALVE DATA																				
PENETRATION DETAIL	FD NUMBER	GENERAL DESIGN CRITERION	FLUID	HIGH ENERGY LINE	BYPASS LEAKAGE PATH	SYSTEM TITLE	VALVE NUMBER	POWER TRAIN	LENGTH OF PIPE, FT.	VALVE TYPE	ACTUATOR	PRIMARY ACTUATION MODE	SECONDARY ACTUATION MODE	ISOLATION SIGNAL	ACCIDENT SIGNAL	RESPONSE TIME	Valve Position					ENGINEERED SAFETY FEATURE	CONTAINMENT ISOLATION VALVE	TYPE C TEST	NOTE	
																	NORMAL	SHUTDOWN	POST-ACCIDENT	POWER FAILURE	ILRT					
	047	56	W	NO	YES	SERVICE WATER TO NNS FAN COILS	V142	-	2	CK	SA	-	-	-	-	-	-	O	C	C	C	C	NO	YES	YES	
							B88	AB	1	BF	AO	A	RM	1	-	60	O	C	C	C	C	C	NO	YES	YES	
93						SPARE																				
94A AND 94B (SEE PAGE 18 OF THIS TABLE)																										
	B430 31.190	56	A	NO	NO	CONTAINMENT OUTSIDE DIFFERENTIAL PRESSURE SENSING	A	-	-	GL	M	M	-	-	-	-	-	LO	LO	LO	LO	LO	YES	NO	TYPE A TEST	
							B	-	-	XC	SA	SA	-	-	-	-	SA	SA	SA	SA	SA	SA	YES	YES		
95A AND 95B (SEE PAGE 18 OF THIS TABLE)																										
95C						SPARE																				
	416	56	A	NO	YES	ILRT	V1	-	8	G	M	M	-	-	-	-	-	LC	LC	LC	-	O	NO	YES	YES	5
97						SPARE																				
	517	56	A	NO	YES	CONTAINMENT VACUUM RELIEF	V2	-	3	CK	SA	-	-	-	-	-	-	C	C	C	-	C	NO	YES	YES	
							B2	B	3	BF	AO	A	RM	8	9	5	C	C	C	C	C	NO	YES	YES		
99						SPARE																				

TABLE 6.2.4-1 CONTAINMENT ISOLATION SYSTEM DATA

PENETRATION DATA						VALVE DATA																			
PENETRATION DETAIL	FD NUMBER	GENERAL DESIGN CRITERION	FLUID	HIGH ENERGY LINE	BYPASS LEAKAGE PATH	SYSTEM TITLE	VALVE NUMBER	POWER TRAIN	LENGTH OF PIPE, FT.	VALVE TYPE	ACTUATOR	PRIMARY ACTUATION MODE	SECONDARY ACTUATION MODE	ISOLATION SIGNAL	ACCIDENT SIGNAL	RESPONSE TIME	Valve Position					ENGINEERED SAFETY FEATURE	CONTAINMENT ISOLATION VALVE	TYPE C TEST	NOTE
																	NORMAL	SHUTDOWN	POST-ACCIDENT	POWER FAILURE	ILRT				
100						SPARE																			
101						SPARE																			
						REFUELING ACCESS SLEEVE																	TYPE B TEST	OPENABLE DURING OUTAGE FOR ACCESS	
103 (SEE PAGE 20 OF THIS TABLE)																									
104						SPARE																			
	388	56	W	NO	YES	FIRE WATER SPRINKLER SUPPLY	V46	-	2	CK	SA	-	-	-	-	-	0	0	C	-	C	NO	YES	YES	
							B1	A	2	BF	AO	A	RM	1	-	60	0	0	C	C	C	NO	YES	YES	
106																									
107 (SEE PAGE 21 OF THIS TABLE)																									
	044	57	W	YES	NO	AUXILIARY FEEDWATER	V162	-	5	GL	M	M	-	-	-	-	LC	LC	LC	LC	LC	NO	YES	NO	1, 20
							V163	-	5	GL	M	M	-	-	-	-	LC	LC	LC	LC	LC	NO	YES	NO	
							V153	-	155	CK	SA	-	-	-	-	-	0	0	0	-	C	YES	NO	NO	
							V10	B	21	GA	MO	A	RM	14	16	24	0	0	0	AI	C	YES	YES	NO	
							V116	A	22	GA	MO	A	RM	14	16	24	0	0	0	AI	C	YES	YES	NO	
							V189	-	6	GL	M	M	-	-	-	-	LC	0	LC	LC	LC	LC	NO	YES	

TABLE 6.2.4-1 CONTAINMENT ISOLATION SYSTEM DATA

PENETRATION DATA						VALVE DATA																							
PENETRATION DETAIL	FD NUMBER	GENERAL DESIGN CRITERION	FLUID	HIGH ENERGY LINE	BYPASS LEAKAGE PATH	SYSTEM TITLE	VALVE NUMBER	POWER TRAIN	LENGTH OF PIPE, FT.	VALVE TYPE	ACTUATOR	PRIMARY ACTUATION MODE	SECONDARY ACTUATION MODE	ISOLATION SIGNAL	ACCIDENT SIGNAL	RESPONSE TIME	Valve Position					ENGINEERED SAFETY FEATURE	CONTAINMENT ISOLATION VALVE	TYPE C TEST	NOTE				
																	NORMAL	SHUTDOWN	POST-ACCIDENT	POWER FAILURE	ILRT								
	044	57	W	YES	NO	AUXILIARY FEEDWATER	V164	-	5	GL	M	M	-	-	-	-	-	LC	LC	LC	LC	LC	NO	YES	NO	1, 20			
							V165	-	5	GL	M	M	-	-	-	-	-	-	LC	LC	LC	LC	LC	LC	LC		NO	YES	NO
							V154	-	70	CK	SA	-	-	-	-	-	-	-	O	O	O	-	C	YES	NO		NO	NO	NO
							V19	B	21	GA	MO	A	RM	14	16	24	O	O	O	AI	C	YES	YES	NO	NO		NO		
							V117	A	22	GA	MO	A	RM	14	16	24	O	O	O	AI	C	YES	YES	NO	NO		NO		
							V190	-	6	GL	M	M	-	-	-	-	-	-	-	LC	O	LC	LC	LC	LC		LC	NO	YES
	044	57	W	YES	NO	AUXILIARY FEEDWATER	V166	-	5	GL	M	M	-	-	-	-	-	LC	LC	LC	LC	LC	NO	YES	NO	1, 20			
							V167	-	5	GL	M	M	-	-	-	-	-	-	LC	LC	LC	LC	LC	LC	LC		NO	YES	NO
							V155	-	155	CK	SA	-	-	-	-	-	-	-	O	O	O	-	C	YES	NO		NO	NO	
							V23	B	21	GA	MO	A	RM	14	16	24	O	O	O	AI	C	YES	YES	NO	NO		NO		
							V118	A	22	GA	MO	A	RM	14	16	24	O	O	O	AI	C	YES	YES	NO	NO		NO		
							V191	-	6	GL	M	M	-	-	-	-	-	-	-	LC	O	LC	LC	LC	LC		LC	NO	YES

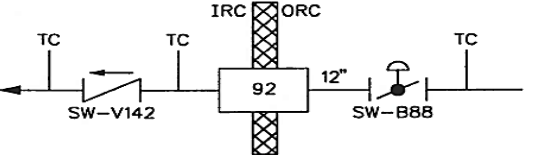
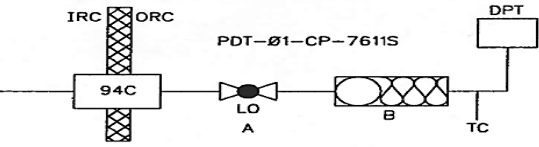
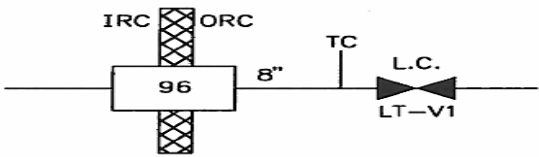
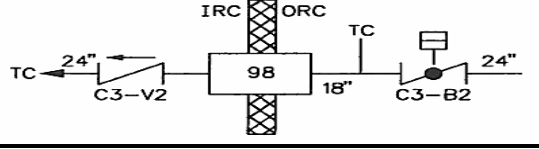
TABLE 6.2.4-1 CONTAINMENT ISOLATION SYSTEM DATA

PENETRATION DATA						VALVE DATA																				
PENETRATION DETAIL	FD NUMBER	GENERAL DESIGN CRITERION	FLUID	HIGH ENERGY LINE	BYPASS LEAKAGE PATH	SYSTEM TITLE	VALVE NUMBER	POWER TRAIN	LENGTH OF PIPE, FT.	VALVE TYPE	ACTUATOR	PRIMARY ACTUATION MODE	SECONDARY ACTUATION MODE	ISOLATION SIGNAL	ACCIDENT SIGNAL	RESPONSE TIME	Valve Position					ENGINEERED SAFETY FEATURE	CONTAINMENT ISOLATION VALVE	TYPE C TEST	NOTE	
																	NORMAL	SHUTDOWN	POST-ACCIDENT	POWER FAILURE	ILRT					
	B430 31.18	56	A	NO	NO	CONTAINMENT VACUUM RELIEF - SENSING B	A	-	5	GL	M	M	-	-	-	-	-	LO	LO	LO	LO	LO	YES	NO	TYPE A TEST	
							B	-	-	XC	SA	SA	-	-	-	-	SA	SA	SA	SA	SA	SA	SA	SA		
	B430 31.18	56	A	NO	NO	CONTAINMENT VACUUM RELIEF - SENSING B	A	-	5	GL	M	M	-	-	-	-	-	LO	LO	LO	LO	LO	YES	NO	TYPE A TEST	
							B	-	-	XC	SA	SA	-	-	-	-	SA	SA	SA	SA	SA	SA	SA	SA		
	B430 31.17	56	A	NO	NO	CONTAINMENT VACUUM RELIEF - SENSING A	A	-	5	GL	M	M	-	-	-	-	-	LO	LO	LO	LO	LO	YES	NO	TYPE A TEST	
							B	-	-	XC	SA	SA	-	-	-	-	SA	SA	SA	SA	SA	SA	SA	SA		

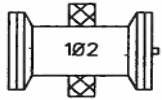
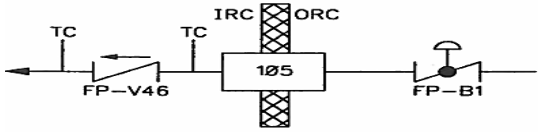
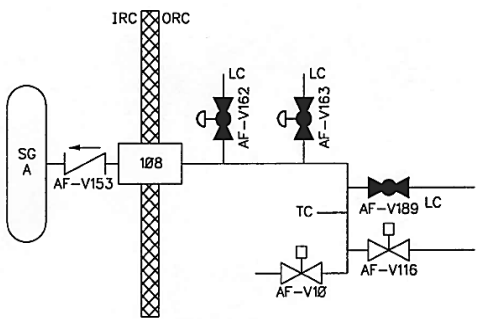
TABLE 6.2.4-1 CONTAINMENT ISOLATION SYSTEM DATA

PENETRATION DATA						VALVE DATA																			
PENETRATION DETAIL	FD NUMBER	GENERAL DESIGN CRITERION	FLUID	HIGH ENERGY LINE	BYPASS LEAKAGE PATH	SYSTEM TITLE	VALVE NUMBER	POWER TRAIN	LENGTH OF PIPE, FT.	VALVE TYPE	ACTUATOR	PRIMARY ACTUATION MODE	SECONDARY ACTUATION MODE	ISOLATION SIGNAL	ACCIDENT SIGNAL	RESPONSE TIME	Valve Position					ENGINEERED SAFETY FEATURE	CONTAINMENT ISOLATION VALVE	TYPE C TEST	NOTE
																	NORMAL	SHUTDOWN	POST-ACCIDENT	POWER FAILURE	ILRT				
	B430 31.17	56	A	NO	NO	CONTAINMENT VACUUM RELIEF - SENSING B	A	-	5	GL	M	M	-	-	-	-	LO	LO	LO	LO	LO	YES	NO	TYPE A TEST	
							B	-	-	XC	SA	SA	-	-	-	-	SA	SA	SA	SA	SA	SA	YES		
	105	56	A	NO		HYDROGEN ANALYZER	V300	A	2	GL	SO	A	RM	1	-	60	O	C	C	C	C	YES	YES	YES	19
							V348	A	1	GL	SO	A	RM	1	-	60	O	C	C	C	C	YES	YES	YES	
	105	56	A	NO		HYDROGEN ANALYZER	V301	A	2	GL	SO	A	RM	1	-	60	O	C	C	C	C	YES	YES	YES	19
							V349	A	1	GL	SO	A	RM	1	-	60	O	C	C	C	C	YES	YES	YES	

TABLE 6.2.4-1 CONTAINMENT ISOLATION SYSTEM DATA

PENETRATION DATA						VALVE DATA																						
PENETRATION DETAIL	FD NUMBER	GENERAL DESIGN CRITERION	FLUID	HIGH ENERGY LINE	BYPASS LEAKAGE PATH	SYSTEM TITLE	VALVE NUMBER	POWER TRAIN	LENGTH OF PIPE, FT.	VALVE TYPE	ACTUATOR	PRIMARY ACTUATION MODE	SECONDARY ACTUATION MODE	ISOLATION SIGNAL	ACCIDENT SIGNAL	RESPONSE TIME	Valve Position					ENGINEERED SAFETY FEATURE	CONTAINMENT ISOLATION VALVE	TYPE C TEST	NOTE			
																	NORMAL	SHUTDOWN	POST-ACCIDENT	POWER FAILURE	ILRT							
	105	56	A	NO		HYDROGEN ANALYZER	V308	B	1	GL	SO	A	RM	1	-	60	C	C	C	C	C	YES	YES	YES	19			
							V314	B	1	GL	SO	A	RM	1	-	60	C	C	C	C	C	YES	YES	YES				
	105	56	A	NO		HYDROGEN ANALYZER	V309	B	2	GL	SO	A	RM	1	-	60	C	C	C	C	C	YES	YES	YES	19			
							V315	B	1	GL	SO	A	RM	1	-	60	C	C	C	C	C	YES	YES	YES				
	844	54, 55	W	YES	NO	RVLIS	-	B	-	-	-	-	-	-	-	-	-	-	-	-	-	-	-	-	NO	NO	TYPE A TEST	FILL VALVE IS SEALED AFTER USE 16

TABLE 6.2.4-1 CONTAINMENT ISOLATION SYSTEM DATA

PENETRATION DATA						VALVE DATA																			
PENETRATION DETAIL	FD NUMBER	GENERAL DESIGN CRITERION	FLUID	HIGH ENERGY LINE	BYPASS LEAKAGE PATH	SYSTEM TITLE	VALVE NUMBER	POWER TRAIN	LENGTH OF PIPE, FT.	VALVE TYPE	ACTUATOR	PRIMARY ACTUATION MODE	SECONDARY ACTUATION MODE	ISOLATION SIGNAL	ACCIDENT SIGNAL	RESPONSE TIME	Valve Position					ENGINEERED SAFETY FEATURE	CONTAINMENT ISOLATION VALVE	TYPE C TEST	NOTE
																	NORMAL	SHUTDOWN	POST-ACCIDENT	POWER FAILURE	ILRT				
	844	54, 55	W	YES	NO	RVLIS	-	B	-	-	-	-	-	-	-	-	-	-	-	-	-	NO	NO	TYPE A TEST	FILL VALVE IS SEALED AFTER USE 16
	844	54, 55	W	YES	NO	RVLIS	-	B	-	-	-	-	-	-	-	-	-	-	-	-	-	NO	NO	TYPE A TEST	FILL VALVE IS SEALED AFTER USE 16
	105	56	A	NO		RCPB LEAK DETECTION RADIATION MONITOR	V-448	A		GL	SO	A	RM	1	-	60	O	O	C	C	C	NO	YES	YES	
							V-449	B		GL	SO	A	RM	1	-	60	O	O	C	C	C	NO	YES	YES	
							V-550	A		GL	SO	A	RM	1	-	60	O	O	C	C	C	NO	YES	YES	
							V-451	B		GL	SO	A	RM	1	-	60	O	O	C	C	C	NO	YES	YES	

TABLE 6.2.4-1 CONTAINMENT ISOLATION SYSTEM DATA

PENETRATION DATA						VALVE DATA																			
PENETRATION DETAIL	FD NUMBER	GENERAL DESIGN CRITERION	FLUID	HIGH ENERGY LINE	BYPASS LEAKAGE PATH	SYSTEM TITLE	VALVE NUMBER	POWER TRAIN	LENGTH OF PIPE, FT.	VALVE TYPE	ACTUATOR	PRIMARY ACTUATION MODE	SECONDARY ACTUATION MODE	ISOLATION SIGNAL	ACCIDENT SIGNAL	RESPONSE TIME	Valve Position					ENGINEERED SAFETY FEATURE	CONTAINMENT ISOLATION VALVE	TYPE C TEST	NOTE
																	NORMAL	SHUTDOWN	POST-ACCIDENT	POWER FAILURE	ILRT				
	844	54, 55	W	YES	NO	RVLIS	-	A	-	-	-	-	-	-	-	-	-	-	-	-	-	NO	NO	TYPE A TEST	FILL VALVE IS SEALED AFTER USE 16
	844	54, 55	W	YES	NO	RVLIS	-	A	-	-	-	-	-	-	-	-	-	-	-	-	-	NO	NO	TYPE A TEST	FILL VALVE IS SEALED AFTER USE 16
	844	54, 55	W	YES	NO	RVLIS	-	A	-	-	-	-	-	-	-	-	-	-	-	-	-	NO	NO	TYPE A TEST	FILL VALVE IS SEALED AFTER USE 16

TABLE 6.2.4-2 CONTAINMENT ISOLATION VALVE POSITION FOLLOWING AN ACCIDENT

Penetration No.	Penetration Name	Essential or Non Essential	Valve Position
M1	MS-SG A	E	CLOSED
M2	MS-SG B	E	CLOSED
M3	MS-SG C	E	CLOSED
M4	FEEDWATER SG A	NE	CLOSED
M5	FEEDWATER SG B	NE	CLOSED
M6	FEEDWATER SG C	NE	CLOSED
M7	NORMAL LETDOWN	NE	CLOSED
M8	CVCS NORMAL CHARGING	NE	CLOSED
M9	SEAL INJECTION RC PUMP A	E	OPENED
M10	SEAL INJECTION RC PUMP B	E	OPENED
M11	SEAL INJECTION RC PUMP C	E	OPENED
M12	RC PUMP SEAL INJECTION AND EXCESS LETDOWN EXCH OUTLET	NE	CLOSED
M13	LOW HEAD SI TO COLD LEG	E	OPENED
M14	LOW HEAD SI TO COLD LEG	E	OPENED
M15	RHR LOOP 1 (NORMAL OPERATION MODE)	NE	CLOSED
M16	RHR LOOP 2 (NORMAL OPERATION MODE)	E	CLOSED
M17	HIGH HEAD SI TO COLD LEG	E	OPENED
M18	LOW HEAD SI TO HOT LEG	E	CLOSED(5)
M19	SPARE	E	N/A
M20	HIGH HEAD SI TO HOT LEG	E	CLOSED(5)
M21	HIGH HEAD SI TO HOT LEG	E	CLOSED(5)
M22	HIGH HEAD SI TO COLD LEG	E	CLOSED(5)
M23	CONTAINMENT SPRAY	E	OPENED**
M24	CONTAINMENT SPRAY	E	OPENED**
M25	CONTAINMENT FAN COOLER AH3-SW IN	E	OPENED
M26	CONTAINMENT FAN COOLER AH2-SW IN	E	OPENED
M27	CONTAINMENT FAN COOLER AH1-SW IN	E	OPENED
M28	CONTAINMENT FAN COOLER AH4-SW IN	E	OPENED
M29	CONTAINMENT FAN COOLER AH3-SW OUT	E	OPENED
M30	CONTAINMENT FAN COOLER AH2-SW OUT	E	OPENED
M31	CONTAINMENT FAN COOLER AH1-SW OUT	E	OPENED
M32	CONTAINMENT FAN COOLER AH4-SW OUT	E	OPENED
M33	POST ACCIDENT GAS SAMPLE RETURN	NE	CLOSED ⁽³⁾
M34	ILRT ROTOMETER	NE	CLOSED
M35	COMPONENT COOLING WATER - RC PUMP	NE	CLOSED
M36	COMPONENT COOLING WATER - RC PUMP	NE	CLOSED

TABLE 6.2.4-2 CONTAINMENT ISOLATION VALVE POSITION FOLLOWING AN ACCIDENT

Penetration No.	Penetration Name	Essential or Non Essential	Valve Position
M37	COMP COOLING WATER EXC LETDN & RCDT	NE	CLOSED
M38	COMP COOLING WATER - EXC LETDN & RCDT	NE	CLOSED
M39	COMP COOLING WATER - RC PUMP THERM BARR	NE	CLOSED
M40	MAKEUP WATER TO PRESSURIZER	NE	CLOSED
M41	SERVICE AIR SUPPLY	NE	CLOSED
M42	RCDT PUMP DISCHARGE	NE	CLOSED
M43	SPARE		N/A
M44	S F PURIFICATION PUMP TO REFUELING CAVITY	NE	CLOSED
M45	REFUELING CAVITY WATER CLEANUP- OUT	NE	CLOSED
M46	SPARE		N/A
M47	SUMP RECIRC (RHR A)	E	OPENED ⁽⁴⁾
M48	SUMP RECIRC (RHR B)	E	OPENED ⁽⁴⁾
M49	SUMP RECIRC (CONT SPRAY A)	E	OPENED ⁽⁴⁾
M50	SUMP RECIRC (CONT SPRAY B)	E	OPENED ⁽⁴⁾
M51	SG A BLOWDOWN	NE	CLOSED
M52	SG B BLOWDOWN	NE	CLOSED
M53	SG C BLOWDOWN	NE	CLOSED
M54	SG A BLOWDOWN SAMPLE	NE	CLOSED
M55	SG B BLOWDOWN SAMPLE	NE	CLOSED
M56	SG C BLOWDOWN SAMPLE	NE	CLOSED
M57	CONTAINMENT PURGE MAKEUP	NE	CLOSED
M58	CONTAINMENT PURGE EXHAUST	NE	CLOSED
M59	VACUUM RELIEF A	NE	CLOSED
M60	SPARE		N/A
M61	H ₂ PURGE MAKE-UP	NE	CLOSED
M62	CONTMT LEAK RATE TEST PRESS INDIC.	NE	CLOSED
M63	H ₂ PURGE EXHAUST	NE	CLOSED
M64	SPARE		N/A
M65	FUEL TRANSFER TUBE	NE	CLOSED
M66	REFUELING ACCESS SLEEVE		N/A
M67-M68	SPARE		N/A
M69	CONTAINMENT PRESSURE SENSING A	E	N/A
M70	CONTAINMENT PRESSURE SENSING B	E	N/A
M71	CONTAINMENT PRESSURE SENSING C	E	N/A
M72	CONTAINMENT PRESSURE SENSING D	E	N/A
M73A	CONTAINMENT HYDROGEN ANALYZER	NE	CLOSED*
M73B	CONTAINMENT HYDROGEN ANALYZER	NE	CLOSED*
M74	CONTAINMENT SUMP PUMP DISCHARGE	NE	CLOSED
M75	SPARE		N/A
M76A	ACCUMULATOR FILL	NE	CLOSED
M76B	ACCUMULATOR TO RWST	NE	CLOSED
M77A	N ₂ TO ACCUMULATOR	NE	CLOSED
M77B	PRT N ₂ & CDT CONNECTION	NE	CLOSED
M77C	RCDT H ₂ SUPPLY & GAS SAMPLE	NE	CLOSED

TABLE 6.2.4-2 CONTAINMENT ISOLATION VALVE POSITION FOLLOWING AN ACCIDENT

Penetration No.	Penetration Name	Essential or Non Essential	Valve Position
M78A	RC LOOP 2 & 3 SAMPLE	NE	CLOSED ⁽³⁾
M78B	PRESS. LIQUID SAMPLE	NE	CLOSED
M78C	PRESS. STEAM SAMPLE	NE	CLOSED
M78D	ACCUMULATOR SAMPLE	NE	CLOSED
M79	FIRE PROTECTION-STANDPIPE SUPPLY	NE	CLOSED
M80	INSTR AIR SUPPLY	NE	CLOSED
M81-M85	SPARES	NE	N/A
M86A	CONTAINMENT HYDROGEN ANALYZER	NE	CLOSED*
M86B	CONTAINMENT HYDROGEN ANALYZER	NE	CLOSED*
M87	SPARE		N/A
M88	POST ACCIDENT LIQUID SAMPLE RETURN	NE	CLOSED ⁽³⁾
M89	SPARE		N/A
M90	DEMIN. WATER TO FUEL TRANSFER SYSTEM CONTR PANEL & REFUELING CAVITY DECON	NE	CLOSED
M91	CONTAINMENT FAN COIL UNITS SW - OUT	NE	CLOSED
M92	CONTAINMENT FAN COIL UNITS SW - IN	NE	CLOSED
M93	SPARE		N/A
M94A,B	CONTAINMENT VACUUM RELIEF SENSING LINES	E	OPEN
M95A,B	CONTAINMENT VACUUM RELIEF SENSING LINES	E	OPEN
M94C	CONTAINMENT OUTSIDE DIFFERENTIAL PRESSURE SENSING	E	OPEN
M95C	SPARE		N/A
M96	CONTAINMENT LEAK RATE TEST SUPPLY & EXHAUST	NE	CLOSED
M97	SPARE		N/A
M98	VACUUM RELIEF B	NE	CLOSED
M99-M101	SPARES		N/A
M103A	RVLIS	E	N/A
M103B	RVLIS	E	N/A
M103C	RVLIS	E	N/A
M104	SPARE		N/A
M105	FIRE PROTECTION SPRINKLER SYS HDR	NE	CLOSED
M106	SPARE		N/A
M107A	RVLIS	E	N/A
M107B	RVLIS	E	N/A
M107C	RVLIS	E	N/A
M108	AUX FEEDWATER TO SG A	E	OPENED+
M109	AUX FEEDWATER TO SG B	E	OPENED+
M110	AUX FEEDWATER TO SG C	E	OPENED+
M102	REFUELING ACCESS SLEEVE		N/A

* ISOLATION VALVE CLOSED ON PHASE A CONTAINMENT ISOLATION SIGNAL. REOPEN MANUALLY FOR POST ACCIDENT H₂ SAMPLING.

** NORMALLY CLOSED. OPEN ON CONTAINMENT SPRAY ACTUATION SIGNAL.

*** A "P" SIGNAL IS DEFINED AS A CONTAINMENT PHASE B SIGNAL.

TABLE 6.2.4-2 (Continued)

- + WILL BE CLOSED TO ISOLATE FAULTED STEAM GENERATOR (ie., LOSS OF SG PRESSURE BOUNDARY)
- 1) ESSENTIAL: LINES REQUIRED TO MITIGATE AN ACCIDENT, OR WHICH, IF UNAVAILABLE COULD INCREASE THE MAGNITUDE OF THE EVENT.
- 2) NON-ESSENTIAL: LINES WHICH ARE NOT REQUIRED TO MITIGATE AN ACCIDENT, AND WHICH IF REQUIRED AT ALL WOULD BE REQUIRED FOR LONG TERM RECOVERY ONLY; i.e., DAYS OR WEEKS FOLLOWING AN ACCIDENT.
- 3) VALVES ARE OPENED INTERMITTENTLY FOR POST-ACCIDENT SAMPLING.
- 4) INITIALLY CLOSED, OPEN ON LOW WATER LEVEL IN RWST.
- 5) OPENED BY OPERATOR ACTION FOR LONG-TERM COOLING.

TABLE 6.2.5-1 - Deleted by Amendment 62

TABLE 6.2.5-2

CONTAINMENT HYDROGEN PURGE SYSTEM COMPONENTS
NON NUCLEAR SAFETY UNITS

1.	Exhaust Fans Quantity Type Material Actual air flow inlet, per fan, cfm Static pressure, in wg Code	1 (one) Centrifugal type, direct-driven ASTM-A36, carbon steel 500 nominal 16.64 Air Moving and Conditioning Association Inc. (AMCA). Anti-Friction Bearing Manufacturer's Association (AFBMA)
2.	Motors Quantity Type Insulation Enclosure & Ventilation Code	One 5 hp, 460 volt, 60 Hz 3 phase horizontal induction type Class H, Type RH Dripproof/Guarded NEMA
3.	Medium Efficiency Filter Quantity Air Flow, cfm Face Velocity, fpm Material	One bank per filter train 500 125 Glass Fiber
4.	HEPA Filters Quantity Air Flow, cfm (total) Cell (Unit) Size Cell Arrangement (Units) Max. Resistance Clean, in wg Max. Resistance Loaded, in wg Efficiency Material	(2) Two banks per train 500 24 in. high, 24 in. wide, ≈ 11 1/2 in. deep 1 Unit 1.0 2.0 99.97 percent when tested with 0.3 micron DOP Glass or glass asbestos paper separated by aluminum inserts supported on cadmium plated steel frame
5.	Charcoal Adsorbers Quantity Air Flow, cfm (total) Bed depth, inches Max. Air Resistance, in wg Efficiency	One bank per filter train 500 nominal 2 inch total 1.1 <u>New activated carbon</u> 99.5 percent of elemental iodine when tested at 25°C and 95 percent relative humidity. 95.0 percent of methyl iodide when tested at 25°C and 95 percent relative humidity <u>Lab test for representative samples of used carbon</u> <u>(18 month test requirement)</u> 90.0 percent of methyl iodide when tested at 25°C and 70 percent relative humidity

	Loading Capacity	2.5 mg of iodine per gram of charcoal elemental and organic
5.	Charcoal Adsorbers (Cont'd)	
	Material	Adsorber, activated coconut shell charcoal enclosure, stainless steel Type 316 ASTM gaskets, Neoprene ASTM D1056, ASTM D1056, Grade SCE-43 frame, Steel ASTM-A36
	Type	Deep bed
6.	Demisters	
	Quantity, per fan	1 bank
	Air Flow, cfm per bank	500
	Max. air resistance, clean, in. wg	1.0
	Max. air resistance, loaded in. wg	2.0
	Efficiency	99 percent when exposed to entrained water particles of 1 to 5 micron size
7.	Electric Heating Coil	
	Quantity per fan	1 bank
	Capacity	5 kW
	Code	Underwriter Laboratory (UL) National Electrical Manufacturing Association (NEMA)

TABLE 6.2.5-3

PARAMETERS FOR ANALYSIS OF HYDROGEN GENERATION AND CONTROL

Hydrogen Dissolved in Reactor Coolant	934 scf
Release Rate for Dissolved Hydrogen	Instantaneous
Amount of Zircaloy in core	37,483 lbs
Fraction of Zirconium Assumed to Oxidize for Purposes of Hydrogen Generation Analysis	5%
Release Rate from Zirconium-Water Reaction	Instantaneous
Fission Product Distribution Model	50% of the halogens and 1% of the solids present in the core are mixed with the coolant water All noble gases are released to the Containment 99% of other fission products remain in fuel rods
Fraction Fission Product Radiation Energy Absorbed by the Coolant	(a) Beta Percent of beta energy absorbed by coolant: 0% (b) Gamma Percent of gamma energy absorbed by coolant: 10%
Hydrogen Yield Rate G (H ₂)	0.5 molecule per 100 ev
Oxygen Yield Rate G(O ₂)	0.25 molecule per 100 ev
Reactor Thermal Power, mwt	2958
Inventory of Corrodible Metal	Table 6.2.5-4
Assumed Hydrogen Generation Rate Due to Aluminum Corrosion	Figure 6.2.5-3
Assumed Hydrogen Generation Rate Due To Zinc Corrosion	Figure 6.2.5-4
Containment Net Free Volume, ft. ³	2.266 x 10 ⁶
Initial Bulk Average Containment Temperature, F	135°
Initial Containment Pressure, psia	16.3

TABLE 6.2.5-3a

POST-LOCA CONTAINMENT TEMPERATURES

Time Interval, sec	Temperature (°F)
0 - 5	232
5 - 10	254
10 - 175	265
175 - 3,600	260
3,600 - 6,000	247
6,000 - 10,000	231
10,000 - 18,000	215
18,000 - 50,000	194
50,000 - 100,000	177
100,000 - 500,000	165
500,000 - 1,000,000	152
1,000,000 - 10,000,000	136

TABLE 6.2.5-4

ALUMINUM INVENTORY IN CONTAINMENT

Item	Surface Area* (ft. ²)	Mass (lbm)
1. Flux Mapping Drive System	82.5	171
2. Source, Intermediate and Power Range Detectors	91.3	244
3. Control Rod Drive Mechanism Connection	71.5	191
4. Rod Position Indicators	86.9	139
5. Miscellaneous Valves	94.6	230
6. Contingency	82.5**	200**
7. Containment building circular bridge crane	41.0	71.5
8. Jib Crane - Removed	0	0
9. Hoist	28.6	50
10. Elevator	28.6	10
11. Manual Pull Stations	0.5	8.1
12. Fire Detectors	4.8	1.7
13. Additional Inventory	29.8	63.5

*10% of uncertainty is included.

**Original design value. Available contingency is tracked administratively.

TABLE 6.2.5-5

GALVANIZED ZINC INVENTORY IN CONTAINMENT**

Group*	Surface Area (ft. ²)	Thickness (Mils)
A. Ductwork Conduits, Cable Trays, Pull Boxes and Junction Boxes		
1 ⁽¹⁾	41188.4	1.5
2 ⁽²⁾	23610.7	1.5
3 ⁽²⁾	10092.4	4
4 ⁽²⁾	4457.4	2
5 ⁽²⁾	118.5	5
B. Grating and Stair Treads ⁽³⁾	56668.5	1.7
C. Inorganic Zinc on the surface of neutron streaming shield ⁽¹⁾	127.6	5.0
D. Zinc on the surface of damper actuators ⁽¹⁾	55.	5.0
E. Tube track in RCB ⁽¹⁾	11458.4	5.0
F. Additional Inventory	1,754.5	

Notes:

(*) Groups were determined by thickness and uncertainty

(1) Includes 10% uncertainty

(2) Includes 15% uncertainty

(3) Includes 5% uncertainty

(**) Additional zinc inventory may be evaluated and tracked as an equivalent amount of aluminum. (See Table 6.2.5-4)

TABLE 6.2.5-6

ZINC-BASE PAINT INVENTORY IN CONTAINMENT

Item	Surface Area (ft. ²)
1. Reactor Coolant Drain Tank Pumps ⁽²⁾	10.46
2. Reactor Coolant Drain Tank Heat Exchanger	56.79
3. Integrated Head	1083.85
4. Regenerate Heat Exchanger	127.16
6. Fuel Transfer System Control Panel	57.58
7. Steam Generator Upper Section	Note 1
8. Steam Generator Lower Section	Note 1
9. Pressurizer	1138.04
10. Reactor Vessel	2217.73
11. Other NSSS Equipment	7739.0
TOTAL	12727.49
TOTAL with 20% uncertainty:	15273.0

Note 1 - No coating applied to Delta-75 Steam Generators. Containment Hydrogen analysis based on previous coating area of 7988.67ft² for Steam Generators and a TOTAL (with 20% uncertainty) of 24859.39

TABLE 6.2.5-7
FAILURE MODE AND EFFECTS ANALYSIS
HYDROGEN MONITORING SYSTEM

Component	Failure Mode	Effects on System	Method of Detection	Monitor	Comments
Sample line	Break or Plug	Loss of sample flow	Low flow alarm	MCRI*	Redundant hydrogen analyzer available
Sample pump	Fails	Loss of sample	Low flow alarm	MCRI	Redundant hydrogen analyzer available
Vacuum pump sample dilution panel	Fails	No backup grab sample available	Operator can distinguish from sample pump	--	Use redundant analyzer for a backup sample
Recorder	Hydrogen concentration indicated higher or lower than actual	Anomalous	compared to the result of the grab sample	MCRI	Redundant hydrogen analyzer available
Power supply	Failure or loss of power	No power to analyzer; Sample and isolation valves fail close	No sample flow Low flow alarm	MCRI	Redundant analyzer powered from redundant power bus

* Main Control Room Indication

TABLE 6.3.1-1 EMERGENCY CORE COOLING SYSTEM FAILURE MODES AND EFFECTS ANALYSIS

Component	Failure Mode	Function*	Effect on System*	Failure Detection Method**	Remarks*
1. Motor operated gate valve 1-LCV-115C (1-LCV-115E analogous)	Fails to close on demand.	Provides isolation of fluid discharge from the VCT to the suction of HHSI/CHG pumps.	Failure reduces redundancy of providing tank discharge isolation. Negligible effect on system operation. Alternate isolation valve I-LCV-115E (1-LCV-115C) provides backup tank discharge isolation.	Valve open/close position indication on Valve close position monitor light and alarm for group monitoring of components at MCB.	Valve is electrically interlocked with isolation valve 1-LCV-115B (I-LCV-115D) and the instrumentation that monitors fluid level of the VCT. Valve closes upon receipt of an SIAS or upon receipt of a VCT "low" water level signal providing that isolation valve 1-LCV-115B (I-LCV-115D) is at full open position.
2. Motor operated gate valve 1-LCV-115B (1-LCV-115D analogous)	Fails to Open on demand.	Provides isolation of fluid discharge from the RWST to the suction of HHSI/CHG pumps and an electrical interlock to the closing of isolation valve 1-LCV-115C (I-LCV-115E).	Failure reduces redundancy of providing fluid flow from RWST to suction of HHSI/CHG pumps. Negligible effect on system operation. Alternate isolation valve I/LCV-115D (1-LCV-115B) opens to provide backup flow path to suction of HHSI/CHG pumps. During the recirculation phase, activation of pull-to-lock switches will maintain RWST isolation valves in the shut position.	Same methods of detection as that stated for item #1 except open position monitoring of components at MCB.	Valve is electrically interlocked with the instrumentation that monitors fluid level of the VCT. Valve opens upon receipt of an SIAS or upon receipt of a VCT "low" water level signal . (Except when the control switches are in the pull-to-lock position)

TABLE 6.3.1-1 EMERGENCY CORE COOLING SYSTEM FAILURE MODES AND EFFECTS ANALYSIS

Component	Failure Mode	Function*	Effect on System*	Failure Detection Method**	Remarks*
3. Centrifugal charging pump 1 (pump 2 analogous)	Fails to deliver working fluid	Provides fluid flow of emergency coolant through the BIT to the RCS at the prevailing incident RCS pressure.	Failure reduces redundancy of providing emergency coolant to the RCS at high RCS pressures. Fluid flow from HHSI/CHG pump 1 (pump 2) will be lost. Minimum flow requirements for HHSI will be met by HHSI/CHG pump #2 (pump 1).	HHSI/CHG pump discharge header pressure and flow indication at MCB. Open/close pump switch-gear circuit breaker indication on MCB. Circuit breaker close position monitor light for group monitoring of component at MCB. Common breaker trip alarm at MCB.	<p>One HHSI/CHG pump is used for normal charging of RCS during plant operation.</p> <p>Charging pump 3 is lined up to SSPS train "A" when replacing pump 1 or on SSPS train "B" when replacing pump 2. Replacement requires operator action for the line up of pump and line up of isolation valves.</p> <p>Technical specifications limiting conditions of operation requires inoperable ECCS subsystem to be restored to an OPERABLE status within 72 hours or be in HOT SHUTDOWN within the next 12 hours. Analysis of HHSI/CHG pump 3 being on line is analogous to that presented for HHSI/CHG pumps 1 and 2.</p>
4. Motor operated gate valve 1-8106	Fails to close on demand.	Provides isolation of fluid flow from the HHSI/CHG pump discharge header to the seal water heat exchanger via minimum flow bypass line.	Failure reduces redundancy of providing isolation of HHSI/CHG pump miniflow line. Negligible effect on system operation. Alternate isolation valves I- 8109A and 1-8109B in HHSI/CHG pump discharge lines provides backup miniflow line isolation.	Same as item #1	

TABLE 6.3.1-1 EMERGENCY CORE COOLING SYSTEM FAILURE MODES AND EFFECTS ANALYSIS

Component	Failure Mode	Function*	Effect on System*	Failure Detection Method**	Remarks*
5. Motor operated globe valve 1-8109A (1-8109B analogous)	Fails to close on demand.	Provides isolation of fluid flow from HHSI/CHG pump 1 (pump 2) to the seal water heat exchanger via minimum flow bypass line.	Failure reduces redundancy of providing isolation of HHSI/CHG pump miniflow line. Negligible effect on system operation. Alternate isolation valve 1-8106 provides backup miniflow line isolation.	Same as item #1.	Valve 1-8109C provides isolation to miniflow line if HHSI/CHG pump 3 is on line. Analysis for this valve being in service is analogous to that presented for valves 1-8109A and 1-8109B.
6. Motor operated gate valve 1-8107 (1-8108 analogous)	Fails to close on demand.	Provides isolation of fluid flow from the HHSI/CHG pump discharge header to the CVCS normal charging line to the RCS.	Failure reduces redundancy of providing isolation of HHSI/CHG pump discharge to normal charging line of CVCS. Negligible effect on system operation. Alternate isolation valve 1-8108 (1-8107) provides backup normal CVCS charging line isolation.	Same as item #1 except no valve close monitor alarm for group monitoring.	
8. Motor operated gate valve 1-8801A (1-8801B analogous)	Fails to open on demand.	Provides isolation of fluid discharge from the BIT to high head injection header connected to the cold legs of RCS coolant loops.	Failure reduces redundancy of providing fluid flow from BIT to high head injection header feeding the cold legs of RCS loops. Negligible effect on system operation. Alternate isolation valve 1-8801B (1-8801A) opens to provide backup flow path to header.	Same as in item #2.	
11. Motor operated globe valve 1-FCV-602A (1-FCV-602B analogous)	Fails open.	Provides regulation of fluid flow through miniflow bypass line to suction of LHSI/RHR pump 1 (pump 2) to protect against overheating of the pump and loss of suction flow to the pump.	Failure reduces working fluid delivered to RCS from LHSI/RHR pump 1 (pump 2). Minimum flow requirements will be met by LHSI/RHR pump 2 (pump 1) delivering working fluid to RCS	Same as item #1. In addition, pump discharge header pressure and flow indication at MCB.	Valves are regulated by signals from flow transmitter located in each pump discharge header. The control valves open when a LHSI/RHR pump discharge flow is less than 746 gpm and close when the flow exceeds 1402 gpm.

TABLE 6.3.1-1 EMERGENCY CORE COOLING SYSTEM FAILURE MODES AND EFFECTS ANALYSIS

Component	Failure Mode	Function*	Effect on System*	Failure Detection Method**	Remarks*
	Fails closed.		Failure results in an insufficient fluid flow through LHSI/RHR pump 1 (pump 2) for a small LOCA or steam line break resulting in possible pump damage. Minimum flow requirements will be met by LHSI/RHR pump 2 (pump 1) and HHSI/CHG pump 2 (pump 1) delivering coolant fluid to RCS.		
12. Residual heat removal pump 1 (pump 2)	Fails to deliver working fluid.	Provides fluid flow of emergency coolant to the RCS when the incident RCS loop pressure drops below shutoff head of pump (160 psig) and provides long term recirculation capability for core cooling following the injection phase of LOCA.	Failure reduces redundancy of providing emergency coolant to the RCS at low RCS pressure. Fluid flow from LHSI/RHR pump 1 (pump 2) will be lost. Minimum flow requirement for LHSI will be met by LHSI/RHR pump 2 (pump 1).	Same as that stated for item #3 except LHSI/RHR pump discharge pressure and flow indication at MCB.	The LHSI/RHR pumps are sized to deliver reactor coolant through the Residual Heat Exchanger to meet the plant cooldown requirements and are used during plant cooldown and startup operation.
13. Motor operated gate valve 1-8811A (1-8812A analogous)	Fails to open on demand.	Provides isolation of fluid discharge from containment sump to suction line of LHSI/RHR pump 1.	Failure reduces redundancy of providing fluid flow from the Containment Sump to the RCS. LHSI/RHR pump 1 not available for recirculation. Minimum flow requirements will be met by LHSI/RHR pump 2 through opening of isolation valves 1-8811B and 1-8812B. Negligible effect on system operation.	Same as item #2.	Valves open automatically on receipt of a 2/4 RWST "Lo-Lo) level signal in coincidence with SI "S" signal being present. Administrative procedures require reactor operator to verify opening of sump isolation valves.
14. Motor operated gate valve 1-8811B (1-8812 B analogous)	Fails to open on demand.	Same function as stated for item #13 except applies to LHSI/RHR pump 2.	Same as item #13 except isolation valves 1-8811A and 1-8812A automatically open with flow provided by LHSI/RHR pump 1.	Same as item #2.	

TABLE 6.3.1-1 EMERGENCY CORE COOLING SYSTEM FAILURE MODES AND EFFECTS ANALYSIS

Component	Failure Mode	Function*	Effect on System*	Failure Detection Method**	Remarks*
15. Motor operated gate valve 1-8809A (1-8809B analogous)	Fails to close on demand.	Provides isolation of fluid discharge from the RWST to suction line of LHSI/RHR pump 1 (pump 2).	Failure reduces redundancy of providing RWST isolation from suction line of LHSI/RHR pump 1 (pump 2). Negligible effect on system operation. A series check valve 1-8958A (1-8958B) provides backup isolation against fluid flow from the suction of LHSI/RHR pump 1 (pump 2) to the RWST.	Same as item #1.	
16.	Deleted by Amendment No. 39				
17. Motor operated gate valve 1-8888A (1-8888B is analogous)	Fails to close.	Provides isolation of fluid flow from LHSI/RHR pump 1 (pump 2) to cold leg injection header of RCS coolant loops.	Failure reduces flow of recirculation coolant to hot legs of RCS coolant loops from LHSI/RHR pump 1 (pump 2). Minimum flow requirements to hot leg of RCS coolant loops will be met by delivery of coolant from LHSI/RHR pump 2 (pump 1) and two HHSI/CHG pumps.	Same as item #1. In addition LHSI/RHR pump discharge header pressure and flow indication and miniflow valve monitoring at MCB.	Hot legs RCS coolant loop recirculation required to prevent boron precipitation problem for long-term core cooling.
18. Motor operated gate valve 1-8889	Fails to open on demand.	Provides isolation of fluid flow from LHSI/RHR pumps to hot leg injection header of RCS coolant loops.	Failure prevents fluid flow from LHSI/RHR pumps to hot leg injection header fo RCS coolant loops.	Same as item #2. In addition, LHSI/RHR pump discharge header pressure and flow indication and miniflow valve monitoring at MCB.	LHSI will be realigned to the cold legs and HHSI will be aligned to the hot legs. This action will provide sufficient cooling to the core and prohibit boron precipitation (Reference 6.3.1-1).

TABLE 6.3.1-1 EMERGENCY CORE COOLING SYSTEM FAILURE MODES AND EFFECTS ANALYSIS

Component	Failure Mode	Function*	Effect on System*	Failure Detection Method**	Remarks*
	Fails to close on demand.		Failure reduces redundancy of providing isolation of recirculation of fluid into hot legs of RCS coolant loops by LHSI/RHR pumps. Negligible effect on recirculation into cold legs of RCS coolant loops. Two HHSI/CHG and two LHSI/RHR pumps can meet minimum flow requirements for RCS cold leg recirculation even with simultaneous flow provided to LHSI hot leg recirculation penetration.		
19. Motor operated gate valve 1-8706A. (1-8706B analogous)	Fails to open on demand.	Provides isolation of fluid flow from LHSI/RHR pump 1 (pump 2) via RHR Heat Exchanger, (exchanger 2) to suction line of HHSI/CHG pump 1 (HHSI/CHG 2).	No effect on system operation. HHSI/CHG pumps 1 and 2 will be provided suction head by LHSI/RHR pump 2 (pump 1) via the common charging pump suction header.	Same as that stated for item #2. In addition, HHSI/CHG pump 1 (pump 2) flow indication at MCB.	
20. Motor operated gate valve 1-LCV-115B/(1-LCV-115D analogous)	Fails to close.	Provides isolation of fluid discharge from the RWST to the suction of HHSI/CHG pump 1 (pump 2) and an electrical interlock to the closing of isolation valve 1-LCV-1154C)1-LCV-115E).	Failure reduces redundancy of providing isolation of fluid discharged from residual Heat Exchanger 1 (Exchanger 2) to RWST. No immediate effect on system operation during recirculation. Alternate isolation check valve 1-8926 in common line from RWST provides backup tank isolation.	Same as item #2.	Valve is activated to open by a VCT "low" water level or by an SIAS. Prior to the closing of the valve following an SIAS, reactor operator resets SIAS.
21. Motor operated gate valve 1-8132A (1-8132B analogous)	Fails to close.	Provides isolation barrier to form two independent flow paths in the vent of a single passive failure.	No effect on system operation. Backup isolation is provided by closing alternate isolation valve 1-8132B (1-8132A)	Same as item #1.	The normal operating position of the valve during recirculation changes if HHSI/CHG pump #3 is on line and is in operation and HHSI/CHG pump #1 is out-of-service.

TABLE 6.3.1-1 EMERGENCY CORE COOLING SYSTEM FAILURE MODES AND EFFECTS ANALYSIS

Component	Failure Mode	Function*	Effect on System*	Failure Detection Method**	Remarks*
22. Motor operated gate valve 1-8133A (1-8133B analogous).	Fails to close.	Provides an isolation barrier to form two independent flow paths in the event of the single passive failure.	No effect on system operation. Backup isolation is provided by closing alternate isolation valve 1-8133B (1-8133A)	Same as item #1.	The normal operating position of the valve during recirculation if HHSI/CHG pump #3 is on line and is in operation and HHSI/CHG pump 2 is out-of-service.
23. Motor operated gate valve 1-8885.	Fails to open on demand.	Provides isolation of fluid flow from HHSI/CHG pump 1 discharge, line to cold legs of RCS coolant loops.	Failure reduces redundancy of providing fluid flow from HHSI/CHG pumps to cold legs of RCS coolant loops. Minimum flow requirements will be met by HHSI/CH pump #2 providing flow of coolant to cold legs via BIT cold leg injection line.	Same as item #2. In addition HHSI/CHG pump 1 flow indication at MCB.	Valve is positioned open by reactor operator for recirculation into cold legs of RCS coolant loops and closed by the operator when recirculation into hot legs of RCS coolant loops is desired during long term incident recovery periods.
	Fails to close on demand.		Failure reduces flow delivery of HHSI/CHG pumps to RCS hot legs. Minimum flow will be met by HHSI/CHG pump #2 providing flow to its hot leg recirculation flow path.		
24. Motor operated gate valve 1-8801A (1-8801B analogous)	Fails to close on demand.	Provides isolation of fluid flow from HHSI/CHG pump #2 discharge line via BIT to cold legs of RCS coolant loops.	Failure reduces redundancy of providing isolation of fluid flow from HHSI/CHG pump 2 to cold legs of RCS coolant loops. Failure reduces flow delivery of HHSI/CHG pumps to RCS hot legs. Minimum flow will be met by HHSI/CHG pump No. 1 providing flow to its hot leg recirculation flow path.	Same as item #2.	Valves are activated to open by an SIAS. Prior to the closing of the valves, reactor operator resets the SIAS. Valves are closed by the reactor operator for recirculation into hot legs of RCS coolant loops and open by the operator when recirculation into cold legs of RCS coolant is desired during long term incident recovery period.
25.	Deleted by Amendment No. 39.				

TABLE 6.3.1-1 EMERGENCY CORE COOLING SYSTEM FAILURE MODES AND EFFECTS ANALYSIS

Component	Failure Mode	Function*	Effect on System*	Failure Detection Method**	Remarks*
26. Motor operated gate valve 1-8884 (1-8886 analogous)	Fails to open on demand.	Provides isolation of fluid flow from HHSI/CHG pump 1 (pump 2) discharge line to hot legs of RCS coolant loops.	Failure reduces redundancy of providing fluid flow from HHSI/CHG pumps to hot legs of RCS coolant loops. Minimum flow requirements will be met by HHSI/CHG pump 2 (pump 1).	Same as item #19.	Valve is positioned open by reactor operator for recirculation into hot legs of RCS coolant loops and closed by the operator when recirculation into cold legs of RCS coolant loops is desired during long term incident recovery period.
	Fails to close on demand.		Failure allows for the simultaneous recirculation of coolant into hot and cold legs at RCS coolant loops during cold leg recirculation operation. Minimum flow requirements will be met by HHSI/CHG pump 2 (pump 1) and LHSI/RHR pump flow to cold legs of RCS coolant loops.	Same as item #19.	
27. Motor operated globe valve 1-8489A (1-8489B analogous)	Fails to open on demand.	Protects HHSI pump from dead heading subsequent on SI coincident with high RCS pressure.	Failure could result in failure of the weak HHSI pump. However, pump from other train is still available and sufficient.	Valve open indication. Monitor Light Box 3A on the MCB.	The valve may open subsequent to an SI since SI may actuate before the high RCS pressure signal clears. As the associated event progresses, the valve will reclose.
	Fails to close on demand.	Isolates to maximize HHSI flow during a LOCA, MSLB etc. On SI coincident with low RCS pressure.	Failure would result in reduction of SI flow by as much as 65 gpm on one train. However, flow from other train is still available and sufficient.	Valve close indication. Monitor Light Box 3A on the MCB.	
28. Manual operated globe valve 2CT-V144SAB-1	Fails to open on demand.	Provides fluid from the RWST to the suction of the hydrostatic test pump.	Failure prevents use of the hydrostatic test pump. However, the pump does not perform a safety function. Hence no safety significance.	Operator unable to open the valve.	

TABLE 6.3.1-1 EMERGENCY CORE COOLING SYSTEM FAILURE MODES AND EFFECTS ANALYSIS

<u>Component</u>	<u>Failure Mode</u>	<u>Function*</u>	<u>Effect on System*</u>	<u>Failure Detection Method**</u>	<u>Remarks*</u>
	Fails to close on demand.	Provides boundary isolation between the safety RWST and the non-safety hydrostatic test pump.	Failure could allow loss of fluid from the RWST through a line rupture in the non-safety hydrostatic test pump piping.	Operator unable to close valve.	This is a 2" 1500 lb ss globe valve in a very low temperature and pressure service. Failure of this valve to close when required is not a credible event.

List of acronyms and abbreviations

- BIT – Boron injection tank
- CHG - Charging
- HHSI – High head safety injection
- LHSI – Low head safety injection
- LOCA – Loss-of-coolant accident
- MCB – Main control board
- RCS – Reactor Coolant System
- RHR – Residual heat removal
- RWST – Refueling water storage tank
- SIAS – safety injection actuation signal
- SIS – Safety Injection System
- SSPS – Solid state protection system
- VCT – Volume control tank

TABLE 6.3.2-1 EMERGENCY CORE COOLING SYSTEM COMPONENT PARAMETERSAccumulators

Number	3
Design pressure (psig)	
internal	700
external	60
Design temperature (F)	300
Operating temperature (F)	120
Normal pressure (psig)	665
Minimum operating pressure (psig)	585
Total volume (ft. ³)	1450 each
Normal operating water volume (ft. ³)	1012 each
Volume N ₂ gas (ft. ³)	438
Boron concentration, (ppm)	2400 - 2600

Centrifugal Charging Pumps

Number	3
Design pressure (psig)	2800 (Note 1)
Design temperature (F)	300
Design flow ^(a) (gpm)	150
Design head (ft.)*	6300
Maximum flow (gpm)**	685
Head at maximum flow (ft.)	3100
Motor rating (hp)	900

Residual Heat Removal Pumps

Number	2
Design pressure (psig)	600
Design temperature (F)	400
Design flow (gpm)	3750
Design head (ft.)	240
NPSH required @ 4500 gpm (ft.)*	19
Available NPSH (ft.)	20.85
Motor Rating (HP)	300

*Orifices are installed in the safety injection headers, to limit runout flow to a maximum of approximately 4500 gpm.

Residual Heat Exchangers

(See Section 5.4.7 for Design Parameters)

Hydrostatic Test Pump

Number	1
Design pressure (psig)	3300
Design temperature (F)	300
Normal operating temperature	ambient
Design flow rate (gpm)	24.5
Develop head (ft) at design flow	7000

Boron Injection Tank

Number	1
Total volume (gal.)	900
Boron concentration (ppm)	0 - 2,600
Design pressure (psig)	2735 (Note 2)
Operating pressure	2712
Design temperature (F)	300
Operating temperature (F)	120

TABLE 6.3.2-1 EMERGENCY CORE COOLING SYSTEM COMPONENT PARAMETERS

<u>Motor Operated Valves</u>	<u>Maximum Opening or Closing Time</u>
<u>Fast</u>	
3" and 4" 1500# valves	10 sec. ^(b)
6" - 12" valves	15 sec. ^(b)
14"	20 sec.
<u>Slow</u>	
Up to and including 8 in.	12 in./min./in. of nominal valve size
Over 8 in.	2 min.

NOTES:

(a) Includes 60 gpm allowance for miniflow.

(b) Stroke times of the following valves are ≤ 15 seconds: LC V115 B/D and 8888 A/B. Stroke times of the following valves are ≤ 20 seconds: 8808 A/B/C, 8811 A/B, and 8812 A/B. Stroke time for 8889 is < 30 seconds. Stroke time for 8706 A/B ≤ 30 seconds.

Note 1: With CVCS alignment in normal or alternate miniflow, a limited portion of the system piping and components may experience a momentary increased pressurization, above the system design pressure, due to the reduction in the flow paths. The piping and components within these flow paths have been qualified to a pressure equal to or greater than this pressure anomaly (up to 3100psig).

Note 2: The Boron Injection Tank has been evaluated for 2800 psig.

TABLE 6.3.2-2

EMERGENCY CORE COOLING SYSTEM RELIEF VALVE DATA

<u>Description</u>	<u>Fluid Discharged</u>	<u>Fluid Inlet Temperature Normal</u>	<u>Set Pressure (psig)</u>	<u>Backpressure Constant (psig)</u>	<u>Maximum Total Backpressure (psig)</u>	<u>Capacity</u>
N2 supply to accumulators	N2	120	700	0	0	1500 scfm
Residual heat removal pump safety injection line	Water	120	600	3	50	20 gpm
Accumulator to Containment	N2 gas	120	700	0	0	1500 scfm
Hydrostatic Test Pump Discharge	Water	120	700	0	0	30 gpm

TABLE 6.3.2-3 MOTOR OPERATED ISOLATION VALVES IN THE EMERGENCY CORE COOLING SYSTEM

Location	Valve Identification	Interlocks	Automatic Features	Position Indication	Alarms
Accumulator Isolation Valves	8808 A,B,C	"S" signal, RCS pressure > unblock	Opens on "S" signal if closed and RCS pressure > unblock	MCB	Yes-out of position
Recirculation Containment Sump Isolation Valves	8811 A,B 8812 A,B	"S" signal, RWST "Lo-Lo" signal	Opens on coincident "S" and RWST "Lo-Lo" signals	MCB	Yes-out of position
CVCS Suction from RWST	LCV-115 B,D	"S" signal	Opens on "S" signal	MCB	None
CVCS Normal Suction	LCV-115 C,E	"S" signal	Closes on "S" signal if CVCS suction valves from RWST open	MCB	Yes-out of position
CVCS Normal Discharge	8107, 8108	"S" signal	Closes on "S" signal	MCB	None
Boron Injection Tank Discharge	8801, A,B	"S" signal	Opens on "S" signal	MCB	Yes-out of position
RWST to RHR Pump Suction	8809, A,B	None	None	MCB	Yes-out of position
Charging Pump Miniflow	8109, A,B 8106	"S" signal	Closes on "S" signal	MCB	Yes-out of position
Charging Pump Miniflow	8109C	"S" signal	Closes on "S" signal	MCB	None
HHSI-HL Recirculation Gate Valves	8884, 8886	None	None	MCB	Yes-out of position
HHSI-CL Recirculation Gate Valve	8885	None	None	MCB	Yes-out of position
LHSI Crossover	8887A,B	None	None	MCB	Yes-out of position
LHSI-Recirculation Gate Valves	8888A,B	None	None	MCB	Yes-out of position
LHSI to RCS Hot Legs	8889	None	None	MCB	Yes-out of position
RHR Discharge to Charging Pump Suction	8706A,B	Cannot be opened unless at least one RHR suction isolation valve in corresponding subsystem closed	None	MCB	Yes-out of position

TABLE 6.3.2-3 MOTOR OPERATED ISOLATION VALVES IN THE EMERGENCY CORE COOLING SYSTEM

Location	Valve Identification	Interlocks	Automatic Features	Position Indication	Alarms
CHG Pump Suction Crossover	8130A,B 8131A,B	None	None	MCB	Yes-out of position
Charging Pump Discharge Crossover	8132A,B 8133A,B	None	None	MCB	Yes-out of position
Charging Pump Alternate Miniflow	8489A,B	"S" signal with LHSI crossover isolates 8706A,B to prevent recirc. water from entering RWST	Open/close on "S" signal and RCS Press	MCB	No
	8490A,B		None	MCB	No

TABLE 6.3.2-4

MATERIALS EMPLOYED FOR
EMERGENCY CORE COOLING SYSTEM COMPONENTS

<u>Component</u>	<u>Material</u>
Accumulators	Carbon steel clad with austenitic stainless steel
Boron Injection Tank	Austenitic stainless steel
Pumps	
Centrifugal charging	Austenitic stainless steel
Residual heat removal	Austenitic stainless steel
Hydrotest	Austenitic stainless steel
Residual heat exchangers	
Shell	Carbon steel
Shell end cap	Carbon steel
Tubes	Austenitic stainless steel
Channel	Austenitic stainless steel
Channel cover	Austenitic stainless steel
Tube sheet	Austenitic stainless steel
Valves	
Motor operated valves containing radioactive fluids	
Pressure containing parts	Austenitic stainless steel or equivalent (Refer to Table 6.1.1-1).
Body-to-bonnet Bolting and nuts	Low alloy steel
Seating surfaces	Hard faced
Stems	Austenitic stainless steel or 17-4 pH stainless
Motor operated valves containing nonradioactive, boron-free fluids	
Body, bonnet and flange	Carbon steel
Stems	Corrosion resistance steel
Diaphragm valves	Austenitic stainless steel
Accumulator check valves	
Parts contacting borated water	Austenitic stainless steel
Clapper arm shaft	17-4 pH stainless
Relief valves	
Stainless steel bodies	Stainless steel
Carbon steel bodies	Carbon steel
All nozzles, discs, spindles and guides	Austenitic stainless steel
Bonnets for stainless steel valves without a balancing bellows	Stainless steel or plated carbon steel
All other bonnets	Carbon steel
Piping	
All piping in contact with borated water	Austenitic stainless steel

TABLE 6.3.2-5

EMERGENCY CORE COOLING SYSTEM RECIRCULATION PIPING PASSIVE FAILURE
ANALYSIS
LONG TERM PHASE

<u>Flow Path</u>	<u>Indication of Loss of Flow Path</u>	<u>Alternate Flow Path</u>
<u>Low Head Recirculation</u>		
From containment sump to low head injection header via the residual heat removal pumps and the residual heat exchangers	Accumulation of water in a residual heat removal pump compartment or reactor auxiliary building sump	Via the independent, identical low head flow path utilizing the second residual heat exchanger and residual heat removal pump
<u>High Head Recirculation</u>		
From containment sump to the high head injection header via residual heat removal pump, residual heat exchanger and the charging pumps	Accumulation of water in a residual heat removal pump compartment or the reactor auxiliary building sump or charging pump compartments	From containment sump to the charging headers via alternate residual heat removal pump, residual heat exchanger

TABLE 6.3.2-6

SEQUENCE OF SWITCHOVER OPERATION FROM
INJECTION TO RECIRCULATION

Manual operator actions are required to complete the switchover from the injection mode to the recirculation mode. During the injection mode, the operator verifies that all ECCS pumps are operating and monitors the RWST and reactor building recirculation sump levels in anticipation of switchover. Also during the injection mode, operator action is required to close the power supply breakers for Charging Pump Discharge Header Crossover valves 8132 A/B and 8133 A/B in preparation for their operation per step six below. By closing the Charging Pump Discharge Header Crossover valve breakers during the injection mode, the time required to perform the actions of Table 6.3.2-6 is unaffected. Charging Pump Suction Header Crossover valves 8130 A/B and 8131 A/B are not required for train separation but their MOV supply breakers are also closed at this time to provide for passive failures during the recirculation mode as required. Upon receipt of the RWST low-low level signal in conjunction with the safety injection signal, the containment sump isolation valves automatically open. Following this automatic action, the operator is required to complete the switchover. The operator normally opens the component cooling water inlet isolation valves to the residual heat removal heat exchanger prior to switchover.

The following manual actions must be performed to align the charging pump suction to the residual heat removal pumps discharge.

1. Verify that the containment sump isolation valves are open and close the residual heat removal pump suction valves from the refueling water storage tank.
2. Close one (not both) of the cold leg header isolation valves associated with the RHR pumps. (This action prevents RHR pump runout in the recirculation condition.) Close the charging pump alternate miniflow isolation valves.
3. Open residual heat removal pump discharge valves to the charging pump suction.

All ECCS pumps are now aligned with suction flow from the containment sump. The operator verifies proper operation and alignment of all ECCS components and proceeds to complete the following manual actions to align the ECCS in redundant flow path for long term recirculation operation.

4. Close refueling water storage tank valves to charging pump suction and place associated control switches into pull-to lock.
5. Open valve in the alternate high head cold leg recirculation line.
6. Close valves (depending on operating charging pumps) in the discharge header to establish two separate high head recirculation systems.

Table 6.3.2-6 (Continued)

The following manual operator actions are required to perform the change-over operation from the cold leg recirculation mode to the hot leg recirculation mode.

1. Close the cold leg header isolation valves associated with the RHR pumps.
2. Deleted.
3. Open the hot leg header isolation valve from the RHR pumps. If the isolation valve does not open, re-align the RHR pumps to the cold leg header.
4. Stop charging pump No. 1. If pump No. 1 was out of service prior to the accident, stop the swing pump (charging pump No. 3).
5. Close the alternate high head cold leg header isolation valve and open the corresponding high head hot leg header isolation valve.
6. Restart the charging pump stopped in Step 4.
7. Stop charging pump No. 2. If pump No. 2 was out of service prior to the accident, stop the swing pump (charging pump No. 3).
8. Close the boron injection tank discharge isolation valves and open the corresponding high head hot leg header isolation valve.
9. Restart the charging pump stopped in step 7.

Contingency actions are required in the event either high head hot leg isolation valves is pressure locked. The following sequence is used to open the pressure locked valve.

1. Open the normal miniflow valves of the associated charging pump for the affected high head hot leg isolation valve.
2. Start the charging pump.
3. Open the affected high head hot leg isolation valve.
4. Shut the normal miniflow valves for the charging pump.

TABLE 6.3.2-7

EMERGENCY CORE COOLING SYSTEM SHARED FUNCTIONS EVALUATION

<u>Component</u>	<u>Normal Operating Arrangement</u>	<u>Accident Arrangement</u>
Refueling water storage tank	Lined up to suction of residual heat removal pumps	Lined up to suction of centrifugal charging and residual heat removal pumps
Centrifugal charging pumps	Lined up for charging service suction from volume control tank, discharge via normal charging line	Suction from refueling water storage tank, discharge lined up to boron injection tank. Valves for realignment meet single failure criteria
Residual heat removal pumps	Lined up to cold legs of reactor coolant piping	Lined up to cold legs of reactor coolant piping
Residual heat exchangers	Lined up to cold legs of reactor coolant piping	Lined up to cold legs of reactor coolant piping

TABLE 6.3.2-8

NORMAL OPERATING STATUS OF EMERGENCY CORE
COOLING SYSTEM COMPONENTS FOR CORE COOLING

Number of charging pumps operable	2*
Number of residual heat removal pumps operable	2
Number of residual heat exchangers operable	2
Refueling water storage tank minimum contained volume (gal.)	434,302**
Boron concentration in refueling water storage tanks, minimum (ppm)	2,400
Boron concentration in accumulator, minimum (ppm)	2,400
Number of accumulators	3
Minimum accumulator pressure (psig)	585
Nominal accumulator water volume (ft. ³)	1,012
System valves, interlocks, and piping required for the above components which are operable	All

*Three charging pumps are installed. A maximum of two may be operable at one time.

**Lower limit of "low" alarm. Note: Technical Specification conservatively adjusts this value per the Technical Specification Bases.

TABLE 6.3.2-9
RWST OUTFLOW LARGE BREAK - NO FAILURES

STEP ⁽¹⁾	TIME REQUIRED PER STEP (SEC) ⁽³⁾⁽⁵⁾	TOTAL ELAPSED TIME (SEC)	RWST FLOW RATE PER STEP (GPM) ⁽²⁾⁽⁶⁾⁽⁷⁾	CHANGE IN RWST VOL. PER STEP (GAL)	TOTAL RWST VOL. CHANGE (GAL)
0	20 ⁽⁴⁾	20	17,820	5,940	5,940
1	62	82	25,055	25,890	31,830
2&3 ⁽⁸⁾	90	172	10,523	15,785	47,615
Completed RWST Isolation ⁽⁹⁾	39	211	2,826	1,837	49,452

NOTES:

- (1) See Table 6.3.2-6 for a description of the steps.
- (2) Flow rates are based on pump flows as follows:
 - RHR pump = 3096.5 gpm per pump
 - Charging pump = 426 gpm per pump
 - CS pump = 2137 gpm per pump
- (3) Valve operating times are maximum operating times.
- (4) Time for valves 8811A/B and 8812A/B to automatically open.
- (5) Time required to complete the required action includes a conservative 30 seconds for operator response time for each manual step.
- (6) The flow rate in this column represents an average value during the entire time interval for its respective step.
- (7) Flow out of the RWST during switchover includes allowances for both pumped flow to the RCS and containment and backflow to the containment sump.
- (8) Following the completion of this step, RHR and Charging pumps are aligned with suction flow from the containment sump.
- (9) Due to the long stroke times of the containment spray valves, the containment spray pump suction is not isolated from the RWST until after the ECCS pumps have been isolated.

Table 6.3.2-9 (Continued)

STEP ⁽¹⁾	TIME REQUIRED PER STEP (SEC) ⁽³⁾⁽⁵⁾	TOTAL ELAPSED TIME (SEC)	RWST FLOW RATE PER STEP (GPM) ⁽²⁾⁽⁶⁾⁽⁷⁾	CHANGE IN RWST VOL. PER STEP (GAL)	TOTAL RWST VOL. CHANGE (GAL)
0	20 ⁽⁴⁾	20	17,586	5,862	5,862
1	62	82	25,444	26,292	32,154
2&3 ⁽⁸⁾	90	172	17,314	25,970	58,125
RWST Isolation ⁽¹¹⁾	39	211	10,098	6,564	64,688

NOTES:

- (1) See Table 6.3.2-6 for a description of the steps.
- (2) Flow rates are based on pump flows as follows:
 - RHR pump = 3096.5 gpm per pump
 - Charging pump = 426 gpm per pump
 - CS pump = 2137 gpm per pump
- (3) Valve operating times are maximum operating times.
- (4) Time for valves 8811A/B and 8812A/B to automatically open.
- (5) Time required to complete the required action includes a conservative 30 seconds for operator response time for each manual step.
- (6) The flow rate in this column represents an average value during the entire time interval for its respective step. This is conservative since valve repositioning may reduce the flow rate during the time interval.
- (7) Flow out of the RWST during switchover includes allowances for both pumped flow to the RCS and containment and backflow to the containment sump.
- (8) Following the completion of this step all ECCS pumps are aligned with suction flow from the containment sump with the exception of one residual heat removal pump due to the single failure.
- (9) Based on Large Break LOCA in conjunction with a single failure of one of the RWST to residual heat removal pump isolation valves (8809A or 8809B) to close on demand.
- (10) Deleted by Amendment No. 49.
- (11) Due to the long stroke times of the containment spray valves, the containment spray pump suction is not isolated from the RWST until after the ECCS pumps have been isolated.

TABLE 6.3.2-10

PUMPS AND VALVES REQUIRED FOR ECCS OPERATION

	Tag #	System	Train	Safety Class	Operator*	
<u>Valves:</u>	9431 A/B	CC	SA/SB	3	M	
	9370	CC	SA	3	M	
	9371	CC	SB	3	M	
	9384	CC	SA	3	M	
	9385	CC	SB	3	M	
	8888 A/B	SI	SA/SB	2	M	
	8887 A/B	SI	SA/SB	2	M	
	8889	SI	SA	2	M	
	8811 A/B	SI	SA/SB	2	M	
	8812 A/B	SI	SA/SB	2	M	
	8809 A/B	SI	SA/SB	2	M	
	8808 A/B/C	SI	SA/SB/SA	2	M	
	8706 A/B	RH	SA/SB	2	M	
	8801 A/B	SI	SA/SB	2	M	
	8803 A/B	SI	SA/SB	2	M**	
	8885	SI	SA	2	M	
	8886	SI	SB	2	M	
	8884	SI	SA	2	M	
	FCV 113 A	CS	SN	3	A	
	8105	CS	SB	3	M	
	8106	CS	SA	2	M	
	8108	CS	SB	2	M	
	8133 A/B	CS	SA/SB	2	M	
	8132 A/B	CS	SA/SB	2	M	
	8109 A/B/C	CS	SB/SB/SB	2	M	
	8131 A/B	CS	SA/SB	2	M	
	8130 A/B	CS	SA/SB	2	M	
	LCV 115 C/E	CS	SA/SB	2	M	
	LCV 115 B/D	CS	SA/SB	2	M	
	8104	CS	SB	2	M	
	3SW - B1SA-1	SW	SA	3	M	
	3SW - B2SB-1	SW	SB	3	M	
	3SW - B3SA-1	SW	SA	3	M	
	3SW - B4SB-1	SW	SB	3	M	
	3SW - B5SA-1	SW	SA	3	M	
	3SW - B6SA-1	SW	SA	3	M	
	<u>Pumps:</u>	APCH 1/2/3				
		APHR 1/2				
		APCC 1/2/3				
		APSN - 1A-SA				
APSN - 1B-SB						

*NOTE: M = MOTOR, A = Air

** Locked Open

TABLE 6.4.2-1

CONTROL ROOM BUTTERFLY VALVES LEAKAGE RATE ESTIMATE

1. COMPONENTS:	Butterfly valves in: a) Exhausts b) Normal Outside Air Intake
SIZE:	12 inch diameter (exhaust) 16 inch diameter (intake)
QUANTITY:	Four ⁽¹⁾ (2 valves arranged in series in each of two paths)
LEAK RATE AT 13.8 PSIG:	0.018 (0.024) cubic feet per day per exhaust (intake) valve ⁽²⁾
LEAK RATE AT + 1/8 INCH W.G. ⁽³⁾ :	0.53 X 10 ⁻⁶ cfm per two valves
2. COMPONENTS:	Butterfly valves in: a) Purge Exhausts b) Purge Make-Up
SIZE:	30 inch diameter (exhaust) 36 inch diameter (make-up)
QUANTITY:	Four ⁽¹⁾ (2 valves arranged in series in each of two paths)
LEAK RATE AT 13.8 PSIG:	0.045 (0.054) cubic feet per day per exhaust (make-up) valve ⁽²⁾
LEAK RATE AT + 1/8 INCH W.G. ⁽³⁾ :	1.24 X 10 ⁻⁶ cfm per two valves
3. COMPONENTS:	Butterfly valves in: Post-Accident Air Intakes (two)
SIZE:	12 inch diameter
QUANTITY:	Four ⁽¹⁾ (2 valves arranged in series in each of two paths)
LEAK RATE AT 13.8 PSIG:	0.018 cubic feet per day per valve ⁽²⁾
LEAK RATE AT + 1/8 INCH W.G. ⁽³⁾ :	0.45 X 10 ⁻⁶ cfm per two valves
<u>TOTAL LEAKAGE TO THE OUTSIDE FROM VALVES:</u>	1) 0.53 X 10 ⁻⁶ cfm 2) 1.24 x 10 ⁻⁶ cfm 3) <u>0.45 x 10⁻⁶ cfm</u>

(For conservatism, 3.0 x 10⁻⁶ cfm is used.)

TOTAL = 2.22 X 10⁻⁶ cfm

NOTES:

1. There are a total of 12 isolation valves, two in series in each air path. However, it has been assumed that only one valve closes in each path following control room isolation.
2. Based on AEC R&D Report NAA-SR-101000, Reference 2, Section A-2, p III 105.
3. For control room positive pressure +1/8 inch w.g.

TABLE 6.4.2-2

SUMMARY OF MAIN CONTROL ROOM LEAK RATE CALCULATION⁽¹⁾

PATH NO.	COMPONENT	UNIT	NUMBER OF UNITS	NUMBER OF REFERENCE DETAIL ⁽¹⁾	LEAKAGE A	COEFFICIENT B	LEAKAGE PER UNIT AP+BP1/2 ⁽²⁾	TOTAL CFM COMPONENT LEAKAGE
1.	Hollow metal door, metal interlocking gasketed weatherstripping, door opening in (4 single and 1 double)	3' 0x7' 0	6	ADS III-A-2	4.0	22.0	8.28	49.68
2.	Door Frames	Ft.	106	ADS I-A-7	4x10 ⁻⁶	0	5x10 ⁻⁷	.00006
3.	Walls	Ft.2	6,000	ADS I-A-2(1)	1x10 ⁻⁶	0	1.25x10 ⁻⁷	.00075
4.	Slab	Ft.2	10,800	ADS I-A-2(1)	1x10 ⁻⁶	0	1.25x10 ⁻⁷	.00135
5.	Juncture of floor slab and wall	Ft.	450	ADS I-A-3(1)	1.6x10 ⁻³	0	.2x10 ⁻⁴	.09
6.	Eave	Ft.	450	ADS I-A-5	6x10 ⁻⁵		.75x10 ⁻⁵	.0034
7.	Corners, columns and wall joints with caulking	Ft.	340	ADS I-A-6 Case 1	1.6x10 ⁻⁵	0	.2x10 ⁻⁵	.0007
8.	Penetrations for electrical cables	Ft.	730	ADS III-D-1	1.3x10 ⁻⁴	0	.1625x10 ⁻⁴	.0118
9.	Penetrations for HVAC ducts	In. of Seal	1,040	ADS III-D-1 Case 2	1.3x10 ⁻⁵	0	.1625x10 ⁻⁵	.00169
10.	Isolation Butterfly Valves			ADS A-2 Case 2				3x10 ⁻⁶⁽⁴⁾
11.	Pipe Penetrations	In. of Seal	116	ADS III-D-1 Case 2	1.3x10 ⁻⁵	0	.1625x10 ⁻⁵	.0002
12.	HVAC Equipment and Ductwork (Outside of Envelope)							15.8
Subtotal (1-12)								66 x 2 ⁽¹⁾
13.	Opening and closing of doors		Note (3)					10.00
Total								142

(1) Based on AEC R+D Report NAA-SR-10100
 (2) Leakage estimate based on AP=0.125 in w.g.
 (3) See standard review plan Section 6.4 III3d2ii
 (4) See Table 6.4.2-1

TABLE 6.4.4-1

TOXIC CHEMICALS STORED ONSITE

<u>TOXIC CHEMICAL</u>	<u>LOCATION</u>	<u>NO. OF TANKS/CAPACITY, EACH</u>	<u>HORIZONTAL DISTANCE FROM THE CONTROL ROOM NORMAL VENTILATION INTAKE, FT.</u>
Sulfuric Acid (H ₂ SO ₄) (100%)	At Cooling Tower	1/7800 gal.	950
	At Turbine Bldg	1/5473 gal.	400
	At Water Treat. Bldg.	1/7820 gal.	530
Sodium Hydroxide	At Cooling Tower	1/1700 gal.	1000
	At Turbine Bldg	1/8883 gal.	380
	At Water Treat. Bldg.	1/10,500 gal.	750
Nitrogen (N ₂) (Liquid)	Gas Storage Area	1 system/10,584 lbs.	700
Carbon Dioxide (CO ₂) (Liquid)	Gas Storage Area	1 system/4,000 lbs. liquid 1,290 lbs. vapor	700
Oxygen (O ₂)	Gas Storage Area	1 System/60,400 scf	700
Hydrogen (H ₂) (Liquid)	Gas Storage Area	1 System/1,500 gal.	700
Nitrogen (N ₂) (Liquid)	Turbine Bldg.	1 System/6,020 gal.	375

TABLE 6.5.1-1 DESIGN DATA FOR FUEL HANDLING BUILDING EMERGENCY EXHAUST SYSTEM

Quantity	Two (2) Identical Units, One Standby
Each Unit contains the following:	
1. <u>Exhaust Fan</u>	
Quantity	1
Type	Centrifugal Direct Drive
Air Flow, Per Fan, acfm	6600
Static Pressure, in. wg.	16.1
Code	Air Moving and Conditioning Association (AMCA), Anti-Friction Bearing Manufacturers Association (AFBMA)
2. <u>Exhaust Fan Motors</u>	
Quantity, Per Fan	1
Type	30 HP, 460 V, 60 Hz 3 phase Induction Type
Insulation	Class B, Powerhouse
Enclosure	Drip-proof
Code	NEMA Class B, IEEE Class 1E
3. <u>HEPA Filters</u>	
Quantity, Per System	Two banks
Air Flow, acfm	6600
Cell (Unit) Size	24" H x 24" W x 11 1/2" deep
Max. Resistance Clean, in. wg.	1.0
Max. Resistance Loaded, in. wg.	2.0
Efficiency	99.97 percent when tested with 0.3 micron Dioctylphtalate smoke
Material	Meets the requirements of ANSI/ASME N509-1980
4. <u>Charcoal Adsorbers</u>	
Type	Multiple gasketless bed cells in air-tight housing
Quantity, Per System	1
New media	Impregnated coconut shell (Meeting the requirement of ANSI/ASME N509-1980 Table 5.1, with the exception that the 30°C/95% relative humidity methyl iodide test is done per ASTM D3803-1989
Depth of Bed (in.)	2"
Face Velocity	40
Average Atmosphere Residence Time	0.25 seconds per two in. of adsorber bed
Adsorber Capacity of Iodine Loading	2.5 mg of total iodine (radioactive plus stable) per gram of activated carbon
<u>Efficiency:</u>	
Elemental iodine	95% at 70% RH
Organic iodine	95% at 70% RH
<u>Adsorbent Acceptance and Inplace Leak Test Criteria</u>	
Carbon Laboratory Acceptance Testing will be performed in accordance with, and will meet the requirements of, position C.6 of R.G. 1.52, Revision 2, with the exceptions listed in Table 6.5.1-2.	
Adsorber In place Leak Testing will be performed in accordance with, and will meet the requirements of, position C.5.d of R.G. 1.52, Revision 2, with the exceptions listed in Table 6.5.1-2.	

TABLE 6.5.1-1 DESIGN DATA FOR FUEL HANDLING BUILDING EMERGENCY EXHAUST SYSTEM

5. <u>Prefilters</u>	
Quantity, Per System	One bank
Type	Medium efficiency, dry and replaceable
Material	Ultra-fine glass fiber
6. <u>Heating Coil</u>	1 per filter train
Quantity	Electric
Capacity (kw)	40 (Sufficiently sized to reduce the relative humidity of the inlet air from 100% to 70%)
Code	Underwriter Laboratories (UL), National Electrical Manufacturers Association (NEMA), National Electric Code (NEC), IEEE Class 1E
Material	Galvanized Steel
7. <u>Demister</u>	
Quantity Per System	1 bank
Air flow acfm	6600
Max. Resistance Clean in. wg	1.28
Max. Resistance Loaded in. wt	2.0
Material	Woven stainless steel and glass fiber mesh
8. <u>Valves</u>	
Quantity Per System	Two per system
Type	Manual and motorized
Air	Butterfly valve
Flow Per Fan, acfm	6600
Material	Stainless steel
Code	ASME III, Class 3 IEEE Class 1E (Motor Operated Valves)

TABLE 6.5.1-2 COMPARISON OF FUEL HANDLING BUILDING EMERGENCY EXHAUST SYSTEM, REACTOR AUXILIARY EMERGENCY EXHAUST SYSTEM AND CONTROL ROOM EMERGENCY FILTRATION SYSTEM WITH REGULATORY POSITIONS OF R.G 1.52, REVISION 2

<u>Regulatory Position</u>	<u>System Design Features</u>
1a,b,c,d,& e	Comply.
2a	Comply.
2b	Comply. Each air cleaning unit and corresponding channel motorized valves are physically separate from each other.
2c	Comply.
2d	Not applicable. The systems are located outside the Containment and therefore not subject to pressure surges.
2e	Comply.
2f	Comply.
2g	The system is instrumented to signal, alarm and record pertinent pressure drops, temperatures and flow rates at the main Control Room as described in Chapter 7.
2h	Components comply with IEEE Standards. Refer to Chapter 7 for detailed information.
2i	Comply. FHB Emergency Exhaust System is automatically actuated by redundant seismic Category I radiation monitors. RAB Emergency Exhaust System is automatically actuated by redundant SIS. Control Room Emergency Filtration System is automatically actuated by redundant SIS or seismic Category I radiation monitors.
2j	The system is designed to facilitate maintenance in accordance with R.G. 8.8. Isolation valves are provided at the inlet and outlet of each filter train. The plant layout and the filter train design permit replacement of each air cleaning unit as two segmented sections without removal of individual components.
2k	The FHB and RAB air cleaning units are exhaust systems and have no outside air intake openings. The outside air intake openings on the control room air cleaning unit are adequately protected and have radiation detectors.
2l	Comply.
3a,b,c,d,e,f,g,h,i,j,	Comply, with the exception that the activated charcoal is manufactured and tested per ANSI/ASME N509-1980 with the exception that the 30°C/95% relative humidity methyl iodide test is done per ASTM D3803-1989.
3d	Reg. Guide 1.5.2 and ANSI-N509-1980 require HEPA filters to be in accordance with MIL-F-51068. MIL-F-50168 has been canceled and replaced by ASME AG-1; therefore, HEPA filter requirements will be allowed to either specification.
3k	The RAB Emergency Exhaust units do not require a low-flow bleed air system; however, the interconnecting duct originally installed for this purpose has been left in place. The FHB emergency exhaust units do not require a low-flow bleed air system and the interconnecting duct originally installed for bleed air purposes was blanked off. The Control Room Emergency Filtration System does not require a low-flow bleed air system.
3l,m,n,o,p	Comply.
4a,b,c,e,	Comply.

TABLE 6.5.1-2 COMPARISON OF FUEL HANDLING BUILDING EMERGENCY EXHAUST SYSTEM, REACTOR AUXILIARY EMERGENCY EXHAUST SYSTEM AND CONTROL ROOM EMERGENCY FILTRATION SYSTEM WITH REGULATORY POSITIONS OF R.G 1.52, REVISION 2

<u>Regulatory Position</u>	<u>System Design Features</u>
4d	This section required that each ESF atmosphere cleanup train should be operated at least 10 hours per month, with the heaters on (if so equipped), in order to reduce the buildup of moisture on the absorbers and HEPA filters. The duration of the monthly operation of each ESF atmosphere cleanup train was changed from requiring 10 continuous hours to 15 continuous minutes with implementation of License Amendment 156, which was based on NRC-approved Technical Specifications Task Force (TSTF) Traveler TSTF-522, Revision 0, "Revise Ventilation System Surveillance Requirements to Operate for 10 hours per Month. Heaters are not required to be on during the monthly operation of each ESF atmosphere cleanup train as a result of License Amendment 170, which is also based upon TSTF-522.
5a,b,c,d,	Comply with the exception that the In-Place Testing be performed in accordance with ANSI/ASME N510-1980. Test agent injection and sampling points are provided as indicated in the Ebasco Equipment Specification CAR-SH-BE-31.
6a, b	Comply with exceptions: The new activated carbon is manufactured and tested per ANSI/ASME N509-1980 with the additional exception that the 30°C/95% relative humidity methyl iodide test is performed per ASTM D3803-1989. Laboratory tests of representative samples of used activated carbon are to be performed per ASTM D3803-1989 at 30°C and 95% relative humidity with a methyl iodide penetration of ≤ 2.5% for 2 inch beds outside of primary containment and a methyl iodide penetration of ≤ 0.5% for 4 inch beds outside of primary containment.

TABLE 6.5.1-3 DESIGN DATA FOR REACTOR AUXILIARY BUILDING EMERGENCY EXHAUST SYSTEM

Quantity	Two (2) identical units one standby
Each unit contains the following:	
1. <u>Exhaust Fans</u>	
Quantity, Per System	1, 100% each, centrifugal with variable inlet vanes, single width, single inlet, belt driven
Capacity, Per Fan acfm	6800
Code	Air Moving and Conditioning Association (AMCA), Anti-Friction Bearing Manufacturer Association (AFBMA)
2. <u>Motors</u>	
Quantity, Per Fan	1
Type	30 HP, 460 V, 60 Hz 3 phase, horizontal induction type
Insulation	Class H
Enclosure and Ventilation	TEFC-XT
Code	NEMA IEEE Class 1E
3. <u>Electric Heating Coils</u>	
Quantity, Per System	1
Type	Electric
Capacity (kW) Per Coil	40 (Sufficiently sized to reduce the relative humidity of the inlet air from 100% to 70%)
Code	Underwriter Laboratories (UL), National Electrical Manufacturers Association (NEMA), National Electric Code (NEC) IEEE Class 1E
Material	Galvanized steel
4. <u>Medium Efficiency Filters</u>	
Quantity, Per System	1 Bank
Type	Extended media
Material	Glass fiber
5. <u>HEPA Filters</u>	
Quantity, Per System	2 banks
Cell Size	24 in. high, 24 in. wide, 11 1/2 in. deep
Max. Resistance Clean, in. wg.	1.0
Max. Resistance Loaded, in. wg.	2.0
Efficiency	99.97 percent when tested with 0.3 micron DOP
Material	Meets the requirements of ANSI/ASME N509-1980
6. <u>Charcoal Adsorbers</u>	
Type	Multiple gasketless bed cells in air-tight housing
Quantity, Per System	1
New Media	Impregnated coconut shell (Meeting the requirements of ANSI/ASME N509 1980, Table 5.1 with the exception that the 30°C/95% relative humidity methyl iodide test is done per ASTM D3803-1989.
Depth of Bed (in.)	2 in.
Face Velocity (fpm)	40
Average Atmosphere Residence Time	0.25 seconds per 2 in. of adsorber bed
Adsorber Capacity of Iodine Loading	2.5 mg of total iodine (radioactive plus stable) per gram of activated carbon

TABLE 6.5.1-3 DESIGN DATA FOR REACTOR AUXILIARY BUILDING EMERGENCY EXHAUST SYSTEM

Efficiency:

Elemental iodine 95% at 70% RH

Organic iodine 95% at 70% RH

6. Charcoal Adsorbers (Cont'd)

Adsorbent Acceptance and Inplace Leak Test Criteria

Carbon Laboratory Acceptance Testing will be performed in accordance with, and will meet the requirements of, position C.6 of R.G 1.52, Revision 2, with the exceptions listed in Table 6.5.1-2. Adsorbent Inplace Leak Testing will be performed in accordance with, and will meet the requirements of, position C.5.d of R.G. 1.52, Revision 2, with the exceptions listed in Table 6.5.1-2.

7. Demister

Quantity, Per System 1 bank

Air Flow acfm 6800

Max. Resistance Clean, in. wg 1.0

Max. Resistance Loaded, in. wg 2.0

Material Woven stainless steel and glass fiber mesh

TABLE 6.5.1-4

FUEL HANDLING BUILDING EMERGENCY EXHAUST SYSTEM SINGLE FAILURE ANALYSIS

COMPONENT IDENTIFICATION AND QUANTITY	FAILURE MODE	EFFECT ON SYSTEM	METHOD OF DETECTION	MONITOR	REMARKS
Exhaust Fans	(2)Fails to operate	Loss of Suction	Low flow alarm	C.R.I**	100% capacity stand-by unit provided
Exhaust Fan Inlet Valve	(2) Fails to open	Loss of Suction	Low flow alarm	C.R.I.	100% capacity stand-by unit provided
Exhaust Fan Discharge Damper	(2) Fails to open during exhaust phase	Loss of Suction	Low flow alarm	C.R.I.	100% capacity stand-by unit provided
Exhaust Fan Inlet Valve	(2)Fails to close	Reverse air flow	Indicating light	C.R.I.	Outlet gravity damper (in same train) will close and prevent reverse flow
HEPA Filter or Demister	(4)Clogs (2)	Air Flow reduction	Low flow alarm	C.R.I.	100% capacity stand-by unit provided
Electrical Heating Coil	(2)Fails to function	Methyl iodide trapping efficiency may reduce	High relative humidity alarm	C.R.I.	100% capacity stand-by unit provided
Diesel Generator	(2)Fails to function	Loss of one fan and filter train	Diesel generator malfunction alarm	C.R.I.	100% capacity stand-by unit provided
Isolation Damper	(12)Fails to close	None			Redundant isolation damper provided in series

**CONTROL ROOM INDICATION

TABLE 6.5.1-5

REACTOR AUXILIARY BUILDING EMERGENCY EXHAUST SYSTEM SINGLE FAILURE ANALYSIS

COMPONENT IDENTIFICATION AND QUANTITY	FAILURE MODE	EFFECT ON SYSTEM	METHOD OF DETECTION	MONITOR	REMARKS
Exhaust Fans	(2)Fails to operate	Loss of Suction	Low Flow Alarm	C.R.I*	Redundant capacity standby unit provided.
Filtration train inlet valve	(2)Fails to open	Loss of Suction	Low Flow Alarm	C.R.I.	Redundant capacity standby unit provided.
Exhaust Fan inlet valve	(2)Fails to open	Loss of Suction	Low Flow Alarm	C.R.I.	Redundant capacity standby unit provided.
Exhaust Fan Discharge Damper	(2)Fails to open during exhaust phase	Loss of Suction	Low Flow Alarm	C.R.I.	Redundant capacity standby unit provided.
Exhaust Fan Inlet Valve (for Decay Cooling mode)	(2)Fails to close	Reverse Air Flow through idle fan	Low Flow Alarm for operating systems	C.R.I.	Gravity damper will close and prevent reverse flow.
HEPA filter or Demister	(4)Clogs (2)	Air Flow Reduction	Low Flow Alarm	C.R.I.	Redundant capacity standby unit provided.
Decay Cooling Valve in Filter Train discharge interconnecting pipe	(1)Closed and cannot be reopened	No effect.	Valve position	C.R.I.	Forced air cooling not required for decay heat removal.
Electric Heating Coil	(2)Fails to function	Methyl Iodide Trapping efficiency may reduce	High relative humidity	C.R.I.	Redundant capacity standby unit provided.
Diesel Generator(2)	Fails to function	Loss of one fan and filter train	D.G. malfunction alarm, flow switch at fan discharge.	C.R.I.*	Redundant capacity standby unit provided.
Isolation Damper On inlet for each cubicle (34) On outlet for each cubicle (20)	Fails to close	None	Alarm on main Control Board.	C.R.I.	Redundant isolation damper provided in series.

* Control Room Indication

TABLE 6.5.2-1

IODINE REMOVAL SYSTEM COMPONENTS

<u>A - Containment Spray Additive Tank</u>	
Volume, gallons	7098
Minimum Liquid Volume in tank, gallons	3268
Design Temperature, °F	200
Design Pressure, psig	15
Operating Temperature, °F	100
Operating Pressure, psig	2
Fluid	27-29% by weight sodium hydroxide Solution with nitrogen (N ₂) cover gas
Material	304 SS
Code	ASME III, Code Class 3
<u>B - Motor Operated Valves</u>	
Quantity	2
Size, Inches	2
Type	Globe
Design Pressure, psig	50
Design Temperature, °F	200
End Connection	SW
Pipe Schedule	40S
Material	304 SS
Fluid	27-29% by weight sodium hydroxide Solution
Operator	Motor
Code	ASME III, Code Class 3
<u>C - Eductor</u>	
Quantity	2
Design Pressure, psig	300
Design Temperature, °F	300
Material	304 SS
Code	ASME III, Code Class 2
<u>D - All other Valves</u>	
Material	304 SS
Code	ASME III Code Class 2 and 3
<u>E - Piping and fittings</u> are of ASME III, Code Class 2 or Class 3	

TABLE 6.5.3-1

PRIMARY CONTAINMENT OPERATION
FOLLOWING A DESIGN BASIS ACCIDENT

General

Type of Structure	Steel-lined, reinforced concrete structure
Appropriate Internal Fission Product Removal System	Containment Spray System
Total Free Volume	2.344 x 10 ⁶ ft ³
Sprayed Volume of Primary Containment	2.014 x 10 ⁶ ft ³
Methods of Hydrogen Removal	Purging by the Hydrogen Purge System

Time-Dependent Parameters	Anticipated	Conservative
Leak Rate of Primary Containment	Less than 0.1% of the Containment free volume per day following a LOCA	0.1% of the Containment free volume per day following a LOCA
Leakage Fractions to Volumes Outside the Primary Containment	60% to the building 40% to the environment	60% to the building 40% to the environment
Effectiveness of Fission Product Removal System (elemental iodine removal constant)	37.1 hr ⁻¹	20 hr ⁻¹
Initiation of Hydrogen Purge	Not required	9 days after a LOCA (if containment pressure is reduced to atmospheric.)
Hydrogen Purge Rate	Not required	125 acfm

FIGURE	TITLE
6.2.1-1	CONTAINMENT TEMPERATURE FOR MOST SEVERE HOT LEG BREAK (DEHLG)
6.2.1-1a	SUMP TEMPERATURE FOR MOST SEVERE HOT LEG BREAK (DEHLG)
6.2.1-2	CONTAINMENT PRESSURE FOR MOST SEVERE HOT LEG BREAK (DEHLG)
6.2.1-3	CONTAINMENT PRESSURE FOR DBA (MOST SEVERE PUMP SUCTION LEG BREAK DEPSLG) MINIMUM SAFETY INJECTION
6.2.1-4	CONTAINMENT PRESSURE FOR DEPSG MAXIMUM SAFETY INJECTION
6.2.1-5a	CONTAINMENT TEMPERATURE FOR DBA (MOST SEVERE PUMP SUCTION LEG BREAK - DEPSLG) MINIMUM SAFETY INJECTION
6.2.1-5b	CONTAINMENT SUMP TEMPERATURE FOR DBA (MOST SEVERE PUMP SUCTION LEG BREAK - DEPSLG) MINIMUM SAFETY INJECTION
6.2.1-6a	CONTAINMENT TEMPERATURE FOR DEPSG MAXIMUM SAFETY INJECTION
6.2.1-6b	CONTAINMENT SUMP TEMPERATURE MOST SEVERE PUMP SUCTION BREAK-DEPSLG MAXIMUM SAFETY INJECTION
6.2.1-7	DELETED BY AMENDMENT NO. 51
6.2.1-8	DELETED BY AMENDMENT NO. 51
6.2.1-9	CONTAINMENT PRESSURE - WORST MSLB (MFIV FAILURE, 30% POWER FULL DEB)
6.2.1-10a	CONTAINMENT TEMPERATURE - WORST MSLB (MFIV FAILURE, 102% POWER FULL DEB)
6.2.1-10b	CONTAINMENT SUMP TEMPERATURE WORST MSLB (MFIV FAILURE, 102% POWER FULL DEB)
6.2.1-11	TAGAMI CONDENSING HEAT TRANSFER COEFFICIENT FOR DBA
6.2.1-12	UCHIDA HEAT TRANSFER COEFFICIENT-WORST MSLB
6.2.1-13	TYPICAL ENERGY DISTRIBUTION IN CONTAINMENT FOR DBA
6.2.1-14	TYPICAL TRANSIENT CONTAINMENT LINER SURFACE TEMPERATURE FOR THE CONTAINMENT TEMPERATURE DBA
6.2.1-15	PRESSURE FOLLOWING INADVERTENT SPRAY ACTUATION
6.2.1-16	CONTAINMENT FAN COOLER PERFORMANCE CURVE FOLLOWING A DBA
6.2.1-17	CONTAINMENT FAN COOLER NORMAL MODE PULLDOWN DATA FOR MINIMUM CONTAINMENT PRESSURE (VACUUM ANALYSIS)
6.2.1-18	SUBCOMPARTMENTS CONTAINMENT BUILDING - PLAN EL 221.00' & 236.00'
6.2.1-19	SUBCOMPARTMENTS CONTAINMENT BUILDING - PLAN EL 261.00' & 286.00'
6.2.1-20	SUBCOMPARTMENTS CONTAINMENT BUILDING SECTIONS A-A & B-B

FIGURE	TITLE
6.2.1-21	REACTOR CAVITY MODEL AND COORDINATE SYSTEM
6.2.1-22	REACTOR CAVITY SUBCOMPARTMENT PRESSURIZATION MODEL (FILL JUNCTIONS NOT SHOWN)
6.2.1-23	SUBCOMPARTMENT PRESSURIZATION MODEL OF STEAM GENERATOR/LOOP 1
6.2.1-24	SUBCOMPARTMENT PRESSURIZATION MODEL OF STEAM GENERATOR/LOOP 1
6.2.1-25	SUBCOMPARTMENT PRESSURIZATION MODEL OF STEAM GENERATOR/LOOP 3
6.2.1-26	SUBCOMPARTMENT PRESSURIZATION MODEL OF STEAM GENERATOR/LOOP 3
6.2.1-27	SUBCOMPARTMENT PRESSURIZATION MODEL OF PRESSURIZER COMPARTMENT AND STEAM GENERATOR/LOOP 2
6.2.1-28a	PRESSURE DIFFERENTIAL IN REACTOR CAVITY, COLD LEG DEB VOL. 1 - VOL. 33 (PSID)
6.2.1-28b	PRESSURE DIFFERENTIAL IN REACTOR CAVITY, COLD LEG DEB VOL. 2 - VOL. 33 (PSID)
6.2.1-28c	PRESSURE DIFFERENTIAL IN REACTOR CAVITY, COLD LEG DEB VOL. 3 - VOL. 33 (PSID)
6.2.1-28d	PRESSURE DIFFERENTIAL IN REACTOR CAVITY, COLD LEG DEB VOL. 4 - VOL. 33 (PSID)
6.2.1-28e	PRESSURE DIFFERENTIAL IN REACTOR CAVITY, COLD LEG DEB VOL. 5 - VOL. 33 (PSID)
6.2.1-28f	PRESSURE DIFFERENTIAL IN REACTOR CAVITY, COLD LEG DEB VOL. 6 - VOL. 33 (PSID)
6.2.1-28g	PRESSURE DIFFERENTIAL IN REACTOR CAVITY, COLD LEG DEB VOL. 7 - VOL. 33 (PSID)
6.2.1-28h	PRESSURE DIFFERENTIAL IN REACTOR CAVITY, COLD LEG DEB VOL. 8 - VOL. 33 (PSID)
6.2.1-28i	PRESSURE DIFFERENTIAL IN REACTOR CAVITY, COLD LEG DEB VOL. 9 - VOL. 33 (PSID)
6.2.1-29	PEAK PRESSURE DIFFERENTIAL IN REACTOR CAVITY COLD LEG VOL. 10 - VOL. 33 (PSID)
6.2.1-30	PEAK PRESSURE DIFFERENTIAL IN REACTOR CAVITY COLD LEG VOL. 11 - VOL. 33 (PSID)
6.2.1-31	PEAK PRESSURE DIFFERENTIAL IN REACTOR CAVITY COLD LEG VOL. 12 - VOL. 33 (PSID)
6.2.1-32	PEAK PRESSURE DIFFERENTIAL IN REACTOR CAVITY COLD LEG VOL. 13 - VOL. 33 (PSID)
6.2.1-33	PEAK PRESSURE DIFFERENTIAL IN REACTOR CAVITY COLD LEG VOL. 14 - VOL. 33 (PSID)
6.2.1-34	PEAK PRESSURE DIFFERENTIAL IN REACTOR CAVITY COLD LEG VOL. 15 - VOL. 33 (PSID)
6.2.1-35	PEAK PRESSURE DIFFERENTIAL IN REACTOR CAVITY COLD LEG VOL. 16 - VOL. 33 (PSID)
6.2.1-36	PEAK PRESSURE DIFFERENTIAL IN REACTOR CAVITY COLD LEG VOL. 17 - VOL. 33 (PSID)
6.2.1-37	PEAK PRESSURE DIFFERENTIAL IN REACTOR CAVITY COLD LEG VOL. 18 - VOL. 33 (PSID)
6.2.1-38	PEAK PRESSURE DIFFERENTIAL IN REACTOR CAVITY COLD LEG VOL. 19 - VOL. 33 (PSID)

FIGURE	TITLE
6.2.1-39	PEAK PRESSURE DIFFERENTIAL IN REACTOR CAVITY COLD LEG VOL. 20 - VOL. 33 (PSID)
6.2.1-40	PEAK PRESSURE DIFFERENTIAL IN REACTOR CAVITY COLD LEG VOL. 21 - VOL. 33 (PSID)
6.2.1-41	PEAK PRESSURE DIFFERENTIAL IN REACTOR CAVITY COLD LEG VOL. 22 - VOL. 33 (PSID)
6.2.1-42	PEAK PRESSURE DIFFERENTIAL IN REACTOR CAVITY COLD LEG VOL. 23 - VOL. 33 (PSID)
6.2.1-43	PEAK PRESSURE DIFFERENTIAL IN REACTOR CAVITY COLD LEG VOL. 24 - VOL. 33 (PSID)
6.2.1-44	PEAK PRESSURE DIFFERENTIAL IN REACTOR CAVITY COLD LEG VOL. 25 - VOL. 33 (PSID)
6.2.1-45	PEAK PRESSURE DIFFERENTIAL IN REACTOR CAVITY COLD LEG VOL. 26 - VOL. 33 (PSID)
6.2.1-46	PEAK PRESSURE DIFFERENTIAL IN REACTOR CAVITY COLD LEG VOL. 27 - VOL. 33 (PSID)
6.2.1-47	PEAK PRESSURE DIFFERENTIAL IN REACTOR CAVITY COLD LEG VOL. 28 - VOL. 33 (PSID)
6.2.1-48	PEAK PRESSURE DIFFERENTIAL IN REACTOR CAVITY COLD LEG VOL. 29 - VOL. 33 (PSID)
6.2.1-49	PEAK PRESSURE DIFFERENTIAL IN REACTOR CAVITY COLD LEG VOL. 30 - VOL. 33 (PSID)
6.2.1-50	PEAK PRESSURE DIFFERENTIAL IN REACTOR CAVITY COLD LEG VOL. 31 - VOL. 33 (PSID)
6.2.1-51	PEAK PRESSURE DIFFERENTIAL IN REACTOR CAVITY COLD LEG VOL. 32 - VOL. 33 (PSID)
6.2.1-52a	PRESSURE DIFFERENTIAL IN REACTOR CAVITY, HOT LEG DEB VOL. 1 - VOL. 33 (PSID)
6.2.1-52b	PRESSURE DIFFERENTIAL IN REACTOR CAVITY, HOT LEG DEB VOL. 2 - VOL. 33 (PSID)
6.2.1-52c	PRESSURE DIFFERENTIAL IN REACTOR CAVITY, HOT LEG DEB VOL. 3 - VOL. 33 (PSID)
6.2.1-52d	PRESSURE DIFFERENTIAL IN REACTOR CAVITY, HOT LEG DEB VOL. 4 - VOL. 33 (PSID)
6.2.1-52e	PRESSURE DIFFERENTIAL IN REACTOR CAVITY, HOT LEG DEB VOL. 5 - VOL. 33 (PSID)
6.2.1-52f	PRESSURE DIFFERENTIAL IN REACTOR CAVITY, HOT LEG DEB VOL. 6 - VOL. 33 (PSID)
6.2.1-52g	PRESSURE DIFFERENTIAL IN REACTOR CAVITY, HOT LEG DEB VOL. 7 - VOL. 33 (PSID)
6.2.1-52h	PRESSURE DIFFERENTIAL IN REACTOR CAVITY, HOT LEG DEB VOL. 8 - VOL. 33 (PSID)
6.2.1-52i	PRESSURE DIFFERENTIAL IN REACTOR CAVITY, HOT LEG DEB VOL. 9 - VOL. 33 (PSID)
6.2.1-53	PEAK PRESSURE DIFFERENTIAL IN REACTOR CAVITY HOT LEG VOL. 10 - VOL. 33 (PSID)
6.2.1-54	PEAK PRESSURE DIFFERENTIAL IN REACTOR CAVITY HOT LEG VOL. 11 - VOL. 33 (PSID)
6.2.1-55	PEAK PRESSURE DIFFERENTIAL IN REACTOR CAVITY HOT LEG VOL. 12 - VOL. 33 (PSID)
6.2.1-56	PEAK PRESSURE DIFFERENTIAL IN REACTOR CAVITY HOT LEG VOL. 13 - VOL. 33 (PSID)
6.2.1-57	PEAK PRESSURE DIFFERENTIAL IN REACTOR CAVITY HOT LEG VOL. 14 - VOL. 33 (PSID)

<u>FIGURE</u>	<u>TITLE</u>
6.2.1-58	PEAK PRESSURE DIFFERENTIAL IN REACTOR CAVITY HOT LEG VOL. 15 - VOL. 33 (PSID)
6.2.1-59	PEAK PRESSURE DIFFERENTIAL IN REACTOR CAVITY HOT LEG VOL. 16 - VOL. 33 (PSID)
6.2.1-60	PEAK PRESSURE DIFFERENTIAL IN REACTOR CAVITY HOT LEG VOL. 17 - VOL. 33 (PSID)
6.2.1-61	PEAK PRESSURE DIFFERENTIAL IN REACTOR CAVITY HOT LEG VOL. 18 - VOL. 33 (PSID)
6.2.1-62	PEAK PRESSURE DIFFERENTIAL IN REACTOR CAVITY HOT LEG VOL. 19 - VOL. 33 (PSID)
6.2.1-63	PEAK PRESSURE DIFFERENTIAL IN REACTOR CAVITY HOT LEG VOL. 20 - VOL. 33 (PSID)
6.2.1-64	PEAK PRESSURE DIFFERENTIAL IN REACTOR CAVITY HOT LEG VOL. 21 - VOL. 33 (PSID)
6.2.1-65	PEAK PRESSURE DIFFERENTIAL IN REACTOR CAVITY HOT LEG VOL. 22 - VOL. 33 (PSID)
6.2.1-66	PEAK PRESSURE DIFFERENTIAL IN REACTOR CAVITY HOT LEG VOL. 23 - VOL. 33 (PSID)
6.2.1-67	PEAK PRESSURE DIFFERENTIAL IN REACTOR CAVITY HOT LEG VOL. 24 - VOL. 33 (PSID)
6.2.1-68	PEAK PRESSURE DIFFERENTIAL IN REACTOR CAVITY HOT LEG VOL. 25 - VOL. 33 (PSID)
6.2.1-69	PEAK PRESSURE DIFFERENTIAL IN REACTOR CAVITY HOT LEG VOL. 26 - VOL. 33 (PSID)
6.2.1-70	PEAK PRESSURE DIFFERENTIAL IN REACTOR CAVITY HOT LEG VOL. 27 - VOL. 33 (PSID)
6.2.1-71	PEAK PRESSURE DIFFERENTIAL IN REACTOR CAVITY HOT LEG VOL. 28 - VOL. 33 (PSID)
6.2.1-72	PEAK PRESSURE DIFFERENTIAL IN REACTOR CAVITY HOT LEG VOL. 29 - VOL. 33 (PSID)
6.2.1-73	PEAK PRESSURE DIFFERENTIAL IN REACTOR CAVITY HOT LEG VOL. 30 - VOL. 33 (PSID)
6.2.1-74	PEAK PRESSURE DIFFERENTIAL IN REACTOR CAVITY HOT LEG VOL. 31 - VOL. 33 (PSID)
6.2.1-75	PEAK PRESSURE DIFFERENTIAL IN REACTOR CAVITY HOT LEG VOL. 32 - VOL. 33 (PSID)
6.2.1-76	PEAK PRESSURE DIFFERENTIAL IN STEAM GENERATOR LOOP-1 VOL. 5 - VOL. 18 (PSID)
6.2.1-77	PEAK PRESSURE DIFFERENTIAL IN STEAM GENERATOR LOOP-1 VOL. 10 - VOL. 18 (PSID)
6.2.1-78	PEAK PRESSURE DIFFERENTIAL IN STEAM GENERATOR LOOP-1 VOL. 12 - VOL. 10 (PSID)
6.2.1-79	PEAK PRESSURE DIFFERENTIAL IN STEAM GENERATOR LOOP-1 VOL. 12 - VOL. 16 (PSID)
6.2.1-80	PEAK PRESSURE DIFFERENTIAL IN STEAM GENERATOR LOOP-1 VOL. 12 - VOL. 17 (PSID)
6.2.1-81	PEAK PRESSURE DIFFERENTIAL IN STEAM GENERATOR LOOP-1 VOL. 12 - VOL. 35 (PSID)
6.2.1-82	PEAK PRESSURE DIFFERENTIAL IN STEAM GENERATOR LOOP-1 VOL. 21 - VOL. 11 (PSID)
6.2.1-83	PEAK PRESSURE DIFFERENTIAL IN STEAM GENERATOR LOOP-1 VOL. 21 - VOL. 13 (PSID)
6.2.1-84	PEAK PRESSURE DIFFERENTIAL IN STEAM GENERATOR LOOP-1 VOL. 21 - VOL. 18 (PSID)

<u>FIGURE</u>	<u>TITLE</u>
6.2.1-85	PEAK PRESSURE DIFFERENTIAL IN STEAM GENERATOR LOOP-1 VOL. 22 - VOL. 11 (PSID)
6.2.1-86	PEAK PRESSURE DIFFERENTIAL IN STEAM GENERATOR LOOP-1 VOL. 22 - VOL. 13 (PSID)
6.2.1-87	PEAK PRESSURE DIFFERENTIAL IN STEAM GENERATOR LOOP-1 VOL. 22 - VOL. 17 (PSID)
6.2.1-88	PEAK PRESSURE DIFFERENTIAL IN STEAM GENERATOR LOOP-1 VOL. 22 - VOL. 21 (PSID)
6.2.1-89	PEAK PRESSURE DIFFERENTIAL IN STEAM GENERATOR LOOP-1 VOL. 22 - VOL. 24 (PSID)
6.2.1-90	PEAK PRESSURE DIFFERENTIAL IN STEAM GENERATOR LOOP-1 VOL. 23 - VOL. 13 (PSID)
6.2.1-91	PEAK PRESSURE DIFFERENTIAL IN STEAM GENERATOR LOOP-1 VOL. 23 - VOL. 18 (PSID)
6.2.1-92	PEAK PRESSURE DIFFERENTIAL IN STEAM GENERATOR LOOP-1 VOL. 23 - VOL. 21 (PSID)
6.2.1-93	PEAK PRESSURE DIFFERENTIAL IN STEAM GENERATOR LOOP-1 VOL. 23 - VOL. 25 (PSID)
6.2.1-94	PEAK PRESSURE DIFFERENTIAL IN STEAM GENERATOR LOOP-1 VOL. 24 - VOL. 13 (PSID)
6.2.1-95	PEAK PRESSURE DIFFERENTIAL IN STEAM GENERATOR LOOP-1 VOL. 24 - VOL. 16 (PSID)
6.2.1-96	PEAK PRESSURE DIFFERENTIAL IN STEAM GENERATOR LOOP-1 VOL. 24 - VOL. 17 (PSID)
6.2.1-97	PEAK PRESSURE DIFFERENTIAL IN STEAM GENERATOR LOOP-1 VOL. 24 - VOL. 23 (PSID)
6.2.1-98	PEAK PRESSURE DIFFERENTIAL IN STEAM GENERATOR LOOP-1 VOL. 24 - VOL. 32 (PSID)
6.2.1-99	PEAK PRESSURE DIFFERENTIAL IN STEAM GENERATOR LOOP-1 VOL. 25 - VOL. 13 (PSID)
6.2.1-100	PEAK PRESSURE DIFFERENTIAL IN STEAM GENERATOR LOOP-1 VOL. 25 - VOL. 18 (PSID)
6.2.1-101	PEAK PRESSURE DIFFERENTIAL IN STEAM GENERATOR LOOP-1 VOL. 26 - VOL. 13 (PSID)
6.2.1-102	PEAK PRESSURE DIFFERENTIAL IN STEAM GENERATOR LOOP-1 VOL. 26 - VOL. 18 (PSID)
6.2.1-103	PEAK PRESSURE DIFFERENTIAL IN STEAM GENERATOR LOOP-1 VOL. 27 - VOL. 11 (PSID)
6.2.1-104	PEAK PRESSURE DIFFERENTIAL IN STEAM GENERATOR LOOP-1 VOL. 27 - VOL. 18 (PSID)
6.2.1-105	PEAK PRESSURE DIFFERENTIAL IN STEAM GENERATOR LOOP-1 VOL. 27 - VOL. 33 (PSID)
6.2.1-106	PEAK PRESSURE DIFFERENTIAL IN STEAM GENERATOR LOOP-1 VOL. 28 - VOL. 11 (PSID)
6.2.1-107	PEAK PRESSURE DIFFERENTIAL IN STEAM GENERATOR LOOP-1 VOL. 28 - VOL. 17 (PSID)
6.2.1-108	PEAK PRESSURE DIFFERENTIAL IN STEAM GENERATOR LOOP-1 VOL. 28 - VOL. 27 (PSID)
6.2.1-109	PEAK PRESSURE DIFFERENTIAL IN STEAM GENERATOR LOOP-1 VOL. 28 - VOL. 30 (PSID)
6.2.1-110	PEAK PRESSURE DIFFERENTIAL IN STEAM GENERATOR LOOP-1 VOL. 28 - VOL. 34 (PSID)
6.2.1-111	PEAK PRESSURE DIFFERENTIAL IN STEAM GENERATOR LOOP-1 VOL. 29 - VOL. 18 (PSID)

<u>FIGURE</u>	<u>TITLE</u>
6.2.1-112	PEAK PRESSURE DIFFERENTIAL IN STEAM GENERATOR LOOP-1 VOL. 29 - VOL. 27 (PSID)
6.2.1-113	PEAK PRESSURE DIFFERENTIAL IN STEAM GENERATOR LOOP-1 VOL. 29 - VOL. 31 (PSID)
6.2.1-114	PEAK PRESSURE DIFFERENTIAL IN STEAM GENERATOR LOOP-1 VOL. 29 - VOL. 35 (PSID)
6.2.1-115	PEAK PRESSURE DIFFERENTIAL IN STEAM GENERATOR LOOP-1 VOL. 30 - VOL. 12 (PSID)
6.2.1-116	PEAK PRESSURE DIFFERENTIAL IN STEAM GENERATOR LOOP-1 VOL. 30 - VOL. 16 (PSID)
6.2.1-117	PEAK PRESSURE DIFFERENTIAL IN STEAM GENERATOR LOOP-1 VOL. 30 - VOL. 17 (PSID)
6.2.1-118	PEAK PRESSURE DIFFERENTIAL IN STEAM GENERATOR LOOP-1 VOL. 30 - VOL. 29 (PSID)
6.2.1-119	PEAK PRESSURE DIFFERENTIAL IN STEAM GENERATOR LOOP-1 VOL. 30 - VOL. 32 (PSID)
6.2.1-120	PEAK PRESSURE DIFFERENTIAL IN STEAM GENERATOR LOOP-1 VOL. 31 - VOL. 5 (PSID)
6.2.1-121	PEAK PRESSURE DIFFERENTIAL IN STEAM GENERATOR LOOP-1 VOL. 31 - VOL. 18 (PSID)
6.2.1-122	PEAK PRESSURE DIFFERENTIAL IN STEAM GENERATOR LOOP-1 VOL. 32 - VOL. 10 (PSID)
6.2.1-123	PEAK PRESSURE DIFFERENTIAL IN STEAM GENERATOR LOOP-1 VOL. 32 - VOL. 18 (PSID)
6.2.1-124	PEAK PRESSURE DIFFERENTIAL IN STEAM GENERATOR LOOP-1 VOL. 33 - VOL. 11 (PSID)
6.2.1-125	PEAK PRESSURE DIFFERENTIAL IN STEAM GENERATOR LOOP-1 VOL. 33 - VOL. 18 (PSID)
6.2.1-126	PEAK PRESSURE DIFFERENTIAL IN STEAM GENERATOR LOOP-1 VOL. 34 - VOL. 3 (PSID)
6.2.1-127	PEAK PRESSURE DIFFERENTIAL IN STEAM GENERATOR LOOP-1 VOL. 34 - VOL. 11 (PSID)
6.2.1-128	PEAK PRESSURE DIFFERENTIAL IN STEAM GENERATOR LOOP-1 VOL. 34 - VOL. 12 (PSID)
6.2.1-129	PEAK PRESSURE DIFFERENTIAL IN STEAM GENERATOR LOOP-1 VOL. 34 - VOL. 33 (PSID)
6.2.1-130	PEAK PRESSURE DIFFERENTIAL IN STEAM GENERATOR LOOP-1 VOL. 35 - VOL. 5 (PSID)
6.2.1-131	PEAK PRESSURE DIFFERENTIAL IN STEAM GENERATOR LOOP-1 VOL. 35 - VOL. 18 (PSID)
6.2.1-132	PEAK PRESSURE DIFFERENTIAL IN STEAM GENERATOR LOOP-1 VOL. 35 - VOL. 33 (PSID)
6.2.1-133	PEAK PRESSURE DIFFERENTIAL IN STEAM GENERATOR LOOP-3 VOL. 13 - VOL. 7 (PSID)
6.2.1-134	PEAK PRESSURE DIFFERENTIAL IN STEAM GENERATOR LOOP-3 VOL. 14 - VOL. 13 (PSID)
6.2.1-135	PEAK PRESSURE DIFFERENTIAL IN STEAM GENERATOR LOOP-3 VOL. 15 - VOL. 7 (PSID)
6.2.1-136	PEAK PRESSURE DIFFERENTIAL IN STEAM GENERATOR LOOP-3 VOL. 15 - VOL. 12 (PSID)
6.2.1-137	PEAK PRESSURE DIFFERENTIAL IN STEAM GENERATOR LOOP-3 VOL. 15 - VOL. 14 (PSID)
6.2.1-138	PEAK PRESSURE DIFFERENTIAL IN STEAM GENERATOR LOOP-3 VOL. 16 - VOL. 7 (PSID)

<u>FIGURE</u>	<u>TITLE</u>
6.2.1-139	PEAK PRESSURE DIFFERENTIAL IN STEAM GENERATOR LOOP-3 VOL. 16 - VOL. 14 (PSID)
6.2.1-140	PEAK PRESSURE DIFFERENTIAL IN STEAM GENERATOR LOOP-3 VOL. 16 - VOL. 15 (PSID)
6.2.1-141	PEAK PRESSURE DIFFERENTIAL IN STEAM GENERATOR LOOP-3 VOL. 16 - VOL. 18 (PSID)
6.2.1-142	PEAK PRESSURE DIFFERENTIAL IN STEAM GENERATOR LOOP-3 VOL. 17 - VOL. 7 (PSID)
6.2.1-143	PEAK PRESSURE DIFFERENTIAL IN STEAM GENERATOR LOOP-3 VOL. 17 - VOL. 12 (PSID)
6.2.1-144	PEAK PRESSURE DIFFERENTIAL IN STEAM GENERATOR LOOP-3 VOL. 17 - VOL. 14 (PSID)
6.2.1-145	PEAK PRESSURE DIFFERENTIAL IN STEAM GENERATOR LOOP-3 VOL. 17 - VOL. 15 (PSID)
6.2.1-146	PEAK PRESSURE DIFFERENTIAL IN STEAM GENERATOR LOOP-3 VOL. 17 - VOL. 18 (PSID)
6.2.1-147	PEAK PRESSURE DIFFERENTIAL IN STEAM GENERATOR LOOP-3 VOL. 17 - VOL. 19 (PSID)
6.2.1-148	PEAK PRESSURE DIFFERENTIAL IN STEAM GENERATOR LOOP-3 VOL. 18 - VOL. 7 (PSID)
6.2.1-149	PEAK PRESSURE DIFFERENTIAL IN STEAM GENERATOR LOOP-3 VOL. 18 - VOL. 8 (PSID)
6.2.1-150	PEAK PRESSURE DIFFERENTIAL IN STEAM GENERATOR LOOP-3 VOL. 19 - VOL. 6 (PSID)
6.2.1-151	PEAK PRESSURE DIFFERENTIAL IN STEAM GENERATOR LOOP-3 VOL. 19 - VOL. 7 (PSID)
6.2.1-152	PEAK PRESSURE DIFFERENTIAL IN STEAM GENERATOR LOOP-3 VOL. 19 - VOL. 8 (PSID)
6.2.1-153	PEAK PRESSURE DIFFERENTIAL IN STEAM GENERATOR LOOP-3 VOL. 19 - VOL. 12 (PSID)
6.2.1-155	PEAK PRESSURE DIFFERENTIAL IN STEAM GENERATOR LOOP-3 VOL. 20 - VOL. 8 (PSID)
6.2.1-156	PEAK PRESSURE DIFFERENTIAL IN STEAM GENERATOR LOOP-3 VOL. 20 - VOL. 14 (PSID)
6.2.1-157	PEAK PRESSURE DIFFERENTIAL IN STEAM GENERATOR LOOP-3 VOL. 20 - VOL. 18 (PSID)
6.2.1-158	PEAK PRESSURE DIFFERENTIAL IN STEAM GENERATOR LOOP-3 VOL. 20 - VOL. 19 (PSID)
6.2.1-159	PEAK PRESSURE DIFFERENTIAL IN STEAM GENERATOR LOOP-3 VOL. 22 - VOL. 8 (PSID)
6.2.1-160	PEAK PRESSURE DIFFERENTIAL IN STEAM GENERATOR LOOP-3 VOL. 21 - VOL. 12 (PSID)
6.2.1-161	PEAK PRESSURE DIFFERENTIAL IN STEAM GENERATOR LOOP-3 VOL. 21 - VOL. 27 (PSID)
6.2.1-162	PEAK PRESSURE DIFFERENTIAL IN STEAM GENERATOR LOOP-3 VOL. 22 - VOL. 21 (PSID)
6.2.1-163	PEAK PRESSURE DIFFERENTIAL IN STEAM GENERATOR LOOP-3 VOL. 22 - VOL. 24 (PSID)
6.2.1-164	PEAK PRESSURE DIFFERENTIAL IN STEAM GENERATOR LOOP-3 VOL. 22 - VOL. 28 (PSID)
6.2.1-165	PEAK PRESSURE DIFFERENTIAL IN STEAM GENERATOR LOOP-3 VOL. 23 - VOL. 12 (PSID)
6.2.1-166	PEAK PRESSURE DIFFERENTIAL IN STEAM GENERATOR LOOP-3 VOL. 23 - VOL. 21 (PSID)

<u>FIGURE</u>	<u>TITLE</u>
6.2.1-167	PEAK PRESSURE DIFFERENTIAL IN STEAM GENERATOR LOOP-3 VOL. 23 - VOL. 24 (PSID)
6.2.1-168	PEAK PRESSURE DIFFERENTIAL IN STEAM GENERATOR LOOP-3 VOL. 23 - VOL. 25 (PSID)
6.2.1-169	PEAK PRESSURE DIFFERENTIAL IN STEAM GENERATOR LOOP-3 VOL. 23 - VOL. 29 (PSID)
6.2.1-170	PEAK PRESSURE DIFFERENTIAL IN STEAM GENERATOR LOOP-3 VOL. 24 - VOL. 8 (PSID)
6.2.1-171	PEAK PRESSURE DIFFERENTIAL IN STEAM GENERATOR LOOP-3 VOL. 24 - VOL. 30 (PSID)
6.2.1-172	PEAK PRESSURE DIFFERENTIAL IN STEAM GENERATOR LOOP-3 VOL. 25 - VOL. 6 (PSID)
6.2.1-173	PEAK PRESSURE DIFFERENTIAL IN STEAM GENERATOR LOOP-3 VOL. 25 - VOL. 8 (PSID)
6.2.1-174	PEAK PRESSURE DIFFERENTIAL IN STEAM GENERATOR LOOP-3 VOL. 25 - VOL. 12 (PSID)
6.2.1-175	PEAK PRESSURE DIFFERENTIAL IN STEAM GENERATOR LOOP-3 VOL. 25 - VOL. 31 (PSID)
6.2.1-176	PEAK PRESSURE DIFFERENTIAL IN STEAM GENERATOR LOOP-3 VOL. 26 - VOL. 8 (PSID)
6.2.1-177	PEAK PRESSURE DIFFERENTIAL IN STEAM GENERATOR LOOP-3 VOL. 26 - VOL. 24 (PSID)
6.2.1-178	PEAK PRESSURE DIFFERENTIAL IN STEAM GENERATOR LOOP-3 VOL. 26 - VOL. 25 (PSID)
6.2.1-179	PEAK PRESSURE DIFFERENTIAL IN STEAM GENERATOR LOOP-3 VOL. 26 - VOL. 32 (PSID)
6.2.1-180	PEAK PRESSURE DIFFERENTIAL IN STEAM GENERATOR LOOP-3 VOL. 27 - VOL. 12 (PSID)
6.2.1-181	PEAK PRESSURE DIFFERENTIAL IN STEAM GENERATOR LOOP-3 VOL. 27 - VOL. 28 (PSID)
6.2.1-182	PEAK PRESSURE DIFFERENTIAL IN STEAM GENERATOR LOOP-3 VOL. 27 - VOL. 29 (PSID)
6.2.1-183	PEAK PRESSURE DIFFERENTIAL IN STEAM GENERATOR LOOP-3 VOL. 28 - VOL. 9 (PSID)
6.2.1-184	PEAK PRESSURE DIFFERENTIAL IN STEAM GENERATOR LOOP-3 VOL. 28 - VOL. 30 (PSID)
6.2.1-185	PEAK PRESSURE DIFFERENTIAL IN STEAM GENERATOR LOOP-3 VOL. 29 - VOL. 12 (PSID)
6.2.1-186	PEAK PRESSURE DIFFERENTIAL IN STEAM GENERATOR LOOP-3 VOL. 29 - VOL. 31 (PSID)
6.2.1-187	PEAK PRESSURE DIFFERENTIAL IN STEAM GENERATOR LOOP-3 VOL. 30 - VOL. 7 (PSID)
6.2.1-188	PEAK PRESSURE DIFFERENTIAL IN STEAM GENERATOR LOOP-3 VOL. 30 - VOL. 9 (PSID)
6.2.1-189	PEAK PRESSURE DIFFERENTIAL IN STEAM GENERATOR LOOP-3 VOL. 30 - VOL. 29 (PSID)
6.2.1-190	PEAK PRESSURE DIFFERENTIAL IN STEAM GENERATOR LOOP-3 VOL. 30 - VOL. 32 (PSID)
6.2.1-191	PEAK PRESSURE DIFFERENTIAL IN STEAM GENERATOR LOOP-3 VOL. 30 - VOL. 5 (PSID)
6.2.1-192	PEAK PRESSURE DIFFERENTIAL IN STEAM GENERATOR LOOP-3 VOL. 31 - VOL. 6 (PSID)
6.2.1-193	PEAK PRESSURE DIFFERENTIAL IN STEAM GENERATOR LOOP-3 VOL. 31 - VOL. 12 (PSID)

<u>FIGURE</u>	<u>TITLE</u>
6.2.1-194	PEAK PRESSURE DIFFERENTIAL IN STEAM GENERATOR LOOP-3 VOL. 32 - VOL. 5 (PSID)
6.2.1-195	PEAK PRESSURE DIFFERENTIAL IN STEAM GENERATOR LOOP-3 VOL. 32 - VOL. 31 (PSID)
6.2.1-196	PEAK PRESSURE DIFFERENTIAL IN STEAM GENERATOR LOOP-2 VOL. 3 - VOL. 16 (PSID)
6.2.1-197	PEAK PRESSURE DIFFERENTIAL IN STEAM GENERATOR LOOP-2 VOL. 3 - VOL. 10 (PSID)
6.2.1-198	PEAK PRESSURE DIFFERENTIAL IN STEAM GENERATOR LOOP-2 VOL. 20 - VOL. 1 (PSID)
6.2.1-199	PEAK PRESSURE DIFFERENTIAL IN STEAM GENERATOR LOOP-2 VOL. 20 - VOL. 3 (PSID)
6.2.1-200	PEAK PRESSURE DIFFERENTIAL IN STEAM GENERATOR LOOP-2 VOL. 21 - VOL. 1 (PSID)
6.2.1-201	PEAK PRESSURE DIFFERENTIAL IN STEAM GENERATOR LOOP-2 VOL. 22 - VOL. 1 (PSID)
6.2.1-202	PEAK PRESSURE DIFFERENTIAL IN STEAM GENERATOR LOOP-2 VOL. 23 - VOL. 1 (PSID)
6.2.1-203	PEAK PRESSURE DIFFERENTIAL IN STEAM GENERATOR LOOP-2 VOL. 24 - VOL. 1 (PSID)
6.2.1-204	PEAK PRESSURE DIFFERENTIAL IN STEAM GENERATOR LOOP-2 VOL. 24 - VOL. 11 (PSID)
6.2.1-205	PEAK PRESSURE DIFFERENTIAL IN STEAM GENERATOR LOOP-2 VOL. 24 - VOL. 17 (PSID)
6.2.1-206	PEAK PRESSURE DIFFERENTIAL IN STEAM GENERATOR LOOP-2 VOL. 24 - VOL. 19 (PSID)
6.2.1-207	PEAK PRESSURE DIFFERENTIAL IN STEAM GENERATOR LOOP-2 VOL. 25 - VOL. 1 (PSID)
6.2.1-208	PEAK PRESSURE DIFFERENTIAL IN STEAM GENERATOR LOOP-2 VOL. 25 - VOL. 11 (PSID)
6.2.1-209	PEAK PRESSURE DIFFERENTIAL IN STEAM GENERATOR LOOP-2 VOL. 25 - VOL. 19 (PSID)
6.2.1-210	PEAK PRESSURE DIFFERENTIAL IN STEAM GENERATOR LOOP-2 VOL. 25 - VOL. 24 (PSID)
6.2.1-211	PEAK PRESSURE DIFFERENTIAL IN STEAM GENERATOR LOOP-2 VOL. 25 - VOL. 26 (PSID)
6.2.1-212	PEAK PRESSURE DIFFERENTIAL IN STEAM GENERATOR LOOP-2 VOL. 25 - VOL. 27 (PSID)
6.2.1-213	PEAK PRESSURE DIFFERENTIAL IN STEAM GENERATOR LOOP-2 VOL. 26 - VOL. 1 (PSID)
6.2.1-214	PEAK PRESSURE DIFFERENTIAL IN STEAM GENERATOR LOOP-2 VOL. 26 - VOL. 17 (PSID)
6.2.1-215	PEAK PRESSURE DIFFERENTIAL IN STEAM GENERATOR LOOP-2 VOL. 26 - VOL. 19 (PSID)
6.2.1-216	PEAK PRESSURE DIFFERENTIAL IN STEAM GENERATOR LOOP-2 VOL. 26 - VOL. 24 (PSID)
6.2.1-217	PEAK PRESSURE DIFFERENTIAL IN STEAM GENERATOR LOOP-2 VOL. 26 - VOL. 27 (PSID)
6.2.1-218	PEAK PRESSURE DIFFERENTIAL IN STEAM GENERATOR LOOP-2 VOL. 27 - VOL. 1 (PSID)
6.2.1-219	PEAK PRESSURE DIFFERENTIAL IN STEAM GENERATOR LOOP-2 VOL. 27 - VOL. 11 (PSID)
6.2.1-220	PEAK PRESSURE DIFFERENTIAL IN STEAM GENERATOR LOOP-2 VOL. 27 - VOL. 17 (PSID)

FIGURE	TITLE
6.2.1-221	PEAK PRESSURE DIFFERENTIAL IN STEAM GENERATOR LOOP-2 VOL. 28 - VOL. 11 (PSID)
6.2.1-222	PEAK PRESSURE DIFFERENTIAL IN STEAM GENERATOR LOOP-2 VOL. 28 - VOL. 17 (PSID)
6.2.1-223	PEAK PRESSURE DIFFERENTIAL IN STEAM GENERATOR LOOP-2 VOL. 28 - VOL. 24 (PSID)
6.2.1-224	PEAK PRESSURE DIFFERENTIAL IN STEAM GENERATOR LOOP-2 VOL. 28 - VOL. 32 (PSID)
6.2.1-225	PEAK PRESSURE DIFFERENTIAL IN STEAM GENERATOR LOOP-2 VOL. 29 - VOL. 11 (PSID)
6.2.1-226	PEAK PRESSURE DIFFERENTIAL IN STEAM GENERATOR LOOP-2 VOL. 29 - VOL. 25 (PSID)
6.2.1-227	PEAK PRESSURE DIFFERENTIAL IN STEAM GENERATOR LOOP-2 VOL. 29 - VOL. 28 (PSID)
6.2.1-228	PEAK PRESSURE DIFFERENTIAL IN STEAM GENERATOR LOOP-2 VOL. 29 - VOL. 30 (PSID)
6.2.1-229	PEAK PRESSURE DIFFERENTIAL IN STEAM GENERATOR LOOP-2 VOL. 29 - VOL. 31 (PSID)
6.2.1-230	PEAK PRESSURE DIFFERENTIAL IN STEAM GENERATOR LOOP-2 VOL. 29 - VOL. 33 (PSID)
6.2.1-231	PEAK PRESSURE DIFFERENTIAL IN STEAM GENERATOR LOOP-2 VOL. 30 - VOL. 17 (PSID)
6.2.1-232	PEAK PRESSURE DIFFERENTIAL IN STEAM GENERATOR LOOP-2 VOL. 30 - VOL. 26 (PSID)
6.2.1-233	PEAK PRESSURE DIFFERENTIAL IN STEAM GENERATOR LOOP-2 VOL. 30 - VOL. 28 (PSID)
6.2.1-234	PEAK PRESSURE DIFFERENTIAL IN STEAM GENERATOR LOOP-2 VOL. 30 - VOL. 31 (PSID)
6.2.1-235	PEAK PRESSURE DIFFERENTIAL IN STEAM GENERATOR LOOP-2 VOL. 30 - VOL. 34 (PSID)
6.2.1-236	PEAK PRESSURE DIFFERENTIAL IN STEAM GENERATOR LOOP-2 VOL. 31 - VOL. 11 (PSID)
6.2.1-237	PEAK PRESSURE DIFFERENTIAL IN STEAM GENERATOR LOOP-2 VOL. 31 - VOL. 17 (PSID)
6.2.1-238	PEAK PRESSURE DIFFERENTIAL IN STEAM GENERATOR LOOP-2 VOL. 31 - VOL. 27 (PSID)
6.2.1-239	PEAK PRESSURE DIFFERENTIAL IN STEAM GENERATOR LOOP-2 VOL. 31 - VOL. 35 (PSID)
6.2.1-240	PEAK PRESSURE DIFFERENTIAL IN STEAM GENERATOR LOOP-2 VOL. 32 - VOL. 10 (PSID)
6.2.1-241	PEAK PRESSURE DIFFERENTIAL IN STEAM GENERATOR LOOP-2 VOL. 32 - VOL. 16 (PSID)
6.2.1-242	PEAK PRESSURE DIFFERENTIAL IN STEAM GENERATOR LOOP-2 VOL. 33 - VOL. 10 (PSID)
6.2.1-243	PEAK PRESSURE DIFFERENTIAL IN STEAM GENERATOR LOOP-2 VOL. 33 - VOL. 34 (PSID)
6.2.1-244	PEAK PRESSURE DIFFERENTIAL IN STEAM GENERATOR LOOP-2 VOL. 33 - VOL. 35 (PSID)
6.2.1-245	PEAK PRESSURE DIFFERENTIAL IN STEAM GENERATOR LOOP-2 VOL. 34 - VOL. 16 (PSID)
6.2.1-246	PEAK PRESSURE DIFFERENTIAL IN STEAM GENERATOR LOOP-2 VOL. 34 - VOL. 35 (PSID)
6.2.1-247	PEAK PRESSURE DIFFERENTIAL IN STEAM GENERATOR LOOP-2 VOL. 35 - VOL. 10 (PSID)

<u>FIGURE</u>	<u>TITLE</u>
6.2.1-248	PEAK PRESSURE DIFFERENTIAL IN STEAM GENERATOR LOOP-2 VOL. 35 - VOL. 16 (PSID)
6.2.1-249	PEAK PRESSURE DIFFERENTIAL IN PRESSURIZER COMPARTMENT VOL. 3 - VOL. 10 (PSID)
6.2.1-250	PEAK PRESSURE DIFFERENTIAL IN PRESSURIZER COMPARTMENT VOL. 3 - VOL. 16 (PSID)
6.2.1-251	PEAK PRESSURE DIFFERENTIAL IN PRESSURIZER COMPARTMENT VOL. 20 - VOL. 1 (PSID)
6.2.1-252	PEAK PRESSURE DIFFERENTIAL IN PRESSURIZER COMPARTMENT VOL. 20 - VOL. 3 (PSID)
6.2.1-253	PEAK PRESSURE DIFFERENTIAL IN PRESSURIZER COMPARTMENT VOL. 21 - VOL. 1 (PSID)
6.2.1-254	PEAK PRESSURE DIFFERENTIAL IN PRESSURIZER COMPARTMENT VOL. 22 - VOL. 1 (PSID)
6.2.1-255	PEAK PRESSURE DIFFERENTIAL IN PRESSURIZER COMPARTMENT VOL. 23 - VOL. 1 (PSID)
6.2.1-256	PEAK PRESSURE DIFFERENTIAL IN PRESSURIZER COMPARTMENT VOL. 24 - VOL. 1 (PSID)
6.2.1-257	PEAK PRESSURE DIFFERENTIAL IN PRESSURIZER COMPARTMENT VOL. 24 - VOL. 11 (PSID)
6.2.1-258	PEAK PRESSURE DIFFERENTIAL IN PRESSURIZER COMPARTMENT VOL. 24 - VOL. 17 (PSID)
6.2.1-259	PEAK PRESSURE DIFFERENTIAL IN PRESSURIZER COMPARTMENT VOL. 24 - VOL. 19 (PSID)
6.2.1-260	PEAK PRESSURE DIFFERENTIAL IN PRESSURIZER COMPARTMENT VOL. 25 - VOL. 1 (PSID)
6.2.1-261	PEAK PRESSURE DIFFERENTIAL IN PRESSURIZER COMPARTMENT VOL. 25 - VOL. 11 (PSID)
6.2.1-262	PEAK PRESSURE DIFFERENTIAL IN PRESSURIZER COMPARTMENT VOL. 25 - VOL. 19 (PSID)
6.2.1-263	PEAK PRESSURE DIFFERENTIAL IN PRESSURIZER COMPARTMENT VOL. 25 - VOL. 24 (PSID)
6.2.1-264	PEAK PRESSURE DIFFERENTIAL IN PRESSURIZER COMPARTMENT VOL. 25 - VOL. 26 (PSID)
6.2.1-265	PEAK PRESSURE DIFFERENTIAL IN PRESSURIZER COMPARTMENT VOL. 25 - VOL. 27 (PSID)
6.2.1-266	PEAK PRESSURE DIFFERENTIAL IN PRESSURIZER COMPARTMENT VOL. 26 - VOL. 1 (PSID)
6.2.1-267	PEAK PRESSURE DIFFERENTIAL IN PRESSURIZER COMPARTMENT VOL. 26 - VOL. 17 (PSID)
6.2.1-268	PEAK PRESSURE DIFFERENTIAL IN PRESSURIZER COMPARTMENT VOL. 26 - VOL. 19 (PSID)
6.2.1-269	PEAK PRESSURE DIFFERENTIAL IN PRESSURIZER COMPARTMENT VOL. 26 - VOL. 24 (PSID)
6.2.1-270	PEAK PRESSURE DIFFERENTIAL IN PRESSURIZER COMPARTMENT VOL. 26 - VOL. 27 (PSID)
6.2.1-271	PEAK PRESSURE DIFFERENTIAL IN PRESSURIZER COMPARTMENT VOL. 27 - VOL. 1 (PSID)
6.2.1-272	PEAK PRESSURE DIFFERENTIAL IN PRESSURIZER COMPARTMENT VOL. 27 - VOL. 11 (PSID)
6.2.1-273	PEAK PRESSURE DIFFERENTIAL IN PRESSURIZER COMPARTMENT VOL. 27 - VOL. 17 (PSID)
6.2.1-274	PEAK PRESSURE DIFFERENTIAL IN PRESSURIZER COMPARTMENT VOL. 28 - VOL. 11 (PSID)

FIGURE	TITLE
6.2.1-275	PEAK PRESSURE DIFFERENTIAL IN PRESSURIZER COMPARTMENT VOL. 28 - VOL. 17 (PSID)
6.2.1-276	PEAK PRESSURE DIFFERENTIAL IN PRESSURIZER COMPARTMENT VOL. 28 - VOL. 24 (PSID)
6.2.1-277	PEAK PRESSURE DIFFERENTIAL IN PRESSURIZER COMPARTMENT VOL. 28 - VOL. 32 (PSID)
6.2.1-278	PEAK PRESSURE DIFFERENTIAL IN PRESSURIZER COMPARTMENT VOL. 28 - VOL. 24 (PSID)
6.2.1-279	PEAK PRESSURE DIFFERENTIAL IN PRESSURIZER COMPARTMENT VOL. 29 - VOL. 25 (PSID)
6.2.1-280	PEAK PRESSURE DIFFERENTIAL IN PRESSURIZER COMPARTMENT VOL. 29 - VOL. 28 (PSID)
6.2.1-281	PEAK PRESSURE DIFFERENTIAL IN PRESSURIZER COMPARTMENT VOL. 29 - VOL. 30 (PSID)
6.2.1-282	PEAK PRESSURE DIFFERENTIAL IN PRESSURIZER COMPARTMENT VOL. 29 - VOL. 31 (PSID)
6.2.1-283	PEAK PRESSURE DIFFERENTIAL IN PRESSURIZER COMPARTMENT VOL. 29 - VOL. 33 (PSID)
6.2.1-284	PEAK PRESSURE DIFFERENTIAL IN PRESSURIZER COMPARTMENT VOL. 30 - VOL. 17 (PSID)
6.2.1-285	PEAK PRESSURE DIFFERENTIAL IN PRESSURIZER COMPARTMENT VOL. 30 - VOL. 26 (PSID)
6.2.1-286	PEAK PRESSURE DIFFERENTIAL IN PRESSURIZER COMPARTMENT VOL. 30 - VOL. 28 (PSID)
6.2.1-287	PEAK PRESSURE DIFFERENTIAL IN PRESSURIZER COMPARTMENT VOL. 30 - VOL. 31 (PSID)
6.2.1-288	PEAK PRESSURE DIFFERENTIAL IN PRESSURIZER COMPARTMENT VOL. 30 - VOL. 34 (PSID)
6.2.1-289	PEAK PRESSURE DIFFERENTIAL IN PRESSURIZER COMPARTMENT VOL. 31 - VOL. 11 (PSID)
6.2.1-290	PEAK PRESSURE DIFFERENTIAL IN PRESSURIZER COMPARTMENT VOL. 31 - VOL. 17 (PSID)
6.2.1-291	PEAK PRESSURE DIFFERENTIAL IN PRESSURIZER COMPARTMENT VOL. 31 - VOL. 27 (PSID)
6.2.1-292	PEAK PRESSURE DIFFERENTIAL IN PRESSURIZER COMPARTMENT VOL. 31 - VOL. 35 (PSID)
6.2.1-293	PEAK PRESSURE DIFFERENTIAL IN PRESSURIZER COMPARTMENT VOL. 32 - VOL. 10 (PSID)
6.2.1-294	PEAK PRESSURE DIFFERENTIAL IN PRESSURIZER COMPARTMENT VOL. 32 - VOL. 16 (PSID)
6.2.1-295	PEAK PRESSURE DIFFERENTIAL IN PRESSURIZER COMPARTMENT VOL. 33 - VOL. 10 (PSID)
6.2.1-296	PEAK PRESSURE DIFFERENTIAL IN PRESSURIZER COMPARTMENT VOL. 33 - VOL. 34 (PSID)
6.2.1-297	PEAK PRESSURE DIFFERENTIAL IN PRESSURIZER COMPARTMENT VOL. 33 - VOL. 35 (PSID)
6.2.1-298	PEAK PRESSURE DIFFERENTIAL IN PRESSURIZER COMPARTMENT VOL. 34 - VOL. 16 (PSID)
6.2.1-299	PEAK PRESSURE DIFFERENTIAL IN PRESSURIZER COMPARTMENT VOL. 34 - VOL. 35 (PSID)
6.2.1-300	PEAK PRESSURE DIFFERENTIAL IN PRESSURIZER COMPARTMENT VOL. 35 - VOL. 10 (PSID)
6.2.1-301	PEAK PRESSURE DIFFERENTIAL IN PRESSURIZER COMPARTMENT VOL. 35 - VOL. 16 (PSID)

FIGURE	TITLE
6.2.1-302	DELETED BY AMENDMENT NO. 46
6.2.1-303	HEAT REMOVAL RATE OF EMERGENCY COOLER UNIT
6.2.1-304	DELETED BY AMENDMENT NO. 46
6.2.1-305	DELETED BY AMENDMENT NO. 46
6.2.1-306	CONTAINMENT VACUUM RELIEF SYSTEM
6.2.1-307	FORCES ON THE REACTOR VESSEL COLD LEG NOZZLE 150 IN ² BREAK
6.2.1-308	MOMENTS ON THE REACTOR VESSEL COLD LEG NOZZLE 150 IN ² BREAK
6.2.2-1	REFER TO FSAR TABLE 1.6-3 FOR DESIGN DOCUMENT INCORPORATED BY REFERENCE
6.2.2-2	REFER TO FSAR TABLE 1.6-3 FOR DESIGN DOCUMENT INCORPORATED BY REFERENCE
6.2.2-3	REFER TO FSAR TABLE 1.6-3 FOR DESIGN DOCUMENT INCORPORATED BY REFERENCE
6.2.2-4	CONTAINMENT FAN COOLER PERFORMANCE CURVE
6.2.2-5	DELETED BY AMENDMENT NO. 48
6.2.2-6	CONTAINMENT SPRAY NOZZLE DROP SIZE HISTOGRAM
6.2.2-7	CONTAINMENT SUMP PLAN
6.2.2-8	CONTAINMENT SUMP SECTION "A-A"
6.2.2-9	CONTAINMENT SUMP SECTION "B-B"
6.2.2-10	REFER TO FSAR TABLE 1.6-3 FOR DESIGN DOCUMENT INCORPORATED BY REFERENCE
6.2.2-11	REFER TO FSAR TABLE 1.6-3 FOR DESIGN DOCUMENT INCORPORATED BY REFERENCE
6.2.2-12	REFER TO FSAR TABLE 1.6-3 FOR DESIGN DOCUMENT INCORPORATED BY REFERENCE
6.2.2-13	REFER TO FSAR TABLE 1.6-3 FOR DESIGN DOCUMENT INCORPORATED BY REFERENCE
6.2.2-14	REFER TO FSAR TABLE 1.6-3 FOR DESIGN DOCUMENT INCORPORATED BY REFERENCE
6.2.2-15	REFER TO FSAR TABLE 1.6-3 FOR DESIGN DOCUMENT INCORPORATED BY REFERENCE
6.2.2-16	REFER TO FSAR TABLE 1.6-3 FOR DESIGN DOCUMENT INCORPORATED BY REFERENCE
6.2.2-17	CONTAINMENT SPRAY PUMP PERFORMANCE CURVE
6.2.2-18	RESIDUAL HEAT REMOVAL PUMP PERFORMANCE CURVE
6.2.2-19	REFER TO FSAR TABLE 1.6-3 FOR DESIGN DOCUMENT INCORPORATED BY REFERENCE
6.2.2-20	CONTAINMENT BUILDING RECIRCULATION SUMP STRAINER ISOMETRIC

FIGURE	TITLE
6.2.5-1	DELETED BY AMENDMENT NO. 62
6.2.5-2	DELETED BY AMENDMENT NO. 62
6.2.5-3	DELETED BY AMENDMENT NO. 62
6.2.5-4	DELETED BY AMENDMENT NO. 62
6.2.5-5	DELETED BY AMENDMENT NO. 58
6.2.5-6	DELETED BY AMENDMENT NO. 62
6.2.5-7	POST ACCIDENT HYDROGEN MONITORING SYSTEM
6.2A-1	TEMPERATURE GRADIENT IN GASEOUS & LIQUID BOUNDARY LAYERS DURING HEAT SINK SURFACE CONDENSATION
6.2A-2	SPRAY EFFICIENCY VS STEAM/AIR RATIO
6.3.2-1	REFER TO FSAR TABLE 1.6-3 FOR DESIGN DOCUMENT INCORPORATED BY REFERENCE
6.3.2-2	REFER TO FSAR TABLE 1.6-3 FOR DESIGN DOCUMENT INCORPORATED BY REFERENCE
6.3.2-3	REFER TO FSAR TABLE 1.6-3 FOR DESIGN DOCUMENT INCORPORATED BY REFERENCE
6.3.2-4	EMERGENCY CORE COOLING SYSTEM PROCESS FLOW DIAGRAM SHEET 1
6.3.2-5	EMERGENCY CORE COOLING SYSTEM PROCESS FLOW DIAGRAM SHEET 2
6.3.2-6	EMERGENCY CORE COOLING SYSTEM PROCESS FLOW DIAGRAM SHEET 3
6.3.2-7	DELETED BY AMENDMENT NO. 27
6.3.2-8	RHR PUMP PERFORMANCE CURVE
6.3.2-9	CHG PUMP PERFORMANCE CURVE
6.4.2-1	DELETED BY AMENDMENT NO. 15
6.5.2-1	DELETED BY AMENDMENT NO. 51
6.5.2-2	CONTAINMENT SPRAY PH TIME HISTORY OF CONTAINMENT SUMP & SPRAY CASE 1
6.5.2-3	CONTAINMENT SPRAY PH TIME HISTORY OF CONTAINMENT SUMP & SPRAY CASE 2
6.5.2-4	DELETED BY AMENDMENT NO. 27
6.5.2-5	DELETED BY AMENDMENT NO. 27
6.5.2-6	DELETED BY AMENDMENT NO. 27

FIGURE 6.2.1-1

CONTAINMENT TEMPERATURE FOR MOST SEVERE HOT LEG BREAK (DEHLG)

DEHL Vapor Temperature

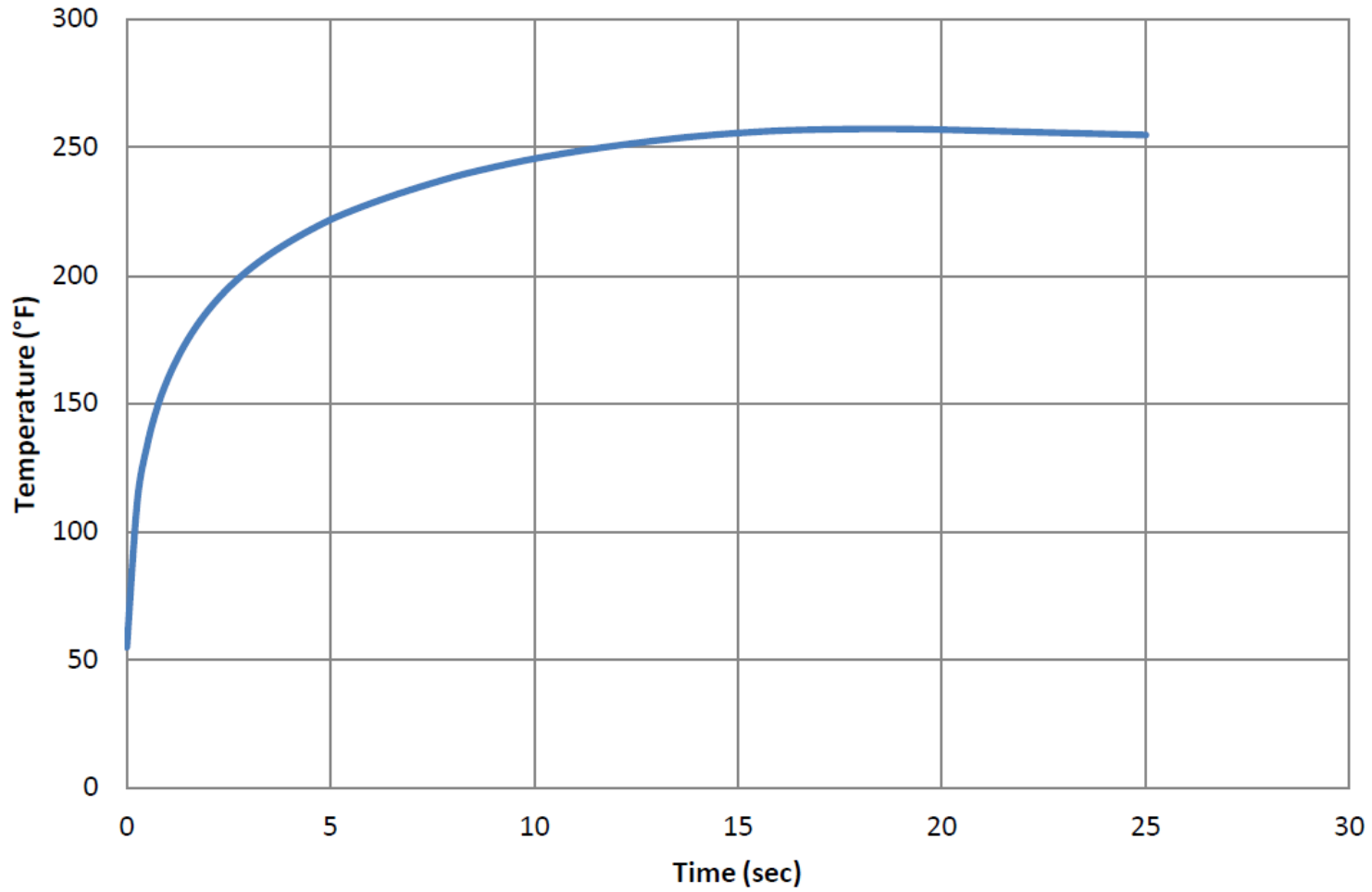

FIGURE 6.2.1-1A

SUMP TEMPERATURE FOR MOST SEVERE HOT LEG BREAK (DEHLG)

DEHL Sump Temperature

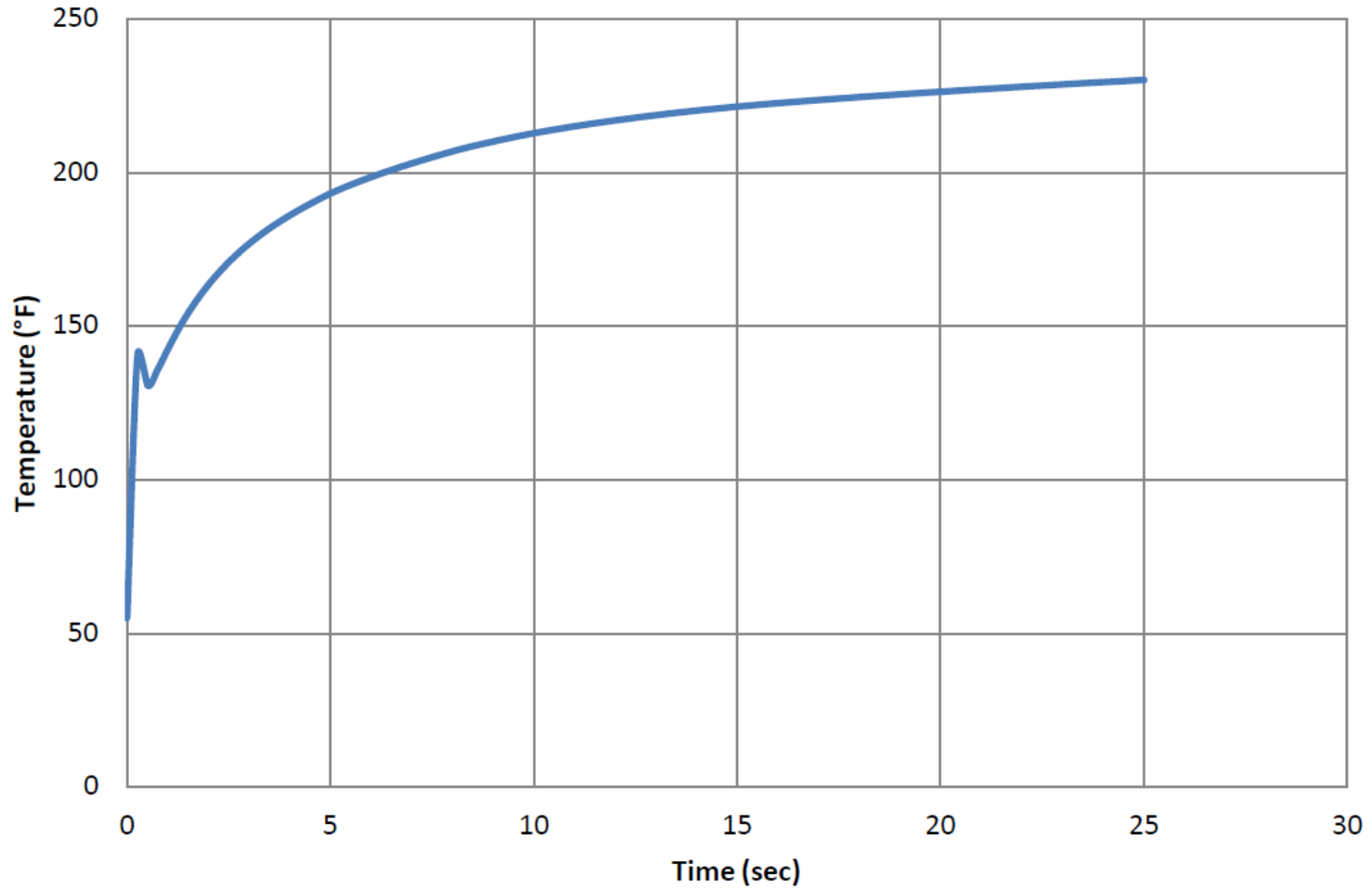

FIGURE 6.2.1-2

CONTAINMENT PRESSURE FOR MOST SEVERE HOT LEG BREAK (DEHLG)

DEHL Pressure

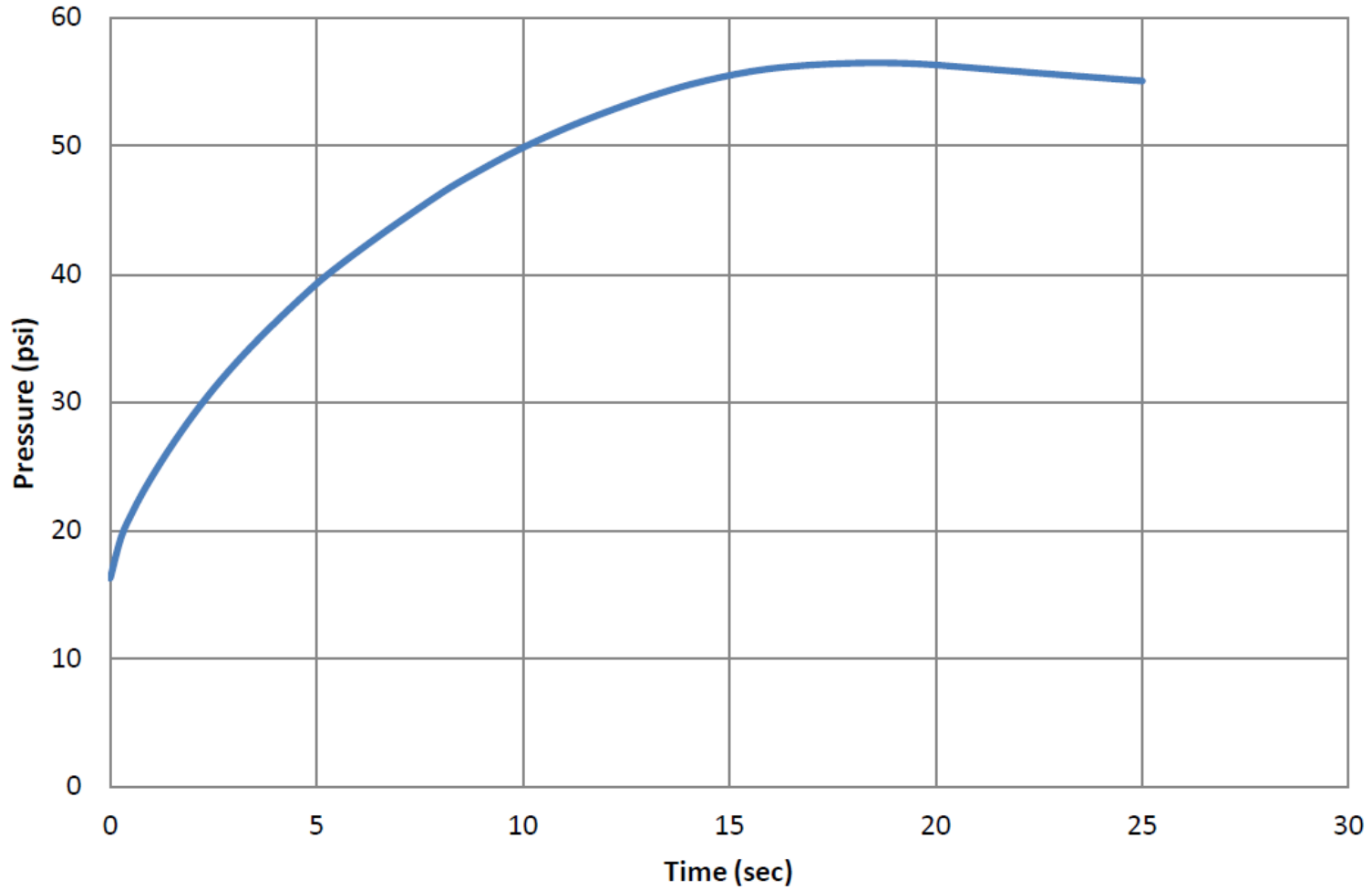

FIGURE 6.2.1-3

CONTAINMENT PRESSURE FOR DBA (MOST SEVERE PUMP SUCTION LEG BREAK – DEPSLG)
MINIMUM SAFETY INJECTION

DEPS Minimum Safeguards Pressure

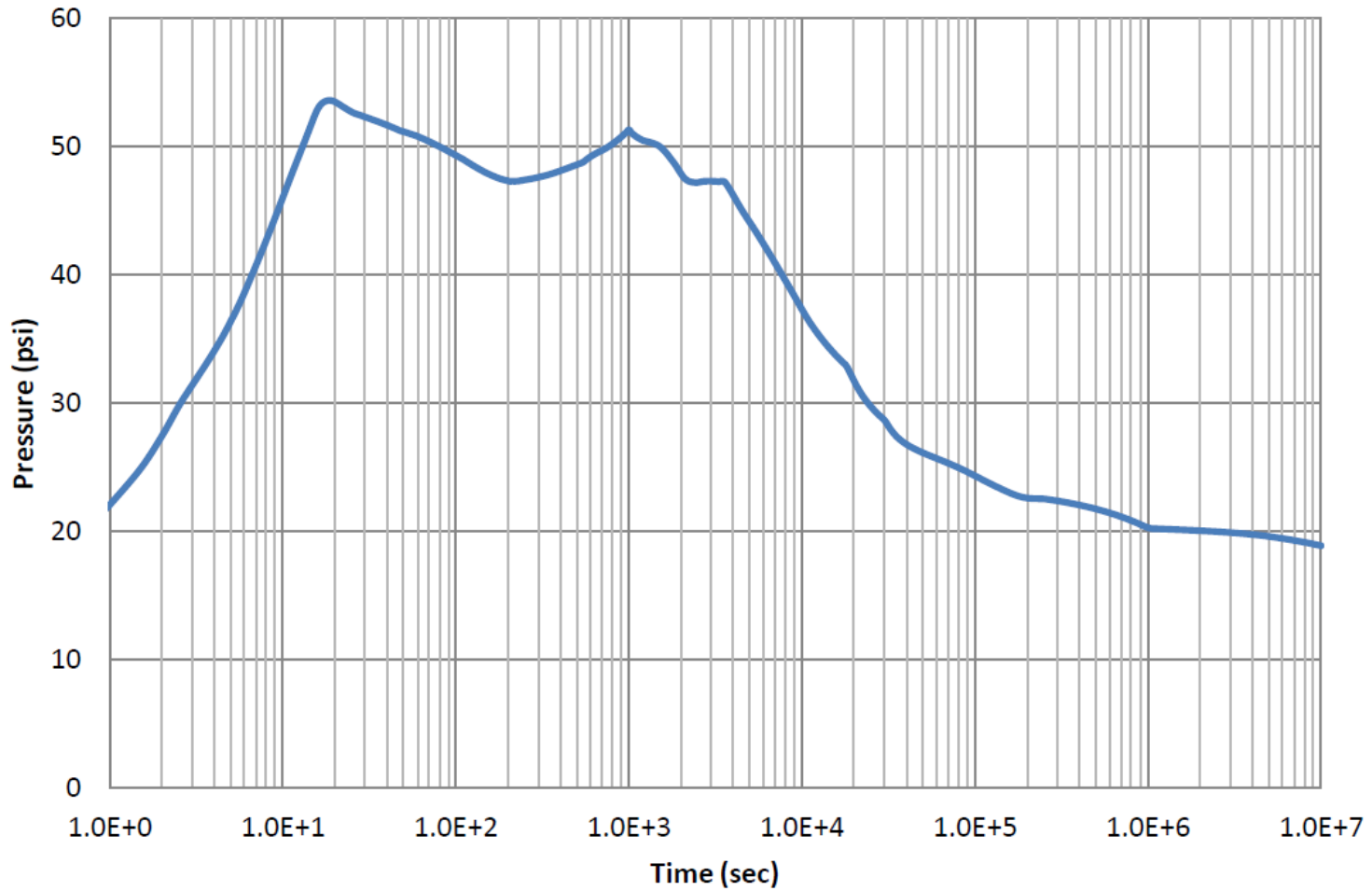

FIGURE 6.2.1-4

CONTAINMENT PRESSURE FOR DEPSG MAXIMUM SAFETY INJECTION

DEPS Maximum Safeguards Pressure

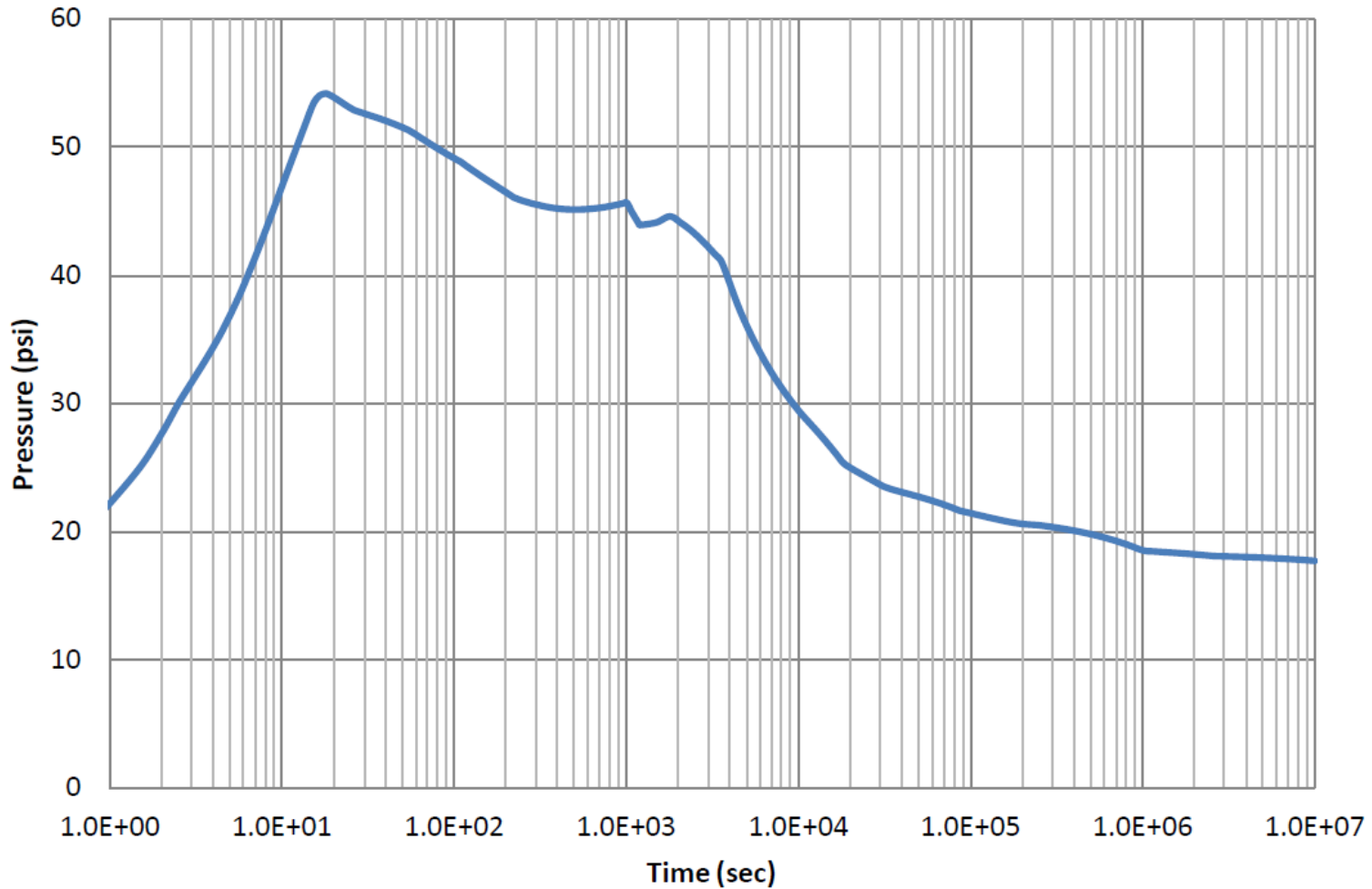

FIGURE 6.2.1-5A

CONTAINMENT TEMPERATURE FOR DBA (MOST SEVERE PUMP SUCTION LEG BREAK – DEPSLG)
MINIMUM SAFETY INJECTION

DEPS Minimum Safeguards Temperature

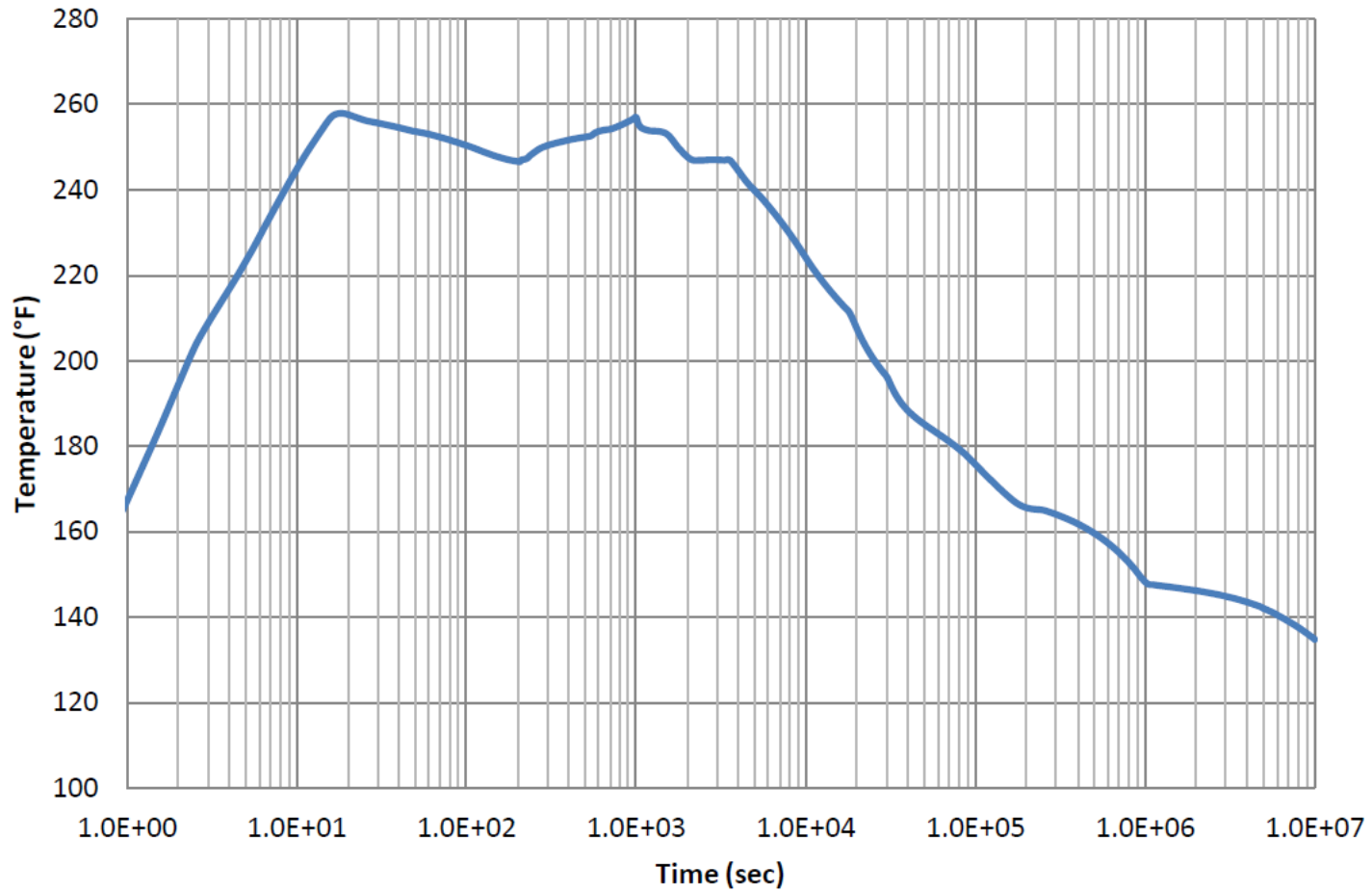

FIGURE 6.2.1-5B

CONTAINMENT SUMP TEMPERATURE FOR DBA
(MOST SEVERE PUMP SUCTION LEG BREAK – DEPSLG)
MINIMUM SAFETY INJECTION

DEPS Minimum Safeguards Sump Temperature

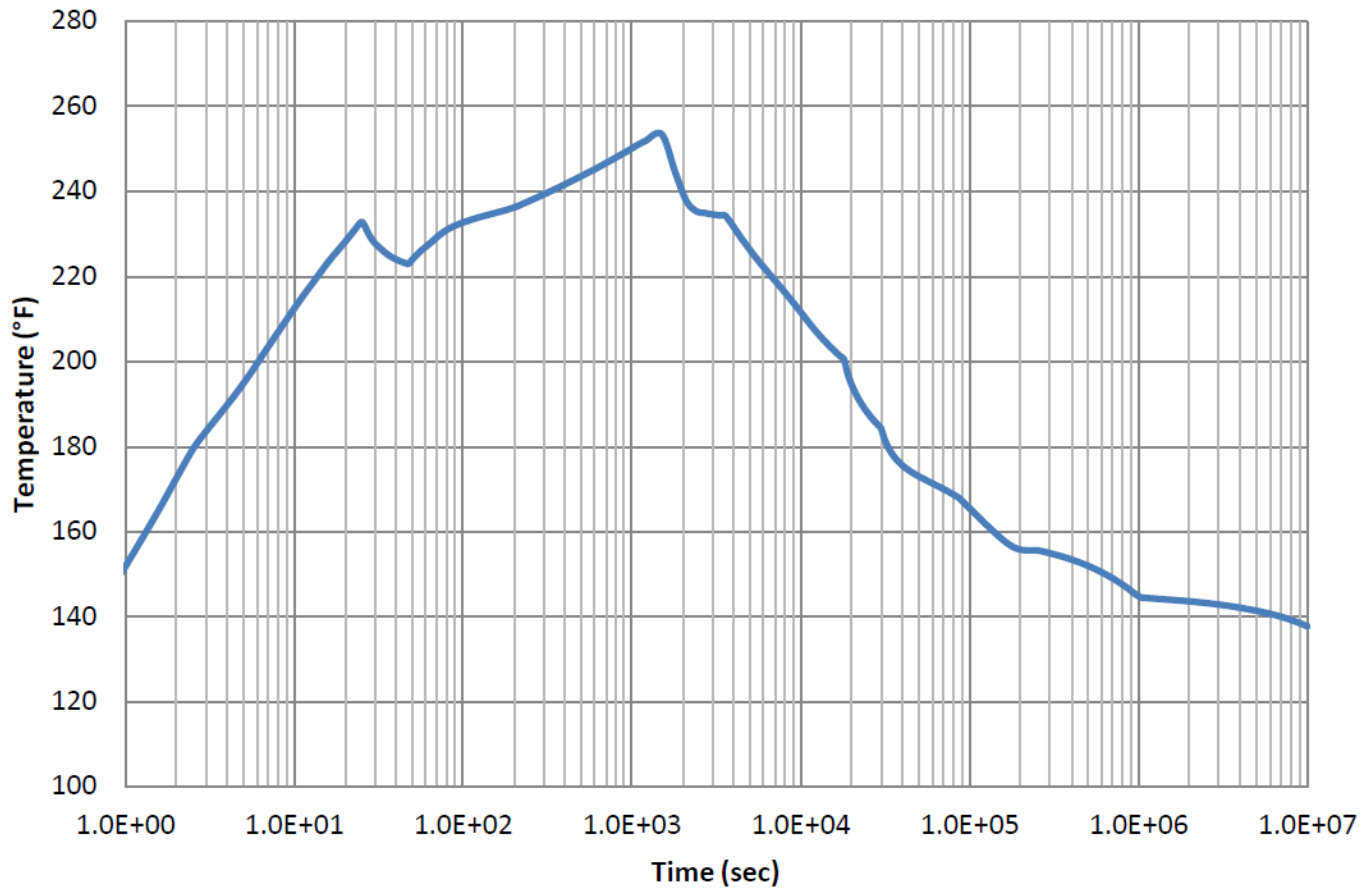

FIGURE 6.2.1-6A

CONTAINMENT TEMPERATURE FOR DEPSG MAXIMUM SAFETY INJECTION

DEPS Maximum Safeguards Temperature

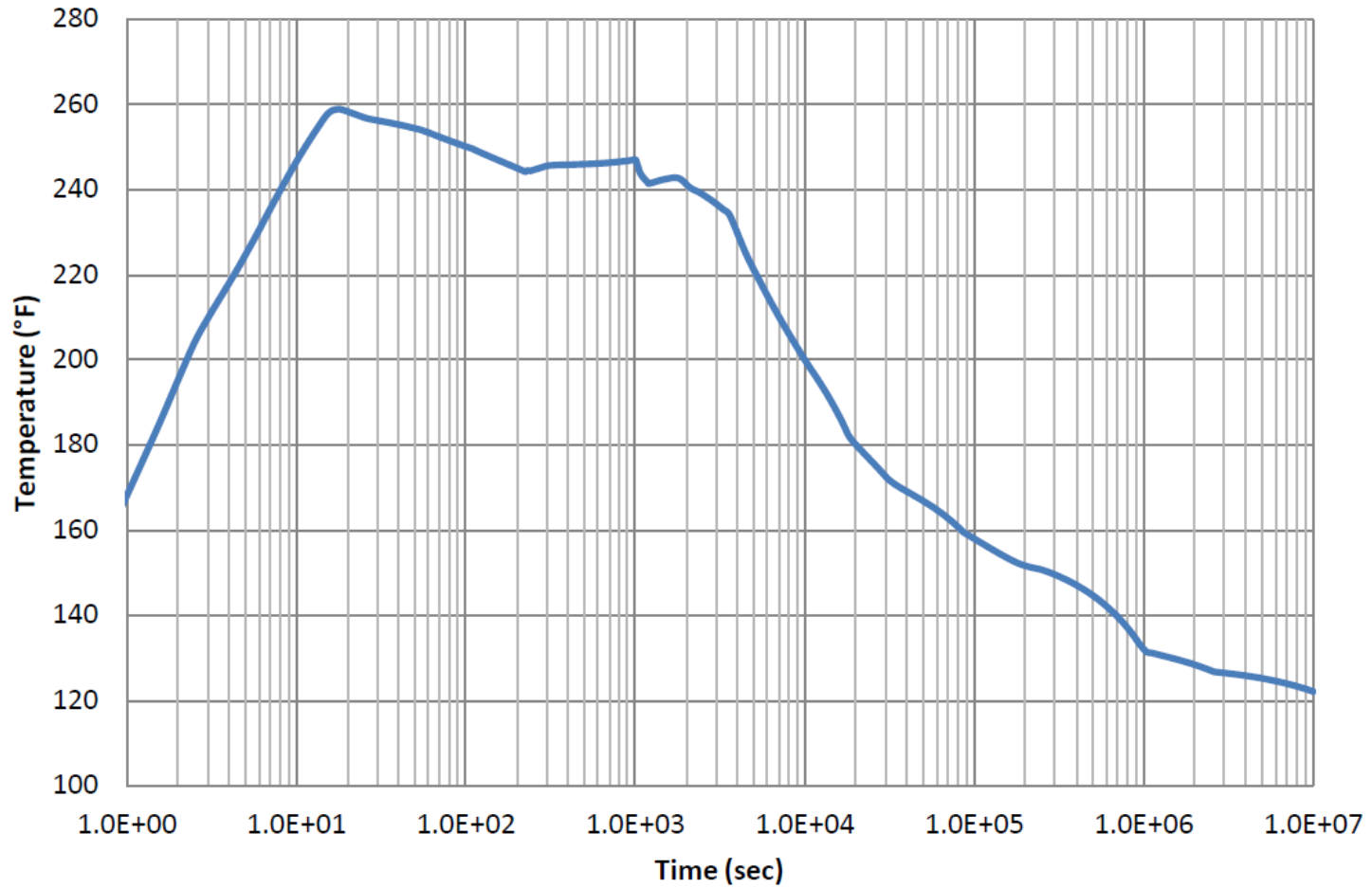

FIGURE 6.2.1-6B

CONTAINMENT SUMP TEMPERATURE
MOST SEVERE PUMP SUCTION BREAK – DEPSLG MAXIMUM SAFETY INJECTION

DEPS Maximum Safeguards Sump Temperature

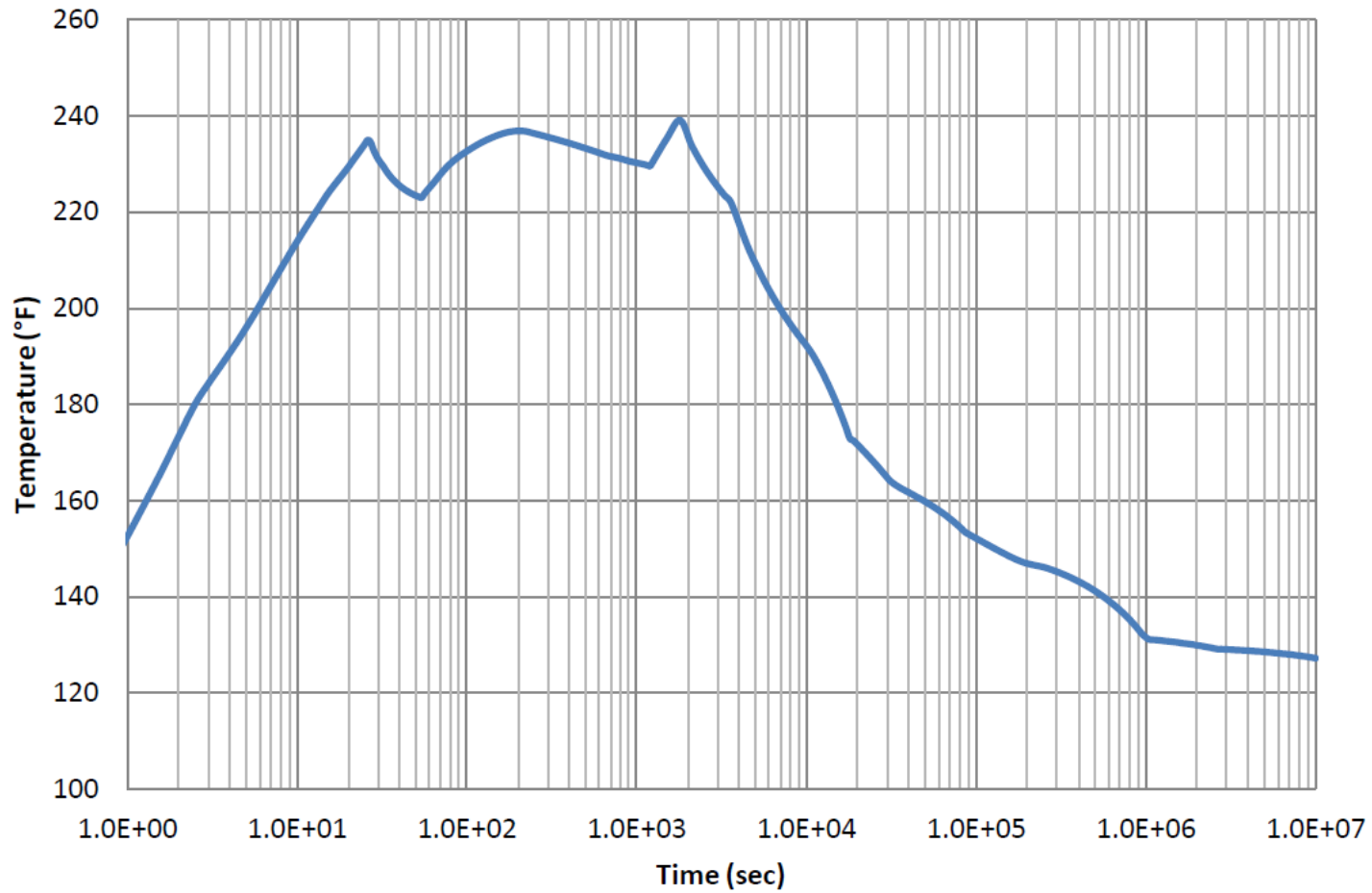

FIGURE 6.2.1-9

CONTAINMENT PRESSURE – WORST MSLB (MFIV FAILURE, 30% POWER FULL DEB)

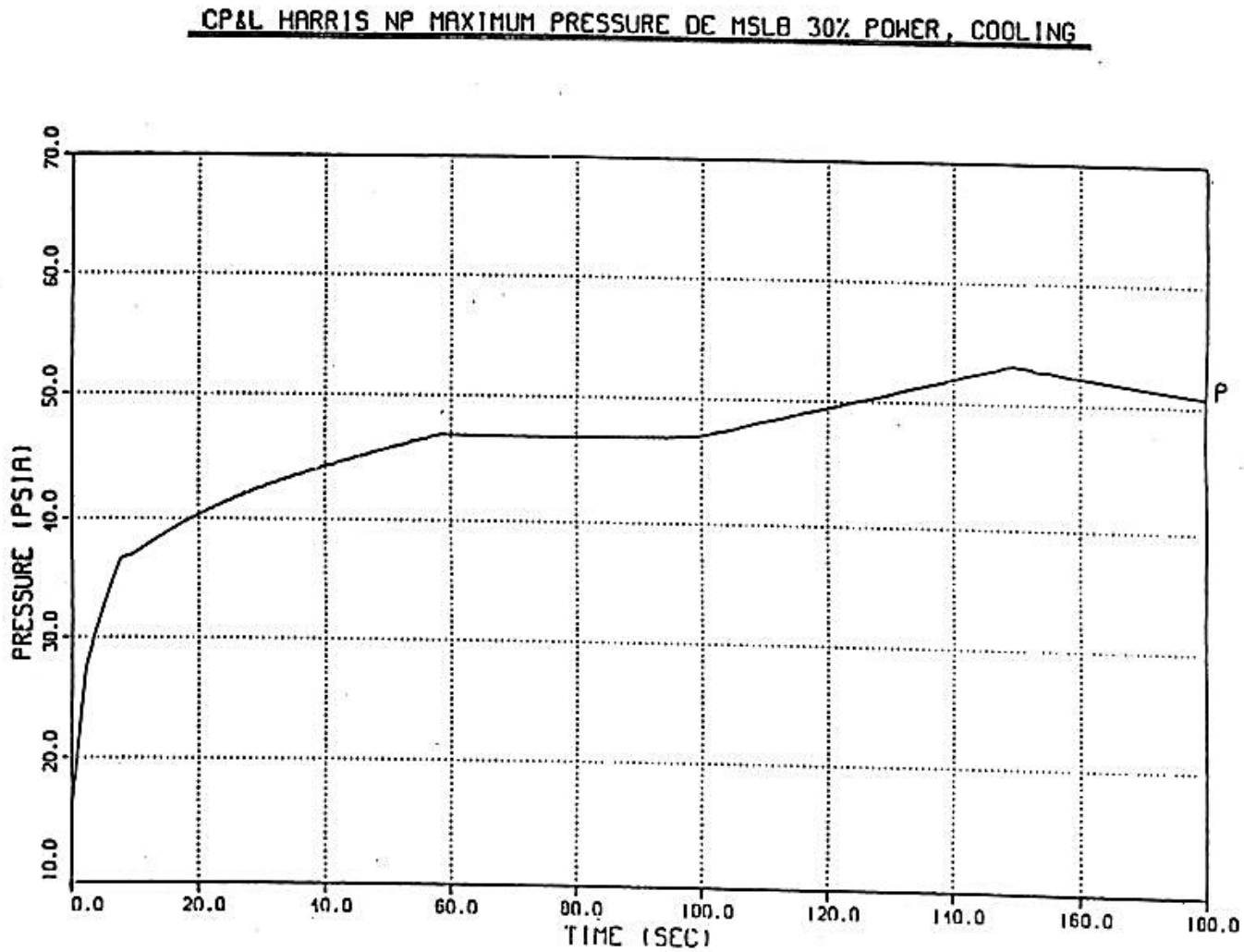

FIGURE 6.2.1-10A

CONTAINMENT TEMPERATURE – WORST MSLB (MFIV FAILURE, 102% POWER FULL DEB)

CP&L HARRIS NP MAXIMUM TEMPERATURE MSLB 102% FIV FAILURE PU

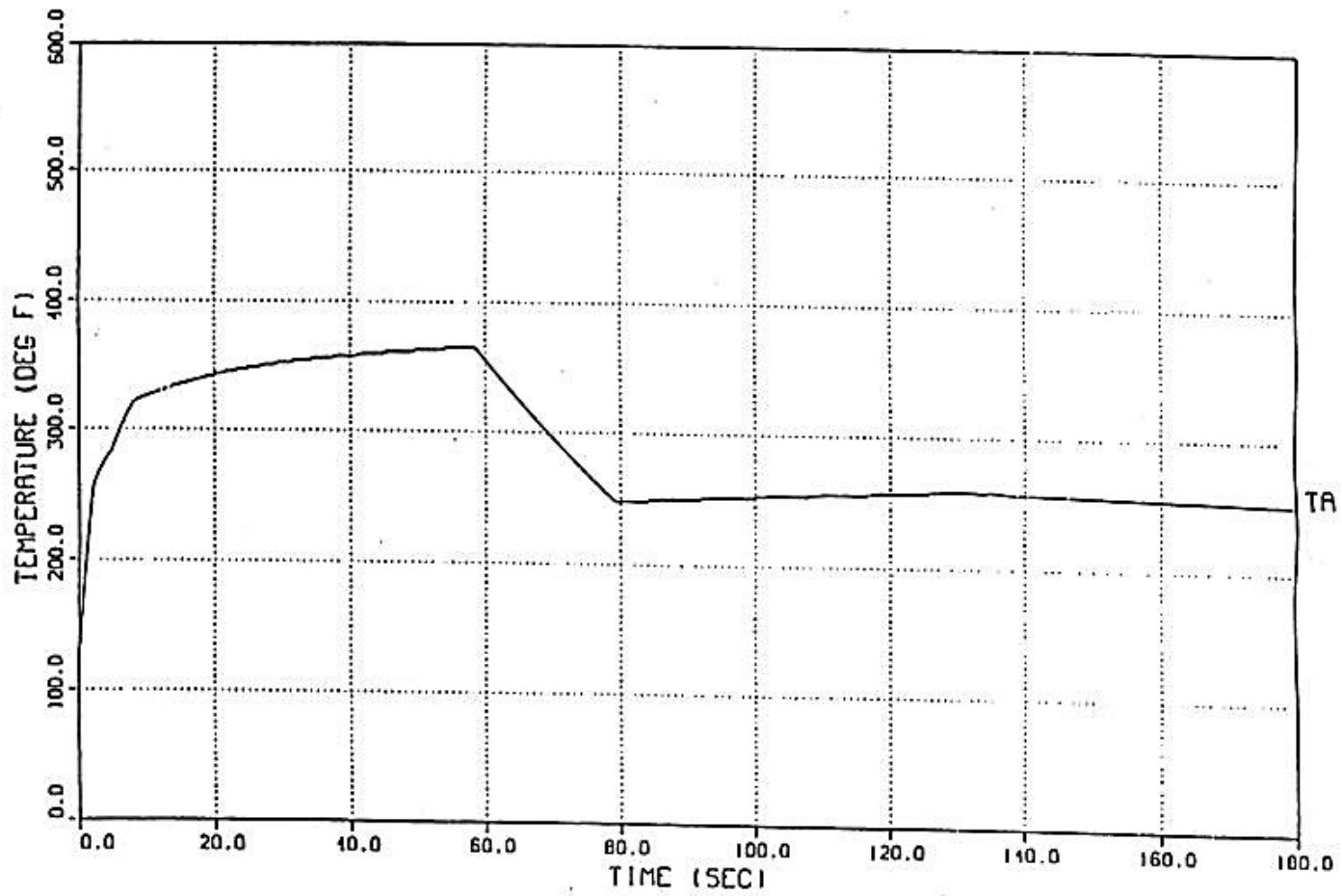

FIGURE 6.2.1-10B

CONTAINMENT SUMP TEMPERATURE WORST MSLB (MFIV FAILURE, 102% POWER FULL DEB)

CP&L HARRIS NP MAXIMUM TEMPERATURE MSLB 102% FIV FAILURE PU

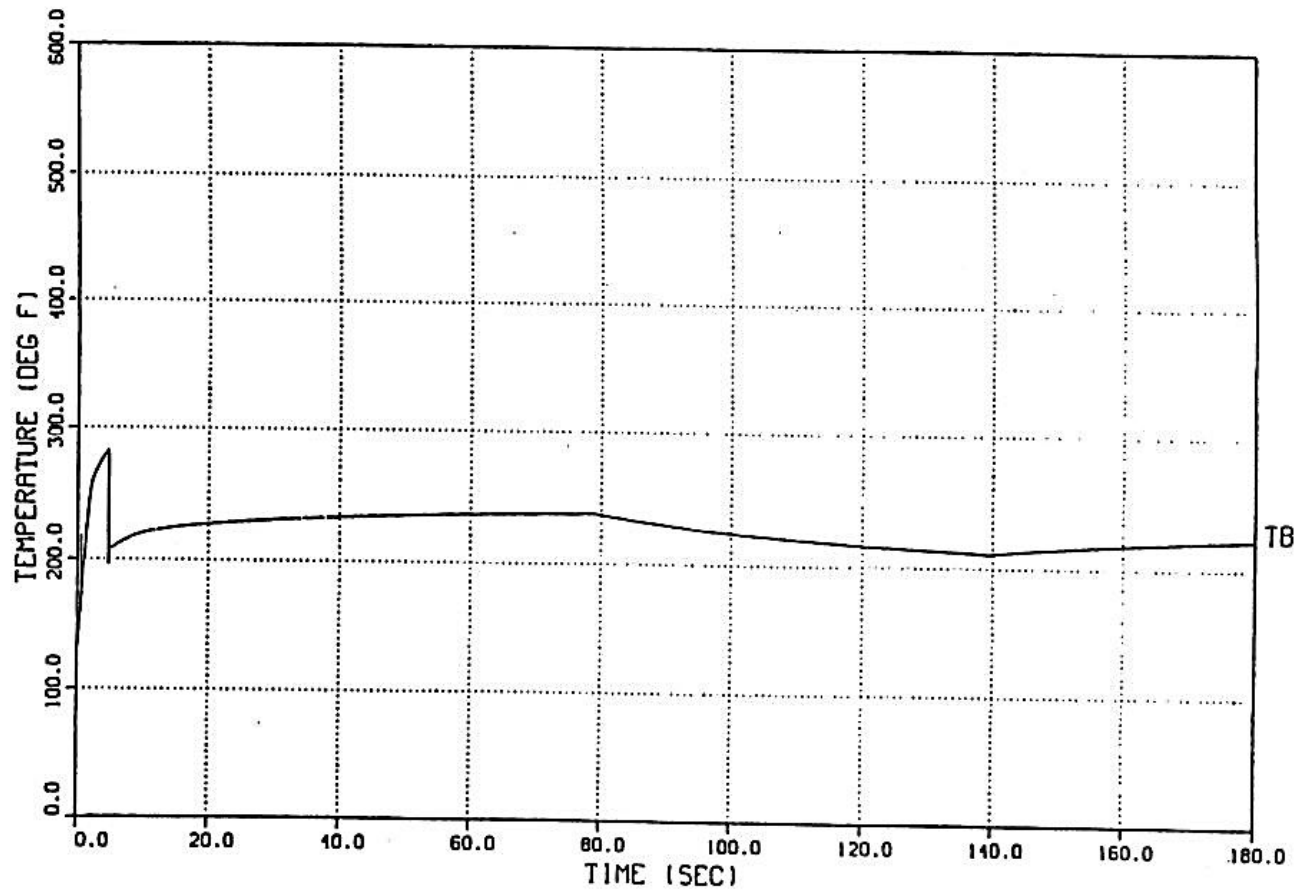

FIGURE 6.2.1-11

TAGAMI CONDENSING HEAT TRANSFER COEFFICIENT FOR DBA

CP&L HARRIS NP MAXIMUM TEMPERATURE MSLB 102% FIV FAILURE PU

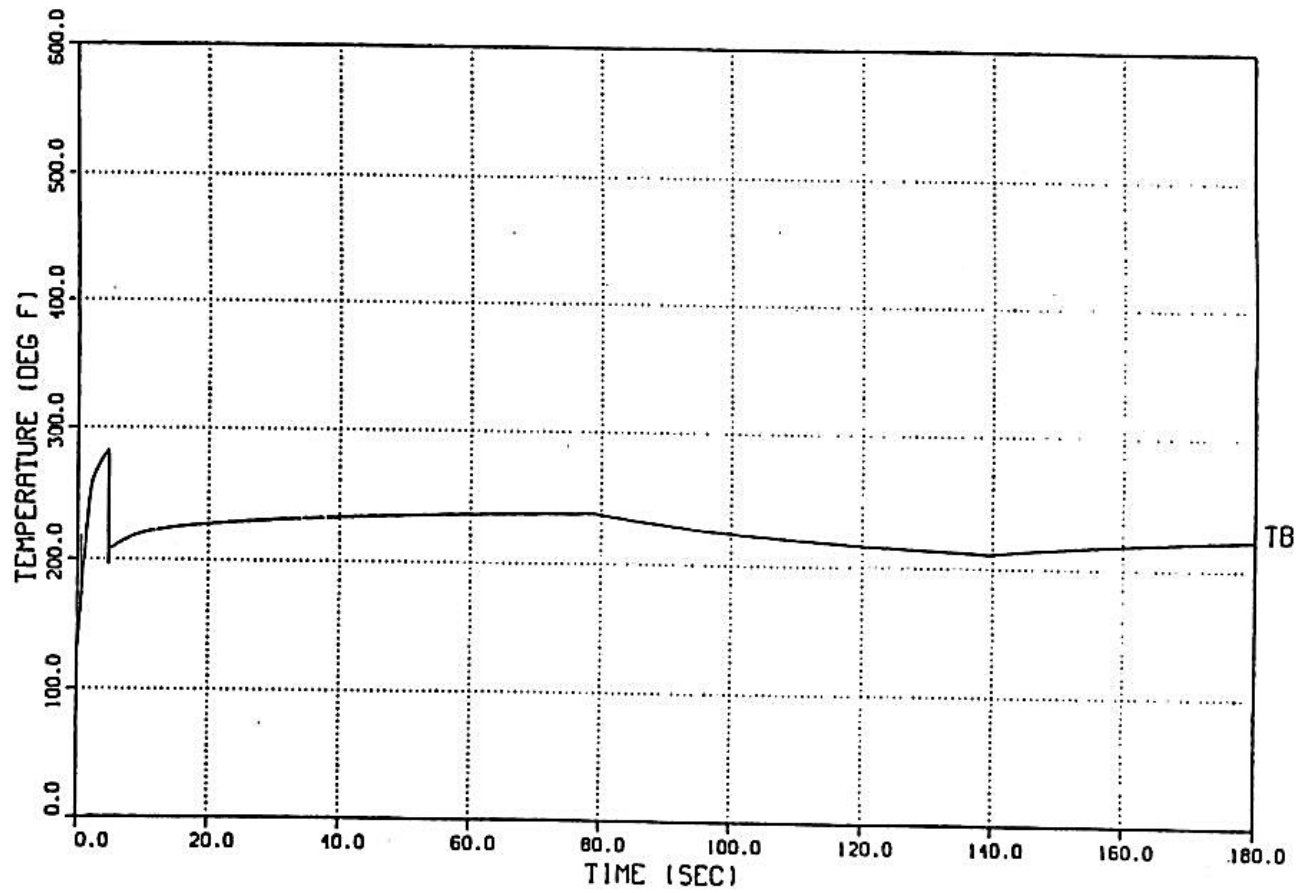

FIGURE 6.2.1-12

UCHIDA HEAT TRANSFER COEFFICIENT – WORST MSLB

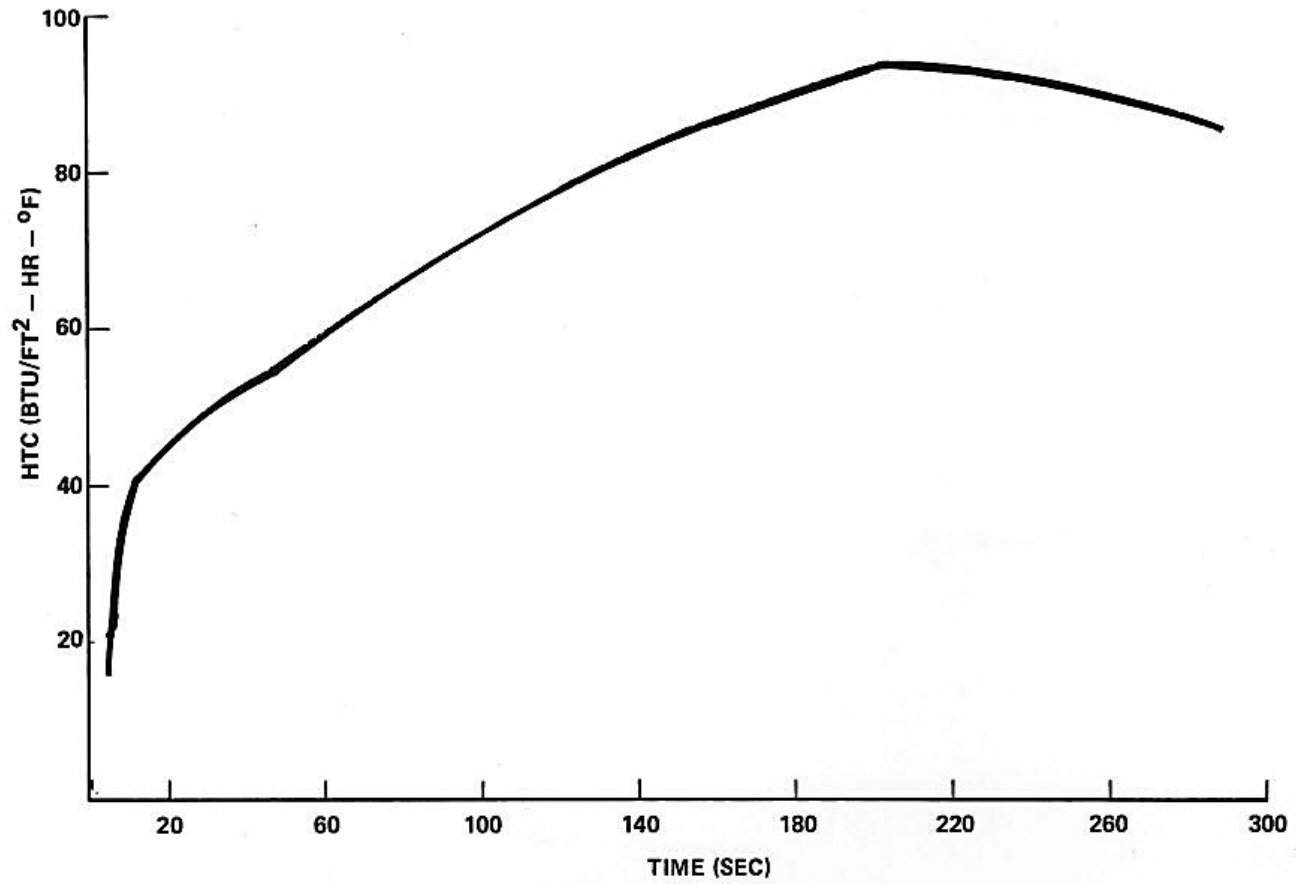

FIGURE 6.2.1-13

TYPICAL ENERGY DISTRIBUTION IN CONTAINMENT FOR DBA

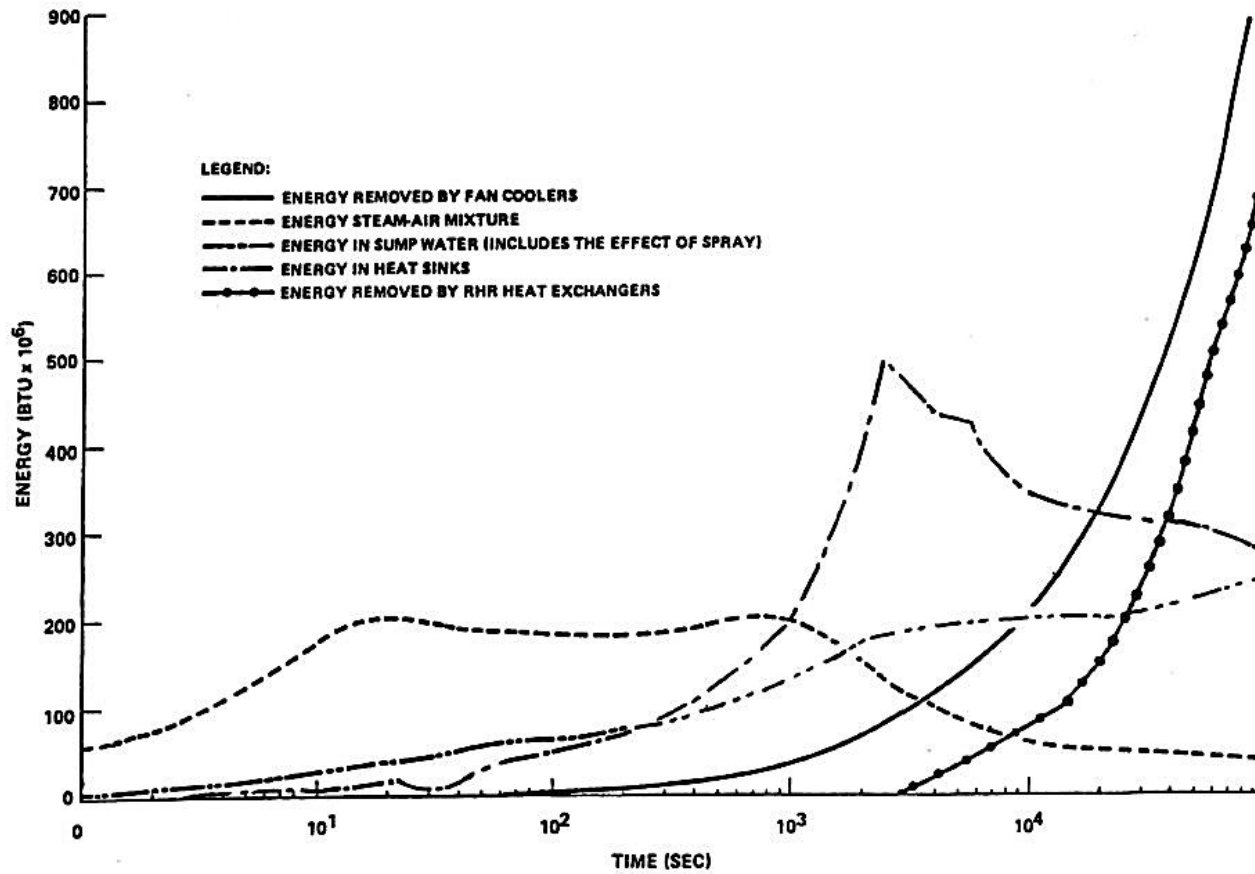

FIGURE 6.2.1-14

TYPICAL TRANSIENT CONTAINMENT LINER SURFACE TEMPERATURE
FOR THE CONTAINMENT TEMPERATURE DBA

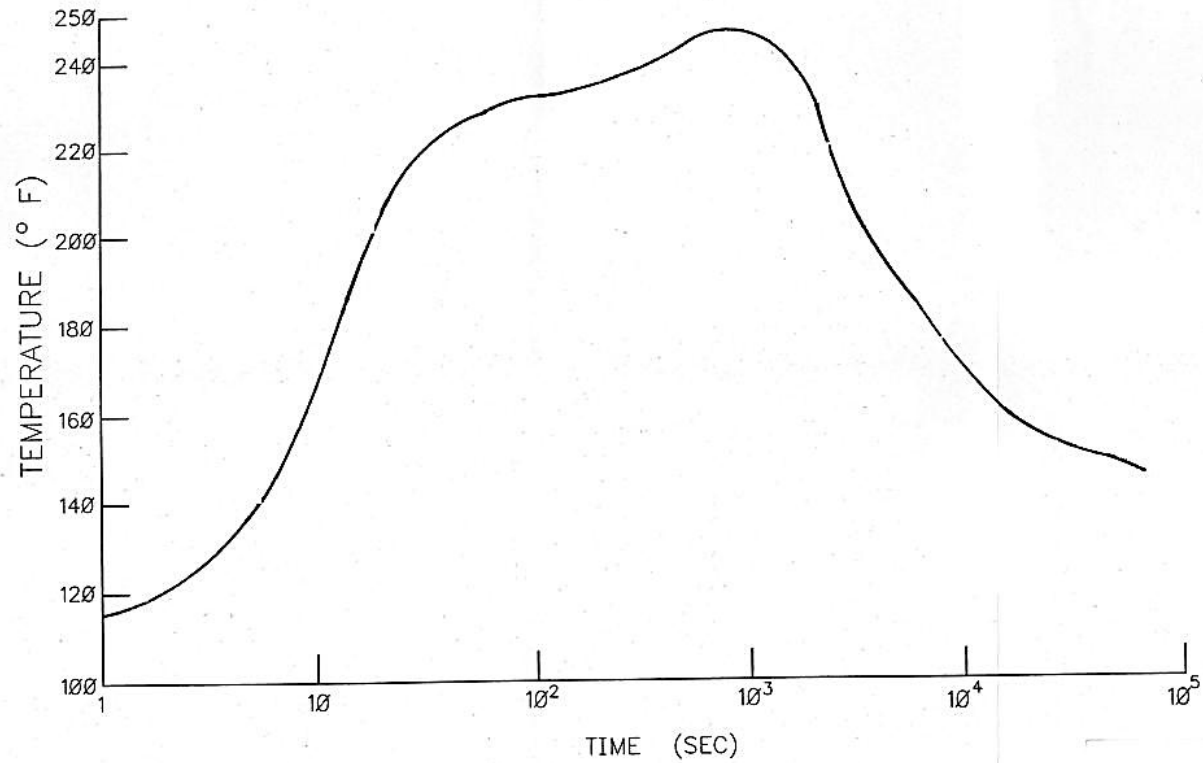

FIGURE 6.2.1-15
PRESSURE FOLLOWING INADVERTENT SPRAY ACTUATION

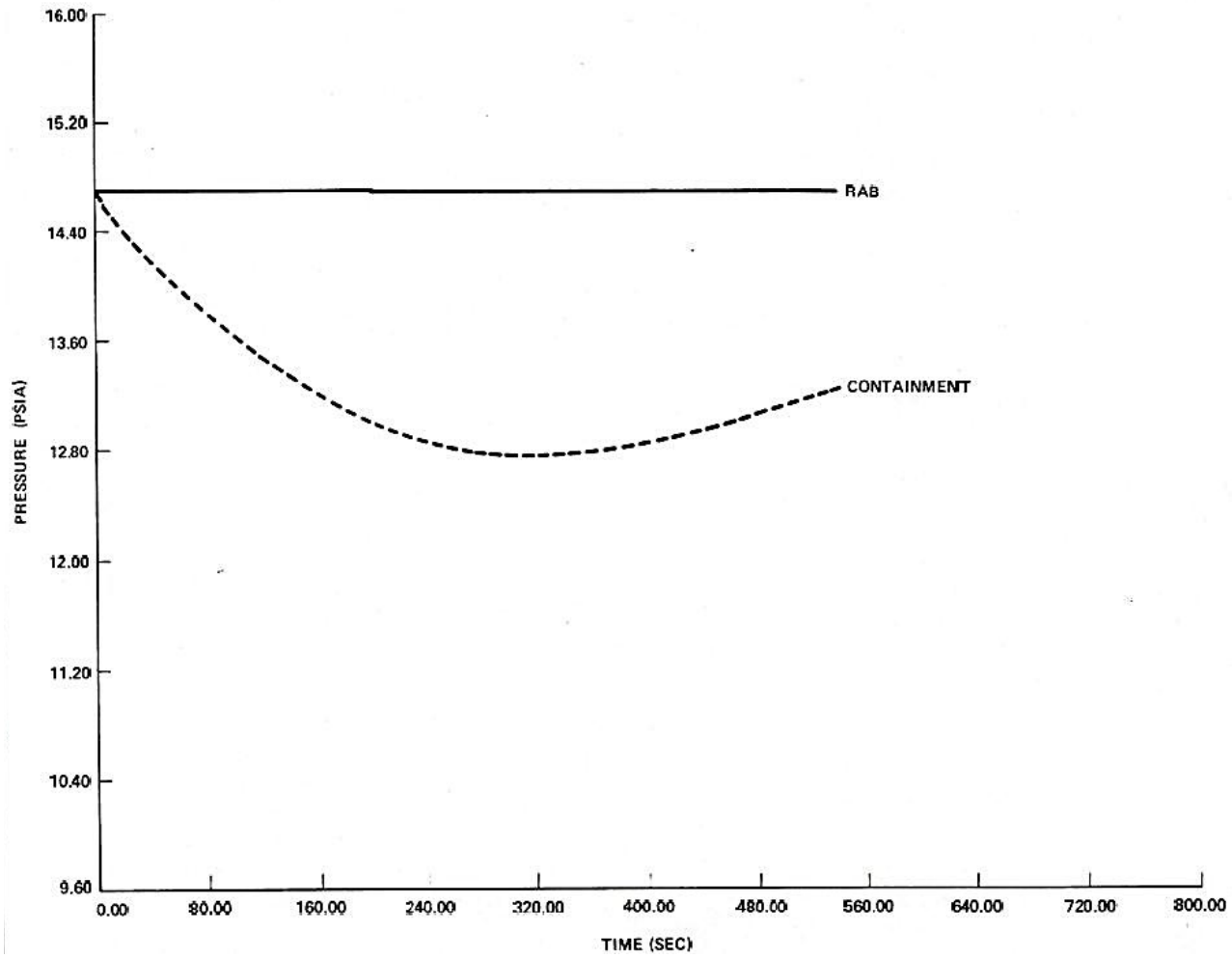
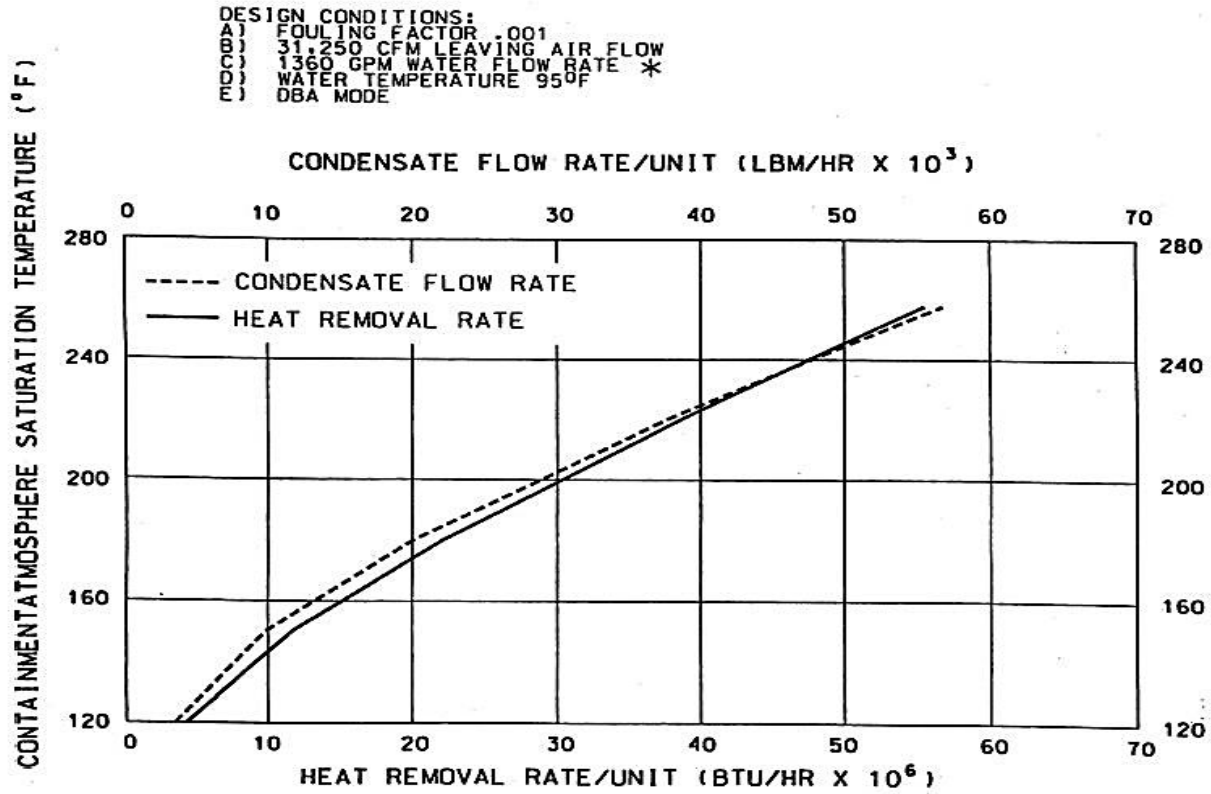

FIGURE 6.2.1-16

CONTAINMENT FAN COOLER PERFORMANCE CURVE FOLLOWING A DBA



* HEAT REMOVAL RATE USED IN THE ANALYSIS WAS REDUCED BASED ON 1300 GPM FLOW RATE

FIGURE 6.2.1-17

CONTAINMENT FAN COOLER NORMAL MODE PULLDOWN DATA
FOR MINIMUM CONTAINMENT PRESSURE (VACUUM ANALYSIS)

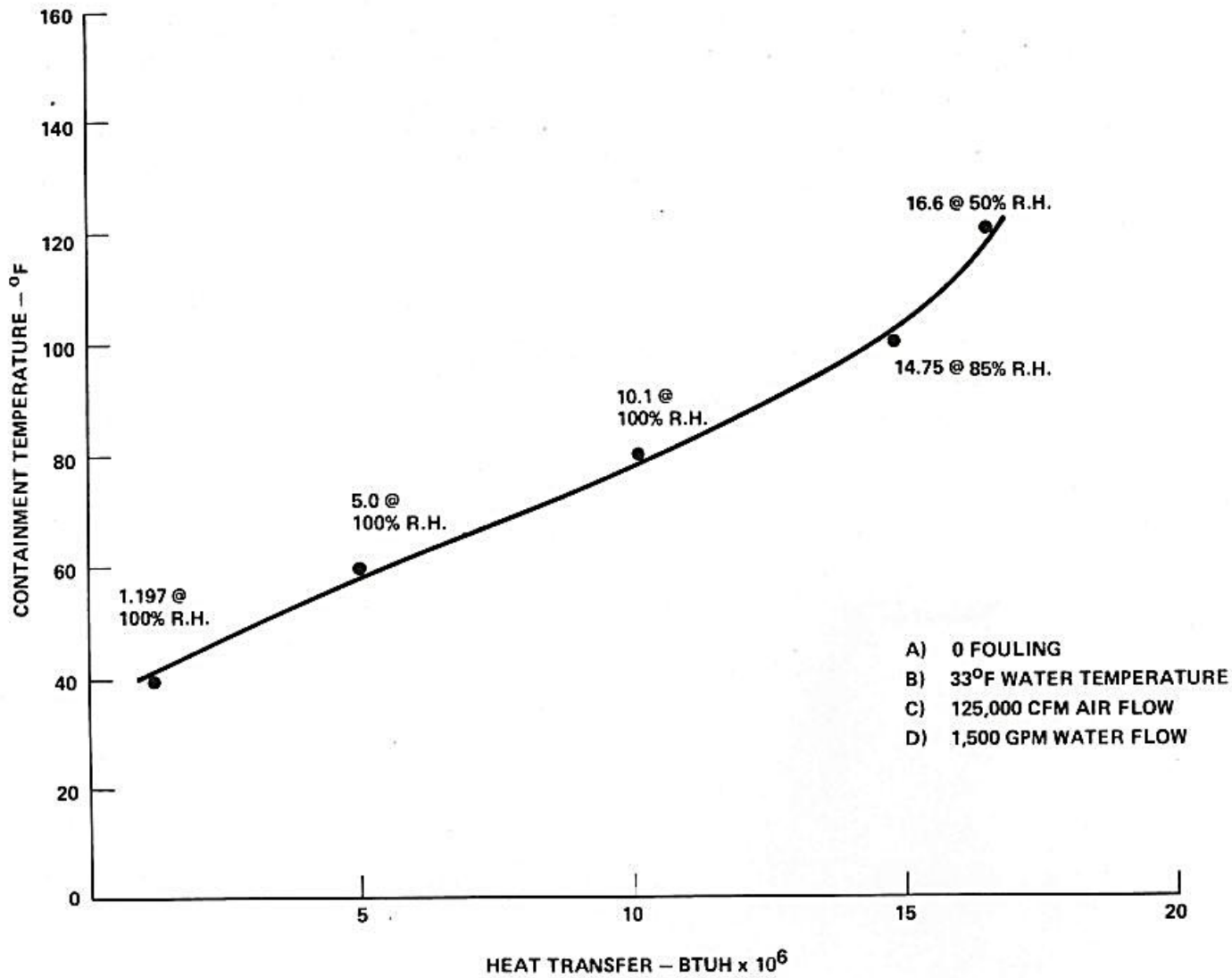

FIGURE 6.2.1-18

SUBCOMPARTMENTS

CONTAINMENT BUILDING – PLAN EL 221.00' & 236.00'

Security-Related Information - Figure Withheld Under 10 CFR 2.390

FIGURE 6.2.1-19

SUBCOMPARTMENTS

CONTAINMENT BUILDING – PLAN EL 261.00' & 286.00'

Security-Related Information - Figure Withheld Under 10 CFR 2.390

FIGURE 6.2.1-20

SUBCOMPARTMENTS

CONTAINMENT BUILDING SECTIONS A-A & B-B

Security-Related Information - Figure Withheld Under 10 CFR 2.390

FIGURE 6.2.1-21

REACTOR CAVITY MODEL AND COORDINATE SYSTEM

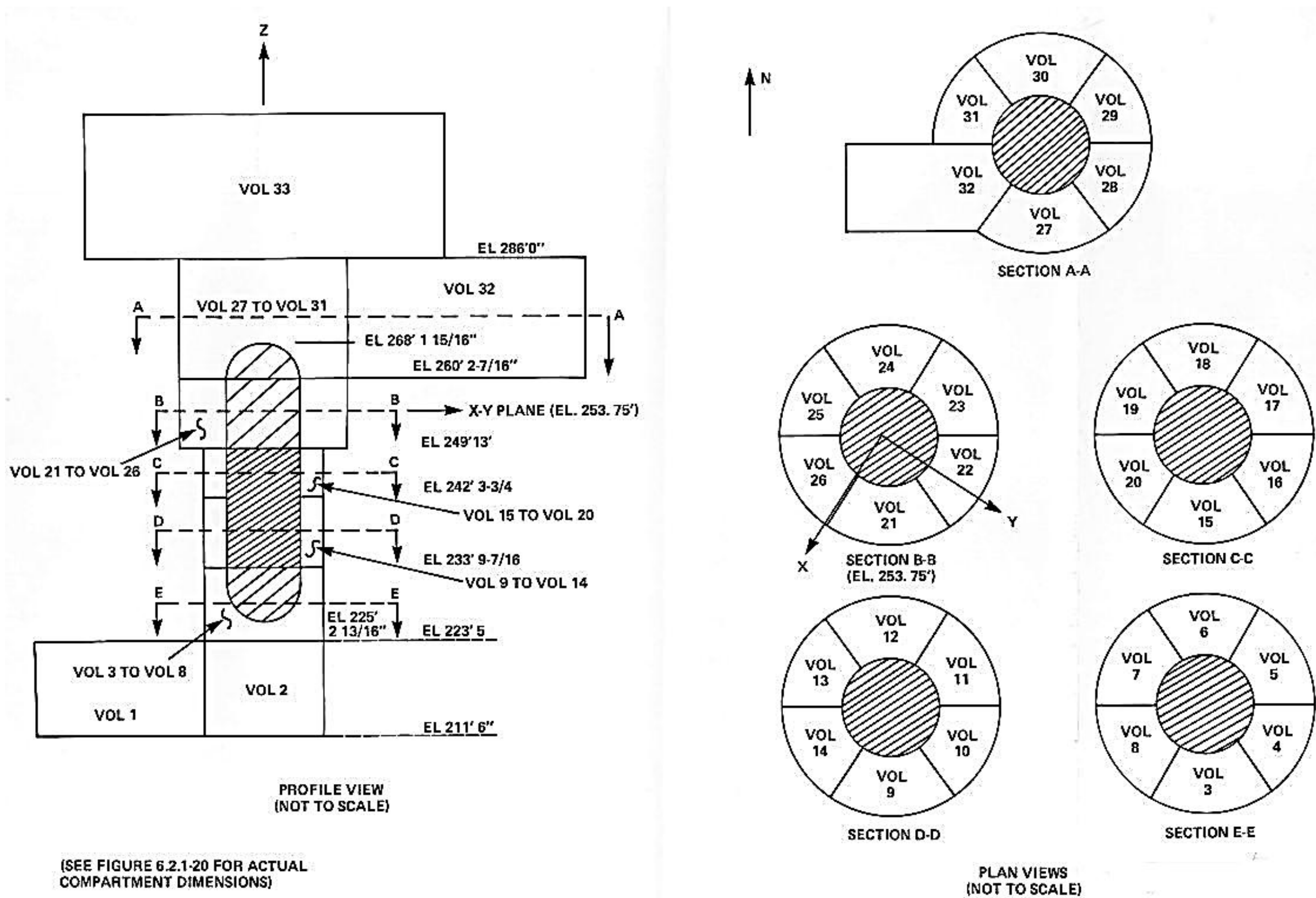

FIGURE 6.2.1-22

REACTOR CAVITY SUBCOMPARTMENT PRESSURIZATION MODEL
(FILL JUNCTIONS NOT SHOWN)

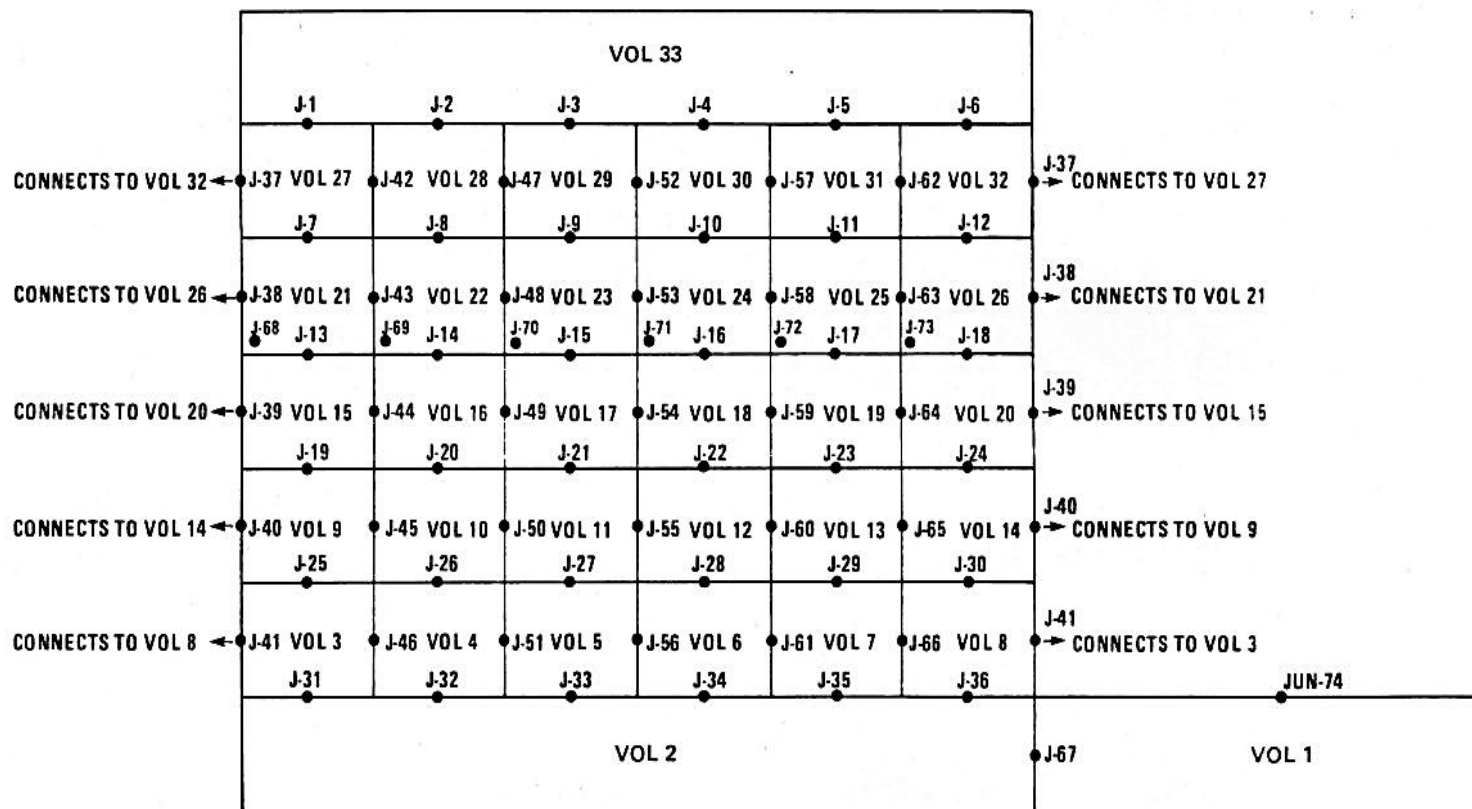

FIGURE 6.2.1-23

SUBCOMPARTMENT PRESSURIZATION MODEL OF STEAM GENERATOR/LOOP 1

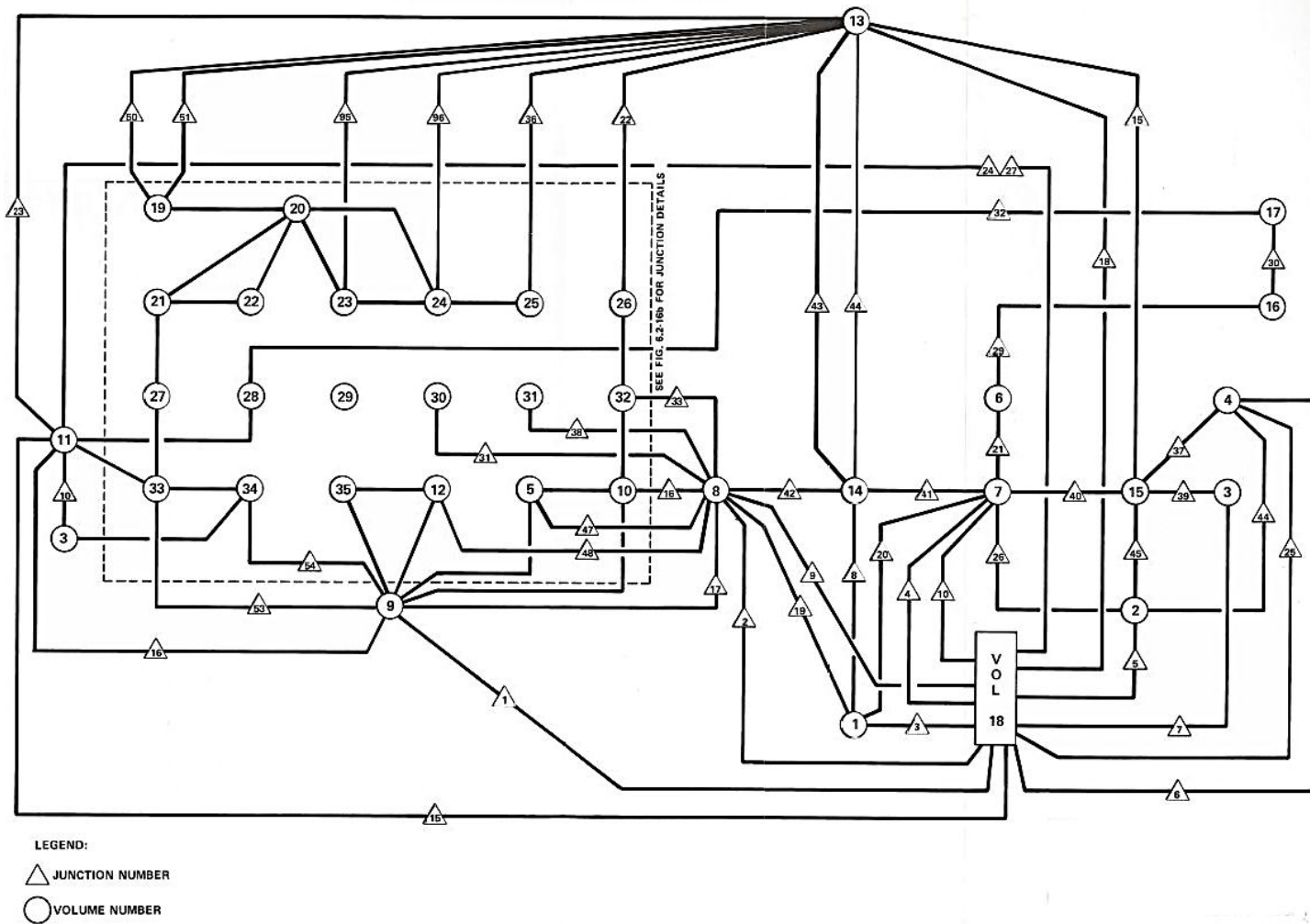
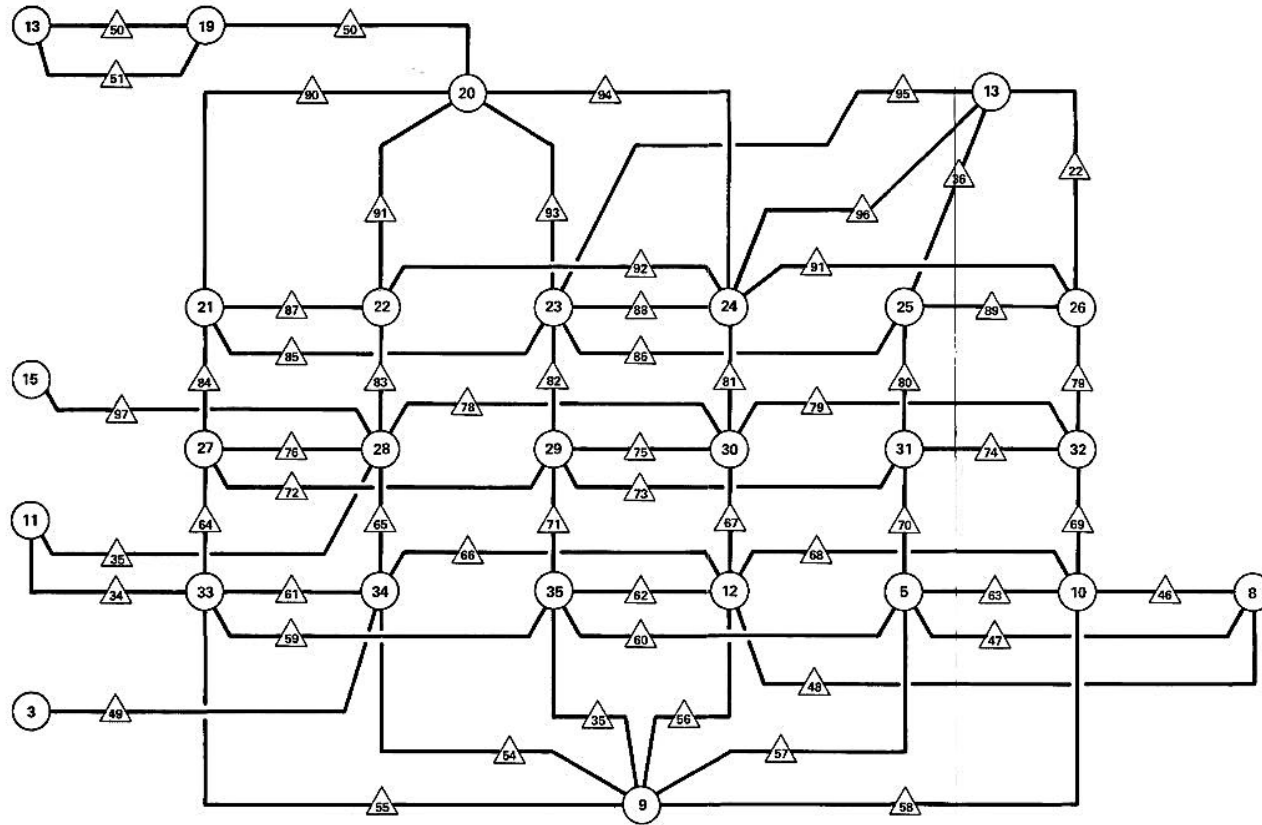

FIGURE 6.2.1-24

SUBCOMPARTMENT PRESSURIZATION MODEL OF STEAM GENERATOR/LOOP 1



LEGEND:
△ JUNCTION NUMBER
○ VOLUME NUMBER

FIGURE 6.2.1-25

SUBCOMPARTMENT PRESSURIZATION MODEL OF STEAM GENERATOR/LOOP 3

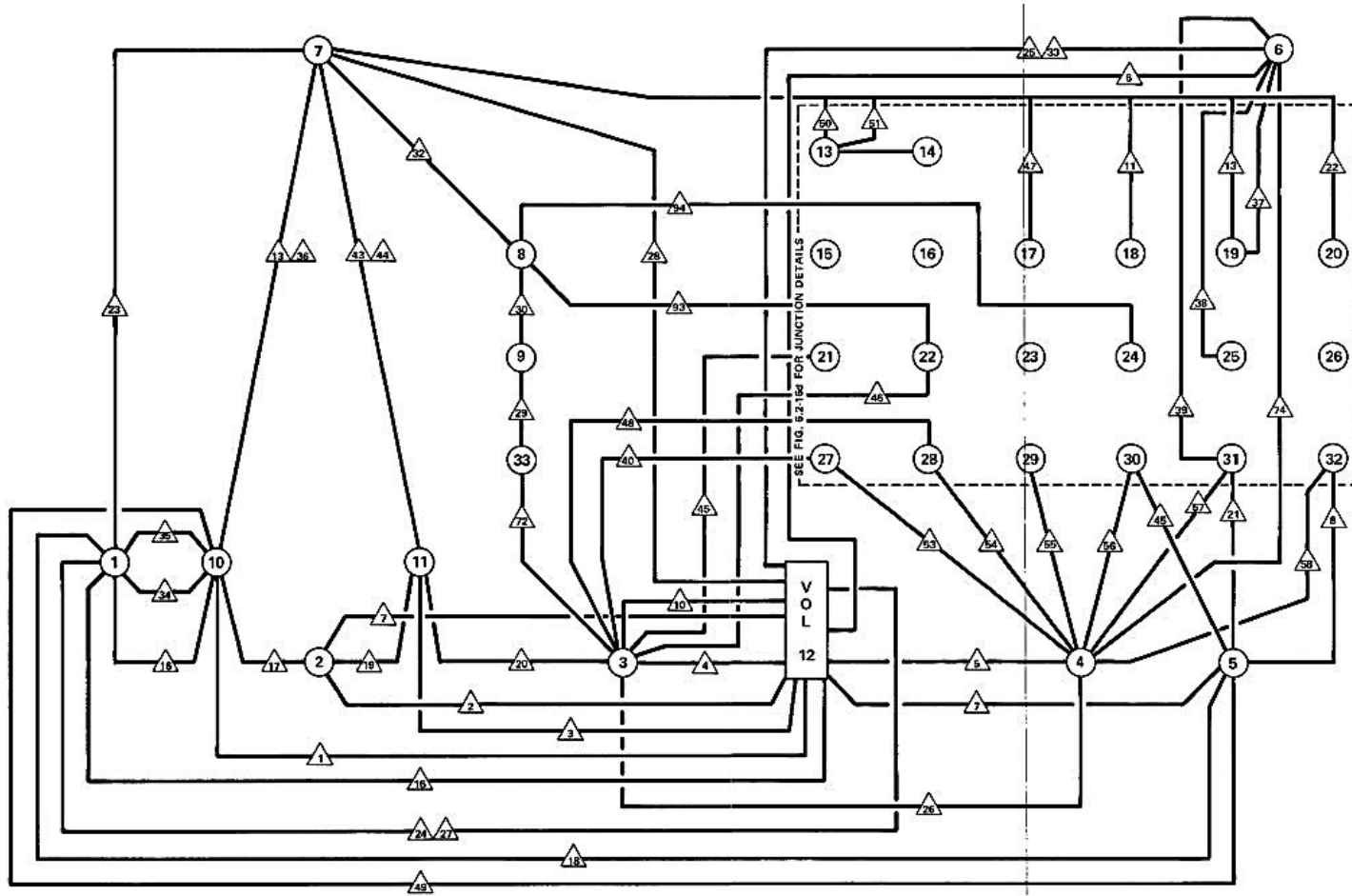

LEGEND:
△ JUNCTION NUMBER
○ VOLUME NUMBER

FIGURE 6.2.1-26

SUBCOMPARTMENT PRESSURIZATION MODEL OF STEAM GENERATOR/LOOP 3

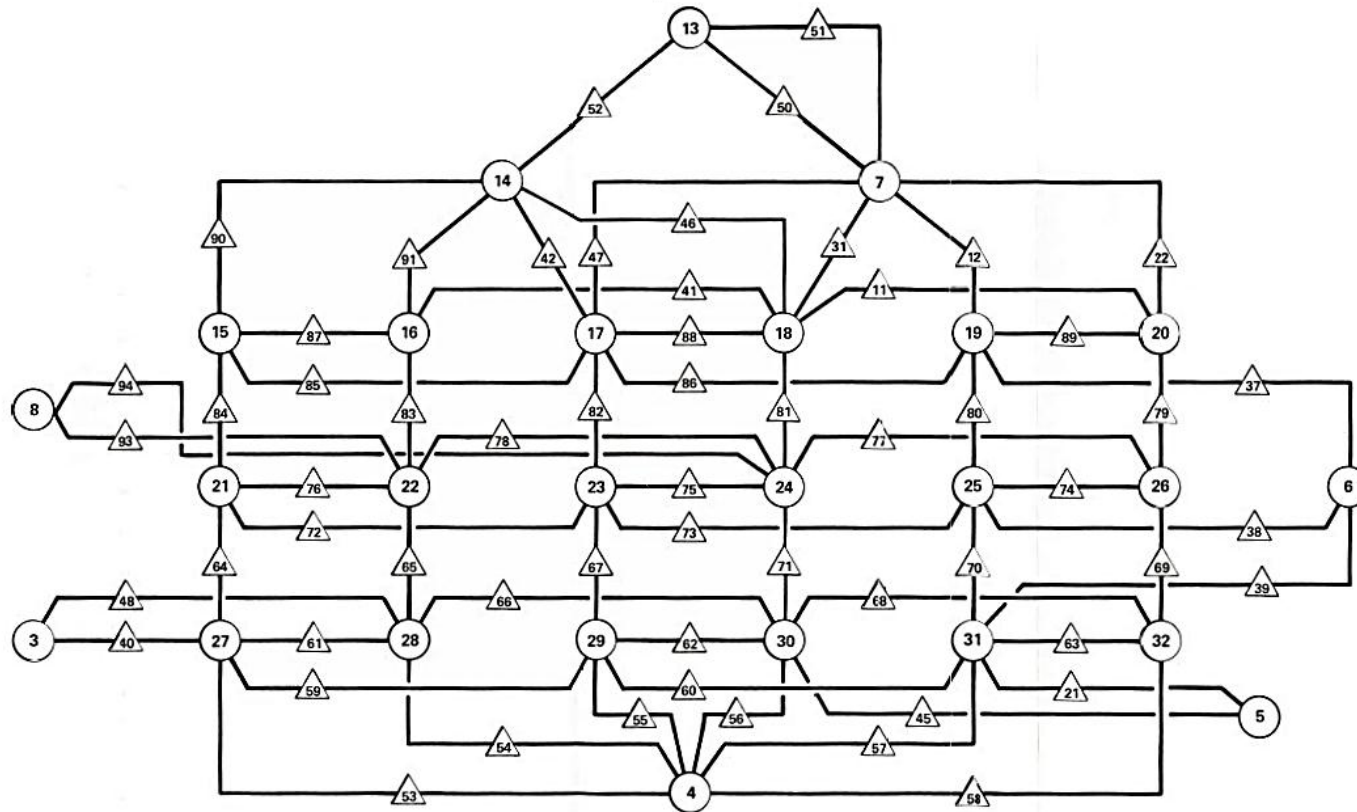

LEGEND:
△ JUNCTION NUMBER
○ VOLUME NUMBER

FIGURE 6.2.1-27

SUBCOMPARTMENT PRESSURIZATION MODEL OF PRESSURIZER COMPARTMENT AND STEAM GENERATOR/LOOP 2

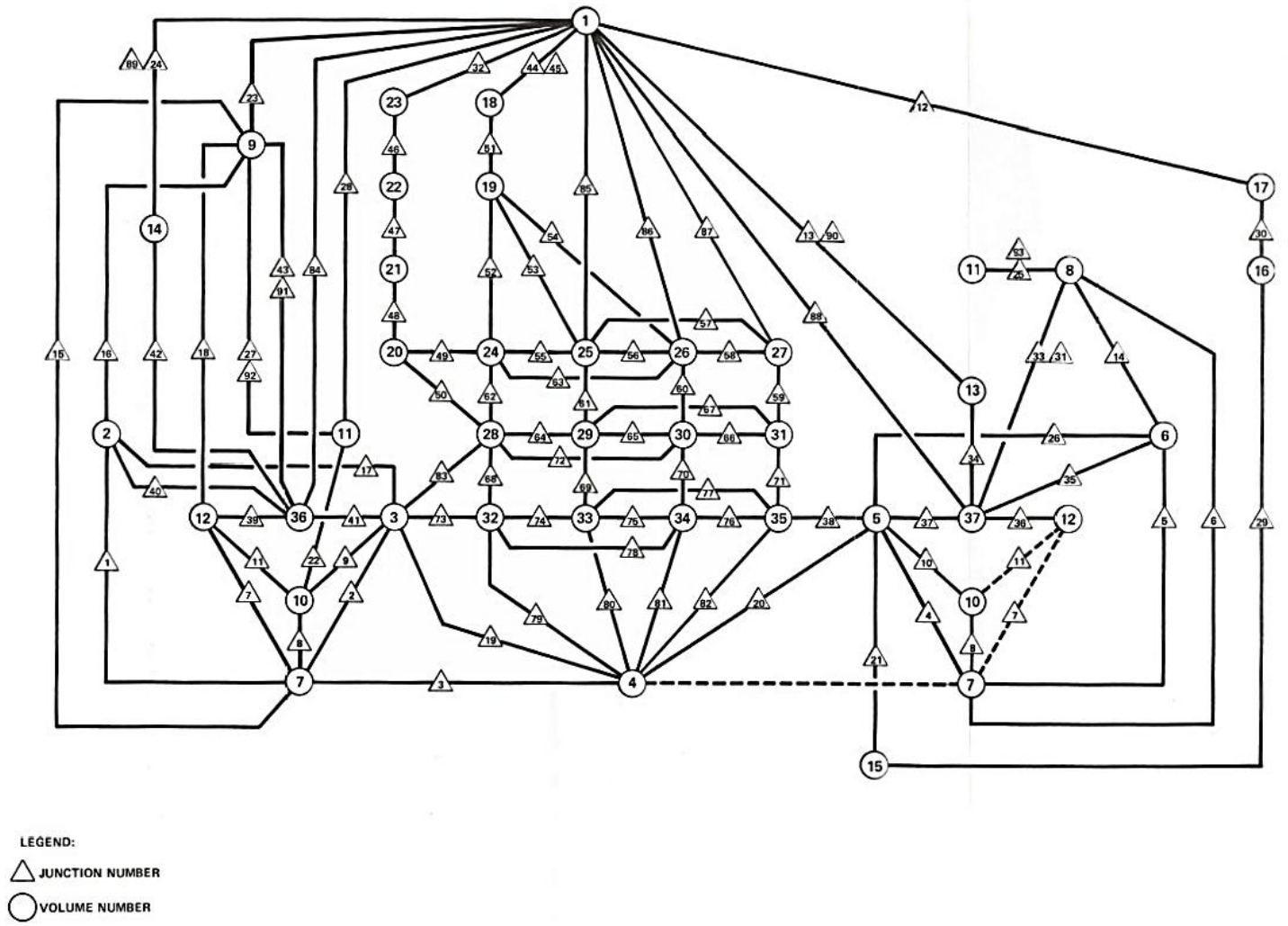

FIGURE 6.2.1-28A

PRESSURE DIFFERENTIAL IN REACTOR CAVITY, COLD LEG DEB

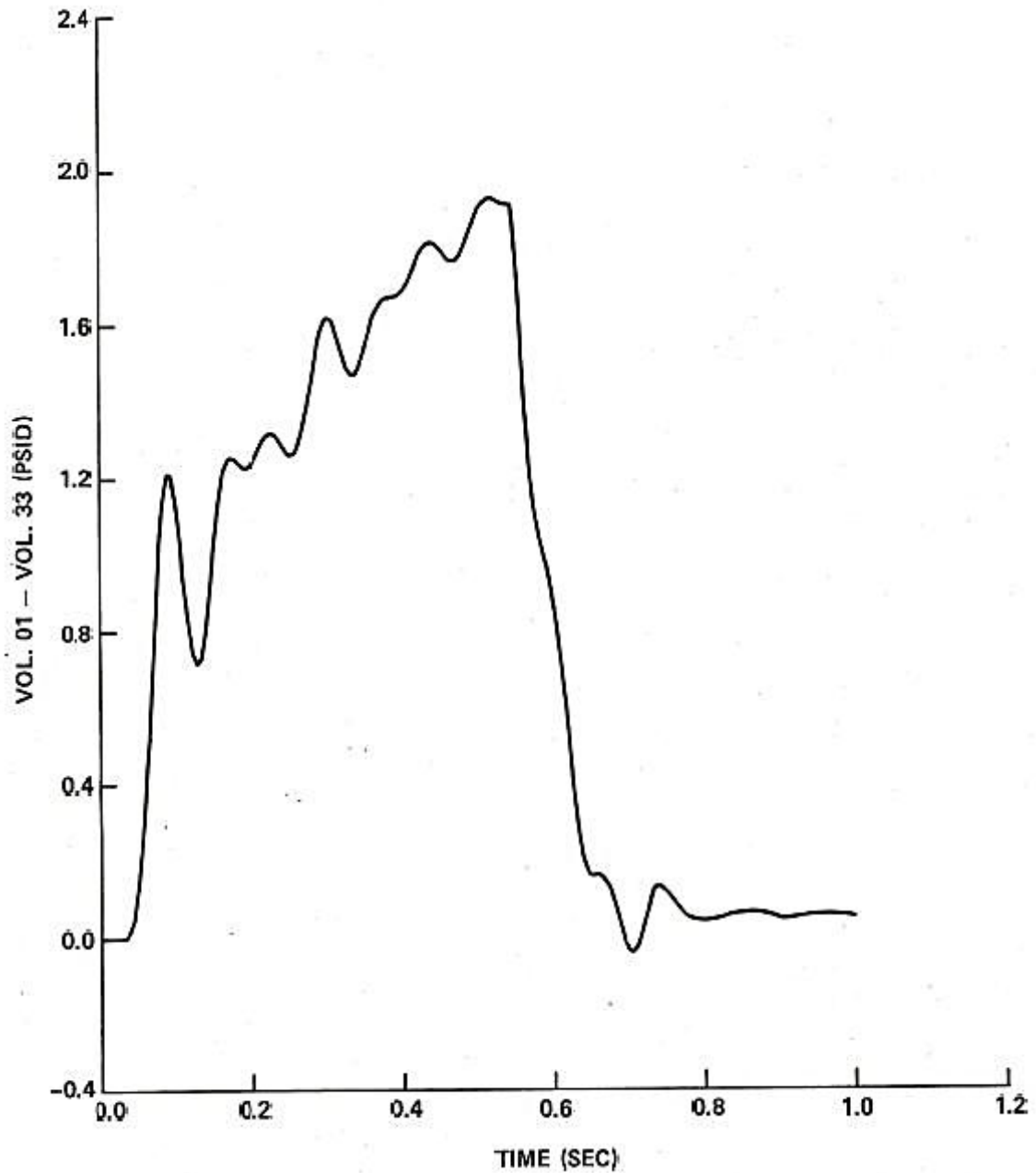

FIGURE 6.2.1-28B

PRESSURE DIFFERENTIAL IN REACTOR CAVITY, COLD LEG DEB

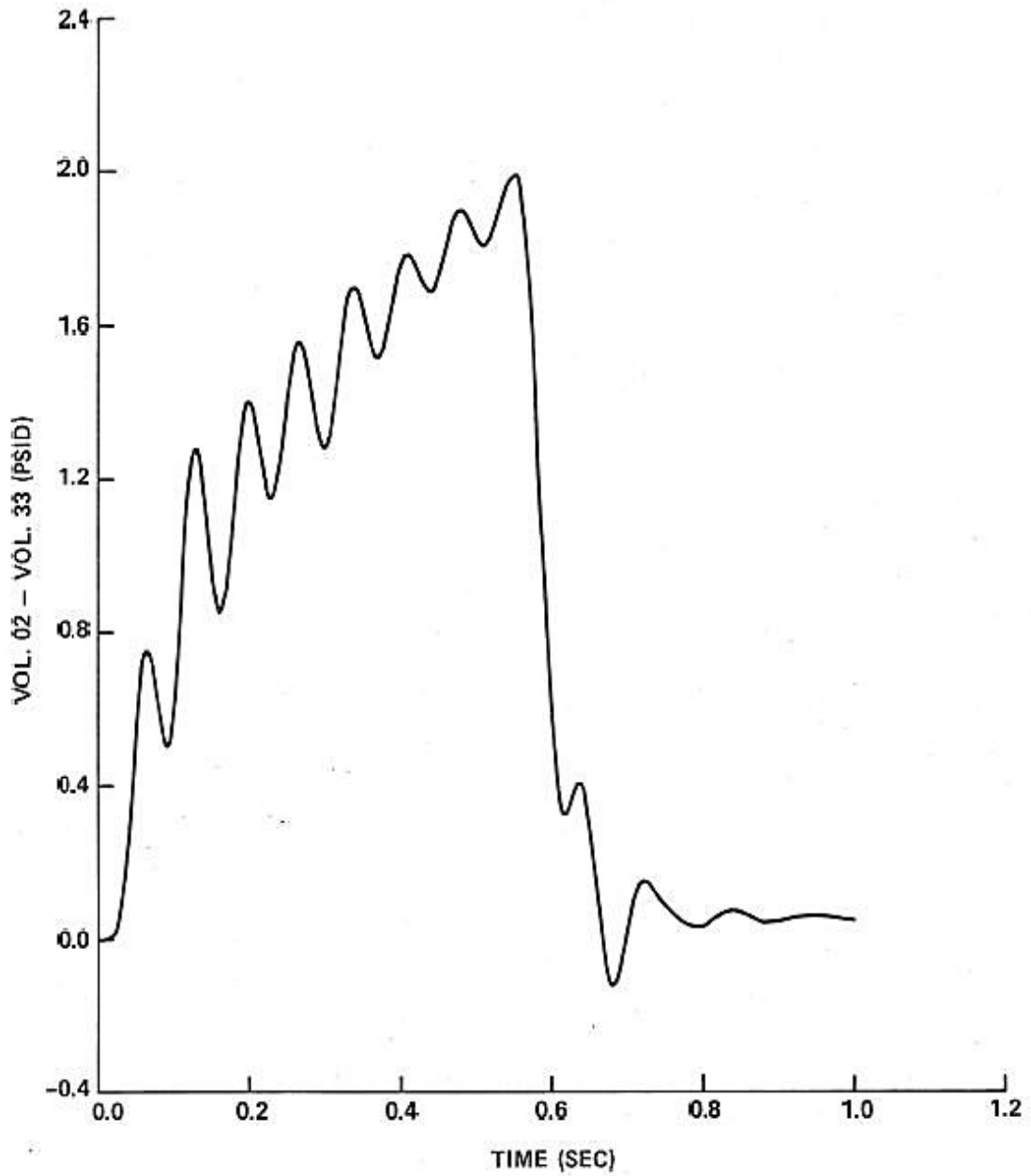

FIGURE 6.2.1-28C

PRESSURE DIFFERENTIAL IN REACTOR CAVITY, COLD LEG DEB

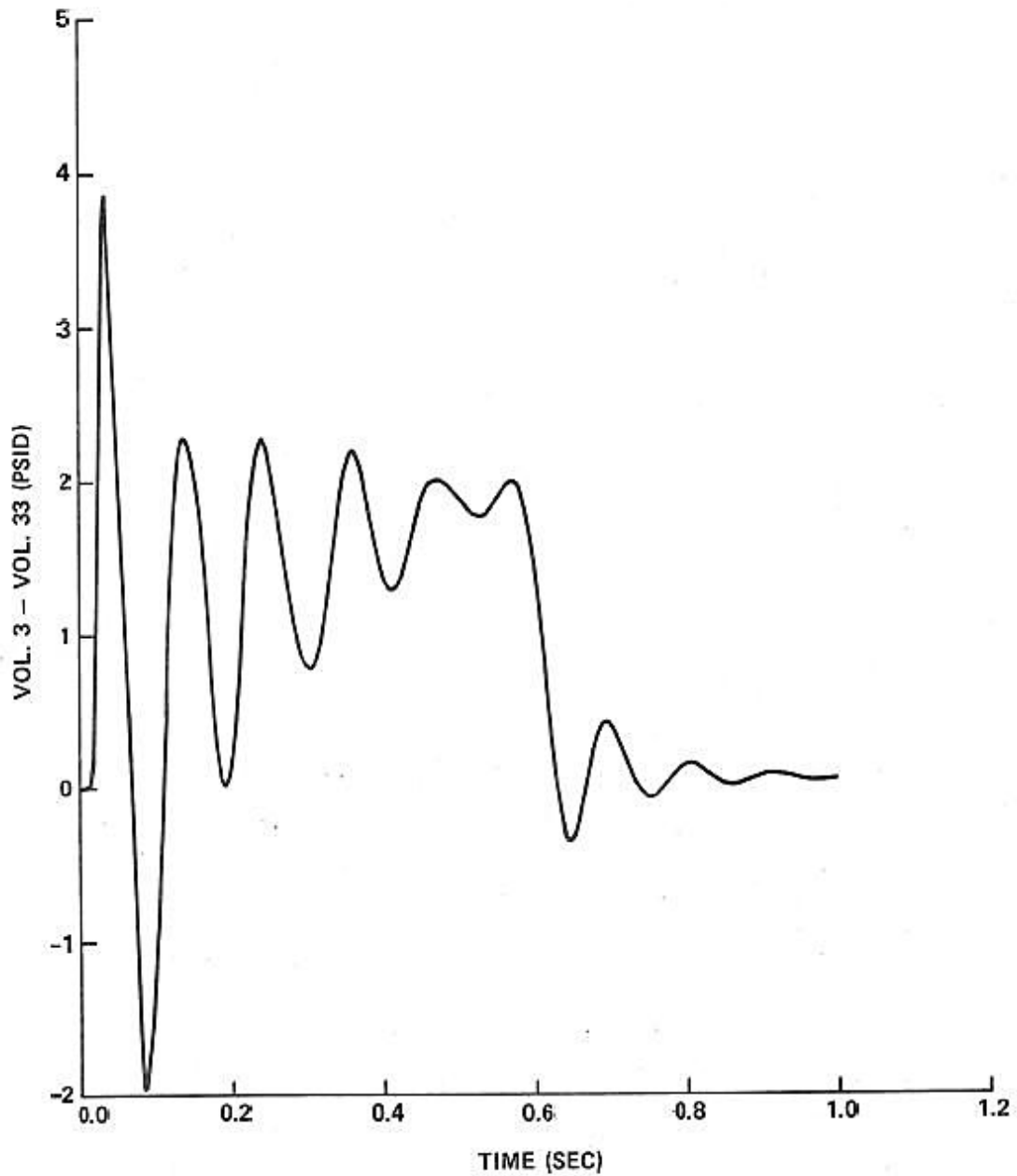

FIGURE 6.2.1-28D

PRESSURE DIFFERENTIAL IN REACTOR CAVITY, COLD LEG DEB

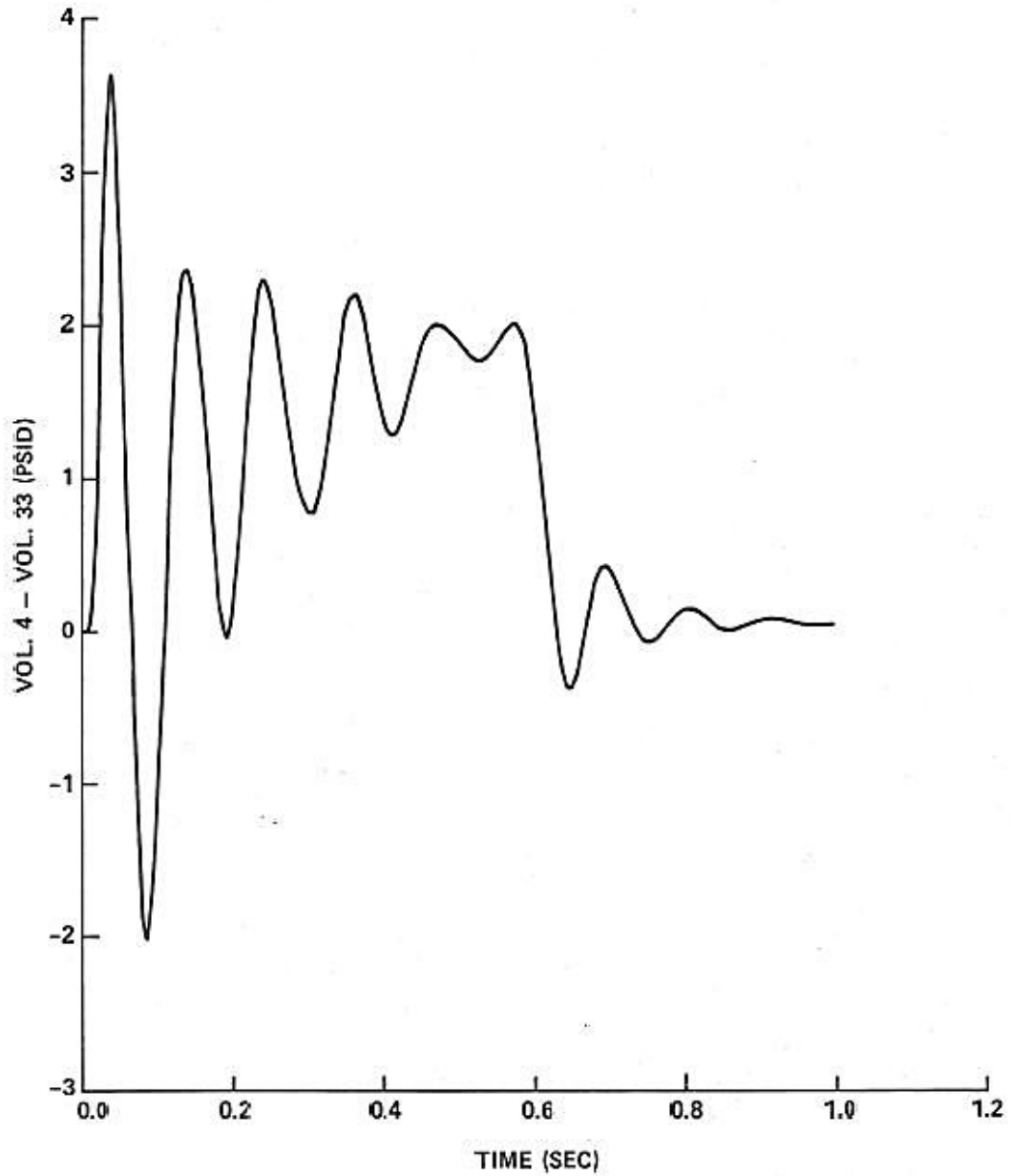

FIGURE 6.2.1-28E

PRESSURE DIFFERENTIAL IN REACTOR CAVITY, COLD LEG DEB

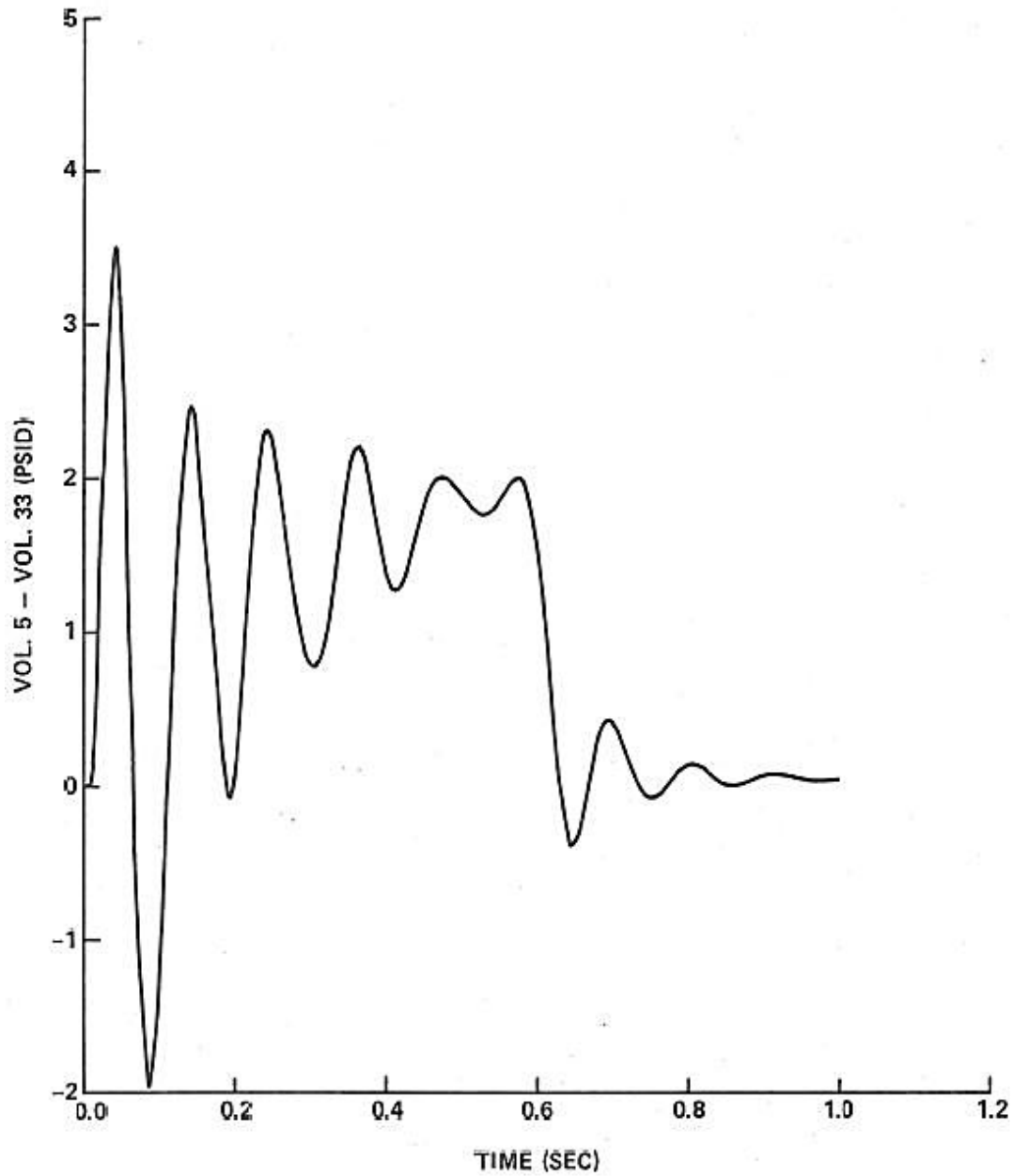

FIGURE 6.2.1-28F

PRESSURE DIFFERENTIAL IN REACTOR CAVITY, COLD LEG DEB

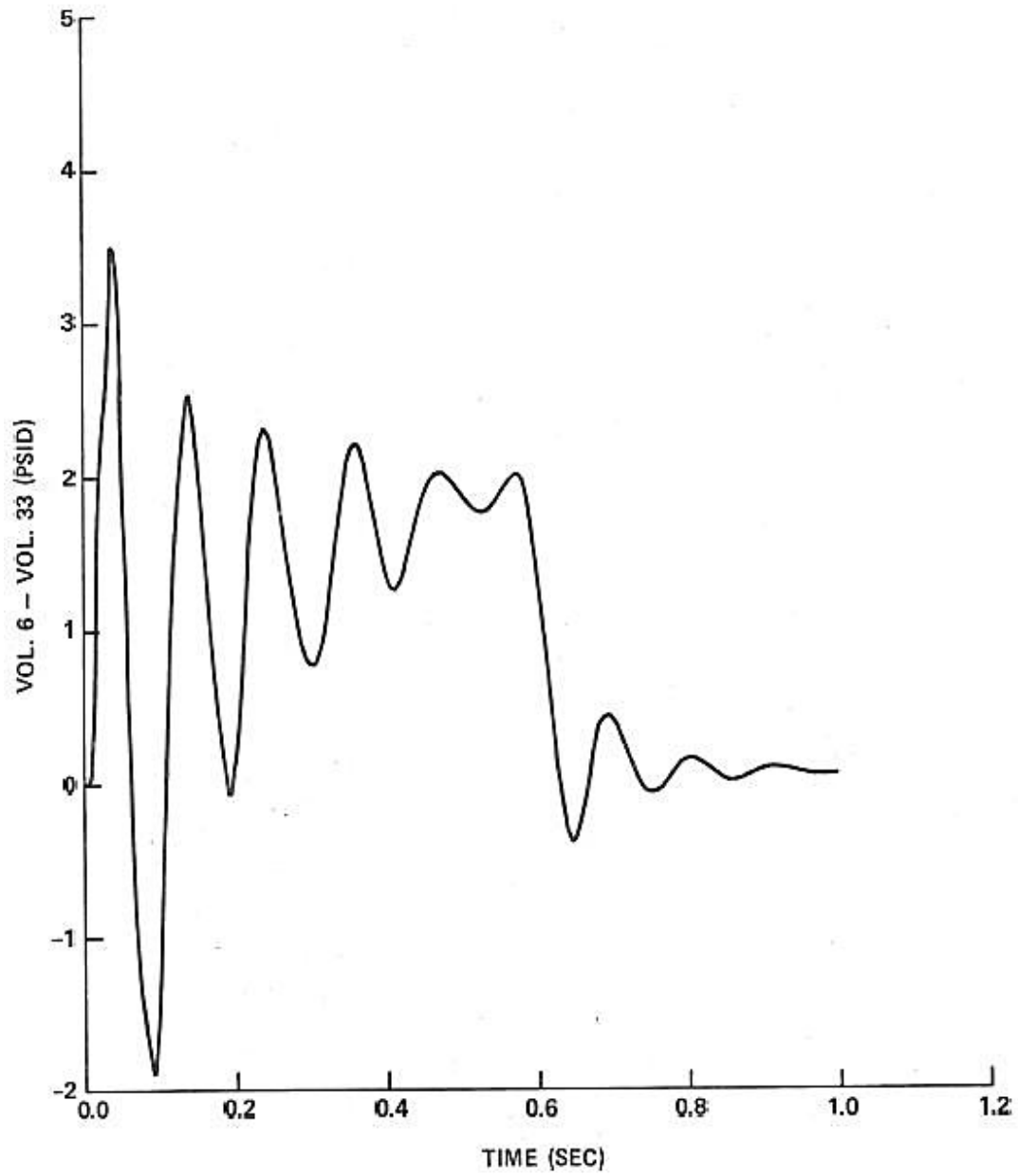

FIGURE 6.2.1-28G

PRESSURE DIFFERENTIAL IN REACTOR CAVITY, COLD LEG DEB

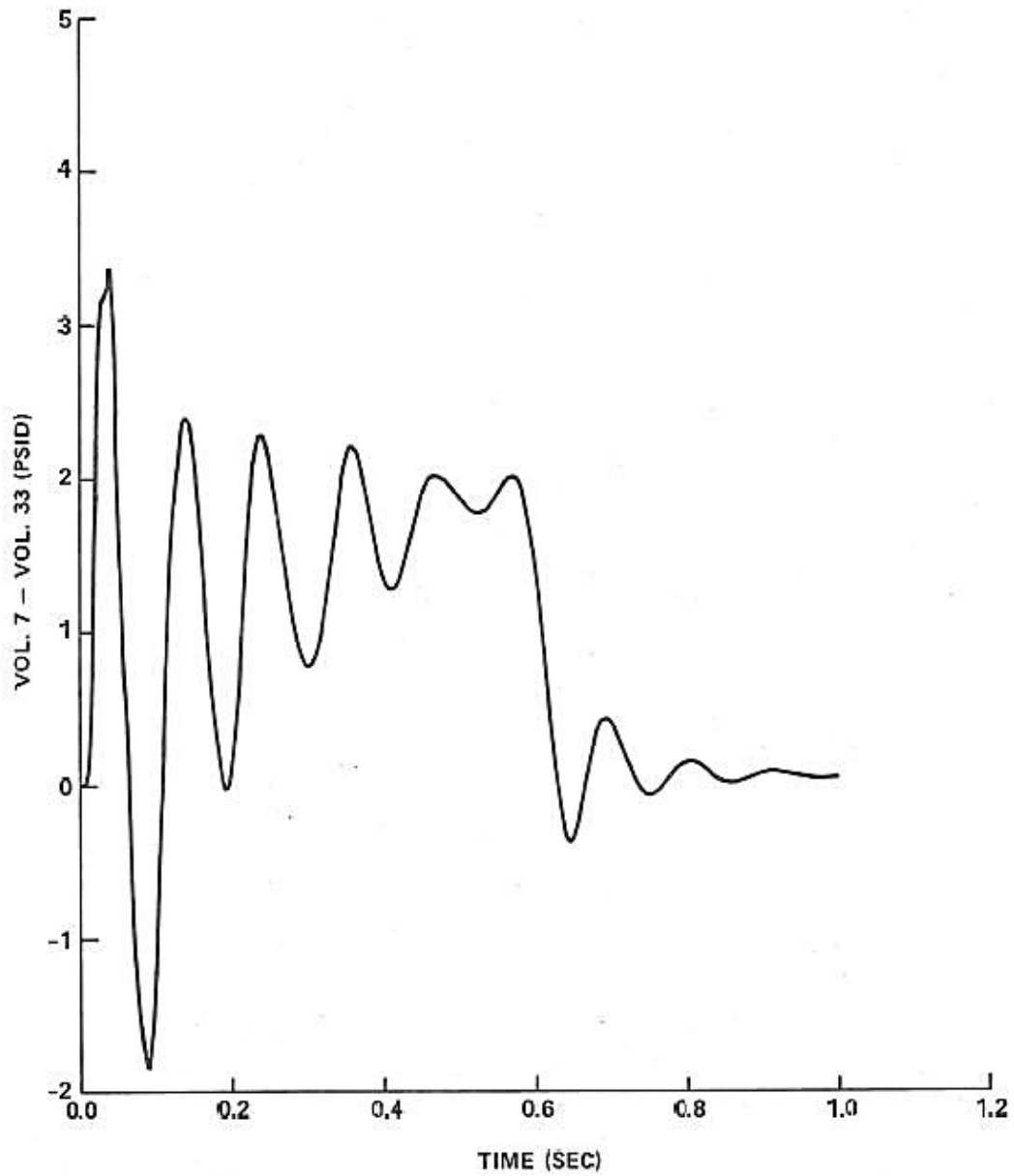

FIGURE 6.2.1-28H

PRESSURE DIFFERENTIAL IN REACTOR CAVITY, COLD LEG DEB

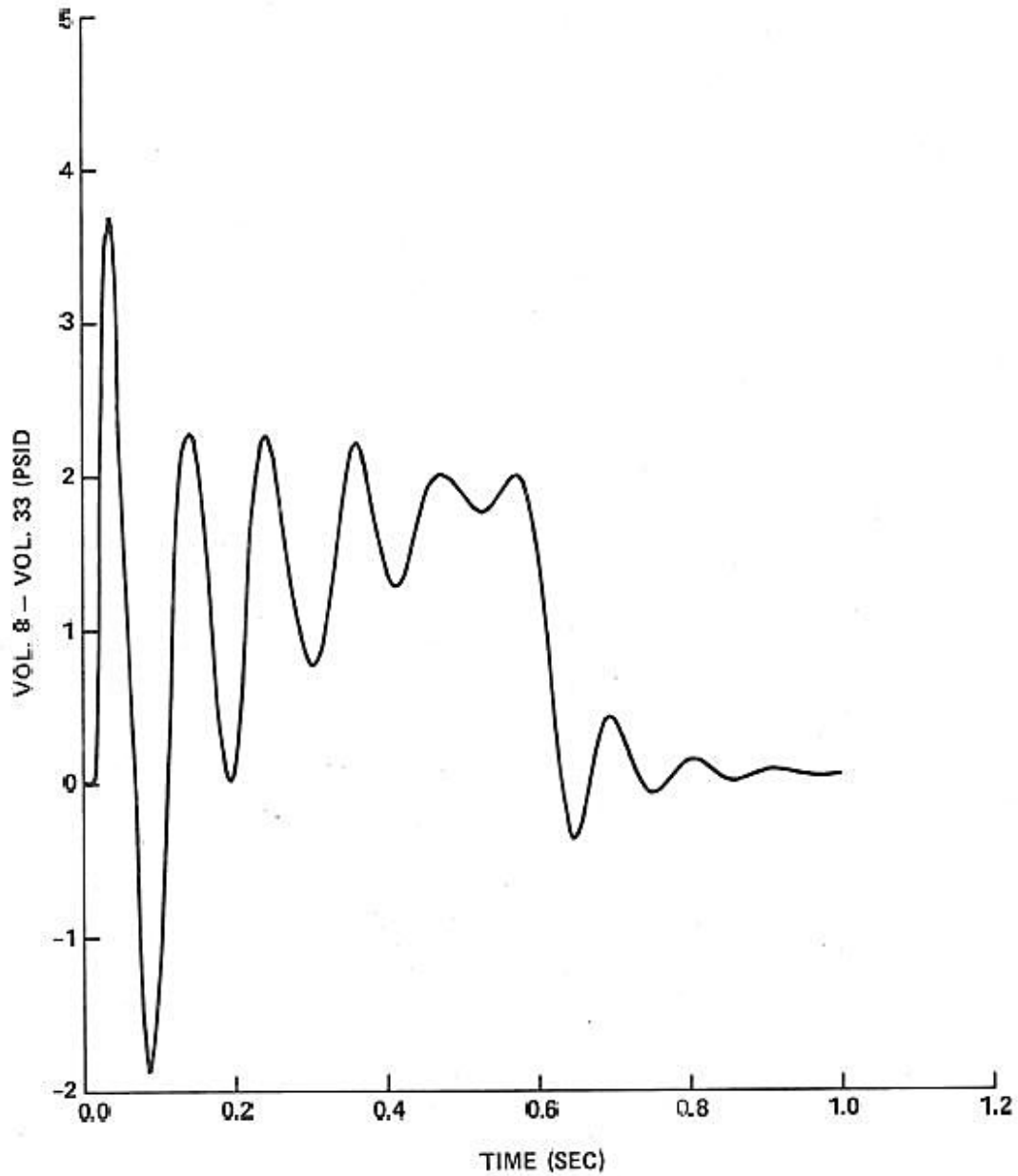

FIGURE 6.2.1-28I

PRESSURE DIFFERENTIAL IN REACTOR CAVITY, COLD LEG DEB

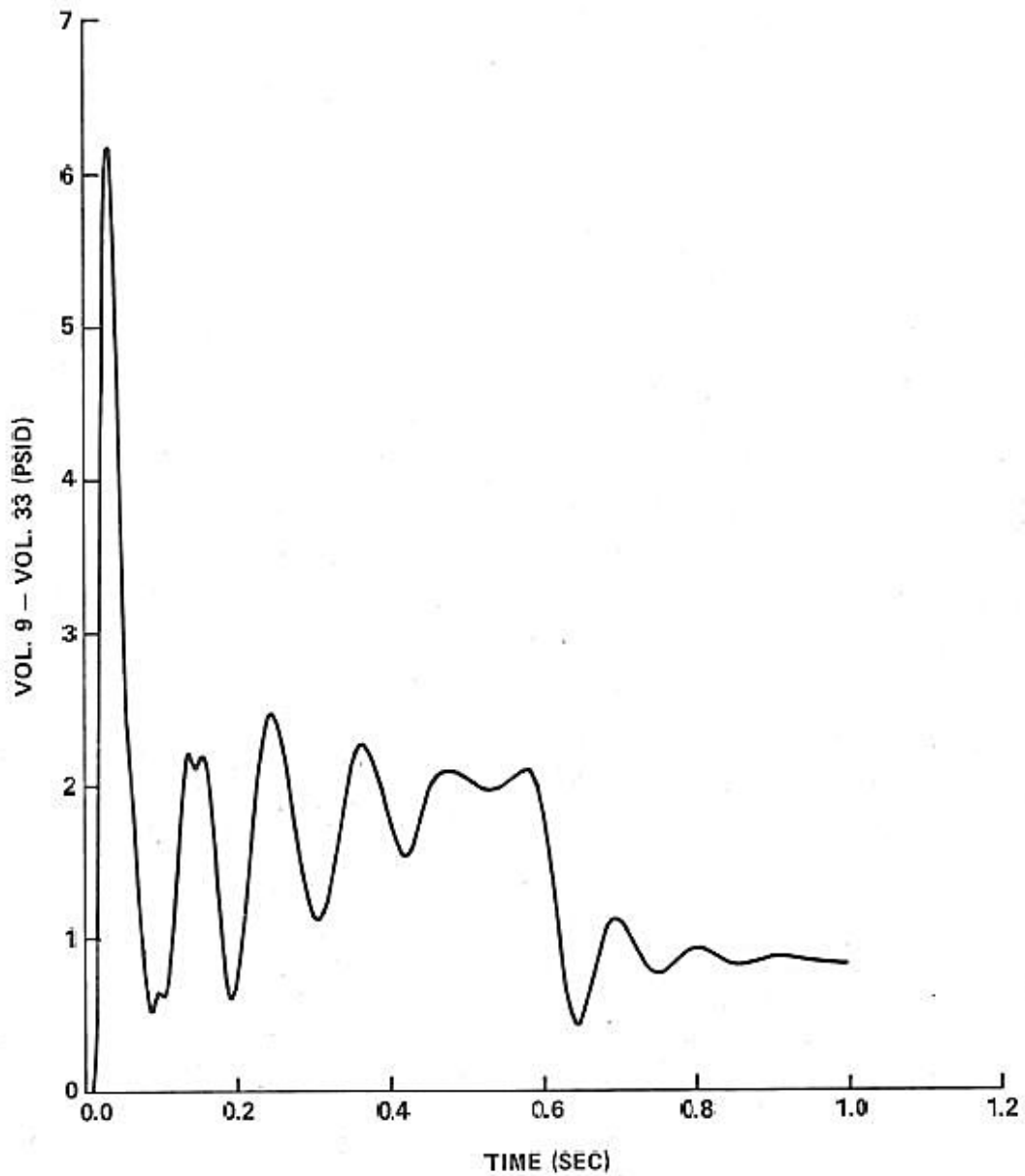

FIGURE 6.2.1-29

PEAK PRESSURE DIFFERENTIAL IN REACTOR CAVITY COLD LEG

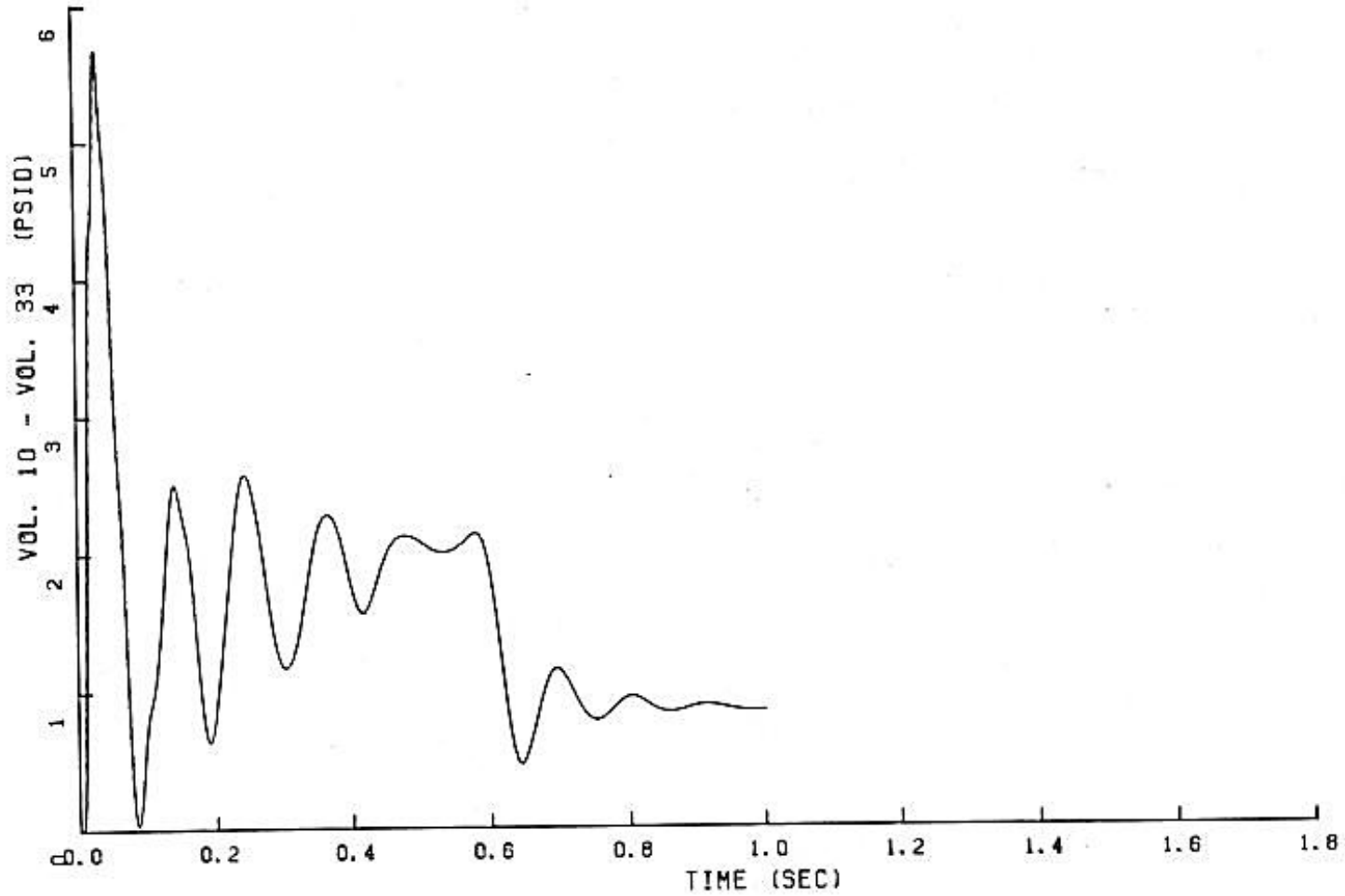

FIGURE 6.2.1-30

PEAK PRESSURE DIFFERENTIAL IN REACTOR CAVITY COLD LEG

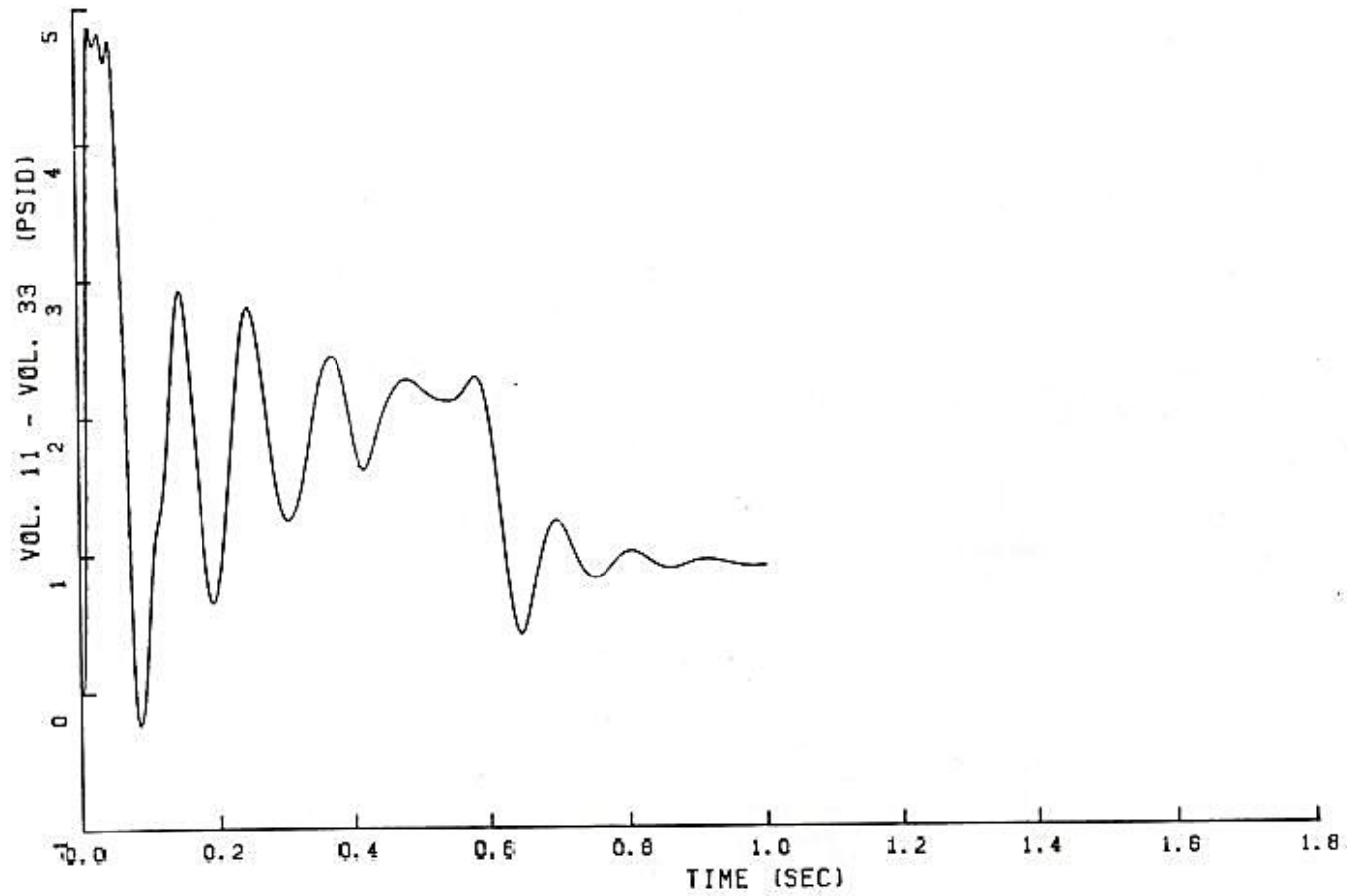

FIGURE 6.2.1-31

PEAK PRESSURE DIFFERENTIAL IN REACTOR CAVITY COLD LEG

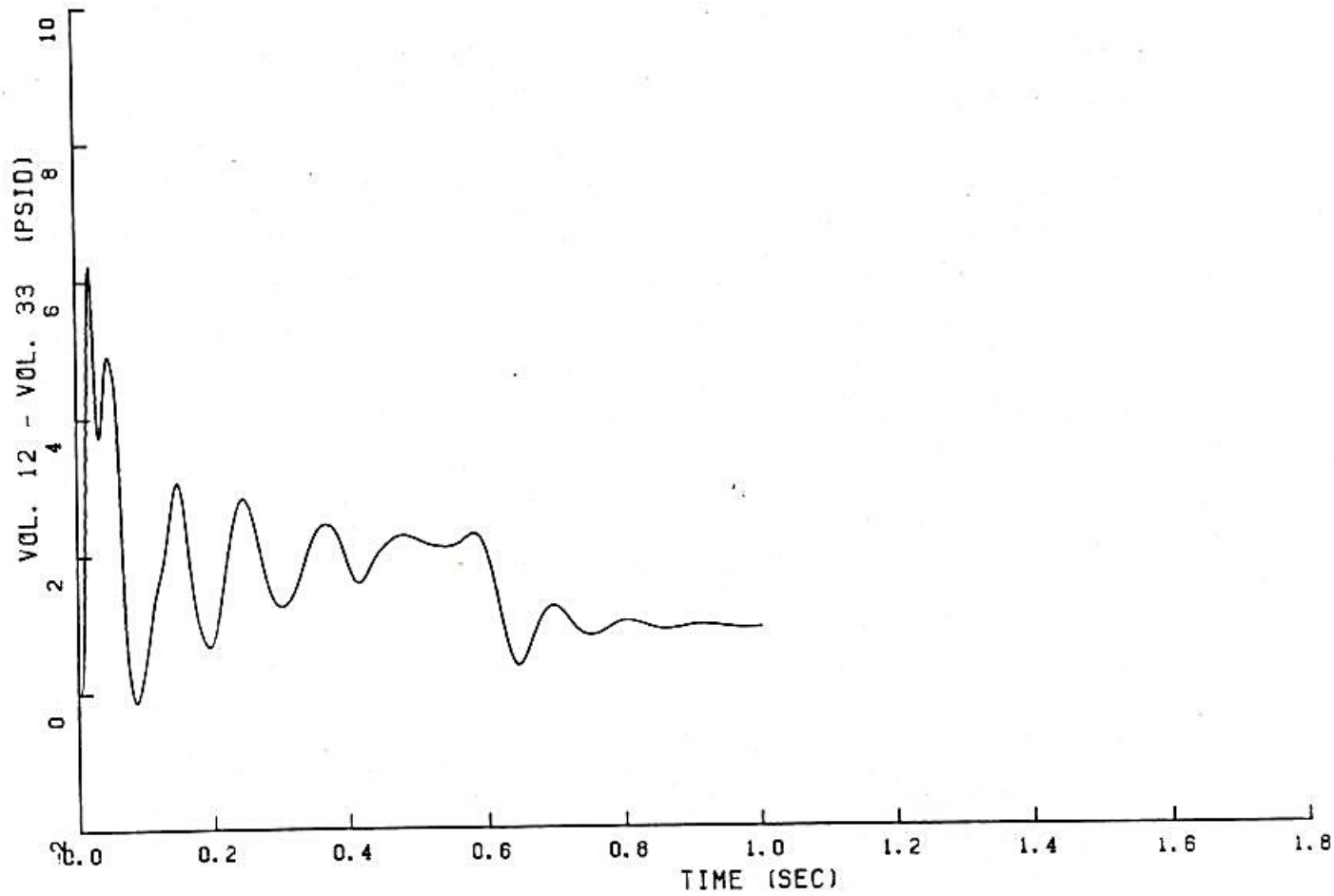

FIGURE 6.2.1-32

PEAK PRESSURE DIFFERENTIAL IN REACTOR CAVITY COLD LEG

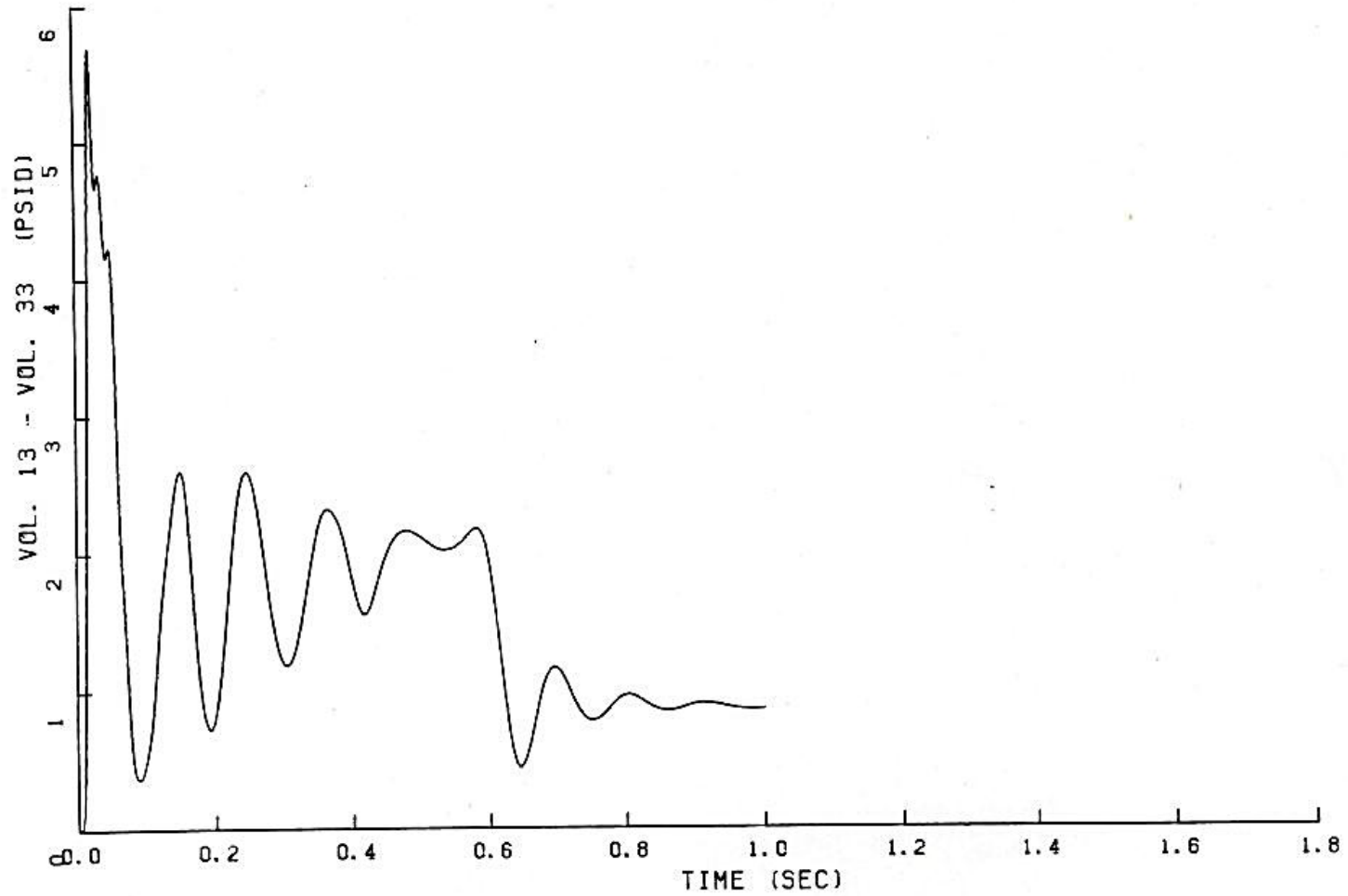

FIGURE 6.2.1-33

PEAK PRESSURE DIFFERENTIAL IN REACTOR CAVITY COLD LEG

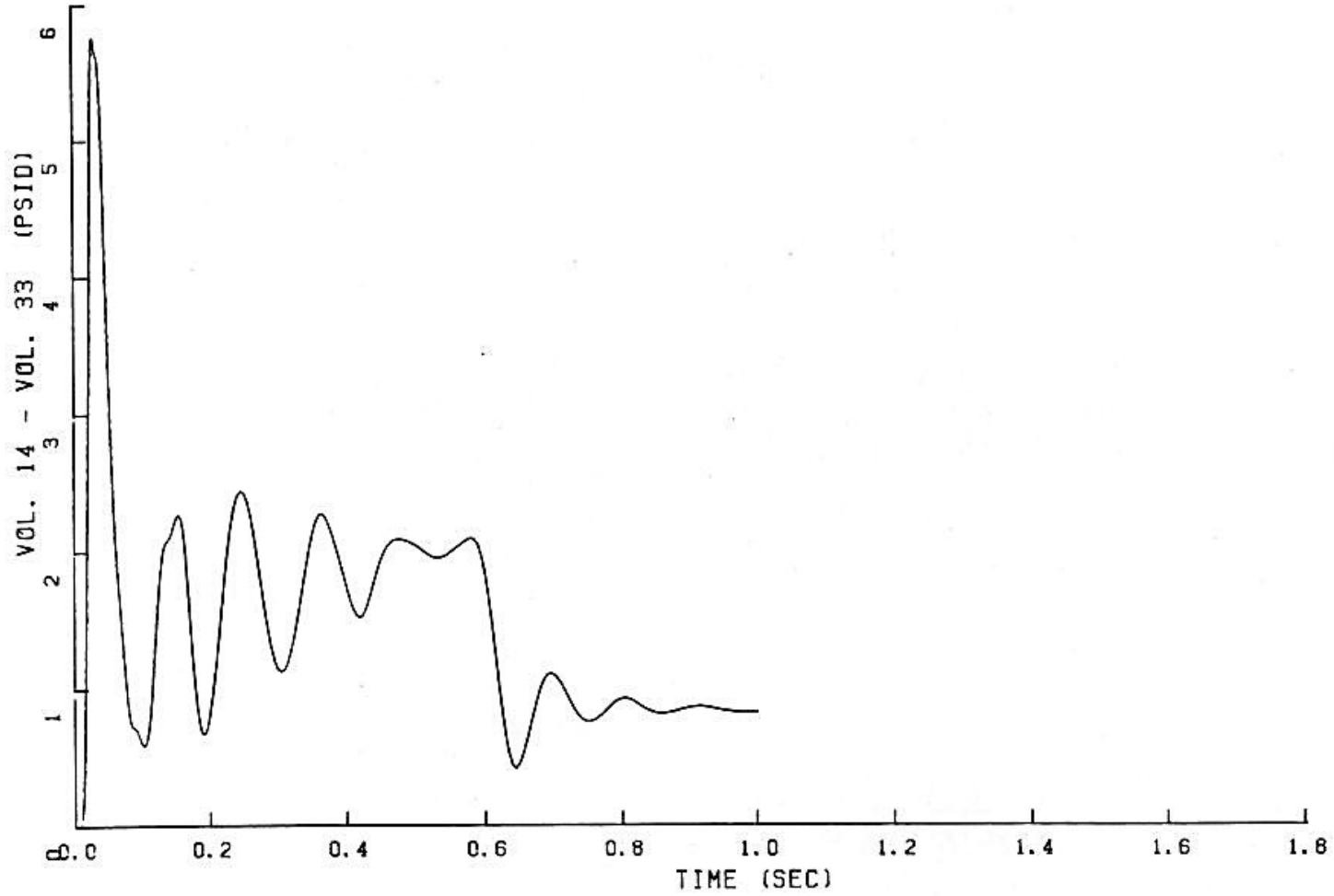

FIGURE 6.2.1-34

PEAK PRESSURE DIFFERENTIAL IN REACTOR CAVITY COLD LEG

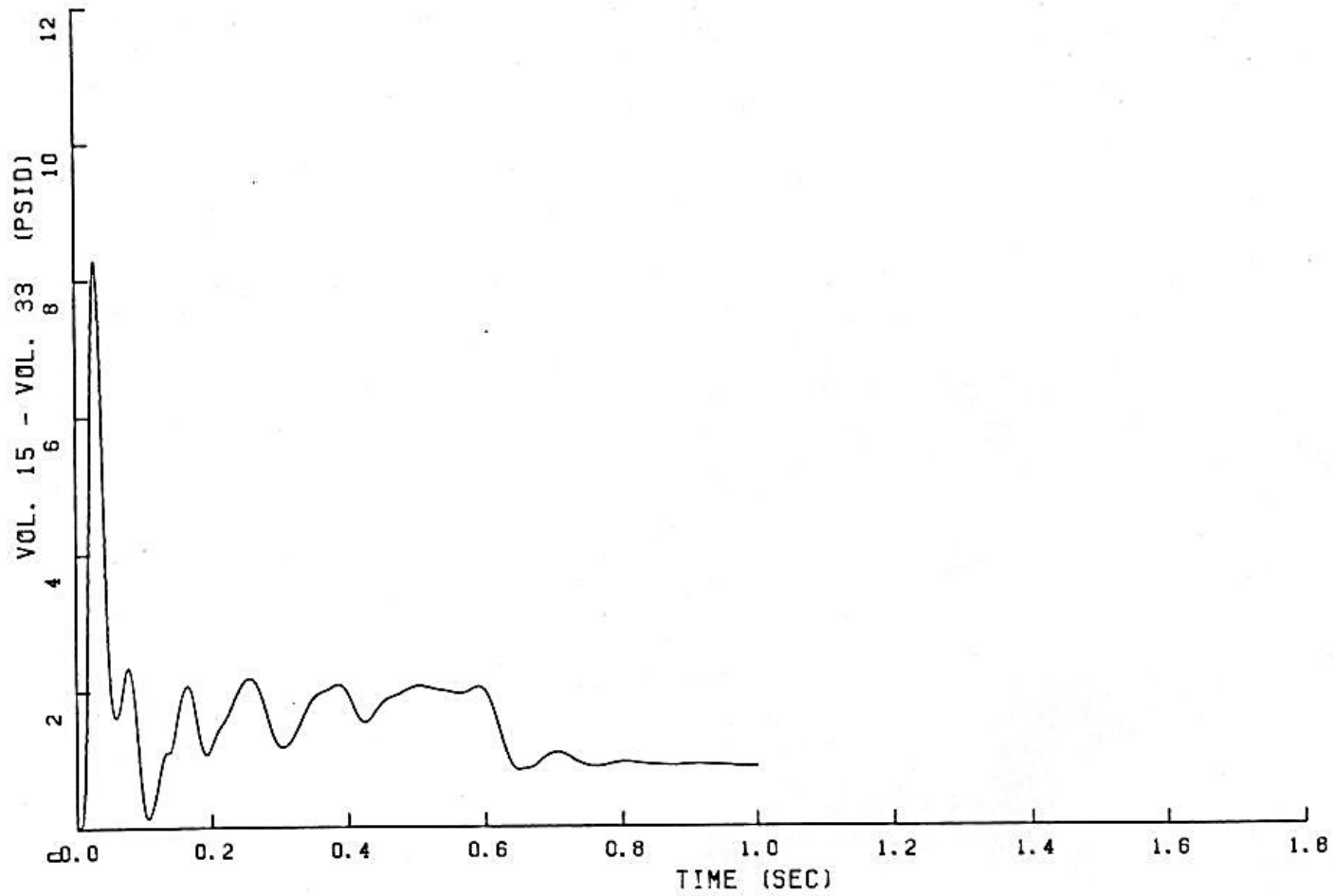

FIGURE 6.2.1-35

PEAK PRESSURE DIFFERENTIAL IN REACTOR CAVITY COLD LEG

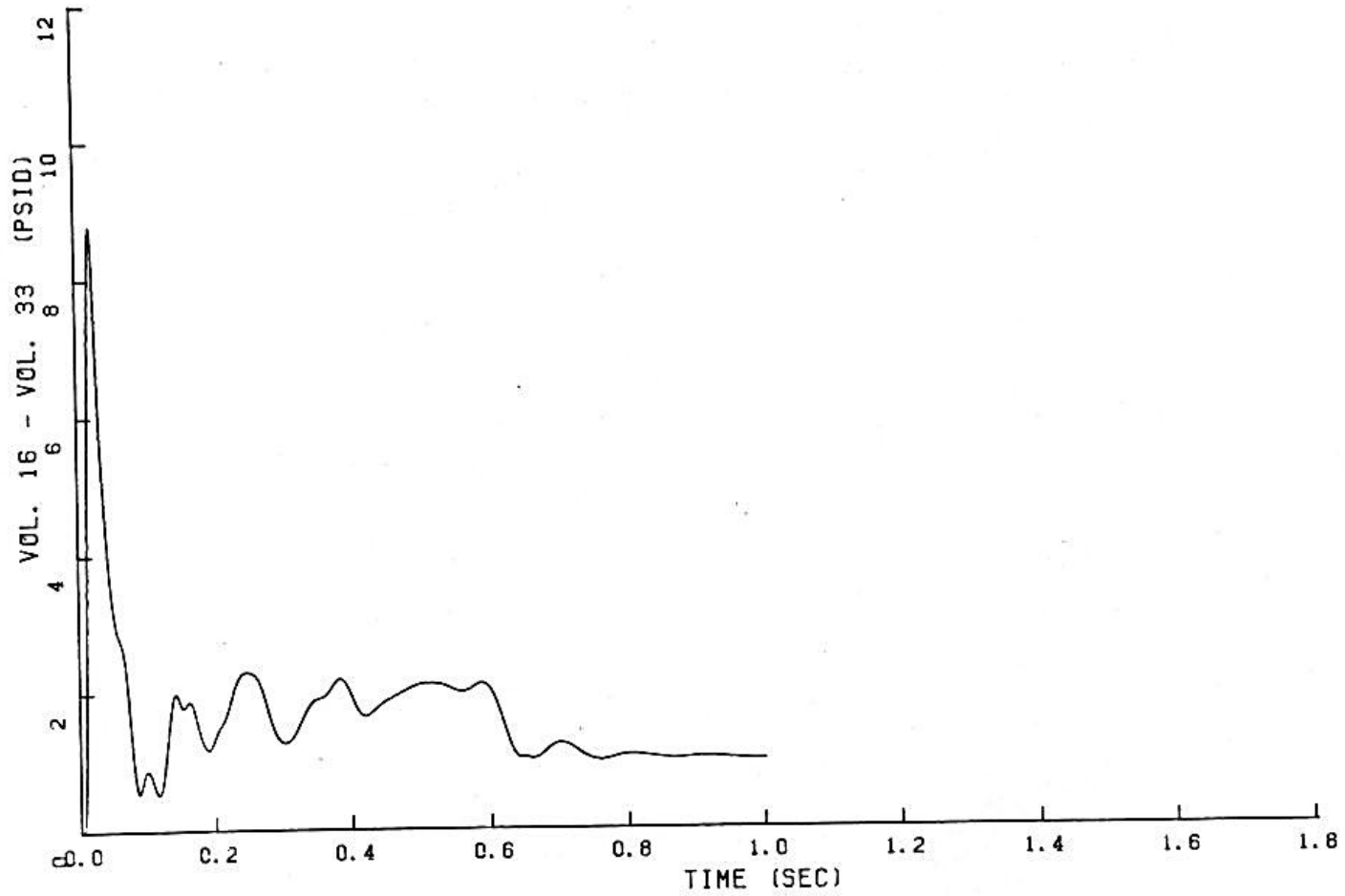

FIGURE 6.2.1-36

PEAK PRESSURE DIFFERENTIAL IN REACTOR CAVITY COLD LEG

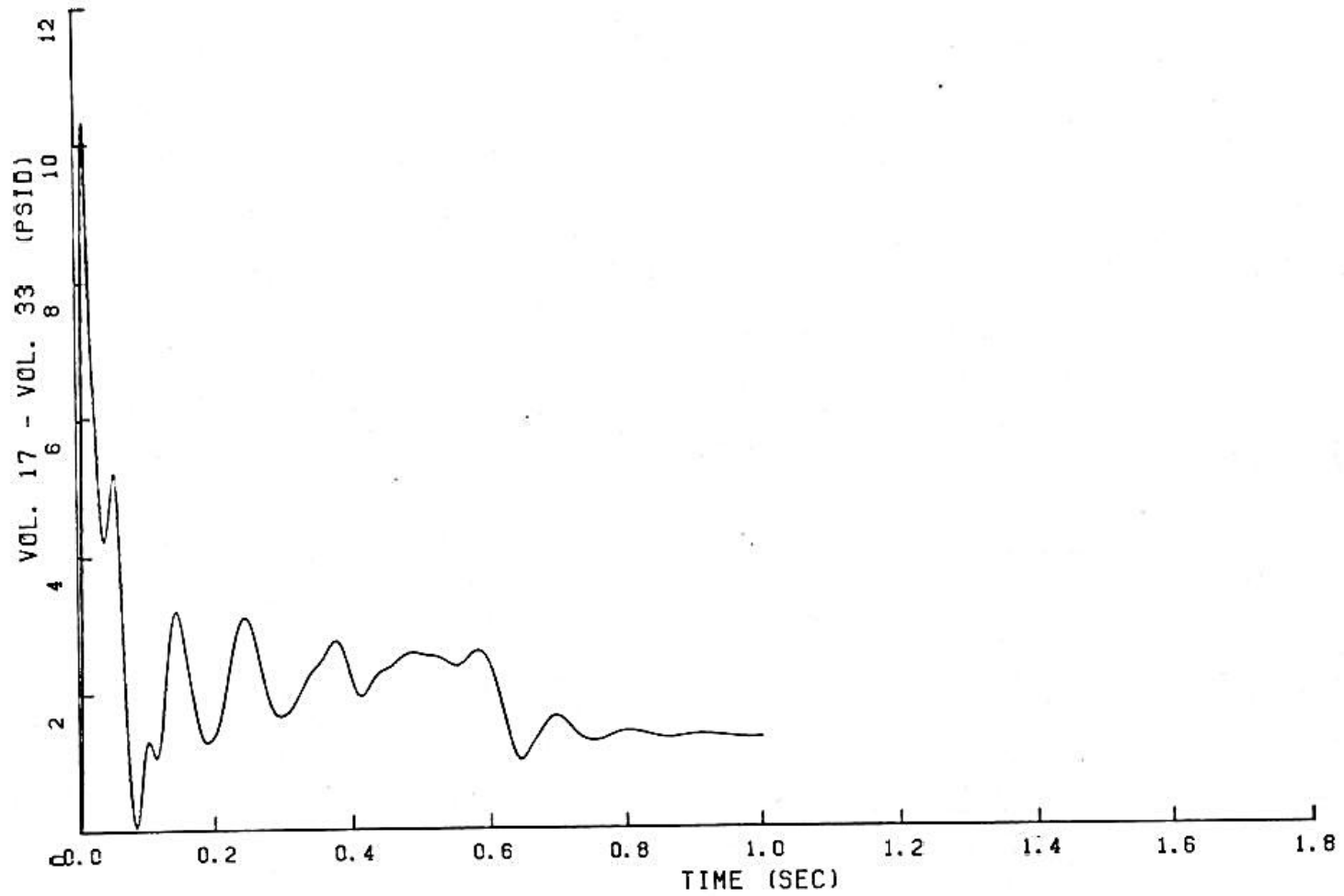

FIGURE 6.2.1-37

PEAK PRESSURE DIFFERENTIAL IN REACTOR CAVITY COLD LEG

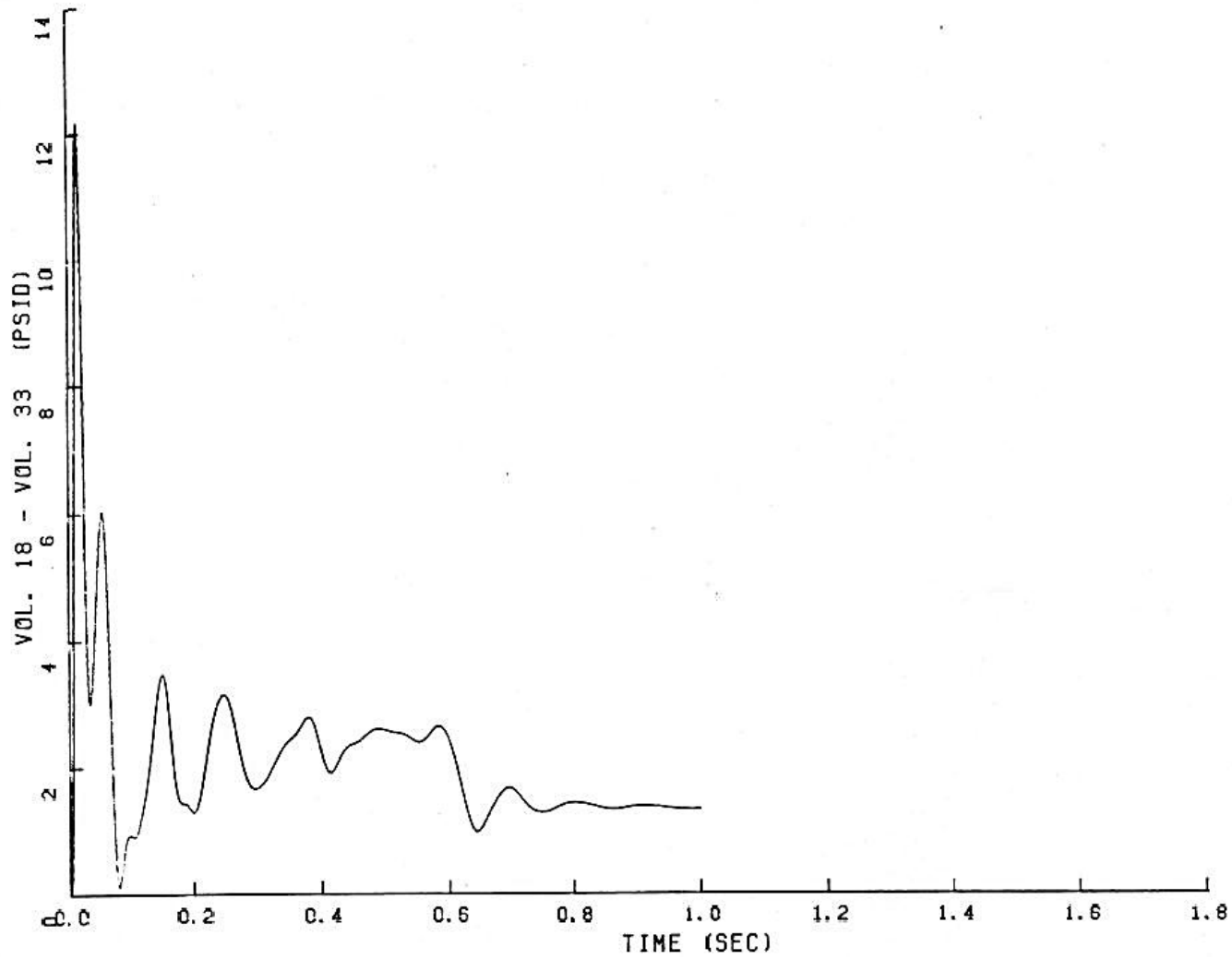

FIGURE 6.2.1-38

PEAK PRESSURE DIFFERENTIAL IN REACTOR CAVITY COLD LEG

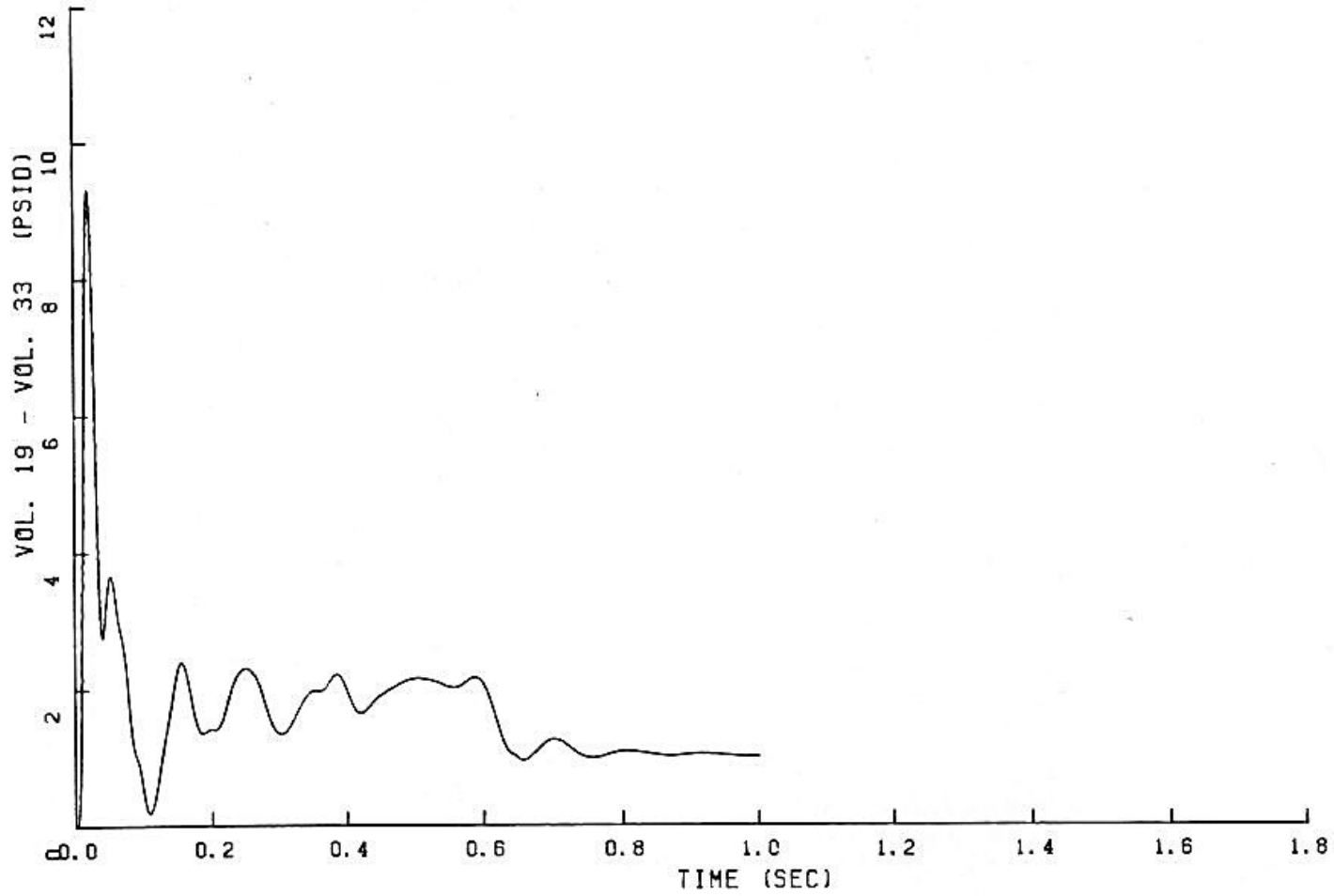

FIGURE 6.2.1-39

PEAK PRESSURE DIFFERENTIAL IN REACTOR CAVITY COLD LEG

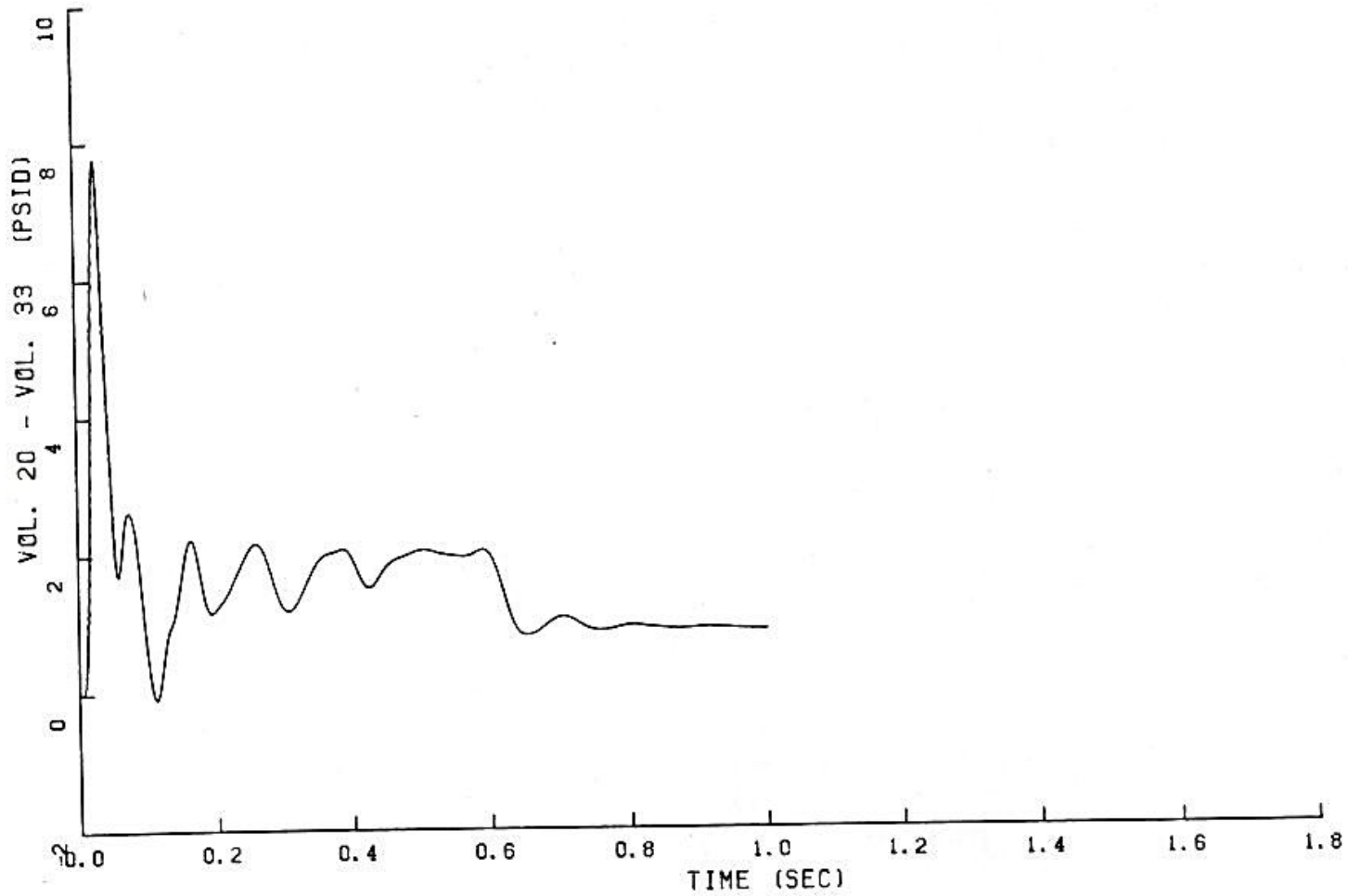

FIGURE 6.2.1-40

PEAK PRESSURE DIFFERENTIAL IN REACTOR CAVITY COLD LEG

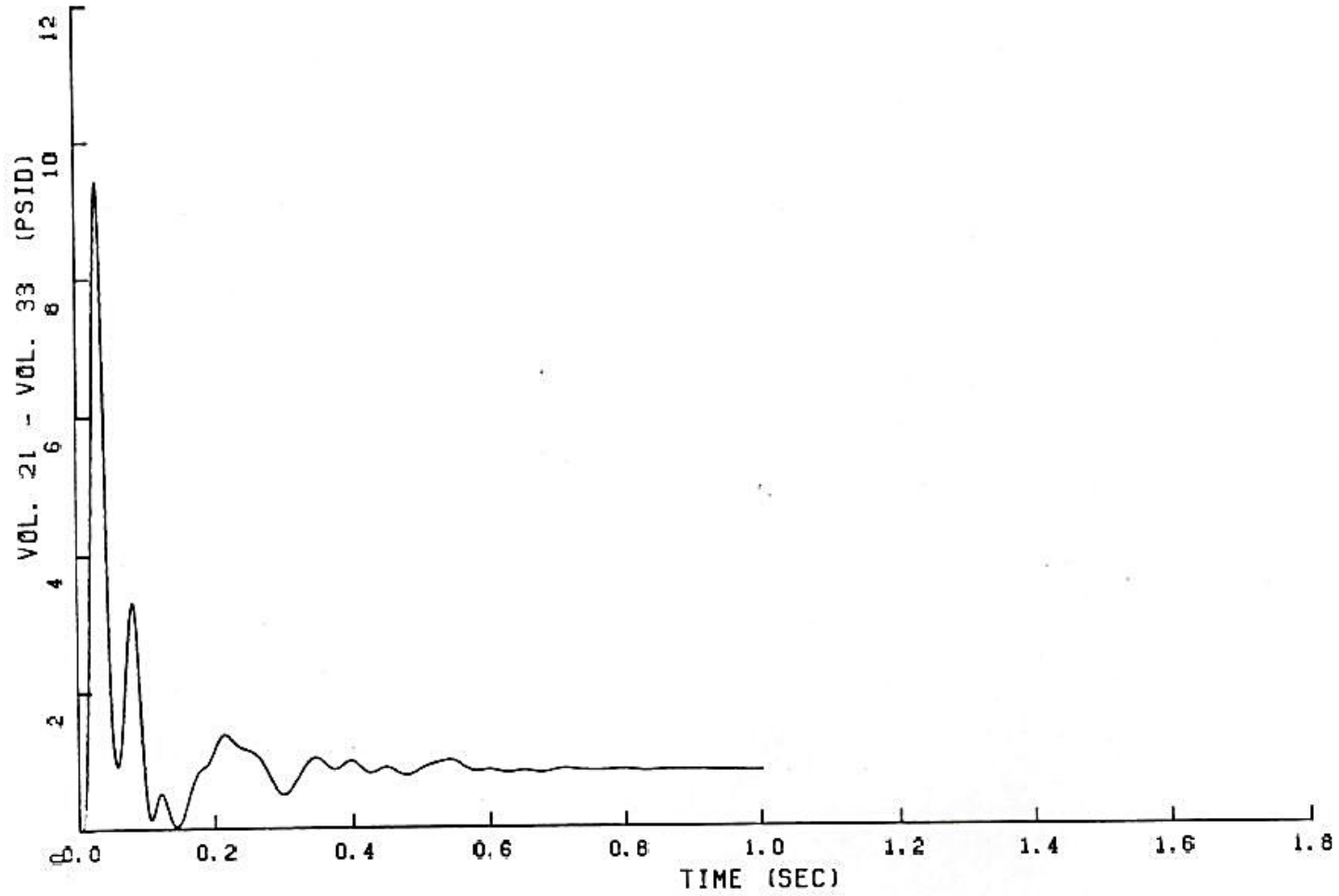

FIGURE 6.2.1-41

PEAK PRESSURE DIFFERENTIAL IN REACTOR CAVITY COLD LEG

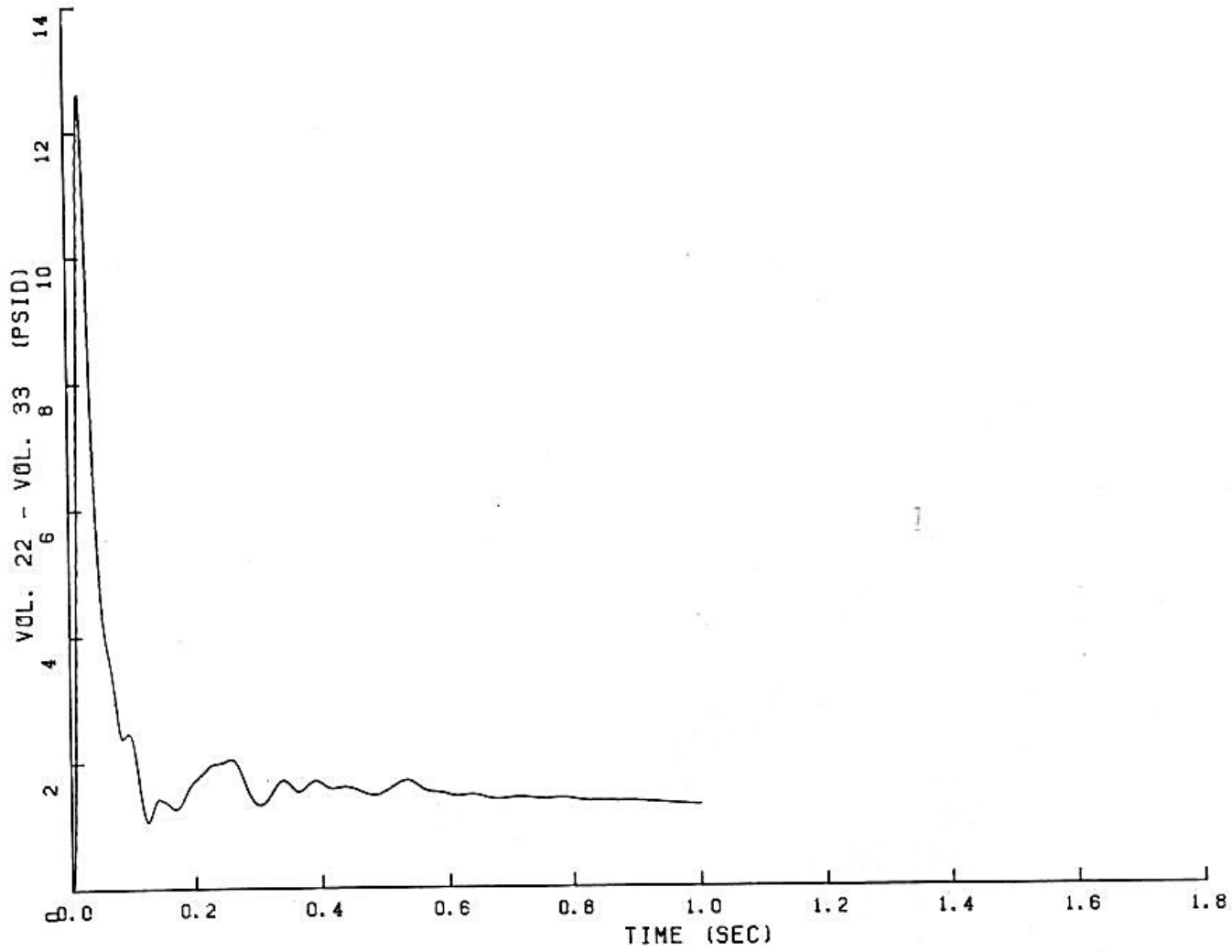

FIGURE 6.2.1-42

PEAK PRESSURE DIFFERENTIAL IN REACTOR CAVITY COLD LEG

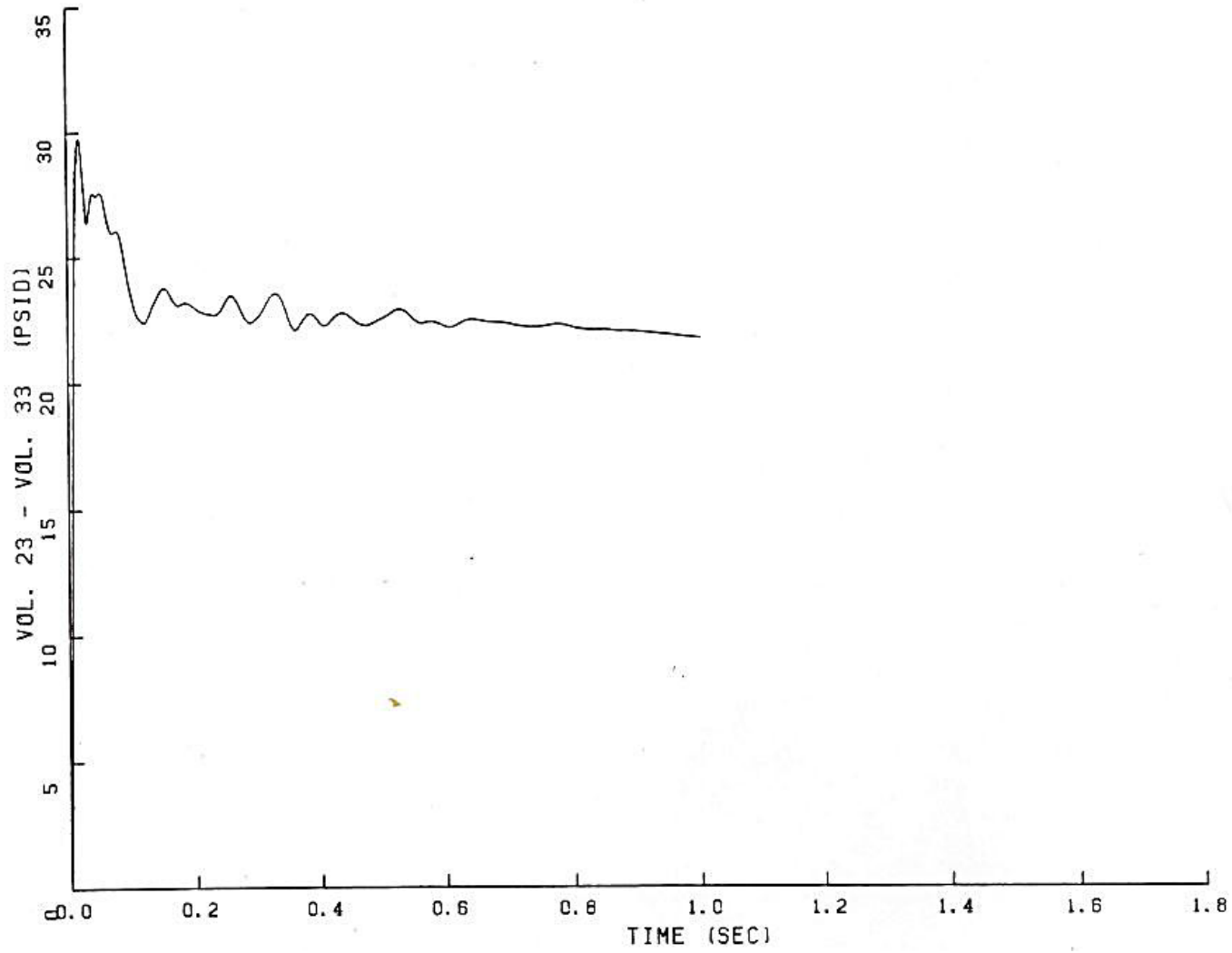

FIGURE 6.2.1-43

PEAK PRESSURE DIFFERENTIAL IN REACTOR CAVITY COLD LEG

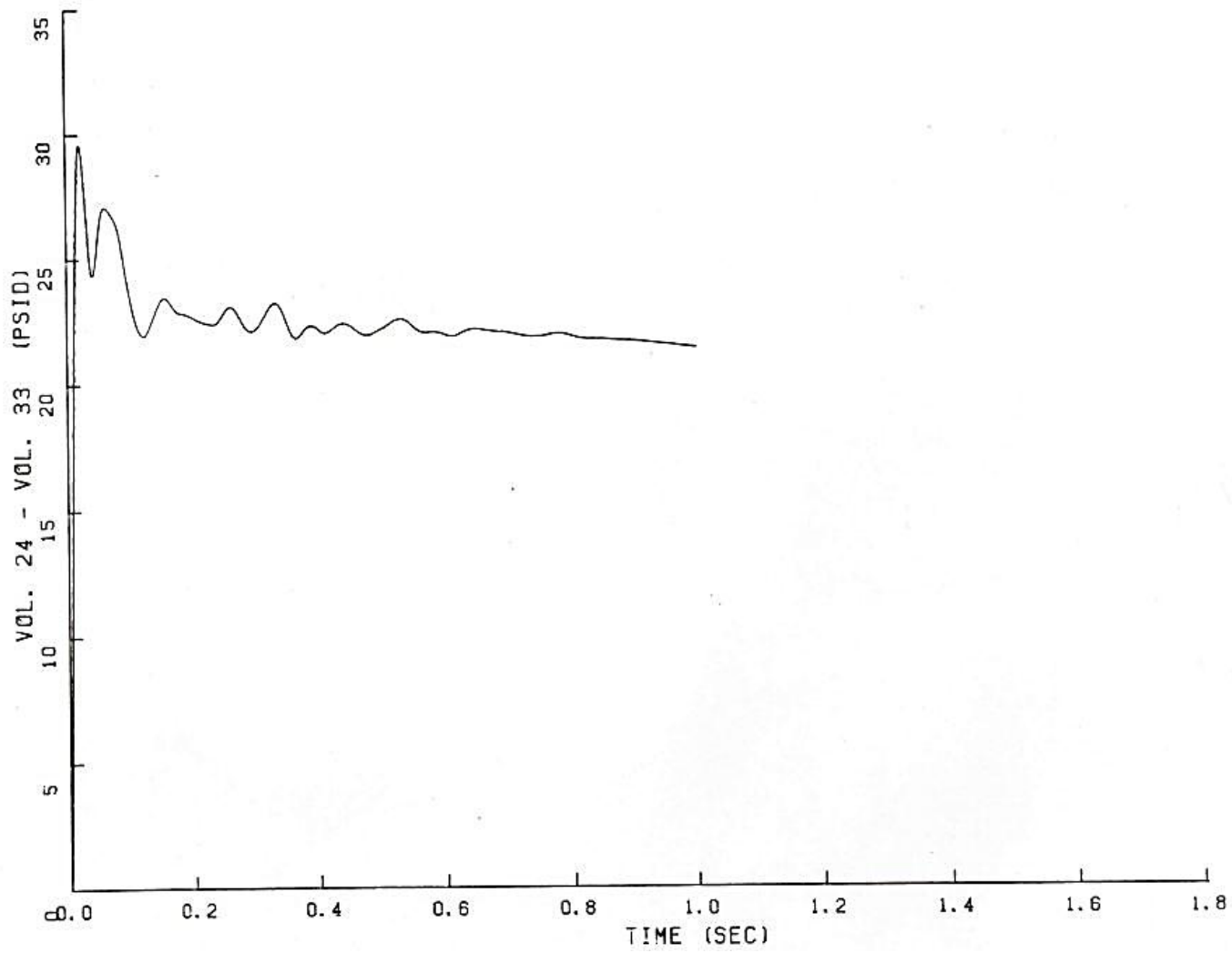

FIGURE 6.2.1-44

PEAK PRESSURE DIFFERENTIAL IN REACTOR CAVITY COLD LEG

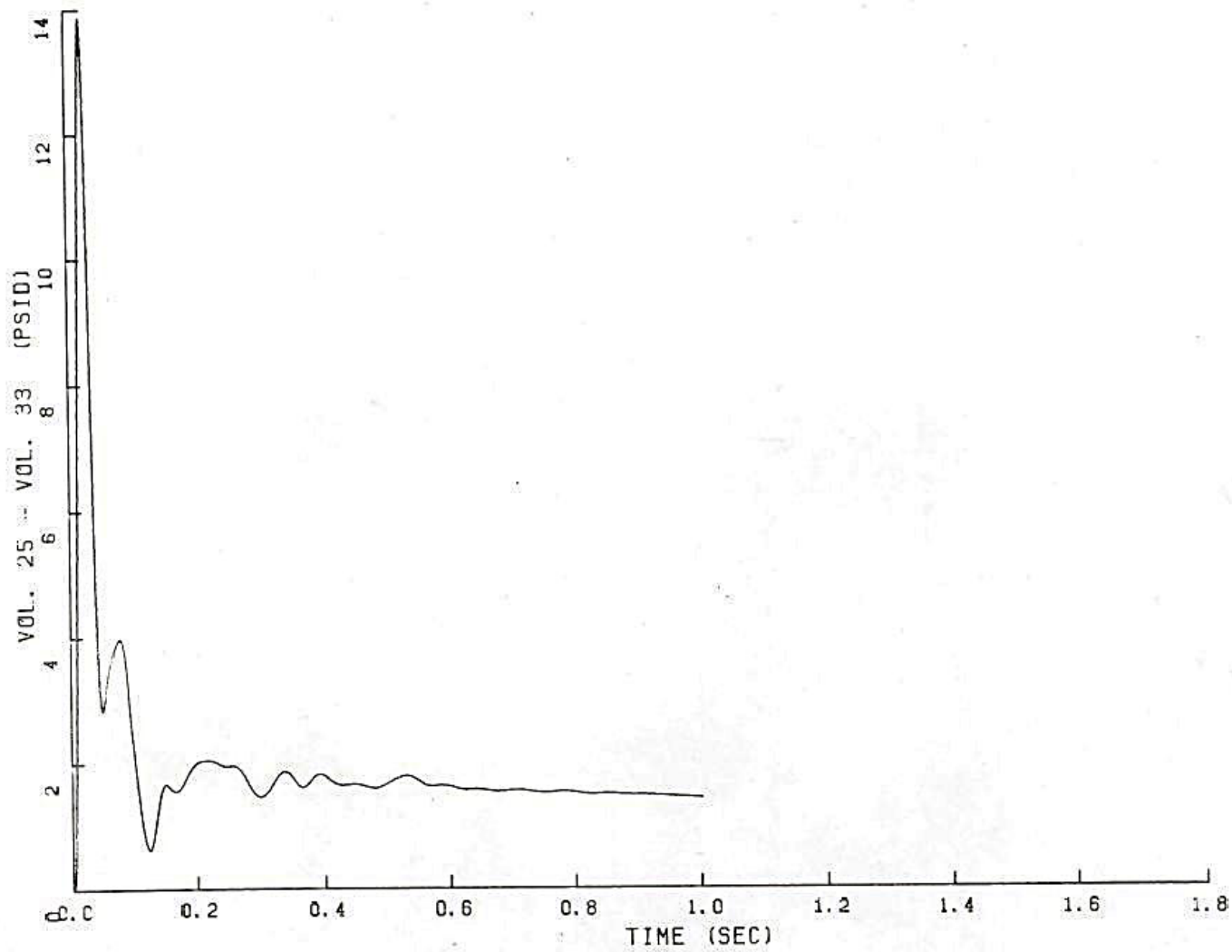

FIGURE 6.2.1-45

PEAK PRESSURE DIFFERENTIAL IN REACTOR CAVITY COLD LEG

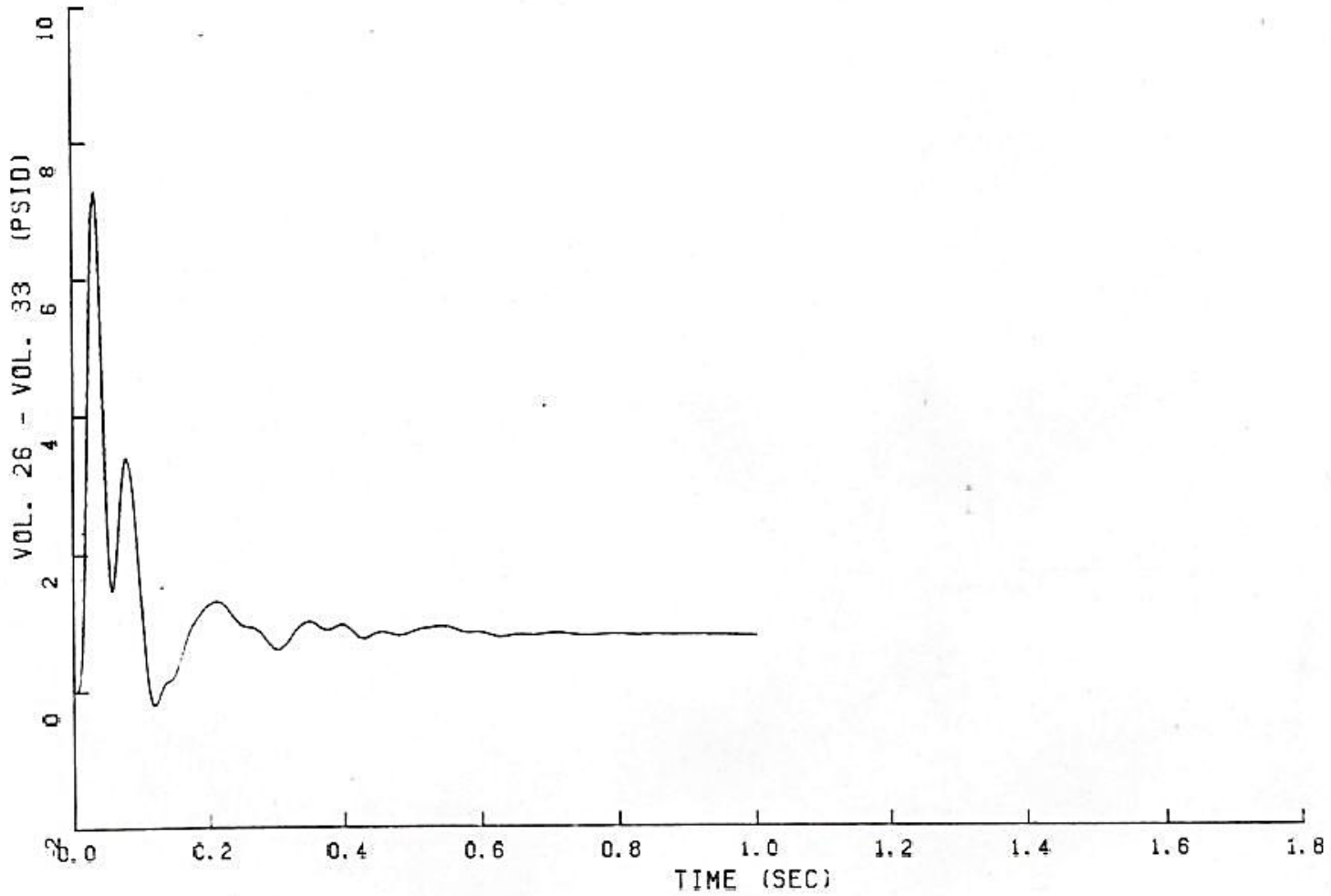

FIGURE 6.2.1-46

PEAK PRESSURE DIFFERENTIAL IN REACTOR CAVITY COLD LEG

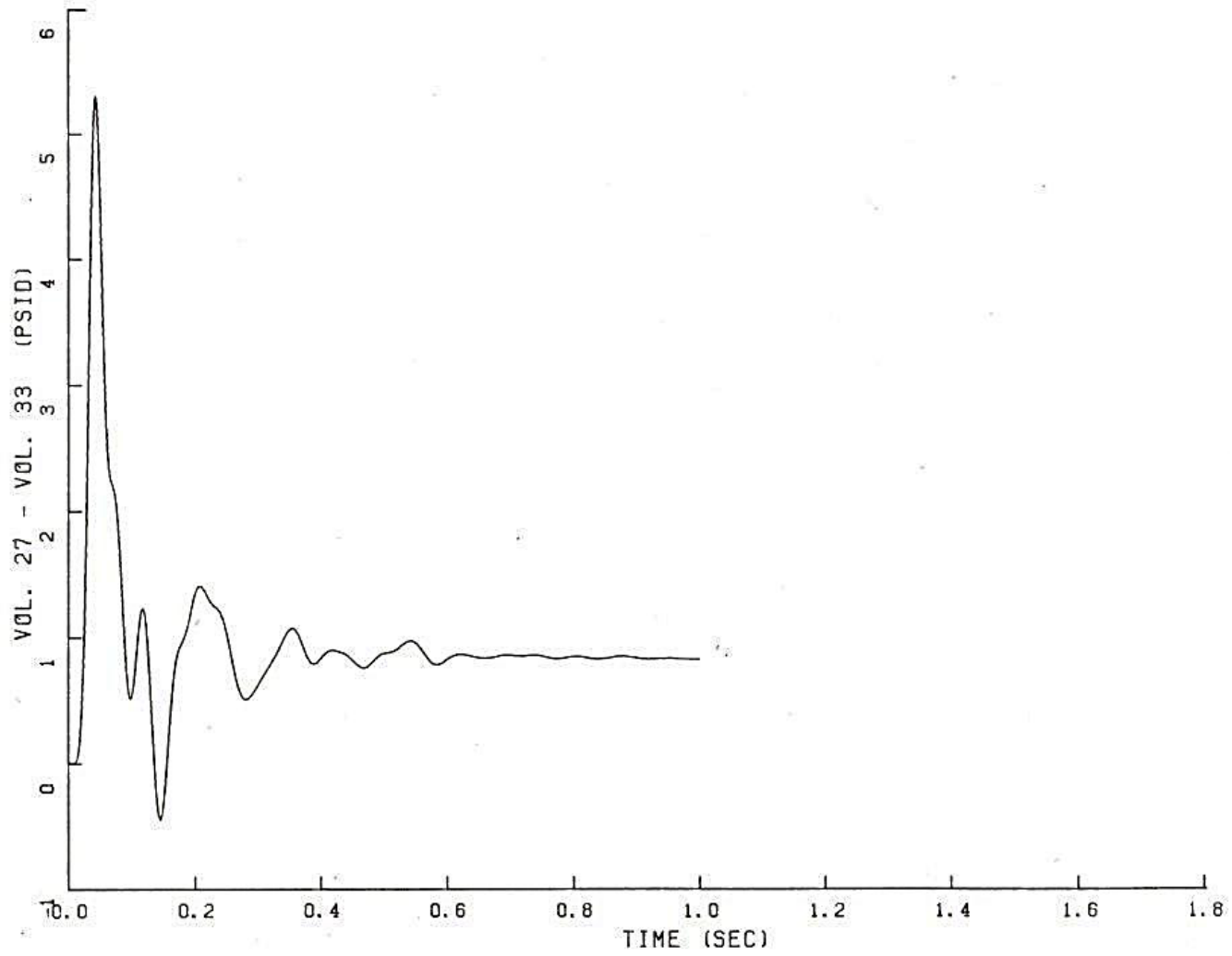

FIGURE 6.2.1-47

PEAK PRESSURE DIFFERENTIAL IN REACTOR CAVITY COLD LEG

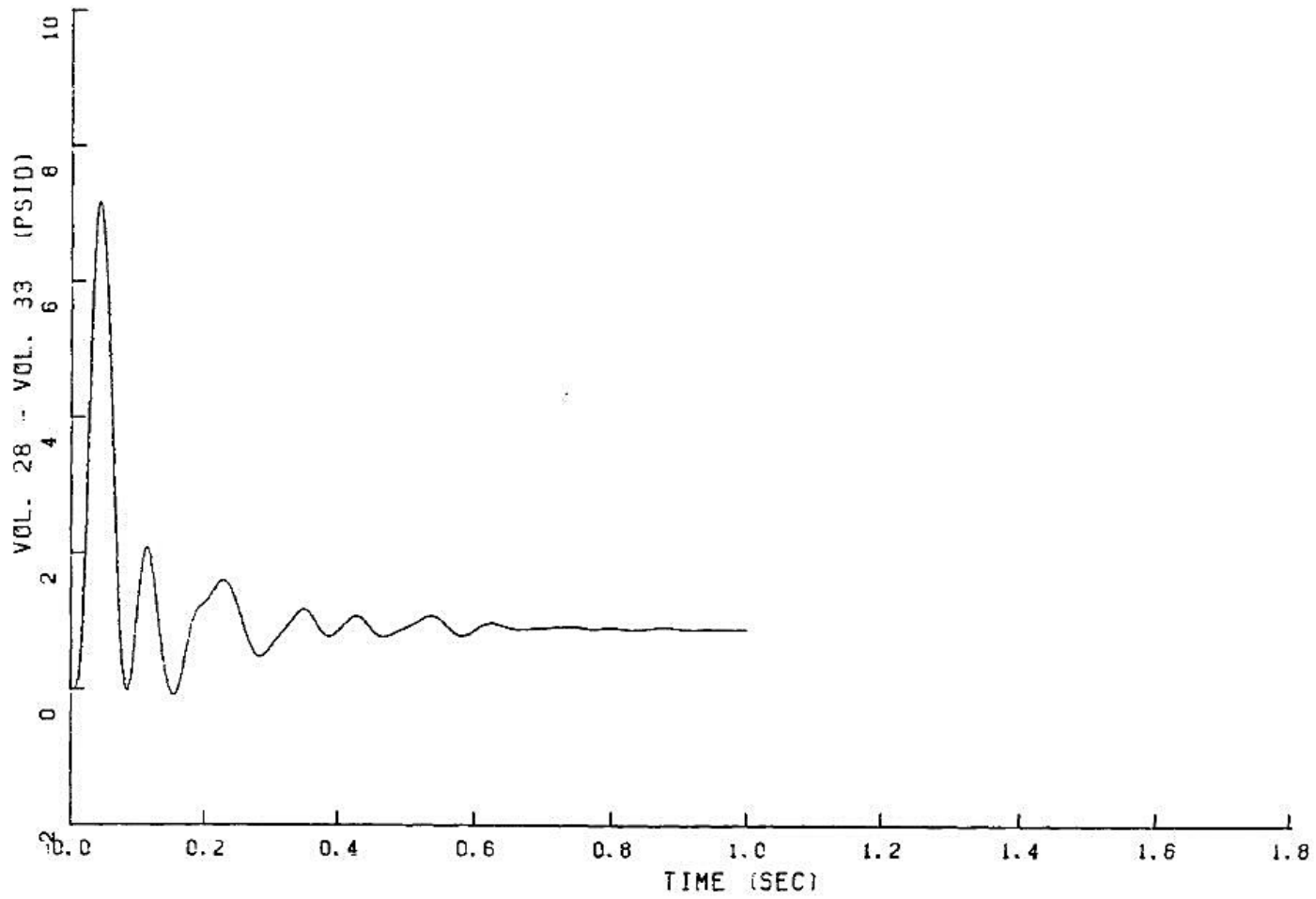

FIGURE 6.2.1-48

PEAK PRESSURE DIFFERENTIAL IN REACTOR CAVITY COLD LEG

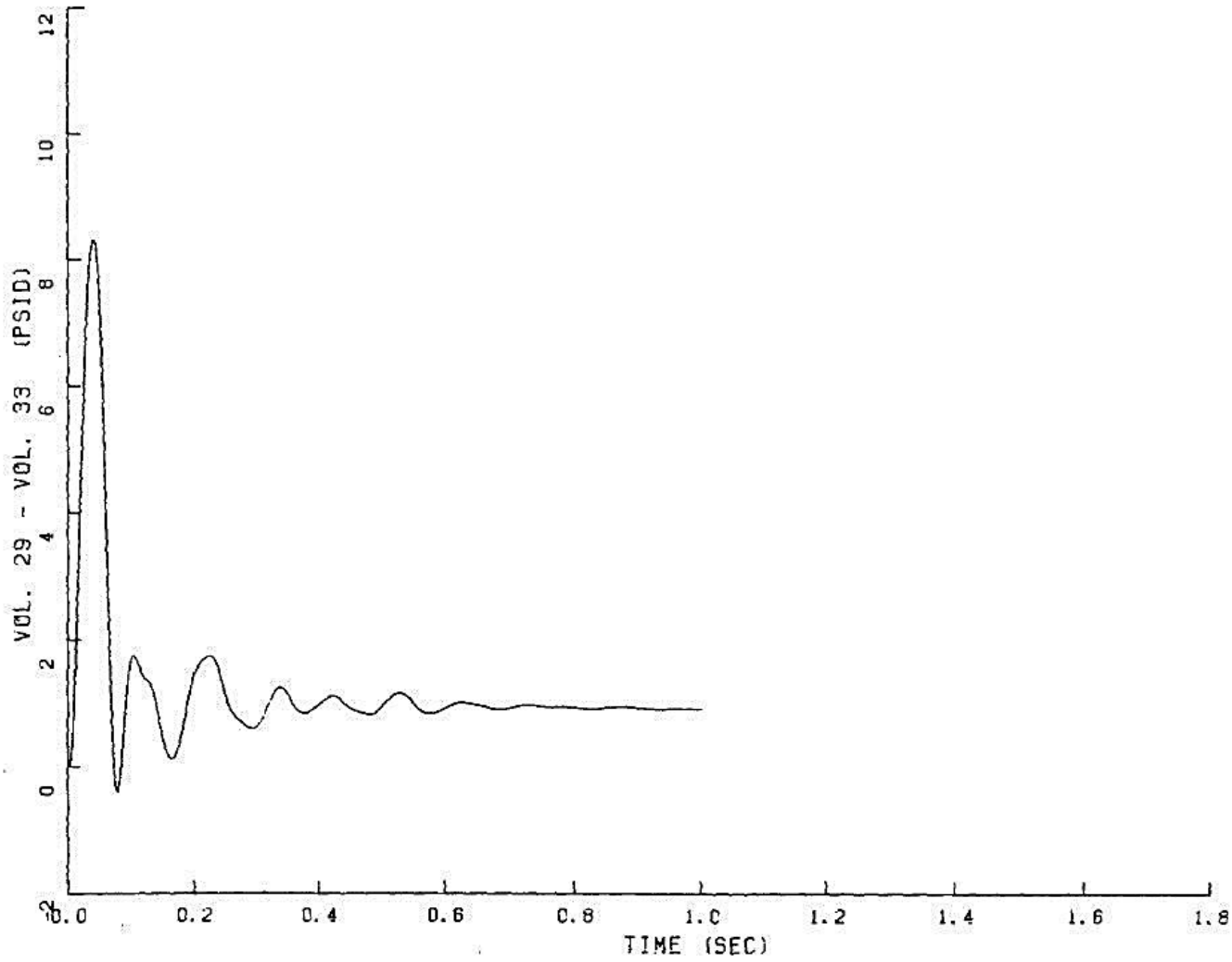

FIGURE 6.2.1-49

PEAK PRESSURE DIFFERENTIAL IN REACTOR CAVITY COLD LEG

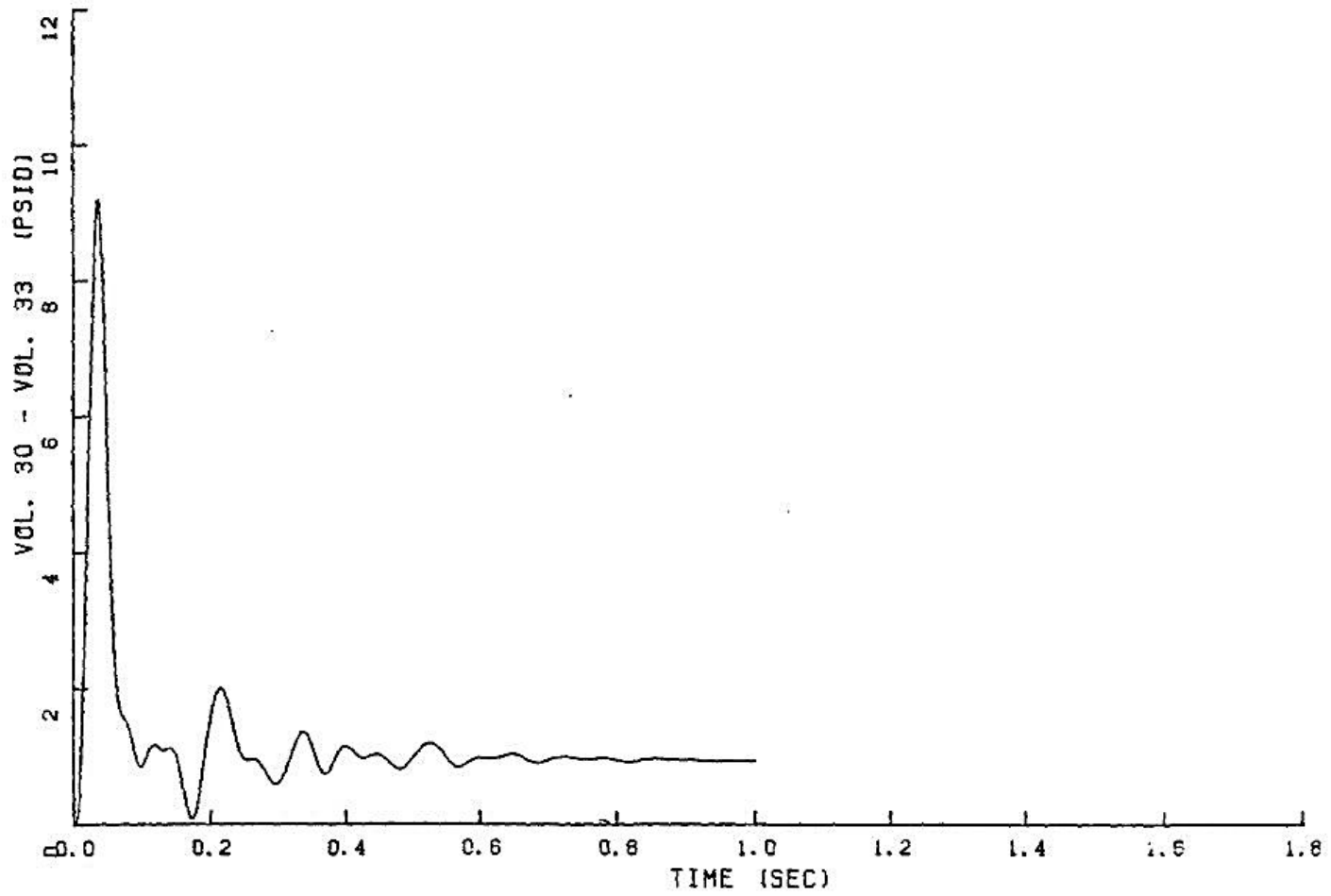

FIGURE 6.2.1-50

PEAK PRESSURE DIFFERENTIAL IN REACTOR CAVITY COLD LEG

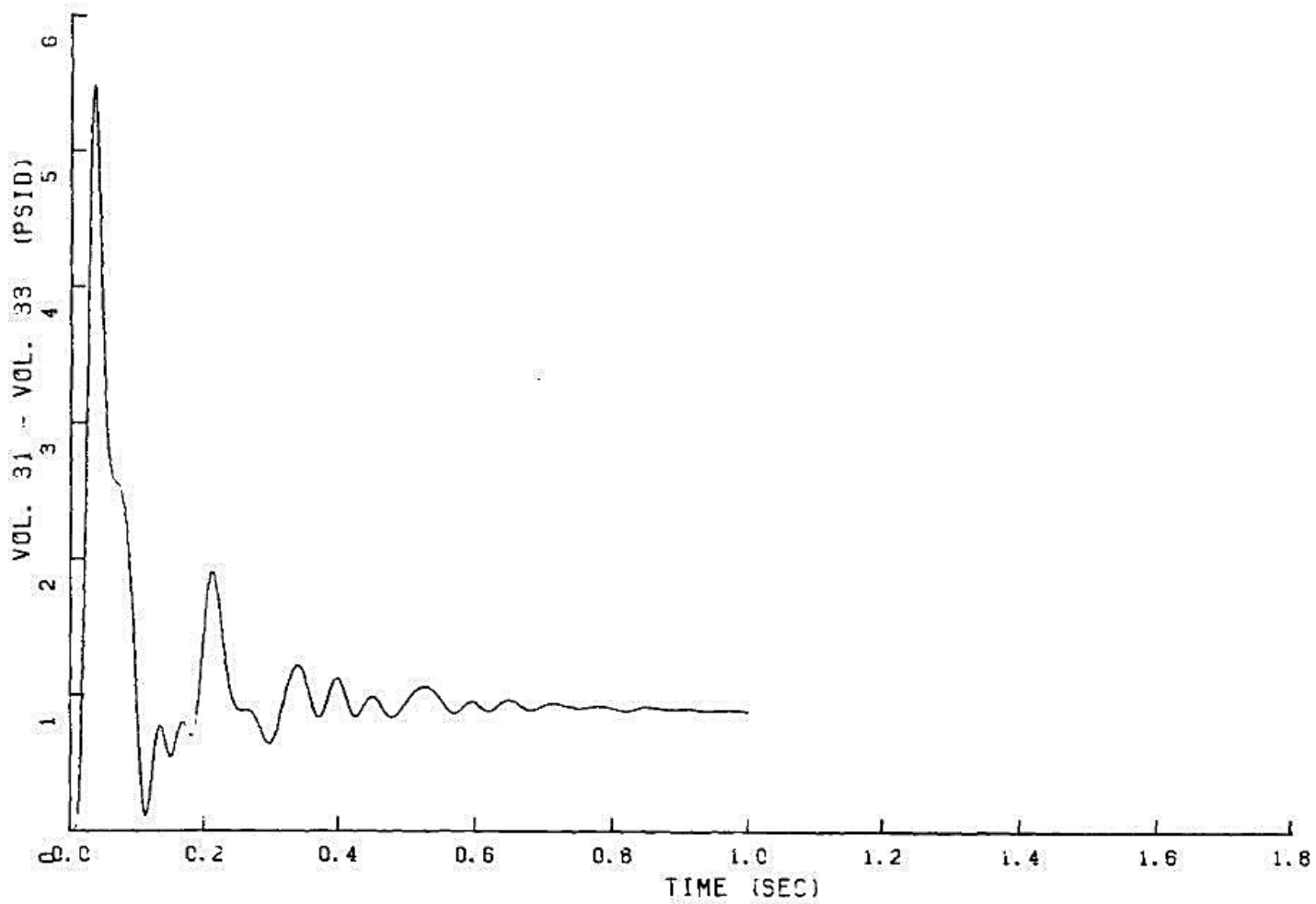

FIGURE 6.2.1-51

PEAK PRESSURE DIFFERENTIAL IN REACTOR CAVITY COLD LEG

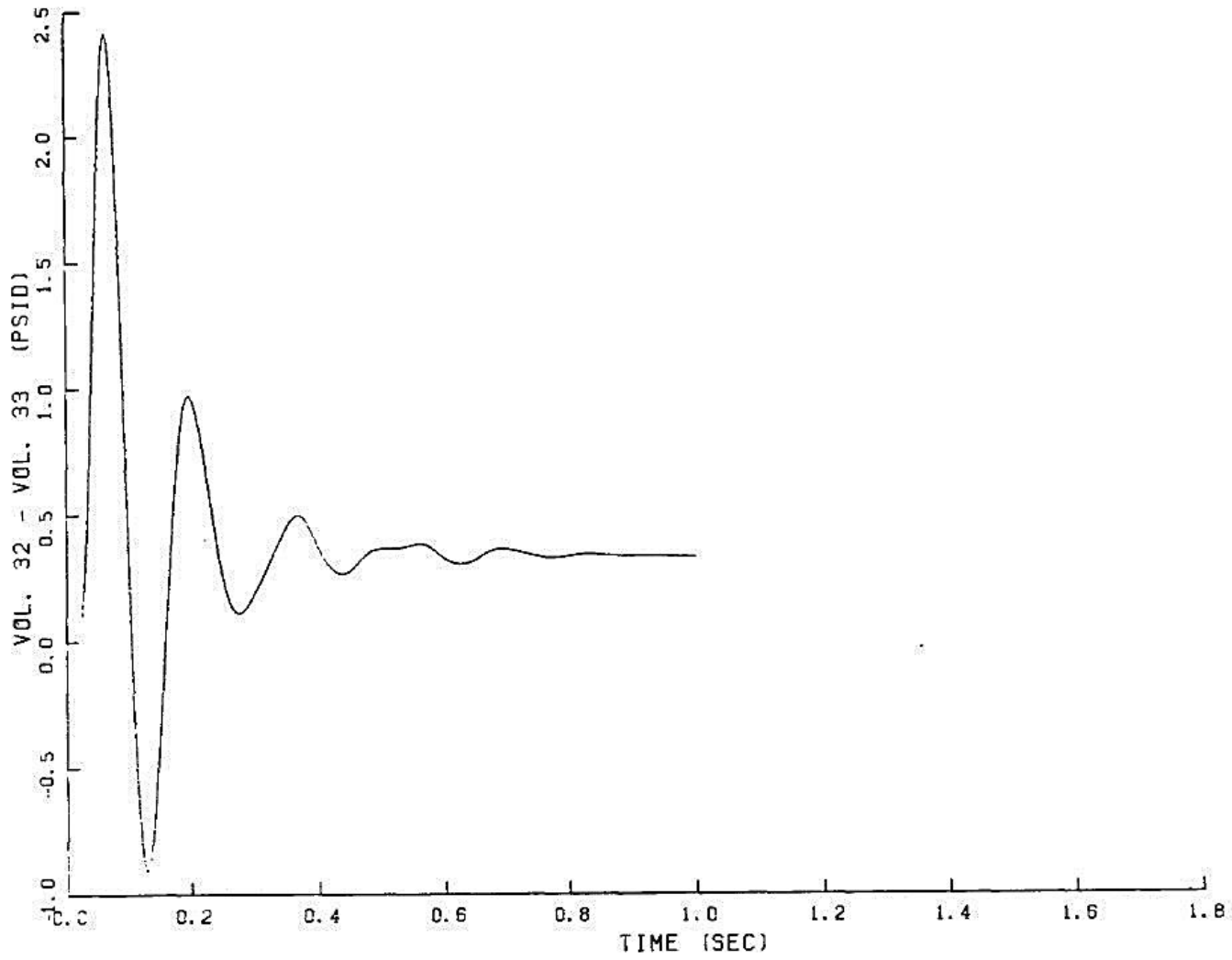

FIGURE 6.2.1-52a

PRESSURE DIFFERENTIAL IN REACTOR CAVITY, HOT LEG DEB

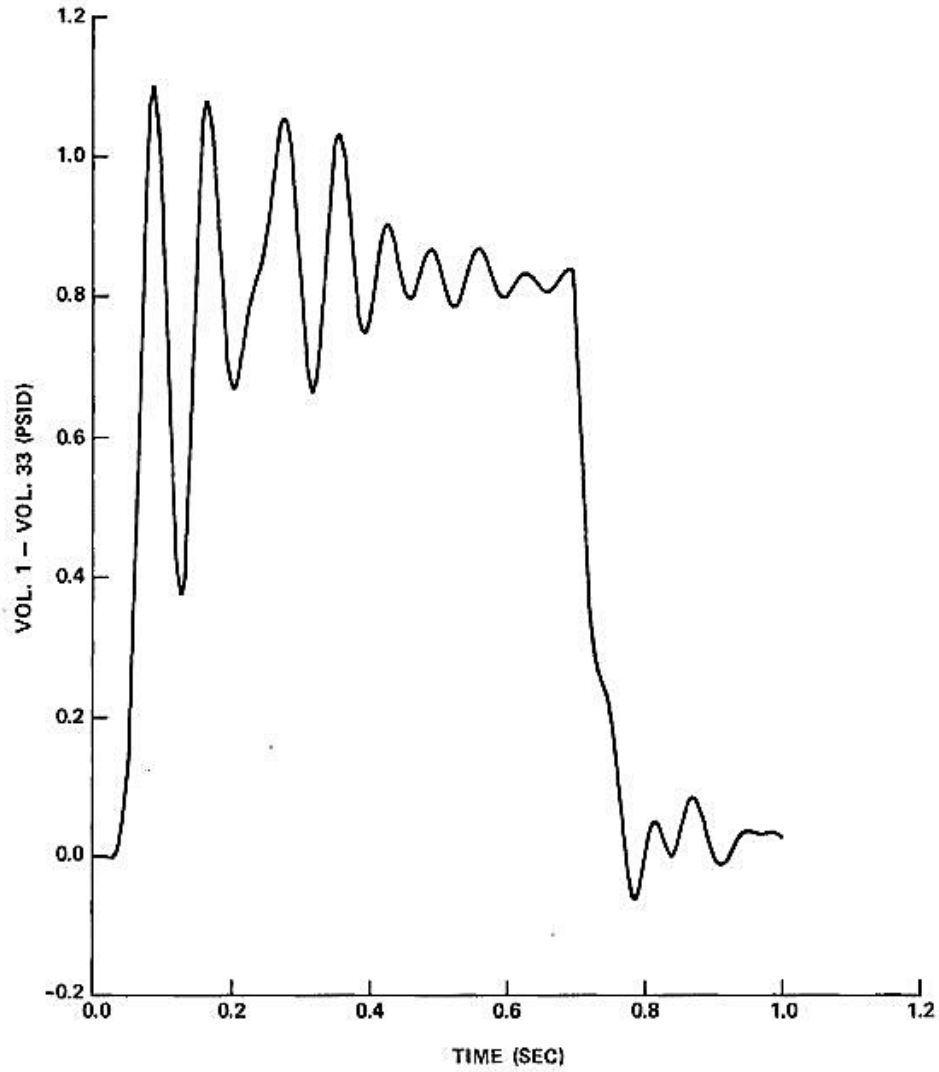

FIGURE 6.2.1-52b

PRESSURE DIFFERENTIAL IN REACTOR CAVITY, HOT LEG DEB

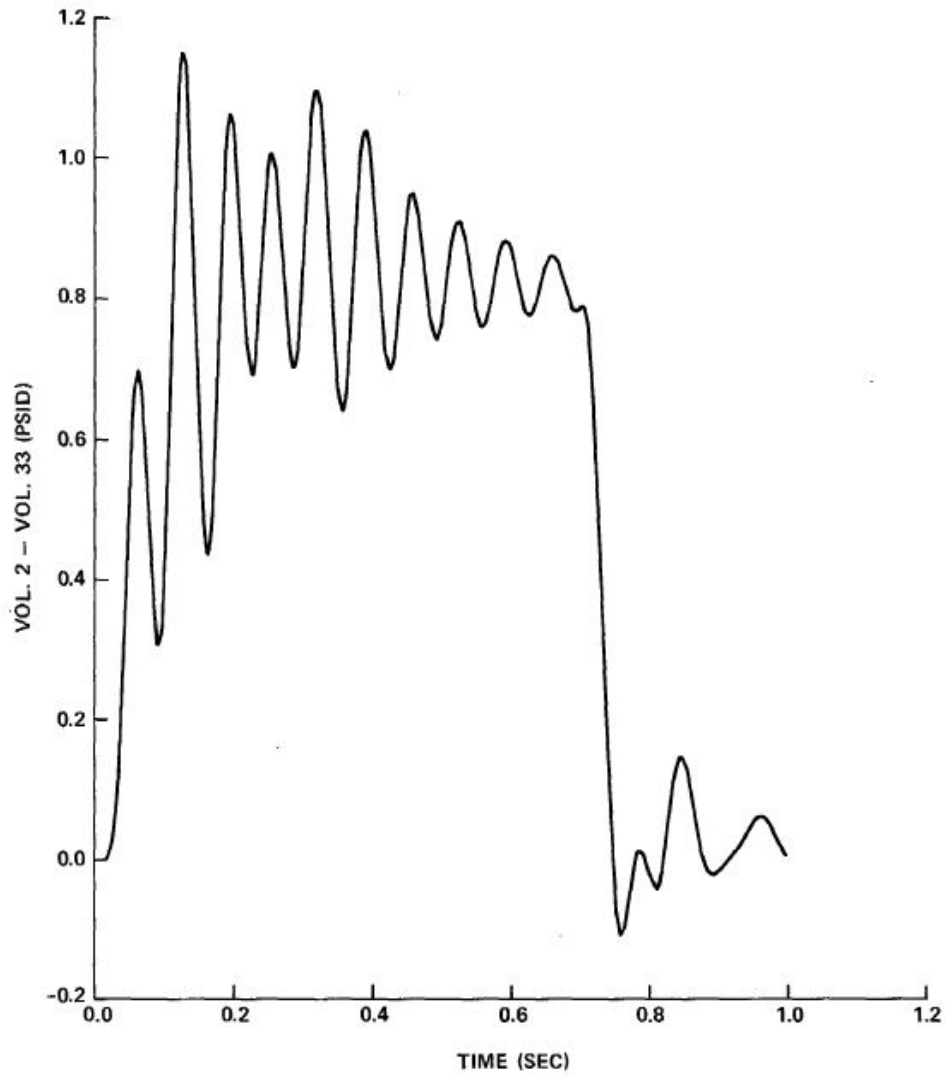

FIGURE 6.2.1-52c

PRESSURE DIFFERENTIAL IN REACTOR CAVITY, HOT LEG DEB

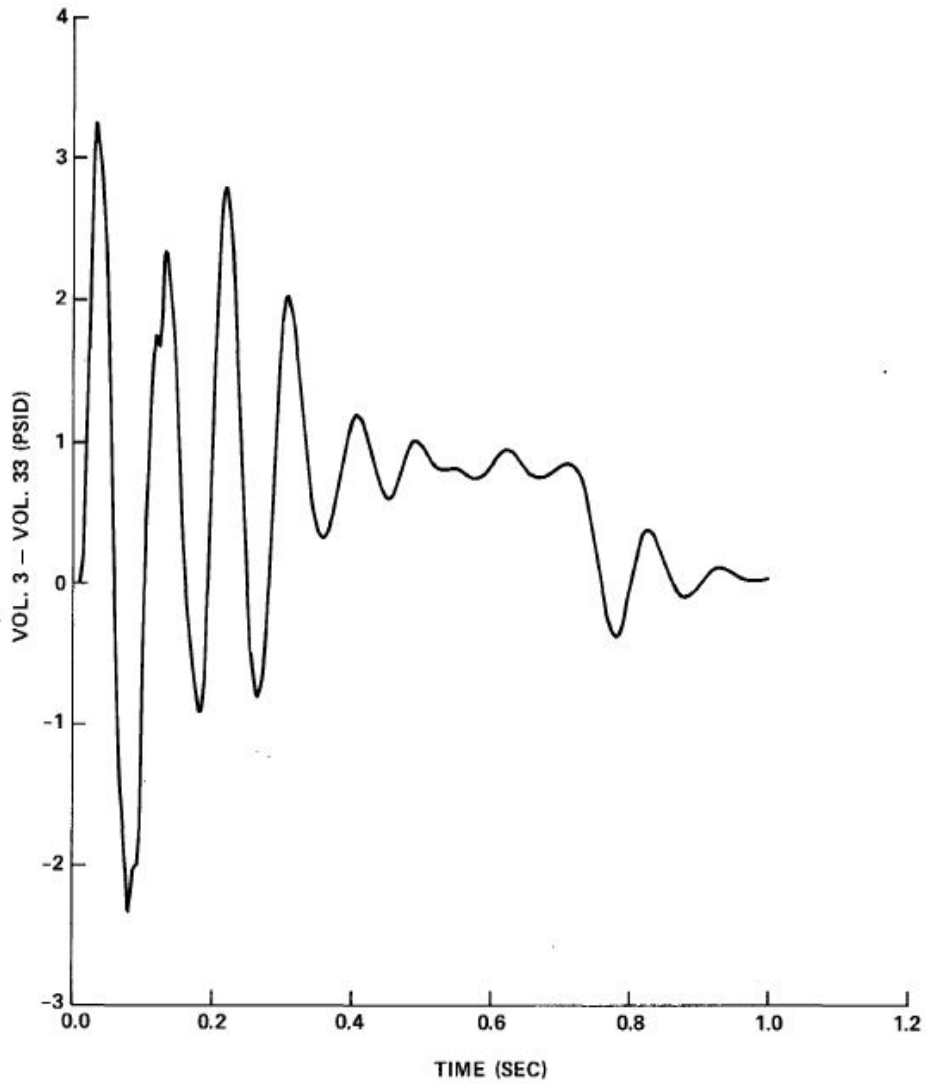

FIGURE 6.2.1-52d

PRESSURE DIFFERENTIAL IN REACTOR CAVITY, HOT LEG DEB

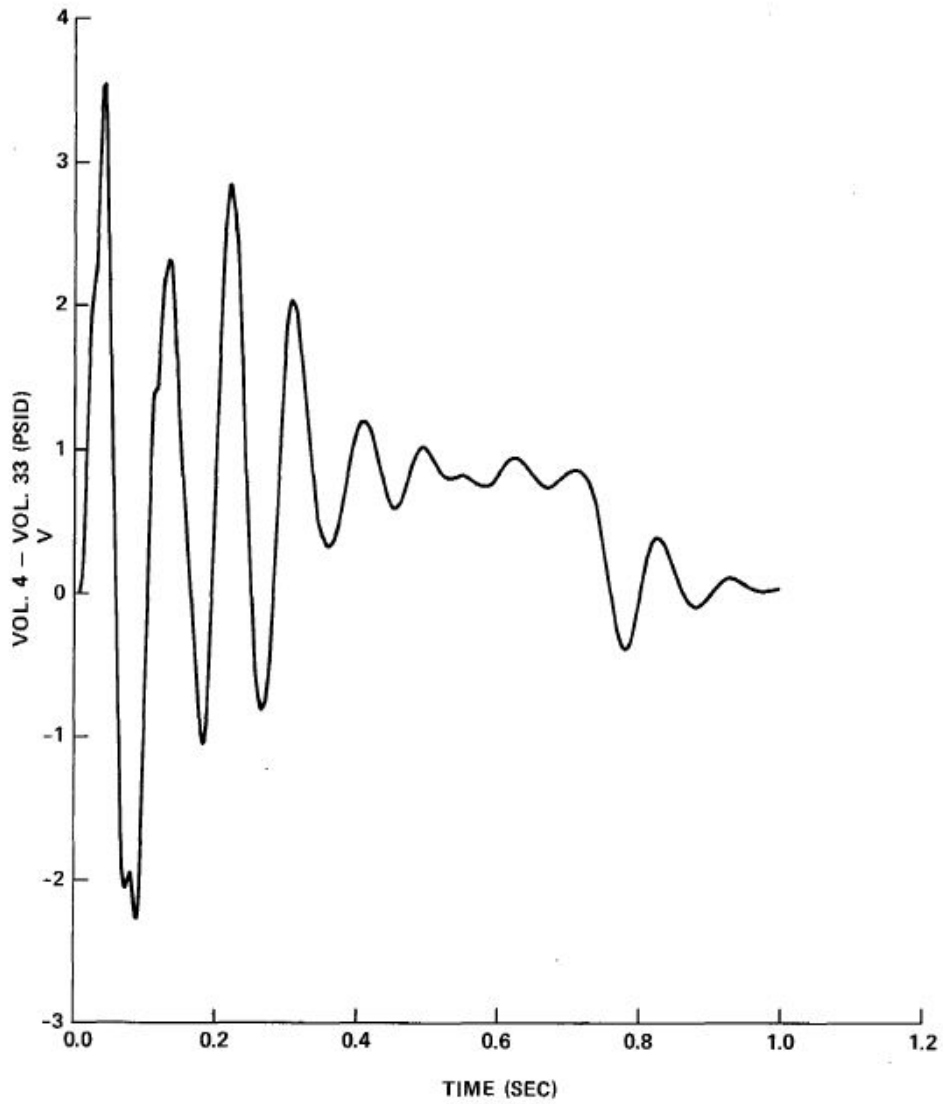

FIGURE 6.2.1-52e

PRESSURE DIFFERENTIAL IN REACTOR CAVITY, HOT LEG DEB

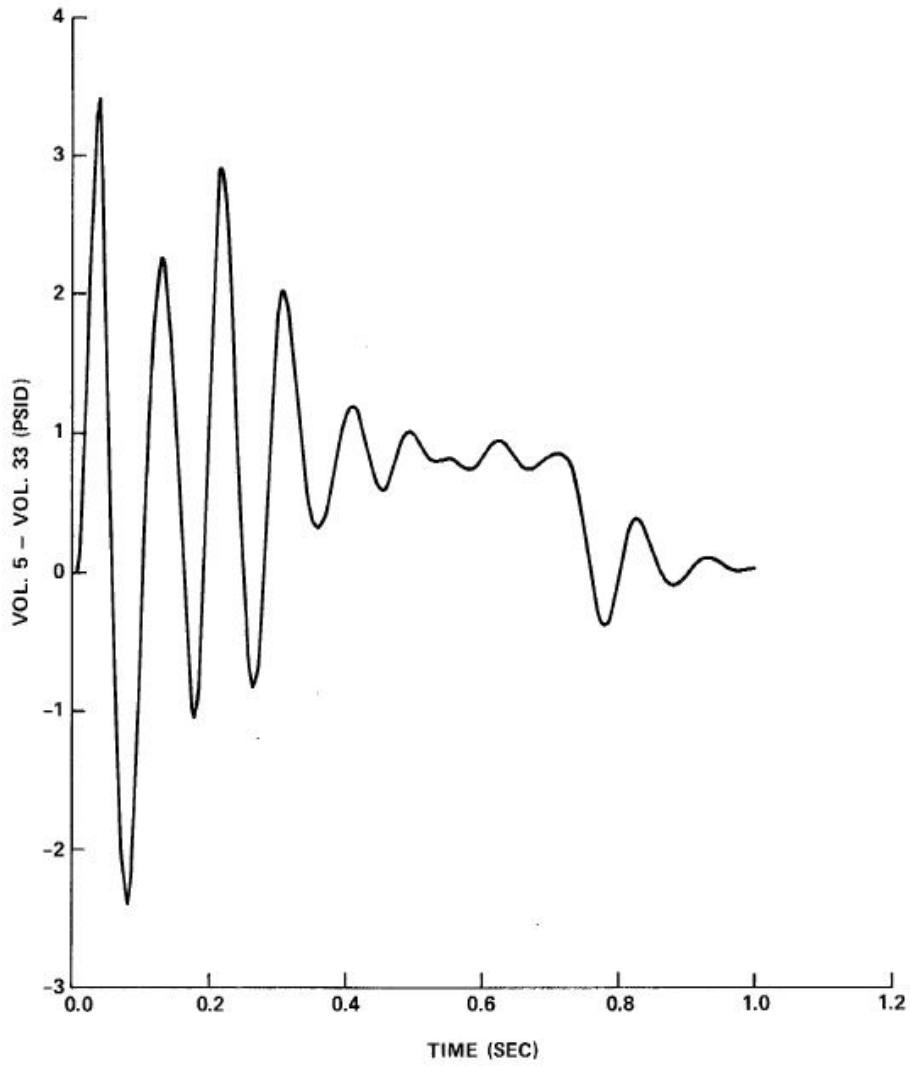

FIGURE 6.2.1-52f

PRESSURE DIFFERENTIAL IN REACTOR CAVITY, HOT LEG DEB

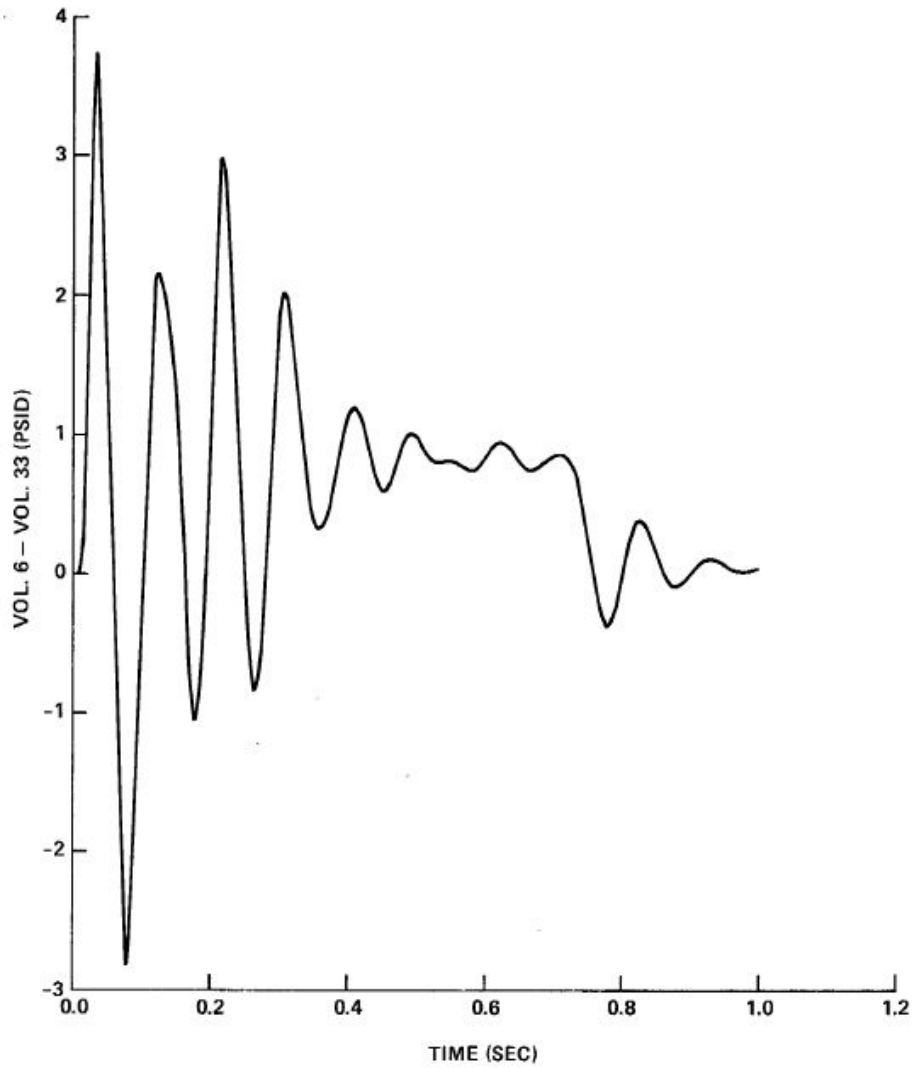

FIGURE 6.2.1-52g

PRESSURE DIFFERENTIAL IN REACTOR CAVITY, HOT LEG DEB

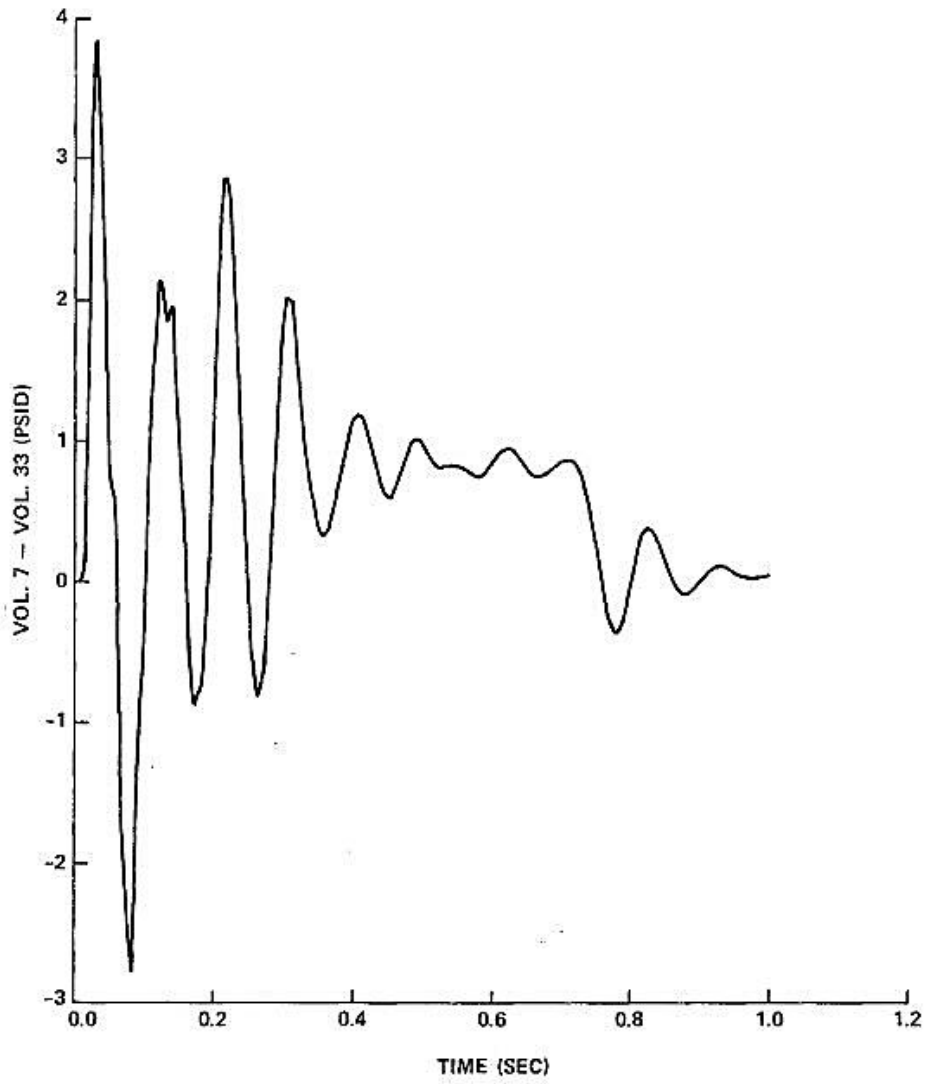

FIGURE 6.2.1-52h

PRESSURE DIFFERENTIAL IN REACTOR CAVITY, HOT LEG DEB

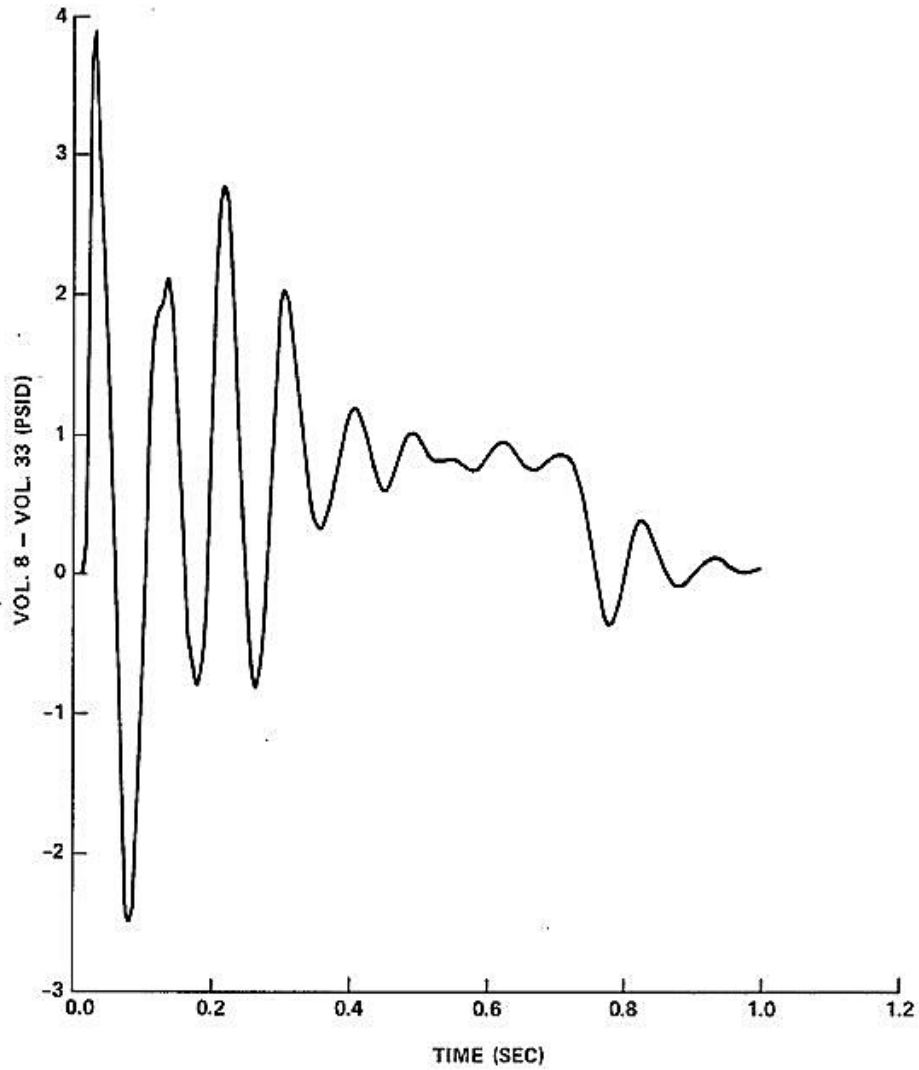

FIGURE 6.2.1-52i

PRESSURE DIFFERENTIAL IN REACTOR CAVITY, HOT LEG DEB

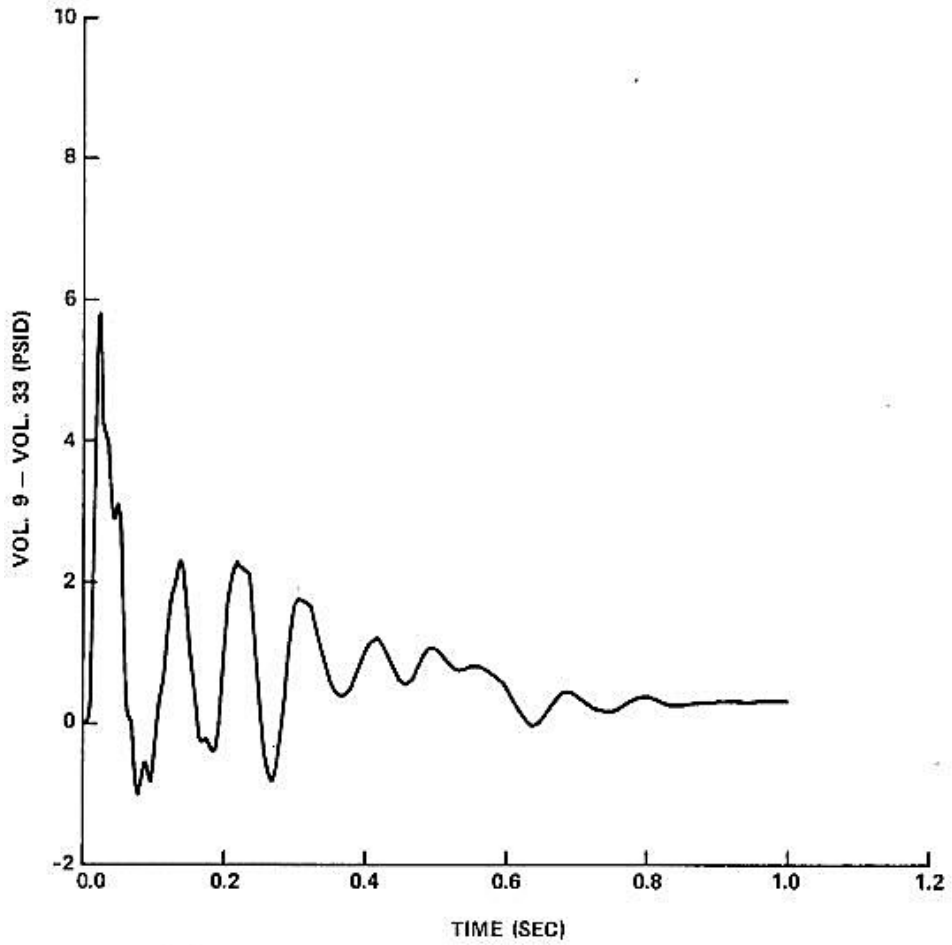

FIGURE 6.2.1-53

PEAK PRESSURE DIFFERENTIAL IN REACTOR CAVITY HOT LEG

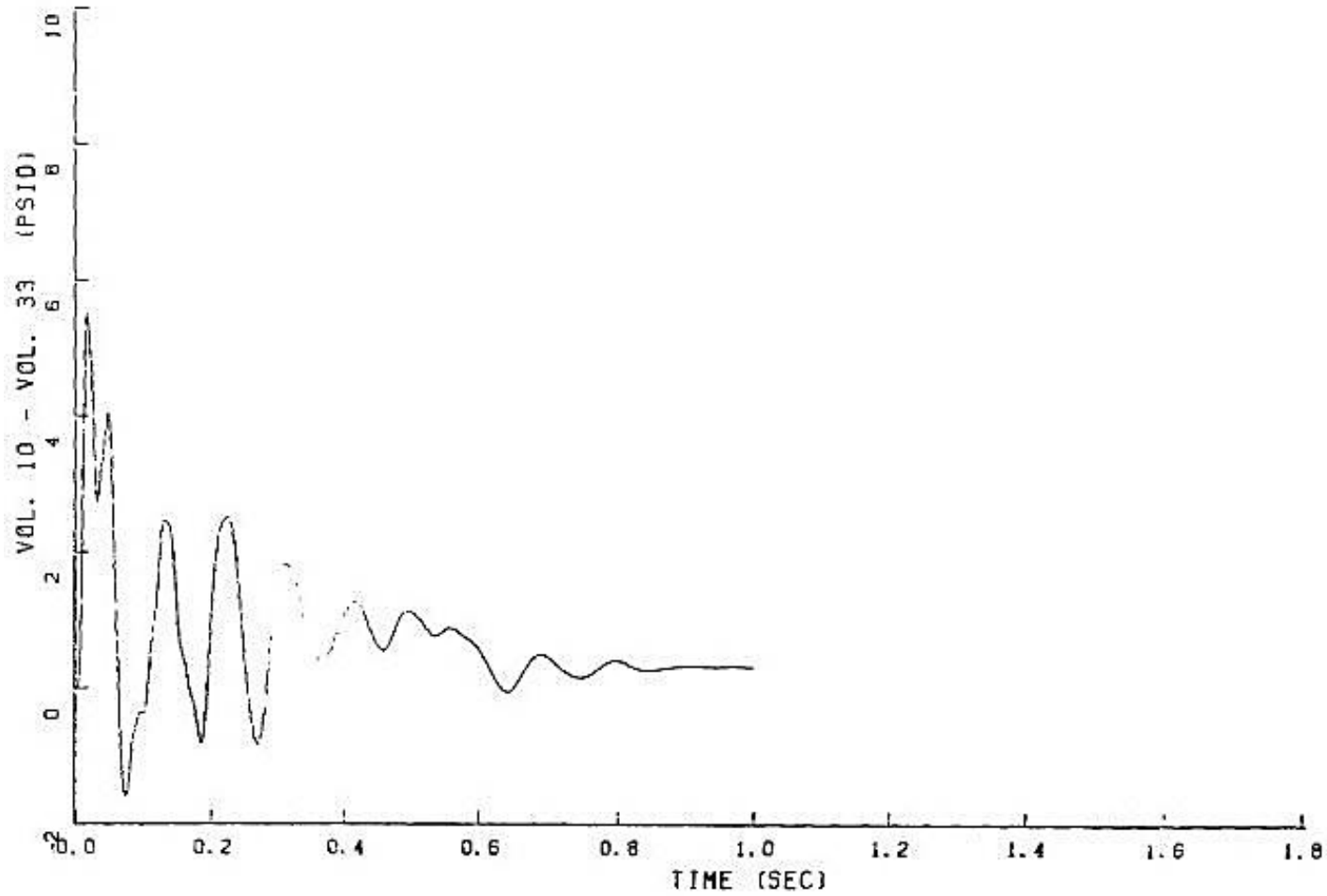

FIGURE 6.2.1-54

PEAK PRESSURE DIFFERENTIAL IN REACTOR CAVITY HOT LEG

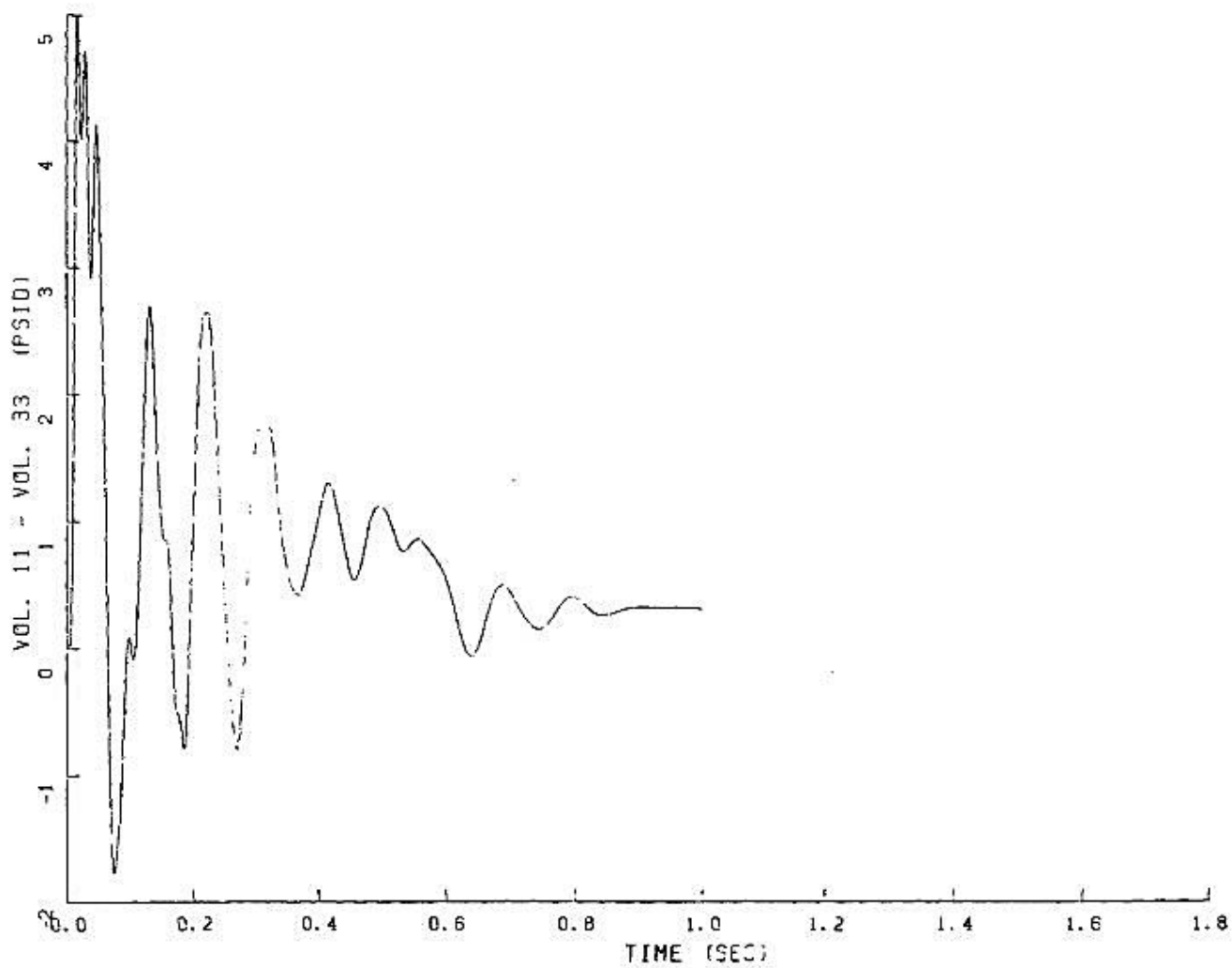

FIGURE 6.2.1-55

PEAK PRESSURE DIFFERENTIAL IN REACTOR CAVITY HOT LEG

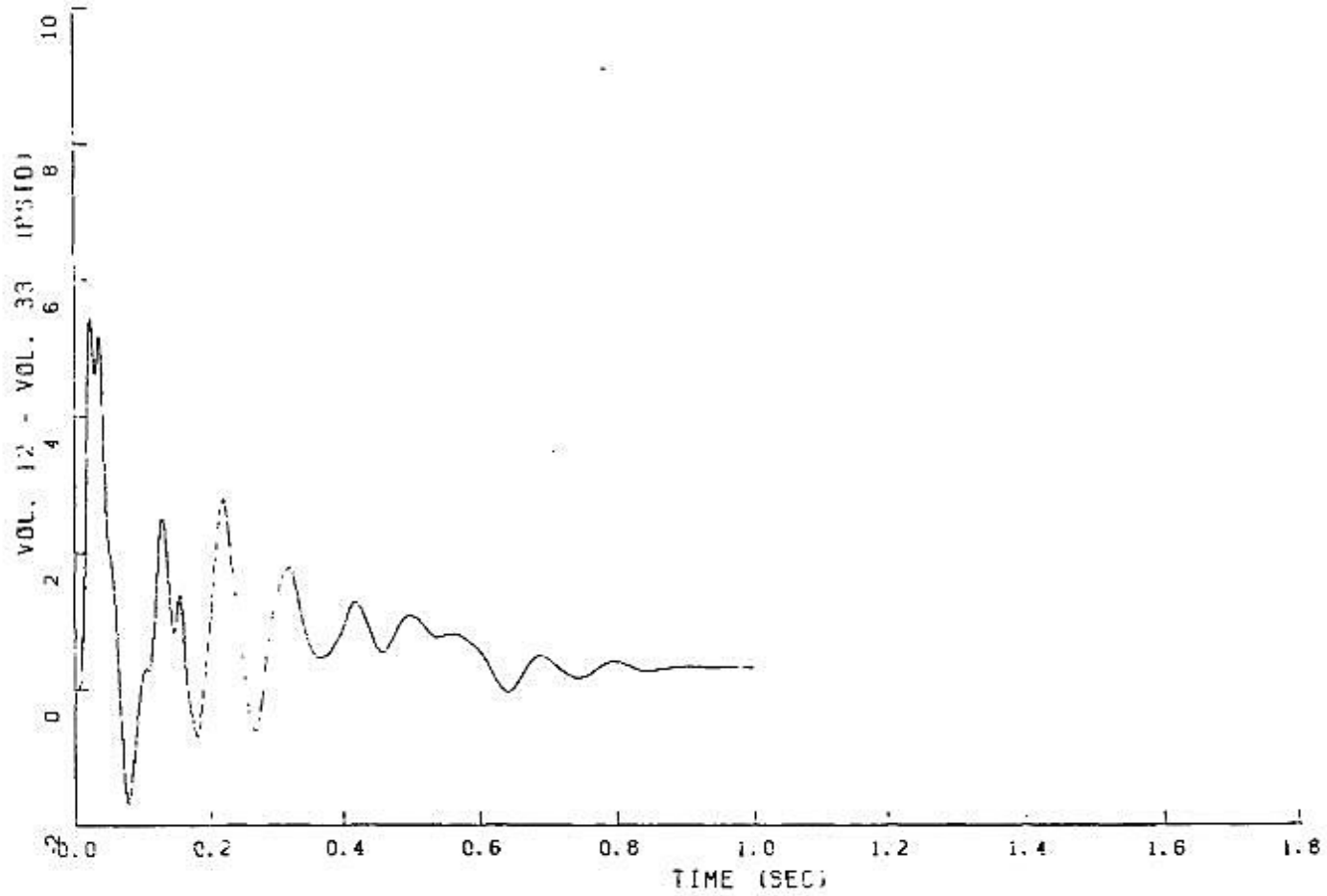

FIGURE 6.2.1-56

PEAK PRESSURE DIFFERENTIAL IN REACTOR CAVITY HOT LEG

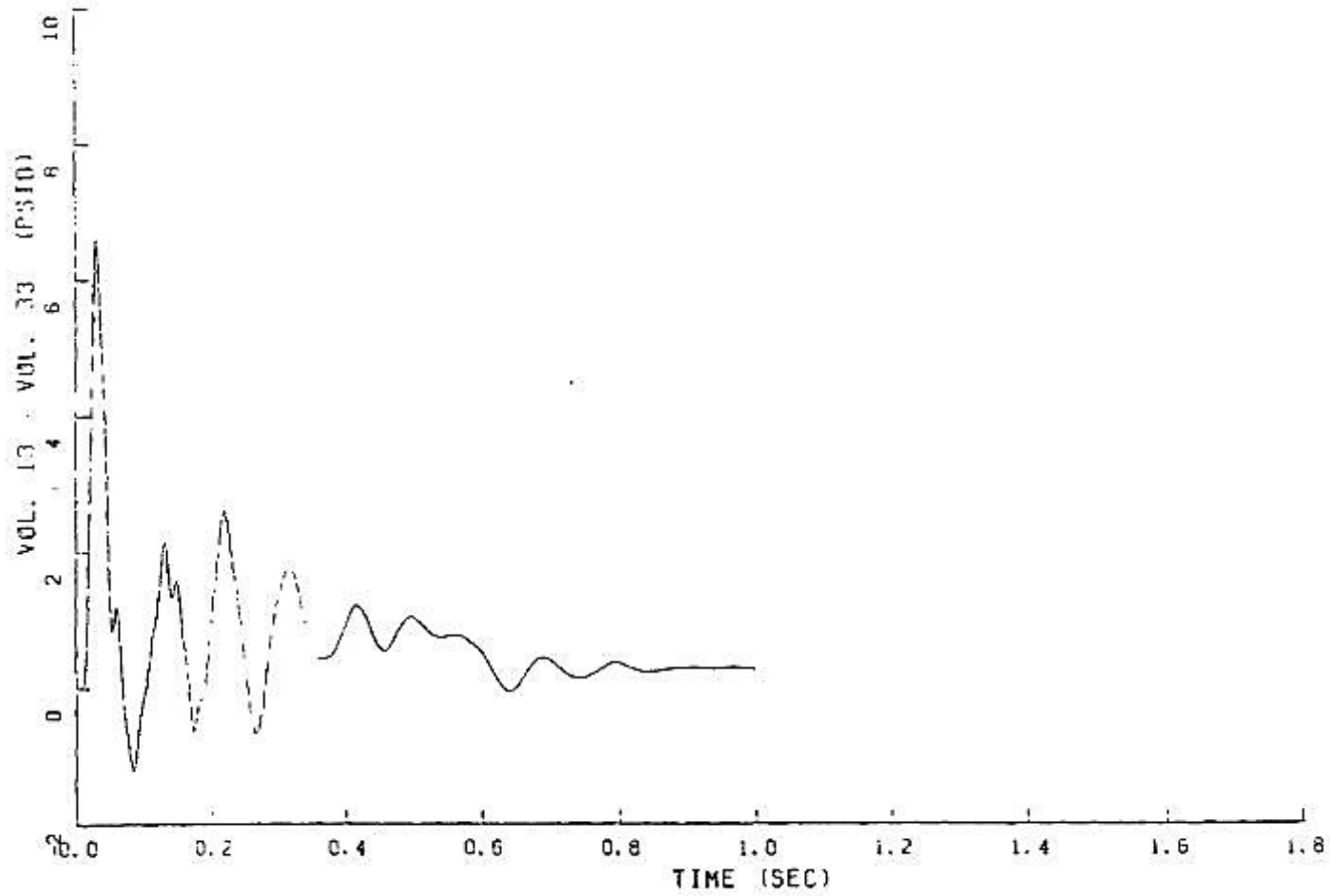

FIGURE 6.2.1-57

PEAK PRESSURE DIFFERENTIAL IN REACTOR CAVITY HOT LEG

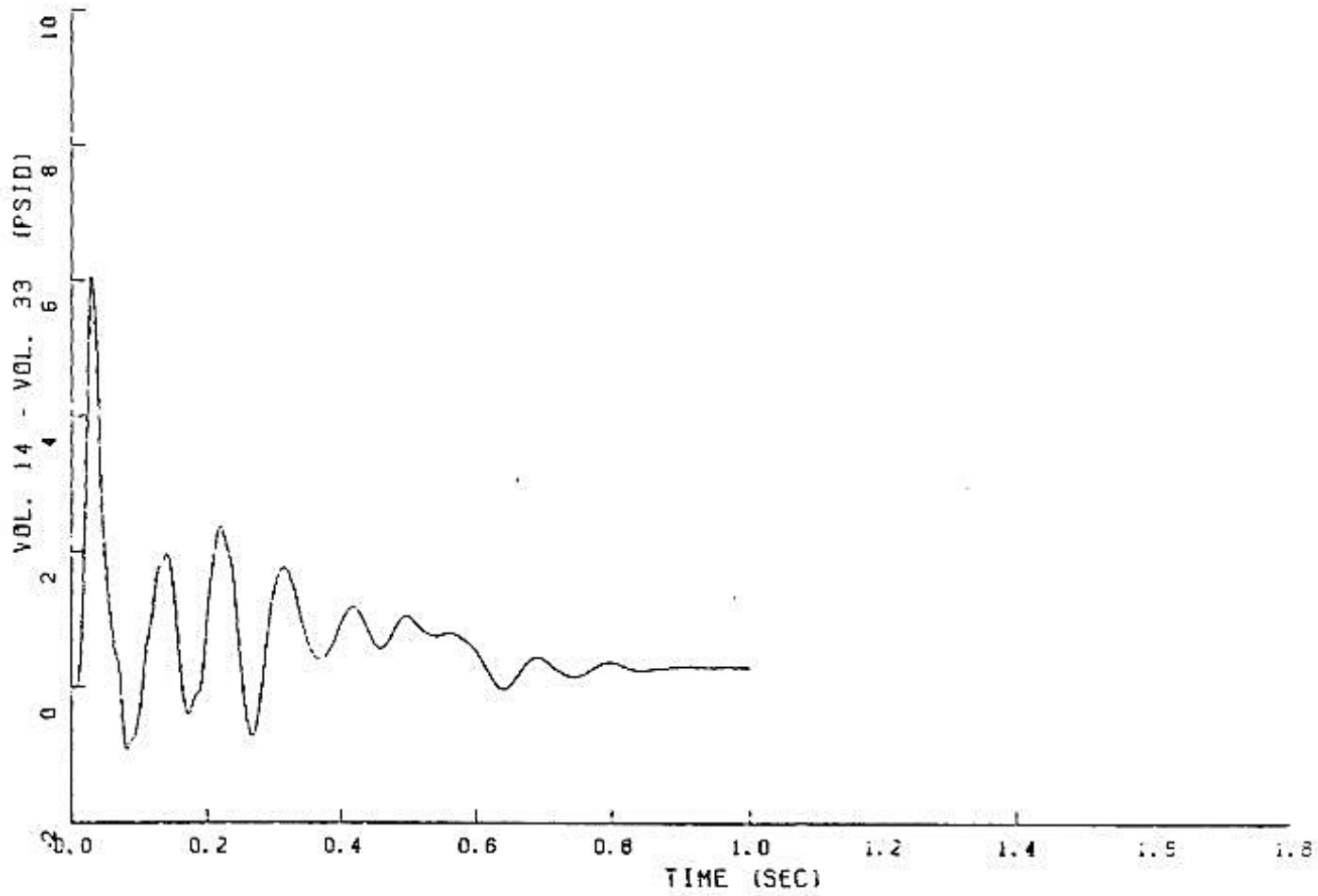

FIGURE 6.2.1-58

PEAK PRESSURE DIFFERENTIAL IN REACTOR CAVITY HOT LEG

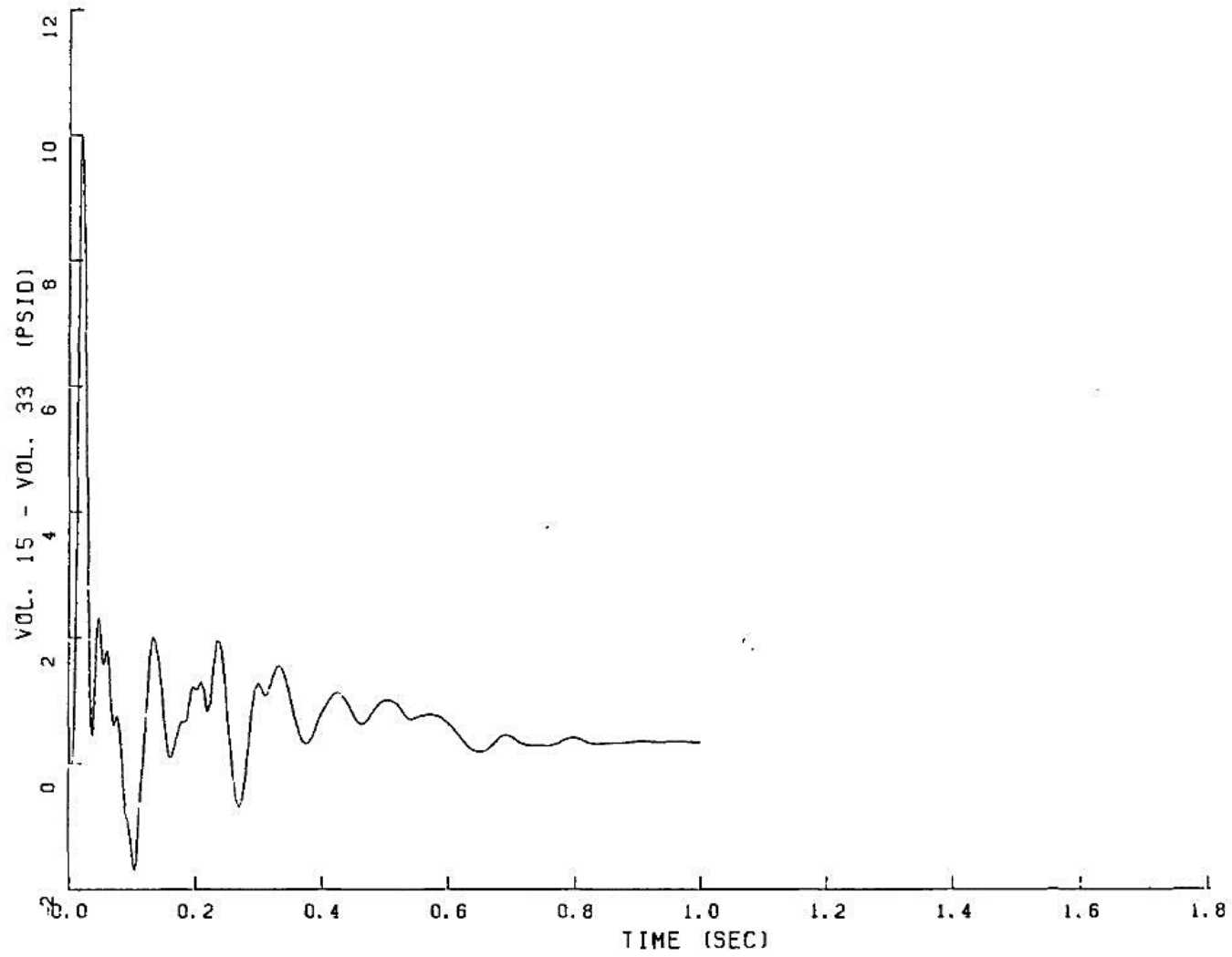

FIGURE 6.2.1-59

PEAK PRESSURE DIFFERENTIAL IN REACTOR CAVITY HOT LEG

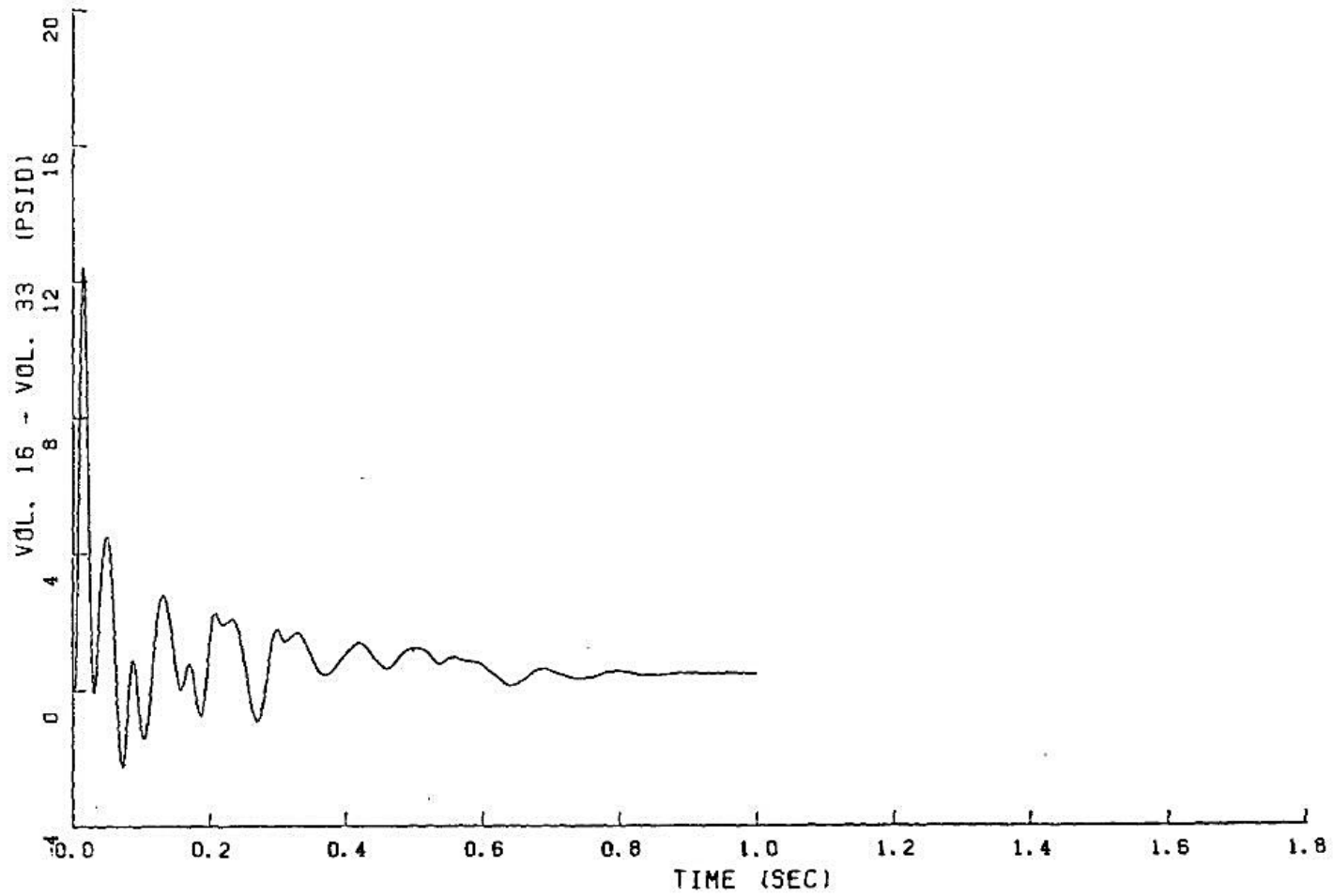

FIGURE 6.2.1-60

PEAK PRESSURE DIFFERENTIAL IN REACTOR CAVITY HOT LEG

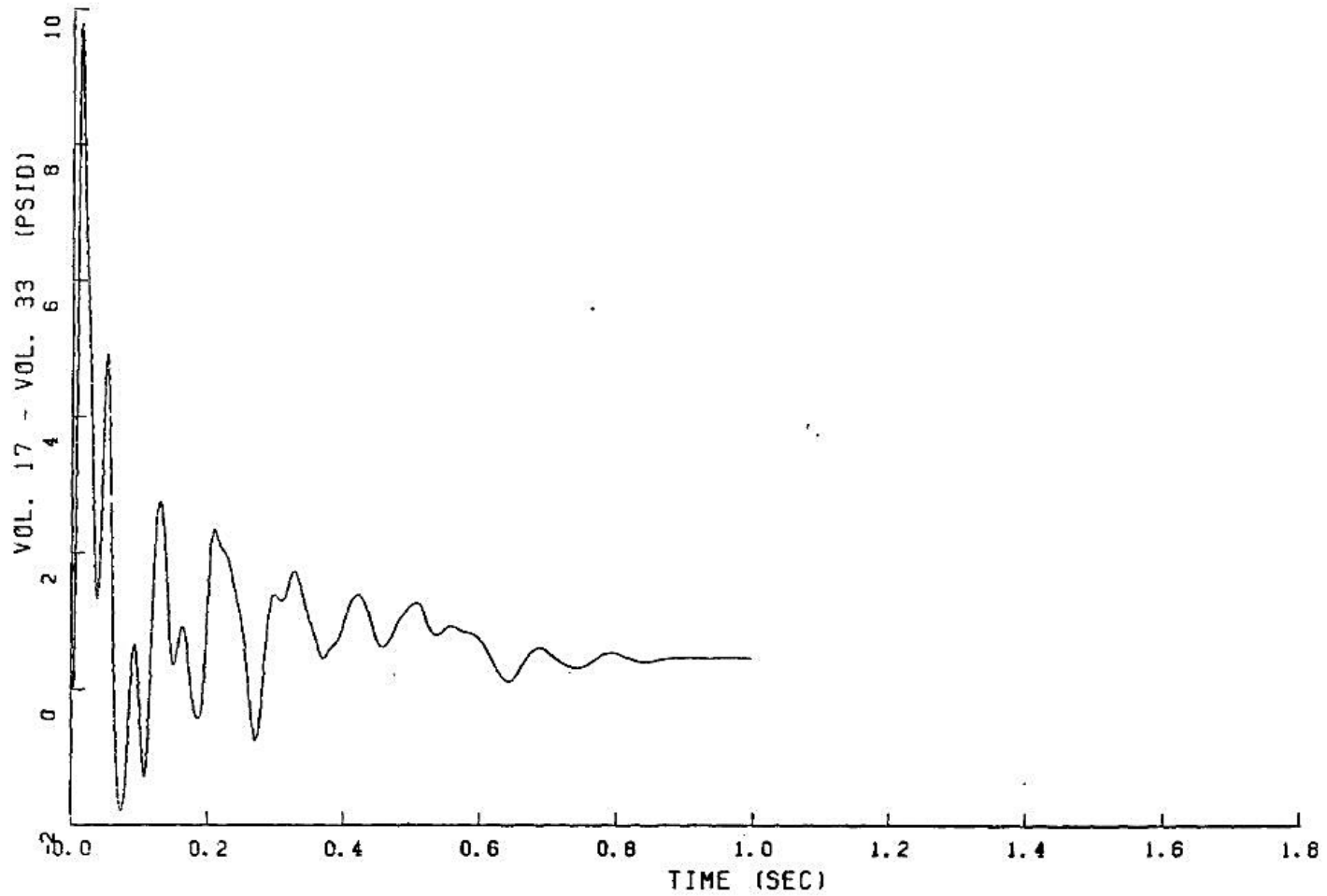

FIGURE 6.2.1-61

PEAK PRESSURE DIFFERENTIAL IN REACTOR CAVITY HOT LEG

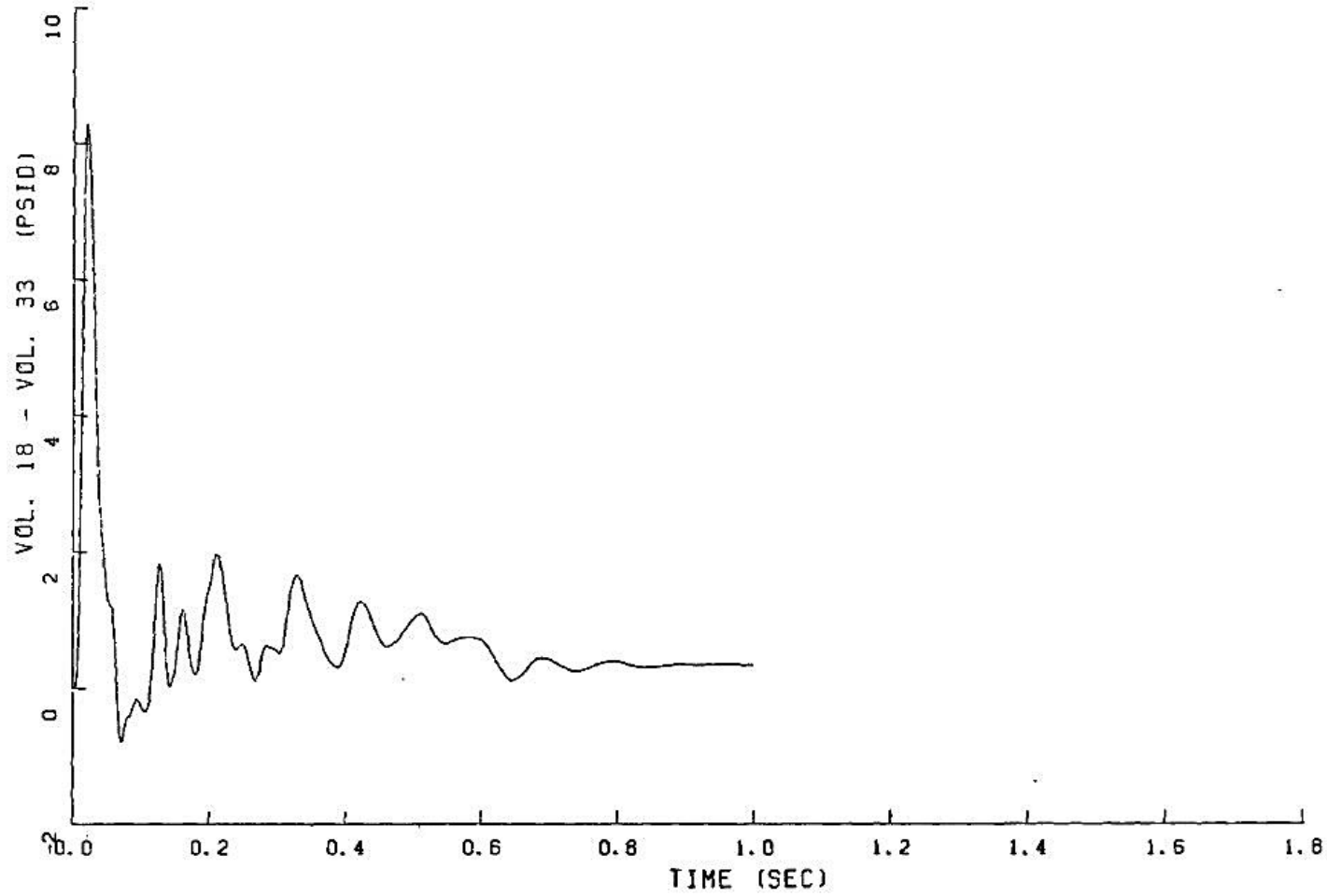

FIGURE 6.2.1-62

PEAK PRESSURE DIFFERENTIAL IN REACTOR CAVITY HOT LEG

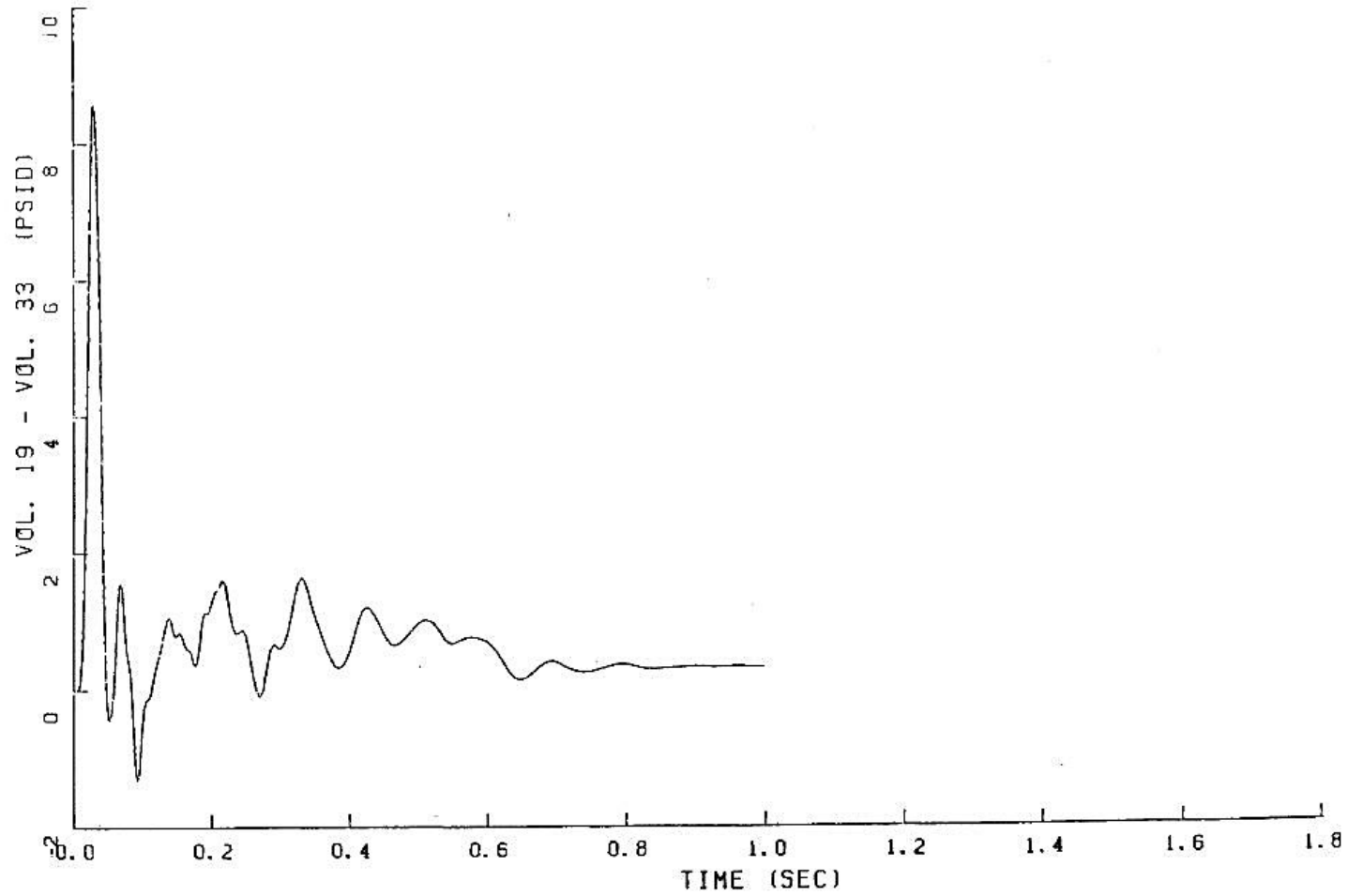

FIGURE 6.2.1-63

PEAK PRESSURE DIFFERENTIAL IN REACTOR CAVITY HOT LEG

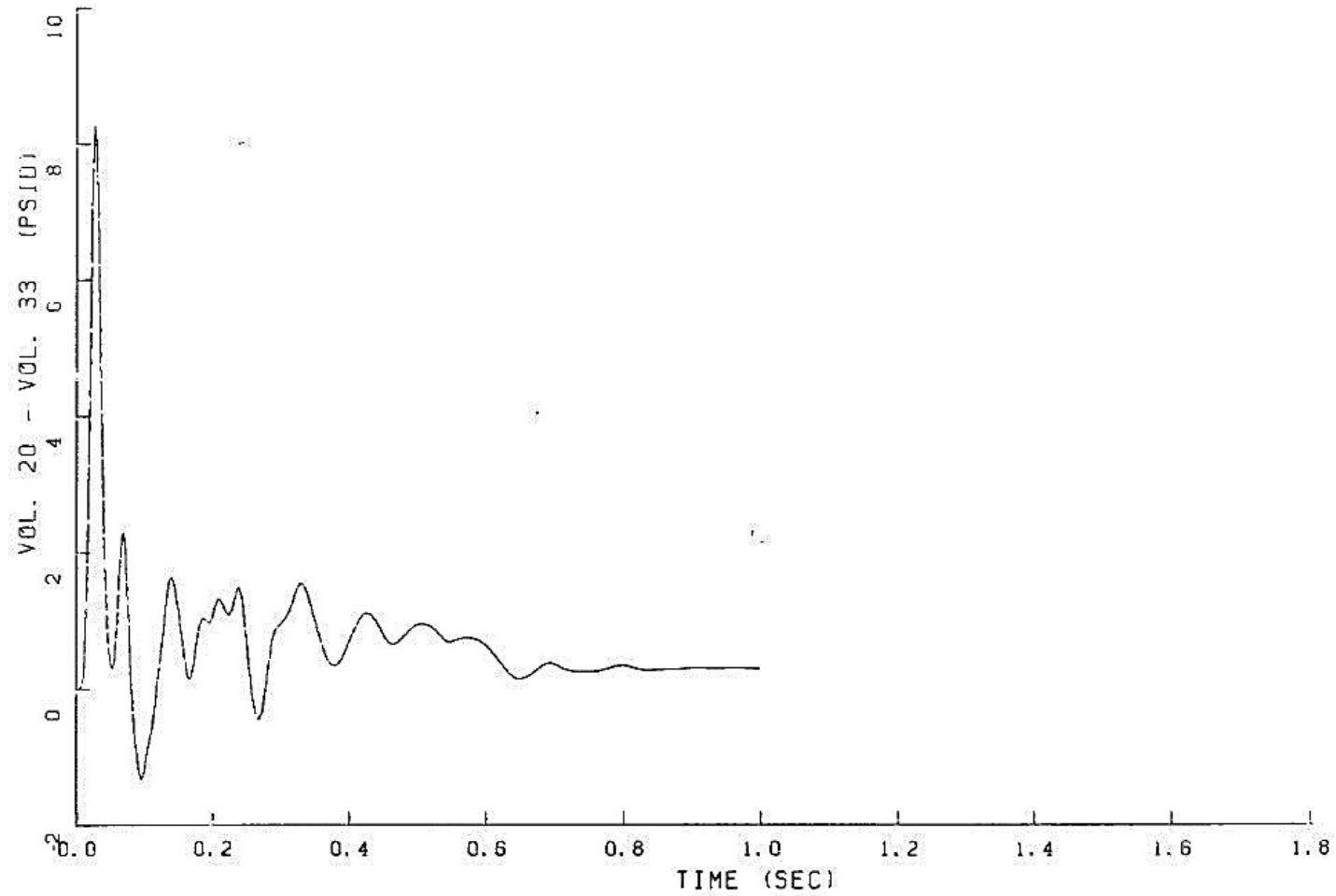

FIGURE 6.2.1-64

PEAK PRESSURE DIFFERENTIAL IN REACTOR CAVITY HOT LEG

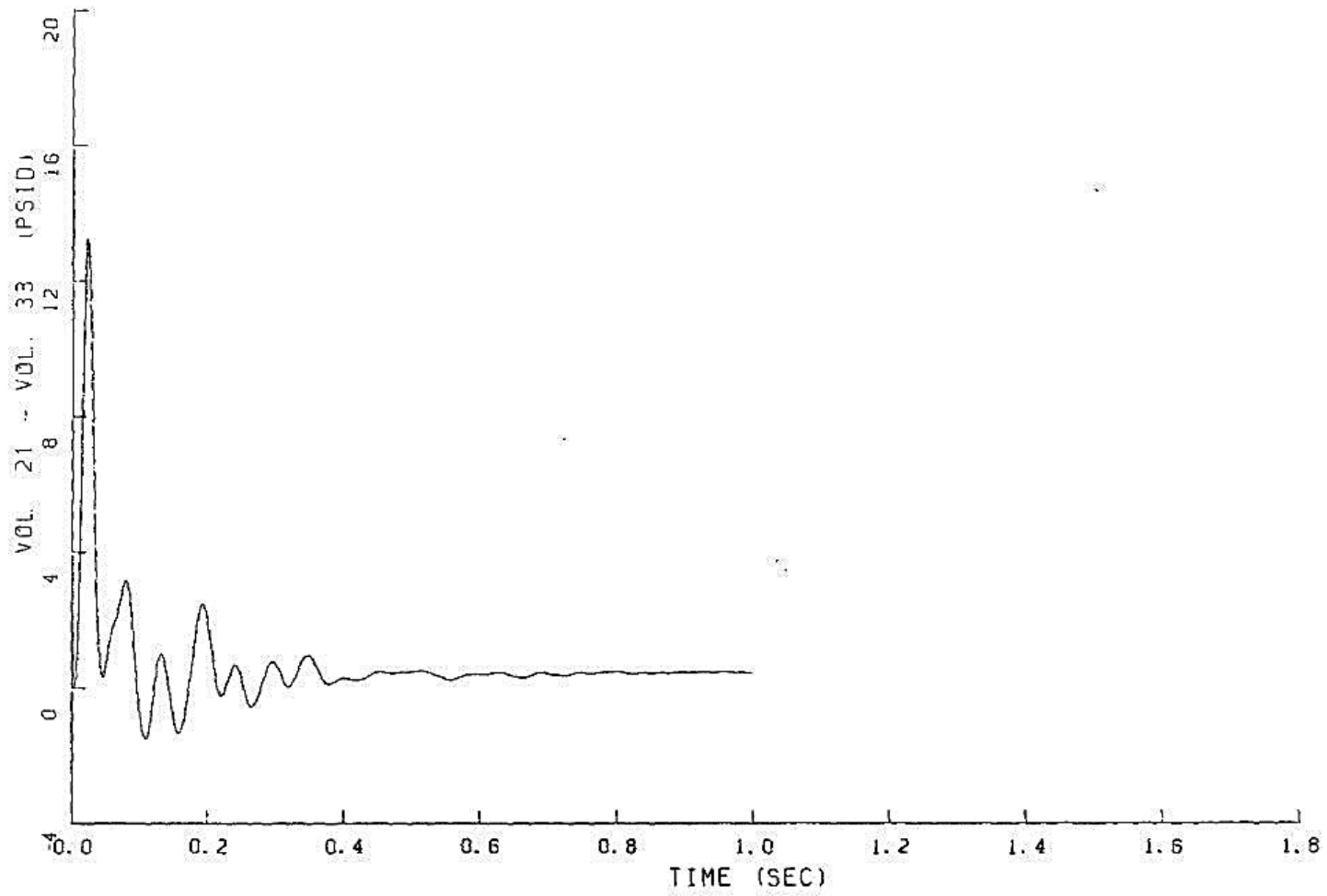

FIGURE 6.2.1-65

PEAK PRESSURE DIFFERENTIAL IN REACTOR CAVITY HOT LEG

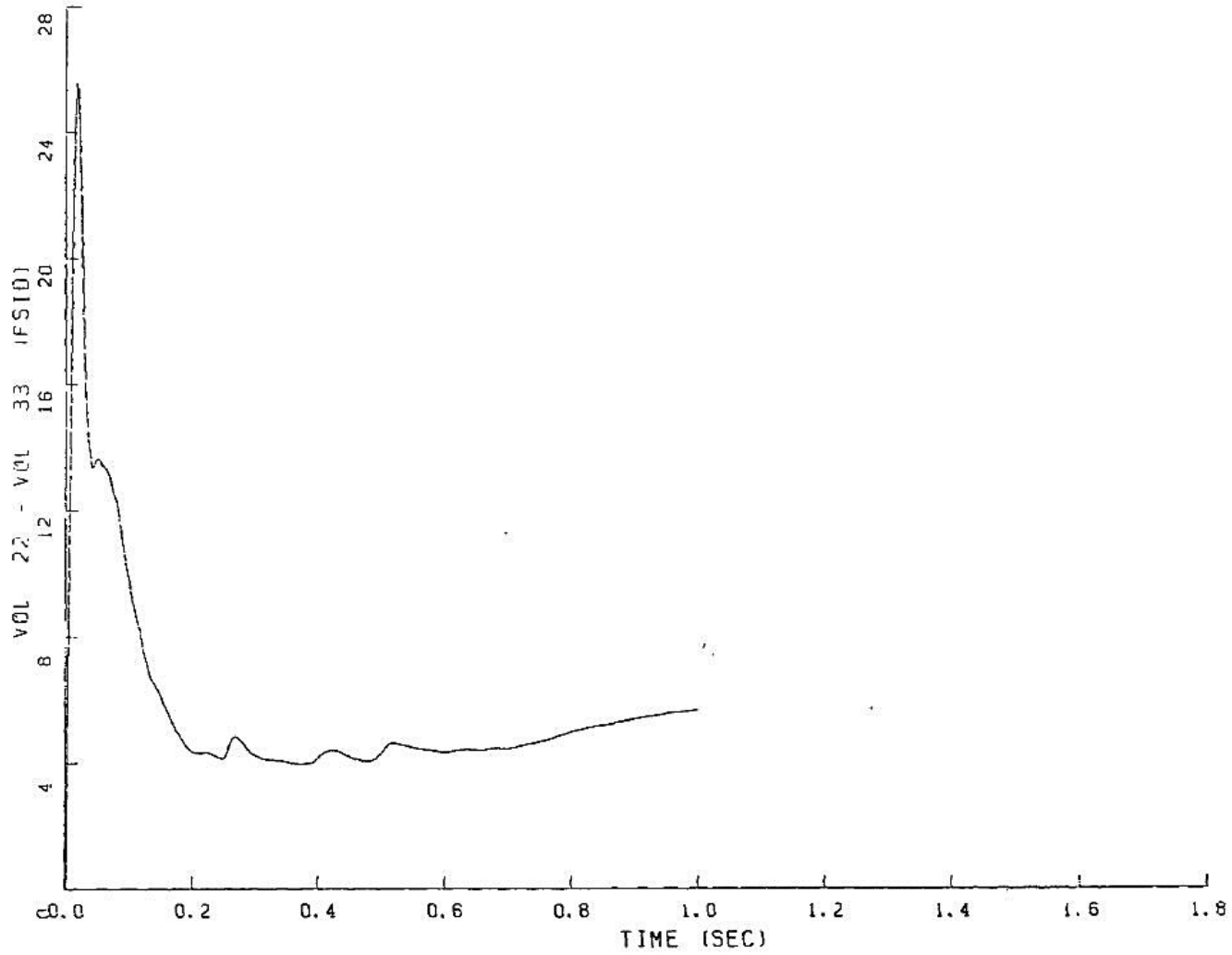

FIGURE 6.2.1-66

PEAK PRESSURE DIFFERENTIAL IN REACTOR CAVITY HOT LEG

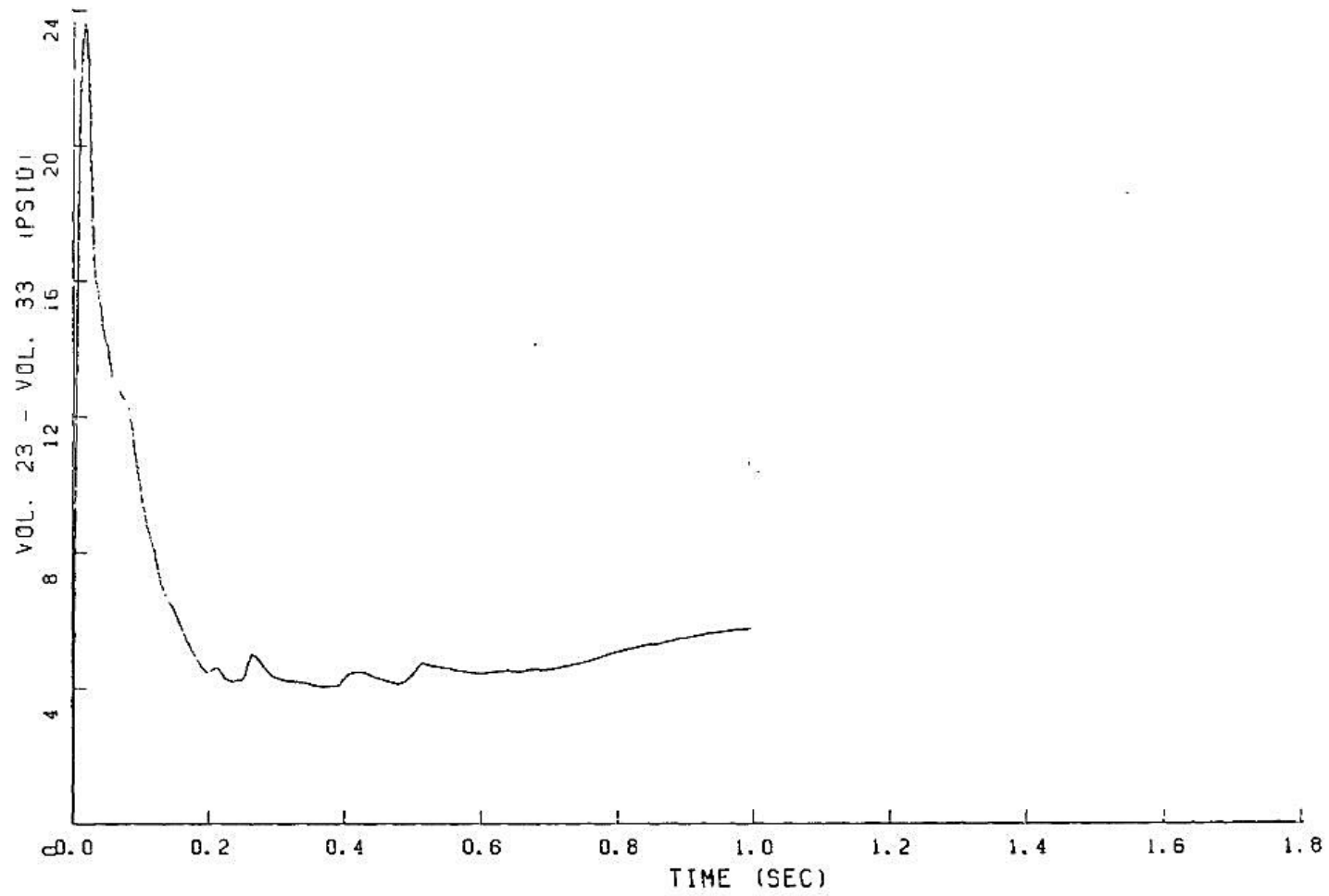

FIGURE 6.2.1-67

PEAK PRESSURE DIFFERENTIAL IN REACTOR CAVITY HOT LEG

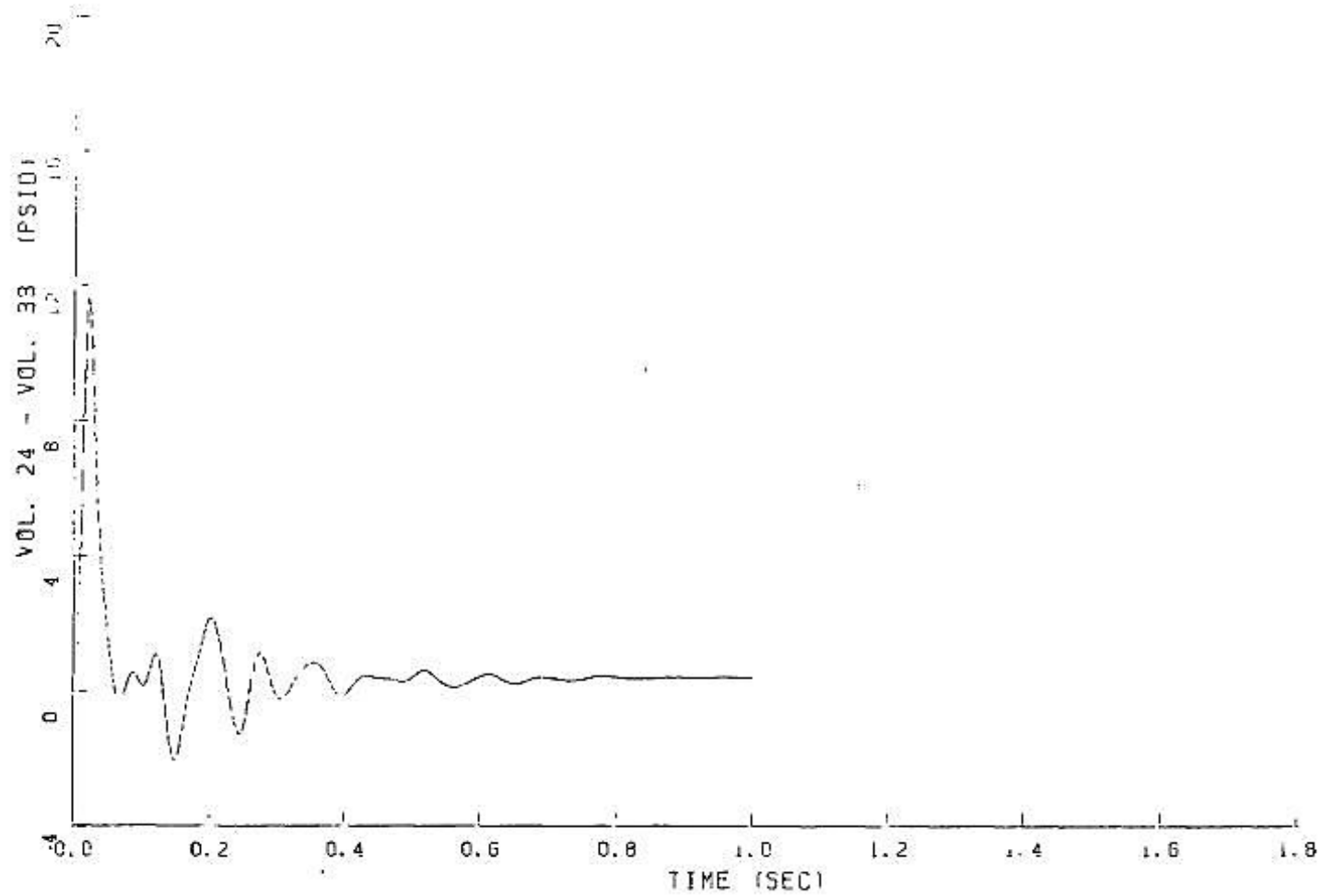

FIGURE 6.2.1-68

PEAK PRESSURE DIFFERENTIAL IN REACTOR CAVITY HOT LEG

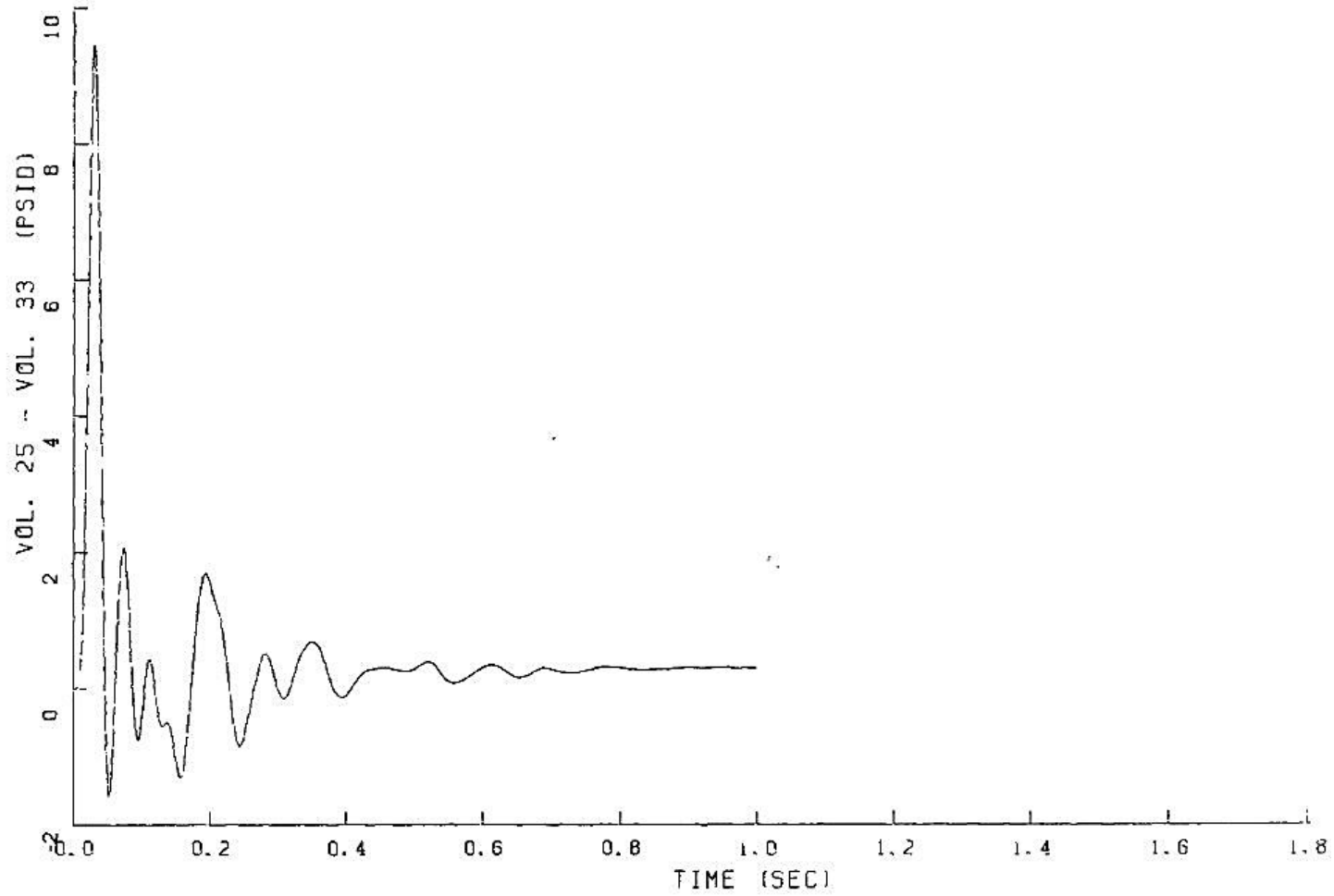

FIGURE 6.2.1-69

PEAK PRESSURE DIFFERENTIAL IN REACTOR CAVITY HOT LEG

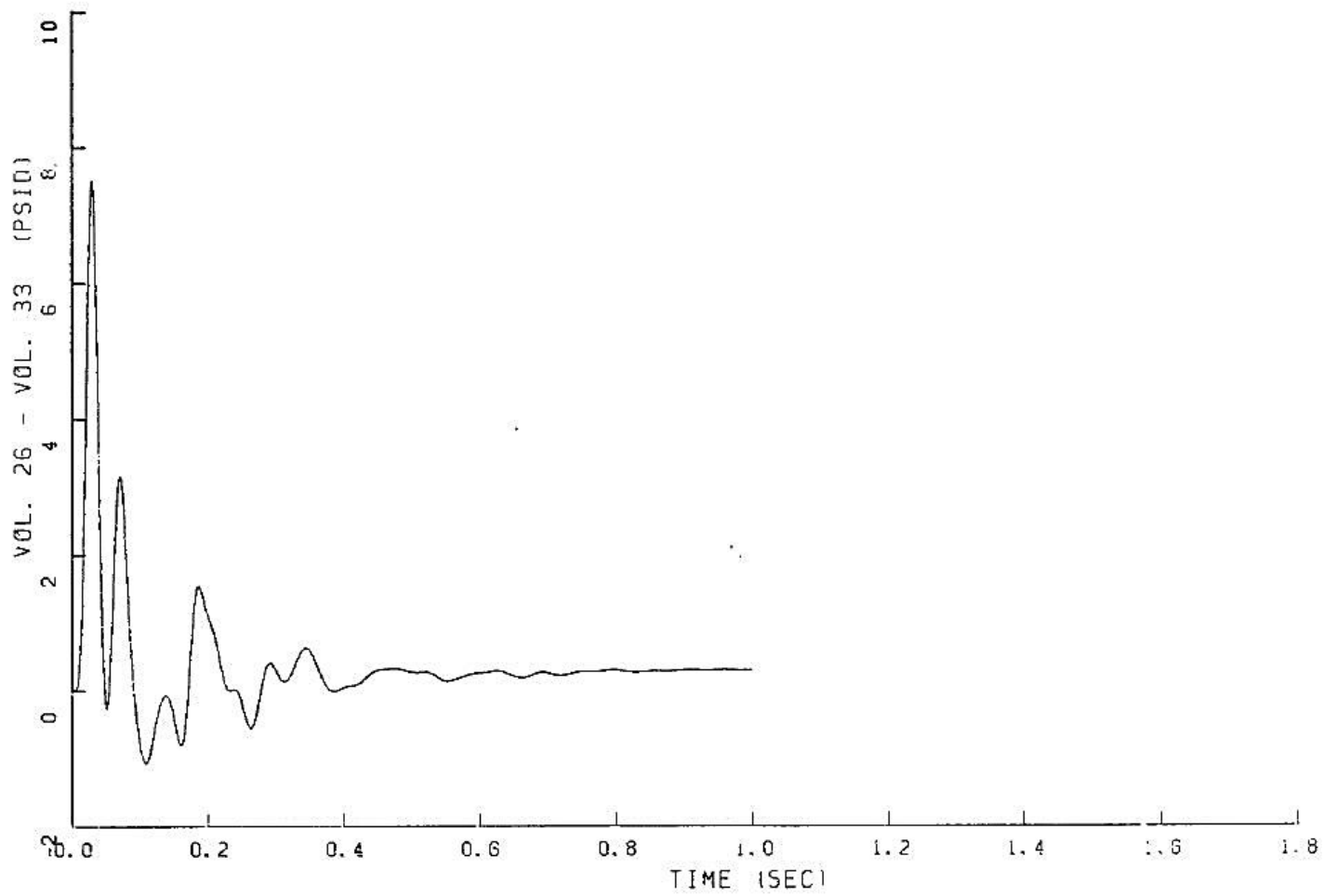

FIGURE 6.2.1-70

PEAK PRESSURE DIFFERENTIAL IN REACTOR CAVITY HOT LEG

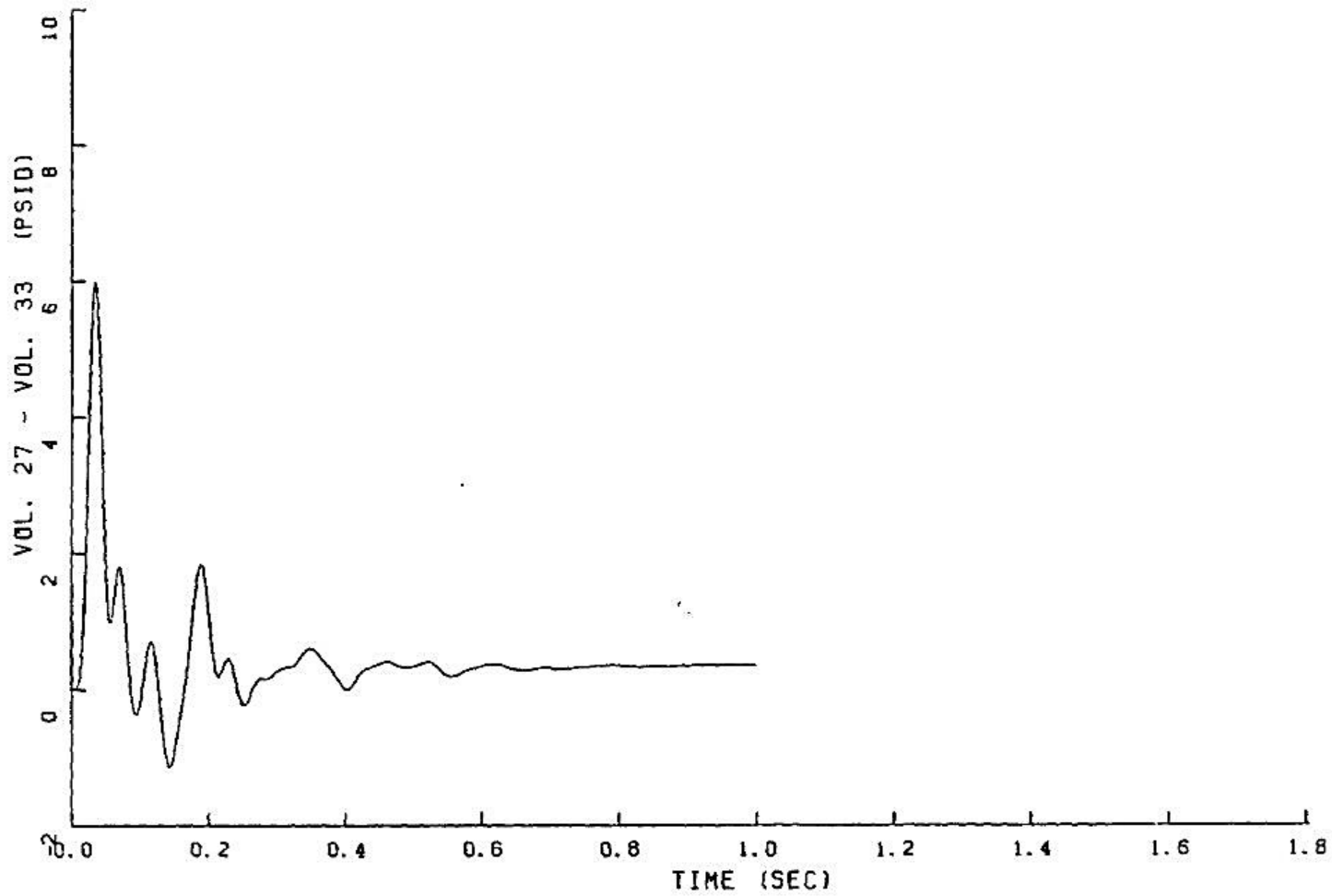

FIGURE 6.2.1-71

PEAK PRESSURE DIFFERENTIAL IN REACTOR CAVITY HOT LEG

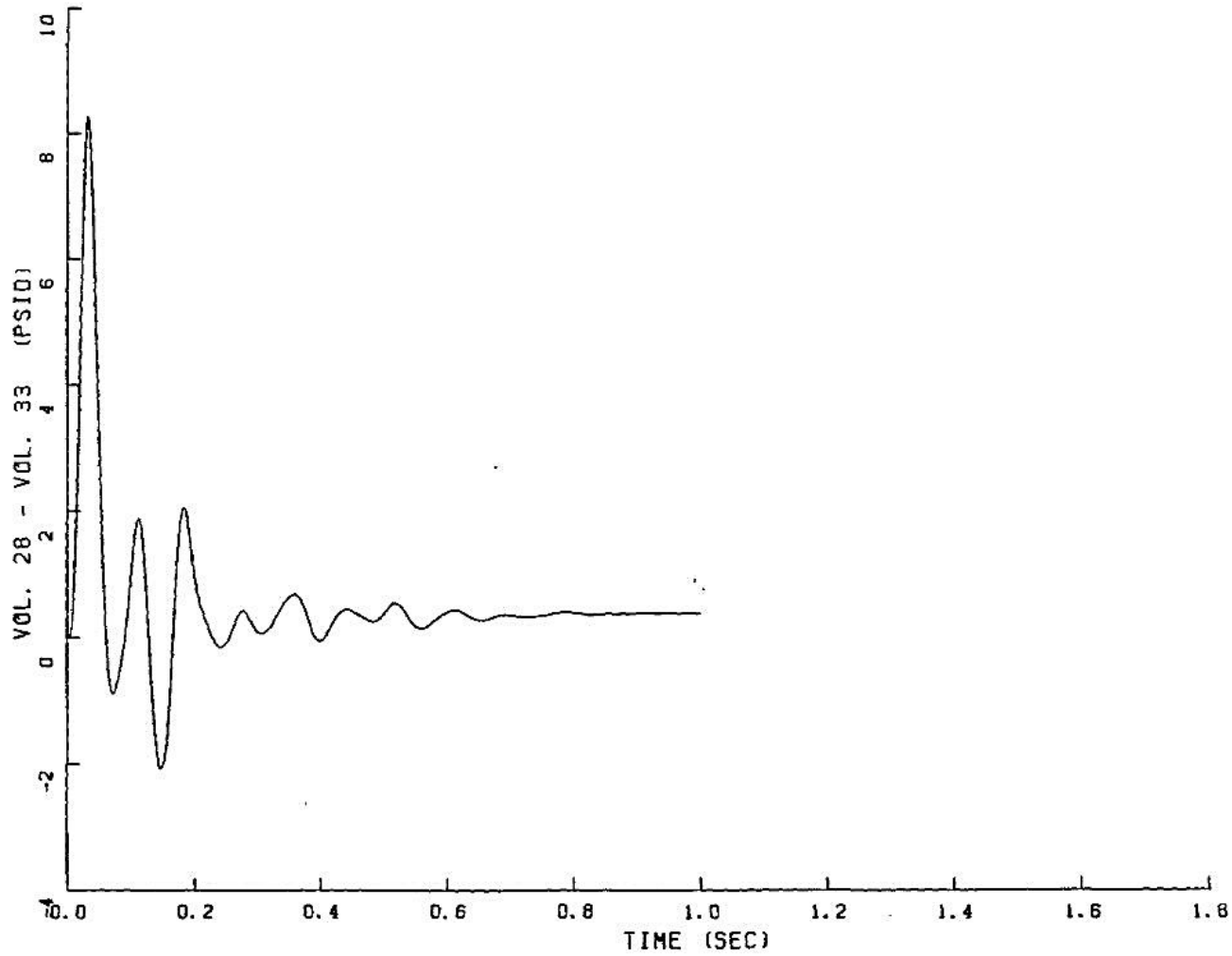

FIGURE 6.2.1-72

PEAK PRESSURE DIFFERENTIAL IN REACTOR CAVITY HOT LEG

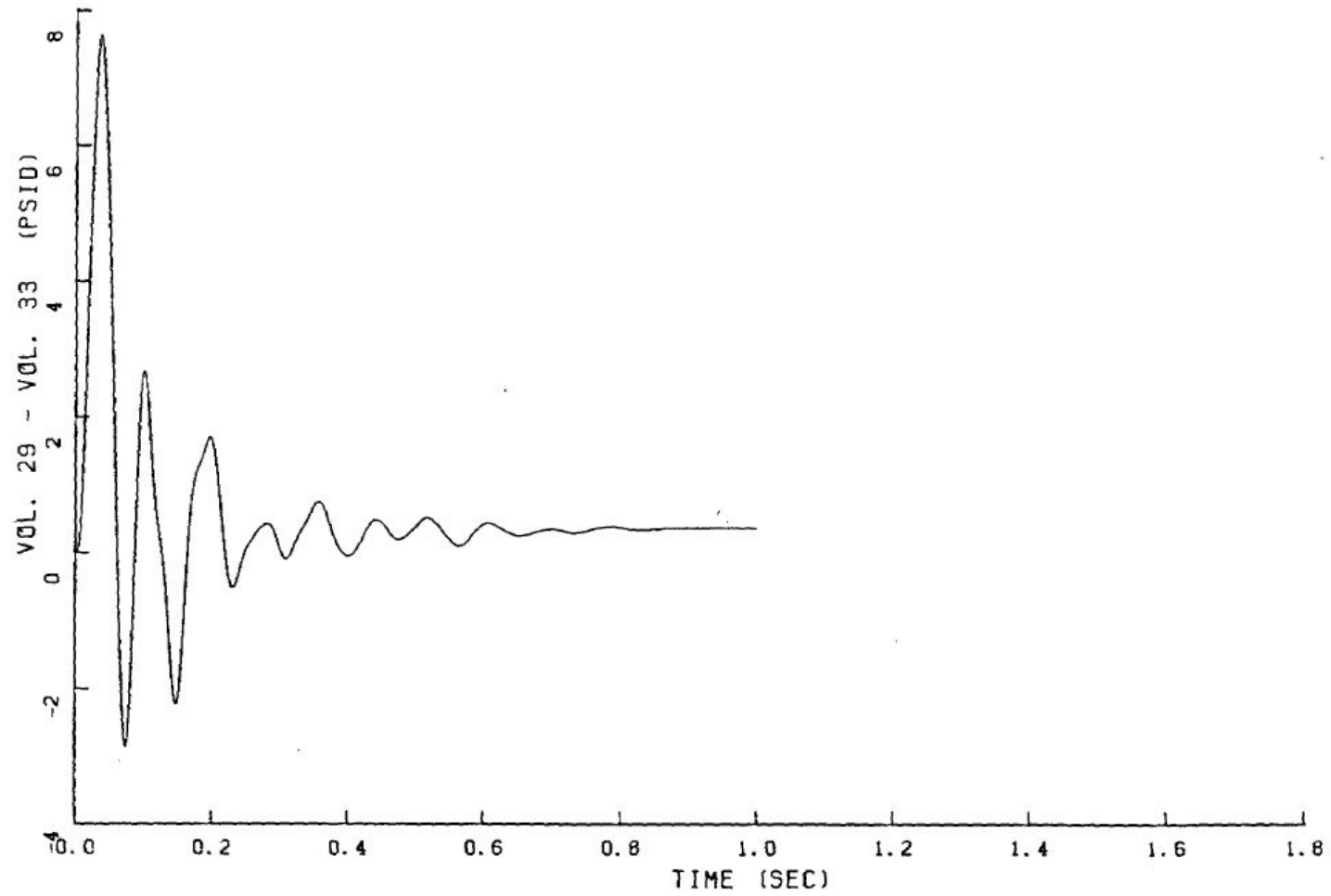

FIGURE 6.2.1-73

PEAK PRESSURE DIFFERENTIAL IN REACTOR CAVITY HOT LEG

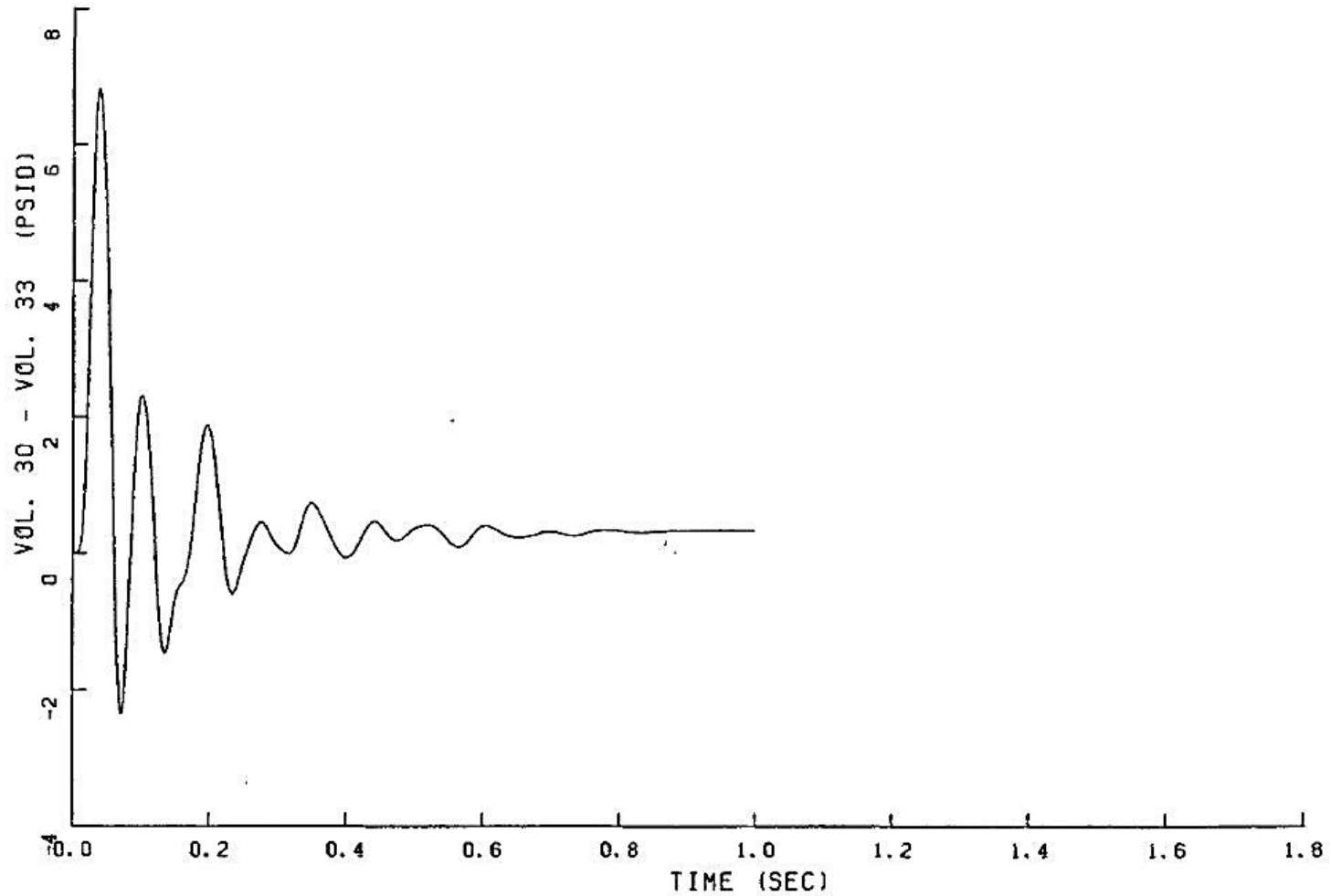

FIGURE 6.2.1-74

PEAK PRESSURE DIFFERENTIAL IN REACTOR CAVITY HOT LEG

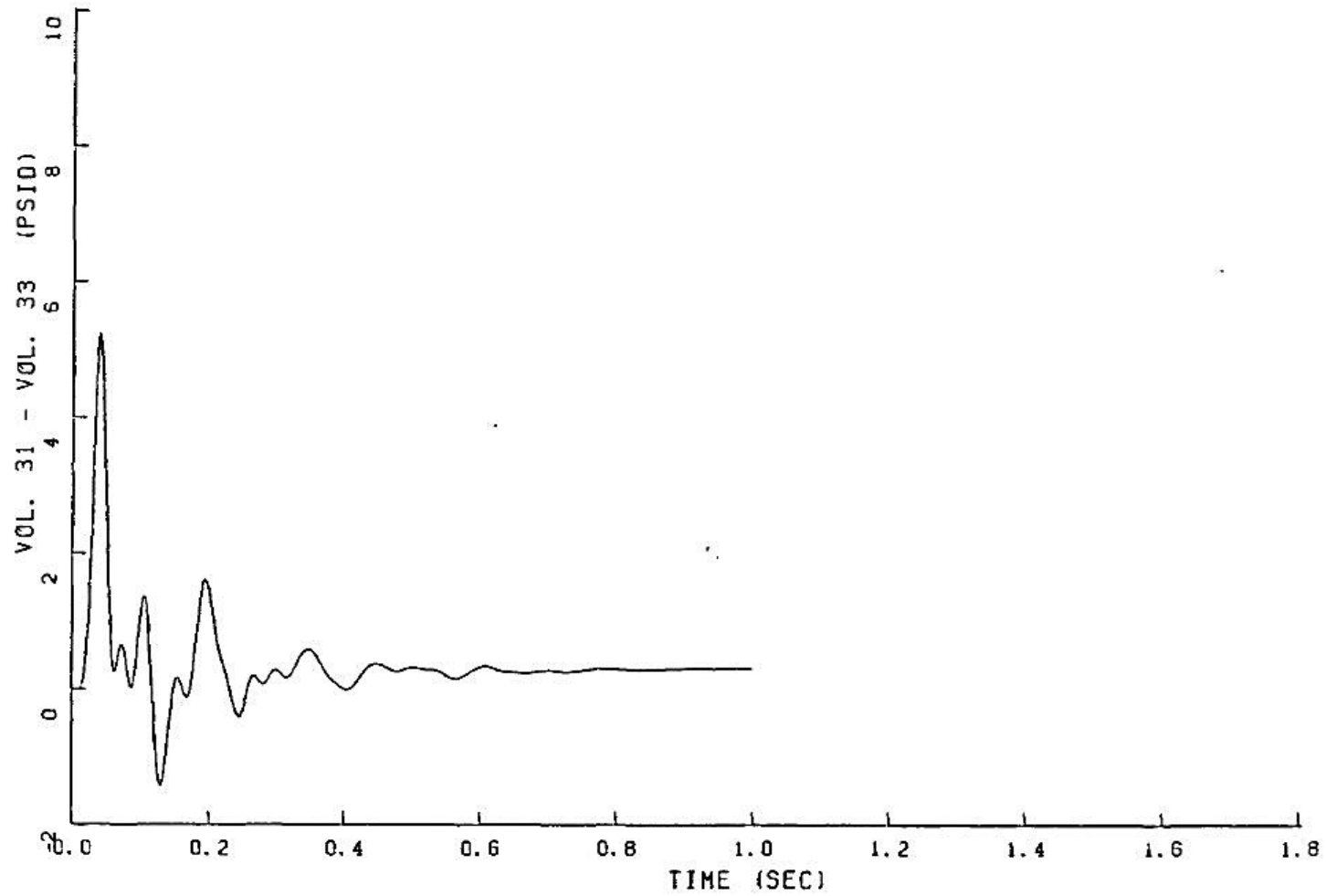

FIGURE 6.2.1-75

PEAK PRESSURE DIFFERENTIAL IN REACTOR CAVITY HOT LEG

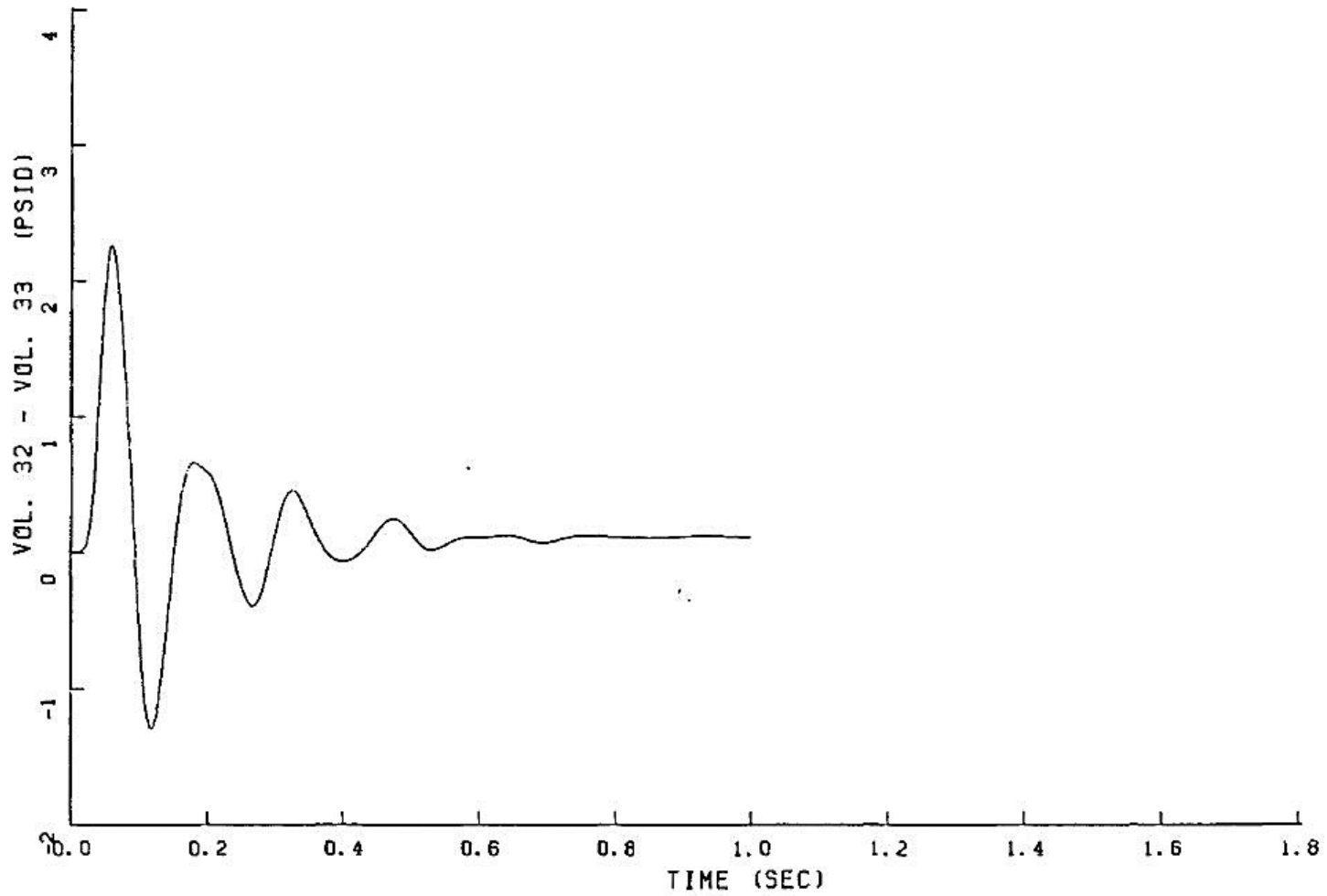

FIGURE 6.2.1-76

PEAK PRESSURE DIFFERENTIAL IN STEAM GENERATOR LOOP - 1

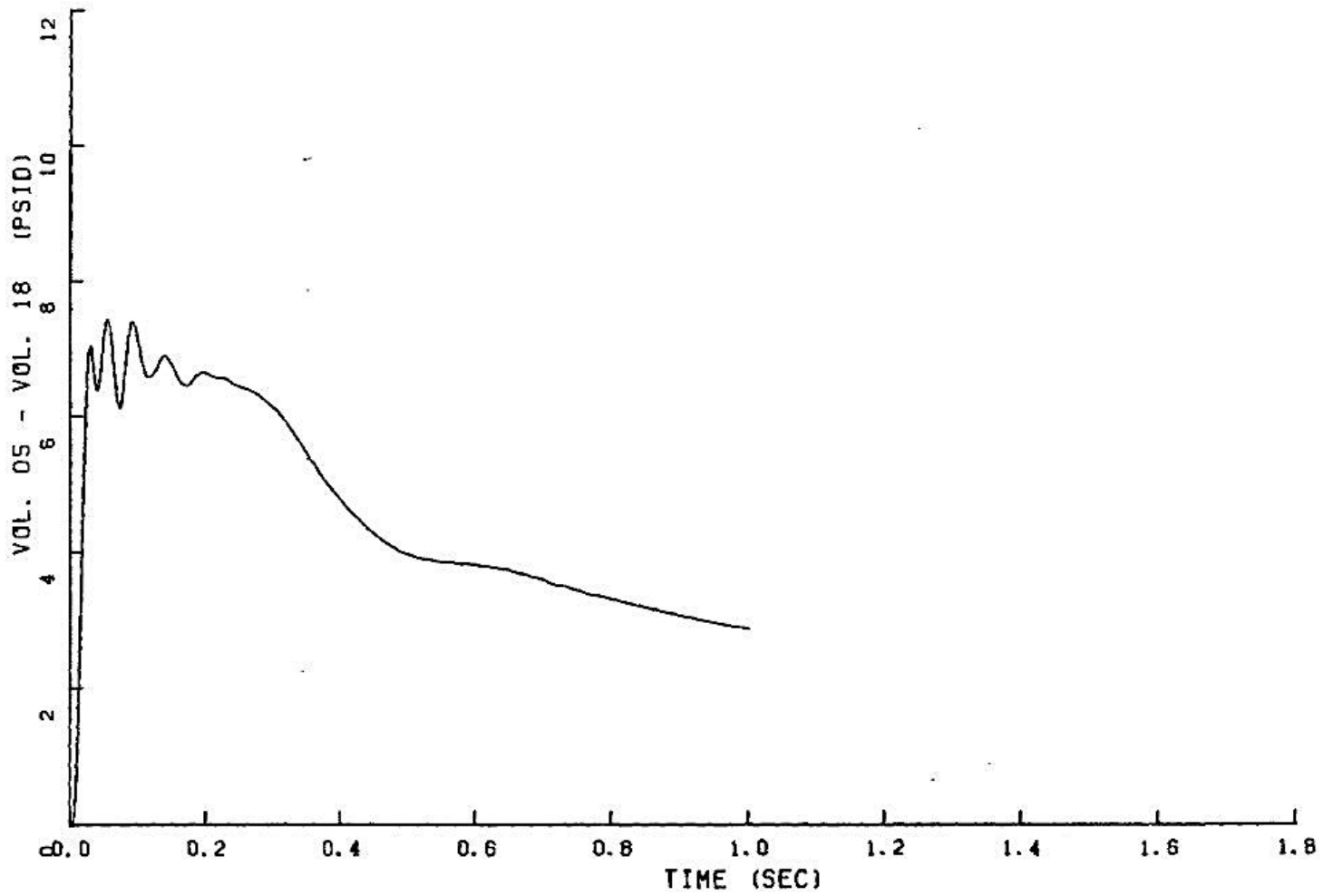

FIGURE 6.2.1-77

PEAK PRESSURE DIFFERENTIAL IN STEAM GENERATOR LOOP - 1

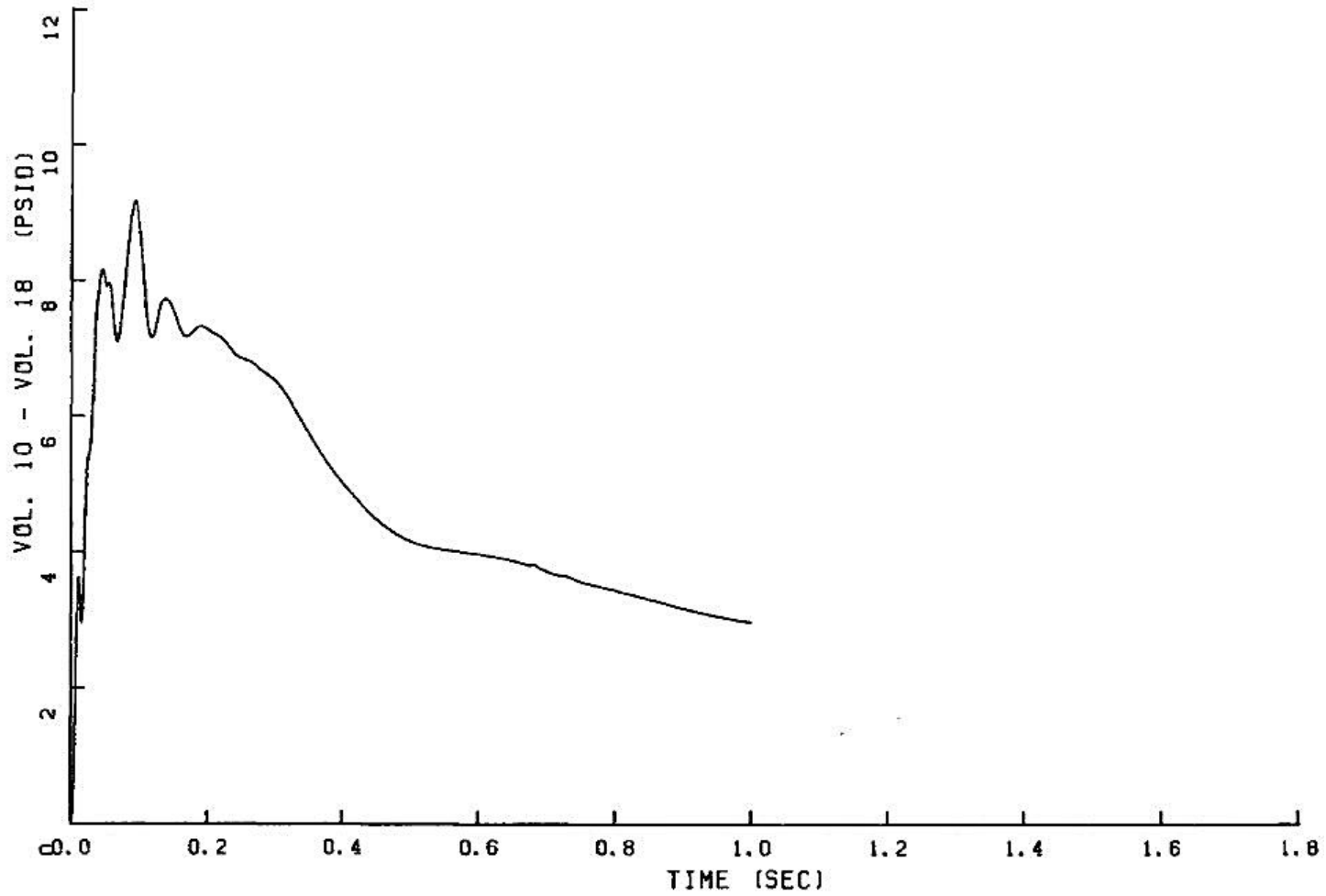

FIGURE 6.2.1-78

PEAK PRESSURE DIFFERENTIAL IN STEAM GENERATOR LOOP - 1

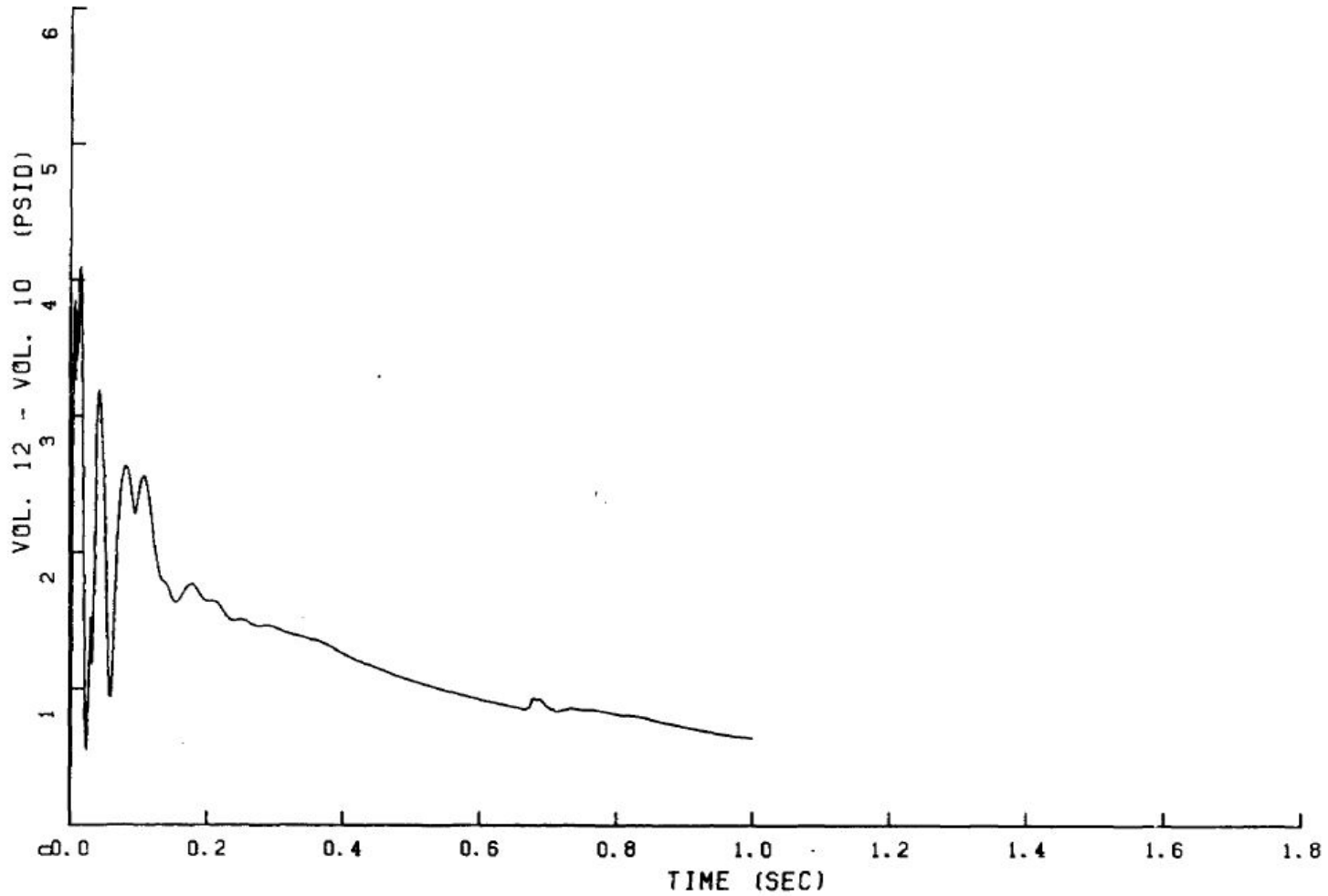

FIGURE 6.2.1-79

PEAK PRESSURE DIFFERENTIAL IN STEAM GENERATOR LOOP - 1

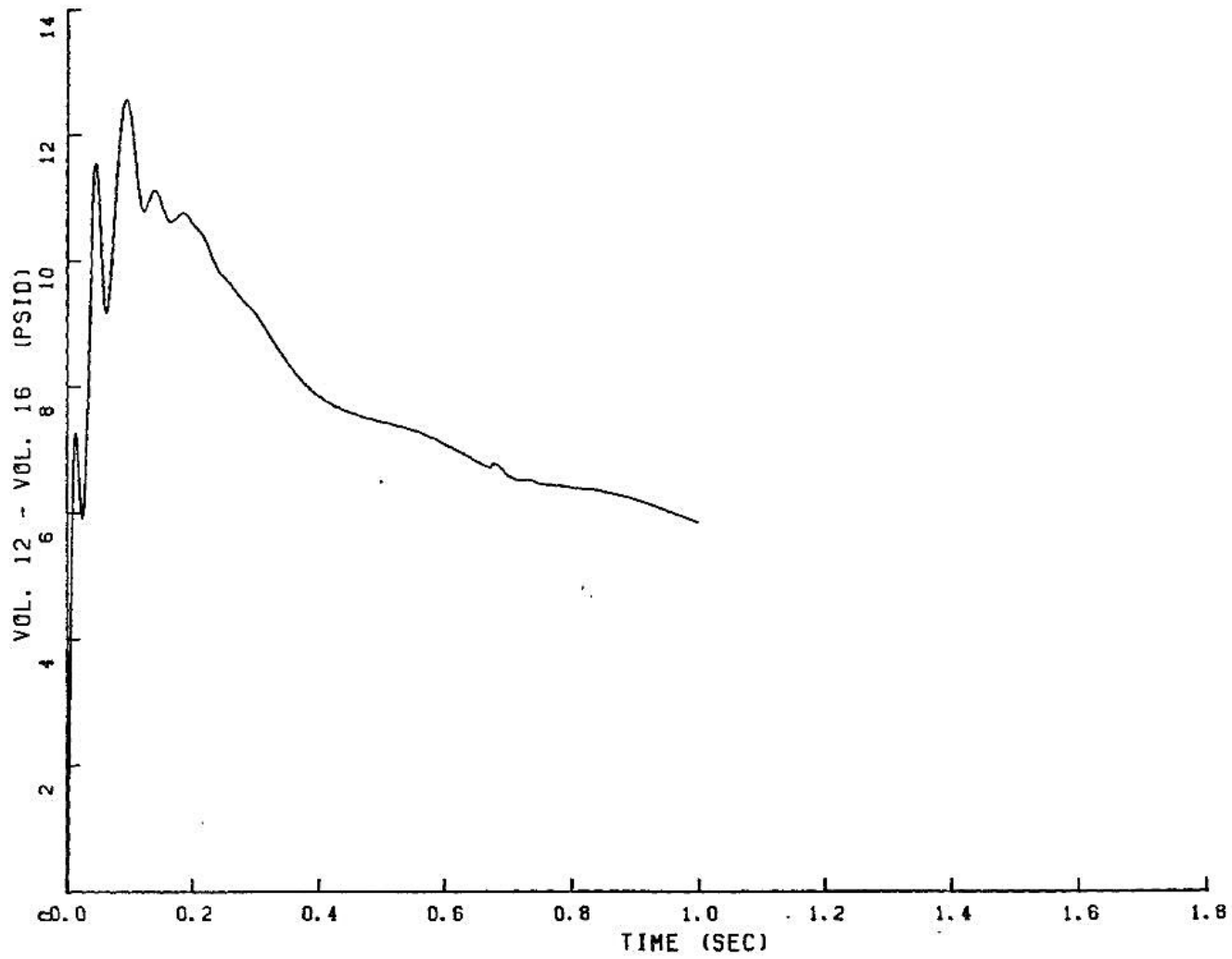

FIGURE 6.2.1-80

PEAK PRESSURE DIFFERENTIAL IN STEAM GENERATOR LOOP - 1

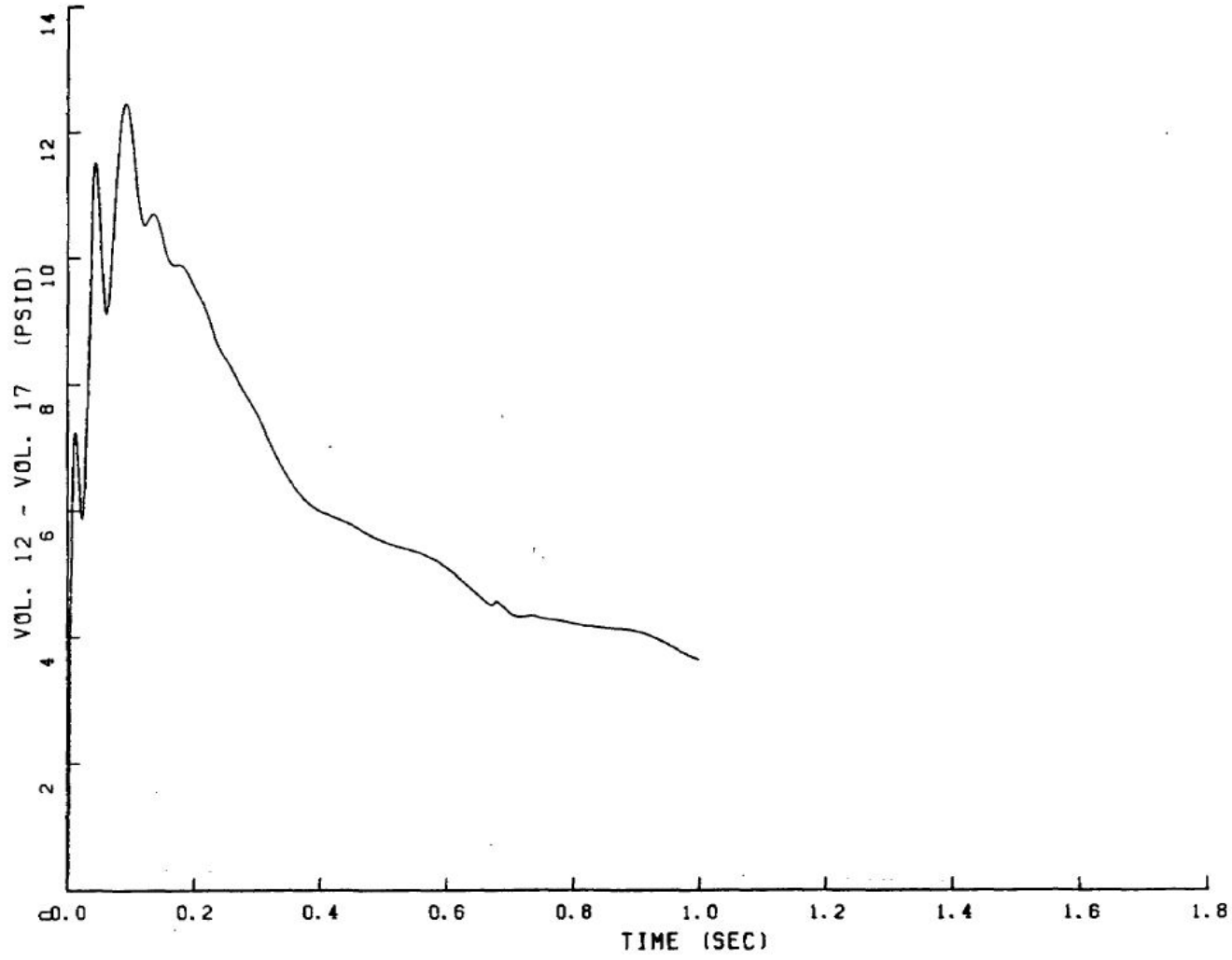

FIGURE 6.2.1-81

PEAK PRESSURE DIFFERENTIAL IN STEAM GENERATOR LOOP - 1

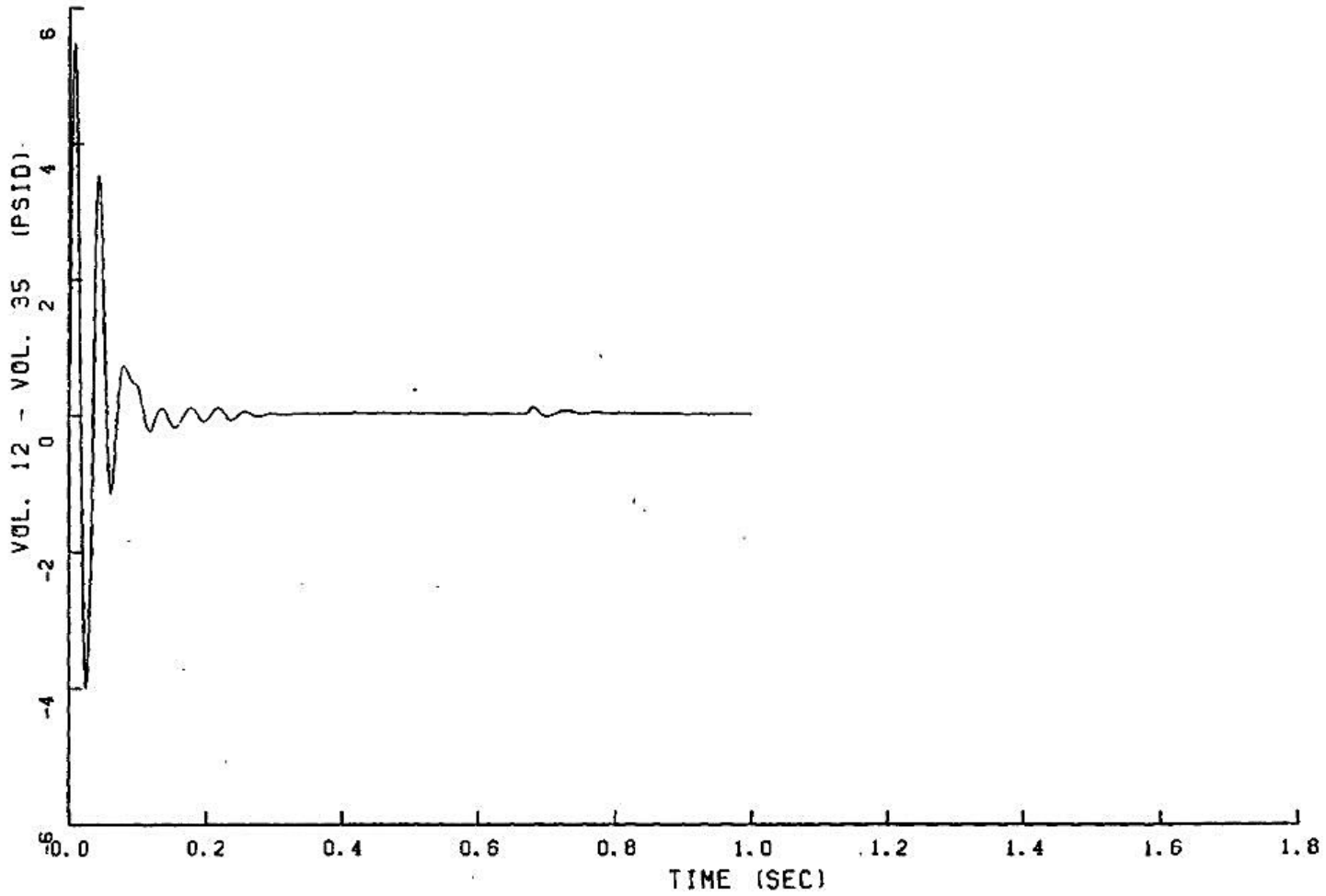

FIGURE 6.2.1-82

PEAK PRESSURE DIFFERENTIAL IN STEAM GENERATOR LOOP - 1

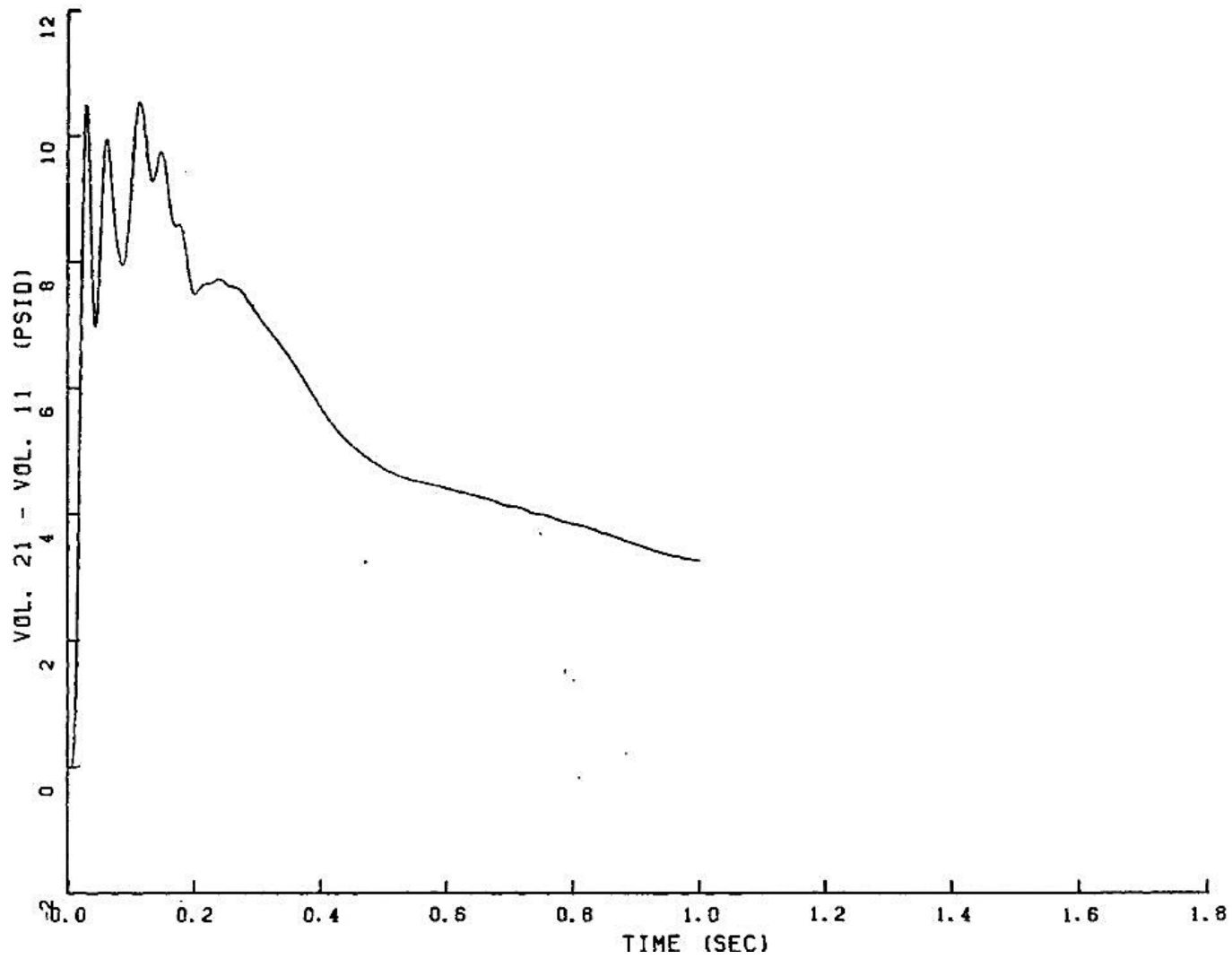

FIGURE 6.2.1-83

PEAK PRESSURE DIFFERENTIAL IN STEAM GENERATOR LOOP – 1

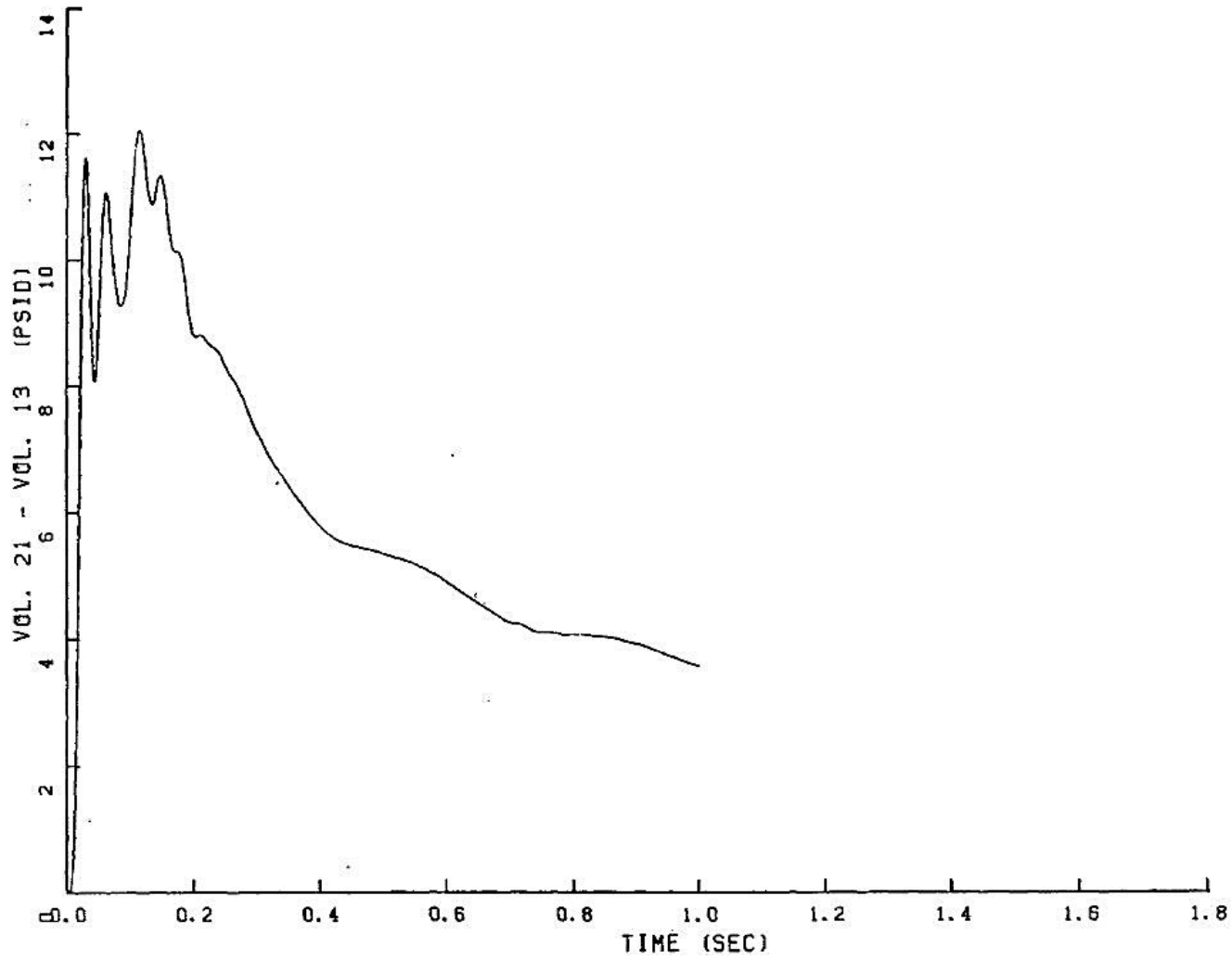

FIGURE 6.2.1-84

PEAK PRESSURE DIFFERENTIAL IN STEAM GENERATOR LOOP - 1

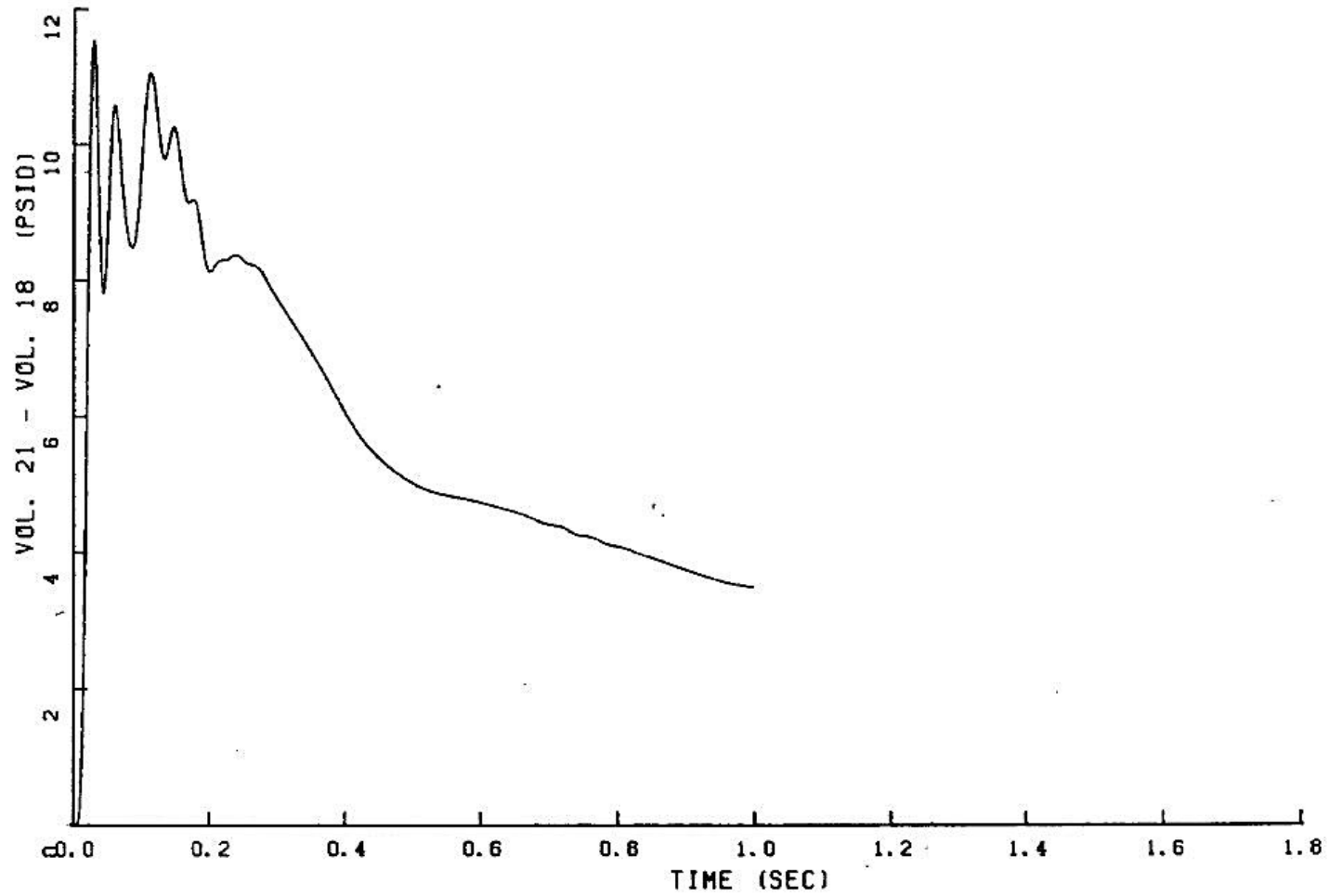

FIGURE 6.2.1-85

PEAK PRESSURE DIFFERENTIAL IN STEAM GENERATOR LOOP - 1

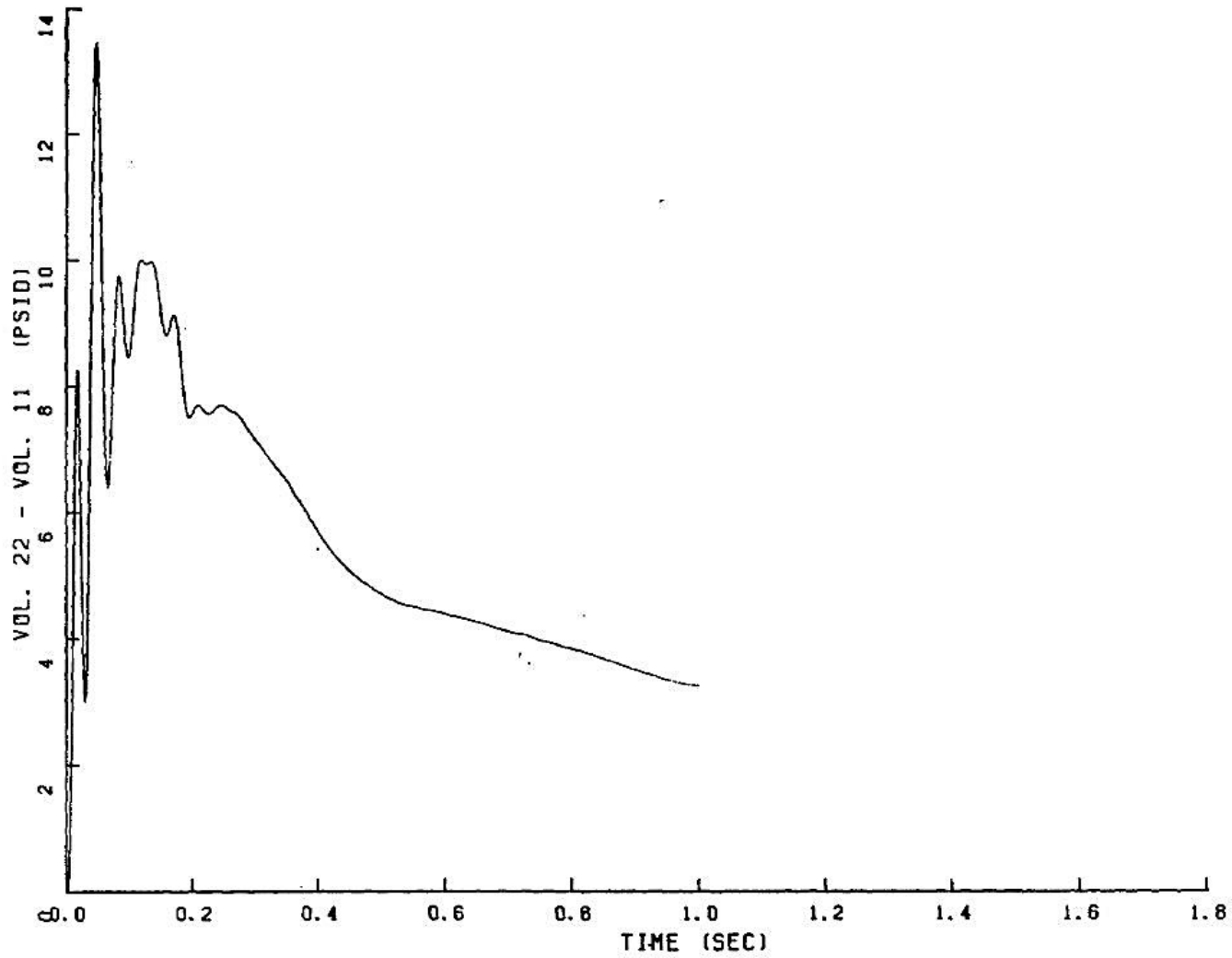

FIGURE 6.2.1-86

PEAK PRESSURE DIFFERENTIAL IN STEAM GENERATOR LOOP - 1

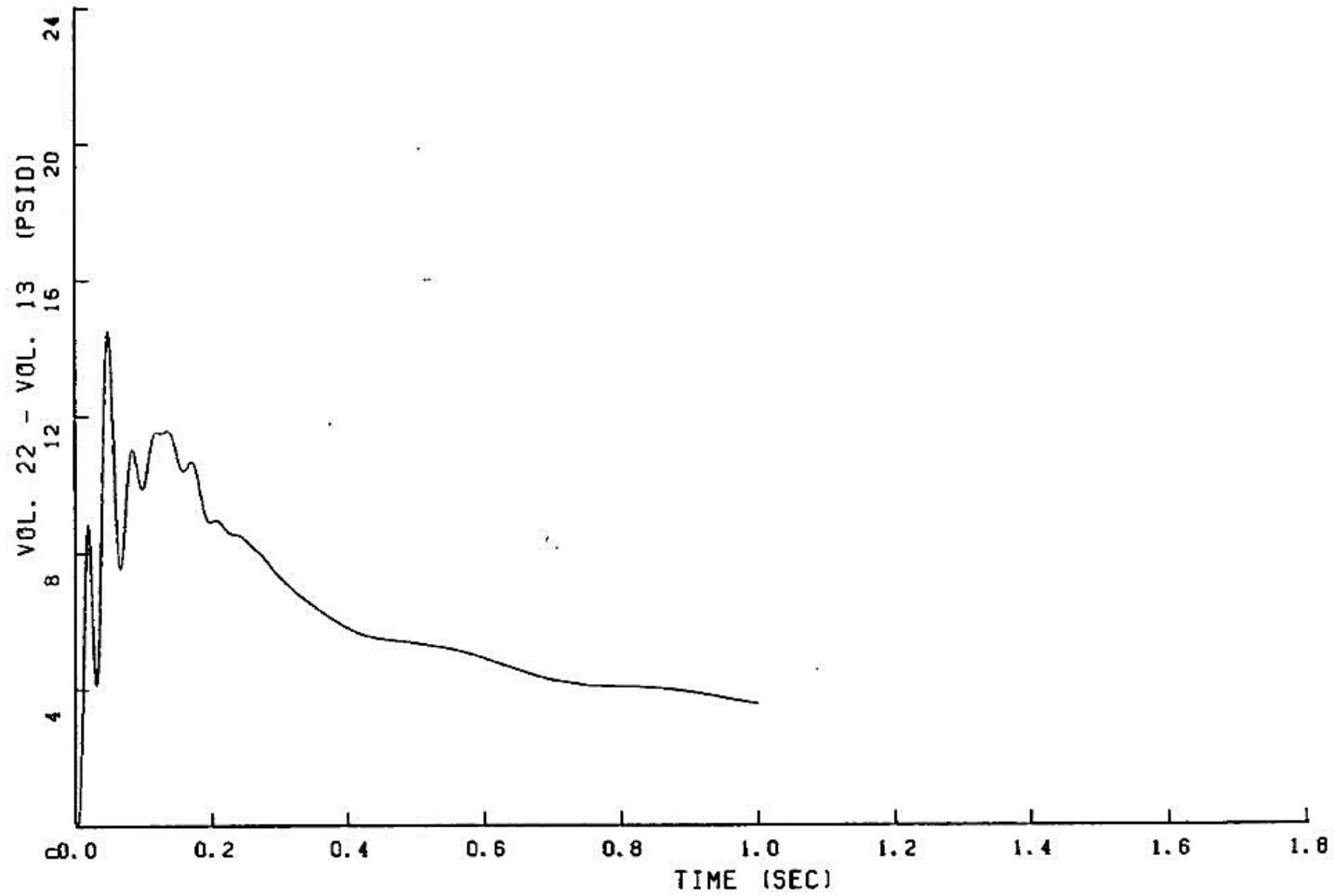

FIGURE 6.2.1-87

PEAK PRESSURE DIFFERENTIAL IN STEAM GENERATOR LOOP - 1

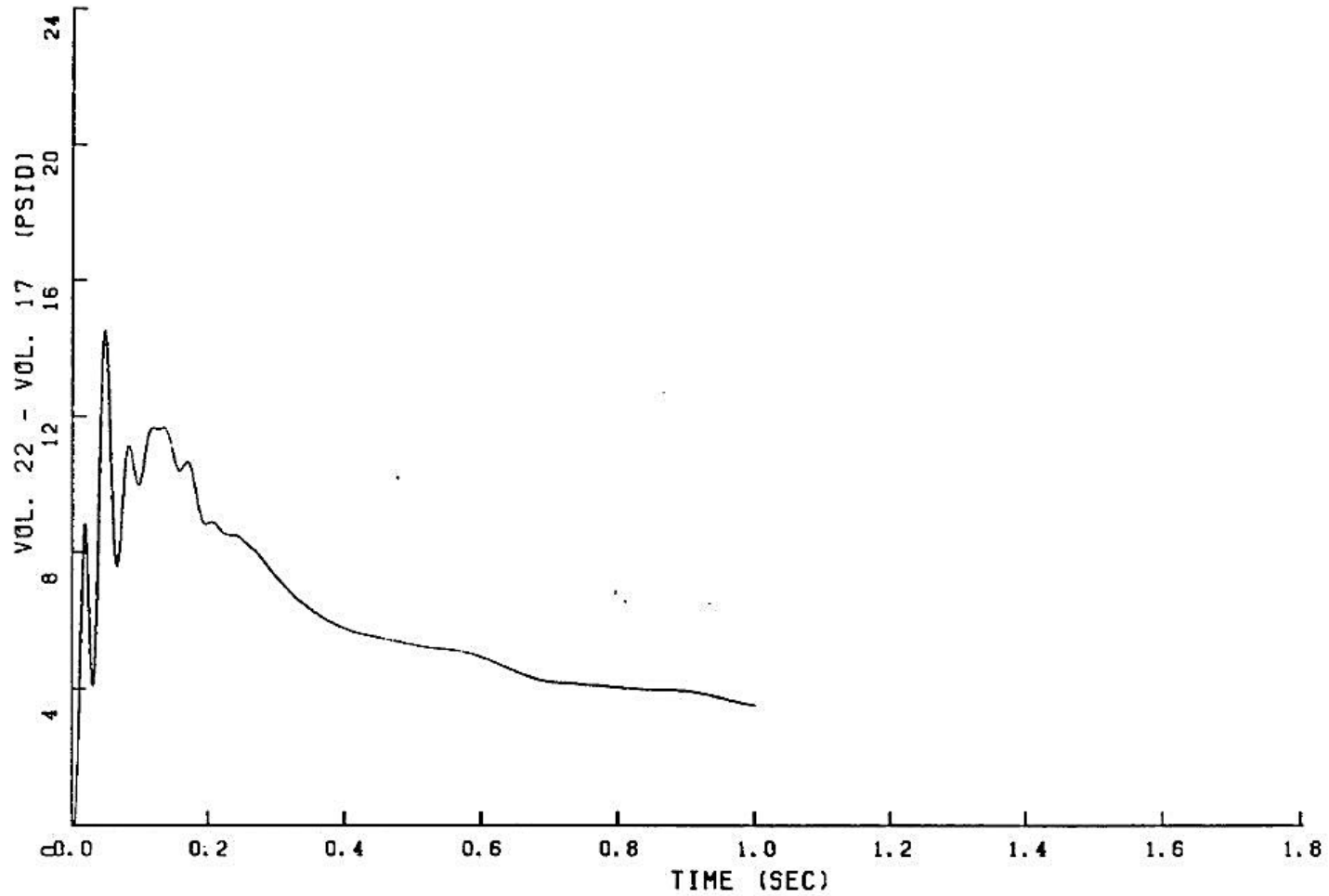

FIGURE 6.2.1-88

PEAK PRESSURE DIFFERENTIAL IN STEAM GENERATOR LOOP - 1

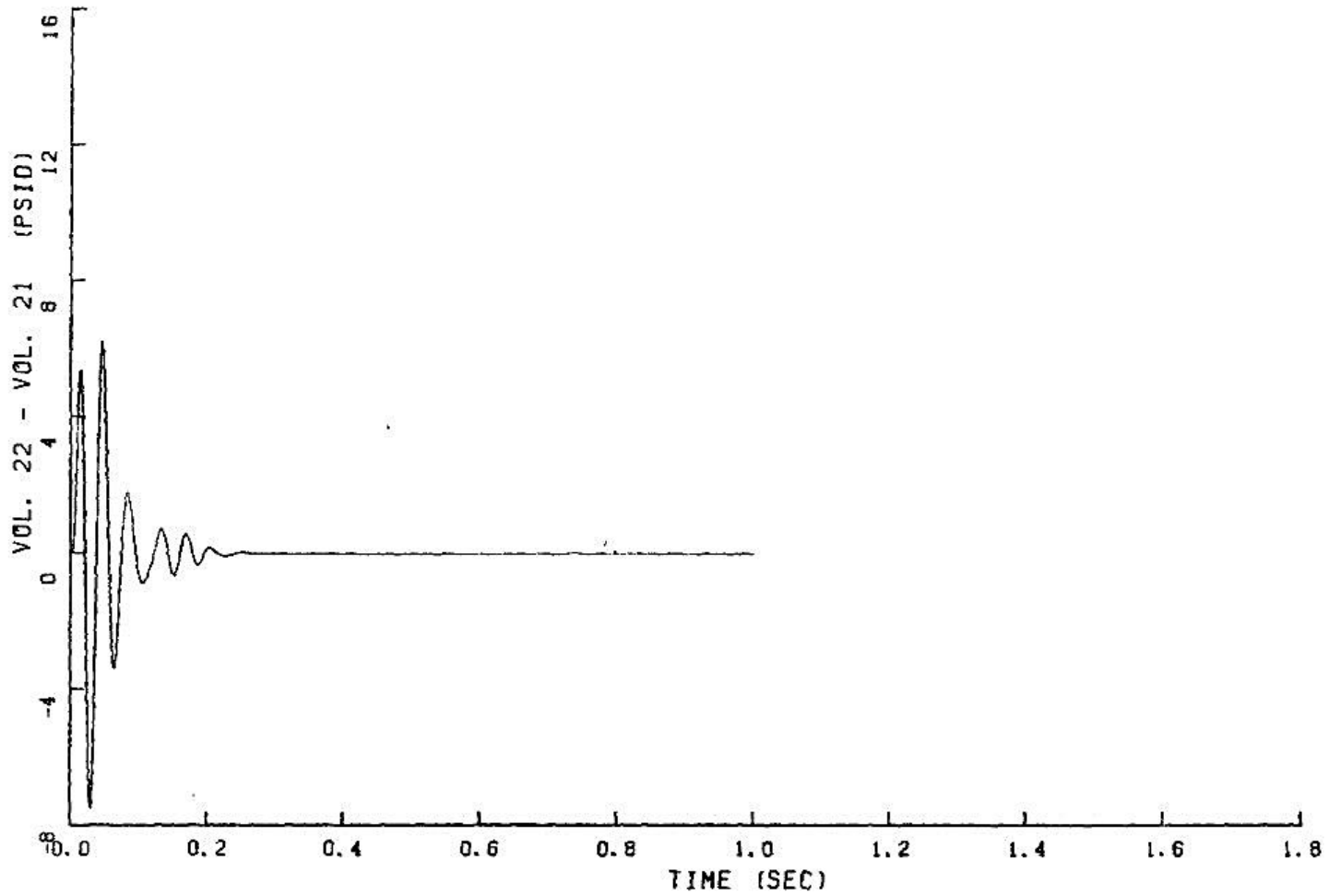

FIGURE 6.2.1-89

PEAK PRESSURE DIFFERENTIAL IN STEAM GENERATOR LOOP - 1

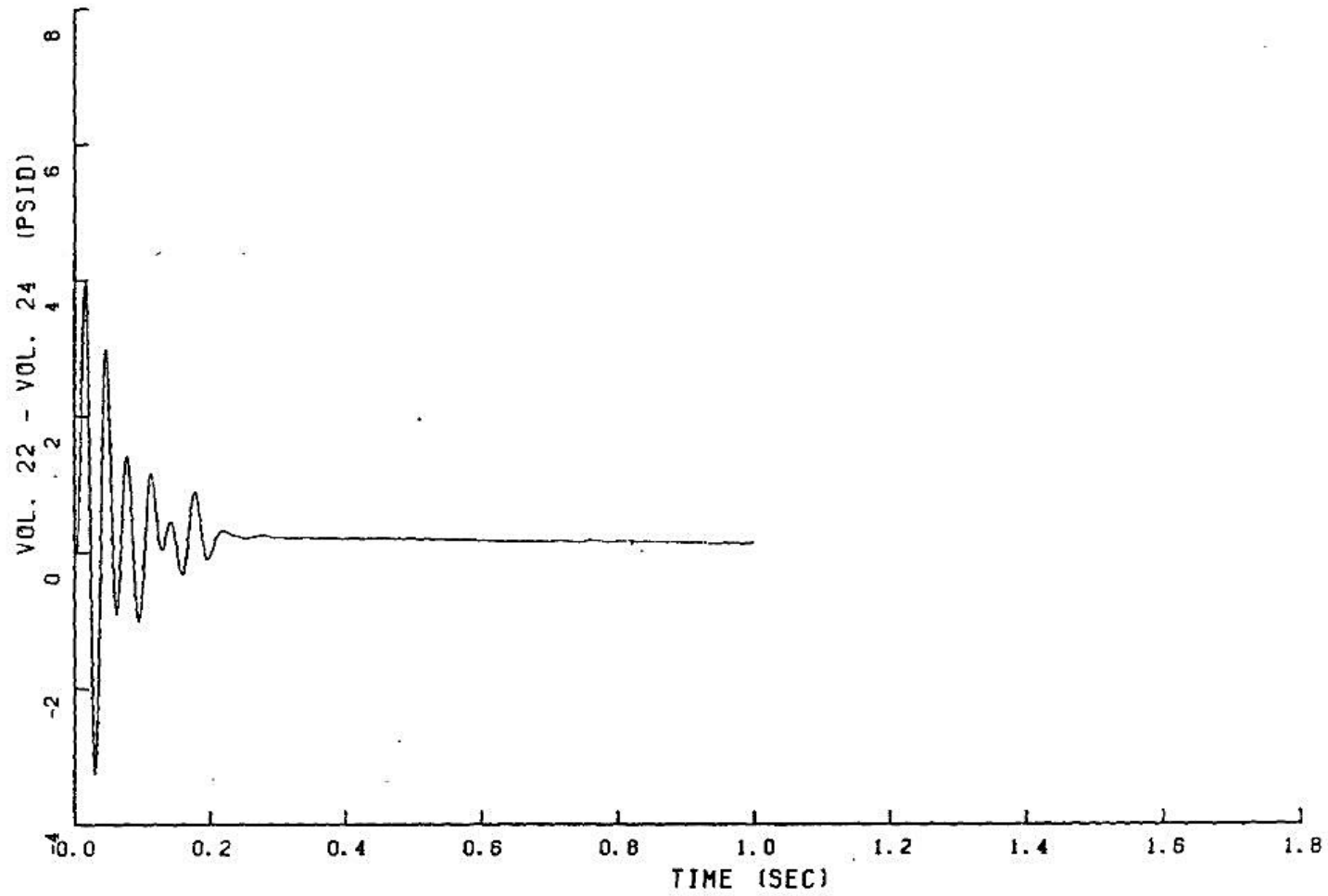

FIGURE 6.2.1-90

PEAK PRESSURE DIFFERENTIAL IN STEAM GENERATOR LOOP - 1

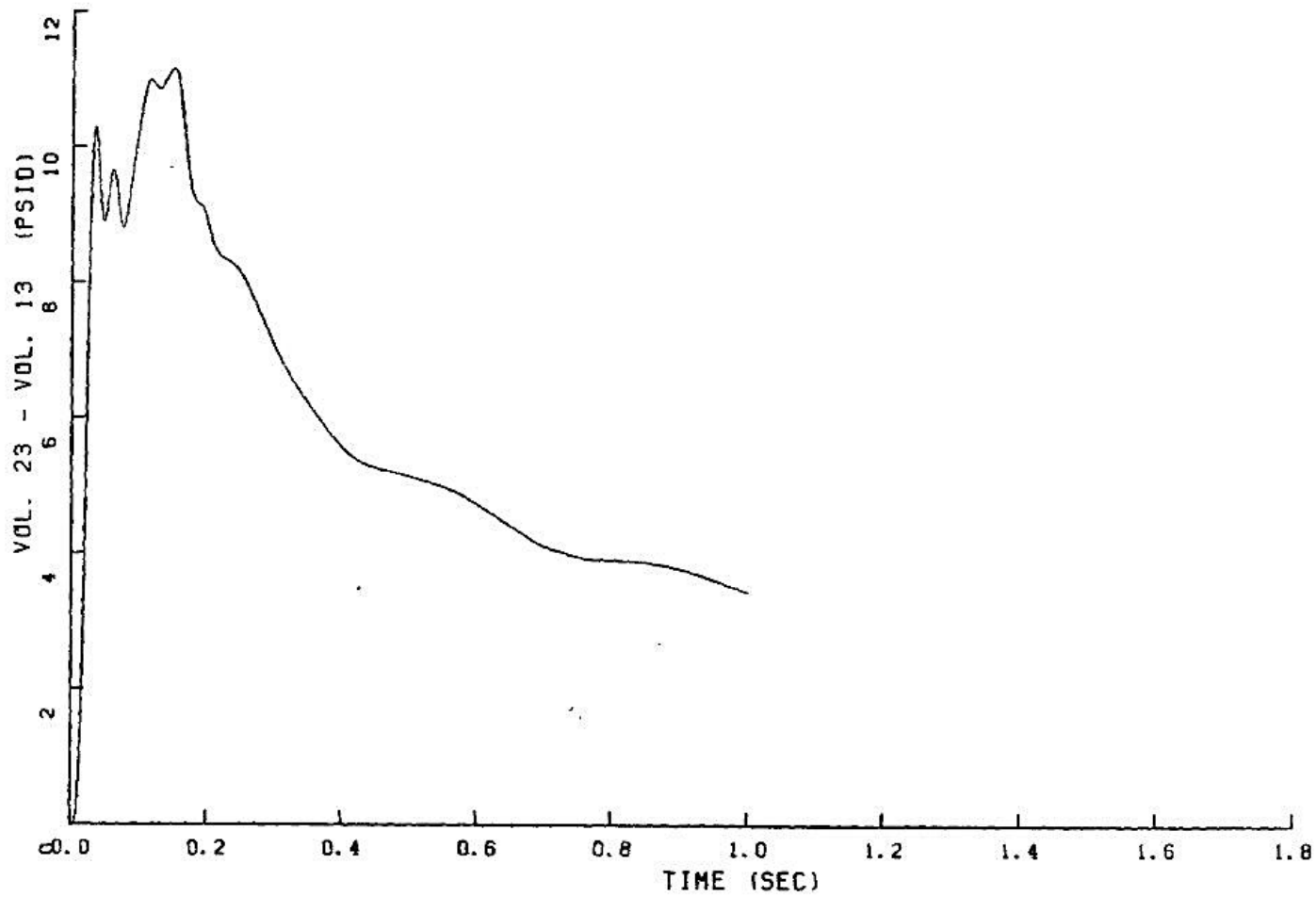

FIGURE 6.2.1-91

PEAK PRESSURE DIFFERENTIAL IN STEAM GENERATOR LOOP - 1

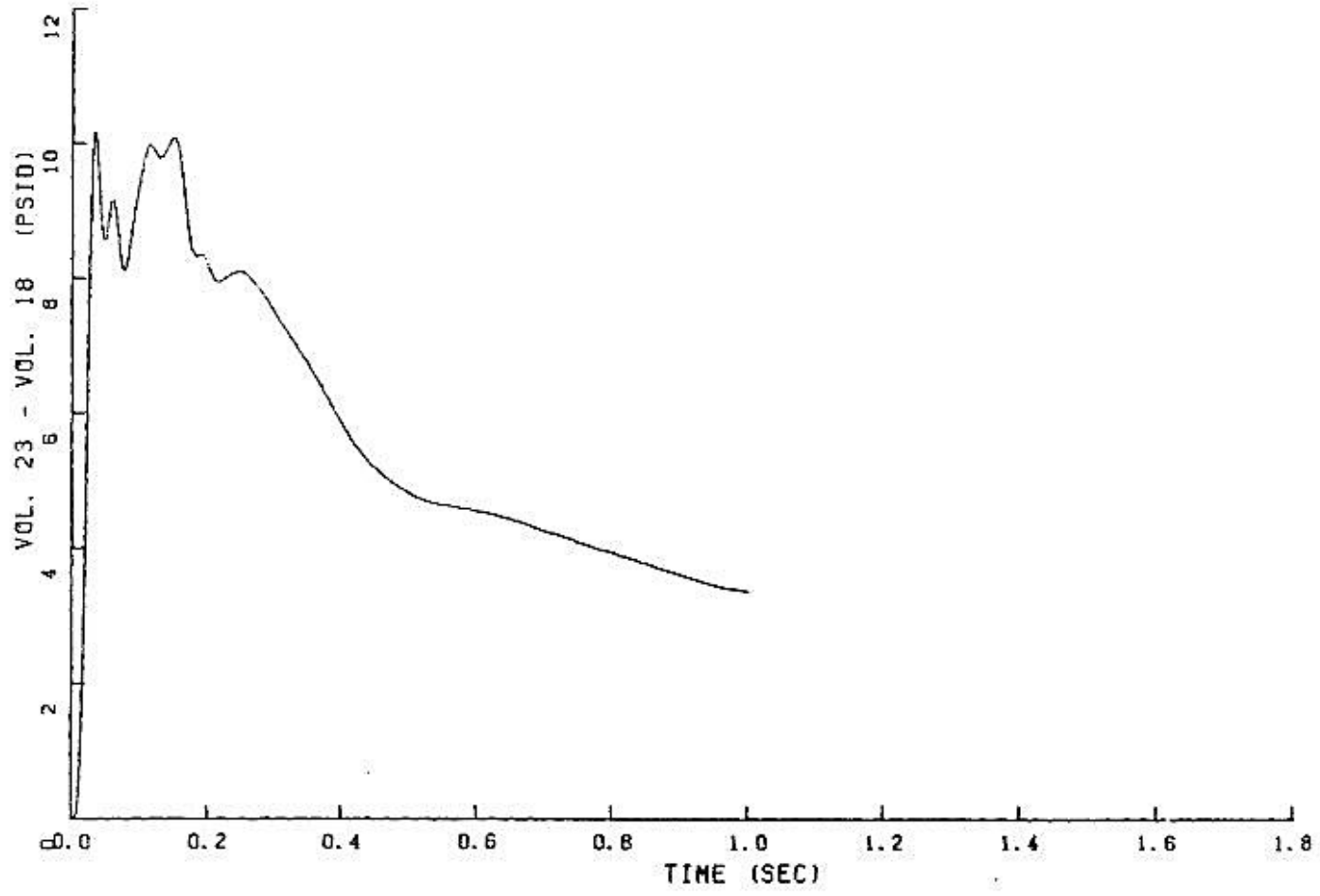

FIGURE 6.2.1-92

PEAK PRESSURE DIFFERENTIAL IN STEAM GENERATOR LOOP - 1

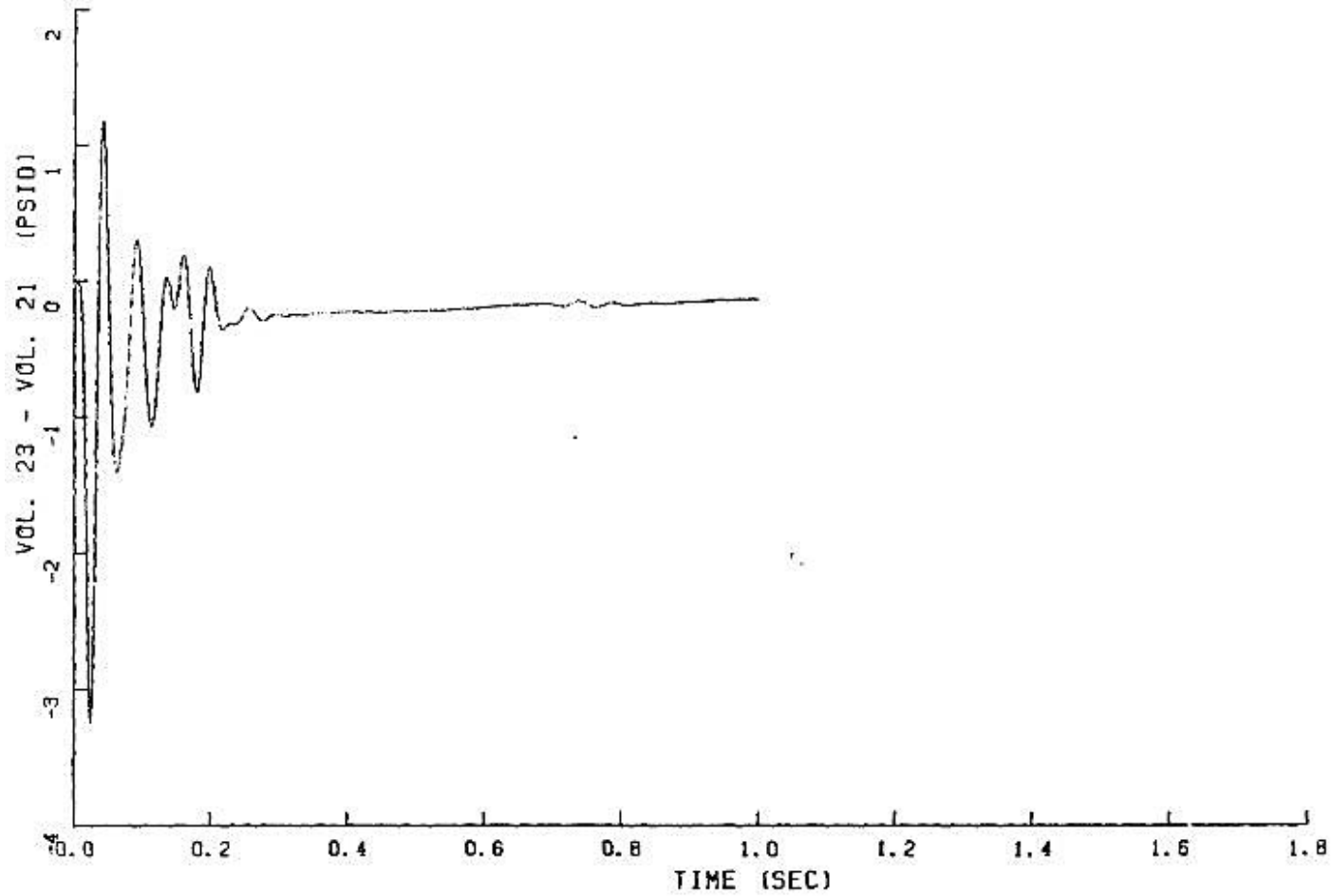

FIGURE 6.2.1-93

PEAK PRESSURE DIFFERENTIAL IN STEAM GENERATOR LOOP - 1

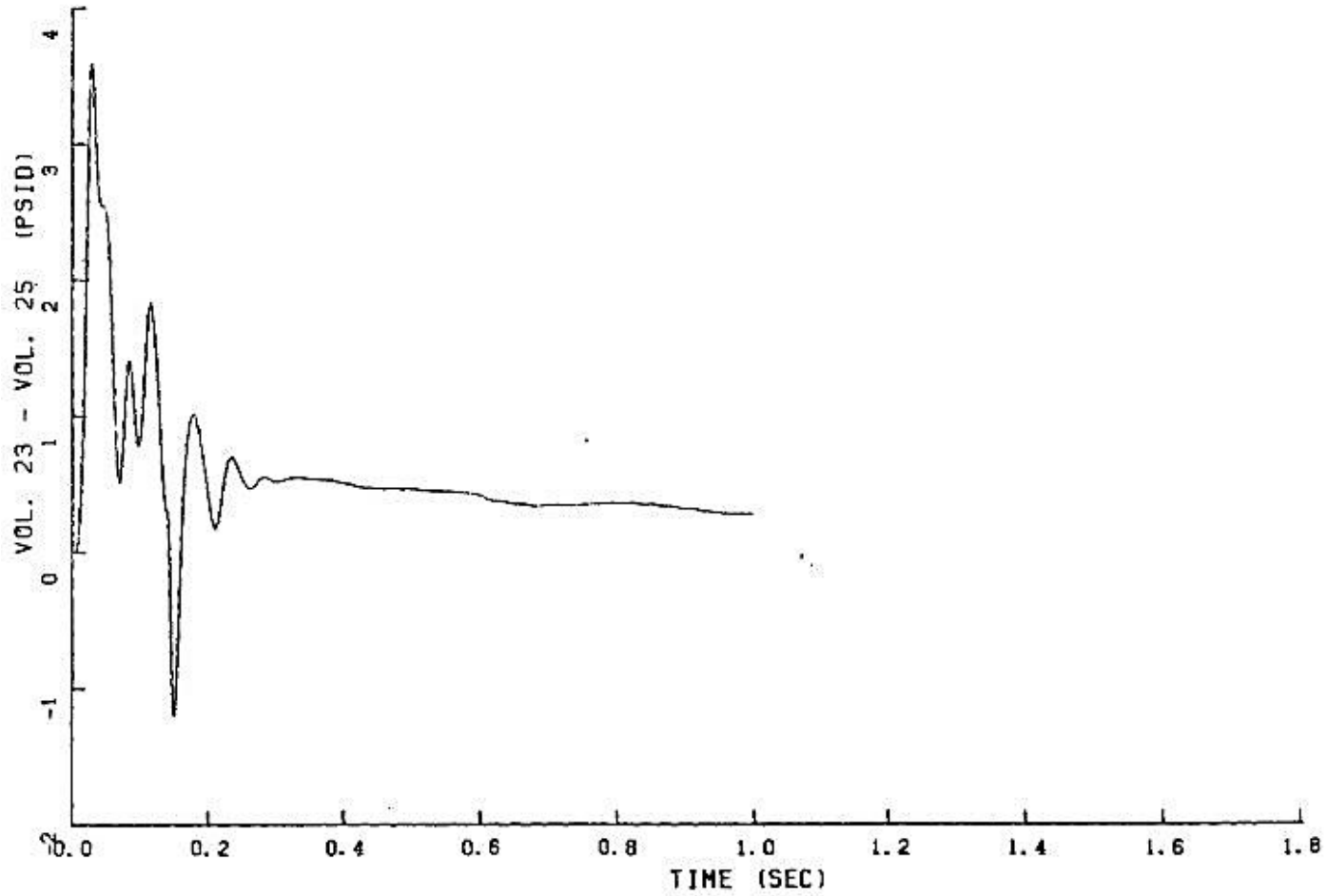

FIGURE 6.2.1-94

PEAK PRESSURE DIFFERENTIAL IN STEAM GENERATOR LOOP - 1

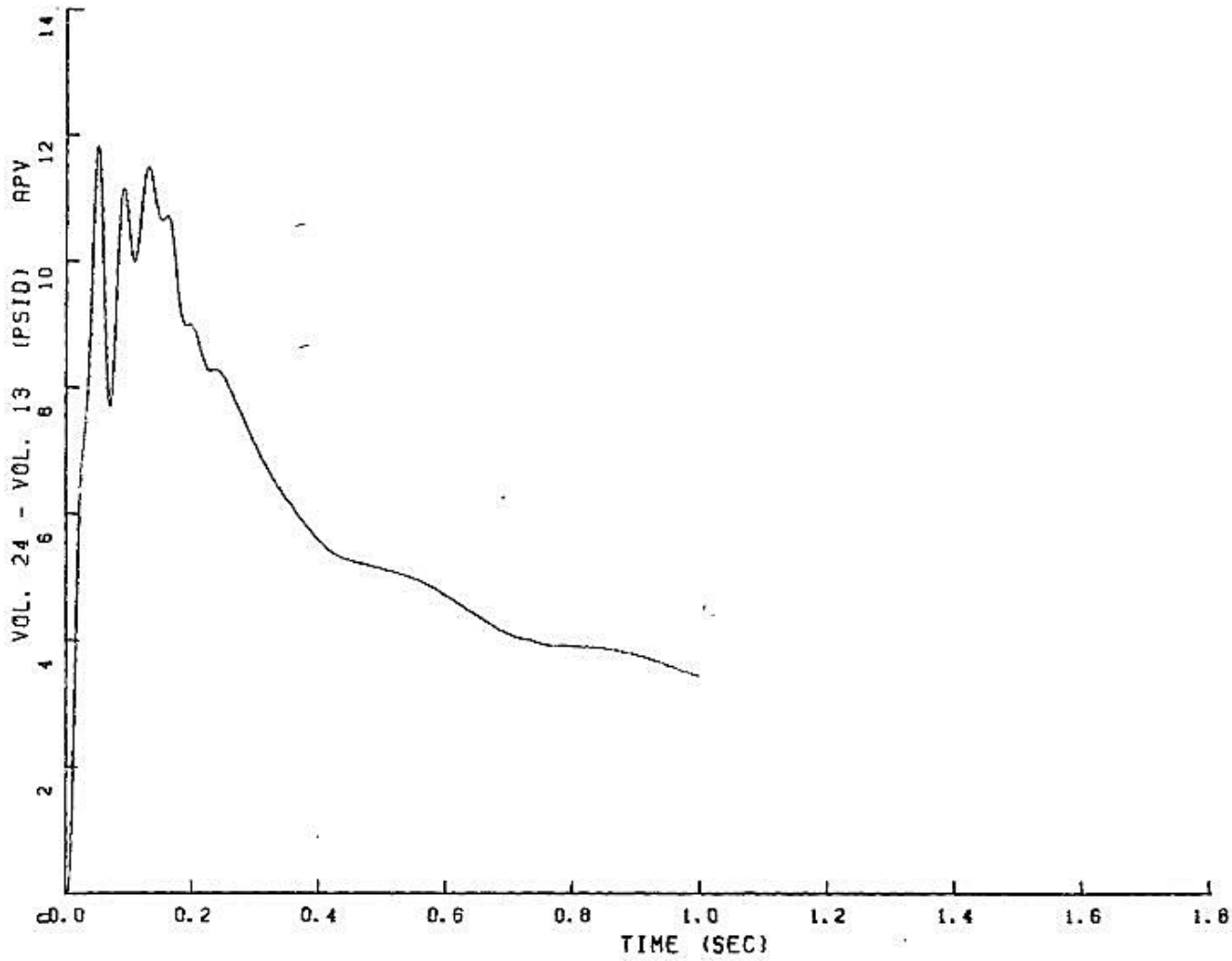

FIGURE 6.2.1-95

PEAK PRESSURE DIFFERENTIAL IN STEAM GENERATOR LOOP - 1

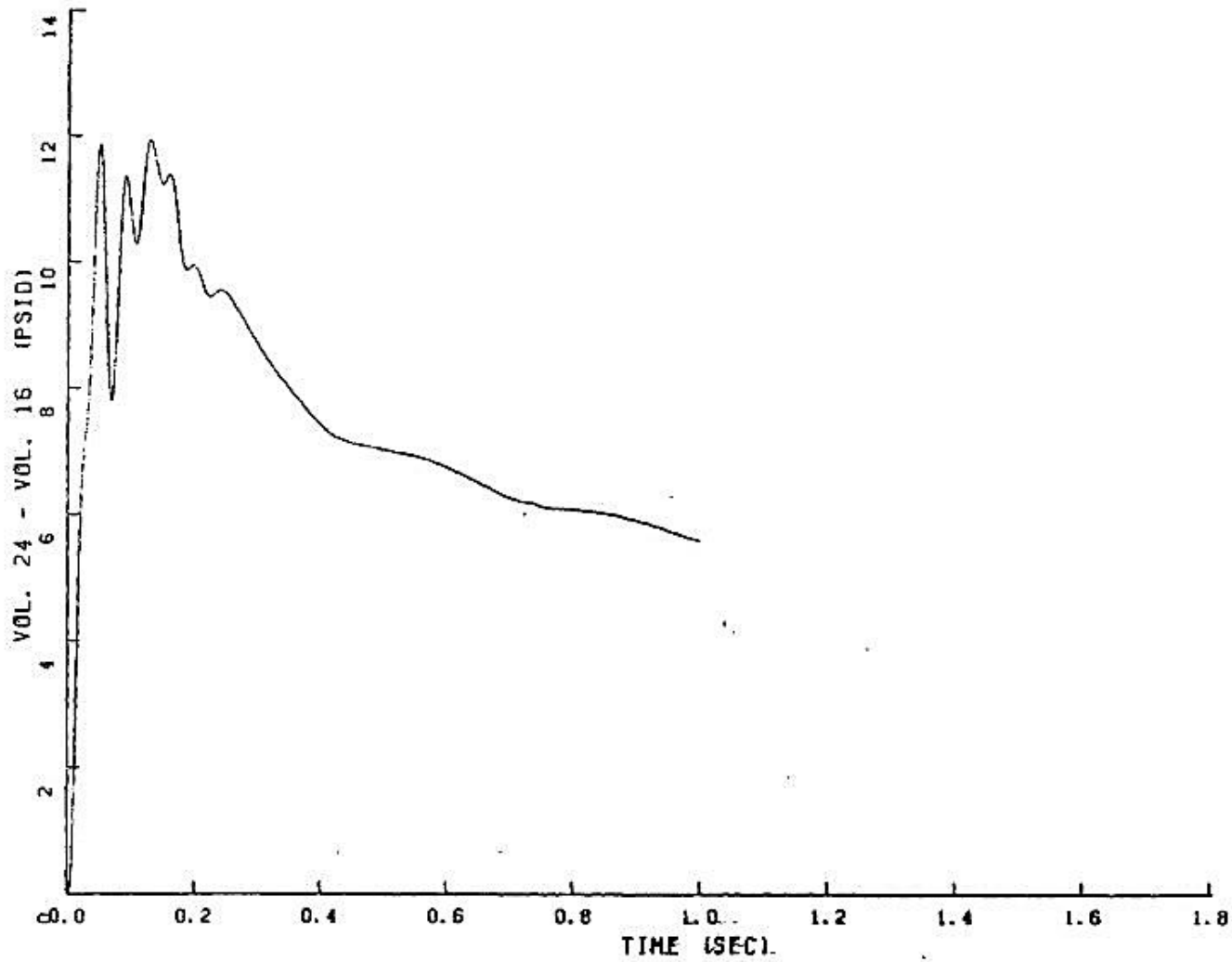

FIGURE 6.2.1-96

PEAK PRESSURE DIFFERENTIAL IN STEAM GENERATOR LOOP - 1

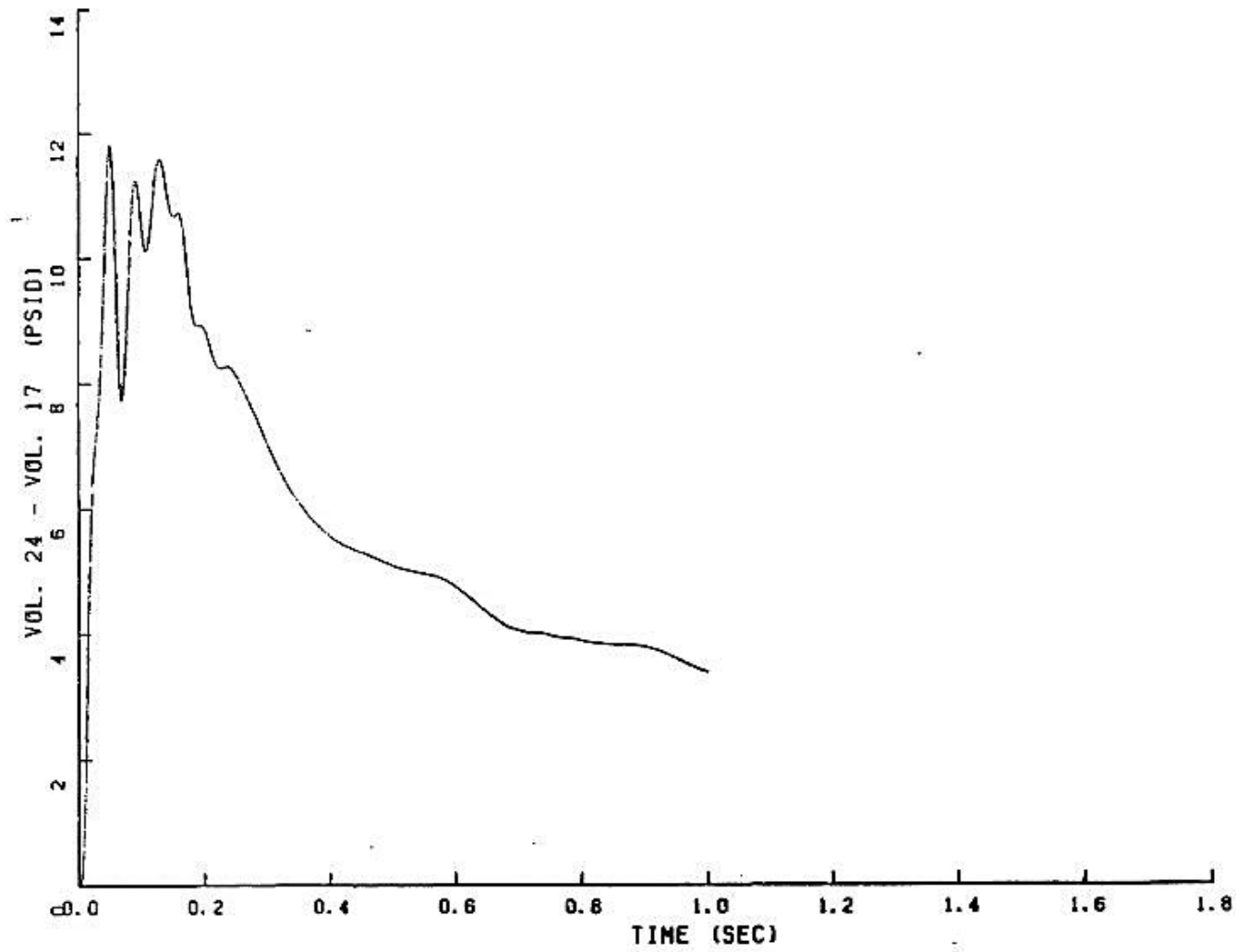

FIGURE 6.2.1-97

PEAK PRESSURE DIFFERENTIAL IN STEAM GENERATOR LOOP – 1

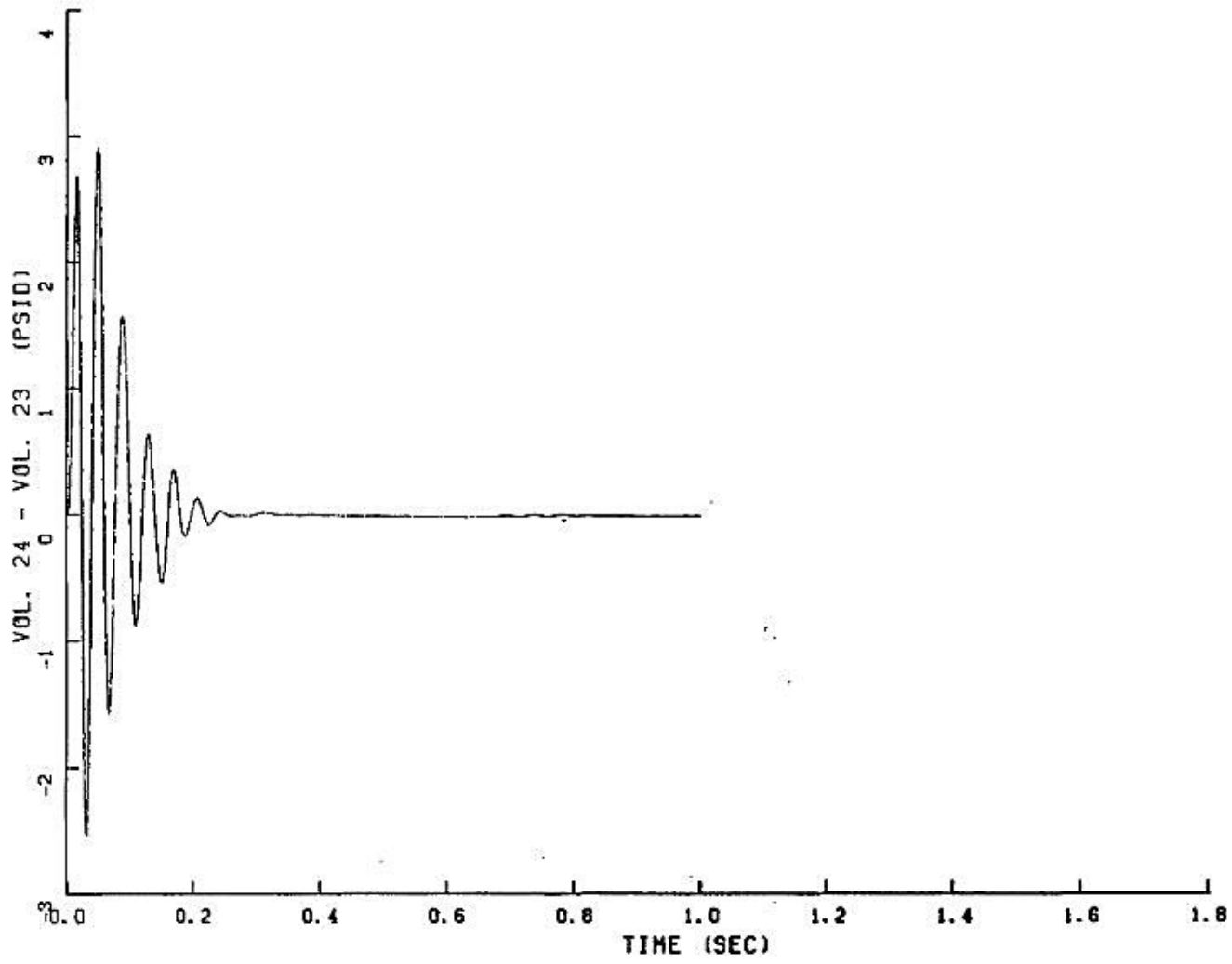

FIGURE 6.2.1-98

PEAK PRESSURE DIFFERENTIAL IN STEAM GENERATOR LOOP - 1

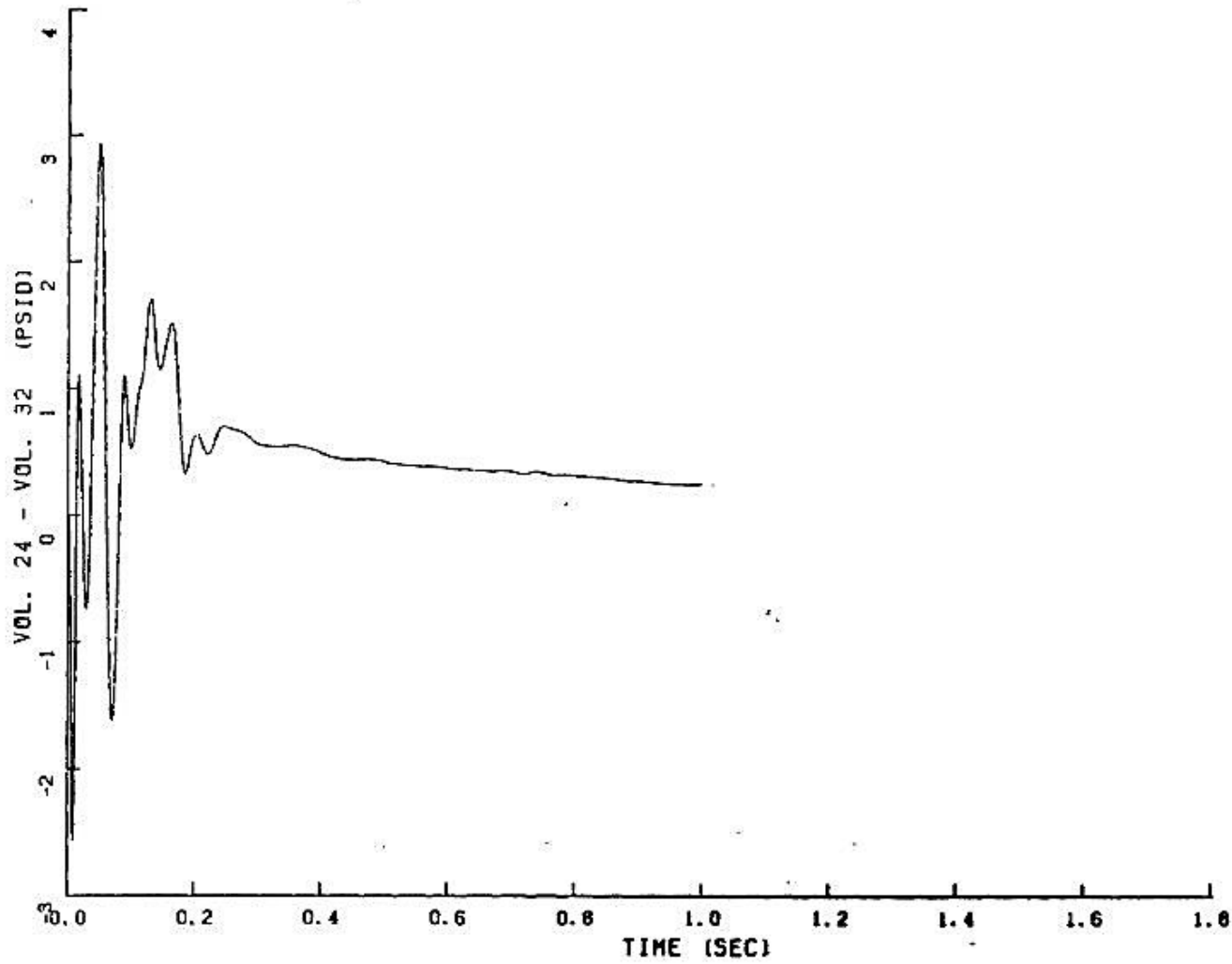

FIGURE 6.2.1-99

PEAK PRESSURE DIFFERENTIAL IN STEAM GENERATOR LOOP - 1

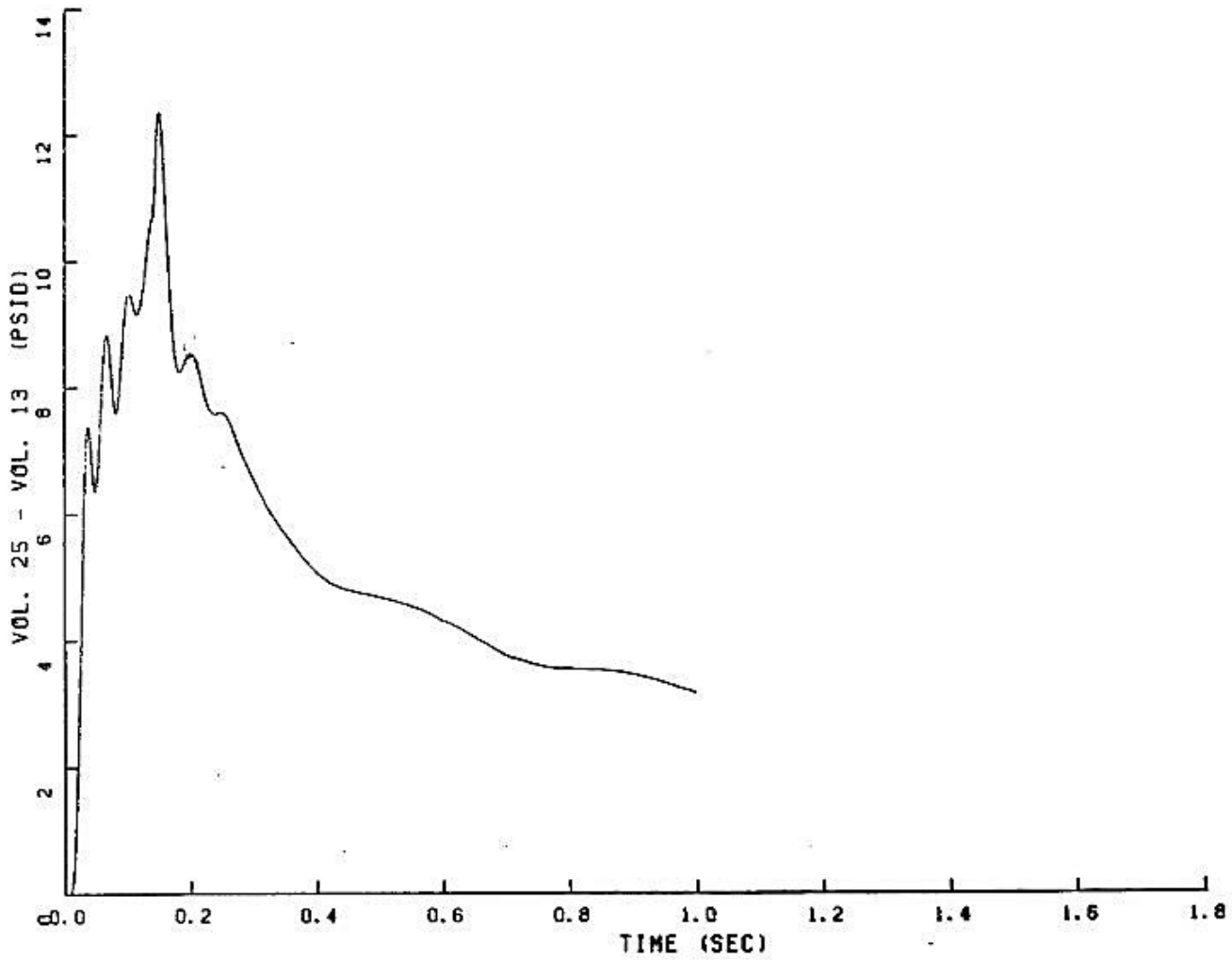

FIGURE 6.2.1-100

PEAK PRESSURE DIFFERENTIAL IN STEAM GENERATOR LOOP - 1

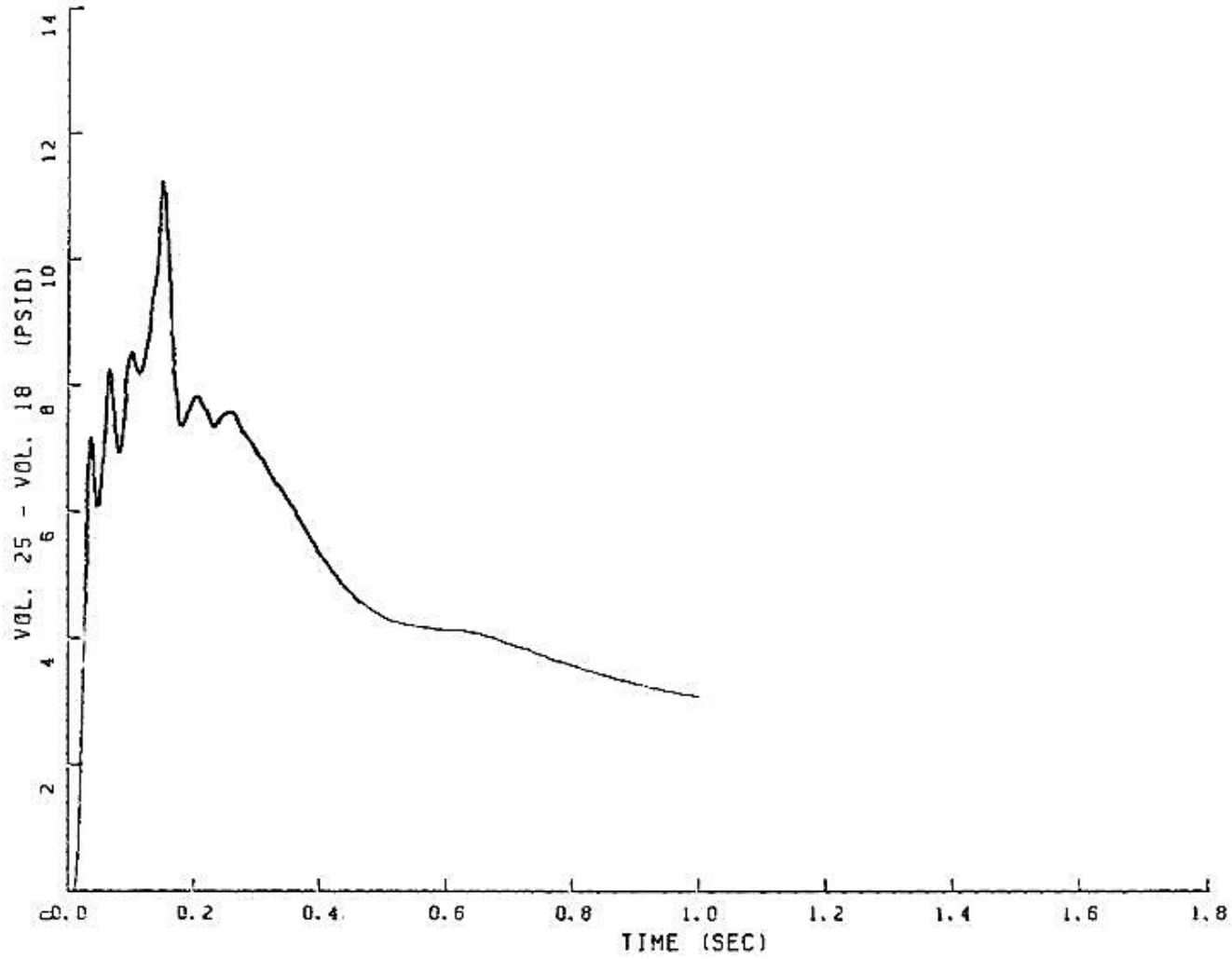

FIGURE 6.2.1-101

PEAK PRESSURE DIFFERENTIAL IN STEAM GENERATOR LOOP - 1

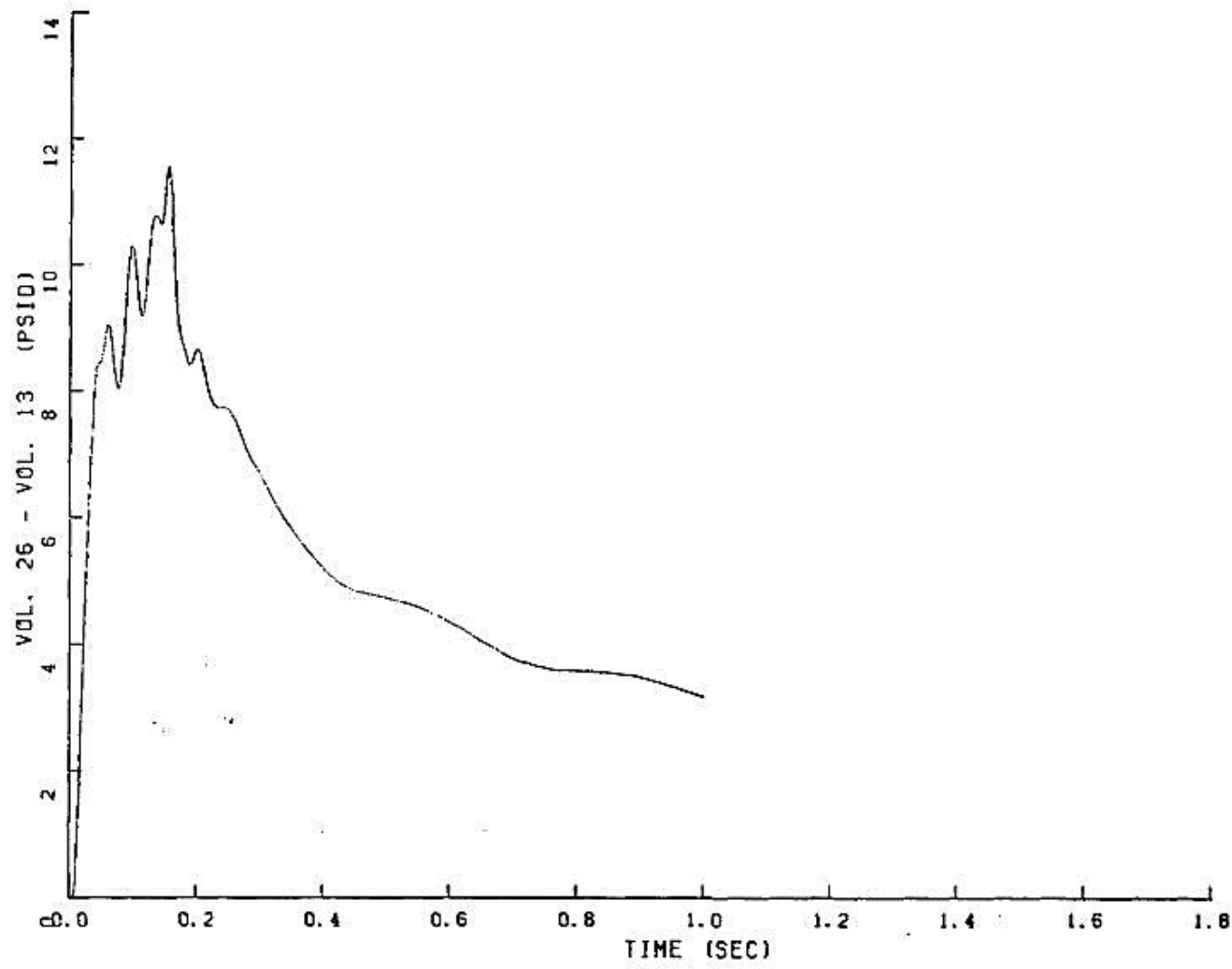

FIGURE 6.2.1-102

PEAK PRESSURE DIFFERENTIAL IN STEAM GENERATOR LOOP - 1

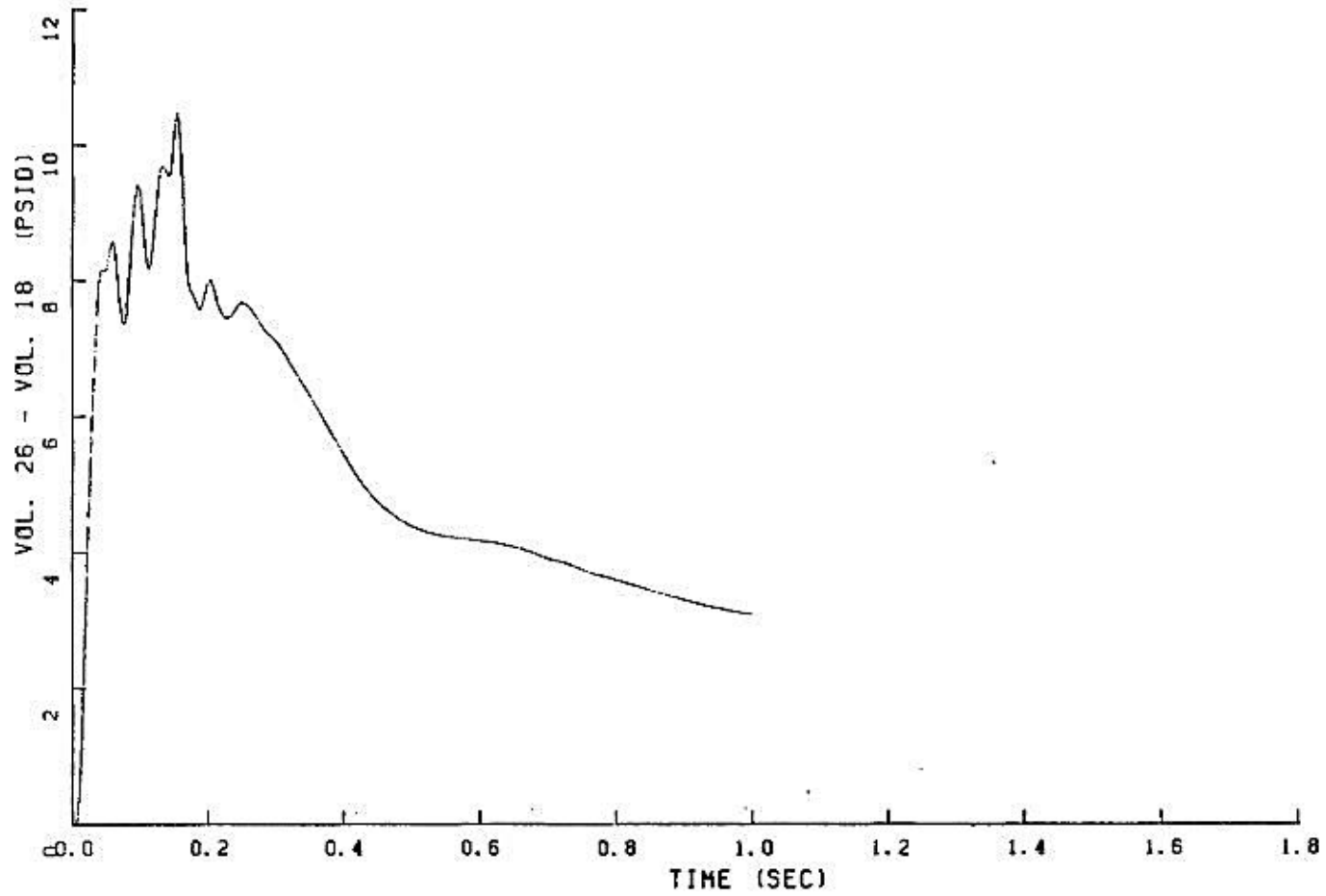

FIGURE 6.2.1-103

PEAK PRESSURE DIFFERENTIAL IN STEAM GENERATOR LOOP - 1

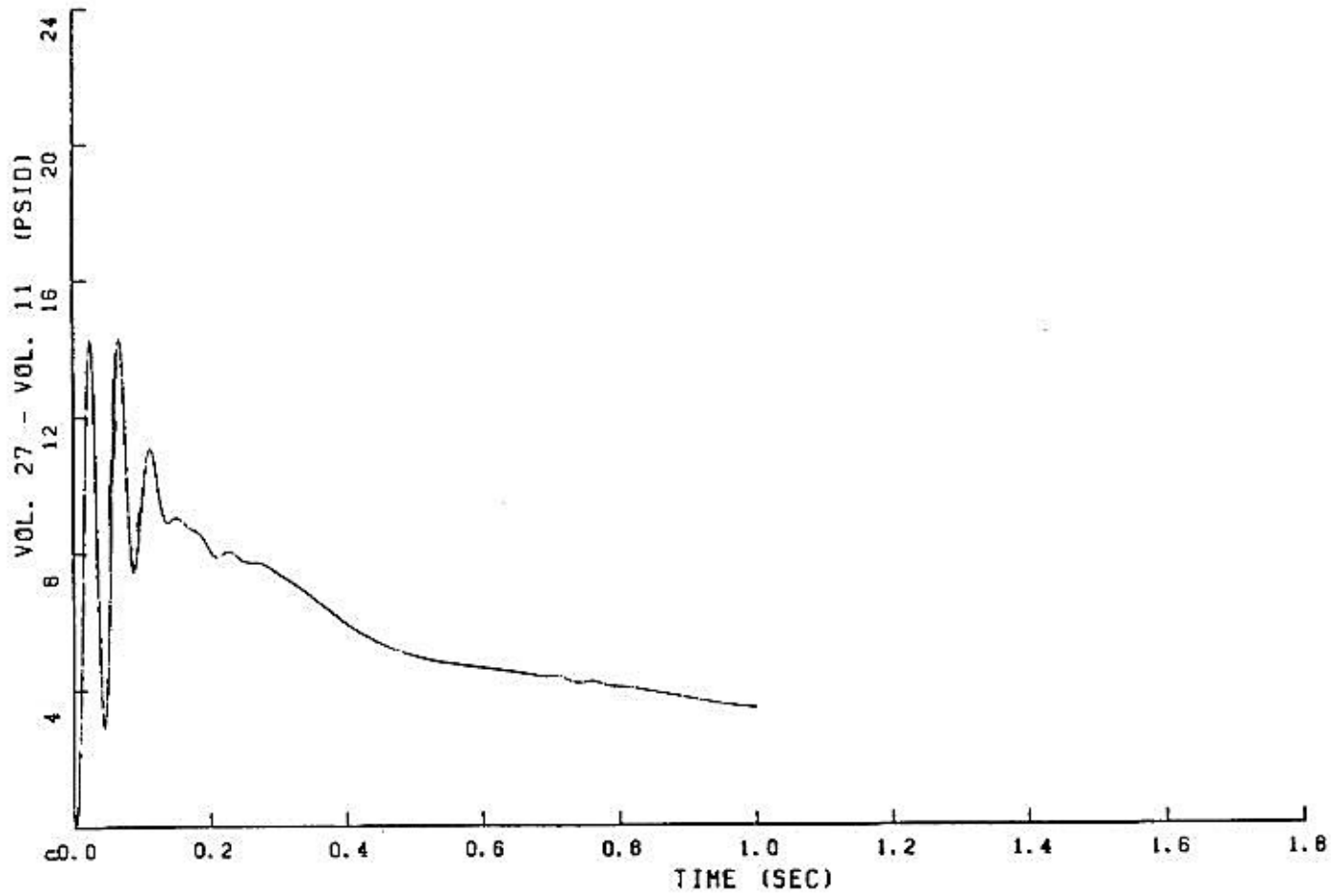

FIGURE 6.2.1-104

PEAK PRESSURE DIFFERENTIAL IN STEAM GENERATOR LOOP - 1

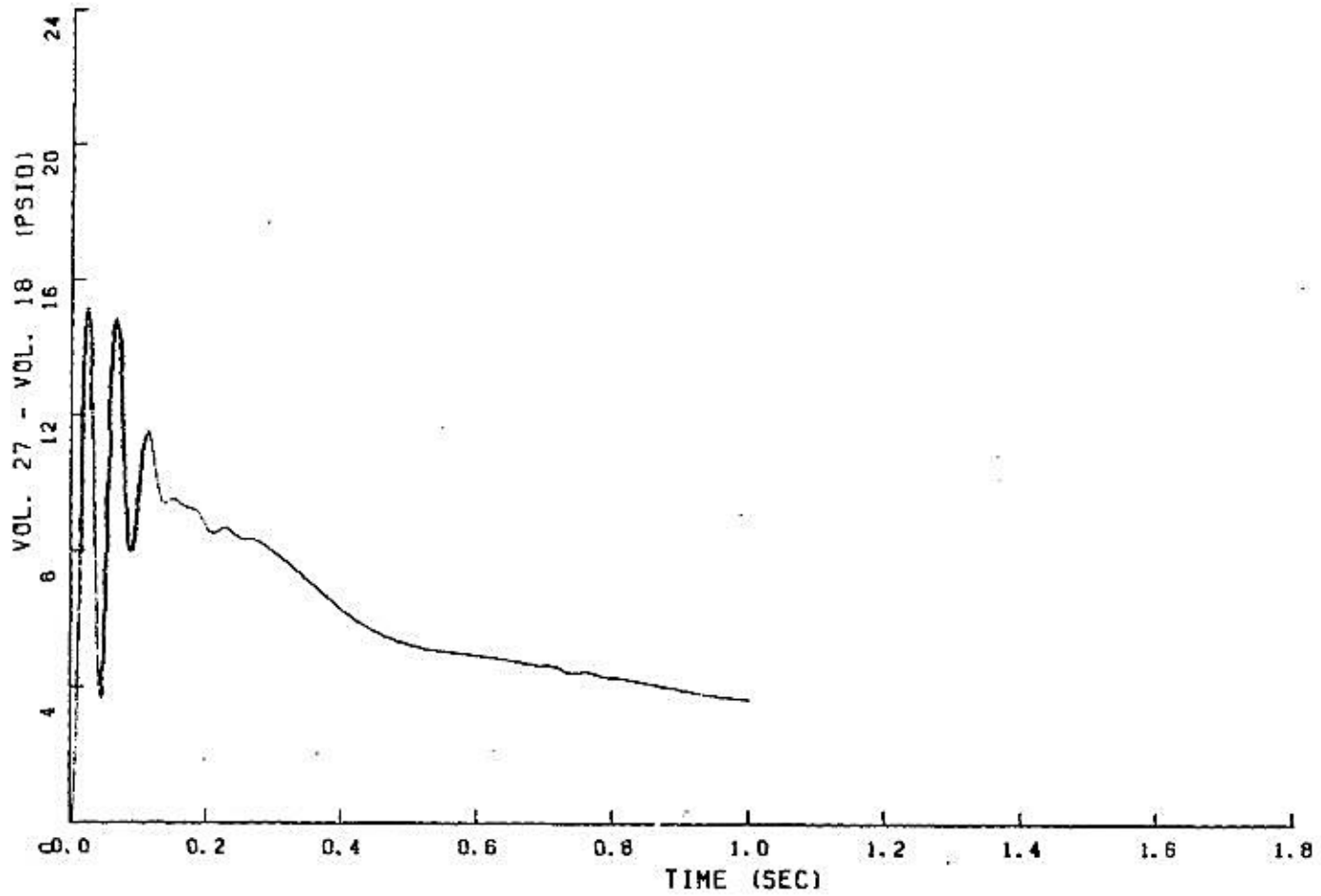

FIGURE 6.2.1-105

PEAK PRESSURE DIFFERENTIAL IN STEAM GENERATOR LOOP - 1

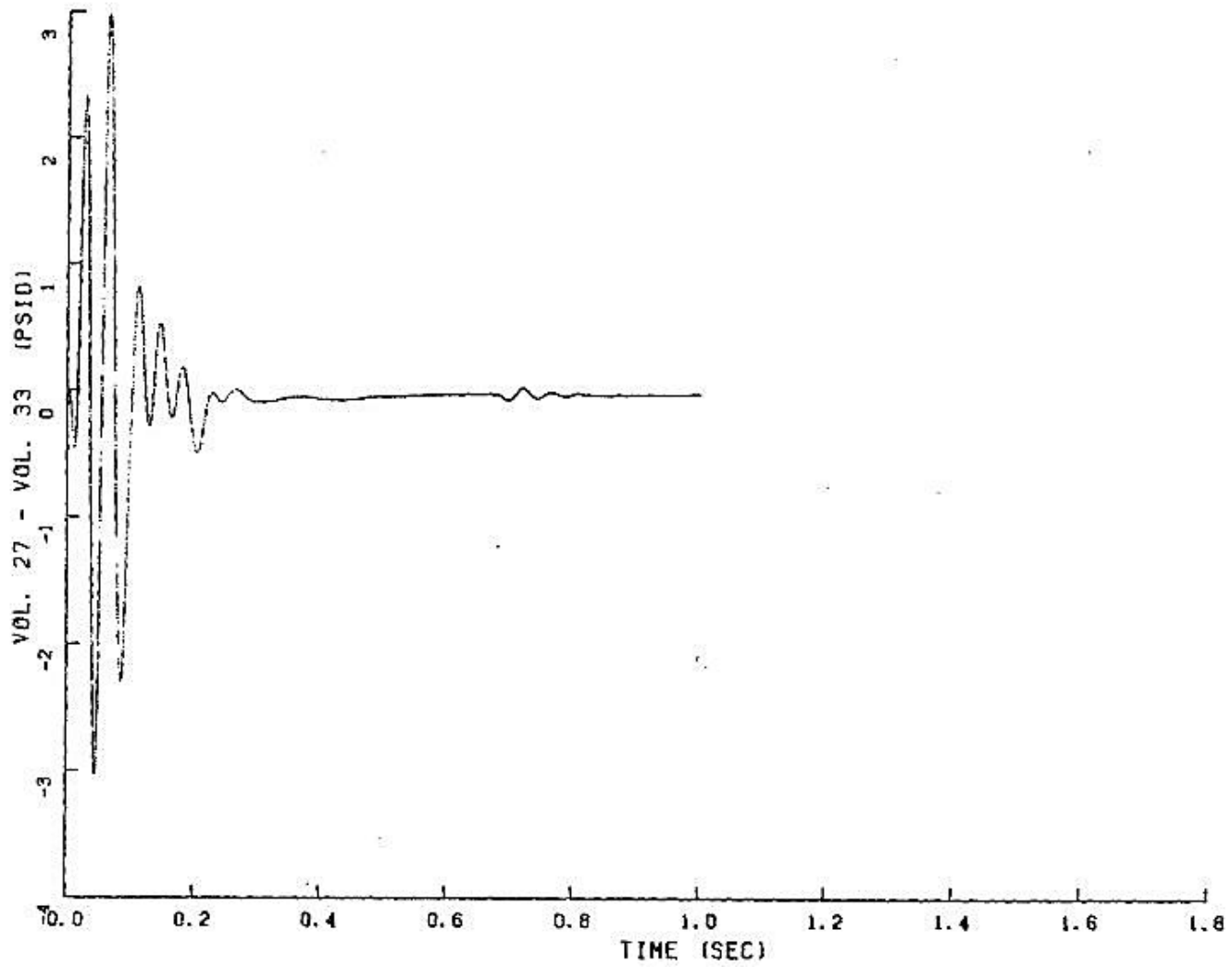

FIGURE 6.2.1-106

PEAK PRESSURE DIFFERENTIAL IN STEAM GENERATOR LOOP - 1

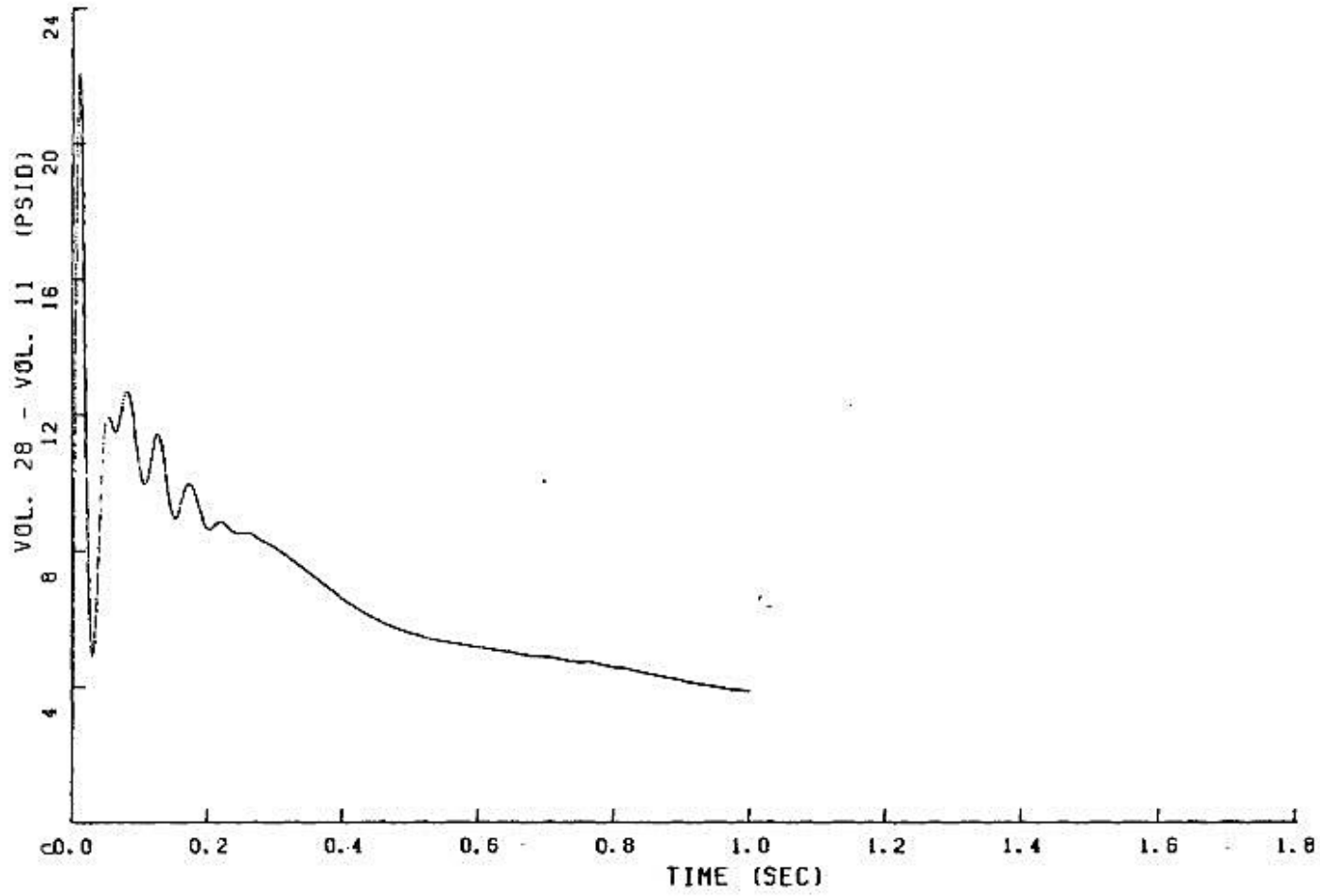

FIGURE 6.2.1-107

PEAK PRESSURE DIFFERENTIAL IN STEAM GENERATOR LOOP - 1

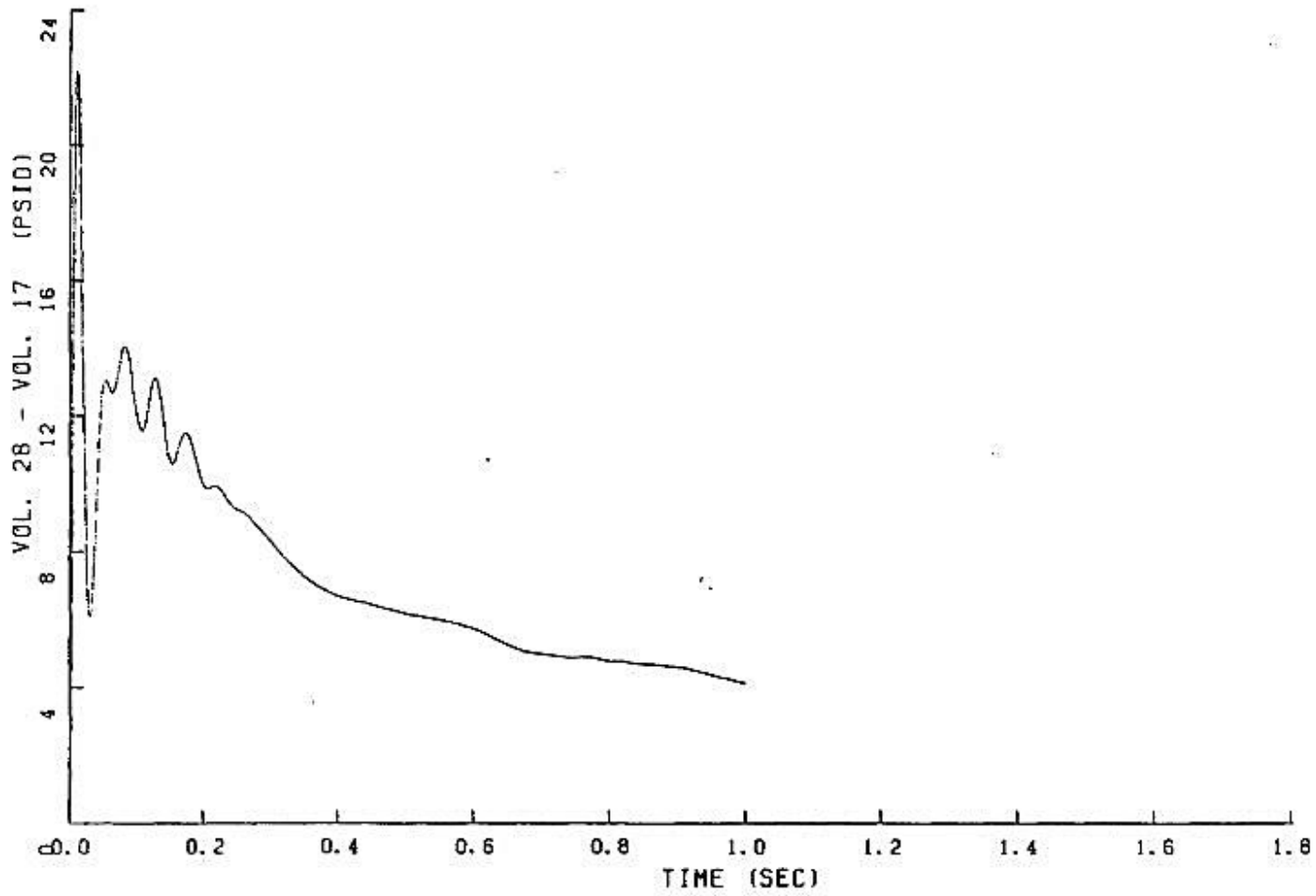

FIGURE 6.2.1-108

PEAK PRESSURE DIFFERENTIAL IN STEAM GENERATOR LOOP - 1

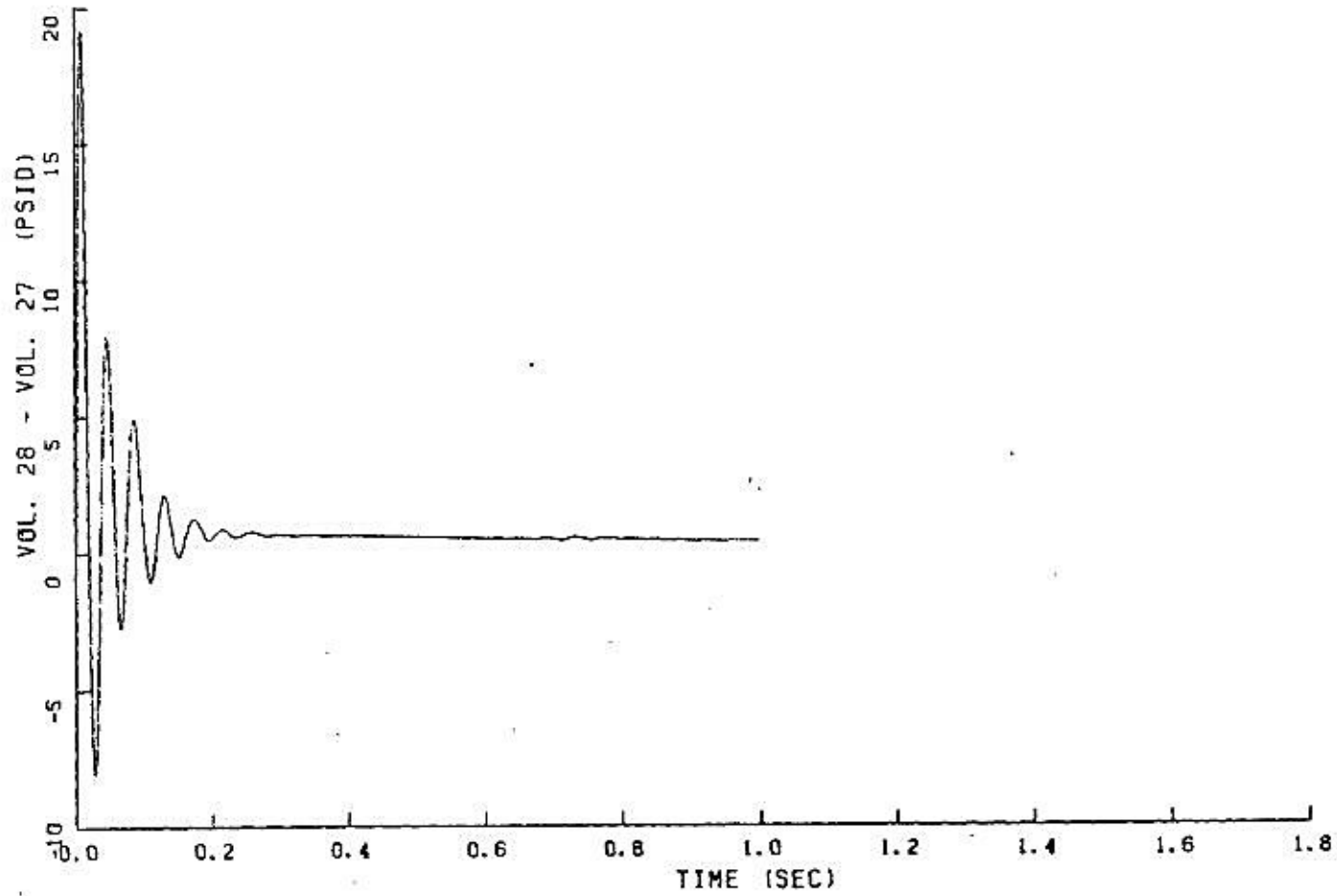

FIGURE 6.2.1-109

PEAK PRESSURE DIFFERENTIAL IN STEAM GENERATOR LOOP – 1

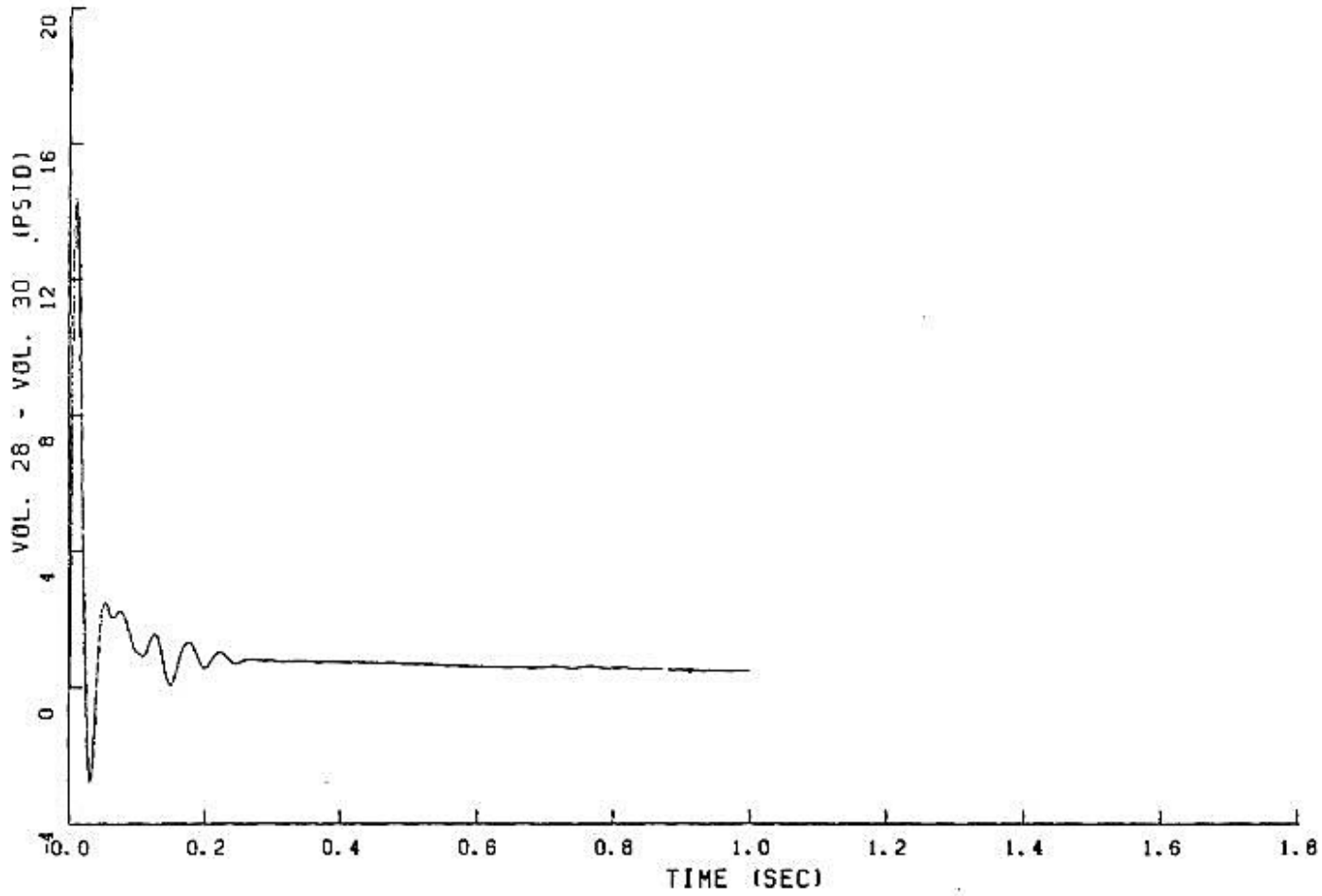

FIGURE 6.2.1-110

PEAK PRESSURE DIFFERENTIAL IN STEAM GENERATOR LOOP - 1

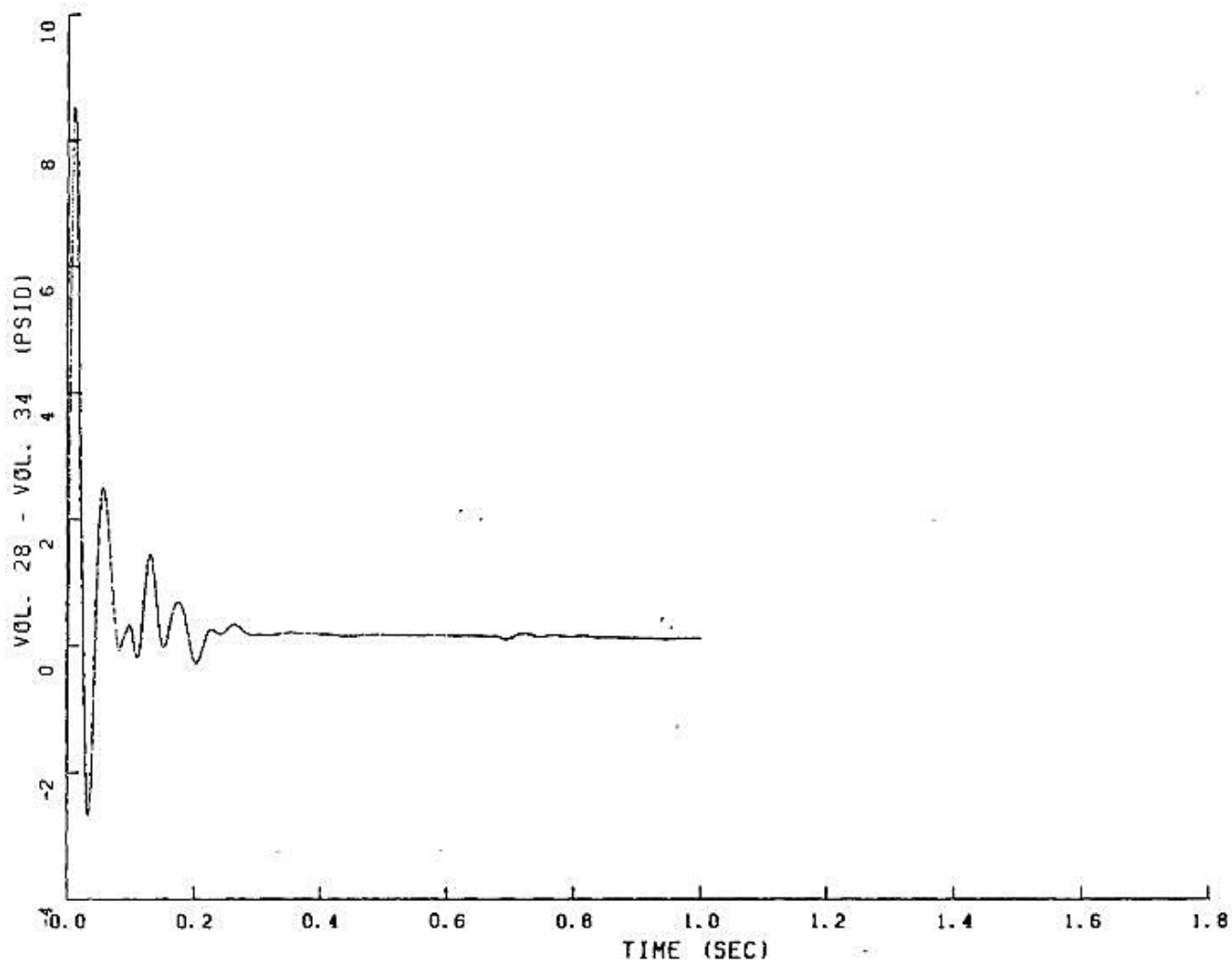

FIGURE 6.2.1-111

PEAK PRESSURE DIFFERENTIAL IN STEAM GENERATOR LOOP - 1

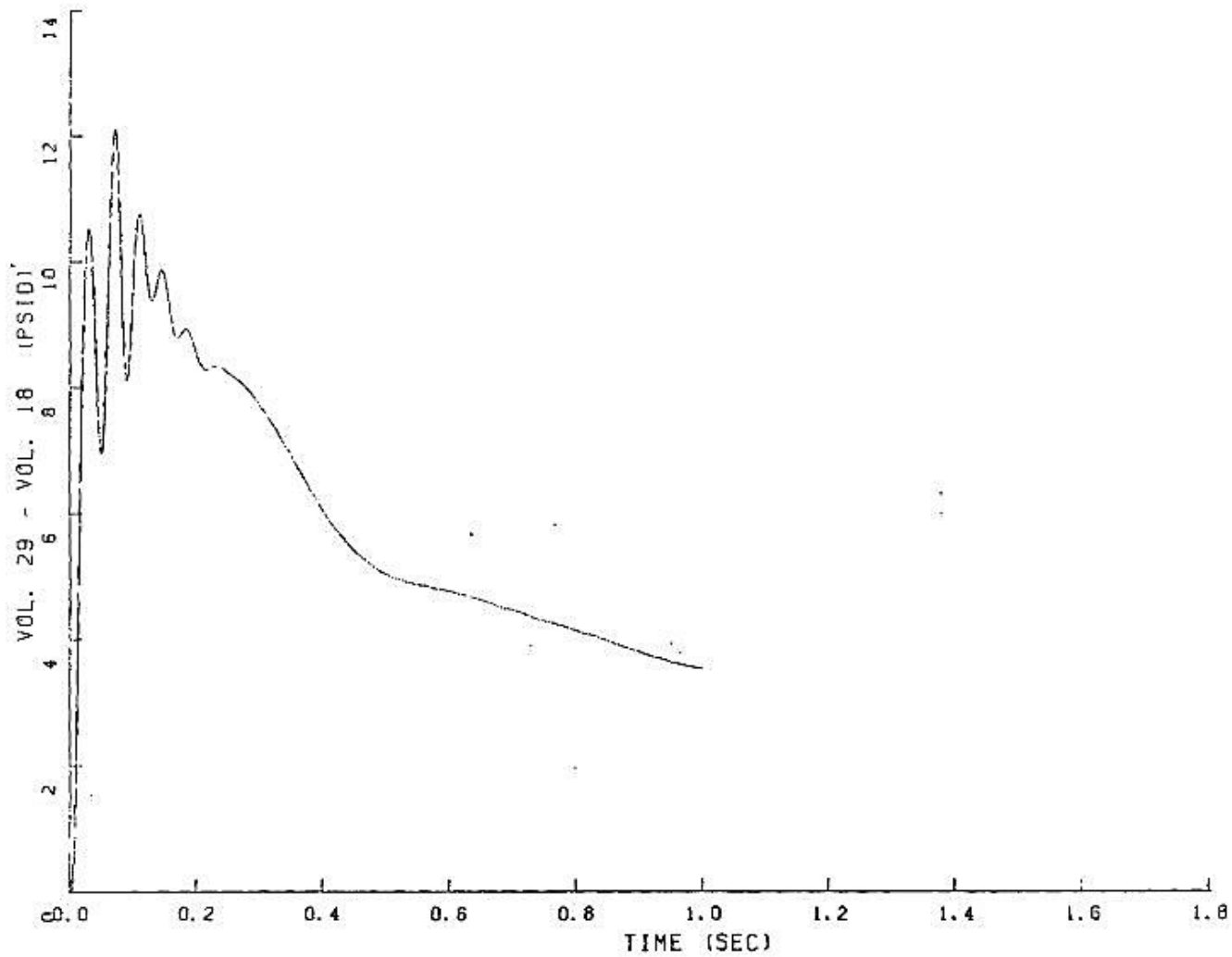

FIGURE 6.2.1-112

PEAK PRESSURE DIFFERENTIAL IN STEAM GENERATOR LOOP - 1

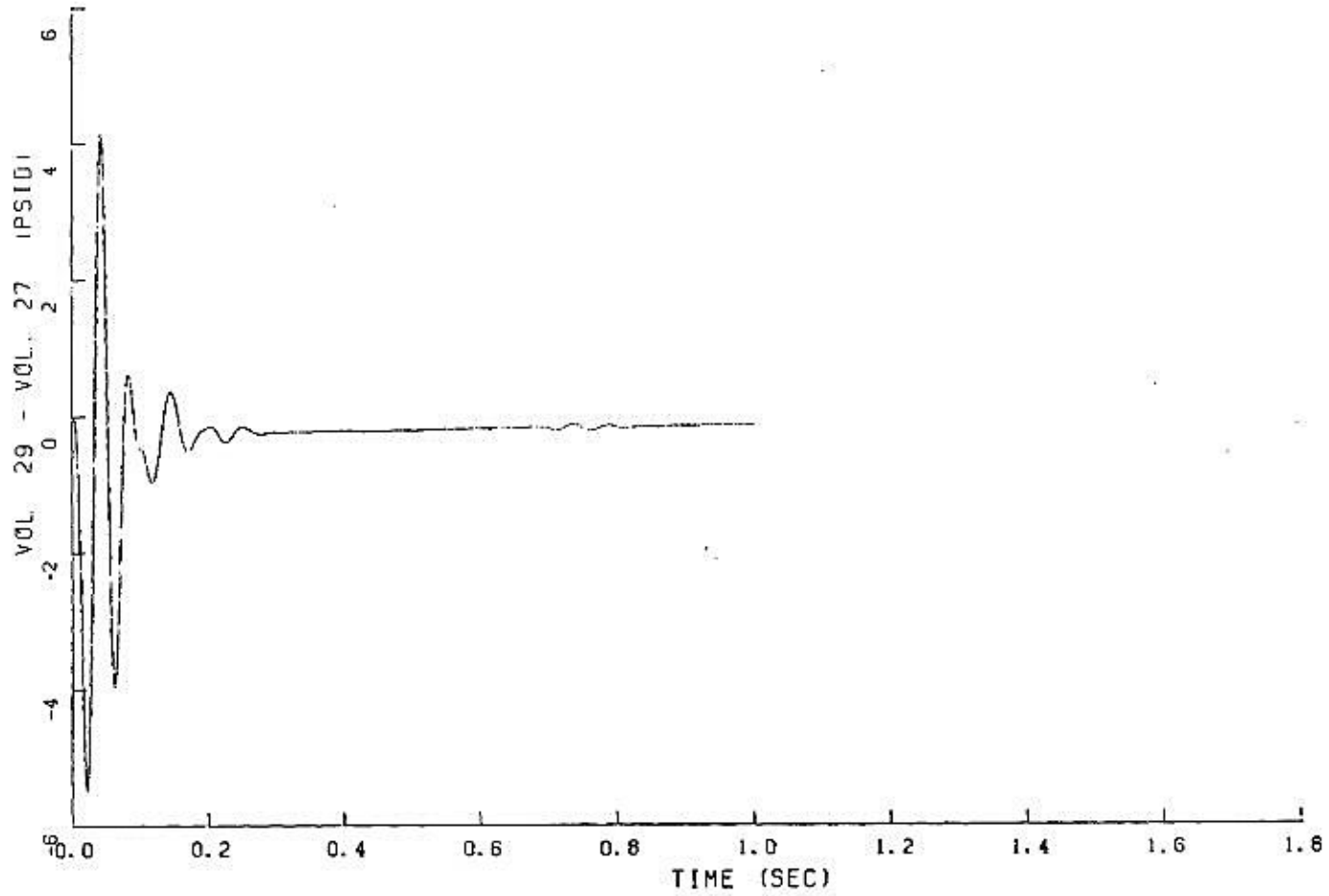

FIGURE 6.2.1-113

PEAK PRESSURE DIFFERENTIAL IN STEAM GENERATOR LOOP - 1

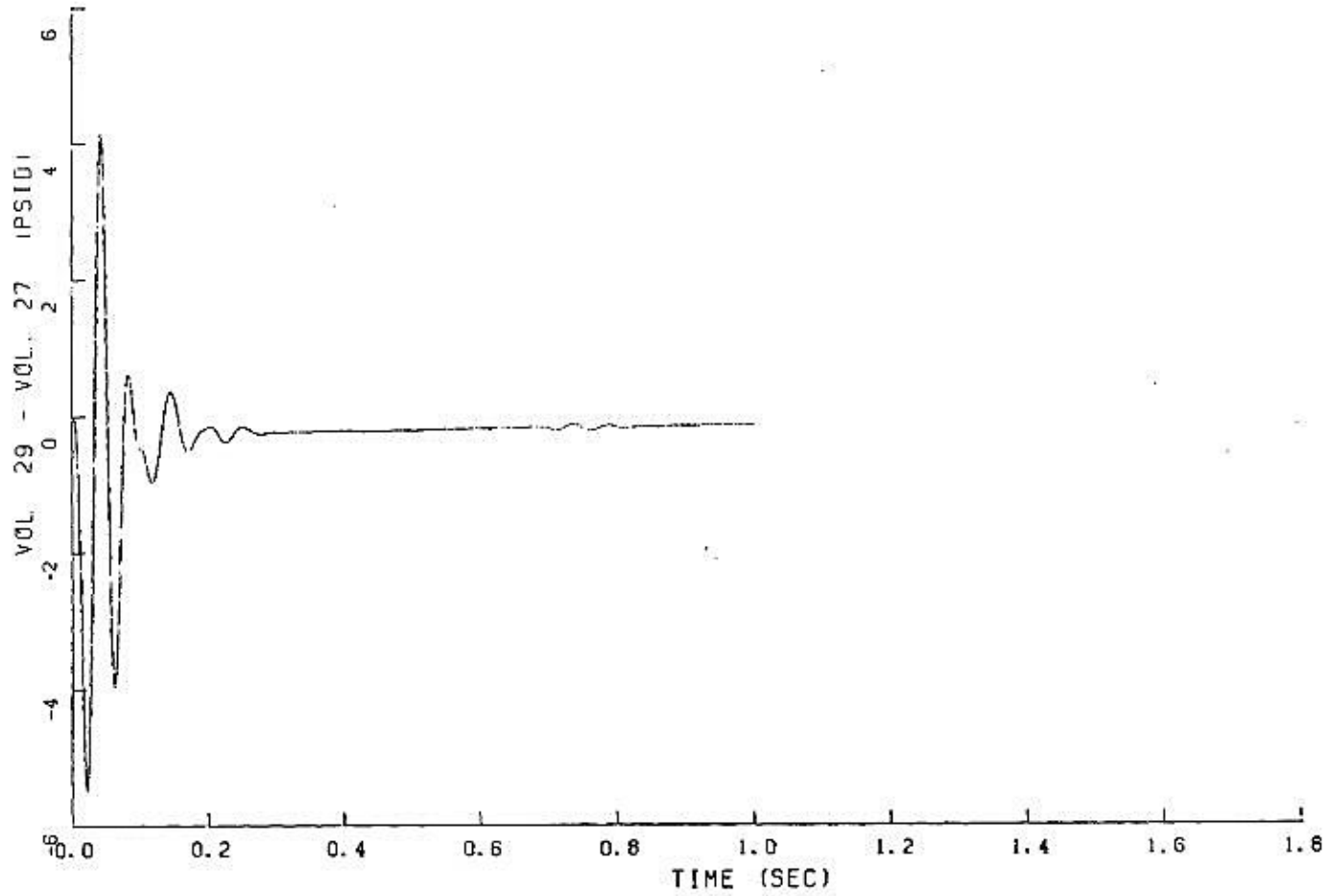

FIGURE 6.2.1-114

PEAK PRESSURE DIFFERENTIAL IN STEAM GENERATOR LOOP - 1

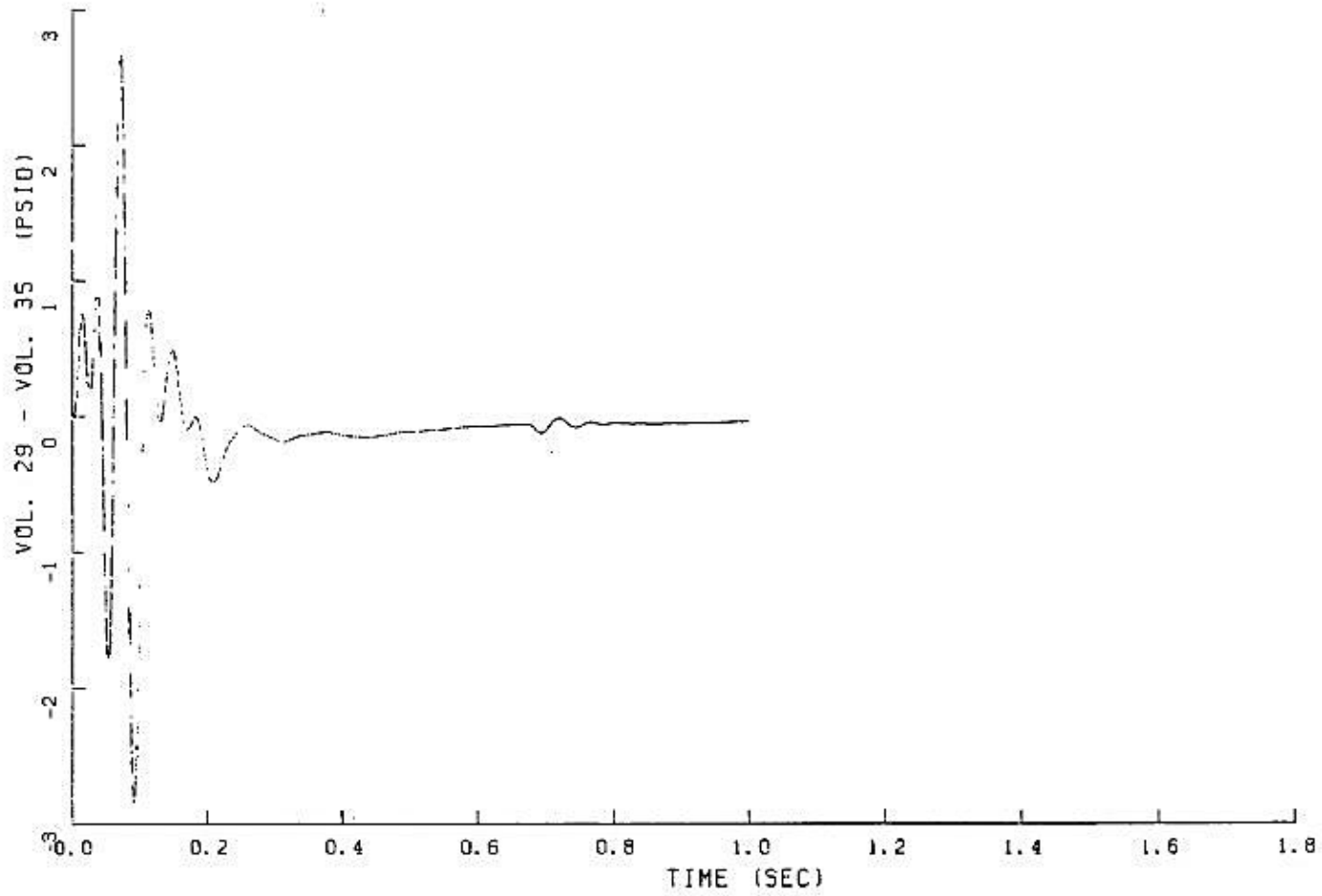

FIGURE 6.2.1-115

PEAK PRESSURE DIFFERENTIAL IN STEAM GENERATOR LOOP - 1

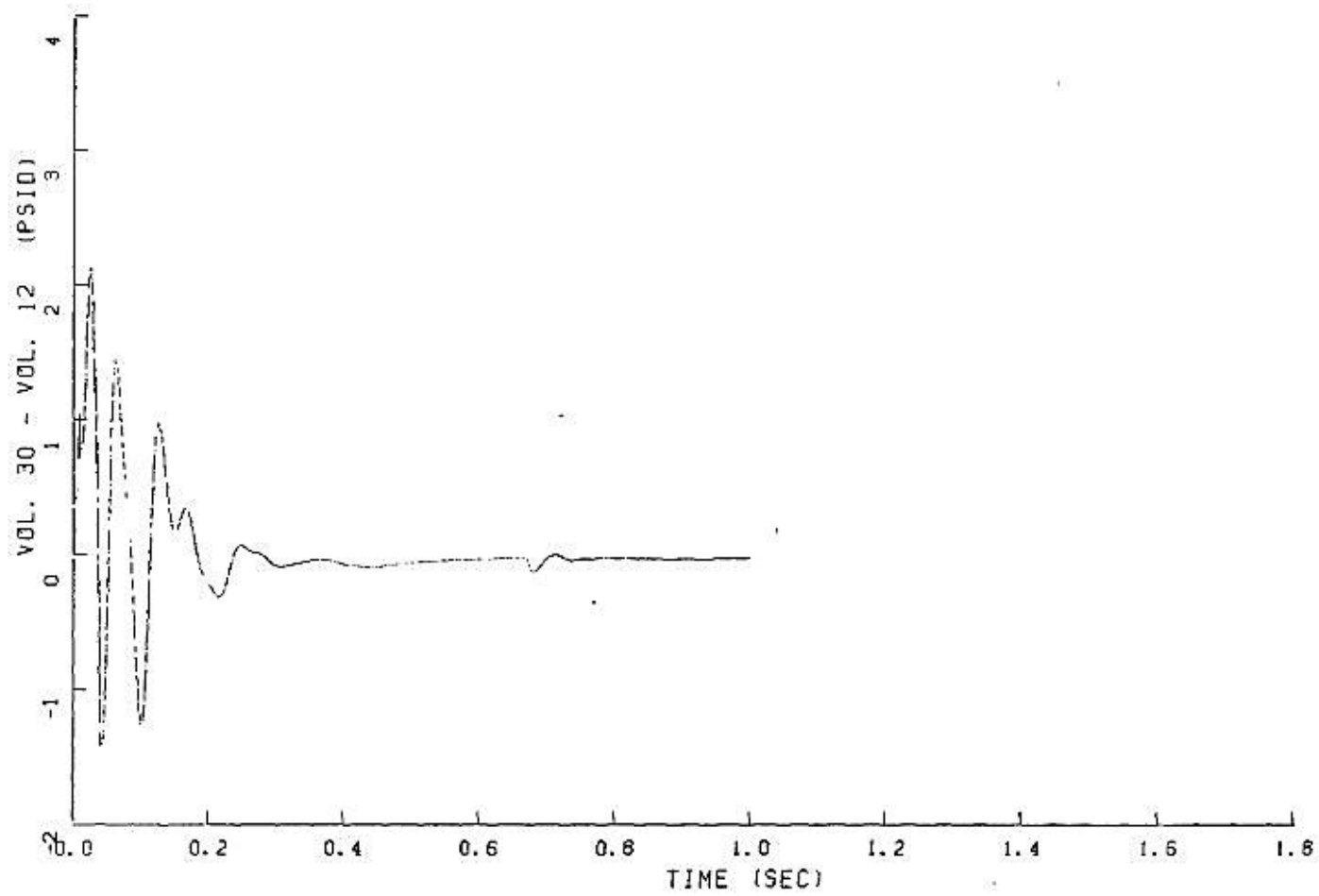

FIGURE 6.2.1-116

PEAK PRESSURE DIFFERENTIAL IN STEAM GENERATOR LOOP - 1

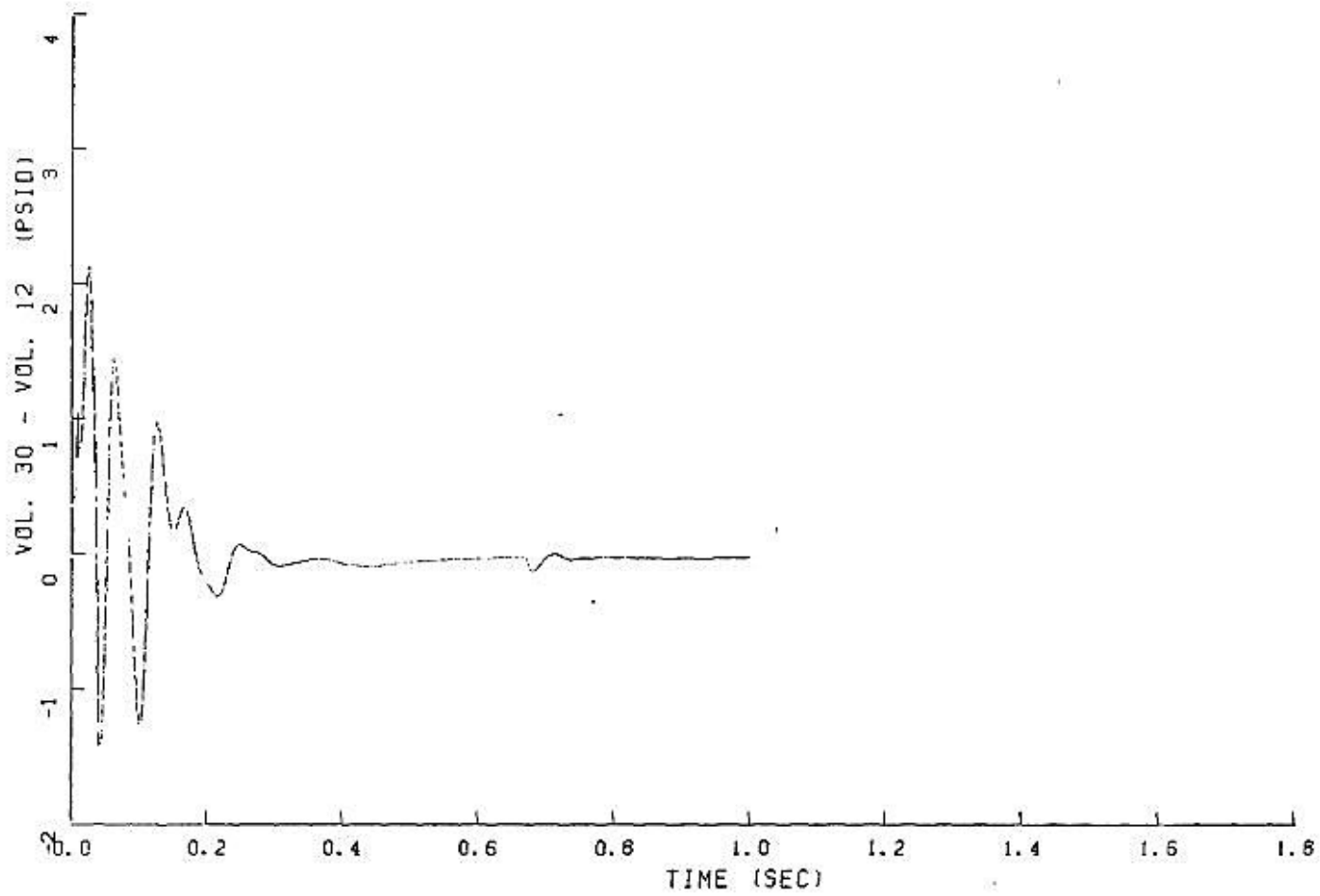

FIGURE 6.2.1-117

PEAK PRESSURE DIFFERENTIAL IN STEAM GENERATOR LOOP - 1

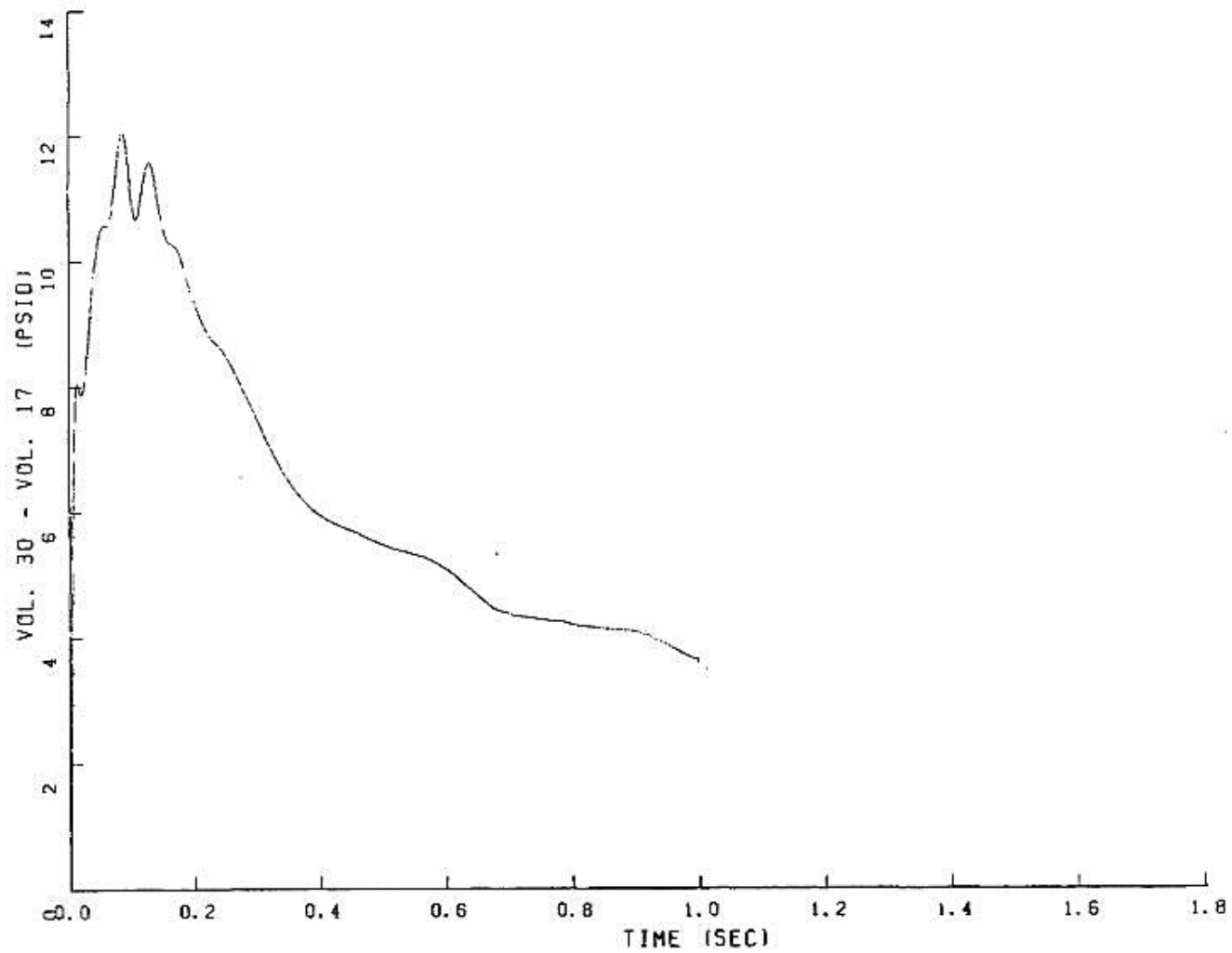

FIGURE 6.2.1-118

PEAK PRESSURE DIFFERENTIAL IN STEAM GENERATOR LOOP – 1

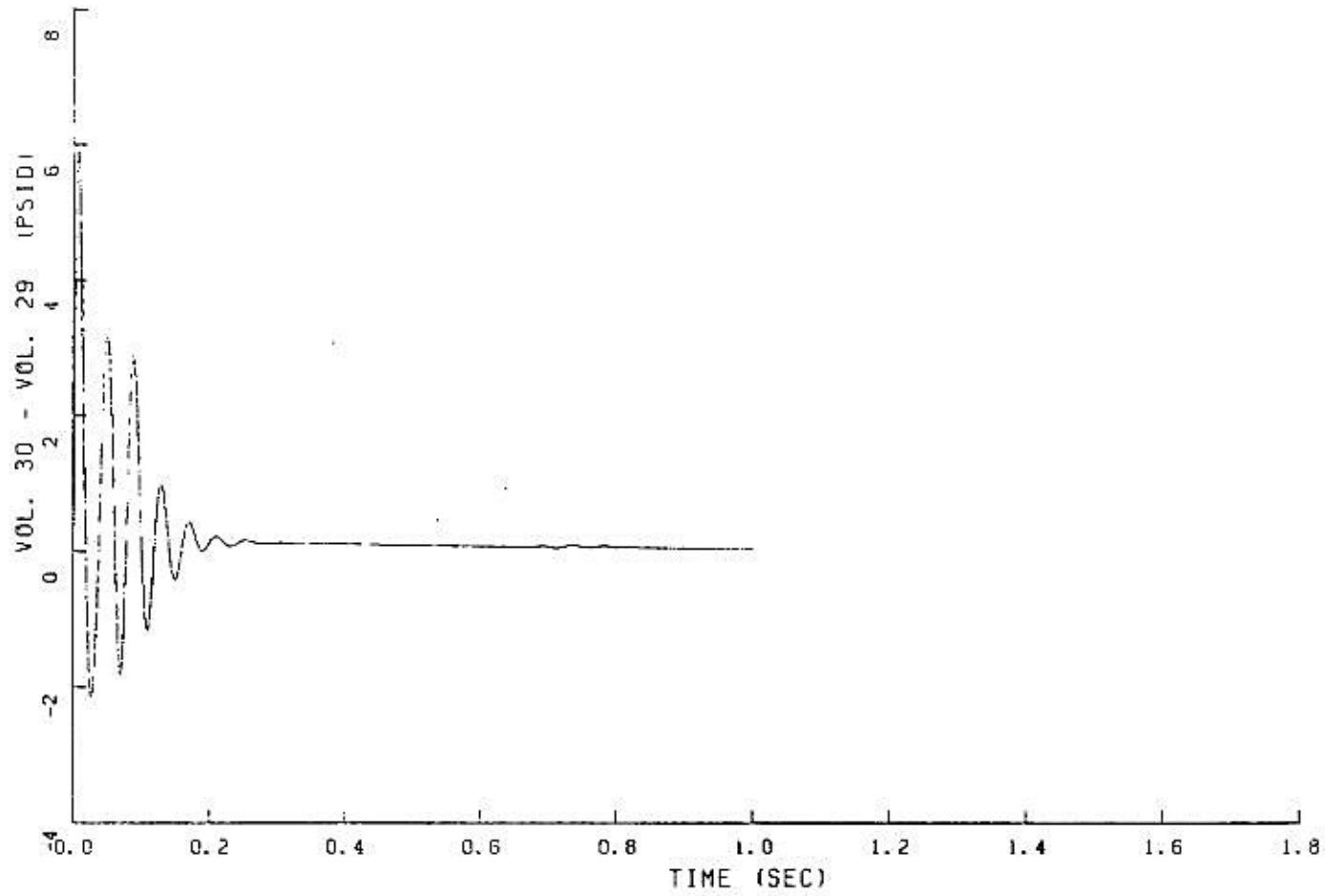

FIGURE 6.2.1-119

PEAK PRESSURE DIFFERENTIAL IN STEAM GENERATOR LOOP - 1

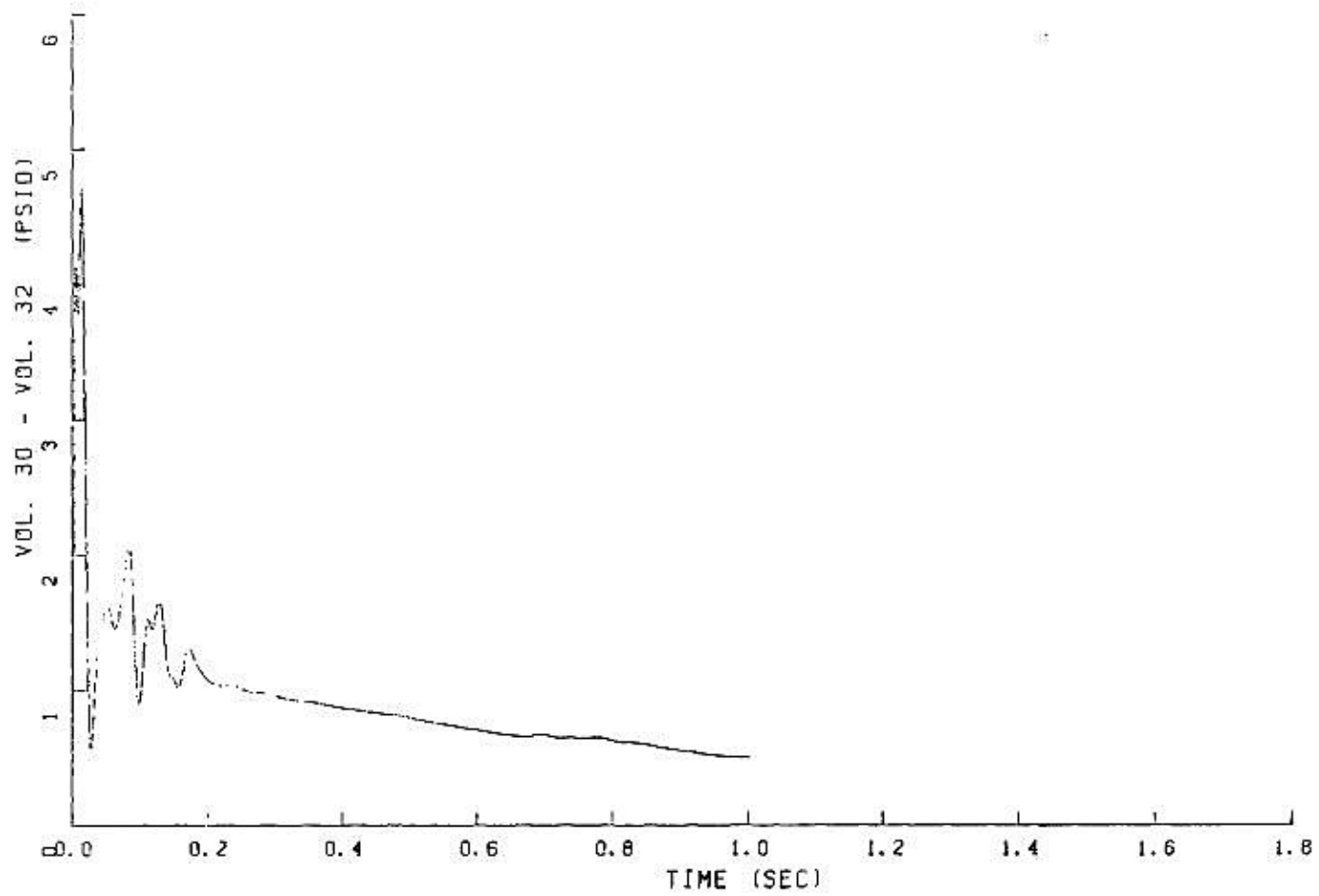

FIGURE 6.2.1-120

PEAK PRESSURE DIFFERENTIAL IN STEAM GENERATOR LOOP - 1

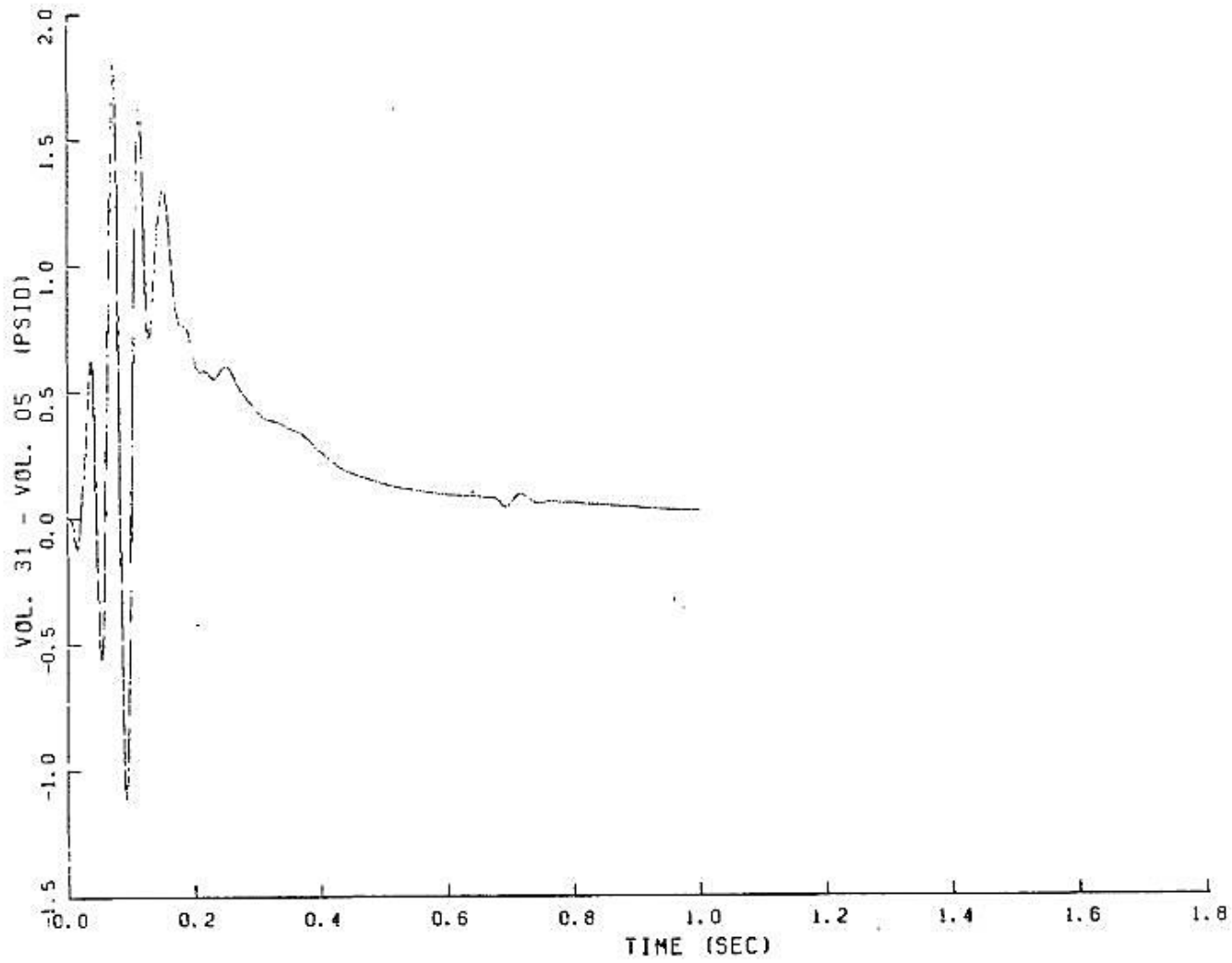

FIGURE 6.2.1-121

PEAK PRESSURE DIFFERENTIAL IN STEAM GENERATOR LOOP - 1

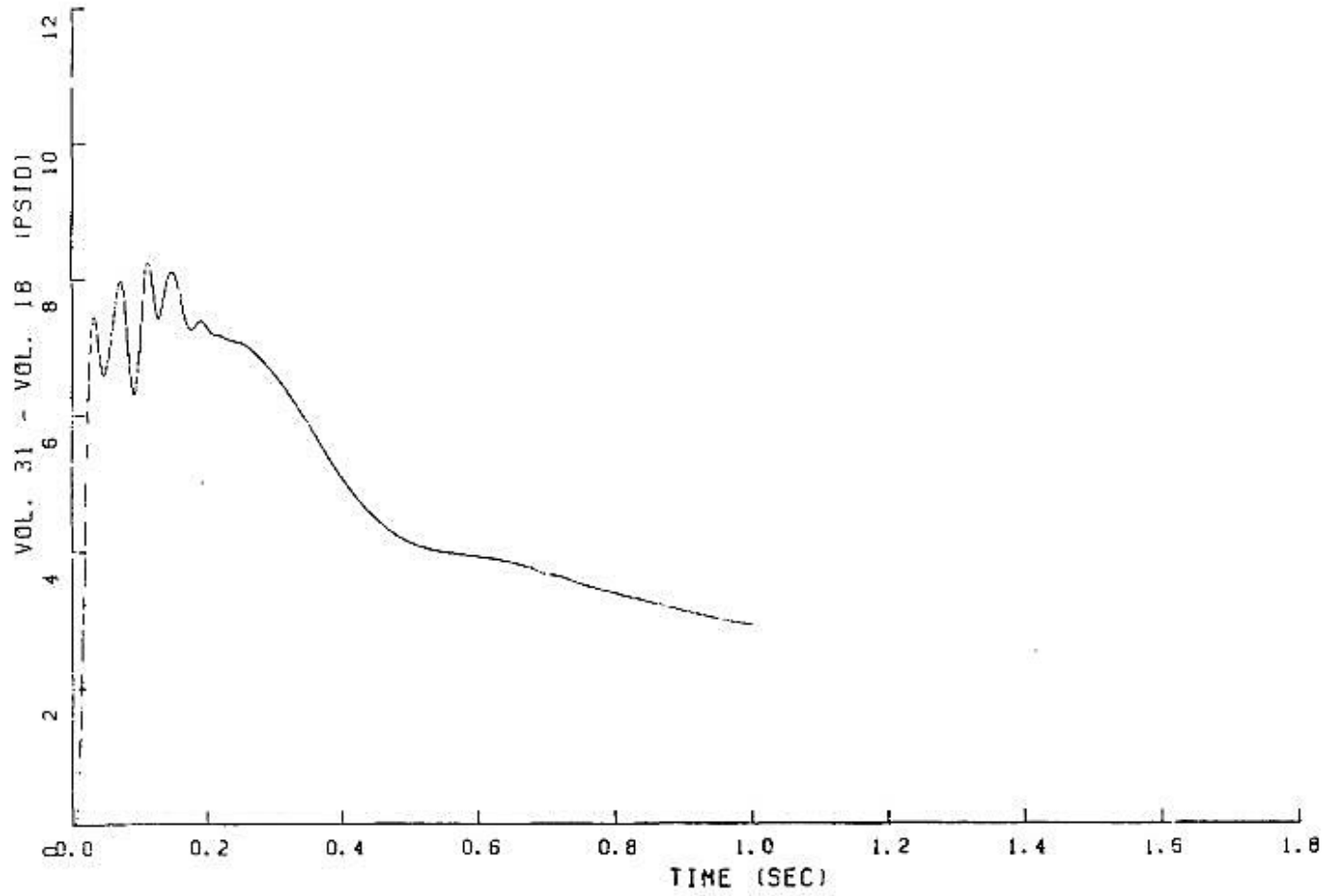

FIGURE 6.2.1-122

PEAK PRESSURE DIFFERENTIAL IN STEAM GENERATOR LOOP - 1

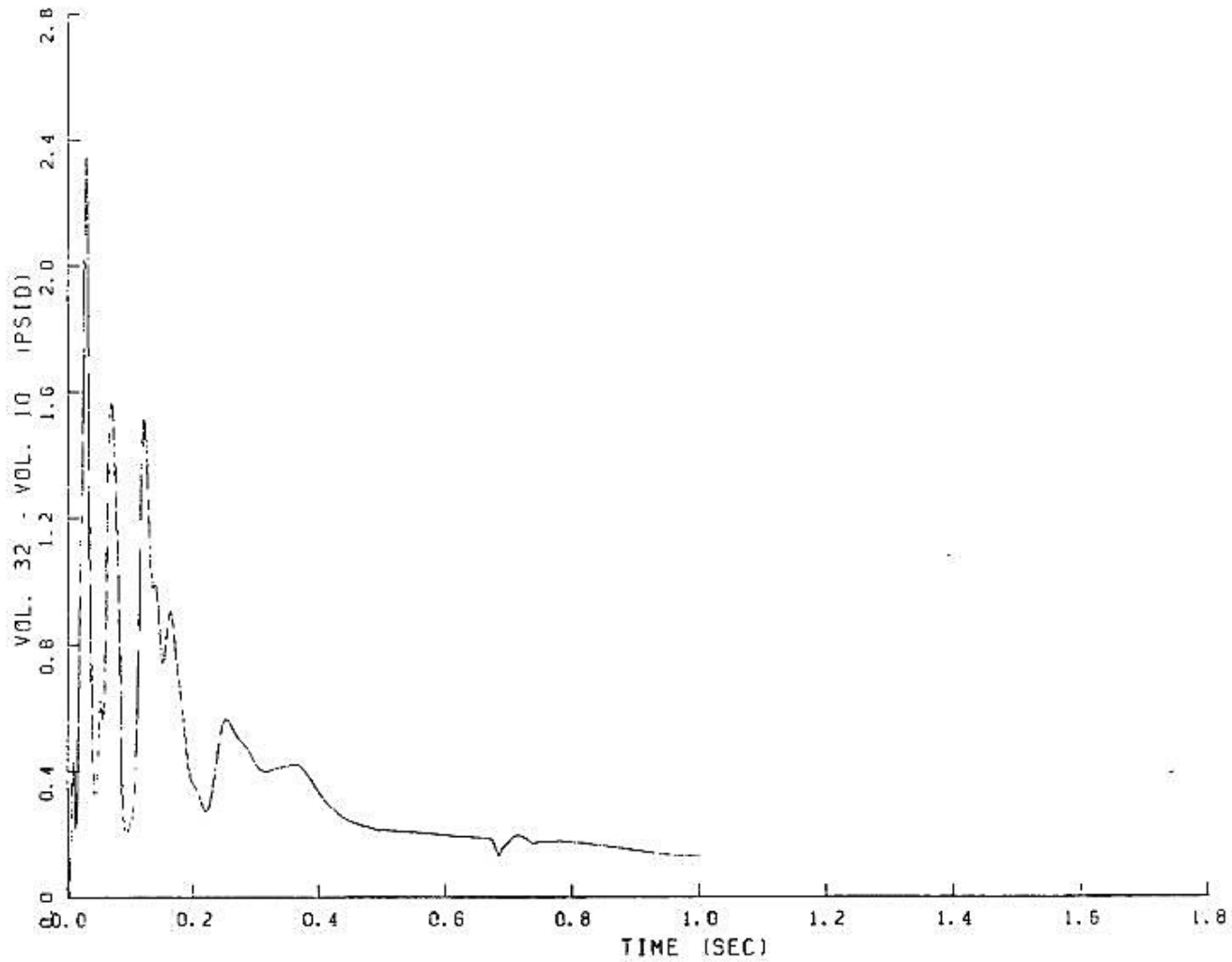

FIGURE 6.2.1-123

PEAK PRESSURE DIFFERENTIAL IN STEAM GENERATOR LOOP - 1

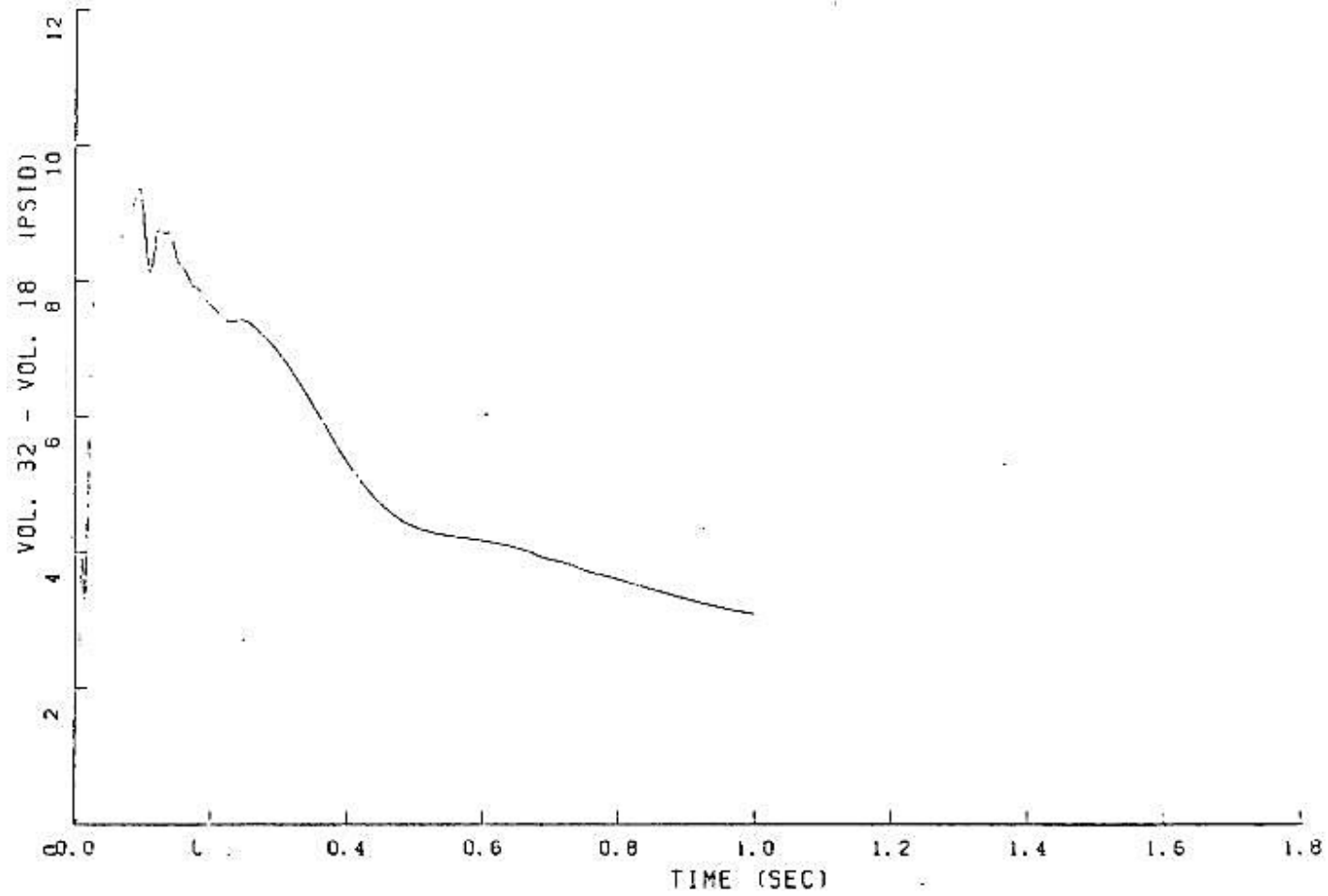

FIGURE 6.2.1-124

PEAK PRESSURE DIFFERENTIAL IN STEAM GENERATOR LOOP - 1

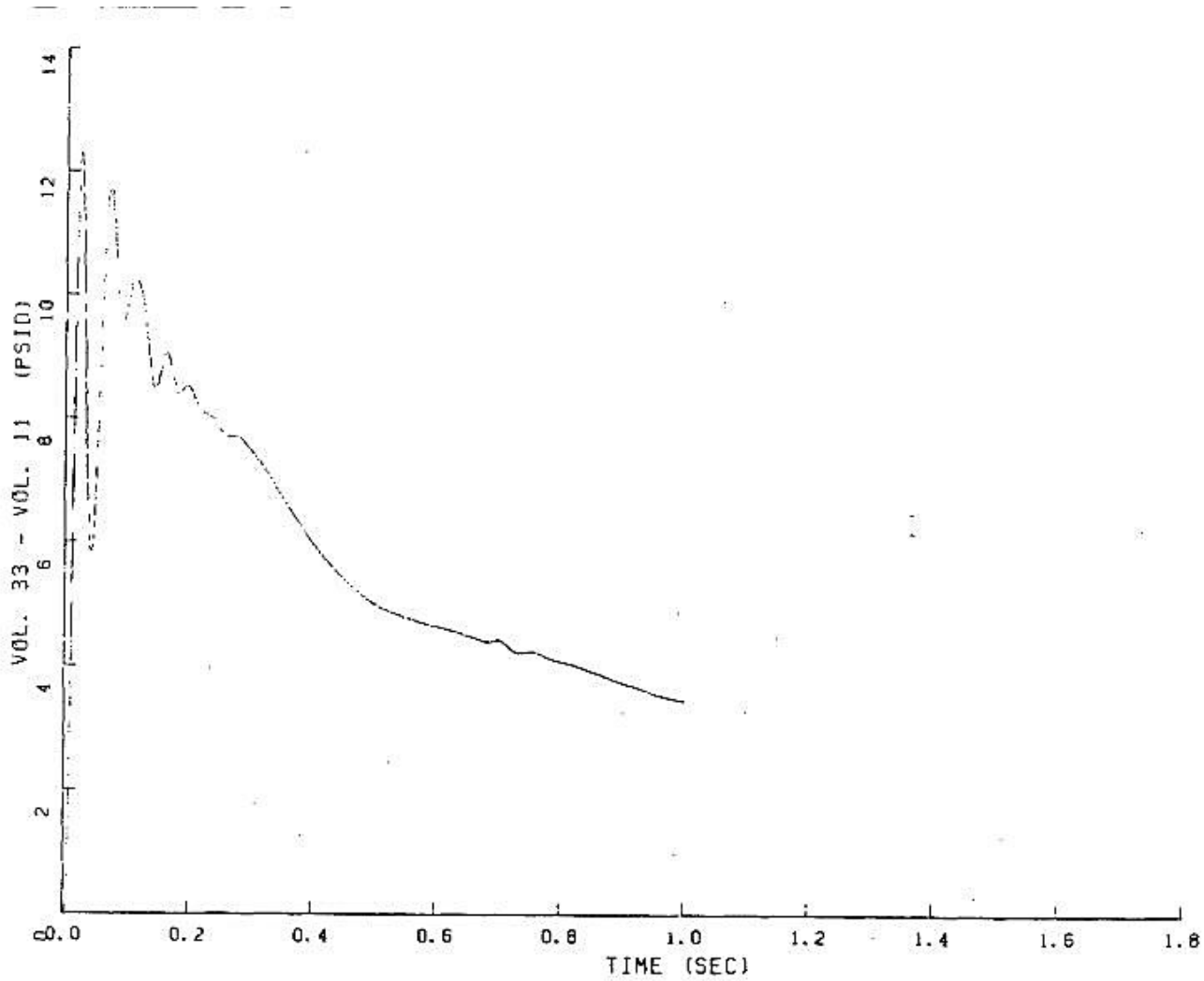

FIGURE 6.2.1-125

PEAK PRESSURE DIFFERENTIAL IN STEAM GENERATOR LOOP - 1

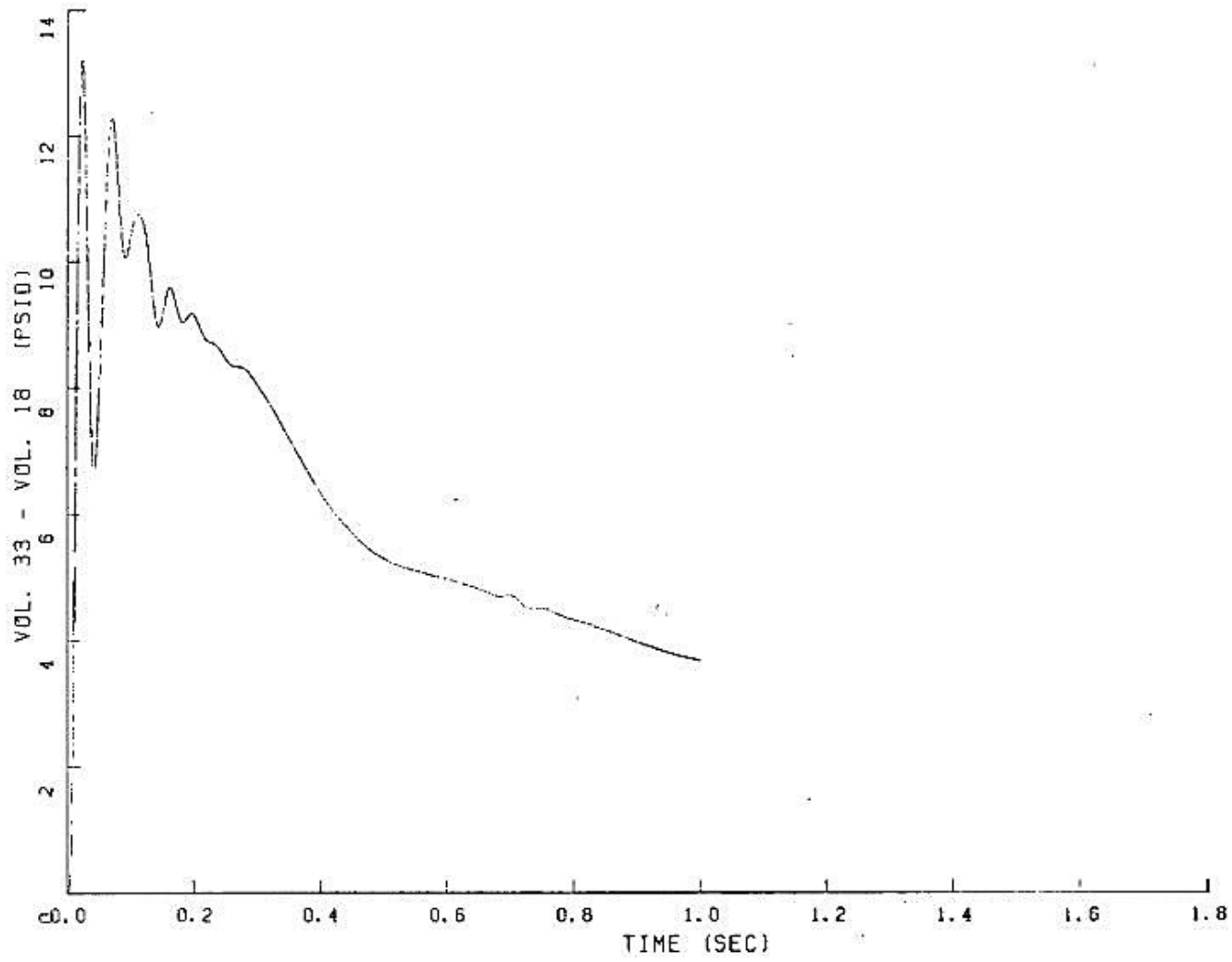

FIGURE 6.2.1-126

PEAK PRESSURE DIFFERENTIAL IN STEAM GENERATOR LOOP - 1

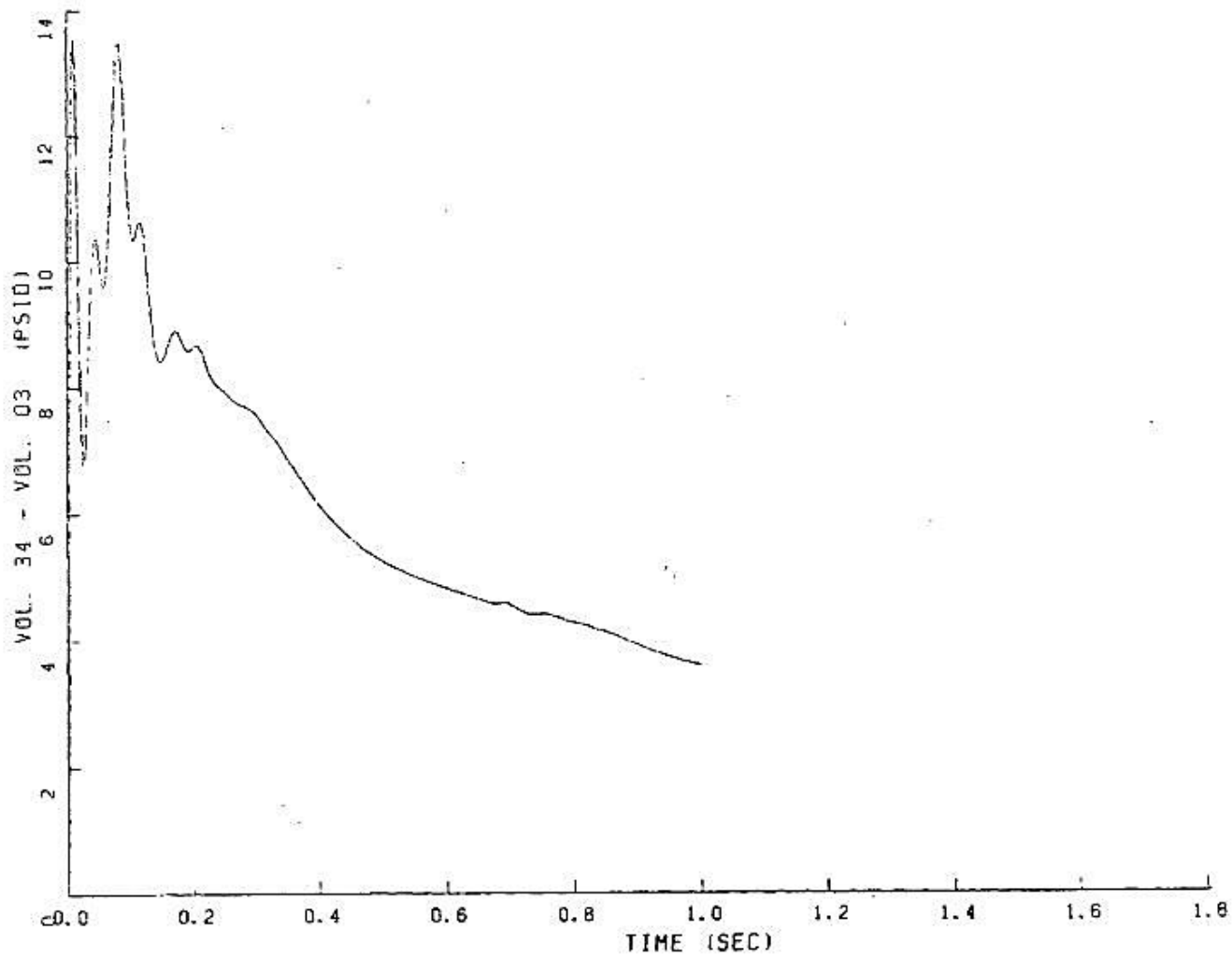

FIGURE 6.2.1-127

PEAK PRESSURE DIFFERENTIAL IN STEAM GENERATOR LOOP - 1

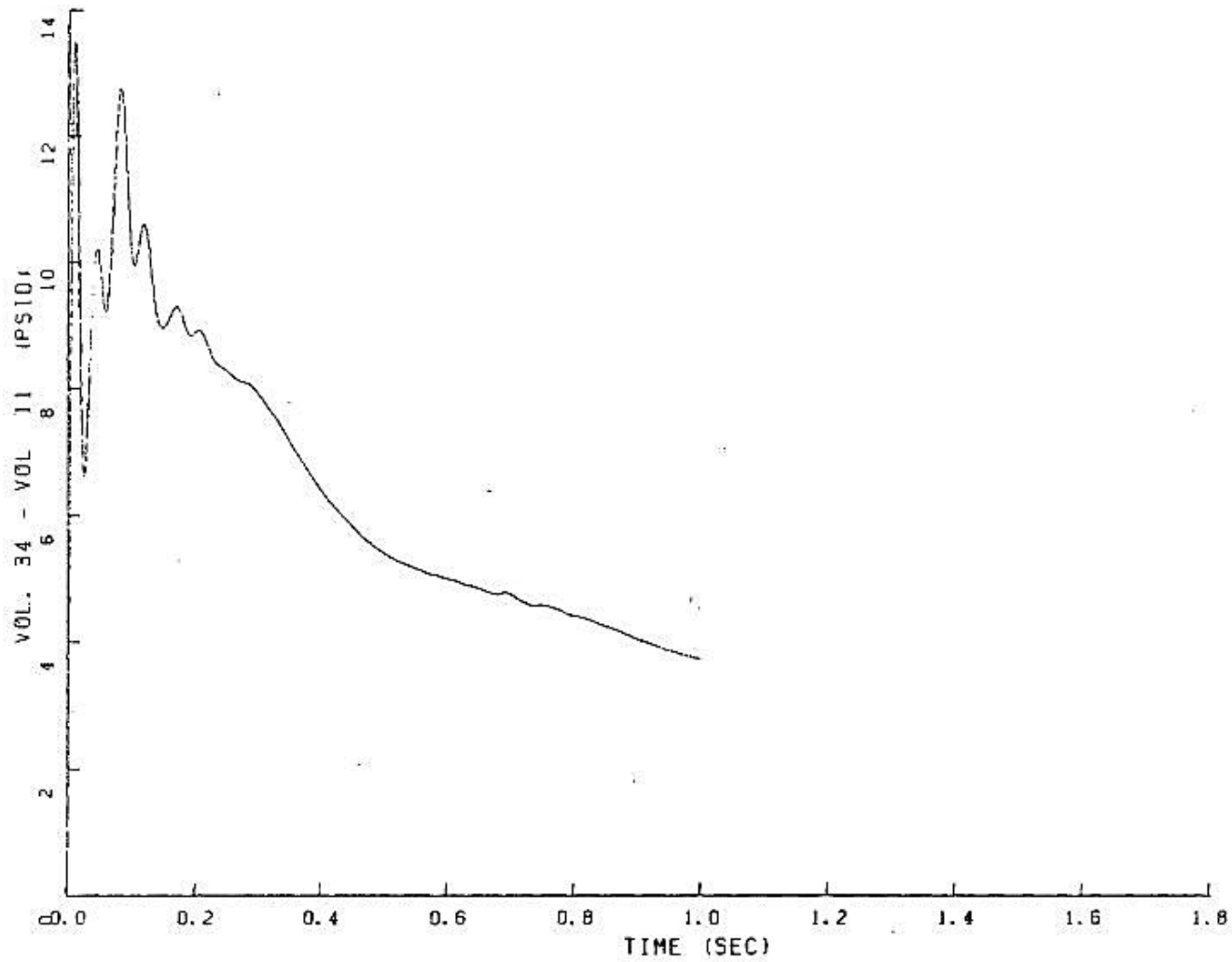

FIGURE 6.2.1-128

PEAK PRESSURE DIFFERENTIAL IN STEAM GENERATOR LOOP - 1

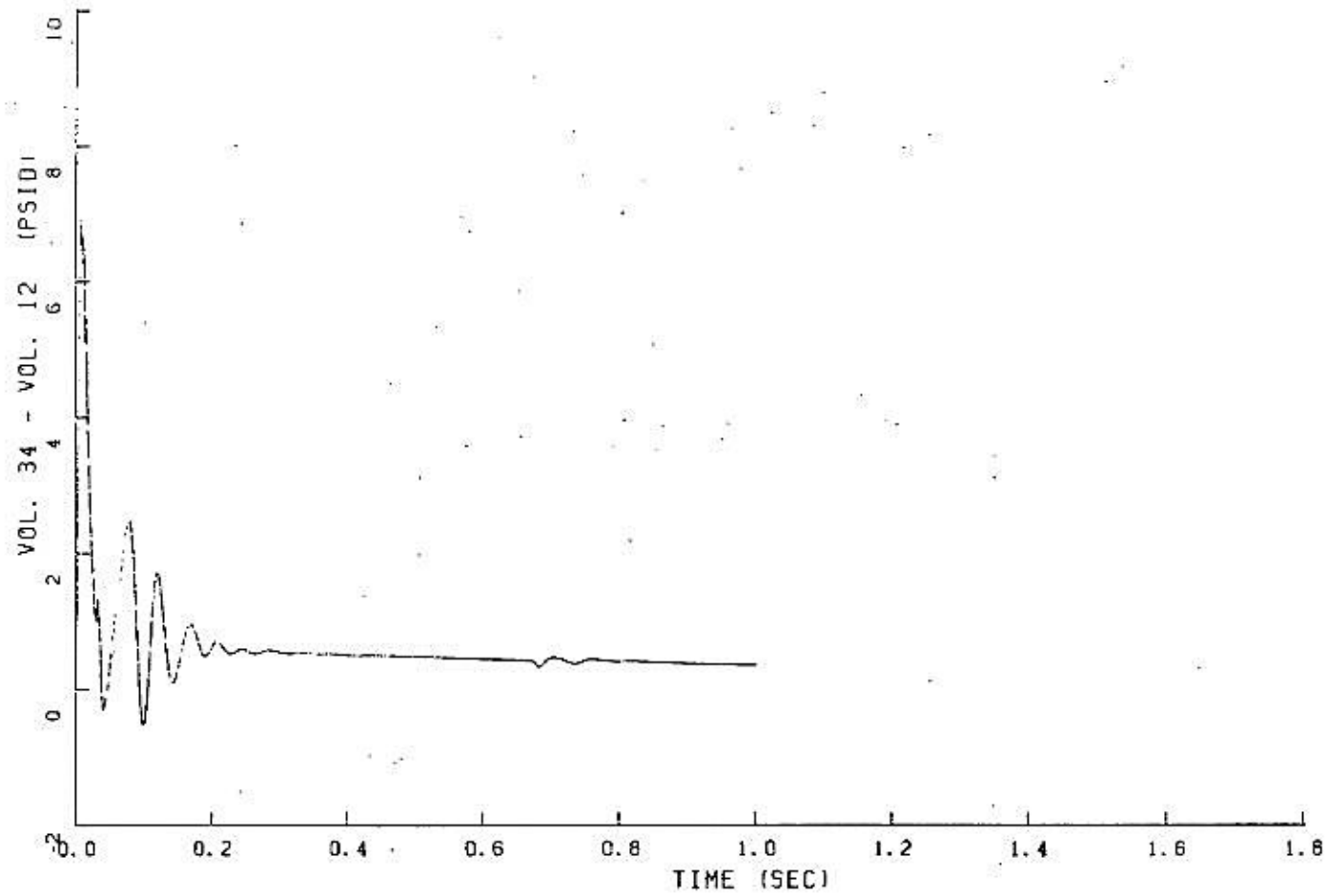

FIGURE 6.2.1-129

PEAK PRESSURE DIFFERENTIAL IN STEAM GENERATOR LOOP - 1

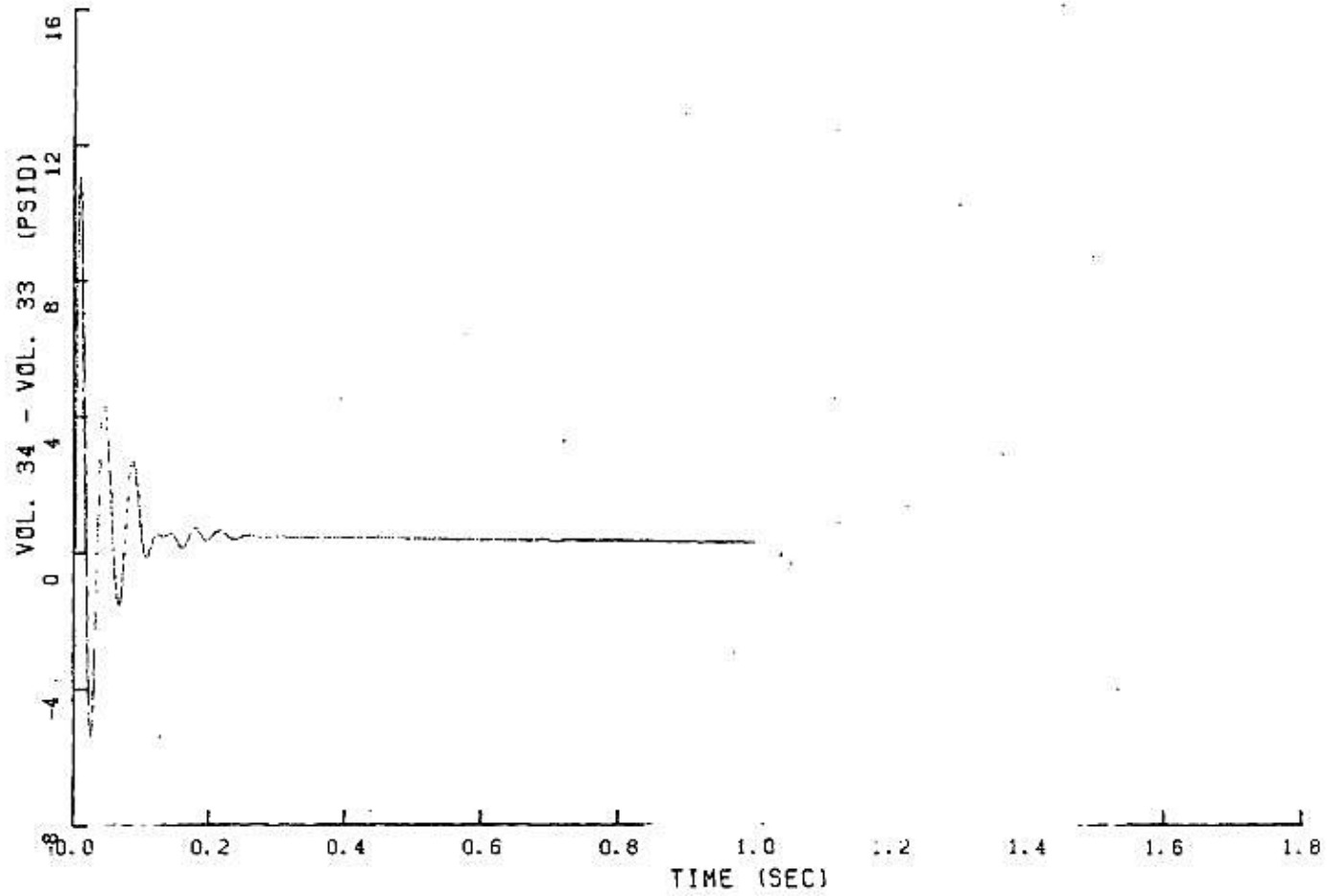

FIGURE 6.2.1-131

PEAK PRESSURE DIFFERENTIAL IN STEAM GENERATOR LOOP - 1

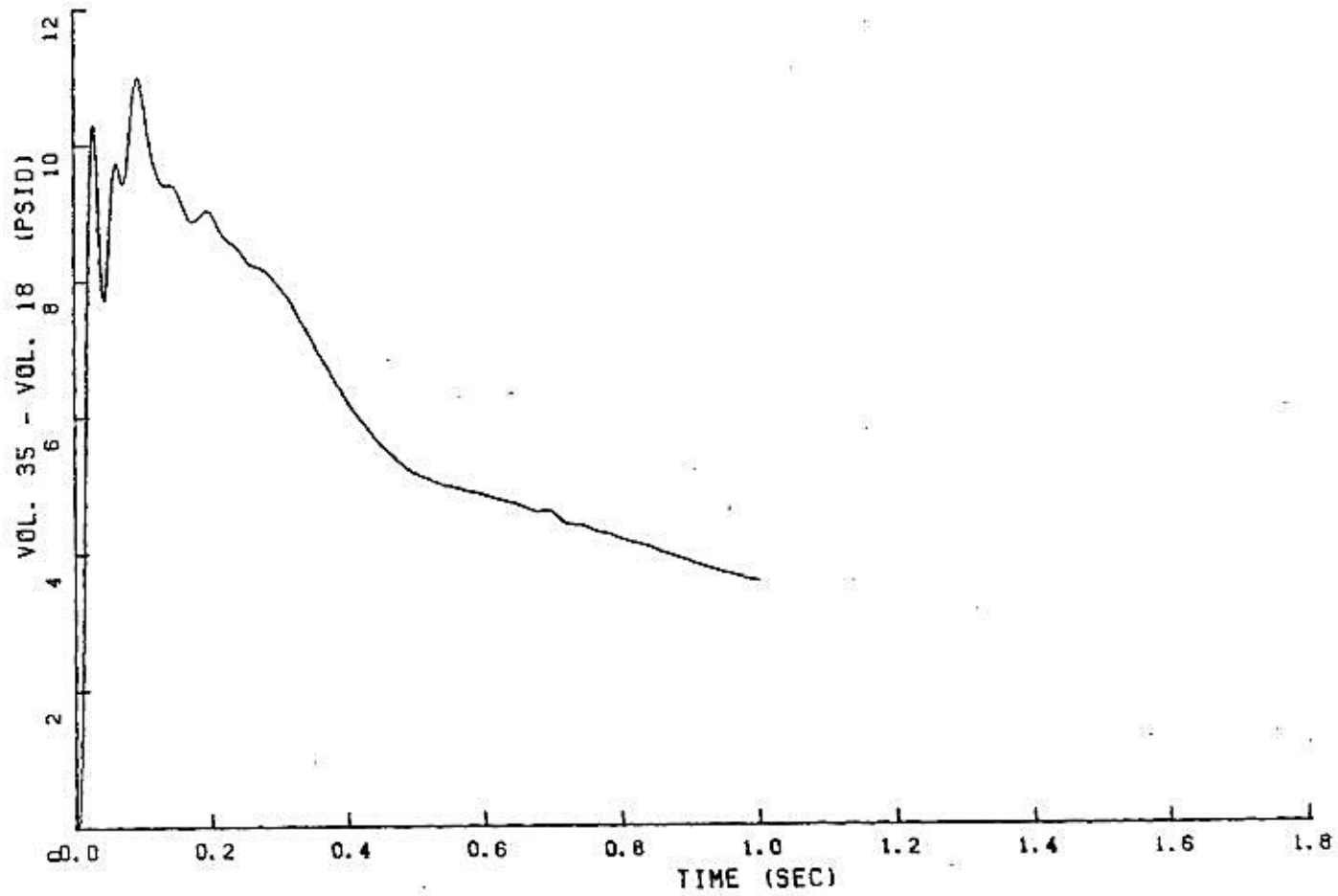

FIGURE 6.2.1-131

PEAK PRESSURE DIFFERENTIAL IN STEAM GENERATOR LOOP - 1

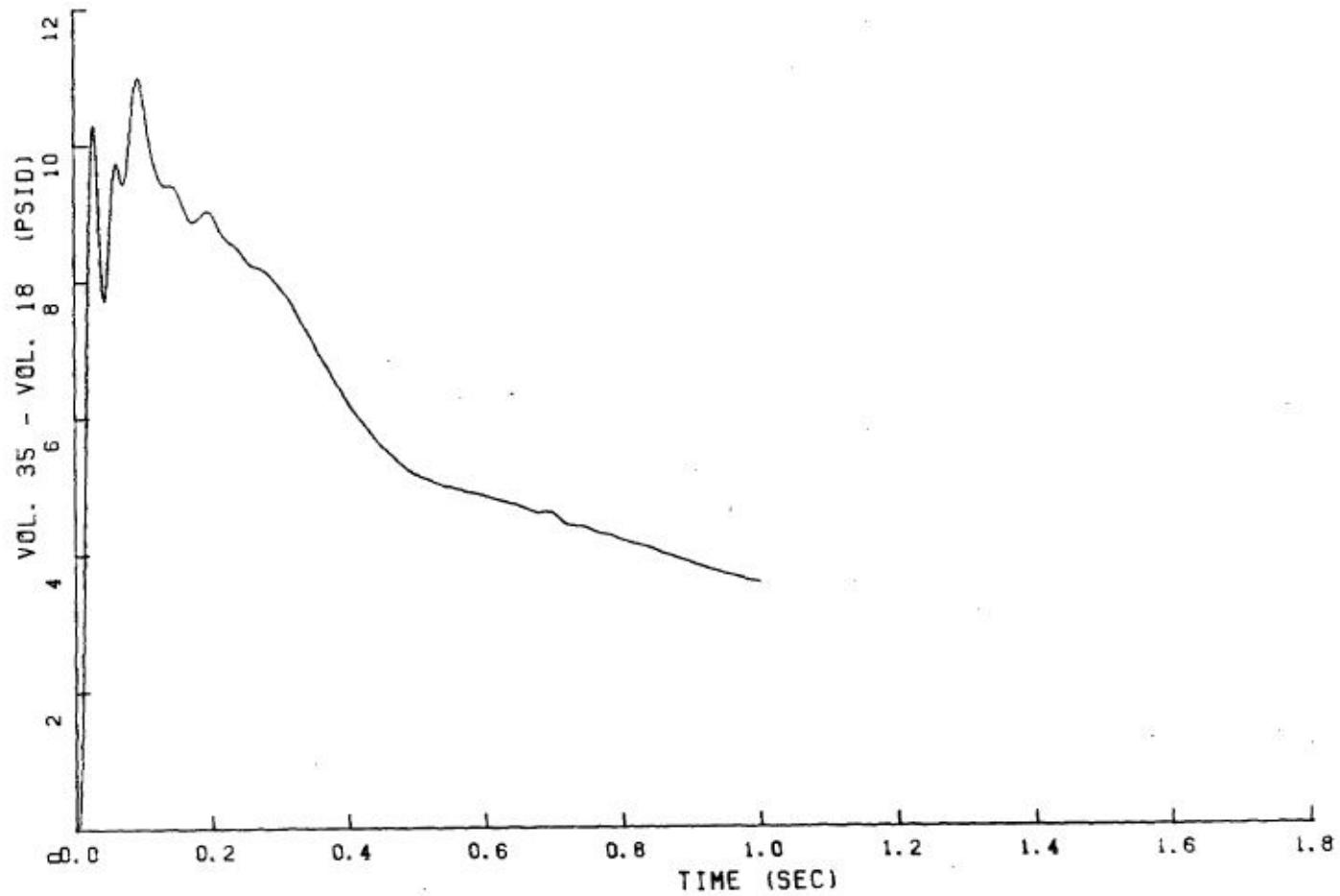

FIGURE 6.2.1-132

PEAK PRESSURE DIFFERENTIAL IN STEAM GENERATOR LOOP - 1

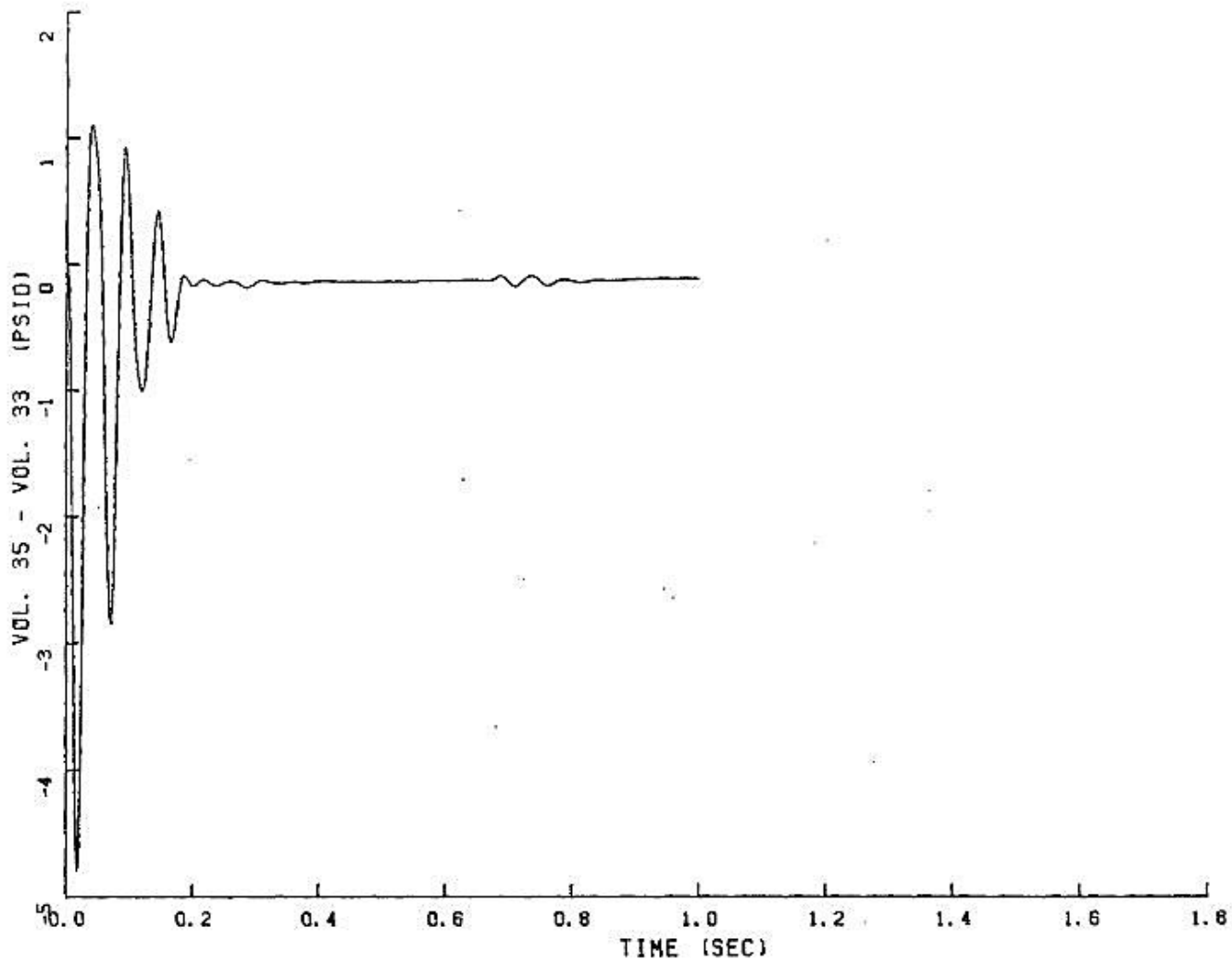

FIGURE 6.2.1-133

PEAK PRESSURE DIFFERENTIAL IN STEAM GENERATOR LOOP - 3

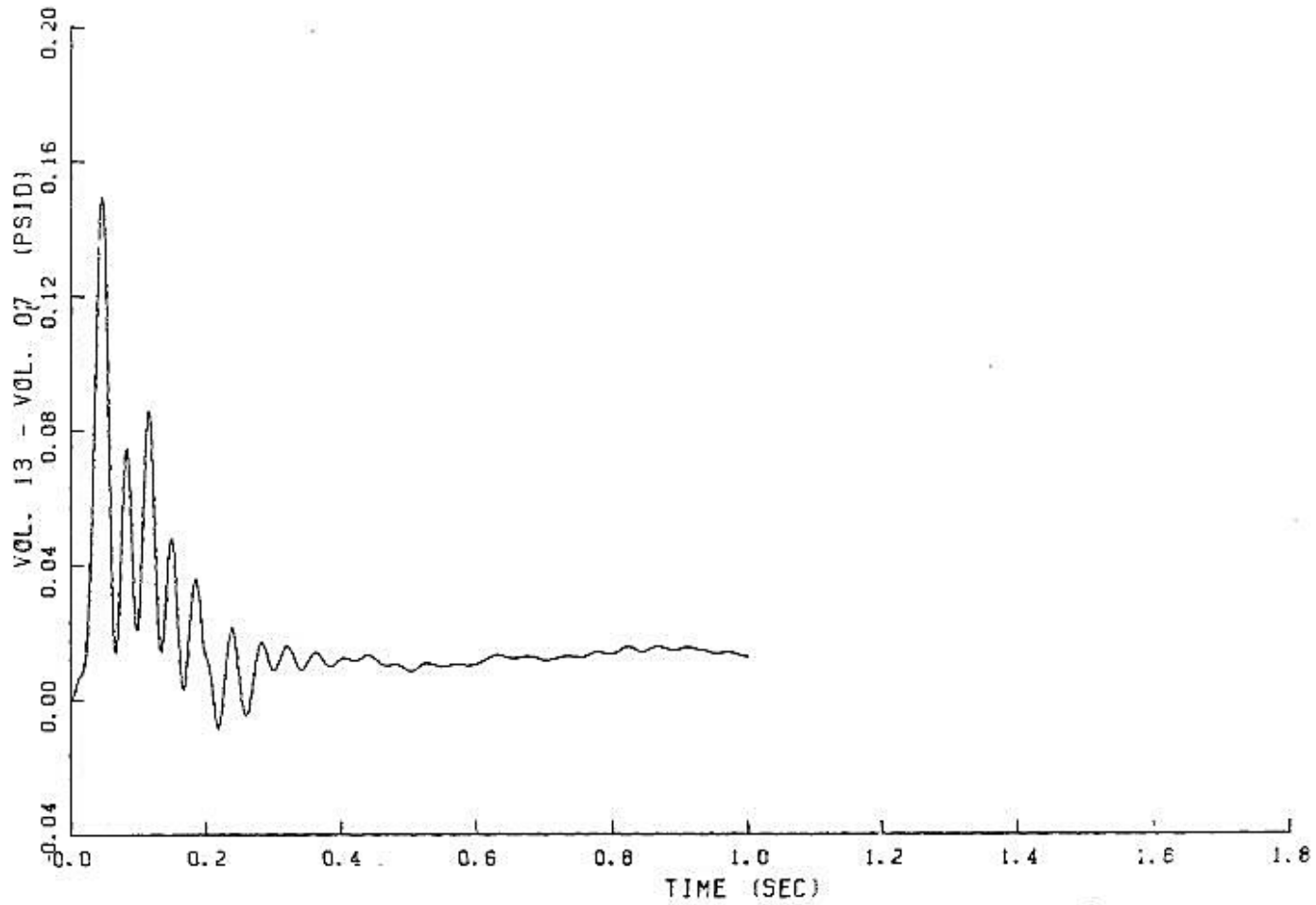

FIGURE 6.2.1-134

PEAK PRESSURE DIFFERENTIAL IN STEAM GENERATOR LOOP - 3

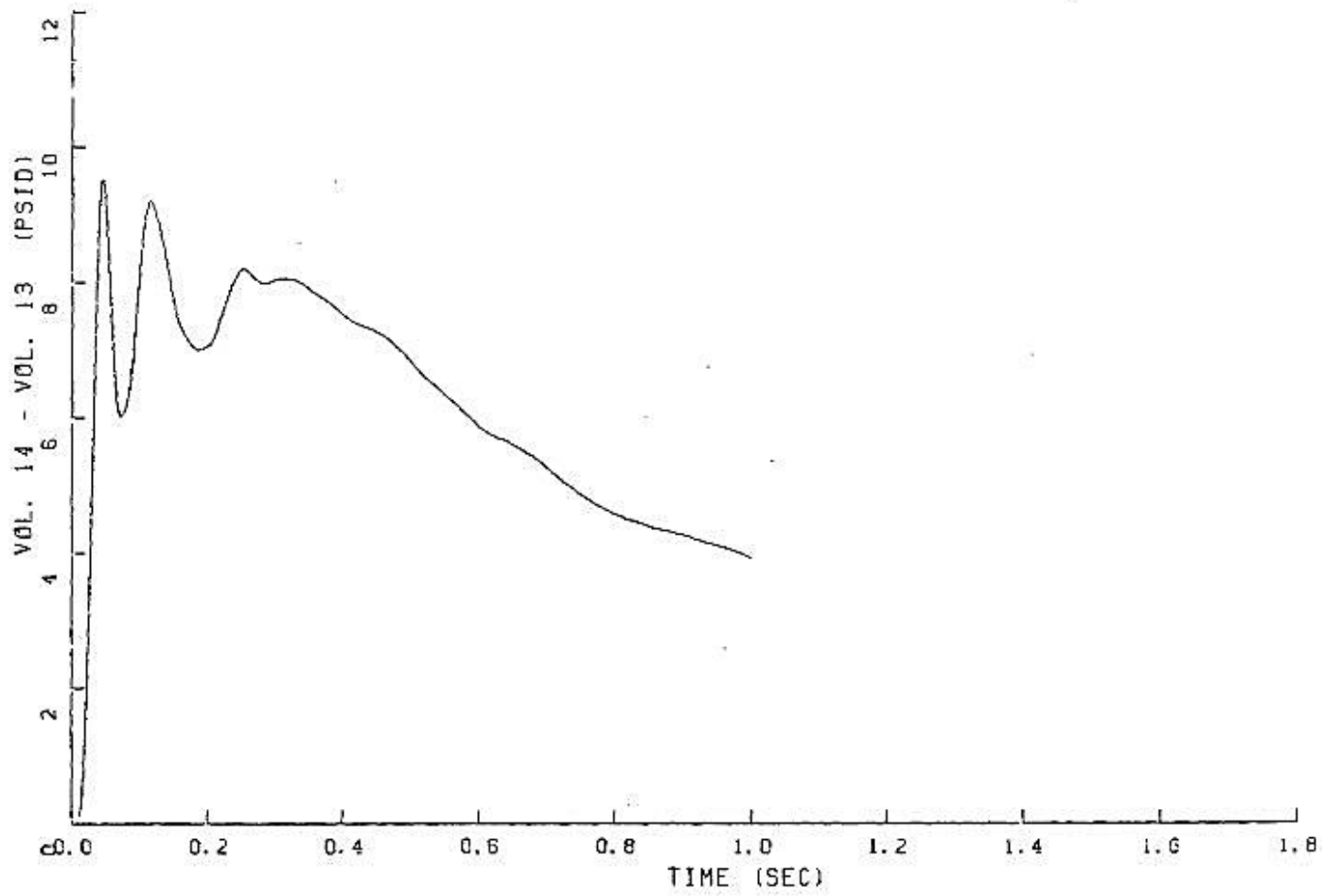

FIGURE 6.2.1-135

PEAK PRESSURE DIFFERENTIAL IN STEAM GENERATOR LOOP - 3

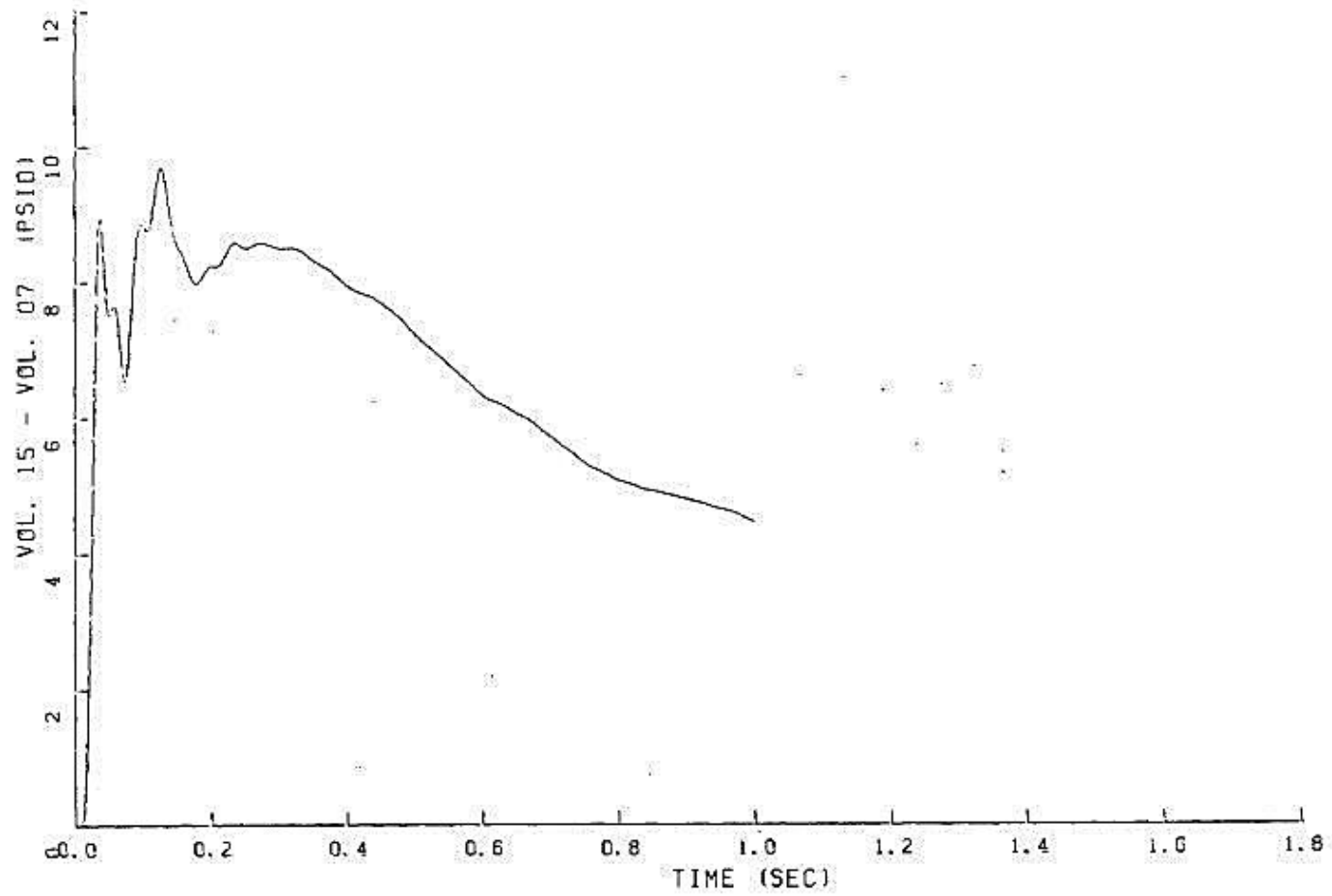

FIGURE 6.2.1-136

PEAK PRESSURE DIFFERENTIAL IN STEAM GENERATOR LOOP - 3

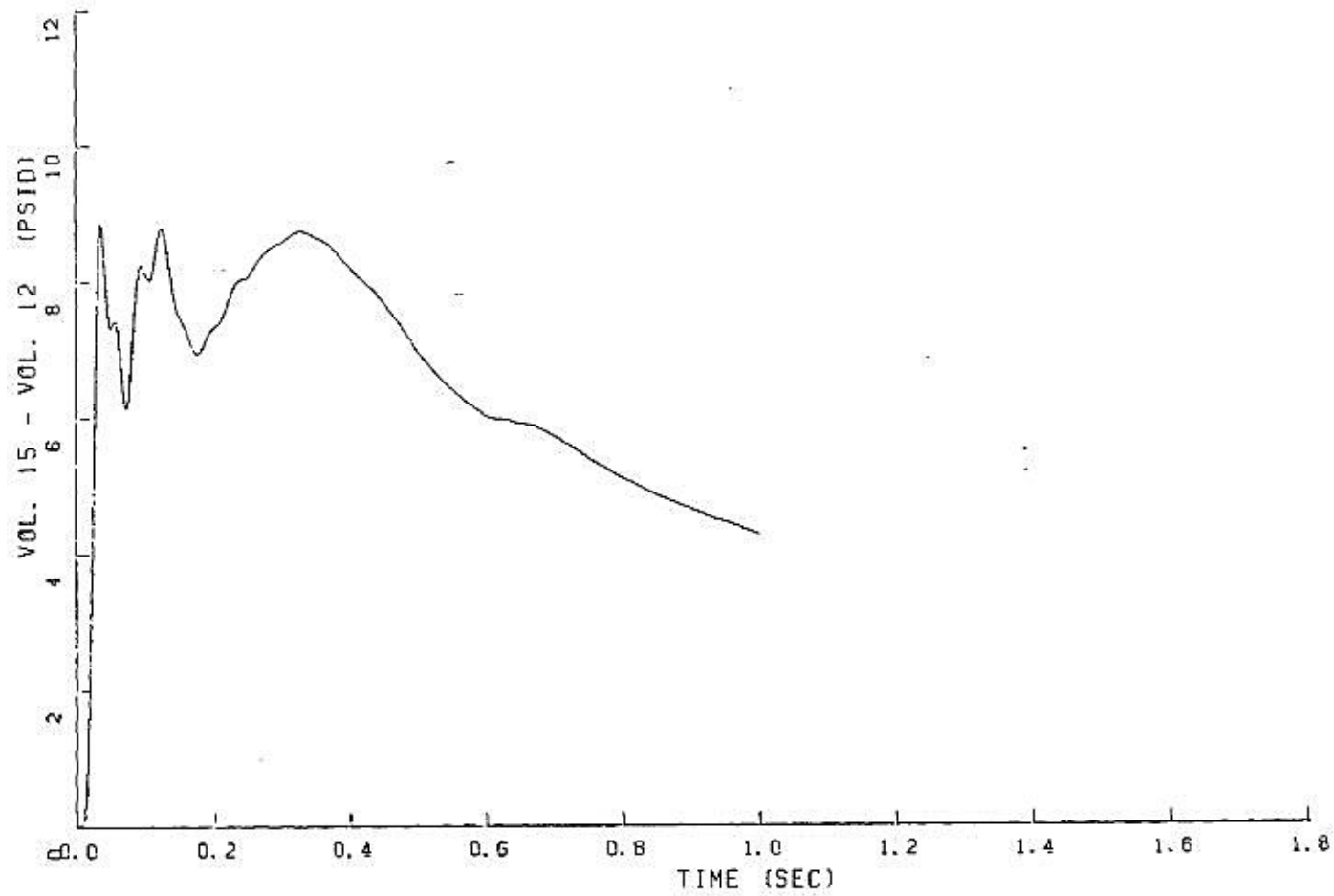

FIGURE 6.2.1-137

PEAK PRESSURE DIFFERENTIAL IN STEAM GENERATOR LOOP - 3

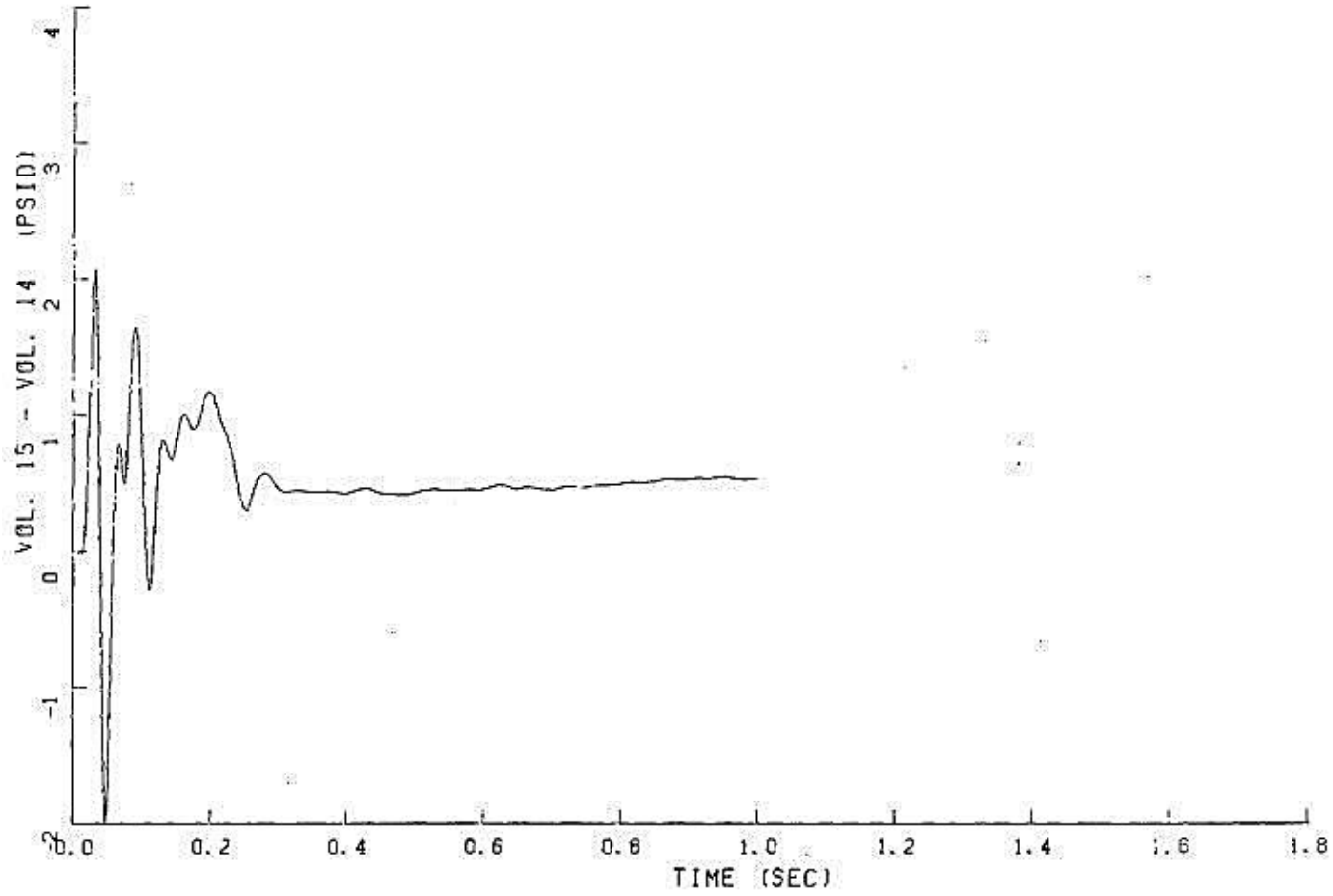

FIGURE 6.2.1-138

PEAK PRESSURE DIFFERENTIAL IN STEAM GENERATOR LOOP - 3

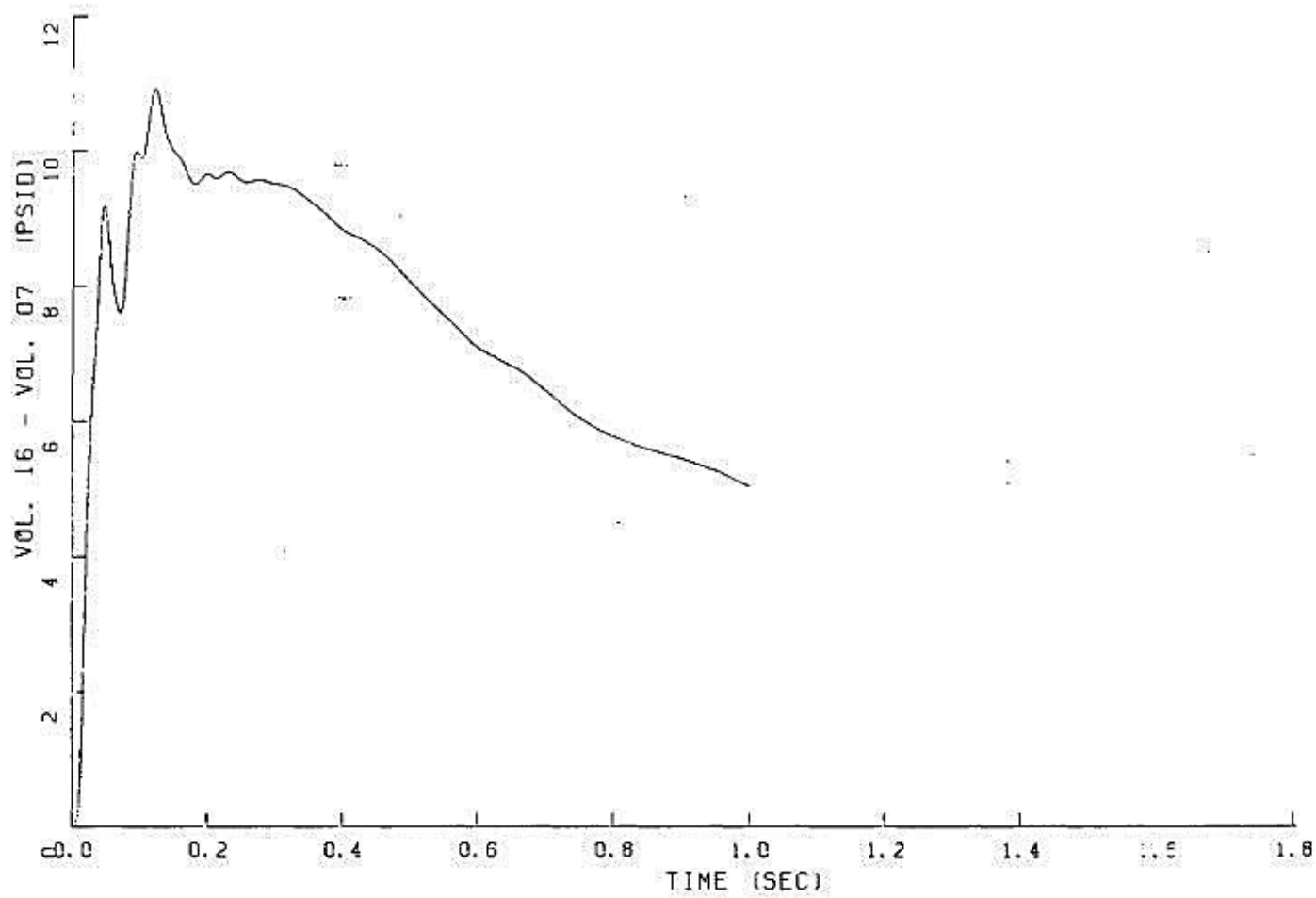

FIGURE 6.2.1-139

PEAK PRESSURE DIFFERENTIAL IN STEAM GENERATOR LOOP - 3

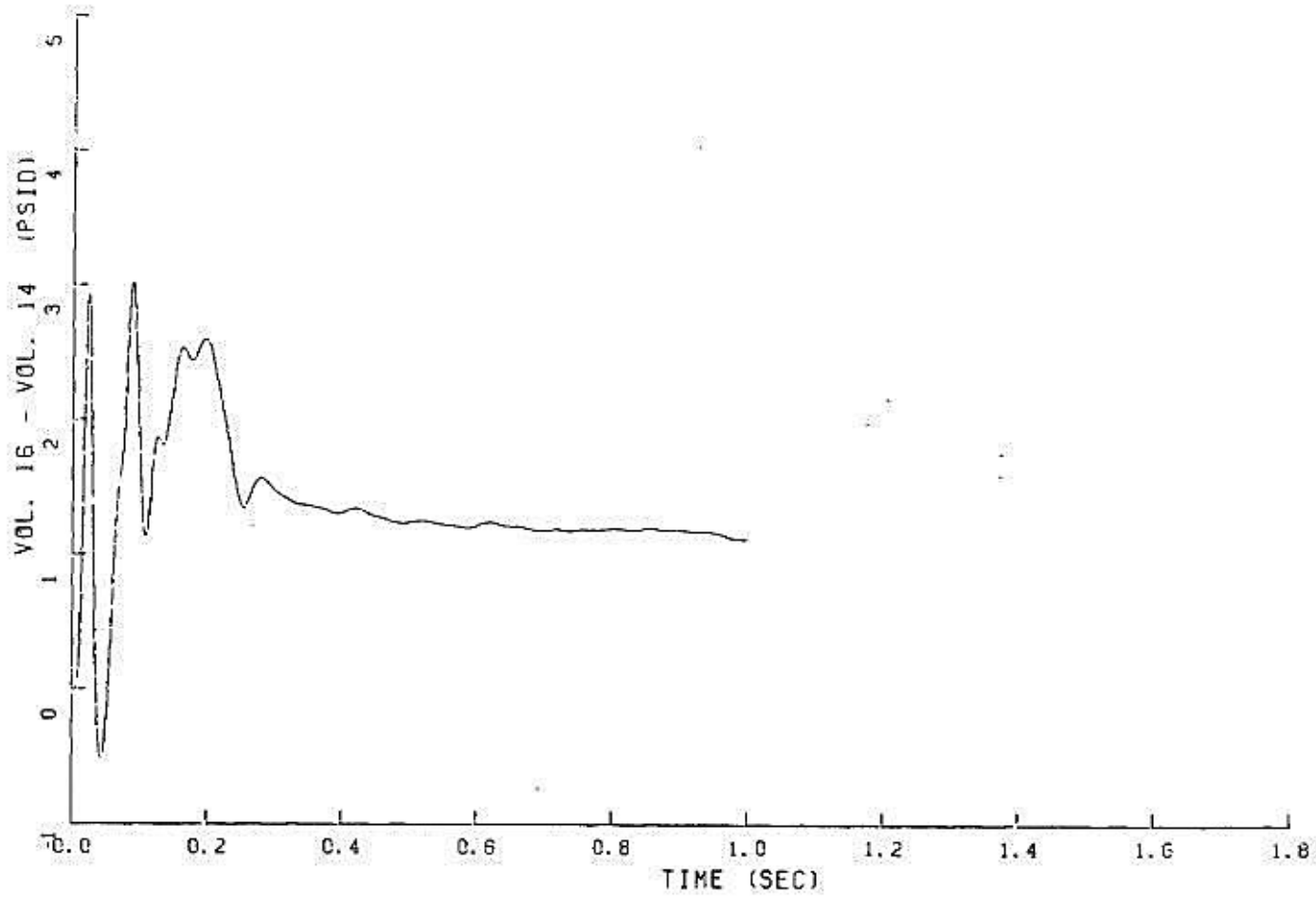

FIGURE 6.2.1-140

PEAK PRESSURE DIFFERENTIAL IN STEAM GENERATOR LOOP - 3

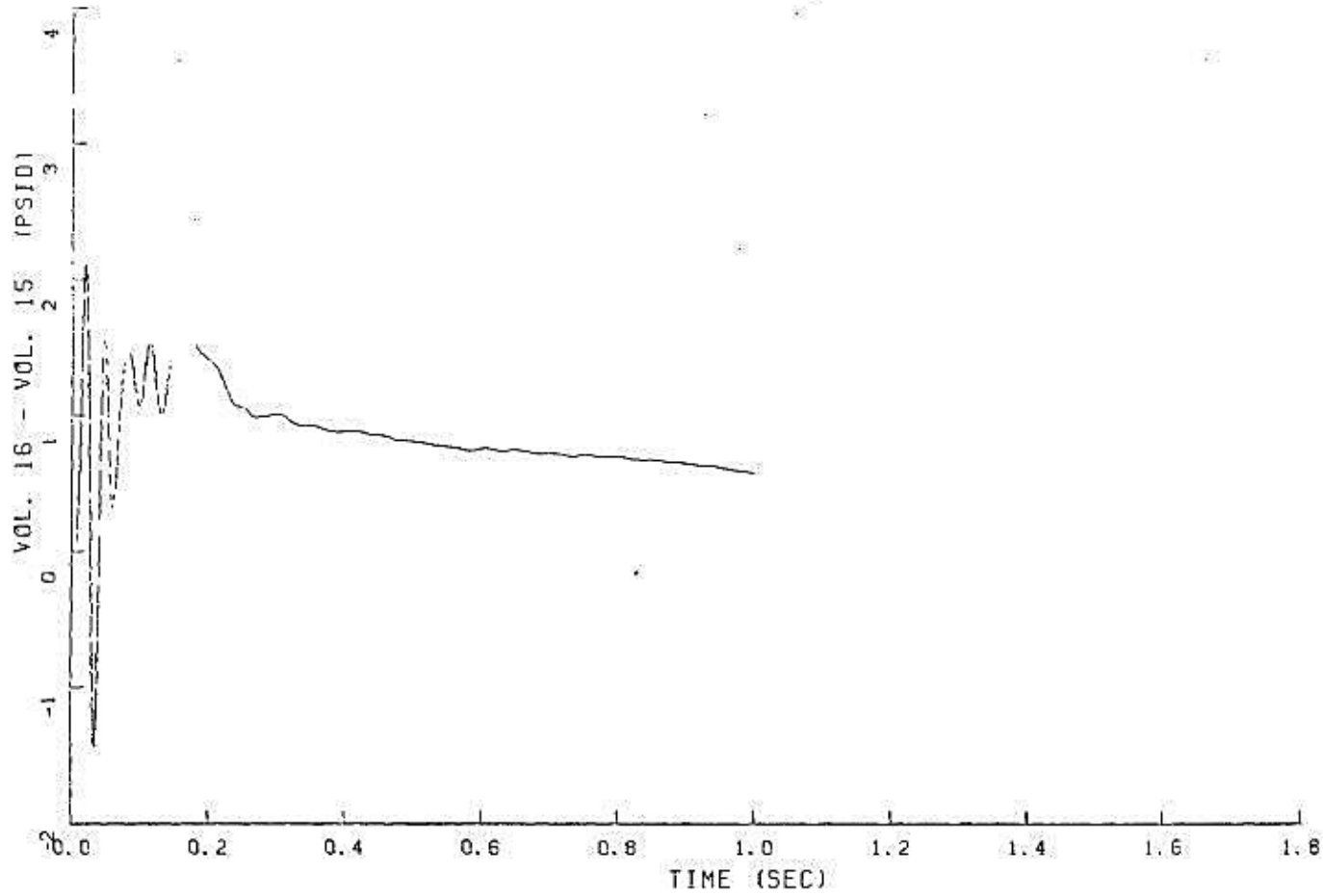

FIGURE 6.2.1-141

PEAK PRESSURE DIFFERENTIAL IN STEAM GENERATOR LOOP – 3

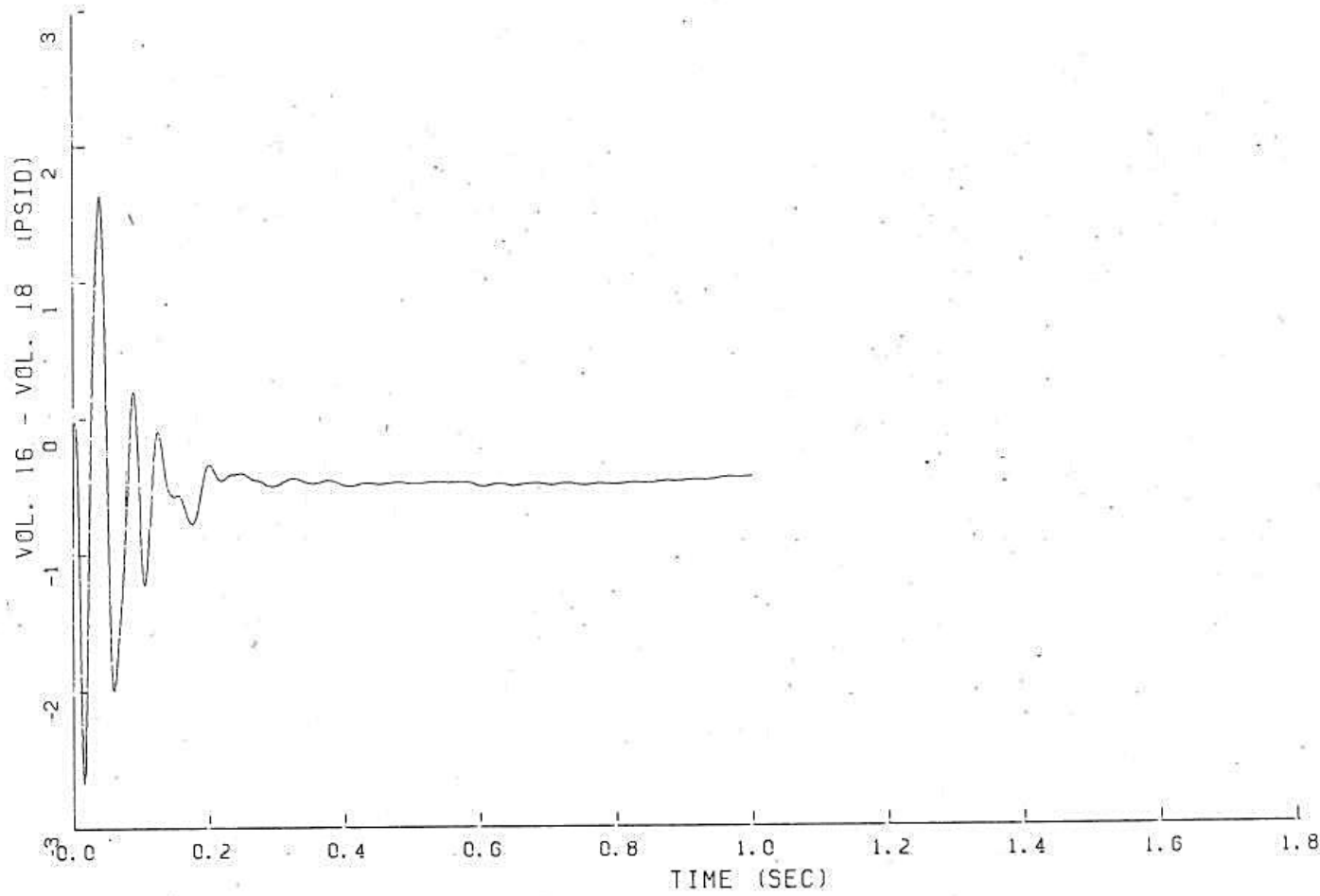

FIGURE 6.2.1-142

PEAK PRESSURE DIFFERENTIAL IN STEAM GENERATOR LOOP – 3

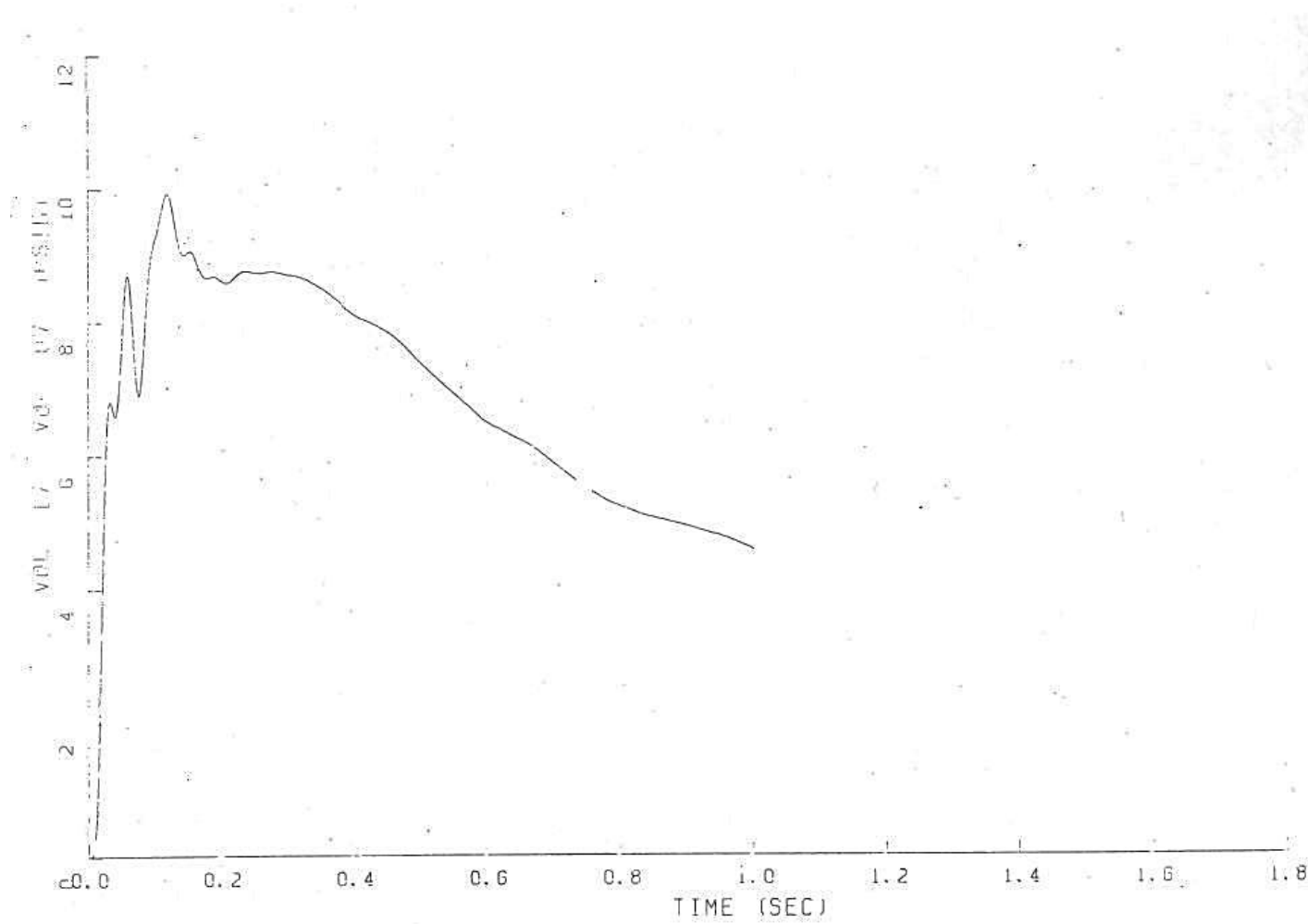

FIGURE 6.2.1-143

PEAK PRESSURE DIFFERENTIAL IN STEAM GENERATOR LOOP – 3

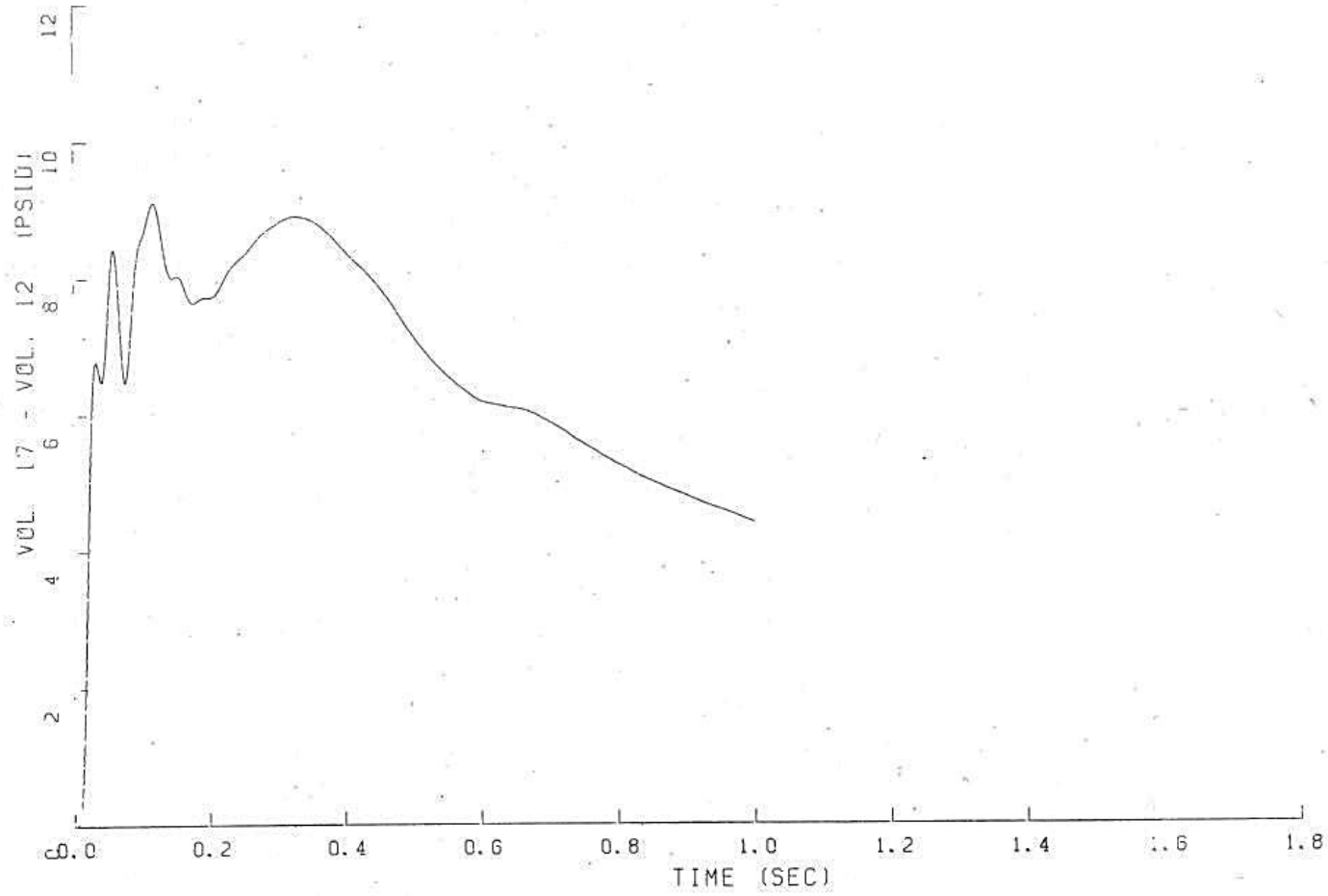

FIGURE 6.2.1-144

PEAK PRESSURE DIFFERENTIAL IN STEAM GENERATOR LOOP – 3

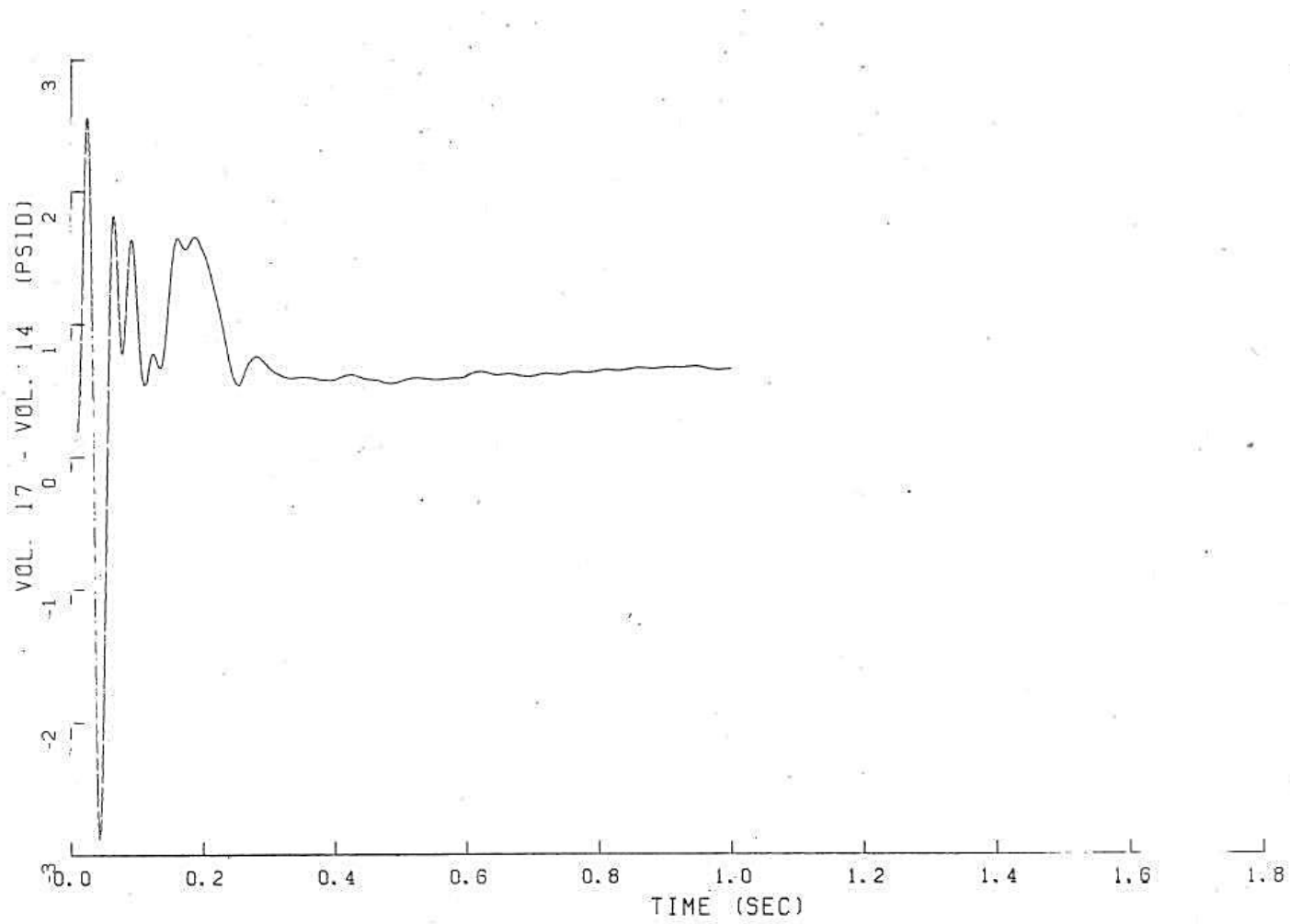

FIGURE 6.2.1-145

PEAK PRESSURE DIFFERENTIAL IN STEAM GENERATOR LOOP – 3

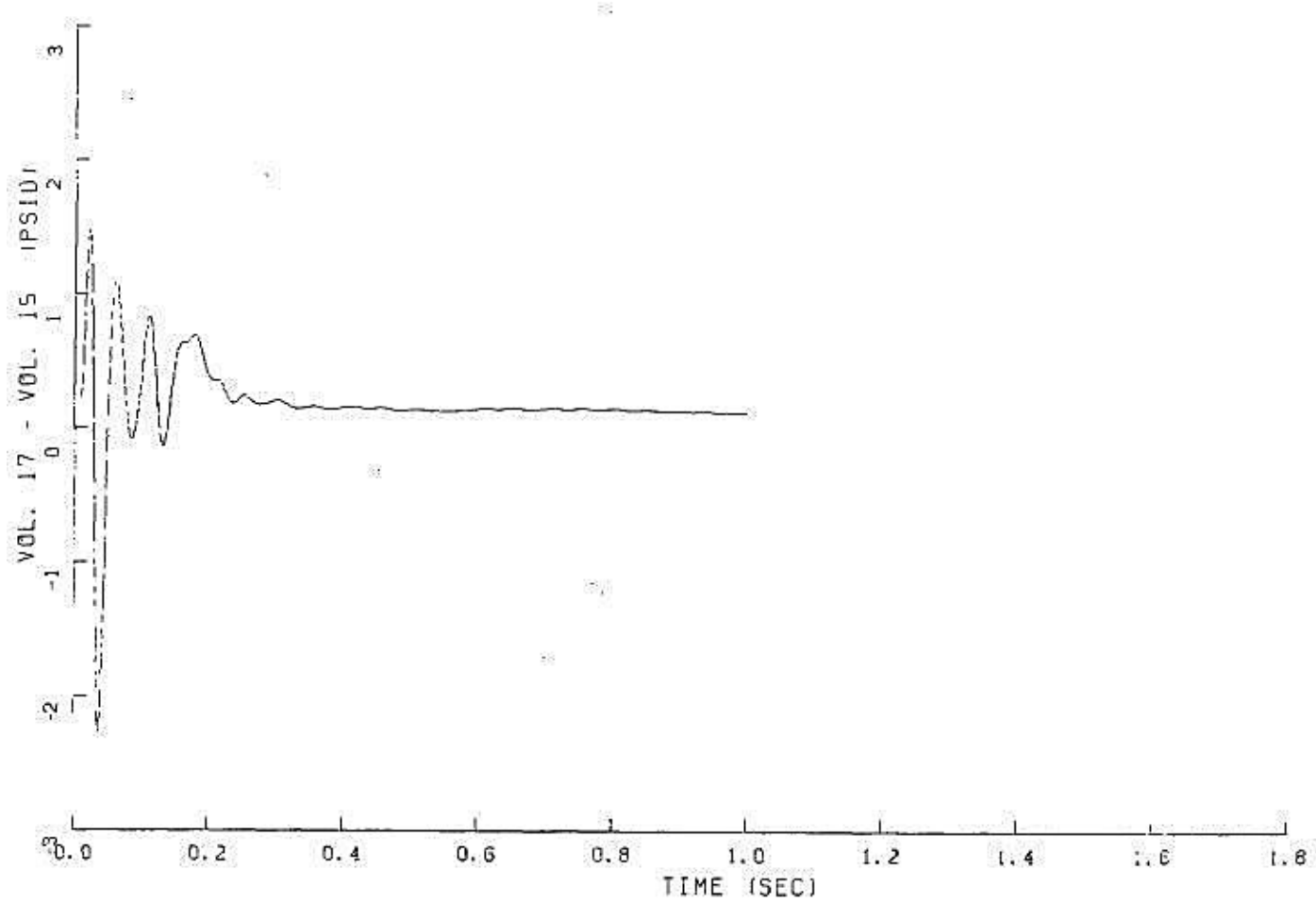

FIGURE 6.2.1-146

PEAK PRESSURE DIFFERENTIAL IN STEAM GENERATOR LOOP - 3

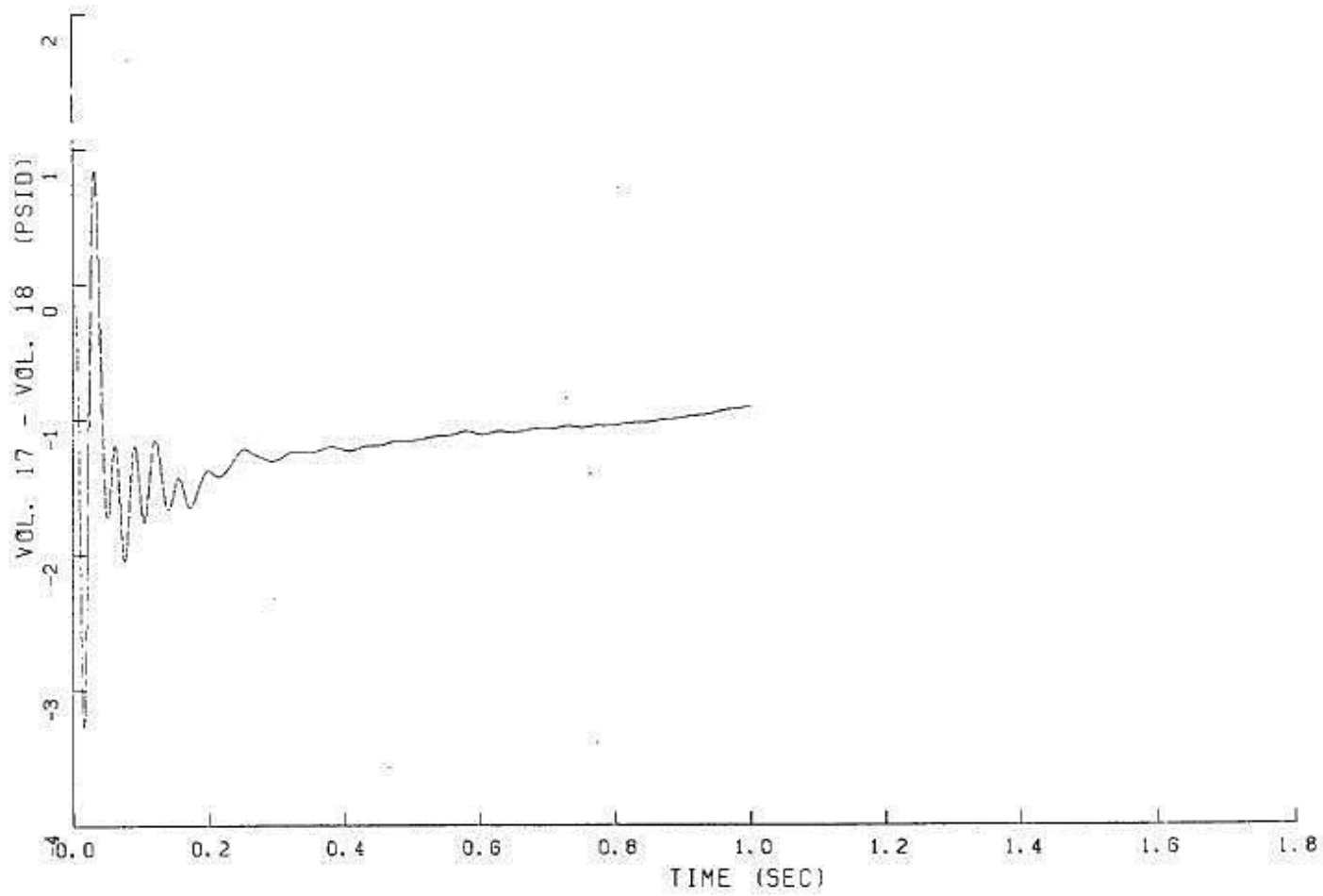

FIGURE 6.2.1-147

PEAK PRESSURE DIFFERENTIAL IN STEAM GENERATOR LOOP - 3

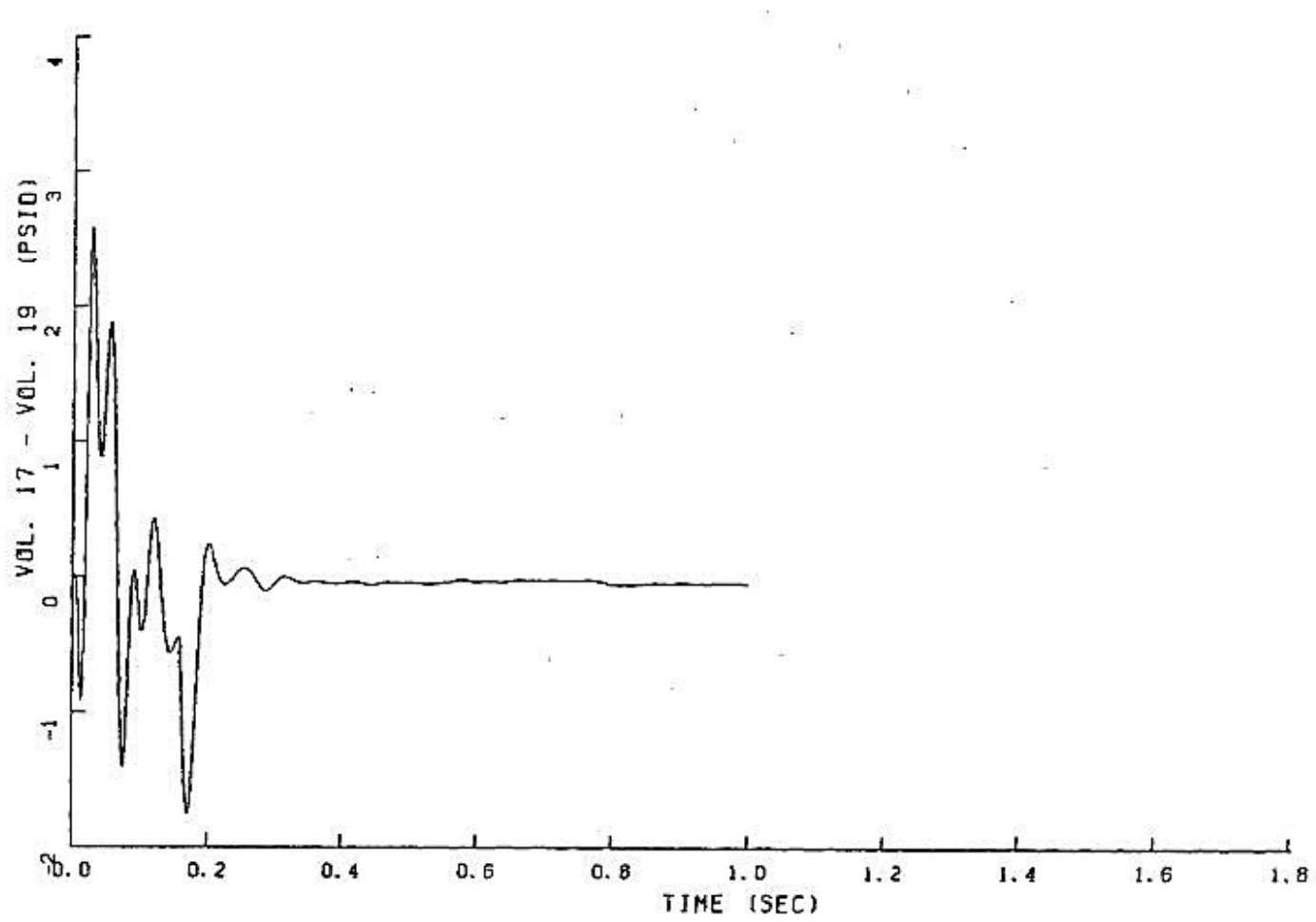

FIGURE 6.2.1-148

PEAK PRESSURE DIFFERENTIAL IN STEAM GENERATOR LOOP - 3

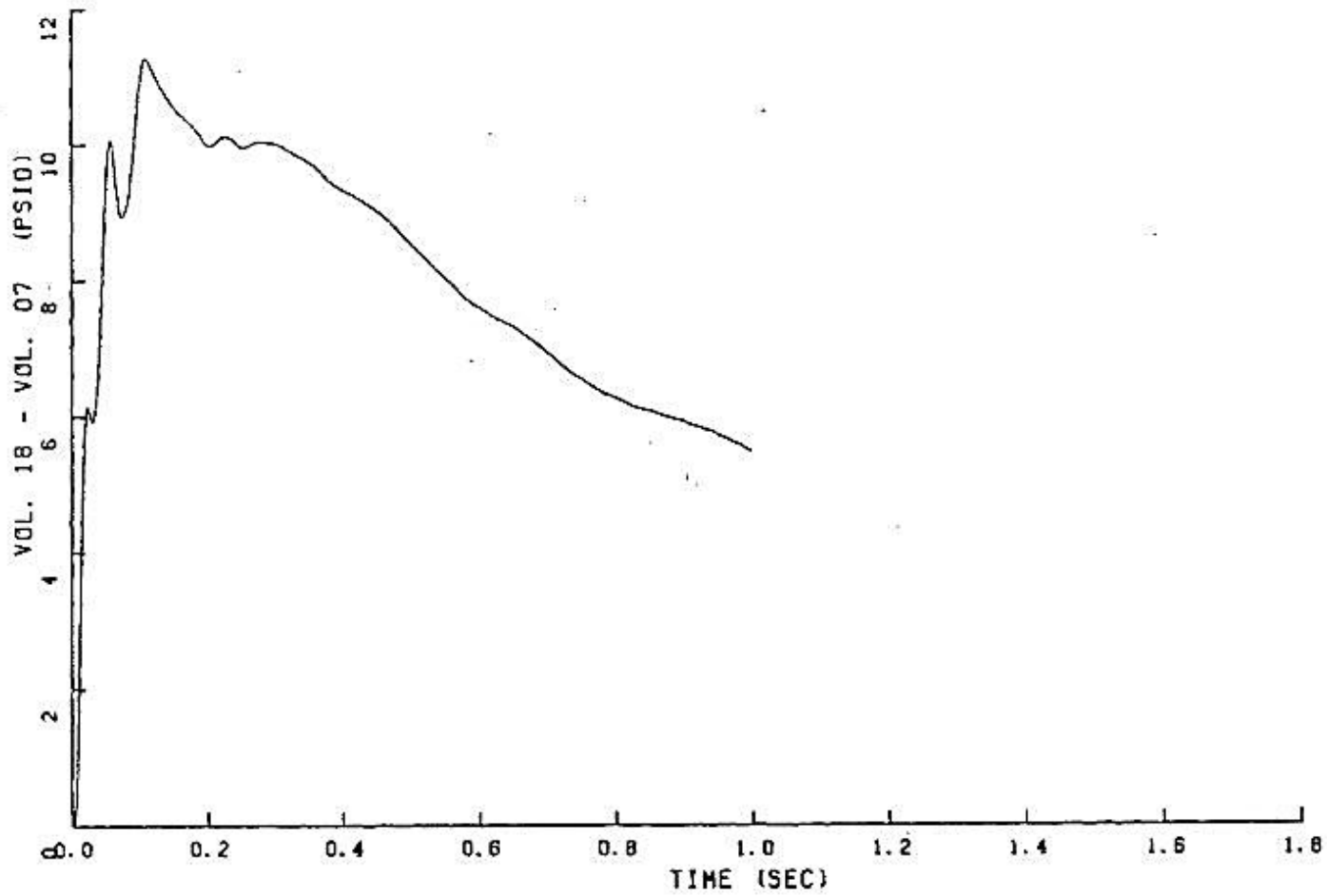

FIGURE 6.2.1-149

PEAK PRESSURE DIFFERENTIAL IN STEAM GENERATOR LOOP - 3

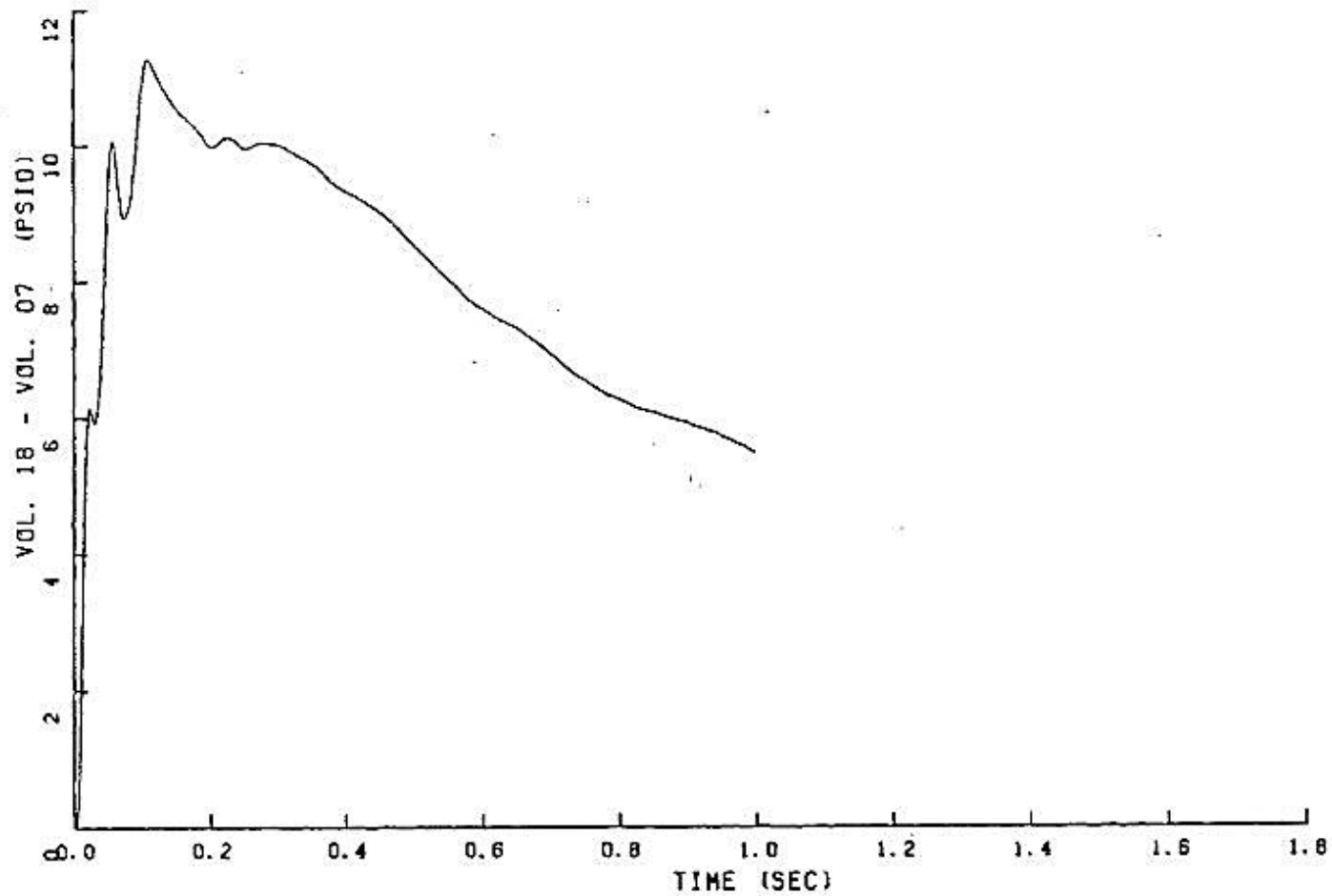

FIGURE 6.2.1-150

PEAK PRESSURE DIFFERENTIAL IN STEAM GENERATOR LOOP - 3

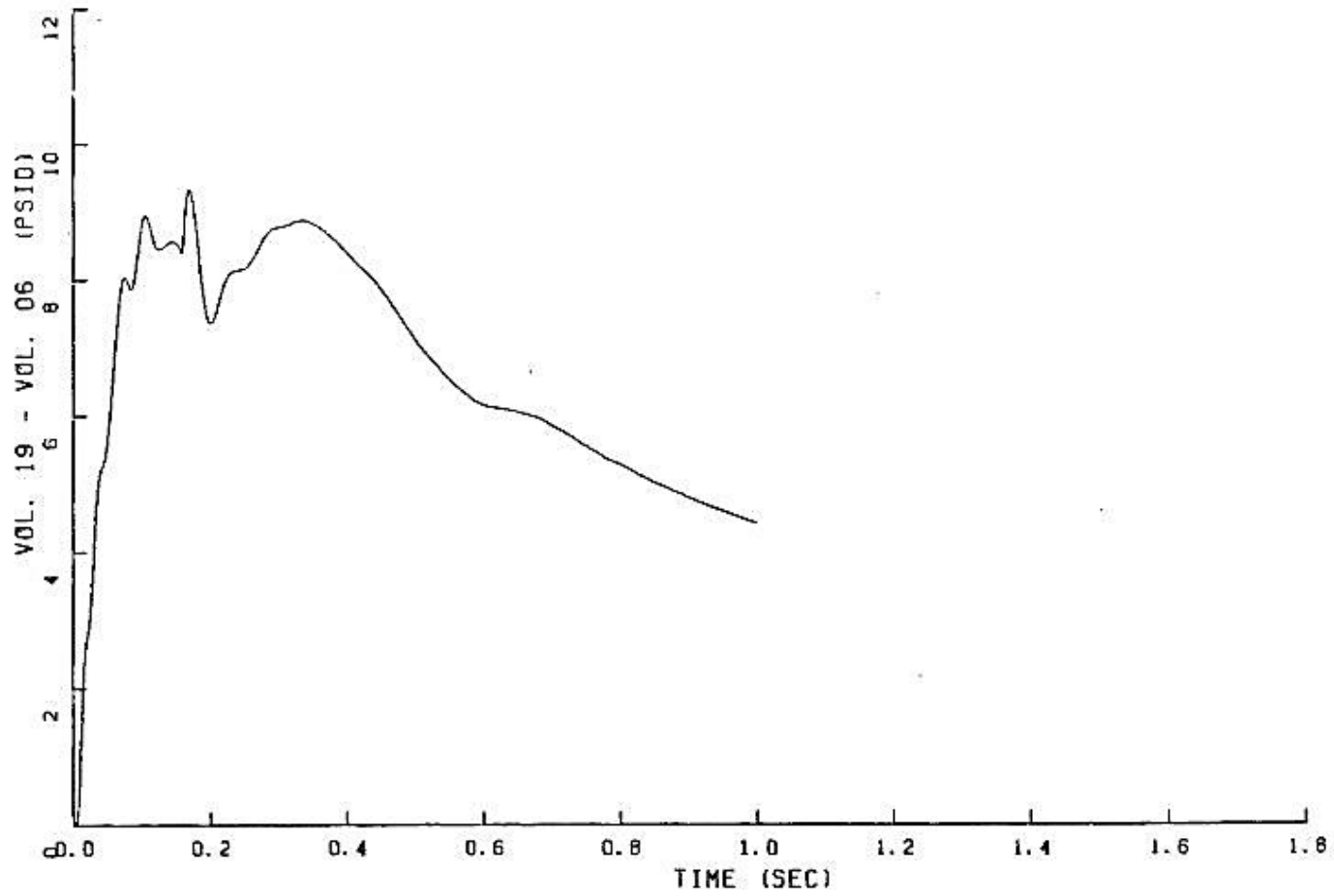

FIGURE 6.2.1-151

PEAK PRESSURE DIFFERENTIAL IN STEAM GENERATOR LOOP – 3

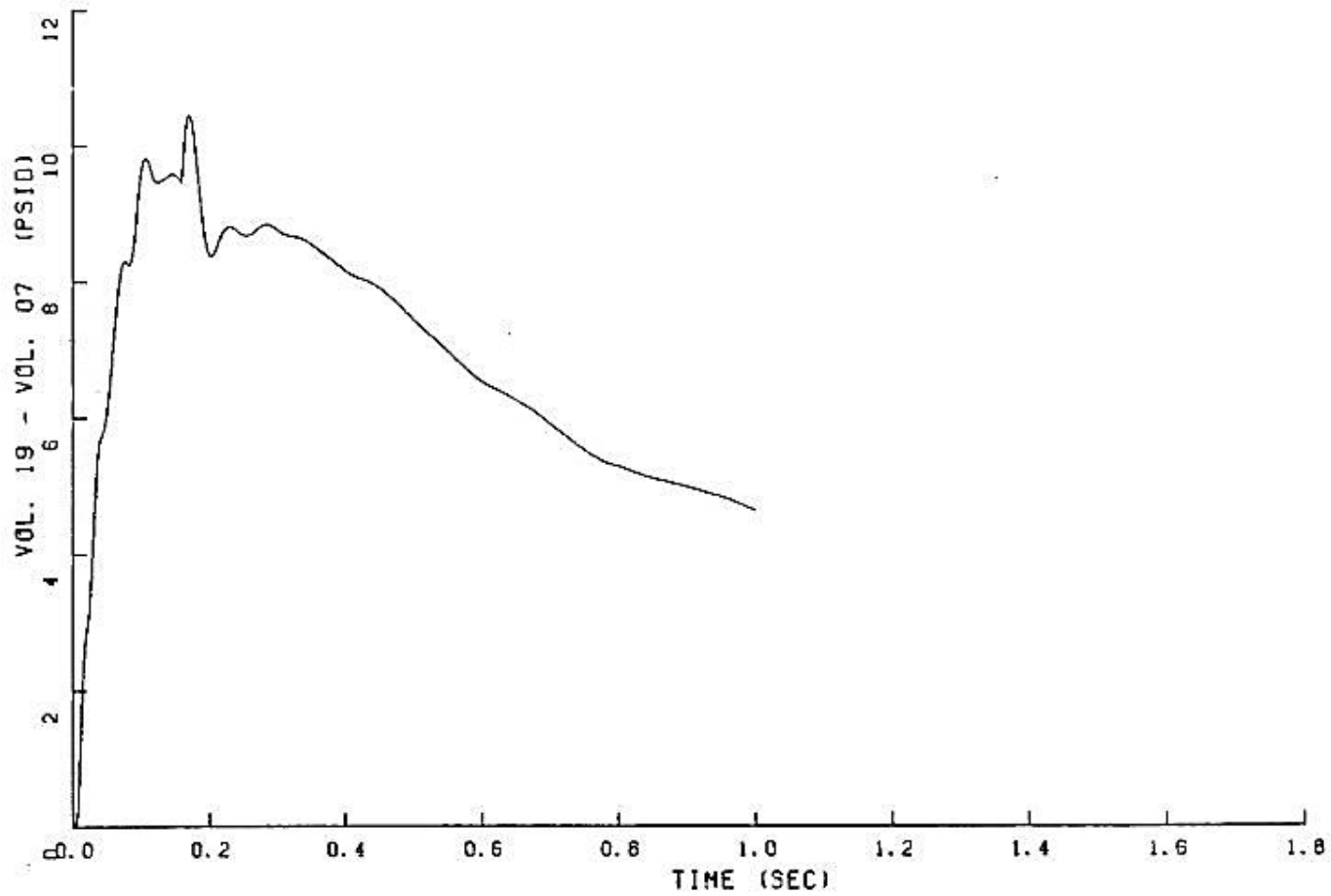

FIGURE 6.2.1-152

PEAK PRESSURE DIFFERENTIAL IN STEAM GENERATOR LOOP - 3

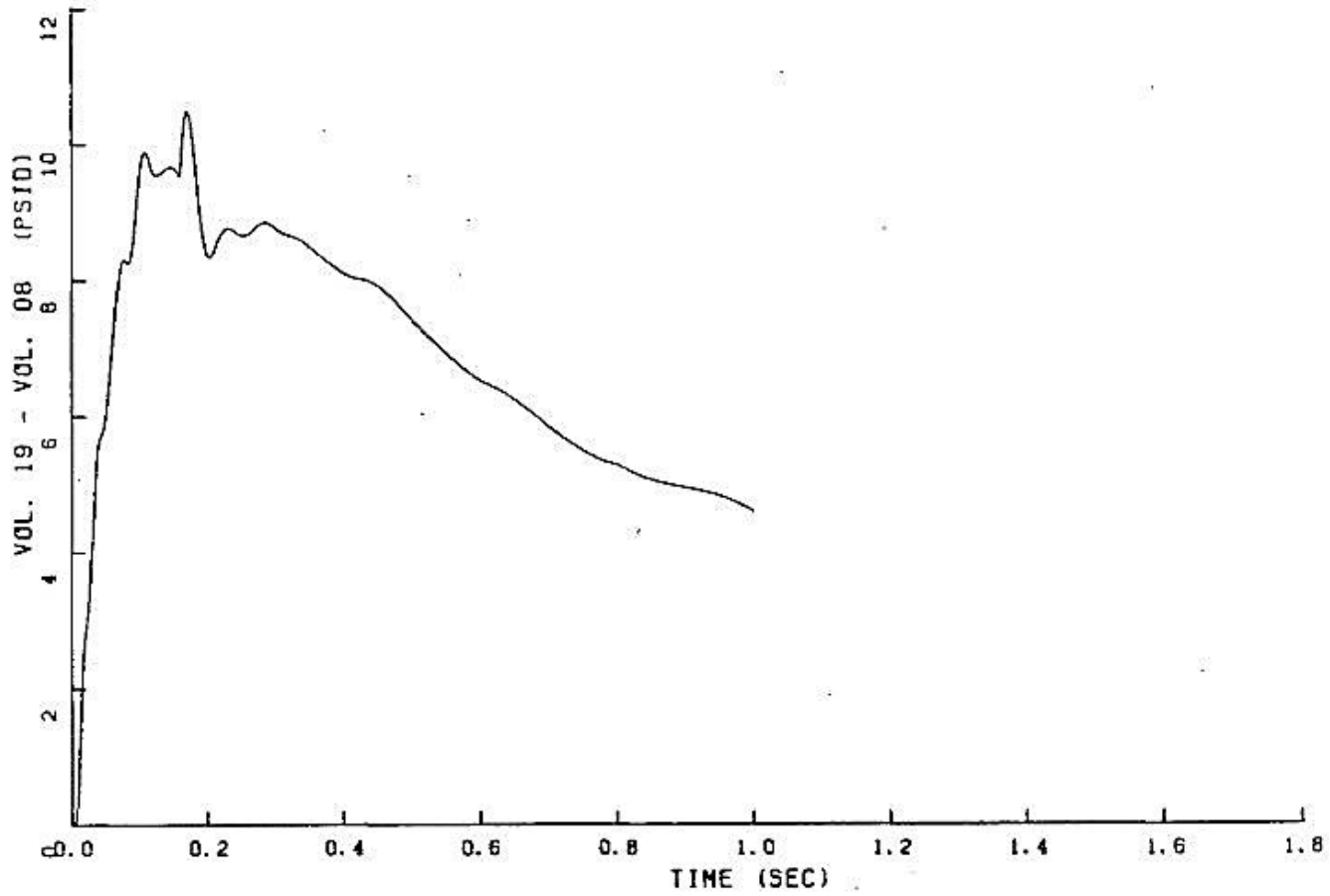

FIGURE 6.2.1-153

PEAK PRESSURE DIFFERENTIAL IN STEAM GENERATOR LOOP - 3

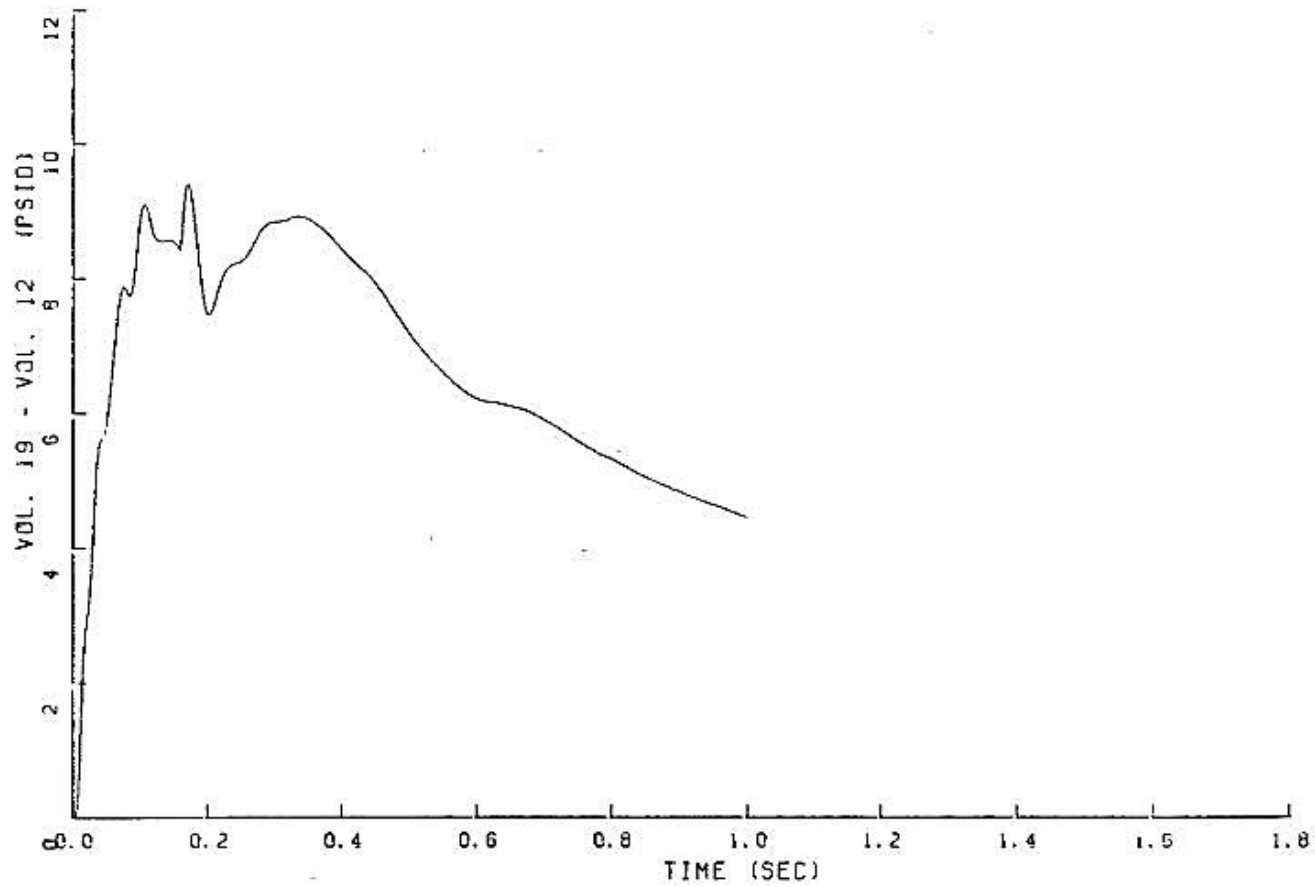

FIGURE 6.2.1-154

PEAK PRESSURE DIFFERENTIAL IN STEAM GENERATOR LOOP - 3

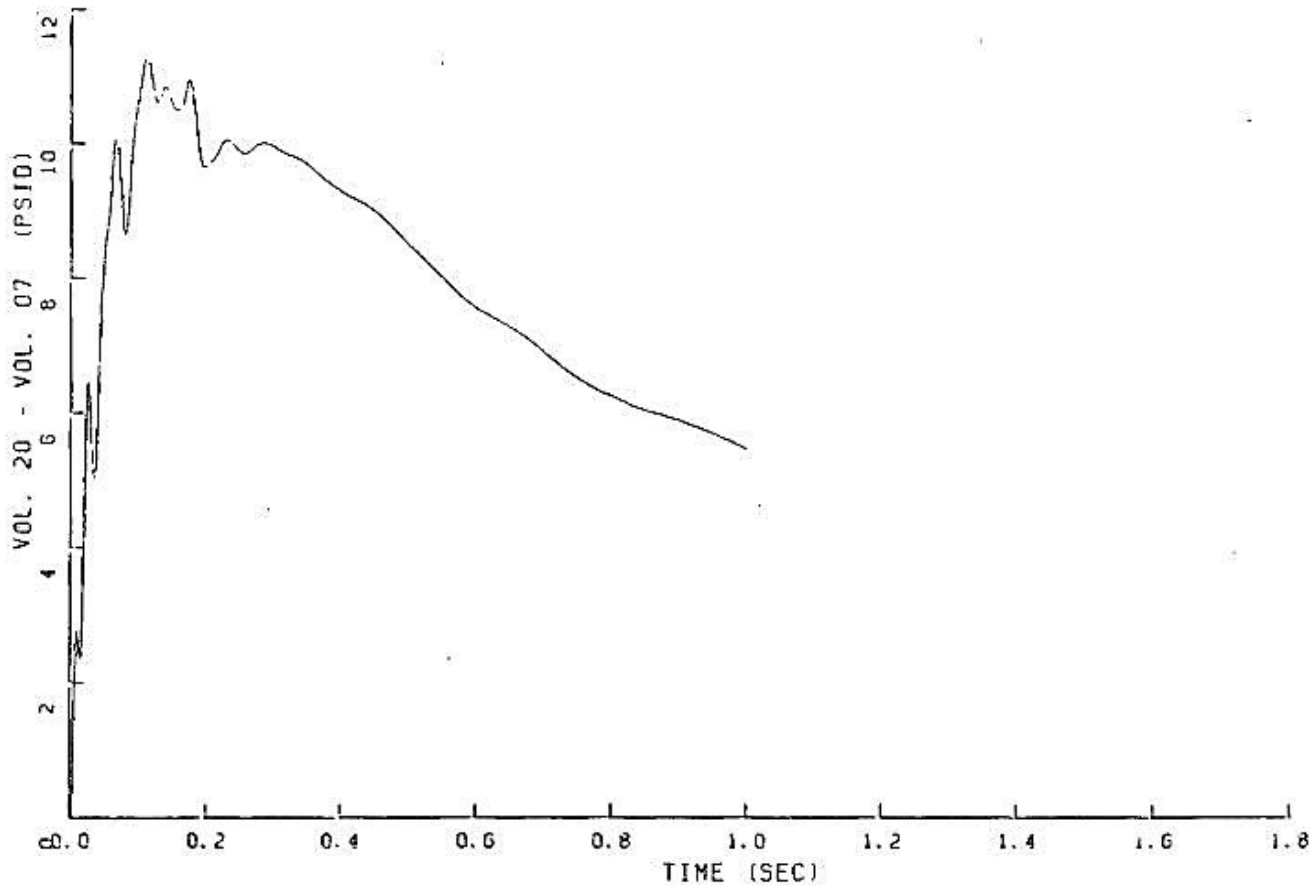

FIGURE 6.2.1-155

PEAK PRESSURE DIFFERENTIAL IN STEAM GENERATOR LOOP - 3

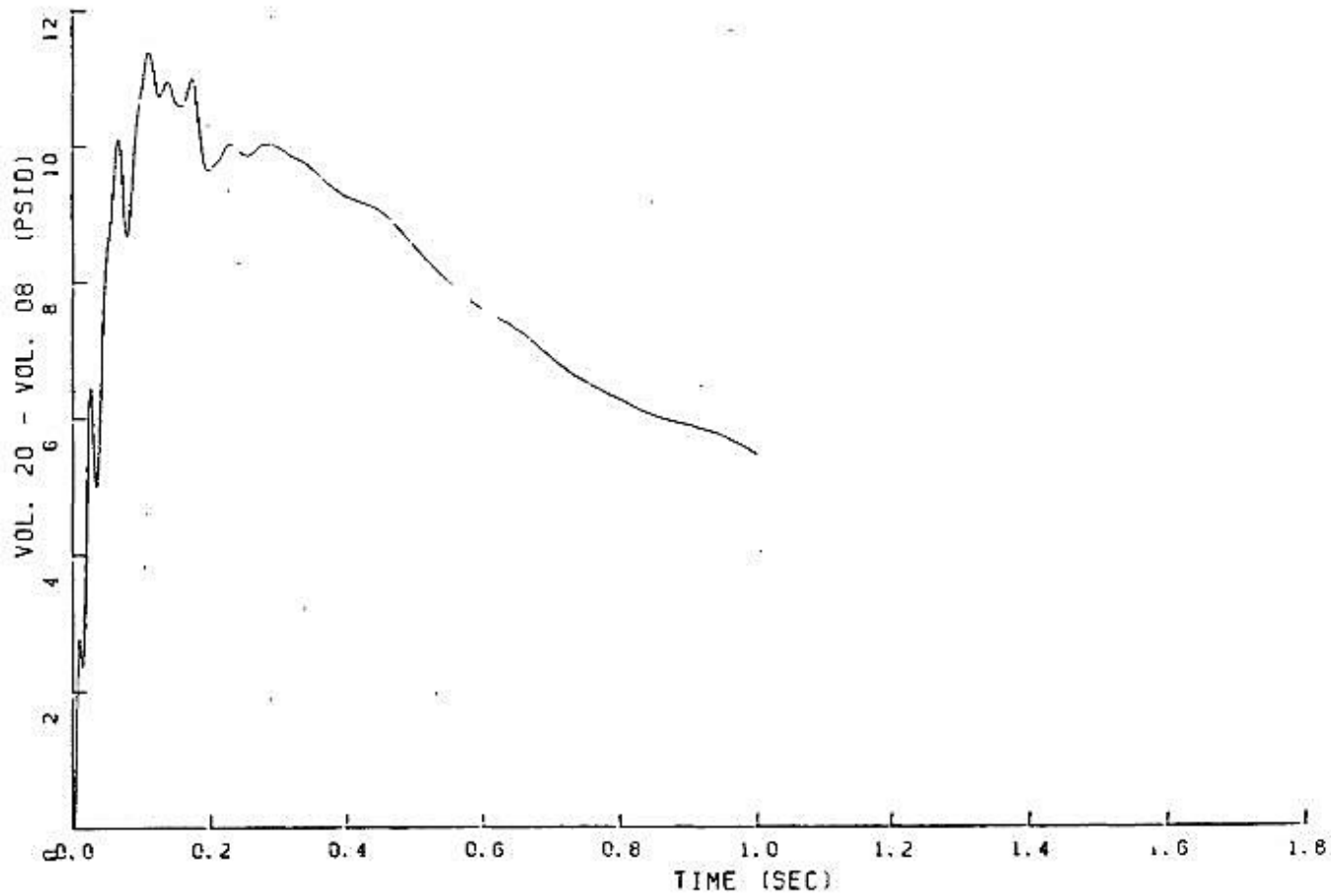

FIGURE 6.2.1-156

PEAK PRESSURE DIFFERENTIAL IN STEAM GENERATOR LOOP - 3

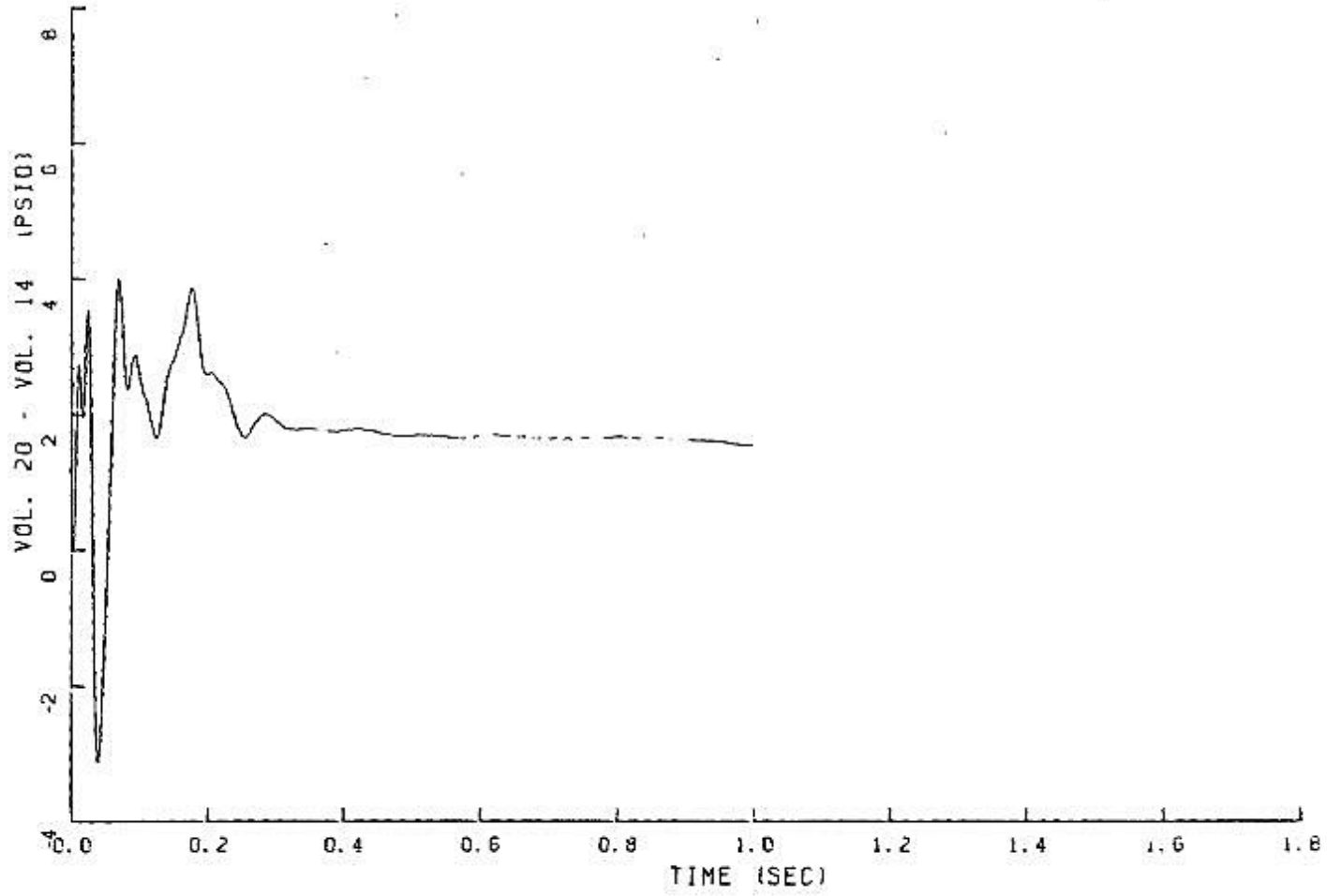

FIGURE 6.2.1-157

PEAK PRESSURE DIFFERENTIAL IN STEAM GENERATOR LOOP - 3

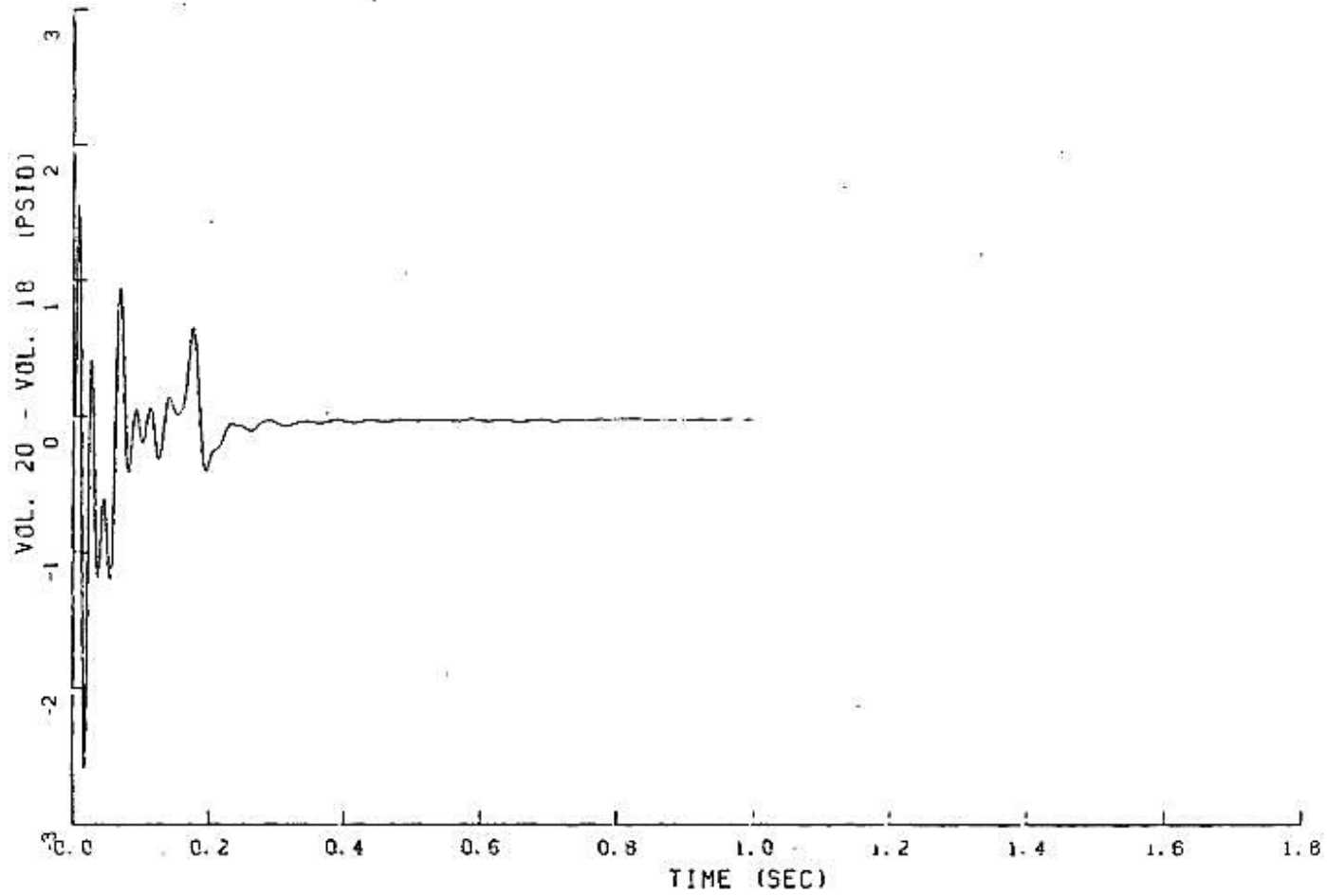

FIGURE 6.2.1-158

PEAK PRESSURE DIFFERENTIAL IN STEAM GENERATOR LOOP – 3

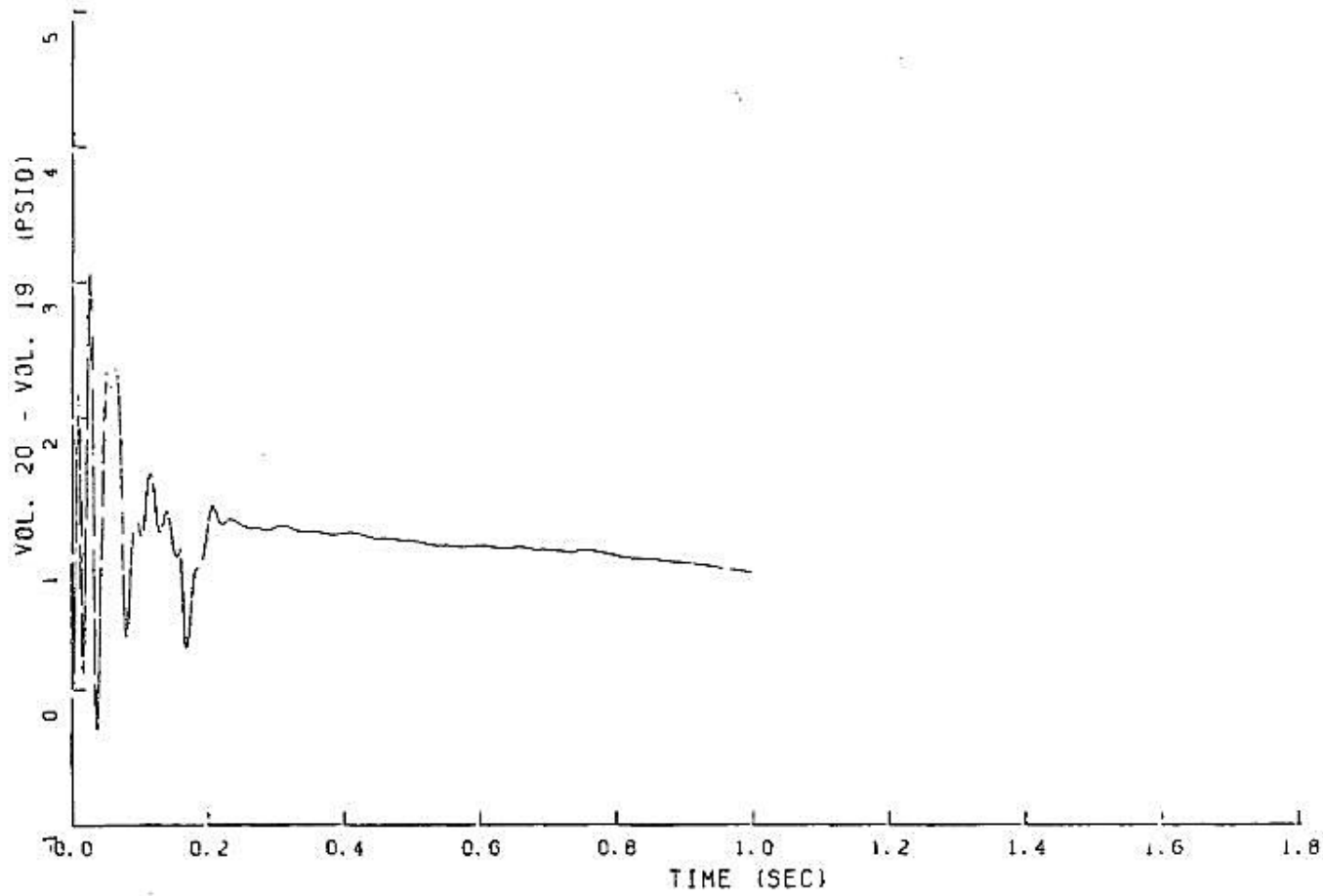

FIGURE 6.2.1-159

PEAK PRESSURE DIFFERENTIAL IN STEAM GENERATOR LOOP - 3

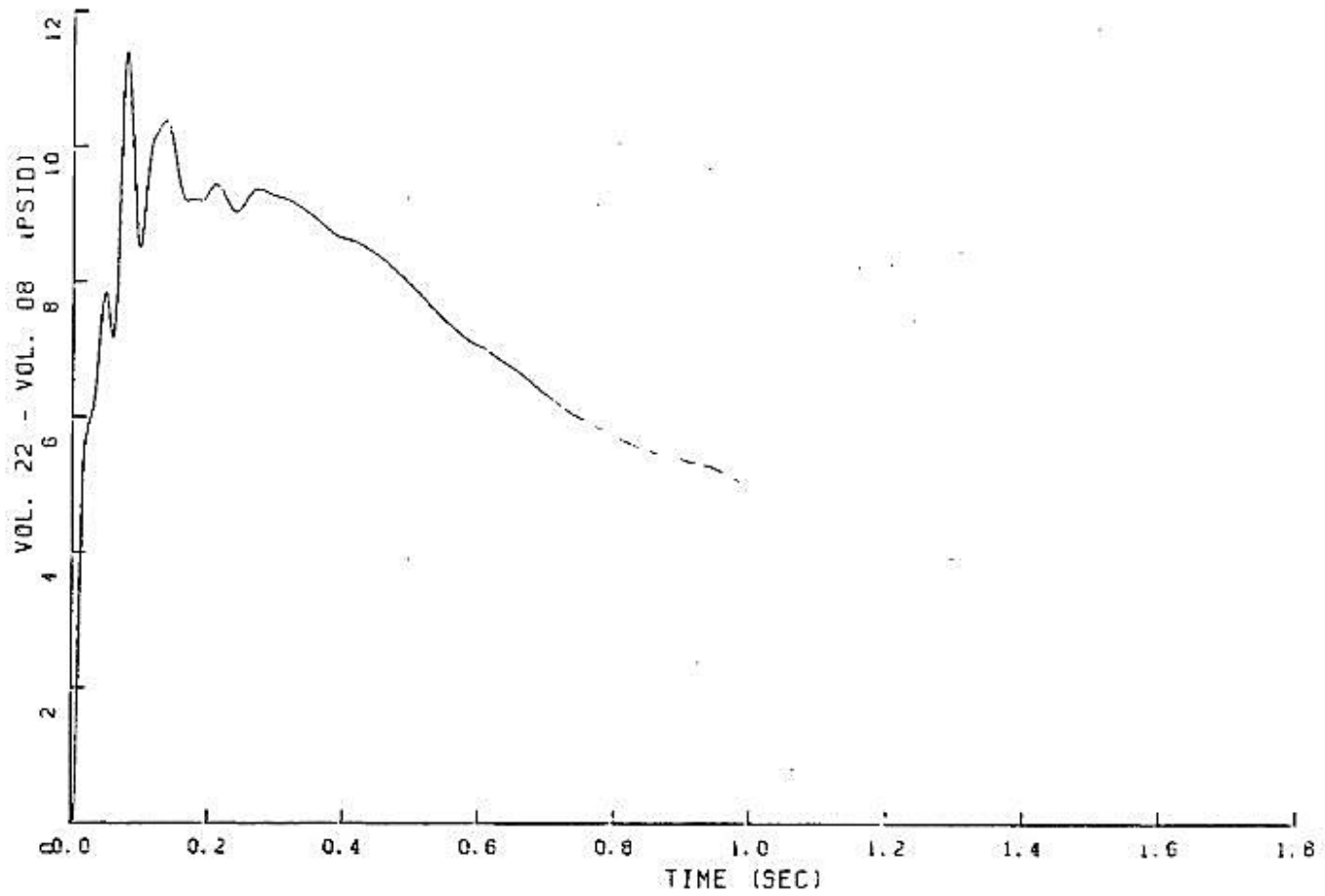

FIGURE 6.2.1-160

PEAK PRESSURE DIFFERENTIAL IN STEAM GENERATOR LOOP - 3

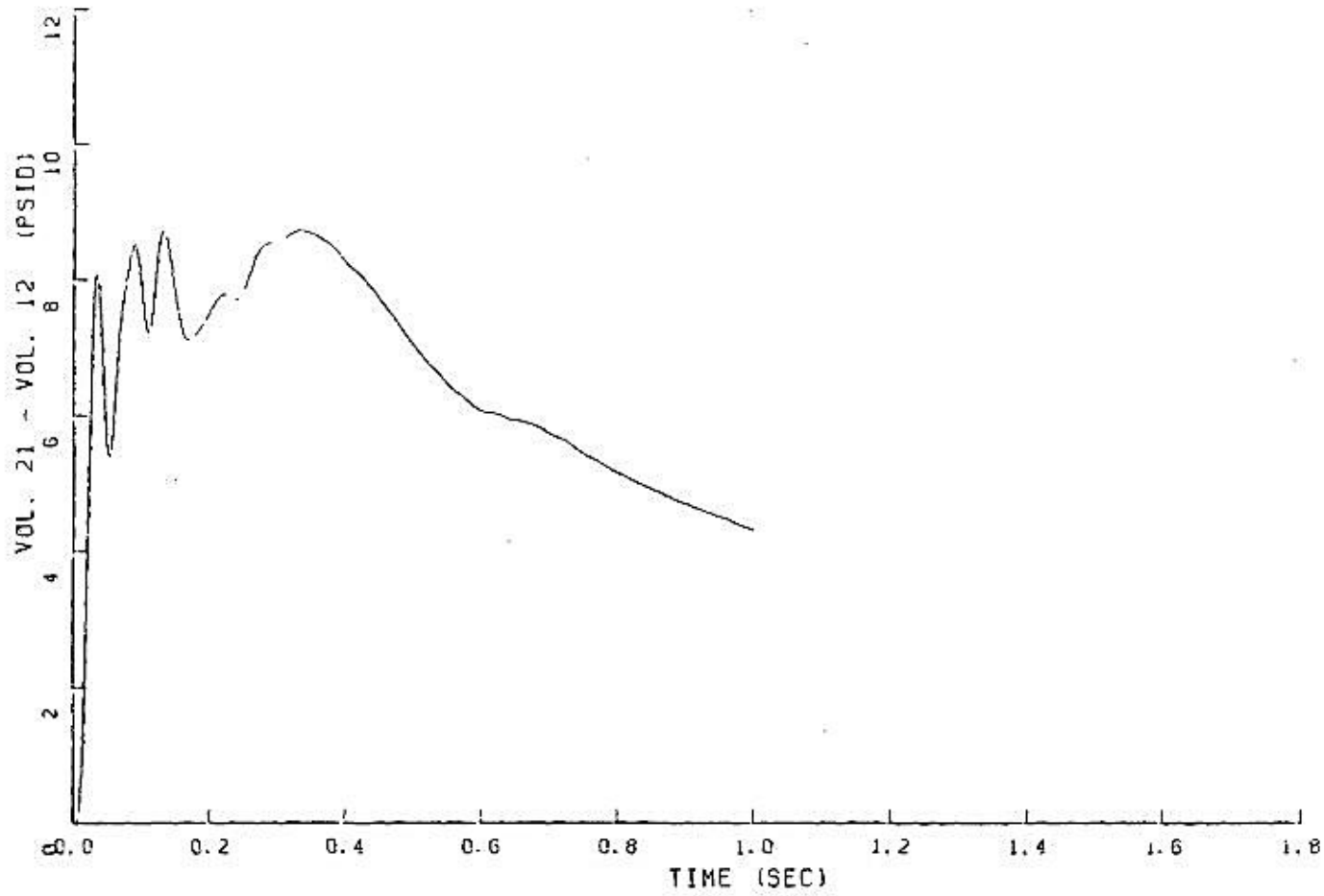

FIGURE 6.2.1-161

PEAK PRESSURE DIFFERENTIAL IN STEAM GENERATOR LOOP - 3

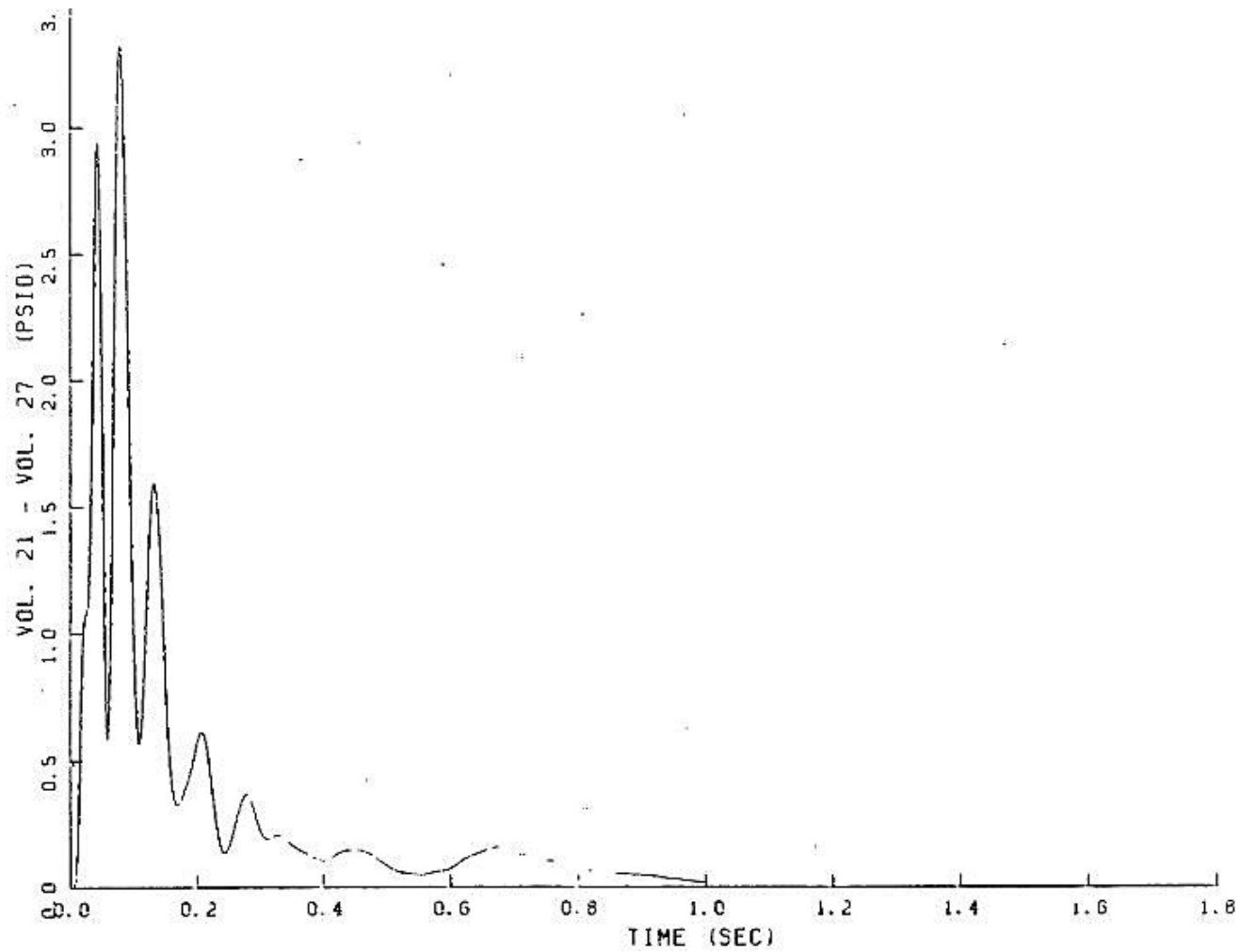

FIGURE 6.2.1-162

PEAK PRESSURE DIFFERENTIAL IN STEAM GENERATOR LOOP – 3

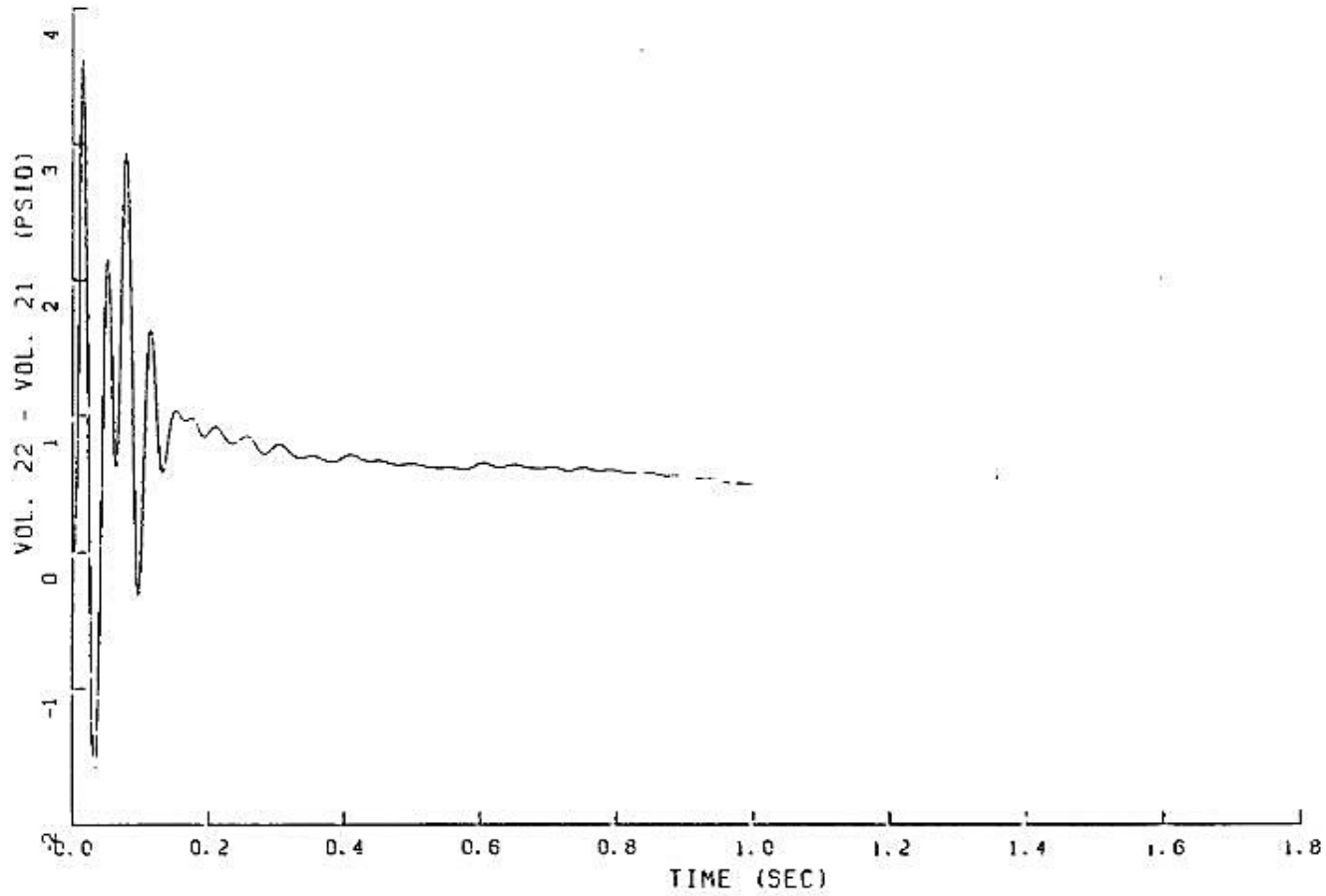

FIGURE 6.2.1-163

PEAK PRESSURE DIFFERENTIAL IN STEAM GENERATOR LOOP - 3

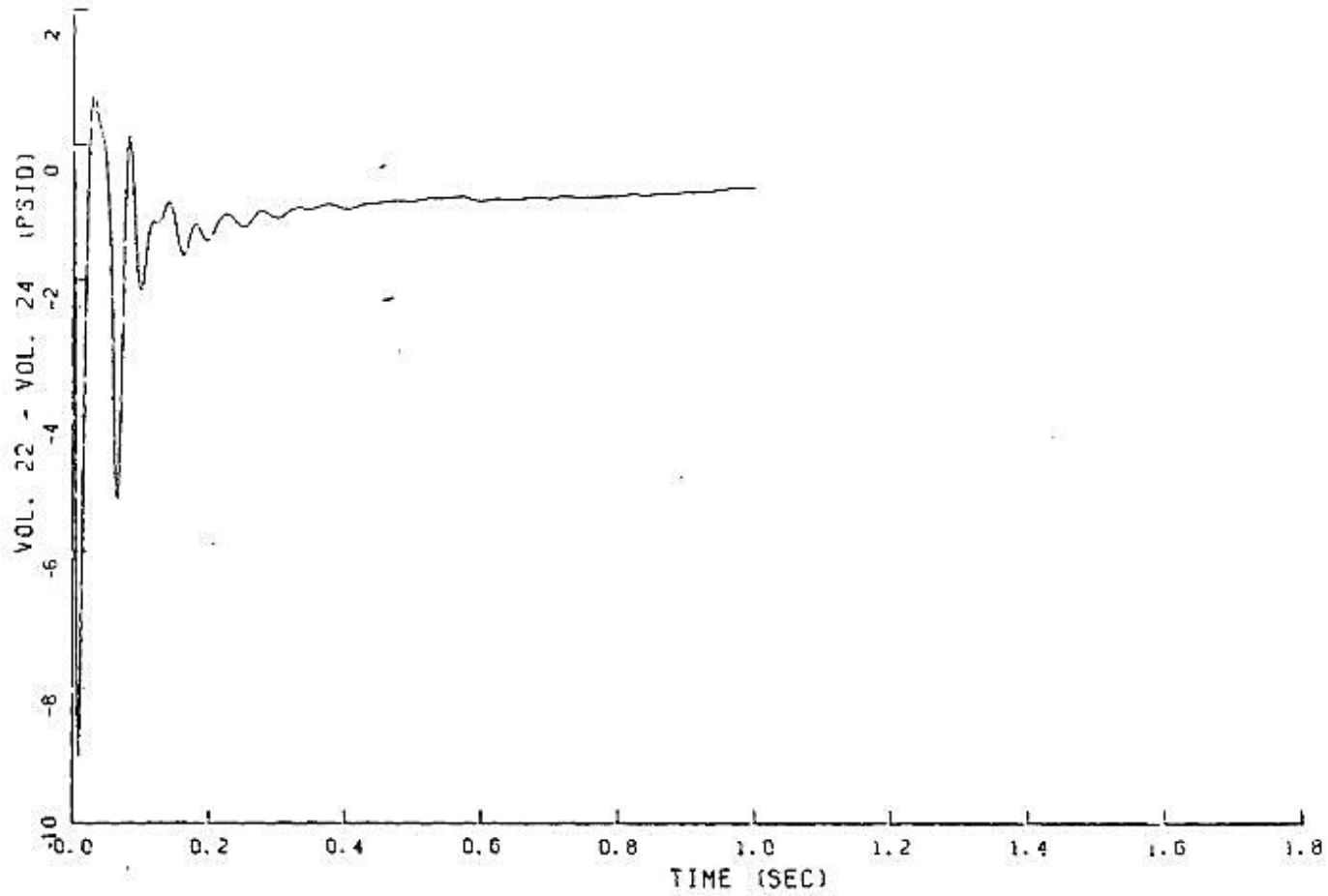

FIGURE 6.2.1-164

PEAK PRESSURE DIFFERENTIAL IN STEAM GENERATOR LOOP - 3

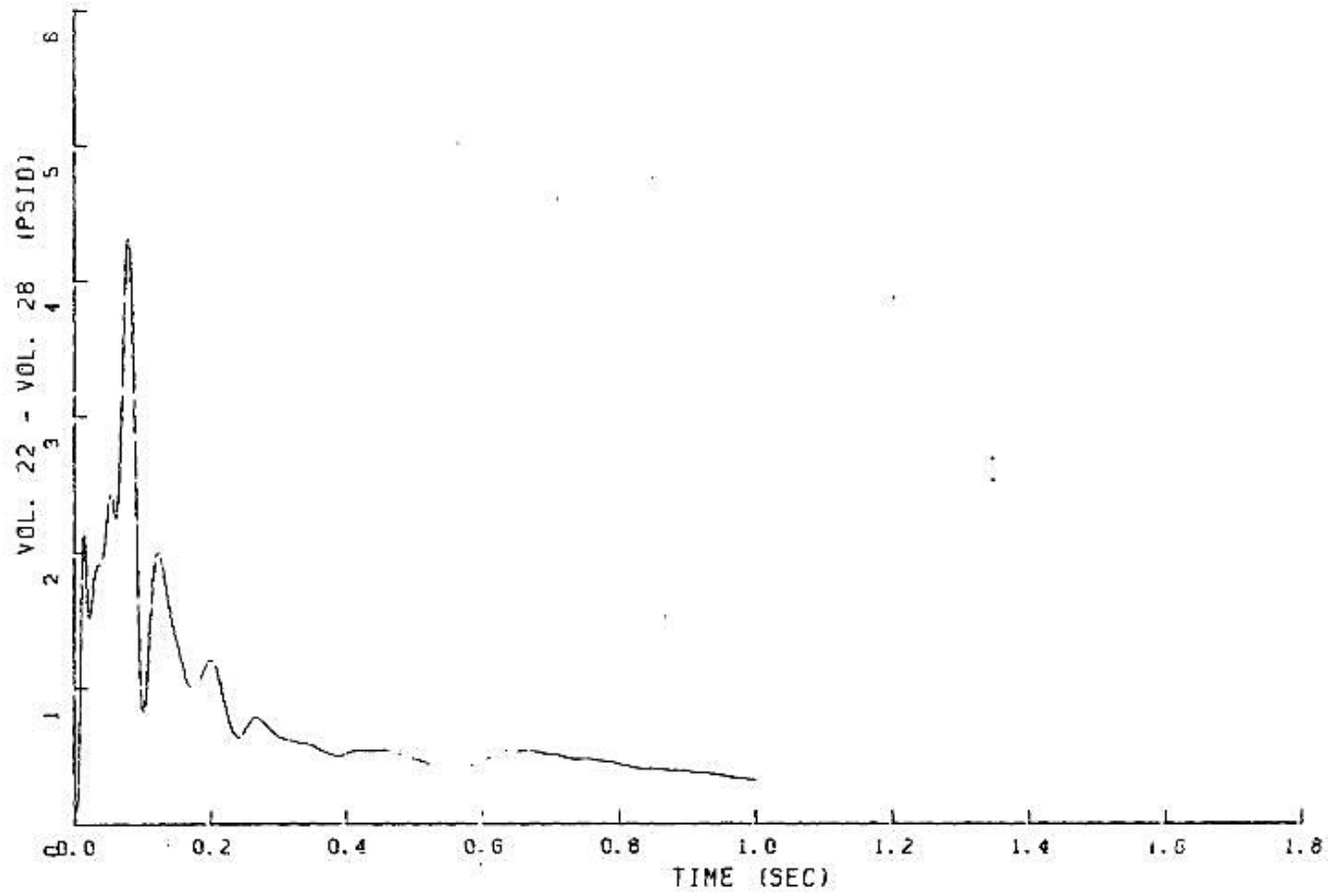

FIGURE 6.2.1-165

PEAK PRESSURE DIFFERENTIAL IN STEAM GENERATOR LOOP – 3

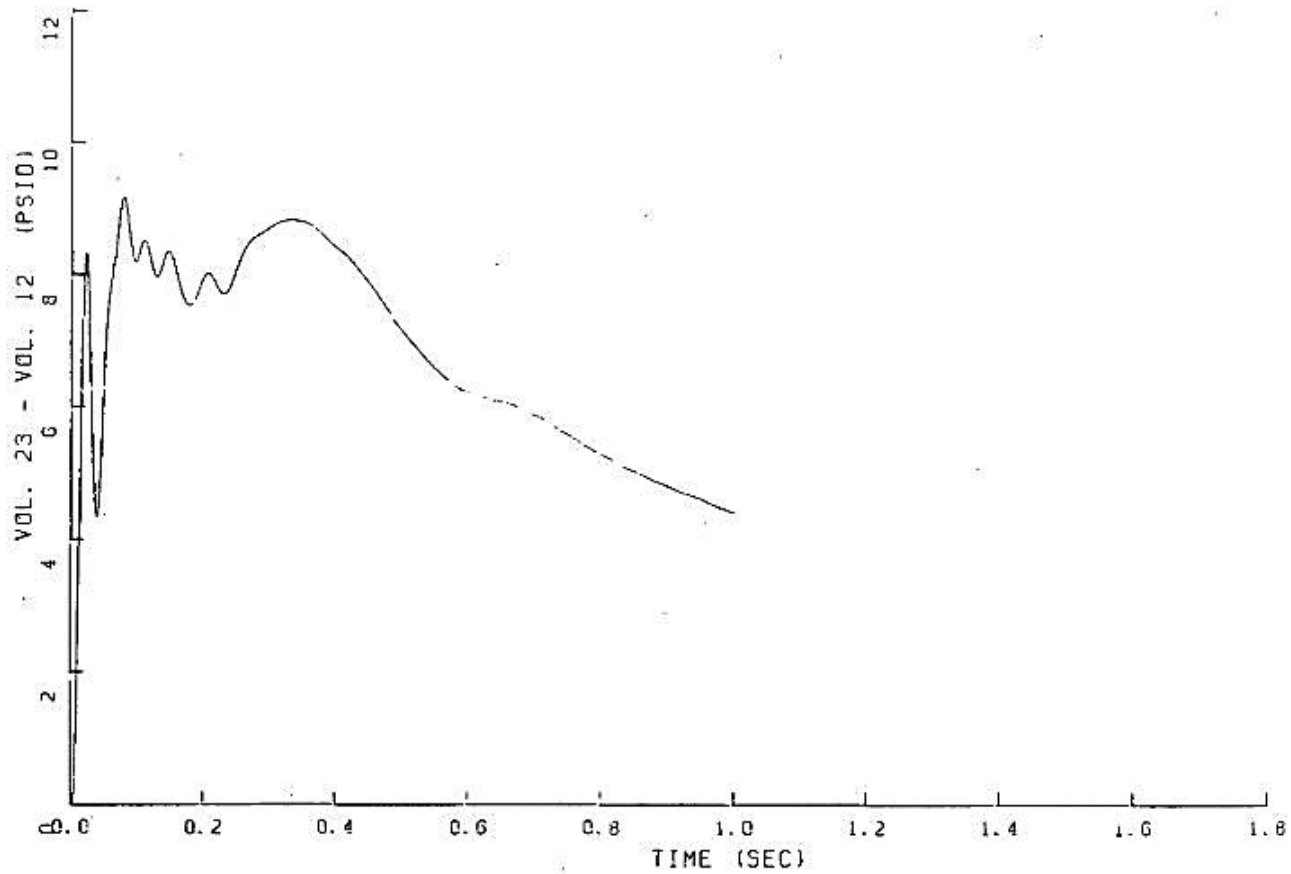

FIGURE 6.2.1-166

PEAK PRESSURE DIFFERENTIAL IN STEAM GENERATOR LOOP – 3

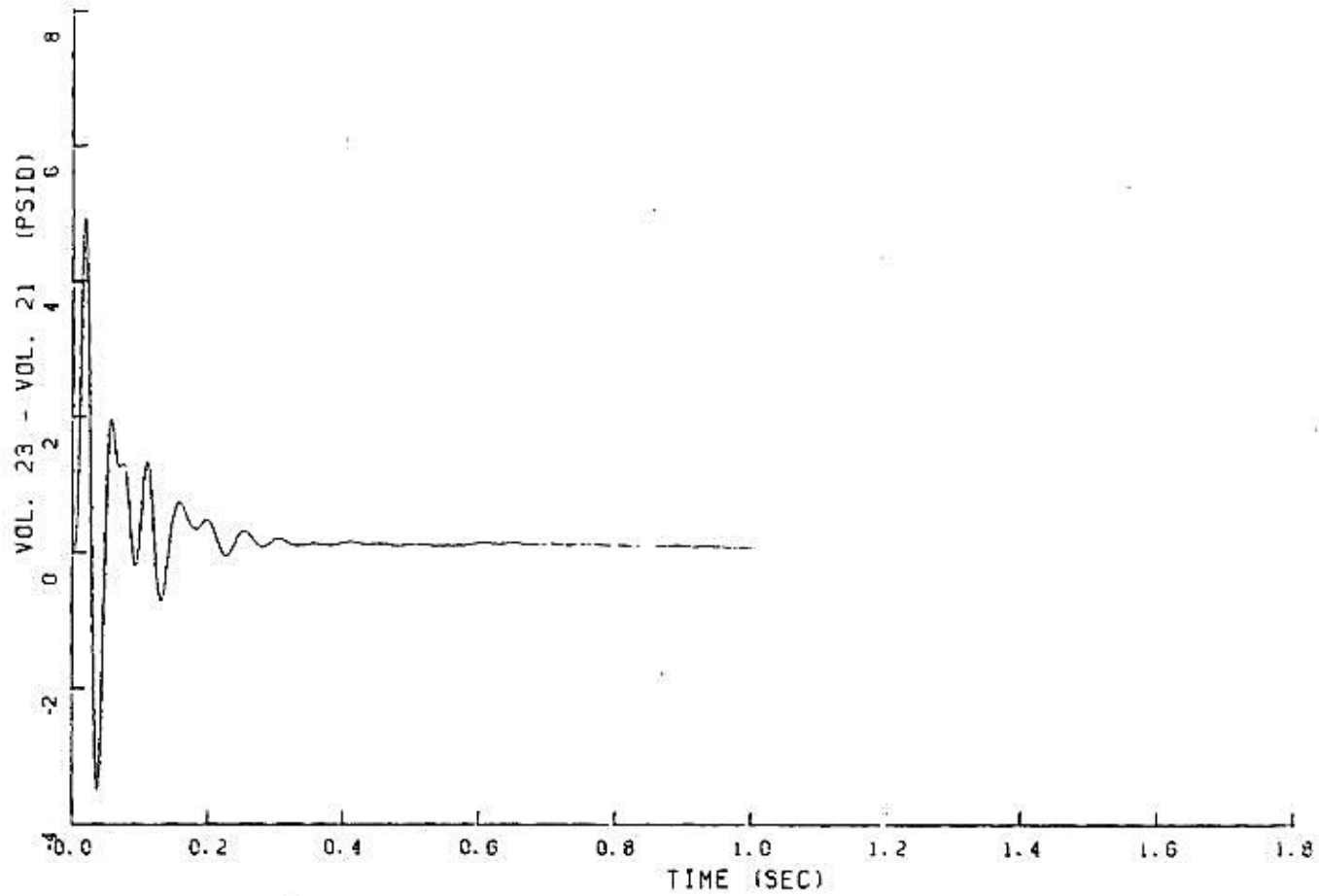

FIGURE 6.2.1-167

PEAK PRESSURE DIFFERENTIAL IN STEAM GENERATOR LOOP - 3

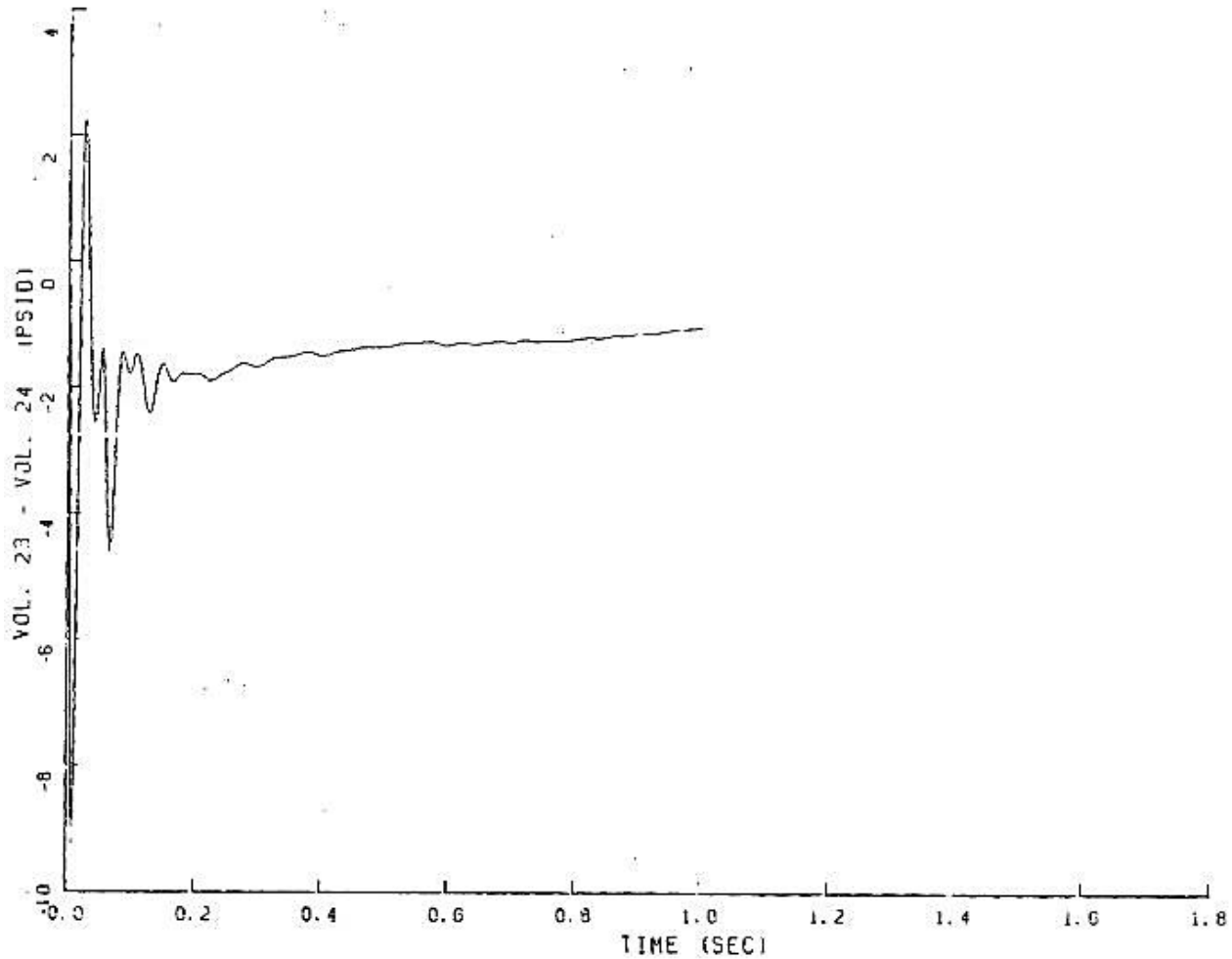

FIGURE 6.2.1-168

PEAK PRESSURE DIFFERENTIAL IN STEAM GENERATOR LOOP - 3

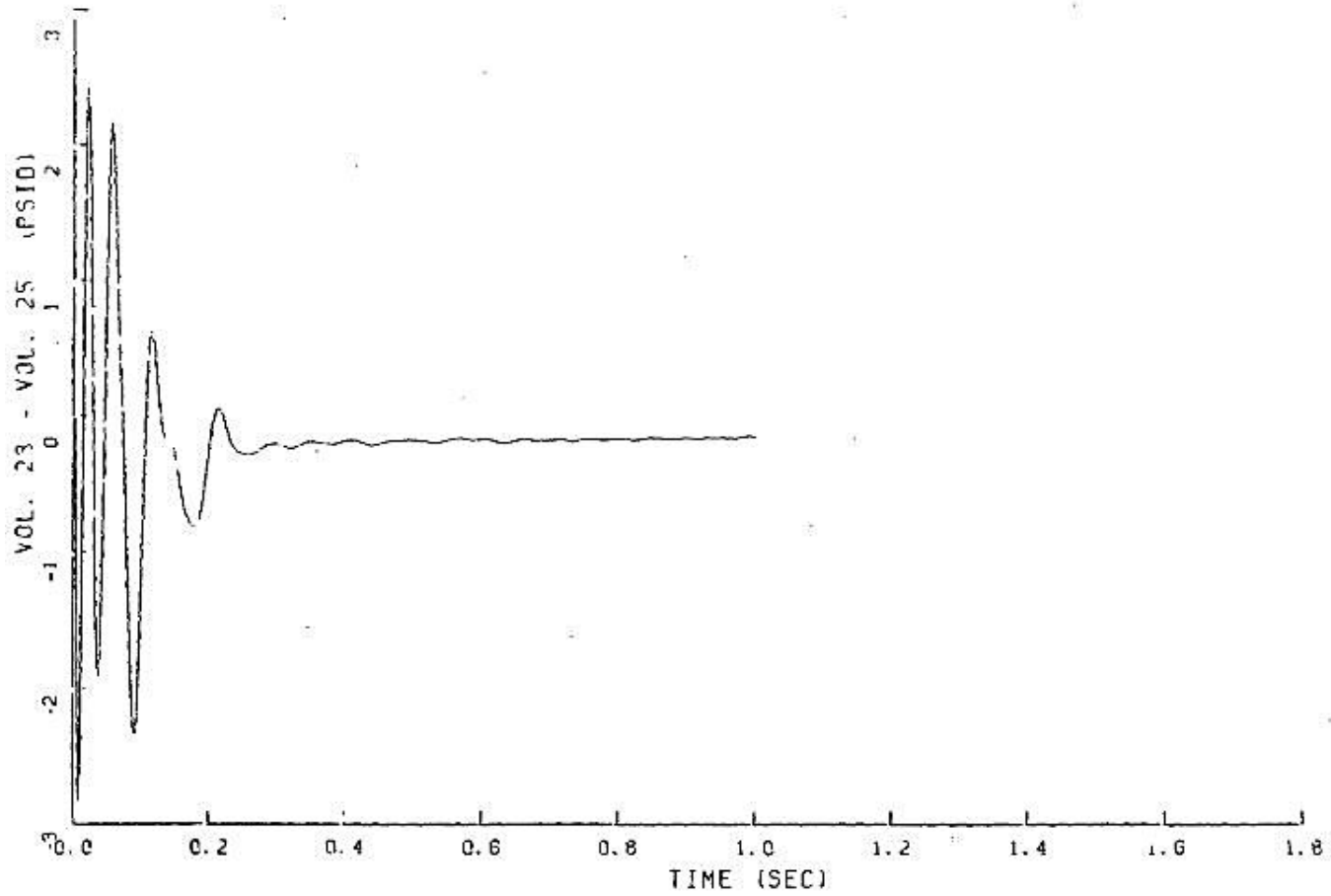

FIGURE 6.2.1-170

PEAK PRESSURE DIFFERENTIAL IN STEAM GENERATOR LOOP - 3

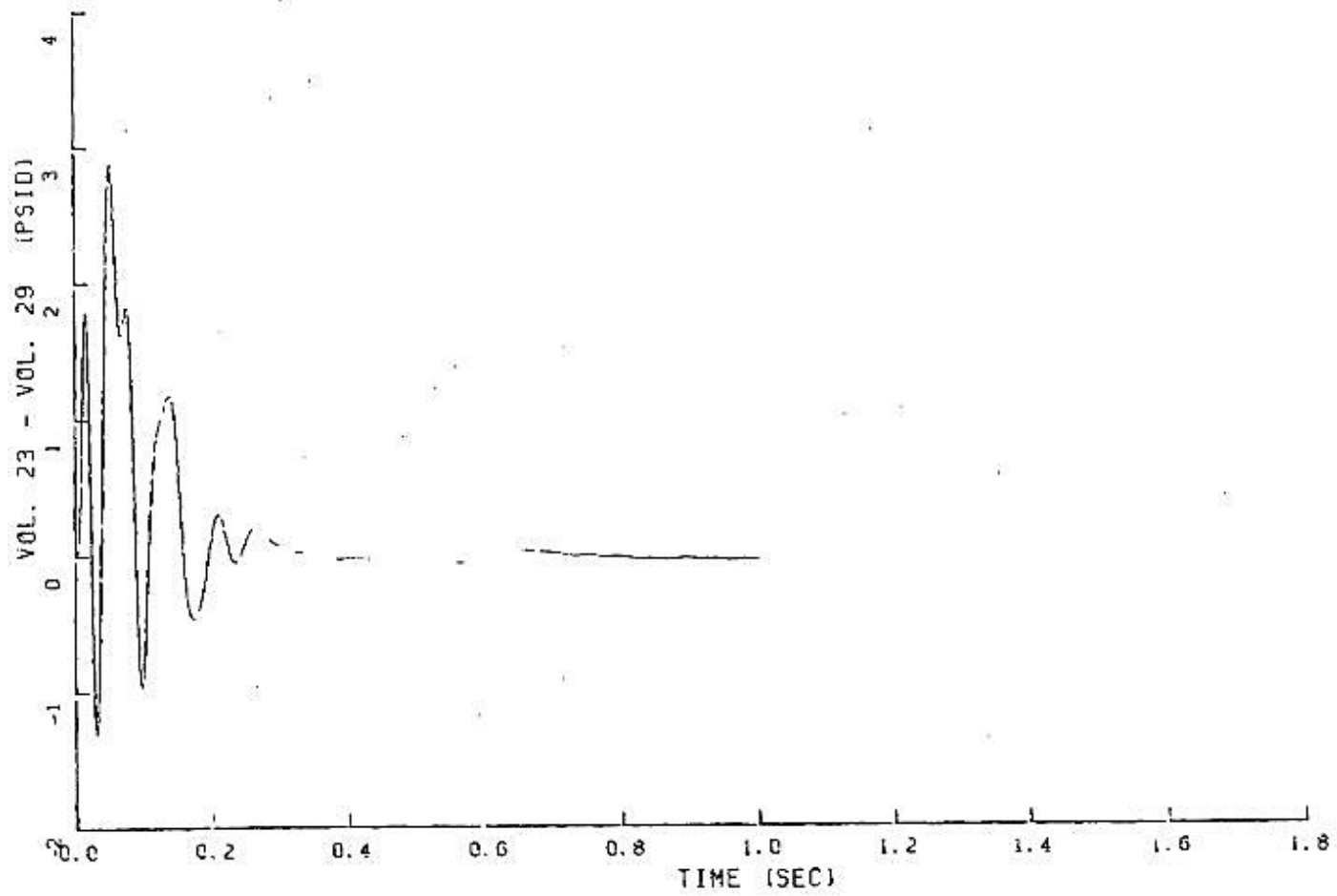

FIGURE 6.2.1-170

PEAK PRESSURE DIFFERENTIAL IN STEAM GENERATOR LOOP - 3

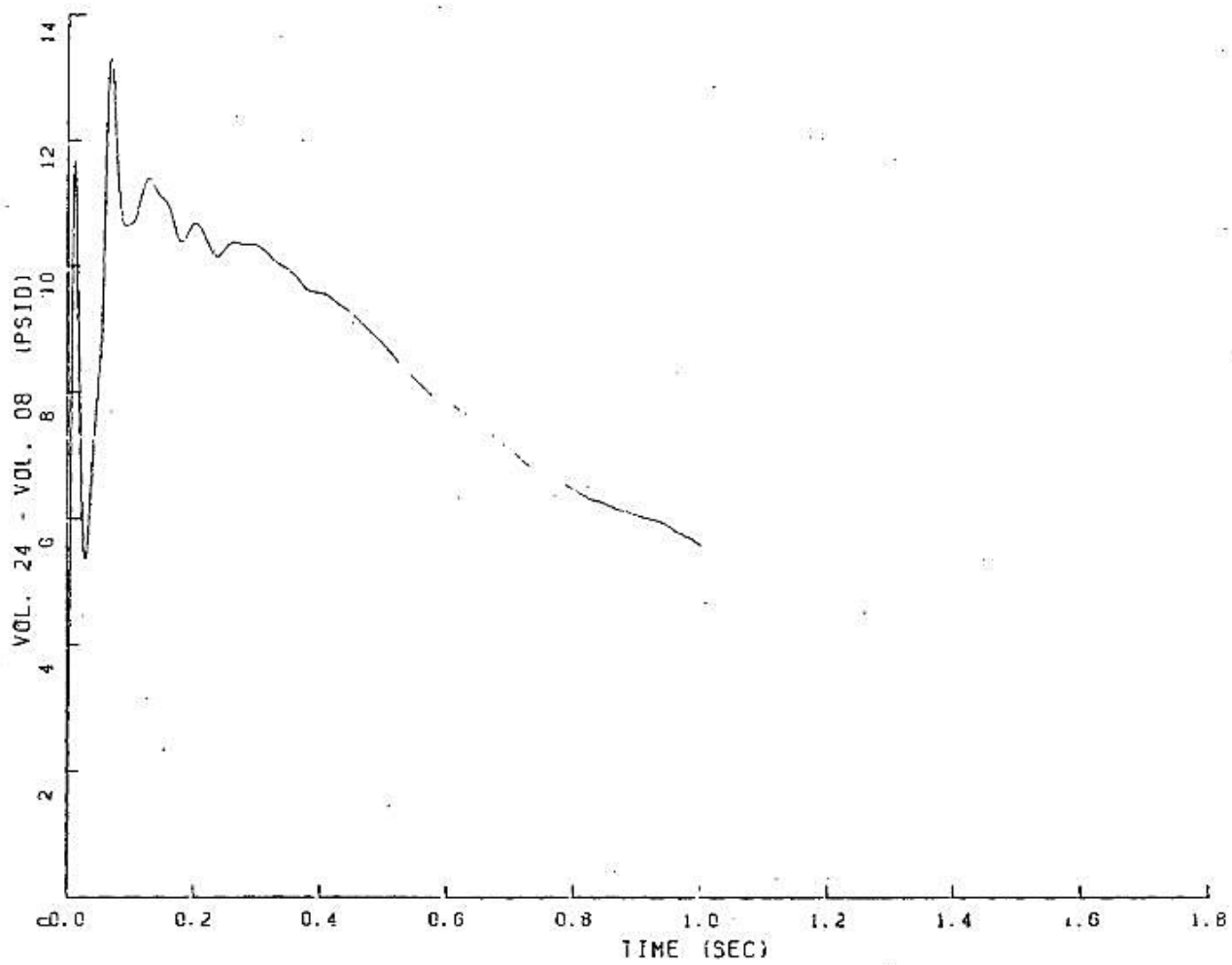

FIGURE 6.2.1-171

PEAK PRESSURE DIFFERENTIAL IN STEAM GENERATOR LOOP - 3

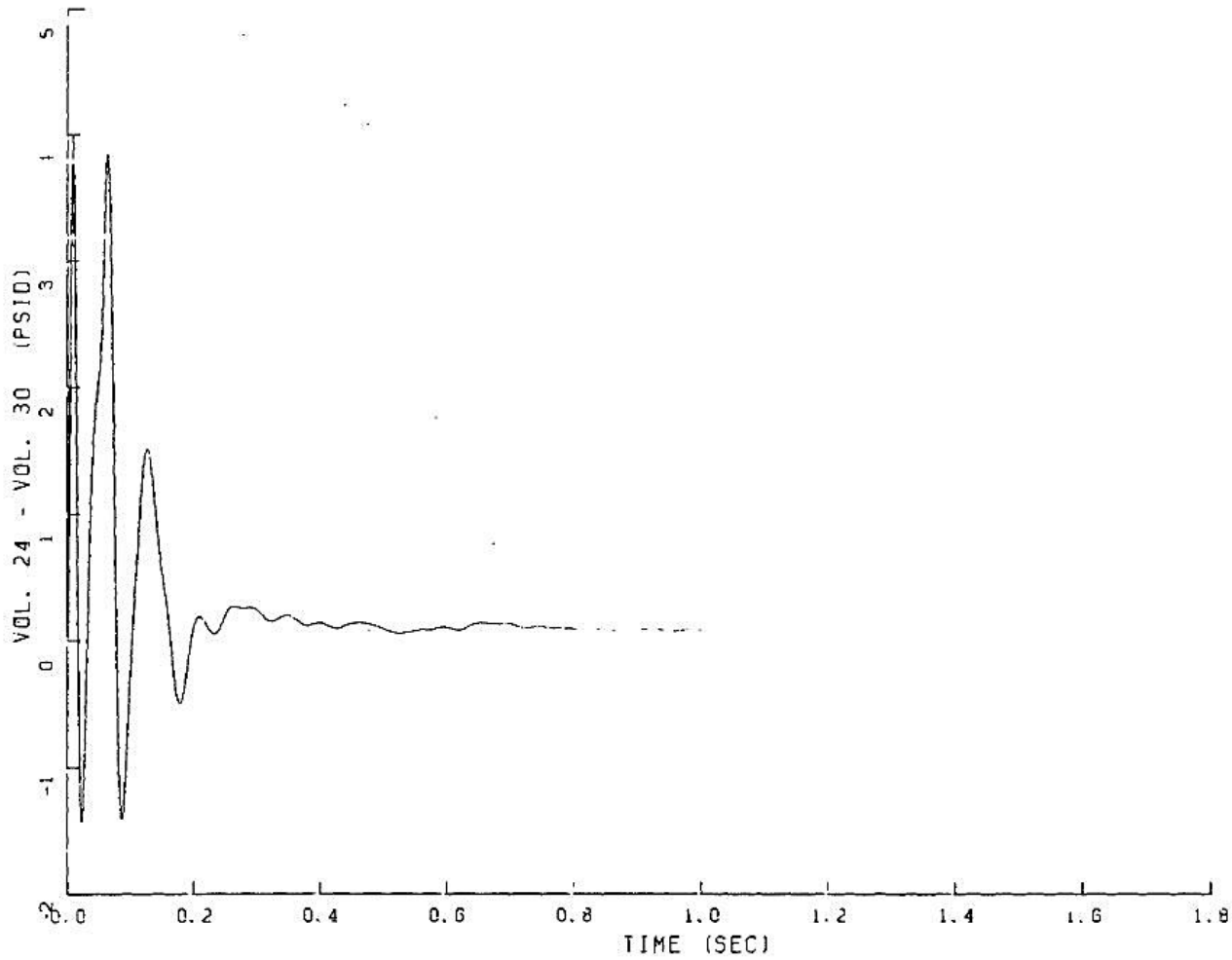

FIGURE 6.2.1-172

PEAK PRESSURE DIFFERENTIAL IN STEAM GENERATOR LOOP - 3

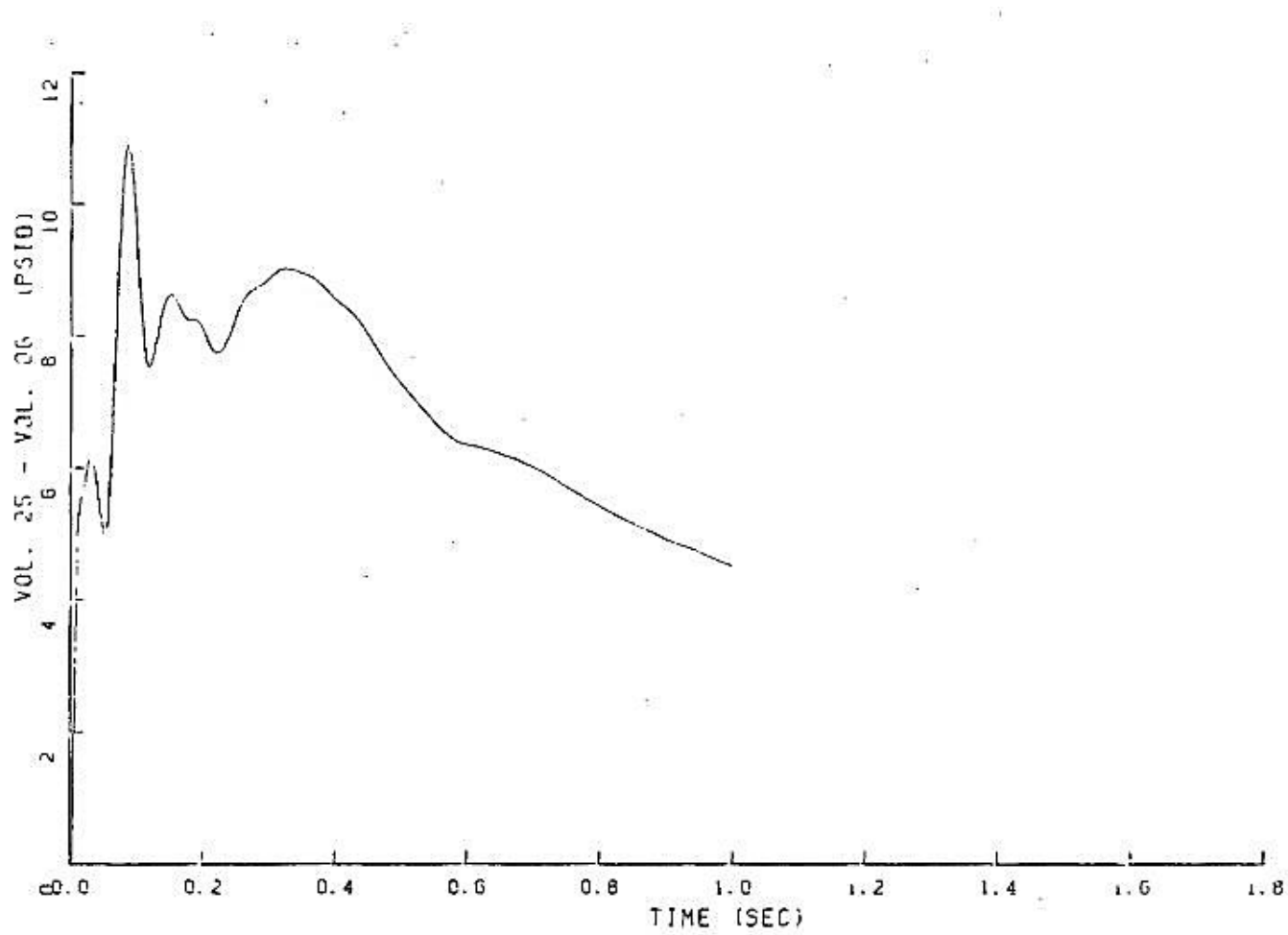

FIGURE 6.2.1-173

PEAK PRESSURE DIFFERENTIAL IN STEAM GENERATOR LOOP - 3

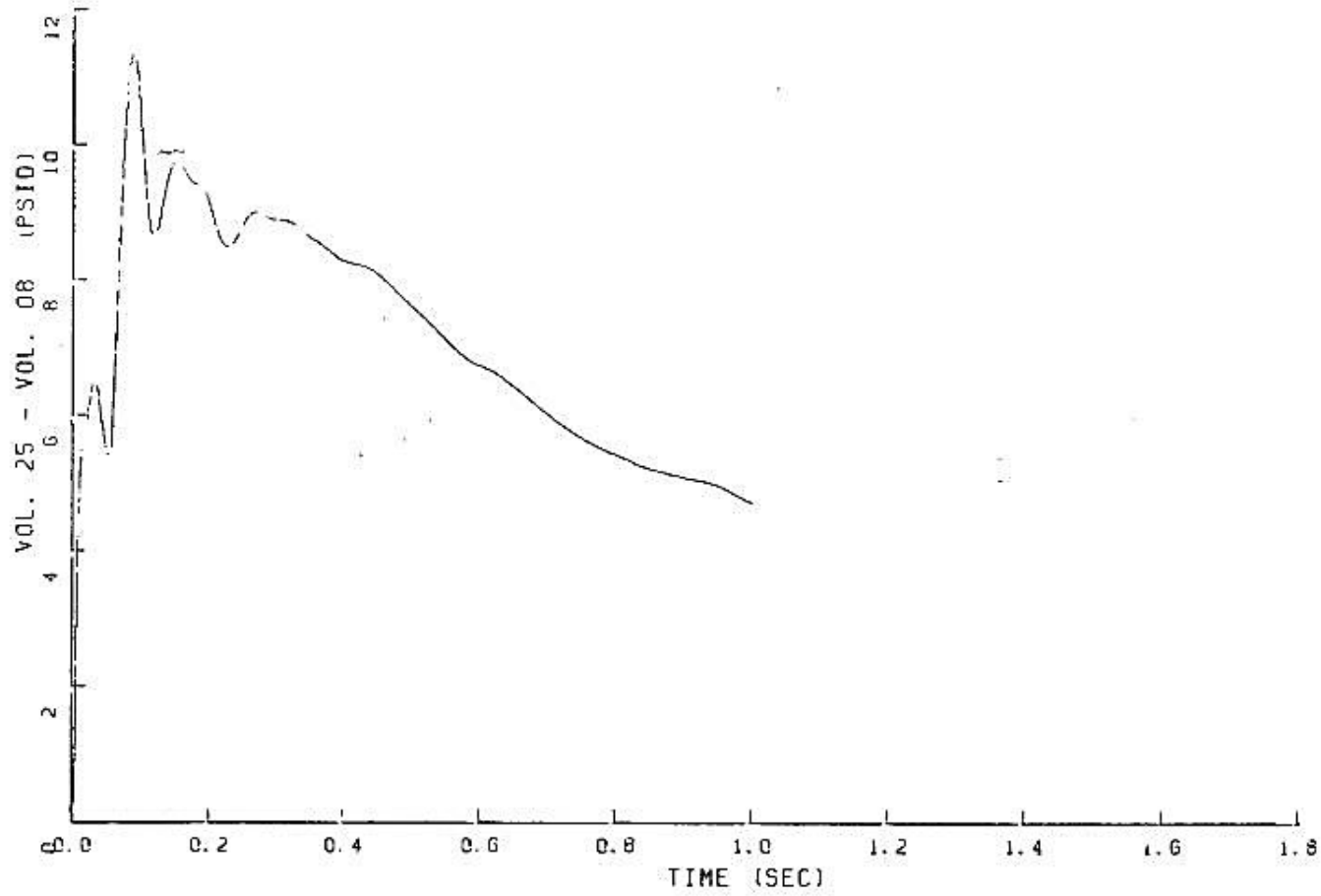

FIGURE 6.2.1-174

PEAK PRESSURE DIFFERENTIAL IN STEAM GENERATOR LOOP - 3

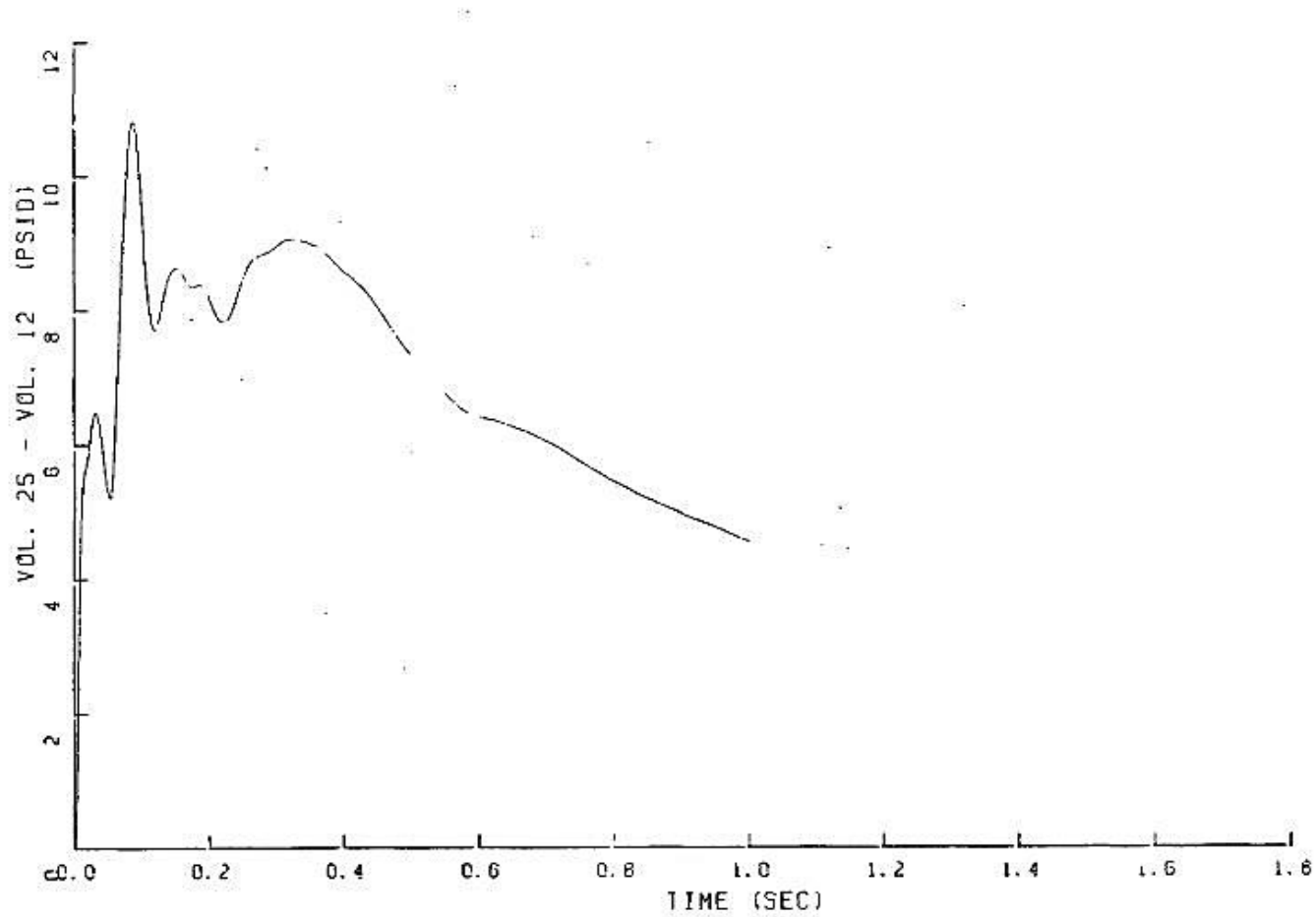

FIGURE 6.2.1-175

PEAK PRESSURE DIFFERENTIAL IN STEAM GENERATOR LOOP - 3

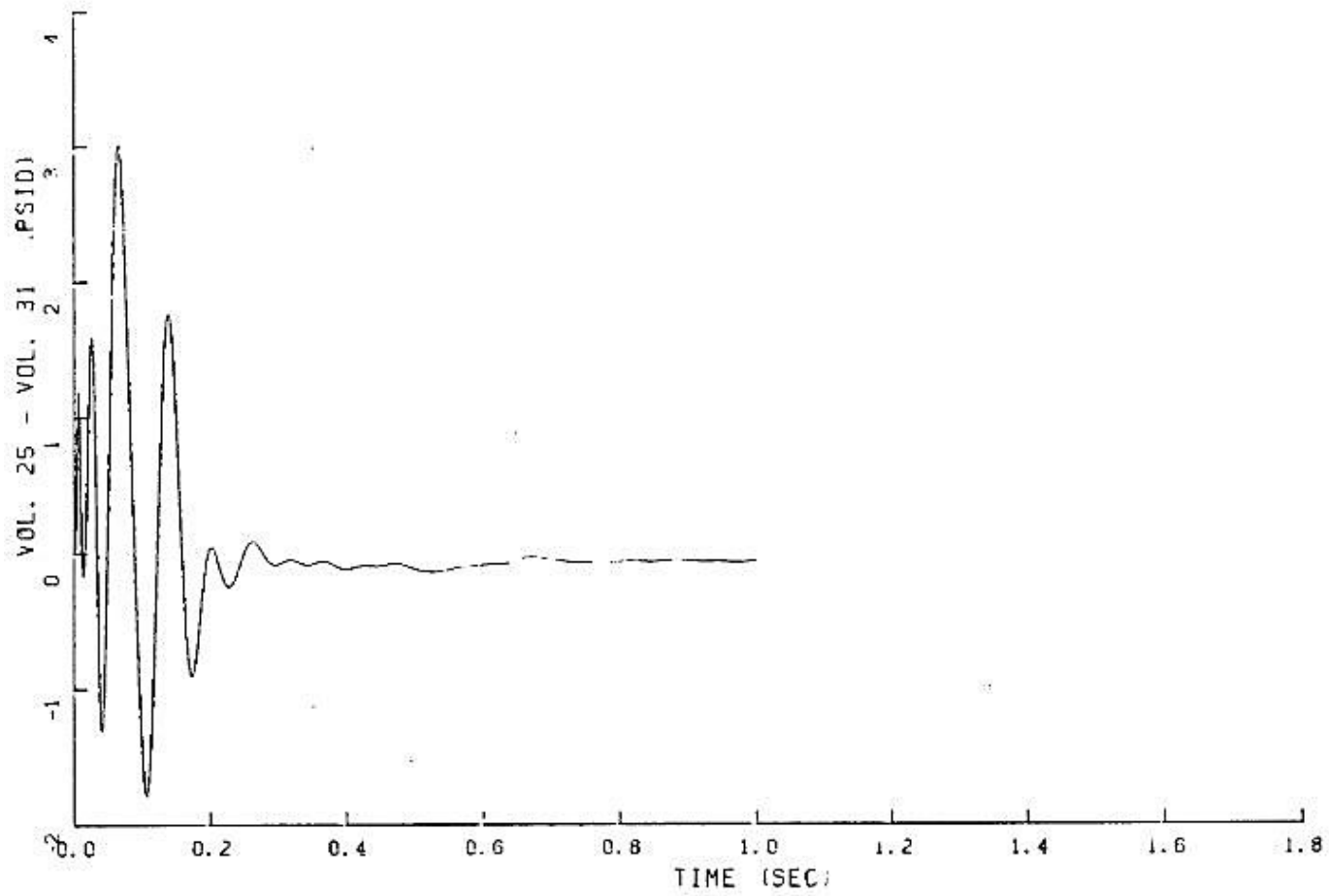

FIGURE 6.2.1-176

PEAK PRESSURE DIFFERENTIAL IN STEAM GENERATOR LOOP - 3

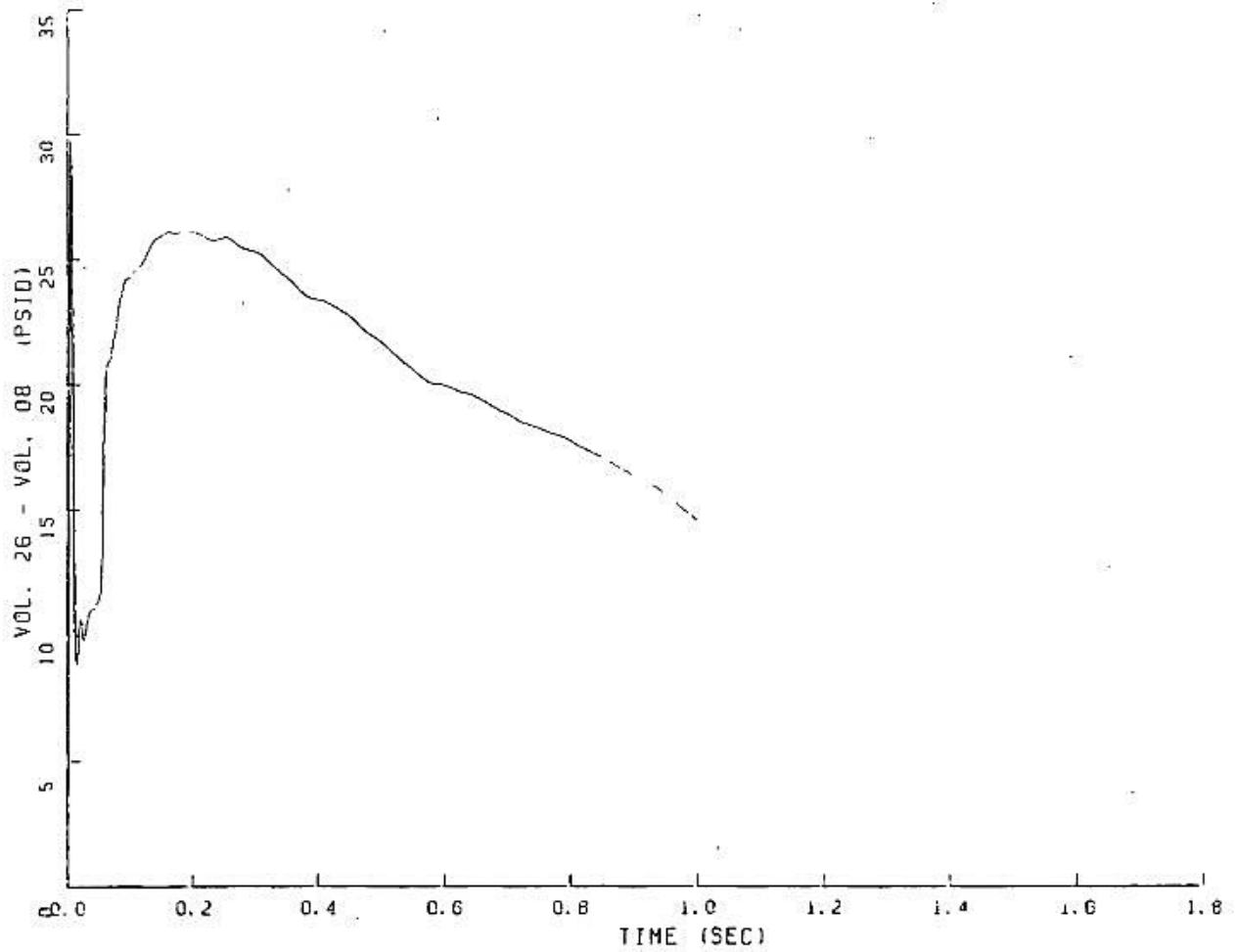

FIGURE 6.2.1-177

PEAK PRESSURE DIFFERENTIAL IN STEAM GENERATOR LOOP - 3

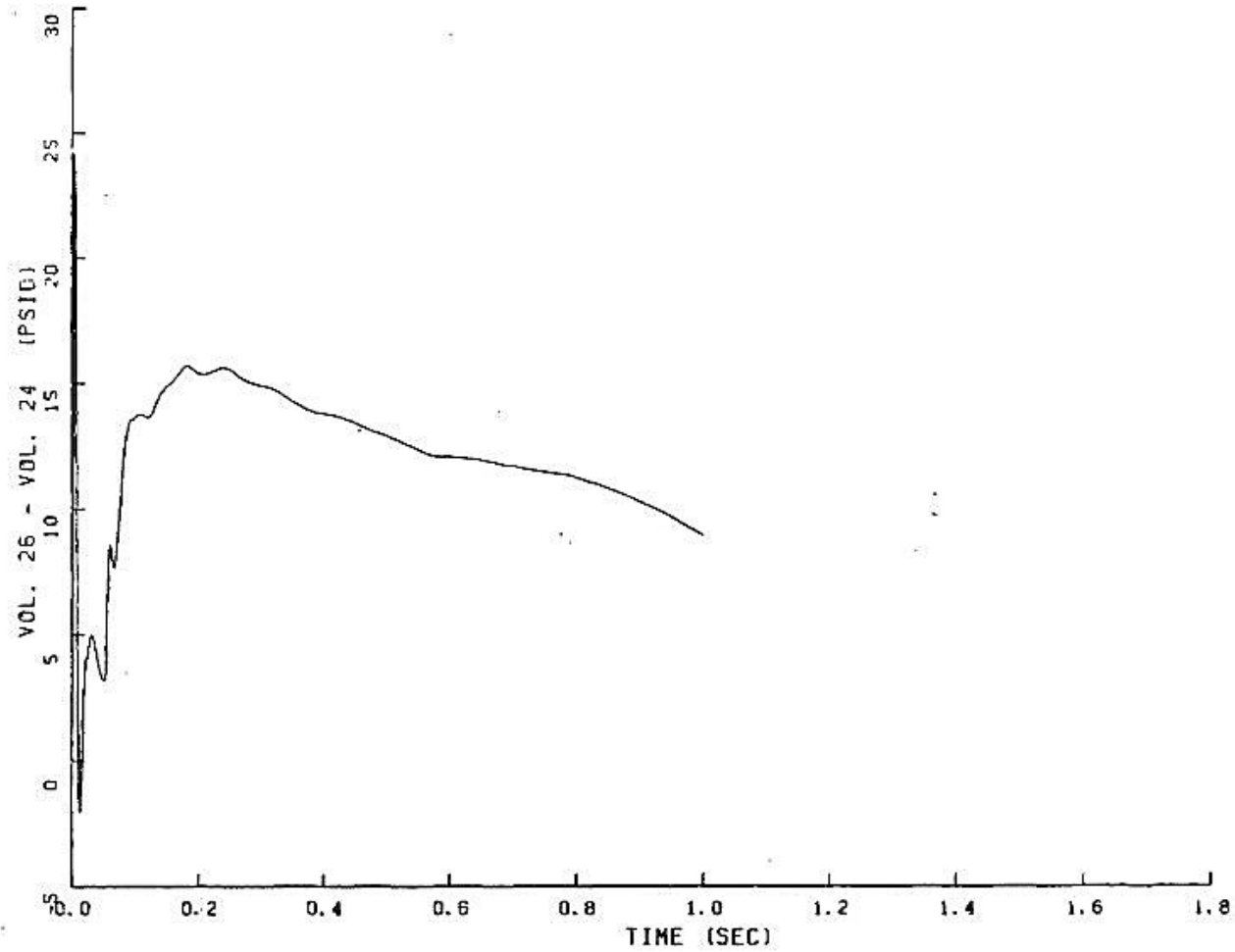

FIGURE 6.2.1-178

PEAK PRESSURE DIFFERENTIAL IN STEAM GENERATOR LOOP - 3

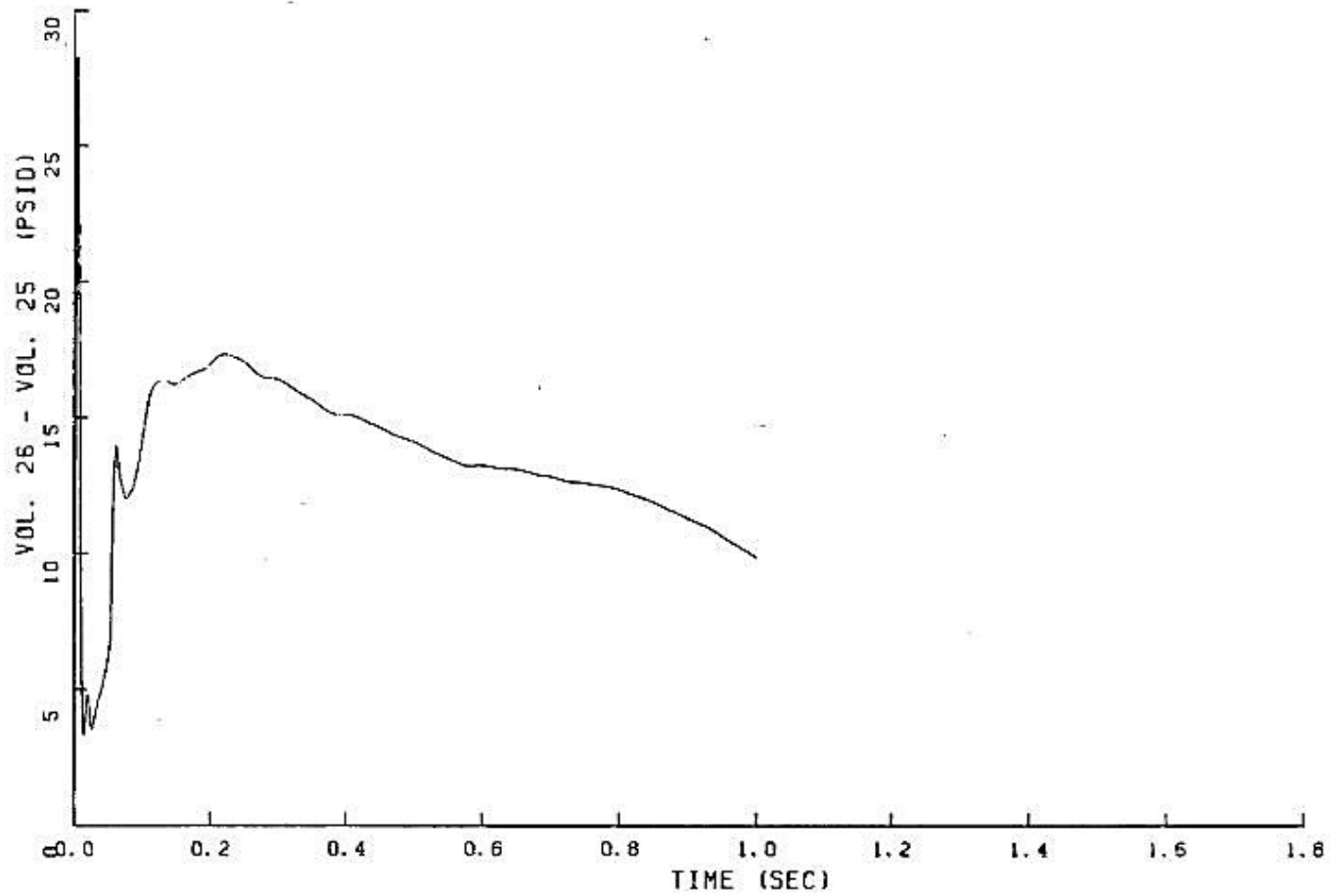

FIGURE 6.2.1-179

PEAK PRESSURE DIFFERENTIAL IN STEAM GENERATOR LOOP - 3

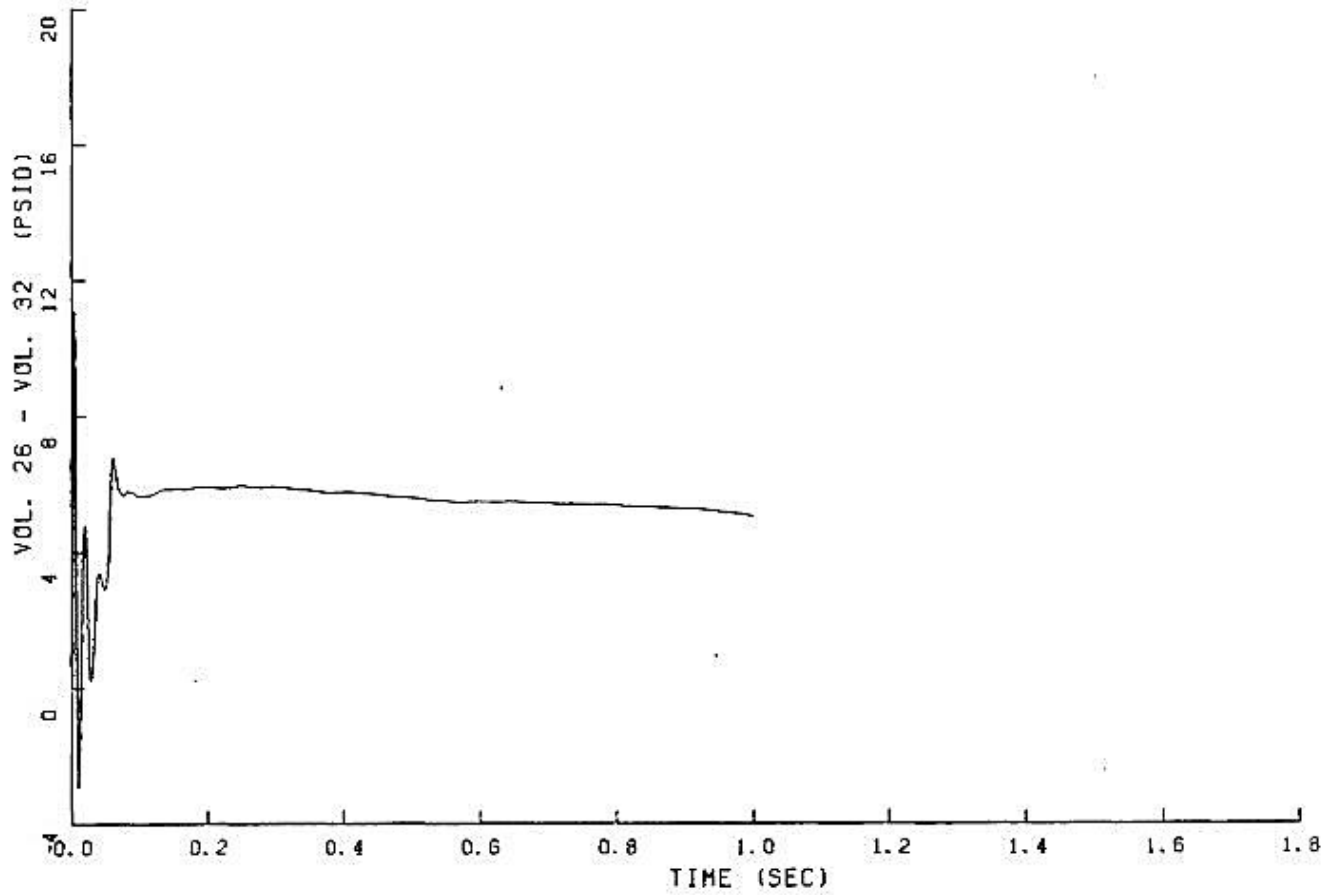

FIGURE 6.2.1-180

PEAK PRESSURE DIFFERENTIAL IN STEAM GENERATOR LOOP - 3

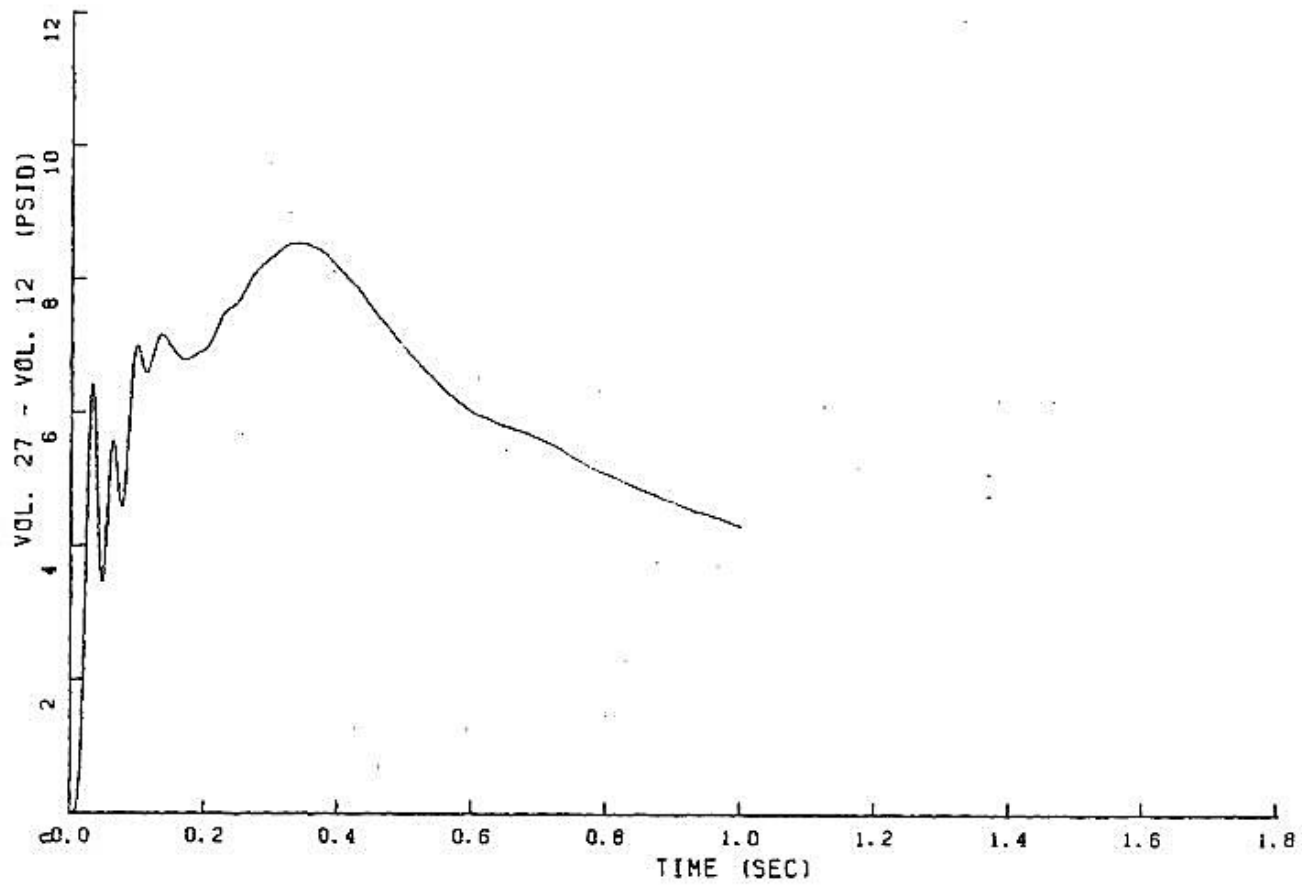

FIGURE 6.2.1-181

PEAK PRESSURE DIFFERENTIAL IN STEAM GENERATOR LOOP - 3

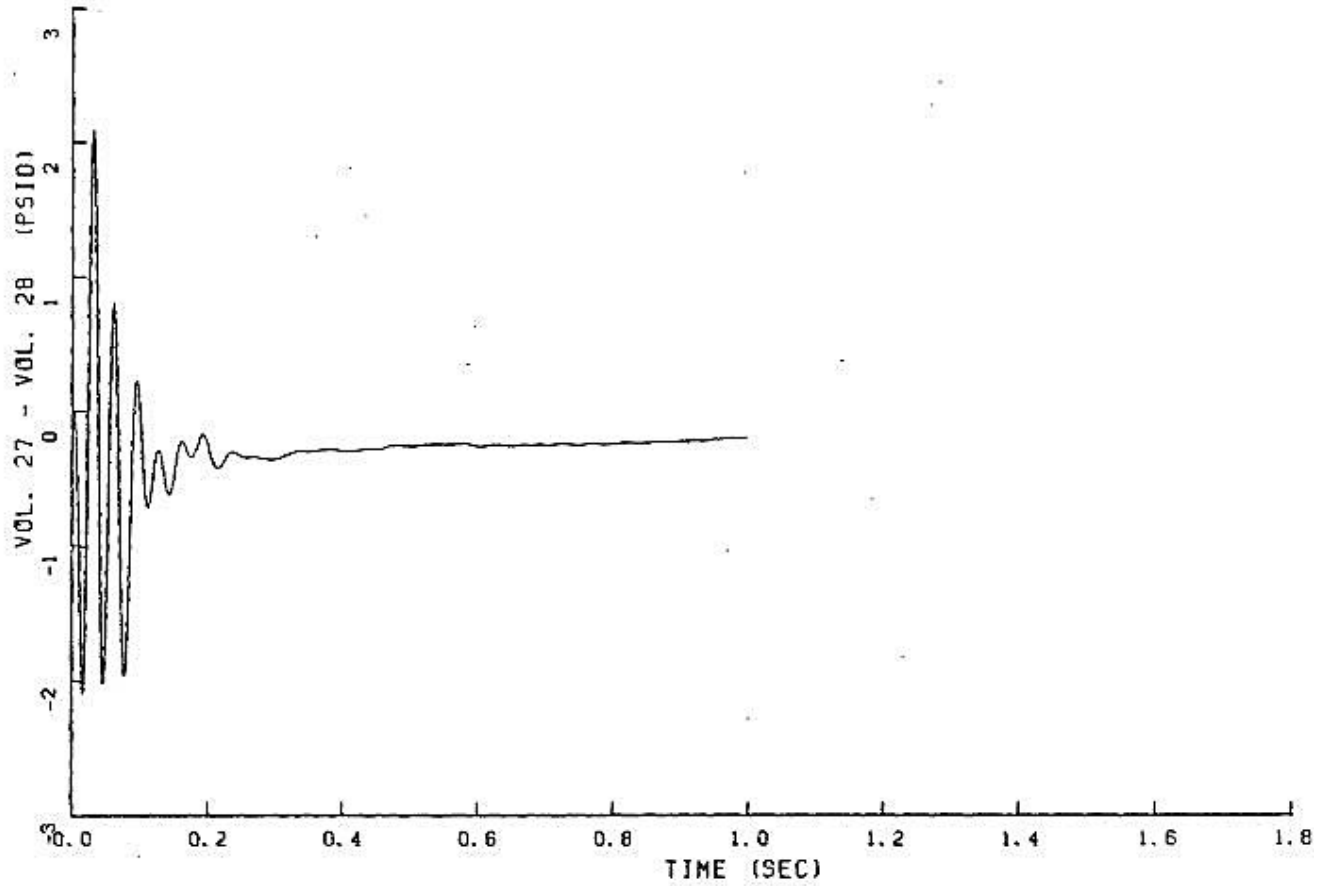

FIGURE 6.2.1-182

PEAK PRESSURE DIFFERENTIAL IN STEAM GENERATOR LOOP - 3

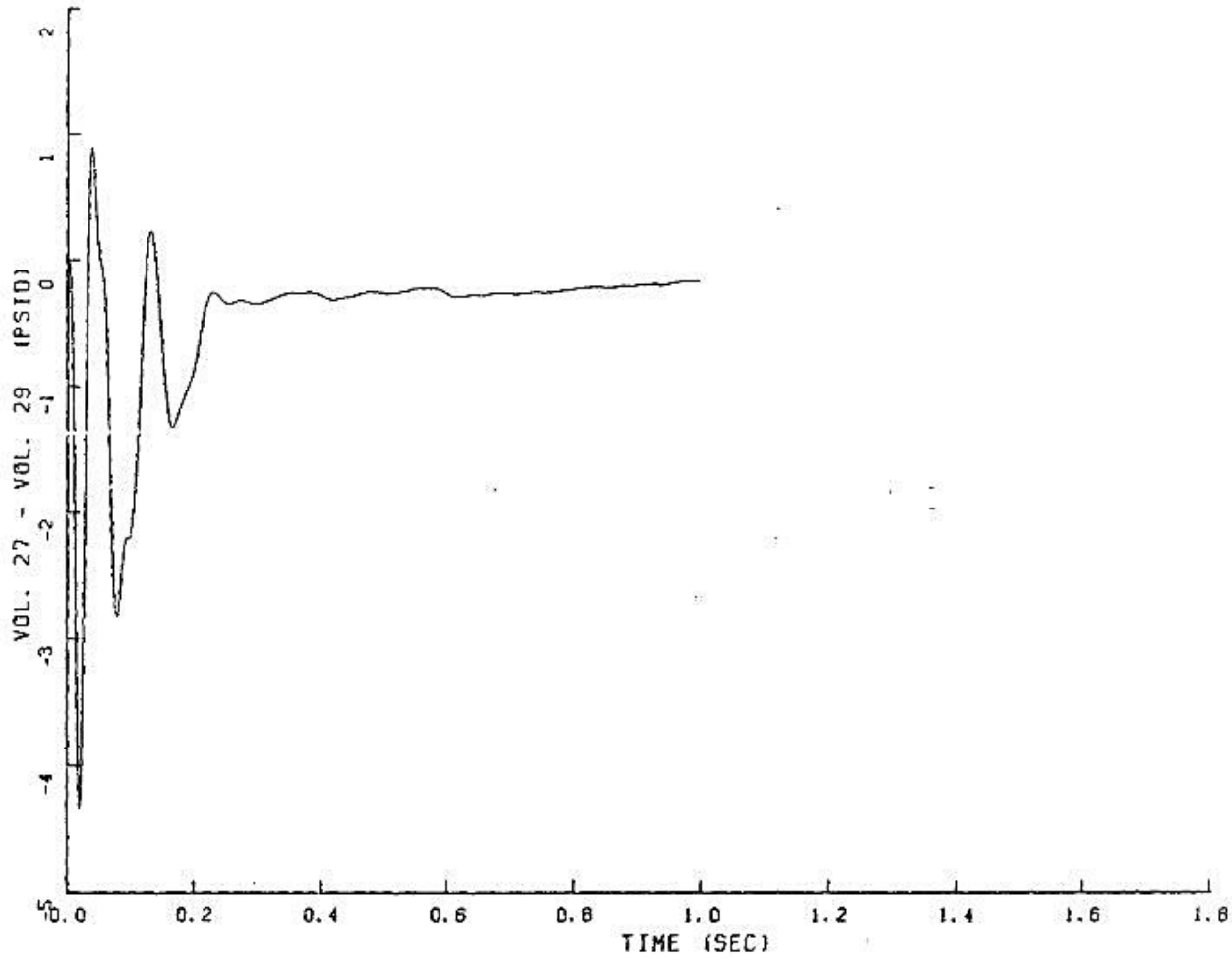

FIGURE 6.2.1-183

PEAK PRESSURE DIFFERENTIAL IN STEAM GENERATOR LOOP - 3

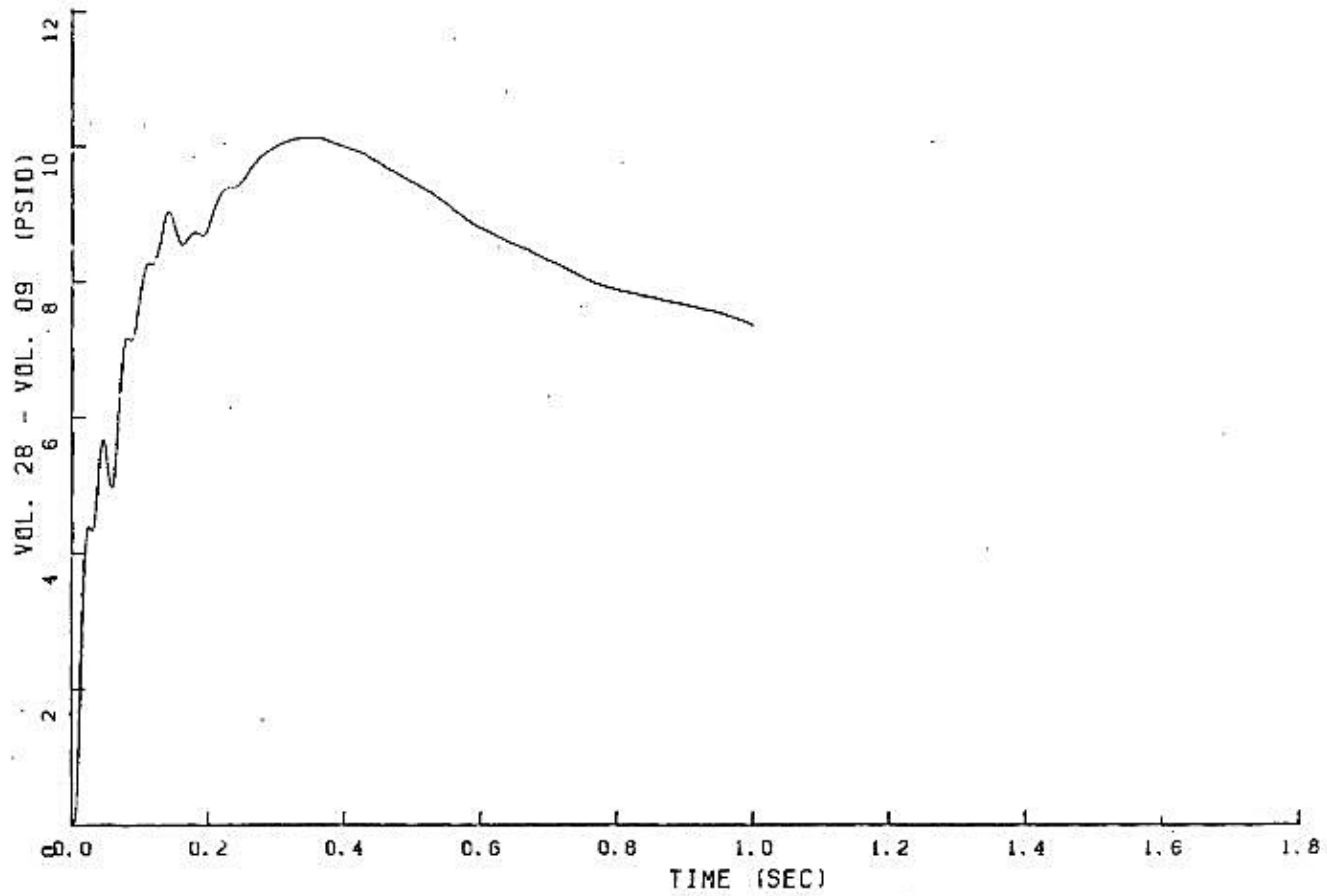

FIGURE 6.2.1-184

PEAK PRESSURE DIFFERENTIAL IN STEAM GENERATOR LOOP - 3

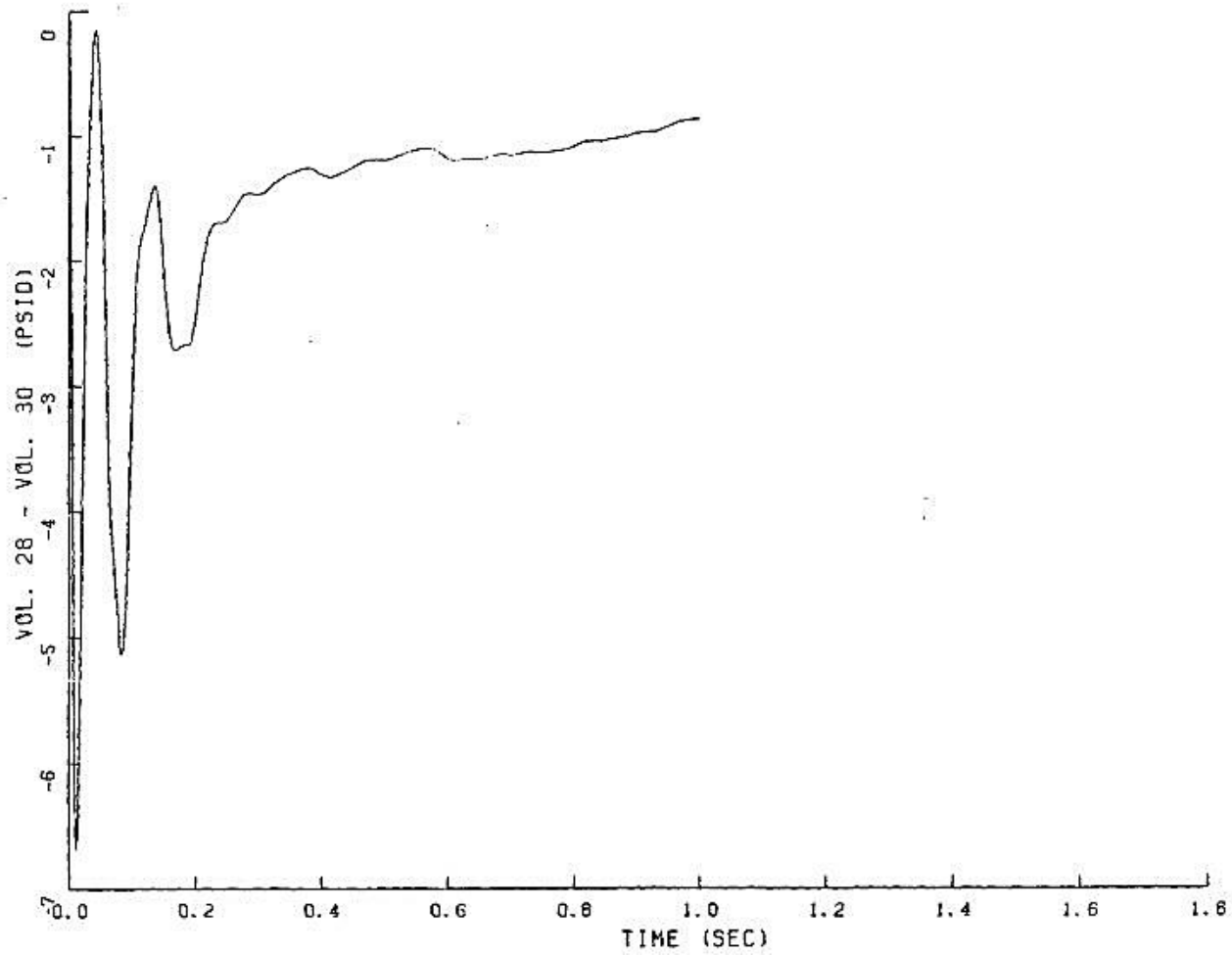

FIGURE 6.2.1-185

PEAK PRESSURE DIFFERENTIAL IN STEAM GENERATOR LOOP - 3

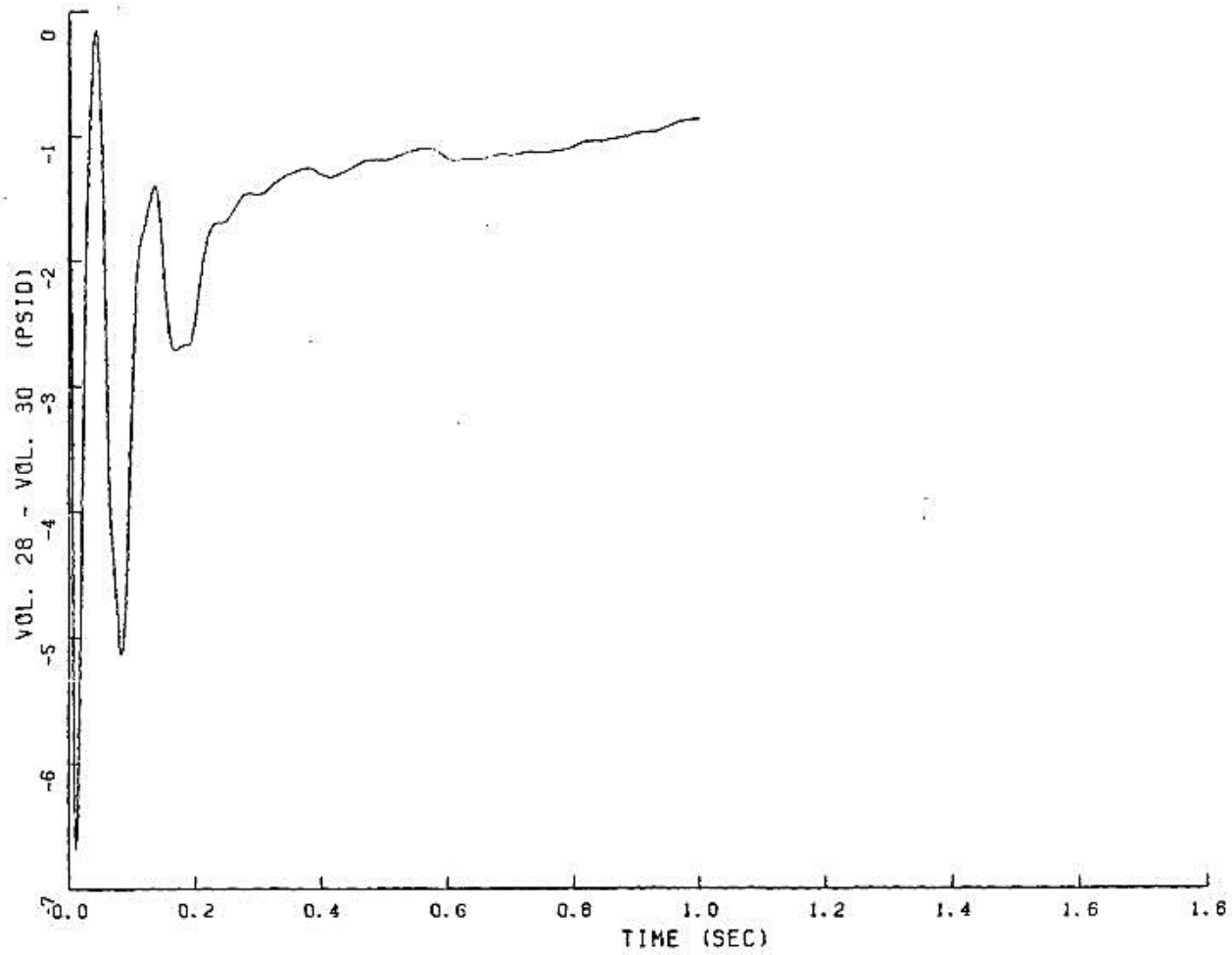

FIGURE 6.2.1-186

PEAK PRESSURE DIFFERENTIAL IN STEAM GENERATOR LOOP - 3

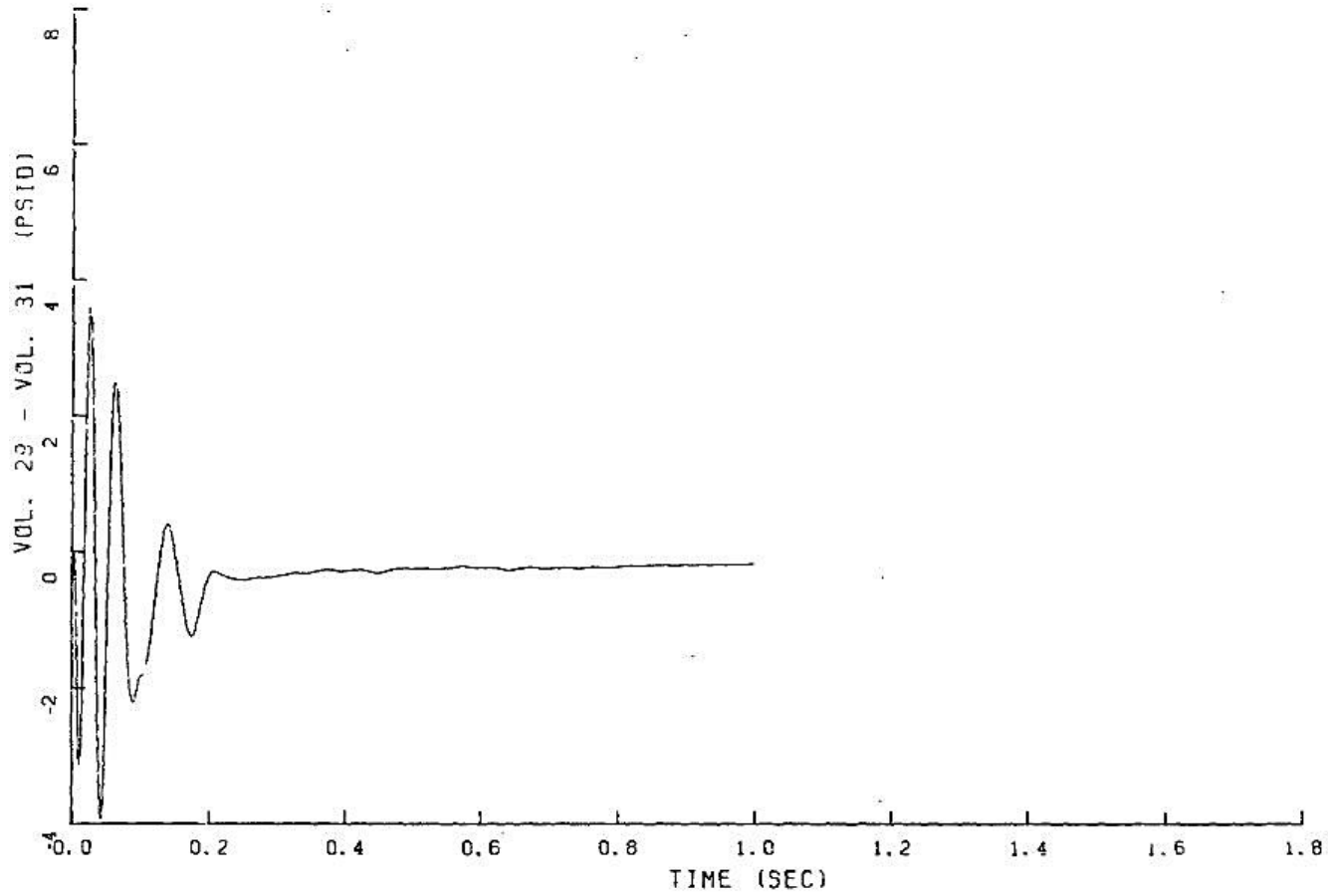

FIGURE 6.2.1-187

PEAK PRESSURE DIFFERENTIAL IN STEAM GENERATOR LOOP - 3

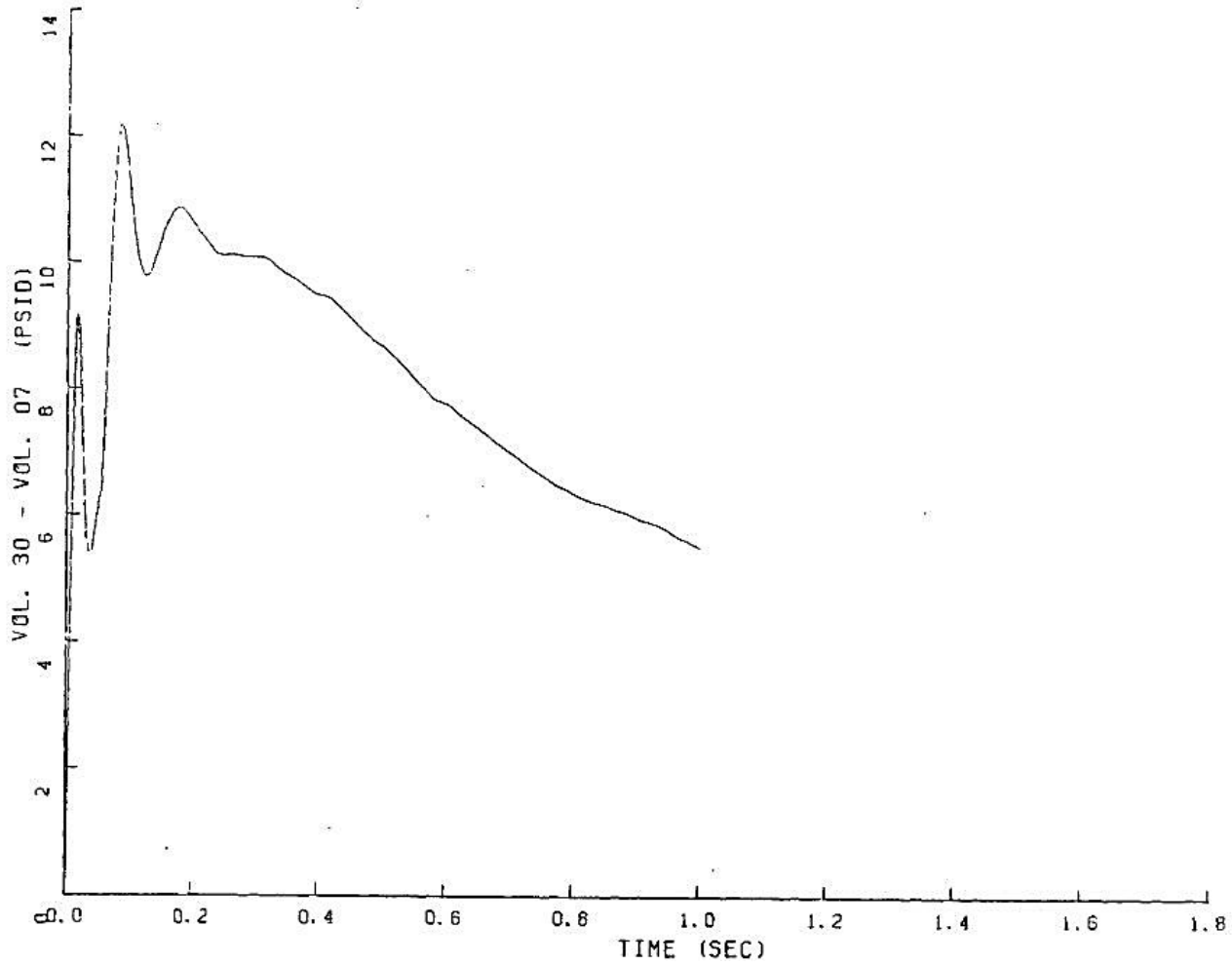

FIGURE 6.2.1-188

PEAK PRESSURE DIFFERENTIAL IN STEAM GENERATOR LOOP - 3

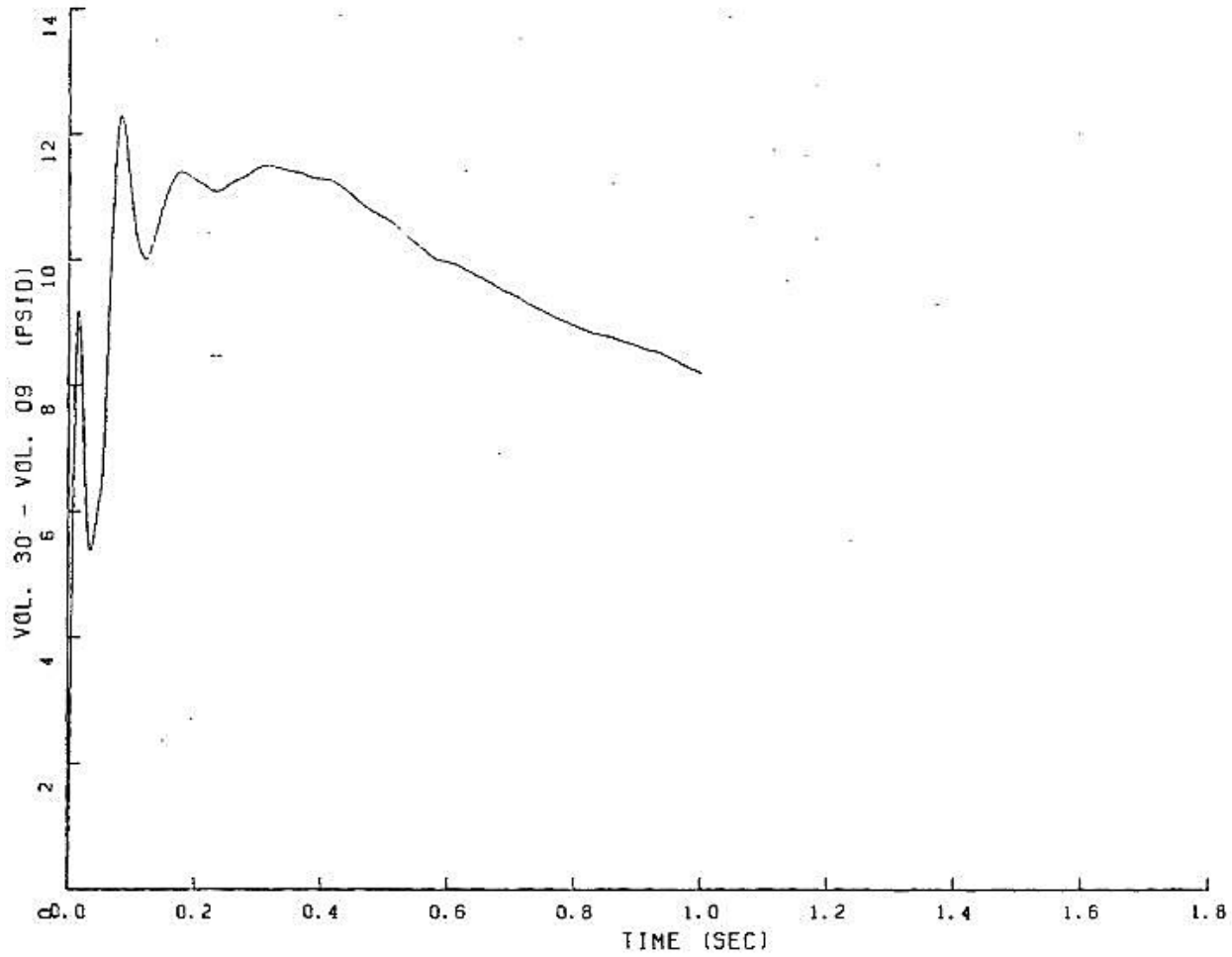

FIGURE 6.2.1-189

PEAK PRESSURE DIFFERENTIAL IN STEAM GENERATOR LOOP - 3

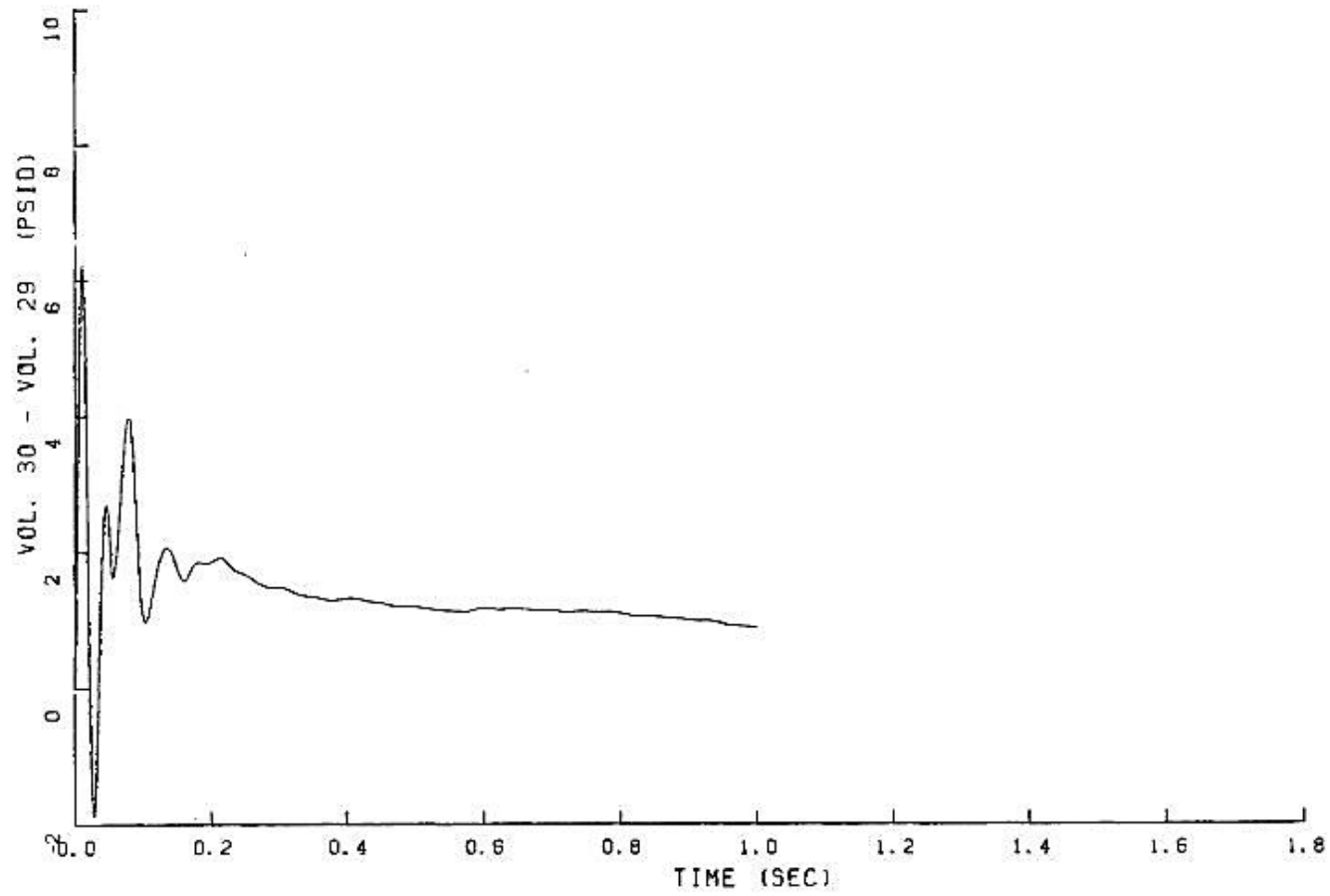

FIGURE 6.2.1-190

PEAK PRESSURE DIFFERENTIAL IN STEAM GENERATOR LOOP - 3

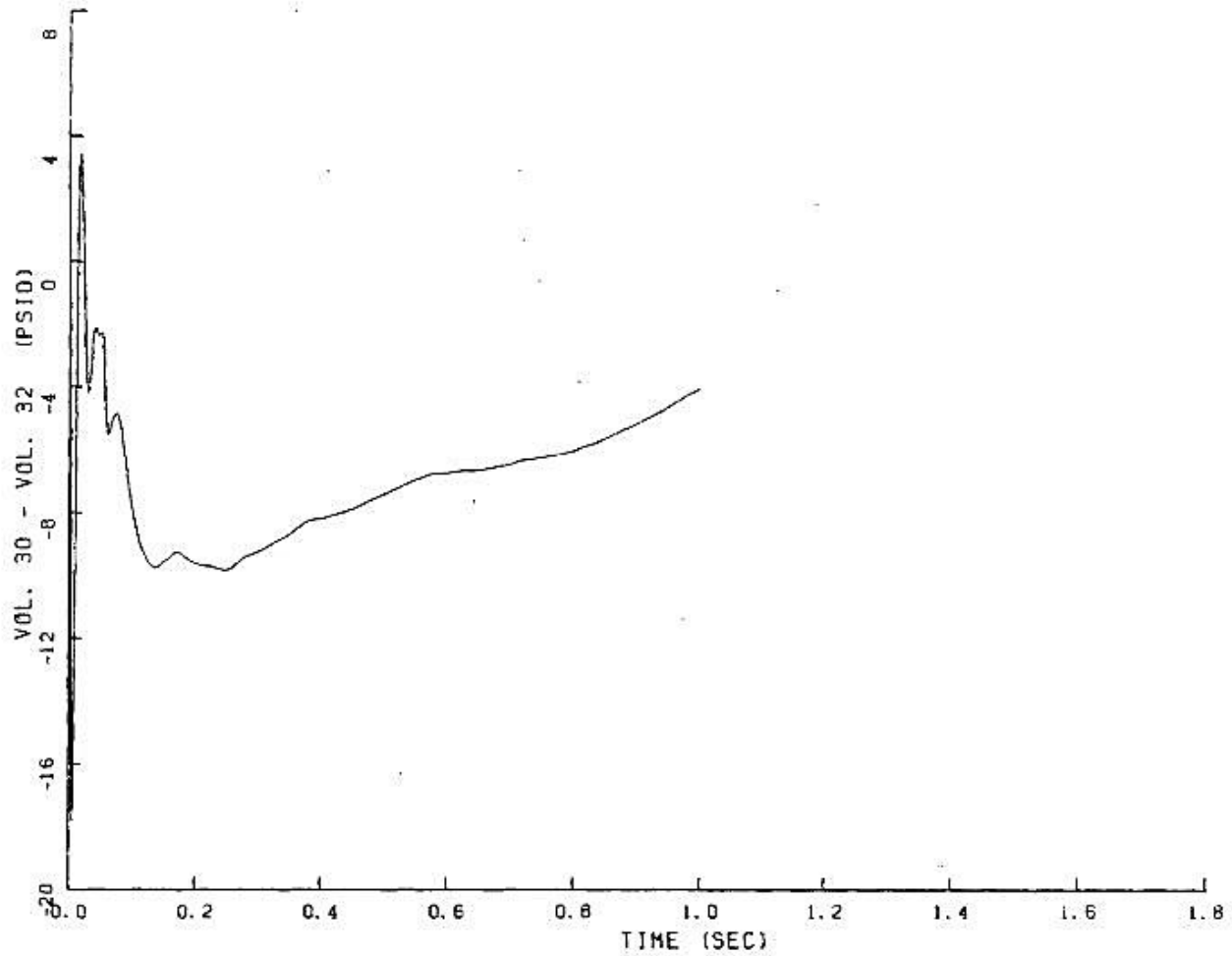

FIGURE 6.2.1-191

PEAK PRESSURE DIFFERENTIAL IN STEAM GENERATOR LOOP – 3

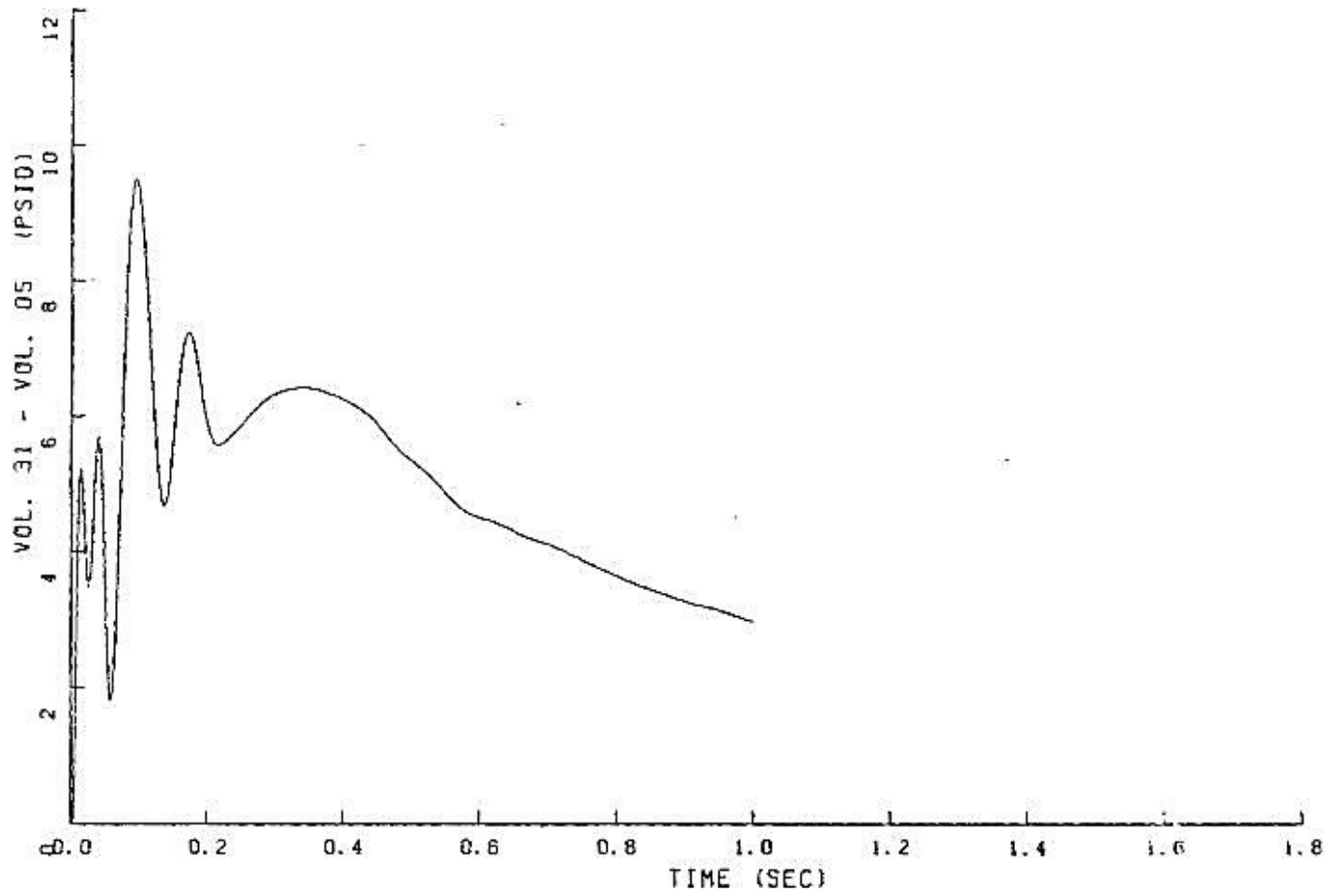

FIGURE 6.2.1-192

PEAK PRESSURE DIFFERENTIAL IN STEAM GENERATOR LOOP - 3

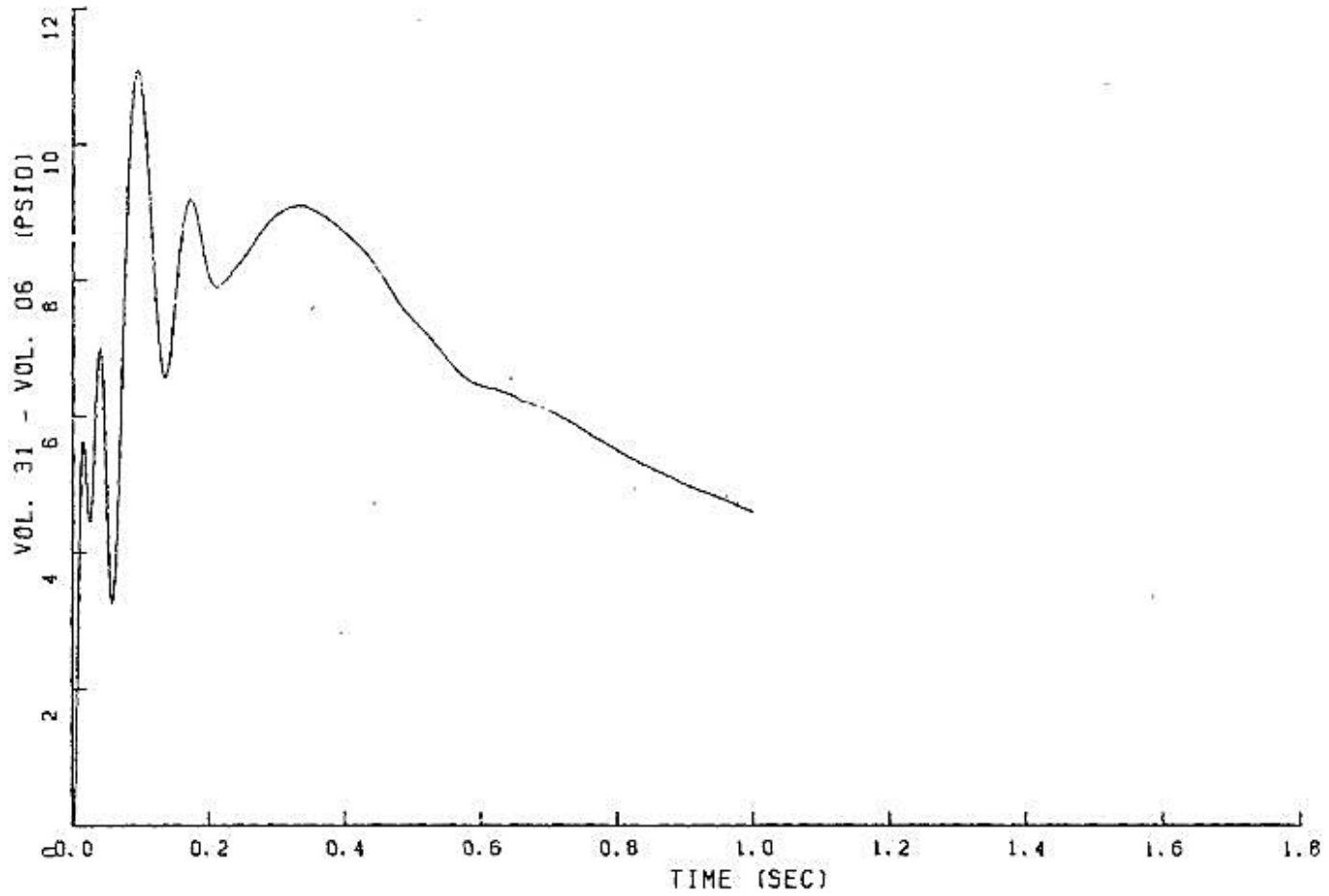

FIGURE 6.2.1-193

PEAK PRESSURE DIFFERENTIAL IN STEAM GENERATOR LOOP - 3

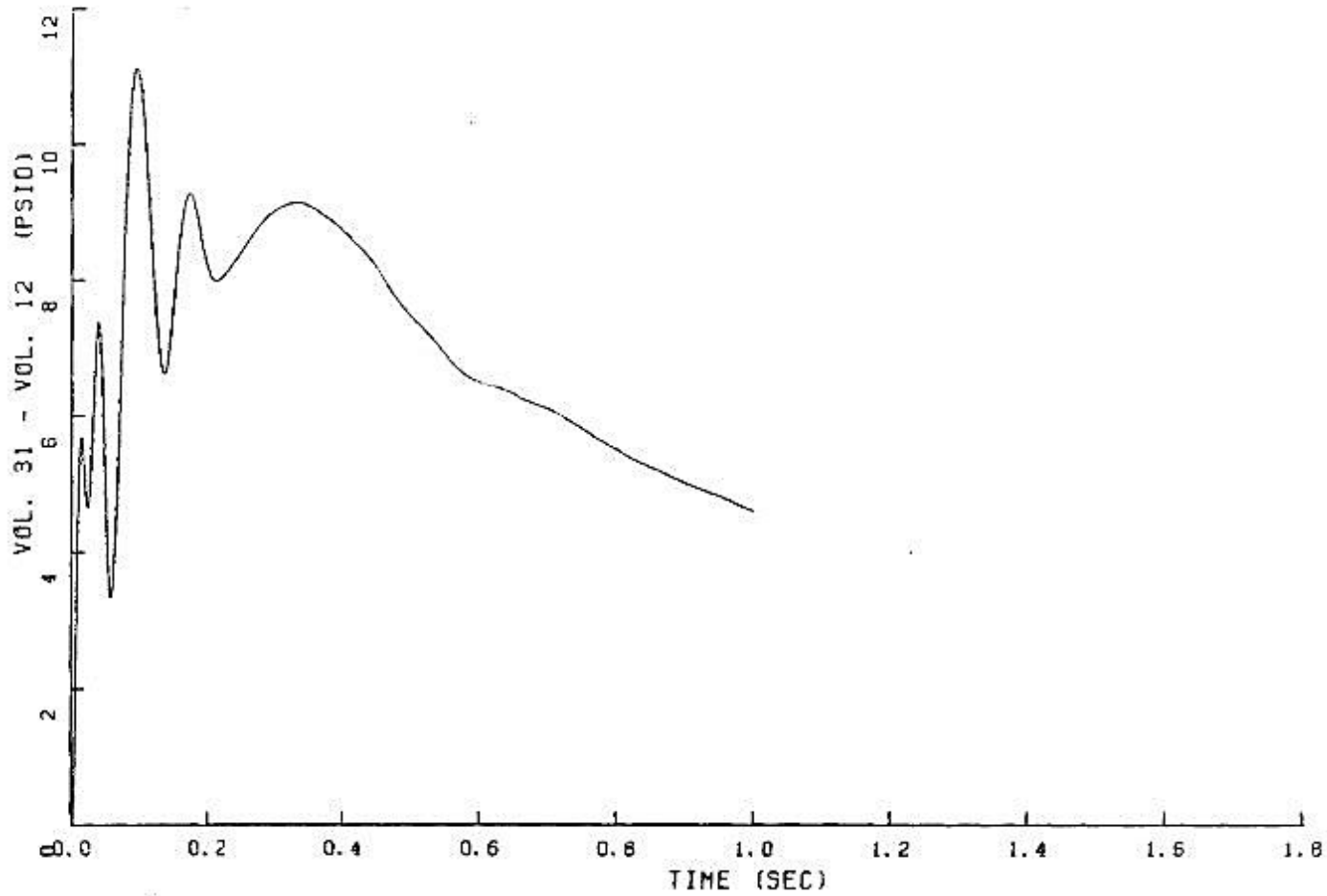

FIGURE 6.2.1-194

PEAK PRESSURE DIFFERENTIAL IN STEAM GENERATOR LOOP - 3

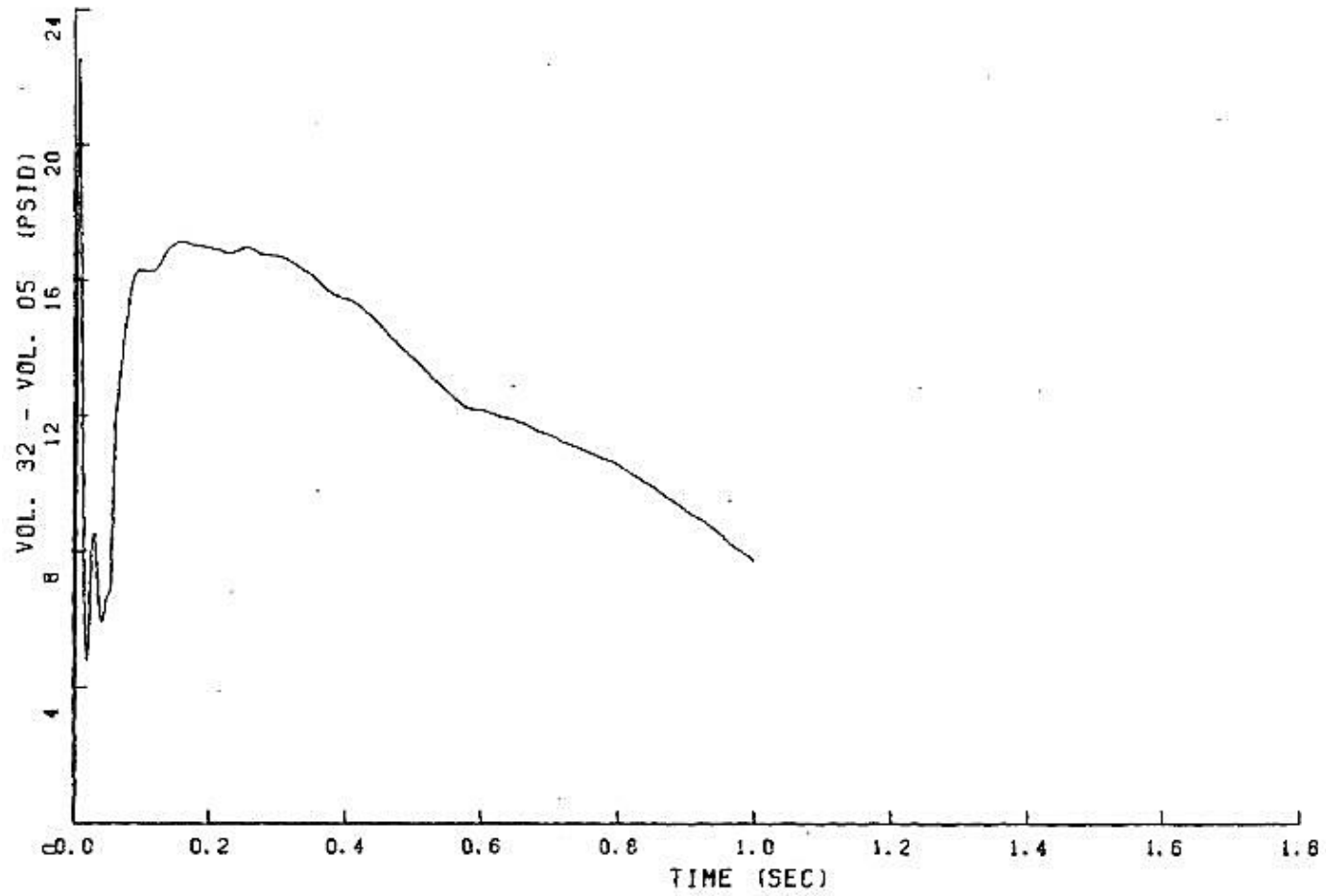

FIGURE 6.2.1-195

PEAK PRESSURE DIFFERENTIAL IN STEAM GENERATOR LOOP – 3

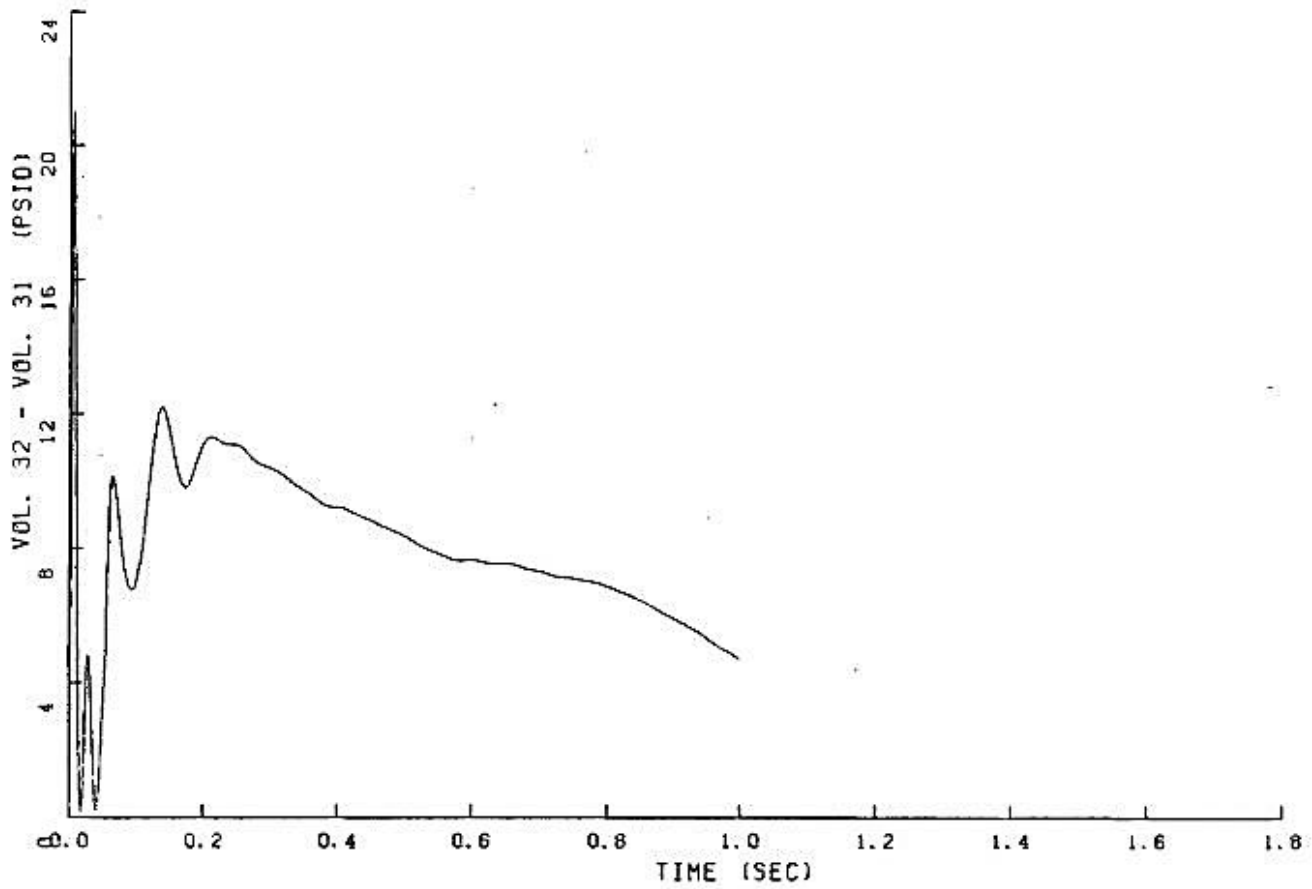

FIGURE 6.2.1-196

PEAK PRESSURE DIFFERENTIAL IN STEAM GENERATOR LOOP - 2

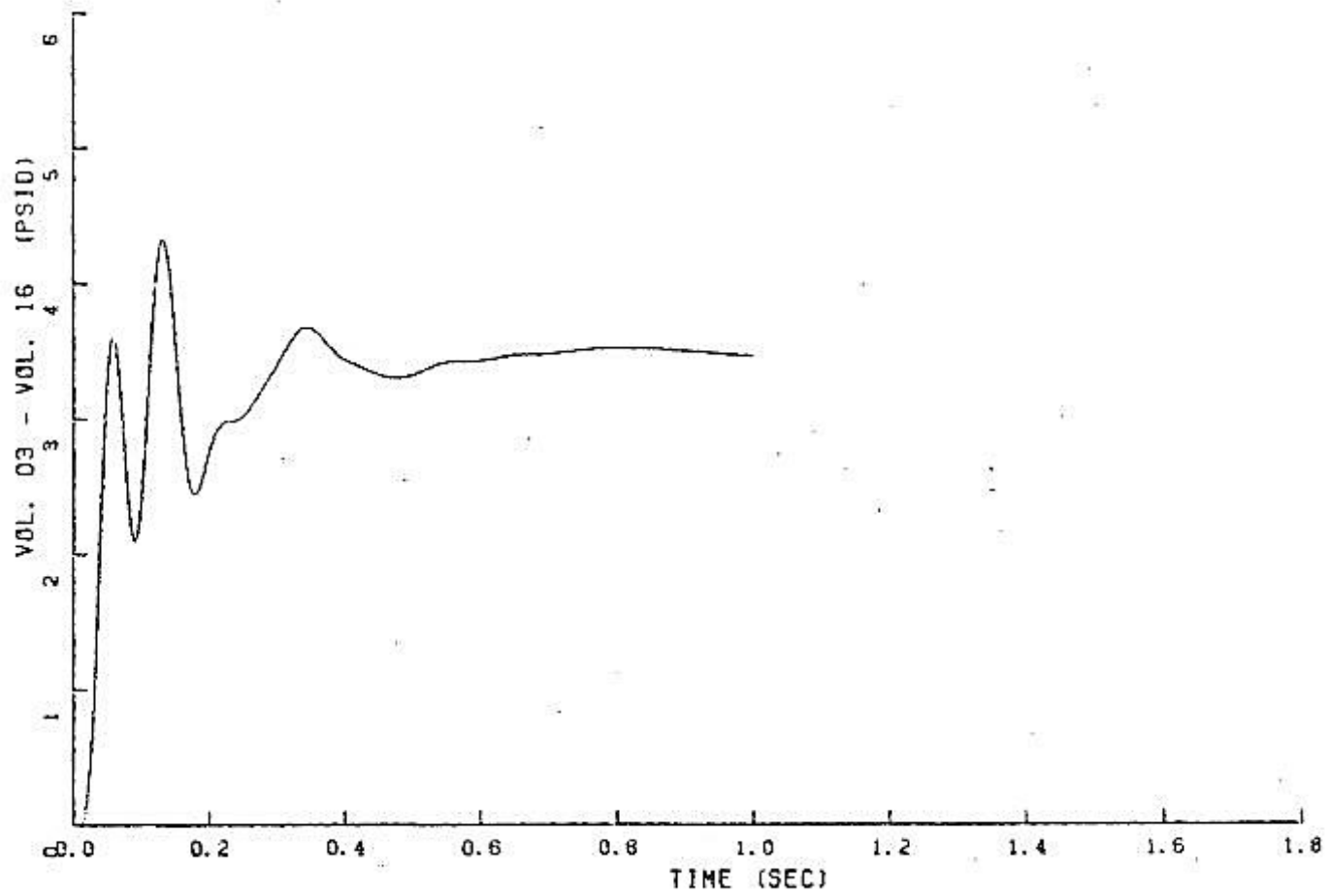

FIGURE 6.2.1-197

PEAK PRESSURE DIFFERENTIAL IN STEAM GENERATOR LOOP - 2

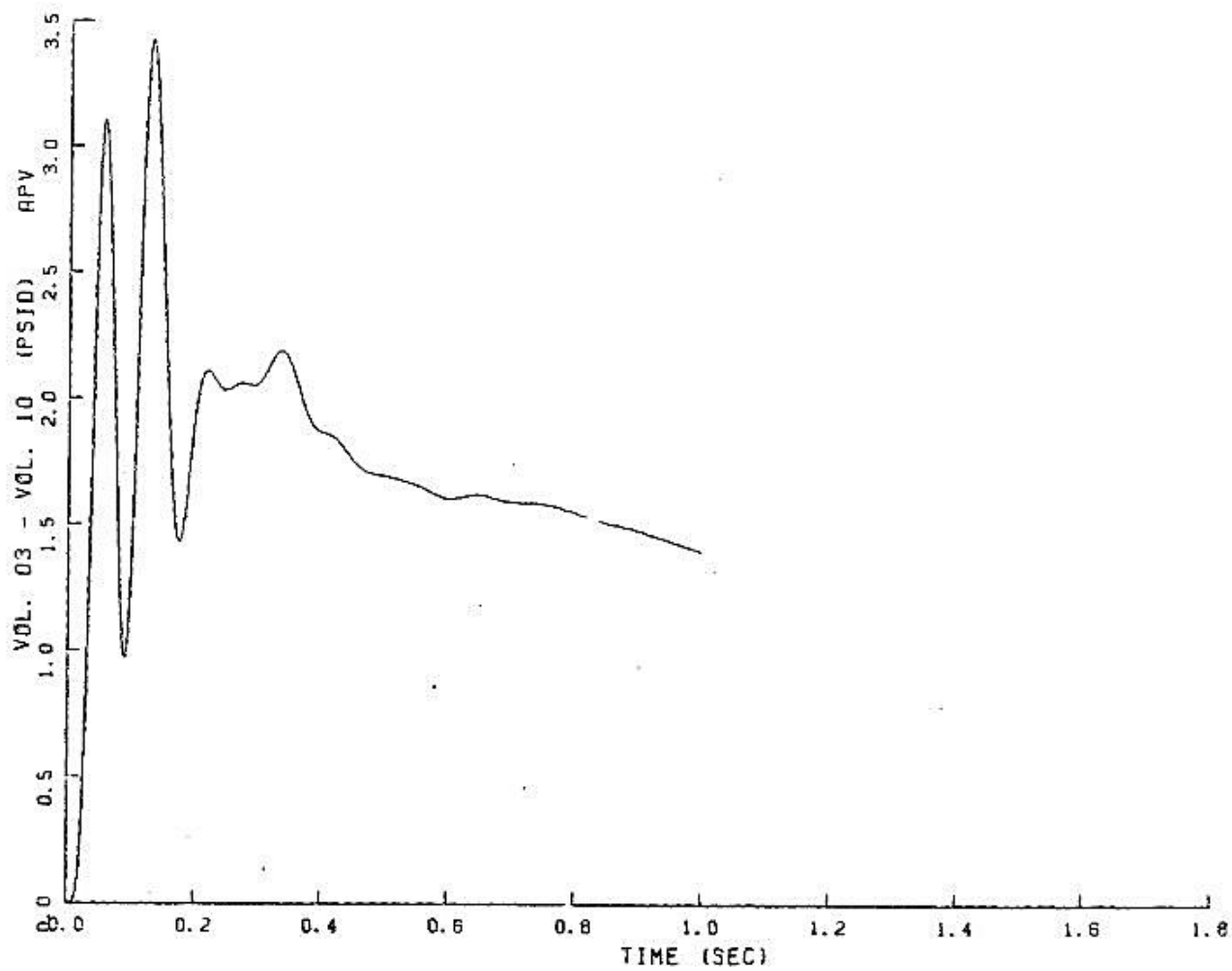

FIGURE 6.2.1-198

PEAK PRESSURE DIFFERENTIAL IN STEAM GENERATOR LOOP - 2

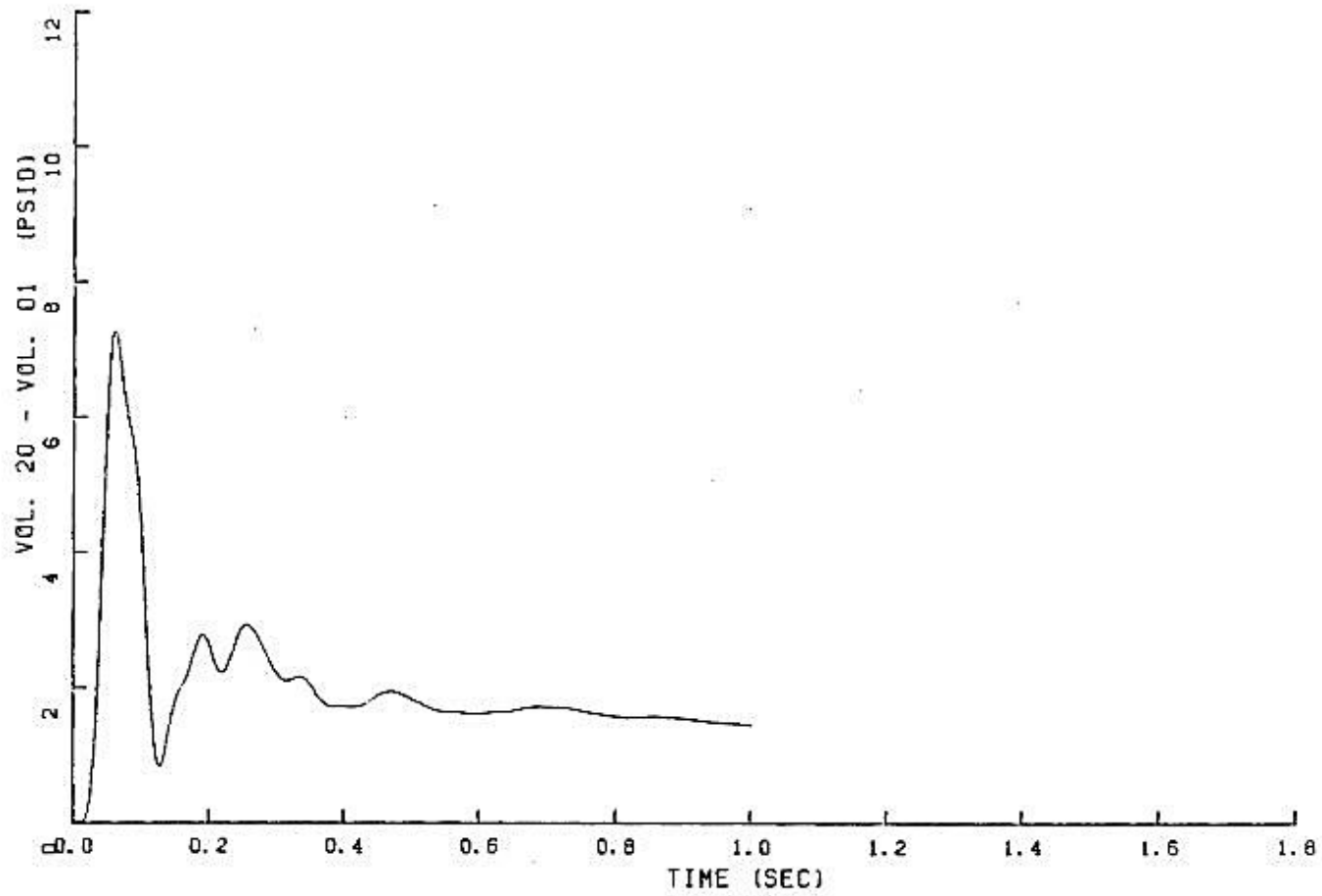

FIGURE 6.2.1-199

PEAK PRESSURE DIFFERENTIAL IN STEAM GENERATOR LOOP - 2

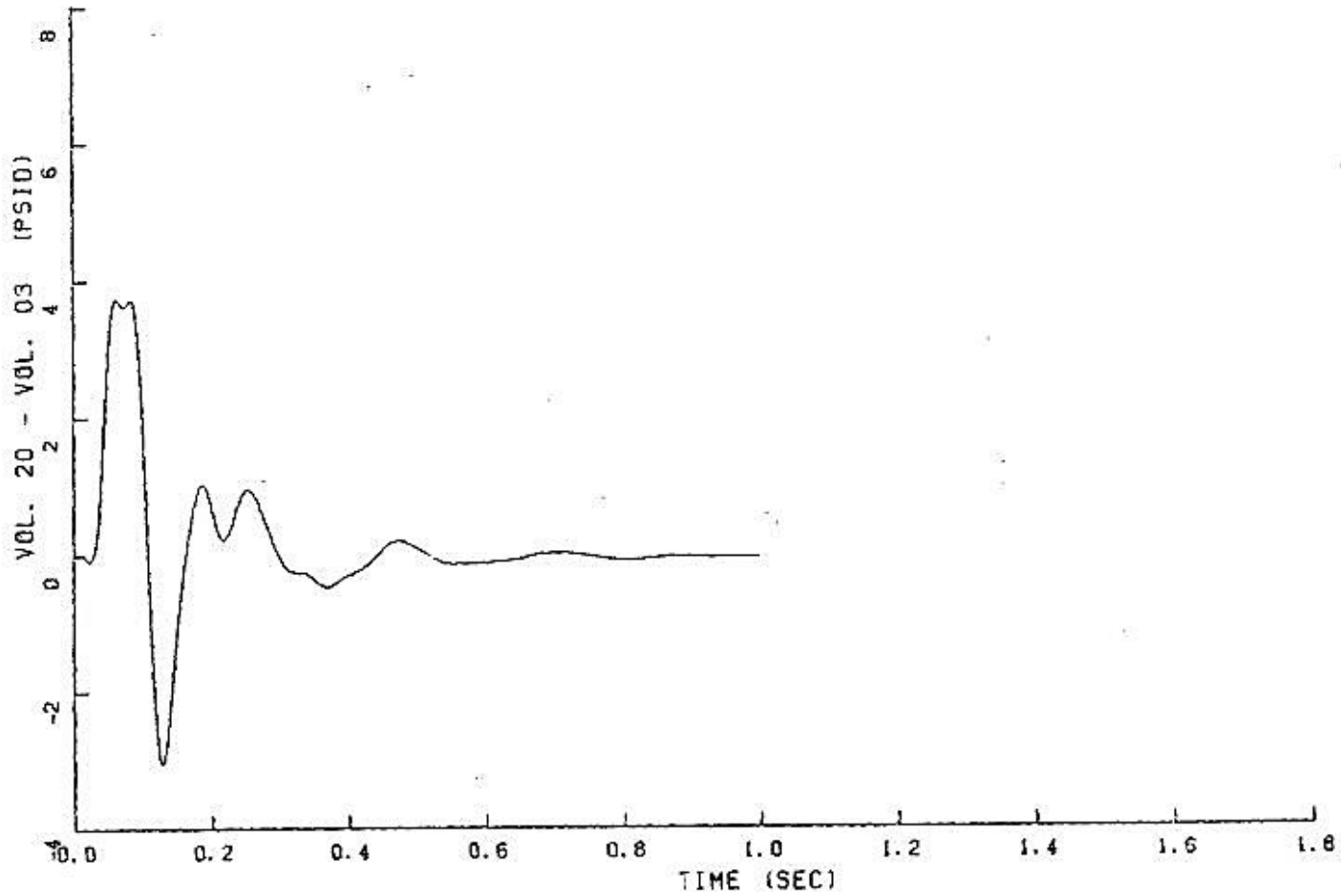

FIGURE 6.2.1-200

PEAK PRESSURE DIFFERENTIAL IN STEAM GENERATOR LOOP - 2

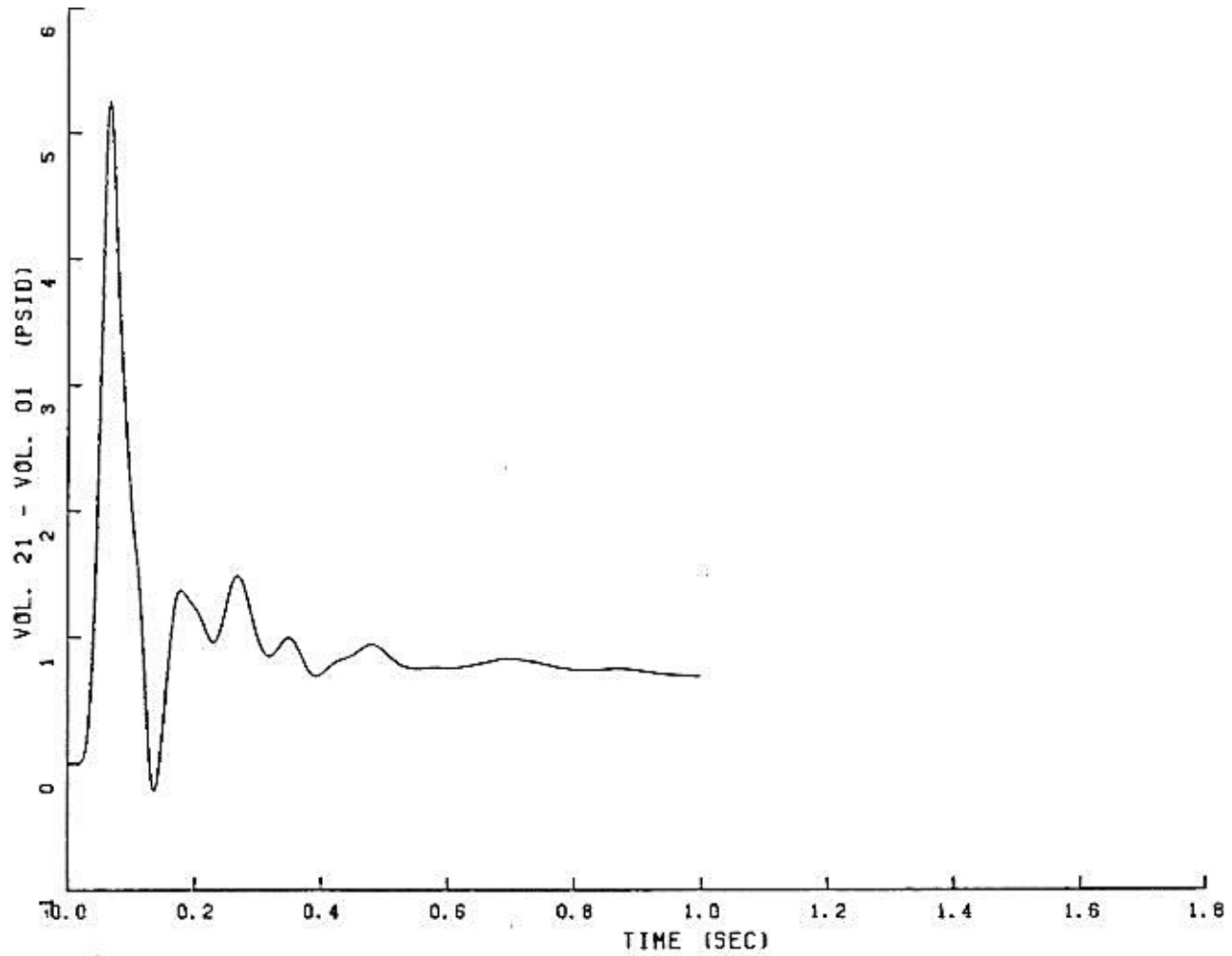

FIGURE 6.2.1-201

PEAK PRESSURE DIFFERENTIAL IN STEAM GENERATOR LOOP - 2

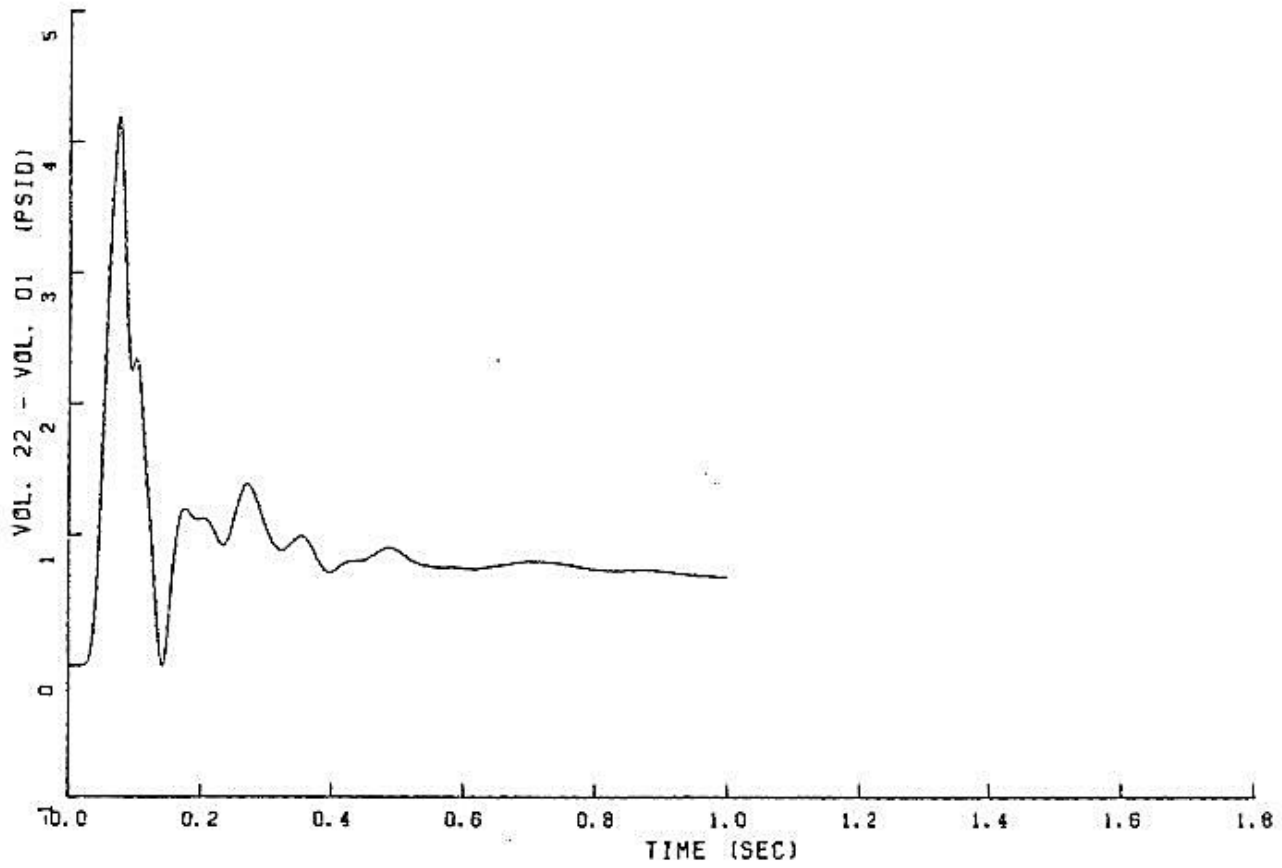

FIGURE 6.2.1-202

PEAK PRESSURE DIFFERENTIAL IN STEAM GENERATOR LOOP – 2

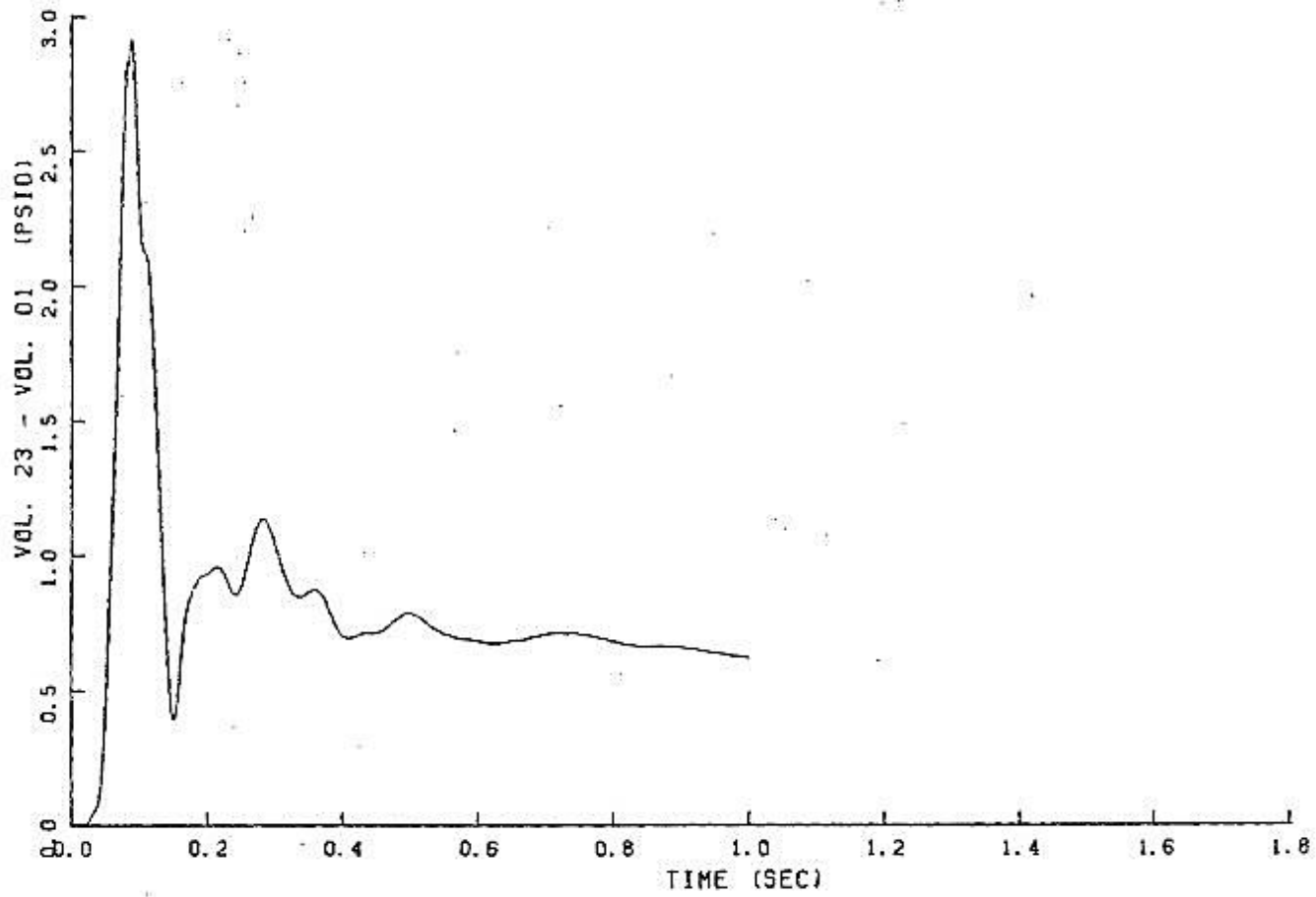

FIGURE 6.2.1-203

PEAK PRESSURE DIFFERENTIAL IN STEAM GENERATOR LOOP – 2

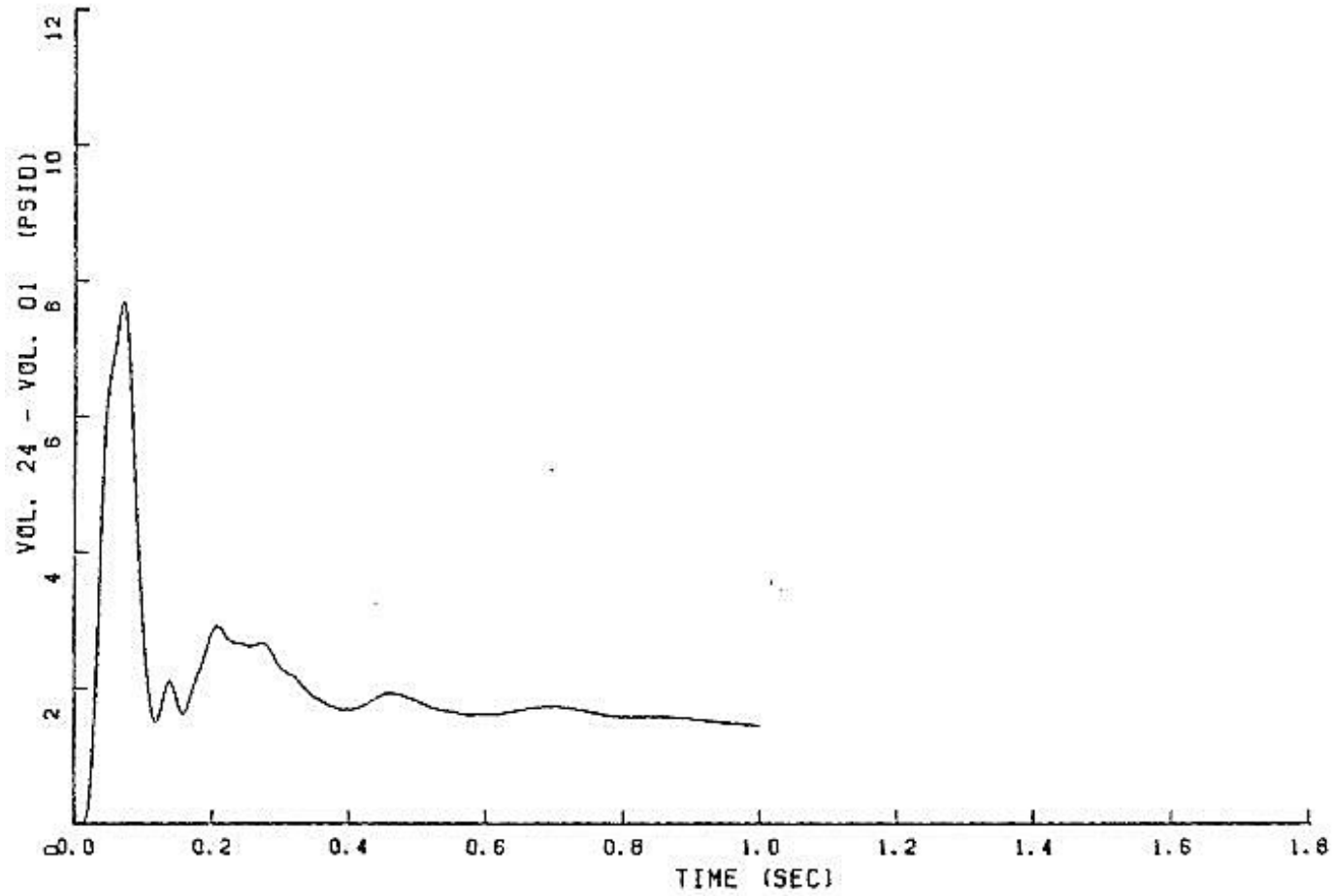

FIGURE 6.2.1-204

PEAK PRESSURE DIFFERENTIAL IN STEAM GENERATOR LOOP - 2

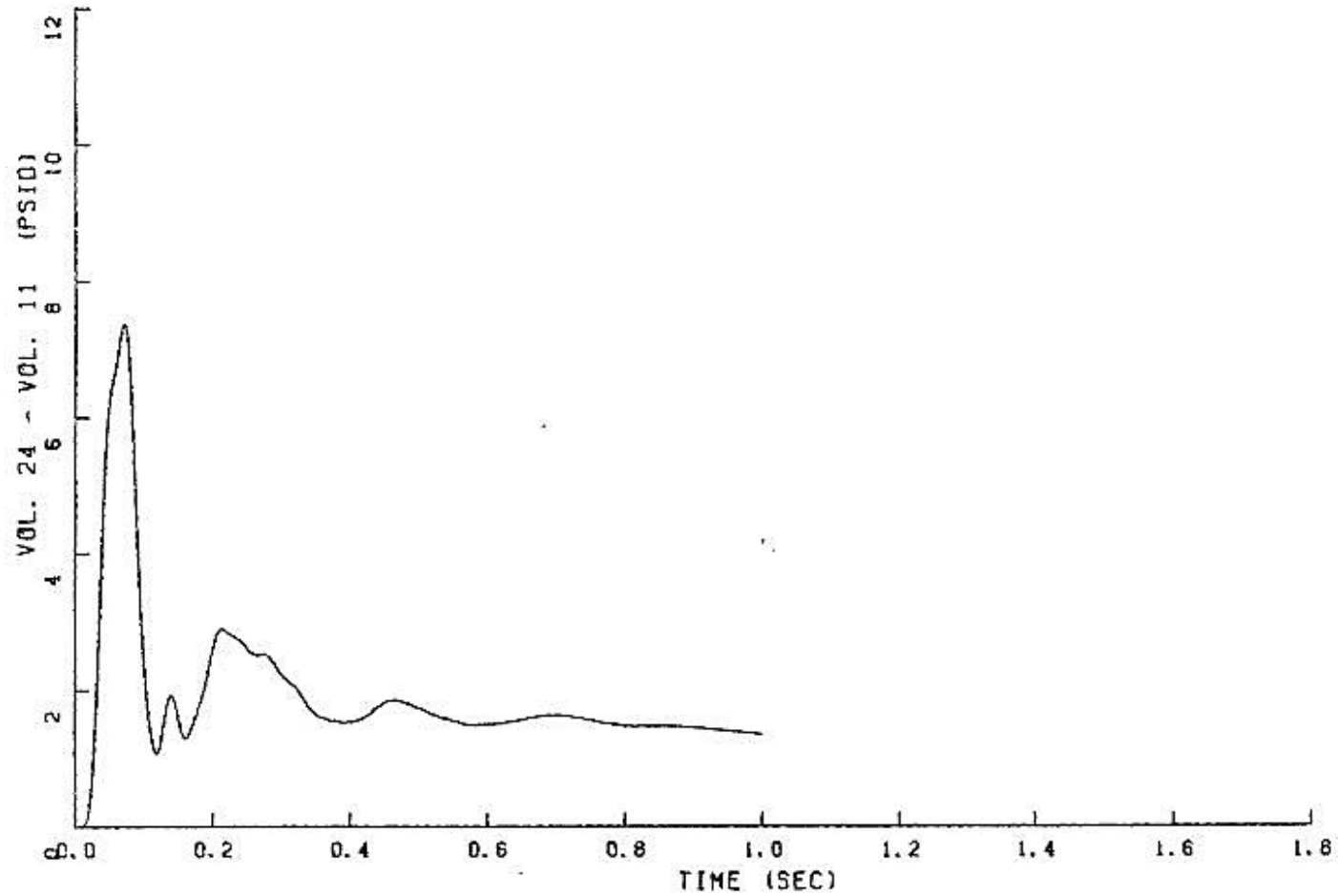

FIGURE 6.2.1-205

PEAK PRESSURE DIFFERENTIAL IN STEAM GENERATOR LOOP – 2

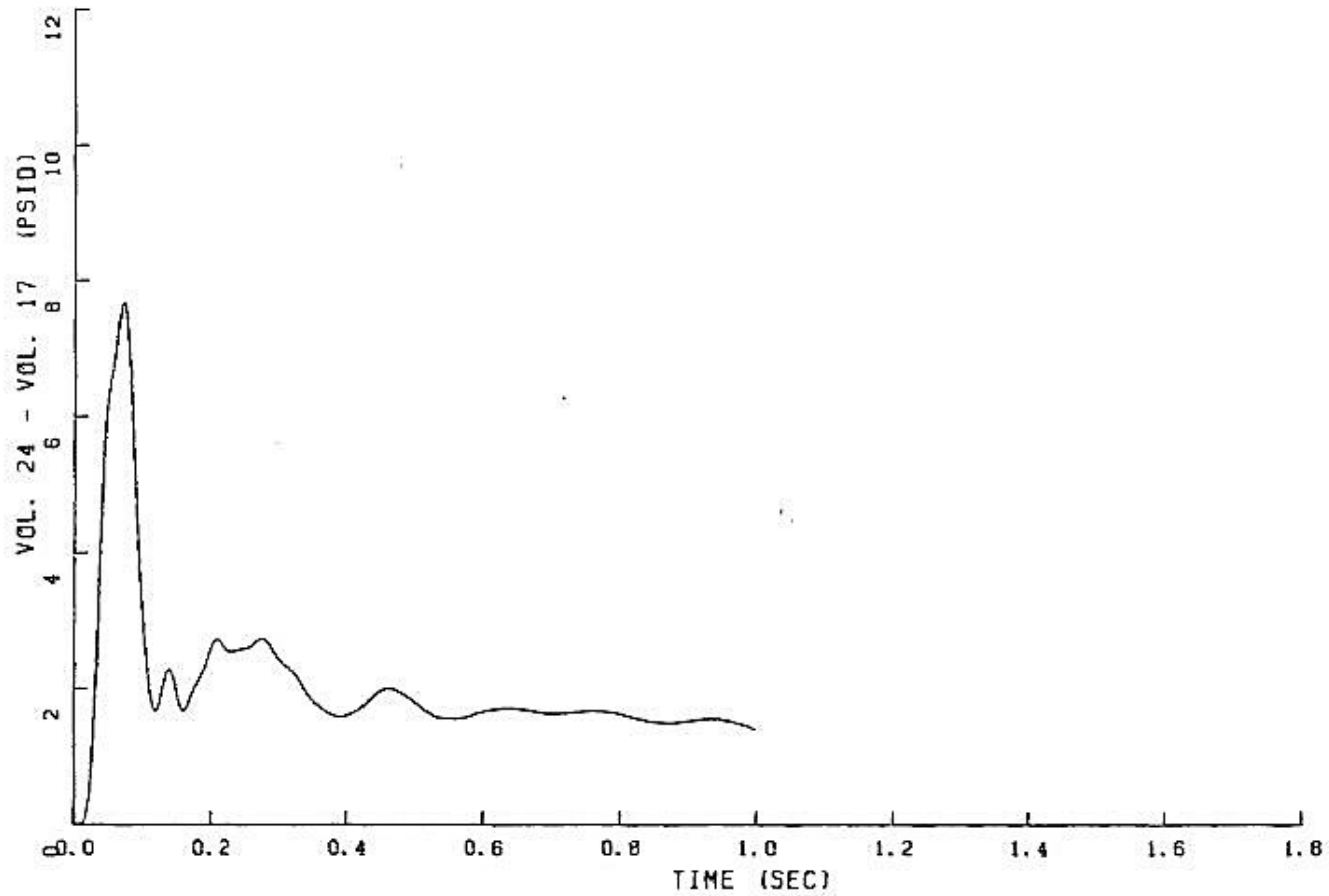

FIGURE 6.2.1-206

PEAK PRESSURE DIFFERENTIAL IN STEAM GENERATOR LOOP - 2

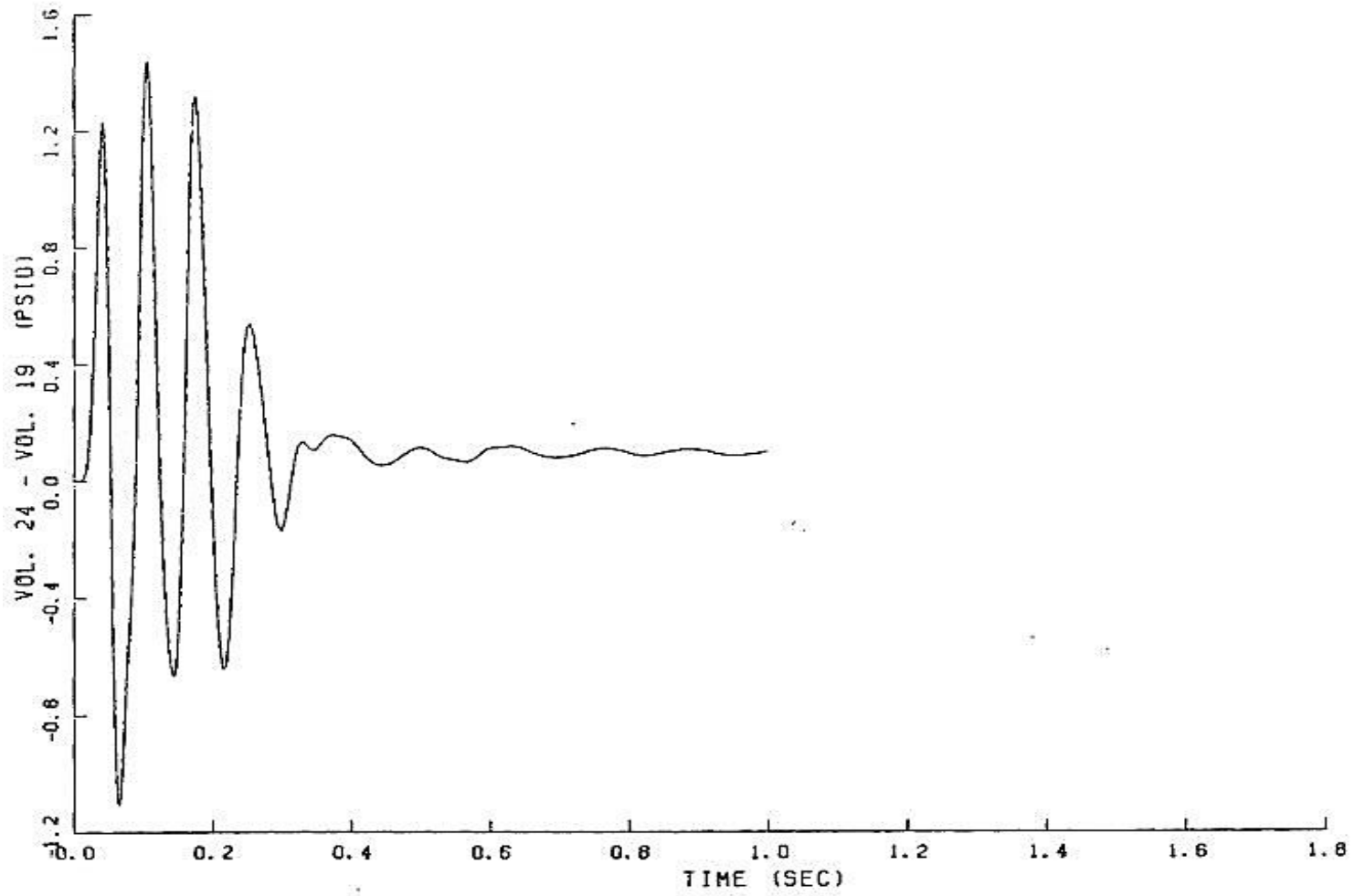

FIGURE 6.2.1-207

PEAK PRESSURE DIFFERENTIAL IN STEAM GENERATOR LOOP - 2

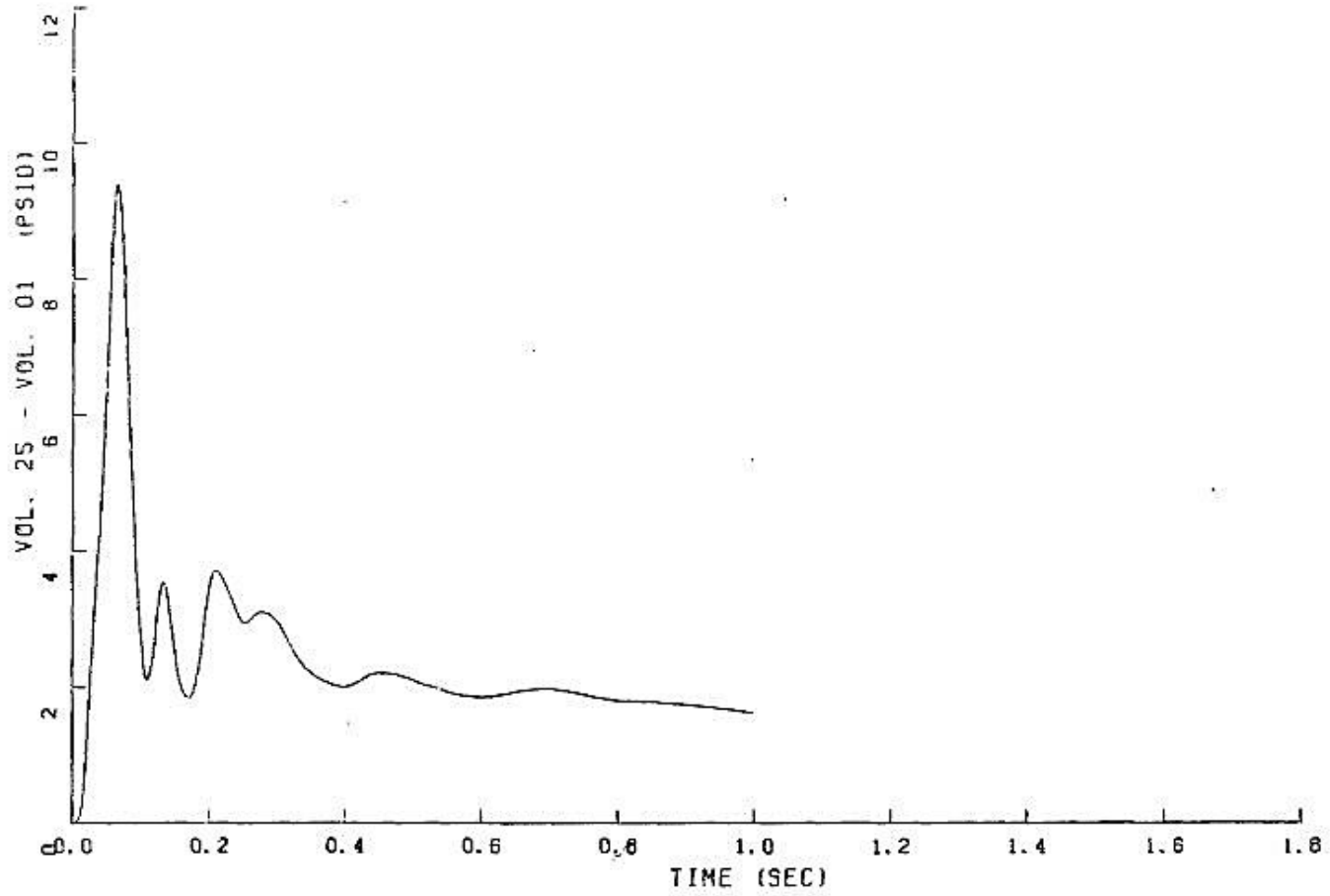

FIGURE 6.2.1-208

PEAK PRESSURE DIFFERENTIAL IN STEAM GENERATOR LOOP - 2

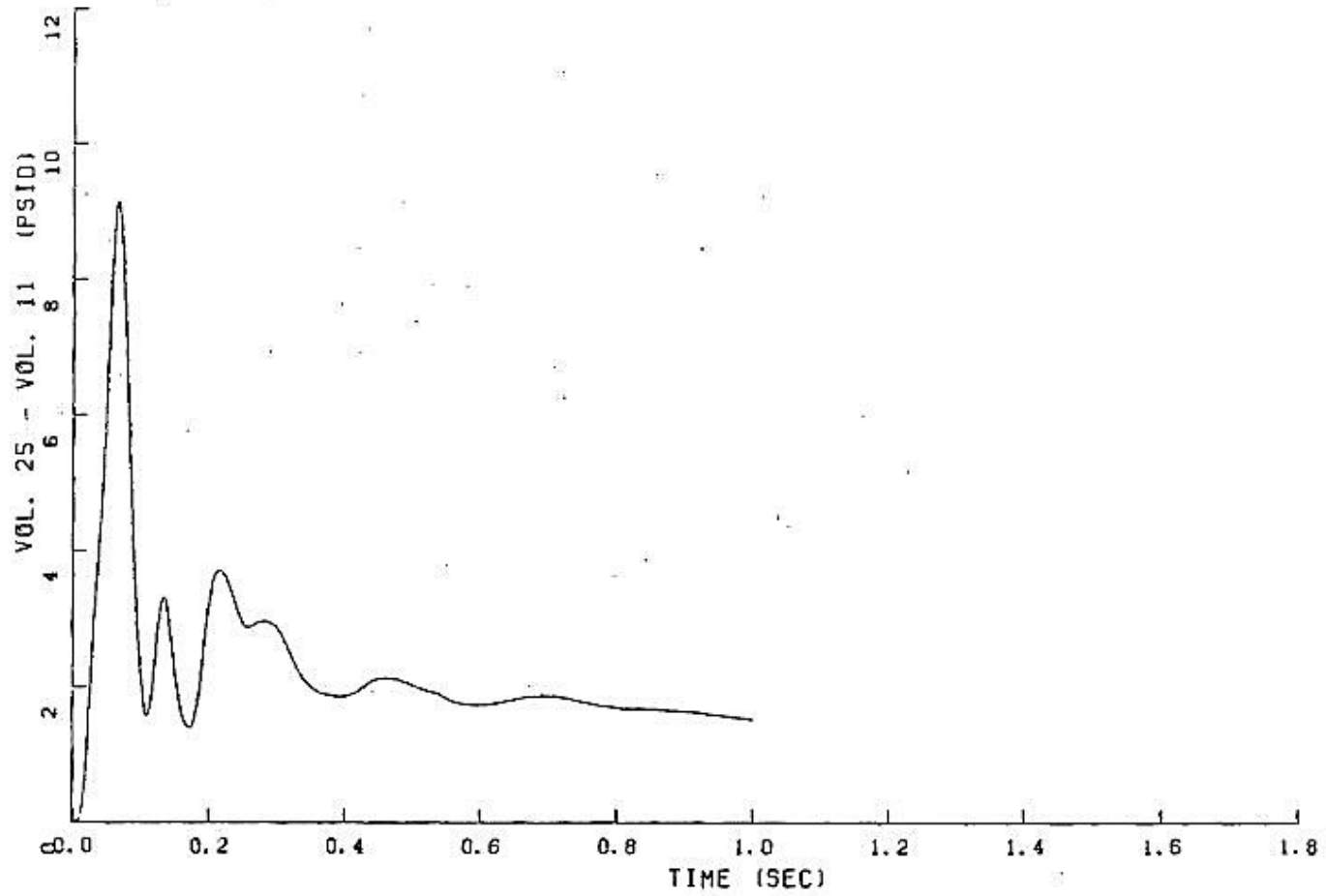

FIGURE 6.2.1-209

PEAK PRESSURE DIFFERENTIAL IN STEAM GENERATOR LOOP - 2

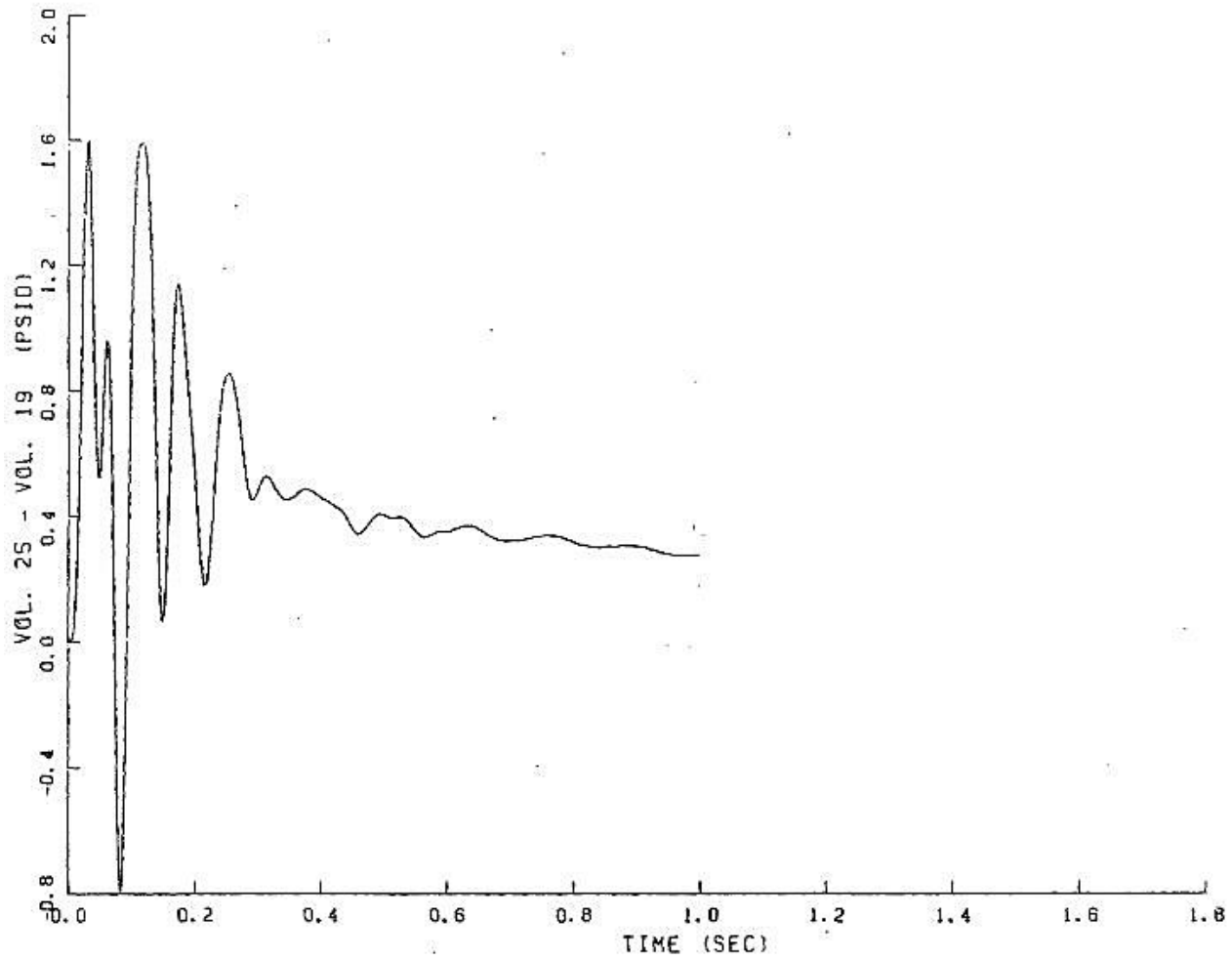

FIGURE 6.2.1-210

PEAK PRESSURE DIFFERENTIAL IN STEAM GENERATOR LOOP – 2

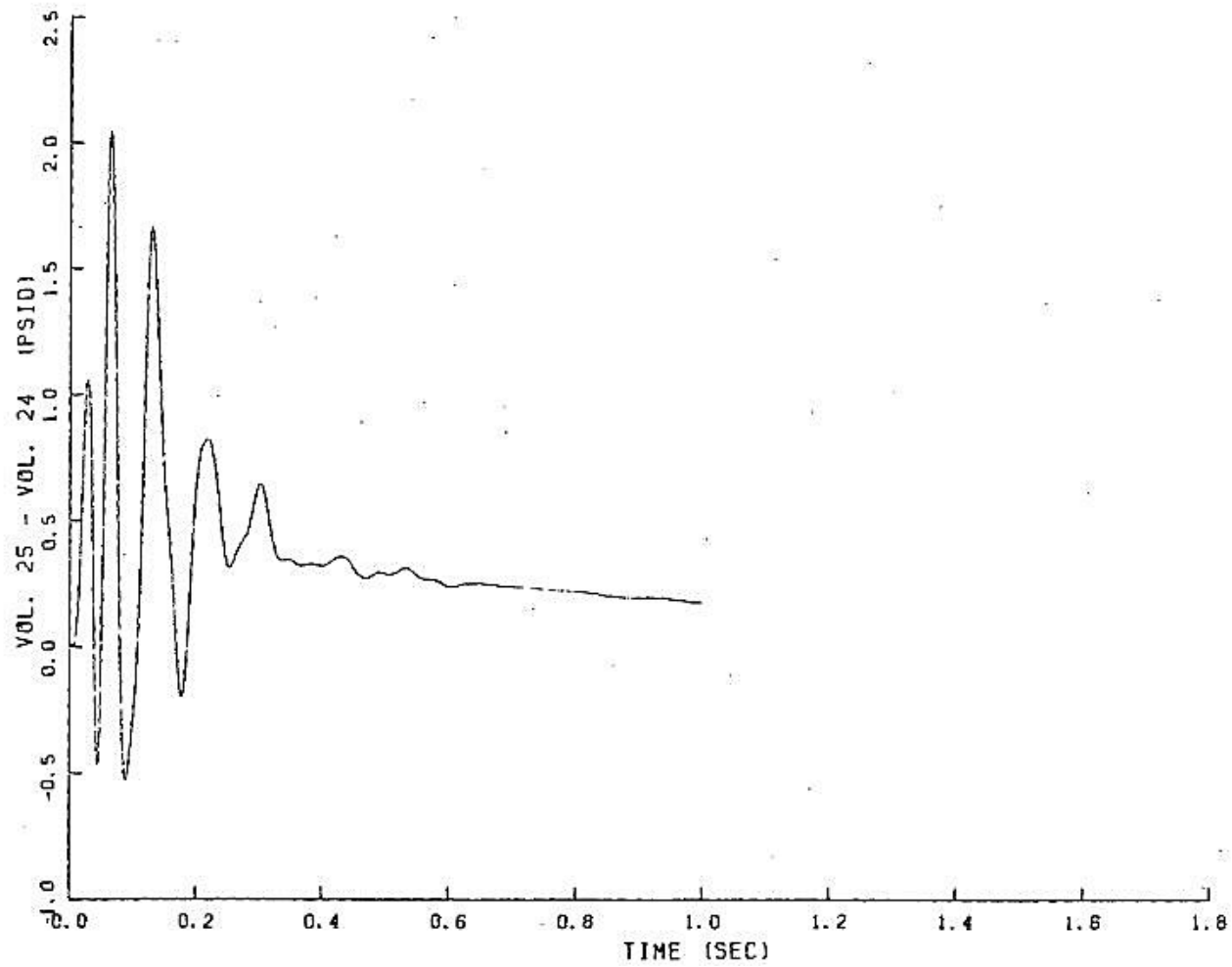

FIGURE 6.2.1-211

PEAK PRESSURE DIFFERENTIAL IN STEAM GENERATOR LOOP - 2

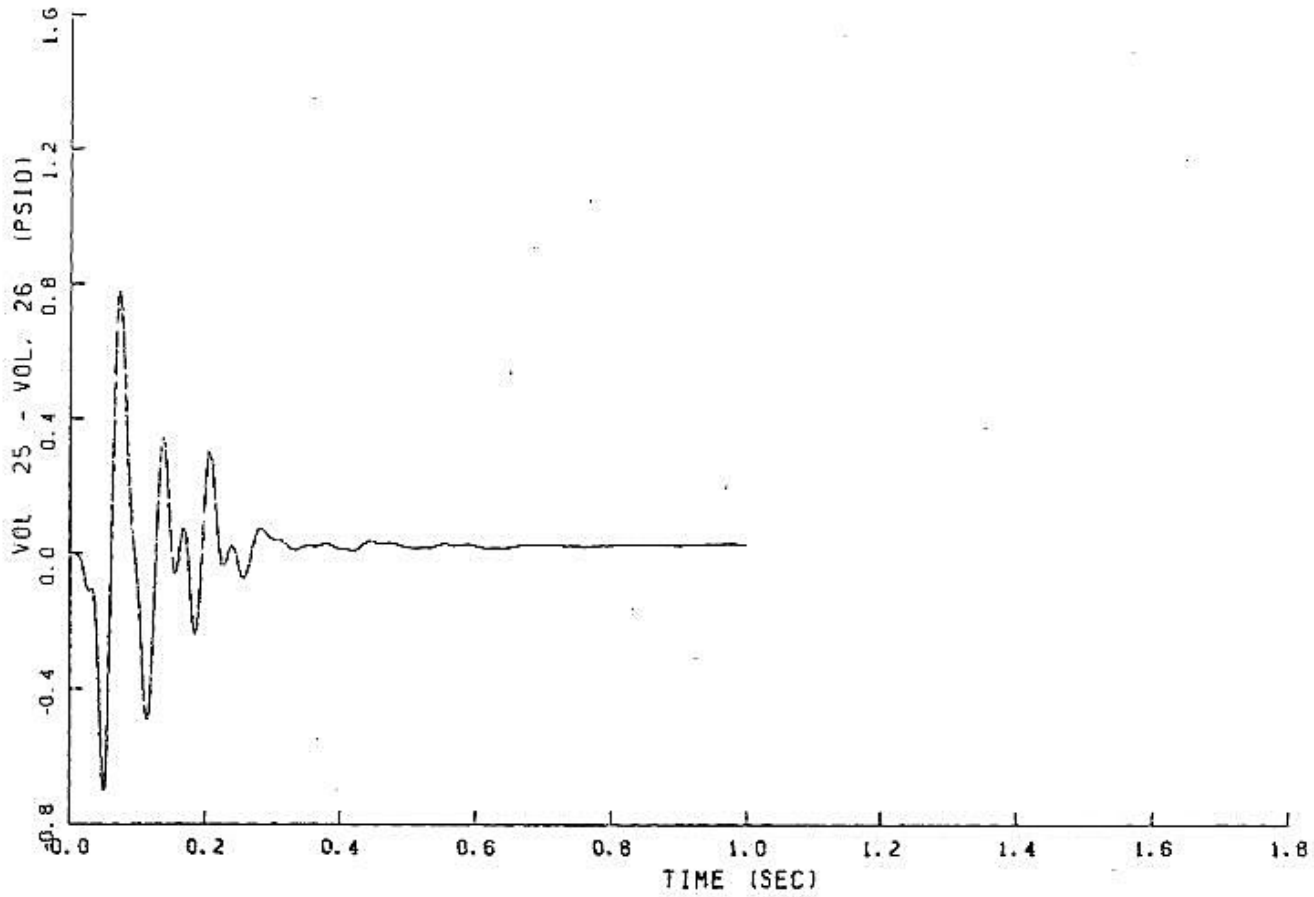

FIGURE 6.2.1-212

PEAK PRESSURE DIFFERENTIAL IN STEAM GENERATOR LOOP – 2

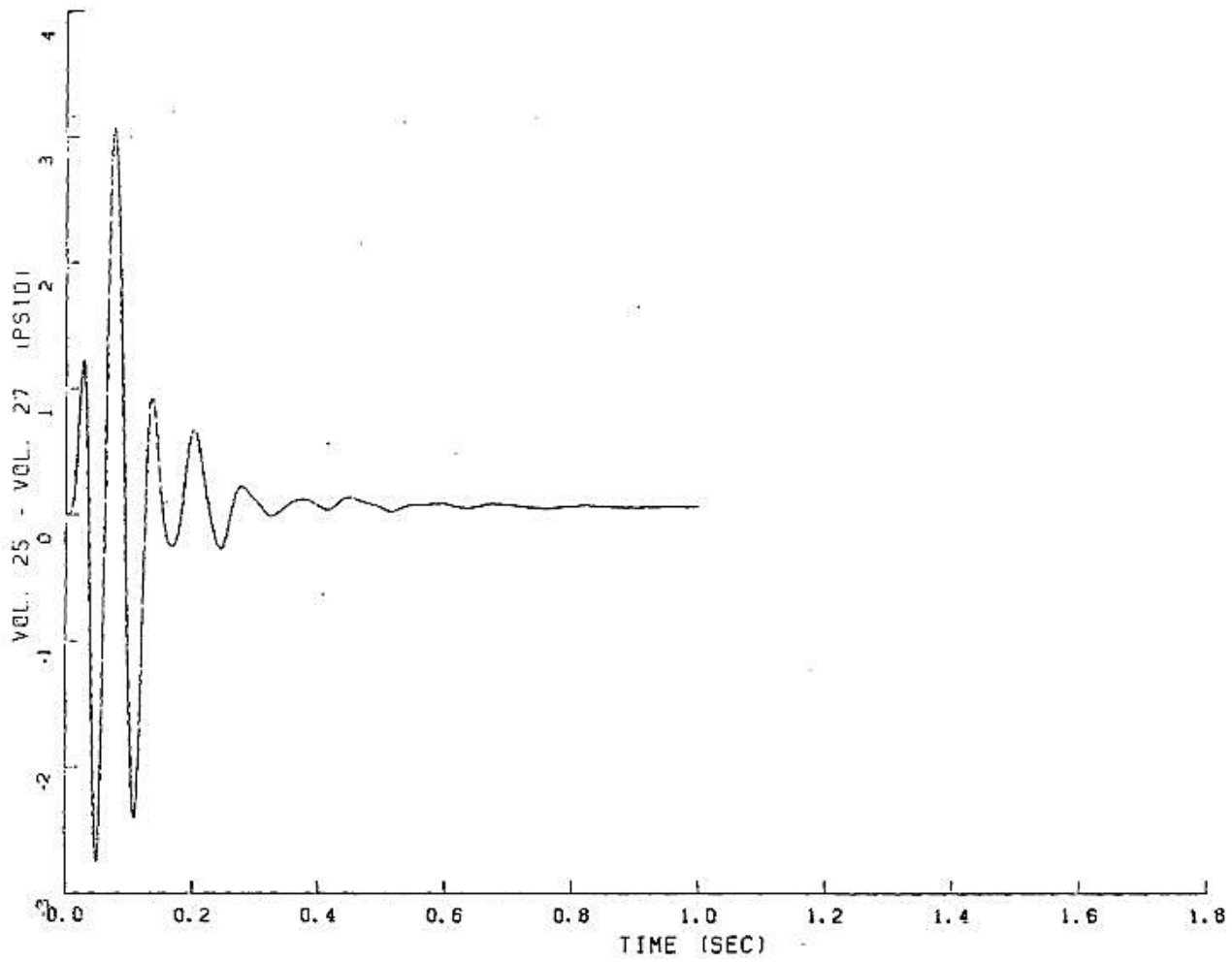

FIGURE 6.2.1-213

PEAK PRESSURE DIFFERENTIAL IN STEAM GENERATOR LOOP - 2

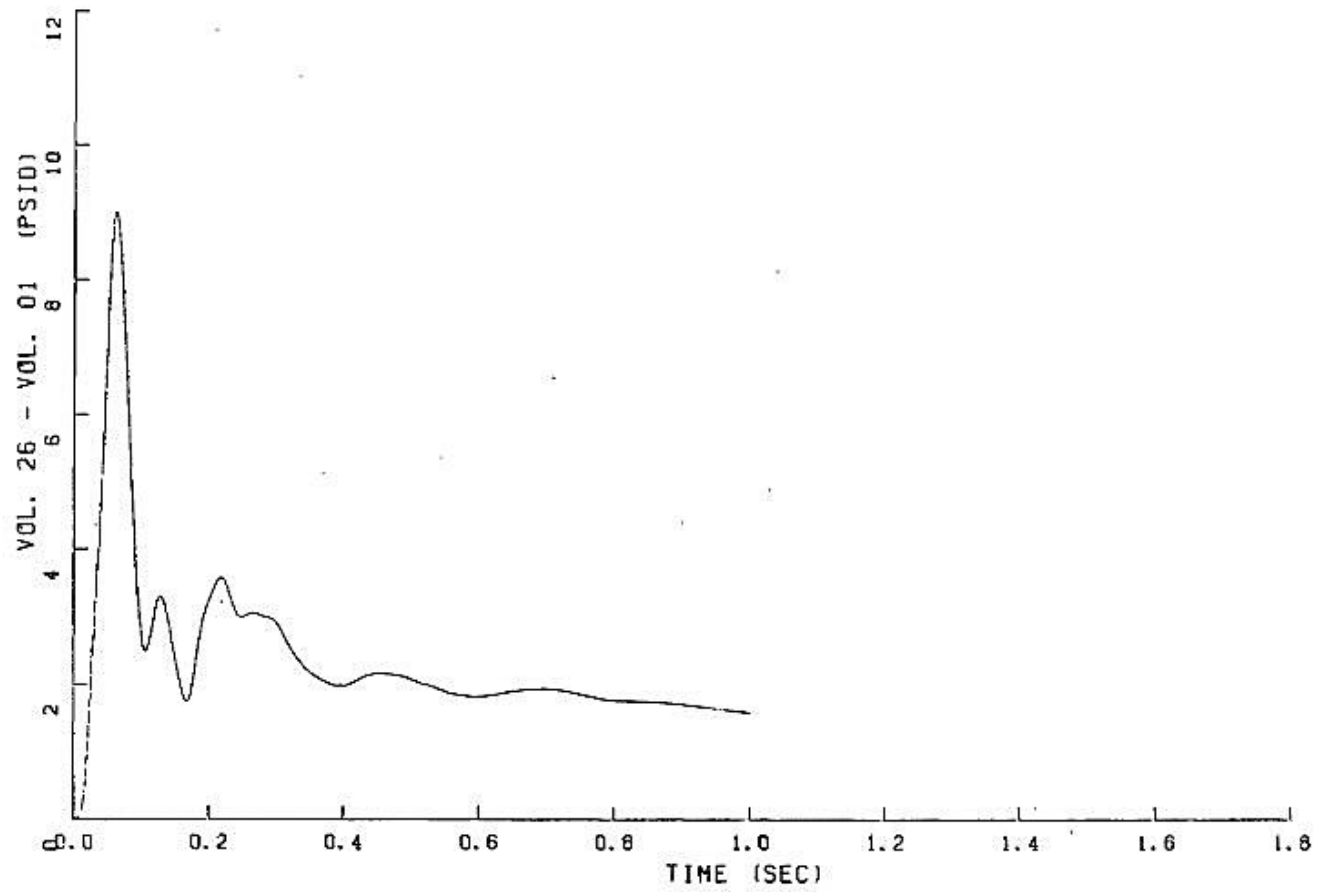

FIGURE 6.2.1-214

PEAK PRESSURE DIFFERENTIAL IN STEAM GENERATOR LOOP - 2

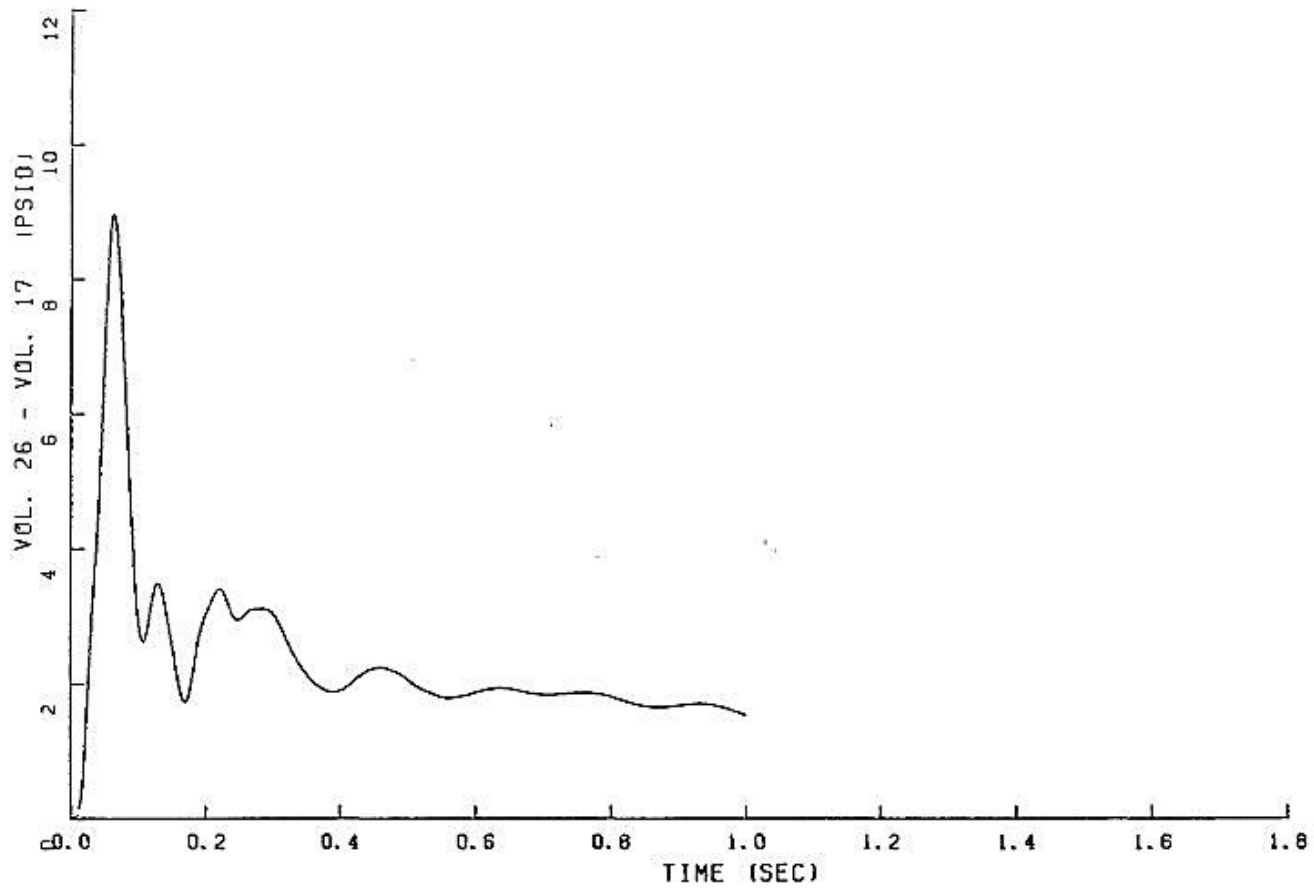

FIGURE 6.2.1-215

PEAK PRESSURE DIFFERENTIAL IN STEAM GENERATOR LOOP - 2

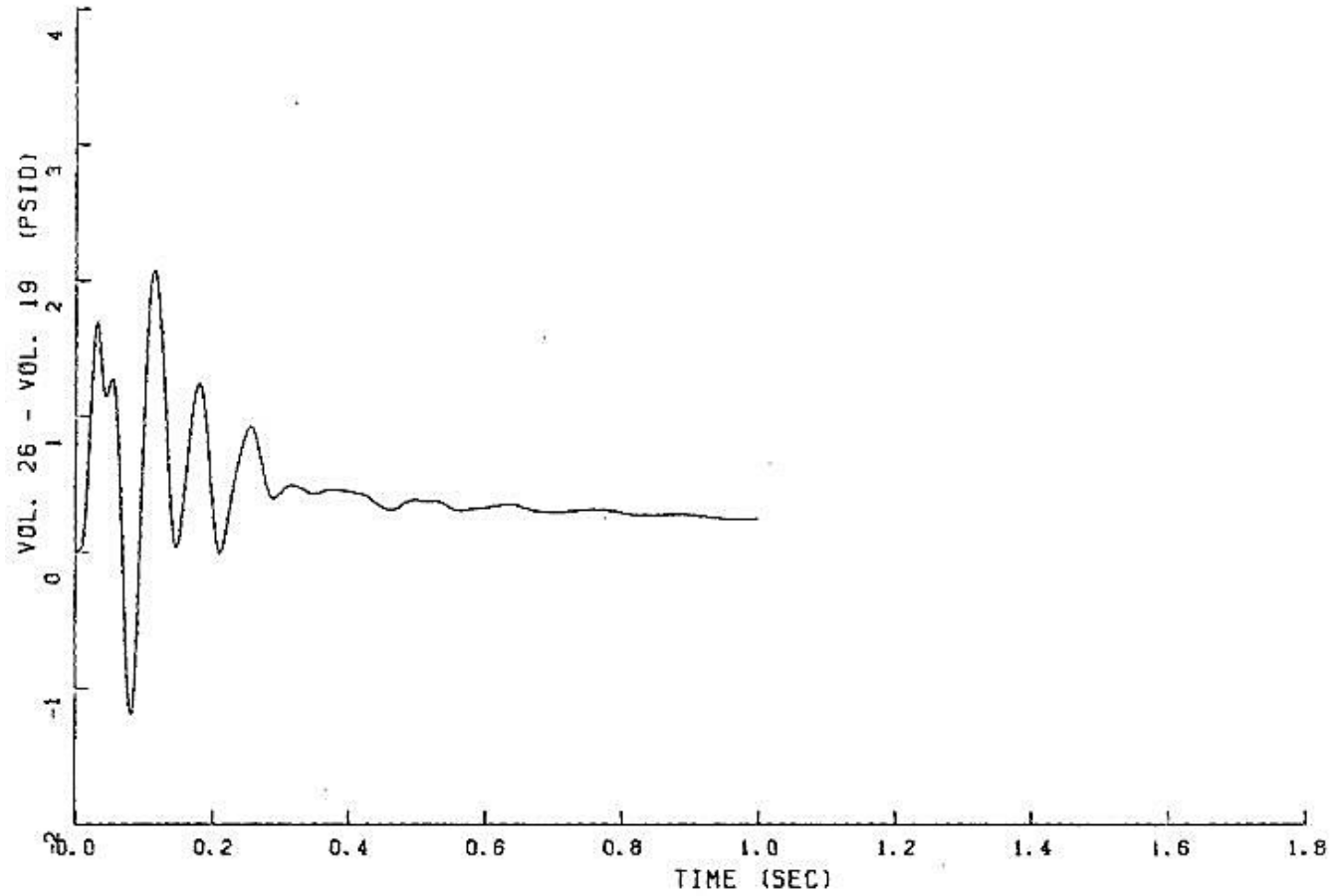

FIGURE 6.2.1-216

PEAK PRESSURE DIFFERENTIAL IN STEAM GENERATOR LOOP – 2

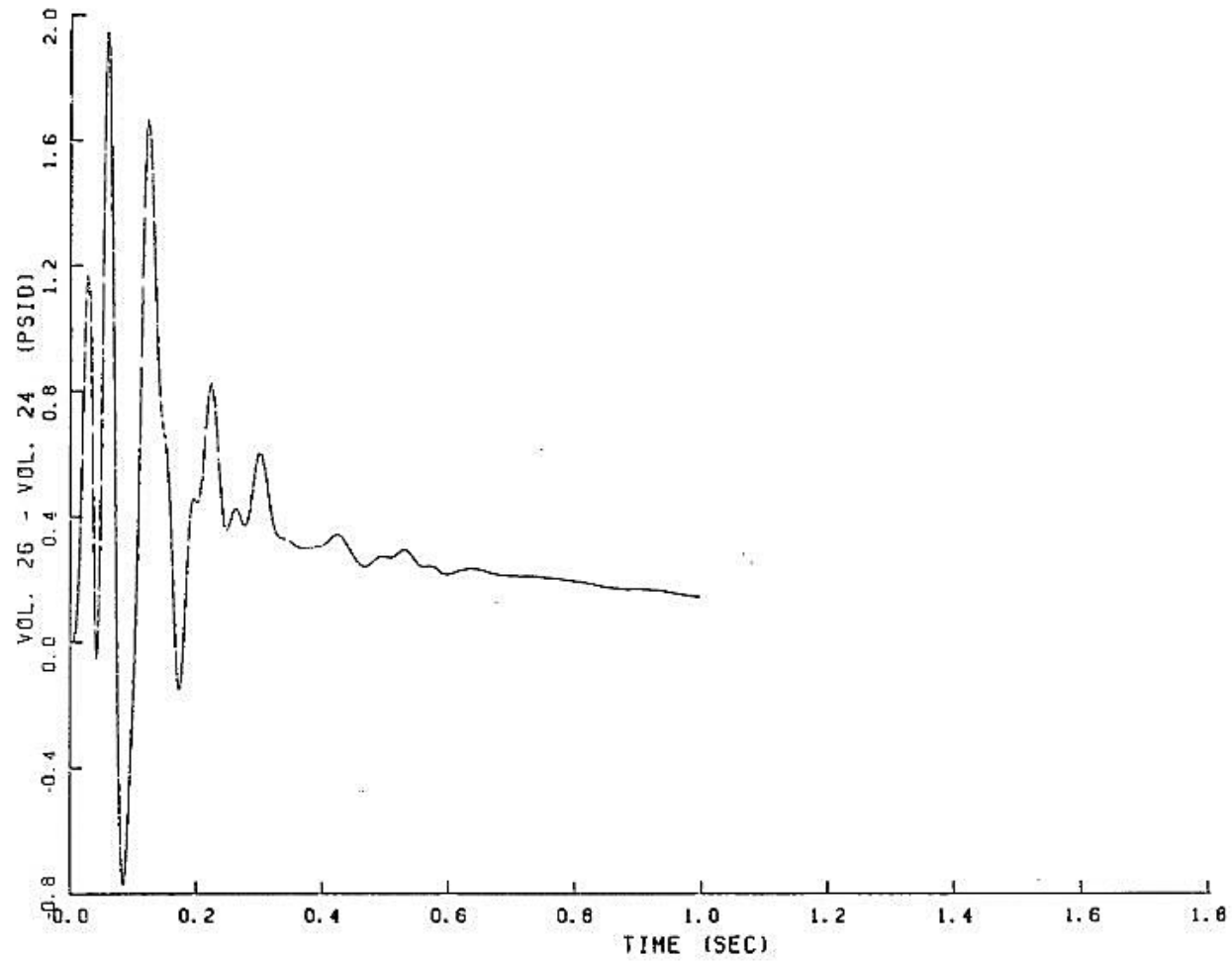

FIGURE 6.2.1-217

PEAK PRESSURE DIFFERENTIAL IN STEAM GENERATOR LOOP – 2

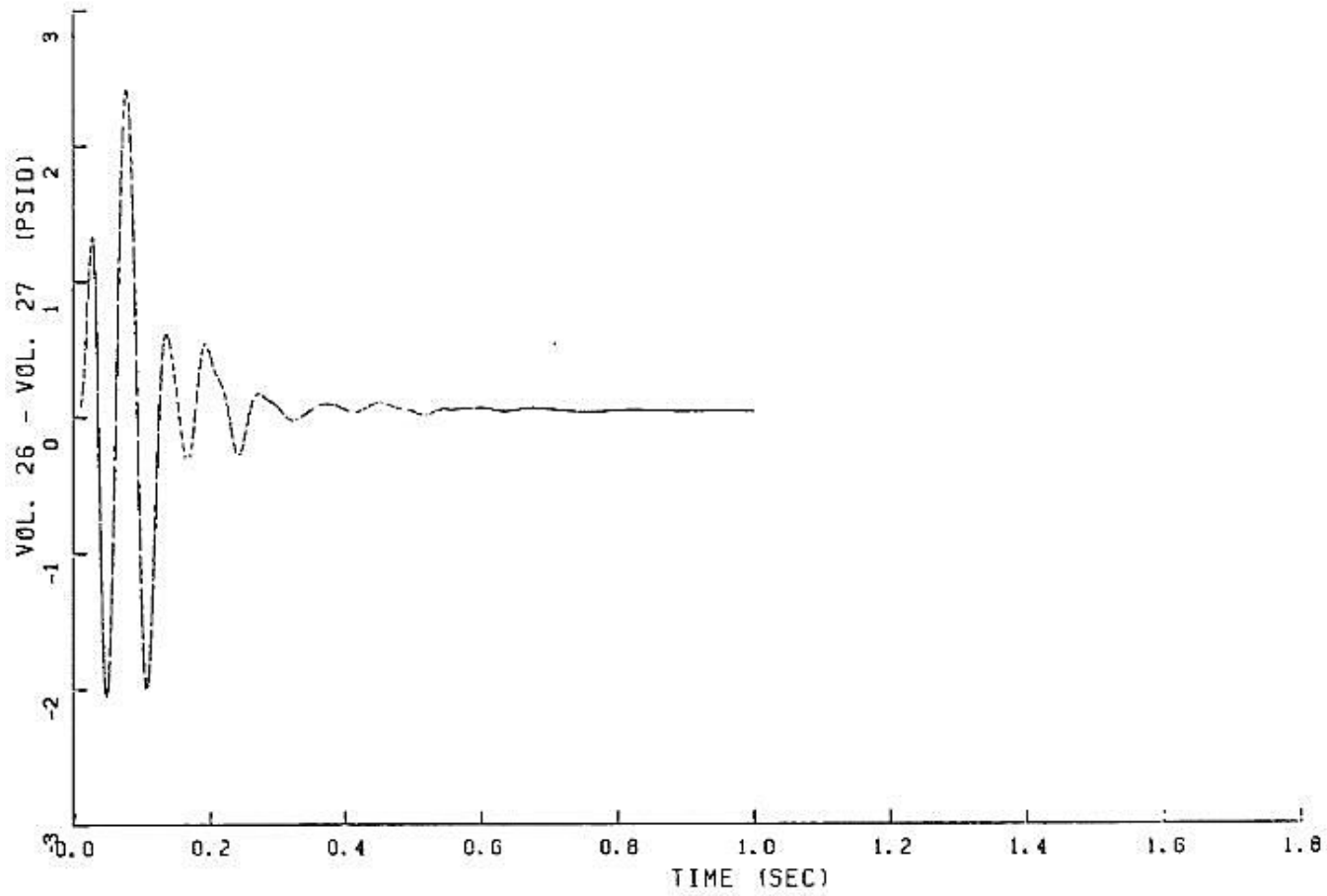

FIGURE 6.2.1-218

PEAK PRESSURE DIFFERENTIAL IN STEAM GENERATOR LOOP - 2

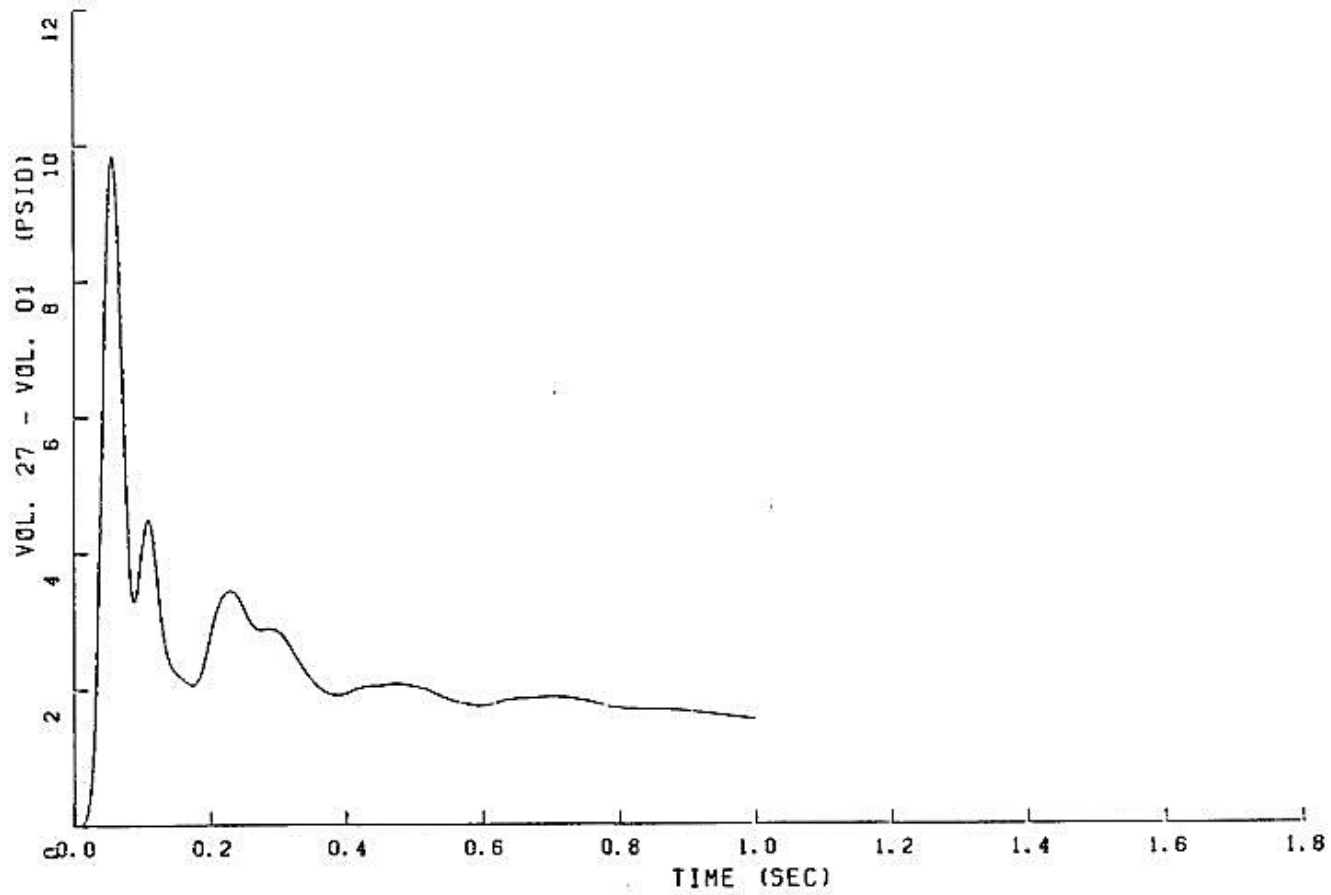

FIGURE 6.2.1-219

PEAK PRESSURE DIFFERENTIAL IN STEAM GENERATOR LOOP - 2

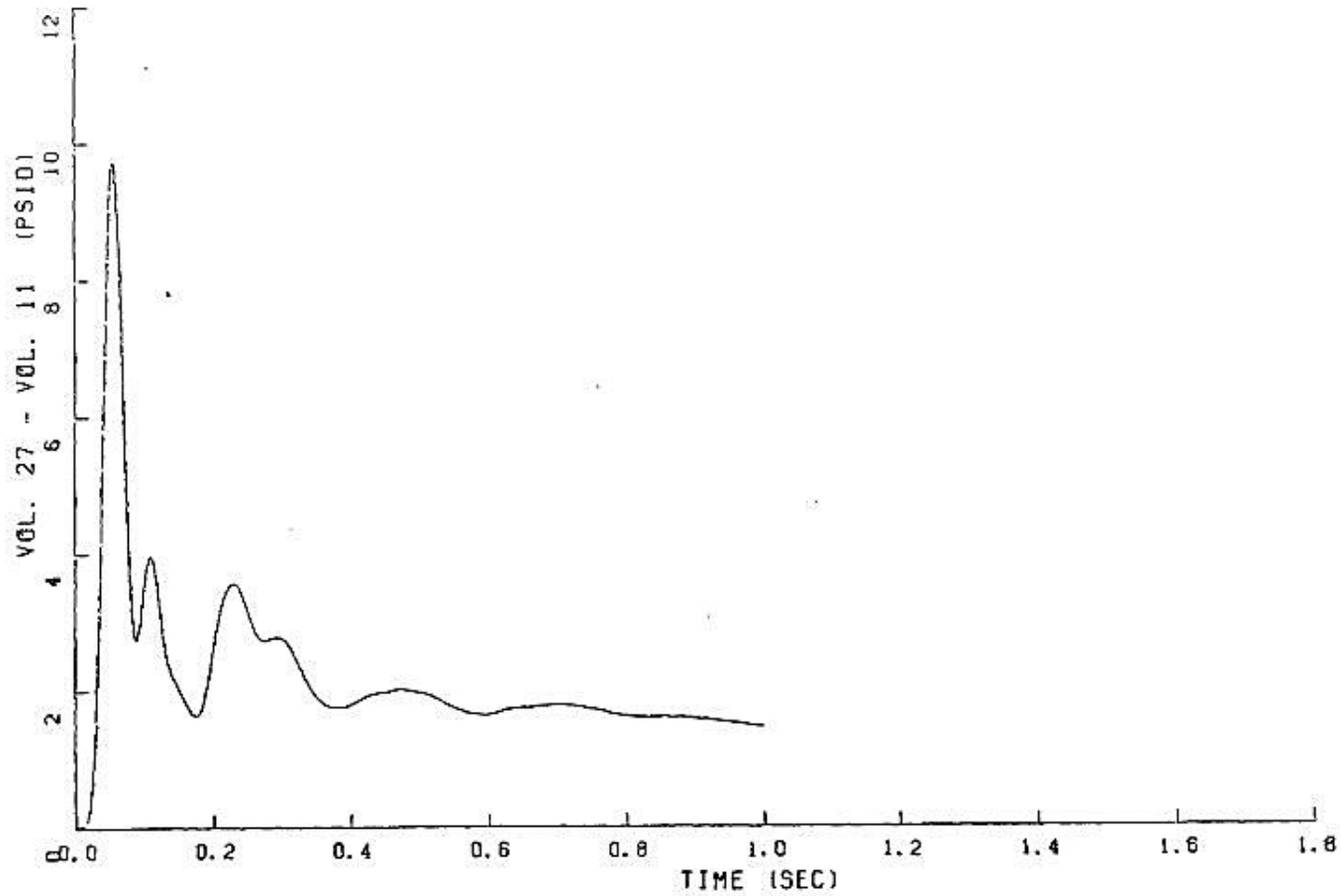

FIGURE 6.2.1-220

PEAK PRESSURE DIFFERENTIAL IN STEAM GENERATOR LOOP - 2

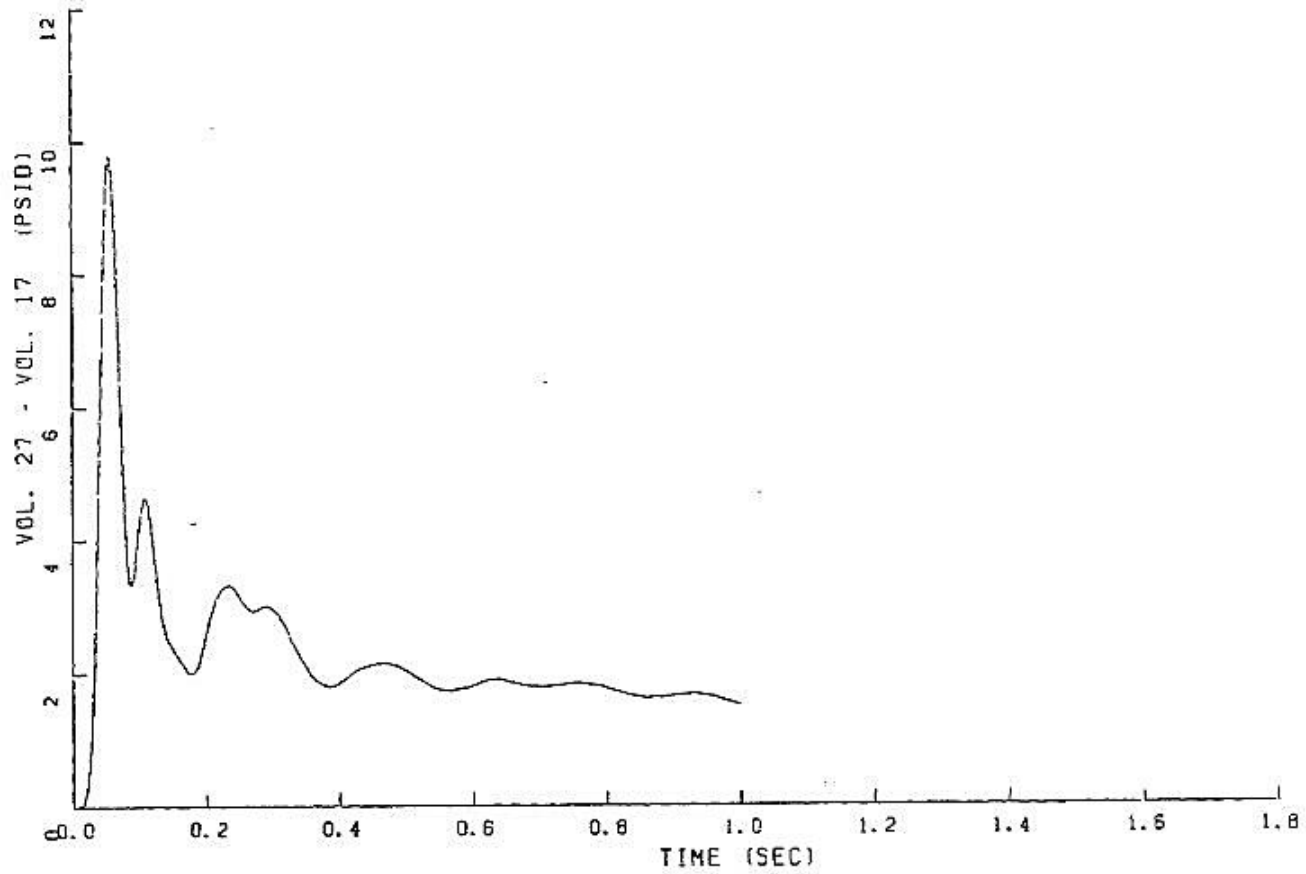

FIGURE 6.2.1-221

PEAK PRESSURE DIFFERENTIAL IN STEAM GENERATOR LOOP - 2

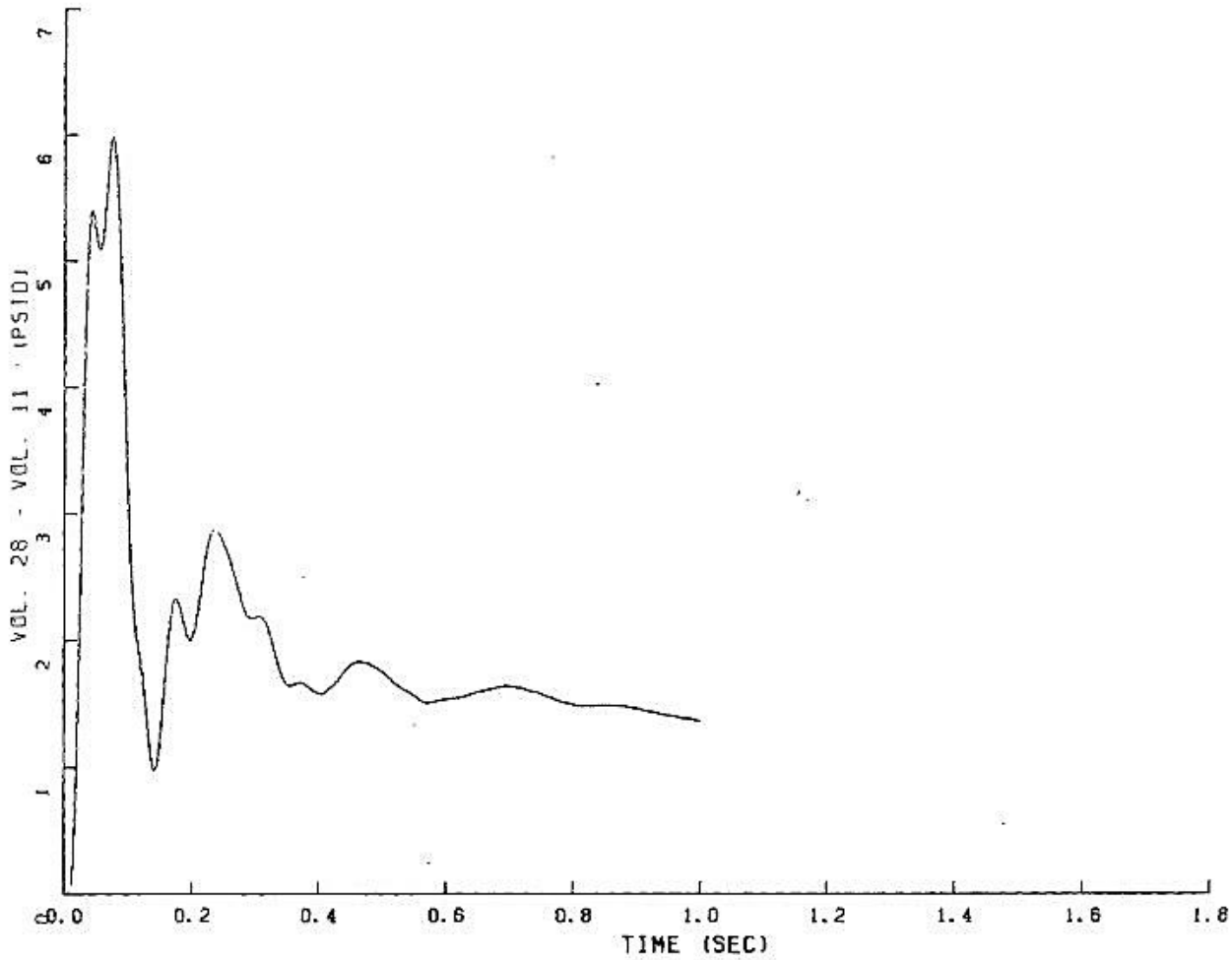

FIGURE 6.2.1-222

PEAK PRESSURE DIFFERENTIAL IN STEAM GENERATOR LOOP - 2

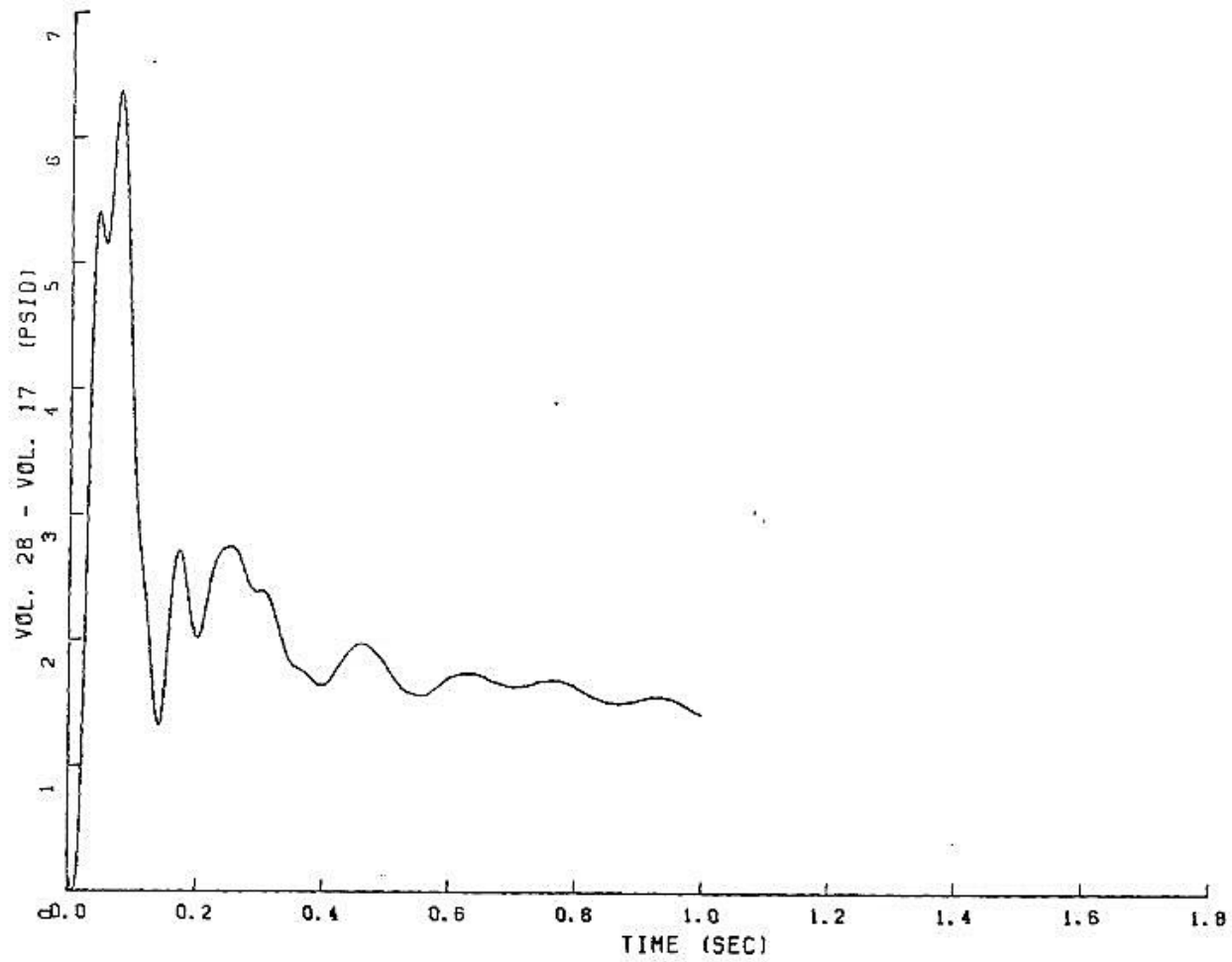

FIGURE 6.2.1-223

PEAK PRESSURE DIFFERENTIAL IN STEAM GENERATOR LOOP – 2

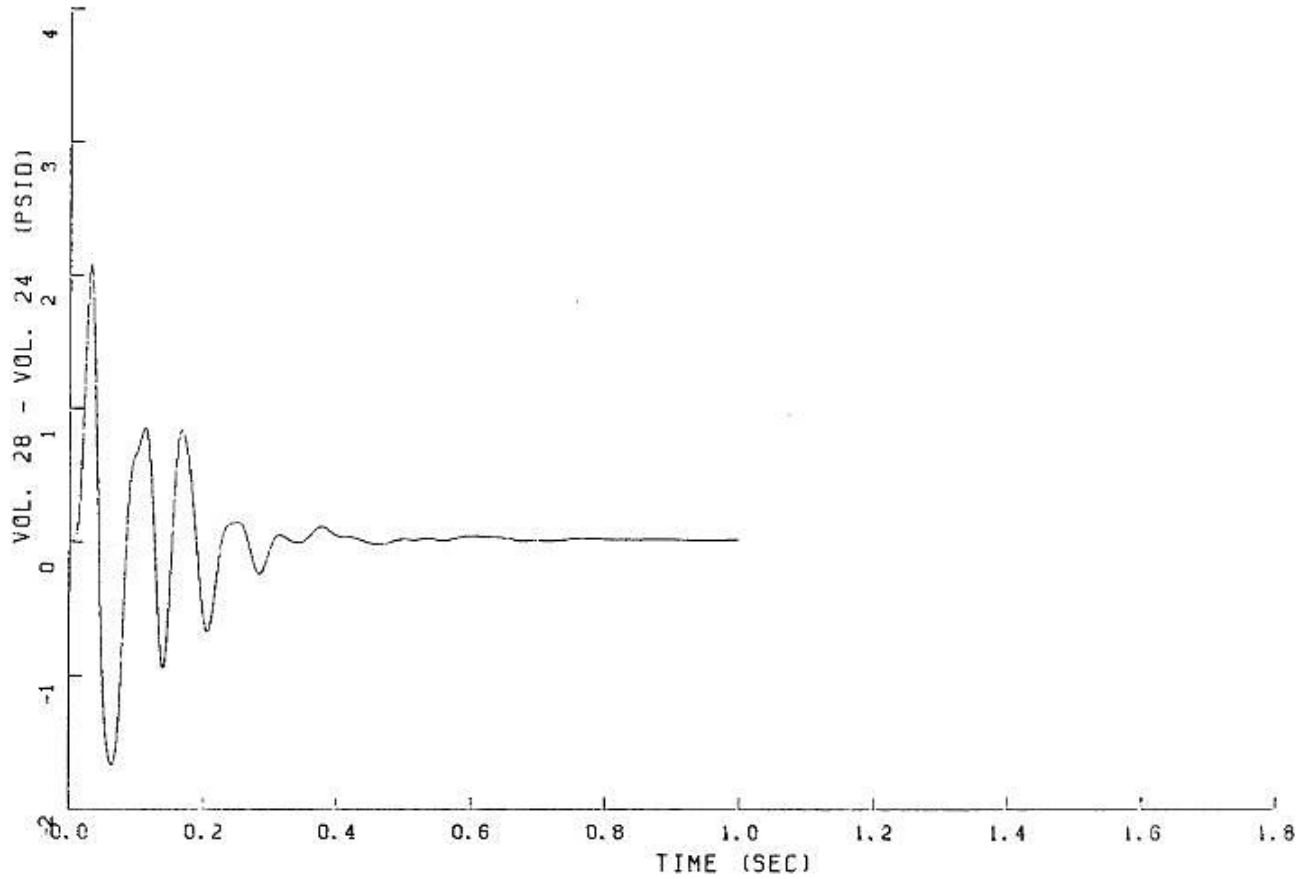

FIGURE 6.2.1-224

PEAK PRESSURE DIFFERENTIAL IN STEAM GENERATOR LOOP - 2

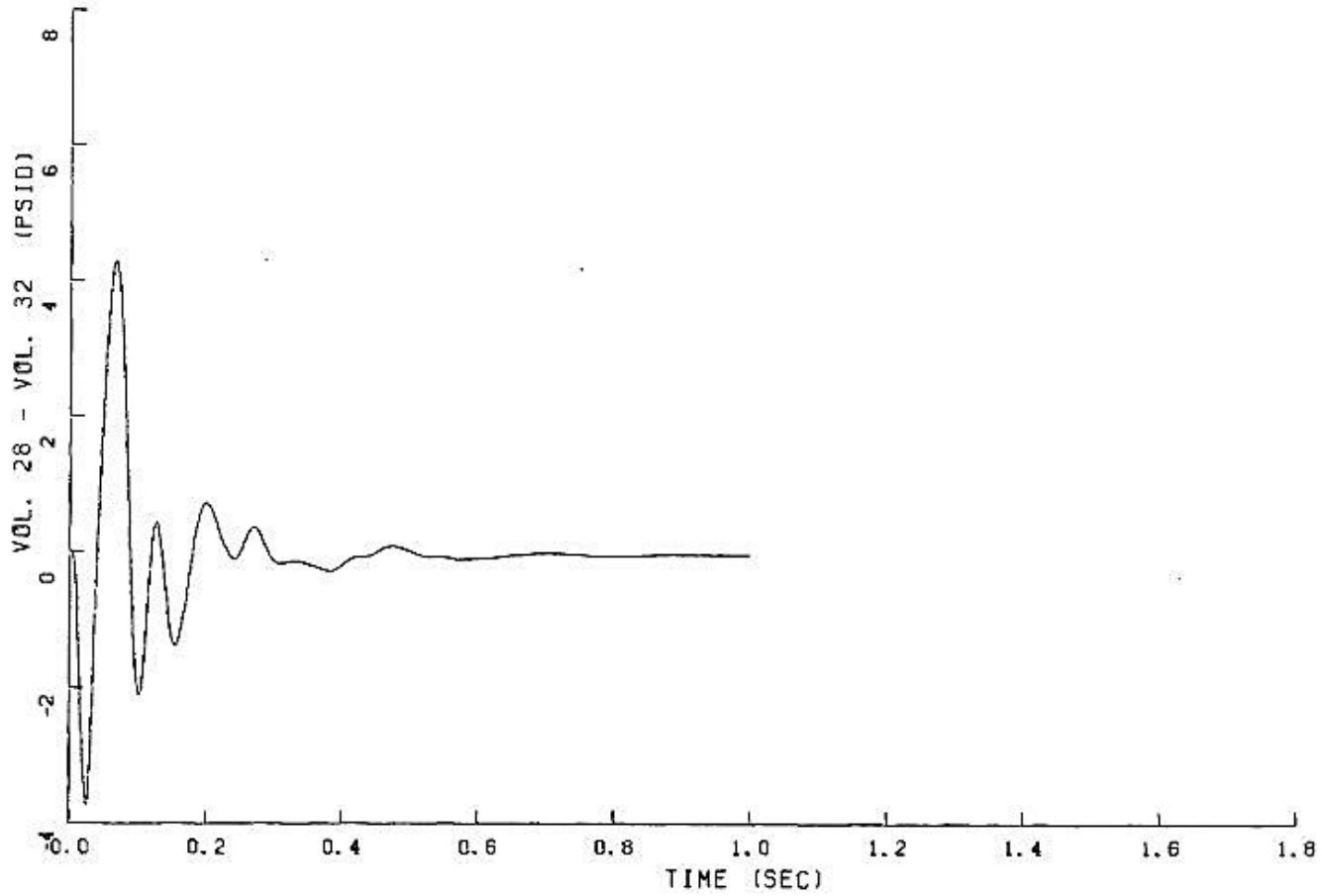

FIGURE 6.2.1-225

PEAK PRESSURE DIFFERENTIAL IN STEAM GENERATOR LOOP – 2

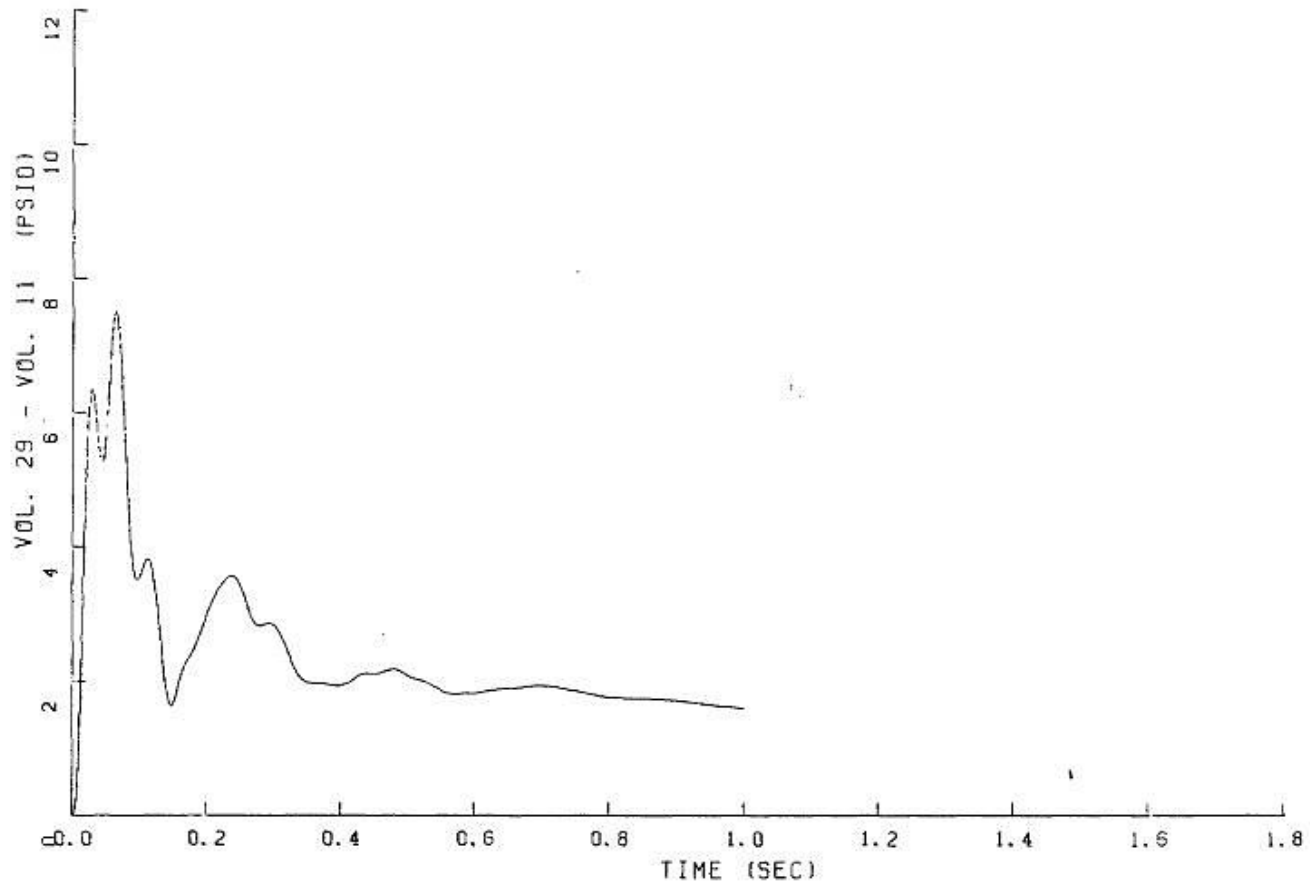

FIGURE 6.2.1-226

PEAK PRESSURE DIFFERENTIAL IN STEAM GENERATOR LOOP – 2

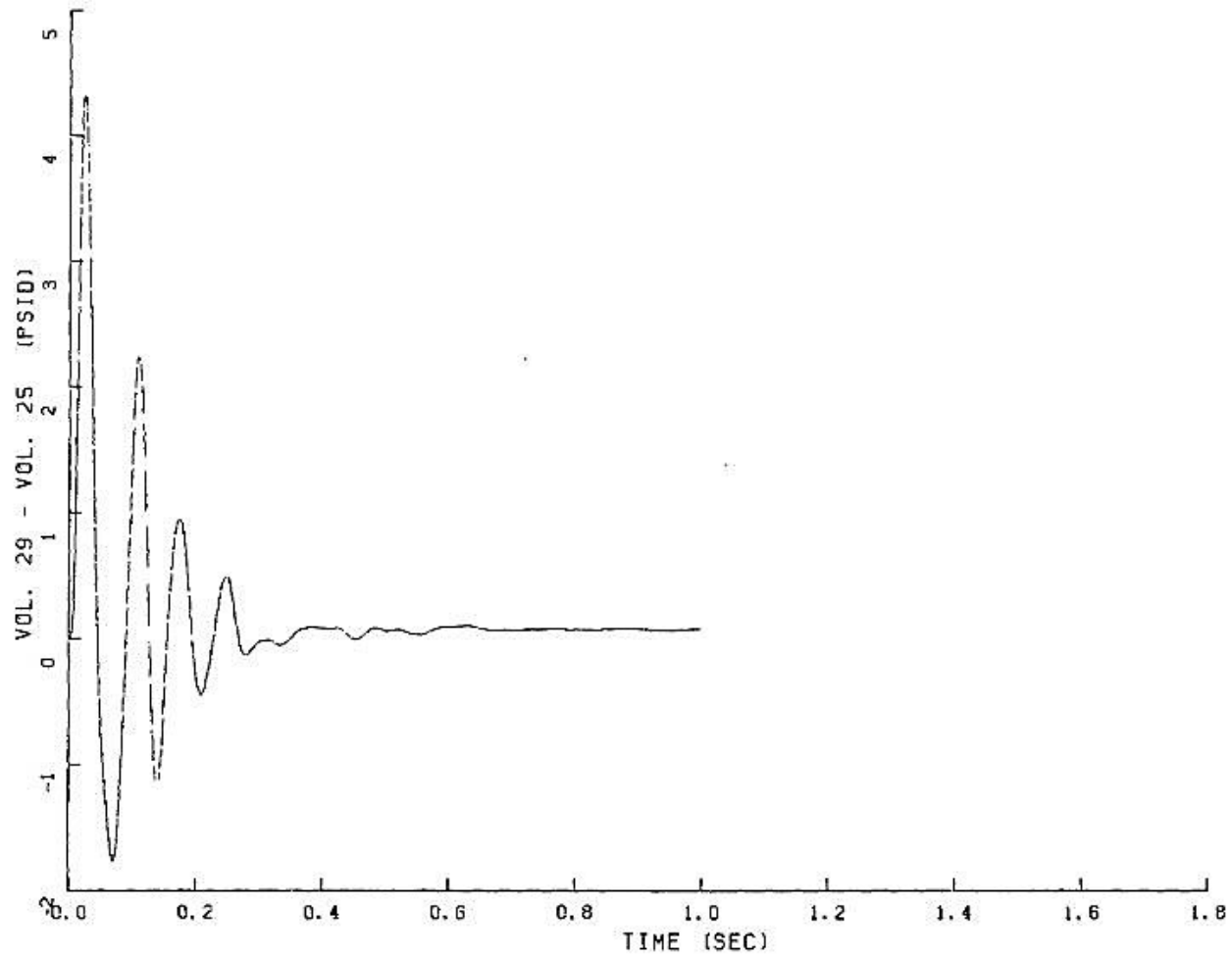

FIGURE 6.2.1-227

PEAK PRESSURE DIFFERENTIAL IN STEAM GENERATOR LOOP - 2

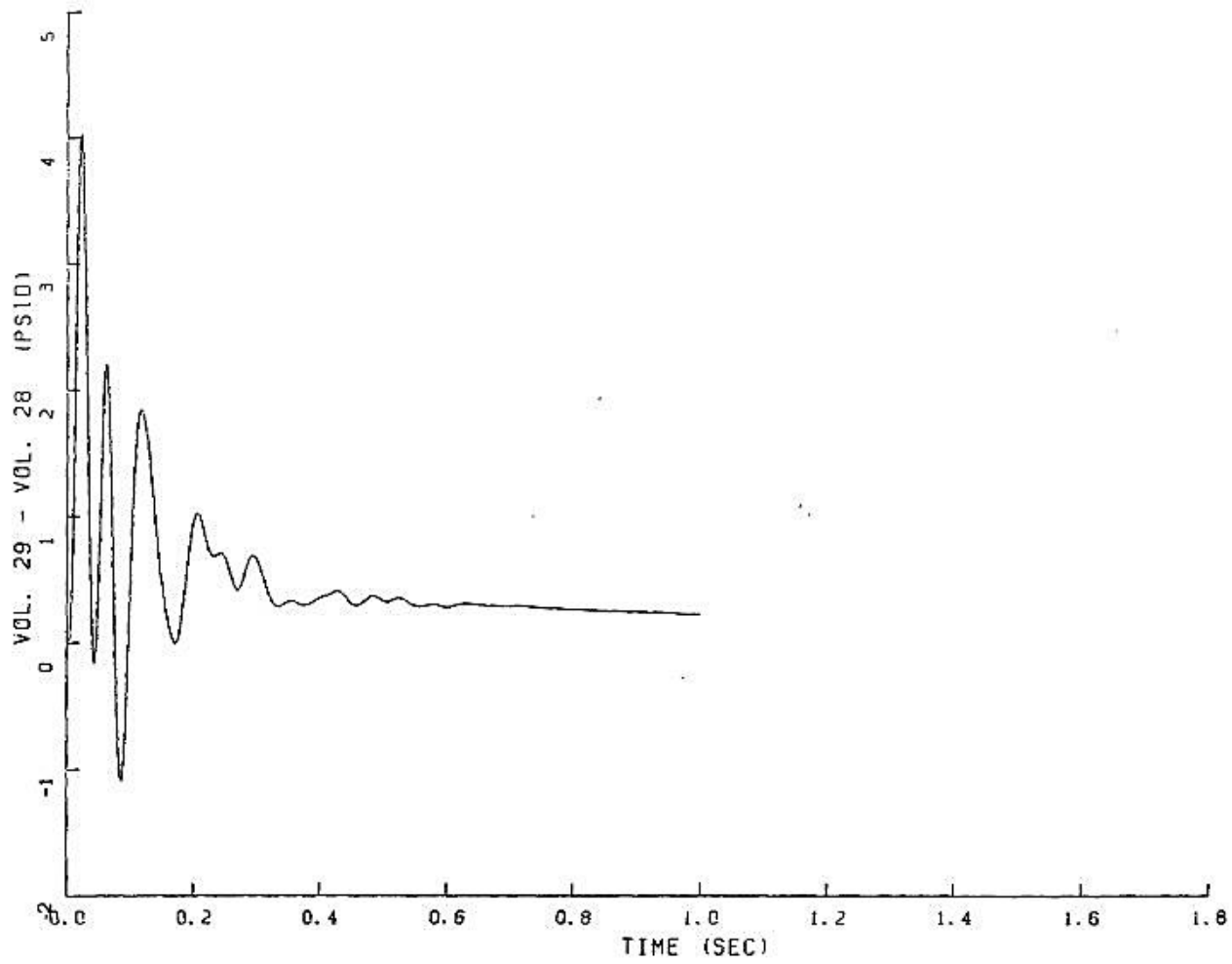

FIGURE 6.2.1-228

PEAK PRESSURE DIFFERENTIAL IN STEAM GENERATOR LOOP – 2

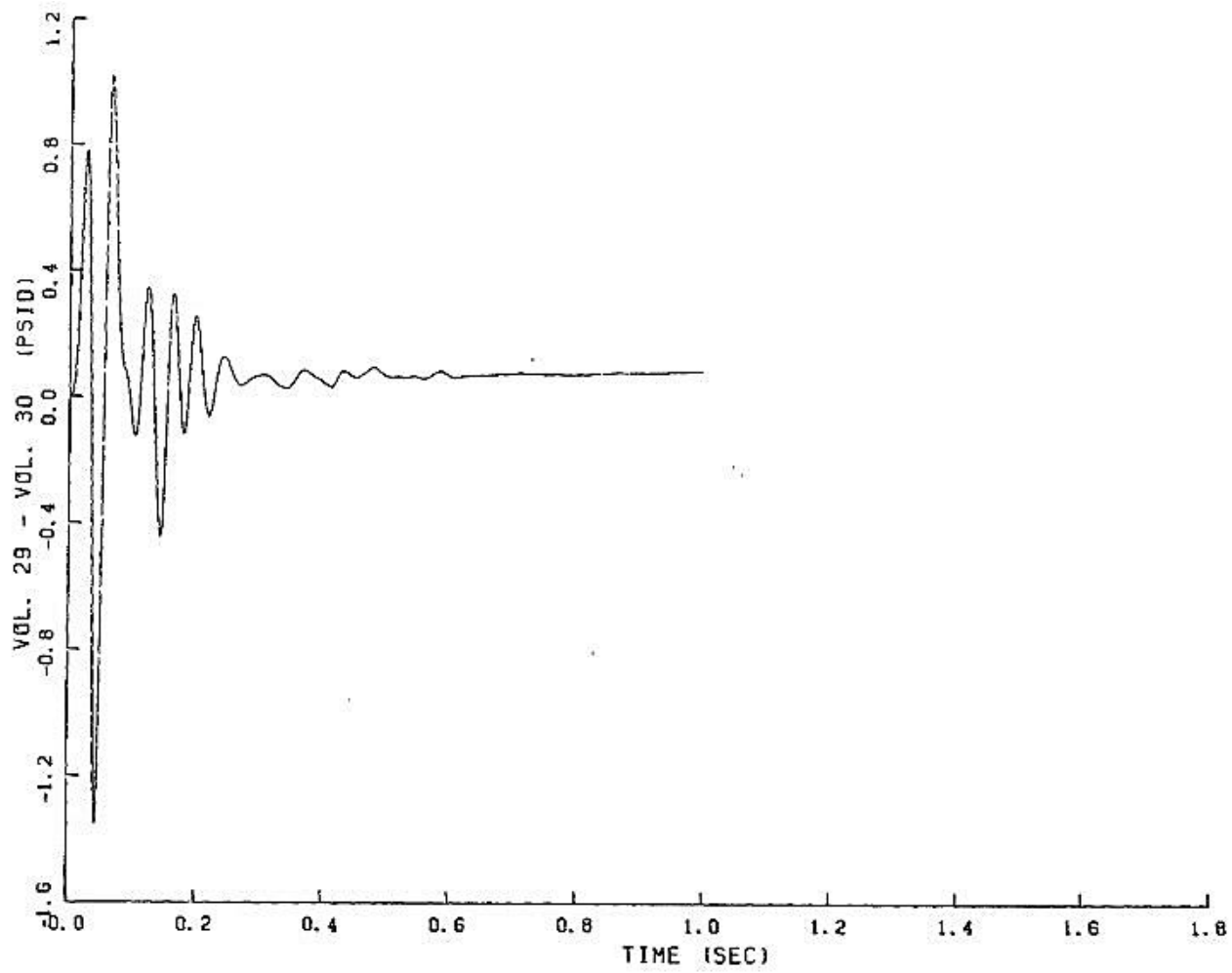

FIGURE 6.2.1-229

PEAK PRESSURE DIFFERENTIAL IN STEAM GENERATOR LOOP – 2

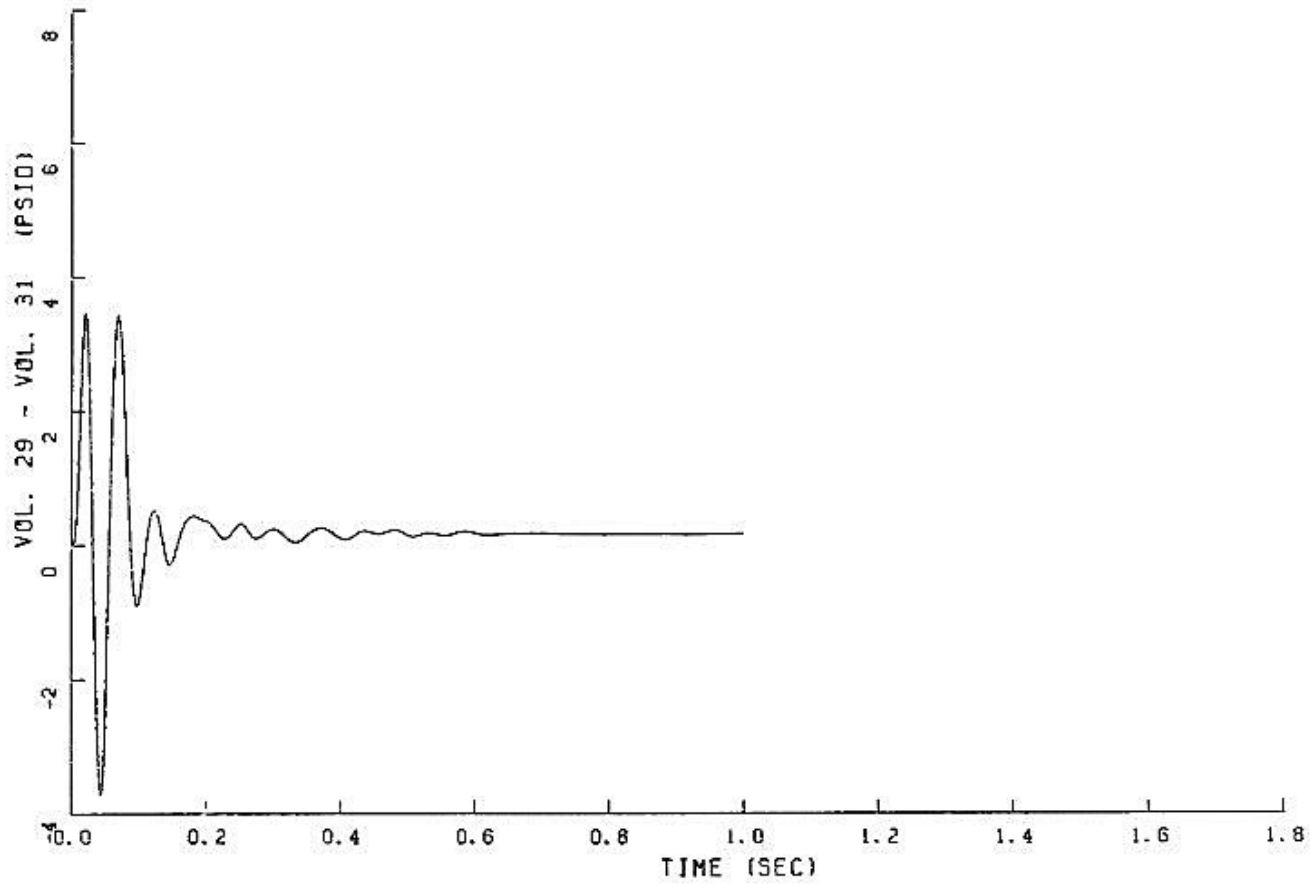

FIGURE 6.2.1-230

PEAK PRESSURE DIFFERENTIAL IN STEAM GENERATOR LOOP – 2

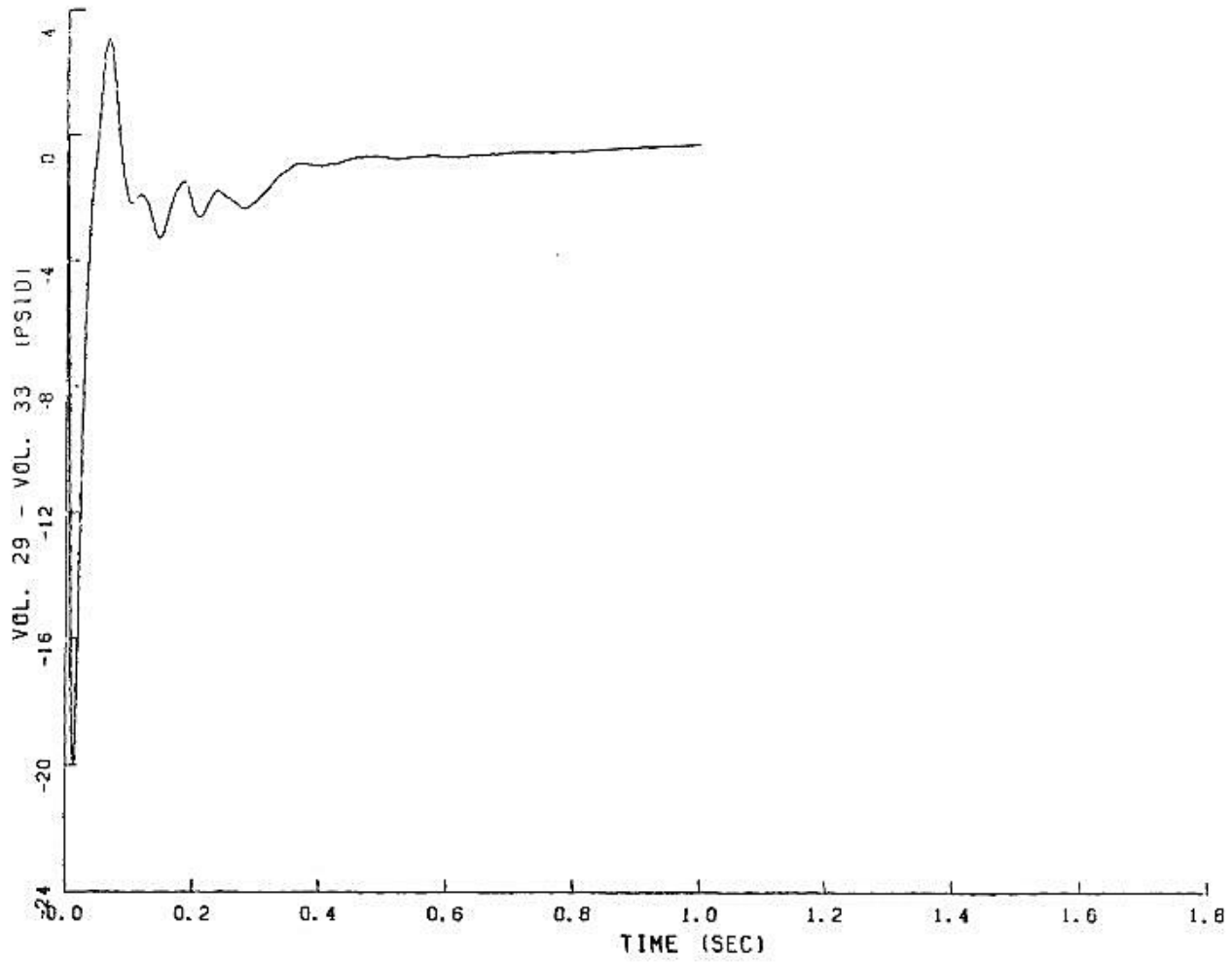

FIGURE 6.2.1-231

PEAK PRESSURE DIFFERENTIAL IN STEAM GENERATOR LOOP - 2

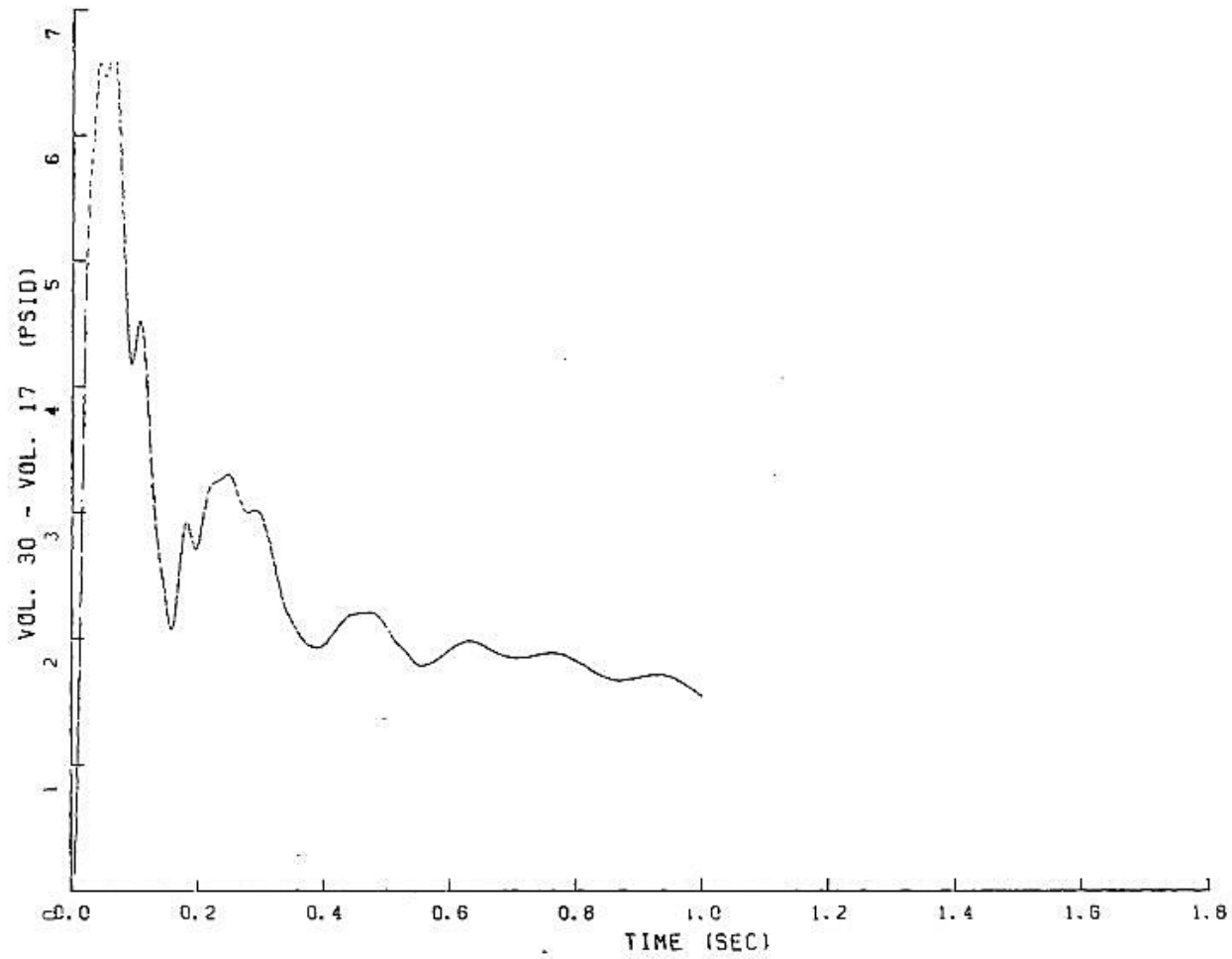

FIGURE 6.2.1-232

PEAK PRESSURE DIFFERENTIAL IN STEAM GENERATOR LOOP - 2

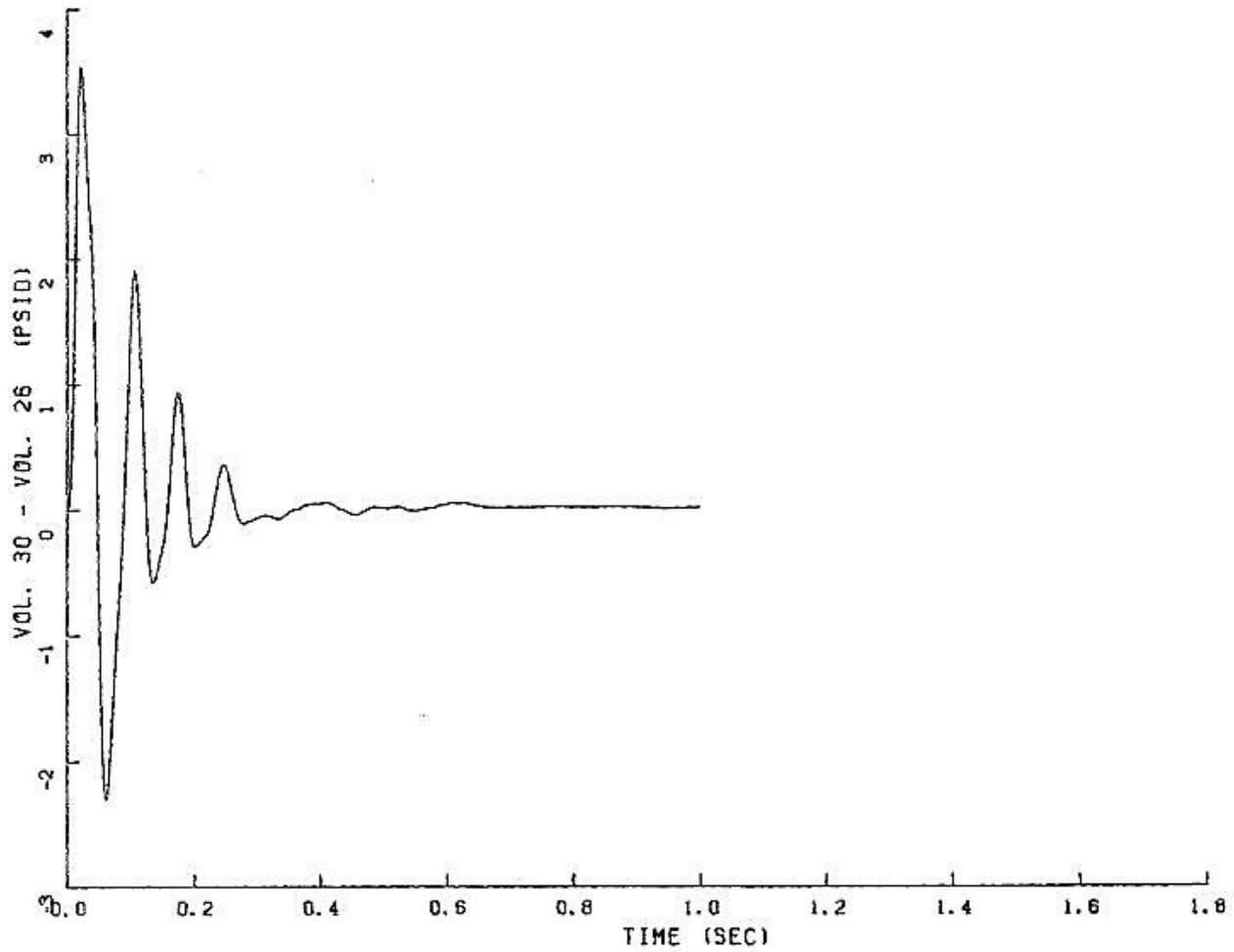

FIGURE 6.2.1-233

PEAK PRESSURE DIFFERENTIAL IN STEAM GENERATOR LOOP - 2

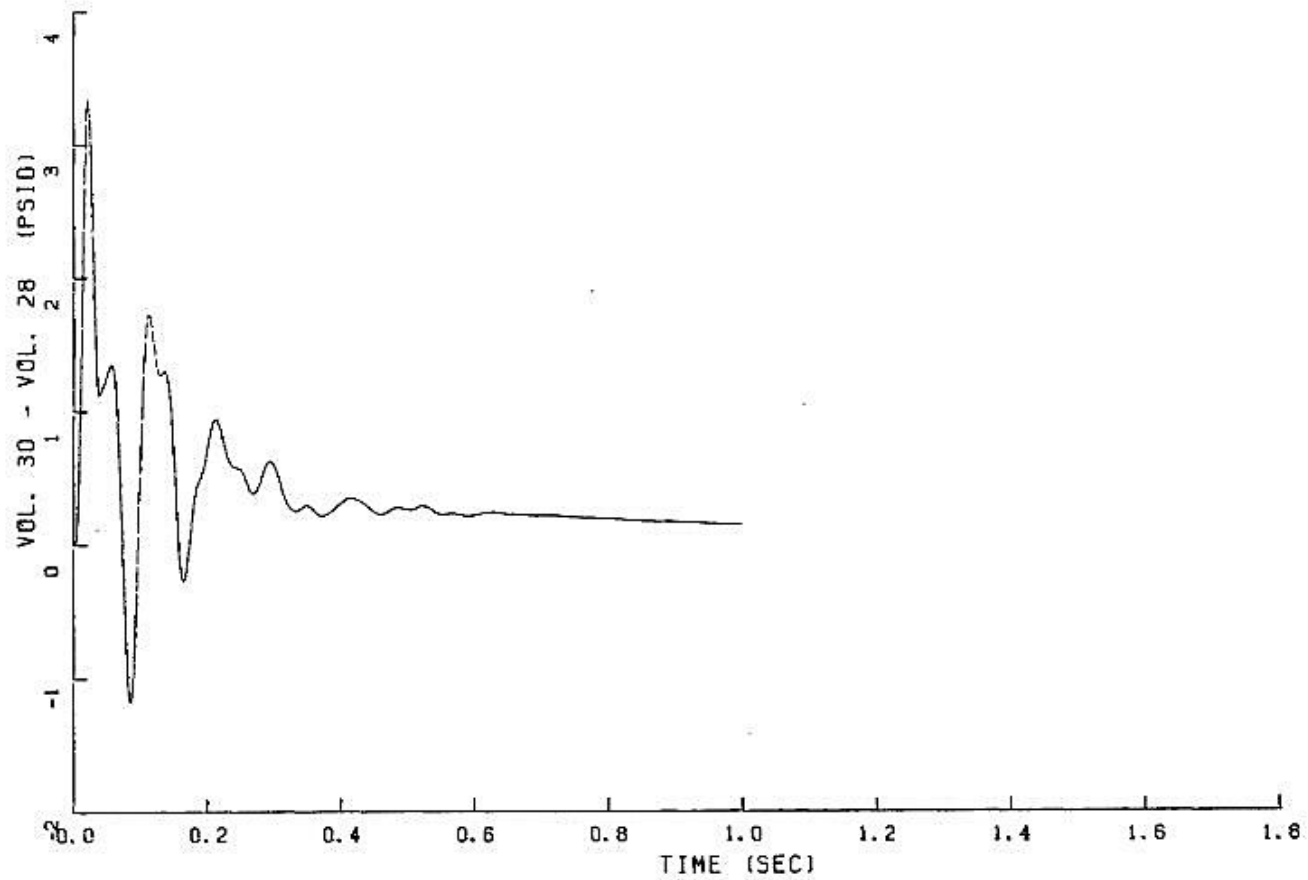

FIGURE 6.2.1-234

PEAK PRESSURE DIFFERENTIAL IN STEAM GENERATOR LOOP - 2

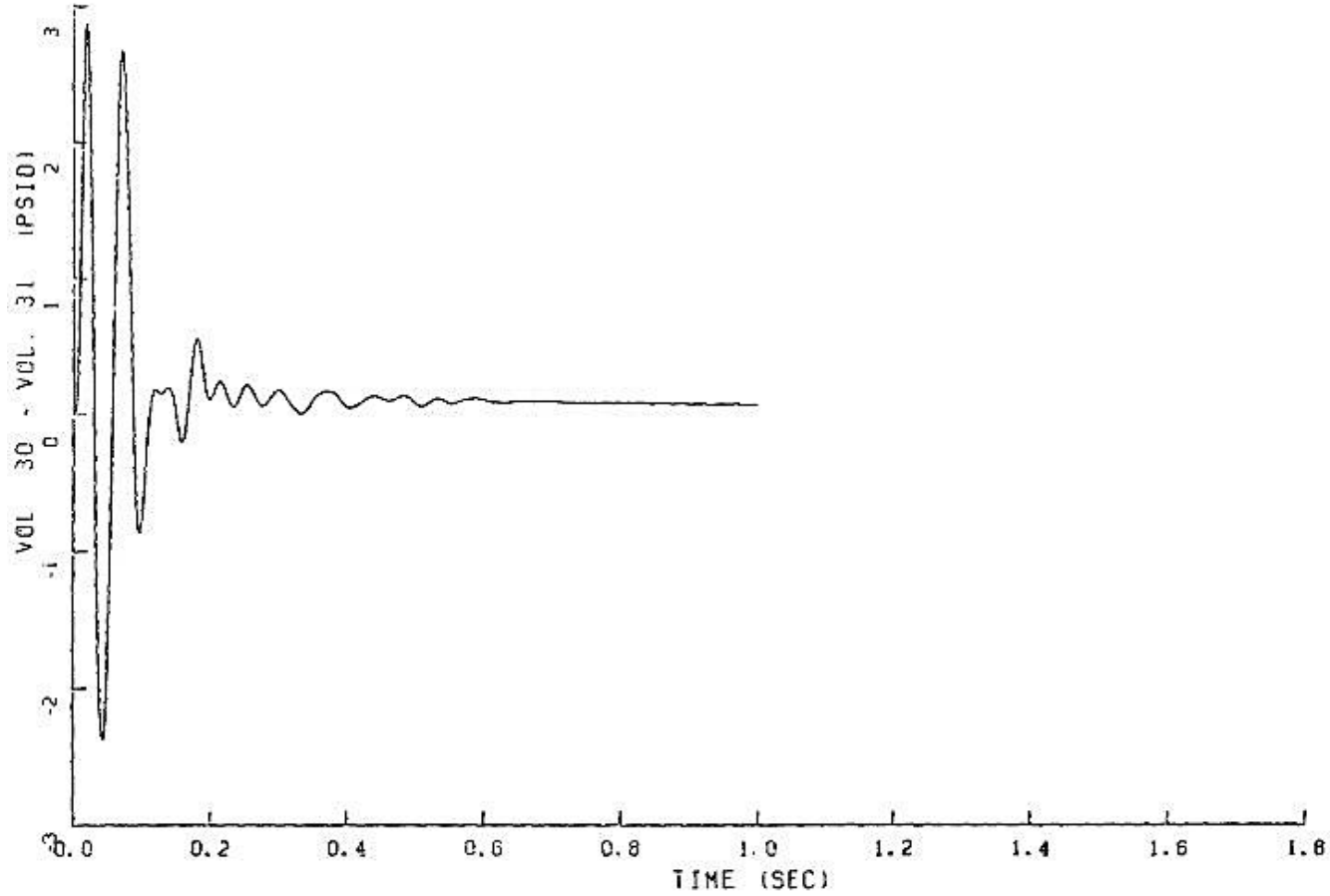

FIGURE 6.2.1-235

PEAK PRESSURE DIFFERENTIAL IN STEAM GENERATOR LOOP – 2

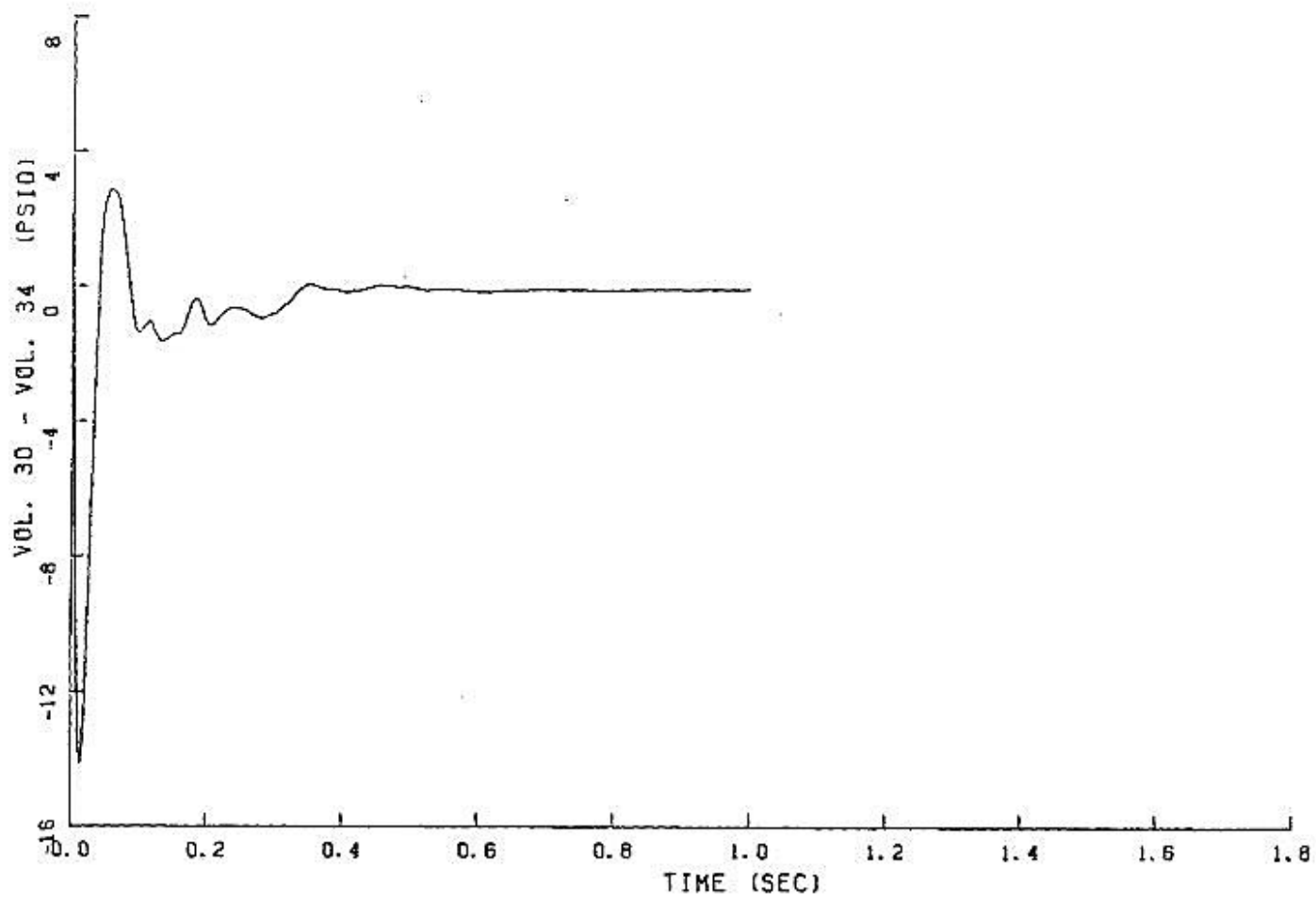

FIGURE 6.2.1-236

PEAK PRESSURE DIFFERENTIAL IN STEAM GENERATOR LOOP - 2

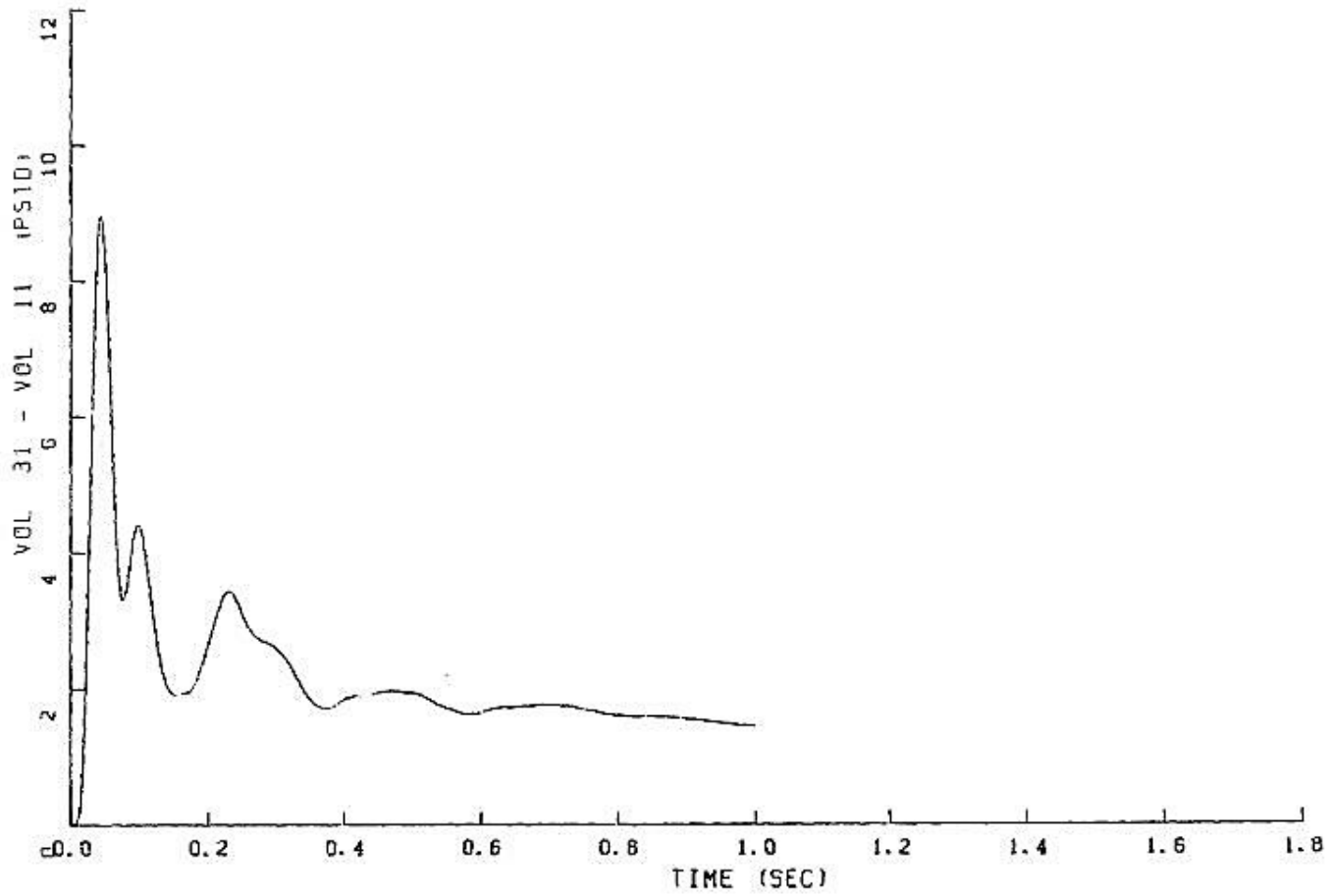

FIGURE 6.2.1-237

PEAK PRESSURE DIFFERENTIAL IN STEAM GENERATOR LOOP - 2

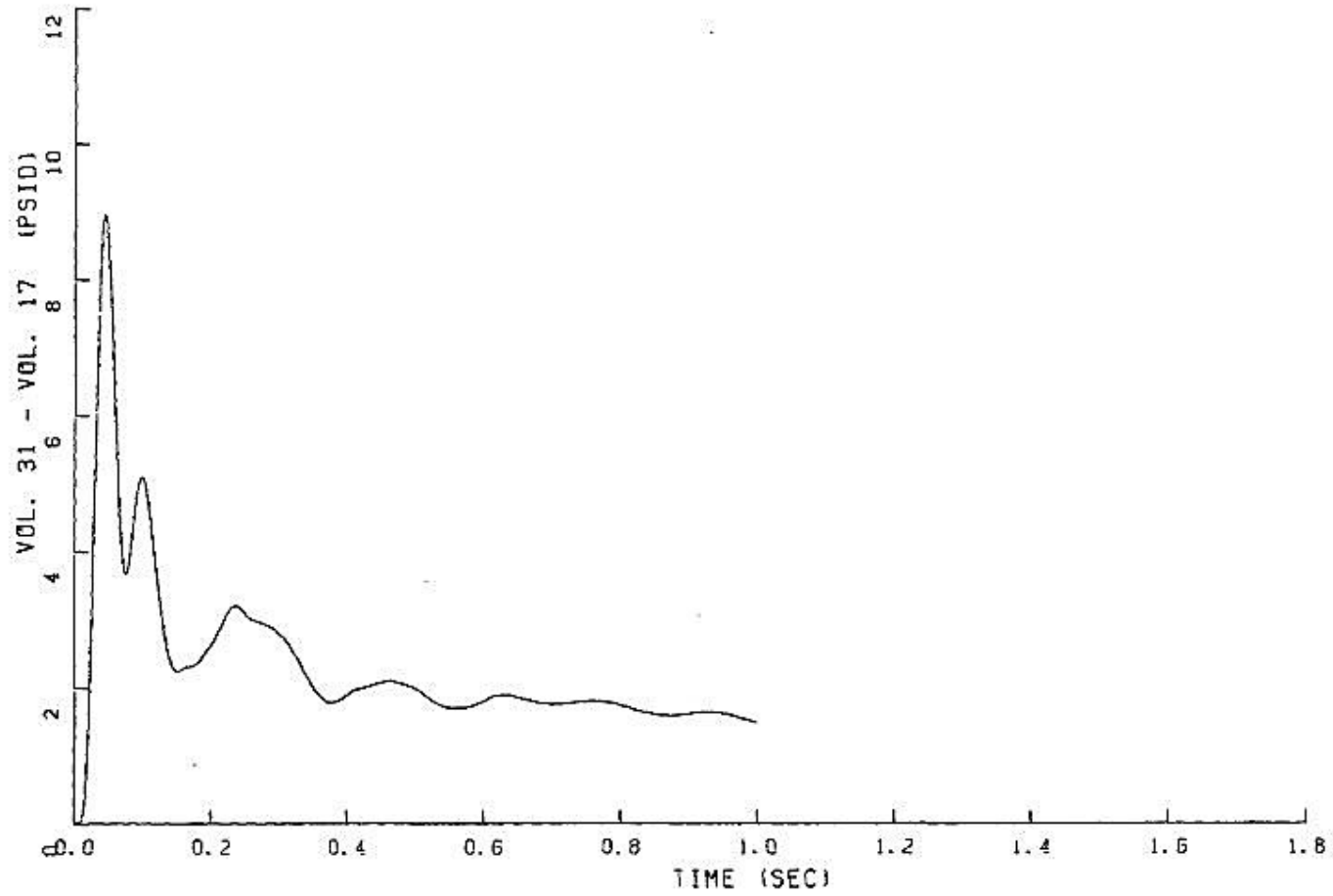

FIGURE 6.2.1-238

PEAK PRESSURE DIFFERENTIAL IN STEAM GENERATOR LOOP - 2

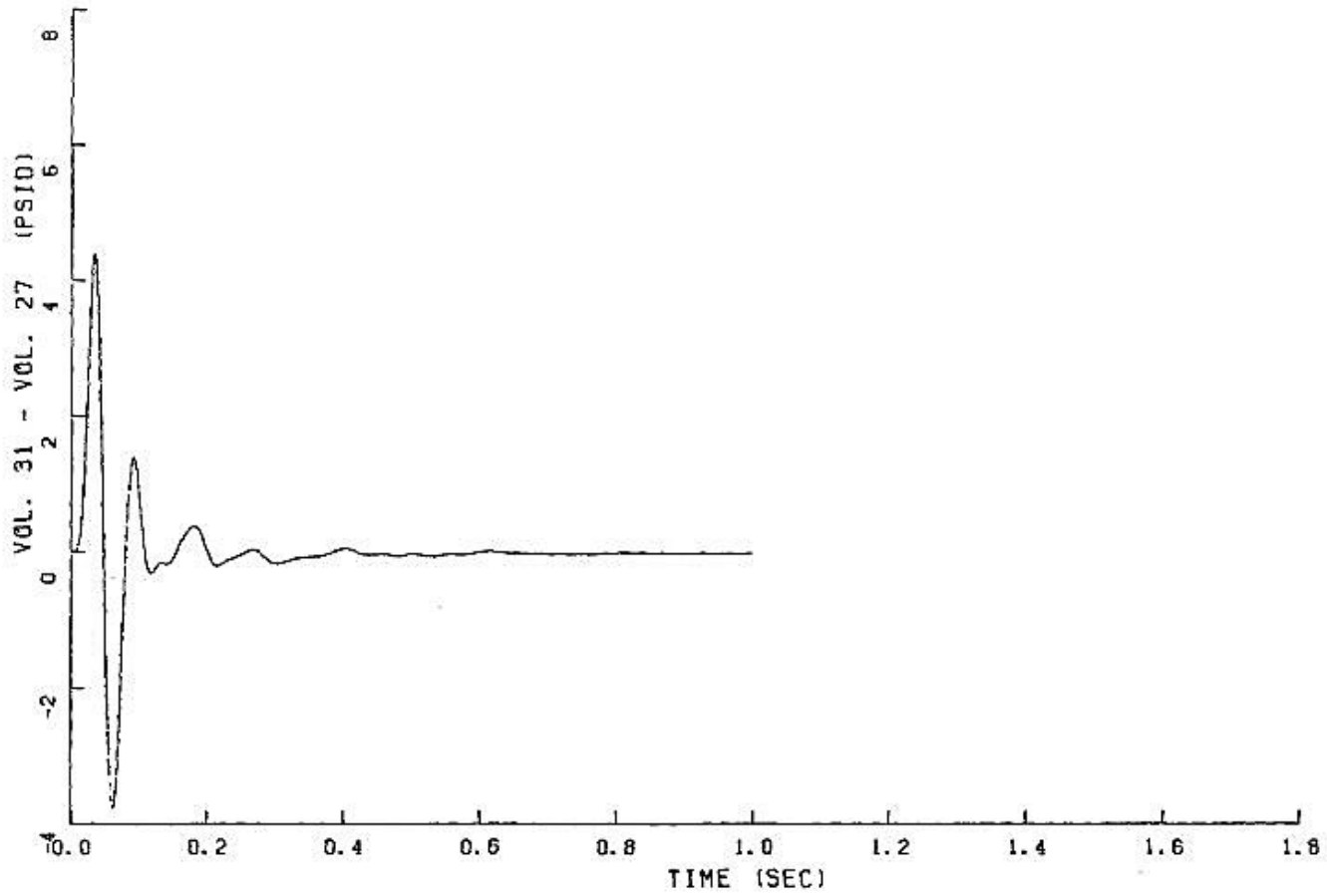

FIGURE 6.2.1-239

PEAK PRESSURE DIFFERENTIAL IN STEAM GENERATOR LOOP - 2

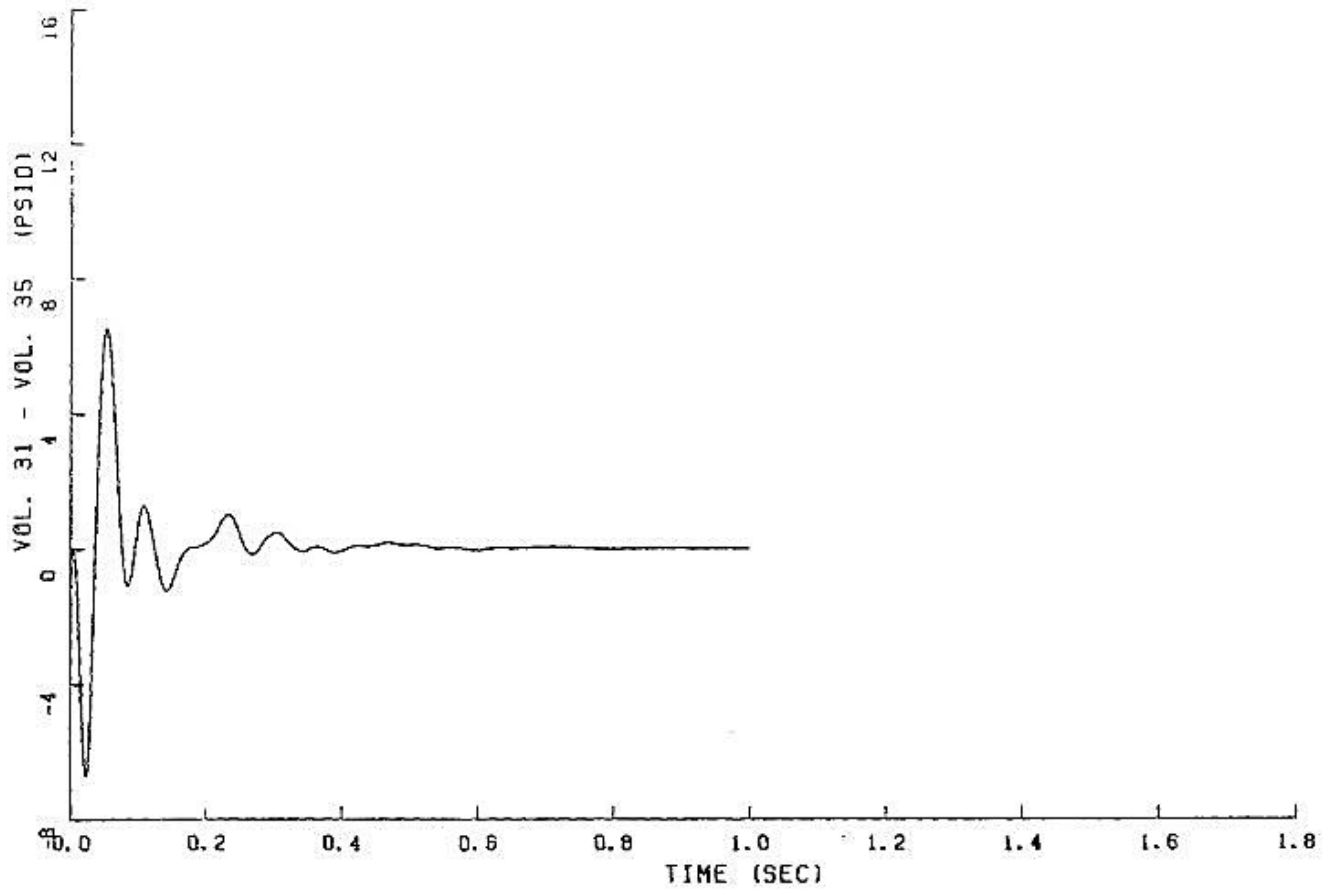

FIGURE 6.2.1-240

PEAK PRESSURE DIFFERENTIAL IN STEAM GENERATOR LOOP – 2

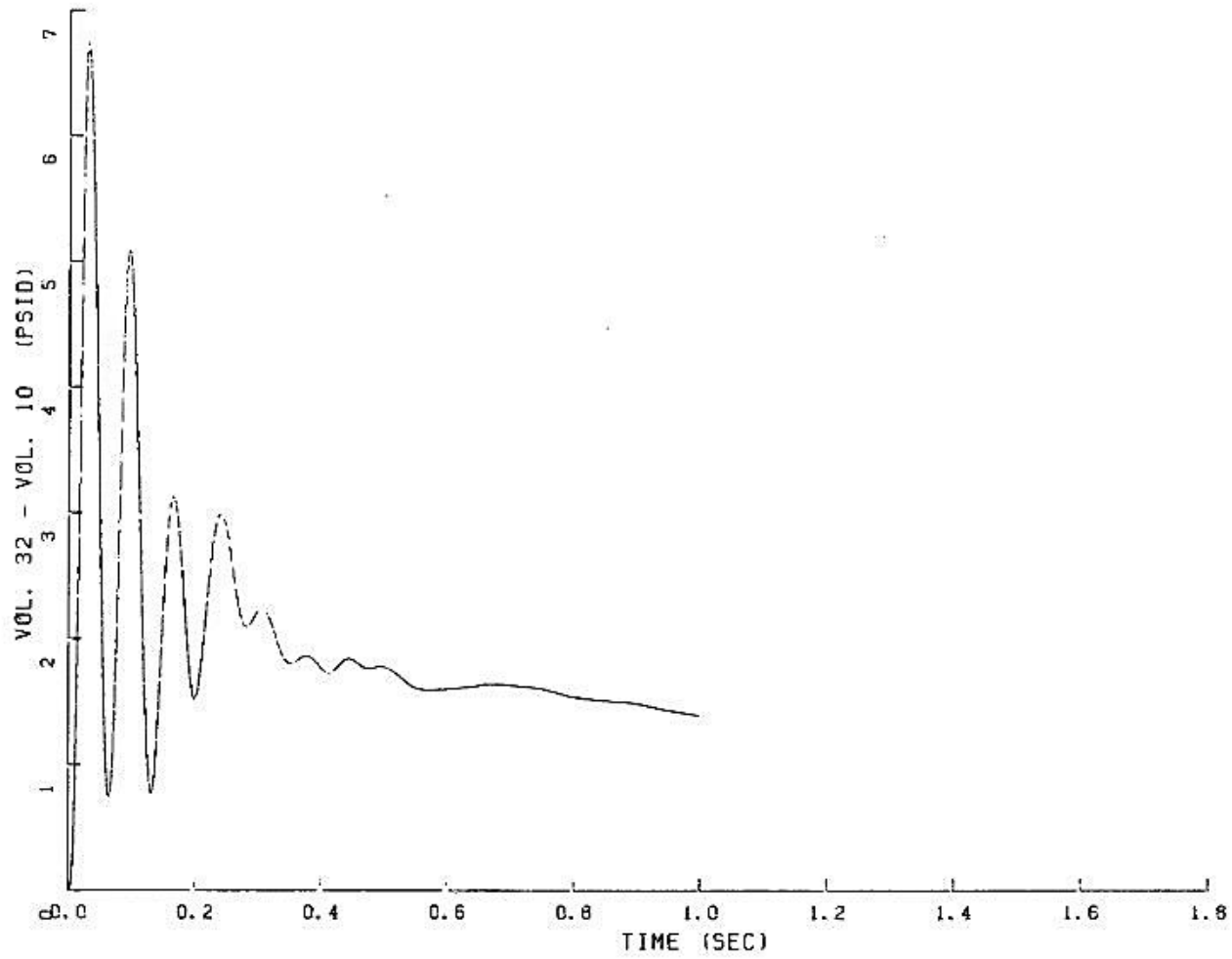

FIGURE 6.2.1-241

PEAK PRESSURE DIFFERENTIAL IN STEAM GENERATOR LOOP – 2

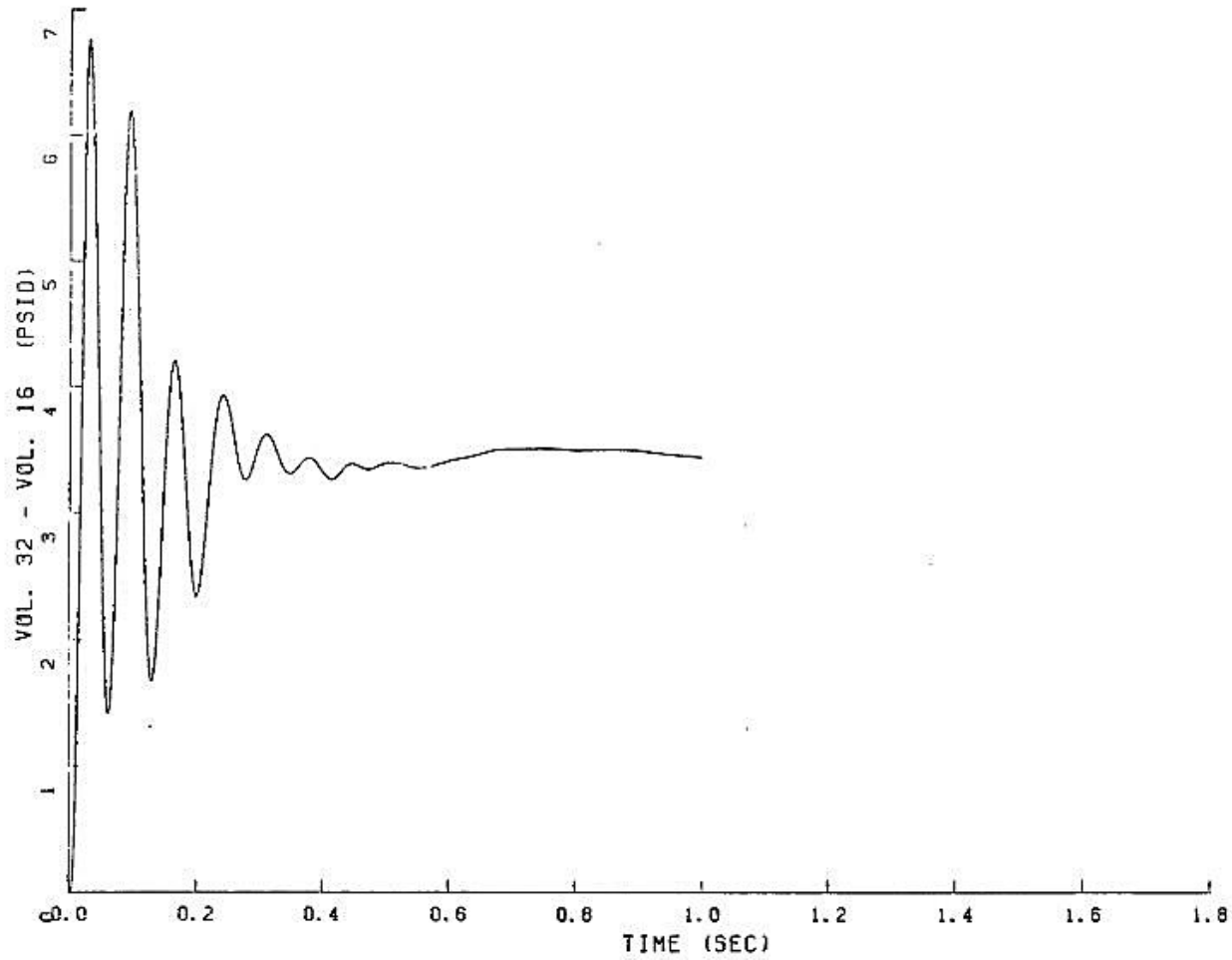

FIGURE 6.2.1-242

PEAK PRESSURE DIFFERENTIAL IN STEAM GENERATOR LOOP - 2

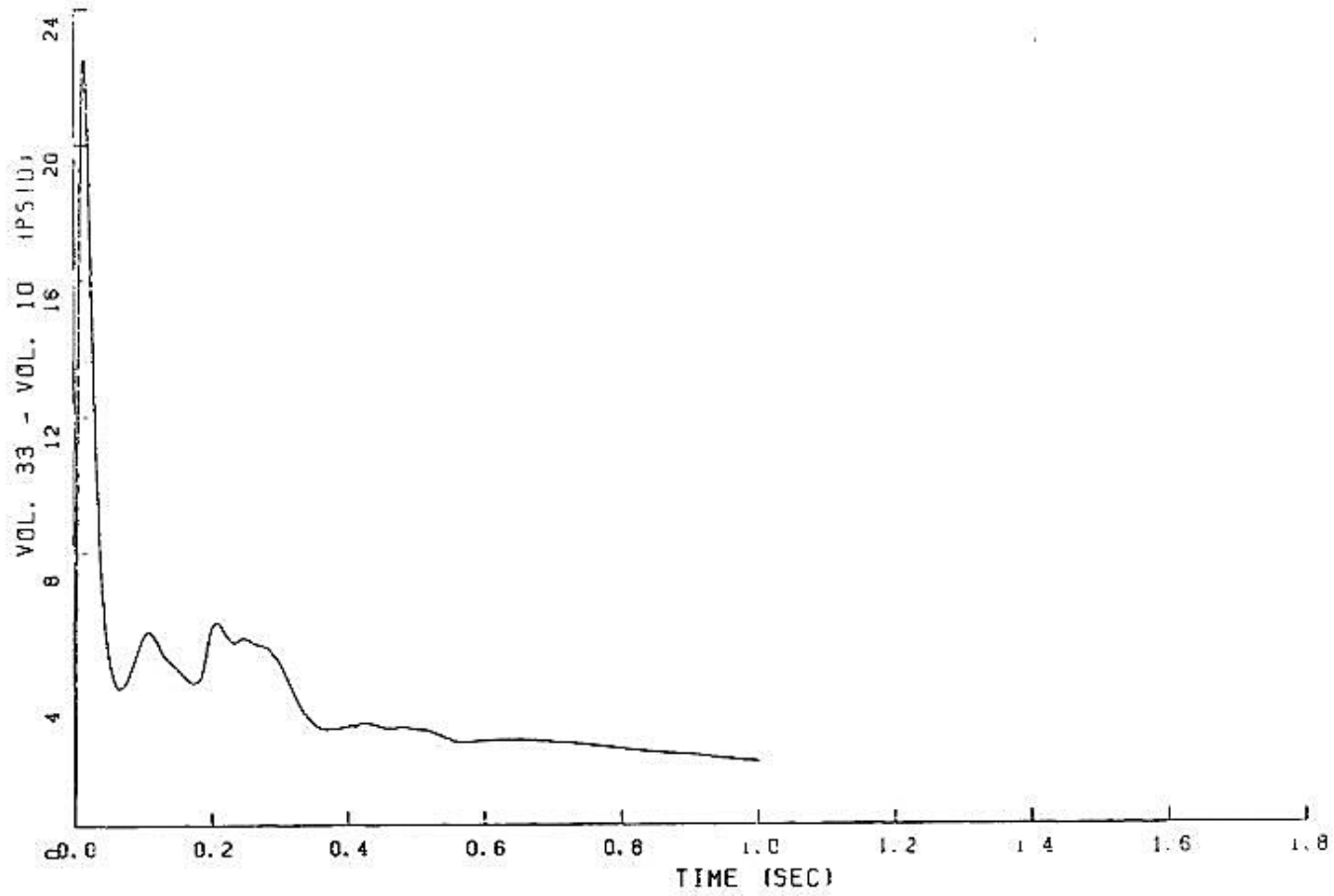

FIGURE 6.2.1-243

PEAK PRESSURE DIFFERENTIAL IN STEAM GENERATOR LOOP - 2

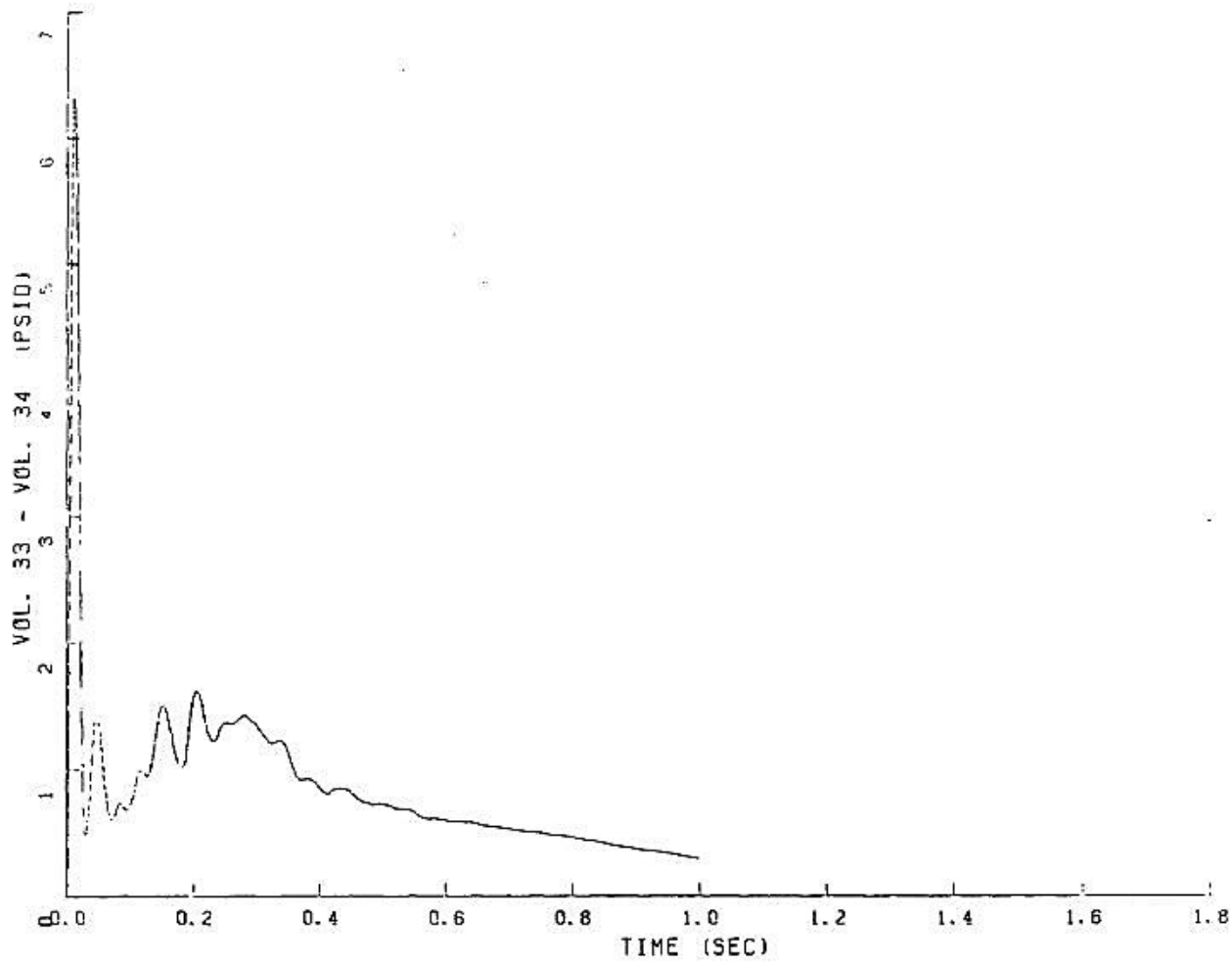

FIGURE 6.2.1-244

PEAK PRESSURE DIFFERENTIAL IN STEAM GENERATOR LOOP - 2

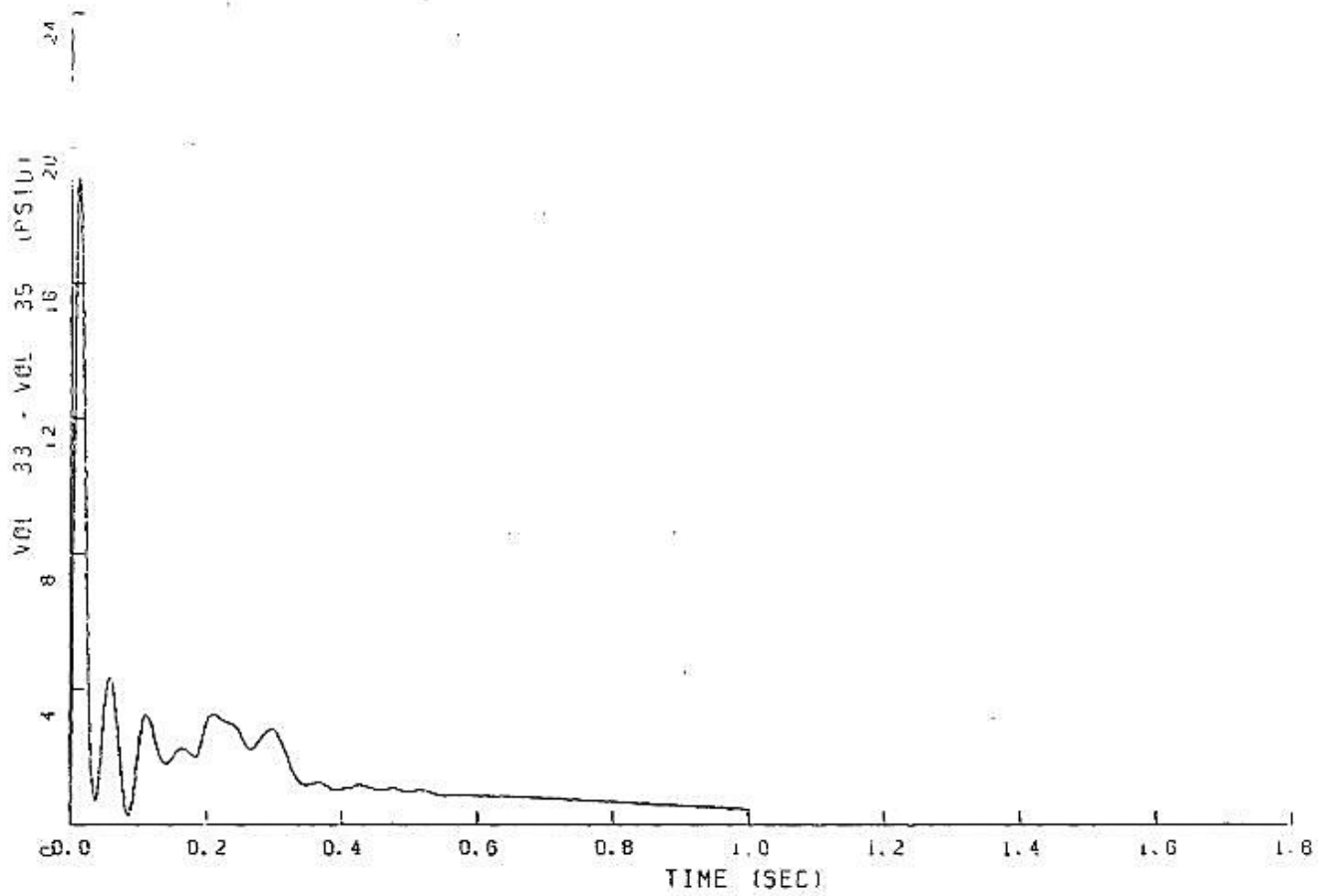

FIGURE 6.2.1-245

PEAK PRESSURE DIFFERENTIAL IN STEAM GENERATOR LOOP - 2

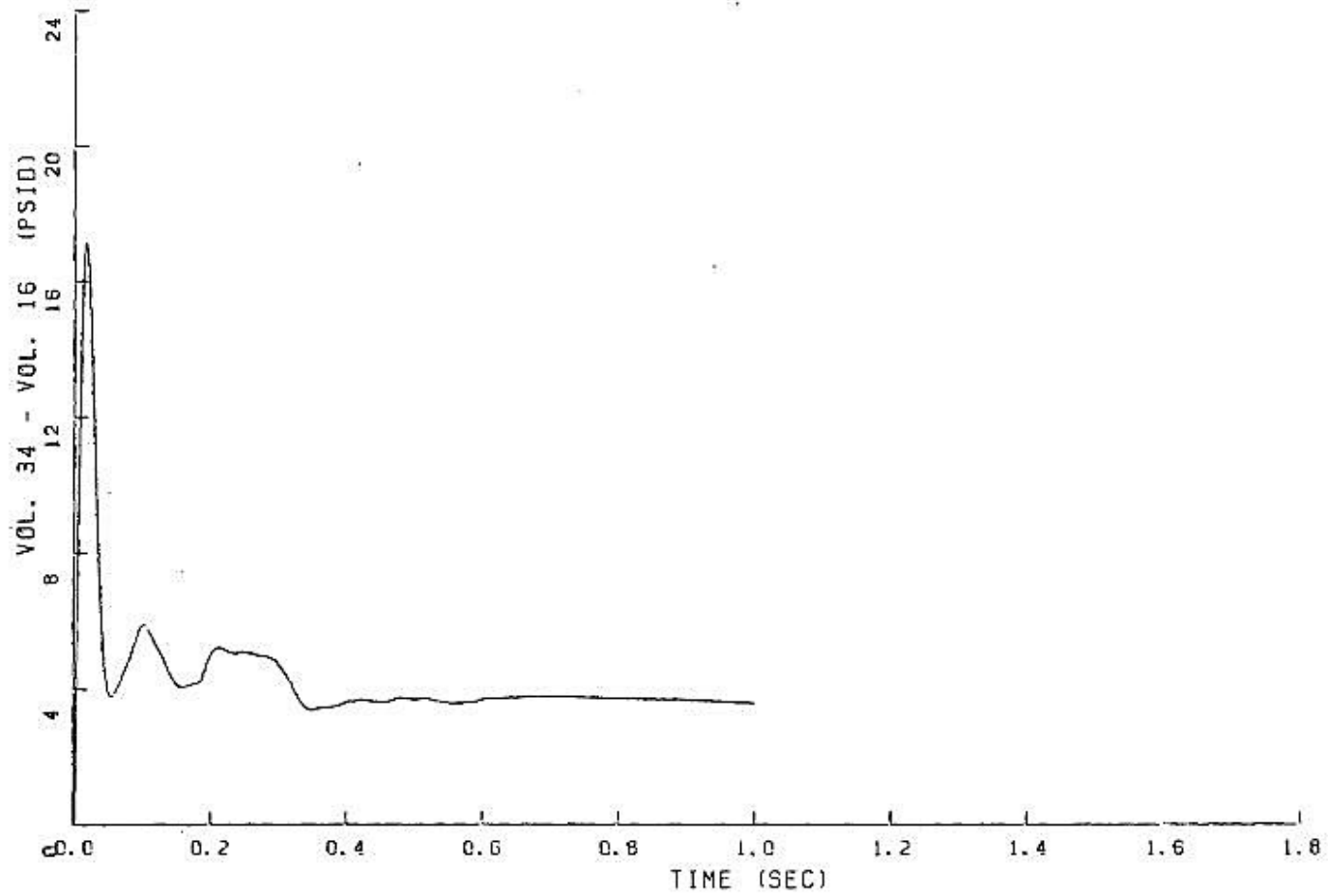

FIGURE 6.2.1-246

PEAK PRESSURE DIFFERENTIAL IN STEAM GENERATOR LOOP – 2

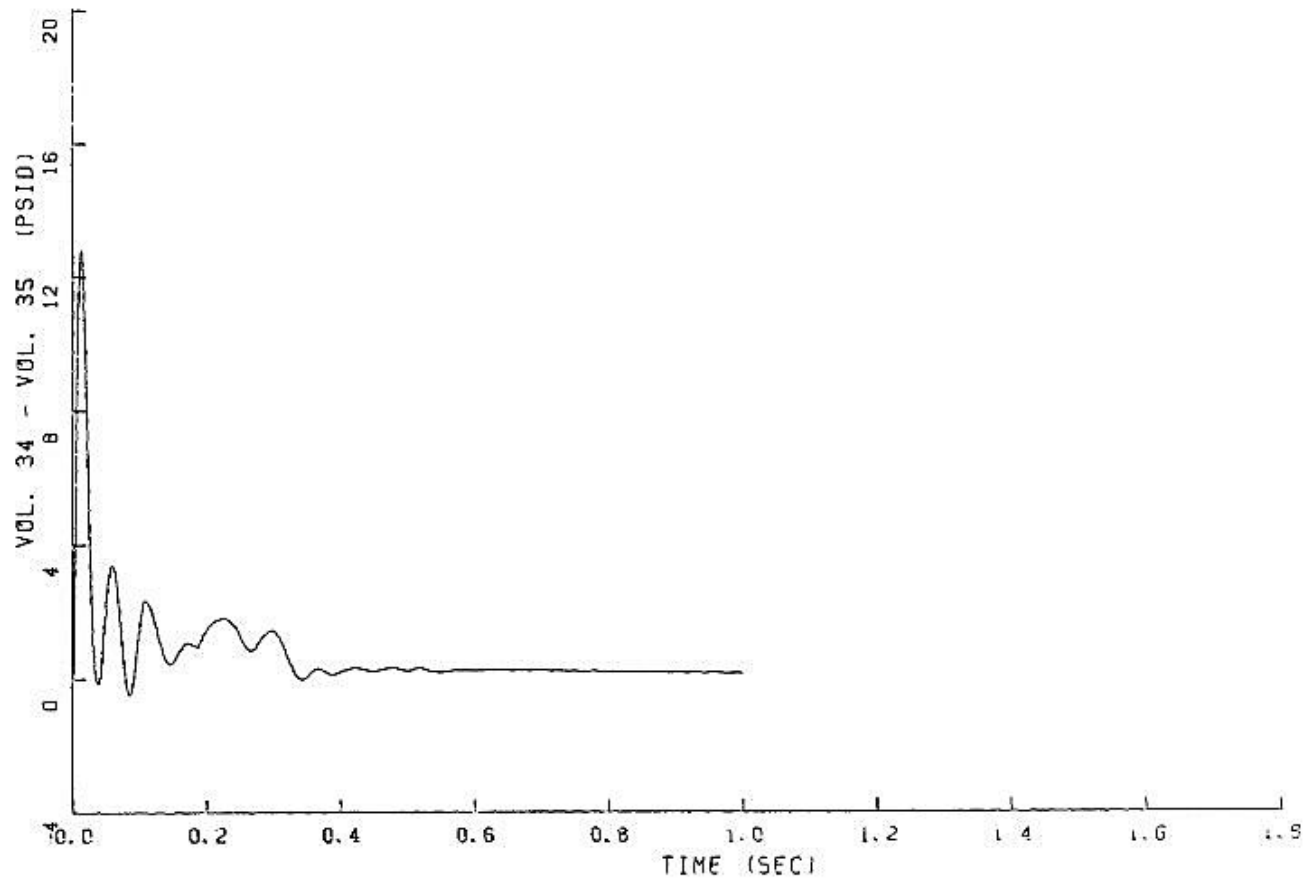

FIGURE 6.2.1-247

PEAK PRESSURE DIFFERENTIAL IN STEAM GENERATOR LOOP – 2

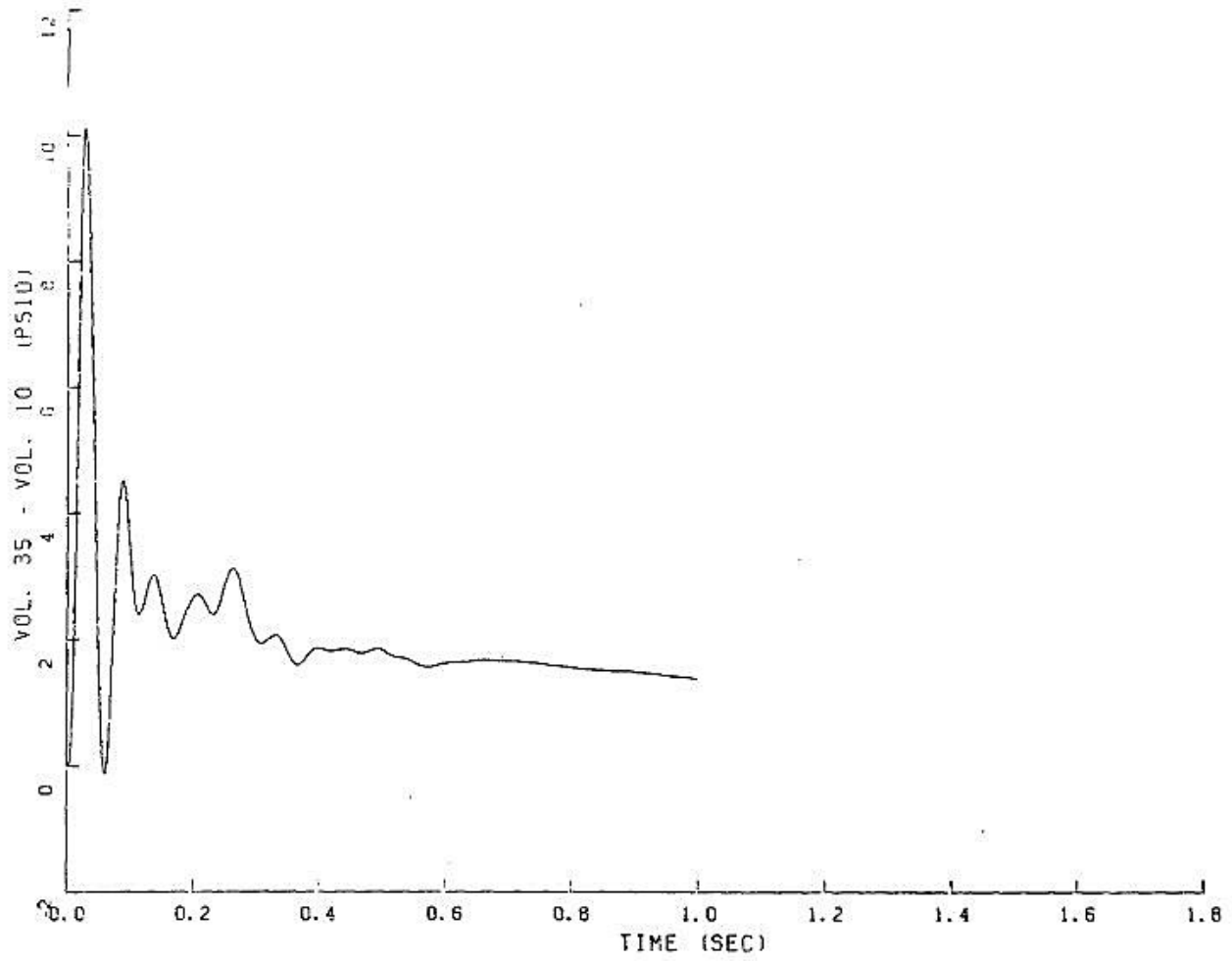

FIGURE 6.2.1-248

PEAK PRESSURE DIFFERENTIAL IN STEAM GENERATOR LOOP - 2

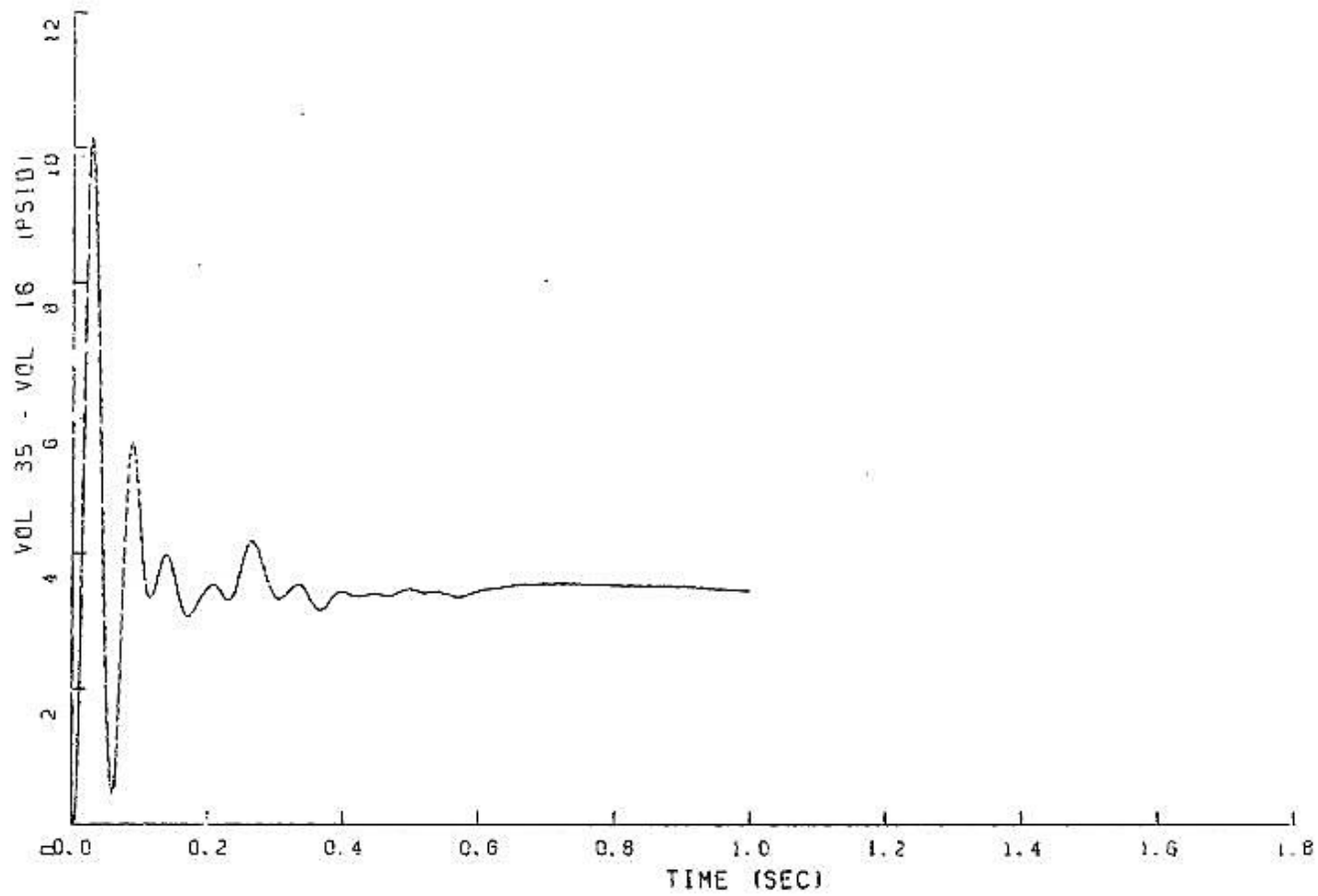

FIGURE 6.2.1-249

PEAK PRESSURE DIFFERENTIAL IN PRESSURIZER COMPARTMENT

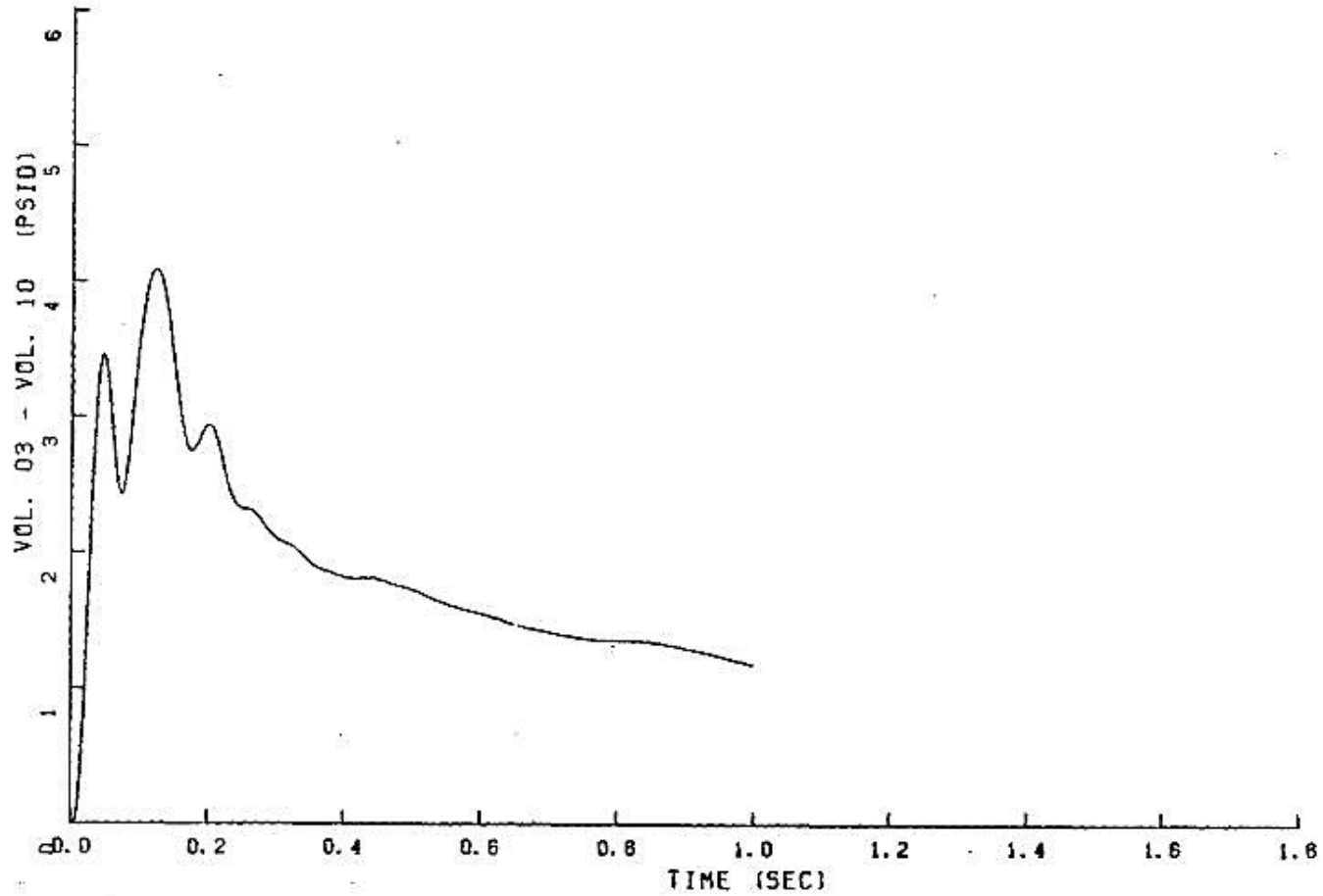

FIGURE 6.2.1-250

PEAK PRESSURE DIFFERENTIAL IN PRESSURIZER COMPARTMENT

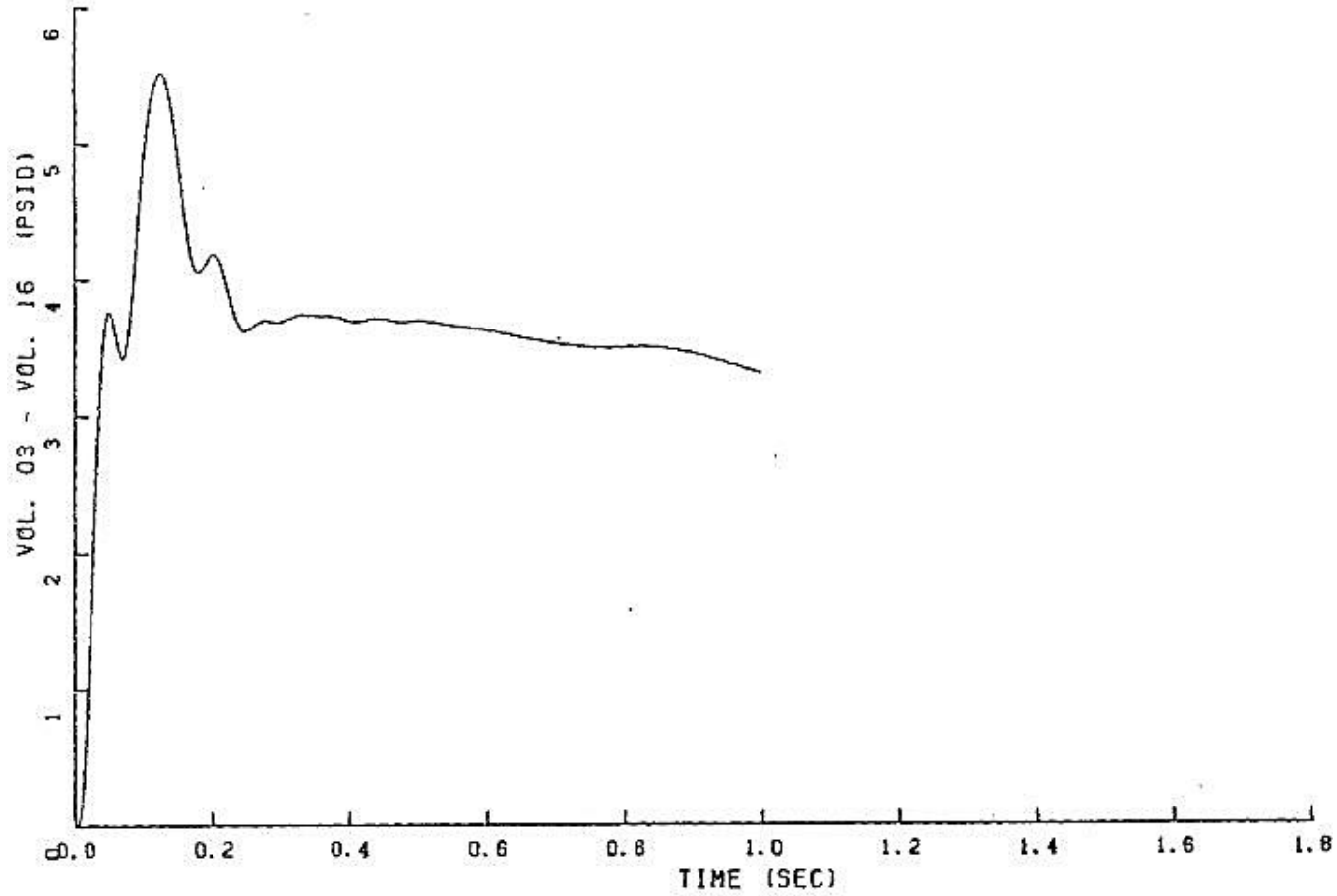

FIGURE 6.2.1-251

PEAK PRESSURE DIFFERENTIAL IN PRESSURIZER COMPARTMENT

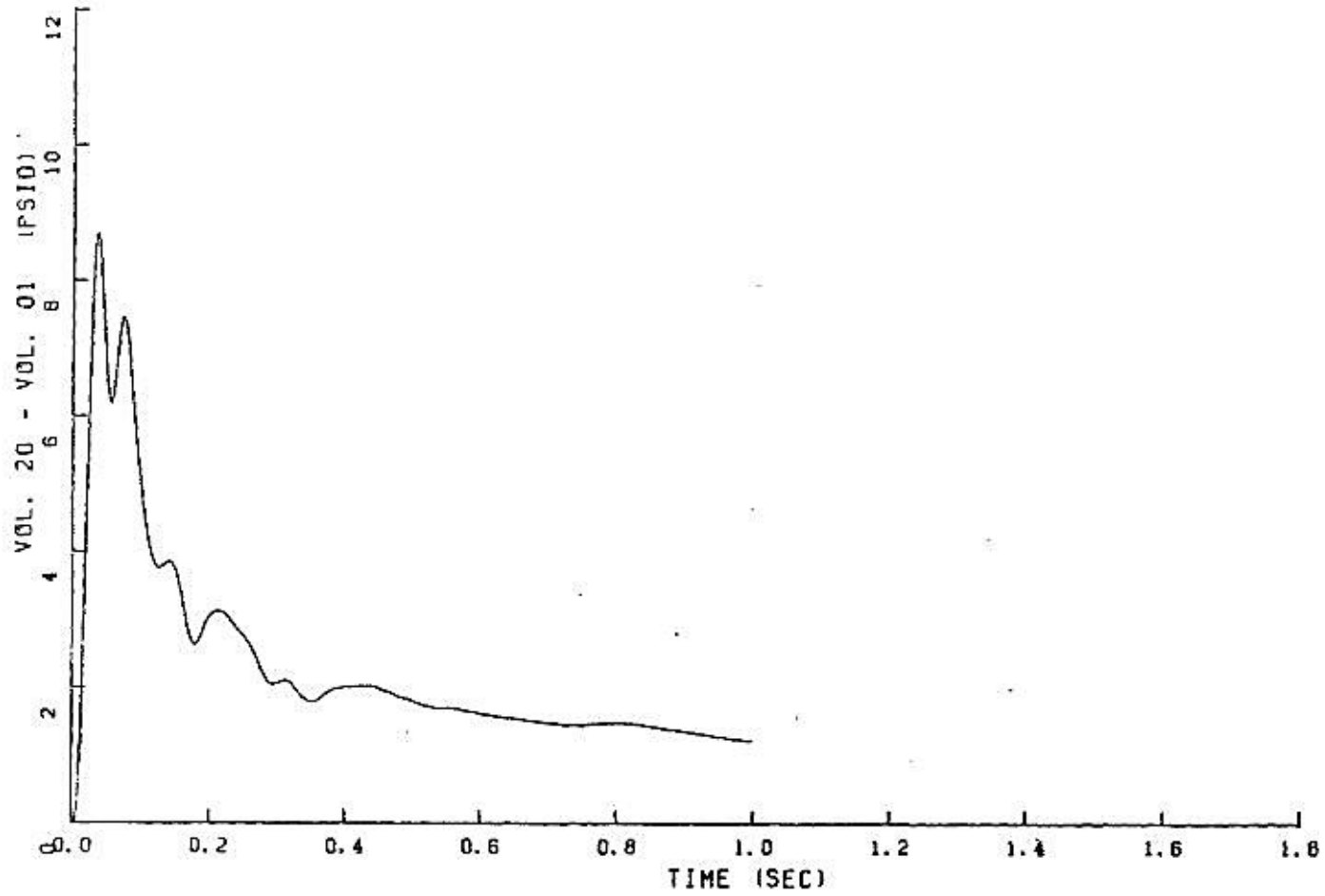

FIGURE 6.2.1-252

PEAK PRESSURE DIFFERENTIAL IN PRESSURIZER COMPARTMENT

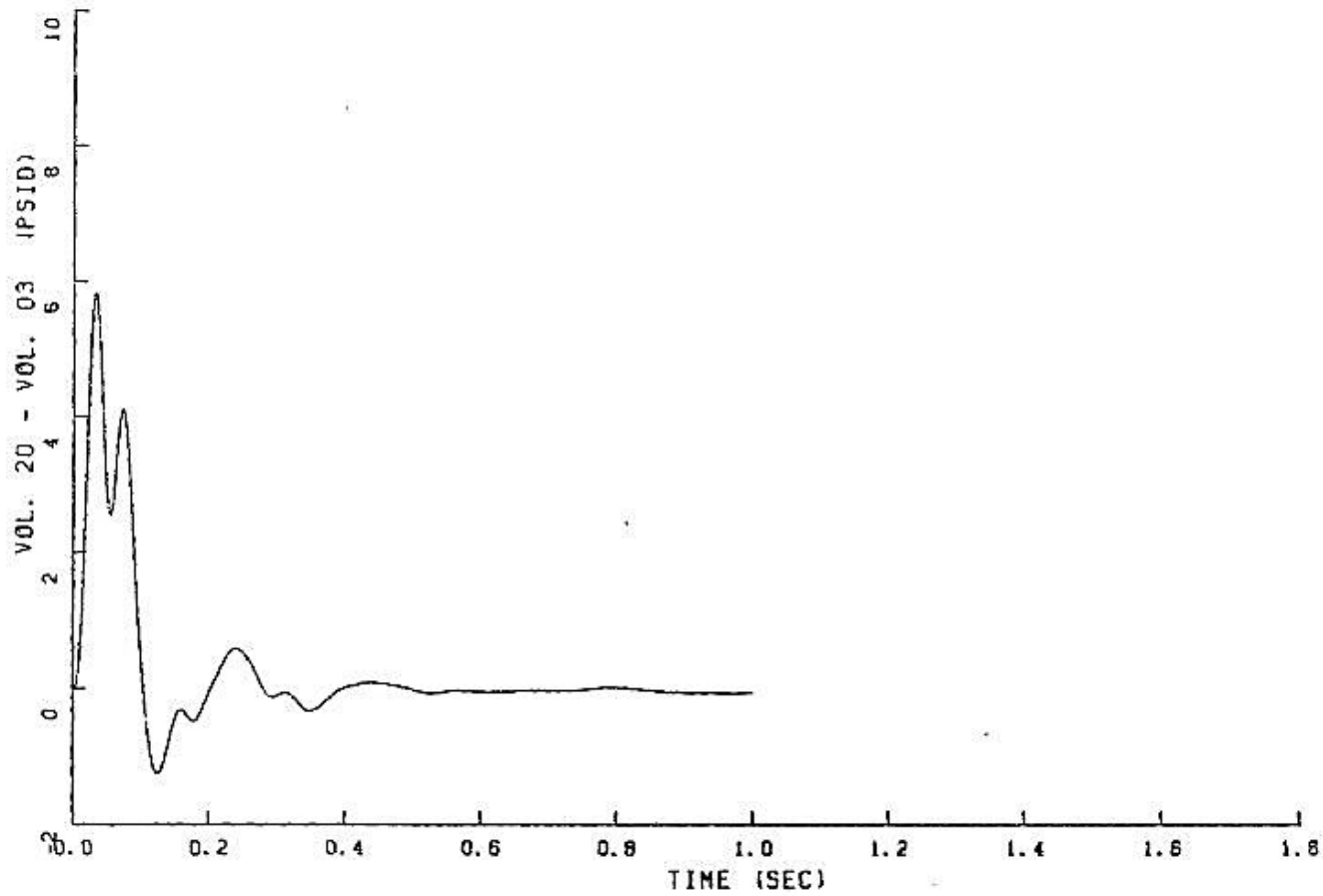

FIGURE 6.2.1-253

PEAK PRESSURE DIFFERENTIAL IN PRESSURIZER COMPARTMENT

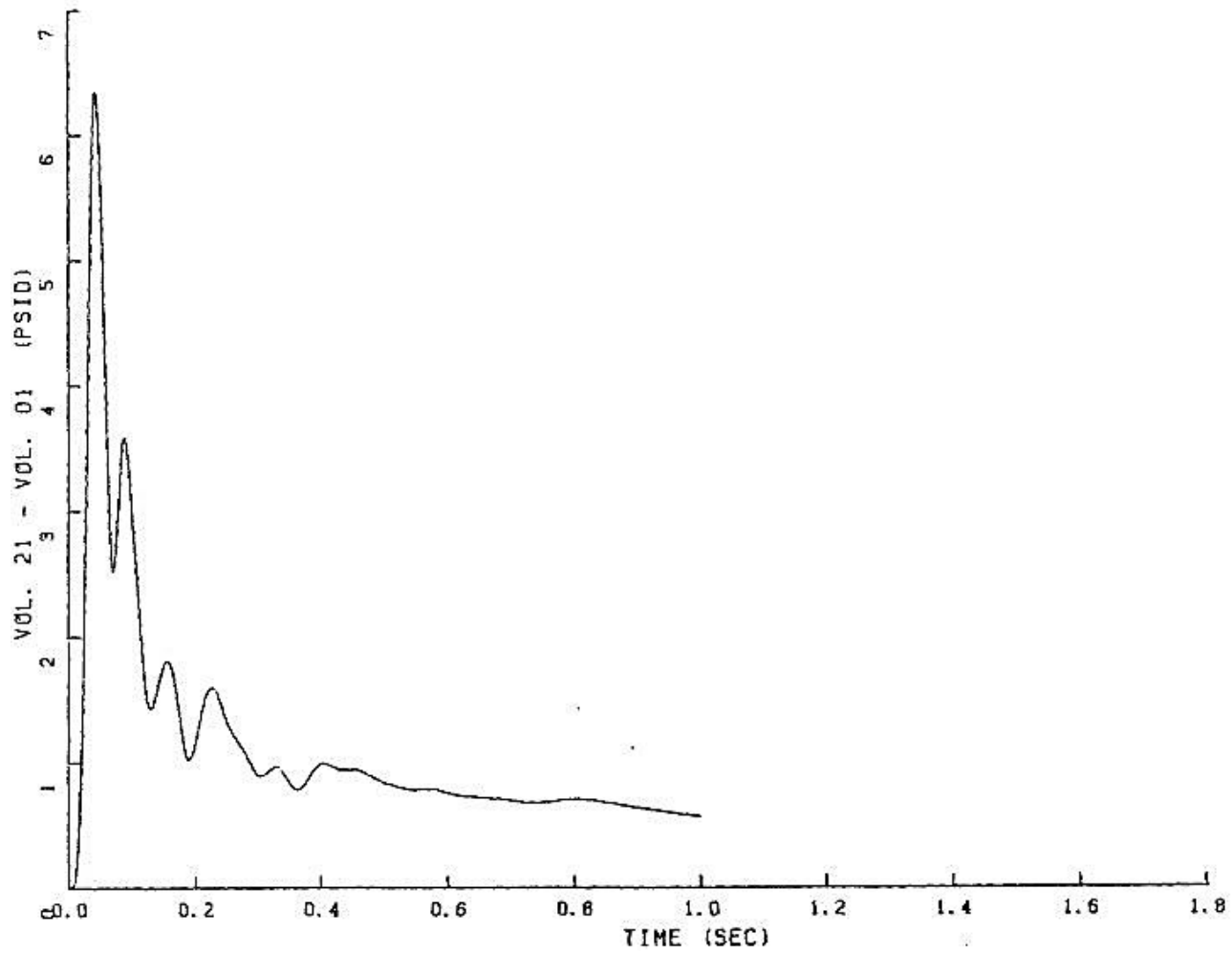

FIGURE 6.2.1-254

PEAK PRESSURE DIFFERENTIAL IN PRESSURIZER COMPARTMENT

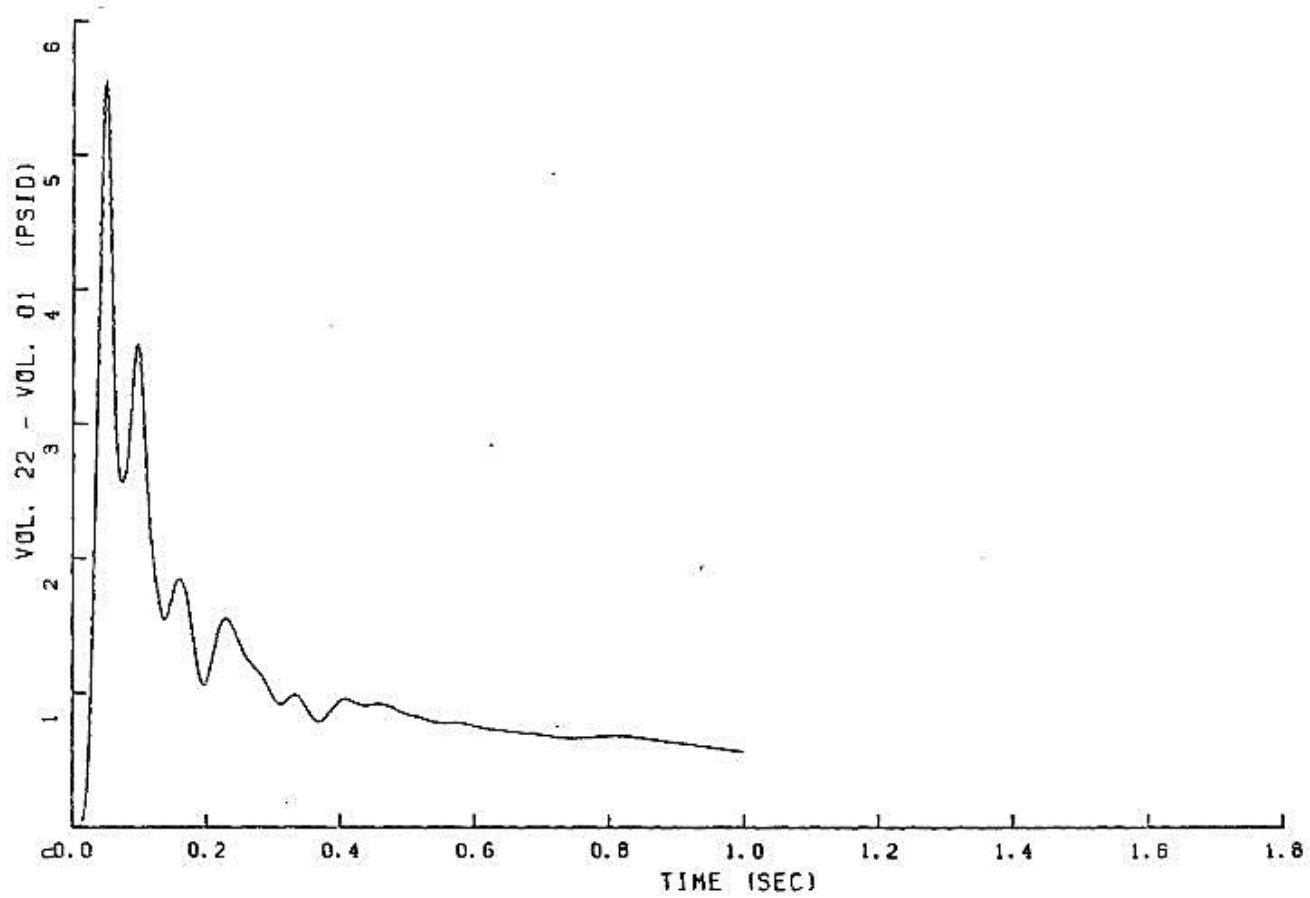

FIGURE 6.2.1-255

PEAK PRESSURE DIFFERENTIAL IN PRESSURIZER COMPARTMENT

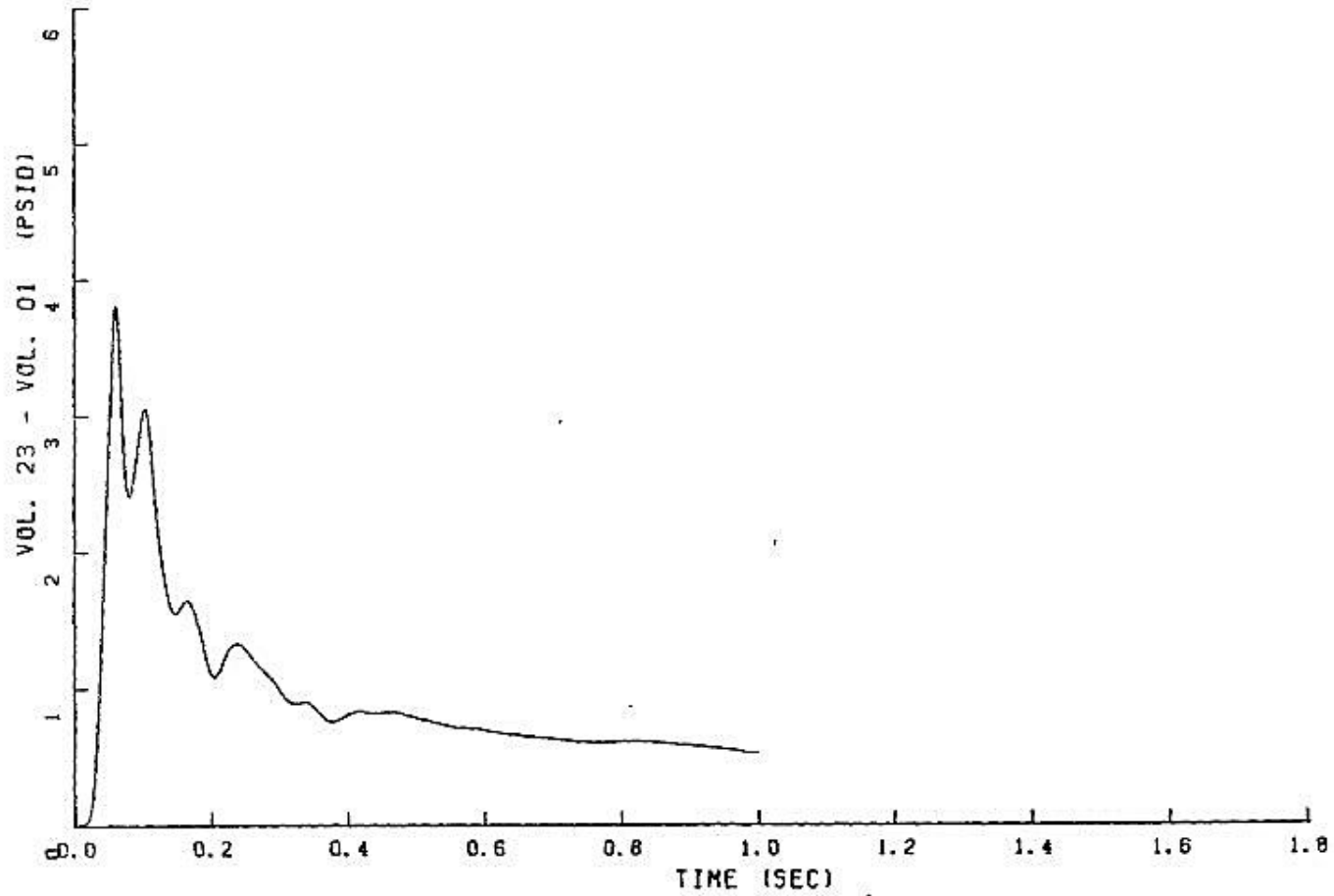

FIGURE 6.2.1-256

PEAK PRESSURE DIFFERENTIAL IN PRESSURIZER COMPARTMENT

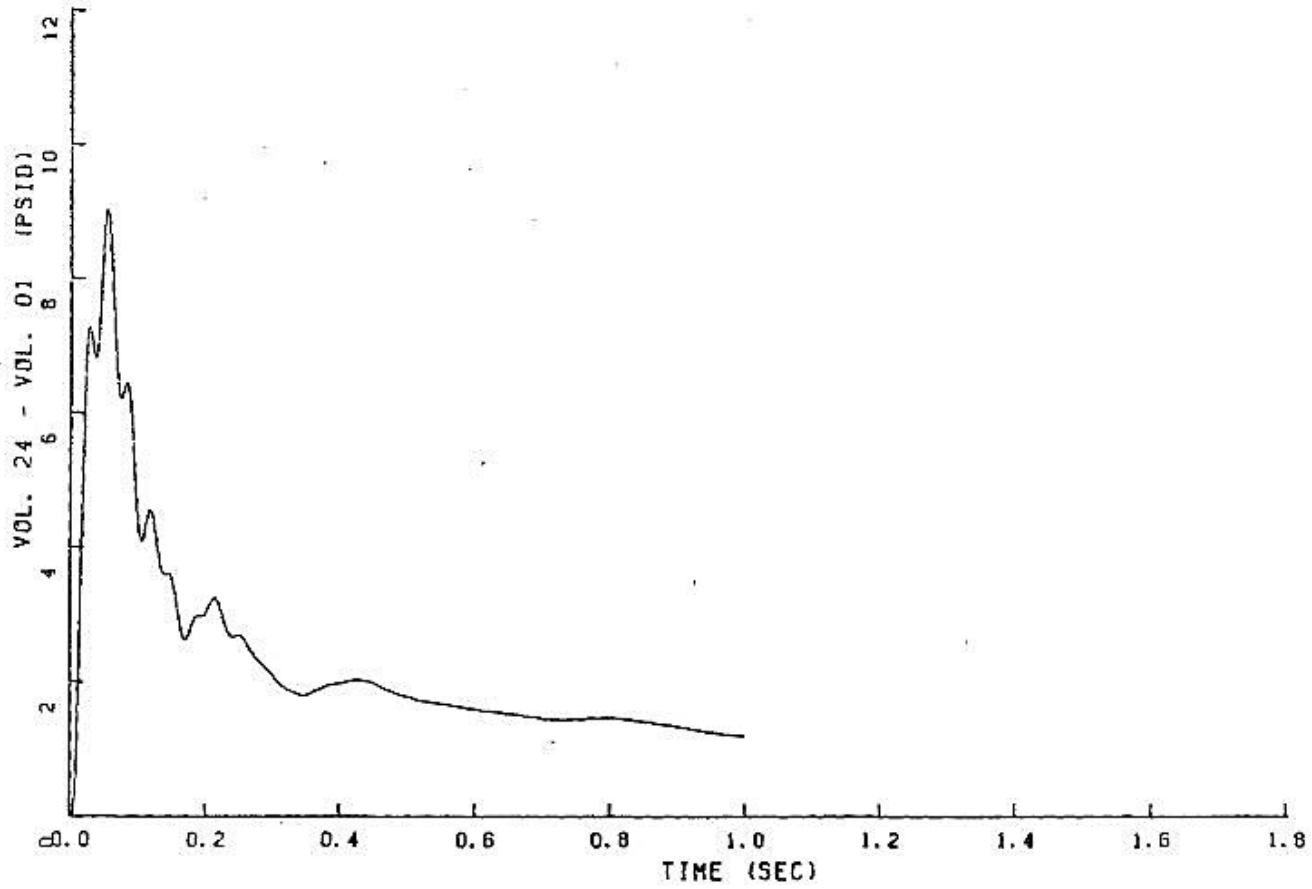

FIGURE 6.2.1-257

PEAK PRESSURE DIFFERENTIAL IN PRESSURIZER COMPARTMENT

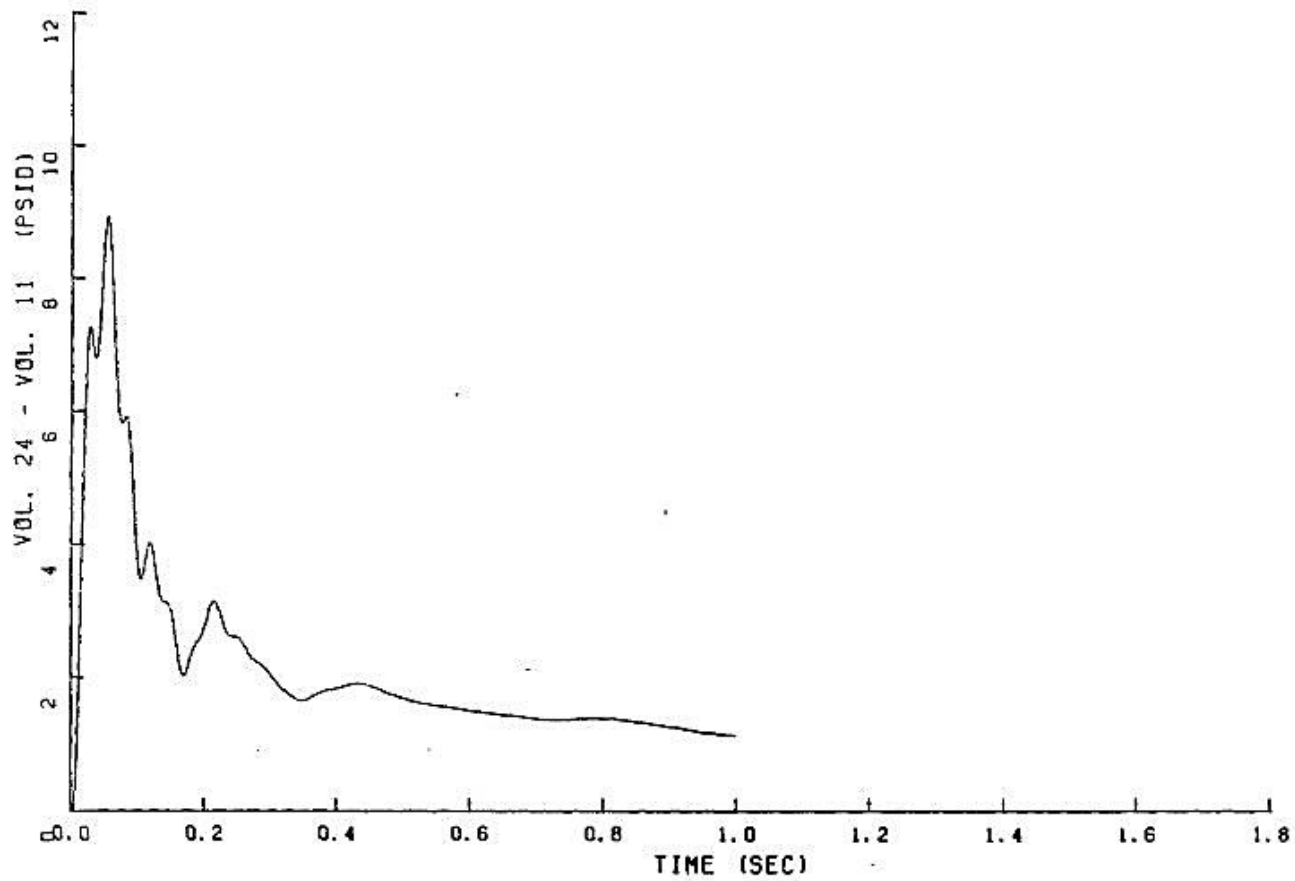

FIGURE 6.2.1-258

PEAK PRESSURE DIFFERENTIAL IN PRESSURIZER COMPARTMENT

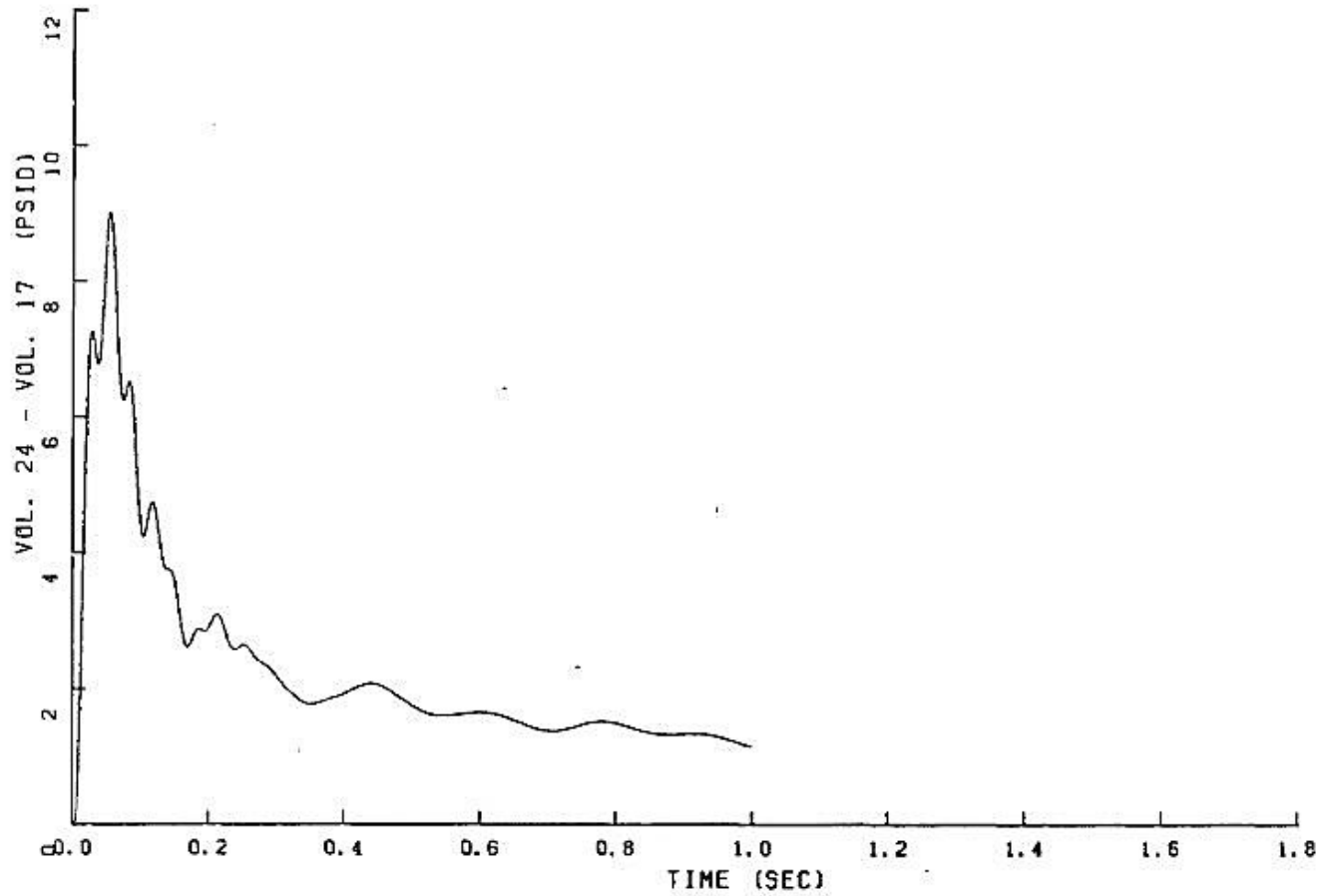

FIGURE 6.2.1-259

PEAK PRESSURE DIFFERENTIAL IN PRESSURIZER COMPARTMENT

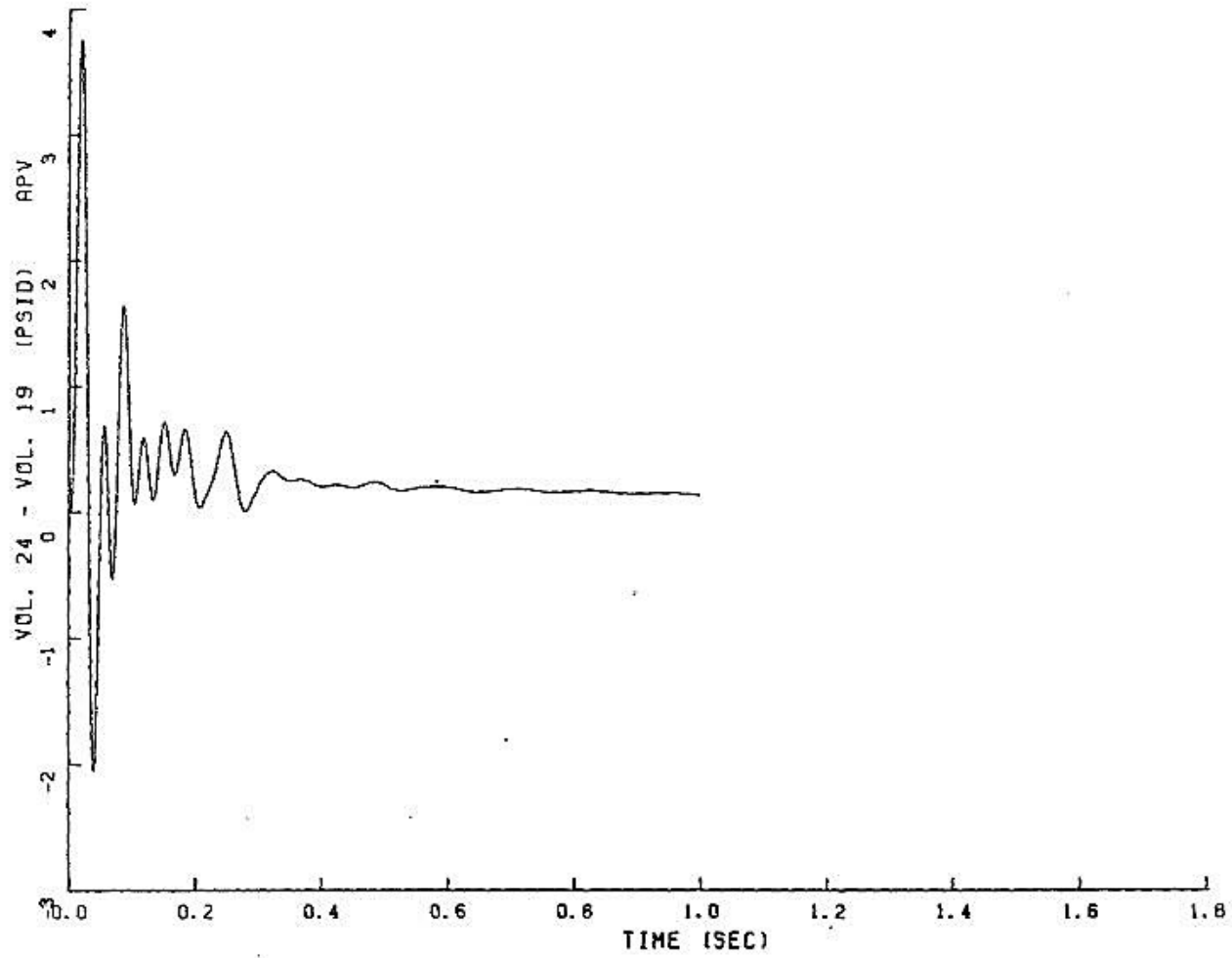

FIGURE 6.2.1-260

PEAK PRESSURE DIFFERENTIAL IN PRESSURIZER COMPARTMENT

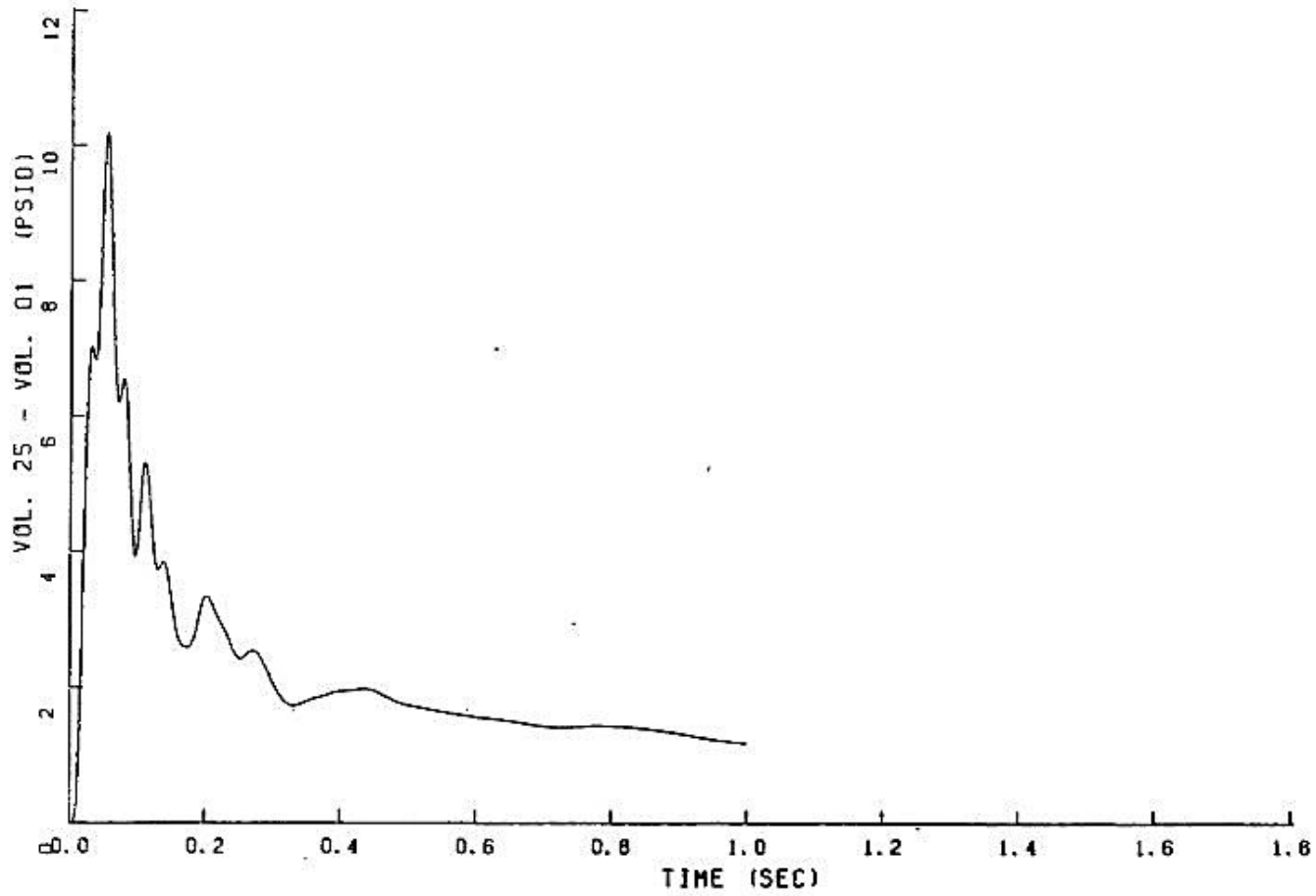

FIGURE 6.2.1-261

PEAK PRESSURE DIFFERENTIAL IN PRESSURIZER COMPARTMENT

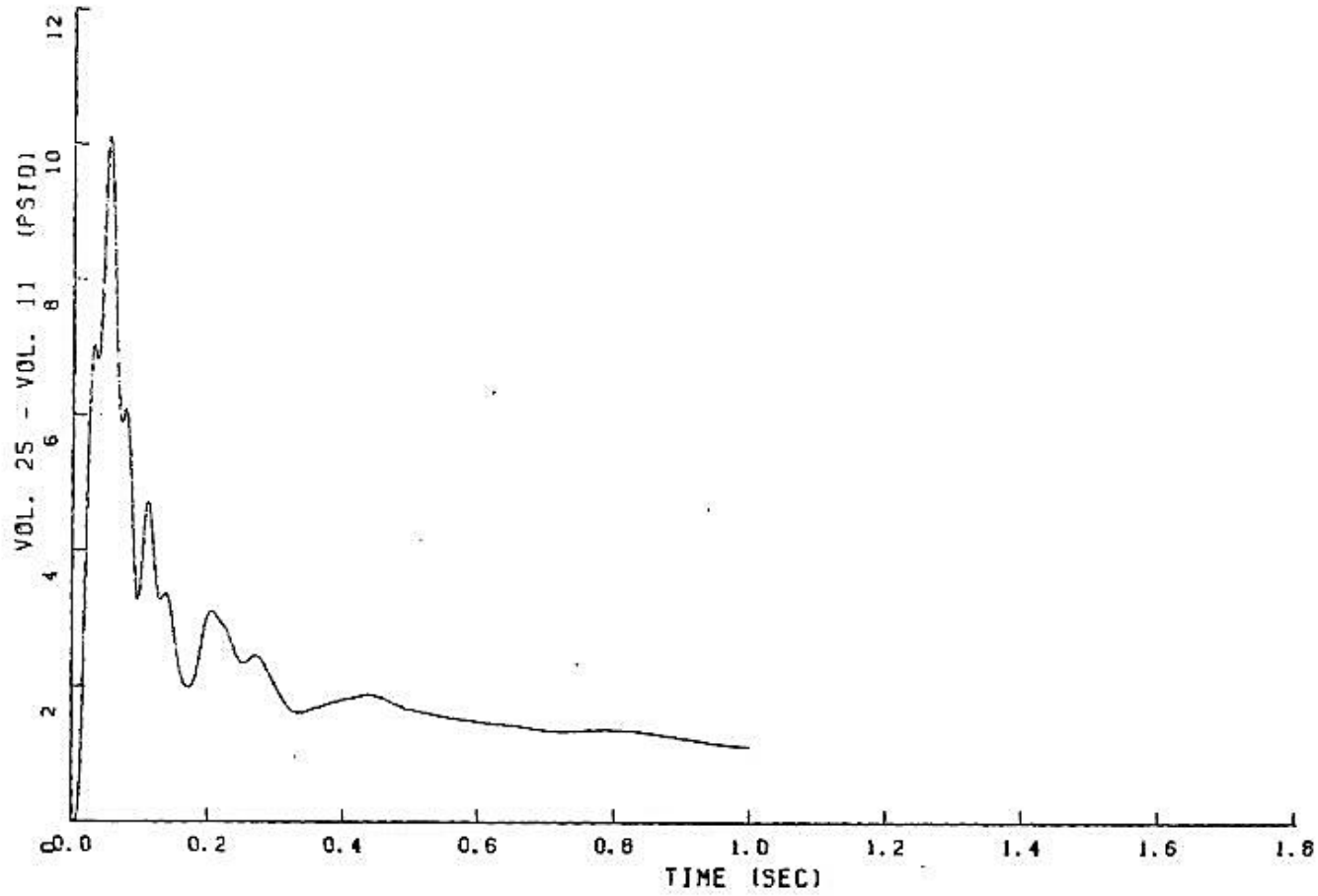

FIGURE 6.2.1-262

PEAK PRESSURE DIFFERENTIAL IN PRESSURIZER COMPARTMENT

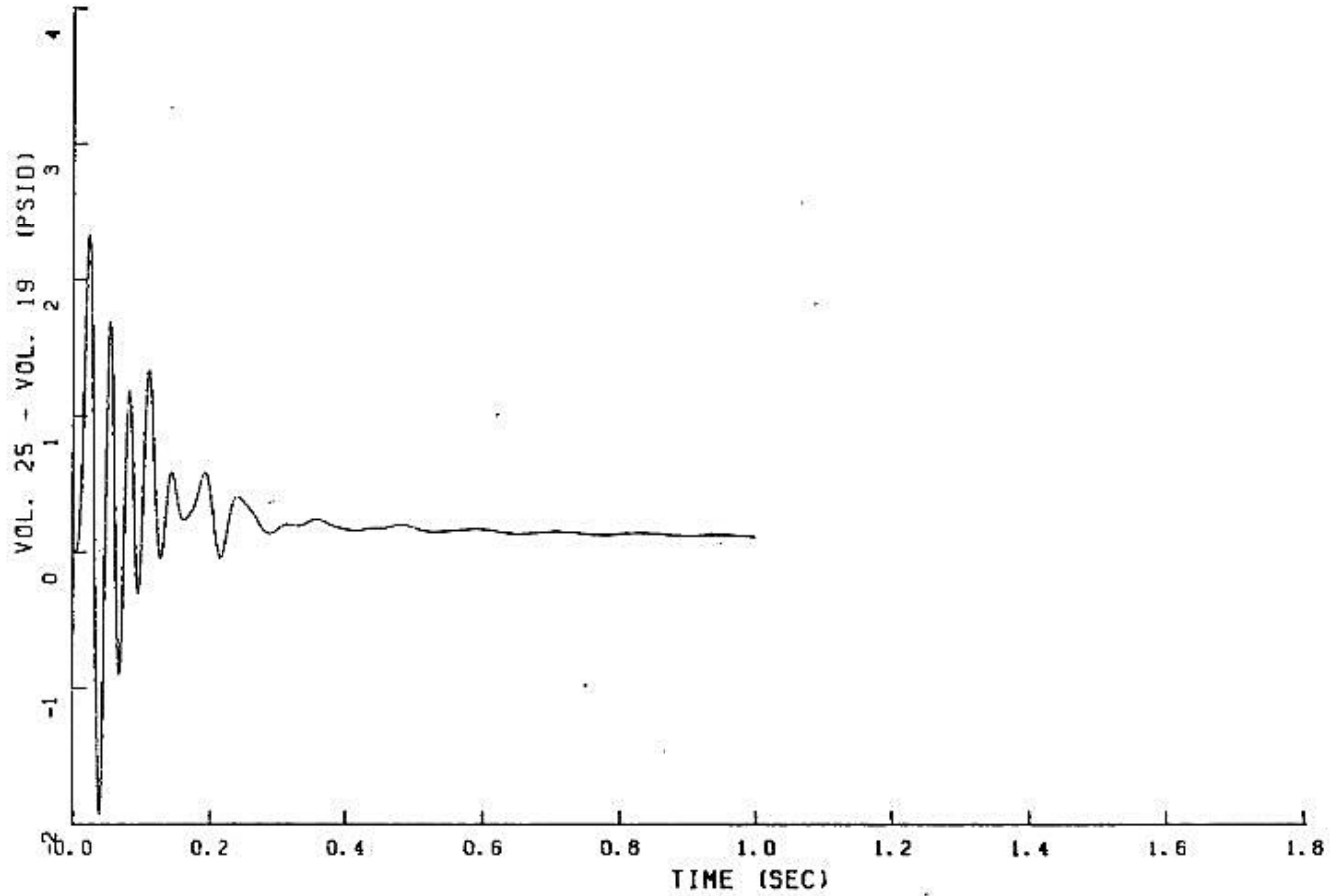

FIGURE 6.2.1-263

PEAK PRESSURE DIFFERENTIAL IN PRESSURIZER COMPARTMENT

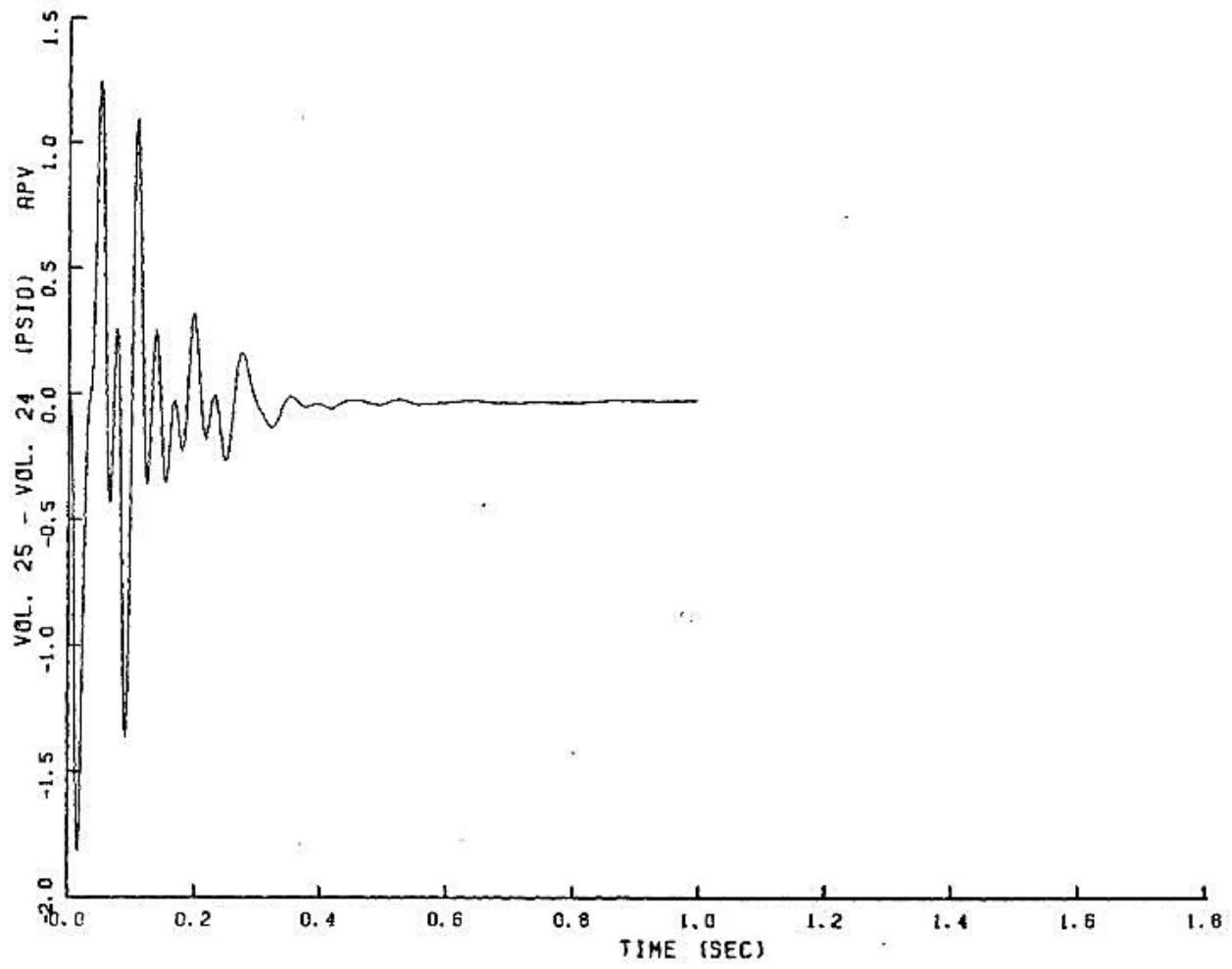

FIGURE 6.2.1-264

PEAK PRESSURE DIFFERENTIAL IN PRESSURIZER COMPARTMENT

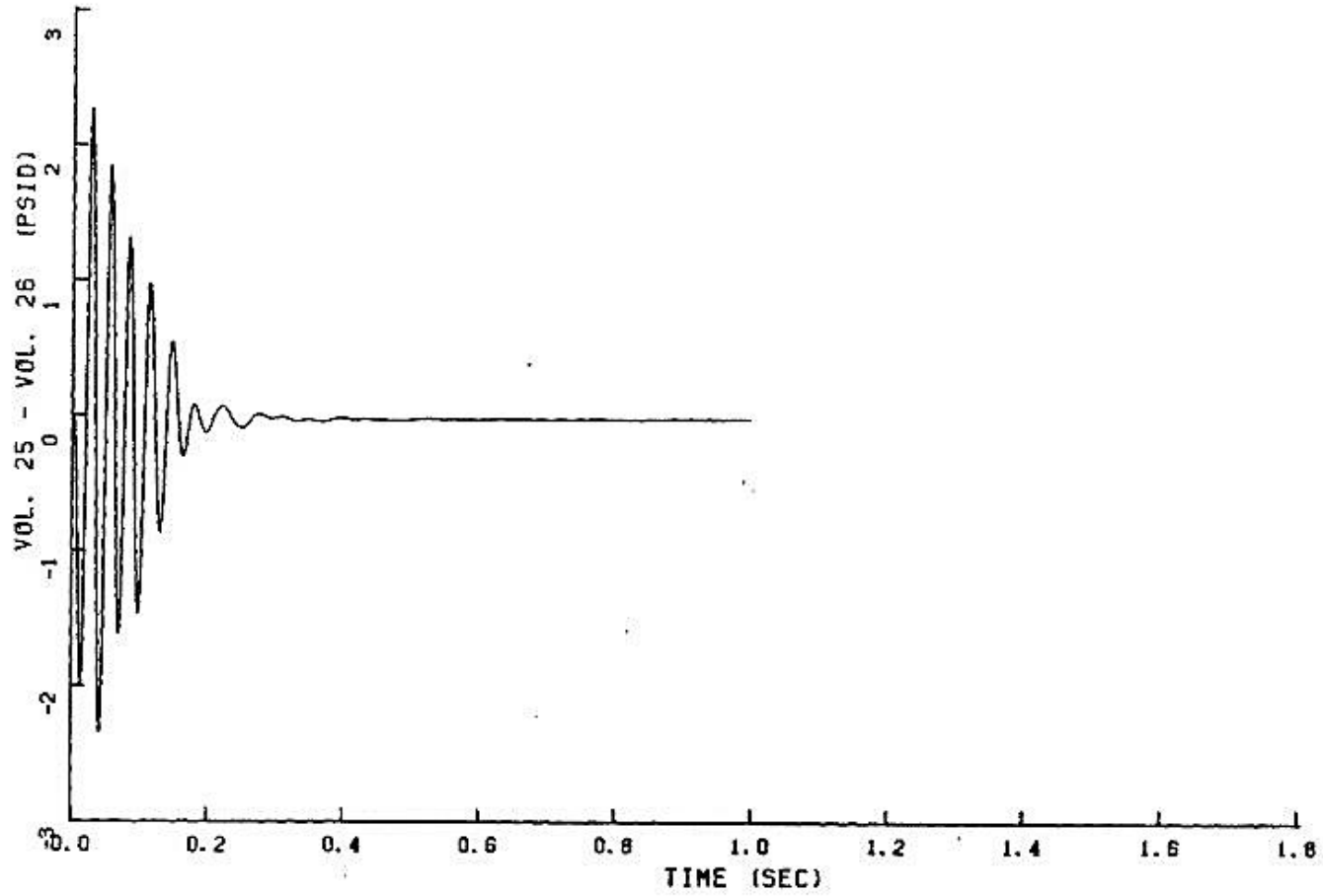

FIGURE 6.2.1-265

PEAK PRESSURE DIFFERENTIAL IN PRESSURIZER COMPARTMENT

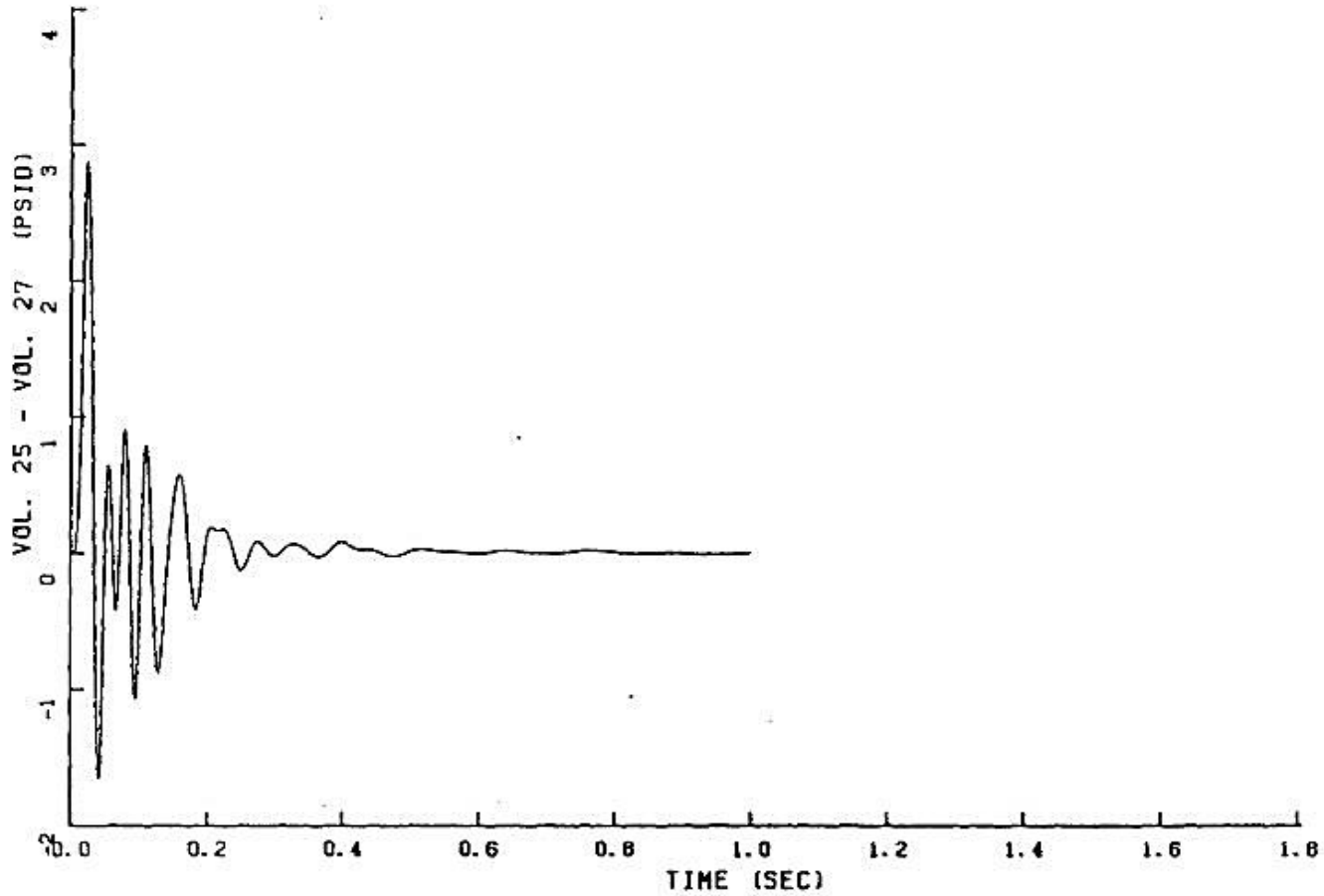

FIGURE 6.2.1-266

PEAK PRESSURE DIFFERENTIAL IN PRESSURIZER COMPARTMENT

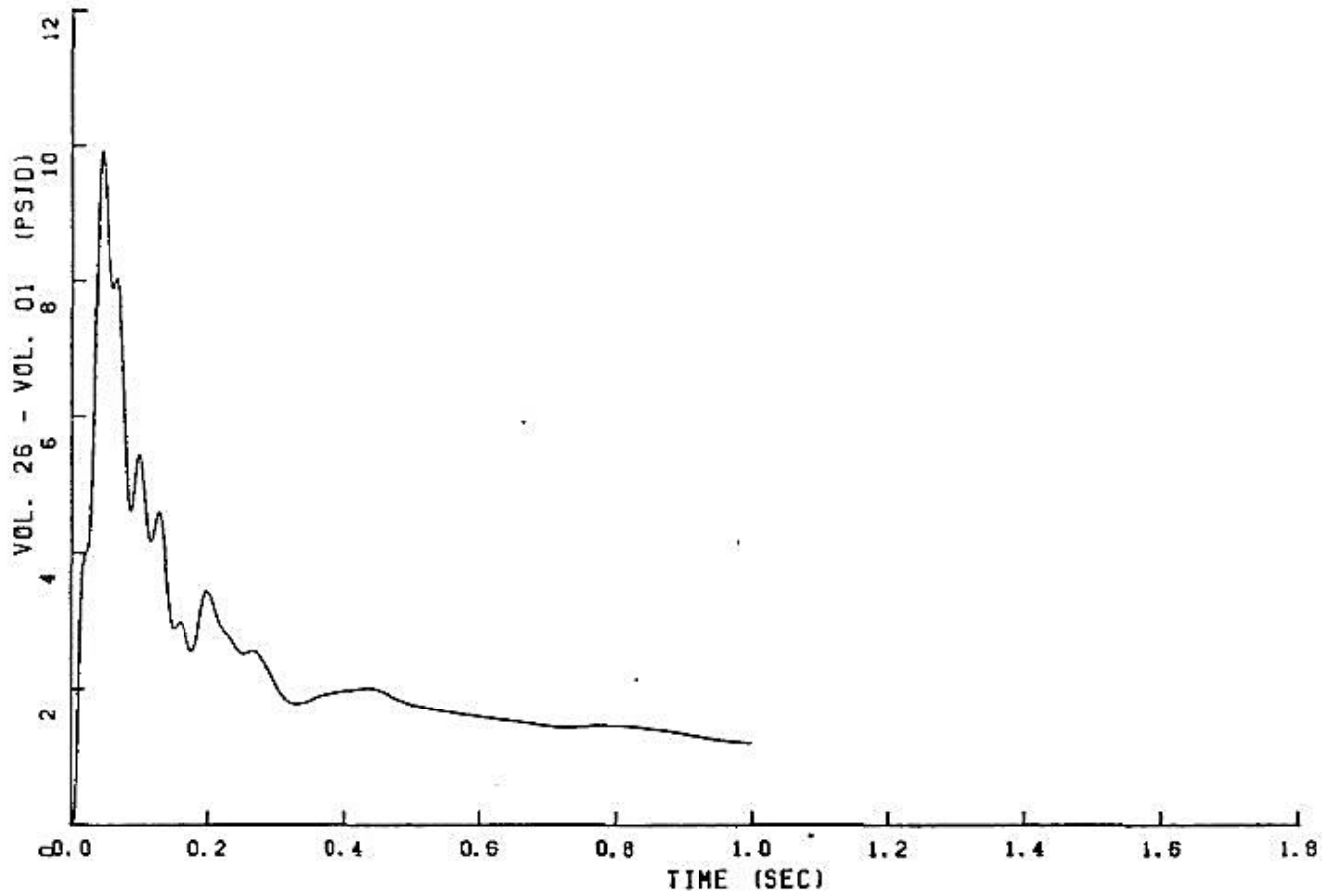

FIGURE 6.2.1-267

PEAK PRESSURE DIFFERENTIAL IN PRESSURIZER COMPARTMENT

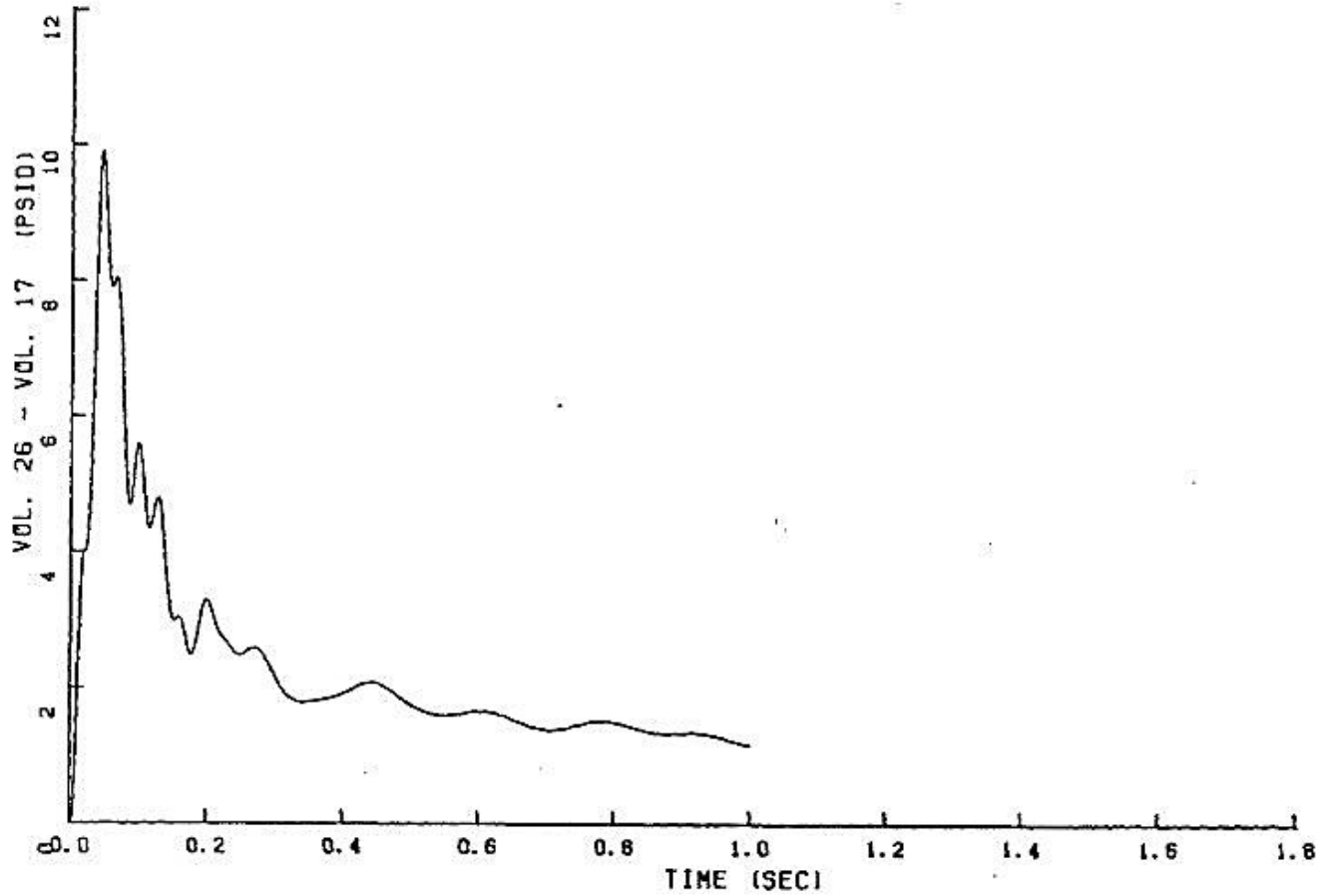

FIGURE 6.2.1-268

PEAK PRESSURE DIFFERENTIAL IN PRESSURIZER COMPARTMENT

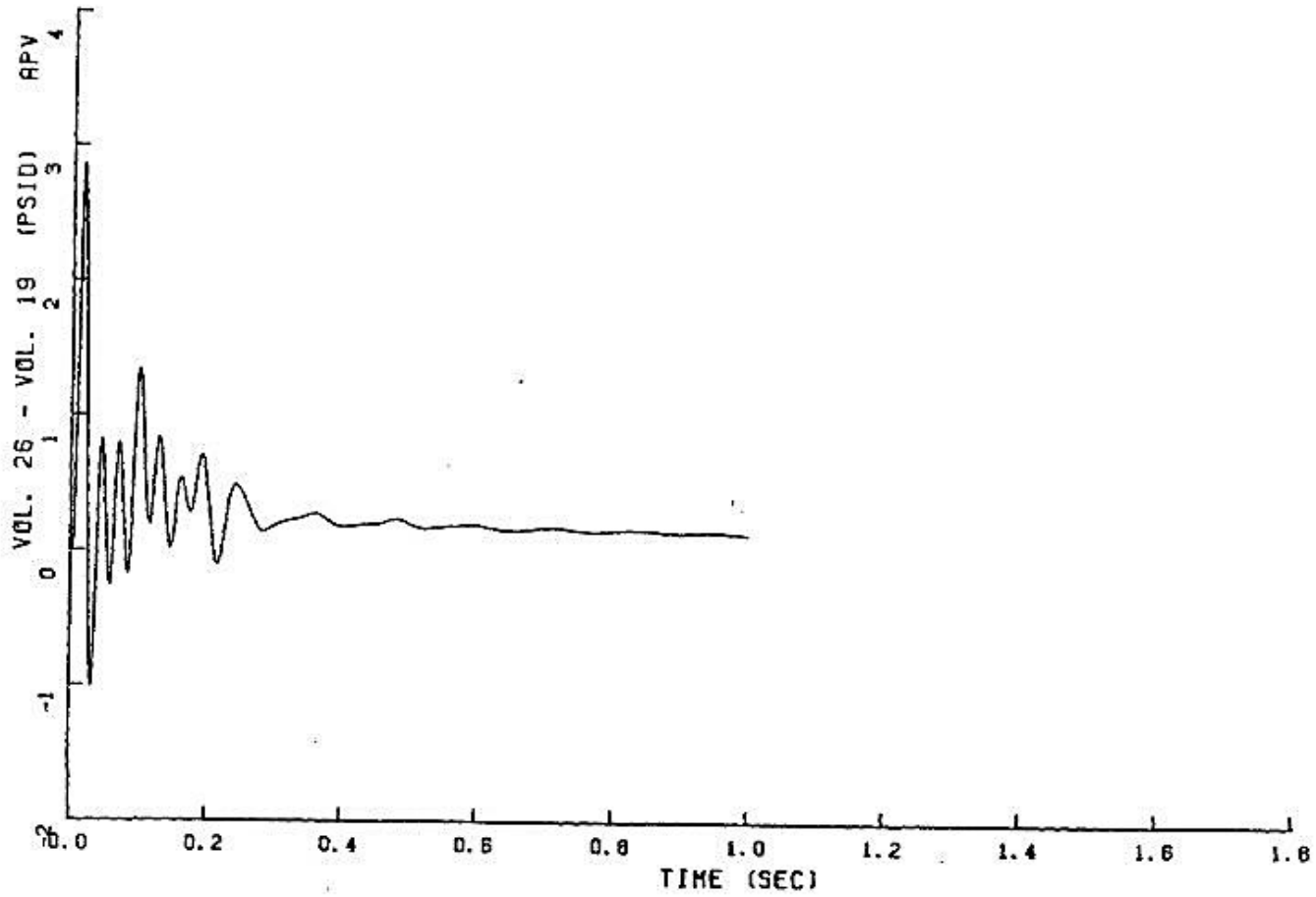

FIGURE 6.2.1-269

PEAK PRESSURE DIFFERENTIAL IN PRESSURIZER COMPARTMENT

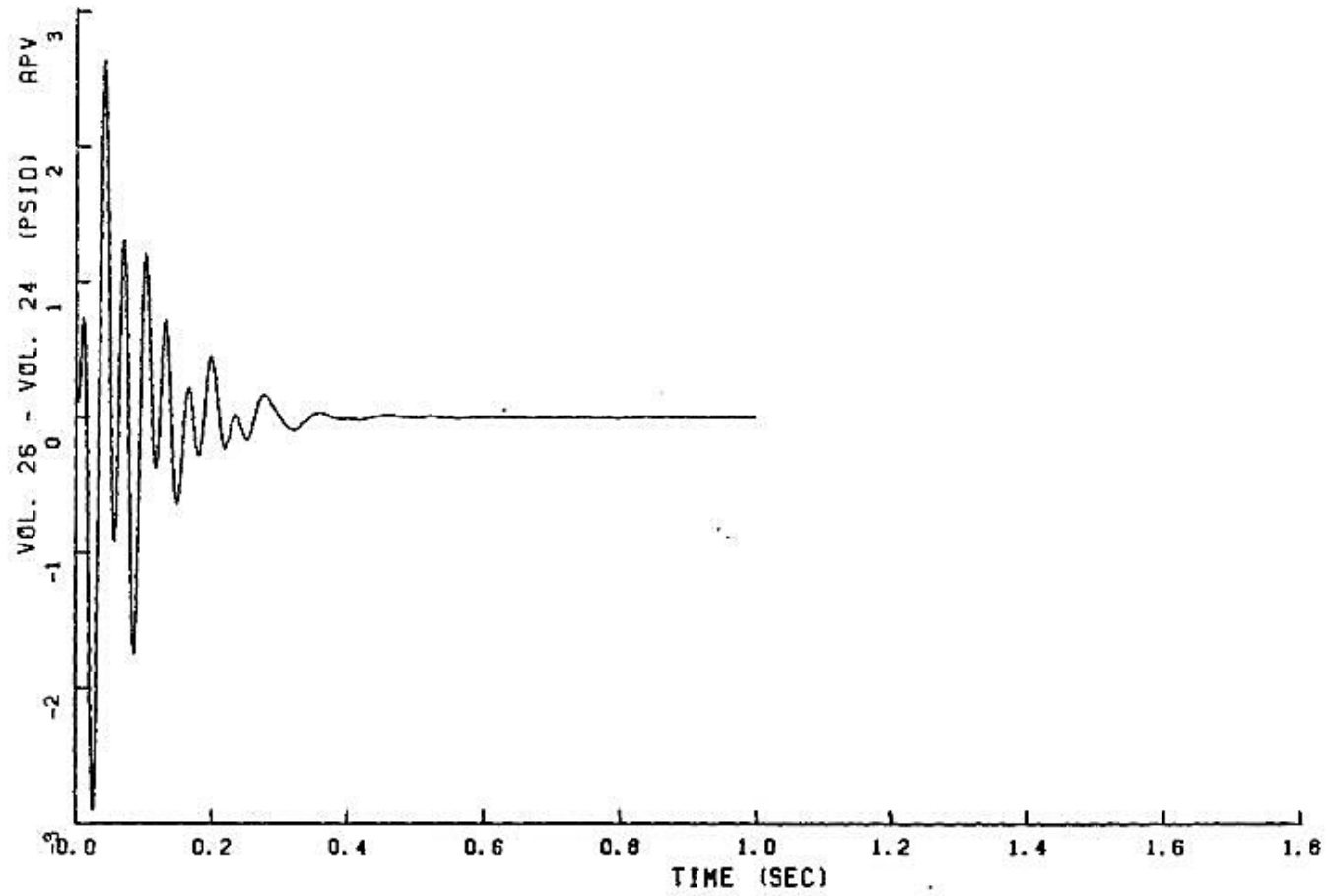

FIGURE 6.2.1-270

PEAK PRESSURE DIFFERENTIAL IN PRESSURIZER COMPARTMENT

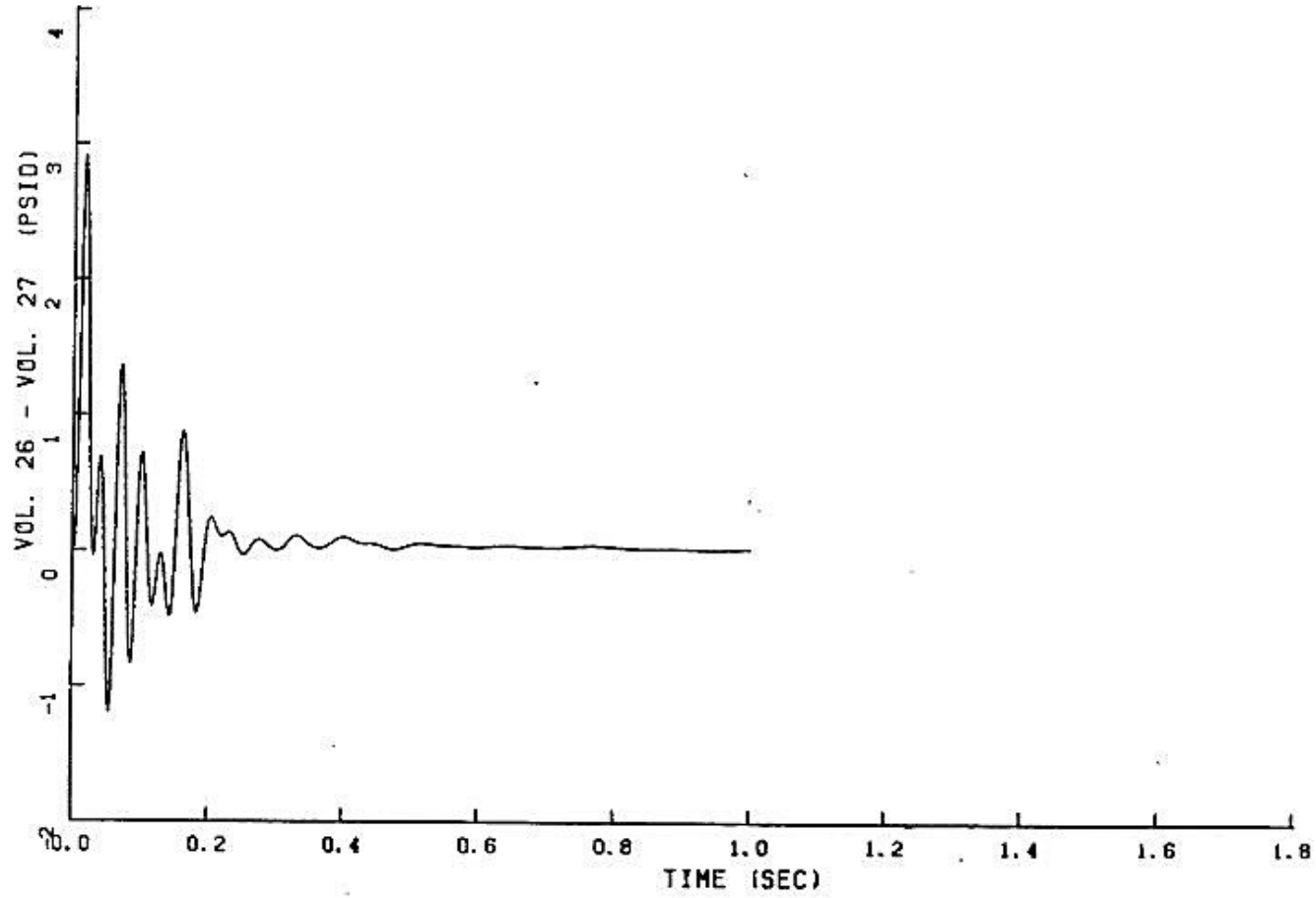

FIGURE 6.2.1-271

PEAK PRESSURE DIFFERENTIAL IN PRESSURIZER COMPARTMENT

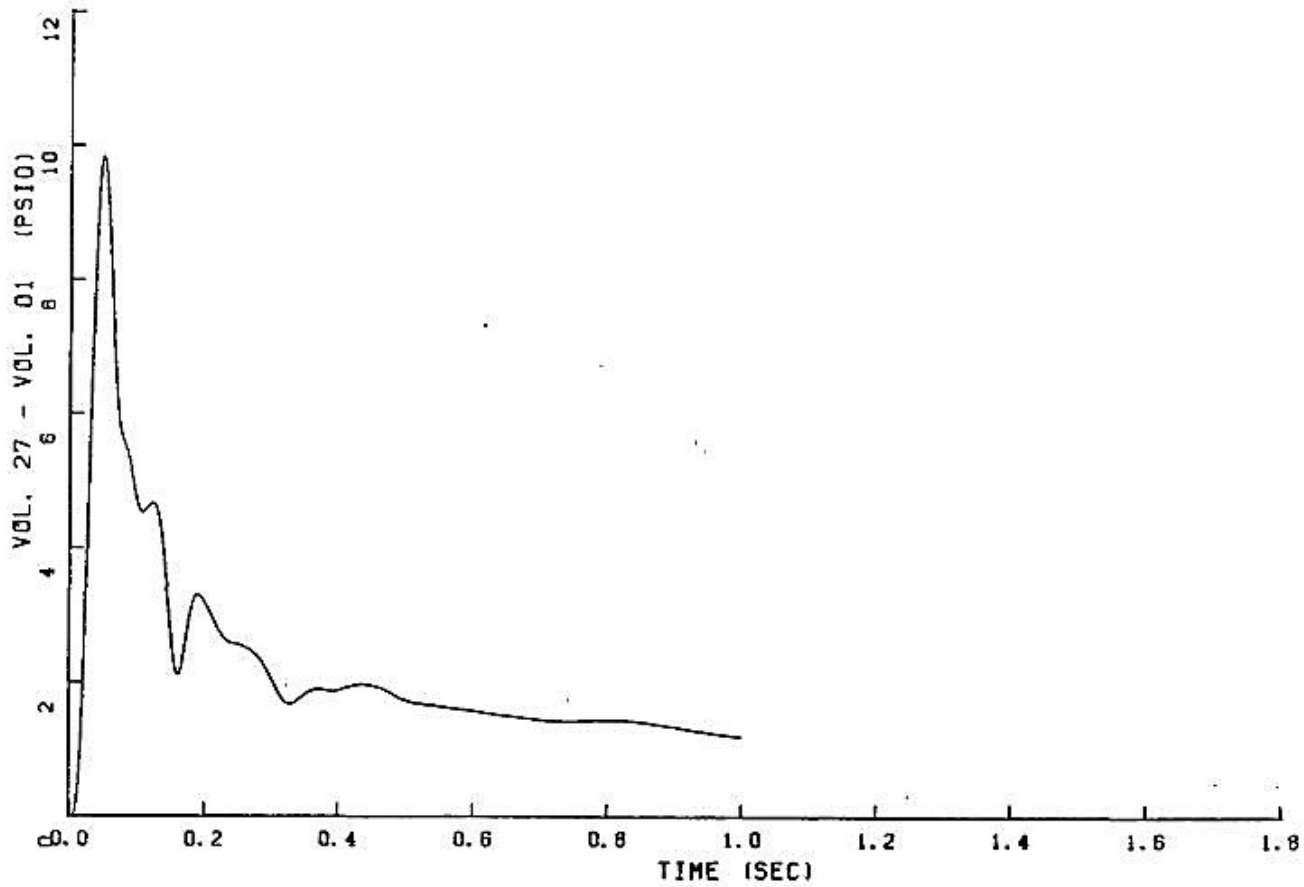

FIGURE 6.2.1-272

PEAK PRESSURE DIFFERENTIAL IN PRESSURIZER COMPARTMENT

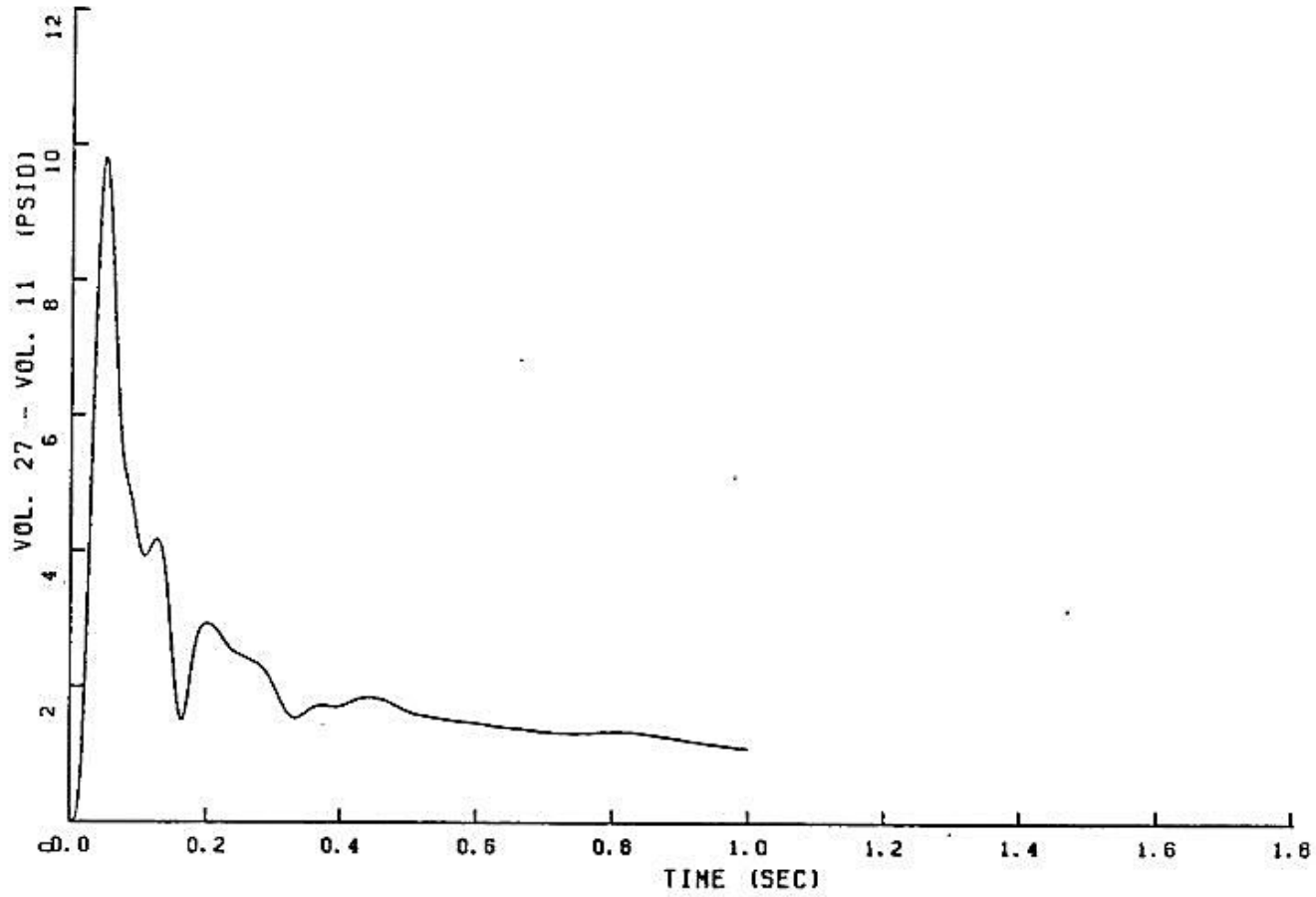

FIGURE 6.2.1-273

PEAK PRESSURE DIFFERENTIAL IN PRESSURIZER COMPARTMENT

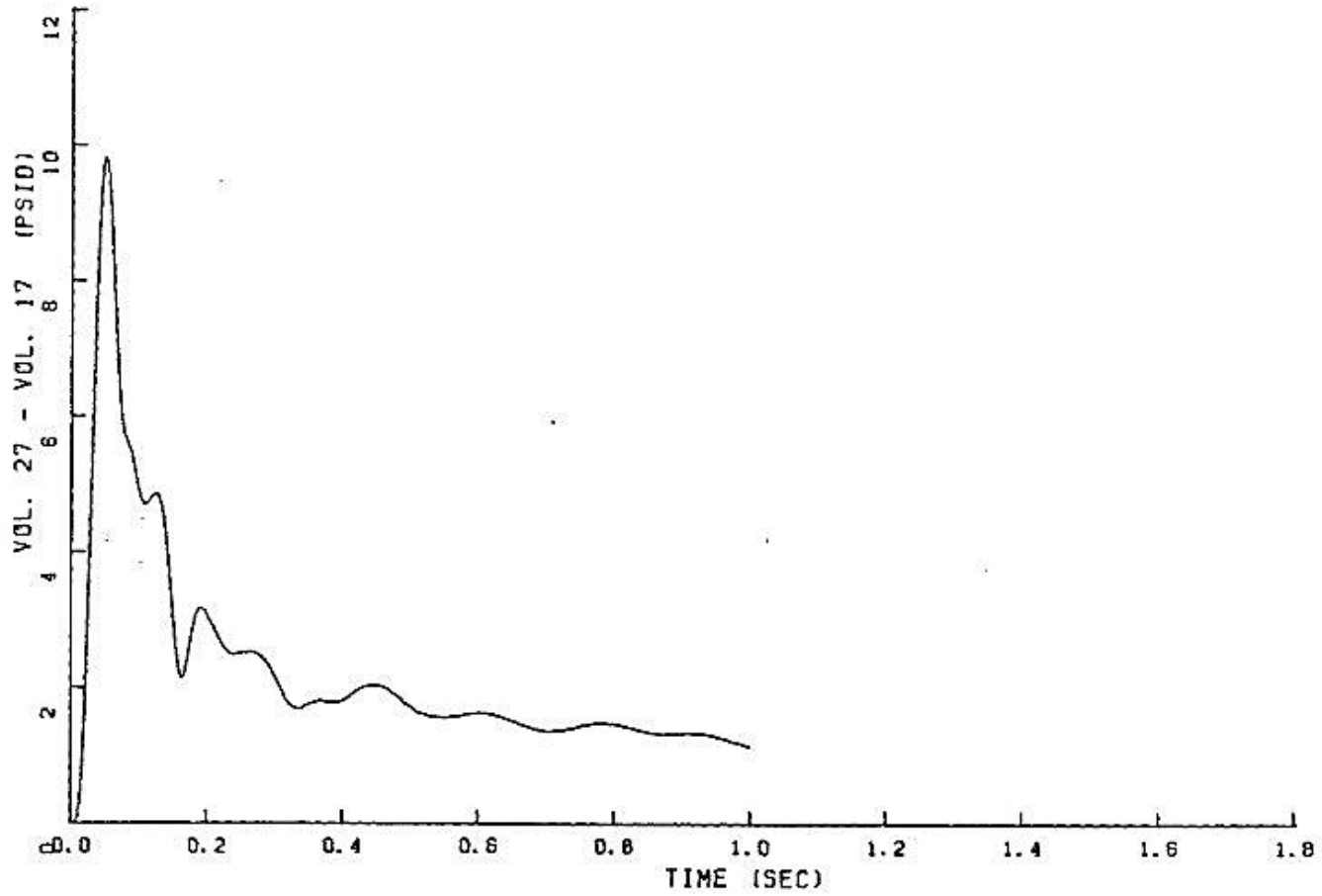

FIGURE 6.2.1-274

PEAK PRESSURE DIFFERENTIAL IN PRESSURIZER COMPARTMENT

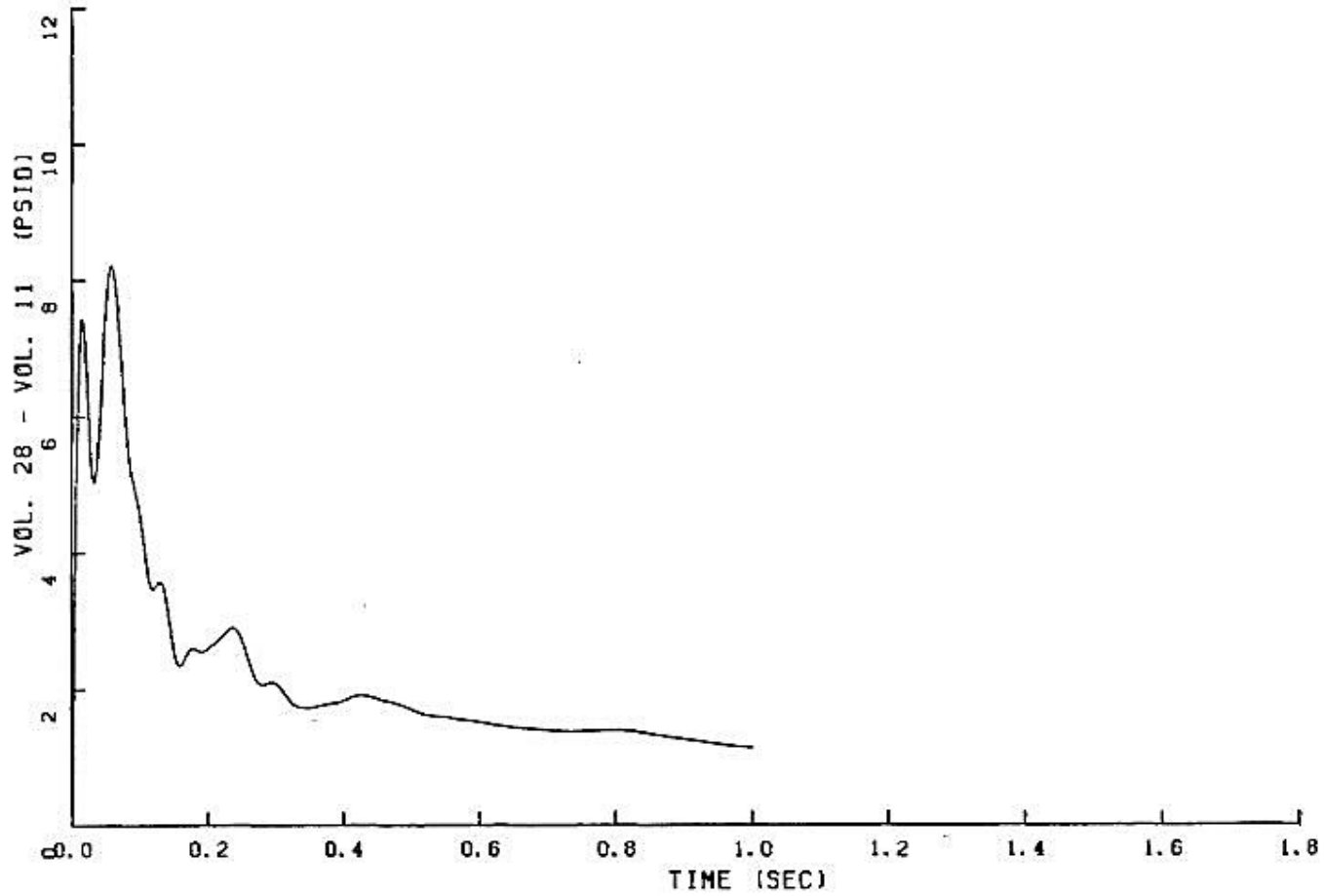

FIGURE 6.2.1-275

PEAK PRESSURE DIFFERENTIAL IN PRESSURIZER COMPARTMENT

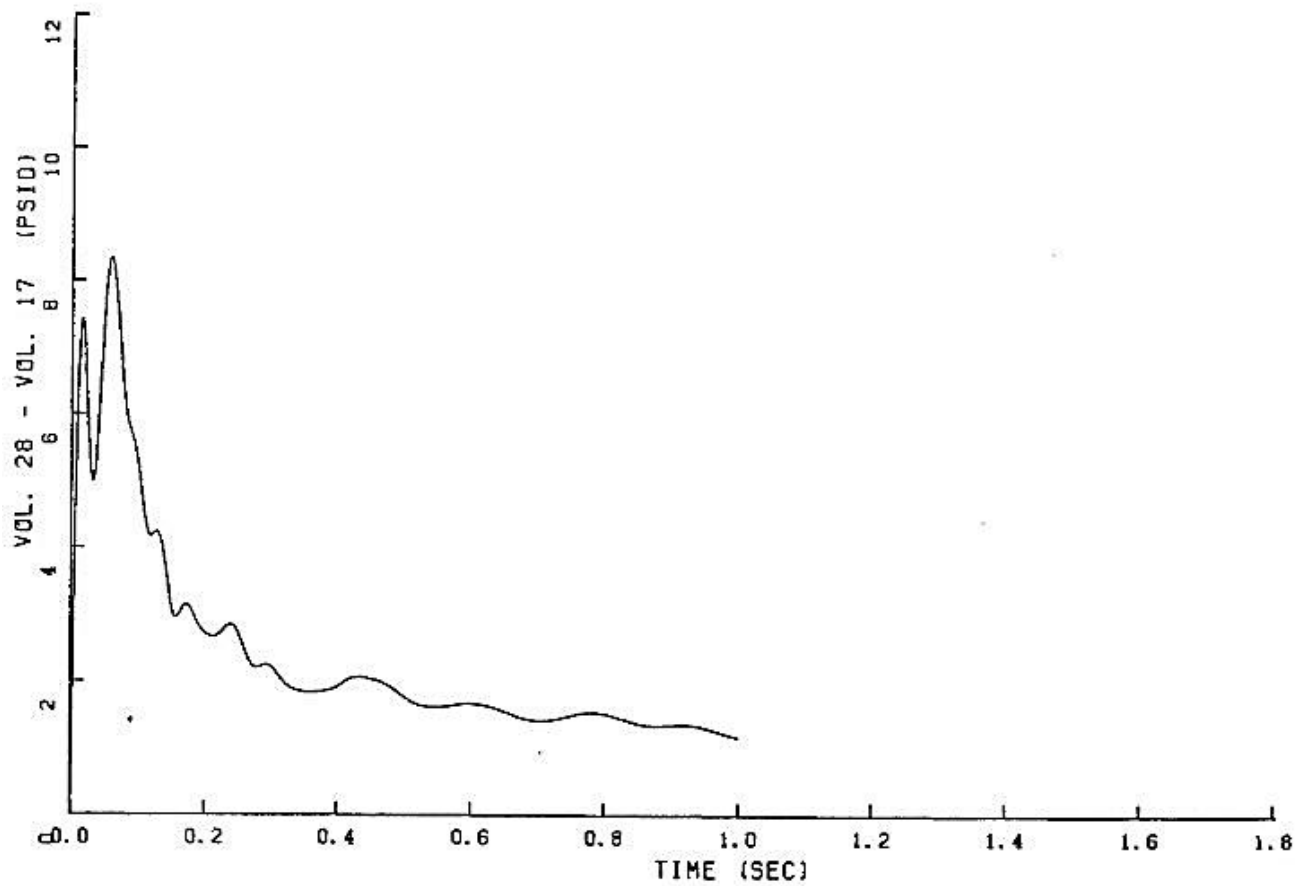

FIGURE 6.2.1-276

PEAK PRESSURE DIFFERENTIAL IN PRESSURIZER COMPARTMENT

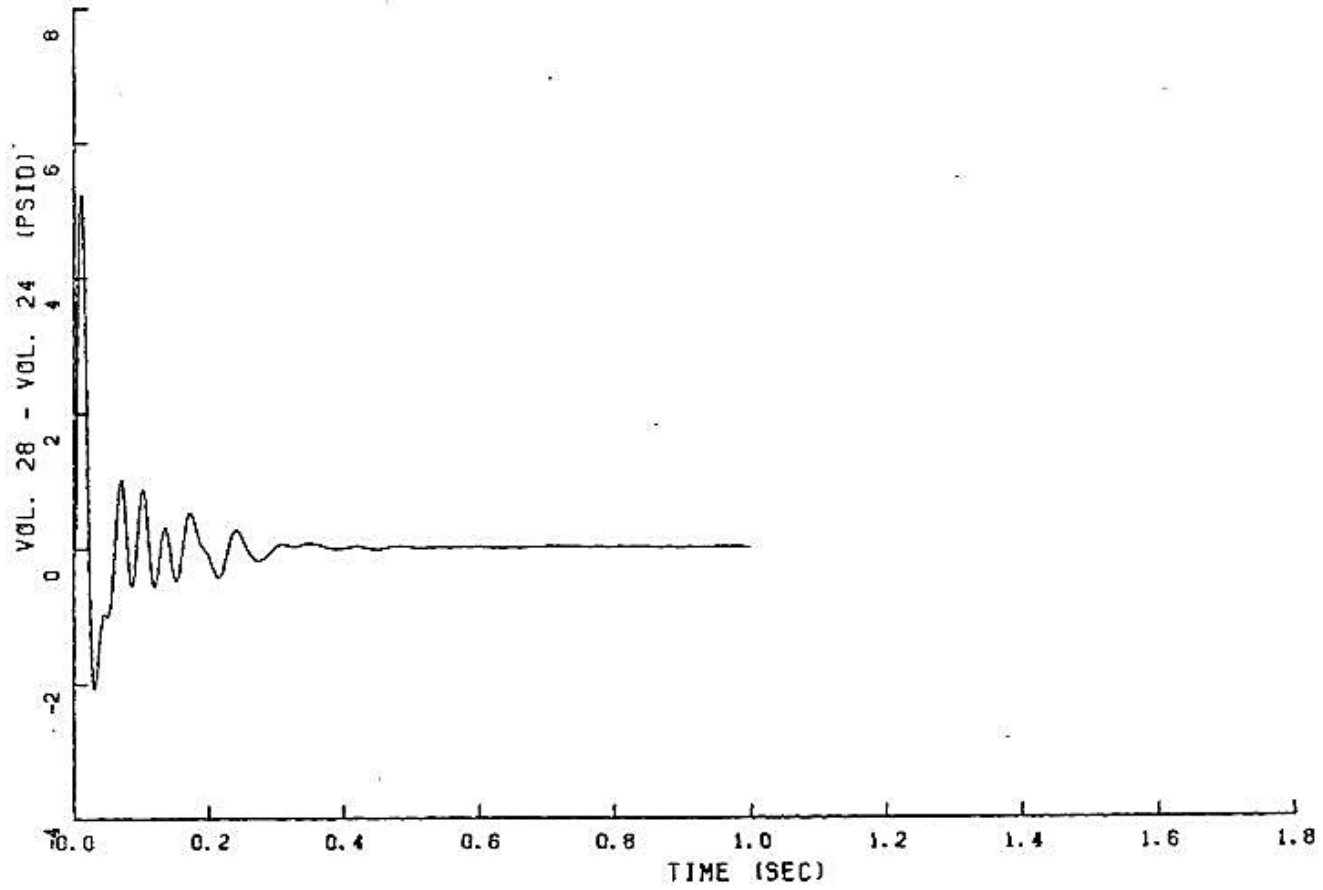

FIGURE 6.2.1-277

PEAK PRESSURE DIFFERENTIAL IN PRESSURIZER COMPARTMENT

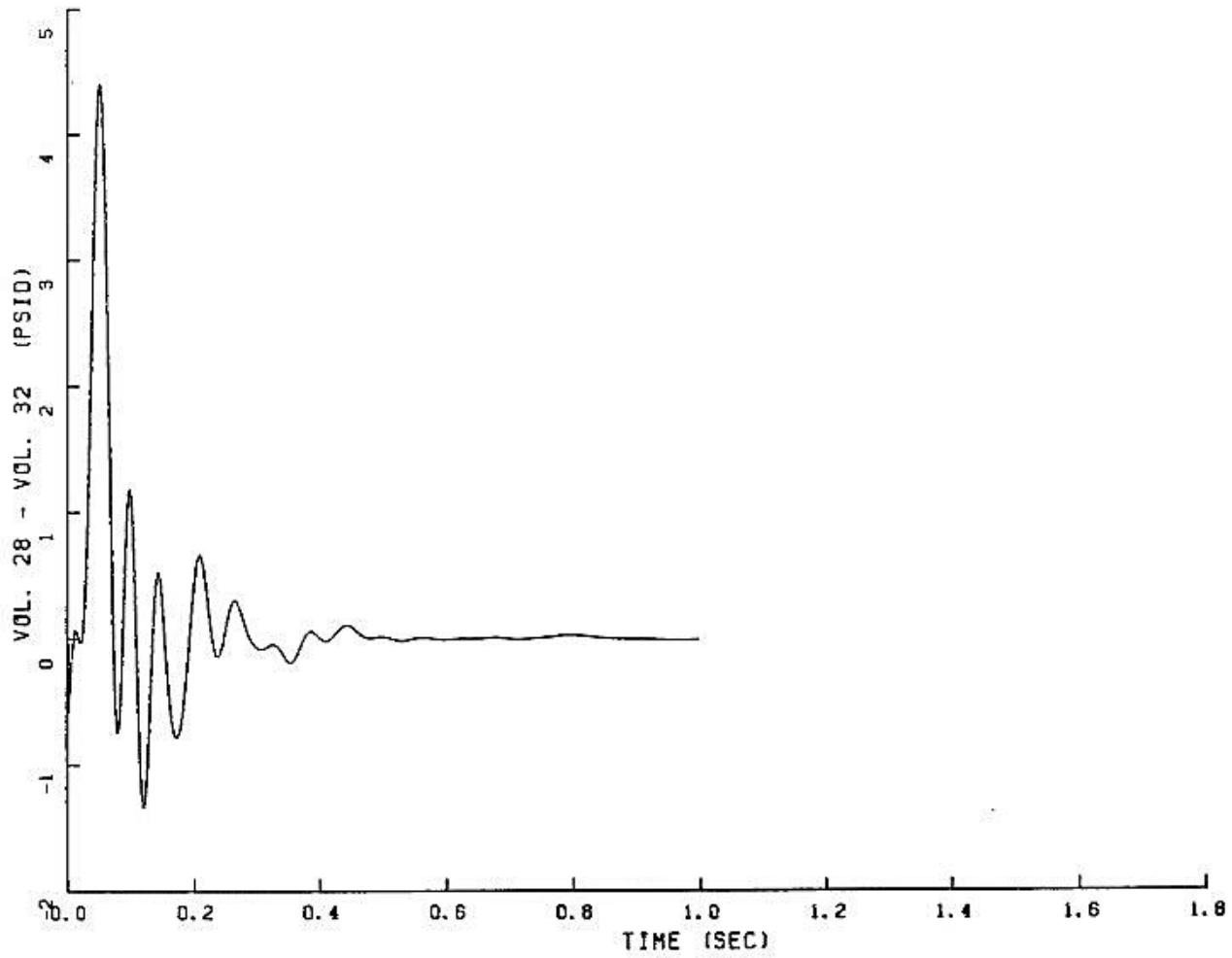

FIGURE 6.2.1-278

PEAK PRESSURE DIFFERENTIAL IN PRESSURIZER COMPARTMENT

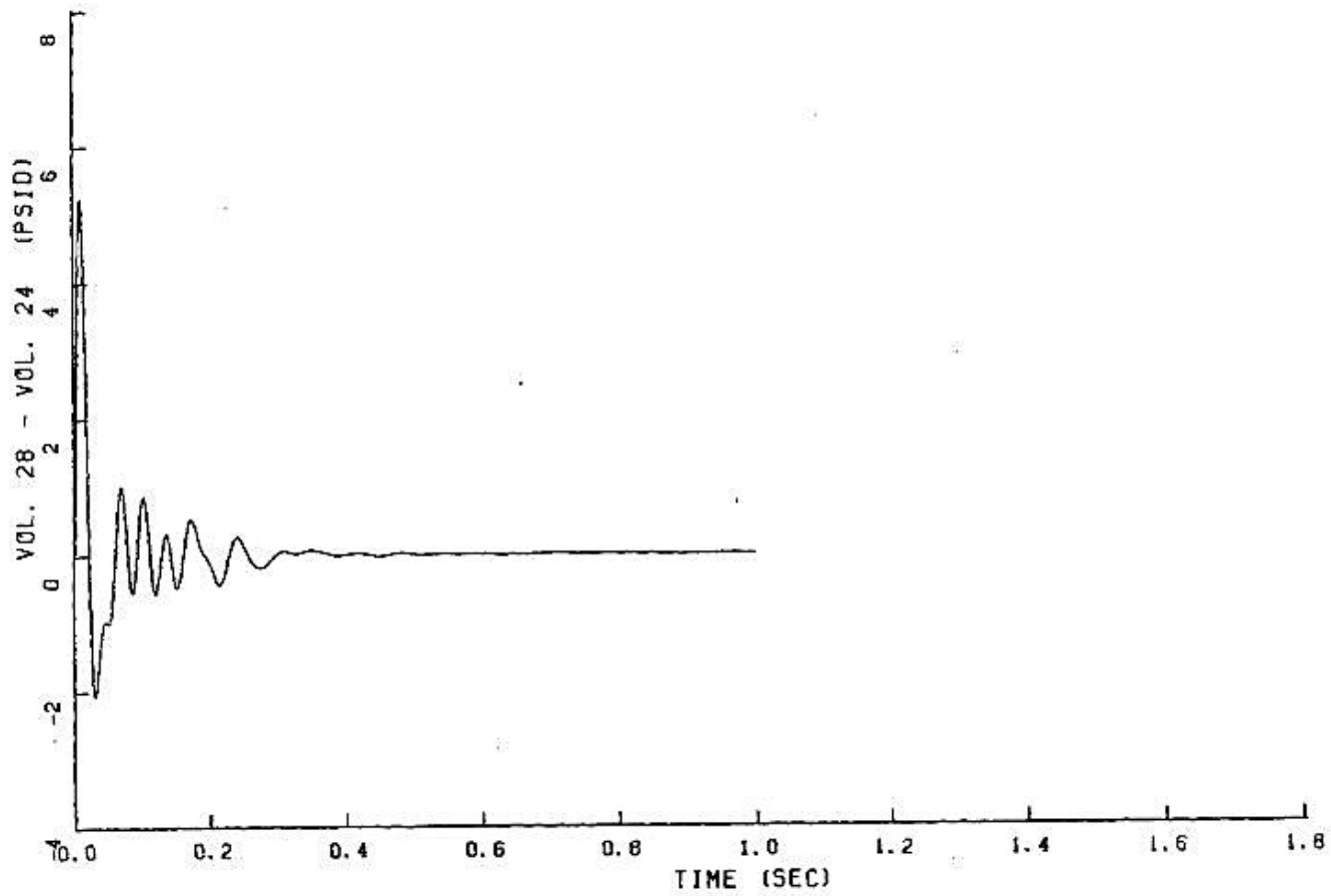

FIGURE 6.2.1-279

PEAK PRESSURE DIFFERENTIAL IN PRESSURIZER COMPARTMENT

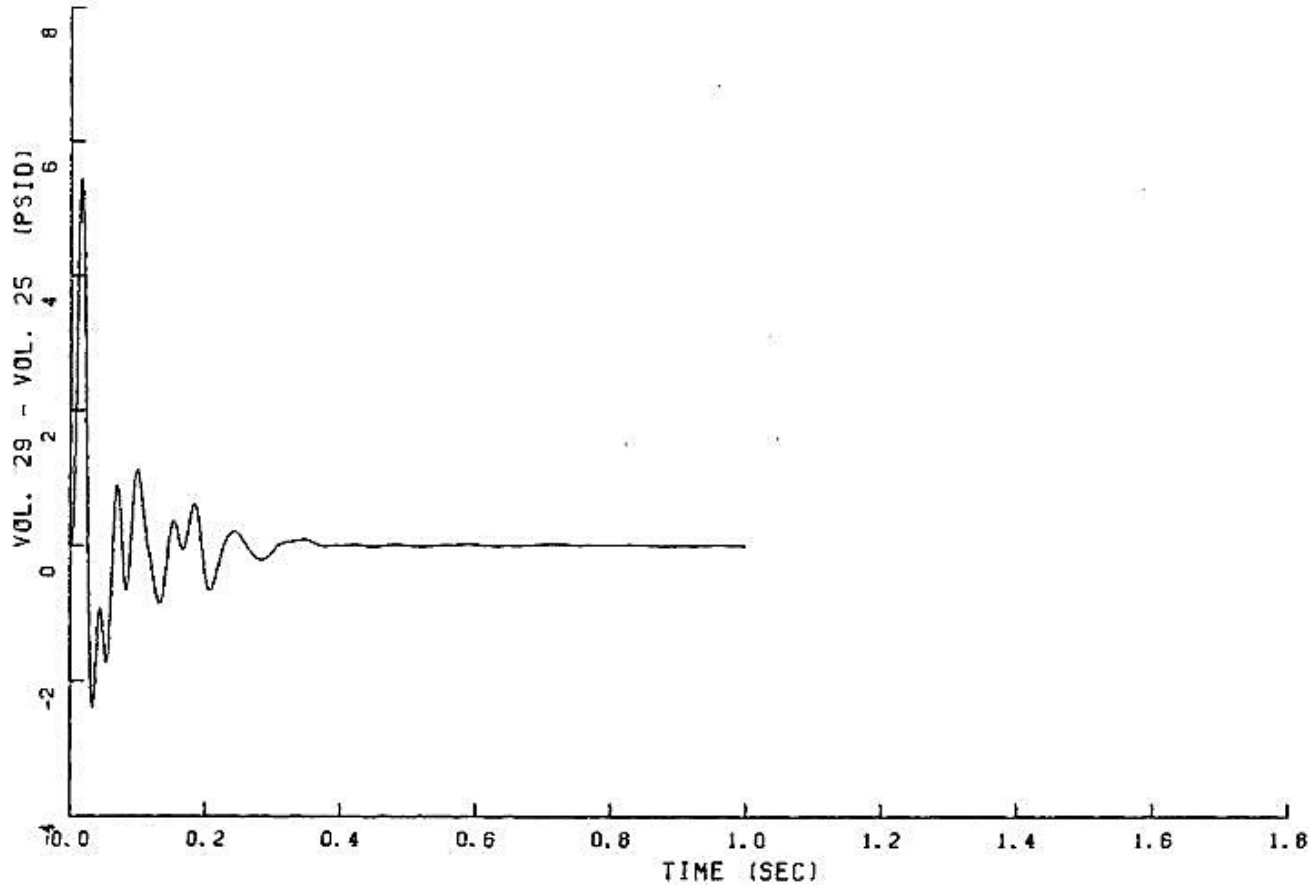

FIGURE 6.2.1-280

PEAK PRESSURE DIFFERENTIAL IN PRESSURIZER COMPARTMENT

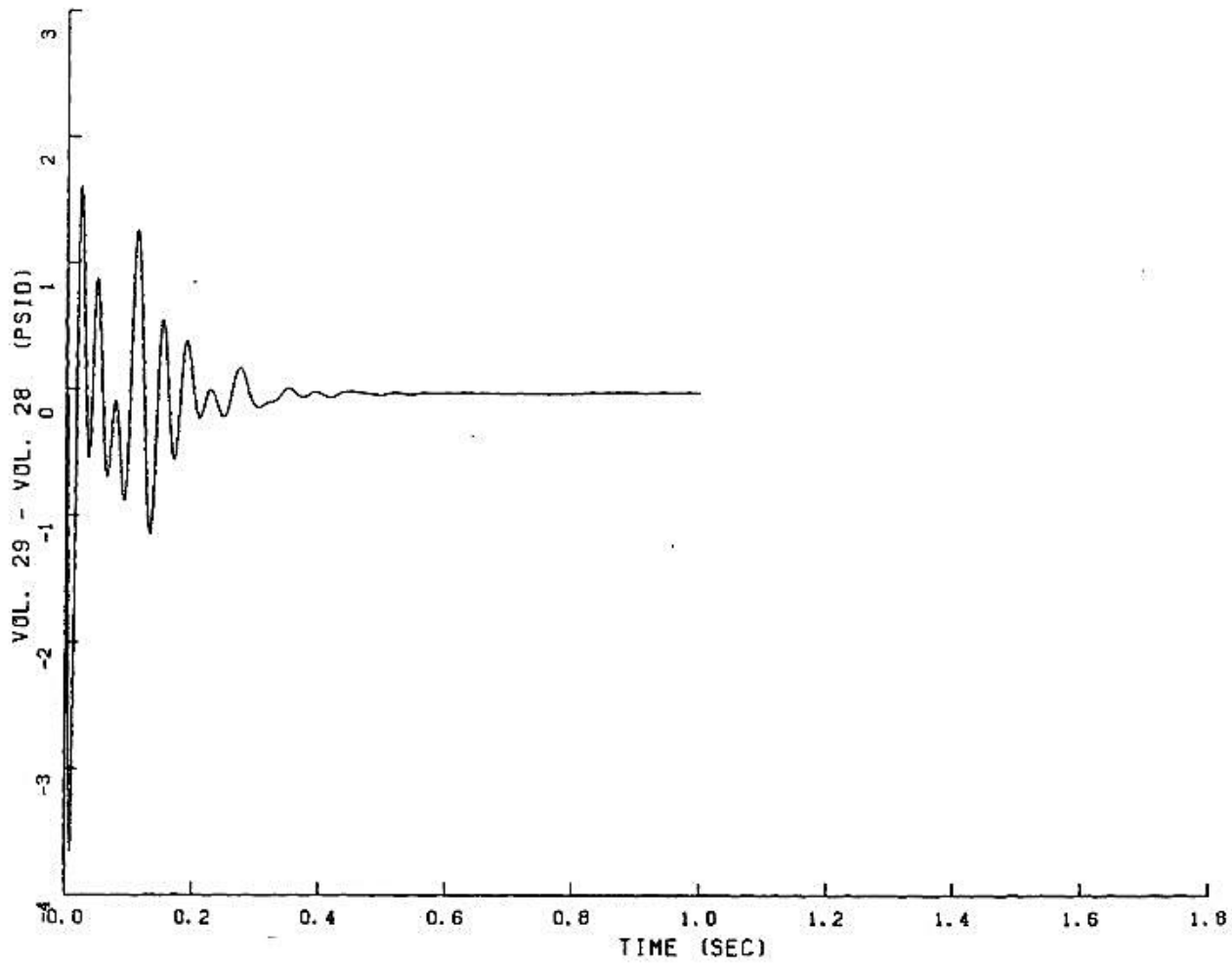

FIGURE 6.2.1-281

PEAK PRESSURE DIFFERENTIAL IN PRESSURIZER COMPARTMENT

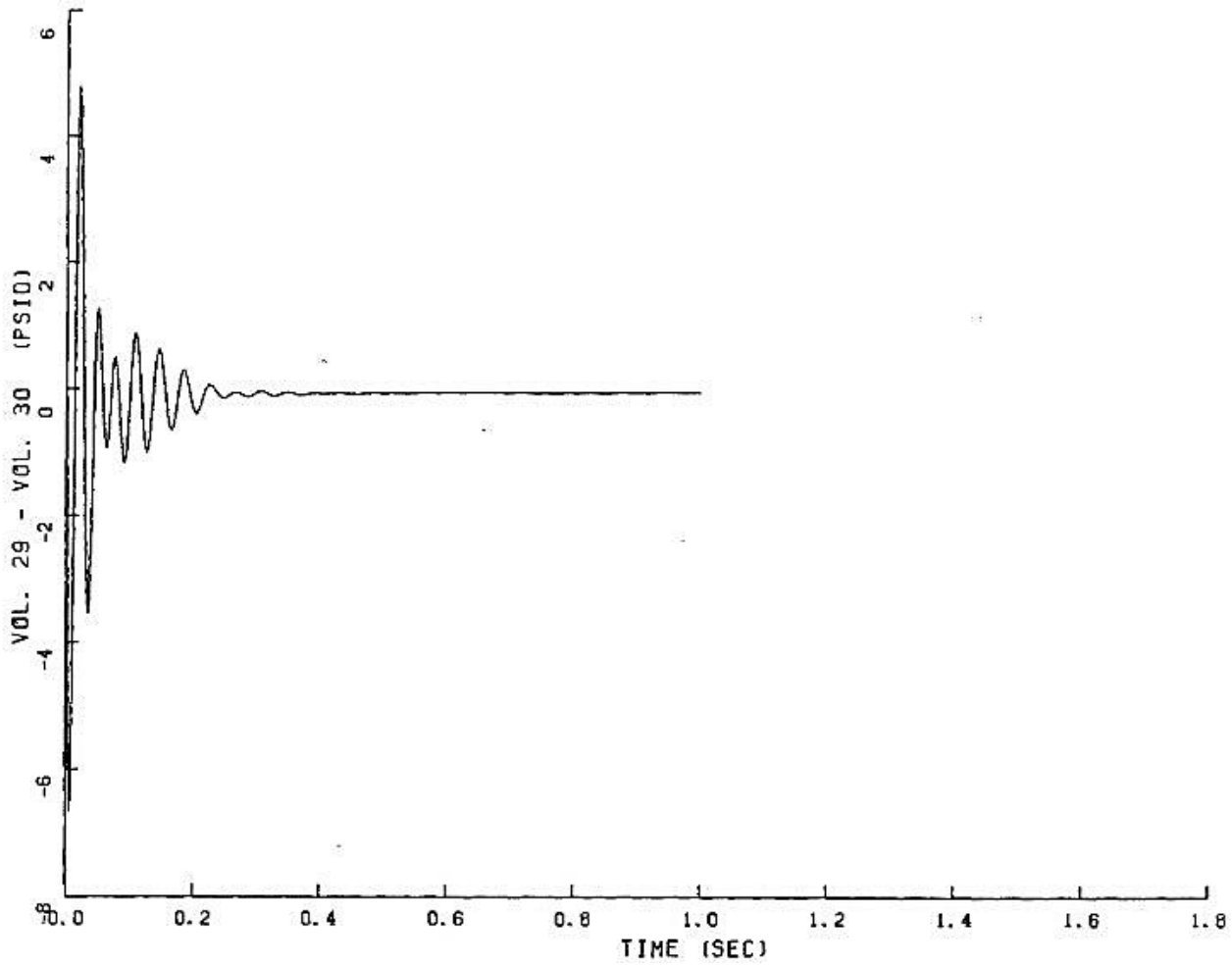

FIGURE 6.2.1-282

PEAK PRESSURE DIFFERENTIAL IN PRESSURIZER COMPARTMENT

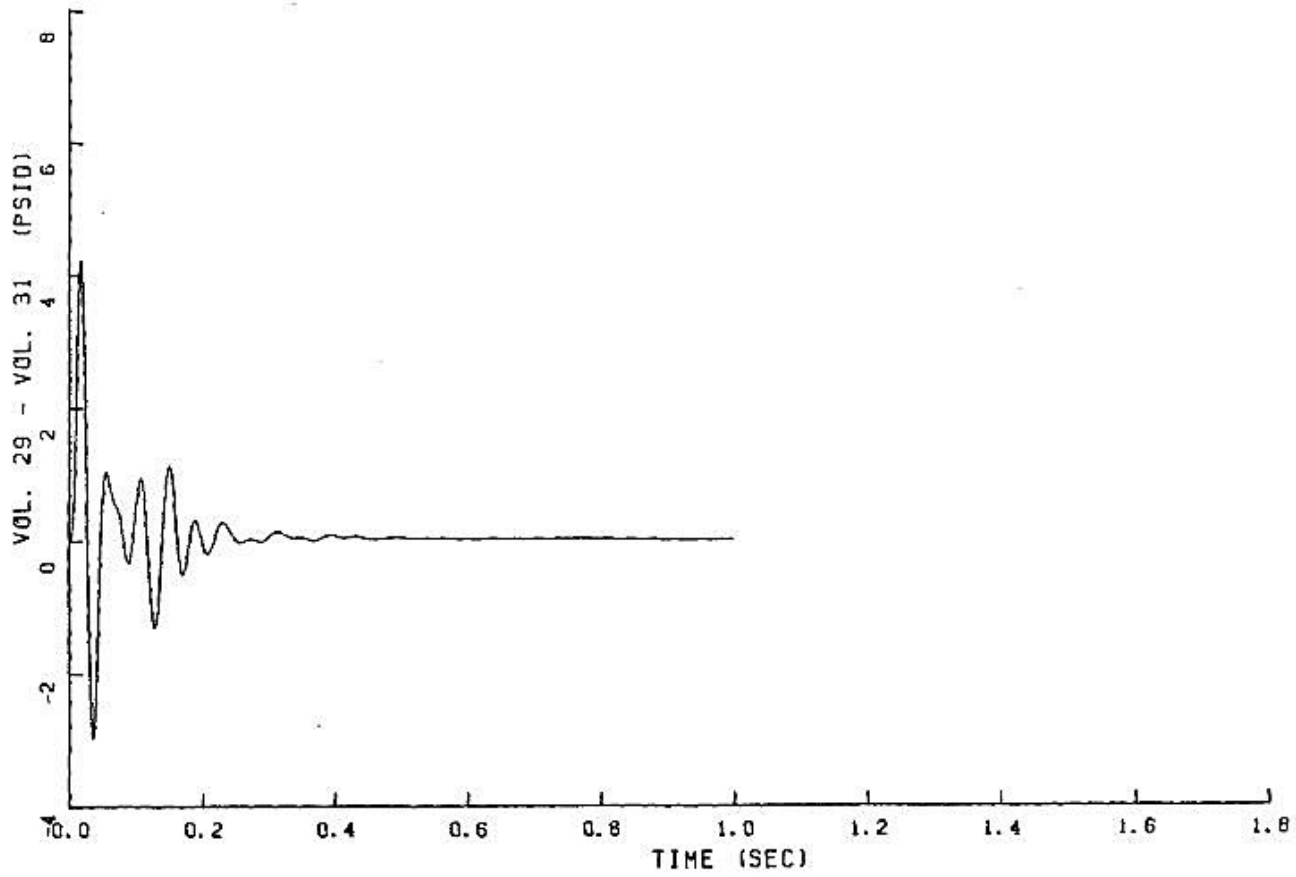

FIGURE 6.2.1-283

PEAK PRESSURE DIFFERENTIAL IN PRESSURIZER COMPARTMENT

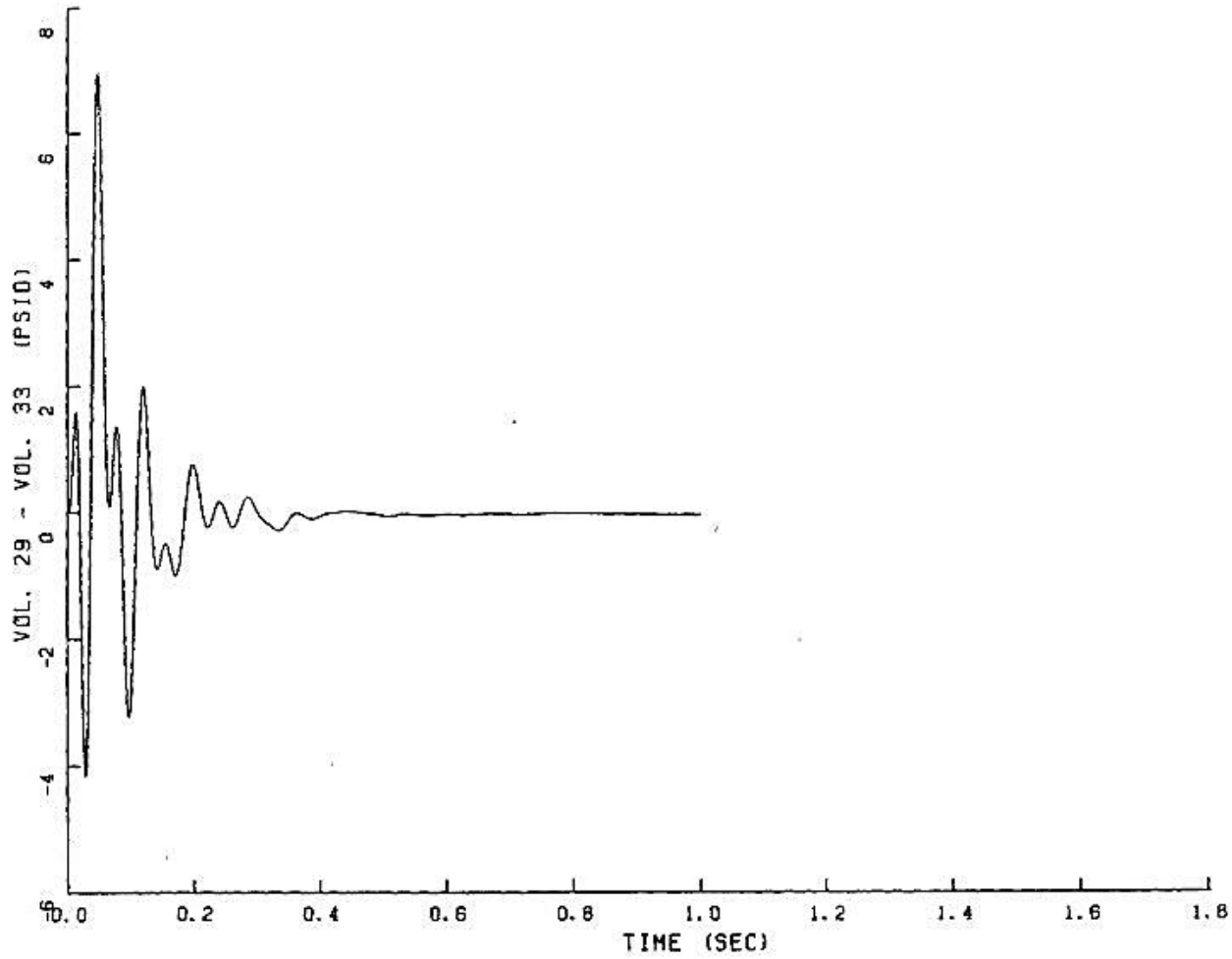

FIGURE 6.2.1-284

PEAK PRESSURE DIFFERENTIAL IN PRESSURIZER COMPARTMENT

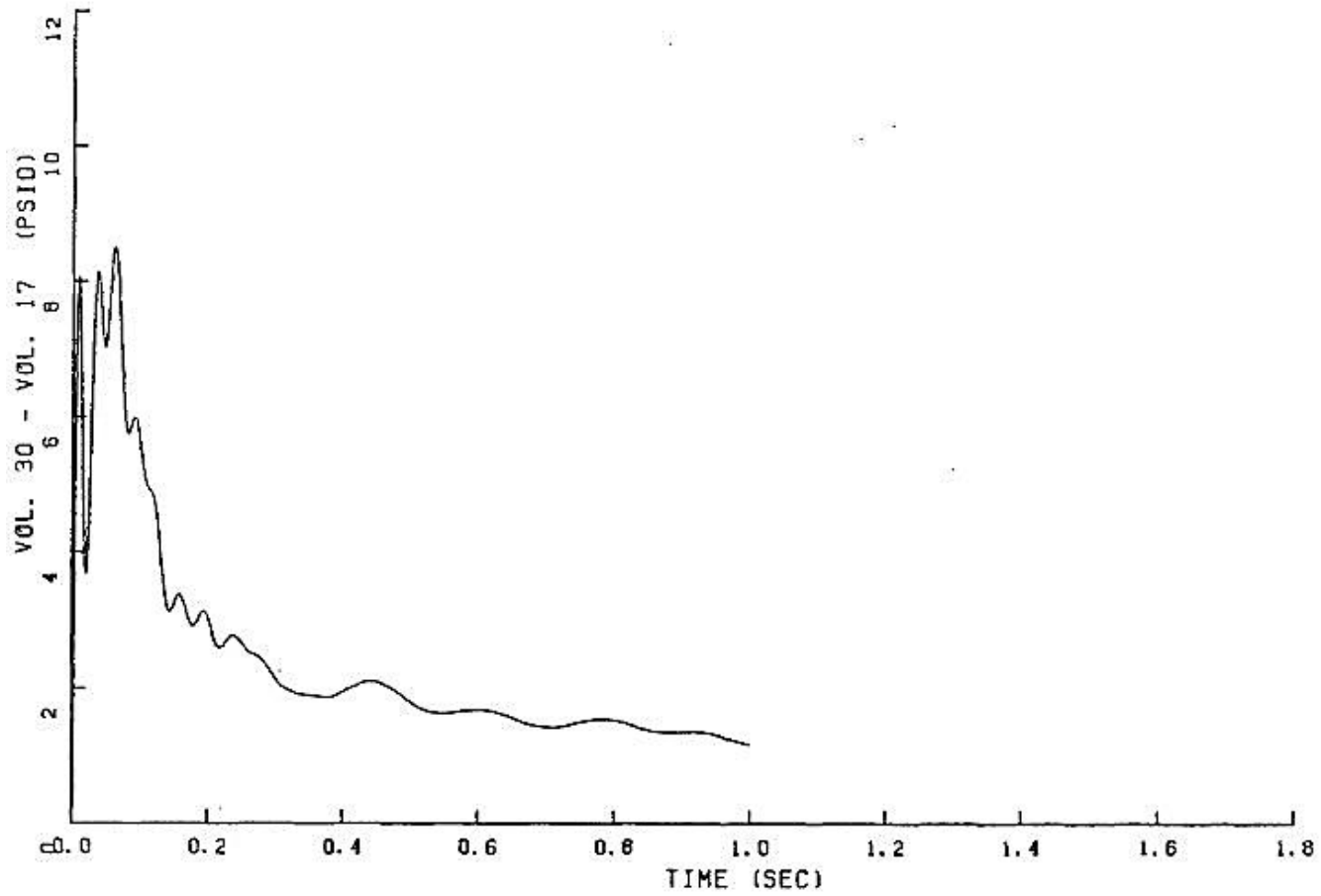

FIGURE 6.2.1-285

PEAK PRESSURE DIFFERENTIAL IN PRESSURIZER COMPARTMENT

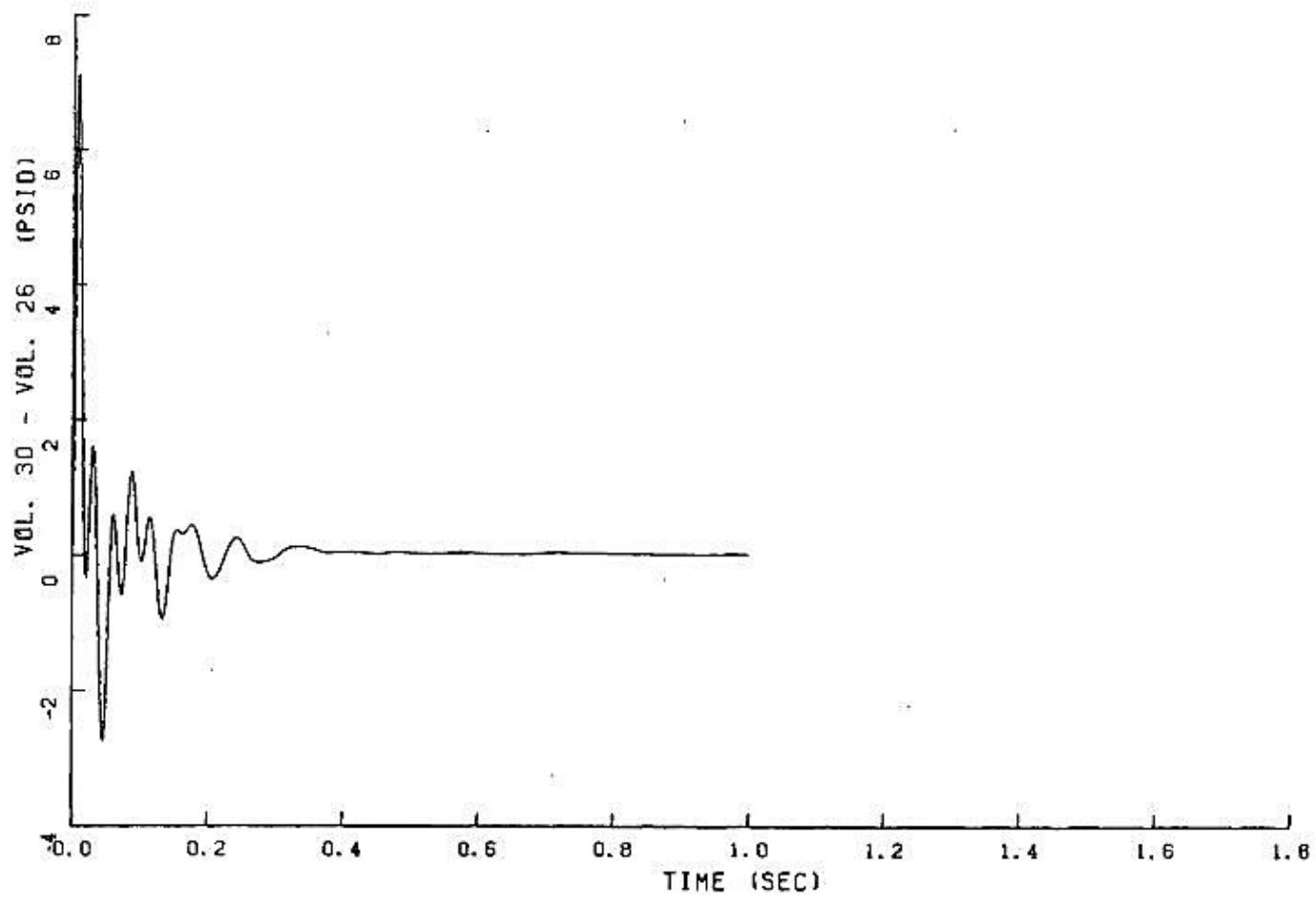

FIGURE 6.2.1-286

PEAK PRESSURE DIFFERENTIAL IN PRESSURIZER COMPARTMENT

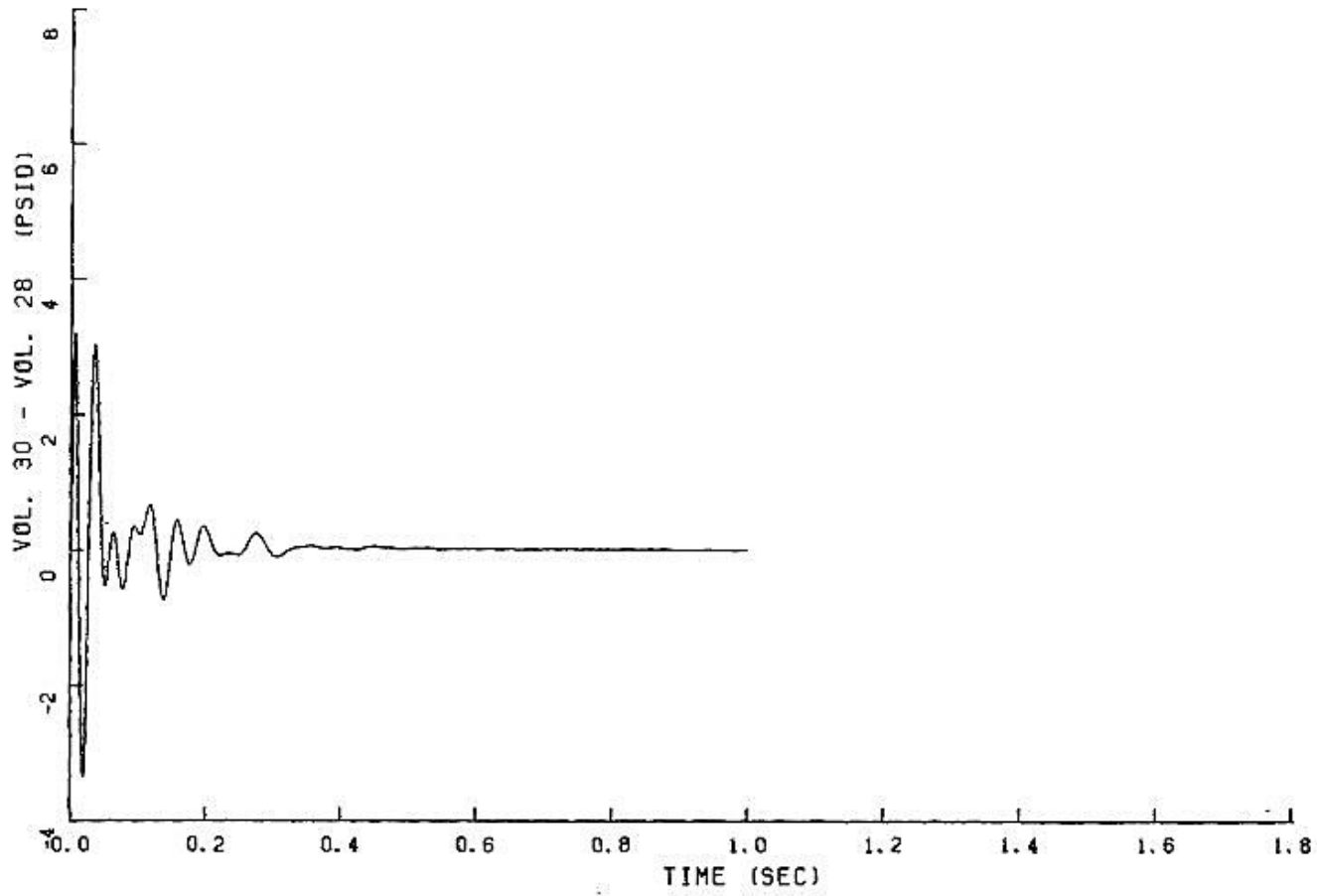

FIGURE 6.2.1-287

PEAK PRESSURE DIFFERENTIAL IN PRESSURIZER COMPARTMENT

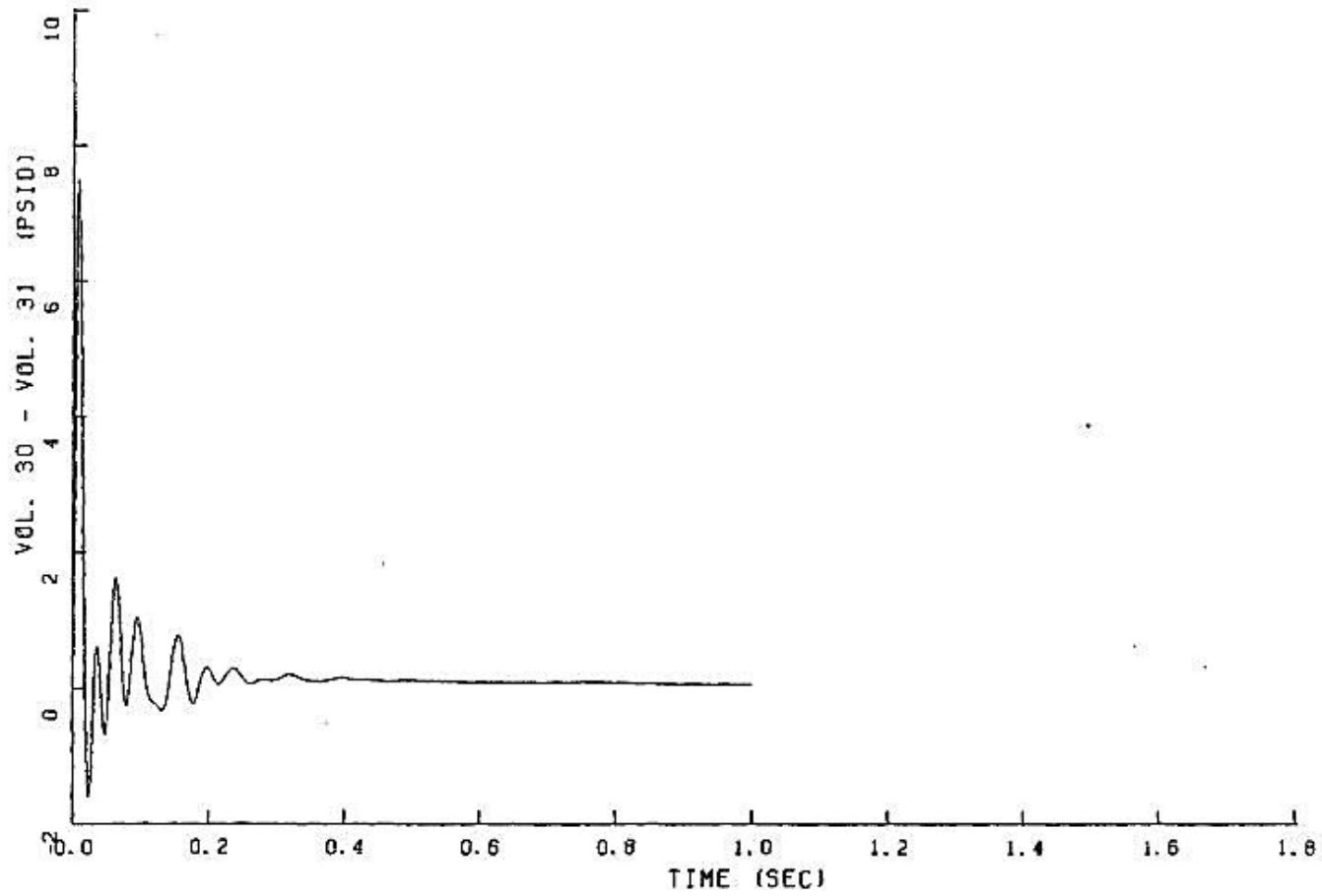

FIGURE 6.2.1-288

PEAK PRESSURE DIFFERENTIAL IN PRESSURIZER COMPARTMENT

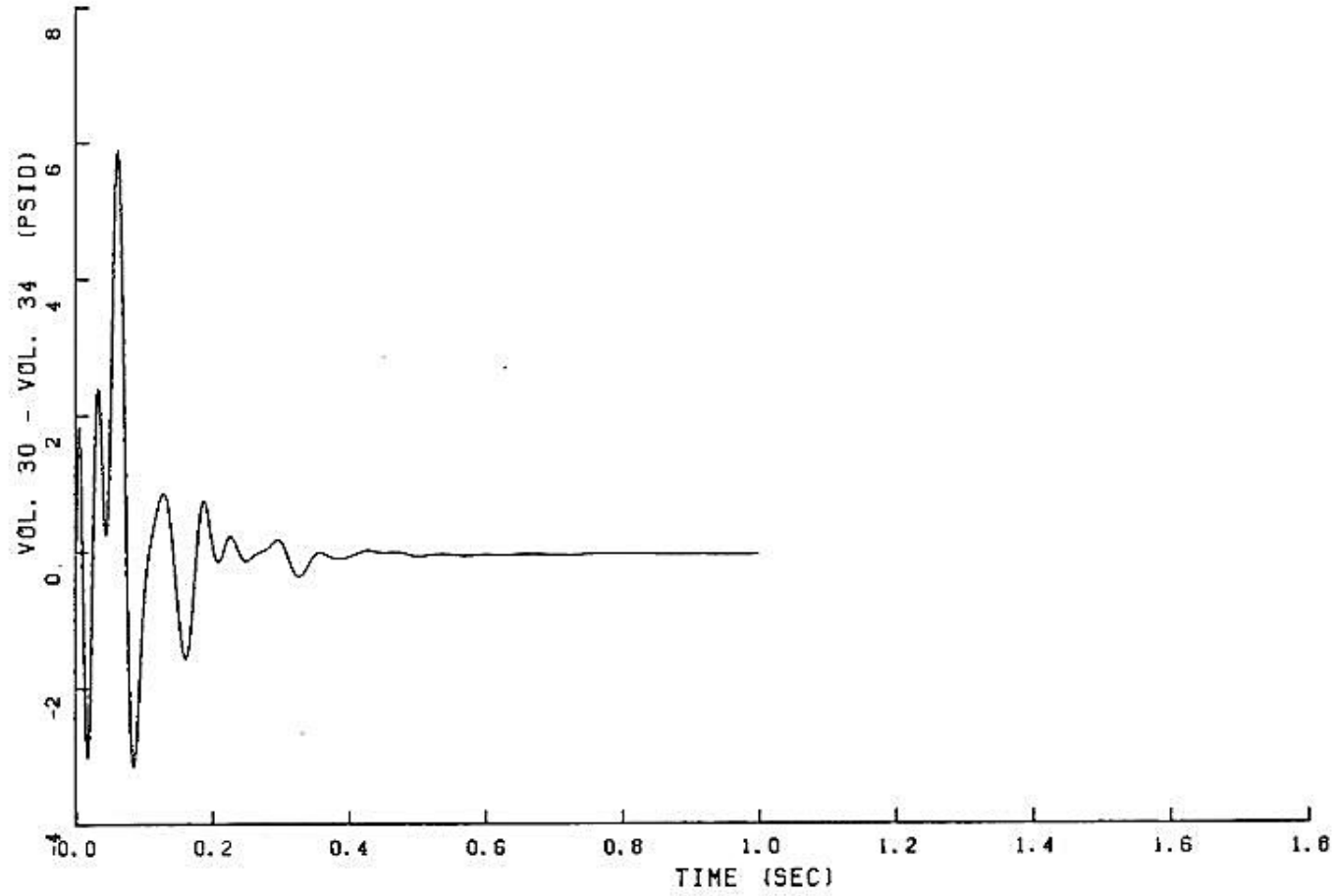

FIGURE 6.2.1-289

PEAK PRESSURE DIFFERENTIAL IN PRESSURIZER COMPARTMENT

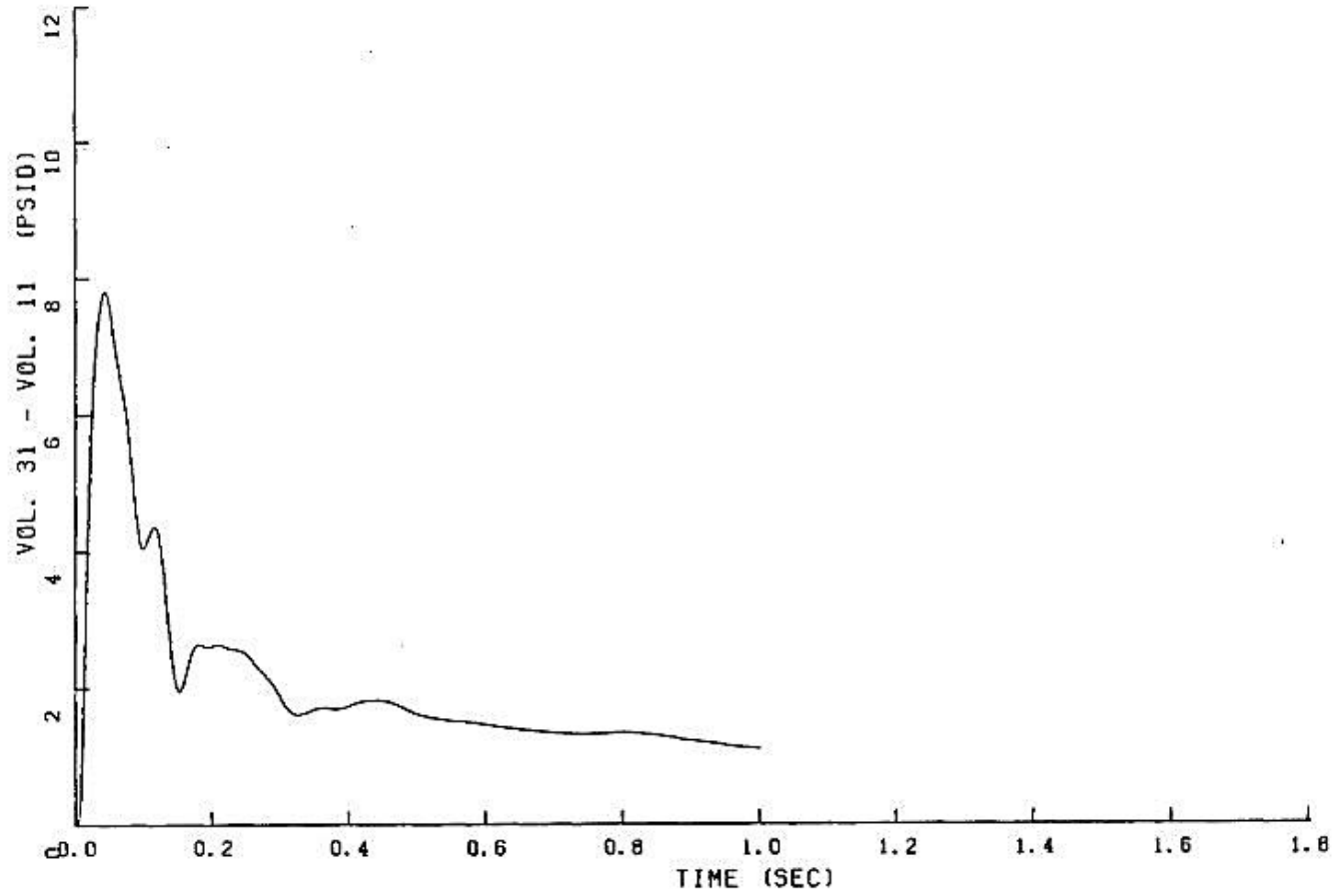

FIGURE 6.2.1-290

PEAK PRESSURE DIFFERENTIAL IN PRESSURIZER COMPARTMENT

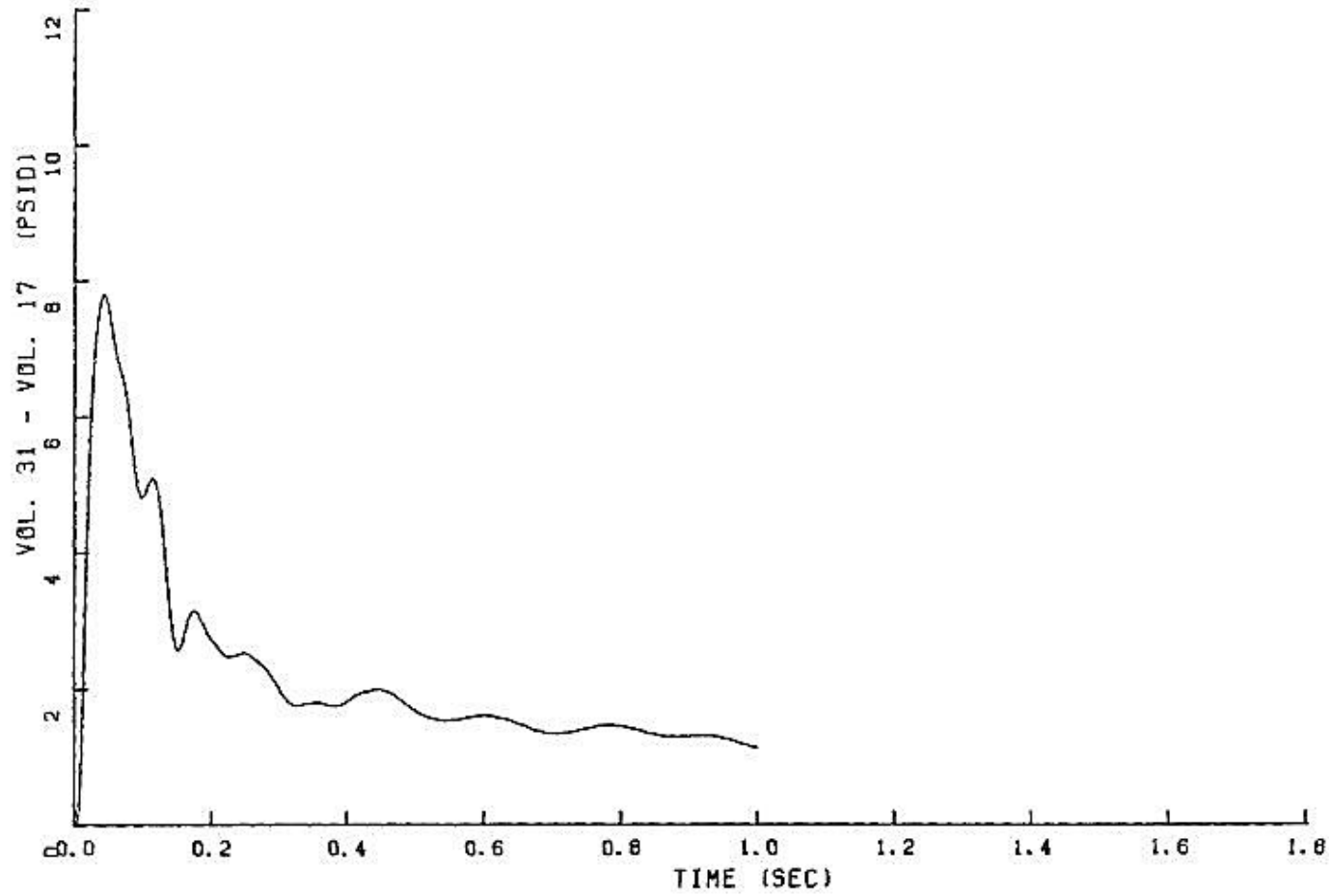

FIGURE 6.2.1-291

PEAK PRESSURE DIFFERENTIAL IN PRESSURIZER COMPARTMENT

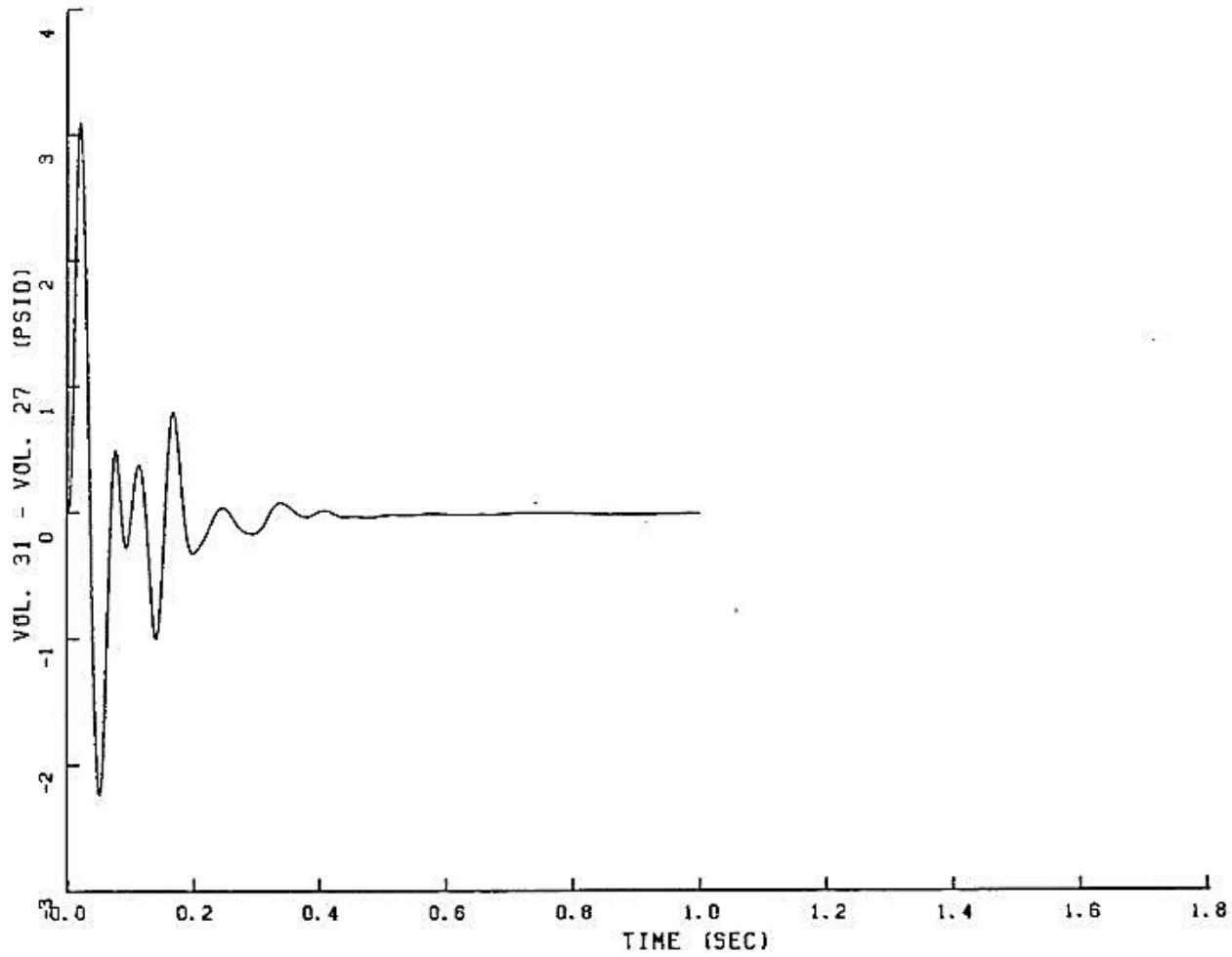

FIGURE 6.2.1-292

PEAK PRESSURE DIFFERENTIAL IN PRESSURIZER COMPARTMENT

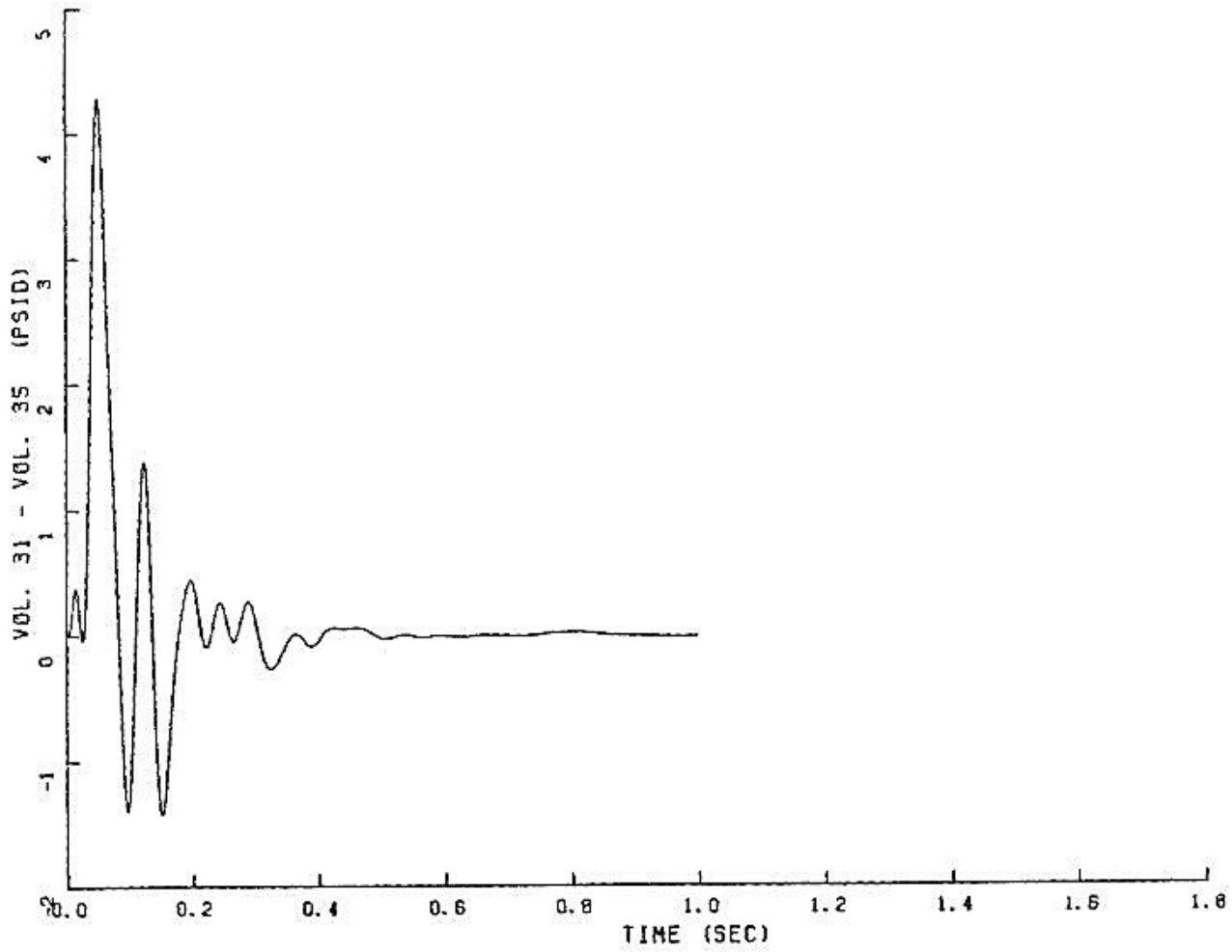

FIGURE 6.2.1-293

PEAK PRESSURE DIFFERENTIAL IN PRESSURIZER COMPARTMENT

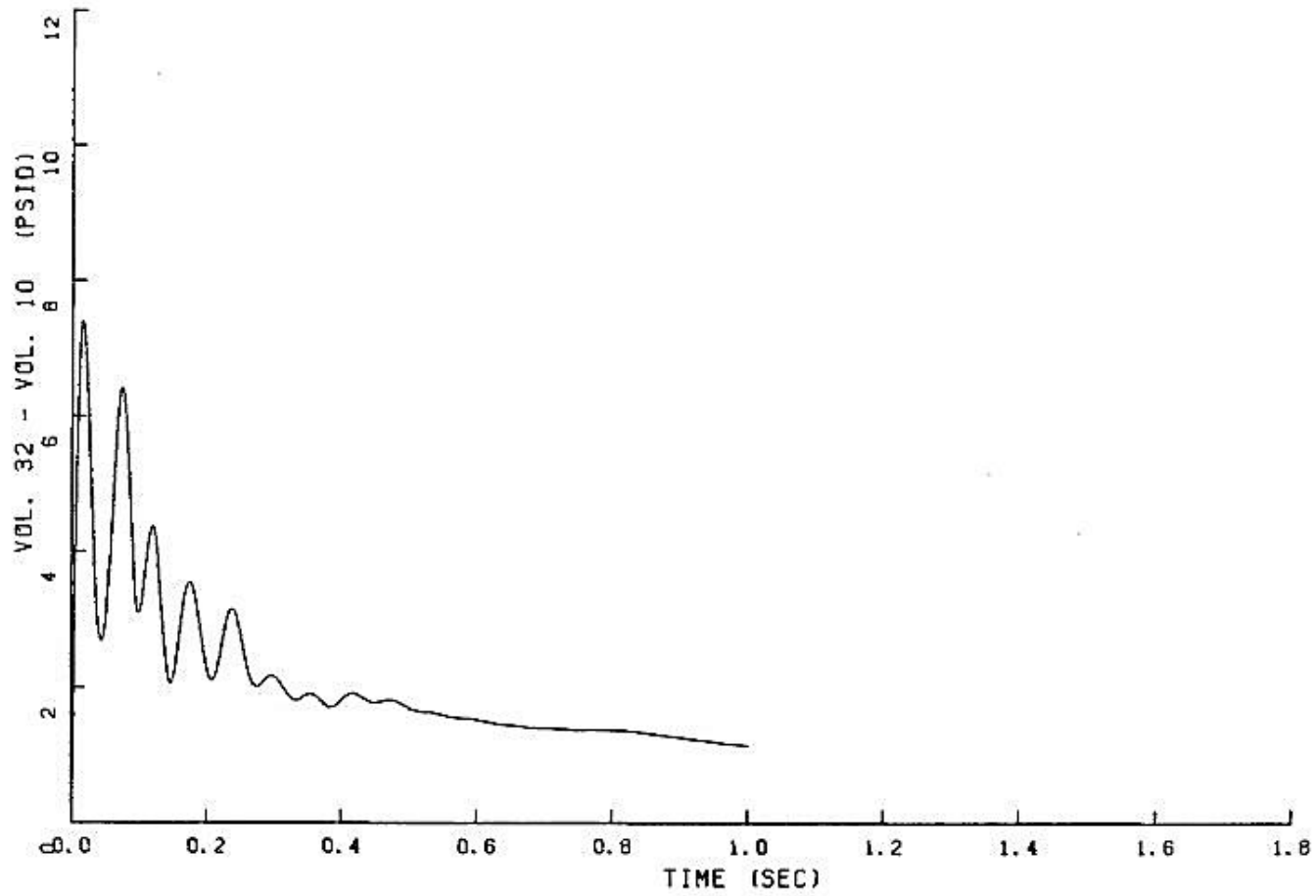

FIGURE 6.2.1-294

PEAK PRESSURE DIFFERENTIAL IN PRESSURIZER COMPARTMENT

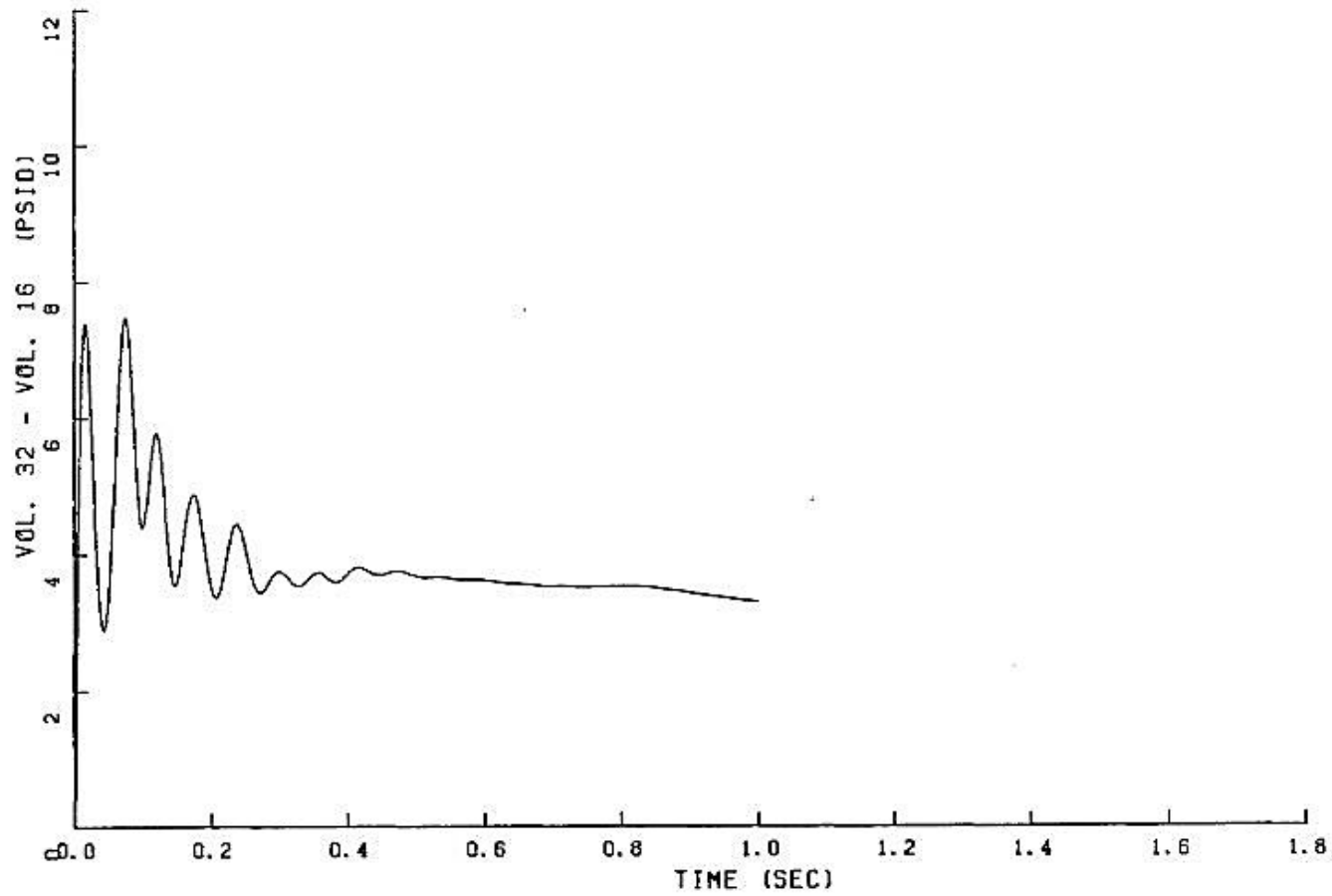

FIGURE 6.2.1-295

PEAK PRESSURE DIFFERENTIAL IN PRESSURIZER COMPARTMENT

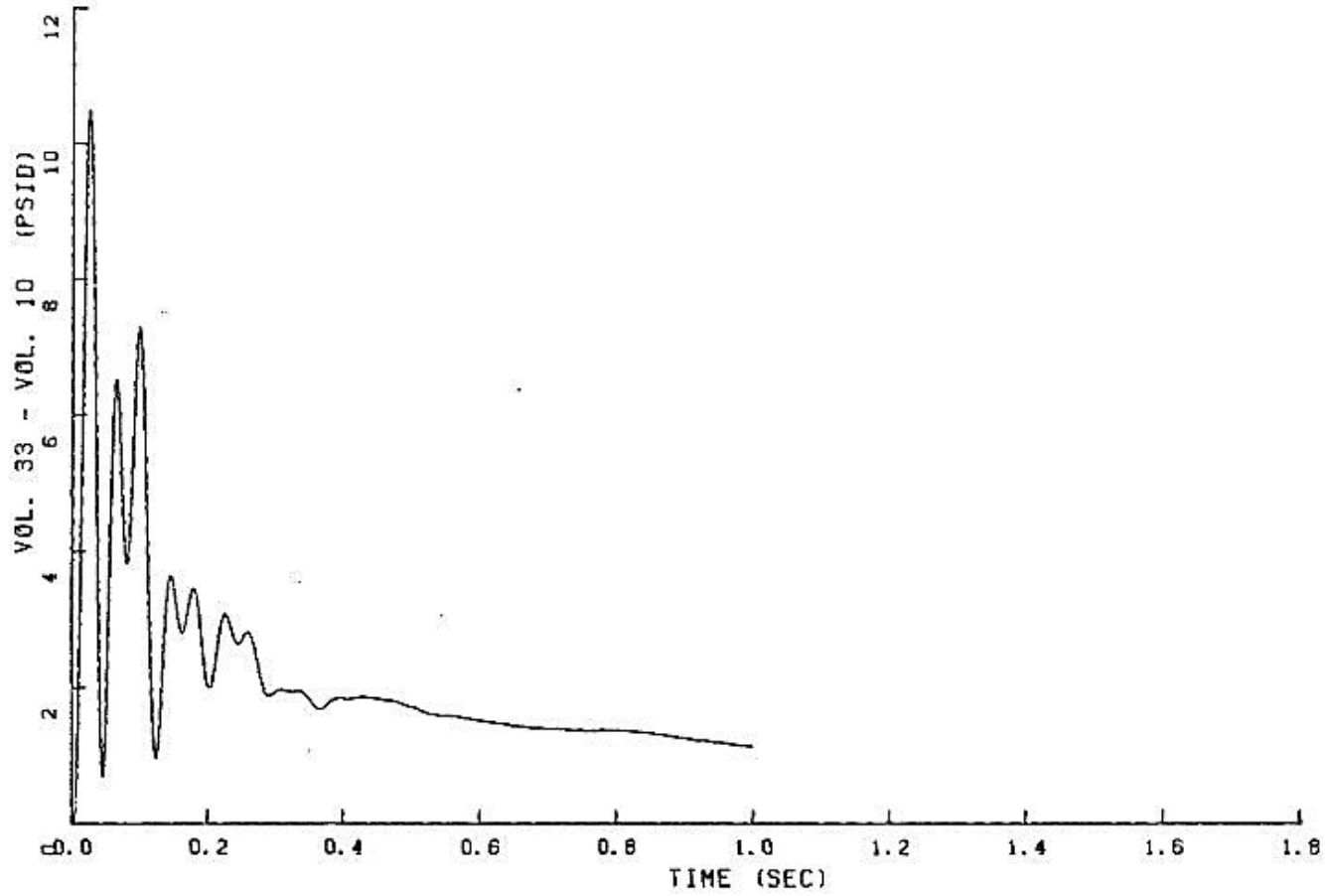

FIGURE 6.2.1-296

PEAK PRESSURE DIFFERENTIAL IN PRESSURIZER COMPARTMENT

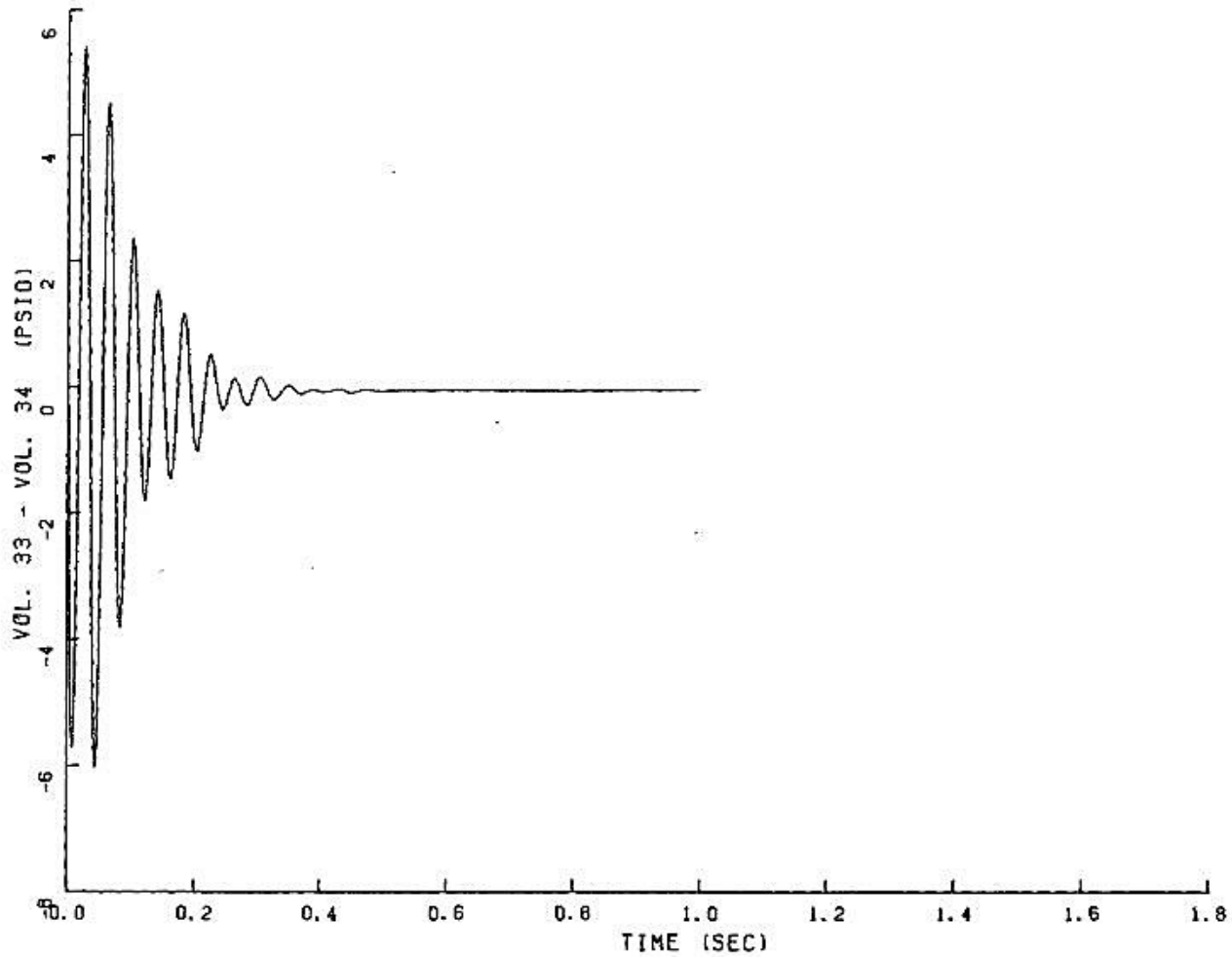

FIGURE 6.2.1-297

PEAK PRESSURE DIFFERENTIAL IN PRESSURIZER COMPARTMENT

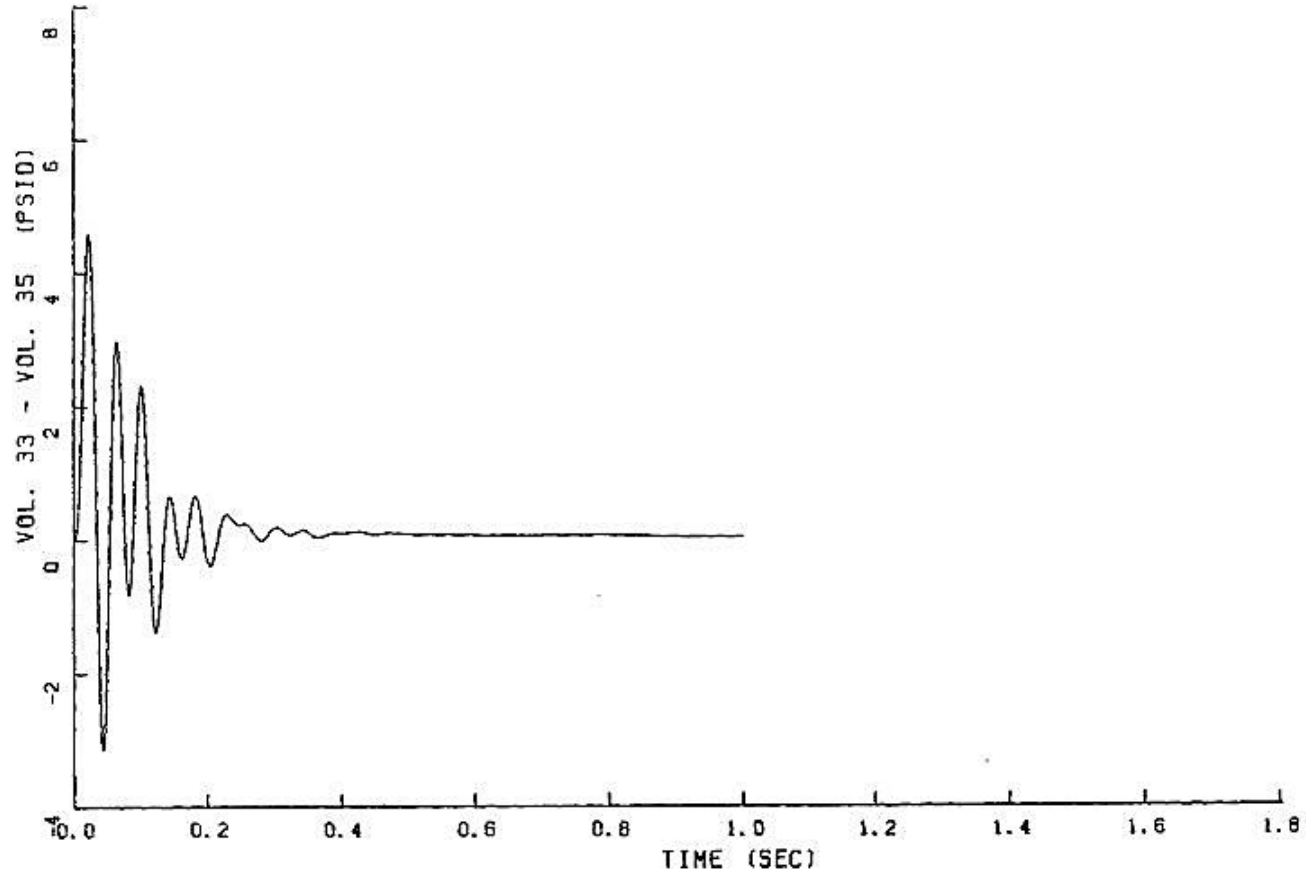

FIGURE 6.2.1-298

PEAK PRESSURE DIFFERENTIAL IN PRESSURIZER COMPARTMENT

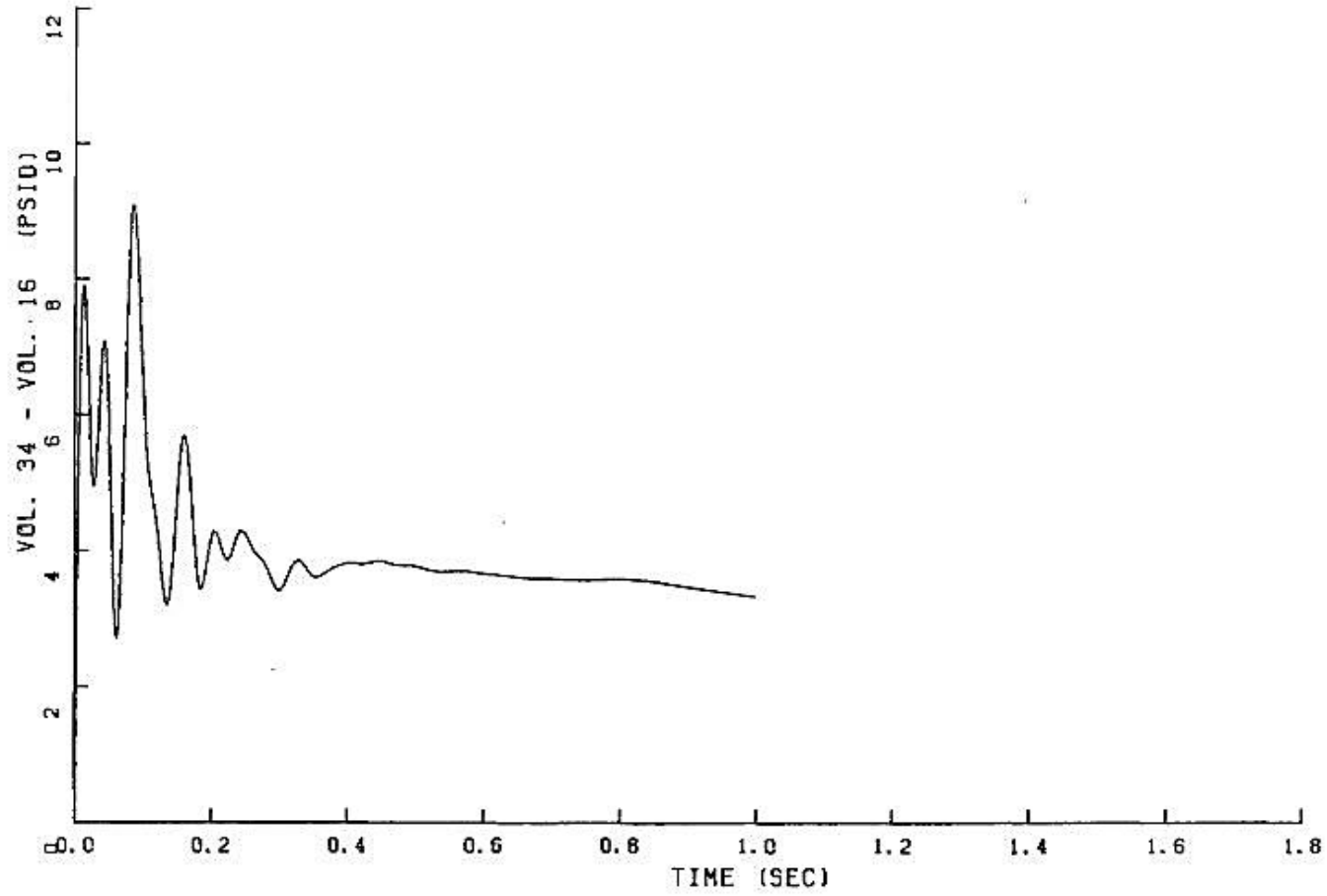

FIGURE 6.2.1-299

PEAK PRESSURE DIFFERENTIAL IN PRESSURIZER COMPARTMENT

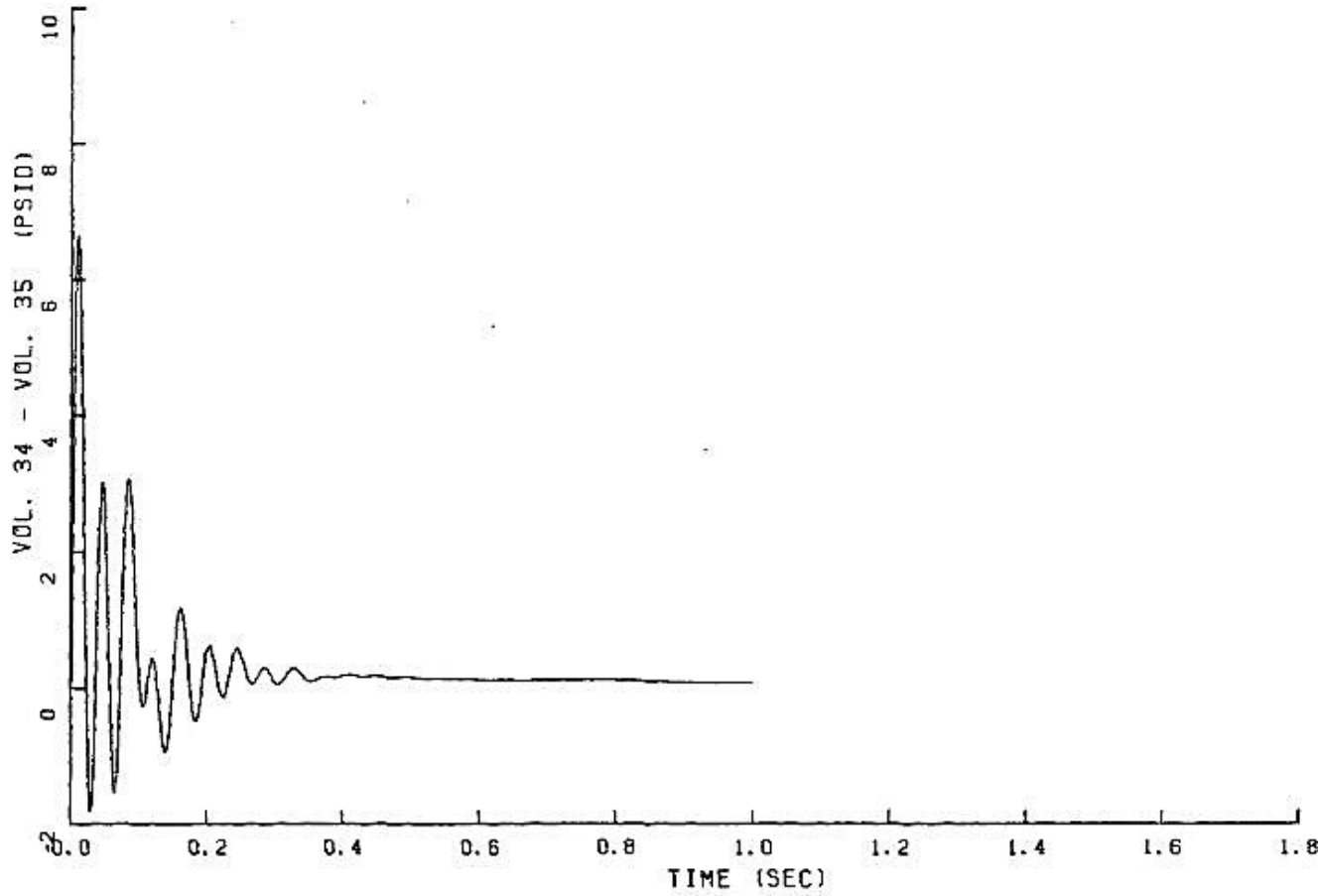

FIGURE 6.2.1-300

PEAK PRESSURE DIFFERENTIAL IN PRESSURIZER COMPARTMENT

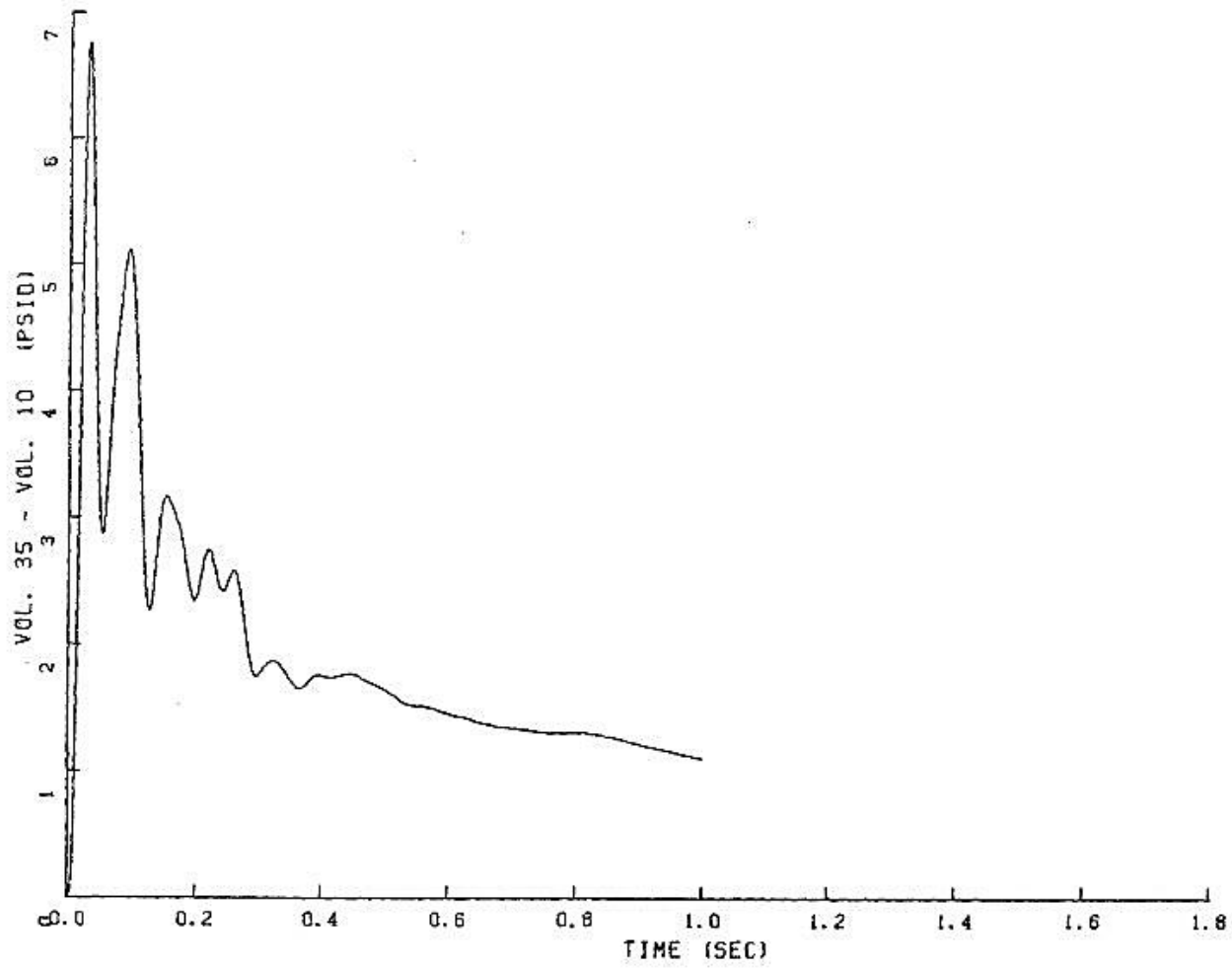

FIGURE 6.2.1-301

PEAK PRESSURE DIFFERENTIAL IN PRESSURIZER COMPARTMENT

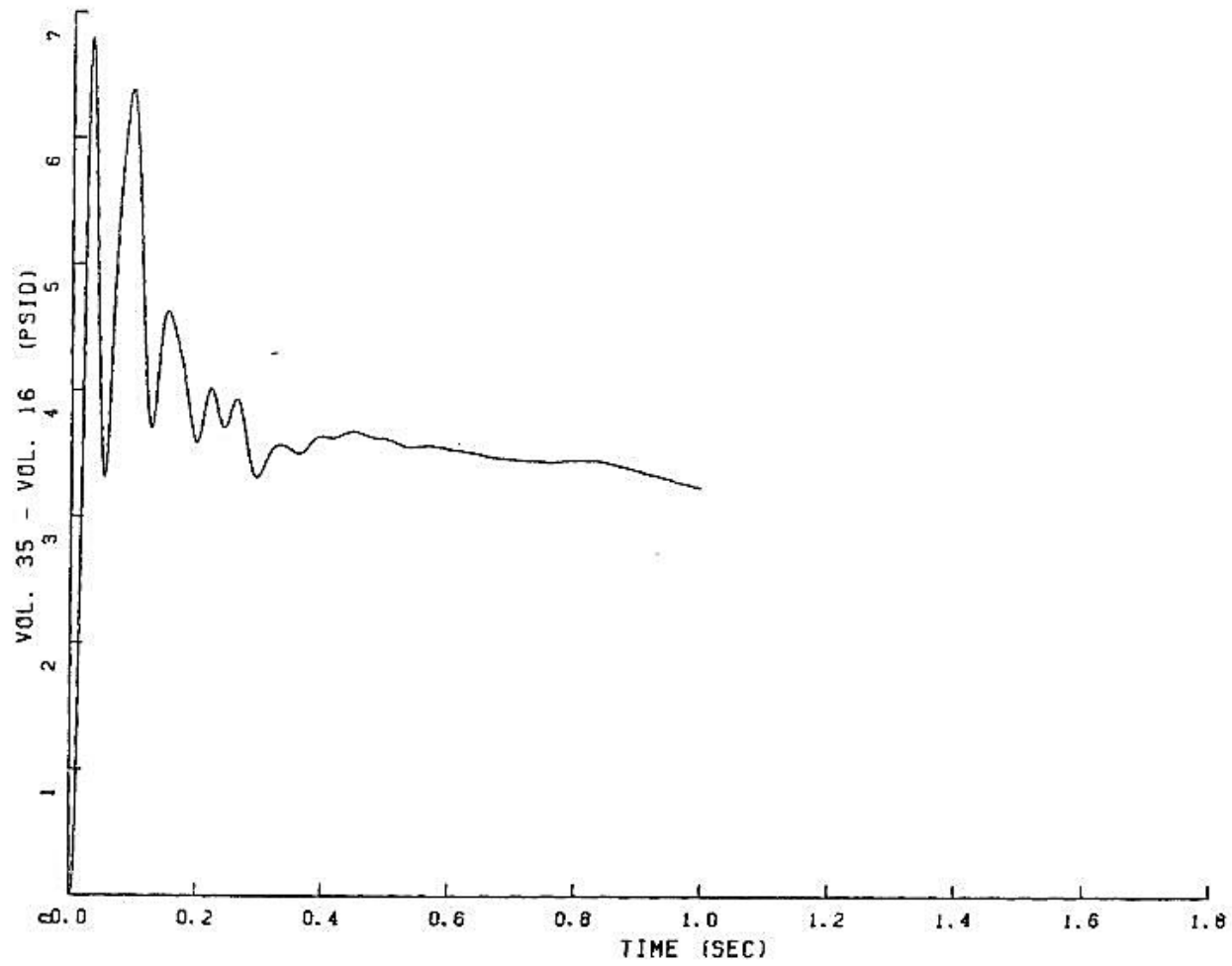

FIGURE 6.2.1-303

HEAT REMOVAL RATE OF EMERGENCY COOLER UNIT

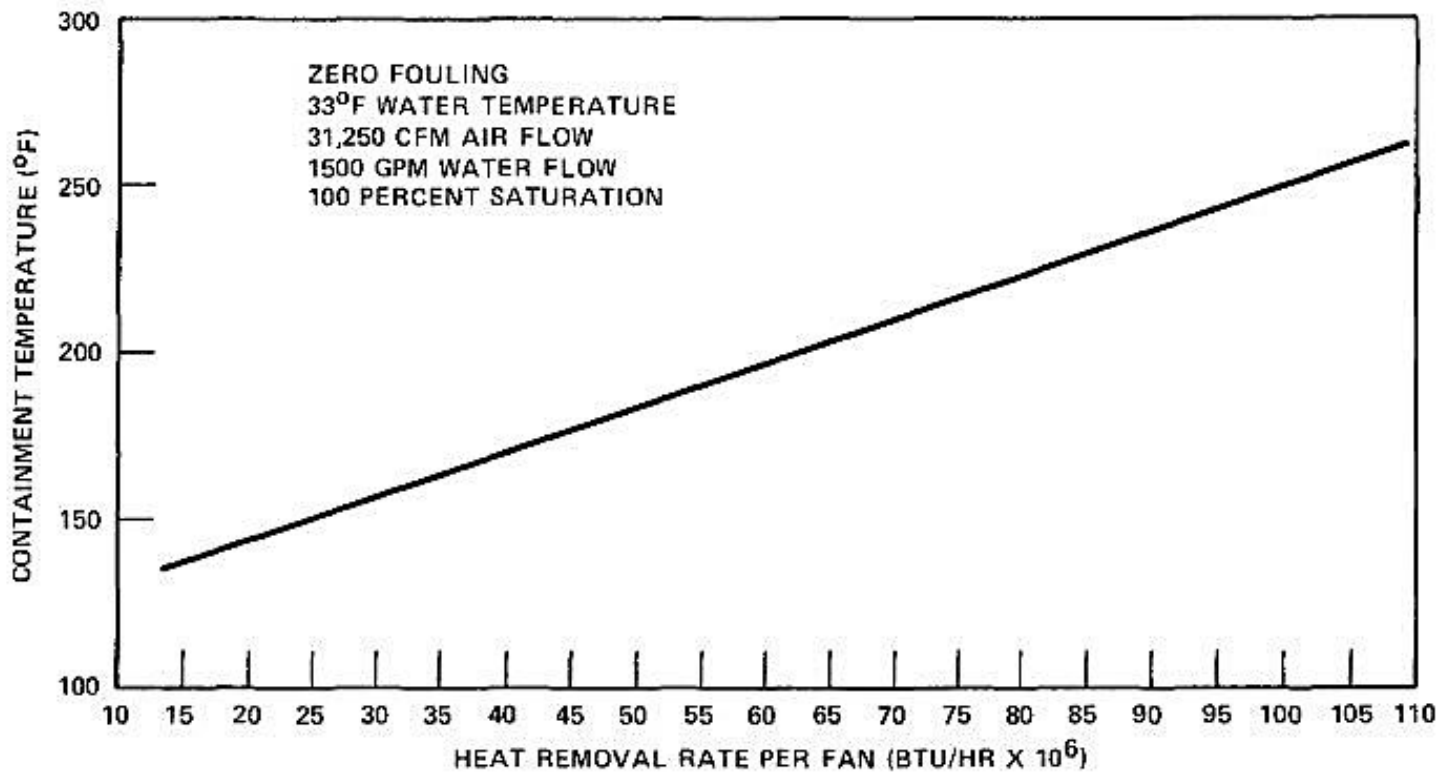
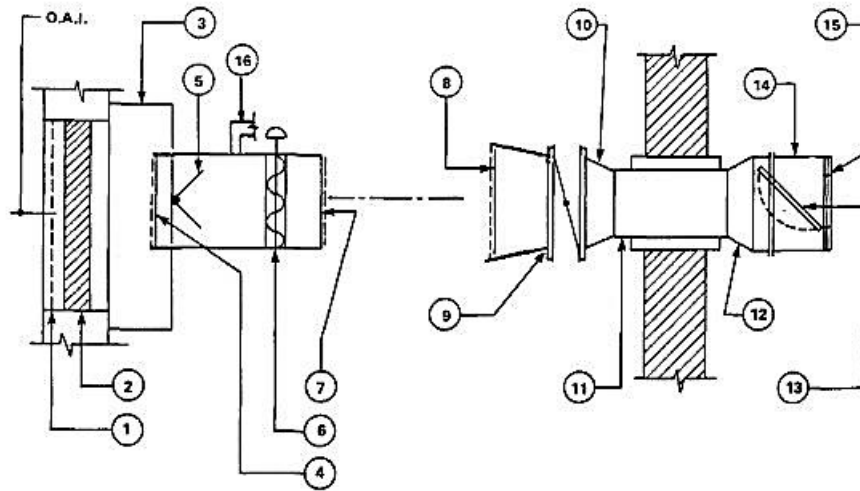

FIGURE 6.2.1-306

CONTAINMENT VACUUM RELIEF SYSTEM



<u>ELEMENT NO.</u>	<u>DESCRIPTION</u>
1	ENTRY WITH SCREEN
2	LOUVER
3	EXIT TO PLENUM
4	ENTRY WITH SCREEN
5	TORNADO DAMPER
6	DAMPER
7	EXIT WITH SCREEN
8	BELL MOUTH ENTRY WITH SCREEN
9	BUTTERFLY VALVE
10	TRANSITION (CONTRACTION)
11	PIPE RUN
12	TRANSITION (EXPANSION)
13	VACUUM RELIEF VALVE
14	SPOOL PIECE
15	EXIT
16	DIVERGING TEE

FIGURE 6.2.1-307

FORCES ON THE REACTOR VESSEL COLD LEG NOZZLE 150 IN² BREAK

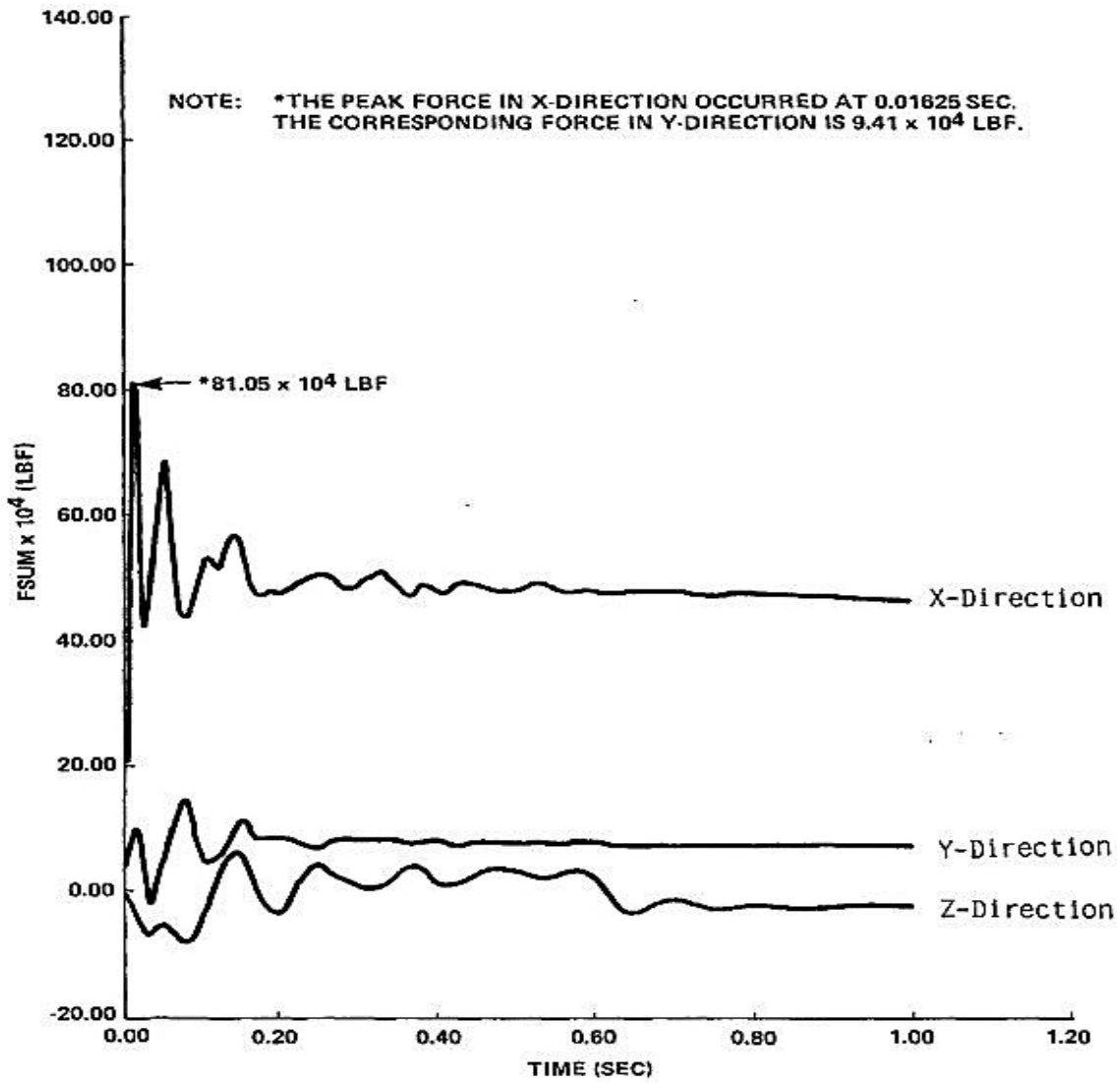

FIGURE 6.2.1-308

MOMENTS ON THE REACTOR VESSEL COLD LEG NOZZLE 150 IN² BREAK

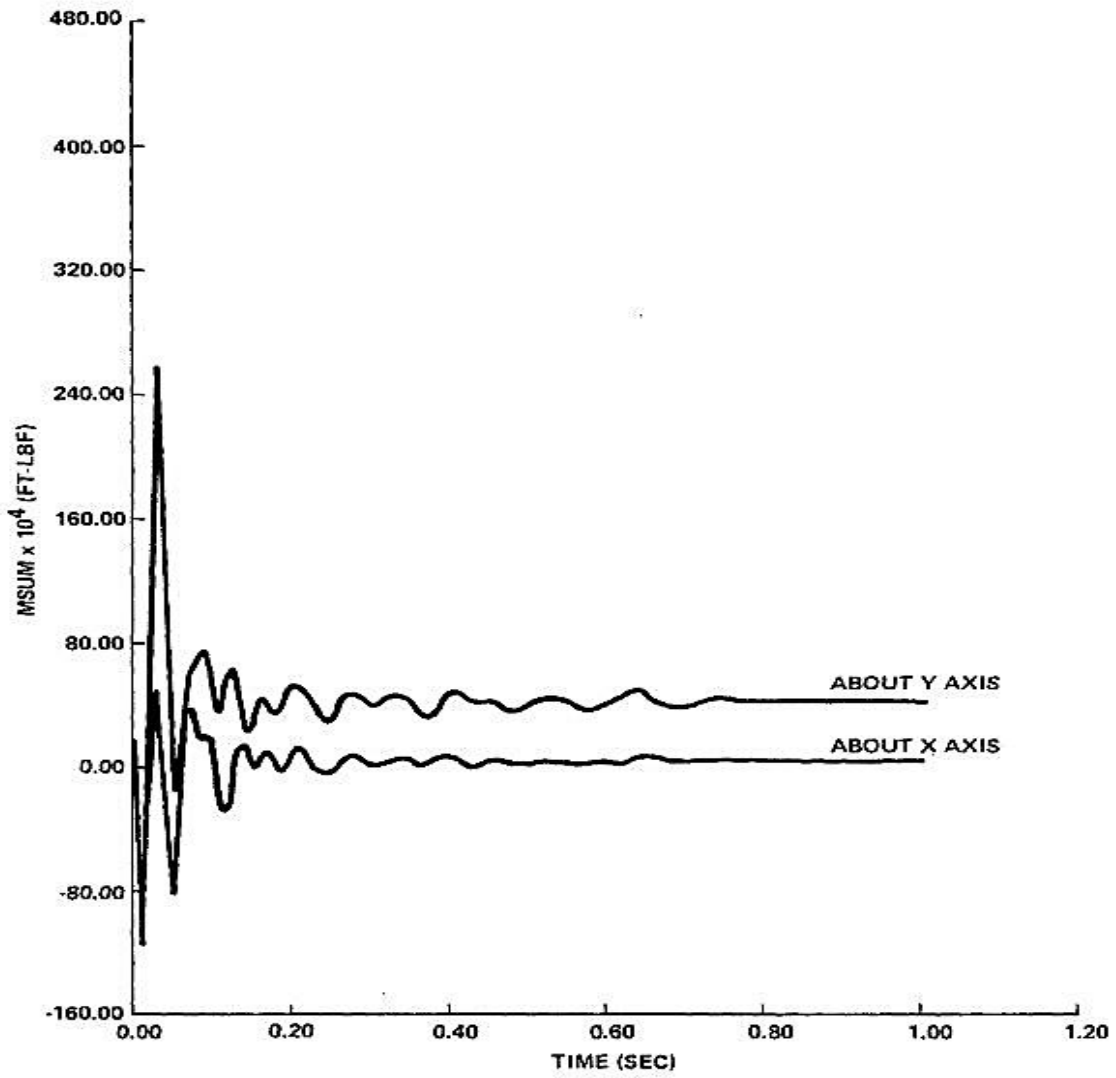

FIGURE 6.2.2-4

CONTAINMENT FAN COOLER PERFORMANCE CURVE

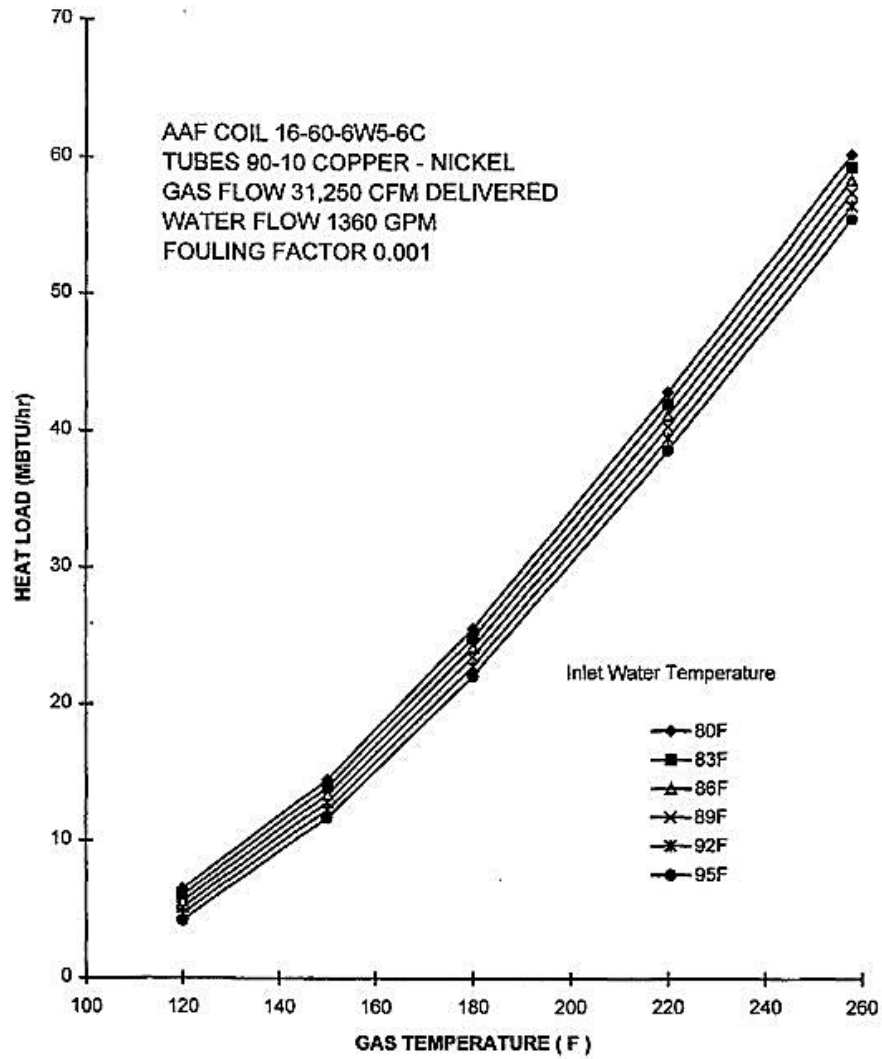

FIGURE 6.2.2-6
CONTAINMENT SPRAY NOZZLE DROP SIZE HISTOGRAM

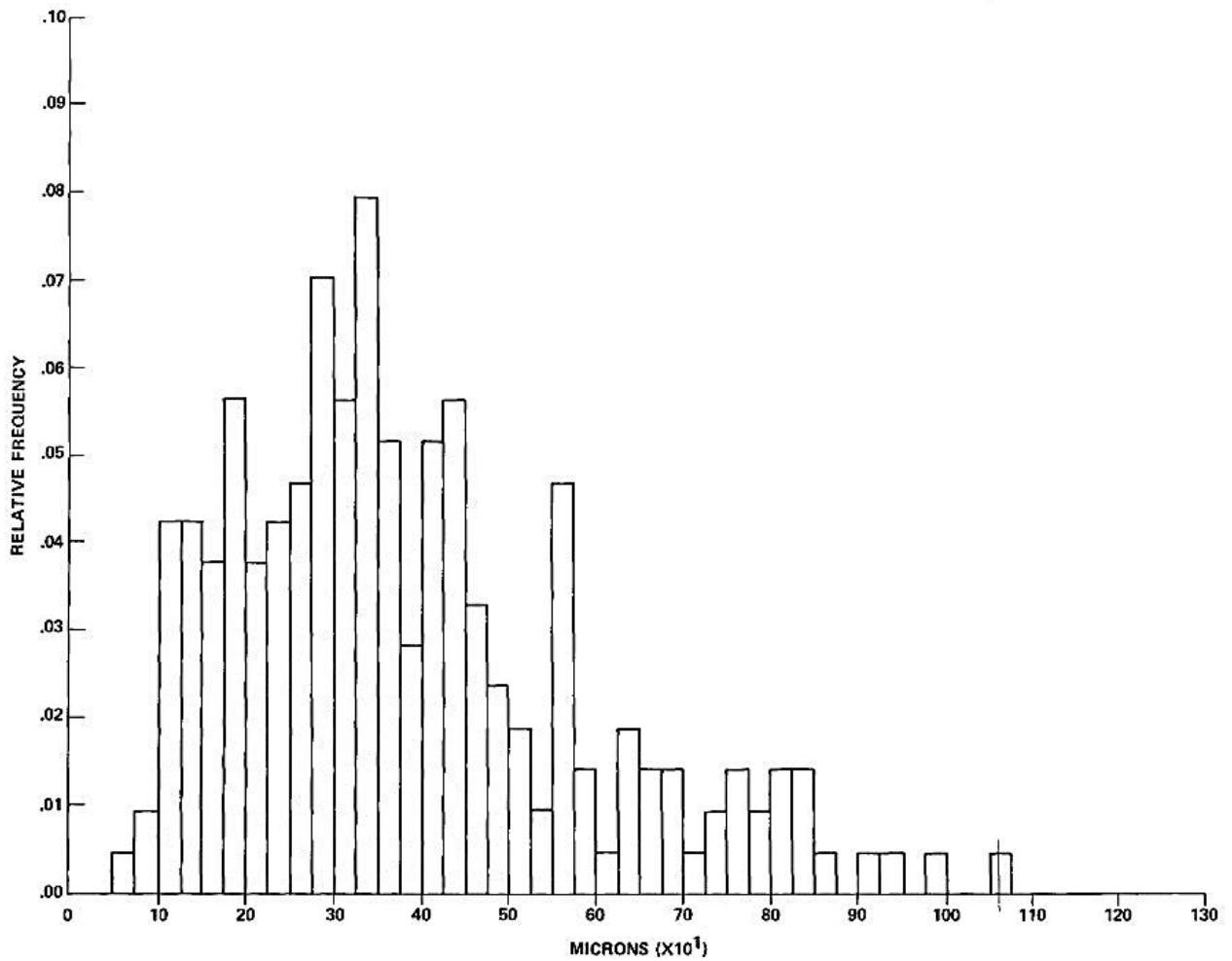

FIGURE 6.2.2-7
CONTAINMENT SUMP PLAN

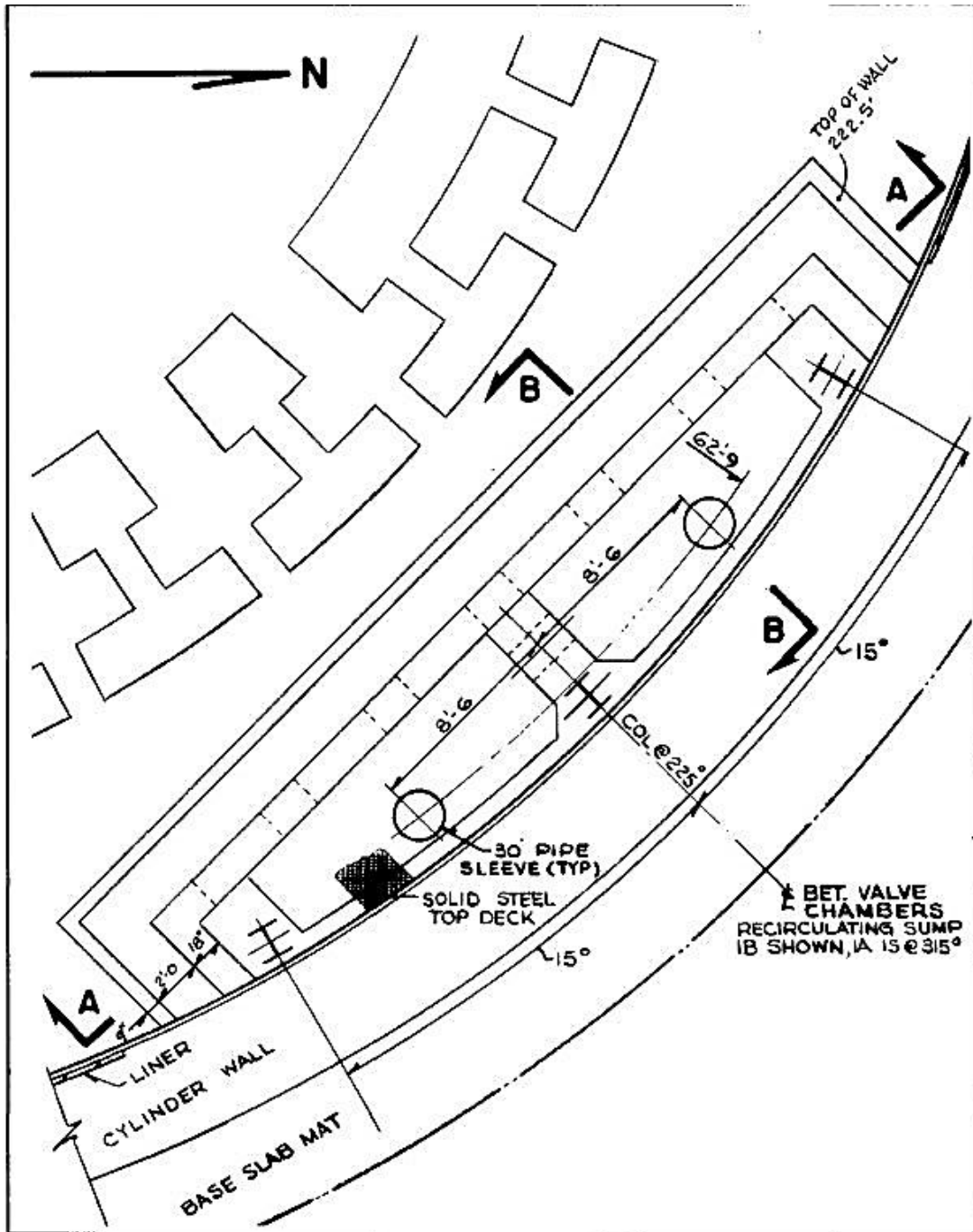

FIGURE 6.2.2-8

CONTAINMENT SUMP SECTION "A – A"

Security-Related Information - Figure Withheld Under 10 CFR 2.390

FIGURE 6.2.2-9

CONTAINMENT SUMP SECTION "B – B"

Security-Related Information - Figure Withheld Under 10 CFR 2.390

FIGURE 6.2.2-17
CONTAINMENT SPRAY PUMP PERFORMANCE CURVE

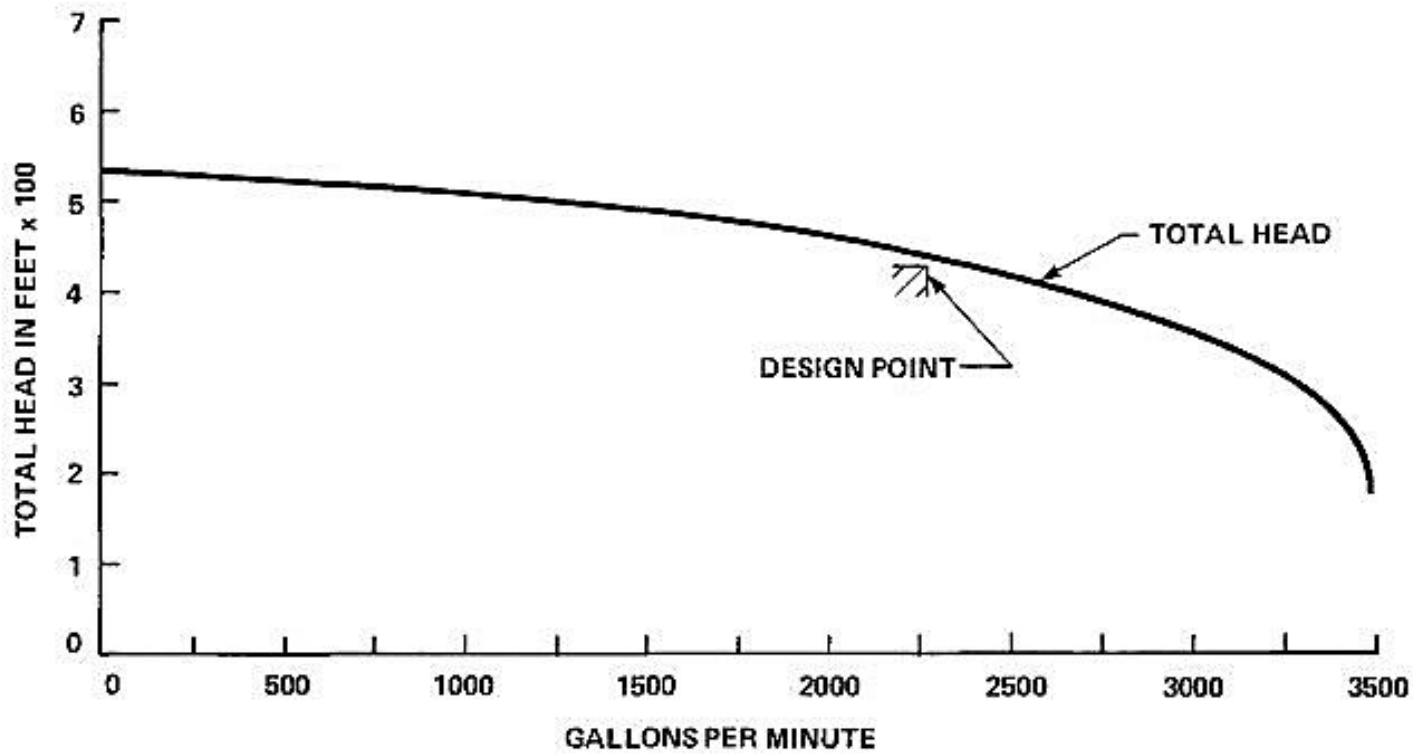

FIGURE 6.2.2-18

RESIDUAL HEAT REMOVAL PUMP PERFORMANCE CURVE

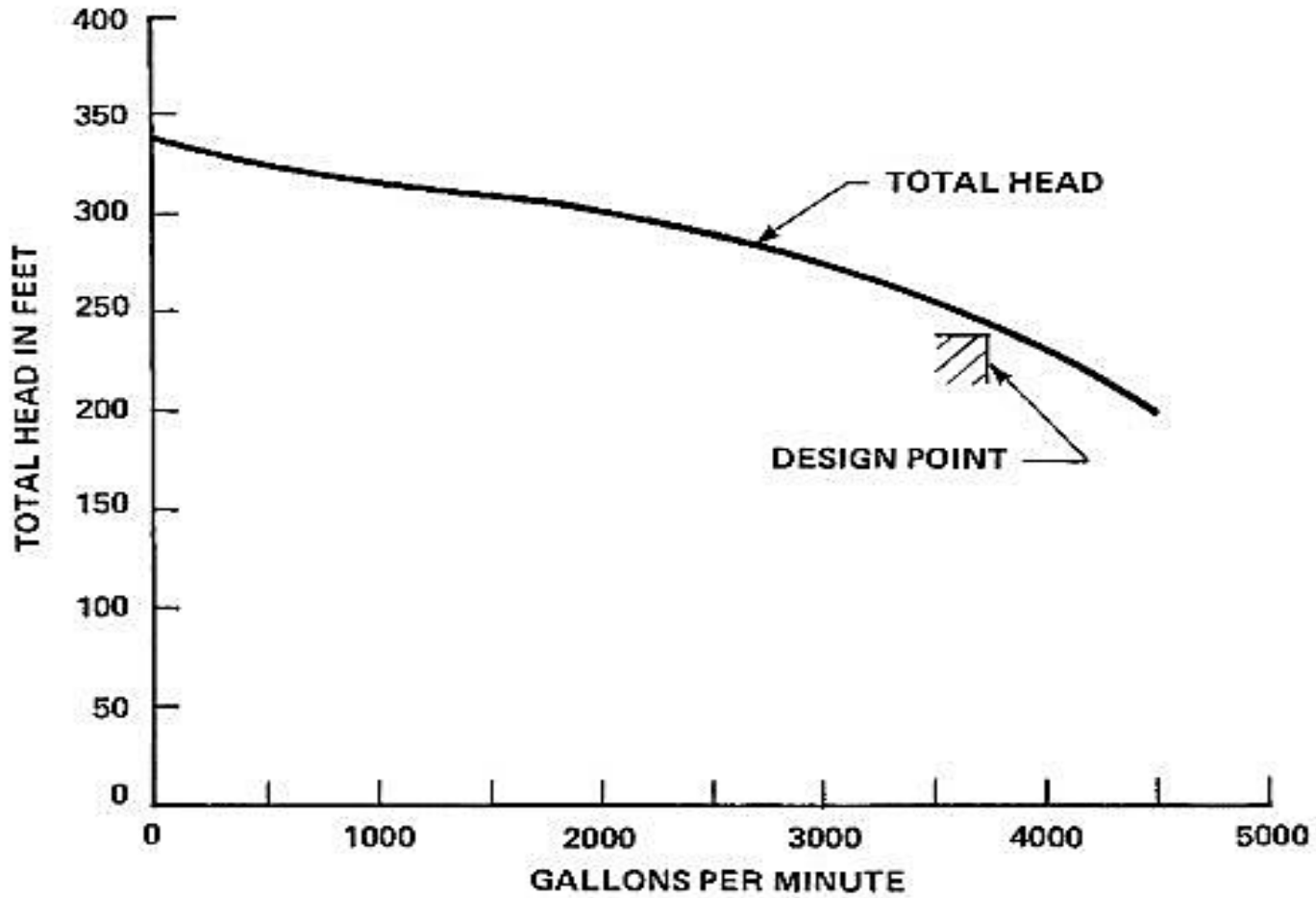
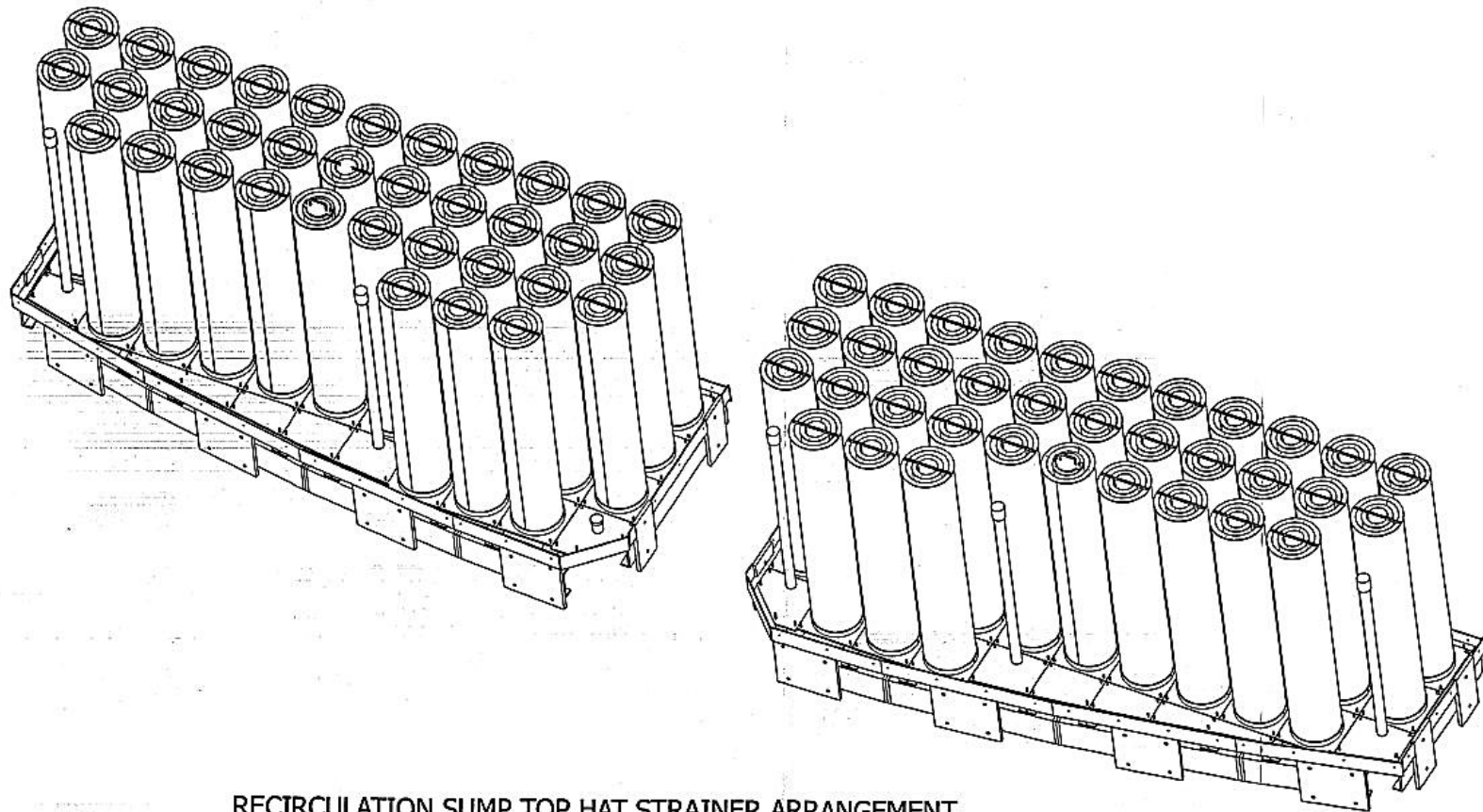

FIGURE 6.2.2-20

CONTAINMENT BUILDING RECIRCULATION SUMP STRAINER ISOMETRIC



RECIRCULATION SUMP TOP HAT STRAINER ARRANGEMENT
TYPICAL OF SUMPS 1A AND 1B

FIGURE 6.2.5-7
POST ACCIDENT HYDROGEN MONITORING SYSTEM

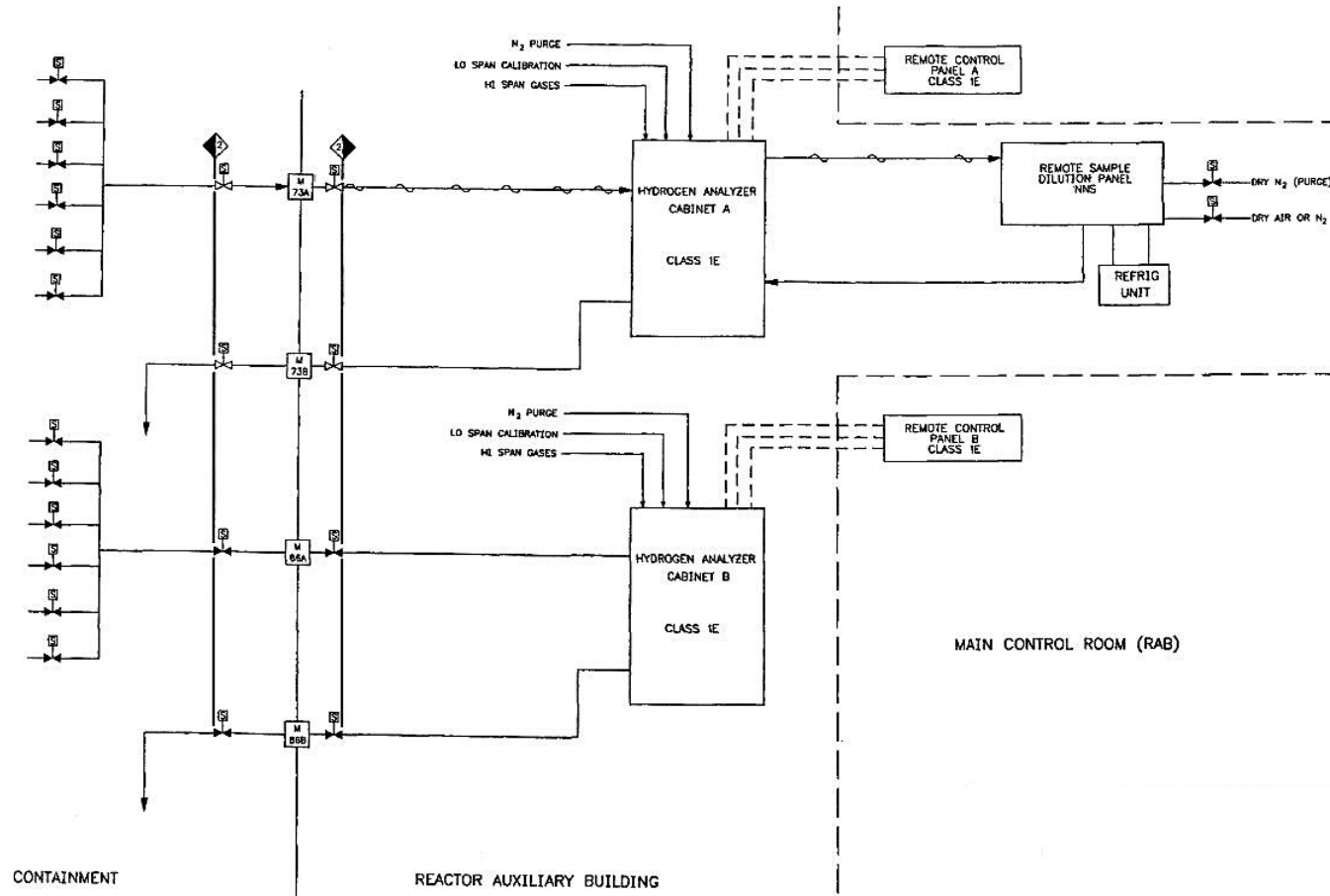

FIGURE 6.2A-1

TEMPERATURE GRADIENT IN GASEOUS & LIQUID BOUNDARY LAYERS DURING HEAT SINK SURFACE CONDENSATION

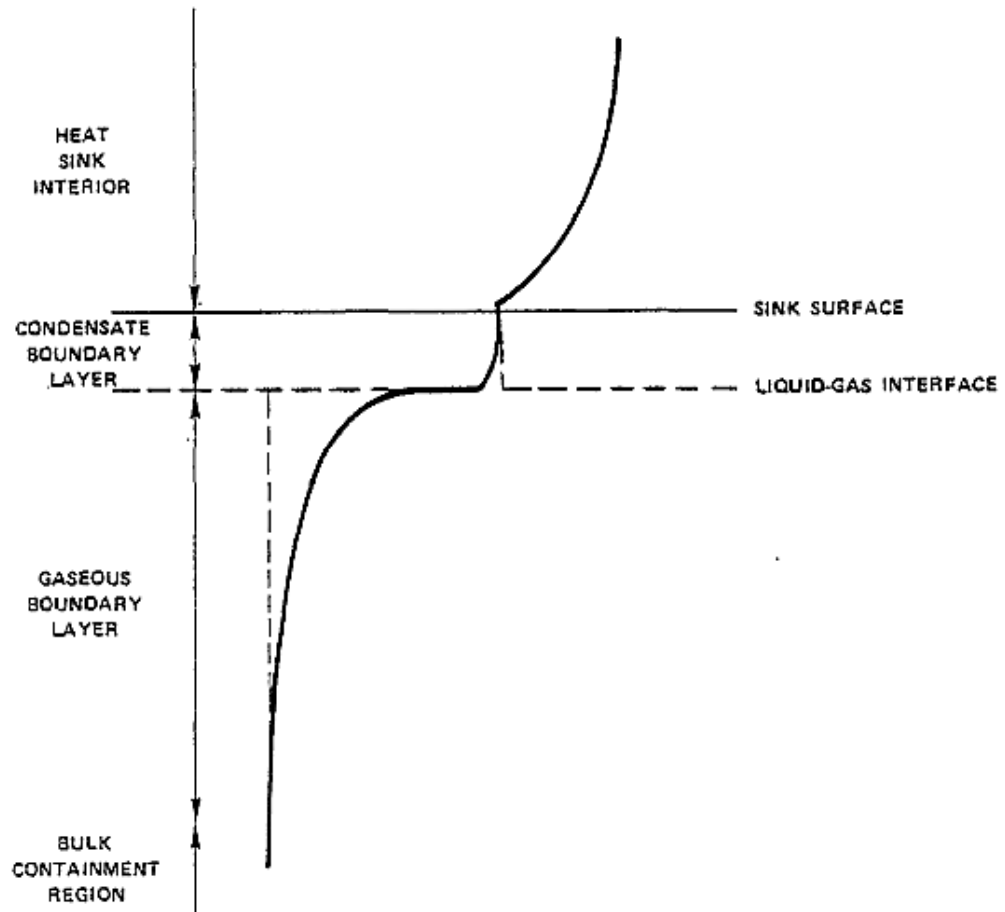
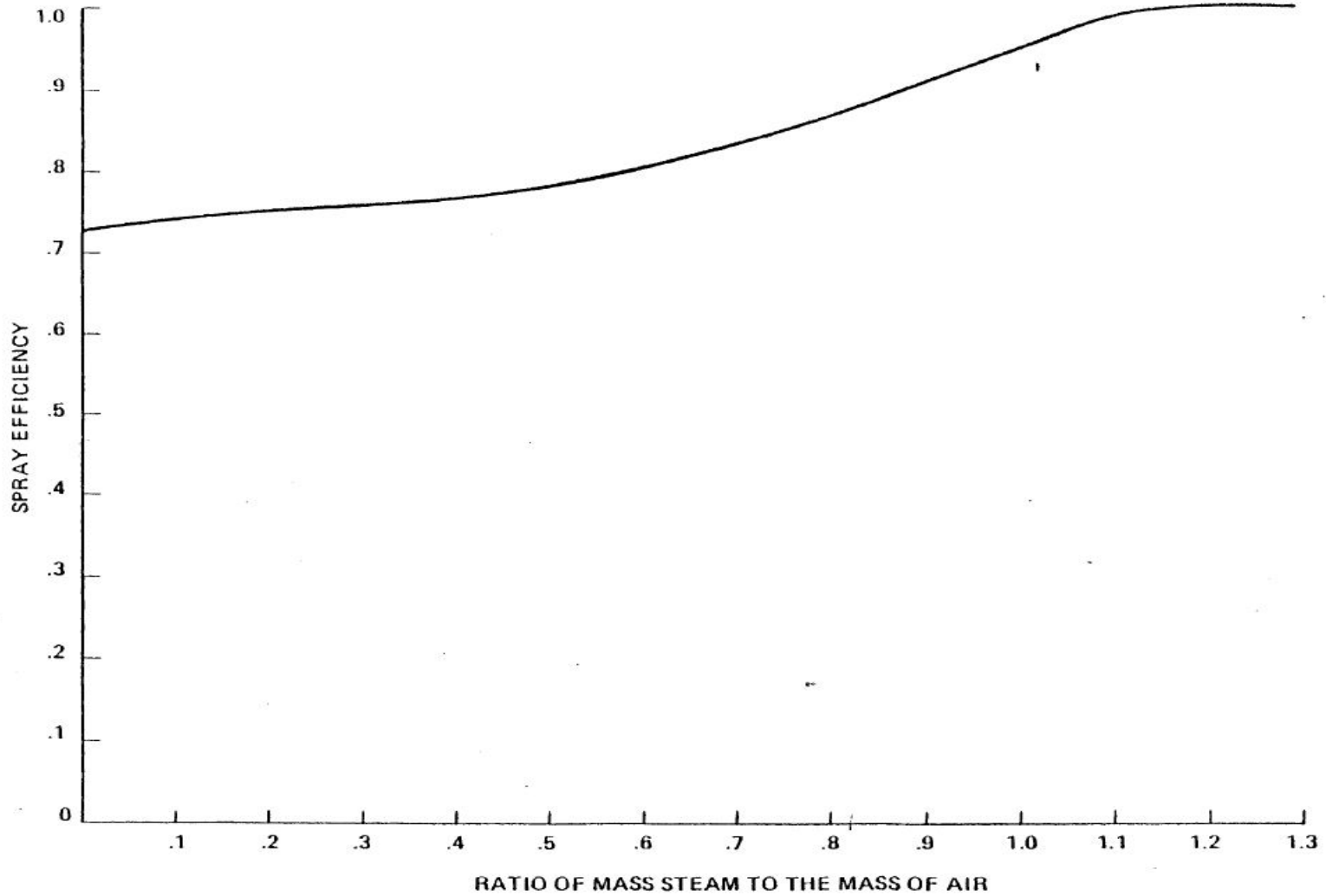

FIGURE 6.2A-2
SPRAY EFFICIENCY VS STEAM/AIR RATIO



NOTES TO FIGURES 6.3.2-4 THROUGH 6.3.2-6

The process flow diagrams are provided for illustrative purposes only and are not intended to represent the flow rates or temperatures used in various accident analyses. The process flow diagrams are developed to provide representative system performance data based on minimum safeguards systems alignment.* The flow rates in the FSAR accident analyses are conservatively applied.

* Valve alignments are provided for all principle modes of ECCS operation.

NOTES TO FIGURES 6.3.2-4 THROUGH 6.3.2-6 (Continued)

VALVE ALIGNMENT TABLE
PRINCIPLE MODES OF ECCS OPERATION

Valve No.	A Normal Standby	B Injection Maximum Safeguards	C Injection Minimum Safeguards (Train A Only)	D Cold Leg Recirculation Maximum Safeguards	E Cold Leg Recirculation Minimum Safeguards (Train A Only)	F Hot Leg Recirculation Maximum Safeguards	G Hot Leg Recirculation Minimum Safeguards (Train A Only)
1A	O	O	O	C	C	C	C
1B	O	O	O	C	O	C	O
2A	O	O	O	O	O	O	O
2B	O	O	O	O	O	O	O
3A	C	C	C	C	C	C	C
3B	C	C	C	C	C	C	C
4A	O	C	C	C	C	C	C
4B	O	C	O	C	O	C	O
5A	C	C	C	O	O	O	O
5B	C	C	C	O	C	O	C
6A	O	O	O	O	O	O	O
6B	O	O	O	O	O	O	O
7A	O	O	O	O	O	C	C
7B	O	O	O	C*	C*	C	O
8	C	C	C	C	C	O	O
9A	C	C	C	O	O	O	O
9B	C	C	C	O	C	O	C
10A	C	C	C	O	O	O	O
10B	C	C	C	O	C	O	C
11A	C	C	C	C	C	C	C
11B	C	C	C	C	C	C	C
12A	C	C	C	C	C	C	C
12B	C	C	C	C	C	C	C
13A	C	O	O	C	C	C	C
13B	C	O	C	C	C	C	C
14A	O	C	C	C	C	C	C
14B	O	C	O	C	O	C	O
15A	O	O	O	O	O	O	O
15B	O	O	O	O	O	O	O
16A	O	O	O	O	O	O	O
16B	O	O	O	O	O	O	O
17A	O	O	O	C	O	C	O
17B	O	O	O	C	O	C	O
18A	O	O	O	C	O	C	O
18B	O	O	O	C	O	C	O
19A	O	C	O	C	O	C	O
19B	O	C	O	C	O	C	O
19C	O	C	O	C	O	C	O
20	O	C	C	C	C	C	C
21A	O	C	C	C	C	C	C
21B	O	C	O	C	O	C	O
22A	O	O	O	O	O	O	O
22B	O	O	O	O	O	O	O
23A	C	O	O	O	O	C	C
23B	C	O	C	O	C	C	C
24	C	C	C	C	C	O	C

Valve No.	A Normal Standby	B Injection Maximum Safeguards	C Injection Minimum Safeguards (Train A Only)	D Cold Leg Recirculation Maximum Safeguards	E Cold Leg Recirculation Minimum Safeguards (Train A Only)	F Hot Leg Recirculation Maximum Safeguards	G Hot Leg Recirculation Minimum Safeguards (Train A Only)
25	C	C	C	C	C	O	O
26	C	C	C	O	C	C	C
29A	O	O	O	O	O	O	O
29B	O	O	O	O	O	O	O
29C	O	O	O	O	O	O	O

NOTES TO FIGURES 6.3.2-4 THROUGH 6.3.2-6 (Continued)PROCESS TABLES MODES OF OPERATION

MODE C - INJECTION/MINIMUM SAFEGUARDS - TRAIN A OPERATING

This mode represents the process conditions for the case of minimum safeguards with RHR pump 1 and CC pump 1 taking suction from the RWST and delivering to the reactor through three cold leg connections.

MODE E - COLD LEG RECIRCULATION/MINIMUM SAFEGUARDS - TRAIN A OPERATING

This mode represents the case of cold leg recirculation with RHR pump 1 on and CC pump 1 operating. In this mode the safeguards pumps operate in series, with only RHR pump 1 capable of taking suction from the containment sump. The recirculated coolant is then delivered by RHR pump 1 to CC pump 1, which delivers to the reactor through three cold leg connections. The RHR pump also delivers flow directly to the reactor through the same three cold leg connections.

MODE G - HOT LEG RECIRCULATION/MINIMUM SAFEGUARDS - TRAIN A OPERATING

This mode represents the case of hot leg recirculation with RHR pump 1 and CC pump 1 operating. In this mode, the safeguards pump again operate in series with only RHR pump 1 taking suction from the containment sump. The recirculated coolant is then delivered by RHR pump 1 to CC pump 1, which delivers to the reactor through three hot leg connections. The RHR pump also delivers directly to the reactor through two hot leg connections. Amendment

NOTES TO FIGURES 6.3.2-4 THROUGH 6.3.2-6 (Continued)

PROCESS TABLE MODE C

Location	Fluid	Pressure (psig)	Temperature (F)	Flow (gpm)
1	Refueling Water	0	70	-
2	Refueling Water	0	70	6160
3	Refueling Water	0	70	2400
4	Refueling Water	0	70	650
5A	Refueling Water	0	70	3760
5B	Refueling Water	-	-	0
6A	Refueling Water	110	70	3760
6B	Refueling Water	-	-	0
7A	Refueling Water	-	70	3760
7B	Refueling Water	-	-	0
8A	Refueling Water	80	70	3760
8B	Refueling Water	-	-	0
9A	Refueling Water	-	-	0
9B	Refueling Water	-	-	0
10A	Refueling Water	-	-	0
10B	Refueling Water	-	-	0
11A	Refueling Water	~50	70	3760
11B	Refueling Water	-	-	0
12	Refueling Water	0	70	1490
13	Refueling Water	0	70	1470
14	Refueling Water	0	70	1400
15	Refueling Water	-	-	0
16	Refueling Water	-	-	0
17	Refueling Water	-	-	0
20A	Reactor Coolant	-	-	0
20B	Reactor Coolant	-	-	0
21	Recirculating Coolant	-	-	0
22A	Recirculating Coolant	-	-	0
22B	Recirculating Coolant	-	-	0
40	Refueling Water	0	70	650
41A	Refueling Water	0	70	650
41B	Refueling Water	-	-	0
42	Refueling Water	-	-	0
43A	Refueling Water	0	70	650
43B	Refueling Water	-	-	0
43S	Refueling Water	-	-	0
44	Refueling Water	-	-	0
45A	Refueling Water	1430	70	650
45B	Refueling Water	-	-	0
45S	Refueling Water	-	-	0
46	Refueling Water	-	-	0
47	Refueling Water	1300	70	50
48	Refueling Water	1300	70	600
49	Refueling Water	-	70	600
50A	Refueling Water	-	-	0
50B	Refueling Water	1000	70	600
51A	Refueling Water	-	-	0
52A	Refueling Water	-	-	0
53A	Refueling Water	-	-	0
51B	Refueling Water	100	70	200
52B	Refueling Water	100	70	200
53B	Refueling Water	100	70	200
54A	Refueling Water	-	-	0
55A	Refueling Water	-	-	0
54B	Refueling Water	-	-	0
55B	Refueling Water	-	-	0
56	Refueling Water	-	-	0
57A	Refueling Water	-	-	0

57B	Refueling Water	-	-	0
60	Nitrogen	0	120	0
61	Nitrogen	0	120	0
62	Nitrogen	0	120	0

NOTES TO FIGURES 6.3.2-4 THROUGH 6.3.2-6 (Continued)

PROCESS TABLE MODE E

Location	Fluid	Pressure (psig)	Temperature (F)	Flow (gpm)
1	Refueling Water	-	-	-
2	Refueling Water	-	-	0
3	Refueling Water	-	-	0
4	Refueling Water	-	-	0
5A	Recirculating Water	12	244	3820
5B	Recirculating Water	-	-	0
6A	Recirculating Water	115	244	3820
6B	Recirculating Water	-	-	0
7A	Recirculating Water	-	244	3820
7B	Recirculating Water	-	-	0
8A	Recirculating Water	85	180	3820
8B	Recirculating Water	-	-	0
9A	Recirculating Water	85	180	650
9B	Recirculating Water	-	-	0
10A	Recirculating Water	-	-	0
10B	Recirculating Water	-	-	0
11A	Recirculating Water	~60	180	3160
11B	Recirculating Water	-	-	0
12	Recirculating Water	0	180	1620
13	Recirculating Water	0	180	1170
14	Recirculating Water	0	180	970
15	Refueling Water	-	-	0
16	Refueling Water	-	-	0
17	Refueling Water	-	-	0
20A	Recirculating Water	-	-	0
20B	Recirculating Water	-	-	0
21	Recirculating Water	0	244	3820
22A	Recirculating Water	0	244	3820
22B	Recirculating Water	-	-	0
40	Recirculating Water	-	-	0
41A	Recirculating Water	-	-	0
41B	Recirculating Water	-	-	0
42	Recirculating Water	-	-	0
43A	Recirculating Water	65	180	650
43B	Recirculating Water	-	-	0
43S	Recirculating Water	-	-	0
44	Refueling Water	-	-	0
45A	Recirculating Water	1475	180	650
45B	Recirculating Water	-	-	0
45S	Recirculating Water	-	-	0
46	Recirculating Water	-	-	0
47	Recirculating Water	1345	180	50
48	Recirculating Water	1345	180	600
49	Recirculating Water	-	180	600
50A	Recirculating Water	-	-	0
50B	Recirculating Water	1045	180	600
51A	Recirculating Water	-	-	0
52A	Recirculating Water	-	-	0
53A	Recirculating Water	-	-	0
51B	Recirculating Water	100	180	200
52B	Recirculating Water	100	180	200
53B	Recirculating Water	100	180	200
54A	Refueling Water	-	-	0
55A	Refueling Water	-	-	0
54B	Refueling Water	-	-	0
55B	Refueling Water	-	-	0
56	Refueling Water	-	-	0
57A	Refueling Water	-	-	0

57B	Refueling Water	-	-	0
60	Nitrogen	0	120	0
61	Nitrogen	0	120	0
62	Nitrogen	0	120	0

NOTES TO FIGURES 6.3.2-4 THROUGH 6.3.2-6 (Continued)

PROCESS TABLE MODE G

Location	Fluid	Pressure (psig)	Temperature (F)	Flow (gpm)
1	Refueling Water	-	-	-
2	Refueling Water	-	-	0
3	Refueling Water	-	-	0
4	Refueling Water	-	-	0
5A	Recirculating Water	12	180	3710
5B	Recirculating Water	-	-	0
6A	Recirculating Water	115	180	3710
6B	Recirculating Water	-	-	0
7A	Recirculating Water	-	180	3710
7B	Recirculating Water	-	-	0
8A	Recirculating Water	85	125	3710
8B	Recirculating Water	-	-	0
9A	Recirculating Water	85	125	650
9B	Recirculating Water	-	-	0
10A	Recirculating Water	-	-	0
10B	Recirculating Water	-	-	0
11A	Recirculating Water	~60	125	3060
11B	Recirculating Water	-	-	0
12	Recirculating Water	-	-	0
13	Recirculating Water	-	-	0
14	Recirculating Water	-	-	0
15	Recirculating Water	55	125	3060
16	Recirculating Water	0	125	1730
17	Recirculating Water	0	125	1730
20A	Recirculating Water	-	-	0
20B	Recirculating Water	-	-	0
21	Recirculating Water	-	-	0
22A	Recirculating Water	0	180	3710
22B	Recirculating Water	-	-	0
40	Refueling Water	-	-	0
41A	Recirculating Water	-	-	0
41B	Recirculating Water	-	-	0
42	Recirculating Water	-	-	0
43A	Recirculating Water	65	125	650
43B	Recirculating Water	-	-	0
43S	Recirculating Water	-	-	0
44	Refueling Water	-	-	0
45A	Recirculating Water	1480	125	650
45B	Recirculating Water	-	-	0
45S	Recirculating Water	-	-	0
46	Recirculating Water	-	-	0
47	Recirculating Water	1350	125	50
48	Recirculating Water	-	-	0
49	Recirculating Water	-	-	0
50A	Recirculating Water	-	-	0
50B	Recirculating Water	-	-	0
51A	Recirculating Water	-	-	0
52A	Recirculating Water	-	-	0
53A	Recirculating Water	-	-	0
51B	Recirculating Water	-	-	0
52B	Recirculating Water	-	-	0
53B	Recirculating Water	-	-	0
54A	Recirculating Water	100	125	200
55A	Recirculating Water	100	125	200
54B	Recirculating Water	-	-	0
55B	Recirculating Water	-	-	0
56	Recirculating Water	0	125	200
57A	Recirculating Water	1125	125	600

57B	Recirculating Water	-	-	0
60	Nitrogen	0	120	0
61	Nitrogen	0	120	0
62	Nitrogen	0	120	0

FIGURE 6.3.2-4

EMERGENCY CORE COOLING SYSTEM PROCESS FLOW DIAGRAM SHEET 1

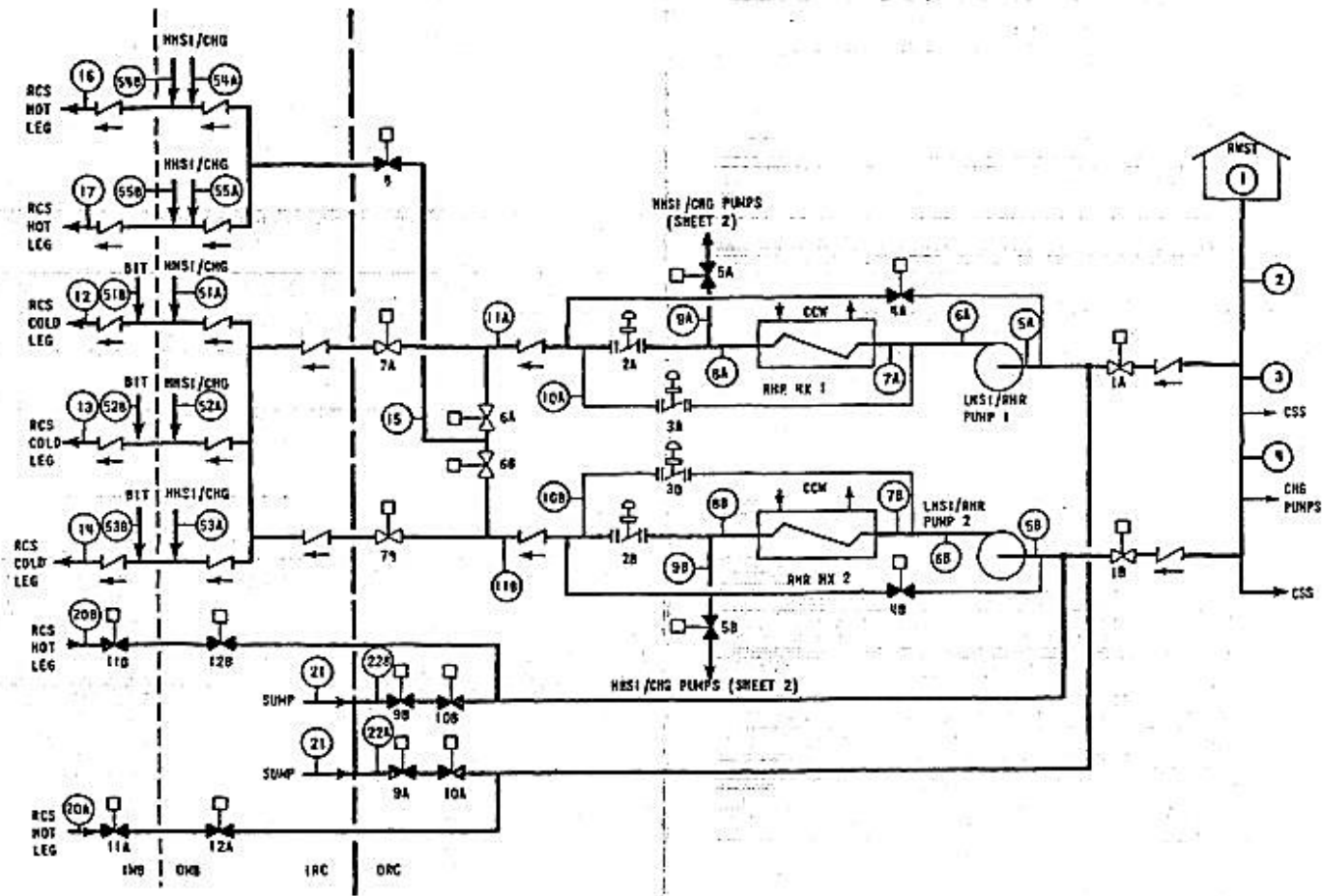
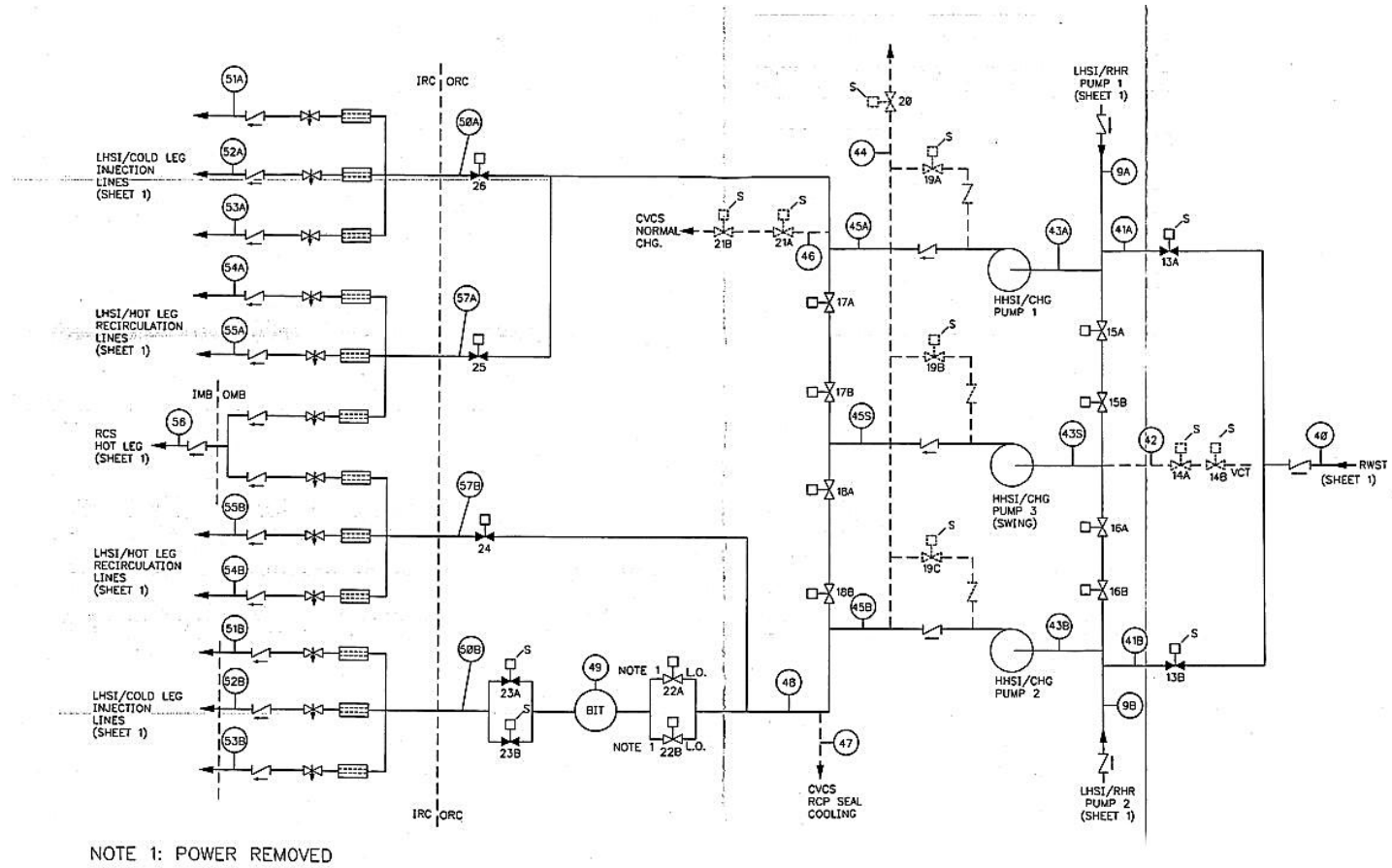

FIGURE 6.3.2-5

EMERGENCY CORE COOLING SYSTEM PROCESS FLOW DIAGRAM SHEET 2



NOTE 1: POWER REMOVED

FIGURE 6.3.2-6

EMERGENCY CORE COOLING SYSTEM PROCESS FLOW DIAGRAM SHEET 3

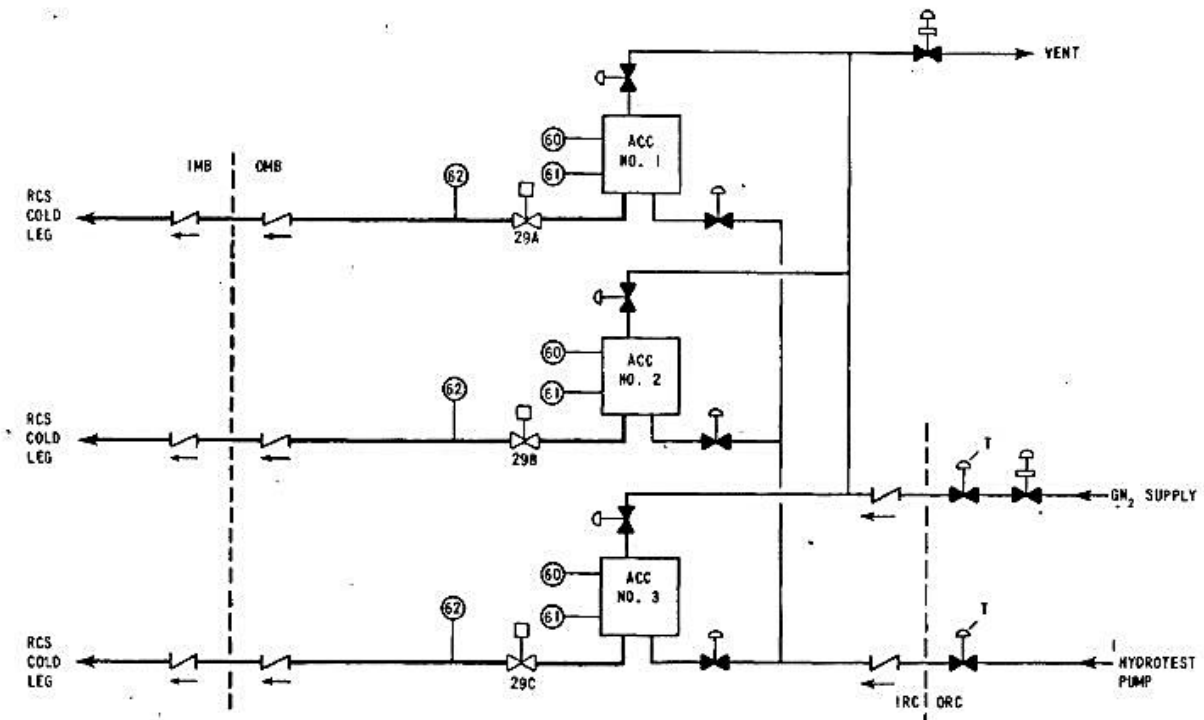

FIGURE 6.3.2-8
RHR PUMP PERFORMANCE CURVE

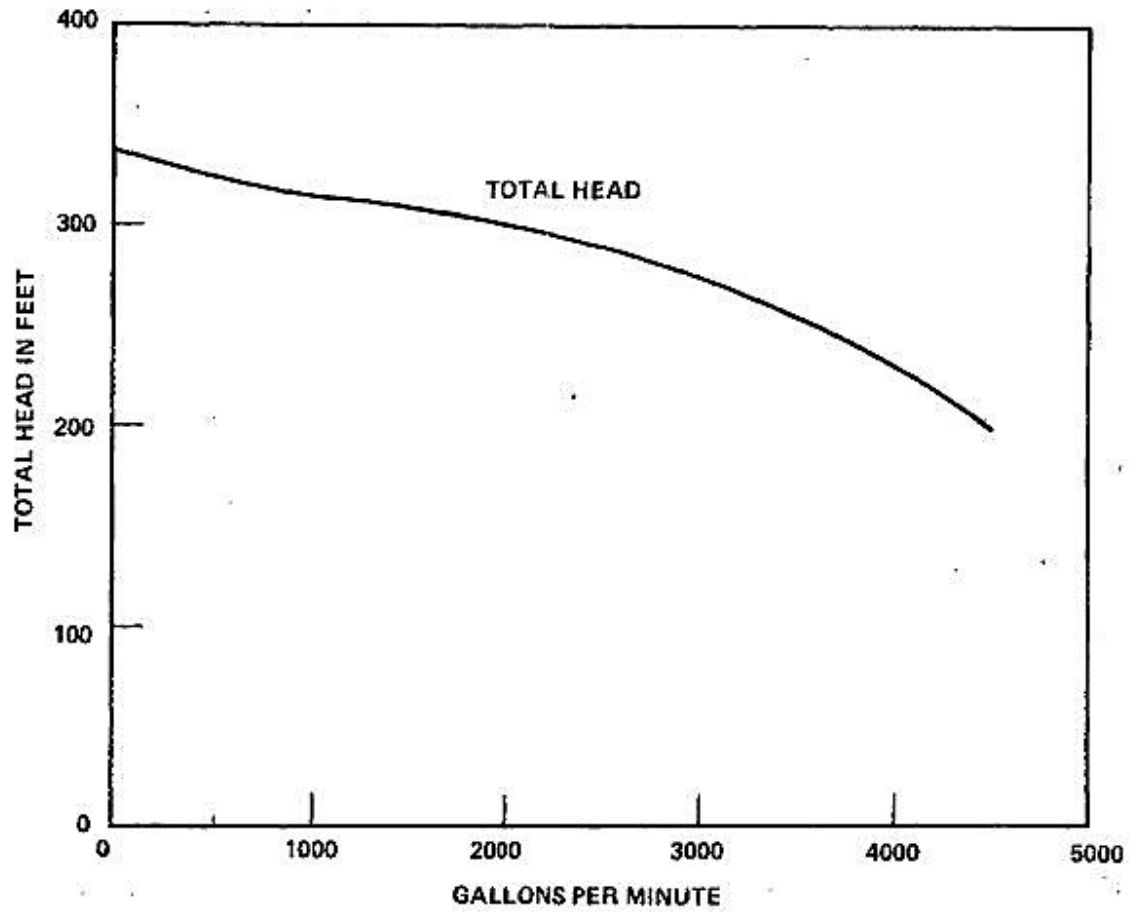

FIGURE 6.3.2-9
CHG PUMP PERFORMANCE CURVE

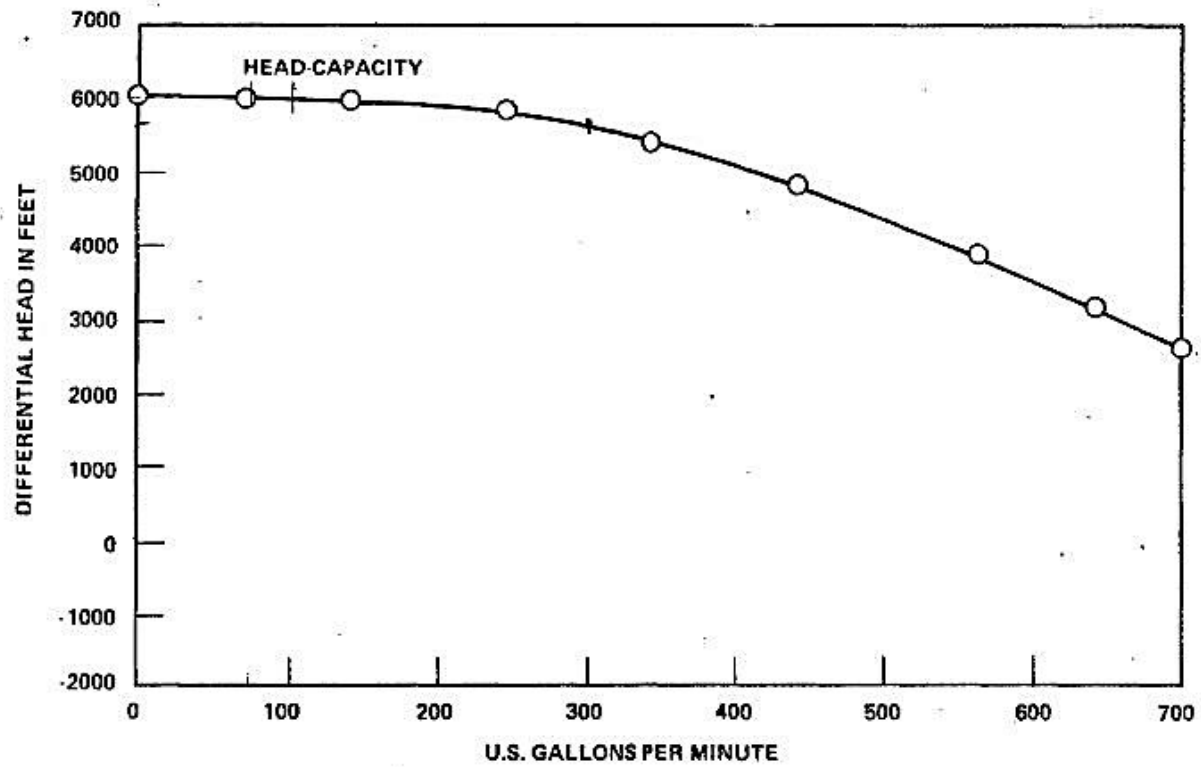

FIGURE 6.5.2-2

CONTAINMENT SPRAY PH TIME HISTORY OF CONTAINMENT SUMP & SPRAY
CASE 1

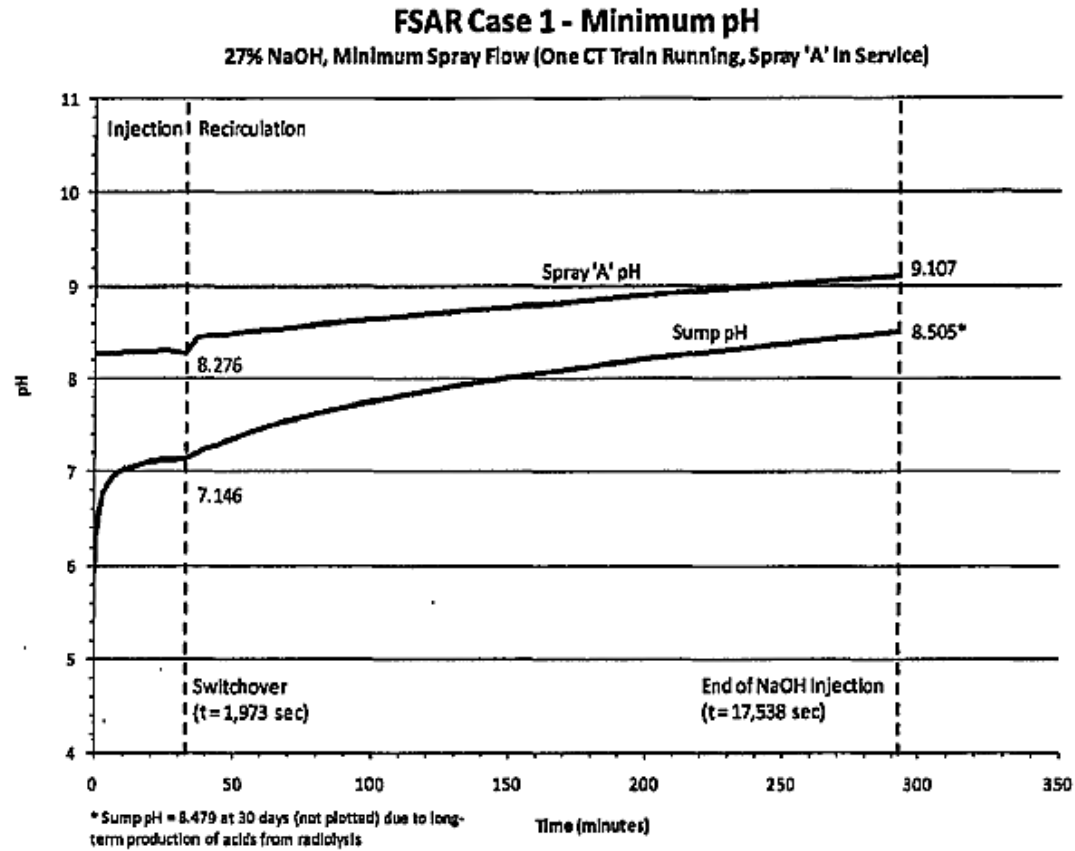

FIGURE 6.5.2-3

CONTAINMENT SPRAY PH TIME HISTORY OF CONTAINMENT SUMP & SPRAY
CASE 2

