



UNION ELECTRIC COMPANY

1901 Gratiot Street, St. Louis

Donald F. Schnell
Vice President

December 27, 1984

Mr. Harold R. Denton, Director
Office of Nuclear Reactor Regulation
U.S. Nuclear Regulatory Commission
Washington, DC 20555

ULNRC- 1004

Dear Mr. Denton:

DOCKET NUMBER 50-483
CALLAWAY PLANT, UNIT 1
ADDITION TO TECHNICAL SPECIFICATION TABLE 4.11-1

- References: 1) ULNRC-937 dated October 3, 1984
2) ULNRC-993 dated December 6, 1984

The referenced letters concern our Technical Specification change request associated with the addition of two Batch Waste Release Tanks. Transmitted herewith are piping and instrumentation diagrams which depict the additional tanks and their associated piping connections. These drawings were requested by NRC Staff (R. Fell and J. Stevens) in a telephone conversation on December 20, 1984.

If further information is needed, please contact us.

Very truly yours,

Robert Schnell
for Donald F. Schnell

DS/RJS/lkr

Attachments

8501020335 841227
PDR ADOCK 05000483
P PDR

*A001 Aperture.
1/3 Card Dist
Drawing
To: Key File-1
J. Holanick-2*

STATE OF MISSOURI)
) S S
CITY OF ST. LOUIS)

Robert J. Schukai, of lawful age, being first duly sworn upon oath says that he is General Manager-Engineering (Nuclear) for Union Electric Company; that he has read the foregoing document and knows the content thereof; that he has executed the same for and on behalf of said company with full power and authority to do so; and that the facts therein stated are true and correct to the best of his knowledge, information and belief.

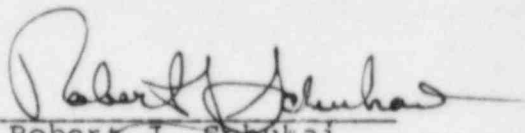
By 
Robert J. Schukai
General Manager-Engineering
Nuclear

SUBSCRIBED and sworn to before me this *27th* day of *December* 1984.

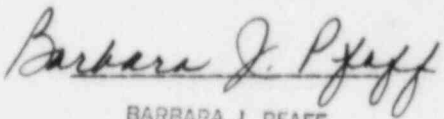
BARBARA J. PFAFF
NOTARY PUBLIC, STATE OF MISSOURI
MY COMMISSION EXPIRES APRIL 22, 1985
ST. LOUIS COUNTY

cc: Gerald Charnoff, Esq.
Shaw, Pittman, Potts & Trowbridge
1800 M. Street, N.W.
Washington, D.C. 20036

Nicholas A. Petrick
Executive Director
SNUPPS
5 Choke Cherry Road
Rockville, Maryland 20850

John H. Neisler
Callaway Resident Office
U.S. Nuclear Regulatory Commission
RR#1
Steedman, Missouri 65077

William Forney
Division of Projects and
Resident Programs, Chief, Section 1A
U.S. Nuclear Regulatory Commission
Region III
799 Roosevelt Road
Glen Ellyn, Illinois 60137

Bruce Little
Callaway Resident Office
U.S. Nuclear Regulatory Commission
RR#1
Steedman, Missouri 65077

Jan Stevens
Office of Nuclear Reactor Regulation
U. S. Nuclear Regulatory Commission
Mail Stop P-316
7920 Norfolk Avenue
Bethesda, MD 20014

Attachment to ULNRC-1004

List of Drawings

84-05-86-M-22HB05, Rev. 1

ECN 84-05-86-M-02HF02, Rev. 10, Seq. 1

ECN 84-05-86-OP-M-02HF03, Rev. 3, Seq. 2

ECN 84-05-86-OP-M-02BM04, Rev. 4, Seq. 1

ECN 84-05-86-M-22HB03, Rev. 0, Seq. 1

ECN 84-05-86-OP-M-22AN01, Rev. 4, Seq. 1

SEE

APERTURE

CARDS

*OVERSIZED DRAWINGS

(ADDITIONAL DOCUMENT PAGES FOLLOW)

APERTURE CARD NO#

8501020340

AVAILABILITY

PDR

CF

HOLD

NUMBERS OF PAGES.

1



Union Electric

CALLAWAY PLANT

ENGINEERING CHANGE NOTICE

WORK ORDER

7820

DATE

OF ECN 12-18-84

TYPE OF DOCUMENT CHANGED

DRAWING

CMP NO.	DOC NO.	REV/SUB	SEQ
84-05-86	M-02HF02	10	1

File No. 0171.1

Page 1 of 1

REASON FOR CHANGE

CMP 84-05-86

DESCRIPTION OF CHANGE

(BEFORE CHANGE)

(COORD. B-2)

PLANT
DISCHARGE LINE

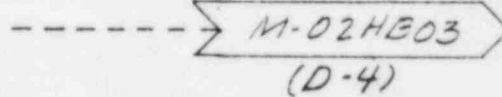

(AFTER CHANGE)

(COORD. B-2)

DISCHARGE
MONITOR TANKS

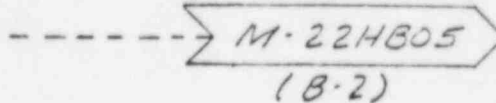

7433-A-102880

RESPONSIBLE ENGINEER

Daniel W. Stebbins

DRAWING CONTROL

DRAWN

ED BICK

CHECKED

HACKNEY

SUPERVISOR

LAUJHARDT

REVIEW AND APPROVAL

SUPERVISING ENGINEER
NA

MANAGER
QA
NA

SUPERINTENDENT
NA

REVIEWING ENGINEER
NA

MANAGER - NUCLEAR ENGINEERING
NA



CALLAWAY PLANT

ENGINEERING CHANGE NOTICE

WORK ORDER
7820

DATE
OF ECN 12-19-84

TYPE OF DOCUMENT CHANGED
DRAWING

CMP NO.	DOC NO.	REV/SUB	SEQ
---------	---------	---------	-----

ECN NO.	84-05-86	OP M-02HF03	3	2
---------	----------	----------------	---	---

File No.	Page <u>1</u> of <u>1</u>
----------	---------------------------

REASON FOR CHANGE

CMP 84-05-86

DESCRIPTION OF CHANGE

BEFORE CHANGE

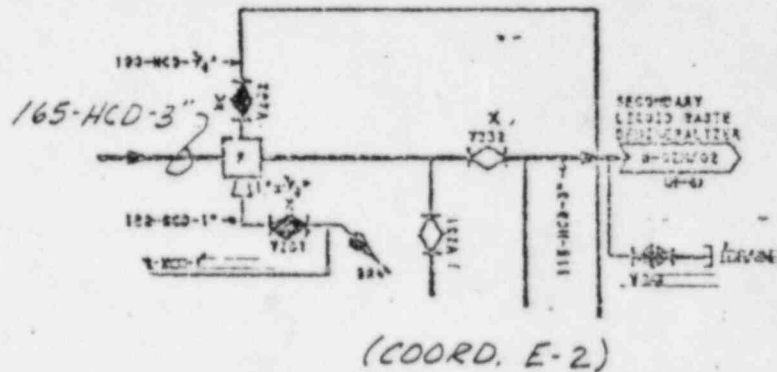
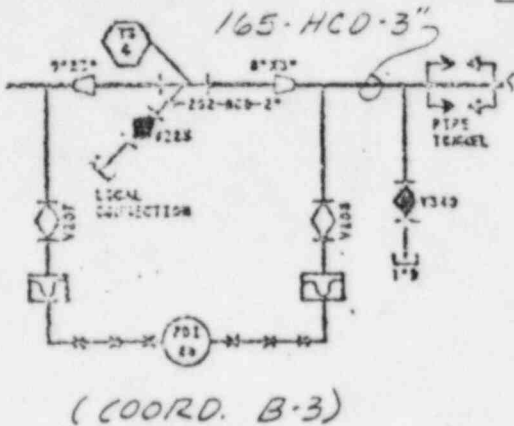

AFTER CHANGE

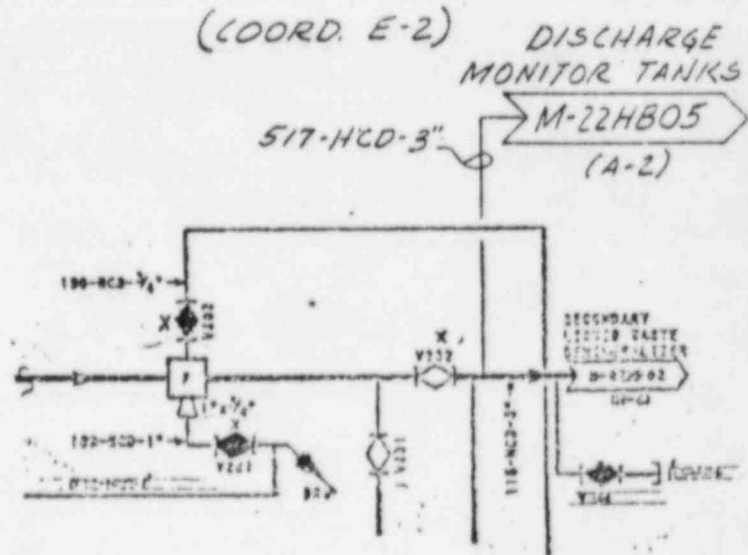
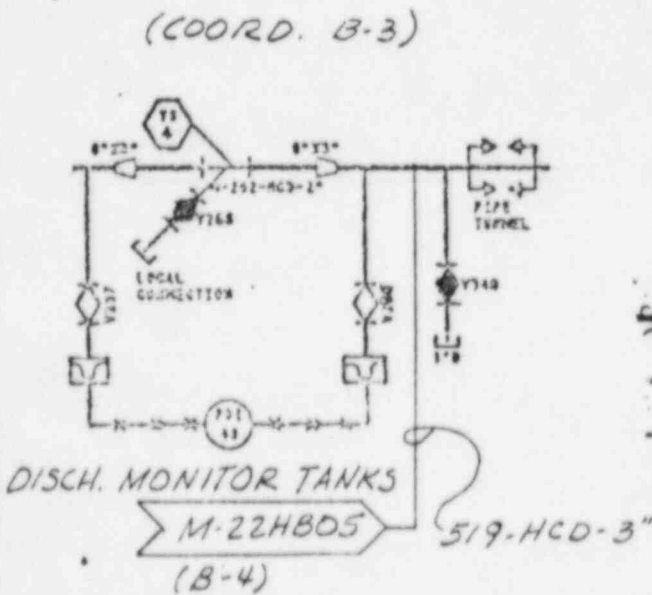

7433-A-102880

RESPONSIBLE ENGINEER <i>Daniel W. Stebbins</i>	DRAWING CONTROL	DRAWN <i>ED BICK</i>	CHECKED <i>HACKNEY</i>	SUPERVISOR <i>LAUNHARDT</i>
REVIEW AND APPROVAL <i>NA</i>	SUPERVISING ENGINEER <i>NA</i>	MANAGER <i>NA</i>	SUPERINTENDENT <i>NA</i>	REVIEWING ENGINEER <i>NA</i>
				MANAGER - NUCLEAR ENGINEERING <i>NA</i>



Union Electric

CALLAWAY PLANT

ENGINEERING CHANGE NOTICE

WORK ORDER

7820

DATE

OF ECN 12-13-84

TYPE OF DOCUMENT CHANGED

DRAWING

CMP NO.	DOC NO.	REV/SUB	SEQ
---------	---------	---------	-----

ECN NO.	84-05-86	OP M-02B04	4	1
---------	----------	---------------	---	---

File No. 0171.1

Page 1 of 1

REASON FOR CHANGE

CMP 84-05-86

DESCRIPTION OF CHANGE

BEFORE CHANGE

(COORD. D-1)

HB-220-HCD-4" PLANT DISCHARGE LINE
 → M-02HB03
 (D-4)

AFTER CHANGE

(COORD. D-1)

DISCHARGE
MONITOR TANKS

----- → M-22HB05
 (B-3)

7433-A-102880

RESPONSIBLE ENGINEER <i>Daniel W. Stubby</i>		DRAWING CONTROL	DRAWN ED BICK	CHECKED HACKNEY	SUPERVISOR LAUNHARDT
REVIEW AND APPROVAL	SUPERVISING ENGINEER NA	MANAGER DA NA	SUPERINTENDENT NA	REVIEWING ENGINEER NA	MANAGER-NUCLEAR ENGINEERING NA



CALLAWAY PLANT

ENGINEERING CHANGE NOTICE

WORK ORDER
7820

DATE
OF ECN 12-18-84

TYPE OF DOCUMENT CHANGED
DRAWING

CMP NO	COC NO	REV/SUB	SEC
84-05-86	M-22HB03	0	1

File No. 0171.1

Page 1 of 1

REASON FOR CHANGE

CMP 84-05-86

DESCRIPTION OF CHANGE

BEFORE CHANGE

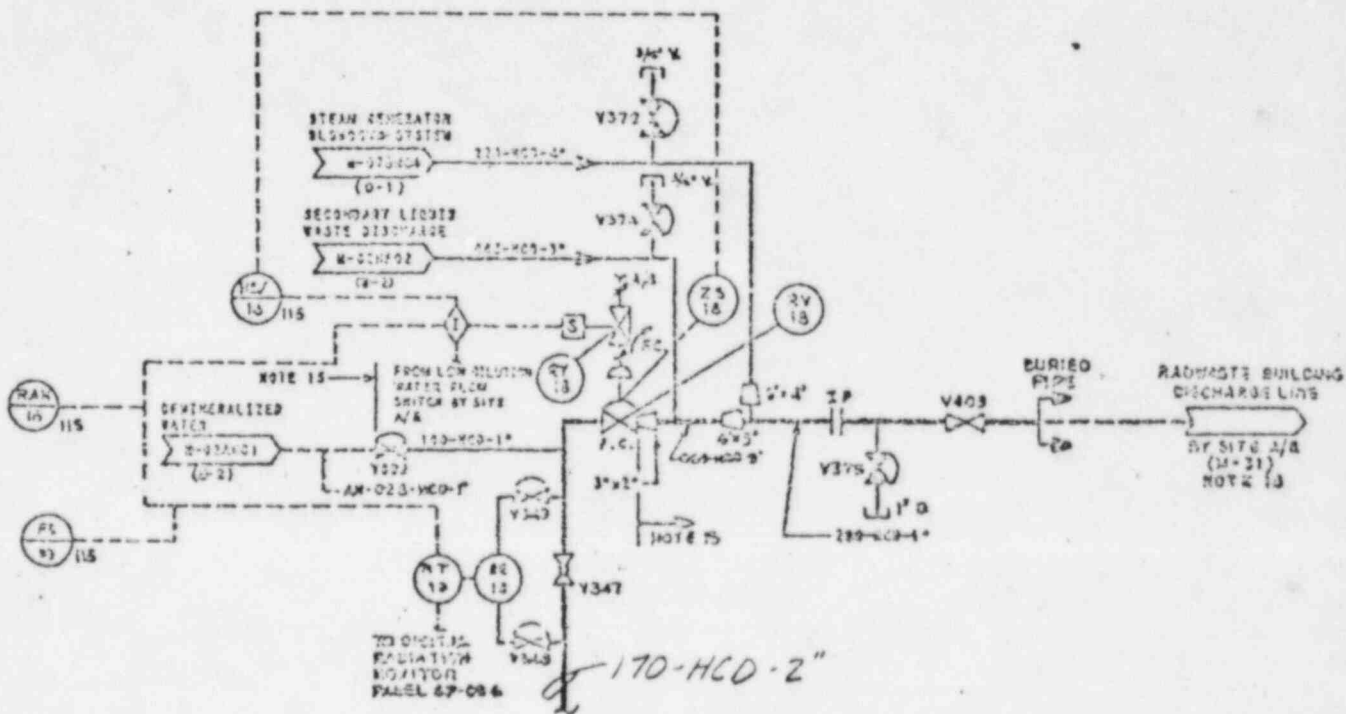

AFTER CHANGE

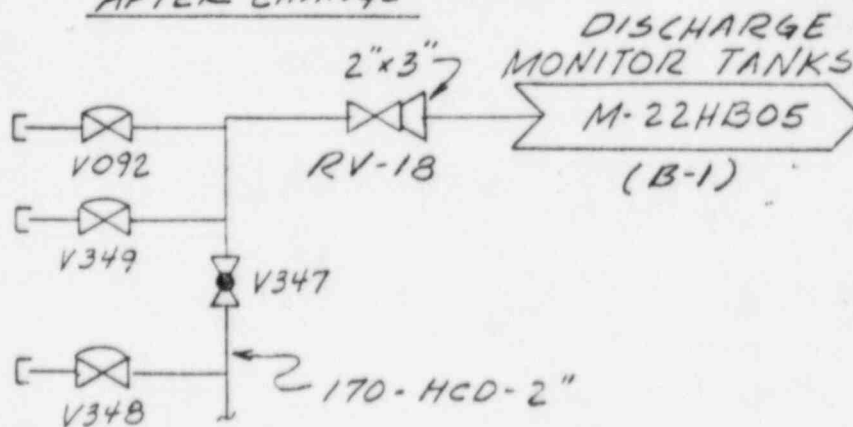

7433-A-102880

RESPONSIBLE ENGINEER <i>Daniel W. Stetler</i>	DRAWING CONTROL	DRAWN <i>EO BICK</i>	CHECKED <i>HACKNEY</i>	SUPERVISOR <i>LAUNHARDT</i>
REVIEW AND APPROVAL <i>NA</i>	SUPERVISING ENGINEER <i>NA</i>	MANAGER QA <i>NA</i>	SUPERINTENDENT <i>NA</i>	REVIEWING ENGINEER <i>NA</i>
				MANAGER-NUCLEAR ENGINEERING <i>NA</i>



CALLAWAY PLANT

ENGINEERING CHANGE NOTICE

WORK ORDER
7820

DATE
OF ECN 12-18-84

TYPE OF DOCUMENT CHANGED
DRAWING

CMP NO.	DOC NO.	REV/SUB	SEQ
84-05-86	OP M-22 ANOI	4	1

File No. 3456 0171.1 Page L of L

REASON FOR CHANGE

CMP 84-05-86

DESCRIPTION OF CHANGE

BEFORE CHANGE

(COORD. B-2)

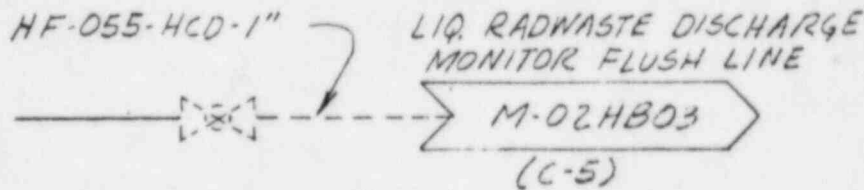

AFTER CHANGE

(COORD. B-2)

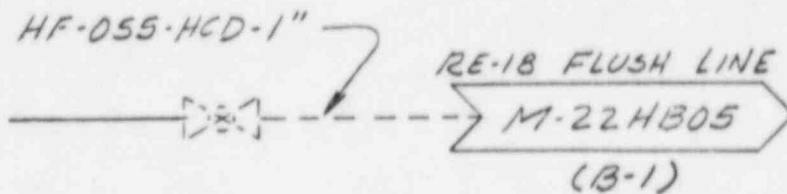

7433-A-102880

RESPONSIBLE ENGINEER <i>David W. Stiller</i>	DRAWING CONTROL	DRAWN <i>EO Bick</i>	CHECKED <i>HACKNEY</i>	SUPERVISOR <i>LAUNHARDT</i>	
REVIEW AND APPROVAL	SUPERVISING ENGINEER <i>NA</i>	MANAGER <i>QA NA</i>	SUPERINTENDENT <i>NA</i>	REVIEWING ENGINEER <i>NA</i>	MANAGER-NUCLEAR ENGINEERING <i>NA</i>