

February 6, 1996

Mr. J. E. Cross  
Senior Vice President  
Nuclear Power Division  
Duquesne Light Company  
Post Office Box 4  
Shippingport, Pennsylvania 15077

SUBJECT: PUBLIC WORKSHOP ON PRESSURE LOCKING AND THERMAL BINDING

Dear Mr. Cross:

This refers to the public workshop conducted in King of Prussia, Pennsylvania on November 2, 1995. The meeting was held to discuss Generic Letter (GL) 95-07, "Pressure Locking and Thermal Binding of Safety-Related Power-Operated Gate Valves," with Region I licensees. Special emphasis was placed on the principal technical issues, experiences and analyses of pressure locking and thermal binding, recommendations in GL 95-07, and planned NRC actions to resolve this concern.

Copies of the meeting agenda, presentations, and a summary of the significant discussion topics from similar meetings held in each of the four NRC Regions are enclosed. In accordance with Section 2.790 of the NRC's "Rules of Practice," Part 2, Title 10, Code of Federal Regulations, a copy of this letter will be placed in the NRC's Public Document Room.

We appreciated the responsiveness and turnout for this meeting, and we will continue to communicate with you regarding this important safety topic. Should you have any questions concerning any of the topics raised, we will be pleased to discuss them further with you.

Sincerely,

Original Signed By:

Eugene M. Kelly, Chief  
Systems Engineering Branch  
Division of Reactor Safety

Docket Nos. 50-334; 50-412

Enclosures:

1. Agenda
2. Summary of Public Workshops
3. Region I Licensee Presentations

9602130135 960206  
PDR ADOCK 05000334  
P PDR

130014

H005/1

Mr. J. E. Cross

2

cc w/encl:

G. S. Thomas, Vice President, Nuclear Services  
 T. P. Noonan, Vice President, Nuclear Operations  
 L. R. Freeland, Manager, Nuclear Engineering Department  
 B. Tuite, General Manager, Nuclear Operations Unit  
 K. L. Ostrowski, Manager, Quality Services Unit  
 R. Brosi, Manager, Nuclear Safety Department  
 H. R. Caldwell, General Superintendent, Nuclear Operations  
 M. Clancy, Mayor  
 NRC Resident Inspector  
 Commonwealth of Pennsylvania  
 State of Ohio

Distribution w/encl:

Region I Docket Room (with concurrences)  
 PUBLIC  
 Nuclear Safety Information Center (NSIC)  
 P. Eselgroth, DRP  
 D. Haverkamp, DRP  
 M. Kalamon, DRP  
 D. Kern, Surry Site, RII  
 J. Stolz, NRR  
 D. Brinkman, NRR  
 W. Dean, OEDO  
 Inspection Program Branch, NRR (IPAS)

DOCUMENT NAME: A:BV

To receive a copy of this document, indicate in the box: "C" = Copy without attachment/enclosure "E" = Copy with attachment/enclosure "N" = No copy

OFFICE	RI/DRS		/		/				
NAME	EKELLY <i>EK</i>								
DATE	02/06/96	02/	/96	02/	/96	02/	/96	02/	/96

OFFICIAL RECORD COPY

**ENCLOSURE 1**

**PRESSURE LOCKING AND  
THERMAL BINDING MEETING AGENDA**

**DOUBLETREE GUEST SUITES  
VALLEY FORGE, PA**

**"The Witherspoon Room"**

**November 2, 1995**

- |                           |   |
|---------------------------|---|
| <b>8:00 - 8:15 a.m.</b>   | Welcome and Opening Remarks by James T. Wiggins, Director, Division of Reactor Safety                                   |
| <b>8:15 - 8:45 a.m.</b>   | "Utility Perspective," by Robert Harris, Program Manager, Northeast Utilities   |
| <b>8:45 - 9:00 a.m.</b>   | "The Headquarters Perspective," by Terence Chan, Chief, Components and Testing Section, NRR, Division of Engineering    |
| <b>9:00 - 9:30 a.m.</b>   | "Pressure Locking and Thermal Binding Experiences," by Tom Scarbrough, Senior Mechanical Engineer, NRR, MEB             |
| <b>9:30 - 9:45 a.m.</b>   | Break   |
| <b>9:45 - 11:15 a.m.</b>  | Breakout Sessions (Meetinghouse and Millhouse)  |
| <b>11:15 - 11:30 a.m.</b> | Breakout Session Results  |
| <b>11:30 - 1:00 p.m.</b>  | Lunch   |
| <b>1:00 - 1:30 p.m.</b>   | "Utility Perspective," by Mark Mjaatvedt and Michael Rose, Senior Project Engineers, Pennsylvania Power & Light Company |
| <b>1:30 - 2:00 p.m.</b>   | "Examples of GL 95-07 Susceptibility And Evaluation Methods," by Howard Rathbun, Mechanical Engineer, NRR, MEB          |
| <b>2:00 - 2:15 a.m.</b>   | Break   |
| <b>2:15 - 4:15 p.m.</b>   | Questions and Answers Panel Session   |
| <b>4:15 - 4:30 p.m.</b>   | Closing Remarks by Eugene Kelly, Chief, Systems Branch, Division of Reactor Safety                                      |



ENCLOSURE 2

UNITED STATES  
NUCLEAR REGULATORY COMMISSION

WASHINGTON, D.C. 20555-0001

November 30, 1995

MEMORANDUM TO: James T. Wiggins, Director  
Division of Reactor Safety, RI

Albert F. Gibson, Director  
Division of Reactor Safety, RII

Geoffrey E. Grant, Director  
Division of Reactor Safety, RIII

Thomas P. Gwynn, Director  
Division of Reactor Safety, RIV

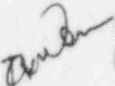
FROM:  Richard H. Wessman, Chief  
Mechanical Engineering Branch  
Division of Engineering

SUBJECT: SUMMARY OF PUBLIC WORKSHOPS TO DISCUSS GENERIC LETTER 95-07,  
"PRESSURE LOCKING AND THERMAL BINDING OF SAFETY-RELATED POWER-  
OPERATED GATE VALVES"

In October and November 1995, the NRC staff conducted one-day public workshops in each Region to discuss Generic Letter (GL) 95-07, "Pressure Locking and Thermal Binding of Safety-Related Power-Operated Gate Valves." The workshops were attended by representatives of nuclear power plant licensees in the applicable Regions. Attachment 1 is a list of meeting participants.

The Mechanical Engineering Branch of NRR, NRR Projects, the Office for the Analysis and Evaluation of Operational Data, the Mechanical Engineering Branch of the Office of Nuclear Regulatory Research, and Regional management and staff participated in the workshops. During each workshop, Regional and NRR management provided their perspectives on the issue of pressure locking and thermal binding, and expectations for licensee action in response to GL 95-07. NRC staff discussed past experience with pressure locking and thermal binding, and the recommendations in GL 95-07. Attachment 2 includes the handouts from the staff presentations.

Personnel from several nuclear power utilities made presentations on their activities in response to the pressure locking and thermal binding issue. Attachment 3 includes the handouts from the industry presentations.

At the conclusion of each meeting, the staff responded to questions from licensees regarding pressure locking and thermal binding. The most significant discussion topics are summarized below:

CONTACT: H. Rathbun, NRR  
415-2787

9601020/147



Actions, Schedules and Submittals

1. The 90-day requested screening action in GL 95-07 was intended for the licensee to identify any critical deficiencies in the past evaluations of potential pressure locking and thermal binding that may have been conducted in response to industry, vendor or NRC communications. The licensee should use best available information and assure that the subject valves are operable. The staff considered that more detailed review and evaluation, and corrective actions, would be included as part of the 180-day requested action.
2. The staff does not plan to extend the proposed schedule for completing the 180-day requested action of GL 95-07. If a licensee establishes corrective action plans as part of its 180-day response that are later determined to be unnecessary or inadequate based on ongoing industry testing and analyses, the licensee would be expected to notify the staff of the change to those plans and the basis for the change. As stated in GL 95-07, a licensee may consider risk significance and outage schedules in developing corrective action schedules. If an immediate operability concern does not exist and risk considerations are appropriate, a licensee might consider corrective action for one train at the next available outage and the other train at the following outage.
3. NRR staff will be conducting the principal review of licensee responses to GL 95-07 and detailed inspections at all facilities are not planned. The staff stated that information provided in response to the 180-day requested action would be most helpful if it briefly summarized the depth of the licensee's review, the susceptible valves by function and identification number, the corrective action completed and planned, and valves acceptable as installed and currently set. Detailed supporting data and calculations are not desired in the submittal but should be retained in plant records.

Identifying Susceptible Valves

4. As yet, licensees have not presented an analytical method for predicting the thrust required to overcome pressure locking or thermal binding as part of a long-term resolution of the susceptibility of a valve to these phenomena. Based on the preliminary test verification efforts to date, the staff has not objected to licensees using one of the several industry analytical methods for predicting thrust requirements as part of an operability decision until a long-term solution can be achieved. However, if a licensee intends to rely on these analytical methods as a long-term solution, test verification will need to be completed.
5. GL 95-07 does not include a specific recommendation for the minimum temperature differential that could be assumed in predicting the occurrence of thermal binding of a gate valve. The staff considers the susceptibility of a gate valve to thermal binding to be a function of several valve-specific parameters, including gate valve type (i.e., solid or flexible wedge), differential temperature, temperature gradient

across the valve and disk, the rate of change of temperatures, the valve size and rating, valve and disk material, and manufacturing tolerances. The staff does not believe that the presence of the same material for both the valve and disk would eliminate the need to consider the potential for thermal binding. The staff suggested that licensees contact their valve manufacturers for more-detailed information.

6. The staff believes that slow ambient temperature changes that normally occur in a nuclear power plant would not be a principal concern for pressure locking or thermal binding, provided the valve has not experienced such problems under these conditions and there are no potential significant heating or cooling sources near the valve.
7. The staff recognizes that conflicting industry test information exists regarding the potential increase in valve bonnet pressure as the temperature of the fluid in the bonnet increases. The industry and staff are both conducting additional tests in this area. The staff believes that, until the pressure versus temperature relationship can be resolved, the pressure rise can be assumed to be significant if the valve bonnet is water solid. However, if a licensee can demonstrate that a small amount of air is present in the valve bonnet, the pressure rise will be minimal except in the case of large temperature changes. A licensee might establish a program to monitor air in the valve bonnet as part of a long-term resolution plan.
8. One or more check valves might not prevent pressure increase in piping between the check valve and the gate valve being evaluated for potential pressure locking. A significant length of piping might mitigate the pressure increase over the time interval between gate valve stroking as part of IST or plant operations. Gate and globe valves with continuous seating force will minimize the potential for significant pressure increase in the piping between these valves and the valve being evaluated for pressure locking, provided inservice test results and methods (e.g., instrumentation) to reveal the pressure increase are considered.
9. The staff recognizes that leakage from the valve bonnet around the valve disk or packing can reduce pressure over time. The staff believes that licensees may be able to justify reliance on such leakage for valves that are first called upon to operate following a significant time interval after the event that might have caused a pressure locking situation to develop.

#### Responding to Susceptible Valves

10. The staff believes that valve-specific information could be useful in addressing whether any immediate concern exists regarding a valve found to be susceptible to pressure locking or thermal binding, provided the valve is normally operated under conditions that might cause these phenomena. The staff noted that the licensee would need to address capability of the actuator under degraded voltage conditions, if

applicable, and structural and electrical capability from accelerated wear or fatigue, over the long term.

11. If a licensee declares a valve inoperable when conducting surveillance testing and follows its plant technical specifications, the provisions of GL 95-07 to address pressure locking and thermal binding during surveillance testing would not apply. If the valve is to remain operable during surveillance testing, the licensee should address the possibility of pressure locking or thermal binding during the conduct of the surveillance. The staff believes that licensees may be able to more readily address the susceptibility of the valve to pressure locking and thermal binding during surveillance testing (e.g., low likelihood of thermally induced pressure locking or thermal binding during the surveillance test).

Regarding surveillance testing and operability of safety-related valves, the staff pointed out that if a system (train) is to be considered operable during the conduct of a surveillance test, then safety-related valves in the system (train) must be capable of repositioning as necessary in response to an engineered safeguards signal. If the licensee cannot assure the valve is capable of repositioning during surveillance, they should declare the system (train) inoperable during surveillance and apply the technical specification LCO. [In a safety evaluation dated October 16, 1995, addressing the scope of the GL 89-10 program at the Hatch nuclear plant, the staff stated that a motor-operated valve placed in a position that prevents the safety-related system (or train) from performing its safety function must be capable of returning to its safety position, or the system (or train) must be declared inoperable.]

12. The staff noted that licensees should address potential adverse effects of proposed corrective action to respond to the susceptibility of a gate valve to pressure locking or thermal binding. The staff discussed an example from one plant where a hole drilled in a valve disk had to be filled because check valve leakage resulted in a flow path from the refueling water storage tank to the reactor building sump.
13. The staff referred licensees to GL 91-18 regarding inappropriate reliance on risk assessments in determining the operability of a safety-related valve.
14. The staff referred licensees to GL 91-18 for the use of manual action to ensure the capability of equipment. The staff noted difficulties in implementing manual action with respect to operating valves that might be pressure locked or thermally bound. For example, high pressure fluid and adverse environments could cause manual action to be unsafe to maintenance personnel and to be difficult to implement.

Miscellaneous

15. The staff is conducting research on various aspects of the pressure locking and thermal binding phenomena. Results of the staff's research will be made available to the industry via generic communication or industry symposia.
16. The staff discussed a recent AEOD report alerting licensees to the potential for damaging valves under surveillance test conditions that exceed design-basis conditions. The AEOD report is included as Attachment 4 to this meeting summary. The staff also noted that preparation for maintenance or surveillance testing could initiate a pressure locking or thermal binding situation.

Comments from workshop participants indicated that the workshops were highly beneficial in increasing licensee understanding of staff expectations regarding GL 95-07 and in promoting the exchange of technical information on the pressure locking and thermal binding issue.

Attachments: As stated

GENERIC LETTER 95-07 PUBLIC WORKSHOP PARTICIPANTS

<u>NAME</u>	<u>ORGANIZATION</u>
<u>All 4 Workshops</u>	
T. Scarbrough	NRC/NRR
H. Rathbun	NRC/NRR
E. Brown	NRC/AEOD
<u>Region I Workshop</u>	
J. Wiggins	NRC/Region I
E. Kelly	NRC/Region I
F. Bower	NRC/Region I
D. Dempsey	NRC/Region I
R. Reyes	NRC/Region I
T. Chan	NRC/NRR
L. Dudes	NRC/NRR
R. Eaton	NRC/NRR
C. Poslusny	NRC/NRR
A. Wang	NRC/NRR
G. Weidenhamer	NRC/RES
T. Kenny	NRC/Region I
K. Kolaczyk	NRC/Region I
D. Moy	NRC/Region I
J. Osborne	BGE
K. Robinson	BGE
J. Szivos	BGE
J. Jerz	Boston Edison
J. Tucker	Boston Edison
J. Doyle	Boston Edison
W. Kline	Boston Edison
L. Cona	ConEd
J. Lomar	ConEd
N. Mah	ConEd
D. Shah	ConEd
S. Loehlein	Duquesne Light Company
P. Slifkin	Duquesne Light Company
E. Coholich	Duquesne Light Company
R. McGoey	GPU Nuclear
J. Correa	GPU Nuclear
J. Tabone	GPU Nuclear
J. Abramovici	GPU Nuclear
B. Knight	GPU Nuclear
T. Carroll	GPU Nuclear
J. Bashista	GPU Nuclear
S. Parsons	GPU Nuclear
B. Lord	MYAPC
S. Nichols	MYAPC
D. Whittier	MYAPC
F. Martsen	NYPA
P. Swinburne	NYPA



P. Grissom	Georgia Power
J. Dailey	Georgia Power
G. Williams	SC&G
R. Justice	SC&G
J. Pease	SC&G
D. Ray	Southern Company
G. Talton	Southern Nuclear
S. Gates	Southern Nuclear
J. Daniels	Southern Nuclear
O. Vidal	Southern Nuclear
R. Golub	TVA
J. Elmerick	TVA
R. Poole	TVA
T. Chan	TVA
H. Benninghoff	TVA
B. DeMars	Virginia Power
E. May	Virginia Power
A. Szczepaniec	INPO
M. Kalsi	Kalsi Engineering

Region III Workshop

R. Wessman	NRC/NRR
J. Jacobson	NRC/Region III (DRS)
S. Burgess	NRC/Region III
J. Guzman	NRC/Region III
M. Shuaibi	NRC/NRR
A. Setlur	AES Corp.
A. Widmer	CEI
S. Benesh	ComEd - Zion
C. Bedford	ComEd - Braidwood
B. Burte	ComEd - Corp.
M. Dowd	ComEd - LaSalle
I. Garza	ComEd - Corp.
B. Jelke	ComEd - Zion
R. Mika	ComEd - Zion
M. Melnicoff	ComEd - NES (PRA)
J. O'Neill	ComEd - Dresden
B. Westphal	ComEd - LaSalle
B. Smith	ComEd - Byron
P. Yost	ComEd
E. Evans	CPCO
P. Flenner	CPCO
R. Gambrell	CPCO
R. Scudder	CPCO
R. Swanson	CPCO
J. Toskey	CPCO
M. Jaworsky	DECO
A. Nayakwadi	DECO
L. Schuerman	DECO
L. Georgopoulos	EMS, Inc.
Y. Patel	EMS, Inc.
W. Miller	IES - Duane Arnold
D. Wiley	IES - Duane Arnold



M. Holbrook  
A. Gort  
N. Howey  
J. Puzauskas  
K. Peterson  
R. Wirkkala  
J. Vitellas  
A. Meligi  
D. Blakely  
B. Gallatin  
N. Peterson  
P. Young  
J. Roberts  
T. Ruiz  
B. Heida  
E. Leinheiser

INEL  
I&M Power  
IONS  
IPCO  
NSP - Monticello  
NSP - Prairie Island  
PUCO  
S&L  
TECO  
TECO - Davis Besse  
TECO - Davis Besse  
Vectra Tech.  
WEPCO - Point Beach  
WEPCO - Point Beach  
WPSCO - Kewaunee  
WPSCO - Kewaunee

Region IV Workshop

T. Gwynn  
K. Brockman  
C. VanDenburgh  
M. Runyan  
C. Myers  
R. Wessman  
S. Bauer  
M. Hooshmand  
M. Renfroe  
B. Matthew  
K. Fitzsimmons  
J. Burton  
R. Jackson  
D. Smith  
K. Taplett  
A. Aldridge  
R. Thacker  
J. Geschwender  
R. Cahn  
T. Raidy  
E. David  
T. Hoyle  
J. Barker  
B. Black  
R. Cockrel  
O. Bhatti  
D. Dillinger  
D. Weninger  
E. Simbles  
C. Sellers  
D. Phillips  
R. Stoddard  
I. Ezekoye

NRC/Region IV  
NRC/Region IV  
NRC/Region IV  
NRC/Region IV  
NRC/Region IV  
NRC/NRR  
Arizona Public Service  
Arizona Public Service  
Arizona Public Service  
Entergy Operations  
Entergy Operations  
Entergy - Grand Gulf  
Entergy - Grand Gulf  
Entergy - Grand Gulf  
HP&L  
HP&L  
NPPD  
OPPD  
PG&E  
Southern Cal. Edison  
Southern Cal. Edison  
Supply System  
Texas Utilities  
Texas Utilities  
Texas Utilities  
Texas Utilities  
Texas Utilities  
Texas Utilities  
Wolf Creek  
ERiN Engineering  
ERIN Engineering  
ERIN Engineering  
Lincoln Electric Systems  
Westinghouse Corp.

K. Eslinger  
R. Plasse  
G. Bruce  
D. Cruz  
M. McGinley  
T. Pucko  
P. Brown  
R. Faix  
B. Harris  
S. Bobbyock  
B. Carsky  
J. Daise  
J. Mitman  
G. Stathes  
S. Singh  
S. Mangi  
G. Miller  
M. Mjaatvedt  
M. Rose  
C. Coddington  
R. Lewis  
S. Gallogly  
M. Hoskins  
D. LaMastra  
J. Nichols  
G. Overbeck  
K. Muller  
B. Buteau  
J. Callaghan  
T. Miller  
J. Duffy  
S. McConarty

NYPA  
NYPA  
NMPC  
NMPC  
NMPC  
North Atlantic Energy Service Corp.  
North Atlantic Energy Service Corp.  
North Atlantic Energy Service Corp.  
NU  
PECO Energy  
PECO Energy  
PECO Energy  
PECO Energy  
PECO Energy  
State of New Jersey  
State of Pennsylvania  
PP&L  
PP&L  
PP&L  
PP&L  
PSE&G  
PSE&G  
PSE&G  
PSE&G  
PSE&G  
PSE&G  
PSE&G  
RG&E  
VY Nuclear Power  
VY Nuclear Power  
VY Nuclear Power  
Yankee Atomic Nuclear Power  
Yankee Atomic Nuclear Power

Region II Workshop

J. Jaudon  
M. Shymlock  
E. Girard  
T. Chan  
M. Worth  
M. Verrilli  
W. McGoun  
W. Wilton  
G. Thearling  
F. Setzer  
K. Beasley  
D. King  
S. Hart  
V. Haramis  
O. Hanek  
W. Bryan  
K. Ledzian  
S. Powell  
B. Naumria

NRC/Region II  
NRC/Region II  
NRC/Region II  
NRC/NRR  
CP&L  
CP&L  
CP&L  
CP&L  
CP&L  
Duke Power  
Duke Power  
Duke Power  
Duke Power  
Duke Power  
FP&L  
FP&L  
Florida Power Corp.  
Florida Power Corp.  
Georgia Power

**PUBLIC WORKSHOP ON  
GENERIC LETTER 95-07,  
"PRESSURE LOCKING AND THERMAL BINDING  
OF SAFETY-RELATED POWER-OPERATED  
GATE VALVES"**

**REGION I November 2, 1995  
REGION II October 24, 1995  
REGION III November 7, 1995  
REGION IV November 9, 1995**

**NRR MANAGEMENT PERSPECTIVE ON  
PRESSURE LOCKING AND THERMAL BINDING**

**Richard H. Wessman/  
Terence L. Chan**

**Mechanical Engineering Branch  
Division of Engineering  
Office of Nuclear Reactor Regulation  
U.S. Nuclear Regulatory Commission**

# NRR MANAGEMENT PERSPECTIVE

## SAFETY SIGNIFICANCE

NRC CONSIDERS PRESSURE LOCKING AND THERMAL BINDING TO BE A SAFETY SIGNIFICANT ISSUE SINCE IT REPRESENTS A POTENTIAL COMMON FAILURE MODE OF A SYSTEM OR SYSTEMS

- VERMONT YANKEE [CORE SPRAY INJECTION VALVES]
- MILLSTONE 2 [CONTAINMENT SUMP RECIRCULATION VALVES]; IN 95-14 ISSUED
- HADDAM NECK [SAFETY INJECTION VALVES]; IN 95-18 ISSUED

# NRR MANAGEMENT PERSPECTIVE

## HISTORY

- NRC COMMUNICATIONS
  - IE CIRCULAR 77-05 (MARCH 29, 1977)
  - IN 81-31 (OCTOBER 8, 1981)
  - IN 92-26 (APRIL 2, 1992)
  - NUREG-1275, VOL. 9 (MARCH 1993)
  - GENERIC LETTER 89-10 (JUNE 28, 1989)
  - GL 89-10, SUPPLEMENT 6 (MARCH 8, 1994)
- INDUSTRY COMMUNICATIONS
  - GE SIL-368 (DECEMBER 1981)
  - INPO SOER 84-7 (DECEMBER 14, 1984)
- ACTIONS PERFORMED IN RESPONSE TO GL 89-10



# **NRR MANAGEMENT PERSPECTIVE**

## **RESOLUTION**

- **GL 95-07 SCHEDULE IS REASONABLE**
  - **INITIAL SCREENING - 90 DAYS**
  - **SUMMARY OF ACTIONS AND ANALYSES - 180 DAYS**
  - **ALLOWS FOR CONSIDERATION OF PLANT OUTAGE AND OPERATION SCHEDULES IN DEVELOPING CORRECTIVE ACTION SCHEDULES**

**RECENT**  
**PRESSURE LOCKING AND THERMAL BINDING**  
**EXPERIENCE AND ANALYSES**

**Thomas G. Scarbrough**

**Mechanical Engineering Branch  
Division of Engineering  
Office of Nuclear Reactor Regulation  
U.S. Nuclear Regulatory Commission**

## **PRESSURE LOCKING AND THERMAL BINDING PHENOMENA**

**PRESSURE LOCKING OF FLEXIBLE WEDGE OR PARALLEL DISK GATE VALVES OCCURS WHEN FLUID IS PRESSURIZED WITHIN VALVE BONNET, AND ACTUATOR IS INCAPABLE OF OVERCOMING ADDITIONAL THRUST REQUIREMENT FROM DIFFERENTIAL PRESSURE ACROSS BOTH VALVE DISKS.**

**THERMAL BINDING RESULTS FROM MECHANICAL INTERFERENCE THAT OCCURS DUE TO DIFFERENT EXPANSION AND CONTRACTION CHARACTERISTICS OF VALVE BODY AND DISK MATERIALS. REOPENING OF A CLOSED VALVE MIGHT BE PREVENTED UNTIL VALVE AND DISK ARE RETURNED TO THEIR ORIGINAL TEMPERATURES.**

**PRESSURE LOCKING AND THERMAL BINDING REPRESENT POTENTIAL COMMON-CAUSE FAILURE MODES THAT CAN RENDER REDUNDANT TRAINS OF SAFETY-RELATED SYSTEMS OR MULTIPLE SAFETY SYSTEMS INCAPABLE OF PERFORMING THEIR SAFETY FUNCTIONS.**

## RELATED INDUSTRY DOCUMENTS

GE SIL 368, "RECIRCULATION DISCHARGE ISOLATION VALVE LOCKING," DECEMBER 1981

GE SIL 368, SUPPLEMENT 1, "GATE VALVE LOCKUP," AUGUST 14, 1989

INPO SOER 84-7, "PRESSURE LOCKING AND THERMAL BINDING OF GATE VALVES," DECEMBER 14, 1984

INPO SER 8-88, "PRESSURE LOCKING OF RESIDUAL HEAT REMOVAL GATE VALVES," MARCH 25, 1988

ASME SECTION III, DIVISION 1 - SUBSECTION NB-3511 - 1980

ANSI B31.1 - 1973

ANSI B16.5 - 1973

POWER ENGINEERING, "BONNET OVERPRESSURIZATION PROTECTION FOR DOUBLE-SEATED VALVES," JANUARY 1985

## RELATED NRC DOCUMENTS

IE CIRCULAR 77-05, "FLUID ENTRAPMENT IN VALVE BONNETS,"  
MARCH 29, 1977

IN 81-31, "FAILURE OF SAFETY INJECTION VALVES TO OPERATE  
AGAINST DIFFERENTIAL PRESSURE," OCTOBER 8, 1981

IN 92-26, "PRESSURE LOCKING OF MOTOR-OPERATED FLEXIBLE  
WEDGE GATE VALVES," APRIL 2, 1992

NUREG-1275, VOL. 9, "OPERATING EXPERIENCE FEEDBACK REPORT -  
PRESSURE LOCKING AND THERMAL BINDING OF GATE VALVES,"  
MARCH 1993

GENERIC LETTER 89-10, "SAFETY-RELATED MOTOR-OPERATED  
VALVE TESTING AND SURVEILLANCE," JUNE 28, 1989

GL 89-10, SUPPLEMENT 6, "INFORMATION ON SCHEDULE AND  
GROUPING, AND STAFF RESPONSES TO ADDITIONAL PUBLIC  
QUESTIONS," MARCH 8, 1994

NUREG/CP-0146, "WORKSHOP (FEBRUARY 1994) ON GATE VALVE  
PRESSURE LOCKING AND THERMAL BINDING," ISSUED JULY 1995

NUREG/CP-0137, VOLUME 2, "PROCEEDINGS OF THIRD NRC/ASME  
SYMPOSIUM ON VALVE AND PUMP TESTING," JULY 1994

IN 95-14, "SUSCEPTIBILITY OF CONT. SUMP RECIRCULATION GATE  
VALVES TO PRESSURE LOCKING," FEBRUARY 28, 1995

IN 95-18, "POTENTIAL PRESSURE-LOCKING OF SAFETY-RELATED  
POWER-OPERATED GATE VALVES," MARCH 15, 1995

IN 95-18, SUPP. 1, "POTENTIAL PRESSURE-LOCKING OF SAFETY-  
RELATED POWER-OPERATED GATE VALVES," MARCH 31, 1995

IN 95-30, "SUSCEPTIBILITY OF LOW-PRESSURE COOLANT INJECTION  
AND CORE SPRAY INJECTION VALVES TO PRESSURE LOCKING,"  
AUGUST 3, 1995

# RECENT PRESSURE LOCKING AND THERMAL BINDING EXPERIENCE AND ANALYSES

## LPCI SYSTEM INJECTION VALVE AT FITZPATRICK

IN JULY 1991, A LPCI SYSTEM INJECTION VALVE AT FITZPATRICK FAILED WHEN ATTEMPTED TO OPEN ABOUT 9 HOURS AFTER A HYDROSTATIC TEST OF THE PIPING.

CAUSE ATTRIBUTED TO HIGH PRESSURE IN THE VALVE BONNET RESULTING IN THRUST GREATER THAN MOTOR CAPABILITY.

LICENSEE INSTALLED VENT LINES ON 4 LPCI AND LPCS VALVES.

INFO NOTICE 92-26 DISCUSSES PRESSURE LOCKING EVENT.

## RHR SUPPRESSION POOL SUCTION VALVE AT GRAND GULF

IN JANUARY 1992, RHR SUPPRESSION POOL SUCTION VALVE AT GRAND GULF FAILED TO OPEN DURING PLANT STARTUP.

CAUSE ATTRIBUTED TO HIGH REACTOR COOLANT TEMPERATURE EXPANDING WATER IN VALVE BONNET RESULTING IN THRUST GREATER THAN MOTOR CAPABILITY.

LICENSEE INSTALLED VENT LINES IN BOTH SUCTION VALVES.

## RCIC STEAM LINE ISOLATION VALVE AT LASALLE

IN FEBRUARY 1993, A RCIC STEAM LINE ISOLATION VALVE AT LASALLE FAILED TO OPEN DURING TESTING.

FAILURE COULD HAVE BEEN CAUSED BY COLLECTION OF CONDENSATE IN THE VALVE BONNET WITH SUBSEQUENT EXPANSION RESULTING IN HIGH THRUST REQUIREMENTS.

LICENSEE DRILLED HOLE IN DISK TO PREVENT LOCKING.



**RECENT  
PRESSURE LOCKING AND THERMAL BINDING  
EXPERIENCE AND ANALYSES  
(continued)**

**PWR CONTAINMENT SUMP RECIRCULATION VALVES**

IN JANUARY 1995, MILLSTONE UNIT 2 NOTIFIED NRC THAT BOTH CONTAINMENT SUMP RECIRCULATION VALVES MIGHT FAIL TO OPEN BECAUSE OF PRESSURE LOCKING DURING LOCA.

LICENSEE INITIALLY DRILLED SMALL HOLE IN CONTAINMENT-SIDE DISKS OF BOTH VALVES. BECAUSE CHECK VALVE LEAKAGE CAUSED INCREASING SUMP LEVEL, LICENSEE REFILLED HOLES AND JUSTIFIED MOV CAPABILITY FOR SHORT TERM UNTIL LONG-TERM SOLUTION CAN BE DEVELOPED.

IN 95-14 ISSUED ON POTENTIAL PRESSURE LOCKING OF PWR CONTAINMENT SUMP RECIRCULATION VALVES.

TI 2515/129 ADDRESSED SUMP VALVES ON A PRIORITY BASIS.

FOR SHORT TERM, APPLICABLE PWR LICENSEES VERIFIED CONTAINMENT SUMP RECIRCULATION VALVES NOT SUSCEPTIBLE TO PRESSURE LOCKING THROUGH MODIFICATION, WATER BARRIER IN SUMP, OR ANALYSIS BASED ON AIR IN VALVE BONNET.

**SAFETY INJECTION VALVES AT HADDAM NECK**

IN MARCH 1995, HADDAM NECK FOUND SEVERAL MOVs IN SAFETY INJECTION SYSTEMS WITH QUESTIONABLE OPERABILITY BECAUSE OF POTENTIAL FOR PRESSURE LOCKING.

IN 95-18 ISSUED.

LICENSEE INSTALLED BONNET VENTS TO RCS ON 4 MOVs AND DRILLED HOLE IN DISK OF 2 MOVs.

**RECENT  
PRESSURE LOCKING AND THERMAL BINDING  
EXPERIENCE AND ANALYSES  
(continued)**

CORE SPRAY VALVE AT VERMONT YANKEE

IN MARCH 1995, NRC STAFF RAISED QUESTIONS REGARDING THE CAPABILITY OF 2 CORE SPRAY INJECTION MOVs TO OPEN BECAUSE OF SUSCEPTIBILITY TO PRESSURE LOCKING.

LEAKING CHECK VALVE INCREASED PRESSURE LOCKING POTENTIAL.

SIMULATED PRESSURE-LOCKING CONDITION REVEALED LESS PRESSURE-LOCKING THRUST THAN PREDICTED, BUT GREATER TOTAL THRUST REQUIREMENT AS A RESULT OF HIGHER-THAN-PREDICTED UNWEDGING LOAD.

LICENSEE DRILLED HOLE IN DISK OF BOTH MOVs.

HPSI MOVs AT MAINE YANKEE

IN MAY 1995 (LER 95-008), LICENSEE DETERMINED THAT TWO MOVs IN THE HPSI SYSTEM AT MAINE YANKEE WERE SUSCEPTIBLE TO PRESSURE LOCKING AS DESCRIBED IN INFO NOTICE 95-18.

FAILURE OF THESE MOVs TO OPEN UPON INITIATION OF RECIRCULATION COOLING COULD RESULT IN A LOSS OF HPSI CAPABILITY AND POSSIBLE PUMP DAMAGE DUE TO INSUFFICIENT NPSH.

FAILURE MIGHT BE CAUSED BY THERMALLY-INDUCED PRESSURE LOCKING OF VALVE BONNET DUE TO HIGH CONTAINMENT SPRAY BUILDING TEMPERATURE.

LICENSEE DRILLED HOLE IN DISK OF BOTH MOVs.

**RECENT  
PRESSURE LOCKING AND THERMAL BINDING  
EXPERIENCE AND ANALYSES  
(continued)**

PORV BLOCK VALVES AT MILLSTONE

IN JUNE 1995, MILLSTONE UNIT 2 DETERMINED THAT THE PORV BLOCK VALVES ARE POTENTIALLY SUSCEPTIBLE TO THERMAL BINDING UNDER CERTAIN CIRCUMSTANCES.

IF THE PORV BLOCK VALVES WERE CLOSED AND A SUBSEQUENT COOLDOWN WERE PERFORMED, THE BLOCK VALVES MAY EXPERIENCE THERMAL BINDING.

LICENSEE INSTALLED LARGER ACTUATORS AND CYCLES VALVES PERIODICALLY DURING COOLDOWN.

LPCI AND CORE SPRAY INJECTION VALVES AT HATCH

ON JULY 21, HATCH DETERMINED THAT A LPCI VALVE IN UNIT 2 MIGHT NOT OPERATE UNDER PRESSURE-LOCKING CONDITIONS.

LICENSEE DECLARED LPCI VALVE INOPERABLE AND TOOK CORRECTIVE ACTION. ANOTHER LPCI VALVE BEING MODIFIED. OTHER LPCI AND CORE SPRAY INJECTION VALVES ALSO EVALUATED.

LICENSEE BELIEVES MANUFACTURER AND SURVEILLANCE TESTING SUPPORTED PAST MOV OPERABILITY.

LEAKING CHECK VALVE CAUSED SURVEILLANCE TEST OF LPCI VALVE TO BE MORE SEVERE THAN DESIGN-BASIS CONDITIONS.

LICENSEES SHOULD ENSURE THAT MOVs CAN ACCOMMODATE SURVEILLANCE TEST CONDITIONS OR MODIFY TEST INTERVALS AS ALLOWED BY OM-10 OR GL 89-04.

**RECENT  
PRESSURE LOCKING AND THERMAL BINDING  
EXPERIENCE AND ANALYSES  
(continued)**

**RECIRCULATION VALVE AT HOPE CREEK**

**IN JULY 1995, A RECIRCULATION VALVE AT HOPE CREEK EXPERIENCED THERMAL BINDING PREVENTING OPENING UNTIL TEMPERATURE EQUALIZED BETWEEN VALVE BODY AND DISK.**

**VALVE DAMAGED WHEN OPENED BY ROTATION OF CONTACT BAR IN TORQUE SWITCH THAT PREVENTED VALVE CLOSING CIRCUIT FROM ENERGIZING.**

**RECIRCULATION VALVE POSITIONED PARTIALLY OPEN TO PREVENT THERMAL BINDING RESULTED IN BYPASS OF COOLING WATER FROM REACTOR CORE AND UNEXPECTED MODE CHANGE.**

**EXAMPLES OF GENERIC LETTER 95-07  
SUSCEPTIBILITY AND EVALUATION METHODS**

**Howard J. Rathbun**

**Mechanical Engineering Branch  
Division of Engineering  
Office of Nuclear Reactor Regulation  
U.S. Nuclear Regulatory Commission**



## **GL 95-07 REQUESTED ACTIONS**

### **WITHIN 90 DAYS**

- 1. PERFORM SCREENING EVALUATION OF OPERATIONAL CONFIGURATIONS OF ALL SAFETY-RELATED POWER-OPERATED GATE VALVES TO IDENTIFY VALVES POTENTIALLY SUSCEPTIBLE TO PRESSURE LOCKING OR THERMAL BINDING; AND**
- 2. DOCUMENT BASIS FOR OPERABILITY OF POTENTIALLY SUSCEPTIBLE VALVES OR, WHERE OPERABILITY CANNOT BE SUPPORTED, TAKE ACTION IN ACCORDANCE WITH INDIVIDUAL PLANT TECH SPECS.**

**SCREENING EVALUATION PROVIDES CONFIDENCE THAT NO SHORT-TERM SAFETY CONCERNS EXIST.**

**WHERE PREVIOUS EVALUATIONS PERFORMED, LICENSEE ENSURES THAT NO CRITICAL DEFICIENCIES EXIST IN PAST EVALUATIONS IN LIGHT OF NEW INFORMATION.**

### **WITHIN 180 DAYS**

- 1. EVALUATE OPERATIONAL CONFIGURATIONS OF SAFETY-RELATED POWER-OPERATED GATE VALVES TO IDENTIFY VALVES SUSCEPTIBLE TO PRESSURE LOCKING AND THERMAL BINDING;**
- 2. PERFORM FURTHER ANALYSES AS APPROPRIATE, AND TAKE NEEDED CORRECTIVE ACTIONS (OR JUSTIFY LONGER SCHEDULES), TO ENSURE THAT SUSCEPTIBLE VALVES ARE CAPABLE OF PERFORMING SAFETY FUNCTION(S) UNDER ALL MODES OF PLANT OPERATION, INCLUDING TEST CONFIGURATION.**

**IF ALREADY PERFORMED ACTION IN RESPONSE TO SUPPLEMENT 6 TO GL 89-10, LICENSEE NEED NOT PERFORM ANY ADDITIONAL ACTION UNDER 1 AND 2 FOR MOVs.**



## **90-DAY REQUESTED ACTION**

**AN EFFECTIVE SCREENING EVALUATION SHOULD CONSIDER (BASED ON CURRENT KNOWLEDGE) THE FOLLOWING ATTRIBUTES:**

**INCLUDE ALL SAFETY-RELATED POWER-OPERATED GATE VALVES**

**INITIAL ASSESSMENT OF SYSTEM OR PLANT CONFIGURATIONS THAT MAY RESULT IN PRESSURE LOCKING OR THERMAL BINDING**

**INITIAL ASSESSMENT OF VALVE'S CAPABILITY TO OVERCOME A PRESSURE LOCKING OR THERMAL BINDING SITUATION SHOULD THE VALVE BE SUSCEPTIBLE**

**DOCUMENT A BASIS FOR OPERABILITY OF THE VALVE**

## GL 95-07 REQUESTED INFORMATION

PROVIDE SUMMARY DESCRIPTION OF:

1. SUSCEPTIBILITY EVALUATION OF OPERATIONAL CONFIGURATIONS PERFORMED IN RESPONSE TO (OR CONSISTENT WITH) 180-DAY REQUESTED ACTION 1, AND FURTHER ANALYSES PERFORMED IN RESPONSE TO (OR CONSISTENT WITH) LONG-TERM REQUESTED ACTION 2, INCLUDING BASES OR CRITERIA FOR DETERMINING THAT VALVES ARE OR ARE NOT SUSCEPTIBLE TO PRESSURE LOCKING OR THERMAL BINDING;
2. RESULTS OF SUSCEPTIBILITY EVALUATION AND FURTHER ANALYSES, INCLUDING LISTING OF SUSCEPTIBLE VALVES;
3. CORRECTIVE ACTIONS, OR OTHER DISPOSITIONING, OF SUSCEPTIBLE VALVES, INCLUDING: (A) EQUIPMENT OR PROCEDURAL MODIFICATIONS COMPLETED AND PLANNED (WITH COMPLETION SCHEDULE FOR SUCH ACTIONS); AND (B) JUSTIFICATION FOR ANY DETERMINATION THAT PARTICULAR SUSCEPTIBLE VALVES ARE ACCEPTABLE AS IS.

CORRECTIVE ACTION SCHEDULE MAY BE BASED ON RISK SIGNIFICANCE, INCLUDING CONSIDERATION OF COMMON CAUSE FAILURE OF MULTIPLE VALVES.

PLANT OPERATION AND OUTAGE SCHEDULES MAY BE CONSIDERED IN DEVELOPING CORRECTIVE ACTION SCHEDULES.

TIME SCHEDULES FOR COMPLETING CORRECTIVE ACTION DO NOT SUPERSEDE NRC REGULATIONS AND TECHNICAL SPECIFICATIONS.

SCHEDULE FOR COMPLETING CORRECTIVE ACTION INDEPENDENT OF GL 89-10.

## **GL 95-07 REQUIRED RESPONSE**

**ALL ADDRESSEES REQUIRED TO SUBMIT:**

- 1. WITHIN 60 DAYS FROM DATE OF GL 95-07, A WRITTEN RESPONSE INDICATING WHETHER OR NOT ADDRESSEE WILL IMPLEMENT REQUESTED ACTIONS.**

**IF ADDRESSEE INTENDS TO IMPLEMENT THE REQUESTED ACTIONS, PROVIDE A SCHEDULE FOR COMPLETION IMPLEMENTATION.**

**IF ADDRESSEE CHOOSES NOT TO TAKE REQUESTED ACTIONS, PROVIDE DESCRIPTION OF ANY PROPOSED ALTERNATIVE COURSE OF ACTION, SCHEDULE FOR COMPLETING ALTERNATIVE COURSE OF ACTION (IF APPLICABLE), AND SAFETY BASIS FOR DETERMINING ACCEPTABILITY OF PLANNED ALTERNATIVE COURSE OF ACTION;**

- 2. WITHIN 180 DAYS FROM DATE OF GL 95-07, A WRITTEN RESPONSE TO THE INFORMATION REQUEST SPECIFIED ABOVE.**

# **PRESSURE LOCKING AND THERMAL BINDING SCOPE**

GL 95-07

**ALL SAFETY-RELATED POWER-OPERATED GATE VALVES WITH A  
SAFETY FUNCTION IN THE OPEN POSITION.**

**INADVERTENT MISPOSITIONING EXCLUDED.**

**ELIMINATE VALVES BASED ON DISK CONFIGURATION (SOLID WEDGE  
NOT SUSCEPTIBLE TO PRESSURE LOCKING, PARALLEL DISK NOT  
SUSCEPTIBLE TO THERMAL BINDING).**

GL 90-06

**PORV BLOCK VALVES**

**EXAMPLES OF OTHER NRC REGULATIONS AND LICENSEE  
COMMITMENTS**

**APPENDIX R WITH REPOSITIONING BY SHORT CIRCUITING**

**ANTICIPATED TRANSIENT WITHOUT SCRAM**

**STATION BLACKOUT**

## EXAMPLE MATRIX FOR EVALUATING GL 95-07 SAFETY-RELATED POWER-OPERATED GATE VALVE SUSCEPTIBILITY

Valve Normal Position	Safety Position	Test or Surveillance Position	Evaluate Susceptibility Within Scope of GL 95-07
Normally Closed	Open	Closed	Yes
Normally Closed	Open	Open	Yes
Normally Closed	Closed	Closed	No *
Normally Closed	Closed	Open	No *
Normally Open	Open	Closed	Yes
Normally Open	Open	Open	No
Normally Open	Closed	Closed	No *
Normally Open	Closed	Open	No *

\* LICENSEES SHOULD BE AWARE OF THE POTENTIAL FOR THERMALLY-INDUCED PRESSURE TRANSIENTS RESULTING IN BONNET OVERPRESSURIZATION

## **GATE VALVES CLOSED FOR SURVEILLANCE OR TESTING**

**NRC REGULATIONS AND LICENSEE SAFETY ANALYSES REQUIRE THAT SAFETY-RELATED SYSTEMS BE CAPABLE OF PERFORMING THEIR SAFETY FUNCTIONS.**

**IF CLOSING A SAFETY-RELATED POWER-OPERATED GATE VALVE FOR TEST OR SURVEILLANCE DEFEATS THE CAPABILITY OF THE SAFETY SYSTEM OR TRAIN, LICENSEE NEEDS TO PERFORM ONE OF THE FOLLOWING WITHIN THE SCOPE OF GL 95-07:**

- 1. VERIFY THAT VALVE IS NOT SUSCEPTIBLE TO PRESSURE LOCKING OR THERMAL BINDING WHILE CLOSED,**
- 2. FOLLOW PLANT TECHNICAL SPECIFICATIONS FOR TRAIN/SYSTEM WHILE VALVE CLOSED,**
- 3. DEMONSTRATE THAT THE ACTUATOR HAS SUFFICIENT CAPACITY TO OVERCOME THESE PHENOMENA, OR**
- 4. MAKE APPROPRIATE HARDWARE AND/OR PROCEDURAL MODIFICATIONS TO PREVENT PRESSURE LOCKING AND THERMAL BINDING.**

**THIS APPROACH IS ALSO APPROPRIATE FOR NON-SAFETY-RELATED VALVES IN SAFETY SYSTEMS.**



# OPERATIONAL CONFIGURATIONS IN SUSCEPTIBILITY EVALUATIONS

ABSENCE OF HEAT SOURCE ELIMINATES VALVES FROM  
THERMALLY-INDUCED PRESSURE LOCKING.

EXTERNAL CONDITIONS DURING NORMAL, SURVEILLANCE OR  
OPERATING CONDITIONS SUCH AS:

    PRESENCE OF INSULATION (BENEFIT NEEDS TO BE JUSTIFIED)

    POTENTIAL HEAT SOURCES: PUMP MOTORS, STEAM DRIVEN  
    TURBINES, HIGH ENERGY PIPING, HIGH TEMPERATURE FLUID

SURVEILLANCE TESTING OR OTHER SPECIAL TEST CONDITIONS  
SUCH AS HYDROSTATIC TESTING.

GENERIC STUDIES SUCH AS THERMAL EFFECTS AND DESIGN-BASIS  
DEPRESSURIZATION.

EFFORTS TO IMPROVE LEAK-TIGHTNESS OF PRIMARY SYSTEM  
VALVE PRESSURE BOUNDARIES.

POTENTIAL FOR WATER FILLING VALVE BONNET (FULL BONNET NOT  
REQUIRED FOR FLUID-INDUCED PRESSURE LOCKING)

INTERNAL SYSTEM OPERATING CONDITIONS.

PRESSURE LOCKING AND THERMAL BINDING WHEN VALVE  
REQUIRED TO OPEN.

VALVE CLOSED AT HIGH TEMPERATURE AND REQUIRED TO OPEN AT  
LOWER TEMPERATURE

ADEQUATELY JUSTIFIED ASSERTIONS OF DIFFERENTIAL  
TEMPERATURE FOR THERMAL BINDING

# **INAPPROPRIATE REASONS FOR ELIMINATING VALVES FROM SUSCEPTIBILITY**

**LEAKAGE RATE**

**ENGINEERING JUDGEMENT WITHOUT JUSTIFICATION**

**LACK OF EVENT OCCURRENCE**

## **EXAMPLES OF VALVES SUSCEPTIBLE TO PRESSURE LOCKING**

**LOW-PRESSURE COOLANT INJECTION (LPCI) AND LOW-PRESSURE  
CORE SPRAY (LPCS) SYSTEM INJECTION VALVES**

**RESIDUAL HEAT REMOVAL (RHR) SYSTEM HOT-LEG CROSSOVER  
ISOLATION VALVES**

**RHR CONTAINMENT SUMP AND SUPPRESSION POOL SUCTION  
VALVES**

**HIGH-PRESSURE COOLANT INJECTION (HPCI) STEAM ADMISSION  
VALVES**

**RHR HEAT EXCHANGER OUTLET VALVES**

**EMERGENCY FEEDWATER ISOLATION VALVES**

**RCIC STEAMLINER ISOLATION VALVE**

# EXAMPLES OF VALVES SUSCEPTIBLE TO THERMAL BINDING

REACTOR DEPRESSURIZATION SYSTEM ISOLATION VALVES

RHR INBOARD SUCTION ISOLATION VALVES

POWER-OPERATED RELIEF VALVE (PORV) BLOCK VALVES

REACTOR COOLANT SYSTEM LETDOWN ISOLATION VALVES

RHR SUPPRESSION POOL SUCTION VALVES

CONTAINMENT ISOLATION VALVES (SAMPLE LINE, LETDOWN HEAT EXCHANGER INLET HEADER)

CONDENSATE DISCHARGE VALVES

REACTOR FEEDWATER PUMP DISCHARGE VALVES

# **SHORT-TERM ACTION FOR GATE VALVES FOUND SUSCEPTIBLE TO PRESSURE LOCKING OR THERMAL BINDING**

**EVALUATE IMMEDIATE OPERABILITY USING BEST AVAILABLE  
METHODS FOR PREDICTING REQUIRED AND AVAILABLE THRUST:**

**BEST AVAILABLE METHODS FOR PREDICTING THRUST  
REQUIRED TO OVERCOME PRESSURE LOCKING INCLUDE  
ENTERGY, ComEd AND HOPE CREEK METHODS AT THIS TIME.**

**METHOD FOR PREDICTING THRUST REQUIRED TO OVERCOME  
THERMALLY INDUCED PRESSURE LOCKING SHOULD CONSIDER  
HEAT TRANSFER, PRESSURE VERSUS TEMPERATURE  
INCREASE, AND AIR VOLUME RELIABILITY.**

**BEST AVAILABLE METHOD FOR PREDICTING AVAILABLE  
THRUST AND WEAK LINK CAPABILITY CONSISTENT WITH  
GL 89-10 PROGRAM.**

**IF CANNOT DEMONSTRATE CAPABILITY TO OVERCOME PRESSURE  
LOCKING AND THERMAL BINDING OF SUSCEPTIBLE VALVE AND  
CANNOT ESTABLISH PROCEDURE CONTROLS TO PREVENT THE  
PHENOMENA, TAKE ACTION IN ACCORDANCE WITH TECH SPECS.**

# **LONG-TERM OPTIONS FOR RESOLVING PRESSURE LOCKING AND THERMAL BINDING OF SUSCEPTIBLE VALVES**

## **ANALYSIS ONLY**

**CONSERVATIVE ACCOUNTING FOR UNCERTAINTIES IN  
ANALYSIS**

## **TESTING ONLY**

**ASSURANCE THAT TEST CONDITIONS BOUND ALL  
OPERATIONAL CONDITIONS**

## **COMBINATION OF TESTING AND ANALYSIS**

**CORRELATION OF TEST RESULTS AND ANALYSIS**

**CONSERVATIVE APPLICATION OF TEST RESULTS**

## **EQUIPMENT MODIFICATIONS**

**SEE FOLLOWING SLIDE.**

## **PROCEDURE MODIFICATIONS**

**MAY BE MOST APPROPRIATE RESOLUTION TO RESOLVE  
THERMAL BINDING**



# EXAMPLES OF VALVE MODIFICATIONS

## PRESSURE LOCKING

DRILL HOLE IN HIGH PRESSURE SIDE OF THE DISK AND ACCOUNT FOR VALVE BEING UNIDIRECTIONAL.

INSTALL PRESSURE RELIEF OR VENT PATH -  
MODIFY OPERATING PROCEDURES IF OPERATOR ACTION IS REQUIRED (SUCH AS REMOTELY OPERATED VALVE)

INSTALL EXTERNAL BYPASS LINE WITH MANUAL VALVE -  
MODIFY OPERATING PROCEDURES

VALVE DISK TRAVEL PRIOR TO HARD SEAT CONTACT AND ACCOUNT FOR LEAKAGE PAST VALVE

## THERMAL BINDING

REPLACE FLEX-WEDGE OR SOLID WEDGE WITH A PARALLEL DISK -  
(1) INVESTIGATE NEW POSSIBILITY FOR PRESSURE LOCKING AND (2) APPROPRIATE TESTS BEFORE PLACING THE VALVE IN SERVICE

PERIODICALLY STROKE VALVE -  
(1) ADEQUATE JUSTIFICATION FOR THE TEMPERATURE INTERVAL AND (2) CONSIDERATION FOR DIVERSION OF FLOW

STOP VALVE DISK TRAVEL PRIOR TO HARD SEAT CONTACT -  
(1) ADEQUATE JUSTIFICATION FOR HIGH TEMPERATURE GRADIENTS AND (2) VALVE DOES NOT PROVIDE COMPLETE ISOLATION

INSTALL A COMPENSATING SPRING PACK WITH TEST VERIFICATION

# **IMPORTANCE OF TRAINING TO RESOLVE PRESSURE LOCKING AND THERMAL BINDING**

## **EXAMPLES:**

**DRILLING A HOLE IN THE HIGH PRESSURE SIDE**

**TRAIN OPERATORS TO REPLACE DISK IN CORRECT  
ORIENTATION**

**PERIODICALLY STROKING THE VALVE**

**TRAIN OPERATORS REGARDING POTENTIAL PLANT  
TRANSIENTS**

# **STAFF PLANS FOR REVIEWING LICENSEE RESPONSES TO GL 95-07**

**REVIEW 60-DAY RESPONSE**

**REVIEW 180-DAY SUBMITTALS**

**CLOSE STAFF REVIEW BY 1 OR MORE OF:**

- 1. NRR REVIEW**
- 2. NRR AUDIT**
- 3. REGION INSPECTION**

**RESOLVE ANY CONCERNS WITH LICENSEE INVOLVING PRESSURE  
LOCKING/THERMAL BINDING WITH ANY APPROPRIATE LICENSEE  
ACTION**

# **NRC SPONSORED RESEARCH**

**THRUST REQUIREMENT VS. BONNET PRESSURE**

**BONNET PRESSURE VS. TEMPERATURE INCREASE**

**INCLUDING THE EFFECTS OF AIR ENTRAPMENT**

**UNCERTAINTY IN ABILITY TO CALCULATE LEAKAGE RATE AND  
IMPACT ON PRESSURE LOCKING**

**UNCERTAINTY IN ABILITY TO RELY ON ENTRAPPED AIR**

**THRUST REQUIREMENT VS. THERMAL BINDING**



**Pressure Locking  
and  
Thermal Binding (PL/TB):**

**Experience at Northeast Utilities (NU)**

November 2, 1995

Bob Harris

Nuclear Engineering Services Division  
Northeast Utilities  
Rope Ferry Road  
Waterford, CT 06385-0128

**NRC Region I Conference on GL 95-07, Wayne, PA**



## Purpose

- ➔ Share NU's Experience with Pressure Locking & Thermal Binding (PL/TB) of Gate Valves based primarily on our actions taken for MOVs as part of GL 89-10 Closure.
- ➔ Discuss preliminary results of GL 95-07 Screening of Power Operated Valves (POVs).



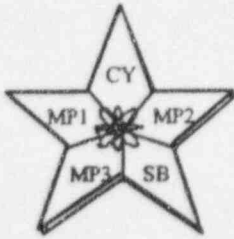

# PL/TB Overview: Vulnerabilities & Corrective Actions

## ➔ Gate Valve Susceptibility

VALVE DESIGN	PL	TB
Solid-Wedge	No	Yes
Flex-Wedge	Yes	Yes<
Parallel/Double Disc	Yes	No

## ➔ Generic Corrective Actions

	HARDWARE* MODS	ADMIN MODS	ANALYSIS
PL	Many	Limited	Cautiously
TB	None*	Primary	N/A

\* Replacement of valve with a different design may be feasible

## ➔ NU has Developed a Detailed Evaluation Procedure (called PI-20)

- ↳ Part of GL 89-10 MOV Program
- ↳ Conservative
- ↳ Engineering Judgment
- ↳ Empirical Data



# PL & TB are Real, but Rare Phenomenon

- ➔ The physical phenomena are real & easily understood once gate valve design is examined in this context.
- ➔ PL/TB occurrences pre-date commercial nuclear plants; are events for valves in fluid systems exposed to temperature and pressure.
- ➔ There have been numerous NRC communications dating back to 1977; INPO 84-7 provides a comprehensive summary.
- ➔ Significantly, Industry-accepted guidance on screening for PL/TB susceptibility has been missing.
- ➔ NRC NUREG-1275 reported **11** instances of PL and **14** of TB, in hundreds of reactor years.
- ➔ NU has experienced **~1/2 dozen** recognized TB events in **~80Ryr**; and no PL known events.
- ➔ Some PL/TB Events may not have been recognized.

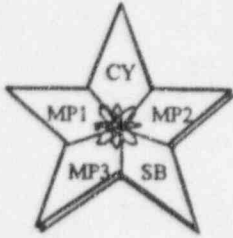

## Actual Occurrence of PL Should be Rare

➔ **Probability of Pressure Locking ( $P_{PL}$ ):**

$$P_{PL} = P_1 \times P_2 \times P_3 \times P_4 \times P_5 \times P_6 \times P_7$$

### **Causal/Mitigating Factors:**

- ① System Condition/Upstream Leakage
- ② Seal Ring Condition/Packing Seal Leak Tight
- ③ Trapped Air in Bonnet
- ④ Process Fluid/External Heating
- ⑤ Insufficient Available Thrust
- ⑥ Temperature/Pressure Regime
- ⑦ Time Duration & Time History
- ⑧ The Unknowns, etc.

➔ **Not Surprisingly *Actual* Occurrence of PL is Difficult to Predict**



# PL&TB are Situational & Complex: Two Examples

## 1 PL is highly Situational:

- ↳ Creare Inc. testing of MP2 Sump Recirculation Valves (see Fig. 1)
- ↳ Small Quantities of Air Mitigates PL
- ↳ Figure 1 shows Situational Nature

## 2 Unique Mechanisms can be Mistaken for PL or TB:

- ↳ Evaluation of MP1 Shutdown Cooling Valves
- ↳ Experienced multiple, recent “binding events
- ↳ Very PRELIMINARY cause attributed to **Pressure Induced Binding** (Kalsi Study)



Fig. 1: Millstone 2  
1/4 Scale Tests at Creare

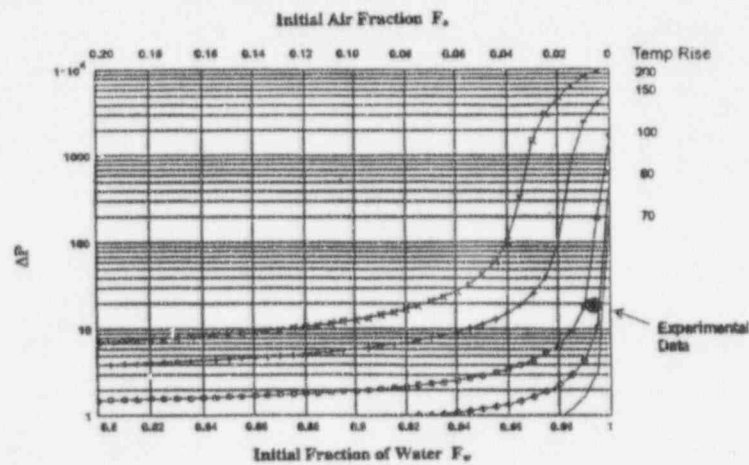
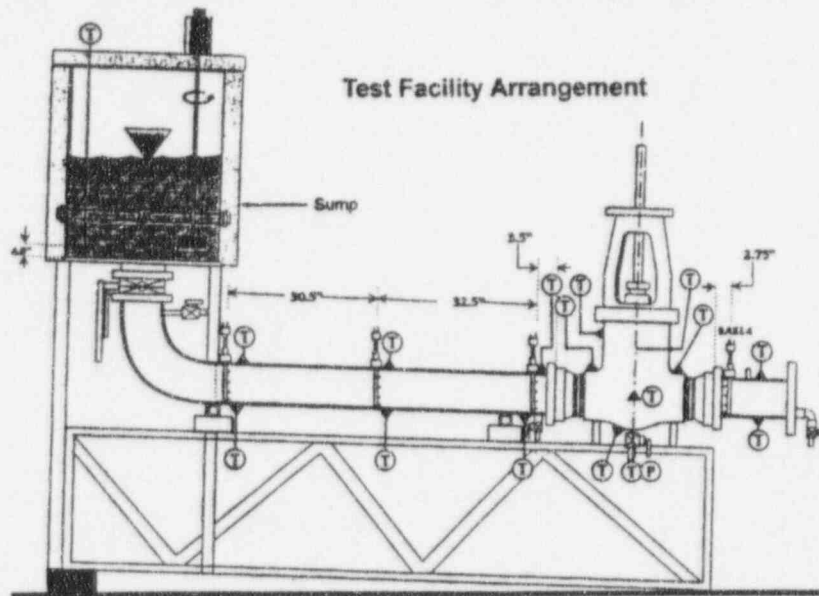



# PL/TB & GL 95-07 Primarily Impact GL 89-10 MOVs

## Preliminary

	CY	MP1	MP2	MP3	SB
All POVs (estimated)	504	~1000	~1200	~2000	~1000
S-R POWs	188	284	534	981	n/a
Less GL 89-10 Valves	(44)	(54)	(52)	(143)	(122)
S-R POV Gate Valves (non 89-10)	6	1	3	6	22
Open Safety Stroke	0	0	0	0	0
<b>Remaining for PL/TB Evaluation</b>	<b>0</b>	<b>0</b>	<b>0</b>	<b>0</b>	<b>0</b>

The Screening Funnel for GL 95-07





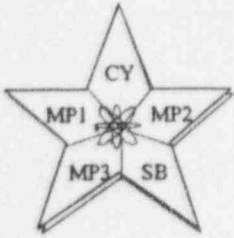

# Modifications Required to Resolve PL/TB for GL 89-10 MOVs

- ➔ NU decided in Fall '94 to resolve PL/TB Issue for MOVs as a part of GL 89-10 Closure.
- ➔ This resulted in a substantial number of Modifications to NU Plants.
- ➔ Affected Systems Include:

TYPICAL SYSTEMS IMPACTED	
<b>PWR</b>	Shutdown Cooling Containment Sump Recirculation Main Steam Safety Injection
<b>BWR</b>	Feedwater Isolation Condenser LP Coolant Injection

## ➔ Summary of Changes

	CY	MP1	MP2	MP3	SB
<b>Hardware Mods:</b>					
Equilizing Line		2	1		
Drill Disc	8		1	2	
Packing Gland Leakoff	9			2	
Planned for next RFO		4		6	10
<b>Admin Mods:</b>					
Procedure Changes	2	6	6		2
Prototype Experiment			2		
Operability Space				2	



# Conclusions

- ➔ PL/TB is real, but rare.
- ➔ Conceptually, PL&TB are reasonably simple phenomenon; however, predicting *actual* occurrences is complex and in many cases beyond State-of-the-Art.
- ➔ PL/TB is primarily a *GL 89-10 issue*, and required several modifications for NU Plants.
- ➔ GL 89-10 PL/TB Methodology is fully applicable to GL 95-07.
- ➔ At NU we had a bias toward hardware “fixes” vs. analysis.
- ➔ Further empirical data would be helpful
- ➔ Our conservative, systematic evaluation procedure (PI-20) provides the guidance to resolve GL 95-07. (some copies available)

# Test Sequence

- **Static (Baseline) Tests**
- **LLRT of Test Valve**
- **Hydro-Pump DP Tests to determine seat to disk friction coefficient**
- **Bonnet Pressure Decay Tests**
- **Alternating Static (Baseline) Tests and Pressure Locking Tests at various bonnet/outlet pressure combinations**
- **Repeat of Test Sequence at different torque switch setting(s)**
- **Thermally Induced Bonnet Pressurization Tests**
- **Thermal Binding Test for Valve Cooldown Effect**

# Predicted Unseating Thrust Versus Measured Pressure Locking Unseating Force for Crane Valve

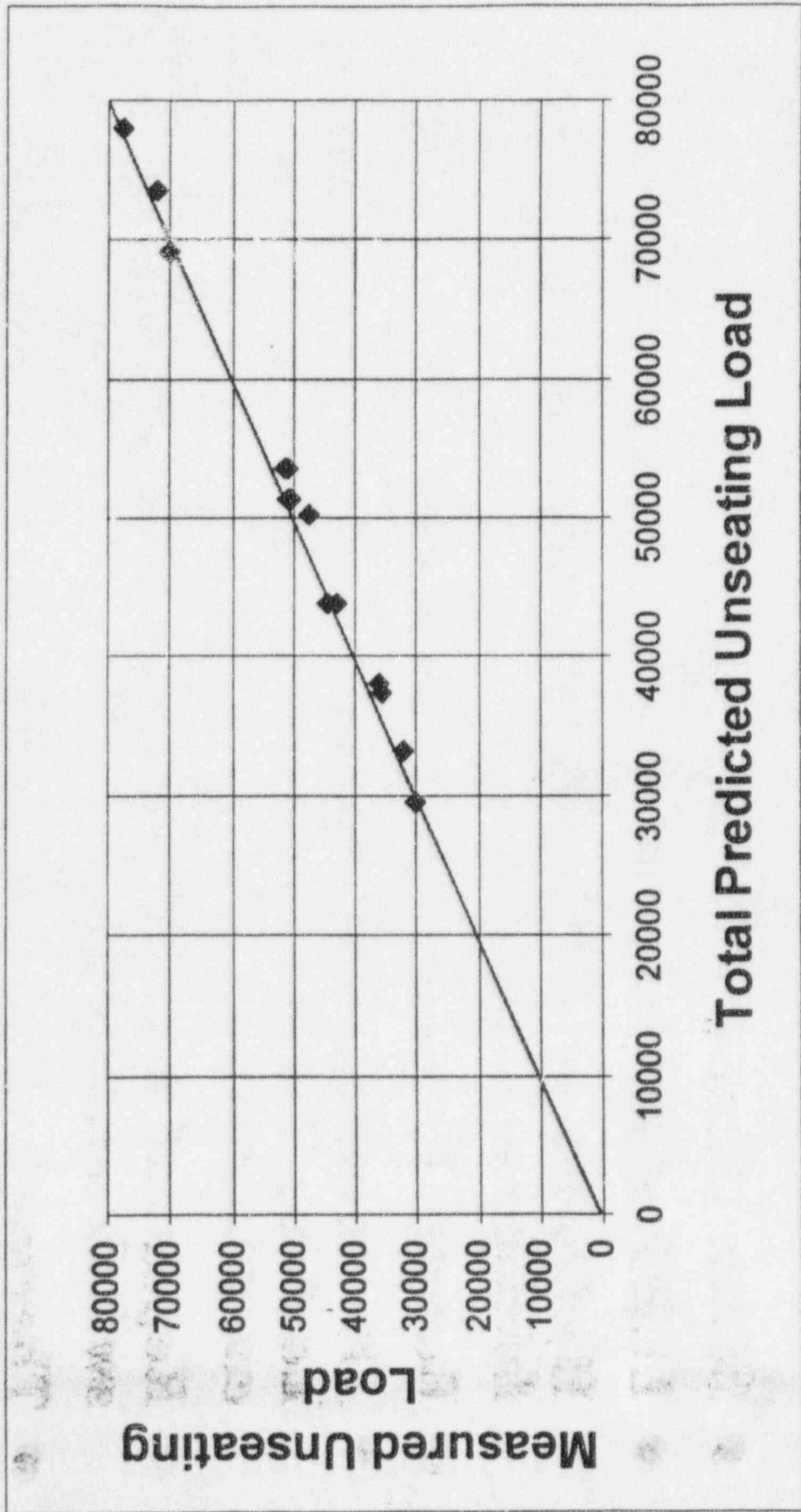

**ComEd**

# Predicted Versus Measured Portion of Pressure Thrust Due to Pressure Forces for Crane Valve

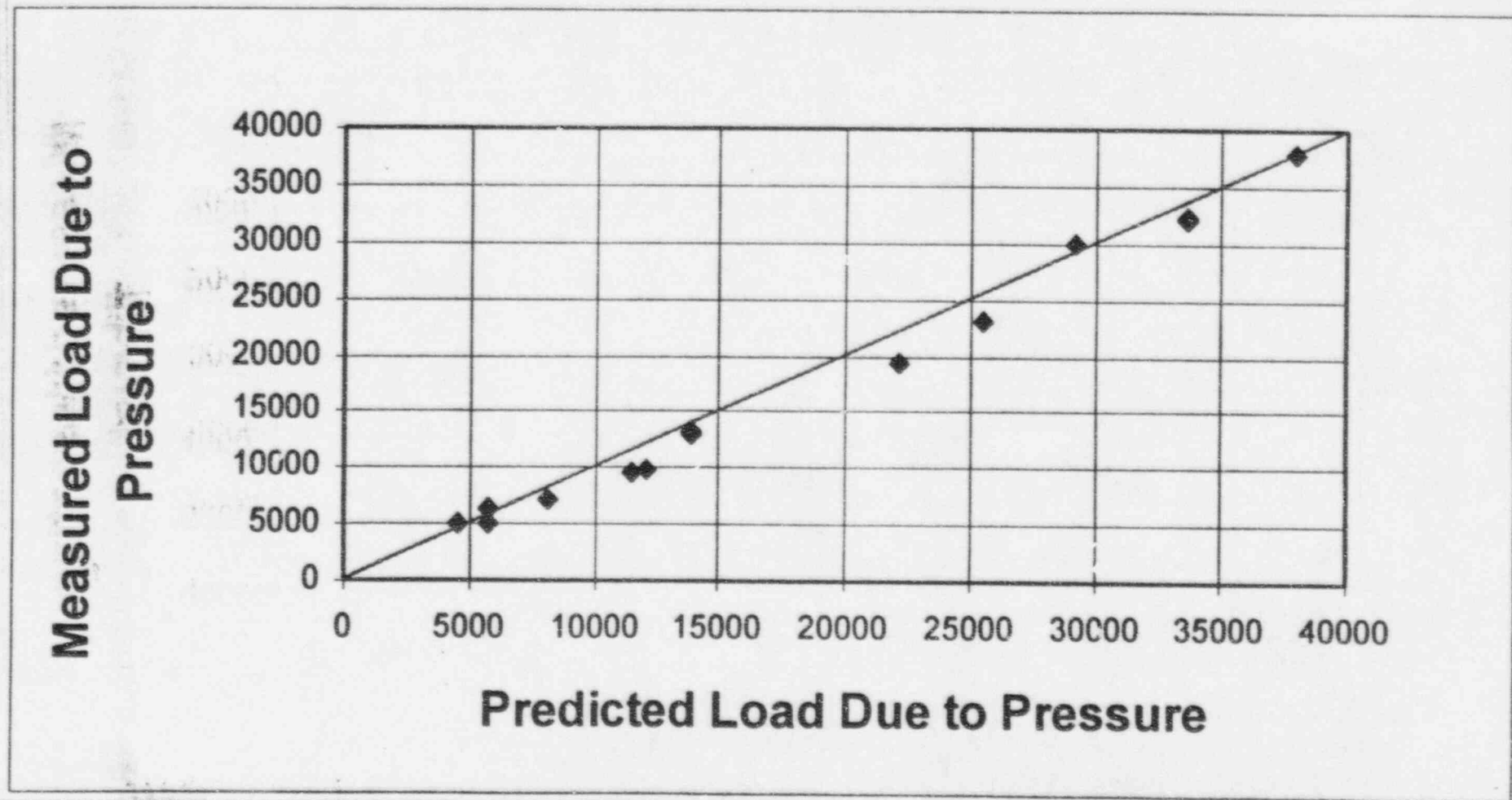

**ComEd**



# Predicted Unseating Thrust Versus Measured Pressure Locking Unseating Thrust for Westinghouse Valve

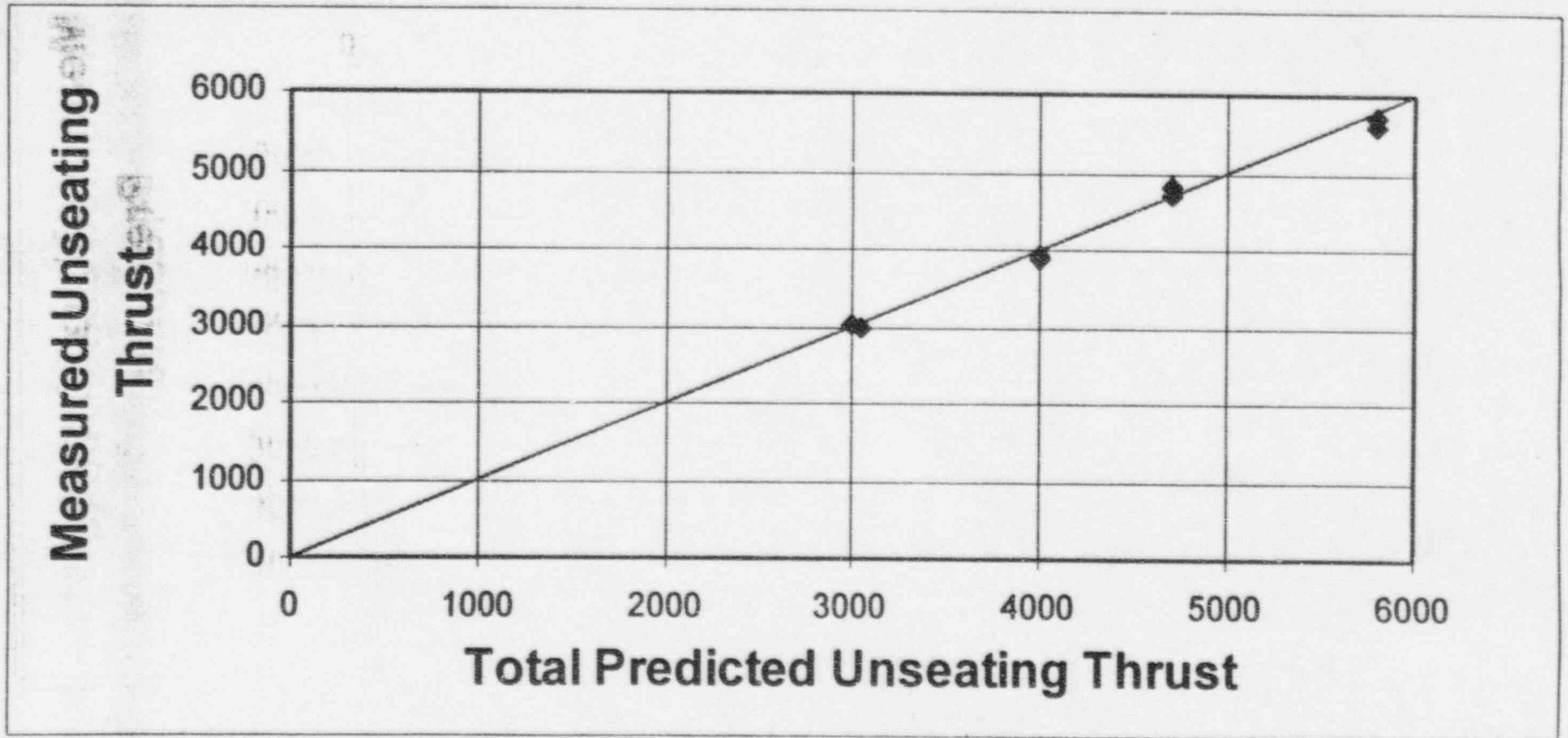

**ComEd**



# Predicted Versus Measured Portion of Unseating Thrust Due to Pressure Forces for Westinghouse Valve

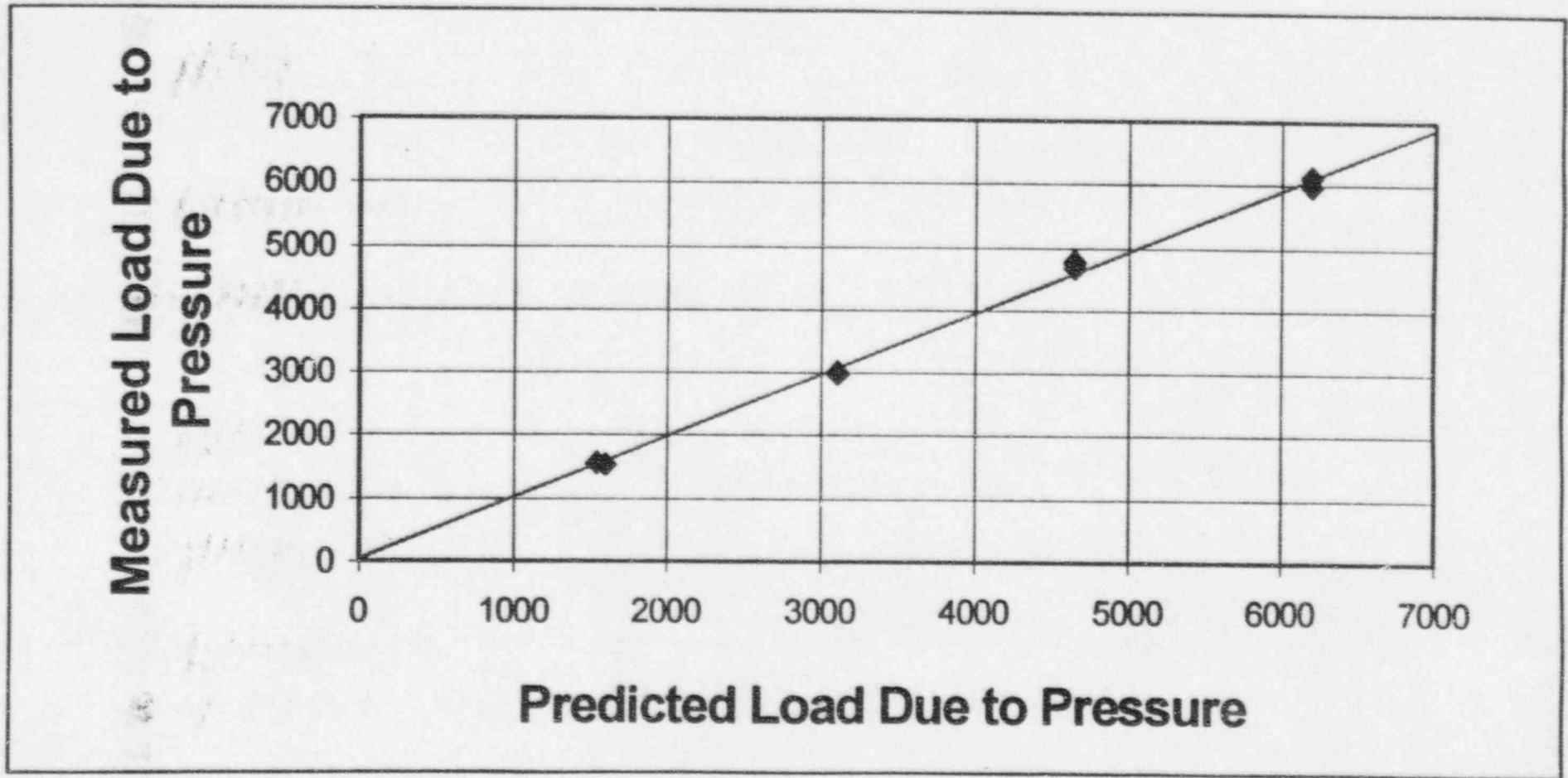

**ComEd**

# Summary of Test Results

- **Accuracy of Roark's Equations for Predicting Pressure Locking Force:**

Initial data analysis indicates that the ComEd model for predicting pressure locking unseating thrust is accurate and conservative

- **Bonnet Depressurization Rates**

Crane Valve: 500 psi to 50 psi / min  
(depending on TSS)

West. Valve: 300 psi to 1 psi / min  
(depending on TSS)



# Summary of Test Results (continued)

## ● Thermally Induced Pressure Rise Data:

Crane Valve: Test could not be performed due to high bonnet depressurization rate

West. Valve: Pressure rise rate of 0.4 psi per degree. Temperature was raised from 70 to 260 degrees F.

## ● Thermal Binding Test Results

Crane Valve: (test is pending)

West. Valve: No increase in unseating thrust for 200 degree temperature drop (low seat mu makes this the expected result)

The logo for ComEd, featuring the word "ComEd" in a bold, sans-serif font. The letter "E" is stylized with a starburst or spark-like graphic behind it. The logo is set against a dark, horizontal background bar.

# Future ComEd Testing Plans

- Thermal Binding Testing of Crane 10" Gate Valve
- Testing of Other Flex-Wedge Gate Valve Designs. The following valve designs are being considered:
  - 10" Borg-Warner Gate Valve (~11/27/95)
  - 6" Anchor/Darling Gate Valve (~11/27/95)
  - 10" Westinghouse Gate Valve (~12/?/95)
- Testing of 6" Anchor/Darling Double-Disk Gate Valve
- Comparison of Thermal Binding Test Data to Analytical Models Under Development
- Analysis of Data Collected by Other Utilities Using ComEd Pressure Locking Model





# Comparison of Static Unseating to Pressure Locking Unseating Thrust for 10" Crane 900# Class Valve

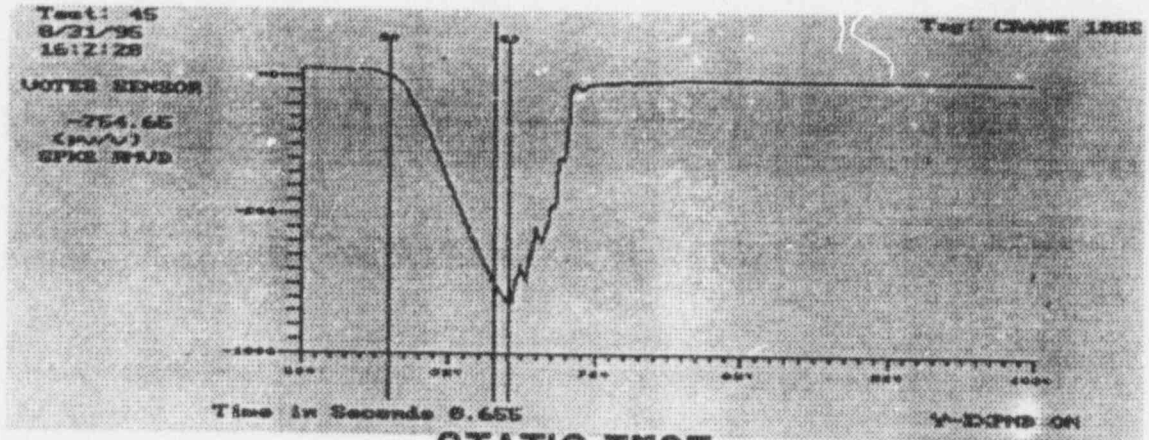

STATIC TEST

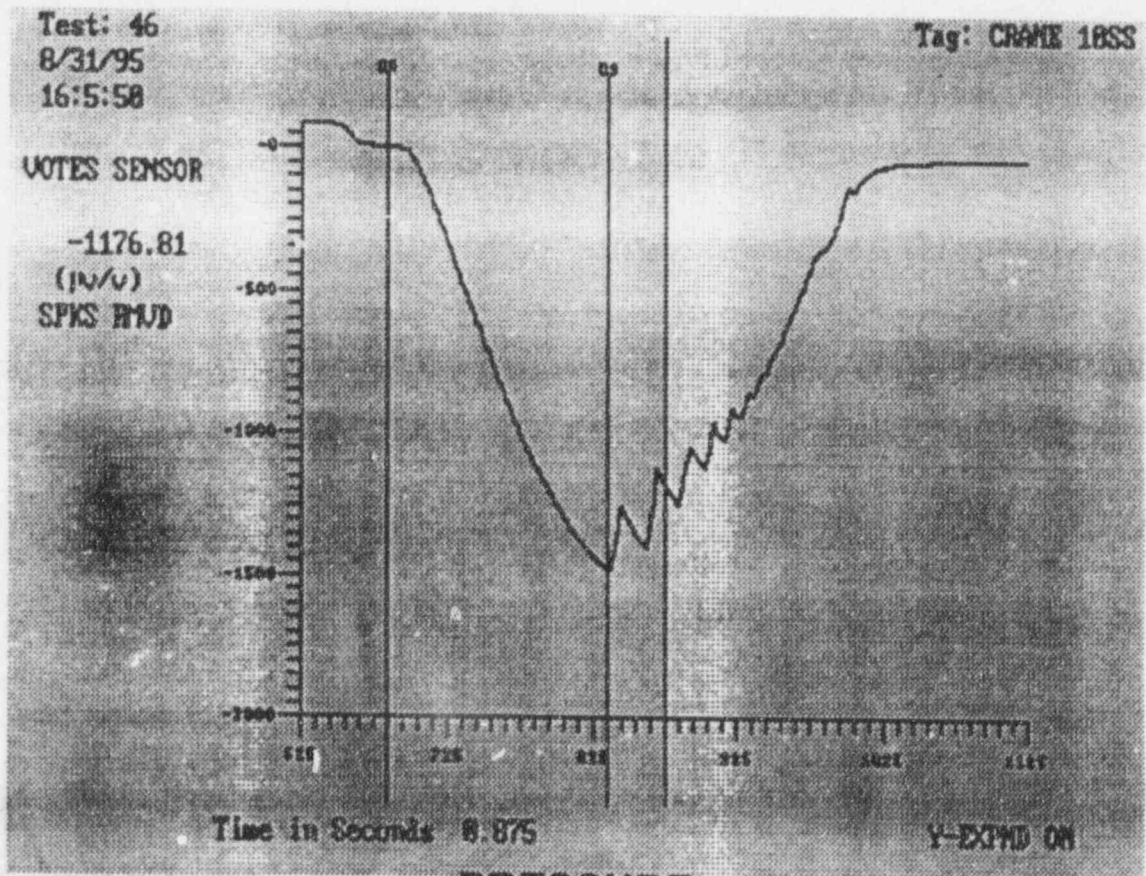

PRESSURE  
LOCKING TEST

$1 \text{ mV/V} \approx 50 \text{ lbf}$

# Example of Hydro-Pump DP Test for Determining Seat Friction Coefficient (10" Crane 900# Class Valve)

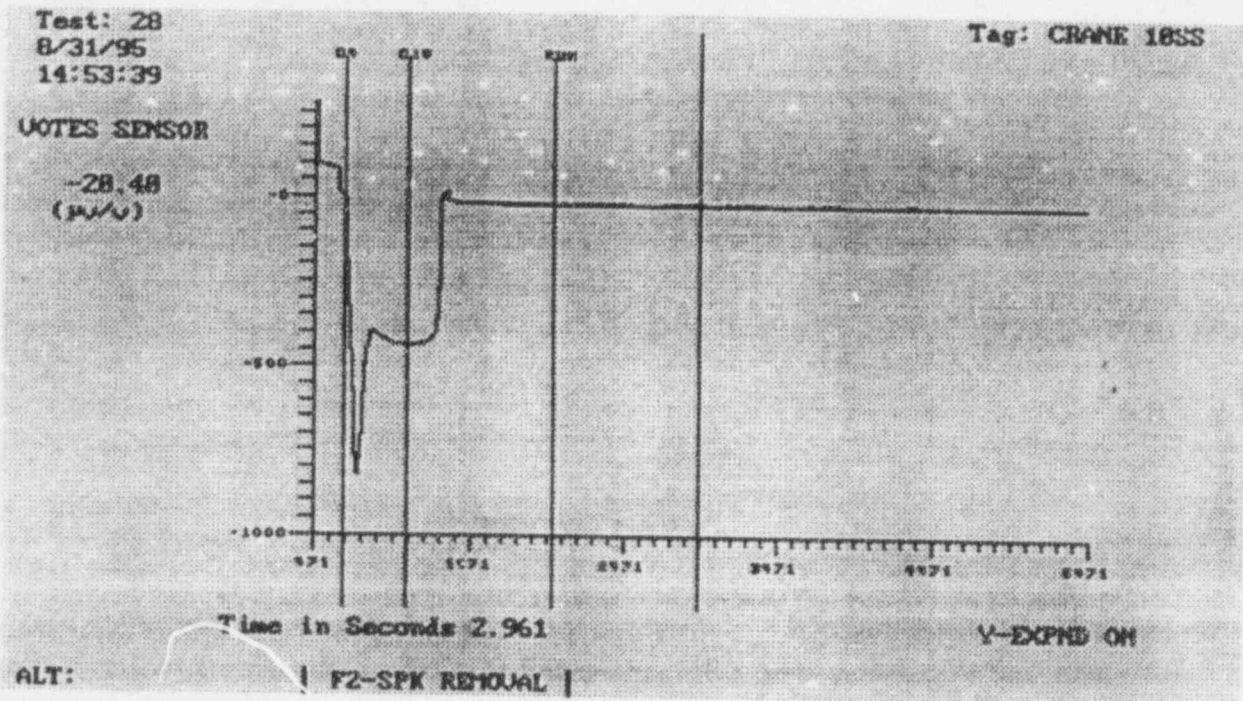

5 SECOND ZOOM

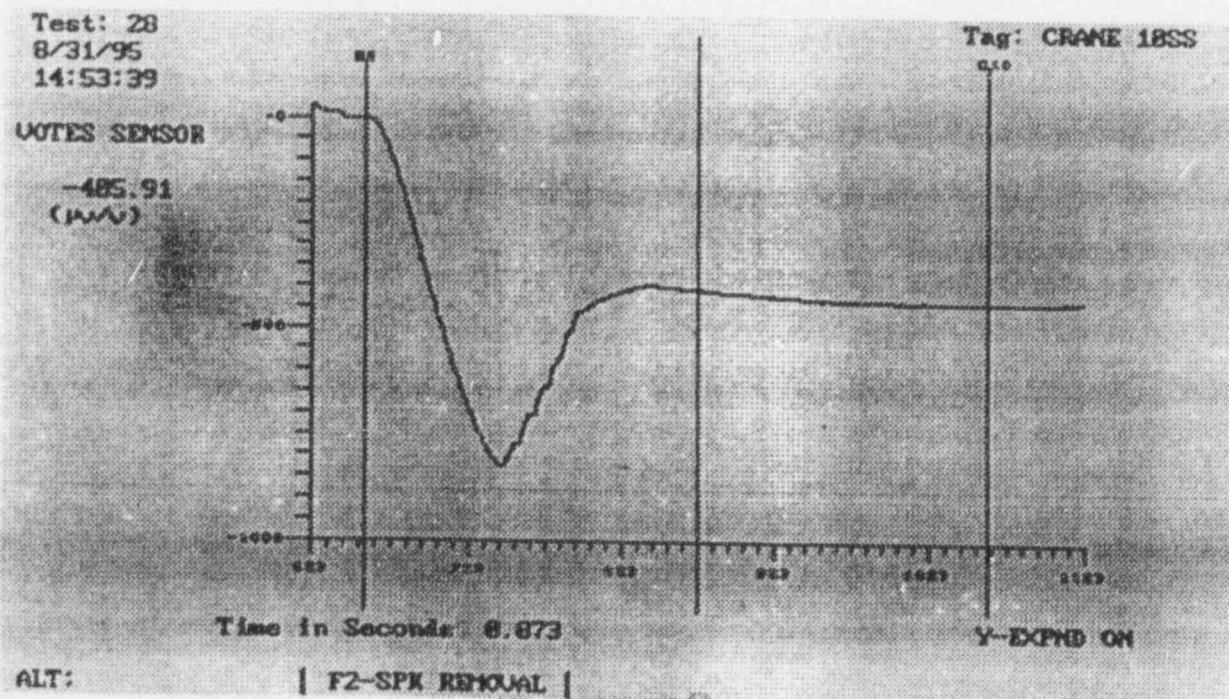

HALF SECOND ZOOM



# Static Test for 4" Westinghouse 1500# Class Gate Valve

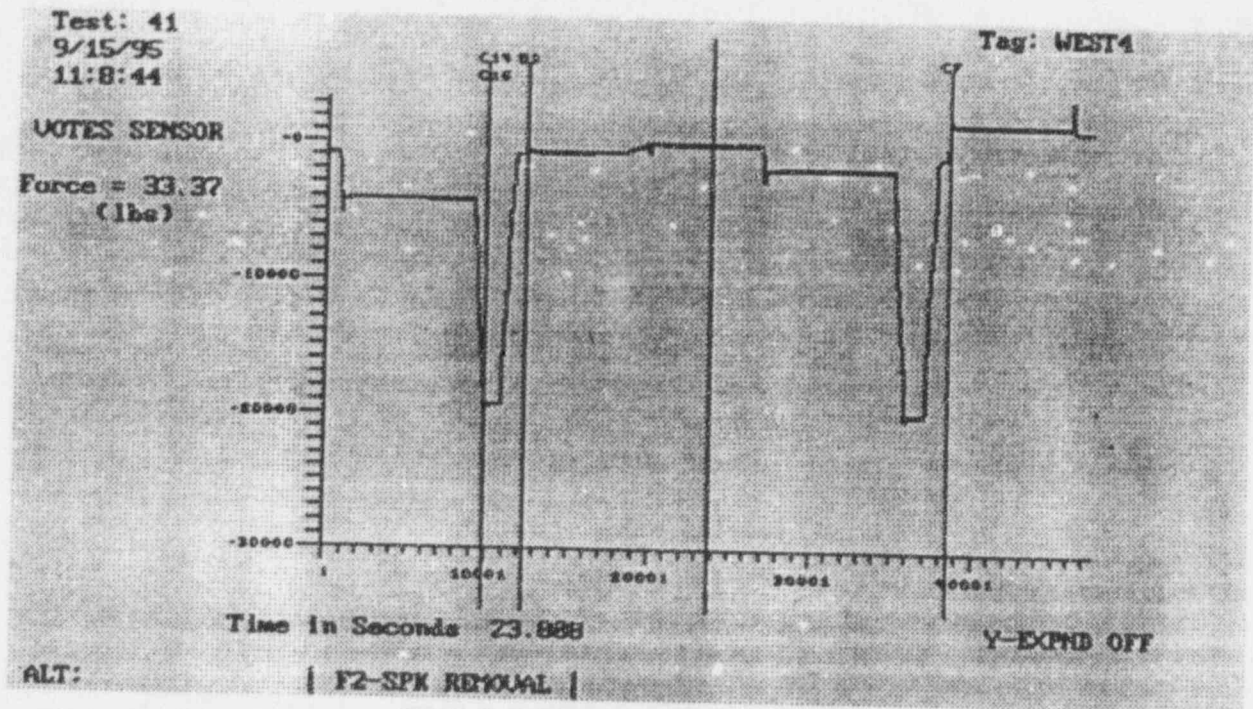

FULL VIEW OF TRACE

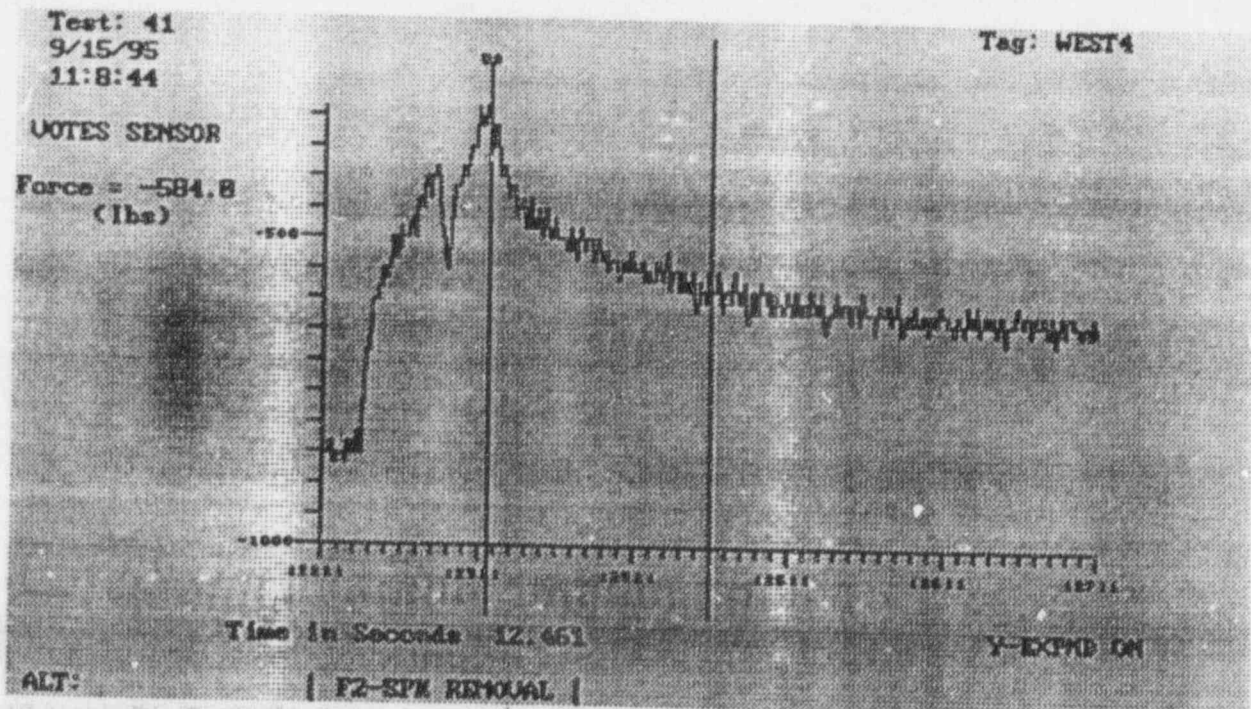

HALF SECOND VIEW OF TRACE

# Comparison of Static Unseating to Pressure Locking Unseating Thrust for 4" Westinghouse 1500# Class Valve

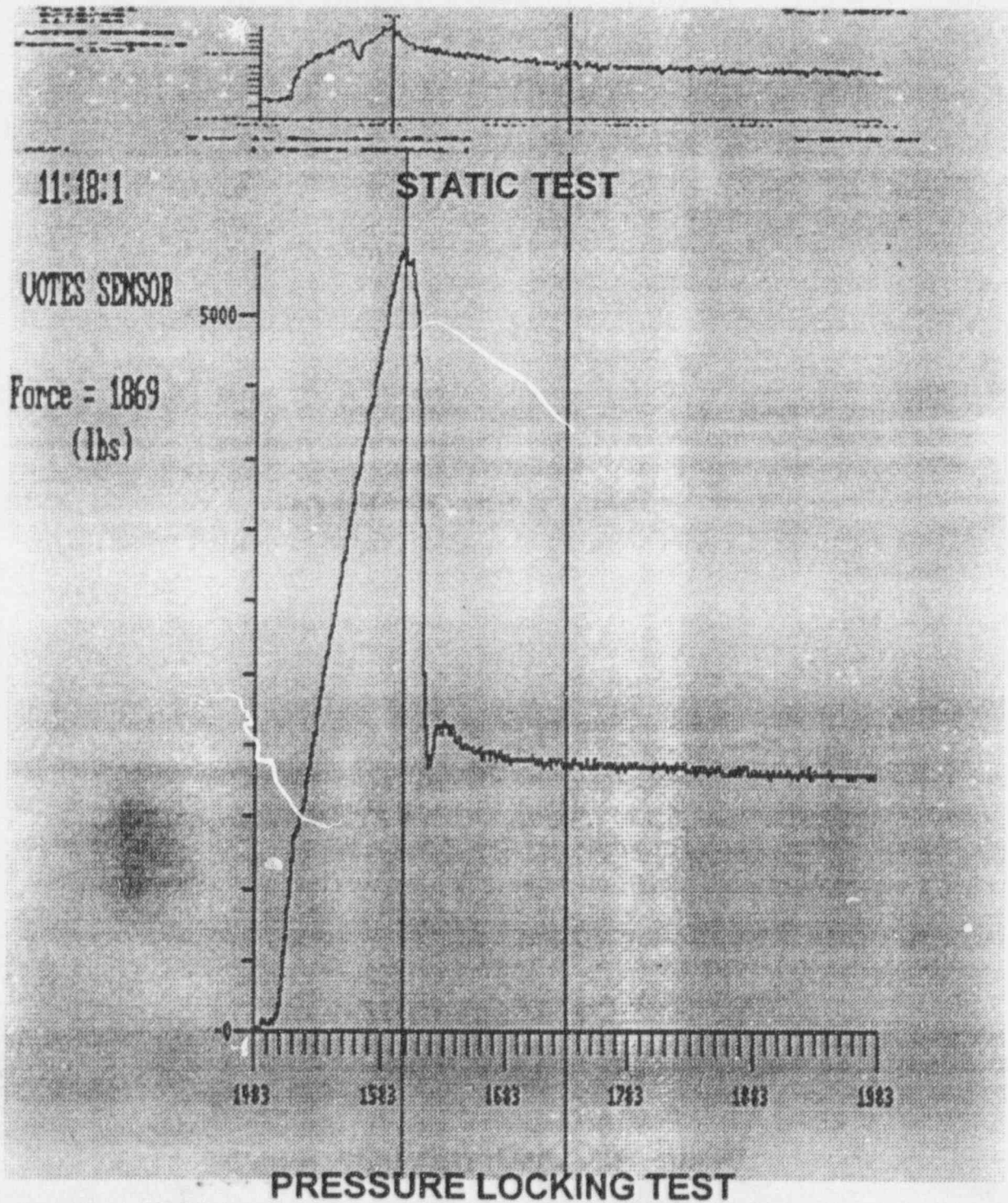



# Example of Hydro-Pump DP Test for Determining Seat Friction Coefficient (4" Westinghouse 1500# Gate Valve)

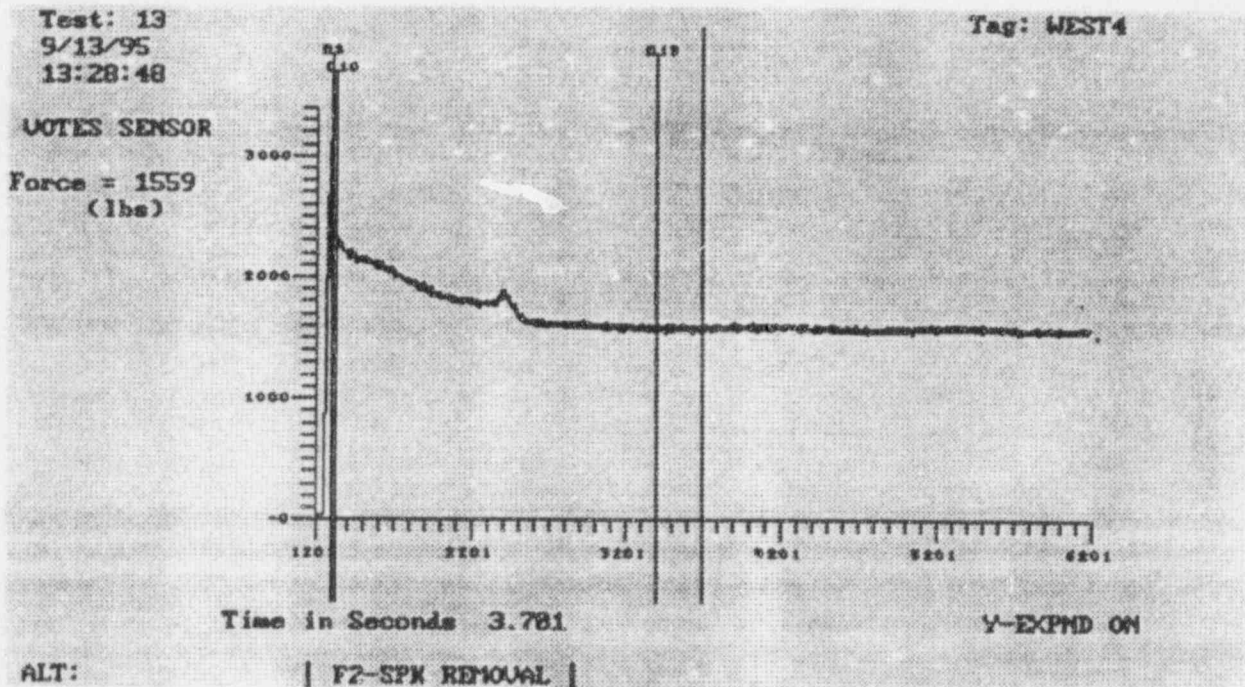

5 SECOND ZOOM

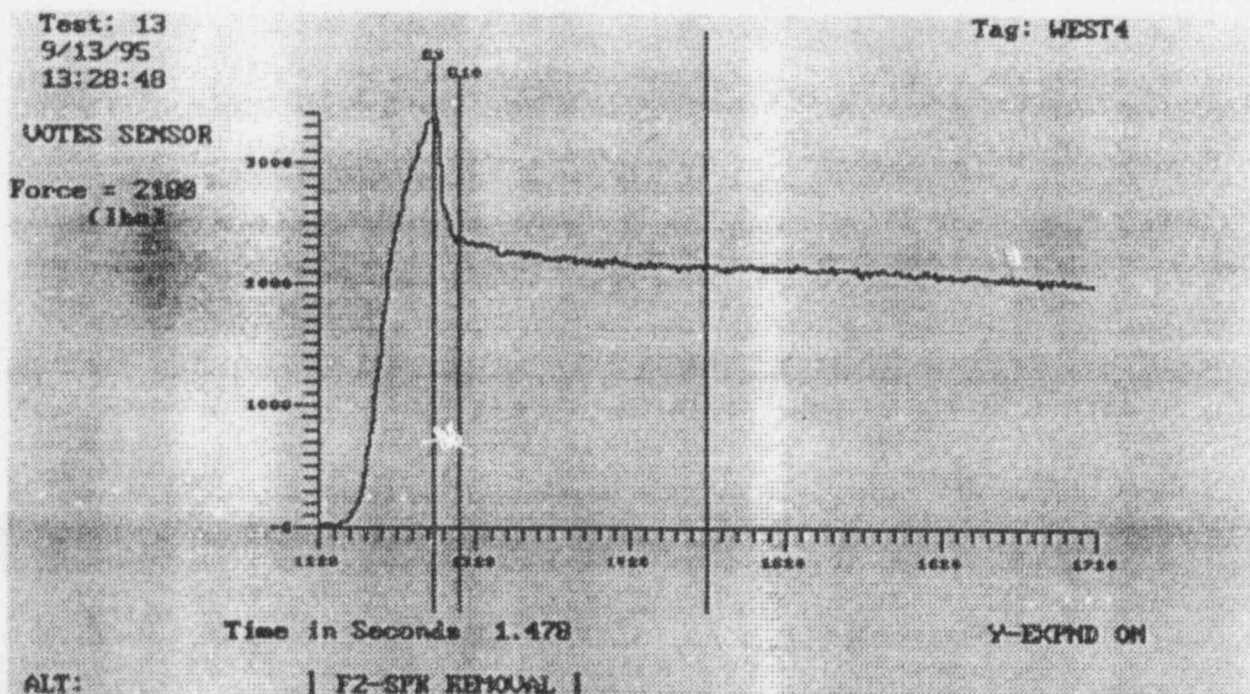

HALF SECOND ZOOM

**PRESSURE LOCKING AND THERMAL BINDING  
PROGRAM AT WNP-2**

**PRESENTED AT:  
PRESSURE LOCKING AND  
THERMAL BINDING WORKSHOP**

**ARLINGTON, TEXAS  
NOVEMBER 9, 1995**

**Presented by: Thomas F. Hoyle**

**MOV PROGRAM LEAD**

**SUPPLY SYSTEM**

**PRESSURE LOCKING AND THERMAL BINDING  
PROGRAM AT WNP-2**

Summary	1
GL 89-10 Actions	2
Contractor	2
Screening Criteria	2
PER & Operability Assessment	3
Modifications	4
Calculations & Enhanced Methodology	4
Testing Plans	4
NRC Inspection 95-24	5
GL 95-07	5
Operability	5
Future Actions	6
Calculational Methodology	Att 1

## SUMMARY

The Washington Public Power Supply System took action as part of the GL 89-10 MOV Program to reassess pressure locking and thermal binding (PL/TB) of gate valves which must perform a safety function to open. Several studies have been conducted over the years at, but did not result in many physical changes to WNP-2 valves. GL 89-10 prompted yet another study. However, this study resulted in three valves being physically modified, the procedure for another valve being revised and extensive calculations performed on several other valves.

The NRC, in a recent MOV inspection, questioned the validity of one aspect on the screening criteria used in the PL/TB study. As a result of this concern and the issuance of GL 95-07, the WNP-2 PL/TB study completed in December, 1993 is being reassessed to determine if the screening criteria used and thus the study results remain valid.

Pressure Locking and Thermal Binding continue to be an industry concern as evidenced by the issuance of GL 95-07. The PL/TB phenomena is quite rare at any individual plant and thus has not been given high priority by most utilities. Non-quantifiable conditions such as seat and packing leakage and air pockets can have major impact on the effects of PL in the conditions exist. Additionally, emphasis is needed on this issue as PL/TB may occur and due to its inherent nature may not be repeatable. Thus, PL/TB may occur but is mis-diagnosed. There is enough industry experience to suggest more detailed review of the phenomena in general and at individual plants.



## GL 89-10 ACTIONS

Supplement 6 of GL 89-10 contains the NRC's expectations with regard to Pressure locking/thermal binding. In Supplement 6, the NRC points out that GL 89-10 recommends that licensees review the design bases of their safety-related MOVs. Licensees are expected to have evaluated the potential for pressure locking or thermal binding of gate valves and take action to ensure that these phenomena do not affect the capability of these MOVs to perform their safety-related function. In Supplement 6, the Staff gives an acceptable approach to addressing PL/TB of gate valves in the GL 89-10 program. The evaluation would include:

- Document an evaluation of gate valves in the GL 89-10 program and: a) identify them as acceptable to pressure locking or thermal binding or b) eliminate them from further consideration.
- The evaluation should include those MOVs which could undergo PL/TB during surveillance testing as well as design basis conditions or normal operation.
- Licensees are given recommendations on acceptable and unacceptable resolutions to this issue.
- It is also stated in Supplement 6 that enforcement actions will depend on the safety significance of the issue.

## CONTRACTOR

The Supply System decided to subcontract the effort to augment staff resources. As with most utilities, the issue of PL/TB was not new. Several other reviews had been conducted to determine if any corrective action was warranted. Minimal in-field work to mitigate PL/TB had been conducted in the past. As a result of the December, 1993 study, the most susceptible PL valves have been in-field worked to eliminate any PL potential. Other less susceptible valves are being re-evaluated for future modification, if required.

## SCREENING CRITERIA

A screening criteria was established to determine susceptibility to PL/TB. The screening for Pressure-Hydraulic Locking consisted of all flexible wedge of parallel disc valves. PL susceptibility was based on the valve bonnet being pressurized with a subsequent depressurization of the upstream and/or downstream piping. This process potentially results in pressure locked between the discs which can cause an increased thrust to operate the valve OPEN. The screening process was in accordance with NRC Special Study, PL/TB of Gate Valves, December 1992, AEOD/S92-07. System operation was also reviewed to determine if open operation was required after PL and if the upstream valve seat would be repressurized before operation which eliminates PL.

The PL/TB report considers Hydraulic Locking to be a subset of PL which occurs when a solid fluid is trapped in the valve bonnet. Hydraulic locking is detrimental when the fluid temperature in the bonnet is increased resulting in a rapid pressure rise. Valve orientation influences the likelihood of vapor or gas pockets which prevent hydraulic lock. The likelihood of a vertically oriented valve bonnet being totally vented of all noncondensables is remote. This is being substantiated by Commonwealth Edison bench tests that induce and measure PL/HL forces. All valves were screened for orientation and temperature.

Thermal Binding (TB) was restricted to solid wedge valves that close at high temperature. The report evaluation found that there were no valves required to open that may have TB potential. As part of the re-evaluation of PL/TB at WNP-2, flex wedge gate valves will also be evaluated for thermal binding. A temperature criteria will be established to determine TB potential.

### PER & OPERABILITY ASSESSMENT

The process used at WNP-2 to document conditions adverse to quality is called the Problem Evaluation Request or PER. The Pressure Locking/Thermal Binding identified eight gate valves susceptible to pressure locking. PER 294-0074 was initiated to document the issue and follow corrective action. The PL/TB report/PER identified the following MOVs as potentially susceptible to pressure locking:

LPCS-V-5	Low Pressure Core Spray injection valve
RCIC-V-13	Reactor Core Isolation Cooling injection valve
RHR-V-8,9	Residual Heat Removal shutdown cooling suction line containment isolation valves
RHR-V-42A,42B,42C	Low Pressure Coolant Injection injection valves
HPCS-V-4	High Pressure Core Spray injection Valve

As can be seen from inspection of the above valve functions, all Emergency Core Cooling injection valves were found susceptible to PL. The PER process drives a prompt operability assessment. This operability assessment found all susceptible valves operable. However, engineering judgement was used which needed more justification for long term resolution of the issue. Calculations were initially done to determine margin. These calculations used the best available information. Because the margin was low in some cases, stronger justification was needed.

## MODIFICATIONS

Two valves, RHR-V-8 & 9, with the least margin were determined not to have a safety function in the open direction. However, since during their normal operation they could be subject to pressure locking, it was decided to perform a modification to the valves.

One other valve, LPCS-V-5, also had low margin and was modified at the next refueling outage.

Another valve, HPCS-V-4 is subject to pressure locking during surveillance testing. The surveillance procedures were modified to identify this potential PL condition to plant operators.

## CALCULATIONS & ENHANCED METHODOLOGY

The remaining four valves, RCIC-V-13 and RHR-V-42A, 42B & 42C, as previously stated were all found to be operable by engineering calculation. RCIC-V-13 had significant margin and was not considered a concern. The LPCI injection valves, RHR-V-42A/42B/42C, were only marginally acceptable. A progressive verification approach was used where the initial calculations were later augmented with more indepth calculations. The calculational methodology used the Grand Gulf approach. After looking at this methodology, it was determined that it should be modified to also include the "wedge pressure effect". Due to the shape of a wedge gate valve a small force is created in the close direction due to the larger area that pressure has to act on in the bonnet. This force was added to the static unwedging load plus the running load. Compensation for the stem piston effect was included. Even after the wedge pressure effect was added, all of the valves were demonstrated by the calculation to be operable under the worst case scenario at degraded voltage. Attachment 1 contains an overview of the calculational methodology used at WNP-2.

To confirm the assumptions in the calculation and to provide additional justification, testing at simulated pressure locked conditions are planned.

## TESTING PLANS

The Supply System's maintenance training organization has a 10", 900 lb flex wedge gate valve which is to be used for the confirmatory testing. The test setup will include welding one end of the valve and adding pressure connections to the closed end and to the bonnet. This way, one pressure can be put on one side of the valve and a different pressure can be put in the bonnet. This should simulate a pressure locked valve. In addition, this valve sticks in the closed direction which is similar to most of the flex wedge gate valves in the plant. The valve has an SMB-2 operator which is smaller than the LPCI injection valve's SMB-3 operator, but the technique is similar. A specific date has not been set for the testing at this time.

Commonwealth Edison has conducted testing of valves under pressure locked conditions. Also, valve 24 of the EPRI Performance Prediction Program was stroked under pressure locked conditions. The Supply System may opt to use the EPRI or CE test results in lieu of the testing described above.

#### **NRC INSPECTION 95-24**

During the WNP-2 MOV Closure Inspection, 95-24, pressure locking of GL 89-10 gate valves was reviewed in considerable detail. The calculational methodology was applauded since it went beyond the Grand Gulf methodology which was considered state of the art. The inspectors did take exception to the premise that hydraulic lock is a subset of pressure lock. We agreed to disagree. The inspection did point out that the basis of the screening criteria did not agree with most of the industry and that additional justification would be needed.

It is noted that the Commonwealth Edison PL testing has been unable to completely vent bonnets to get water solid conditions. The CE testing seems to demonstrate that under static conditions the previously published numbers for pressure rise may be very conservative.

#### **GENERIC LETTER 95-07**

At WNP-2, GL 95-07 does not appear to change the basic recommendations included in GL 89-10, Supplement 6. Recent NRC enforcement actions with respect to hydraulic lock and the inspection at WNP-2 have had an impact on how the previous report on PL/TB is viewed today.

#### **OPERABILITY**

One of the most important issues with PL/TB is identifying susceptible valves and then being able to continue operations. A conservative and timely call on operability may well declare a valve or valves inoperable. This, of course, is not very palatable with plant management. If one looks at the WNP-2 MOVs above, the LPCI injection valves, one quickly concludes that all valves are roughly the same. And if they were susceptible to PL/TB, then a plant shutdown would be warranted. Many times if enough time is allotted to perform a detailed analysis more margin exists than originally thought. Therefore, a conservative call on operability might unnecessarily shut the plant down.

## FUTURE ACTIONS

The Supply System plans to re-evaluate its position on PL/TB. The screening criteria, particularly for hydraulic lock and thermal binding will be re-assessed. To date hydraulic lock has been viewed as a subset of PL. In other words if pressure locking (depressurization event) did not occur first than hydraulic lock would not occur. Another assumption is that horizontally installed valves will not experience hydraulic lock since there will always be some small air pocket. This may well be the case but justification for this position is not readily apparent. Thermal binding has been dispelled for all flex wedge gate valves. Again, this position may need additional justification or re-evaluation.



# **CALCULATIONAL METHODOLOGY**

**ATTACHMENT 1**



## **Summation of Static Unwedging & Running Loads and Pressure Forces**

- **Static Unwedging Load**
- **Running Load**
- **Piston Effect**
- **Wedge Pressure Effect**
- **Pressure Locking Load**

## Static Unwedging Load

The unseating load measured during static testing consists of:

- The load required to overcome open packing load
- The force required to overcome the seat to disk contact load under static conditions

The Static Unwedging Loads (SUW) exist under pressure locking conditions.

## Running Load

- The load measured under design basis dP conditions, or
- The calculated load for design basis dP based on the accepted valve factor.

The Running Load (RL) is conservatively included in the Required Thrust to Open (RTO) for pressure locking.

## Piston Effect

- The difference between the bonnet pressure and ambient pressure outside the valve body results in a stem ejection force (or piston effect). This force is in the direction which assist valve opening. The magnitude of this force is calculated using the equation below:

$$F_{piston} = (\pi/4) \times D^2 \times (P_{bonnet} - P_{atm})$$

## Vertical Downward Force on Disk

- Pressure exerts a downward force on the valve disk.
- This force is calculated for each side of the disk by multiplying the vertical projected area of the valve disk times the differential pressure across that disk face. The equation below is used:

$$F_{\text{vert}} = (\pi/4) \times D^2 \times \sin(\theta_{\text{seat}}) \times [2P_{\text{bonnet}} - P_{\text{inlet}} - P_{\text{outlet}}]$$



## Pressure Locking Force

- Determine the force exerted on the seat ring by the disc due to internal pressure using Roark, Table 24, Case 2d.

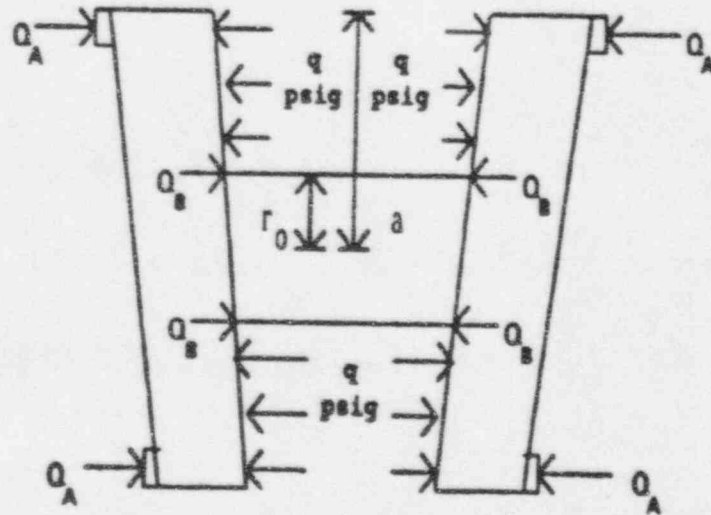

## Pressure Locking Force (cont'd)

- Determine forces exerted by external pressures on the high and low pressure sides using Case 2d and 1b.

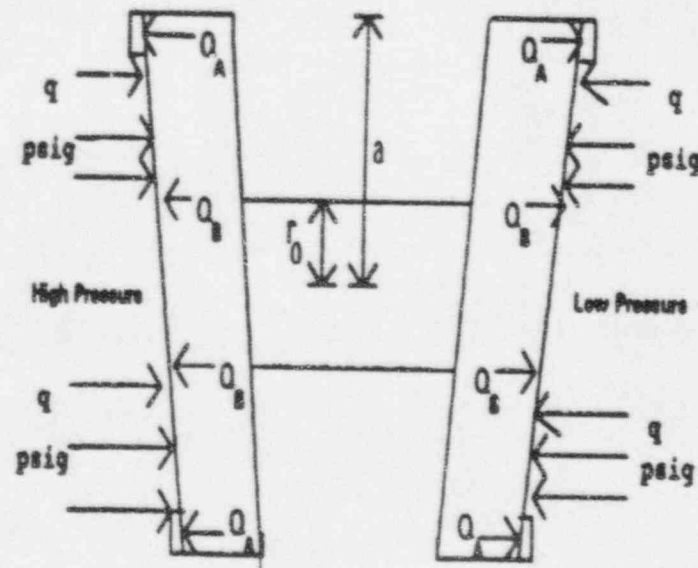

## Pressure Locking Force (cont'd)

- Case 1b for increased force on the low pressure disc due to hub area that was left out of Case 2d equations.

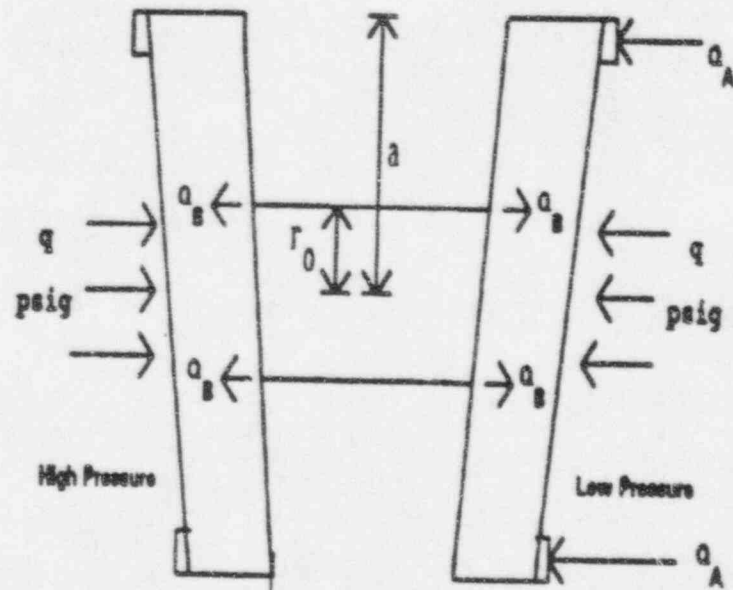

## Pressure Locking Force (cont'd)

- The above analysis results in total disc force from pressure locking on the high pressure side and the low pressure side.
- The required thrust to overcome pressure locking only ( $RT_p$ ) is the total disc force due to pressure locking times the valve factor.

## Required Thrust To Open

- The RTO is indicated below:

$$RTO = SUW + RL - F_{piston} + F_{vert} + RT_p$$



NRC Region 4  
Arlington, Texas

Workshop on Generic Letter 95-07  
Pressure Locking and Thermal Binding  
November 9, 1995

# Thermal Binding Analysis

Bill R. Black, P.E.  
TU Electric

# THERMAL BINDING & PRESSURE LOCKING OF GATE VALVES

- Of COURSE it can be Analyzed!
- Do We Need To?  
If so for Some MOVs,  
at What Level of Sophistication?
- Challenge: Validate Analytical Method

## DO WE NEED TO?

- If we can't justify operability on the basis of prior operation with conditions equal or greater than the design pressure/thermal conditions.

## AT WHAT LEVEL OF SOPHISTICATION?

- as little as we can get by with!
- Formulas for Stress and Strain, Roark & Young

## MODEL VALIDATION - WHAT TESTING?

- The Least Possible
- In the Lab

## LOADS ON THE DISK AFFECTING UNSEATING THRUST ( $T_{un,t}$ )

- Design Basis Upstream & Downstream Pressure
- Residual Wedging from Prior Closing Stroke
- Loads due to Temperature Changes:
  - Bonnet Cavity Pressure
  - Stem Elongation/Body Shrinkage after closing
  - Piping Loads on Valve End
  - Different Rates of Thermal Growth/Shrinkage:  
Disk, Seat Rings, Body

$$T_{un,t} = T_{un,d} + T_{un,bp} + T_{un,sg} + T_{un,ax}$$

## DESIGN BASIS UPSTREAM & DOWNSTREAM PRESSURE

- Use Results of Generic Letter 89-10 for determining dynamic unseating thrust **T<sub>un,d</sub>**
- Use As-Built Total Closing Stroke Stem Thrust (greater closing thrust → greater unseating thrust)
- Use Upstream & Downstream Pressure postulated when Thermal Binding potential is also postulated (large valves: DP increases unseating thrust)



## CALCULATING GL 95-07 LOADS:

**$T_{un,bp}$  &  $T_{un,sg}$  &  $T_{un,ax}$**

$T_{un,bp}$  = additional unseating load required to overcome the effects of the bonnet cavity pressure

Being developed by Commonwealth Edison

- Similar simple analytical model
- Testing in progress to validate the model

## CALCULATING GL 95-07 LOADS:

$T_{un,bp}$  &  $T_{un,sg}$  &  $T_{un,ax}$

DETERMINE:  $\mu_{avg} =$  average seat friction coeff.

$$\frac{T_{un,s}}{TTOTc} < \frac{(\mu_{avg} \cos\theta - \sin\theta)(\cos\theta - \mu_{avg} \sin\theta)}{(\mu_{avg} \cos\theta + \sin\theta)(\cos\theta + \mu_{avg} \sin\theta)}$$

where  $\theta =$  Seat angle

$T_{un,s} =$  Static Unseating Thrust

$TTOTc =$  Prior Static Total Closing Thrust

## CALCULATING GL 95-07 LOADS:

$T_{un,bp}$  &  $T_{un,sg}$  &  $T_{un,ax}$

DETERMINE:  $K_m$  = MOV stiffness along stem axis, excluding the stem

$$K_m = \frac{\Delta T T O T c}{(\Delta \theta_{sn}/360^\circ)(L_{stem}) - (\Delta T T O T c)(K_{stem})}$$

where  $K_{stem} = (K_{threaded}^{-1} + K_{threaded,inc}^{-1} + K_{solid}^{-1})^{-1}$

## CALCULATING GL 95-07 LOADS:

$T_{un,bp}$  &  $T_{un,sg}$  &  $T_{un,ax}$

$$T_{un,sg} = (\Delta T_{sg})(A)$$

where

$$A = \frac{(\mu_{avg} \cos\theta - \sin\theta)(\cos\theta - \mu_{avg} \sin\theta)}{(\mu_{avg} \cos\theta + \sin\theta)(\cos\theta + \mu_{avg} \sin\theta)}$$

$$\Delta T_{sg} = (Cts)(L_{exp})(\Delta temp,sg)(K_{mov})$$

$$K_{mov} = (K_m^{-1} + K_{threaded}^{-1} + K_{solid}^{-1} + K_{solid,inc}^{-1})^{-1}$$

## CALCULATING GL 95-07 LOADS:

$T_{un,bp}$  &  $T_{un,sg}$  &  **$T_{un,ax}$**

$$T_{un,ax} = (F_{body,therm}) \cdot (2) \cdot \frac{(\mu_{avg} \cos\theta - \sin\theta)}{(\cos\theta + \mu_{avg} \sin\theta)}$$

$$F_{body,therm} = \frac{(Kba)(Knet,a)}{Kba + Knet,a} \cdot (\sum C_i \cdot L_i \cdot \Delta temp_i)$$

$Kba$  = body stiffness between ends of seat rings

$Knet,a$  = net stiffness along pipe axis of the 2 seat rings, 2 wedge "plates" and wedge "hub"



# THERMAL BINDING MODEL VALIDATION STATUS

Transmit to Commonwealth Edison	10-25-95
Transmit to Westinghouse Owner's Group	11- 1 -95

Commonwealth Edison presentation to Region 3 on  
11-7-95: pursuing validation testing of model.

Copy of TU Electric transmittal to Commonwealth  
Edison is available to any interested party.



October 25, 1995

Mr. Brian Bunte  
Commonwealth Edison  
708-663-3824  
708-663-7118 FAX

Dear Mr. Bunte:

TU Electric has created and is trying to validate an analytical model of gate valve body, seat ring, gate wedge, stem, and extended structure stiffnesses. It is intended that the model will be used to analyze the effects of differential pressure distributions on, and temperature changes in, the structural elements. If successful, the model will be a useful tool in responding to the recent NRC Generic Letter 95-07. Your on-going tests to assess these effects may provide data by which validation of the analytical model may be accomplished.

This letter is intended to solicit your cooperation in assessing the present analytical model developed by TU Electric. Our cooperative efforts may result in providing utilities with a less expensive way to resolve Generic Letter 95-07 concerns.

If you have insights which would beneficially refine TU Electric's efforts, you are cordially invited to share these with us. The methodology we are presently planning to use for modeling the stiffnesses of the various structural components (excluding the stem and the extended valve structure) is described below.

1. Use simple flat plate, and solid or hollow right cylinders, in combination to simulate the structures.
2. Model the hub of the wedge as a solid cylinder of radius  $r_{hub}$ , and length  $L_{hub}$ . The stiffness  $K_{hub}$  of the hub model relating axial deflection to an axial load uniformly applied over the end of the cylinder (along the pipe axis) is:

$$\begin{aligned} K_{hub} &= (\text{Area})(\text{Young's Modulus}) / (\text{Length}) \\ &= [(\pi)(r_{hub})^2] [E_{wedge} / L_{hub}] \end{aligned}$$

3. Model each of the two disks of the wedge as a flat plate of outer radius  $a_{disk}$ , thickness  $t_{disk}$ , and inner radius  $r_{hub}$ . Model the inner edge as rigidly fixed, and the outer edge as free. Model the applied load on the disk seat ring as a ring load of radius  $r_{load}$  equal to the mean valve body seat radius. The stiffness  $K_{plate}$  of each plate model relating bending

Mr. Bunte : Valve Data for TU Electric

deflection of the plate at radius  $r_{load}$  to the ring load at that diameter is (Ref. 1, Table 24, Case 11):

$$K_{plate} = [2 \pi r_{load} D / (a_{disk})^3] / [(C_2 / C_8) \{ (r_{load} C_9 / r_{hub}) - L_9 \} - (r_{load} C_3 / r_{hub}) + L_3]$$

where  $D = E_{wedge} (t_{disk})^3 / 12 (1 - \nu^2)$

4. The overall stiffness  $K_{wedge}$  of the wedge is the series combination of the stiffnesses of the hub and the two disks:

$$K_{wedge} = [(1 / K_{plate}) + (1 / K_{hub}) + (1 / K_{plate})]^{-1}$$

5. Given an compressive ring load of magnitude  $F_{seat}$  and radius  $r_{load}$  applied to the upstream wedge seat and reacted at the downstream wedge seat, the relative deflection  $y_{seat}$  of the upstream seat toward the downstream seat is:

$$y_{seat} = F_{seat} / K_{wedge}$$

It is important to select values for the hub radius and length, and the disk plate thickness and outer radius so that the model closely simulates the actual wedge's relative seat deflection under the same loading. TU Electric presently believes the plate thickness  $t_{disk}$  should be the average thickness of the actual wedge's plate from the bottom of the disk to the top of the wedge and from the inner radius  $r_{hub}$  to the outside radius  $a_{disk}$ .

Figures 1 through 3 provide illustrations of the dimensions which may be appropriate for the model described above. Note the following derived dimensions:

$t_{disk}$  = thickness of wedge plate along the pipe centerline from the outer surface of the plate (point A) to the average thickness of the sloped inner surface of the plate (point B). Point B is the point on the axis of the pipe which intersects a plane perpendicular to the pipe axis and at a distance  $((L_a + L_b)/2)$  from the stem centerline.

$L_{hub}$  =  $L_a + L_b$

$r_{load}$  =  $(D2 + E2) / 2$

6. Model each of the valve body seat ring inserts as hollow right cylinders of inside diameter  $E3$  and outside diameter  $D3$  and average length  $L_{sr}$  (in a plane perpendicular to the stem axis and containing the pipe axis). The stiffness  $K_{sr}$  of the seat ring model relating deflection along the pipe axis to an axial load  $F_{seat}$  uniformly applied over the end of the seat ring is:

$$K_{sr} = (\text{Cross-sectional Area})(\text{Young's Modulus}) / (\text{Length}) \\ = [(\pi)(D3^2 - E3^2)/4] [E_{sr} / L_{sr}]$$

7. Model the valve body between the outer ends of the seat ring inserts as a hollow right circular cylinder of inner diameter  $r_{body}$  and outer radius equal to the sum  $(r_{body} + t_{body})$  and length  $L_{body}$  equal to the sum  $(2 L_{sr} + 2 t_{disk} + L_{hub})$ . The stiffness  $K_{body}$  of the valve body model relating deflection along the pipe axis to a load  $F_{seat}$  uniformly applied over the end of the seat ring along the pipe axis is:

$$K_{body} = (\text{Cross-sectional Area})(\text{Young's Modulus}) / (\text{Length}) \\ = [(\pi)((r_{body} + t_{body})^2 - r_{body}^2)] [E_{body} / L_{body}]$$

Other dimensions needed in order for TU Electric to perform the desired analyses are illustrated in Figure 4: the length  $L_{se}$  of the stem from the bottom of the stem "T Head" to the bottom of the packing chamber in the valve bonnet when the valve is in the closed position with the disk pushed hard into the valve body seat by the stem, and the length  $L_{sn}$  of the stem from the bottom of the "T Head" to the start of the threaded section of the stem. Also required is the length  $L_{stem}$  of the stem from the bottom of the stem "T Head" to the bottom of the actuator stem nut when the stem is pushing the wedge hard into the valve body seat:

$$L_{stem} = L_{toy} + Y_{sn}$$

where  $L_{toy}$  = length of the stem from the bottom of the stem "T Head" to the top of the yoke-actuator mounting platform when the stem is pushing the wedge hard into the valve body seat  
 $Y_{sn}$  = distance from the top of the yoke (the base of the actuator) to the bottom of the stem nut inside the actuator.

Note: TU Electric can obtain the value of the dimension  $Y_{sn}$  by inspection of an appropriate actuator sample. You are requested to provide the values of dimensions  $L_{se}$ ,  $L_{sn}$ , and  $L_{toy}$ .

Mr. Bunte : Valve Data for TU Electric

TU Electric will use the above dimensions to also quantify loads resulting from the thermal growth or contraction of the structural components. It is intended that confidence in the applicability of the analytical model will be gained by comparing test results with the results of the analytical model. As needed, the model will be refined.

Test data which is being collected by Commonwealth Edison can be used along with the needed dimensions and material properties to evaluate or verify the model. To accomplish this, **in addition to the data identified above, please provide the following test data and other information for use by TU Electric in evaluating the analytical model:**

- A. Static test data from pairs of closing and subsequent opening strokes. Data for several pairs of close and open strokes is desirable for addressing repeatability of valve performance. For the duration of these tests, the temperature of the valve body and internal components shall be maintained at room temperature.
- |   |                    |
|---|--------------------|
| Thrust at control switch trip,          | T <sub>cst,s</sub> |
| Total thrust after control switch trip, | TTOT <sub>s</sub>  |
| Peak unseating thrust,                  | T <sub>un,s</sub>  |
- B. With the valve fully closed, measure the amount of stem thrust increase resulting from further rotation of the stem nut. Small amounts of rotation, 10 to 15 degrees, are sufficient if measured accurately (within about 5% of reading) along with the resulting stem thrust changes that are also accurately measured. Provide the results of the measurements and the accuracies of the measurements.
- C. Stem geometry as follows:
- Stem unthreaded section diameter
  - Stem threaded section outside diameter, thread pitch, thread lead, and thread style: (ACME standard or stub)
- D. Materials of the valve body, valve body seat ring inserts, the wedge (obturator), and the stem. If available, also provide:
- the average thermal coefficients of expansion (in/in/degree F) for the ranges of temperature changes experienced by the wedge, the seat rings, the valve body, the stem inside the valve body, and the stem outside the valve body during testing of the valve assemblies for thermal binding effects.
  - Young's Modulus for each material

Mr. Bunte : Valve Data for TU Electric

- E. The sequence and values of temperature of the wedge upstream face, the hub, the wedge downstream face (if these are different), the upstream and downstream valve body seat ring inserts, and the valve body between the outer ends of the seat ring inserts.

Your interest in this effort as previously expressed to me is greatly encouraging to me. I look forward to our cooperation in evaluating the analytical model. If you have any questions, please contact Sid Chiu at 817-897-6510 or me at 817-897-6477. Our FAX number is 817-897-0868.

Sincerely,

*Bill R. Black*  
Bill R. Black, P.E.

Attachments

(Figures 1-4)

(Hand-written development of analysis method, 5 pages)

cc: Sid Chiu



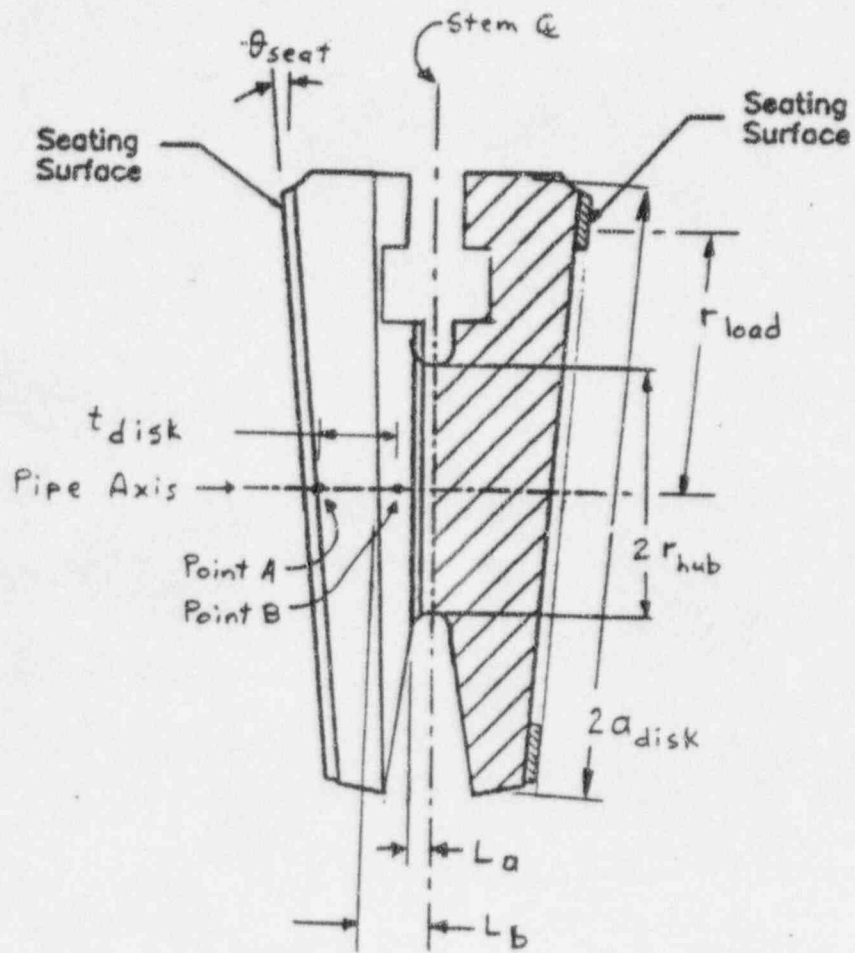

DIMENSIONS FOR FLEXIBLE WEDGE GATE VALVES

FIGURE 1

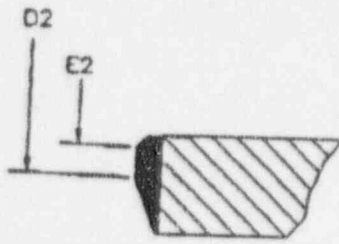
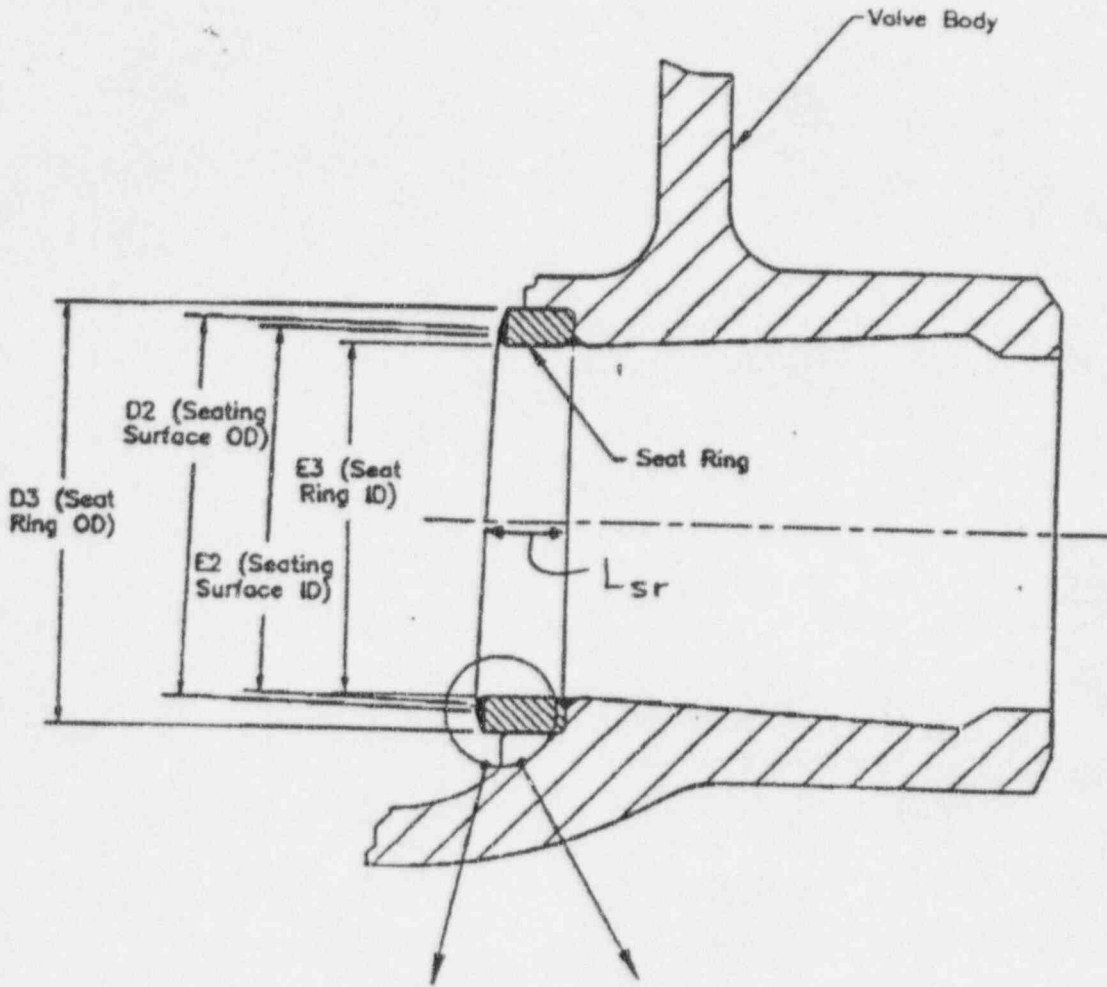

Chamfer

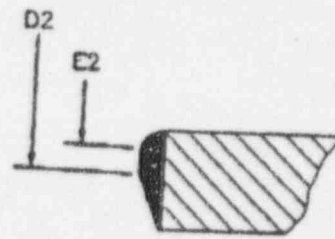

Radius

D2 and E2 are Diameters to the Edge of the Flat Seating Surface, Measured in the Plane of the Seat Ring.

### SEAT RING DIAMETERS

FIGURE 2

11-10  
11-11  
11-12  
11-13  
11-14  
11-15  
11-16  
11-17  
11-18  
11-19  
11-20  
11-21  
11-22  
11-23  
11-24  
11-25  
11-26  
11-27  
11-28  
11-29  
11-30  
11-31  
11-32  
11-33  
11-34  
11-35  
11-36  
11-37  
11-38  
11-39  
11-40  
11-41  
11-42  
11-43  
11-44  
11-45  
11-46  
11-47  
11-48  
11-49  
11-50  
11-51  
11-52  
11-53  
11-54  
11-55  
11-56  
11-57  
11-58  
11-59  
11-60  
11-61  
11-62  
11-63  
11-64  
11-65  
11-66  
11-67  
11-68  
11-69  
11-70  
11-71  
11-72  
11-73  
11-74  
11-75  
11-76  
11-77  
11-78  
11-79  
11-80  
11-81  
11-82  
11-83  
11-84  
11-85  
11-86  
11-87  
11-88  
11-89  
11-90  
11-91  
11-92  
11-93  
11-94  
11-95  
11-96  
11-97  
11-98  
11-99  
11-100

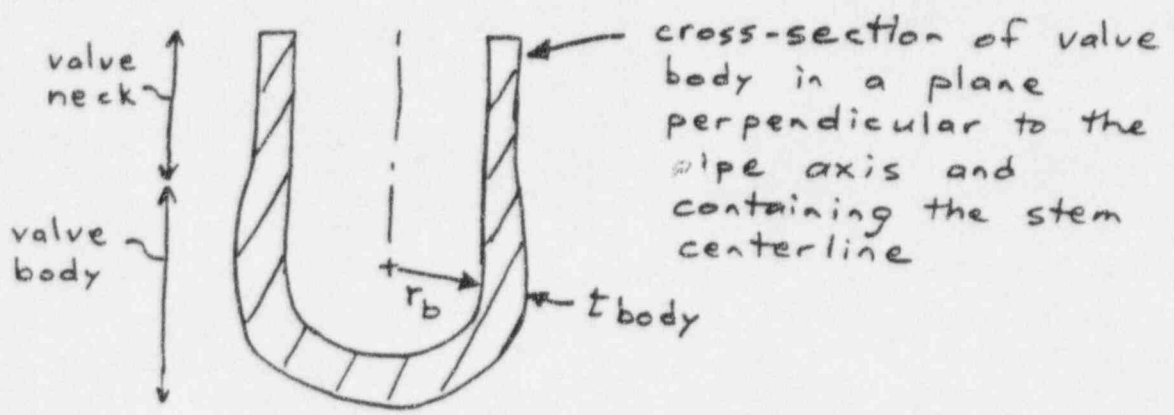

$r_b$  = typical inside radius of valve body in the cross-section illustrated above.

$t_{body}$  = typical valve body as-built wall thickness in the cross-section illustrated above.

Figure 3



Determine average seat friction coefficient from test:

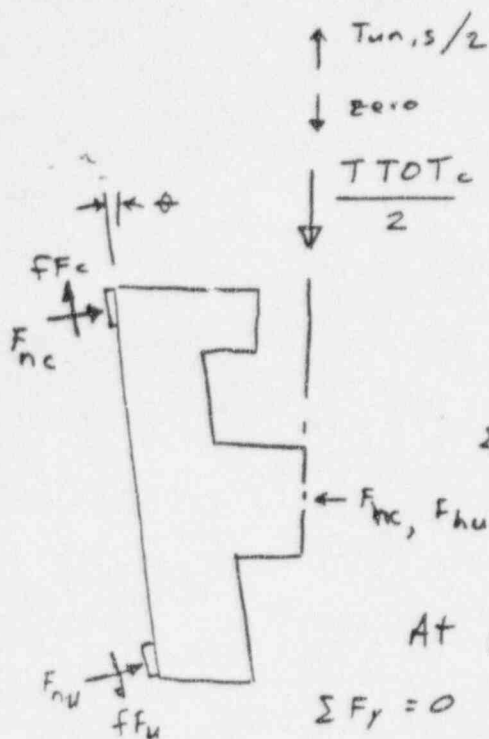

At peak seating, impending slip:

$$\Sigma F_y = 0, \quad f_{fc} = \mu F_{nc}$$

$$\frac{T_{TOTc}}{2} = F_{nc} \sin \theta + \mu F_{nc} \cos \theta$$

$$= F_{nc} [\sin \theta + \mu \cos \theta]$$

$$\therefore F_{nc} = \frac{T_{TOTc}}{2(\sin \theta + \mu \cos \theta)}$$

$$\Sigma F_x = 0: F_{nc} [\cos \theta - \mu \sin \theta] = F_{hc}$$

$$\therefore F_{hc} = \frac{T_{TOTc} (\cos \theta - \mu \sin \theta)}{2(\sin \theta + \mu \cos \theta)}$$

At peak unwedging, impending slip:

$$\Sigma F_y = 0, \quad f_{fu} = \mu F_{nu}$$

$$(T_{un,s}/2) + F_{nu} \sin \theta = \mu F_{nu} \cos \theta$$

$$\therefore T_{un,s} = 2 F_{nu} (\mu \cos \theta - \sin \theta)$$

$$\text{and } F_{nu} = T_{un,s} / [2(\mu \cos \theta - \sin \theta)]$$

$$\Sigma F_x = 0 \Rightarrow F_{nu} \cos \theta + \mu F_{nu} \sin \theta = F_{hu}$$

$$F_{nu} (\cos \theta + \mu \sin \theta) = F_{hu}$$

$$\therefore F_{hu} = \frac{T_{un,s} (\cos \theta + \mu \sin \theta)}{2(\mu \cos \theta - \sin \theta)}$$

Since

$$\frac{T_{un,s} (\cos \theta + \mu \sin \theta)}{2(\mu \cos \theta - \sin \theta)} < \frac{F_{hc}}{2(\sin \theta + \mu \cos \theta)}$$

$$\therefore \frac{T_{un,s}}{T_{TOTc}} < \frac{(\mu \cos \theta - \sin \theta)(\cos \theta - \mu \sin \theta)}{(\mu \cos \theta + \sin \theta)(\cos \theta + \mu \sin \theta)} = A$$

Example: assume  $\theta = 7^\circ$ :  $\frac{T_{un,s}}{T_{TOTc}} = 0.50$ :

Thus, given measured values of  $T_{un,s}$  and  $T_{TOTc}$ , and given the seat angle  $\theta$ , the average seat coefficient  $\mu$  can be determined iteratively.

$\mu$	$(T_{un,s}/T_{TOTc})$	A	$[(T_{un,s}/T_{TOTc}) - A]$
0.40	0.5	0.4806	0.0194
0.50	0.5	0.5356	-0.0356
0.42	0.5	0.4939	0.0061
0.43	0.5	0.5000	-0.0000

$\mu_{max} = 0.43$

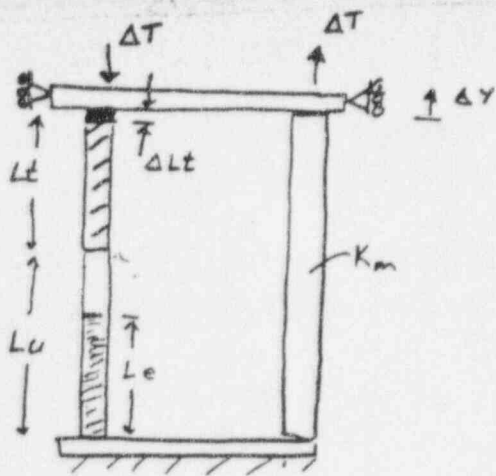

$K_m$  = stiffness along stem axis of disk, body seats, body, all connections, yoke, actuator housing, drive sleeve, etc., but excluding the stem.

$K_{ss}$  = stiffness of solid stem section

$K_{st}$  = stiffness of threaded stem section

$\Delta T_{TOT}$  = increase in total thrust.

$\Delta \theta_{sn}$  = degrees stem rotation for thrust increase  $\Delta T_{TOT}$

Testing: measure  $\Delta T$  and  $\Delta \theta_{sn}$

$$\Delta Y = \Delta T_{TOT} / K_m = \Delta L_t - (\Delta T_{TOT} / K_{st}) - (\Delta T_{TOT} / K_{ss}) - (\Delta T_{TOT} / K_{sti})$$

$$\frac{\Delta T_{TOT}}{K_m} = \left( \frac{\Delta \theta_{sn}}{360^\circ} \right) (L_{stem}) - \Delta T_{TOT} \left( \frac{1}{K_{st}} + \frac{1}{K_{ss}} + \frac{1}{K_{sti}} \right)$$

where  $L_{stem}$  = stem lead (inch/rev)

$$\therefore K_m = \frac{\Delta T_{TOT}}{\left( \frac{\Delta \theta_{sn}}{360^\circ} \right) (L_{stem}) - \Delta T_{TOT} \left( \frac{1}{K_{st}} + \frac{1}{K_{ss}} + \frac{1}{K_{sti}} \right)}$$

### Thermal Stem Growth

$$\Delta Y = \Delta T_{tsg} / K_m = \Delta L_e - \Delta T_{tsg} / K_{st} - \Delta T_{tsg} / K_{ss} - \Delta T_{tsg} / K_{ssi}$$

$$\frac{\Delta T_{tsg}}{K_m} = (c_{ts} \cdot L_e \cdot \Delta T_{tsg}) - \Delta T_{tsg} \left( \frac{1}{K_{st}} + \frac{1}{K_{ss}} + \frac{1}{K_{ssi}} \right)$$

$$\therefore \frac{\Delta T_{tsg}}{K_m} + \Delta T_{tsg} \left( \frac{1}{K_{st}} + \frac{1}{K_{ss}} + \frac{1}{K_{ssi}} \right) = c_{ts} \cdot L_e \cdot \Delta T_{tsg}$$

$$\Delta T_{tsg} \left( \frac{1}{K_m} + \frac{1}{K_{st}} + \frac{1}{K_{ss}} + \frac{1}{K_{ssi}} \right) = c_{ts} \cdot L_e \cdot \Delta T_{tsg}$$

$$\Delta T_{tsg} = c_{ts} \cdot L_e \cdot \Delta T_{tsg} \left( \frac{1}{K_m} + \frac{1}{K_{st}} + \frac{1}{K_{ss}} + \frac{1}{K_{ssi}} \right)^{-1}$$

$$K_{ss} = \frac{\pi (D_u)^2}{4} \frac{E_s}{L_u}$$

$$K_{ssi} = \frac{\pi (D_u)^2 E_s}{4 (c_{ts} \cdot L_e \cdot \Delta T_{tsg})}$$

$$K_{st} = \frac{\pi (D_t)^2}{4} \frac{E_s}{L_t}$$

$$K_{sti} = \frac{\pi (D_t)^2 \cdot E_s}{4 \left( \frac{\Delta \theta_{sn}}{360^\circ} \right) (L_{stem})}$$

$$\Delta T_{tsg,un} = (\Delta T_{tsg}) (A), \text{ additional unseating thrust}$$

where  $c_{ts}$  = therm. exp. coeff. of stem matl.

$L_e$  = length of stem undergoing temp increase  $\Delta T_{tsg}$

$\Delta T_{tsg}$  = closing thrust increase due to temperature increase  $\Delta T_{tsg}$ .

$L_t$  = threaded stem length up to base of stem nut

$L_u$  = unthreaded stem length



$\Delta T_{tbs}$  = Increase in post-close stem thrust due to thermal shrink of body

$\Delta T_{tbs} = \Delta L_{tbs} \cdot K_{net, b}$

where  $\Delta L_{tbs}$  = reduction in body length along stem axis minus reduction in disk length along stem axis

$\Delta L_{tbs} = c_{tb} \cdot L_{eb} \cdot |\Delta t_{bs}| - c_{td} \cdot L_{ed} \cdot |\Delta t_{ds}|$

$c_{tb}$  = therm. exp. coeff. for body matl.

$c_{td}$  = therm. exp. coeff. for disk matl.

$L_{eb}$  = length along stem axis from seat axis to top of valve neck which experiences temp change

$L_{ed}$  = length along stem axis from seat axis to base of stem which experiences temp. change.

$\Delta t_{bs}$  = temp. decrease affecting valve body

$\Delta t_{ds}$  = temp. decrease affecting disk

$K_{net, b} = \left[ \frac{1}{K_s} + \frac{1}{K_m} \right]^{-1} = \frac{K_s K_m}{K_s + K_m}$

$\Delta T_{tbs, un} = (\Delta T_{tbs}) (A)$

$= \Delta L_{tbs} \cdot K_{net, b} \cdot A$

$\Delta T_{tbs, un} = [(c_{tb} \cdot L_{eb} \cdot |\Delta t_{bs}|) - (c_{td} \cdot L_{ed} \cdot |\Delta t_{ds}|)] \frac{K_s \cdot K_m \cdot A}{(K_s + K_m)}$

31 007  
 40 001  
 40 002  
 40 003  
 40 004  
 40 005  
 40 006  
 40 007  
 40 008  
 40 009  
 40 010  
 40 011  
 40 012  
 40 013  
 40 014  
 40 015  
 40 016  
 40 017  
 40 018  
 40 019  
 40 020  
 40 021  
 40 022  
 40 023  
 40 024  
 40 025  
 40 026  
 40 027  
 40 028  
 40 029  
 40 030  
 40 031  
 40 032  
 40 033  
 40 034  
 40 035  
 40 036  
 40 037  
 40 038  
 40 039  
 40 040  
 40 041  
 40 042  
 40 043  
 40 044  
 40 045  
 40 046  
 40 047  
 40 048  
 40 049  
 40 050  
 40 051  
 40 052  
 40 053  
 40 054  
 40 055  
 40 056  
 40 057  
 40 058  
 40 059  
 40 060  
 40 061  
 40 062  
 40 063  
 40 064  
 40 065  
 40 066  
 40 067  
 40 068  
 40 069  
 40 070  
 40 071  
 40 072  
 40 073  
 40 074  
 40 075  
 40 076  
 40 077  
 40 078  
 40 079  
 40 080  
 40 081  
 40 082  
 40 083  
 40 084  
 40 085  
 40 086  
 40 087  
 40 088  
 40 089  
 40 090  
 40 091  
 40 092  
 40 093  
 40 094  
 40 095  
 40 096  
 40 097  
 40 098  
 40 099  
 40 100  
 40 101  
 40 102  
 40 103  
 40 104  
 40 105  
 40 106  
 40 107  
 40 108  
 40 109  
 40 110  
 40 111  
 40 112  
 40 113  
 40 114  
 40 115  
 40 116  
 40 117  
 40 118  
 40 119  
 40 120  
 40 121  
 40 122  
 40 123  
 40 124  
 40 125  
 40 126  
 40 127  
 40 128  
 40 129  
 40 130  
 40 131  
 40 132  
 40 133  
 40 134  
 40 135  
 40 136  
 40 137  
 40 138  
 40 139  
 40 140  
 40 141  
 40 142  
 40 143  
 40 144  
 40 145  
 40 146  
 40 147  
 40 148  
 40 149  
 40 150  
 40 151  
 40 152  
 40 153  
 40 154  
 40 155  
 40 156  
 40 157  
 40 158  
 40 159  
 40 160  
 40 161  
 40 162  
 40 163  
 40 164  
 40 165  
 40 166  
 40 167  
 40 168  
 40 169  
 40 170  
 40 171  
 40 172  
 40 173  
 40 174  
 40 175  
 40 176  
 40 177  
 40 178  
 40 179  
 40 180  
 40 181  
 40 182  
 40 183  
 40 184  
 40 185  
 40 186  
 40 187  
 40 188  
 40 189  
 40 190  
 40 191  
 40 192  
 40 193  
 40 194  
 40 195  
 40 196  
 40 197  
 40 198  
 40 199  
 40 200  
 40 201  
 40 202  
 40 203  
 40 204  
 40 205  
 40 206  
 40 207  
 40 208  
 40 209  
 40 210  
 40 211  
 40 212  
 40 213  
 40 214  
 40 215  
 40 216  
 40 217  
 40 218  
 40 219  
 40 220  
 40 221  
 40 222  
 40 223  
 40 224  
 40 225  
 40 226  
 40 227  
 40 228  
 40 229  
 40 230  
 40 231  
 40 232  
 40 233  
 40 234  
 40 235  
 40 236  
 40 237  
 40 238  
 40 239  
 40 240  
 40 241  
 40 242  
 40 243  
 40 244  
 40 245  
 40 246  
 40 247  
 40 248  
 40 249  
 40 250  
 40 251  
 40 252  
 40 253  
 40 254  
 40 255  
 40 256  
 40 257  
 40 258  
 40 259  
 40 260  
 40 261  
 40 262  
 40 263  
 40 264  
 40 265  
 40 266  
 40 267  
 40 268  
 40 269  
 40 270  
 40 271  
 40 272  
 40 273  
 40 274  
 40 275  
 40 276  
 40 277  
 40 278  
 40 279  
 40 280  
 40 281  
 40 282  
 40 283  
 40 284  
 40 285  
 40 286  
 40 287  
 40 288  
 40 289  
 40 290  
 40 291  
 40 292  
 40 293  
 40 294  
 40 295  
 40 296  
 40 297  
 40 298  
 40 299  
 40 300  
 40 301  
 40 302  
 40 303  
 40 304  
 40 305  
 40 306  
 40 307  
 40 308  
 40 309  
 40 310  
 40 311  
 40 312  
 40 313  
 40 314  
 40 315  
 40 316  
 40 317  
 40 318  
 40 319  
 40 320  
 40 321  
 40 322  
 40 323  
 40 324  
 40 325  
 40 326  
 40 327  
 40 328  
 40 329  
 40 330  
 40 331  
 40 332  
 40 333  
 40 334  
 40 335  
 40 336  
 40 337  
 40 338  
 40 339  
 40 340  
 40 341  
 40 342  
 40 343  
 40 344  
 40 345  
 40 346  
 40 347  
 40 348  
 40 349  
 40 350  
 40 351  
 40 352  
 40 353  
 40 354  
 40 355  
 40 356  
 40 357  
 40 358  
 40 359  
 40 360  
 40 361  
 40 362  
 40 363  
 40 364  
 40 365  
 40 366  
 40 367  
 40 368  
 40 369  
 40 370  
 40 371  
 40 372  
 40 373  
 40 374  
 40 375  
 40 376  
 40 377  
 40 378  
 40 379  
 40 380  
 40 381  
 40 382  
 40 383  
 40 384  
 40 385  
 40 386  
 40 387  
 40 388  
 40 389  
 40 390  
 40 391  
 40 392  
 40 393  
 40 394  
 40 395  
 40 396  
 40 397  
 40 398  
 40 399  
 40 400  
 40 401  
 40 402  
 40 403  
 40 404  
 40 405  
 40 406  
 40 407  
 40 408  
 40 409  
 40 410  
 40 411  
 40 412  
 40 413  
 40 414  
 40 415  
 40 416  
 40 417  
 40 418  
 40 419  
 40 420  
 40 421  
 40 422  
 40 423  
 40 424  
 40 425  
 40 426  
 40 427  
 40 428  
 40 429  
 40 430  
 40 431  
 40 432  
 40 433  
 40 434  
 40 435  
 40 436  
 40 437  
 40 438  
 40 439  
 40 440  
 40 441  
 40 442  
 40 443  
 40 444  
 40 445  
 40 446  
 40 447  
 40 448  
 40 449  
 40 450  
 40 451  
 40 452  
 40 453  
 40 454  
 40 455  
 40 456  
 40 457  
 40 458  
 40 459  
 40 460  
 40 461  
 40 462  
 40 463  
 40 464  
 40 465  
 40 466  
 40 467  
 40 468  
 40 469  
 40 470  
 40 471  
 40 472  
 40 473  
 40 474  
 40 475  
 40 476  
 40 477  
 40 478  
 40 479  
 40 480  
 40 481  
 40 482  
 40 483  
 40 484  
 40 485  
 40 486  
 40 487  
 40 488  
 40 489  
 40 490  
 40 491  
 40 492  
 40 493  
 40 494  
 40 495  
 40 496  
 40 497  
 40 498  
 40 499  
 40 500  
 40 501  
 40 502  
 40 503  
 40 504  
 40 505  
 40 506  
 40 507  
 40 508  
 40 509  
 40 510  
 40 511  
 40 512  
 40 513  
 40 514  
 40 515  
 40 516  
 40 517  
 40 518  
 40 519  
 40 520  
 40 521  
 40 522  
 40 523  
 40 524  
 40 525  
 40 526  
 40 527  
 40 528  
 40 529  
 40 530  
 40 531  
 40 532  
 40 533  
 40 534  
 40 535  
 40 536  
 40 537  
 40 538  
 40 539  
 40 540  
 40 541  
 40 542  
 40 543  
 40 544  
 40 545  
 40 546  
 40 547  
 40 548  
 40 549  
 40 550  
 40 551  
 40 552  
 40 553  
 40 554  
 40 555  
 40 556  
 40 557  
 40 558  
 40 559  
 40 560  
 40 561  
 40 562  
 40 563  
 40 564  
 40 565  
 40 566  
 40 567  
 40 568  
 40 569  
 40 570  
 40 571  
 40 572  
 40 573  
 40 574  
 40 575  
 40 576  
 40 577  
 40 578  
 40 579  
 40 580  
 40 581  
 40 582  
 40 583  
 40 584  
 40 585  
 40 586  
 40 587  
 40 588  
 40 589  
 40 590  
 40 591  
 40 592  
 40 593  
 40 594  
 40 595  
 40 596  
 40 597  
 40 598  
 40 599  
 40 600  
 40 601  
 40 602  
 40 603  
 40 604  
 40 605  
 40 606  
 40 607  
 40 608  
 40 609  
 40 610  
 40 611  
 40 612  
 40 613  
 40 614  
 40 615  
 40 616  
 40 617  
 40 618  
 40 619  
 40 620  
 40 621  
 40 622  
 40 623  
 40 624  
 40 625  
 40 626  
 40 627  
 40 628  
 40 629  
 40 630  
 40 631  
 40 632  
 40 633  
 40 634  
 40 635  
 40 636  
 40 637  
 40 638  
 40 639  
 40 640  
 40 641  
 40 642  
 40 643  
 40 644  
 40 645  
 40 646  
 40 647  
 40 648  
 40 649  
 40 650  
 40 651  
 40 652  
 40 653  
 40 654  
 40 655  
 40 656  
 40 657  
 40 658  
 40 659  
 40 660  
 40 661  
 40 662  
 40 663  
 40 664  
 40 665  
 40 666  
 40 667  
 40 668  
 40 669  
 40 670  
 40 671  
 40 672  
 40 673  
 40 674  
 40 675  
 40 676  
 40 677  
 40 678  
 40 679  
 40 680  
 40 681  
 40 682  
 40 683  
 40 684  
 40 685  
 40 686  
 40 687  
 40 688  
 40 689  
 40 690  
 40 691  
 40 692  
 40 693  
 40 694  
 40 695  
 40 696  
 40 697  
 40 698  
 40 699  
 40 700  
 40 701  
 40 702  
 40 703  
 40 704  
 40 705  
 40 706  
 40 707  
 40 708  
 40 709  
 40 710  
 40 711  
 40 712  
 40 713  
 40 714  
 40 715  
 40 716  
 40 717  
 40 718  
 40 719  
 40 720  
 40 721  
 40 722  
 40 723  
 40 724  
 40 725  
 40 726  
 40 727  
 40 728  
 40 729  
 40 730  
 40 731  
 40 732  
 40 733  
 40 734  
 40 735  
 40 736  
 40 737  
 40 738  
 40 739  
 40 740  
 40 741  
 40 742  
 40 743  
 40 744  
 40 745  
 40 746  
 40 747  
 40 748  
 40 749  
 40 750  
 40 751  
 40 752  
 40 753  
 40 754  
 40 755  
 40 756  
 40 757  
 40 758  
 40 759  
 40 760  
 40 761  
 40 762  
 40 763  
 40 764  
 40 765  
 40 766  
 40 767  
 40 768  
 40 769  
 40 770  
 40 771  
 40 772  
 40 773  
 40 774  
 40 775  
 40 776  
 40 777  
 40 778  
 40 779  
 40 780  
 40 781  
 40 782  
 40 783  
 40 784  
 40 785  
 40 786  
 40 787  
 40 788  
 40 789  
 40 790  
 40 791  
 40 792  
 40 793  
 40 794  
 40 795  
 40 796  
 40 797  
 40 798  
 40 799  
 40 800  
 40 801  
 40 802  
 40 803  
 40 804  
 40 805  
 40 806  
 40 807  
 40 808  
 40 809  
 40 810  
 40 811  
 40 812  
 40 813  
 40 814  
 40 815  
 40 816  
 40 817  
 40 818  
 40 819  
 40 820  
 40 821  
 40 822  
 40 823  
 40 824  
 40 825  
 40 826  
 40 827  
 40 828  
 40 829  
 40 830  
 40 831  
 40 832  
 40 833  
 40 834  
 40 835  
 40 836  
 40 837  
 40 838  
 40 839  
 40 840  
 40 841  
 40 842  
 40 843  
 40 844  
 40 845  
 40 846  
 40 847  
 40 848  
 40 849  
 40 850  
 40 851  
 40 852  
 40 853  
 40 854  
 40 855  
 40 856  
 40 857  
 40 858  
 40 859  
 40 860  
 40 861  
 40 862  
 40 863  
 40 864  
 40 865  
 40 866  
 40 867  
 40 868  
 40 869  
 40 870  
 40 871  
 40 872  
 40 873  
 40 874  
 40 875  
 40 876  
 40 877  
 40 878  
 40 879  
 40 880  
 40 881  
 40 882  
 40 883  
 40 884  
 40 885  
 40 886  
 40 887  
 40 888  
 40 889  
 40 890  
 40 891  
 40 892  
 40 893  
 40 894  
 40 895  
 40 896  
 40 897  
 40 898  
 40 899  
 40 900  
 40 901  
 40 902  
 40 903  
 40 904  
 40 905  
 40 906  
 40 907  
 40 908  
 40 909  
 40 910  
 40 911  
 40 912  
 40 913  
 40 914  
 40 915  
 40 916  
 40 917  
 40 918  
 40 919  
 40 920  
 40 921  
 40 922  
 40 923  
 40 924  
 40 925  
 40 926  
 40 927  
 40 928  
 40 929  
 40 930  
 40 931  
 40 932  
 40 933  
 40 934  
 40 935  
 40 936  
 40 937  
 40 938  
 40 939  
 40 940  
 40 941  
 40 942  
 40 943  
 40 944  
 40 945  
 40 946  
 40 947  
 40 948  
 40 949  
 40 950  
 40 951  
 40 952  
 40 953  
 40 954  
 40 955  
 40 956  
 40 957  
 40 958  
 40 959  
 40 960  
 40 961  
 40 962  
 40 963  
 40 964  
 40 965  
 40 966  
 40 967  
 40 968  
 40 969  
 40 970  
 40 971  
 40 972  
 40 973  
 40 974  
 40 975  
 40 976  
 40 977  
 40 978  
 40 979  
 40 980  
 40 981  
 40 982  
 40 983  
 40 984  
 40 985  
 40 986  
 40 987  
 40 988  
 40 989  
 40 990  
 40 991  
 40 992  
 40 993  
 40 994  
 40 995  
 40 996  
 40 997  
 40 998  
 40 999  
 40 1000



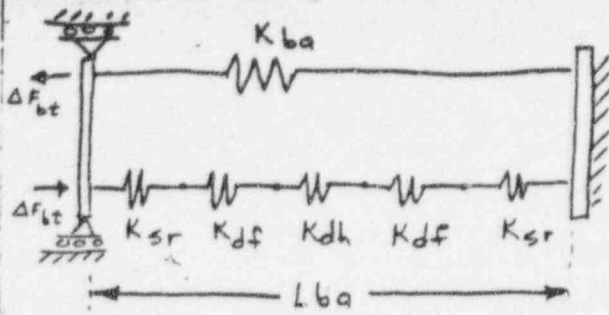

$K_{ba}$  = valve body stiffness from seat ring to seat ring, approximated as pipe of ID = nominal pipe size  
 $OD = ID + 4(t_{min,w})$   
 $t_{min,w}$  = min wall thickness

$$K_{ba} = \frac{\pi (OD^2 - ID^2) / 4 \cdot (E_b)}{L_{ba}}$$

$L_{ba}$  = distance between outer ends of seat rings, along pipe axis

$K_{sr}$  = stiffness of downstream and upstream valve body seat rings along pipe axis

$$K_{sr} = \frac{\pi (OD_r^2 - ID_r^2) / 4 \cdot (E_r)}{L_{sr}}$$

where

$OD_r$  = outside diameter of seat ring

$ID_r$  = inside diameter of seat ring

$E_r$  = Young's Modulus of seat ring matl.

$L_{sr}$  = average length along pipe axis of seat ring.

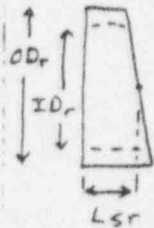

Model disk as solid circular hub with solid flat plate ends with uniform flange thickness.

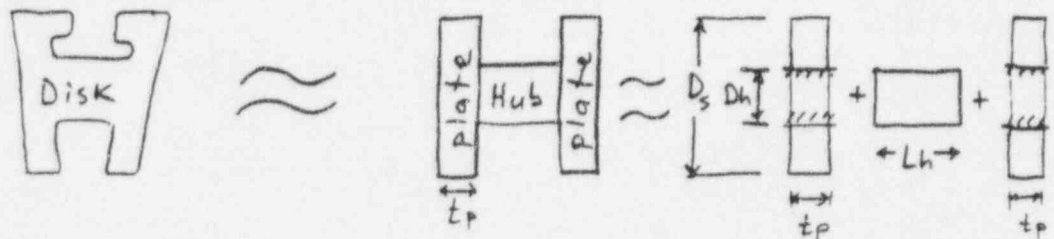

Model disk flexure by assuming the plate ends are fixed at the hub diameter  $D_h$  and free at the mean seat radius  $D_s$ :

$$D_s = (OD_r + ID_r) / 2$$

Change in length  $L_{ba}$  due to temperature change accompanies change in compressive load between body seat rings and disk, the compressive load in the disk hub.

$K_{df}$  = stiffness of disk plate for ring load  $F_{bt}$  at free outer diameter (from Roark 5th ed. Table 24 Case 16):

$$K_{df} = \frac{2\pi (D_h/2) D}{(D_s/2)^3} \left( \frac{C_3 C_7}{C_1 C_9 - C_3 C_7} \right), \quad D = \frac{E_d \cdot (t_p)^3}{12(1-\nu^2)}$$

where  $E_d$  = Young's Modulus of the disk material

$\nu$  = Poisson's ratio, assumed to be 0.30

$t_p$  = disk plate average thickness

$D_h$  = disk hub diameter

$C_1, C_3, C_7,$  and  $C_9$  = Roark 5th ed Table 24

$K_h$  = stiffness of disk hub for axial load  $F_{bt}$

$$K_h = \frac{\pi(Dh)^2(E_d)}{4 L_h}$$

Thermal Expansion or Contraction Loads :

$$e_{ba} = e_{sr1} + e_{df1} + e_{dh} + e_{df2} + e_{sr2}$$

$$e_{ba} = C_{tba} \cdot L_{ba} \cdot \Delta t_{ba} + \frac{F_{bt}}{K_{ba}}$$

$$\text{Also, } e_{ba} = C_{tsr} \cdot L_{sr} \cdot (\Delta t_{sr1} + \Delta t_{sr2}) + C_{td} \cdot t_p \cdot (\Delta t_{d1} + \Delta t_{d2}) + C_{td} \cdot L_h \cdot \Delta t_h - \frac{F_{bt}}{K_{net,a}}$$

$$K_{net,a} = \left[ \frac{2}{K_{sr}} + \frac{2}{K_{df}} + \frac{1}{K_h} \right]^{-1}$$

$$\begin{aligned} \therefore \frac{F_{bt}}{K_{ba}} + \frac{F_{bt}}{K_{net,a}} &= \left[ C_{tsr} \cdot L_{sr} \cdot (\Delta t_{sr1} + \Delta t_{sr2}) + C_{td} \cdot t_p \cdot (\Delta t_{d1} + \Delta t_{d2}) \right. \\ &\quad \left. + C_{td} \cdot L_h \cdot \Delta t_h - C_{tba} \cdot L_{ba} \cdot \Delta t_{ba} \right] \\ &= F_{bt} \frac{(K_{ba} + K_{net,a})}{K_{ba} \cdot K_{net,a}} \end{aligned}$$

$$\therefore F_{bt} = \frac{K_{ba} \cdot K_{net,a}}{(K_{ba} + K_{net,a})} \left[ C_{tsr} \cdot L_{sr} \cdot (\Delta t_{sr1} + \Delta t_{sr2}) + C_{td} \cdot t_p \cdot (\Delta t_{d1} + \Delta t_{d2}) + C_{td} \cdot L_h \cdot \Delta t_h - C_{tba} \cdot L_{ba} \cdot \Delta t_{ba} \right]$$

where  $e_{ba}$ ,  $e_{sr1}$ ,  $e_{df1}$ ,  $e_{dh}$ ,  $e_{df2}$ ,  $e_{sr2}$  are the elongations of the parts of corresponding stiffnesses  $K_{ba}$ ,  $K_{sr}$ ,  $K_{df}$ ,  $K_{dh}$ ,  $K_{df}$ , and  $K_{sr}$ ; and

- where  $C_{tba}$  = therm. exp. coeff. of body matl.
- $C_{tsr}$  = " " " " seat ring matl.
- $C_{td}$  = " " " " disk matl.
- $\Delta t_{ba}$  = increase (- if decrease) of temp. of body matl.
- $\Delta t_{sr1}$  = " " " " " ... downstream seat ring
- $\Delta t_{sr2}$  = " " " " " ... upstream seat ring
- $\Delta t_{d1}$  = " " " " " ... downstream disk plate
- $\Delta t_{d2}$  = " " " " " ... upstream disk plate
- $\Delta t_h$  = " " " " " ... disk hub matl.

From pg.1:  $F_{hu} = T_{un,s} (\cos \theta + \mu \sin \theta) / [2(\mu \cos \theta - \sin \theta)]$

$$\therefore \Delta T_{ax,un} = F_{bt} \frac{2(\mu \cos \theta - \sin \theta)}{(\cos \theta + \mu \sin \theta)}$$

ENCLOSURE 3

# “Utility Perspective”

Pennsylvania Power & Light Co.

Susquehanna SES

Units 1 & 2

# PP&L Perspective

- Previous Experience at Susquehanna SES
- Plan for Addressing Generic Letter 95-07
- Susceptibility Evaluation Criteria
- Pressure Locking/Thermal Binding  
Analytical Methodology

## Previous PL/TB Experience

- Monitored industry activity via our Industry Events Review Program (IERP)
- Implemented corrective actions in response to these industry events
- Continue to monitor industry activity to improve overall plant safety



## Previous PL/TB Experience

- In response to INPO SOER 84-7, all MOV/AOVs evaluated for PL/TB
  - 388 valves evaluated
  - 26 valves identified with PL/TB concerns
  - All valves handled thru our deficiency management program
    - Operability/Reportability
    - Corrective Actions

# Previous PL/TB Experience

- Drilled holes in the discs of the following valves to prevent Pressure Locking:
  - LPCI & Core Spray injection valves
  - Feedwater Pump discharge valves
- Procedure changes made to the following valves:
  - HPCI & RCIC IB Steam Supply CIVs (PL)
  - RHR Heat Exchanger discharge valves (TB)

# Plan for Addressing GL 95-07

- Develop Susceptibility Evaluation Criteria
- Develop PL/TB Analytical Methodology
- Perform Screening/Operability Evaluations
- Perform Detailed Analyses - Confirm Susceptibility
- Incorporate PL/TB into MOV Calculations
- Identify Corrective Actions as necessary

# Risks Associated with GL 95-07

- 180 Day Completion Schedule
  - Concern: New issues arise during evaluation period
- Lack of Accepted Analytical Methodology
  - Concern: Developing methodologies in parallel with industry testing

# Susceptibility Evaluation Criteria

- General Exclusion Criteria
- Thermal Binding Exclusion Criteria
- Pressure Locking Exclusion Criteria
- Specific Scenarios for PL/TB
  - Focus on specific conditions of concern
  - Supports detailed analyses to confirm susceptibility later

**GENERIC LETTER 95-07**

**PRESSURE LOCKING/THERMAL BINDING**

**ANALYTICAL METHODOLOGY**

**CONSIDERATIONS**



## PP&L EXPERIENCE

VALVE	INITIATOR	ACTION	PREVENTS
RHR F015	84-07	MODIFICATION	PL
CS F005	84-07	MODIFICATION	PL
HPCI F002	INPO OE 5906	PROCED. REV.	TIPL
RCIC F007	INPO OE 5906	PROCED. REV.	TIPL
RHR F003	SSES TB	PROCED. REV.	TB
FW 0603	SSES TIPL	MODIFICATION	TIPL

## ASSUMPTIONS

- PL / TB FORCES ADDITIVE TO STATIC UNSEATING
- MOV CAPABILITY BASED UPON G.L. 89-10 CRITERIA
- PL/TB MOV SCENARIO USED TO DEVELOP G.L.  
89-10 ALLOWABLE THRUST

CONSIDER - TEMPERATURE

- PRESSURE

- VOLTAGE

- TIMELINE



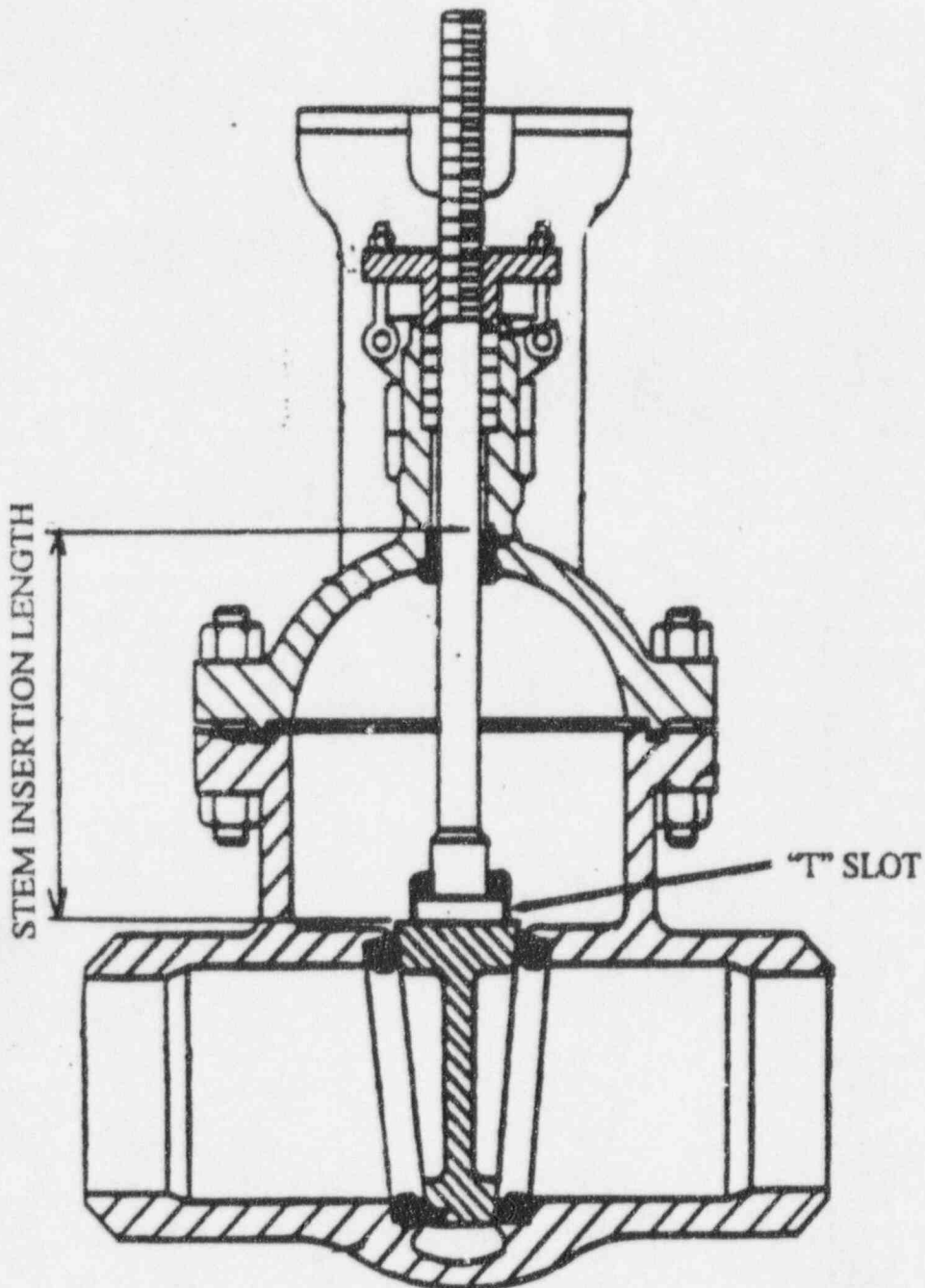



## DETERMINE THERMAL GROWTH $\delta L$

VALVE CONDITION	THERMAL MOVEMENT	$\delta L$
HOT OPEN	NONE	0
CLOSED	STEM ELONGATION	$L_s \alpha_s \Delta T_1$
CYCLE VALVE	NEGATE STEM ELONGATION	$-L_s \alpha_s \Delta T_1$
COOLDOWN	STEM CONTRACTION BODY CONTRACTION	$L_s (\alpha_B - \alpha_s) \Delta T_2$

## THERMAL GROWTH

$$\delta L = L_{TEE} (\alpha_{BODY} - \alpha_{STEM}) \Delta T_{BODY} + (L_{SI} - L_{TEE}) [(\alpha_{BODY}) \Delta T_{BODY} - (\alpha_{STEM}) \Delta T_{SR}]$$

$\delta L$  = RELATIVE THERMAL GROWTH

$L_{SI}$  = LENGTH OF STEM INSERTED INTO BODY

$\Delta T_{SR}$  =  $\Delta T$  OF STEM INITIALLY RETRACTED FROM THE VALVE BODY



# CONVERT THERMAL GROWTH TO FORCE

$$\frac{\Delta \text{THRUST}}{\delta L} = \frac{\Delta \text{THRUST/SEC}}{V_{ST}}$$

$\Delta \text{THRUST/SEC}$ : FROM VOTES

$$V_{ST} = (\text{MOTOR RPM}) (\text{STEM LEAD}) (1/60)/\text{OAR}$$

$$\Delta \text{THRUST} = \frac{[\Delta \text{THRUST/SEC}] \delta L}{V_{ST}}$$

Test: 5  
10/14/93  
15:46:31

CALIBRATION/  
ALK SENSOR  
-14814.5  
(lbs)

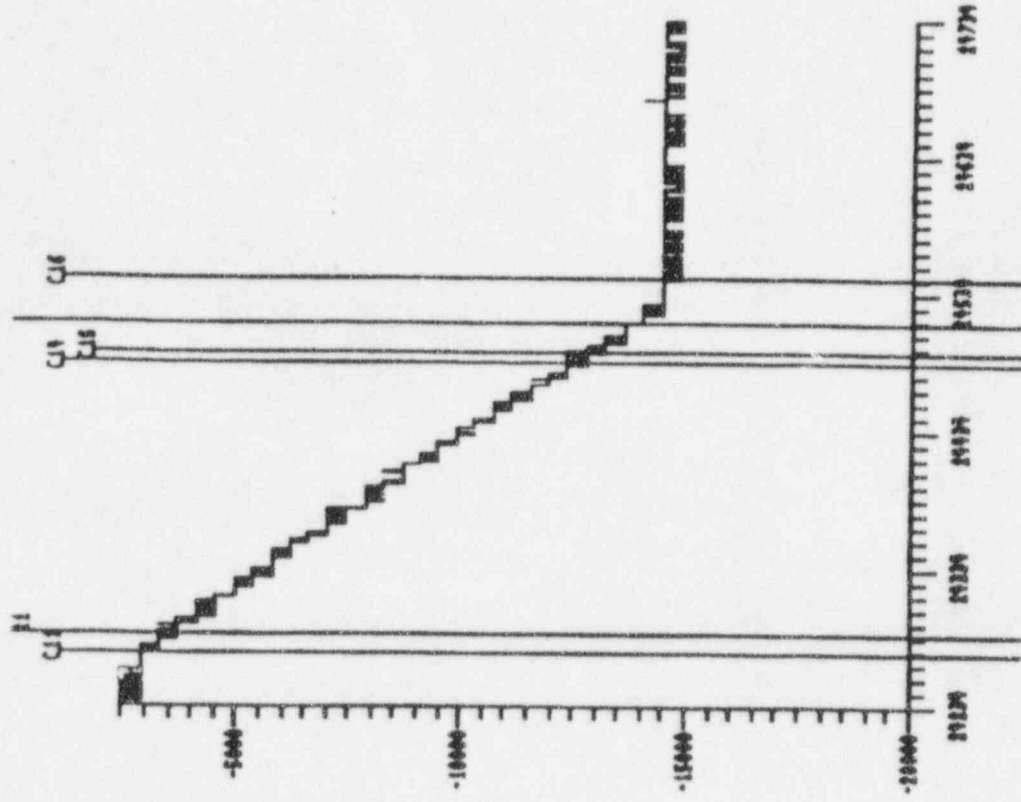

Time in Seconds 24.513 From 0.227

## ASSUMPTIONS

- THRUST VS STEM POSITION IS LINEAR
- STEM SPEED IS CONSTANT
- ALL THERMAL GROWTH RESULTS IN WEDGING
- $\alpha_S$  &  $\alpha_B$  ARE REASONABLE
- STEM OUTSIDE OF BODY IS COLD
- YOKE SHRINKAGE CANCELS OUT THAT OF EXTERNAL STEM
- ALL THERMAL FORCE ADDED TO UNSEATING

## PHILOSOPHY

- ASSURE SAFE PLANT OPERATION
- USE BEST AVAILABLE INFORMATION
- CONSERVATISM FOR UNCERTAINTY

# “Utility Perspective”

Pennsylvania Power & Light Co.

Susquehanna SES

Units 1 & 2



# PP&L Perspective

- Previous Experience at Susquehanna SES
- Plan for Addressing Generic Letter 95-07
- Susceptibility Evaluation Criteria
- Pressure Locking/Thermal Binding  
Analytical Methodology



## Previous PL/TB Experience

- Monitored industry activity via our Industry Events Review Program (IERP)
- Implemented corrective actions in response to these industry events
- Continue to monitor industry activity to improve overall plant safety

# Previous PL/TB Experience

- In response to INPO SOER 84-7, all MOV/AOVs evaluated for PL/TB
  - 388 valves evaluated
  - 26 valves identified with PL/TB concerns
  - All valves handled thru our deficiency management program
    - Operability/Reportability
    - Corrective Actions

# Previous PL/TB Experience

- Drilled holes in the discs of the following valves to prevent Pressure Locking:
  - LPCI & Core Spray injection valves
  - Feedwater Pump discharge valves
- Procedure changes made to the following valves:
  - HPCI & RCIC IB Steam Supply CIVs (PL)
  - RHR Heat Exchanger discharge valves (TB)

# Plan for Addressing GL 95-07

- Develop Susceptibility Evaluation Criteria
- Develop PL/TB Analytical Methodology
- Perform Screening/Operability Evaluations
- Perform Detailed Analyses - Confirm Susceptibility
- Incorporate PL/TB into MOV Calculations
- Identify Corrective Actions as necessary

# Risks Associated with GL 95-07

- 180 Day Completion Schedule
  - Concern: New issues arise during evaluation period
- Lack of Accepted Analytical Methodology
  - Concern: Developing methodologies in parallel with industry testing