



James W Cook  
Vice President - Projects, Engineering  
and Construction

General Offices: 1945 West Parnall Road, Jackson, MI 49201 • (517) 788-0453

August 30, 1983

Harold R Denton, Director  
Office of Nuclear Reactor Regulation  
US Nuclear Regulatory Commission  
Washington, DC 20555

MIDLAND ENERGY CENTER  
MIDLAND DOCKET NOS 50-329, 50-330  
NRC REQUEST FOR ADDITIONAL INFORMATION ON THE  
SEISMIC MARGIN REVIEW REPORT  
FILE: B3.7.1 SERIAL: 25479

- REFERENCE: (1) LETTER FROM J W COOK TO H R DENTON  
SERIAL 21047, DATED FEBRUARY 16, 1983
- (2) LETTER FROM E G ADENSAM (NRC) TO J W COOK  
DATED JUNE 21, 1983

In reference (1), Consumers Power Company submitted Volume VI of the Seismic Margin Review Report titled, "Borated Water Storage Tank and Foundation," for the Staff's review. Subsequently, in reference (2) the NRC requested additional information on Volume VI in question number 130.29. As an attachment to this letter, CPCo is submitting the response to question 130.29 for Staff review.

It is expected that this information will enable the NRC Staff to complete its review of Volume VI of the Seismic Margin Review Report.

A large, handwritten signature in cursive that reads 'James W. Cook'.

JWC/MFC/bjw

- CC RJCook, Midland Resident Inspector  
JGKeppler, Administrator, NRC Region III  
DSHood, US NRC  
FRinaldi, US NRC  
GHarstead, Harstead Engineering Company  
GBagchi, US NRC  
RBosnak, US NRC  
MAMiller, US NRC Licensing Branch No 4

Handwritten initials 'Boo' with a vertical line through them.

oc0883-0552a100

8309090587 830830  
PDR ADOCK 05000329  
A PDR

CONSUMERS POWER COMPANY  
Midland Units 1 and 2  
Docket No 50-329, 50-330

Letter Serial 25479 Dated August 30, 1983

At the request of the Commission and pursuant to the Atomic Energy Act of 1954, and the Energy Reorganization Act of 1974, as amended and the Commission's Rules and Regulations thereunder, Consumers Power Company submits additional information on the Seismic Margin Review Report Volume VI titled, "Borated Water Storage Tank and Foundation."

CONSUMERS POWER COMPANY

By J W Cook  
J W Cook, Vice President  
Projects, Engineering and Construction

Sworn and subscribed before me this 31 day of August, 1983

Bartara B. Townsend  
Notary Public  
Jackson County, Michigan

My Commission Expires September 8, 1984

REQUEST FOR ADDITIONAL INFORMATION

130.0 \* Structural Engineering Branch

130.29 Provide the following additional information with respect to Volume VI of the Seismic Margin Review report titled, "Borated Water Storage Tank and Foundation" transmitted by your letter of February 16, 1983.

Question 130.29.1 Clarify in Section 1.1 that a modified Housner response spectrum is used in the development of the SME and not just the Housner response spectrum.

Response: The SME response spectrum used for the structural evaluation of the BWST was the envelope of the Housner spectrum and the site-specific response spectrum developed for structures founded at the top-of-fill at the Midland site. Clarification of the use of the Housner spectrum versus the modified Housner for the SME occurred during cross-examination of Dr. Richard J. Holt before the Atomic Safety and Licensing Board on October 13, 1981 (Reference 1). During this testimony it was specifically stated that the original Housner spectrum and not the modified Housner spectrum would be used in the development of the SME spectrum. The SME, site-specific, Housner, and modified Housner response spectra are illustrated in Figure Q&R 130.29.1-1.

For this SME evaluation, it is appropriate to utilize earthquake response spectra which are representative of actual earthquakes which might occur at the Midland site (with low probability of being exceeded). The site-specific response spectrum is representative of actual earthquake motion although it has been broadened to account for uncertainties in earthquake frequency content and site conditions. The Housner spectra, which is the envelope of spectra from actual earthquake time histories, is included in the SME definition to assure that conservative earthquake ground motion is accounted for in the low frequency regime. The Modified Housner response spectrum is unrealistic because no real earthquake ground motion would produce this response spectrum.

References:

1. Testimony before the Atomic Safety and Licensing Board, Nuclear Regulatory Commission, In The Matter Of Consumers Power Company Midland Plant, Units 1 and 2, Docket No. 50-329 OL&OM, 50-330 OL&OM, October 13, 1981, p. 4509-4704.

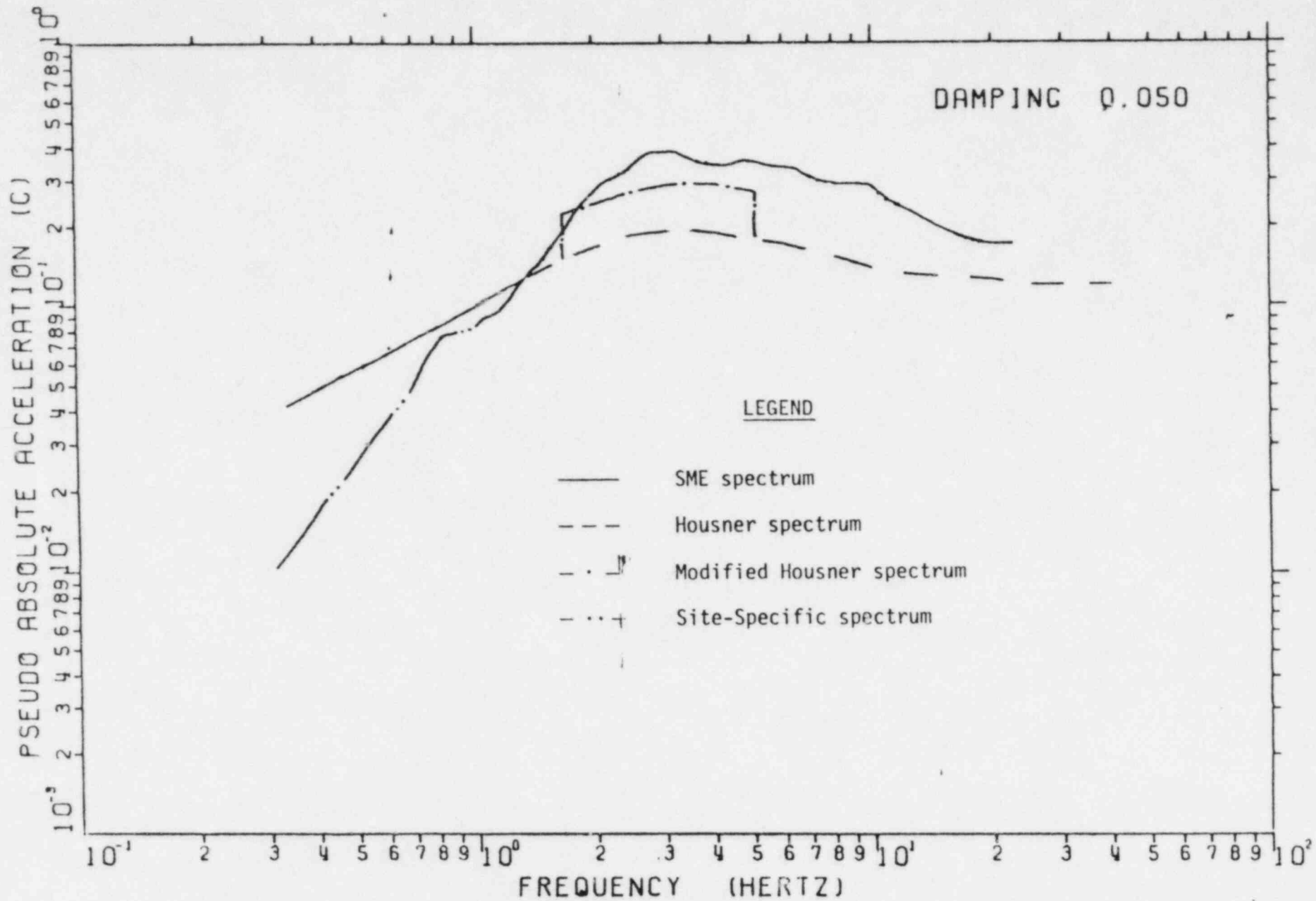

FIGURE Q&R 130.29.1-1 TOP-OF-FILL SME RESPONSE SPECTRUM

Question 130.29.2 Does the word "foundation" at the end of the third sentence of the second paragraph of Section 2.1 mean the ring beam and the sand central support?

Response: The sentence referred to by this question could more accurately be stated as: "Thus, the primary seismic modeling concern is to conservatively model the seismic forces induced by this water on the tank shell, ring beam and soil underlying the ring footing." These are the items for which code margin and seismic margin factors have been evaluated as discussed in Chapters 4 and 5 of the report. Seismic-induced forces on the sand central support do not result in a potential mode of failure for the BWST.

Question 130.29.3 Provide the following information, for Section 2.2.1, relevant to the seismic models:

- a. Discuss in more detail why the model identified in Figure VI-2-2 is a better representation than the model in Figure VI-2-1.
- b. State why you assume that the hydrodynamic pressure is constant from elevation  $y = 0.15h$  to the bottom of the tank.
- c. Provide a comparison between the methods identified in References 6 and 7. A summary of specific assumptions, model and results should be provided for staff review.
- d. Address the development of the constant 1.453 in Equation 2-3.
- e. Address Equation 2-4 by providing a specific reference within Reference 2 and/or providing a copy of related pages.

Response:

- a. Figures VI-2-1 and VI-2-2 do not represent separate models for evaluating BWST horizontal impulsive mode response. Figure VI-2-1 is shown for the purpose of illustrating how the impulsive fluid mass is lumped to the various degrees of freedom in the model. Figure VI-2-2 provides the actual numerical values describing the model in detail including weights, dimensions, and beam and soil spring properties.
- b. The idealized hydrodynamic pressure distribution in which the pressure increases linearly from zero at the top of the fluid ( $y = 0$ ) to the constant value from Equation 2-3 at  $y = 0.15$  and greater is based on the recommendation of Reference 6. This distribution is a reasonable approximation as shown in Figure Q&R 130.29.3-1 (reproduced from Reference 6) by the comparison of actual and the approximate distribution for different tank mode shapes.

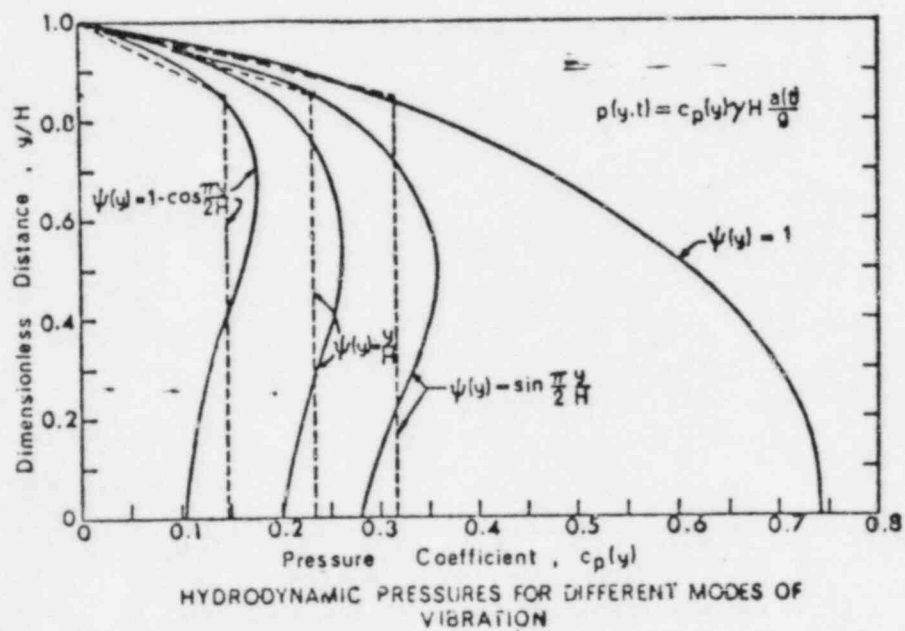
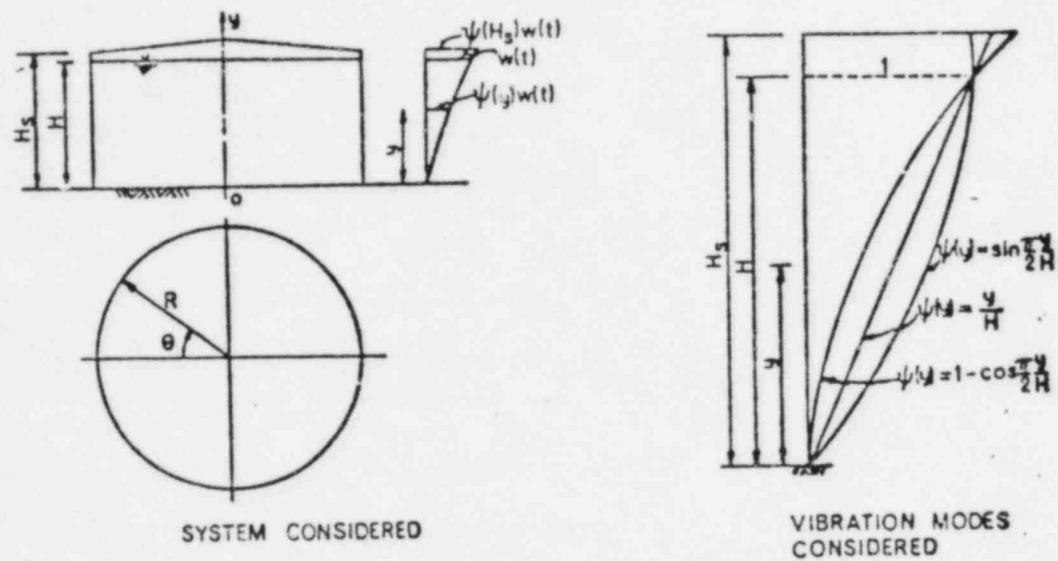
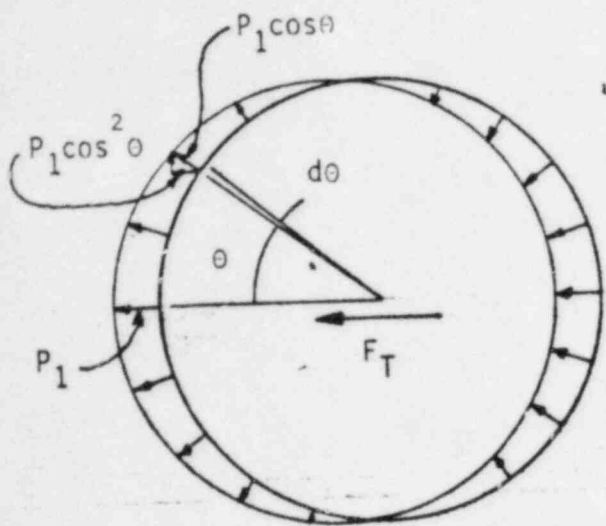

FIGURE Q&R 130.29.3-1 COMPARISON OF ACTUAL AND APPROXIMATE HYDRODYNAMIC PRESSURE DISTRIBUTIONS FOR VARIOUS TANK MODE SHAPES



- c. Both References 6 and 7 provide methods for evaluating the dynamic forces induced by the lateral component of earthquake motion in liquid filled cylindrical tanks considering the effects of tank flexibility. Reference 6 presents the development of a simple approximate procedure for assessing the effects of tank flexibility considering impulsive fluid forces. Reference 7 summarizes the procedure presented in Reference 6 and also presents; an exact solution of the hydrodynamic effects induced in rigid tanks; the formulation and application of a more refined analysis than presented in Reference 6 in which the tank is analyzed by use of a shell theory; and studies of the natural frequencies and modes of vibration of both empty and liquid filled tanks.
- d. Equation 2-3 is developed by equating the component of the impulsive hydrodynamic pressure acting in the direction of the seismic excitation multiplied by the wetted tank surface area with the seismic-induced base shear. The hydrodynamic pressure is assumed to be distributed as a cosine wave around the tank circumference and constant up to 85 percent of its height; then linearly reducing to zero at the top of the fluid. The derivation of Equation 2-3 is presented in Figure Q&R\_130.29.3-2.
- e. Equation 2-4 is taken from Reference 6 and not Reference 2 as stated in the report. Equation 2-4 is given in Table 2 of Reference 6.



PLAN VIEW

Circumferential Pressure Distribution

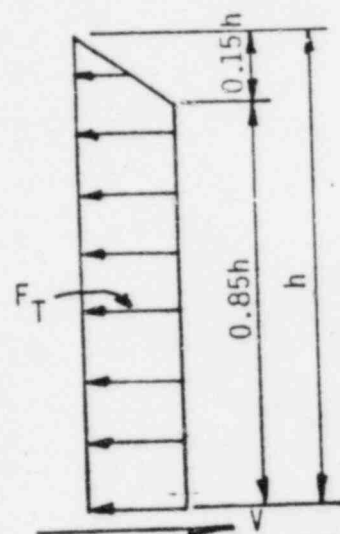

CROSS-SECTION VIEW

Pressure Distribution with Height

$F_T$  = total horizontal force per unit height, at any elevation

$$F_T = \int_0^{2\pi} P_1 \cos^2 \theta (R d\theta) = \pi R P_1$$

$V$  = seismic-induced base shear

$$V = F_T (0.85h) + \frac{F_T}{2} (0.15h) = 0.925 F_T h$$

$$V = 0.925 \pi R P_1 h = 0.925 \pi (D/2) P_1 h$$

$$P_1 = \frac{V}{1.453 D h}$$

FIGURE Q&R 130.29.3-2 DERIVATION OF EQUATION 2-3

Question 130.29.4 With respect to Section 2.2.3, investigate and discuss results of the effect on the fundamental frequency and hydrodynamic pressures due to vertical ground motion for the borated water storage tanks.

Response: Section 2.2.3 of the BWST report discusses the evaluation of the fundamental vertical frequency and Section 3.3 discusses the hydrodynamic pressures due to vertical ground motion. In both of these sections, the tank and fluid has been approximated as rigid for the vertical direction and the only vertical flexibility is due to vertical soil-structure interaction.

Actually, there is some flexibility of the tank and fluid in the vertical direction due to the tank breathing mode enabling vertical fluid vibration. The fundamental frequency for the tank and fluid in the vertical direction for a fixed-base mode (i.e., no vertical soil-structure interaction) is 8.1 Hz. This value has been determined by the formula given by Kana\*. Accounting for this flexibility results in a reduction in the vertical fundamental frequency and a small increase in the total pressures at the critical locations on the tank shell as shown for the lower bound soil case in Table Q&R 130.29.4-1

---

\* Kana, D. D. and Craig, R. "Parametric Oscillations of a Longitudinally Excited Cylindrical Shell Containing Liquid, Journal of Spacecraft and Rockets, 5, 1, pp 13-21, January, 1968.

TABLE Q&amp;R 130.29.4-1

	Assuming Rigid Tank	Accounting for Tank-Fluid Vertical Flexibility
Fundamental Vertical Frequency	4.3 Hz	3.9 Hz
Total Pressure on the tank shell		
3/8" tank	2.22 ksf	2.27 ksf
1/4" tank	1.70 ksf	1.74 ksf

The coupled tank-fluid-soil response for vertical seismic excitation has been computed by a model consisting of spring elements representing the tank and fluid which produce a fixed-base fundamental frequency of about 8.1 Hz and which is attached to ground by a vertical soil spring. The lower bound soil case is considered as this case produced the largest seismic response for horizontal excitation. The mode shapes and total wall pressures (i.e., combined hydrostatic and hydrodynamic pressures) are compared in Figure Q&R 130.29.4-1 for the rigid tank approximation and including tank/fluid vertical flexibility.

The results presented above indicate that the rigid tank approximation was adequate for the BWST evaluation. Although the vertical fundamental frequency is overestimated by about 10 percent, the maximum tank shell pressure (i.e., combined hydrostatic plus hydrodynamic pressures) is underestimated by only about 2 percent. The resulting minimum hoop stress code margin, CM, and seismic margin,  $F_{SME}$ , as reported in Section 4.4.2, are changed from 2.13 and 8.40 to 2.08 and 7.28, respectively, when vertical flexibility is accurately accounted for. Thus, the conclusions of the BWST report are not significantly affected by the rigid tank approximation for vertical ground motion.

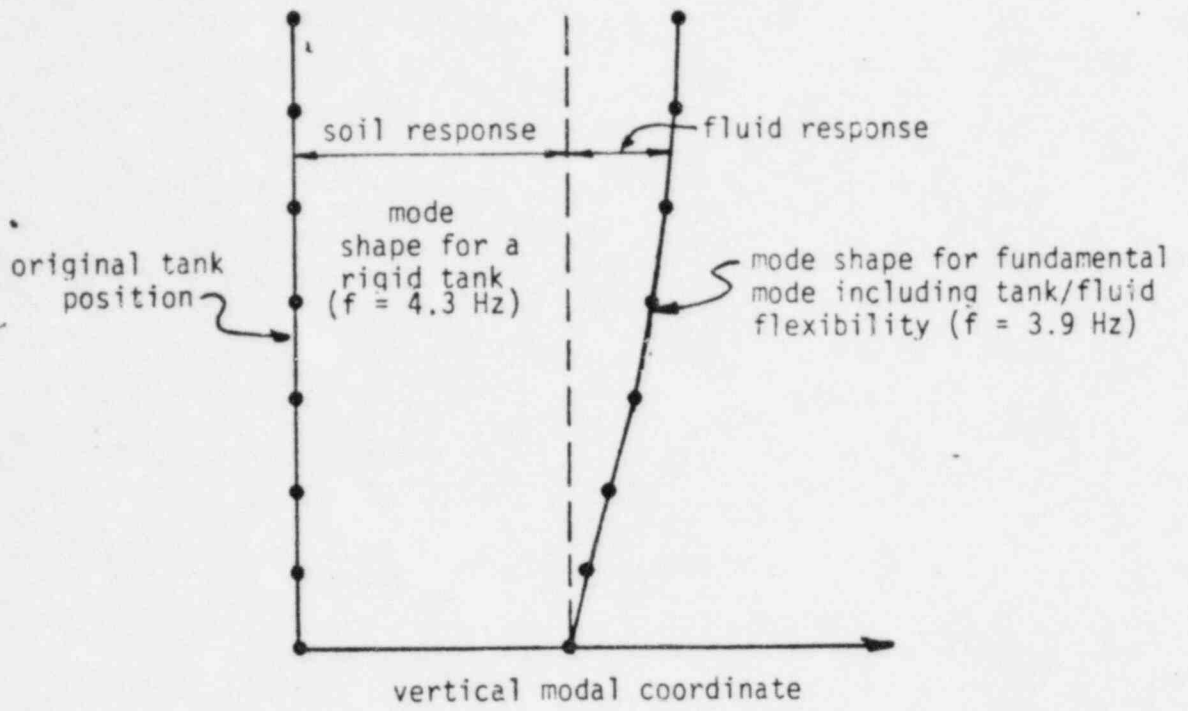

a) Mode Shapes

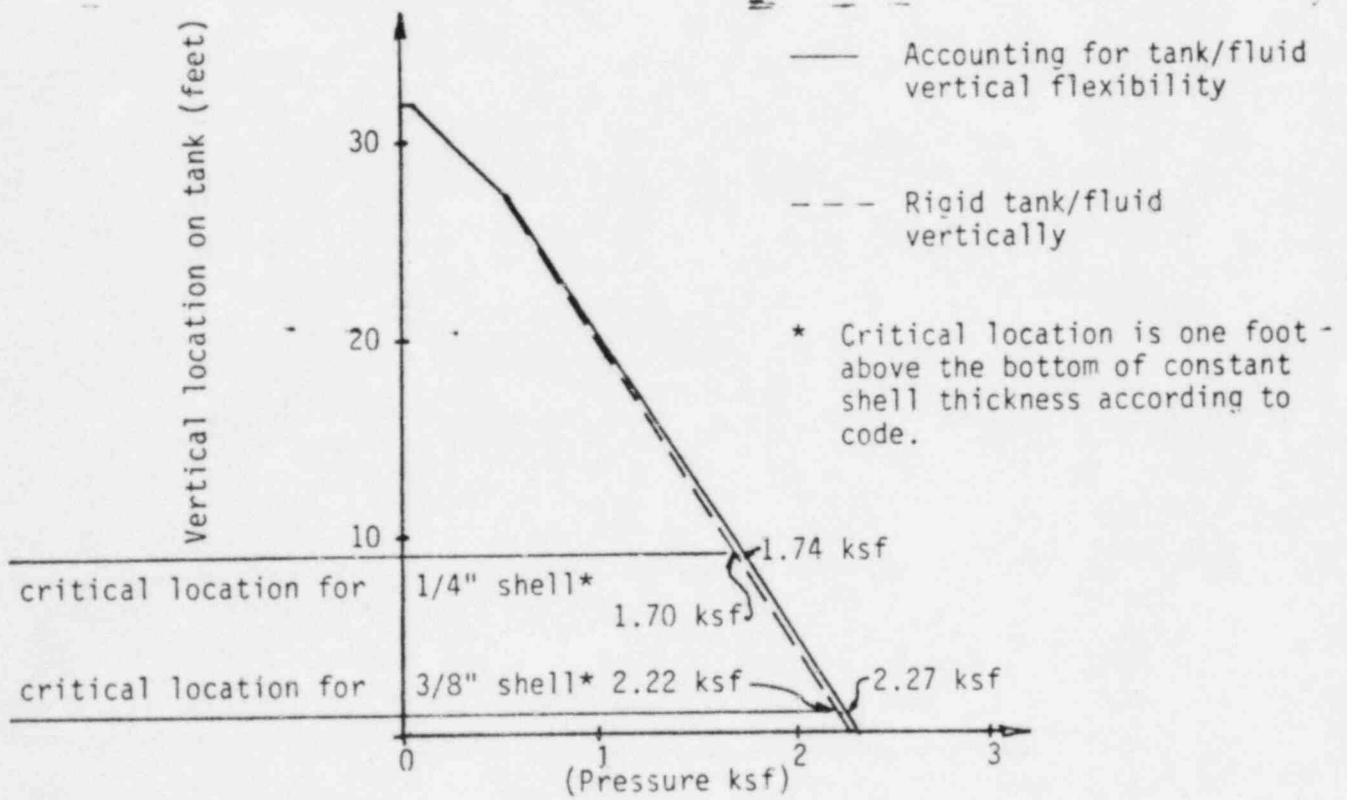

b) Total Wall Pressure

FIGURE Q&R 130.29.4-1 EFFECT OF ACCOUNTING FOR VERTICAL TANK/FLUID FLEXIBILITY

Question 130.29.5 We agree, for Section 2.3.2, with the use of rocking stiffness based upon the difference in stiffnesses of disks of radius equal to 28.75 feet and 24 feet. However, the overturning moment should be based upon the hydrodynamic wall pressures which does not include  $M_B$  (Equation 2-4). Discuss this concern and its effect.

Response: Base moment due to hydrodynamic wall pressures is determined from the dynamic analysis of the BWST including rocking soil-structure interaction where the rocking stiffness corresponds to the difference in stiffness of disks of the outer and inner radius of the ring foundation. The value of the maximum wall pressure moment is 8154 foot-kips. In addition, there is base moment due to hydrodynamic bottom pressures as determined from Equation 2-4. The bottom pressure maximum moment is 4930 foot-kips. It is our judgment that, in the rocking mode, the tank can respond somewhat independently of the contained water because the flexible tank bottom does not induce significant rocking response of the fluid. Thus, the bottom pressure does not significantly affect rocking soil-structure interaction.

Note that a two-foot circumferential strip of the tank bottom is directly above the ring foundation and the portion of the 4930 foot-kip moment acting on this strip (1350 foot-kips) is added to the 8154 foot-kip moment resulting from horizontal wall pressures. The resulting moment of 9404 foot-kips acting on the ring foundation is used to determine the seismic margin of the ring beam, anchor bolts, underlying soil, etc. The remaining bottom pressure moment of 3580 foot-kips acts directly on the soil beneath the central region of the tank.

The seismic-induced base moment is comprised of components due to tank wall pressure and tank bottom pressure. The contribution of each component to rocking soil-structure interaction and seismic loads on the ring foundation and supporting soil have been considered in an appropriate manner.

Question 130.29.6 Equation 3-2 in Section 3.3, appears to be valid if hoop stiffness of the tank can be assumed as rigid. Demonstate that the fundamental frequency of the tank is greater than 33 hertz.

Response: Refer to the response to Question 130.29.4 for this question.



Question 130.29.7 Address in Section 4.4.2 any potential increase in hoop stress due to the vertical ground acceleration and any change in stress and safety margin due to consideration for potential corrosion development.

Response: The seismic-induced hoop stress due to vertical ground acceleration has been incorporated into the hoop stress used to evaluate code and seismic margins. The total hoop stress in the tank shell includes a hydrostatic component and hydrodynamic components resulting from seismic response in the sloshing, impulsive and vertical modes. Hydrodynamic pressures due to vertical seismic response have been further addressed by the responses to Questions 130.29.4 and 130.29.6.

The BWST is made of Type 304L stainless steel and the original design specification\* for the tank states that no corrosion allowance is required. For a stainless steel tank containing water, corrosion is not a problem.

---

\* Bechtel Specification 7220-C-18(Q), Appendix F, "Design Specification for Subcontract for Field-Erected Borated Water Storage Tanks for the Consumers Power Company Midland Plant Units 1 and 2", January 24, 1978.

Question 130.29.8 In Section 4.4.2, why have you considered dead load in conjunction with the seismic load, combined as SRSS?

Response: Hydrodynamic loads and hydrostatic loads have been combined together by absolute summation. The individual components of the hydrodynamic loading due to vertical response, horizontal impulsive response, and horizontal sloshing responses are combined by SRSS to give the total hydrodynamic load. This resultant total hydrodynamic load is added to the hydrostatic load by absolute summation to give total wall pressure,  $P$ , which is used to evaluate the maximum tank hoop stress as given in Table VI-4-1. The combination of hydrostatic and hydrodynamic load components is illustrated in Figure VI-3-2 of the report.

Question 130.29.9 State in Section 4.4.3 if you have used Figure NC 3922.11 of the ASME Code Section III to determine the maximum compressive stress. Also, address any considerations given in your analyses for potential corrosion development and its effect on total stress and margin of safety.

Response: The original tank design specification\* specifies that the design pressure for these tanks is atmospheric and the tanks shall be constructed in accordance with ASME Boiler and Pressure Vessel Code, Section III Subsection NC, 1974. For atmospheric storage tanks, the applicable requirements in the code are given in NC 3800. NC 3800 specifies design requirements conforming to NC 3100 and NC 3300 and does not refer to NC 3900 which includes Figure NC 3922.1-1. NC 3300 contains the design relations presented in Section 4.4 of the BWST report. Even though Figure NC 3922.1-1 is not a design requirement for the BWST, this tank would also meet these criteria because for the thickness to radius ratio of this tank, the stress limits from Figure NC 3922.1-1 are identical to Equation 4-3 in the BWST report.

The BWST is made of Type 304L stainless steel and the original design specification\* for the tank states that no corrosion allowance is required. For a stainless steel tank containing water, corrosion is not a problem.

---

\* Bechtel Specification 7220-C-18(Q), Appendix F, "Design Specification for Subcontract for Field-Erected Borated Water Storage Tanks for the Consumers Power Company Midland Plant Units 1 and 2", January 24, 1978.