



MARATHON MANAGEMENT COMPANY
(A SUBSIDIARY OF MARATHON WATCH COMPANY LTD.)
67A STEELCASE RD. WEST, MARKHAM, ONT. L3R 2M4

TEL: (416) 475-0420
TELEX: 06-980040
Cable: Morwein-Markham
FAX: (416) 475-2535

August 8, 1989

Nuclear Regulatory Commission
1 White Flint North
11555 Rockville Pike
Rockville, MD 20852

Attention: Floyd Deschamps

Dear Mr. Deschamps,

Enclosed herewith please find drawings and prints for the navigational watch and military wrist watch general purpose.

We need a license for the above two types of watches, and have already sent a cheque for \$580.00 to cover for extra charges on license application 3H of 170 (31).

Thank you very much for your co-operation.

Yours truly,

MARATHON WATCH COMPANY LTD.

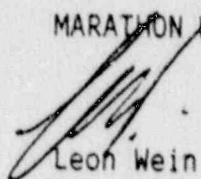

Leon Wein

/lz

Encl.

9002020279 900130
PDR FDIA
BICKMAN90-11 PDR

A/S

Bofte military wrist watch

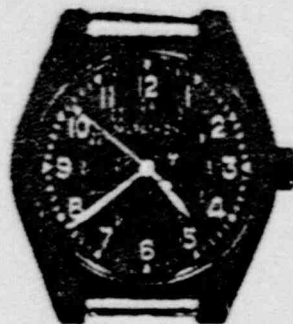
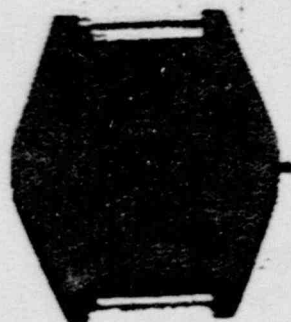

- 3.
- 1) \varnothing outside = 34mm inches 1.34
 - 2) \varnothing inside = 25.70mm inches 1.02
 - 3) space between bars and case = 7.50mm inches 0.06
 - 4) space between lugs = 16mm inches 0.63
 - 5) thickness of crown = 2.20mm inches 0.09
 - 6) \varnothing of crown = 5.50mm inches 0.22
 - 7) total thickness of watch = 9.70 mm inches 0.39
 - 8) \varnothing total of crystal = 30.70 mm inches 1.21
 - 9) \varnothing dial opening = 27.60mm inches 1.09

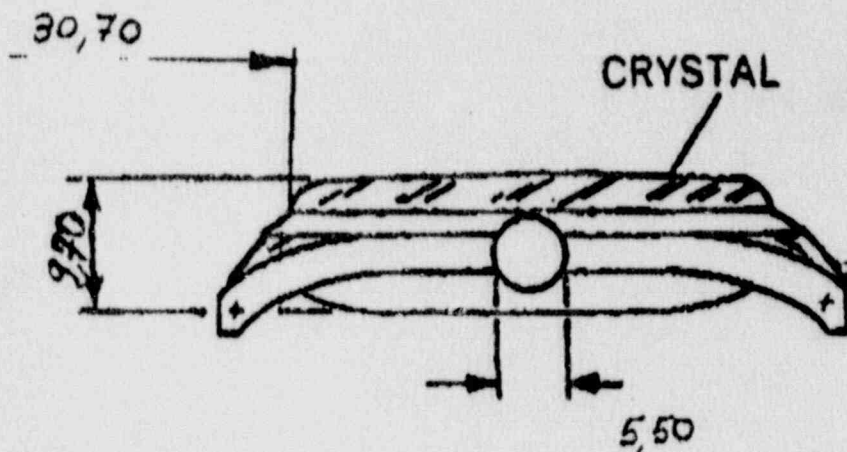
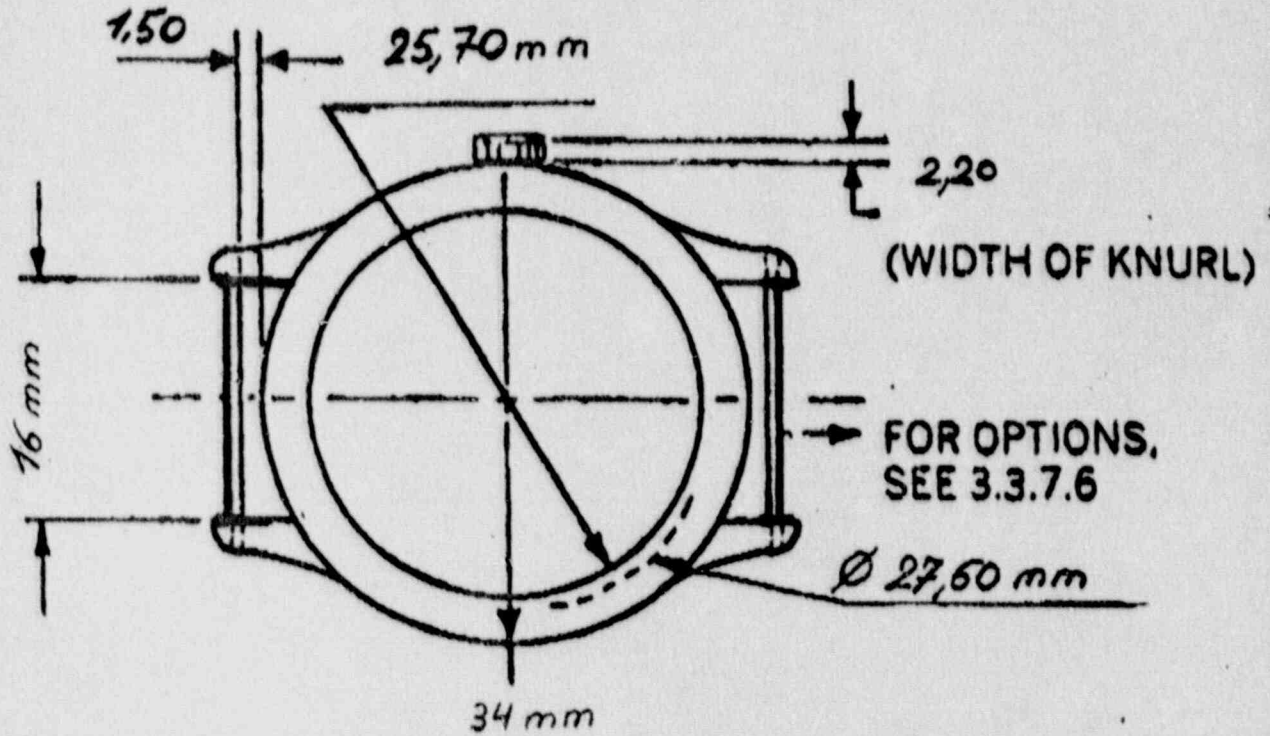

DIMENSIONS IN INCHES
TOLERANCES + .010 (UNLESS OTHERWISE SPECIFIED)

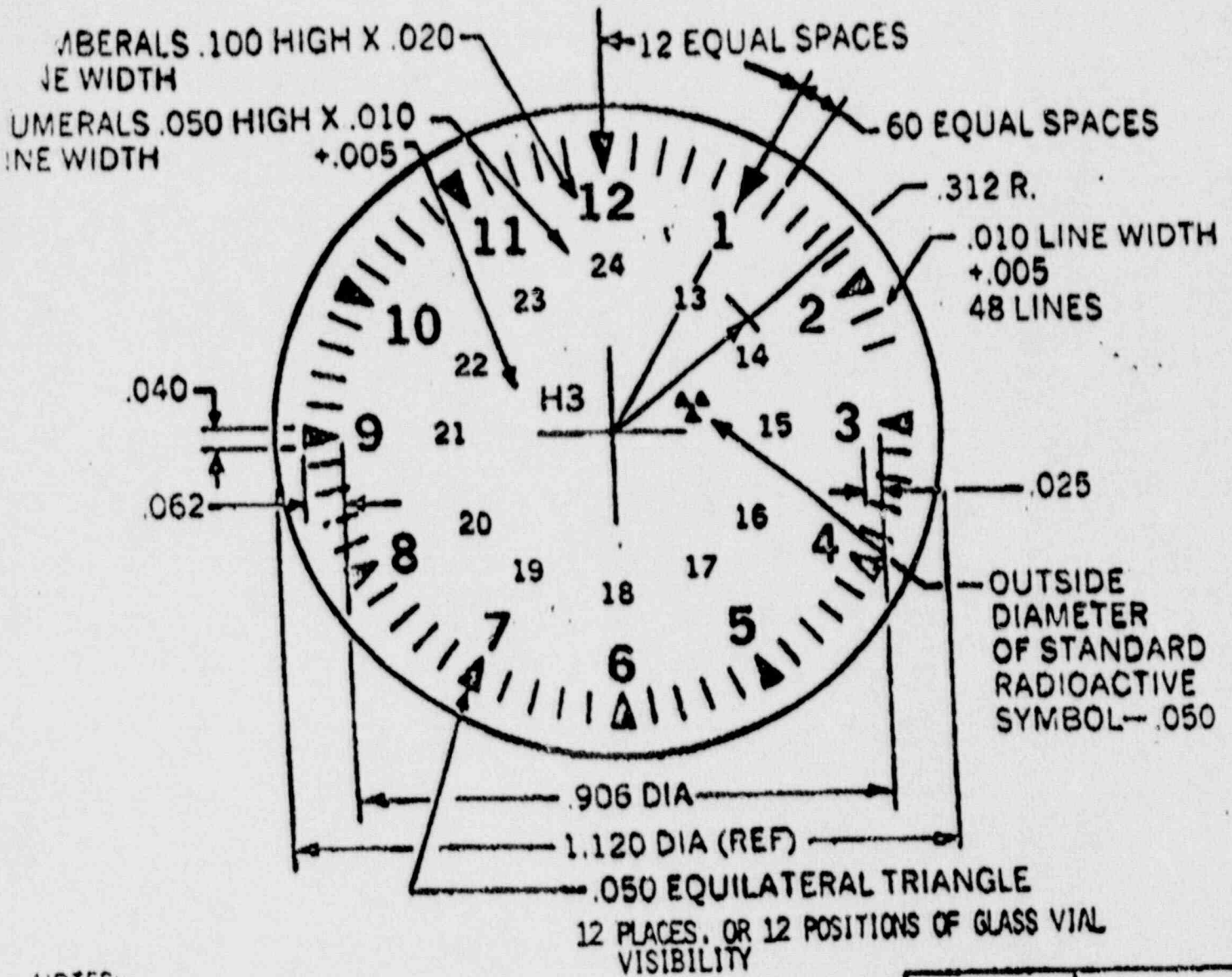

NOTES:

1. Dial face background in accordance with FED-STD-595 Color Black No. 37038.
2. Numbers and graduations in accordance with FED-STD-595 Color White No. 37875.
3. All triangles to be luminescent green.
4. H3 and  shall be centrally located and clearly visible.

Dimensions in inches
 unless otherwise
 specified
 Tolerances
 - Decimals + .010

INCHES	MIL
.005	.127
.010	.254
.020	.508
.025	.635
.040	1.016
.050	1.270
.062	1.575
.100	2.540
.312	7.9248
.906	23.012
1.120	28.575

FIGURE 1

MILITARY WRIST WATCH

- 1) dial
- 2) rotating bezel
- 3) case
- 4) back
- 5) cover for recess of battery
- 6) complete case

NAVIGATIONAL WATCH

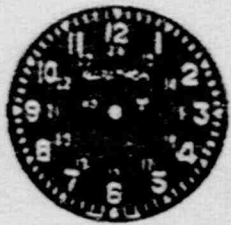

1

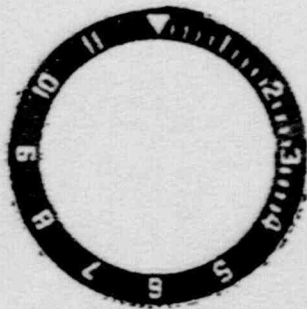

2

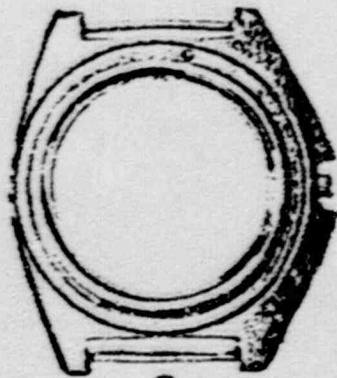

3

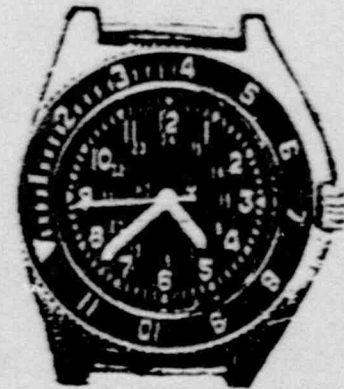

6



5

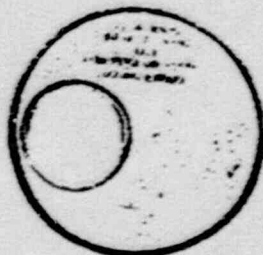

4

5

REMARKS - ALL SAND BLASTING.

SHEET 2/4

NAVIGATIONAL WATCH

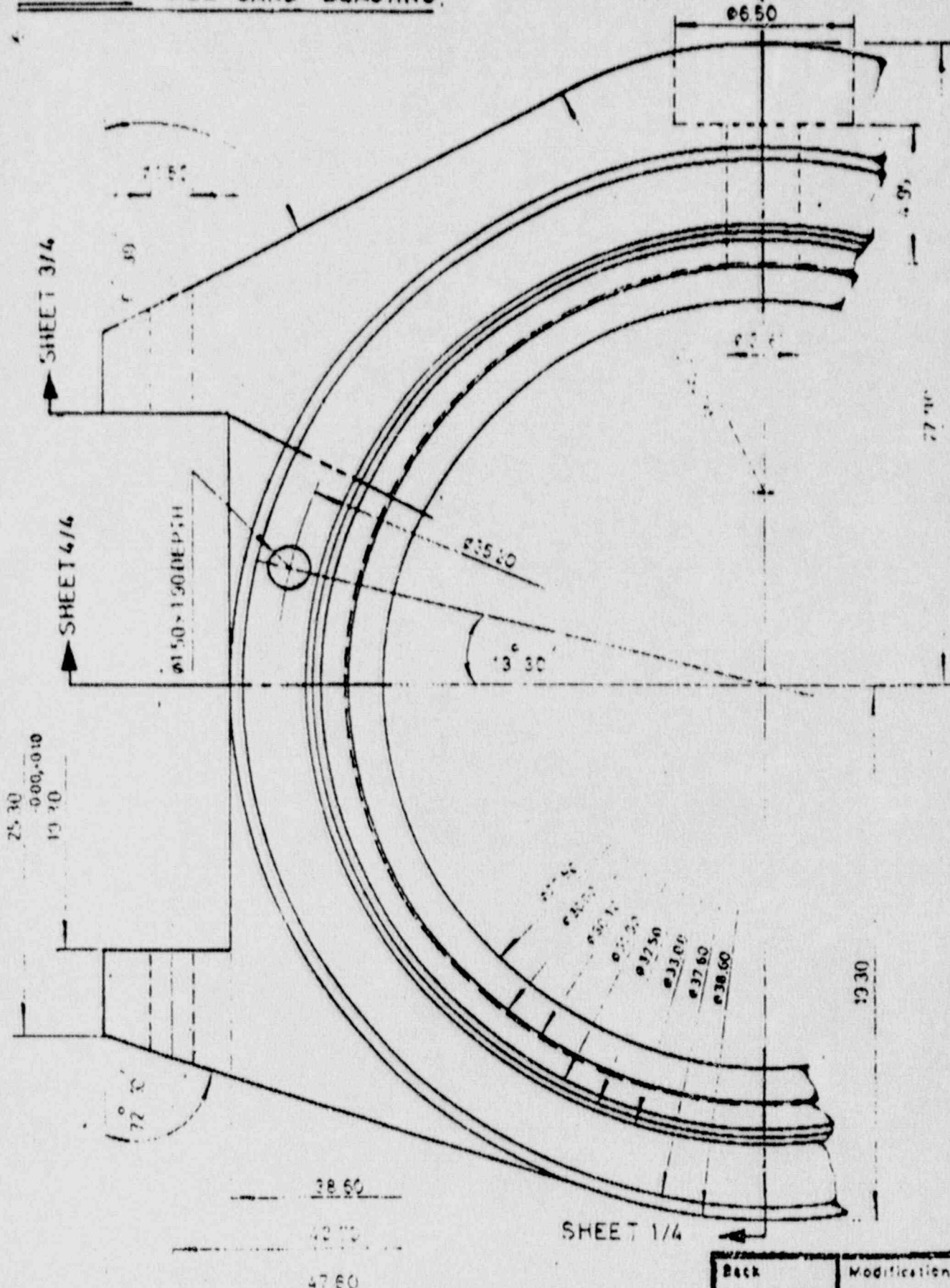

Dimensions in m.m. General tolerance ±0.10 & ±1°

Back		Modification	
SE NO 23CA			
Lunette	Tecl. No.	Order No.	
L 622	305		

NAVIGATIONAL WATCH

SIDE VIEW AT 9 H

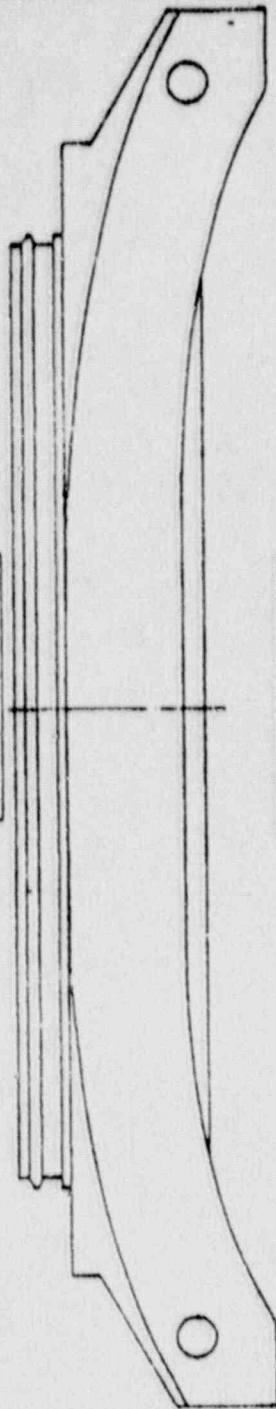

SIDE VIEW AT 3 H

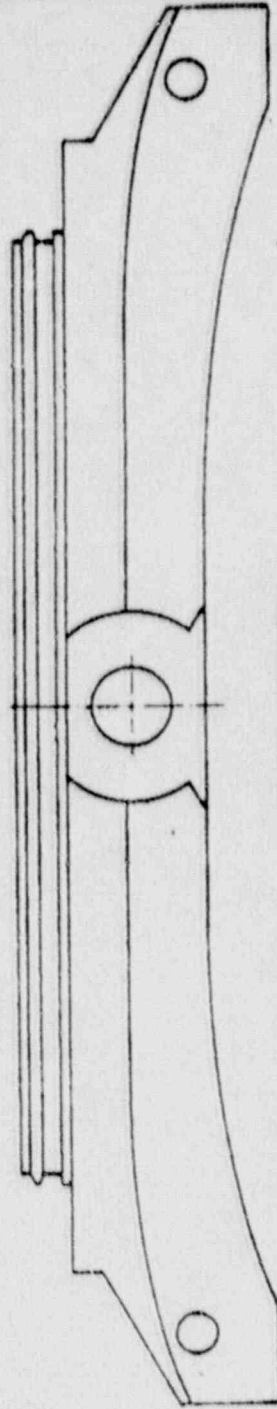

FRONT VIEW

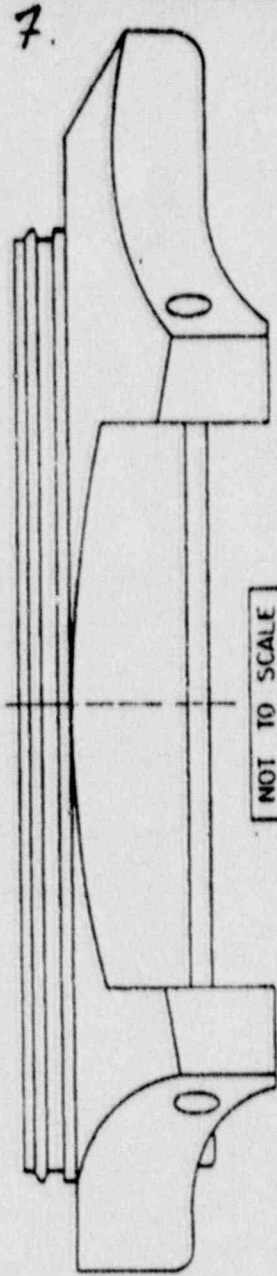

NOT TO SCALE

Dimensions in m.m. General tolerance ± 0.10 & $\pm 1^\circ$

GALLET

n°3

CAL RONDA 373

