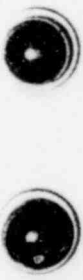


MS-V-308

MS-V-258

MS-V-118



STEAM GENERATOR  
FEED PUMP RELAY



EMERGENCY  
STOP



FEED TO 2B STM GEN  
CLOSE EF-V12 OPEN



MS-V-11A

STEAM GENERATOR  
FEED PUMP RELAY



2B STEAM GENERATOR  
FEED PUMP RELAY



FEED TO 2A STM GEN  
CLOSE EF-V11A OPEN



PCOR ORIGINAL

8001160865





PART-STOP-AUTO  
DIESEL FIRE  
PUMP UNIT 2



VERT SHARP  
DELUGE VALVE  
FS-V429A



NORTH OF  
DELUGE VALVE  
FS-V430A



SOUTH OF DIV  
DELUGE VALVE  
FS-V431A



DELUGE  
DELUGE VLVS  
FS-V425A & V426A



WATER DELUGE  
VLV FS-V433A



WAT DRAFT  
COOL TOWER  
CW-C-1A  
DELUGE VLVS

BE  
A  
AA

PCOR ORIGINAL

TECTION  
EL 7



FIRE MAIN  
PRESSURE

TEST

CHAR  
FILTER  
VLV FS  
THRU

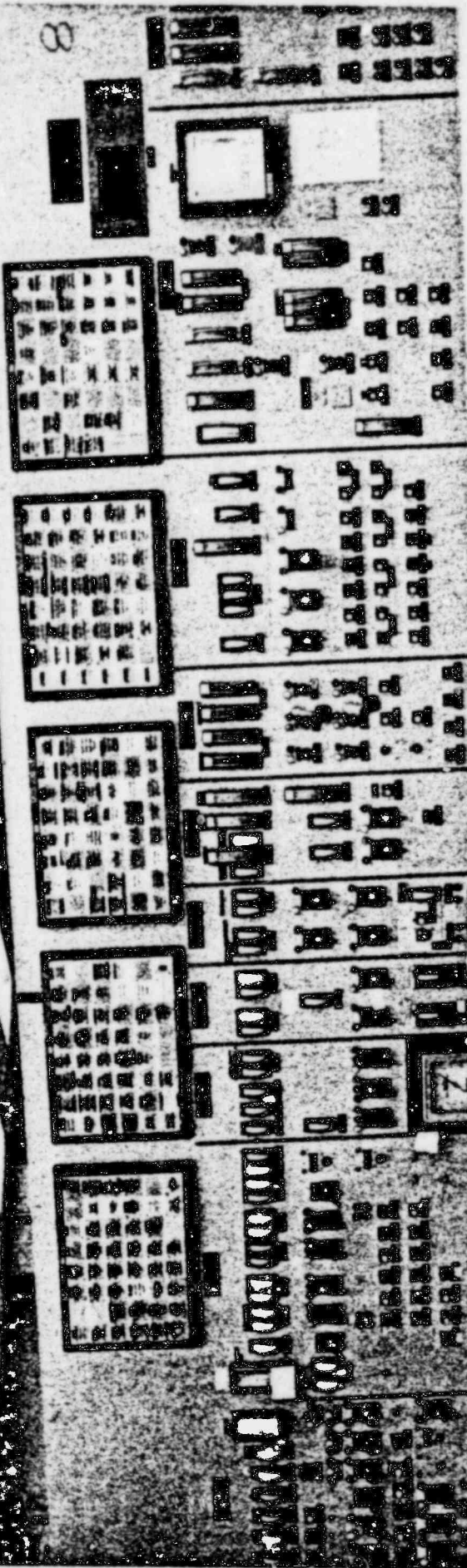
CONTROL ROOM  
BYPASS FLTR  
DELUGE VALVE  
FS-V413

DIESEL  
FIRE PUMP  
UNIT 1

MOTOR  
FIRE PUMP  
UNIT 1

COOL TOWER  
FIRE PUMP  
UNIT 1











INTERMEDIATE  
COOLING PUMP  
SUCTION



INTERMEDIATE  
COOLING PUMP  
DISCHARGE



IC SURGE  
TANK LEVEL



IC-P-1A  
INTERMEDIATE  
COOLING PUMP



IC-P-1B  
INTERMEDIATE  
COOLING PUMP



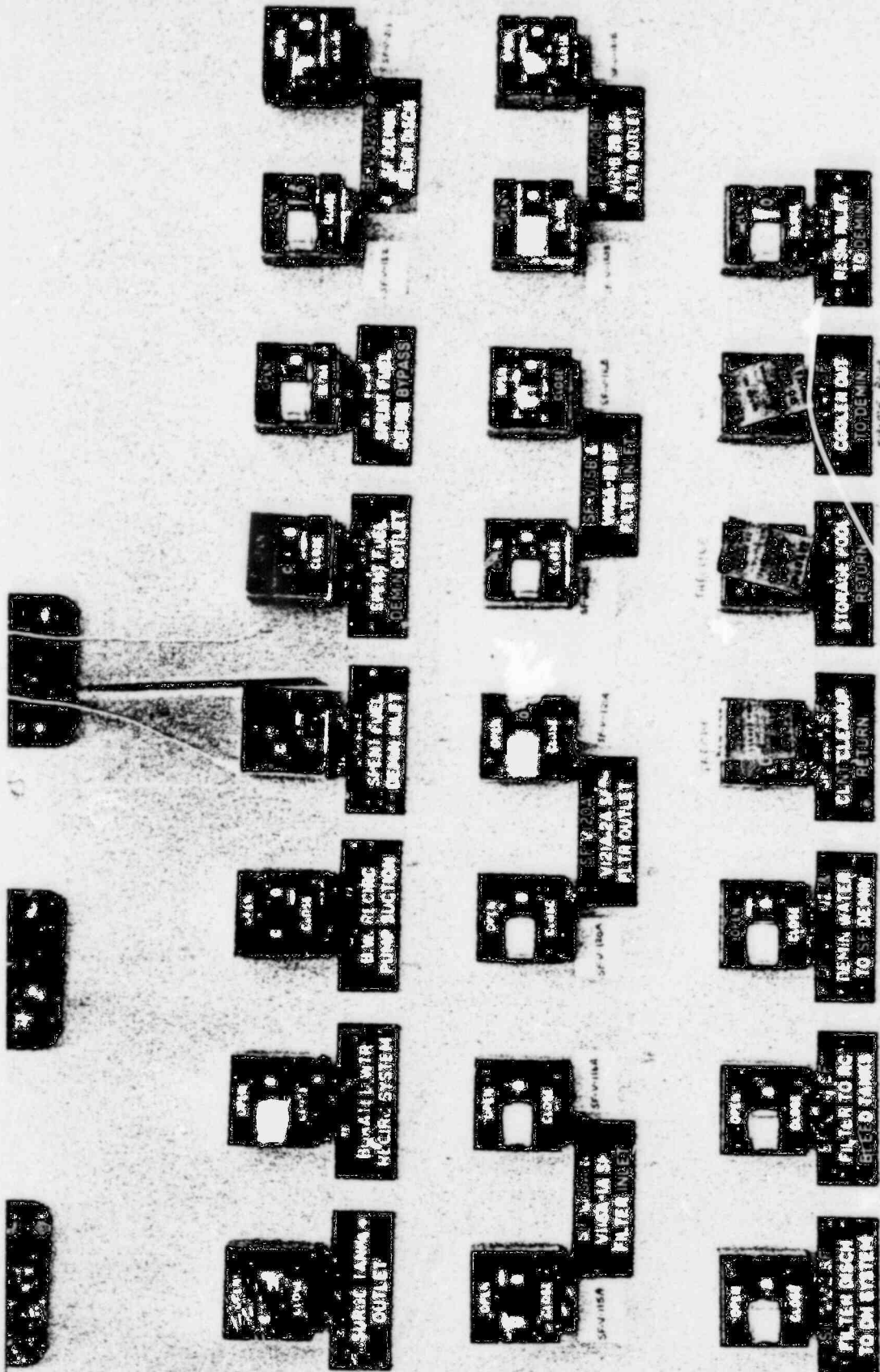
OPEN 14  
SHUT 20



Dw-46 IC  
SURGE TANK  
MAKEUP



ANNUNCIATOR  
TEST



705

400

800

URGE LEVEL

N 14  
T 20

TANK  
HELD

CF-V3A  
IA CF TANK  
VENT

DO NOT OPERATE 40

CF-V3A  
IA CF TANK  
VENT

DO NOT OPERATE 40

CF-V3A  
IA CF TANK  
VENT

CF-V3B  
IB CF TANK  
VENT

CF-V3B  
IB CF TANK  
VENT

DO NOT OPERATE 42

CF-V3B  
IB CF TANK  
VENT

OPEN  
CLOSE  
BS-P-1A TO  
SPRAY HEADER

OPEN  
CLOSE  
CF-V3A OF  
TK BLEED TO  
RC HOLDUP TK

OPEN  
CLOSE  
BS-P-1B TO  
SPRAY HEADER

TEST  
GREEN CHANNEL

TEST  
GREEN CHANNEL

TEST  
YELLOW CHANNEL

TEST  
BLUE CHANNEL

REACTOR BLDG  
PRESSURE SW  
TEST

4 PSIG  
RPS TEST

H VI2BA/  
88 DH PMP  
W CNTL SW

HEAT REMOVAL  
PUMPS

DH-P-1A  
DECAY HEAT  
REMOVAL PUMP

DH-P-1B  
DECAY HEAT  
REMOVAL PUMP

DECAY HEAT  
COOLANT FLOW  
TO REACTOR

DECAY HEAT  
COOLANT FLOW  
TO REACTOR

LH-VI2B  
DH-P-1B TO  
MAKEUP PUMPS

CAUTION  
DO NOT OPEN DH-VSAB IF DH-VSA B  
IS OPEN OR THE PIST WILL DRAIN  
IN O REACTOR BUILDING

*Open 10/18/58  
to Ex. Control Room  
to drain water from  
to Ex. Control Room  
to Ex. Control Room*

DH-VSA B W  
STORAGE TANK  
TO DH-P-1A



2270-2370 PPM  
53.6 - 58

BORATED  
WATER STORAGE TANK

BORATED  
WATER STORAGE TANK

BORATED  
WATER STORAGE TANK

BORATED  
WATER STORAGE TANK

BORATED  
WATER STORAGE TANK

*Do not open DH-V  
to drain water from  
the Reactor building to Ex.  
to Ex. Control Room*

DH-VSB B W  
STORAGE TANK  
TO DH-P-1B



J03  
OPEN

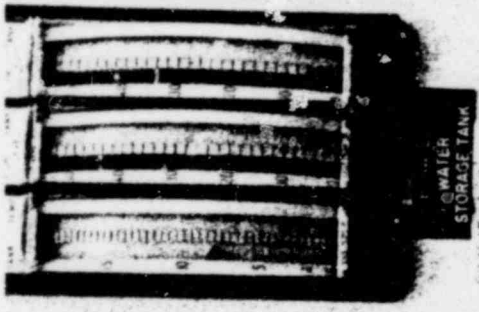
J00  
OPEN

OPEN

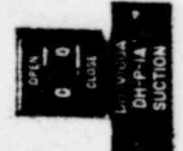
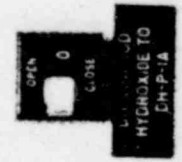
OPEN

OPEN

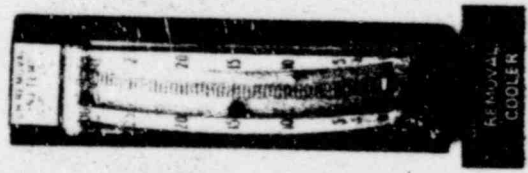




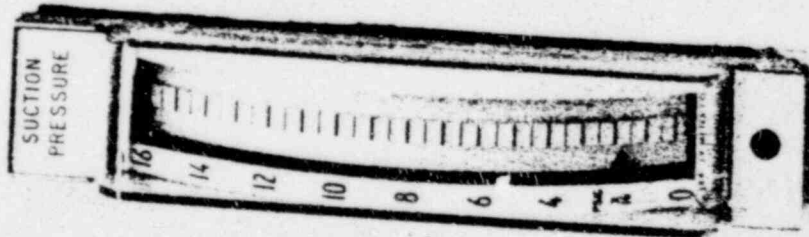
Handbook used for the chemical prop. in the water will just do.



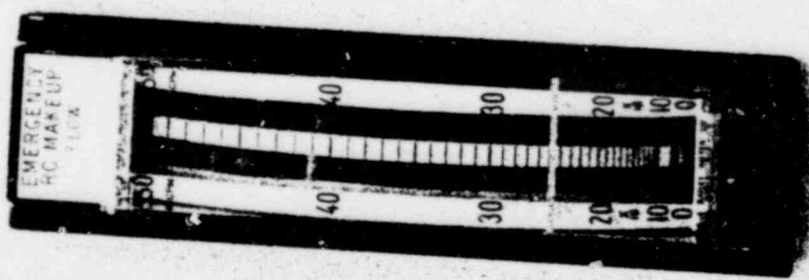
DO NOT OPEN DH-VI2B-IB OR DH-VI2B-IB IN THE AREA OF THE BLDG. WILL DISASSEMBLE IN 10 MIN. BLDG. WILL DISASSEMBLE IN 10 MIN. BLDG. WILL DISASSEMBLE IN 10 MIN.



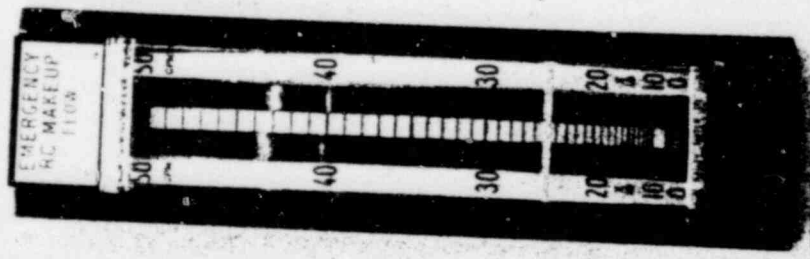
**REACTOR  
COOLANT AND  
MAKE-UP**



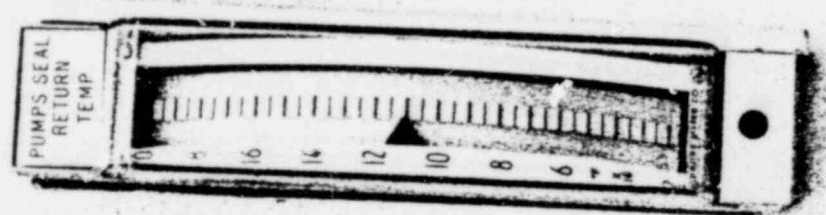
**REACTOR  
COOLANT  
MAKE-UP PUMP**



**A LINE B**

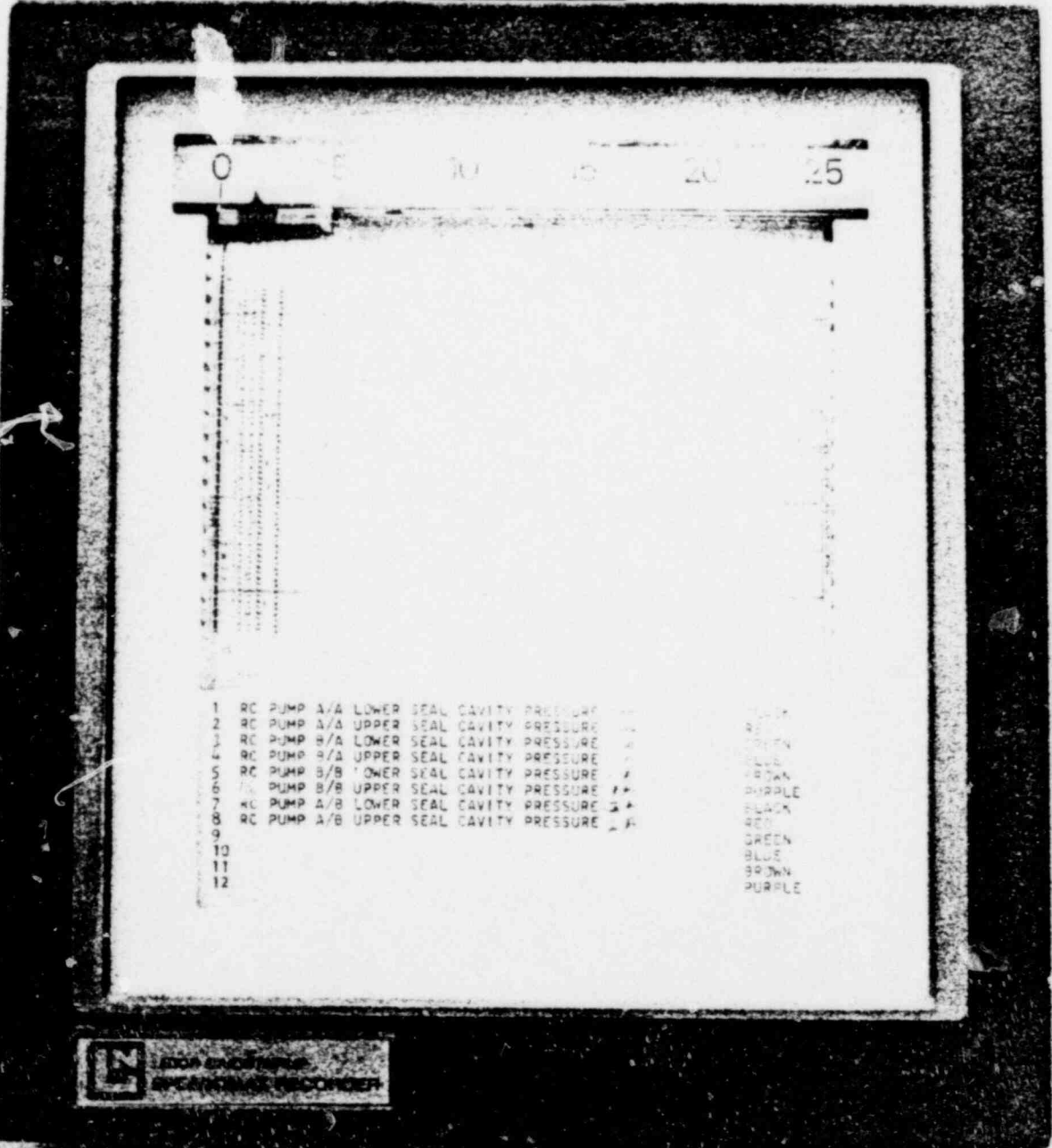


**C LINE D**



VIBRATION &  
LOOSE PARTS  
AUDIO MNTR

18 864808

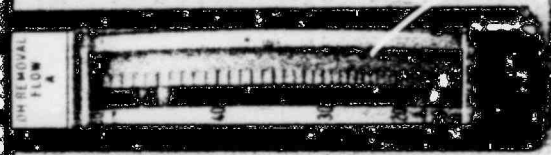


EDDY CURRENT  
RECORDING REPRODUCER

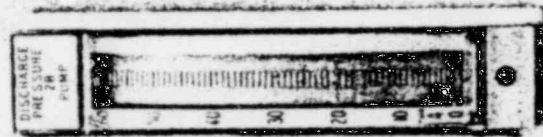
RC PUMP A/A  
CAVITY PRESS

# DECAY HEAT REMOVAL

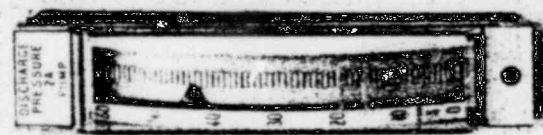
354 1-1/2" W.  
S.S. 3000 #12



DECAY HEAT  
COOLANT FLOW  
TO REACTOR



DISCHARGE  
PRESSURE  
PUMP



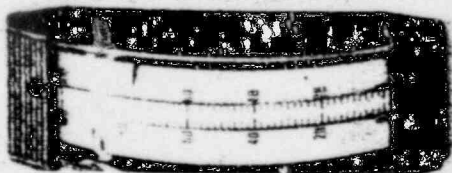
DISCHARGE  
PRESSURE  
PUMP



DISCHARGE  
PRESSURE  
PUMP



DH PUMP  
SUCTION  
TEMP



DH V28A7  
FLOWCNTL W



DISCHARGE  
PRESSURE  
PUMP



DISCHARGE  
PRESSURE  
PUMP

1170-2370 #P-8  
33-8-388

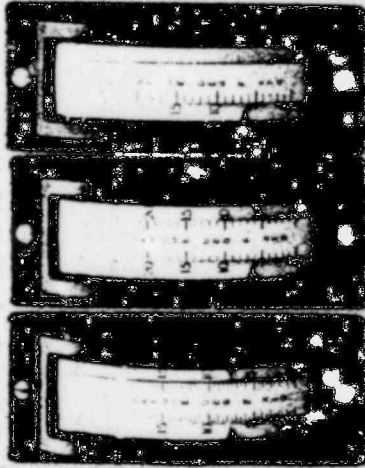
DISCHARGE  
PRESSURE  
PUMP



# SPENT FUEL



SPENT FUEL COOLANT PUMPS

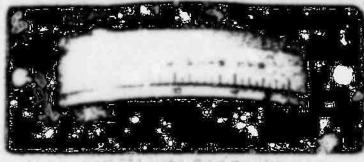


SPENT FUEL COOLANT TEMPERATURES

A Control B SF Cool Pool SF Cool Pool Cask Pool



SPENT FUEL COOLANT SURGE TANK LEVEL



BORATED WTR RECIRC PUMP DISCH PRESS

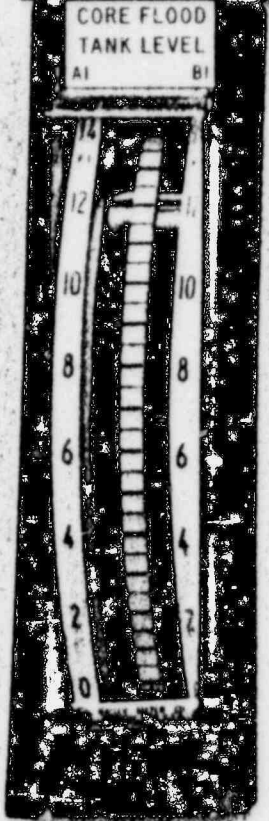


SPENT FUEL DEMINERALIZATION FLOW

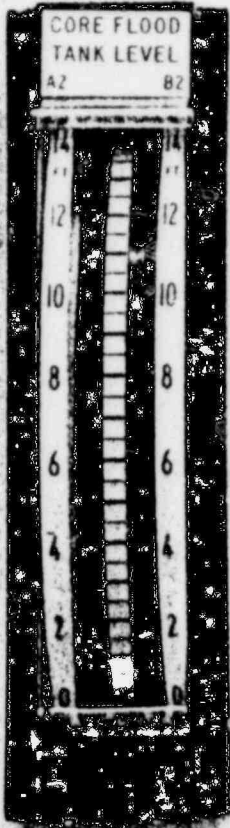


# CORE FLOODING & BUILDING SPRAY

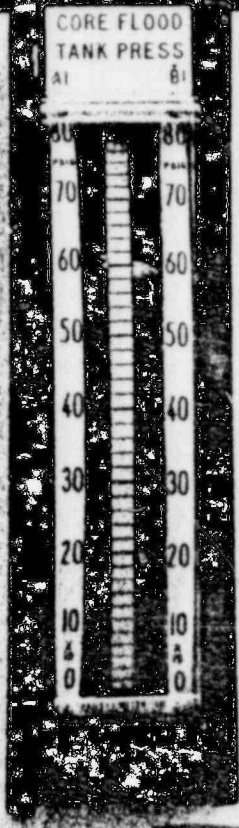
12-7-10-3



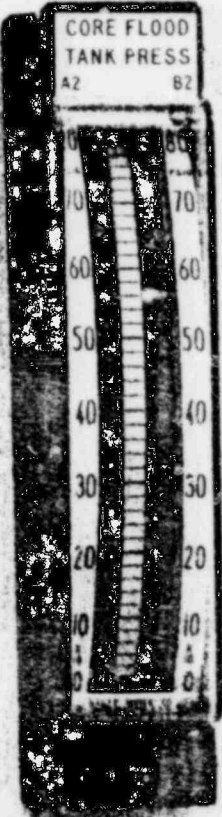
CORE FLOODING



875-020 PSI



CORE FLOODING TANKS



SPEN  
COO  
PU

# INTERMEDIATE COOLING

120 ALARM

INTERMED COOLER OUT TEMP



COMBINED

RETURN



INTERMEDIATE COOLING

COMBINED

PUMP DISCH



INTERMEDIATE COOLING WATER FLOW

CITY PUMP 500 GPM

INTERMED COOLING SYSTEM FLOW



CRD-ROLLER MAT-COOLING COILS FLOW

MAX-100 MIN-10

CRD COOLING FLOW



12-7

CO TA AT



Notify Unit I  
of  
Flow Change

NUC SER RVR  
WATER PUMP

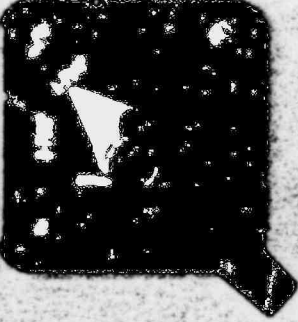
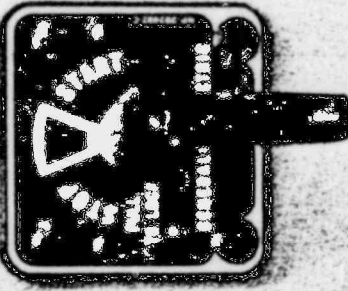
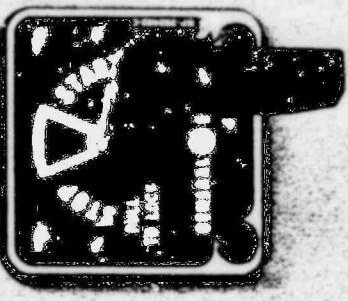
SER RVR  
WATER PUMP

MECH ROOM  
TWR INLET  
OUTLET PUMP

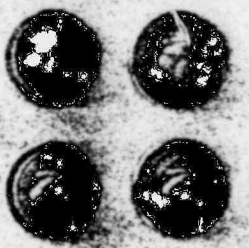
NR-P-1B  
NUC SER RVR  
WATER PUMP

NR-P-A  
NUC SER RVR  
WATER PUMP

NR-P-1A/1B  
BACKUP



NR RIVER  
WATER PUMP  
DISCH PRESS





OPEN  
CLOSE  
NR 46A  
NR WTR TO IA  
DISCH HEADER

OPEN  
CLOSE  
NR 46A  
NR WTR TO IA  
NUC SERV-CLR

OPEN  
CLOSE  
NR 46A  
NR WTR TO IA  
NUC SERV-CLR

OPEN  
CLOSE  
NR 46A  
NR WTR TO IA  
NUC SERV-CLR

OPEN  
CLOSE  
NR 46A  
NR WTR TO IA  
NUC SERV-CLR

OPEN  
CLOSE  
NR 46A  
NR WTR TO IA  
NUC SERV-CLR

OPEN  
CLOSE  
NR 46A  
NR WTR TO IA  
NUC SERV-CLR

OPEN  
CLOSE  
NR 46A  
NR WTR TO IA  
NUC SERV-CLR

OPEN  
CLOSE  
NR 46A  
NR WTR TO IA  
NUC SERV-CLR

OPEN  
CLOSE  
NR 46A  
NR WTR TO IA  
NUC SERV-CLR

OPEN  
CLOSE  
NR 46A  
NR WTR TO IA  
NUC SERV-CLR

OPEN  
CLOSE  
NR 46A  
NR WTR TO IA  
NUC SERV-CLR

OPEN  
CLOSE  
NR 46A  
NR WTR TO IA  
NUC SERV-CLR

OPEN  
CLOSE  
NR 46A  
NR WTR TO IA  
NUC SERV-CLR

OPEN  
CLOSE  
NR 46A  
NR WTR TO IA  
NUC SERV-CLR

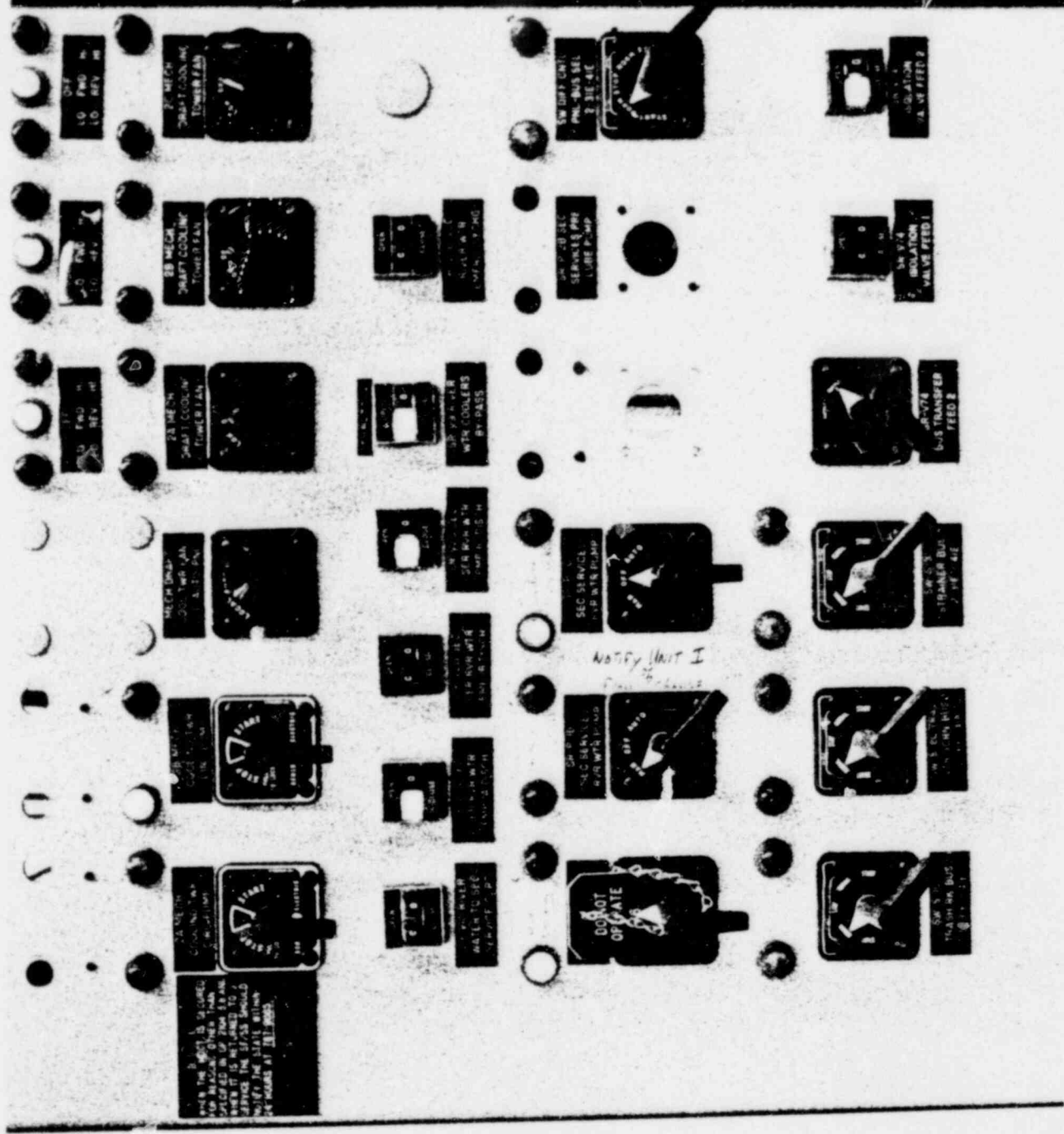
OPEN  
CLOSE  
NR 46A  
NR WTR TO IA  
NUC SERV-CLR

OPEN  
CLOSE  
NR 46A  
NR WTR TO IA  
NUC SERV-CLR

OPEN  
CLOSE  
NR 46A  
NR WTR TO IA  
NUC SERV-CLR

OPEN  
CLOSE  
NR 46A  
NR WTR TO IA  
NUC SERV-CLR

OPEN  
CLOSE  
NR 46A  
NR WTR TO IA  
NUC SERV-CLR



10 FWD  
 10 REV  
 10 REV

10 FWD  
 10 REV  
 10 REV

10 FWD  
 10 REV  
 10 REV

10 FWD  
 10 REV  
 10 REV

10 FWD  
 10 REV  
 10 REV

10 FWD  
 10 REV  
 10 REV

28 MECH  
 SMART COOLING  
 TOWER FAN

28 MECH  
 SMART COOLING  
 TOWER FAN

28 MECH  
 SMART COOLING  
 TOWER FAN

28 MECH  
 SMART COOLING  
 TOWER FAN

28 MECH  
 SMART COOLING  
 TOWER FAN

28 MECH  
 SMART COOLING  
 TOWER FAN

THE UNIT IS SECURED  
 AND THE GATE IS CLOSED.  
 WHEN IT IS RETURNED TO  
 SERVICE THE GATE SHOULD  
 BE KEPT CLOSED WITHIN  
 24 HOURS AT ALL TIMES.

28 MECH  
 SMART COOLING  
 TOWER FAN

28 MECH  
 SMART COOLING  
 TOWER FAN

28 MECH  
 SMART COOLING  
 TOWER FAN

28 MECH  
 SMART COOLING  
 TOWER FAN

28 MECH  
 SMART COOLING  
 TOWER FAN

SW 1072 UNIT  
 PNL-BUS SEL  
 3 31E 4E

SW 1072 UNIT  
 PNL-BUS SEL  
 3 31E 4E

SW 1072 UNIT  
 PNL-BUS SEL  
 3 31E 4E

SW 1072 UNIT  
 PNL-BUS SEL  
 3 31E 4E

SW 1072 UNIT  
 PNL-BUS SEL  
 3 31E 4E

SW 1072 UNIT  
 PNL-BUS SEL  
 3 31E 4E

SW 1074  
 ISOLATION  
 VALVE FEED 2

SW 1074  
 ISOLATION  
 VALVE FEED 1

SW 1074  
 ISOLATION  
 VALVE FEED 2

SW 1074  
 ISOLATION  
 VALVE FEED 2

SW 1074  
 ISOLATION  
 VALVE FEED 2

SW 1074  
 ISOLATION  
 VALVE FEED 2

NOTIFY UNIT I

DO NOT OPERATE

SEC SERVICE

SEC SERVICE

SEC SERVICE

SW 1074

SW 1074

SW 1074

SW 1074

SW 1074

SW 1074

SW 1074

SW 1074

SW 1074

SW 1074

SW 1074

SW 1074

SW 1074

SW 1074

SW 1074

SW 1074

SW 1074

SW 1074

SW 1074

SW 1074

SW 1074

SW 1074

SW 1074

SW 1074

SW 1074

SW 1074

SW 1074

SW 1074

SW 1074

SW 1074

SW 1074

SW 1074

SW 1074

SW 1074

SW 1074

SW 1074

SW 1074

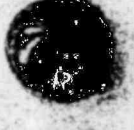
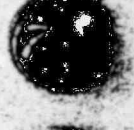
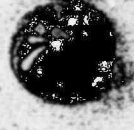
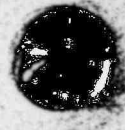
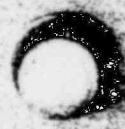
SW 1074

SW 1074

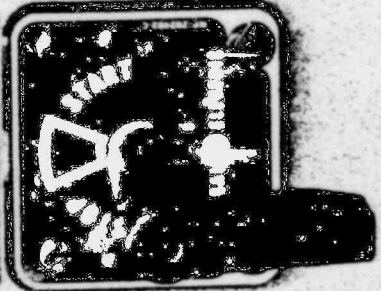
IT I  
Change

WATER PUMP

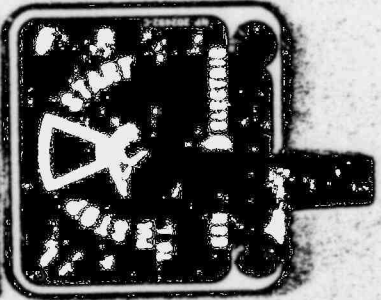
WATER PUMP



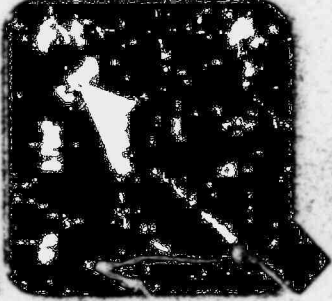
NR P-1C  
NUC SER RVR  
WATER PUMP



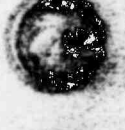
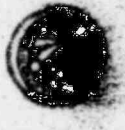
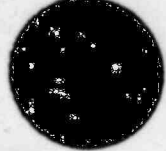
NR-P-1D  
NUC SER RVR  
WATER PUMP



NR-P-1C/1D  
BACKUP



NR-P-4A NUCL  
SERV RVR WTR  
PRE-LINE PMP



NR-P-4B NUCL  
SERV RVR WTR  
PRE-LINE PMP

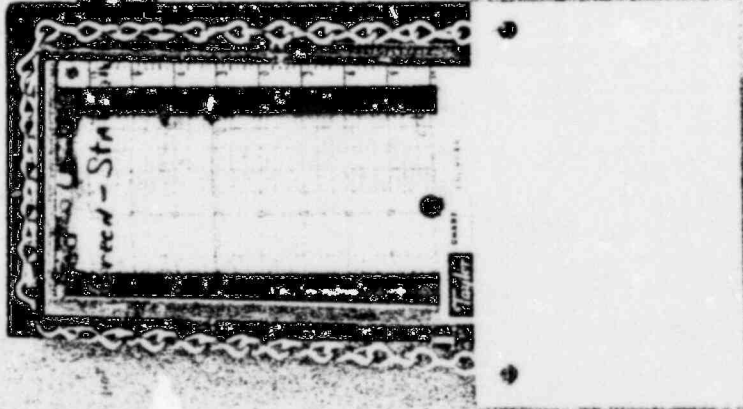
THROUGH TRENCH BY THE

3

NUCLEAR  
SERV RIVER  
WATER

River 21  
3/27/61  
3/28/61  
8/27/61  
8/28/61

ENR-DTR-3622



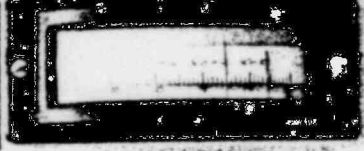
19-00019  
19-00018

19-00019  
19-00018



MECH COOLING  
TWR UNIT  
OUTLET TEMP

19-00019

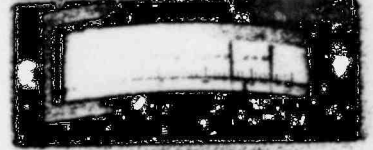


NR-21A  
NUC SER RVR  
WATER PUMP

19-00018



NR-21B  
NUC SER RVR  
WATER PUMP



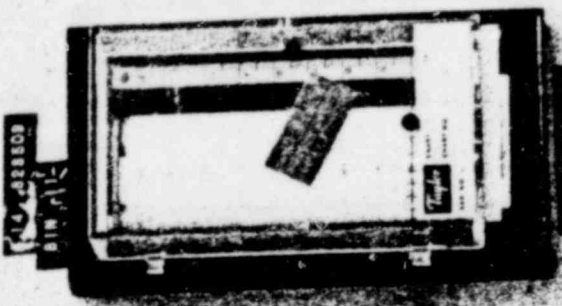
NR-21C  
NUC SER RVR  
WATER PUMP



assy Unit I  
of  
Flow Control



# SECONDARY RIVER WATER SYSTEMS



SR-V65 MECH  
COOLING TWR  
BY-PASS VLV

20 P 1080



SR RIVER WTR  
PUMP DISCH  
HDR PRESS

TI 1078



RIVER WATER  
OUTLET TEMP

TI 1072



RIVER WATER  
OUTLET TEMP

TI 1071



RIVER WATER  
OUTLET TEMP

20 P 2



2B MECH TWR  
CIRC PUMP  
AMPS

20 P 2A



2A MECH TWR  
CIRC PUMP  
AMPS



SR MECH  
DRAFT TOWER  
INLET



SR WATER  
FROM SEC  
SERVICE CLRS



SR SEC  
SERV CLRS  
BACKWASH



NATURAL DRAFT  
COOLING TWR  
MAKE-UP WTR



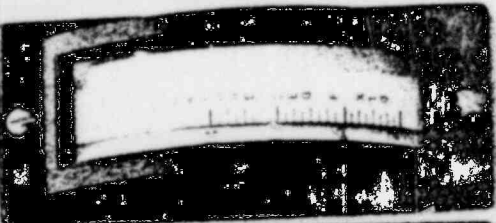
SR-V65 MECH  
COOLING TWR  
BY-PASS VLV

**SC CLOSED  
COOLING  
WATER**

COOLER PUMP DISCH.

INLET MON. HEADER

SC-TI-488 SC-TI-488



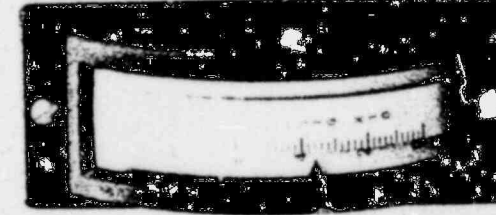
SC WATER  
TEMP



SC WATER  
PUMP DISCH



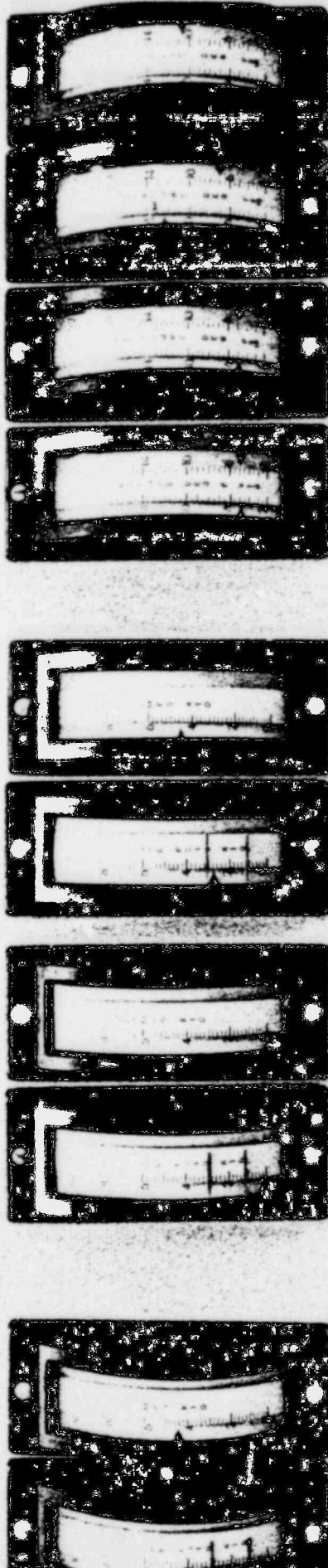
SC WATER  
PUMP SUCTION



SC COOLER  
HEADER

COOLERS  
IB

**NUCLEAR  
SERV-RIVER  
WATER**



NR-P-10  
NUC SER RVR  
WATER PUMP

NR-P-1C  
NUC SER RVR  
WATER PUMP

NR-P-1D  
NUC SER RVR  
WATER PUMP

NUC SER UNIT T.

# NUCLEAR SERV CLOSED COOLING

IN C  
OL

SUCT. PRESS  
20-24 PSIG

DISCH PRESS  
527

SUPPLY RETURN  
NS TE

553

554

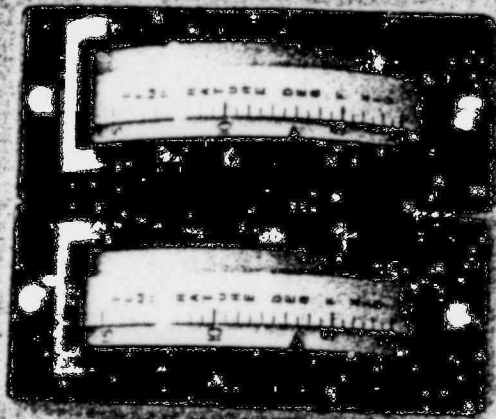
COMBINED  
RETURN



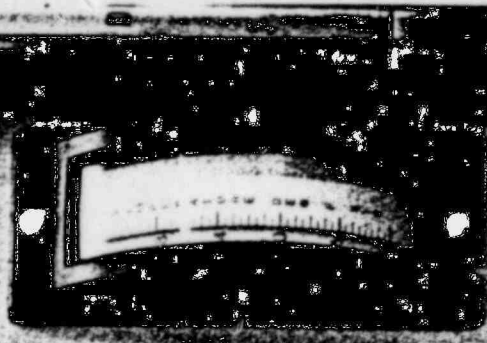
DECAY  
CLOSED  
LINE LOOP



NS CLOSED  
COOLING  
WATER PUMPS



NS CLOSED  
COOLING  
WATER TEMP

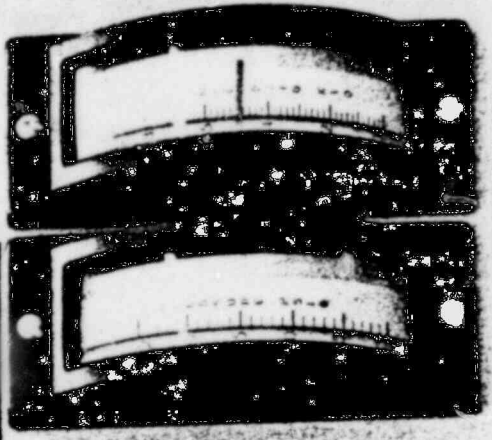


INTAKE  
COOL  
TEMPER

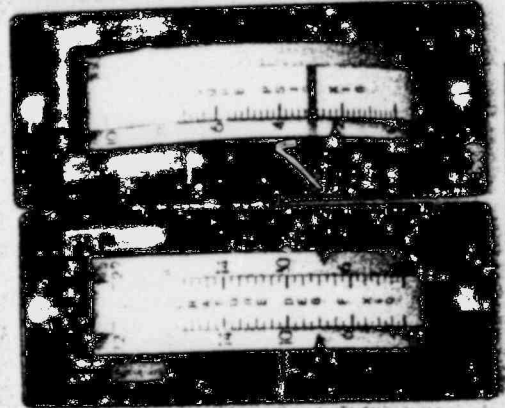
NUCLEA  
CLO  
COO

DECAY HEAT  
CLOSED  
COOLING

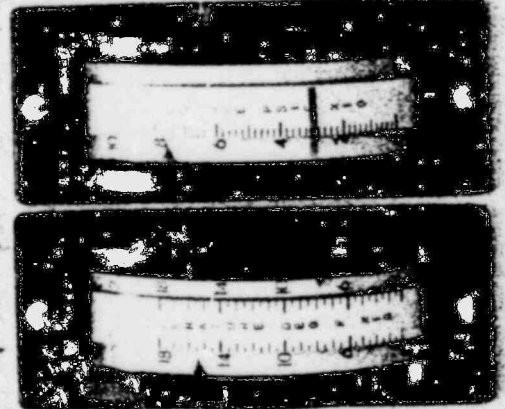
SUCT. PRESS DISCH PRE  
22-24 PSIG 527



NS CLOSED  
COOLING  
WATER PUMPS



IB DECAY  
HEAT CLOSED  
COOLING LOOP



IA DECAY  
HEAT CLOSED  
COOLING LOOP

ON  
OFF



ON

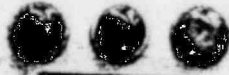
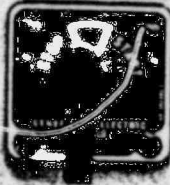
SPRINKLER  
R. W. T. D.



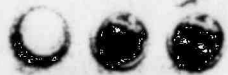
WATER  
LEVEL



SCHEMATIC  
SHOW CLOSED  
CLO. WITH PUMP



SCHEMATIC  
SHOW CLOSED  
CLO. WITH PUMP



SCHEMATIC  
SHOW CLOSED  
CLO. WITH PUMP



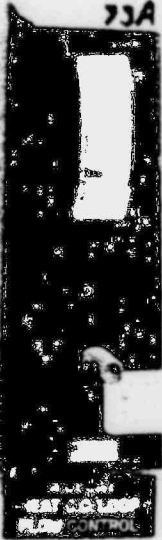
DP-P-14  
DECAY HEAT  
CLOS. CLO. PUMP



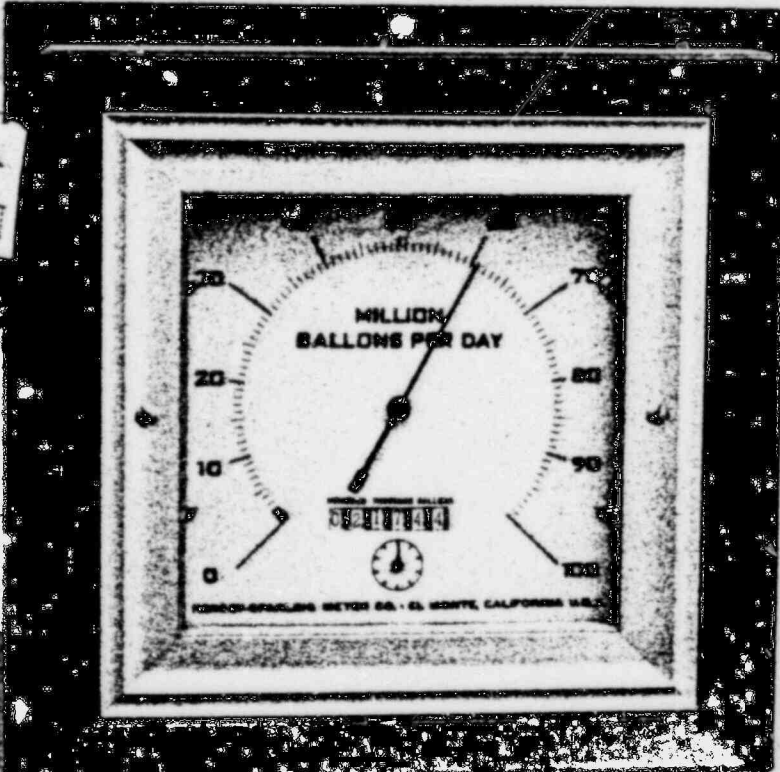
48 NUCL  
LUBE PMP

Handwritten note on a piece of paper.

73A



DAY CONTROL



NSP-1A  
NO CLS CLP  
WATER PUMP

NSP-1B  
NO CLS CLP  
WATER PUMP

UC-P-1B  
DECAY HEAT  
CLP PUMP

NSP-1CNS  
CLS CLP WTR  
PUMP ROOM

NSP-1CNS  
CLS CLP WTR  
PUMP ROOM

INTERMEDIATE  
COOLING PUMP  
FUNCTION

UC-P-1A  
INTERMEDIATE  
COOLING PUMP

COOLED  
COOLING  
TANK LEVEL

718

COOLERS  
RELAY

NS-V21-A  
COOLERS  
BYPASS

NS-V21-B  
COOLERS  
BYPASS

ES

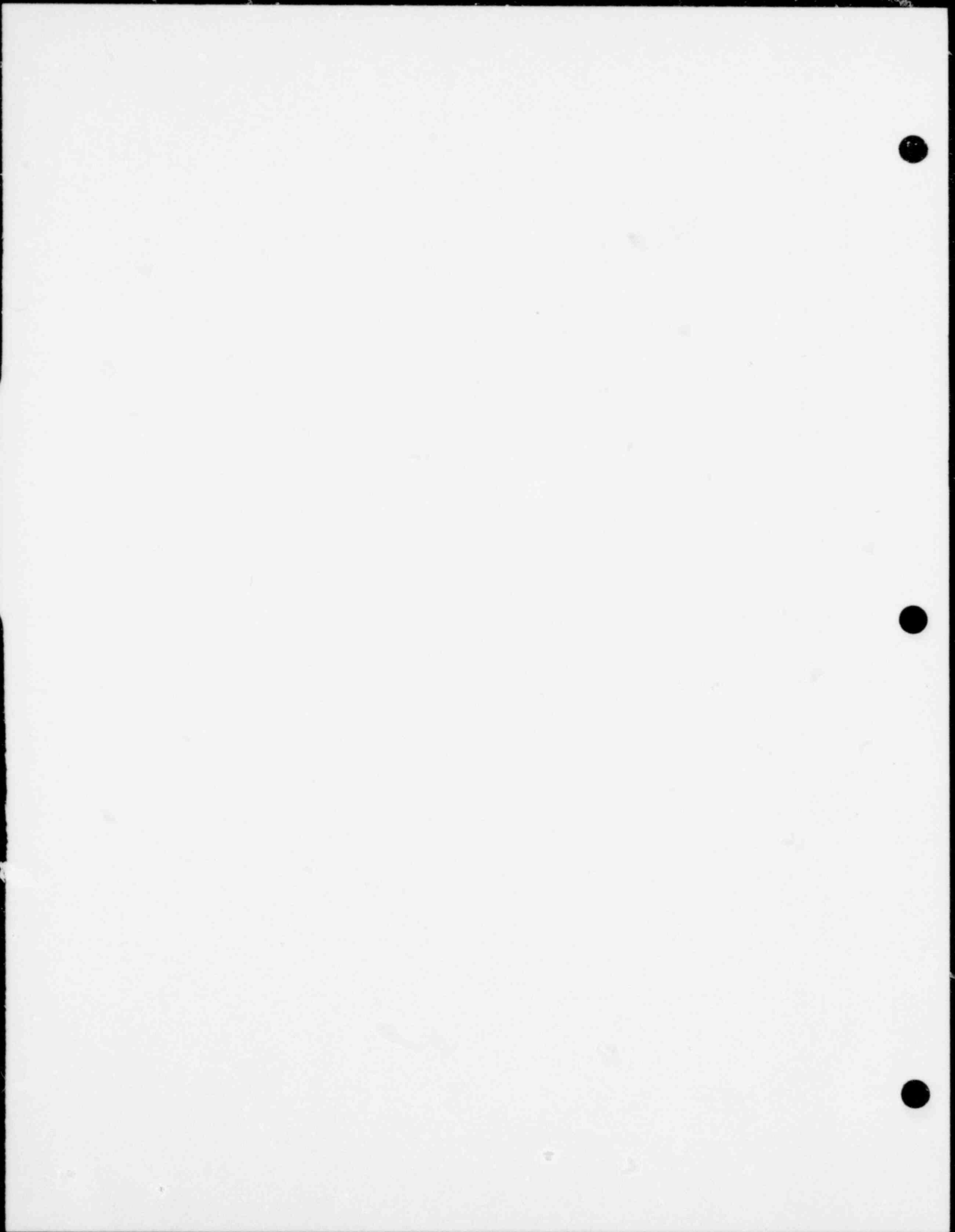
ES

ES

ES

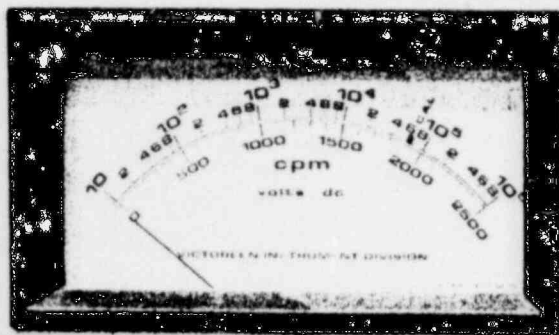
NS-V21-A  
COOLERS  
RELAY

NS-V21-B  
COOLERS  
RELAY





VE GREEN  
53EII



NPR-226  
BASED ON CS-137  
CPM METER  
KSEII

CALIBRATED  
DATE 7-1-75  
DO NOT  
TAMPER

cal. h.v. oper.  
off / | / oper.

alert  
c.s.  
high  
fall

VE GREEN

filter to

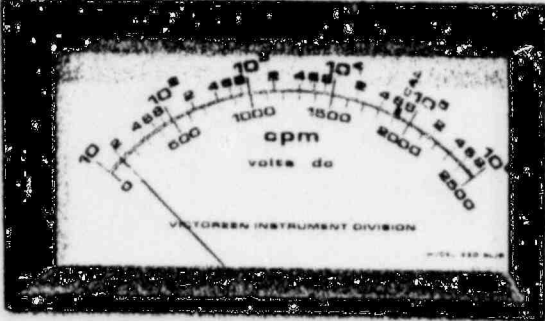
NPR-226  
REACTOR GAS PURGE  
EXHAUST DUCT A

START  
MOTOR RUN  
STOP

VICTOREEN

power flow fault  
off power on purge

part. iodine  
flow alarm  
norm. off prog. advance  
filter tear



NPR-222  
BASED ON CS-137  
CPM METER  
KSEII

CALIBRATED  
DATE 7-1-75  
DO NOT  
TAMPER

cal. h.v. oper.  
off / | / oper.

alert  
c.s.  
high  
fall

NPR-222  
REACTOR GAS PURGE  
EXHAUST DUCT A

START  
MOTOR RUN  
STOP

VICTOREEN

power flow fault  
off power on purge

part. iodine  
flow alarm  
norm. off prog. advance  
filter tear

BASED ON KR-85  
CPM (METER)  
3.55 E

CALIBRATION

Panel D

VICTOREEN

filter tear



RADIATION  
MONITORING  
SYSTEM  
TROUBLE

HP-R-220    HP-R-220    HP-R-220    HP-R-220    HP-R-220    HP-R-220    HP-R-220    HP-R-220

NORM DEFLT    NORM DEFLT    NORM DEFLT    NORM DEFLT    NORM DEFLT    NORM DEFLT    NORM DEFLT    NORM DEFLT

A row of eight circular control knobs, each with a handle and a scale. The first seven knobs have labels above them, and the eighth knob is unlabeled.

HP-R-220    HP-R-220    HP-R-220    HP-R-220    HP-R-220    SPARE    HP-R-220    HP-R-220

NORM DEFLT    NORM DEFLT    NORM DEFLT    NORM DEFLT    NORM DEFLT    NORM DEFLT    NORM DEFLT    NORM DEFLT

A second row of eight circular control knobs, similar to the first row. The sixth knob is labeled 'SPARE'.

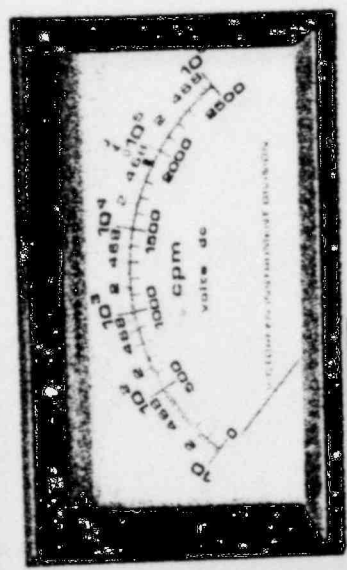
CPM/MIN  
3.895E12

CALIBRATION

3.55 E7

1000

1000



HPR-226  
BASED ON I-51  
CALIBRATION

CALIBRATION

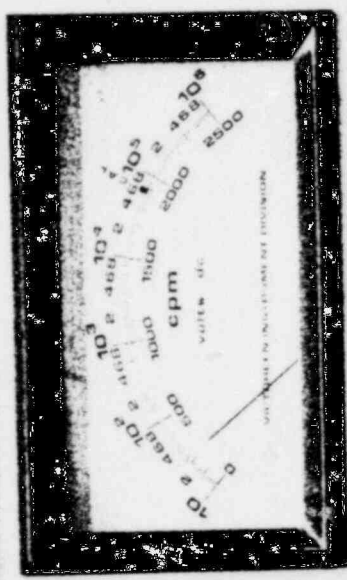
cal. h.v. oper. off /

alert

o.s.

fall

high



HPR-227  
BASED ON I-51  
CALIBRATION

CALIBRATION

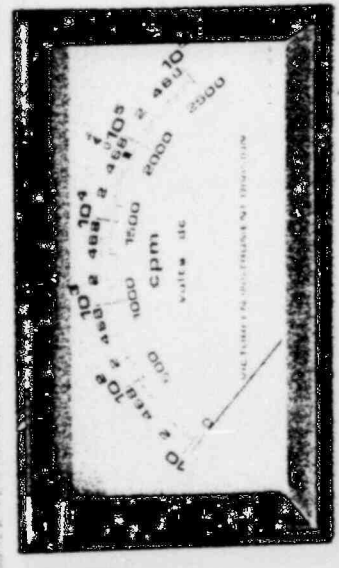
cal. h.v. oper. off /

alert

o.s.

fall

high



HPR-227  
BASED ON I-51  
CALIBRATION

CALIBRATION

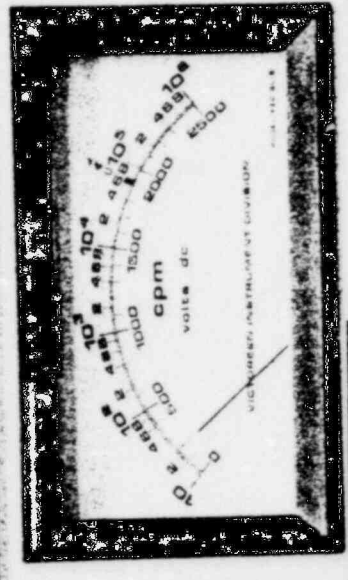
cal. h.v. oper. off /

alert

o.s.

fall

high



HPR-228  
BASED ON I-51  
CALIBRATION

CALIBRATION

cal. h.v. oper. off /

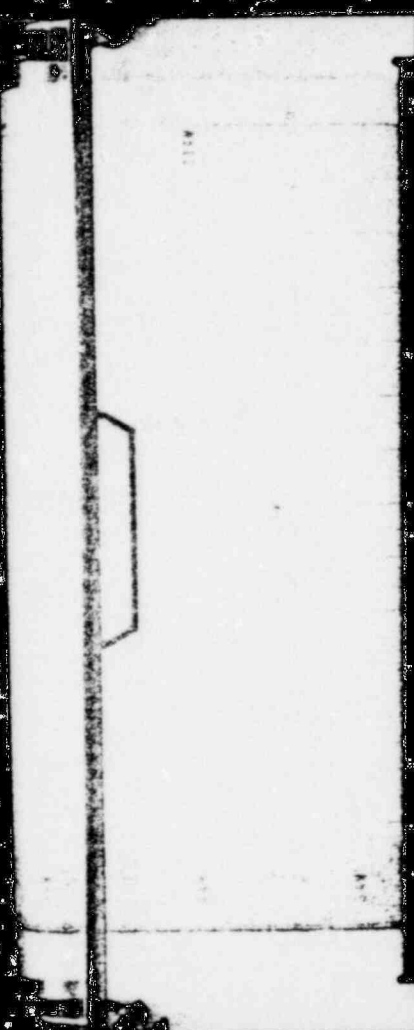
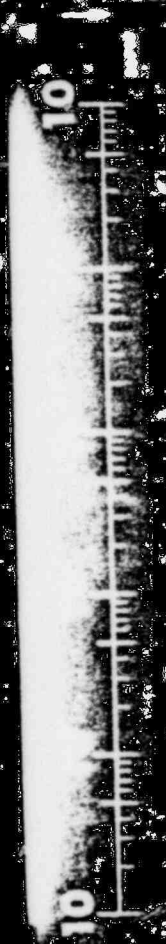
alert

o.s.

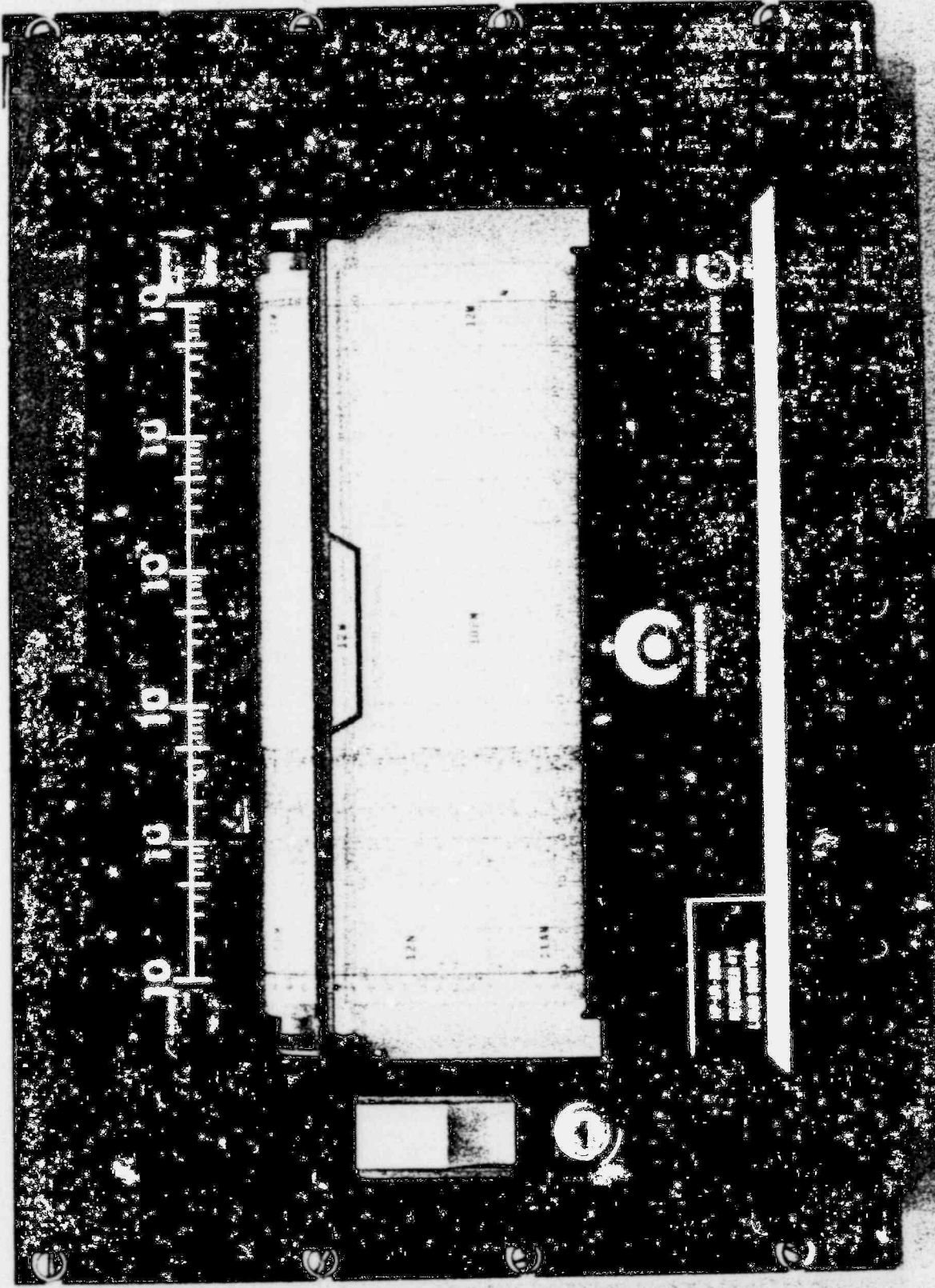
fall

high

ESTERLINE ANGUS

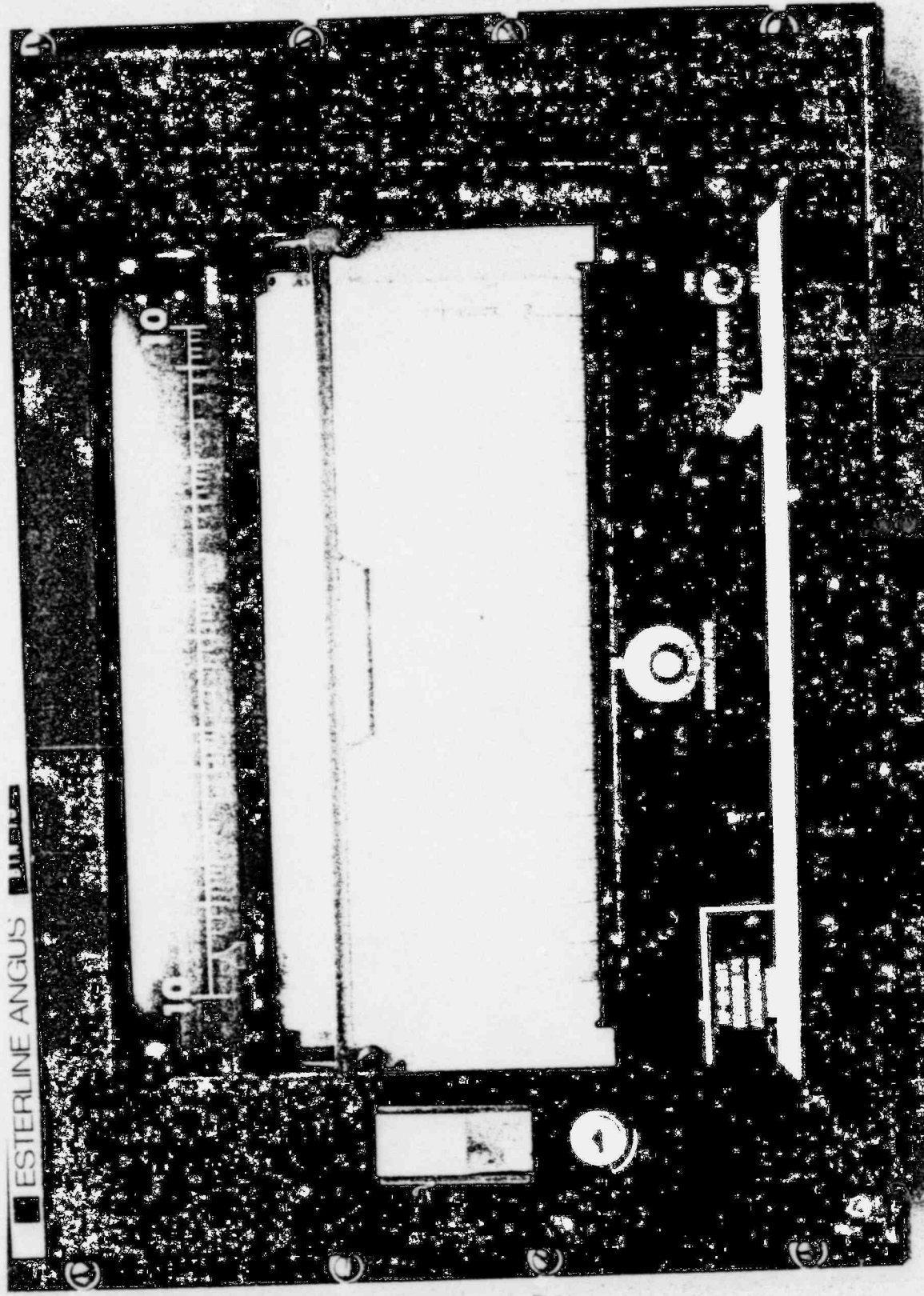


RECORDER #5  
ATMOSPHERIC MONITOR  
CASE NO. 82-7017 IN



RECORDER #7  
LEAD MONITOR  
SERIAL NO. 12345678

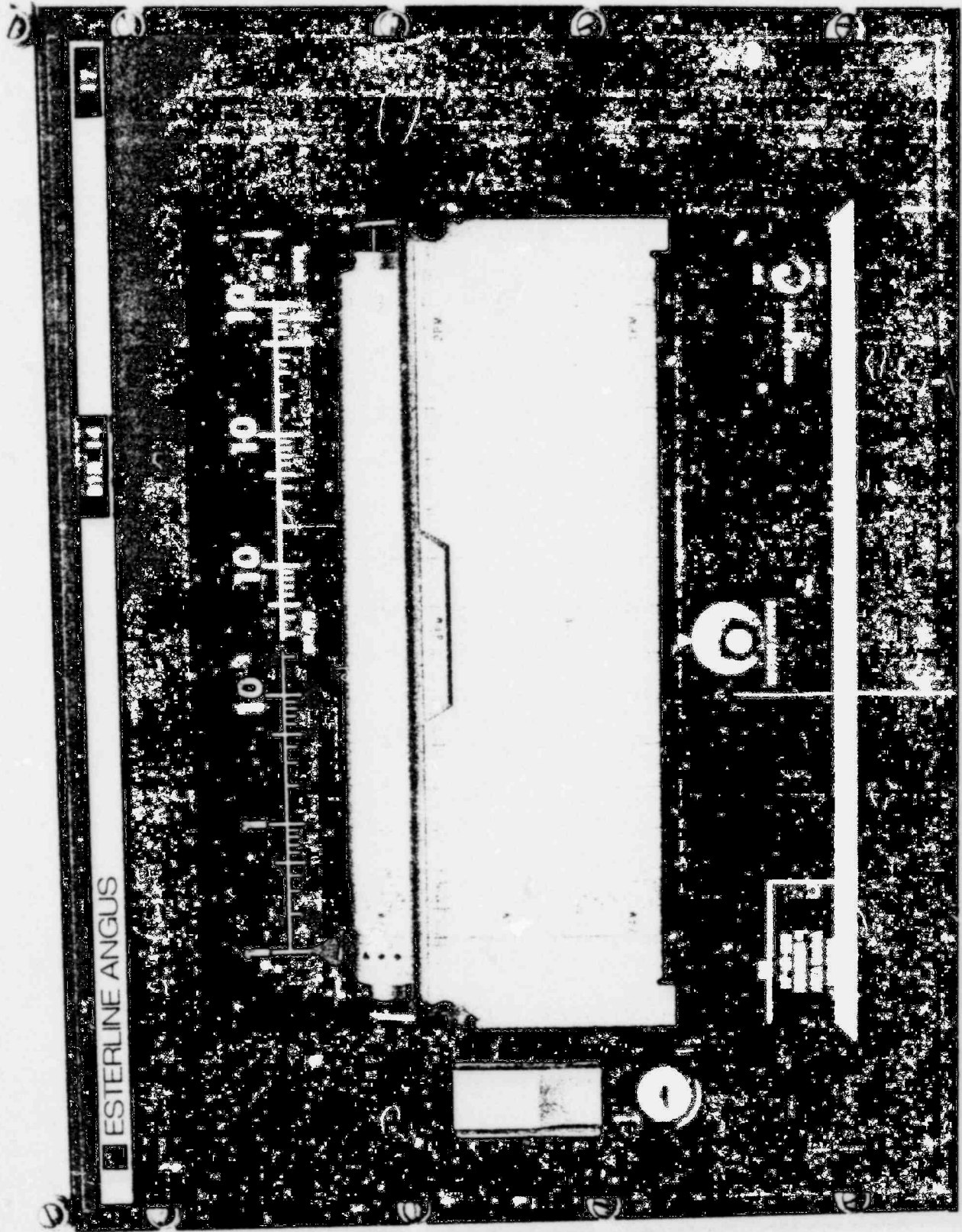
ESTERLINE ANGUS



HP-UK-1007

RECORDER #4

Atmospheric Sciences  
Census No. 12/0007/10



ESTERLINE ANGUS

10 10 10 10 10

cal. h.v. per. off / oper.

VICTOREN INSTRUMENT DIVISION  
volts dc

10<sup>6</sup> scale  
10<sup>5</sup> scale  
10<sup>4</sup> scale

20000  
10000  
5000  
2000  
1000  
500  
200  
100  
50  
20  
10  
5  
2  
1  
0.5  
0.2  
0.1  
0.05  
0.02  
0.01

alerts  
o.s.  
fall  
high

**HPR-22A  
BASED ON I-131  
CPM/MIN  
3.1895E12**

CALIBRATED  
DATE 5-27-55  
DO NOT  
TAMPER

cal. h.v. per. off / oper.

VICTOREN INSTRUMENT DIVISION  
volts dc

10<sup>6</sup> scale  
10<sup>5</sup> scale  
10<sup>4</sup> scale

20000  
10000  
5000  
2000  
1000  
500  
200  
100  
50  
20  
10  
5  
2  
1  
0.5  
0.2  
0.1  
0.05  
0.02  
0.01

alerts  
o.s.  
fall  
high

**HPR-22A  
BASED ON I-131  
CPM/MIN  
3.1895E12**

CALIBRATED  
DATE 5-27-55  
DO NOT  
TAMPER

cal. h.v. per. off / oper.

VICTOREN INSTRUMENT DIVISION  
volts dc

10<sup>6</sup> scale  
10<sup>5</sup> scale  
10<sup>4</sup> scale

20000  
10000  
5000  
2000  
1000  
500  
200  
100  
50  
20  
10  
5  
2  
1  
0.5  
0.2  
0.1  
0.05  
0.02  
0.01

alerts  
o.s.  
fall  
high

**HPR-22B  
BASED ON I-131  
CPM/MIN  
3.1895E12**

CALIBRATED  
DATE 5-27-55  
DO NOT  
TAMPER

cal. h.v. per. off / oper.

VICTOREN INSTRUMENT DIVISION  
volts dc

10<sup>6</sup> scale  
10<sup>5</sup> scale  
10<sup>4</sup> scale

20000  
10000  
5000  
2000  
1000  
500  
200  
100  
50  
20  
10  
5  
2  
1  
0.5  
0.2  
0.1  
0.05  
0.02  
0.01

alerts  
o.s.  
fall  
high

**HPR-22IB  
BASED ON I-131  
CPM/MIN  
3.1895E12**

CALIBRATED  
DATE 5-27-55  
DO NOT  
TAMPER

cal. h.v. per. off / oper.

10<sup>6</sup> scale  
10<sup>5</sup> scale  
10<sup>4</sup> scale

20000  
10000  
5000  
2000  
1000  
500  
200  
100  
50  
20  
10  
5  
2  
1  
0.5  
0.2  
0.1  
0.05  
0.02  
0.01

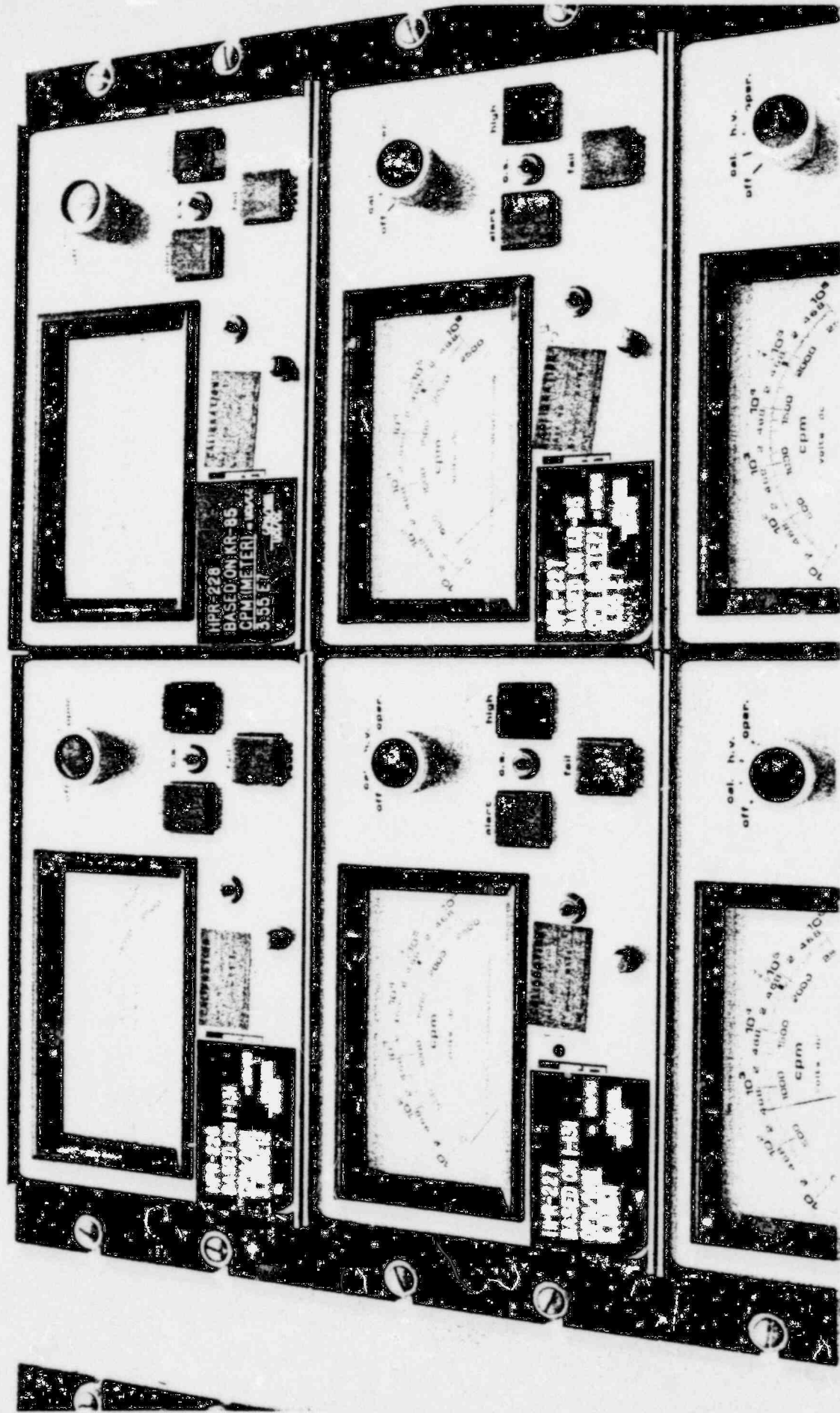
cal. h.v. per. off / oper.

10<sup>6</sup> scale  
10<sup>5</sup> scale  
10<sup>4</sup> scale

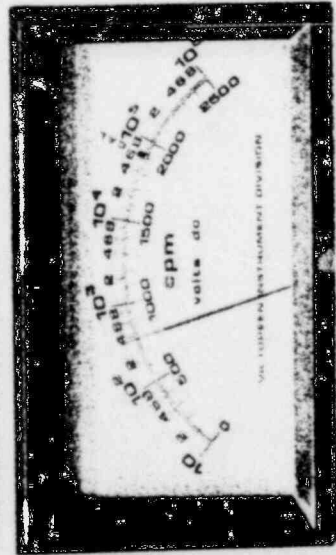
20000  
10000  
5000  
2000  
1000  
500  
200  
100  
50  
20  
10  
5  
2  
1  
0.5  
0.2  
0.1  
0.05  
0.02  
0.01



**LIQUID MONITORS**



54766

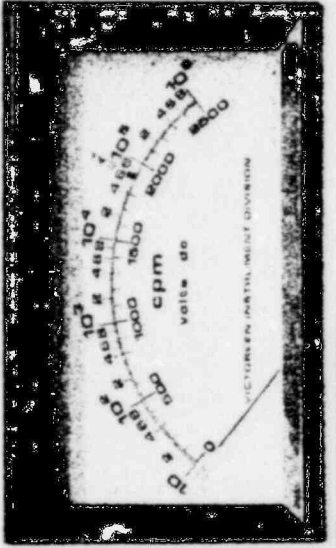


**MS-185**  
 BASED ON GS-137  
 CALIBRATED ON 1/13/56

CALIBRATED  
 DATE 1/13/56  
 BY J. T. HARRIS

cal. h.v. **1000** high  
 off / oper. **1000**  
 alert o.s. fall

54766

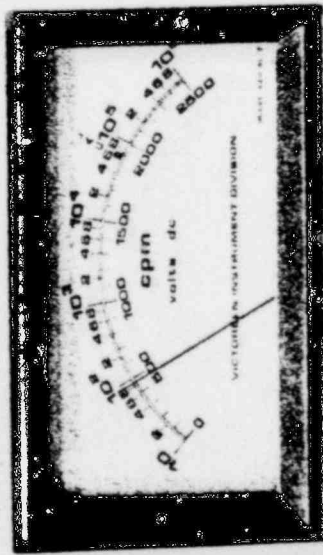


**MS-185**  
 BASED ON GS-137  
 CALIBRATED ON 1/13/56

CALIBRATED  
 DATE 1/13/56  
 BY J. T. HARRIS

cal. h.v. **1000** high  
 off / oper. **1000**  
 alert o.s. fall

54766

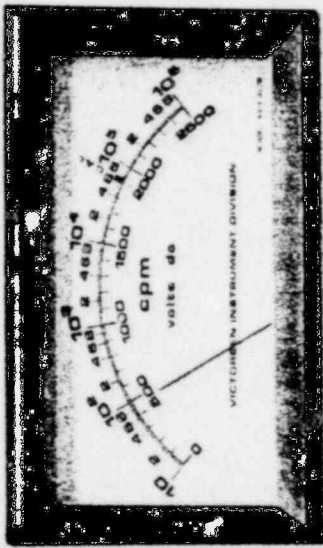


**MS-185**  
 BASED ON GS-137  
 CALIBRATED ON 1/13/56

CALIBRATED  
 DATE 1/13/56  
 BY J. T. HARRIS

cal. h.v. **1000** high  
 off / oper. **1000**  
 alert o.s. fall

54766



**MS-185**  
 BASED ON GS-137  
 CALIBRATED ON 1/13/56

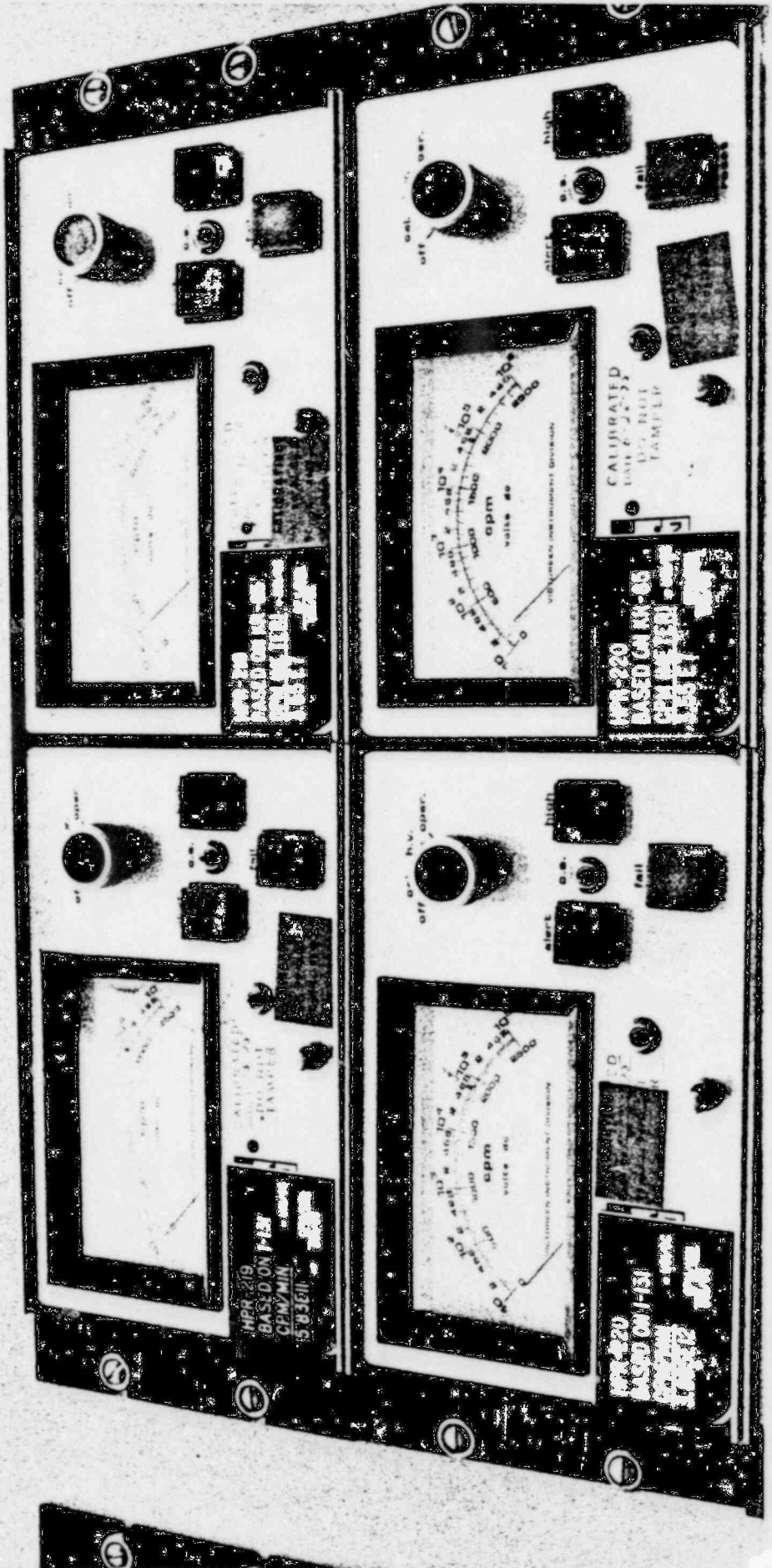
CALIBRATED  
 DATE 1/13/56  
 BY J. T. HARRIS

cal. h.v. **1000** high  
 off / oper. **1000**  
 alert o.s. fall

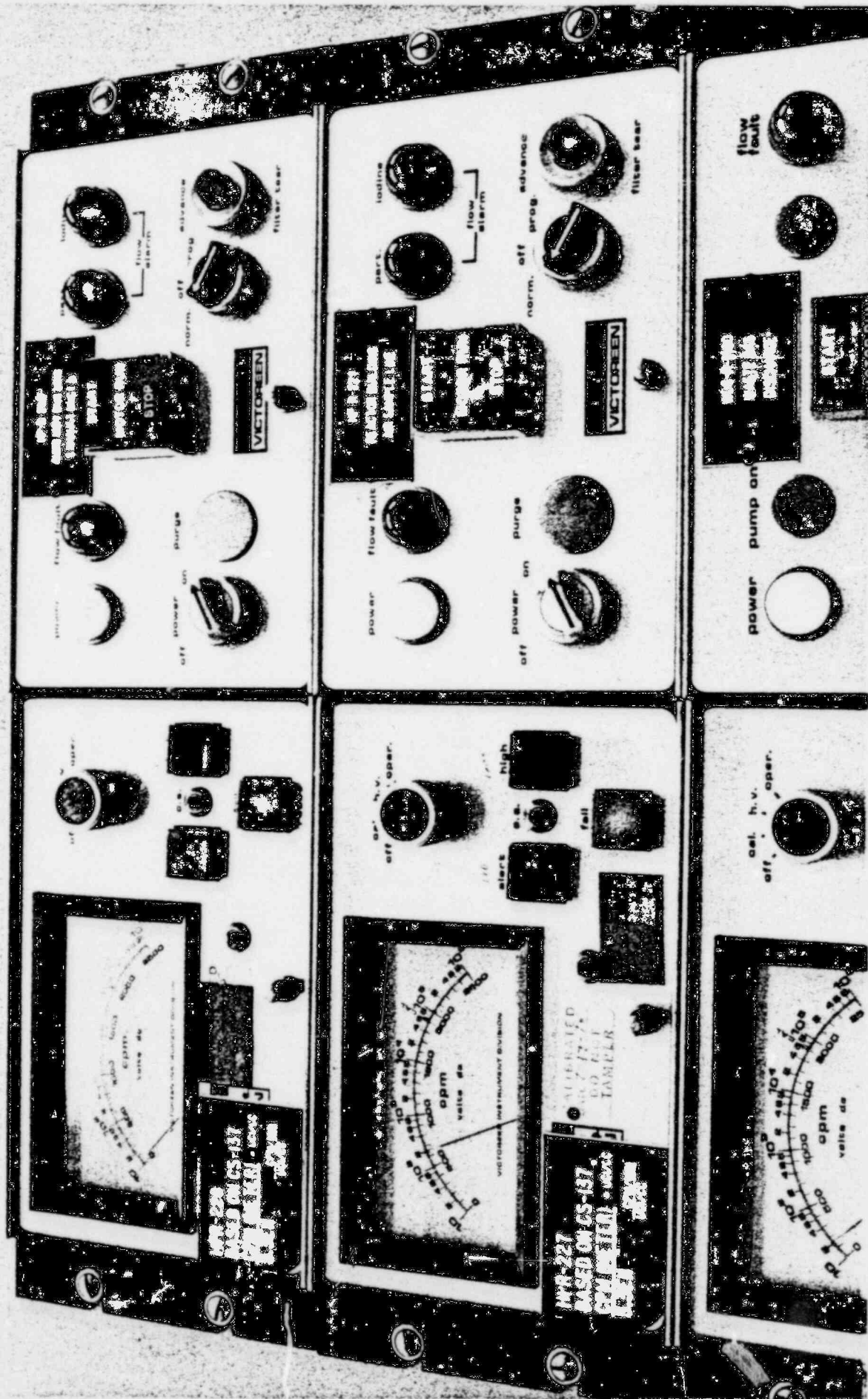
12

RADIATION MONITORING PANEL

PROCESS MONITORS



**PROCESS MONITORS**





**EQUIPMENT WATCH**

**INSTRUMENT PANEL AREA**

**M/R/h**

**M/R/h**

**M/R/h**

**M/R/h**

**M/R/h**

**M/R/h**

**M/R/h**

**M/R/h**

**M/R/h**

**M/R/h**

**M/R/h**

**M/R/h**

**M/R/h**

**M/R/h**

**M/R/h**

**M/R/h**

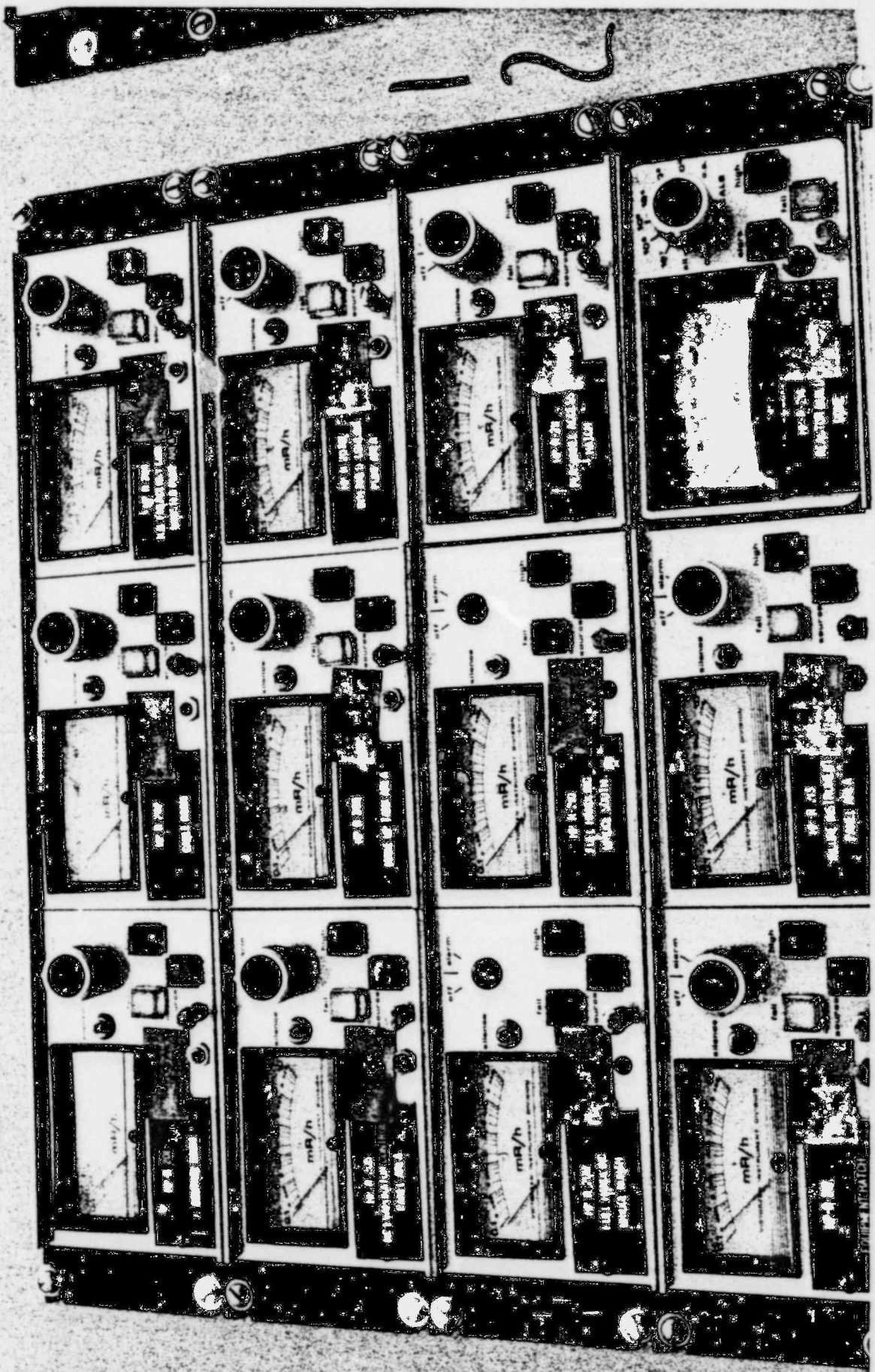
**PROCESS MONITORS**

The control panel is organized into several distinct sections:

- Top Left Section:** Features a large analog gauge with a scale from 0 to 100. Below it is a control panel with a 'CALIBRATION' label and a warning: 'DO NOT TAMPER'. A 'VICTOREEN' logo is visible. To the right are several indicator lights labeled 'flow alarm', 'alarm', 'adv. alarm', and 'filter tear'.
- Top Right Section:** Contains another large analog gauge with a scale from 0 to 100. Below it are indicator lights for 'power', 'flow fault', 'off power on', and 'purge'. A 'VICTOREEN' logo is present. Further right are lights for 'part.', 'flow alarm', 'norm.', 'off prog advance', and 'filter tear'.
- Bottom Left Section:** Includes a large analog gauge with a scale from 0 to 100. Below it are indicator lights for 'off oper.', 'high', 'fall', and 'oper.'. A 'VICTOREEN' logo is visible. To the right are lights for 'part.', 'flow alarm', 'norm.', 'off prog advance', and 'filter tear'.
- Bottom Right Section:** Features a large analog gauge with a scale from 0 to 100. Below it are indicator lights for 'power', 'flow fault', 'off power on', and 'purge'. A 'VICTOREEN' logo is present. Further right are lights for 'part.', 'flow alarm', 'norm.', 'off prog advance', and 'filter tear'.

Additional labels and components include 'VICTOREEN' logos, 'START' buttons, and various warning and status indicators throughout the panel.

AREA MONITORS



1 2

CPM METER  
913E7

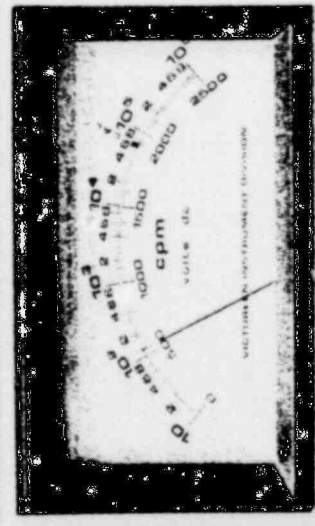
WATER COOLING WATER LOCATIONS

CPM METER  
913E7

CPM METER  
913E7

WATER COOLING WATER LOCATIONS

CPM METER  
913E7



1005  
BASED ON CS-137  
CPM METER  
913E7

cal. h.v. oper.  
off

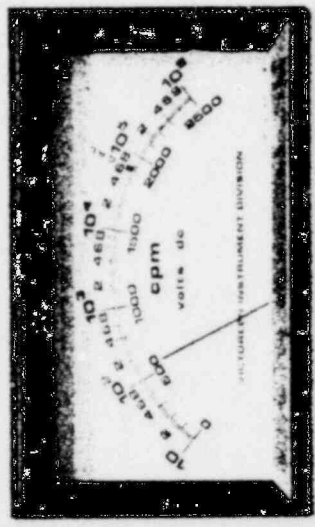
400 alert

3000 high

o.s.

fail

CS-137  
VICTORIAN INSTRUMENT DIVISION



1011  
BASED ON CS-137  
CPM METER  
913E7

cal. h.v. oper.  
off

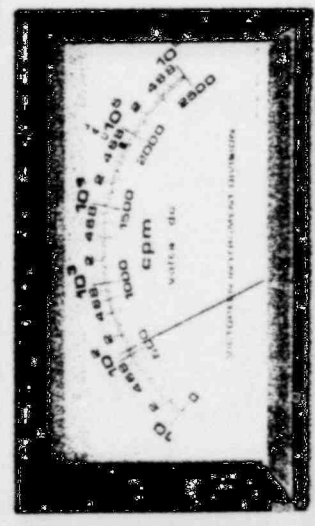
start

high

o.s.

fail

LIQUID WASTE DOMESTIC PLANT



1008  
BASED ON CS-137  
CPM METER  
913E7

cal. h.v. oper.  
off

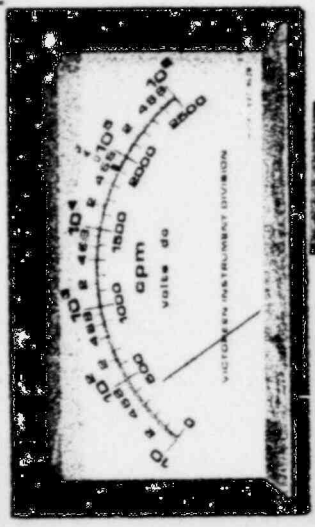
400 alert

3000 high

o.s.

fail

CS-137  
VICTORIAN INSTRUMENT DIVISION



1010  
BASED ON CS-137  
CPM METER  
913E7

cal. h.v. oper.  
off

start

high

o.s.

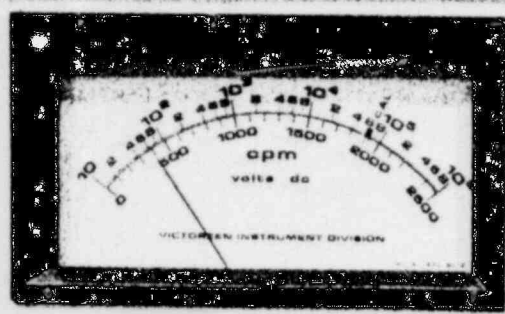
fail

LIQUID WASTE DOMESTIC PLANT



DCR-3389  
BASED ON CS-137  
CPM METER  
9:13E7  
100V/500mA

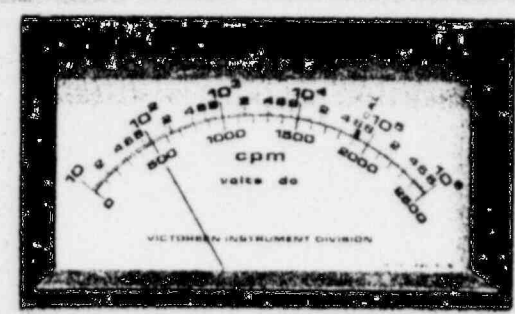
DCR-3760  
BASED ON CS-137  
CPM METER  
100V/500mA



cal. h.v.  
off | oper.



400 2000  
alarm high  
o.s.



cal. h.v.  
off | oper.



alarm high  
o.s.

NSR-3401  
BASED ON CS-137  
CPM METER  
100V/500mA

SPR-3402  
BASED ON CS-137  
CPM METER  
100V/500mA

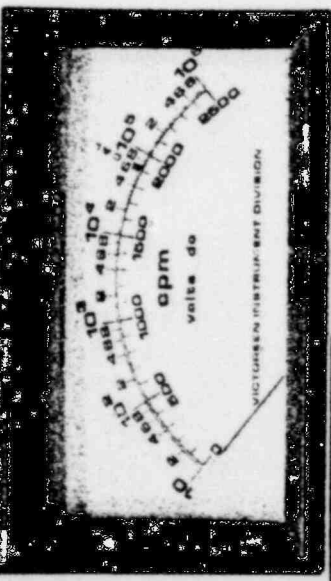
STATUS PANEL

FLOW NORMAL

MU-R-720 IC-R-1091 IC-R-1092 IC-R-1093 WOL-R-1311 DC-R-3399 DC-R-3400 NS-R-3401 SP-R-3402

FLOW FAULT

10/17/68



**HPR-229**  
**BASED ON I-31**  
**CPM/MIN**  
**1000/12**

cal. h.v. oper.  
 off



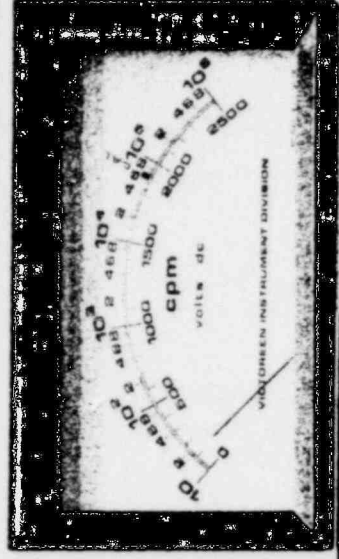
alert

g.s.

high



fail



**HPR-229**  
**BASED ON I-31**  
**CPM/MIN**  
**1000/12**

CALIBRATED  
 DATE 5-23-75  
 DO NOT  
 TAMPER

cal. h.v. oper.  
 off



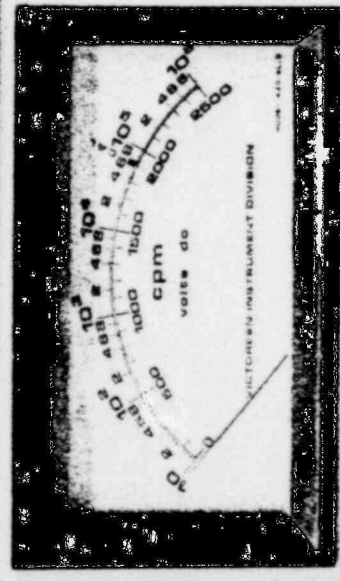
alert

g.s.

high



fail



**HPR-229**  
**BASED ON I-31**  
**CPM/MIN**  
**1000/12**

CALIBRATED  
 DATE 6-9-75

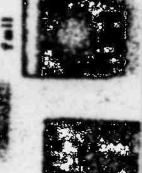
cal. h.v. oper.  
 off



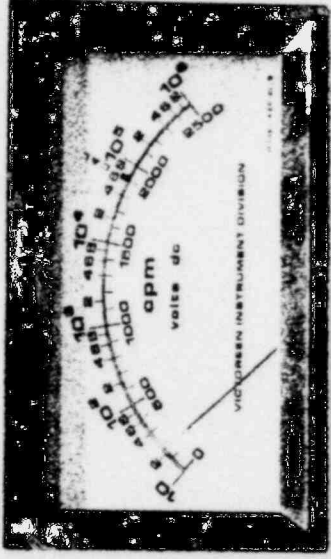
alert

g.s.

high



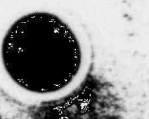
fail



**HPR-229**  
**BASED ON I-31**  
**CPM/MIN**  
**1000/12**

CALIBRATED  
 DATE 5-23-75  
 DO NOT  
 TAMPER

cal. h.v. oper.  
 off



alert

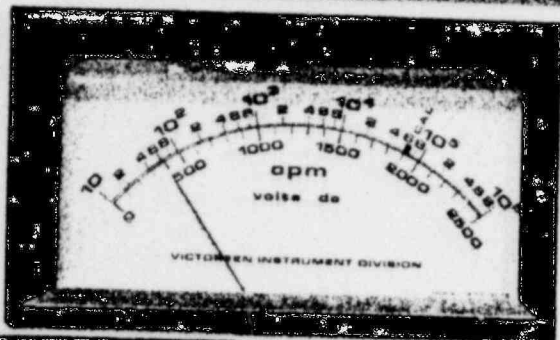
g.s.

high



fail

filter tear



cal. h.v. off. oper.



alert

s.s.



high

fall



WDC-R-1400  
BASED ON KR-85  
CPM METER  
SLS ET

CALIBRATED  
DATE 6-27-76  
DO NOT  
TAMPER

READY GAS TANK  
DISCHARGE

power pump on



WDC-R-1400  
DECAY GAS  
TANK B  
DISCHARGE

flow  
fault



START  
MOTOR RUN  
STOP

off power on purge

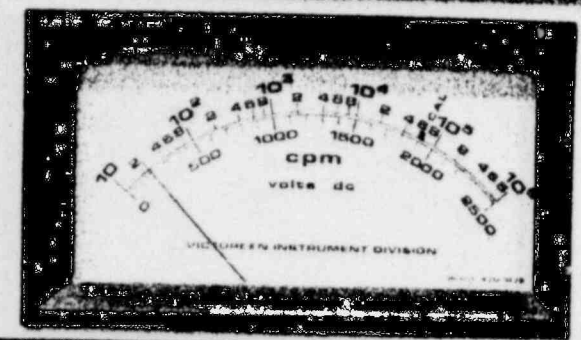


off norm. prog. advance



VICTOREEN

filter tear



cal. h.v. off. oper.



alert

s.s.



high

fall



WDC-740  
BASED ON KR-85  
CPM METER  
SLS ET

CALIBRATED  
DATE 6-27-76  
DO NOT  
TAMPER

READY GAS TANK  
DISCHARGE

power pump on



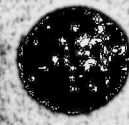
WDC-740  
CONCENTRATOR  
WORLD PUMP  
EXHAUST

flow  
fault

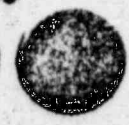
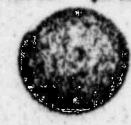


START  
MOTOR RUN  
STOP

off power on purge



off norm. prog. advance



VICTOREEN

filter tear

VALVE POSITION

**1PH-221A**  
 BASED ON CS-137  
 CALIBRATED  
 VICTOREEN INSTRUMENT DIVISION

cal. h.v. oper.  
 off. /

alert

high

g.s.

fall

1PH-221A

power

flow fault

part.

iodine

flow alarm

norm.

off prog. advance

filter tear

VICTOREEN

START  
 MOTOR RUN  
 STOP

**1PH-221B**  
 BASED ON CS-137  
 CALIBRATED  
 VICTOREEN INSTRUMENT DIVISION

cal. h.v. oper.  
 off. /

alert

high

g.s.

fall

1PH-221B

power

flow fault

part.

iodine

flow alarm

norm.

off prog. advance

filter tear

VICTOREEN

START  
 MOTOR RUN  
 STOP

**1PH-221C**  
 BASED ON CS-137  
 CALIBRATED  
 VICTOREEN INSTRUMENT DIVISION

cal. h.v. oper.  
 off. /

alert

high

g.s.

fall

1PH-221C

power

flow fault

part.

iodine

flow alarm

norm.

off prog. advance

filter tear

VICTOREEN

START  
 MOTOR RUN  
 STOP

**1PH-221D**  
 BASED ON CS-137  
 CALIBRATED  
 VICTOREEN INSTRUMENT DIVISION

cal. h.v. oper.  
 off. /

alert

high

g.s.

fall

1PH-221D

power

flow fault

part.

iodine

flow alarm

norm.

off prog. advance

filter tear

VICTOREEN

START  
 MOTOR RUN  
 STOP

**1PH-221E**  
 BASED ON CS-137  
 CALIBRATED  
 VICTOREEN INSTRUMENT DIVISION

cal. h.v. oper.  
 off. /

alert

high

g.s.

fall

1PH-221E

power

flow fault

part.

iodine

flow alarm

norm.

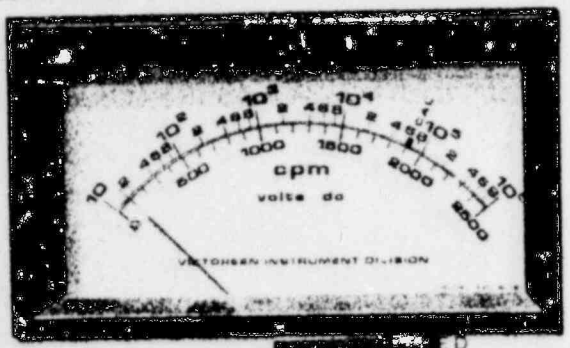
off prog. advance

filter tear

VICTOREEN

START  
 MOTOR RUN  
 STOP

UCI/66



**HPR-229**  
**BASED ON CS-137**  
**CPM METER** - volts  
 2.35E11

cal. h.v. oper.  
 off



alert high  
 off on  
 fall

**HPR-229**  
**NO IODINE IN FLOW METER**

power flow fault

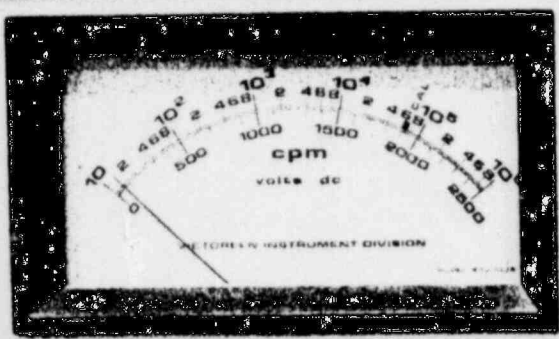
part. iodine  
 flow alarm

**START**  
**MOTOR RUN**  
**STOP**

off power on purge

norm. off prog. advance  
 filter tear

**VICTOREEN**



**HPR-225**  
**BASED ON CS-137**  
**CPM METER** - volts  
 5.35E11

cal. h.v. oper.  
 off



alert high  
 off on  
 fall

**HPR-225**  
**NO IODINE IN FLOW METER**  
**NO IODINE IN FLOW METER**

power flow fault

part. iodine  
 flow alarm

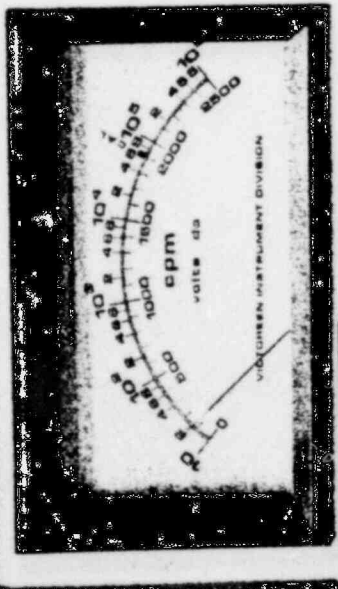
**START**  
**MOTOR RUN**  
**STOP**

off power on purge

norm. off prog. advance  
 filter tear

**VICTOREEN**

CALIBRATED  
 DATE 7-2-7  
 DO NOT  
 TAMPER



**WDCR-1480**  
 BASED ON NR-85  
 CALIBRATED BY  
 136517

cal. h.v. oper.  
 off



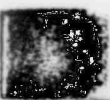
alert



o.s.



fail



high



power pump on



flow fault



off power on purge



norm. prog. advance



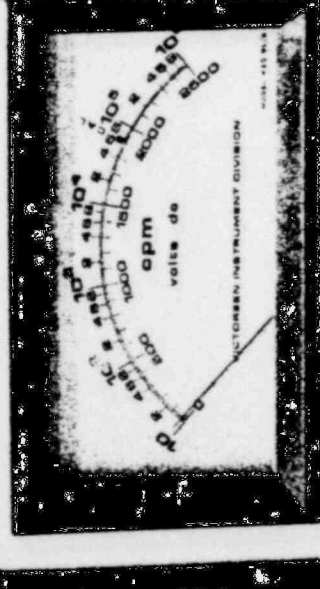
filter tear



WDCR-1480  
 WASTE GAS  
 DISCHARGE

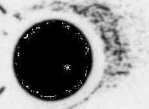
START  
 MOTOR RUN  
 STOP

VICTOREEN



**WDCR-1486**  
 BASED ON NR-85  
 CALIBRATED BY  
 136517

cal. h.v. oper.  
 off



alert



o.s.



fail



high



power pump on



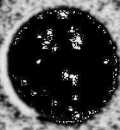
flow fault



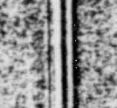
off power on purge



norm. prog. advance



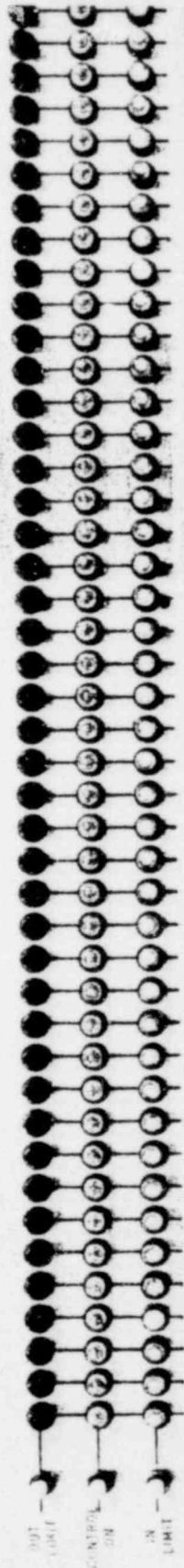
filter tear



WDCR-1486  
 WASTE GAS  
 DISCHARGE

START  
 MOTOR RUN  
 STOP

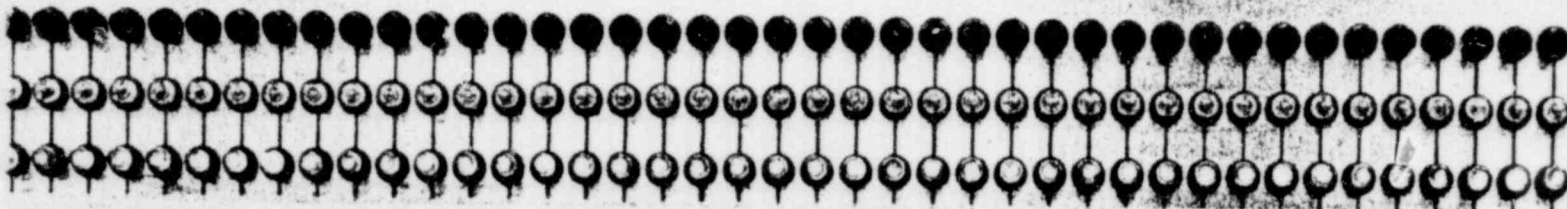
VICTOREEN



CONTROL AND ACTION

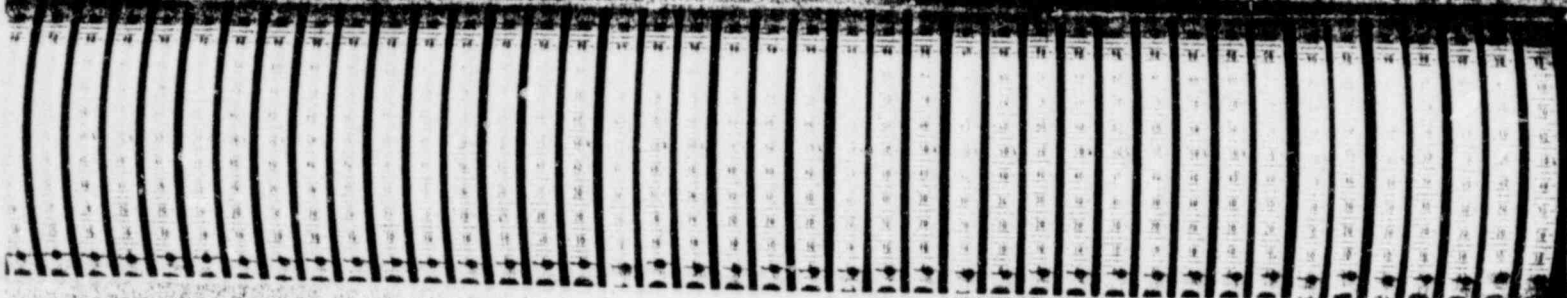
DIAMOND TOWER

29 481824  
SINIA



POSITION  
RESET  
 RAISE  
 LOWER

G5	G5	G5	G5	G5	G5	G5	G5	G5	G5	G5	G5	G6	G6	G6	G6	G6	G6	G6	G6	G6	G6	G6	G7	G7	G7	G7	G7	G7	G7	G7	G7	G7	G7	G7	G7	G7	G7	G7	G7	G7
2	3	4	5	6	7	8	9	10	11	12	1	2	3	4	5	6	7	8	9	10	11	12	1	2	3	4	5	6	7	8	9	1	2	3	4	5	6	7	8	



ABSOL.  
REL.  
POSITION  
SELECT

CONTROL ROD POSITION



SR 2 DPM

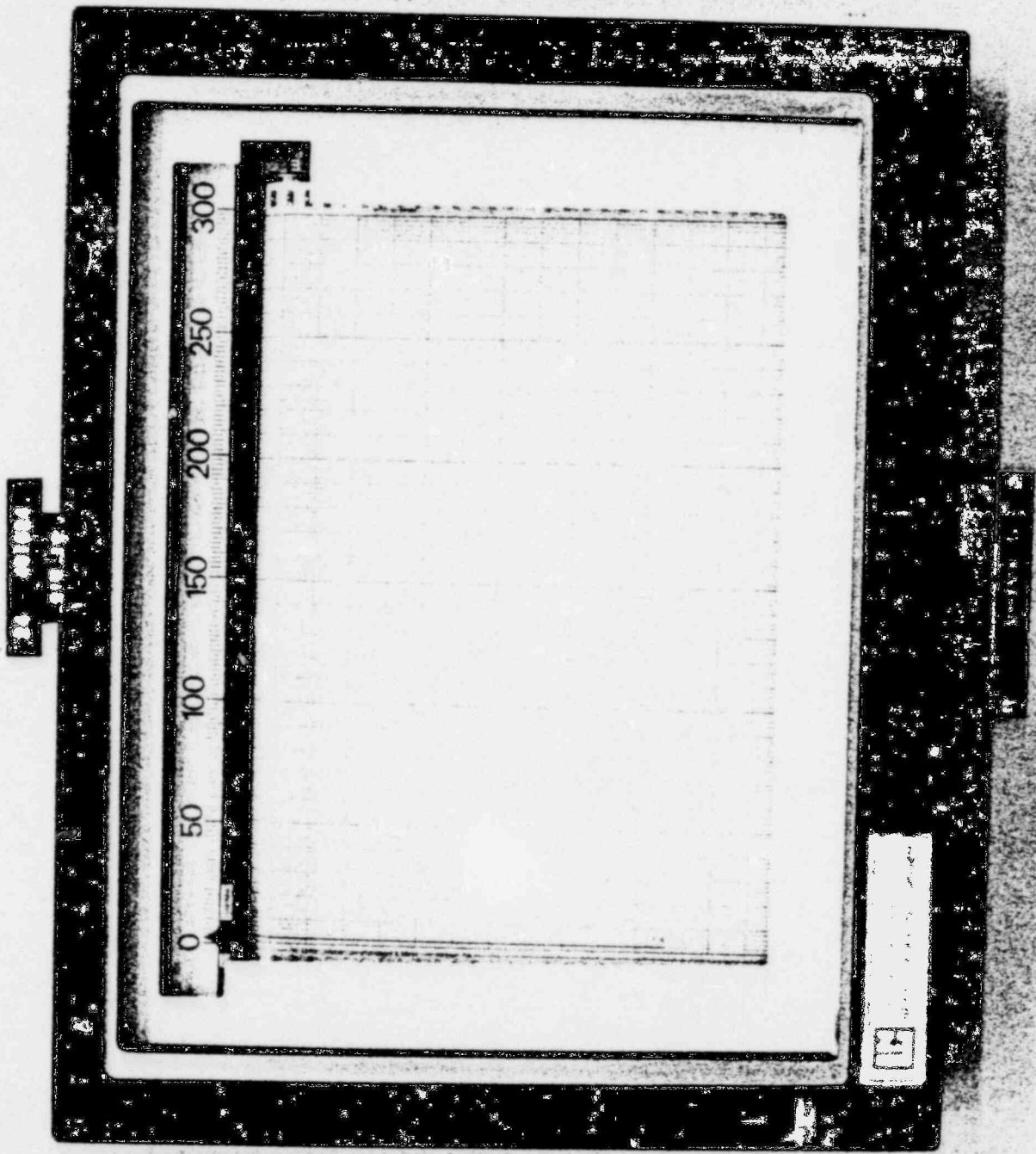
SR 2 DPM  
START-UP  
RATE ROD  
WITHDRAWAL  
INHIBIT  
IR 3 DPM

ASYMMETRIC  
ROD  
PATTERN  
9 INCHES

CRD MOTOR  
ROTATION  
FAULT

SEQUENCE  
FAULT

GROUP 6/7  
MISALIGNMENT  
FAULT  
8 INCHES



PANEL 13, 15

RC TRIP  
DISTABLE  
BT 1

SAFETY INJECTION  
CHANNEL 1  
GRP 1

AUTO

TEST

RB ISOLATION  
AND COOLING  
CHAN 1 TRIP

RB ISOL & COOL  
CHANNEL 1  
GRP 1 GRP 2 GRP 3

AUTO

TEST

RB SPRAY  
CHANNEL 1  
TRIP

SAFETY INJECTION  
MANUAL ACTUATION  
GRP 1 GRP 2 GRP 3

TEST

TEST

TEST

RC TRIP  
DISTABLE  
BT 2

SAFETY INJECTION  
CHANNEL 2  
GRP 1 GRP 2 GRP 3

AUTO

TEST

RB ISOLATION  
AND COOLING  
CHAN 2 TRIP

RB ISOL & COOL  
CHANNEL 2  
GRP 1 GRP 2 GRP 3

AUTO

TEST

RB SPRAY  
CHANNEL 2  
TRIP

RB ISOL & COOL  
MANUAL ACTUATION  
GRP 1 GRP 2 GRP 3

TEST

TEST

TEST

RC TRIP  
DISTABLE  
BT 3

SAFETY INJECTION  
CHANNEL 3  
GRP 1 GRP 2 GRP 3

AUTO

TEST

RB ISOLATION  
AND COOLING  
CHAN 3 TRIP

RB ISOL & COOL  
CHANNEL 3  
GRP 1 GRP 2 GRP 3

AUTO

TEST

RB SPRAY  
CHANNEL 3  
TRIP

START

STOP

EMERGENCY  
SEQUENCE  
TEST

ANNUNCIATOR  
TEST

TEST

STABLE  
BIT

SAFETY INJECTION  
CHANNEL 1  
GRP 1 GRP 2 GRP 3

AUTO

TEST

ISOLATE  
AND COOLING  
CHAIN TRIP

RBSISOL & COOL  
Channel 2  
GRP 1 GRP 2 GRP 3

AUTO

TEST

RBSISOL & COOL  
Channel 3  
GRP 1 GRP 2 GRP 3

AUTO

TEST

STABLE  
BIT

SAFETY INJECTION  
CHANNEL 2  
GRP 1 GRP 2 GRP 3

AUTO

TEST

ISOLATE  
AND COOLING  
CHAIN TRIP

RBSISOL & COOL  
Channel 1  
GRP 1 GRP 2 GRP 3

AUTO

TEST

RBSISOL & COOL  
Channel 3  
GRP 1 GRP 2 GRP 3

AUTO

TEST

STABLE  
BIT

SAFETY INJECTION  
CHANNEL 3  
GRP 1 GRP 2 GRP 3

AUTO

TEST

ISOLATE  
AND COOLING  
CHAIN TRIP

RBSISOL & COOL  
Channel 1  
GRP 1 GRP 2 GRP 3

AUTO

TEST

RBSISOL & COOL  
Channel 3  
GRP 1 GRP 2 GRP 3

AUTO

TEST

START  
SEQUENCE  
TEST!

MANUAL  
TEST

YES

SAFETY INJECTION  
Channel 1  
GRP 1 GRP 2 GRP 3

AUTO

TEST

SAFETY INJECTION  
Channel 2  
GRP 1 GRP 2 GRP 3

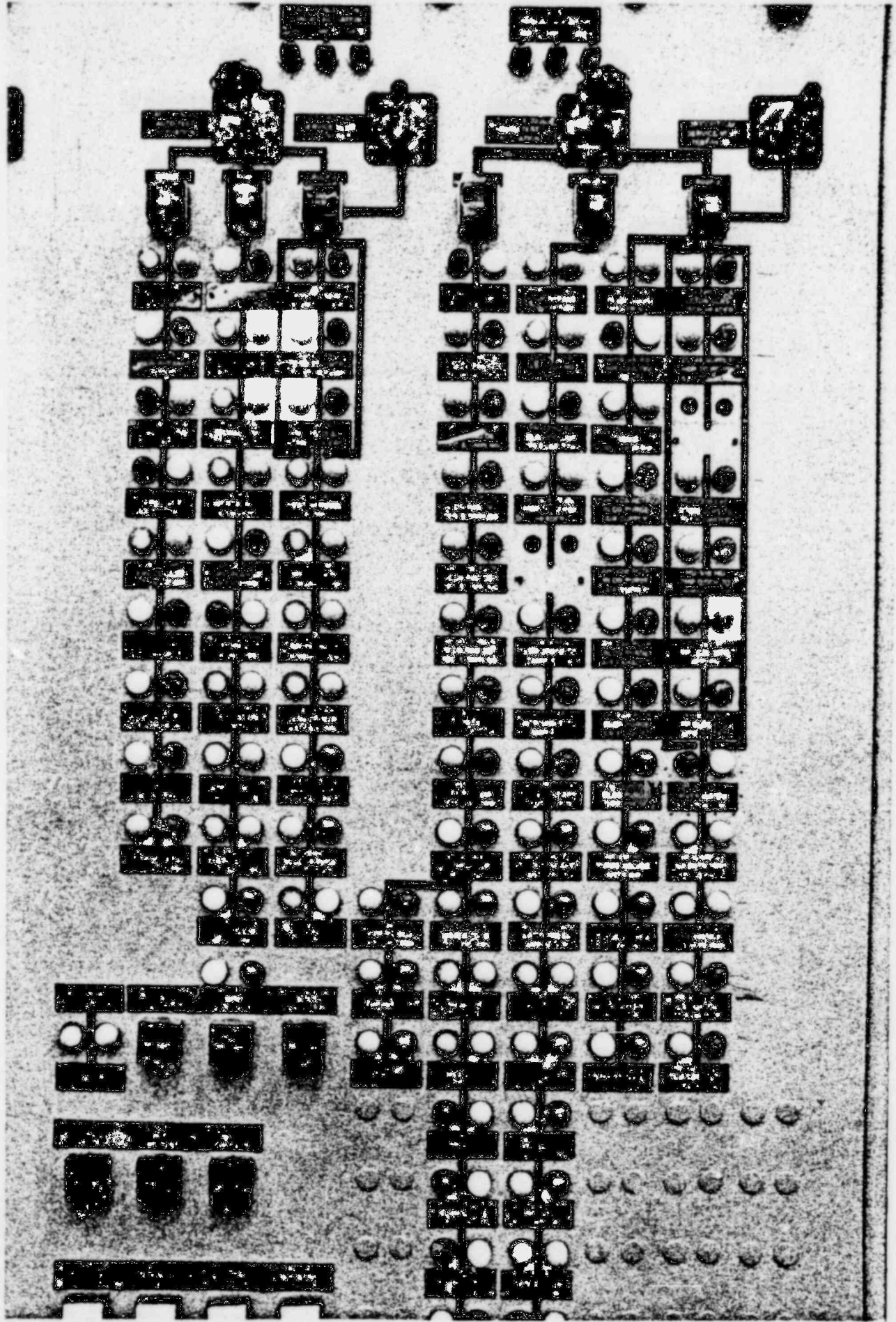
AUTO

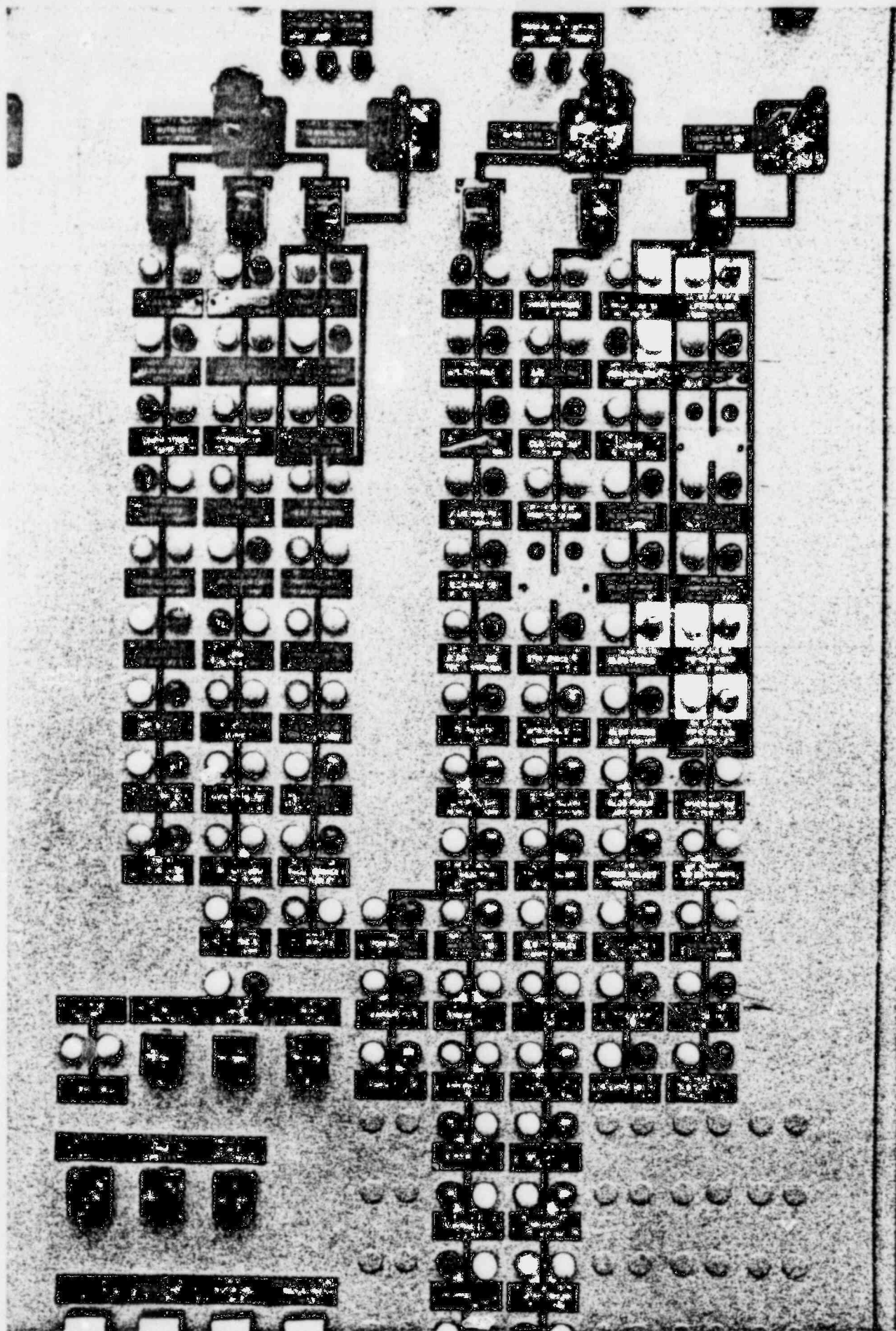
TEST

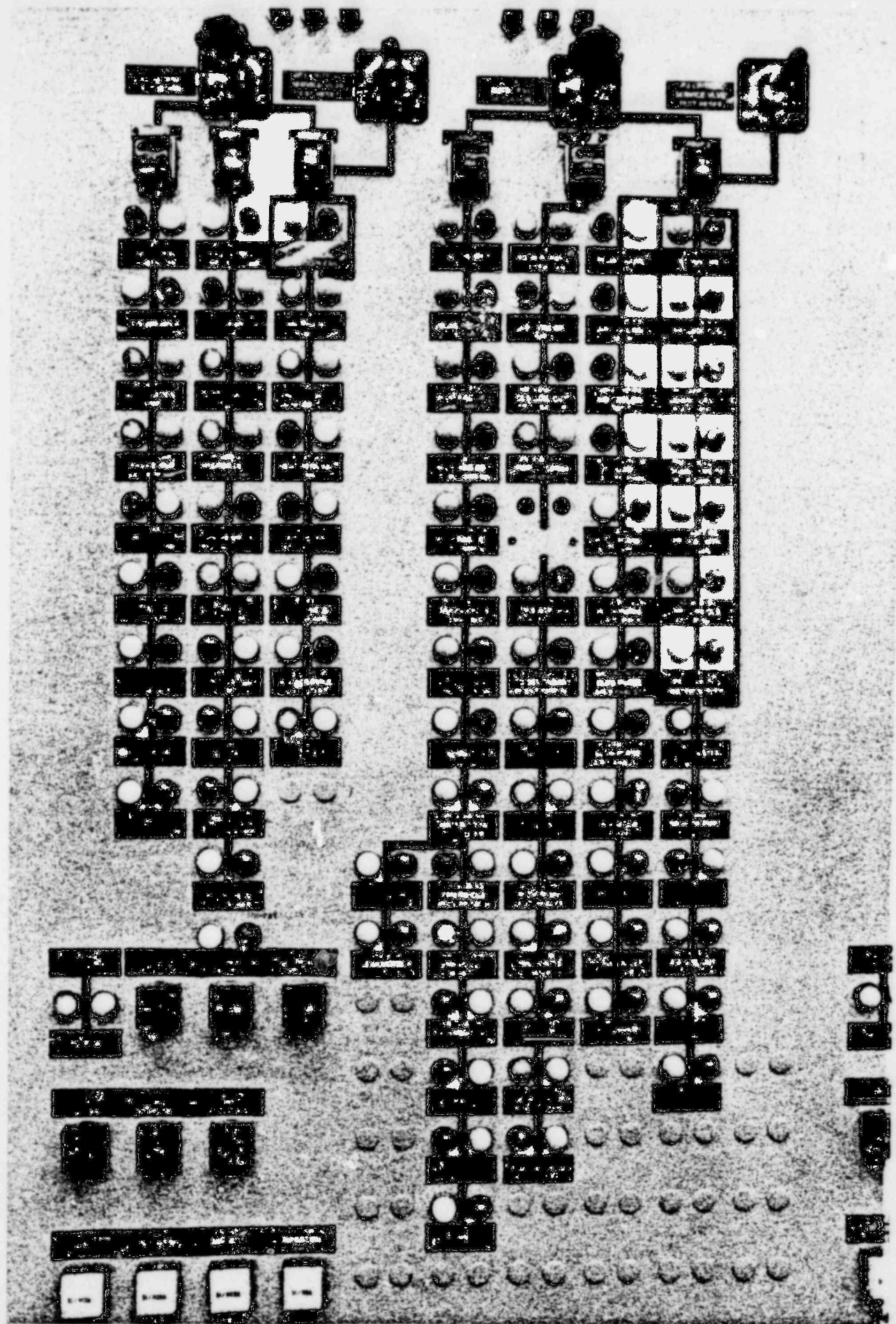
SAFETY INJECTION  
Channel 3  
GRP 1 GRP 2 GRP 3

AUTO

TEST

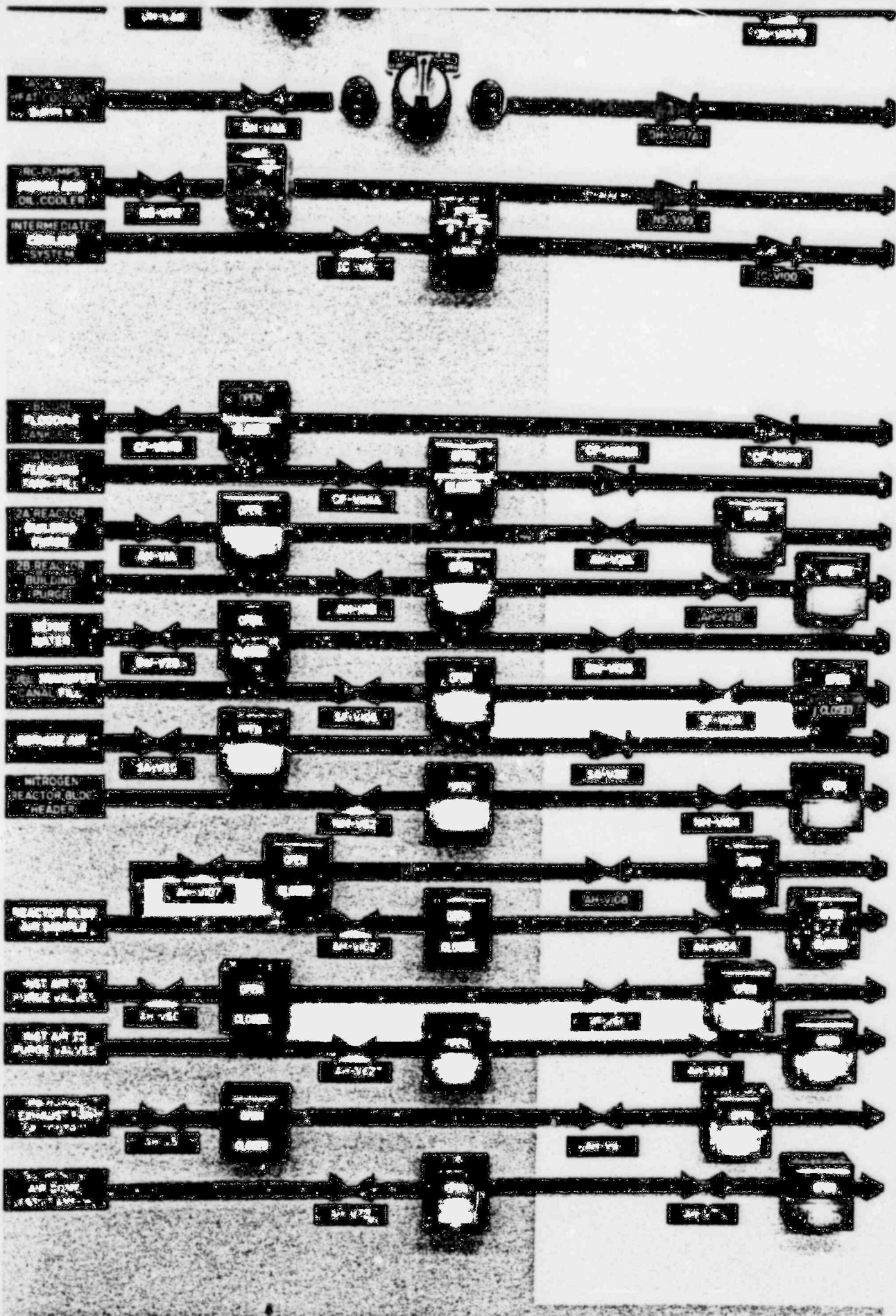


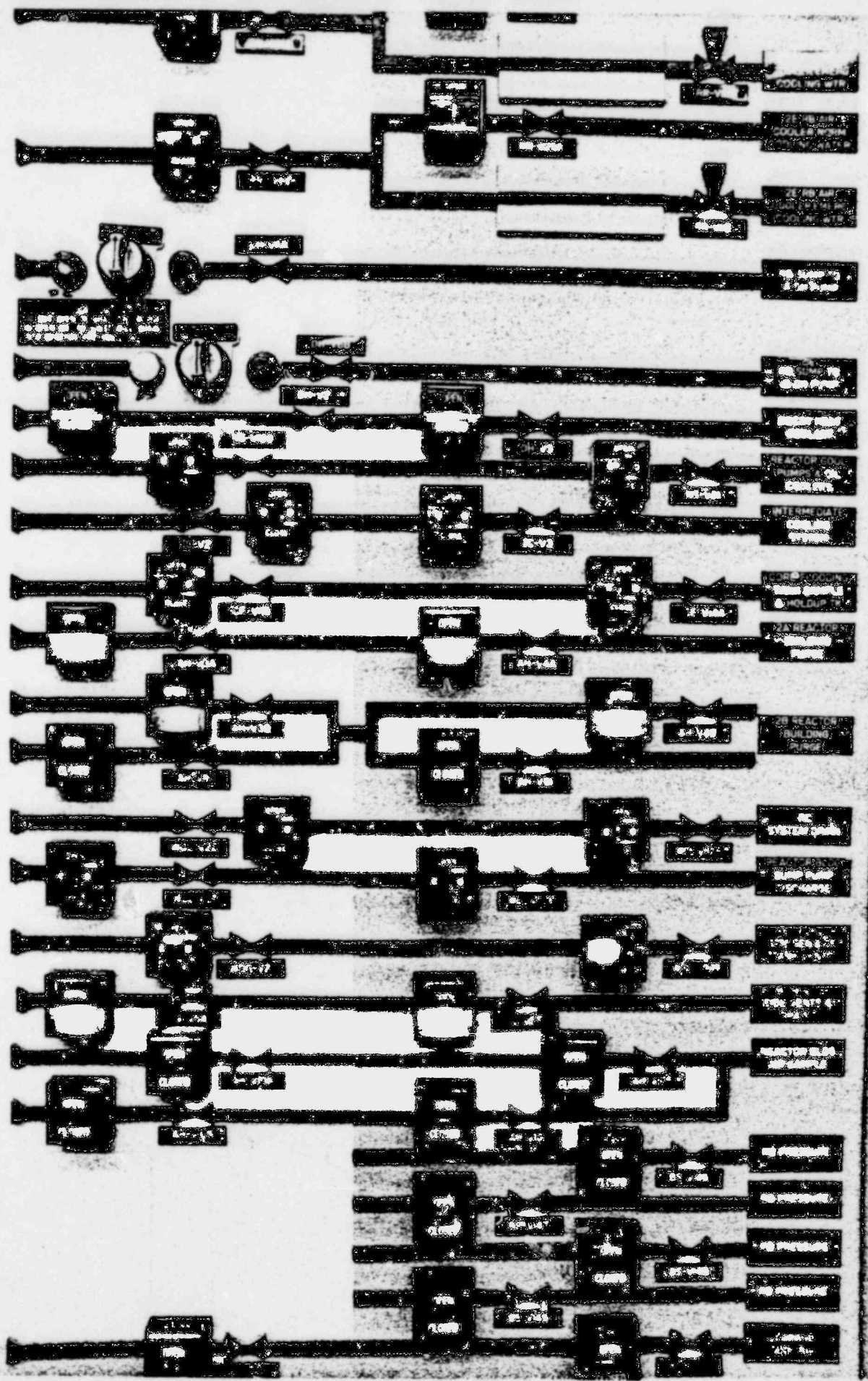


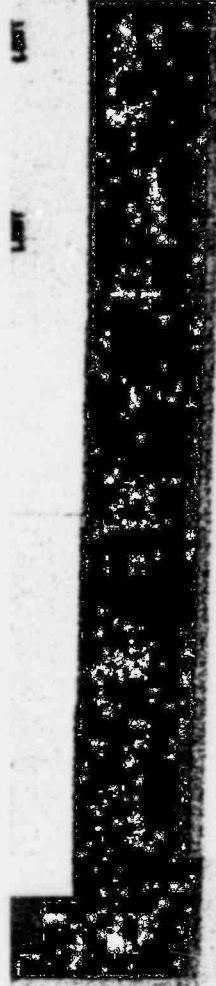




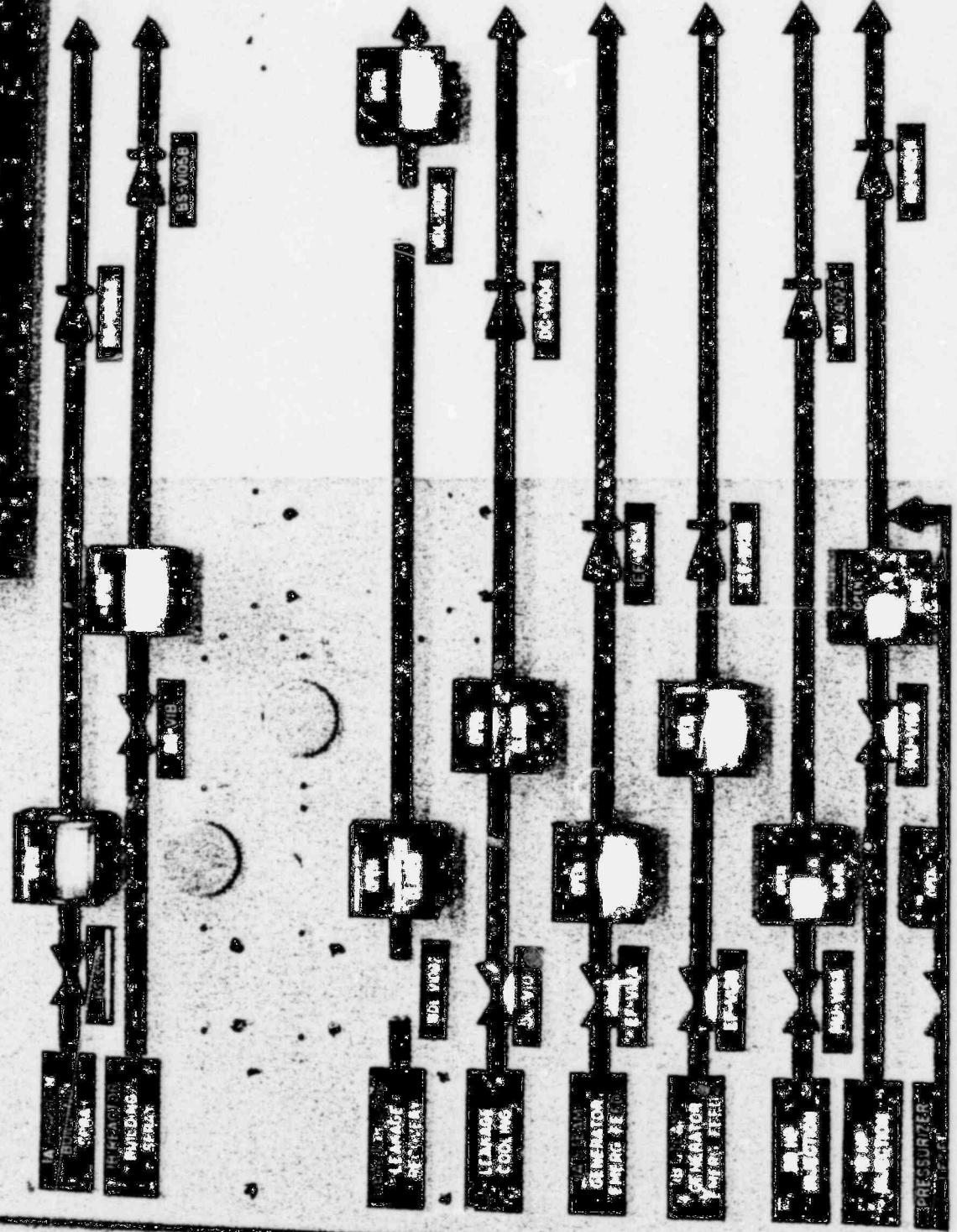


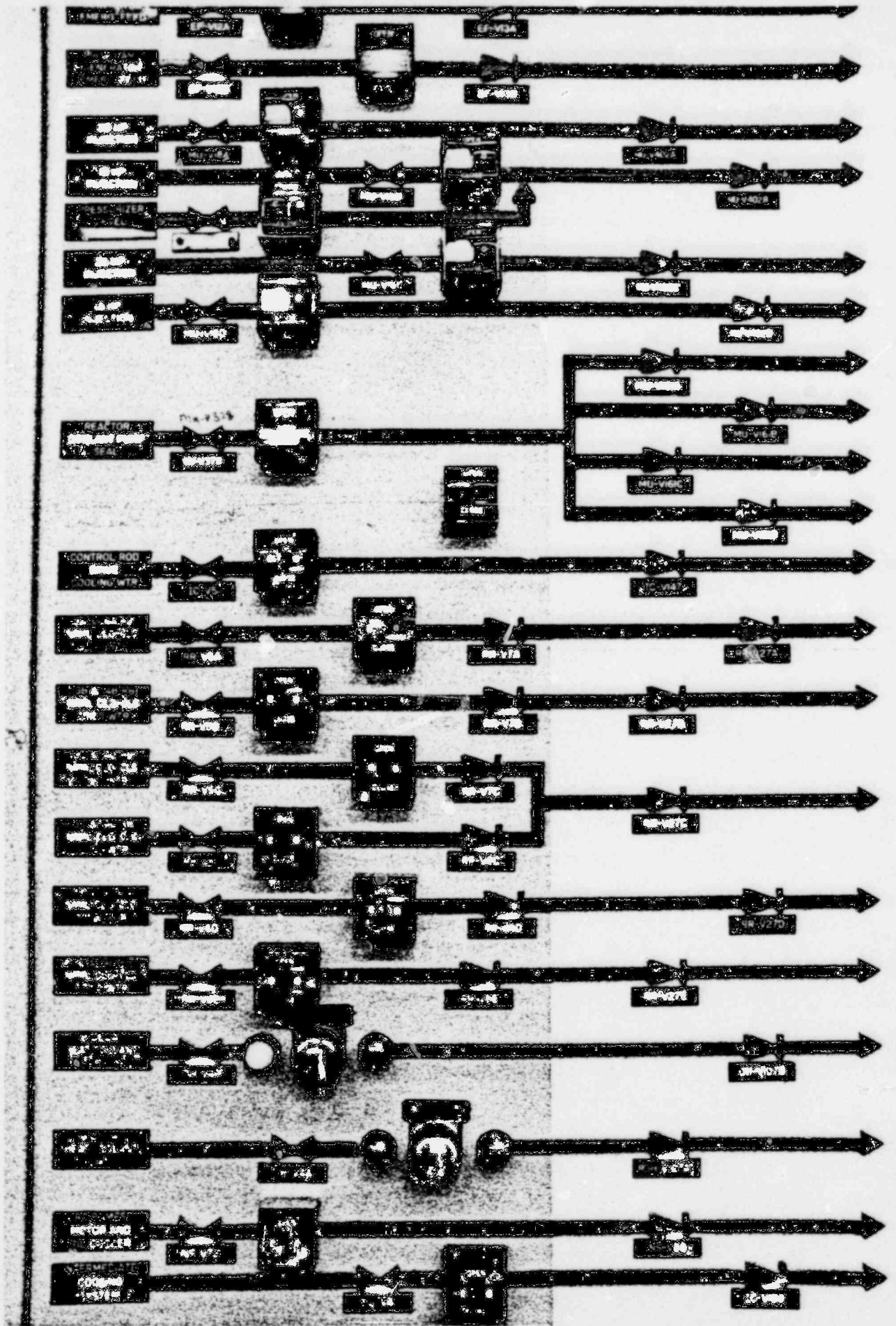




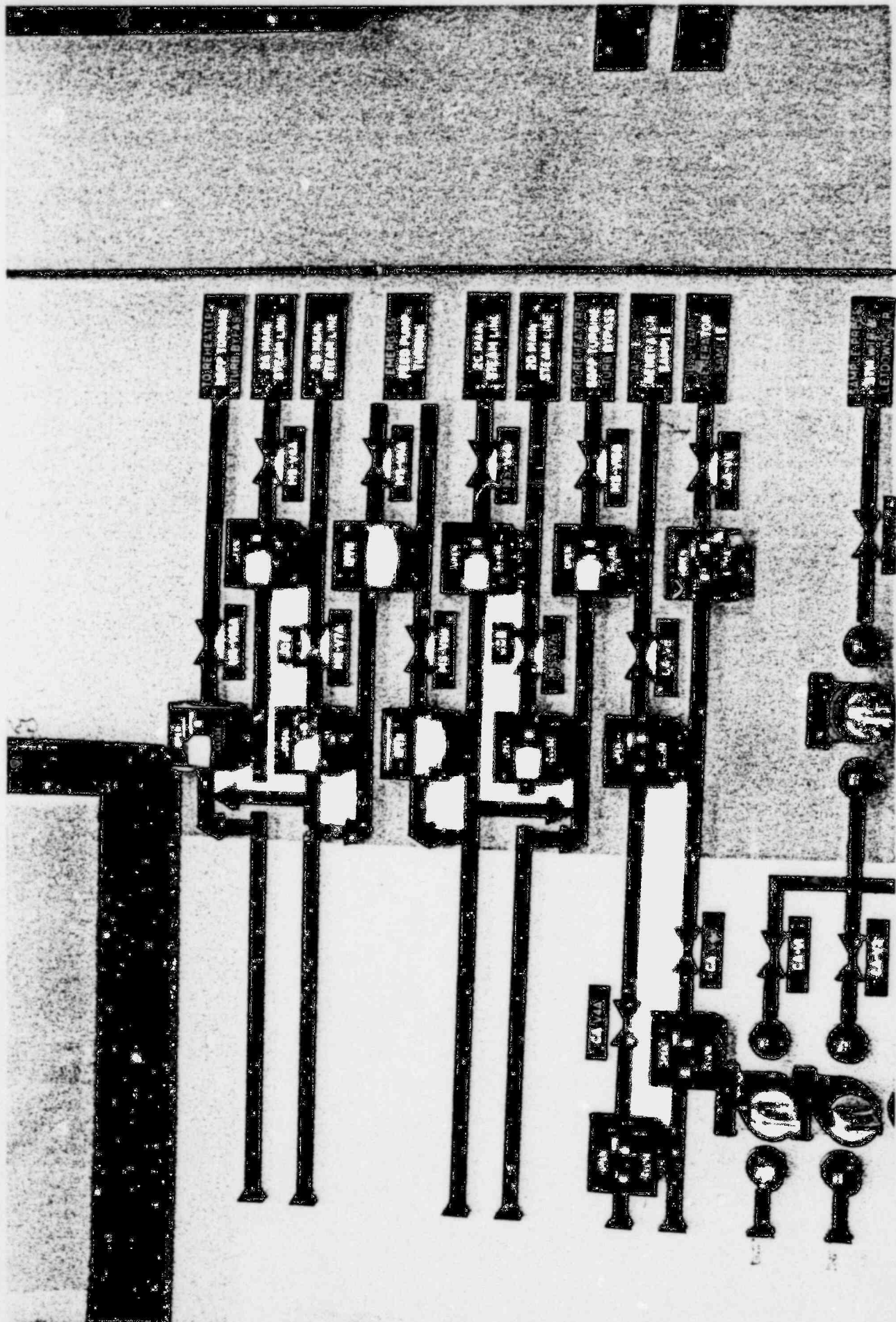


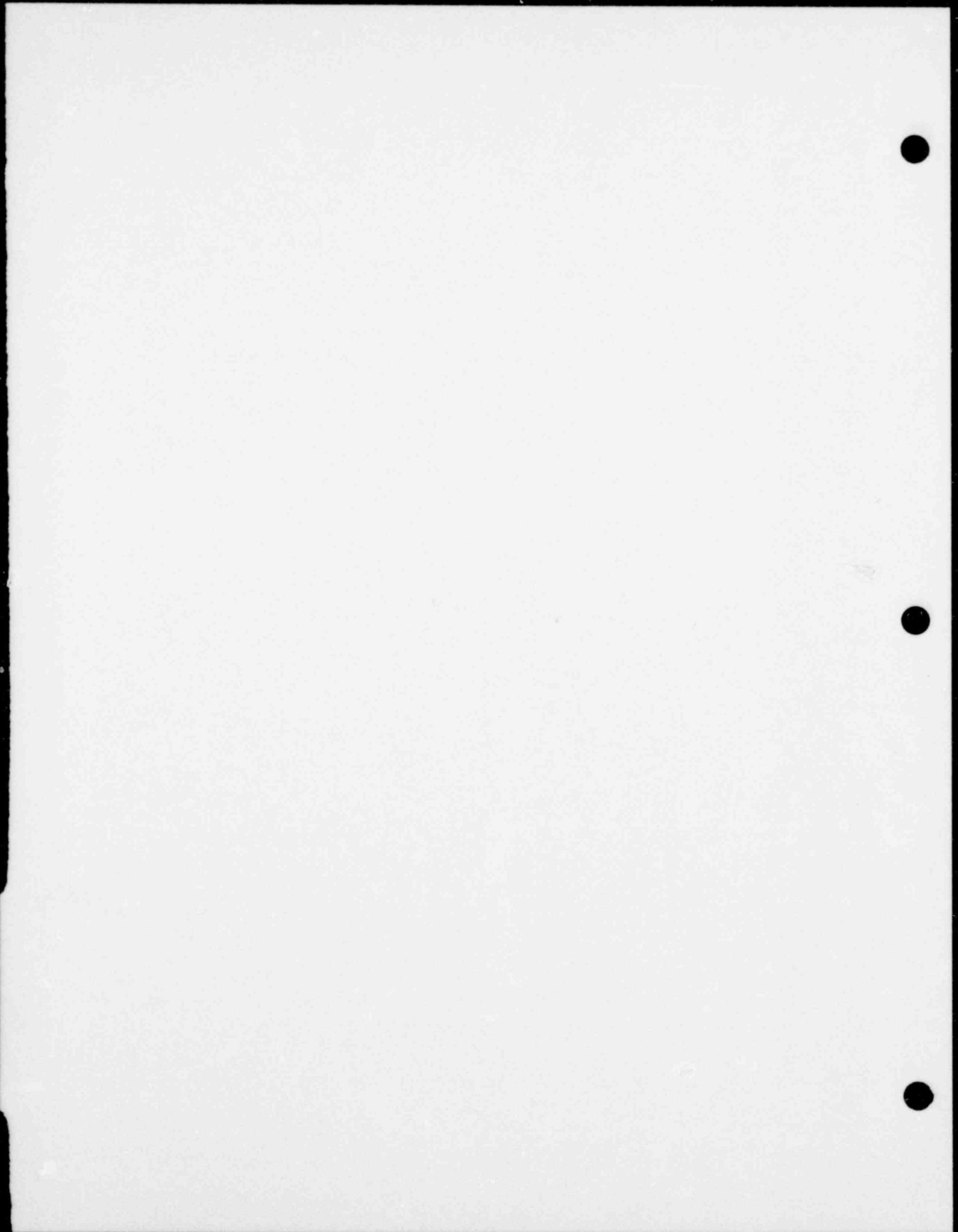
51



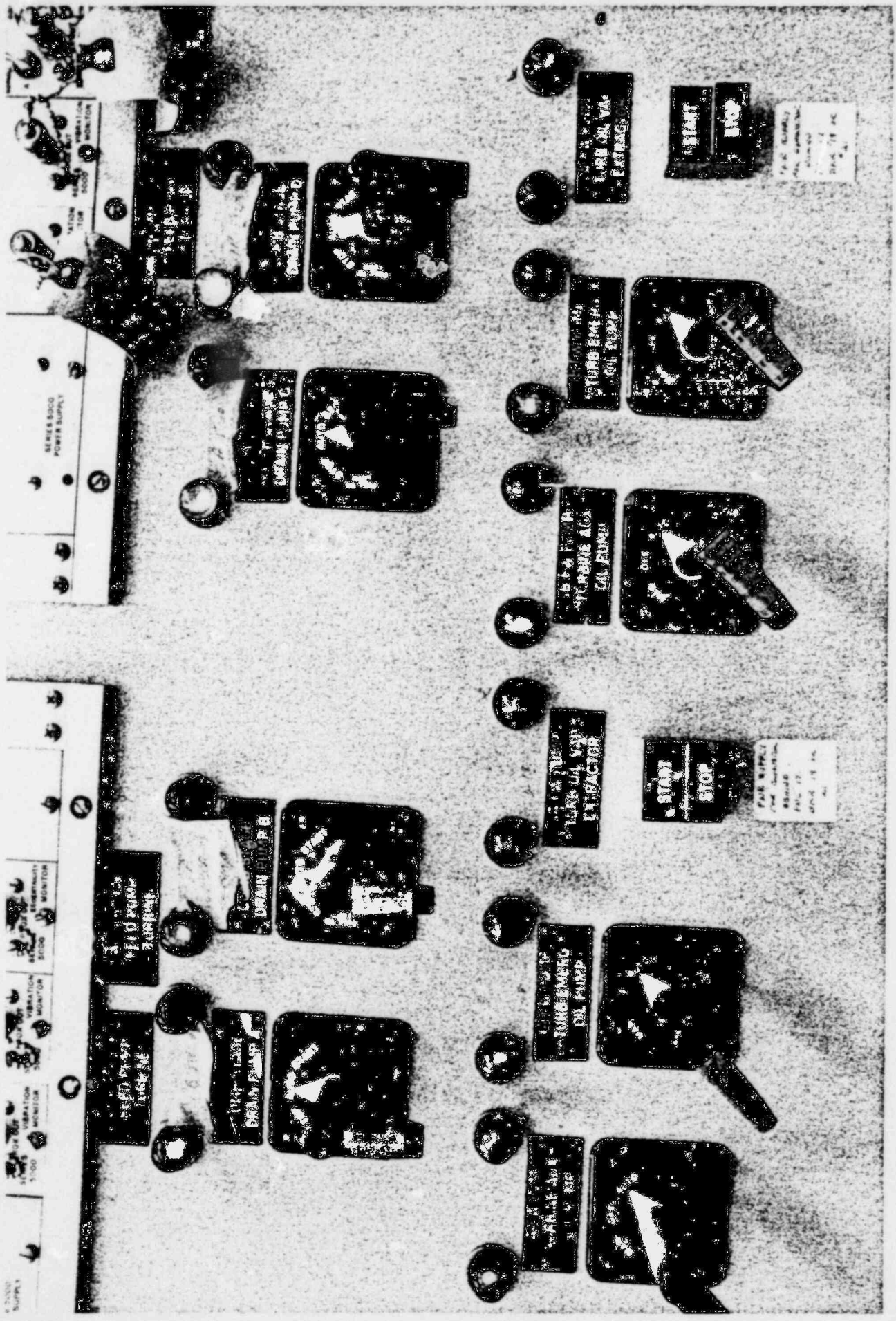












POWER SUPPLY

11000 VIBRATION MONITOR

11000 VIBRATION MONITOR

11000 VIBRATION MONITOR

11000 VIBRATION MONITOR

11000 VIBRATION MONITOR

11000 VIBRATION MONITOR

11000 VIBRATION MONITOR

11000 VIBRATION MONITOR

11000 VIBRATION MONITOR

11000 VIBRATION MONITOR

11000 VIBRATION MONITOR

11000 VIBRATION MONITOR

11000 VIBRATION MONITOR

11000 VIBRATION MONITOR

11000 VIBRATION MONITOR

11000 VIBRATION MONITOR

11000 VIBRATION MONITOR

11000 VIBRATION MONITOR

11000 VIBRATION MONITOR

11000 VIBRATION MONITOR

11000 VIBRATION MONITOR

11000 VIBRATION MONITOR

11000 VIBRATION MONITOR

11000 VIBRATION MONITOR

11000 VIBRATION MONITOR

11000 VIBRATION MONITOR

11000 VIBRATION MONITOR

11000 VIBRATION MONITOR

11000 VIBRATION MONITOR

11000 VIBRATION MONITOR

11000 VIBRATION MONITOR

11000 VIBRATION MONITOR

11000 VIBRATION MONITOR

11000 VIBRATION MONITOR

11000 VIBRATION MONITOR

11000 VIBRATION MONITOR

11000 VIBRATION MONITOR

11000 VIBRATION MONITOR

11000 VIBRATION MONITOR

11000 VIBRATION MONITOR

11000 VIBRATION MONITOR

11000 VIBRATION MONITOR

11000 VIBRATION MONITOR

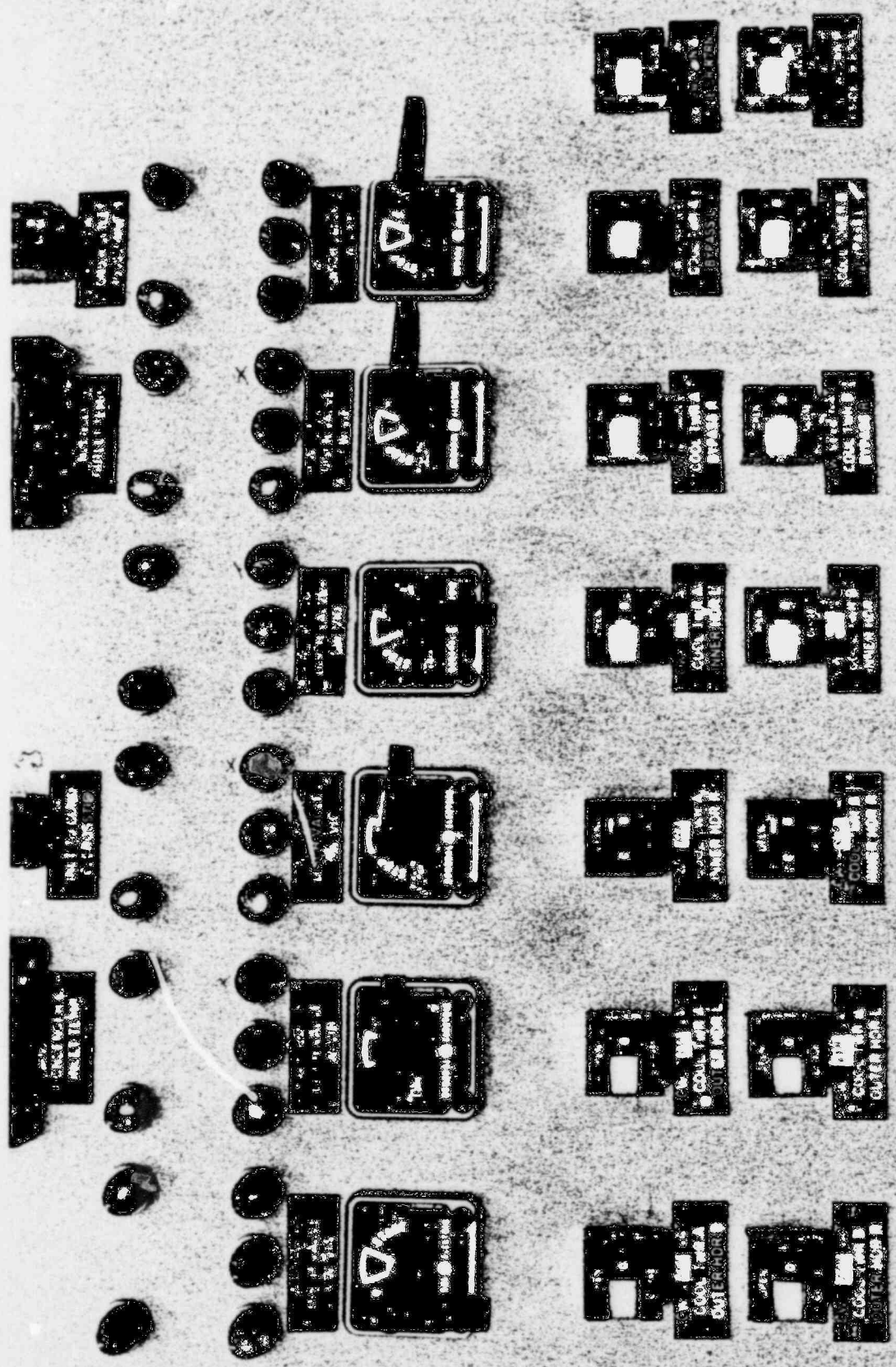
11000 VIBRATION MONITOR

START STOP

FAIR WIPPL  
11000 VIBRATION MONITOR  
PART 17  
APR 15 1964

START STOP

FAIR WIPPL  
11000 VIBRATION MONITOR  
PART 17  
APR 15 1964

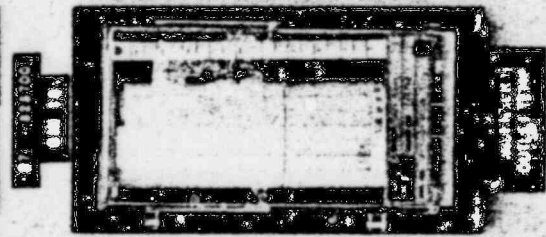




CIRC WATER

11 12 13 14 15 16 17 18 19 20 21 22 23 24 25 26 27 28 29 30 31 32 33 34 35 36 37 38 39 40 41 42 43 44 45 46 47 48 49 50 51 52 53 54 55 56 57 58 59 60 61 62 63 64 65 66 67 68 69 70 71 72 73 74 75 76 77 78 79 80 81 82 83 84 85 86 87 88 89 90 91 92 93 94 95 96 97 98 99 100

ORDER NUMBER 1  
POSITION OF DEVICE  
OFF AT  
DATE



CONNECT

CONNECT

TEMP. H. 14.100  
DEF. PRESS. H.

DRY. DRAM  
TANK LEVEL LO

WATER IN  
MANTLE  
N. TRUBLE

3/4 IN. VACUUM  
RUPTURE  
T. SOURCE

RC-418  
LEVEL H/LO

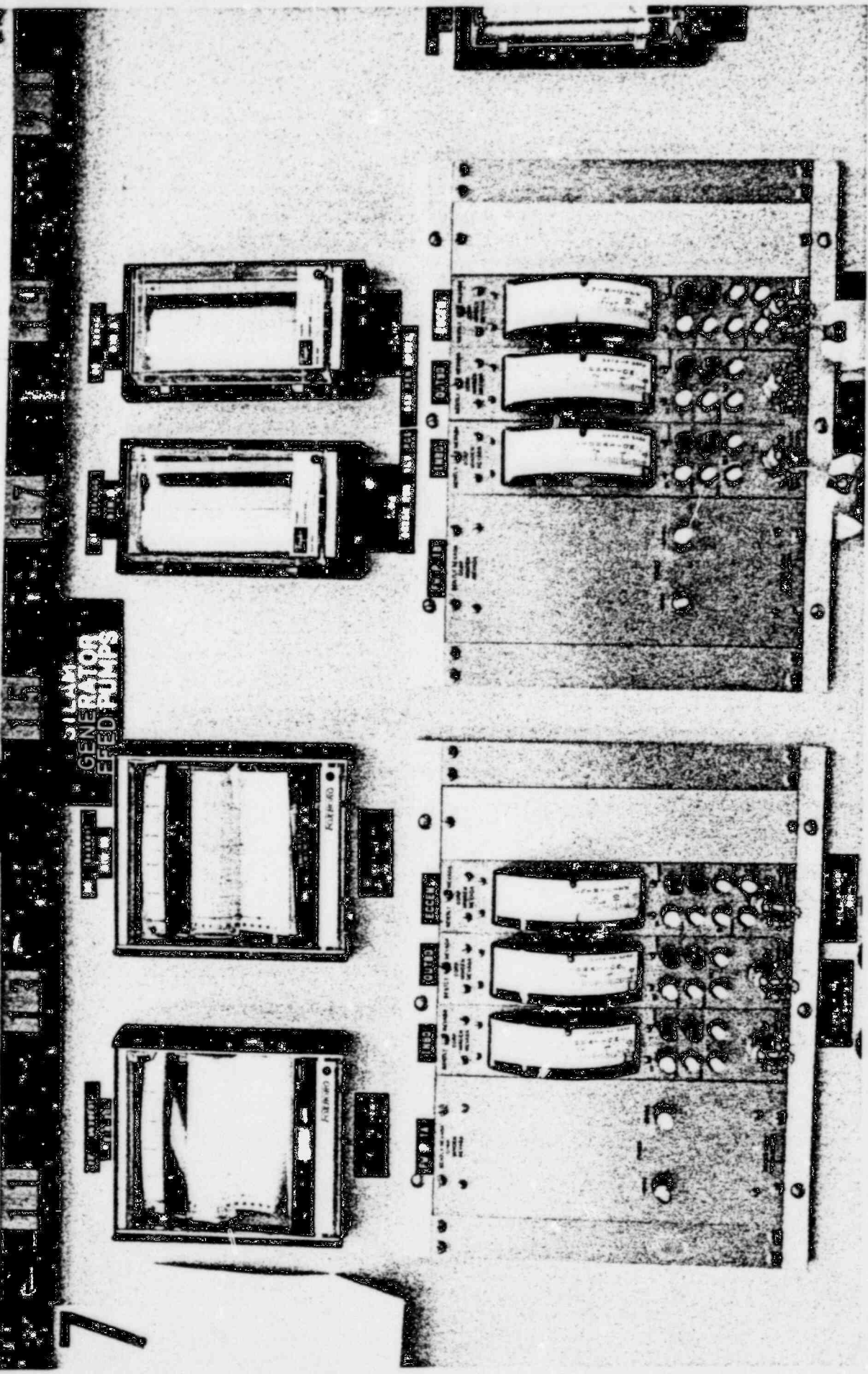
DEF. PRESS.  
TANK

TURBINE  
CONTROL VALVES  
CLOSED

W. TANK FLOW  
TURBINE  
THROTTLE MARKER  
BELOW H

W. TANK FLOW  
TURBINE  
ON TANK  
LEVEL H/AS

W. TANK FLOW  
DAMAGE DRAIN TANK  
79-1-18  
LEVEL H



**7**  
**GENERATOR  
FEED PUMPS**

**PUMP NO. 10**

MONITOR/CONTROL PANEL FOR PUMP NO. 10

**PUMP NO. 11**

MONITOR/CONTROL PANEL FOR PUMP NO. 11

**PUMP NO. 12**

MONITOR/CONTROL PANEL FOR PUMP NO. 12

**PUMP NO. 13**

MONITOR/CONTROL PANEL FOR PUMP NO. 13

**CONTROL PANEL**

SECTION 1: PUMP NO. 10

SECTION 2: PUMP NO. 11

SECTION 3: PUMP NO. 12

**CONTROL PANEL**

SECTION 4: PUMP NO. 13

SECTION 5: PUMP NO. 14

SECTION 6: PUMP NO. 15

**7**

POSITION

PT 22  
Casting expansion

**Casting Expansion**

**Rotor Position**

Generator End Generator End  
Rotor Rotor  
Exc Exc

CASTING EXPAN AND ROTOR POSITION

PT 22  
Differential expansion

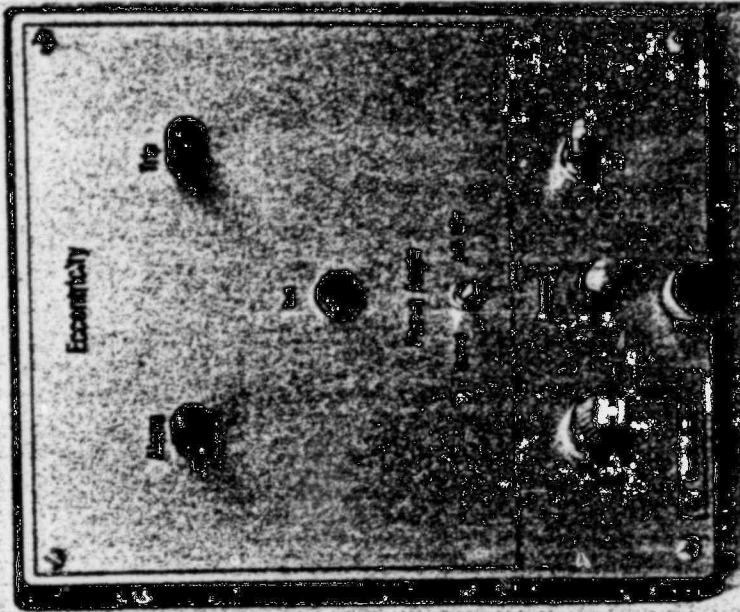
**Differential Expansion**

Rotor Long Rotor Short  
Exc Exc  
Exc Exc

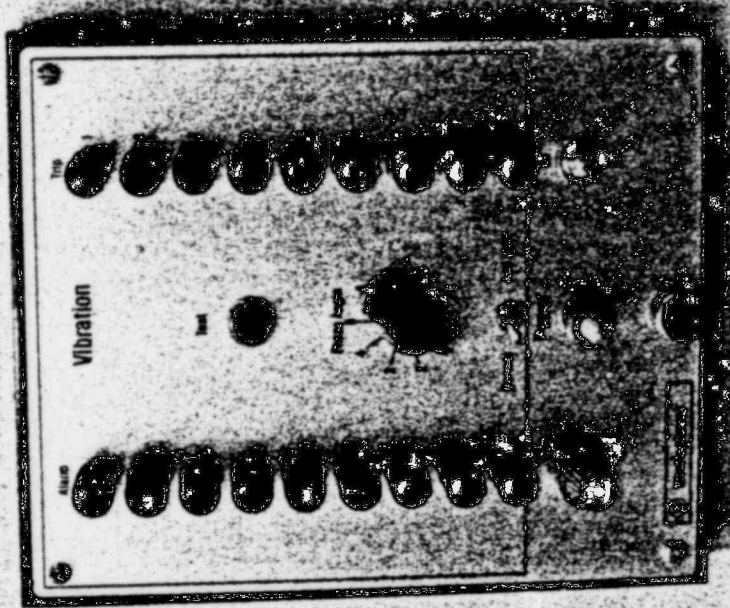
**Differential Expansion**

Rotor Long Rotor Short  
Exc Exc  
Exc Exc

DIFFERENTIAL EXPANSION

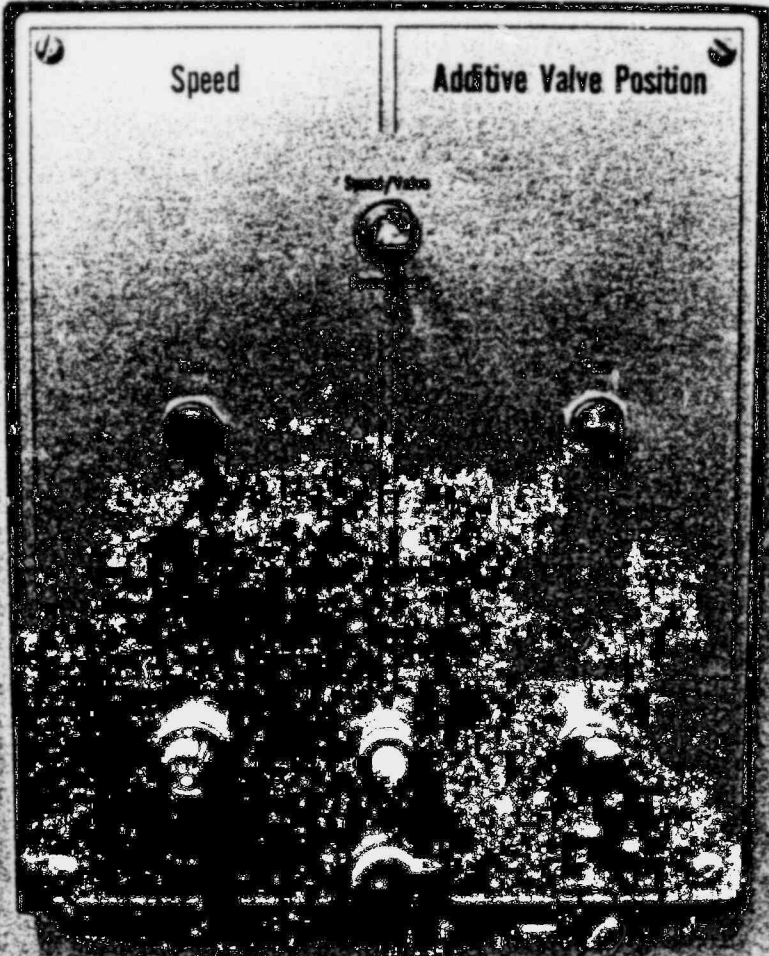


ECCENTRICITY



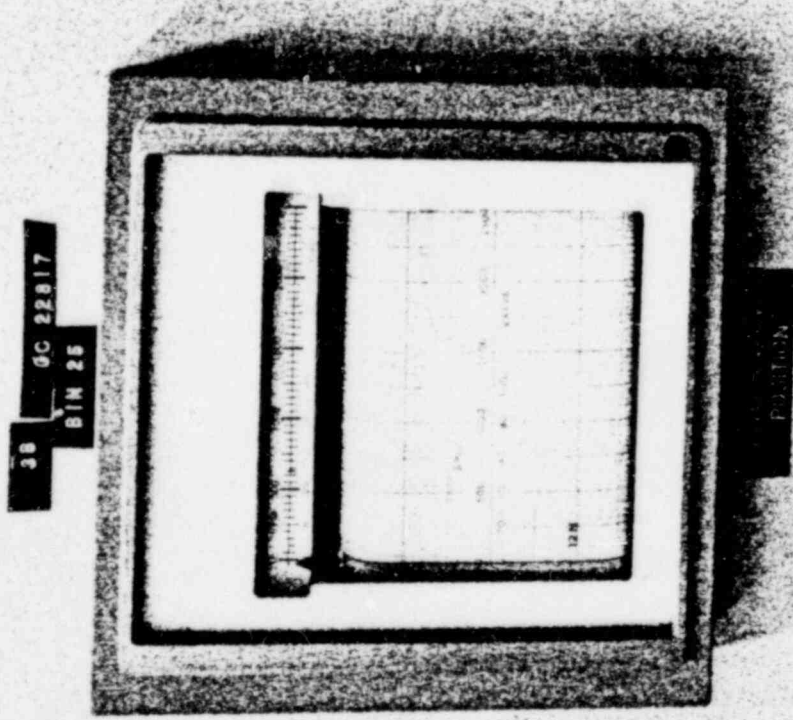
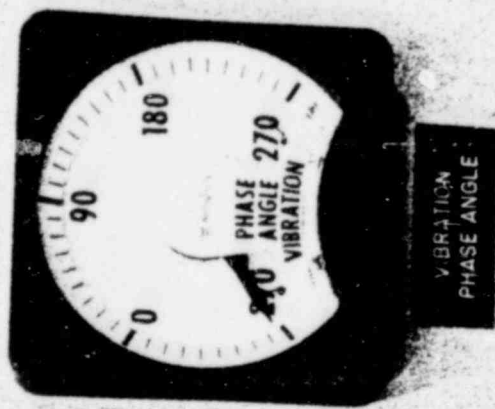
VIBRATION

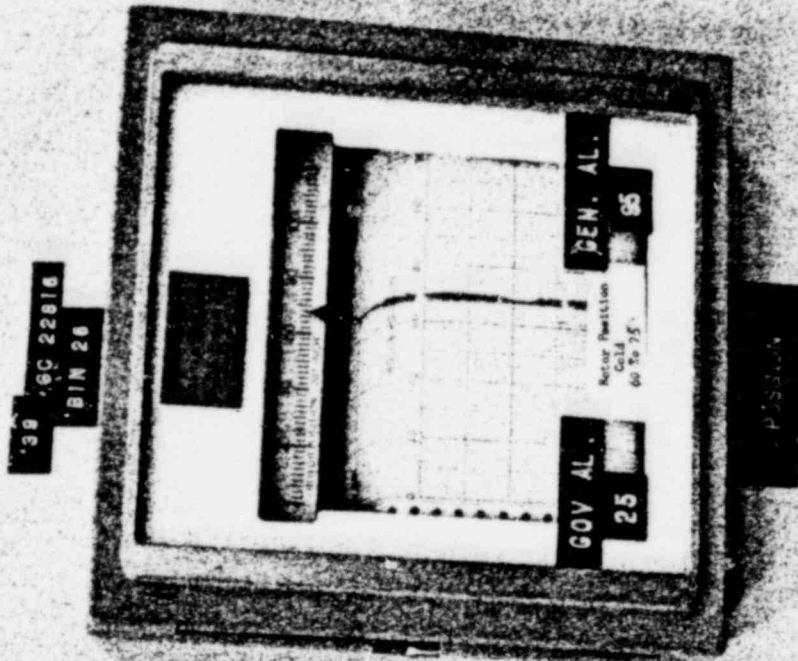
POSITION

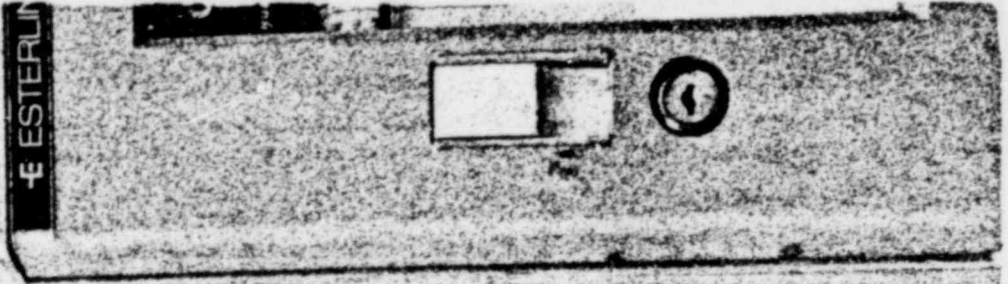


SPEED -  
GOVERN VALVE  
POSITION







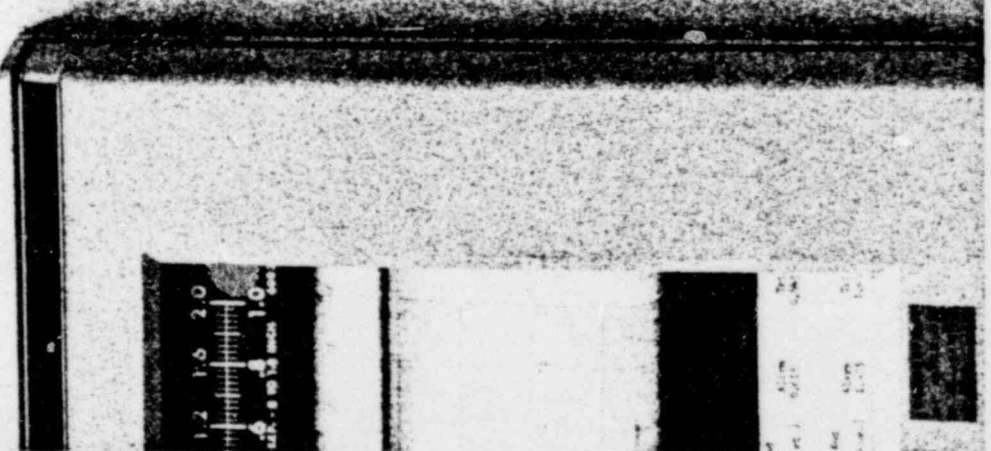


VALVE #1-MOT.-1B-MS-V31A  
VALVE #2-MOT.-1A-MS-V37A  
VALVE #3-MOT.-2B-MS-V31B  
VALVE #4-MOT.-2A-MS-V37B

REHEAT CONTROL SYSTEM

A control panel for a reheat system. It features a central circular gauge with a needle and a scale. Below the gauge are two horizontal gauges. To the left of the central gauge is a vertical column of four indicator lights labeled "TEMP", "REHEAT", "REHEAT", and "REHEAT". To the right of the central gauge is another vertical column of four indicator lights labeled "REHEAT", "REHEAT", "REHEAT", and "REHEAT".

REHEAT CONTROL VALVES



SAVED BY  
PAGE 1

31 00 0000  
31 00 0000

CESTERLINE ANGUS

200 400 600 800 1000 1200

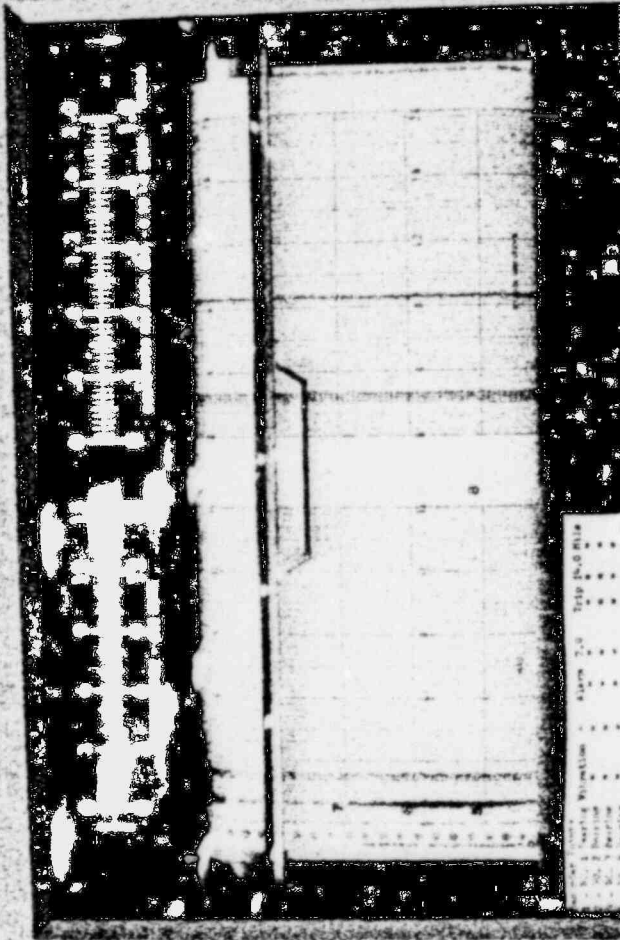
CESTERLINE ANGUS

31 00 0000  
31 00 0000

31 00 0000

FAO 1000  
P1004

ESTERLINE ANGUS



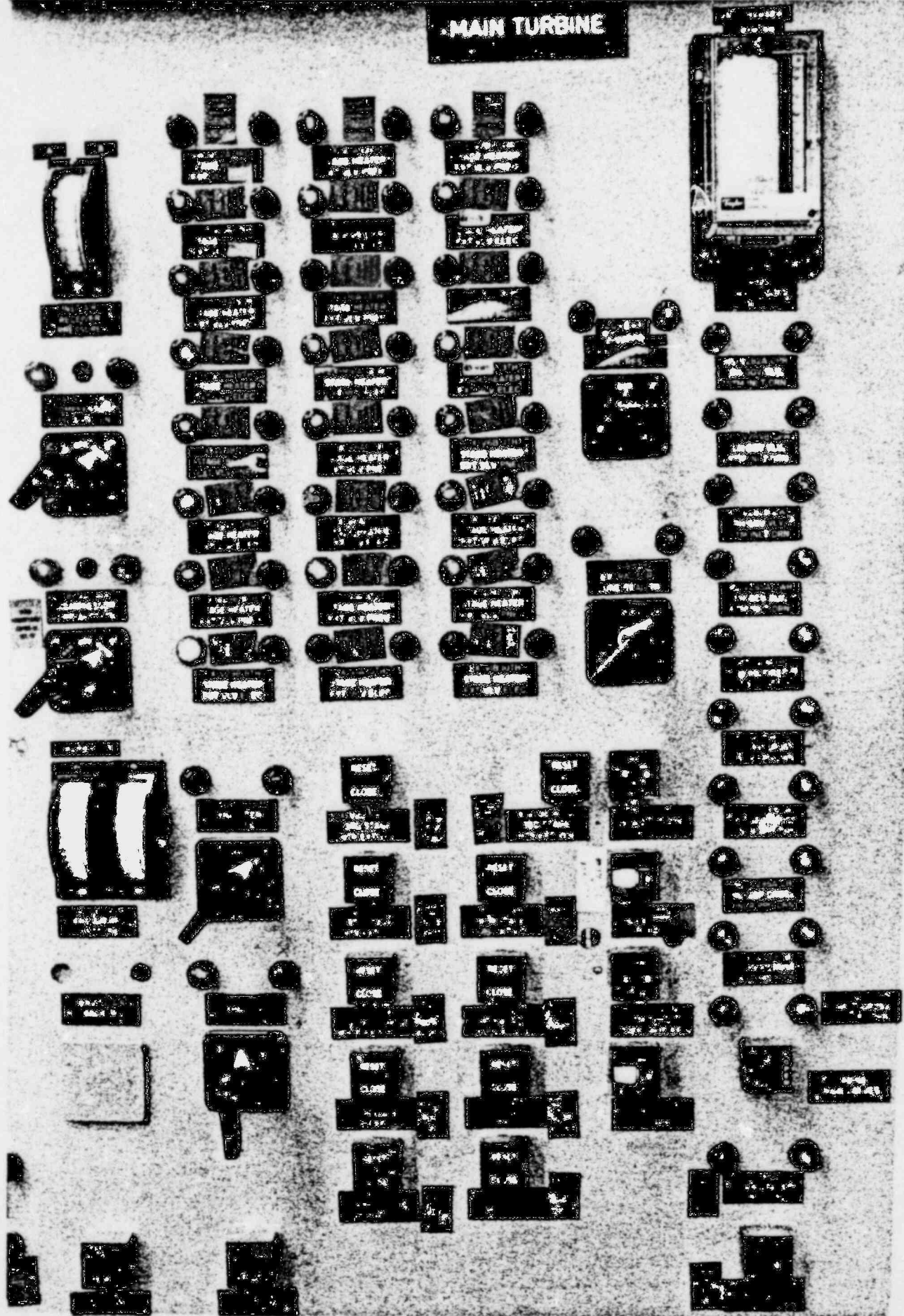
Setting	Function	Alarm	Tip	Tip No. 0
1	Normal			
2	Normal			
3	Normal			
4	Normal			
5	Normal			
6	Normal			
7	Normal			
8	Normal			
9	Normal			
10	Normal			
11	Normal			
12	Normal			
13	Normal			
14	Normal			
15	Normal			
16	Normal			
17	Normal			
18	Normal			
19	Normal			
20	Normal			
21	Normal			
22	Normal			
23	Normal			
24	Normal			
25	Normal			
26	Normal			
27	Normal			
28	Normal			
29	Normal			
30	Normal			

Alarm	Tip	Alarm	Tip
0.525 (Long)	0.264	0.615	0.264
0.275 (Short)	0.615	0.615	0.615
0.305 (Long)	1.435	0.615	1.435
0.315 (Short)	1.435	0.615	1.435

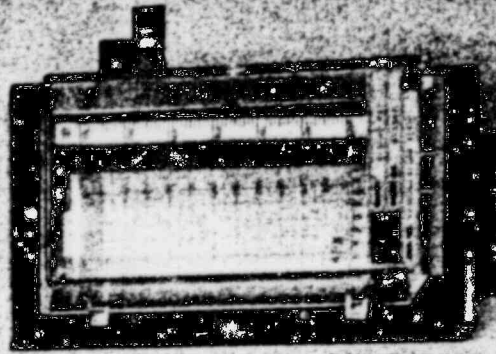
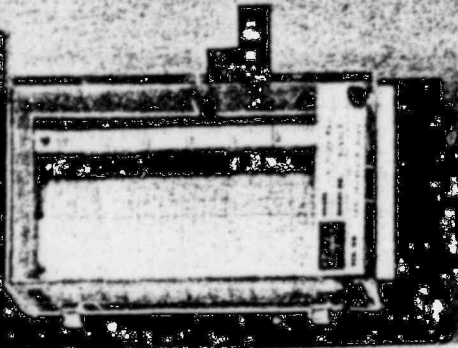
ESTERLINE ANGUS

ESTERLINE ANGUS

MAIN TURBINE



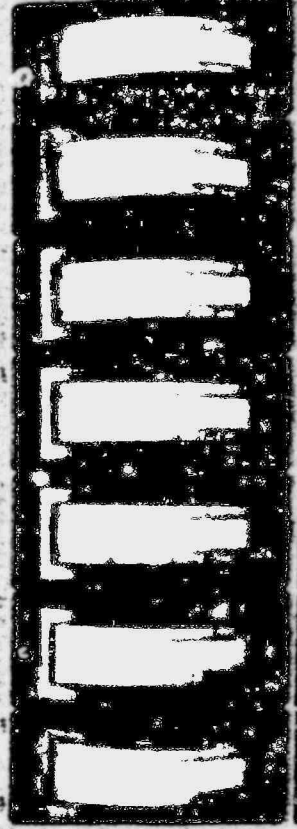
MAIN AND  
AUXILIARY  
STEAM



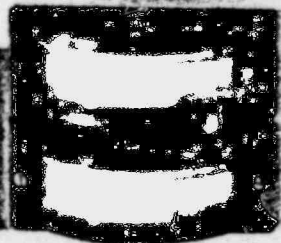
FEEDWATER



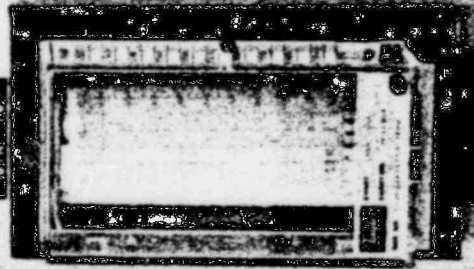
FEEDWATER  
FEEDWATER  
FEEDWATER  
FEEDWATER  
FEEDWATER



FEEDWATER  
FEEDWATER  
FEEDWATER  
FEEDWATER  
FEEDWATER



FEEDWATER  
FEEDWATER



FEEDWATER  
FEEDWATER

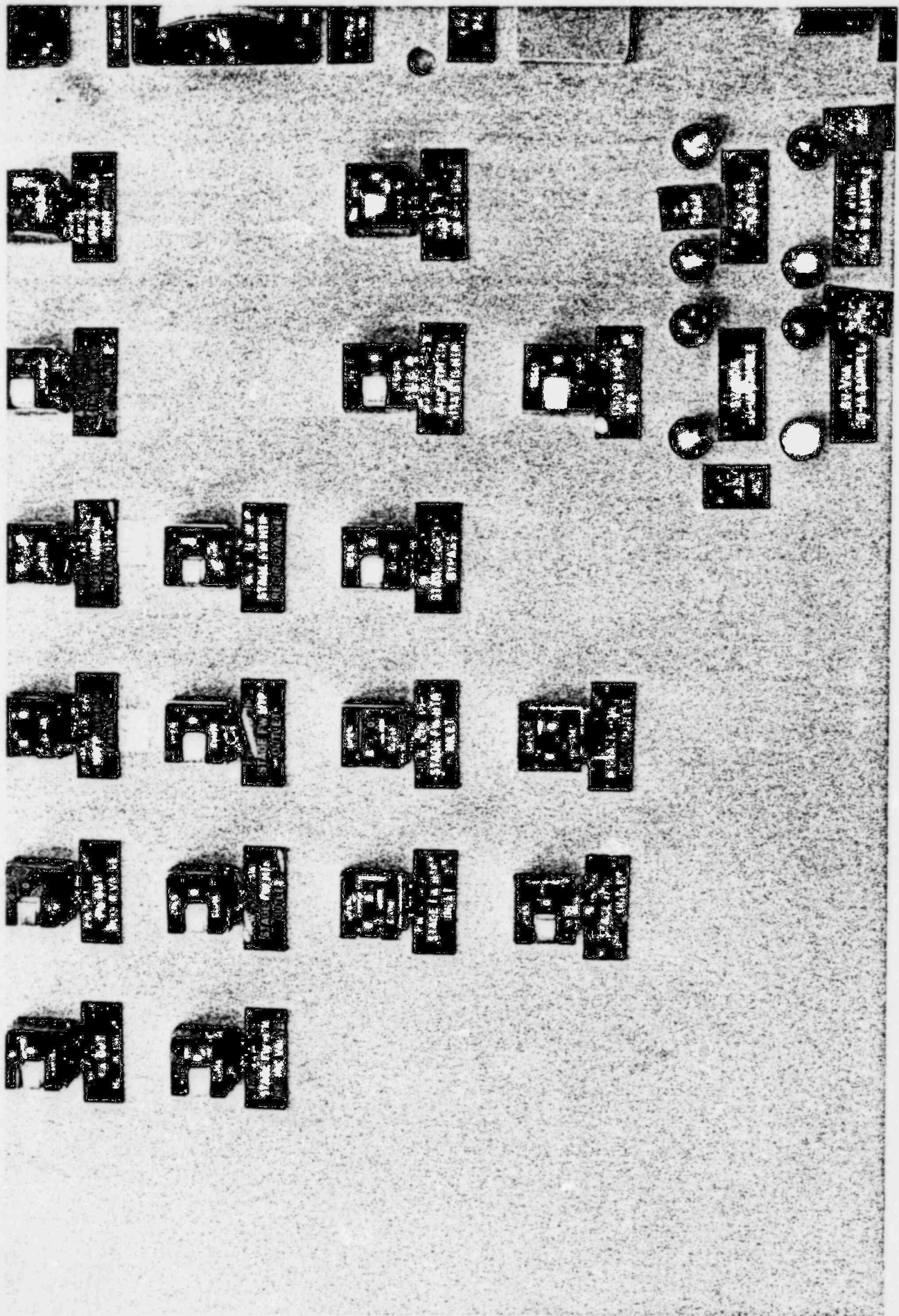


FEEDWATER  
FEEDWATER

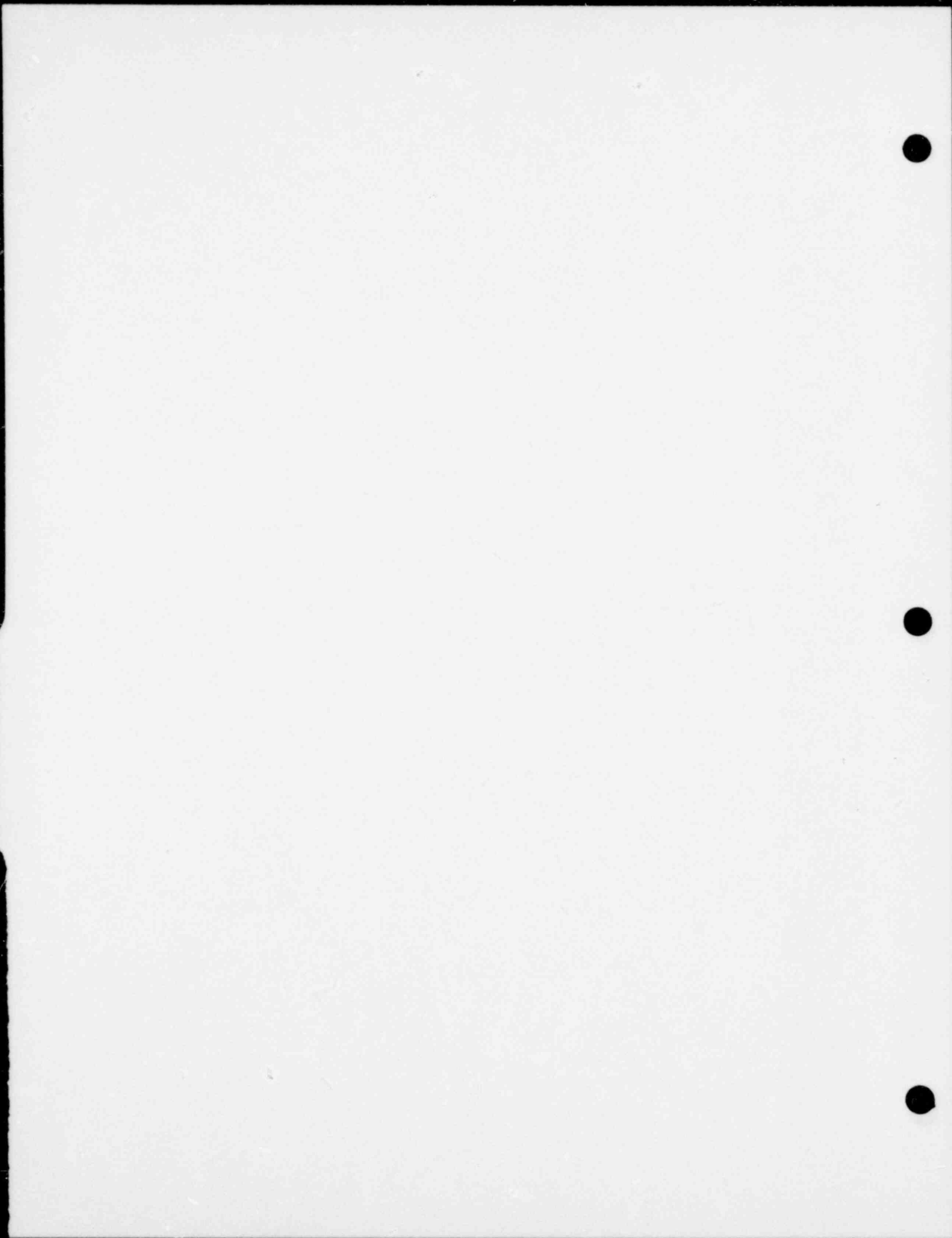


FEEDWATER  
FEEDWATER

FEEDWATER  
FEEDWATER



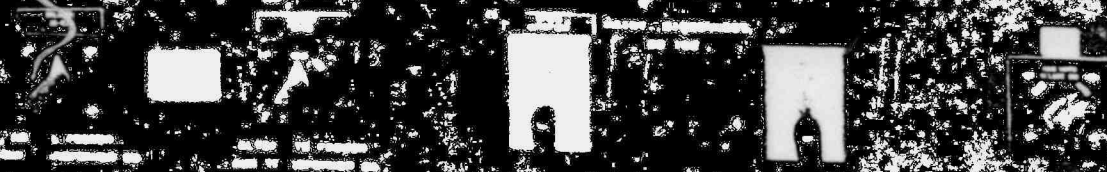




BB

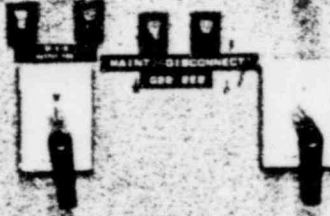
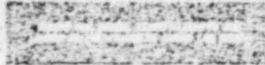
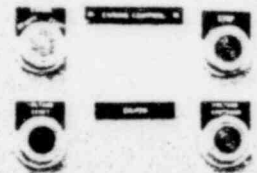
NO. 1	NO. 2	NO. 3	NO. 4	NO. 5	NO. 6	NO. 7	NO. 8
1000	1000	1000	1000	1000	1000	1000	1000
1000	1000	1000	1000	1000	1000	1000	1000
1000	1000	1000	1000	1000	1000	1000	1000
1000	1000	1000	1000	1000	1000	1000	1000
1000	1000	1000	1000	1000	1000	1000	1000
1000	1000	1000	1000	1000	1000	1000	1000
1000	1000	1000	1000	1000	1000	1000	1000
1000	1000	1000	1000	1000	1000	1000	1000
1000	1000	1000	1000	1000	1000	1000	1000

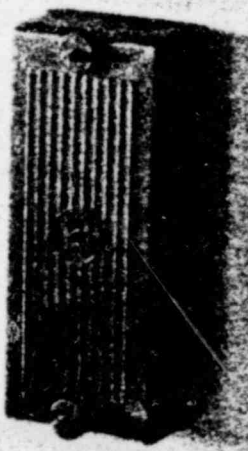
WARNING: ALL INSTRUMENTS ATTACHED ARE  
VULNERABLE TO ELECTRIC SHOCK





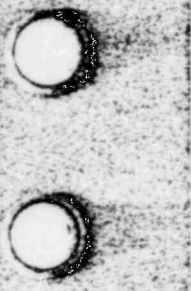
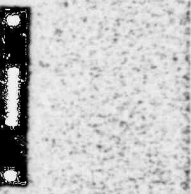
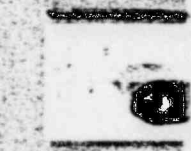
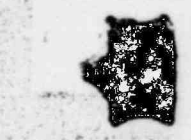
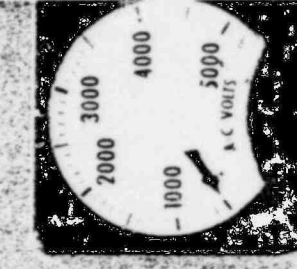
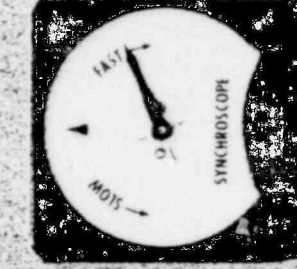
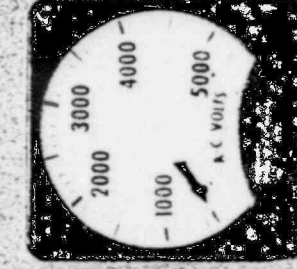
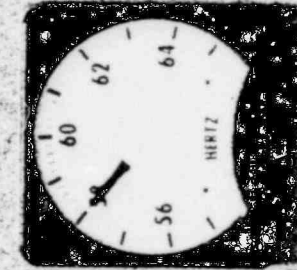
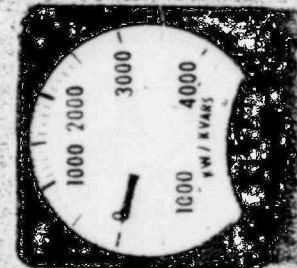
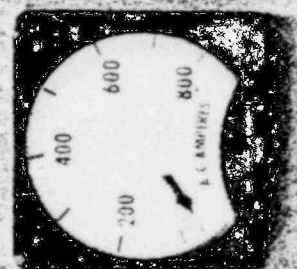
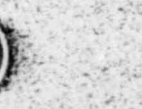
NO. 1 ALERT LIGHT TEMPERATURE	NO. 2 ALERT LIGHT TEMPERATURE	NO. 3 ALERT LIGHT TEMPERATURE	NO. 4 ALERT LIGHT TEMPERATURE	NO. 5 ALERT LIGHT TEMPERATURE	NO. 6 ALERT LIGHT TEMPERATURE	NO. 7 ALERT LIGHT TEMPERATURE	NO. 8 ALERT LIGHT TEMPERATURE
NO. 9 ALERT LIGHT TEMPERATURE	NO. 10 ALERT LIGHT TEMPERATURE	NO. 11 ALERT LIGHT TEMPERATURE	NO. 12 ALERT LIGHT TEMPERATURE	NO. 13 ALERT LIGHT TEMPERATURE	NO. 14 ALERT LIGHT TEMPERATURE	NO. 15 ALERT LIGHT TEMPERATURE	NO. 16 ALERT LIGHT TEMPERATURE

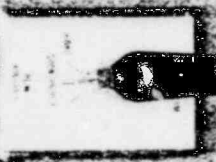
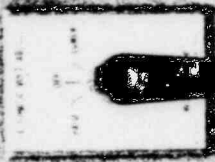
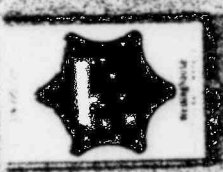
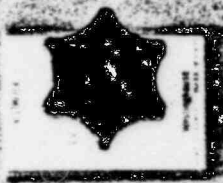
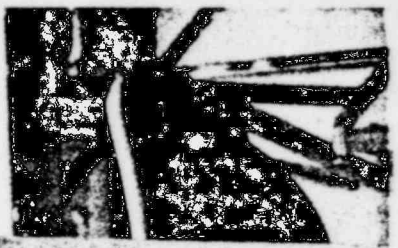
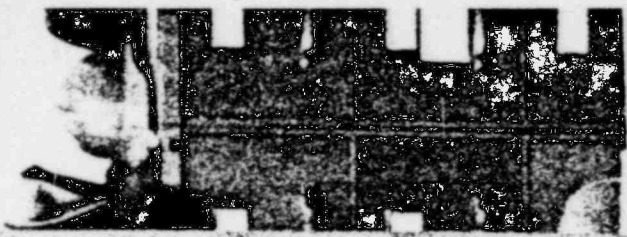




LOW JACKET WATER PRESSURE	LOW LUBE OIL PRESSURE	HIGH GEN. BEARING TEMPERATURE	OVERSPEED TRIPPED	HIGH/LOW FUEL OIL LEVEL DAY TANK	FAILURE TO START	LOW STARTING AIR PRESSURE	ARM SWITCH NOT IN AUTOMATIC POSITION
HIGH JACKET WATER TEMPERATURE	HIGH LUBE OIL TEMPERATURE	LOW FUEL OIL PRESSURE	DIESEL GENERATOR RUNNING	GENERATOR FIELD GROUND	LOW LUBE OIL TEMPERATURE	HIGH ENGINE EXHAUST TEMPERATURE	GENERATOR D.C. LOSS OF FIELD
OPERATION OF OUT OF STEP RELAY	GENERATOR OVERVOLTAGE (50%)	LOW LUBE OIL DAY TANK LEVEL	CRANK CASE PRESSURE	HIGH FUEL OIL STRAINER DIFF. PRESSURE	GENERATOR OVERCURRENT BY PASS	STARTING AIR MANUAL VALVE NOT FULLY OPEN	OPERATE ENGINE ALARM RE-SET
STATOR TEMPERATURE	LOW RIVER WATER SUPPLY PRESSURE	LOW JACKET WATER TANK LEVEL	HIGH FUEL OIL FILTER DIFF. PRESSURE	FUEL OIL TRANSFER PUMP OVERLOAD	GENERATOR NEGATIVE PHASE SEQUENCE	LOW JACKET WATER TEMPERATURE	GENERATOR TROUBLE

OPERATOR'S STATION	GENERATOR OVERLOAD	LOW JACKET WATER SUPPLY PRESSURE	LOW JACKET WATER TANK LEVEL	CRANK CASE PRESSURE	HIGH FUEL OIL PRESSURE	GENERATOR OUT OF PHASE	STARTING AIR MANUAL VALVE NOT FULLY OPEN	OPERATOR ENGINE ALARM RE-SET
HIGH STATOR TEMPERATURE	LOW RIVER WATER SUPPLY PRESSURE	LOW JACKET WATER TANK LEVEL	FUEL OIL FILTER DIFF. PRESSURE	FUEL OIL TRANSFER PUMP OVERLOAD	GENERATOR RE-GENERATIVE PHASE SEQUENCE	LOW JACKET WATER TEMPERATURE		

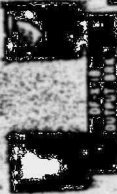




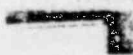
00-9-112



00-9-112



MAINT. DISCONNECT  
SEE SEE

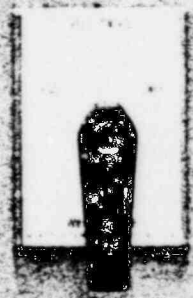
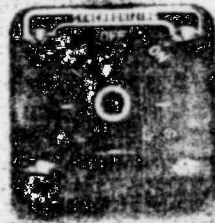


TEST FEEDER  
TRANSFORMER



BREAKER  
2A-222

BREAKER  
2B-222



BREAKER  
2A-222

BREAKER  
2B-222

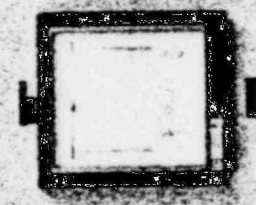
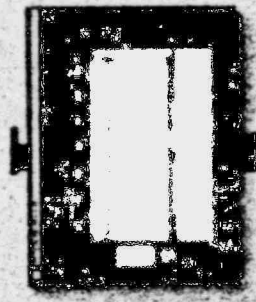
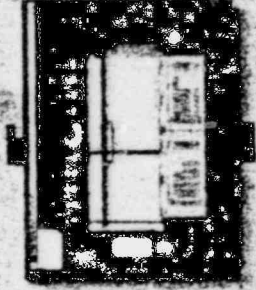
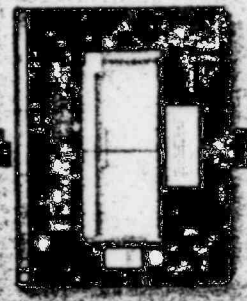
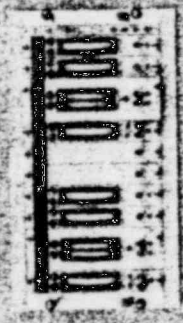
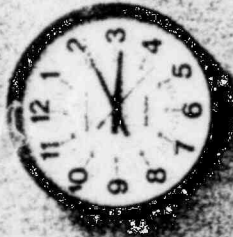
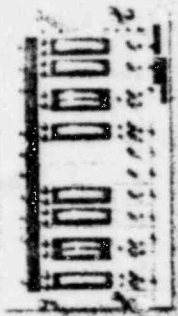


NORM. FEEDER  
AUX. TRANSFORMER 2A

ALTERN. FEEDER  
AUX. TRANSFORMER 2B

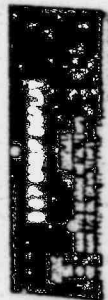






1	2	3	4	5	6	7	8	9	10	11	12	13	14	15	16	17	18	19	20	21	22	23	24	25	26	27	28	29	30	31	32	33	34	35	36	37	38	39	40	41	42	43	44	45	46	47	48	49	50	51	52	53	54	55	56	57	58	59	60	61	62	63	64	65	66	67	68	69	70	71	72	73	74	75	76	77	78	79	80	81	82	83	84	85	86	87	88	89	90	91	92	93	94	95	96	97	98	99	100
---	---	---	---	---	---	---	---	---	----	----	----	----	----	----	----	----	----	----	----	----	----	----	----	----	----	----	----	----	----	----	----	----	----	----	----	----	----	----	----	----	----	----	----	----	----	----	----	----	----	----	----	----	----	----	----	----	----	----	----	----	----	----	----	----	----	----	----	----	----	----	----	----	----	----	----	----	----	----	----	----	----	----	----	----	----	----	----	----	----	----	----	----	----	----	----	----	----	----	-----

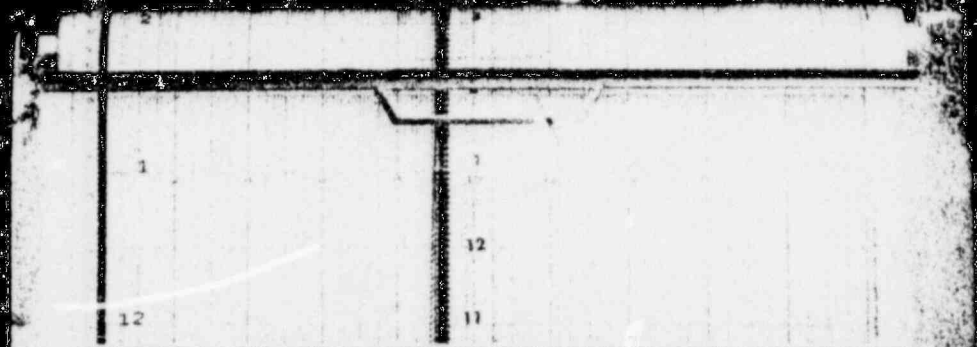
78 79 80 81 82 83 84 85 86 87 88 89 90 91 92 93 94 95 96 97 98 99 100



13 400340

# ESTERLINE ANGUS

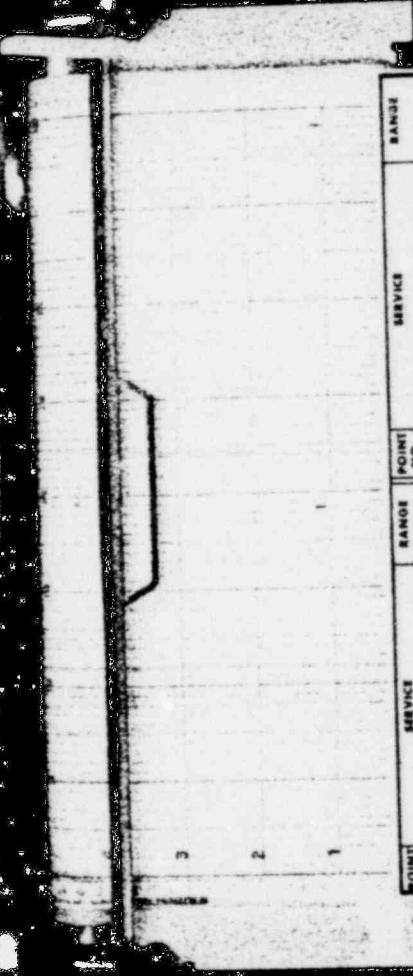
ALL These  
TEMP ARE  
IN °F



POINT NO.	SERVICE	RANGE	POINT NO.	SERVICE	RANGE
1	S-H SYSTEM FLUID	0-300F	13	GEN. WINDING H2 COOLERS 1 & 2	0-200C
2	SPARE		14	SPARE	
3	GEN. STATOR COIL PHASE A	0-200C	15	GEN. COLD GAS FROM H2 COOLER NO. 1	0-200C
4	GEN. STATOR COIL PHASE B	0-200C	16	GEN. COLD GAS FROM H2 COOLER NO. 2	0-200C
5	GEN. STATOR COIL PHASE C	0-200C	17	GEN. STATOR WINDING 104	0-200C
6	GEN. STATOR COIL GAS DISCH. PT. 1	0-200C	18	GEN. STATOR WINDING 105	0-200C
7	GEN. STATOR COIL GAS DISCH. PT. 2	0-200C	19	GEN. STATOR WINDING 106	0-200C
8	GEN. STATOR COIL GAS DISCH. PT. 3	0-200C	20	EXCITER AIR FROM COOLERS	0-200C
9	GEN. STATOR COIL GAS DISCH. PT. 4	0-200C	21	SPARE	
10	GEN. STATOR COIL GAS DISCH. PT. 5	0-200C	22	EXCITER AIR TO COOLER NO. 1	0-200C
11	GEN. STATOR COIL GAS DISCH. PT. 6	0-200C	23	EXCITER AIR TO COOLER NO. 2	0-200C
12	SPARE		24	SPARE	

TURBINE  
GENERATOR  
TEMPERATURES

10 0110



POINT NO.	SERVICE	RANGE	POINT NO.	SERVICE	RANGE
1	STEAM GEN. 1A OUTLET	0-800F	13	DH COOLANT FROM REACT. DH PUMP'S	0-400F
2	STEAM GEN. 1A OUTLET	0-800F	14	DH COOLANT FROM DH COOLER A	0-800F
3	STEAM GEN. 1B OUTLET	0-800F	15	DH COOLANT FROM DH COOLER B	0-800F
4	STEAM GEN. 1B OUTLET	0-800F	16	FRESHWATER TO STEAM GEN. 1A	0-800F
5	STEAM GEN. 1B OUTLET	0-800F	17	FRESHWATER TO STEAM GEN. 1A	0-800F
6	REACTOR COOLANT TO STEAM GEN. 1B	0-800F	18	SPALL	0-800F
7	REACTOR COOLANT TO STEAM GEN. 1A	0-800F	19	LETDOWN COOLER OUTLET A	0-800F
8	SPARS	0-800F	20	LETDOWN COOLER OUTLET B	0-800F
9	REACTOR COOLANT PUMP SUCTION EC-P-1B	0-800F	21	LETDOWN COOLERS INLET	0-800F
10	REACTOR COOLANT PUMP SUCTION EC-P-1A	0-800F	22	SPARS	0-800F
11	REACTOR COOLANT PUMP SUCTION EC-P-1A	0-800F	23	REACTOR COOLANT MAKEUP TANK	0-800F
12	DH COOLANT FROM REACTOR DH PUMP A	0-800F	24	MECHANICAL BRANT COOLING TOWER	0-800F

STEAM GEN. 1  
PRIMARY  
SYSTEM TEMPS



ESTERLINE ANGUS



0 100 200 300 400 500 600 700

Product and price information for Angus cattle

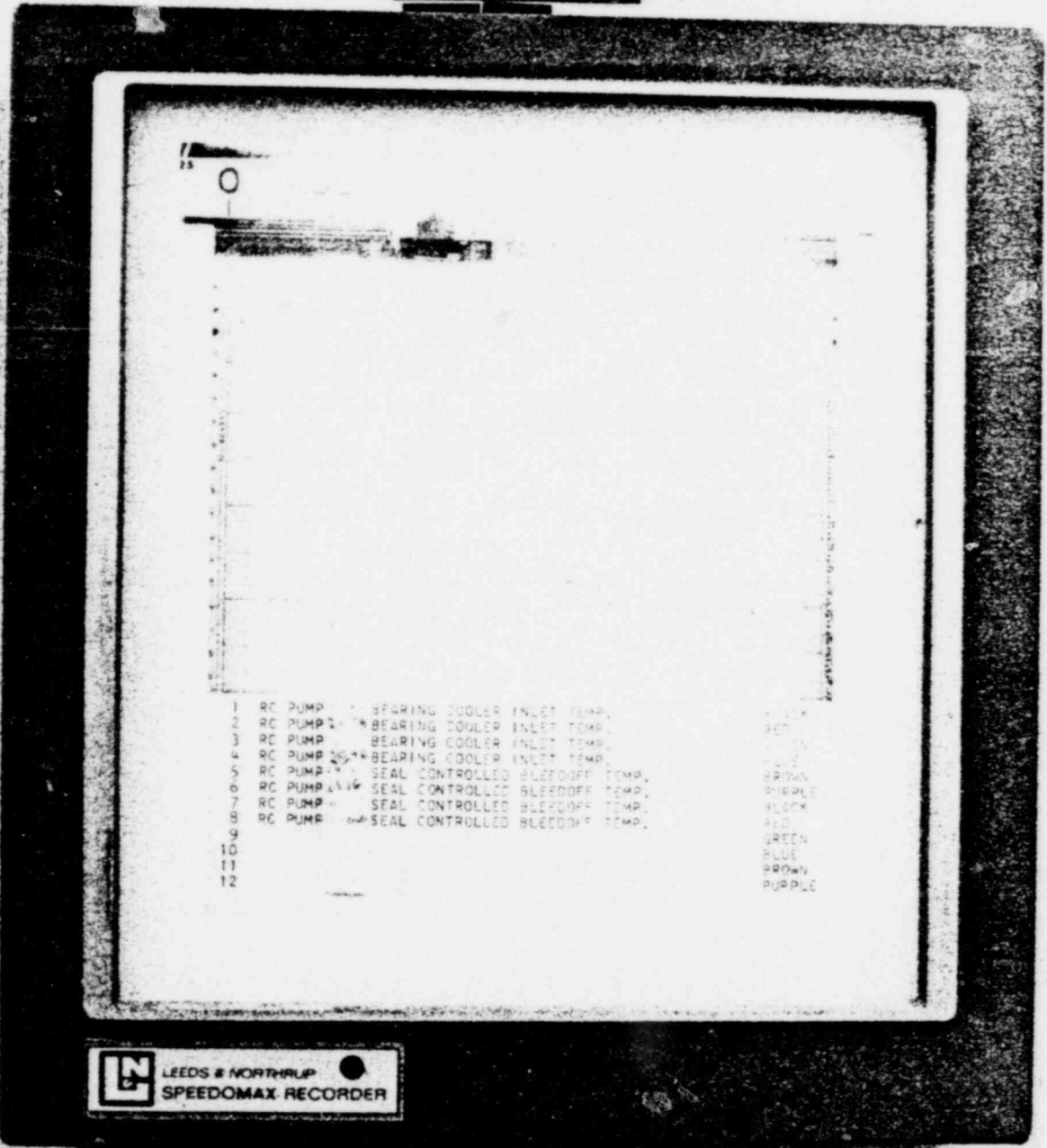
REG. NO.	DATE OF BIRTH	WEIGHT	PRICE	BUYER	SELLER
100	1/15/70	100	100	...	...
200	2/15/70	200	200	...	...
300	3/15/70	300	300	...	...
400	4/15/70	400	400	...	...
500	5/15/70	500	500	...	...
600	6/15/70	600	600	...	...
700	7/15/70	700	700	...	...

REF. ANGLUS ANGUS TEMP. SYSTEM

RADWIS POSIBLE ANGUS REGOY SYSTEM TEMP.

RADWIS POSIBLE ANGUS REGOY SYSTEM TEMP.

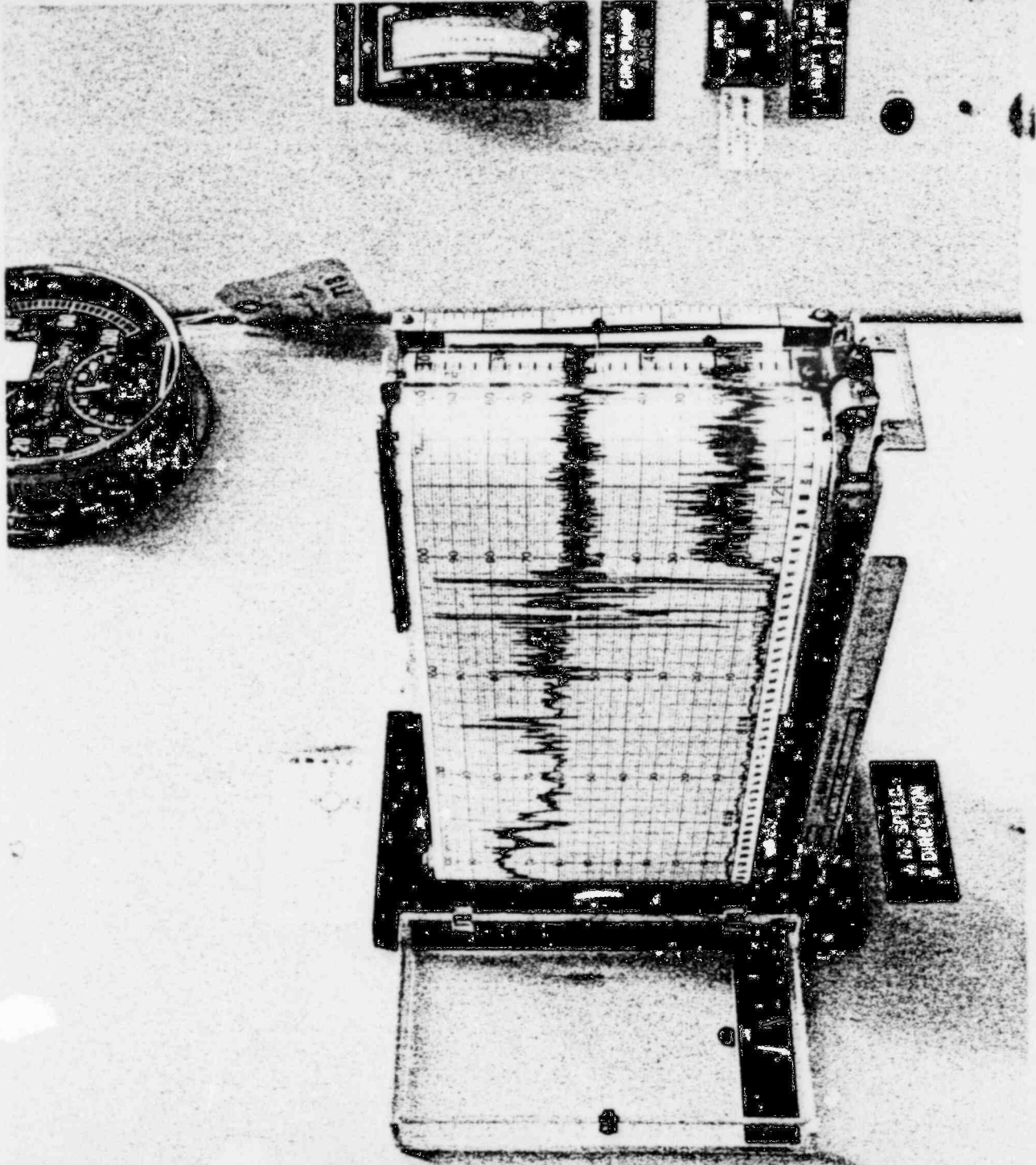
11 664525



LEEDS & NORTHRUP  
SPEEDOMAX RECORDER

REACTOR  
COOLANT PUMP  
TEMPERATURES

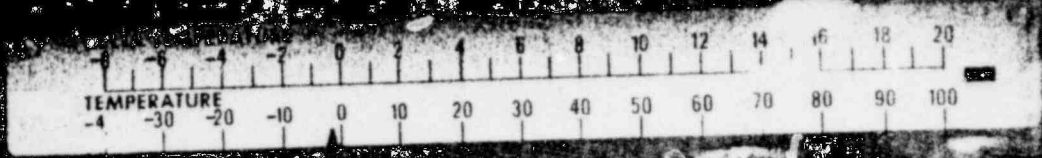






ESTERLINE ANGUS

B1A



ON  
POWER  
OFF

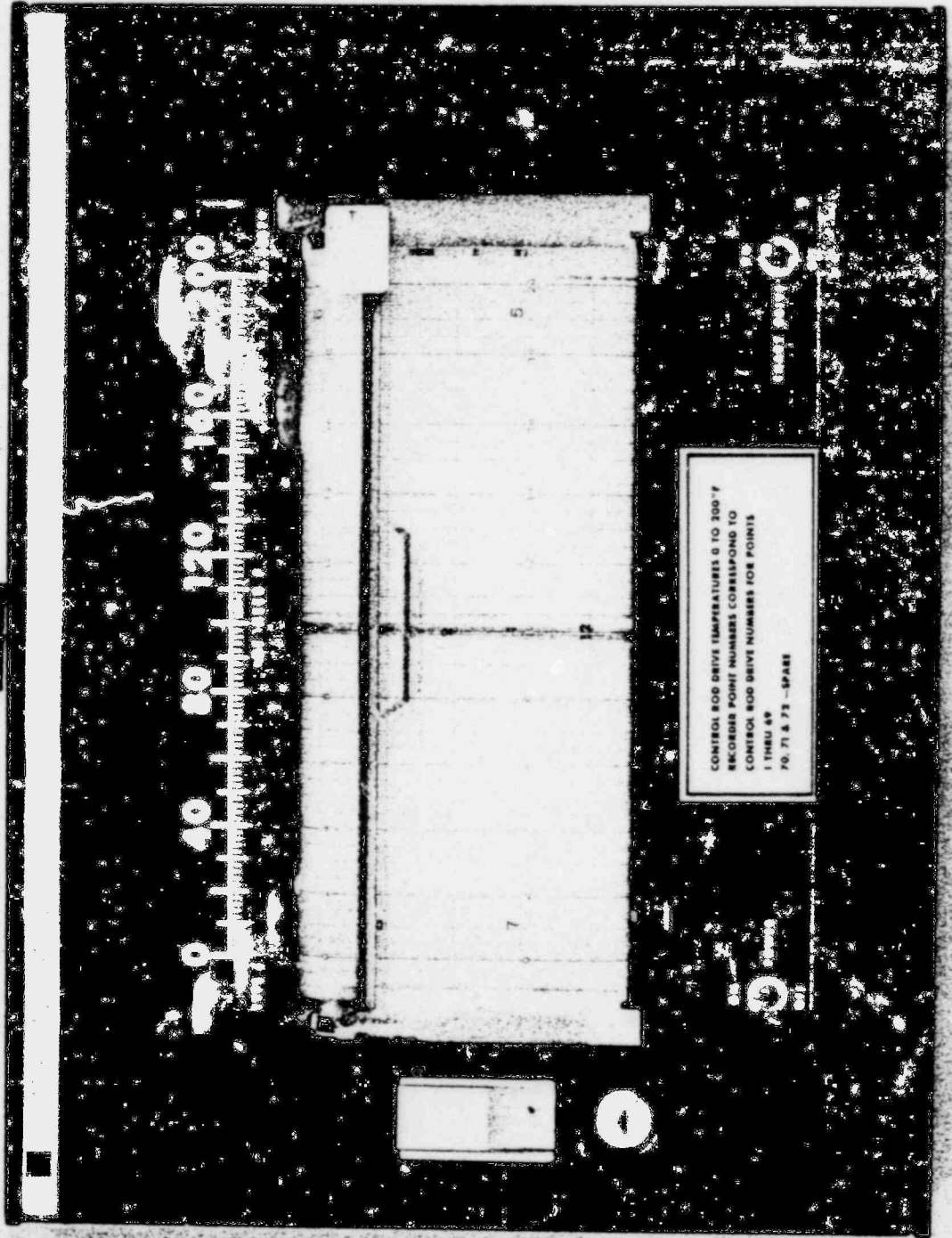
OFF

ON  
OFF

OUTSIDE AIR  
TEMPERATURE

Control Rod Drive Temperatures

3711



RC-W-797

SECTION  
CIRCUIT

IRID

RC P 2A  
MOTOR  
MILS PK-PK

RC P 2A  
MOTOR  
MILS PK-PK

RC P 2A  
MOTOR  
MILS PK-PK

RC P 2A  
MOTOR  
MILS PK-PK

RC P 2A  
MOTOR  
MILS PK-PK

RC P 2A  
MOTOR  
MILS PK-PK

RC P 2A  
MOTOR  
MILS PK-PK

RC P 2A  
MOTOR  
MILS PK-PK

RC P 2A  
MOTOR  
MILS PK-PK

RC P 2A  
MOTOR  
MILS PK-PK

RC P 2A  
MOTOR  
MILS PK-PK

RC P 2A  
MOTOR  
MILS PK-PK

RC P 2A  
MOTOR  
MILS PK-PK

RC P 2A  
MOTOR  
MILS PK-PK

RC P 2A  
MOTOR  
MILS PK-PK

RC P 2A  
MOTOR  
MILS PK-PK

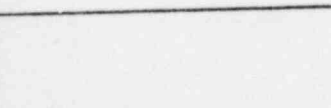
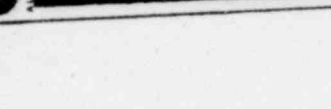
RC P 2A  
MOTOR  
MILS PK-PK

RC P 2A  
MOTOR  
MILS PK-PK

RC P 2A  
MOTOR  
MILS PK-PK

RC P 2A  
MOTOR  
MILS PK-PK

RC P 2A  
MOTOR  
MILS PK-PK



ALARM TRIP  
VIBRATION MILS PK-PK  
MILS PK-PK

ALARM TRIP  
VIBRATION MILS PK-PK  
MILS PK-PK

ALARM TRIP  
VIBRATION MILS PK-PK  
MILS PK-PK

ALARM TRIP  
VIBRATION MILS PK-PK  
MILS PK-PK

ALARM TRIP  
VIBRATION MILS PK-PK  
MILS PK-PK

ALARM TRIP  
VIBRATION MILS PK-PK  
MILS PK-PK

ALARM TRIP  
VIBRATION MILS PK-PK  
MILS PK-PK

ALARM TRIP  
VIBRATION MILS PK-PK  
MILS PK-PK

ALARM TRIP  
VIBRATION MILS PK-PK  
MILS PK-PK

ALARM TRIP  
VIBRATION MILS PK-PK  
MILS PK-PK

ALARM TRIP  
VIBRATION MILS PK-PK  
MILS PK-PK

ALARM TRIP  
VIBRATION MILS PK-PK  
MILS PK-PK

ALARM TRIP  
VIBRATION MILS PK-PK  
MILS PK-PK

ALARM TRIP  
VIBRATION MILS PK-PK  
MILS PK-PK

ALARM TRIP  
VIBRATION MILS PK-PK  
MILS PK-PK

IRID 8801

IRID 8801

IRID 8804

IRID 8803

IRID 8802

IRID 8801

IRID 8801

IRID 8802

IRID 8803

IRID 8801

IRID 8801

IRID 8801

IRID 8801

IRID 8801

IRID 8801

IRID 8801

IRID 8801

IRID 8801

IRID 8801

IRID 8801

IRID 8801

IRID 8801

POWER

POWER

POWER

POWER

POWER

POWER

POWER

POWER

POWER

POWER

POWER

POWER

POWER

POWER

POWER

POWER

POWER

POWER

POWER

POWER

POWER

POWER

IRID  
METER  
STAGE

RL-U-1701

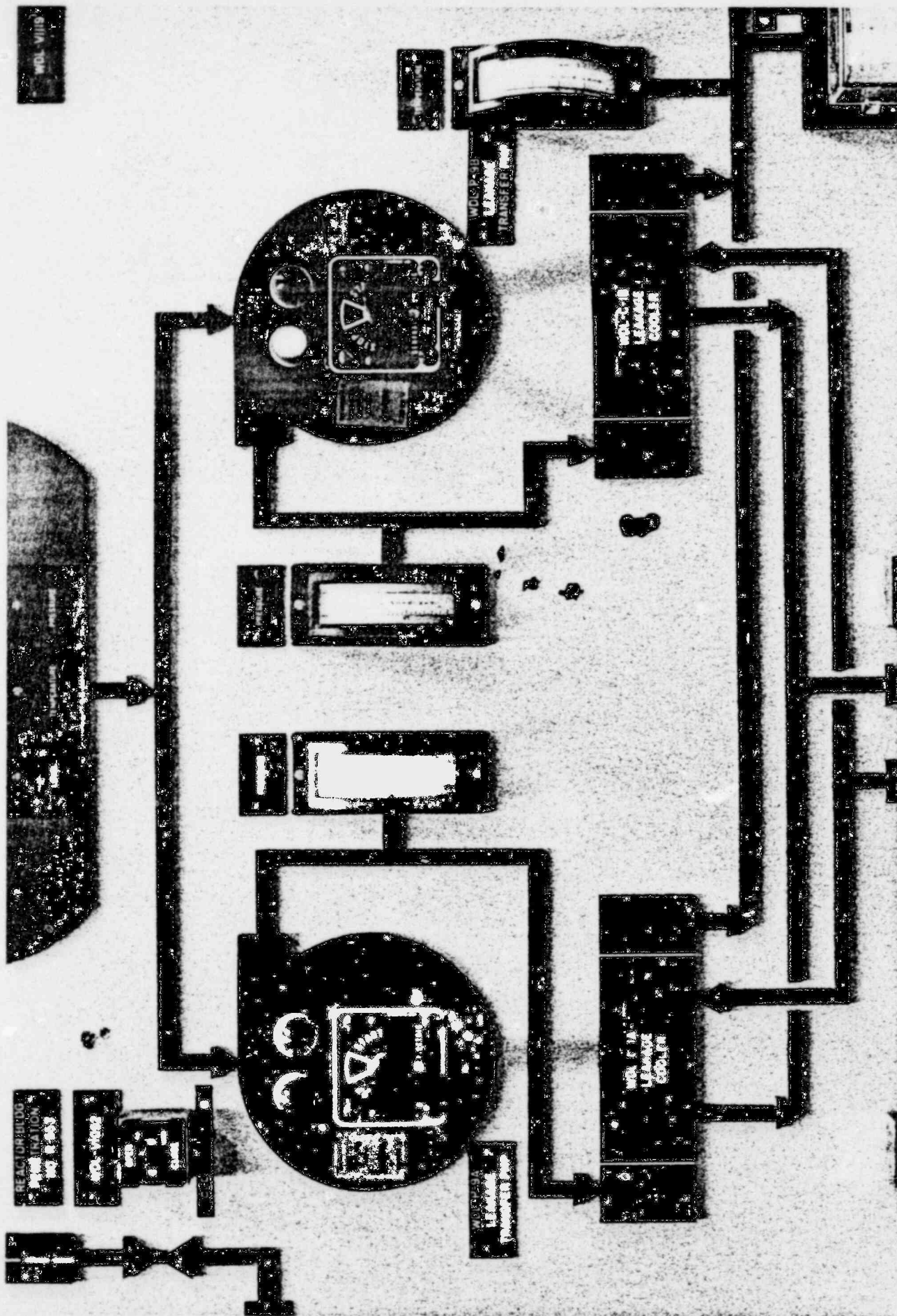
FIG. 1  
SCALE  
5 INCH

FIG. 2  
SCALE  
5 INCH

IRID 8802	IRID 8801	IRID 8803	IRID 8804	IRID 8805	IRID 8806	IRID 8807	IRID 8808
VIBRATION MILLS PA-PA ALARM TRIP VIBRATION MILLS PA-PA ALARM TRIP THRUST POSITION MILLS PA-PA ALARM TRIP VIBRATION MILLS PA-PA ALARM TRIP VIBRATION MILLS PA-PA ALARM TRIP VIBRATION MILLS PA-PA ALARM TRIP THRUST POSITION MILLS PA-PA ALARM TRIP VIBRATION MILLS PA-PA ALARM TRIP VIBRATION MILLS PA-PA ALARM TRIP VIBRATION MILLS PA-PA ALARM TRIP VIBRATION MILLS PA-PA ALARM TRIP	READ SET POINT SERIAL OUTPUT SERIAL OUTPUT SERIAL OUTPUT SERIAL OUTPUT SERIAL OUTPUT SERIAL OUTPUT SERIAL OUTPUT	READ SET POINT SERIAL OUTPUT SERIAL OUTPUT SERIAL OUTPUT SERIAL OUTPUT SERIAL OUTPUT SERIAL OUTPUT SERIAL OUTPUT	READ SET POINT SERIAL OUTPUT SERIAL OUTPUT SERIAL OUTPUT SERIAL OUTPUT SERIAL OUTPUT SERIAL OUTPUT SERIAL OUTPUT	READ SET POINT SERIAL OUTPUT SERIAL OUTPUT SERIAL OUTPUT SERIAL OUTPUT SERIAL OUTPUT SERIAL OUTPUT SERIAL OUTPUT	READ SET POINT SERIAL OUTPUT SERIAL OUTPUT SERIAL OUTPUT SERIAL OUTPUT SERIAL OUTPUT SERIAL OUTPUT SERIAL OUTPUT	READ SET POINT SERIAL OUTPUT SERIAL OUTPUT SERIAL OUTPUT SERIAL OUTPUT SERIAL OUTPUT SERIAL OUTPUT SERIAL OUTPUT	READ SET POINT SERIAL OUTPUT SERIAL OUTPUT SERIAL OUTPUT SERIAL OUTPUT SERIAL OUTPUT SERIAL OUTPUT SERIAL OUTPUT

IRID 8802  
IRID 8801  
IRID 8803  
IRID 8804  
IRID 8805  
IRID 8806  
IRID 8807  
IRID 8808

PANEL SA. 9



WOL 11/15

REACTOR 1: 1000 LITER REACTOR

CO<sub>2</sub> - WATER

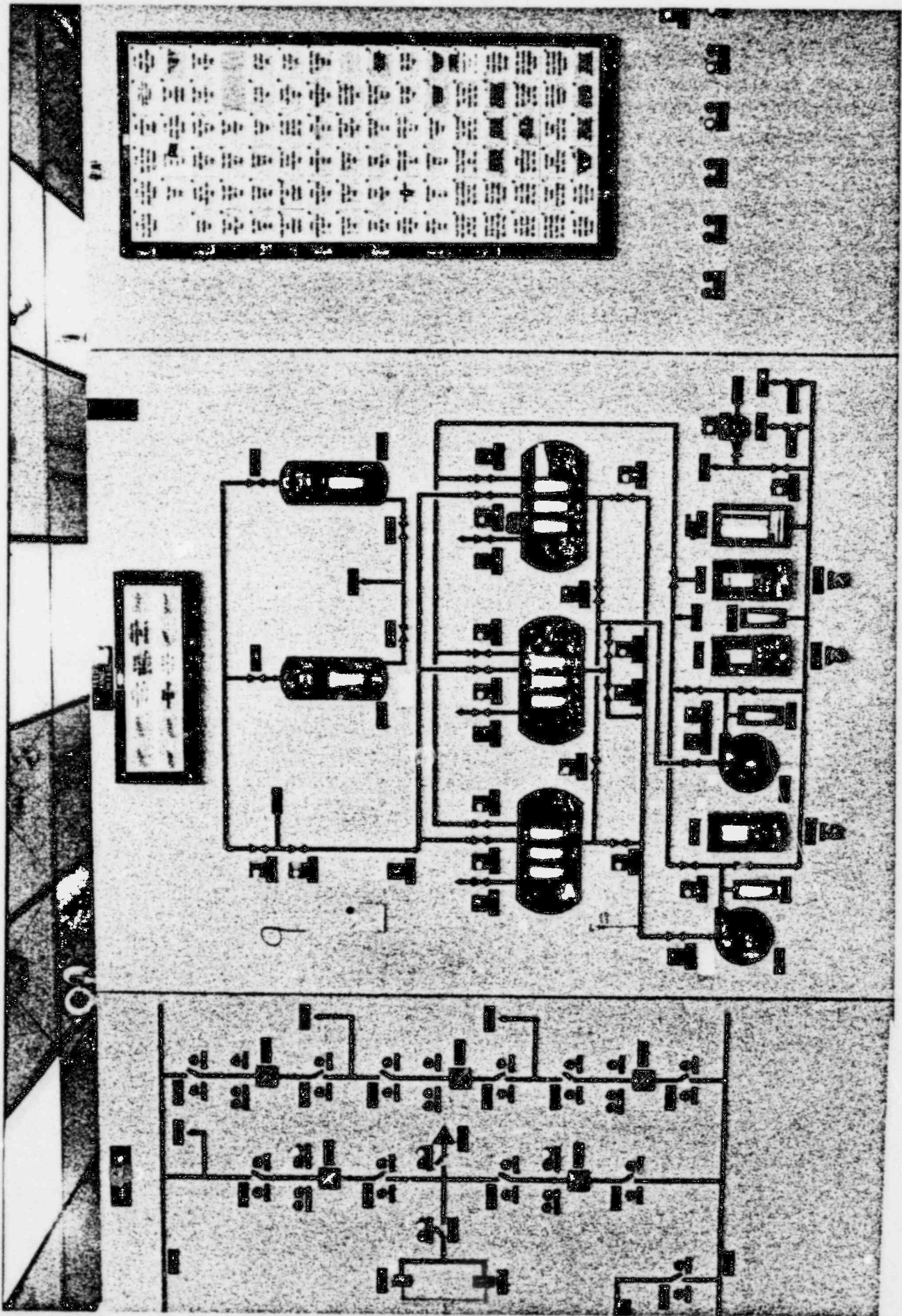
HEAT EXCHANGER

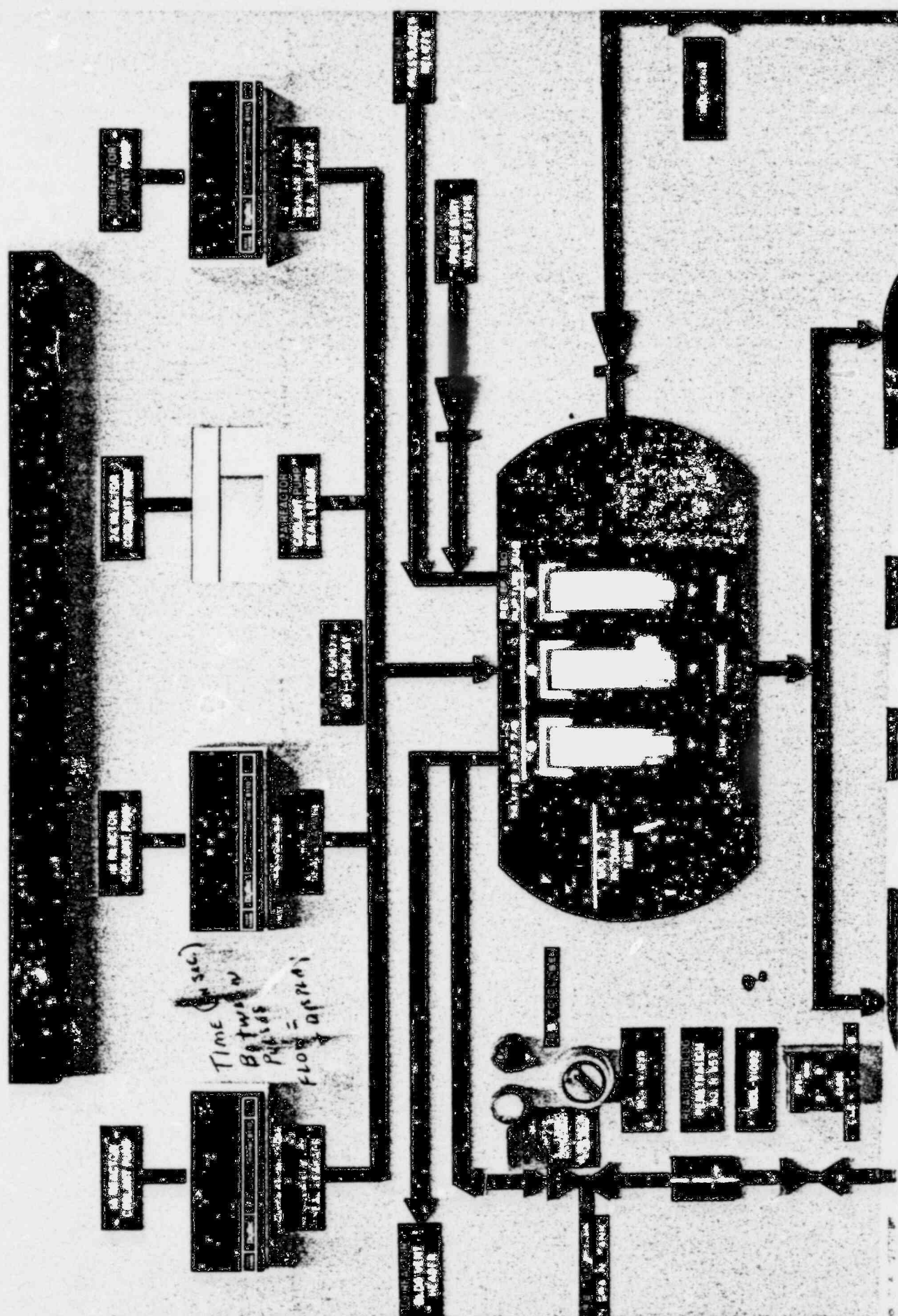
HEAT EXCHANGER

CO<sub>2</sub> - WATER TRANSFER COLUMN

CO<sub>2</sub> - WATER DISTILLATION COLUMN

CO<sub>2</sub> - WATER DISTILLATION COLUMN





TIME (sec)  
 Between  
 Pumps = 1200s  
 FLOW 0.12141

SOLVENT PUMP

CONTROL PANEL

MOTOR

REACTOR

HEATER

SOLVENT PUMP

CONTROL PANEL

MOTOR

REACTOR

SOLVENT PUMP

CONTROL PANEL

REACTOR

HEATER

SOLVENT PUMP

CONTROL PANEL

CONDENSER

RECYCLE

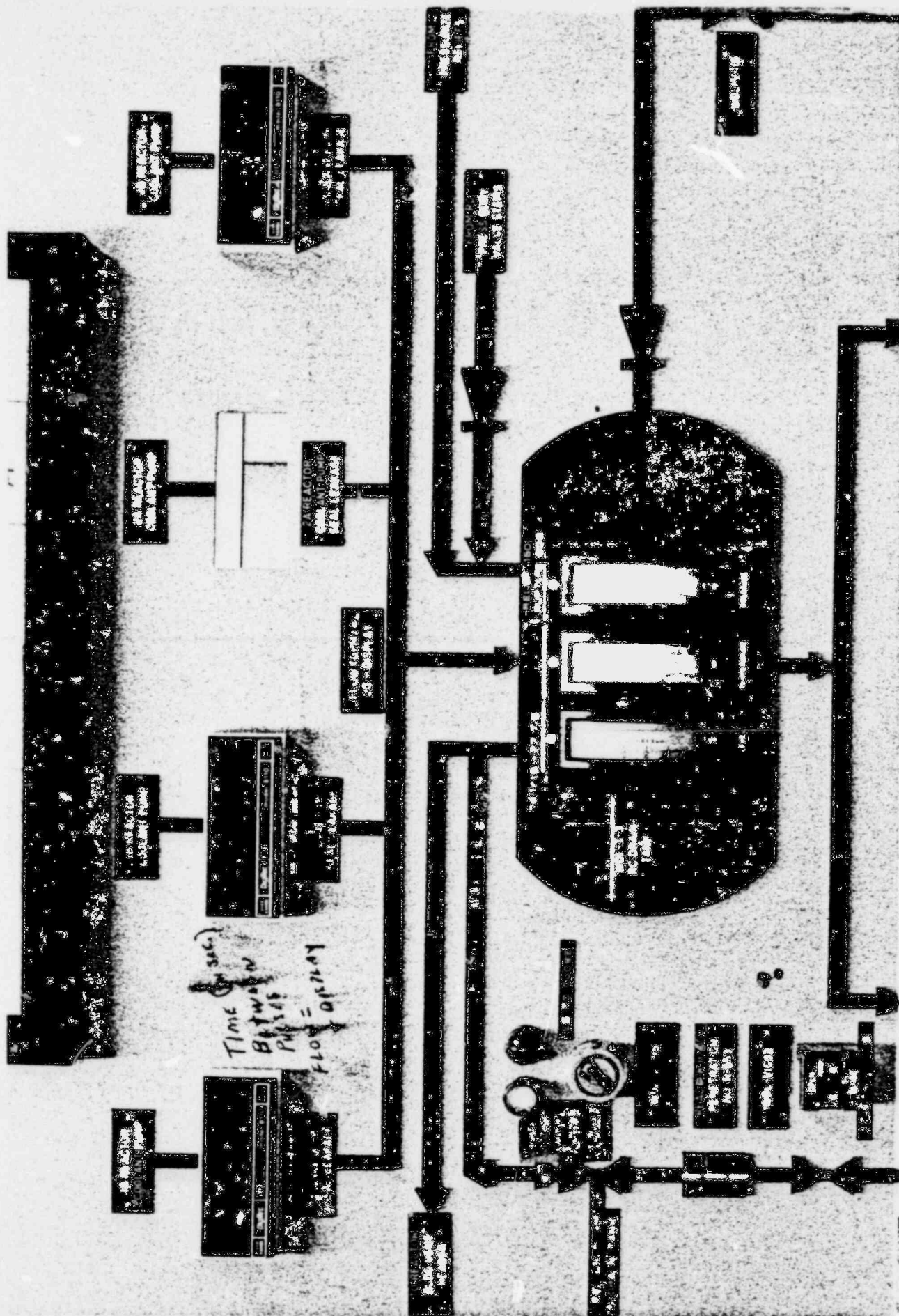
COOLANT PUMP

CONTROL PANEL

MOTOR

REACTOR





CONTROL PANEL  
 DISPLAY  
 CONTROL PANEL

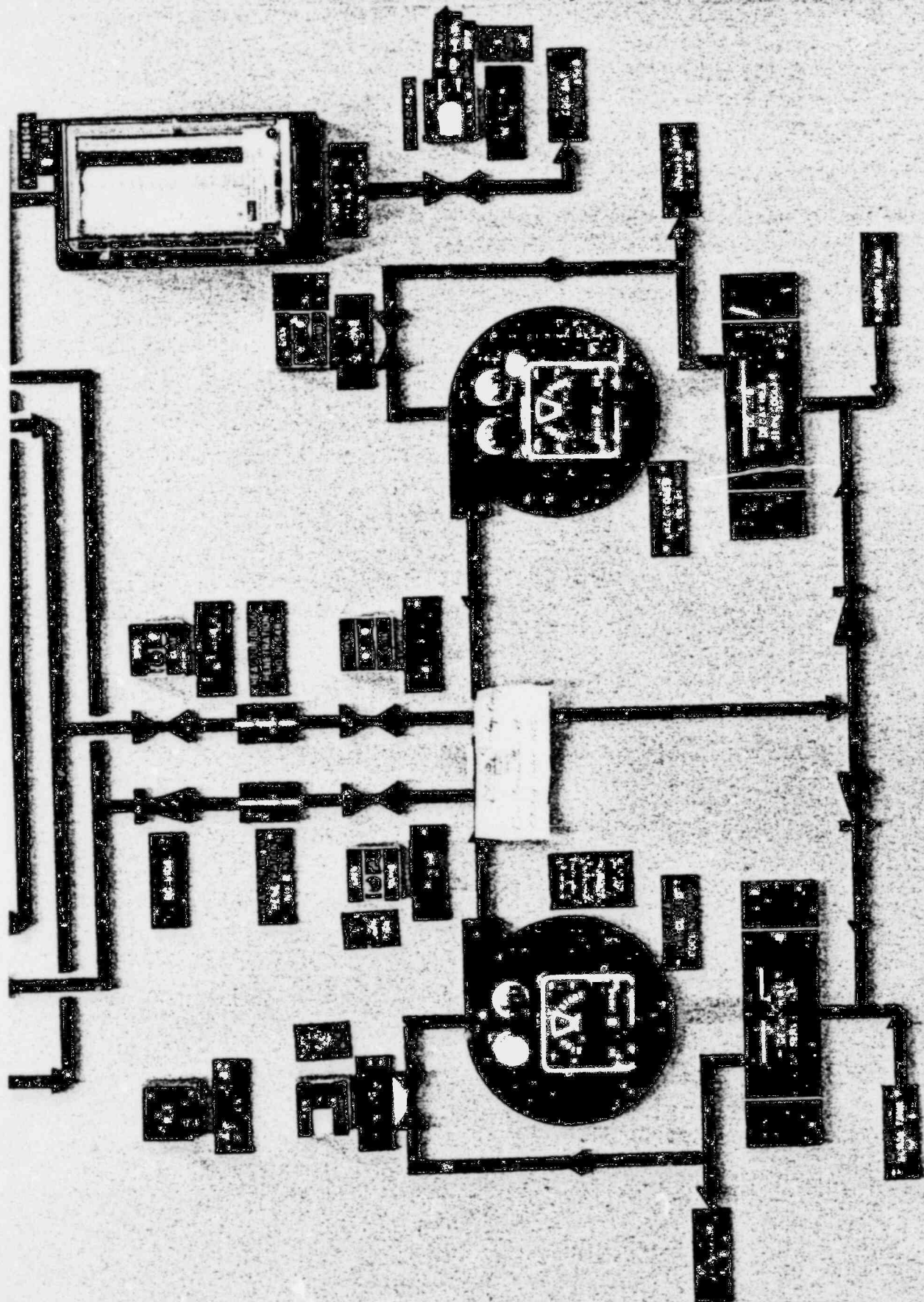
CONTROL PANEL  
 DISPLAY  
 CONTROL PANEL

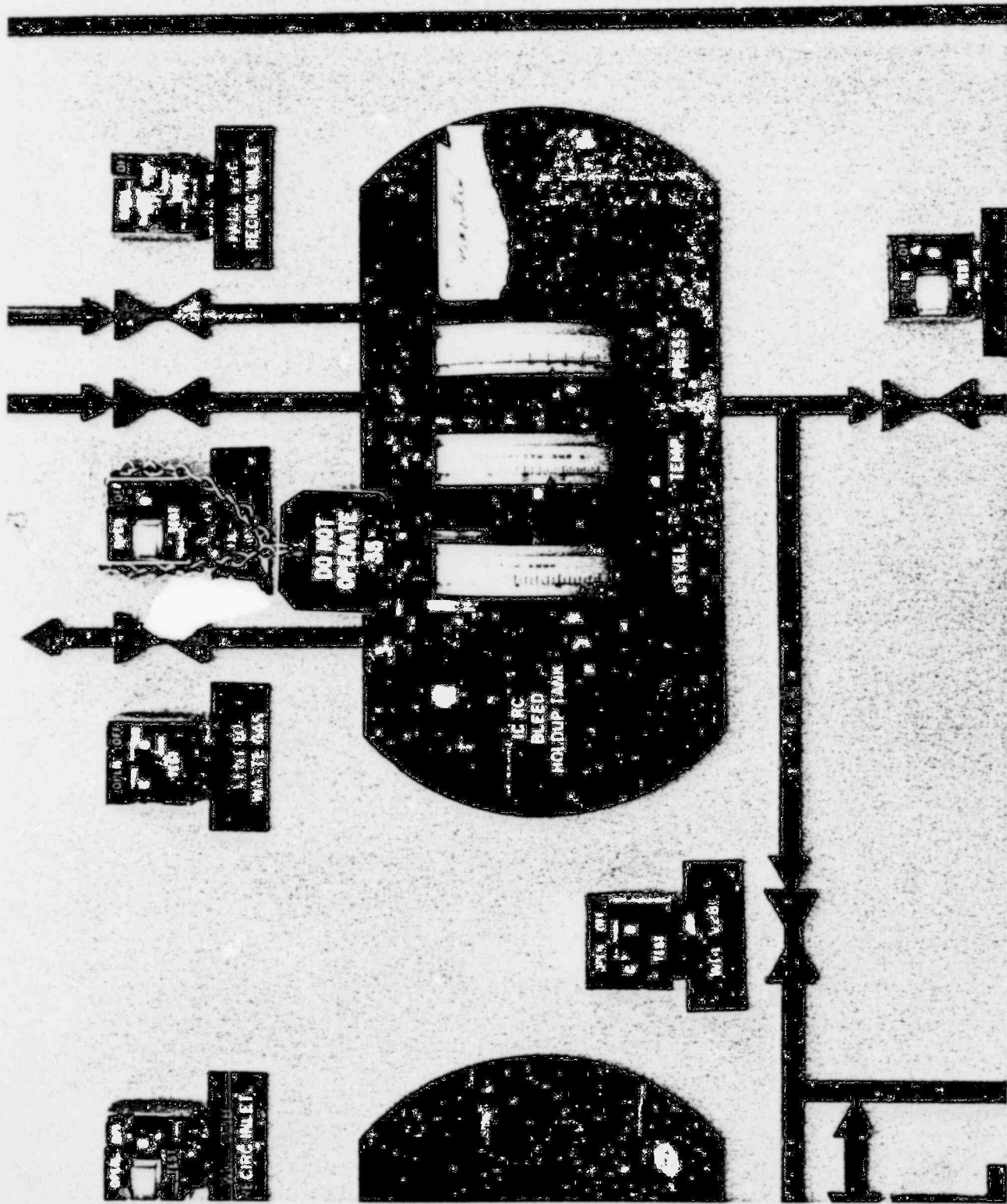
CONTROL PANEL  
 DISPLAY  
 CONTROL PANEL

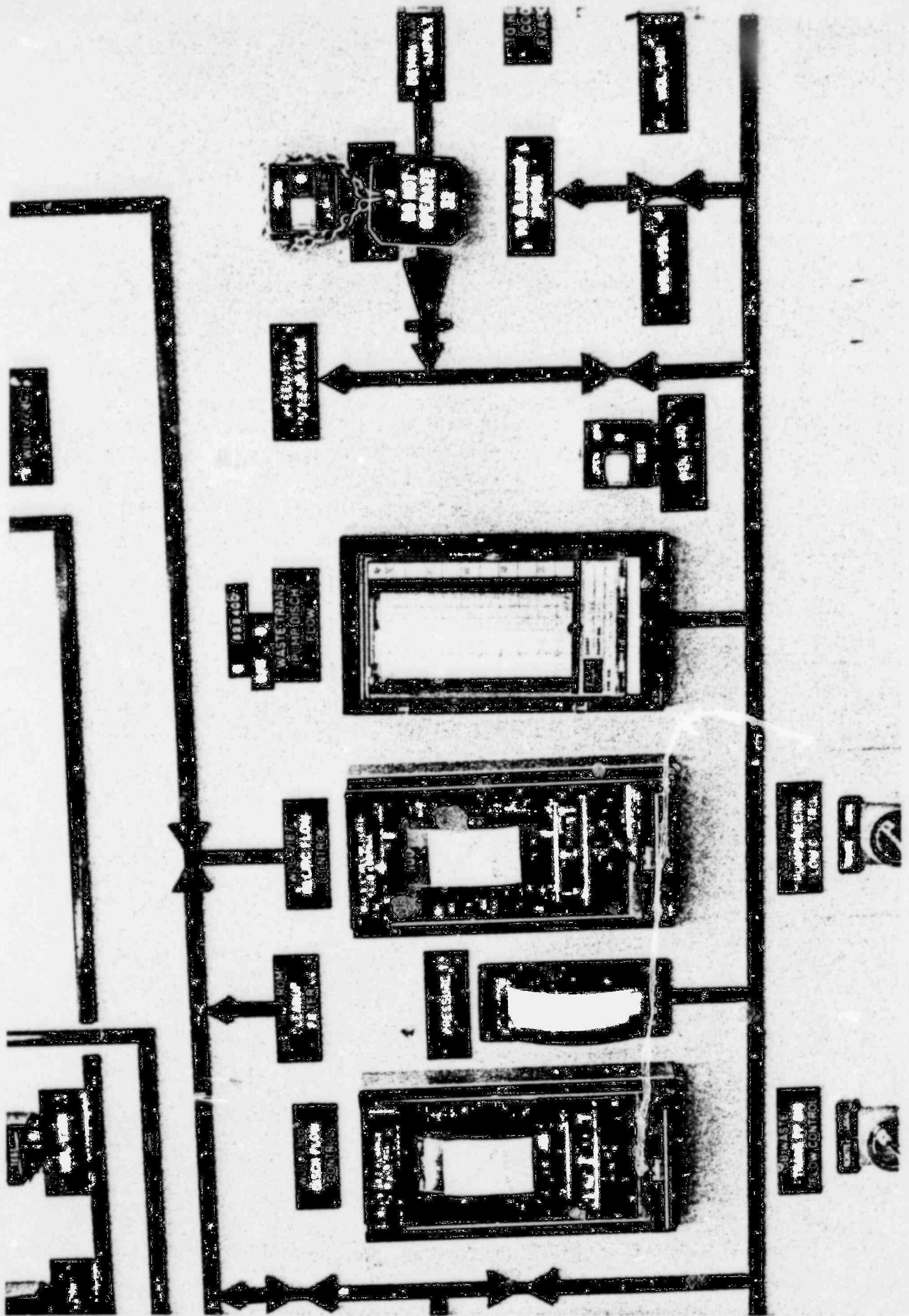
CONTROL PANEL  
 DISPLAY  
 CONTROL PANEL

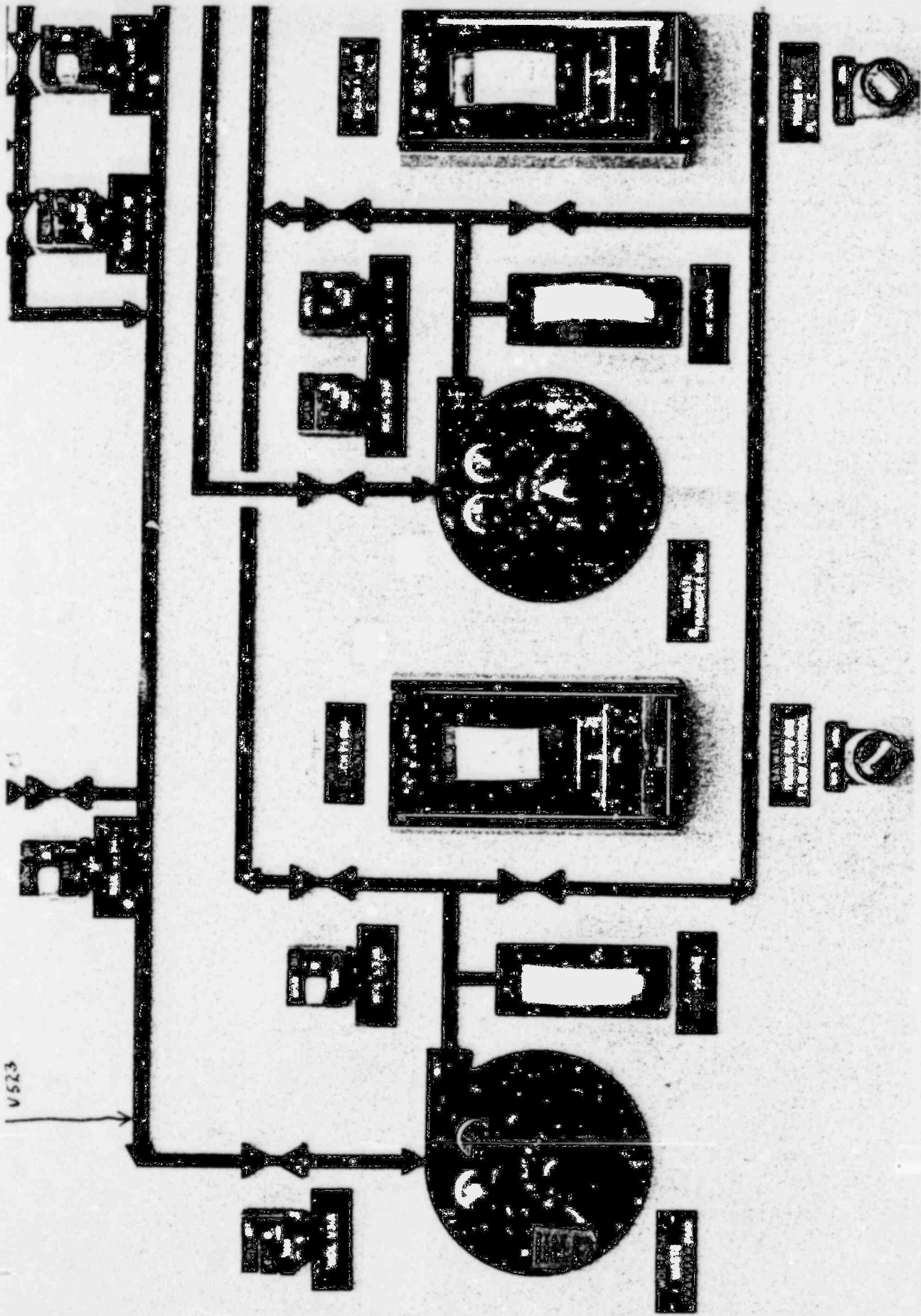
CONTROL PANEL  
 DISPLAY  
 CONTROL PANEL

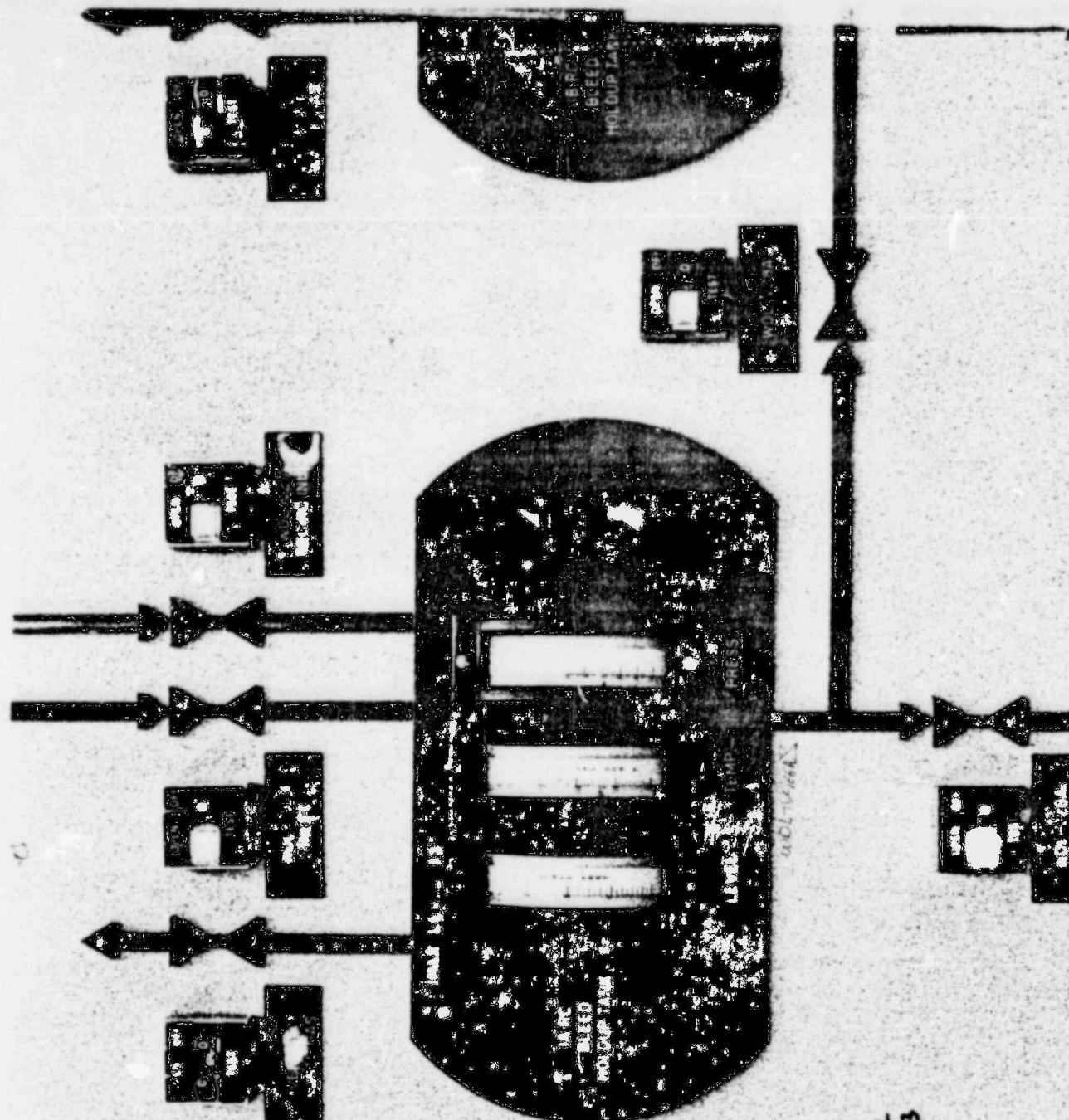
CONTROL PANEL  
 DISPLAY  
 CONTROL PANEL









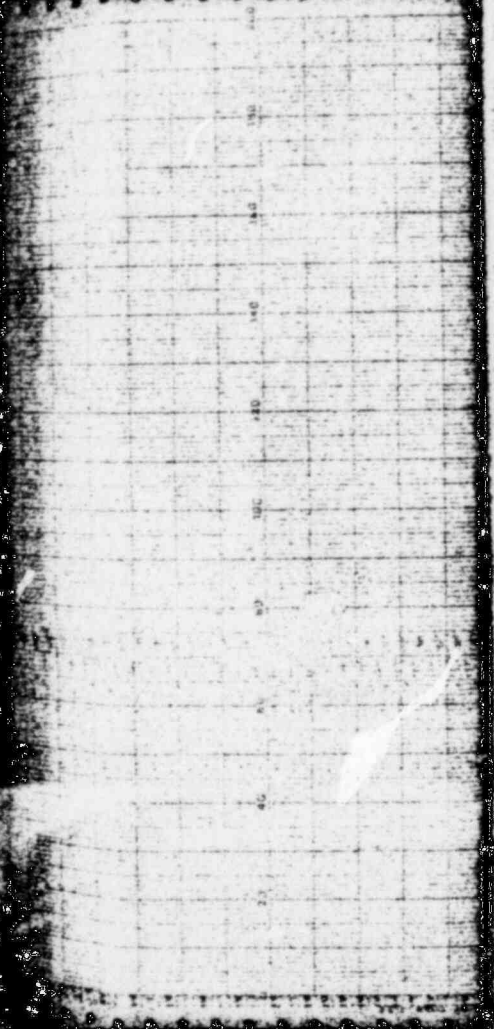


DN  
V523  
wDL



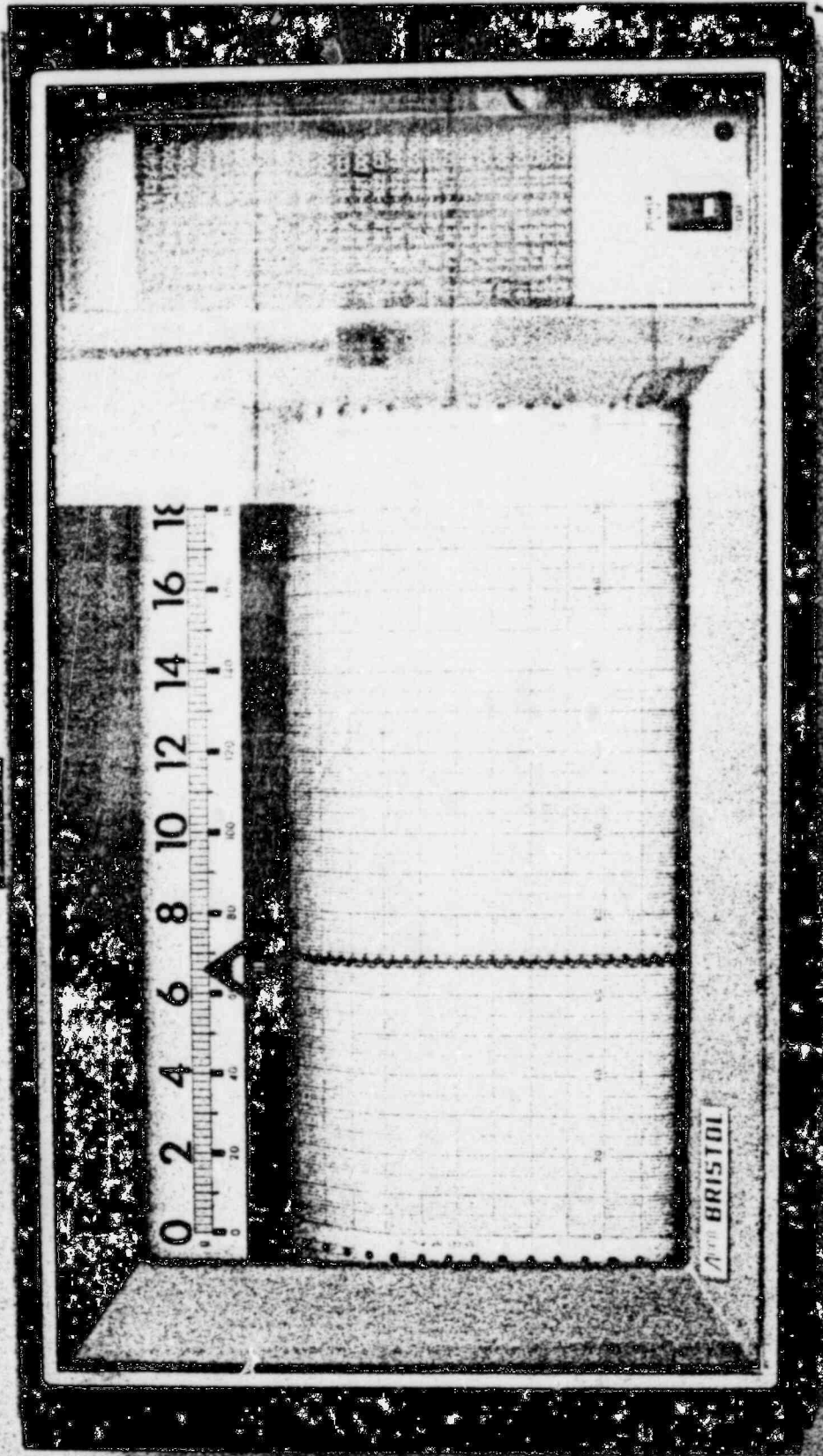
THE NATIONAL ARCHIVE  
1100 COLLEGE AVENUE  
COLLEGE PARK, MARYLAND 20740  
SERIALS ACQUISITION  
500 UNIVERSITY DRIVE  
ANN ARBOR, MICHIGAN 48106  
SERIALS ACQUISITION  
UNIVERSITY MICROFILMS  
SERIALS ACQUISITION  
300 N. ZEEB ROAD  
ANN ARBOR, MICHIGAN 48106  
SERIALS ACQUISITION  
UNIVERSITY MICROFILMS  
SERIALS ACQUISITION  
300 N. ZEEB ROAD  
ANN ARBOR, MICHIGAN 48106

0 2 4 6 8 10 12 14 16 18 20  
50 100 150 200 250

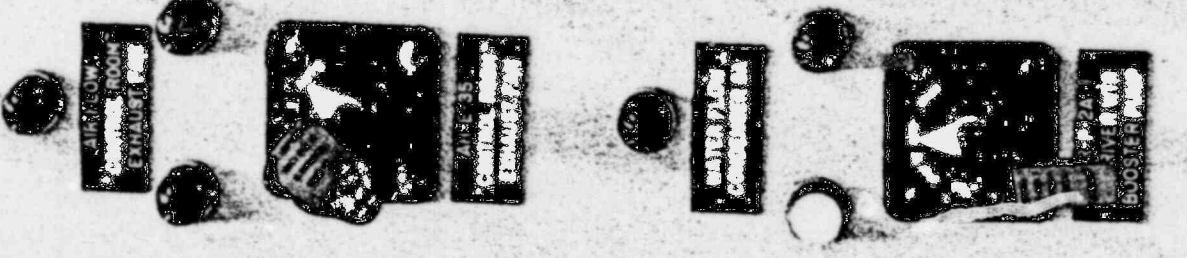
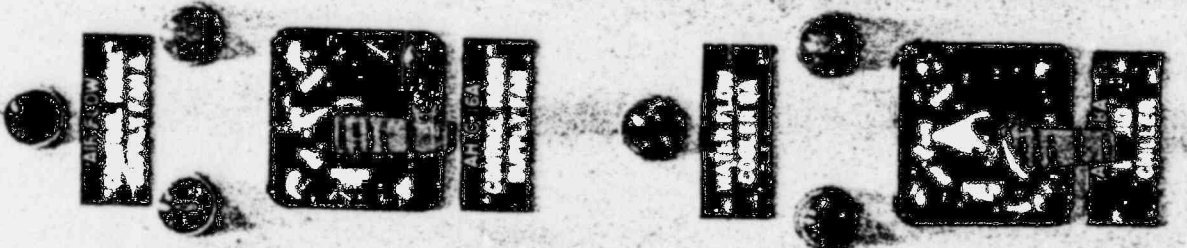
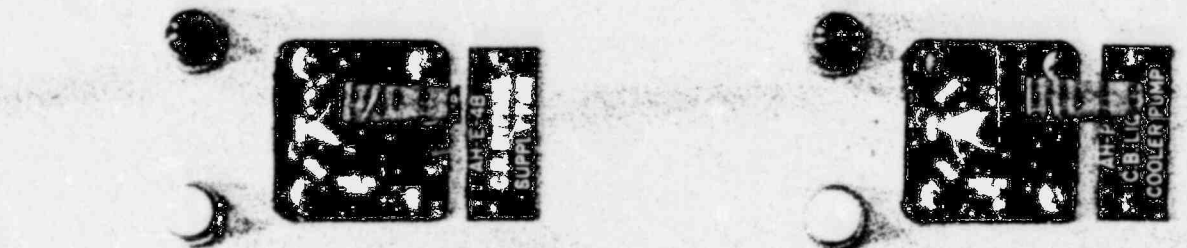
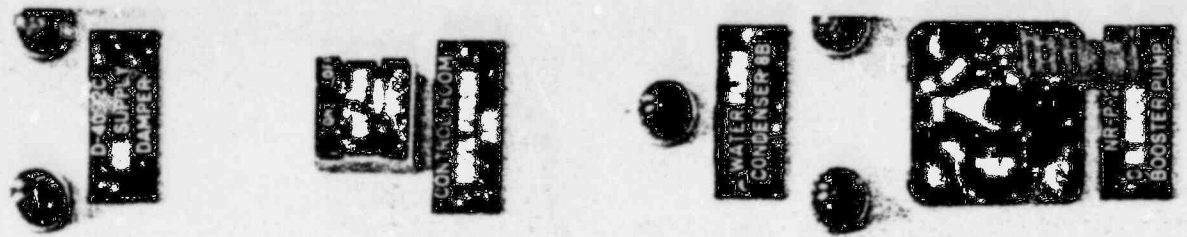


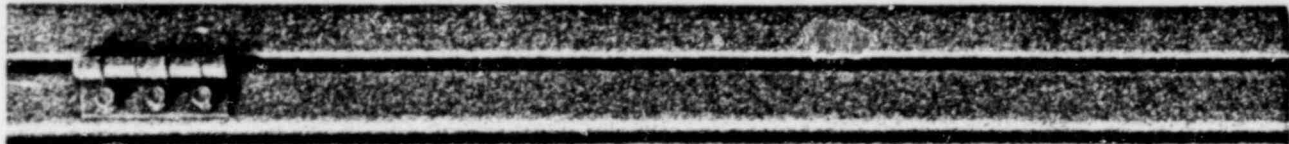


BRISTOL  
BIN



BRISTOL  
THERMOGRAPH  
TEMPERATURE





ACROSS THE SYSTEMS ANNOUNCER

D-5857 EAST DO ROOM MOTION DAMPER	D-5858 EAST DO ROOM MOTION DAMPER	AIR FAN SUPPLY FAN AIR E-248	D-5859 EAST DO ROOM MOTION DAMPER	D-5860 EAST DO ROOM MOTION DAMPER	AIR FAN SUPPLY FAN AIR E-249	AIR FAN SUPPLY FAN AIR E-248
D-5861 EAST DO ROOM MOTION DAMPER	D-5862 EAST DO ROOM MOTION DAMPER	AIR FAN SUPPLY FAN AIR E-249	D-5863 EAST DO ROOM MOTION DAMPER	D-5864 EAST DO ROOM MOTION DAMPER	AIR FAN SUPPLY FAN AIR E-249	AIR FAN SUPPLY FAN AIR E-249
D-5865 EAST DO ROOM MOTION DAMPER	D-5866 EAST DO ROOM MOTION DAMPER	AIR FAN SUPPLY FAN AIR E-249	D-5867 EAST DO ROOM MOTION DAMPER	D-5868 EAST DO ROOM MOTION DAMPER	AIR FAN SUPPLY FAN AIR E-249	AIR FAN SUPPLY FAN AIR E-249

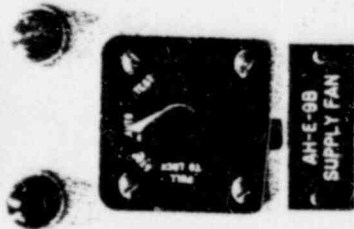


FAN - CLOSERS  
EIM FILTER  
DAMPERS

AIR FLOW  
AH-E-9A  
SUPPLY FAN



AIR FLOW  
AH-E-9B  
SUPPLY FAN

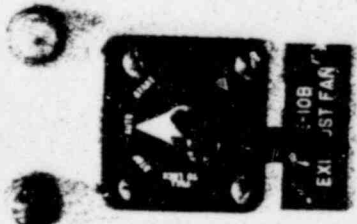


OPEN - CLOSED  
FRESH AIR  
DAMPER D6714

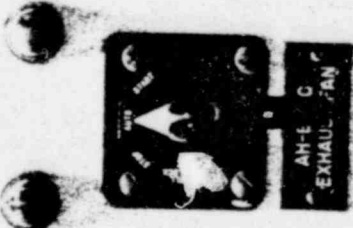
AIR FLOW  
AH-E-10A  
EXHAUST FAN



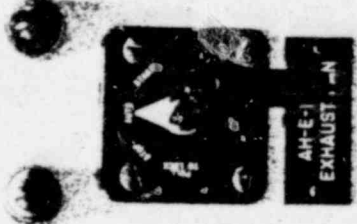
AIR FLOW  
AH-E-10B  
EXHAUST FAN



AIR FLOW  
AH-E-10C  
EXHAUST FAN



AIR FLOW  
AH-E-10D  
EXHAUST FAN

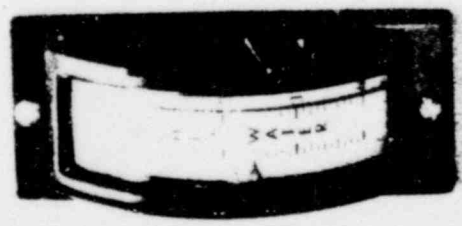


OPEN - CLOSED  
EXH. FILTER  
DAMPERS

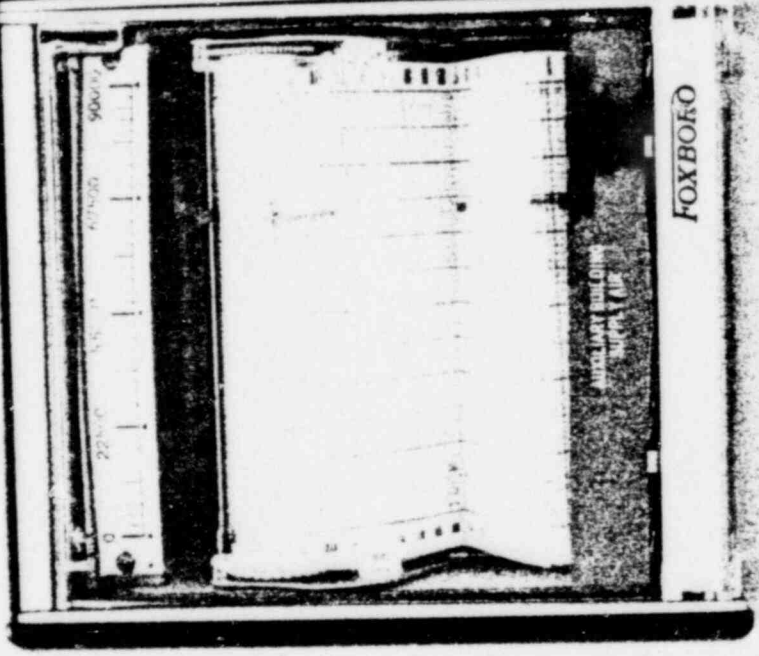


47 53212 6TX  
BIM 32

48 53212 6TX  
BIM 32

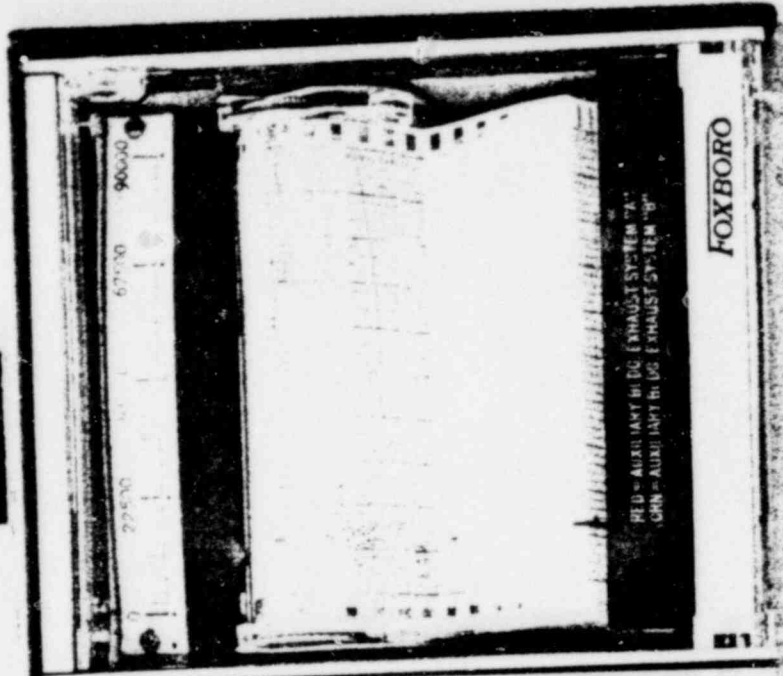


DIFF. PRESS.  
AUX. BLDG. VS.



FOXBORO

AIR FLOW  
AUX. BLDG  
SUPPLY

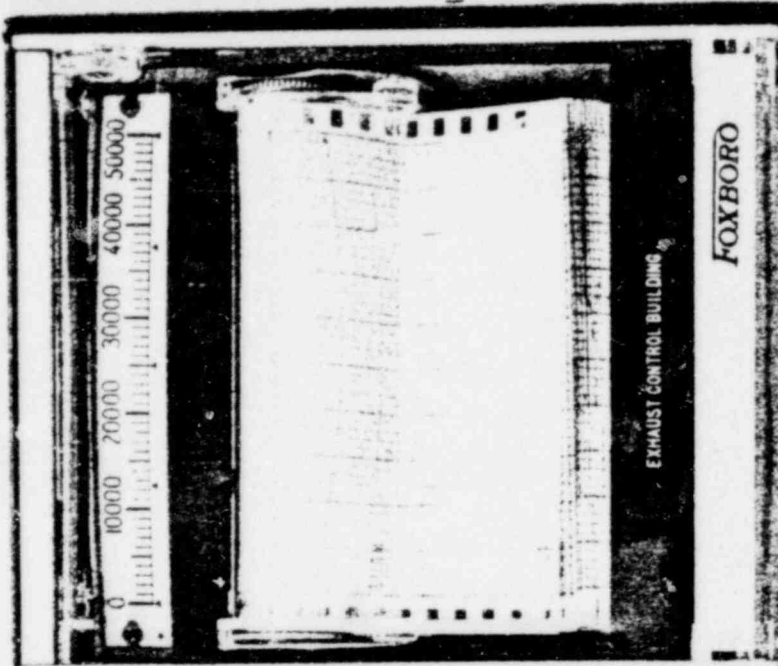


FOXBORO

AIR FLOW  
AUX. BLDG  
EXHAUST

48 53061 6TX

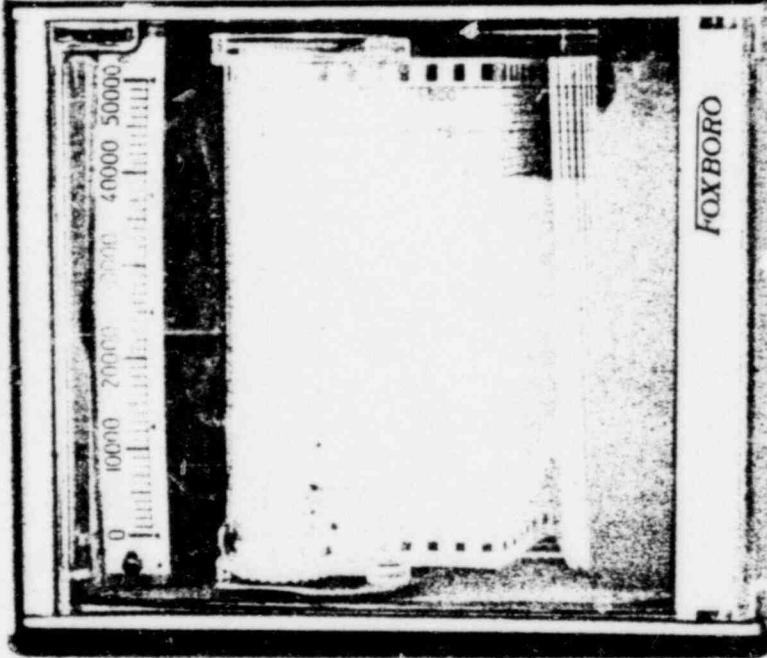
BIM 31



AIR FLOW CONTROL BLDG EXHAUST

45 53061 6TX

BIM 31

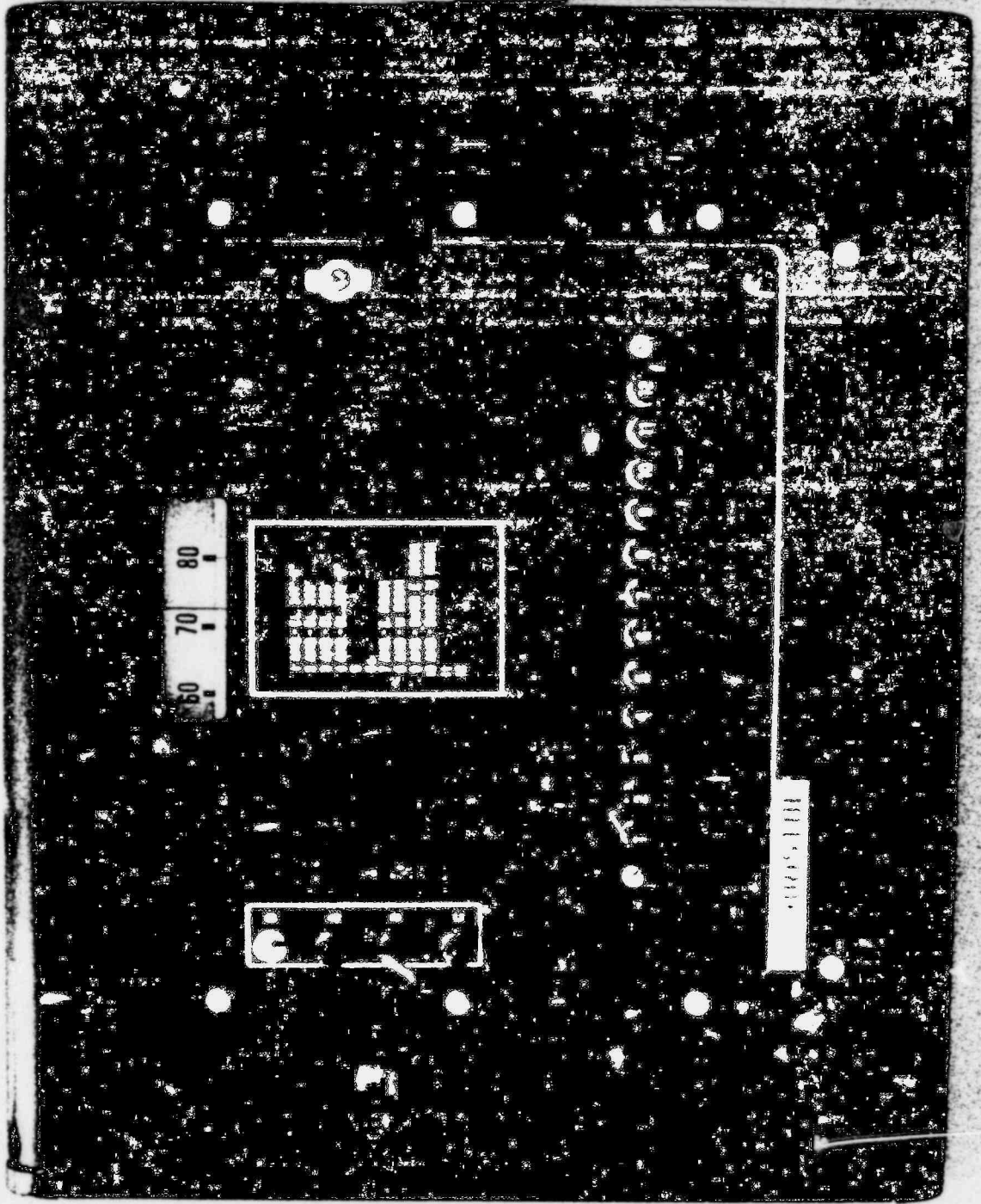


AIR FLOW CONTROL BLDG SUPPLY

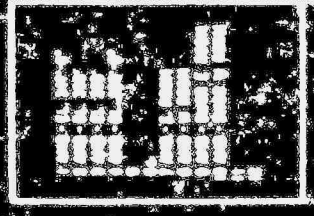
OPEN OFF OFF ON

D-4073 CABLE RM. AIR SUPPLY DAMP





60 70 80



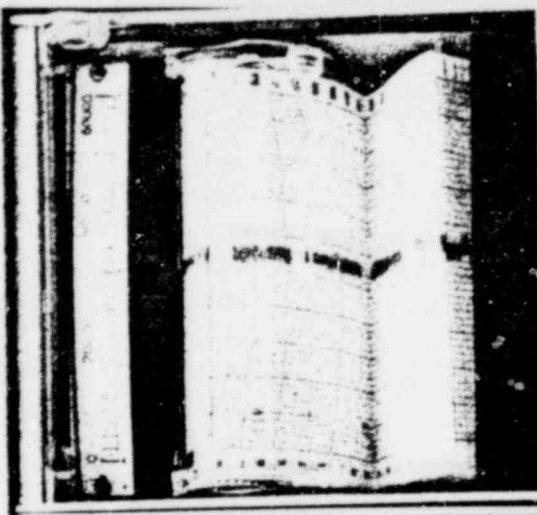
00051111

TEMPERATURES  
DIESEL & FUEL



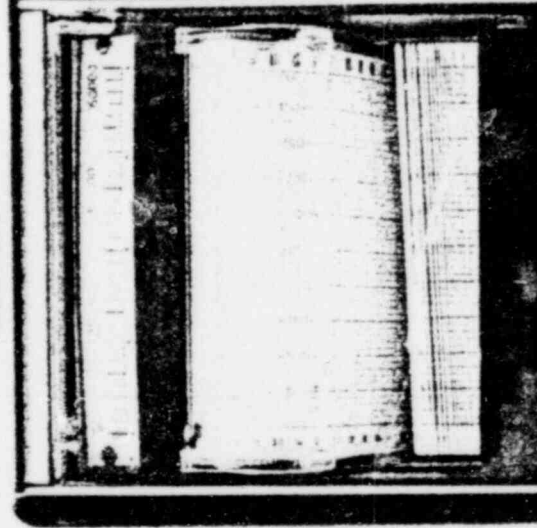
BIN 30

BIN 30



FOXBORO

AIR FLOW  
FUEL BLDG  
SUPPLY



FOXBORO

AIR FLOW  
FUEL BLDG  
EXHAUST



DIFF. PRESS.  
FUEL VS AIR  
BUILDINGS

V 3  
OUT SIDE  
AIR

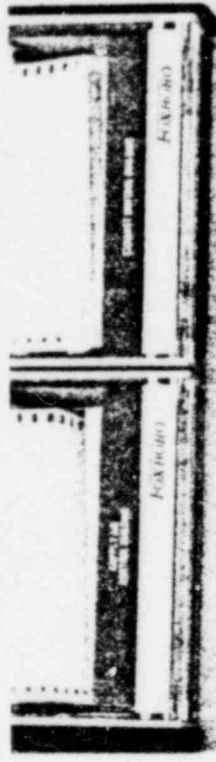


AIR FLOW



AIR FLOW





D-4073  
CABLE RM AIR  
SUPPLY DAMP



AIR FLOW CABLE ROOM EXHAUST FAN		AIR-E-20 CABLE ROOM EXHAUST FAN	AIR FLOW CONTROL ROOM EXHAUST FAN	
AIR FLOW MECH ROOM FAN COIL A		C-19A MECH ROOM FAN COIL	AIR FLOW CONTROL ROOM SUPPLY FAN A	
AIR FLOW CABLE ROOM FAN COIL A		A1-L-17A CABLE ROOM SUPPLY FAN	AIR FLOW CONTROL ROOM SUPPLY FAN B	
AIR FLOW CABLE ROOM FAN COIL B		A1-M-7B CABLE ROOM SUPPLY FAN	AIR FLOW CONTROL ROOM SUPPLY FAN B	
AIR FLOW MECH ROOM FAN COIL B		A1-C-1 MECH ROOM FAN COIL	D-4092C CR SUPPLY DAMPER	
AIR FLOW MECH ROOM EXHAUST FAN		A1-E-8 MECH ROOM EXHAUST FAN	D-4092C CR SUPPLY DAMPER	
AIR FLOW MECH ROOM SUPPLY FAN		A1-E-30 MECH ROOM SUPPLY FAN	D-4092C CR SUPPLY DAMPER	

AH-E-7A  
SUPPLY FAN  
FLOW

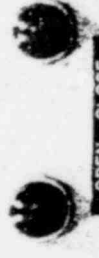


AH-E-7A  
AUX. BLDG  
SUPPLY FAN

AH-E-7B  
SUPPLY FAN  
FLOW



AH-E-7B  
AUX BLDG  
SUPPLY FAN



OPEN - CLOSE  
FRESH AIR  
DAMPER D4002



AH-E-4I  
ELEVATOR RM  
FAN

AH-E-8A  
EXHAUST FAN  
FLOW



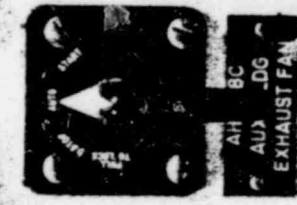
E-8A  
A. BLDG  
EXHAUST FAN

AH-E-8B  
EXHAUST FAN  
FLOW



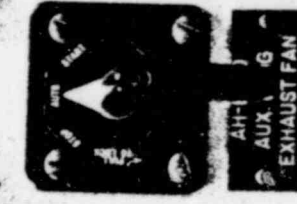
E-8B  
A BLDG  
EXHAUST FAN

AH-E-8C  
EXHAUST FAN  
FLOW



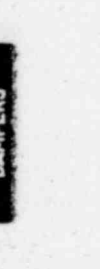
AH-8C  
AUX \_DG  
EXHAUST FAN

AH-E-8D  
EXHAUST FAN  
FLOW

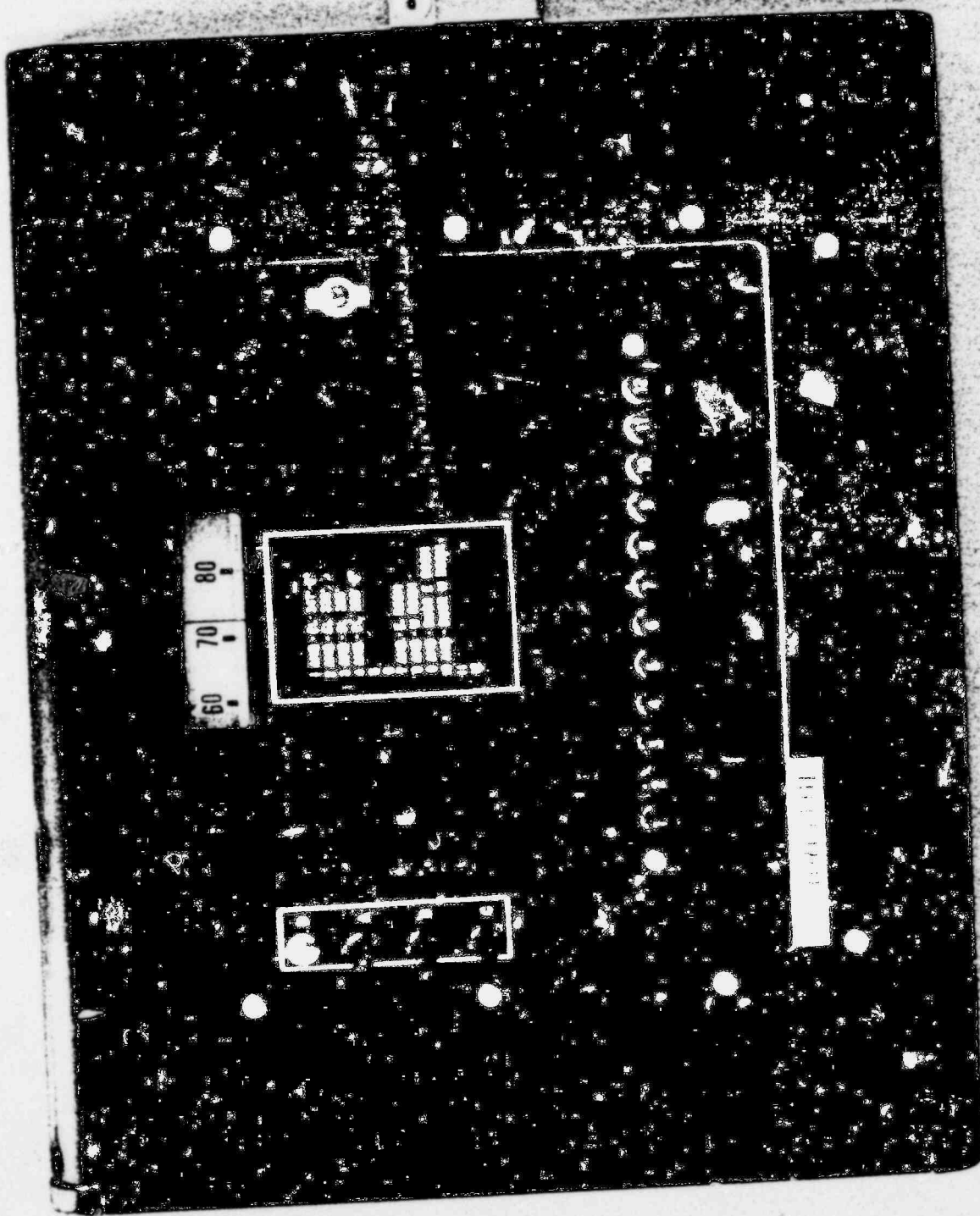


AH-1  
AUX \_G  
EXHAUST FAN

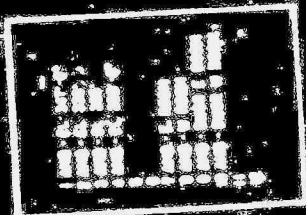
OPEN - CLOSED  
EXH. FILTER  
DAMPERS



EXHST FILTER  
BYPASS MODE



60 70 80



TEMPERATURE & FUEL BUILDING

TEMPERATURE & FUEL BUILDING

**FUNCTIONS**

OPEN  
CLOSE

*Joyle*

AH-V-25  
H<sub>2</sub> PURGE VLV  
B POWERED

OPEN  
CLOSE

AH-V-25  
H<sub>2</sub> PURGE VLV  
A POWERED

NORMAL START  
STOP

AH-V-34  
H<sub>2</sub> PURGE FAN  
B POWERED

STOP  
START

AH-V-34  
H<sub>2</sub> PURGE FAN  
A POWERED

AIR FLOW  
R B PENETRAT  
COOLING STRT

OPEN  
CLOSE

AH-V-21A  
AC COIL TEST  
DC COIL TEST

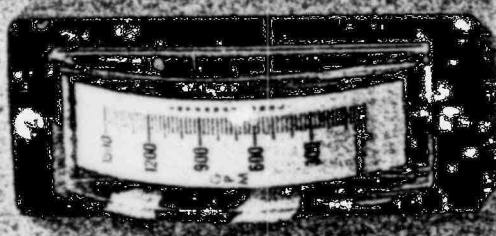
TEST  
TEST

AH-V-BI-94  
PEN COOL

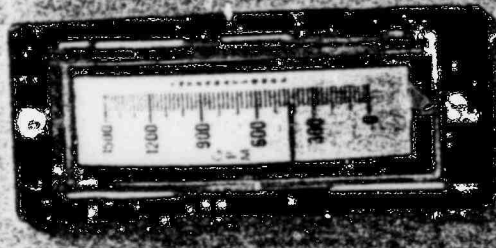
OPEN  
CLOSE

AH-V-21B  
AC COIL TEST  
DC COIL TEST

TEST  
TEST



WATER FLOW  
R.B. COOLER C.



WATER FLOW  
R.B. COOLER D.



WATER FLOW  
R.B. COOLER E.

E-11G  
COOLER  
DAMPER

FAST

AH-E-11C  
AIR COOLER  
DAMPER

SLOW FAST  
OFF AUTO

AH-E-11D  
AIR COOLER  
DAMPER

SLOW FAST  
OFF AUTO

AH-E-11E  
AIR COOLER  
DAMPER

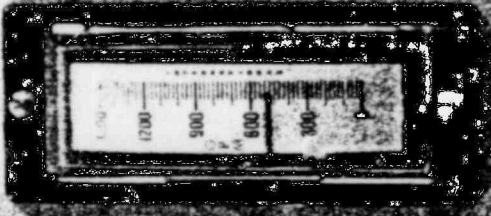
FLOW FAST  
OFF AUTO

AIR  
FLOW  
METER  
B PO

AIR  
FLOW  
METER  
A P  
B



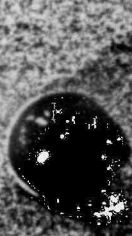
WATER FLOW  
R.B. COOLER C



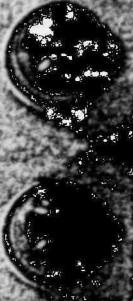
WATER FLOW  
R.B. COOLER B



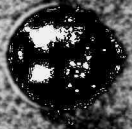
WATER FLOW  
R.B. COOLER A



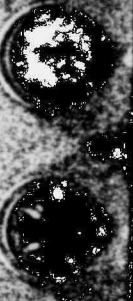
AH-E-11C  
AIR COOLER  
DAMPER



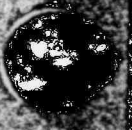
FAST  
AUTO  
SLOW  
OFF



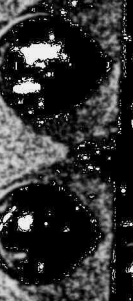
AH-E-11B  
AIR COOLER  
DAMPER



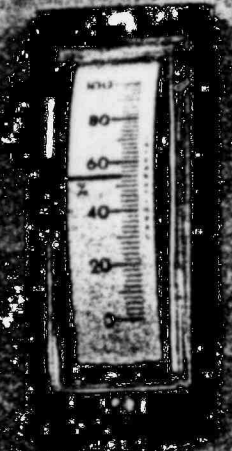
FAST  
AUTO  
SLOW  
OFF



AH-E-11A  
AIR COOLER  
DAMPER



FAST  
AUTO  
SLOW  
OFF



REL HUMIDITY  
R.B. EL. 305 S



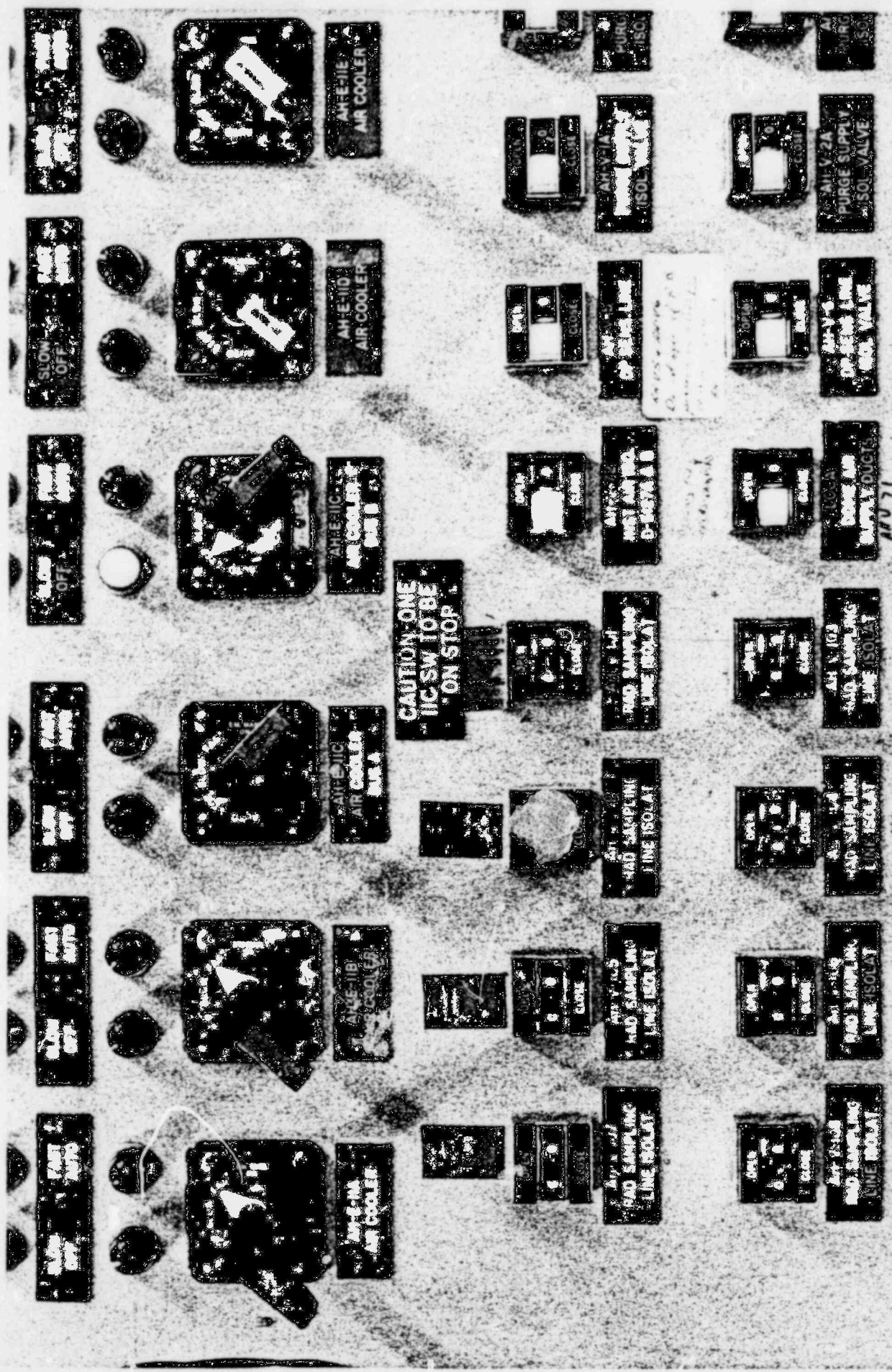
REL HUMIDITY  
R.B. EL. 305 N



WATER FLOW  
R.B. COOLER A



WATER FLOW  
R.B. COOLER B



SLOW OFF

FAST PURGE

FAST PURGE

FAST PURGE

FAST PURGE

FAST PURGE

AH-E-10 AIR COOLER

AH-E-11 AIR COOLER

AH-E-12 AIR COOLER

AH-E-13 AIR COOLER

AH-E-14 AIR COOLER

AH-E-15 AIR COOLER

AH-E-16 AIR COOLER

AH-E-17 AIR COOLER

AH-E-18 AIR COOLER

AH-E-19 AIR COOLER

AH-E-20 AIR COOLER

AH-E-21 AIR COOLER

CAUTION - ONE IIC SW TO BE ON STOP

AH-E-22 AIR COOLER

AH-E-23 AIR COOLER

AH-E-24 AIR COOLER

AH-E-25 AIR COOLER

AH-E-26 AIR COOLER

AH-E-27 AIR COOLER

AH-E-28 AIR COOLER

AH-E-29 AIR COOLER

AH-E-30 AIR COOLER

AH-E-31 AIR COOLER

AH-E-32 AIR COOLER

AH-E-33 AIR COOLER

AH-E-34 AIR COOLER

AH-E-35 AIR COOLER

AH-E-36 AIR COOLER

Handwritten note on a small piece of paper.

AH-E-37 AIR COOLER

AH-E-38 AIR COOLER

AH-E-39 AIR COOLER

AH-E-40 AIR COOLER

AH-E-41 AIR COOLER

AH-E-42 AIR COOLER

AH-E-43 AIR COOLER

AH-E-44 AIR COOLER

AH-E-45 AIR COOLER

AH-E-46 AIR COOLER

AH-E-47 AIR COOLER

AH-E-48 AIR COOLER

AH-E-49 AIR COOLER

AH-E-50 AIR COOLER

AH-E-51 AIR COOLER

AH-E-52 AIR COOLER

AH-E-53 AIR COOLER

AH-E-54 AIR COOLER

AH-E-55 AIR COOLER

AH-E-56 AIR COOLER

AH-E-57 AIR COOLER

AH-E-58 AIR COOLER

AH-E-59 AIR COOLER

AH-E-60 AIR COOLER

AH-E-61 AIR COOLER

AH-E-62 AIR COOLER

AH-E-63 AIR COOLER

AH-E-64 AIR COOLER

AH-E-65 AIR COOLER

AH-E-66 AIR COOLER

AH-E-67 AIR COOLER

AH-E-68 AIR COOLER

AH-E-69 AIR COOLER

AH-E-70 AIR COOLER

AH-E-71 AIR COOLER

AH-E-72 AIR COOLER

AH-E-73 AIR COOLER

AH-E-74 AIR COOLER

AH-E-75 AIR COOLER

AH-E-76 AIR COOLER

AH-E-77 AIR COOLER

AH-E-78 AIR COOLER

AH-E-79 AIR COOLER

AH-E-80 AIR COOLER

AH-E-81 AIR COOLER

AH-E-82 AIR COOLER

AH-E-83 AIR COOLER

AH-E-84 AIR COOLER

AH-E-85 AIR COOLER

AH-E-86 AIR COOLER

AH-E-87 AIR COOLER

AH-E-88 AIR COOLER

AH-E-89 AIR COOLER

AH-E-90 AIR COOLER

AH-E-91 AIR COOLER

AH-E-92 AIR COOLER

AH-E-93 AIR COOLER

AH-E-94 AIR COOLER

AH-E-95 AIR COOLER

AH-E-96 AIR COOLER

AH-E-97 AIR COOLER

AH-E-98 AIR COOLER

AH-E-99 AIR COOLER

AH-E-100 AIR COOLER

AH-E-101 PURGE SUPPLY VALVE

AH-E-102 PURGE SUPPLY VALVE

AH-E-103 PURGE SUPPLY VALVE

AH-E-104 PURGE SUPPLY VALVE

AH-E-105 PURGE SUPPLY VALVE

AH-E-106 PURGE SUPPLY VALVE

AH-E-107 PURGE SUPPLY VALVE

AH-E-108 PURGE SUPPLY VALVE

AH-E-109 PURGE SUPPLY VALVE

AH-E-110 PURGE SUPPLY VALVE

AH-E-111 PURGE SUPPLY VALVE

AH-E-112 PURGE SUPPLY VALVE

AH-E-113 PURGE SUPPLY VALVE

AH-E-114 PURGE SUPPLY VALVE

AH-E-115 PURGE SUPPLY VALVE

AH-E-116 PURGE SUPPLY VALVE

AH-E-117 PURGE SUPPLY VALVE

AH-E-118 PURGE SUPPLY VALVE

AH-E-119 PURGE SUPPLY VALVE

AH-E-120 PURGE SUPPLY VALVE





AH-C-15A-H  
PURGE SUPPLY  
DUCT HEATERS

AH-C-47A-H  
PURGE SUPPLY  
DUCT HEATERS

AH-E-12A  
R B PURGE  
SUPPLY FLOW

AH-E-12B  
R B PURGE  
SUPPLY FLOW



AH-E-400  
R.B. PENETRATING  
COOLING FAN



AH-E-12A  
R B PURGE  
SUPPLY FAN



AH-E-12B  
R B PURGE  
SUPPLY FAN



62  
AIR  
VALVE

AH-E-19A  
R B PURGE  
EXHAUST FLOW

AH-E-19B  
R B PURGE  
EXHAUST FLOW



63  
AIR  
VALVE



AH-E-19A  
R B PURGE  
EXHAUST FAN



AH-E-19B  
R B PURGE  
EXHAUST FAN



EXHAUST  
DAMPER



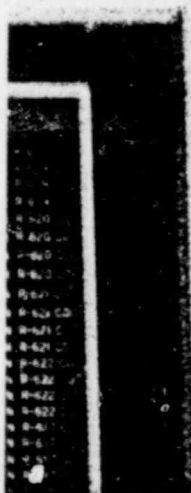
EXHAUST  
DAMPER



EXHAUST  
DAMPER

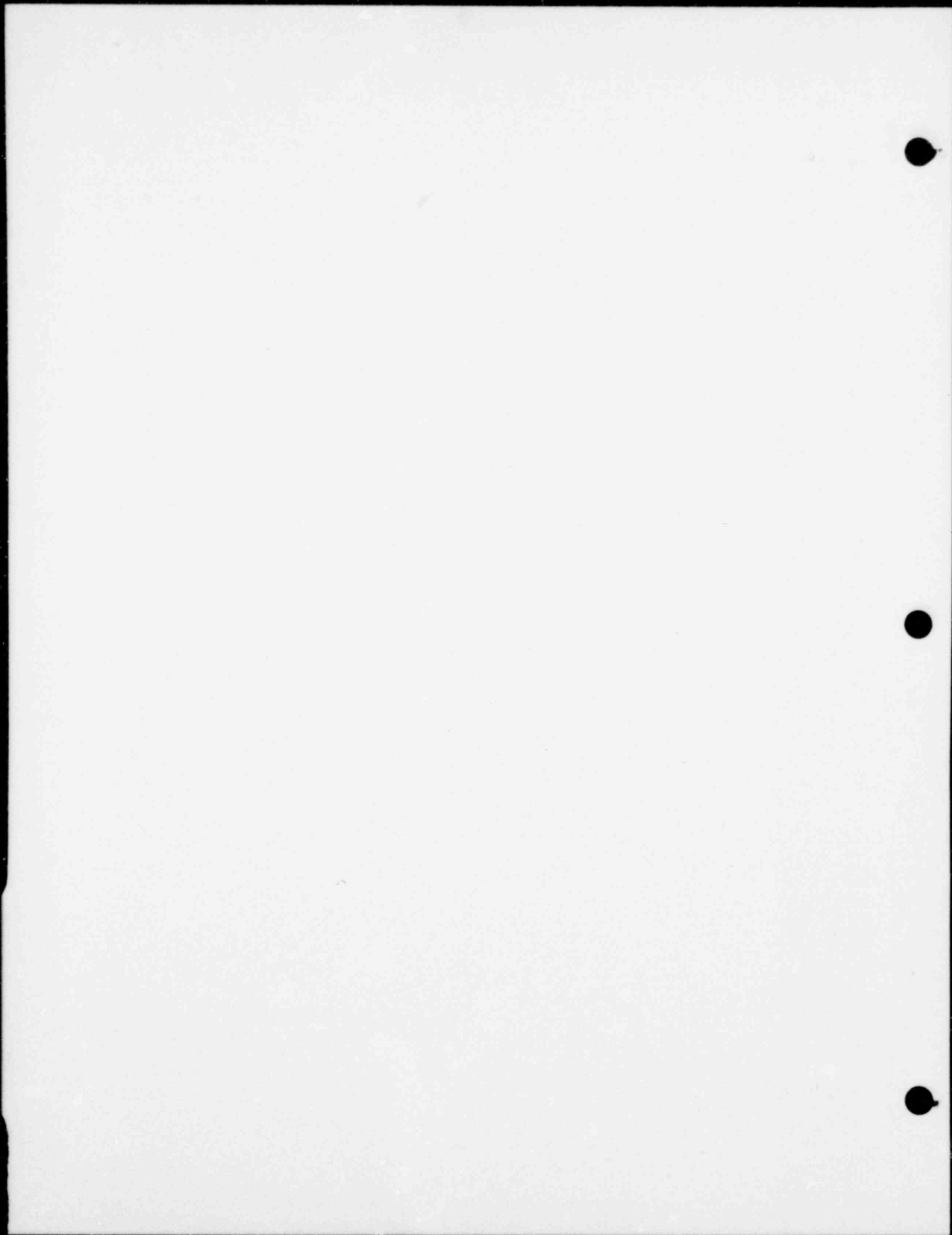


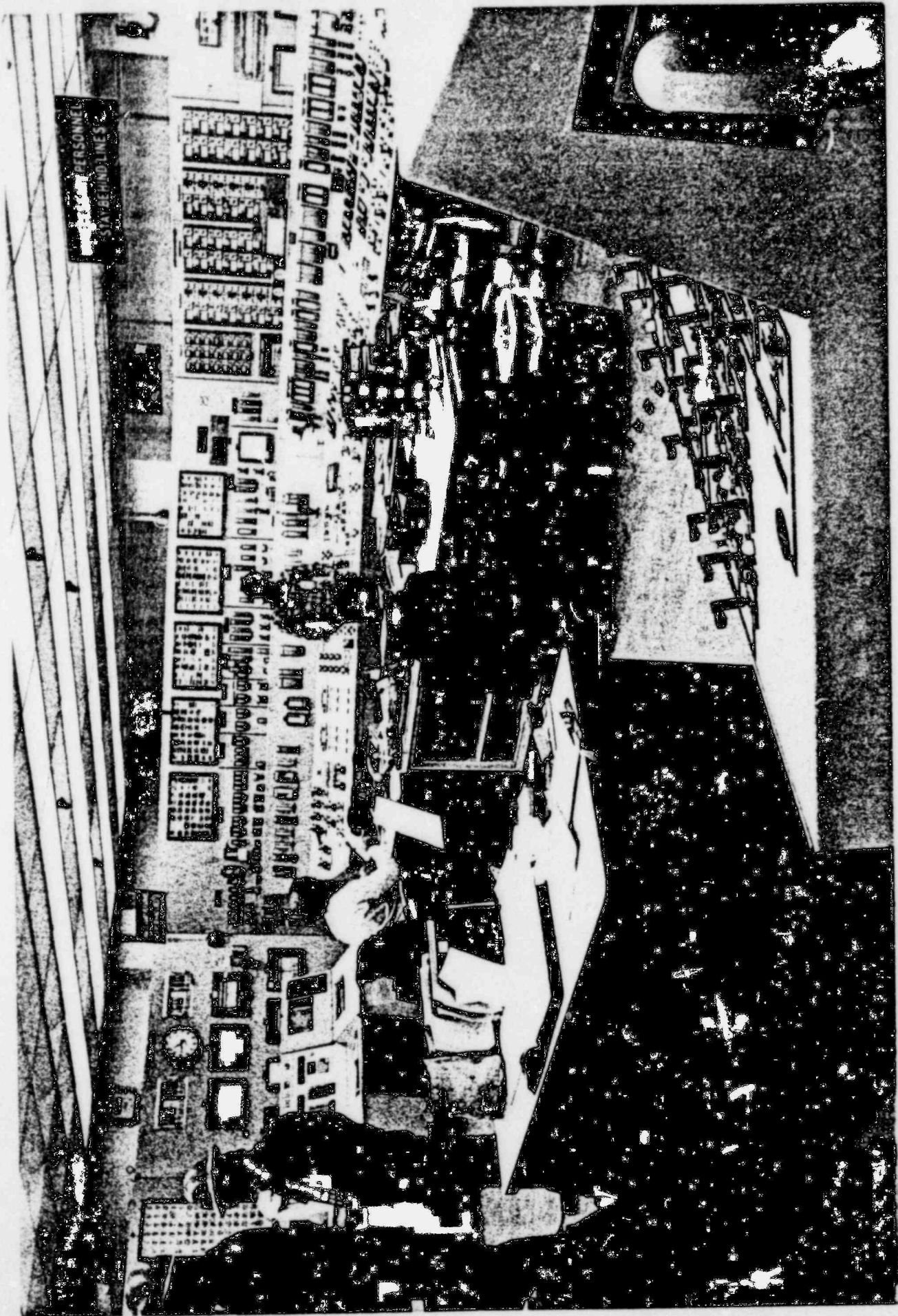
EXHAUST  
DAMPER

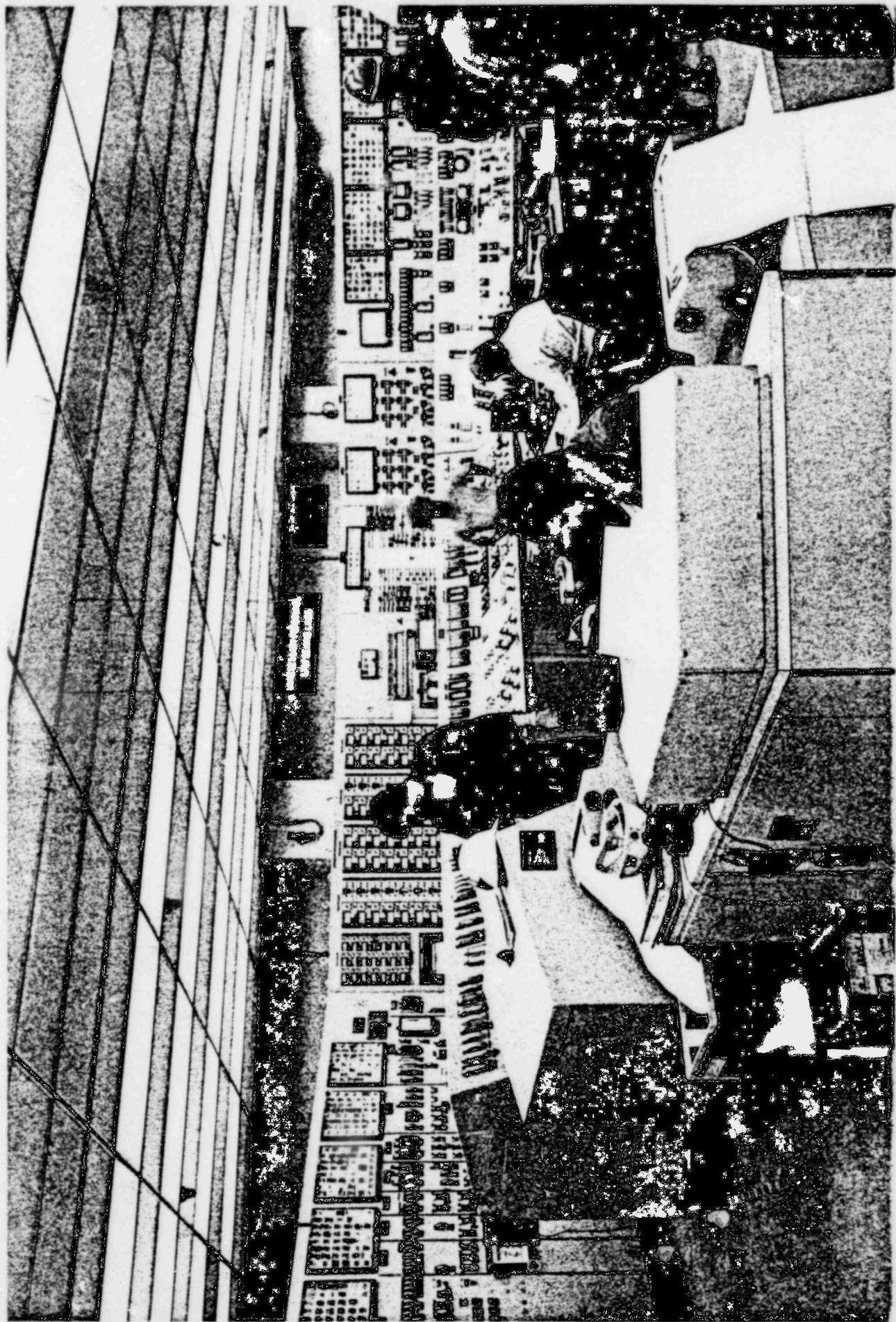


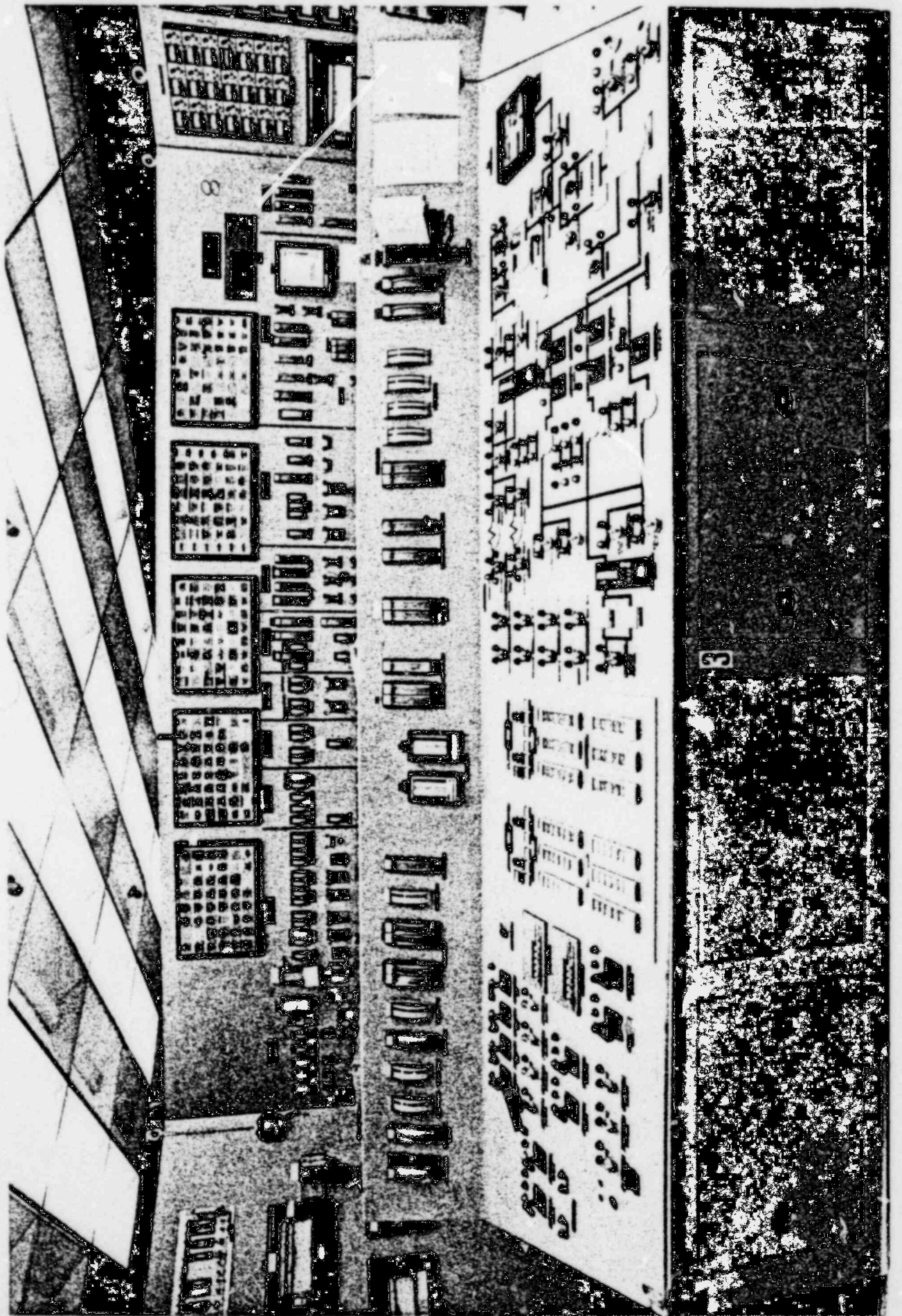
64  
65  
66  
67  
68  
69  
70  
71  
72  
73  
74  
75  
76  
77  
78  
79  
80  
81  
82  
83  
84  
85  
86  
87  
88  
89  
90  
91  
92  
93  
94  
95  
96  
97  
98  
99  
100



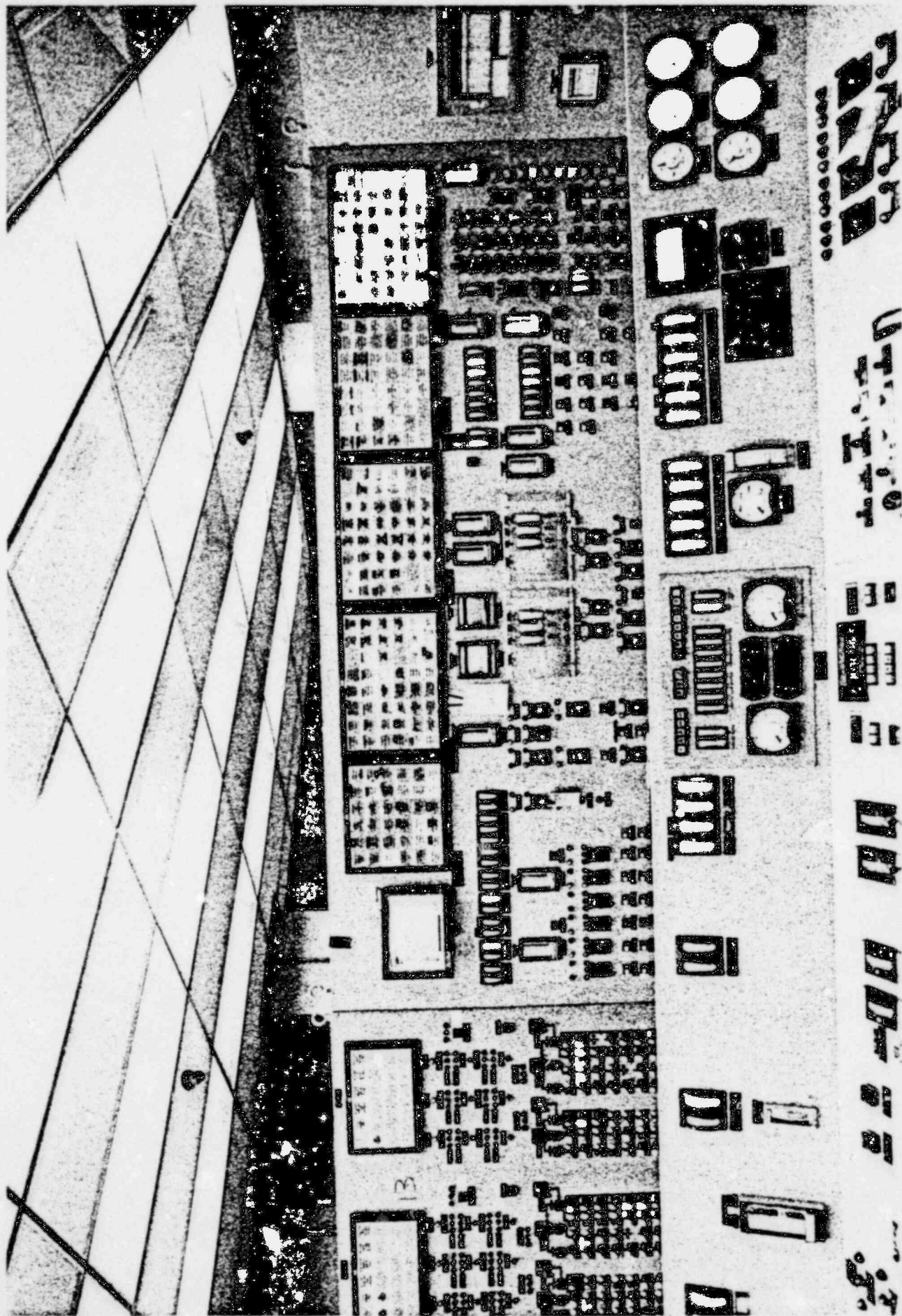




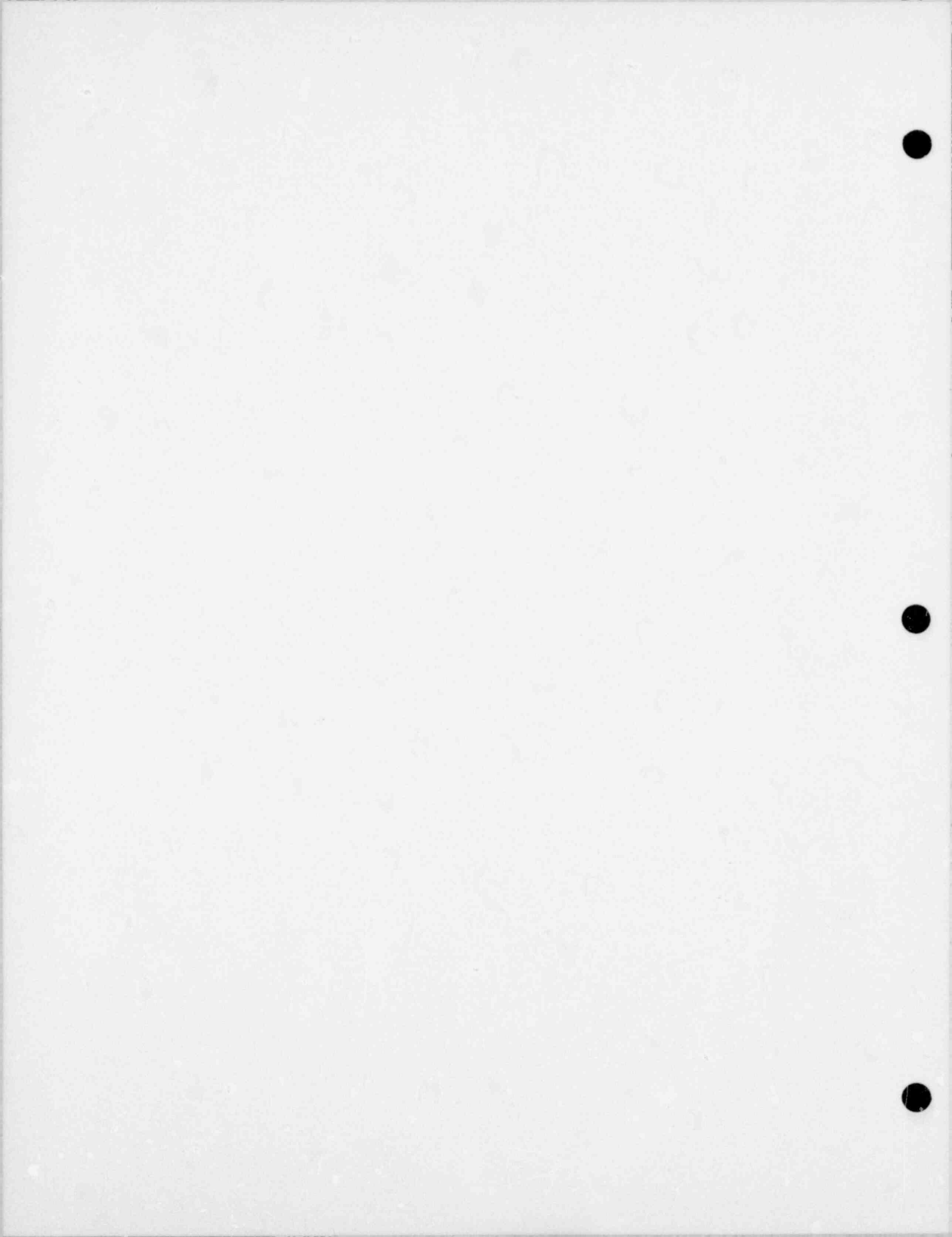












BY PASS PERMIT

BY PASS PERMIT

BY PASS PERMIT

BY PASS PERMIT

BY PASS PERMIT

Channel Trapped

BY PASS PERMIT

BY PASS PERMIT

BY PASS PERMIT

BY PASS PERMIT

BY PASS PERMIT

Bailey

Channel Trapped

BY PASS PERMIT

BY PASS PERMIT

BY PASS PERMIT

BY PASS PERMIT

BY PASS PERMIT

Bailey

Channel Trapped

BY PASS PERMIT

BY PASS PERMIT

BY PASS PERMIT

BY PASS PERMIT

BY PASS PERMIT

Bailey

Channel Trapped

RESET

---

< 1800

---

< 1800

---

FBI

---

> 1800

---

AND MORE

---

PERMIT

BY PASS PERMIT

PROTECTION FUNCTION FULLY ENABLED

Channel Trapped

PROTECTION FUNCTION FULLY ENABLED

Channel Trapped

PROTECTION FUNCTION FULLY ENABLED

Channel Trapped

Channel Trapped

RESET

---

< 1800

---

< 1800

---

FBI

---

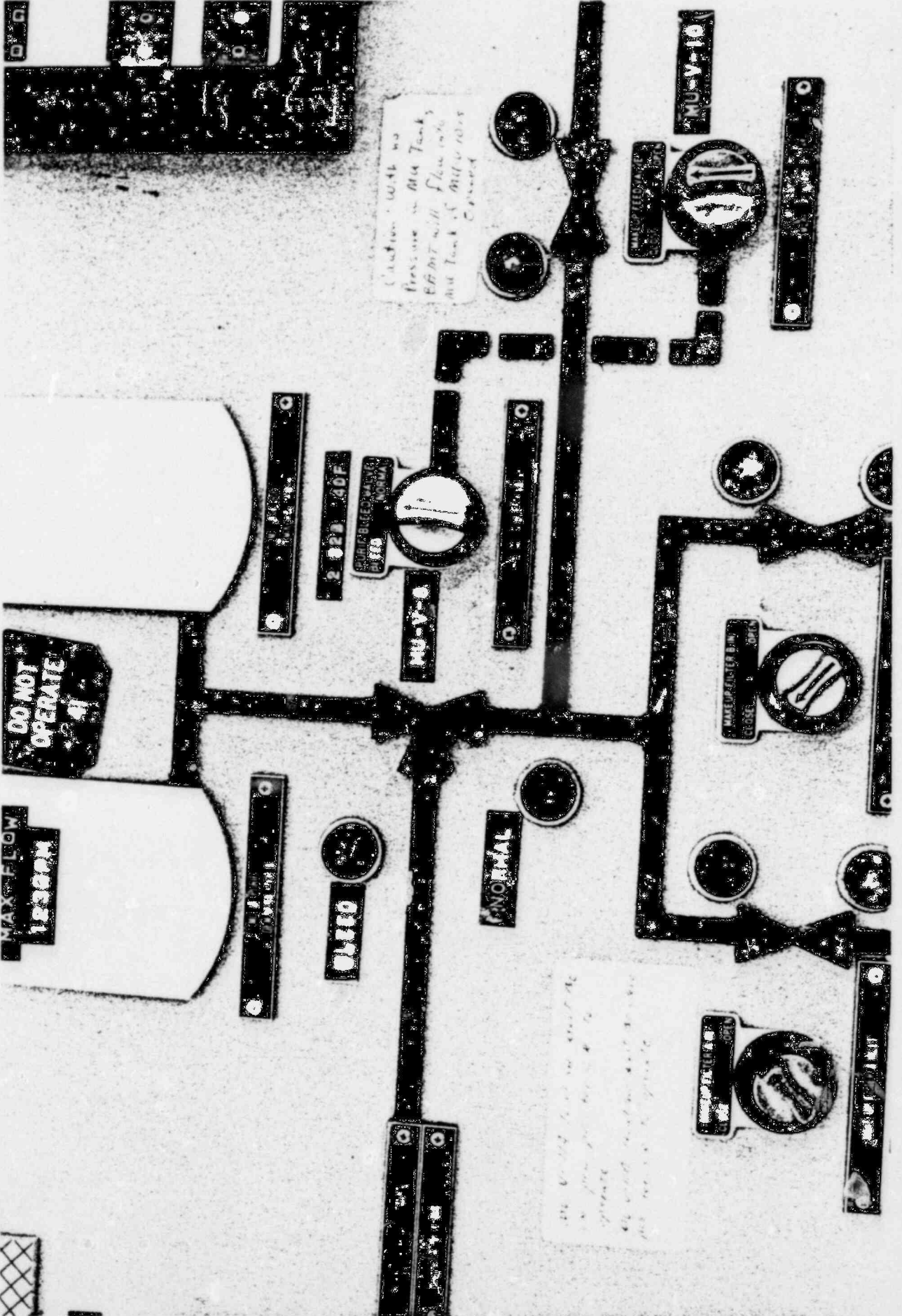
> 1800

---

AND MORE

---

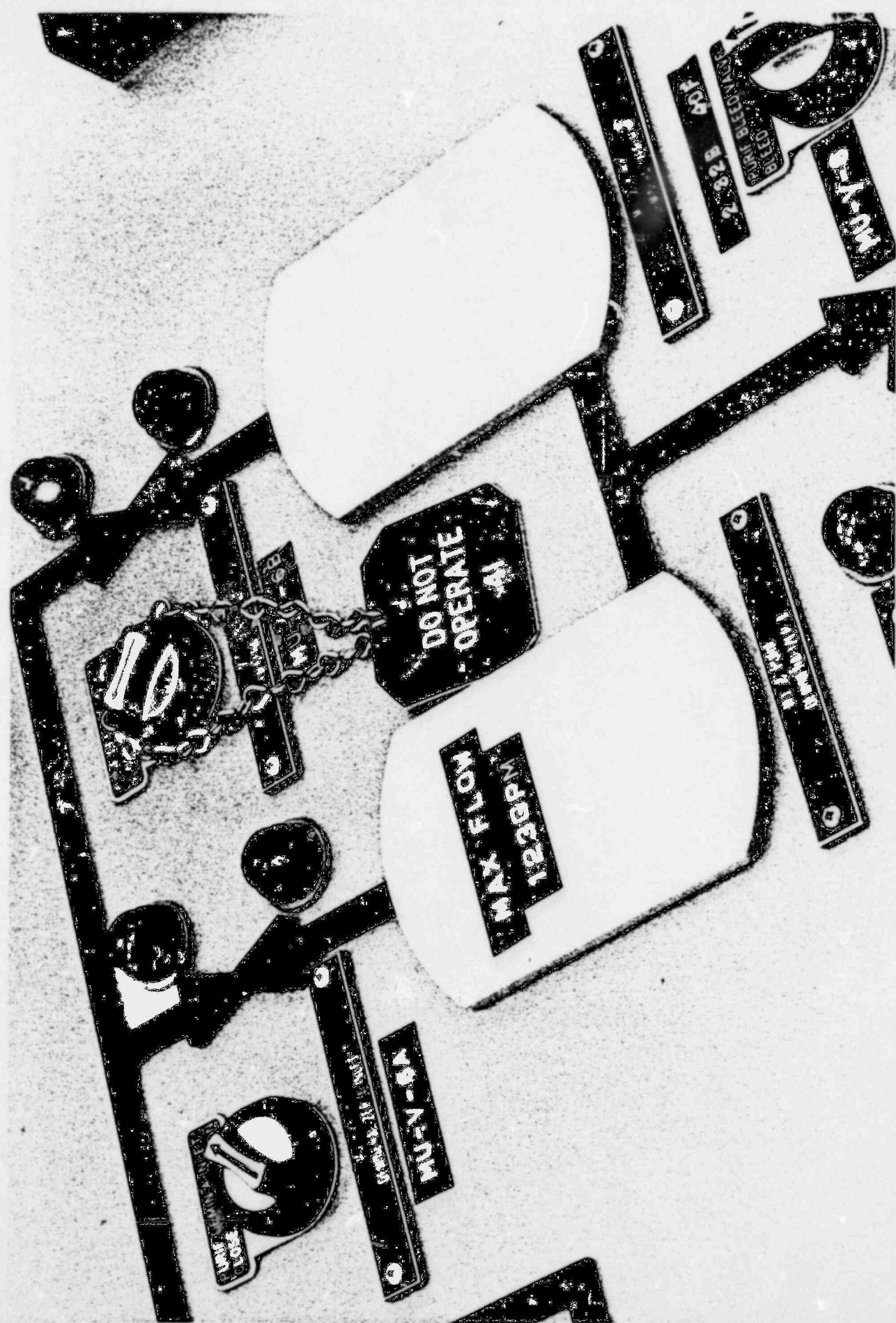
PERMIT



Caution: with no pressure in this Tank Effort will flow into this Tank if this valve is closed

The valve is to be closed by the operator when the pressure in the tank is low





DO NOT OPERATE

MAX FLOW  
1200RPM

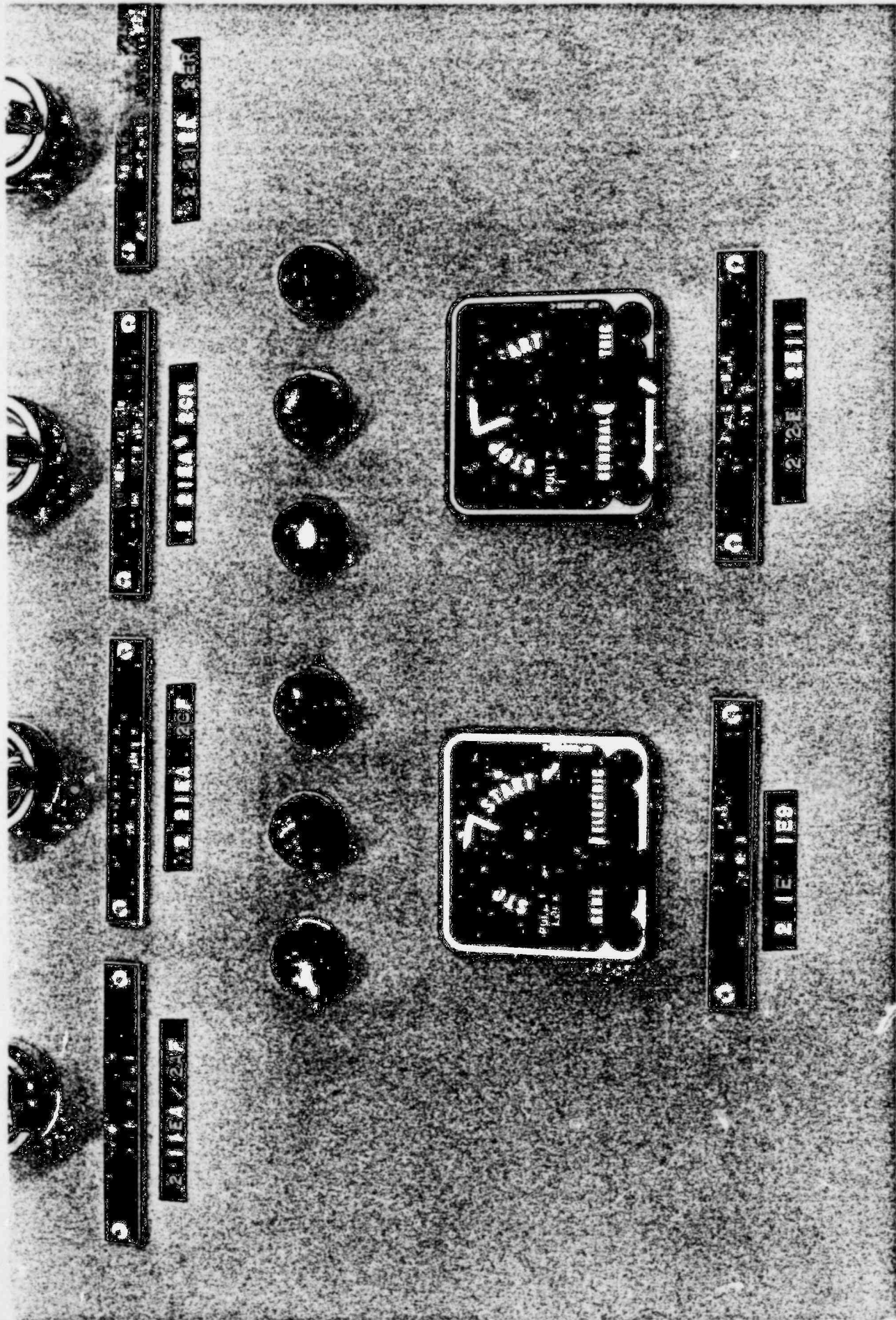
DO NOT OPERATE

MAX FLOW 1200RPM

MAX FLOW 1200RPM

MAX FLOW 1200RPM

MAX FLOW 1200RPM



2-11EA-217

2-11EA-218

2-11EA-219

2-11EA-220

2-11EA-221

2-11EA-222

2-11EA-223

2-11EA-224

2-11EA-225

2-11EA-226

2-11EA-227

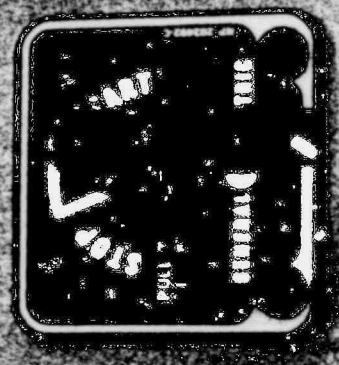
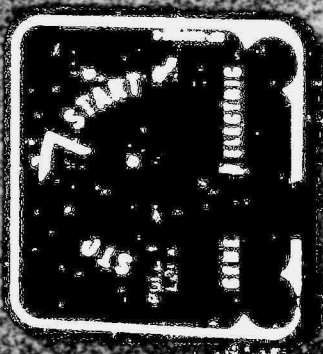
2-11EA-228

2-11EA-229

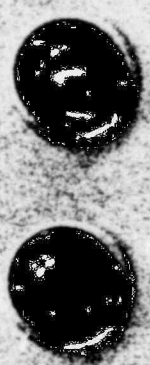
2-11EA-230

2-11EA-231

2-11EA-232

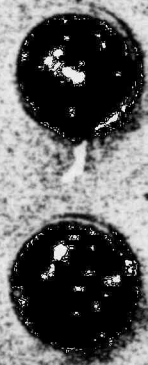


2-111111



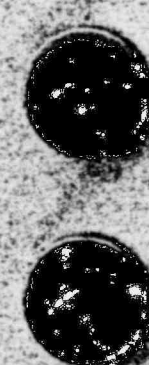
2-111111

2-1111A 00R



2-111111

2-1111A 70P



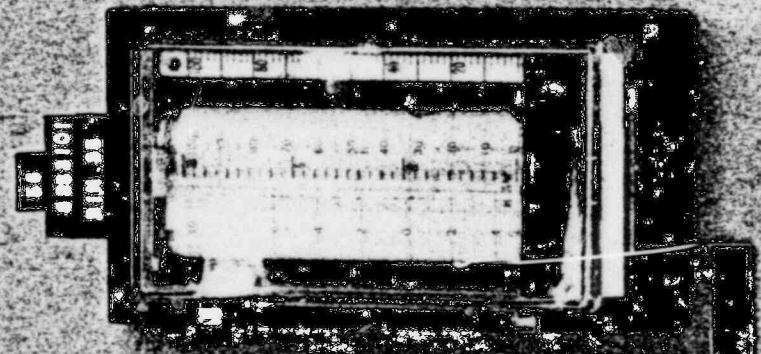
2-111111

DH-V-1 OR

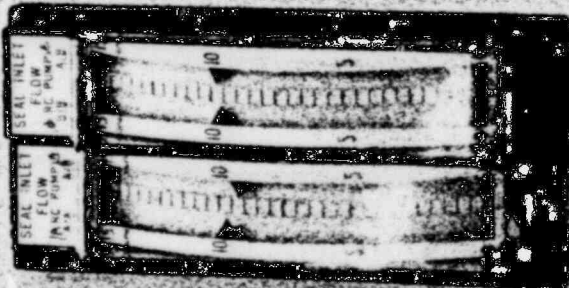
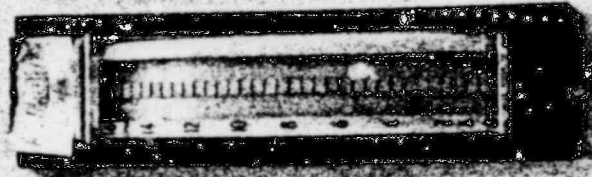
DH-V-171

SELECT AT

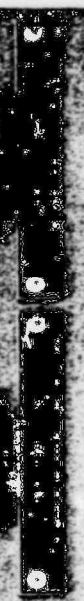
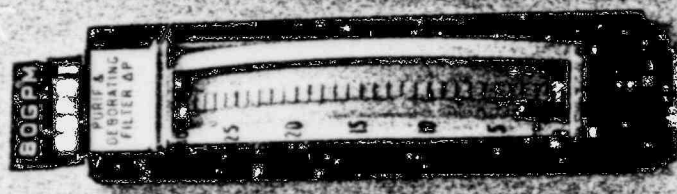
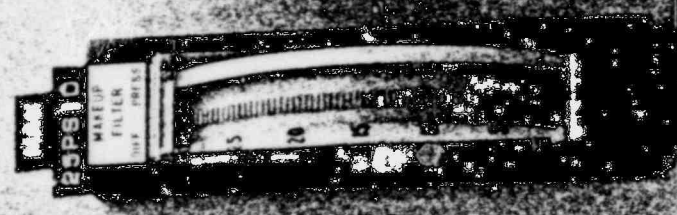
2-1111B



MAN TEMP. 100F



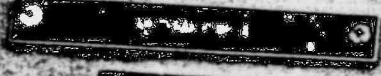
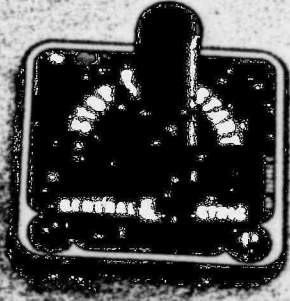
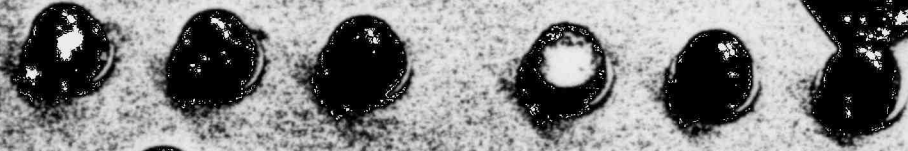




SMALL  
LARGE  
P. 80  
P. 100

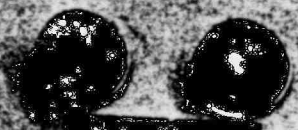
5

DO NOT  
OPERATE  
45



2 12 184

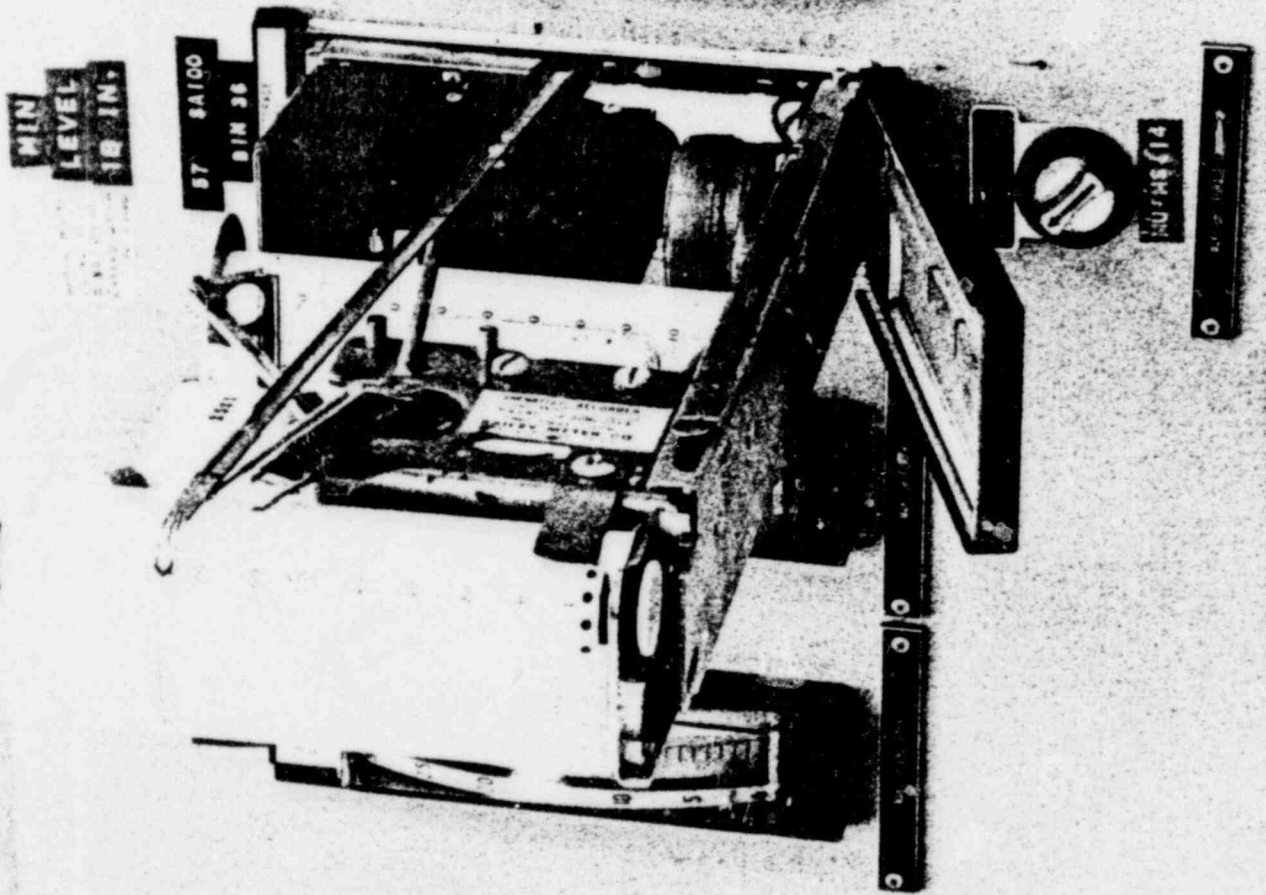
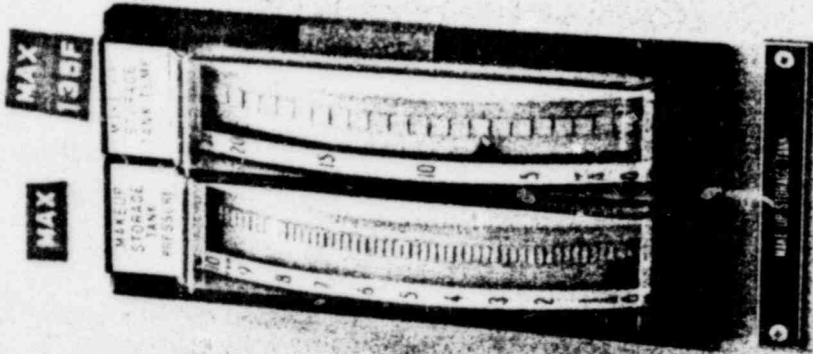
2 SE 255



85-Y-3A

85-Y-3B

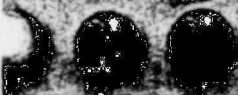








DNCC SURGE



SERV CLOSED  
REF COMP



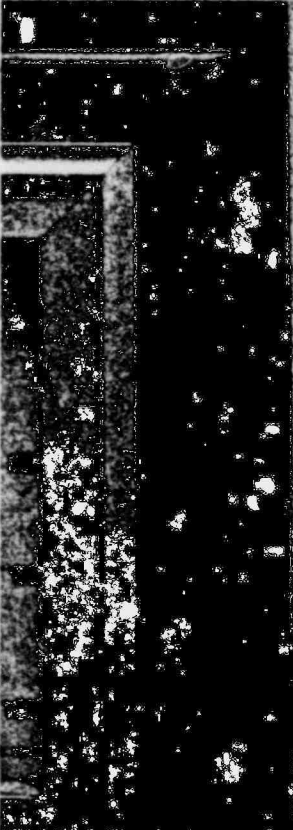
DC-P-1A  
DECAY HEAT  
WCLSD CLG PMP



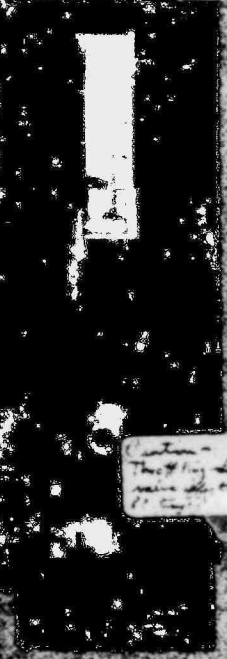
*Handwritten note:*  
This is a warning  
to check the  
status of the decay pump.



DC-P-1B  
DECAY HEAT  
CLSD CLG PMP



73A

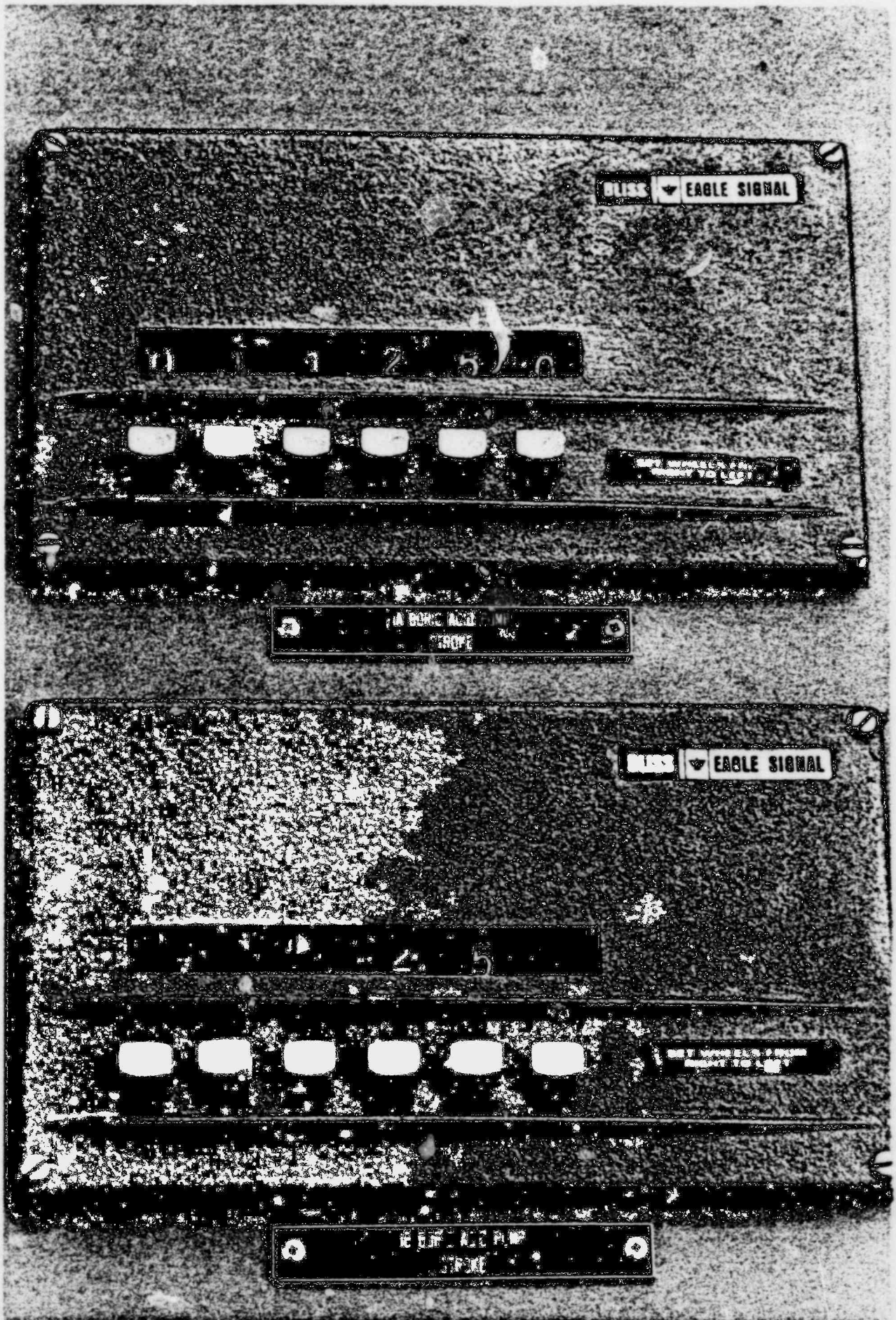


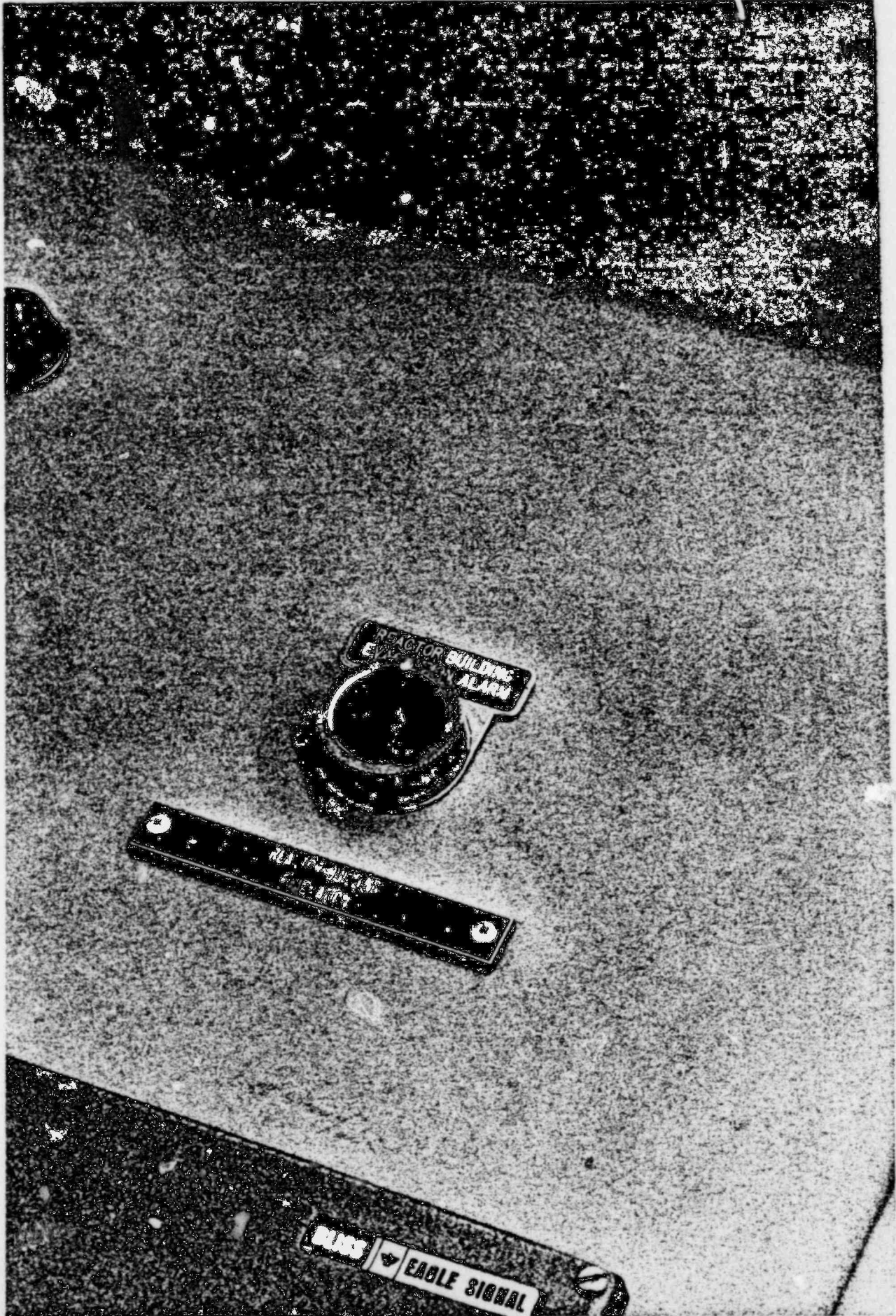
*Handwritten note:*  
This is a warning  
to check the  
status of the decay pump.

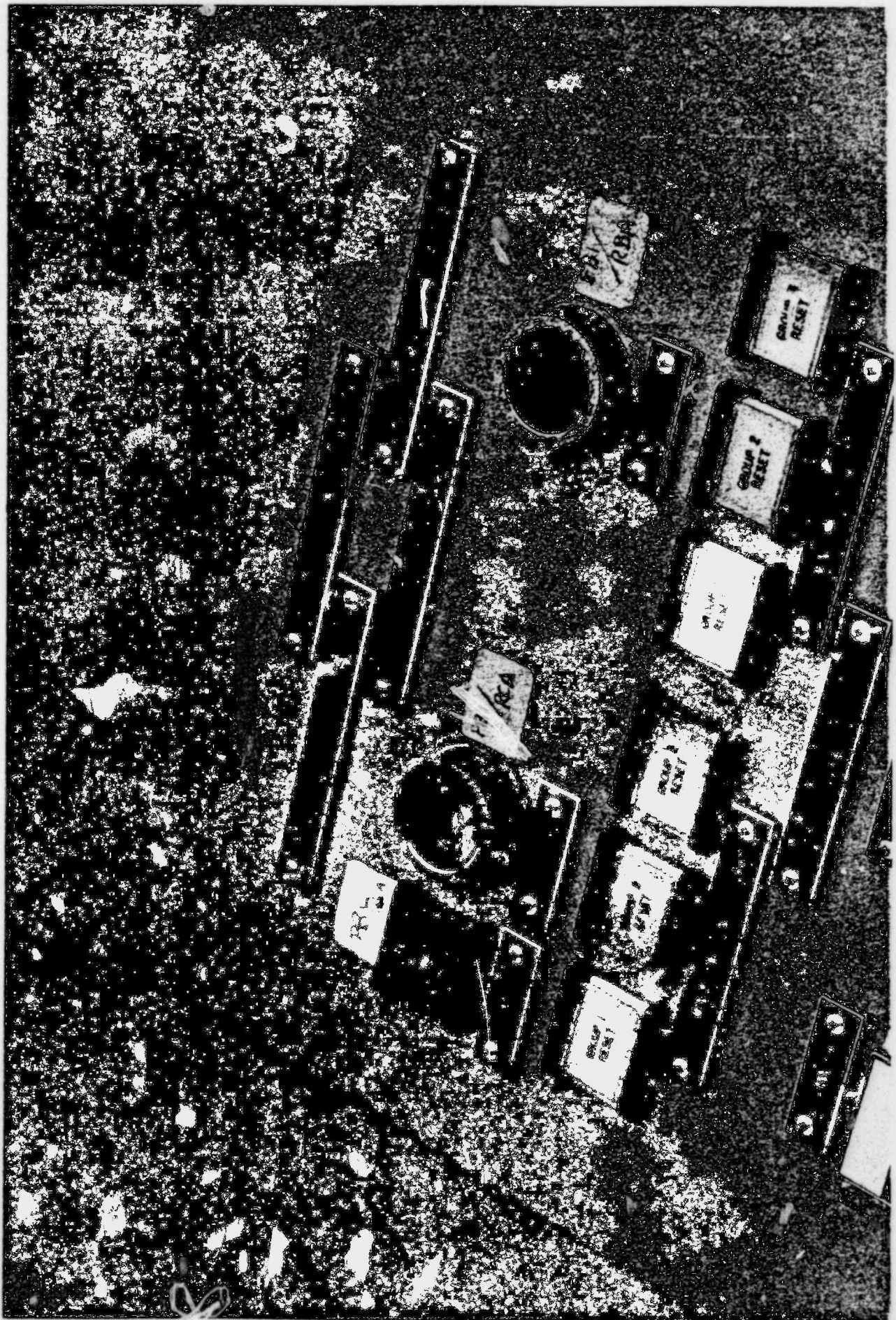
73B



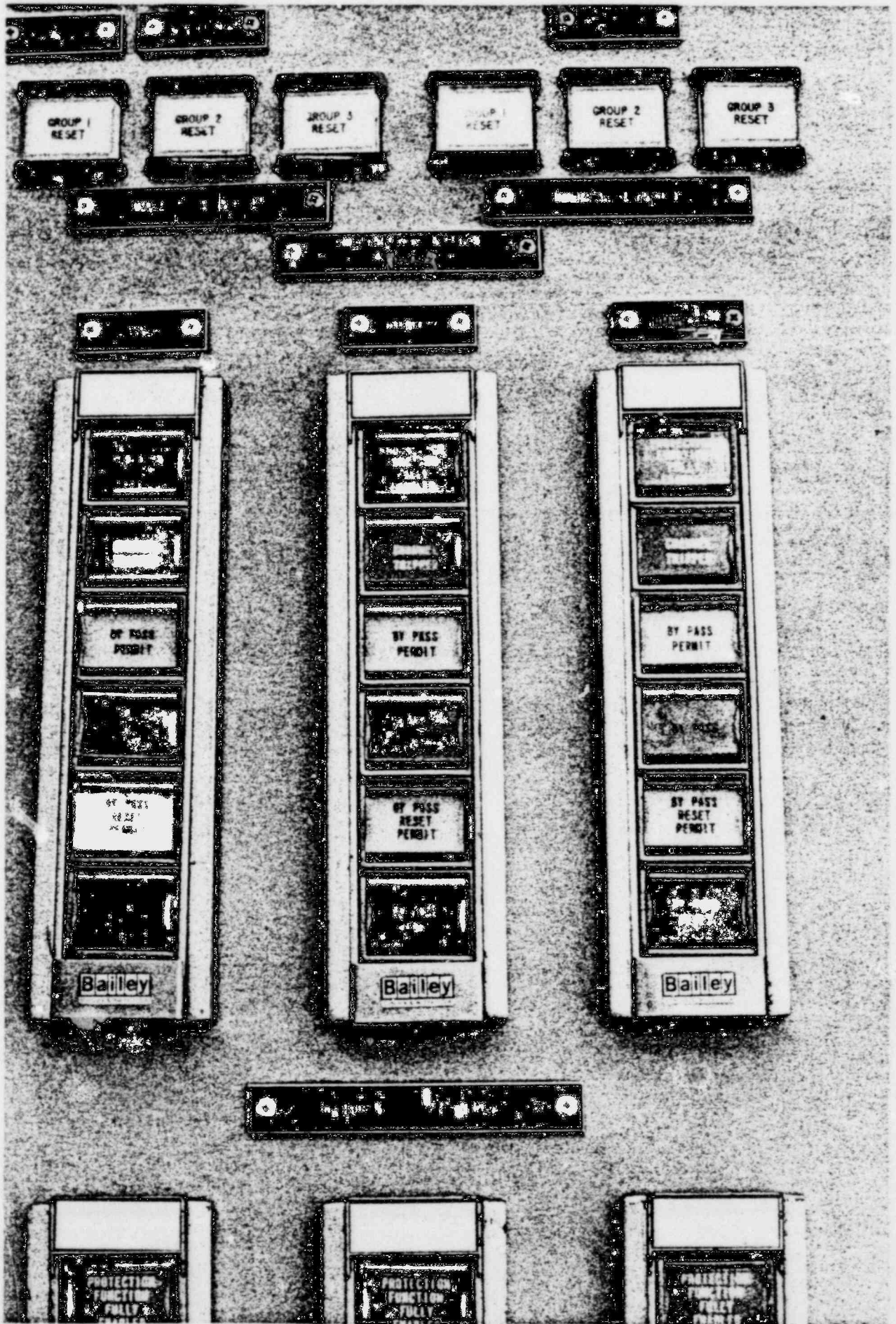
ES

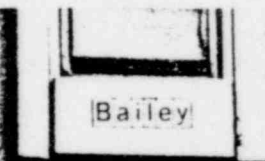


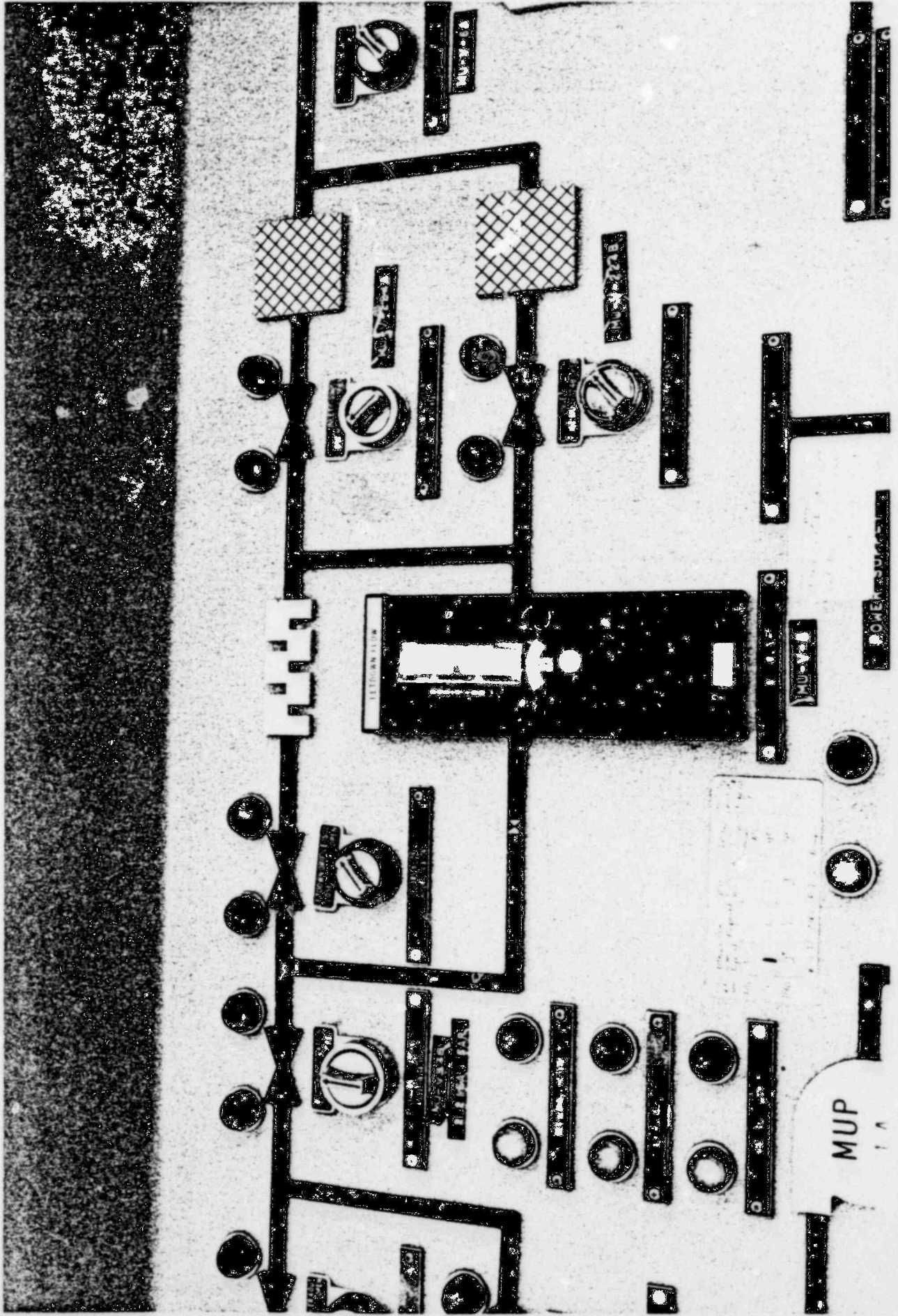












MEM

DI

DI

TELETYPE

MUP

POWER SUPPLY

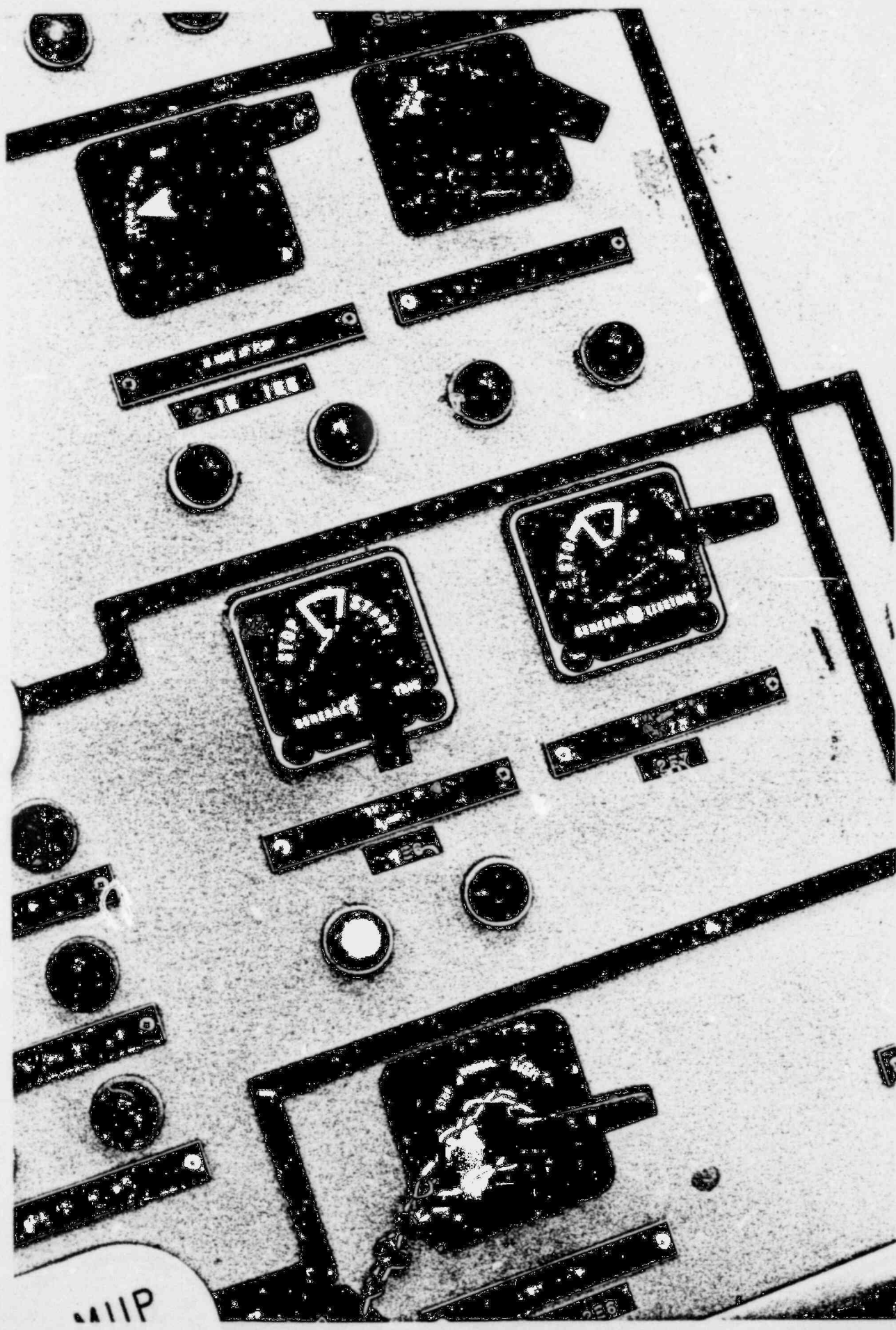
DI

DI

DI

DI





MIP

S855

2. 11. 118

STOP  
CONTACT

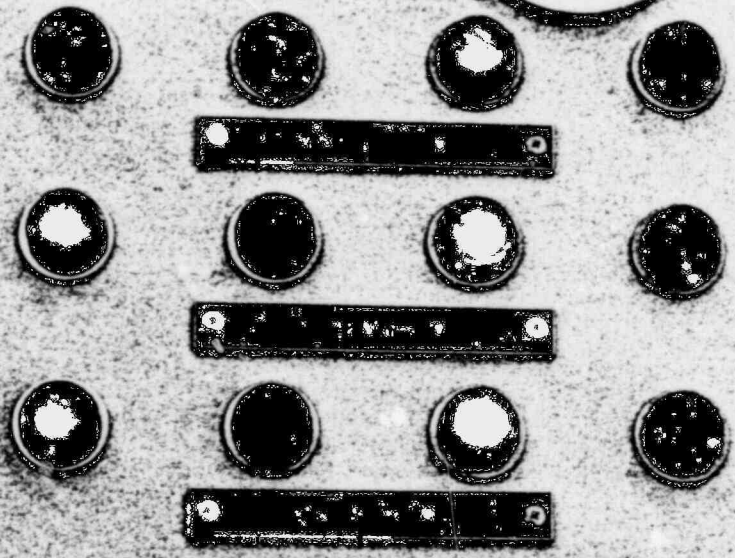
GENERAL

257

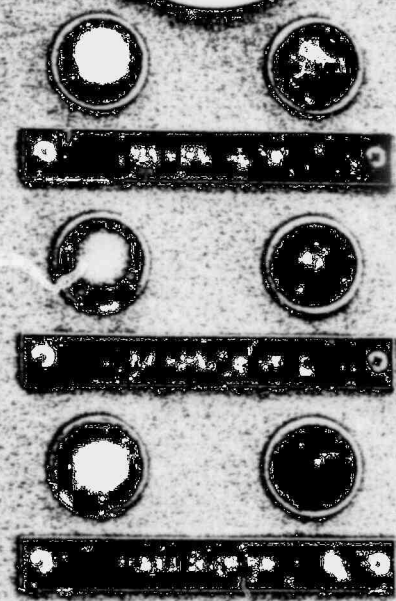
YES

258

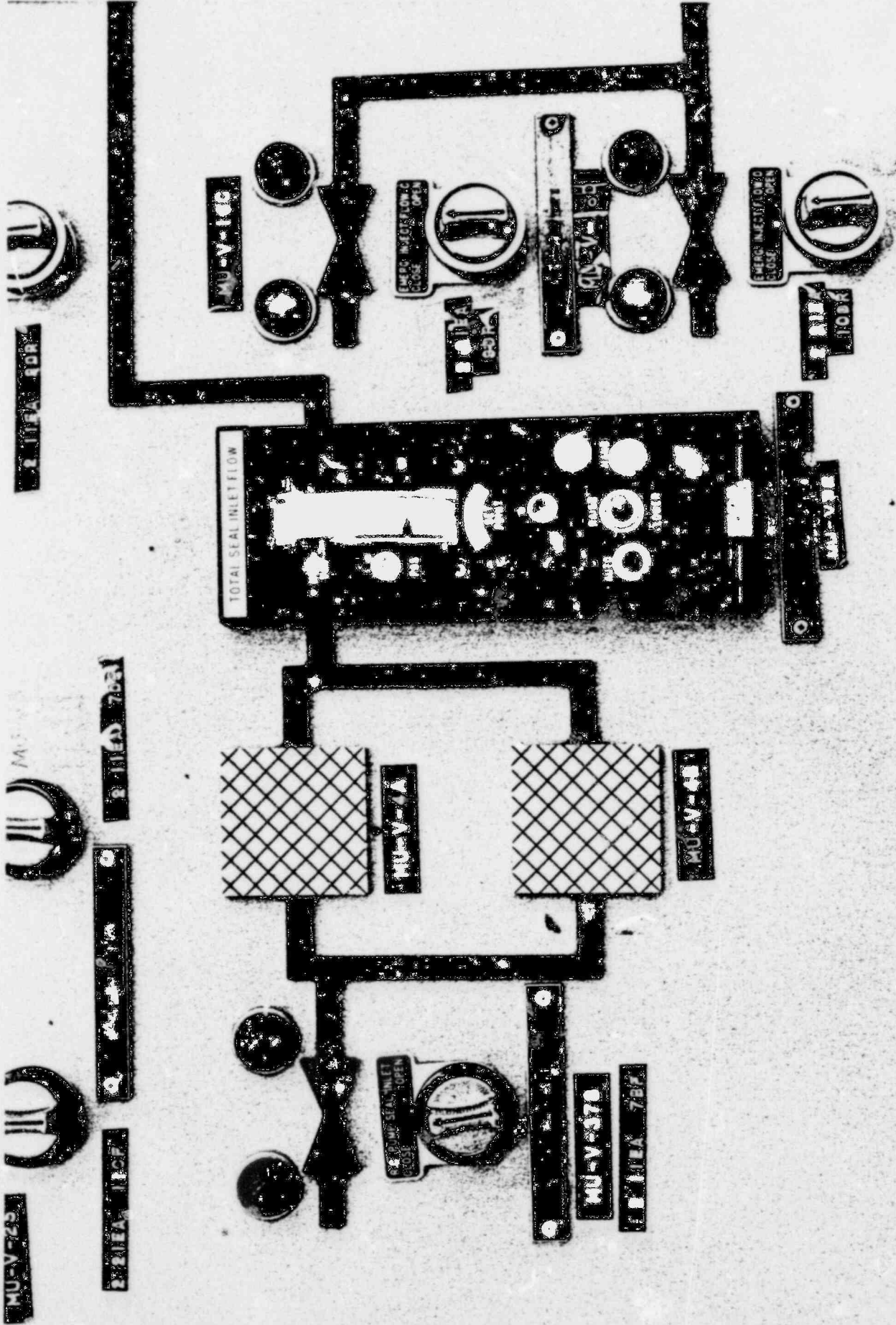
MUP  
IA



MUP  
IB



MUP  
IC



MU-V-29



MU-V-30

EMERGENCY INJECTION

EMERGENCY INJECTION

EMERGENCY INJECTION

MU-V-100

EMERGENCY INJECTION

MU-V-7A

MU-V-370

EMERGENCY INJECTION

MU-V-40

EMERGENCY INJECTION

EMERGENCY INJECTION

EMERGENCY INJECTION

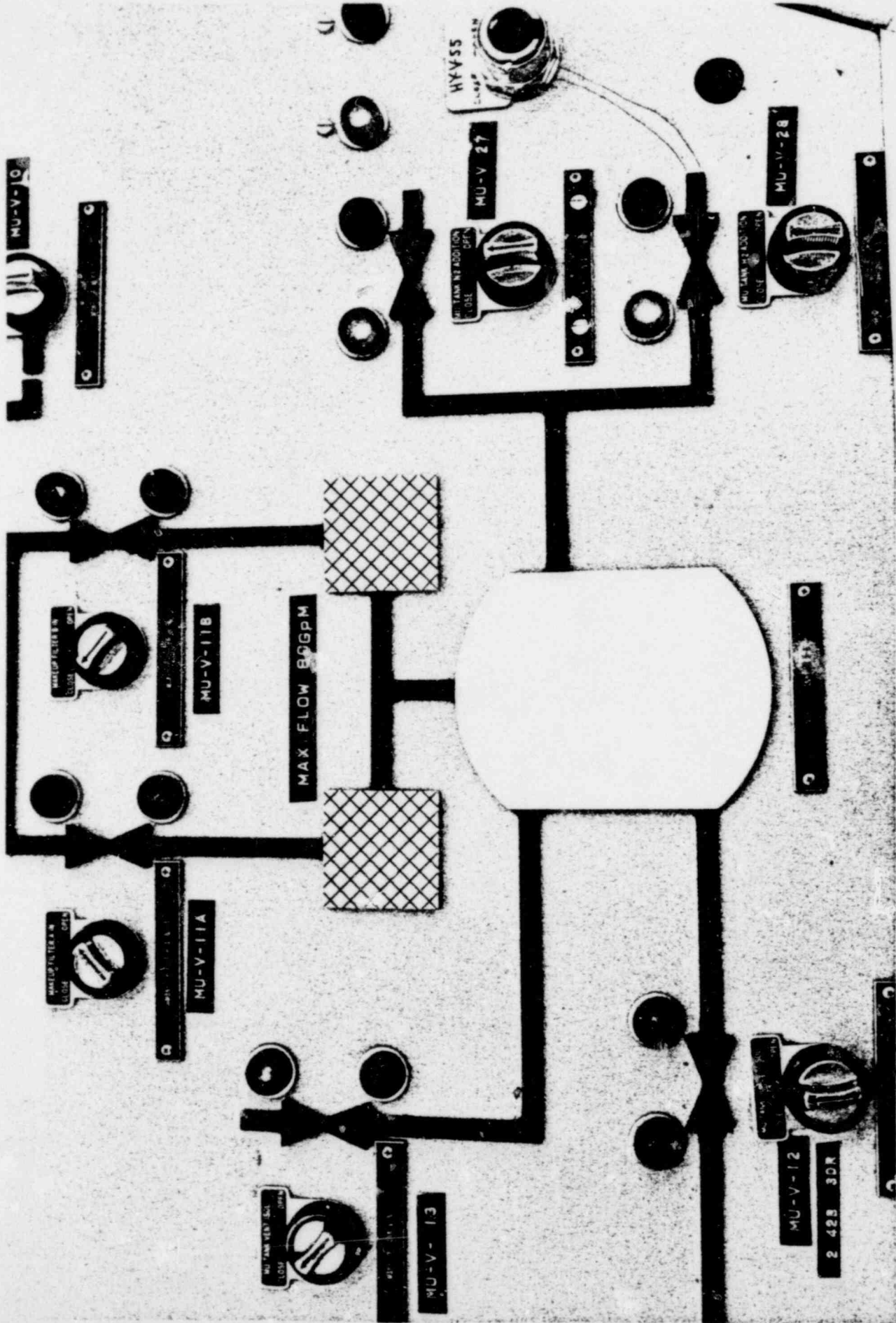
EMERGENCY INJECTION

EMERGENCY INJECTION

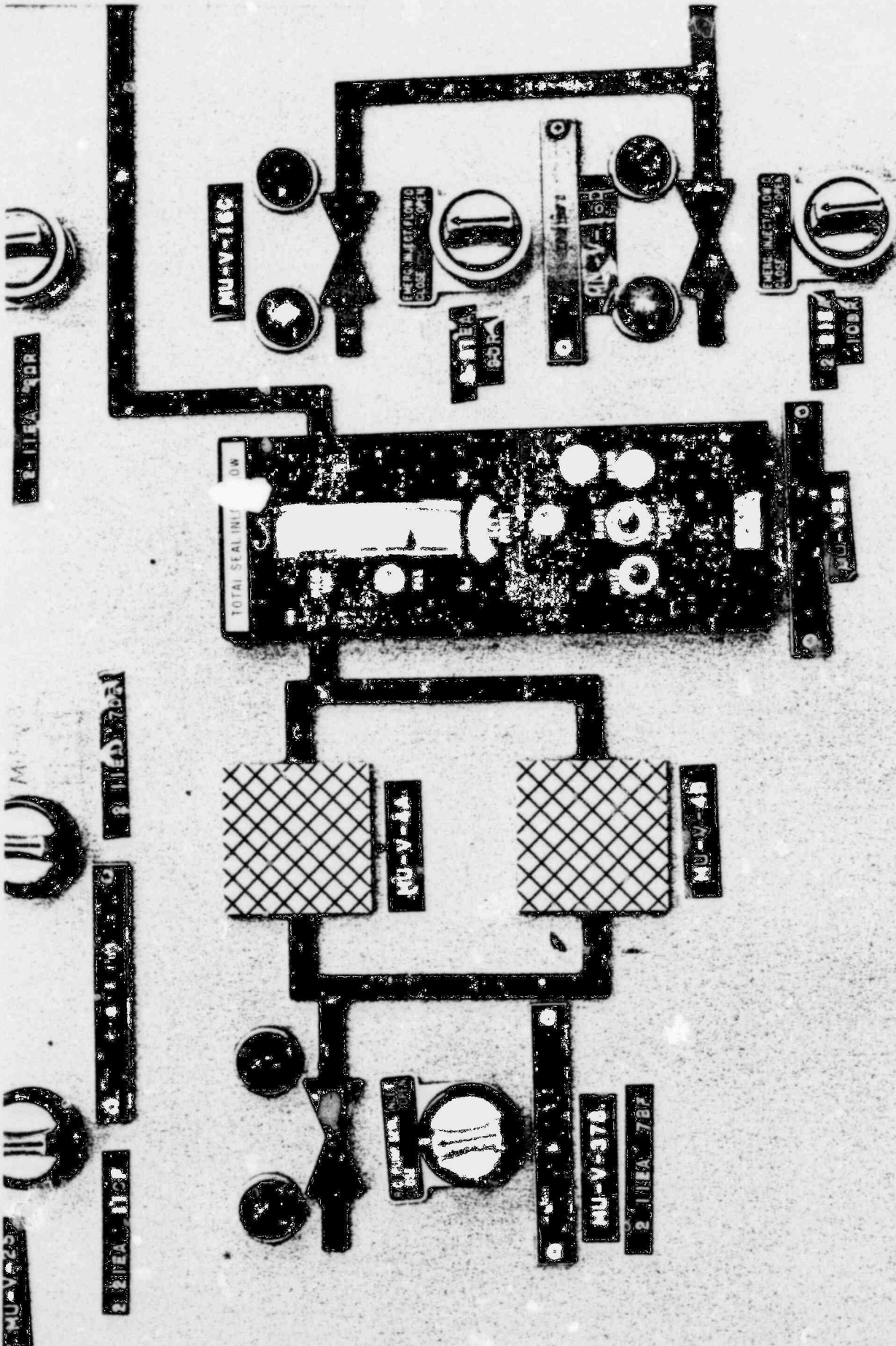
TOTAL SEAL INJECTION

EMERGENCY INJECTION









MU-V-350

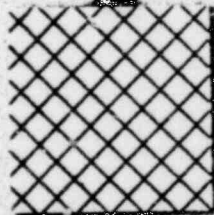
2 LINEA 707



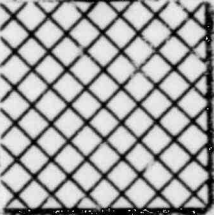
2 LINEA 708



2 LINEA 706



MU-V-4A



MU-V-4B



TOTAL SEAL INJECTION  
FLOW

MU-V-100

EMERGENCY FLOW CONTROL  
CLOSE OPEN

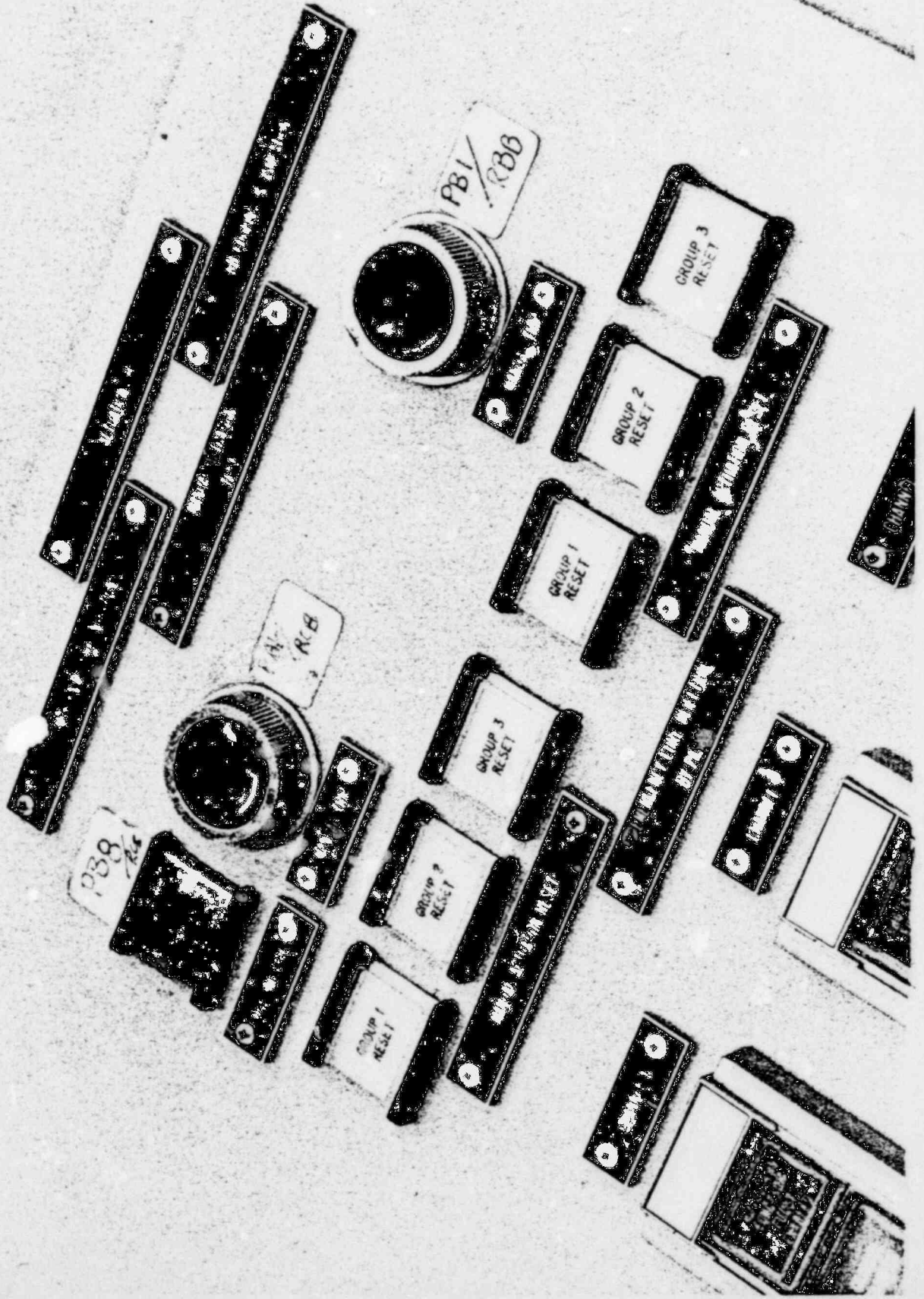
MU-V-370

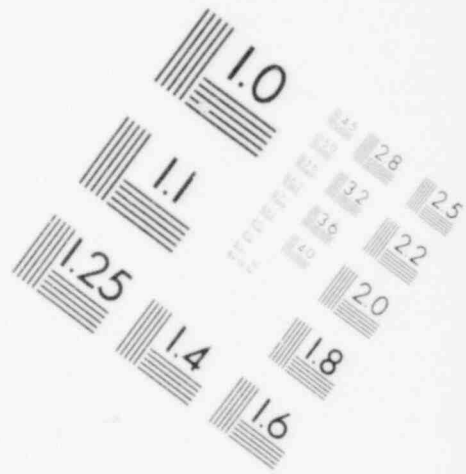
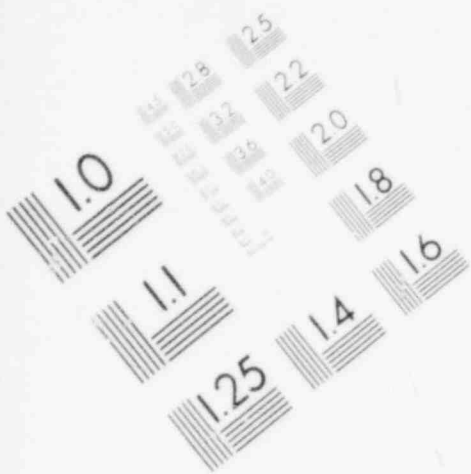
EMERGENCY FLOW CONTROL  
CLOSE OPEN

EMERGENCY FLOW CONTROL  
CLOSE OPEN

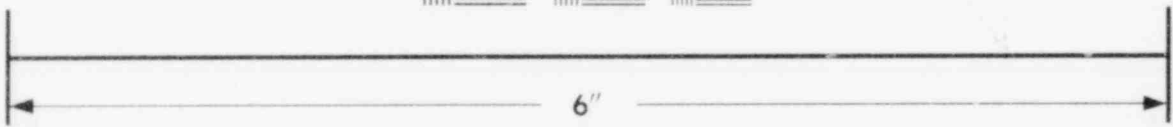
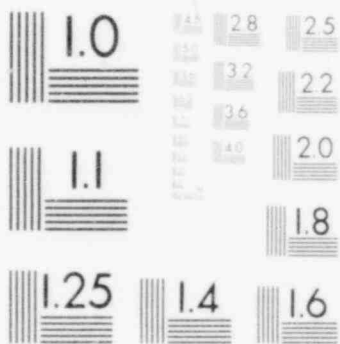
2 LINEA 709

MU-V-350

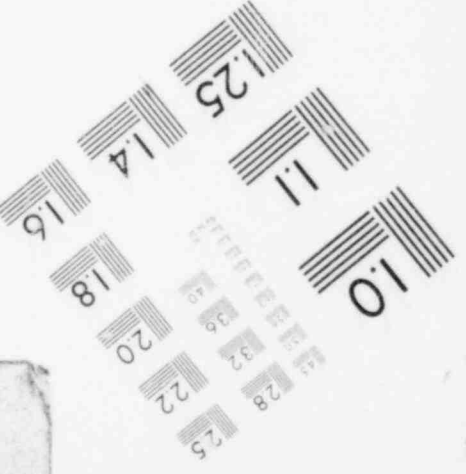
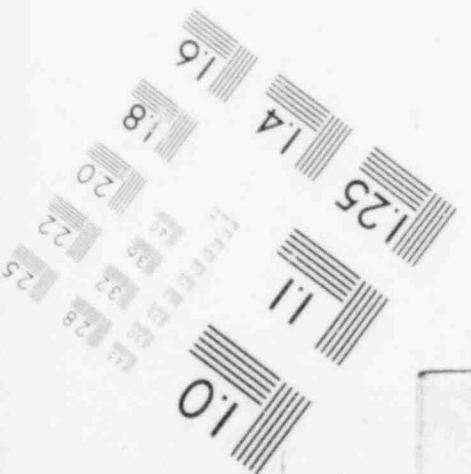


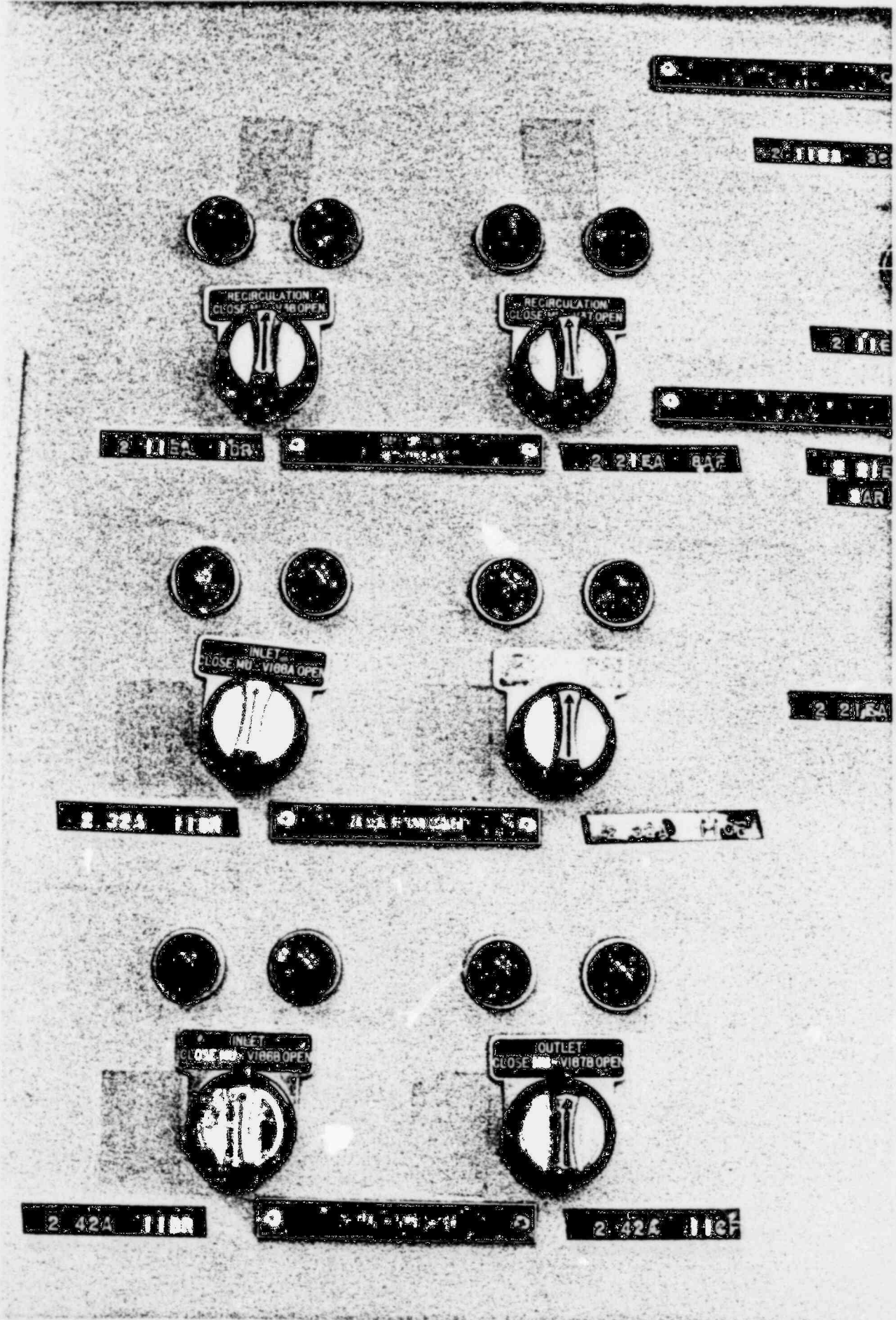


**IMAGE EVALUATION  
TEST TARGET (MT-3)**



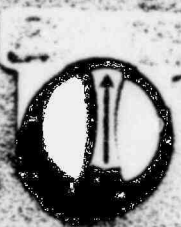
**MICROCOPY RESOLUTION TEST CHART**





2 11EA 11BR

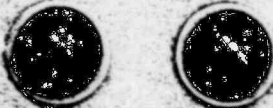
2 21EA 11BR



2 32A 11BR

2 42A 11BR

2 42B 11BR



2 42A 11BR

2 42B 11BR

2 42C 11BR

2 1/2 EA 70F

2 1/2 EA 70F

2 1/2 EA 70F



MU-V-25

R.C. PUMP SEAL RETURN  
CLOSE

R.C. PUMP SEAL RETURN  
CLOSE

2 1/2 EA 70F

R.C. PUMP SEAL RETURN

2 1/2 EA 70F

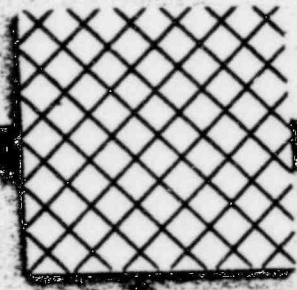


R.C. PUMP SEAL INLET  
CLOSE OPEN

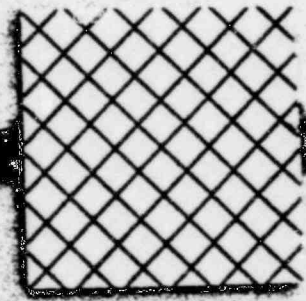
2 1/2 EA 70F

MU-V-378

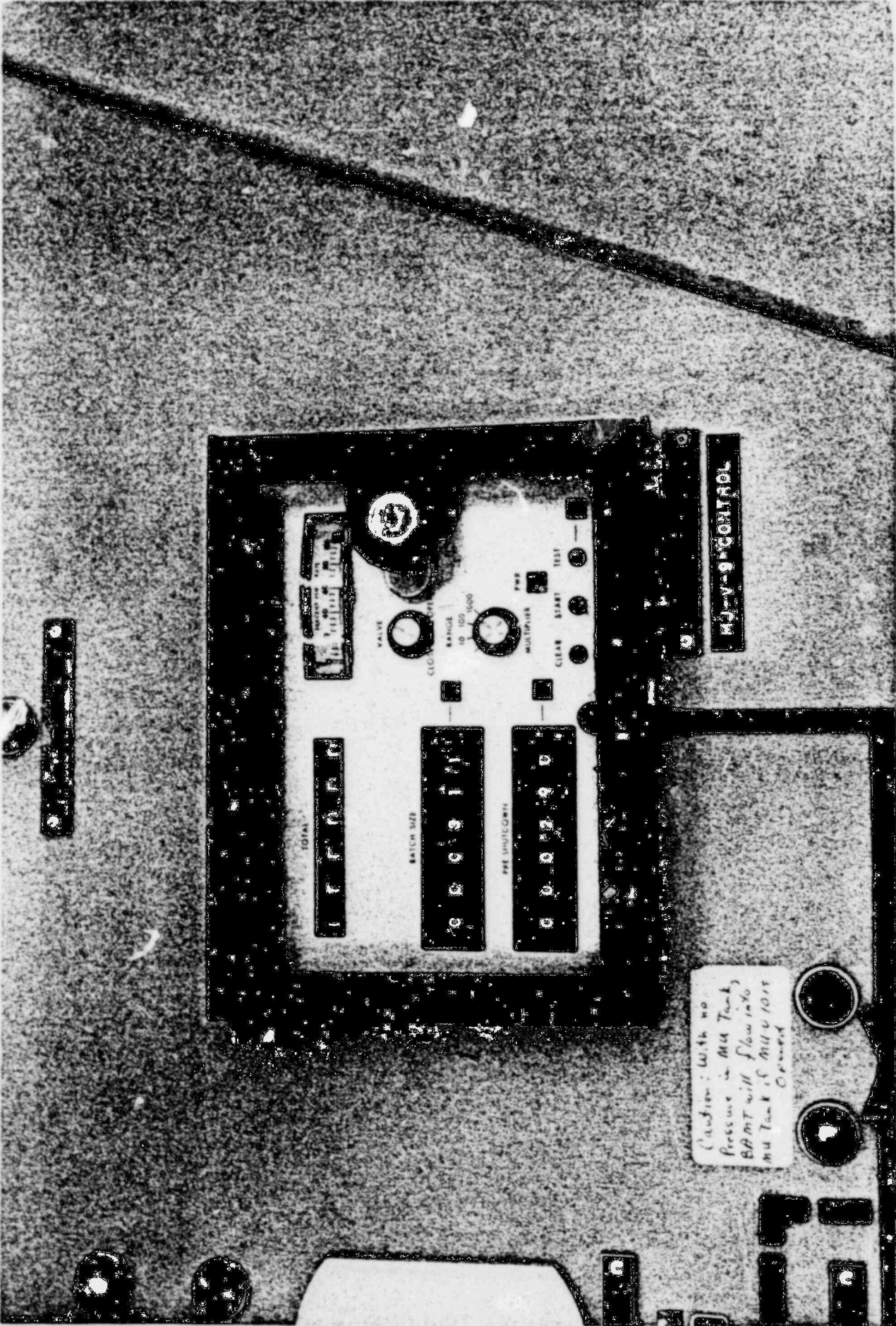
2 1/2 EA 70F



MU-V-4A



MU-V-4B



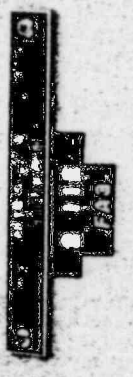
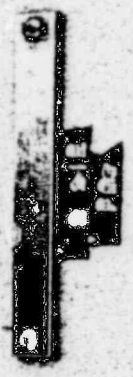
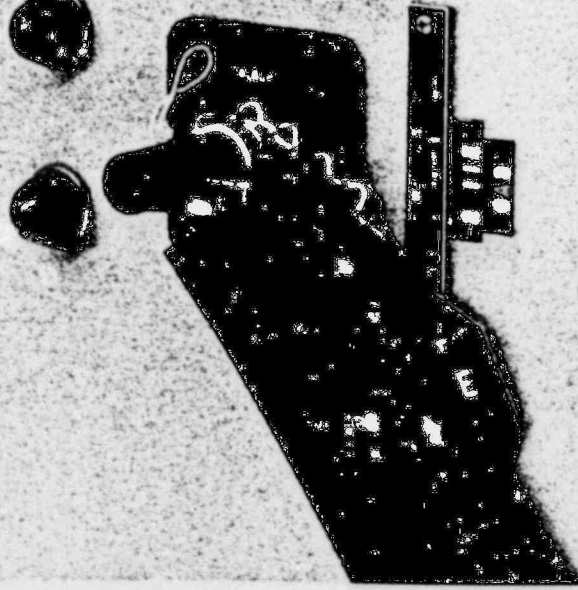
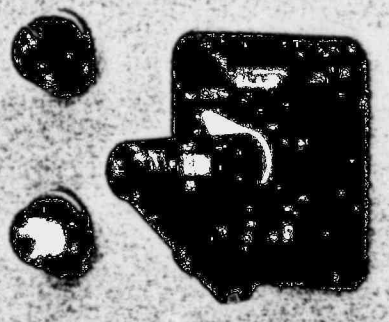
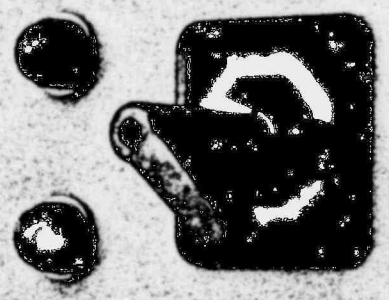
MJ-V-9 CONTROL

TOTAL

BATCH SIZE

PRE SHUTDOWN

Caution: With no  
pressure in M4 Tank,  
BATT will flow into  
M4 Tank if M4V 1015  
Closed



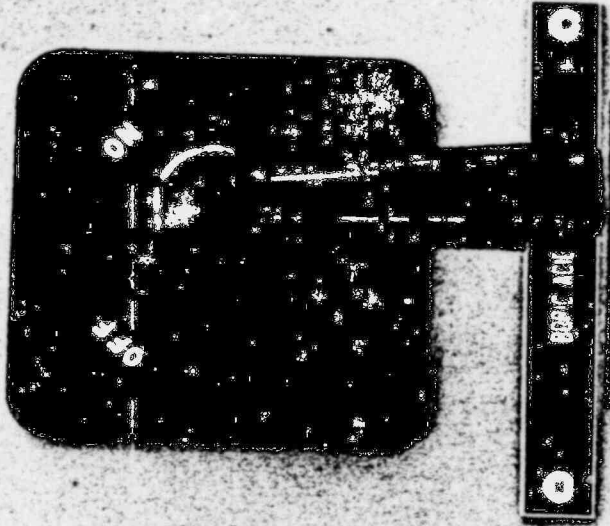
22-71EA-24A

22-71EA-24B

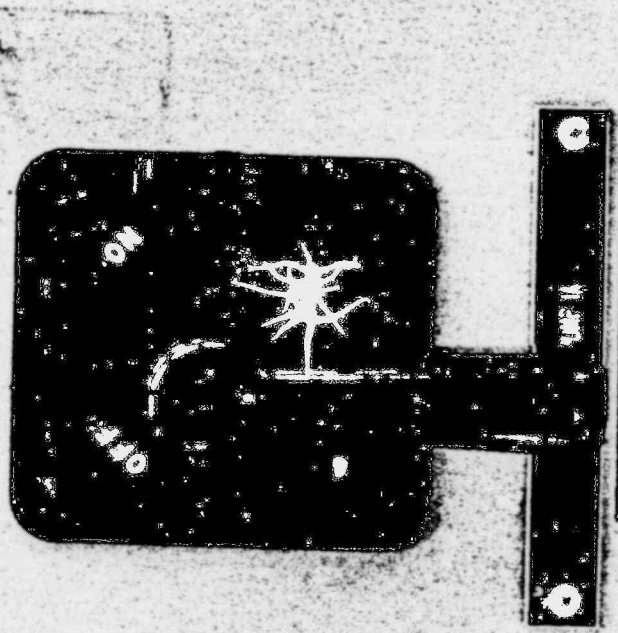
22-71EA-24C

22-71EA-24D



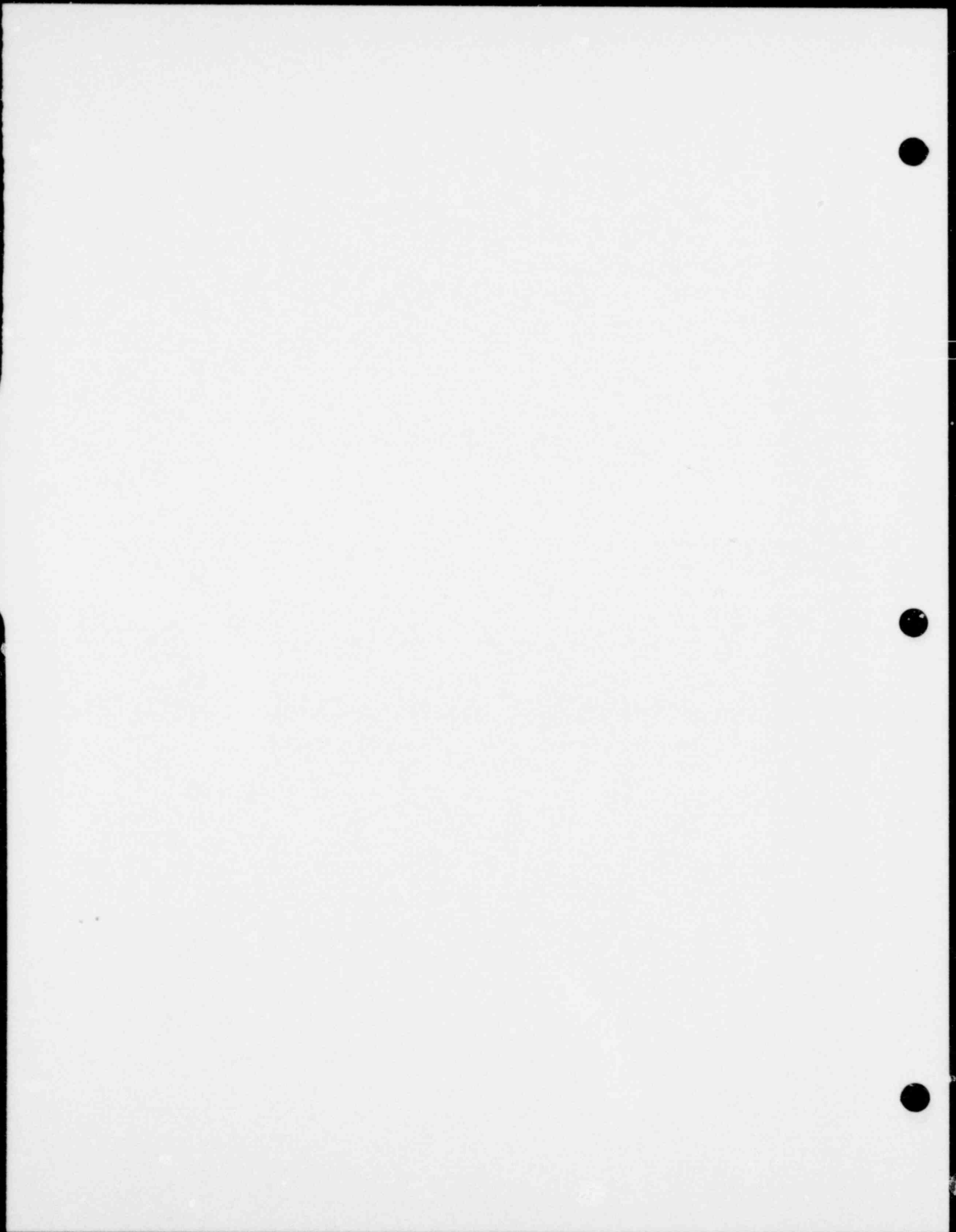


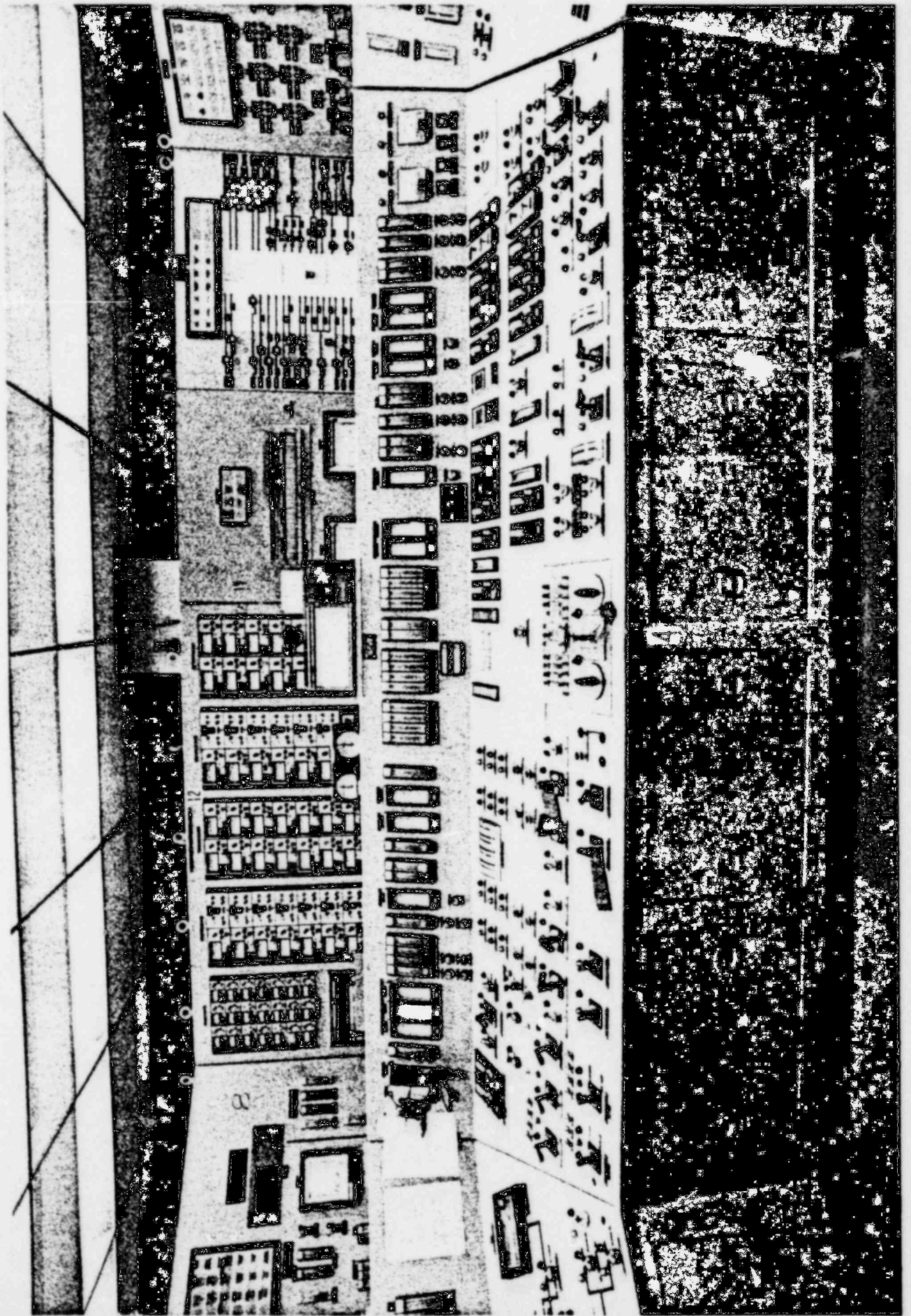
2 42A 2AF

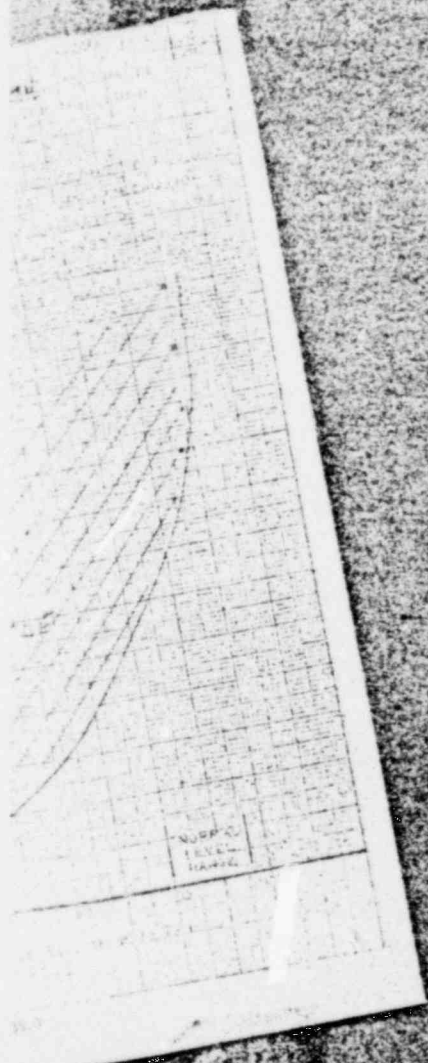
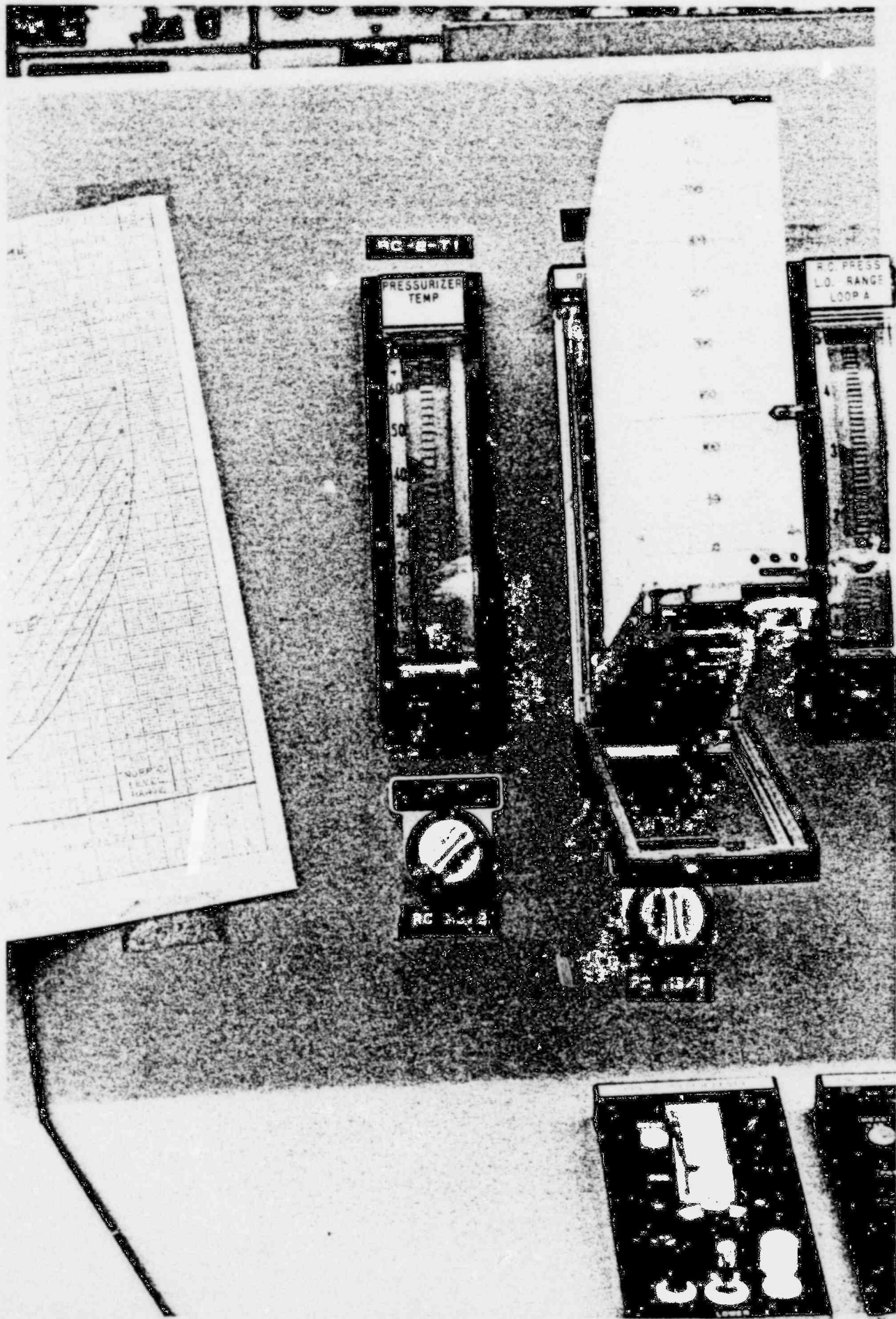


2 62A 2AF









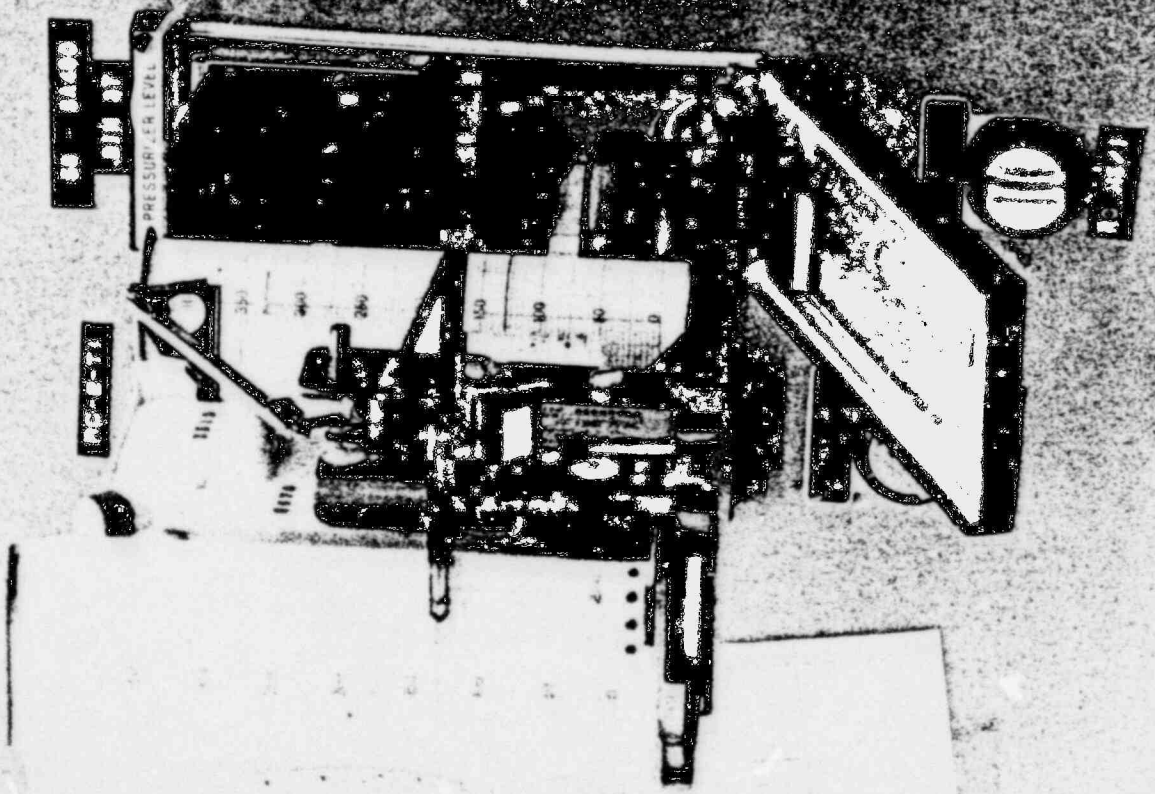
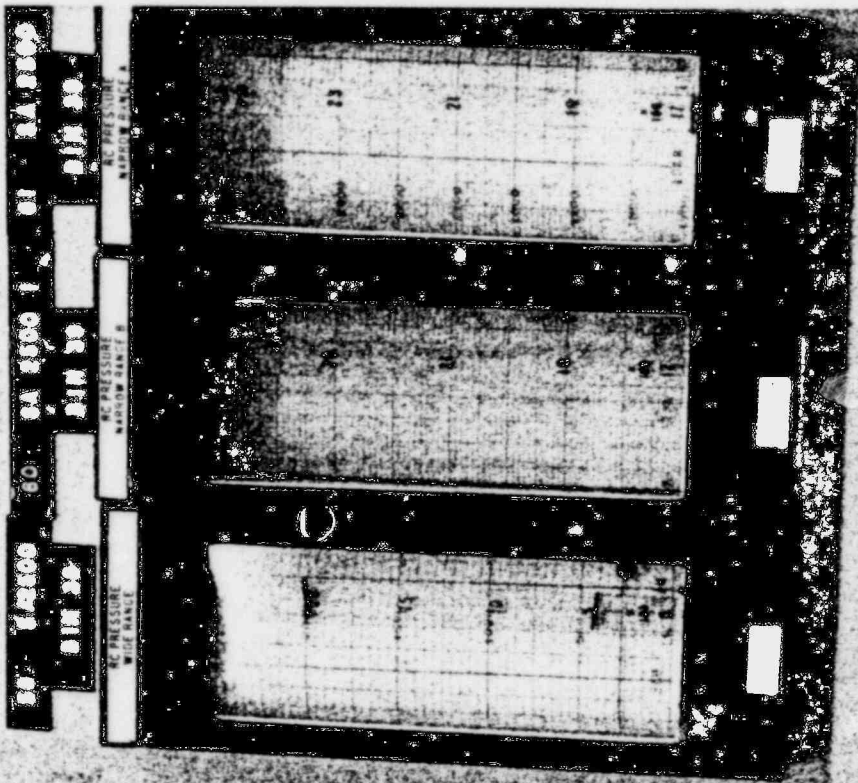
RC-8-71  
PRESSURIZER  
TEMP

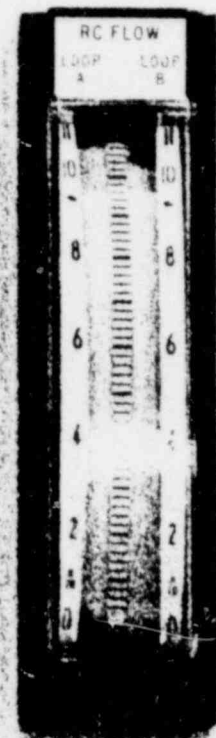
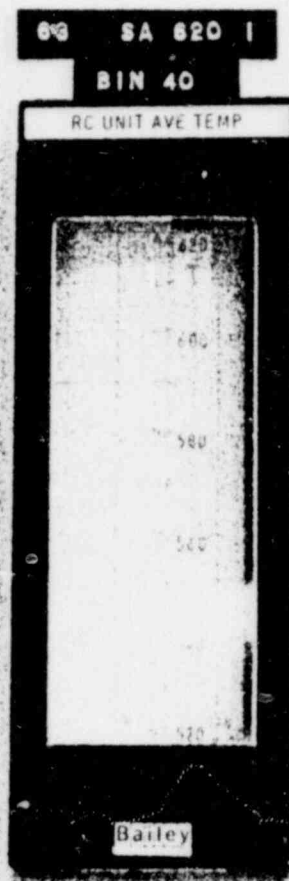
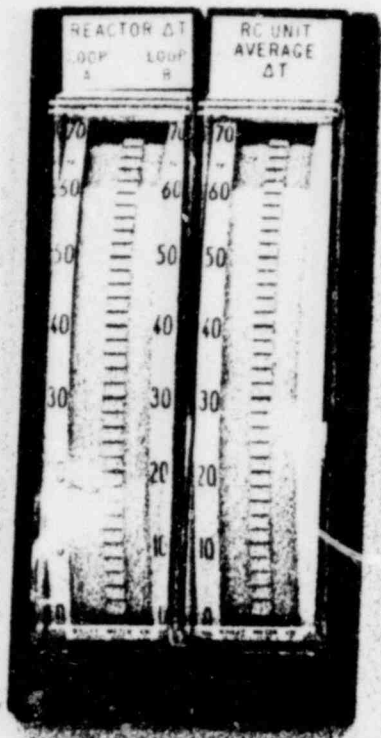
R.C. PRESS  
L.O. RANGE  
LOOP A

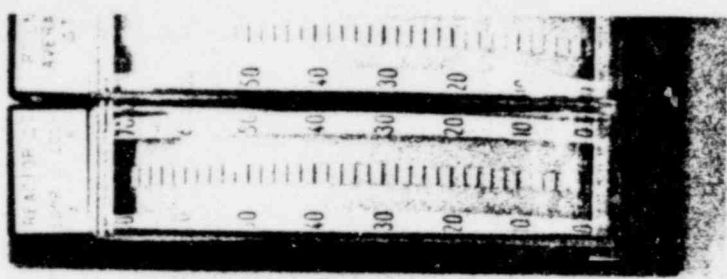
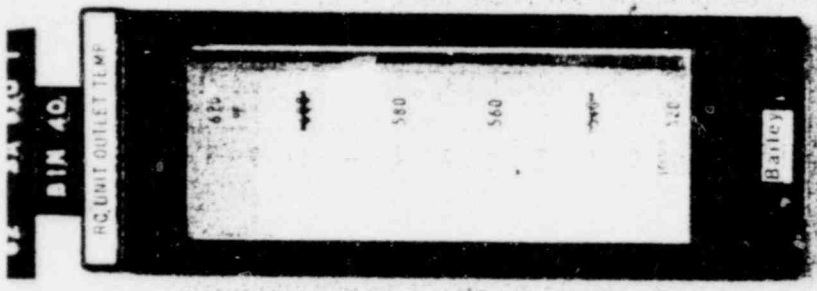
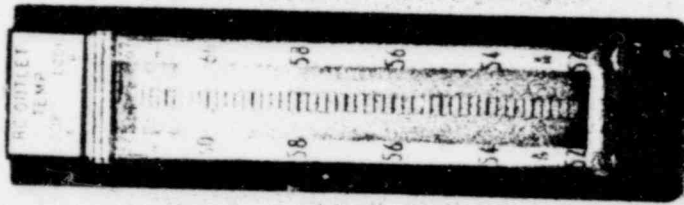
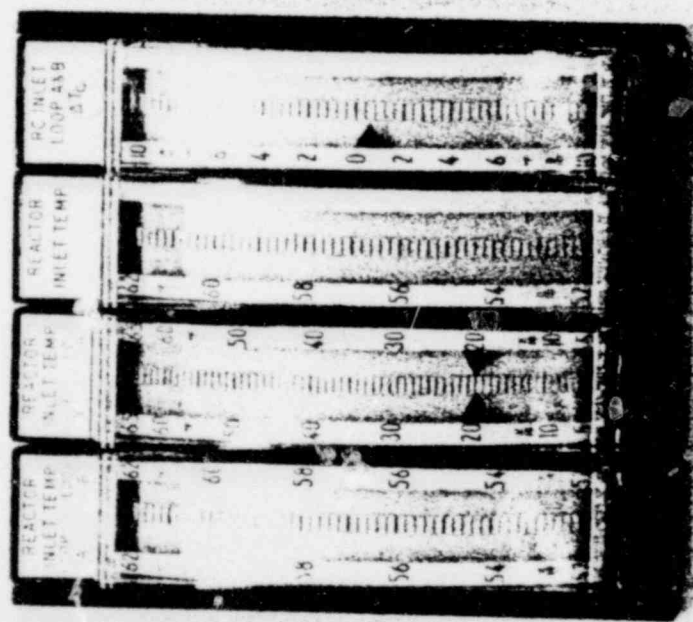
RC-8-83

RC-8-84

LOOP A







LOOP A TC NARROW  
TT1 TAT IT3



LOOP B TC NARROW  
TT1 TAT IT3



LOOP A TC WIDE  
TT2 TT4



LOOP B TC WIDE  
TT2 TT4



LOOP A TT1 TT4



LOOP B TT1 TT4



REACTOR TT1  
LOOP A UNIT LOOP B

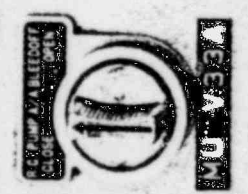
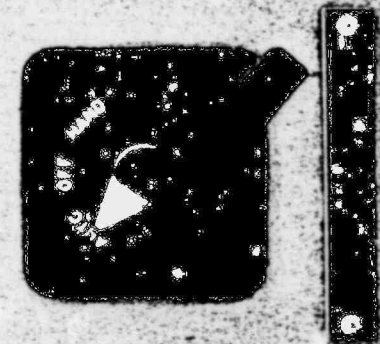
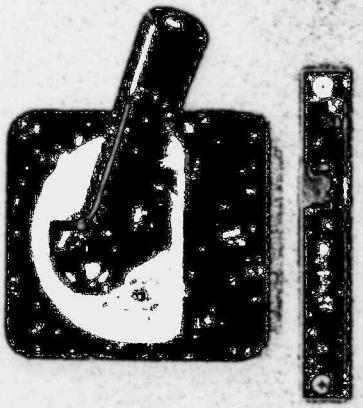
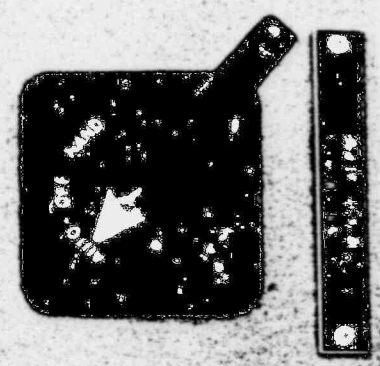


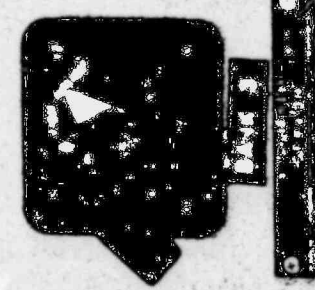
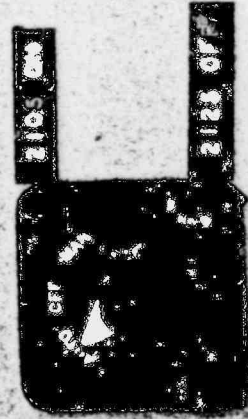
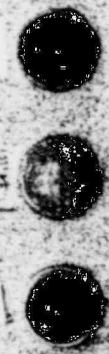
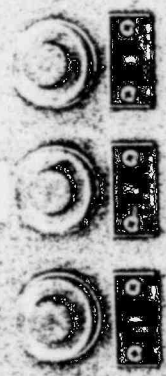
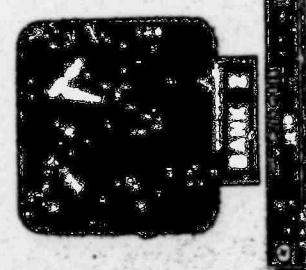
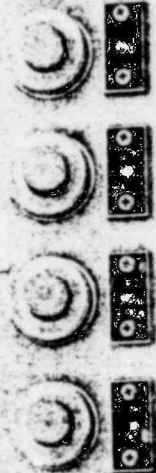
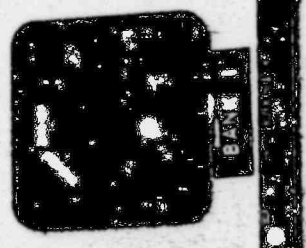
REACTOR INLET

REACTOR INLET

REACTOR INLET

REACTOR INLET



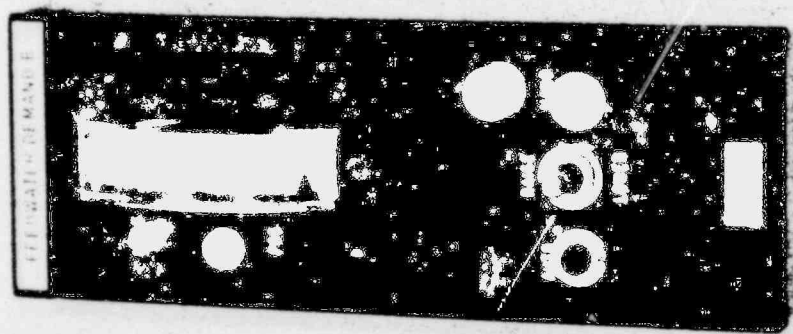
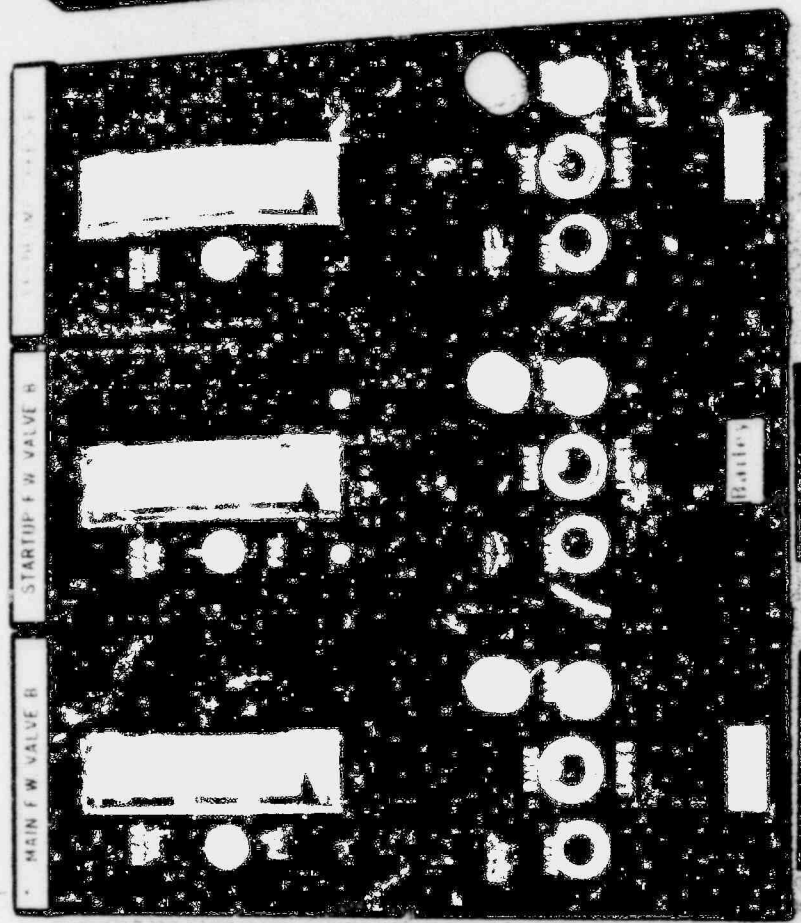






FM-V-25A

FM-V-25A



FM-V-30B

FM-V-30B





21 OPERATIONAL TESTS

21 OPERATIONAL TESTS



2 EMERGENCY FEED PUMP DISCHARGE TO CONDENSER

2 EMERGENCY FEED PUMP DISCHARGE TO CONDENSER

closed

X F. W. VALVE B

STOP START EMERGENCY MANUAL

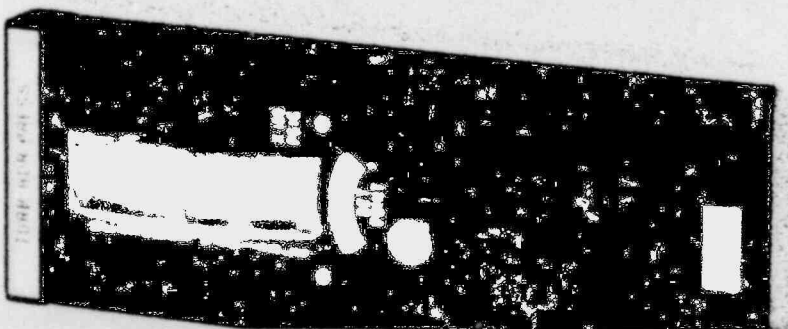
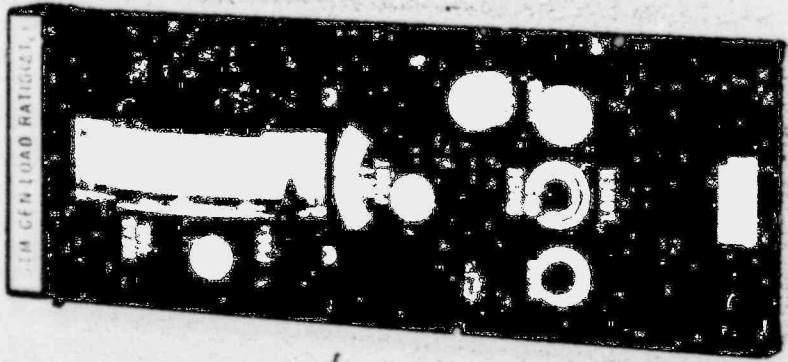
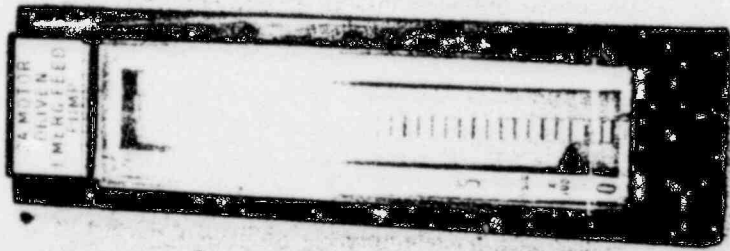
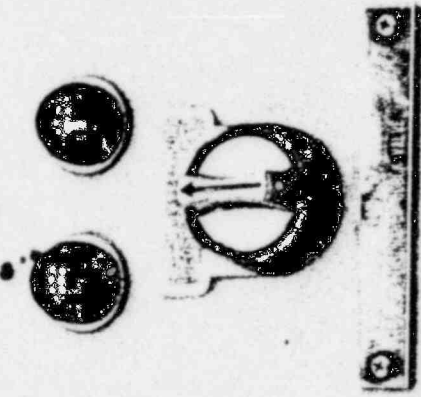
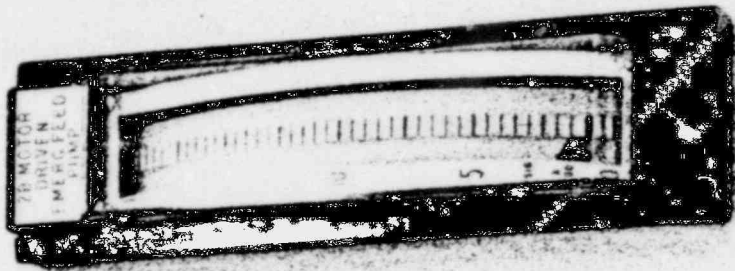
EF-V-11B

FOXBORO

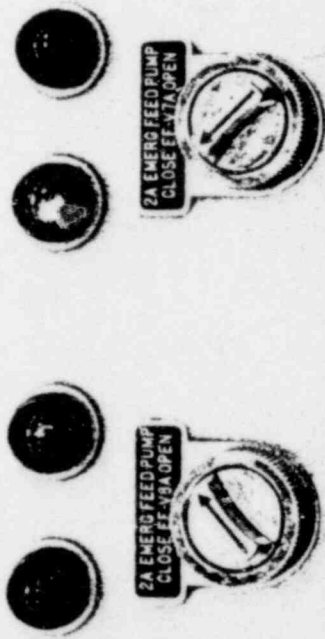
SAT POINT

MANUAL AUTO

FOXBORO



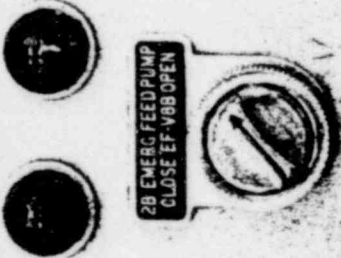
ON 1901  
ON  
IN  
LIMIT



EF-P-2A DISCHARGE TO  
CONDENSER STORAGE TANK

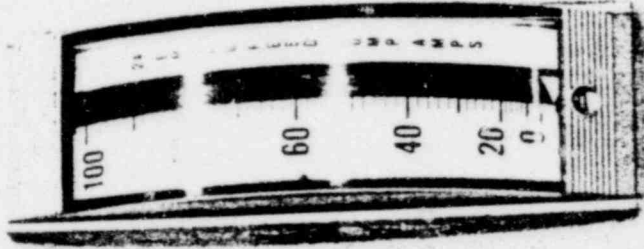
EF-P-2B DISCHARGE TO  
CONDENSER H

**CAUTION**  
DO NOT OPEN BOTH EF-V7&8 VALVES  
ON SAME LINE AT SAME TIME OR  
COND. STOR. TANKS WILL DRAIN TO  
THE MAIN CONDENSER.



EF-P-2A DISCHARGE TO  
CONDENSER STORAGE TANK

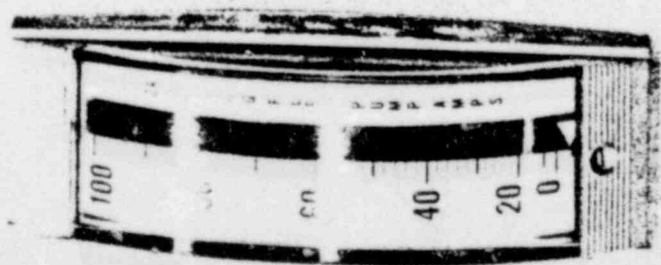
EF-P-2B DISCHARGE TO  
CONDENSER H



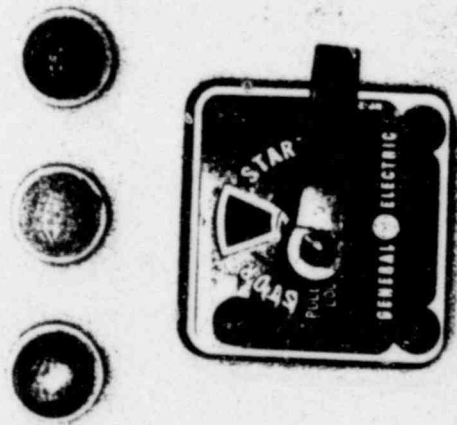
24 EMERG. FEED PUMP CURRENT



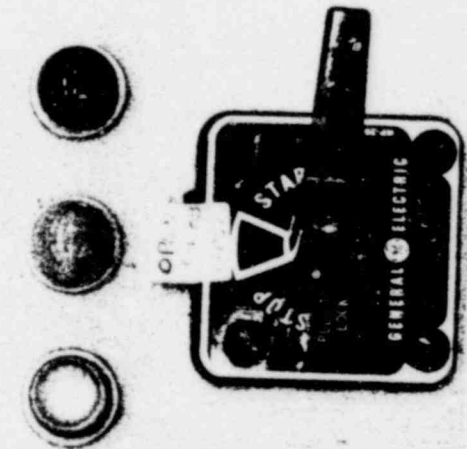
24 EMERG FEED P



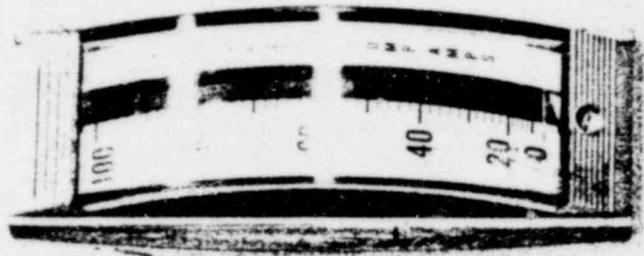
24 EMERG FEED PUMP  
FEED PUMP CURRENT



24 EMERG FEED PUMP



28 EMERG FEED PUMP



28 EMERG FEED PUMP  
FEED PUMP CURRENT

28 1/8 PUMP  
SPEED RANGE AVAIL

28 1/8 PUMP  
SPEED RANGE AVAIL

24 1/8 PUMP  
SPEED RANGE AVAIL

24 1/8 PUMP  
SPEED RANGE AVAIL



28 1/8 PUMP SPEED

OPEN  
0  
CLOSE

LF-V35  
FW BYPASS  
FOR EF-V12B

OPEN  
0  
CLOSE

LF-V35A  
FW BYPASS  
FOR EF-V12A



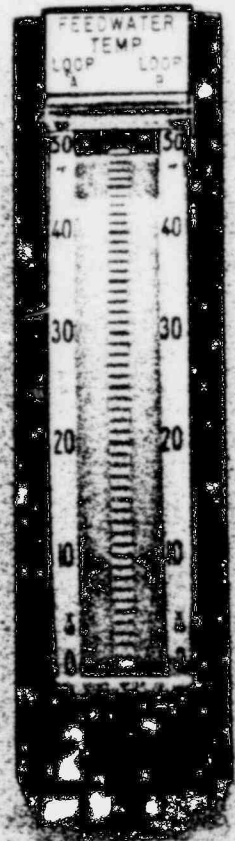
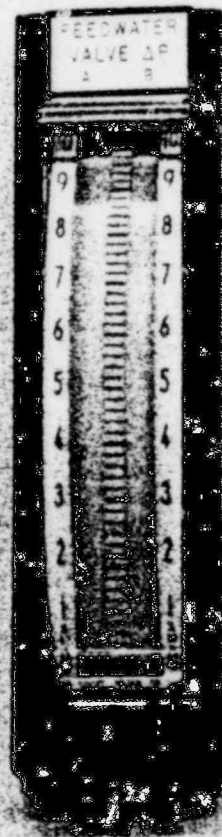
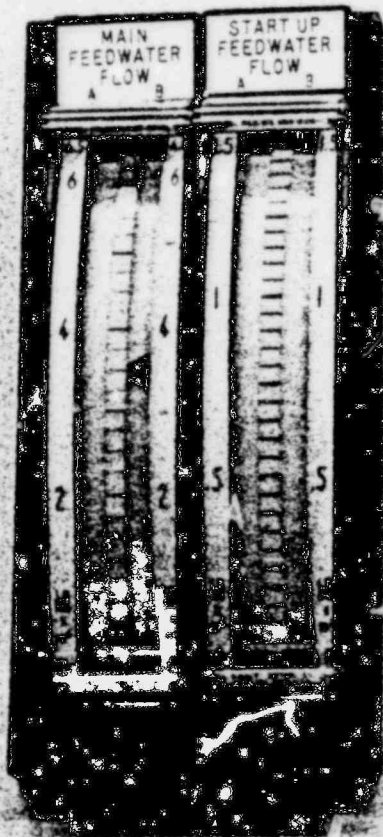
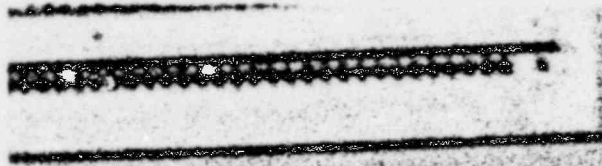
24 1/8 PUMP SPEED

OPEN  
0  
CLOSE

EF-V32D  
FW BYPASS  
FOR EF-VIIB

OPEN  
0  
CLOSE

LF-V32A  
FW BYPASS  
FOR EF-VIIA



MAIN FEEDWATER FLOW  
FT1 FT2



MAIN FEEDWATER FLOW  
FT1 FT2



FEEDWATER VALVE ΔP  
FT1 FT2



FEEDWATER VALVE ΔP  
FT1 FT2

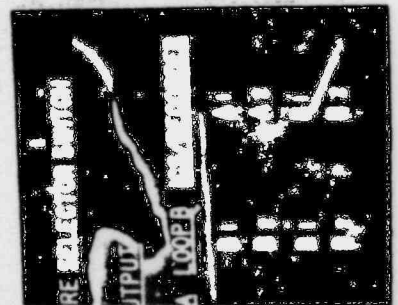
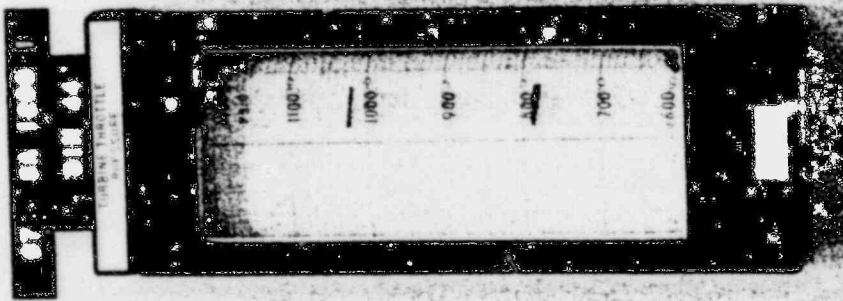
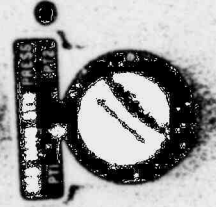
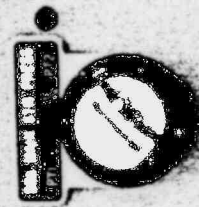
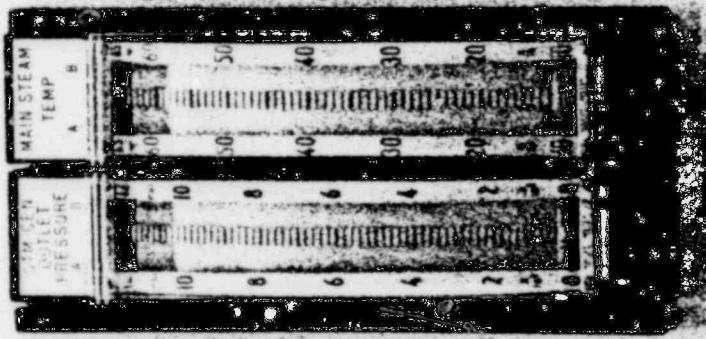
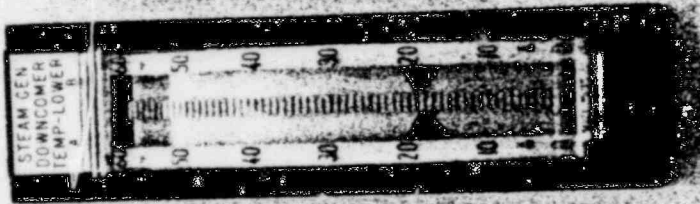
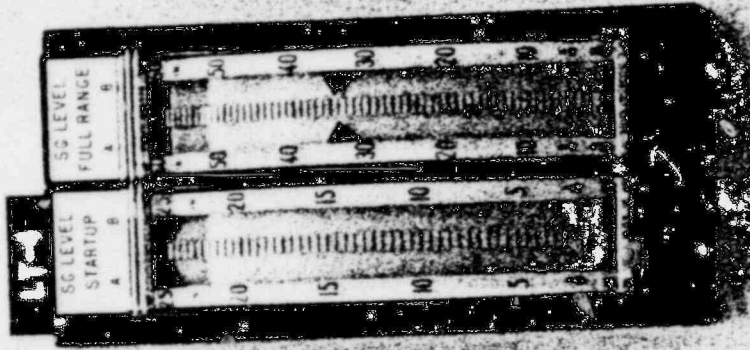


FEEDWATER TEMP  
TT1 TT2

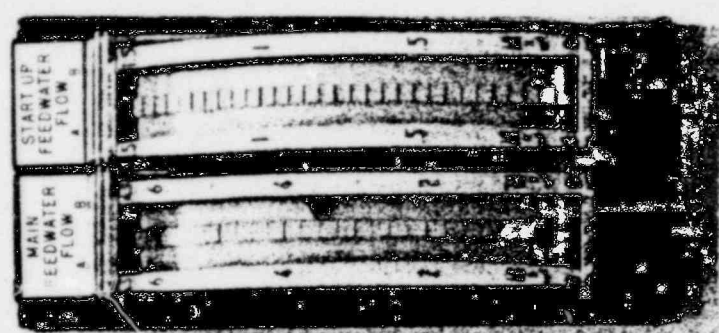
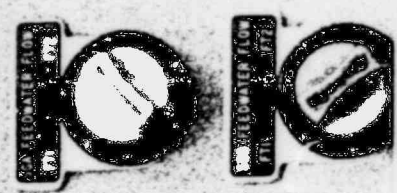
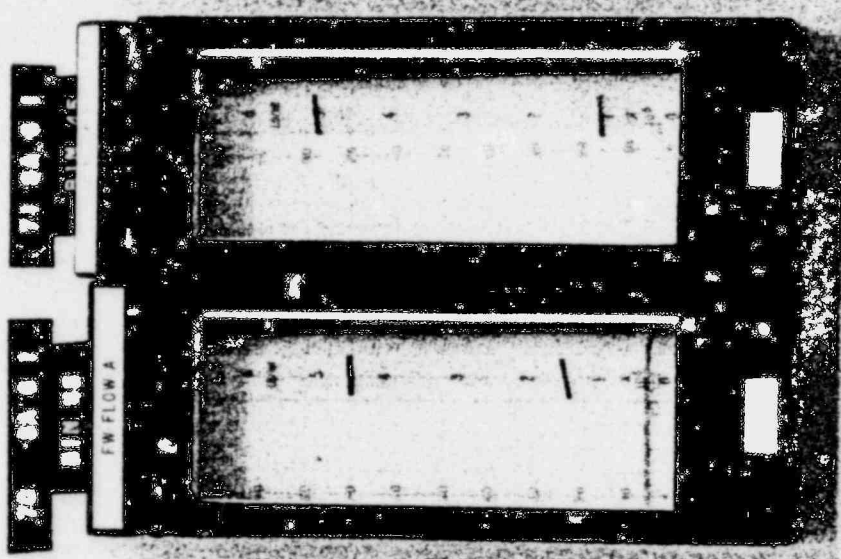
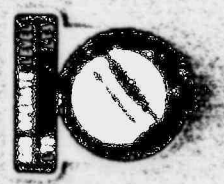
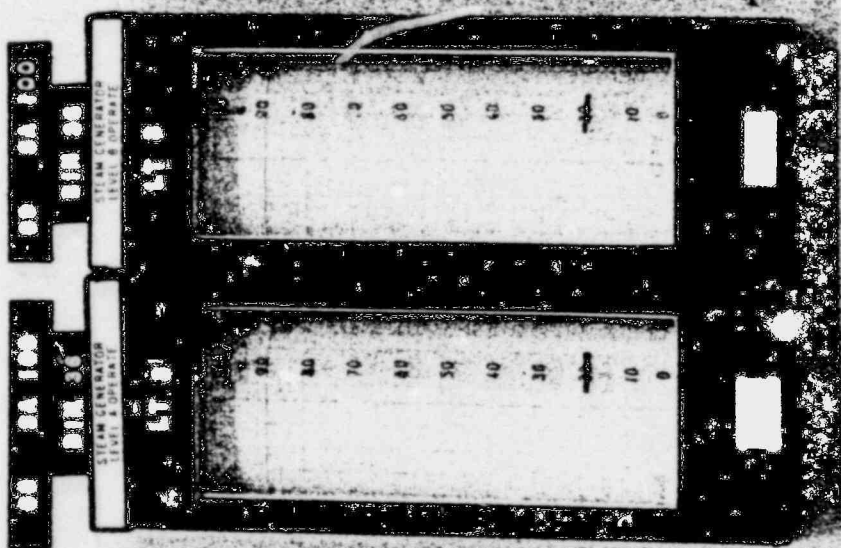
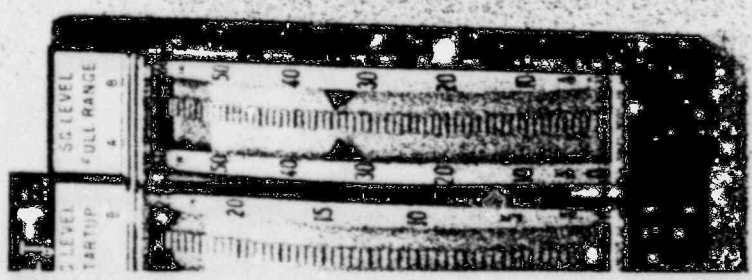


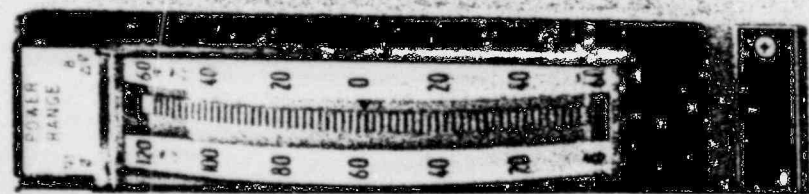
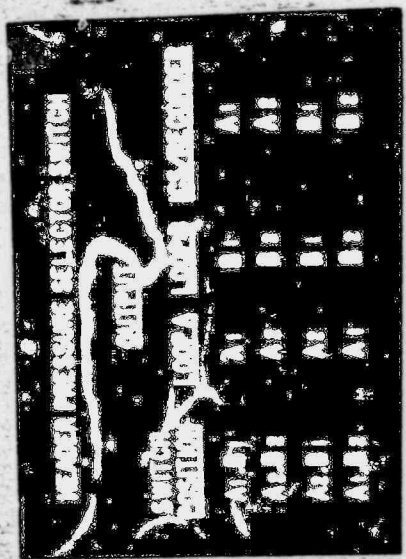
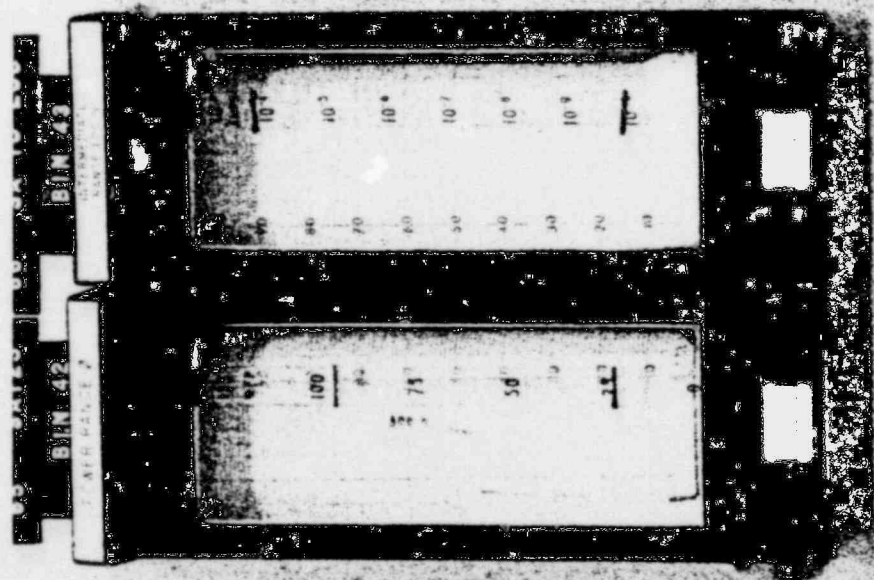
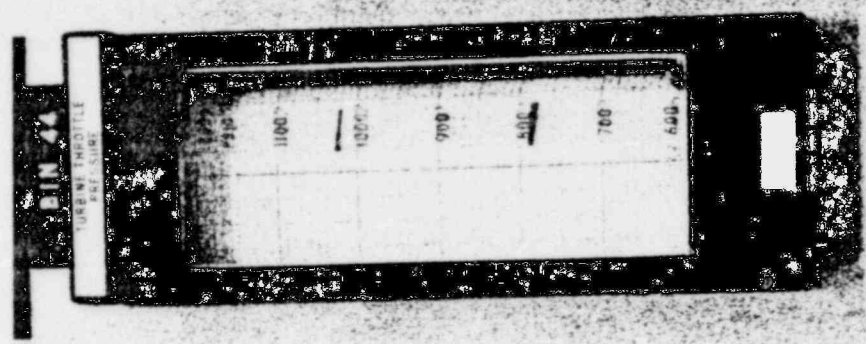
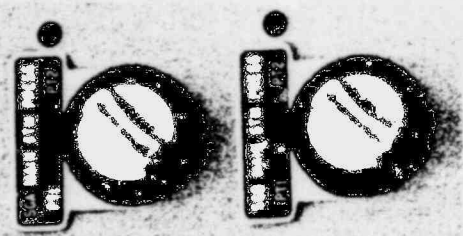
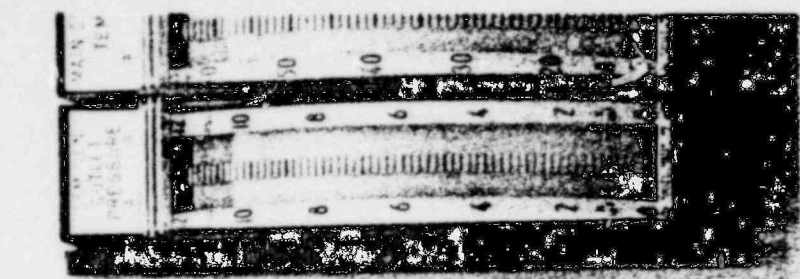
FEEDWATER TEMP  
TT1 TT2



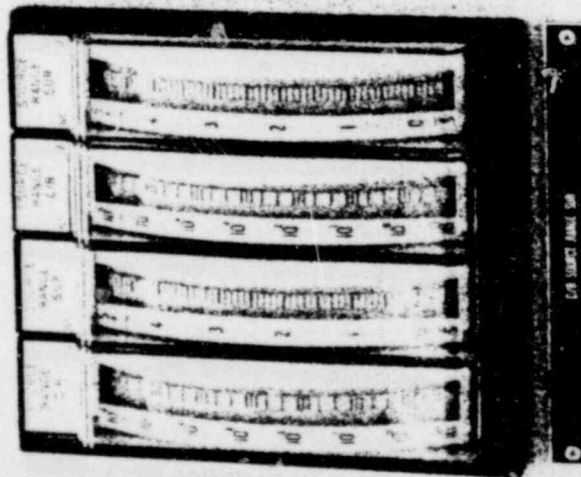
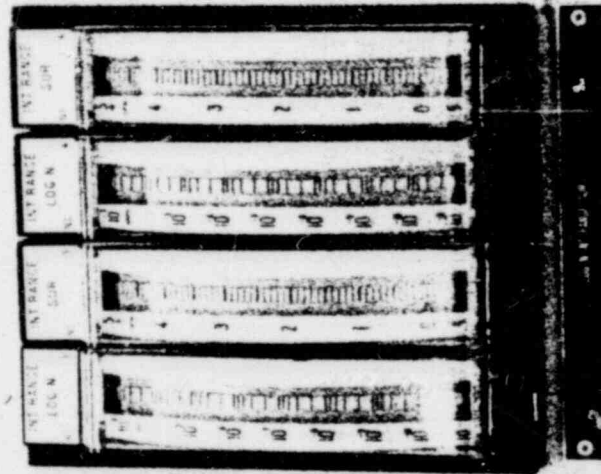
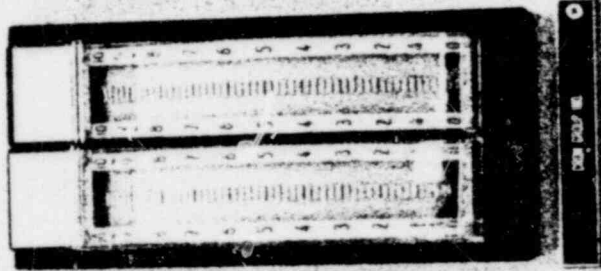
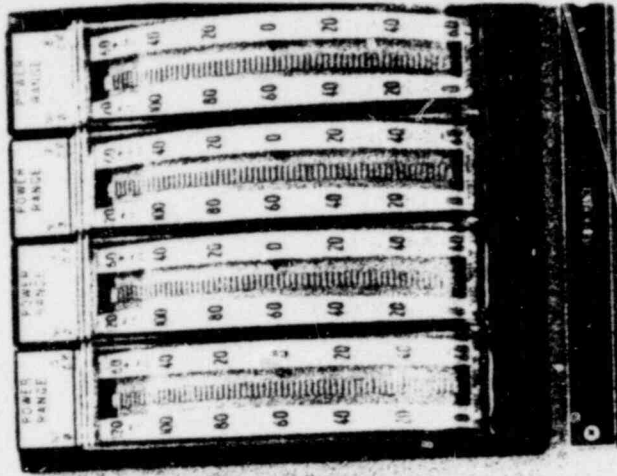




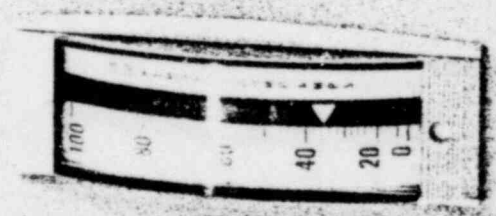
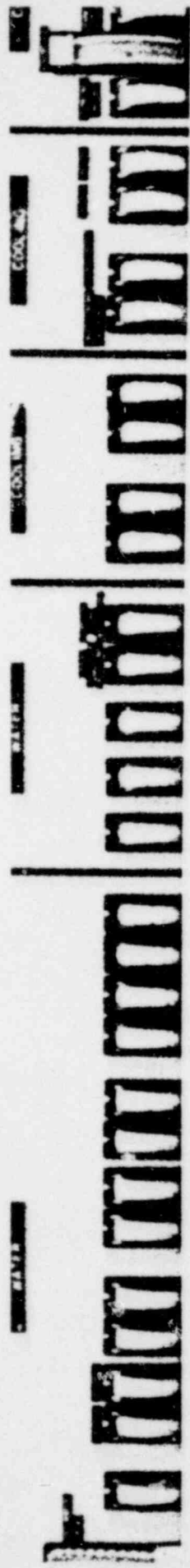




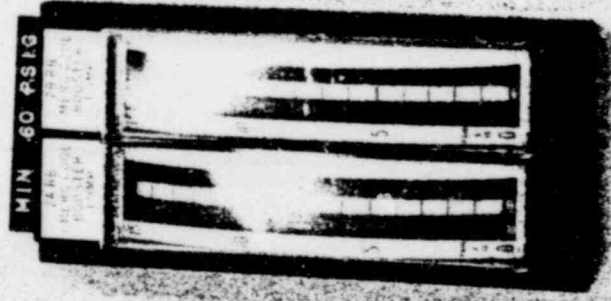
THIS RECORDER CAN BE  
CONNECTED TO M-1, M-2, M-3  
OR M-4. VERIFY PROPER  
PATCH. SEE COMPUTER  
CARTNET & ICAS. 1540  
ROW 10



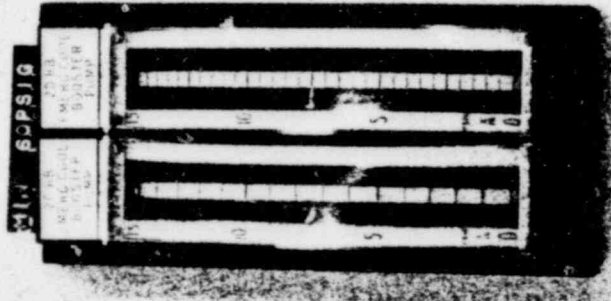
CELESTIAL AVERAGE TEMPS  
CELESTIAL FAHRENHEIT



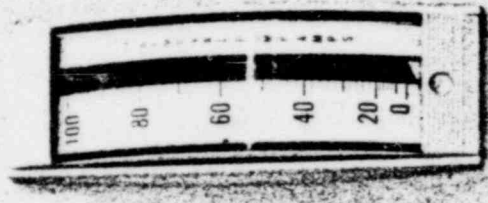
WATER PUMP



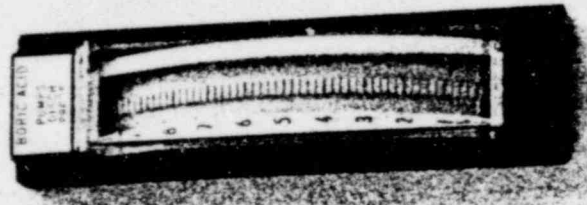
WATER PUMP



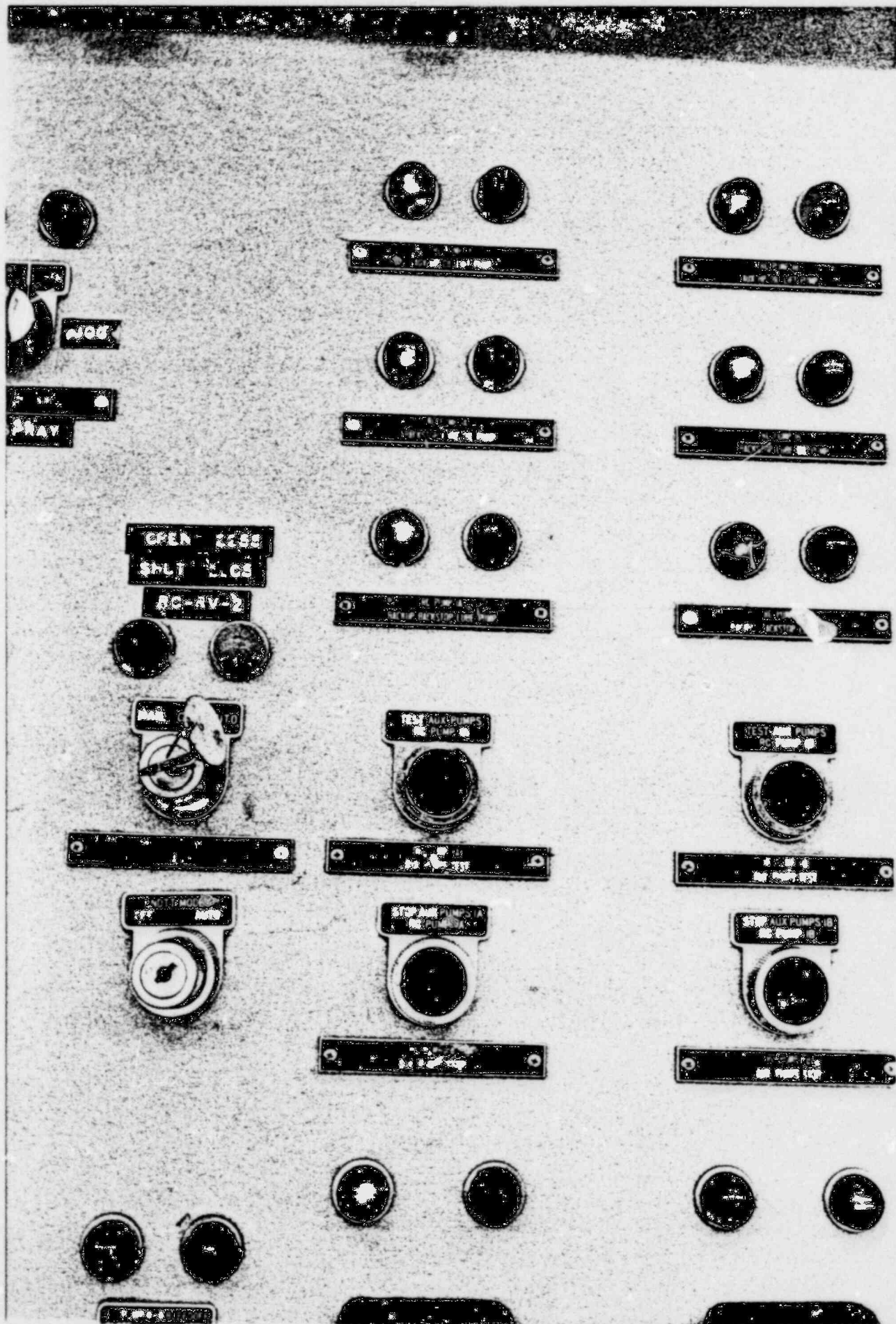
WATER PUMP



WATER PUMP



ROTOR K10



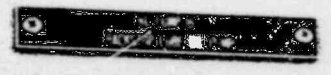
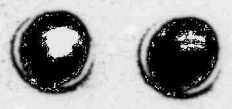
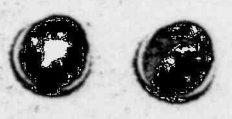
W00

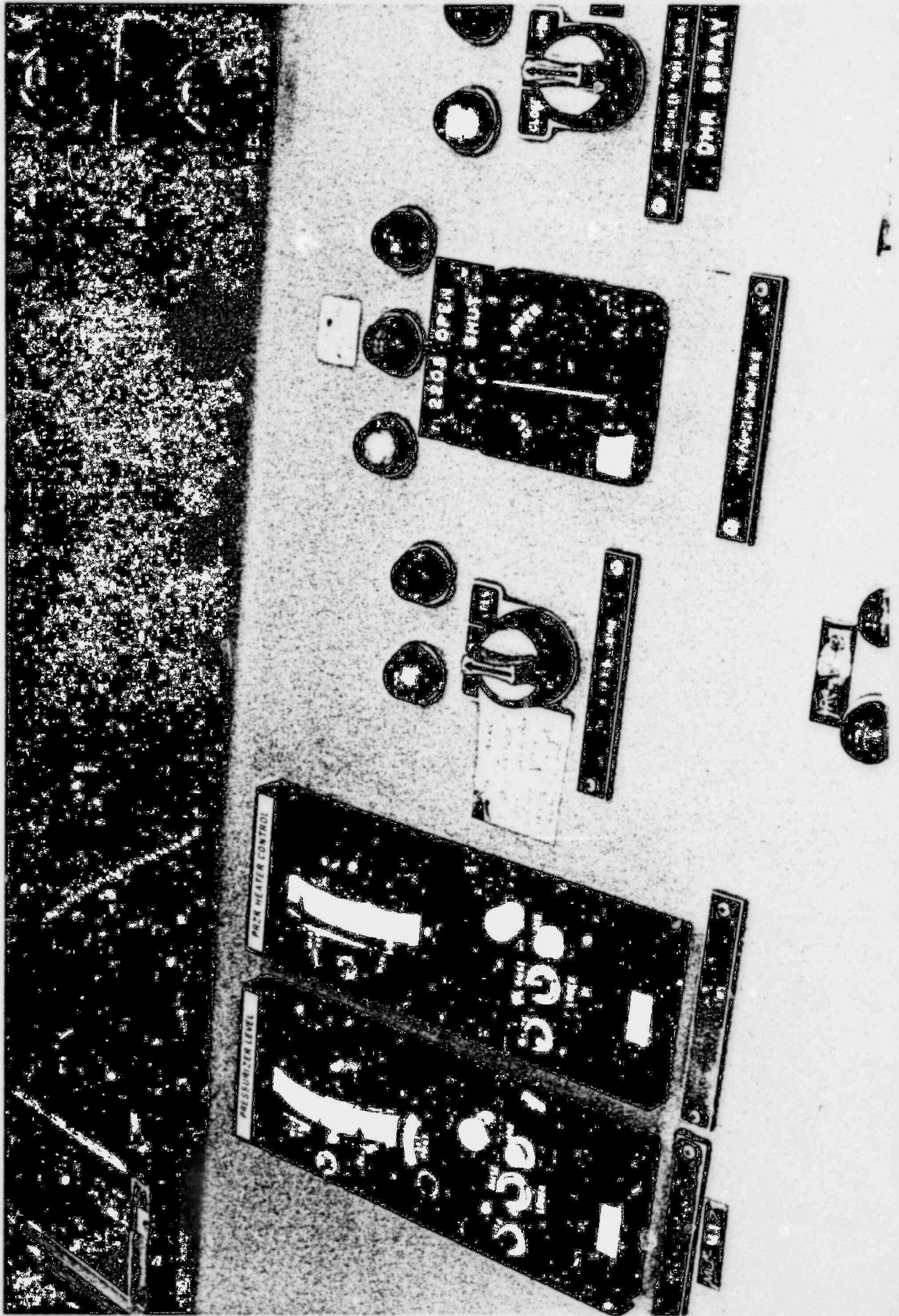


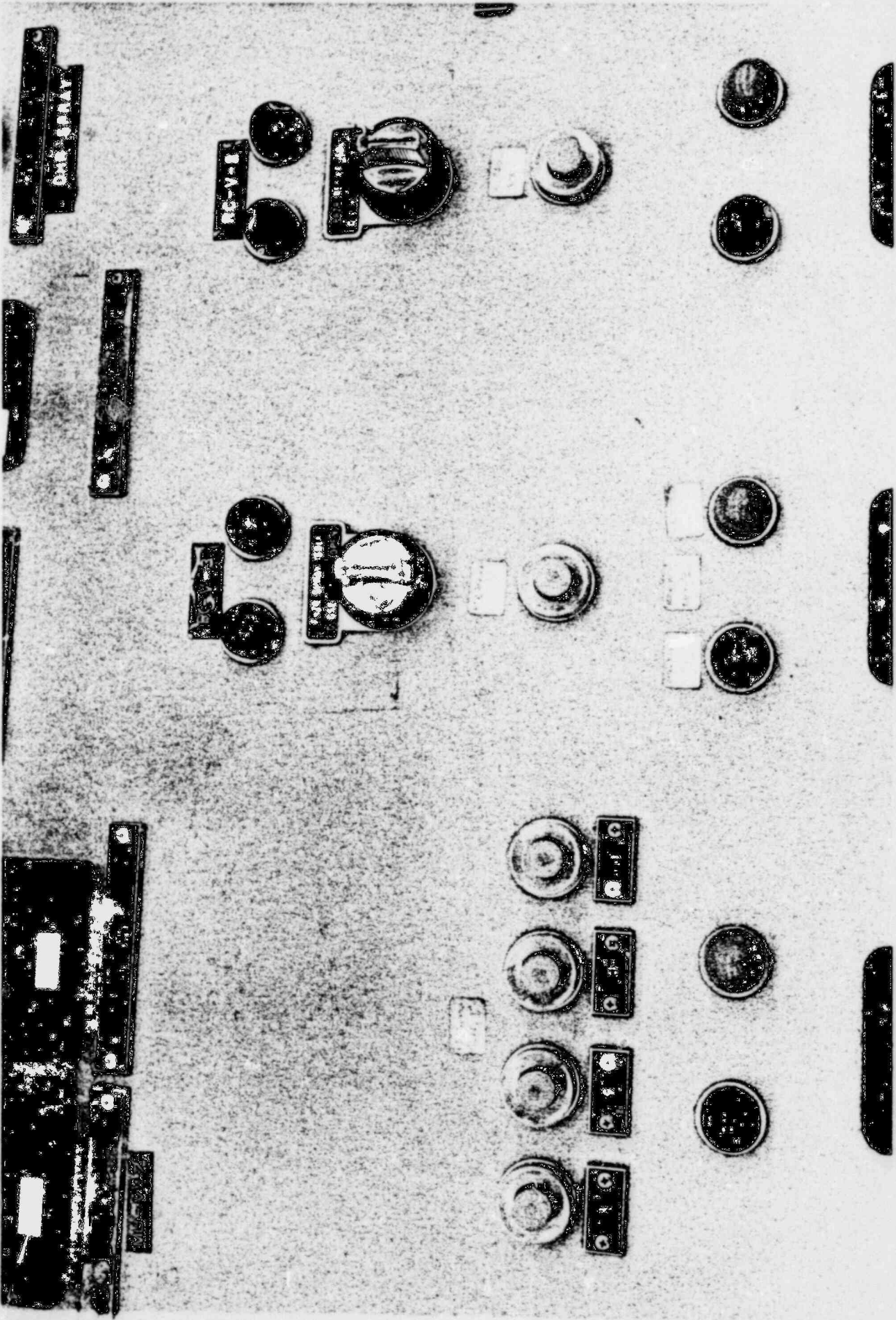
RAY

OPEN 2500  
SLT 2.05

RC-IV-2







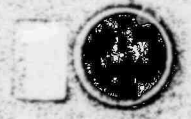
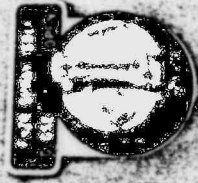
ONE SPRAY

RC-V-1

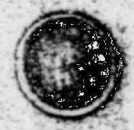
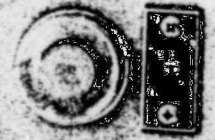
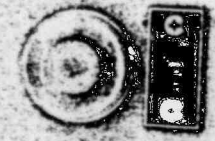


RC-V-1

RC-V-1



RC-V-1



RC-V-1

RC-V-1

RC-V-1

1. REACTOR TRIP  
2. REACTOR TRIP

3. REACTOR TRIP  
4. REACTOR TRIP

5. REACTOR TRIP  
6. REACTOR TRIP  
7. REACTOR TRIP  
8. REACTOR TRIP  
9. REACTOR TRIP  
10. REACTOR TRIP

11. REACTOR TRIP  
12. REACTOR TRIP

13. REACTOR TRIP  
14. REACTOR TRIP

15. REACTOR TRIP  
16. REACTOR TRIP

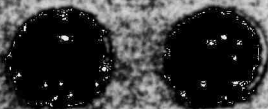
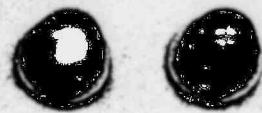
17. REACTOR TRIP  
18. REACTOR TRIP

19. REACTOR TRIP  
20. REACTOR TRIP

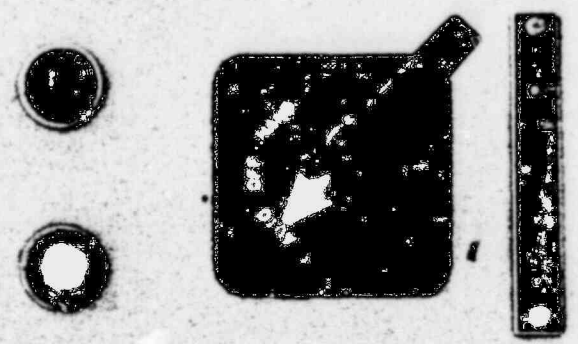
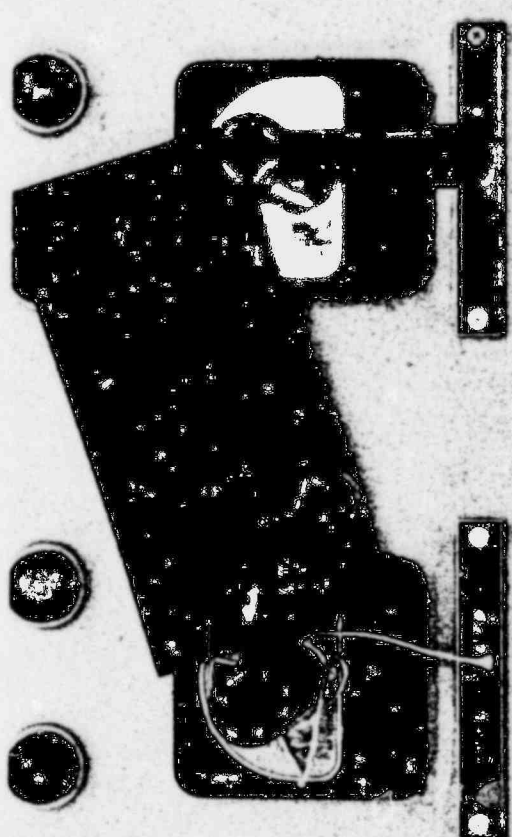
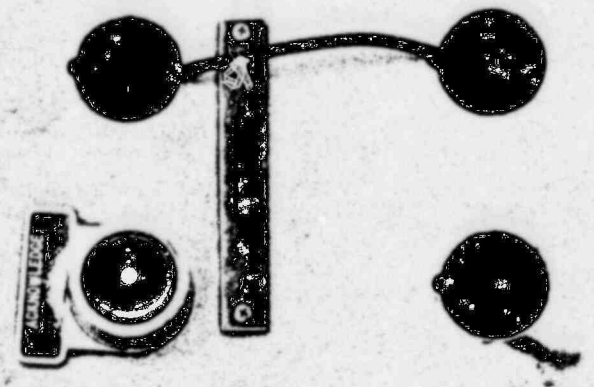
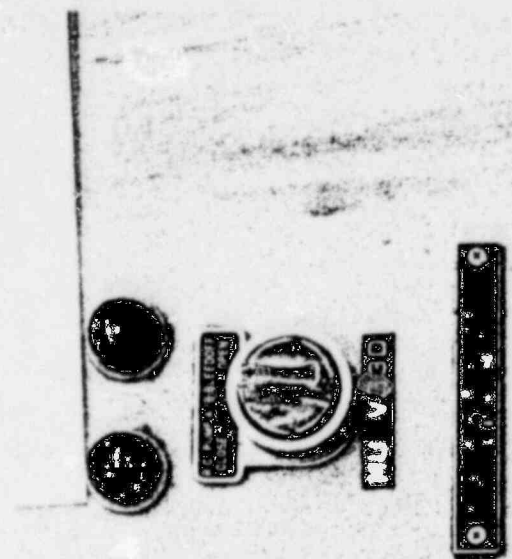


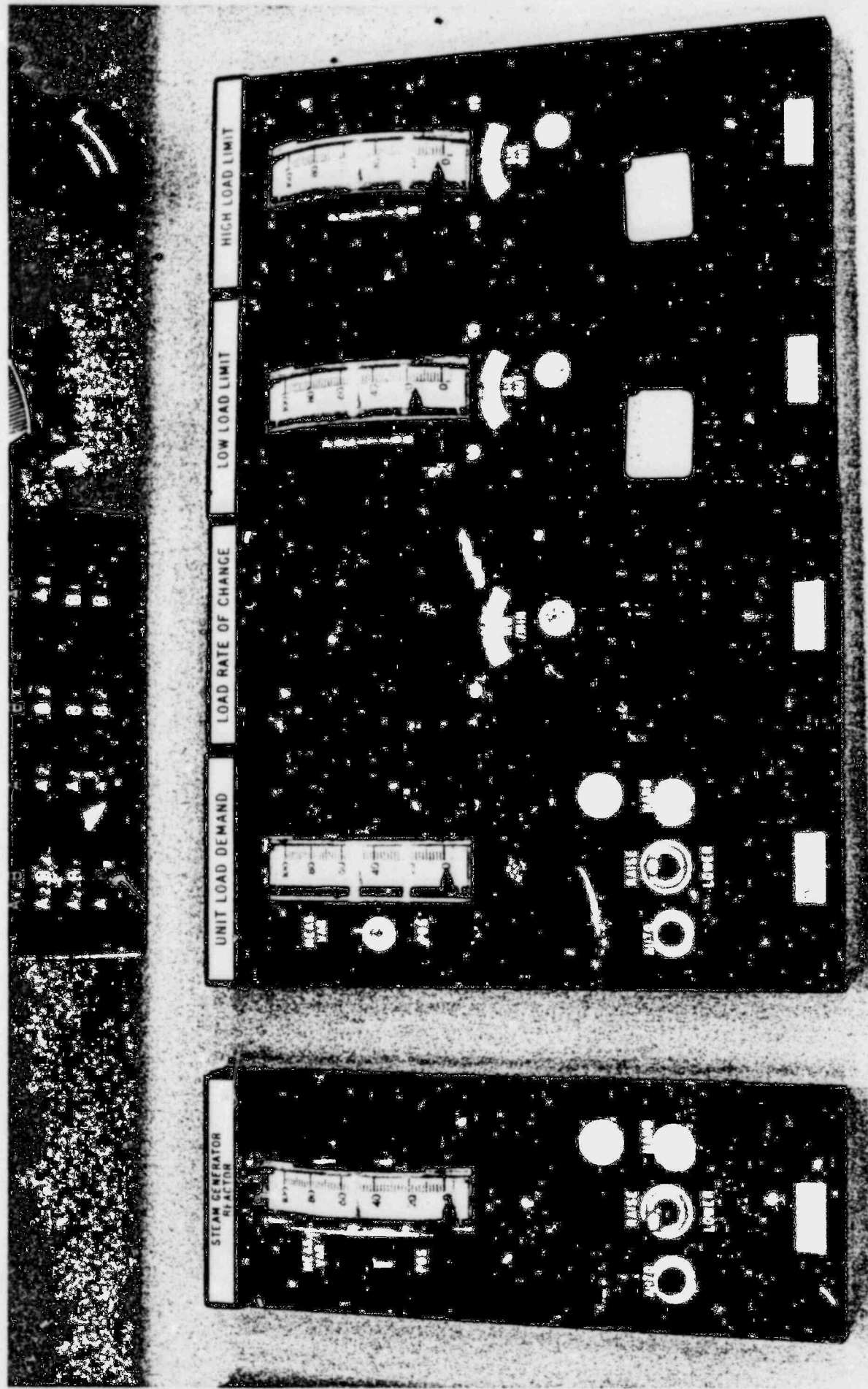
REACTOR TRIP











STEAM GENERATOR  
REACTOR



RAISE  
LOWER  
STOP  
RESET

UNIT LOAD DEMAND



RAISE  
LOWER  
STOP  
RESET

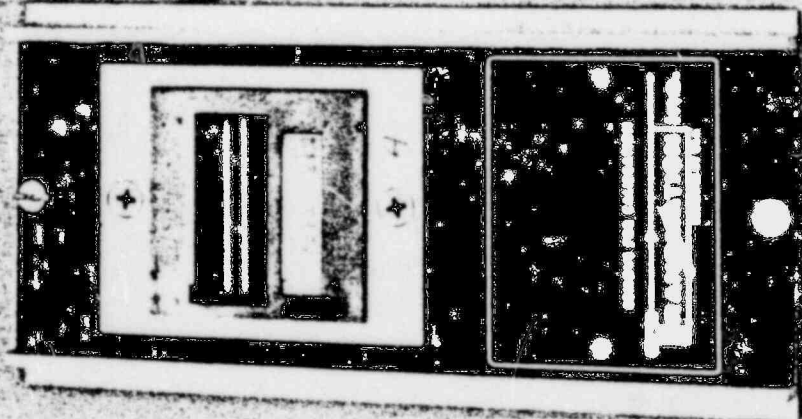
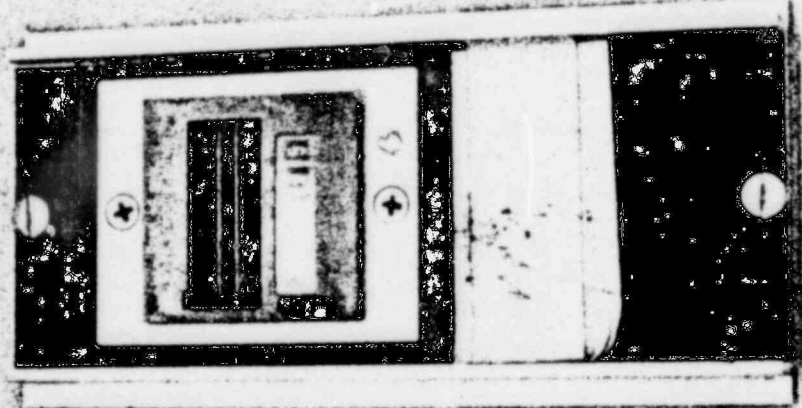
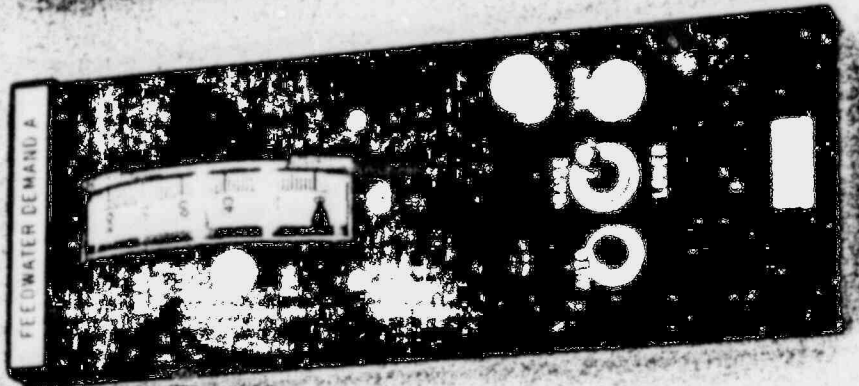
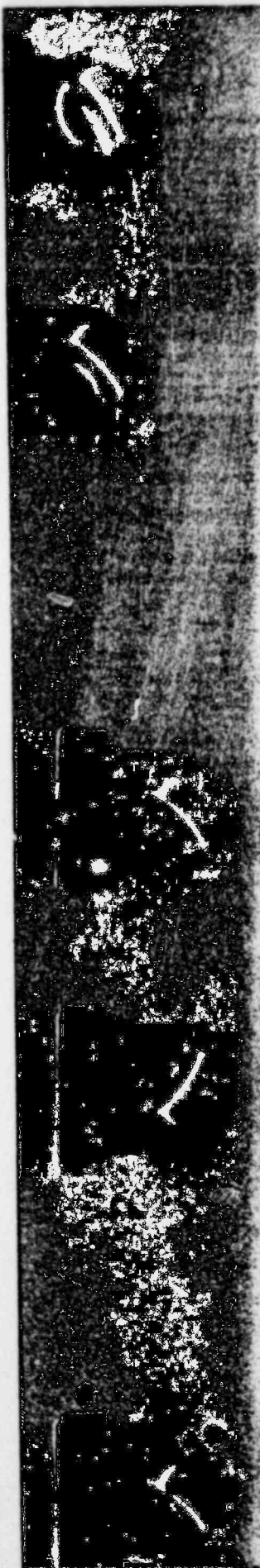
LOAD RATE OF CHANGE

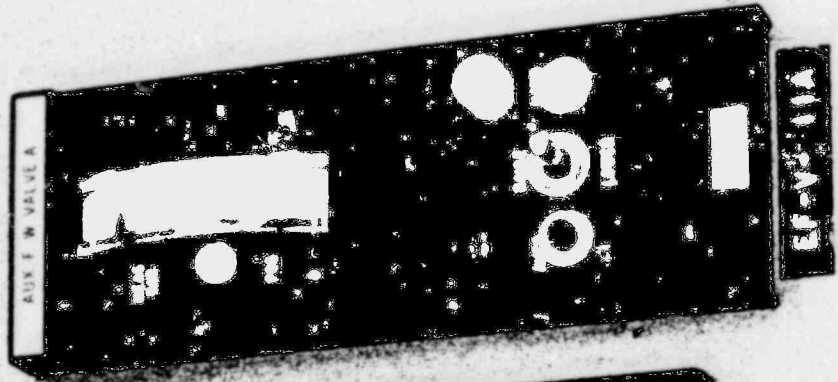


LOW LOAD LIMIT

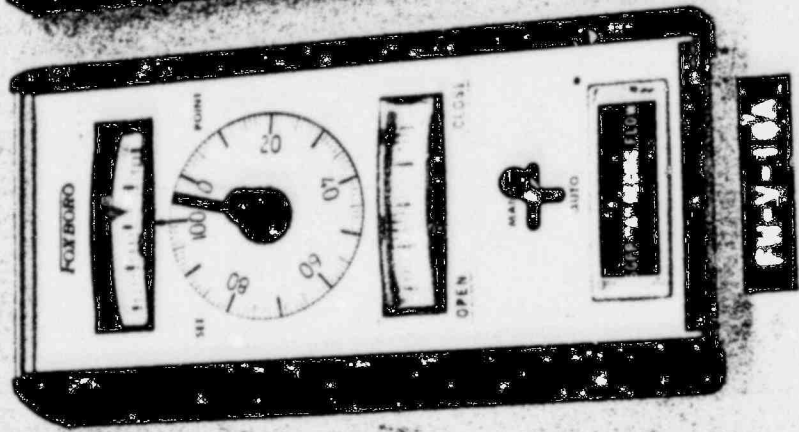
HIGH LOAD LIMIT



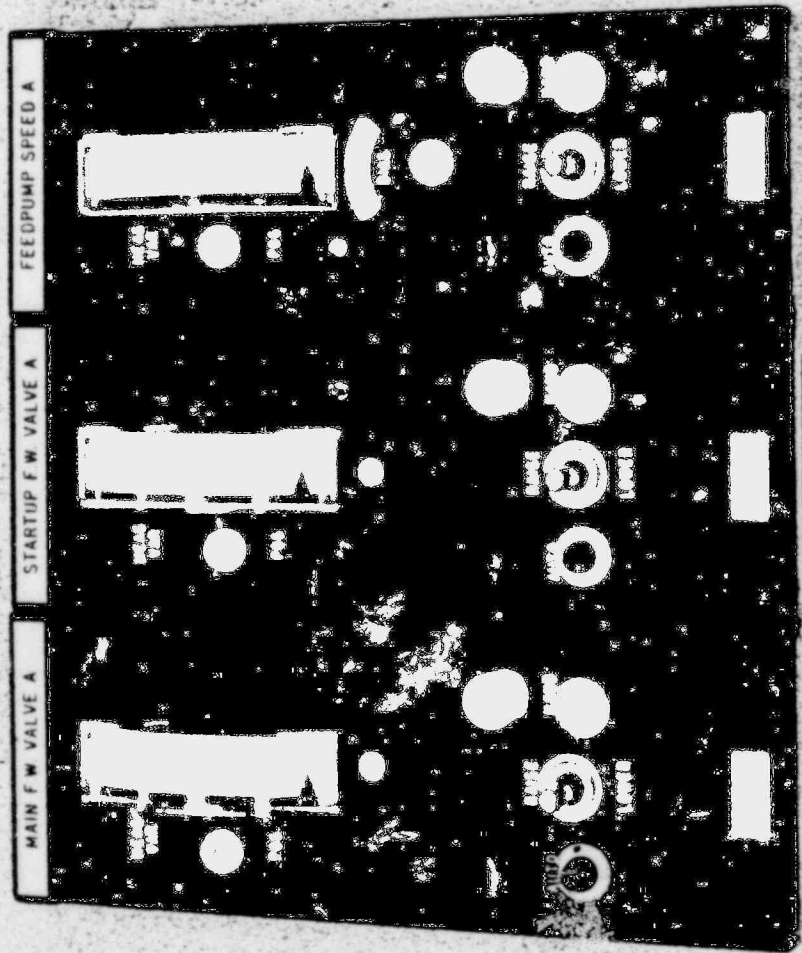




EF-V-11A

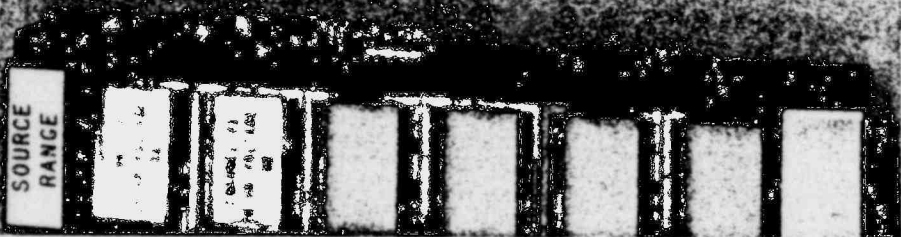
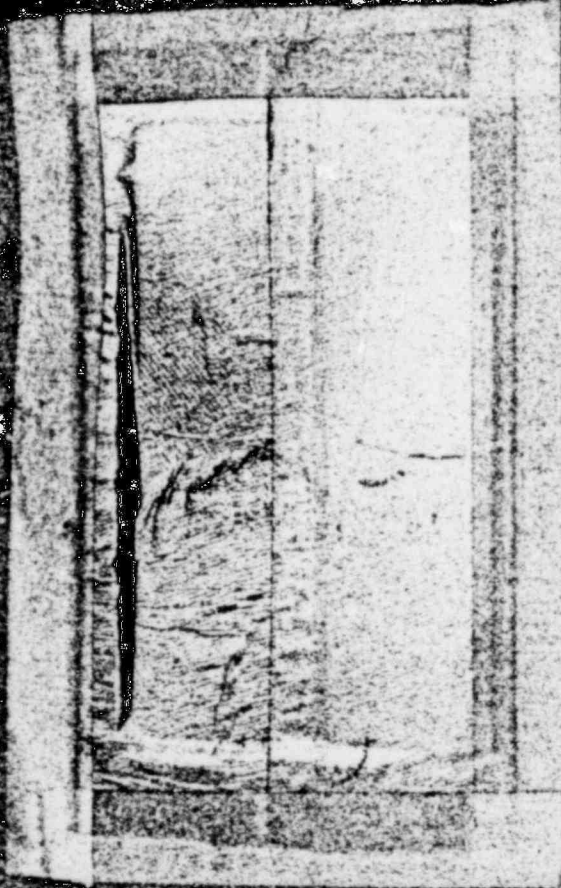
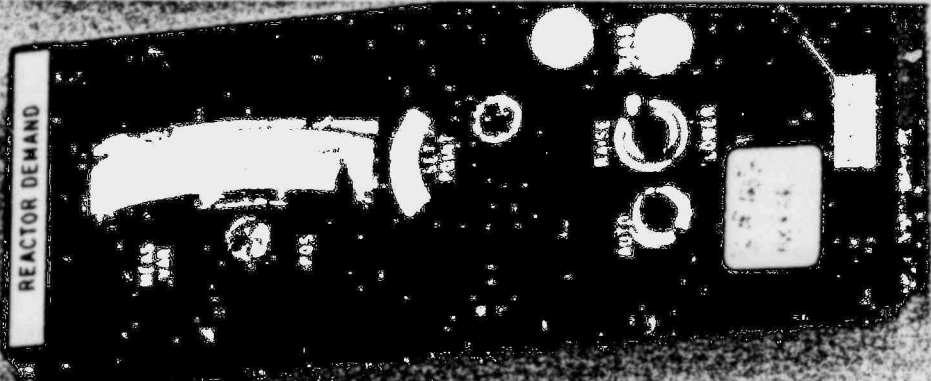


FM-Y-10A



FM-Y-30A

FM-Y-30A



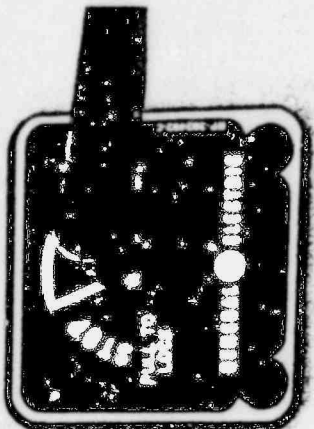
60754776

PANEL 5

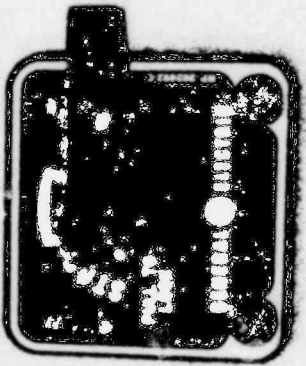




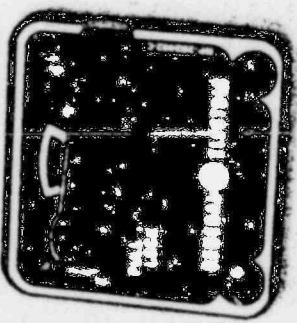
IC COND PUMP BUS 2-4



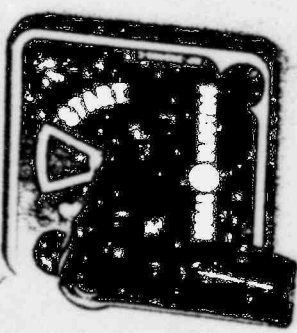
IC COND PUMP BUS 2-3



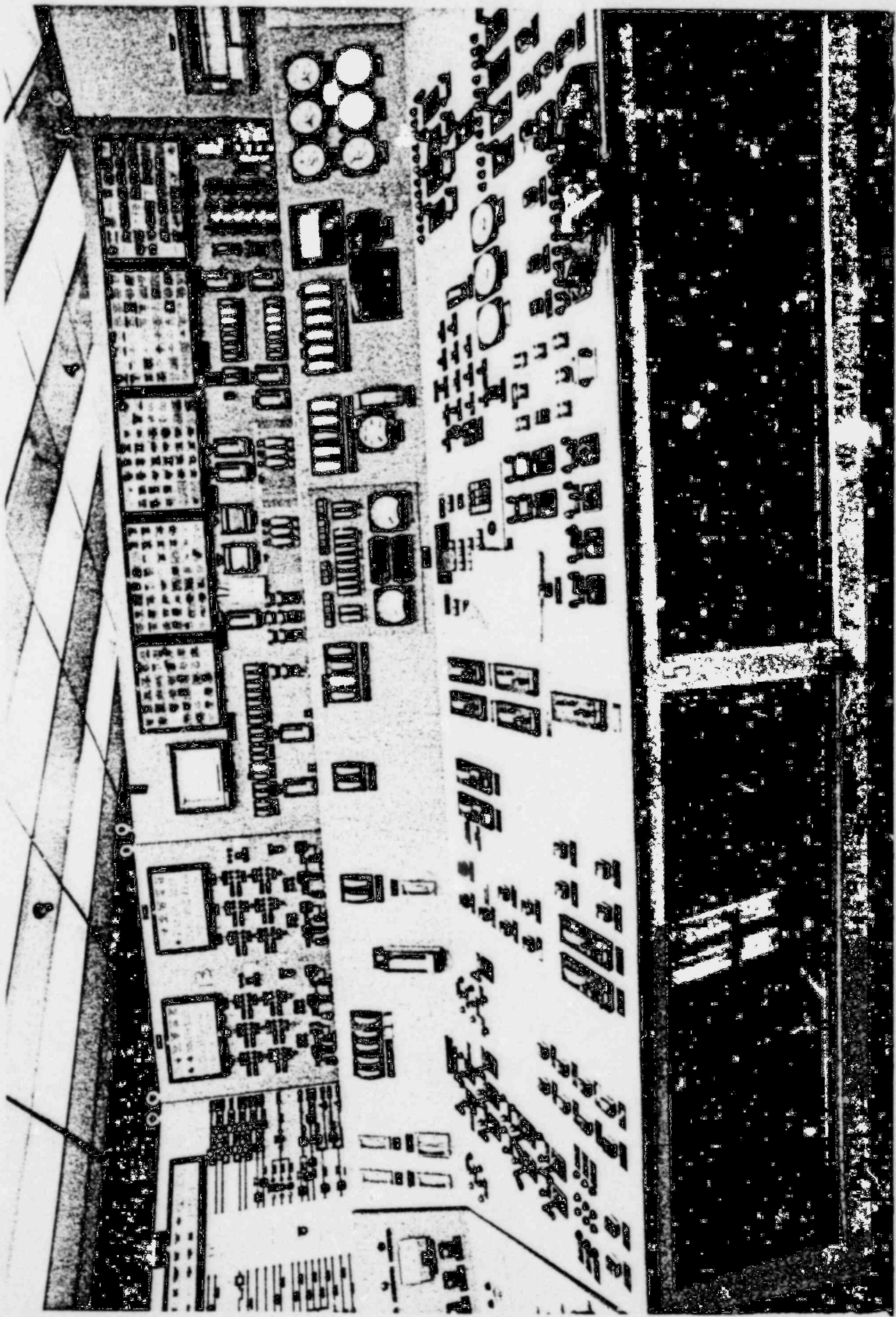
COND PUMP



IC COND PUMP









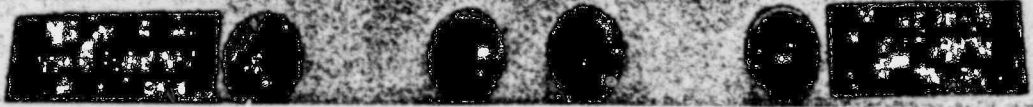
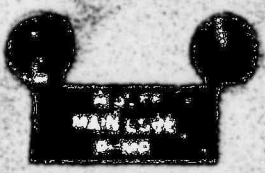
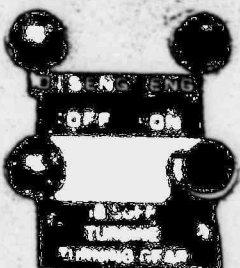
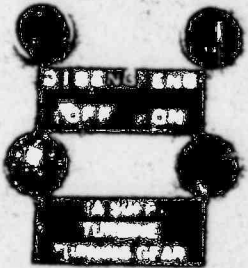
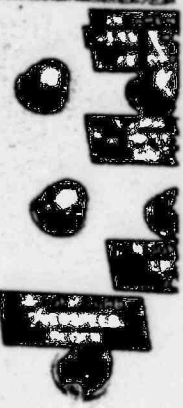
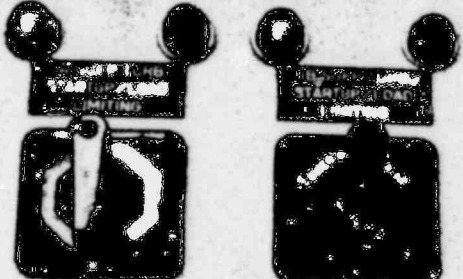
ON WHEN  
LESS THAN  
OPEN

IA SGFP TURB  
HP STOP  
VALVE

IA SGFP TURB  
LP STOP  
VALVE

IA SG FEED  
PUMP TURBINE  
TRIP RESET

IA SG





IA SGFP TURB  
LP STOP  
VALVE TEST



IB SGFP TURB  
LP STOP  
VALVE TEST



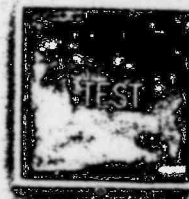
IA SGFP TURB  
HP STOP  
VALVE TEST



IB SGFP TURB  
HP STOP  
VALVE TEST



IA SGFP  
AUX LUBE  
PUMP TEST



IB SGFP  
AUX LUBE  
PUMP TEST



IA SGFP  
EMERG OIL  
PUMP TEST



IB SGFP  
EMERG OIL  
PUMP TEST

MS-V210A IA  
SGFP TURBINE  
I STG DRN



IB IB  
TURBINE  
STG DRN

MS-V228A IA  
SGFP TURBINE  
LP DRAIN



MS-V228B IB  
SGFP TURBINE  
LP DRAIN

MS-V211A IA  
SGFP TURBINE  
HP DRAIN



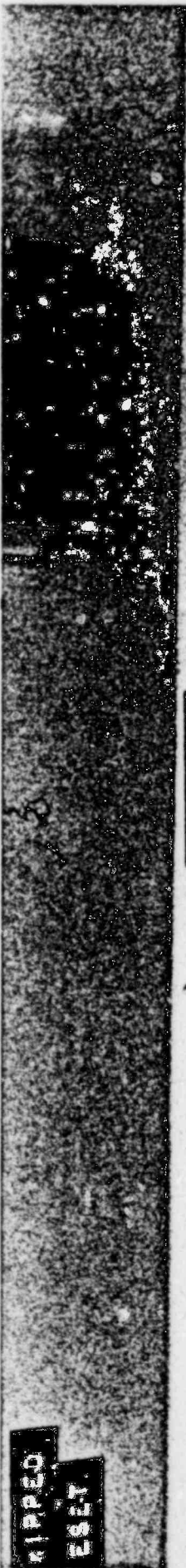
MS-V211B IB  
SGFP TURBINE  
HP DRAIN

OPEN  
CLOSE

IA SGFP  
TURBINE  
DRAINS

OPEN  
CLOSE

IB SGFP  
TURBINE  
DRAINS



TRIPPED  
RESET

3 SGFP TURB  
HP STOP  
TRIP RESET

ON WHEN  
LESS THAN  
1/2 OPEN

1B SGFP TURB  
HP STOP  
VALVE

1B SGFP TURB  
LP STOP  
VALVE

1A SGFP TURB  
OVERSPEED  
BLOCK

1B SGFP TURB  
OVERSPEED  
BLOCK

3A SGFP TURB  
OVERSPEED  
TRIP RESET

1B SGFP TURB  
OVERSPEED  
TRIP RESET







FW-V8A IASG  
FEED PUMP  
DISCHARGE



FW-V8B IBSG  
FEED PUMP  
DISCHARGE

MEAS VAR.  
HEADER PRESS.  
600 - 1200 PSIG

POS  
AIR SIGNAL TO  
BYPASS VALVES



CO V55 COND  
BOOST PUMP  
HDR BLOCK

LOW PRESS

HEATER BYPASS



FW-V19A IASG  
STARTUP FW  
DOWNSTREAM



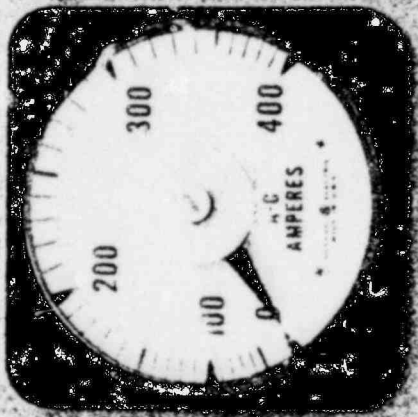
FW-V19B IBSG  
STARTUP FW  
DOWNSTREAM



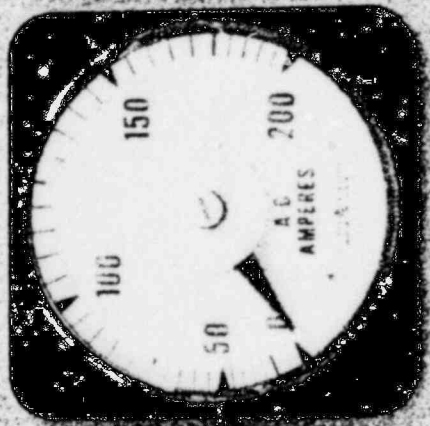
FW-V20A IASG  
STARTUP FW  
UPSTREAM



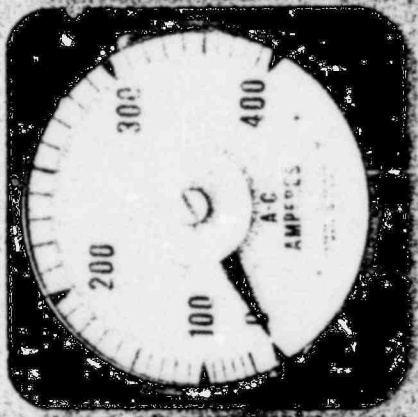
FW-V20B IBSG  
STARTUP FW  
UPSTREAM



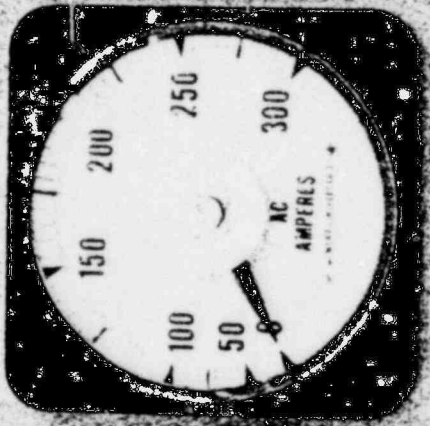
2C COND BOOSTER PUMP



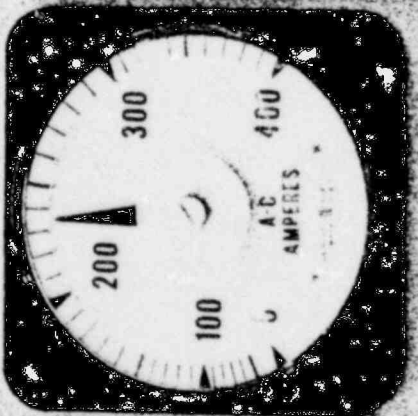
2C IC COND PUMP



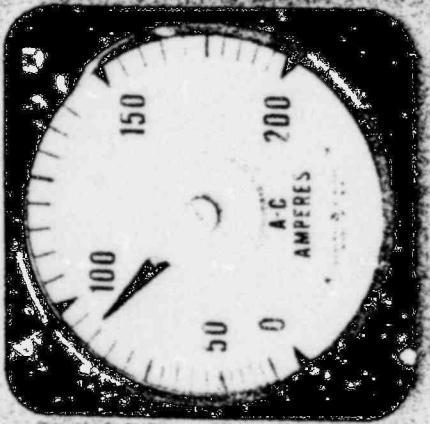
2B COND BOOSTER PUMP



1B COND PUMP

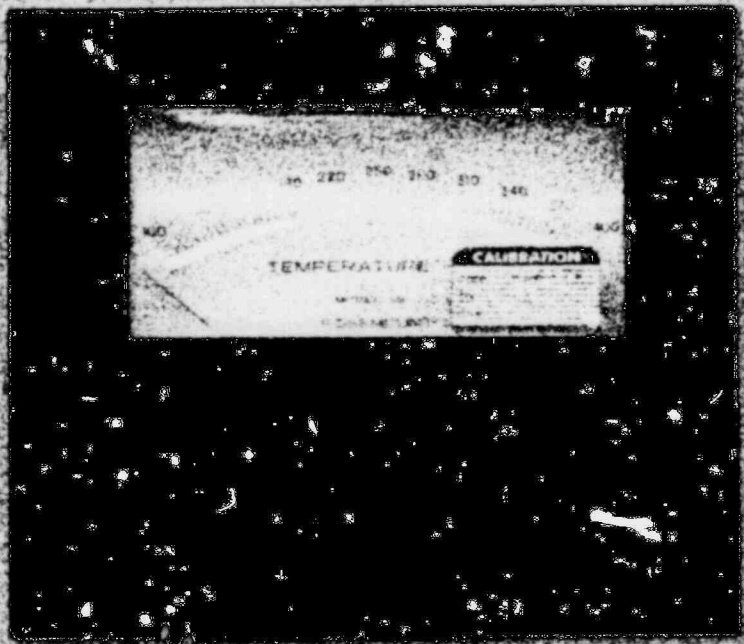


2A COND BOOSTER PUMP



1A COND PUMP

Handwritten notes: "Pump" and "4000"

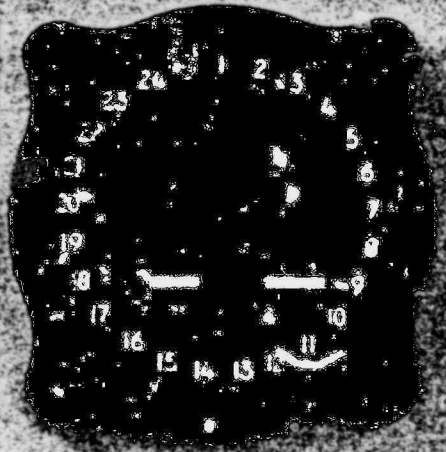


**LEAKAGE CHECK**

MAIN TO COND. °F  
 MAIN TO COND. °C  
 BLEED DRAIN TO COND. °F  
 STEAM DRAIN TO COND. °F

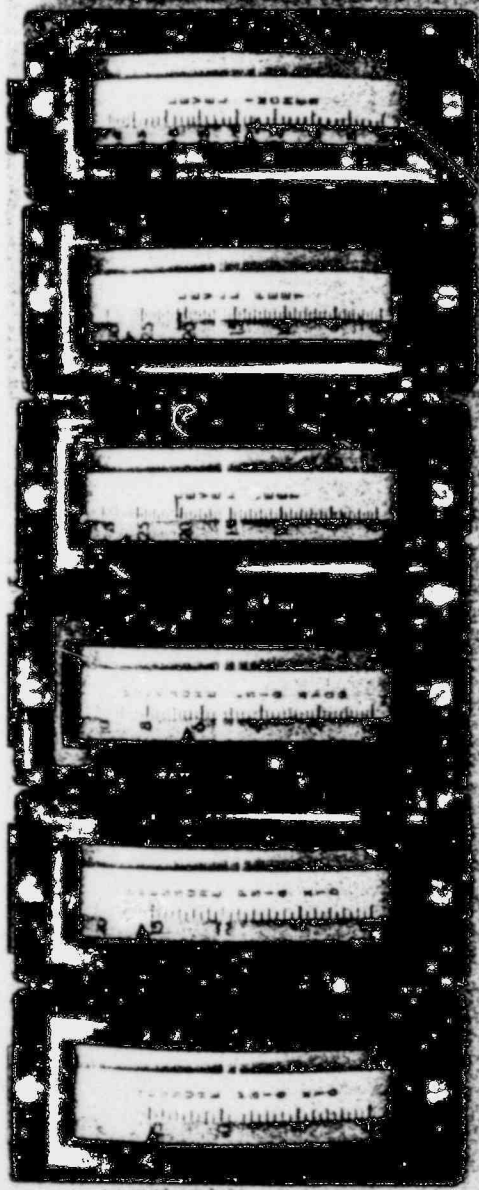
MAIN TO COND. °C  
 MAIN TO COND. °F  
 BLEED DRAIN TO COND. °C  
 STEAM DRAIN TO COND. °C

STEAM DRAIN TO COND. °C  
 BLEED DRAIN TO COND. °C  
 BLEED DRAIN TO COND. °F  
 STEAM DRAIN TO COND. °F  
 COND. °F

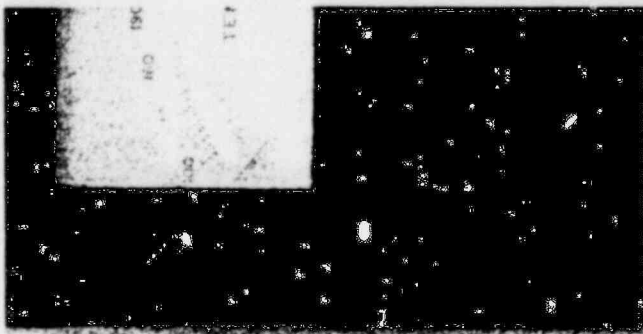


**HTR DRAINS  
LEAKAGE  
CHECK**





COND BOOSTER PUMPING UNIT  
 COND BOOSTER PUMPING UNIT  
 COND BOOSTER PUMPING UNIT  
 COND BOOSTER PUMPING UNIT  
 COND BOOSTER PUMPING UNIT



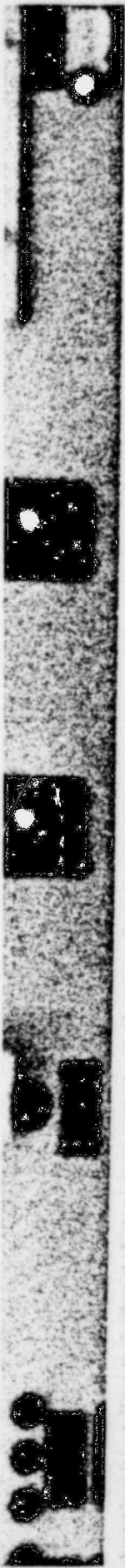
COND STORAGE TANK  
 COND STORAGE TANK

**HEATER DRAINS LEAKAGE CHECK**

PL SERVICE

- 1 MOIST. SEP. AND REHTR. MO-T-2A DRAIN TO COND. "C"
- 2 MOIST. SEP. AND REHTR. MO-T-2B DRAIN TO COND. "C"
- 3 MOIST. SEP. AND REHTR. MO-T-2A HP BLEED DRAIN TO COND. "C"
- 4 MOIST. SEP. AND REHTR. MO-T-2A HP STEAM DRAIN TO COND. "C"
- 5 FW HTR. FW-J-2A DRAIN TO COND. "C"
- 6 FW HTR. FW-J-2B DRAIN TO COND. "C"
- 7 FW HTR. FW-J-2C DRAIN TO COND. "C"
- 8 HTR. DRAIN TR. MO-T-1 DRAIN TO COND. "C"
- 9 FW HTR. FW-J-2A DRAIN TO COND. "C"
- 10 FW HTR. FW-J-2B DRAIN TO COND. "C"
- 11 MOIST. SEP. AND REHTR. MO-T-1A DRAIN TO COND. "C"
- 12 MOIST. SEP. AND REHTR. MO-T-1B DRAIN TO COND. "C"
- 13 MOIST. SEP. AND REHTR. MO-T-1A HP BLEED DRAIN TO COND. "C"
- 14 MOIST. SEP. AND REHTR. MO-T-1A HP STEAM DRAIN TO COND. "C"
- 15 FW HTR. FW-J-2A DRAIN TO COND. "C"
- 16 FW HTR. FW-J-2B DRAIN TO COND. "C"
- 17 MOIST-SEP. AND REHTR. MO-T-1B HP STEAM DRAIN TO COND. "C"
- 18 MOIST. SEP. AND REHTR. MO-T-1B HP BLEED DRAIN TO COND. "C"
- 19 MOIST. SEP. AND REHTR. MO-T-2B HP BLEED DRAIN TO COND. "C"
- 20 MOIST. SEP. AND REHTR. MO-T-2B HP STEAM DRAIN TO COND. "C"
- 21 HTR. DRAIN TANK MO-T-1 DRAIN TO COND. "C"
- 22 FW HTR. FW-J-2B DRAIN TO COND. "C"
- 23
- 24





MAX 115 F

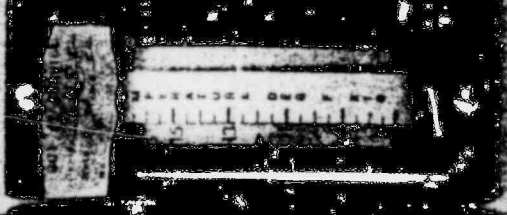


GENERATOR COLD AIR TEMP

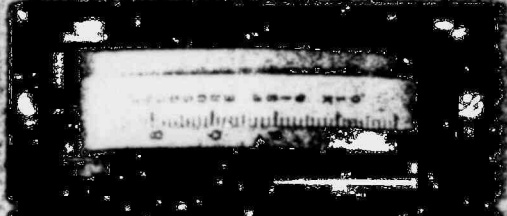
MAX 122



EXCITER COLD AIR TEMP

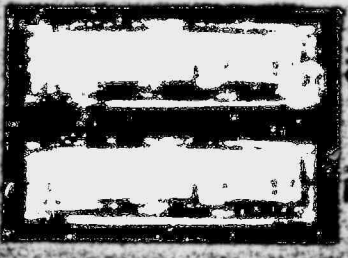


TURBINE OIL TEMP



SC CLOSED COOLING DRIP PRESSURE

STATUS



TV GV TRACKING METER





28 MAIN  
STEAM TEMP °C

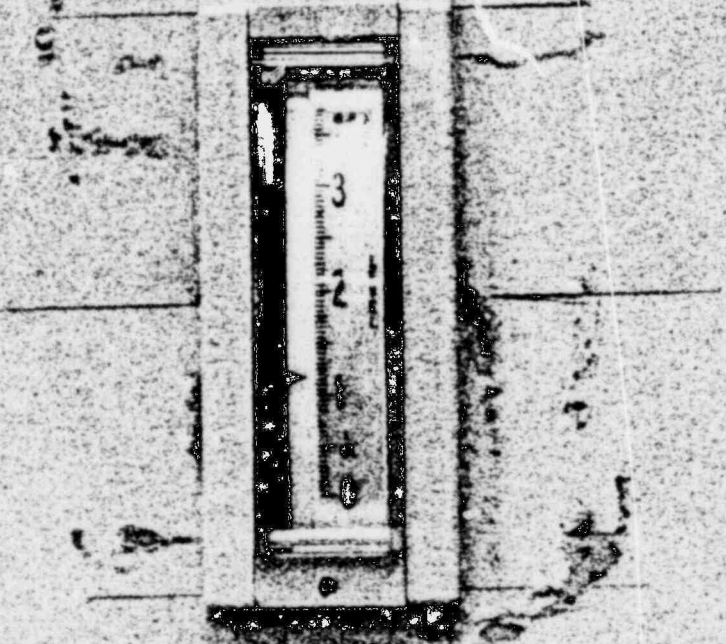
2A MAIN  
STEAM TEMP



1A S6FF TURB  
LUBE OIL  
TEMPERATURE

1B S6FF TURB  
LUBE OIL  
TEMPERATURE

UNCOMP PZR  
LEV L LTR



OPERATE LEVEL

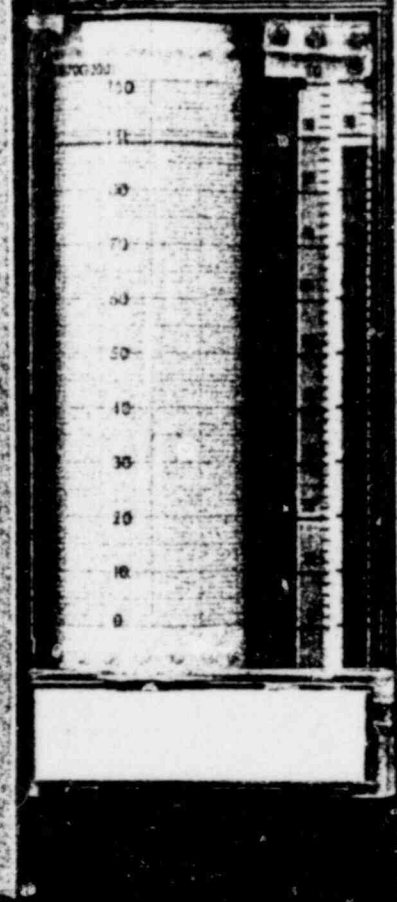
BLUE

RED

B-LT2

A-LT2

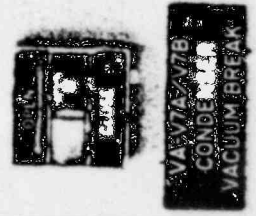
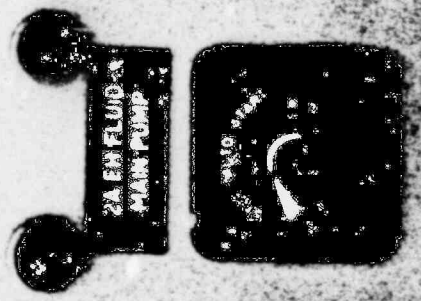
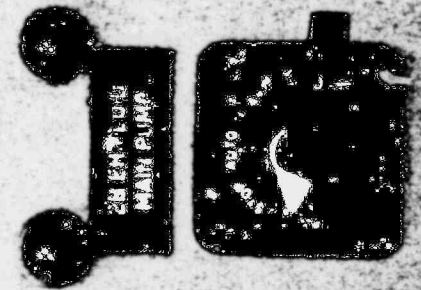
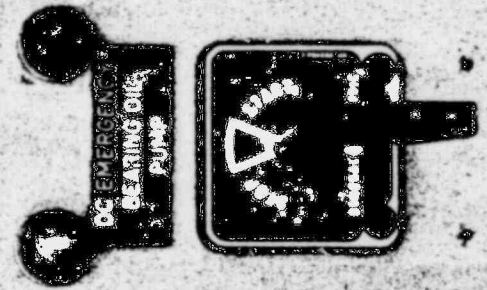
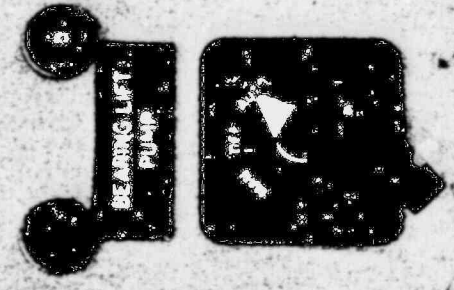
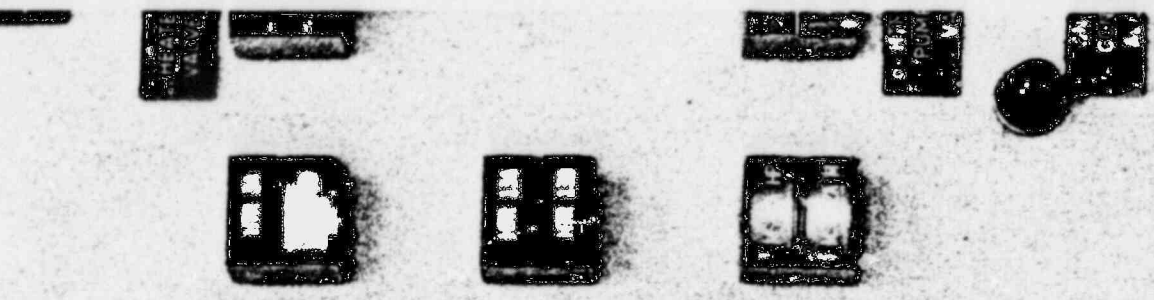
SP1A/B DR2



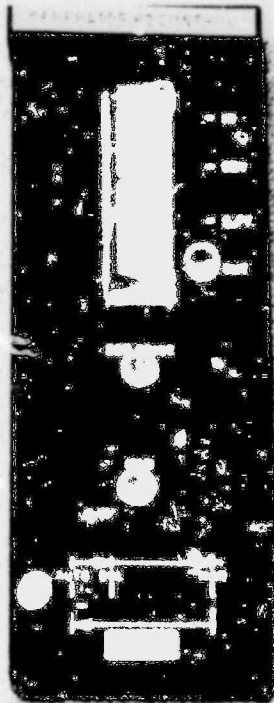
ON WHEN  
LESS THAN



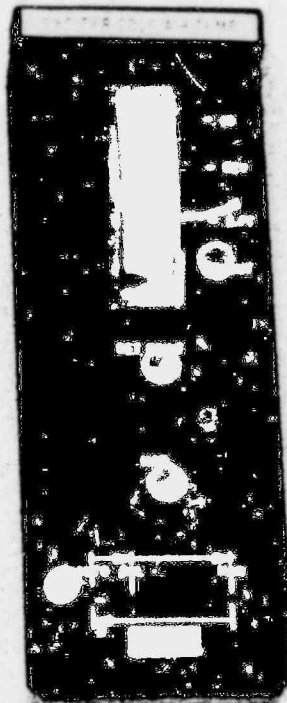
System



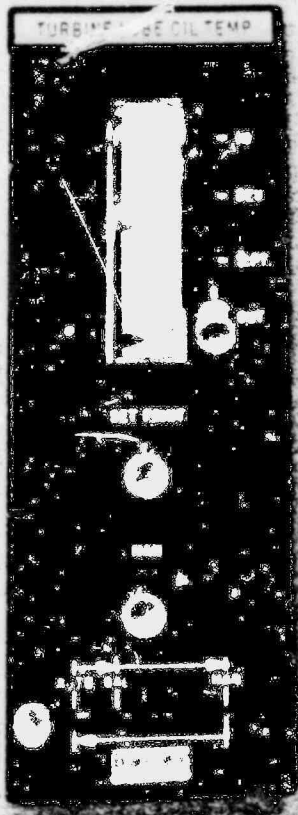
VAV7A/V7B  
CONDENSER  
VACUUM BREAK



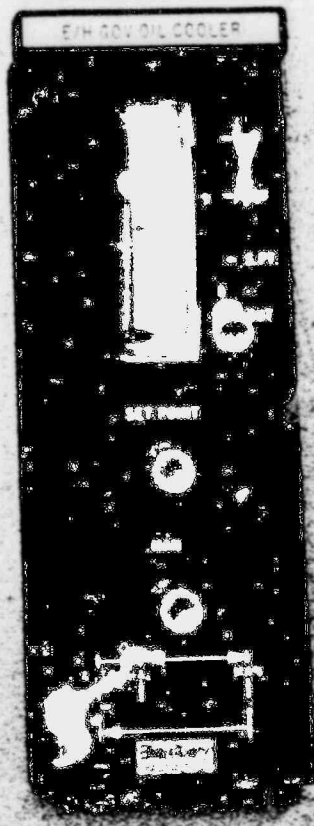
GENERATOR  
HYDROGEN  
TEMP CONTROL



EXCITER COLD  
AIR TEMP  
CONTROL



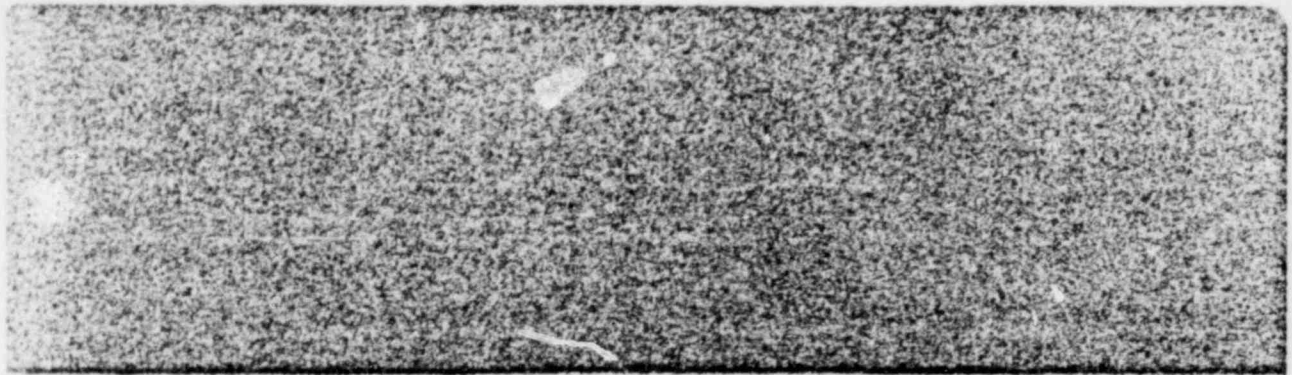
TURBINE LUBE  
OIL TEMP  
CONTROL



ELEC/HYD GOV  
OIL COOLER  
TEMP CONTROL

7  
*Handwritten notes:*  
...  
...  
...  
...  
...

CONT  
CONT  
WOR



MEAS VAR.  
HEADER PRESS.  
600 - 1200 PSIG

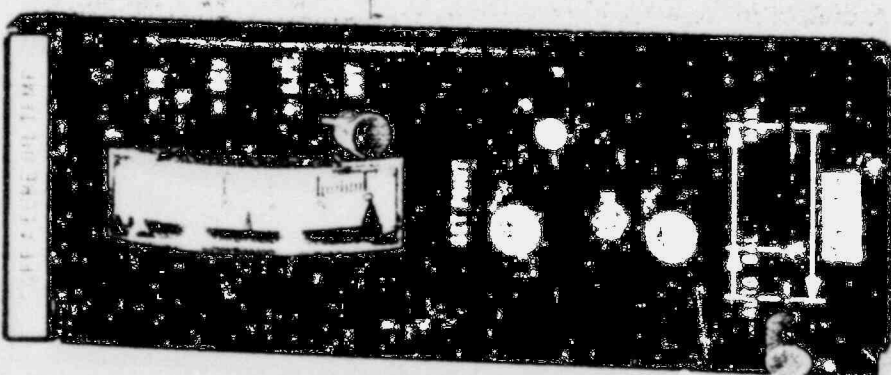
POS  
AIR SIGNAL TO  
BYPASS VALVES



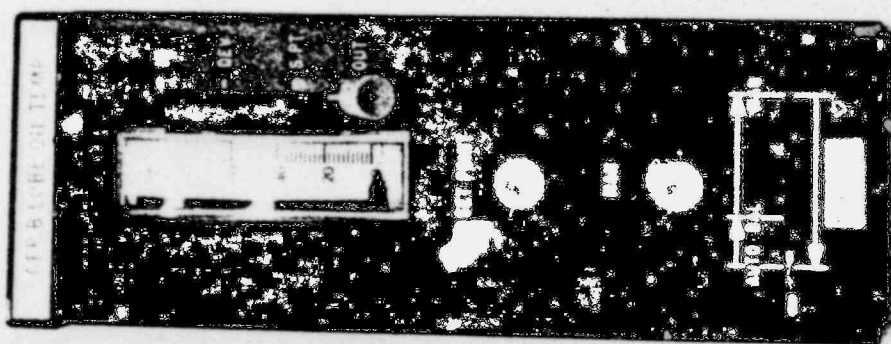
HS-V25A & 26A  
IA SG MAIN  
STM TO COND



HS-V25B & 26B  
IB SG MAIN  
STM TO COND



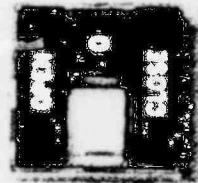
IA SGFP TURB  
LUBE OIL  
TEMP CONTROL



IB SGFP TURB  
LUBE OIL  
TEMP CONTROL



MS-V23A IA  
SG MS BYPASS  
TO COND BLCK



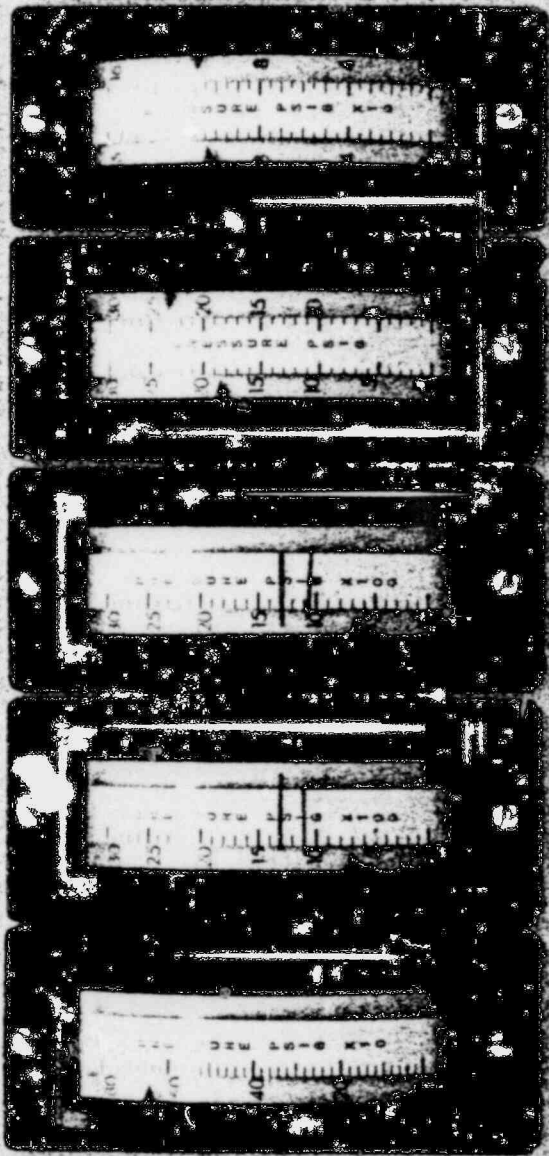
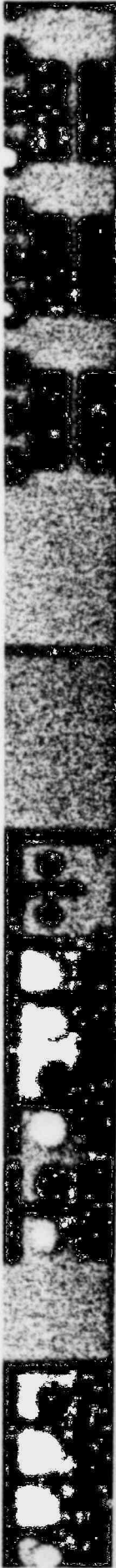
MS-V23B IB  
SG MS BYPASS  
TO COND BLCK



MS-V24A IA  
SG MS BYPASS  
TO COND BLCK



MS-V24B IB  
SG MS BYPASS  
TO COND BLCK



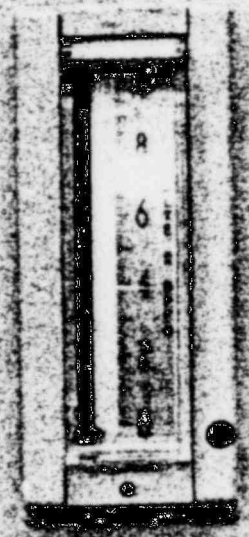
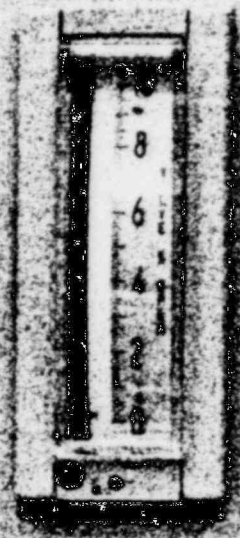
1A SG FEED  
PUMP DISCH  
PRESSURE

1B SG FEED  
PUMP DISCH  
PRESSURE

1C SG FEED  
PUMP DISCH  
PRESSURE

1D SG FEED  
PUMP DISCH  
PRESSURE

APP 567P  
CONSOLE C.

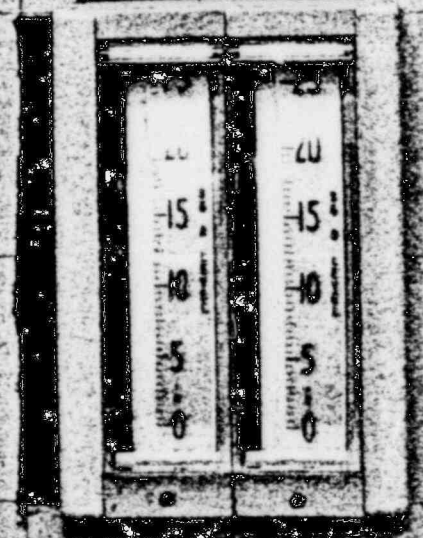


1 SGFP TURB  
A-LE POSN  
LOAD LMIT

2 SGFP TURB  
VALVE POSN  
LOAD LMIT

UMC - P PZR  
LEVEL 1 T

5 RTUP LEVEL  
A-LTS B-LTS



ON WHEN  
LESS THAN  
1/2 MEN

1A SGFP TURB  
HP STOP

TRIP

TURBINE TRIP

HEATER DRAIN VALVE CLOSED

HTR 3A

HTR 4A 3  
4

HTR 1A 5  
6

HTR 13A  
HTR 13B

HTR 14A

MSR 13A  
MSR 13B

HTR 14A

HTR 14B 11  
12

HTR DRAIN PUMP DISCH VALVES

ON LEVEL CONTROL ALL OPEN

Re

AR

EAR

EAR

LIFT

AP

DR  
AUX

36

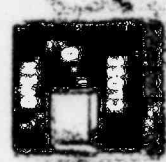
100



CO V35C 20  
COND BOOSTER  
PUMP RECIRC



HD-V110C 1C  
HTR DRAIN  
PUMP RECIRC



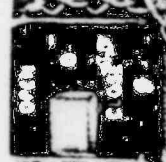
CO V35B 2B  
COND BOOSTER  
PUMP RECIRC



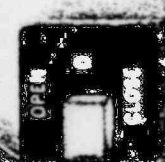
EX V71B  
DEAERATING  
STEAM H COND



HD-V110B 1B  
HTR DRAIN  
PUMP RECIRC



CO V35A 2A  
COND BOOSTER  
PUMP RECIRC



EX V71A  
DEAERATING  
STEAM C COND



HD-V110A 1A  
HTR DRAIN  
PUMP RECIRC

DO NOT  
OPERATE  
20



HEATER  
PUMP  
OIL PUMP







IA HEATER  
DRAIN PUMP  
AUX OIL PUMP



IB HEATER  
DRAIN PUMP  
AUX OIL PUMP



IC HEATER  
DRAIN PUMP  
AUX OIL PUMP

Don't  
Operate  
any  
Oil  
Pump  
Safety

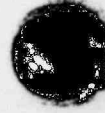
DO NOT  
OPERATE



IA HEATER  
DRAIN PIPE



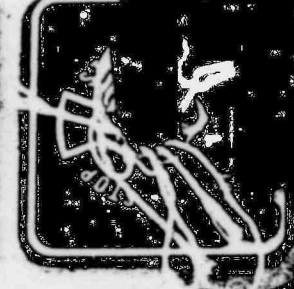
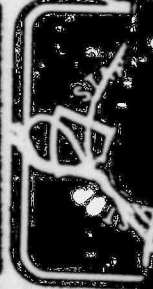
IB HEATER  
DRAIN PIPE



IC HEATER  
DRAIN PUMP  
BUS 2-3



IC HEATER  
DRAIN PUMP  
BUS 2-4



DEA  
STEA

IC  
H

TO STOP  
RESET  
SOLENOID



DC BUS TRIP  
EH CABINET



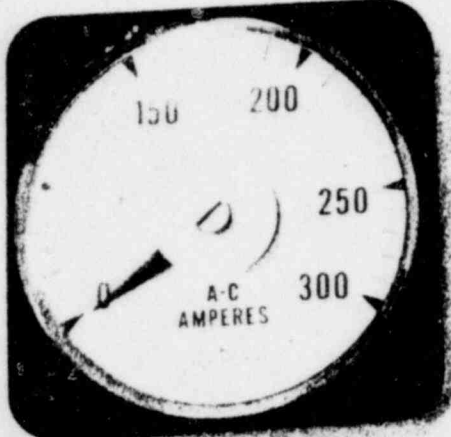
2A COND  
BOOSTER PUMP  
AUX OIL PUMP

STOP 1  
TRIPPED  
RELAY

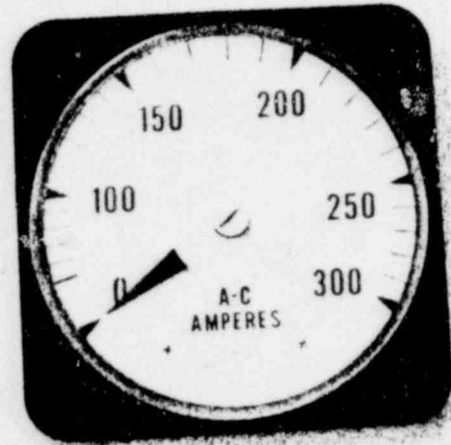
OVER SPEED  
SOLENOID  
VALVE 1

HEATER DRAIN  
PUMPS DISCH  
PRESSURE

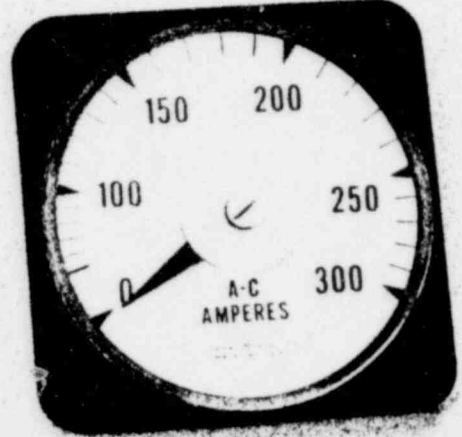
STOP 2  
PRIMARY  
RELAY



1A-HEATER  
DRAIN PUMP



1B-HEATER  
DRAIN PUMP



1C-HEATER  
DRAIN PUMP



1A COND  
PUMP



TURBINE  
SUPERVISORY  
INDICATION

TRIP LATCH  
RESET OPERATOR  
NORMAL

EH FLUID  
EMERG TRIP  
SOLENOID

TRIP LATCH  
RESET OPERATOR  
ACTUATED

TRIP LATCH  
RESET OPERATOR  
NORMAL

EH FLUID  
EMERG TRIP  
SOLENOID

GOVERNOR  
OVERSPEED  
TRIP RELAY

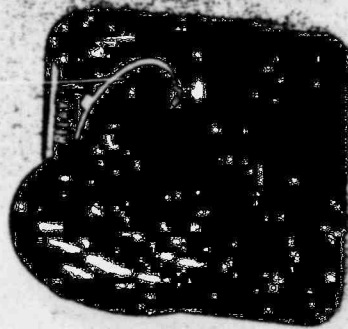
TELEPS  
OVERSPEED  
ALARM RELAY

VAC TRIP  
LATCH  
SOLENOID

AUTO STOP  
RESET  
SOLENOID

OVER SPEED  
SOLENOID  
VALVE 2

DC BUS TRIP  
EH CABINET



TURBINE AUTO  
STOP 2  
SUPERVISORY

AUTO STOP 1  
TRIPPED  
AUX RELAY

OVER SPEED  
SOLENOID  
VALVE 1

LOW EH FLUID  
LEVEL  
LOCKOUT

TURBINE AUTO  
STOP 1  
SUPERVISORY

AUTO STOP 2  
AUXILIARY  
RELAY

TURBINE AUTO  
STOP 1  
SUPERVISORY

AUTO STOP 2  
AUXILIARY  
RELAY



HE  
PL

**SYSTEM**

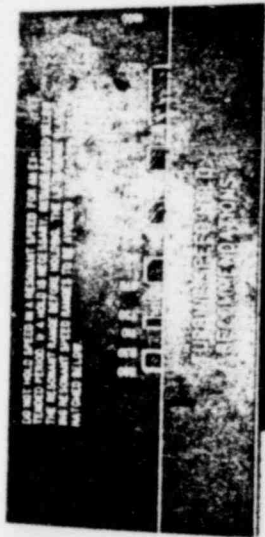
0 0 2 0  
 LOW LOAD LIMIT  
 MW

THROTTLE PRESSURE  
 CONTROLLER

120  
 ACCELERATION RATE  
 RPM PER MIN

VALVE TEST LEFT

TEST 10-1	TEST 10-2	TEST 10-3	TEST 10-4
TEST 10-5	TEST 10-6	TEST 10-7	TEST 10-8
TEST 10-9	TEST 10-10	TEST 10-11	TEST 10-12



TURBINE MODES

REFERENCE CONTROL

TURBINE MANUAL

TURBINE MANUAL

IN SERVICE | OVERSPEED TEST

TEST | OFF | TEST

OVERSPEED PROTECTION CONTROLLER

PHONE

MAINTENANCE TEST

0 9 3 0  
 HIGH LOAD LIMIT  
 MW

VALVE POSITION  
 LIMITER

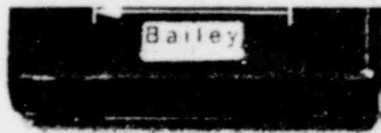
200  
 LOAD RATE  
 MW PER MIN

VALVE TEST RIGHT

TEST 10-1	TEST 10-2	TEST 10-3	TEST 10-4
TEST 10-5	TEST 10-6	TEST 10-7	TEST 10-8
TEST 10-9	TEST 10-10	TEST 10-11	TEST 10-12

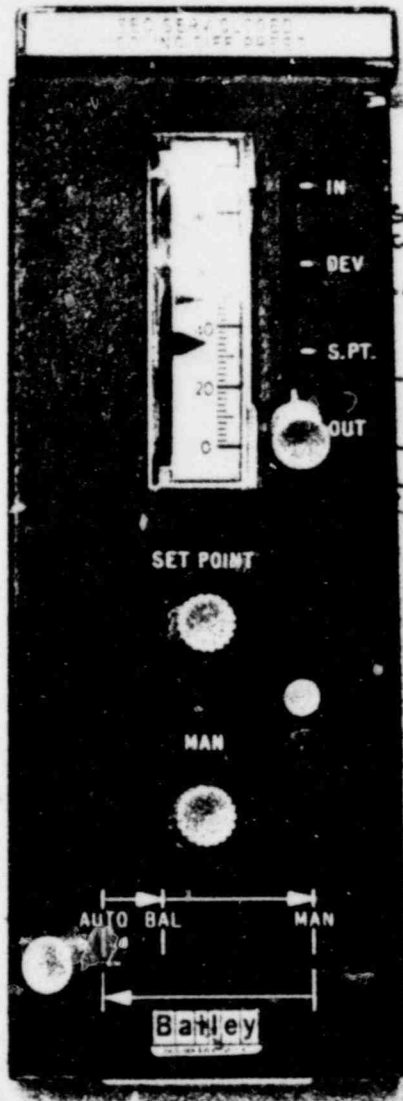
EH FILL  
 EMERG  
 SOLEN

LOW



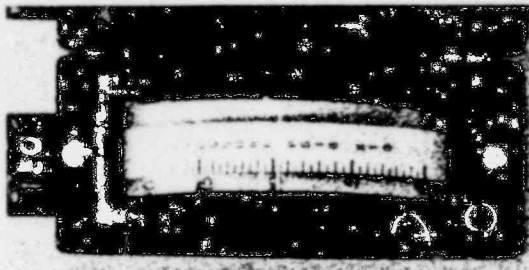
TURBINE LUBE  
OIL TEMP  
CONTROL

ELEC/HYD GOV  
OIL COOLER  
TEMP CONTROL

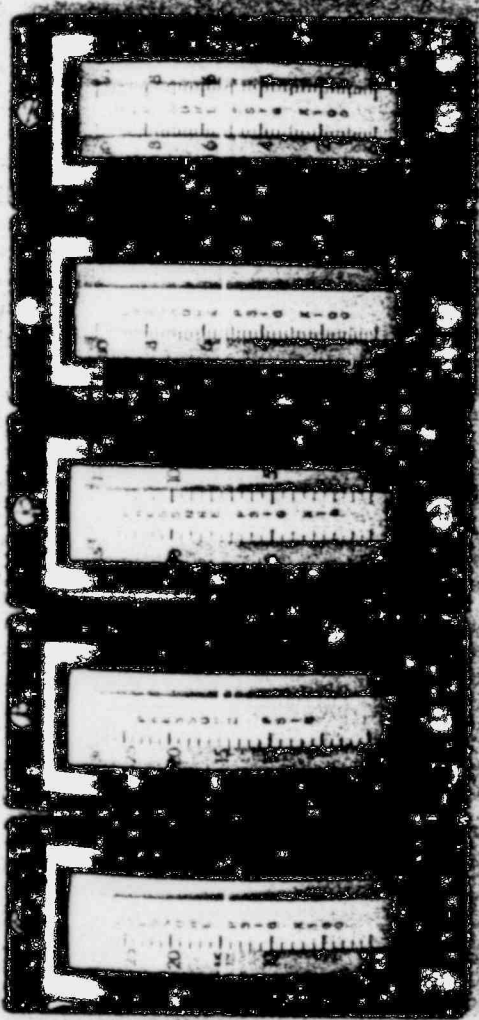


*Sign  
Chart  
Δ Set  
Actual  
Set point  
V. v. v.  
Bal. balance*

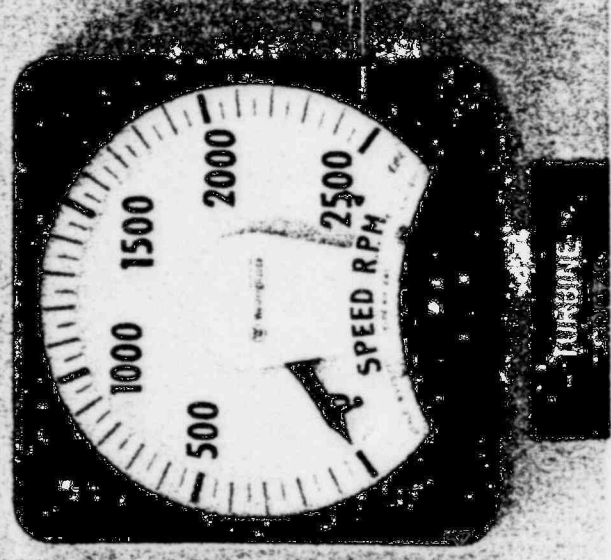
SC CLOSED  
COOLING DIFF  
PRESS CONTRL



100  
TURNS AVAILABLE  
CHANGING  
PRESSURE



TURNS AVAILABLE  
CHANGING  
PRESSURE  
TURNS AVAILABLE  
CHANGING  
PRESSURE  
TURNS AVAILABLE  
CHANGING  
PRESSURE  
TURNS AVAILABLE  
CHANGING  
PRESSURE



TURBINE



STATUS



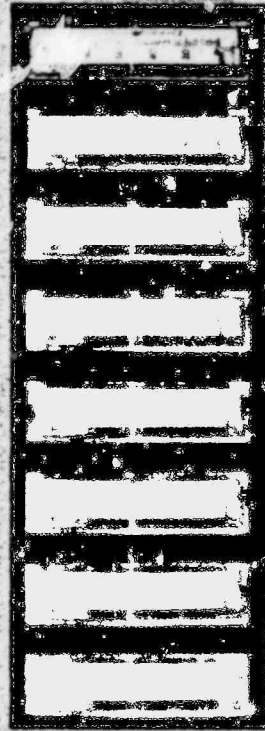
LIMITS



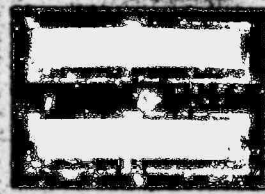
REFERENCES



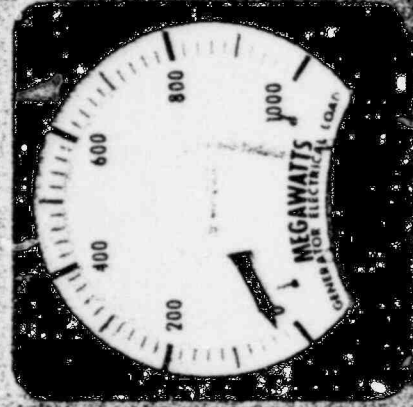
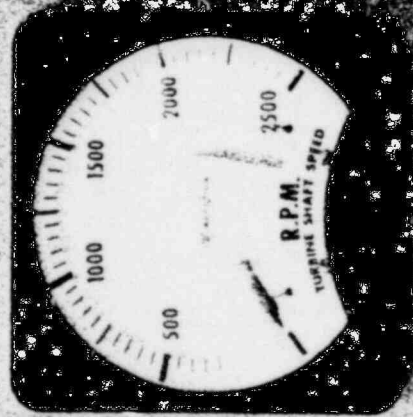
TV GV  
TRACKING METER



T-1 T-2 T-3 T-4 G-1 G-2 G-3 G-4  
THROTTLE VALVE POSITION  
GOVERNOR VALVE POSITION



GOV VALVE  
CONT. POSITION  
LIMIT

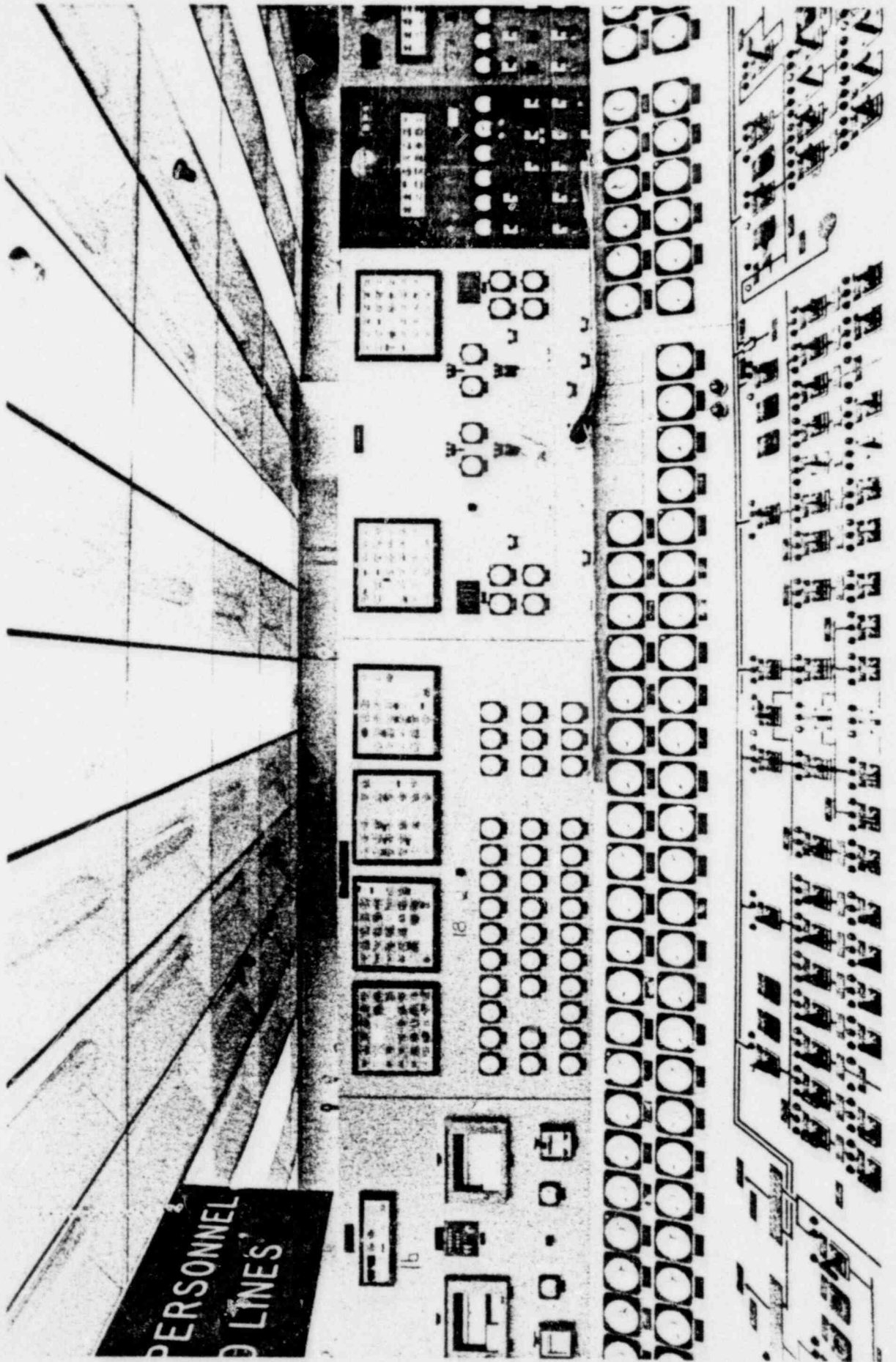


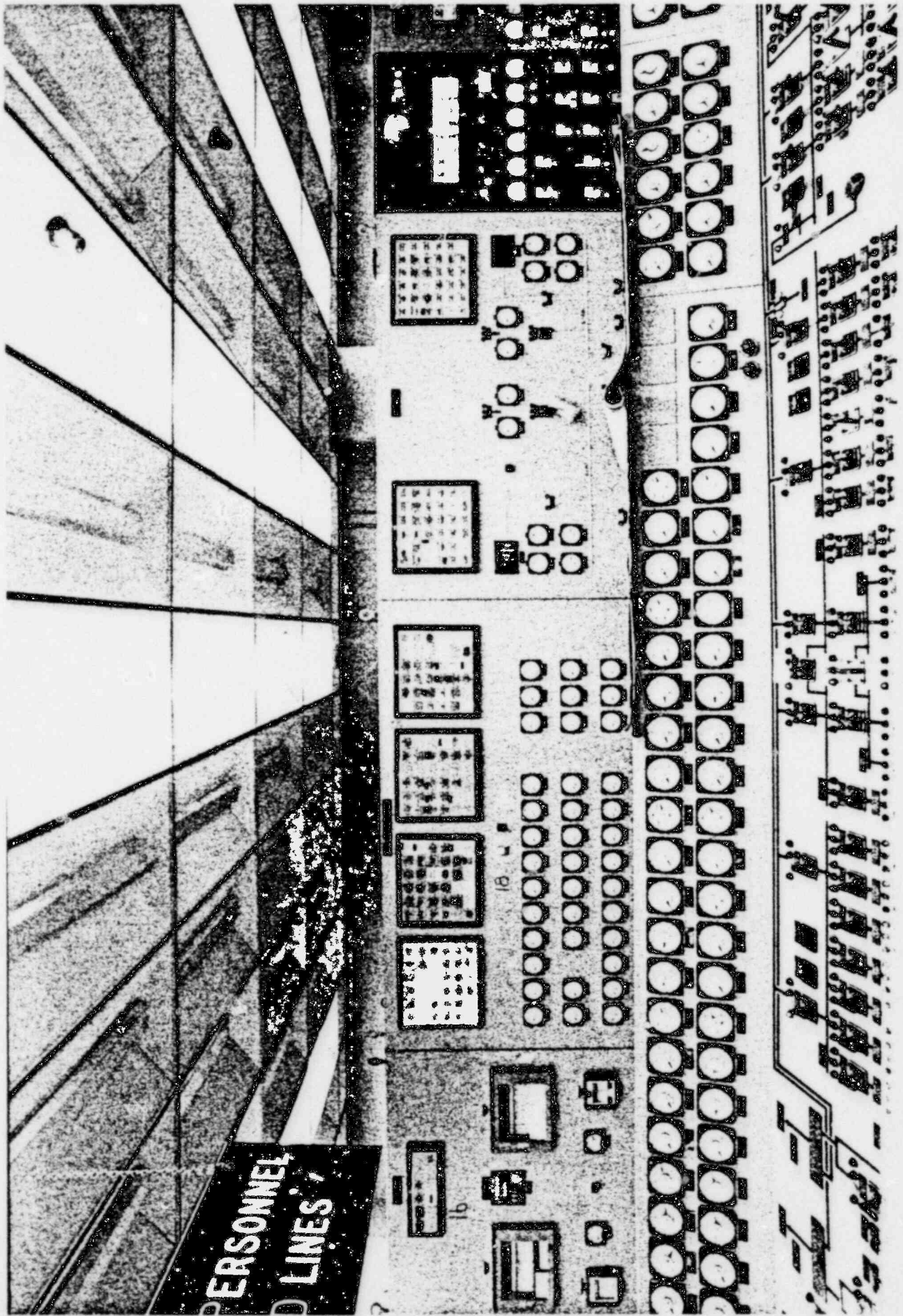
W E H TURBINE CONTROL

TURBINE CONTROL SYSTEM





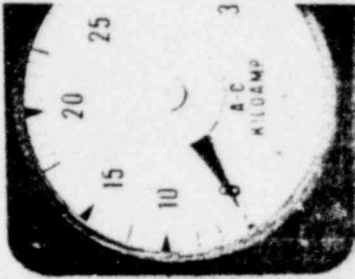




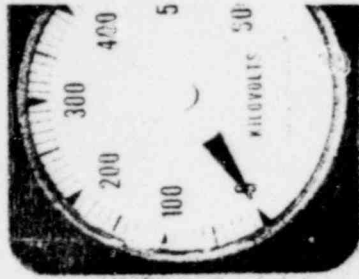
PERSONNEL  
LINES

16

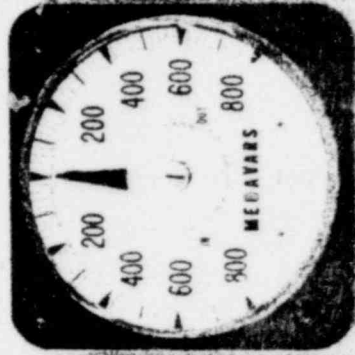
16



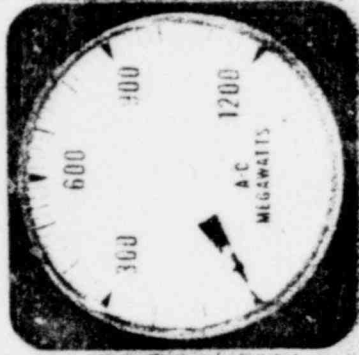
GENERATOR  
AMPS GA



RUNNING BUS  
KV



GENERATOR  
MEGAWATTS



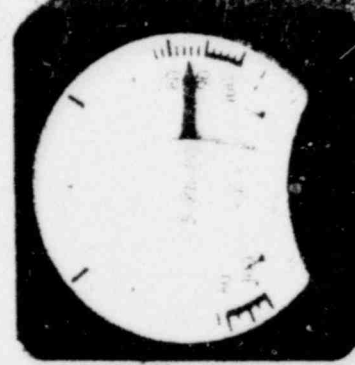
GENERATOR  
MEGAWATTS



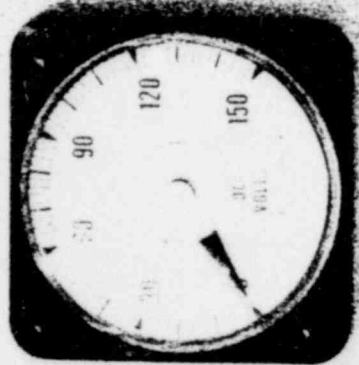
HYDROGEN  
PRESSURE



HYDROGEN  
SEAL OIL  $\Delta$ P



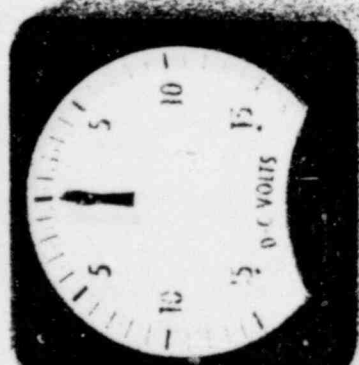
HYDROGEN  
PURITY



EXCITER  
VOLTAGE



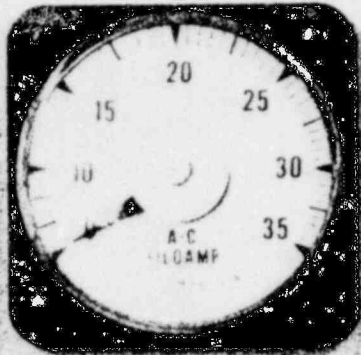
EXCITER  
AMPS



EXCITER  
VOLTAGE  
BALANCE



VALID DATA  
500 KV



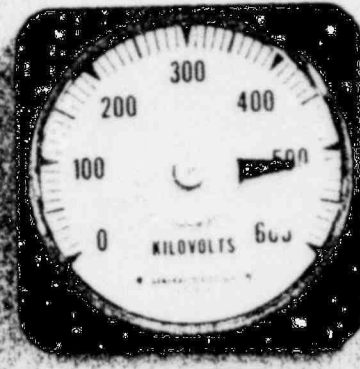
GENERATOR  
AMPS DC



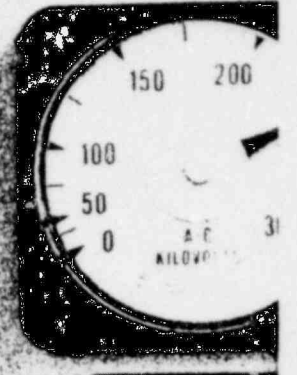
GENERATOR  
AMPS AC



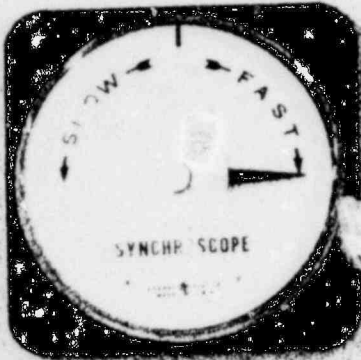
GENERATOR  
FREQUENCY



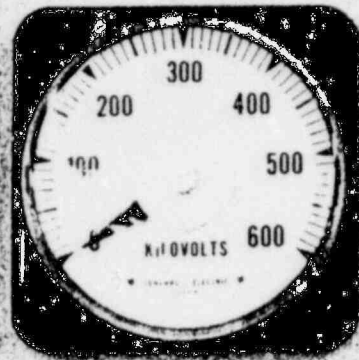
600V BUS A  
VOLTS



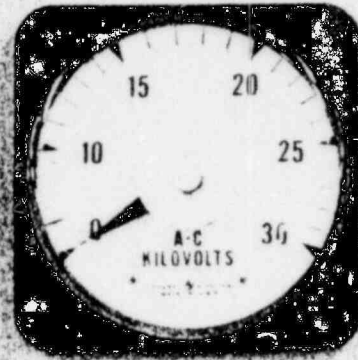
230KV BUS A  
VOLTS



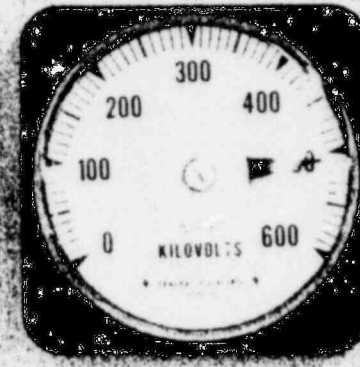
GENERATOR  
SYNCHROSCOPE



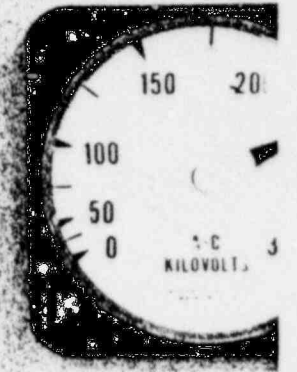
INCOMING BUS  
KV



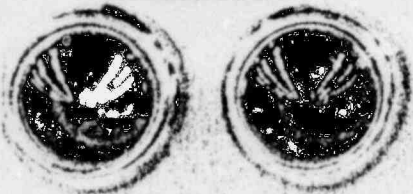
GENERATOR  
KV

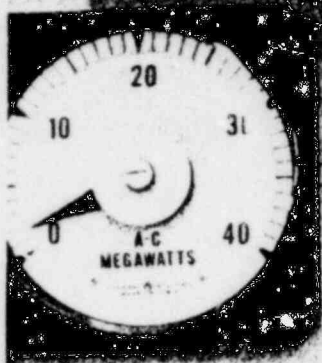


600V BUS B  
VOLTS

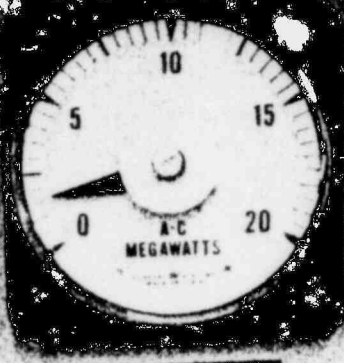


230KV BUS B  
VOLTS

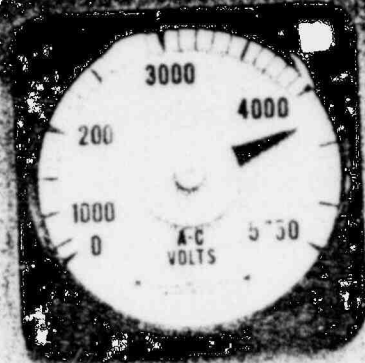
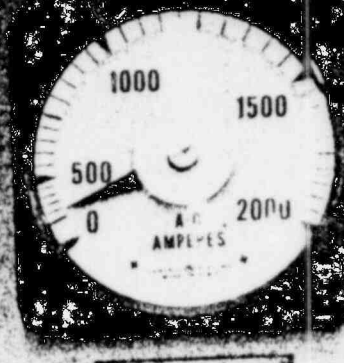




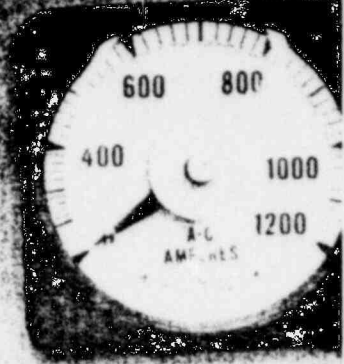
BREAKER  
22-48 MW



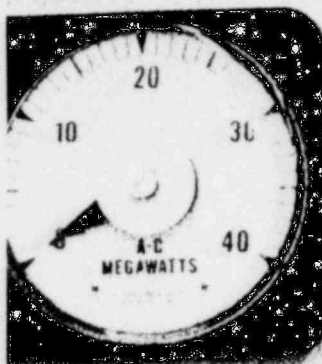
4160 V  
BUS 2-8  
MW



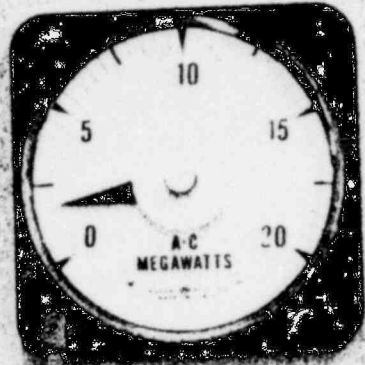
BUS 2-8  
VOLT



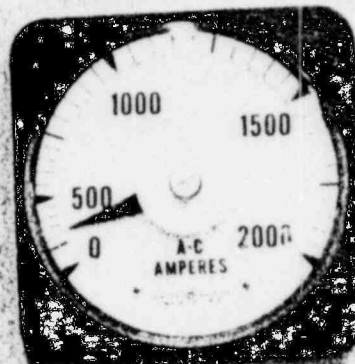
4160  
BUS 2-8  
AMPS



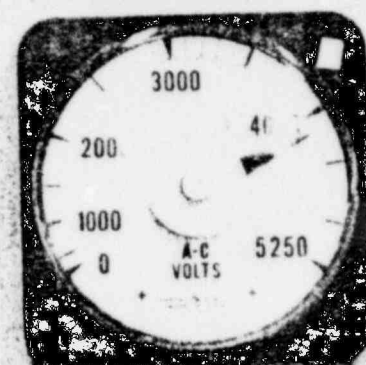
BREAKER  
22-48 MW



4160 V  
BUS 2-8  
MW



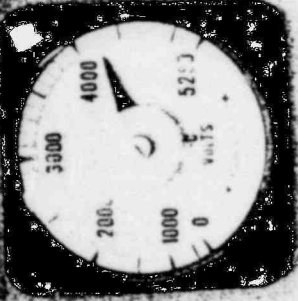
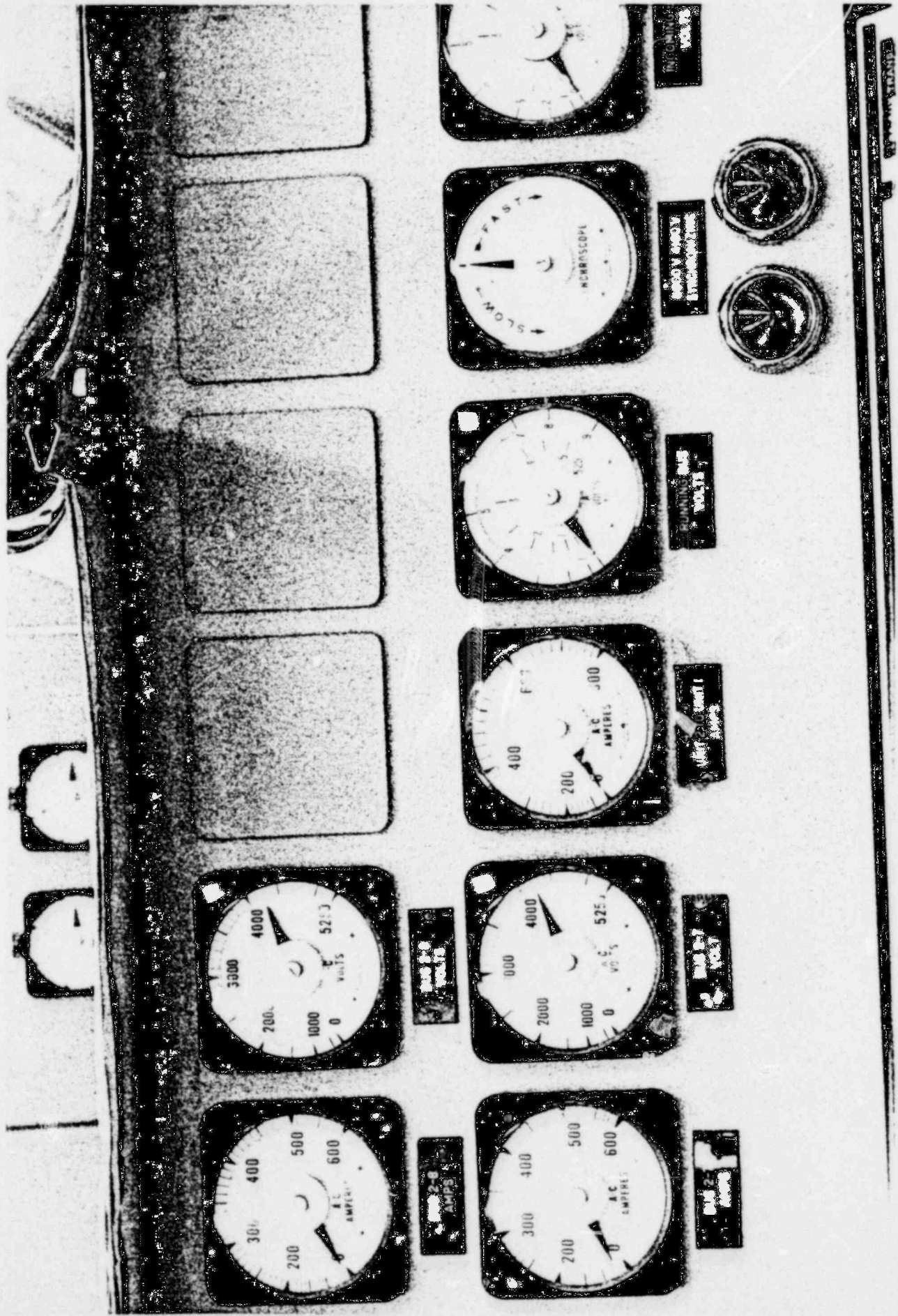
BUS 2-8  
AMPS



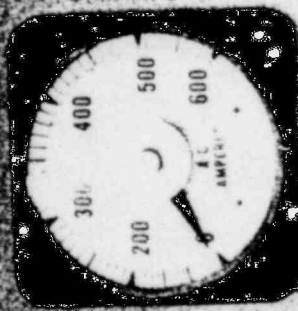
BUS 2-8  
VOLT



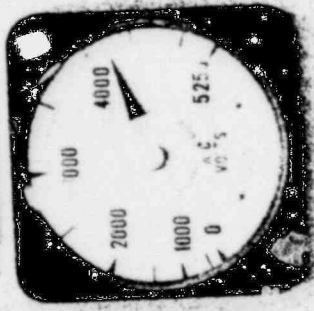
BUS  
2-8



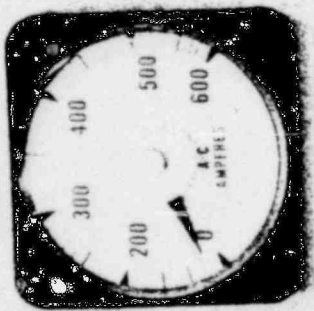
TACHOMETER



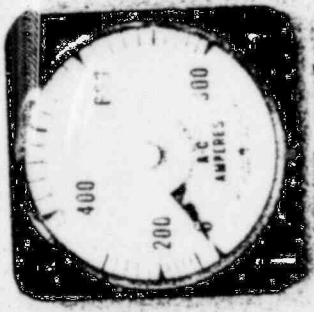
A.C. AMPS



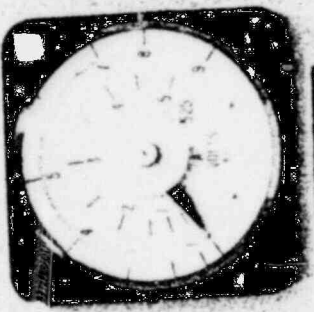
VOLTS



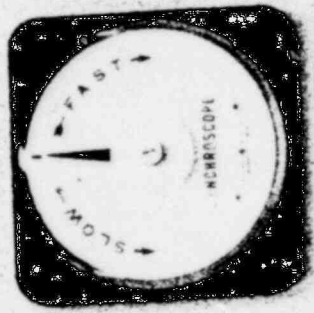
A.C. AMPS



A.C. AMPS

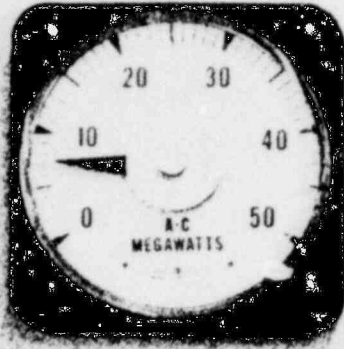


VOLTS

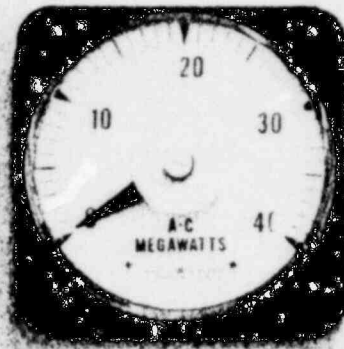


SLOWLY APPROX. TEMPERATURE

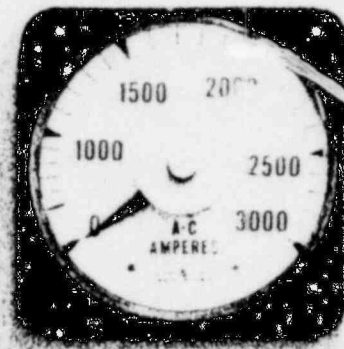




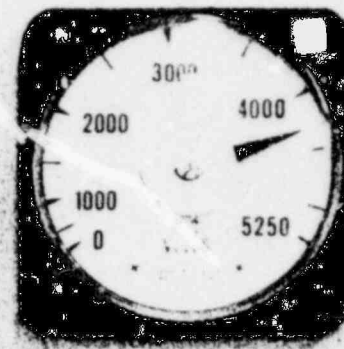
BREAKER  
22-23 MW



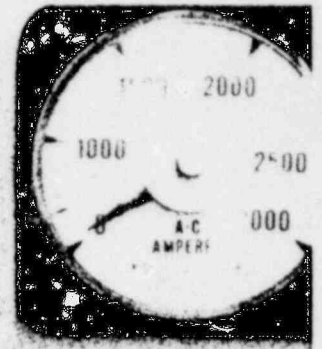
BREAKER  
24-25 MW



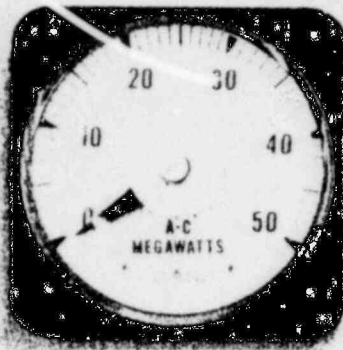
BREAKER  
26-27 AMP



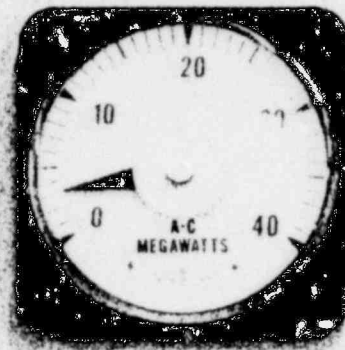
BREAKER  
28-29 AMP



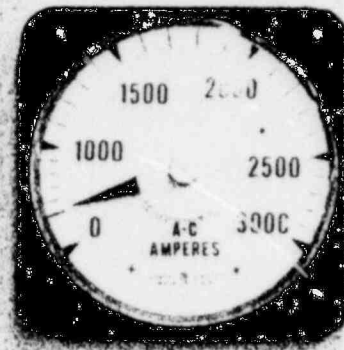
BREAKER  
30-31 AMP



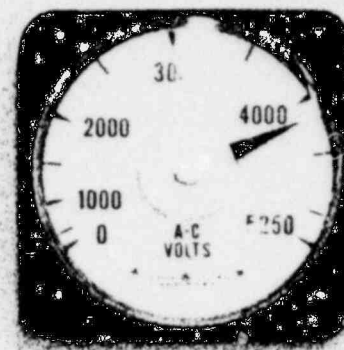
BREAKER  
26-27 MW



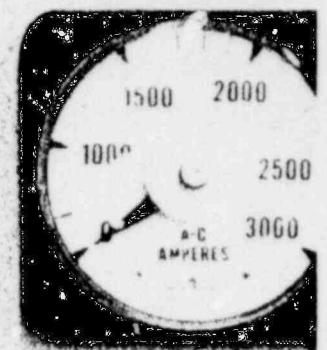
BREAKER  
28-29 MW



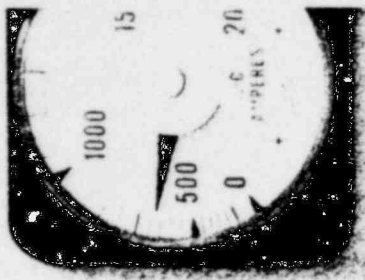
BREAKER  
29-30 AMP



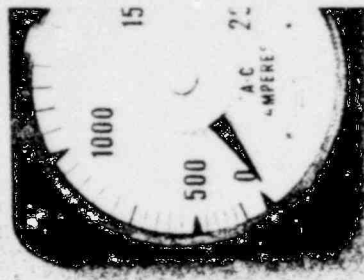
BREAKER  
30-31 VOLTS



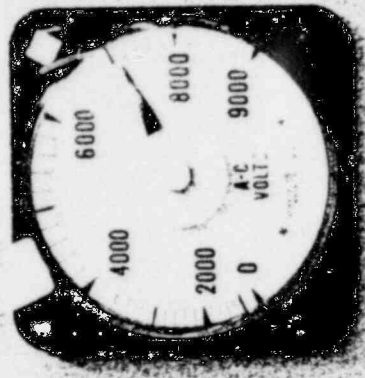
BREAKER  
32-33 AMP



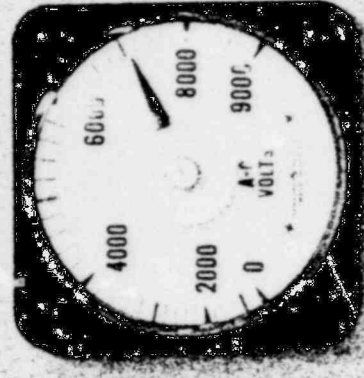
BREAKER  
24-28 AMP



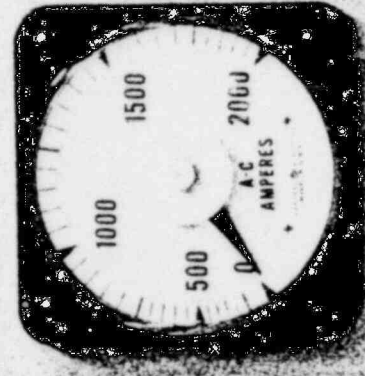
BREAKER  
24-28 AMP



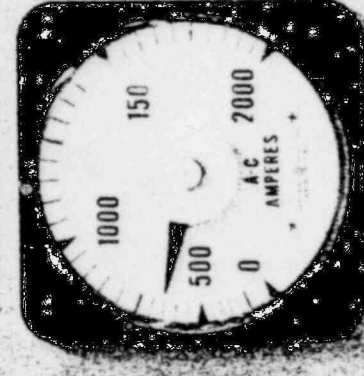
BUS 2-3  
VOLTS



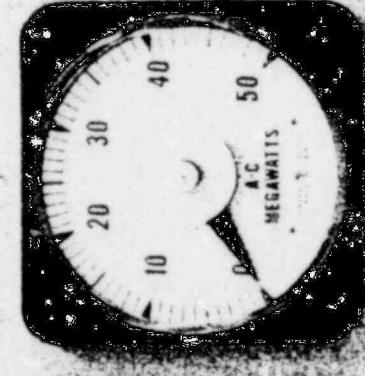
BUS 24  
VOLTS



BREAKER  
24-28 AMP



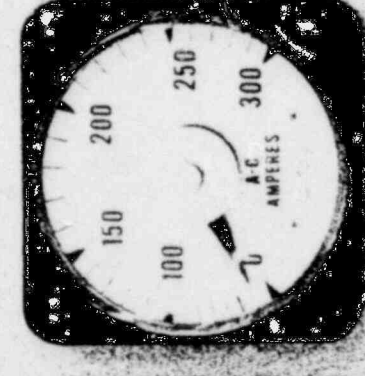
BREAKER  
24-28 AMP



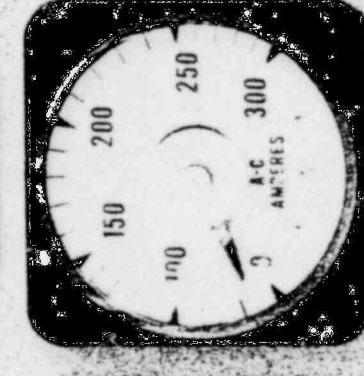
BREAKER  
24-28 MW



BREAKER  
24-28 MW



AUX TRANS 24  
PERMANENT AMP



AUX TRANS 24  
PERMANENT AMP

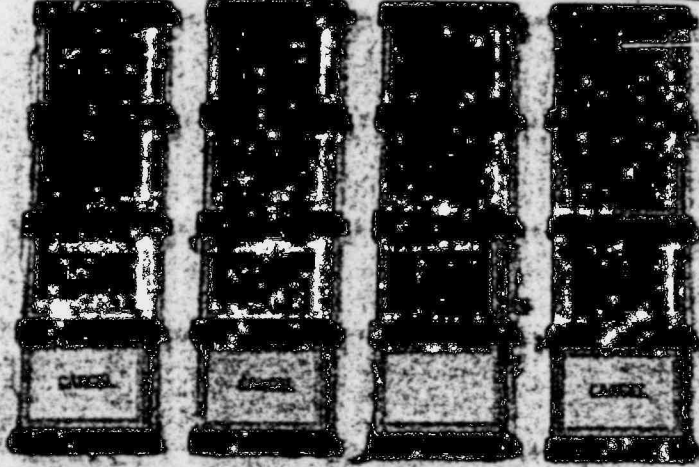


230V  
SWITCHBOARD

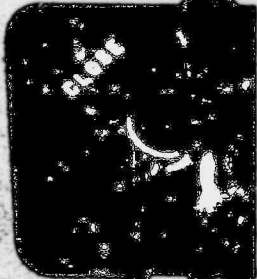


GEN BKR DISC  
SW B2-03 & B2-05  
SUPERV  
CHECKBACK SW

GEN BKR DISC  
B2-2001 & B2-2101  
SUPERV  
CHECKBACK SW

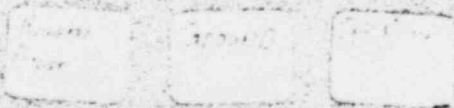


GEN BREAKER  
DISCONNECT  
B2-04/B205

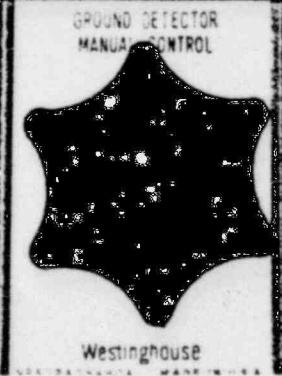


GEN BKR  
B2-02  
SUPERV  
CHECKBACK SW

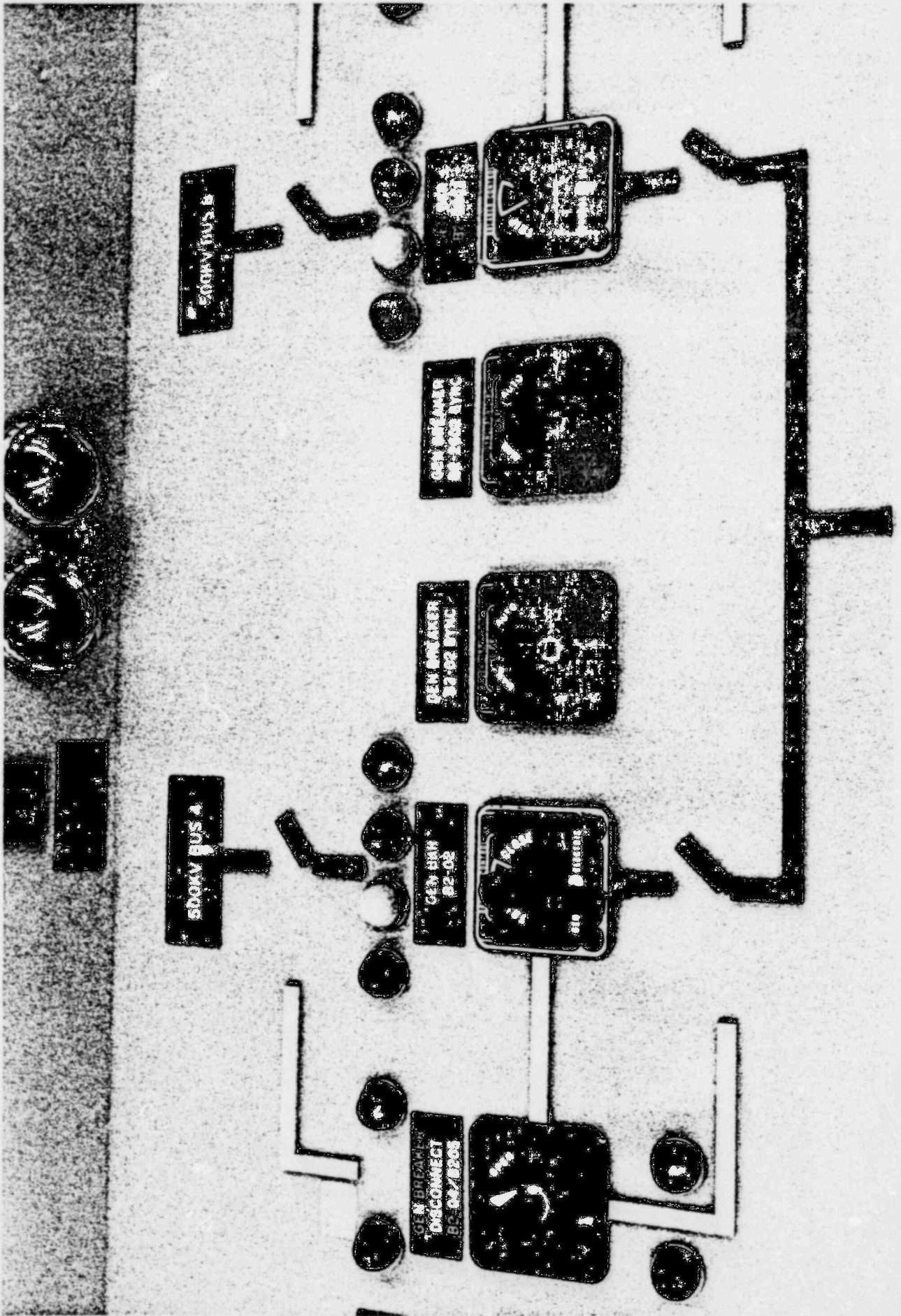
GEN BKR  
B2-2002  
SUPERV  
CHECKBACK SW

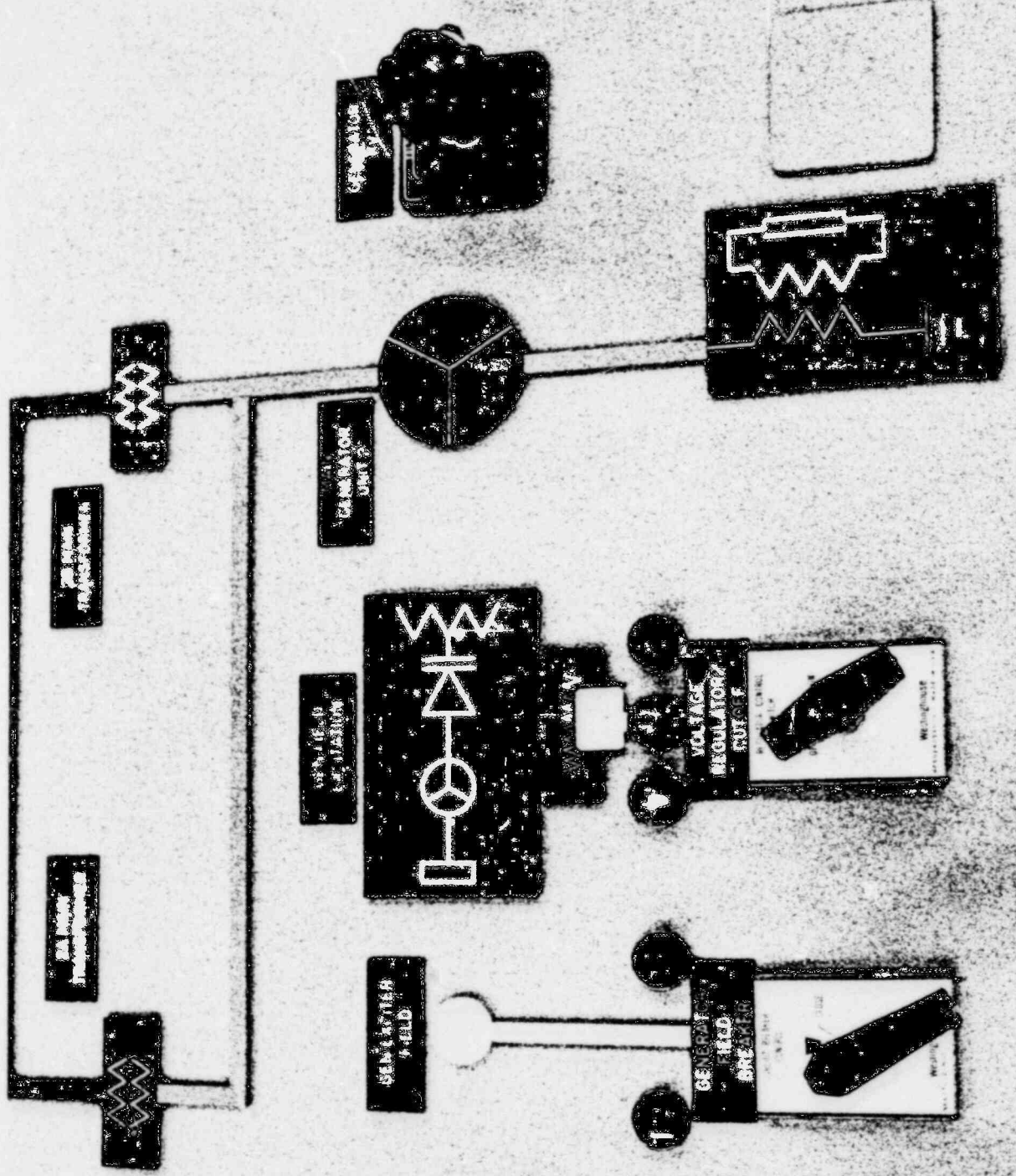


GEN FIELD  
GROUND DET.



Westinghouse





**VOLTAGE REGULATOR**

**GEN COIL FIELD**

**VOLTAGE REGULATOR**

**GEN COIL FIELD**

**MOTOR OPER BASE**

**GEN COIL FIELD**



**VOLTAGE REGULATOR**

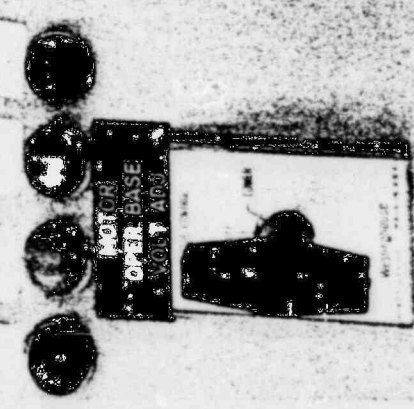
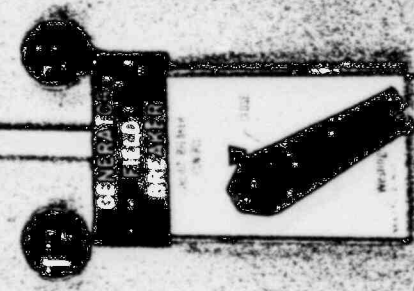
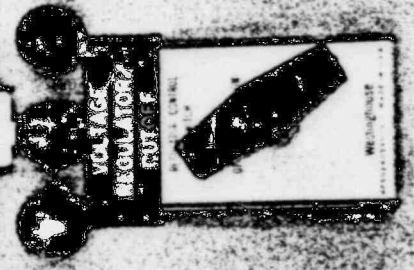
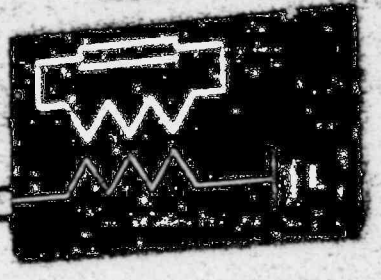
**GEN COIL FIELD**

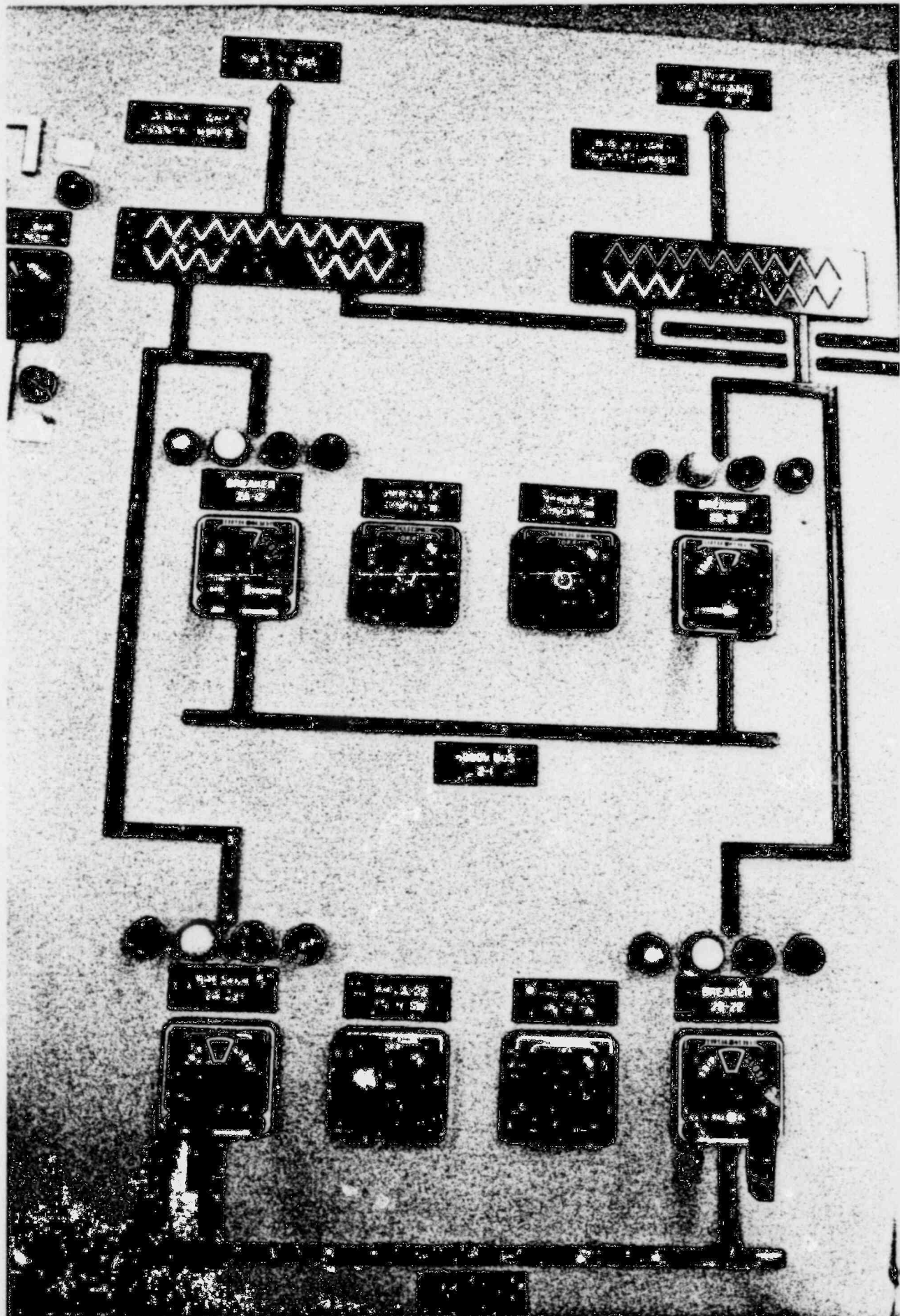
**GEN COIL FIELD**

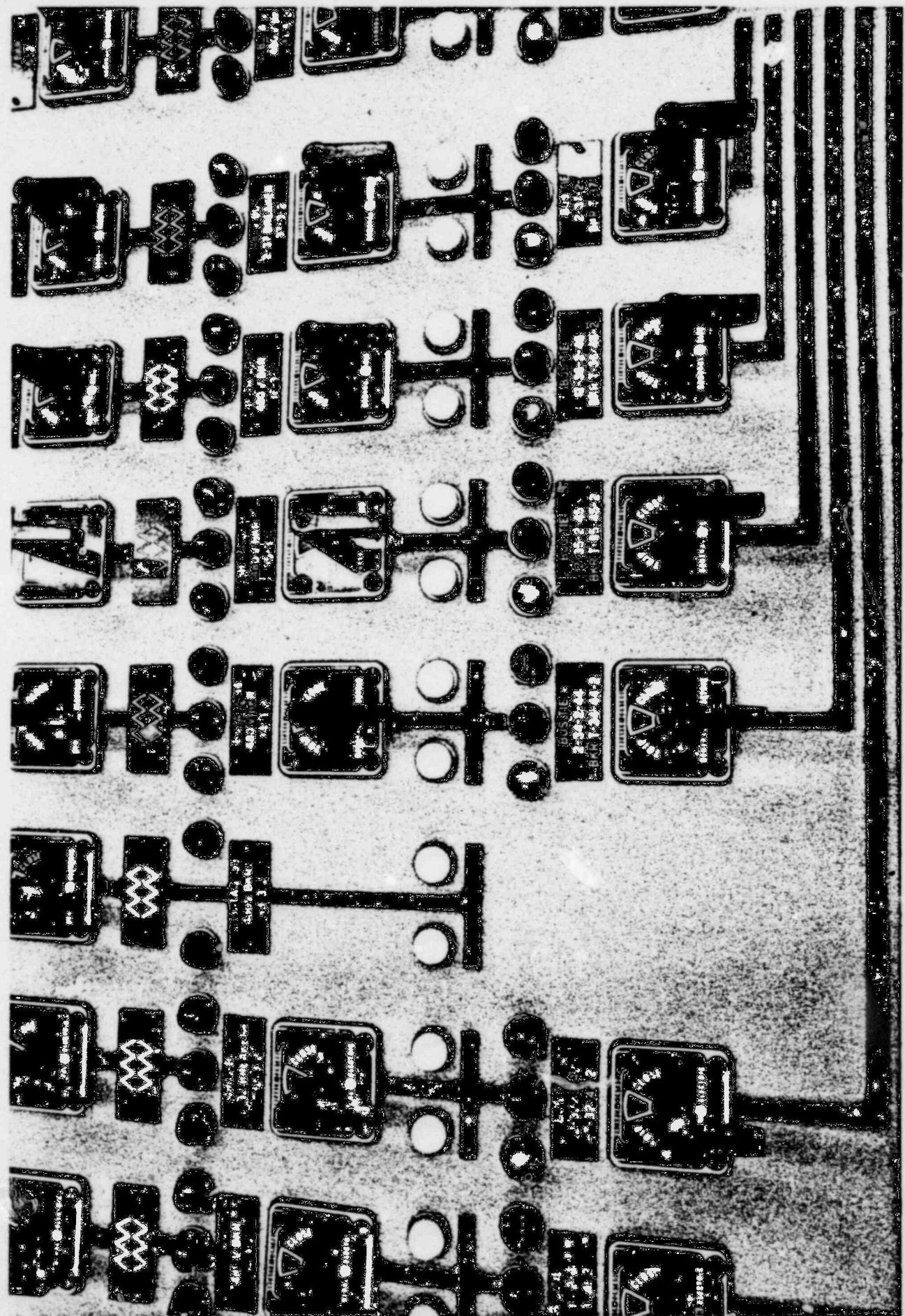
**VOLTAGE REGULATOR**

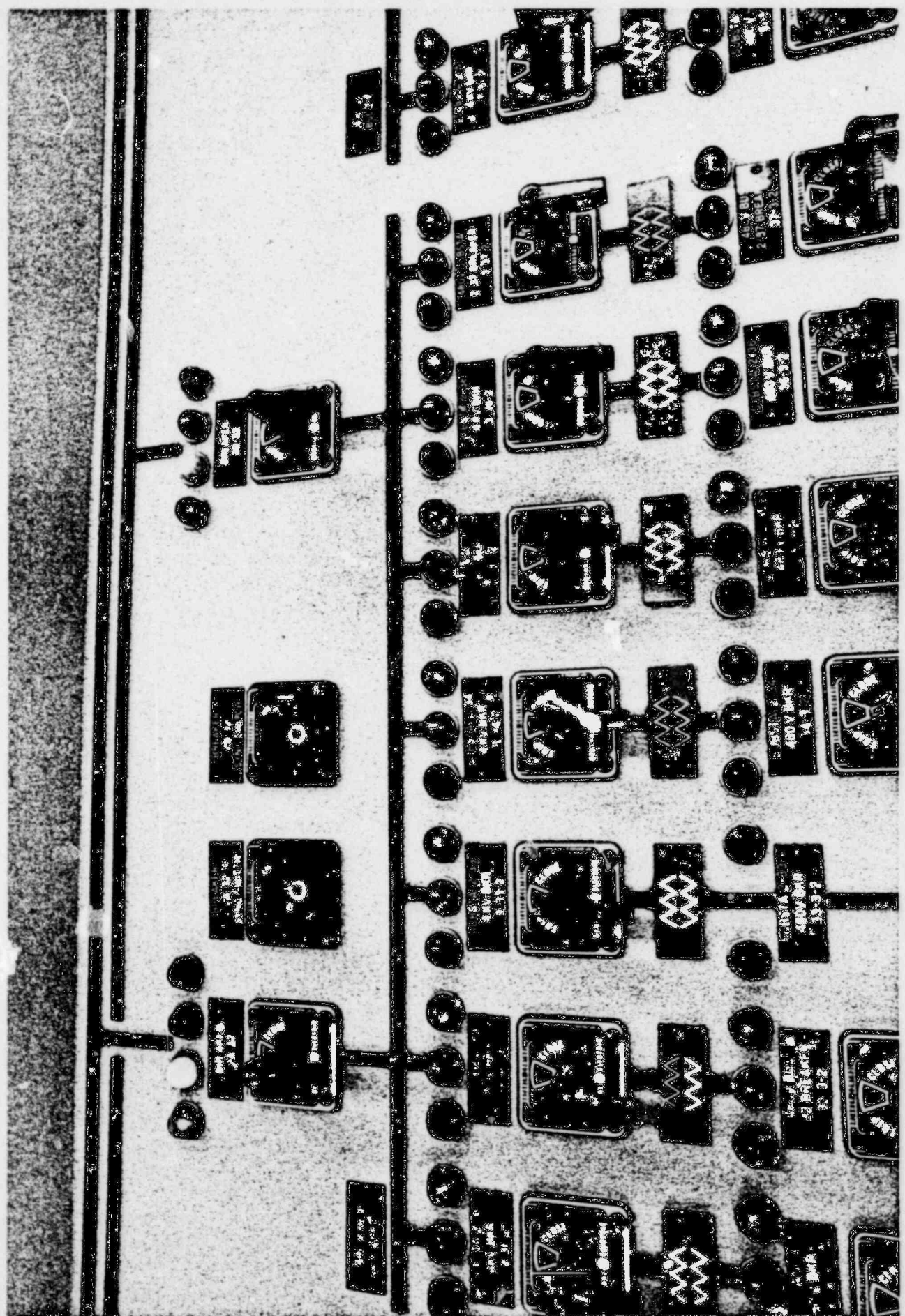
**MOTOR OPER BASE**

**GEN COIL FIELD**



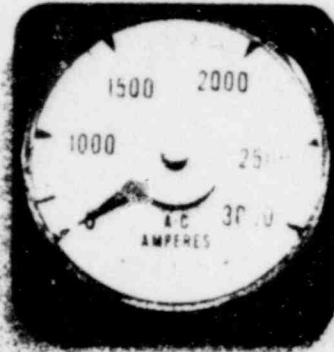








480V USS  
2-35



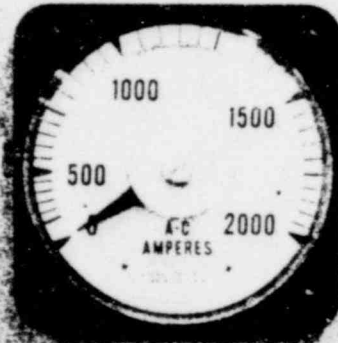
480V USS  
2-36



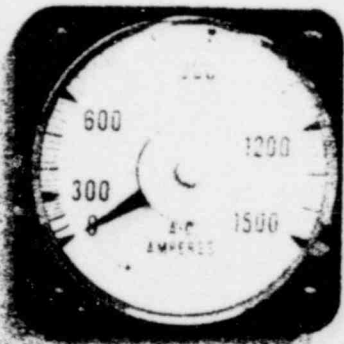
480V USS  
2-37



480V BUS TIE  
2-35/2-45



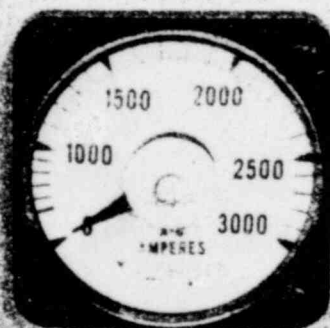
480V BUS TIE  
2-36/2-46



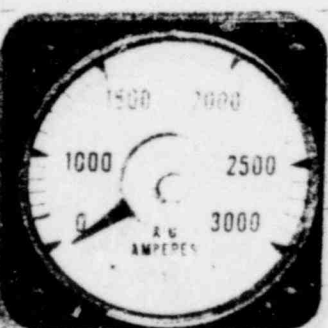
480V BUS TIE  
2-37/2-47



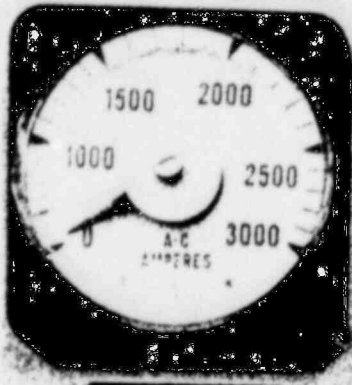
480V USS  
2-45



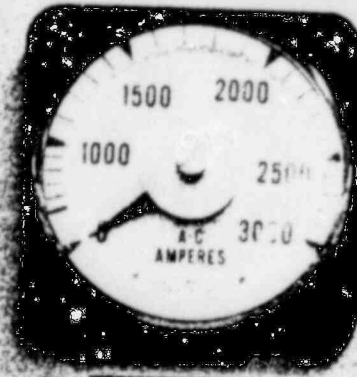
480V USS  
2-46



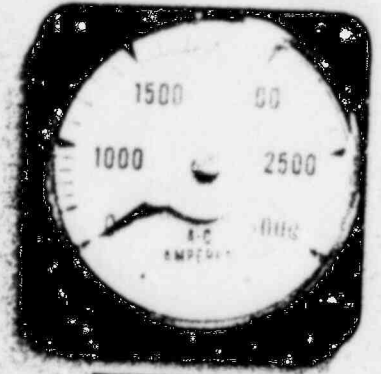
480V USS  
2-47



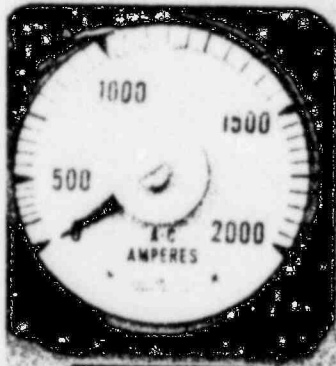
480V 1500  
2-28



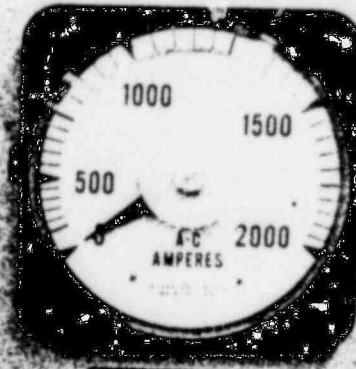
480V 1500  
2-28



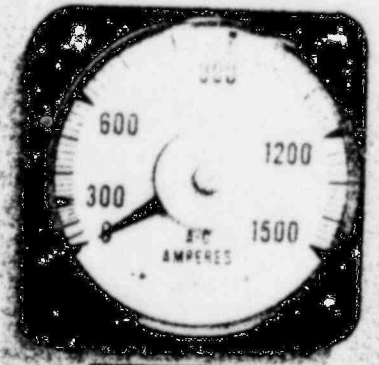
480V 1500  
2-28



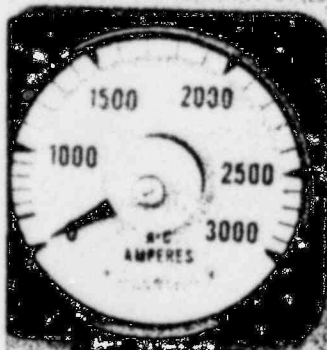
480V 1000 TIE  
2-28/2-48



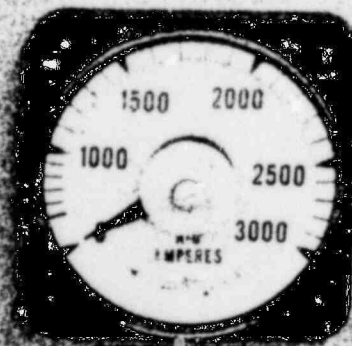
480V 1000 TIE  
2-28/2-48



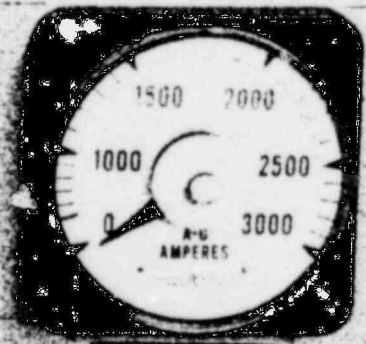
480V 600 TIE  
2-27/2-47



480V 1500  
2-45



480V 1500  
2-45



480V 1500  
2-45

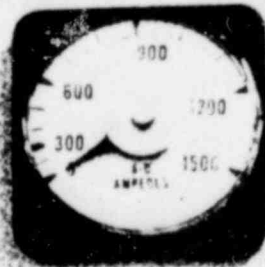




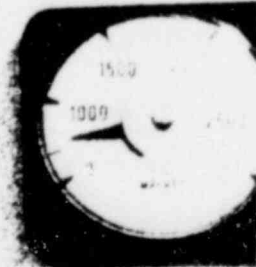
480V USS  
2-31



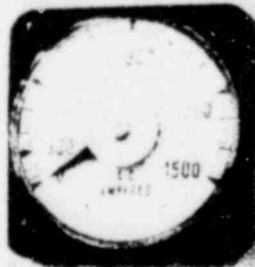
480V USS  
2-32



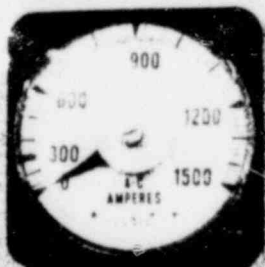
480V USS  
2-33



480V USS  
2-34



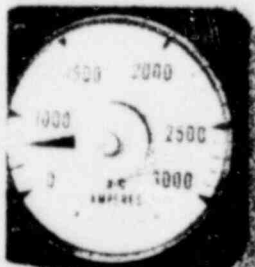
480V BUS TIE  
2-31/2-41



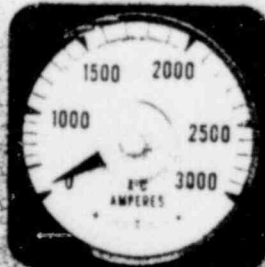
480V BUS TIE  
2-32/2-42



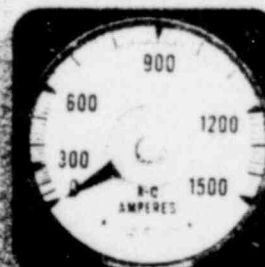
480V BUS TIE  
2-34/2-44



480V USS  
2-41



480V USS  
2-42



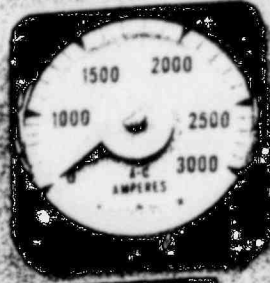
480V USS  
2-43



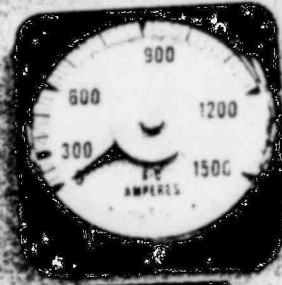
480V USS  
2-44



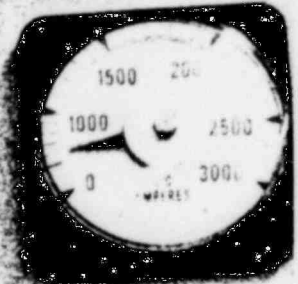
1500 AMP  
2-30



1000 AMP  
2-30



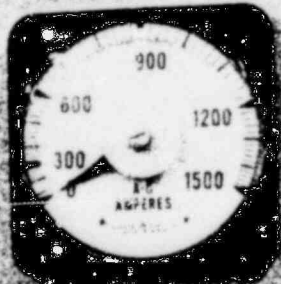
300 AMP  
2-30



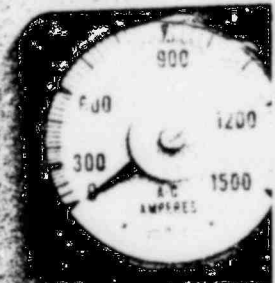
1000 AMP  
2-30



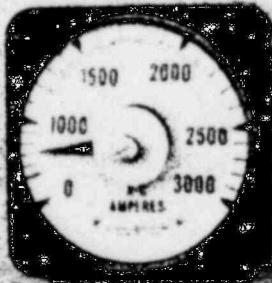
300 AMP  
2-30



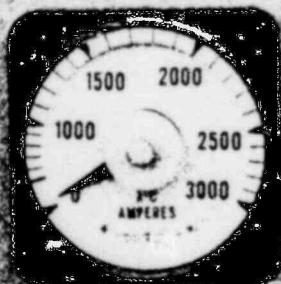
300 AMP  
2-30



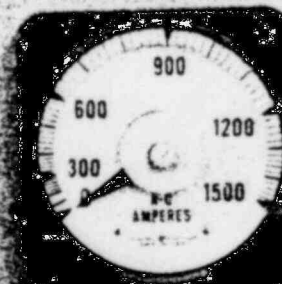
300 AMP  
2-30



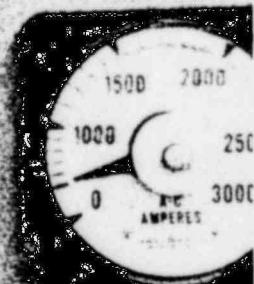
1000 AMP  
2-30



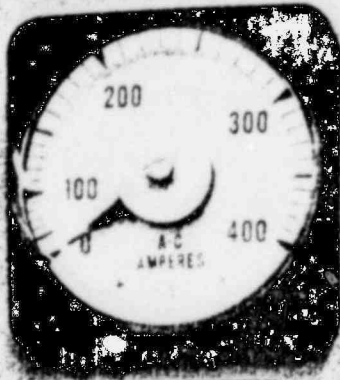
1000 AMP  
2-30



300 AMP  
2-30



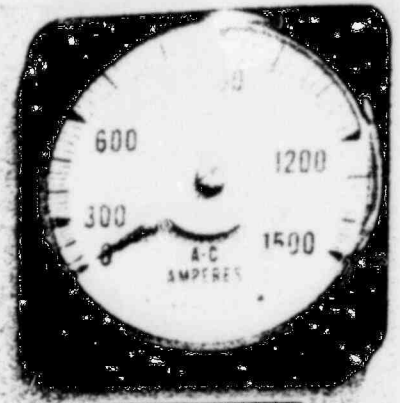
1000 AMP  
2-30



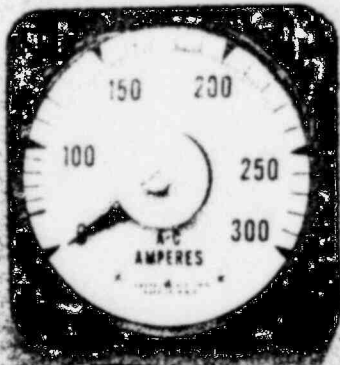
480V USS  
2-51



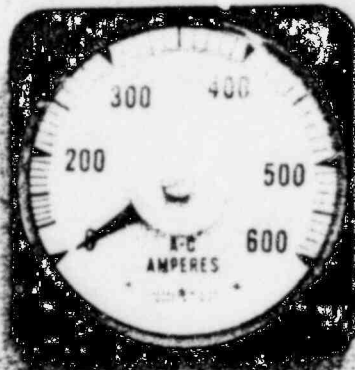
480V USS  
2-72



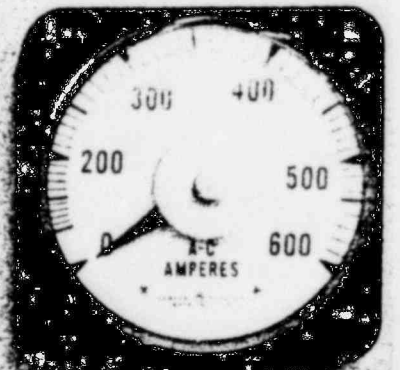
480V/USS  
2-71



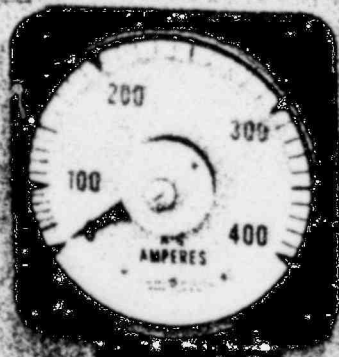
480V BUS TIE  
2-51/2-51



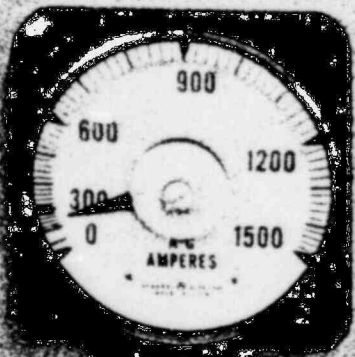
480V BUS TIE  
2-72/2-72



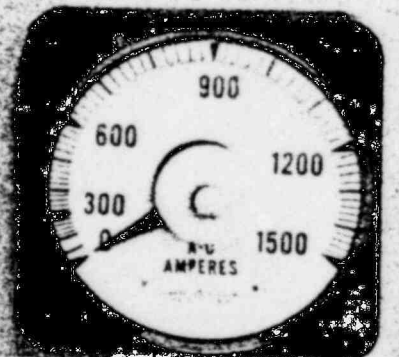
480V BUS TIE  
2-71/2-71



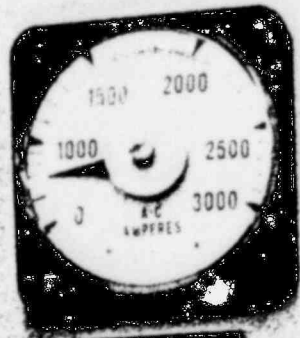
480V USS  
2-51



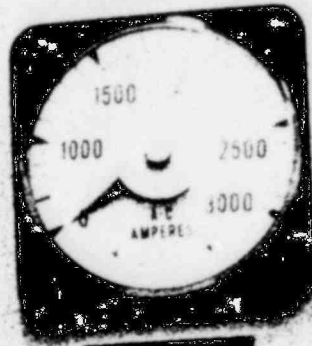
480V USS  
2-72



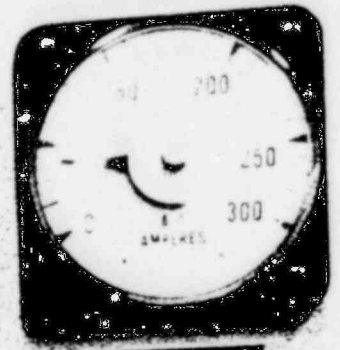
480V USS  
2-71



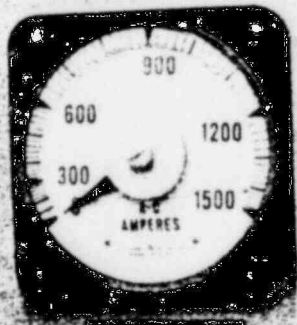
400V-60S TIC  
2-AM



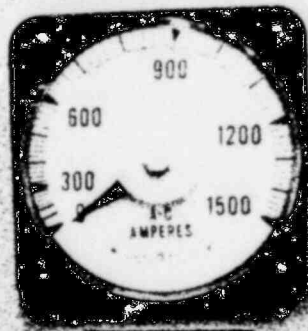
400V-60S TIC  
2-AM



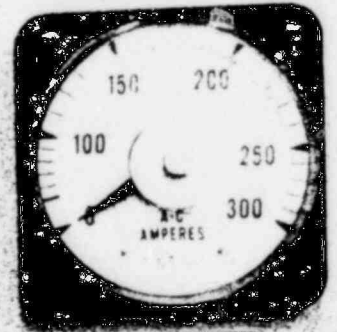
400V-60S TIC  
2-AM



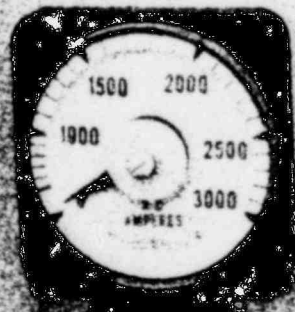
400V-60S TIC  
2-AM



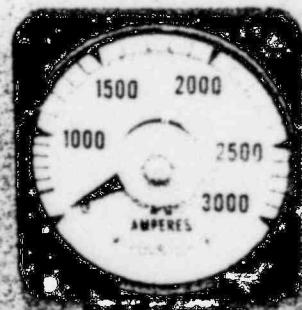
400V-60S TIC  
2-AM



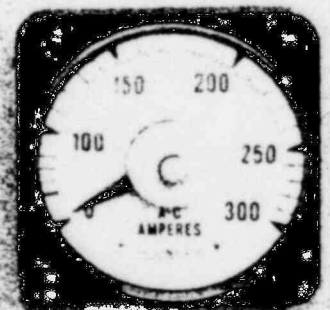
400V-60S TIC  
2-AM



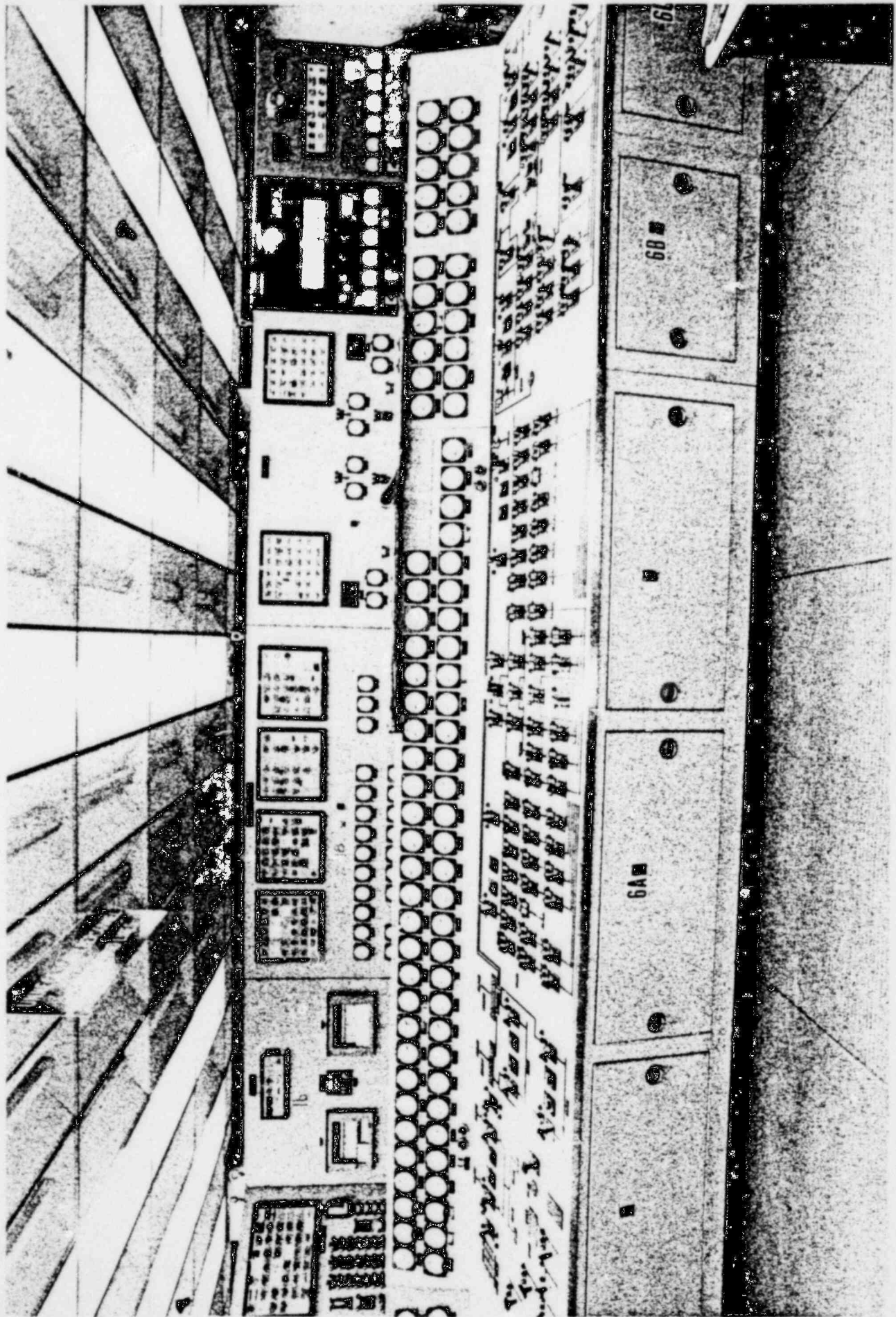
400V-60S TIC  
2-AM

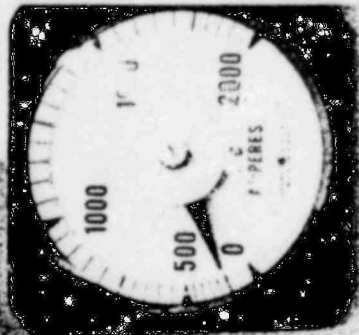


400V-60S TIC  
2-AM

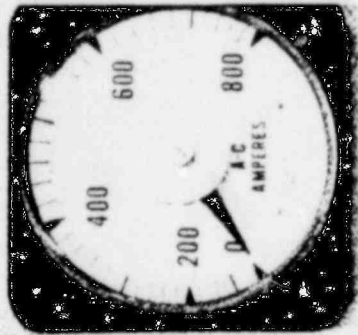


400V-60S TIC  
2-AM

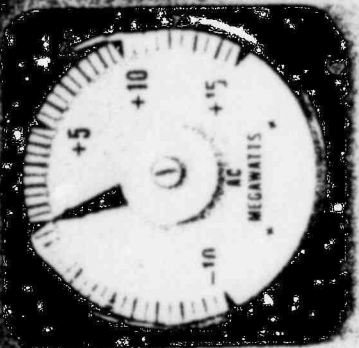




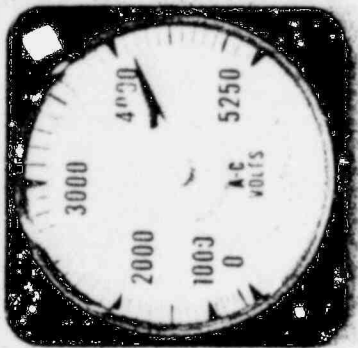
1000 500 0 2000  
AMPERS



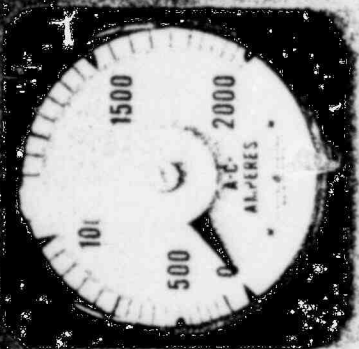
400 200 0 800  
A-C AMPERES



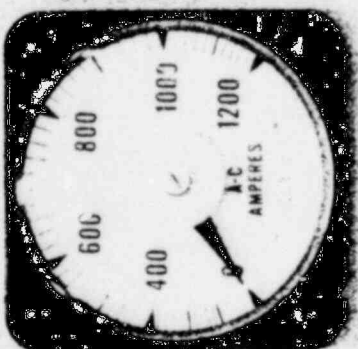
+5 +10 +15 -10  
MEGAWATTS



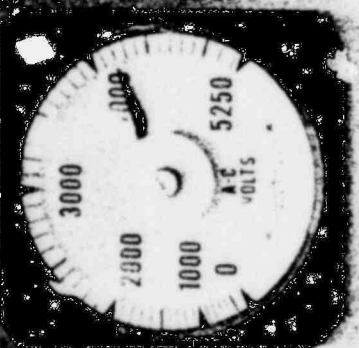
3000 2000 1000 0 4000 5250  
A-C VOLTS



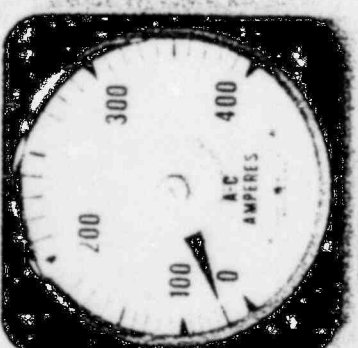
1500 100 500 0 2000  
A-C AMPERES



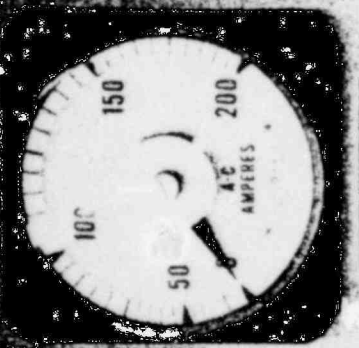
800 600 400 0 1000 1200  
A-C AMPERES



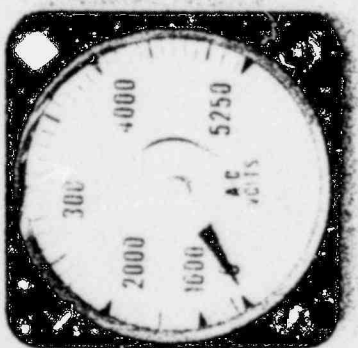
3000 2000 1000 0 5250  
A-C VOLTS



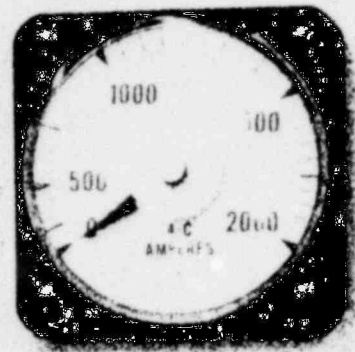
300 200 100 0 400  
A-C AMPERES



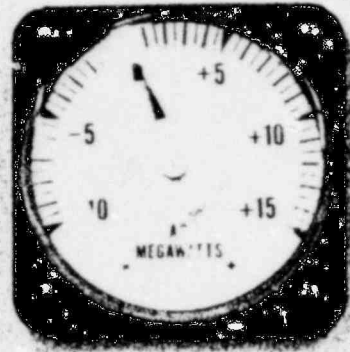
150 100 50 0 200  
A-C AMPERES



300 200 100 0 4000 5250  
A-C VOLTS



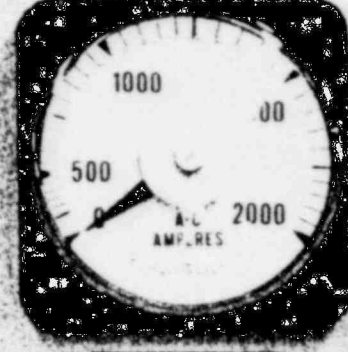
BREAKER  
20-250 AMP



BREAKER  
20-250 MW



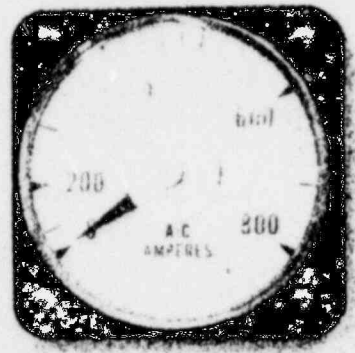
BREAKER  
20-250 MW



BREAKER  
20-250 AMP



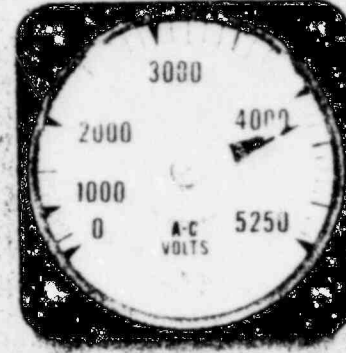
BREAKER  
20-250 VOLTS



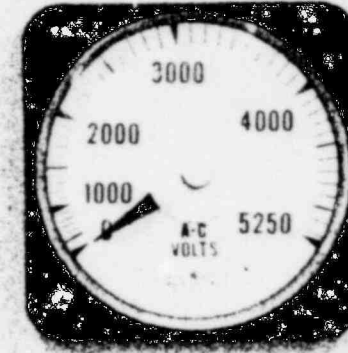
BREAKER  
20-250 AMP



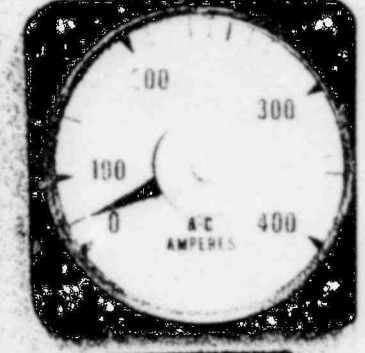
BREAKER  
20-250 MW



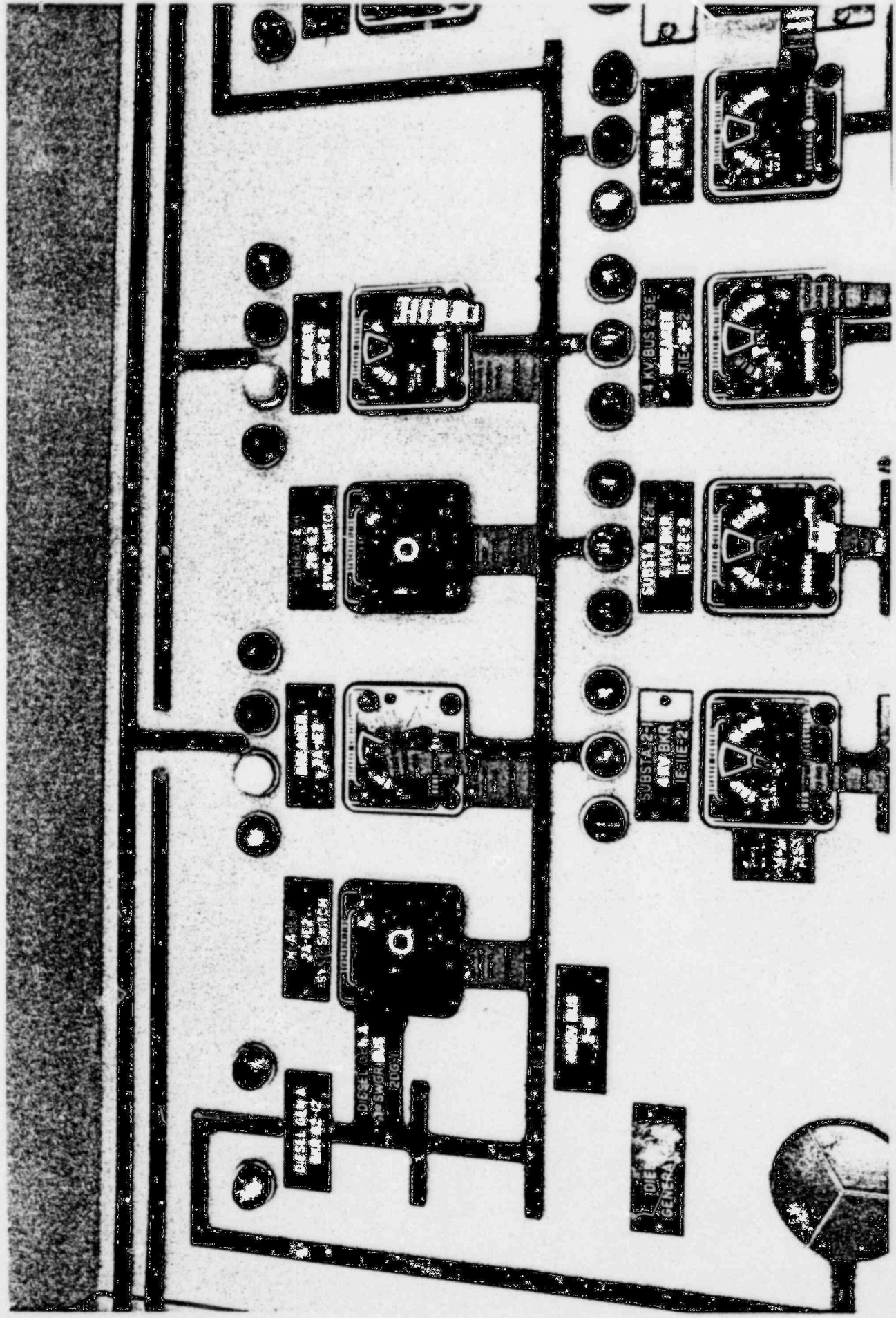
4160V  
20-250 VOLTS



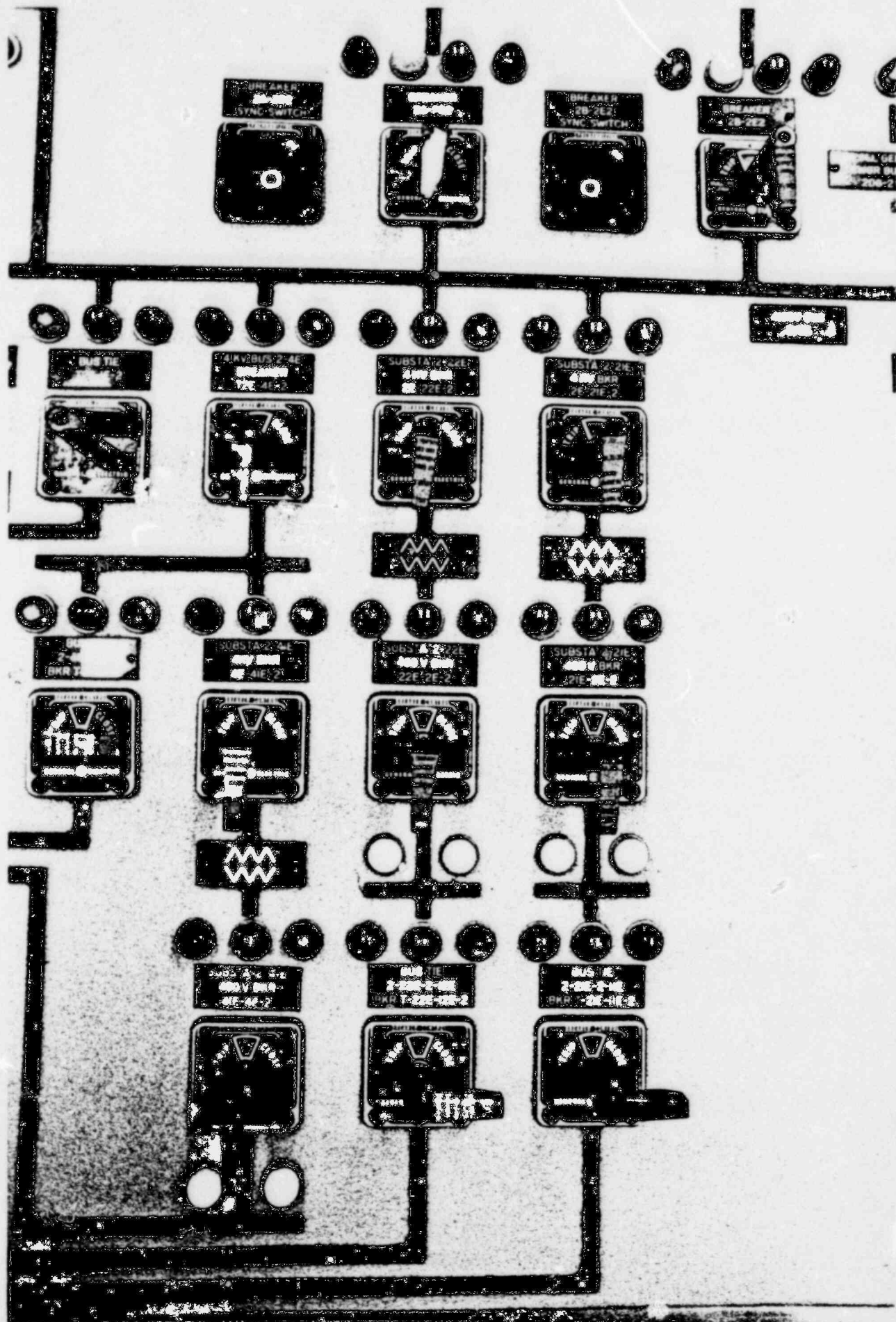
BREAKER  
20-250 VOLTS

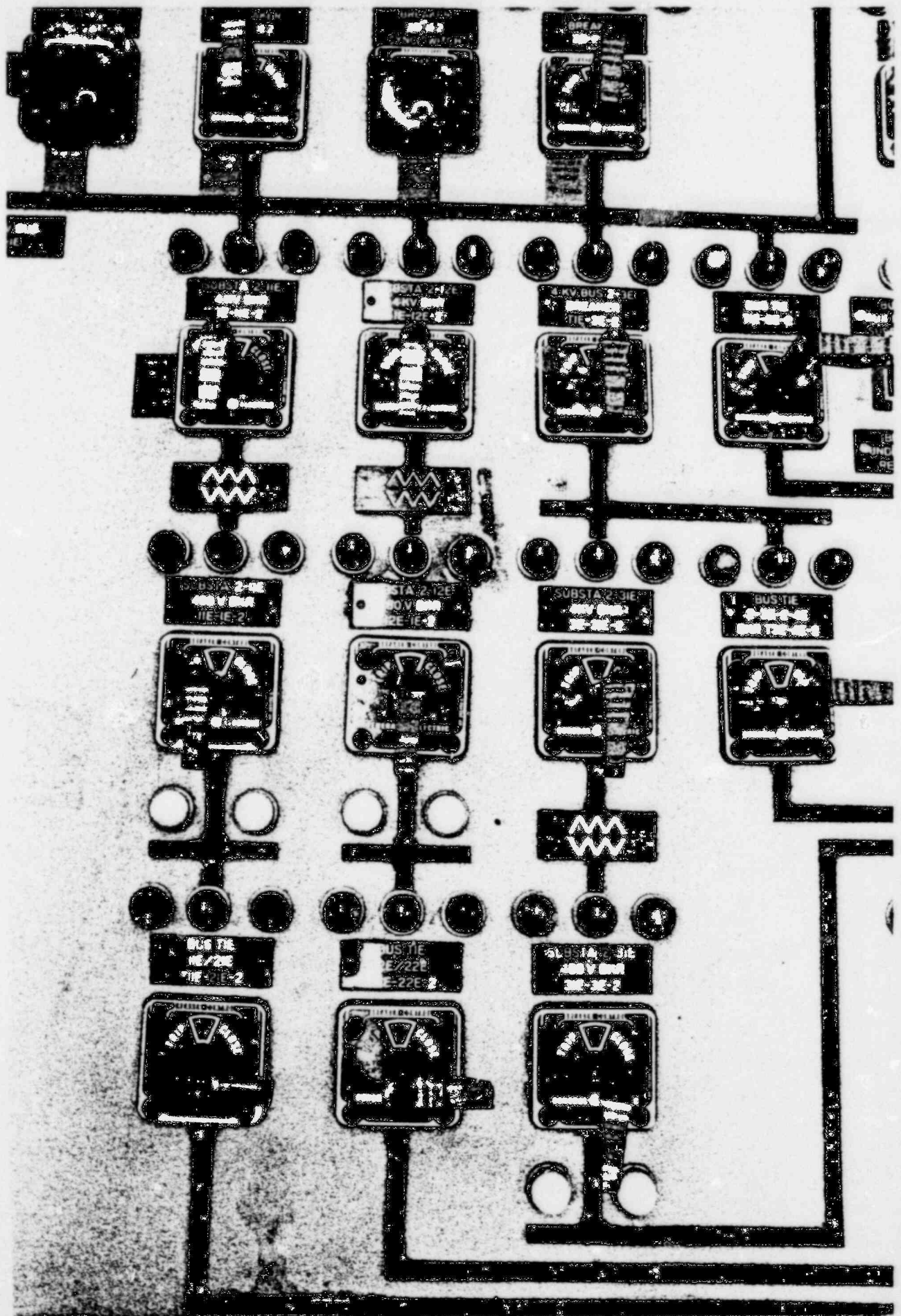


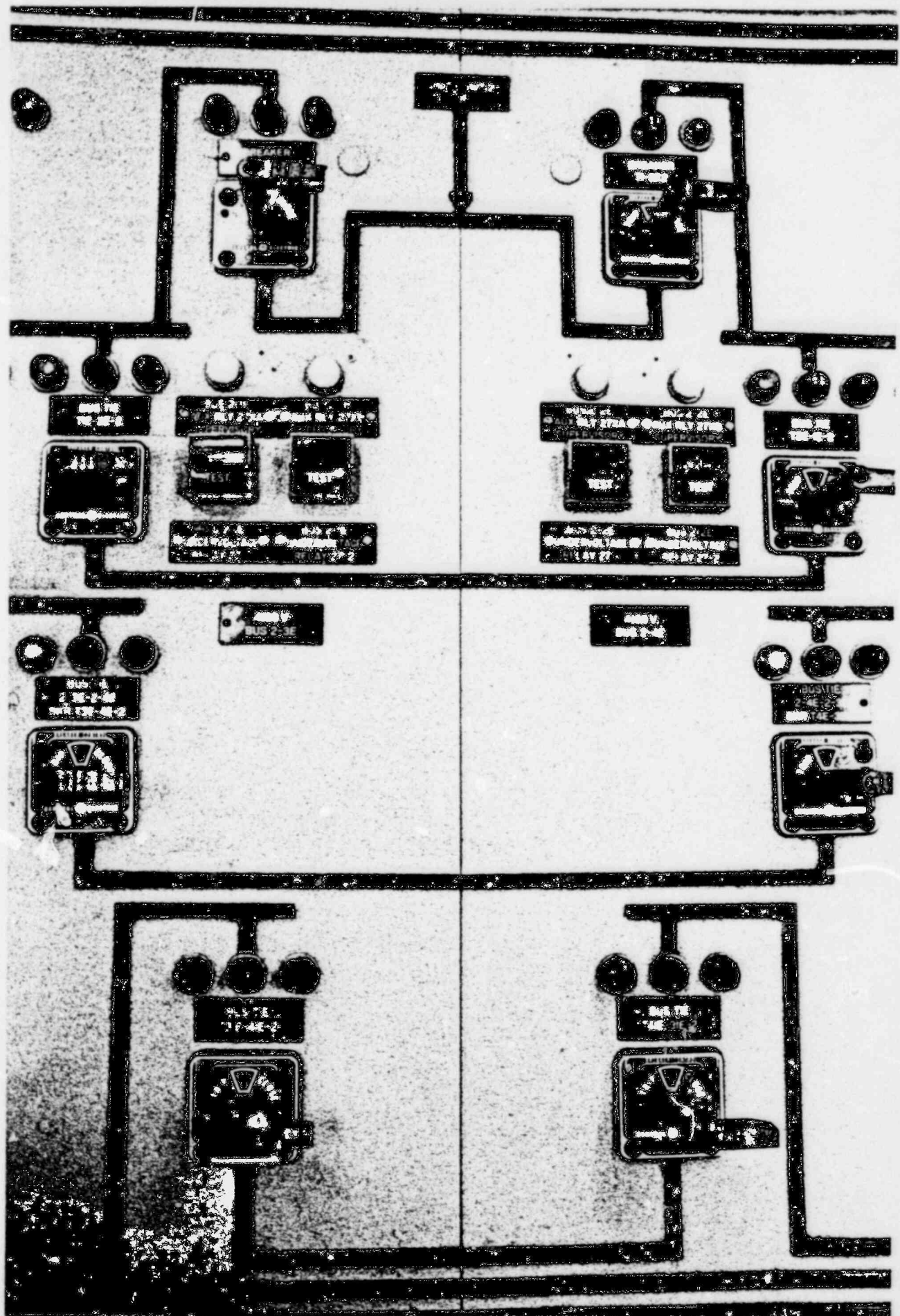
BREAKER  
20-250 AMP

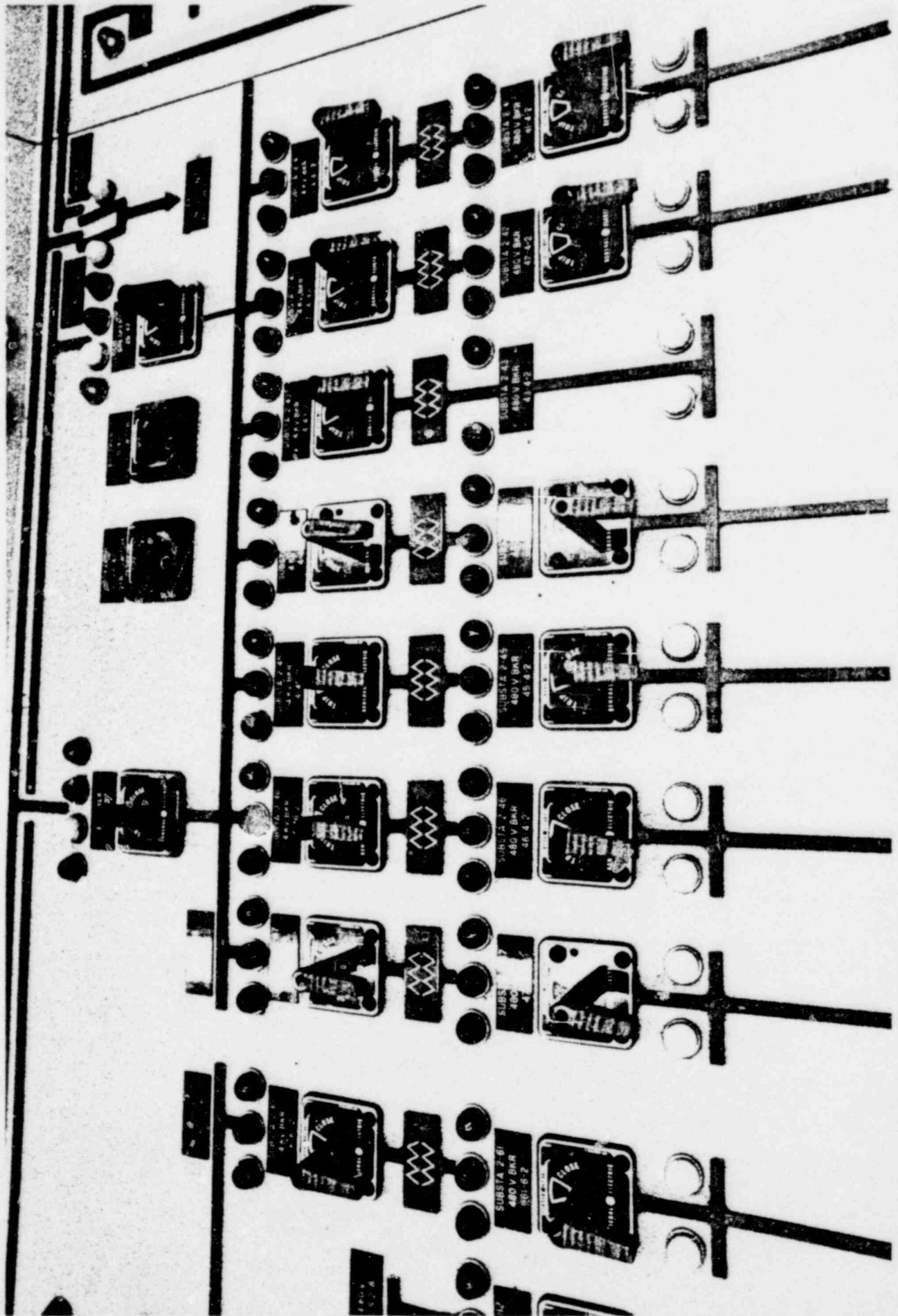


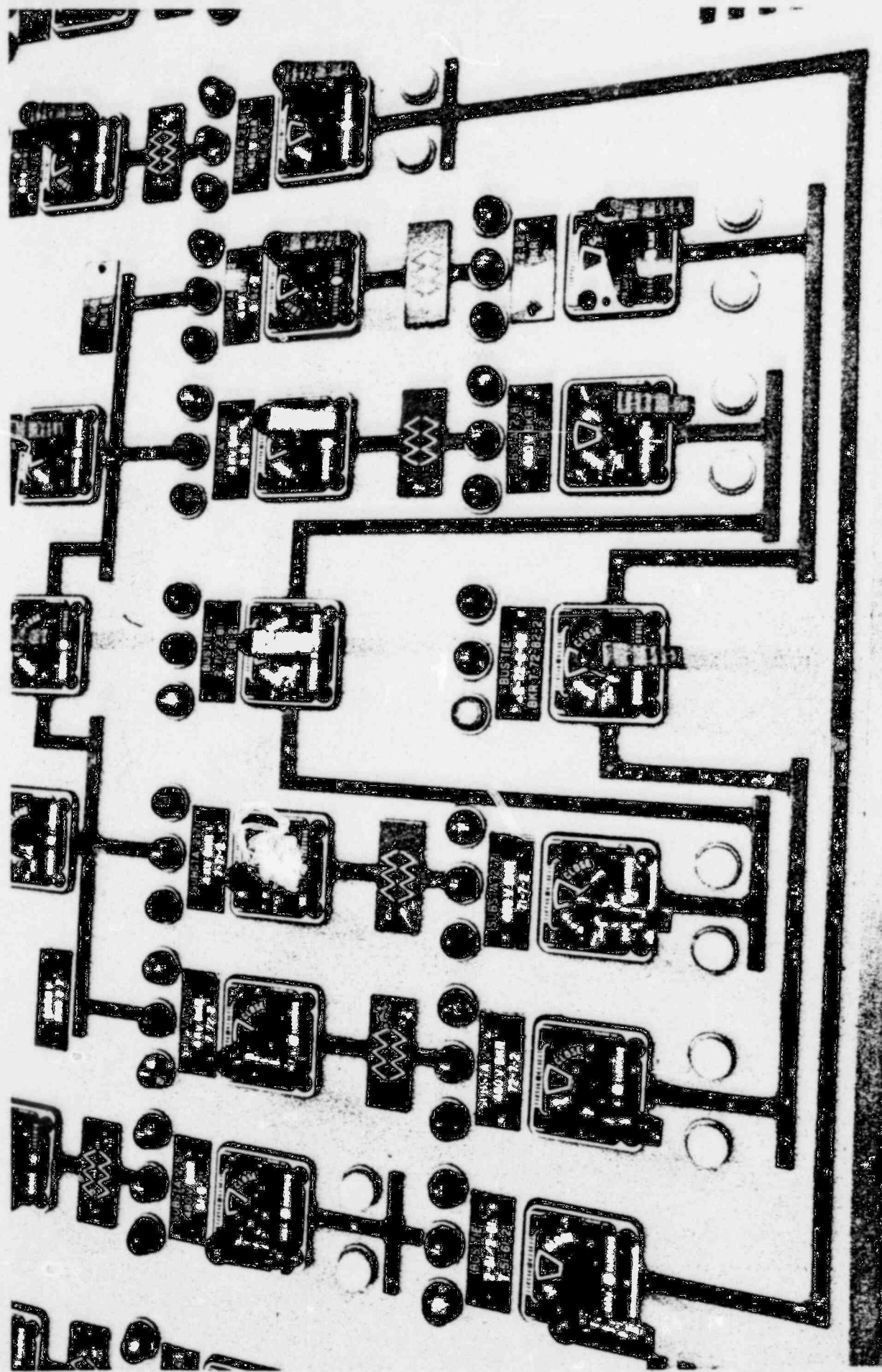










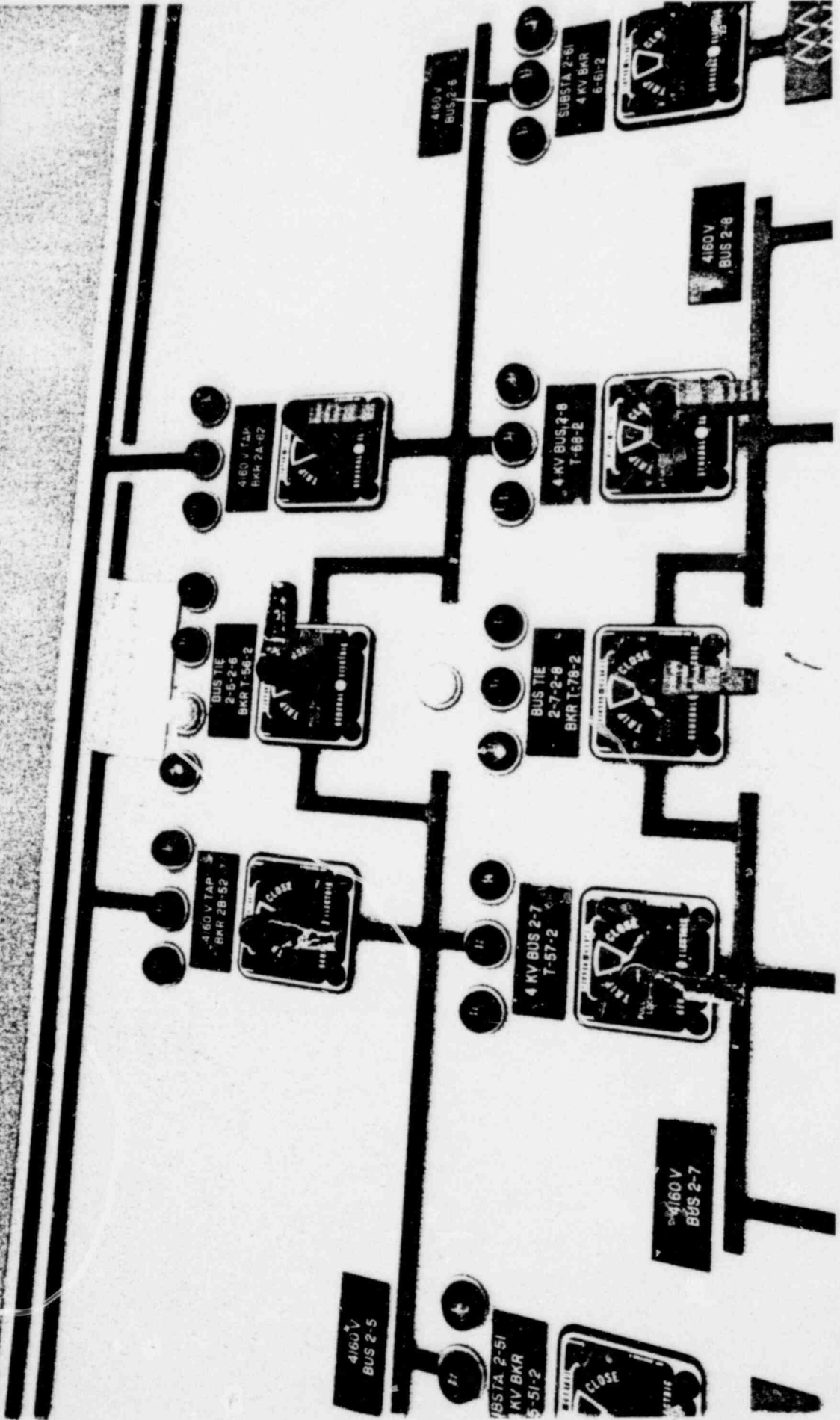


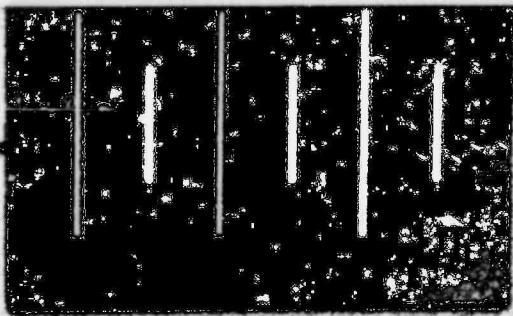
BUS 2-5  
AMPS

BUS 2-5  
VOLT

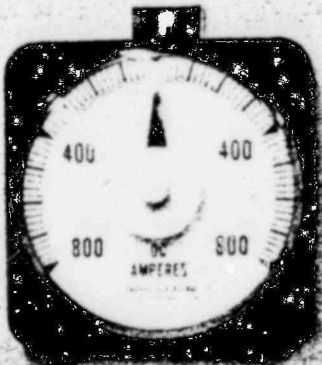
BUS 2-5  
TAP

BUS 2-5  
TAP

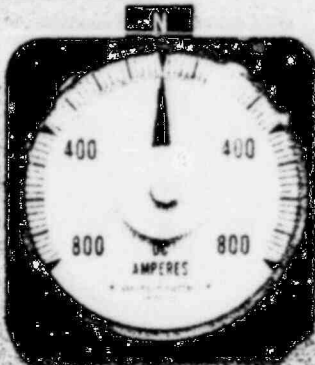




SWAPON  
BATTERY 2-2

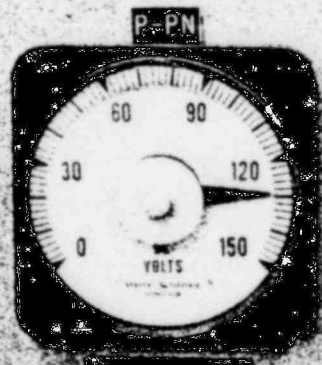


SWAPON  
BATTERY 2-2  
AMPS

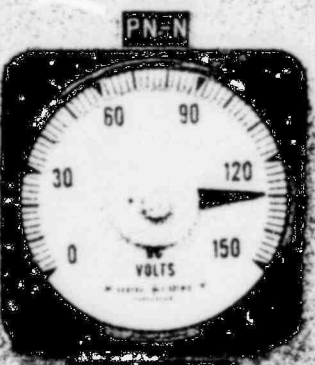


SWAPON  
BATTERY 2-2  
AMPS

250V DC  
BREAKER  
2 DC-582

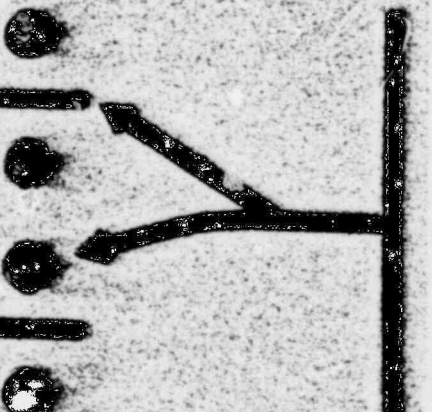
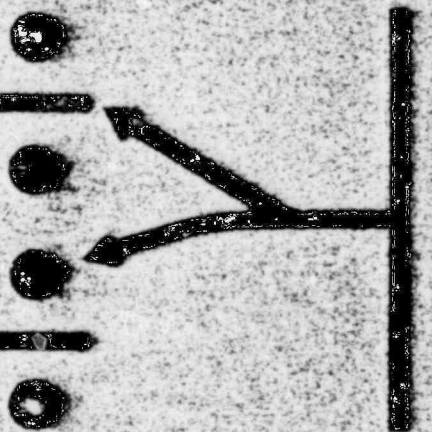
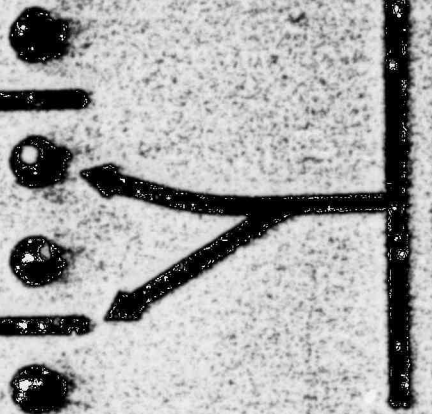
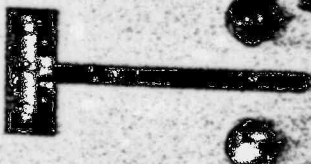
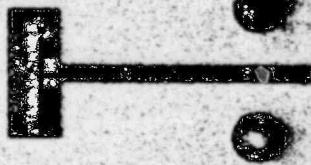
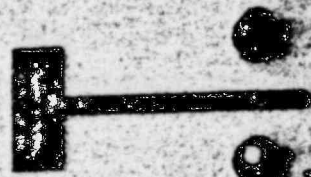
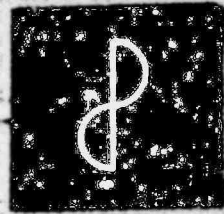
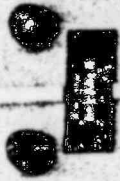


P-PN  
DC BUS 2-2  
VOLTS

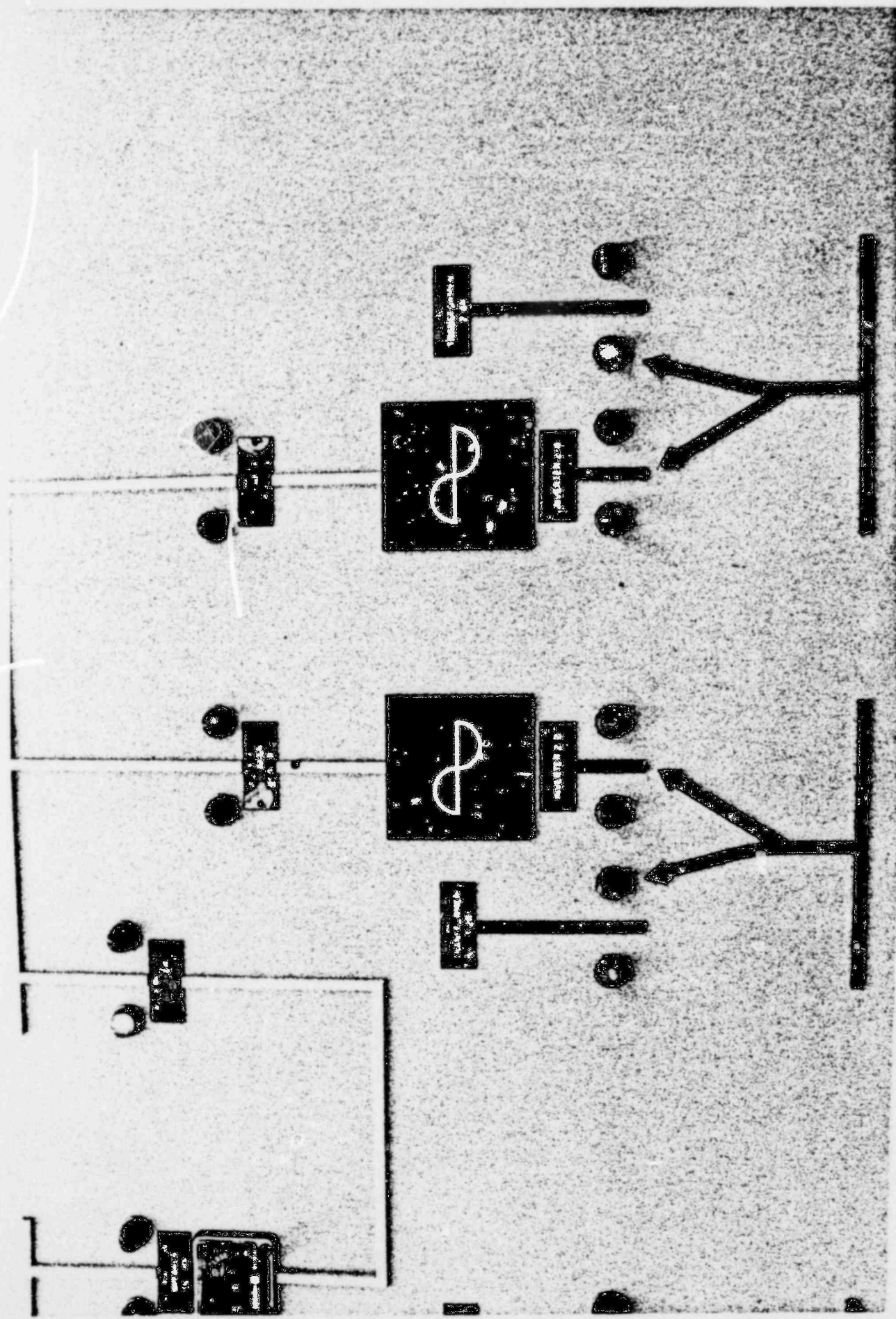


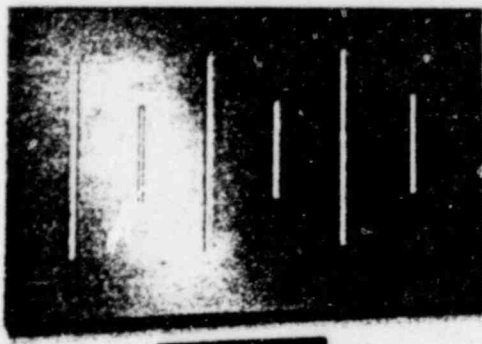
PN-N  
DC BUS 2-2  
VOLTS



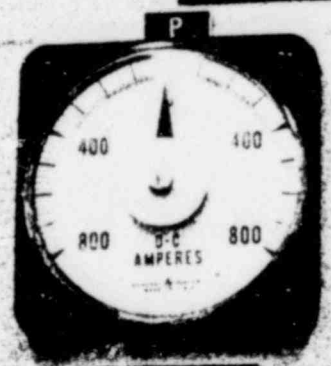




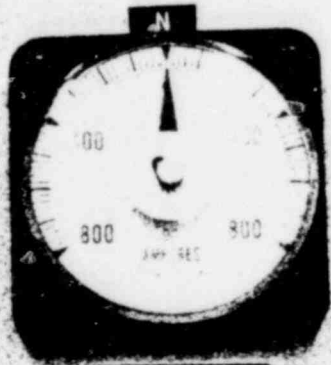




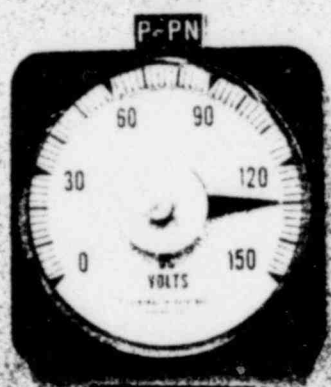
STATION  
BATTERY 2-1



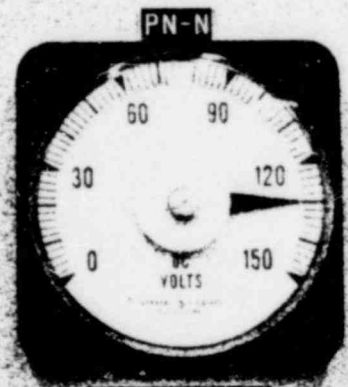
BATTERY 2-1  
AMPS



STATION  
BATTERY 2-1  
AMPS



DC BUS 2-1  
VOLTS



DC BUS 2-1  
VOLTS

