



UFSAR Revision 29.0

 <p>INDIANA MICHIGAN POWER <small>An AEP Company</small></p>	<p>INDIANA MICHIGAN POWER D. C. COOK NUCLEAR PLANT UPDATED FINAL SAFETY ANALYSIS REPORT</p>	<p>Revised: 28.0 Section: 14 A&G Page: i of ii</p>
--	---	--

14.A RADIATION SOURCES (APPENDIX 14A)	1
14.A.1 Core Activities	1
14.A.2 Fuel Handling Activities	1
14.A.3 Reactor Coolant Activities	1
14.A.4 Reactor Coolant Tritium Activities	2
General Discussion.....	2
A. Release of Ternary Produced Tritium	2
B. Tritium Produced from Boron Reactions	2
C. Tritium Produced from Lithium Reactions	3
D. Tritium Production from Deuterium Reactions	3
E. Tritium Sources from the Reactor Employing Ag-In-Cd Absorber Rods	3
F. Revised Tritium Source Term Data.....	4
14.A.5 Volume Control Tank Activities	5
14.A.6 Gas Decay Tank Activities	5
14.G CORE AND INTERNALS INTEGRITY ANALYSIS	6
14.G.1 Reactor Internals Response under Blowdown and Seismic Excitation	6
14.G.2 Acceptance Criteria for Results of Analyses	7
14.G.3 Allowable Deflection and Stability Criteria	7
14.G.4 Allowable Stress Criteria	8
14.G.5 Method of Analysis	8
Blowdown Model	8
FORCE Model for Blowdown.....	9
Vertical Excitation Model for Blowdown.....	10
Vertical Excitation Model for Earthquake.....	10
Transverse Excitation Model for Blowdown.....	11

UFSAR Revision 29.0

 <p>INDIANA MICHIGAN POWER <small>An AEP Company</small></p>	<p>INDIANA MICHIGAN POWER D. C. COOK NUCLEAR PLANT UPDATED FINAL SAFETY ANALYSIS REPORT</p>	<p>Revised: 28.0 Section: 14 A&G Page: ii of ii</p>
--	--	---

Transverse Excitation Model for Earthquake 12

The concentrated masses attached to the barrel represent the following:..... 13

Conclusions - Mechanical Analysis 14

14.G.6 References for Appendix 14.G **14**

UFSAR Revision 29.0

 <p>INDIANA MICHIGAN POWER An AEP Company</p>	<p>INDIANA MICHIGAN POWER D. C. COOK NUCLEAR PLANT UPDATED FINAL SAFETY ANALYSIS REPORT</p>	<p>Revised: 28.0 Section: 14 A&G Page: 1 of 14</p>
---	---	--

14.A RADIATION SOURCES (APPENDIX 14A)

This appendix presents the quantities of radioactive isotopes present in the core, highest rated fuel assembly, reactor coolant, volume control tank and gas decay tank. A brief discussion of the derivations is also provided.

14.A.1 Core Activities

The total core fission product inventory is determined using the ORIGEN-ARP computer code and is based on a core power level of 3480 MWt. This core power level is equal to the Unit 2 licensed rated thermal power level of 3468 MWt plus 0.34% measurement uncertainty. This Unit 2 core power level bounds the Unit 1 core power level.

Numerical values for isotopes which are important for analyzing the offsite radiological consequences of design basis accidents are based on the guidance of Regulatory Guide 1.183 and are presented in Table 14.A.1-1.

14.A.2 Fuel Handling Activities

The inventory of fission products in a fuel assembly is dependent on the rating of the assembly. The radial peaking factor for the highest rated fuel assembly out of 193 fuel assemblies is 1.65. The gap model discussed in Regulatory Guide 1.183 is used to determine the fuel cladding gap activities for nuclides that are available for release to the environment. Thus, 5 percent of the total assembly halogens and noble gases, except for 8 percent for I-131 and 10 percent for Kr-85, are assumed to be in the fuel cladding gap.

The fission product inventory in the fuel cladding gap of the highest rated fuel assembly at shutdown is listed in Table 14.A.2-1.

14.A.3 Reactor Coolant Activities

The parameters used in the calculation of the reactor coolant fission product concentrations, including pertinent information concerning the expected coolant cleanup flow rate, demineralizer effectiveness, and volume control tank noble gas stripping behavior, are listed in Table 14.A.3-1. The resulting reactor coolant equilibrium fission product concentrations are listed in Table 14.A.3-3.

The concentrations listed in Table 14.A.3-3 have been calculated assuming that small cladding defects (fuel rods containing pinhole or fine cracks) equivalent to 1 percent of the fuel rods are

UFSAR Revision 29.0

 <p>INDIANA MICHIGAN POWER <small>An AEP Company</small></p>	<p>INDIANA MICHIGAN POWER D. C. COOK NUCLEAR PLANT UPDATED FINAL SAFETY ANALYSIS REPORT</p>	<p>Revised: 28.0 Section: 14 A&G Page: 2 of 14</p>
--	--	--

uniformly distributed throughout the core. The fission product escape rate coefficients are, therefore, based on an average fuel temperature.

With the exception of the iodine isotopes, the equilibrium RCS activities are normalized to a total gross activity of 100/E-bar. The adjusted noble gas concentrations from Table 14.A.3-3 correspond to a dose equivalent Xe-133 of 215.1 $\mu\text{Ci/gm}$.

For iodines, the inventory based on 1% fuel defects is normalized to 1 $\mu\text{Ci/gm}$ dose equivalent I-131. The iodine appearance rates during normal power operation are listed in Table 14.A.3-5.

14.A.4 Reactor Coolant Tritium Activities

General Discussion

During the fissioning of uranium, tritium atoms are generated in the fuel at a rate of approximately 8×10^{-5} atoms per fission (1.05×10^{-2} curies/mwt - day). Other sources of tritium include neutron reactions with boron (in the coolant for shim control), neutron reactions with lithium (utilized in the coolant for pH control, and produced in the coolant by neutron reactions with boron), and by neutron reactions with naturally occurring deuterium in light water. The source term data is presented in Tables 14.A.4-1 and 14.A.4-2.

A. Release of Ternary Produced Tritium

The tritium formed by ternary fission in uranium fueled reactors can be retained in the fuel, accumulate in the void between the fuel and cladding, react with cladding material (zirconium tritide), or diffuse through the cladding into the coolant. Operating experience at the Shippingport reactor (zircaloy clad) indicated that less than 1% of the ternary produced tritium is released to the reactor coolant. In order to insure adequate sizing of liquid waste treatment facilities, WNES conservatively assumes that 30% of the ternary produced tritium is released to coolant. This assumption then requires that the waste treatment system be sized to process approximately 4 reactor coolant system volumes in addition to normal reactor plant liquid wastes. Anticipated ternary tritium loss to the reactor coolant is 1%.

B. Tritium Produced from Boron Reactions

The neutron reactions with boron resulting in the production of tritium are:

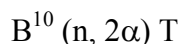

UFSAR Revision 29.0

 <p>INDIANA MICHIGAN POWER An AEP Company</p>	<p style="text-align: center;">INDIANA MICHIGAN POWER D. C. COOK NUCLEAR PLANT UPDATED FINAL SAFETY ANALYSIS REPORT</p>	<p>Revised: 28.0 Section: 14 A&G Page: 3 of 14</p>
--	--	--



Of the above reactions, only the first two contribute significantly to the tritium production. The $B^{11} (n, T) Be^9$ reaction has a threshold of 14 Mev and a cross section of ~ 5 mb, since the number of neutrons produced at this energy are less than 10^9 n/cm²-sec the tritium produced from this reaction is negligible. The B^{10} reaction may be neglected, since the Be^9 has been found to be unstable.

C. Tritium Produced from Lithium Reactions

The neutron reactions with lithium resulting in the production of tritium are:

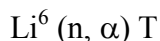
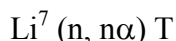

In the WNES designed reactors, lithium is used to maintain the reactor coolant pH. Reactor coolant pH is controlled during power operation by adjusting lithium as a function of the coolant boron concentration. A cation demineralizer is included in the Chemical and Volume Control System to remove the excess lithium produced in the $B^{10} (n, \alpha) Li^7$ reactions.

The $Li^6 (n, \alpha) T$ reaction is controlled by limiting the Li^6 impurity in the lithium used in the reactor coolant and in lithiating the demineralizers to less than 0.001 parts of Li^6 . This limitation has been in effect on WAPD designed reactors since 1962.

D. Tritium Production from Deuterium Reactions

Since the amount of naturally occurring deuterium is less than 0.00015 the tritium produced from this reaction is negligible; less than 1 curie per year.

E. Tritium Sources from the Reactor Employing Ag-In-Cd Absorber Rods

Basic Assumptions and Plant Parameters:

1.	Core thermal power	3391 MWt
2.	Plant load factor	0.8
3.	Core volume	1153 ft ³
4.	Core volume fractions	
	a. UO ₂	.3052
	b. Zr + SS	.1000
	c. H ₂ O	.5948

UFSAR Revision 29.0

 <p style="font-size: small;">An AEP Company</p>	<p>INDIANA MICHIGAN POWER D. C. COOK NUCLEAR PLANT UPDATED FINAL SAFETY ANALYSIS REPORT</p>	Revised: 28.0 Section: 14 A&G Page: 4 of 14
--	--	---

- | | | |
|-----|--|---------------------------|
| 5. | Initial reactor coolant boron level | |
| | a. Initial cycle | 840 ppm |
| | b. Equilibrium cycle | 1200 ppm |
| 6. | Reactor coolant volume | 12,560 ft ³ |
| 7. | Reactor coolant transport times | |
| | a. In-core | 0.77 sec |
| | b. Out-of-core | 10.87 sec |
| 8. | Reactor coolant peak lithium level (99.9% pure Li ⁷) | * |
| 9. | Core averaged neutron fluxes: | n/cm ² -sec |
| | a. E > 6 Mev | 2.91 x 10 ¹² |
| | b. E > 5 Mev | 7.90 x 10 ¹² |
| | c. 3 Mev ≤ E ≤ 6 Mev | 2.26 x 10 ¹³ |
| | d. 1 Mev ≤ E ≤ 5 Mev | 5.31 x 10 ¹³ |
| | e. E < 0.625 ev | 2.26 x 10 ¹³ |
| 10. | Neutron reaction cross-sections | |
| | a. B ¹⁰ (n, 2α) T: σ(1 Mev ≤ E ≤ 5 Mev) = | 31.6 mb (spectrum weight) |
| | σ(E > 5 Mev) = | 75 mb |
| | b. Li ⁷ (n, nα V) T: σ(3 Mev ≤ E ≤ 6 Mev) = | 39.1 mb (spectrum weight) |
| | σ(E > 6 Mev) = | 400 mb |
| 11. | Fraction of ternary tritium diffusing through zirconium cladding | |
| | a. Design value | 0.30 |
| | b. Expected value | 0.01 |

F. Revised Tritium Source Term Data

Because of the importance of the ternary fission source on the operation of the plant, Westinghouse has been closely following operating plant data. A program is being conducted at the R. E. Ginna Plant to follow this in detail. The R. E. Ginna Plant has a zircaloy clad core with silver-indium-cadmium control rods. The operating levels of boron concentration during the startup of the plant are approximately 1100 to 1200 ppm of boron. In addition, burnable poison rods in the core contain boron, which will contribute some tritium to the coolant, but only during the first cycle. Data during the operation of the plant has indicated very clearly that the present design sources were indeed conservative. The tritium released is essentially from the boron

* Controlled during operation based on boron concentration per coordinated Li/B control to minimize corrosion.

UFSAR Revision 29.0

 <p>INDIANA MICHIGAN POWER An AEP Company</p>	<p>INDIANA MICHIGAN POWER D. C. COOK NUCLEAR PLANT UPDATED FINAL SAFETY ANALYSIS REPORT</p>	<p>Revised: 28.0 Section: 14 A&G Page: 5 of 14</p>
--	--	--

dissolved in the coolant and a ternary fission source, which is less than ten percent. In addition to this data, other operating plants with zircaloy clad cores have also reported low tritium concentrations in the reactor coolant systems after considerable periods of operation.

The revised tritium source term data developed as a result of this program is presented in Table 14.A.4-2.

14.A.5 Volume Control Tank Activities

The 400 ft³ volume control tank is assumed to contain 120 ft³ (offsite) and 267 ft³ (control room) of liquid and 280 ft³ (offsite) and 133 ft³ (control room) of vapor. Tables 14.A.5-1a and 14.A.5-1b list the activities in the volume control tank with clad defects in 1% of the fuel rods.

14.A.6 Gas Decay Tank Activities

The maximum noble gas radionuclide activity available for release from a single gas decay tank is restricted by a technical requirements manual curie limit set on a tank such that in the event of a unique unplanned release, the resulting whole body dose at the nearest site boundary will not exceed 0.5 rem. This limit is 43,800 curies dose equivalent Xe-133.

For the control room dose consequence analysis, the tank activity shown in Table 14.A.5-2 is conservatively assumed to hold the entire RCS noble gas inventory from Table 14.A.3-3 and is derived using a maximum RCS volume of 12,535.4 ft³ with a 3% expansion factor. These values correspond to a total dose equivalent Xe-133 of 59,256.4 Curies.

UFSAR Revision 29.0

	<p style="text-align: center;">INDIANA MICHIGAN POWER D. C. COOK NUCLEAR PLANT UPDATED FINAL SAFETY ANALYSIS REPORT</p>	<p>Revised: 28.0 Section: 14 A&G Page: 6 of 14</p>
---	--	--

14.G CORE AND INTERNALS INTEGRITY ANALYSIS

14.G.1 Reactor Internals Response under Blowdown and Seismic Excitation

A loss-of-coolant accident may result from a rupture of reactor coolant piping. During the blowdown of the coolant, critical components of the core are subjected to vertical and horizontal excitation as a result of rarefaction waves propagating inside the reactor vessel.

For these large breaks, the reduction in water density greatly reduces the reactivity of the core, thereby shutting down the core whether the rods are tripped or not. The subsequent refilling of the core by the Emergency Core Cooling System uses borated water to maintain the core in a subcritical state. Therefore, the main requirement is to assure effectiveness of the Emergency Core Cooling System. Insertion of the control rods, although not needed, gives further assurance of ability to shut the plant down and keep it in a safe shutdown condition.

The pressure waves generated within the reactor are highly dependent on the location and nature of the postulated pipe failure. In general, the more rapid the severance of the pipe, the more severe the imposed loadings on the components. A one-millisecond severance time is taken as the limiting case.

In the case of the hot leg break, the vertical hydraulic forces produce an initial upward lift of the core. A rarefaction wave propagates through the reactor hot leg nozzle into the interior of the upper core barrel. Since the wave has not reached the flow annulus on the outside of the barrel, the upper barrel is subjected to an impulsive compressive wave. Thus, dynamic instability (buckling) or large deflections of the upper core barrel or both is the possible response of the barrel during hot leg blowdown. In addition to the above effects, the hot leg break results in transverse loading on the upper core components as the fluid exits the hot leg nozzle.

In the case of the cold leg break, a rarefaction wave propagates along a reactor inlet pipe, arriving first at the core barrel at the inlet nozzle of the broken loop. The upper barrel is then subjected to a nonaxisymmetric expansion radial impulse which changes as the rarefaction wave propagates both around the barrel and down the outer flow annulus between vessel and barrel. After the cold leg break, the initial steady-state hydraulic lift forces (upward) decrease rapidly (within a few milliseconds) and then increase in the downward direction. These cause the reactor core and lower support structure to move initially downward.

UFSAR Revision 29.0

 <p>INDIANA MICHIGAN POWER <small>An AEP Company</small></p>	<p>INDIANA MICHIGAN POWER D. C. COOK NUCLEAR PLANT UPDATED FINAL SAFETY ANALYSIS REPORT</p>	<p>Revised: 28.0 Section: 14 A&G Page: 7 of 14</p>
--	--	--

If a simultaneous seismic event with the intensity of the design basis earthquake (DBE) is postulated with the loss-of-coolant accident, the imposed loading on the internals components may be additive in certain cases, and therefore the combined loading must be considered. In general, however, the loading imposed by the earthquake is small compared to the blowdown loading.

14.G.2 Acceptance Criteria for Results of Analyses

The criteria for acceptability in regard to mechanical integrity analysis is that adequate core cooling and core shutdown must be assured. This implies that the deformation of the reactor internals must be sufficiently small so that the geometry remains substantially intact. Consequently, the limitations established on the internals are concerned principally with the maximum allowable deflections and/or stability of the parts in addition to a stress criterion to assure integrity of the components.

14.G.3 Allowable Deflection and Stability Criteria

Upper Barrel - The upper barrel deformation has the following limits:

- a. To insure a shutdown and cooldown of the core during blowdown, the basic requirement is a limitation on the outward deflection of the barrel at the locations of the inlet nozzles connected to the unbroken lines. A large outward deflection of the barrel in front of the inlet nozzles, accompanied with permanent strains, could close the inlet area and stop the cooling water coming from the accumulators. (The remaining distance between the barrel and the vessel inlet nozzle after the accident must be such that the inlet flow area be approximately the same as that of the accumulator pipes.) Consequently, a permanent barrel deflection in front of the unbroken inlet nozzles larger than a certain limit, called the "no loss of function" limit, could impair the efficiency of the Emergency Core Cooling System.
- b. To assure rod insertion and to avoid disturbing the Control Rod Cluster guide structure, the barrel should not interfere with the guide tubes. This condition also requires a stability check to assure that the barrel will not buckle under the accident loads.

Control Rod Cluster Guide Tubes - The guide tubes in the upper core support package house the control rods. The deflection limits were established from tests.

UFSAR Revision 29.0

 <p>INDIANA MICHIGAN POWER <small>An AEP Company</small></p>	<p>INDIANA MICHIGAN POWER D. C. COOK NUCLEAR PLANT UPDATED FINAL SAFETY ANALYSIS REPORT</p>	<p>Revised: 28.0 Section: 14 A&G Page: 8 of 14</p>
--	--	--

Fuel Assembly - The limitations for this case are related to the stability of the thimbles in the upper end. The upper end of the thimbles must not experience stresses above the allowable dynamic compressive stresses. Any buckling of the upper end of the thimbles due to axial compression could distort the guide line and thereby affect the free fall of the control rod.

Upper Package - The local vertical deformation of the upper core plate, where a guide tube is located, shall be below 0.100 inches. This deformation will cause the plate to contact the guide tube since the clearance between plate and guide tube is 0.100 inches. This limit will prevent the guide tubes from undergoing compression. For a plate local deformation of 0.150 inches, the guide tube will be compressed and deformed transversely to the upper limit previously established; consequently, the value of 0.150 inches is adopted as the no loss of function local deformation, with an allowable limit of 0.100 inches.

14.G.4 Allowable Stress Criteria

For this faulted condition the allowable stress criteria is given by Figure 14.G-1. This figure defines various criteria based upon their corresponding method of analysis.

To account for multi-axial stress, the von Mises Theory is also considered.

14.G.5 Method of Analysis

Blowdown Model

BLODWN-2 is a digital computer program developed for the purpose of calculating local fluid pressure, flow, and density transients that occur in PWR coolant systems during a loss-of-coolant accident (Reference 2). This program applies to the subcooled, transition, and saturated two-phase blowdown regimes. This is in contrast to programs such as WHAM (Reference 3), which are applicable only to the subcooled region and which, due to their method of solution, could not be extended into the region in which large changes in the sonic velocities and fluid densities take place. BLODWN-2 is based on the method of characteristics, wherein the resulting set of ordinary differential equations obtained from the laws of conservation of mass, momentum, and energy, are solved numerically using a fixed mesh in both space and time.

Although spatially one-dimensional conservation laws are employed, the code can be applied to describe three-dimensional system geometries by use of the equivalent piping networks. Such piping networks may contain any number of pipes or channels of various diameters, dead ends, branches (with up to six pipes connected to each branch), contractions, expansions, orifices,

UFSAR Revision 29.0

 <p>INDIANA MICHIGAN POWER <small>An AEP Company</small></p>	<p>INDIANA MICHIGAN POWER D. C. COOK NUCLEAR PLANT UPDATED FINAL SAFETY ANALYSIS REPORT</p>	<p>Revised: 28.0 Section: 14 A&G Page: 9 of 14</p>
--	--	--

pumps, and free surfaces (such as in the pressurizer). System losses such as friction, contraction, expansion, etc., are considered.

BLODWN-2 predictions have been compared with numerous test data as reported in WCAP-7401 (Reference 4) It is shown that the BLODWN-2 digital computer program gives good agreement in both the subcooled and the saturated blowdown regimes.

FORCE Model for Blowdown

BLODWN-2 evaluates the pressure and velocity transients for a maximum of 2400 locations throughout the system. These pressure and velocity transients are stored as a permanent tape file and are made available to the program FORCE, which utilizes a detailed geometric description in evaluating the loadings on the reactor internals.

Each reactor component for which FORCE calculations are required is designated as an element and assigned an element number. Forces acting upon each of the elements are calculated, summing the effects of:

1. The pressure differential across the element.
2. Flow stagnation on, and unrecovered orifice losses across the element.
3. Friction losses along the element.

Input to the code, in addition to the BLODWN-2 pressure and velocity transients, includes the effective area of each element on which the force acts due to the pressure differential across the element, a coefficient to account for flow stagnation and unrecovered orifice losses, and the total area of the element along which the shear forces act.

The mechanical analysis has been performed using conservative assumptions in order to obtain results with extra margin. Some of the most significant are:

- a. The mechanical and hydraulic analysis has been performed separately without including the effect of the water-solid interaction. Peak pressures obtained from the hydraulic analysis will be attenuated by the deformation of the structures.
- b. When applying the hydraulic forces no credit is taken for the stiffening effect of the fluid environment, which will reduce the deflections and stresses in the structure.
- c. The multi-mass model described below is considered to have a sufficient number of degrees-of-freedom to represent the most important modes of vibration in the

UFSAR Revision 29.0

 <p>INDIANA MICHIGAN POWER An AEP Company</p>	<p>INDIANA MICHIGAN POWER D. C. COOK NUCLEAR PLANT UPDATED FINAL SAFETY ANALYSIS REPORT</p>	<p>Revised: 28.0 Section: 14 A&G Page: 10 of 14</p>
--	--	---

vertical direction. This model is conservative in the sense that further mass-spring resolution of the system would lead to further attenuation of the shock effects obtained with the present model.

Vertical Excitation Model for Blowdown

For the vertical excitation, the reactor internals are represented by a multi-mass system connected with springs and dashpots simulating the elastic response and the viscous damping of the components. Also incorporated in the multi-mass system is a representation of the motion of the fuel elements relative to the fuel assembly grids. The fuel elements in the fuel assemblies are kept in position by friction forces originating from the preloaded fuel assembly grid fingers. Coulomb type friction is assumed in the event that sliding between the rods and the grid fingers occurs. Figure 14.G-2 shows the spring-mass system used to represent the internals. In order to obtain an accurate simulation of the reactor internals response, the effects of internal damping, clearances between various internals, snubbing action caused by solid impact, Coulomb friction induced by fuel rod motion relative to the grids, and preloads in hold-down springs have been incorporated in the analytical model. The reactor vessel is regarded as a fixed base while the internals undergo relative displacement with respect to their initial position. The modeling is conducted in such a way that uniform masses are lumped into easily identifiable discrete masses while elastic elements are represented by springs. Table 14.G-1 lists the various masses, springs, etc.

The appropriate dynamic differential equations for the multi-mass model describing the aforementioned phenomena are formulated and the results obtained using a digital computer program which computes the response of the multi-mass model when excited by a set of time dependent forcing functions. The appropriate forcing functions are applied simultaneously and independently to each of the masses in the system. The results from the program give the forces, displacements, and deflections as functions of time for all the reactor internals components (lumped masses). Reactor internals response to both hot and cold leg pipe ruptures is analyzed. The forcing functions used in the study are obtained from hydraulic analyses of the pressure and flow distribution around the entire reactor coolant system as caused by double-ended severance of a reactor coolant system pipe.

Vertical Excitation Model for Earthquake

As shown in WCAP-7332-L (References 1), the reactor internals are modeled as a single degree of freedom system for vertical earthquake analysis. The maximum acceleration at the vessel support is increased by an amplification due to the building-soil interaction.

UFSAR Revision 29.0

 <p>INDIANA MICHIGAN POWER <small>An AEP Company</small></p>	<p style="text-align: center;">INDIANA MICHIGAN POWER D. C. COOK NUCLEAR PLANT UPDATED FINAL SAFETY ANALYSIS REPORT</p>	<p>Revised: 28.0 Section: 14 A&G Page: 11 of 14</p>
--	--	---

Transverse Excitation Model for Blowdown

Various reactor internals components are subjected to transverse excitation during blowdown. Specifically, the barrel, guide tubes, and upper support columns are analyzed to determine their response to this excitation.

Core Barrel - For the hydraulic analysis of the pressure transients during hot leg blowdown, the maximum pressure drop across the barrel is a uniform radial compressive impulse. The barrel is then analyzed for dynamic buckling using these conditions and the following conservative assumptions:

- a. The effect of the fluid environment is neglected (water stiffening is not considered);
- b. the shell is treated as simply supported.

During cold leg blowdown, the upper barrel is subjected to a non-axisymmetric expansion radial impulse which changes as the rarefaction wave propagates both around the barrel and down the outer flow annulus between vessel and barrel.

The analysis of transverse barrel response to cold leg blowdown is performed as follows:

1. The upper core barrel is treated as a simply supported cylindrical shell of constant thickness between the upper flange weldment and the lower core barrel weldment without taking credit for the supports at the barrel midspan offered by the outlet nozzles. This assumption leads to conservative deflection estimates of the upper core barrel.
2. The upper core barrel is analyzed as a shell with four variable sections to model the support flange, upper barrel, reduced weld section and a portion of the lower core barrel.
3. The barrel with the core and thermal shield is analyzed as a beam fixed at the top and elastically supported at the lower radial support and the dynamic response is obtained.

Guide Tubes - The dynamic loads on RCC guide tubes are more severe for a loss-of-coolant accident caused by hot leg rupture than for an accident by cold leg rupture, since the cold leg break leads to much smaller changes in the transverse coolant flow over the RCC guide tubes. Thus, the analysis is performed only for a hot leg blowdown.

UFSAR Revision 29.0

 <p>INDIANA MICHIGAN POWER <small>An AEP Company</small></p>	<p>INDIANA MICHIGAN POWER D. C. COOK NUCLEAR PLANT UPDATED FINAL SAFETY ANALYSIS REPORT</p>	<p>Revised: 28.0 Section: 14 A&G Page: 12 of 14</p>
--	--	---

The guide tubes in closest proximity to the ruptured outlet nozzle are the most severely loaded. The transverse guide tube forces during the hot leg blowdown decrease with increasing distance from the ruptured nozzle location.

A detailed structural analysis of the RCC guide tubes was performed to establish the equivalent cross-section properties and elastic end support conditions. An analytical model was verified both dynamically and statically by subjecting the control rod cluster guide tube to a concentrated force applied at the transition plate. In addition, the guide tube was loaded experimentally using a triangular distribution to conservatively approximate the hydraulic loading. The experimental results consisted of a load deflection curve for the RCC guide tube plus verification of the deflection criteria to assure RCC insertion.

The response of the guide tubes to the transient loading due to blowdown may be found by utilizing the equivalent single freedom system for the guide tube, using experimental results for equivalent stiffness and natural frequency.

The time dependence of the hydraulic transient loading has the form of a step function with a constant slope front and a rise time to peak force of the same order of the guide tube fundamental period in water. The dynamic application factor in determining the response is a function of the ramp impulse rise time divided by the period of the structure.

Upper Support Columns - Upper support columns located close to the broken nozzle during hot leg break will be subjected to transverse loads due to cross flow.

The loads applied to the columns were computed with a similar method to the one used for the guide tubes; i.e., taking into consideration the increase in flow across the column during the accident. The columns were studied as beams with variable section and the resulting stresses were obtained using the reduced section modulus at the slotted portions.

Transverse Excitation Model for Earthquake

The reactor building with the reactor vessel support, the reactor vessel, and the reactor internals are included in this analysis. The mathematical model of the building, attached to the ground, is identical to that used to evaluate the building structure. The reactor internals are mathematically modeled by beams, concentrated masses, and linear springs.

All masses, water, and metal are included in the mathematical model. All beam elements have the component weight or mass distributed uniformly, e.g., the fuel assembly mass and barrel mass. Additionally, wherever components are attached uniformly their mass is included as an additional uniform mass, e.g., baffles and formers acting on the core barrel. The water near and

UFSAR Revision 29.0

 <p>INDIANA MICHIGAN POWER <small>An AEP Company</small></p>	<p>INDIANA MICHIGAN POWER D. C. COOK NUCLEAR PLANT UPDATED FINAL SAFETY ANALYSIS REPORT</p>	<p>Revised: 28.0 Section: 14 A&G Page: 13 of 14</p>
--	--	---

about the beam elements is also included at a distributed mass. Horizontal components are considered as a concentrated mass acting on the barrel. This concentrated mass also includes components attached to the horizontal members, since these are the media through which the reaction is transmitted. The water near and about these separated components is considered as being additive at these concentrated mass points.

The concentrated masses attached to the barrel represent the following:

- a. The upper core support structure, including the upper vessel head and one-half the upper internals;
- b. the upper core plate, including one-half the thermal shield and the other half of the upper internals;
- c. the lower core plate, including one-half of the lower core support columns;
- d. the lower one-half of the thermal shield; and
- e. the lower core support, including the lower instrumentation and the remaining half of the lower support columns.

The modulus of elasticity is chosen at its hot value for the three major materials found in the vessel, internals, and fuel assemblies. In considering shear deformation, the appropriate cross-sectional area is selected along with a value for Poisson's ratio. The fuel assembly moment of inertia is derived from experimental results by static and dynamic tests performed on fuel assembly modes. These tests provide stiffness values for use in this analysis.

The fuel assemblies are assumed to act together and are presented by a single beam. The following assumptions are made in regard to connection restraints. The vessel is pinned to the vessel support and part of the containment building. The barrel is clamped to the vessel at the barrel flange and spring connected to the vessel at the lower core barrel radial support. This spring corresponds to the radial support stiffness for two opposite supports acting together. The beam representing the fuel assemblies is pinned to the barrel at the locations of the upper and lower core plates.

The response spectrum method has been used in the calculation. After computing the transverse natural frequency and obtaining the normal modes of the complete structure, the maximum response is obtained from the superposition of the usual mode responses with the conservative assumptions that all the modes are in phase and that all the peaks occur simultaneously.

UFSAR Revision 29.0

 <p>INDIANA MICHIGAN POWER <small>An AEP Company</small></p>	<p style="text-align: center;">INDIANA MICHIGAN POWER D. C. COOK NUCLEAR PLANT UPDATED FINAL SAFETY ANALYSIS REPORT</p>	<p>Revised: 28.0 Section: 14 A&G Page: 14 of 14</p>
--	--	---

Conclusions - Mechanical Analysis

The results of the analysis, applicable to the Cook design, are presented in Tables 14.G-2 and 14.G-3. These tables summarize the maximum deflections and stresses for blowdown, seismic, and blowdown plus seismic loadings.

The stresses due to the DBE (vertical and horizontal components) were combined in the most unfavorable manner with the blowdown stresses in order to obtain the largest principal stress and deflection.

These results indicate that the maximum deflections and stress in the critical structures are below the established allowable limits. For the transverse excitation, it is shown that the upper barrel does not buckle during a hot leg break and that it has an allowable stress distribution during a cold leg break.

Even though control rod insertion is not required for plant shutdown, this analysis shows that most of the guide tubes will deform within the limits established experimentally to assure control rod insertion, with the exceptions shown in Table 14.G-2, It can be seen in the table that 54 of the 61 guide tubes are below the N.L.F. limit. For those guide tubes deflected above the N.L.F. limit, it must be assumed that the rods will not drop. However, the conclusion reached is that the core will shut down in an orderly fashion due to the formation of voids, and this orderly shutdown will be aided by the great majority of rods that do drop.

14.G.6 References for Appendix 14.G

1. WCAP-7332-L, "Indian Point Unit No. 2 Reactor Internals Mechanical Analysis for Blowdown Excitation," G. J. Bohm, February 1970.
2. S. Fabric, "BLODWN-2: Digital Computer Program for Calculation of Hydraulic Transients During a Loss-of-Coolant Accident," Transactions Am. Nucl. Soc., p. 358, 1969 Annual Meeting, Seattle, June 15-19.
3. S. Fabric, "Computer Program WHAM for Calculation of Pressure Velocity, and Force Transients in Liquid Filled Piping Networks," Kaiser Engineers Report No. 67-49-R (November, 1967).
4. S. Fabric, "Loss of Coolant Analysis: Comparison Between BLODWN-2 Code Results and Test Data," WCAP-7401, November 1969.

S_m = DESIGN STRESS INTENSITY VALUE AT TEMPERATURE, GIVEN BY THE ASME SECTION III CODE
 PRIMARY STRESSES (NOTES 1, 2, 9 AND 10)

MEMBRANE
 P_M

BENDING
 P_B

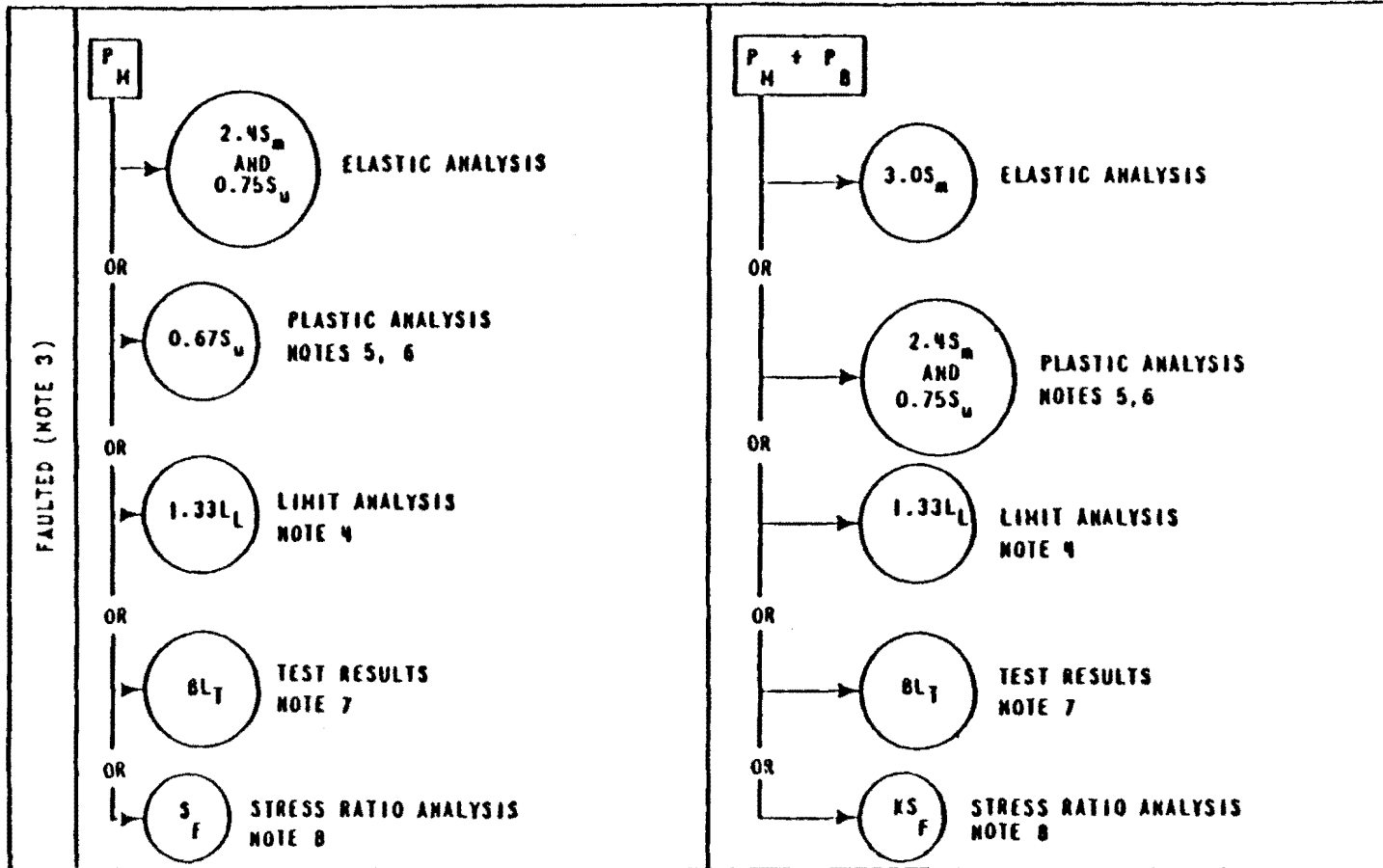

PRIMARY STRESSES (NOTES 1, 2, 9 AND 10)

Figure 14.G-1 Reactor Internals Allowable Stress Criteria

HISTORICAL

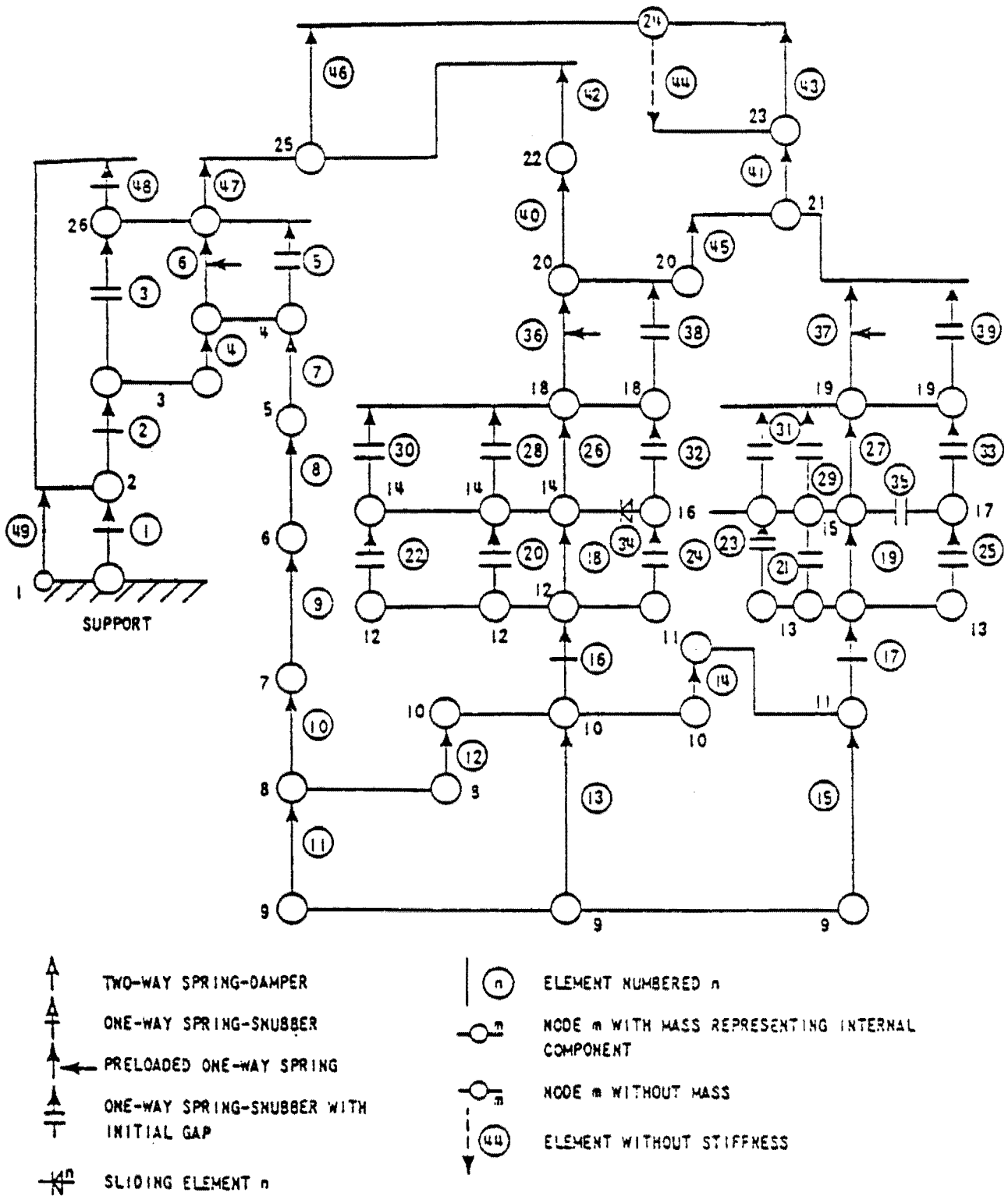

Figure 14.G-2 Loop Reactor Mathematical Model for Vertical Response

July, 1987